

DOCKETED

Docket Number:	24-IEPR-04
Project Title:	Wave and Tidal Energy
TN #:	257956
Document Title:	Wave and Tidal Energy Evaluation of Feasibility, Costs, and Benefits Senate Bill 605 Report
Description:	Wave and Tidal Energy: Evaluation of Feasibility, Costs, and Benefits Senate Bill 605 Report
Filer:	Raquel Kravitz
Organization:	California Energy Commission
Submitter Role:	Commission Staff
Submission Date:	7/23/2024 1:33:44 PM
Docketed Date:	7/23/2024



**CALIFORNIA
ENERGY COMMISSION**



**CALIFORNIA
NATURAL
RESOURCES
AGENCY**

California Energy Commission
CONSULTANT REPORT

Wave and Tidal Energy: Evaluation of Feasibility, Costs, and Benefits

Senate Bill 605 Report

Prepared for: California Energy Commission

Prepared by: Aspen Environmental Group



H. T. HARVEY & ASSOCIATES

Ecological Consultants

July 2024 | CEC-700-2024-005

California Energy Commission

Prime Contractor:

Aspen Environmental Group

235 Montgomery St., Suite 967

San Francisco, CA 94104

www.aspeneg.com

Agreement Number: 700-22-004

Danielle Mullany

Commission Agreement Project Manager

Jessica Eckdish

Manager

CLIMATE INITIATIVES BRANCH

Elizabeth Huber

Director

**SITING, TRANSMISSION, AND ENVIRONMENTAL PROTECTION
DIVISION**

Drew Bohan

Executive Director

DISCLAIMER

This report was prepared as the result of work sponsored by the California Energy Commission (CEC). It does not necessarily represent the views of the CEC, its employees, or the State of California. The CEC, the State of California, its employees, contractors, and subcontractors make no warrant, express or implied, and assume no legal liability for the information in this report; nor does any party represent that the use of this information will not infringe upon privately owned rights. This report has not been approved or disapproved by the CEC nor has the CEC passed upon the accuracy or adequacy of the information in this report.

ABSTRACT

Senate Bill 650 (SB 650, Padilla, Chapter 405, Statutes of 2023) directs the California Energy Commission (CEC) to evaluate the feasibility, costs, and benefits of using wave energy and tidal energy as forms of clean energy for California. This evaluation is to be included in the CEC's *2025 Integrated Energy Policy Report (IEPR)* in consultation with other appropriate state agencies, including the Ocean Protection Council, the Department of Fish and Wildlife, the State Lands Commission, and the California Coastal Commission.

This consultant report evaluates the required six areas to inform the *2025 IEPR*, including the evaluation of factors that may increase the use of wave and tidal energy resources; provide findings on the latest research, technology, and economics of deploying these resources; evaluate transmission, permitting requirements, and workforce development needs; identify near-term actions and investment needs; and identify monitoring strategies to evaluate the impacts of wave and tidal energy resources to marine environments.

Keywords: Offshore renewable energy; wave and tidal energy resources; offshore energy; offshore development; decarbonization; coastal, cultural, and environmental resources; renewable energy; reliability; transmission; *Integrated Energy Policy Report*; Senate Bill 650

Please use the following citation for this report:

Lee, Susan and Vida Strong. (Aspen Environmental Group). 2022. *Wave and Tidal Energy: Evaluation of Feasibility, Costs, and Benefits. SB 605 Report*. California Energy Commission. CEC Publication Number CEC-700-2024-005.

TABLE OF CONTENTS

Abstract	i
Executive Summary.....	1
CHAPTER 1: ` Technology and Economic Feasibility of Wave and Tidal Energy	4
1.1 Introduction.....	4
1.2 Wave Energy Technology Overview.....	4
1.2.1 Attenuators	7
1.2.2 Point Absorbers	9
1.2.3 Pressure Differential WECs	12
1.2.4 Oscillating Water Column WECs.....	12
1.2.5 Overtopping WECs.....	13
1.2.6 Oscillating Wave Surge Converters.....	15
1.3 Tidal Energy Technology Overview	16
1.3.1 Axial Flow Turbines.....	18
1.3.2 Crossflow Turbines	20
1.3.3 Reciprocating Devices	21
1.3.4 Tidal Kites	21
1.3.5 Archimedes Screw	22
1.3.6 Vortex-Induced Vibration Devices	23
1.4 Marine Energy Applications in California.....	23
1.4.1 Commercial-Scale Projects	23
1.4.2 Distributed Marine Energy	24
1.4.3 Marine Energy Test Sites.....	26
1.4.4 Marine Energy Prize Opportunities	27
1.5 Challenges to Developing Marine Energy	28
1.5.1 Technology Development.....	28
1.5.2 Resource Variability	28
1.5.3 Grid Integration.....	28
1.5.4 Environmental Impact.....	29
1.5.5 Cost Competitiveness.....	29
1.5.6 Socioeconomic Factors.....	30
CHAPTER 2: Factors Contributing to Increased Use of Wave and Tidal Energy in California.....	31
2.1 Factors Influencing Uptake of Marine Energy	31
2.2 Potential Market.....	31
2.3 Increasing Cost Competitiveness and Investment Appeal.....	32

2.3.1	Cost Reduction Through Focused Development	33
2.3.2	Building on Niche Opportunities	34
2.3.3	Grid Services and Temporal Advantages.....	34
2.3.4	Incentives to Support Investment	34
2.4	Community Support.....	35
2.4.1	Reduced Ecological Conflict	35
2.4.2	Reduced Conflict With Existing Marine Uses.....	36
2.5	Existing Pathway to Permitting	36
2.6	Community Benefits	37
2.6.1	Emergency Power Supply	37
2.6.2	Coastal Protection.....	38
2.6.3	Climate Resilience.....	38
2.7	Comparison With Other Renewable Energy Technologies.....	38
2.8	Conclusion	39
CHAPTER 3: Transmission Needs and Transmission Permitting Requirements		40
3.1	Transmission Overview	40
3.1.1	Cables.....	40
3.1.2	Offshore Substations.....	42
3.1.3	Transmission Overview Conclusion.....	43
3.2	Tidal and Wave Energy Transmission Configurations	43
3.2.1	Onshore and Very Nearshore Configurations	44
3.2.2	Nearshore and Offshore Configurations.....	44
3.2.3	Deepwater Offshore Configurations	46
3.3	Grid Integration Challenges.....	46
CHAPTER 4: Permitting Requirements for Wave and Tidal Energy Projects		48
4.1	Agency Roles and Permitting Requirements	48
4.1.1	Federal Agency Roles and Requirements	49
4.1.2	State Agency Roles and Requirements	52
4.2	Collaborative Review and Approval.....	54
4.2.1	Use of Adaptive Management in Project Permitting	55
CHAPTER 5: Economic and Workforce Development Needs		57
5.1	Inputs: Costs and Local Share Requirements	57
5.2	Outputs: Workforce and Economic Development Impacts	59
5.3	Maximizing Job Creation and Economic Development	64
5.4	Limitations of the JEDI Model.....	64

CHAPTER 6: Monitoring Strategies to Gather Data for Evaluation of Environmental Impacts.....	65
6.1 Potential Environmental Impacts of Wave and Tidal Energy Technologies in Coastal and Marine Ecosystems.....	65
6.2 Adaptive Management.....	65
6.3 Monitoring Strategies With Adaptive Management.....	67
CHAPTER 7: The Future of Marine Energy in California.....	75
Glossary	77
APPENDIX A: SB 605 (Padilla): Wave and Tidal Energy	A-1

LIST OF FIGURES

Figure 1: Examples of Attenuator Wave Energy Converters	9
Figure 2: Examples of Point Absorber Wave Energy Converters.....	11
Figure 3: Example of an Oscillating Water Column Wave Energy Converter	13
Figure 4: Example of an Overtopping Wave Energy Converter	14
Figure 5: Example of an Oscillating Wave Surge Wave Energy Converter.....	16
Figure 6: Examples of Axial-Flow Turbines.....	20
Figure 7: Cross-Flow Turbine Examples	21
Figure 8: BeamReach Reciprocating Device	21
Figure 9: Tidal Kite Conceptual Operating Diagram and Device	22
Figure 10: Conceptual Design of Archimedes Screw Array	23
Figure 11: Schematic of Wave Hub Test Facility	43
Figure 12: Potential Layout for Wave Energy Project	45
Figure 13: Adaptive Management Iterative Cycle	56
Figure 14: Workforce Impacts of Wave and Tidal Energy Development	63
Figure 15: Economic Impacts of Wave and Tidal Energy Development	63
Figure 16: Verdant Power Turbines on a Triframe Base	70

LIST OF TABLES

Table 1: Summary of Six Main Wave Energy Converter Devices	6
--	---

Table 2: Summary of Six Main Tidal Energy Current Device Archetypes.....	17
Table 3: Comparative Advantages of Wave and Tidal Energy	39
Table 4: Mapping of Inputs from SAM to JEDI Model.....	58
Table 5: Summary of Key JEDI Inputs	59
Table 6: Jobs and Economic Impact, 10 MW Wave Energy Project during Construction and Installation.....	61
Table 7: Jobs and Economic Impact, 10 MW Wave Energy Project During Operating Years	62
Table 8: Jobs and Economic Impact, 10 MW Tidal Energy Project During Construction and Installation.....	62
Table 9: Jobs and Economic impact, 10 MW Tidal Energy Project During Operating Years	63
Table 10: MeyGen Project Stressors, Receptors, and Studies	71

EXECUTIVE SUMMARY

This report complies with the first requirement of Senate Bill (SB) 605, as presented in Section (a) of the law (now chaptered in Public Resources Code [PRC] Chapter 18, Division 15, Section 25996). The law requires that the CEC “evaluate the feasibility, costs, and benefits of using wave energy and tidal energy as forms of clean energy in the state.” The evaluation is to include all the following topics (Chapters of this report are defined for each component of the law):

(b) For purposes of the evaluation identified in subdivision (a), the commission shall do all of the following:

- (1) Evaluate factors that may contribute to the increased use of wave energy and tidal energy in the state. (Chapter 2)
- (2) Provide findings on the latest research about the technological and economic feasibility of deploying offshore wave and tidal energy in the state (Chapter 1).
- (3) Evaluate wave energy and tidal energy project potential transmission needs (Chapter 3) and permitting requirements (Chapter 4).
- (4) Evaluate wave energy and tidal energy project economic and workforce development needs (Chapter 5).
- (5) Identify near-term actions, particularly related to investments and the workforce for wave energy and tidal energy projects, to maximize job creation and economic development, while considering affordable electric rates and bills (Chapter 6)
- (6) Identify a robust monitoring strategy designed to gather sufficient data to evaluate the impacts from wave energy and tidal energy projects to marine and tidal ecosystems and affected species, including, but not limited to, fish, marine mammals, and aquatic plants, to inform adaptive management of the projects (Chapter 7)

California’s primary legislative mandate for clean energy resources is Senate Bill (SB) 100 (De León, Chapter 312, Statutes of 2018). SB 100 updates California’s Renewables Portfolio Standard to ensure that at least 60 percent of the state’s electricity is from renewable sources by 2030 and sets a goal that a 100 percent of powering all retail electricity sold in the state with renewable and zero-carbon resources by 2045. Wave and tidal energy resources could become part of the portfolio of renewable energy resources needed to meet SB 100 requirements.

Wave energy conversion harnesses the kinetic and potential energy present in ocean waves and converts it into usable electricity. Waves form as the result of wind interacting with the ocean surface and wave growth depends on wind blowing in a constant direction. Due to the global direction of wind and the size of the Pacific Ocean, the California coastline could have more than 37 gigawatts of resource potential. Wave energy converter technologies fall into six categories that function at different depths and conditions and may be floating, submerged, or attached to a fixed structure.

Tidal energy resources also convert water current or movement into energy. The California coastline could have the potential to generate more than 1.8 terawatts per year using tidal energy. Tidal energy converter technologies vary and may be floating, submerged, or fixed and attached to a platform such as port pilings. Both wave and tidal energy resources lack commercial-scale deployment, although there are significant research, development, and demonstration that have been completed. Also, there could be opportunity to host small-scale and pilot projects as distributed energy resources serving nearby energy needs such as ports, remote communities, and military installations.

Developing marine energy resources has many challenges that affect feasibility, scalability, and economic viability. Challenges to developing marine energy resources include resource variability, grid integration, environmental impacts, and cost competitiveness with other renewable resources. Additional considerations include impacts to local and regional communities including social and cultural resources, and underserved communities impacts. There must be extensive collaboration and coordination among developers, communities, California Native American tribes, and local and state government. Project permitting and licensing processes are complex and lengthy.

Greater development and deployment of wave and tidal energy resources are expected to occur when cost competitiveness and investment appeal improve. Wave and tidal energy resources could become more commercially viable with cost reductions through increased electricity production, testing and demonstration, and application of niche opportunities such as serving nearby demand. Larger-scale and utility-scale deployment could occur with market mechanisms, such as tax credits and other incentives that bring capital costs down.

Transmission will be needed for wave and tidal energy resource deployment to allow for distributed applications and future commercial-scale applications. In the longer term, there may be larger commercial applications, which could require transmission technologies like those seen in development for commercial floating offshore wind farms in California. Those technologies include dynamic high-voltage export cables, floating offshore substation designs, and other technologies that enable high-capacity subsea transmission.

Federal, state, and local agencies will have various permitting requirements based on project type and purpose, as well as potential impacts. The four federal agencies involved in permitting wave and tidal resource projects are the Federal Energy Regulatory Commission, the U.S. Army Corps of Engineers, the U.S. Coast Guard, and the Bureau of Ocean Energy Management. All federal agencies authorizing a discretionary action must also comply with the National Environmental Policy Act by preparing environmental reviews for projects and impacts to guide agency decision making.

State agency permitting roles also depend on the wave and tidal resource project type, purpose, and location. There are extensive permitting, certification, and compliance requirements such as California Environmental Quality Act. The primary state agencies include the California State Lands Commission, State or Regional Water Resources Control Board, California Department of Fish and Wildlife, California Coastal Commission, or other jurisdictions. Agencies and others familiar with the permitting processes indicate that the most

effective and efficient process is one that involves all parties early and often. Further, opportunities to share information and avoid duplicative efforts can be identified.

The main drivers to maximizing job creation and economic development are local requirements for labor and materials and the total project size. Increasing the total deployment of wave and tidal energy could result in increased job creation and economic development. An important consideration for local job development is training for a skilled workforce to construct, install, operate, and maintain wave and tidal energy facilities. Workforce training may include community college or union-led programs, apprenticeships, and transitioning workers from existing maritime industries (including oil and gas) to wave and tidal energy.

Identifying robust monitoring strategies designed to gather sufficient data to evaluate the impacts from wave energy and tidal energy projects on marine and tidal ecosystems is critical to project permitting, especially when existing data may be insufficient to anticipate or understand impacts. Monitoring the presence and behavior of affected species, including fish, marine mammals, invertebrates, and aquatic plants, and evaluating the monitoring results guide adaptive management plan adjustments and add to the wider data base.

While commercial-scale marine energy projects in California have not been implemented to date, the state's abundant wave resources and supportive policy environment present opportunities for further research and development and demonstration to support large-scale deployment of marine energy technologies. Continued efforts in this field have the potential to contribute to California's clean energy goals and promote sustainable development along its coastline.

The report findings indicate that wave and tidal energy resources can provide consistent generation, and are zero-carbon and renewable resources that can help the state achieve its climate policy goals. The state is committed to environmental stewardship and biodiversity conservation in marine energy development including wave and tidal resources. These projects will need to be designed and operated considering potential environmental impacts, including habitat disturbance, marine mammal interactions, commercial and recreational fisheries, and ecosystem disruption. They will also need to adhere to environmental regulations and mitigation requirements to minimize adverse effects on marine ecosystems and wildlife. Overall, California's future vision for marine energy is one of sustainable development and resilience where the state's coastal resources are harnessed responsibly.

CHAPTER 1:

Technology and Economic Feasibility of Wave and Tidal Energy

1.1 Introduction

Marine energy or *marine kinetic energy* refers to the renewable energy derived from the various forms of energy found in oceans and seas. The total marine energy resource in the United States has been estimated to be 2,300 terawatt-hours per year (TWh/year).¹ This amount is roughly equivalent to half of the electricity generated across the nation. If harnessed at just one-tenth efficiency, marine energy has the potential to power more than 20 million U.S. homes.² Marine energy has several advantages, including the consistent availability and predictability of waves and tides, which makes it a reliable and consistent source of power. It can contribute to California’s transition to cleaner and more sustainable energy sources.

Marine energy encompasses a range of energy sources and technologies that harness this energy to generate electricity, including wave, current (for example, tidal, ocean boundary currents [such as Gulf Stream], and riverine), ocean thermal, and salinity gradient conversion. This report focuses on wave and tidal energy, which are the subject of SB 605.

This chapter summarizes the technological and economic feasibility of deploying offshore wave and tidal energy in the state. This chapter is organized as follows:

- Wave Energy Technology Overview
- Tidal Energy Technology Overview
- Marine Energy Applications in California
- Challenges to Developing Marine Energy

1.2 Wave Energy Technology Overview

Wave energy conversion refers to the harnessing the kinetic and potential energy present in ocean waves and converting it into usable electricity. Waves form as the result of wind interacting with the ocean surface. Thus, the energy of waves is highest at the surface of the ocean and decays with depth. Wave growth depends on the length over which the wind blows in a constant direction, also known as *fetch*.

1 Kilcher, L., M. Fogarty, and M. Lawson. 2021. [Marine Energy in the United States: An Overview of Opportunities](https://www.nrel.gov/docs/fy21osti/78773.pdf). National Renewable Energy Laboratory, NREL/TP-5700-78773, Golden, Colorado, <https://www.nrel.gov/docs/fy21osti/78773.pdf>.

2 United States Energy Information Administration (U.S. EIA). 2020. "[Annual Energy Outlook 2020](https://www.eia.gov/aeo)." U.S. Department of Energy, Washington, D.C., 81 pp. <https://www.eia.gov/aeo>.

According to the National Renewable Energy Laboratory (NREL) Wave Energy Atlas, the total theoretical wave energy resource along the U.S. coastline is estimated to exceed 2,000 TWh annually. Due to the global direction of wind, and the sheer size of the Pacific Ocean, the potential for wave energy conversion is greatest at midlatitudes, between 30° and 60° north latitude, which include the California coast. Along California's 840 miles of coastline, the estimated wave resource alone has been reported at more than 37 gigawatts (GW),³ generating 140 TWh/year, capable of powering up to 13 million homes.⁴ The California Wave Energy Assessment⁵ determined that wave energy has the potential to provide 23 percent of the state's energy needs. NREL's estimates are based on the proportion of the energy available in wave motion that can be captured using existing technology options. Estimates do not consider external constraints (such as socioeconomic, environmental regulatory, or computing-use issues), nor do they apply projected technological innovations in wave energy converter (WEC) technologies.

Due to variability in wave resources as a function of region and water depth, there are many WEC technologies. Most (but not all) of these technologies fall into six main device archetypes:

- Attenuators
- Point absorbers
- Pressure differentials
- Oscillating water columns
- Overtopping
- Oscillating wave surge converters

Table 1 summarizes six main WEC device archetypes and identifies examples of existing devices within each archetype (device name or developer of each device). A single device may fall into several archetype categories. Here, they are categorized by the primary principle of operation.

3 Beyene, A. and J. H. Wilson. 2007. "[Digital Mapping of California Wave Energy Resource.](https://cdip.ucsd.edu/themes/media/docs/publications_references/journal_articles/Digital_Mapping_of_California_Wave_Energy_Resource.pdf)" *International Journal of Energy Research*, 31, 1156-1168. doi:10.1002/er.1326, https://cdip.ucsd.edu/themes/media/docs/publications_references/journal_articles/Digital_Mapping_of_California_Wave_Energy_Resource.pdf.

4 Kilcher, L., M. Fogarty, and M. Lawson. 2021. [Marine Energy in the United States: An Overview of Opportunities.](https://www.nrel.gov/docs/fy21osti/78773.pdf) National Renewable Energy Laboratory, NREL/TP-5700-78773, Golden, Colorado, <https://www.nrel.gov/docs/fy21osti/78773.pdf>.

5 Electric Power Research Institute (EPRI). 2007. [California Ocean Wave Energy Assessment.](https://www.revision.net/documents/California%20Ocean%20Wave%20Energy%20Assessment.pdf) Report by EPRI for the California Energy Commission, 85 pp., <https://www.revision.net/documents/California%20Ocean%20Wave%20Energy%20Assessment.pdf>.

Table 1: Summary of Six Main Wave Energy Converter Devices

Device Archetype	Example Technologies and/or Device Developers	Configuration	Optimal Conditions
Attenuator	Crestwing, Mocean Blue X, Pelamis, OCEANTEC	Generally floating with mooring line(s) and bottom anchor(s)	Offshore swell, tens of meters water depth (outside breaker zone)
Point absorber	AquaHarmonics, CalWave Power Technologies Inc. xWave™, Columbia Power Technologies SeaRAY, CorPower Ocean, EcoWave Power, Fred. Olsen BOLT Lifesaver, Northwest Energy Innovations Azura, Ocean Power Technologies PowerBuoy®, Oscilla Power Triton-C	Floating, semi-submerged, or submerged with mooring line(s) and bottom anchor(s)	Optimal conditions: moderate to high wave energy densities (offshore)
Pressure differential	AWS Ocean Waveswing, Bombora Wave mWave, Carnegie CETO	Submerged with mooring line(s) and bottom anchor(s)	Flexible
Oscillating water column	Ocean Energy OE, Oceanlinx, Wavegen LIMPET	Shore-based, fixed structure, or floating, moored offshore	Flexible
Overtopping	Tapchan, Wave Dragon	Shore-based, fixed structure, or floating, moored offshore	Flexible
Oscillating wave surge	Aquamarine Power Oyster, Langlee Wave Power Robusto™, Resolute Marine	Surface floating or subsurface and moored and/or bottom-mounted	Relatively shallow water depths (10-12 m)

Source: Aspen Environmental Group

WEC devices may be modular or flexible (or both) in design for use in a wide variety of environmental conditions, or they may be designed for deployment in specific locations, such as onshore, nearshore, or offshore.⁶

- Onshore WECs are typically fixed structures that are deployed on land or in very shallow water. These can be integrated into breakwaters or piers or built as stand-alone structures. Onshore WEC installations are easy to maintain and require less marinization relative to offshore WECs. However, onshore WECs typically generate less electricity than the offshore counterparts because of the decrease in energy as waves propagate to shore.
- Nearshore devices are deployed within a few hundred meters of shore, in water depths of 10–25 m. They are generally mounted directly to the seafloor; however, some devices have floating, semisubmerged, or submerged components as well.
- Offshore WECs are deployed in waters deeper than 25 m. These devices may float at the surface, be near the surface (semisubmerged), or be submerged. As such, they require moorings and anchors to hold them in place. These devices exploit the highest energy in waves, before breaking, and therefore must be designed to withstand large forces. Offshore devices are also more difficult and costly to maintain and require longer transmission lines to shore (if grid-connected).

WEC devices are still in the early stages of development, and numerous technologies are being tested to improve efficiency and reliability and minimize environmental impact, which will vary by device and location. A 2020 report⁷ provides a review of WEC technologies that have been tested around the world, indicating device deployment location and date(s) and rated power capacity of each WEC. The Liquid Grid⁸ provides a global database of WEC technology developers, device names, and types, indicating development of 16 attenuators, 58 point absorbers, 11 pressure differentials, 18 oscillating water columns, 7 overtopping and terminators (grouped together here because of the similar concept of operations), 10 oscillating wave surges, and 12 other WEC devices.

1.2.1 Attenuators

Wave attenuators are single surface-floating bodies or multiple connected bodies that rise and fall with wave motion (Figure 1). Electricity is generated through mechanical turbine rotation or hydraulic pumps that are driven by the flexing motion of the device. Attenuators are oriented parallel with waves and are generally deployed in offshore locations (tens of meters, beyond where waves break) to capture wave swell. Because these devices float at the ocean surface, deployment methods generally involve mooring lines and seabed anchoring systems.

6 López, I., J. Andreu, S. Ceballos, I. Martínez de Alegría, and I. Kortabarria. 2013. "[Review of Wave Energy Technologies and the Necessary Power-Equipment.](https://www.sciencedirect.com/science/article/abs/pii/S1364032113004541)" *Renewable and Sustainable Energy Reviews*, 27, 413-434, <https://www.sciencedirect.com/science/article/abs/pii/S1364032113004541>.

7 Ahamed, R., K. McKee, and I. Howard. 2020. "[Advancements of Wave Energy Converters Based on Power Take Off Systems: A Review.](https://doi.org/10.1016/j.oceaneng.2020.107248)" *Ocean Engineering*, 204, 107248, <https://doi.org/10.1016/j.oceaneng.2020.107248>.

8 The Liquid Grid [webpage](https://theliquidgrid.com/the-liquid-grid-blog/), <https://theliquidgrid.com/the-liquid-grid-blog/>. Accessed July 11, 2024.

Some notable attenuator device technologies that are (or were) at high technology readiness level (TRL) are/were developed by Crestwing, Mocean Energy, OCEANTEC, and Pelamis.

Mocean Energy is developing two attenuator-type WECs, one for Powering the Blue Economy™ (PBE) applications (“Blue Star”)⁹ and the other aimed at utility-/commercial-scale wave farm deployments (“Blue Horizon”). Both devices, along with the associated “Blue X” prototype, are based on the same design concept of surface-following hinged rafts. The Blue X 10 kilowatt (kW) prototype completed successful testing at the European Marine Energy Centre (EMEC) test facility in Billia Croo, Orkney, United Kingdom (UK) in 2021, in 25 meters (m) water depth. Blue X was not grid-connected; generated power was stored in 30 kilowatt-hour (kWh) batteries during at-sea testing. The device was deployed on two identical mooring lines with anchor clump weight, ground chain, riser chain, and polypropylene line.

The Pelamis WEC was a two-body, semisubmerged, cylindrical structure that exploited wave motion to operate hydraulic motors for power generation.¹⁰ In 2004, a full-scale prototype 1.5 MW rated device was deployed at the EMEC wave device test site and was the first WEC to supply wave-generated electricity to the Scottish national grid. About eight years later, a second device was deployed at the same test area after design improvements. The Pelamis WECs were moored to the seabed in roughly 50 m water depth using standard drag embedment anchors. Unfortunately, Pelamis Wave Power went into administration (bankruptcy) in late 2014, and the device was decommissioned in 2016. The Pelamis assets are in Orkney and owned by Orkney Islands Council.

9 Caio, A, T. Davey, and J. C. McNatt. 2021. [“Preliminary Hydrodynamic Assessment of Mocean Energy’s Blue Star WEC Via Fast-Turnaround Physical Model Testing.”](https://tethys-engineering.pnnl.gov/publications/preliminary-hydrodynamic-assessment-mocean-energys-blue-star-wec-fastturnaround) *Proceedings of the 14th European Wave and Tidal Energy Conference*, Plymouth, U.K., September 5–9 2021. <https://tethys-engineering.pnnl.gov/publications/preliminary-hydrodynamic-assessment-mocean-energys-blue-star-wec-fastturnaround>.

10 Drew, B., A. R. Plummer, and M. N. Sahinkaya. 2009. [“A Review of Wave Energy Converter Technology.”](https://doi.org/10.1243/09576509JPE782) *Proceedings of the Institution of Mechanical Engineers, Proceedings Part A: Journal of Power and Energy*, 223, 887-902. <https://journals.sagepub.com/doi/10.1243/09576509JPE782>.

Figure 1: Examples of Attenuator Wave Energy Converters



Crestwing WEC

Source: Crestwing



Mocean Energy Blue X

Source: Mocean Energy

1.2.2 Point Absorbers

The basic concept of a point absorber WEC involves a floating buoy or platform that moves up and down or back and forth in response to the motion of passing waves. This movement, relative to a fixed structure (like an anchor), is then converted into mechanical energy using a power take-off mechanism, such as hydraulic pistons or linear generators. The mechanical energy is further converted into electricity, typically through hydraulic systems or direct drive generators.

Point absorbers are typically smaller and more mobile than other WEC device archetypes, making them suitable for a variety of marine environments. Furthermore, point absorbers are often modular in design, making them easier to install, maintain, and relocate as needed. Point absorbers can be deployed individually or in arrays, allowing scalability and flexibility. They are particularly effective in areas with moderate to high wave energy densities and can be designed to withstand harsh marine conditions. Some examples of point absorber devices are the CalWave Power Technologies Inc. (CalWave) xWave™, Columbia Power Technologies (C Power) SeaRAY, CorPower Ocean, EcoWave Power, Fred. Olsen BOLT Lifesaver, Northwest Energy Innovations Azura, Ocean Power Technologies (OPT) PowerBuoy®, and Oscilla Power Triton-C (Figure 2).

CalWave completed a 10-month open-ocean pilot test of its xWave™ WEC off San Diego in 2022. The xWave was deployed and anchored in 22 m depth with a power transmission cable to Scripps Pier (University of California, San Diego). The device was semisubmerged, suspended in the water column with taut mooring lines, and held in place with four gravity anchors. Several postinstallation environmental monitoring campaigns were conducted while the xWave was deployed, including

- Short-duration (three-day) habitat and sediment visualization and tracking and fish activity monitoring using a 360-degree camera.

- Visual monitoring for marine mammals, fish, birds, and reptiles using cameras mounted on the device and periodic dive surveys.
- Passive acoustic monitoring using short-term (order of 1 hour or less) drifting broadband hydrophones and acoustic particle motion sensors longer term (up to three days) measurements using a moored three-element particle motion array.

(NoiseSpotter™).¹¹ CalWave determined that the project was exceedingly unlikely to contribute to cumulative adverse effects on marine mammals, fish, birds, invertebrates, reptiles, or the physical environment. CalWave plans to deploy one of its x100™ units (100 kW) at the PacWave wave energy test site (Newport, Oregon) in 2025. (See Marine Energy Test Sites in Section 1.4.4).

Columbia Power Technologies (C-Power) has developed WEC technologies to generate and store electricity for at-sea power needs. Its SeaRAY™ k2 autonomous offshore power system (AOPS) consists of the SeaRAY k2 WEC and the AOPS device. The k2 WEC is a heave-and – surge point absorber¹² is secured to the seabed with a three-point mooring, and the AOPS is a power, energy storage, and real-time communication device designed for PBE applications, specifically to support uncrewed offshore activities and equipment. The SeaRAY AOPS is scheduled for testing over six months at the Hawai'i Wave Energy Test Site (WETS) in 2024. (See Marine Energy Test Sites in Section 1.4.4.)

OPT's PowerBuoy® is a point absorber WEC designed to power onboard sensors or systems by harnessing wave energy and storing generated electricity in an integrated battery pack. It is a floating WEC that is moored on the seabed in water depths between 20 m and 3,000 m. The PowerBuoy is equipped with at-sea two-way communication capability for real-time data transfer. In a joint effort with the Naval Postgraduate School, it will be deployed in Monterey Bay, California, for one year to demonstrate capabilities as an at-sea infrastructure node to support the Department of Defense Joint Force's operational needs.

The Oscilla Power Triton-C device operates by harnessing the relative motion between the floating buoy and submerged components as waves pass through it. The Triton-C consists of a floating buoy tethered to a seabed anchor, with a heave plate submerged beneath the surface. As waves pass through the device, the buoy moves up and down with the wave motion, while the heave plate remains relatively stationary due to the connection to the seabed anchor. This differential motion between the buoy and heave plate generates mechanical energy, which is then converted into electricity using a power take-off system.¹³ The Oscilla Power Triton-C is undergoing development and testing to validate the performance and commercial viability. It

11 Raghukumar, K., G. Chang, F. Spada, and C. Jones. 2020. "[A Vector Sensor-Based Acoustic Characterization System for Marine Renewable Energy.](https://doi.org/10.3390/jmse8030187)" *Journal of Marine Science and Engineering*, 8, 187. doi:10.3390/jmse8030187, <https://www.mdpi.com/2077-1312/8/3/187>.

12 A heave-and-surge point absorber creates more energy from the additional points of movement.

13 Coe, R. G., B. J. Rosenberg, E. W. Quon, C. C. Chartrand, Y.-H. Yu, J. van Rij, and T. R. Mundon. 2019. "[CFD Design-Load Analysis of a Two-Body Wave Energy Converter.](https://doi.org/10.1007/s40722-019-00129-8)" *Journal of Ocean Engineering and Marine Energy*, Springer (online), <https://doi.org/10.1007/s40722-019-00129-8>.

will be deployed at the Hawai'i Wave Energy Test Site (WETS) (Section 1.4.4), pending weather conditions, in 2025.

Figure 2: Examples of Point Absorber Wave Energy Converters



CalWave xWave™

Source: CalWave

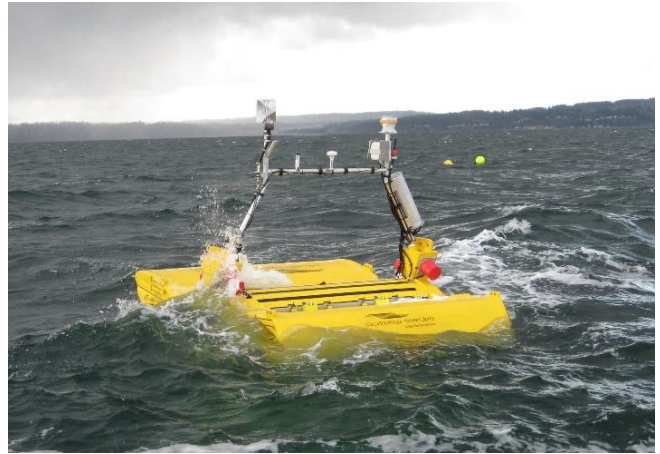

C-Power SeaRay

Source: C-Power



CorPower Ocean C4

Source: CorPower



Fred. Olsen BOLT Lifesaver

Source: Fred. Olsen



Northwest Energy Innovations Azura



Oscilla Power Triton-C



Source: Northwest Energy Innovations

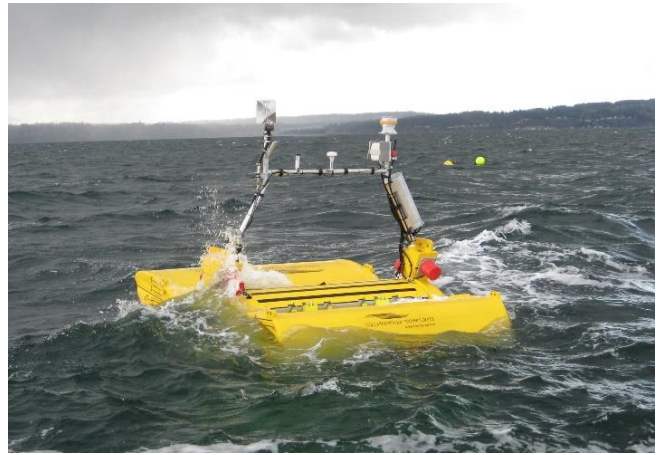

Source: Oscilla Power

1.2.3 Pressure Differential WECs

A pressure differential WEC generates electricity by harnessing the difference in pressure between two points caused by the motion of ocean waves, the crest and trough. This difference in pressure drives compression on one side of the device and expansion on the other. Power is extracted through air flow between the two sides, which is converted into mechanical or electrical energy.

A notable pressure differential WEC is the AWS Ocean Energy LTD Archimedes Waveswing (AWS).¹⁴ The AWS Waveswing's submerged buoy responds to differences in subsea water pressure caused by passing waves and converts this motion to electricity using a direct-drive generator. It is suitable for deployment in 25 m water depth or greater as a single unit or as part of an array. A unit can be configured for rating between 15 kW and 500 kW. A 16 kW Waveswing device was tested at the EMEC test site in Orkney over a variety of wave conditions.

1.2.4 Oscillating Water Column WECs

Oscillating water column WECs are devices designed to generate electricity by using the oscillating motion of water within a chamber as waves pass by. These WECs typically consist of a partially submerged chamber open to the sea. As a wave enters the chamber, the water level rises, compressing the air trapped inside. As the wave recedes, the water level drops, causing the air inside the chamber to expand. This cyclical motion of the water column creates oscillating air pressure differentials within the chamber. The oscillating air pressure within the chamber is used to drive a turbine or generator. When the air pressure increases, it forces air out of the chamber through a turbine, generating electricity. As the pressure decreases, air flows back into the chamber through the turbine, which can also generate electricity.

14 de Sousa Prado, M.G., F. Gardner, M. Damen, and H. Polinder. 2006. "[Modelling and Test Results of the Archimedes Wave Swing](https://doi.org/doi:10.1243/09576509JPE284)." *Institution of Mechanical Engineers, Proceedings Part A: Journal of Power and Energy*, 220, 855–858, <https://doi.org/doi:10.1243/09576509JPE284>.

Oscillating water column WECs come in various designs, including shoreline installations (such as Wavegen Land Installed Marine Power Energy Transmitter (LIMPET), nearshore structures, and offshore (such as Ocean Energy OE [scheduled for testing at WETS in 2024] and Oceanlinx MK3 [sank in adverse weather conditions in 2010]; Figure 3). They can be fixed to the seabed or floating, depending on the deployment location and environmental conditions.

The Wavegen LIMPET was the first commercial WEC that was connected to the United Kingdom National Grid at Islay, Scotland.¹⁵ It was a shore-based, oscillating water column device with an inclined concrete tube as the chamber. The tube opening was below water level, facilitating oscillations in water level within the chamber and compression and expansion of trapped air, which rotated turbines to generate electricity. The LIMPET was rated to 250 kW and capable of supplying 1,800 MWh of electricity in a year. It was commissioned in 2000 and decommissioned in 2012.

Figure 3: Example of an Oscillating Water Column Wave Energy Converter



Ocean Energy OE Buoy

Source: Ocean Energy

1.2.5 Overtopping WECs

Overtopping WECs typically consist of a sloping structure or a seawall with a reservoir behind it. As waves approach the structure, they climb up and spill over the crest, filling the reservoir with water. Being impounded, the water accumulated in the reservoir is at a higher elevation than the surrounding ocean. The water collected in the reservoir is then released through turbines or sluice gates. This controlled release of water drives turbines or generators, converting the potential energy of the stored water into electricity. Overtopping WECs are known for simplicity, robustness, and adaptability to a wide range of wave conditions. There are several variations of overtopping WECs, including fixed structures (for example,

15 Heath, T. V. 2000. "[Chapter 334 – The Development and Installation of the Limpet Wave Energy Converter.](#)" *World Renewable Energy Congress IV*, pp. 1619–1622, <http://doi.org/10.1016/B978-008043865-8/50334-2>.

Tapchan),¹⁶ floating devices, and hybrid systems combining overtopping with other wave energy capture methods. Each design has advantages and disadvantages, depending on factors such as wave climate, deployment location, and desired power output. They can efficiently capture wave energy and convert it into electricity, making them suitable for grid-connected and remote applications.

One of the most well-known overtopping devices is the Wave Dragon¹⁷ (Figure 4). The Wave Dragon is a floating WEC that is designed such that waves overtop a ramp, elevating the water level such that it is above sea level. The “extra” water is released through turbines to generate electricity and then returned to the ocean. The Wave Dragon precommercial demonstration project off the Pembrokeshire Coast at Long Point, Wales, UK, involved mooring the device in water depth greater than 25 m to capture higher energy swell. The device was kept stationary using six to eight concrete gravity mooring blocks and a series of catenary mooring lines connecting the anchors to the floating surface buoy. The commercial demonstration project at Milla Fjord Site (up to 112 MW) was recently cancelled because of the inability to secure a lease site.

Figure 4: Example of an Overtopping Wave Energy Converter



Wave Dragon

Source: Wave Dragon

16 Friedriksen, A. E. 1986. "[Tapered Channel Wave Power Plants, Energy for Rural and Island Communities.](https://doi.org/10.1016/B978-0-08-033423-3.50029-0)" *Proceedings of the Fourth International Conference Held at Inverness Scotland*, September 16–19, 1985, 179-182, <https://doi.org/10.1016/B978-0-08-033423-3.50029-0>.

17 Christensen, L., E. Friis-Madsen, and J. P. Kofoed. 2005. "[The Wave Energy Challenge: The Wave Dragon Case.](https://vbn.aau.dk/en/publications/the-wave-energy-challenge-the-wave-dragon-case)" *Proceedings of the POWER-GEN 2005 Europe Conference, Milan, Italy, June 2005*, <https://vbn.aau.dk/en/publications/the-wave-energy-challenge-the-wave-dragon-case>.

1.2.6 Oscillating Wave Surge Converters

Oscillating wave surge converters consist of a buoyant structure that moves back and forth (surges) in response to the passing waves. As waves pass by, the surge motion of the buoyant structure generates mechanical energy. This energy is then converted into electricity using power take-off systems, which can include hydraulic pumps, turbines, or generators. Like overtopping WECs, oscillating wave surge converters come in a wide variety of configurations, including floating devices, fixed structures, and hybrid systems that combine surge motion with other methods. These devices can be deployed in coastal regions or offshore installations. Four example oscillating wave surge converter devices are the Langlee Wave Power Robusto™,¹⁸ Aquamarine Power Oyster,¹⁹ Resolute Marine WEC as part of its Wave2O™ wave-powered desalination system (Figure 5), and WavePiston, which was installed at full scale February 8, 2024, at the Oceanic Platform of the Canary Islands in Gran Canaria.

The Aquamarine Power Oyster consisted of a power connector frame and a power capture unit. The power connector frame was mounted directly in the seabed with concrete piles, and the power capture unit, a hinged buoyant flap that moved back and forth with wave motion, was suspended just below the surface. The flap motion drove hydraulic pistons that pumped high-pressured water to a turbine to generate electricity. The Oyster was tested at the EMEC test site in Orkney in 10–15 m water depth in 2012. Unfortunately, as with some other WEC developers described here, Aquamarine Power went into administration in 2015.

18 Pecher, A., J. P. Kofoed, J. Espedal, and S. Hagberg. 2010. "[Results of an Experimental Study of the Langlee Wave Energy Converter.](#)" *Proceedings of the Twentieth International Offshore and Polar Engineering Conference, Beijing, China*, June 20–25, 2019, 877-885, https://www.researchgate.net/publication/220018894_Results_of_an_Experimental_Study_of_the_Langlee_Wave_Energy_Converter.

19 Henry, A., K. Doherty, L. Cameron, T. Whittaker, and R. Doherty. 2010. "[Advances in the Design of the Oyster Wave Energy Converter.](#)" *Proceedings of the Marine Renewables and Offshore Wind Conference, Royal Institute of Naval Architects, RINA HQ, London, UK*. doi:10.3940/rina.mre.2010.14, https://www.researchgate.net/publication/287968424_Advances_in_the_Design_of_the_Oyster_Wave_Energy_Converter.

Figure 5: Example of an Oscillating Wave Surge Wave Energy Converter



Resolute Marine Energy WEC

Source: Resolute Marine Energy

1.3 Tidal Energy Technology Overview

Tidal and current energy is a form of marine renewable energy derived from harnessing the movement of water. This movement can be from ocean circulation patterns, cyclical movement due to tides, or from the flow of rivers and streams. Unlike the U.S. East Coast, where the Gulf Stream flows from Florida to Maine, California does not have a consistent and suitably energetic ocean current that flows along its coast.

The dominant form of marine circulation patterns along California's coast come from tides. Tidal currents are generated by gravitational forces of the Moon and the Sun on the Earth's oceans. The gravitational pull of the celestial bodies creates bulges of water on Earth's surface, leading to the periodic and predictable rise and fall of sea level. The water velocity depends on how much the water surface has to rise and fall in response to the tide generating forces. Where tidal waters flow between land masses, such as adjacent islands or a narrows, the water moves more swiftly. The power associated with tides is a function of the current velocity cubed and the water density (Neill et. al 2018). Typical current speeds of 0.5 meters per second (m/s) up to 3 m/s are generally targeted for consideration of tidal energy conversion.²⁰

NREL has estimated that tidal energy along the U.S. West Coast could produce up to 4.1 TWh/year with California resources exceeding 1.8 TWh/year.²¹ These estimates are based on the proportion of the energy available in tidal currents that can be captured using existing

²⁰ Kilcher, et al. 2021. [Marine Energy in the United States: An Overview of Opportunities.](#)

²¹ Ibid.

technology options. They do not consider external constraints (such as socioeconomic, environmental regulatory, or computing-use issues), nor do they apply projected technological innovations in energy conversion technologies. While this tidal energy is a fraction of the estimated wave energy in California, the potential to supplement regional needs, and critical monitoring or infrastructure projects, should not be ignored.

Humans have harnessed the flow of water for centuries and the development of tidal and current energy systems continues that long tradition. This section focuses on technologies that may be used to harness tidal currents for energy production. Tidal energy converters (TECs) come in a variety of sizes, shapes, and energy capture methods. The size may vary depending on available resource, deployment area, and mounting methods. A summary of six common device archetypes is outlined in this report that could be considered for use in California (Table 2):

- Axial-flow turbines
- Cross flow turbines Oscillating hydrofoil
- Tidal kite
- Archimedes screw
- Vortex induced vibration

Industry examples are from both U.S.-based and international companies, sourced from publicly accessible online references such as TETHYS and The Liquid Grid. This report does not contain an exhaustive list of all technologies in development.

Table 2: Summary of Six Main Tidal Energy Current Device Archetypes

Device Archetype	Example Technologies and Developers	Configuration	Optimal Conditions
Axial-Flow Turbines	Andritz Hydro, Blue Shark Power Systems, Gkinetic Energy, Hydrokinetic Energy Corp, Magallanes Renovables, Nova Innovation, Orbital Marine Power, Sabella, MeyGen by SAE Renewables, Sustainable Marine, Verdant Power	Multiple blades attached to rotor. Can be deployed as single or multiple units on a base.	Water depths are dependent on turbine size. Can operate in systems with both tidal and unidirectional flow.
Cross Flow Turbines	Ocean Renewable Power Company (ORPC), GCK Technology, Marine Energy Corporation	Floating, semi-submerged, or submerged with mooring line(s)	When oriented horizontally, channelized flow with predictable direction. When oriented

Device Archetype	Example Technologies and Developers	Configuration	Optimal Conditions
		and bottom anchor(s)	vertically, direction agnostic. Can operate in systems with both tidal and unidirectional flow.
Oscillating Hydrofoil	Tidal Sails	Fixed to sediment bed with one or multiple foils oriented perpendicular to flow direction.	Strong tidal oscillations
Tidal Kite	Minesto AB, Aquantis Inc	Submerged generating unit with cable affixed to sediment bed.	Can be optimized to meet range of tidal conditions
Archimedes Screw	Jupiter Hydro, HydroCoil Power Inc	Helix screw oriented in line with flow attached to floating platform.	Water depths are dependent on turbine size. Can operate in systems with both tidal and unidirectional flow
Vortex Induced Vibration	WITT Energy, Vortex Hydro Energy	Spherical or tubular units attached to generator.	Can be affixed to pilings or other submerged structures in turbulent areas. Can be direction agnostic depending on shape

1.3.1 Axial Flow Turbines

Axial-flow turbines have spinning blades whose axis of rotation is oriented with the direction of the current. They mimic wind turbines in shape and energy extraction method (Figure 6). The turbines can come in a variety of sizes (with diameters reaching in excess of 20 m), number of blades (typically two to three), and power outputs (up to 1.5 MW). Devices can be tuned to specific conditions by varying the blade shape and orientation. Turbines may be allowed to rotate to orient with flow direction or remain fixed. Some systems may have a ducting system to direct flow toward the blade. In comparison to the other device types outlined in this report, the axial flow turbines are typically the largest in size.

In the United States, sites like the Roosevelt Island Tidal Energy (RITE) Project by Verdant Power used a triframe system with three turbines (Figure 6) to demonstrate the viability of power generation in the East River, New York, where velocities can be greater than 2 m/s. The units were permitted by the Federal Energy Regulatory Commission (FERC) and New York State Energy Research & Development Authority (NYSERDA), performed to internationally accepted standards, and provided power to the local energy grid.²² Verdant performed extensive environmental evaluations and implemented an adaptive management strategy as part of its site stewardship.²³ Upon reaching the expiration of the pilot project permit, the platform and devices were decommissioned.

Tidal power is also being harnessed in European markets. An example is the MeyGen Tidal Energy project in Pentland Firth on the north coast of Scotland. Up to 398 MW of power have been approved and will be developed in stages.²⁴ The site uses turbines developed by companies including Lockheed Martin, to operate in tidal currents between 1 and 3 m/s. As these turbines are rated to produce up to 1.5 MW of power, the site will house arrays of units to meet energy demand. This grid-connected site will provide power to the region as part of a regional commitment to renewable energy.

Developments like the RITE and MeyGen projects represent commercial-scale developments with devices deployed in coastal waters. California may have regions such as San Francisco Bay, Humboldt Bay, or San Diego Bay that have tidal resources to support projects of this scale.

22 Li, Y., J. A. Colby, N. Kelly, R. Thresher, B. Jonkman, and S. Hughes. 2010. "[Inflow Measurement in a Tidal Strait for Deploying Tidal Current Turbines: Lessons, Opportunities and Challenges.](#)" *ASME 2010 29th International Conference on Ocean, Offshore and Arctic Engineering, Shanghai, China*. Vol. 3. pp. 569–576. doi:10.1115/OMAE2010-20911 – via ASME, https://www.researchgate.net/publication/267605954_Inflow_Measurement_in_a_Tidal_Strait_for_Deploying_Tidal_Current_Turbines_Lessons_Opportunities_and_Challenges.

23 Gunawan, B., V. S. Neary, and J. Colby. 2014. "[Tidal Energy Site Resource Assessment in the East River Tidal Strait, Near Roosevelt Island, New York, New York.](#)" *Renewable Energy*, 71, pp. 509–517, <https://doi.org/10.1016/j.renene.2014.06.002>.

24 Black and Veatch. 2020. [Lessons Learnt from the Design, Installation and Initial Operations Phases of the 6MW 4-Turbine Tidal Array in Scotland's Pentland Firth](#). Report by Black & Veatch. Report for UK Department for Business, Energy and Industrial Strategy (BEIS), <https://tethys-engineering.pnnl.gov/publications/lessons-learnt-design-installation-initial-operations-phases-6mw-4-turbine-tidal-array>.

Figure 6: Examples of Axial-Flow Turbines



Verdant Power RITE Project

Source: Verdant Power



MeyGen Project by SAE Renewables

Source: SAE Renewables

1.3.2 Crossflow Turbines

Crossflow turbines have a set of blades that spin in the direction of flow and can be mounted horizontally or vertically. As these turbines spin, the design of the blades must minimize the flow across the blade as it returns to face the flow. Helical blades, eponymously known as *Gorlov blades*, are often used that help optimize the force across the blade during rotation. These systems may be attached to floating structures or fixed to the seabed. The size of crossflow turbines and related infrastructure can be scaled to meet site requirements.

Devices such as the TidGen system, developed by Ocean Renewable Power Company (ORPC), is a submerged system that can adjust to different water depths in the water column to capture the ideal current speeds (Figure 7). ORPC builds on their success of the RivGen system, a floating cross-flow turbine designed for rivers and unidirectional flow where current velocities are typically the swiftest at or near the river surface.²⁵ The evolution of this technology and overlap in concepts make it a viable option for sites along California with multiple forms of tidal and current energy. ORPC successfully deployed a version of the TideGen system in Cobscook Bay, Maine, in 2014. The units measured about 30 m long, and more than 5 m tall (Figure 7). ORPC is field testing systems capable of generating 80 to 160 kW in current speeds of 2.5–3.5 m/s and those efforts will continue in 2024.

Other devices such as those in development by Mavi Innovations are floating systems, moored to the seafloor via anchor lines (Figure 7). The range of deployment methods allows for a wide variety of applications. These units can be deployed as single systems for microgrid uses or arrays depending on the power requirements and available resource.

25 Donegan, J. 2019. "[EWTEC 2019 Powering the Blue Economy Specialists Panel: ORPC and Microgrid Inverters](https://tethys.pnnl.gov/publications/ewtec-2019-powering-blue-economy-specialists-panel-orpc-microgrid-inverters)." Presented at 13th European Wave and Tidal Energy Conference (EWTEC 2019), Napoli, Italy, <https://tethys.pnnl.gov/publications/ewtec-2019-powering-blue-economy-specialists-panel-orpc-microgrid-inverters>.

Figure 7: Cross-Flow Turbine Examples



Ocean Renewable Power Company TidGen

Source: Ocean Renewable Power Company



Mavi Innovations cross-flow turbine

Source: Mavi Innovations

1.3.3 Reciprocating Devices

Reciprocating devices, also referred to as *oscillating hydrofoils*, take advantage of lift and drag to move through the water column, driving a piston or energy take-off mechanism as the hydrofoil changes direction. The systems can be oriented horizontally or vertically and fixed or floating. Designs range from one large hydrofoil that moves up and down as the forces of lift and drag act on the wing, or multiple smaller foils that move in tandem (Figure 8). Tidal Sails' device, BeamReach, was inspired by sailboats and incorporates a series of evenly spaced wings attached to cables that take advantage of the lift/drag principles of hydrofoil wings to engage a rotor and generate power.

Figure 8: BeamReach Reciprocating Device

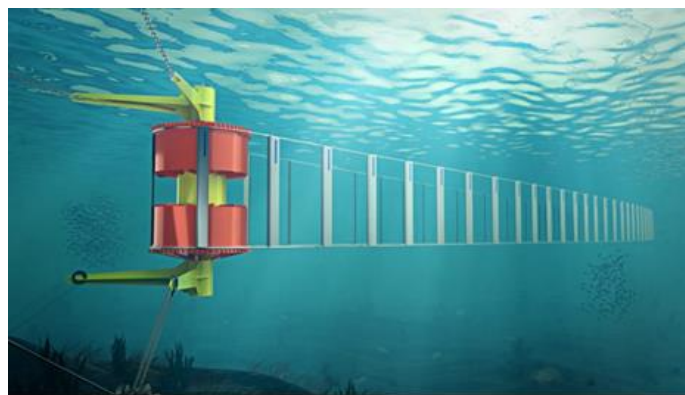

Source: Tidal Sails

1.3.4 Tidal Kites

Tidal kites combine the axial turbine and hydrofoil concepts of other marine devices. A submerged, neutrally buoyant hydrofoil and axial-flow turbine is attached to a cable, allowing the unit to maintain position in the water column. As the tidal currents pass over the system,

the turbine turns and generates electricity. The unit can orient itself into the current and over a tidal cycle moves to areas of the strong flow due to the forces on the wing.

The Dragon 12 system designed by Minesto, deployed in the Faroe Islands, Denmark, is an industry-leading example of the tidal kite technology. The 28-tonne, 12-meter-wide device is tethered to the seafloor and moves in a figure-eight pattern as the currents act upon the structure and can generate up to 1.2 MW of power (Figure 9). This diving pattern results in the device experiencing greater velocities than the current speed alone, resulting in the potential to produce more power than if the unit had a fixed position in the water column. The Faroe Islands have a goal to be powered by 100 percent renewable energy by 2030, and the grid-connected Minesto deployments are contributing to that effort.

Figure 9: Tidal Kite Conceptual Operating Diagram and Device

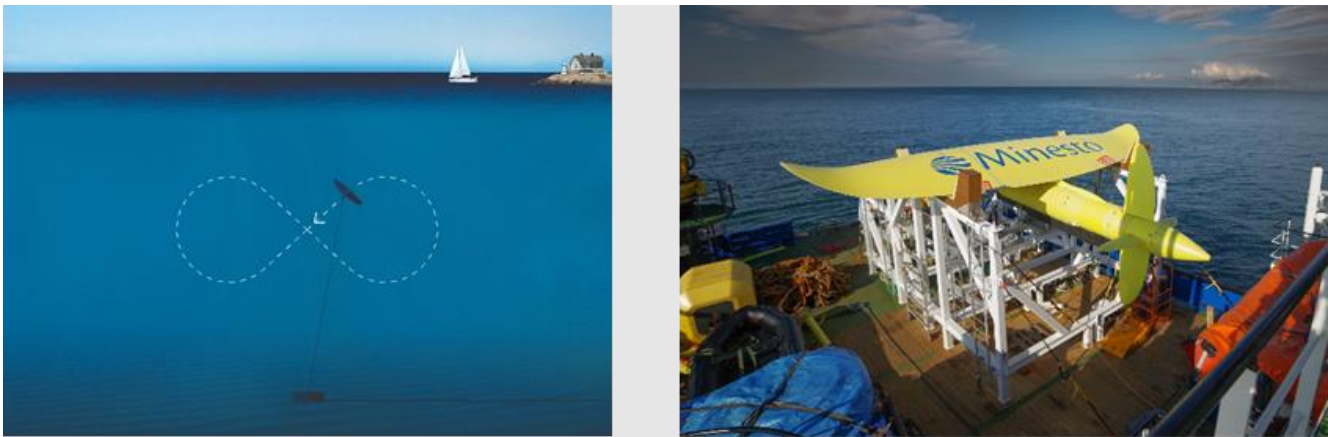

Source: Minesto

1.3.5 Archimedes Screw

The *Archimedes Screw*, or *horizontal axis auger*, is based on designs dating back 5,000 years to move or pump water. A helical blade is wrapped around an axis that, when powered, can move water to a higher elevation (Figure 10). To generate power, the flow of water moves the spiral blade and axis shaft connected to a generator. These devices have found success in fish passage systems on rivers and dams to reduce impacts to natural migration patterns and they have potential to be used to generate power in tidal systems. Floating platforms like the one proposed by Jupiter Hydro can be scaled to meet site demands or units could be fixed to structures. The modular design of these devices, as with many of the TECs, makes implementation scalable.

Figure 10: Conceptual Design of Archimedes Screw Array

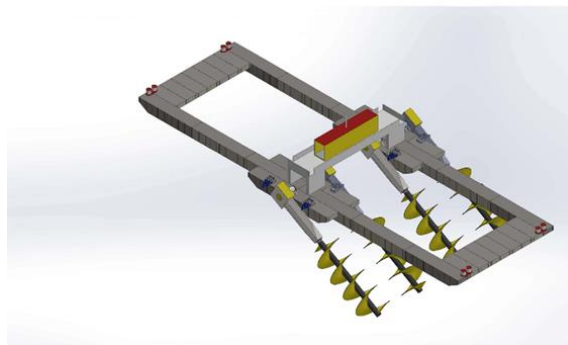

Source: Jupiter Hydro

1.3.6 Vortex-Induced Vibration Devices

Vortex-induced vibration devices take advantage of a physical phenomenon when turbulent flow passes around a round object. In this case, as flow passes over the cylindrical or spherical structure attached to a generator, the vibrational energy induced by turbulence is captured and converted to power. Developers such as Vortex Hydro Energy have tested this technology in laboratory and controlled settings. Scaled deployments or pilot studies at locations with submerged structures, like bridge pilings or piers, would be ideal as they can generate more turbulent flow to agitate the device.

1.4 Marine Energy Applications in California

Potential marine energy projects in California can be broadly categorized as commercial-scale or distributed energy.

1.4.1 Commercial-Scale Projects

Commercial-scale projects can be described as deployments of multiple devices in arrays that are grid-connected. Although several commercial-scale tidal energy projects have obtained FERC licenses in the United States (such as Admiralty Inlet, Washington; Cobscook Bay, Maine; and RITE, New York), larger-scale marine energy applications in California will likely be focused on wave energy as opposed to tidal energy because of available resources. Recall that the estimated wave energy resource for California is nearly 100 times greater than that estimated for tidal energy.

As of late 2023, the only active wave energy projects in the United States that have secured FERC licenses are associated with wave energy test sites: Jeanette's Pier, PacWave South Wave Energy Test Site, and the Hawai'i Wave Energy Test Site (WETS). (See Marine Energy Test Sites in Section 1.4.4.) Several other wave energy projects had initiated the FERC licensing projects including:

- CalWave Wave Energy Test Site in the Santa Barbara Channel, California, from 2014 to 2016.
- Camp Rilea in Oregon from 2015 to 2016.

- Columbia Power SeaRay in Puget Sound, Washington, from 2010 to 2012.
- Humboldt WaveConnect in Northern California from 2008 to 2011.
- Yakutat in Alaska from 2009 to 2017.

The OPT Reedsport project in Oregon successfully obtained permits and operated from 2006 to 2012 but is inactive.

While commercial-scale marine energy projects in California have not been implemented to date, the state's abundant wave resources and supportive policy environment present opportunities for further research and development and demonstration to support large-scale deployment of marine energy technologies. Continued efforts in this field have the potential to contribute to California's clean energy goals and promote sustainable development along its coastline.

1.4.2 Distributed Marine Energy

Distributed marine energy applications in California are smaller-scale deployments and pilot projects rather than large-scale commercial operations. These smaller-scale projects may involve onshore wave or tidal energy converters or both installed along breakwaters, shorelines, quay walls, or piers, or offshore devices such as oscillating wave surge converters installed in shallow waters to provide localized energy sources. Singular devices, arrays of devices, or hybrid solutions (for example, marine energy combined with solar or wind) may be integrated with microgrid networks to monitor, control, and optimize energy generation, distribution, and consumption. Distributed marine energy systems would enhance continuity during grid outages, natural disasters, and other disruptions. Key distributed energy applications in California may include:

- **Ports and harbors.** Ports and harbors can make use of various onshore or offshore marine energy systems to meet localized energy needs and enhance the sustainability and resiliency of operations.
- **Remote communities.** In remote coastal communities or islands, marine energy technologies such as small-scale wave energy converters or tidal turbines can provide a reliable and sustainable source of electricity. These distributed energy systems can be integrated into microgrids to supplement or replace diesel generators, reducing reliance on imported fossil fuels and improving energy resilience.
- **Community-based initiatives.** Community-based organizations and nonprofit groups in coastal areas of California have shown interest in exploring marine energy as a sustainable energy solution. These initiatives often involve local stakeholders, including fishermen, environmental organizations, and indigenous communities in the planning and development of distributed marine energy projects that align with community priorities and values.
- **Military installations.** Marine energy technologies can be deployed in off-grid locations along California's coastline for military installations. These distributed energy systems can provide decentralized and sustainable power for military bases, installations, and operations in coastal and maritime environments.

- **Powering the Blue Economy™ (PBE).** PBE activities involve using marine energy technologies to support and enhance various sectors and activities within California’s rich ocean economy. PBE projects have several applications,²⁶ notably:
 - *Ocean observation.* Marine energy technologies can power ocean observation platforms and systems used for environmental monitoring, marine research, and resource management. Marine energy-powered buoys, uncrewed surface or underwater vehicles, and other remote sensing platforms enable autonomous, sustained collection of real-time data on ocean conditions, marine biodiversity, and climate change impacts, supporting sustainable management practices and decision-making in marine environments. Marine energy technologies can also be leveraged for environmental monitoring to ensure responsible development across the seaspaces, such as offshore wind energy projects, aquaculture, and seawater mining.
 - *Marine aquaculture.* Marine energy can provide sustainable power solutions for offshore aquaculture operations, including fish farms, shellfish cultivation, and algae farming. Renewable energy sources can supply electricity for aeration, lighting, monitoring, feeding systems, and other infrastructure required for aquaculture activities.
 - *Seabed/seawater mining.* At-sea mining operations require significant energy inputs for processes such as extraction, separation, and concentration of minerals or resources from seawater or the seabed, as well as support functions such as desalination for potable drinking water. These operations are typically conducted offshore, where high concentrations of minerals or resources are found. Marine energy can provide a sustainable and reliable source of power for offshore mining platforms, processing facilities, and equipment, enabling continuous operation in remote or offshore locations.
 - *Desalination.* Marine energy can be integrated with various desalination technologies to reduce operating costs, energy consumption, and greenhouse gas emissions associated with traditional fossil-fuel powered desalination plants.
 - *Coastal resilience and disaster recovery.* Marine energy can play a role in enhancing coastal resilience and disaster recovery efforts by providing decentralized power solutions for coastal infrastructure and communities. Off-grid renewable energy systems, including WECs and TECs, can supply electricity to remote coastal areas vulnerable to power outages during extreme weather, helping communities maintain critical services and emergency response capabilities. In some locations, these systems may act to modify coastal

26 LiVecchi, A., A. Copping, D. Jenne, A. Gorton, R. Preus, G. Gill, R. Robichaud, R. Green, S. Geerlofs, S. Gore, D. Hume, W. McShane, C. Schmaus, and H. Spence. 2019. [Powering the Blue Economy; Exploring Opportunities for Marine Renewable Energy in Maritime Markets](https://www.energy.gov/sites/prod/files/2019/03/f61/73355.pdf). U.S. Department of Energy, Office of Energy Efficiency and Renewable Energy, Washington, D.C. 207 pp. <https://www.energy.gov/sites/prod/files/2019/03/f61/73355.pdf>.

processes and potentially reduce erosion or increase accretion along the shoreline.

- *Maritime transport and logistics.* Marine energy solutions can support the maritime transport sector by providing clean and efficient power for ships, ferries, and port operations. Hybrid propulsion systems and shore power infrastructure can reduce emissions and improve energy efficiency in shipping activities, contributing to California's efforts to decarbonize the maritime industry and reduce air pollution in port communities.
- *Blue tourism and recreation.* Sustainable energy solutions powered by marine energy can support recreational activities and tourism along California's coastline, including eco-friendly resorts, marine leisure facilities, and adventure tourism ventures.

Distributed marine energy applications show promise for many applications in California yet are still in the early stages of development due to the many challenges of marine energy, as described below. See Section 1.4.4 for an overview of the InDEEP Challenge, designed to encourage innovation in distributed marine energy converters. By leveraging marine energy to power various sectors and activities within the Blue Economy, California can promote sustainable development, enhance environmental stewardship, and strengthen resilience to climate change impacts in coastal communities while fostering economic growth and innovation in the ocean economy.

1.4.3 Marine Energy Test Sites

Marine energy test sites play a crucial role in developing and advancing WEC and TEC technologies. Testing in actual marine environments with real-world ocean conditions, including varying tidal currents, wave heights, periods, and directions, allows developers to assess the performance of their technologies under different conditions, providing valuable data for design optimization and performance validation. Marine energy test sites provide accurate measurements of hydrodynamics, wave characteristics, and energy fluxes, enabling developers to determine the energy yield of their devices and identify optimal deployment conditions that best match their device power matrices (energy capture as a function of tidal current velocity or wave height and period).

Test sites also include environmental monitoring to assess potential impacts on marine ecosystems and wildlife, contributing to responsible and sustainable development of marine energy projects. By subjecting prototypes to rigorous testing protocols, developers can identify strengths, weaknesses, and areas for improvement, ensuring that their technologies are ready for commercial deployment. Marine energy test sites in the United States include the General Sullivan Bridge, PacWave Wave North and South Energy Test Sites (PacWave), and Hawai'i Wave Energy Test Site (WETS).

- The **General Sullivan Bridge**, New Hampshire, is operated by the University of New Hampshire. It is along a constriction along the Lower Piscataqua River where it enters Little Bay. Developers can perform pilot or full-scale tests for vertical-axis turbines and "large-scale" (1:3 to 1:5 scale) tests for large-diameter horizontal axis turbines. The site

operators provide modeled dynamics of the tidal system and data from several sensors to promote evaluation of local hydrodynamics and environmental conditions.

- **PacWave** is off the coast of Newport, Oregon, and will provide access to a high-energy wave climate, making it an ideal location for testing WECs. It is under development, projected to accommodate grid-connected testing in spring/summer of 2025. The PacWave South site will consist of four test berths where WEC devices can be deployed and evaluated. Each berth is equipped with infrastructure for power transmission, data collection, and monitoring of environmental parameters. The PacWave site operates in compliance with federal and state regulations, including permits and environmental impact assessments. Testing opportunities will be available for wave energy developers to validate their technologies at various scales, from small-scale prototypes to full-scale demonstration projects, either singly or in small arrays. PacWave North provides a non-grid-connected offshore test site for testing single WECs.
- **WETS** is at the Marine Corps Base Hawai'i, Kaneohe Bay, Oahu, Hawaii, and has been in operation since 2004. WETS consists of three grid-connected test berths at 30 m, 60 m, and 80 m water depths, with installed capacity of 0.25 MW to 1 MW. The Hawai'i Natural Energy Institute provides support for testing at WETS in the form of device performance analysis, numerical modeling, wave measurements and predictions, environmental monitoring, and logistical (deployment) support. Multiple WECs have been tested at WETS including PowerBuoy BP-40, Northwest Energy Innovations 18 kW Azura, and the Fred. Olsen BOLT Lifesaver. The C-Power 2 kW SeaRay, Oscilla Triton-C, and Ocean Energy 500 kW OE35 buoy are slated for testing in 2024.

1.4.4 Marine Energy Prize Opportunities

The following marine energy prizes are offered by DOE, in collaboration with other federal agencies (such as National Oceanic and Atmospheric Administration [NOAA]), to encourage development of marine energy technologies for distributed energy/PBE applications:

- **InDEEP.** The Innovating Distributed Embedded Energy Prize (InDEEP) is a three-phase, two-year DOE competition to develop new materials for WECs to support distributed embedded marine energy applications. Phase I of the competition opened in March 2023, with the winner announced in November 2023. Phase II and Phase III winners are anticipated to be announced in July 2024 and February 2025, respectively.
- **Waves to Water Prize.** In June 2019, the DOE launched the Waves to Water Challenge, which consisted of five stages and \$3.3 million in prize money. One hundred fourteen teams entered the challenge to accelerate the development of small-scale, flexible, wave-powered desalination systems aimed at providing potable drinking water in disaster relief scenarios and to remote coastal communities. The winner of this challenge was announced in April 2022.
- **Ocean Observing Prize and Power at Sea Prize.** The goal of the Ocean Observing Prize and Power at Sea Prize is to develop innovative technologies to support Ocean Observing applications. The Ocean Observing Prize kicked off in September 2019 with 78 teams vying for up to \$2.4 million in total prizes. The winner of the first competition,

DISCOVER, was announced in April 2020. The second competition, DEVELOP, is underway. Expanding on the Ocean Observing Prize, the Power at Sea Prize will support teams for technologies in early phases of development, from conception to early testing. It was launched in November 2023, and a winner is anticipated to be announced in June 2025.

1.5 Challenges to Developing Marine Energy

Marine energy projects face several challenges that affect feasibility, scalability, and economic viability. The key challenges lie in technological development, resource variability, grid integration, environmental impact, cost competitiveness, and socioeconomic issues.²⁷

1.5.1 Technology Development

Many marine energy technologies are still in the early stages of development and may not have reached maturity or demonstrated sufficient reliability for commercial-scale or even smaller, pilot-scale deployment. One of the main issues with wave energy projects is the lack of convergence on a particular device or even device archetype. As of 2018, the Liquid Grid accounted for 116 devices in seven device archetype categories (overtopping and terminator combined here) — 58 point absorbers alone. This variety creates difficulties in project planning, including design, installation, and operation, and has great influence on the regulatory landscape as there is little project precedent on which to base decisions. Additional challenges are related to technology readiness, performance optimization, and durability in remote and harsh marine environments. To date, sustained, high-performance marine energy operations over a year or more have not been achieved in the United States for most technologies.

1.5.2 Resource Variability

The availability and intensity of marine energy resources, such as waves, tides, and currents, can vary widely over time and location. Predicting and managing this variability are essential for optimizing the performance and energy yield of marine energy projects, particularly in regions with complex oceanographic conditions. The strong variability in waves and hydrodynamics is likely to be exacerbated by effects of climate change, and future conditions may be more difficult to forecast.

1.5.3 Grid Integration

Integrating marine energy into existing electricity grids can pose technical and logistical challenges, particularly in remote or offshore locations with limited grid infrastructure. Grid connection costs, grid stability, power conditioning (for integration with the local grid), and regulatory frameworks for renewable energy integration need to be considered to ensure reliable and efficient power delivery from marine energy projects to end users. The potential distributed marine energy applications described above would be directly served by marine

27 Aderinto, T. and H. Li. 2018. "[Ocean Wave Energy Converters: Status and Challenges](https://www.mdpi.com/1996-1073/11/5/1250)." *Energies*, 11, 1250, doi: 10.3390/en11051250. <https://www.mdpi.com/1996-1073/11/5/1250>.

energy technologies, and, therefore, no grid integration would be required. See Chapter 3, Transmission Needs and Transmission Permitting Requirements, for additional information.

1.5.4 Environmental Impact

Marine energy deployments could impact marine ecosystems and wildlife through habitat alteration, collision risk, noise disturbance, and electromagnetic fields.²⁸ Potential environmental impacts can vary substantially from one WEC design to another, adding complexity to analysis of impacts and monitoring strategies by design type. For example, marine mammal entanglement is likely to be less of an issue for a device with a single mooring versus one with multiple moorings. Addressing environmental concerns and obtaining regulatory approvals can be challenging, requiring comprehensive impact assessments, stakeholder engagement, and mitigation measures to minimize adverse effects on marine biodiversity and ecosystem services.²⁹ See Chapter 4, Permitting Requirements for Wave and Tidal Energy Project, and Chapter 6, Monitoring Strategies for Wave and Tidal Energy, for additional information.

1.5.5 Cost Competitiveness

Achieving cost competitiveness with other forms of renewable energy, such as wind and solar, remains a challenge for marine energy developers, particularly for technologies that are still relatively new or low in deployment volume. For example, the levelized cost of energy (LCOE) of pilot-scale wave energy projects has been estimated to range between \$0.37/kWh and \$1.22/kWh.³⁰ In their 2021 report,³¹ Reguero and Menendez reported LCOE of new WEC technologies on the order of \$0.55/kWh, which is three times higher than conventional sources and four times higher than other renewables (solar and wind). These high costs are driven by upfront capital costs, operational costs, and relatively low conversion efficiencies of devices. Environmental permitting costs for marine energy projects can be especially significant due to

28 Copping, A. and L. Hemery. 2020. [OES-Environmental 2020 State of the Science Report: Environmental Effects of Marine Renewable Energy Development Around the World](https://tethys.pnnl.gov/publications/state-of-the-science-2020). Report for Ocean Energy Systems (OES). doi:10.2172/1632878, <https://tethys.pnnl.gov/publications/state-of-the-science-2020>.

Nelson P. A., D. Behrens, J. Castle, G. Crawford, R. N. Gaddam, S. C. Hackett, J. Largier, D. P. Lohse, K. L. Mills, P. T. Raimondi, M. Robart, W. J. Sydeman, S. A. Thompson, and S. Woo. 2008. [Developing Wave Energy In Coastal California: Potential Socio-Economic And Environmental Effects](https://www.researchgate.net/publication/255702311_Developing_Wave_Energy_in_Coastal_California_Potential_Socio-Economic_and_Environmental_Effects). California Energy Commission, PIER Energy-Related Environmental Research Program & California Ocean Protection Council CEC-500-2008-083. https://www.researchgate.net/publication/255702311_Developing_Wave_Energy_in_Coastal_California_Potential_Socio-Economic_and_Environmental_Effects.

29 Peplinski, W.J., J. Roberts, G. Klise, S. Kramer, Z. Barr, A. West, and C. Jones. 2021. "Marine Energy Environmental Permitting and Compliance Costs." *Energies*, 4, 4710, <https://doi.org/10.3390/en14164719>.

30 Chang, G., C. A. Jones, J. D. Roberts, and V. S. Neary. 2018. "A Comprehensive Evaluation of Factors Affecting the Levelized Cost of Wave Energy Conversion Projects." *Renewable Energy*, 127, 344–354, <https://doi.org/10.1016/j.renene.2018.04.071>.

31 Reguero, B.G. and P. Menendez. 2021. [Wave Energy Conversion in California Under the Present and Future Climate and Economic Feasibility Analysis of Different Technologies \(coming soon\)](https://opc.ca.gov/directory/projects/wave-energy-conversion-in-california-under-the-present-and-future-climate-and-economic-feasibility-analysis-of-different-technologies-we3c/). California Sea Grant Report, 58 pp. <https://opc.ca.gov/directory/projects/wave-energy-conversion-in-california-under-the-present-and-future-climate-and-economic-feasibility-analysis-of-different-technologies-we3c/>.

high uncertainties driven by the lack of environmental baseline data and historical databases on potential effects of these nascent technologies.³²

Securing financing for commercial-scale marine energy projects can be challenging due to perceived investment risks, uncertainties surrounding technology performance and revenue generation, and limited track record of successful deployments. Access to project financing, including debt and equity investment, grants, and subsidies, is critical for overcoming financial barriers and attracting private sector investment in marine energy development.

1.5.6 Socioeconomic Factors

Marine energy projects, like many other renewable energy initiatives, can create a range of social issues that stem from their potential impacts on communities, livelihoods, and cultural heritage. Concerns may arise about potential changes to fish and fisheries and other marine organisms or their marine habitats, as well as potential conflicts with commercial and recreational fishing, navigation, or marine conservation areas. Marine energy projects can affect cultural heritage sites, archaeological resources, and indigenous cultural practices associated with the ocean. Indigenous communities, in particular, may have spiritual, cultural, and subsistence connections to marine environments that need to be respected and protected. Marine energy device deployment may raise concerns about changes to the natural landscape, coastal views, and recreational activities such as surfing or beachgoing, potentially affecting tourism, property values, and local perceptions of project acceptability.

Conflicts over property rights, land and sea use, and resource access can arise among project developers, private landowners, government agencies, and other stakeholders. These issues can vary based on scale, too. For example, commercial-scale deployment of a WEC device may create an extensive offshore “exclusion area,” whereas deployment of a single device would raise far fewer concerns. Addressing these potential impacts and ensuring the coexistence of marine energy and other ocean and coastal ocean uses are essential for maintaining social acceptance and minimizing disruption to local economies.

Addressing the challenges discussed above requires collaboration and coordination among stakeholders, including government, industry, researchers, local communities, and other stakeholders, to overcome technical, economic, environmental, social, and regulatory barriers and unlock the full potential of marine energy as a sustainable and reliable source of renewable energy.

32 Peplinski, W. J., J. Roberts, G. Klise, S. Kramer, Z. Barr, A. West, and C. Jones. 2021. “[Marine Energy Environmental Permitting and Compliance Costs](https://doi.org/10.3390/en14164719).” *Energies*, 4, 4710, <https://doi.org/10.3390/en14164719>.

CHAPTER 2:

Factors Contributing to Increased Use of Wave and Tidal Energy in California

2.1 Factors Influencing Uptake of Marine Energy

This chapter identifies the situations and locations where marine energy technology has greatest potential application and the comparative advantages of wave and tidal energy that are likely to lead to greater future adoption.

A list of stakeholder requirements for commercially successful wave energy projects was identified in 2017, using a broad definition of stakeholders that included utility operators, government regulators, WEC technology providers and associated suppliers, and the public. The list of requirements remains relevant to development of marine energy in California:

- Have a market competitive cost of energy (Capital Expenditure [CAPEX] and Operating Expenditure [OPEX] as low as possible, high energy production, high availability, low financing and insurance rates).
- Provide a secure investment opportunity (low uncertainty of supply and high survivability).
- Be reliable for grid operations (predictable, high production relative to nameplate capacity, provide ancillary services such as storage and smoothing).
- Have community support (acceptability).
- Provide community benefits (job creation, low-pollution energy, minimal impact on consumers and taxpayers, increased energy security).
- Have a pathway to permitting and certification.
- Be safe.
- Have a large potential market (for example, operable in physical and social conditions found in many locations).³³

The following sections address these factors in the context of marine energy in California.

2.2 Potential Market

Key drivers of the market for clean energy sources are the climate commitments and objectives of state and federal governments. Demand for renewable energy has been driven by emissions reduction targets to replace carbon-based energy generation. Electricity generation in California relies heavily on natural gas, and contributions from hydropower,

33 Babarit, A., D. Bull, K. Dykes, R. Malins, K. Nielsen, R. Costello, J. Roberts, C. Ferreira, B. Kennedy, and J. Weber. 2017. "[Stakeholder Requirements for Commercially Successful Wave Energy Converter Farms.](https://doi.org/10.1016/j.renene.2017.06.040)" *Renewable Energy*, 113, 742–755, <https://doi.org/10.1016/j.renene.2017.06.040>.

solar, and wind can vary based on available water flows, daylight, and season. Senate Bill (SB) 100 (De León, Chapter 312, Statutes of 2018) updates California’s Renewables Portfolio Standard to ensure that at least 60 percent of the state’s electricity is from renewable sources by 2030 and sets a goal that a 100 percent of powering all retail electricity sold in the state with renewable and zero-carbon resources by 2045.

Marine energy has attributes that make it an attractive component of the future energy mix in California, either complementing or competing with alternative renewable sources. Tidal energy likely only has potential commercial application at the entrance to the San Francisco Bay, which represents about 89 percent of the tidal energy resource for California. Potential distributed energy applications may exist for tidal energy generation at Humboldt Bay, Heckman Island, San Diego Bay, and Tomales Bay.³⁴ Although the highly predictable nature of tidal energy and relatively high-capacity factor mean that the technology merits further consideration, factors that are likely to increase the uptake of wave energy will be the central topic of this discussion.

As noted in Chapter 1, the wave energy resource availability in California is relatively high, and the coefficient of variation is relatively low, which is attractive from an investment perspective.³⁵ The wave energy resource within 10 nautical miles of the California shoreline is estimated to be 220 TWh/yr. This estimated capacity is more than 120 times the estimated tidal energy resource for the state (1.8 TWh/yrs.) and was equivalent to 45 percent of state energy demand in 2019.³⁶

The economic benefits of being a market leader and developer of commercially viable technologies that are exportable to other regions is substantial. Modeling conducted in the European Union (EU) estimated that the benefits of being early adopters resulted in a roughly 2.5 multiplier effect for the jobs and economic activity provided by the ocean energy market.³⁷

2.3 Increasing Cost Competitiveness and Investment Appeal

Much of the focus on renewable electricity to date has been on solar and wind, as they are more mature technologies with a lower LCOE. In contrast, marine energy is at an early stage of technological maturity. Over time, the costs of marine energy projects are expected to decrease with increased capacity installation. The learning rate (also known as the *experience curve*) is a measure of the reduction in the technology cost for every doubling of installed

34 Kilcher, L., M. Fogarty, and M. Lawson. 2021. [Marine Energy in the United States: An Overview of Opportunities](https://www.nrel.gov/docs/fy21osti/78773.pdf). National Renewable Energy Laboratory, NREL/TP-5700-78773, Golden, Colorado, <https://www.nrel.gov/docs/fy21osti/78773.pdf>.

35 Guo, B. and J. V. Ringwood. 2021. "A Review of Wave Energy Technology From a Research and Commercial Perspective." *IET Renew. Power Gener.* 15: 3065–3090, <https://doi.org/10.1049/rpg2.12302>.

36 Kilcher, L., et al. 2021. [Marine Energy in the United States: An Overview of Opportunities](https://www.nrel.gov/docs/fy21osti/78773.pdf).

37 Jeffrey, H., S. Pennock, J. Villate, P. Ruiz-Minguella, D. Cagney, and L. Pirttimaa. 2022. [A European Ocean Energy Industry – the €140bn Economic Opportunity](https://tethys-engineering.pnnl.gov/publications/european-ocean-energy-industry-eu140bn-economic-opportunity). Report by ETIP Ocean (European Technology and Innovation Platform for Ocean Energy). Report for European Commission, <https://tethys-engineering.pnnl.gov/publications/european-ocean-energy-industry-eu140bn-economic-opportunity>.

capacity, following Wright's Law.³⁸ The learning rate of wave energy is estimated to be between 10 and 15 percent overall (with lower rates of around 5 percent for more mature components), meaning that the technology costs decrease for each doubling in marine energy production is likely to see a substantial reduction in technology cost.³⁹ There is some disagreement among industry experts as to the magnitude and timing of the likely reductions in LCOE, although all agree that costs will fall dramatically over time.⁴⁰

2.3.1 Cost Reduction Through Focused Development

Substantial cost reductions are required to achieve competitive LCOEs, with a recent paper estimating that capital expenditure and operating expenditure should be reduced by 45 percent and that developers should target a 200 percent increase in annual energy production (AEP).⁴¹ As energy production is the denominator in LCOE calculations, increasing AEP lowers LCOE. Additional reductions in costs may be achieved through convergence of WEC technologies and collaboration or concentration of R&D efforts. These may include a standardized set of sea conditions against which different devices are assessed.⁴²

The early focus within the industry has been on increasing energy conversion efficiency. WECs that are targeted to optimize performance in smaller waves may have better economic performance, as they are able to operate at peak production over a wider range of conditions. This would also facilitate effective operation in Southern California in the summer months when waves are relatively small but demand for electricity, especially for cooling, is high.⁴³

Increasing survivability also increases AEP by reducing downtime and risk, which reduces insurance and financing costs. To ensure that the devices can withstand extreme wave conditions, they are engineered for robustness, which increases capital construction costs. The WEC testing facility in Oregon (PacWave South Project) provides opportunities to field test

38 Wright, T. P. 1936. "[Factors Affecting the Cost of Airplanes.](https://pdodds.w3.uvm.edu/research/papers/others/1936/wright1936a.pdf)" *J. Aeronaut. Sci.* 3, 122–128, <https://pdodds.w3.uvm.edu/research/papers/others/1936/wright1936a.pdf>.

39 Pennock, S., A. Garcia-Teruel, D. R. Noble, O. Roberts, A. de Andres, C. Cochrane, and H. Jeffrey. 2022. "[Deriving Current Cost Requirements from Future Targets: Case Studies for Emerging Offshore Renewable Energy Technologies.](https://doi.org/10.3390/en15051732)" *Energies* 2022, 15, 1732, <https://doi.org/10.3390/en15051732>.

40 Baca, E., R. T. Philip, D. Greene, and H. Battey. 2022. [Expert Elicitation for Wave Energy LCOE Futures.](https://www.nrel.gov/docs/fy22osti/82375.pdf) United States: N. p., 2022. Web. doi:10.2172/1885577. <https://www.nrel.gov/docs/fy22osti/82375.pdf>.

41 Chang, G., C. A. Jones, J. D. Roberts, and V.S. Neary. 2018. "[A Comprehensive Evaluation of Factors Affecting the Levelized Cost of Wave Energy Conversion Projects.](https://doi.org/10.1016/j.renene.2018.04.071)" *Renewable Energy*, 127, 344–354, <https://doi.org/10.1016/j.renene.2018.04.071>.

42 Hodges J., J. Henderson, L. Ruedy, M. Soede, J. Weber, P. Ruiz-Minguela, H. Jeffrey, E. Bannon, M. Holland, R. Maciver, D. Hume, J-L Villate, and T. Ramsey. 2021. [An International Evaluation and Guidance Framework for Ocean Energy Technology.](https://www.ocean-energy-systems.org/publications/oes-documents/guidelines/document/an-international-evaluation-and-guidance-framework-for-ocean-energy-technology/) IEA-OES, <https://www.ocean-energy-systems.org/publications/oes-documents/guidelines/document/an-international-evaluation-and-guidance-framework-for-ocean-energy-technology/>.

43 de Andres A., A. MacGillivray, O. Roberts, R. Guanache, and H. Jeffrey. 2017. "[Beyond LCOE: A Study of Ocean Energy Technology Development and Deployment Attractiveness.](https://www.sciencedirect.com/science/article/abs/pii/S2213138816301618)" *Sustain. Energy Technol. Assess.*, 19, pp. 1–16, 10.1016/j.seta.2016.11.001, <https://www.sciencedirect.com/science/article/abs/pii/S2213138816301618>.

technologies under conditions like those in California and identify opportunities to reduce construction costs while retaining survivability.

2.3.2 Building on Niche Opportunities

At present, marine energy has greatest commercial application where traditional and alternative renewable energy sources are expensive or impractical, for example, in remote communities or in offshore applications where either baseline or emergency electricity is provided by diesel generators. Replacing electricity generated using fossil fuels is particularly attractive in areas with air quality issues.

Wave energy is well-suited to power ocean-based industry and other uses located at sea or close to shore, producing power at the point of consumption, which eliminates transmission considerations. Ocean observation stations, offshore platforms, navigational aids, and desalination are examples of candidates for WEC.⁴⁴ These niche market applications can provide a bridge between R&D and commercial, utility-scale operation.⁴⁵

2.3.3 Grid Services and Temporal Advantages

The value of electricity depends heavily on the relationship between supply and demand, which typically are related to time-of day for production and use of power. As a result, the economic viability of wave power is not determined by a strict comparison of LCOE figures. The unique production advantages of wave energy will play a key role in its profitability.⁴⁶ Wave energy can be reliably predicted up to three days in advance, which is beneficial for grid operations.⁴⁷ Wave energy has a value factor that is close to unity, meaning that the availability of energy tracks closely with that of demand. Therefore, WECs may be well-suited to providing a base load generation service.⁴⁸ On a seasonal scale, wave energy peaks in the winter, which coincides with peak demand for heating. Replacing the use of natural gas for space and water heating is critical to meeting emission reduction and building decarbonization targets.

2.3.4 Incentives to Support Investment

To reduce financing and insurance costs, the government can derisk the investment by acting as either a lender or guarantor of loans to marine energy developers. The government can also provide economic incentives for development and deployment of marine energy systems. Market incentives such as feed-in tariffs, tax credits, accelerated depreciation schedules,

44 LiVecchi, A., et al. 2019. "[Powering the Blue Economy; Exploring Opportunities for Marine Renewable Energy in Maritime Markets.](#)"

45 Guo, B., and J. V. Ringwood. 2021. "[A Review of Wave Energy Technology From a Research and Commercial Perspective.](#)" *IET Renew. Power Gener.* 15: 3065–3090, <https://doi.org/10.1049/rpg2.12302>.

46 de Andres A., et al. 2017. "[Beyond LCOE: A Study of Ocean Energy Technology Development and Deployment Attractiveness.](#)"

47 Sasaki W. 2017. "[Predictability of Global Offshore Wind and Wave Power.](#)" *Int J Marine Energy*, 17, pp. 98–109, <https://doi.org/10.1016/j.ijome.2017.01.003>.

48 de Andres A., et al. 2017. "[Beyond LCOE: A Study of Ocean Energy Technology Development and Deployment Attractiveness.](#)"

government grants, and loans either wholly or partially backed by government funds are all factors that have been used to stimulate advancement of marine energy programs in the United States and overseas. Beyond market incentives, the U.S. Government has in place funding programs and tax credits to support the further development and implementation of marine energy. In particular, the Inflation Reduction Act (IRA) of 2022 provides several applicable tax credit schemes for deploying hydrokinetic energy.⁴⁹ There are also several feed-in tariff programs in California, specifically by the State of California (ReMAT), City of Palo Alto, Marin Clean Energy, Redwood Coast Energy Authority, Sonoma Clean Power, Sacramento Municipal Utility District, and Los Angeles Department of Water & Power.⁵⁰

Tax credits and price guarantees can help a WEC company recoup its development costs more quickly once the technology is at early commercialization scale but does not specifically address the product development funding gap that occurs between R&D and early commercialization. Guo and Ringwood refer to this gap as the “valley of death,” defined by the dip of the cash flow curve between the R&D and initial commercialization development stages.⁵¹

2.4 Community Support

Unlike some forms of energy production, and with the caveat that the technology is not yet well known, studies on community sentiment toward wave energy have shown it is generally considered in a positive light by residents of the west coast of North America. Although community support may vary with level of knowledge and attachment to coastal areas.⁵² As with any renewable energy project, extensive community involvement will be required to ensure the public can participate in all aspects of project development.

2.4.1 Reduced Ecological Conflict

Marine energy density is around 5 times that of wind and 10 times that of solar. This density means that the spatial requirement for equivalent energy output is reduced, if conversion efficiencies are similar. Although WECs have many of the same potential ecological impacts as floating wind turbine platforms, the scale of the infrastructure is substantially smaller. Relative to offshore wind energy, marine energy projects typically have a smaller spatial footprint,

49 DOE. 2022. “[Inflation Reduction Act Tax Credit Opportunities for Hydropower and Marine Energy](https://www.energy.gov/eere/water/inflation-reduction-act-tax-credit-opportunities-hydropower-and-marine-energy#:~:text=Summary%20of%20Federal%20Tax%20Credits%20for%20Hydropower%20and%20Marine%20Energy&text=%245.50%2Fmegawatt%2Dhour%20%2B%20additional,projects%20beginning%20construction%20before%202025).” Department of Energy. Retrieved March 21, 2024, <https://www.energy.gov/eere/water/inflation-reduction-act-tax-credit-opportunities-hydropower-and-marine-energy#:~:text=Summary%20of%20Federal%20Tax%20Credits%20for%20Hydropower%20and%20Marine%20Energy&text=%245.50%2Fmegawatt%2Dhour%20%2B%20additional,projects%20beginning%20construction%20before%202025>.

50 CPUC. 2019. “[Overview of Feed-In Tariff Programs — October 2019](https://www.cpuc.ca.gov/-/media/cpuc-website/industries-and-topics/documents/energy/rps/overview-of-feed-in-tariff-programs---oct-2019.pdf).” Review of Overview of Feed-In Tariff Programs — October 2019, <https://www.cpuc.ca.gov/-/media/cpuc-website/industries-and-topics/documents/energy/rps/overview-of-feed-in-tariff-programs---oct-2019.pdf>.

51 Guo, B., et al. 2021. “[A Review of Wave Energy Technology From a Research and Commercial Perspective](#).”

52 Stelmach, Greg and Shawn Olson Hazboun, Diane Brandt, and Hilary Boudet. 2020. “[Public Perceptions of Wave Energy Development on the West Coast of the U.S.: Risks, Benefits, and Coastal Attachment](https://www.osti.gov/pages/servlets/purl/1992663),” <https://www.osti.gov/pages/servlets/purl/1992663>.

limited visual impact, and no risk due to bird strikes, which all reduce seaspace conflicts. They are also typically closer to the shoreline and in shallower water with less complicated mooring infrastructure compared to offshore wind.

There may be positive impacts associated with deployment of some marine energy infrastructure, which could produce an artificial reef effect, or attract pelagic, or open sea, fish.⁵³ Attempts to limit biofouling may reduce this benefit. Marine energy installations could preclude recreational and commercial fishing and may act as de facto conservation areas. These installations may benefit commercial and recreational fishing in adjacent areas that could offset any spatial limitations on those activities at installations.

2.4.2 Reduced Conflict With Existing Marine Uses

Marine energy devices can be built and deployed within the confines of existing marine industry precincts. They do not face the same transportation or port infrastructure challenges associated with increasingly large wind turbine blades and platform and tower components, but the generation output is a fraction of the offshore wind energy turbines proposed for installation offshore California's coast.

The smaller scale of energy production also reduces the limitations posed by the transmission network. The WEC array can scale as transmission upgrades are completed, rather than needing to complete those upgrades or complex network modeling before grid connection. Alternatively, the connection can be to a microgrid or to direct usage in distributed energy or PBE applications, rather than to the broader network.

2.5 Existing Pathway to Permitting

Although it is a relatively new sector, a pathway to permitting wave and tidal energy projects has been established, and lessons have been learned from offshore wind development and other marine industries on the East Coast and overseas. The DOE's Marine Energy Environmental Toolkit for Permitting and Licensing was compiled to provide marine energy developers with organized, accurate, and relevant information relating to regulations in the specific area in which they are hoping to launch their technology.⁵⁴ Part of the permitting pathway is identifying and minimizing the conflicts outlined above and maximizing community benefits.

53 Kramer S, Hamilton C, Spencer G, and H. Ogston. 2015. *Evaluating the Potential for Marine and Hydrokinetic Devices to Act as Artificial Reefs or Fish Aggregating Devices, Based on Analysis of Surrogates in Tropical, Subtropical, and Temperate U.S. West Coast and Hawaiian Coastal Waters*. Report by H.T. Harvey & Associates for the U.S. Department of Energy, Golden, Colorado. <https://tethys.pnnl.gov/publications/evaluating-potential-marine-hydrokinetic-devices-act-artificial-reefs-or-fish>.

54 DOE. 2024. "New Permitting Toolkit Released to Speed Marine Energy Development. Department of Energy," <https://www.energy.gov/eere/water/articles/new-permitting-toolkit-released-speed-marine-energy-development>. Retrieved March 21, 2024.

2.6 Community Benefits

Marine energy has the potential to provide a range of community benefits, some of which are unique advantages of the technology and some of which are specific to applications or geographies within the state. Community benefits agreements, local procurement policies, and workforce development programs can ensure that marine energy projects deliver tangible social, economic, and environmental benefits to impacted communities, including job creation, infrastructure investment, and revenue sharing.

Marine energy can provide energy security to communities isolated by geography or by their distance from existing electricity generation or that must rely on local generation using fossil fuels. This benefit is particularly relevant in northwest California, which also aligns with the highest wave energy resource in the state. This also is a region where solar energy potential is lower and more variable due to insolation and higher cloudiness. This region is also subject to power safety shutoffs because the electricity comes long distances across mountainous and forested terrain. By providing marine-based energy sources for isolated communities, these locations would be more resilient, and the electricity can support entrepreneurship in such activities as aquaculture and algae farming.

Renewable energy, including wave and tidal energy, can also provide energy security at the state level. California imports some electricity produced using natural gas or uses natural gas to produce electricity in California power plants. Moving to renewable energy sources reduces this reliance on natural gas and reduces exposure to global market forces that influence fuel prices.

2.6.1 Emergency Power Supply

Marine energy is not affected by extreme events in the same way as competing power sources, making it a good candidate for supplying emergency power and ancillary services. Wave and tidal energy converters continue to produce energy during wind and rainfall events that render other renewable energy sources less effective. Marine energy availability may increase during extreme weather if the devices are designed to withstand the high energy conditions and are able to effectively operate with the changes in amplitude and frequency. Wind turbines may be placed in shutdown mode during high (or low) wind conditions. Furthermore, solar panels do not operate effectively under overcast conditions and do not produce power at night. Transmission lines connecting remote power generators with load centers may be deenergized during high wind events to reduce the potential for wildfire or may be affected by outages due to fallen trees or other disasters.⁵⁵

Reductions in electricity supply from other sources during extreme weather drives up the price of electricity, allowing WECs to capitalize in high-price periods when access to other sources is

55 DOE. 2017. Office of Energy Efficiency & Renewable Energy. "[How Do Wind Turbines Survive Severe Storms?](https://www.energy.gov/eere/articles/how-do-wind-turbines-survive-severe-storms#:~:text=Feathering%20the%20Blades,to%20ride%20out%20severe%20gusts.)" Department of Energy, <https://www.energy.gov/eere/articles/how-do-wind-turbines-survive-severe-storms#:~:text=Feathering%20the%20Blades,to%20ride%20out%20severe%20gusts.>

reduced. This fact increases the commercial viability if survivability and continued operation can be achieved and maintained.

2.6.2 Coastal Protection

Coastal protection from erosive wave energy is a potential ancillary benefit of the deployment of WECs. Although numerical modeling and physical testing are required to identify the potential reduction in wave energy in the lee of a WEC array, previous modeling suggests a reduction in energy of 10 to 40 percent of incident energy.⁵⁶ WECs can also be incorporated in coastal installation designs such as sea walls. Physical and ecological studies would be required to ensure that undesirable impacts are avoided.

In addition to support for the clean energy transition, the auxiliary benefits of marine energy mean that funding availability may be available from sources aligned with coastal climate adaptation and resilience and energy justice. Examples of these benefits include using WECs to temper storm surge or acting as protective but not obstructive barriers for ecological protection.⁵⁷

2.6.3 Climate Resilience

Ocean waves are a reliable source of energy even under drought conditions and less reliable rainfall patterns,⁵⁸ so this generation source would not be affected by variations in precipitation or weather as could occur with hydroelectric power. Marine energy can also supplement or replace the drinking water and electricity generated associated with stream flows, increasing resilience to drought. Where geographical factors permit, marine energy could be integrated with pumped storage hydro to store potential energy. Marine-powered desalination can provide sustainable supplies of freshwater in water-stressed locations and provide the ability to combat saline intrusion into groundwater through injection of desalinated water.

2.7 Comparison With Other Renewable Energy Technologies

Table 3 provides a multicriteria analysis of the comparative strengths and weaknesses of renewable energy technologies across a range of attributes. For each attribute (row), the different technologies (columns) are scored relative to each other. The scores are not intended to be objective assessments of the respective technologies. Scores are based on four levels:

- High (the best technology in comparison with the others)

56 Moradi, M., N. Chertouk, and A. Ilinca. 2022. "[Modelling of a Wave Energy Converter Impact on Coastal Erosion, a Case Study for Palm Beach-Azur, Algeria.](https://doi.org/10.3390/su142416595)" *Sustainability* 2022, 14, 16595, <https://doi.org/10.3390/su142416595>.

57 LiVecchi, A., et al. 2019. [Powering the Blue Economy; Exploring Opportunities for Marine Renewable Energy in Maritime Markets.](#)

58 Qiu M., N. Ratledge, I. M. L. Azevedo, N. S. Diffenbaugh, and M. Burke. 2023. "[Drought Impacts on the Electricity System, Emissions, and Air Quality in the Western United States.](https://www.pnas.org/doi/full/10.1073/pnas.2300395120)" *Proc Natl Acad Sci U S A.* 2023 Jul 11;120(28):e2300395120. doi: 10.1073/pnas.2300395120, <https://www.pnas.org/doi/full/10.1073/pnas.2300395120>.

- Medium, Low (least beneficial technology in comparison with others)
- Unknown

The characteristics of any technology will likely vary by location due to site characteristics, resource availability, level of demand, availability of transmission infrastructure, and the existing energy generation mix.

Table 3: Comparative Advantages of Wave and Tidal Energy

Technologies: Attributes:	Offshore Wind	Onshore Wind	Solar	Hydro	Wave and Tidal
Pathway to Permitting	Moderate	High	High	Low	Moderate
Suitability for Remote and PBE* Applications	High	Moderate	Moderate	Moderate	High
Availability (Seasonal and Time of Day)	Moderate	Moderate	Low	Moderate	High
Resilience to Extreme Weather and Climate Change	Low	Low	Low	Low	Moderate
Ecological Impact	Unknown	Moderate	Moderate	High	Unknown

Source: Powering the Blue Economy

2.8 Conclusion

Wave energy is a substantial resource in California — one that is flexible in production and installation. It provides unique strategic advantages to developers and users alike. These competitive advantages increase profitability but also address less obvious but equally important factors of grid stability, environmental stewardship, community resilience, and energy independence. Although additional government support is necessary to aid in the transition to full commercialization, the potential market is substantial, particularly for distributed energy. Further research is required to identify the spatial and commercial contexts in which this energy source will have the greatest potential.

CHAPTER 3:

Transmission Needs and Transmission Permitting Requirements

Subsea transmission is critical to harnessing the power of the ocean for use on land. While offshore transmission systems may have similarities to the onshore grid, the distance, depth of water, and export capacity add complexities to a successful interconnection to the grid.

3.1 Transmission Overview

To better understand the technologies and details around wave- and tidal-generated energy transmission, it is important to provide some background on subsea transmission. Transmission systems use two types of electric currents, alternating current (AC) or direct current (DC). AC is more commonly found in onshore transmission and is typically used for subsea transmission when the overall export capacities are limited, roughly less than 1000 megawatts (MW), and the distance from shore is less than 80 km (50 miles).⁵⁹ In the future, wave and tidal farms may reach large enough capacity levels (greater than 1000 MW) or may be set up at distances greater than 80–100 km (50–62 miles) from shore. In those cases, DC systems and high-voltage DC export cables could be used to minimize electrical losses.

DC systems would require conversion to AC before connecting to the grid. This chapter assumes that AC transmission will be used for all near-future applications of wave and tidal energy and the discussion focuses on AC transmission only. Based on this assumption, the transmission technologies required to enable near-future applications of wave and tidal energy exist and are commercially available.

3.1.1 Cables

Transmission cable type is another consideration in subsea transmission schemes. Array cables are low- or medium-voltage cables that connect energy converters to a common point, such as an offshore substation. These cables are typically rated at 30 to 36 kV and are installed in single lengths from one converter to another, forming one string that will connect to the substation. The power is gathered at the substation, or a similar connection point, where it can be stepped up to a higher voltage before being exported to shore via a single subsea export cable. Export cables are typically rated between 100 to 200 kV but may be lower for lower-capacity applications. In some lower-capacity applications that are also close to shore,

59 *Molecular Diversity Preservation International*. Bidadfar, Ali, Oscar Saborío-Romano, Jayachandra Naidu Sakamuri, Vladislav Akhmatov, Nicolaos Antonio Cutululis, and Poul Ejnar Sørensen. 2019 "[Coordinated Control of HVDC and HVAC Power Transmission Systems Integrating a Large Offshore Wind Farm](https://www.mdpi.com/1996-1073/12/18/3435)." <https://www.mdpi.com/1996-1073/12/18/3435>.

CSEE. 2021. "[Comparison of Cost-Effective Distances for LFAC with HVAC and HVDC in Their Connections for Offshore and Remote Onshore Wind Energy](https://ieeexplore.ieee.org/stamp/stamp.jsp?arnumber=9420336)." *CSEE Journal of Power and Energy Systems*, Vol. 7, No.5, September 2021, <https://ieeexplore.ieee.org/stamp/stamp.jsp?arnumber=9420336>.

the array cables can bypass the need for an offshore connection point and can run directly onshore, connecting straight to the grid. Studies show that a substation generally is not necessary if the project is small (100 MW or less), it is within 15 km (9.3 miles) of shore, or the connection to the grid is at the collection voltage (for example, 32 kV).⁶⁰

Export and array cables can be static or dynamic, depending on whether the associated energy converter is floating or fixed. Static cables are used for fixed applications, while dynamic cables are necessary for floating applications. A standard static AC cable is typically a three-phase cable, where each core is insulated individually, but all three cores share a common armor. A dynamic AC cable requires a more flexible form of insulation to limit the fatigue experienced by the cable due to the movements and tensile loads created by the ocean.

These dynamic cables are becoming increasingly common in offshore wind applications and leverage metallic corrugated tubular sheaths instead of lead to reduce the risk of fatigue on the cable. This use of corrugated tubular sheaths is especially true for high-voltage export cables, which require a “dry design” that will keep the system dry for the lifetime of the cable. In the case of floating wave and tidal energy applications, site-specific ancillary equipment can also be used as added support for dynamic cables, such as dynamic bend stiffeners, buoyancy modules, abrasion protection, bend restrictors, and other types of equipment to increase the structural integrity of the dynamic cable.⁶¹

While high-voltage dynamic export cables require a dry design, wave and tidal applications could also leverage “wet design” cable systems as an option for lower-voltage transmission. Cable systems of wet design are typically rated at 36 kV or lower, which is a typical export level seen in the current applications for wave and tidal energy.⁶² A cable with a wet design does not have a metallic water barrier, which means water will permeate through the polymer sheaths and saturate the insulation system over time. A recent push to develop cables with a wet design has led Nexans, with several other partners, to begin developing a 66 kV wet design cable with an aluminum alloy conductor.⁶³ These wet design cables have a smaller environmental footprint since they are lead-free and are significantly lighter than dry-designed cables. They are also lower cost and better used in dynamic applications compared to dry design cables, making them a strong option for current and near-future wave and tidal energy transmission.

60 WETF. 2024. “[Wind Energy: The Facts, Electrical System](https://www.wind-energy-the-facts.org/electrical-system-7.html),” <https://www.wind-energy-the-facts.org/electrical-system-7.html>.

61 Guide to a Floating Offshore Windfarm. “[B.1.1 Array Cable](https://guidetofloatingoffshorewind.com/guide/b-balance-of-plant/b-1-cables/b-1-1-array-cable/),” <https://guidetofloatingoffshorewind.com/guide/b-balance-of-plant/b-1-cables/b-1-1-array-cable/>. Accessed July 11, 2024.

62 Ocean Grid. “[Wet Design Cables](https://oceangridproject.no/research/wet-design-cables#progress),” <https://oceangridproject.no/research/wet-design-cables#progress>. Accessed July 11, 2024.

63 Ibid.

3.1.2 Offshore Substations

Offshore transmission will often require some form of offshore substation to collect and export power to shore. As previously mentioned, there are some applications of offshore transmission, especially when the converters are close to shore and the export capacity is low, where the array cables run straight to shore and the need for an offshore substation is bypassed. For wave and tidal applications over 15 km (9.3 miles) from shore with greater than 100 MW of capacity, an offshore substation is expected to be required.

An offshore substation collects power from the array cables and transforms the voltage before export to shore via a subsea export cable. Offshore substations also stabilize the voltage and provide grid protection while minimizing the number of cables required to bring the power onshore, potentially reducing permitting efforts and costs. The characteristics of these substations vary. One type of offshore substation commonly seen in offshore wind applications is on the surface of the water, either fixed to the seafloor or floating. Another type of offshore substation is a subsea substation, which functions similarly to an above-water offshore substation, but the electrical technologies rest on the seafloor.

Wave and tidal energy applications can also use smart subsea hubs, in addition to traditional fixed, floating, or subsea substations. Smart subsea hubs can be used to aggregate power from multiple converters into a single export cable while allowing isolation of an individual converter for device maintenance, separate disconnection and reconnection, and fault location.⁶⁴ These smart subsea hubs connect the dynamic array cables from each energy converter to a single subsea export cable, which then feeds into the onshore grid. The subsea hub enables the disconnection of a device while allowing the other connected devices to continue generating.⁶⁵ Figure 11 is an illustration of a smart subsea hub used in the project Wave Hub. PacWave South is using a subsea hub, but the developer had to supply the hub.

64 Engineering Technology Applications Ltd. 2024. "[Smart Hub,](https://eta-ltd.com/smart-hub/)" <https://eta-ltd.com/smart-hub/>.

65 *Sea Technology*. 2018. "[Wave Energy Converter and Smart Subsea Hub Installed,](https://sea-technology.com/wave-energy-converter-and-smart-subsea-hub-installed)" <https://sea-technology.com/wave-energy-converter-and-smart-subsea-hub-installed>.

Figure 11: Schematic of Wave Hub Test Facility

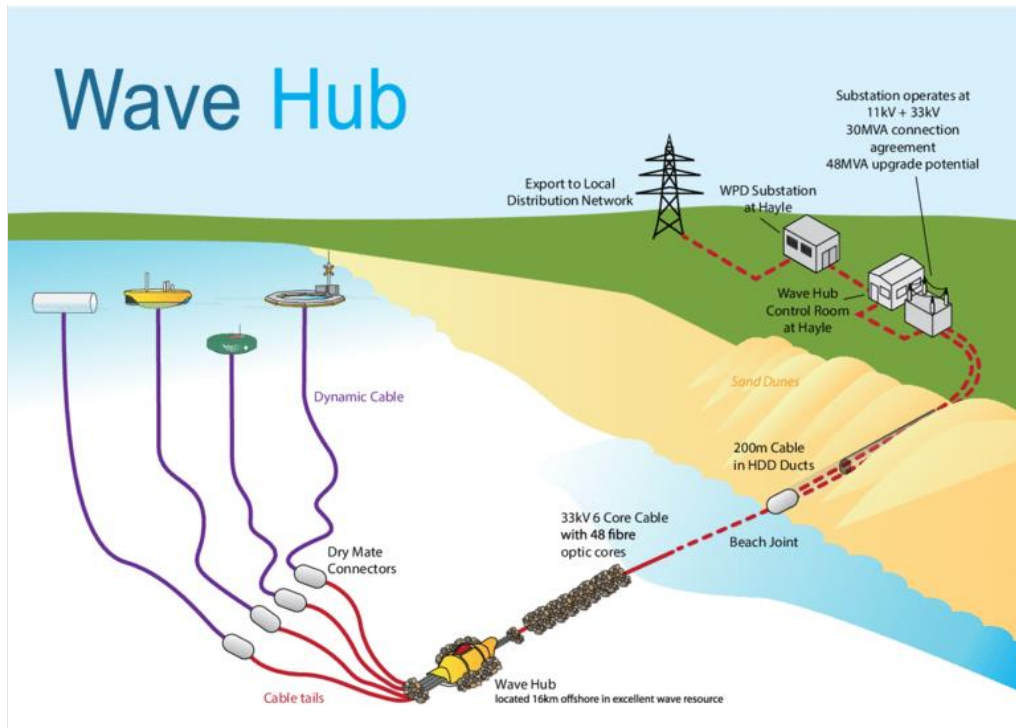

Source: Wave Hub (PT 2010)

Traditional offshore substations or subsea substations would likely be used for larger, commercial projects with higher levels of export capacity. These substations would have the capability to step the voltage up for more efficient transmission through a high-voltage export cable. The smart subsea hubs appear to be a strong fit for wave and tidal applications that do not require higher voltage export but require a transmission technology to connect and protect the array cables.

3.1.3 Transmission Overview Conclusion

In summary, the transmission technologies necessary for wave and tidal energy converters, both for distributed applications and future larger, commercial applications, exist. In the longer term, there may be even larger commercial applications with more than a GW of export capacity, which will require transmission technologies like those seen in development for commercial floating offshore wind farms in California. Dynamic high-voltage export cables, floating offshore substation designs, and other technologies that enable high-capacity subsea transmission may be used as developers permit for larger wave and tidal projects.

3.2 Tidal and Wave Energy Transmission Configurations

As discussed in Section 3.1, transmission and the associated technologies do not depend on whether the energy converters are wave or tidal, rather on the depth of the water, the capacity of export, and whether the generating assets are fixed or floating. This section

explores the transmission technologies necessary for onshore and nearshore configurations, nearshore and offshore applications, and deepwater offshore applications.

3.2.1 Onshore and Very Nearshore Configurations

Tidal and wave energy converters that are onshore or very nearshore (within several meters from shore) will have a similar integration and transmission scheme to what is seen with the interconnection of other onshore renewable resources. Other onshore renewable resources include solar arrays and wind farms, commensurate to the relative capacity and interconnecting voltage levels of these projects. Research indicates that tidal energy converters will likely be restricted to very nearshore applications for California, such as the mouth of the San Francisco Bay. There are also a few wave energy converters that operate onshore. These onshore, or very nearshore, applications of wave and tidal energy will likely require only a few meters of cabling technology to interconnect to the grid.

In addition, this evaluation assumed that the capacity of these applications would be no more than 500 MW due to spatial and permitting constraints experienced close to shore. These onshore configurations would likely leverage lower-voltage AC cables (32 kV). These cables are typically three core, insulated cables and would likely be buried and interconnected straight to the grid at that same voltage level.

The very nearshore converters would leverage almost identical transmission as onshore, but the lower-voltage, static AC cables would likely be buried and brought to shore through conduits installed using a technique such as horizontal directional drilling.⁶⁶ In instances of higher-capacity commercial applications of very nearshore technologies, the lower-voltage AC cables would likely connect at a common point, such as a substation or hub, and use a single, static subsea export cable to limit the number of cables being run onshore and minimize electrical losses. Depending on the size of the wave or tidal array, the export cable may feature a higher voltage rating, such as 66 kV or even 132 kV. The transmission for onshore and very nearshore tidal and wave configurations uses standard technologies for interconnecting renewable resources and are generally less complex compared to configurations needed for projects farther from shore.

3.2.2 Nearshore and Offshore Configurations

Nearshore wave and tidal configurations are used in 10–25 meters (33–82 feet) of water depth and a few hundred meters from shore. Offshore wave and tidal configurations are used at greater than 25 meters (82 feet) of water depth and can be beyond 100 km (62 miles) from shore. As noted in Section 3.2.1, tidal configurations are assumed relevant only for very nearshore applications. Therefore, this section focuses on nearshore and offshore wave energy configurations that are less than 750 meters (2,460 feet) of water depth. Beyond that, wave energy converters would be operating in significant depths and would require different transmission considerations discussed in Section 3.2.3.

66 TETHYS. 2024. "[Horizontal Directional Drill,](https://tethys.pnnl.gov/taxonomy/term/19937)" <https://tethys.pnnl.gov/taxonomy/term/19937>.

Nearshore or offshore wave configurations may use fixed or floating technologies. The wave energy converters would use multiple lower-voltage dynamic array cables (32 or 66 kV), each connected to a generating unit to collect the power. These cables would likely connect at a common point, either a fixed, floating, or subsea substation, a subsea hub, or potentially a combination of both. The energy would be collected at this common connection point and either stepped up to a higher voltage or left at the collection voltage and then exported onshore via a single export cable, which can be static or dynamic depending on the type of substation.

For floating wave energy configurations that use a floating substation, the export cable would be required to be dynamic between the floating offshore substation and the seabed. After that point, the export cable can use static subsea technology and ancillary equipment to deliver power onshore. The cable would likely be buried under the seafloor or to rest on the seafloor with protective equipment to minimize potential for damage with vessel anchors or fishing gear. Figure 12 illustrates a potential layout for a fixed offshore or nearshore wave energy array.

Figure 12: Potential Layout for Wave Energy Project

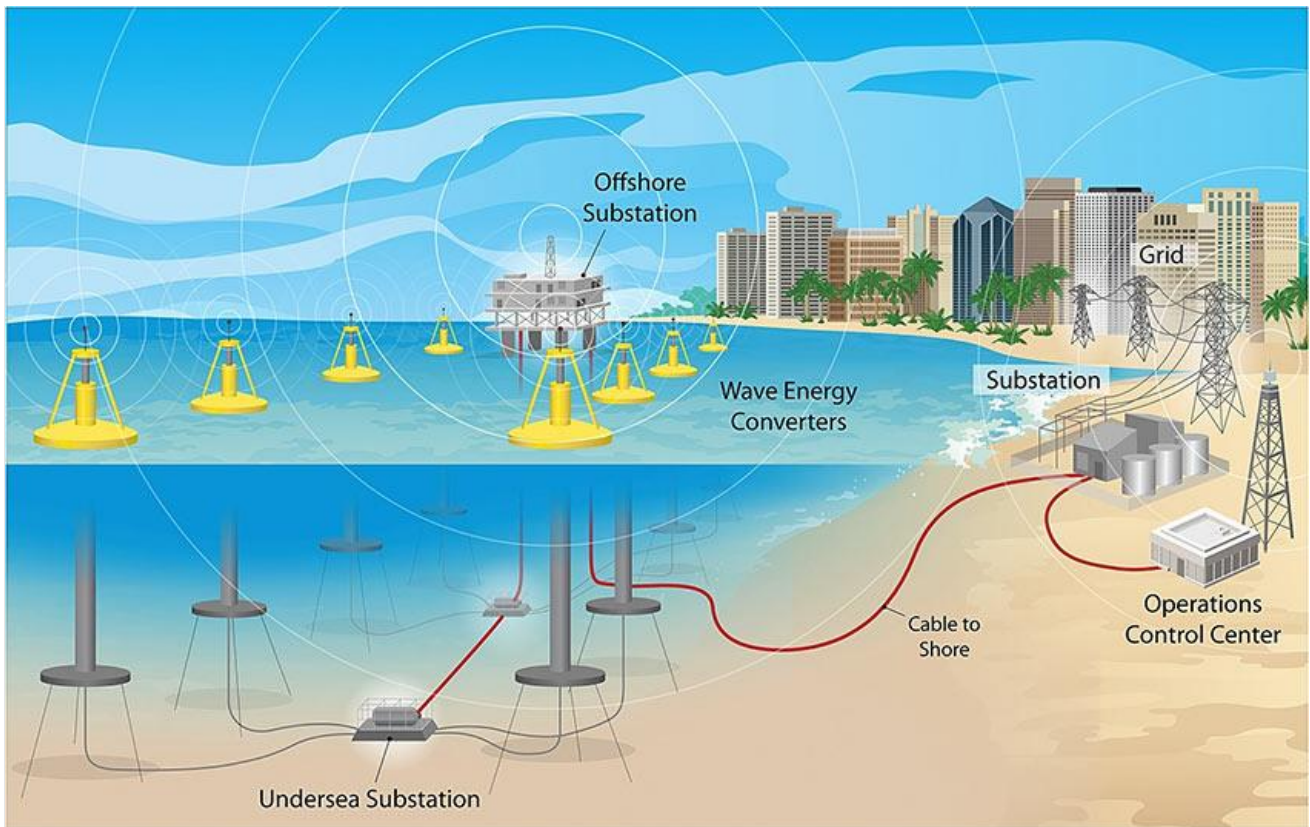

Source: Colorado State University (CSU 2021)

While these nearshore and offshore configurations use transmission systems like those used for onshore configurations, the water depth and distances offshore add complexities the farther from shore the energy converters are deployed. As distance and depth increase,

transmission technologies face electrical losses and physical risks. Seismic venting, seabed conditions, crevasses, and other cabling challenges present potential risks for offshore transmission. Cooling and heating concerns, extreme weather events, corrosion, and similar risks are also important considerations for wave energy configurations further from shore. In addition, maintenance and repair can be expensive and complex for offshore transmission technologies.

While nearshore and offshore configurations offer strong potential for energy generation off the coast of California, it will be important to consider the technical limitations faced by offshore transmission. The wave and tidal energy industry will rely mostly on existing transmission technology and will benefit from current research in offshore wind which is facing many of the same technical challenges. In the future, wave and tidal energy converters could be colocated with larger generating assets, such as floating solar arrays or floating offshore wind, as well as energy storage assets. These colocated generating assets may share higher capacity transmission technologies.

3.2.3 Deepwater Offshore Configurations

WECs may also be located hundreds of kilometers from shore and in thousands of meters of water depth. These deepwater configurations would likely be smaller, distributed applications supporting other marine activities, such as ocean observation or floating offshore wind. The power generated in deep water applications is unlikely to be exported to shore, rather would be used to support existing transmission systems for marine activities. This application of wave energy would require the use of dynamic cables. It can be assumed that the total capacity of these deepwater configurations would be small, likely not requiring any form of substation or export cable. The dynamic AC cables could also be expected to be at a lower voltage rating, such as 32 kV, and would be expected to travel a short distance to the deepwater offshore infrastructure they would be supporting. If there were numerous wave energy converters, a small subsea or floating offshore substation or smart subsea hub could be implemented as a connection point, streamlining the export to the supported deepwater activities.

3.3 Grid Integration Challenges

Offshore energy generation, including wave and tidal energy as well as wind, may be in areas with limited onshore transmission infrastructure. Economic, logistical, and technical factors often determine where marine power connections will make landfall. These remote, sometimes scarcely or seasonally populated, areas generally have energy infrastructure that is sufficient to cater to local needs but may not have room to accommodate marine power sources. As part of system planning, power systems are designed with optimal technical specifications for the elements comprising the local grid to meet specific local needs. Existing grid infrastructure in these areas may be inadequate to take on massive injections of power without substantial multiyear planning, upgrade, and expansion. Beyond challenges with connecting offshore power to the onshore grid, the power for larger commercial-scale deployments will also need to reach load centers across the regional grid, which may result in the need for onshore transmission upgrades or new lines.

Maintaining grid reliability, stability, and resilience at the transmission level is of utmost importance when integrating any new energy resources. This maintenance is especially true of offshore or marine resources due to the specific locational challenges these resources present. Sophisticated time-consuming technical analysis and studies are required for integration of offshore resources into the grid. These studies reveal constraint mitigation and grid infrastructure expansion needs under various system conditions over the near and long terms due to the additional power injection. While these studies have significant costs associated with them, they also set the foundation for more contentious conversations surrounding overall integration costs and financing, cost allocation and cost recovery mechanisms, and measuring net benefit to local and regional ratepayers when compared to their contributions to the projects.

At a regional level, transmission expansion efforts are multifaceted challenges from a logistical, cost recovery, and system stability standpoint. When substations need to be expanded to incorporate additional equipment, for instance, additional land often needs to be acquired to be able to adhere to safety standards. Land acquisition for infrastructure expansion and obtaining rights-of-way (ROW) for transmission lines and transmission towers and access for associated maintenance are an underappreciated area of concern and should be considered when evaluating marine energy grid connection proposals.

CHAPTER 4:

Permitting Requirements for Wave and Tidal Energy Projects

This chapter identifies federal, state, and local roles in permitting wave and tidal energy projects based on the project type and purpose. It describes permitting requirements for these projects based on location, power output, and grid connectivity, including examples of permit conditions that address adaptive management.

A range of wave and tidal energy technologies are being conceived, designed, and tested around the world. These technologies may be deployed nearshore or offshore in shallow or deep water, depending on marine and coastal physical conditions, wave and tide behavior at potential installation sites, and intended use of the generated power. The devices may rest on or be anchored firmly to the seabed or be floating and may work as single units or be deployed in arrays. The power thus generated may be delivered onshore for local use, be interconnected to the regional power grid, or be used offshore. This range of characteristics is likely to result in different information needs during permit reviews for different WEC devices.

As noted in Chapter 1, the deployment of technologies that capture wave and tidal energy and deliver the harnessed power to end users can impact marine ecosystems and wildlife. These effects can, in turn, disrupt local economies that rely on marine-based harvesting and tourism. Therefore, they undergo rigorous review and oversight. Wave and tidal energy projects are evaluated and approved by a host of agencies, with various licenses and permits being issued and mitigation and monitoring commitments being imposed. The specific list of agencies involved on any project may vary, based on the nature of the technology being deployed, the project location, and the physical and biological characteristics of the proposed installation site.

4.1 Agency Roles and Permitting Requirements

During the approval process, permitting agencies consider the characteristics of the technology being used and the nature of the location where it is to be installed, assessing the type and degree of effects that may occur on the physical and biological characteristics of the site and its vicinity. These characteristics considerations include the ocean bed, water column, water surface, and air space above the water. In addition to impacts on marine physical and biological conditions, a range of social issues may arise. Examples include impacts on coastal communities where power comes ashore or from where units are deployed and maintained, impacts on marine-based livelihoods, and impacts to features and areas of important cultural heritage. Agencies also consider whether a particular installation is for testing and data collection, which may be of limited duration and have short-term effects, or if it is planned as a commercial endeavor with a multidecade useful life and having more extended effects temporally and spatially.

Project developers can face a complex array of agency permitting requirements and uncertainty around which regulatory processes and standards may apply to their project. Regulatory complexity can increase costs and affect developers' ability to secure project financing. A lack of information on the potential impacts of new technologies is an additional complication, particularly with emerging technologies. Because the technology is new, there have been limited opportunities to evaluate the environmental impacts.⁶⁷

To address information needs and fill information gaps, agencies such as the U.S. Department of Energy (DOE) and the Bureau of Offshore Energy Management (BOEM) are collecting relevant data and reports and making the information freely available. For example, DOE supports several National Laboratories that maintain the Portal and Repository for Information on Marine Renewable Energy (PRIMRE) that provides access to several knowledge hubs, as well as other tools and resources providing a variety of marine energy data and information intended to support the growing marine energy community. For example, the Marine and Hydrokinetic Data Repository knowledge hub houses relevant reports and includes datasets of wave energy in the U.S. Exclusive Economic Zone.⁶⁸ And the Marine Energy Atlas knowledge hub is an interactive tool providing omnidirectional wave power offshore.⁶⁹

In 2010, California signed a memorandum of understanding with FERC under which the parties agreed to participate fully and maintain communication to make the regulatory process efficient and timely. They agreed to coordinate efforts for NEPA and CEQA requirements and agreed that no FERC license would be issued that will affect land, water, or natural resources without concurrence from the California Coastal Commission (CCC) or, in the case of San Francisco Bay, the Bay Conservation and Development Commission.

The DOE's *Handbook of Marine Hydrokinetic Regulatory Processes*, updated by the Pacific Northwest National Laboratory in 2020, includes chapters on federal processes and authorizations, as well review processes in several coastal states, including California agencies and authorizations potentially needed in review and approval of wave and tidal energy projects.⁷⁰

4.1.1 Federal Agency Roles and Requirements

The four primary federal agencies involved in approving wave and tidal energy projects are the Federal Energy Regulatory Commission (FERC), the U.S. Army Corps of Engineers (USACE), the U.S. Coast Guard (USCG), and the Bureau of Ocean Energy Management (BOEM).

67 UMaine. 2015. [Understanding and Informing Permitting Decisions for Tidal Energy Development Using an Adaptive Management Framework](https://umaine.edu/johnsonlab/wp-content/uploads/sites/361/2017/09/Johnson-and-Jansujwicz-2015b.pdf), <https://umaine.edu/johnsonlab/wp-content/uploads/sites/361/2017/09/Johnson-and-Jansujwicz-2015b.pdf>.

68 Marine and Hydrokinetic Data Repository. 2023. "[High Resolution Ocean Surface Wave Hindcast \(US Wave\) Data](https://mhkdr.openei.org/submissions/326)," <https://mhkdr.openei.org/submissions/326>.

69 NREL. 2024. "[Marine Energy Atlas](https://maps.nrel.gov/marine-energy-atlas/?vL=OmnidirectionalWavePowerMerged)," <https://maps.nrel.gov/marine-energy-atlas/?vL=OmnidirectionalWavePowerMerged>.

70 U.S. DOE. 2020. [Handbook of Marine Hydrokinetic Regulatory Processes](https://www.energy.gov/sites/prod/files/2020/09/f78/mhk-regulatory-processes-handbook-2020.pdf), <https://www.energy.gov/sites/prod/files/2020/09/f78/mhk-regulatory-processes-handbook-2020.pdf>.

Successful review and approval of projects require early involvement and coordination among these agencies, as well as other federal and state agencies with mandated responsibilities for marine resources such as fisheries and aquatic species. All federal agencies authorizing a discretionary action must also comply with the National Environmental Policy Act (NEPA) by preparing an environmental assessment of the proposed project and related impacts and using this document to guide agency decision making.

4.1.1.1 Federal Energy Regulatory Commission

FERC is the primary licensing authority and lead federal agency for most wave and tidal energy projects (which it identifies as “hydrokinetic” projects), even in federal waters where BOEM generally has jurisdiction.⁷¹ Within California state waters, between the shore and 3 nautical miles to sea, FERC typically has authority over marine projects when the generated power interconnects to the electric power grid, but not typically for projects in state waters if the generated power is not delivered to the grid. An example of this exception is a demonstration project in state waters that is not delivering power to shore.

Those seeking to develop a project under FERC licensing authority first seek a preliminary permit that is issued for up to four years.⁷² This permit does not authorize construction but gives the developer priority to study a project at a specific site for the duration of the permit (for example, a “guaranteed first-to-file” status). Under a preliminary permit, the permittee must submit reports with specific required information, provide a schedule of activities and target dates, and periodically report on the status of its studies.

A license to construct and operate a hydrokinetic electric generation facility for up to 30–50 years can follow one of three FERC licensing processes: the Integrated Licensing Process (ILP), the Traditional Licensing Process (TLP), or the Alternative Licensing Process (ALP). The ILP is the default process and prescribes a process and timeline for working with other regulatory agencies such as the NMFS and USFWS.

Commission approval is needed to use the Traditional or Alternative Licensing Process. The TLP involves a three-stage prefilng process involving consultations, studies, and a final application. The ALP provides a more collaborative approach and is designed to improve communication among affected entities. It tailors the prefilng consultation process to the circumstances of each case, combines into a single process the prefilng consultation and environmental review processes under NEPA and other statutes. It also allows preparation of a preliminary draft environmental assessment (EA) by the applicant or an environmental impact study (EIS) by a contractor selected by FERC and funded by the applicant.⁷³

U.S. Army Corps of Engineers. The USACE issues permits under the Rivers and Harbors Act for placing fill or objects in navigable waters under federal and state jurisdictions. This act is

71 BOEM. 2020. “[Partnering With Federal Energy Regulatory Commission](https://www.boem.gov/environment/environmental-studies/partnering-federal-energy-regulatory-commission),” <https://www.boem.gov/environment/environmental-studies/partnering-federal-energy-regulatory-commission>.

72 FERC. 2024. “[Hydrokinetic Projects](https://www.ferc.gov/licensing/hydrokinetic-projects),” <https://www.ferc.gov/licensing/hydrokinetic-projects>.

73 FERC. 2005. “[Licensing Processes](https://www.ferc.gov/licensing/licensing-processes),” <https://www.ferc.gov/licensing/licensing-processes>.

administered under the Section 404 nationwide permit process. General permits under Section 404 of the Clean Water Act authorize activities that have minimal individual and cumulative adverse environmental effects. General permits can be issued for no more than five years. Nationwide permits (NWPs) are issued under Section 404 or Section 10 of the Rivers and Harbors Act of 1899 or both, and NWP 52 specifically addresses pilot-scale hydrokinetic projects. Permits are required under Section 10 for structures or work or both in or affecting navigable waters of the United States. Consultation with USACE will determine what permits may apply. Power lines crossing navigable waters of the United States are under USACE authority unless they are subject to the regulatory authority of FERC as part of a water power project.⁷⁴

U.S. Coast Guard. The USCG is responsible for marine safety, including obstruction of navigational waterways in federal and state waters. Navigation and Vessel Inspection Circular No. 03-23 provides guidance on navigational safety in and around offshore renewable energy installations.⁷⁵ The USCG has the authority to circulate and enforce regulations with respect to lights and other warning devices, safety equipment, and other matters relating to the promotion of safety of life and property. Circular No. 03-23 specifies that tidal and wave energy converters fixed to the seabed and extending above the surface should be marked like wind turbine generators in a wind farm. Surface or subsurface wave and tide converters are to be marked by appropriate navigation aids as determined by the district commander. Single devices (such as experimental devices being tested) not visible above the surface should be marked with a buoy and flashing light. As well, the USCG has authority to establish safety zones around wave and tidal energy resource facilities.

Bureau of Ocean Energy Management. The BOEM is responsible for the leasing of lands under federal waters offshore. Jurisdiction for grid-connected tide and wave energy projects on the OCS is shared by the BOEM and FERC, subject to the MOU between BOEM and FERC. BOEM has authority to issue leases, easements, and rights-of way, and FERC has authority over the construction and operation of the projects on the OCS. Thus, lease issuance by BOEM is a prerequisite for a license from FERC for implementing a tide or wave energy project in federal waters.

Other Federal Agencies. Other agencies involved in the review, comment, and approval for marine energy projects are primarily resource protection-oriented in their responsibilities. They include the National Oceanic and Atmospheric Administration (NOAA) Fisheries (for consultations on essential fish habitat, endangered species, and marine mammals under their jurisdiction) and U.S. Fish and Wildlife Service (USFWS) for consultations on migratory birds

74 U.S. Army Corps of Engineers. 2021. [Nationwide Permit 52 — Water-Based Renewable Energy Generation Pilot Projects](https://www.swt.usace.army.mil/Portals/41/docs/missions/regulatory/2021%20NWP/2021%20nwp-52.pdf?ver=CbN57uEQ3mD97IiqOcdJAA%3D%3D), <https://www.swt.usace.army.mil/Portals/41/docs/missions/regulatory/2021%20NWP/2021%20nwp-52.pdf?ver=CbN57uEQ3mD97IiqOcdJAA%3D%3D>.

75 United States Coast Guard. 2023. [Navigation and Vessel Inspection Circular No. 03-23. Guidance on Navigational Safety in and Around Offshore Renewable Energy Installations \(OREI\)](https://www.dco.uscg.mil/Portals/9/DCO%20Documents/5p/5ps/NVIC/2020/2023/NVIC%2003-23_MarinerGuidance_OREI_FINAL_10_20_2023_V2_CG-5P%20SIGNED.pdf?ver=OwCdqfYvDktgp8AIzB6zZw%3d%3d), https://www.dco.uscg.mil/Portals/9/DCO%20Documents/5p/5ps/NVIC/2020/2023/NVIC%2003-23_MarinerGuidance_OREI_FINAL_10_20_2023_V2_CG-5P%20SIGNED.pdf?ver=OwCdqfYvDktgp8AIzB6zZw%3d%3d.

and endangered species under its jurisdiction. Each resource agency approaches the review of a proposed project from the perspective of its core mission. The permitting processes would vary not only by jurisdiction of the project, but also based on the technology, purpose, and proposed location. For example, a buoy generating power from wave energy that is used to support marine data collection would have a different permitting process than a nearshore wave energy converter providing power to a coastal user.

4.1.2 State Agency Roles and Requirements

Depending on the nature and location of a project, California approvals applicable to tide and wave energy projects are likely to include most of the following:

- CEQA compliance and Certification
- Section 401 Water Quality Certification
- CZMA Federal Consistency Determination
- Coastal Development Permit
- State Tidelands Lease
- California Endangered Species Consultation
- Land and Streambed Alteration Agreement
- Scientific Collecting Permit

Like federal agencies, state agencies' permitting processes would vary based on jurisdiction, technology, purpose, and installation location.

4.1.2.1 State Lands Commission

The SLC administers most offshore lands under state jurisdiction and issues state tidelands leases. This administration makes the SLC a primary state agency involved in review and approval of offshore projects. As part of the process, SLC staff reviews applications and makes recommendations to the Commission for action. In reviewing lease applications, SLC staff considers several factors, including consistency with the public trust doctrine, protection of natural resources and other values, preservation or enhancement of public access to state lands, and consistency with its tribal and environmental justice policies. Before issuing a lease, CEQA requirements must be met. This environmental review often is done in conjunction with other state agencies that also need to approve the project or aspects of the project. Applications must include an outline of the proposed project, supporting environmental data, and payment of appropriate fees.

4.1.2.2 State or Regional Water Resources Control Board

The SWRCB is responsible for issuing a Section 401 Water Quality Certification under the Clean Water Act and the California Code of Regulations. Regarding tidal and wave energy projects, the SWRCB has authority over wetlands and riparian areas affected by such projects. The SWRCB are responsible for the California Ocean Plan: "... protect the beneficial uses of

California's marine waters through establishing water quality objectives and implementation provisions in statewide water quality control plans and policies. Ocean standards plans and policies include: the Water Quality Control Plan for Ocean Waters of California (Ocean Plan); the Water Quality Control Plan for Control of Temperature in the Coastal and Interstate Waters and Enclosed Bays and Estuaries of California (California Thermal Plan); and the Water Quality Control Policy on the Use of Coastal and Estuarine Waters for Power Plant Cooling (Once-Through Cooling Policy).⁷⁶

In its application, a project proponent must identify all the local, state, and federal authorizations required for the project and provide copies of either the actual license or permits, or applications for the authorizations. The Water Quality Certification is issued if the proposed project would comply with water quality standards. Conditions may be attached to address potential impacts to beneficial uses and other standards. A certification also is required for a federal permit or license to be issued.

4.1.2.3 California Department of Fish and Wildlife

The CDFW provides the conservation, protection, restoration, and management of fish, wildlife, and native plants and preserves and restores the ecosystems (including ecological processes) on which they depend for use and enjoyment by the public. The California Endangered Species Act (CESA) allows CDFW to authorize project proponents as a responsible agency to take state -listed, -threatened, -endangered, or -candidate species if certain conditions are met under Fish and Game Code Section 2081. The permitting program administers the incidental take provisions of CESA to ensure regulatory compliance and statewide consistency. CDFW also has regulatory authority over fully protected species identified in the Fish and Game Code.⁷⁷

CDFW also manages activities within about 145 Marine Protected Areas (MPAs), including areas designated as state marine conservation areas (SMCAs), state marine reserves (SMR), state marine parks (SMPs), and marine recreational management areas. Each of the three main types of MPAs (SMRs, SMCAs, and SMPs) has different rules about the activities that may or may not be undertaken within the MPA. These activities are regulated by the Marine Life Protection Act (MLPA, passed by the California Legislature in 1999) and defined in the Marine Life Protection Program (MLPP) in the *2016 Master Plan for Marine Protected Areas*.⁷⁸ The master plan acknowledges that no permits for hydrokinetic energy projects had been issued as of 2016, but that the CDFW would coordinate with the SLC regarding management of potential

76 SWRCB. 2019. "[Ocean Standards](https://www.waterboards.ca.gov/water_issues/programs/ocean/)," https://www.waterboards.ca.gov/water_issues/programs/ocean/.

77 CDFW. 2024. "[Fully Protected Animals](https://wildlife.ca.gov/Conservation/Fully-Protected)," <https://wildlife.ca.gov/Conservation/Fully-Protected>.

78 CDFW. 2016. [Master Plan for Marine Protected Areas](https://nrm.dfg.ca.gov/FileHandler.ashx?DocumentID=133535&inline), <https://nrm.dfg.ca.gov/FileHandler.ashx?DocumentID=133535&inline>.

renewable energy projects. Permit issuance would be governed by regulations governing MPAs, MMAs, and special closures.⁷⁹

4.1.2.4 California Coastal Commission (or San Francisco Bay Conservation and Development Commission, Local Government and Local Roles)

The CCC and BCDC have permitting requirements and conduct federal consistency review. BCDC's jurisdiction is within and adjacent to San Francisco Bay, and the CCC's jurisdiction is within the coastal zone along the rest of the California coast. Along most of the coast, the CCC has certified programs that allow local government to conduct much of the permitting, although the CCC retains its permit authority in coastal waters and within some terrestrial areas. Along with the permit requirements, the CCC and BCDC conduct federal consistency review within their jurisdictions, under the federal Coastal Zone Management Act (CZMA).

The CZMA provides joint federal and state management of coastal resources in two main ways. For activities and development proposed by federal agencies, the CCC or BCDC reviews the federal agency's consistency determination. For projects requiring a federal permit, license, or funding, the CCC or BCDC reviews a consistency certification. In both instances, the review is meant to determine whether a proposed project is consistent with the state's Coastal Zone Management Programs. Most WEC and tidal energy projects will require a permit or federal consistency review or both from either the CCC or BCDC. In most cases, a coastal development permit needed from the local government can be consolidated with the CCC's review. Developers are responsible for determining additional local or regional government permitting requirements, which may vary throughout the state. Detailed information about permitting requirements and federal consistency review is available on the CCC and BCDC websites.

4.2 Collaborative Review and Approval

One important finding of agency officials, academics, and others evaluating the processes under which wave and tidal energy projects have been approved in the past is that the most effective and efficient process is one that involves all parties early and often. Approving the installation of an experimental prototype for a limited duration may take just a few months to several years and requires numerous documents, applications, reviews, and approvals. By engaging agencies from the outset, agency staff is better able to understand project objectives, the points of view of other agencies, the issues to be addressed, and the regulatory processes to be executed. Opportunities to share information and avoid duplicative efforts can be identified. Process managers can maintain a schedule, as well as catalogue what is needed by each agency, what processes agencies will follow, and when those are expected to occur. The process overall is led by the principal approving agencies (such as the FERC, USACE, State Land Commission, and California Coastal Commission) but involves the reviewing and decision-

79 Cornell Law School. 2024. [Cal. Code Regs. Tit. 14, § 632 — Marine Protected Areas \(MPAs\), Marine Managed Areas \(MMAs\), and Special Closures](https://www.law.cornell.edu/regulations/california/14-CCR-632), <https://www.law.cornell.edu/regulations/california/14-CCR-632>.

making agencies as well who will be addressing specific aspects of the project as it relates to their areas of responsibility and authority.

4.2.1 Use of Adaptive Management in Project Permitting

Adaptive management recognizes that circumstances evolve, needed information is often lacking or incomplete, and effective decision-making requires ongoing learning and adjustment. Adaptive management is a dynamic process that helps address uncertainty by monitoring and evaluating technology/environment interactions to gain new insights used to improve plans and approaches to project siting and operation, changes to monitoring studies (if warranted), and impact mitigation. A permit or approval issued with an adaptive management component allows a project or action to advance based on the best available information at the time. But it requires program implementation to monitor the project and gather additional information that will allow adjustments that better achieve the outcomes and objectives envisioned under the permit.

When information is sparse or missing, experience-based professional judgments are used to predict the probable effects of interactions between a proposed project or action and the resource to which a permit or approval applies. These judgments often draw on experiences in other marine-based industries. When information is not as robust as desired, an adaptive management approach needs to be implemented. The adaptive management approach is intended to be project-specific, considering the technology characteristics, specific location, and resources of concern; using monitoring results to guide interactions; and adjusting management practices as warranted by the new information. Reduced restrictions or conditions identified in the original permit or plan, are subject to change depending on what is discovered.

Adaptive management is a stepwise iterative process, as shown in Figure 13. It involves planning, acting, and evaluating:

- Plan
 - a. Define or redefine the problem, assessing current conditions, risks, and uncertainties, based on what is known.
 - b. Establish goals, objectives, and performance measures.
 - c. Design an adaptive management plan that incorporates the identified goals and performance measures and appropriate monitoring methods.
- Execute
 - a. Implement the adaptive management plan as designed and permitted,
 - b. Monitor the impacts and outcomes to determine the effectiveness of the adopted plan relative to goals.
- Evaluate and respond
 - a. Analyze, synthesize, and evaluate the information collected.
 - b. Communicate the current understanding based on monitoring and data collection and revised models.

c. *Adjust project management* based on new understanding and knowledge.

Figure 13: Adaptive Management Iterative Cycle



Adapted from Delta Independent Science Board, 2016

Adaptive management addresses possible risks that are not fully knowable at the outset of a project and are not addressed through avoidance or minimization measures imposed as conditions of a permit. Adaptive management includes methods for addressing uncertainty and, importantly, also provides monitoring and evaluation feedback to better support goals and objectives. Implementation and results also can provide data and experience that will guide future projects.

Adaptive management can treat managed actions as monitored experiments. This adaptive management may be particularly applicable at small scales, where smaller-scale projects offer more options and fewer constraints to experimentation. They also present fewer risks because of the limited extent or duration of the project or both. Innovations at this scale can, in turn, inform the management or design of larger-scale projects and potentially guide scaling from pilot projects to commercial-scale projects.⁸⁰

Chapter 6 identifies several projects in the United States and elsewhere that have successfully used adaptive management as an integral part of the permitting and approval processes.

80 *Maine and Coastal Fisheries*. 2022. "[Adaptive Management in Practice and the Problem of Application at Multiple Scales—Insights from Oyster Reef Restoration on Florida’s Gulf Coast,](https://afspubs.onlinelibrary.wiley.com/doi/full/10.1002/mcf2.10192)" <https://afspubs.onlinelibrary.wiley.com/doi/full/10.1002/mcf2.10192>.

CHAPTER 5:

Economic and Workforce Development Needs

For the purposes of this evaluation, Guidehouse consultants used the National Renewable Energy Laboratory’s (NREL) Jobs and Economic Development Impact (JEDI) Model for marine and hydrokinetic power⁸¹ to estimate economic development impacts from wave and tidal energy projects. Guidehouse modeled two sizes of wave and tidal energy projects: distributed systems (10 MW) and small commercial farms (100 MW).

Given a set of cost- and local-share⁸² inputs, the JEDI model outputs local workforce and economic development impacts during the construction and installation periods and during operating years. Impacts are categorized into three categories: direct, indirect, and induced effects. The inputs and outputs to the JEDI model are discussed in Sections 5.1 and 5.2, respectively.

5.1 Inputs: Costs and Local Share Requirements

To generate jobs and economic development impacts, the JEDI model requires inputs, including descriptive data, capital costs, operating and maintenance costs, financial parameters, and local-share requirements. Guidehouse used NREL’s System Advisor Model (SAM) for Marine Energy⁸³ to inform most of the cost inputs to the JEDI model. SAM provides costs in 2023 dollars for the device, balance of system, and operations and maintenance. Based on the description of inputs for SAM and the JEDI model, Guidehouse mapped costs from SAM to the JEDI model, as shown in Table 4.

81 NREL. 2024. “[JEDI Marine and Hydrokinetic Power Model](https://www.nrel.gov/analysis/jedi/marine-hydro.html),” <https://www.nrel.gov/analysis/jedi/marine-hydro.html>.

82 *Local share* is defined as the percentage of expenditure spent in the state or local region where the system is installed.

83 NREL. 2024. “[Marine Energy](https://sam.nrel.gov/marine-energy.html),” <https://sam.nrel.gov/marine-energy.html>.

Table 4: Mapping of Inputs From SAM to JEDI Model

SAM Cost Category	Mapped JEDI Category(s)
Device	Device
Development	Permitting
Engineering & management	
Plant commissioning	
Site access	
Electrical infrastructure	Underwater Electrical Collector System, Underwater Transmission Cable, Cable Landing, and Grid Interconnection
Assembly & installation	Installation/Labor
Operations	Operations and maintenance
Maintenance	

Source: Guidehouse analysis

For local-share inputs in the JEDI model, Guidehouse used the domestic content requirement to obtain the additional 10 percent tax credit established by the Inflation Reduction Act of 2022 (IRA) for renewable projects that qualify for the production tax credit or investment tax credit as a simplifying assumption. To meet the domestic content bonus criteria, a project that begins construction after December 31, 2026, must include at least 55 percent domestic content for manufactured products.⁸⁴

Marine and hydrokinetic facilities, which include wave and tidal energy projects, qualify for the production tax credit. As well, Guidehouse assumed that wave and tidal projects will have a sourcing strategy that satisfies the requirements for the domestic content bonus established by the IRA. Guidehouse also assumed that wave and tidal deployments of 10 MW or greater will not begin construction until after December 31, 2026. Given these assumptions, local share was set at 55 percent for equipment, which includes the device, underwater electrical collector system, underwater transmission cable, cable landing and grid interconnection, and balance of plant. Domestic content was also set at 55 percent for materials and services for operating and maintenance. The default value of 0 percent was used for domestic content of installation and operating and maintenance labor.

84 McGuireWoods. 2023. [Domestic Content 10 Percent Bonus Guidance Released \(IRS Notice 2023-38\)](https://www.mcguirewoods.com/client-resources/alerts/2023/5/domestic-content-bonus-guidance-released-irs-notice-2023-38/).
<https://www.mcguirewoods.com/client-resources/alerts/2023/5/domestic-content-bonus-guidance-released-irs-notice-2023-38/>.

The remaining inputs to the JEDI model, primarily financial parameters, were the default values in the JEDI model. The final inputs for each system size are summarized in Table 5.

Table 5: Summary of Key JEDI Inputs

	Tidal – 10 MW		Tidal – 100 MW		Wave – 10 MW		Wave – 100 MW	
	Total (\$ million)	\$/kW	Total (\$ million)	\$/kW	Total (\$ million)	\$/kW	Total (\$ million)	\$/kW
Capital Costs								
Equipment	\$26.7	\$2,673	\$242.8	\$2,428	\$109.8	\$10,980	\$1,032.8	\$10,328
Installation and Labor	\$12.9	\$1,285	\$58.7	\$587	\$12.8	\$1,283	\$58.6	\$586
Permitting	\$14.4	\$1,445	\$51.4	\$514	\$16.7	\$1,667	\$72.6	\$726
Sales Tax	\$2.3	\$232	\$21.0	\$210	\$9.5	\$951	\$89.4	\$894
Total Capital Costs	\$56.4	\$5,635	\$373.9	\$3,739	\$148.8	\$14,881	\$1,253.5	\$12,535
Annualized O&M Costs								
Labor	\$0.6	\$61	\$3.6	\$36	\$0.6	\$56	\$3.4	\$34
Materials and Services	\$2.1	\$207	\$12.4	\$124	\$2.1	\$211	\$12.6	\$126
Sales Tax	\$0.1	\$10	\$0.6	\$6	\$0.1	\$10	\$0.6	\$6
Total O&M Costs	\$2.8	\$278	\$16.6	\$166	\$2.8	\$278	\$16.6	\$166

Source: Guidehouse analysis

5.2 Outputs: Workforce and Economic Development Impacts

The JEDI model outputs local workforce and economic development impacts during the construction and installation period, and during operating years. These are categorized as direct, indirect, and induced impacts.

- **Direct impacts** include on-site construction and installation labor and project development industries. These are the immediate jobs and economic impacts created by the project expenditures, such as contractors and crews hired to install the system.
- **Indirect impacts** include equipment and supply chain impacts, as well as local revenues driven by the increase in demand for goods and services from direct on-site

project spending. These include construction material and component suppliers, analysts and attorneys who assess project feasibility and negotiate contract agreements, banks financing the projects, and all equipment and manufacturers of replacement and repair parts.

- Equipment and supply chain refers to spending on materials and equipment related to construction, installation, and development, as well as purchases of other goods and offsite services.
- Local revenue includes applicable property and sales tax, as well as any return on investment paid to local investors.
- **Induced impacts** are effects driven by reinvestment and spending of earnings by direct and indirect beneficiaries. These include increased business at local restaurants, hotels, and retail establishments, among other effects.

The JEDI model outputs the total jobs created within each category, as well as earnings, economic output, and total value added. Earnings, economic output, and value added during the construction and installation period are reported as total values for the entire period. During operating years, they are reported as annual values.

- **Jobs** refer to the total full-time equivalent (FTE) employment for one year, otherwise known as **job-years**. For example, 100 FTEs working for a construction period of two years would represent 200 job-years.
- **Earnings** refers to wage and salary compensation paid to workers and benefits.
- **Economic output** refers to economic activity or the value of production in the state or local economy.
- **Value added** is the difference between the total gross output and the cost of intermediate inputs. It is composed of payments made to workers (wages, salaries, and benefits), property-related income (payments from interest, rents, royalties, dividends, and profits), indirect business taxes (excise and sales taxes paid by individuals to businesses), and taxes on production and imports less subsidies.

Table 5 through Table 8 show detailed outputs for 10 MW wave and tidal energy projects. Most of the jobs required are in equipment and supply chain, followed by induced impacts (such as restaurant, hotel, and retail workers). Direct project development, construction, and required installation jobs are relatively small compared to the indirect and induced impact categories. Economic impacts follow similar trends as the workforce impacts. During the operating period, the onsite labor impacts include all onsite operators and technicians, as well as administration and management, for the lifetime of the project (typically 20 years or more).⁸⁵

85 *International Journal of Environmental Research and Public Health*. Zhang X, Zhang L, Yuan Y, Zhai Q. 2020. [Life Cycle Assessment on Wave and Tidal Energy Systems: A Review of Current Methodological Practice](https://www.ncbi.nlm.nih.gov/pmc/articles/PMC7084860/). <https://www.ncbi.nlm.nih.gov/pmc/articles/PMC7084860/>.

Table 5 shows the workforce and economic impact for a 10 MW wave energy project during construction and installation. A 10 MW wave energy project will require about 584 job-years (292 FTE jobs annually based on a two-year construction period) and generate \$78.4 million in total value added to the economy.

Table 6 shows the workforce and economic impact for a 10 MW wave energy project during the operating years of the project. Most jobs needed during the operating years are in onsite labor, which makes up about 17 of the total 27 annual jobs required. The annual value added to the economy is \$2.1 million.

Table 7 shows impacts for a 10 MW tidal energy project during construction and installation. The total workforce impact is less than half that of an equivalent size wave energy project, at 243 job-years (121 FTE jobs annually for a two-year construction period). The economic impact of a 10 MW tidal energy project is also less than half that of a 10 MW wave energy project, at \$31.5 million of total value added.

Table 8 shows impacts for a 10 MW tidal energy project during the operating years of the project. The tidal project requires roughly the same number of jobs annually, compared to an equivalent size wave energy project. Many jobs needed are in onsite labor, which makes up about 18 of the total 28 annual jobs required. The annual value added to the economy is equivalent to that of a 10 MW wave energy project, at \$2.1 million.

Table 6: Jobs and Economic Impact, 10 MW Wave Energy Project During Construction and Installation

	Job-Years	Total Earnings (\$MM, 2023)	Total Output (\$MM, 2023)	Total Value Added (\$MM, 2023)
Project Development and Onsite Labor Impacts	79.4	\$6.0	\$13.8	\$9.1
Construction and Installation Labor	6.2	\$1.0	--	--
Construction and Installation Related Services	73.2	\$5.0	--	--
Equipment and Supply Chain Impacts	323.2	\$28.2	\$101.2	\$46.7
Induced Impacts	181.2	\$13.1	\$36.8	\$22.6
Total Impacts	583.7	\$47.3	\$151.7	\$78.4

Source: JEDI model outputs via Guidehouse analysis

Table 7: Jobs and Economic Impact, 10 MW Wave Energy Project During Operating Years

	Annual Jobs	Annual Earnings (\$MM, 2023)	Annual Output (\$MM, 2023)	Annual Value Added
Onsite Labor Impacts	16.9	\$0.6	\$0.6	\$0.6
Local Revenue and Supply Chain Impacts	6.2	\$0.5	\$1.9	\$1.1
Induced Impacts	3.7	\$0.3	\$0.8	\$0.5
Total Impacts	26.8	\$1.4	\$3.3	\$2.1

Source: JEDI model outputs via Guidehouse analysis

Table 8: Jobs and Economic Impact, 10 MW Tidal Energy Project During Construction and Installation

	Job-Years	Total Earnings (\$MM, 2023)	Total Output (\$MM, 2023)	Total Value Added (\$MM, 2023)
Project Development and Onsite Labor Impacts	69.4	\$5.3	\$12.0	\$8.0
Construction and Installation Labor	6.2	\$1.0	--	--
Construction and Installation Related Services	63.3	\$4.3	--	--
Equipment and Supply Chain Impacts	104.5	\$8.9	\$30.5	\$15.0
Induced Impacts	68.7	\$4.9	\$13.9	\$8.5
Total Impacts	242.7	\$19.2	\$56.4	\$31.5

Source: JEDI model outputs via Guidehouse analysis

Table 9: Jobs and Economic Impact, 10 MW Tidal Energy Project During Operating Years

	Annual Jobs	Annual Earnings (\$MM, 2023)	Annual Output (\$MM, 2023)	Annual Value Added
Onsite Labor Impacts	18.2	\$0.6	\$0.6	\$0.6
Local Revenue and Supply Chain Impacts	6.2	\$0.5	\$1.9	\$1.1
Induced Impacts	3.7	\$0.3	\$0.8	\$0.5
Total Impacts	28.1	\$1.4	\$3.3	\$2.1

Source: JEDI model outputs via Guidehouse analysis

Figure 14 and Figure 15 summarize the workforce and economic impacts, respectively, of wave and tidal energy development projects at 10 MW and 100 MW. The workforce needed and economic impacts during the construction and installation period last for the construction period of 2 years, while the impacts during operating years continue throughout the project lifetime of 20 years or more.

Figure 14 shows that the workforce needed for a 100 MW wave energy project is about eight times greater than that for a 10 MW project. However, scaling up a 10 MW tidal energy project to 100 MW requires a workforce that is only about five times larger. During the operating years, wave and tidal energy projects require roughly the same workforce at each scale (roughly 30 jobs for a 10 MW project and 120 jobs for a 100 MW project).

Figure 15 indicates that the economic impacts follow a similar trend as workforce impacts when scaling wave and tidal energy projects from 10 MW to 100 MW, in that economic impacts are about eight times greater for wave energy and about five times greater for tidal energy. Similarly, during the operating years, wave and tidal energy projects generate nearly the same economic impacts at each scale (roughly \$2 million for a 10 MW project, and \$10 million for a 100 MW project).

Figure 14: Workforce Impacts of Wave and Tidal Energy Development



Source: JEDI model outputs via Guidehouse analysis

Figure 15: Economic Impacts of Wave and Tidal Energy Development



Source: JEDI model outputs via Guidehouse analysis

5.3 Maximizing Job Creation and Economic Development

The main drivers to maximize job creation and economic development are the local-share requirements for labor and materials and total project size. While Guidehouse modeled a local share of 55 percent, based on the requirements for receiving the domestic content bonus established by the IRA, increasing local-share requirements would increase local workforce development, consequently spurring the surrounding economy. Increasing the local share for materials also spurs local economic development. However, California's existing materials production and manufacturing capabilities may not be sufficient to satisfy local production of commercial-size wave and tidal energy projects.

Increasing the total deployment of wave and tidal energy will naturally increase job creation and economic development. While the future of wave and tidal energy in California is uncertain, the 100 MW scenarios demonstrate the scale of workforce needed to develop small commercial-scale wave and tidal energy facilities, with the potential to scale up to even larger deployments, approaching that of offshore wind.

An important consideration for local job development is training to develop a skilled workforce ready to construct, install, operate, and maintain wave and tidal energy facilities. Training may take the form of community college programs or union-led programs, apprenticeships, and transitioning workers from existing maritime industries (including oil and gas) to wave and tidal energy.

5.4 Limitations of the JEDI Model

Because wave and tidal energy deployment is relatively nascent compared to other offshore energy generation, especially at the commercial level, the available data and research on wave and tidal technologies may not accurately reflect project data for commercialized systems. Furthermore, the JEDI model for marine and hydrokinetic power is itself outdated. Guidehouse corrected for this obsolescence by researching costs from more recent studies where possible, primarily leveraging NREL's System Advisor Model, which was recently updated in December 2023.

Lastly, the JEDI model is only partially functional for systems other than the reference size of 10 MW. For the 100 MW wave and tidal energy scenarios, the model produced outputs only for indirect and induced impacts. Guidehouse assumed that the proportion of direct, indirect, and induced impacts remained the same for each system size and scaled outputs for the larger scenarios according to those assumptions.

CHAPTER 6:

Monitoring Strategies to Gather Data for Evaluation of Environmental Impacts

Identifying a robust monitoring strategy designed to gather sufficient data to evaluate the impacts from wave energy and tidal energy projects on marine and tidal ecosystems is critical to project permitting, especially when existing data may be insufficient to anticipate or understand impacts. Monitoring the presence and behavior of affected species, including fish, marine mammals, invertebrates, and aquatic plants, and evaluating the monitoring results guide adaptive management plan adjustments and add to the wider database.

6.1 Potential Environmental Impacts of Wave and Tidal Energy Technologies in Coastal and Marine Ecosystems

The equipment or units being developed to capture wave and tidal energy employ a range of components and strategies that interact in different ways with the physical and biological environment. These interactions may affect the seabed, water column, and marine organisms in different ways, depending on the setting and the physical and operating characteristics of the technology. Effects will also occur where transmission cables make landfall. The set of potential impacts for each project may be like those of other marine projects, allowing for adoption of particular mitigation strategies or allowing a potential impact to be “retired” from consideration.⁸⁶ However, given the variation in the types and characteristics of wave and tidal energy technology and the range of marine environments in which they might be deployed, some issues may be unique or not well understood, owing to the nature of the specific equipment and installation site.

6.2 Adaptive Management

As discussed in Chapter 4, adaptive management is a way of moving forward in the face of uncertainty about potential impacts. The term *adaptive management* has been in use for decades and is used in a variety of situations, including addressing complex environmental management problems. Put simply, adaptive management is a structured approach to management and decision-making that accumulates and incorporates knowledge to reduce uncertainty.⁸⁷ It is a structured science- and experience-based approach to environmental management. It aids decision-making in the face of uncertainty about possible outcomes by

86 Copping, A. E. and L. G. Hemery, editors. 2020. [OES-Environmental 2020 State of the Science Report: Environmental Effects of Marine Renewable Energy Development Around the World](https://tethys.pnnl.gov/publications/state-of-the-science-2020). Report for Ocean Energy Systems (OES). DOI: 10.2172/1632878, <https://tethys.pnnl.gov/publications/state-of-the-science-2020>.

87 Gregory, R. et al. 2012. [Structural Decision Making. A Practical Guide to Environmental Management Choices](https://onlinelibrary.wiley.com/doi/book/10.1002/9781444398557). Wiley-Blackwell, Chichester, UK. <https://onlinelibrary.wiley.com/doi/book/10.1002/9781444398557>.

acquiring new knowledge, experience, and stakeholder input in the management of natural resources under changing or uncertain conditions.⁸⁸

Adaptive management is an iterative process with sequential phase of planning, doing, and evaluating outcomes that then leads to modifying plans and actions as needed based on what has been learned.

Adaptative management is particularly important for nascent industries where there may be a range of unknowns regarding interacts of equipment and practices with the environment. In the case of wave and tidal energy and associated new technologies, an adaptive management plan considers previous studies in different industries (such as offshore oil and gas, offshore wind, and underwater cables) that have examined similar situations and may identify issues and posit potential solutions. These studies may also lead to some issues being discounted when there has been repeated demonstration of no or minimal impact. In any event, for a new technology there will always likely be situations for which definitive information is not available.

Using adaptive management, agencies and permitting authorities can set monitoring and operating conditions on a project that minimize risk of harm while collecting information on how a technology is interacting the environment. Adaptive management often involves an initial small installation of the monitoring technology with a set of requirements for collecting data and reporting. The initial results are evaluated to determine next steps and whether requirements can be lifted or modified. Based on the decision, additional phases of the project may be authorized and monitored. The WEC installations in California have thus far successfully used this pilot project approach in the initial permit applications.

The heart of adaptive management is monitoring and the analysis of results based on a set plan. Analysis is followed by decision-making on the need to adjust management based on the monitoring results. While it sounds straightforward, the decision-making can falter when findings must be interpreted and communicated to multiple decision makers, who must decide whether and what modifications may be needed. Factors that may discourage adoption of the process include:

- Inconclusive science, making it difficult for resource managers and approving authorities to make decisions in the face of uncertainty about risks.
- Lack of clarity on the developer's role in decision making, control over their project, and effect on project costs.
- A slow process, which fails to keep up with the urgency of management decisions.
- Regulations and permit requirement that may restrict flexibility to adopt new approaches.
- Sufficient reliable funding for monitoring and management may be difficult to obtain

88 Delta Stewardship Council. 2016. [Improving Adaptive Management in the Sacramento-San Joaquin Delta](https://deltacouncil.ca.gov/pdf/isb/products/2016-02-19-adaptive-management-report.pdf), <https://deltacouncil.ca.gov/pdf/isb/products/2016-02-19-adaptive-management-report.pdf>.

- Monitoring costs that may be greater than perceived benefits, reducing long-term interest
- Benefits of adaptive management that may not be immediately apparent, reducing incentives for the approach.

The approach should not be undertaken if there is no opportunity to apply what is learned, if there is little uncertainty as to what actions need to be taken, or if there is little agreement on goals and objectives among the parties involved.

6.3 Monitoring Strategies With Adaptive Management

Installing and operating wave and tidal energy equipment in a marine environment (or in the case of transmission line interconnection, on land) can act as stressors on the physical and biological environment at and near the project or on species (both resident and migrant) that are in the area. Examples of the potential receptors include the physical conditions present at and near a site and the biological resources that are present or transit the area. In the abstract, the number of interactions between equipment and the environment can be large. However past studies in other marine-based industries and similar siting situations help narrow the possibilities.

DOE maintains a growing interactive website repository of studies of receptor/stressor interactions that can help agencies and developers identify and focus on potential interactions between receptors and the stressors of interest.⁸⁹ The website arrays a column of receptors against a row of stressors. Receptor topics include bats, birds, ecosystem processes, fish, human dimensions, invertebrates, marine mammals, physical environment, reptiles, and terrestrial mammals. Stressor topics include noise, changes in flow, habitat change, collision, EMF, attraction, avoidance, displacement, chemicals, entrapment, and lighting.

At the intersection of each receptor column and stressor row is a link to relevant articles posted in the database that examine that set of receptor/stressor interactions. This intersection lets parties identify and focus on potential technology/environment interactions that need to be considered, based on the equipment characteristics, and the conditions at the location where it is to be sited. This intersection can inform permitting and licensing by providing information on the interactions that may be able to be avoided, mitigation that may be required to address significant interactions, and need for additional information collection through an adaptive management strategy designed to fill data gaps.

A 2019 European Union study of wave and tidal energy technologies assessed a wide array of environmental mitigation and monitoring strategies.⁹⁰ The study considered types of interaction, receptors, project phase, and environmental management measures. It also identified the effect of management measures, including advantages and challenges. Among

89 Marine Energy. 2024. "[Interactions](https://marineenergy.app/env.html)," <https://marineenergy.app/env.html>.

90 TETHYS. 2019. [SEA Wave: Strategic Environmental Assessment of Wave Energy Technologies](https://tethys.pnnl.gov/sites/default/files/publications/SEA_Wave_D2.2.pdf), https://tethys.pnnl.gov/sites/default/files/publications/SEA_Wave_D2.2.pdf.

the types of issues considered when evaluating the effects of a wave or tidal energy technology were:

- Barrier to movement.
- Changes in sediment dynamics.
- Changes in tidal flow, flux, and turbulence structures.
- Dissipation of wave energy.
- Collision risk.
- Displacement.
- Electromagnetic fields (EMF).
- Entanglement.
- Entrapment.
- Habitat creation.
- Introduction of marine nonnative species.
- Lighting.
- Loss of seabed habitat.
- Pollution impacts.
- Underwater noise.
- Vessel disturbance.

There are numerous examples of successful adaptive management approaches in the United States and abroad. For example, in the United States, the ecological restoration in San Diego Bay was prompted by the need to address damage from highway and flood channel construction and provide habitat for endangered species. The effort included collaborations among scientists with various state and federal agencies. Frequent meetings allowed information to be shared among the parties. Needed actions, as well as standards and design of the mitigation, were adjusted based on the results of ecosystem monitoring.⁹¹ Other ongoing long-term efforts include restoration of the Kissimmee River in Florida and the Glen Canyon Dam Adaptive Management Program (which adopted an explicit experimental approach, using controlled flows from dam releases to assess options for restoring sandbar habitat and protecting endangered fish).

Adaptive management has been used in approvals for wave and tidal energy projects as well. In the United States, the wave and tidal energy sector is developing, with many current efforts in the concept, demonstration, and data collection stages. Several efforts have resulted in demonstration or pilot projects that have used adaptive management strategies in assessing their environmental effects, particularly on biological resources. Examples of adaptive management approaches include TidGen Project in Maine, the Roosevelt Island Tidal Energy Project in New York, and the PacWave South project in Oregon.

6.3.1.1 TidGen Project

In Maine, Ocean Renewable Power Company (ORPC) was granted a pilot project license by FERC in 2012 to install and operate its TidGen Project involving a single horizontal-axis tidal turbine in Cobscook Bay. Using conditional licensing, with adaptive management as a basis, ORPC demonstrated that its tidal unit would have minimal effects on marine wildlife. The central objective was to use six agreed-upon monitoring pans to collect data on fisheries and marine life interactions with the installed equipment and evaluate the effects of underwater

91 Zedler, J.B, and J. Calloway. 2003. [Adaptive Restoration: A Strategic Approach for Integrating Research Into Restoration Projects](https://www.researchgate.net/publication/328718028_Adaptive_restoration_A_strategic_approach_for_integrating_research_into_restoration_projects). In D.J. Rapport et al: *Managing for Healthy Ecosystems*. Lewis Publishers, Boca Raton, FL. https://www.researchgate.net/publication/328718028_Adaptive_restoration_A_strategic_approach_for_integrating_research_into_restoration_projects.

noise on sockeye salmon, marine mammals, and seabirds. The adaptive management process resulted in several license modifications clarifying monitoring requirements and, in some cases, lowering the frequency of monitoring required for specific surveys. Underwater noise measurements demonstrated that during pile driving when plywood was installed between the hammer and the follower noise levels were below National Marine Fisheries Service thresholds of concern for salmon.

Based on the data and the established thresholds, FERC removed seasonal restrictions on piledriving. Trained monitors were deployed during the installation and operational phases to observe marine mammal presence and behavior around the turbine. This deployment was done before, during, and after key installation and maintenance activities. The initial plan included shutdown triggers based on exclusion zone distances and time durations since last sighting. Dedicated monitors observed minimal changes in the presence and behavior of animals during piledriving, and incidental observations did not show any behavioral changes or adverse encounters or collisions with the equipment. This information allowed the project to transition to using only incidental observations rather than dedicated monitors for mammals.

Separately, ORPC also established the RivGen project in Alaska that included a fish monitoring plan using underwater video cameras as part of the adaptive management plan. The monitoring revealed the absence of injuries and saw no altered fish behavior near the turbine. This revelation led to retirement of collision risk for fish around the unit as a matter of concern.

Roosevelt Island Tidal Energy Project. In 2012, FERC issued a 10-year pilot license to Verdant Power to install up to 30 turbines in three phases in New York's East River. The first phase involved three turbines on a triframe (Figure 16). Additional triframe-mounted turbines were deployed in subsequent phases. This was the first commercially licensed tidal power project in the United States and was decommissioned in 2021. The project used adaptive management to support execution of seven monitoring of environmental effects (MEE) plans. Here adaptive management was not applied to manage the project; rather, it was used to reduce uncertainty in seven MEE plans to address key environmental questions. The monitoring was designed to address questions related to species presence and the effects of the turbines and noise on their presence, distribution, and abundance. The studies addressed microscale interaction of:

- Species with the turbines
- Fish populations in the project vicinity
- Occurrence of protected fish species
- Potential for impacts on seabirds
- Occurrence of underwater project-generated noise
- Impact on recreation

Figure 16: Verdant Power Turbines on a Triframe Base



Source: RITE – Verdant Power

PacWave South Project. Oregon State University’s PacWave South Project involves four grid-connected berths to support testing of commercial-scale wave energy converters. These berths allow developers to monitor and test their devices. As part of its adaptive management framework, OSU committed to implementing monitoring programs for underwater noise, habitat changes, and EMF to validate assumptions about the level and duration of potential effects. The monitoring regime is coupled with processes for taking management actions in consultation with specific regulatory agencies and an adaptive management committee. Under the process, project effects are reviewed to make changes to the monitoring approach as needed and initiate actions where these effects exceed certain thresholds or mitigation criteria. The process guides ongoing and subsequent decisions, such as the need to adopt specific protection, mitigation, and enhancement measures, to assure that the potential effects are within desired thresholds.

Overseas, examples of a stepwise adaptive management approach to tidal projects include the MeyGen project in Scotland, the SeaGen project in Northern Ireland, and the DeltaStream project in Wales.⁹²

MeyGen Tidal Project. The MeyGen tidal energy project, the world’s largest commercial tidal development, is applying a staged consent process. The ultimate capacity of the project is expected to be 398 MW. The project site is 2 km (1.24 miles) from Scotland’s north-east tip near the island of Stroma, where a natural channel accelerates millions of tons of water flowing between the North Sea and the Atlantic Ocean. The full project received consent to install 61 submerged turbines. Initially, four 1.5 MW turbines were installed and monitored to measure the behavior of mobile species near the turbines. The environmental assessment

92 TETHYS. 2020. [OES 2020 State of the Science Report](#).

process concluded that there might be significant adverse effects due to predicted levels of collision with protected species. Comprehensive monitoring measured the behavior of mobile species near the turbines, and the findings were to be used to validate collision risk models. Species of concern included seabirds, grey seals, harbor seals, Atlantic salmon, and sea lampreys. The stepwise installation and monitoring approach determines impacts and identifies strategies for moving forward based on monitoring outcomes. For the project, postinstallation monitoring requirements are summarized in Table 10.⁹³ These are typical stressors and receptors for marine energy projects which would requires similar studies and monitoring.

Table 10: MeyGen Project Stressors, Receptors, and Studies

Stressor	Receptor	Study Description
Changes in Flow	Physical Environment	Undertaken surveys to detect significant changes in habitats due to the presence of the turbines. Hydro dynamics/benthic surveys, export cable route and turbine locations and modelling to validate predictions. Validation of hydrodynamic model. Monitor the dispersion of sediment and drill cuttings from potential pile installation and HDD bore breakthrough.
Habitat Change	Human Communities, Navigation, Fisheries	Vessel traffic monitoring Long-term impacts upon local fisherman
Collision	Marine Mammals	Collision/encounter interactions with the tidal turbines for marine mammals
Collision	Fish	Collision/encounter interactions with the tidal turbines fish of concern.
Collision	Birds	Collision/encounter interactions with the tidal turbines for diving birds, marine mammals, and fish of conservation concern.
Displacement	Marine Mammals	Disturbance and displacement of marine mammals during construction and operation.
Displacement	Fish	Disturbance and displacement of fish during construction and operation.

93 TETHYS. 2024. "[MeyGen Tidal Energy Project](https://tethys.pnnl.gov/project-sites/meygen-tidal-energy-project)," <https://tethys.pnnl.gov/project-sites/meygen-tidal-energy-project>.

Stressor	Receptor	Study Description
Displacement	Birds	Monitoring of potential displacement and disturbance of birds
Noise	Marine Mammals	Acoustic monitoring of operational noise

Adapted from "[MeyGen Tidal Energy Project](https://tethys.pnnl.gov/project-sites/meygen-tidal-energy-project)," <https://tethys.pnnl.gov/project-sites/meygen-tidal-energy-project>.

SeaGen Tidal Turbine. SeaGen installation in Northern Ireland include twin 16-meter diameter rotors on a mobile cross arm supported on a single pile 3 meters in diameter. The system generated 1.2 MW of power from tidal motion. For the SeaGen project, a critical concern was potential impacts on harbor seal use of Strangford Lough (inlet) and the possible risk of collisions with turbine blades for harbor seals and harbor porpoises. A monitoring plan was developed as a condition of the license and complemented by an adaptive management approach that required continuous review of monitoring data and management measures by an independently chaired scientific steering group. Monitoring showed that seals and harbor porpoises tend to avoid the SeaGen turbine, which reduced the likelihood of marine mammal collisions.

The three main receptors considered within the environmental monitoring program were marine mammals; benthic, or ocean floor, ecology; and tidal flow and energy.⁹⁴ For marine mammals, several data collection methods were used, including:

- Shore-based survey.
- Passive acoustic monitoring.
- Carcass postmortem.
- Aerial survey.
- Harbor seal telemetry.
- Underwater noise monitoring.
- Data collection during mitigation using active sonar.

Analysis of the data collected during the monitoring program provided several key findings. These were that no major impacts on marine mammals have been detected during the three years of postinstallation monitoring and porpoise activity declined during installation. However, there have been no long-term changes in abundance of either seals or porpoises attributable to the presence or operation of the device.

The only changes observed after three years of operation of the installed device were relatively small-scale changes in the behavior and distribution of seals and harbor porpoises, suggesting a degree of local avoidance of the device. Overall, the seals transited at a relatively higher rate during periods of slack tide, indicating avoidance. Moreover, this slack water

94 TETHYS. 2011. [SeaGen Environmental Monitoring Programme Final Report](https://tethys.pnnl.gov/sites/default/files/publications/Final_EMP_report_SeaGen.pdf), https://tethys.pnnl.gov/sites/default/files/publications/Final_EMP_report_SeaGen.pdf.

window when the turbine is not operating or is moving very slowly ensured that there is always an opportunity for transit past the turbine. This avoidance reduced the risk of any direct interactions with the moving rotors and suggested that seals and porpoises can adjust their distributions at local scales in response to a potential hazard.

A few of the metrics monitored were highly variable, and comparisons between phases could not confidently rule out undetected changes. For example, there was a case for grey seal and porpoise sighting rates from shore-based visual observation locations. Given the wide-ranging nature of these species, monitoring parties considered it unlikely that any changes at scale would have a significant effect at the population level.

The benthic ecology was monitored using diver surveys. Analysis of data collected determined that the changes observed appeared gradual and in line with natural variation. Colonization of the device since the installation replaced the community lost during foundation construction.

Acoustic Doppler Current Profiling (ADCP) was used to measure changes to tidal flow. The data showed no evidence of significant change to the velocity or flow direction within the Lough following turbine installation.

Although not a key feature of the environmental monitoring, bird data were collected in combination with the shore-based marine mammal surveys. The data showed that while some fine-scale displacement of birds had been noted in the immediate vicinity of the device, the overall numbers in the area remained stable. The findings of the environmental monitoring program provide confidence that SeaGen can continue to operate with no likely significant impacts on the marine environment.

DeltaStream Tidal Turbine. The DeltaStream project involved a 12-month deployment of a single 400 kW turbine on a gravity-based frame in Ramsey Sound, west of St. Davids, Wales. The greatest environmental concerns were for turbine blade collisions of a variety of protected species, including harbor porpoise and grey seal. A detailed collision monitoring and adaptive management plan established the monitoring approach to determine the real level of collision risks in the face of uncertainty. Mitigation included the potential for limiting turbine operation during sensitive times such as marine species migration and the use of acoustic deterrents to encourage migrating species to avoid the immediate area. Owing to equipment failure and liquidation of the company, the system never operated for a significant length of time.

Overall, the principles of adaptive management can be applied to addressing uncertainty and knowledge gaps. Allowing single devices or small arrays to be studied in a marine setting using an approach that includes defined mitigation and monitoring, valuable information about the characteristics of a technology and the particular stressor/receptor interactions are collected. This knowledge then informs subsequent projects, including larger-scale installations, and narrows the issues of concern to be addressed in the licensing and monitoring process going forward.

As noted in the OES 2020 State of the Science Report, agencies will need to “establish clear and mandatory elements of adaptive management plans, including the design of and

conditions for post-installation monitoring, stakeholder engagement, information sharing, and thresholds for adaptive management intervention.”⁹⁵

95 TETHYS. 2020. *OES 2020 State of the Science Report*. <https://tethys.pnnl.gov/publications/state-of-the-science-2020>.

CHAPTER 7:

The Future of Marine Energy in California

Notwithstanding the challenges, advancements in marine energy technologies suggest a promising future for harnessing the vast energy potential of the world's oceans. The future vision for marine energy in California is one characterized by innovation, sustainability, and resilience, where the state's abundant marine resources are harnessed to power a diverse range of applications and support the transition to a clean energy economy.

California envisions continued innovation and advancement in marine energy technologies to result in more efficient, reliable, and cost-effective, enabling deployments at multiple scales, likely focusing initially on PBE applications and distributed energy projects. Marine energy can play an important role in California's energy mix, complementing other renewable energy sources such as wind and solar. Integrated energy systems that combine marine energy with other renewable technologies (for example, codesign) such as offshore wind, as well as with energy storage, grid infrastructure, and demand-side management can enhance grid flexibility, stability, and resilience, supporting the state's transition to a low-carbon energy future.

Marine energy infrastructure can be leveraged to enhance coastal resilience and climate adaptation efforts in California. Renewable energy installations can provide decentralized power solutions for coastal communities vulnerable to sea-level rise, storm surges, and extreme weather events, ensuring reliable and resilient energy supply and supporting disaster response and recovery efforts. California's marine energy sector can contribute to the growth of the Blue Economy, supporting sustainable economic development and job creation in coastal regions. Marine energy projects can create opportunities for innovation, entrepreneurship, and workforce development in areas such as technology development, manufacturing, installation, operations, and maintenance.

California remains committed to environmental stewardship and biodiversity conservation in marine energy development. Projects will need to be designed and operated with thoughtful consideration of potential environmental impacts, including habitat disturbance, marine mammal interactions, commercial and recreational fisheries, and ecosystem disruption, and adhere to environmental regulations and mitigation measures to minimize adverse effects on marine ecosystems and wildlife. California's future vision for marine energy includes meaningful engagement with coastal communities, indigenous peoples, and stakeholders to ensure that projects are developed collaboratively, transparently, and equitably. Community benefits agreements, local procurement policies, and workforce development programs can ensure that marine energy projects deliver tangible social, economic, and environmental benefits to impacted communities, including job creation, infrastructure investment, and revenue sharing.

Overall, California's future vision for marine energy is one of sustainable development, resilience, and inclusive growth, where the state's coastal resources are harnessed responsibly

to power a thriving Blue Economy and support the well-being of present and future generations. Continued collaboration, innovation, and commitment from government, industry, researchers, tribes, and stakeholders will be essential to realizing this vision and unlocking the full potential of marine energy in California.

GLOSSARY

Attenuator: A single surface-floating bodies or multiple connected bodies that rise and fall with wave motion and electricity is generated through mechanical turbine rotation or hydraulic pumps that are driven by the flexing motion of the device.

Axial-flow turbines have spinning blades whose axis of rotation is oriented with the direction of the current. They mimic wind turbines in shape and energy extraction method.

Bureau of Ocean Energy Management (BOEM): The federal agency under the U.S. Department of Interior that manages development of U.S. Outer Continental Shelf energy and mineral resources. BOEM manages overall offshore wind processes which includes four phases: planning and analysis, leasing, site assessment, and construction and operation.

California coastal zone: A legislatively defined geographic region that establishes the area regulated under the Coastal Act encompassing the land and water areas along the length of the California coastline from the Oregon border to the border of Mexico, extending seaward to the state's outer limit of jurisdiction, including all offshore islands, and extending inland generally 1,000 yards from the mean high tide line of the sea.

California Independent System Operator (California ISO): The California ISO manages the flow of electricity on high-voltage power lines, operates a wholesale energy market, and oversees infrastructure planning.

Community benefits agreement (CBA): A legally binding agreement that has been negotiated and agreed upon between a developer and one or more communities, tribes, or stakeholder groups that are expected to be affected by the potential impacts resulting from lease development. A CBA is unique and tailored to the individual needs and circumstances of communities. BOEM has offered developers bid credits in previous offshore wind lease sales (such as the PACW-1) in exchange for a future executed CBA(s).

Consistency determinations (CDs): A consistency determination is submitted to the CCC when a federal agency activity affects the coastal zone. It is a project description and analysis of the coastal zone effects of the activity based on the policies of the Coastal Act.

Crossflow turbines: Have a set of blades that spin in the direction of flow and can be mounted horizontally or vertically. As these turbines spin, the design of the blades must minimize the flow across the blade as it returns to face the flow.

Demand-side resources: Demand-side resources serve resource adequacy needs by reducing load, which reduces the need for additional generation. Typically, these resources result from energy efficiency or demand response and load management.

Distributed energy resources (DER) refers to typically smaller generation units that are located on the consumer's side of the meter or providing generation to serve nearby load.

European Marine Energy Centre (EMEC): Marine technology test facility located in the United Kingdom.

Floating offshore wind: Offshore wind turbines deployed in water depths that necessitate floating structures and are stabilized by moorings and anchors. Floating offshore wind technology allows for offshore wind to be deployed in deeper waters where fixed bottom offshore wind is not feasible. Due to the nearshore dropoff of the Pacific Continental Shelf, floating offshore wind is the only feasible option for California.

Gigawatt (GW): One thousand megawatts (1,000 MW) or 1 million kilowatts (1,000,000 kW) or 1 billion watts (1,000,000,000 watts) of electricity. One GW is enough to supply the electric demand of about 1 million average California homes.

Incident energy: The amount of energy, at a prescribed distance from the equipment, generated during an electrical arc event. It increases as the magnitude of current flowing in the fault and clearing time increase.

Levelized cost of energy (LCOE): The average total cost of an energy generation project per unit of total electricity generated. Also referred to as the levelized cost of electricity, LCOE is a measurement to assess and compare alternative methods of energy production.

Megawatt (MW): One thousand kilowatts (1,000 kW) or 1 million (1,000,000) watts. One MW is enough electrical capacity to power 1,000 average California homes. (Assuming a loading factor of 0.5 and an average California home having a 2 kilowatt peak capacity.)

Nameplate capacity: The total manufacturer-rated capacities (or full-load sustained energy generation output) of equipment such as turbines, generators, condensers, transformers, and other system components. Offshore wind turbine nameplate capacities are rated in megawatts (MW).

National Environmental Policy Act (NEPA) requires federal agencies to assess the environmental effects of their proposed actions prior to making decisions.

Oscillating water column wave energy converters generate electricity by using the oscillating motion of water within a chamber as waves pass by. These WECs typically consist of a partially submerged chamber open to the sea.

Oscillating wave surge converters: Oscillating wave surge converters consist of a buoyant structure that moves back and forth (surges) in response to the passing waves to create energy.

Outer Continental Shelf (OCS): Includes the submerged lands between state jurisdiction to 200 nautical miles (nm) from shore. The OCS is the portion of the internationally recognized continental shelf of the United States, which does not fall under the jurisdictions of the individual U.S. states.

Overtopping wave energy converters consist of a sloping structure or a seawall with a reservoir behind it. As waves approach the structure, they climb up and spill over its crest,

filling the reservoir with water. Being impounded, the water accumulated in the reservoir is at a higher elevation than the surrounding ocean. The water collected in the reservoir is then released through turbines or sluice gates. This controlled release of water drives turbines or generators, converting the potential energy of the stored water into electricity.

Point absorbers Typically involve a floating buoy or platform that moves up and down or back and forth in response to the motion of passing waves. This movement, relative to a fixed structure (like an anchor), is then converted into mechanical energy using a power take-off mechanism, such as hydraulic pistons or linear generators.

Pressure differential wave energy converter generates electricity by harnessing the difference in pressure between two points caused by the motion of ocean waves, the crest, and trough.

Project developer (or developer): A project developer is responsible for developing and managing the project, including activities required to secure financing and permits, determine the project's design and engineering aspects, and engage with partners, agencies, and stakeholders. A developer is the owner and operator of the energy project.

Port: This term is used both for the harbor area where ships are docked and for the agency (port authority), which administers use of public wharves and port properties. Offshore wind will require ports and waterfront facilities to support a range of activities, including construction and staging of floating platform foundations, manufacturing and storage of components, final assembly, and long-term operations and maintenance.

Project phase(s): Offshore wind project activities can be categorized into chronological phases. Key offshore wind project workforce and supply chain development phases include supply chain and manufacturing, integration and assembly, and operations and maintenance. These project phases overlap with the BOEM renewable energy program phases: planning, leasing, site assessment, and construction and operations. Offshore wind developers incorporate both categories of project phases into a project timeline.

Senate Bill 605 (SB 605): The law requires that the CEC evaluate the feasibility, costs, and benefits of using wave energy and tidal energy as forms of clean energy California's state and federal coastal waters.

Supply chain: The sequence or system of organizations or operations that work together to design, produce, and deliver a product or service to a market. The offshore wind supply chain refers to the companies involved in the creation and implementation of offshore wind components.

Tidal energy converters (TEC): Technologies that create electricity using tidal or current movement.

Terrawatt-hour (TWh): A unit of energy that represents one trillion watts of power used for one hour.

Wave energy converter (WEC): Technologies that use wave movement to create electricity. These can be both onshore and offshore installations.

Workforce: All the workers needed to support a project or industry. The workforce for offshore wind consists of workers needed to perform all types of jobs related to the offshore wind ecosystem for all project phases.

APPENDIX A:

SB 605 (Padilla): Wave and Tidal Energy

SB 605 (Padilla): Wave and Tidal Energy

CHAPTER 405

An act to add Chapter 18 (commencing with Section 25996) to Division 15 of, and to repeal Section 25996.1 of, the Public Resources Code, relating to energy.

[Approved by Governor October 07, 2023. Filed with Secretary of State October 07, 2023.]

LEGISLATIVE COUNSEL'S DIGEST

SB 605, Padilla. Wave and tidal energy.

Existing law requires the State Energy Resources Conservation and Development Commission (Energy Commission) to undertake various actions in furtherance of meeting the state's clean energy and pollution reduction objectives, including actions related to energy infrastructure.

This bill would require the Energy Commission, as part of a specified 2024 energy policy review, in consultation with other appropriate state agencies to evaluate the feasibility, costs, and benefits of using wave energy and tidal energy, as specified. The bill would require the commission, in coordination and consultation with the California Coastal Commission, the Department of Fish and Wildlife, the Ocean Protection Council, and the State Lands Commission, to work with other state and local agencies and stakeholders to identify suitable sea space for offshore wave energy and tidal energy projects in state and federal waters. The bill would require the Energy Commission to submit a written report to the Governor and the Legislature on or before January 1, 2025, that includes a summary of findings from the evaluation and considerations that may inform legislative and executive actions, as specified.

Bill Text

THE PEOPLE OF THE STATE OF CALIFORNIA DO ENACT AS FOLLOWS:

SECTION 1.

Chapter 18 (commencing with Section 25996) is added to Division 15 of the Public Resources Code, to read:

CHAPTER 18. Wave Energy and Tidal Energy

25996.

(a) As part of the 2024 energy policy review prepared pursuant to subdivision (c) of Section 25302, the commission, in consultation with other appropriate state agencies, including, but not limited to, the Ocean Protection Council, the Department of Fish and Wildlife, the State

Lands Commission, and the California Coastal Commission, shall evaluate the feasibility, costs, and benefits of using wave energy and tidal energy as forms of clean energy in the state.

(b) For purposes of the evaluation identified in subdivision (a), the commission shall do all of the following:

- (1) Evaluate factors that may contribute to the increased use of wave energy and tidal energy in the state.
- (2) Provide findings on the latest research about the technological and economic feasibility of deploying offshore wave and tidal energy in the state.
- (3) Evaluate wave energy and tidal energy project potential transmission needs and permitting requirements.
- (4) Evaluate wave energy and tidal energy project economic and workforce development needs.
- (5) Identify near-term actions, particularly related to investments and the workforce for wave energy and tidal energy projects, to maximize job creation and economic development, while considering affordable electric rates and bills.
- (6) Identify a robust monitoring strategy designed to gather sufficient data to evaluate the impacts from wave energy and tidal energy projects to marine and tidal ecosystems and affected species, including, but not limited to, fish, marine mammals, and aquatic plants, to inform adaptive management of the projects.

(c) (1) The commission, in coordination and consultation with the California Coastal Commission, the Department of Fish and Wildlife, the Ocean Protection Council, and the State Lands Commission, shall work with other state and local agencies, the offshore wave energy and tidal energy industry, the commercial and recreational fishing communities, California Native American tribes, nongovernmental organizations, and other stakeholders to identify suitable sea space for offshore wave energy and tidal energy projects in state and federal waters.

(2) For purposes of identifying suitable sea space, the commission shall consider all of the following:

- (A) Existing data and information on offshore wave energy and tidal energy resource potential and commercial viability.
- (B) Existing transmission facilities and infrastructure, and necessary additional transmission facilities and infrastructure.
- (C) Protection of cultural and biological resources with the goal of prioritizing ocean areas that pose the least conflict to those resources.

(3) For purposes of this subdivision, the commission shall incorporate the information developed by the federal Bureau of Ocean Energy Management's California Intergovernmental Renewable Energy Task Force, as applicable.

(4) The commission, in coordination and consultation with the California Coastal Commission, Department of Fish and Wildlife, Ocean Protection Council, State Lands Commission, other state and local agencies, the offshore wind energy industry, the commercial and recreational fishing communities, California Native American tribes, nongovernmental organizations, and other stakeholders, shall identify measures that would avoid, minimize, and mitigate significant adverse environmental and ecosystem impacts and use conflicts, and for monitoring and adaptive management for offshore wave energy and tidal energy projects, consistent with California's long-term goals relating to renewable energy, reduction of greenhouse gas emissions, and biodiversity.

(5) Nothing in this subdivision modifies the authority of any state agency over project-specific siting and permitting.

(6) The commission shall seek to coordinate and consult with federal agencies, as appropriate and applicable, in performing the work required by this subdivision.

25996.1.

(a) On or before January 1, 2025, the commission shall submit a written report to the Governor and the Legislature that includes both of the following:

(1) A summary and findings from the evaluation and work described in Section 25996.

(2) Considerations that may inform legislative and executive actions to facilitate, encourage, and promote the development and increased use of technologically and economically feasible wave energy and tidal energy technologies, infrastructure, and facilities in the state.

(b) (1) The report described in this section shall be submitted to the Legislature pursuant to Section 9795 of the Government Code.

(2) Pursuant to Section 10231.5 of the Government Code, this section shall remain in effect only until January 1, 2029, and as of that date is repealed.