

**DOCKETED**

<b>Docket Number:</b>	22-BSTD-02
<b>Project Title:</b>	2022 Energy Code Compliance Software && Supporting Documents
<b>TN #:</b>	242767
<b>Document Title:</b>	Gina Rodda Comments - 2022 Nonresidential and Multifamily ACM Manual
<b>Description:</b>	N/A
<b>Filer:</b>	System
<b>Organization:</b>	Gina Rodda
<b>Submitter Role:</b>	Public
<b>Submission Date:</b>	4/25/2022 11:03:50 AM
<b>Docketed Date:</b>	4/25/2022

*Comment Received From: Gina Rodda  
Submitted On: 4/25/2022  
Docket Number: 22-BSTD-02*

**2022 draft CBECC ACM Gabel Energy**

*Additional submitted attachment is included below.*

**DOCKETED**

<b>Docket Number:</b>	22-BSTD-02
<b>Project Title:</b>	2022 Energy Code Compliance Software & Supporting Documents
<b>TN #:</b>	242465
<b>Document Title:</b>	Draft Nonresidential and Multifamily Alternative Calculation Method Reference Manual
<b>Description:</b>	Draft nonresidential and multifamily alternative calculation method reference manual for public review and comment.
<b>Filer:</b>	Haile Bucaneg
<b>Organization:</b>	California Energy Commission
<b>Submitter Role:</b>	Commission Staff
<b>Submission Date:</b>	3/25/2022 10:48:24 AM
<b>Docketed Date:</b>	3/25/2022



**CALIFORNIA  
ENERGY COMMISSION**



**CALIFORNIA  
NATURAL  
RESOURCES  
AGENCY**

California Energy Commission

## **STAFF REPORT**

# **(Draft) Nonresidential And Multifamily Alternative Calculation Method Reference Manual**

For the 2022 Building Energy Efficiency Standards  
Title 24, Part 6, and Associated Administrative  
Regulations in Part 1.

**Month Year | CEC-**

A decorative graphic at the bottom of the page consisting of overlapping, semi-transparent geometric shapes in shades of blue and green, creating a modern, abstract design.

# California Energy Commission

Haile Bucaneg

RJ Wichert

## **Primary Authors**

Haile Bucaneg

Che Geiser

RJ Wichert

## **Project Managers**

William Vicent

## **Office Manager**

**BUILDING STANDARDS OFFICE**

Michael J. Sokol

## **Deputy Director**

**EFFICIENCY DIVISION**

Drew Bohan

## **Executive Director**

### DISCLAIMER

**Staff members of the California Energy Commission prepared this report. As such, it does not necessarily represent the views of the Energy Commission, its employees, or the State of California. The Energy Commission, the State of California, its employees, contractors, and subcontractors make no warrant, express or implied, and assume no legal liability for the information in this report; nor does any party represent that the uses of this information will not infringe upon privately owned rights. This report has not been approved or disapproved by the Energy Commission nor has the Commission passed upon the accuracy or adequacy of the information in this report.**

## ACKNOWLEDGMENTS

The California Energy Commission (CEC) adopted and put into effect the first *Building Energy Efficiency Standards* 1978 and have updated these standards periodically in the intervening years. The *Building Energy Efficiency Standards* are a unique California asset that has placed the state on the forefront of energy efficiency, sustainability, energy independence, and climate change issues, and have provided a template for national standards within the United States as well as for other countries around the globe. They have benefitted from the conscientious involvement and enduring commitment to the public good of many persons and organizations along the way. The *2022 Building Energy Efficiency Standards* for residential and nonresidential buildings development and adoption process continues a long-standing practice of maintaining the standards with technical rigor, challenging but achievable design and construction practices, public engagement, and full consideration of the views of stakeholders.

The revisions in the *2022 Building Energy Efficiency Standards* for residential and nonresidential buildings were conceptualized, evaluated, and justified through the excellent work of CEC staff and consultants working under contract to the CEC, supported by the utility-organized Codes and Standards Enhancement Initiative, and shaped by the participation of more than 150 stakeholders and the contribution of formal public comments.

CEC Efficiency Division staff would like to acknowledge Commissioner Andrew McAllister and his adviser, Bill Pennington, for their unwavering leadership throughout the standards development; Payam Bozorgchami, P.E., who served as project manager and senior engineer for the 2022 standards code cycle; Mazi Shirakh, P.E., who served as the senior engineer and senior technical lead for solar photovoltaic standards; Will Vicent, who served as the Manager for the Buildings Standards Office; Javier Perez, who served as the lead for multifamily buildings; Peter Strait, who served as the supervisor for the Standards Development Unit; Che Geiser, who served as the supervisor for the Standards Tools Unit; James Qaqundah, Matt Chalmers, Josephine Crosby, Chester Hong, and Michael Murza, who provided legal counsel; and technical staff contributors of the Building Standards Office including: Simon Lee, P.E.; Jeff Miller, P.E.; Ronald Balneg; Cheng Moua, P.E.; Michael Shewmaker; Danny Tam; RJ Wichert; Thao Chau; Haider Alhabibi; and Danuta Drozdowicz. Additional staff input and assistance came from the Energy Hotline staff and the CEC's web team.

Critical support for the staff in conceptualizing, evaluating, and reviewing this document came from NORESO and the Codes and Standards Enhancement Initiative which is supported by a consortium of California utility providers which includes the Pacific Gas and Electric Company, Southern California Edison Company, San Diego Gas & Electric

Company, the Sacramento Municipal Utility District, and the Los Angeles Department of Water and Power.

## ABSTRACT

The California Energy Commission's (CEC) *2022 Building Energy Efficiency Standards* for residential and nonresidential buildings allow compliance by either a prescriptive or performance method. The performance compliance approach uses computer modeling software to trade off efficiency measures. Performance compliance is the most popular compliance method because of the flexibility it provides in building design.

Compliance software must be certified by the CEC, following rules established for modeling software. This document establishes the rules for creating a building model, describing how the proposed design is defined, explaining how the standard design is established, and reporting on the Performance Compliance Certificate. This document also describes the procedure for performance calculation, necessary rule sets, reference method for testing compliance software accuracy, and the minimum reporting requirements. The CEC reserves the right to approve vendor software for limited implementations of what is documented in this manual.

This *Nonresidential and Multifamily Alternative Calculation Method Reference Manual* explains how the proposed and standard designs are determined. The explanation for single-family building proposed and standard designs are described in the *Single-Family Residential Alternative Calculation Method Reference Manual*.

The public domain compliance software provided by the CEC is called California Building Energy Code Compliance (CBECC). CBECC and all third-party software must meet rules described in the Nonresidential and Multifamily Buildings ACM Reference Manual.

**Keywords:** ACM, alternative calculation method, Building Energy Efficiency Standards, California Energy Commission, California Building Energy Code Compliance, CBECC, Performance Compliance Certificate, compliance manager, compliance software, computer compliance, energy budget, time dependent valuation, energy code, energy use, prescriptive compliance, performance compliance, design, proposed design, standard design, VRF

Please use the following citation for this report:

Bozorgchami, Payam, P.E.; Haile Bucaneg; Che Geiser; Simon Lee; Michael Shewmaker; Danny Tam; and RJ Wichert. *2022 Nonresidential And Multifamily Alternative Calculation Method Reference Manual*. California Energy Commission, Building Standards Office. CEC---



# Table of Contents

<b>1. Overview</b>	<b>1-1</b>
1.1 Purpose	1-1
1.2 Modeling Assumptions	1-1
1.3 Scope	1-1
1.4 Organization	1-2
1.5 Reference Method	1-2
1.6 Software Approval	1-3
1.7 Compliance	1-6
1.7.1 Type of Project Submittal .....	1-6
1.7.2 Scope of Compliance Calculations .....	1-6
1.7.3 Climate Zones .....	1-7
1.7.4 Time Dependent Valuation .....	1-7
1.7.5 Source Energy .....	1-7
1.7.6 Reporting Requirements for Unsupported Features .....	1-8
1.8 Approval Process	1-8
1.8.1 Application Checklist .....	1-8
1.8.2 Types of Approval.....	1-10
1.8.3 Challenges .....	1-11
1.8.4 Decertification of Compliance Software Programs .....	1-12
1.9 Vendor Requirements	1-14
1.9.1 Availability to California Energy Commission .....	1-14
1.9.2 Enforcement Agency Support .....	1-14
1.9.3 User Support .....	1-14
1.9.4 Compliance Software Vendor Demonstration .....	1-14
<b>2. General Modeling Procedures</b>	<b>2-1</b>
2.1 General Requirements for User-Entered Data	2-1
2.1.1 General.....	2-1

2.1.2	Building Envelope Descriptions .....	2-1
2.1.3	Space Use Classification .....	2-1
2.1.4	Treatment of Descriptors Not Fully Addressed by This Document.....	2-2
2.2	Thermal Zones, HVAC Zones, and Space Functions	2-2
2.2.1	Definitions.....	2-2
2.3	Software Modeling Requirements for Zones	2-4
2.3.1	Required Zone Modeling Capabilities.....	2-4
2.3.2	Modeling Requirements for Unconditioned Spaces .....	2-4
2.3.3	Space Use Classification Considerations .....	2-4
2.4	Unmet Load Hours	2-6
2.5	Calculation Procedures	2-7
2.6	HVAC Capacity Requirements and Sizing	2-9
2.6.1	Specifying HVAC Capacities for the Proposed Design.....	2-10
2.6.2	Sizing Equipment in the Standard Design .....	2-10
2.6.3	Handling Proposed Design with No HVAC Equipment .....	2-11
2.7	Ventilation Requirements	2-12
<b>3.</b>	<b>Compliance Software Test Requirements</b>	<b>3-1</b>
3.1	General Requirements	3-1
3.1.1	Scope .....	3-1
3.1.2	Calculation Methods.....	3-2
3.1.3	Climate Data .....	3-3
3.1.5	Time Dependent Valued (TDV) Energy.....	3-3
3.1.6	Source Energy.....	3-3
3.1.7	Thermal Mass.....	3-3
3.1.8	Modeling Space Temperature .....	3-3
3.1.9	Heat Transfer Between Thermal Zones .....	3-4
3.1.10	Control and Operating Schedules.....	3-4
3.1.11	Systems Simulation.....	3-5

3.2	Special Documentation and Reporting Requirements	3-7
3.2.1	Building Envelope .....	3-7
3.2.2	Interior Lighting .....	3-7
3.2.3	HVAC Exceptional Conditions .....	3-8
3.3	ASHRAE Standard 140-2007 Tests	3-9
3.4	Ruleset Implementation Tests	3-9
3.4.1	Introduction .....	3-9
3.4.2	Overview.....	3-10
3.4.3	Ruleset Implementation Tests .....	3-11
3.5	Software Sensitivity Tests	3-12
<b>4.</b>	<b>Content and Format of Standard Reports</b>	<b>4-1</b>
<b>5.</b>	<b>Nonresidential Building Descriptors Reference</b>	<b>5-1</b>
5.1	Overview	5-1
5.1.1	Definition of Building Descriptors .....	5-1
5.1.2	HVAC System Map .....	5-3
5.1.3	Special Requirements for Additions and Alterations Projects .....	5-12
5.2	Project Data	5-13
5.2.1	General Information.....	5-13
5.2.2	Existing Building Classification .....	5-17
5.2.3	Partial Compliance Model Input Classification .....	5-18
5.2.4	Building Model Classification.....	5-19
5.2.5	Geographic and Climate Data .....	5-20
5.2.6	Site Characteristics .....	5-24
5.2.7	Calendar .....	5-25
5.3	Thermal Zones	5-26
5.3.1	General Information.....	5-26
5.3.2	Interior Lighting .....	5-28
5.3.3	Receptacle Loads.....	5-29
5.3.4	Occupants.....	5-29

5.4	Space Uses	5-29
5.4.1	General Information.....	5-30
5.4.2	Infiltration.....	5-31
5.4.3	Occupants.....	5-34
5.4.4	Interior Lighting .....	5-36
5.4.5	Daylighting Control .....	5-51
5.4.6	Receptacle Loads.....	5-60
5.4.7	Commercial Refrigeration Equipment .....	5-62
5.4.8	Elevators, Escalators and Moving Walkways .....	5-63
5.4.9	Process, Gas.....	5-64
5.4.10	Water Heating Use.....	5-68
5.5	Building Envelope Data	5-68
5.5.1	Materials.....	5-68
5.5.2	Construction Assemblies.....	5-70
5.5.3	Roofs.....	5-72
5.5.4	Exterior Walls .....	5-78
5.5.5	Exterior Floors.....	5-85
5.5.6	Doors.....	5-88
5.5.7	Fenestration.....	5-91
5.5.8	Below-Grade Walls.....	5-101
5.5.9	Slab Floors in Contact with Ground .....	5-104
5.5.10	Heat Transfer between Thermal zones .....	5-107
5.5.11	Simplified Geometry Simulation Option.....	5-108
5.6	HVAC Zone Level Systems	5-109
5.6.1	Space Temperature Control.....	5-109
5.6.2	Terminal Device Data.....	5-110
5.6.3	Terminal Heating .....	5-111
5.6.4	Baseboard Heat.....	5-112

5.6.5	VRF Zone Systems (Indoor Units) .....	5-113
5.6.6	Zone Level Air Flow .....	5-117
5.7	HVAC Secondary Systems	5-130
5.7.1	Basic System Information.....	5-130
5.7.2	System Controls .....	5-132
5.7.3	Fan and Duct Systems .....	5-138
5.7.4	Outdoor Air Controls and Economizers .....	5-161
5.7.5	Cooling Systems .....	5-165
5.7.6	Heating Systems.....	5-184
5.7.7	Heat Recovery.....	5-192
5.8	HVAC Primary Systems	5-196
5.8.1	Boilers .....	5-196
5.8.2	Chillers.....	5-203
5.8.3	Cooling Towers.....	5-214
5.8.4	Water-side Economizers.....	5-221
5.8.5	Pumps .....	5-224
5.8.6	Variable Refrigerant Flow (VRF) Systems.....	5-231
5.8.7	Plant Management.....	5-235
5.8.8	Thermal Energy Storage .....	5-237
5.9	Miscellaneous Energy Uses	5-240
5.9.2	Exterior Lighting .....	5-256
5.9.3	Other Electricity Use .....	5-256
5.9.4	Other Gas Use.....	5-257
5.10	Onsite Energy Generation and Storage	5-258
5.10.1	Onsite Photovoltaic Energy Generation.....	5-258
5.10.2	Battery Storage .....	5-259
5.11	Common Data Structures	5-260
5.11.1	Schedule .....	5-260

5.11.2	Holidays .....	5-261
5.11.3	Surface Geometry .....	5-261
5.11.4	Opening Geometry .....	5-261
5.11.5	Opening Shade .....	5-262
5.11.6	Construction Assembly .....	5-262
5.11.7	Fenestration Construction.....	5-262
5.11.8	Material.....	5-262
5.11.9	Slab Construction.....	5-262
5.12	Exterior Surface Properties	5-262
5.12.1	Occupant Heat Rate .....	5-263
5.12.2	Furniture and Contents.....	5-263
5.12.3	Reference Position in a Space.....	5-263
5.13	Two-Dimensional Curve	5-263
5.13.1	Three-Dimensional Curve .....	5-263
5.13.2	Temperature Reset Schedule .....	5-263
<b>6.</b>	<b>Multifamily Building Descriptors Reference</b>	<b>6-1</b>
6.1	Standard Design Multifamily	6-1
6.2	Proposed Design Multifamily	6-1
6.3	Self-Utilization Credit Multifamily	6-2
6.4	Demand Response Multifamily	6-2
6.4.1	Precooling Multifamily .....	6-2
6.5	Photovoltaic and Battery Storage Requirements	6-3
6.5.1	Photovoltaics Requirements Three Habitable Stories or Less.....	6-3
6.5.2	Photovoltaics and Battery Storage Requirements More Than Three Habitable Stories	6-8
6.6	The Building	6-11
6.6.1	Dwelling Units per Space.....	6-12
6.6.2	Number of Bedrooms.....	6-12
6.6.3	Number of Occupants .....	6-13

6.6.4	Lighting Classification Method.....	6-13
6.6.5	Multifamily General Lighting Power .....	6-14
6.6.6	Multifamily Additional Lighting Power .....	6-15
6.6.7	Multifamily Additional Lighting Power Task Area .....	6-17
6.6.8	Multifamily Building Custom Lighting Power.....	6-17
6.6.9	Multifamily Wall Display Power .....	6-18
6.6.10	Multifamily Wall Display Length.....	6-18
6.6.11	Multifamily Task Lighting Power .....	6-19
6.6.12	Multifamily Task Lighting Area .....	6-19
6.6.13	Multifamily Decorative and Special Effect Lighting Power .....	6-19
6.6.14	Multifamily Decorative and Special Effect Lighting Area .....	6-20
6.7	Air Leakage and Infiltration	6-20
6.7.1	Building Air Leakage and Infiltration (ACH50) .....	6-20
6.7.2	Defining Air Net Leakage.....	6-21
6.7.3	Quality Insulation Installation .....	6-22
6.7.4	Dwelling Unit Types .....	6-23
6.8	Building Materials and Construction	6-23
6.8.1	Materials .....	6-23
6.8.2	Construction Assemblies.....	6-26
6.8.3	Spray-Foam Insulation .....	6-29
6.9	Building Mechanical Systems	6-30
6.9.1	Heating Subsystems .....	6-30
6.9.2	Cooling Subsystems .....	6-39
6.9.3	Distribution Subsystems .....	6-49
6.9.4	Space-Conditioning Fan Subsystems .....	6-67
6.9.5	Space-Conditioning Systems.....	6-67
6.9.6	Indoor Air Quality Ventilation.....	6-69
6.9.7	Ventilation Source.....	6-74

6.9.8	Design Ventilation Rate .....	6-75
6.9.9	Exhaust Fan Power Index.....	6-76
6.9.10	Recovery Type.....	6-76
6.9.11	Heat/Energy Recovery for Multifamily.....	6-77
6.9.12	Recovery Air Flow Rate .....	6-77
6.9.13	Zone System Heat Recovery Effectiveness.....	6-78
6.9.14	Exhaust Air Sensible Heat Recovery Effectiveness .....	6-78
6.9.15	Exhaust Air Sensible Part-Load Effectiveness .....	6-79
6.9.16	Economizer Enabled during Heat Recovery .....	6-79
6.10	Conditioned Zones	6-80
6.10.1	Zone Type.....	6-80
6.10.2	Conditioned Floor Area.....	6-81
6.10.3	Number of Stories.....	6-81
6.10.4	Conditioned Zone Assumptions .....	6-85
6.10.5	Internal Gains.....	6-87
6.10.6	Exterior Surfaces.....	6-87
6.11	Attics	6-96
6.11.1	Attic Components.....	6-97
6.11.2	Ceiling Below Attic .....	6-98
6.11.3	Attic Roof Surface and Pitch .....	6-99
6.11.4	Attic Conditioning.....	6-99
6.11.5	Attic Edge.....	6-100
6.11.6	The Roof Deck.....	6-102
6.12	Domestic Hot Water (DHW)	6-105
6.12.2	Individual Dwelling Units .....	6-108
6.12.3	Multiple Dwelling Units – Central Water Heating .....	6-109
6.12.4	Solar Thermal Water Heating Credit.....	6-110
6.13	Additions/Alterations	6-110



6.13.1	Whole Building.....	6-110
6.13.2	Alteration-Along Approach.....	6-110
6.13.3	Addition-Along Approach.....	6-111
6.13.4	Existing + Addition + Alteration Approach.....	6-112
6.14	Documentation	6-124

## List of Figures and Tables

Figure 1: Hierarchy of Space Functions, HVAC Zones, and Thermal Zones .....	2-3
Figure 2: Calculation Process for Title 24 Compliance .....	2-7
Figure 3: Results Spreadsheet Excerpt from Appendix 3B .....	3-18
Figure 4: Prototype Model Definition from Appendix 3A .....	3-20
Figure 5: Base Case Definition from Appendix 3A .....	3-21
Figure 6: Input Parameter Variation for Medium Office from Appendix 3A.....	3-22
Figure 7: Information Flow .....	5-2
Figure 8: SAT Cooling Setpoint Reset Based on Outdoor Air Temperature (OAT) .....	5-137
Figure 9: Energy Use Details .....	6-4
Figure 10: Community Solar .....	6-5
Figure 11: Energy Use Details .....	6-9
Figure 12: Surface Definitions .....	6-12
Figure 13: Example Construction Data Screen .....	6-26
Figure 14: Overhang Dimensions.....	6-93
Figure 15: Sidefin Dimensions .....	6-94
Figure 16: Attic Model Components .....	6-96
Figure 17: Section at Attic Edge with Standard Truss.....	6-100
Figure 18: Section at Attic Edge with a Raised Heel Truss.....	6-101
Figure 19: Components of the Attic Through Roof Deck.....	6-102
Table 1: Climate Zones Tested .....	3-15
Table 2: HVAC System Map.....	5-3
Table 3: System Descriptions .....	5-8
Table 4: Lighting Specification.....	5-36
Table 5: Light Heat Gain Parameters for Typical Operating Conditions .....	5-49
Table 6: Heavy Mass Wall (Heat Capacity $\geq 15$ Btu/ft <sup>2</sup> -F) .....	5-84
Table 7 Metal Building Walls .....	5-85

Table 8 Wood-Framed Walls .....	5-85
Table 9: Standard Design Building Below-Grade Wall Construction Assemblies .....	5-103
Table 10: Standard Design Fan Control Method.....	5-140
Table 11: Minimum Nominal Efficiency for Electric Motors (Percent) .....	5-146
Table 12: Type and Number of Chillers .....	5-204
Table 13: Default Minimum Unloading Ratios .....	5-208
Table 14: Self-Utilization Credits.....	6-7
Table 15: Air Leakage Distribution .....	6-21
Table 16: Modeling Rules for Unverified Insulation Installation Quality.....	6-22
Table 17: Materials List.....	6-24
Table 18: Required Thickness Spray Foam Insulation (in inches).....	6-29
Table 19: Standard Design Heating System.....	6-31
Table 20: HVAC Heating Equipment Types .....	6-32
Table 21: Heat Pump Equipment Types .....	6-33
Table 22: HVAC Cooling Equipment Types (Other Than Heat Pumps) .....	6-39
Table 23: Summary of Space Conditioning Measures Requiring Verification.....	6-42
Table 24: HVAC Distribution Type and Location Descriptors .....	6-51
Table 25: Summary of Verified Distribution Systems.....	6-52
Table 26: Summary of Standard Design Duct Location.....	6-54
Table 27: Location of Default Duct Surface Area .....	6-56
Table 28: Buried Duct Effective R-Values .....	6-61
Table 29: Buried Duct Effective R-Values .....	6-61
Table 30: Buried Duct Effective R-Values .....	6-62
Table 31 Buried Duct Effective R-Values .....	6-63
Table 32: Buried Duct Effective R-Values .....	6-63
Table 33: Buried Duct Effective R-Values .....	6-64
Table 34: Duct/Air Handler Leakage .....	6-65
Table 35: IAQ System Component Accessibility Criteria.....	6-72

Table 36: IAQ Fans .....	6-74
Table 37: Hourly Thermostat Set Points.....	6-84
Table 38: Conditioned Zone Thermal Mass Objects.....	6-85
Table 39: Standard Design for Roofs/Ceilings.....	6-114
Table 40: Addition Standard Design for Walls and Doors.....	6-116
Table 41: Standard Design for Fenestration (in Walls and Roofs) .....	6-118
Table 42: Standard Design for Overhangs, Sidesfins, and Other Exterior Shading .....	6-119
Table 43: Standard Design for Floors.....	6-120
Table 44: Standard Design for Air Leakage and Infiltration .....	6-121
Table 45: Standard Design for Space Conditioning Systems .....	6-121
Table 46: Standard Design for Duct Systems.....	6-123
Table 47: Standard Design for Water Heater Systems.....	6-123

# 1. Overview

---

## 1.1 Purpose

The *Nonresidential and Multifamily Alternative Calculation Method (ACM) Reference Manual* explains the requirements for approval of nonresidential and multifamily Title 24 compliance software in California. Approved software is used to demonstrate minimum compliance with the Building Energy Efficiency Standards (Energy Code), CALGreen, or any metric approved by the California Energy Commission (CEC). The procedures and processes described in this manual are designed to provide consistency and accuracy while preserving integrity of compliance. This manual address software for nonresidential buildings, hotels, and motels, and multifamily residential buildings as outlined in Title 24, Part 6, Subchapter 5, §140.1 and Subchapter 11, §170.1. A separate ACM reference manual applies to single-family residential buildings. The approval process for nonresidential software programs is specified in Title 24, Part 1, Section 10-101 through Section 10-110 of the California Code of Regulations.

---

## 1.2 Modeling Assumptions

When calculating annual energy use, it is necessary to make assumptions about how the proposed building is operated. Operating assumptions include thermostat settings, number of occupants, receptacle loads, process loads, hot water loads, and operation schedules for heating, ventilation, and air-conditioning (HVAC) systems, lighting systems, and other systems. Sometimes these data are known with some certainty, and other times (for instance, for speculative buildings), it is necessary to make estimates. Some of these inputs are prescribed (fixed for the proposed and standard design buildings and cannot be changed), while others are defaults.

---

## 1.3 Scope

This manual is intended to be used as a reference for the modeling methods of the California Building Energy Code Compliance (CBECC) software and a guide to software programs seeking certification as Title 24 compliance software for nonresidential buildings.

The *ACM Reference Manual* can be modified during a code cycle without a formal rulemaking. Therefore, the goal of the software development team is to provide periodic updates to improve the accuracy and usability of compliance software.

---

## **1.4 Organization**

This document is organized in five chapters and several appendices, as follows:

Chapters and descriptions:

1. Overview  
The purpose, organization, and content of the manual.
2. General Modeling Procedures  
An overview of the modeling process, outlining the modeling rules and assumptions that are implemented in the same way for the standard design and the proposed design, and procedures for determining system types and equipment sizes.
3. Software Requirements  
Requirements for the simulation engines and implementation of compliance rules used to make calculations, and special reporting requirements for non-standard building features.
4. Content and Format of Standard Reports  
The content and organization of the standard reports produced by qualifying software.
5. Nonresidential Building Descriptors Reference  
The acceptable range of inputs for the proposed design and a specification for the standard design for Nonresidential Buildings.
6. Multifamily Building Descriptors Reference  
The acceptable range of inputs for the proposed design and a specification for the standard design for Multifamily Buildings.

In addition, there are several appendices that contain reference material supporting definition of the proposed design and standard design. The numbering for these appendices generally aligns with the chapter numbers in the main manual that reference the appendices.

---

## **1.5 Reference Method**

The reference procedures and method described in this manual establish the basis of comparison for all software. The approval process ensures that a minimum level of energy efficiency is achieved regardless of the software used. This level is accomplished by:

- Specifying a series of reference method comparison tests that candidate software passed.
- Specifying input that may vary for credit, and input that is fixed or restricted.
- Defining standard report output requirements.
- Certifying the software vendor requirements in this manual.

---

## 1.6 Software Approval

The *Nonresidential and Multifamily Buildings ACM Reference Manual* is an approved document, separate from the formally adopted ACM regulations. This approval gives the CEC flexibility to incorporate new modeling procedures or features, or fix errata, within the code cycle. The document is said to be in continuous maintenance. Software may be certified with the capability of modeling specific building systems or features.

The CEC's purpose in approving additional capabilities is to accommodate new technologies which have only begun to penetrate the market and new modeling algorithms. Newly added capabilities that evaluate measures already in relatively common use shall have their standard design for the measure based on the common construction practice (or the typical base situation) for that measure since common practice is the inherent basis of the standards for all measures not explicitly regulated. For example, the CEC has no interest in an optional capability that evaluates the energy effects of dirt on windows unless a new technology produces substantial changes in this aspect of a building relative to buildings without this technology. The burden of proof that an additional capability should be approved lies with the applicant.

Companion documents that are helpful in preparing software for certification include the latest editions of the following CEC publications:

- Energy Efficiency Standards
- Appliance Efficiency Regulations
- Nonresidential Compliance Manual
- Alternative Calculation Method (ACM) Approval Manual
- Reference Nonresidential Appendices
- Reference Appendices

In this manual the term "standards" means the *Building Energy Efficiency Standards*, Title 24, Part 6 of the California Code of Regulations. The term "compliance" means that a building design in an application for a building permit complies with the "standards" and meets the requirements described for building designs therein.

There are a few special terms that are used in this manual. The CEC approves software for use in demonstrating compliance. CEC approval means that the CEC accepts the applicant's certification that software meets the requirements of this manual. The proponent of candidate software is referred to as a *vendor*. The vendor shall follow the procedure described in this document to certify publicly to the CEC that the software meets the criteria in this document for:

- Accuracy and reliability when compared to the reference method.
- Suitability in terms of the accurate calculation of the correct energy budget, the generation of output for transmission to standardized forms, and documentation on how the program demonstrates compliance.

In addition to explicit technical criteria, CEC approval will also depend upon the CEC's evaluation of:

- Enforceability in terms of reasonably simple, reliable, and rapid methods of verifying compliance and application of energy efficiency features modeled by the software and the inputs used to characterize those features by the software users.
- Dependability of the installation and energy savings of features modeled by the software. The CEC will evaluate the probability that the measure actually will be installed and remain functional. The CEC shall also determine that the energy impacts of the features that the software is capable of modeling will be reasonably and accurately reflected in real building applications of those features. In particular, it is important that the software does not encourage the replacement of actual energy savings with theoretical energy savings due to tradeoffs allowed by the software.

For the vendor, receiving approval of software includes preparing an application, working with the CEC staff to answer questions from either CEC staff or the public, and providing any necessary additional information regarding the application. The application includes the four basic elements outlined below. CEC staff evaluates the software based on the completeness of the application and overall responsiveness to staff and public comment.

The four basic requirements for approval include:

1. Required capabilities.
  - a. Software shall have all the required input capabilities explained in Chapter 2 General Modeling Procedures.



- b. Software shall meet software requirements and documentation requirements for applicable features supported by the software, as described in Chapter 3 Compliance Software Test Requirements.
2. Accuracy of simulation.
  - a. The software shall demonstrate acceptable levels of accuracy by performing and passing the required certification tests discussed in Chapter 3.5 Software Sensitivity Tests.
  - b. The software vendor conducts the specified certification tests in Chapter 3.4 Ruleset Implementation Tests, evaluates the results, and certifies in writing that the software passes the tests. The CEC will perform spot checks and may require additional tests to verify that the proposed software is appropriate for compliance.
  - c. When energy analysis techniques are compared, two potential sources of discrepancies are the differences in user interpretation when entering the building specifications, and the differences in the software algorithms (mathematical models) for estimating energy use. The approval tests minimize differences in interpretation by providing explicit detailed descriptions of the test buildings that must be analyzed. For differences in the software algorithms, the CEC allows algorithms that yield equivalent results.
3. User's Manual.
  - a. The vendor shall include a user manual or help system or both that provides appropriate guidance for specifying inputs and running a simulation for compliance.
4. Program support.
5. The vendor shall provide ongoing user and enforcement agency support as described in the *ACM Approval Manual*.

The CEC may hold one or more public workshops with vendor participation to allow public review of the vendor's application. Such workshops may identify problems or discrepancies that may necessitate revisions to the application.

CEC approval of software programs is intended to provide flexibility in complying with the standards. In achieving this flexibility, however, the software shall not degrade the standards or evade the intent of the standards to achieve a particular level of energy efficiency. The vendor has the burden of proof to demonstrate the accuracy and

reliability of the software relative to the reference method and demonstrate the conformance of the software to the requirements of this manual.

---

## 1.7 Compliance

### 1.7.1 Type of Project Submittal

Software shall require the user to identify the type of compliance for the project. The software shall require the user to choose one of the following options:

- New Building or Addition Alone. Software may do this by treating an addition alone as a new building, but an addition modeled in this way shall be reported on all output forms as an addition (modeled alone).
- Addition Plus Alteration of Existing Building (if software is approved for this optional capability).
- Alteration of Existing Building (if software is approved for this optional capability).

### 1.7.2 Scope of Compliance Calculations

For each building or separately permitted space, software shall also require the user to identify the scope of the compliance submittal from a combination of the following list:

- Envelope
- Lighting or Partial Lighting
- Mechanical or Partial Mechanical (may include or exclude Domestic Hot Water)

Each combination requires specific assumptions, input procedures, and reporting requirements. Modeling assumptions are documented in [Chapter 5 Nonresidential Building Descriptors Reference](#) and [Chapter 6 Multifamily Building Descriptors Reference](#). Reporting requirements are documented in [Chapter 4 Content and Format of Standard Reports](#). Software shall produce only compliance reports specific to the scope of the submittal determined for the run. For example, if the scope is envelope only, only the PRF-01 forms with envelope-only components are produced.

Lighting compliance for a partial compliance scenario may be for the entire building or may be specified for only portions of the building. When the building applies for partial lighting compliance, the space(s) where lighting for the space is unknown or undefined shall be marked as "undefined," and the compliance software shall use the standard design lighting power for the user-defined space type for both the proposed design and standard design. Under this compliance scope, the entire building shall be modeled, and the compliance forms shall indicate the spaces for which lighting compliance is not performed.

The combination of the above scopes will determine the standard design that the proposed design is compared to. When a scope is excluded from the performance calculation, the standard design will match the proposed for all features covered by that scope. Specific rules for each building model descriptor can be found in [Chapter 5 Nonresidential Building Descriptors Reference](#) and [Chapter 6 Multifamily Building Descriptors Reference](#) of this manual.

### **1.7.3 Climate Zones**

The program shall account for variations in energy use due to the effects of the California climate zones and local weather data. Climate information for compliance simulations shall use the applicable data set in Reference Appendix JA2.

### **1.7.4 Time Dependent Valuation**

The candidate software shall calculate the hourly energy use for both the standard design and the proposed design by applying a time dependent valuation (TDV) factor for each hour of the reference year. TDV factors have been established by the CEC for residential and nonresidential occupancies, for each of the climate zones, and for each fuel (electricity, natural gas, and propane). The procedures for TDV energy are documented in Reference Appendix JA3. The Total TDV for a project consists of a TDV for efficiency measures (Efficiency TDV) and TDV for flexibility measures (PV/flexibility TDV). To comply through the performance compliance approach, the Total TDV and Efficiency TDV of the proposed design must be equal to or less than the Total TDV and Efficiency TDV of the standard design.

### **1.7.5 Source Energy**

The candidate software shall calculate the long-run marginal, hourly source energy use for both the standard design and the proposed design. Hourly source energy assumes utilities meet all RPS and other obligations and is projected over the 30-year life of the building.

The possible bounds for source energy for electricity are about 10,500 Btu/kWh upper bound (proxy low efficiency powerplant) and 0 Btu/kWh lower bound (renewable generation). Delivery losses are the same as the delivery losses used for TDV.

Avoided source energy from incremental renewable generation depends on renewable portfolio standard (RPS) goals. This is represented as an RPS percentage value which increases annually. The avoided source energy can further vary based on the specific resource used, such as wind, solar or energy storage.

Natural gas long-run source energy is based on the percentage of renewable gas used by utilities. Increased use of renewable gas decreases the source energy impact of retail natural gas consumption.

Propane long-run source energy does not vary on annual basis. This is because there are no renewable gas offsets that can be used to support propane. The long-run marginal source energy of propane is constant and considered to be the source energy of propane gas. This is calculated as a direct conversion factor of 100 kBtu/therm.

The hourly source energy provided by the CEC is used to determine compliance. To comply through the performance compliance approach, the source energy of the proposed design must be equal to or less than the source energy of the standard design.

### **1.7.6 Reporting Requirements for Unsupported Features**

The compliance software shall meet required capabilities and pass applicable certification tests as defined in [Chapter 3 Compliance Software Test Requirements](#). While the vendor's software does not need to implement every modeling rule in the *ACM Reference Manual*, all software features, systems, components, and controls that are modeled must follow the modeling guidelines in the *ACM Reference Manual*. Vendors seeking certification for software programs to be used for Title 24 compliance should clearly state the extent of the capabilities of their software with respect to compliance. Support of a modeling feature includes correctly processing user input, specifying the standard design correctly, applying that information to simulation models, and processing the results.

Any building features or systems that cannot be modeled in **a compliance software program shall show compliance using prescriptive forms.**

---

## **1.8 Approval Process**

### **1.8.1 Application Checklist**

The following items shall be included in an application package submitted to the CEC for software approval:

- Compliance Software Vendor Certification Statement. A copy of the statement provided by the Energy Commission to the applicant, signed by the software vendor, certifying that the software meets all CEC requirements, including accuracy and reliability when used to demonstrate compliance with the energy code.

- Computer Runs. Copies of the computer runs specified in Chapter 3 Compliance Software Test Requirements of this manual on machine-readable form as specified in Chapter 3 Compliance Software Test Requirements to enable verification of the runs.
- Help System and/or User's Manual. The vendor shall submit a complete copy of the help system and/or software user's manual, including material on the use of the software for compliance.
- Copy of the Compliance Software and Weather Data. A machine-readable copy of the software for random verification of compliance analyses. The vendor shall use approved CEC weather files.
- TDV Factor Documentation. The software shall be able to apply the TDV multipliers described in Reference Appendix JA3 and calculate Efficiency TDV, and PV/flexibility TDV.
- Source Energy. The software shall be able to calculate source energy as described in Chapter 1.6.5 Source Energy.
- Application Fee. The vendor shall provide an application fee of \$1,000.00 as authorized by § 25402.1(b) of the Public Resources Code, payable to the "State of California" to cover costs of evaluating the application and to defray reproduction costs.

A cover letter acknowledging the shipment of the completed application package should be sent to:

Executive Director  
California Energy Commission  
715 P Street, MS-39  
Sacramento, CA 95814-5512

Two copies of the full application package should be sent to:

Compliance Software Nonresidential Certification  
California Energy Commission  
715 P Street, MS-26  
Sacramento, CA 95814-5512

Following submittal of the application package, the CEC may request additional information under Title 24, Part 1, Section 10-110. This additional information is often necessary due to the complexity of software. Failure to provide such information in a timely manner may be considered cause for rejection or disapproval of the application.

A resubmittal of a rejected or disapproved application will be considered a new application and must include a new application fee.

## **1.8.2 Types of Approval**

This manual addresses two types of software approval: full program approval (including amendments to programs that require approval) and approval of new program features and updates.

If software vendors make a change to their programs as described below, the change must be approved by the CEC. Furthermore, any software change that affects the energy use calculations for compliance, the modeling capabilities for compliance, the format and/or content of compliance forms, or any other change that would affect compliance requires approval.

Changes that do not affect compliance, such as changes to the user interface, may follow a simplified or streamlined procedure for approval. To comply with this simpler process, the software vendor shall certify to the CEC that the new program features do not affect the results of any calculations performed by the program, shall notify the CEC of all changes; and shall provide the CEC with one updated copy of the program and help system/user's manual. Examples of such changes include fixing logical errors in computer program code that do not affect the numerical results (bug fixes) and new interfaces.

### **1.8.2.1 Full Approval and Reapproval of Compliance Software**

The CEC requires program approval when candidate software has never been approved by the CEC, when the software vendor changes the program algorithms, or when any other change occurs that in any way affects the compliance results. The CEC may also require that all approved software be approved again whenever substantial revisions are made to the standards or to the CEC's approval process.

The CEC may change the approval process and require that all software be approved again for several reasons, including:

- If the standards undergo a major revision that alters the basic compliance process, then software would have to be updated and reapproved for the new process.
- If new analytic capabilities come into widespread use, then the CEC may declare them to be required software capabilities and may require all software vendors to update their programs and submit them for reapproval.

When reapproval is necessary, the CEC will notify all software vendors of the timetable for renewal, a new version of this manual will be published, and the CEC will provide instructions for reapproval.

Reapproval shall be accompanied by a cover letter explaining the type of amendment(s) requested and copies of other documents, as necessary. The timetable for reapproval of amendments is the same as for full program approval.

### **1.8.2.2 Approval of New Features and Updates**

Changes to previously approved software not affecting the compliance analysis may be approved through a streamlined procedure.

Modifications to previously approved software, including new features and program updates, are subject to the following procedure:

- The software vendor shall prepare an addendum to the compliance supplement or software user's manual when new features or updates affect the outcome or energy efficiency measure choices, describing the change to the software. If the change is a new modeling capability, the addendum shall include instructions for using the new modeling capability for compliance.
- The software vendor shall notify the CEC by letter of the change that has been made to the software. The letter shall describe in detail the nature of the change and the reason it is being made. The notification letter shall be included in the revised compliance supplement or software user's manual.
- The software vendor shall provide the CEC with an updated copy of the software and include any new forms created by the software (or modifications in the standard reports).

The CEC will respond within 45 days. The CEC may approve the change, request additional information, refuse to approve the change, or require that the software vendor make specific changes to either the compliance supplement addendum or the software program itself.

With CEC approval, the vendor may issue new copies of the software with the compliance supplement addendum and notify software users and building officials.

### **1.8.3 Challenges**

Building officials, program users, program vendors, CEC staff, or other interested parties may challenge any nonresidential software approval. If any interested party believes that a compliance program, an algorithm, or method of calculation used in a compliance program, a particular capability, or other aspect of a program provides

inaccurate results or results that do not conform to the criteria described in this manual, the party may challenge the program.

#### **1.8.4 Decertification of Compliance Software Programs**

The CEC may decertify (rescind approval of) an alternative calculation method through the following means:

- All software programs are decertified when the standards undergo substantial changes, which occur about every three years.
- Any software can be decertified by a letter from the software vendor requesting that a particular version (or versions) of the software be decertified. The decertification request shall briefly describe the nature of the program errors or "bugs" that justify the need for decertification.
- Any "initiating party" may begin decertifying any software according to the steps outlined below. The intent is to include a means whereby unfavorable software tests, serious program errors, flawed numeric results, improper forms, and/or incorrect program documentation not discovered in the certification process can be verified and use of the particular software version discontinued. In this process, there is ample opportunity for the CEC, the software vendor, and all interested parties to evaluate any alleged problems with the software program.

NOTE 1: The primary rationale for a challenge is unfavorable software tests, which means that for some particular building design with a set of energy efficiency measures, the software fails to meet the criteria used for testing software programs described in [Chapter 3 Compliance Software Test Requirements](#).

NOTE 2: Another challenge rationale is flawed numeric results, where the software meets the test criteria in [Chapter 3 Compliance Software Test Requirements](#), in particular, when software fails to properly create the standard design building.

Following is a description of the process for challenging software or initiating a decertification procedure:

1. Any party may initiate a review of software approval by sending a written communication to the Executive Director. (The CEC may be the initiating party for this type of review by noticing the availability of the same information listed here.)

The initiating party shall:

- State the name of the software and the program version number(s) that contain the alleged errors.



- Identify concisely the nature of the alleged errors in the software that require review.
  - Explain why the alleged errors are serious enough in the effect on analyzing buildings for compliance to justify a decertification procedure.
  - Include appropriate data on any media compatible with Windows 7 or newer and/or information sufficient to evaluate the alleged errors.
2. The Executive Director shall make a copy or copies of the initial written communication available to the software vendor and interested parties within 30 days.
  3. Within 75 days of receipt of the written communication, the Executive Director may request any additional information needed to evaluate the alleged software errors from the party who initiated the decertification review. If the additional information is incomplete, this procedure will be delayed until the initiating party submits complete information.
  4. Within 75 days of receipt of the initial written communication, the Executive Director may convene a workshop to gather additional information from the initiating party, the software vendor, and interested parties. All parties will have 15 days after the workshop to submit additional information regarding the alleged program errors.
  5. Within 90 days after the Executive Director receives the application or within 30 days after receipt of complete additional information requested of the initiating party, whichever is later, the Executive Director shall either:
    - Determine that the software need not be decertified.
    - Submit to the CEC a written recommendation that the software be decertified.
  6. The initial written communication, all relevant written materials, and the Executive Director's recommendation shall be placed on the consent calendar and considered at the next business meeting after submission of the recommendation. The matter may be removed from the consent calendar at the request of one of the Commissioners.
  7. If the CEC approves the software decertification, it shall take effect 60 days later. During the first 30 days of the 60-day period, the Executive Director shall send out a notice to building officials and interested parties announcing the decertification.

All initiating parties have the burden of proof to establish that the review of alleged software errors should be granted. The decertification process may be terminated at any time by mutual written consent of the initiating party and the Executive Director.

As a practical matter, the software vendor may use the 180- to 210-day period outlined here to update the software program, get it reapproved by the CEC, and release a revised version that does not have the problems initially brought to the attention of the CEC. The software vendor may wish to be the initiating party to ensure that a faulty program version is taken off the market.

---

## **1.9 Vendor Requirements**

Each vendor shall meet all of the following requirements as part of the software approval and as part of an ongoing commitment to users of the particular program.

### **1.9.1 Availability to California Energy Commission**

All software vendors are required to submit at least one fully working program version of the software to the CEC. An updated copy or access to the approved version of the software shall be kept by the CEC to maintain approval for compliance use of the software.

The CEC agrees not to duplicate the software except for analyzing it, for verifying building compliance with the compliance software, or for verifying that only approved versions of the software are used for compliance.

### **1.9.2 Enforcement Agency Support**

Software vendors shall provide a copy of the software user's manual/help system to all enforcement agencies who request one in writing.

### **1.9.3 User Support**

Software vendors shall offer support to their users with regard to the use of the software for compliance purposes. Vendors may charge a fee for user support.

### **1.9.4 Compliance Software Vendor Demonstration**

The CEC may request that software vendors offer a live demonstration of the capabilities of their software. One or more demonstrations may be requested before approval is granted.

## 2. General Modeling Procedures

---

### 2.1 General Requirements for User-Entered Data

#### 2.1.1 General

This document lists the building descriptors that are used in the compliance simulation. Users must provide valid data for all descriptors that do not have defaults specified and that apply to parts of the building that must be modeled.

#### 2.1.2 Building Envelope Descriptions

The user shall provide accurate descriptions for all building envelope assemblies including exterior walls, windows, doors, roofs, exterior floors, slab-on-grade floors, below-grade walls, and below-grade floors. The user shall provide data for all of the required descriptors listed in [Chapter 5.5 Building Envelope Data](#) that correspond with these assemblies. However, the following exception applies:

- Exterior surfaces with an azimuth orientation and tilt differing by no more than 45° that is otherwise the same, may be described as a single surface or described as using multipliers. This specification would permit a circular form to be described as an octagon.

#### 2.1.3 Space Use Classification

The user must designate space use classifications that best match the uses for which the building or spaces are designed. Space use classifications determine the default occupant density, occupant activity level, receptacle power, service water heating, lighting load, daylighting setpoints, and operating schedules used in the analysis. Process loads and refrigeration loads are also provided for applicable space types. Each space use classification must be associated with a ventilation space function which sets the outdoor ventilation requirement for the space. The user must choose a ventilation space function from one or more options depending on the space function.

The user must specify the space use classifications using the area category method. The area category method uses the area categories in the standard design, which were developed for lighting requirements. The area category method requires area category entry of floor area and space use designations. More than one building area category may be used if the building is a mixed-use facility.

The user may override the default assumptions for some building descriptors dependent on the space use classification with supporting documentation. Details are provided in [Chapter 5.4 Space Uses](#) of this manual.

### **2.1.4 Treatment of Descriptors Not Fully Addressed by This Document**

This document provides input and rating rules covering a full range of energy-related features encountered in commercial buildings. However, this goal is unlikely to ever be achieved due to the large number of features that must be covered, and the continuous evolution of building materials and technologies. Building features or systems not covered in this manual must apply for approval via the exceptional calculation method to the CEC. This manual may be amended with provisions to model additional features or HVAC systems during the code cycle. When this occurs, it is the responsibility of the software vendor to pass the necessary acceptance tests and apply for approval for the new building feature(s).

---

## **2.2 Thermal Zones, HVAC Zones, and Space Functions**

### **2.2.1 Definitions**

An *HVAC zone* is a physical space within the building that has a thermostat and zonal system for maintaining thermal comfort. HVAC zones are identified on the HVAC plans. HVAC zones should not be split between thermal zones; however, a thermal zone may include more than one HVAC zone.

A *space function* is a subcomponent of a thermal zone that has specific standard design lighting requirements and for which there are associated defaults for occupancy, receptacle loads, and hot water consumption. Space functions are associated with ventilation space functions which set outdoor air ventilation requirements documented in the ACM appendices. An HVAC zone may contain more than one space function. Appendix 5.4A lists the space functions that may be used with the software. Daylit areas should be assigned to specific spaces, even if they have the same classification from Appendix 5.4A, so that lighting reductions due to daylighting can be determined at the appropriate resolution.

**Figure 1: Hierarchy of Space Functions, HVAC Zones, and Thermal Zones**

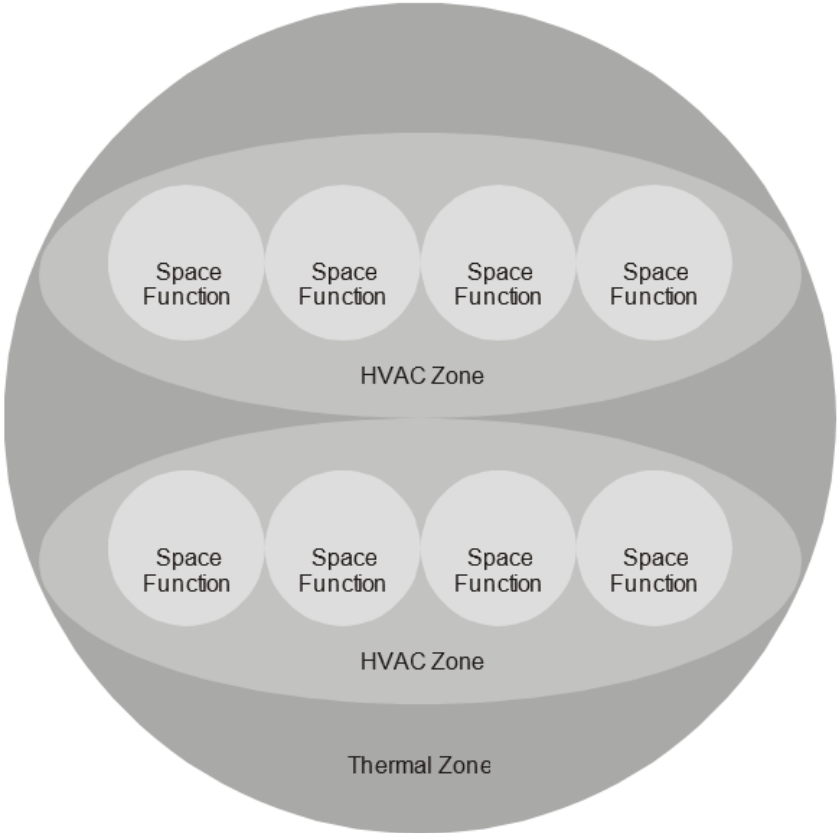

Source: NORESO for California Energy Commission

## **2.3 Software Modeling Requirements for Zones**

### **2.3.1 Required Zone Modeling Capabilities**

For California compliance, software shall accept input for and be capable of modeling a minimum of 50 thermal zones, each with a control. Compliance software may use zone multipliers for identical zones.

### **2.3.2 Modeling Requirements for Unconditioned Spaces**

Unconditioned space is enclosed space that is neither directly nor indirectly conditioned. Examples include stairways, warehouses, unoccupied adjacent tenant spaces, attached sunspaces, attics, and crawl spaces.

Unconditioned spaces shall be modeled if they are part of the permitted space. All applicable envelope information shall be specified in a similar manner to conditioned space.

If unconditioned space is not a part of the permitted space, the space may be either explicitly modeled or the impact thereof on the permitted space may be approximated by modeling the space as outdoor space. For unconditioned spaces that are explicitly modeled, all internal gains and operational loads (occupants, water heating, receptacle, lighting, and process loads) shall be modeled as specified in Appendix 5.4A.

Return air plenums are considered indirectly conditioned spaces and shall be modeled as part of the adjacent conditioned space with equipment, lighting, and occupant loads at zero.

Indirectly conditioned spaces can either be occupied or unoccupied. For spaces that are unoccupied, such as plenums, attics, or crawlspaces, lighting, receptacle, and occupant loads shall be zero. For spaces that can be occupied, such as stairwells or storage rooms, modeling assumptions shall be taken from Appendix 5.4A.

Unconditioned spaces may not be located in the same thermal zone as conditioned spaces. Conditioned spaces and indirectly conditioned spaces may be located in the same thermal or in separate zones. When located in the same thermal zone, the indirectly and directly conditioned spaces assumed to have the space temperature schedule. When indirectly conditioned space is assigned to its own thermal zone, the zone cannot have heating/cooling system, but can have a ventilation or exhaust system.

### **2.3.3 Space Use Classification Considerations**

Thermal zones shall be combined only if the spaces have similar space conditioning requirements and operating schedules. Space function inputs, as how they translate to

thermal zone and HVAC system analysis assumptions, are defined by the following rules:

**Schedule Group:** There are many different schedule groups defined in Appendix 5.4B for California compliance. Each schedule group defines building-specific hourly profiles for thermostat setpoints, HVAC system availability, occupancy, lighting, receptacles, service hot water, gas equipment, infiltration, refrigeration elevators, and escalators.

**Space Functions:** Each building space is assigned one space function. Design internal loads and other space function input assumptions, including the assigned schedule group described above, are defined in Appendix 5.4A. The schedule group and the schedule values for each space function are prescribed for compliance analysis.

These space functions are common to many different building types and, therefore, the user can assign any of the available schedule groups defined in Appendix 5.4B. This addresses the issue of conflicting schedule profiles if these common functions are combined into a single thermal zone or served by the same HVAC system as surrounding zones. In the event the user does not assign a schedule group to these common space types, default assumptions are defined in the Appendix 5.4B.

**Thermal Zones:** Spaces can be combined into thermal zones. In this situation, peak internal loads and other design inputs for the thermal zone are determined by weight-averaging the space function design inputs by floor area. When spaces are combined into thermal zones, the thermal zone schedules (occupancy, HVAC schedule, lighting schedule, space setpoint schedule), are based on the schedule group of the predominant space function on the building floor (by floor area) included in the thermal zone.

**HVAC Systems:** In many cases, more than one conditioned thermal zone is served by an HVAC system, which has scheduled availability (ON or OFF) to address the occupancy and internal load patterns of the thermal zones it serves. For systems that serve more than one thermal zone, the HVAC schedule group and availability schedule are determined by the most predominant schedule group (by floor area) represented in the thermal zones served.

The schedule group in the standard design is defined for each building story according to the predominant space function type and the schedule group assignment in Appendix 5.4A. Residential spaces and covered process spaces shall be served by dedicated systems, separate from nonresidential spaces.

---

## 2.4 Unmet Load Hours

This manual uses the term “unmet load hours” (UMLH) as a criterion for sizing standard design equipment and for other purposes. The concept of unmet load hours applies to thermal zones but is summed for hours whenever any conditioned thermal zone in the building has unmet loads. For a thermal zone, it represents the number of hours during a year when the HVAC system serving the thermal zone is unable to maintain the setpoint temperatures for heating and/or cooling. During periods of unmet loads, the space temperature drifts above the cooling setpoint or below the heating setpoint. A thermal zone is considered to have UMLH if the space is outside the throttling range for heating or cooling. The throttling range is defined in [Chapter 5.6.1 Space Temperature Control](#) as the space temperature difference between no cooling and full cooling, or between no heating and full heating. It is assumed that the cooling and heating setpoints are “centered” on the throttling range so that a cooling setpoint of 75°F results in an acceptable temperature band of 74°F to 76°F. The throttling range is fixed at 2°F for simulating both the standard design and proposed design.

An UMLH can occur only during periods when the HVAC system is scheduled to operate. UMLH are accounted for in each zone of the building. No zone in the building should exceed the maximum allowed UMLH.

UMLH can occur because fans, air flows, coils, furnaces, air conditioners, or other equipment are undersized. UMLH can also occur due to user errors, including mismatches between the thermostat setpoint schedules and HVAC operating schedules or from other input errors, for instance, high internal gains or occupant loads. The term, as used in this manual, addresses only equipment that is undersized. It is the responsibility of the user to address other causes of UMLH in the proposed design.

UMLH apply to thermal zones that contain any space type that is normally occupied. Thermal zones that contain only the space types listed below will not have UMLH applied to them:

- Commercial and industrial storage areas
- Corridors, restrooms, stairs, and support areas
- Electrical, mechanical, telephone rooms
- Laundry rooms
- Locker/dressing rooms
- Parking garage areas
- Unoccupied gross floor areas



- Spaces that are not subject to any UMLH checks or restrictions are listed in Appendix 5.4A.

## 2.5 Calculation Procedures

The general calculation procedure is illustrated below in Figure 2: Calculation Process for Title 24 Compliance. The proposed design *TDV* energy, Efficiency *TDV*, and source energy use is compared to the standard design and must be equal to and less than the standard design for the project to comply through the performance method.

**Figure 2: Calculation Process for Title 24 Compliance**

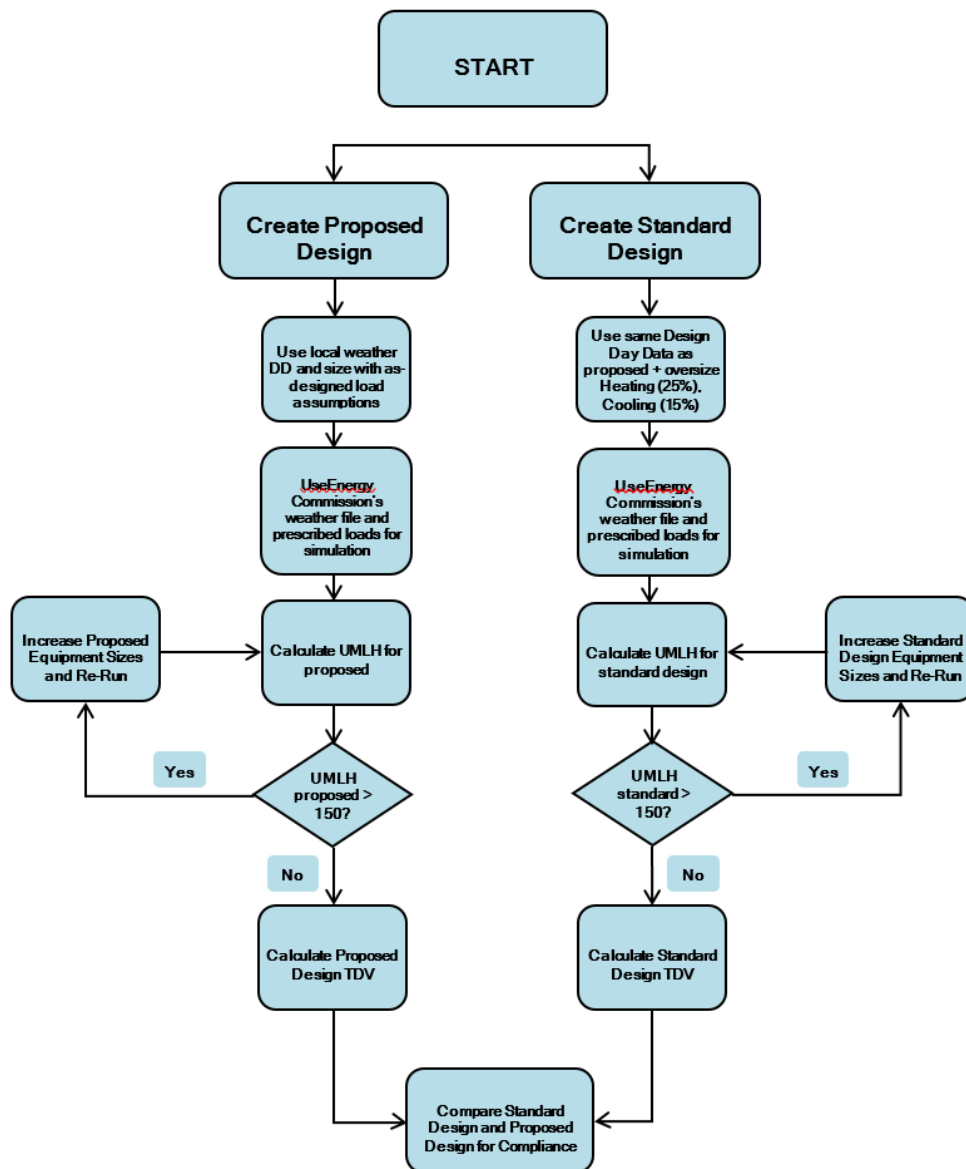

Source: NORESCO for California Energy Commission

1. The process begins with a detailed description of the proposed design. Information is provided in enough detail to enable an estimate of annual energy use for a typical weather year. This information includes the building envelope, lighting systems, HVAC systems, water heating systems, and other important energy-using systems. This collection of information is referred to in this manual as building descriptors. Details on the building descriptors are provided in Chapter 5 Nonresidential Building Descriptors Reference and Chapter 6 Multifamily Building Descriptors Reference.
2. Before the calculations are performed, some of the building descriptors are modified for the proposed design to incorporate prescribed modeling assumptions. Prescribed modeling assumptions include occupant density, equipment power density, ventilation rates, and water heating loads.
3. The next step is to make a simulation of the proposed design to determine how well the heating and cooling loads are being satisfied. The indicator is UMLH, the number of occupied hours during the year when the space temperature in one or more thermal zones is outside the throttling range. A large number of hours indicate that the equipment is undersized.
4. Test the number of UMLH in the proposed design and proceed only if the hours for each zone in the building are less than or equal to 150 for the year.
5. If the UMLH are greater than 150 for the year, a warning will be presented after the simulation is complete and the compliance report will be watermarked as not usable for compliance. No zone, other than the irregularly occupied space types listed above, may exceed 150 UMLH. If the problem is heating, then the size of the boiler or furnace may need to be increased. If the problem is cooling, then the size of the coils or chillers may need to be increased, or users can add a phantom cooling system by checking a box in the thermal zone "Add Cooling System to Meet Load". In some cases, adjusting the zone airflows may also solve the UMLH issue. It is up to the designer to adjust equipment sizes as necessary.
6. If the UMLH are fewer than or equal to 150, then the final simulation is performed. If no changes are made in the model, this may be the same simulation in step 3. These calculations produce the results that are compared to the standard design, which is calculated in steps 7 through 16.
7. Create the standard design following the rules in this manual. The standard design has the same floor area, number of floors, and spatial configuration as the proposed design; however, systems and components are modified to be in minimum compliance with the standard design. The HVAC systems for the

standard design are established according to rules in this manual and depend on the primary building activity (residential or nonresidential), the floor area, and the number of stories. See Chapter 5.1 Overview.

8. Sizing calculations are performed for the standard design and heating equipment is oversized by 25 percent and cooling equipment by 15 percent.
9. The number of unmet UMLH for the standard design is then tested to see if they are greater than 150 for any zone(s). This is not likely since the heating and cooling equipment is oversized by 15 percent for cooling, and 25 percent for heating in step 8.
10. If the UMLH in the standard design are greater than 150, then equipment capacity in the standard design is increased so that the unmet hours are fewer than or equal to 150. See the discussion below on how equipment sizes are increased.
11. Once the tests on UMLH are satisfied, then the energy consumption of the standard design is calculated. If the tests on unmet hours are satisfied the first time through, this step is the same as step 9.
12. Finally, the proposed design Total TDV energy, Efficiency TDV, and source energy use and standard design Total TDV energy, Efficiency TDV, and source energy use are compared for compliance.

---

## **2.6 HVAC Capacity Requirements and Sizing**

To ensure that the simulated space-conditioning loads are adequately met, adequate capacity must be available in each of the components of the HVAC system; for example, supply-air flow rates, cooling coils, chillers, and cooling towers. If any component of the system is incapable of adequate performance, the simulation may understate the required energy inputs for space conditioning and report unmet load hours. Adequate capacities are required in the simulations of both the proposed design and standard design. The subchapters below describe the procedures that shall be followed to ensure that both versions of the design are simulated with adequate space-conditioning capacities.

The UMLH requirement may be updated to prevent HVAC systems that show as undersized according to compliance software modeling constraints from receiving a compliance credit. This does not mandate that a specific cooling or heating capacity be specified; that is the role of the engineer of record for the building. With this change, if the proposed design appears as undersized, the user will be prompted to adjust plant, system, and/or zonal capacities as needed to meet the UMLH criteria.

The special case of a building designed with no cooling system (typically, in a temperate coastal climate) is accommodated by the compliance software automatically adding a minimally compliant packaged constant volume single zone system.

### **2.6.1 Specifying HVAC Capacities for the Proposed Design**

As shown in Figure 2: Calculation Process for Title 24 Compliance, the proposed design shall have no more than 150 UMLH for any thermal zone. If this limit is exceeded, the software allows the user to make changes to the proposed design building description to bring the UMLH equal to or below 150. This process is not automated by the software. There are two tests that must be met to avoid excess UMLH:

- Space loads must be satisfied. Space temperatures in all thermal zones must be maintained within one-half of the throttling range (1°F with a 2°F throttling range) of the scheduled heating or cooling thermostat setpoints. This criterion may be exceeded for no more than 150 hours for a typical year.
- System loads must be satisfied. Plant equipment must have adequate capacity to satisfy the HVAC system loads. This criterion may be exceeded for no more than 150 hours for a typical year.

If either the space or system loads do not meet the above criteria, the user should indicate the condition on the forms to add necessary equipment capacity to the proposed design. If the space conditioning criteria are not met because the HVAC equipment in the proposed design lacks the capability to provide either heating or cooling, equipment capable of providing the needed space conditioning must be specified by the user.

Equipment sizes for the proposed design shall be entered into the model by the energy analyst and shall agree with the equipment sizes specified in the construction documents. When the simulations of these actual systems indicate that specified space conditions are not being adequately maintained in one or more thermal zone(s), the user shall be prompted to make changes to equipment sizes or zones as necessary. This occurs when the UMLH exceed 150 for the year. The use of equipment sizes that do not match the actual equipment sizes as indicated on construction documents triggers an exceptional condition that is noted on the compliance forms.

### **2.6.2 Sizing Equipment in the Standard Design**

For sizing heating and cooling equipment capacities, the compliance software shall use design day schedules as specified in [Chapter 5.2 Project Data](#). For cooling capacity sizing, compliance software shall use the OnDay schedule from Appendix 5.4B for occupant, lighting, and equipment schedules, respectively. For heating capacity sizing,

compliance software shall use the OffDay schedule from Appendix 5.4B for occupant, lighting, and equipment schedules, respectively.

Equipment in the standard design is automatically oversized by the program (25 percent for heating and 15 percent for cooling). If the automatic oversizing percentage is not sufficient to meet demands, then UMLH are evaluated at the building level by looking at the UMLH for each of the thermal zones being modeled. The zone with the greatest number of UMLH shall not exceed 150.

If the total number of UMLH for cooling and/or heating exceeds 150, then equipment capacities of cooling and/or heating equipment must be increased by the software incrementally.

1. The first step is to determine whether heating or cooling UMLH are the bigger problem. If heating UMLH are the bigger problem, upsize the heating equipment capacity. If cooling UMLH is the problem, upsize the cooling equipment capacity.
2. If the cooling is undersized, the equipment is resized by first increasing the design airflow of all zones with significant UMLH (greater than 150 for a zone) by 10 percent, then the equipment capacity for the system(s) serving the affected zones is increased to handle the increased zone loads. For a central plant, the chiller(s) and towers are resized proportionally to handle the increased system loads.

If heating is undersized, the same procedure is followed with zone terminal units resized first, heating equipment second, and finally boilers as necessary.

The capacity of the boiler or furnace shall be increased in 5 percent increments and the simulation rerun until the loads are met. For heat pumps, the capacity of the coil is increased so that the additional load is not met by auxiliary heat.

### **2.6.3 Handling Proposed Design with No HVAC Equipment**

If a compliance model does not contain an HVAC system, the compliance software will generate an error and not run the simulation. For zones not designed for cooling or in cases where the design may provide insufficient cooling, the user can select "Add cooling system to meet load" and the software will automatically generate a minimally compliant single zone HVAC system to meet the cooling loads for the zone. The compliance software shall make an appropriate note on compliance documentation indicating that the modeled HVAC system does not match design requirements. If the compliance software provides a means for the user to identify that the building has no cooling system, this information is reported on the compliance reports.

---

## **2.7 Ventilation Requirements**

Design decisions regarding outside air ventilation shall be based on §120.1 of the standards. If local codes do not apply, minimum values from Appendix 5.4A shall be used. [Chapter 5.6 HVAC Zone Level Systems](#) of the ACM has additional information on the ventilation requirements used in the building descriptors for the proposed and standard design. While no compliance credit can be claimed for reducing ventilation rates in the proposed design below the required levels, the user can specify higher ventilation rates in the proposed design.

## 3. Compliance Software Test Requirements

This chapter contains the procedures used to test and certify vendor's compliance software as acceptable for compliance with Title 24, Part 6. Compliance software must also follow all modeling rules specified in [Chapter 5 Building Descriptors Reference](#). The tests used to verify software functionality and accuracy of simulation results are referred to as the reference method. The tests fall into the following categories:

- Tests to verify that the software is evaluating thermal loads and the response of the HVAC systems to these loads in an acceptable manner. These tests reference *ASHRAE Standard 140-2007, Standard Method of Test for Evaluation of Building Energy Analysis Computer Programs*.
- Tests that verify that compliance software is capable of modeling envelope, lighting, HVAC, and water heating efficiency features and provides precise estimates of energy tradeoffs and reasonably accurate predictions of building energy consumption.
- Tests to verify that the standard design building is created correctly. For example, the standard design HVAC system is properly specified, other components of the standard design are correctly defined, and rules that fix and restrict inputs (such as schedules and plug loads) are properly applied. These tests do not verify simulation outputs but may require simulations to be run to specify inputs that depend on system sizing.
- The reference method is designed to cover representative software functionality for building envelope, space uses, lighting, daylighting, HVAC, and water heating, both for simulation performance and for proper implementation of ACM rules specified in Chapter 5 Building Descriptors Reference. The CEC reserves the right to add ruleset implementation tests or software sensitivity tests to verify existing or future compliance software requirements. Moreover, the CEC reserves the right to adjust the passing criteria for the software sensitivity tests to reflect the capabilities of commonly available energy simulation programs.

---

### 3.1 General Requirements

#### 3.1.1 Scope

The compliance software must satisfy the requirements contained in this chapter.

The compliance software shall be capable of modeling at least 50 thermal zones.

The compliance software shall be capable of modeling at least 15 HVAC systems.

### **3.1.2 Calculation Methods**

The compliance software shall calculate the annual consumption of all end uses in buildings, including fuel and electricity for:

- HVAC (heating, cooling, fans, and ventilation).
- Lighting (both interior and exterior).
- Receptacles and miscellaneous electric.
- Service water heating.
- Process energy uses.
- All other energy end uses that typically pass through the building meter.

The compliance software shall perform a simulation on an hourly time interval (at a minimum) over a one-year period (8,760 hours) with the ability to model changes in weather parameters, schedules, and other parameters for each hour of the year. This is achieved by specifying a 24-hour schedule for each day of the week plus holidays.

#### **3.1.2.1 Calculating Design Loads**

The software shall be capable of performing design load calculations for determining required HVAC equipment capacities and air and water flow rates using accepted industry calculation methods for the standard design.

#### **3.1.2.2 Checking Simulation Output for Unmet Loads**

The software shall be capable of checking the output of the energy analysis module for the proposed design to ensure that space conditions are maintained within the tolerances specified (maximum of 150 thermal zone UMLH per year).

#### **3.1.2.3 Adjusting Capacities**

For the standard design building, the software shall be capable of modifying capacities, temperatures, or flow rates for standard design building HVAC system components causing excessive UMLH according to the procedures in [Chapter 2 General Modeling Procedures](#).

#### **3.1.2.4 Error Handling**

The software shall send a warning to the user when unmet loads exceed 150 hours and provide information to the user describing the error that has occurred.



### **3.1.3 Climate Data**

The compliance software shall perform simulations using the official CEC weather files and design conditions documented in Reference Appendix JA2.

The compliance software shall calculate solar radiation on exterior surfaces on an hourly basis from the values of direct normal irradiance and diffuse horizontal irradiance contained in the climate data, taking ground reflectance into account.

The rating software shall be capable of simulating time-of-use rates and apply both demand and energy charges for each time period of the rate schedule.

### **3.1.5 Time Dependent Valued (TDV) Energy**

The compliance software shall be capable of applying the CEC TDV multipliers for each hour of the simulation. See CEC Reference Appendix JA3.

### **3.1.6 Source Energy**

The compliance software shall be capable calculating source energy for each hour of the simulation as described in Chapter 1.6.5.

### **3.1.7 Thermal Mass**

The calculation procedures used in the compliance software shall account for the effect of thermal mass on loads due to occupants, lights, solar radiation, and transmission through building envelope on the amount of heating and cooling required to maintain the specified space temperature schedules and on variation in space temperature.

### **3.1.8 Modeling Space Temperature**

The compliance software shall incorporate a dynamic simulation of space temperature that accounts for:

- Dynamics in change in heating and cooling setpoint temperatures.
- Deadband between heating and cooling thermostat settings.
- Temperature drift in transition to setback or setup thermostat schedules.
- Temperature drift in periods when heating or cooling capability are scheduled off.
- Temperature drift when heating or cooling capability of the system is limited by heating or cooling capacity, air flow rate, or scheduled supply air temperature.
- Indirectly conditioned thermal zones, where the temperature is determined by internal loads, heat transfer through building envelope, and heat transfer between thermal zones.

### **3.1.9 Heat Transfer Between Thermal Zones**

The compliance software shall be capable of modeling heat transfer between a thermal zone and adjacent thermal zones.

The compliance software shall account for the effect of this heat transfer on the space temperature, space conditioning loads, and resulting energy use in the thermal zone and in adjacent thermal zones.

### **3.1.10 Control and Operating Schedules**

The compliance software shall be capable of modeling control and operating schedules that can vary by:

- The hour of the day.
- The day of the week.
- Holidays, which are treated as a special day of the week.

The compliance software shall be capable of explicitly modeling all of the schedules specified in Appendix 5.4B of this manual.

#### **3.1.10.1 Loads Calculation**

The load calculations described in this chapter relate to the simulation engine, and not to the procedure used by the design engineer to size and select equipment.

#### **3.1.10.2 Internal Loads**

The compliance software shall be capable of calculating the hourly cooling loads due to occupants, lights, receptacles, and process loads.

The calculation of internal loads shall account for the dynamic effects of thermal mass.

The compliance software shall be capable of simulating schedules for internal loads in the form given in Appendix 5.4B.

The simulation of cooling load due to lights shall account for:

- The effect of the proportion of radiant and convective heat, which depends on the type of light and on the dynamic response characteristic.
- A portion of heat from lights going directly to return air; the amount depends on the type and location of fixture.

#### **3.1.10.3 Building Envelope Loads**

The compliance software shall calculate heat transfer through walls, roofs, and floors for each thermal zone, accounting for the dynamic response due to thermal

characteristics of the particular construction as defined in [Chapter 5 Building Descriptors Reference](#).

The calculation of heat transfer through walls and roofs shall account for the effect of solar radiation absorbed on the exterior surface, which depends on orientation and absorptance of the surface.

The compliance software shall calculate heat transfer through windows and skylights, accounting for both temperature difference and transmission of solar radiation through the glazing.

Calculation of cooling load due to transmission of solar radiation through windows and skylights shall account for:

- The variation of thermal properties of the fenestration system with ambient temperature.
- Orientation (azimuth and tilt of surface).
- The effect of shading from overhangs, side fins, or exterior horizontal slats.

#### **3.1.10.4 Infiltration**

The compliance software shall be capable of simulating infiltration that varies by the time of day and day of the week. Schedules are provided in Appendix 5.4B.

### **3.1.11 Systems Simulation**

#### **3.1.11.1 General**

The compliance software shall be capable of modeling:

- The standard design building systems defined in Chapter 5 Building Descriptors Reference.
- The lighting, water heating, HVAC, and miscellaneous equipment detailed in Chapter 5 Building Descriptors Reference.
- All compulsory and required features, as detailed in Chapter 5 Building Descriptors Reference.

The capability to model multiple zone systems shall allow at least 15 thermal zones to be served by one multiple-zone system.

The compliance software shall be capable of modeling plenum air return.

### **3.1.11.2 HVAC Zone Level Systems**

The compliance software shall be capable of simulating the effect on space temperature and energy use of:

- Limited capacity of terminal heating devices.
- Limited capacity of terminal cooling devices.
- Limited rate of air flow to thermal zones.

### **3.1.11.3 HVAC Secondary Systems and Equipment**

The compliance software shall be capable of simulating the effect on energy use and space temperature in thermal zones served by the HVAC system of:

- Limited heating capacity.
- Limited cooling capacity.

The simulation of HVAC systems shall account for:

- Temperature rise of supply air due to heat from supply fan, depending on the location of the fan.
- Temperature rise of return air due to heat from return fan.
- Temperature rise of return air due to heat from lights to return air stream.
- Fan power as a function of supply air flow in variable air volume systems.

### **3.1.11.4 HVAC Primary Systems and Equipment**

The compliance software shall be capable of simulating the effect on energy use of limited heating or cooling capacity of the central plant system.

If the compliance software is not capable of simulating the effect of limited heating or cooling capacity of the central plant system on space temperature in affected thermal zones, then it shall issue a warning message when loads on the central plant system are not met.

### **3.1.11.5 Equipment Performance Curves**

The compliance software shall be capable of modeling the part-load efficiency and variation in capacity of equipment as follows:

- Furnace efficiency as a function of part load.
- Boiler efficiency as a function of part load, supply hot water temperature, and return hot water temperature.

- Water-cooled compressors, including heat pumps and chillers, efficiencies as a function of part load, evaporator fluid, or air temperature and condensing fluid temperature.
- Air-cooled compressors, including heat pumps, direct expansion cooling and chillers, efficiencies as a function of part load, ambient dry-bulb temperature, and wet-bulb temperature returning to the cooling coil.
- Evaporative cooling system efficiency as a function of ambient wet-bulb temperature.
- Cooling tower efficiency as a function of range and ambient wet-bulb temperature.

### **3.1.11.6 Economizer Control**

The compliance software shall be capable of modeling integrated air- and water-side economizers.

---

## **3.2 Special Documentation and Reporting Requirements**

### **3.2.1 Building Envelope**

#### **3.2.1.1 Roof Radiative Properties**

The user shall enter three-year aged roof reflectance and emittance for roofs that have been certified by the Cool Roof Rating Council. The software shall report the product identification number(s) of any roofing products used on the building, so that aged reflectance and emittance can be verified by the code official.

### **3.2.2 Interior Lighting**

#### **3.2.2.1 Regulated Interior Lighting Power**

Complete lighting plans and space plans are required for the tailored method. Prescriptive compliance forms for the tailored method shall be developed and the plans examiner shall verify them.

Whenever any of the additional lighting power allowance for qualified lighting systems (the two rightmost columns in standards Table 140.6-C) are claimed, the compliance software shall indicate on the compliance forms that verification is required.

#### **3.2.2.2 Indoor Lighting Power (see [Chapter 5.4.4 Interior Lighting](#))**

Compliance software shall print all applicable lighting forms and report the lighting energy use and the lighting level (watts/ft<sup>2</sup>) for the entire project. Compliance software

shall report "no lighting installed" for nonresidential spaces with no installed lighting. Compliance software shall report "default residential lighting" for housing units of multifamily residential buildings and hotel/motel guest rooms.

If the modeled lighting power density (LPD) is different than the actual LPD calculated from the fixture schedule for the building, the compliance software shall model the larger of the two values for sizing the mechanical systems and for the compliance run. Compliance software shall report the larger value on PRF-01. Lighting levels schedules shall be adjusted by any lighting control credit watts if input by the user.

Lighting power is not modeled in unconditioned spaces that are modeled but lighting in those spaces is required to meet the prescriptive requirements for regulated unconditioned spaces, such as commercial and industrial storage spaces, and parking garages. When these types of spaces are entered, the compliance software must report in the Special Features section that these spaces must comply with the prescriptive requirements for such spaces.

### **3.2.2.3 Design Illumination Setpoint**

Spaces that have low design illuminance levels, below the ranges specified in Appendix 5.4A, shall provide documentation showing the design illuminance to be used as the daylight illumination setpoint.

## **3.2.3 HVAC Exceptional Conditions**

### **3.2.3.1 Equipment Sizing**

When any proposed equipment size for secondary equipment or central plant equipment does not match the equipment, size listed on construction documents, an exceptional condition shall be reported on compliance forms.

### **3.2.3.2 Process and Filtration Pressure Drop Allowance**

Any nonzero value entered for supply fan process and filtration pressure drop are flagged as an exceptional condition in the compliance documentation.

### **3.2.3.3 Natural Ventilation Specified**

When natural ventilation is specified by the user for the proposed design for Hotel/Motel dwelling units, the software shall report an exceptional condition that the conditions in §120.1(c) of the standards must be met. When natural ventilation is specified for common use area in multifamily buildings, the software shall report an exceptional condition that the conditions in §160.2(c) of the standards must be met.

### **3.3 ASHRAE Standard 140-2007 Tests**

This method of testing is provided for analyzing and diagnosing building energy simulation software using software-to-software and software-to-quasi-analytical-solution comparisons. The method allows different building energy simulation programs, representing different degrees of modeling complexity, to be tested by comparing the predictions from other building energy programs to the simulation results provided by the compliance software in question.

Compliance software must publish the results of ASHRAE 140-2014 tests, but these tests are not part of the reference method.

---

### **3.4 Ruleset Implementation Tests**

#### **3.4.1 Introduction**

The tests in this chapter are intended to verify that the software correctly constructs the standard design model and applies rules of the Nonresidential ACM appropriately to the proposed and standard design models. The ruleset implementation tests cover representative portions of the rules for building envelope, lighting, daylighting, space use data, and HVAC. For each test, a set of three models is defined:

- User Model – The user model contains the user inputs for the as-designed building. In most cases, the values for the proposed design will be taken from user inputs with no modification. However, there are some cases where the building input is prescribed for the proposed design or constrained by mandatory minimums or other rules.
- Proposed Design Model – The proposed model is defined by the rules in the *Nonresidential and Multifamily Buildings ACM Reference Manual*, created by the vendor software, and is the building modeled for compliance. This model takes user inputs for building geometry, building envelope, space functions, lighting, and HVAC, and is used in the compliance simulation.
- Standard Design Model – This is the baseline model defined by the *Nonresidential and Multifamily Buildings ACM Reference Manual* modeling rules. It is used to set the energy budget which is the basis for comparison that determines whether a building passes compliance using the performance method.

These tests do not require that simulation outputs be verified, but they do require that simulation input files for the proposed design and standard design are properly constructed according to the rules in the *Nonresidential and Multifamily Buildings ACM*

*Reference Manual*. Some tests require that sizing runs be performed for HVAC inputs with values that are dependent on autosized standard design systems.

### 3.4.2 Overview

The test runs described in this chapter represent the Title 24 Nonresidential ACM code compliance calculation and use the following prototype models: small office building, medium office building, large office building, warehouse building, and small hotel. For further details on the prototype models, refer to [Chapter 3.5 Software Sensitivity Tests](#). Each standard design test case shall be created by modifying the prototype model as described in [Chapter 3.4 Ruleset Implementation Tests](#) of this document. The modified prototype model shall form the proposed case for each test run. The standard design model shall be generated by compliance software as per the rules in the *Nonresidential and Multifamily Buildings ACM Reference Manual*. The standard design and proposed model files for each test case shall then be evaluated to verify that:

- The standard design building envelope constructions are correctly substituted for exterior opaque surfaces and fenestrations.
- The fenestration area in the standard design building is reduced in accordance with the *Nonresidential and Multifamily Buildings ACM Reference Manual*, when the proposed design fenestration area is greater than 40 percent of the exterior wall.
- The skylight area in the standard design building is adjusted in accordance with the *Nonresidential and Multifamily Buildings ACM Reference Manual*, when applicable.
- Default schedules of operation are applied for both the standard design building and the proposed design building.
- The proposed and standard design cases use the same defaults, or tailored inputs, for internal loads as required by the *Nonresidential and Multifamily Buildings ACM Reference Manual*.
- The standard design building lighting system is correctly specified.
- Receptacle loads and process loads are modeled according to the rules in the *Nonresidential and Multifamily Buildings ACM Reference Manual*.
- The standard design building uses the correct system types as prescribed in Table 5: System Descriptions of the *Nonresidential and Multifamily Buildings ACM Reference Manual*.



- An economizer (of the right type) is included in the standard design building, if required.
- The primary and secondary standard design building systems are properly specified and sized.
- Fan inputs are correctly specified for the standard design building.
- Prescribed modeling assumptions are applied for both the standard design building and the proposed design building.
- Conditioned, indirectly conditioned, and unconditioned spaces are modeled.
- Other standard design building specifications and/or modeling assumptions are correctly applied.

As the software developer verifies the various test conditions, the input and output files should be annotated with comments or other methods to demonstrate that the modeling rules specified in the *Nonresidential and Multifamily Buildings ACM Reference Manual* are correctly applied. Software developers should use the spreadsheets included in Appendix 3C to report the results of these tests. These annotated files shall then be submitted to the CEC for further evaluation. Any errors discovered shall be corrected by making modifications to the software, the runs shall be repeated, and the new results shall be annotated for submittal to the CEC.

The standard design tests are labeled using the format:

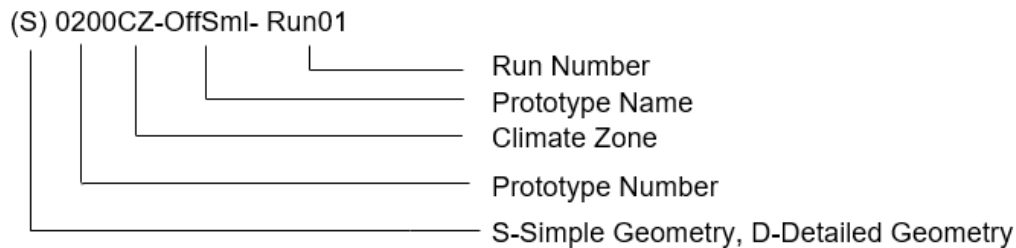

### 3.4.3 Ruleset Implementation Tests

The tests listed in Appendix 3C shall be performed to verify that the compliance software correctly creates the standard design model and applies modeling rules as per the requirements of the *Nonresidential and Multifamily Buildings ACM Reference Manual*.

The characteristics of the user model and inputs to be verified in the proposed and standard design models are described in Appendix 3C.

### 3.4.3.1 Results Comparison

The applicant shall perform all tests specified in [Chapter 3.4 Ruleset Implementation Tests](#) and [Chapter 3.5 Software Sensitivity Tests](#) and report the outputs in the forms provided in Appendix 3C. The standard design for some inputs, such as cooling efficiency and pump power, depend upon the autosizing of the HVAC equipment. The ruleset implementation tests do not check that the autosized capacity matches the reference method but that the standard design input is properly defined in relation to the autosized capacity.

---

## 3.5 Software Sensitivity Tests

This chapter details the eligibility requirements for an applicant simulation program for use as compliance software. A series of quantitative tests called software sensitivity tests shall be performed to measure the change in energy consumption when changing specified input parameters. Applicant software results will be compared against predetermined reference results to demonstrate that the applicant software is acceptable for use in code compliance. All the test cases described in Appendix 3A shall be performed and results summarized in the forms contained in Appendix 3B.

### 3.5.1.1 Overview

The applicant software shall perform a suite of software sensitivity tests to demonstrate that the performance is acceptable for code compliance. The applicant software test results shall be compared against a base case called the reference test case. The reference test case is the corresponding match of a particular test case simulated already on EnergyPlus engine. The reference test case results, as determined by the CEC, are tabulated in Appendix 3B.

Test cases specific for simplified geometry are only for software with 2D inputs for building geometry. Software with a 2D geometry approach shall seek certification by submitting the simplified geometry test cases. In addition, they are also required to produce results for HVAC tests that will be compared against the HVAC reference test results that are common for both simplified and detailed geometry.

The test cases will assess the sensitivity of the applicant software to various inputs ranging from envelope thermal conductance to HVAC system performance. Each case tests the effect of the input component on building end-use energy and annual TDV. The following six building components will be tested through a series of tests:

- Opaque envelope
- Glazing

- Lighting
- Daylighting
- Receptacle loads
- HVAC system parameters

### 3.5.1.2 Prototype Models

The software sensitivity tests are performed on four prototype models that are a subset of the U.S. Department of Energy (DOE) prototype building models developed by PNNL for analysis of ASHRAE Standard 90.1. The prototype models are EnergyPlus model input files of the DOE prototype building models, modified to comply with the requirements of Title 24. The prototype models will be the reference baseline runs for the test cases. The applicant software shall replicate the building models below using the same inputs as the prototype models. The models so replicated will be the applicant baseline models for the test cases.

A summary of the prototype models is provided in Appendix 3A. Detailed input files of the reference baseline models are available from the CEC's Building Energy Efficiency Software Consortium web page at <http://bees.archenergy.com/>.

Prototype models used for software sensitivity test cases are:

#### **SMALL OFFICE (0200CZ-OFFSML):**



The small office building model is a single-story rectangular building of 5,500 square feet. It has punched windows and a hipped roof with an attic. There are five zones, each served by packaged single-zone air conditioner units. For more details refer Appendix 3A. This prototype is used for simple geometry test cases only.

#### **MEDIUM OFFICE BUILDING (0300CZ-OFFMED):**

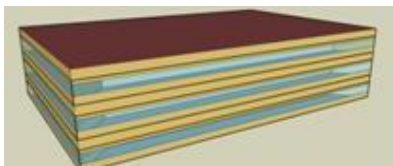

The medium office building model is a three-story rectangular building with an overall area of 53,600 square feet. It has a window-to-wall ratio of 33 percent with

fenestration distributed evenly across all four façades. The zones are served by DX cooling and gas furnace heating with hot water reheat. For more details refer Appendix 3A. This prototype is used for both detailed geometry and simple geometry test cases.

#### **LARGE OFFICE BUILDING (0400CZ-OFFLRG):**

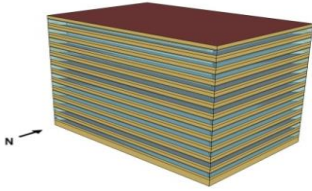

The large office building has 12 floors and a basement floor with glass windows with a window-to-wall ratio of 40 percent on the above-grade walls. The total area of the building is 498,600 square feet. The HVAC system type used is a variable air volume (VAV) system. For more details refer Appendix 3A.

#### **STAND-ALONE RETAIL (0500CZ-RETLMED):**

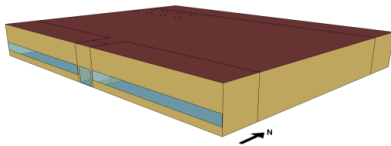

The stand-alone retail building is a single-story rectangular building measuring 178 feet by 139 feet. The total area is 24,695 square feet. Windows are located only on the street-facing façade and occupy 25.4 percent of that façade. The building is divided into five thermal zones that are served by packaged single-zone systems as described in Appendix 3A. This prototype is used for both detailed geometry and simple geometry test cases.

#### **STRIP MALL BUILDING STRIP MALL-PSZ SYSTEM (1000CZ-RETLSTRP):**

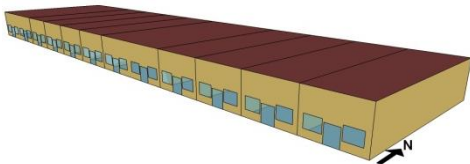

The strip mall building area is 22,500 square feet. It has 10 zones each with rooftop units. The building has windows in the street-facing façade and has an overall window-to-wall ratio of 10.5 percent. For more details refer to Appendix 3A.

### **3.5.1.3 Climate Zones**

The software sensitivity test cases use building models for 5 of the 16 California climate zones. Most tests are performed with two or three climate zones to capture the

sensitivity of the input characteristics to extremes in weather conditions. The test cases are performed in climate zones that represent mild, hot, and cold climates respectively.

**Table 1: Climate Zones Tested**

Climate Zone	Example City/Weather File
1	Arcata/ARCATA_725945
6	Torrance/TORRANCE_722955
7	San Diego Lindbergh/ SAN-DIEGO-LINDBERGH_722900
15	Palm Springs/PALM-SPRINGS-INTL_722868
16	Blue Canyon/BLUE-CANYON_725845

Source: California Energy Commission

**3.5.1.4 Labeling Test Runs**

Each test case in the software sensitivity test is labeled uniquely to make it easier to keep track of the runs and to facilitate analysis. The following scheme is used:

XXYYYYZZ-Prototype-RunDescription

Where:

- XX denotes the Prototype Number
- YY denotes Test Run Number
- ZZ denote Climate zone

Detailed Geometry Example:

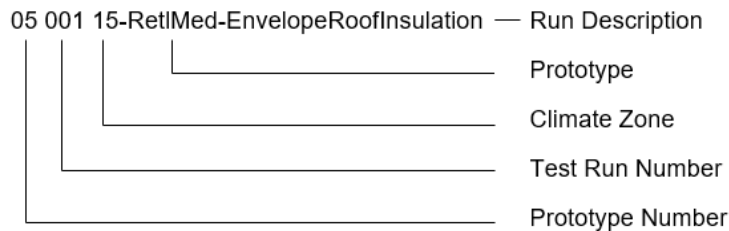

Simplified Geometry Example:

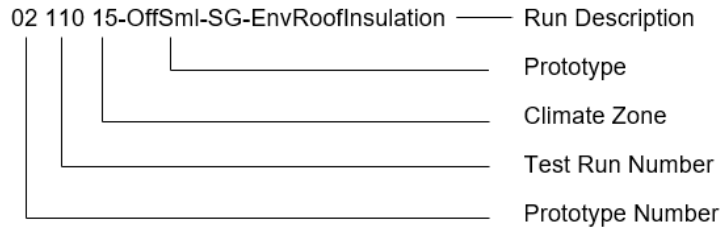

### 3.5.1.5 Test Criteria

Applicant software vendors shall perform a series of computer runs. Each of these runs shall be a systematic variation of the applicant base case model as described in [Chapter 3.5.1.7 Software Sensitivity Test Cases](#). The applicant test case results will be compared to the reference results to verify that applicant software meets the requirements of the *Nonresidential and Multifamily ACM Reference Manual*. Simulation results for each test case will be compiled in forms provided in Appendix 3B. Compiled results will include annual site energy consumption for each end use, overall site energy consumption, total unmet load hours, annual TDV and percent variation of annual TDV, annual Source Energy and percent variation of annual Source Energy, and total end use site energy.

The annual TDV percent variation shall be calculated using the formula:

$$TDV_{\%} = (TDV_b - TDV_n) / TDV_b$$

Where,  $TDV_{\%}$  is the TDV percent variation,

- $TDV_n$  is the annual TDV for test case number n and
- $TDV_b$  is the annual TDV for the base case run.
- The annual Source Energy percent variation shall be calculated using the formula:
  - $Source\ Energy_{\%} = (Source\ Energy_b - Source\ Energy_n) / Source\ Energy_b$
  - $Source\ Energy_{\%}$  is the Source Energy percent variation,
  - $Source\ Energy_n$  is the Source Energy for test case number n and
  - $Source\ Energy_b$  is the Source Energy for the base case run.

To be accepted, the applicant software should fulfill the passing criteria as determined by the CEC:

For each test case the change in energy for the test case must be in the same direction as the Reference Method test case result and must be equal to the Reference Method test case percentage change in TDV energy, plus or minus 0.5 percent of baseline TDV energy.

If any of the tests required for the Title 24 compliance feature set fails to meet these criteria, the applicant software will not be accepted for compliance use.

### **3.5.1.6 Reporting Test Results**

For each test case, the TDV energy use of the modeled building is reported (kBtu/ft<sup>2</sup>), along with the TDV energy use attributed to the major fuel types (electricity, gas), site energy use, and energy end-use intensity for the regulated end uses (cooling, heating, lighting, and so forth). The following energy totals are reported:

1. Annual TDV EUI (kBtu/ft<sup>2</sup>)
2. Annual Source Energy EUI (kBtu/ft<sup>2</sup>)
3. Annual SiteEUI – Electricity (kWh/ft<sup>2</sup>)
4. Annual SiteEUI – Natural Gas (therm/ft<sup>2</sup>)
5. Annual Total End Use Site Energy EUI – kBtu/ft<sup>2</sup>

#### Site Energy End Uses

6. Site Energy: Heating (kBtu/ft<sup>2</sup>)
7. Site Energy: Cooling (kBtu/ft<sup>2</sup>)
8. Site Energy: Interior Lighting (kBtu/ft<sup>2</sup>)
9. Site Energy: Interior Equipment (kBtu/ft<sup>2</sup>)
10. Site Energy: Fans (kBtu/ft<sup>2</sup>) (Airside Fans, does not include tower fans)
11. Site Energy: Pumps (kBtu/ft<sup>2</sup>)
12. Site Energy: Towers (kBtu/ft<sup>2</sup>) Water heating (kBtu/ft<sup>2</sup>)
13. TDV percent Variation – this field is used for the compliance test
14. Total End Use Site Energy percent - percentage change in site energy use
15. Pass/Fail – test fails if it does not meet passing criteria
16. Unmet load hours (UMLH) – defined as the zone with the most UMLH
  - a. Reference Model Occupied UMLH
  - b. Applicant Model Occupied UMLH
  - c. Reference Model Number of Zones with excess UMLH (>150)
  - d. Applicant Model Number of Zones with excess UMLH (>150)

**Figure 3: Results Spreadsheet Excerpt from Appendix 3B**

Version number	Test Case	Variation from Baseline						Pass/Fail
		TDV % variation		Total End Use Site Energy % Variation				
		Reference Model	Applicant Model	Reference Model	Applicant Model			
CBECC-Com 2019.1.2	<b>0300006-OffMed-Baseline</b>							
CBECC-Com 2019.1.2	0318006-OffMed-BotOpWinNoInterlock	0.88%		3.45%		Yes	Yes	Pass
CBECC-Com 2019.1.2	0318106-OffMed-BotMidOpWinNoInterlock	1.73%		7.16%		Yes	Yes	Pass
CBECC-Com 2019.1.2	0318206-OffMed-BotMidTopOpWinNoInterlock	2.68%		11.09%		Yes	Yes	Pass
CBECC-Com 2019.1.2	0318306-OffMed-BotMidOpWinNoInterlockTopInterlock	1.73%		7.16%		Yes	Yes	Pass
CBECC-Com 2019.1.2	<b>0400006-OffLrg-Baserun</b>							
CBECC-Com 2019.1.2	0418406-OffLrg-TES-ChlrPriority	-0.26%		0.94%		No	Yes	Pass
CBECC-Com 2019.1.2	0418506-OffLrg-TES-StoPriority	-3.46%		1.65%		No	Yes	Pass
CBECC-Com 2019.1.2	<b>0400006-OffLrg-Baserun</b>					Yes		
CBECC-Com 2019.1.2	0419006-OffLrg-ActiveBeam	10.29%		15.64%		Yes	Yes	Pass
CBECC-Com 2019.1.2	0419106-OffLrg-PassiveBeam	12.88%		19.19%		Yes	Yes	Fail

Source: NORESCO for California Energy Commission

The results spreadsheet provides the results of the reference method for each test and provides a column (in orange) for the vendor to report the results from the candidate compliance software.

The variation from baseline section of the spreadsheet shows the percentage change in TDV energy use (kBtu/ft<sup>2</sup>) and source energy from the base case for testing. The percentage must be within the passing criteria for the candidate software to pass this test.

Also reported is the number of UMLH during occupied hours for the building. An UMLH for a specific zone in Title 24 compliance is defined as any hour when the zone has an unmet cooling or heating load. This is typically reported by the software for each zone in the building. For the test case results, two unmet load hour metrics must be reported: the number of UMLH for the zone with the greatest number of UMLH, and the number of zones that fail the *Nonresidential and Multifamily ACM Reference Manual* criteria for acceptable UMLH. (Any zones with greater than 150 hours fail the criteria.)

The spreadsheet where the results are documented indicates whether the candidate software passes or fails a test. The result in column AL of the spreadsheet indicates whether the candidate software passes the test.



### **3.5.1.7 Software Sensitivity Test Cases**

Test cases assess the energy impact of one or more of the building or system input characteristics on the baseline model. Each test suite consists of a series of unique test cases aimed to test the effect of a specific characteristic on building energy performance. Simulations are grouped according to test criteria and subgrouped based on the reference model type to allow for direct comparison of results. For each test case, the applicant software will modify the applicant baseline model with specific inputs as described in the test case description chapter.

The test cases are simulated on multiple California weather files to evaluate the sensitivity of the building or system input to extremes in climate. Results of the test case runs and the TDV percentage variation over the baseline run shall be compiled and compared against the reference results.

Detailed descriptions of the standard design models are provided in Appendix 3A. CBECC input files for all baseline and test case models are available from the CEC's, Building Energy Efficiency Software Consortium web page <http://bees.archenergy.com>. Details on each test description can be found in Appendix 3A under the test criteria tab.

### **3.5.1.8 Results Documentation**

The applicant shall perform simulations for all tests specified above. A detailed description of each test case is provided in Appendix 3A, and report results in the forms is provided in Appendix 3B. Some of the prototype models have variants of the baseline model. These include 1) stand-alone duct loss baseline, a variant of the stand-alone retail model; 2) StripMall-PTAC model, a variant of StripMall-PSZ model; and 3) StripMall-Fan Coil model, a variant of StripMall- PSZ model. For details refer to Appendix 3A.

Three test cases are presented here as an example: one for building envelope, one for lighting and daylighting, and one for HVAC. The development of the other required test cases follows the same process.

Example Test Case: 0301315-OffMed-GlazingWindowSHGC

For this test case, the U-factor and solar heat gain coefficient (SHGC) of all vertical fenestration is decreased by 20 percent. The prototype used for this test case is a medium office building.



Before the test cases are run, the first step is to generate the prototype models for the four reference buildings, which are required for all of the tests. The four prototype models are defined in the prototype model spreadsheet of Appendix 3A. (Note: While many of the prototype model inputs are based on Title 24 prescriptive requirements,

the prototype models do not exactly conform to minimum Title 24 requirements but are intended to test the sensitivity of the candidate software simulation results to common variations in building inputs.)

**STEP 1. GENERATE PROTOTYPE MODELS.**

The first step is to generate the prototype building for the medium office building. The detailed specification of the medium office building is listed in Appendix 3A. A portion of the inputs are shown in Figure 4: Prototype Model Definition from Appendix 3A. The prototypes are defined for the reference models on the prototype model tab of Appendix 3A.

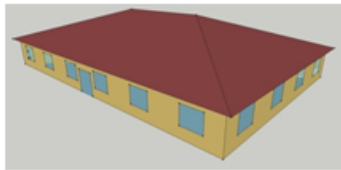
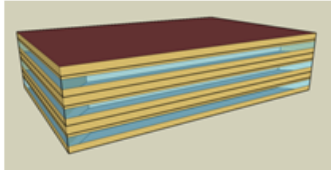
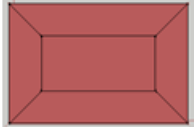
**Figure 4: Prototype Model Definition from Appendix 3A**

Prototype Description	Small Office Building	Medium Office Building
Vintage	New Construction	New Construction
Location	CZ-6/15/16	CZ-3/6/15/16
Fuel Type	gas, electricity	gas, electricity
Total Floor Area (sq feet)	5500 (90.8 ft x 60.5ft)	53600 (163.8 ft x 109.2 ft)
Building shape		
Aspect Ratio	1.5	1.5
Number of Floors	1	3
Window Fraction (Window-to-Wall Ratio)	24.4% for South and 19.8% for the other three orientations (Window Dimensions: 6.0 ft x 5.0 ft punch windows for all façades)	33% (Window Dimensions: 163.8 ft x 4.29 ft on the long side of facade 109.2 ft x 4.29 ft on the short side of the façade)
Window Locations	evenly distributed along four façades	evenly distributed along four façades
Shading Geometry	none	none
Azimuth	non-directional	non-directional
Thermal Zoning	Perimeter zone depth: 16.4 ft. Four perimeter zones, one core zone and an attic zone. Percentages of floor area: Perimeter 70%, Core 30%	Perimeter zone depth: 15 ft. Each floor has four perimeter zones and one core zone. Percentages of floor area: Perimeter 40%, Core 60%
		

Source: NORESO for California Energy Commission

The prototype model definition in the spreadsheet contains links to other input definitions:

Rows 19, 26, 45: Links to layer-by-layer exterior construction assembly definitions in the *Construction Assembly* tab

Row 52: links to layer-by-layer interior construction assembly definitions in the *Construction Assembly* tab

**STEP 2. DEFINE BASE CASE AND VARIATION FOR TEST RUN.**

The base case is defined as the starting point for each test. In many tests, the base case will be one of the prototype models. However, in some cases a variation of the prototype may serve as the base case for the test.

For this test, the base case is found by looking at the test criteria tab of Appendix 3A.

**Figure 5: Base Case Definition from Appendix 3A**

Y4      f <sub>x</sub> Decrease U value & SHGC of windows by 20% compared to baseline case					
	A	U	V	W	X
2	Test Run Name	20CZ06MediumOffice Envelope FloorslabInsulation	21CZ06MediumOffice Envelope Infiltration	22CZ06MediumOffice Glazing WindowU	23CZ06MediumOffice Glazing WindowSHGC
3	Baseline	CZ06MediumOffice	CZ06MediumOffice	CZ06MediumOffice	CZ06MediumOffice
4	Test Description	Change Floor slab F factor to 0.45	Increase Exterior Wall Infiltration by 10% compared to baseline case	Decrease U value of windows by 20% compared to baseline case	Decrease SHGC of windows by 20% compared to baseline case
5	Location	CZ06	CZ06	CZ06	CZ06

Source: NORESCO for California Energy Commission

For this test, the baseline field in row 3 of the *Test Criteria* tab shows that the baseline is *CZ06MediumOffice*, the medium office prototype in Climate Zone 6.

This same *Test Criteria* tab shows the input(s) to be verified, which are highlighted in purple. For this test, the SHGC of all vertical fenestration is reduced by 20 percent, from 0.25 to 0.20.

**Figure 6: Input Parameter Variation for Medium Office from Appendix 3A**

A	U	V	W	X
Test Run Name	20CZ06MediumOffice Envelope FloorslabInsulation	21CZ06MediumOffice Envelope Infiltration	22CZ06MediumOffice Glazing WindowU	23CZ06MediumOffice Glazing WindowSHGC
Baseline	CZ06MediumOffice	CZ06MediumOffice	CZ06MediumOffice	CZ06MediumOffice
Test Description	Change Floor slab F factor to 0.45	Increase Exterior Wall Infiltration by 10% compared to baseline case	Decrease U value of windows by 20% compared to baseline case	Decrease SHGC of windows by 20% compared to baseline case
Location	CZ06	CZ06	CZ06	CZ06
Dimensions				
Tilts and orientations		<a href="#">Refer MediumOffice</a>		
Window				
Dimensions				
Glass-Type and frame				
U-factor (Btu / h * ft <sup>2</sup> * °F)			0.29	
SHGC				0.2
Visible transmittance				
Operable area				

Source: NORESCO for California Energy Commission

**STEP 3. RUN THE BASE CASE MODEL AND GENERATE TEST RESULTS.**

Once the base case model is developed, the simulation is run, and the results are recorded onto the spreadsheet of test cases. See Appendix 3B.

The candidate software shall report electricity use by end use, gas use by end use, TDV energy, and UMLH. For compliance, UMLH are defined at the zone level, and the zone with the greatest number of UMLH must pass the criteria specified in the sizing procedure.

For the reference tests, the capacities and flow rates of the HVAC system can be found in Appendix 3A under the *Sizing Values* tab.

**STEP 4. RUN THE TEST CASE MODEL (WITH THE REDUCED SHGC) AND REPORT THE RESULTS.**

The model is rerun, and the energy results and outputs are reported. The percentage change in energy use is reported.

**STEP 5. REPORT THE CHANGE IN REGULATED TDV ENERGY USE AND SOURCE ENERGY USE FROM THE BASE CASE AS A PERCENTAGE CHANGE.**

The reported percentage change in energy use from the candidate compliance software must fall within the passing criteria for the reference method.

## **4. Content and Format of Standard Reports**

Consult the *Nonresidential Compliance Manual* for the reports required to be manually generated for any project. For nonresidential compliance, the PRF-01 report is generated by the software. For residential compliance, the Low-rise Multifamily Certification of Compliance (LMCC) report is generated by the software.

## **5. Nonresidential Building Descriptors Reference**

---

### **5.1 Overview**

This chapter specifies, for each building descriptor, the rules that apply to the proposed design and to the standard design.

#### **5.1.1 Definition of Building Descriptors**

Building descriptors provide information about the proposed design and the standard design. In this chapter, the building descriptors are discussed in the generic terms of engineering drawings and specifications. By using generic building descriptors, this manual avoids bias toward one particular energy simulation engine. The building descriptors in this chapter are compatible with commonly used simulation software.

Each energy simulation program has a unique way of accepting building information. EnergyPlus uses a comma delimited data file called an Input Data File (IDF). DOE-2 uses BDL (building design language) to accept information. It is the responsibility of the compliance software to translate the generic terms used in this chapter into the “native language” of the simulation program. Figure 7: [Information Flow](#) illustrates the flow of information.

**Figure 7: Information Flow**

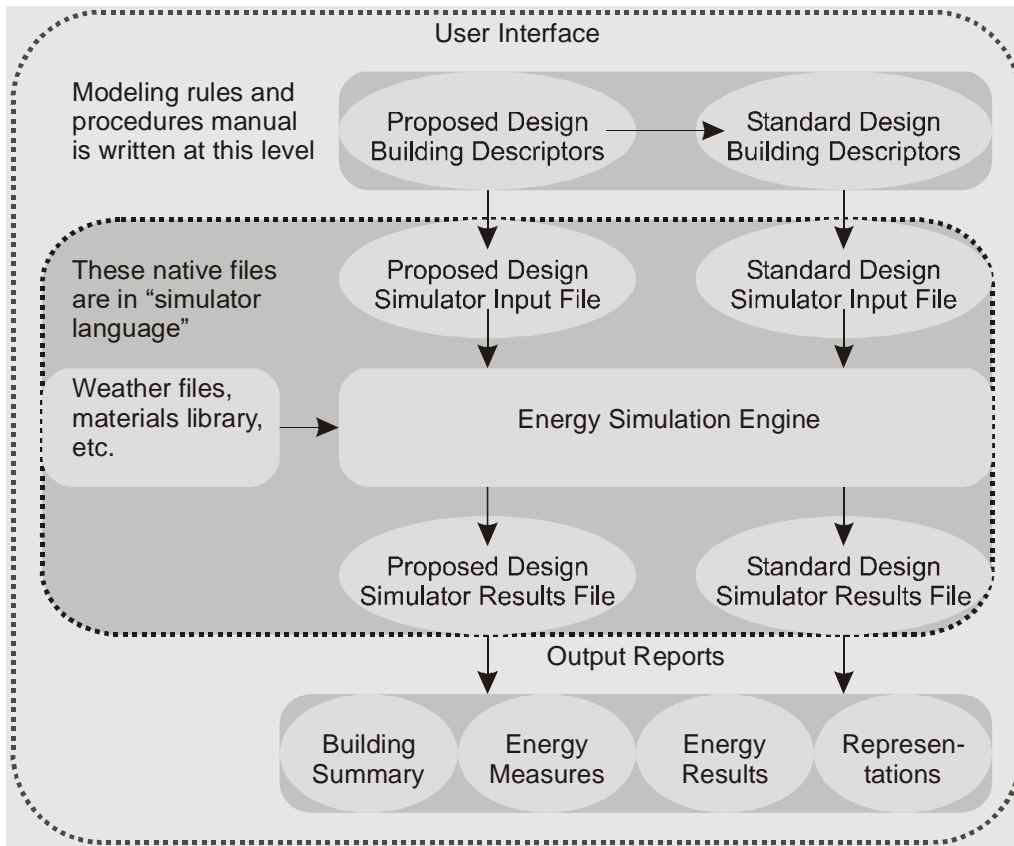

Source: NORESO for California Energy Commission

**Organization of Information**

Building descriptors are grouped under objects or building components. A wall or exterior surface (an object) would have multiple building descriptors dealing with the geometry, thermal performance, and so forth. Each building descriptor contains the following pieces of information:

**BUILDING DESCRIPTOR TITLE**

*Applicability:* Information on when the building descriptor applies to the proposed design.

*Definition:* A definition for the building descriptor.

*Units:* The units that are used to prescribe the building descriptor; A "List" indicates that a fixed set of choices applies, and the user shall be allowed to enter only one of the values in the list.

*Input Restrictions:* Any restrictions on information that may be entered for the proposed design.

*Standard Design:* This defines the value for the “standard design” or baseline building applied for this building descriptor. A value of “same as proposed” indicates that the building descriptor is neutral, i.e., the value is set to match the proposed design value. In many cases, the value may be fixed or may be determined from a table lookup. In some cases, the input may not be applicable.

*Standard Design: Existing Building:* Standard design for existing buildings if different than new buildings.

### 5.1.2 HVAC System Map

The HVAC system in the standard design depends on the primary building activity, the size of the building, and the number of floors. Details about these systems are provided in subsequent chapters.

Many of the building descriptors have a one-to-one relationship between the proposed design and the standard design; for example, every wall in the proposed design has a corresponding wall in the standard design. For HVAC systems, however, this one-to-one relationship generally does not hold. The number and type of HVAC systems serving the proposed design and the standard design may be completely different in type and components.

The HVAC systems in the standard design are determined by Table 2: HVAC System Map, which is based on space type, system cooling capacity, number of above-grade floors, climate zone, conditioned floor area, and, for some spaces, process load, and laboratory exhaust rate. Table 3: System Descriptions, provides additional detail for each standard design system.

For systems 1, 3, 7, 9, 10, and 11, each thermal zone shall be modeled with a respective HVAC system. For systems 5, and 6, each floor shall be modeled with a separate HVAC system. Floors with identical thermal zones and occupancies can be grouped for modeling.

**Table 2: HVAC System Map**

<b>Space Type</b>	<b>System Cooling Capacity</b>	<b>Above-Grade Floors</b>	<b>Climate Zone</b>	<b>Standard Design</b>
Multifamily				(See Chapter 6)
Hotel/motel guestrooms	No limit	No limit	All	System 1a – RAC
Retail or grocery	< 65 kBtu/h	Buildings ≤ 3 floors	2-15	System 3b – SZHP



<b>Space Type</b>	<b>System Cooling Capacity</b>	<b>Above-Grade Floors</b>	<b>Climate Zone</b>	<b>Standard Design</b>
Retail or grocery	≥ 65 kBtu/h	Buildings ≤ 3 floors	2-15	System 7b – SZVAVHP
Retail or grocery	< 65 kBtu/h	Buildings ≤ 3 floors	1, 16	System 3a – SZAC
Retail or grocery	≥ 65 kBtu/h	Buildings ≤ 3 floors	1, 16	System 7c – SZVAVDFHP
School	< 65 kBtu/h	Buildings ≤ 3 floors	2-15	System 3b – SZHP
School	≥ 65 kBtu/h	Buildings ≤ 3 floors	2-15	System 7b – SZVAVHP
School	< 65 kBtu/h	Buildings ≤ 3 floors	1, 16	System 3c – SZDFHP
School	≥ 65 kBtu/h	Buildings ≤ 3 floors	1, 16	System 7c – SZVAVDFHP
Warehouse and light manufacturing that do not include mechanical cooling in the proposed design (see note 3)	No limit	No limit	All	System 9 – HEATVENT
Office in buildings with warehouse and light manufacturing space	< 65 kBtu/h	Buildings ≤ 3 floors	All	System 3b – SZHP

<b>Space Type</b>	<b>System Cooling Capacity</b>	<b>Above-Grade Floors</b>	<b>Climate Zone</b>	<b>Standard Design</b>
Office in buildings with warehouse and light manufacturing space	≥ 65 kBtu/h	Buildings ≤ 3 floors	All	System 7b – SZVAVHP
Office, financial institution, and library	< 65 kBtu/h	Buildings ≤ 3 floors	1-15	System 3b – SZHP
Office, financial institution, and library	≥ 65 kBtu/h	Buildings ≤ 3 floors	1-15	System 7b – SZVAVHP
Office, financial institution, and library	< 65 kBtu/h	Buildings ≤ 3 floors	16	System 3c – SZDFHP
Office, financial institution, and library	≥ 65 kBtu/h	Buildings ≤ 3 floors	16	System 7c – SZVAVDHP
Covered process computer room with total process load ≤ 800kW	No limit	No limit	All	System 11 – CRAC Unit
Covered process computer room with total process load > 800kW	No limit	No limit	All	System 10 – CRAH Unit
Covered process laboratory with total building laboratory design maximum exhaust < 15,000 cfm and total building area < 25,000 ft <sup>2</sup>	No limit	Buildings ≤ 3 floors	All	System 7a – SZVAVAC

<b>Space Type</b>	<b>System Cooling Capacity</b>	<b>Above-Grade Floors</b>	<b>Climate Zone</b>	<b>Standard Design</b>
Covered process laboratory with total building laboratory design maximum exhaust > 15,000 cfm and total building conditioned floor area < 150,000 ft <sup>2</sup>	No limit	No limit	All	System 5 – PVAV
Covered process laboratory with total building laboratory design maximum exhaust > 15,000 cfm and total building conditioned floor area ≥ 150,000 ft <sup>2</sup>	No limit	No limit	All	System 6 – BVAV
Covered process commercial kitchen for buildings which use System 6 – BVAV	No limit	No limit	All	System 13a – BKITCHMAU
Covered process commercial kitchen for buildings which don't use System 6 – BVAV	No limit	No limit	All	System 13b – PKITCHMAU

<b>Space Type</b>	<b>System Cooling Capacity</b>	<b>Above-Grade Floors</b>	<b>Climate Zone</b>	<b>Standard Design</b>
Healthcare facilities	No limit	No limit	All	Same as the Proposed Design
All other spaces in buildings < 25,000 ft <sup>2</sup>	< 65 kBtu/h	Buildings ≤ 3 floors	All	System 3a – SZAC
All other spaces in buildings < 25,000 ft <sup>2</sup>	≥ 65 kBtu/h	Buildings ≤ 3 floors	All	System 7a – SZVAVAC
All other spaces in buildings < 25,000 ft <sup>2</sup>	No limit	4 - 5 floors	All	System 5 – PVAV
All other spaces in buildings < 25,000 ft <sup>2</sup>	No limit	> 5 floors	All	System 6 – BVAV
All other spaces in buildings 25,000 – 150,000 ft <sup>2</sup>	No limit	≤ 5 floors	All	System 5 – PVAV
All other spaces in buildings 25,000 – 150,000 ft <sup>2</sup>	No limit	> 5 floors	All	System 6 – BVAV
All other spaces in buildings > 150,000 ft <sup>2</sup>	No limit	No limit	All	System 6 – BVAV

Source: California Energy Commission

**Table 3: System Descriptions**

<b>System Type</b>	<b>Description</b>	<b>Detail</b>
System 1a – RAC	Residential air conditioner	Single-zone system with constant volume fan, no economizer, direct expansion cooling, and gas furnace heating.
System 2 – RESERVED		
System 3a – SZAC	Packaged single-zone air conditioner	Single-zone system with constant volume fan, direct expansion cooling, and gas furnace heating.
System 3b – SZHP	Packaged single-zone heat pump	Single-zone system with constant volume fan, direct expansion heat pump cooling and heating, and electric resistance supplemental heating.
System 3c – SZDFHP	Packaged single-zone dual fuel heat pump	Single-zone system with constant volume fan, direct expansion heat pump cooling and heating, and gas supplemental heating.
System 5 – PVAV	Packaged VAV	Multi-zone packaged system with variable volume fan, direct expansion cooling, gas furnace heating, and hot water reheat terminal units served by a central gas boiler.
System 6 – BVAV	Built-up VAV	Multi-zone built-up system with variable volume fan, chilled water cooling provided by a water cooled chiller and cooling tower, and hot water heating provided by central gas boiler.
System 7a – SZVAVAC	Packaged single-zone variable air volume air conditioner	Single-zone system with variable air volume fan, direct expansion variable-speed drive cooling, and gas furnace heating.

System Type	Description	Detail
		<p>Minimum fan speed ratio of 0.2 for laboratory spaces and 0.5 for all other spaces.</p> <p>Integrated economizer for standard design cooling capacities <math>\geq 33</math> kBtu/h.</p>
System 7b – SZVAVHP	Packaged single-zone variable air volume heat pump	Single-zone system with variable air volume fan, direct expansion heat pump cooling and heating, variable-speed drive on supply fan, and electric resistance supplemental heating.
System 7c – SZVAVDFHP	Packaged single-zone variable air volume dual fuel heat pump	Single-zone system with variable air volume fan, direct expansion heat pump cooling and heating, variable-speed drive on supply fan, and gas supplemental heating.
System 8 – RESERVED		
System 9 – HEATVENT	Heating and ventilation only	Single-zone system providing ventilation with a constant volume fan and gas furnace heating.
System 10 – CRAH	Computer room air handler	Single-zone built-up system with variable volume fan, chilled water cooling provided by a water cooled chiller and cooling tower, and no heating.
System 11 – CRAC	Computer room air conditioner	Single-zone packaged system with variable volume fan, direct expansion cooling, variable-speed drive supply fan, and no heating
System 13a – BKITCHMAU	Built-up kitchen makeup air unit	Built-up single-zone makeup air unit with dedicated exhaust fan, chilled water cooling, and hot water heating.

System Type	Description	Detail
System 13b – PKITCHMAU	Packaged kitchen makeup air unit	Packaged single-zone makeup air unit with dedicated exhaust fan, direct expansion cooling, and gas furnace heating.

Source: California Energy Commission

The standard design systems serving mixed-use buildings are different from the standard design systems serving nonresidential space types. Also, spaces containing covered processes are served by dedicated standard design systems separate from systems serving other nonresidential space types. Examples include hotel/motel guestroom and related spaces located over retail and other similar conditions. For example, a 100,000 ft<sup>2</sup> building that has retail and restaurant on floor 1, offices on floors 2, 3, and 4, a 600 kW process load computer room on each office floor, and guestrooms on floors 5, 6, and 7 would have the following systems in the standard design:

- A System 13a or b – BKITCHMAU serving the restaurant
- Retail spaces follow the system map, since the building has more than 3 stories
- A System 6 – BVAV serving all office spaces
- Separate System 11 – CRAC systems serving each computer room
- Separate System 1a – RAC systems serving each guestroom space, with a System 6 – BVAV system serving corridors and other non-guestroom spaces on each floor

The standard design building shall have only one central chilled or hot water plant, so if there are multiple systems that incorporate a plant (for example, CRAH and VAVS), then a single plant shall serve all plant loads.

**5.1.2.1 Additions and Alterations System Modification**

For additions and alterations projects, the standard design building shall follow the same rules as the HVAC system map above, except that the building that will follow the logic of the system map rules may be the modeled building (the addition or alteration alone, or the addition or alteration and a portion of the existing building), or the entire building (the entire existing building, plus an addition, if present).

The following rules apply to any building that has both heating and cooling systems.

1. Plant: If the change in plant cooling capacity exceeds 50 percent of the existing total cooling capacity of all cooling systems, the system map is based on the entire building characteristics. (See [Chapter 5.2.2 Existing Building Classification](#).)

2. **Airside System:** If the change in cooling capacity of the airside system (for example, air handling units, DX packaged units) of all cooling sources other than chilled water exceeds 50 percent of the existing rated cooling capacity for the building, then the HVAC system map is based on the entire building characteristics. Also, if the combined net cooling capacity of all altered airside systems exceeds 90 percent of the building cooling capacity, then the HVAC system map is based on the entire building characteristics.
3. **Zone Level:** If the change in the cooling capacity of the zonal systems (for example, SZAC units) exceeds 50 percent of the rated total cooling capacity of all zonal systems in the existing building, then the HVAC system map is based on the entire existing building characteristics. Also, if the combined net cooling capacity of all altered zonal systems exceeds 90 percent of the building cooling capacity, then the HVAC system map is based on the entire building characteristics.
4. If none of these three conditions apply, then the HVAC system map is based on the building characteristics of the modeled building for additions and alterations compliance, which may be just a portion of the entire building.

Since some additions and alterations projects will trigger the HVAC system map for the standard design, the user must enter a minimum set of building characteristics for the entire building (existing plus any addition); existing building floor area and number of stories must be entered.

### **Heating-Only System Modification**

The following rules apply to any building that has only heating-only systems.

1. **Plant:** If the change in plant heating capacity exceeds 50 percent of the existing total space heating capacity of all heating systems, the system map is based on the entire building characteristics.
2. **Airside System:** If the change in heating capacity of the airside system (unitary DX equipment, heat pumps, for example) of all heating sources other than heating hot water exceeds 50 percent of the existing rated cooling capacity for the building, then the HVAC system map is based on the entire building characteristics. Also, if the combined net heating capacity of all altered airside systems exceeds 90 percent of the building heating capacity, then the HVAC system map is based on the entire building characteristics.
3. **Zone Level:** If the change in the heating capacity of the zonal systems (SZAC units, for example), exceeds 50 percent of the rated total heating capacity of all zonal systems in the existing building, then the HVAC system map is based on the entire existing building characteristics. Also, if the combined net cooling capacity of all



altered zonal systems exceeds 90 percent of the building cooling capacity, then the HVAC system map is based on the entire building characteristics.

4. If none of these three conditions above apply, then the HVAC system map is based on the building characteristics of the modeled building for additions and alterations compliance, which may be just a portion of the entire building.

Since some additions and alterations projects will trigger the HVAC system map for the standard design, the user must enter a minimum set of building characteristics for the entire building (existing plus any addition): existing building floor area and number of stories must be entered.

### **5.1.3 Special Requirements for Additions and Alterations Projects**

Compliance projects containing additions and/or alterations require that the user designate each building component (envelope construction assemblies and fenestration, lighting, HVAC, and water heating) as either new, altered, or existing. Many of the building descriptors in Chapter 5 Building Descriptors Reference of this manual do not have explicit definitions for the standard design when the project is an addition and/or alterations project. For these terms, the standard design rules for existing, altered components follow the same rule as the standard design rule for newly constructed buildings.

For example, the receptacle loads are prescribed for both the proposed design building and standard design building for a newly constructed buildings compliance project. For additions or alterations to an existing building, since the rules are not explicitly defined in the building descriptor in [Chapter 5.3.3 Receptacle Loads](#), the same rules apply to the proposed design and standard design for the additions or alterations compliance project.

Building descriptors that are prescribed for the proposed and standard design models for newly constructed buildings projects are also prescribed for the proposed and standard design models for additions and alterations projects.

For additions and alterations projects, there are three modeling approaches that can be taken when modeling the existing building:

1. Model the addition or altered portion alone. For this option, the addition or alteration is modeled as a stand-alone building, and the boundary or interface between the addition and/or alteration and the preexisting building is modeled as an adiabatic partition (an adiabatic wall, ceiling, roof, or floor).
2. Model the entire existing building and any additions and alterations. For this option, the existing, unaltered components of the building would be modeled "as designed" (as specified by the user), with the standard design components modeled the same as the proposed design.

3. Model part of the existing building and any additions and alterations. For this option, all components of the existing, unaltered building (HVAC, lighting, envelope, spaces) would have to be distinguished from the components that are added and altered. The existing building components would be modeled "as designed" (as specified by the user), with the standard design components modeled the same as the proposed design. Added or altered building components would follow the rules for additions and alterations.

When either Option 1 or Option 3 is used, the adiabatic partitions shall not be considered as part of gross exterior wall area or gross exterior roof area for the window/wall ratio (WWR) and skylight/roof ratio (SRR) calculations.

---

## 5.2 Project Data

This chapter specifies inputs for project level information, including the location of the project and information on who is working on who is responsible for different portions of the building project.

### 5.2.1 General Information

The general information of the project identifies the basic information for where the project will be implemented and identifies a person to be responsible for different portions of the project. In a building project, the location of the project will help to inform the climate zone applicable to the project.

The various roles that are identified can be used to coordinate among the design and modeling teams. By identifying a main lead for various parts of the building, questions regarding the design of specific building components can more quickly be answered.

Specifying the building project compliance type is important for developing the building model. The compliance type will inform a number of assumptions made in the standard and proposed design. It is important to correctly identify the compliance type as this can have a major effect on modeling results.

#### **PROJECT NAME**

*Applicability:* All projects.

*Definition:* Name used for the project if one is applicable.

*Units:* Up to 50 alphanumeric characters.

*Input Restrictions:* Input is optional for the proposed design.

*Standard Design:* Not applicable.

*Standard Design: Existing Building:*

**BUILDING LOCATION**

*Applicability:* All projects.

*Definition:* Street address, city, state, and zip code.

*Units:* Up to 50 alphanumeric characters on each of two lines.

*Input Restrictions:* Input is optional for the proposed design.

*Standard Design:* Not applicable.

*Standard Design: Existing Building:*

**PROJECT OWNER**

*Applicability:* All projects.

*Definition:* Owner(s) of the project or individual or organization for whom the building permit is sought; should include name, title, organization, email, and phone number.

*Units:* Up to 50 alphanumeric characters on each of two lines.

*Input Restrictions:* Input is optional for the proposed design.

*Standard Design:* Not applicable.

*Standard Design: Existing Building:*

**ENVELOPE DESIGNER**

*Applicability:* All projects.

*Definition:* Person responsible for the building design; information should include name, title, organization, email, and phone number.

*Units:* Up to 50 alphanumeric characters on each of two lines.

*Input Restrictions:* Input is optional for the proposed design.

*Standard Design:* Not applicable.

*Standard Design: Existing Building:*

**MECHANICAL DESIGNER**

*Applicability:* All projects.

*Definition:* Person responsible for the mechanical design; information should include name, title, organization, email, and phone number.

*Units:* Up to 50 alphanumeric characters on each of two lines.

*Input Restrictions:* Input is optional for the proposed design.

*Standard Design:* Not applicable.

*Standard Design: Existing Building:*

**LIGHTING DESIGNER**

*Applicability:* All projects.

*Definition:* Person responsible for the lighting design; information should include name, title, organization, email, and phone number.

*Units:* Up to 50 alphanumeric characters on each of two lines.

*Input Restrictions:* Input is optional for the proposed design.

*Standard Design:* Not applicable.



*Standard Design: Existing Building:*

**DOCUMENTATION AUTHOR**

*Applicability:* All projects.

*Definition:* Person responsible for inputting building information and performing the compliance analysis; information should include name, title, organization, email, and phone number.

*Units:* Up to 50 alphanumeric characters on each of two lines.

*Input Restrictions:* Input is optional for the proposed design.

*Standard Design:* Not applicable.

*Standard Design: Existing Building:*

**DATE**

*Applicability:* All projects.

*Definition:* Date of completion of the compliance analysis or the date of its most-recent revision.

*Units:* Date format.

*Input Restrictions:* Input is optional for the proposed design.

*Standard Design:* Not applicable.

*Standard Design: Existing Building:*

**COMPLIANCE TYPE**

*Applicability:* All projects.

*Definition:* Type of compliance project (newly constructed buildings, partial compliance or additions and alterations).

*Units:* List:

- **NewComplete:** newly constructed buildings project
- **NewEnvelope:** newly constructed buildings, partial compliance with envelope
- **NewEnvelopeAndLighting:** newly constructed buildings, partial compliance with envelope and lighting
- **NewEnvelopeAndPartialLighting:** newly constructed buildings, partial compliance with envelope and lighting compliance for some spaces
- **NewEnvelopeAndMechanical:** newly constructed buildings, partial compliance with mechanical and envelope only
- **NewMechanical:** newly constructed buildings, partial compliance with mechanical. This is the complement of a partial compliance with envelope and lighting, which should have already been performed.
- **NewMechanicalAndLighting:** newly constructed buildings, partial compliance with mechanical and lighting only. The building should have already passed an Envelope Only partial compliance.
- **NewMechanicalAndPartialLighting:** newly constructed buildings, partial compliance with mechanical and lighting compliance for some spaces. The building should have already passed an Envelope Only partial compliance.
- **ExistingAlteration:** alteration project
- **ExistingAdditionAndAlteration:** project with both additions and alterations
- **AdditionComplete:** an addition modeled alone
- **AdditionEnvelope:** an existing building with partial envelope compliance for a new addition
- **AdditionEnvelopeAndLighting:** an existing building with partial envelope and lighting compliance for a new addition
- **AdditionEnvelopeAndPartialLighting:** an addition to an existing building that includes the building envelope and lighting for some of the spaces. For the spaces with lighting defined in the proposed design, the space function type must be defined as well. For undefined spaces, the lighting status is "future" and both the proposed design and standard design are set to match the prescriptive lighting power limits.

- **AdditionEnvelopeAndMechanical:** an addition modeled with as-designed envelope and mechanical components, but the interior lighting design has not yet been defined. For this option, interior lighting must comply prescriptively.
- **AdditionMechanical:** an addition modeled with the as-designed mechanical system, including any plant, system, or zone level equipment, as well as ventilation. For this option, all envelope and lighting components are modeled as defined by the user in both the proposed design and standard designs.
- **AdditionMechanicalAndLighting:** an addition modeled with as designed mechanical and lighting equipment. In this design, all building envelope components in the standard design are set to match those in the proposed design, since the envelope is assumed to have complied via a separate permit.
- **AdditionMechanicalAndPartialLighting:** an addition modeled with as designed mechanical equipment and with lighting systems defined for part of the building. This model is the complement to the AdditionEnvelopeAndParitalLighting compliance option, since Envelope and lighting compliance for the spaces not included in this compliance permit are assumed to have already been modeled (and permitted).

Input Restrictions: As designed.

Standard Design: Same as proposed.

Standard Design: Existing Building:

### 5.2.2 Existing Building Classification

The existing building classification provides general information on the building used for information and reporting purposes. The number of stories in the existing building and area of the building, including any additions, are required inputs.

#### EXISTING BUILDING NUMBER OF STORIES

*Applicability:* Additions and alterations.

*Definition:* Total number of stories of the building (For information and reporting purposes only).

*Units:* Integer

*Input Restrictions:* As designed.

*Standard Design:* Not applicable.

*Standard Design: Existing Building:* Same as the proposed design.

#### EXISTING BUILDING FLOOR AREA

*Applicability:* Additions and alterations.

*Definition:* Total floor area of an existing building, including any additions, if present (For information and reporting purposes only).

*Units:* ft<sup>2</sup>.

*Input Restrictions:* As designed.

*Standard Design:* Not applicable.

Standard Design: Existing Building: Not applicable.

### **5.2.3 Partial Compliance Model Input Classification**

Earlier chapters of this reference manual have described the available partial compliance scenarios. The compliance software that supports these scenarios must define the inputs for both the proposed design and the standard design for unpermitted portions of the building.

1. **Envelope Only:** The user specifies the building envelope and all spaces, space types, and thermal zones in the building. The standard design rules are applied to the envelope components. For all lighting and HVAC inputs, the proposed design values are prescribed and follow the rules for the standard design, including modeling the same HVAC systems determined using the newly constructed buildings HVAC system map in [Chapter 5.1.2 HVAC System Map](#).
2. **Envelope and Lighting Only:** The user specifies the building envelope, spaces, space types, thermal zones and all lighting, and any daylighting, where present. For all HVAC inputs, the proposed design values are prescribed and follow the rules for the standard design, including modeling the same HVAC systems determined using the newly constructed buildings HVAC system map in [Chapter 5.1.2 HVAC System Map](#).
3. **Envelope and Mechanical Only:** This compliance option assumes that the building will use separately permitted prescriptive lighting compliance. The user specifies the building envelope, spaces, space types, thermal zones, and mechanical systems in the building. For all lighting inputs, the proposed design values are prescribed and follow the rules for the standard design.
4. **Envelope and Partial Lighting Only:** This compliance option is used for projects where the building envelope is defined, and where the lighting in some of the spaces is defined. The user specifies the building envelope, all spaces, space types, thermal zones, and lighting for spaces with lighting systems defined, and any daylighting, where present. For all HVAC inputs, the proposed design values are prescribed and follow the rules for the standard design, including modeling the same HVAC systems

determined using the newly constructed buildings HVAC system map in [Chapter 5.1.2 HVAC System Map](#).

5. Mechanical Only: This compliance option assumes that the building has already been permitted for envelope and lighting. The envelope and lighting systems for both the proposed design and the standard design are modeled as designed. (For example, if the building vertical fenestration area exceeds prescriptive WWR limits, the limits are NOT applied to the standard design. Instead, the actual vertical fenestration area is used.) The mechanical systems of the proposed model are described as-designed, and the newly constructed buildings rules and system map are applied to the HVAC system of the standard design.
6. Mechanical and Lighting Only: This compliance option assumes that the building has already been permitted for envelope compliance. All spaces and space types must be defined by the user, and all envelope components for the proposed design are "as designed" (must be defined by the user). The standard design lighting and HVAC components are set to match the standard design.
7. Mechanical and Partial Lighting Compliance: This compliance option assumes that the building has already been permitted for Envelope and Partial Lighting compliance (option 3 above). The envelope components, spaces, and space types, and permitted lighting spaces are entered as designed for the proposed design and, for these components, the standard design is set to be the same as the proposed. For the other components as part of the permit application, the mechanical systems and new lighting systems are entered by the user for the proposed design as designed, and the standard design components for the mechanical (HVAC) system and new lighting systems are defined by the newly constructed buildings standard design rules.
8. Envelope and Partial Mechanical: For projects where mechanical systems are not defined for all thermal zones. When the "HVAC is Unknown" checkbox is enabled at the thermal zone, the proposed mechanical system for that zone will be defaulted to match the standard design. Possible uses for this compliance option include "core and shell" projects and existing/addition/alteration projects with unknown existing mechanical equipment.

Building descriptors with inputs for both the proposed design and standard design that are restricted to prescribed values (for example, equipment performance curves) follow the same rules for prescribed values for any of the partial compliance projects listed above.

#### 5.2.4 Building Model Classification

The function of the building or the various building spaces will have an effect on a number of energy related requirements. This includes illuminance and allowed lighting power. The



function of the building or various building spaces can be determined using the Area Category Method or the Tailored Method. The Area Category Method is described in §140.6(c)2 and the Tailored Method is described in §140.6(c)3 of the standards.

### **SPACE CLASSIFICATION TYPE**

*Applicability:* All projects.

*Definition:* One of two available classification methods for identifying the function of the building or the functions of spaces within the building, which in turn determine energy-related requirements for the standard design. Appendix 5.4A lists the building classifications that are available under the area category method.

The Area Category method uses a separate space classification for each space in the building according to its function.

The Tailored Lighting method allows specification of function-specific illuminance level categories and space geometry to assign allowed lighting power, following §140.6(c)3 of the standards.

*Units:* List (See Appendix 5.4A).

*Input Restrictions* As designed.

*Standard Design: Existing Building:* Same as proposed.

### **5.2.5 Geographic and Climate Data**

The following data needs to be specified or derived in some manner. Software developers may use any acceptable method to determine the data. For California, city, state, and county are required to determine climate data from the available data in Reference Appendix JA2.

#### **ZIP CODE**

*Applicability:* All projects.

*Definition:* California postal designation.

*Units:* List (see Reference Appendix JA2).

*Input Restrictions:* As designed.

*Standard Design: Existing Building:* Not applicable.

#### **LATITUDE**

*Applicability:* All projects.

*Definition:* The latitude of the project site.

*Units:* Degrees (°).

*Input Restrictions:* Not a user input.

*Standard Design:* Latitude of representative city from Reference Appendix JA2.

*Standard Design: Existing Building:*

**LONGITUDE**

*Applicability:* All projects.

*Definition:* The longitude of the project site.

*Units:* Degrees (°).

*Input Restrictions:* Not a user input.

*Standard Design:* Longitude of representative city from Reference Appendix JA2.

*Standard Design: Existing Building:*

**ELEVATION**

*Applicability:* All projects.

*Definition:* The height of the building site above sea level.

*Units:* Feet (ft).

*Input Restrictions:* None.

*Standard Design:* Elevation of representative city from Reference Appendix JA2.

*Standard Design: Existing Building:*

**CALIFORNIA CLIMATE ZONE**

*Applicability:* All projects.

*Definition:* One of the 16 California climate zones.

*Units:* List (see Reference Appendix JA2).

*Input Restrictions:* None.

*Standard Design:* Same as proposed.

*Standard Design: Existing Building:*

**CITY**

*Applicability:* All projects.

*Definition:* The city where the project is located.

*Units:* Alphanumeric string.

*Input Restrictions:* None.

*Standard Design:* Representative city from Reference Appendix JA2.

*Standard Design: Existing Building:*

## **DESIGN DAY DATA**

*Applicability:* All projects.

*Definition:* A data structure indicating design day information used for the sizing of the proposed system. Note: this information may not necessarily match the information used in the annual compliance simulation.

*Units:* Data structure contains the following:

- Design DB (0.5%), mean coincident wet-bulb, daily range, day of year.

*Input Restrictions:* The design day information is taken from one of the 86 pre-defined California weather files, for the location within the same climate zone that is closest to the proposed building's location. (This is not input by the user.).

*Standard Design:* Not applicable.

*Standard Design: Existing Building:*

## **WEATHER FILE**

*Applicability:* All projects.

*Definition:* The hourly (i.e., 8,760 hour per year) weather data to be used in performing the building energy simulations. Weather data must include outside dry-bulb temperature, outside wet-bulb temperature, atmospheric pressure, wind speed, wind direction, cloud amount, cloud type (or total horizontal solar and total direct normal solar), clearness number, ground temperature, humidity ratio, density of air, and specific enthalpy.

*Units:* Data file.

*Input Restrictions:* The weather file selected shall be in the same climate zone as the proposed design. If multiple weather files exist for one climate zone, then the weather file closest in distance to the proposed design and in the same climate zone shall be used.

*Standard Design:* Weather data shall be the same for both the proposed design and standard design.

*Standard Design: Existing Building:*

## **GROUND REFLECTANCE**

*Applicability:* All projects.

*Definition:* Ground reflectance affects daylighting calculations and solar gain. The reflectance can be specified as a constant for the entire period of the energy simulation or it may be scheduled, which can account for snow cover in the winter.

*Units:* Data structure: schedule, fraction.

*Input Restrictions:* Prescribed. The weather file determines the ground reflectance. The ground reflectance shall be set to 0.2 when the snow depth is 0 or undefined and set to 0.6 when the snow depth is greater than 0.

*Standard Design:* Same as proposed.

*Standard Design: Existing Building:*

### **LOCAL TERRAIN**

*Applicability:* All projects.

*Definition:* An indication of how the local terrain shields the building from the prevailing wind. Estimates of this effect are provided in the ASHRAE Handbook of Fundamentals.

*Units:* List: the list shall contain only the following choices:

- Flat, open country
  - Exponent ( $\alpha$ ): 0.14
  - Boundary layer thickness,  $\delta$  (m): 270
- Rough, wooded country, Suburbs
  - Exponent ( $\alpha$ ): 0.22
  - Boundary layer thickness,  $\delta$  (m): 370
- Towns and cities
  - Exponent ( $\alpha$ ): 0.33
  - Boundary layer thickness,  $\delta$  (m): 460
- Ocean
  - Exponent ( $\alpha$ ): 0.10
  - Boundary layer thickness,  $\delta$  (m): 210
- Urban, industrial, forest
  - Exponent ( $\alpha$ ): 0.22
  - Boundary layer thickness,  $\delta$  (m): 370

The exponent and boundary layer are used in the following equation to adjust the local wind speed:

$$V_z = V_{met} \left( \frac{\delta_{met}}{Z_{met}} \right)^{\alpha_{met}} \left( \frac{Z}{\delta} \right)^{\alpha}$$

Where:

- $Z$  - altitude, height above ground (m)
- $V_z$  - wind speed at altitude  $Z$  (m/s)
- $\alpha$  - wind speed profile exponent at the site
- $\delta$  - wind speed profile boundary layer thickness at the site (m)
- $Z_{met}$  - height above ground of the wind speed sensor at the meteorological station (m)
- $V_{met}$  - wind speed measured at the meteorological station (m/s)
- $\alpha_{met}$  - wind speed profile exponent at the meteorological station
- $\delta_{met}$  - wind speed profile boundary layer thickness at the meteorological station. (m)

The wind speed profile coefficients;  $\alpha$ ,  $\delta$ ,  $\alpha_{met}$ , and  $\delta_{met}$ ; are variables that depend on the roughness characteristics of the surrounding terrain. Typical values for  $\alpha$  and  $\delta$  are shown in the table above.

*Input Restrictions:* Weather data should be representative of the long-term conditions at the site.

*Standard Design:* The standard design terrain should be equal to the proposed design.

*Standard Design: Existing Building:*

### 5.2.6 Site Characteristics

General site characteristics including building shading and the fuel source availability are provided for the building. Building shading from external sources are not used for compliance calculations.

#### SHADING OF BUILDING SITE

*Applicability:* All projects.

*Definition:* Shading of building fenestration, roofs, or walls by surrounding terrain, vegetation, and the building itself.

*Units:* Data structure.

*Input Restrictions:* The default and fixed value are for the site to be unshaded. External shading from other buildings or other objects is not modeled for Title 24 compliance in the ACM. Building self-shading is accounted for using the detailed geometry method.

*Standard Design:* The proposed design and standard design are modeled with identical assumptions regarding shading of the building site.

*Standard Design: Existing Building:*

**SITE FUEL SOURCE**

*Applicability:* All projects.

*Definition:* The fuel source that is available at the site for water heating, space heating or other fuel purposes. For most buildings connected to a utility service, this will be natural gas.

*Units:* List.

*Input Restrictions:* The following choices are available:

- Natural Gas
- Propane

Standard Design: Natural gas.

Standard Design: Existing Building:

**5.2.7 Calendar**

The calendar year entered in the software is used to coordinate weather events from the weather files to specific days of the week. The schedule of holidays will also be coordinated to the calendar year.

**YEAR FOR ANALYSIS**

*Applicability:* All projects.

*Definition:* The calendar year to be used for the annual energy simulations. This input determines the correspondence between days of the week, and the days on which weather events on the weather tape occur and has no other impact.

*Units:* List: choose a year (other than a leap year).

*Input Restrictions:* Use year 2009.

*Standard Design:* Same calendar year as the proposed design.

**SCHEDULE OF HOLIDAYS**

*Applicability:* All projects.

*Definition:* A list of dates on which holidays are observed and on which holiday schedules are used in the simulations.

*Units:* Data structure.

*Input Restrictions:* The following ten holidays represent the prescribed set. When a holiday falls on a Saturday, the holiday is observed on the Friday preceding the Saturday. If the holiday falls on a Sunday, the holiday is observed on the following Monday.

- New Year's Day                      January 1
- Martin Luther King Day            Third Monday in January
- Presidents Day                      Third Monday in February
- Memorial Day                        Last Monday in May
- Independence Day                  July 4
- Labor Day                              First Monday in September
- Columbus Day                        Second Monday in October
- Veterans Day                         November 11
- Thanksgiving Day                  Fourth Thursday in November
- Christmas Day                        December 25

*Standard Design:* The standard design shall observe the same holidays specified for the proposed design.

*Standard Design: Existing Building:*

## 5.3 Thermal Zones

A thermal zone is a space or collection of spaces having similar space-conditioning requirements, the same heating and cooling setpoint, and is the basic thermal unit (or zone) used in modeling the building. A thermal zone will include one or more spaces. Thermal zones may be grouped together, but systems serving combined zones shall be subject to efficiency and control requirements of the combined zones. Nonresidential buildings with identical floors served by like systems may be modeled with floor multipliers.

### 5.3.1 General Information

The general information is used to identify the various thermal zones included in the building project. This information will include whether the thermal zone is directly or indirectly conditioned and the floor area of the thermal zone. The HVAC system that is used to service the specific thermal zone is also identified.

#### **THERMAL ZONE NAME**

*Applicability:* All projects.

*Definition:* A unique identifier for the thermal zone made up of 50 or fewer alphanumeric characters.

*Units:* Alphanumeric string.

*Input Restrictions:* None.

*Standard Design:* Not applicable.

*Standard Design: Existing Building:*

### **THERMAL ZONE DESCRIPTION**

*Applicability:* All projects.

*Definition:* A brief description of the thermal zone that identifies the spaces which make up the thermal zone or other descriptive information. The description should tie the thermal zone to the building plans.

*Units:* Alphanumeric string.

*Input Restrictions:* None.

*Standard Design:* Not applicable.

*Standard Design: Existing Building:*

### **THERMAL ZONE TYPE**

*Applicability:* All projects.

*Definition:* Designation of the thermal zone as a directly conditioned, unconditioned, or plenum (i.e., unoccupied but partially conditioned as a consequence of its role as a path for returning air) space.

*Units:* List: directly conditioned, unconditioned or plenum.

*Input Restrictions:* The default thermal zone type is "directly conditioned."

*Standard Design:* The descriptor is identical for the proposed design and standard design.

*Standard Design: Existing Building:*

### **SYSTEM NAME**

*Applicability:* All projects.

*Definition:* The name of the HVAC system that serves this thermal zone. The purpose of this building descriptor is to link the thermal zone to a system (child points to parent). Software can make this link in other ways.



*Units:* Text, unique.

*Input Restrictions:* None.

*Standard Design:* The standard design may have a different system mapping if the standard design has a different HVAC type than the proposed design.

*Standard Design: Existing Building:*

## **FLOOR AREA**

*Applicability:* All projects.

*Definition:* The gross floor area of a thermal zone; including walls and minor spaces for mechanical or electrical services such as chases that are not assigned to other thermal zones.

*Units:* Square feet (ft<sup>2</sup>).

*Input Restrictions:* The floor area of the thermal zone is derived from the floor area of the individual spaces that make up the thermal zone.

*Standard Design:* Same as proposed design.

*Standard Design: Existing Building:*

### **5.3.2 Interior Lighting**

Inputs for interior lighting are specified at the space level (see specification below). In those instances, when thermal zones contain just one space, the inputs here will be identical to the inputs for the single space that is contained within the thermal zone.

For those instances when a thermal zone contains more than one space, the software shall either model the lighting separate for each space and sum energy consumption and heat gain for each time step of the analysis, or it must incorporate some procedure to sum inputs or calculate weighted averages such that the lighting power used at the thermal zone level is equal to the combination of lighting power for each of the spaces contained in the thermal zone.

In some cases, combining lighting power at the space level into lighting power for the thermal zone may be challenging and would have to be done at the level of each time step in the simulation. These cases include:

- A thermal zone that contains some spaces that have daylighting and others that do not.
- A thermal zone that contains spaces with different schedules of operation.

- A thermal zone that contains some spaces that have a schedule adjusted in some way for lighting controls and other spaces that do not.
- Combinations of the above.

### 5.3.3 Receptacle Loads

Inputs for receptacle and process loads are specified at the space level (see specification below). In those instances, when thermal zones contain just one space, the inputs here will be identical to the inputs for the single space that is contained within the thermal zone.

For those instances when a thermal zone contains more than one space, the software shall either model the receptacle and process loads separate for each space and sum energy consumption and heat gain for each time step of the analysis or it must incorporate some procedure to sum inputs or calculate weighted averages such that the receptacle and process loads used at the thermal zone level are equal to the combination of receptacle and process loads for each of the spaces contained in the thermal zone.

When the spaces contained in a thermal zone have different schedules, combining receptacle and process loads from the space level may be challenging and would have to be done at the level of each time step in the simulation. See discussion above on lighting.

### 5.3.4 Occupants

Inputs for occupant loads are specified at the space level (see specification below). In those instances, when thermal zones contain just one space, the inputs here will be identical to the inputs for the single space that is contained within the thermal zone.

For those instances when a thermal zone contains more than one space, the software shall either model the occupant loads separate for each space and the heat gain for each time step of the analysis or it must incorporate some procedure to sum inputs or calculate weighted averages such that the occupant loads used at the thermal zone level are equal to the combination of occupant loads for each of the spaces contained in the thermal zone.

When the spaces contained in a thermal zone have different occupant schedules, rolling up occupant loads from the space level may be challenging and would have to be done at the level of each time step in the simulation. Spaces with differences in full-load equivalent operating hours of more than 40 hours per week shall not be combined in a single zone. See discussion above on lighting.

---

## 5.4 Space Uses

Each thermal zone discussed above may be subdivided into spaces. This chapter presents the building descriptors that relate to the space uses. Space uses and the defaults associated with them are listed in Appendix 5.4A. Every thermal zone shall have at least

one space, as defined in this chapter. Daylit spaces should generally be separately defined by space type and/or orientation.

### **5.4.1 General Information**

The general information is used to identify the various spaces included in each thermal zone. This information will include the area of each space as well as how the space will be used. The function of the space will inform certain standard design requirements such as lighting power density for the space.

#### **SPACE FUNCTION TYPE**

*Applicability:* All projects.

*Definition:* The space function type that defines occupancy, internal load, and other characteristics, as indicated in Appendix 5.4A.

If lighting compliance is not performed, use either approach but actual LPDs cannot be entered for the spaces; the LPDs of the building match the standard design.

The allowed space function types in area category are available from Appendix 5.4A. The building or space type determines the following standard design inputs:

- Number of occupants (occupant density)
- Equipment power density
- Lighting power density
- Hot water load
- Schedules (from Appendix 5.4B)

*Units:* List.

*Input Restrictions:* Only selections shown in Appendix 5.4A may be used.

For unconditioned spaces, the user must enter “unconditioned” as the occupancy and ventilation; internal loads and uses are set to zero. Compliance software shall require the user to identify if lighting compliance is performed (lighting plans are included or have already been submitted).

*Standard Design:* Same as proposed design.

*Standard Design: Existing Building:* Same as proposed design.

#### **VENTILATION SPACE FUNCTION**

*Applicability:* All projects.

*Definition:* A unique identifier for ventilation requirements. A given space type may have different ventilation functions available, which define the design ventilation rate and minimum ventilation rates for the space, and any exhaust air requirements.

*Units:* List (from Reference Manual Appendix 5.4A).

*Input Restrictions:* As designed (selection from list)

*Standard Design:* Same as proposed design.

*Standard Design: Existing Building:* Same as proposed design.

## **FLOOR AREA**

*Applicability:* All projects.

*Definition:* The floor area of the space.

The area of the spaces that make up a thermal zone shall sum to the floor area of the thermal zone.

*Units:* Square feet (ft<sup>2</sup>).

*Input Restrictions:* Area shall be measured to the outside of exterior walls and to the center line of partitions.

*Standard Design:* Area shall be identical to the proposed design.

*Standard Design: Existing Building:* Same as proposed design.

## **5.4.2 Infiltration**

Infiltration of outside air into a building, and leakage of air from inside of the building will affect the space conditioning energy use of the building. There are a number of methods used to identify the air leakage or infiltration rate of the building. The method used to identify the air leakage rate and the inputs required are to be provided.

### **INFILTRATION METHOD**

*Applicability:* All projects.

*Definition:* Energy simulation programs have a variety of methods for modeling uncontrolled air leakage or infiltration. Some procedures use the effective leakage area which is generally applicable for small residential scale buildings. The component leakage method requires the user to specify the average leakage through the building envelope per unit area (ft<sup>2</sup>). Other methods require the specification of a maximum rate, which is modified by a schedule. The flow per exterior wall area method shall be used.

*Units:* The infiltration method is prescribed. No input is provided.

*Input Restrictions:* The flow per exterior wall area calculation method is prescribed; a fixed infiltration rate shall be specified and calculated as a leakage per area of exterior envelope, including the gross area of exterior walls and fenestration but excluding roofs and exposed floors.

*Standard Design:* The infiltration method used for the standard design shall be the same as the proposed design.

*Standard Design: Existing Building:*

## **INFILTRATION DATA**

*Applicability:* All projects.

*Definition:* Information needed to characterize the infiltration rate in buildings.

For the flow per exterior wall area calculation method, inputs are described below.

*Units:* Infiltration rate shall be calculated each hour using the following equation:

$$\text{Infiltration} = I_{design} \cdot F_{schedule} \cdot (A + B \cdot |t_{zone} - t_{odb}| + C \cdot ws + D \cdot ws^2)$$

The infiltration is then found by multiplying the infiltration rate by the area of the exterior walls in the thermal zone.

Where:

- *Infiltration Rate* - zone infiltration airflow per unit wall area (m<sup>3</sup>/s-m<sup>2</sup>)
- *Infiltration* - zone infiltration airflow (m<sup>3</sup>/s)
- *I<sub>design</sub>* - zone infiltration airflow rate at reference conditions (m<sup>3</sup>/s-m<sup>2</sup>)
- *F<sub>schedule</sub>* - fractional adjustment from a prescribed schedule, based on HVAC availability schedules in Appendix 5.4B (unitless)
- *t<sub>zone</sub>* - zone air temperature (°C)
- *t<sub>odb</sub>* - outdoor dry bulb temperature (°C)
- *ws* - the wind speed (m/s)
- *A* - overall coefficient (unitless)
- *B* - temperature coefficient (1/°C)
- *C* - wind speed coefficient (s/m)
- *D* - wind speed squared coefficient (s<sup>2</sup>/m<sup>2</sup>)

*Input Restrictions:*

The proposed design shall use the equation listed above, with coefficients A, B, and D set to 0. C shall be set to 0.10016 hr/mile (0.224 s/m). *I<sub>design</sub>* shall be:

- 0.3696 cfm/ft<sup>2</sup> for buildings that do not have air barriers,
- 0.2352 cfm/ft<sup>2</sup> for buildings that have air barriers that are not verified,
- 0.1680 cfm/ft<sup>2</sup> for buildings that have air barriers verified by visual inspection as described in §140.9(a)9Cii of the standards, and

0.1344 cfm/ft<sup>2</sup> for buildings that have air barriers verified by whole building air leakage testing as described in §140.9(a)9Ci of the standards. For nonresidential spaces with operable windows that do not have mechanical system interlocks, the CBECC software shall automatically increase the infiltration rate by 0.15 cfm/ft<sup>2</sup> whenever the outside air temperature is between 50°F and 90°F and when the HVAC system is operating. Multifamily dwelling units are exempt from mechanical system interlocks.

*Standard Design:* The standard design shall use the equation listed above, with coefficients A, B, and D set to 0. C shall be set to 0.10016 hr/mile (0.224 s/m).  $I_{design}$  shall be 0.2352 cfm/ft<sup>2</sup>

*Standard Design: Existing Building:*

### **INFILTRATION SCHEDULE**

*Applicability:* A When an infiltration method is used that requires the specification of a schedule.

*Definition:* With the ACH method and other methods (see above), it may be necessary to specify a schedule that modifies the infiltration rate for each hour or time step of the simulation. Typically, the schedule is either on or off but can also be fractional.

*Units:* Data structure: schedule, fractional.

*Input Restrictions:* The infiltration schedule shall be prescribed based on the HVAC system operating schedules from Appendix 5.4B. The infiltration schedule shall be set equal to 1 when the HVAC system is scheduled off and 0.25 when the HVAC system is scheduled on. This is based on the assumption that when the HVAC system is on it brings the pressure of the interior space above the pressure of the exterior, decreasing the infiltration of outside air. When the HVAC system is off, interior pressure drops below exterior pressure and infiltration increases.

The implementation of the prescriptive requirement for interlocks for operable windows will model mixed mode ventilation as an increased infiltration rate when outside air conditions allow for nonresidential buildings only, excluding healthcare and multifamily residential buildings and spaces.

*Standard Design:* For multifamily residential buildings, the infiltration schedule is equal to 1 for all hours.

For other buildings, the infiltration schedule for the standard design shall be set equal to 1 when the HVAC system is scheduled off and 0.25 when the HVAC system is scheduled on.

*Standard Design: Existing Building:*

### 5.4.3 Occupants

For space level information on occupancy, lighting, and plug load schedules, as well as occupant density, allowed lighting power density. Appendix 5.4A provides a table of allowed space types.

#### FIXED SEATING IN SPACE

*Applicability:* All projects that have a space with fixed seating (such as a theater or auditorium).

*Definition:* This is a flag that indicates that the space has fixed seating. If checked, this flag allows the user to override the default occupancy with values that comply with the California Building Code.

*Units:* Boolean. 

*Input Restrictions:* As designed.

May not be used with multifamily  residential, hotel/motel, unoccupied, and unleased tenant area spaces. The default is false.

*Standard Design:* Same as proposed.

*Standard Design: Existing Building:* The number of occupants must be identical for both the proposed and standard design cases.

#### NUMBER OF OCCUPANTS

*Applicability:* High-rise residential projects. 

*Definition:* The number of people in a space.

The number of people is modified by an hourly schedule (see below), which approaches but does not exceed 1.0. Therefore, the number of people specified by the building descriptor is similar to design conditions as opposed to average occupancy.

*Units:* The number of people may be specified in an absolute number, ft<sup>2</sup>/person, or people/1000 ft<sup>2</sup>.

*Input Restrictions:* The number of occupants is prescribed, and the values are given by Space Type in Appendix 5.4A for nonresidential buildings. For high-rise residential buildings, the rules established in Chapter 6 of the Nonresidential and Multifamily Buildings ACM

Reference Manual apply., For high-rise residential spaces, the number of occupants is defined as: Max (number of bedrooms +1, 2). 

*Standard Design:* The number of occupants must be identical for both the proposed and standard design cases.

The number of occupants must be identical for both the proposed and standard design cases.

### **OCCUPANT HEAT RATE**

*Applicability:* All projects.

*Definition:* The sensible and latent heat produced by each occupant in an hour.

This depends on the activity level of the occupants and other factors. Heat produced by occupants must be removed by the air conditioning system as well as the outside air ventilation rate and can have a significant impact on energy consumption.

*Units:* Btu/h specified separately for sensible and latent gains.

*Input Restrictions:* The occupant heat rate is prescribed by Appendix 5.4A for nonresidential buildings and by Chapter 6 of the Nonresidential ACM Reference Manual for multifamily residential buildings.

*Standard Design:* The occupant heat rate for the standard design shall be the same as the proposed design.

*Standard Design: Existing Building:* Same as proposed.

### **OCCUPANCY SCHEDULE**

*Applicability:* All projects.

*Definition:* The occupancy schedule modifies the number of occupants to account for expected operational patterns in the building. The schedule adjusts the heat contribution from occupants to the space on an hourly basis to reflect time-dependent usage patterns. The occupancy schedule can also affect other factors such as outside air ventilation, depending on the control mechanisms specified.

*Units:* Data structure: schedule, fractional.

*Input Restrictions:* The occupant schedule is prescribed by Appendix 5.4A for nonresidential buildings and by Chapter 6 of the Nonresidential ACM Reference Manual for multifamily residential and other residential buildings.

*Standard Design:* Occupancy schedules are identical for proposed and standard design buildings.



*Standard Design: Existing Building:* Same as proposed.

### 5.4.4 Interior Lighting

The building descriptors in this chapter are provided for each lighting system. Typically, a space will have only one lighting system but, in some cases, it could have two or more. Examples include a general and task lighting system in offices, or hotel multi-purpose rooms that have lighting systems for different functions. It may also be desirable to define different lighting systems for areas that are daylit and those that are not.

#### LIGHTING CLASSIFICATION METHOD

*Applicability:* Each space in the building.

*Definition:* Indoor lighting power can be specified using the area category method or the tailored method.

Area category method can be used for all areas of the building with space types listed in Appendix 5.4A. This method can be used by itself or with the tailored lighting method.

Tailored lighting method can be used for spaces with primary function listed in Table 140.6-D of the standards. The tailored lighting method is intended to accommodate special lighting applications. The tailored lighting method can be used by itself for all areas of the building or with the area category method. For a given area only one classification type can be used.

*Units:* List.

*Input Restrictions:* Only area category or tailored lighting are allowed.

*Standard Design:* Same as proposed.

*Standard Design: Existing Building:* Same as proposed.

**Table 4: Lighting Specification**

<b>Options: Lighting Classification Method</b>	<b>Area category method</b>	<b>Tailored lighting Method</b>
Allowed combinations with other lighting classification methods	May be combined with tailored method in same building, but not in same space.	May be combined with area category method, in same building, but not in same space.

<b>Options: Lighting Classification Method</b>	<b>Area category method</b>	<b>Tailored lighting Method</b>
Allowed Regulated lighting power types	(For all building types except multifamily buildings:)  General lighting power  Additional lighting power	(For all building types except multifamily buildings:)  General lighting power  Wall display lighting power  Floor display and task lighting power  Decorative/special effect lighting power  Very valuable display case lighting power
Allowed Regulated lighting power types	(For Multifamily Buildings:)  Multifamily General lighting power  Multifamily Additional lighting power	(For Multifamily Buildings:)  Multifamily General lighting power  Multifamily Wall display lighting power  Multifamily Task lighting power  Multifamily Decorative/special effect lighting power
Allowed Trade- offs	General lighting between conditioned spaces using area category method  General lighting between conditioned spaces using area category and tailored method	General lighting between conditioned spaces using tailored method  General lighting between conditioned spaces using tailored and area category method

Source: California Energy Commission

Exception: With the area category method, additional lighting power can be used only if the tailored lighting method is not used in any area of the building.

**REGULATED INTERIOR LIGHTING POWER DENSITY**

*Applicability:* All projects when lighting compliance is performed.

*Definition:* Total connected lighting power density for all regulated interior lighting power

This includes the loads for lamps and ballasts. The total regulated interior lighting power density is the sum of general lighting power and applicable custom lighting power per floor area in a space. Calculation of lighting power for conditioned spaces is done separately from unconditioned spaces.

Lighting in unconditioned spaces can be modeled, but total lighting power in unconditioned spaces is not enforced in the compliance software. Lighting in unconditioned spaces must follow prescriptive compliance and must be documented on appropriate compliance forms. No tradeoffs are allowed between lighting in conditioned spaces and lighting in unconditioned spaces.

*Units:* W/ft<sup>2</sup>.

*Input Restrictions:* Proposed value is:

- a. For the area category method: the sum of the proposed general lighting power and the proposed general lighting exceptional power within a conditioned space or a user input value if no interior lighting systems are modeled.
- b. For the tailored lighting method: the sum of the proposed general lighting power and the proposed custom lighting power within a conditioned space or a user input value if no interior lighting systems are modeled.

When lighting compliance is not performed, the lighting power may not be entered and is set equal to the lighting level of the standard design, which is set to the levels for the selected occupancy from Appendix 5.4A.

*Standard Design:* For spaces without special task lighting, wall display lighting or similar requirements, this input will be the same as the general lighting power density. See the general lighting power building descriptor for details.

With the area category and tailored method regulated interior lighting power for each space will be the sum of general lighting power and allowed custom lighting power.

*Standard Design: Existing Building:* For alterations where less than  luminaires have been modified the standard design is the existing lighting condition before the alteration. If 40 or more luminaires have been modified, the prescriptive requirements for newly constructed buildings apply.

**GENERAL LIGHTING POWER**

*Applicability:* All spaces or projects.

*Definition:* General lighting power is the power used by installed electric lighting that provides a uniform level of illumination throughout an area, exclusive of any provision for special visual tasks or decorative effect, and also known as ambient lighting.

*Units:* Watts.

*Input Restrictions:* As designed.

For spaces without special task lighting, wall display lighting or similar requirements, this input will be the same as the regulated lighting power.

Trade-offs in general lighting power are allowed between spaces all using the area category method, between spaces all using the tailored lighting method and between spaces that use area category and tailored methods. See Table 4: Lighting Specification for details.

*Standard Design:* With the area category method, general lighting power is the product of the lighting power densities for the space type from Appendix 5.4A and the floor areas for the corresponding conditioned spaces.

With the tailored lighting method, general lighting power is the product of the lighting power density for the primary function type in Table 140.6-D of the standards and the floor area of the space. The lighting power density is given as a function of room cavity ratio (RCR) and interior illumination level in Table 140.6-G. No interpolation is allowed for this table.

The general lighting power in the tailored method is calculated by the following steps:

Step 1. Determine illumination level from Table 140.6-D by matching the primary function area in Table 140.6-D with the space type in Appendix 5.4A.

Step 2. Calculate the room cavity ratio (RCR) by using the applicable equation in Table 140.6-F.

- Rectangular Rooms:  $RCR = 5 \times H \times (L+W) / (L \times W)$
- Irregular Rooms:  $RCR = 2.5 \times H \times P / A$

Where: L = length of room; W = width of room; H = vertical distance from the work plane to the centerline of the lighting fixture; P = perimeter of room, and A = area of room

Step 3. Determine the general lighting in the space(s) using the tailored method by a look-up in Table 140.6-G, where the general lighting LPD is a function of illuminance level and RCR. No interpolation is allowed for this table. A space between two illuminance levels (for example, 150 lux) uses the applicable LPD from the next lower illuminance level (100 lux).

The standard design uses the irregular room RCR equation for both simplified and detailed geometry models.

The standard design lighting power is modified by a factor of 1/1.20 (0.833) if the simplified geometry approach is used and if the visible transmittance of any fenestration in the space does not meet the prescriptive requirements established in §140.3 of the standards.

*Standard Design: Existing Building:* When the lighting status is “existing” (and unaltered) for the space, the standard design is the same as the existing, proposed design.

When the lighting status is “altered” for the space, and at least 10 percent of existing luminaires have been altered:

- a) If the lighting status is “existing”, then the standard design LPD is the same as the proposed design.
- b) If the lighting status is “new”, then the standard design LPD is same as newly constructed buildings.
- c) If the lighting status is “altered”, then the standard design LPD is the same as newly constructed buildings.

#### **ADDITIONAL LIGHTING POWER**

*Applicability:* Spaces that use the area category method – for all building types except multifamily buildings; note that some additional lighting power allowances are only applicable to certain space types. See Table 140.6-C of the standards.

*Definition:* The standards provide an additional lighting power allowance for qualified lighting systems. The additional lighting power allowance for qualified lighting systems is treated separately as “use-it-or-lose-it” lighting--the user receives no credit (standard design matches proposed) but there is a maximum power allowance for each item). The qualified lighting systems and their allowed additional lighting power allowance values are listed in the two right-most columns in standards Table 140.6-C.

*Units:* Data structure. This input has the following data elements – each data element corresponds to the additional lighting allowance of the functional area types listed in standards Table 140.6-C:

1. Decorative/display lighting, Aging Eye/Low-vision – approved areas (W/ft<sup>2</sup>)
2. Tunable white or dim-to-warm lighting, Aging Eye/Low-vision – approved areas (W/ft<sup>2</sup>)
3. Transition Lighting OFF at night, Aging Eye/Low-vision – Main Entry Lobby (W/ft<sup>2</sup>)
4. Additional ATM or Ticket Machine lighting – Parking Garage Area (W/each)
5. Decorative/Display Lighting, approved areas (W/ft<sup>2</sup>)
6. Detailed Task Work, approved areas (W/ft<sup>2</sup>)
7. External Illuminated Mirror, Fitting Room (W/each)

8. First ATM or Ticket Machine lighting – Parking Garage Area (W/each)
9. Internal Illuminated Mirror, Fitting Room (W/each)
10. Portable lighting for office areas (W/ft<sup>2</sup>)
11. Precision specialized work lighting, approved areas (W/ft<sup>2</sup>)
12. Specialized task work lighting, approved areas (W/ft<sup>2</sup>)
13. Tunable white or dim-to-warm lighting, approved areas (W/ft<sup>2</sup>)
14. Videoconferencing studio lighting (W/ft<sup>2</sup>)
15. White board or chalk board lighting, Classroom, Lecture, Training, Vocational Area (W/linear foot)

*Input Restrictions:* As designed.

*Standard Design:* The standard design additional lighting power (ALP) is given by the following equation:

$$ALP_{std} = \sum_{i=1}^8 \min (GALP_{prop,i}, ALPA_i \times ALPTA_i)$$

Where:

*ALP<sub>std</sub>*

The additional lighting power (ALP) of the standard design

*ALP<sub>prop,i</sub>*

The proposed ALP of the allowance is in the data structure above. If there is no proposed lighting system in the proposed design serving as the qualified lighting system, the ALP<sub>prop,i</sub> should be assigned with a zero value (no allowance permitted and given). If there is a proposed lighting system serving as the qualified lighting system, the ALP<sub>prop,i</sub> should be assigned with a one (1) value.

*ALPA<sub>i</sub>*

The additional lighting power allowance (ALP), which is the maximum allowed additional lighting power indicated in the two rightmost columns in Table 140.6-C of the standards.

*ALTA<sub>i</sub>*

The additional lighting power task area (ALPTA) for the i<sup>th</sup> allowance, where the task area corresponds to the functional area with the additional lighting power allowance in Table 140.6-C of the standards.

*Standard Design: Existing Building:* Not applicable.

**ADDITIONAL LIGHTING POWER TASK AREA**

*Applicability:* Spaces that use area category method.

*Definition:* The area associated with each of the additional lighting allowances in the ALP building descriptor.

*Units:* ft<sup>2</sup>.

*Input Restrictions:* As designed but cannot exceed the floor area of the space.

*Standard Design:* Same as proposed.

*Standard Design: Existing Building:* Same as proposed.

**CUSTOM LIGHTING POWER**

*Applicability:* All spaces or projects that use the tailored lighting method.

*Definition:* Custom lighting power covers lighting sources that are not included as general lighting, including qualified lighting systems specified in the two rightmost columns of Table 140.6-C and lighting systems in Table 140.6-D of the standards. This lighting must be entered separately from the general lighting because it is not subject to tradeoffs.

Software shall allow the user to input a custom lighting input for the allowed lighting system. If area category method is used, custom lighting power cannot be used if the tailored method is used for any area of the building. See Table 4: Lighting Specification for details.

*Units:* Watts.

*Input Restrictions:* As designed.

*Standard Design:* Same as proposed but subject to the maximum limits specified in the two rightmost columns of Table 140.6-C and Table 140.6-D of the standards. For spaces using the tailored method, the maximum allowed custom power is defined by the following procedure:

The standard design custom lighting power is calculated by the sum of the following four terms:

- 1) The product of the standard design wall display power and the standard design wall display length.
- 2) The product of the standard design floor and task lighting power and the standard design floor and task lighting area.
- 3) The product of the standard design decorative and special effect lighting power, and the standard design ornamental and special effect lighting area; and

- 4) The product of the standard design very valuable display case power and the standard design very valuable display case area, subject to prescriptive limits in Table 140.6-D.

*Standard Design: Existing Building:* For alterations where less than 10 percent of existing luminaires have been modified, the standard design is the existing lighting condition before the alteration. If 10 percent or more luminaires have been altered, the custom lighting power for the standard design is the same as proposed, but subject to the limits specified in the footnotes to Table 140.6-C of the standards.

### **WALL DISPLAY POWER**

*Applicability:* All spaces that use the tailored method. This is applicable to all building types except multifamily buildings.

*Definition:* The lighting power allowed for wall display, as specified in standards Table 140.6-D, column 3.

*Units:* W/ft.

*Input Restrictions:* As designed.

*Standard Design:* The standard design lighting power is the lesser of the proposed design wall display power or the limit specified in Table 140.6-D for the applicable space type.

*Standard Design: Existing Building:* Same as proposed.

### **WALL DISPLAY LENGTH**

*Applicability:* All spaces that use the tailored method.

*Definition:* The horizontal length of the wall display lighting area using the tailored method for the space.

*Units:* Ft.

*Input Restrictions:* As designed but this value cannot exceed the floor area of the space.

*Standard Design:* Same as proposed.

*Standard Design: Existing Building:* Same as proposed.

### **FLOOR AND TASK LIGHTING POWER**

*Applicability:* All spaces that use the tailored method.

*Definition:* The lighting power allowed for floor display and task lighting, as specified in Table 140.6-D, column 4 of the standards.

*Units:* W/ft<sup>2</sup>.

*Input Restrictions:* As designed .



*Standard Design:* The standard design floor and task lighting power is the lesser of the proposed design floor and task lighting power or the limit specified in Table 140.6-D, column 4, for the applicable space type.

*Standard Design: Existing Building:* Same as proposed.

#### **FLOOR AND TASK LIGHTING AREA**

*Applicability:* All spaces that use the tailored method.

*Definition:* The lighting area that is served by the floor and task lighting defined using the tailored method for the space.

*Units:* ft<sup>2</sup>.

*Input Restrictions:* As designed but this value cannot exceed the floor area of the space.

*Standard Design:* Same as proposed.

*Standard Design: Existing Building:* Same as proposed.

#### **DECORATIVE AND SPECIAL EFFECT LIGHTING POWER**

*Applicability:* All spaces that use the tailored method.

*Definition:* The lighting power allowed for decorative and special effect lighting, as specified in Table 140.6-D, column 5 of the standards.

*Units:* W/ft<sup>2</sup>.

*Input Restrictions:* As designed.

*Standard Design:* The standard design decorative and special effect lighting power is the lesser of the proposed design decorative and special effect lighting power or the limit specified in Table 140.6-D, column 5, for the applicable space type.

*Standard Design: Existing Building:* Same as proposed.

#### **DECORATIVE AND SPECIAL EFFECT LIGHTING AREA**

*Applicability:* All spaces that use the tailored method.

*Definition:* The lighting area that is served by the decorative and special effect lighting defined using the tailored method for the space.

*Units:* ft<sup>2</sup>.

*Input Restrictions:* As designed but this value cannot exceed the floor area of the space.

*Standard Design:* Same as proposed.

*Standard Design: Existing Building:* Same as proposed.

**VERY VALUABLE DISPLAY CASE LIGHTING POWER**

*Applicability:* All spaces that use the tailored method. This is applicable to all building types except multifamily buildings.

*Definition:* The lighting power allowed for very valuable display case lighting, as specified in standards §140.6(c)3J.

*Units:* W/ft<sup>2</sup>.

*Input Restrictions:* As designed

*Standard Design:* The standard design very valuable display case lighting power is the lesser of:

- a) The product of the area of the primary function and 0.5 W/ft<sup>2</sup>;
- b) The product of the area of the display case and 7 W/ft<sup>2</sup>; or
- c) The adjusted lighting power for very valuable display lighting.

*Standard Design: Existing Building:* Same as proposed.

**VERY VALUABLE DISPLAY CASE LIGHTING AREA**

*Applicability:* All spaces that use the tailored method.

*Definition:* The area of the very valuable display case(s) in plain view.

*Units:* ft<sup>2</sup>.

*Input Restrictions:* As designed but this value cannot exceed the floor area of the space.

*Standard Design:* Same as proposed.

*Standard Design: Existing Building:* Same as proposed.

**NON-REGULATED INTERIOR LIGHTING POWER**

*Applicability:* All projects.

*Definition:* For California, §140.6(a)3 of the energy efficiency standards identifies non-regulated (exempted) lighting.

*Units:* ft<sup>2</sup>.

*Input Restrictions:* As designed

The non-regulated lighting power should be cross-referenced to the type of exception and to the construction documents. The default for non-regulated lighting power is zero.

*Standard Design:* The non-regulated interior lighting in the standard design shall be the same as the proposed design.

*Standard Design: Existing Buildings:* Same as proposed.

### **LIGHTING SCHEDULES**

*Applicability:* All projects.

*Definition:* Schedule of operation for interior lighting power used to adjust the energy use of lighting systems on an hourly basis to reflect time-dependent patterns of lighting usage.

*Units:* Data structure: schedule, fractional.

*Input Restrictions:* The lighting schedule is prescribed for California compliance. An appropriate schedule from Appendix 5.4B shall be used.

*Standard Design:* The non-regulated interior lighting in the standard design shall be the same as the proposed design.

*Standard Design: Existing Building:* Same as proposed.

### **TAILORED LIGHTING GENERAL ILLUMINATION HEIGHT**

*Applicability:* Spaces that have special tailored lighting power allowances.

*Definition:* The illumination height is the vertical distance from the work plane to the centerline of the luminaire. This distance is used in the room cavity ratio (RCR) calculation which determines the allowed general lighting power density for a tailored lighting space.

*Units:* Ft.

*Input Restrictions:* As designed.

*Standard Design:* Same as proposed

The illumination height, H, is used to calculate the RCR and therefore the standard design general lighting power. See general lighting power for details.

*Standard Design: Existing Building:* Same as proposed.

### **FLOOR/WALL DISPLAY MOUNTING HEIGHT ABOVE FLOOR**

*Applicability:* Spaces that have wall display or floor display lighting and tailored lighting power allowances.

*Definition:* The mounting height of wall display or floor display lighting above the floor.

*Units:* List one of four choices:

1. <10'-6"
2. 10'-6" – 14'-0"
3. >14'-0" – 18'-0"
4. 18'-0"

*Input Restrictions:* As designed.

*Standard Design:* As designed.

The entered value maps to Table 140.6-E of the standards, that provides an adjustment multiplier for the tailored lighting wall power allowance in Table 140.6-D. The multiplier is 1.00 if the mounting height is less than 10 ft 7 inches, 0.85 if the mounting height is 10 feet 7 inches to 14 feet, 0.75 if the mounting height is greater than 14 feet up to 18 feet, and 0.70 if the mounting height is greater than 18 feet. The compliance software uses this adjustment multiplier to set the standard design lighting power.

*Standard Design: Existing Building:* Same as proposed.

### **FIXTURE TYPE**

*Applicability:* All interior light fixtures.

*Definition:* The type of lighting fixture, which is used to determine light heat gain distribution.

*Units:* List: one of three choices:

1. Recessed with lens
2. Recessed/downlight
3. Not in ceiling

*Input Restrictions:* As designed.

*Standard Design:* Recessed/downlight.

*Standard Design: Existing Building:* Recessed/downlight

### **LUMINAIRE TYPE**

*Applicability:* All interior light fixtures.

*Definition:* The type of lighting luminaire used to determine the light heat gain distribution

The dominant luminaire type determines the daylight dimming characteristics when there is more than one type of luminaire in the space.

*Units:* List:

- a) Linear fluorescent
- b) Compact fluorescent lamp
- c) Incandescent
- d) Light emitting diode (LED)
- e) Metal halide

- f) Mercury vapor
- g) High pressure sodium

*Input Restrictions:* As designed.

*Standard Design:* Linear fluorescent.

*Standard Design: Existing Building:* Linear fluorescent.

### **LIGHT HEAT GAIN DISTRIBUTION**

*Applicability:* All projects.

*Definition:* The distribution of the heat generated by the lighting system that is directed to the space, the plenum, the HVAC return air, or to other locations

This input is a function of the luminaire type and location. Luminaires recessed into a return air plenum contribute more of their heat to the plenum or the return air stream if the plenum is used for return air, while pendant mounted fixtures hanging in the space contribute more of their heat to the space. Common luminaire type/space configurations are listed in Table 3, Chapter 18, 2009 ASHRAE Handbook of Fundamentals, summarized in [Table 5](#). Typically, the data will be linked to a list of common luminaire configurations similar to [Table 5: Light Heat Gain Parameters for Typical Operating Conditions](#) so that the user chooses a luminaire type category and heat gain is automatically distributed to the appropriate locations.

*Units:* List (of luminaire types) or data structure consisting of a series of decimal fractions that assign heat gain to various locations.

*Input Restrictions:* Heat gain distribution is fixed to [Table 5: Light Heat Gain Parameters for Typical Operating Conditions](#) values based on the luminaire, fixture, and distribution type.

Where lighting fixtures having different heat venting characteristics are used within a single space, the wattage weighted average heat-to-return-air fraction shall be used.

*Standard Design:* The standard design shall use the values in [Table 7: Light Heat Gain Parameters for Typical Operating Conditions](#) for recessed fluorescent luminaires without lens.

*Standard Design: Existing Building:* Same as newly constructed buildings.

**Table 5: Light Heat Gain Parameters for Typical Operating Conditions**

Based on Table 3, Chapter 18, 2009 ASHRAE Handbook - Fundamentals

<b>Fixture Type</b>	<b>Luminaire Type</b>	<b>Return Type</b>	<b>Space Fraction</b>	<b>Radiative Fraction</b>
Recessed with Lens	Linear Fluorescent	Ducted/Direct	1.00	0.67
Recessed with Lens	Linear Fluorescent	Plenum	0.45	0.67
Recessed/Downlight	Linear Fluorescent	Ducted/Direct	1.00	0.58
Recessed/Downlight	Linear Fluorescent	Plenum	0.69	0.58
Recessed/Downlight	CFL	Ducted/Direct	1.00	0.97
Recessed/Downlight	CFL	Plenum	0.20	0.97
Recessed/Downlight	Incandescent	Ducted/Direct	1.00	0.97
Recessed/Downlight	Incandescent	Plenum	0.75	0.97
Recessed/Downlight	LED	Ducted/Direct	1.00	0.97
Recessed/Downlight	LED	Plenum	0.20	0.97
Recessed/Downlight	Metal Halide	Ducted/Direct	1.00	0.97
Recessed/Downlight	Metal Halide	Plenum	0.75	0.97
Non in Ceiling	Linear Fluorescent	Ducted/Direct	1.00	0.54
Non in Ceiling	Linear Fluorescent	Plenum	1.00	0.54
Non in Ceiling	CFL	Ducted/Direct	1.00	0.54
Non in Ceiling	CFL	Plenum	1.00	0.54
Non in Ceiling	Incandescent	Ducted/Direct	1.00	0.54
Non in Ceiling	Incandescent	Plenum	1.00	0.54
Non in Ceiling	LED	Ducted/Direct	1.00	0.54

Fixture Type	Luminaire Type	Return Type	Space Fraction	Radiative Fraction
Non in Ceiling	LED	Plenum	1.00	0.54
Non in Ceiling	Metal Halide	Ducted/Direct	1.00	0.54
Non in Ceiling	Metal Halide	Plenum	1.00	0.54
Non in Ceiling	Mercury Vapor	Ducted/Direct	1.00	0.54
Non in Ceiling		Plenum	1.00	0.54
Non in Ceiling	High Pressure Sodium	Ducted/Direct	1.00	0.54
Non in Ceiling		Plenum	1.00	0.54

Source: California Energy Commission

In this table, the Space Fraction is the fraction of the lighting heat gain that goes to the space; the radiative fraction is the fraction of the heat gain to the space that is due to radiation, with the remaining heat gain to the space due to convection.

**LIGHTING POWER ADJUSTMENT FACTORS (PAF)**

*Applicability:* All projects.

*Definition:* Automatic controls that are not already required by the Energy Code and which reduce lighting power uniformly over the day can be modeled as power adjustment factors. Power adjustment factors represent the percent reduction in lighting power that will approximate the effect of the control. Models account for such controls by multiplying the controlled watts by (1-PAF).

Eligible California power adjustment factors are defined in Table 140.6-A. Reduction in lighting power using the PAF method can be used only for nonresidential controlled general lights. Only one PAF can be used for a qualifying lighting system unless multiple adjustment factors are allowed in Table 140.6-A of the standards. Controls for which PAFs are eligible are listed in Table 140.6-A of the standards and include:

- a) Occupancy Sensing Controls in offices larger than 250 square feet.
- b) Demand Response Controls – Demand responsive lighting control that reduces lighting power consumption in response to a demand response signal for qualifying building types.
- c) Institutional tuning – lighting tuned to not use more than 85 percent of rated power, per §140.6 of the standards.

- d) Daylight dimming plus off controls – daylight dimming controls that automatically shut off luminaires when natural lighting provides an illuminance level of at least 150 percent of the space requirement.
- e) Horizontal slats – interior or exterior horizontal slats on fenestration adjacent to daylight areas
- f) Light shelves – interior or exterior light shelves adjacent to daylight areas

Clerestories are modeled as Power Adjustment Factors and are not modeled directly by compliance software. Compliance software shall have a means of disregarding daylight through clerestory windows when using the PAF. If handled with a PAF, daylight controls in zones with clerestory windows should be disabled.

Units: List: eligible control types (see above) linked to PAFs

*Input Restrictions:* PAF shall be fixed for a given control and area type.

*Standard Design:* PAF is zero.

*Standard Design: Existing Building:* PAF is zero.

### **5.4.5 Daylighting Control**

This group of building descriptors is applicable for spaces that have daylighting controls or daylighting control requirements.

California prescribes a modified version of the split flux daylighting methods to be used for compliance. This is an *internal daylighting method* because the calculations are automatically performed by the simulation engine. For skylit daylight areas (aka top-lighted areas) or sidelit daylight areas, California compliance prescribes an internal daylighting model consistent with the split flux algorithms used in many simulation programs. With this method the simulation model has the capability to model the daylighting contribution for each hour of the simulation and make an adjustment to the lighting power for each hour, taking into account factors such as daylighting availability, geometry of the space, daylighting aperture, control type, and the lighting system. The assumption is that the geometry of the space, the reflectance of surfaces, the size and configuration of the daylight apertures, and the light transmission of the glazing are taken from other building descriptors.

For daylight control using a simplified geometry approach, daylight control for both the primary daylight zone and secondary daylight zone (mandatory) must be indicated on the compliance forms. If the simplified geometry approach is used and the visible transmittance of fenestration does not meet prescriptive requirements, the standard design lighting power is reduced by 20 percent as a penalty. See [Chapter 5.4.4 Interior Lighting](#).

### **DAYLIGHT CONTROL REQUIREMENTS**



*Applicability:* All spaces with exterior fenestration.

*Definition:* The extent of daylighting controls in skylit and sidelit areas of the space.

*Units:* List.

*Input Restrictions:* When the installed general lighting power in the primary daylit zone exceeds 120W, daylighting controls are required, per the Title 24 mandatory requirements.

*Standard Design:* For nonresidential spaces, when the installed general lighting power in the skylit, primary sidelit, or secondary sidelit daylit zone exceeds 120W, daylighting controls are required, per the Title 24 mandatory requirements. Controls are not required if total glazing area is less than 24 ft<sup>2</sup> or for luminaires in sidelit daylit zones in retail merchandise sales and wholesale showroom areas.

For parking garages, when the installed general lighting power in the primary sidelit and secondary sidelit daylit zone exceeds 60W, daylighting controls are required, per the Title 24 mandatory requirements. Luminaires located in daylit transition zones or dedicated ramps are exempt from this requirement. Controls are not required if total glazing and openings are less than 36 ft<sup>2</sup>.

*Standard Design: Existing Buildings:* When lighting systems in an existing altered building are not modified as part of the alteration, daylighting controls are the same as the proposed design.

When an alteration increases the area of a lighted space, increases lighting power in a space, or when luminaires are modified in a space where proposed design lighting power density is greater than 85 percent of the standard design LPD, daylighting control requirements are the same as for newly constructed buildings.

### **SKYLIT, PRIMARY, AND SECONDARY DAYLIT AREA**

*Applicability:* All daylit spaces.

*Definition:* The floor area that is daylit.

The skylit area is the portion of the floor area that gets daylighting from a skylight. Two types of sidelit daylit areas are recognized. The primary daylit area is the portion that is closest to the daylighting source and receives the most illumination. The secondary daylit area is an area farther from the daylighting source, which still receives useful daylight.

The primary daylit area for side lighting is a band near the window with a depth equal to the distance from the floor to the top of the window and width equal to window width plus 0.5 times window head height wide on each side of the window opening. The secondary daylit area for side lighting is a band beyond the primary daylit area that extends a distance double the distance from the floor to the top of the window and width equal to window

width plus 0.5 times window head height wide on each side of the window opening. Area beyond a permanent obstruction taller than 6 feet should not be included in the primary and secondary daylight area calculation.

The skylit area is a band around the skylight well that has a depth equal to 70 percent of the ceiling height from the edge of the skylight well. The geometry of the skylit daylit area will be the same as the geometry of the skylight. Area beyond a permanent obstruction taller than 50 percent of the height of the skylight from the floor should not be included in the skylit area calculation.

Double counting due to overlaps is not permitted. If there is an overlap between secondary and primary or skylit areas, the effective daylit area used for determining reference position shall be the area minus the overlap.

*Units:* ft<sup>2</sup>.

*Input Restrictions:* The daylit areas in a space are derived using other modeling inputs like dimensions of the fenestration and ceiling height of the space.

*Standard Design:* The daylit areas in the standard design are derived from other modeling inputs, including the dimensions of the fenestration and ceiling height of the space. Daylit area calculation in the standard design is done after window to wall ratio and skylight to roof ratio rules in Section Chapter 5.5.7 Fenestration of this manual are applied.

*Standard Design: Existing Buildings:* Same as newly constructed buildings when skylights are added/replaced and general lighting altered.

### **INSTALLED GENERAL LIGHTING POWER IN THE PRIMARY AND SKYLIT DAYLIT ZONE**

*Applicability:* All spaces.

*Definition:* The installed lighting power of general lighting in the primary and skylit daylit zone.

The primary and skylit daylit zone shall be defined on the plans and be consistent with the definition of the primary and skylit daylit zone in the standards. Note that a separate building descriptor, fraction of controlled lighting, defines the fraction of the lighting power in the space that is controlled by daylighting.

*Units:* Watts.

*Input Restrictions:* As designed.

*Standard Design:* The installed lighting power for the standard design is the product of the primary daylit area and the LPD for general lighting in the space.

Standard Design: Existing Buildings: Same as newly constructed buildings when skylights are added/replaced and general lights are altered.

**INSTALLED GENERAL LIGHTING POWER IN THE SECONDARY DAYLIT ZONE**

Applicability: All spaces.

Definition: The installed lighting power of general lighting in the secondary daylit zone.

The secondary daylit zone shall be defined on the plans and be consistent with the definition of the secondary daylit zone in the standards. Note that a separate building descriptor, fraction of controlled lighting, defines the fraction of the lighting power in the space that is controlled by daylighting.

Units: Watts.

Input Restrictions: As designed.

Standard Design: The installed lighting power for the standard design is the product of the secondary daylit area and the LPD for general lighting in the space.

Standard Design: Existing Buildings: Same as newly constructed buildings when skylights are added/replaced and general lights are altered.

**REFERENCE POSITION FOR ILLUMINANCE CALCULATIONS**

*Applicability:* All spaces or thermal zones, depending on which object is the primary container for daylighting controls.

*Definition:* The position of the two daylight reference points within the daylit space.

Lighting controls are simulated so that the illuminance at the reference position is always maintained at or above the illuminance setpoint. For step switching controls, the combined daylight illuminance plus uncontrolled electric light illuminance at the reference position must be greater than the setpoint illuminance before the controlled lighting can be dimmed or tuned off for stepped controls. Similarly, dimming controls will be dimmed so that the combination of the daylight illuminance plus the controlled lighting illuminance is equal to the setpoint illuminance.

Preliminary reference points for primary and secondary daylit areas are located at the farthest end of the daylit area aligned with the center of each window. For skylit area, the preliminary reference point is located at the center of the edge of the skylit area closest to the centroid of the space. In each case, the Z – coordinate of the reference position (elevation) shall be located 2.5 feet above the floor.

Up to two final reference positions can be selected from among the preliminary reference positions identified in for each space.

Units: Data structure.

**Input Restrictions:** The user does not specify the reference position locations; reference positions are automatically calculated by the compliance software based on the procedure outlined below. Preliminary reference positions are each assigned a relative daylight potential (RDP) which estimates the available illuminance at each position, and the final reference position selection is made based on the RDP.

**Relative Daylight Potential:** An estimate of daylight potential at a specific reference position. This is NOT used directly in the energy simulation, but it used to determine precedence for selecting the final reference points. The relative daylight potential is calculated as a function of effective aperture, azimuth, illuminance setpoint and the type (skylit, primary sidelit, or secondary sidelit) of the associated daylight zone. RDP is defined as:

$$RDP = C_1 \times EA_{dz} + C_2 \times SO + C_3$$

Where:  $C_1, C_2,$  and  $C_3$  are selected from the following table.

☒	Skylit·Daylit·Zones☒			Primary·Sidelit·Daylit·Zones☒			Secondary·Sidelit·Daylit·Zones☒		
	$C_1$ ☒	$C_2$ ☒	$C_3$ ☒	$C_1$ ☒	$C_2$ ☒	$C_3$ ☒	$C_1$ ☒	$C_2$ ☒	$C_3$ ☒
☒ Illuminance·Setpoint☒									
☒ ≤·200·lux☒	3927☒	0☒	3051☒	1805☒	-0.40☒	3506☒	7044☒	-3.32☒	1167☒
☒ ≤·1000·lux☒	12046☒	0☒	-421☒	6897☒	-7.22☒	475☒	1512☒	-2.88☒	-22☒
☒ >·1000·lux☒	5900☒	0☒	-516☒	884☒	-5.85☒	823☒	212☒	-0.93☒	57☒

**Illuminance Setpoint:** This is defined by the user, and is entered by the user, subject to the limits specified in Appendix 5.4A, determined from the space type.

**Source Orientation (SO):** The angle of the outward facing normal of the daylight source’s parent surface projected onto a horizontal plane, expressed as degrees from south. This is not a user input but is calculated from the geometry of the parent surface. For skylights, the source orientation is not applicable. For vertical fenestration, it is defined:

$$SO = |(180 - Azimuth)|$$

Where: Azimuth is defined as the azimuth of the parent object containing the fenestration associated with the preliminary reference point.

**Effective Aperture (EA):** For this calculation, effective aperture represents the effectiveness of all sources which illuminate a specific reference position in contributing to the daylight available to the associated daylit zone. In cases where daylit zones from multiple fenestration objects intersect, the effective aperture of an individual daylit zone is adjusted to account for those intersections according to the following rules:

- For skylit and primary sidelit daylit zones, intersections with other skylit or primary sidelit daylit zones are considered.
- For secondary sidelit daylit zones, intersections with any toplit or sidelit (primary or secondary) daylit zones are considered.

Effective aperture is defined as follows:

$$EA_{dz} = (VT_{fdz} \times A_{fdz} + \sum F_i \times VT_i \times A_i) / A_{dz}$$

Where:

- $EA_{dz}$  - Is the combined effective aperture of all daylight sources illuminating a specific daylit zone.
- $VT_{fdz}$  - Is the user specified visible transmittance of the fenestration object directly associated with the daylit zone.
- $A_{fdz}$  - Is the area of the fenestration object directly associated with the daylit zone.
- $VT_i$  - Is the user specified visible transmittance of the fenestration object associated with each intersecting daylit zone.
- $A_i$  - Is the area of the fenestration object directly associated with each intersecting daylit zone.
- $F_i$  - Is the fraction of intersecting area between the daylit zone in question and each intersecting daylit zone:
- $F_i = A_{intersection} / A_{dzi}$
- $A_{dzi}$  - Is the area of each intersecting daylit zone (including area that might fall outside a space or exterior boundary).
- $A_{dz}$  - Is the area of the daylit zone (including area that might fall outside a space or exterior boundary).

**First Reference Position:** Select the preliminary reference point with the highest relative daylight potential (RDP) from among all preliminary reference points located within either

top or primary sidelit daylit zones. If multiple reference points have identical RDPs, select the reference point geometrically closest to the centroid of the space.

**Second Reference Position:** Select the preliminary reference point with the highest RDP from amongst all remaining preliminary reference points located within either top or primary sidelit daylit zones. If multiple reference points have identical RDPs, select the reference point geometrically closest to the centroid of the space.

*Standard Design:* Reference positions for the standard design shall be selected using the same procedure as those selected for the proposed design.

*Standard Design: Existing Buildings:* Additions or alternations of lighting in spaces trigger the daylighting control requirements whenever the total installed lighting in the daylit zone is 120 W or greater, and the reference positions shall be determined in the same manner as with newly constructed buildings. This only applies when alterations or additions to the lighting in an existing building trigger daylighting control requirements.

### **ILLUMINATION ADJUSTMENT FACTOR**

*Applicability:* All Daylit Spaces.

*Definition:* Recent studies have shown that the split flux interreflection component model used in many simulation programs overestimates the energy savings due to daylighting, particularly deep in the space. A set of two adjustment factors is provided, one for the primary daylit zone and one for the secondary daylit zone.

For simulation purposes, the input daylight illuminance setpoint will be modified by the illuminance adjustment factor as follows:

$$[\text{LightSetpoint}]_{\text{adj}} = \text{LightSetpoint} \times \text{Adjustment Factor}$$

*Units:* Unitless

*Input Restrictions:* Prescribed values for space type in Appendix 5.4A.

*Standard Design:* The standard design illumination adjustment factors shall match the proposed.

*Standard Design: Existing Buildings:* Same as newly constructed buildings when skylights are added/replaced and general light is altered.

### **FRACTION OF CONTROLLED LIGHTING**

*Applicability:* Daylit Spaces.

*Definition:* The fraction of the general lighting power in the primary and skylit daylit zone, or secondary sidelit daylit zone that is controlled by daylighting controls.

*Units:* Numeric: fraction for primary and skylit daylit zone, and fraction for secondary zone

*Input Restrictions:* As designed for secondary daylit areas. Primary, secondary and skylit daylit area fraction of controlled general lighting shall be as designed when the daylight control requirements building descriptor indicates that they are not required and shall be 1 when controls are required.

*Standard Design:* When daylight controls are required according to the daylight control requirements building descriptor in either the primary daylit and skylit zone, or the secondary daylit zone, or both, the fraction of controlled lighting shall be 1.

*Standard Design: Existing Buildings:* Same as for newly constructed buildings when skylights are added/replaced, and general light is altered.

### **DAYLIGHTING CONTROL TYPE**

*Applicability:* Daylit Spaces.

*Definition:* The type of control that is used to control the electric lighting in response to daylight available at the reference point.

Options:

- Stepped switching controls: The electric power input and light output vary in discrete, equally spaced steps.
- Continuous dimming controls: The fraction to rated power to fraction of rated output that is a linear interpolation of the minimum power fraction at the minimum dimming light fraction to rated power at full light output. See Figure 8: Example Continuous Dimming Control.
- Continuous dimming + off controls: Same as continuous dimming controls except that these controls can turn all the way off when none of the controlled light output is needed.

**Figure 8: Example of Lighting Power Fraction Continuous Dimming and Continuous Dimming Plus OFF Daylighting Controls (with Minimum Dimming Fraction of 10 Percent)**

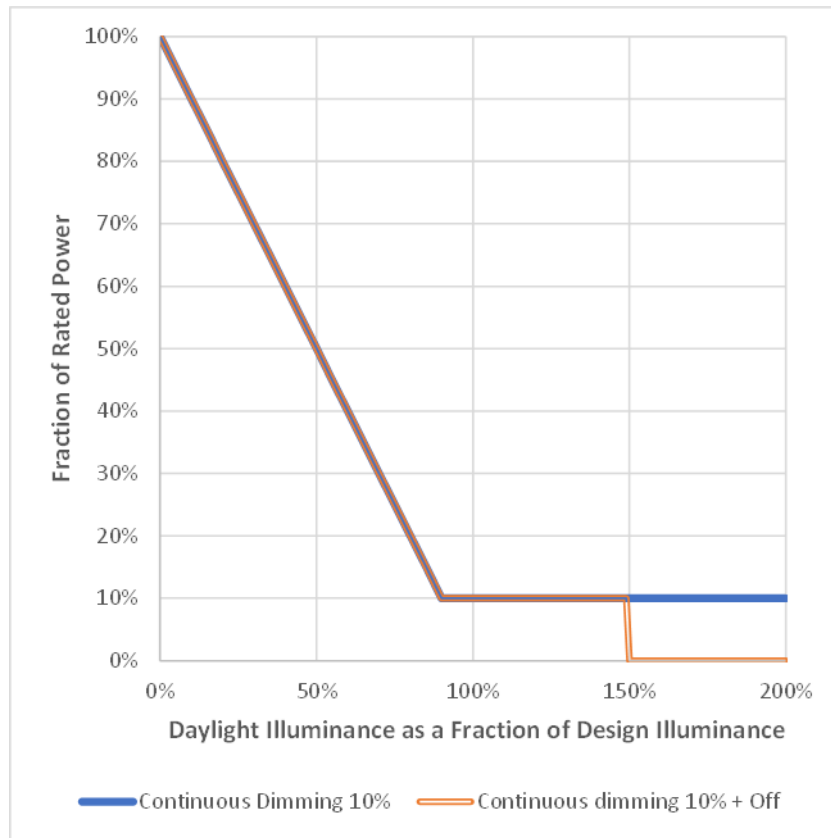

Source: Energy Solutions for California Energy Commission

Units: List (see above).

*Input Restrictions:* Daylighting control type must be specified when daylighting control is required. For parking garage with daylighting control, the users must use continuous dimming plus off control or stepped switching control to meet the mandatory requirement.

*Standard Design:* Parking garage in standard design uses continuous plus off daylighting control. All other spaces in standard design use continuous daylighting control.

*Standard Design: Existing Buildings:* Same as for newly constructed buildings when skylights are added/replaced, and general light is altered.

**MINIMUM DIMMING POWER FRACTION**

*Applicability:* Daylit spaces.

*Definition:* The minimum power fraction when controlled lighting is fully dimmed. Minimum power fraction = minimum power / full rated power.



*Units:* Numeric: fraction.

*Input Restrictions:* In proposed design if continuous daylighting control is used, the dimming fraction must be 0.1 or lower. No restriction if other control types are used.

*Standard Design:* Standard design uses a minimum dimming power fraction of 0.1.

*Standard Design: Existing Buildings:* Same as for newly constructed buildings when skylights are added/replaced, and general light is altered.

### **MINIMUM DIMMING LIGHT FRACTION**

*Applicability:* Daylighting and dimming controls.

*Definition:* The minimum light output when controlled lighting is fully dimmed. Minimum light fraction = minimum light output / rated light output.

*Units:* Numeric: fraction.

*Input Restrictions:* No restrictions.

*Standard Design:* Standard design uses a minimum dimming light fraction of 0.1.

*Standard Design: Existing Buildings:* Same as for newly constructed buildings when skylights are added/replaced, and general light is altered.

### **5.4.6 Receptacle Loads**

Receptacle loads contribute to heat gains in spaces and directly use energy.

#### **RECEPTACLE POWER**

*Applicability:* All building projects.

*Definition:* Receptacle power is power for typical general service loads in the building. Receptacle power includes equipment loads normally served through electrical receptacles, such as office equipment and printers, but does not include either task lighting or equipment used for HVAC purposes. Receptacle power values are slightly higher than the largest hourly receptacle load that is actually modeled because the receptacle power values are modified by the receptacle schedule, which approaches but does not exceed 1.0.

*Units:* Total power (W) or the space power density (W/ft<sup>2</sup>)

Compliance software shall also use the following prescribed values to specify the latent heat gain fraction and the radiative/convective heat gain split.

For software that specifies the fraction of the heat gain that is lost from the space, this fraction shall be prescribed at 0.

Heat Gain Fractions:

- Receptacle Power
  - Radiative: 0.20
  - Latent: 0.00
  - Convective: 0.80
- Gas Equipment Power
  - Radiative: 0.15
  - Latent: 0.00
  - Convective: 0.00

*Input Restrictions:* Prescribed to values from Appendix 5.4A for nonresidential buildings.

For multifamily residential buildings, the rules established in Chapter 6 of the Nonresidential ACM Reference Manual apply.

For computer room space, receptacle load minimum is 20 W/ft<sup>2</sup>.

*Standard Design:* Same as proposed.

*Standard Design: Existing Buildings:* Same as for newly constructed buildings.

### **RECEPTACLE SCHEDULE**

*Applicability:* All projects.

*Definition:* Schedule for receptacle power loads used to adjust the intensity on an hourly basis to reflect time-dependent patterns of usage.

*Units:* Data structure: schedule, fraction.

*Input Restrictions:* Prescribed to schedule in Appendix 5.4A for nonresidential buildings. For multifamily residential buildings, the rules established in Chapter 6 of the Nonresidential ACM Reference Manual apply.

*Standard Design:* Same as proposed.

*Standard Design: Existing Buildings:* Same as for newly constructed buildings.

### **UPS EFFICIENCY**

*Applicability:* Computer rooms and data centers with computer rooms.

*Definition:* The efficiency of the Uninterruptible Power Supply (UPS) systems in a computer room. This only applies with computer room process loads with a minimum power density of 20 W/sf.

*Units:* Percentage, 0 to 100%.

*Input Restrictions:* Prescribed to schedule in Appendix 5.4A for nonresidential buildings. For multifamily residential buildings, the rules established in Chapter 6 of the Nonresidential ACM Reference Manual apply.

*Standard Design:* The UPS Efficiency shall match the requirements in Table 140.9-A.

*Standard Design: Existing Buildings:* Same as for newly constructed buildings.

### **5.4.7 Commercial Refrigeration Equipment**

Commercial refrigeration equipment includes the following:

- Walk-in refrigerators
- Walk-in freezers
- Refrigerated casework

Refrigeration equipment is modeled as neutral plug loads, with standard design power matching the proposed design.

#### **REFRIGERATION MODELING METHOD**

*Applicability:* All buildings that have commercial refrigeration for cold storage or display

*Definition:* The method used to estimate refrigeration energy and to model the thermal interaction with the space where casework is located.

- Title 24 defaults. With this method, the power density values provided in Appendix 5.4A0F0F are used; schedules are assumed to be continuous operation.

*Units:* List (see above).

*Input Restrictions:* The Title 24 defaults shall be used.

*Standard Design:* Title 24 defaults.

*Standard Design: Existing Buildings:* Same as for newly constructed buildings.

#### **REFRIGERATION POWER**

*Applicability:* All buildings that have commercial refrigeration for cold storage or display.

*Definition:* Commercial refrigeration power is the average power for all commercial refrigeration equipment, assuming constant year-round operation. Equipment includes walk-in refrigerators and freezers, open refrigerated casework, and closed refrigerated casework. It does not include residential type refrigerators used in kitchenettes or refrigerated vending machines. These are covered under receptacle power.

*Units:* W/ft<sup>2</sup>.

*Input Restrictions:* With the Title 24 defaults method, the values in Appendix 5.4A are prescribed. These values are multiplied times the floor area of the rated building to estimate the refrigeration power.

*Standard Design:* Refrigeration power is the same as the proposed design when the Title 24 defaults are used.

*Standard Design: Existing Buildings:* Same as for newly constructed buildings.

### **5.4.8 Elevators, Escalators and Moving Walkways**

Elevators, escalators and moving walkways account for 3 percent to 5 percent of electric energy use in buildings.<sup>1</sup> Buildings up to about five to seven stories typically use hydraulic elevators because of their lower initial cost. Mid-rise buildings commonly use traction elevators with geared motors, while multifamily buildings typically use gearless systems where the motor directly drives the sheave. The energy-using components include the motors and controls as well as the lighting and ventilation systems for the cabs.

Elevators, escalators, and moving walkways are modeled as a plug loads, with the standard design power matching the proposed design.

#### **ELEVATOR & ESCALATOR POWER**

*Applicability:* All buildings that have commercial elevators, escalators, or moving walkways.

*Definition:* The power for elevators, escalators and moving walkways are modeled as plug loads.

*Units:* W/unit.

*Input Restrictions:* The power values are prescribed for the proposed design.

*Standard Design:* Same as the proposed design.

*Standard Design: Existing Buildings:* Not applicable.

#### **ELEVATOR & ESCALATOR SCHEDULE**

*Applicability:* All buildings that have commercial elevators, escalators, or moving walkways.

*Definition:* The schedule of operation for elevators, escalators, and moving walkways. This is used to convert elevator/escalator power to energy use.

*Units:* Data structure: schedule, state.

---

<sup>1</sup> Sachs, Harvey M., Opportunities for Elevator Energy Efficiency Improvements, American Council for an Energy Efficiency Economy, April 2005.

*Input Restrictions:* The operating schedule is prescribed and indicated in Appendix 5.4B.

*Standard Design:* Same as the proposed design.

*Standard Design: Existing Buildings:* Not applicable.

### **5.4.9 Process, Gas**

Commercial gas equipment includes the following:

- Ovens
- Fryers
- Grills
- Other equipment

The majority of gas equipment is located in the space and may contribute both sensible and latent heat. Gas equipment is modeled by specifying the rate of peak gas consumption and a fractional schedule that is prescribed in Appendix 5.4B. The procedure consists of prescribed power and energy values for use with both the proposed and standard design buildings. No credit for commercial gas energy efficiency features is offered.

The prescribed values are provided in Appendix 5.4A. Schedules are defaulted to be continuous operation.

#### **GAS EQUIPMENT POWER**

*Applicability:* All buildings that have commercial gas equipment.

*Definition:* Commercial gas power is the average power for all commercial gas equipment, assuming constant year-round operation.

*Units:* Btu/h-ft<sup>2</sup>.

Compliance software shall also use the following prescribed values to specify the latent heat gain fraction and the radiative/convective heat gain split.

For software that specifies the fraction of the heat gain that is lost from the space, this fraction shall be prescribed at 0.

Gas Equipment Power Heat Gain Fractions:

Radiative = 0.15, Latent = 0, Convective = 0

*Input Restrictions:* The values in Appendix 5.4A are prescribed. However, these values may be overridden with a "0" value for buildings that are designed to use only electricity as the source.

*Standard Design:* Same as the proposed design.

*Standard Design: Existing Buildings:* Not applicable.

### **GAS EQUIPMENT SCHEDULE**

*Applicability:* All buildings that have commercial gas equipment.

*Definition:* The schedule of operation for commercial gas equipment. This is used to convert gas power to energy use.

*Units:* Data structure: schedule, fractional.

*Input Restrictions:* Continuous operation is prescribed.

*Standard Design:* Same as the proposed design.

*Standard Design: Existing Buildings:* Not applicable.

### **GAS EQUIPMENT LOCATION**

*Applicability:* All buildings that have commercial gas equipment.

*Definition:* The assumed location of the gas equipment for modeling purposes.

*Units:* List (in the space or external).

*Input Restrictions:* As designed.

*Standard Design:* Same as the proposed design.

*Standard Design: Existing Buildings:* Not applicable.

### **RADIATION FACTOR**

*Applicability:* Gas appliances located in the space.

*Definition:* The fraction of heat gain to appliance energy use.

*Units:* Fraction.

*Input Restrictions* Default value is 0.15. Other values can be used when a detailed inventory of equipment is known. The override value shall be based on data in Table 5C, Chapter 18, ASHRAE HOF, 2009, or similar tested information from the manufacturer.

*Standard Design* Same as the proposed design.

*Standard Design: Existing Buildings:* Not applicable.

### **USAGE FACTOR**

*Applicability:* Gas appliances located in the space.

*Definition:* A duty cycle or usage factor to appliance energy use.

The radiation factor and usage factor are used together to determine the sensible heat gain to the space:

$$Q_{\text{sens}} = Q_{\text{input}} \times \text{FU} \times \text{FR}$$

Where  $Q_{\text{input}}$  is the heat input of the equipment in Btu/h or Btu/h-ft<sup>2</sup>,

FU is the usage factor and

FR is the radiation factor

*Units:* Fraction.

*Input Restrictions:* Default value is 0.70. Other values can be used when a detailed inventory of equipment is known. The override value shall be based on data in Table 5C, Chapter 18, ASHRAE HOF, 2009, or similar tested information from the manufacturer.

*Standard Design:* Same as the proposed design.

*Standard Design: Existing Buildings:* Not applicable.

### **GAS PROCESS LOADS**

*Applicability* Spaces with process loads.

*Definition:* Process load is the gas energy consumption in the conditioned space of a building resulting from an activity or treatment not related to the space conditioning, lighting, service water heating, or ventilating of a building as it relates to human occupancy. Process load may include sensible and/or latent components.

Compliance software shall model and simulate process loads only if the amount of the process energy and the location and type of process equipment are specified in the construction documents. This information shall correspond to specific special equipment shown on the building plans and detailed in the specifications.

*Units:* Data structure: sensible (Btu/h), latent (Btu/h).

*Input Restrictions:* Compliance software shall receive input for sensible and/or latent process load for each zone in the proposed design. The process load input shall include the amount of the process load (Btu/h-ft<sup>2</sup>) and the thermal zone where the process equipment is located. The modeled information shall be consistent with the plans and specifications of the building.

*Standard Design:* The standard design shall use the same gas process loads and sensible and latent contribution and radiative/convective split for each zone as the proposed design.

*Standard Design: Existing Buildings:* Same as newly constructed buildings.

### **ELECTRIC PROCESS LOADS**

*Applicability:* Spaces with electric process loads.

*Definition:* Process load is the electrical energy consumption in the conditioned space of a building resulting from an activity or treatment not related to the space conditioning, lighting, service water heating, or ventilating of a building as it relates to human occupancy.

Data center loads including transformers, uninterruptible power supplies, power delivery units, server fans and power supplies are considered receptacle loads, not process loads, and the equipment schedules are given in Appendix 5.4B.

Compliance software shall model and simulate process loads only if the amount of the process energy and the location and type of process equipment are specified in the construction documents. This information shall correspond to specific special equipment shown on the building plans and detailed in the specifications. The compliance software shall inform the user that the software will output process loads including the types of process equipment and locations on the compliance forms.

*Units:* Data structure: load (kW).

For electric process loads, the radiative fraction shall be defaulted to 0.2 and the convective fraction shall be defaulted to 0.8 by the compliance software. The user may enter other values for the radiative/convective split, but the compliance software shall verify that the values add to 1.

*Input Restrictions:* Compliance software shall receive input for sensible and/or latent process load for each zone in the proposed design. The process load input shall include the amount of the process load (Btu/h-ft<sup>2</sup>) and the thermal zone where the process equipment is located. The modeled information shall be consistent with the plans and specifications of the building.

*Standard Design:* The standard design shall use the same process loads and radiative/convective split for each zone as the proposed design.

*Standard Design: Existing Buildings:* Same as newly constructed buildings.

## **GAS PROCESS LOAD SCHEDULE**

*Applicability:* All buildings that have commercial gas equipment.

*Definition:* The schedule of process load operation. Used to convert gas power to energy use.

*Units:* Data structure: schedule, fractional.

*Input Restrictions:* As designed.

*Standard Design:* Same as the proposed design.

*Standard Design: Existing Buildings:* Not applicable.



### **ELECTRIC PROCESS LOAD SCHEDULE**

*Applicability:* All buildings that have commercial gas equipment.

*Definition:* The schedule of electric process load operation.

*Units:* Data structure: schedule, fractional.

*Input Restrictions:* As designed.

*Standard Design:* Same as the proposed design.

*Standard Design: Existing Buildings:* Not applicable.

### **5.4.10 Water Heating Use**

This chapter defines the water heating load (use rate) and system requirements on a space level.

#### **SPACE WATER HEATING USE RATE**

*Applicability:* All spaces.

*Definition:* The water heating use rate for a space in a building.

*Units:* Gal/h.

*Input Restrictions:* The values in Appendix 5.4A are prescribed.

*Standard Design:* Same as the proposed design.

*Standard Design: Existing Buildings:* Not applicable.

#### **SPACE WATER HEATING FUEL TYPE**

*Applicability:* All spaces.

*Definition:* A mapping that defines the standard design water heating fuel type for a space.

*Units:* List; gas or electric.

*Input Restrictions:* As designed.

*Standard Design:* Prescribed from the table in Appendix 5.4A.

*Standard Design: Existing Buildings:* Not applicable.

---

## **5.5 Building Envelope Data**

### **5.5.1 Materials**

Energy simulation programs commonly define construction assemblies by listing a sequence of material layers that make up the construction assembly. Appendix 5.5 has a list of standard materials that may be referenced by construction assemblies. Alternate methods

may be used to define construction assemblies such as specifying the U-factor and optionally, a metric describing thermal mass such as heat capacity (HC). These alternate methods may not require identification of materials. When a material is defined, all of the properties listed below must be defined. Some materials listed in Appendix 5.5 are non-homogeneous, for instance, framing members with insulation in the cavity. The properties of each material layer can be found in ACM Appendix 5.5.

**MATERIAL NAME**

*Applicability:* Opaque constructions.

*Definition:* The name of a construction material used.

*Units:* Text: unique.

*Input Restrictions:* Material name is a required input for materials not available from the standard list in ACM Appendix 5.5. The user may not modify entries for predefined materials.

*Standard Design:* Not applicable.

*Standard Design: Existing Buildings:* Not applicable.

**DENSITY**

*Applicability:* Opaque constructions.

*Definition:* The density, mass per unit volume, of the construction material as documented in Appendix 5.5A.

*Units:* lb/ft<sup>3</sup>.

*Input Restrictions:* Prescribed from Appendix 5.5A.

*Standard Design:* Not applicable.

*Standard Design: Existing Buildings:* Not applicable.

**SPECIFIC HEAT**

*Applicability:* Opaque constructions.

*Definition:* The specific heat capacity of a material is numerically equal to the quantity of heat that must be supplied to a unit mass of the material to increase its temperature by 1°F

*Units:* Btu/lb·°F.

*Input Restrictions:* Prescribed from Appendix 5.5A.

*Standard Design:* Not applicable.

*Standard Design: Existing Buildings:* Not applicable.

**THERMAL CONDUCTIVITY**

*Applicability:* All non-standard materials.

*Definition:* The thermal conductivity of a material of unit thickness is numerically equal to the quantity of heat that will flow through a unit area of the material when the temperature difference through the material is 1°F.

*Units:* Btu/lb·°F.

*Input Restrictions:* Prescribed from Appendix 5.5A.

*Standard Design:* Not applicable.

*Standard Design: Existing Buildings:* Not applicable.

**THICKNESS**

*Applicability:* All non-standard materials.

*Definition:* The thickness of a material.

*Units:* Inches.

*Input Restrictions:* Prescribed from Appendix 5.5A.

*Standard Design:* Not applicable.

*Standard Design: Existing Buildings:* Not applicable.

**5.5.2 Construction Assemblies**

For California compliance, construction assemblies for the proposed design shall be created by selecting from a library of building construction layers in ACM Appendix 5.5A. The compliance software shall specify composite layers that consist of both framing and insulation. It shall use established methods defined in the ASHRAE Handbook of Fundamentals for calculating effective R-values of composite layers.

**GEOMETRY**

The geometry of roofs, walls, floors, doors, and fenestration should match the construction documents or as-built drawings as accurately as possible. Unusual curved surfaces such as a dome or semi-circular wall may be approximated by a series of constructions.

**MASS WALLS**

For mass walls, the user first chooses the mass layer from Appendix 5.5A. After that, the user may select an insulating layer from Appendix 5.5A for outside and/or inside the mass wall.

**BALLASTED ROOFS, VEGETATED ROOFS, CONCRETE PAVERS, AND OTHER MASS ROOFS**

An additional layer may be added to the roof construction assembly when thermal mass is used above the roof membrane. This exception is intended to allow ballasted roofs, concrete pavers, and other massive elements to be explicitly modeled. To qualify, the weight of the stone ballast, the concrete pavers or other elements must exceed 25 lb/ft<sup>2</sup>. The thickness, heat capacity, conductance and density of the additional mass layer shall be based on the measured physical properties of the material. If the surface properties of the additional mass material have been verified through the Cool Roof Rating Council (CRRC), the CRRC reported properties may be used for the proposed design. Otherwise, the mass layer shall be modeled with an aged reflectance of 0.10 and  emittance of 0.75.

### **ASSEMBLY NAME**

Applicability: All projects.

Definition: The name of a construction assembly that describes a roof, wall, or floor assembly. The name generally needs to be unique so it can be referenced precisely by surfaces.

Units: Text.

Input Restrictions: Required input and name must be unique.

Standard Design: Not applicable.

Standard Design: Existing Buildings: Not applicable.

### **SPECIFICATION METHOD**

Applicability: All projects.

Definition: The method of describing a construction assembly. The common method is to describe the construction assembly as a series of layers, each layer representing a material. For slab-on-grade constructions, exterior insulation levels are specified, and the compliance software determines the corresponding F-factor from Reference Appendix JA4 tables.

Units: List: layers, F-factor.

Input Restrictions: The layers method shall be used for all above-grade constructions.

Standard Design: For each construction, the proposed design specification method shall be used.

Standard Design: Existing Buildings: Same as newly constructed buildings.

### **LAYERS**

*Applicability:* All construction assemblies that use the layers method of specification

*Definition:* A structured list of material names that describe a construction assembly, beginning with the exterior finish and progressing through the assembly to the interior finish. Material names must be from the standard list (Appendix E) or defined (see above) ACM Appendix 5.5A.

*Units:* List: layers of construction assembly

*Input Restrictions:* The user is required to describe all layers in the actual assembly and model the proposed design based the layer descriptions.

*Standard Design:* See building descriptors for roofs, exterior walls, exterior floors, doors, fenestration, and below-grade walls.

*Standard Design: Existing Buildings:* Same as newly constructed buildings

### **5.5.3 Roofs**

#### **ROOF NAME**

*Applicability:* All roof surfaces.

*Definition:* A unique name or code that identifies the roof and ties it to the construction documents submitted for energy code review. It is not mandatory to name roofs.

*Units:* Text.

*Input Restrictions:* Name must be unique.

*Standard Design:* N/A.

*Standard Design: Existing Buildings:* N/A.

#### **ROOF TYPE**

*Applicability:* All roof surfaces.

*Definition:* A roof classification defined in the standards. This descriptor can be derived from other building descriptors and it may not be necessary for the software user to specify it directly.

*Units:* List: attic and other roofs; metal building roofs; and roofs with insulation entirely above deck metal building, wood framed or other.

*Input Restrictions:* Not applicable for newly constructed buildings; as designed for existing buildings.

*Standard Design:* All roofs in the standard design are modeled as wood-framed and other.

*Standard Design: Existing Buildings:* Same as proposed.

#### **ROOF GEOMETRY**

*Applicability:* All roofs.

*Definition:* Roof geometry defines the position, orientation, azimuth, tilt, and dimensions of the roof surface. The details of how the coordinate system is implemented may vary between software programs. The data structure for surfaces is described in the reference section of this chapter.

*Units:* Data structure: surface.

*Input Restrictions:* There are no restrictions other than that the surfaces defined must agree with the building being modeled, as represented on the construction drawings or as-built drawings.

*Standard Design:* Roof geometry will be identical in the proposed and standard design building designs.

For alterations, roof geometry will be fixed, based on one of the building prototypes (office, retail, etc.).

*Standard Design: Existing Buildings:* Same as newly constructed buildings.

*Input Restrictions:* Not applicable for newly constructed buildings; as designed for existing buildings

*Standard Design:* All roofs in the standard design are modeled as wood-framed and other.

*Standard Design: Existing Buildings:* Same as proposed.

## **ROOF SOLAR REFLECTANCE**

*Applicability:* All opaque exterior roof surfaces exposed to ambient conditions.

*Definition:* The solar reflectance of a material. For roofing materials, the three-year aged reflectance value from CRRC testing should be used if available.

*Units:* Unitless.

*Input Restrictions:* Must be in the range of 0 to 1.

For roofs that are part of newly constructed buildings, if asphalt shingles or composition shingles are not rated by the CRRC, the default aged solar reflectance shall be equal to 0.08 for asphalt roofs and 0.10 for all other roof types. The default value may be overridden when roof materials are used that the CRRC has tested and are called for in the construction documents. In cases where the default value is overridden, the user is required to submit documentation identifying the test procedure that was used to establish the non-default values. If the aged CRRC reflectance is not known, the aged CRRC reflectance may be calculated from the initial CRRC reflectance using the following equation:

$$p_{aged} = 0.2 + \beta \cdot (p_{init} - 0.2)$$

Where,

- paged - the calculated aged reflectance
- $\beta$  - 0.65 for field-applied coatings, 0.7 for all other roof surfaces
- pinit - the initial CRRC reflectance

As a compliance option, low-sloped roofs that use aggregate may specify an aged reflectance of 0.50 if the product meets the following criteria:

1. Conforms to material standard ASTM D1863.
2. Conforms to ASTM D448, size number equal between No.6 and No.7.
3. Has a CRRC-tested initial solar reflectance that meets or exceeds 0.55 using the ASTM E1918 test procedure with aggregate passing a No. 4 sieve and is retained by a No. 8 sieve that conforms to ASTM D448, conducted by a CRRC-accredited independent laboratory meeting the requirement of §10-113(d)4 of the Building Energy Efficiency Standards.
4. Has a label on bags or containers of aggregate stating that the materials conform to ASTM D1863 and ASTM D448.

*Standard Design:* For newly constructed buildings, the standard design reflectance is defined in Table 140.3-B for nonresidential buildings, Table 140.3-C for guest rooms of hotel/motel buildings containing guestrooms, Table 140.3-D for relocatable classroom buildings, and Table 170.2-A for multifamily buildings.

For alterations to more than 50 percent of the roof area or roof areas above 2,000 ft<sup>2</sup>, the standard design shall be modeled as the more efficient of either the existing conditions or the values required for cool roofs under §141.0 and §180.2 of the standards.

*Standard Design: Existing Buildings:* For alterations to more than 50 percent of the roof area or roof areas above 2,000 ft<sup>2</sup>, the standard design shall be modeled as the more efficient of either the existing conditions or the values required for cool roofs under §141.0 and §180.2.

## **ROOF THERMAL EMITTANCE**

*Applicability:* All opaque exterior roof surfaces exposed to ambient conditions.

*Definition:* The thermal emittance of a material. For roofing materials, the three-year aged emittance value from CRRC testing should be used if available.

*Units:* Unitless.

*Input Restrictions:* Must be in the range of 0 to 1.

For roofs, newly constructed buildings: as designed, from CRRC values. If CRRC rating information is not available, the default thermal emittance shall be 0.85. Aggregate that meets the following criteria may specify a thermal emittance of 0.85:

1. Conforms to material standard ASTM D1863.
2. Conforms to ASTM D448, size number equal between No.6 and No.7.
3. Has a CRRC-tested initial solar reflectance that meets or exceeds 0.55 using the ASTM E1918 test procedure with aggregate passing a No. 4 sieve and is retained by a No. 8 sieve that conforms to ASTM D448, conducted by a CRRC accredited independent laboratory meeting the requirement of §10-113(d) 4 of the Building Energy Efficiency Standards.
4. Has a label on bags or containers of aggregate stating that the materials conform to ASTM D1863 and ASTM D448.

*Standard Design:* For roofs, newly constructed buildings, the standard design thermal emittance shall be 0.75.

For alterations to more than 50 percent of the roof area or roof areas above 2,000 ft<sup>2</sup>, the standard design shall be modeled as the more efficient of either the existing conditions or a thermal emittance of 0.85.

*Standard Design: Existing Buildings:* If the existing roof is unaltered, same as proposed. For alterations, the standard design is 0.85.

For alterations to more than 50 percent of the roof area or roof areas above 2,000 ft<sup>2</sup>, the standard design shall be modeled as the more efficient of either the existing conditions or a thermal emittance of 0.80.

## **ROOF CONSTRUCTION**

Applicability: All roofs.

Definition: A specification containing a series of layers that result in a construction assembly for the proposed design. The first layer in the series represents the outside (or exterior) layer and the last layer represents the inside (or interior) layer. See the building descriptors above for roof construction type.

Units: List: layers.

Input Restrictions: The area-weighted average of the roof construction assembly U-factors, defined by a series of layers, must be equal to or more efficient than the mandatory U-factor requirements of §120.7 and §160.1 of the standards for newly constructed buildings, and §141.0 and §180.2 of the standards for alterations. Note that these U-Factor requirements assume an exterior air film of R-0.17 and an interior air film of R-0.61. Each layer specified must be listed in the materials database in the ACM Appendix 5.5.



## Newly constructed buildings

- Metal Building: U – 0.098
- Wood Framed and Others: U – 0.075

## Additions and Alterations

- Roof / Ceiling Insulation: See §141.0(b)2Biii and §180.2(b)2B of the standards

Appropriate R-values for insulation can be calculated using the formula below.

$$R_{insulation} = (1/U\text{Factor}) - R_{Layer(1)} - R_{Layer(2)} - R_{Layer(3)} - R_{Layer(n)}$$

$$R_{insulation} = R_{ins_{continuous}} + R_{ins_{framing}}$$

Ceilings that form the boundary between the modeled building of an additions and alterations project and the existing, un-modeled portion of the building may be modeled as adiabatic roofs (no heat transfer).

*Standard Design:* Roofs in the standard design are of the type “insulation entirely above deck.” The insulation requirement is determined by climate zone. The standard design building roof construction shall be modeled as layers as defined. See Appendix 5.5 for details.

For newly constructed buildings, the standard design roof type is wood framed and other, and the roof is a standing seam metal roof, with the R-value of continuous insulation adjusted to match the prescriptive standards for wood-framed and other roofs. The U-factor required for roof construction is defined in Table 140.3-B, 140.3-C, 140.3-D, or Table 170.2-A of the standards. Programs that model a U-factor shall include an exterior and interior air film resistance. The standard design construction is based on JA4 Table 4.2.7 and assumes an exterior air film of R-0.17 and an interior air film of R-0.61.

The standard design construction shall include the following layers:

- Layer 1
  - Metal Standing Seam 1/16 in.
  - R - 0.00
- Layer 2
  - Continuous Insulation
  - R - Based on Climate Zone
- Layer 3
  - Open Framing + No Insulation
  - R - 0.00

The value of the continuous insulation layer entirely above framing shall be set to achieve the following R-values:

Nonresidential Buildings: Continuous Insulation

- Climate Zones 2, 3, 4, 9-16
  - R - 28.63 (U-0.034)
- Climate Zones 1, 5
  - R - 28.63 (U-0.034)
- Climate Zones 7, 8
  - R - 19.62 (U-0.049)
- Climate Zones 6
  - R - 19.62 (U-0.049)

Multifamily Residential Buildings and Hotel/Motel Guestrooms: Continuous Insulation

- Climate Zones 1, 2, 4, 8-16
  - R - 34.93 (U-0.028)
- Climate Zone 7
  - R - 24.86 (U-0.039)
- Climate Zones 3, 5, 6
  - R - 28.63 (U-0.034)

For mixed-use buildings, the roof standard design requirements shall be determined by which space type (nonresidential or residential) is the majority of the floor area of the adjoining conditioned spaces.

For re-locatable classroom buildings, the standard design shall use the construction assembly corresponding to the most stringent of requirements in any climate zone, or R-28.63 continuous insulation.

For alterations, any approved roof type may be used. The U-factor in the standard design shall be modeled as the more efficient of either the existing conditions or the values stated in §141.0 and §180.2 of the standards. Where applicable, selection shall be based on building type, assembly, and climate zone. A construction of layers shall be defined to yield an equivalent U-factor.

*Standard Design: Existing Buildings:* For existing buildings, if the roof component is not altered, the standard design roof construction shall match the proposed design roof construction of the existing building. If the roof is altered, the roof component shall meet

the prescriptive requirements for newly constructed buildings for the roof type of the existing building.

The roof type of the existing building is either a metal building roof or a wood-framed or other roof. The standard design roof assemblies for altered roofs are shown below for the appropriate climate zones.

Alterations Roof Standard Design:

For alterations, any approved roof type may be used. The U-factor in the standard design shall be modeled as the more efficient of either the existing conditions or the values stated in §141.0 and §180.2 of the standards. Where applicable, selection shall be based on building type, assembly, and climate zone. A construction of layers shall be defined to yield an equivalent U-factor.

## 5.5.4 Exterior Walls

### WALL NAME

*Applicability:* All walls.

*Definition:* A unique name or code that relates the exterior wall to the design documents. This is an optional input since there are other acceptable ways to key surfaces to the construction documents.

*Units:* Text.

*Input Restrictions:* Must be unique.

*Standard Design:* None.

*Standard Design: Existing Buildings:* None.

### WALL TYPE

*Applicability:* All walls.

*Definition:* One of four categories of above-grade wall assemblies used to determine minimum insulation requirements for walls. The five wall type categories are as follows:

1. Mass Light
2. Mass Heavy
3. Metal building
4. Metal framing
5. Wood framing and other walls

A mass light wall is defined as a wall with total heat capacity greater than 7 but less than 15 Btu/ft<sup>2</sup>-. A mass heavy wall is defined as a wall with a total heat capacity of 15 Btu/ft<sup>2</sup>-

°F or greater. (Heat capacity is defined as the product of the specific heat in Btu/lb-°F, the thickness in ft, and the density in lb/ft<sup>3</sup>.)

*Units:* List: mass light, mass heavy, metal building walls, metal framing walls, and wood framing and other walls

*Input Restrictions:* This input is required for existing buildings when any wall is altered. This input is not required for newly constructed buildings.

*Standard Design:* All walls in the standard design building are modeled as “metal framed.”

*Standard Design: Existing Buildings:* Same as proposed.

### **WALL GEOMETRY**

*Applicability:* All walls

*Definition:* Wall geometry defines the position, orientation, azimuth, and tilt of the wall surface. The data structure for surfaces is described in the reference section of this chapter.

*Units* Data structure: surface

*Input Restrictions:* As designed

*Standard Design:* Same as proposed

*Standard Design: Existing Buildings:* Same as proposed

### **WALL FIRE RATING**

*Applicability:* All walls in multifamily buildings.

*Definition:* The fire rating for the exterior walls in the building.

*Units:* hr (integer – typically, 1 hr, 2 hr).

*Input Restrictions:* This input is required for existing buildings when any wall is altered. This input is not required for newly constructed buildings.

*Standard Design:* Not required.

*Standard Design: Existing Buildings:* Same as proposed.

### **WALL SOLAR REFLECTANCE**

*Applicability:* All opaque exterior walls exposed to ambient conditions.

*Definition:* The solar reflectance of a material.

*Units:* Unitless ratio.

*Input Restrictions:* For walls and other non-roof surfaces, the value is prescribed to be 0.3.

*Standard Design:* For walls and other non-roof surfaces, the value is prescribed to be 0.3.

*Standard Design: Existing Buildings:* 0.3.

### **WALL THERMAL EMITTANCE**

*Applicability:* All opaque exterior walls exposed to ambient conditions.

*Definition:* The thermal emittance of a material.

*Units:* Unitless ratio.

*Input Restrictions:* For walls and other non-roof surfaces, the value is prescribed to be 0.9.

*Standard Design:* For walls and other non-roof surfaces, the thermal emittance is 0.9.

*Standard Design: Existing Buildings:* For walls and other non-roof surfaces, the thermal emittance is 0.9.

### **WALL CONSTRUCTION**

*Applicability:* All walls that use the layers method.

*Definition:* A specification containing a series of layers that result in a construction assembly for the proposed design. The first layer in the series represents the outside (or exterior) layer and the last layer represents the inside (or interior) layer. See the building descriptors above for wall construction type.

*Units:* List: Layers.

*Input Restrictions:* The area weighted-average of the construction assembly U-factors, defined by a series of layers, must be equal to or more efficient than the mandatory U-factor requirements of §120.7 and §160.1 of the standards for newly constructed buildings. Note that these U-Factor requirements assume an exterior air film of R-0.17 and an interior air film of R-0.68. Each layer specified, with the exception of composite layers, must be listed in the materials database in the ACM Appendix 5.5A.

#### Newly Constructed

- Metal Building
  - U – 0.113
- Metal Framed
  - U – 0.151 (R-13 cavity + R-2 continuous insulation, or equivalent)
- Light Mass Walls
  - U – 0.440
- Heavy Mass Walls

- U – 0.690
- Wood Framed and Others
  - U – 0.110
- Spandrel Panels / Glass Curtain Walls
  - U – 0.280

#### Additions and Alterations

- Metal Building
  - U – 0.113
- Metal Framed
  - U – 0.217
- Wood Framed and Others
  - U – 0.110
- Spandrel Panels / Glass Curtain Walls
  - U – 0.280

Appropriate R-values for insulation can be calculated using the formula below.

$$R_{insulation} = (1/UFactor) - R_{Layer(1)} - R_{Layer(2)} - R_{Layer(3)} - R_{Layer(n)}$$

$$R_{insulation} = R_{ins_{continuous}} + R_{ins_{framing}}$$

Walls that form the boundary between the modeled building of an additions and alterations project and the existing, un-modeled portion of the building may be modeled as adiabatic walls (no heat transfer).

*Standard Design:* The U-factor required for wall construction of the standard design building is defined in Table 140.3-B, 140.3-C, 140.3-D, or 170.2-A of the standards. Programs that model a U-factor shall use an exterior and interior air film resistance. The standard design construction is based on JA4 Table 4.3.3 and assumes an exterior air film of R-0.17 and an interior air film of R-0.68.

For metal framed walls, the standard design construction shall include the following layers:

- Layer 1
  - Stucco – 7/8 in.
  - R - 0.18
- Layer 2
  - Building Paper
  - R – 0.06

- Layer 3
  - Continuous Insulation
  - R - Based on Climate Zone
- Layer 4
  - Closed Framing and No Ins.
  - R – 0.65
- Layer 5
  - Gypsum Board – 1/2 in.
  - R – 0.45

*Standard Design: Existing Buildings:* The value of the continuous insulation layer entirely outside framing shall be set to achieve the following R-values:

Nonresidential Buildings: Continuous Insulation

- Climate Zones 1, 6, and 7
  - R – 14.47
- Climate Zones 2, 4, 5, and 8 – 16
  - R – 15.99
- Climate Zone 3
  - R – 11.90

Multifamily Residential Buildings and Hotel/Motel Guestrooms: Continuous Insulation

- Climate Zones 1 - 6, and 8-16
  - R – 12.30
- Climate Zone 7
  - R – 7.33

For mixed-use buildings that contain both nonresidential and residential spaces, walls adjacent to nonresidential spaces shall use the Nonresidential Buildings standard design construction, and walls adjacent to residential and multifamily residential spaces shall use the multifamily residential standard design construction.

For relocatable classroom buildings, the standard design shall use the construction assembly corresponding to the most stringent of requirements in any climate zone, or R-13.94 continuous insulation.

	CZ2,10-16	CZ 1	CZ 4	CZ 3	CZ 5-9
JA4 U-factor	0.170	0.196	0.227	0.278	0.440
Layer 1	4 in MW CMU, 115 lb/sf 4.3.6-B5	4 in MW CMU, 115 lb/sf 4.3.6-B5	4 in MW CMU, 115 lb/sf 4.3.6-B5	4 in MW CMU, 115 lb/sf 4.3.6-B5	8 in NW CMU, 125 lb/ft <sup>2</sup> , partly grouted, reinforced with insulated cells 4.3.6-C10
Layer 2*	3" furring space with R-21 insulation and metal clips 4.3.14-V15 (equiv R-4.8 c.i.)	2.5" furring space with R-13 insulation and metal clips 4.3.14-R13 (equiv R-3.8 c.i.)	2" furring space with R-13 insulation and metal clips 4.3.14-N11 (equiv R-3.3 c.i.)	1.5" furring space with R-9 insulation and metal clips 4.3.14-J9 (equiv R-2.5 c.i.)	N/A
Layer 3	N/A	N/A	N/A	N/A	N/A
...	N/A	N/A	N/A	N/A	N/A
Layer n	N/A	N/A	N/A	N/A	N/A

Source: California Energy Commission



**Table 6: Heavy Mass Wall (Heat Capacity  $\geq 15$  Btu/ft<sup>2</sup>-F)**

	CZ2,10-16	CZ 1	CZ 4	CZ 3	CZ 5-9	
JA4 U-factor	0.160	0.184	0.211	0.253	0.650	0.690
Layer 1	8 in. NW CMU, 125 lb/ft <sup>2</sup> , solid grout, reinforced 4.3.5-A10	8 in. NW CMU, 125 lb/ft <sup>2</sup> , solid grout, reinforced 4.3.5-A10	8 in. NW CMU, 125 lb/ft <sup>2</sup> , solid grout, reinforced 4.3.5-A10	8 in. NW CMU, 125 lb/ft <sup>2</sup> , solid grout, reinforced 4.3.5-A10	8 in NW CMU, 125 lb/ft <sup>2</sup> , solid grout, reinforced 4.3.5-A9	8 in. NW CMU, 125 lb/ft <sup>2</sup> , solid grout, reinforced 4.3.5-A10
Layer 2*	3" furring space with R-21 insulation and metal clips 4.3.14-V15 (equiv R-4.8 c.i.)	2.5" furring space with R-13 insulation and metal clips 4.3.14-R13 (equiv R-3.8 c.i.)	2" furring space with R-13 insulation and metal clips 4.3.14-N11 (equiv R-3.3 c.i.)	1.5" furring space with R-9 insulation and metal clips 4.3.14-J9 (equiv R-2.5 c.i.)	N/A	N/A
Layer 3	N/A	N/A	N/A	N/A	N/A	N/A
	N/A	N/A	N/A	N/A	N/A	N/A
Layer n	N/A	N/A	N/A	N/A	N/A	N/A

Source: California Energy Commission

**Table 7 Metal Building Walls**

	<b>CZ15</b>	<b>CZ 2,4,5,8,9,10-14,16</b>	<b>CZ 1,3,6,7</b>
JA4 U-factor	0.057	0.061	0.113
Layer 1	R-13 batt insulation draped over purlins and compressed	R-13 batt insulation draped over purlins and compressed	R-13 batt insulation draped over purlins and compressed Rlayer=8.85
Layer 2*	Second layer R-13 batt insulation	Second layer R-10 batt insulation	N/A
Layer 3	N/A	N/A	N/A
...	N/A	N/A	N/A
Layer n	N/A	N/A	N/A

Source: California Energy Commission

**Table 8 Wood-Framed Walls**

	<b>CZ15</b>	<b>CZ 2,4,9-14,16</b>	<b>CZ 4</b>	<b>CZ 3</b>
JA4 U-factor	0.042	0.059	0.102	0.110
Layer 1	2x4, 16" o.c. with R-13 batt ins	2x4, 16" o.c., with R-11 batt ins	2x4, 16" o.c. with R-13 batt ins	2x4, 16" o.c. with R-11 batt ins
Layer 2*	R-14 continuous insulation	R-8 continuous insulation	N/A	N/A

### 5.5.5 Exterior Floors

**FLOOR NAME**

*Applicability:* All floor surfaces.

*Definition:* A unique name or code that relates the exposed floor to the design documents.

Exposed floors include floors exposed to the outdoors and floors over unconditioned spaces, but do not include slab-on-grade floors, below grade floors, or interior floors.

*Units:* Text.

*Input Restrictions:* Must be unique.

*Standard Design:* None.

*Standard Design: Existing Buildings:* None.

**FLOOR TYPE**

*Applicability:* All exterior floor surfaces, optional.

*Definition:* The category that defines the standard design prescriptive floor requirements.

*Units:* List: mass or other.

*Input Restrictions:*

*Standard Design:* The standard design building floors shall be of type "other".

*Standard Design: Existing Buildings:* Same as proposed.

## **FLOOR GEOMETRY**

*Applicability:* All exterior floors.

*Definition:* Floor geometry defines the position, orientation, azimuth, and tilt of the floor surface. The details of how the coordinate system is implemented may vary between software programs. The data structure for surfaces is described in the reference section of this chapter.

*Units:* Data structure: surface.

*Input Restrictions:* As designed. Required input.

*Standard Design:* Standard design building floor geometry is identical to the proposed design.

*Standard Design: Existing Buildings:* Same as proposed.

## **Floor Construction**

*Applicability:* All floors.

*Definition:* A specification containing a series of layers that result in a construction assembly for the proposed design. The first layer in the series represents the outside (or exterior) layer and the last layer represents the inside (or interior) layer. See the building descriptors above for floor construction type.

*Units:* List: Layers.

*Input Restrictions:* The area weighted-average of the floor construction assembly U-factors, defined by a series of layers, must be equal to or more efficient than the mandatory U-factor requirements of §120.7 and §160.1 of the standards for newly constructed buildings, and §141.0 and §180.2 of the standards for alterations. Note that these U-factor requirements assume an exterior air film of R-0.17 and an interior air film of R-0.92. Each layer specified must be listed in the materials database in the ACM Appendix 5.5A.

Newly constructed buildings

- Raised Mass Floors
  - U – 0.269

- Other Floors
  - U – 0.071
- Heated Slab Floors
  - Climate Zone (see §120.7 and §160.1)

#### Additions and Alterations

- Metal Building
  - U – 0.113
- Metal Framed
  - U – 0.217
- Wood Framed and Others
  - U – 0.110
- Spandrel Panels / Glass Curtain Walls
  - U – 0.280

Appropriate R-values for insulation can be calculated using the formula below.

$$R_{insulation} = (1/U_{Factor}) - R_{Layer(1)} - R_{Layer(2)} - R_{Layer(3)} - R_{Layer(n)}$$

$$R_{insulation} = R_{inscontinuous} + R_{insframing}$$

Floors that form the boundary between the modeled building of an addition and alteration project and the existing, un-modeled portion of the building may be modeled as adiabatic floors (no heat transfer).

*Standard Design:* The U-factor required for floor construction is defined in Table 140.3-B, 140.3-C, 140.3-D, or 170.2-A of the standards. Programs that model a U-factor shall use an exterior and interior air film resistance. The standard design construction is based on JA4 Table 4.4.5 and assumes an exterior air film of R-0.17 and an interior air film of R-0.92.

For metal framed floors, the standard design construction shall include the following layers:

- Layer 1
  - Open Framing + No Ins.
  - R – 0.00
- Layer 2
  - Continuous Insulation
  - R – Based on Climate Zone
- Layer 3
  - Plywood – 5/8 in.

- R – 0.78
- Layer 4
  - Carpet and Pad – 3/4 in.
  - R – 1.30

*Standard Design: Existing Buildings:* The value of the continuous insulation layer entirely above or below framing shall be set to achieve the following R-values:

Nonresidential Buildings: Continuous Insulation

- Climate Zones 1
  - R – 17.66
- Climate Zones 2, 11, and 14 -16
  - R – 22.47
- Climate Zones 3 – 10, 12, and 13
  - R – 10.91

Multifamily Residential Buildings and Hotel/Motel Guestrooms: Continuous Insulation

- Climate Zones 1, 2, 14, and 16
  - R – 26.24
- Climate Zones 3 – 6, 8 – 13, and 15
  - R – 22.47
- Climate Zones 7
  - R – 10.91

The standard design floor that serves as the boundary between the modeled additions and alterations building and the existing, unmodeled portion of the building is modeled as an adiabatic floor, to match the proposed design. The standard design floor construction for existing buildings depends on the floor type.

### **Raised Floors, Floor Type = Other (framed floors)**

Source: California Energy Commission

### **Raised Floors, Floor Type= Mass**

## **5.5.6 Doors**

### **DOOR NAME**

*Applicability* All exterior doors, optional input.

*Definition* A unique name or code that relates the door to the design documents submitted. Doors that are more than 50 percent glass are treated as windows and must be determined and entered by using the Fenestration building descriptors.

*Units:* Text: unique.

*Input Restrictions:* None.

*Standard Design:* None.

*Standard Design: Existing Buildings:* None.

## **DOOR TYPE**

*Applicability:* All exterior doors, required input.

*Definition:* One of two door classifications of either: swinging or non-swinging. Non-swinging are generally roll-up doors. The prescriptive U-factor requirements depend on door type and climate. This building descriptor may be derived from other building descriptors, in which case a specific input is not necessary.

*Units:* List: swinging or non-swinging.

*Input Restrictions:* The door type shall be consistent with the type of door represented on the construction documents or as-built drawings.

*Standard Design:* The standard design building door type shall be the same as the proposed design.

*Standard Design: Existing Buildings:* Same as newly constructed buildings.

## **DOOR GEOMETRY**

*Applicability:* All exterior doors.

*Definition:* Door geometry defines the position and dimensions of the door surface relative to its parent wall surface. The azimuth and tilt (if any) of the door is inherited from the parent surface. The position of the door within the parent surface is specified through (X, Y) coordinates. The size is specified as a height and width (all doors are generally assumed to be rectangular in shape). The details of how the geometry of doors is specified may vary for each energy simulation program.

*Units:* Data structure: opening.

*Input Restrictions:* As designed.

*Standard Design:* Door geometry in the standard design building is identical to the proposed design.

*Standard Design: Existing Buildings:* Same as newly constructed buildings.

**DOOR CONSTRUCTION**

*Applicability:* All exterior doors.

*Definition:* The thermal transmittance of the door, including the frame.

*Units:* Btu/h·ft<sup>2</sup>·°F.

*Input Restrictions:* The construction assembly must be equal to or more efficient than the mandatory U-factor requirements of §110.6 of the standards for newly constructed buildings. There are no restrictions for alterations.

*Standard Design:* For newly constructed buildings, the U-factor required for door construction is defined in Table 140.3-B, 140.3-C, 140.3-D, or 170.2-A of the standards.

Nonresidential Buildings – U Factor:

Non-Swinging Doors:

- Climate Zones 1, and 16
  - U – 0.50
- Climate Zones 2 – 15
  - U – 1.45

Swinging Doors:

- Climate Zones 1 – 16
  - U – 0.70

Multifamily Residential Buildings and Hotel/Motel Guestrooms – U Factor:

Non-Swinging Doors:

- Climate Zones 1, and 16
  - U – 0.50
- Climate Zones 2 – 15
  - U – 1.45

Swinging Doors:

- Climate Zones 1 – 16
  - U – 0.70

*Standard Design: Existing Buildings:* For alterations, the U-factor in the standard design is either the same standard design as the newly constructed buildings standard design if the door is replaced, or the equal to the existing door construction, if the door is unaltered. Where applicable, selection shall be based on building type, assembly, and climate zone.

**OPERABLE DOOR OPENING TYPE**

*Applicability:* All exterior doors.

*Definition:* The opening type that determines whether interlocks with mechanical cooling and heating are required, per §140.4(n) and §170.2(c)4L. If manual, then interlocks are required when operable windows are present in any nonresidential space, excluding multifamily residential and healthcare spaces and buildings. If self-closing or a glazed door, interlocks are not required and are not present in the standard design.

*Units:* Btu/h·ft<sup>2</sup>·°F.

*Input Restrictions:* List: Self-Closing, Manual, Glazed Door.

*Standard Design:* Same as Proposed.

*Standard Design: Existing Buildings:*

**5.5.7 Fenestration**

Note that fenestration includes windows, doors that have  percent or more glazed area, and skylights. A skylight is fenestration that has a tilt of less than 60 degrees from horizontal.

**FENESTRATION NAME**

*Applicability:* All fenestration, optional input.

*Definition:* A unique name or code that relates the fenestration to the design documents and a parent surface.

*Units:* Text: unique.

*Input Restrictions:* None.

*Standard Design:* None.

*Standard Design: Existing Buildings:* None.

**FENESTRATION TYPE (VERTICAL FENESTRATION)**

*Applicability:* All vertical fenestration.

*Definition:* This is a classification of vertical fenestration that determines the thermal performance and solar performance requirement for vertical fenestration.

*Units:* List: Fixed, Operable, Curtain Wall, Glazed Doors, or NAFS 2017 Performance Class AS (for multifamily only).

*Input Restrictions:* As designed

*Standard Design:* Same as the proposed design



*Standard Design: Existing Buildings:* Same as newly constructed buildings

### **FENESTRATION TYPE (SKYLIGHTS)**

*Applicability:* All skylights

*Definition:* This is a classification of skylights that determines the thermal performance and solar performance requirement for vertical fenestration

*Units List:* Glass, Curb-mounted, Glass, Deck-mounted, Plastic, or Tubular Daylighting Devices (TDD)

*Input Restrictions:* As designed

*Standard Design:* Same as the proposed design

*Standard Design: Existing Buildings:* Same as newly constructed buildings

### **DEFAULT FENESTRATION TYPE**

*Applicability:* All fenestration that uses default thermal performance factors

*Definition:* This is a classification of fenestration that determines the thermal performance for fenestration using defaults from standards § 110.6, Table 110.6-A. This is used for fenestration without National Fenestration Rating Council (NFRC) ratings or for fenestration for altered buildings that includes window films.

*Units :* List: fixed, operable, greenhouse/garden, doors, or skylight

*Input Restrictions:* As designed

*Standard Design:* Not applicable

*Standard Design: Existing Buildings:*

### **DEFAULT GLAZING TYPE**

*Applicability:* All fenestration that uses default thermal performance factors

*Definition:* This is a classification of fenestration that determines the thermal performance for fenestration using defaults from standards § 110.6, Table 110.6-A. This is used for fenestration without NFRC ratings or for fenestration for altered buildings that includes window films.

*Units:* List: single pane, double pane, glass block

*Input Restrictions:* As designed

Glass block is only allowed if the default fenestration type is operable or fixed.

*Standard Design:* Not applicable

*Standard Design: Existing Buildings:*

**DEFAULT FRAMING TYPE**

*Applicability:* All fenestration that uses default thermal performance factors and window films for altered fenestration

*Definition:* This is a classification of fenestration that determines the thermal performance for fenestration using defaults from standards § 110.6, Table 110.6-A. This is used for fenestration without NFRC ratings or for fenestration for altered buildings that includes window films.

*Units:* List: metal, metal with thermal break, or nonmetal

*Input Restrictions:* As designed

*Standard Design:* Not applicable

*Standard Design: Existing Buildings:*

**FENESTRATION GEOMETRY**

*Applicability:* All fenestration.

*Definition:* Fenestration geometry defines the position and dimensions of the fenestration surface within its parent surface and the identification of the parent surface. The orientation and tilt are inherited from the parent surface. The details of how the coordinate system is implemented may vary between compliance software programs.

Display Perimeter:

Display perimeter is the length of an exterior wall in a B-2 occupancy that immediately abuts a public sidewalk, measured at the sidewalk level for each story that abuts a public sidewalk. The compliance software shall allow the user to specify a value for the length of display perimeter, in feet, for each floor or story of the building. The user entry for display perimeter shall have a default value of zero. Note: Any non-zero input for display perimeter is an exceptional condition that shall be reported on the PRF-1 exceptional condition list and shall be reported on the ENV forms. The value for display perimeter is used as an alternate means of establishing maximum wall fenestration area in the standard design (§140.3 of the standards).

The display perimeter shall be calculated separately for west-facing fenestration, and for non-west facing fenestration.

Floor Number:

The compliance software shall also allow the user to specify the display perimeter associated with each floor (story) of the building.

*Units:* Data structure: opening

Geometry is defined relative to the parent surface and can include setbacks.

Inputs include:

Geometry of opening (window or skylight), parent surface, display perimeter (optional), percent of roof area exempt from skylight requirements §140.3 of the standards.

*Input Restrictions:* As designed

Specification of the fenestration position within its parent surface is required for the following conditions:

- 1) Exterior shading is modeled from buildings, vegetation, or other objects; or
- 2) If daylighting is modeled within the adjacent space.

*Standard Design:* The standard design calculates the window wall ratio (WWR) for each orientation and the overall window wall ratio for the building. The window wall ratio is the total fenestration area (including framing) divided by the gross exterior wall area (excluding wall area that is underground). Note that exterior wall area that is below grade, but has exposure to ambient conditions, and any associated fenestration, is included in the WWR calculation.

The standard design vertical fenestration area and horizontal fenestration area for spaces that are specified as computer rooms or data centers (a server process load of 20W/ft<sup>2</sup> or higher) shall be zero.

For all other buildings, the geometry of the fenestration in the standard design shall be identical to the proposed design with the following exceptions:

**Exception 1:** Either the whole building window wall ratio or west window wall ratio exceeds 40 percent.

**Exception 2:** If display perimeter is entered, the fenestration area exceeds the greater of 40 percent of the gross wall area (excluding adiabatic walls) and six times the display perimeter.

**Exception 1:** The fenestration is adjusted based on the following conditions:

Case 1.  $WWR_o > 0.40$ ,  $WWR_w \leq 0.40$

In this case, the fenestration area of all windows is reduced by multiplying the fenestration area by the ratio  $0.40/WWR_o$ . The dimensions of each window are reduced by increasing the sill height so that the window height is modified by the multiplier  $(0.40/WWR_o)$  so that the same window width is maintained.

Case 2:  $WWR_o < 0.40$ .  $WWR_w > 0.40$

In this case, the fenestration area of all windows on the west orientation is reduced by multiplying the fenestration area by the ratio  $0.40/WWR_o$ . The dimensions of each window are reduced by multiplying the proposed window dimension by increasing the sill height so that the window height is modified by the multiplier  $(0.40/WWR_o)$ , so that the window width is maintained.

Case 3:  $WWR_o > 0.40$ .  $WWR_w > 0.40$

If both the west window wall ratio and the overall window wall ratio exceed the prescriptive limit of 0.40, the fenestration areas must be reduced by:

1) Adjust the west window area multiplying the west window area by the ratio  $0.4/WWR_w$ .

2) Calculate the WWR of the north, east and south facades:

$$WWR_{nes} = \text{Window Area}_{nes} / \text{Gross Wall Area}_{nes}$$

3) Adjust the window area of the windows on the north, east and south facades by the following ratio:

$$\text{WindowArea}_{N,std} = \text{WindowArea}_{N,prop} \times 0.4 / WWR_{nes}$$

$$\text{WindowArea}_{E,std} = \text{WindowArea}_{E,prop} \times 0.4 / WWR_{nes}$$

$$\text{WindowArea}_{S,std} = \text{WindowArea}_{S,prop} \times 0.4 / WWR_{nes}$$

4) Adjust each window geometry for the west façade by multiplying the window height by  $(0.4/WWR_w)$  by adjusting the sill height and by maintaining the same window width.

5) Adjust each window geometry for the north, east and south façade by multiplying the window height by  $(0.4/WWR_{nes})$  by adjusting the sill height and by maintaining the same window width.

**Exception 2:** If the display perimeter is entered and the window area exceeds the prescriptive limit, the window area for the standard design is calculated by multiplying the proposed window area by the following ratio:

$$\text{WindowArea}_{std} = 6 \times \text{DisplayPerimeter}$$

The geometry of each window is modified by the following, and by modifying the sill height but not the head height position relative to the floor:

$$\text{WindowHeight}_{std} = \text{WindowHeight}_{prop} \times (\text{WindowArea}_{std} / \text{WindowArea}_{prop})$$

$$\text{WindowWidth}_{std} = \text{WindowWidth}_{prop}$$

The following rules apply for calculating geometry of skylights. For the calculation of the standard design skylight area, the gross roof area is defined as the total roof area, including skylights, that is directly over conditioned space.

The skylight area of the standard design is set:

- 1) For buildings without atria or with atria having a height less than 55 feet over conditioned space, the smaller of the proposed skylight area and 5 percent of the gross roof area that is over conditioned space.
- 2) For buildings with atria at a height of 55 ft or greater over conditioned spaces, the smaller of the proposed skylight area and 10 percent of the gross roof area that is over conditioned space.
- 3) For buildings with atria or other roof area directly over unconditioned spaces, the smaller of the proposed skylight area or 5 percent of the roof area excluding the atria area and excluding any adiabatic walls, if present in the modeled building. The skylight area of the atria or roof area directly over unconditioned space is not included in the skylight area limit in this case.

The skylight area for atria over unconditioned space is not included in determining the skylight to roof ratio (SRR) for the building.

Depending on the following condition, adjustments to the SRR as described shall be made.

- i. For open spaces other than auditoriums, churches, movie theaters, museums and refrigerated warehouses, for buildings in climate zones 2 through 15, and when spaces have ceiling heights greater than 15 ft and floor areas greater than 5000 ft<sup>2</sup>, the skylight area shall be the greater of 3 percent or the area required to provide daylight coverage through skylights or primary side lighting to 75 percent of the floor area in the space. See 5.4.5 for detail description on primary daylit area and skylit daylit area.
- ii. If the above condition is met and  $SRR \leq 0.05$ , no adjustments are needed.
- iii. If the condition is met and  $SRR > 0.05$ , skylight dimensions = Existing Dimension x  $[1 - \sqrt{(0.05/SRR \text{ of Proposed Building})}]$
- iv. If the condition is not met triggering the need for additional skylights, the standard design case shall be modeled with new skylights irrespective of the skylight location of the proposed case. The new skylights shall be distributed uniformly such that there is no overlapping of primary daylit areas from skylights or sidelights. The dimension of the new skylights shall be the same as the proposed design if calculated new  $SRR \leq 0.05$ . If  $SRR > 0.05$ , skylight dimensions = existing dimension x  $[1 - \sqrt{(0.05/SRR \text{ of proposed building})}]$ .

Note that the adjustments to SRR are done after adjustments to WWR if any are completed.

*Standard Design: Existing Buildings:* For alterations of existing vertical fenestration or skylights, where no fenestration area is added, the fenestration geometry of the standard design shall be the same as the proposed for the existing building.

For additions of vertical fenestration or skylights, where the additional fenestration causes the fenestration area to exceed the limit of 40 percent window to wall ratio (WWR) for the building, 40 percent WWR for the west orientation of the building, 5 percent skylight to roof ratio (SRR) for existing buildings without atria 55 feet or higher, or 10 percent SRR for existing buildings with atria 55 feet or higher, the fenestration geometry for the standard design shall be adjusted from the proposed design according to the rules set forth under the standard design rules.

For additions of vertical fenestration and/or skylights that do not cause the fenestration area to exceed any of these limits, the fenestration geometry of the standard design shall be the same as the proposed design.

### **SKYLIGHT REQUIREMENT EXCEPTION FRACTION**

*Applicability:* All buildings with interior ceiling heights greater than 15 feet.

*Definition:* The fraction of floor area that is exempt from the minimum skylight area requirement for spaces with high ceilings.

Identifying areas subject to §140.3 of the standards:

When a proposed space has ceiling heights greater than 15 ft, with exterior surfaces having a tilt angle less than 60 degrees (roofs) and no more than three stories above grade, the user shall enter the fraction of the modeled space that is exempt from requirements of §140.3 of the standards. If the proposed design has skylights, the user shall also indicate the area of the proposed design daylight area under skylights in this space. When the user enters a value greater than zero percent for the fraction of the space area exempt to §140.3 of the standards, the compliance software shall require that the user indicate at least one of the following exceptions:

1. The building is not located in climate zone 1 or climate zone 16
2. Designed general lighting is less than 0.5 W/ft<sup>2</sup>
3. Existing walls on plans result in enclosed spaces less than 5,000 ft<sup>2</sup>
4. Future walls or ceilings on plans result in enclosed spaces less than 5,000 ft<sup>2</sup> or ceiling heights less than 15 ft
5. Plans or documents show that space is an auditorium, religious building of worship, movie theater, museum, or refrigerated warehouses

*Units:* List five exceptions listed above (specified if fraction > 0).

*Input Restrictions:* No restrictions, other than that the vertical fenestration type must agree with the type specified on the construction documents or the as-built drawings.

*Standard Design:* Same as the proposed design.

*Standard Design: Existing Buildings:* Not applicable.

## **FENESTRATION CONSTRUCTION**

*Applicability:* All fenestration.

*Definition:* A collection of values that together describe the performance of a fenestration system.

The values that are used to specify the criteria are U-factor, SHGC, and VT. U-factor and SHGC inputs are whole-window values.

*Units:* Data structure: shall include at a minimum the following properties as specified by NFRC ratings:

U-factor: whole window U-factor

SHGC: whole window solar heat gain coefficient

VT: visible transmittance

*Input Restrictions:* For newly constructed buildings, performance information for fenestration shall be obtained from NFRC test results or shall be developed from procedures outlined in §110.6 of the standards, as specified below. Values entered shall be consistent with the specifications and the construction documents.

For manufactured products:

- U-factor, SHGC, and VT shall be equivalent to NFRC rated values.
- For products not rated by NFRC, U-factor, SHGC and VT shall be determined from CEC default tables (110.6 A and B).
- For site-built products:
  - U-factor, SHGC, and VT shall be equivalent to NFRC rated values.
  - For products not rated by NFRC, up to 200 ft<sup>2</sup> of fenestration (total of new and altered) may use center of glass properties and Reference Appendix NA6 equations to calculate U-factor, SHGC, and VT. Any site-built fenestration in excess of 200 ft<sup>2</sup> must use the default values in Table 110.6-A and 110.6-B.

For buildings with fenestration area that meets requirements for use of center-of-glass U-factor and SHGC, the fenestration overall U-factor, SHGC, and VT shall be determined by the following equations from the Reference Appendix NA6:

$$UT = C1 + (C2 \cdot Uc)$$

$$\text{SHGCT} = 0.08 + (0.86 \cdot \text{SHGCc})$$

$$\text{VTT} = \text{VTF} \cdot \text{VTC}$$

Where,

- UT - U-factor is the total performance of the fenestration including glass and frame
- C1 - Coefficient selected from Table NA6-5 in Reference Appendix NA6
- C2 - Coefficient selected from Table NA6-5 in Reference Appendix NA6
- UC - Center of glass U-factor calculated in accordance with NFRC 100 Section 4.5.3.1
- SHGCT - Total SHGC performance including glass and frame SHGCC = Center of glass SHGC calculated in accordance with NFRC 200 Section 4.5.1.1
- VTT - Is the total performance of the fenestration including glass and frame
- VTF - 0.53 for projecting windows, such as casement and awning windows
- VTF - 0.67 for operable or sliding windows
- VTF - 0.77 for fixed or non-operable windows
- VTF - 0.88 for curtain wall/storefront, site-built and manufactured non-curb mounted skylights
- VTF - 1.0 for curb mounted manufactured skylights
- VTC - Center of glass VT is calculated in accordance with NFRC 200 Section 4.5.1.1 or NFRC 202 for Translucent Products or NFRC 203 for Tubular Daylighting Devices and Hybrid Tubular Daylighting Devices or ASTM E972

For skylights, the default values shall be the alternate default U-factor and SHGC using default calculations specified above and in Reference Appendix NA6 or the U-factor and SHGC listed in Table 110.6-A and Table 110.6-B in the standards.

*Standard Design:* For newly constructed buildings, the requirements for vertical fenestration U factor, SHGC, and visible light transmission by window or skylight type and framing type are specified in Table 140.3-B, C, or D of the standards. For plastic skylights, SHGC of 0.50 is assumed.

*Standard Design: Existing Buildings:* The U-factor, SHGC, and VT in the standard design shall be modeled as design if unchanged, as the values stated in Table 141.0-A of the standards when the existing window area is unchanged (different than the newly constructed buildings performance requirement), or Table 140.3-B, C, or D of the standards for all other cases.

The standard design does not include window films.

## **EXTERNAL SHADING DEVICES**



*Applicability:* All fenestration.

*Definition:* Devices or building features that are documented in the construction documents and shade the glazing, such as overhangs, fins, shading screens, and setbacks of windows from the exterior face of the wall.

The Title 24 compliance software shall be capable of modeling vertical fins, horizontal slats, and overhangs. Recessed windows may also be modeled with side fins, horizontal slats, and overhangs.

*Units:* Data structure: surface.

*Input Restrictions:* No restrictions other than that the inputs must match the construction documents.

*Standard Design:* The standard design building is modeled without external shading devices.

*Standard Design: Existing Buildings:* No shading devices.

#### **INTERNAL SHADING DEVICES**

*Applicability:* All fenestration.

*Definition:* Curtains, blinds, louvers, or other devices that are applied on the room side of the glazing material.

Glazing systems that use blinds between the glazing layers are also considered internal shading devices. Glass coatings, components, or treatments of the glazing materials are addressed through the fenestration construction building descriptor.

*Units:* Not applicable – not modeled for compliance.

*Input Restrictions:* Not applicable – interior shading is not modeled for compliance.

*Standard Design:* Not applicable – interior shading is not modeled for compliance.

*Standard Design: Existing Buildings:* No interior shades.

#### **DYNAMIC GLAZING PRESENT**

*Applicability:* All fenestration that has dynamic glazing.

*Definition:* This is a flag used for reporting purposes only. Dynamic glazing is not modeled directly in compliance software.

*Units:* Boolean.

*Input Restrictions:* None.

*Standard Design:* False (not present).

*Standard Design: Existing Buildings:* Not Applicable.

### **5.5.8 Below-Grade Walls**

#### **BELOW-GRADE WALL NAME**

*Applicability:* All projects, optional input.

*Definition:* A unique name that keys the below-grade wall to the construction documents.

*Units:* Text: unique.

*Input Restrictions:* None.

*Standard Design:* Not applicable.

*Standard Design: Existing Buildings:* Same as proposed.

#### **BELOW-GRADE WALL GEOMETRY**

*Applicability:* All projects.

*Definition:* A geometric construct that describes the dimensions and placement of walls located below grade. Below-grade walls have soil or crushed rock on one side and interior space on the other side. Some simulation models take the depth below grade into account when estimating heat transfer so the geometry may include height and width.

*Units:* Data structure: below-grade wall geometry.

*Input Restrictions:* As designed.

*Standard Design:* The geometry of below-grade walls in the standard design building is identical to the below-grade walls in the proposed design.

*Standard Design: Existing Buildings:* Same as proposed.

#### **BELOW-GRADE WALL CONSTRUCTION**

*Applicability:* All projects, required input.

*Definition:* A specification containing a series of layers that result in a construction assembly for the proposed design. The first layer in the series represents the outside (or exterior) layer and the last layer represents the inside (or interior) layer. See the building descriptors above for below-grade wall construction type.

*Units:* Data structure: construction assembly.

The construction can be described as a C-factor which is similar to a U-factor, except that the outside air film is excluded, or the construction can be represented as a series of layers, like exterior constructions.

*Input Restrictions:* The construction assembly, defined by a series of layers, must be equal to or more efficient than the mandatory R-value and C-factor requirements of §120.7 of the standards for newly constructed buildings, and §141.0 of the standards for alterations. Note that these requirements only apply when the slab floor connected to the below-grade wall is heated.

For newly constructed buildings, the inputs shall agree with the construction documents. Values for the C-factor shall be taken from Table 4.3.5, 4.3.6, or 4.3.7 of Reference Appendix JA4.

For alterations there are no restrictions.

*Standard Design:* For newly constructed buildings, see Table 13. The standard design building shall use default values for C-factor. The height shall be the same as specified in the proposed design.

For below-grade walls, the standard design construction shall include the layers described in Appendix 5.7 and in the table below.

For alterations, the C-factor in the standard design shall be modeled as the more efficient of either the existing conditions, or the values stated above for newly constructed buildings standard design.

For below-grade walls, the alteration standard design assembly shall include the appropriate existing layers.

*Standard Design: Existing Buildings:* Same as proposed.

**Table 9: Standard Design Building Below-Grade Wall Construction Assemblies**

<b>Construction</b>	<b>Layer</b>	<b>Thickness (inch)</b>	<b>Conductivity (Btu/h ft°F)</b>	<b>Density (lb./ft<sup>2</sup>)</b>	<b>Specific Heat (Btu/lb °F)</b>	<b>R-value (ft<sup>2</sup>·°F ·h/Btu)</b>	<b>C-factor (Btu/ft<sup>2</sup>·°F ·h)</b>
NR	115 lb./ft <sup>3</sup> CMU, solid grout	8	0.45	115	0.20	0.87	1.140
R-7.5 c.i.	115 lb./ft <sup>3</sup> CMU, solid grout	8	0.45	115	0.20	0.87	
	R-10 continuous insulation	1.8	0.02	1.8	0.29	7.50	
	Total assembly					8.37	0.119
R-10 c.i.	115 lb./ft <sup>3</sup> CMU, solid grout	8	0.45	115	0.20	0.87	
	R-10 continuous insulation	2.4	0.02	1.8	0.29	10.00	
	Total assembly					10.87	0.092
R-12.5 c.i.	115 lb./ft <sup>3</sup> CMU, solid grout	8	0.45	115	0.20	0.87	
	R-10 continuous insulation	3.0	0.02	1.8	0.29	12.50	
	Total assembly					13.37	0.075

Source: California Energy Commission

### **5.5.9 Slab Floors in Contact with Ground**

These building descriptors apply to slab-on-grade or below-grade floors that are in direct contact with the ground.

#### **SLAB FLOOR NAME**

*Applicability:* All slab floors, optional.

*Definition:* A unique name or code that relates the exposed floor to the construction documents.

*Units:* Text: unique.

*Input Restrictions:* None.

*Standard Design:* Not applicable.

*Standard Design: Existing Buildings:* Not applicable.

#### **SLAB FLOOR TYPE**

*Applicability:* All slab floors, required.

*Definition:* One of two types and two subtypes of floors in contact with ground:

- 1) Heated slab-on-grade floors,
- 2) Unheated slab-on-grade floors
- 3) Heated below-grade floors
- 4) Unheated below-grade floors.

Heated slab-on-grade floors include all floors that are heated directly in order to provide heating to the space. Unheated slab-on-grade floors are all other floors in contact with ground.

*Units:* List: restricted to the four selections listed above.

*Input Restrictions:* None.

*Standard Design:* The slab for type is unheated (either unheated slab-on-grade for slab-on-grade floors or unheated below-grade for below-grade floors).

*Standard Design: Existing Buildings:* Same as proposed.

#### **SLAB FLOOR GEOMETRY**

*Applicability:* All slab floors, required.

*Definition:* A geometric construct representing a slab floor in contact with the earth.

The geometric representation can vary depending on how the energy simulation software models slabs-on-grade. Some models require that only the perimeter of the slab be entered. Other models divide the slab into a perimeter band within 2 ft of the edge and the interior portion or core area, such that the perimeter area and the core area sum to the total area of the slab.

*Units:* Data structure: surface.

This may include area, perimeter exposed.

*Input Restrictions:* None.

*Standard Design:* The geometry of the slab floor in the standard design building is identical to the slab floor in the proposed design.

*Standard Design: Existing Buildings:* Same as proposed.

### **SLAB FLOOR CONSTRUCTION**

*Applicability:* All slab floors, required.

*Definition:* A specification containing a series of layers that result in a construction assembly for the proposed design.

The first layer in the series represents the outside (or exterior) layer and the last layer represents the inside (or interior) layer. See the building descriptors above for slab floor construction type.

A description of how the slab is insulated (or not)

How the construction is described will depend on the energy simulation model. The construction can be represented by an F-factor that represents the entire construction (floor and insulation).

Simple models may include just an F-factor, representing an instantaneous heat loss/gain to outside air. The F-factor could be related to the configuration of insulation in the proposed design. Other slab loss models may require that the surface area of the slab floor be divided between the perimeter and the interior. The insulation conditions then define heat transfer between both outside air and ground temperature.

The insulation condition for slabs includes the R-value of the insulation and the distance it extends into the earth at the slab edge and how far it extends underneath the slab.

*Units:* F-factor from Reference Appendix JA4; this is one selection from list 1 and one selection from list 2. Note that some combinations from list 1 and list 2 are not allowed, see Reference Appendix JA4 Table 4.4.8 and Table 4.4.7 for details.

List 1:

- None / 12 in vertical
- 12 in horizontal / 24 in vertical
- 24 in horizontal / 36 in vertical
- 36 in horizontal / 48 in vertical
- 48 in horizontal / Fully insulated slab

List 2:

- R-0 / R-20 / R-45
- R-5 / R-25 / R-50
- R-7.5 / R-30 / R-55
- R-10 / R-35
- R-15 / R-40

The software shall also provide the following slab insulation options:

1. Horizontal+Vertical, R-5 vertical down to the horizontal insulation and R-5 horizontal insulation extending 4 feet inwards from the perimeter
2. Horizontal+Vertical, R-10 vertical down to the horizontal insulation and R-7 horizontal insulation extending 4 feet inwards from the perimeter

These two combinations of slab insulation are mapped to an F-factor in Appendix 5.4B.

*Input Restrictions:* The construction assembly, defined by an F-factor, must be equal to or more efficient than the mandatory F-factor requirements of §120.7 of the standards for newly constructed buildings, and §141.0 of the standards for alterations.

For newly constructed buildings, F-factors shall be taken from Table 4.4.8 of Reference Appendix JA4 for heated slab floors and Table 4.4.7 for unheated slab floors. For all methods, inputs shall be consistent with the construction documents. For heated slab floors, the F-factor shall be determined by the mandatory R-value and installation requirements in §110.8 of the standards. That information is used in Table 4.4.8 of Reference Appendix JA4 to determine the required F-factor. The same requirements apply for alterations.

*Standard Design:* Slab loss shall be modeled with the simple method (F-factor).

The standard design construction shall include the following layer:

Layer 1: Concrete 140lb/ft<sup>3</sup> – 6 in. (R - 0.44)

The standard design shall include no insulation, equivalent to an F-factor of 0.73.

For alterations, the F-factor in the standard design shall be modeled as the more efficient of either the existing conditions, or the values stated above for newly constructed buildings standard design.

*Standard Design: Existing Buildings:* Same as proposed.

### **5.5.10 Heat Transfer between Thermal zones**

#### **PARTITION NAME**

*Applicability:* All partitions, optional.

*Definition:* A unique name or code that relates the partition to the construction documents.

*Units:* Text: unique.

*Input Restrictions:* The text should provide a key to the construction documents.

*Standard Design:* Not applicable.

*Standard Design: Existing Buildings:* Not applicable.

#### **PARTITION GEOMETRY**

*Applicability:* All partitions.

*Definition:* A geometric construct that defines the position and size of partitions that separate one thermal zone from another.

The construct shall identify the thermal zones on each side of the partition. Since solar gains are not generally significant for interior partitions, the geometry of partitions is sometimes specified as an area along with identification of the thermal zones on each side.

*Units:* Data structure: surface with additional information identifying the two thermal zones that the partition separates.

*Input Restrictions:* No restrictions other than agreement with the construction documents.

*Standard Design:* The geometry of partitions in the standard design building shall be identical to the proposed design.

*Standard Design: Existing Buildings:* Same as proposed.

#### **PARTITION CONSTRUCTION**

*Applicability:* All partitions.

*Definition:* A description of the construction assembly for the partition.

*Units:* Data structure: construction assembly.

*Input Restrictions:* As designed.



*Standard Design:* Partitions in the standard design shall be steel framed walls with 5/8-inch gypsum board on each side. For walls, partitions in the standard design building shall be steel-framed walls with 5/8-inch gypsum board on each side. For interior floors and ceilings, standard design construction shall be a metal deck, 4 inches of heavyweight (140 lb./ft<sup>3</sup>) concrete, and 3/4" thick carpet.

*Standard Design: Existing Buildings:* Same as proposed.

### **DEMISING PARTITION CONSTRUCTION**

*Applicability:* All demising walls and demising partitions (ceilings, floors) that separate conditioned spaces from unconditioned spaces.

*Definition:* A description of the construction assembly for the partition.

*Units:* Data structure: construction assembly.

*Input Restrictions:* As designed.

*Standard Design:* For walls, when the proposed design demising partition is metal-framed or other, the standard design shall be a metal-framed wall meeting the mandatory U-factor requirements of §120.7 (b) of the Standards.

For walls, when the proposed design demising partition is wood-framed, the standard design shall be a wood-framed wall with the opaque portions of the wall meeting the mandatory U-factor requirements of §120.7 (b) of the Standards.

For windows in demising walls, the fenestration area shall equal the fenestration area of the proposed design. The window U-factor for fenestration in demising walls shall equal the fixed window prescriptive U-factor requirement of 5.5.7. Neither solar heat gain nor daylighting through interior demising windows will be modeled.

Demising ceiling partitions, separating conditioned space from unconditioned space and attics, shall be insulated to the same levels as exterior roofs in Chapter 5.5.3. Demising floor partitions shall be insulated to the same levels as exterior floors in Chapter 5.5.5.

*Standard Design: Existing Buildings:* Demising ceiling partitions, separating conditioned space from unconditioned space and attics shall be insulated to the same levels as exterior roofs in Chapter 5.5.3. Demising floor partitions shall be insulated to the same levels as exterior floors in Chapter 5.5.5.

#### **5.5.11 Simplified Geometry Simulation Option**

The compliance software may have an option to model a building with simplified two-dimensional (2D) geometry. This is an optional capability as an alternative to modeling the three-dimensional (3D) geometry of a building. If the compliance software only provides a 2D building model, the following features cannot be modeled:

- Daylighting controls and dimming
- Exterior shading or self-shading

All mandatory and prescriptive daylight controls must be present when submitting a compliance project using software that only models a building with 2D geometry.

The compliance software must pass all reference method tests corresponding to 2D geometry to meet certification requirements as compliance software. Consult Appendix 3B of the *ACM Reference Manual* for additional information. The software must pass the rule set implementation tests, and for the sensitivity tests that verify simulation accuracy, there are 2D tests specified for building envelope, but for other building components such as lighting and HVAC, the software is compared against the results of the reference method, which uses a 3D geometry model.

The compliance software must have sufficient information to specify each exterior surface when modeling a building with 2D geometry. At a minimum, building surface azimuth, elevation, and area are required and the tilt, azimuth and area is specified for roof components. The model must use only vertical walls for the analysis. The model follows all other ACM requirements for space and zone definitions, lighting, and HVAC specifications, and follows the same rules for the standard design and proposed design constraints.

The model also requires the following explicit inputs from the user:

- Total Building Story Count – the total number of stories
- Total Above Grade Stories – the total number of stories above grade, used in determination of multifamily residential classification

---

## **5.6 HVAC Zone Level Systems**

This group of building descriptors relate to HVAC systems at the zone level. There is not a one-to-one relationship between HVAC components in the proposed design and the standard design since the standard design system is determined from building type, size, and heating source. The applicability of each building descriptor for each of standard design systems is indicated in tables under the building descriptor standard design rules. Additions and alterations should follow the same requirements stated for newly constructed buildings proposed designs and newly constructed buildings standard designs unless otherwise noted in the descriptor.

### **5.6.1 Space Temperature Control**

#### **SPACE THERMOSTAT THROTTLING RANGE**

*Applicability:* All thermal zones.

*Definition:* The number of degrees that the room temperature must change to cause the HVAC system to go from no heating or cooling (i.e., space temperatures floating) to full heating or cooling.

*Units:* Degrees Fahrenheit (°F).

*Input Restrictions:* The prescribed value is 2°F. (This is equivalent to a +/- 1°F temperature tolerance around the heating and cooling setpoint.) No input is needed, and the prescribed value may not be overridden.

*Standard Design:* Same as the proposed design.

*Standard Design: Existing Buildings:*

### **SPACE TEMPERATURE SCHEDULE**

*Applicability:* All thermal zones.

*Definition:* An hourly space thermostat schedule.

*Units:* Data structure: temperature schedule.

*Input Restrictions:* Prescribed.

The schedule group is specified for the given space type in Appendix 5.4A, and the schedule values are specified in Appendix 5.4B.

*Standard Design:* Schedules in the standard design shall be identical to the proposed design.

*Standard Design: Existing Buildings:*

## **5.6.2 Terminal Device Data**

### **TERMINAL TYPE**

*Applicability:* All thermal zones.

*Definition:* A terminal unit includes any device serving a zone (or group of zones collected in a thermal zone) that has the ability to re-heat or re-cool in response to the zone thermostat. This includes:

- None or Uncontrolled(the case for single zone units)
- VAV box
- Series fan-powered VAV box
- Parallel fan-powered VAV box
- Dual-duct mixing box (constant volume and VAV)

*Units:* List (see above).

*Input Restrictions:* As designed.

*Standard Design:* Only applicable for multiple zone systems 5 (packaged VAV) and 6 (built-up VAV). See [Chapter 5.1.2 HVAC System Map](#) for a summary of the HVAC mapping.

For healthcare facilities, same as the Proposed Design.

*Standard Design: Existing Buildings:* Same as proposed design for unaltered components; same as newly constructed buildings rules for new secondary systems or terminal units.

### **5.6.3 Terminal Heating**

This group of building descriptors applies to proposed design systems that have reheat coils at the zone level. The building descriptors are applicable for standard design systems 5 and 6.

#### **TERMINAL HEAT TYPE**

*Applicability:* Systems that have reheat coils at the zone level.

*Definition:* The heating source for the terminal unit. This includes:

- Electric resistance
- Gas furnace
- Oil furnace
- Hot water
- Steam

*Units:* List (see above).

*Input Restrictions:* As designed.

*Standard Design:* Hot water for terminal units with reheat coils.

For healthcare facilities, same as the Proposed Design.

*Standard Design: Existing Buildings:*

#### **TERMINAL HEAT CAPACITY**

*Applicability:* Systems that have reheat coils at the zone level.

*Definition:* The heating capacity of the terminal heating source.

*Units:* Btu/h.

*Input Restrictions:* As designed.

If the unmet load hours exceed 150, the energy analyst and design team may have to increase the size of the equipment so that the unmet load hours are less than 150.

*Standard Design:* The software shall automatically size the terminal heating capacity to be 25 percent greater than the design loads.

*Standard Design: Existing Buildings:*

### **REHEAT DELTA T ( $\Delta T_{reheat}$ )**

*Applicability:* Systems that have reheat coils at the zone level.

*Definition:* This is an alternate method to enter the terminal heat capacity, which can be calculated as follows:

$$\Delta T_{reheat} = T_{reheat} - T_{cool\_supply}$$
$$\Delta T_{reheat} = Q_{coil} / 1.09 \times CFM$$

Where:

- $\Delta T_{reheat}$  - Heat rise across the terminal unit heating coil (F)
- $T_{reheat}$  - Heating air temperature at design (F)
- $T_{cool\_supply}$  - Supply air temperature at the heating coil (F)
- $Q_{coil}$  - Heating coil load (Btu/h)
- $CFM$  - Airflow (ft<sup>3</sup>/min)

*Units:* Degrees Fahrenheit (°F).

*Input Restrictions:* As designed but may need to be increased if zone unmet load hours are greater than 150.

*Standard Design:* Method not used for standard design. The temperature difference shall be no more than 40°F. See heat capacity.

*Standard Design: Existing Buildings:*

## **5.6.4 Baseboard Heat**

### **BASEBOARD CAPACITY**

*Applicability:* All thermal zones.

*Definition:* Total heating capacity of the baseboard unit(s).

*Units:* Btu/h.

*Input Restrictions:* As designed.

*Standard Design:* Not applicable.

*Standard Design: Existing Buildings:*

### **BASEBOARD HEAT CONTROL**

*Applicability:* All thermal zones with baseboard heating.

*Definition:* Defines the control scheme of base board heating as controlled by a space thermostat.

*Units:* List (fixed as By Space Thermostat).

*Input Restrictions:* Controlled by space thermostat is the only type allowed if baseboard heating is used.

*Standard Design:* Not applicable.

*Standard Design: Existing Buildings:*

### **BASEBOARD HEAT SOURCE**

*Applicability:* All thermal zones with furnaces or baseboard heating at the zone.

*Definition:* Heating source.

*Units:* List

- Electric heat
- Gas furnace
- Hot water

*Input Restrictions:*

*Standard Design:* Not applicable, except for healthcare facilities, same as the Proposed Design.

*Standard Design: Existing Buildings:*

### **5.6.5 Variable Refrigerant Flow (VRF) Zone Systems (Indoor Units)**

The following inputs are required when zone systems are connected to a VRF system (condensing unit).

#### **ACCEPTANCE TEST REQUIRED**

*Applicability:* VRF.

*Definition:* Flag if acceptance test is required.

*Units:* Boolean.

*Input Restrictions:* None.

*Standard Design:* Not applicable.

*Standard Design: Existing Buildings:*

**VRF ZONE SYSTEM TYPE**

*Applicability:* VRF.

*Definition:* Type of zone system.

*Units:* VRF.

*Input Restrictions:* VRF.

*Standard Design:* Not applicable.

*Standard Design: Existing Buildings:*

**COUNT**

*Applicability:* VRF.

*Definition:* The number of duplicate systems represented by the current system. All system attributes must be identical for multiple system assignment.

*Units:* None.

*Input Restrictions:* None.

*Standard Design:* Not applicable.

*Standard Design: Existing Buildings:*

**INDOOR UNIT TYPE**

*Applicability:* VRF.

*Definition:* Ducted or Unducted.

*Units:* List – Ducted, Unducted.

*Input Restrictions:* None.

*Standard Design:* Not applicable.

*Standard Design: Existing Buildings:*

**DESIGN SUPPLY AIR TEMPERATURE (COOLING)**

*Applicability:* VRF.

*Definition:* Design SAT in cooling for the zone.

*Units:* Deg F.

*Input Restrictions:* As Designed.

*Standard Design:* Not applicable.

*Standard Design: Existing Buildings:*

**DESIGN SUPPLY AIR TEMPERATURE (HEATING)**

*Applicability:* VRF.

*Definition:* Design SAT in heating for the zone.

*Units:* Deg F.

*Input Restrictions:* As Designed.

*Standard Design:* Not applicable.

*Standard Design: Existing Buildings:*

**NET COOLING CAPACITY**

*Applicability:* VRF.

*Definition:* Net cooling capacity of the zone system (one system if count>1), which includes all cooling to the zone but excludes any fan motor heat.

*Units:* Btu/h.

*Input Restrictions:* None.

*Standard Design:* Not applicable.

*Standard Design: Existing Buildings:*

**NET HEATING CAPACITY**

*Applicability:* VRF.

*Definition:* Net heating capacity of the zone system (one system if count>1), which includes all cooling to the zone but excludes any fan motor heat.

*Units:* Btu/h.

*Input Restrictions:* None.

*Standard Design:* Not applicable.

*Standard Design: Existing Buildings:*

**SUPPLY FAN CAPACITY FOR COOLING**

*Applicability:* VRF.

*Definition:* The supply fan flow rate when the zone requires cooling.

*Units:* cfm (for each mode).

*Input Restrictions:* None.

*Standard Design:* Not applicable.



*Standard Design: Existing Buildings:*

**SUPPLY FAN CAPACITY FOR HEATING**

*Applicability:* VRF.

*Definition:* The supply fan flow rate when the zone requires heating.

*Units:* cfm (for each mode).

*Input Restrictions:* None.

*Standard Design:* Not applicable.

*Standard Design: Existing Buildings:*

**SUPPLY FAN CAPACITY FOR DEADBAND**

*Applicability:* VRF.

*Definition:* Identify the supply fan airflow rate in deadband (floating) mode.

*Units:* cfm (for each mode).

*Input Restrictions:* None.

*Standard Design:* Not applicable.

*Standard Design: Existing Buildings:*

**SUPPLY TEMP CONTROL**

*Applicability:* VRF.

*Definition:* The method of controlling the system supply air temperature.

*Units:* List (Constant, reset by outside air, reset by demand).

*Input Restrictions:* No Supply Air Temperature Control.

*Standard Design:* Not applicable.

*Standard Design: Existing Buildings:*

**AUXILIARY POWER WHEN ON**

*Applicability:* VRF.

*Definition:* The parasitic electrical energy use of the zone terminal unit when either terminal unit coil is operating.

*Units:* Watts or Btu/h.

*Input Restrictions:* None.

*Standard Design:* Not applicable.

*Standard Design: Existing Buildings:*

**AUXILIARY POWER WHEN OFF**

*Applicability:* VRF.

*Definition:* The parasitic electrical energy use of the zone terminal unit when the terminal unit coils are off.

*Units:* Watts or Btu/h.

*Input Restrictions:* None.

*Standard Design:* Not applicable.

*Standard Design: Existing Buildings:*

**SUPPLY FAN AIRFLOW CAPACITY CONTROL**

*Applicability:* VRF.

*Definition:* The supply fan airflow shall be capable of specifying one (constant volume), two or variable speed control and power relationships for each fan unit.

*Units:* Fractional inputs for speed and power as a function of full flow and power.

*Input Restrictions:* Not to exceed 1.0 and no less than 50% flow.

*Standard Design:* Not applicable.

*Standard Design: Existing Buildings:*

**5.6.6 Zone Level Air Flow**

**5.6.6.1 Variable Air Volume (VAV) Air Flow**

This group of building descriptors applies to proposed design systems that vary the volume of air at the zone level. The building descriptors are applicable for standard design systems 5 and 6.

**DESIGN AIRFLOW**

*Applicability:* Systems that vary the volume of air at the zone level.

*Definition:* The air delivery rate at design conditions.

*Units:* Cfm.

*Input Restrictions:* As designed.

If the unmet load hours in the proposed design are greater than 150, the user may have to modify the design airflow value manually.

*Standard Design:* For systems 5 and 6, the software shall automatically size the system airflow to meet both:

- a) The standard design peak cooling load based on a supply-air-to-room-air temperature difference of 20°F for exterior zones or 15°F for interior zones, the required ventilation air from Table 120.1-A of the standards, or makeup air, whichever is greater.
- b) The standard design peak heating load based on 50 percent zone flow and 95°F supply air temperature.

An exterior zone is defined as a type of thermal zone that has any exterior walls, and that has a non-zero amount of vertical fenestration (windows). Any zone that does not meet the definition of an exterior zone is an interior zone.

*Standard Design: Existing Buildings:*

### **TERMINAL MINIMUM STOP**

*Applicability:* Systems that vary the volume of air at the zone level

*Definition:* The minimum airflow that will be delivered by a terminal unit before reheating occurs

*Units:* Unitless fraction of airflow (cfm) or specific airflow (cfm/ft<sup>2</sup>)

*Input Restrictions:* Input must be greater than or equal to the outside air ventilation rate

*Standard Design:* For systems 5 and 6, packaged VAV units and built-up VAV air handling units, set the minimum airflow to be the minimum outside air ventilation rate.

For laboratories, the minimum airflow fraction shall be fixed at a value equivalent to the greater of the proposed design minimum exhaust requirements or the minimum ventilation rate.

*Standard Design: Existing Buildings:*

### **TERMINAL HEATING CONTROL TYPE**

*Applicability:* VAV boxes with reheat

*Definition:* The control strategy for the heating mode.

Single Maximum:

In the single maximum control mode, the airflow is set to a minimum constant value in both the deadband and heating mode. This airflow can vary but is typically 30 to 50 percent of maximum. This control mode typically has a higher minimum airflow than the minimum used in the dual maximum below, resulting in more frequent reheat.

**Figure 9: Single Maximum VAV Box Control**

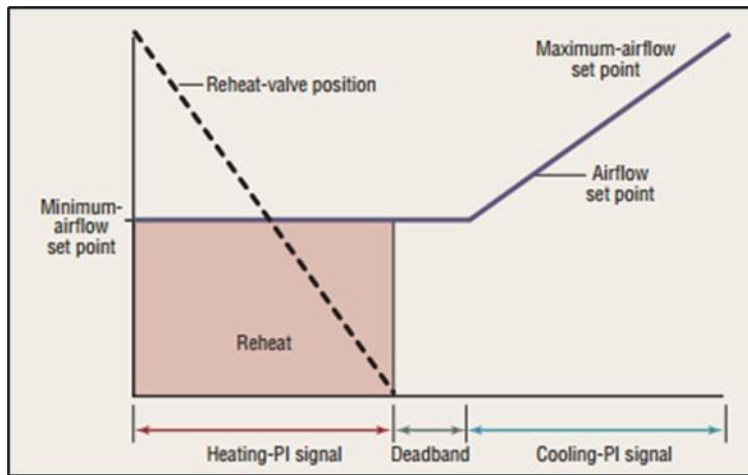

Source: Taylor Engineering

Dual Maximum:

Raises the supply air temperature (SAT) as the first stage of heating and increases the airflow to the zone as the second stage of heating.

1. The first stage of heating consists of modulating the zone supply air temperature setpoint up to a maximum setpoint no larger than 95°F while the airflow is maintained at the dead band flow rate.
2. The second stage of heating consists of modulating the airflow rate from the dead band flow rate up to the heating maximum flow rate (50 percent of design flow rate).

**Figure 10: Dual Maximum Control Sequence**

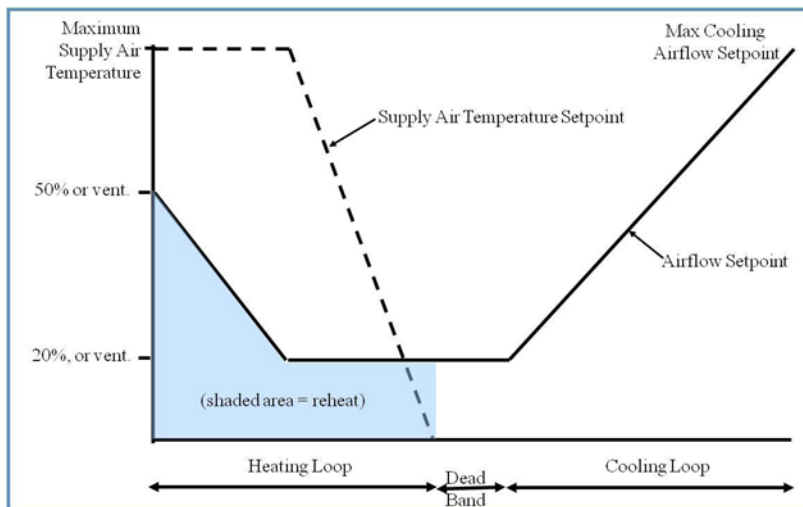

Source: Taylor Engineering

Units: List:

- Single maximum
- Dual maximum

*Input Restrictions:* Fixed at single maximum if control system type is not direct digital control (DDC) control to the zone level

*Standard Design:* Dual maximum.

*Standard Design: Existing Buildings:*

### **5.6.6.2 Fan Powered Boxes**

#### **FAN POWERED BOX TYPE**

*Applicability:* Thermal zones that have fan powered boxes.

*Definition:* Defines the type of fan-powered induction box.

*Units:* List :

- series
- parallel

*Input Restrictions:* As designed.

*Standard Design:* Not applicable.

For healthcare facilities, same as the Proposed Design.

*Standard Design: Existing Buildings:*

#### **TERMINAL FAN POWER**

*Applicability:* Thermal zones that have fan powered boxes.

*Definition:* Rated power input of the fan in a fan-powered box.

*Units:* W/cfm.

*Input Restrictions:* As designed.

*Standard Design:* Not applicable.

For healthcare facilities, same as the Proposed Design.

*Standard Design: Existing Buildings:*

#### **FAN POWERED BOX INDUCED AIR ZONE**

*Applicability:* Thermal zones that have fan powered boxes.

*Definition:* Zone from which a series or parallel fan-powered box draws its air.

*Units:* List (of zones).

*Input Restrictions:* As designed.

*Standard Design:* Not applicable.

For healthcare facilities, same as the Proposed Design.

*Standard Design: Existing Buildings:*

### **PARALLEL POWERED INDUCTION UNIT (PIU) INDUCTION RATIO**

*Applicability:* Thermal zones that have fan-powered boxes.

*Definition:* Ratio of induction-side airflow of a fan-powered box at design heating conditions to the primary airflow.

*Units:* Ratio.

*Input Restrictions:* As designed.

*Standard Design:* Not applicable.

For healthcare facilities, same as the Proposed Design.

*Standard Design: Existing Buildings:*

### **PARALLEL FAN BOX THERMOSTAT SETPOINT**

*Applicability:* Thermal zones that have fan powered boxes.

*Definition:* Temperature difference above the heating setpoint at which the parallel fan is turned on.

*Units:* Degrees Fahrenheit (°F).

*Input Restrictions:* 2°F above the heating setpoint schedule.

*Standard Design:* Not applicable.

For healthcare facilities, same as the Proposed Design.

*Standard Design: Existing Buildings:*

### **TERMINAL VENTILATION ONLY CONTROL SCHEDULE**

*Applicability:* Systems that vary the volume of air at the zone level and supply ventilation only air to a space.

*Definition:* The input shall control the terminal unit to vary airflow to match ventilation requirements only, by means of schedule or link to a space ventilation object which specifies the ventilation airflow requirements.

*Units:* User selection for ventilation only controls.

*Input Restrictions:* Yes/No.

*Standard Design:* Not applicable.

*Standard Design: Existing Buildings:* Not applicable.

### **5.6.6.3 Zone Exhaust**

This group of building descriptors describes the  of exhaust and the schedule or control for this exhaust. An exhaust system can serve one thermal zone or multiple thermal zones. Energy is summed for the exhaust system level, not the thermal zone level.

This chapter also contains unique inputs for kitchen exhaust systems that must meet requirements of §140.9 of the Standards.

#### **KITCHEN EXHAUST HOOD LENGTH**

*Applicability:* Exhaust fans in spaces of type kitchen, commercial food preparation.

*Definition:* The exhaust hood length.

*Units:* ft.

*Input Restrictions:* As designed.

*Standard Design:* Same as the proposed design.

*Standard Design: Existing Buildings:*

#### **KITCHEN EXHAUST HOOD STYLE**

*Applicability:* Exhaust fans in spaces of type kitchen, commercial food preparation.

*Definition:* The hood style as defined in Table 140.9-C of the standards.

*Units:* List:

- Wall-mounted canopy
- Single island
- Double island
- Eyebrow
- Backshelf/Passover

*Input Restrictions:* As designed.

*Standard Design:* Same as the proposed design.

*Standard Design: Existing Buildings:*

#### **KITCHEN EXHAUST HOOD COOKING DUTY**

*Applicability:* Exhaust fans in spaces of type kitchen, commercial food preparation.

*Definition:* The hood cooking duty as defined in Table 140.9-C of the standards.

*Units:* List:

- Light-duty
- Medium-duty
- Heavy-duty
- Extra heavy-duty

*Input Restrictions:* As designed.

*Standard Design:* Same as the proposed design.

*Standard Design: Existing Buildings:*

### **EXHAUST FAN NAME**

*Applicability:* All thermal zones.

*Definition:* A reference to an exhaust fan system that serves the thermal zone.

*Units:* Text or other unique reference to an exhaust fan system defined in the secondary systems section.

*Input Restrictions:* As designed.

*Standard Design:* Same as the proposed design.

*Standard Design: Existing Buildings:*

### **EXHAUST AIR FLOW RATE**

*Applicability:* All thermal zones.

*Definition:* Rate of exhaust from a thermal zone.

*Units:* Cfm.

*Input Restrictions:* For nonresidential and hotel/motel spaces, Proposed exhaust air flow rate must meet the minimum exhaust requirements of §120.1(c)4 for applicable spaces in Table 120.1-B.

For laboratory spaces and zones, the design exhaust air flow rate is specified by the user, but a warning shall be posted if less than 1 cfm/ft<sup>2</sup>.

*Standard Design:* Same as the proposed design but not above the maximum of the standard design ventilation rates listed in Appendix 5.4A and required exhaust ventilation rates from Standards Table 120.1-B for spaces that do not include covered processes. Exception for buildings with over 5,000 cfm of kitchen exhaust; the standard design is a



function of the kitchen exhaust hood length, kitchen exhaust hood style, and kitchen exhaust hood cooking duty, and is determined by Title 24 standards, Table 140.9-A.

For lab exhaust systems, the standard design exhaust flow rate is the same as the proposed.

For healthcare facilities, same as the Proposed Design.

*Standard Design: Existing Buildings:*

### **EXHAUST MINIMUM AIR FLOW RATE**

*Applicability:* All laboratory zones.

*Definition:* Minimum rate of exhaust from a zone.

*Units:* cfm/ft<sup>2</sup>.

*Input Restrictions:* As designed for non-process zones.

For laboratory zones, the exhaust air flow rate is the maximum of the hood scheduled exhaust air flow rate and the minimum ventilation rate. A warning is posted if the minimum exhaust rate is 2 ACH or less.

*Standard Design:* For laboratory systems with minimum exhaust flow rates exceeding 10 ACH exhaust, the exhaust minimum air flow rate is equal to the proposed design minimum. For VAV laboratory systems with variable flow and variable speed drive exhaust fan control, the exhaust minimum air flow rate is the proposed design minimum exhaust air flow rate.

*Standard Design: Existing Buildings:*

### **EXHAUST FAN SCHEDULE**

*Applicability:* All thermal zones.

*Definition:* Schedule indicating the pattern of use for exhaust air from the thermal zone.

*Units:* Data structure: schedule, fraction.

*Input Restrictions:* For non-process spaces, schedule is prescribed based on occupancy type and specified in Appendix 5.4B. Exhaust fans for non-process loads shall be modeled as constant volume and always on.

Exhaust schedules for kitchen exhaust hoods are prescribed and specified in Appendix 5.4B, and dependent on whether the exhaust is constant or variable volume.

Exhaust schedules for laboratory spaces are prescribed and specified in Appendix 5.4B, and dependent on whether the exhaust is constant or variable volume. If the exhaust is variable flow, the compliance software shall automatically use either the no sash control or sash

control laboratory variable exhaust schedule or a volume-weighted interpolated average of the two schedules if only a fraction of the exhaust hoods have sash control.

*Standard Design:* Same as the proposed design for non-covered process spaces.

Exhaust schedules for kitchen exhaust hoods are prescribed and specified in Appendix 5.4B.

For laboratory spaces, the standard design is constant volume if the proposed exhaust system is constant volume and has a minimum exhaust air flow rate greater than 10 ACH. Otherwise, the standard design is variable volume. If the standard design is variable volume and the proposed laboratory space is fume hood intense (as defined in Standards Table 140.9-C) then the standard design will use the Appendix 5.4B modified VAV schedule for hoods with sash controls, volume-weighted by the fraction of exhaust that is served by exhaust hoods with vertical-only sashes. If the standard design is variable volume and the proposed space is not fume hood intense then the standard design shall use the VAV exhaust schedule for non-controlled sashes.

For healthcare facilities, same as the proposed design.

*Standard Design: Existing Buildings:*

#### **EXHAUST FAN FRACTION SASH CONTROL**

*Applicability:* Zones with laboratory exhaust hoods with vertical sashes.

*Definition:* The airflow-weighted fraction of exhaust hoods with vertical sashes that have automatic sash controls. This input is needed to appropriately model cases where only a fraction of the exhaust hoods that have automatic sash controls.

*Units:* Fraction.

*Input Restrictions:* As Designed (between 0 and 1).

*Standard Design:* 1 if sash controls are required for the laboratory space (per Table 140.9-D of the Standards).

For healthcare facilities, same as the Proposed Design.

*Standard Design: Existing Buildings:* As Designed (between 0 and 1).

#### **5.6.6.4 Outdoor Air Ventilation**

##### **VENTILATION SOURCE**

*Applicability:* All thermal zones.

*Definition:* The source of ventilation for a thermal zone. The choices are:

- Natural (by operable openings)
- Forced (by fan)

*Units:* List: None, Natural, or Forced.

*Input Restrictions:* For hotel/motel guest rooms, as designed.

For all other occupancies, Forced.

*Standard Design:*

For hotel/motel guest rooms, same as the proposed.

For other occupancies, Forced if the proposed design is also 'Forced', otherwise 'None'.

*Standard Design: Existing Buildings:*

## **VENTILATION STANDARD**

*Applicability:* Thermal zones with special ventilation requirements, such as a process space, which have no defined requirements in Title 24.

*Definition:* Minimum ventilation rates for:

- Title 24 (default)
- Other

*Units:* List: See above.

*Input Restrictions:* None.

User should be prepared to show justification for not using Title 24 ventilation source. If 'Other' is used, the user must enter a description of which standard applies, such as OSHPD3, Animal Shelter, etc.

*Standard Design:* Same as proposed.

*Standard Design: Existing Buildings:* Same as proposed.

## **DESIGN VENTILATION RATE**

*Applicability:* All thermal zones.

*Definition:* The quantity of ventilation air that is provided to the space for the specified thermal zone at maximum occupancy.

This is adjusted by the occupancy fraction to determine the design ventilation rate for the space.

*Units:* Cfm.

*Input Restrictions:*

As defined by the user, provided that the total outside air ventilation rate to the building story matches the standard design outside air ventilation rate for the building story within a specified tolerance (within 20%).

To accommodate transfer air requirements for makeup air for exhaust from other zones, the design ventilation rate may be between 95 percent and 110 percent of code required ventilation rates for on a building story without penalty.

Ventilation rates below 95% of the code required ventilation rate for a building story are not allowed.

If the ventilation source is natural for hotel/motel guestroom spaces, then the proposed design ventilation will be modeled as infiltration.

*Standard Design:* For labs and healthcare facilities, same as the Proposed Design.

If the total exhaust airflow requirement on the building floor does not exceed the total ventilation requirement, then the standard design outside air ventilation rate shall be the same as the proposed. The standard design ventilation rate is the same as the proposed but is constrained to be between 95% and 110% of the code ventilation requirement. If the proposed ventilation rate exceeds the limits above, the standard design ventilation rate for each space shall be the proposed rate uniformly reduced such that the total ventilation air delivered to the building story is equal to the maximum allowed ventilation air rate:

Design Ventilation Rate<sub>std</sub> = Design Ventilation Rate<sub>prop</sub> x ( BFVent<sub>std</sub> / BFVent<sub>prop</sub> )

Where:

BFVent<sub>min</sub> is the building floor design minimum required ventilation flow, as specified by the standards, and

BFVent<sub>prop</sub> is the building floor design ventilation flow for the proposed design.

*Standard Design: Existing Buildings:* Same as the proposed, if unaltered. If space type is altered such that different ventilation rate requirements apply, the outside air ventilation rate should follow the same rules as for newly constructed buildings.

## **OCCUPANCY FRACTION**

*Applicability:* All thermal zones.

*Definition:* The space design requirements for ventilation at design occupancy that are compliant with space egress requirements and design ventilation requirements.

The occupancy fraction also affects hot water use requirements for the space.

*Units:* Unitless fraction.

*Input Restrictions:* Default of 0.5 as designed with a minimum value of 0.5 and a maximum value of 5.

*Standard Design:* 0.5.

*Standard Design: Existing Buildings:* 0.5.

## **BUILDING FLOOR VENTILATION REQUIREMENT**

*Applicability:* Internal variable, calculated for each building story (floor).

*Definition:* The total outside air ventilation airflow requirement for all spaces on a building story or floor.

This is calculated by summing the ventilation levels for each space and comparing it to the minimum required ventilation rate and the design exhaust air flow requirements.

*Units:* cfm (ft<sup>3</sup>/min).

*Input Restrictions:* Not a user input; derived by summing the ventilation and exhaust air flows from all spaces on the building floor.

*Standard Design:* For labs and healthcare facilities, same as the Proposed Design.

For all other spaces:

This is calculated by the following procedure:

1. Calculate the proposed ventilation for the building story as the sum of design ventilation flow for each space included on a building story, including all conditioned spaces except space designated as lab space.
2. Calculate the proposed exhaust for the building story as the sum of design exhaust flow for each space on the building story, including all conditioned spaces except spaces designated as lab space.
3. Calculate the code minimum ventilation requirement as the sum of all minimum required ventilation airflows, as defined by Appendix 5.4A, for all spaces in the building story.
4. If the proposed exhaust is greater than the code minimum ventilation rate, then:
  - a. Total standard design building story ventilation requirement shall be: Standard ventilation = Min (proposed ventilation, proposed exhaust x 1.2)

Otherwise:

Standard ventilation = Min (code minimum ventilation, proposed ventilation)

*Standard Design: Existing Buildings:*

## **MINIMUM VENTILATION RATE**

*Applicability:* All thermal zones that have variable ventilation control.

*Definition:* The minimum quantity of ventilation air that must be provided to the space when it is occupied.

*Units:* cfm (ft<sup>3</sup>/min).

*Input Restrictions:* As designed but not lower than code minimum (default value).

The default value shall be the larger of 15 cfm times the design occupancy times the occupancy fraction or the conditioned floor area times the applicable ventilation rate from Appendix 5.4A.

For spaces where demand control ventilation is installed, the minimum ventilation rate is specified by the greater of the rate in Table 120.1-A or 15 cfm times the scheduled occupancy for that hour.

For hotel/motel guestroom spaces where the proposed design ventilation source is natural ventilation, the minimum ventilation rate will be modeled as infiltration.

*Standard Design:* For labs and healthcare facilities, same as the Proposed Design.

For spaces where demand control ventilation is required, the minimum ventilation rate is specified by the greater of the rate in Appendix 5.4A or 15 cfm times the scheduled occupancy for that hour.

*Standard Design: Existing Buildings:*

#### **VENTILATION CONTROL METHOD**

*Applicability:* All thermal zones

*Definition:* The method used to determine outside air ventilation needed for each hour in the simulation.

This information is reported to the system serving the zone. The method of controlling outside air at the system level in response to this information is discussed under secondary systems. Options at the zone level are:

- CO2 sensors in the space: The outside air is varied to maintain a maximum CO2 concentration in the space. This shall be approximated by multiplying the ventilation rate per occupant times the number of occupants for that hour. (When turnstile counts are used to automatically adjust ventilation levels based on occupancy, this method may also be used.)
- Fixed ventilation rate: Outside air is delivered to the zone at a constant rate and is equal to the design ventilation rate (see above).

*Units:* List (see above)

*Input Restrictions:* As designed

If the space includes a design occupant density greater than or equal to 25 persons per 1,000 ft<sup>2</sup>, and the system includes an airside economizer, or if the design airflow rate for the system exceeds 3,000 cfm, the input is restricted to CO2 sensors in the space.

Note: a classroom space greater than 750 ft<sup>2</sup> must have an occupancy sensor for ventilation control and setback to meet the mandatory Title 24 Standards requirements of §120.2(e)3. This requirement should be indicated on the appropriate compliance form submittal.

*Standard Design:* For healthcare facilities, same as the Proposed Design.

If the default occupancy for the specified space function from Appendix 5.4B is greater than or equal to 25 persons per 1,000 ft<sup>2</sup> and the system includes an airside economizer, set control method to CO<sub>2</sub> sensors in the space. Otherwise, set to fixed ventilation rate.

*Standard Design: Existing Buildings:*

### **DEMAND CONTROL VENTILATION (DCV) MINIMUM VENTILATION SCHEDULE**

*Applicability:* All projects.

*Definition:* The DCV minimum schedule modifies the ventilation airflow rate for a given space based on the controllability of a ventilation system and the allowance of the energy standard for the space to modulate outdoor air. The schedule is dependent on the occupancy schedule for a space type and shall include a lower limit to airflow based on spaces where minimum ventilation air has a lower limit greater than 0.

*Units:* Data Structure: schedule, fractional.

*Input Restrictions:* The DCV minimum ventilation schedule is prescribed for California compliance based on a space type.

*Standard Design:* DCV minimum ventilation schedules shall be used in all spaces where DCV is a mandatory requirement. DCV minimum ventilation schedules can be different between the proposed and standard design buildings based on a proposed building adopting DCV control in spaces the energy standard does not require.

*Standard Design: Existing Buildings:* Same as proposed.

---

## **5.7 HVAC Secondary Systems**

This group of building descriptors relate to the secondary HVAC systems. There is not a one-to-one relationship between secondary HVAC system components in the proposed and standard design since the standard design system is determined from building type, size, and number of floors. The standard design for a given building descriptor indicates the appropriate value for each applicable system type.

### **5.7.1 Basic System Information**

#### **HVAC SYSTEM NAME**

*Applicability:* All system types.

*Definition:* A unique descriptor for each HVAC system.

*Units:* Text, unique.

*Input Restrictions:* When applicable, input should match the tags that are used on the plans.

*Standard Design:* None.

*Standard Design: Existing Buildings:* None.

## **SYSTEM TYPE**

*Applicability:* All system types

*Definition:* A unique descriptor which identifies the HVAC system type. The System Type indicates the cooling and heat source, and whether the system serves a single zone or multiple zones.

*Units:* List from the choices below

*Input Restrictions:* PTAC – Packaged Terminal Air Conditioner

PTHP – Packaged Terminal Heat Pump

SZAC – Single-zone Air Conditioner

SZHP – Single-zone heat pump

PVAV\* – Packaged Variable Air Volume (VAV) with Reheat

VAV\* – Built-up VAV with Reheat

SZVAV-AC – Single Zone VAV Air Conditioner

SZVAV-HP – Single Zone VAV Heat Pump

HV – Heating and Ventilation Only

CRAC – Computer Room Air Conditioner

CRAH – Computer Room Air Handler

FPFC – Four-pipe Fan Coil

WSHP – Water-source Heat Pump

SPVAC – Single package vertical air conditioner

SPVHP – Single package vertical heat pump

DOASVAV – Dedicated Outdoor Air System with Variable Air Volume Airflow

DOASCAV – Dedicated Outdoor Air System with Constant Air Volume Airflow



Chilled Beam – Active or Passive chilled beams

\* Choice includes series and parallel fan-powered boxes as zone terminal units

*Standard Design:* Based on the prescribed system type in the HVAC system map (see Chapter 5.1.2).

*Standard Design: Existing Buildings:*

## **5.7.2 System Controls**

### **5.7.2.1 Control System Type**

#### **CONTROL SYSTEM TYPE**

*Applicability:* All HVAC systems that serve more than one control zone, as well as the hydronic systems that serve building HVAC systems.

*Definition:* The type of control system for multi-zone HVAC systems and their related equipment.

This input affects the proposed design system specification for zone level controls, supply air temperature reset controls, ventilation controls and fan and pump static pressure part-load curves. See the following building descriptors:

- Ventilation control method
- Terminal heating control type
- Pump part-load curve
- Fan part-load curve
- Optimal start
- Capacity Limit

*Units:* None.

*Input Restrictions:* List one of the following inputs:

Direct digital control (DDC) control to the zone level – DDC systems with control to the zone level.

Other – other control systems, including pneumatic and DDC systems without control to the zone level.

*Standard Design:*

DDC control to the zone level.

*Standard Design: Existing Buildings:*

## **CAPACITY LIMIT**

*Applicability:* All air systems – not applicable for zone systems.

*Definition:* The capacity limit establishes how an air system is utilized for thermal load conditioning or for ventilation only. The user choices are:

- Sensible Load
- Total Load
- Ventilation Only

*Units:* None.

*Input Restrictions:* None.

*Standard Design:* Sensible load shall be the default for all standard design systems.

*Standard Design: Existing Buildings:*

## **5.7.2.2 Schedules**

### **AIR HANDLER SCHEDULE**

*Applicability:* All systems that do not cycle with loads.

*Definition:* A schedule that indicates when the air handler operates continuously.

*Units:* Data structure: schedule, on/off.

*Input Restrictions:* For healthcare facilities, same as the Proposed Design. For all others, schedule group is prescribed in Appendix 5.4A and schedule values are prescribed in Appendix 5.4B. See Chapter 2.3.3 on how software shall assign schedules when the spaces served by the system are assigned to different schedule groups in Appendix 5.4A.

The fan schedules and HVAC operations are defined so that the air handlers provide the necessary outside air 1 hour prior to scheduled occupancy.

When a fan system serves several occupancies, the fan schedule is based on the predominant occupancy.

*Standard Design:* Same as the proposed design.

*Standard Design: Existing Buildings:*

### **AIR HANDLER FAN CYCLING**

*Applicability:* All fan systems.

*Definition:* This building descriptor indicates whether the system supply fan operates continuously or cycles with building loads when the HVAC schedule indicates the building is

occupied. (See night cycle control input for fan operation during unoccupied hours.) The fan systems in most commercial buildings operate continuously.

*Units:* List continuous or cycles with loads.

*Input Restrictions:* As designed if the HVAC system serves zones with a dedicated outside air source for ventilation; otherwise, continuous.

*Standard Design:* For healthcare facilities, same as the Proposed Design. For all others, cycles with loads for hotel/motel guestroom systems; continuous for all other standard design system types.

*Standard Design: Existing Buildings:*

### **OPTIMAL START CONTROL**

*Applicability:* Systems with the control capability for flexible scheduling of system start time based on building loads.

*Definition:* Optimal start control adjusts the start time of the HVAC unit such that the space is brought to setpoint just prior to occupancy. This control strategy modifies the heating, cooling, and fan schedules.

*Units:* Boolean (Yes/No).

*Input Restrictions:* Fixed at yes if control system type is DDC to the zone level; otherwise, as designed.

*Standard Design:* For healthcare facilities, same as the Proposed Design. For all others, fixed at yes if control system type is DDC to the zone level.

*Standard Design: Existing Buildings:*

### **NIGHT-CYCLE HVAC FAN CONTROL**

*Applicability:* All air systems – not applicable for zone systems.

*Definition:* The control of an HVAC system that is triggered by the heating or cooling temperature setpoint for thermal zones during periods when the heating, cooling and fan systems are scheduled to be off. For this control, the space is controlled to the setback or setup temperature only; this control is not equivalent to a night purge control. The choices are:

- Cycle on call from any zone
- Cycle on call from the primary control zone
- Stay off

- Cycle zone fans only (for systems with fan-powered boxes) Restart fans below given ambient temperature.

*Units:* None.

*Input Restrictions:* Cycle on call from any zone, except for systems with fan-powered boxes, where either cycle on call from any zone or cycle zone fans only is allowed.

*Standard Design:* For healthcare facilities, same as the Proposed Design. For all others, cycle on call from any zone.

*Standard Design: Existing Buildings:*

### **5.7.2.3 Supply Air Temperature Control**

#### **COOLING SUPPLY AIR TEMPERATURE**

*Applicability:* Applicable to all systems.

*Definition:* The supply air temperature setpoint at design cooling conditions.

*Units:* Degrees Fahrenheit (°F).

*Input Restrictions:* As designed.

*Standard Design:* For healthcare facilities, same as the Proposed Design. For all others, 15°F below the space temperature setpoint for interior zones that are served by multiple zone systems and for computer rooms without air containment (where space temperature equals return air temperature); for all other zones, 20°F below the space temperature setpoint

*Standard Design: Existing Buildings:*

#### **HEATING SUPPLY AIR TEMPERATURE**

*Applicability:* All systems.

*Definition:* The supply air temperature leaving the air handler when the system is in a heating mode (not the air temperature leaving the reheat coils in VAV boxes).

*Units:* Degrees Fahrenheit (°F).

*Input Restrictions:* As designed.

*Standard Design:* For healthcare facilities, same as the Proposed Design. For all others, 95°F for all system types with heating, except 60°F for multiple zone systems; no heating for data centers and computer rooms.

*Standard Design: Existing Buildings:*

#### **SUPPLY AIR TEMPERATURE CONTROL**

*Applicability:* Any cooling system.

*Definition:* The method of controlling the supply air temperature. Choices are:

- No Control – for this scheme the coils are energized whenever there is a call for heating or cooling at the zone.
- Fixed (constant)
- Reset by warmest zone, airflow first
- Reset by warmest zone, temperature first
- Reset by outside air dry-bulb temperature
- Scheduled setpoint

*Units:* List (see above).

*Input Restrictions:* As designed.

*Standard Design:* For healthcare facilities, same as the Proposed Design. For all others, for standard design systems 1 through 4 and 7 through 13, the SAT control is No Control. For systems 5 and 6, the SAT control shall be reset by warmest zone, airflow first.

*Standard Design: Existing Buildings:*

### **RESET SCHEDULE BY OSA**

*Applicability:* When the proposed design resets SAT by outside air dry-bulb temperature.

*Definition:* A linear reset schedule that represents the SAT setpoint as a function of outdoor air dry-bulb temperature.

This schedule is defined by the following data points (see Figure 11):

- The coldest supply air temperature
- The corresponding (hot) outdoor air dry-bulb setpoint
- The warmest supply air temperature
- The corresponding (cool) outdoor air dry-bulb setpoint

**Figure 8: SAT Cooling Setpoint Reset Based on Outdoor Air Temperature (OAT)**

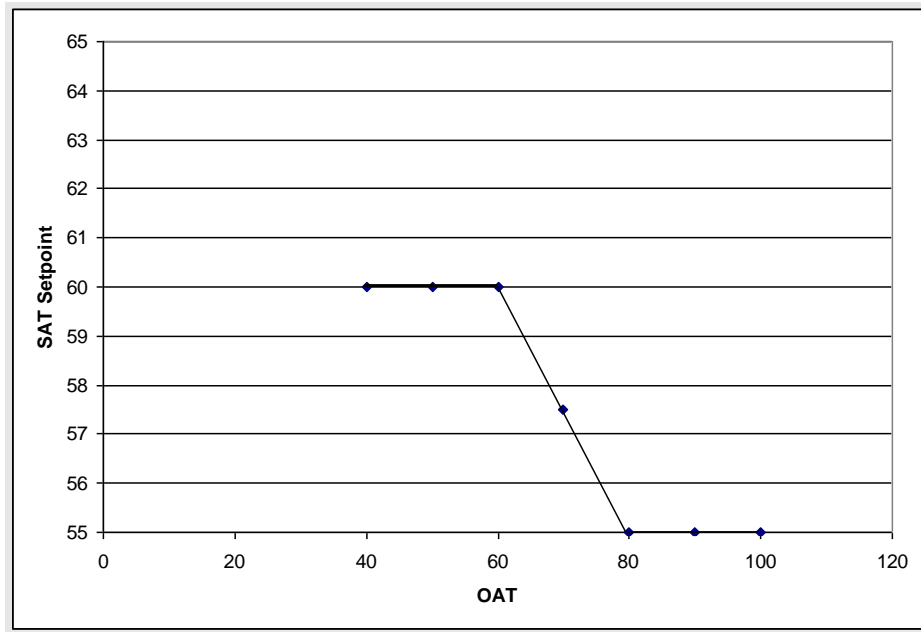

Source: NORESO for California Energy Commission

*Units:* Data structure (two matched pairs of SAT and OAT, see above).

*Input Restrictions:* As designed.

*Standard Design:* For healthcare facilities, same as the Proposed Design. For all others, not applicable.

*Standard Design: Existing Buildings:*

### **DOAS COOLING COIL SUPPLY AIR TEMPERATURE CONTROL**

*Applicability:* DOASVAV and DOASCAV systems.

*Definition:* The supply air temperature setpoint at design cooling conditions for the cooling coil leaving air temperature. The method of controlling the supply air temperature. Choices are:

- Fixed (constant)
- Reset by outside air dry-bulb temperature
- Scheduled setpoint

*Units:* List (see above).

*Input Restrictions:* As designed.

*Standard Design:* Not applicable to standard designs.

*Standard Design: Existing Building:*

## 5.7.3 Fan and Duct Systems

### 5.7.3.1 Standard Design Fan System Summary

The standard design fan system is summarized in this chapter. See Chapter 5.1.2 HVAC System Map, Table 2 for the HVAC standard design system mapping.

When the proposed design has exhaust fans (toilets or kitchens) or fume hood exhaust systems, the standard design has the same exhaust systems.

### 5.7.3.2 Supply Fans

#### SUPPLY FAN MODELING METHOD

*Applicability:* All fan systems.

*Definition:* Fans can be modeled in one of three ways. The simple method is for the user to enter the electric power per unit of flow (W/cfm). This method is commonly used for zonal equipment and other small fan systems. A more detailed method is to model the fan as a system whereby the static pressure, fan efficiency, part-load curve, and motor efficiency are specified at design conditions. A third method is to specify brake horsepower at design conditions instead of fan efficiency and static pressure. This is a variation of the second method whereby brake horsepower is specified in lieu of static pressure and fan efficiency. The latter two methods are commonly used for VAV and fan systems with significant static pressure.

*Units:* List power-per-unit-flow, static pressure, or brake horsepower.

*Input Restrictions:* As designed.

*Standard Design:* For healthcare facilities, same as the Proposed Design. For all other cases, power-per-unit-flow.

*Standard Design: Existing Buildings:*

#### SUPPLY FAN POWER RATIO

*Applicability:* All fan systems.

*Definition:* The standard design fan power requirements apply to all fans that operate at design conditions. To apportion the fan power to the supply fan and exhaust fans, a ratio is defined that is the ratio of supply fan power to total system fan power.

*Units:* Unitless ratio.

*Input Restrictions:* As designed, not a user input.

This is the ratio of the supply fan power to total system fan power, which includes supply fans, exhaust fans, any return fans, and any series-powered fans.

*Standard Design:* Same as proposed.

*Standard Design: Existing Buildings:* Same as proposed.

### **SUPPLY FAN DESIGN AIRFLOW**

*Applicability:* All fan systems

*Definition:* The air flow rate of the supply fan(s) at design conditions.

This building descriptor sets the 100 percent point for the fan part-load curve.

*Units:* CFM (ft<sup>3</sup>/min)

*Input Restrictions:* As designed\*

\*The airflow is typically between 250 cfm/ton and 500 cfm/ton; values well outside of this range may cause simulation engine runtime efforts that must be addressed by the user (currently there are no input restrictions on this).

*Standard Design:* For healthcare facilities, same as the Proposed Design. For all others, The program shall automatically size the air flow at each thermal zone to meet the loads. The design air flow rate calculation shall be based on a 20°F temperature differential between supply air and the room air 20°F temperature differential between the supply air and the return air for exterior zones and a 15°F temperature differential for interior zones served by multiple zone systems. The design supply air flow rate is the larger of the flow rate required to meet space conditioning requirements and the required ventilation flow rate.

For equipment with DX cooling coils, the program applies the results of a sizing run, and oversizes the cooling coil capacity and airflows by 15% to obtain the appropriate airflow.

For multizone systems, the supply fan design air flow rate shall be the system airflow rate that satisfies that coincident peak of all thermal zones at the design supply air temperature.

*Standard Design: Existing Buildings:*

### **FAN CONTROL METHOD**

*Applicability:* All fan systems.

*Definition:* A description of how the supply (and return/relief) fan(s) are controlled.

The options include:

- Constant volume
- Variable-flow, inlet, or discharge dampers
- Variable-flow, inlet guide vanes



- Variable-flow, variable speed drive (VSD)
- Variable-flow, variable pitch blades
- Two-speed

For variable-speed fans, the fan control method determines which part-load performance curve to use.

*Units:* List (see above).

*Input Restrictions:* As designed.

*Standard Design:* For healthcare facilities, same as the Proposed Design. Based on the prescribed system type. Refer to the HVAC System Map in 5.1.2.

*Existing Buildings:*

**Table 10: Standard Design Fan Control Method**

<b>Standard Design building System</b>	<b>Fan Control Method</b>
System 1 – SZAC	Constant volume, cycling
System 3 – PSZ-AC	Constant volume
System 5 – Packaged VAV with Reheat	Variable-flow, variable speed drive (VSD)
System 6 – VAV with Reheat	Variable-flow, variable speed drive (VSD)
System 7 – Single Zone VAV	Variable-flow, variable-speed drive (VSD)
System 9 – Heating and Ventilation	Constant volume
System 10 – CRAH Units	Variable-flow, variable speed drive (VSD)*
System 11 – CRAC Units	Variable-flow, variable speed drive (VSD)*

\* For CRAH Units, fan volume shall be linearly reset from 100 percent air flow at 100 percent cooling load to minimum airflow at 50 percent cooling load and below.

Source: California Energy Commission

**SUPPLY FAN BRAKE HORSEPOWER**

*Applicability:* All fan systems, except those specified using the power-per-unit-flow method.

*Definition:* The design shaft brake horsepower of each supply fan.

This input does not need to be supplied if the supply fan kW is supplied.

*Units:* Horsepower (hp).

*Input Restrictions:* As designed.

If this building descriptor is specified for the proposed design, then the static pressure and fan efficiency are not.

The compliance software shall apply the following rule to specify the proposed design bhp, based on user input:

A standard motor size table (hp) is defined as: 1/12, 1/8, 1/4, 1/2, 3/4, 1, 1.5, 2, 3, 5, 7.5, 10, 15, 20, 25, 30, 40, 50, 60, 75, 100, 125, 150, and 200.

The user entered brake horsepower for the proposed design is compared against the next smaller motor size from the user entered supply fan motor horsepower. The proposed design supply fan brake horsepower (bhp) is set to the maximum of the user entered bhp and 95 percent of the next smaller motor horsepower:

Proposed bhp = max(user bhp, 95 percent × MHPi-1)

Where User bhp is the user entered supply fan brake horsepower:

MHPi is the proposed (nameplate) motor horsepower

MHPi-1 is the next smaller motor horsepower from the Standard Motor Size table above. For example, if the proposed motor horsepower is 25, the next smaller motor horsepower from the table above is 20, and 95 percent of the next smaller motor horsepower is 19.

*Standard Design:* Not applicable (the standard design maps to a HVAC system type, which has a power-per-unit-flow allowance based on the components in the given system type).

*Standard Design: Existing Buildings:* Same as proposed if existing and unaltered.

### **SUPPLY FAN MOTOR HORSEPOWER**

*Applicability:* All fan systems, except those specified using the power-per-unit-flow method.

*Definition:* The motor nameplate horsepower of the supply fan.

*Units:* List: choose from standard motor sizes: 1/12, 1/8, 1/4, 1/2, 3/4, 1, 1.5, 2, 3, 5, 7.5, 10, 15, 20, 25, 30, 40, 50, 60, 75, 100, 125, 150, 200

*Input Restrictions:* As designed.

This building descriptor is required for the static pressure or the brake horsepower methods.

*Standard Design:* Set to the standard motor efficiency for the next larger nominal HP size, from NEMA standards.

*Standard Design: Existing Buildings:* Set to the standard motor efficiency for the next larger nominal HP size, from NEMA standards.

### **SUPPLY FAN STATIC PRESSURE**

*Applicability:* All fan systems using the static pressure method.

*Definition:* The design static pressure for the supply fan.

This is important for both fan electric energy usage and duct heat gain calculations.

*Units:* Inches of water column (in. H<sub>2</sub>O).

*Input Restrictions:* As designed.

The design static pressure for the supply fan does not need to be specified if the supply fan brake horsepower (bhp) is specified.

*Standard Design:* Not applicable. Defined in the software as a function of brake horsepower or power-per-unit flow.

*Standard Design: Existing Buildings:* Not applicable.

### **SUPPLY FAN EFFICIENCY**

*Applicability:* All fan systems using the static pressure method.

*Definition:* The efficiency of the fan at design conditions; this is the static efficiency and does not include motor losses.

*Units:* Unitless.

*Input Restrictions:* As designed.

The supply fan efficiency does not need to be specified if the supply fan brake horsepower (bhp) is specified.

*Standard Design:* 65%.

Not applicable for the four-pipe fan coil system.

*Standard Design: Existing Buildings:* Not applicable.

### **SUPPLY MOTOR EFFICIENCY**

*Applicability:* All supply fans, except those specified using the power-per-unit-flow method.

*Definition:* The full-load efficiency of the motor serving the supply fan.

*Units:* Unitless.

*Input Restrictions:* As designed.

Not applicable when the power-per-unit-flow method is used.

*Standard Design:*

*Existing Buildings:* Same as proposed.

**FAN POWER ADJUSTMENT**

*Applicability:* Any system with special requirements for filtration or other process requirements.

*Definition:* Additional system brake horsepower related to application-specific filtration requirements or other process requirements.

An exceptional condition shall be included on compliance documentation when the user selects one of these adjustment conditions.

*Units:* List.

*Input Restrictions:* The user chooses one or more fan power adjustment credits from the list below. For the credits that are indicated as 'calculation required' the user enters the pressure drop for each device.

Adjustment Credits (Multi-zone VAV) (W/cfm)

<b>Device</b>	<b>≤ 5,000 cfm</b>	<b>&gt; 5,000 cfm; ≤ 10,000 cfm</b>	<b>&gt; 10,000 cfm</b>
Return of exhaust systems required by code to be fully ducted	0.089	0.100	0.116
Exhaust filters, scrubbers, or other exhaust treatment (calculation required, see note)	0.177	0.198	0.231
Particulate filtration credit: MERV 16 or greater and electronically enhanced filters	0.265	0.280	0.333
Carbon and other gas-phase air cleaners (calculation required, see note)	0.176	0.188	0.224

<b>Device</b>	<b>≤ 5,000 cfm</b>	<b>&gt; 5,000 cfm; ≤ 10,000 cfm</b>	<b>&gt; 10,000 cfm</b>
Biosafety cabinet (calculation required, see note)	0.177	0.198	0.231
Energy Recovery (Enthalpy Recovery Ratio ≥ 0.60 and <0.65) if standard design requires heat recovery	0.374	0.318	0.289

Source: California Energy Commission

Adjustment credits, All other fan systems (W/cfm)

<b>Device</b>	<b>≤ 5,000 cfm</b>	<b>&gt; 5,000 cfm; ≤ 10,000 cfm</b>	<b>&gt; 10,000 cfm</b>
Return of exhaust systems required by code to be fully ducted	0.091	0.102	0.116
Exhaust filters, scrubbers, or other exhaust treatment (calculation required, see note)	0.179	0.202	0.232
Particulate filtration credit: MERV 16 or greater and electronically enhanced filters	0.264	0.292	0.342
Carbon and other gas-phase air cleaners (calculation required, see note)	0.177	0.197	0.231

<b>Device</b>	<b>≤ 5,000 cfm</b>	<b>&gt; 5,000 cfm; ≤ 10,000 cfm</b>	<b>&gt; 10,000 cfm</b>
Biosafety cabinet (calculation required, see note)	0.179	0.202	0.232
Energy Recovery (Enthalpy Recovery Ratio ≥ 0.60 and <0.65)	0.381	0.329	0.293
Single Zone VAV Systems that are capable of turning down to 50% of full load airflow at a maximum of 30% design wattage	0.070	0.100	0.089

For any row with "calculation require," include a field that allows the user to enter static pressure and multiply by the value in the cell. The value in the cell is based on 1.0 in. w.c. pressure drop.

Source: California Energy Commission

*Standard Design:* Same as proposed.

*Standard Design: Existing Buildings:* Same as proposed for new HVAC equipment; not applicable for existing, unaltered systems.

**Table 11: Minimum Nominal Efficiency for Electric Motors (Percent)**

<b>Motor Horsepower</b>	<b>Efficiency (%)</b>
1	85.5
1.5	86.5
2	86.5
3	89.5
5	89.5
7.5	91.7
10	91.7
15	92.4
20	93.0
25	93.6
30	93.6
40	94.1
50	94.5
60	95.0
75	95.4
100	95.4
125	95.4
150	95.8
200	96.2
250	96.2
300	96.2
350	96.2
400	96.2
450	96.2
500	96.2

Source: California Energy Commission

### **FAN POSITION**

*Applicability:* All supply fans.

*Definition:* The position of the supply fan relative to the cooling coil.

The configuration is either draw through (fan is downstream of the coil) or blow through (fan is upstream of the coil).

*Units* List (see above).

*Input Restrictions:* As designed.

*Standard Design:* Draw through.

*Standard Design: Existing Buildings:*

### **MOTOR POSITION**

*Applicability:* All supply fans.

*Definition:* The position of the supply fan motor relative to the cooling air stream.

The choices are in the air stream or out of the air stream.

*Units:* List (see above).

*Input Restrictions:* As designed.

*Standard Design:* In the air stream.

*Standard Design: Existing Buildings:*

### **FAN PART-FLOW POWER CURVE**

*Applicability:* All variable flow fan systems.

*Definition:* A part-load power curve that represents the percentage full-load power draw of the supply fan as a function of the percentage full-load air flow.

The curve is typically represented as a quadratic equation with an absolute minimum power draw specified.

*Units:* Unitless ratio.

*Input Restrictions:* As designed.

The user shall not be able to select VSD with static pressure reset if the building does not have DDC controls to the zone level. The default fan curve shall be selected from Appendix 5.7 for the type of fan specified in the proposed design.

$$PLR = (a) + (b \times FanRatio) + (c \times FanRatio^2) + (d \times FanRatio^3)$$



$$PLR = PowerMin$$

Where:

- *PLR* - Ratio of fan power at part load conditions to full load fan power
- *PowerMn* - Minimum fan power ratio
- *FanRatio* - Ratio of cfm at part-load to full-load cfm
- *a, b, c, and d* - Constants from the table below

*Standard Design:* For healthcare facilities, same as the Proposed Design. For all others, Not applicable for standard design constant volume systems. The curve VSD with static pressure reset fans shall be used for variable volume systems.

*Standard Design: Existing Buildings:*

**SUPPLY FAN POWER INDEX**

*Applicability:* Fan systems that use the power-per-unit-flow method.

*Definition:* The supply fan power (at the motor) per unit of flow.

*Units:* W/cfm.

*Input Restrictions:* As designed or specified in the manufacturers’ literature.

*Standard Design:*

For all other buildings:

System 1a – RAC (Residential Air Conditioner) : 0.45 W/CFM

System 10 – CRAC and System 11 – CRAH systems: 0.58 W/CFM.

Other systems: The fan electrical power input of the standard design will be based on which components are present in the given HVAC system type, and what the prescriptive fan power budget allows for each airflow range.

The standard design fan input electrical power will be determined by the system type and airflow range described in the table below:

Supply and Return Fan W/cfm by system type

<b>System No.</b>	<b>≤ 5,000 cfm</b>	<b>&gt; 5,000 cfm; ≤ 10,000 cfm</b>	<b>&gt; 10,000 cfm</b>
3a – SZAC	0.802	0.780	0.748
3b – SZHP (no furnace)	0.744	0.720	0.676

<b><u>System No.</u></b>	<b><u>≤ 5,000 cfm</u></b>	<b><u>&gt; 5,000 cfm; ≤ 10,000 cfm</u></b>	<b><u>&gt; 10,000 cfm</u></b>
3c – SZDFHP (with furnace)	<u>0.802</u>	<u>0.780</u>	<u>0.748</u>
7a – SZVAVAC	<u>0.802</u>	<u>0.780</u>	<u>0.748</u>
7b – SZVAVHP	<u>0.744</u>	<u>0.720</u>	<u>0.676</u>
7c – SZVAVDFHP (with furnace)	<u>0.802</u>	<u>0.780</u>	<u>0.748</u>
5 – PVAV	<u>1.000</u>	<u>1.022</u>	<u>0.964</u>
6 – VAV	<u>0.977</u>	<u>1.013</u>	<u>0.947</u>
9 – HEATVENT	<u>0.616</u>	<u>0.620</u>	<u>0.605</u>

Source: California Energy Commission

*Standard Design: Existing Buildings:* Same as proposed if existing and unaltered; otherwise use newly constructed buildings values with the following additional credits (includes supply and return/relief/exhaust):

<b><u>System No.</u></b>	<b><u>≤ 5,000 cfm</u></b>	<b><u>&gt; 5,000 cfm; ≤ 10,000 cfm</u></b>	<b><u>≥ 10,000 cfm</u></b>
MZ-VAV (Systems 5 and 6)	<u>0.205</u>	<u>0.174</u>	<u>0.159</u>
All other (Systems 1, 3, 7, and 9)	<u>0.209</u>	<u>0.182</u>	<u>0.162</u>

Source: California Energy Commission

Not applicable for all systems except the four-pipe fan coil (FPFC).

### 5.7.3.3 Return/Relief Fans

The standard design building has no return fan. The standard design system has a relief fan only if the standard design system has an economizer.

#### PLENUM ZONE

*Applicability:* Any system with return ducts or return air plenum.

*Definition:* A reference to the thermal zone that serves as return plenum or where the return ducts are located.

*Units:* Text, unique.

*Input Restrictions:* As designed.

*Standard Design:* Not applicable.

*Standard Design: Existing Buildings:*

### **RETURN AIR PATH**

*Applicability:* Any system with return ducts or return air plenum.

*Definition:* Describes the return path for air.

Can be ducted return, plenum return, or direct-to-unit.

*Units:* List (see above).

*Input Restrictions:* As designed.

*Standard Design:* Applicable when the standard design has a relief fan. For standard design systems 1 and 2, the return air path shall be direct-to-unit. For standard design systems 3 through 11, the standard design shall be ducted return.

*Standard Design: Existing Buildings:*

### **RETURN/RELIEF FAN MODELING METHOD**

*Applicability:* All fan systems.

*Definition:* The specification method for return fan power. The simple method is for the user to enter the electric power-per-unit of flow (W/cfm). A more detailed method is to model the fan as a system whereby the static pressure, fan efficiency, part-load curve, and motor efficiency are specified at design conditions. A third method is to specify brake horsepower at design conditions instead of fan efficiency and static pressure. This is a variation of the second method whereby brake horsepower is specified in lieu of static pressure and fan efficiency. The latter two methods are commonly used for VAV and fan systems with significant static pressure.

*Units:* List power-per-unit-flow, static pressure, or brake horsepower.

*Input Restrictions:* As designed.

*Standard Design:* Not applicable (the standard design does not include return fans, and relief fans are not explicitly modeled).

*Standard Design: Existing Buildings:* Not applicable.

### **RETURN/RELIEF FAN DESIGN AIRFLOW**

*Applicability:* All systems with a return or relief fan

*Definition:* The design air flow fan capacity of the return or relief fan(s).

This sets the 100 percent fan flow point for the part-load curve (see below).

*Units:* Cfm

*Input Restrictions:* For return fans, as designed

*Standard Design:* For healthcare facilities, same as the Proposed Design. For all others, not modeled.

*Standard Design: Existing Buildings:*

### **RETURN/RELIEF FAN BRAKE HORSEPOWER**

*Applicability* Any system with return fans that uses the brake horsepower method.

*Definition:* The design shaft brake horsepower of the return/relief fan(s).

*Units:* Brake horsepower (bhp).

*Input Restrictions:* As designed.

The compliance software shall apply the following pre-processing rule to specify the proposed design return/relief fan brake horsepower, based on user input:

A standard motor size table (hp) is defined as: 1/12, 1/8, 1/4, 1/2, 3/4, 1, 1.5, 2, 3, 5, 7.5, 10, 15, 20, 25, 30, 40, 50, 60, 75, 100, 125, 150, and 200.

The return/relief fan brake horsepower is determined from user inputs of brake horsepower and motor horsepower for the proposed design, in the same manner as the supply fan brake horsepower.

Proposed bhp = min (user bhp, 95 percent x MHPi-1)

Where:

Proposed bhp is the return/relief fan brake horsepower used in the simulation.

User bhp is the actual fan bhp as entered by the user; and

MHPi-1 is the motor horsepower of the next smaller motor size from the standard motor size table above; MHPi is the motor size that the user enters for the return/relief fan.

See the supply fan brake horsepower descriptor for further details.

*Standard Design:* For healthcare facilities, same as the Proposed Design. For all others, not modeled.

*Standard Design: Existing Buildings:*

**RETURN/RELIEF FAN MOTOR HORSEPOWER**

*Applicability:* All fan systems, except those specified using the power-per-unit-flow method.

*Definition:* The motor nameplate horsepower of the supply fan.

*Units:* List choose from standard motor sizes: 1/12, 1/8, 1/4, 1/2, 3/4, 1, 1.5, 2, 3, 5, 7.5, 10, 15, 20, 25, 30, 40, 50, 60, 75, 100, 125, 150, 200

*Input Restrictions:* As designed.

This building descriptor is required for the static pressure or the brake horsepower methods.

*Standard Design:* Not modeled.

*Standard Design: Existing Buildings:*

**RETURN/RELIEF DESIGN STATIC PRESSURE**

*Applicability:* Any system with return or relief fans that uses the static pressure method.

*Definition:* The design static pressure for return fan system.

This is important for both fan electric energy usage and duct heat gain calculations.

*Units:* Inches of water column (in. H<sub>2</sub>O gauge).

*Input Restrictions:* As designed. The design static pressure for the return fan does not need to be specified if the return fan brake horsepower (bhp) is specified.

*Standard Design:* For healthcare facilities, same as the Proposed Design. For all others, not applicable (there are no return fans, and the relief fan is not modeled).

*Standard Design: Existing Buildings:*

**RETURN/RELIEF FAN EFFICIENCY**

*Applicability:* Any system with return or relief fans that uses the static pressure method.

*Definition:* The efficiency of the fan at design conditions. This is the static efficiency and does not include the efficiency loss of the motor.

*Units:* Unitless.

*Input Restrictions:* As designed. The return/relief fan efficiency does not need to be specified if the return fan brake horsepower (bhp) is specified.

*Standard Design:* For healthcare facilities, same as the Proposed Design. For all others, not applicable.

*Standard Design: Existing Buildings:*

#### **RETURN/RELIEF MOTOR EFFICIENCY**

*Applicability:* All return fans, except those specified using the power-per-unit-flow method.

*Definition:* The full-load efficiency of the motor serving the supply fan.

*Units:* Unitless.

*Input Restrictions:* As designed. Not applicable when the power-per-unit-flow method is used.

*Standard Design:* Not applicable.

*Standard Efficiency: Existing Buildings:*

#### **MOTOR POSITION**

*Applicability:* All return fans.

*Definition:* The position of the supply fan motor relative to the cooling air stream. The choices are in the air stream or out of the air stream.

*Units:* List (see above).

*Input Restrictions:* As designed.

*Standard Design:* In the air stream.

*Standard Design: Existing Buildings:*

#### **FAN PART-FLOW POWER CURVE**

*Applicability:* All return fans for variable flow fan systems.

*Definition:* A part-load power curve which represents the percentage full-load power draw of the supply fan as a function of the percentage full-load air flow.

*Units:* Unitless ratio.

*Input Restrictions:* As designed. The default fan curve shall be selected from Appendix 5.7 for the type of fan specified in the proposed design.

*Standard Design:* For healthcare facilities, same as the Proposed Design. For all others, not applicable.

*Standard Design: Existing Buildings:*

#### **5.7.3.4 Exhaust Fan Systems**

The standard design shall track the proposed design exempt process exhaust flow rate up to the prescribed outside air ventilation rate by space type (see Appendix 5.4A for the

standard design maximum exhaust rate). Covered process exhaust includes garage ventilation, lab exhaust and exhaust from kitchens with over 5,000 cfm of exhaust. Rules for the standard design covered process exhaust rate and fan power are discussed in the following chapters.

Exhaust fan flow is specified and scheduled for each thermal zone. An exhaust fan system may serve multiple thermal zones. For the standard design, total outside air ventilation supply airflow may need to be adjusted so that the design supply airflow for each floor of the building matches the total design exhaust airflow for that floor.

### **EXHAUST FAN NAME**

*Applicability:* All exhaust systems serving multiple thermal zones.

*Definition:* A unique descriptor for each exhaust fan. This should be keyed to the construction documents, if possible, to facilitate plan checking. Exhaust rates and schedules at the thermal zone level refer to this name.

*Units:* Text, unique.

*Input Restrictions:* Where applicable, this should match the tags that are used on the plans.

*Standard Design:* The standard design shall have an exhaust system that corresponds to the proposed design. However, if the user has specified an exhaust system as the ventilation system an equivalent standard design system will not be modeled since the standard design has its own definition for ventilation systems. The name can be identical to that used for the proposed design or some other appropriate name may be used.

*Standard Design: Existing Buildings:*

### **EXHAUST FAN SYSTEM MODELING METHOD**

*Applicability:* All exhaust fan systems.

*Definition:* Compliance software can model fans in three ways. See definition for supply system modeling method.

*Units:* List: power-per-unit-flow, static pressure, or brake horsepower.

*Input Restrictions:* As designed.

*Standard Design:* The standard design shall use the static pressure method.

*Standard Design: Existing Buildings:*

### **EXHAUST FAN POWER RATIO**

*Applicability:* All fan systems.

*Definition:* The standard design fan power requirements apply to all fans that operate at design conditions. To apportion the fan power to the supply fan and exhaust fans, a ratio is defined that is the ratio of non-exempt exhaust fan power to total system fan power.

*Units:* List power-per-unit-flow, static pressure, or brake horsepower.

*Input Restrictions:* As designed, not a user input.

This is the ratio of the exhaust fan power to total system fan power, which includes: supply fans, exhaust fans, and return fans.

*Standard Design:* Same as proposed.

*Standard Design: Existing Buildings:* Same as proposed.

### **EXHAUST FAN DESIGN AIRFLOW**

*Applicability:* All exhaust fan systems.

*Definition:* The rated design air flow rate of the exhaust fan system. This building descriptor defines the 100 percent flow point of the part-flow curve. Actual air flow is the sum of the flow specified for each thermal zone, as modified by the schedule for each thermal zone.

*Units:* Cfm.

*Input Restrictions:* As designed. The total design exhaust flow capacity for building (conditioned space) shall not exceed the sum of building story minimum ventilation (outdoor) air flow. Exhaust makeup can be transferred from other zones in the building provided that the total building exhaust rate does not exceed the total minimum outside air flow rate.

*Standard Design:* For healthcare facilities, same as the Proposed Design. For all others, same as proposed design, but with the same limitations described under input restrictions. The design supply air ventilation rate for zone(s) may need to be adjusted by the software, so that the total design outside air ventilation rate supplied to all zones on a floor equals the total exhaust fan design airflow for all zones on the floor.

*Standard Design: Existing Buildings:*

### **EXHAUST FAN CONTROL METHOD**

*Applicability:* All exhaust fan systems

*Definition:* A description of how the exhaust fan(s) are controlled. The options include:

- Constant volume
- Variable-flow, variable speed drive (VSD)

*Units:* List (see above)



*Input Restrictions:* As designed, when exhaust fan flow at the thermal zone level is varied through a schedule, one of the variable-flow options shall be specified.

*Standard Design:* For healthcare facilities, same as the Proposed Design. For all others, The standard design exhaust fan control shall be the same as the proposed design, but subject to the conditions described above.

For exhaust fans serving kitchen spaces, the fan control method is constant volume for fans with flow rate 5,000 cfm and below, and variable flow, variable speed drive for fans with flow rate greater than 5,000 cfm.

For exhaust fans serving laboratory spaces, the fan control method is variable-flow, variable speed drive when the minimum exhaust flow is 10 ACH or less. If the lab exhaust flow minimum is greater than 10 ACH, the control method is the same as proposed.

*Standard Design: Existing Buildings:*

### **EXHAUST FAN BRAKE HORSEPOWER**

*Applicability:* All exhaust fan systems.

*Definition:* The design shaft brake horsepower of the exhaust fan(s).

*Units:* Brake horsepower (bhp).

*Input Restrictions:* As designed.

The compliance software implements a pre-processing rule to specify the proposed design exhaust fan brake horsepower (bhp), based on user input:

A standard motor size table (hp) is defined as: 1/12, 1/8, 1/4, 1/2, 3/4, 1, 1.5, 2, 3, 5, 7.5, 10, 15, 20, 25, 30, 40, 50, 60, 75, 100, 125, 150, 200

The exhaust fan brake horsepower is determined from user inputs of brake horsepower and motor horsepower for the proposed design, in the same manner as the supply fan brake horsepower.

Proposed bhp = max (user bhp, 95 percent x MHPi-1)

Where:

Proposed bhp is the return/relief fan brake horsepower used in the simulation,

User bhp is the actual fan bhp as entered by the user

MHPi-1 is the motor horsepower of the next smaller motor size from the standard motor size table above; MHPi is the motor size that the user enters for the exhaust fan

See the supply fan brake horsepower descriptor for further details.

*Standard Design:* For healthcare facilities, same as the Proposed Design.

For laboratory exhaust, where the building lab design exhaust flow exceeds 10,000 cfm, 0.65 W/cfm. If the user designates that the system includes scrubbers or other air treatment devices, the standard design exhaust fan power shall be 0.85 W/cfm.

For all others, the standard design exhaust fan brake horsepower is equal to the fan system power allowance times the exhaust fan power ratio.

### **EXHAUST FAN MOTOR HORSEPOWER**

*Applicability:* All fan systems, except those specified using the power-per-unit-flow method.

*Definition:* The motor nameplate horsepower of the supply fan.

*Units:* List - choose from standard motor sizes: 1/12, 1/8, 1/4, 1/2, 3/4, 1, 1.5, 2, 3, 5, 7.5, 10, 15, 20, 25, 30, 40, 50, 60, 75, 100, 125, 150, 200

*Input Restrictions:* As designed.

This building descriptor is required for the static pressure or the brake horsepower methods.

*Standard Design:* Not applicable.

*Standard Design: Existing Buildings:*

### **EXHAUST FAN DESIGN STATIC PRESSURE**

*Applicability:* Any system with exhaust fans that uses the static pressure method.

*Definition:* The design static pressure for exhaust fan system.

*Units:* Inches of water column (in. of water).

*Input Restrictions:* As designed. The design static pressure for the exhaust fan does not need to be specified if the exhaust fan brake horsepower (bhp) or power-per-unit flow is specified.

*Standard Design:* For healthcare facilities, same as the Proposed Design.

For kitchen exhaust fans, the static pressure is fixed at 0.65 W/cfm. For lab exhaust fans, fan power is specified as W/cfm, so this input is not applicable.

For all other exhaust fans, the standard design fan static pressure shall be the same as the proposed design.

*Standard Design: Existing Buildings*

### **EXHAUST FAN EFFICIENCY**

*Applicability:* Any exhaust fan system that uses the static pressure method.

*Definition:* The efficiency of the exhaust fan at rated capacity.

This is the static efficiency and does not include losses through the motor.

*Units:* Unitless.

*Input Restrictions:* For kitchen exhaust fans, the fan efficiency is prescribed at 50 percent.

For all other exhaust fans, as designed. The exhaust fan efficiency does not need to be specified if the return fan brake horsepower (bhp) is specified.

*Standard Design:* For healthcare facilities, same as the Proposed Design.

For kitchen exhaust fans, the fan efficiency is 50%, while for lab exhaust it is 62%.

For all other exhaust fans, the standard design efficiency (and resulting W/cfm) is 65%.

*Standard Design: Existing Buildings:*

### **EXHAUST FAN MOTOR EFFICIENCY**

*Applicability:* All exhaust fan systems.

*Definition:* The full-load efficiency of the motor serving the exhaust fan.

*Units:* Unitless.

*Input Restrictions:* As designed.

*Standard Design:* For healthcare facilities, same as the Proposed Design.

For exempt process fans other than lab, kitchen, and garage exhaust fans, same as proposed. For all other fans, the value is taken from Table 11.

*Standard Design: Existing Buildings*

### **FAN PART-FLOW POWER CURVE**

*Applicability:* All variable flow exhaust fan systems.

*Definition:* A part-load power curve that represents the ratio full-load power draw of the exhaust fan as a function of the ratio full-load air flow.

*Units:* Unitless ratio.

*Input Restrictions:* As designed.

The default fan curve shall be selected from Appendix 5.7 for the type of fan specified in the proposed design.

*Standard Design:* For healthcare facilities, same as the proposed design. For all others, the standard design fan curve shall be selected from Appendix 5.7 for the type of fan specified in the proposed design.

*Standard Design: Existing Buildings*

### **EXHAUST FAN POWER INDEX**

*Applicability:* Exhaust systems serving hotel/motel guestrooms.

*Definition:* The fan power of the exhaust fan per unit of flow.

This building descriptor is applicable only with the power-per-unit-flow method.

*Units:* W/CFM.

*Input Restrictions:*

As designed.

*Standard Design:* For healthcare facilities, same as the Proposed Design.

For hotel/motel guestrooms, 0.58 W/CFM.

*Standard Design: Existing Buildings*

### **5.7.3.5 Garage Exhaust Fan Systems**

When garage exhaust fan systems are modeled the fans shall be modeled as constant volume fans, with the fan power determined by whether or not the fan has CO controls.

#### **GARAGE EXHAUST FAN NAME**

*Applicability:* All garage exhaust systems.

*Definition:* A unique descriptor for each garage exhaust fan or fan system.

Fans with equivalent efficiency and motor efficiencies may be combined and modeled as one fan.

*Units:* Text, unique.

*Input Restrictions:* Where applicable, this should match the tags that are used on the plans.

*Standard Design:* The standard design shall have an exhaust system that corresponds to the proposed design. The name can be identical to that used for the proposed design or some other appropriate name may be used.

*Standard Design: Existing Buildings:*

#### **GARAGE EXHAUST FAN SYSTEM MODELING METHOD**

*Applicability:* All exhaust fan systems.

*Definition:* Software commonly models fans in three ways, see definition for supply system modeling method.

*Units:* List power-per-unit-flow, static pressure, or brake horsepower.

*Input Restrictions:* Brake horsepower method (fixed value).

*Standard Design:* The standard design building shall use the power-per-unit-flow method.

*Standard Design: Existing Buildings:*

#### **GARAGE EXHAUST FAN RATED CAPACITY**

*Applicability:* All exhaust systems.

*Definition:* The rated design air flow rate of the garage exhaust fan system.

*Units:* Cfm.

*Input Restrictions:* As designed.

*Standard Design:* Same as proposed design.

*Standard Design: Existing Buildings:*

#### **GARAGE EXHAUST FAN CONTROL METHOD**

*Applicability:* All exhaust fan systems.

*Definition:* The control method for the garage exhaust fan.

This input determines the fan power for the exhaust fan. No other fan inputs are required.

*Units:* List constant volume or CO control.

*Input Restrictions:* None.

If constant volume is selected, proposed fan power is as designed.

If CO control is selected, proposed fan power is 12.5 percent of the design fan power.

*Standard Design:* Same as proposed.

*Standard Design: Existing Buildings:*

### **5.7.3.6 Duct Systems in Unconditioned Space**

#### **DUCT LEAKAGE RATE**

*Applicability:* Any single-zone systems with ducts in unconditioned space serving zones of 5,000 ft<sup>2</sup> or less.

*Definition:* The leakage rate from the duct system into unconditioned space.

All leakage is assumed to occur to unconditioned space (not to outdoors).

*Units:* Percentage of design airflow (%).

*Input Restrictions:* For new systems: If duct leakage testing is performed as per instructions in the Reference Appendices and certified by a Home Energy Rating System (HERS) rater or Acceptance Test Technician (ATT), as designed. If not tested, 15 percent.

For existing, altered systems: 15 percent if tested and verified by the HERS procedures in Reference Appendix NA2. If untested or if failed test, 20 percent.

*Standard Design:* Not applicable.

*Standard Design: Existing Buildings:*

### **DUCT LEAKAGE HERS FAN POWER ADJUSTMENT**

*Applicability:* Single zone, constant volume systems with ducts in unconditioned space, serving 5000 ft<sup>2</sup>.

*Definition:* A fan power penalty or credit based on the testing performed when ducts are in unconditioned spaces.

*Units:* List: Penalty, No Change Credit.

*Input Restrictions:* Not a user input.

Penalty: if the HERS duct leakage testing isn't done when required, or if the testing fails the duct leakage rate criteria.

No Change: testing not required.

Credit: testing not required, but HERS testing performed and leakage rates are verified.

*Standard Design:* All in conditioned space.

*Standard Design: Existing Buildings:*

## **5.7.4 Outdoor Air Controls and Economizers**

### **5.7.4.1 Outside Air Controls**

#### **MAXIMUM OUTSIDE AIR RATIO**

*Applicability:* All systems with modulating outside air dampers.

*Definition:* The descriptor is used to limit the maximum amount of outside air that a system can provide as a percentage of the design supply air. It is used where the installation has a restricted intake capacity.

Units: Ratio.

*Input Restrictions:* 1.0 for all systems above 33,000 Btu/h net cooling capacity; 0.9 for other systems.

*Standard Design:* 1.0 for all systems above 33,000 Btu/h net cooling capacity; 0.9 for other systems.

*Standard Design: Existing Buildings:*

### **DESIGN OUTSIDE AIR FLOW**

*Applicability:* All systems with outside air dampers.

*Definition:* The rate of outside air that needs to be delivered by the system at design conditions. This input may be derived from the sum of the design outside air flow for each of the zones served by the system.

*Units:* Cfm.

*Input Restrictions:* As designed but no lower than the ventilation rate of the standard design.

*Standard Design:* For healthcare facilities, same as the Proposed Design.

For systems serving laboratory spaces, the system shall be 100 percent outside air.

*Standard Design: Existing Buildings:*

### **OUTDOOR AIR CONTROL METHOD**

*Applicability:* All HVAC systems that deliver outside air to zones.

*Definition:* The method of determining the amount of outside air that needs to be delivered by the system.

Each of the zones served by the system report their outside air requirements on an hourly basis. The options for determining the outside air at the zone level are discussed above. This control method addresses how the system responds to this information on an hourly basis. Options include:

- Average Flow - The outside air delivered by the system is the sum of the outside air requirement for each zone, without considering the position of the VAV damper in each zone. The assumption is that there is mixing between zones through the return air path.

*Units:* List (see above).

*Input Restrictions:* As designed.

*Standard Design:* Average flow.

*Standard Design: Existing Buildings:*

### **5.7.4.2 Air Side Economizers**

#### **ECONOMIZER CONTROL TYPE**

*Applicability:* All systems with an air-side economizer

*Definition:* An air-side economizer increases outside air ventilation during periods when system cooling loads can be reduced from increased outside air flow. The control types include:

- No economizer.
- Fixed dry-bulb. The economizer is enabled when the temperature of the outside air is equal to or lower than temperature fixed setpoint (e.g., 75°F).
- Differential dry-bulb. The economizer is enabled when the temperature of the outside air is lower than the return air temperature.
- Differential enthalpy. The economizer is enabled when the enthalpy of the outside air is lower than the return air enthalpy.
- Differential dry-bulb and enthalpy. The system shifts to 100 percent outside air or the maximum outside air position needed to maintain the cooling SAT setpoint, when the outside air dry-bulb is less than the return air dry-bulb AND the outside air enthalpy is less than the return air enthalpy. This control option requires additional sensors.

*Units:* List (see above)

*Input Restrictions:* As designed

*Standard Design:* For healthcare facilities, same as the Proposed Design. For all others, The control should be no economizer when the standard design net cooling capacity < 33,000 Btu/h and when the standard design cooling system is not a computer room air handling unit (CRAH). Otherwise, the standard design shall assume an integrated fixed dry-bulb economizer.

An exception is that economizers shall not be modeled for systems serving multifamily residential or hotel/motel guestroom occupancies.

*Standard Design: Existing Buildings:*

### **ECONOMIZER INTEGRATION LEVEL**

*Applicability:* Airside economizers.

*Definition:* This input specifies whether or not the economizer is integrated with mechanical cooling. It is up to the modeling software to translate this into software-specific inputs to model this feature. The input could take the following values:

- Non-integrated - The system runs the economizer as the first stage of cooling. When the economizer is unable to meet the load, the economizer returns the outside air



damper to the minimum position and the compressor turns on as the second stage of cooling.

- Integrated - The system can operate with the economizer fully open to outside air and mechanical cooling active (compressor running) simultaneously, even on the lowest cooling stage.

*Units:* List (see above).

*Input Restrictions:* List non-integrated or integrated.

*Standard Design:* Integrated for systems above capacity 33,000 Btu/h net cooling capacity.

*Standard Design: Existing Buildings:*

### **ECONOMIZER HIGH TEMPERATURE LOCKOUT**

*Applicability:* Systems with fixed dry-bulb economizer.

*Definition:* The outside air setpoint temperature above which the economizer will return to minimum position.

*Units:* Degrees Fahrenheit (°F).

*Input Restrictions:* As designed.

*Standard Design:* For all others, the required high temperature lockout is based on Table 140.4-G for fixed dry bulb device types. For computer rooms with containment, the economizer shall have a fixed dry-bulb high limit of 80°F.

- Climate Zones 1, 3, 5, 11-16 – Temperature  $T_{oa} > 75$  °F
- Climate Zones 2, 4, 10 – Temperature  $T_{oa} > 73$  °F
- Climate Zones 6, 8, 9 - Temperature  $T_{oa} > 71$  °F
- Climate Zone 7 - Temperature  $T_{oa} > 69$  °F

*Standard Design: Existing Buildings:*

### **ECONOMIZER LOW TEMPERATURE LOCKOUT**

*Applicability:* Systems with air-side economizers

*Definition:* A feature that permits the lockout of economizer operation (return to minimum outside air position) when the outside air temperature is below the lockout setpoint.

*Units:* Degrees Fahrenheit (F°)

*Input Restrictions:* As designed

*Standard Design:*

Not applicable.

*Standard Design: Existing Buildings:*

### **ECONOMIZER HIGH ENTHALPY LOCKOUT**

*Applicability:* Systems with differential enthalpy economizers.

*Definition:* The outside air enthalpy above which the economizer will return to minimum position.

*Units:* Btu/lb.

*Input Restrictions:* As designed.

The default is 28 Btu/lb (high altitude locations may require different setpoints.) The compliance software shall apply a fixed offset and add 2 Btu/lb to the user-entered value.

*Standard Design:* Not applicable.

*Standard Design: Existing Buildings:*

## **5.7.5 Cooling Systems**

### **5.7.5.1 General**

This group of building descriptors applies to all cooling systems.

#### **COOLING SOURCE**

*Applicability:* All systems.

*Definition:* The source of cooling for the system; either chilled water, direct expansion (DX), or other.

*Units:* List (see above).

*Input Restrictions:* As designed (determined automatically from system type).

*Standard Design:* The standard design cooling source is:

For built-up VAV (system 6) and CRAH (system 10): chilled water,

For heating and ventilation (system 9), none, and

For all other systems, direct expansion (DX)

*Standard Design: Existing Buildings:* Same as proposed for unaltered.

#### **GROSS TOTAL COOLING CAPACITY**

*Applicability:* All cooling systems.

*Definition:* The total gross cooling capacity (both sensible and latent) of a cooling coil or packaged DX system at AHRI conditions. The building descriptors defined in this chapter

assume that the fan is modeled separately, including any heat it adds to the air stream. The cooling capacity specified by this building descriptor should not consider the heat of the fan.

*Units:* Btu/h.

*Input Restrictions:* NOT A USER INPUT.

For packaged equipment that has the fan motor in the air stream such that it adds heat to the cooled air, the software shall calculate the net total cooling capacity as follows:

$$Q_{t,net,rated} = Q_{t,gross,rated} - Q_{fan,rated}$$

Where:

- $Q_{t,net,rated}$  - The net total cooling capacity of a packaged unit as rated by AHRI (Btu/h)
- $Q_{t,gross,rated}$  - The AHRI rated total cooling capacity of a packaged unit (Btu/h)  
 $Q_{fan,rated}$ ; the heat generated by the fan and fan motor (if fan motor is in airstream) at AHRI rated conditions

If the gross and net total cooling capacities at AHRI conditions are known, the fan heat at rated conditions is the difference between the two values. If either the gross or net total cooling capacity is unknown, the fan heat at rated conditions shall be accounted for by using Equation 4:

$$Q_{fan,rated} = Q_{t,gross,rated} \times 0.0415$$

Equation 4 is based on an AHRI rated fan power of 0.365 W/cfm, and a cooling airflow of 400 cfm/ton.

If the number of UMLH in the proposed design exceeds 150, the software shall warn the user to resize the equipment.

*Standard Design:* The gross total cooling capacity of the systems in the standard design is determined from the standard design net cooling capacity, and from applying the fan power rules above for adjusting for fan heat.

*Standard Design: Existing Buildings:*

### **GROSS SENSIBLE COOLING CAPACITY**

*Applicability:* All cooling systems.

*Definition:* The gross sensible cooling capacity of the coil or packaged equipment at AHRI conditions. The building descriptors defined in this chapter assume that the fan is modeled separately, including any heat it adds to the air stream. The cooling capacity specified by this building descriptor should be adjusted to calculate the net sensible cooling capacity, which includes the effect of fan motor heat.

The sensible heat ratio (SHR) used by some energy simulation tools can be calculated from the sensible cooling capacity and total cooling capacity:

SHR = sensible cooling capacity/total cooling capacity

*Units:* Btu/h.

*Input Restrictions:* As designed.

For packaged equipment, the compliance software adjusts the user input of gross sensible cooling capacity to account for the effect of fan motor heat as follows:

$$Q_{s,net,rated} = Q_{s,gross,rated} - Q_{fan,rated}$$

Where:

- $Q_{s,net,rated}$  - The AHRI rated (from manufacturers' literature) or net sensible cooling capacity of a packaged unit (Btu/h)
- $Q_{t,gross,rated}$  - The AHRI rated (from manufacturers' literature) or gross sensible cooling capacity of a packaged unit (Btu/h)
- $Q_{fan,rated}$  - The heat generated by the fan and fan motor (if fan motor is in air stream) at AHRI rated or hourly conditions (Btu/h). See gross total cooling capacity building descriptor.

If the number of UMLH in the proposed design exceeds 150, the software shall warn the user to resize the equipment.

*Standard Design:* The gross total cooling capacity of the systems serving the standard design is autosized by the compliance software, and then oversized by 15 percent.

*Standard Design: Existing Buildings:*

### **GROSS TOTAL COOLING CAPACITY CURVE**

*Applicability:* All cooling systems.

*Definition:* A curve that represents the available total cooling capacity as a function of cooling coil and/or condenser conditions. The common form of these curves is given as follows:

$$Q_{t,available} = CAP_{FT} \times Q_{t,adj}$$

For air-cooled direct expansion:

$$CAP_{FT} = a + b(t_{wb}) + c(t_{wb})^2 + d(t_{odb}) + e(t_{odb})^2 + f(t_{wb} \times t_{odb})$$

For water-cooled direct expansion:

$$CAP_{FT} = a + b(t_{wb}) + c(t_{wb})^2 + d(t_{wt}) + e(t_{wt})^2 + f(t_{wb} \times t_{wt})$$

For chilled water coils:

$$CAP_{FT} = a + b(t_{wb}) + c(t_{wb})^2 + d(t_{db}) + e(t_{db})^2 + f(t_{wb} \times t_{db})$$

Where:

- $Q_{t,available}$  - Available cooling capacity at specified evaporator and/or condenser conditions (MBH)
- $Q_{t,adj}$  - Adjusted capacity at AHRI conditions (Btu/h)
- $CAP_{FT}$  - A multiplier to adjust  $Q_{t,adj}$
- $t_{wb}$  - The entering coil wet-bulb temperature (°F)
- $t_{db}$  - The entering coil dry-bulb temperature (°F)
- $t_{wt}$  - The water supply temperature (°F)
- $t_{odb}$  - The outside air dry-bulb temperature (°F)

Note: If an air-cooled unit employs an evaporative condenser,  $t_{odb}$  is the effective dry-bulb temperature of the air leaving the evaporative cooling unit.

Software may represent the relationship between cooling capacity and temperature in ways other than the equations given above.

*Units:* Data structure.

*Input Restrictions:* As designed.

The equations and coefficients given above are the default.

*Standard Design:* Use the default curves or equivalent data for other models.

*Standard Design: Existing Buildings:*

### **COIL LATENT MODELING METHOD**

*Applicability:* All DX cooling systems.

*Definition:* The method of modeling coil latent performance at part-load conditions.

*Units:* List.

*Input Restrictions:* One of the following values:

Bypass factor – used by DOE-2 based programs.

NTU-effectiveness – used by EnergyPlus.

*Standard Design:* Same as proposed.

*Standard Design: Existing Buildings:*

### **COIL BYPASS FACTOR**

*Applicability:* All DX cooling systems using the bypass factor coil latent modeling method.

*Definition:* The ratio of air that bypasses the cooling coil at design conditions to the total system airflow.

*Units:* Ratio.

*Input Restrictions:* Prescribed values defined in Appendix 5.7.

*Standard Design:* Defaults.

*Standard Design: Existing Buildings:*

### **COIL BYPASS FACTOR ADJUSTMENT CURVE**

*Applicability:* All DX cooling systems using the bypass factor coil latent modeling method.

*Definition:* Adjustments for the amount of coil bypass due to the following factors:

- Coil airflow rate as a percentage of rated system airflow
- Entering air wet-bulb temperature
- Entering air dry-bulb temperature
- Part load ratio

*Units:* Data structure.

*Input Restrictions:* Where applicable, prescribed (fixed) simulation engine defaults based on HVAC system type. The following default values shall be used for the adjustment curves:

$$CBF_{adj} = CBF_{rated}(Coil_{BF,Flow})(Coil_{BF,FT})(Coil_{BF,FPLR})$$

$$Coil_{BF,Flow} = a + b(CFMR) + c(CFMR)^2 + d(CFMR)^3$$

$$Coil_{BF,FT} = a + b(T_{wb}) + c(T_{wb})^2 + d(T_{db}) + e(T_{db})^2 + f(T_{wb})(T_{db})$$

$$Coil_{BF,FPLR} = a + b(PLR)$$

Where:

- $CBF_{rated}$  - The coil bypass factor at AHRI rating conditions
- $CBF_{adj}$  - The coil bypass factor adjusted for airflow and coil conditions
- $CFMR$  - The ratio of airflow to design airflow
- $Coil_{BF,Flow}$  - A multiplier on the rated coil bypass factor to account for variation in air flow across the coil (take coefficients from Table 34)
- $Coil_{BF,FT}$  - A multiplier on the rated coil bypass factor to account for a variation in coil entering conditions (take coefficients from Table 35)
- $Coil_{BF,FPLR}$  - A multiplier on the rated coil bypass factor to account for the part load ratio (take coefficients from Table 36)

- $T_{wb}$  - The entering coil wet-bulb temperature (F)
- $T_{db}$  - The entering coil dry-bulb temperature (F)
- $PLR$  - Part load ratio

*Standard Design:* Defaults.

*Standard Design: Existing Buildings:*

### **COOLING CAPACITY AIRFLOW ADJUSTMENT CURVE**

*Applicability:* All DX cooling systems using the NTU effectiveness coil latent modeling method.

*Definition:* Normalized curve that varies cooling capacity as a function of airflow, which affects system latent capacity.

*Units:* Data structure.

*Input Restrictions:* Where applicable, prescribed (fixed) simulation engine defaults based on HVAC system type. The following default values shall be used for the adjustment curves:

$$CoolCap_{adj} = CoolCap_{rated} \times CoolCap_{FFLOW} \times CoolCap_{FT}$$

Where:

- $CFMR$  - The ratio of airflow to design airflow
- $CoolCap_{FFLOW}$  - A multiplier on the rated coil capacity to account for variation in air flow across the coil (take coefficients from Table 33)
- $CoolCap_{FT}$  - A multiplier on the rated coil bypass factor to account for a variation in coil entering conditions (take coefficients from Table 34)

The curve takes the form:

$$CoolCap_{FFLOW} = a + b(CFMR) + c(CFMR)^2 + d(CFR)^3$$

With the coefficients defined in Appendix 5.7.

*Standard Design:* Use defaults as described above.

*Standard Design: Existing Buildings:*

### **5.7.5.2 Direct Expansion**

#### **DIRECT EXPANSION COOLING EFFICIENCY**

*Applicability:* All DX cooling systems.

*Definition:* The cooling efficiency of a direct expansion (DX) cooling system at AHRI rated conditions as a ratio of output over input in Btu/h per W, excluding fan energy.

The abbreviation used for this full-load efficiency is Energy Efficiency Ratio (EER).

For all unitary and applied equipment where the fan energy is part of the equipment efficiency rating, the EER shall be adjusted as follows:

$$EER_{adj} = \frac{Q_{t,net,rated} + Q_{fan,rated}}{\frac{Q_{t,net,rated}}{EER} - \frac{Q_{fan,rated}}{3.413}}$$

Where:

- $EER_{adj}$  - The adjusted EER for simulation purposes
- $EER$  - The rated EER
- $Q_{t,net,rated}$  - The AHRI rated total gross cooling capacity of a packaged unit (kBtu/h)
- $Q_{fan,rated}$  - The AHRI rated fan energy, specified in Equation 7 for the gross total cooling capacity building descriptor

*Units:* Btu/h-W.

*Input Restrictions:* As designed, except that the user-entered value must meet mandatory minimum requirements of Table 110.2-A, Table 110.2-B, Table 110.2-C, or Table 110.2-E for the applicable equipment type. When possible, specify the SEER and EER for packaged equipment with cooling capacity less than 65,000 Btu/h from manufacturer’s literature. For equipment with capacity above 65,000 Btu/h, specify EER.

Equipment subject to minimum efficiency requirements under the Appliance Efficiency Regulations (small packaged air conditioners and heat pumps with SEER ratings) must meet the applicable mandatory minimum efficiency requirements.

When EER is not available for packaged equipment with SEER ratings (AHRI cooling capacity of 65,000 Btu/h or smaller), it shall be calculated as follows:

$$EER = MIN(-0.0194 \times SEER^2 + 1.0864 \times SEER, 13)$$

The default EER shall be calculated by the equation above but constrained to be no greater than 13.

Evaporative cooling systems that pass the requirements of the Western Cooling Challenge may be modeled with an EER as if the equipment were packaged unitary equipment. See Chapter 5.7.5.4.

*Standard Design:* Use the minimum cooling efficiency (EER) from tables in Tables 110.2-A, 110.2-B, and 110.2-E in §110.2 of the standards.

For multifamily buildings, use the minimum EER required by the Appliance Efficiency Regulations for equipment subject to EER rating. For equipment not subjected to EER rating, the standard is 11.7 EER.

*Standard Design: Existing Buildings:*



### **SEASONAL ENERGY EFFICIENCY RATIO**

*Applicability:* DX equipment with AHRI cooling capacity of 65,000 Btu/h or smaller

*Definition:* The seasonal cooling efficiency of a direct expansion (DX) cooling system at AHRI rated conditions as a ratio of output over input in Btu/h per W, excluding fan energy. The software must accommodate user input in terms of either the EER or the SEER. For equipment with SEER ratings, EER shall be taken from manufacturers' data when it is available.

*Units:* Btu/h-W

*Input Restrictions:* As designed

This input is required for small DX systems. The Direct Expansion Cooling Efficiency input is optional for these systems.

*Standard Design:* Use the minimum SEER from the 2019 Title 20 Appliance Efficiency Standards, document CEC-140-2019-002

*Standard Design: Existing Buildings:*

### **INTEGRATED ENERGY EFFICIENCY RATIO**

*Applicability:* DX equipment with AHRI cooling capacity of 65,000 Btu/h or greater.

*Definition:* Integrated Energy Efficiency Ratio.

This is a SEER that is a composite rating for a range of part-load conditions and different ambient conditions. The rating is determined according to AHRI procedures. Equipment with this rating is subject to mandatory minimum requirements.

This input is currently only used for mandatory minimum efficiency checks.

*Units:* Btu/h-W.

*Input Restrictions:* As designed.

If the IEER rating is below mandatory minimum required levels specified in §110.2 of the standards, the compliance run shall fail.

*Standard Design:* Not applicable.

*Standard Design: Existing Buildings:*

### **DIRECT EXPANSION COOLING EFFICIENCY TEMPERATURE ADJUSTMENT CURVE**

*Applicability:* DX equipment.

*Definition:* A curve that varies the cooling efficiency of a direct expansion (DX) coil as a function of evaporator conditions, condenser conditions, and for small packaged equipment, part-load ratio.

For air-cooled DX systems:

$$EIR_{FT} = a + b(t_{wb}) + c(t_{wb})^2 + d(t_{odb}) + e(t_{odb})^2 + f(t_{wb})(t_{odb})$$

For water-cooled DX systems:

$$EIR_{FT} = a + b(t_{wb}) + c(t_{wb})^2 + d(t_{wt}) + e(t_{wt})^2 + f(t_{wb})(t_{wt})$$

$$P_{operating} = P_{rated}(EIR_{FPLR})(EIR_{FT})(CAP_{FT})$$

Where:

- $EIR_{FPLR}$  - Part-load ratio based on available capacity (not rated capacity)
- $EIR_{FT}$  - A multiplier on the EIR to account for the wet-bulb temperature entering the coil and the outdoor dry-bulb temperature
- $t_{wb}$  - The entering coil wet-bulb temperature (F)
- $t_{wt}$  - The water supply temperature (F)
- $t_{odb}$  - The outside-air dry-bulb temperature (F)
- $P_{rated}$  - Rated power draw at AHRI conditions (kW)
- $P_{operating}$  - Power draw at specified operating conditions (kW)

*Units:* Data structure.

*Input Restrictions:* User may input curves or use default curves. If defaults are overridden, the software must indicate that supporting documentation is required on the output forms.

For DX equipment with a capacity greater than 65,000 Btu/h, the user may not enter data on the temperature dependent equipment performance. However, the ACM compliance software vendor may work with manufacturers to collect such data and build this data into the ACM compliance software. The user may either select equipment for which the ACM compliance software vendor has collected or use the defaults.

*Standard Design:* For all systems except packaged DX units with cooling capacity  $\leq$  65,000 Btu/h, use default curves from Appendix 5.7. For packaged DX units with cooling capacity less than or equal to 65,000 Btu/h that have SEER ratings, the user inputs EER and SEER. The software generates the equipment performance curve based on SEER and EER inputs.

*Standard Design: Existing Buildings:*

## **NUMBER OF COOLING STAGES**

*Applicability:* Single zone VAV systems and DX systems with multiple stages.

*Definition:* This applies to single zone VAV and any HVAC systems with multiple compressors or multiple discrete stages of cooling. This system is a packaged unit with multiple compressors and a two-speed or variable-speed fan.

*Units:* None (Integer).

*Input Restrictions:* As designed, but systems with more than 2 stages will be modeled with 2 stages.

*Standard Design:* The standard design shall be two for the single zone VAV baseline and packaged VAV baseline.

*Standard Design: Existing Buildings:*

### **TOTAL COOLING CAPACITY RATIO BY STAGE**

*Applicability:* Single zone VAV systems and DX systems with multiple stages.

*Definition:* This provides the total cooling capacity of each cooling stage, at AHRI rated conditions. The capacity is expressed as an array, with each entry a fraction of the total rated cooling capacity for the unit. For example, if the stage cooling capacity is 4 tons (48,000 Btu/h) and the total cooling capacity is 8 tons (96,000 Btu/h), the capacity is expressed as "0.50" for that stage.

*Units:* Array of fractions.

*Input Restrictions:* As designed.

*Standard Design:* For healthcare facilities, same as the Proposed Design. For all others, the default shall be (0.50, 1) for the single zone VAV baseline.

*Standard Design: Existing Buildings:*

### **CONDENSER TYPE**

*Applicability:* All direct expansion systems including heat pumps.

*Definition:* The type of condenser for a DX cooling system.

The choices are:

- Air-cooled
- Water-cooled

*Units:* List (see above).

*Input Restrictions:* As designed.

*Standard Design:* For healthcare facilities, same as the Proposed Design. For all others, based on the prescribed system type.

Refer to the HVAC System Map in Chapter 5.1.2 HVAC System Map

Standard Design: Existing Buildings:

### **SUPPLEMENTARY DX COOLING UNIT**

*Applicability:* Required when no cooling system is specified, or when a zone has excessive unmet load hours.

*Definition:* The specification of a supplementary DX cooling system that must be used when the user-defined cooling system results in unmet load hours exceeding 150 for any zone.

*Units:* List.

*Input Restrictions:* The compliance software shall define the following prescribed system characteristics:

Cooling Capacity (Btu/h) – Autosized by software.

Efficiency –

Cooling Load  $\geq$  65,000 Btu/h: Minimum efficiency from Table 110.2-A, based on cooling capacity and assuming 3-phase.

Cooling Load  $<$  65,000 Btu/h: Minimum SEER from the 2019 Title 20 Appliance Efficiency Standards, document CEC-140-2019-002

System airflow – Autosized by software

Economizer - none

Design supply air temperature - 55°F

Supply air temperature control - None

Design heating supply air temperature - 95°F

*Standard Design:* Not applicable.

*Standard Design: Existing Buildings:*

### **5.7.5.3 Evaporative Cooler**

This is equipment that pre-cools the outside air that is brought into the building. It may be used with any type of cooling system that brings in outside air. This equipment is not applicable for the standard design.

### **EVAPORATIVE COOLING TYPE**

*Applicability:* Systems with evaporative cooling

*Definition:* The type of evaporative pre-cooler, including:

- None
- Non-integrated direct
- Non-integrated indirect
- Non-integrated direct/Indirect
- Integrated direct
- Integrated indirect
- Integrated direct/indirect

An integrated cooler can operate together with compressor or CHW cooling. A non-integrated cooler will shut down the evaporative cooling whenever it is unable to provide 100 percent of the cooling required.

Direct evaporative cooling can only be applied to the outside air. Indirect evaporative cooling can be applied to outside air or return air.

*Units:* None.

*Input Restrictions:* As designed.

*Standard Design:* For healthcare facilities, same as the Proposed Design. For all others, not applicable

*Standard Design: Existing Buildings:*

### **EVAPORATIVE COOLING SYSTEM CAPACITY**

*Applicability:* Systems with evaporative cooling.

*Definition:* The total sensible cooling capacity of the evaporative cooling system at design outdoor dry-bulb conditions. This value may be derived from other inputs of supply fan design air rated capacity (Chapter 5.7.3 Fan and Duct Systems), direct stage effectiveness, indirect stage effectiveness, and design outdoor conditions.

*Units:* None.

*Input Restrictions:* Not applicable.

Derived input. If there are excessive unmet load hours in any zone served by the evaporative cooling system, a supplementary DX cooling unit must be defined by the user. See Chapter 5.7.5.2 Direct Expansion.

*Standard Design:* For healthcare facilities, same as the Proposed Design. For all others, not applicable.

*Standard Design: Existing Buildings:*

### **DIRECT STAGE EFFECTIVENESS**

*Applicability:* Systems with evaporative cooling.

*Definition:* The effectiveness of the direct stage of an evaporative cooling system. Effectiveness is defined as:

$$Direct_{EFF} = \frac{T_{db} + T_{direct}}{T_{db} - T_{wb}}$$

Where:

- $Direct_{EFF}$  - The direct stage effectiveness
- $T_{db}$  - The entering air dry-bulb temperature
- $T_{wb}$  - The entering air wet-bulb temperature
- $T_{direct}$  - The direct stage leaving dry-bulb temperature

*Units:* Numeric ( $0 \leq EFF \leq 1$ ).

*Input Restrictions:* As designed.

*Standard Design:* For healthcare facilities, same as the Proposed Design. For all others, not applicable.

*Standard Design: Existing Buildings:*

### **INDIRECT STAGE EFFECTIVENESS**

*Applicability:* Systems with evaporative cooling.

*Definition:* The effectiveness of the indirect stage of an evaporative cooling system. Effectiveness is defined as:

$$Indirect_{EFF} = \frac{T_{db} + T_{indirect}}{T_{db} - T_{wb}}$$

Where:

- $Indirect_{EFF}$  - The indirect stage effectiveness
- $T_{db}$  - The entering air dry-bulb temperature
- $T_{wb}$  - The entering air wet-bulb temperature
- $T_{indirect}$  - The indirect stage leaving dry-bulb temperature

*Units:* Numeric ( $0 \leq EFF \leq 1$ ).

*Input Restrictions:* As designed.

*Standard Design:* For healthcare facilities, same as the Proposed Design. For all others, not applicable.

*Standard Design: Existing Buildings:*

### **EVAPORATIVE COOLING PERFORMANCE CURVES**

*Applicability:* Systems with evaporative cooling.

*Definition:* A curve that varies the evaporative cooling effectiveness as a function of primary air stream airflow. The default curves are given as:

$$PLR = \frac{CFM_{operating}}{CFM_{design}}$$
$$EFF_{FFLOW} = a + b(PLR) + c(PLR)^2$$

Where:

- $PLR$  - Part load ratio of airflow based on design airflow
- $EFF_{FFLOW}$  - A multiplier on the evaporative cooler effectiveness to account for variations in part load
- $CFM_{operating}$  - Operating primary air stream airflow (cfm)
- $CFM_{design}$  - Design primary air stream airflow (cfm)

*Units:* Data structure.

*Input Restrictions:* User may input curves or use default curves. If defaults are overridden, the software must indicate that supporting documentation is required on the output forms.

*Standard Design:* For healthcare facilities, same as the Proposed Design. For all others, not applicable.

*Standard Design: Existing Buildings:*

### **AUXILIARY EVAPORATIVE COOLING POWER**

*Applicability:* Systems with evaporative cooling.

*Definition:* The auxiliary energy of the indirect evaporative cooler fan, and the pumps for both direct and indirect stages.

*Units:* Watts.

*Input Restrictions:* As designed.

*Standard Design:* Not applicable.

*Standard Design: Existing Buildings:*

### **AUXILIARY EVAPORATIVE COOLING POWER**

*Applicability:* Systems with evaporative cooling.

*Definition:* The auxiliary energy of the indirect evaporative cooler fan, and the pumps for both direct and indirect stages.

*Units:* Watts.

*Input Restrictions:* As designed.

*Standard Design:* Not applicable.

*Standard Design: Existing Buildings:*

#### **5.7.5.4 Four-Pipe Fan Coil Systems**

This chapter contains building descriptors required to model four-pipe fan coil systems. Note that this system requires an outside air ventilation source to serve the zones and that an airside economizer is not available.

Supply air flow rates are set at the zone level. Chilled water flow rates are set according to the rules in Chapter 5.8.5 Pumps.

Additional HVAC components (chiller, boiler, pumps) are needed to fully define this system. If a water-side economizer is specified with this system, refer to Chapter 5.8.4 Water-side Economizers for a list of applicable building descriptors.

#### **CAPACITY CONTROL METHOD**

*Applicability:* Four-pipe fan coil systems.

*Definition:* The control method for the fan coil unit at the zone.

The following choices are available:

- Constant Fan Variable Flow
- Cycling Fan
- Variable Fan Constant Flow
- Variable Fan Variable Flow

*Units:* List (with choices above)

*Input Restrictions:* Not a user input. It comes from building descriptors for fan control and chiller loop flow control.

*Standard Design:* Not applicable.

*Standard Design: Existing Buildings:*

#### **RATED GROSS CAPACITY**

*Applicability:* Four-pipe fan coil systems.



*Definition:* The gross cooling capacity of the cooling coil.

*Units* Btu/h.

*Input Restrictions:* None.

*Standard Design:* For healthcare facilities, same as the Proposed Design. For all others, not applicable.

*Standard Design: Existing Buildings:*

#### **COOLING COIL DESIGN FLOW RATE**

*Applicability:* Four-pipe fan coil systems and chilled beams

*Definition:* The design flow rate of the cooling coil

*Units:* Gallons per minute (gpm)

*Input Restrictions:* None

*Standard Design:* For healthcare facilities, same as the Proposed Design. For all others, Not applicable

*Existing Buildings:*

#### **5.7.5.5 Chilled Beams**

Active and passive chilled beams can be modeled, in a similar manner to four-pipe fan coil systems. Active chilled beams are modeled as a four-pipe fan coil object. The zone fan for the beam is not specified by the user but is internally added to the compliance model with no fan power.

#### **CHILLED BEAM NAME**

*Applicability:* Chilled beams.

*Definition:* A unique name designating the chilled beam.

*Units:* None.

*Input Restrictions:* None.

*Standard Design:* For healthcare facilities, same as the proposed design. For all others, not applicable.

*Standard Design: Existing Buildings:*

#### **CHILLED BEAM TYPE**

*Applicability:* Chilled beams.

*Definition:* Specification of the beam as active or passive.

*Units:* List:

- Active
- Passive

*Input Restrictions:* None.

*Standard Design:* For healthcare facilities, same as the proposed design. For all others, not applicable.

*Standard Design: Existing Buildings:*

### **DESIGN COOLING CAPACITY**

*Applicability:* Chilled beams.

*Definition:* The designed cooling capacity of the chilled beam.

*Units:* Btu/h.

*Input Restrictions:* None.

*Standard Design:* For healthcare facilities, same as the Proposed Design. For all others, not applicable.

*Standard Design: Existing Buildings:*

### **DESIGN CHILLED WATER TEMPERATURE**

*Applicability:* Chilled beams.

*Definition:* The minimum supplied chilled water temperature to the beam.

This is typically at least 2°F higher than the space dewpoint temperature at design conditions, to prevent condensation.

*Units:* °F.

*Input Restrictions:* None.

*Standard Design:* For healthcare facilities, same as the Proposed Design. For all others, not applicable.

*Standard Design: Existing Buildings:*

### **MAXIMUM CHILLED WATER TEMPERATURE**

*Applicability:* Chilled beams.

*Definition:* The maximum supplied chilled water temperature to the beam. This allows for chilled water temperature reset at the source.

*Units:* °F.

*Input Restrictions:* Should be equal to or greater than the design chilled water temperature.

*Standard Design:* For healthcare facilities, same as the Proposed Design. For all others, not applicable.

*Standard Design: Existing Buildings:*

**ACTIVE BEAM MAXIMUM PRIMARY FLOW RATE**

*Applicability:* Chilled beams.

*Definition:* The design flow rate of the active fan.

*Units:* Cfm.

*Input Restrictions:* As designed.

*Standard Design:* For healthcare facilities, same as the Proposed Design. For all others, not applicable.

*Standard Design: Existing Buildings:*

**ACTIVE BEAM INDUCED AIR RATE**

*Applicability:* Active chilled beams.

*Definition:* The rate at which induced air is drawn through the chilled beam.

The total airflow across the beam is the sum of the maximum primary flow rate and the active beam induced air flow rate.

*Units:* Cfm.

*Input Restrictions:* None.

*Standard Design:* For healthcare facilities, same as the Proposed Design. For all others, Not applicable.

*Standard Design: Existing Buildings:*

**ACTIVE FAN STATIC PRESSURE**

*Applicability:* Chilled beams.

*Definition:* The design status of the active fan.

*Units:* in. of water.

*Input Restrictions:* None.

*Standard Design:* For healthcare facilities, same as the Proposed Design. For all others, not applicable.

*Standard Design: Existing Buildings:*

**ACTIVE FAN STATIC EFFICIENCY**

*Applicability:* Chilled beams.

*Definition:* The fan static efficiency.

*Units:* in. of water.

*Input Restrictions:* Between 0 and 1.

*Standard Design:* For healthcare facilities, same as the Proposed Design. For all others, not applicable

*Standard Design: Existing Buildings:*

**ACTIVE FAN MOTOR EFFICIENCY**

*Applicability:* Chilled beams.

*Definition:* The motor efficiency of the fan.

*Units:* in. of water.

*Input Restrictions:* None.

*Standard Design:* For healthcare facilities, same as the Proposed Design. For all others, not applicable.

*Standard Design: Existing Buildings:*

**CHILLED BEAM HEATING CAPACITY**

*Applicability:* Chilled beams.

*Definition:* The heating capacity of the chilled beam.

*Units:* Btu/h.

*Input Restrictions:* None; defaults to 1 if no heating.

*Standard Design:* For healthcare facilities, same as the Proposed Design. For all others, not applicable.

*Standard Design: Existing Buildings:*

**CHILLED BEAM HEATING SOURCE**

*Applicability:* Chilled beams.

*Definition:* Defaults to electric resistance, whether there is heating provided by the beam or not.

*Units:* None.

*Input Restrictions:* Electric resistance.

*Standard Design:* For healthcare facilities, same as the Proposed Design. For all others, not applicable.

*Standard Design: Existing Buildings:*

## **5.7.6 Heating Systems**

### **5.7.6.1 General**

#### **HEATING SOURCE**

*Applicability:* All systems that provide heating.

*Definition:* The source of heating for the heating and preheat coils. The choices are:

- Hot water
- Electric resistance
- Electric heat pump
- Gas furnace
- Oil furnace

*Units:* List (see above).

*Input Restrictions:* As designed.

*Standard Design:* Based on the prescribed system type. Refer to the HVAC system map in Chapter 5.1.2 HVAC System Map.

*Standard Design: Existing Building:* Same as proposed if unaltered.

### **5.7.6.2 Hydronic/Steam Heating Coils**

Systems with boilers have heating coils, including standard design systems with hot water heating.

#### **HEATING COIL CAPACITY**

*Applicability:* All systems with a heating coil.

*Definition:* The heating capacity of a heating coil at AHRI conditions.

*Units:* Btu/h.

*Input Restrictions:* As designed.

The user may need to manually adjust the capacity if the number of unmet load hours exceeds 150.

*Standard Design:* Auto size with a heating oversizing factor of 25 percent. If the number of unmet load hours for the standard design exceeds 150, increase the heating coil capacity as indicated in Chapter 2.6.2 Sizing Equipment in the Standard Design.

*Standard Design:*

*Standard Design: Existing Buildings:*

### **5.7.6.3 Furnace**

#### **FURNACE CAPACITY**

*Applicability:* Systems with a furnace.

*Definition:* The full load heating capacity of the unit.

*Units:* Btu/h.

*Input Restrictions:* As designed. The user may need to manually adjust the capacity if the number of unmet load hours exceeds 150.

*Standard Design:* Auto size with an oversizing factor of 25 percent (let the software determine heating capacity based on the building loads). If the number of unmet load hours for the standard design exceeds 150, increase the furnace capacity as indicated in Chapter 2.4 Unmet Load Hours and 2.6.2 Sizing Equipment in the Standard Design.

*Standard Design: Existing Buildings:*

#### **FURNACE FUEL HEATING EFFICIENCY**

*Applicability:* Systems with a furnace.

*Definition:* The full load thermal efficiency of either a gas or oil furnace at design conditions. The software must accommodate input in either thermal efficiency ( $E_t$ ) or annual fuel utilization efficiency (AFUE). Where AFUE is provided,  $E_t$  shall be calculated as:

$$E_t = 0.0051427 * ( \text{FurnAFUE} * 100 ) + 0.3989$$

Where:

- $AFUE$  - The annual fuel utilization efficiency (%)
- $E_t$  - The thermal efficiency (fraction)

*Units:* Fraction.

*Input Restrictions:* As designed.

*Standard Design:* Look up the requirement from the equipment efficiency tables in Table 6.8.1E of the Appliance Efficiency Standards. The standard design efficiency requirement is

located in Table E-3 or Table E-4 of the *Appliance Efficiency Standards*. Use the heating input of the standard design system to determine the size category.

*Standard Design: Existing Buildings:*

### **FURNACE FUEL HEATING PART LOAD EFFICIENCY CURVE**

*Applicability:* Systems with a furnace.

*Definition:* An adjustment factor that represents the percentage of full load fuel consumption as a function of the percentage full load capacity. This curve shall take the form of a quadratic equation as follows:

$$Fuel_{partload} = Fuel_{rated} \times FHeatPLC$$
$$FHeatPLC = a + b(Q_{partload}/Q_{rated}) + c(Q_{partload}/Q_{rated})^2$$

Where:

- $FHeatPLC$  - The fuel heating part load efficiency curve
- $Fuel_{rated}$  - The fuel consumption at part load conditions (Btu/h)
- $Q_{partload}$  - The capacity at part load conditions (Btu/h)
- $Q_{rated}$  - The capacity at rated conditions (Btu/h)

*Units:* Data structure.

*Input Restrictions:* Fixed.

*Standard Design: Existing Buildings:* Fixed.

### **FURNACE FUEL HEATING PILOT**

*Applicability:* Systems that use a furnace for heating.

*Definition:* The fuel input for a pilot light on a furnace.

*Units:* Btu/h.

*Input Restrictions:* As designed.

*Standard Design:* Zero (pilotless ignition).

*Standard Design: Existing Buildings*

### **FURNACE FUEL HEATING FAN/AUXILIARY**

*Applicability:* Systems that use a furnace for heating.

*Definition:* The fan energy in forced draft furnaces and the auxiliary (pumps and outdoor fan) energy in fuel-fired heat pumps.

*Units:* Kilowatts (kW).

*Input Restrictions:* As designed.

*Standard Design:* For healthcare facilities, same as the Proposed Design. For all others, not applicable.

*Standard Design: Existing Buildings:*

#### **5.7.6.4 Electric Heat Pump**

##### **ELECTRIC HEAT PUMP HEATING CAPACITY**

*Applicability:* All heat pumps.

*Definition:* The full load heating capacity of the unit, excluding supplemental heating capacity at AHRI rated conditions.

*Units:* Btu/h.

*Input Restrictions:* As designed.

*Standard Design:* Auto size and use an oversizing factor of 25 percent. The software determines heating capacity based on the building loads.

*Standard Design: Existing Buildings:*

##### **ELECTRIC HEAT PUMP SUPPLEMENTAL HEATING SOURCE**

*Applicability:* All heat pumps.

*Definition:* The auxiliary heating source for a heat pump heating system.

The common control sequence is to lock out the heat pump compressor when the supplemental heat is activated. Other building descriptors may be needed if this is not the case. Choices for supplemental heat include:

- Electric resistance
- Gas furnace
- Oil furnace
- Hot water
- Other

*Units:* List (see above).

*Input Restrictions:* As designed.

*Standard Design:* For healthcare facilities, same as the Proposed Design. For all others, Electric resistance.

*Standard Design: Existing Buildings*



### ELECTRIC HEAT PUMP HEATING EFFICIENCY

*Applicability:* All heat pumps.

*Definition:* The heating efficiency of a heat pump at AHRI rated conditions as a dimensionless ratio of output over input. The software must accommodate user input of either the coefficient of performance (COP) or the heating season performance factor (HSPF). Where HSPF is provided, COP shall be calculated as:

$$COP = (0.2778 \times HSPF) + 0.9667$$

For all unitary and applied equipment where the fan energy is part of the equipment efficiency rating, the COP shall be adjusted as follows to remove the fan energy:

$$COP_{adj} = \frac{\frac{HCAP_{rated} - Q_{fan,rated}}{3.413}}{\frac{HCAP_{rated}}{COP \times 3.413} - \frac{Q_{fan,rated}}{3.413}}$$

Where:

- $COP_{adj}$  - The adjusted coefficient of performance for simulation purposes
- $COP$  - The AHRI rated coefficient of performance
- $HCAP_{rated}$  - The AHRI rated heating capacity of a packaged unit (kBtu/h)
- $Q_{fan,rated}$  - ARI rated fan power, equal to the gross rated cooling capacity times 0.04.

*Units:* Unitless.

*Input Restrictions:* As designed.

*Standard Design:* For healthcare facilities, same as the Proposed Design. For all others, not applicable.

*Standard Design: Existing Buildings:*

### ELECTRIC HEAT PUMP HEATING CAPACITY ADJUSTMENT CURVE(S)

*Applicability:* All heat pumps.

*Definition:* A curve or group of curves that represent the available heat-pump heating capacity as a function of evaporator and condenser conditions. The default curves are given as:

$$Q_{available} = CAP_{FT} \times Q_{rated}$$

For air-cooled heat pumps:

$$CAP_{FT} = a + b(t_{odb}) + c(t_{odb})^2 + d(t_{odb})^3$$

For water-cooled heat pumps:

$$CAP_{FT} = a + b(t_{db}) + d(t_{wt})$$

Where:

- $Q_{available}$  - Available heating capacity at present evaporator and condenser conditions (kBtu/h)
- $t_{db}$  - The entering coil dry-bulb temperature (°F)
- $t_{wt}$  - The water supply temperature (°F)
- $t_{odb}$  - The outside-air dry-bulb temperature (°F)
- $Q_{rated}$  - Rated capacity at AHRI conditions (in kBtu/h)

*Units:* Data structure.

*Input Restrictions:* Fixed. Use curves in Appendix 5.7 for water-source or air-source heat pumps as appropriate.

*Standard Design:* For healthcare facilities, same as the Proposed Design. For all others, not applicable.

*Standard Design: Existing Buildings:*

### **ELECTRIC HEAT PUMP HEATING EFFICIENCY ADJUSTMENT CURVE(S)**

*Applicability:* All heat pumps.

*Definition:* A curve or group of curves that varies the heat pump heating efficiency as a function of evaporator conditions, condenser conditions and part-load ratio. The default curves are given as:

$$PLR = \frac{Q_{operating}}{Q_{available}(t_{db}, t_{odb/wt})}$$

$$EIR_{FPLR} = a + b(PLR) + c(PLR)^2 + d(PLR)^3$$

*Air-Source Heat Pumps:*

$$EIR_{FT} = a + b(t_{odb}) + c(t_{odb})^2 + d(t_{odb})^3$$

*Water-Source Heat Pumps:*

$$EIR_{FT} = a + b(t_{wt}) + d(t_{db})$$

$$P_{operating} = P_{rated}(EIR_{FPLR})(EIR_{FT})(CAP_{FT})$$

Where:

- $PLR$  - Part-load ratio based on available capacity (not rated capacity)
- $EIR_{FPLR}$  - A multiplier on the EIR of the heat pump as a function of part-load ratio

- $EIR_{FT}$  - A multiplier on the EIR of the heat pump as a function of the wet-bulb temperature entering the coil and the outdoor dry-bulb temperature
- $Q_{operating}$  - Present load on heat pump (Btu/h)
- $Q_{available}$  - Heat pump available capacity at present evaporator and condenser conditions (Btu/h)
- $t_{db}$  - The entering coil dry-bulb temperature (°F)
- $t_{wt}$  - The water supply temperature (°F)
- $t_{odb}$  - The outside air dry-bulb temperature (°F)
- $P_{rated}$  - Rated power draw at AHRI conditions (kW)
- $P_{operating}$  - Power draw at specified operating conditions (kW)

Units: None.

Input Restrictions: Fixed from appropriate curve from Appendix 5.7.

Standard Design: For healthcare facilities, same as the Proposed Design. For all others, not applicable.

Standard Design: Existing Buildings:

#### **ELECTRIC HEAT PUMP SUPPLEMENTAL HEATING CAPACITY**

*Applicability:* All heat pumps.

*Definition:* The design heating capacity of a heat pump supplemental heating coil at AHRI conditions.

*Units:* Btu/h.

*Input Restrictions:* As designed.

*Standard Design:* For healthcare facilities, same as the Proposed Design. For all others, not applicable.

*Standard Design: Existing Buildings*

#### **ELECTRIC SUPPLEMENTAL HEATING CONTROL TEMP**

*Applicability:* All heat pumps.

*Definition:* The outside dry-bulb temperature below which the heat pump supplemental heating is allowed to operate.

*Units:* Degrees Fahrenheit (°F).

*Input Restrictions:* As designed; default to 40°F.

*Standard Design:* For healthcare facilities, same as the Proposed Design. For buildings with dual-fuel heat pumps (supplemental gas heat), 45°F. For all other heat pumps 35°F.

*Standard Design: Existing Buildings*

### **HEAT PUMP COMPRESSOR MINIMUM OPERATING TEMP**

*Applicability:* All heat pumps.

*Definition:* The outside dry-bulb temperature below which the heat pump compressor is disabled.

*Units:* Degrees Fahrenheit (°F).

*Input Restrictions:* As designed.

*Standard Design:* For healthcare facilities, same as the Proposed Design. For all others, not applicable.

*Standard Design: Existing Buildings:*

### **COIL DEFROST**

*Applicability:* Air-cooled electric heat pump.

*Definition:* The defrost control mechanism for an air-cooled heat pump.

The choices are:

- Hot-gas defrost, on-demand
- Hot-gas defrost, timed 3.5 minute cycle
- Electric resistance defrost, on-demand
- Electric resistance defrost, timed 3.5 minute cycle

Defrost shall be enabled whenever the outside air dry-bulb temperature drops below 40°F.

*Units:* List (see above).

*Input Restrictions:* Default to use hot-gas defrost, timed 3.5 minute cycle. User may select any of the above.

*Standard Design:* For healthcare facilities, same as the Proposed Design. For all others, not applicable.

*Standard Design:*

*Existing Buildings:*

### **COIL DEFROST kW**

*Applicability:* Heat pumps with electric resistance defrost.

*Definition:* The capacity of the electric resistance defrost heater.

*Units:* Kilowatts (kW).

*Input Restrictions:* As designed; defaults to 0 if nothing is entered.

*Standard Design:* For healthcare facilities, same as the Proposed Design. For all others, not applicable.

*Standard Design:*

*Existing Buildings:*

### **CRANK CASE HEATER KW**

*Applicability:* All heat pumps.

*Definition:* The capacity of the electric resistance heater in the crank case of a direct expansion (DX) compressor. The crank case heater operates only when the compressor is off.

*Units:* Kilowatts (kW).

*Input Restrictions:* As designed; defaults to 0.1 if nothing is entered.

*Standard Design:* For healthcare facilities, same as the Proposed Design. For all others, not applicable.

*Standard Design: Existing Buildings:*

### **CRANK CASE HEATER SHUTOFF TEMPERATURE**

*Applicability:* All heat pumps.

*Definition:* The outdoor air dry-bulb temperature above which the crank case heater is not permitted to operate.

*Units:* Degrees Fahrenheit (°F).

*Input Restrictions:* As designed; defaults to 50°F.

*Standard Design:* For healthcare facilities, same as the Proposed Design. For all others, not applicable.

*Standard Design: Existing Buildings:*

## **5.7.7 Heat Recovery**

### **RECOVERY TYPE**

*Applicability:* All systems with airside heat recovery.

*Definition:* The type of heat recovery system.

*Units:* List: sensible, latent, or total (sensible and latent).

*Input Restrictions:* As designed.

*Standard Design:* For healthcare facilities, same as the Proposed Design.

For all others, sensible if impacted based on requirements in 140.4(q). Not applicable for all systems.

*Standard Design: Existing Buildings:* For healthcare facilities, same as the Proposed Design.

For all others, sensible if impacted based on requirements in 140.4(q). Not applicable for all systems.

### **RECOVERY AIR FLOW RATE**

*Applicability:* All systems with airside heat recovery.

*Definition:* The design air flow rate through the heat recovery system.

*Units:* CFM.

*Input Restrictions:* As designed.

*Standard Design:* For healthcare facilities, same as the Proposed Design.

For all others, assume balanced flow if impacted based on requirements in 140.4(q). Not applicable for all systems.

*Standard Design: Existing Buildings:* Assume balanced flow if impacted based on requirements in 140.4(q). Not applicable for all systems.

### **EXHAUST AIR SENSIBLE HEAT RECOVERY EFFECTIVENESS**

*Applicability:* Any system with outside air heat recovery.

*Definition:* The effectiveness of an air-to-air heat exchanger between the building exhaust and entering outside air streams. Effectiveness is defined as:

$$HREFF = \frac{EEA_{db} - ELA_{db}}{EEA_{db} - OSA_{db}}$$

Where:

- $HREFF$  - The air-to-air heat exchanger effectiveness
- $EEA_{db}$  - The exhaust air dry-bulb temperature entering the heat exchanger
- $ELA_{db}$  - The exhaust air dry-bulb temperature leaving the heat exchanger
- $OSA_{db}$  - The outside air dry-bulb temperature

*Units:* Two unitless numbers (ratio between 0 and 1), separate for cooling and heating.

*Input Restrictions:* As designed.

*Standard Design:* For healthcare facilities, same as the Proposed Design.

For all others, the sensible effectiveness is 60% if using for HVAC systems impacted based on requirements in 140.4(q). Not applicable for all systems.

*Standard Design: Existing Buildings:* The sensible effectiveness is 60% if using for HVAC systems impacted based on requirements in 140.4(q). Not applicable for all systems.

### **EXHAUST AIR SENSIBLE PART-LOAD EFFECTIVENESS**

*Applicability:* Any system with outside air heat recovery.

*Definition:* The effectiveness of an air-to-air heat exchanger between the building exhaust and entering outside air streams at 75 percent of design airflow. Effectiveness is defined as:

$$HREFF = \frac{EEA_{db} - ELA_{db}}{EEA_{db} - OSA_{db}}$$

Where:

- $HREFF$  - The air-to-air heat exchanger effectiveness
- $EEA_{db}$  - The exhaust air dry-bulb temperature entering the heat exchanger
- $ELA_{db}$  - The exhaust air dry-bulb temperature leaving the heat exchanger
- $OSA_{db}$  - The outside air dry-bulb temperature

*Units:* Two unitless numbers (ratio between 0 and 1), separate for cooling and heating.

*Input Restrictions:* As designed.

*Standard Design:* For healthcare facilities, same as the Proposed Design.

For all others, the sensible effectiveness is 65% if using for HVAC systems impacted based on requirements in 140.4(q). Not applicable for all systems.

*Standard Design: Existing Buildings:* The sensible effectiveness is 65% if using for HVAC systems impacted based on requirements in 140.4(q). Not applicable for all systems.

### **EXHAUST AIR LATENT HEAT RECOVERY EFFECTIVENESS**

*Applicability:* Any system with outside air enthalpy heat recovery.

*Definition:* The latent heat recovery effectiveness of an air-to-air heat exchanger between the building exhaust and entering outside air streams. Effectiveness is defined as:

$$HREFF = \frac{EEA_w - ELA_w}{EEA_w - OSA_w}$$

Where:

- $HREFF$  - The air-to-air heat exchanger effectiveness
- $EEA_w$  - The exhaust air humidity ratio (fraction of mass of moisture in air to mass of dry air) entering the heat exchanger
- $ELA_w$  - The exhaust air humidity ratio leaving the heat exchanger
- $OSA_w$  - The outside air humidity ratio

Note: For sensible heat exchangers, this term is not applicable

*Units:* Two unitless numbers (ratio between 0 and 1), separate for cooling and heating.

*Input Restrictions:* As designed.

*Standard Design:* For healthcare facilities, same as the Proposed Design. For all others, not applicable.

*Standard Design: Existing Buildings:* For healthcare facilities, same as the Proposed Design. For all others, not applicable.

### **EXHAUST AIR LATENT PART-LOAD EFFECTIVENESS**

*Applicability:* Any system with outside air enthalpy heat recovery.

*Definition:* The latent heat recovery effectiveness of an air-to-air heat exchanger between the building exhaust and entering outside air streams at 75 percent of design airflow. Effectiveness is defined as:

$$HREFF = \frac{EEA_w - ELA_w}{EEA_w - OSA_w}$$

Where:

- $HREFF$  - The air-to-air heat exchanger effectiveness
- $EEA_w$  - The exhaust air humidity ratio (fraction of mass of moisture in air to mass of dry air) entering the heat exchanger
- $ELA_w$  - The exhaust air humidity ratio leaving the heat exchanger
- $OSA_w$  - The outside air humidity ratio

Note: For sensible heat exchangers, this term is not applicable.

*Units:* Two unitless numbers (ratio between 0 and 1), separate for cooling and heating.

*Input Restrictions:* As designed.

*Standard Design:* For healthcare facilities, same as the Proposed Design. For all others, not applicable.

*Standard Design: Existing Buildings:*



**ECONOMIZER ENABLED DURING HEAT RECOVERY**

*Applicability:* All systems with airside heat recovery.

*Definition:* A flag to indicate whether or not the economizer is enabled when heat recovery is active.

*Units:* Boolean.

*Input Restrictions:* As designed.

*Standard Design:* For healthcare facilities, same as the Proposed Design.

For all others, the economizer is disabled for HVAC systems impacted based on requirements in 140.4(q). Not applicable for all systems.

*Standard Design: Existing Buildings:*

The economizer is disabled for HVAC systems impacted based on requirements in 140.4(q). Not applicable for all systems.

---

**5.8 HVAC Primary Systems****5.8.1 Boilers****BOILER NAME**

*Applicability:* All boilers.

*Definition:* A unique descriptor for each boiler, heat pump, central heating heat-exchanger, or heat recovery device.

*Units:* None.

*Input Restrictions:* User entry.

Where applicable, this should match the tags that are used on the plans for the proposed design.

*Standard Design:* For healthcare facilities, same as the Proposed Design. For all others, Boilers are only designated in the standard design if the baseline system type uses hot water for space heating.

*Standard Design: Existing Buildings:*

**BOILER FUEL SOURCE**

*Applicability:* All boilers.

*Definition:* The fuel source for the central heating equipment.

The choices are:

- Gas
- Oil
- Electricity

*Units:* List (see above).

*Input Restrictions:* As designed.

This input is restricted, based on the choice of boiler type, according to the following rules:

- Steam Boiler
  - Electricity - n/a
  - Gas - n/a
  - Steam - Allowed
- Hot Water Boiler
  - Electricity - n/a
  - Gas - Allowed
  - Steam - n/a

*Standard Design:* For healthcare facilities, same as the Proposed Design. For all others, Gas.

*Standard Design: Existing Buildings:* Same as proposed for existing, unaltered; same as newly constructed buildings if altered.

### **BOILER TYPE**

*Applicability:* All boilers.

*Definition:* Type of fluid used for heat transfer.

The choices are:

- HotWater
- Steam

*Units:* List (see above).

*Input Restrictions:* As designed.

*Standard Design:* HotWater boiler.

*Standard Design: Existing Buildings:* Same as proposed for existing, unaltered; same as newly constructed buildings if altered.

### **BOILER DRAFT TYPE**

*Applicability:* All boilers.

*Definition:* How combustion airflow is drawn through the boiler.

The choices are Natural, MechanicalNoncondensing, or Condensing.

Natural draft boilers use natural convection to draw air for combustion through the boiler. Natural draft boilers are subject to outside air conditions and the temperature of the flue gases.

Condensing boilers reclaim heat of condensation from water in the flue gas to achieve efficiencies of 90 percent. However, if the water entering the boiler (return water temperature) is too hot, then condensing does not occur, and the boiler operates at efficiencies below 82 percent. Condensing boilers require a draft fan to ensure airflow through the complex flue gas passages.

Natural draft and MechanicalNoncondensing boilers cannot achieve efficiencies above about 82 percent.

*Units:* List (see above).

*Input Restrictions:* As designed.

*Standard Design:* For healthcare facilities, same as the Proposed Design. For all others, condensing.

*Standard Design: Existing Buildings:*

### **NUMBER OF IDENTICAL BOILER UNITS**

*Applicability:* All boilers.

*Definition:* The number of identical units for staging.

*Units:* Numeric: integer.

*Input Restrictions:* As designed; default is 1.

*Standard Design:* The standard design shall have one boiler when the standard design plant serves a conditioned floor area of 15,000 ft<sup>2</sup> or less and have two equally size boilers for plants serving more than 15,000 ft<sup>2</sup>.

*Standard Design: Existing Buildings:*

### **BOILER DESIGN CAPACITY**

*Applicability:* All boilers.

*Definition:* The heating capacity at design conditions.

*Units:* Btu/h.

*Input Restrictions:* As designed.

If unmet load hours exceed 150, the user may need to manually adjust boiler design capacity.

*Standard Design:* The boiler is sized to be 25 percent larger than the peak loads of the standard design. Standard design boilers shall be sized using weather files containing 99.6 percent heating design temperatures and 0.5 percent dry-bulb and 1 percent wet-bulb cooling design temperatures.

*Standard Design: Existing Buildings:*

### **BOILER EFFICIENCY TYPE**

*Applicability:* All boilers.

*Definition:* The full load efficiency of a boiler is expressed as one of the following:

- Annual fuel utilization efficiency (AFUE) is a measure of the boiler's efficiency over a predefined heating season.
- Thermal efficiency ( $E_t$ ) is the ratio of the heat transferred to the water divided by the heat input of the fuel.
- Combustion efficiency ( $E_c$ ) is the measure of how much energy is extracted from the fuel and is the ratio of heat transferred to the combustion air divided by the heat input of the fuel.

*Units:* List (see above).

*Input Restrictions:* None.

*Standard Design:* AFUE for all gas and oil-fired boilers with less than 300,000 Btu/h capacity.

Thermal efficiency ( $E_t$ ) for all gas and oil-fired boilers with capacities between 225,000 and 2,500,000 Btu/h.

Combustion efficiency ( $E_c$ ), for all gas and oil-fired boilers with capacities above 2,500,000 Btu/h.

*Standard Design: Existing Buildings:*

### **BOILER EFFICIENCY**

*Applicability:* All boilers.

*Definition:* The full load efficiency of a boiler at rated conditions (see efficiency type above) expressed as a dimensionless ratio of output over input. The software must accommodate input in either thermal efficiency ( $E_t$ ), combustion efficiency ( $E_c$ ), or AFUE. The software shall make appropriate conversions to thermal efficiency if either AFUE or combustion efficiency is entered as the rated efficiency.

Where AFUE is provided,  $E_t$  shall be calculated as follows:

- $0.75 \leq AFUE < 0.80$  -  $E_t = (0.1 \times AFUE) + 0.725$
- $0.80 \leq AFUE \leq 0.10$  -  $E_t = (0.875 \times AFUE) + 0.105$

If combustion efficiency is entered, the compliance software shall convert the efficiency to thermal efficiency by the relation:

$$E_t = E_c - 0.015$$

All electric boilers will have an efficiency of 98 percent.

*Units:* Ratio.

*Input Restrictions:* As designed.

*Standard Design:* Boilers with rated capacity 1 MMBtu and below for the standard design have the minimum efficiency listed in Table E-4 of the *California Appliance Efficiency Regulations*.

Gas-fired boilers with rated capacity above 1 MMBtu have a standard design efficiency of 90 percent.

*Standard Design: Existing Buildings:*

### **BOILER PART-LOAD PERFORMANCE CURVE**

*Applicability:* All boilers.

*Definition:* An adjustment factor that represents the percentage full load fuel consumption as a function of the percentage full load capacity. This curve shall take the form of a quadratic equation as follows:

$$Fuel_{partload} = Fuel_{design} [FHeatPLC(Q_{partload}, Q_{rated})]$$

$$FHeatPLC = \left( a + b \left( \frac{Q_{partload}}{Q_{rated}} \right) + c \left( \frac{Q_{partload}}{Q_{rated}} \right)^2 \right)$$

Where:

- $FHeatPLC$  - The fuel heating part-load efficiency curve
- $Fuel_{partload}$  - The fuel consumption at part-load conditions (Btu/h)
- $Fuel_{design}$  - The fuel consumption at design conditions (Btu/h)
- $Q_{partload}$  - The boiler capacity at part-load conditions (Btu/h)
- $Q_{rated}$  - The boiler capacity at design conditions (Btu/h)
- $a$  - Constant
- $b$  - Constant

- *c* - Constant

*Units:* Ratio.

*Input Restrictions:* Prescribed to the part-load performance curve in the ACM Appendix 5.7, based on the boiler draft type.

*Standard Design:* The standard design uses the mechanical draft fan curve in Appendix 5.7.

*Standard Design: Existing Buildings:*

### **BOILER FORCED DRAFT FAN POWER**

*Applicability:* All mechanical draft boilers.

*Definition:* The fan power of the mechanical draft fan at design conditions.

*Units:* Nameplate horsepower.

*Input Restrictions:* As designed.

The software shall convert the user entry of motor horsepower to fan power in watts by the following equation:

$$\text{Fan Power} = \text{Motor HP} (7.46) (0.5)$$

*Standard Design:* For healthcare facilities, same as the Proposed Design. For all others, Sized for an energy input ratio of 0.001018 (0.2984 W per kBtu/h heat input).

*Standard Design: Existing Buildings:*

### **BOILER MINIMUM UNLOADING RATIO**

*Applicability:* All boilers.

*Definition:* The minimum unloading capacity of a boiler expressed as a percentage of the rated capacity. Below this level, the boiler must cycle to meet the load.

*Units:* Percent (%).

*Input Restrictions:* As designed.

If the user does not use the default value, the software must indicate that supporting documentation is required on the output forms. Fixed at 1 percent (this accounts for jacket losses and start/stop losses).

*Standard Design:* For healthcare facilities, same as the Proposed Design. For all others, 1 percent.

*Standard Design: Existing Buildings:*

### **BOILER MINIMUM FLOW RATE**

*Applicability:* All boilers.

*Definition:* The minimum flow rate recommended by the boiler manufacturer for stable and reliable operation of the boiler.

*Units:* Gpm.

*Input Restrictions:* As designed.

If the boiler(s) is piped in a primary only configuration in a variable flow system then the software shall assume there is a minimum flow bypass valve that allows the hot water pump to bypass water from the boiler outlet back to the boiler inlet to maintain the minimum flow rate when boiler is enabled.

Note: The boiler entering water temperature must accurately reflect the mixed temperature (colder water returning from the coil(s) and hotter bypass water) to accurately model boiler efficiency as a function of boiler entering water temperature.

*Standard Design:* For healthcare facilities, same as the Proposed Design. For all others, 0 gpm.

*Standard Design: Existing Buildings:*

### **HOT WATER SUPPLY TEMPERATURE**

*Applicability:* All boilers.

*Definition:* The temperature of the water produced by the boiler and supplied to the hot water loop.

*Units:* Degrees Fahrenheit (°F).

*Input Restrictions:* As designed.

*Standard Design:* For healthcare facilities, same as the Proposed Design. For all others, Use 180°F for standard design boiler.

*Standard Design: Existing Buildings:*

### **HOT WATER TEMPERATURE DIFFERENCE**

*Applicability:* All boilers.

*Definition:* The difference between the temperature of the water returning to the boiler from the hot water loop and the temperature of the water supplied to the loop.

*Units:* Degrees Fahrenheit (°F).

*Input Restrictions:* As designed.

*Standard Design:* For healthcare facilities, same as the Proposed Design. For all others, Use 40°F for standard design boiler.

*Standard Design: Existing Buildings:*

### **HOT WATER SUPPLY TEMPERATURE RESET**

*Applicability:* All boilers.

*Definition:* Variation of the hot water supply temperature with outdoor air temperature.

*Units:* Degrees Fahrenheit (°F).

*Input Restrictions:* As designed (not allowed for non-condensing boilers).

*Standard Design:* For healthcare facilities, same as the Proposed Design. For all others, the hot water supply temperature is fixed at 160 °F.

*Standard Design: Existing Buildings:*

## **5.8.2 Chillers**

### **CHILLER NAME**

*Applicability:* All chillers.

*Definition:* A unique descriptor for each chiller.

*Units:* Text, unique.

*Input Restrictions:* User entry: where applicable, this should match the tags that are used on the plans.

*Standard Design:* For healthcare facilities, same as the Proposed Design. For all others, Chillers are only designated when the standard design system uses chilled water.

*Standard Design: Existing Buildings:*

### **CHILLER TYPE**

*Applicability:* All chillers.

*Definition:* The type of chiller, either a vapor-compression chiller or an absorption chiller.

Vapor compression chillers operate on the reverse Rankine cycle, using mechanical energy to compress the refrigerant, and include:

- Reciprocating\*
- Scroll\*
- Screw\*
- Centrifugal – uses rotating impeller blades to compress the air and impart velocity



- Direct-Fired Single Effect Absorption – uses a single generator and condenser
- Direct-Fired Double Effect Absorption – uses two generators/ concentrators and condensers, one at a lower temperature and the other at a higher temperature. It is more efficient than the single effect, but it must use a higher temperature heat source.
- Indirect-Fired Double Effect Absorption
- Gas Engine-Driven

\*Positive displacement – includes reciprocating (piston-style), scroll and screw compressors.

*Units:* List (see above). The software shall support all chiller types listed above.

*Input Restrictions:* As designed.

*Standard Design:* For healthcare facilities, same as the Proposed Design. For all others, the standard design chiller is based on the design capacity of the standard design as follows:

**Table 12: Type and Number of Chillers**

<b>Building Peak Cooling Load</b>	<b>Number and type of chiller(s)</b>
≤ 300 tons	One water-cooled screw chiller
300 < Load < 600	Two water-cooled screw chillers, sized equally
≥ 600 tons	A minimum of two water-cooled centrifugal chillers, sized to keep the unit size below 800 tons

Source: California Energy Commission

*Standard Design: Existing Buildings:*

**NUMBER OF IDENTICAL CHILLER UNITS**

*Applicability:* All chillers.

*Definition:* The number of identical units for staging.

*Units:* None.

*Input Restrictions:* As designed; default is 1.

*Standard Design:* For healthcare facilities, same as the Proposed Design. For all others, From the number indicated in Chiller Type.

*Standard Design: Existing Buildings:*

**NUMBER OF IDENTICAL CHILLER UNITS**

*Applicability:* All chillers.

*Definition:* The fuel source for the chiller.

The choices are:

- Electricity (for all vapor-compression chillers)
- Gas (absorption units only, designated as direct-fired units)
- Hot water (absorption units only, designated as indirect-fired units)
- Steam (absorption units only, designated as indirect-fired units)

*Units:* List (see above).

*Input Restrictions:* As designed.

This input is restricted, based on the choice of chiller type, according to the following rules:

- Reciprocating
  - Electricity - Allowed
  - Gas - n/a
  - Hot Water - n/a
  - Steam - n/a
- Scroll
  - Electricity - Allowed
  - Gas - n/a
  - Hot Water - n/a
  - Steam - n/a
- Screw
  - Electricity - Allowed
  - Gas - n/a
  - Hot Water - n/a
  - Steam - n/a
- Centrifugal
  - Electricity - Allowed
  - Gas - n/a
  - Hot Water - n/a

- Steam - n/a
- Single Effect Absorption
  - Electricity - n/a
  - Gas - Allowed
  - Hot Water - Allowed
  - Steam - Allowed
- Direct-Fired Double Effect Absorption
  - Electricity - n/a
  - Gas - Allowed
  - Hot Water - Allowed
  - Steam - Allowed
- Indirect-Fired Absorption
  - Electricity - n/a
  - Gas - Allowed
  - Hot Water - Allowed
  - Steam - Allowed

*Standard Design:* For healthcare facilities, same as the Proposed Design. For all others, Electricity.

*Standard Design: Existing Buildings:*

### **CHILLER RATED CAPACITY**

*Applicability:* All chillers.

*Definition:* The cooling capacity of a piece of heating equipment at rated conditions.

*Units:* Btu/h or tons.

*Input Restrictions:* As designed.

The user may need to manually adjust the capacity if the number of unmet load hours exceeds 150.

*Standard Design:* Determine loads for standard design and oversize by 15 percent.

*Standard Design: Existing Buildings:*

### **CHILLER RATED EFFICIENCY**

*Applicability:* All chillers.

*Definition:* The efficiency of the chiller (EER for air-cooled chillers, kW/ton for water-cooled electric chillers, and COP for fuel-fired and heat-driven chillers) at AHRI 550/590 rated full-load conditions.

*Units:* Ratio (kW/ton, COP, EER, depending on chiller type and condenser type).

Water-cooled electric chiller - kW/ton.

Air-cooled or evaporatively-cooled electric chiller - EER

All non-electric chillers – COP

*Input Restrictions:* As designed.

Must meet the minimum requirements of Table 110.2-D.

*Standard Design:* Use the minimum efficiency requirements from Tables 110.2-D Path B.

If chiller type is reciprocating, scroll, or screw, use the efficiency for positive displacement chillers from Table 110.2-D.

*Standard Design: Existing Buildings:* Same as proposed if unaltered; same as newly constructed buildings rules if altered or replacement.

### **INTEGRATED PART-LOAD VALUE**

*Applicability:* All chillers.

*Definition:* The part-load efficiency of a chiller developed from a weighted average of four rating conditions, according to AHRI Standard 550.

*Units:* Ratio (kW/ton, COP, EER, depending on chiller type and condenser type).

Water-cooled electric chiller - kW/ton

Air-cooled or evaporatively-cooled electric chiller - EER

All non-electric chillers – COP

*Input Restrictions:* As designed; must meet the minimum requirements of Table 110.2-D.

*Standard Design:* Not used.

When the standard design system has a chiller, the standard design will always use Path B performance curves.

*Standard Design: Existing Buildings:*

### **CHILLER MINIMUM UNLOADING RATIO**

*Applicability:* All chillers.

*Definition:* The minimum unloading capacity of a chiller expressed as a fraction of the rated capacity.

Below this level the chiller must either cycle to meet the load or false-load the compressor (such as with hot gas bypass).

**Table 13: Default Minimum Unloading Ratios**

<b>Chiller Type</b>	<b>Default Unloading Ratio</b>
Reciprocating	25%
Screw	15%
Centrifugal	10%
Scroll	25%
Single Effect Absorption	10%
Double Effect Absorption	10%

*Units:* Percent (%).

*Input Restrictions:* As designed but constrained to a minimum value of 10 percent. If the user does not employ the default values, supporting documentation is required.

*Standard Design:* For healthcare facilities, same as the Proposed Design. For all others, use defaults listed above.

*Standard Design: Existing Buildings:*

**CHILLER MINIMUM PART LOAD RATIO**

*Applicability:* All chillers.

*Definition:* The minimum unloading capacity of a chiller expressed as a fraction of the rated capacity.

Below this level the chiller must cycle to meet the load. If the chiller minimum part-load ratio (PLR) is less than the chiller minimum unloading ratio, then the compliance software shall assume hot gas bypass operation between the minimum PLR and the minimum unloading ratio.

*Units:* Percent (%).

*Input Restrictions:* As designed but constrained to a minimum value of 10 percent. If the user does not employ the default values, supporting documentation is required.

*Standard Design:* For healthcare facilities, same as the Proposed Design. For all others, When the standard design has a screw chiller, the minimum PLR is 15 percent. When the standard design has a centrifugal chiller, the minimum PLR is 10 percent.

*Standard Design: Existing Buildings:*

### **CHILLER COOLING CAPACITY ADJUSTMENT CURVE**

*Applicability:* All chillers.

*Definition:* A curve or group of curves or other functions that represent the available total cooling capacity as a function of evaporator and condenser conditions and perhaps other operating conditions. The default curves are given as:

$$Q_{available} = CAP_{FT}(Q_{rated})$$

For air-cooled chillers:

$$CAP_{FT} = a + b(t_{chws}) + c(t_{chws})^2 + d(t_{odb}) + e(t_{odb})^2 + f(t_{chws})(t_{odb})$$

For water-cooled chillers:

$$CAP_{FT} = a + b(t_{chws}) + c(t_{chws})^2 + d(t_{cws}) + e(t_{cws})^2 + f(t_{chws})(t_{cws})$$

Where:

- $Q_{available}$  - Available cooling capacity at present evaporator and condenser conditions (MBH)
- $t_{chws}$  - The chilled water supply temperature (°F)
- $t_{cws}$  - The condenser water supply temperature (°F)
- $t_{odb}$  - The outside air dry-bulb temperature (°F)
- $Q_{rated}$  - Rated capacity at AHRI conditions (MBH)

Note: If an air-cooled unit employs an evaporative condenser,  $t_{odb}$  is the effective dry-bulb temperature of the air leaving the evaporative cooling unit.

Separate curves are provided for Path A and Path B chillers in Appendix 5.7.

*Units:* Data structure.

*Input Restrictions:* Prescribed curves are provided in Appendix 5.7 for the proposed design chiller type and the compliance path (A or B). If the default curves are overridden, supporting documentation is required.

*Standard Design:* For healthcare facilities, same as the Proposed Design (choose from available performance curves, no custom curves). For all others, Use prescribed curve for Path B chiller as applicable to the standard design chiller type.

*Standard Design: Existing Buildings:*

**ELECTRIC CHILLER COOLING EFFICIENCY ADJUSTMENT CURVES**

*Applicability:* All chillers.

*Definition:* A curve or group of curves that varies the cooling efficiency of an electric chiller as a function of evaporator conditions, condenser conditions and part-load ratio.

Note: For variable-speed chillers, the part-load cooling efficiency curve is a function of both part-load ratio and leaving condenser water temperature. The default curves are given as:

$$PLR = \frac{Q_{operating}}{Q_{available}(t_{chws}, t_{cws/odb})}$$

$$EIR_{FPLR} = a + b(PLR) + c(PLR)^2$$

Variable Speed:

$$EIR_{FPLR} = a + b(PLR) + c(PLR)^2$$

Air-Cooled:

$$EIR_{FT} = a + b(t_{chws}) + c(t_{chws})^2 + d(t_{odb}) + e(t_{odb})^2 + f(t_{chws})(t_{odb})$$

Water-Cooled:

$$EIR_{FT} = a + b(t_{chws}) + c(t_{chws})^2 + d(t_{cws}) + e(t_{cws})^2 + f(t_{chws})(t_{cws})$$

$$P_{operating} = P_{rated}(EIR_{FPLR})(EIR_{FT})(CAP_{FT})$$

Where:

- $PLR$  - Part-load ratio based on available capacity (not rated capacity)
- $Q_{operating}$  - Present load on chiller (Btu/h)
- $Q_{available}$  - Chiller available capacity at present evaporator and condenser conditions (Btu/h)
- $t_{chws}$  - The chilled water supply temperature (°F)
- $t_{cws}$  - The condenser water supply temperature (°F)
- $t_{odb}$  - The outside air dry-bulb temperature (°F)
- $P_{rated}$  - Rated power draw at AHRI conditions (kW)
- $P_{operating}$  - Power draw at specified operating conditions (kW)

Note: If an air-cooled chiller employs an evaporative condenser,  $t_{odb}$  is the effective dry-bulb temperature of the air leaving the evaporative cooling unit.

*Units:* Data structure.

*Input Restrictions:* Curves are prescribed in Appendix 5.7 given the chiller capacity and type. A separate set of curves are provided for Path A chillers and Path B chillers. The path

is determined by comparing software inputs of full-load efficiency and integrated part-load value with the requirements of standards Table 110.2-D.

*Standard Design:* For healthcare facilities, same as the Proposed Design. For all others, Use Path B curves specified in Appendix 5.7.

*Standard Design: Existing Buildings:*

**FUEL AND STEAM CHILLER COOLING EFFICIENCY ADJUSTMENT CURVES**

*Applicability :* All chillers.

*Definition:* A curve or group of curves that varies the cooling efficiency of a fuel-fired or steam chiller as a function of evaporator conditions, condenser conditions, and part-load ratio. The default curves are given as follows:

Default curves for steam-driven single and double effect absorption chillers:

$$PLR = \frac{Q_{operating}}{Q_{available}(t_{chws}, t_{cws/odb})}$$

$$FIR_{FPLR} = a + b(PLR) + c(PLR)^2$$

$$FIR_{FT} = a + b(t_{chws}) + c(t_{chws})^2 + d(t_{cws}) + e(t_{cws})^2 + f(t_{chws})(t_{cws})$$

$$Fuel_{partload} = (Fuel_{rated})(FIR_{FPLR})(FIR_{FT})(CAP_{FT})$$

Default curves for direct-fired double effect absorption chillers:

$$PLR = \frac{Q_{operating}}{Q_{available}(t_{chws}, t_{cws/odb})}$$

$$FIR_{FPLR} = a + b(PLR) + c(PLR)^2$$

$$FIR_{FT1} = a + b(t_{chws}) + c(t_{chws})^2$$

$$FIR_{FT2} = d + e(t_{cws}) + f(t_{cws})^2$$



$$Fuel_{partload} = (Fuel_{rated})(FIR_{FPLR})(FIR_{FT1})(FIR_{FT2})(CAP_{FT})$$

The default curves for engine driven chillers are the same format as those for the steam-driven single and double effect absorption chillers but there are three sets of curves for different ranges of operation based on the engine speed.

Where:

- $PLR$  - Part-load ratio based on available capacity (not rated capacity)
- $FIR_{FPLR}$  - A multiplier on the fuel input ratio (FIR) to account for part-load conditions
- $FIR_{FT}$  - A multiplier on the fuel input ratio (FIR) to account for the chiller water supply temperature and the condenser water temperature
- $FIR_{FT1}$  - A multiplier on the fuel input ratio (FIR) to account for chilled water supply temperature
- $FIR_{FT2}$  - A multiplier on the fuel input ratio (FIR) to account for condenser water supply temperature
- $CAP_{FT}$  - A multiplier on the capacity of the chiller (Equation 45)
- $Q_{operating}$  - Present load on chiller (in Btu/h)
- $Q_{available}$  - Chiller available capacity at present evaporator and condenser conditions (in Btu/h)
- $t_{chws}$  - The chilled water supply temperature (in °F)
- $t_{cws}$  - The condenser water supply temperature (in °F)
- $t_{odb}$  - The outside air dry-bulb temperature (°F)
- $Fuel_{rated}$  - Rated fuel consumption at AHRI conditions (in Btu/h)
- $Fuel_{partload}$  - Fuel consumption at specified operating conditions (in Btu/h)

*Units:* Data structure.

*Input Restrictions:* Restricted to curves specified in Appendix 5.7.

*Standard Design:* Use prescribed curves specified in Appendix 5.7.

*Standard Design: Existing Buildings:*

### **CHILLED WATER SUPPLY TEMPERATURE**

*Applicability:* All chillers.

*Definition:* The chilled water supply temperature of the chiller at design conditions.

*Units:* Degrees Fahrenheit (°F).

*Input Restrictions:* As designed.

*Standard Design:* For healthcare facilities, same as the Proposed Design. For all others, the standard design chilled water supply temperature is set to 44°F.

*Standard Design: Existing Buildings:*

### **CHILLED WATER RETURN TEMPERATURE**

*Applicability:* All chillers.

*Definition:* The chilled water return temperature setpoint at design conditions.

*Units:* Degrees Fahrenheit (°F).

*Input Restrictions:* As designed.

*Standard Design:* For healthcare facilities, same as the Proposed Design. For all others, the standard design chilled water return temperature is set to 64°F.

*Standard Design: Existing Buildings:*

### **CHILLED WATER SUPPLY TEMPERATURE CONTROL TYPE**

*Applicability:* All chillers.

*Definition:* The method by which the chilled water setpoint temperature is reset.

The chilled water setpoint may be reset based on demand or outdoor air temperature.

*Units:* List none, outside air-based reset, or demand-based reset.

*Input Restrictions:* As designed.

*Standard Design:* For healthcare facilities, same as the Proposed Design. For all others, Outside air-based reset.

*Standard Design: Existing Buildings:*

### **CHILLED WATER SUPPLY TEMPERATURE RESET**

*Applicability:* All chillers.

*Definition:* The reset schedule for the chilled water supply temperature. The chilled water setpoint may be reset based on demand or outdoor air temperature.

*Units:* Degrees Fahrenheit (°F).

*Input Restrictions:* As designed.

*Standard Design:* For healthcare facilities, same as the Proposed Design. For all others, 10°F from design chilled water supply temperature.

The chilled water supply temperature reset follows an outside air reset scheme, where the setpoint is 44°F at outside air conditions of 80°F dry-bulb and above; the setpoint is 54°F at

outside air conditions of 60°F dry-bulb and below; and ramps linearly from 44°F to 54°F as the outside air dry-bulb temperature varies between 80°F and 60°F.

*Standard Design: Existing Buildings:*

### **CONDENSER TYPE**

*Applicability:* All chillers.

*Definition:* The type of condenser for a chiller.

The choices are:

- Air-cooled
- Water-cooled

Air-cooled chillers use air to cool the condenser coils. Water-cooled chillers use cold water to cool the condenser and additionally need either a cooling tower or a local source of cold water. Evaporatively-cooled chillers are similar to air-cooled chillers, except a water mist is used to cool the condenser coil, making them more efficient.

*Units:* List (see above).

*Input Restrictions:* As designed.

*Standard Design:* For healthcare facilities, same as the Proposed Design. For all others, the standard design chiller is always assumed to have a water-cooled condenser, although the chiller type will change depending on the design capacity.

*Standard Design: Existing Buildings:*

### **5.8.3 Cooling Towers**

**Standard Design Summary.** Standard design system 6 has one or more cooling towers. One tower is assumed to be matched to each standard design chiller. Each standard design chiller has its own condenser water pump that operates when the chiller is brought into service.

#### **COOLING TOWER NAME**

*Applicability:* All cooling towers.

*Definition:* A unique descriptor for each cooling tower.

*Units:* Text, unique.

*Input Restrictions:* User entry: where applicable, this should match the tags that are used on the plans.

*Standard Design:* Descriptive name that keys the standard design building plant

*Standard Design: Existing Buildings:*

### **COOLING TOWER TYPE**

*Applicability:* All cooling towers.

*Definition:* Type of cooling tower employed.

The choices are:

- Open tower, centrifugal fan
- Open tower, axial fan

Open cooling towers collect the cooled water from the tower and pump it directly back to the cooling system. Closed towers circulate the evaporated water over a heat exchanger to indirectly cool the system fluid.

*Units:* List (see above).

*Input Restrictions:* As designed.

*Standard Design:* For healthcare facilities, same as the Proposed Design. For all others, the standard design cooling tower is an open tower axial fan device.

*Standard Design: Existing Buildings:*

### **COOLING TOWER CAPACITY**

*Applicability:* All cooling towers.

*Definition:* The tower thermal capacity per cell adjusted to Cooling Technology Institute (CTI) rated conditions of 95°F condenser water return, 85°F condenser water supply, and 78°F wet-bulb with a 3 gpm/nominal ton water flow. The default cooling tower curves below are at unity at these conditions.

*Units:* Btu/h.

*Input Restrictions:* As designed.

*Standard Design:* The standard design building chiller is autosized and increased by 15 percent. The tower is sized to supply 85°F condenser water at design conditions for the oversized chiller.

*Standard Design: Existing Buildings:*

### **COOLING TOWER NUMBER OF CELLS**

*Applicability:* All cooling towers.

*Definition:* The number of cells in the cooling tower.

Each cell will be modeled as equal size. Cells are subdivisions in cooling towers into individual cells, each with their own fan and water flow, that allow the cooling system to respond more efficiently to lower load conditions.

*Units* Numeric: integer.

*Input Restrictions:* As designed.

*Standard Design:* One cell per tower and one tower per chiller.

*Standard Design: Existing Buildings:*

### **COOLING TOWER TOTAL FAN HORSEPOWER**

*Applicability:* All cooling towers.

*Definition:* The sum of the nameplate rated horsepower (hp) of all fan motors on the cooling tower. Pony motors should not be included.

*Units:* Gpm/hp or unitless if energy input ratio (EIR) is specified (if the nominal tons but not the condenser water flow is specified, the condenser design water flow shall be 3.0 gpm per nominal cooling ton).

*Input Restrictions:* As designed, but the cooling towers shall meet minimum performance requirements in Standards Table 110.2-G.

*Standard Design:* For healthcare facilities, same as the Proposed Design. For all others, the cooling tower fan horsepower is 60 gpm/hp, with the following exceptions:

1. Cooling towers in climate zones 1 or 16 shall set the standard design to the mandatory minimum, 42.1 gpm/hp
2. Cooling towers with a design condenser water flow of 900 gpm or less shall set the standard design to the mandatory minimum, 42.1 gpm/hp

*Standard Design: Existing Buildings:* 42.1 gpm/hp.

### **COOLING TOWER DESIGN WET-BULB**

*Applicability:* All cooling towers.

*Definition:* The design wet-bulb temperature that was used for selection and sizing of the cooling tower.

*Units:* Degrees Fahrenheit (°F).

*Input Restrictions:* Specified from design wet-bulb conditions from Reference Appendix JA2 for the city where the building is located, or the city closest to where the building is located.

*Standard Design:* Specified from design wet-bulb conditions from Reference Appendix JA2 for the city where the building is located, or from the city closest to where the building is located.

*Standard Design: Existing Buildings:*

### **COOLING TOWER DESIGN ENTERING WATER TEMPERATURE**

*Applicability:* All cooling towers.

*Definition:* The design condenser water supply temperature (leaving tower) that was used for selection and sizing of the cooling tower.

*Units:* Degrees Fahrenheit (°F).

*Input Restrictions:* As designed; default to 85°F.

*Standard Design:* 85°F or 10°F above the design wet-bulb temperature, whichever is lower.

*Standard Design: Existing Buildings:*

### **COOLING TOWER DESIGN RETURN WATER TEMPERATURE**

*Applicability:* All cooling towers.

*Definition:* The design condenser water return temperature (entering tower) that was used for selection and sizing of the cooling tower.

*Units:* Degrees Fahrenheit (°F).

*Input Restrictions:* As designed; default to 95°F.

*Standard Design:* Set to a range of 10°F (10°F above the cooling tower design entering water temperature).

*Standard Design: Existing Buildings:*

### **COOLING TOWER CAPACITY ADJUSTMENT CURVE**

*Applicability:* All cooling towers.

*Definition:* A curve or group of curves that represent the available total cooling capacity as a function of outdoor air wet-bulb, condenser water supply, and condenser water return temperatures.

The default curves are given as follows:

$$\text{Approach} = \text{Coeff}(1) + \text{Coeff}(2) \cdot \text{FRair} + \text{Coeff}(3) \cdot (\text{FRair})^2 + \text{Coeff}(4) \cdot (\text{FRair})^3 + \text{Coeff}(5) \cdot \text{FRwater} + \text{Coeff}(6) \cdot \text{FRair} \cdot \text{FRwater} + \text{Coeff}(7) \cdot (\text{FRair})^2 \cdot \text{FRwater} + \text{Coeff}(8) \cdot (\text{FRwater})^2 + \text{Coeff}(9) \cdot \text{FRair} \cdot (\text{FRwater})^2 +$$

$$\begin{aligned}
& \text{Coeff}(10) \cdot (\text{FRwater})^3 + \text{Coeff}(11) \cdot \text{Twb} + \text{Coeff}(12) \cdot \text{FRair} \cdot \text{Twb} + \text{Coeff}(13) \cdot (\text{FRair})^2 \cdot \text{Twb} \\
& + \text{Coeff}(14) \cdot \text{FRwater} \cdot \text{Twb} + \text{Coeff}(15) \cdot \text{FRair} \cdot \text{FRwater} \cdot \text{Twb} + \text{Coeff}(16) \cdot (\text{FRwater})^2 \cdot \text{Twb} + \\
& \text{Coeff}(17) \cdot (\text{Twb})^2 + \text{Coeff}(18) \cdot \text{FRair} \cdot (\text{Twb})^2 + \text{Coeff}(19) \cdot \text{FRwater} \cdot (\text{Twb})^2 + \\
& \text{Coeff}(20) \cdot (\text{Twb})^3 + \text{Coeff}(21) \cdot \text{Tr} + \text{Coeff}(22) \cdot \text{FRair} \cdot \text{Tr} + \text{Coeff}(23) \cdot \text{FRair} \cdot \text{FRair} \cdot \text{Tr} + \\
& \text{Coeff}(24) \cdot \text{FRwater} \cdot \text{Tr} + \text{Coeff}(25) \cdot \text{FRair} \cdot \text{FRwater} \cdot \text{Tr} + \\
& \text{Coeff}(26) \cdot (\text{FRwater})^2 \cdot \text{Tr} + \text{Coeff}(27) \cdot \text{Twb} \cdot \text{Tr} + \text{Coeff}(28) \cdot \text{FRair} \cdot \text{Twb} \cdot \text{Tr} + \\
& \text{Coeff}(29) \cdot \text{FRwater} \cdot \text{Twb} \cdot \text{Tr} + \\
& \text{Coeff}(30) \cdot (\text{Twb})^2 \cdot \text{Tr} + \text{Coeff}(31) \cdot (\text{Tr})^2 + \text{Coeff}(32) \cdot \text{FRair} \cdot (\text{Tr})^2 + \text{Coeff}(33) \cdot \text{FRwater} \cdot (\text{Tr})^2 \\
& + \text{Coeff}(34) \cdot \text{Twb} \cdot (\text{Tr})^2 + \text{Coeff}(35) \cdot (\text{Tr})^3
\end{aligned}$$

Where:

- FRair – ratio of airflow to airflow at design conditions
- FRwater – ratio of water flow to water flow at design conditions
- Tr – tower range (°F)
- Twb – wet-bulb temperature

Coefficients for this performance curve are provided in Appendix 5.7.

*Units:* Data structure.

*Input Restrictions:* User must use one of the prescribed curves defined in Appendix 5.7.

*Standard Design:* Use one of the prescribed curves defined in Appendix 5.7.

*Standard Design: Existing Buildings:*

### **COOLING TOWER SET POINT CONTROL**

*Applicability:* All cooling towers.

*Definition:* The type of control for the condenser water supply.

The choices are fixed, or wet-bulb reset.

A fixed control will modulate the tower fans to provide the design condenser water supply temperature at all times when possible. A wet-bulb reset control will reset the condenser water setpoint to a fixed approach to outside air wet-bulb temperature. The approach defaults to 10°F. A lower approach may be used with appropriate documentation.

*Units:* List (see above).

*Input Restrictions:* As designed; default to 95°F

*Standard Design:* For healthcare facilities, same as the Proposed Design. For all others, fixed at the 0.4 percent design wet-bulb temperature, which is prescribed and specified for each of the 86 weather data files.

*Standard Design: Existing Buildings:*

### **COOLING TOWER CAPACITY CONTROL**

*Applicability:* All cooling towers.

*Definition:* Describes the modulation control employed in the cooling tower.

Choices include:

- Fluid Bypass provides a parallel path to divert some of the condenser water around the cooling tower at part-load conditions.
- Fan Cycling is a simple method of capacity control where the tower fan is cycled on and off. This is often used on multiple-cell installations.
- Two-Speed Fan/Pony Motor are the same from an energy perspective. A lower horsepower pony motor is an alternative to a two-speed motor. The pony motor runs at part-load conditions (instead of the full-sized motor) and saves fan energy when the tower load is reduced. Additional building descriptors are triggered when this method of capacity control is selected.
- Variable-Speed Fan is a variable frequency drive is installed for the tower fan so that the speed can be modulated.

*Units:* List (see above).

*Input Restrictions:* As designed.

*Standard Design:* For healthcare facilities, same as the Proposed Design. For all others, Variable-speed fan.

*Standard Design: Existing Buildings:*

### **COOLING TOWER LOW-SPEED AIRFLOW RATIO**

*Applicability:* All cooling towers with two-speed or pony motors.

*Definition:* The percentage full-load airflow that the tower has at low speed or with the pony motor operating; equivalent to the percentage full-load capacity when operating at low speed.

*Units:* Ratio.

*Input Restrictions:* As designed.

*Standard Design:* For healthcare facilities, same as the Proposed Design. For all others, Not applicable.



*Standard Design: Existing Buildings:*

### **COOLING TOWER LOW-SPEED kW RATIO**

*Applicability:* All cooling towers with two-speed or pony motors.

*Definition:* The percentage full-load power that the tower fans draw at low speed or with the pony motor operating.

*Units:* Ratio.

*Input Restrictions:* Calculated, using the as-designed flow ratio and the cooling tower power adjustment curve below.

*Standard Design:* For healthcare facilities, same as the Proposed Design. For all others, Not applicable.

*Standard Design; Existing Buildings:*

### **COOLING TOWER POWER ADJUSTMENT CURVE**

*Applicability:* All cooling towers with VSD control.

*Definition:* A curve that varies the cooling tower fan energy usage as a function of part-load ratio for cooling towers with variable speed fan control. The default curve is given as:

$$PLR = \frac{Q_{operating}}{Q_{available}(t_R, t_A, t_{OWB})}$$

$$TWR_{Fan-FPLR} = a + b(PLR) + c(PLR)^2 + d(PLR)^3$$

$$P_{operating} = P_{rated}(TWR_{Fan-FPLR})$$

Where:

- $PLR$  - Part-load ratio based on available capacity (not rated capacity)
- $Q_{operating}$  - Present load on tower (in Btu/h)
- $Q_{available}$  - Tower available capacity at present range, approach, and outside wet-bulb conditions (in Btu/h)
- $t_{OWB}$  - The outside air wet-bulb temperature (°F)
- $t_R$  - The tower range (°F)
- $t_A$  - The tower approach (°F)
- $P_{rated}$  - Rated power draw at CTI conditions (kW)
- $P_{operating}$  - Power draw at specified operating conditions (kW)

Refer to Appendix 5.7 for the fixed cooling tower curve coefficients.

*Units:* Data structure.

*Input Restrictions:* User shall use only default curves.

*Standard Design:* Use default curves given above.

*Standard Design: Existing Buildings:*

### **COOLING TOWER MINIMUM SPEED**

*Applicability:* All cooling towers with a VSD control.

*Definition:* The minimum fan speed setting of a VSD controlling a cooling tower fan expressed as a ratio of full load speed.

*Units:* Ratio.

*Input Restrictions:* As designed; default is 0.50.

*Standard Design:* For healthcare facilities, same as the Proposed Design. For all others, 0.5.

*Standard Design: Existing Buildings:*

## **5.8.4 Water-side Economizers**

None of the standard design building systems use a water-side economizer.

### **WATER-SIDE ECONOMIZER NAME**

*Applicability:* All water-side economizers.

*Definition:* The name of a water-side economizer for a cooling system.

*Units:* Text, unique.

*Input Restrictions:* Descriptive reference to the construction documents; default is no water-side economizer.

*Standard Design:* For healthcare facilities, same as the Proposed Design. For all others, No water economizer.

*Standard Design: Existing Buildings:*

### **WATER ECONOMIZER TYPE**

*Applicability:* All water-side economizers.

*Definition:* The type of water-side economizer. Choices include:

- None
- Heat exchanger in parallel with chillers. This would be used with an open cooling tower and is often referred to as a non-integrated economizer because the chillers are locked out when the plant is in economizer mode.

- Heat exchanger in series with chillers. This would be used with an open cooling tower and is often referred to as integrated because the chillers can operate simultaneously with water economizer operation.
- Direct water economizer. This would be used with a closed cooling tower. In this case, a heat exchanger is not needed. This type works only as a non-integrated economizer (also known as strainer-cycle).

*Units:* List (see above).

*Input Restrictions:* As designed.

*Standard Design:* For healthcare facilities, same as the Proposed Design. For all others, No water economizer.

*Standard Design: Existing Buildings:*

### **WATER-SIDE ECONOMIZER HX EFFECTIVENESS**

*Applicability:* Water-side economizers with an open cooling tower.

*Definition:* The effectiveness of a water-side heat exchanger at design conditions.

This is defined as:

$$Q_{econ} = (m_{CHW})(Cp_{CHW})(\epsilon)(T_{CHW,R} - T_{CW,S})$$

Where:

- $Q_{econ}$  - The maximum load that the economizer can handle
- $m_{CHW}$  - The chilled water flow rate
- $Cp_{CHW}$  - The chilled water specific heat
- $T_{CHW,R}$  - The chilled water return temperature
- $T_{CW,S}$  - The condenser water supply temperature
- WSEeff - The effectiveness of the water-side economizer coil
- tea - The entering coil air dry-bulb temperature (°F)
- tla - The leaving coil air dry-bulb temperature (°F)
- tea - The entering coil water temperature (°F)

*Units:* Ratio

*Input Restrictions:* As designed; default is 60 percent

*Standard Design:* For healthcare facilities, same as the Proposed Design. For all others, No water economizer

*Standard Design: Existing Buildings:*

### **WATER-SIDE ECONOMIZER HEAT EXCHANGER HEAT TRANSFER COEFFICIENT**

*Applicability:* Water-side economizers with an open cooling tower.

*Definition:* The heat transfer coefficient of the plate-and-frame heat exchanger with the waterside economizer.

*Units:* Btu/h-°F .

*Input Restrictions:* As designed.

*Standard Design:* For healthcare facilities, same as the Proposed Design. For all others, Not applicable.

*Standard Design: Existing Buildings:*

### **WATER-SIDE ECONOMIZER APPROACH**

*Applicability:* All water-side economizers.

*Definition:* The design temperature difference between the chilled water temperature leaving the heat exchanger and the condenser water inlet to the heat exchanger.

*Units:* Degrees Fahrenheit (°F).

*Input Restrictions:* As designed; default is 4°F.

*Standard Design:* For healthcare facilities, same as the Proposed Design. For all others, No water economizer.

*Standard Design: Existing Buildings:*

### **WATER-SIDE ECONOMIZER MAXIMUM CWS**

*Applicability:* All water-side economizers.

*Definition:* The control temperature (condenser water supply temperature) above which the water-side economizer is disabled.

*Units:* Degrees Fahrenheit (°F).

*Input Restrictions:* As designed; default is 50°F.

*Standard Design:* For healthcare facilities, same as the Proposed Design. For all others, No water economizer.

*Standard Design: Existing Buildings:*

### **WATER-SIDE ECONOMIZER AVAILABILITY SCHEDULE**

*Applicability:* All water-side economizers.

*Definition:* A schedule which represents the availability of the water-side economizer.

*Units:* Data structure: schedule, on/off.

*Input Restrictions:* As designed.

*Standard Design:* For healthcare facilities, same as the Proposed Design. For all others, No water economizer.

*Standard Design: Existing Buildings:*

### **WATER-SIDE ECONOMIZER AUXILIARY KW**

*Applicability:* Water-side economizers with an open tower.

*Definition:* The electrical input (pumps and auxiliaries) for a dedicated pump for the chilled water side of the heat exchanger.

This power is in excess of the condenser water pumps and cooling tower fans for the system during water-side economizer operation.

*Units:* KW or kW/ton.

*Input Restrictions:* As designed.

*Standard Design:* For healthcare facilities, same as the Proposed Design. For all others, No water economizer.

*Standard Design: Existing Buildings:*

## **5.8.5 Pumps**

**Standard Design Summary** - Hot water pumping in the standard design shall be modeled as a variable flow, primary only system. Two-way valves are assumed at the heating coils.

Chilled water pumping in the standard design (system 6) is a primary system. Each chiller has its own primary and condenser water pumps that operate when the chiller is activated.

**General Notes** - The building descriptors in this chapter are repeated for each pumping system. See the pump service building descriptor for a list of common pump services.

### **PUMP NAME**

*Applicability:* All pumps.

*Definition:* A unique descriptor for each pump.

*Units:* Text, unique.

*Input Restrictions:* User entry: where applicable, should match the tags that are used on the plans.

*Standard Design:* Same as proposed design.

If there is no equivalent in the proposed design, assign a sequential tag to each piece of equipment. The sequential tags should indicate the pump service as part of the descriptor (e.g., CW for condenser water, CHW for chilled water, or HHW for heating hot water).

*Standard Design: Existing Buildings:*

### **PUMP SERVICE**

*Applicability:* All pumps.

*Definition:* The service for each pump.

Choices include:

- Chilled water
- Chilled water (primary)
- Chilled water (secondary)
- Heating water
- Heating water (primary)
- Heating water (secondary)
- Service hot water
- Condenser water
- Loop water (for hydronic heat pumps)

*Units:* List (see above).

*Input Restrictions:* As designed.

*Standard Design:* As needed by the standard design system.

*Standard Design: Existing Buildings:*

### **NUMBER OF PUMPS**

*Applicability:* All pumps.

*Definition:* The number of identical pumps in service in a particular loop, e.g., the heating hot water loop, chilled water loop, or condenser water loop.

*Units:* Numeric: integer.

*Input Restrictions:* As designed.

*Standard Design:* There will be one heating hot water pump for each boiler, one chilled water pump, and one condenser water pump for each chiller.

*Standard Design: Existing Buildings:*

**WATER LOOP DESIGN**

*Applicability:* All pumps.

*Definition:* The heating and cooling delivery systems can consist of a simple primary loop system, or more complicated primary/secondary loops or primary/secondary/tertiary loops.

*Units:* List (see above).

*Input Restrictions:* As designed.

*Standard Design:* For healthcare facilities, same as the Proposed Design. For all others, assume primary loops only for heating hot water; for chilled water loops, a primary loop design is assumed.

*Standard Design: Existing Buildings:*

**PUMP MOTOR MODELING METHOD**

*Applicability:* All pumps.

*Definition:* Software commonly models pumps in one of two ways. The simple method is for the user to enter the electric power per unit of flow (W/gpm). This method is commonly used for smaller systems. A more detailed method requires a specification of the pump head, design flow, impeller, and motor efficiency.

*Units:* List power-per-unit-flow or detailed.

*Input Restrictions:* Detailed.

*Standard Design:* Detailed for chilled water and condenser water pumps; power-per-unit-flow for heating hot water and service hot water pumps.

*Standard Design: Existing Buildings:*

**PUMP MOTOR POWER-PER-UNIT-FLOW**

*Applicability:* All proposed design pumps that use the power-per-unit-flow method.

*Definition:* The electric power of the pump divided by the flow at design conditions.

*Units:* W/gpm.

*Input Restrictions:* As designed.

*Standard Design:* For healthcare facilities, same as the Proposed Design. For all others, Not applicable for chilled water and condenser water pumps; 19 W/gpm for heating hot water and service hot water pumps.

*Standard Design: Existing Buildings:*

**PUMP MOTOR HORSEPOWER**

*Applicability:* All pumps.

*Definition:* The nameplate motor horsepower.

*Units:* Horsepower (hp).

*Input Restrictions:* Constrained to be a value from the following standard motor sizes:

1/12, 1/8, 1/4, 1/2, 3/4, 1, 1.5, 2, 3, 5, 7.5, 10, 15, 20, 25, 30, 40, 50, 60, 75, 100, 125, 150, 200

*Standard Design:* Not applicable.

*Standard Design: Existing Buildings:*

### **PUMP DESIGN HEAD**

*Applicability:* All standard and proposed design pumps that use the detailed method.

*Definition:* The head of the pump at design flow conditions.

*Units:* ft of water.

*Input Restrictions:* As designed but subject to an input restriction. The user inputs of pump design head, impeller efficiency, cooling tower design entering water temperature, and cooling tower design return water temperature shall be used to calculate the proposed brake horsepower. This shall be compared to the pump motor.

horsepower for the next smaller motor size ( $MHP_{i-1}$ ) than the one specified by the user ( $MHP_i$ ).

The proposed design for the pump design head shall be constrained so that the resulting brake horsepower is no smaller than 95 percent of the next smaller motor size:

$$design\ bhp_{prop} = \max [design\ bhp_{prop-user-head}, 0.95(MHP_{i-1})]$$

Where:

- $design\ bhp_{prop}$  - The brake horsepower used in the simulation
- $design\ bhp_{prop-user-head}$  - The brake horsepower resulting from the user input of design head
- $MHP_i$  - The pump motor horsepower specified by the user
- $i$  - The index into the standard motor size table for the user motor horsepower
- $MHP_{i-1}$  - The motor horsepower for the next smaller motor size. For example, if the user-specified pump motor horsepower is 25, the next smaller motor size in the table above is 20

Since all other user inputs that affect the proposed design brake horsepower are not modified, the proposed design pump design head is adjusted in the same proportion as the



pump brake horsepower in the equation above. If the user-entered pump design head results in a brake horsepower that is at least 95 percent of the horsepower of the next smaller motor size, no modification of the user input is required.

*Standard Design:* For healthcare facilities, same as the Proposed Design. For all others, For chilled water pumps:

$(40 \text{ ft}) + (0.03 \text{ ft/ton}) \times [\text{chiller plant nominal capacity (tons)}]$

(not to exceed 100 ft)

For condenser water pumps: 45 ft

*Standard Design: Existing Building:*

### **IMPELLER EFFICIENCY**

*Applicability:* All pumps in proposed design that use the detailed modeling method.

*Definition:* The full load efficiency of the impeller.

*Units:* Ratio.

*Input Restrictions:* As designed.

*Standard Design:* For healthcare facilities, same as the Proposed Design. For all others, not applicable.

*Standard Design: Existing Building:*

### **MOTOR EFFICIENCY**

*Applicability:* All pumps in proposed design that use the detailed modeling method.

*Definition:* The full load efficiency of the pump motor.

*Units:* Ratio.

*Input Restrictions:* For healthcare facilities, same as the Proposed Design. For all others, As designed.

*Standard Design:* The motor efficiency is taken from Table 11, using the next larger motor size than the calculated standard design brake horsepower.

*Standard Design: Existing Buildings:*

### **PUMP MINIMUM SPEED**

*Applicability:* All two-speed or variable-speed pumps.

*Definition:* The minimum pump speed for a two-speed for variable-speed pump.

For two-speed pumps this is typically 0.67 or 0.5.

Note: The pump minimum speed is not necessarily the same as the minimum flow ratio since the system head may change.

*Units:* Ratio.

*Input Restrictions:* As designed.

*Standard Design:* For healthcare facilities, same as the Proposed Design. For all others, 0.10.

*Standard Design: Existing Buildings:*

### **PUMP DESIGN FLOW (GPM)**

*Applicability:* All pumps.

*Definition:* The flow rate of the pump at design conditions; derived from the load, and the design supply and return temperatures.

*Units:* gpm or gpm/ton for condenser and primary chilled water pumps.

*Input Restrictions:* Not a user input.

*Standard Design:* For healthcare facilities, same as the Proposed Design. For all others, the temperature change on the evaporator side of the chillers is 20°F (64°F less 44°F) and this equates to a flow of 1.2 gpm/ton. The temperature change on the condenser side of the chillers is 12°F, which equates to a flow of 2.0 gpm/cooling ton. A VSD is required for heating pumps when the service area is greater than or equal to 120,000 ft<sup>2</sup>. For hot water pumps servicing boilers, the flow rate in gpm shall correspond to a loop temperature drop of 40°F.

*Standard Design: Existing Buildings:*

### **PUMP CONTROL TYPE**

*Applicability:* All pumps.

*Definition:* The type of control for the pump.

Choices are:

- Fixed speed, fixed flow
- Fixed speed, variable flow (the default, with flow control via a valve)
- Two-speed
- Variable speed, variable flow

*Units:* List, see above.

*Input Restrictions:* As designed; default is “fixed speed, variable flow”, which models the action of a constant speed pump riding the curve against two-way control valves.

*Standard Design:* For healthcare facilities, same as the Proposed Design. For all others, the chilled water pumps shall be modeled as variable-speed, variable flow, and the condenser water pumps shall be modeled as fixed speed. The hot water pumps shall be modeled as fixed-speed, variable flow, riding the curve.

*Standard Design: Existing Buildings:*

## **PUMP OPERATION**

*Applicability:* All pumps.

*Definition:* The type of pump operation can be either on-demand, standby, or scheduled. On-demand operation means the pumps are only pumping when their associated equipment is cycling. Chiller and condenser pumps are on when the chiller is on and the heating hot water pump operates when its associated boiler is cycling. Standby operation allows hot or chilled water to circulate through the primary loop of a primary/secondary loop system or through a reduced portion of a primary-only system, assuming the system has appropriate three-way valves. Scheduled operation means that the pumps and their associated equipment are turned completely off according to occupancy schedules, time of year, or outside conditions. Under scheduled operation, when the systems are on, they are assumed to be in on-demand mode.

*Units:* List (see above).

*Input Restrictions:* As designed.

*Standard Design:* The standard design system pumps are assumed to operate in on-demand mode. The chilled water and condenser pumps are tied to the chiller operation, cycling on and off with the chiller, and the heating hot water pumps are tied to the boiler operation.

*Standard Design: Existing Buildings:*

## **PUMP PART-LOAD CURVE**

*Applicability:* All pumps.

*Definition:* A part-load power curve for the pump:

$$CIRC - PUMP - FPLR = a + b(PLR) + c(PLR)^2 + d(PLR)^3$$

$$P_{pump} = P_{design}(CIRC - PUMP - FPLR)$$

Where:

- $PLR$  - Part-load ratio (the ratio of operating flow rate in gpm to design flow rate in gpm)
- $P_{pump}$  - Pump power draw at part-load conditions (W)
- $P_{design}$  - Pump power draw at design conditions (W)

Refer to Appendix 5.7 for a specification of the default pump part-load curve, and the pump part-load curve if there is differential pressure reset (if DDC controls are present).

*Standard Design:* For healthcare facilities, same as the Proposed Design. For all others, DP Reset curve for chilled water pumps; heating hot water pump power is assumed to be constant even though the pump is riding the curve.

*Standard Design: Existing Buildings:*

### **5.8.6 Variable Refrigerant Flow (VRF) Systems**

Variable refrigerant flow systems consist of an outdoor unit and one or more zonal systems as indoor units. The required system level inputs are shown below. Refer to the HVAC zone level systems chapter for zonal (indoor) units connected to a VRF system. Equipment performance curves are prescribed and defined in Appendix 5.4B for VRF systems.

#### **VRF SYSTEM NAME**

*Applicability:* VRF.

*Definition:* A unique name designating the VRF System.

*Units:* None.

*Input Restrictions:* None.

*Standard Design:* Not applicable.

*Standard Design: Existing Buildings:*

#### **HEAT RECOVERY**

*Applicability:* VRF.

*Definition:* Identification if heat recovery (refrigerant loop) is present.

*Units:* Boolean.

*Input Restrictions:* None (default : No).

*Standard Design:* Not applicable.

*Standard Design: Existing Buildings:*

#### **CONTROL PRIORITY**

*Applicability:* VRF.

*Definition:* A control parameter used to determine when outdoor unit is in heating or cooling.

*Units:* List: MasterThermostat Priority or Load Priority.

*Input Restrictions:* None.

*Standard Design:* Not applicable.

*Standard Design: Existing Buildings:*

### **CONTROL ZONE**

*Applicability:* Master Thermostat Control Zone.

*Definition:* The name of the control zone that controls the outdoor unit, when the Control Priority is Master Thermostat Priority.

*Units:* None.

*Input Restrictions:* None.

*Standard Design:* Not applicable.

*Standard Design: Existing Buildings:*

### **MINIMUM PART-LOAD RATIO**

*Applicability:* VRF.

*Definition:* The minimum part-load ratio for the heat pump. Below this ratio the unit will cycle to meet the load.

*Units:* Unitless.

*Input Restrictions:* 0 to 1.

*Standard Design:* Not applicable.

*Standard Design: Existing Buildings:*

### **RATED EER**

*Applicability:* VRF.

*Definition:* Full load cooling efficiency (Btu/h of net cooling output divided by the electrical energy consumption in Watts) per AHRI rating conditions.

*Units:* Btu/h-W.

*Input Restrictions:* None.

*Standard Design:* Not applicable.

*Standard Design: Existing Buildings:*

**RATED COP**

*Applicability:* VRF.

*Definition:* Full load heating efficiency (net heating output divided by the electrical energy consumption, both in the same units) per AHRI rating conditions.

*Units:* None.

*Input Restrictions:* None.

*Standard Design:* Not applicable.

*Standard Design: Existing Buildings:*

**RATED INDOOR TYPE**

*Applicability:* VRF.

*Definition:* A flag to determine when the VRF system was rated with ducted or unducted indoor units.

*Units:* List: ducted, unducted.

*Input Restrictions:* None.

*Standard Design:* Not applicable.

*Standard Design: Existing Buildings:*

**EQUIVALENT PIPE LENGTH**

*Applicability:* VRF.

*Definition:* The equivalent pipe length between the farthest terminal unit and the condensing unit, including liquid refrigerant line length, fitting losses, and other losses.

*Units:* ft.

*Input Restrictions:* None.

*Standard Design:* Not applicable.

*Standard Design: Existing Buildings:*

**MAX VERTICAL HEIGHT**

*Applicability:* VRF.

*Definition:* The vertical height difference between the highest or lowest terminal unit and outdoor unit.

*Units:* ft.

*Input Restrictions:* None.

*Standard Design:* Not applicable.

*Standard Design: Existing Buildings:*

**DEFROST HEAT SOURCE**

*Applicability:* VRF.

*Definition:* The defrost heat source type.

*Units:* List – electric or gas.

*Input Restrictions:* None.

*Standard Design:* Not applicable.

*Standard Design: Existing Buildings:*

**DEFROST CONTROL STRATEGY**

*Applicability:* VRF.

*Definition:* The control method for enabling defrost.

*Units:* List – TimedCycle or OnDemand.

*Input Restrictions:* None.

*Standard Design:* Not applicable.

*Standard Design: Existing Buildings:*

**MAX DEFROST TEMP**

*Applicability:* VRF.

*Definition:* The maximum outdoor dry-bulb temperature at which defrost will occur.

*Units:* Deg F.

*Input Restrictions:* None.

*Standard Design:* Not applicable.

*Standard Design: Existing Buildings:*

**CRANKCASE HEATER CAPACITY**

*Applicability:* VRF.

*Definition:* The capacity of the resistive defrost heating element.

*Units:* W.

*Input Restrictions:* None.

*Standard Design:* Not applicable.

*Standard Design: Existing Buildings:*

### **COMPRESSOR QUANTITY**

*Applicability:* VRF.

*Definition:* The number of compressors in the condenser, which determines crankcase heater operation.

*Units:* Deg F.

*Input Restrictions:* None.

*Standard Design:* Not applicable.

*Standard Design: Existing Buildings:*

## **5.8.7 Plant Management**

Plant management is a method of sequencing equipment. Separate plant management schemes may be entered for chilled water systems, hot water systems, etc. The following building descriptors are specified for each load range, e.g., when the cooling load is below 300 tons, between 300 tons and 800 tons, and greater than 800 tons.

### **EQUIPMENT TYPE MANAGED**

*Applicability:* All plant systems.

*Definition:* The type of equipment under a plant management control scheme.

Choices include:

- Chilled water cooling
- Hot water space heating
- Condenser water heat rejection
- Service water heating
- Electrical generation

*Units:* None.

*Input Restrictions:* As designed.

*Standard Design:* Same as the proposed design.

*Standard Design: Existing Buildings:*

### **EQUIPMENT SCHEDULE**



*Applicability:* All plant equipment.

*Definition:* A schedule that identifies when the equipment is in service.

*Units:* Data structure.

*Input Restrictions:* As designed.

*Standard Design:* Operation staging when multiple equipment is used.

*Standard Design: Existing Buildings:*

### **EQUIPMENT OPERATION**

*Applicability:* All plant equipment.

*Definition:* Equipment operation can be either on-demand or always-on.

On-demand operation means the equipment cycles on when it is scheduled to be in service and when it is needed to meet building loads. Otherwise, it is off.

Always-on means that equipment runs continuously when it scheduled to be in service. For the purpose of the compliance model, always-on is used for equipment such as chillers that are base-loaded, and on-demand equipment is scheduled to be on only when the base-loaded equipment (one or more) cannot meet the load.

*Units:* None.

*Input Restrictions:* As designed; default is on-demand.

*Standard Design:* Assume on-demand operation.

*Standard Design: Existing Buildings:*

### **EQUIPMENT STAGING SEQUENCE**

*Applicability:* All plant equipment.

*Definition:* The staging sequence for plant equipment (chillers and boilers) indicates how multiple pieces of equipment will be staged on and off when a single piece of equipment is unable to meet the load. In both the proposed and standard design, the compliance software uses the optimal sequence to determine plant staging based on part-load performance. This descriptor is used to identify sequencing when the plant contains unequal equipment, where the order in which the plant equipment is enabled affects plant energy use.

*Units:* Structure – an array, where each element includes a) the load range, in minimum tons and maximum tons; and b) a list of equipment that is enabled to operate. The equipment will run in the priority matching the order of the equipment listed.

*Input Restrictions:* As designed; user may specify load ranges for staging each plant equipment.

*Standard Design:* Not applicable.

The standard design chiller and boiler plant each consist of one or more equal chillers or boilers, so the loading order is not applicable.

*Standard Design: Existing Buildings:*

### **5.8.8 Thermal Energy Storage**

The compliance model inputs below document the requirements to model a chilled water thermal energy storage system with compliance software. Some systems (ice storage, eutectic salts) cannot be modeled with compliance software.

#### **THERMAL ENERGY STORAGE SYSTEMS NAME**

*Applicability:* All thermal energy storage systems.

*Definition:* A unique descriptor for thermal energy storage systems.

*Units:* Text, unique.

*Input Restrictions:* Where applicable, this should match the tags that are used on the plans such that a plan reviewer can make a connection.

*Standard Design:* Not applicable.

*Standard Design: Existing Buildings:*

#### **THERMAL ENERGY STORAGE SYSTEMS TYPE**

*Applicability:* All thermal energy storage systems.

*Definition:* The type of thermal energy storage system being used.

Chilled water storage system is the only currently supported option.

*Units:* List chilled water.

*Input Restrictions:* As designed.

*Standard Design:* Not applicable.

*Standard Design: Existing Buildings:*

#### **DISCHARGE PRIORITY**

*Applicability:* All thermal energy storage systems.

*Definition:* A descriptor determines whether the storage system or a chiller will operate first to meet cooling loads during the discharge period. Storage priority will normally provide

larger demand charge savings but requires a larger storage system. Chiller priority allows use of a significantly smaller storage system, but demand reduction will be smaller.

*Units:* List storage or chiller.

*Input Restrictions:* As designed.

*Standard Design:* Not applicable.

*Standard Design: Existing Buildings:*

### **OPERATION MODE SCHEDULE**

*Applicability:* All thermal energy storage systems.

*Definition:* A schedule which controls operating mode of the thermal energy storage system.

A thermal energy storage system can be discharging (supplying chilled water to meet cooling loads), charging (receiving chilled water to be stored for later use), or off. The operation mode schedule specifies one of these modes for each of the 8,760 hours in a year.

*Units:* Data structure - thermal energy storage mode schedule, specifies charging, discharging, or off on an hourly basis.

*Input Restrictions:* As designed.

*Standard Design:* Not applicable.

*Standard Design: Existing Buildings:*

### **RATED CAPACITY**

*Applicability:* All thermal energy storage systems.

*Definition:* The design cooling capacity of the thermal energy storage system.

The rated cooling capacity of the thermal energy storage system is determined by design flow rate of the thermal energy storage system and the temperature difference between the fluid system supply and return water temperature during discharging.

*Units:* Btu/hr.

*Input Restrictions:* As designed.

*Standard Design:* Not applicable.

*Standard Design: Existing Buildings:*

### **TANK LOCATION**

*Applicability:* All thermal energy storage systems.

*Definition:* The location of the heat pump water heater for determining losses and heat energy interaction with the surroundings.

*Units:* List zone, outdoors, or underground.

*Input Restrictions:* As designed.

*Standard Design:* Not applicable.

*Standard Design: Existing Buildings:*

### **TANK SHAPE**

*Applicability:* All thermal energy storage systems.

*Definition:* The shape of the energy storage system tank used to calculate surface area of the tank for heat gain/loss calculations.

*Units:* List: Vertical cylinder, Horizontal cylinder, or rectangular.

*Input Restrictions:* As designed.

*Standard Design:* Not applicable.

*Standard Design: Existing Buildings:*

### **TANK VOLUME**

*Applicability:* All thermal energy storage systems.

*Definition:* The volume of water held in the thermal energy storage system tank.

The tank volume and the rated capacity will determine how long the storage system can meet the load.

*Units:* Gallons.

*Input Restrictions:* As designed.

*Standard Design:* Not applicable.

*Standard Design: Existing Buildings:*

### **TANK HEIGHT**

*Applicability:* All thermal energy storage systems.

*Definition:* For vertical cylinder or rectangular tank, the height will be the maximum internal height of water held in the upright storage tank. For horizontal cylinder tank, the height of the storage tank will be the inner diameter of the storage tank.

*Units:* Feet.

*Input Restrictions:* As designed.

*Standard Design:* Not applicable.

*Standard Design: Existing Buildings:*

### **TANK LENGTH TO WIDTH RATIO**

*Applicability:* All thermal energy storage systems.

*Definition:* The length to width ratio of a rectangular storage tank in plan view. It is required only if tank shape is rectangular.

If the tank is square, the length to width ratio is one. For a rectangular tank, the ratio will be greater than one since the length of the tank is always greater than the width of the tank. This is used to determine the surface area of the tank.

*Units:* Unitless ratio.

*Input Restrictions:* As designed.

*Standard Design:* Not applicable.

*Standard Design: Existing Buildings:*

### **TANK R-VALUE**

*Applicability:* All thermal energy storage systems.

*Definition:* The insulation applied to the tank used in calculating the tank U-factor.

*Units:* R-value (h-ft<sup>2</sup>-F/Btu).

*Input Restrictions:* As designed.

*Standard Design:* Not applicable.

*Standard Design: Existing Buildings:*

---

## **5.9 Miscellaneous Energy Uses**

Miscellaneous energy uses are defined as those that may be treated separately since they have little or no interaction with the conditioned thermal zones or the HVAC systems that serve them.

### **5.9.1.1 System Loads and Configuration**

#### **WATER HEATING SYSTEM NAME**

*Applicability:* All water heating systems.

*Definition:* A unique descriptor for each water heating system.

A system consists of one or more water heaters, a distribution system, an estimate of hot water use, and a schedule for that use. Nonresidential buildings will typically have multiple

systems, perhaps a separate electric water heater for each office break room, etc. Other building types such as hotels and hospitals may have a single system serving the entire building.

*Units:* Text, unique.

*Input Restrictions:* Where applicable, this should match the tags that are used on the plans such that a plan reviewer can make a connection.

*Standard Design:* The naming convention for the standard design system shall be similar to the proposed design.

*Standard Design: Existing Buildings:*

### **WATER HEATING PEAK USE**

*Applicability:* All water heating systems, required.

*Definition:* An indication of the peak hot water usage (e.g., service to sinks, showers, kitchen appliances, etc.). When specified per occupant, this value is multiplied by design occupancy density values and modified by service water heating schedules to obtain hourly load values which are used in the simulation.

Peak consumption is commonly specified as gallons per hour (gph) per occupant, dwelling unit, hotel room, patient room, or floor area. If consumption is specified in gph, then additional inputs would be needed such as supply temperature, cold water inlet temperature, etc.

Software that specifies peak use as a thermal load in Btu/h can apply ACM rules for the mains (cold water inlet) temperature and supply temperature to convert the prescribed peak use from gph/person to Btu/h-person. The thermal load does not include conversion efficiencies of water heating equipment.

*Units:* gph/person.

*Input Restrictions:* For nonresidential spaces, prescribed values from Appendix 5.4A if a service hot water heating system is installed; otherwise, all values are 0.

For multifamily residential spaces and residential living spaces of hotels and motels (guestrooms), the rules in Chapter 6 of the Nonresidential ACM Reference Manual are followed.

*Standard Design:* Prescribed values from Appendix 5.4A if a service hot water heating system is installed; otherwise, all values are 0.

For multifamily residential spaces and residential living spaces of hotels and motels (guestrooms), the rules in Chapter 6 of the Nonresidential ACM Reference Manual are followed.

*Standard Design: Existing Buildings:*

### **WATER HEATING SCHEDULE**

*Applicability:* All water heating systems.

*Definition:* A fractional schedule reflecting the time pattern of water heating use.

This input modifies the water heating peak use described above.

*Units:* Data structure - schedule, fractional.

*Input Restrictions:* The schedules from Appendix 5.4A shall be used. For multifamily residential spaces and residential living spaces of hotels and motels (guestrooms), the rules in Chapter 6 of the Nonresidential ACM Reference Manual are followed.

*Standard Design:* The schedules from Appendix 5.4A shall be used. For high-rise residential spaces and residential living spaces of hotels and motels (guestrooms), the rules in Chapter 6 of the Nonresidential ACM Reference Manual are followed.

*Standard Design: Existing Buildings:*

### **WATER HEATING SYSTEM CONFIGURATION**

*Applicability:* All water heating systems.

*Definition:* The configuration and layout of the water heating system including the number of water heaters; the size, location, length, and insulation of distribution pipes; recirculation systems and pumps; and any other details about the system that would affect the energy model.

*Units:* Data structure.

*Input Restrictions:* None.

*Standard Design:* For healthcare facility spaces, the same as Proposed. For multifamily residential buildings, the rules in Chapter 6 of the Nonresidential ACM Reference Manual shall be followed.

For all other spaces, the standard design shall have one gas storage water heater if any of the spaces have a Space Water Heating Fuel Type of Gas (from Appendix 5.4A), and the standard design building will have on electric water heater if the any of the spaces have a Space Water Heating Fuel Type of Electric.

*Standard Design: Existing Buildings:*

## **WATER MAINS TEMPERATURE SCHEDULE**

*Applicability:* All water heating systems.

*Definition:* A monthly temperature schedule indicating the water mains temperature.

This temperature and the setpoint temperature are used to convert the load into a water flow rate.

*Units:* Data structure - schedule, °F.

*Input Restrictions:* For nonresidential spaces, the schedules from Appendix 5.4A shall be used. The water mains temperature schedule shall be fixed for a given climate zone.

For multifamily residential spaces and residential living spaces of hotels and motels (guestrooms), the rules in Chapter 6 of the Nonresidential ACM Reference Manual are followed.

*Standard Design:* For nonresidential spaces, the schedules from Appendix 5.4A shall be used. The water mains temperature schedule shall be fixed for a given climate zone.

For high-rise residential spaces and residential living spaces of hotels and motels (guestrooms), the rules in Chapter 6 of the Nonresidential ACM Reference Manual are followed.

*Standard Design: Existing Buildings:*

### **5.9.1.2 Water Heaters**

This chapter describes the building descriptors for water heaters. Typically, a building will have multiple water heating systems and each system can have multiple water heaters, so these building descriptors may need to be specified more than once.

#### **WATER HEATER NAME**

*Applicability:* All water heaters.

*Definition:* A unique descriptor for each water heater in the system.

Some systems will have multiple pieces of equipment. For instance, a series of water heaters plumbed in parallel or a boiler with a separate storage tank.

*Units:* Text, unique.

*Input Restrictions:* Where applicable, this should match the tags that are used on the plans such that a plan reviewer can make a connection.

*Standard Design:* The naming convention for the standard design system shall be similar to the proposed design.

*Standard Design: Existing Buildings:*



## **WATER HEATER TYPE AND SIZE**

*Applicability:* All water heaters.

*Definition:* This building descriptor includes information needed to determine the criteria from baseline standards. The choices and the associated rated capacity (heat input rate) are listed in the *2015 Appliance Efficiency Regulations*, except that oil-fired water heaters and boilers are not supported.

*Units:* List conventional, heat pump split, or heat pump packaged.

*Input Restrictions:* As designed.

*Standard Design:* For healthcare facility spaces, the same as Proposed. For all other spaces, the standard design shall have one gas storage water heater if any of the spaces have a space water heating fuel type of gas (from Appendix 5.4A), and the standard design building will have one electric water heater if any of the spaces have a space water heating fuel type of electric.

For multifamily residential spaces and residential living spaces of hotels and motels (guestrooms), the rules in Chapter 6 of the *Nonresidential ACM Reference Manual* are followed.

*Standard Design: Existing Buildings:* Same as proposed if water heater is existing.

## **RATED CAPACITY**

*Applicability:* All water heaters.

*Definition:* For gas and electric resistance water heaters, the heating capacity of a water heater (input rate) at the rated conditions specified in DOE 10 CFR Part 430 or ANSI Z21.10. For heat pump water heaters, the rated heating capacity supplied to the water (output rate).

*Units:* Thousands of British thermal units per hour (MBH).

*Input Restrictions:* As designed.

*Standard Design:* The capacity of the standard design water heaters will be based on the larger of the total design hot water consumption rate (gallons/hr) of all the spaces in the building or 75 gallons per hour. The consumption rate is converted to Btu/hr ( $\times$  (design supply temp – 55)  $\times$  8.2877 pounds/gallon  $\times$  1 Btu/pound-F). That value is multiplied by 0.60 to find the heat that must be supplied to the water.

All of the water heaters in the proposed design are similarly converted to a total Btu/hr heat output, summed across the water heaters, and multiplied by 0.60.

The standard design uses the smaller of these values and divides by thermal efficiency to find energy input.

If the standard design has both a gas water heater and an electric water heater, the total capacity will be pro-rated between the two based on the total hot water consumption rate of the spaces with water heating fuel type of electric or gas.

*Standard Design: Existing Buildings:*

### **STORAGE VOLUME**

*Applicability:* Storage water heaters.

*Definition:* The volume of a storage water heater used in the standby loss calculations and standard design calculations of energy factor and uniform energy factor.

*Units:* Gallons.

*Input Restrictions:* As designed.

*Standard Design:* The volume of the standard design water heaters will be based on the larger of the total design hot water consumption rate (gallons/hr) of all the spaces in the building or 75 gallons per hour. That value is multiplied by 1 hour and 0.40 to determine the storage volume.

All of the water heaters in the proposed design are similarly converted to a total Btu/hr heat output, summed across the water heaters. This value is multiplied by 0.40 and converted to gallons ( $\text{design supply temp} - 55$ ) / 8.2877 pounds/gallon / 1 Btu/pound-F x 1 hr).

The standard design uses the smaller of these values.

If the standard design has both a gas water heater and an electric water heater, the total volume will be pro-rated between the two based on the total hot water consumption rate of the spaces with water heating fuel type of electric or gas.

For multifamily residential spaces and residential living spaces of hotels and motels (guestrooms), the rules in Chapter 6 of the *Nonresidential ACM Reference Manual* are followed.

*Standard Design: Existing Buildings:*

### **INPUT POWER**

*Applicability:* Heat pump water heaters.

*Definition:* The total design electrical input to a heat pump water heater at design conditions.

This power includes the input to the compressor, controls, evaporator fan, and pump (if present).

*Units:* Kilowatts (kW).

*Input Restrictions:* As designed.

*Standard Design:* Not applicable.

*Standard Design: Existing Buildings:*

### **STORAGE TANK LOCATION**

*Applicability:* Heat pump water heaters.

*Definition:* The location of a heat pump water heater.

*Units:* List:

- Conditioned
- Unconditioned

*Input Restrictions:* List see above.

*Standard Design:*

*Standard Design: Existing Buildings:*

### **ENERGY FACTOR**

*Applicability:* Equipment covered by the National Appliance Energy Conservation Act (NAECA), which includes small storage and instantaneous water heaters.

*Definition:* The energy factor (EF) is the ratio of the energy delivered by the water heater divided by the energy used, in the same units. EF is calculated according to the DOE 10 CFR Part 430 test procedure, which specifies a 24-hour pattern of draws, a storage temperature, inlet water temperature, and other test conditions. These conditions result in the energy delivered for the test period. Energy inputs are measured for the same test period and the EF ratio is calculated.

*Units:* Unitless ratio.

*Input Restrictions:* Building descriptors for the proposed design should be consistent with equipment specified on the construction documents or observed in the candidate building.

For water heaters manufactured after June 1, 2017, that contain a Uniform Energy Factor, the EF shall not be input by the user, but shall be calculated by:

$$F = \frac{(NUb) - (N^2PUa)}{d(U - N) + c(N^2P - NPU) - Ub + NPUa}$$

Where:

- *F* - Energy Factor
- *N* - Recovery Efficiency
- *P* - Power Input (W)
- *U* - UEF
- *N* - Recovery efficiency defined as 0.80 for storage water heater UEF to EF conversion

Draw Pattern

- Very Small
  - a. a - 0.250266
  - b. 57.5
  - c. 0.039864
  - d. 67.5
- Low
  - a. 0.065860
  - b. 57.5
  - c. 0.039864
  - d. 67.5
- Medium
  - a. 0.045503
  - b. 57.5
  - c. 0.039864
  - d. 67.5
- High
  - a. 0.029794
  - b. 57.5
  - c. 0.039864
  - d. 67.5

*Standard Design:* For nonresidential buildings and nonresidential spaces, the energy factor for the standard design system shall be determined from the *Appliance Efficiency Regulations*.

For multifamily residential spaces and residential living spaces of hotels and motels (guestrooms), the rules in Chapter 6 of the *Nonresidential ACM Reference Manual* are followed.

*Standard Design: Existing Buildings:*

### **UNIFORM ENERGY FACTOR**

*Applicability:* Equipment covered by NAECA that is rated after June 1, 2017, with a Uniform Energy Factor (UEF) that includes small storage and instantaneous water heaters.

*Definition:* The UEF defines an efficiency level for a specific targeted use pattern.

*Units:* Unitless ratio.

*Input Restrictions:* Must meet mandatory minimum requirements defined by federal or state appliance efficiency standards.

*Standard Design:* Not applicable.

*Standard Design: Existing Buildings:*

### **FIRST HOUR RATING**

*Applicability:* Water heating storage tanks with a UEF rating.

*Definition:* The first hour rating is a measure of the overall capacity of the water heater that incorporates both the heat input rate and the tank storage capacity and is used to determine the draw pattern.

*Units:* gal/hr.

*Input Restrictions:* As designed.

*Standard Design:* Not applicable.

*Standard Design: Existing Buildings:*

### **DRAW PATTERN**

*Applicability:* Storage water heating tanks with a UEF rating.

*Definition:* The draw pattern is determined as: very small, low, medium, or high from the user entry of first hour rating (FHR).

Very small: 0-18 gal/hr

Low: 18-51 gal/hr

Medium: 51-75 gal/hr

High: > 75 gal/hr

*Units:* List:

- Very small
- Low
- Medium
- High

*Input Restrictions:* Not user editable. Draw pattern is determined from FHR user input.

*Standard Design:* Not applicable.

*Standard Design: Existing Buildings:*

### **THERMAL EFFICIENCY**

*Applicability:* Oil and gas-fired water heaters or gas-service water heater systems not covered by NAECA.

*Definition:* The full load efficiency of a water heater at rated conditions expressed as a dimensionless ratio of output over input. It is also referred to as recovery efficiency.

*Units:* Unitless ratio.

*Input Restrictions:* Building descriptors for the proposed design should be consistent with equipment specified on the construction documents or observed in the candidate building.

*Standard Design:* For nonresidential buildings and nonresidential spaces, the thermal efficiency is determined from Table F-2 in the *Appliance Efficiency Regulations*.

For multifamily residential spaces and residential living spaces of hotels and motels (guestrooms), the rules in Chapter 6 of the *Nonresidential ACM Reference Manual* are followed.

*Standard Design: Existing Buildings:*

Baseline efficiency is set from the Appliance Efficiency Regulations

### **TANK STANDBY LOSS**

*Applicability:* Water heaters not covered by NAECA.

*Definition:* The tank standby loss for storage tanks, which includes the effect of recovery efficiency.

*Units:* Btu/h for the entire tank.

*Input Restrictions:* Standby loss is calculated as:

$$STBY = 577.5 \times S \times VOL$$

Where:

- *S* - The standby loss fraction listed in the CEC's Appliance Database of Certified Water Heaters
- *VO* - The actual storage capacity of the water heater as listed in the CEC's Appliance Database of Certified Water Heaters (gallons)

*Standard Design:* Table F-2 of the Appliance Efficiency Standards.

*Standard Design: Existing Buildings:*

### **TANK OFF-CYCLE LOSS COEFFICIENT**

*Applicability:* Water heaters.

*Definition:* The tank standby loss coefficient (*UA*) for the water heater.

For small water heaters covered by NAECA, the loss coefficient is a derived parameter, a function of the *EF* and recovery efficiency.

*Units:* Btu/h - °F.

*Input Restrictions:* For NAECA covered water heaters, the loss coefficient is calculated by:

$$UA = \frac{\frac{1}{EF} - \frac{1}{RE}}{67.5 \left( \frac{24}{41094} - \frac{1}{RE(P_{on})} \right)}$$

Where:

- *EF* - The energy factor of the rated water heater (unitless)
- *RE* - The recovery efficiency of the rated water heater. If this data is not available, the default shall be 0.78 for gas water heaters and 0.93 for electric water heaters.
- *P<sub>on</sub>* - The input power to the water heater, in Btu/h

*Standard Design:* For nonresidential spaces, 10 Btu/h-F. For multifamily residential spaces and residential living spaces of hotels and motels (guestrooms), the rules in Chapter 6 of the *Nonresidential ACM Reference Manual* are followed.

*Standard Design: Existing Buildings:*

The baseline loss coefficient for NAECA water heaters shall be 10 Btu/h-F for gas-fired water heaters

### **OFF CYCLE PARASITIC LOSSES**

*Applicability:* Water heaters.

*Definition:* The rate of parasitic losses, such as a pilot light or controls, when the water heater is not heating.

*Units:* Watts.

*Input Restrictions:* As designed.

*Standard Design:* 0.

*Standard Design: Existing Buildings:*

**OFF CYCLE FUEL TYPE**

*Applicability:* Water heaters.

*Definition:* The type of fuel that serves energy using parasitic equipment, such as a pilot light or controls, when the water heater is not heating.

*Units:* List electricity, gas, oil, or propane.

*Input Restrictions:* As designed.

*Standard Design:* Not applicable.

*Standard Design: Existing Buildings:*

**ON-CYCLE PARASITIC LOSSES**

*Applicability:* Water heaters.

*Definition:* The rate of parasitic losses, such as a pilot light or controls, when the water heater is not heating. It may be different than off-cycle losses if the flue energy is considered.

*Units:* Watts.

*Input Restrictions:* As designed.

*Standard Design:* Not applicable.

*Existing Buildings:*

**ON-CYCLE FUEL TYPE**

*Applicability:* Water heaters

*Definition:* The type of fuel that serves energy using parasitic equipment, such as a pilot light or controls, when the water heater is not heating

*Units:* List electricity, gas, oil, or propane

*Input Restrictions:* As designed

*Standard Design:* Not applicable

*Standard Design: Existing Buildings*

**WATER HEATER AMBIENT LOCATION**

*Applicability:* Water heaters.



*Definition:* The location of the water heater for determining losses and energy interaction with the surroundings.

*Units:* List schedule, zone, outdoors.

*Input Restrictions:* As designed.

*Standard Design:* Not applicable.

*Standard Design: Existing Buildings:*

### **WATER HEATER COMPRESSOR LOCATION**

*Applicability:* Heat pump water heaters.

*Definition:* The location of the heat pump compressor for determining losses and energy interaction with the surroundings.

The air temperature at the compressor location also controls the compressor's crankcase heater operation.

*Units:* List zone, outdoors.

*Input Restrictions:* As designed

*Standard Design:* Not applicable

*Standard Design: Existing Buildings*

### **TANK STANDBY LOSS FRACTION**

*Applicability:* Storage tank water heaters.

*Definition:* The tank standby loss fraction for storage tanks.

*Units:* Unitless.

*Input Restrictions:* Prescribed to the value listed in the Appliance Database of Certified Water Heaters.

*Standard Design:* Not applicable.

The part-load curve procedure in Title 24 can be an alternate method of specifying the effects of standby and parasitic losses on performance. The primary method is to specify a loss coefficient for the storage tank.

*Standard Design: Existing Buildings:*

### **FUEL WATER HEATER PART-LOAD EFFICIENCY CURVE**

*Applicability:* Water heating equipment for which a loss coefficient is not specified (alternate method).

*Definition:* A set of factors that adjust the full-load thermal efficiency for part load conditions; set as a curve.

*Units:* Percent (%).

*Input Restrictions:* The following prescribed curve shall be used based on user inputs. The curve shall take the form of a quadratic equation as follows:

$$Fuel_{partload} = Fuel_{design} \times FHeatPLC$$

$$FHeatPLC = \left( a + b \left( \frac{Q_{partload}}{Q_{rated}} \right) \right)$$

For Title 24, the coefficients shall be determined by:

$$a = \frac{STBY}{INPUT}$$

$$b = \frac{(INPUT \times RE) - STBY}{SRL}$$

$$PLR_n = \frac{SRL \times F_{whpl(n)}}{INPUT \times RE}$$

Recovery efficiency substituted with thermal efficiency when applicable.

For boilers, instantaneous gas, or other storage type water heaters, not in the scope of covered consumer products as defined in the Title 10 or the Code of Federal Regulations, Part 430:

$$STBY = 577.5 \times S \times VOL$$

Required inputs and standard and proposed design assumptions depend on the type of water heater and whether or not it is a DOE covered consumer product.

Where:

- $FHeatPLC$  - The fuel heating part load efficiency curve
- $Fuel_{partload}$  - The fuel consumption at part-load conditions (Btu/h)
- $Fuel_{design}$  - The fuel consumption at design conditions (Btu/h)

- $Q_{partload}$  - The water heater capacity at part-load conditions (Btu/h)
- $Q_{rated}$  - The water heater capacity at design conditions (Btu/h)
- $PLR_n$  - Part-load ratio for the  $n^{\text{th}}$  hour and shall always be less than 1
- $INPUT$  - The input capacity of the water heater expressed in Btu/hr
- $STBY$  - Hourly standby loss expressed in Btu/hr. For large storage gas water heaters,  $STBY$  is listed in the CEC's appliance database. The value includes pilot energy and standby losses. For all systems, refer to equation N2-62.
- $SRL$  - The standard recovery load, taken from Appendix 5.4A, in Btu/hr, adjusted for the number of occupants according to the occupancy schedules.
- $S$  - The standby loss fraction listed in the CEC's Appliance Database of Certified Water Heaters
- $VOL$  - The actual storage capacity of the water heater as listed in the Appliance Database of Certified Water Heaters

*Standard Design:* Not applicable.

*Standard Design: Existing Buildings:*

### **5.9.1.3 Recirculation Systems**

This chapter describes the building descriptors for hot water recirculation systems. The standard design has a recirculation system when the proposed design does. This is one aspect of the water heating system configuration (see above).

Recirculating systems shall follow the rules set forth in Appendix E of the *Residential ACM Reference Manual*.

### **5.9.1.4 Water Heating Auxiliaries**

#### **EXTERNAL STORAGE TANK INSULATION**

*Applicability:* All water heating systems that have an external storage tank.

*Definition:* Some water heating systems have a storage tank that is separate from the water heater(s) that provides additional storage capacity. This building descriptor addresses the heat loss related to the external tank, which is an additional load that must be satisfied by the water heater(s).

*Units:* R-value (h-ft<sup>2</sup>-F/Btu).

*Input Restrictions:* As specified in manufacturer data and documented on the construction documents.

*Standard Design:* Heat loss associated with the storage tank in the standard design shall meet the requirements for an unfired storage tank in the baseline standards which is an

insulation R-value of 12.5. The surface area and location of the storage tank shall be the same as the proposed design.

*Standard Design: Existing Buildings:*

#### **EXTERNAL STORAGE TANK AREA**

*Applicability:* All water heating systems that have an external storage tank.

*Definition:* Some water heating systems have a storage tank that is separate from the water heater(s) that provides additional storage capacity. This documents the entire exterior surface area of the tank.

*Units:* ft<sup>2</sup>.

*Input Restrictions:* As specified in manufacturer specifications.

*Standard Design:* Not applicable.

*Standard Design: Existing Buildings:*

#### **EXTERNAL STORAGE TANK LOCATION**

*Applicability:* All water heating systems that have an external storage tank.

*Definition:* Location of the storage tank, used to determine the heat loss rate and energy exchange with the surroundings.

*Units:* List schedule, zone, outdoors.

*Input Restrictions:* As designed.

*Standard Design:* Not applicable.

*Standard Design: Existing Buildings:*

#### **SOLAR THERMAL**

*Applicability:* Water heating systems with a solar thermal system.

*Definition:* A solar thermal water heating system consists of one or more collectors. Water is passed through these collectors and is heated under the right conditions. There are two general types of solar water heaters: integrated collector storage (ICS) systems and active systems. Active systems include pumps to circulate the water, storage tanks, piping, and controls. ICS systems generally have no pumps and piping is minimal.

Solar systems may be tested and rated as a complete system or the collectors may be separately tested and rated. Solar Rating & Certification Corporation (SRCC) OG-300 is the test procedure for whole systems and SRCC OG-100 is the test procedure for collectors. The building descriptors used to define the solar thermal system may vary with each software application and with the details of system design.

The solar fraction shall be estimated by the f-chart procedure for solar water heating systems.

*Units:* Unitless fraction.

*Input Restrictions:* For multifamily residential buildings, the solar fraction provided by the solar DHW system shall be between 0 and 1. For all other buildings, the value is 0 (solar thermal may not be modeled for compliance.).

*Standard Design:* The standard design has no solar auxiliary system.

*Standard Design: Existing Buildings:*

### **COMBINED SPACE HEATING AND WATER HEATING**

*Applicability:* Projects that use a boiler to provide both space heat and water heating.

*Definition:* A system that provides both space heating and water heating from the same equipment, generally the space heating boiler. Such systems are restricted by the baseline standards but may be modeled in the candidate building. The restrictions are due to the misalignment of the space heating load and the water heating load. The first is highly intermittent and weather dependent, and the latter is more constant and not generally weather-related.

*Units:* Data structure.

*Input Restrictions:* The proposed design may have a combined space and water heating system.

*Standard Design:* The standard design shall be modeled with separate space heating and water heating systems.

*Standard Design: Existing Buildings:*

### **5.9.2 Exterior Lighting**

Outdoor lighting requirements are specified in §140.7 of the standards. Outdoor lighting shall not be modeled in the proposed design or standard design, and no tradeoffs are available with other building end uses or systems. Outdoor lighting shall meet all prescriptive requirements in the standards.

### **5.9.3 Other Electricity Use**

This set of building descriptors should be used to include any miscellaneous electricity use that would add to the electric load of the building and would be on the building meter. These energy uses are assumed to be outside the building envelope and do not contribute heat gain to any thermal zone.

### **MISCELLANEOUS ELECTRIC POWER**

*Applicability:* All buildings with miscellaneous electric equipment located on the building site.

*Definition:* The power for miscellaneous equipment.

*Units:* Watts (W).

*Input Restrictions:* As designed.

*Standard Design:* Same as the proposed design.

*Standard Design: Existing Buildings:*

### **MISCELLANEOUS ELECTRIC SCHEDULE**

*Applicability:* All buildings with miscellaneous electric equipment located on the building site.

*Definition:* The schedule of operation for miscellaneous electric equipment that is used to convert electric power to energy use.

*Units:* Data structure - schedule, fractional.

*Input Restrictions:* The schedule specified for the building should match the operation patterns of the system.

*Standard Design:* Same as the proposed design.

*Standard Design: Existing Buildings:*

### **5.9.4 Other Gas Use**

This set of building descriptors should be used to include any miscellaneous gas use that would add to the load of the building and would be on the building meter. These energy uses are assumed to be outside the building envelope and do not contribute heat gain to any thermal zone.

### **OTHER GAS POWER**

*Applicability:* All buildings that have commercial gas equipment.

*Definition:* Gas power is the peak power which is modified by the schedule (see below).

*Units:* Btu/h-ft<sup>2</sup>.

*Input Restrictions:* As designed.

*Standard Design:* Same as the proposed design.

*Standard Design: Existing Buildings:*

### **OTHER GAS SCHEDULE**

*Applicability:* All buildings that have commercial gas equipment.

*Definition:* The schedule of operation for commercial gas equipment that is used to convert gas power to energy use.

*Units:* Data structure - schedule, fractional.

*Input Restrictions:* Continuous operation is prescribed.

*Standard Design:* Same as the proposed design.

*Standard Design: Existing Buildings:*

---

## **5.10 Onsite Energy Generation and Storage**

### **5.10.1 Onsite Photovoltaic Energy Generation**

#### **PV RATED CAPACITY**

*Applicability:* All buildings that have onsite photovoltaics.

*Definition:* The rated DC capacity of the system in kilowatts.

*Units:* kW.

*Input Restrictions:* Non-negative value.

*Standard Design:* Requirement in 2022 Title 24 Part 6, Table 140.10-A, times the conditioned floor area of the building.

*Standard Design: Existing Buildings:* Same as the proposed.

#### **PV AZIMUTH**

*Applicability:* All buildings that have onsite photovoltaics.

*Definition:* The azimuth in degrees from true North (180F for South, for instance). Not applicable for building-integrated panels or panels installed with no tilt.

*Units:* Degrees.

*Input Restrictions:* 0 to 360 degrees.

*Standard Design:* 180 degrees (face South).

*Standard Design: Existing Buildings:* Same as the proposed.

#### **PV TILT**

*Applicability:* All buildings that have onsite photovoltaics.

*Definition:* The tilt of the PV panels from horizontal, in degrees.

*Units:* Degrees.

*Input Restrictions:* 0 to 90 degrees.

*Standard Design:* 10 degrees.

*Standard Design: Existing Buildings:* Same as the proposed.

### **PV TRACKING**

*Applicability:* All buildings that have onsite photovoltaics.

*Definition:* Tracking systems can have one-axis or two-axis tracking.

*Units:* Degrees.

*Input Restrictions:* List: None, 1-axis, 2-axis.

*Standard Design:* None.

*Standard Design: Existing Buildings:* Same as the proposed.

### **PV INVERTER EFFICIENCY**

*Applicability:* All buildings that have onsite photovoltaics.

*Definition:* The rated efficiency of the inverter in converting DC to AC power.

*Units:* Percent.

*Input Restrictions:* 0-100 percent.

*Standard Design:* 94 percent.

*Standard Design: Existing Buildings:* Same as the proposed.

## **5.10.2 Battery Storage**

### **BATTERY ENERGY STORAGE CAPACITY**

*Applicability:* All buildings that have onsite battery storage.

*Definition:* The storage capacity of all onsite battery storage, in kWh.

*Units:* kWh.

*Input Restrictions:* Positive number.

*Standard Design:* The battery storage matches requirements in 2022 Title 24, Part 6 Table 140.10-B, times the conditioned floor area.

*Standard Design: Existing Buildings:* Same as the proposed.

### **BATTERY POWER STORAGE CAPACITY**



*Applicability:* All buildings that have onsite battery storage.

*Definition:* The power storage capacity of all onsite battery storage. This equals the building load (power) that can be offset when the battery is discharging. Typical batteries have rated power storage for 2 to 4 hours of discharge capacity.

*Units:* kW.

*Input Restrictions:* Positive number.

*Standard Design:* The battery storage matches requirements in 2022 Title 24, Part 6 Table 140.10-B, times the conditioned floor area.

*Standard Design: Existing Buildings:* Same as the proposed.

### **BATTERY DISCHARGE CONTROL**

*Applicability:* All buildings that have onsite battery storage.

*Definition:* Batteries for energy storage can be controlled by one or more strategies.

*Units:* kW.

*Input Restrictions:* List:

Charge NEM – PV production exceeds building load

Charge Off-Peak – PV production off-peak charges battery even if building load exceeds demand

Discharge On-Peak

*Standard Design:* Fixed sequence of.

*Standard Design: Existing Buildings:* Same as the proposed.

---

## **5.11 Common Data Structures**

This chapter describes common data structures. The data structures presented here define objects and example parameters needed to define them. The parameters described are the most common for energy simulation engines. However, other parameters or data constructs are acceptable. The fields used by the simulation program must be mapped to the fields used by the building descriptor.

### **5.11.1 Schedule**

This data structure provides information on how equipment, people, lights, or other items are operated on an hourly basis. The ultimate construct of a schedule is an hourly time series for the simulation period, typically 8,760 hours (365 days, 24 hours per day).

Software has often built up the hourly schedule from 24-hour schedules for different day types such as weekdays, Saturdays, Sundays, holidays, etc.

There are several types of schedules:

- Temperature schedules specify a temperature to be maintained in a space, a temperature to be delivered from an air handler, or the leaving temperature from a chiller or other equipment.
- Fraction schedules specify the fraction of lights that are on, the fraction of people that are in the space, the fraction of maximum infiltration, or other factors.
- On/off schedules specify when equipment is operating or when infiltration is occurring.
- Time period schedules define periods of time for equipment sequencing, utility tariffs, etc. A time period schedule typically breaks the year in to two or more seasons. For each season, day types are identified such as weekday, Saturday, Sunday, and holidays. Each day type in each season is then divided into time periods.

### **5.11.2 Holidays**

A series of dates defining holidays for the simulation period. Dates identified are operated for the schedule specified for holidays.

### **5.11.3 Surface Geometry**

This data structure represents the location, size, and position of a surface. Surfaces include roofs, walls, floors, and partitions. Surfaces are typically planar and can be represented in various manners, including:

- Rectangular surfaces, which may be represented by a height and width along with the X, Y, and Z of surface origin, and the tilt and azimuth.
- By a series of vertices (X, Y, and Z coordinates defining the perimeter of a surface). More complex polygons may be represented in this manner.

### **5.11.4 Opening Geometry**

This data structure represents the location and size of an opening within a surface. The most common method of specifying the geometry of an opening is to identify the parent surface, the height and width of the opening, and the horizontal and vertical offset (X and Y coordinates relative to the origin of the parent surface). An opening can also include a recess into the parent surface, which provides shading. However, other geometric constructs are acceptable.

### **5.11.5 Opening Shade**

This data structure describes the dimensions and position of external shading devices such as overhangs, side fins, or louvers that shade the opening. Overhangs are specified in terms of the projection distance, height above the opening, and extension distance on each side of the opening.

### **5.11.6 Construction Assembly**

This data structure describes the layers that make up the construction of a wall, roof, floor, or partition. Typically, a construction consists of a sequence of materials, described from the outside surface to the inside surface.

### **5.11.7 Fenestration Construction**

This data structure describes the frame, glass, and other features of a window or skylight. Information may be defined in multiple ways, but the criterion is published as a combination of U-factor, solar heat gain coefficient (SHGC), and visible light transmission (VT). Some simulation programs use more detailed methods of describing the performance of fenestration that consider the angle of incidence of sun striking the fenestration and other factors, such as the properties of each pane and the fill. The compliance software only uses whole window performance properties (U-factor, SHGC, VT).

### **5.11.8 Material**

This data structure describes a material that is used to build up a construction assembly. Typical material properties include specific heat, density, conductivity, and thickness. Materials can also be described in terms of their thermal resistance. The latter approach is sometimes used to approximate construction layers that are not homogeneous, such as framing members in combination with cavity insulation.

### **5.11.9 Slab Construction**

This data structure describes the composition of a slab-on-grade. The compliance model has building descriptors for the perimeter length and the F-factor, which represents the heat loss per lineal foot.

---

## **5.12 Exterior Surface Properties**

This data structure describes the characteristics of exterior surfaces. Exterior surface properties may include emissivity, reflectivity, and roughness. The first two govern radiation exchange from the surface, while the latter governs the magnitude of the exterior air film resistance.

### **5.12.1 Occupant Heat Rate**

This data structure represents the rate of heat and moisture generated by building occupants. This is typically specified in terms of a sensible heat rate and a latent heat rate. Both are specified in Btu/h.

### **5.12.2 Furniture and Contents**

This data structure represents the thermal mass effect of furniture and other building contents. This is expressed in terms of lb/ft<sup>2</sup> for the space in question.

### **5.12.3 Reference Position in a Space**

This data structure locates a reference point in a space, typically for the purposes of daylighting control. The typical construct for the reference point is a set of coordinates (X, Y, and Z) relative to the space coordinate system.

---

## **5.13 Two-Dimensional Curve**

This data structure explains one parameter in terms of another. An example is a curve that modifies the efficiency of an air conditioner relative to the fraction of time that the equipment operates within the period of an hour. The relationship can be expressed in terms of the X and Y coordinates of points on the curve, or it can be expressed as an equation.

### **5.13.1 Three-Dimensional Curve**

This data structure explains one parameter in terms of two others. An example is a curve that modifies the efficiency of an air conditioner relative to the outside air dry-bulb temperature and the wet-bulb temperature of air returning to the coil. The relationship is a three-dimensional surface and can be expressed in terms of the X and Y coordinates of points on the curve, or it can be expressed as an equation.

### **5.13.2 Temperature Reset Schedule**

This data structure describes the relationship between one temperature and another. For example, the independent variable might be outside air temperature and the dependent variable is supply air temperature. In this case, a common schedule would be to set the supply air temperature at 55°F when the outside air temperature is 80°F or warmer and at 62°F when the outside air temperature is 58°F or cooler with the supply air temperature scaling between 55°F and 62°F when the outside air temperature is between 80°F and 58°F.

## 6. Multifamily Building Descriptors Reference

---

### 6.1 Standard Design Multifamily

For multifamily buildings, the standard design building, from which the energy budget is established, is in the same location and has the same floor area, volume, and configuration as the proposed design. For additions and alterations, the standard design shall have the same wall and fenestration areas and orientations as the proposed building. The details are described below.

The *energy budget* for the residential standard design is the energy that would be used by a building similar to the proposed design if the proposed building met the requirements of the prescriptive standards. The compliance software generates the standard design automatically, based on fixed and restricted inputs and assumptions. Custom energy budget generation shall not be accessible to program users for modification when the program is used for compliance or when the program generates compliance forms.

The basis of the standard design is prescriptive requirements from §170.2 of the Energy Code. Prescriptive requirements vary by climate zone. Reference Appendices, Joint Appendix JA2, Table 2-1, contains the 16 California climate zones and representative cities. The climate zone is based on the zip code for the proposed building, as documented in JA2.1.1.

The following chapters present the details of how the proposed design and standard design are determined. For many modeling assumptions, the standard design is the same as the proposed design. When a building has special features, for which the CEC has established alternate modeling assumptions, the standard design features will differ from the proposed design so the building receives appropriate credit for its efficiency. When measures require verification by a Home Energy Rating System (HERS) rater or are designated as a *special feature*, the specific requirement is listed on the LMCC.

---

### 6.2 Proposed Design Multifamily

The multifamily building configuration is defined by the user through entries that include floor areas, wall areas, roof and ceiling areas, fenestration (which includes skylights), and door areas, the performance characteristics such as U-factors, R-values, solar heat gain coefficient (SHGC), solar reflectance, and information about the orientation and tilt is required for roofs, fenestration, and other elements, and end use energy use such as HVAC, lighting, and DHW. Details about any solar generation

systems and battery storage are also defined. The user entries for all these building elements are consistent with the actual building design and configuration. If the compliance software models the specific geometry of the building by using a coordinate system or graphic entry technique, the data generated are consistent with the actual building design and configuration.

---

### **6.3 Self-Utilization Credit Multifamily**

When a PV system is coupled with battery storage system, the software allows a portion of the PV/flexibility TDV to be traded against the efficiency TDV. This modest credit can be used for tradeoffs against building envelope and efficiencies of the equipment installed in the building. More detail is provided in Chapter 6.5.1

---

### **6.4 Demand Response Multifamily**

Appropriate demand response controls allow building operators to reduce the total cost of energy by automating the response of a building to changes in electricity rates. Demand response is an increasingly important function as distributed energy resources become more common, as customers have access to time-of-use (TOU) electricity rates, and incentive programs are designed to encourage customers to reduce energy use during peak demand. Demand response occurs on a range of timescales from seconds to seasons and represents any demand change in response to grid or economic needs. In addition to current TOU electricity rates, in the future, utilities will likely connect electricity costs to high-frequency fluctuations in supply and demand for electricity.

#### **6.4.1 Precooling Multifamily**

Precooling takes advantage of TOU rate schedules that are the default rates for many utility companies. The software simulates the dwelling unit being precooled in the hours preceding the onset of the highest peak rates (typically between 4 p.m. and 7 p.m.) and shutting off the cooling system for most, or all, of the highest peak period hours. For participating customers, the thermostat receives a signal from the local utility that contains the information for start and stop of the precooling period, which is determined by the forecasted temperatures for that day.

Precooling credit requires the dwelling owner to enter into an agreement with the local utility. This agreement provides a discount to the homeowner/ratepayer in exchange for controlling the thermostat during critical peak periods. The thermostat and demand response requirements are from the Standards §110.12(a) and Reference Appendices, Joint Appendix JA5.

---

## 6.5 Photovoltaic and Battery Storage Requirements

Requirements for PV systems and battery storage systems are dependent on the number of stories of the building. Multifamily buildings with three or fewer habitable stories have different requirements than multifamily buildings more with more than three habitable stories. Modeling software will calculate PV system and battery storage systems based on the number of habitable stories of the buildings

### 6.5.1 Photovoltaics Requirements Three Habitable Stories or Less

The PV requirements are applicable to newly constructed multifamily buildings three habitable stories or less. PV system details are from PVWatts, which is a web application developed by the National Renewable Energy Laboratory. See Appendix F. for more information.

#### PHOTOVOLTAICS STANDARD DESIGN THREE HABITABLE STORIES OR LESS

The standard design PV system (based on California flexible installation [CFI] assumptions) is sized to generate just enough electricity to offset the annual kWh consumption for a mixed fuel building that meets all the 2022 prescriptive requirements.

This standard design PV system is shown on the energy use details screen where the standard design site (kilowatt-hours [kWh]) total is zero after the PV is subtracted (Figure 12).

For PV sizing calculations, the software assumes the CFI orientation (150-270 degrees), standard efficiency for modules and inverters, fixed tracking, standard (excluding horizon) shading, and roof tilt of 22.61 degrees (5:12 pitch).

#### PHOTOVOLTAICS PROPOSED DESIGN THREE HABITABLE STORIES OR LESS

The proposed PV system is sized to generate the amount of electricity to offset the annual kWh consumption of the proposed design.

For PV sizing calculations, the software includes user-defined values for:

1. Array orientation, including CFI1 (installation of 150–270 degrees, CFI2 (installation of 105-300), or the actual orientation.
2. Module type, including standard (for example, poly- or monocrystalline silicon modules), premium (for example, high-efficiency monocrystalline silicon modules with anti-reflective coatings), or thin film (in other words, low efficiency such as 11 percent).
3. Inverter efficiency.

- 4. Array tilt in degrees or roof pitch, or CFI1 or CFI2 (installation up to 7:12).
- 5. Array tracking type including fixed, single-axis tracking, and two-axis tracking.
- 6. Annual solar access percentage, excluding horizon shading, of the modules.

The PV size is reported in kWdc.

**Figure 9: Energy Use Details**

Compliance Summary   CO2 Emissions   Energy Design Rating   Energy Use Details   CO2 Details							
End Use	Standard Design Site (kWh)	Standard Design Site (therms)	Standard Design (kTDV/ft <sup>2</sup> -yr)	Proposed Design Site (kWh)	Proposed Design Site (therms)	Proposed Design (kTDV/ft <sup>2</sup> -yr)	Compliance Margin (kTDV/ft <sup>2</sup> -yr)
Space Heating	157	231.6	20.34	157	231.6	20.34	0.00
Space Cooling	1,560		38.39	1,560		38.39	0.00
IAQ Ventilation	247		2.53	247		2.53	0.00
Water Heating	88	121.2	9.91	88	121.2	9.91	0.00
Self Utilization Credit						0.00	0.00
Compliance Total			71.17			71.17	0.00
Photovoltaics	-6,268		-54.30	-6,268 *		-54.30	- %
Battery						0.00	
Flexibility							
Inside Lighting	616		6.96	616		6.96	
Appl. & Cooking	1,078	47.9	15.08	1,078	47.9	15.08	
Plug Loads	2,371		25.00	2,371		25.00	
Exterior	152		1.60	152		1.60	
<b>TOTAL</b>	<b>0</b>	400.8	65.51	0	400.8	65.51	
Generation Coincident Peak Demand (kW): Standard Design: 2.85 Proposed Design: 2.85 Reduction: 0.00							
* PV System resized to 3.94 kWdc (a factor of 3.937) to achieve 'Standard Design PV' PV scaling							

Source: California Energy Commission

**COMMUNITY SOLAR THREE HABITABLE STORIES OR LESS**

For projects that use an approved Neighborhood Solar Shares (NSS) program to provide the required PV, click the "Use Community Solar" checkbox on the PV tab and select the NSS program from the drop-down list. The software will automatically use the PV characteristics of the NSS program site to size the required PV system for the building.



Figure 10: Community Solar

Project	Analysis	EDR / PV	Battery	Notes	Building	Appliances / DHW	ADU	IAQ
<input checked="" type="checkbox"/> Use Community Solar		Project: <input type="text" value="- select CS project -"/>						

Source: California Energy Commission

**EXCEPTIONS TO THE PV REQUIREMENTS THREE HABITABLE STORIES OR LESS**

1. No PV system is required if the solar access roof area (SARA) is less than 80 contiguous square feet. SARA of the building is described in §170.2(f) of the Energy Code.
2. No PV system is required when the minimum PV system size specified by §170.2(f) of the Energy Code is less than 1.8 kWdc.
3. Buildings with enforcement-authority-approved roof designs, where the enforcement authority determines it is not possible for the PV system, including panels, modules and components and supports and attachments to the roof structure, to meet the requirements of the American Society of Civil Engineers (ASCE), Standard 7-16, Chapter 7, Snow Loads.
4. For buildings that are approved by the local planning department prior to January 1, 2020, with mandatory conditions for approval, shading from roof designs and configurations for steep-sloped roofs, which are required by the mandatory conditions for approval, shall be considered for the annual solar access calculations and roof areas that are not allowed by the mandatory conditions for approval to have PVs shall not be considered in determining the SARA.
5. PV system sizes determined using Equation 170.2-C may be reduced by 25 percent if installed in conjunction with battery storage system. The battery storage system shall meet the qualification requirements specified in Joint Appendix JA12 and have a minimum usable capacity of 7.5 kWh.

When the solar electric generation system meets one of the prescriptive exceptions, the standard design is modeled with an appropriately sized PV system. The proposed design is modeled with a system size that does not exceed the PV size required by the standard design.

**BATTERY STORAGE THREE HABITABLE STORIES OR LESS**

Detailed calculations for PV and battery storage are included in Appendices C and D.

The software provides credit for a battery storage system coupled with a PV array. If specified, the battery storage size must be 5 kWh or larger. For Part 6 compliance, PV has no impact on energy efficiency requirements or the efficiency TDV unless a battery storage system is included and the self-utilization credit is modeled.

Including a battery storage system allows downsizing the PV system to reach a specific TDV target.

Software includes a checkbox option to allow excess PV generation credit for above-code programs. This option, combined with a battery storage system, allows any PV size with full TDV credit.

### **BATTERY CONTROLS THREE HABITABLE STORIES OR LESS**

The three control options available, which are described in *Reference Appendix Joint Appendix 12*, are:

1. Basic (Default Control). A simple control strategy that provides a modest credit. The software assumes that the batteries are charged anytime PV generation (generation) is greater than the house load (load); conversely, the batteries are discharged when load exceeds generation. This control strategy does not allow the batteries to discharge into the grid.
2. Time of Use. To qualify for the TOU control, the battery storage system shall be installed in the default operation mode to allow charging from an on-site PV system or from the utility grid if a standalone battery storage system. The battery storage system shall begin discharging during the highest-priced TOU hours of the day, which varies by time of the year and the local utility. At a minimum, the system shall be capable of programming three seasonal TOU schedules, such as spring, summer, and winter. This option allows discharging directly into the grid.
3. Advanced Demand Flexibility Control. To qualify for the advanced demand flexibility control, the battery storage system shall be programmed by default as basic control or TOU control, as described above. The battery storage control shall meet the demand-responsive control requirements specified in §110.12(a). The battery storage system shall have the capability to change the charging and discharging periods in response to signals from the local utility or a third-party aggregator. Upon receiving a demand response signal from a grid operator, this option allows discharging directly into the grid.

Qualification for battery storage systems is described in Reference Appendices, Joint Appendix JA12.

**VERIFICATION AND REPORTING HABITABLE STORIES OR LESS**

PV required size and battery system storage details are reported as special features on the LMCC.

**SELF-UTILIZATION CREDIT THREE HABITABLE STORIES OR LESS**

The 2022 Energy Code do not allow a tradeoff between the Efficiency TDV and the effect of PV on the Total TDV unless battery storage is provided. When the PV system is coupled with at least a 5 kWh battery storage system, the software allows a portion of the PV/flexibility TDV to be traded against the Efficiency TDV. A modest self-utilization credit can be used for tradeoffs against building envelope and efficiencies of the equipment installed in the building. A checkbox is provided in the software to enable this credit.

The magnitude of the credit is equal to the 90 percent of the difference between the 2022 and 2016 Standards envelope requirements, including:

1. Below-deck batt roof insulation value of R-19 for the 2022 Standards, and R-13 for the 2016 Standard.
2. Wall U-factor of 0.048 for the 2022 Standards, and U-factor of 0.051 for the 2016 Standards.
3. Window U-factor of 0.30 for the 2022 Standards, and window U-factor of 0.32 for the 2016 Standards.
4. In cooling climate zones, window SHGC of 0.23 for the 2022 Standards, and 0.25 for the 2016 Standards.
5. QII requirement in the 2022 standards, and no QII requirements in the 2016 Standards.

**Table 14: Self-Utilization Credits**

<b>Climate Zone</b>	<b>Multifamily</b>
01	10%
02	7%
03	6%
04	8%
05	5%
06	3%

Climate Zone	Multifamily
07	2%
08	6%
09	7%
10	6%
11	8%
12	9%
13	8%
14	8%
15	6%
16	8%

Source: California Energy Commission

**6.5.2 Photovoltaics and Battery Storage Requirements More Than Three Habitable Stories**

The PV system and battery storage system requirements in this chapter are applicable to newly constructed multifamily buildings more than three habitable stories. PV system details are from PVWatts, which is a web application developed by the National Renewable Energy Laboratory. See Appendix F. for more information.

**PHOTOVOLTAICS STANDARD DESIGN MORE THAN THREE HABITABLE STORIES**

For multifamily buildings more than three habitable stories and mixed occupancy buildings more than three habitable stories with at least 80 percent of the floor area used for residential occupancy, a newly installed PV system meeting the minimum qualification requirements of Reference Joint Appendix JA11 is required. The PV size in kWdc is the smaller of the PV system size determined by Equation 170.2-D, or the total of all available SARA multiplied by 14 W/ft<sup>2</sup>.

**PHOTOVOLTAICS PROPOSED DESIGN MORE THAN THREE HABITABLE STORIES**

The proposed PV system is sized to generate the amount of electricity to offset the annual kWh load of the proposed design.

For PV sizing calculations, the software includes user-defined values for:

1. Array orientation, including CFI1 (installation of 150–270 degrees, CFI2 (installation of 105-300), or the actual orientation.

2. Module type, including standard (for example, poly- or monocrystalline silicon modules), premium (for example, high-efficiency monocrystalline silicon modules with anti-reflective coatings), or thin film (in other words, low efficiency such as 11 percent).
3. Inverter efficiency.
4. Array tilt in degrees or roof pitch, or CFI1 or CFI2 (installation up to 7:12).
5. Array tracking type including fixed, single-axis tracking, and two-axis tracking.
6. Annual solar access percentage, excluding horizon shading, of the modules.

The PV size is reported in kWdc.

**Figure 11: Energy Use Details**

Compliance Summary   CO2 Emissions   Energy Design Rating   Energy Use Details   CO2 Details							
End Use	Standard Design Site (kWh)	Standard Design Site (therms)	Standard Design (kTDV/ft <sup>2</sup> -yr)	Proposed Design Site (kWh)	Proposed Design Site (therms)	Proposed Design (kTDV/ft <sup>2</sup> -yr)	Compliance Margin (kTDV/ft <sup>2</sup> -yr)
Space Heating	157	231.6	20.34	157	231.6	20.34	0.00
Space Cooling	1,560		38.39	1,560		38.39	0.00
IAQ Ventilation	247		2.53	247		2.53	0.00
Water Heating	88	121.2	9.91	88	121.2	9.91	0.00
Self Utilization Credit						0.00	0.00
Compliance Total			71.17			71.17	0.00
Photovoltaics	-6,268		-54.30	-6,268 *		-54.30	- %
Battery						0.00	
Flexibility							
Inside Lighting	616		6.96	616		6.96	
Appl. & Cooking	1,078	47.9	15.08	1,078	47.9	15.08	
Plug Loads	2,371		25.00	2,371		25.00	
Exterior	152		1.60	152		1.60	
<b>TOTAL</b>	<b>0</b>	<b>400.8</b>	<b>65.51</b>	<b>0</b>	<b>400.8</b>	<b>65.51</b>	
Generation Coincident Peak Demand (kW): Standard Design: 2.85 Proposed Design: 2.85 Reduction: 0.00							
* PV System resized to 3.94 kWdc (a factor of 3.937) to achieve 'Standard Design PV' PV scaling							

Source: California Energy Commission

**EXCEPTIONS TO THE PV REQUIREMENTS MORE THAN THREE HABITABLE STORIES**

1. No PV system is required if the total solar access roof area (SARA) is less than three percent of the conditioned floor area. SARA of the building is described in §170.2(g) of the Energy Code.

2. No PV system is required when the minimum PV system size specified by §170.2(g) of the Energy Code is less than 4 kWdc.
3. No PV system is required if the solar access roof area (SARA) is less than 80 contiguous square feet.
4. Buildings with enforcement-authority-approved roof designs, where the enforcement authority determines it is not possible for the PV system, including panels, modules and components and supports and attachments to the roof structure, to meet the requirements of the American Society of Civil Engineers (ASCE), Standard 7-16, Chapter 7, Snow Loads.
5. Multi-tenant buildings in areas where a load serving entity does not provide either a Virtual Net Energy Metering or community solar program.

When the solar electric generation system meets one of the prescriptive exceptions, the standard design is modeled with an appropriately sized PV system. The proposed design is modeled with a system size that does not exceed the PV size required by the standard design.

#### **BATTERY STORAGE STANDARD DESIGN MORE THAN THREE HABITABLE STORIES**

For multifamily buildings more than three habitable stories that are required to have a PV System through §170.2(g), a battery storage system meeting qualification requirements of Reference Joint Appendix JA12 is also required. The battery system capacity and rated power is determined by Equation 170.2-E and Equation 170.2-F respectively.

#### **BATTERY STORAGE PROPOSED DESIGN MORE THAN THREE HABITABLE STORIES**

Detailed calculations for PV and battery storage are included in Appendices C and D.

The software provides credit for a battery storage system coupled with a PV array. If specified, the battery storage size must be 5 kWh or larger. For Part 6 compliance, PV has no impact on energy efficiency requirements or the efficiency TDV unless a battery storage system is included and the self-utilization credit is modeled.

Including a battery storage system allows downsizing the PV system to reach a specific TDV target.

Software includes a checkbox option to allow excess PV generation credit for above-code programs. This option, combined with a battery storage system, allows any PV size with full TDV credit.

**EXCEPTIONS TO THE BATTERY STORAGE REQUIREMENTS MORE THAN THREE HABITABLE STORIES**

1. No battery storage system is required if the installed PV system size is less than 15 percent of the size determined by Equation 170.2-D.
2. No battery storage system is required when the required battery storage system rated capacity is less than 10 kWh.
3. For multi-tenant buildings, the energy capacity and power capacity of the battery storage system shall be based on the tenant spaces with more than 5,000 square feet of conditioned floor area. For single-tenant buildings with less than 5,000 square feet of conditioned floor area, no battery storage system is required.

When the solar electric generation system meets one of the prescriptive exceptions, the standard design is modeled with an appropriately sized battery storage system. The proposed design is modeled with a system size that does not exceed the battery system capacity and rated power required by the standard design.

---

**6.6The Building****PROPOSED DESIGN**

The building is defined through entries for zones, surfaces, and equipment. Zone types include attic, conditioned space, crawl space, basements, and garages. The roof (such as asphalt shingles or tile) is defined as either part of the attic or part of a cathedral ceiling (also called a *rafter roof*). The software models surfaces separating conditioned space from exterior or unconditioned spaces (such as a garage or storage) as interior surfaces adjacent to the unconditioned zone. Exterior surfaces of an attached garage or storage space are modeled as part of the unconditioned zone.

The input file will include entries for floor areas, wall, door, roof and ceiling areas, and fenestration and skylight areas, as well as the water-heating, space-conditioning, ventilation, and distribution systems.

Each surface area is entered along with performance characteristics, including building materials, U-factor, and SHGC. The orientation and tilt (Figure 15 are required for envelope elements.

Building elements are to be consistent with the actual building design and configuration.

**STANDARD DESIGN**

To determine the standard design, the software creates a building with the same general characteristics (number of stories, attached garage, climate zone). Energy features are set to be equal to §170.2, Table 170.2-A and Table 170.2-K for multifamily

buildings. For additions and alterations, the standard design for existing features in the existing building shall have the same wall and fenestration areas and orientations as the proposed building. The details are below.

### VERIFICATION AND REPORTING

All inputs that are used to establish compliance requirements are reported on the LMCC.

**Figure 12: Surface Definitions**

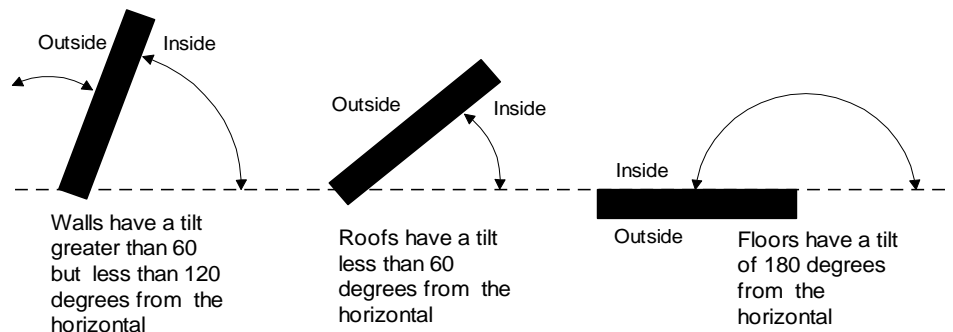

Source: California Energy Commission

### 6.6.1 Dwelling Units per Space

Multifamily residential projects have multiple dwelling units within the project. The dwelling units per space represents the number of residential living units within a single compliance model space and is shown as a positive integer.

#### PROPOSED DESIGN

The proposed design represents the building as designed.

#### STANDARD DESIGN

The standard design assumes 1 dwelling unit per space. This applies for both newly constructed buildings projects and existing building projects.

### 6.6.2 Number of Bedrooms

Multifamily residential projects can have multiple bedrooms within a dwelling unit. The user will provide the number of bedrooms per dwelling unit as an integer with a minimum of 0 and a maximum of 5.

#### PROPOSED DESIGN

The proposed design represents the number of bedrooms per dwelling unit as designed.

#### STANDARD DESIGN



The standard design assumes the same number of bedrooms per dwelling unit as identified in the proposed design. This applies for both newly constructed buildings projects and existing building projects.

### **6.6.3 Number of Occupants**

*Applicability:* Multifamily residential projects will need to specify the number of people in a space. The number of people is modified by an hourly schedule (see below), which approaches but does not exceed 1.0. Therefore, the number of people specified by the building descriptor is similar to design conditions as opposed to average occupancy.

The number of people may be specified in an absolute number, ft<sup>2</sup>/person, or people/1000 ft<sup>2</sup>.

#### **PROPOSED DESIGN**

The number of occupants is prescribed, and the values are given by Space Type in Appendix 5.4A for nonresidential buildings. For multifamily residential buildings, the rules established in Chapter 6 of the Nonresidential ACM Reference Manual apply., For multifamily residential spaces, the number of occupants is defined as: Max (number of bedrooms +1, 2).

#### **STANDARD DESIGN:**

The number of occupants must be identical for both the proposed and standard design cases. This applies for both newly constructed buildings and existing building projects.

### **6.6.4 Lighting Classification Method**

For each space in the building the indoor lighting power is specified. Indoor lighting power can be specified using the area category method or the tailored method.

#### **PROPOSED DESIGN**

Area category method can be used for all areas of the building with space types listed in Appendix 5.4A. This method can be used by itself or with the tailored lighting method.

Tailored lighting method can be used for spaces with primary function listed in Table 140.6-D of the standards. The tailored lighting method is intended to accommodate special lighting applications. The tailored lighting method can be used by itself for all areas of the building or with the area category method. For a given area only one classification type can be used.

Only area category or tailored lighting are allowed.

The area category method can be used for multifamily general lighting power and multifamily additional lighting power. The tailored lighting method can be used for multifamily general lighting power, multifamily wall display lighting power, multifamily task lighting power and multifamily decorative/special effect lighting power.

### **STANDARD DESIGN**

The method used in the proposed design to specify indoor lighting power is also used to determine the indoor lighting power for the standard design. This applies for both newly constructed buildings and existing building projects.

### **6.6.5 Multifamily General Lighting Power**

All common area spaces in multifamily buildings may have multifamily general lighting power. General lighting power is the power used by installed electric lighting that provides a uniform level of illumination throughout an area, exclusive of any provision for special visual tasks or decorative effect, and also known as ambient lighting.

### **PROPOSED DESIGN**

For spaces without special task lighting, wall display lighting or similar requirements, this input will be the same as the regulated lighting power.

Trade-offs in general lighting power are allowed between spaces all using the area category method, between spaces all using the tailored lighting method and between spaces that use area category and tailored methods.

### **STANDARD DESIGN**

With the area category method, general lighting power is the product of the lighting power densities for the space type from Appendix 5.4A and the floor areas for the corresponding conditioned spaces.

With the tailored lighting method, general lighting power is the product of the lighting power density for the primary function type in Table 170.2-N of the standards and the floor area of the space. The lighting power density is given as a function of room cavity ratio (RCR) and interior illumination level in Table 170.2-Q. No interpolation is allowed for this table.

The general lighting power in the tailored method is calculated by the following steps:

Step 1. Determine illumination level from Table 170.2-N by matching the primary function area in Table 170.2-N with the space type in Appendix 5.4A.

Step 2. Calculate the room cavity ratio (RCR) by using the applicable equation in Table 170.2-P.

- Rectangular Rooms:  $RCR = 5 \times H \times (L+W) / (L \times W)$
- Irregular Rooms:  $RCR = 2.5 \times H \times P / A$

Where: L = length of room; W = width of room; H = vertical distance from the work plane to the centerline of the lighting fixture; P = perimeter of room, and A = area of room

Step 3. Determine the general lighting in the space(s) using the tailored method by a look-up in Table 170.2-Q, where the general lighting LPD is a function of illuminance level and RCR. No interpolation is allowed for this table. A space between two illuminance levels (for example, 150 lux) uses the applicable LPD from the next lower illuminance level (100 lux).

The standard design uses the irregular room RCR equation for both simplified and detailed geometry models.

The standard design lighting power is modified by a factor of 1/1.20 (0.833) if the simplified geometry approach is used and if the visible transmittance of any fenestration in the space does not meet the prescriptive requirements established in §170.2(b) of the standards.

When the lighting status is "existing" (and unaltered) for the space, the standard design is the same as the existing, proposed design.

When the lighting status is "altered" for the space, and at least 10 percent of existing luminaires have been altered:

- a) If the lighting status is "existing", then the standard design LPD is the same as the proposed design.
- b) If the lighting status is "new", then the standard design LPD is same as newly constructed buildings.
- c) If the lighting status is "altered", then the standard design LPD is the same as newly constructed buildings.

### **6.6.6 Multifamily Additional Lighting Power**

Common areas spaces in multifamily buildings that use the area category method can identify multifamily additional lighting power. Some additional lighting power allowances are only applicable to certain space types. See Table 170.2-M of the standards.

#### **PROPOSED DESIGN**

The standards provide an additional lighting power allowance for qualified lighting systems. The additional lighting power allowance for qualified lighting systems is treated separately as "use-it-or-lose-it" lighting--the user receives no credit (standard

design matches proposed) but there is a maximum power allowance for each item). The qualified lighting systems and their allowed additional lighting power allowance values are listed in the two right-most columns in standards Table 170.2-M.

Data structure. This input has the following data element – each data element corresponds to the additional lighting allowance of the functional area types listed in standards Table 170.2-M:

1. Decorative/Display Lighting, corresponding functional areas (W/ft<sup>2</sup>)
2. Decorative/display lighting, corresponding Aging Eye/Low-vision functional areas (W/ft<sup>2</sup>)
3. Decorative/display and Portable lighting for office areas (W/ft<sup>2</sup>)
4. Detailed Task Work, corresponding functional areas (W/ft<sup>2</sup>)
5. First ATM or Ticket Machine lighting – Parking Garage Area (W/each)
6. Additional ATM or Ticket Machine lighting – Parking Garage Area (W/each)
7. Transition Lighting OFF at night, Aging Eye/Low-vision – Main Entry Lobby (W/ft<sup>2</sup>)
8. Tunable-white or dim-to-warm for Health Care/Assisted Living (W/ft<sup>2</sup>)

### STANDARD DESIGN

The standard design additional lighting power (ALPM) for multifamily buildings is given by the following equation:

$$ALPM_{std} = \sum_{i=1}^8 \min (ALPM_{prop,i}, ALPAM_i \times ALTAM_i)$$

Where:

$ALPM_{std}$

The additional lighting power (ALPM) of the standard design

$ALPM_{prop,i}$

The proposed ALPM of the allowance i in the data structure above. If there is no proposed lighting system in the proposed design serving as the qualified lighting system, the  $ALPM_{prop,i}$  should be assigned with a zero value (no allowance permitted and given). If there is a proposed lighting system serving as the qualified lighting system, the  $ALPM_{prop,i}$  should be assigned with a one (1) value.

$ALPAM_i$

The additional lighting allowance (ALPAM), which is the maximum allowed additional lighting power indicated in the two rightmost columns in Table 170.2-M of the standards.

$ALTAM_i$

The additional lighting task area (ALTAM) for the  $i^{\text{th}}$  allowance, where the task area correspond to the functional area with the additional lighting power allowance in Table 170.2-M of the standards.

Multifamily additional lighting power does not apply to existing buildings.

### **6.6.7 Multifamily Additional Lighting Power Task Area**

Common areas spaces in multifamily buildings that use area category method can identify multifamily additional lighting power task area.

#### **PROPOSED DESIGN**

The area associated with each of the additional lighting allowances in the ALP building descriptor. This area is based on the proposed designed but cannot exceed the floor area of the space.

#### **STANDARD DESIGN**

The standard design multifamily additional lighting power task area is the same as the proposed. This applies for both newly constructed buildings and existing building projects.

### **6.6.8 Multifamily Building Custom Lighting Power**

Multifamily spaces or projects that use the tailored lighting method can identify multifamily building custom lighting power.

#### **PROPOSED DESIGN**

Custom lighting power covers lighting sources that are not included as general lighting, including qualified lighting system designated in the two rightmost columns of Table 170.2-M and lighting systems in Table 170.2-N of the standards. This lighting must be entered separately from the general lighting because it is not subject to tradeoffs.

Software shall allow the user to input a custom lighting input for the allowed lighting system. If area category method is used, custom lighting power cannot be used if the tailored method is used for any area of the building.

#### **STANDARD DESIGN**

Same as proposed but subject to the maximum limits specified in the two rightmost columns of Table 170.2-M and lighting systems in Table 170.2-N of the standards. For spaces using the tailored method, the maximum allowed custom power is defined by the following procedure:

The standard design custom lighting power is calculated by the sum of the following four terms:

- 1) The product of the standard design wall display power and the standard design wall display length.
- 2) The product of the standard design floor and task lighting power and the standard design floor and task lighting area.
- 3) The product of the standard design decorative and special effect lighting power, and the standard design ornamental and special effect lighting area; and
- 4) The product of the standard design very valuable display case power and the standard design very valuable display case area, subject to prescriptive limits in Table 170.2-N.

For alterations where less than 10 percent of existing luminaires have been modified, the standard design is the existing lighting condition before the alteration. If 10 percent or more luminaires have been altered, the custom lighting power for the standard design is the same as proposed, but subject to the limits specified in the two rightmost columns of Table 170.2-M of the standards.

### **6.6.9 Multifamily Wall Display Power**

All common use area spaces in multifamily buildings that use the tailored method can identify multifamily wall display power.

#### **PROPOSED DESIGN**

The lighting power allowed for wall display, as specified in standards Table 170.2-N, column 3.

#### **STANDARD DESIGN**

The standard design lighting power is the lesser of the proposed design wall display power or the limit specified in Table 170.2-N for the applicable space type.

For existing buildings, the multifamily wall display power standard design is the same as the proposed design.

### **6.6.10 Multifamily Wall Display Length**

All common use area spaces in multifamily buildings that use the tailored method can identify multifamily wall display length.

#### **PROPOSED DESIGN**

The horizontal length of the wall display lighting area using the tailored method for the space. The length is based on the proposed design but this value cannot exceed the floor area of the space.

**STANDARD DESIGN**

The standard design multifamily wall display length is the same as the proposed design. This applies for both newly constructed buildings and existing building projects.

**6.6.11 Multifamily Task Lighting Power**

All common use area spaces in multifamily buildings that use the tailored method can identify multifamily task lighting power.

**PROPOSED DESIGN**

The lighting power allowed for task lighting, as specified in Table 170.2-N, column 4 of the standards.

**STANDARD DESIGN**

The standard design task lighting power is the lesser of the proposed design task lighting power or the limit specified in Table 170.2-N, column 4, for the applicable space type.

For existing buildings, the multifamily task lighting power allowed is the same as proposed design.

**6.6.12 Multifamily Task Lighting Area**

All common use area spaces in multifamily buildings that use the tailored method can identify multifamily task lighting area.

**PROPOSED DESIGN**

The lighting area that is served by the task lighting defined using the tailored method for the space. The area is based on the proposed design but this value cannot exceed the floor area of the space.

**STANDARD DESIGN**

The standard design multifamily task lighting area is the same as the proposed design. This applies for both newly constructed buildings and existing building projects.

**6.6.13 Multifamily Decorative and Special Effect Lighting Power**

All common use area spaces in multifamily buildings that use the tailored method can identify multifamily decorative and special effect lighting power.

**PROPOSED DESIGN**

The lighting power allowed for decorative and special effect lighting, as specified in Table 170.2-N, column 5 of the standards.

#### **STANDARD DESIGN**

The standard design decorative and special effect lighting power is the lesser of the proposed design ornamental and special effect lighting power or the limit specified in Table 170.2-N, column 5, for the applicable space type.

For existing buildings, the multifamily decorative and special effect lighting power for the standard design is the same as the proposed design.

### **6.6.14 Multifamily Decorative and Special Effect Lighting Area**

All common use area spaces in multifamily buildings that use the tailored method can identify multifamily decorative and special effect lighting area.

#### **PROPOSED DESIGN**

The lighting area that is served by the decorative and special effect lighting defined using the tailored method for the space.

The multifamily decorative and special effect lighting area is based on the proposed design but this value cannot exceed the floor area of the space.

#### **STANDARD DESIGN**

The multifamily decorative and special effect lighting area for the standard design is the same as the proposed design. This applies for both newly constructed buildings and existing building projects.

---

## **6.7 Air Leakage and Infiltration**

Air leakage is a building level characteristic. The compliance software distributes the leakage over the envelope surfaces in accordance with the building configuration and constructs a pressure flow network to simulate the airflows between the conditioned zones, unconditioned zones, and outside.

### **6.7.1 Building Air Leakage and Infiltration (ACH50)**

The airflow through a blower door at 50 pascals (Pa) of pressure measured in cubic feet per minute is called CFM50. CFM50 multiplied by 60 minutes, divided by the volume of conditioned space, is the air changes per hour at 50 Pa, called ACH50.

#### **PROPOSED DESIGN**

ACH50 defaults to 7 for multifamily buildings that have heating and cooling system ducts, or both, outside conditioned space, and for buildings with no cooling system. In



multifamily buildings, due to the lack of an applicable measurement standard, ACH50 is fixed at 7.

**STANDARD DESIGN**

The standard design shall have 7 ACH50 (ducted space-conditioning).

**VERIFICATION AND REPORTING**

Due to the lack of an applicable measurement standard, the ACH50 for multifamily buildings is fixed a 7 and cannot be lowered. HERS verification is not required because the proposed design cannot be lowered beyond the standard design defined ACH50 of 7.

**6.7.2 Defining Air Net Leakage**

The compliance software creates an air leakage network for the proposed and standard design using the building description. Air leakage is distributed across the envelope surfaces according to the factors in Table 15. The air network is insensitive to wind direction. For buildings modeled with multiple conditioned zones, either a 20-square-foot open door or 30-square-foot open stairwell (in a multistory building) is assumed between any two conditioned zones.

**Table 15: Air Leakage Distribution**  
(Percentage of Total Leakage by Surface)

<b>Building Configuration</b>	<b>Ceilings</b>	<b>Floors</b>	<b>Exterior Walls</b>	<b>House to Garage</b>
Slab on Grade	50	0		
Raised Floor	40	10		
No Garage			50	0
Attached Garage			40	10

Source: California Energy Commission

The only difference between the air network for the proposed and standard designs is the ACH50 if the user specifies a value lower than the default.

Multifamily buildings that have floors between dwelling units must define each floor as a separate zone, or each dwelling unit as a separate zone.

### 6.7.3 Quality Insulation Installation

The compliance software user may specify quality insulation installation (QII) for the proposed design as “yes” or “no.” The effective R-value of cavity insulation is reduced, as shown in Table 16 in buildings with no QII. When set to “no,” framed walls, ceilings, and floors are modeled with added winter heat flow between the conditioned zone and attic to represent construction cavities open to the attic. QII does not affect the performance of continuous sheathing in any construction.

#### PROPOSED DESIGN

The compliance software user may specify compliance with QII. The default is “no” for QII. This results in a 30% derating applied to the cavity insulation.

#### STANDARD DESIGN

The standard design is modeled with “yes” for verified QII for newly constructed multifamily buildings and additions greater than 700 square feet in Climate Zones 1-6 and 8-16 (Climate Zone 7 has no QII for multifamily buildings). This results in the removal of the 30% derating to the cavity insulation.

#### VERIFICATION AND REPORTING

The presence of QII is reported in the HERS required verification listings on the LMCC. Verified QII is certified by the installer and field verified to comply with RA3.5. Credit for verified QII applies to ceilings/attics, knee walls, exterior walls, and exterior floors.

For alterations to existing pre-1978 construction, if the existing wall construction is assumed to have no insulation, no wall degradation is assumed for the existing wall.

**Table 16: Modeling Rules for Unverified Insulation Installation Quality**

Component	Modification
Walls, Floors, Attic Roofs, Cathedral Ceilings	Multiply the cavity insulation R-value/inch by 0.7.
Ceilings Below Attic	Multiply the blown and batt insulation R-value/inch by $0.96 - 0.00347 * R$ .
Ceilings Below Attic	Add a heat flow from the conditioned zone to the attic of 0.015 times the area of the ceiling below attic times (the conditioned zone temperature — attic temperature) whenever the attic is colder than the conditioned space.

Source: California Energy Commission

### 6.7.4 Dwelling Unit Types

Internal gains and IAQ ventilation calculations depend on the conditioned floor area and number of bedrooms. For multifamily buildings with individual IAQ ventilation systems, each combination of bedrooms and conditioned floor area has a different minimum ventilation CFM that must be verified. In buildings with multiple dwelling units, a dwelling unit type has the same floor area, number of bedrooms, and appliances (washer/dryer in the dwelling unit).

#### PROPOSED DESIGN

For each dwelling unit type the user inputs the following information:

- Unit name
- Quantity of this unit type in building
- Conditioned floor area (CFA) in square feet per dwelling unit
- Number of bedrooms

#### STANDARD DESIGN

The standard design shall have the same conditioned floor area and number of bedrooms and type of dwelling units as the proposed design.

#### VERIFICATION AND REPORTING

The number of units of each type and minimum IAQ ventilation for each unit is reported on the LMCC for field verification.

---

## 6.8 Building Materials and Construction

### 6.8.1 Materials

Only materials approved by the CEC may be used in defining constructions. Additional materials may be added to the compliance manager at the CEC's discretion.

Table 17 shows a partial list of the materials available for construction assemblies. Additional material information can be found in *Reference Appendix Joint Appendix 4*.

#### MATERIAL NAME

The material name is used to select the material for a construction.

#### THICKNESS

Some materials, such as three-coat stucco, are defined with a specific thickness (not editable by the compliance user). The thickness of other materials, such as softwood used for framing, is selected by the compliance user based on the construction of the building.

**CONDUCTIVITY**

The conductivity of the material is the steady-state heat flow per square foot, per foot of thickness, or per degree Fahrenheit temperature difference. It is used in simulating the heat flow in the construction.

**Table 17: Materials List**

<b>Material Name</b>	<b>Thickness (in.)</b>	<b>Conductivity (Btu/h-°F-ft)</b>	<b>Coefficient for Temperature Adjustment of Conductivity (°F(-1))</b>	<b>Specific Heat (Btu/lb-°F)</b>	<b>Density (lb/ft<sup>3</sup>)</b>	<b>R-Value per Inch (°F-ft<sup>2</sup>-h/Btu-in)</b>
Gypsum Board	0.5	0.09167	0.00122	0.27	40	0.9091
Wood Layer	Varies	0.06127	0.0012	0.45	41	1.36
Synthetic Stucco	0.375	0.2		0.2	58	0.2
3 Coat Stucco	0.875	0.4167		0.2	116	0.2
All other siding						0.21
Carpet	0.5	0.02		0.34	12.3	4.1667
Light Roof	0.2	1		0.2	120	0.0833
5 PSF Roof	0.5	1		0.2	120	0.0833
10 PSF Roof	1	1		0.2	120	0.0833
15 PSF Roof	1.5	1		0.2	120	0.0833
25 PSF Roof	2.5	1		0.2	120	0.0833
TileGap	0.75	0.07353		0.24	0.075	1.1333
SlabOnGrade	3.5	1		0.2	144	0.0833

Material Name	Thickness (in.)	Conductivity (Btu/h-°F-ft)	Coefficient for Temperature Adjustment of Conductivity (°F(-1))	Specific Heat (Btu/lb-°F)	Density (lb/ft <sup>3</sup> )	R-Value per Inch (°F-ft <sup>2</sup> -h/Btu-in)
Earth		1		0.2	115	0.0833
SoftWood		0.08167	0.0012	0.39	35	1.0204
Concrete		1		0.2	144	0.0833
Foam Sheathing	varies	varies	0.00175	0.35	1.5	Varies
Ceiling Insulation	varies	varies	0.00418	0.2	1.5	Varies
Cavity Insulation	varies	varies	0.00325	0.2	1.5	Varies
Vertical Wall Cavity	3.5	0.314	0.00397	0.24	0.075	
GHR Tile	1.21	0.026	0.00175	0.2	38	
ENSOPRO	0.66	0.03	0.00175	0.35	2	
ENSOPRO Plus	1.36	0.025	0.00175	0.35	2	
Door						5

Source: California Energy Commission

### COEFFICIENT FOR TEMPERATURE ADJUSTMENT OF CONDUCTIVITY

The conductivity of insulation materials varies with temperature according to the coefficient listed. Other materials have a coefficient of zero (0), and the conductivity does not vary with temperature.

### SPECIFIC HEAT

The specific heat is the amount of heat in British thermal units (Btu) it takes to raise the temperature of 1 pound of the material 1 degree Fahrenheit (Btu/lb-°F).

### DENSITY

The density of the material is the weight of the material in pounds per cubic foot (lb/ft<sup>3</sup>).

**R-VALUE PER INCH**

The R-value is the resistance to heat flow for a 1-inch thick layer.

**6.8.2 Construction Assemblies**

“Constructions” are defined by the compliance user for use in defining the building. The user assembles a construction from one or more layers of materials, as shown in Figure 16. For framed constructions, there is a framing layer that has parallel paths for the framing and the cavity between the framing members. The layers that are allowed depend on the surface type. The compliance manager calculates a winter design U-factor that is compared to a construction that meets the prescriptive standard. The U-factor is displayed as an aid to the user. The calculations used in the energy simulation are based on each layer and framing rather than the U-factor.

**Figure 13: Example Construction Data Screen**

The screenshot shows a software interface for configuring a construction assembly. At the top, a tab labeled 'Construction Data' is active. Below it, a dropdown menu shows 'Currently Active Construction: R19 R5 Stucco Wall'. The main configuration area includes several fields: 'Construction Name' (R19 R5 Stucco Wall), 'Can Assign To' (Exterior Walls), and 'Construction Type' (Wood Framed Wall). Below these is a section for 'Construction Layers (inside to outside)' with two columns: 'Cavity Path' and 'Frame Path'. Each column has five rows of dropdown menus for 'Inside Finish', 'Sheathing / Insulation', 'Cavity / Frame', 'Sheathing / Insulation', and 'Exterior Finish'. The 'Cavity Path' values are Gypsum Board, - no sheathing/insul., R 19 in 5-1/2 in. cavity (R-18), R5 Sheathing, and Synthetic Stucco. The 'Frame Path' values are Gypsum Board, - no sheathing/insul., 2x6 @ 16 in. O.C., R5 Sheathing, and Synthetic Stucco. A checkbox for 'Non-Standard Spray Foam in Cavity' is unchecked. At the bottom, the 'Winter Design U-value' is displayed as 0.051 Btu/h-ft<sup>2</sup>-°F, with a note that it meets the maximum code requirement of 0.051 U-value (0.051).

Source: California Energy Commission

### **ASSEMBLY TYPES**

The types of assemblies are:

- Exterior wall
- Interior wall
- Underground wall
- Attic roof
- Cathedral roof
- Ceiling below attic
- Interior ceiling
- Interior floor
- Exterior floor (over unconditioned space or exterior)
- Floor over crawl space

### **CONSTRUCTION TYPE**

1. Ceiling below attic (the roof structure is not defined here, but is part of the attic), wood-framed. In a residence with a truss roof, the ceiling is where the insulation is located, while the structure above the ceiling is encompassed by the term "attic" or "roof." The attic or roof consists of (moving from inside to outside) the radiant barrier, below-deck insulation, framing, above-deck insulation, and the roofing product, such as asphalt or tile roofing. See more in Chapter [6.11.2 Ceiling Below Attic](#).
2. Cathedral ceiling (with the roof defined as part of the assembly), wood-framed. Since there is no attic, the roof structure is connected to the insulated assembly at this point.
3. Roof, structurally insulated panels (SIP).
4. Walls (interior, exterior, underground), wood- or metal-framed, or SIP.
5. Floors (over exterior, over crawl space, or interior).
6. Party surfaces separate conditioned space included in the analysis from conditioned space that may or may not be included in the analysis. Party surfaces for spaces that are modeled include surfaces between multifamily dwelling units. Party surfaces for spaces not included in the analysis include spaces joining an

addition alone to the existing dwelling. Interior walls, ceilings, or floors can be party surfaces.

### **CONSTRUCTION LAYERS**

All assemblies have a cavity path and a frame path.

Spray-foam insulation R-values are calculated based on the nominal thickness of the insulation multiplied by the default thermal resistivity per inch, or the total R-value may be calculated based on the thickness of the insulation multiplied by the tested R-value per inch as certified by the Department of Consumer Affairs, Bureau of Household Goods and Services (see details Chapter 6.8.3 Spray-Foam Insulation and Reference Appendices, Residential Appendix RA3.5).

As assemblies are completed, the screen displays whether the construction meets the prescriptive requirement for that component.

### **PROPOSED DESIGN**

The user defines a construction for each surface type included in the proposed design. Any variation in insulation R-value, framing size or spacing, interior or exterior sheathing, or interior or exterior finish requires the user to define a different construction. Insulation R-values are based on manufacturer-rated properties rounded to the nearest whole R-value. Layers such as sheetrock, wood sheathing, stucco, and carpet whose properties are not compliance variables are included as generic layers with standard thickness and properties.

Walls separating the house from an attached unconditioned attic or garage are modeled as interior walls with unconditioned space as the adjacent zone, which the compliance manager recognizes as a "demising wall." Floors over a garage are modeled as an interior or demising floor. The exterior walls, floor, and ceiling/roof of the garage are modeled as part of the unconditioned garage zone.

### **STANDARD DESIGN**

The compliance software assembles a construction that meets the prescriptive standards for each user-defined construction or assembly.

### **VERIFICATION AND REPORTING**

All proposed constructions, including insulation, frame type, frame size, and exterior finish or exterior condition, are listed on the LMCC. Nonstandard framing (e.g., 24" on center wall framing, advanced wall framing) is reported as a special feature.



**6.8.3 Spray-Foam Insulation**

The R-values for spray-applied polyurethane foam (SPF) insulation differ depending on whether the product is open cell or closed cell.

**Table 18: Required Thickness Spray Foam Insulation (in inches)**

<b>Required R-values for SPF insulation</b>	<b>R-11</b>	<b>R-13</b>	<b>R-15</b>	<b>R-19</b>	<b>R-21</b>	<b>R-22</b>	<b>R-25</b>	<b>R-30</b>	<b>R-38</b>
Required thickness closed cell @ R5.8/inch	2.00	2.25	2.75	3.50	3.75	4.00	4.50	5.25	6.75
Required thickness open cell @ R3.6/inch	3.0	3.5	4.2	5.3	5.8	6.1	6.9	8.3	10.6

Source: California Energy Commission

Additional documentation and verification requirements for a value other than the default values shown in Table 18 are required. (See RA3.5.6.)

**6.8.3.1 Medium Density Closed-Cell SPF Insulation**

The default R-value for spray-foam insulation with a closed cellular structure is R-5.8 per inch, based on the installed nominal thickness of insulation. Closed-cell insulation has an installed nominal density of 1.5 to 2.5 pounds per cubic foot (pcf).

**6.8.3.2 Low-Density Open-Cell SPF Insulation**

The default R-value for spray-foam insulation with an open cellular structure is calculated as R-3.6 per inch, based on the nominal required thickness of insulation. Open-cell insulation has an installed nominal density of 0.4 to 1.5 pounds per cubic foot (pcf).

**PROPOSED DESIGN**

The user will select either typical values for open-cell or closed-cell spray-foam insulation or higher-than-typical values and enter the total R-value (rounded to the nearest whole value).

**STANDARD DESIGN**

The compliance software assembles a construction that meets the prescriptive standards for each assembly type (ceiling/roof, wall, and floor).

## **VERIFICATION AND REPORTING**

When the user elects to use higher-than-typical R-values for open-cell or closed-cell spray-foam insulation, a special features note is included on the LMCC requiring documentation requirements specified in Reference Appendices, Joint Appendix JA4.1.7. Furthermore, a HERS verification requirement for the installation of spray-foam insulation using higher-than-default values is included on the LMCC.

---

## **6.9 Building Mechanical Systems**

A space-conditioning system (also referred to as HVAC system) is made up of the heating subsystem (also referred to as "heating unit," "heating equipment," or "heating system"); cooling subsystem (also referred to as "cooling unit," "cooling equipment," or "cooling system"); the distribution subsystem details (if any); and fan subsystem (if any). Ventilation cooling systems and indoor air-quality-ventilation systems are defined as part of the dwelling unit information for multifamily buildings.

### **6.9.1 Heating Subsystems**

The heating subsystem describes the equipment that supplies heat to a space-conditioning system. Heating subsystems are categorized according to the types shown in Table 21.

#### **PROPOSED DESIGN**

The user selects the type and supplies required inputs from those listed in Tables 20 and 21 for the heating subsystem, including the appropriate rated heating efficiency. Except for heat pumps, the rated heating capacity is not used as a compliance variable by the compliance software.

When the proposed space-conditioning system is a heat pump, the user specifies the rated heating capacity at 47°F and 17°F for the heat-pump compressor. The capacity is used to determine the effect of backup electric resistance heat in the simulation. The specified capacities are listed on the LMCC for verification by a HERS rater.

#### **STANDARD DESIGN**

For dwelling unit space conditioning systems, the standard design heating subsystem is dependent on climate zone and number of habitable stories. For multifamily buildings with three habitable stories or less in Climate Zones 1-15 the space conditioning system is a heat pump. For multifamily buildings with three habitable stories or less in Climate Zone 16 the space conditioning system is an air conditioner with furnace. For multifamily buildings with more than three habitable stories in Climate Zones 2-15 the space conditioning system is a heat pump. For multifamily buildings with more than

three habitable stories in Climate Zones 1 and 16 the space conditioning system is a dual-fuel heat pump.

When the standard design is a heat pump, the equipment used in the standard design building is an electric split-system heat pump with default ducts in the attic and a heating seasonal performance factor (HSPF) meeting the current *Appliance Efficiency Regulations* minimum efficiency for heat pumps. The standard design heat-pump compressor size is determined by the software as the larger of the compressor size calculated for air-conditioning load, or the compressor with a 47°F rating that is 75 percent of the heating load (at the heating design temperature).

When the standard design is a gas heating system, the equipment used in the standard design building is a gas furnace (or propane if natural gas is not available) with default ducts in the attic and an annual fuel utilization efficiency (AFUE) meeting the *Appliance Efficiency Regulations* minimum efficiency for central systems.

See Table 19 for complete details on heating systems noted above.

**Table 19: Standard Design Heating System**

<b>Proposed Design</b>	<b>Standard Design</b>
Three or less habitable stories; Climate Zones 1-15	Single zone system with constant volume fan, no economizer, DX heat pump with electric resistance supplemental heat
Three or less habitable stories; Climate Zones 16	Single zone system with constant volume fan, no economizer, DX cooling and furnace
More than three habitable stories; Climate Zones 2-15	Single zone system with constant volume fan, no economizer, DX heat pump with electric resistance supplemental heat
More than three habitable stories; Climate Zones 1 and 16	Single zone system with constant volume fan, no economizer, DX heat pump with gas furnace supplemental heat

Source: California Energy Commission

**VERIFICATION AND REPORTING**

The proposed heating system type and rated efficiency are reported in the compliance documentation on the LMCC. For heat pumps, which are supplemented by electric

resistance backup heating, the HERS-verified rated heating capacity of each proposed heat pump is reported on the LMCC. Installed capacities must be equal to or larger than the capacities reported for modeled at 47° and 17° (RA 3.4.4.2).

**Table 20: HVAC Heating Equipment Types**

Name	Heating Equipment Description
CntrlFurnace	Gas- or oil-fired central furnaces, propane furnaces, or heating equipment considered equivalent to a gas-fired central furnace, such as wood stoves that qualify for the wood heat exceptional method. Gas fan-type central furnaces have a minimum AFUE=80%. Distribution can be gravity flow or use any of the ducted systems.
PkgGasFurnace	The furnace side of a packaged air-conditioning system. Packaged gas or propane furnaces have a minimum AFUE=81%. Distribution can be any of the ducted systems.
WallFurnace Gravity	Noncentral gas- or oil-fired wall furnace, gravity flow. Equipment has varying efficiency requirements by capacity. Distribution is ductless.
WallFurnace Fan	Noncentral gas- or oil-fired wall furnace, fan-forced. Equipment has varying efficiency requirements by capacity. Distribution is ductless.
FloorFurnace	Noncentral gas- or oil-fired floor furnace. Equipment has varying efficiency requirements by capacity. Distribution is ductless.
RoomHeater	Noncentral gas- or oil-fired room heaters. Noncentral gas- or oil-fired wall furnace, gravity flow. Equipment has varying efficiency requirements by capacity. Distribution is ductless.
WoodHeat	Wood-fired stove. In areas with no natural gas available, a wood-heating system with any backup heating system is allowed to be installed if exceptional method criteria described in the <i>Residential Compliance Manual</i> are met.
Boiler	Gas or oil boilers. Distribution systems can be radiant, baseboard, or any of the ducted systems. Boiler may be specified for dedicated hydronic systems. Systems in which the boiler provides space heating and fires an indirect gas water heater (IndGas) may be listed as Boiler/CombHydro Boiler and is listed under "Equipment Type" in the HVAC Systems listing.

Name	Heating Equipment Description
Electric	All electric heating systems other than space-conditioning heat pumps. Included are electric resistance heaters, electric boilers, and storage water heat pumps (air-water) (StoHP). Distribution system can be radiant, baseboard, or any of the ducted systems.
CombHydro	Water-heating system can be any gas water heater. Distribution systems can be radiant, baseboard, or any of the ducted systems and can be used with any of the terminal units (FanCoil, RadiantFlr, Baseboard, and FanConv).
SZDFHP	Single-zone system with constant volume fan, direct expansion heat pump cooling and heating, and gas supplemental heating.

Source: California Energy Commission

**Table 21: Heat Pump Equipment Types**

Name	Heat Pump Equipment Description
SplitHeatPump	Central split heat pump system. Distribution system is one of the ducted systems.
SDHV SplitHeat Pump	Small duct, high velocity, central split-system that produces at least 1.2 inches of external static pressure when operated at the certified air volume rate of 220–350 CFM per rated ton of cooling and uses high-velocity room outlets generally greater than 1,000 fpm that have less than 6.0 square inches of free area.
Ductless MiniSplit HeatPump	A heat pump system that has an outdoor section and one or more ductless indoor sections. The indoor section(s) cycle on and off in unison in response to an indoor thermostat.
Ductless MultiSplit HeatPump	A heat pump system that has an outdoor section and two or more ductless indoor sections. The indoor sections operate independently and can be used to condition multiple zones in response to multiple indoor thermostats.
DuctlessVRF HeatPump	A variable-refrigerant-flow (VRF) heat pump system that has one or more outdoor sections and two or more ductless indoor sections. The indoor sections operate independently and can be used to condition multiple zones in response to multiple indoor thermostats.
PkgHeatPump	Central packaged heat pump systems. Central packaged heat pumps are heat pumps in which the blower, coils, and

Name	Heat Pump Equipment Description
	compressor are contained in a single package, powered by single-phase electric current, air-cooled, and rated below 65,000 Btu/h. The distribution system is one of the ducted systems.
RoomHeatPump	Noncentral room air-conditioning systems. These include packaged terminal (commonly called "through-the-wall") units and any other ductless heat pump systems.
SglPkgVertHeatPump	Single-package vertical heat pump. This is a package air conditioner that uses reverse cycle refrigeration as the prime heat source and may include secondary supplemental heating by means of electrical resistance.
PkgTermHeatPump	Packaged terminal heat pump. This is a package terminal air conditioner that uses reverse cycle refrigeration as the prime heat source; has a supplementary heating source available, with the choice of electric resistant heat; and is industrial equipment.
DuctedMiniSplitHeat Pump	Ducted minisplit heat pump is a system that has an outdoor section and one or more ducted indoor sections. The indoor section(s) cycle on and off in unison in response to an indoor thermostat.
DuctedMultiSplitHeat Pump	Ducted multisplit heat pump is a system that has a single outdoor section, and two or more ducted indoor sections. The indoor sections operate independently and can be used to condition multiple zones in response to multiple indoor thermostats.
Ducted+DuctlessMulti SplitHeatPump	Multisplit heat pump system with a combination of ducted and ductless indoor units.
AirToWater HeatPump	An indoor conditioning coil, a compressor, and a refrigerant-to-water heat exchanger that provides heating and cooling functions. Also, able to heat domestic hot water.
Ground Source HeatPump	An indoor conditioning coil with air-moving means, a compressor, and a refrigerant-to-ground heat exchanger that provides heating, cooling, or heating and cooling functions. May also have the ability to heat domestic hot water.

Name	Heat Pump Equipment Description
Variable Capacity Heat Pump	VCHP — Meets all the requirements of the VCHP Compliance Option.
SZDFHP	Single-zone system with constant volume fan, direct expansion heat pump cooling and heating, and gas supplemental heating.

Source: California Energy Commission

### 6.9.1.1 Verified Heating Seasonal Performance Factor (HSPF and HSPF2)

#### PROPOSED DESIGN

The software allows the user to specify the HSPF/HSPF2 value for heat pump equipment.

#### STANDARD DESIGN

The standard design is the minimum allowable HSPF for the type of heat pump equipment modeled in the proposed design, based on the applicable *Appliance Efficiency Regulations*. For central-heating and cooling equipment, the minimum efficiency is 8.0 HSPF/6.7 HSPF2 for packaged heat pumps or 8.2 HSPF/7.5 HSPF2 for split heat pumps.

#### VERIFICATION AND REPORTING

If an HSPF/HSPF2 for the proposed design is higher than the default minimum efficiency modeled in software, the HSPF/HSPF2 requires field verification. The HSPF/HSPF2 rating is verified using rating data from the Air-Conditioning, Heating, and Refrigeration Institute ([AHRI Directory of Certified Product Performance](#) website or another directory of certified product performance ratings approved by the CEC for determining compliance. Verified SEER/SEER2 is reported in the HERS-required verification listings on the LMCC.

### 6.9.1.2 Combined Hydronic Space/Water Heating

Combined hydronic space/water heating is a system whereby a water heater is used to provide space heating and water heating. Dedicated hydronic space-heating systems are also a modeling capability. Space-heating terminals may include fan coils, baseboards, and radiant floors.

For combined hydronic systems, the water-heating portion is modeled normally. For space heating, an effective AFUE is calculated for gas water heaters. For electric water

heaters, an effective HSPF/HSPF2 is calculated. The procedures for calculating the effective AFUE or HSPF/HSPF2 are described below.

Combined hydronic space-conditioning cannot be combined with heat pump water heating or with zonal control credit.

**PROPOSED DESIGN**

When a fan coil is used to distribute heat, the fan energy and the heat contribution of the fan motor must be considered. The algorithms for fans used in combined hydronic systems are the same as those used for gas furnaces and are described in Appendix G.

If a large fan coil is used and air-distribution ducts are in the attic, crawl space, or other unconditioned space, the efficiency of the air-distribution system must be determined using methods consistent with those described in Chapter 6.9.3 Distribution Systems. Duct efficiency is accounted for when the distribution type is ducted.

**6.9.1.3 Commercial or Consumer Storage Gas Water Heater**

When storage gas water heaters are used in combined hydronic applications, the effective AFUE is given by the following equation:

$$AFUE_{eff} = RE - \left[ \frac{PL}{RI} \right] \quad \text{Equation 1}$$

Where:

- AFUE<sub>eff</sub> - The effective AFUE of the gas water heater in satisfying the space heating load.
- RE - The recovery efficiency (or thermal efficiency) of the gas storage water heater. A default value of 0.70 may be assumed if the recovery efficiency is unknown. This value is generally available from the CEC appliance directory.
- PL - Pipe losses (kBtu/h). This can be assumed to be zero when less than 10 feet of piping between the water heater storage tank and the fan coil or other heating elements are in unconditioned space.
- RI - The rated input of the gas water heater (kBtu/h) available from the CEC appliance directory.

**6.9.1.4 Instantaneous Gas Water Heater**

When instantaneous gas water heaters are used in combined hydronic applications, the effective AFUE is given by the following equation:

$$AFUE_{eff} = UEF \quad \text{Equation 2}$$

Where:



- $AFUE_{eff}$  - The effective AFUE of the gas water heater in satisfying the space heating load.
- UEF - The rated uniform energy factor of the instantaneous gas water heater.

### 6.9.1.5 Storage Electric Water Heater

The HSPF of storage water heaters used for space heating in a combined hydronic system is given by the following equations.

$$HSPF_{eff} = 3.413 \left[ 1 - \frac{PL}{3.413kW_i} \right] \quad \text{Equation 3}$$

Where:

- $HSPF_{eff}$  - The effective HSPF of the electric water heater in satisfying the space-heating load.
- PL - Pipe losses (kBtu/h). Assumed zero when less than 10 feet of piping between the water heater storage tank and the fan coil or other heating elements are in unconditioned space.
- $kW_i$  - The kilowatts of input to the water heater available from the CEC's appliance directory.

### STANDARD DESIGN

When a hydronic system is proposed to use electricity is used for heating, the heating equipment for the standard design is an electric split-system heat pump with an HSPF meeting the *Appliance Efficiency Regulations* requirements for split-systems. The standard design heat pump compressor size is determined by the software based on the compressor size calculated for the air-conditioning system.

When electricity is not used for heating, the equipment used in the standard design building is a gas furnace (or propane if natural gas is not available) with default ducts in the attic and an AFUE meeting the *Appliance Efficiency Regulations* minimum efficiency for central systems. When a proposed design uses electric and non-electric heat, the standard design is a gas furnace.

### 6.9.1.6 Special Systems — Hydronic Distribution Systems and Terminals

Hydronic distribution systems in unconditioned spaces are included in the building model to account for heat loss to these unconditioned spaces. Heat loss is affected by the length of piping in unconditioned spaces, pipe size, pipe insulation thickness, and pipe insulation R-value.

### PROPOSED DESIGN

This listing is completed for hydronic systems that have more than 10 feet of piping (plan view) in unconditioned space. As many rows as necessary may be used to describe the piping system.

### **STANDARD DESIGN**

The standard design is established for a hydronic system in the same way as for a central system, as described in [Chapter 6.9.1 Heating Subsystems](#).

### **VERIFICATION AND REPORTING**

A hydronic or combined hydronic system is reported on the LMCC.

Other information reported includes:

- Piping Run Length (ft). The length (plan view) of distribution pipe in unconditioned space, in feet, between the primary heating/cooling source and the point of distribution.
- Nominal Pipe Size (in.). The nominal (as opposed to true) pipe diameter in inches.
- Insulation Thickness (in.). The thickness of the insulation in inches. Enter "none" if the pipe is uninsulated.

*Insulation R-value (hr-ft<sup>2</sup>-°F/Btu).* The installed R-value of the pipe insulation. Minimum pipe insulation for hydronic systems is as specified in §160.4(f).

#### **6.9.1.7 Ground-Source Heat Pump**

A ground-source heat pump system, which uses the earth as a source of energy for heating and as a heat sink for energy when cooling, is simulated as a minimum efficiency split-system equivalent to the standard design with default duct conditions in place of the proposed system. The mandatory efficiencies for ground-source heat pumps are a minimum coefficient of performance (COP) for heating and EER/EER2 for cooling.

#### **6.9.1.8 Air-to-Water Heat Pumps**

Air-to-water heat pumps (AWHPs) must be listed in the Title 20 MAEDbS database. For the proposed design, fixed compressor speed AWHPs would be modeled equivalent to the prescriptive air source heat pump in heating and cooling operation. Variable compressor speed AWHPs would be treated with a 2% reduction in hourly heating energy use and an 8% reduction in hourly cooling energy use, relative to the prescriptive air source heat pump.

## 6.9.2 Cooling Subsystems

The cooling subsystem describes the equipment that supplies cooling to a space-conditioning system.

### PROPOSED DESIGN

Cooling subsystems are categorized according to the types shown in Table 22. The user selects the type of cooling equipment and enters basic information to model the energy use of the equipment. Enter the cooling equipment type and additional information based on the equipment type and zoning, such as the SEER/SEER2 and EER/EER2. For some types of equipment, the user may also specify if the equipment has a multispeed compressor and if the system is zoned or not via checkboxes. For ducted cooling systems, the cooling airflow from the conditioned zone through the cooling coil is input as CFM per ton. The rated cooling capacity is not a compliance variable.

Until there is an approved compliance option for ductless heat pumps (ducted and ductless minisplit, and multisplit), these systems are simulated as a minimum efficiency split-system equivalent to the standard design with default duct conditions.

See chapters below for the details of specific inputs.

### STANDARD DESIGN

The cooling system for the standard design building is a nonzonal control system, split-system ducted cooling system, meeting the minimum requirements of the *Appliance Efficiency Regulations*. The standard design system shall assume verified refrigerant charge in Climate Zones 2 and 8–15 for all systems. Mandatory fan efficacy is assumed in all climate zones. For equipment not subjected to EER rating, the standard is 11.7 EER.

**Table 22: HVAC Cooling Equipment Types (Other Than Heat Pumps)**

Name	Cooling Equipment Description
NoCooling	Entered when the proposed building is not cooled or when cooling is optional (to be installed at some future date). Both the standard design equivalent building and the proposed design use the same default system (refer to Chapter 6.9.5.3 No Cooling).
SplitAirCond	Split air-conditioning systems. Distribution system is one of the ducted systems. (Efficiency metric: SEER/SEER2 and EER/EER2)

Name	Cooling Equipment Description
PkgAirCond	Central packaged air-conditioning systems less than 65,000 Btu/h cooling capacity. Distribution system is one of the ducted systems. (Efficiency metric: SEER/SEER2 and EER/EER2)
LrgPkgAirCond	Large packaged air-conditioning systems rated at or above 65,000 Btu/h cooling capacity. Distribution system is one of the ducted systems.
SDHVSplitAirCond	Small-duct, high-velocity, split A/C system.
DuctlessMiniSplitAirCond	Ductless minisplit A/C system having an outdoor section and one or more indoor sections. The indoor sections cycle on and off in unison in response to an indoor thermostat.
DuctlessMultiSplitAirCond	Ductless multisplit A/C system having an outdoor section and two or more indoor sections. The indoor sections operate independently and can be used to condition multiple zones in response to multiple indoor thermostats.
DuctlessVRFairCond	Ductless variable refrigerant flow (VRF) A/C system.

Name	Cooling Equipment Description
SglPkgVertAirCond	Single-packaged vertical A/C is a self-contained cooling system that is factory-assembled, is arranged vertically, can be mounted on the exterior or interior of a space and, can be installed through the wall. These units can be ducted or ductless. They are rated using ANSI/AHRI 390(I-P)-2003.
PkgTermAirCond	Packaged terminal A/C (PTAC) is a self-contained cooling system that is installed through the wall. These systems do not use ducts. They are rated using AHRI 310/380-2017.
DuctedMiniSplitAirCond	Ducted minisplit A/C system having an outdoor section and one or more indoor sections. The indoor sections cycle on and off in unison in response to an indoor thermostat.
DuctedMultiSplitAirCond	Ducted multisplit A/C system having an outdoor section and two or more indoor sections. The indoor sections operate independently and can be used to condition multiple zones in response to multiple indoor thermostats.
Ducted+DuctlessMulti SplitAirCond	Combination of ducted and ductless multisplit A/C system have an outdoor section and two or more indoor sections. The indoor sections operate independently and can be used to condition multiple zones in response to multiple indoor thermostats.
RoomAirCond	<p>Room air conditioner is a self-contained cooling system that is installed through the wall. These systems do not use ducts. They are rated using ANSI/ASHRAE Standard 16-2016.</p> <p>Same as DuctlessSplitAirCond except that cooling is not supplied to each habitable space in the dwelling unit.</p>
EvapCondenser	Evaporatively cooled condensers. A split mechanical system, with a water-cooled condenser coil.

Source: California Energy Commission

**VERIFICATION AND REPORTING**

Information shown on the LMCC includes cooling equipment type and cooling efficiency (SEER/SEER2 or EER/EER2 or both). Measures requiring verification (Table 23) are listed in the HERS verification section of the LMCC.

**6.9.2.1 Verified Refrigerant Charge or Fault Indicator Display**

Proper refrigerant charge is necessary for electrically driven compressor air-conditioning systems to operate at full capacity and efficiency. Software calculations set the compressor efficiency multiplier to 0.90 to account for the effect of improper refrigerant charge or 0.96 for proper charge.

**PROPOSED DESIGN**

The software allows the user to indicate if systems will have diagnostically tested refrigerant charge or a field-verified fault indicator display (FID). This allowance applies only to ducted split-systems and packaged air-conditioners and heat pumps.

**STANDARD DESIGN**

The standard design building is modeled with either diagnostically tested refrigerant charge or a field-verified FID if the building is in Climate Zone 2 or 8–15, and refrigerant charge verification is required by §170.2(c)3B and Table 170.2-K for the proposed cooling system type.

**VERIFICATION AND REPORTING**

Refrigerant charge or FID require field verification or diagnostic testing and are reported in the HERS required verification listings on the LMCC. Details on refrigerant charge measurement are discussed in *Reference Residential Appendix RA3.2*. Information on the requirements for FIDs is in *Reference Joint Appendix JA6.1*.

**Table 23: Summary of Space Conditioning Measures Requiring Verification**

Measure	Description	Procedures
Verified Refrigerant Charge	Air-cooled air-conditioners and air-source heat pumps must be tested diagnostically to verify that the system has the correct refrigerant charge. The system must also meet the system airflow requirement.	RA1.2, RA3.2
Verified Fault Indicator Display	A fault indicator display can be installed as an alternative to refrigerant charge testing.	RA3.4.2

Measure	Description	Procedures
Verified System Airflow	When compliance requires verified system airflow greater than or equal to a specified criterion.	RA3.3
Verified Air-Handling Unit Fan Efficacy	To verify that fan efficacy (watt/CFM) is less than or equal to a specified criterion.	RA3.3
Verified HSPF/HSPF2, SEER/SEER2 or EER/EER2	Credit for increased efficiency by installation of specific air-conditioner or heat pump models.	RA3.4.4.1
Verified Heat Pump Capacity	Optional verification of heat-pump system capacity.	RA3.4.4.2
Evaporatively Cooled Condensers	Must be combined with duct leakage testing, refrigerant charge, and verified EER/EER2.	RA3.1.4.3, RA3.2, RA3.4.3, RA3.4.4.1
Whole-House Fan	When verification of the whole-house fan is selected or required, airflow, watt draw, and capacity are verified.	RA3.9
Central Fan Ventilation Cooling System	When compliance includes this type of ventilation cooling, airflow and fan efficacy are verified.	RA3.3.4

Source: California Energy Commission

### 6.9.2.2 Verified System Airflow

Adequate airflow to the conditioned space is required to allow ducted air-conditioning systems to operate at full efficiency and capacity. Efficiency is achieved by the air-distribution system design by improving the efficiency of motors or by designing and installing air distribution systems that have less resistance to airflow. Software calculations account for the effect of airflow on sensible heat ratio and compressor efficiency.

For systems other than small-duct, high-velocity types, a value less than 350 CFM/ton (minimum 150 CFM/ton) is a valid input only if zonally controlled equipment is selected and multispeed compressor is not selected. Inputs less than 350 CFM/ton for zonally controlled systems require verification using procedures in *Reference Appendices, Residential Appendix RA3.3*.

§160.3(b)5L requires verification that the central air-handling unit airflow rate is greater than or equal to 350 CFM/ton for systems other than small-duct, high-velocity types or 250 CFM/ton for small-duct, high-velocity systems. Values greater than the required CFM/ton may be input for compliance credit, which requires diagnostic testing using procedures in *Reference Appendices, Residential Appendix RA3.3*.

For single-zone systems:

- As an alternative to verification of 350 CFM/ton for systems other than small-duct, high-velocity types or 250 CFM/ton for small-duct, high-velocity systems, HERS verification of a return duct design that conforms to the specification given in Table 160.3-A or B may be used to demonstrate compliance.
- The return duct design alternative is not an input to the compliance software but must be documented on the certificate of installation.
- If a value greater than 350 CFM/ton for systems other than small-duct, high-velocity types or greater than 250 CFM/ton for small-duct, high-velocity systems is modeled for compliance credit, the alternative return duct design method using Table 160.3-A or B is not allowed for demonstrating compliance.
- Variable capacity systems including multispeed and variable-speed compressor systems must verify airflow rate (CFM/ton) for system operation at the maximum compressor speed and the maximum air handler fan speed.

For zonally controlled systems:

- The Table 160.3-A or B return duct design alternative is not allowed for zonally controlled systems.
- Variable capacity systems including multispeed, variable-speed, and single-speed compressor systems must all verify airflow rate (CFM/ton) by operating the system at maximum compressor capacity and maximum system fan speed in every zonal control mode with all zones calling for conditioning.
- Single-speed compressor systems must also verify airflow rate (CFM/ton) in every zonal control mode.
- For systems that input less than 350 CFM/ton, HERS verification compliance cannot use group sampling.

### **PROPOSED DESIGN**

The default cooling airflow is 150 CFM/ton for a system with “zonally controlled” selected and “multispeed compressor” not selected (single-speed). Users may model airflow for these systems greater than or equal to 150 CFM/ton, which must be verified



using the procedures in *Reference Appendices, Residential Appendix RA3.3*. Inputs less than the rates required by §160.3(b)5L will be penalized in the compliance calculation.

The default cooling airflow is 350 CFM/ton for systems other than small-duct, high-velocity types or 250 CFM/ton for small-duct, high-velocity systems. Users may model a higher-than-default airflow for these systems and receive credit in the compliance calculation if greater-than-default system airflow is diagnostically tested using the procedures of *Reference Appendices, Residential Appendix RA3.3*.

### **STANDARD DESIGN**

The standard design shall assume a system that complies with mandatory (§160.3) and prescriptive (§170.2) requirements for the applicable climate zone.

### **VERIFICATION AND REPORTING**

The airflow rate verification compliance target (CFM or CFM/ton) is reported in the HERS required verification listings of the LMCC. When there is no cooling system, it is reported on the LMCC as a special feature.

#### **6.9.2.3 Verified Air-Handling Unit Fan Efficacy**

The mandatory requirement in §160.3(b)5L is for an air-handling unit fan efficacy less than or equal to 0.45 watts/CFM for gas furnace air-handling units, 0.58 watts/CFM for air-handling units that are not gas furnaces, and 0.62 W/CFM for small-duct, high-velocity systems as verified by a HERS rater. Users may model a lower fan efficacy (W/CFM) and receive credit in the compliance calculation if the proposed fan efficacy value is diagnostically tested using the procedures in *Reference Appendices, Residential Appendix RA3.3*.

For single-zone systems:

- Installers may elect to use an alternative to HERS verification of the watts/CFM required by §160.3(b)5L: HERS verification of a return duct design that conforms to the specification given in Table 160.3-A or B.
- The return duct design alternative is not an input to the compliance software but must be documented on the certificate of installation.
- If a value less than the watts/CFM required by §160.3(b)5L is modeled by the software user for compliance credit, the alternative return duct design method using Table 160.3-A or B is not allowed for use in demonstrating compliance.
- Multispeed or variable-speed compressor systems must verify fan efficacy (watt/CFM) for system operation at the maximum compressor speed and the maximum air handler fan speed.

For zonally controlled systems:

- The Table 160.3-A or B return duct design alternative is not allowed for zonally controlled systems.
- Variable capacity systems including multispeed, variable-speed, and single-speed compressor systems must all verify fan efficacy (watt/CFM) by operating the system at maximum compressor capacity and maximum system fan speed with all zones calling for conditioning.
- Single-speed compressor systems must verify fan efficacy in every zonal control mode.

### **PROPOSED DESIGN**

The software shall allow the user to enter the fan efficacy. The default mandatory value is 0.45, 0.58, or 0.62 W/CFM, depending on the applicable system type. However, users may specify a lower value and receive credit in the compliance calculation if verified and diagnostically tested using the procedures of *Reference Appendices, Residential Appendix RA3.3*.

If no cooling system is installed, a default value of 0.45 W/CFM is assumed.

### **STANDARD DESIGN**

The standard design shall assume a verified fan efficacy complying with the mandatory requirement of less than or equal to the following:

- 0.45 W/CFM for gas furnace air-handling units, as well as air-handling unit that are not gas furnaces and have a capacity less than 54,000 BTU/h
- 0.58 W/CFM for air-handling units that are not gas furnaces and have a capacity greater than or equal to 54,000 BTU/h
- 0.62 W/CFM for small duct high velocity forced air systems.

### **VERIFICATION AND REPORTING**

For user inputs lower than the default mandatory requirement, fan efficacy is reported in the HERS-required verification listings of the LMCC.

For default mandatory 0.45 or 0.58 watts/cfm, the choice of either fan efficacy or alternative return duct design according to Table 160.3-A or B is reported in the HERS-required verification listings of the LMCC.

No cooling system is reported as a special feature on the LMCC.

#### **6.9.2.4 Verified Energy Efficiency Ratio (EER/EER2)**

##### **PROPOSED DESIGN**

Software shall allow the user the option to enter an EER/EER2 rating for central cooling equipment. For equipment that is rated only with an EER/EER2 (room air-conditioners), the user will enter the EER/EER2. The *Appliance Efficiency Regulations* require a minimum SEER/SEER2 and EER/EER2 for central cooling equipment. Only if a value higher than a default minimum EER/EER2 is used is it reported as a HERS-verified measure.

##### **STANDARD DESIGN**

The standard design is based on the default minimum efficiency EER/EER2 for the type of cooling equipment modeled in the proposed design, based on the applicable *Appliance Efficiency Regulations*. The standard design for central air-conditioning equipment is 11.7 EER/11.2 EER2 for split systems.

##### **VERIFICATION AND REPORTING**

If an EER/EER2 higher than the default minimum efficiency is modeled in software, the EER/EER2 requires field verification. The EER/EER2 rating is verified using rating data from [AHRI Directory of Certified Product Performance](#) website or another directory of certified product performance ratings approved by the CEC for determining compliance. Verified EER is reported in the HERS-required verification listings on the LMCC.

#### **6.9.2.5 Verified Seasonal Energy Efficiency Ratio (SEER/SEER2)**

##### **PROPOSED DESIGN**

The software allows the user to specify the SEER/SEER2 value.

##### **STANDARD DESIGN**

The standard design is based on the default minimum efficiency SEER/SEER2 for the type of cooling equipment modeled in the proposed design, based on the applicable *Appliance Efficiency Regulations*. For central-cooling equipment, the minimum efficiency is 14 SEER/13.8 SEER2 for split systems.

##### **VERIFICATION AND REPORTING**

If a SEER/SEER2 higher than the default minimum efficiency is modeled in software, the SEER/SEER2 requires field verification. The higher-than-minimum SEER/SEER2 rating is verified using rating data from [AHRI Directory of Certified Product Performance](#) website or another directory of certified product performance ratings approved by the CEC for

determining compliance. Verified SEER/SEER2 is reported in the HERS-required verification listings on the LMCC.

### **6.9.2.6 Verified Evaporatively Cooled Condensers**

#### **PROPOSED DESIGN**

Software shall allow users to specify an evaporatively cooled condensing unit. The installation must comply with the requirements of Reference Appendices, Residential Appendix RA4.3.2 to ensure the predicted energy savings are achieved. This credit must be combined with verified refrigerant charge testing, EER/EER2, and duct leakage testing.

#### **STANDARD DESIGN**

The standard design is based on a split-system air-conditioner meeting the requirements of §170.2(c) and Table 170.2-K.

#### **VERIFICATION AND REPORTING**

An evaporatively-cooled condensing unit, verified EER/EER2, and duct leakage testing are reported in the HERS required verification listings on the LMCC.

### **6.9.2.7 Evaporative Cooling**

Evaporative cooling technology is best suited for dry climates where direct, indirect, or indirect-direct cooling of the supply air stream can occur without compromising indoor comfort. Direct evaporative coolers are the most common system type available but provide less comfort and deliver more moisture to the indoor space. They are assumed equivalent to a minimum split-system air-conditioner. The evaporative cooling modeling method addresses two performance issues. The first performance issue is the increase in indoor relative humidity levels during periods with extended cooler operation. Since modeling of indoor air moisture levels is beyond the capability of the CSE engine, a simplified algorithm is used to prohibit evaporative cooler operation during load hours when operation is expected to contribute to uncomfortable indoor conditions. The algorithm disallows cooler operation when outdoor wet bulb temperatures are 70°F, or above. The second performance issue relates to evaporative cooler capacity limitations. Since evaporative coolers are 100 percent outdoor air systems, the related capacity is limited by the outdoor wet bulb temperature. Each hour with calculated cooling load, the algorithm will verify that the cooling capacity is greater than the calculated cooling load.

#### **PROPOSED DESIGN**

Software shall allow users to specify one of three types of evaporative cooling: (1) direct evaporative cooler, the most commonly available system type; (2) indirect; or (3) indirect-direct. Product specifications and other modeling details are found in the CEC appliance directory for evaporative cooling. Direct system types are assigned an efficiency of 14 SEER (or minimum appliance efficiency standard for split-system cooling). The default system type is evaporative direct. For indirect or indirect-direct, select the appropriate type from the CEC appliance directory and input a 13 EER as well as the airflow and media saturation effectiveness or cooling effectiveness from the CEC appliance directory.

### **STANDARD DESIGN**

The standard design is based on a split-system air-conditioner meeting the requirements of §170.2(c) and Table 170.2-K.

### **VERIFICATION AND REPORTING**

When a direct evaporative cooling system is modeled, the system type and minimum efficiency are shown in the appropriate section of the LMCC. When indirect or indirect-direct evaporative cooling is modeled, the EER/EER2 verification is shown in the HERS verification section of the LMCC along with the system type, airflow, and system effectiveness.

## **6.9.3 Distribution Subsystems**

If multiple HVAC distribution systems serve a building, each system, and the conditioned space it serves may be modeled in detail separately or the systems may be aggregated and modeled as one large system. If the systems are aggregated, they must be the same type, and all meet the same minimum specifications.

For duct efficiency calculations, the supply duct begins at the exit from the furnace or air-handler cabinet.

### **6.9.3.1 Distribution Type**

Fan-powered, ducted distribution systems can be used with most heating or cooling systems. When ducted systems are used with furnaces, boilers, or combined hydronic/water heating systems, the electricity used by the fan is calculated. R-value and duct location are specified when a ducted system is specified.

### **PROPOSED DESIGN**

The compliance software shall allow the user to select from the basic types of HVAC distribution systems and locations listed in Table 24. For ducted systems, the default

location of the HVAC ducts and the air handler are in conditioned space for multifamily buildings and in the attic for all other buildings.

**Table 24: HVAC Distribution Type and Location Descriptors**

<b>Name</b>	<b>HVAC Distribution Type and Location Description</b>
Ducts located in attic (ventilated and unventilated)	Ducts located overhead in the attic space.
Ducts located in a crawl space	Ducts located under floor in the crawl space.
Ducts located in a garage	Ducts located in an unconditioned garage space.
Ducts located within the conditioned space (except < 12 linear ft)	Ducts located within the conditioned floor space except for less than 12 linear feet of duct, furnace cabinet, and plenums — typically an HVAC unit in the garage mounted on return box with all other ducts in conditioned space.
Ducts located entirely in conditioned space	HVAC unit or systems with all HVAC ducts (supply and return) within the conditioned floor space. Location of ducts in conditioned space eliminates conduction losses but does not change losses due to leakage. Leakage either from ducts that are not tested for leakage or from sealed ducts is modeled as leakage to outside the conditioned space.
Distribution system without ducts (none)	Air-distribution systems without ducts such as ductless split-system air-conditioners and heat pumps, window air-conditioners, through-the-wall heat pumps, wall furnaces, floor furnaces, radiant electric panels, combined hydronic heating equipment, electric baseboards, or hydronic baseboard finned-tube natural convection systems, etc.
Ducts located in outdoor locations	Ducts in exposed locations outdoors.
Verified low-leakage ducts located entirely in conditioned space	Duct systems for which air leakage to outside is equal to or less than 25 CFM when measured in accordance with Reference Residential Appendix RA3.1.4.3.8.
Ducts located in multiple places	Ducts with different supply and return duct locations.

Source: California Energy Commission

**Table 25: Summary of Verified Distribution Systems**

Measure	Description	Procedures
Verified Duct Sealing	Mandatory measures require that space-conditioning ducts be sealed. Field verification and diagnostic testing are required to verify that approved duct system materials are used and that duct leakage meets the specified criteria.	RA3.1.4.3
Verified Duct Location, Reduced Surface Area and R-value	Compliance credit can be taken for improved supply duct location, reduced surface area, and R-value. Field verification is required to verify that the duct system was installed according to the duct design, including location, size and length of ducts, duct insulation R-value, and installation of buried ducts. <sup>1</sup> For buried duct measures, verified QII is required, as well as duct sealing.	RA3.1.4.1, 3.1.4.1.1
Low-Leakage Ducts in Conditioned Space	When the standards specify use of the procedures in Reference Appendices, Residential Appendix RA3.1.4.3.8 to determine if the space-conditioning system ducts are entirely in directly conditioned space, the duct system location is verified by diagnostic testing. Compliance credit can be taken for verified duct systems with low air leakage to the outside when measured in accordance with Reference Appendices, Residential Appendix RA3.1.4.3.8. Field verification for ducts in conditioned space is required. Duct sealing is	RA3.1.4.3.8



Measure	Description	Procedures
	required.	
Hydronic Delivery in Conditioned Space	Compliance credit can be taken for hydronic delivery systems with no ducting or piping in unconditioned space. For radiant ceiling panels, the verifications in Reference Appendices, Residential Appendix RA3.4.5 must be completed to qualify.	RA3.4.5
Low-Leakage Air-Handling Units	Compliance credit can be taken for installing a factory-sealed air-handling unit tested by the manufacturer and certified to the CEC to have met the requirements for a low-leakage air-handling unit. Field verification of the air handler model number is required. Duct sealing is required.	RA3.1.4.3.9
Verified Return Duct Design	Verification to confirm that the return duct design conforms to the criteria given in Table 150.0-B or Table 150.0-C. as an alternative to meeting 0.45 or 0.58 W/CFM fan efficacy of §150.0(m)0.	RA3.1.4.4
Verified Bypass Duct Condition	Verification to determine if system is zonally controlled and confirm that bypass ducts condition modeled matches installation.	RA3.1.4.6

1. Compliance credit for increased duct insulation R-value (not buried ducts) may be taken without field verification if the R-value is the same throughout the building, and for supply ducts located in crawl spaces and garages where all supply registers are either in the floor or within 2 feet of the floor. If these conditions are met, HERS rater verification is not required.

Source: California Energy Commission

The software will allow users to select default assumptions or specify any of the verified or diagnostically tested HVAC distribution system conditions in the proposed design

(Table 25), including duct leakage target, R-value, supply and return duct area, diameter, and location.

**STANDARD DESIGN**

The standard heating and cooling system for central systems is modeled with air distribution ducts located as described in Table 26, with duct leakage as specified in Table 21. The standard design duct insulation is determined by Table 170.2-K as R-6 in Climate Zones 3 and 5–7, and R-8 in Climate Zones 1, 2, 4, and 8–16. The standard design building is assumed to have the same number of stories as the proposed design for determining the duct efficiency.

**Table 26: Summary of Standard Design Duct Location**

<b>Configuration of the Proposed Design</b>	<b>Standard Design Duct Location</b>	<b>Detailed Specifications</b>
Attic over the dwelling unit	Ducts and air handler located in the attic	Ducts sealed (mandatory requirement) No credit for verified R-value, location, or duct design
No attic but crawl space or basement	Ducts and air handler located in the crawl space or basement	Ducts sealed (mandatory requirement) No credit for verified R-value, location, or duct design
Multifamily buildings with no attic, crawl space or basement	Ducts and air handler located indoors	Ducts sealed (mandatory requirement) No credit for verified R-value, location, or duct design

This table is applicable only when the standard design system has air-distribution ducts

Source: California Energy Commission

**VERIFICATION AND REPORTING**

Distribution type, location, R-value, and the determination of whether tested and sealed will be shown on the LMCC. If there are no ducts, the absence of ducts is shown as a

special feature on the LMCC. Any duct location other than attic (for example, crawl space) is shown as a special feature on the LMCC. Ducts in crawl space or the basement shall include a special feature note if supply registers are within 2 feet of the floor. Measures that require HERS verification will be shown in the HERS required verification section of the LMCC.

### **6.9.3.2 Duct Location**

Duct location determines the external temperature for duct conduction losses, the temperature for return leaks, and the thermal regain of duct losses.

#### **PROPOSED DESIGN**

If any part of the supply or return duct system is in an unconditioned attic, that entire duct system is modeled with an attic location. If no part of the supply or return duct system is located in the attic, but the duct system is not entirely in conditioned space, it is modeled in the unconditioned zone, which contains the largest fraction of the surface area. If the supply or return duct system is entirely in conditioned space, the duct system is modeled in conditioned space.

For ducted HVAC systems with some or all ducts in unconditioned space, the user specifies the R-value and surface area of supply and return ducts and the duct location.

Duct location and areas other than the defaults shown in Table 27 may be used following the verification procedures in *Reference Appendices, Residential Appendix RA3.1.4.1*.

#### **STANDARD DESIGN**

The standard design duct location is determined from the building conditions (Table 26).

#### **VERIFICATION AND REPORTING**

Duct location is reported on the LMCC. Ducts entirely in conditioned space and verified low-leakage ducts entirely in conditioned space are reported in the HERS-required verification listing on the LMCC.

Default duct locations are shown in Table 27. The duct surface area for crawl space and basement applies only to buildings or zones with all ducts installed in the crawl space or basement. If the duct is installed in locations other than crawl space or basement, the default duct location is "Other." For houses with two or more stories, 35 percent of the default duct area may be assumed to be in conditioned space, as shown in Table 27.

The surface area of ducts in conditioned space is ignored in calculating conduction losses.

**Table 27: Location of Default Duct Surface Area**

<b>Supply Duct Location</b>	<b>One story</b>	<b>Two or more stories</b>
All in crawl space	100% crawl space	65% crawl space, 35% conditioned space
All in basement	100% basement	65% basement, 35% conditioned space
Other	100% attic	65% attic, 35% conditioned space

Source: California Energy Commission

### 6.9.3.3 Duct Surface Area

The supply-side and return-side duct surface areas are treated separately in distribution efficiency calculations. The duct surface area is determined using the following methods.

### 6.9.3.4 Default Return Duct Surface Area

Default return duct surface area is calculated using:

$$A_{r,out} = K_r \times A_{floor}$$

#### Equation 4

Where  $K_r$  (return duct surface area coefficient) is 0.05 for one-story buildings and 0.1 for two or more stories and  $A_{floor}$  is the floor area.  $A_{r,out}$  is the surface area of the return duct.

### 6.9.3.5 Default Supply Duct Surface Area

#### STANDARD DESIGN

The standard design and default proposed design supply duct surface area is calculated using Equation 5.

$$A_{s,out} = 0.27 \times A_{floor} \times K_s \quad \text{Equation 5}$$

Where  $K_s$  (supply duct surface area coefficient) is 1 for one-story buildings and 0.65 for two or more stories and  $A_{floor}$  is the floor area.  $A_{s,out}$  is the surface area of the return duct.

### 6.9.3.6 Supply Duct Surface Area for Less Than 12 feet of Duct in Unconditioned Space

#### PROPOSED DESIGN

For proposed design HVAC systems with air handlers outside the conditioned space but with less than 12 linear feet of duct outside the conditioned space, including air handler and plenum, the supply duct surface area outside the conditioned space is calculated using Equation 6. The return duct area remains the default for this case.

$$A_{s,out} = 0.027 \times A_{floor} \quad \text{Equation 6}$$

### 6.9.3.7 Diagnostic Duct Surface Area

Proposed designs may claim credit for reduced surface area using the procedures in *Reference Appendices, Residential Appendix RA3.1.4.1*.

The surface area of each duct system segment shall be calculated based on the associated inside dimensions and length. The total supply surface area in each unconditioned location (attic, attic with radiant barrier, crawl space, basement, other) is the sum of the area of all duct segments in that location. The surface area of ducts completely inside conditioned space need not be input in the compliance software and is not included in the calculation of duct system efficiency. The area of ducts in floor cavities or vertical chases that are surrounded by conditioned space and separated from unconditioned space with draft stops are also not included. The software assumes the user input duct system area is 85 percent of the total duct system area. The other 15 percent is assumed to be air handler, plenum, and connectors. Because of this, the total duct system area used in the building simulation is:

Simulated Duct System Area = 1.1765 multiplied by the total user entered duct system area

### 6.9.3.8 Bypass Duct

§170.2(c)3C prohibits use of bypass ducts unless a bypass duct is otherwise specified on the certificate of compliance. A bypass duct may be needed for some single-speed outdoor condensing unit systems. The software allows users to specify a bypass duct for the system. Selection of a bypass duct does not trigger changes in the ACM modeling defaults, but verification by a HERS rater is required to use the procedure in *Reference Appendices, Residential Appendix RA3.1.4.6*.

Specification of a zonally controlled system with a single-speed condensing unit will trigger a default airflow rate value of 150 CFM/ton for the calculations. User input less than 350 CFM/ton reduces the compliance margin as compared to systems that model 350 CFM/ton as described in [Chapter 6.9.2.2](#) Verified System Airflow.

## PROPOSED DESIGN

Software shall allow users to specify whether a bypass duct is used for a zonally controlled forced air system.

**STANDARD DESIGN**

The standard design is based on a split-system air-conditioner meeting the requirements of §170.2 and Table 170.2-K. The system is not a zonally controlled system.

**VERIFICATION AND REPORTING**

An HVAC system with zonal control, and the determination of whether the system is assumed to have a bypass duct or have no bypass duct, is reported in the HERS-required verification listings on the LMCC.

**6.9.3.9 Duct System Insulation**

For conduction calculations in the standard and proposed designs, 85 percent of the supply and return duct surface is assumed duct material at the related specified R-value, and 15 percent is assumed air handler, plenum, connectors, and other components at the mandatory minimum R-value.

The area weighted effective R-value is calculated by the compliance software using Equation 7, including each segment of the duct system that has a different R-value.

$$R_{\text{eff}} = \frac{(A_1 + A_2 \dots + A_N)}{\left[ \frac{A_1}{R_1} + \frac{A_2}{R_2} \dots + \frac{A_N}{R_N} \right]} \quad \text{Equation 7}$$

Where:

- $R_{\text{eff}}$  - Area weighted effective R-value of duct system for use in calculating duct efficiency,  
(h-ft<sup>2</sup>-°F/Btu)
- $A_N$  - Area of duct segment n, square feet
- $R_N$  - R-value of duct segment n including film resistance (duct insulation rated R + 0.7)  
(h-ft<sup>2</sup>-°F/Btu)

**PROPOSED DESIGN**

The software user inputs the R-value of the proposed duct insulation and details. The default duct thermal resistance is based on Table 170.2-K, which is R-6 in Climate Zones 3 and 5–7, R-8 in Zones 1, 2, 4, and 8–16.

Duct location and duct R-value are reported on the LMCC. Credit for systems with mixed insulation levels, nonstandard supply and return duct surface areas, or ducts buried in the attic require the compliance and diagnostic procedures in *Reference Appendices, Residential Appendix RA3.1.4.1*.

If verified duct design is selected, the user must enter the duct design into the software. For each duct segment entered, the user must specify Type (supply/return), Buried (yes/no, per Chapter [6.9.3.10](#) Buried Attic Ducts), Diameter (inside/nominal), Length, and Duct Insulation R-value. User-entered duct design must be verified by a HERS rater according to the procedures in *Reference Appendices, Residential Appendix RA3.1.4.1.1*. User-entered duct design and duct location are reported on the LMCC when nonstandard values are specified.

### **STANDARD DESIGN**

The required duct insulation R-value is from Table 170.2-K for the applicable climate zone used in the standard design.

### **VERIFICATION AND REPORTING**

Duct type (supply/return), nominal diameter, length, R-value, and location, and supply and return areas are reported on the LMCC. Verified duct design is reported in the HERS-required verification listing on the LMCC.

### **6.9.3.10 Buried Attic Ducts**

Ducts partly, fully, or deeply buried in blown attic insulation in dwelling units meeting the requirements for verified QII may take credit for increased effective duct insulation. To qualify for buried duct credit, ducts must meet mandatory insulation levels (R-6) prior to burial, be directly or within 3.5 inches of ceiling gypsum board and be surrounded by at least R-30 attic insulation. Moreover, credit is available only for duct runs where the ceiling is level, there is at least 6 inches of space between the duct outer jacket and the roof sheathing, and the attic insulation has uniform depth. Existing ducts are exempt from mandatory minimum insulation levels, but to qualify for buried duct credit, they must have greater than R-4.2 insulation before burial.

In addition to the above requirements, deeply buried ducts must be buried by at least 3.5 inches of insulation above the top of the duct insulation jacket and located within a lowered area of the ceiling, a deeply buried containment system, or buried by at least 3.5 inches of uniformly level insulation. Mounding insulation to achieve the 3.5-inch burial level is not allowed.

Deeply buried duct containment systems must be installed such that the walls of the system are at least 7 inches wider than the duct diameter (3.5 inches on each side of

duct), the walls extend at least 3.5 inches above the duct outer jacket, and the containment area surrounding the duct must be completely filled with blown insulation.

The duct design shall identify the segments of the duct that meet the requirements for being buried, and these are input into the software separately from nonburied ducts. For each buried duct, the user must enter the duct size, R-value, and length, and determination of whether the duct qualifies as deeply buried. The user must also indicate if a duct uses a deeply buried containment system. The software calculates the weighted average effective duct system R-value based on the user-entered duct information, blown insulation type (cellulose or fiberglass), and R-value.

Duct-effective R-values are broken into three categories: partially, fully, and deeply, with each having different burial levels and requirements. Partially buried ducts have less than 3.5 inches of exposed duct depth, fully buried ducts have insulation depth at least level with the duct jacket, and deeply buried ducts have at least 3.5 inches of insulation above the duct jacket in addition to the above requirements. Effective duct R-value used by the software are listed in Table 28, Table 29, Table 30, Table 31, Table 32, and Table 33.

#### **PROPOSED DESIGN**

The software calculates the effective R-value of buried ducts based on user-entered duct size, R-value, and length; attic insulation level and type; and determination of whether the duct meets the requirements of a deeply buried duct by using a lowered ceiling chase or a containment system. This feature must be combined with verified QII, verified duct location, reduced surface area and R-value, and verified minimum airflow. The software will allow any combination of duct runs and the associated buried condition, and the overall duct system effective R-value will be a weighted average of the combination. The default is no buried ducts.

#### **STANDARD DESIGN**

The standard design has no buried ducts.

#### **VERIFICATION AND REPORTING**

Buried duct credit is reported in the HERS required verification listing on the CF1R.



**Table 28: Buried Duct Effective R-Values**

R-8 Ducts With Blown Fiberglass Attic Insulation

Duct Diameter	R-30 Ceiling	R-38 Ceiling	R-40 Ceiling	R-43 Ceiling	R-49 Ceiling	R-60 Ceiling
3"	R-18	R-26	R-26	R-26	R-26	R-26
4"	R-13	R-18	R-26	R-26	R-26	R-26
5"	R-13	R-18	R-18	R-26	R-26	R-26
6"	R-13	R-18	R-18	R-18	R-26	R-26
7"	R-13	R-13	R-18	R-18	R-26	R-26
8"	R-8	R-13	R-13	R-18	R-18	R-26
9"	R-8	R-13	R-13	R-13	R-18	R-26
10"	R-8	R-13	R-13	R-13	R-18	R-26
12"	R-8	R-8	R-8	R-13	R-13	R-26
14"	R-8	R-8	R-8	R-8	R-13	R-18
16"	R-8	R-8	R-8	R-8	R-8	R-13
18"	R-8	R-8	R-8	R-8	R-8	R-13
20"	R-8	R-8	R-8	R-8	R-8	R-8
22"	R-8	R-8	R-8	R-8	R-8	R-8
24"	R-8	R-8	R-8	R-8	R-8	R-8

Source: California Energy Commission

**Table 29: Buried Duct Effective R-Values**

R-8 Ducts with Blown Cellulose Attic Insulation

Duct Diameter	R-30 Ceiling	R-38 Ceiling	R-40 Ceiling	R-43 Ceiling	R-49 Ceiling	R-60 Ceiling
3"	R-14	R-20	R-20	R-20	R-32	R-32
4"	R-14	R-14	R-20	R-20	R-20	R-32
5"	R-8	R-14	R-14	R-20	R-20	R-32
6"	R-8	R-14	R-14	R-14	R-20	R-32
7"	R-8	R-14	R-14	R-14	R-20	R-20
8"	R-8	R-8	R-8	R-14	R-14	R-20

Duct Diameter	R-30 Ceiling	R-38 Ceiling	R-40 Ceiling	R-43 Ceiling	R-49 Ceiling	R-60 Ceiling
9"	R-8	R-8	R-8	R-8	R-14	R-20
10"	R-8	R-8	R-8	R-8	R-14	R-20
12"	R-8	R-8	R-8	R-8	R-8	R-14
14"	R-8	R-8	R-8	R-8	R-8	R-8
16"	R-8	R-8	R-8	R-8	R-8	R-8
18"	R-8	R-8	R-8	R-8	R-8	R-8
20"	R-8	R-8	R-8	R-8	R-8	R-8
22"	R-8	R-8	R-8	R-8	R-8	R-8
24"	R-8	R-8	R-8	R-8	R-8	R-8

Source: California Energy Commission

**Table 30: Buried Duct Effective R-Values**

R-6 Ducts with Blown Fiberglass Attic Insulation

Duct Diameter	R-30 Ceiling	R-38 Ceiling	R-40 Ceiling	R-43 Ceiling	R-49 Ceiling	R-60 Ceiling
3"	R-15	R-24	R-24	R-24	R-24	R-24
4"	R-15	R-24	R-24	R-24	R-24	R-24
5"	R-11	R-15	R-24	R-24	R-24	R-24
6"	R-11	R-15	R-15	R-24	R-24	R-24
7"	R-11	R-15	R-15	R-15	R-24	R-24
8"	R-11	R-15	R-15	R-15	R-24	R-24
9"	R-6	R-11	R-11	R-15	R-24	R-24
10"	R-6	R-11	R-11	R-15	R-15	R-24
12"	R-6	R-6	R-11	R-11	R-15	R-24
14"	R-6	R-6	R-6	R-6	R-11	R-15
16"	R-6	R-6	R-6	R-6	R-11	R-15
18"	R-6	R-6	R-6	R-6	R-6	R-11
20"	R-6	R-6	R-6	R-6	R-6	R-11
22"	R-6	R-6	R-6	R-6	R-6	R-6
24"	R-6	R-6	R-6	R-6	R-6	R-6

Source: California Energy Commission

**Table 31 Buried Duct Effective R-Values**

R-6 Ducts with Blown Cellulose Attic Insulation

Duct Diameter	R-30 Ceiling	R-38 Ceiling	R-40 Ceiling	R-43 Ceiling	R-49 Ceiling	R-60 Ceiling
3"	R-12	R-18	R-18	R-18	R-31	R-31
4"	R-12	R-18	R-18	R-18	R-31	R-31
5"	R-12	R-12	R-18	R-18	R-18	R-31
6"	R-6	R-12	R-12	R-18	R-18	R-31
7"	R-6	R-12	R-12	R-12	R-18	R-31
8"	R-6	R-12	R-12	R-12	R-18	R-31
9"	R-6	R-6	R-6	R-12	R-12	R-18
10"	R-6	R-6	R-6	R-6	R-12	R-18
12"	R-6	R-6	R-6	R-6	R-6	R-12
14"	R-6	R-6	R-6	R-6	R-6	R-12
16"	R-6	R-6	R-6	R-6	R-6	R-6
18"	R-6	R-6	R-6	R-6	R-6	R-6
20"	R-6	R-6	R-6	R-6	R-6	R-6
22"	R-6	R-6	R-6	R-6	R-6	R-6
24"	R-6	R-6	R-6	R-6	R-6	R-6

Source: California Energy Commission

**Table 32: Buried Duct Effective R-Values**

R-4.2 Ducts With Blown Fiberglass Attic Insulation

Duct Diameter	R-30 Ceiling	R-38 Ceiling	R-40 Ceiling	R-43 Ceiling	R-49 Ceiling	R-60 Ceiling
3"	R-13	R-22	R-22	R-22	R-22	R-22
4"	R-13	R-22	R-22	R-22	R-22	R-22
5"	R-13	R-22	R-22	R-22	R-22	R-22
6"	R-13	R-13	R-22	R-22	R-22	R-22
7"	R-9	R-13	R-13	R-22	R-22	R-22

Duct Diameter	R-30 Ceiling	R-38 Ceiling	R-40 Ceiling	R-43 Ceiling	R-49 Ceiling	R-60 Ceiling
8"	R-9	R-13	R-13	R-13	R-22	R-22
9"	R-9	R-13	R-13	R-13	R-22	R-22
10"	R-4.2	R-9	R-13	R-13	R-13	R-22
12"	R-4.2	R-9	R-9	R-9	R-9	R-22
14"	R-4.2	R-4.2	R-4.2	R-9	R-9	R-22
16"	R-4.2	R-4.2	R-4.2	R-4.2	R-9	R-13
18"	R-4.2	R-4.2	R-4.2	R-4.2	R-4.2	R-9
20"	R-4.2	R-4.2	R-4.2	R-4.2	R-4.2	R-9
22"	R-4.2	R-4.2	R-4.2	R-4.2	R-4.2	R-4.2
24"	R-4.2	R-4.2	R-4.2	R-4.2	R-4.2	R-4.2

Source: California Energy Commission

**Table 33: Buried Duct Effective R-Values**

R-4.2 Ducts with Blown Cellulose Attic Insulation

Duct Diameter	R-30 Ceiling	R-38 Ceiling	R-40 Ceiling	R-43 Ceiling	R-49 Ceiling	R-60 Ceiling
3"	R-15	R-15	R-29	R-29	R-29	R-29
4"	R-9	R-15	R-15	R-15	R-29	R-29
5"	R-9	R-15	R-15	R-15	R-29	R-29
6"	R-9	R-9	R-15	R-15	R-15	R-29
7"	R-4.2	R-9	R-9	R-15	R-15	R-29
8"	R-4.2	R-9	R-9	R-9	R-15	R-29
9"	R-4.2	R-9	R-9	R-9	R-15	R-15
10"	R-4.2	R-4.2	R-9	R-9	R-9	R-15
12"	R-4.2	R-4.2	R-4.2	R-4.2	R-9	R-15
14"	R-4.2	R-4.2	R-4.2	R-4.2	R-4.2	R-9
16"	R-4.2	R-4.2	R-4.2	R-4.2	R-4.2	R-9
18"	R-4.2	R-4.2	R-4.2	R-4.2	R-4.2	R-4.2
20"	R-4.2	R-4.2	R-4.2	R-4.2	R-4.2	R-4.2
22"	R-4.2	R-4.2	R-4.2	R-4.2	R-4.2	R-4.2

Duct Diameter	R-30 Ceiling	R-38 Ceiling	R-40 Ceiling	R-43 Ceiling	R-49 Ceiling	R-60 Ceiling
24"	R-4.2	R-4.2	R-4.2	R-4.2	R-4.2	R-4.2

Source: California Energy Commission

**6.9.3.11 Duct/Air Handler Leakage**

The total duct/air handler leakage shown in Table 34 is used in simulating the duct system. The supply duct leakage for each case is the table value multiplied by 0.585. The return leakage is the table value multiplied by 0.415.

**PROPOSED DESIGN**

For each ducted system, the software user specifies one of the duct/air handler leakage cases shown in Table 34.

**STANDARD DESIGN**

For ducted systems, the standard design is sealed and tested duct systems in existing dwelling units or new duct systems.

**VERIFICATION AND REPORTING**

Sealed and tested duct systems are listed in the HERS verification section of the LMCC. Duct leakage is measured in accordance with procedures and values specified in Reference Appendices, Residential Appendix RA3.

**6.9.3.12 Low Leakage Air Handlers**

A low-leakage air handler may be specified as well as a lower duct leakage value. (See Chapter 6.9.3.11 Duct/Air Handler Leakage.) Installation requires installing one of the list of approved low-leakage air handling units published by the CEC. The manufacturer certifies that the appliance complies with the requirements of Reference Appendices, Joint Appendices JA9.2.1, 9.2.2, 9.2.3, and 9.2.4.

**Table 34: Duct/Air Handler Leakage**

Case	Duct Leakage	Air Handler Leakage	Total Duct/Air Handler Leakage
Sealed and tested new or altered duct systems in conditioned or unconditioned	12%	Included in duct leakage	12%

Case	Duct Leakage	Air Handler Leakage	Total Duct/Air Handler Leakage
space in a multifamily dwelling unit			
Verified low-leakage ducts in conditioned space	0%	0%	0%
Low leakage air handlers in combination with sealed and tested new duct systems	5% or as measured	0%	5% or as measured

Source: California Energy Commission

**PROPOSED DESIGN**

Credit can be taken for installing a factory-sealed air-handling unit tested by the manufacturer and certified to the CEC to meet the requirements for a low-leakage air-handler. Field verification of the air handler model number is required.

**STANDARD DESIGN**

The standard design has a normal air handler.

**VERIFICATION AND REPORTING**

A low-leakage air handler is reported on the compliance report and field verified in accordance with the procedures specified in Reference Appendices, Residential Appendix RA3.1.4.3.9.

**6.9.3.13 Verified Low-Leakage Ducts in Conditioned Space**

**PROPOSED DESIGN**

For ducted systems, the user may specify that all ducts are entirely in conditioned space, and the software will model the duct system with no leakage and no conduction losses.

**STANDARD DESIGN**

The standard design has ducts in the default location.

**VERIFICATION AND REPORTING**

Systems that have all ducts entirely in conditioned space are reported on the compliance documents and verified by measurements showing duct leakage to outside conditions is equal to or less than 25 CFM when measured in accordance with *Reference Appendices, Residential Appendix RA3*.

#### **6.9.4 Space-Conditioning Fan Subsystems**

Fan systems move air for air-conditioning, heating, and ventilation systems. The software allows the user to define the fans to be used for space-conditioning, IAQ, and ventilation cooling. IAQ and ventilation cooling are discussed in [Chapter 6.9.6](#) Indoor Air Quality Ventilation.

##### **PROPOSED DESIGN**

For the space-conditioning fan system, the user selects the type of equipment and enters basic information to model the energy use of the equipment. For ducted central air-conditioning and heating systems, the fan efficacy default is the mandatory minimum verified efficacy of 0.45, 0.58, or 0.62 W/CFM, depending on applicable system type (also assumed when there is no cooling system).

##### **STANDARD DESIGN**

The standard design shall assume a verified fan efficacy complying with the mandatory requirement of less than or equal to 0.45, 0.58, or 0.62 watts/CFM, depending on the applicable system type.

##### **VERIFICATION AND REPORTING**

Minimum verified fan efficacy is mandatory for all ducted cooling systems. Fan efficacy is reported in the HERS required verification listings on the LMCC.

#### **6.9.5 Space-Conditioning Systems**

This chapter describes the general procedures for heating and cooling systems in multifamily buildings. The system includes the cooling system, the heating system, distribution system, and mechanical fans.

If multiple systems serve a building, each system, and the conditioned space it serves may be modeled in detail separately or the systems may be aggregated and modeled as one large system. If the systems are aggregated, they must be the same type and all meet the same minimum specifications.

##### **6.9.5.1 Multiple System Types Within Building**

##### **PROPOSED DESIGN**

For proposed designs using more than one heating system type, equipment type, or fuel type, and the types do not serve the same floor area, the user shall zone the building by system type.

#### **STANDARD DESIGN**

The standard design shall have the same zoning and heating system types as the proposed design.

#### **VERIFICATION AND REPORTING**

The heating system type of each zone is shown on the LMCC.

#### **6.9.5.2 Multiple Systems Serving Same Area**

If a space or a zone is served by more than one heating system, compliance is demonstrated with the most TDV energy-consuming system serving the space or the zone. For spaces or zones that are served by electric resistance heat in addition to other heating systems, the electric resistance heat is deemed the most TDV energy-consuming system unless the supplemental heating meets the exception to §150.1(c)6. See eligibility criteria in *Residential Compliance Manual* Section 4.2.2 for conditions under which the supplemental heat may be ignored.

For floor areas served by more than one cooling system, equipment, or fuel type, the system, equipment, and fuel type that satisfy the cooling load are modeled.

#### **6.9.5.3 No Cooling**

##### **PROPOSED DESIGN**

When the proposed design has no cooling system, the proposed design is required to model the standard design cooling system defined in §170.2 and Table 170.2-K. Since the proposed design system is identical to the standard design system, there is no penalty or credit.

##### **STANDARD DESIGN**

The standard design system is the specified in §170.2 and Table 170.2-K for the applicable climate zone.

##### **VERIFICATION AND REPORTING**

No cooling is reported as a special feature on the LMCC.

#### **6.9.5.4 Zonally Controlled Forced-Air Cooling Systems**

Zonally controlled central forced-air cooling systems must be able to deliver, in every zonal control mode, an airflow to the dwelling of  $\geq$  350 CFM per ton of nominal cooling



capacity and operating at an air-handling unit fan efficacy of  $\leq 0.45$  or  $0.58$  W/CFM depending on the applicable system type. This is a HERS-verified measure, complying with Reference Appendices, *Residential Appendix RA3.3*.

An exception allows multispeed or variable-speed compressor systems, or single-speed compressor systems to meet the mandatory airflow (CFM/ton) and fan efficacy (watt/CFM) requirements by operating the system at maximum compressor capacity, and system fan speed with all zones calling for conditioning, rather than in every zonal control mode.

### **PROPOSED DESIGN**

The user selects zonally controlled as a cooling system input.

### **STANDARD DESIGN**

The standard design building does not have a zonally controlled cooling system.

### **VERIFICATION AND REPORTING**

Zonally controlled forced-air cooling systems are required to have the system bypass duct status verified by a HERS rater according to the procedures in *Reference Appendices, Residential Appendix RA3.1.4.6*, and the fan efficacy and airflow rate are required to be verified according to the procedures in *RA3.3*.

## **6.9.6 Indoor Air Quality Ventilation**

For newly constructed buildings and additions greater than 1,000 ft<sup>2</sup>, the Energy Code requires that all dwelling units meet the requirements of ASHRAE Standard 62.2 with the amendments specified in §160.2(b)2. Providing acceptable IAQ by mechanical ventilation is one of the requirements of Standard 62.2. For multifamily dwelling units, the required mechanical ventilation rate is equal to the total ventilation required for the dwelling minus the calculated annually averaged infiltration rate.

The total required ventilation rate for the dwelling unit is calculated using Energy Code, Equation 160.2-B.

### **Equation 8 (Equation 160.2-B)**

$$Q_{\text{total}} = 0.03A_{\text{floor}} + 7.5(N_{\text{br}} + 1)$$

Where:

- $Q_{\text{total}}$  - Total required ventilation rate (CFM)
- $A_{\text{floor}}$  - Conditioned floor area in square feet (ft<sup>2</sup>)
- $N_{\text{br}}$  - Number of bedrooms (not fewer than one)

The effective infiltration rate of the dwelling is calculated using Equation 150.0-C or 150.0-D of the Energy Code.

**Equation 9 (Equation 150.0-C & D)**

$$Q_{50} = V_{du} \times ACH_{50} / 60 \text{ min}$$

Where:

- $Q_{50}$  - Leakage rate at 50 Pa
- $V_{du}$  - Dwelling unit conditioned volume (ft<sup>3</sup>)
- $ACH_{50}$  - Air changes per hour at 50 Pa (0.2 inch water).

The software uses a default of 2  $ACH_{50}$  unless the user input dwelling unit leakage is less than 2  $ACH_{50}$ , in which case the user input value is used in the above equation.

The effective annual average infiltration rate is calculated using Energy Code, Equation 150.0-E.

**Equation 10 (Equation 150.0-E)**

$$Q_{inf} = 0.052 \times Q_{50} \times wsf \times [H/H_r]^z$$

Where:

- $Q_{inf}$  - Effective annual infiltration rate (CFM) (L/s)
- $Q_{50}$  - Leakage rate at 50 Pa (from equation 150.0-C or 150.0-D)
- $wsf$  - Weather and shielding factor from Table 150.0-D
- $H$  - Vertical distance between the lowest and highest above-grade points within the pressure boundary (ft)
- $H_r$  - Reference height, 8.2 ft
- $Z$  - 0.4 for calculating the effective annual average infiltration rate

For horizontally attached dwelling units, the required mechanical ventilation rate is calculated using Equation 150.0-F of the Energy Code.

**Equation 11 (Equation 150.0-F)**

$$Q_{fan} = Q_{total} - \phi (Q_{inf} \times A_{ext})$$

Where:

- $Q_{fan}$  - Fan flow rate in cubic feet per minute (CFM)
- $Q_{total}$  - Total required ventilation rate (CFM)
- $Q_{inf}$  - Effective annual average infiltration rate, CFM from Equation 150.0-E
- $A_{ext}$  - Reduction factor accounting for leaks from adjacent dwelling units; 1 for single-family detached homes, or the ratio of exterior envelope surface area that is not attached to garages or other dwelling units to the total envelope surface

area for attached dwelling units not sharing ceilings or floor with other dwelling units, occupiable spaces, public garages, or commercial spaces

- $\phi - 1$  for balanced ventilation systems and  $Q_{inf}/Q_{total}$  otherwise

For estimating the energy impact of this requirement in compliance software, the minimum ventilation rate is met by either a standalone IAQ fan system or a central air handler fan system that can introduce outdoor air.

The simplest IAQ fan system is an exhaust fan/bathroom fan that meets the criteria in ASHRAE Standard 62.2 for air delivery and minimal noise. More advanced IAQ fan systems that have a supply or both supply and exhaust fans are possible. To calculate the energy use of standalone IAQ fan systems, the systems are assumed to be on continuously.

To calculate the energy use of central fan integrated ventilation, the systems are assumed to be on for at least 20 minutes each hour as described below. The fan flow rate and fan power ratio may be different from the values used when the system is on to provide for heating or cooling, depending on the design or controls on the IAQ ventilation portion of the system.

### **PROPOSED DESIGN**

The proposed design shall incorporate a mechanical ventilation system meeting the above mandatory measures. The compliance software allows the user to specify the IAQ ventilation type (see Table 36), CFM of outdoor ventilation air equal to or greater than what is required by the Energy Code, and W/CFM. The user must also indicate whether the dwelling unit is attached or detached and the vertical distance between the lowest and highest above-grade points. For balanced systems, the software allows the user to specify the Sensible Recovery Efficiency (SRE) and Adjusted Sensible Recovery Efficiency (ASRE) if the system has energy or heat recovery.

For multifamily, the default minimum IAQ fan system is a balanced standalone system.

Systems with supply ducts (balanced and supply-only) are simulated with increased fan wattage and reduced SRE and ASRE to account for maintenance and installation factors affecting system efficacy. For these systems, fan wattage is increased by a factor of 1.10 (10 percent increase in wattage) and SRE and ASRE are reduced by a factor of 0.90 (10 percent decrease in recovery efficiencies). For IAQ systems with fault indicator displays (FID) meeting the below specifications, these factors don't apply.

### **IAQ SYSTEM FAULT INDICATOR DISPLAY REQUIREMENTS**

1. Fault indication responding to the following categories:

- a. Filter check or maintenance, either based on performance or a predetermined schedule.
  - b. Low supply airflow.
  - c. Low exhaust airflow.
  - d. Sensor failure for sensors that assist in monitoring or controlling for the following operations, where such operations are provided: airflow regulation, frost control, supply air tempering, and economizing.
2. Fault indication using one or more of the following means:
- a. A visual display that is readily accessible to occupants of the dwelling unit and located on or within one foot of the IAQ system control.
  - b. An electronic application.
  - c. An audible alarm accompanied by a visual display.
3. Instrumentation and reporting of the following:
- a. Airflow.
  - b. Fan power.
4. FID certified to CEC by the manufacturer as meeting the above requirements.

To receive compliance credit relative to the standard design, balanced and supply-only systems must have accessible supply air filters, outside air inlets, and heat/energy recovery cores (if applicable) as specified in Table 35. For systems not meeting these requirements, compliance credit will be neutralized (see IAQ system standard design for details).

**Table 35: IAQ System Component Accessibility Criteria**

<b>Dwelling Unit Ventilation System Component</b>	<b>Location</b>	<b>Accessible Determination</b>
Outdoor Air Intake	All locations	Intakes louvers, grilles, or screens shall be >3/8 inches except where prohibited by local jurisdictions or other code requirements.
Outdoor Air Intake	Exterior wall, soffit, or gable end	For single-family, a point on the perimeter of the outdoor air intake shall be located within 10 feet of a

Dwelling Unit Ventilation System Component	Location	Accessible Determination
		walking surface or grade or the system shall meet the IAQ System FID requirements in the RACM Reference Manual. For multifamily, complies.
Outdoor Air Intake	Roof	Access shall be provided in accordance with California Mechanical Code Section 304.3.1 requirements for appliances.
Filters and Heat Exchangers	Serviceable from conditioned space, unconditioned basements, or mechanical closets. Heat exchangers may also be serviceable from unconditioned attics if the IAQ system meets the FID requirements in the RACM Reference Manual.	The H/ERV or supply ventilation system access panel shall be located within 10 feet of the walking surface.
Filters and Heat Exchangers	Roof	For multifamily only, access shall be provided in accordance with California Mechanical Code Section 304.31 requirements for appliances.

Source: California Energy Commission

**STANDARD DESIGN**

The standard design mechanical ventilation system type (balanced, supply, or exhaust) is the same as the proposed. Fan efficacy is 0.35 W/CFM for exhaust or supply systems and 0.70 W/CFM for balanced systems. Airflow rate is equal to the proposed design value or 1.25 times the CFM required by the Energy Code, whichever is smaller. The standard design has no heat recovery.

If the proposed IAQ system uses the central air handler fan, the standard design IAQ fan efficacy is 0.45 W/CFM for gas furnaces, 0.58 W/CFM for heat pumps, or 0.62 W/CFM for small duct high velocity systems.

If the proposed design is balanced or supply-only and doesn't meet the accessible requirements listed in Table 35, the standard design W/CFM equals the proposed or the default value whichever is lower and if the proposed system has heat recovery the standard will have heat recovery with SRE and ASRE equal to the proposed system.

**VERIFICATION AND REPORTING**

The required ventilation rate to comply with the Energy Code and the means to achieve compliance are indicated on the LMCC CF1R, example data provided in Table 36. The IAQ system characteristics are reported in the HERS required verification listing on the LMCC. The diagnostic testing procedures are in Reference Appendices, Residential Appendix RA3.7.

Special features are reported on the LMCC when the proposed system has heat or energy recovery or when the proposed fan efficacy is less than (i.e., more efficient than) 0.7 W/CFM.

**Table 36: IAQ Fans**

Type	Description	Inputs
Standalone IAQ Fan (exhaust, supply, or balanced)	Dedicated fan system that provides IAQ ventilation to meet or exceed the requirements of Energy Code §160.2(b)2.	CFM, W/CFM, and SRE and ASRE for balanced systems
Central Fan Integrated (CFI) (variable or fixed speed)	Automatic operation of the air handler for IAQ ventilation. Ventilation type uses a special damper to induce outdoor IAQ ventilation air and distribute it through the HVAC duct system. Mixing type distributes and mixes IAQ ventilation air supplied by a separate standalone IAQ fan system.	CFM, W/CFM

Source: California Energy Commission

**6.9.7 Ventilation Source**

Residential unit thermal zones the ventilation source may be natural, through operable openings, or forced, through fans.

**PROPOSED DESIGN**

The source of ventilation for a thermal zone is based on the proposed design and is natural, forced, or none.

#### **STANDARD DESIGN**

For residential units the standard design ventilation system is forced. The standard design mechanical ventilation system type (balanced, supply, or exhaust) is the same as the proposed and serves the same number of dwelling units as the proposed. If the proposed system is central serving multiple dwelling units, the standard design also is central and serves the same number of dwelling units.

### **6.9.8 Design Ventilation Rate**

Residential unit thermal zones must identify the quantity of ventilation air that is provided to the space.

#### **PROPOSED DESIGN**

The quantity of ventilation air that is provided to the space for the specified thermal zone at maximum occupancy is first determined.

This is adjusted by the occupancy fraction to determine the design ventilation rate for the space.

As defined by the user, provided that the total outside air ventilation rate to the building story matches the standard design outside air ventilation rate for the building story within a specified tolerance (within 20%).

To accommodate transfer air requirements for makeup air for exhaust from other zones, the design ventilation rate may be between 95 percent and 120 percent of the code required ventilation rate for multifamily residential spaces and thermal zones.

Ventilation rates below 95% of the code required ventilation rate for a building story are not allowed.

If the ventilation source is natural for residential dwelling spaces, then the proposed design ventilation will be modeled as infiltration.

#### **STANDARD DESIGN**

For multifamily residential building dwelling units, the standard design ventilation rate is the greater of the code minimum ventilation rate and the proposed design minimum ventilation rate, but subject to a limit of 110% of the code-minimum required ventilation rate. If the proposed ventilation rate exceeds the limits above, the standard design ventilation rate for each space shall be the proposed rate uniformly reduced such that the total ventilation air delivered to the building story is equal to the maximum allowed ventilation air rate:

Design Ventilation Rate<sub>std</sub> = Design Ventilation Rate<sub>prop</sub> x ( BFVent<sub>std</sub> / BFVent<sub>prop</sub> )

Where:

BFVent<sub>min</sub> is the building floor design minimum required ventilation flow, as specified by the standards, and

BFVent<sub>prop</sub> is the building floor design ventilation flow for the proposed design.

For existing buildings, the standard design is the same as the proposed design, if unaltered. If space type is altered such that different ventilation rate requirements apply, the outside air ventilation rate should follow the same rules as for newly constructed buildings.

### **6.9.9 Exhaust Fan Power Index**

Exhaust systems serving multifamily residential units and hotel/motel guestrooms must identify the exhaust fan power for the exhaust fan.

#### **PROPOSED DESIGN**

The exhaust fan power index is the fan power of the exhaust fan per unit of flow.

This building descriptor is applicable only with the power-per-unit-flow method.

For multifamily residential dwelling units:

For systems with supply ducts (balanced, supply-only, and HRV/ERV), simulated fan power is increased by an additional factor of 1.10 to account for maintenance and installation performance factors. For IAQ systems with fault indicator displays (FID) meeting the specifications in the Chapter 6.9.6, these factors don't apply.

#### **STANDARD DESIGN**

For residential dwelling units the exhaust fan power index is 0.7 W/CFM.

Additionally, for multifamily residential dwelling units, if the proposed system type is balanced, supply-only, or HRV/ERV, and the system maintenance components (supply air filters, outside air inlets, and heat/energy recovery cores) are not accessible, then the Standard Design wattage equals Proposed or 0.7 W/CFM whichever is lower.

### **6.9.10 Recovery Type**

All systems with airside heat recovery must identify the recovery type.

#### **PROPOSED DESIGN**

The type of heat recovery system is based on the proposed design and identified as sensible, latent, or total (sensible and latent).



## **STANDARD DESIGN**

The standard design for multifamily buildings is sensible if using balance system serving multiple dwelling units in Climate Zones 1, 2, and 11-16. In Climate Zones 3-10 the recovery type is identified as not applicable.

For existing buildings, the recovery type is sensible if using balance system serving multiple dwelling units in Climate Zones 1, 2, and 11-16. In Climate Zones 3-10 the recovery type is identified as not applicable.

### **6.9.11 Heat/Energy Recovery for Multifamily**

Zones serving multifamily apartments heat or energy recovery systems must be identified.

## **PROPOSED DESIGN**

The details of heat or energy recovery systems used in the multifamily residential zones are identified based on the proposed design.

## **STANDARD DESIGN**

If the Proposed Design is a balanced system serving multiple dwelling units, in Climate Zones 1, 2, and 11-16, the Standard Design is a heat recovery ventilation system with a sensible recovery effectiveness of 67% in both heating and cooling and includes bypass of the heat exchanger when outdoor temperatures are cool. In all other climate zones, the Standard Design is a balanced ventilation system without heat recovery system. In all climate zones, the Standard Design meets the fan efficacy requirements in §170.2(c)4A.

### **6.9.12 Recovery Air Flow Rate**

All systems with airside heat recovery must identify the recovery air flow rate.

## **PROPOSED DESIGN**

The design air flow rate through the heat recovery system in CFM is based on the proposed design.

## **STANDARD DESIGN**

The standard design for multifamily buildings is the minimum of the proposed design ventilation air flow rate or 110% of the design ventilation rate for the space if using a balanced system serving multiple dwelling units in Climate Zones 1, 2, and 11-16. Not applicable for Climate Zones 3-10.

For existing multifamily, the minimum of the proposed design ventilation air flow rate or 110% of the design ventilation rate for the space if using a balanced system serving

multiple dwelling units in Climate Zones 1, 2, and 11-16. Not applicable for Climate Zones 3-10.

### 6.9.13 Zone System Heat Recovery Effectiveness

Energy recovery ventilation systems with HVI ratings serving multifamily dwelling units must identify the zone system heat recovery effectiveness.

#### PROPOSED DESIGN

The zone system heat recover effectiveness is the effectiveness of air-to-air heat exchanger in multifamily residential exhaust systems. This is represented as a ratio (ASRE/100).

Simulated heat recovery effectiveness is 0.90 of design to account for maintenance and installation performance factors and no HERS verification of recovery effectiveness.

#### STANDARD DESIGN

If the Proposed System has inaccessible maintenance components as defined in 2022 RACM Reference manual, Standard equals Proposed.

All others, not applicable.

### 6.9.14 Exhaust Air Sensible Heat Recovery Effectiveness

Any system with outside air heat recovery must identify the exhaust air sensible heat recovery effectiveness.

#### PROPOSED DESIGN

The effectiveness of an air-to-air heat exchanger between the building exhaust and entering outside air streams is defined as:

$$HREFF = \frac{EEA_{db} - ELA_{db}}{EEA_{db} - OSA_{db}}$$

Where:

- $HREFF$  - The air-to-air heat exchanger effectiveness
- $EEA_{db}$  - The exhaust air dry-bulb temperature entering the heat exchanger
- $ELA_{db}$  - The exhaust air dry-bulb temperature leaving the heat exchanger
- $OSA_{db}$  - The outside air dry-bulb temperature

This results in two unitless numbers (ratio between 0 and 1), separate for cooling and heating, and is based on the proposed design.

#### STANDARD DESIGN

The sensible effectiveness is 67% if using balance system serving multiple dwelling units in Climate Zones 1, 2, and 11-16. Not applicable for Climate Zones 3-10.

For existing buildings, the sensible effectiveness is 67% if using balance system serving multiple dwelling units in Climate Zones 1, 2, and 11-16. Not applicable for Climate Zones 3-10.

### 6.9.15 Exhaust Air Sensible Part-Load Effectiveness

Any system with outside air heat recovery must identify exhaust air sensible part load effectiveness.

#### PROPOSED DESIGN

The effectiveness of an air-to-air heat exchanger between the building exhaust and entering outside air streams at 75 percent of design airflow is defined as:

$$HREFF = \frac{EEA_{db} - ELA_{db}}{EEA_{db} - OSA_{db}}$$

Where:

- $HREFF$  - The air-to-air heat exchanger effectiveness
- $EEA_{db}$  - The exhaust air dry-bulb temperature entering the heat exchanger
- $ELA_{db}$  - The exhaust air dry-bulb temperature leaving the heat exchanger
- $OSA_{db}$  - The outside air dry-bulb temperature

This results in two unitless numbers (ratio between 0 and 1), separate for cooling and heating, and is based on the proposed design.

#### STANDARD DESIGN

The sensible effectiveness is 67% if using balance system serving multiple dwelling units in Climate Zones 1, 2, and 11-16. Not applicable for Climate Zones 3-10.

For existing buildings, the sensible effectiveness is 67% if using balance system serving multiple dwelling units in Climate Zones 1, 2, and 11-16. Not applicable for Climate Zones 3-10.

### 6.9.16 Economizer Enabled during Heat Recovery

All systems with airside heat recovery must identify if the economizer is enabled during heat recovery.

#### PROPOSED DESIGN

A flag is included to indicate whether or not the economizer is enabled when heat recovery is active. Whether or not the economizer is enabled is based on the proposed design.

### **STANDARD DESIGN**

The economizer is disabled if using balance system serving multiple dwelling units in Climate Zones 1, 2, and 11-16. Not applicable for Climate Zones 3-10.

For existing buildings, the economizer is disabled if using balance system serving multiple dwelling units in Climate Zones 1, 2, and 11-16. Not applicable for Climate Zones 3-10.

---

## **6.10 Conditioned Zones**

The software requires the user to enter the characteristics of one or more conditioned zones. Subdividing dwelling units into conditioned zones for input convenience or increased accuracy is optional.

### **6.10.1 Zone Type**

#### **PROPOSED DESIGN**

The zone is defined as conditioned, living, or sleeping. Other zone types include garage, attic, and crawl space.

#### **STANDARD DESIGN**

The standard design is conditioned.

#### **VERIFICATION AND REPORTING**

When the zone type is living or sleeping, this is reported as a special feature on the LMCC. 

### **6.10.1.1 Heating Zonal Control Credit**

With the heating zonal control credit, the sleeping and living areas are modeled separately for heating, each with its own separate thermostat schedule and internal gain assumptions. Zonal control cannot be modeled with heat pump heating. The total nonclosable opening area between zones cannot exceed 40 ft<sup>2</sup>. Other eligibility criteria for this measure are presented in the *Residential Compliance Manual, Chapter 4*. 

#### **PROPOSED DESIGN**

The user selects zonal control as a building level input with separate living and sleeping zones.

**STANDARD DESIGN**

The standard design building is not zoned for living and sleeping separately.

**VERIFICATION AND REPORTING**

Zonal control is reported as a special feature on the LMCC 

**6.10.2 Conditioned Floor Area**

The total conditioned floor area (CFA) is the raised floor as well as the slab-on-grade floor area of the conditioned spaces measured from the exterior surface of exterior walls. Stairs are included in conditioned floor area as the area beneath the stairs and the tread of the stairs.

**PROPOSED DESIGN**

The compliance software requires the user to enter the total conditioned floor area of each conditioned zone.

**STANDARD DESIGN**

The standard design building has the same conditioned floor area and same conditioned zones as the proposed design.

**VERIFICATION AND REPORTING**

The conditioned floor area of each conditioned zone is reported on the LMCC 

**6.10.3 Number of Stories**

**6.10.3.1 Number of Stories of the Zone**

**PROPOSED DESIGN**

The number of stories of the zone.

**STANDARD DESIGN**

The standard design is the same as the proposed design.

**6.10.3.2 Ceiling Height**

**PROPOSED DESIGN**

The average ceiling height of the proposed design is the conditioned volume of the building envelope. The volume (in cubic feet) is determined from the total conditioned floor area and the average ceiling height.

**STANDARD DESIGN**

The volume of the standard design building is the same as the proposed design.

**VERIFICATION AND REPORTING**

The conditioned volume of each zone is reported on the LMCC.

**6.10.3.3 Free Ventilation Area**

Free ventilation area is the window area adjusted to account for bug screens, window framing and dividers, and other factors.

**PROPOSED DESIGN**

Free ventilation area for the proposed design is calculated as 5 percent of the fenestration area (rough opening), assuming all windows are operable.

**STANDARD DESIGN**

The standard design value for free ventilation area is the same as the proposed design.

**VERIFICATION AND REPORTING**

Free ventilation is not reported on the LMCC.

**6.10.3.4 Ventilation Height Difference**

Ventilation height difference is not a user input.

**PROPOSED DESIGN**

The default assumption for the proposed design is 2 feet for one-story buildings or one-story dwelling units and 8 feet for two or more stories (as derived from number of stories and other zone details).

**STANDARD DESIGN**

The standard design modeling assumption for the elevation difference between the inlet and the outlet is 2 feet for one-story dwelling units and 8 feet for two or more stories.

**6.10.3.5 Zone Elevations**

The elevation of the top and bottom of each zone is required to set up the airflow network.

**PROPOSED DESIGN**

The user enters the height of the top surface the lowest floor of the zone relative to the ground outside as the “bottom” of the zone. The user also enters the ceiling height (the floor-to-floor height [ceiling height plus the thickness of the intermediate floor structure] is calculated by the software).

Underground zones are indicated with the number of feet below grade (e.g., -8).

**STANDARD DESIGN**

The standard design has the same vertical zone dimensions as the proposed design.

**6.10.3.6 Mechanical Systems****PROPOSED DESIGN**

The software requires the user to specify a previously defined HVAC system to provide heating and cooling for the zone and an IAQ ventilation system. The user may also specify a ventilation cooling system that applies to this and other conditioned zones.

**STANDARD DESIGN**

The software assigns standard design HVAC, IAQ ventilation, and ventilation cooling systems based on §170.2 and Table 170.2-K for the applicable climate zone.

**6.10.3.7 Natural Ventilation**

Natural ventilation (from windows) is available during cooling mode when needed and available, as shown in Table 37. The amount of natural ventilation used by computer software for natural cooling is the lesser of the maximum potential amount available and the amount needed to drive the interior zone temperature down to the natural cooling setpoint. When natural cooling is not needed or is unavailable, no natural ventilation is used.

Computer software shall assume that natural cooling is needed when the building is in “cooling mode,” when the outside temperature is below the estimated zone temperature, and when the estimated zone temperature is above the natural cooling setpoint temperature. Only the amount of ventilation required to reduce the zone temperature to the natural ventilation setpoint temperature is used, and the natural ventilation setpoint temperature is constrained by the compliance software to be greater than the heating setpoint temperature.

**Table 37: Hourly Thermostat Set Points**

Hour	Cooling	Venting	Heat Pump Heating	Standard Gas Heating Single-Zone	Zonal Control Gas Heating Living	Zonal Control Gas Heating Sleeping
1	78	Off	68	65	65	65
2	78	Off	68	65	65	65
3	78	Off	68	65	65	65
4	78	Off	68	65	65	65
5	78	Off	68	65	65	65
6	78	68*	68	65	65	65
7	78	68	68	65	65	65
8	83	68	68	68	68	68
9	83	68	68	68	68	68
10	83	68	68	68	68	65
11	83	68	68	68	68	65
12	83	68	68	68	68	65
13	83	68	68	68	68	65
14	82	68	68	68	68	65
15	81	68	68	68	68	65
16	80	68	68	68	68	65
17	79	68	68	68	68	68
18	78	68	68	68	68	68
19	78	68	68	68	68	68
20	78	68	68	68	68	68
21	78	68	68	68	68	68
22	78	68	68	68	68	68
23	78	68	68	68	68	68
24	78	Off	68	65	65	65

*\*Venting starts in the hour the sun comes up.*

Source: California Energy Commission



## 6.10.4 Conditioned Zone Assumptions

### 6.10.4.1 Internal Thermal Mass

Internal mass objects are completely inside a zone so that they do not participate directly in heat flows to other zones or outside. They are connected to the zone radiantly and convectively and participate in the zone energy balance by passively storing and releasing heat as conditions change.

Table 38 shows the standard interior conditioned zone thermal mass objects and the calculation of the simulation inputs that represent them.

**Table 38: Conditioned Zone Thermal Mass Objects**

Item	Description	Simulation Object
Interior walls	The area of one side of the walls completely inside the conditioned zone is calculated as the conditioned floor area of the zone minus ½ of the area of interior walls adjacent to other conditioned zones. The interior wall is modeled as a construction with 25 percent 2x4 wood framing and sheetrock on both sides.	Wall exposed to the zone on both sides
Interior floors	The area of floors completely inside the conditioned zone is calculated as the difference between the CFA of the zone and the sum of the areas of zone exterior floors and interior floors over other zones. Interior floors are modeled as a surface inside the zone with a construction of carpet, wood decking, 2x12 framing at 16 in. on-center with miscellaneous bridging, electrical, and plumbing, and a sheetrock ceiling below.	Floor/ceiling surface exposed to the zone on both sides
Furniture and heavy contents	Contents of the conditioned zone with significant heat storage capacity and delayed thermal response, for example heavy furniture, bottled drinks, canned goods, contents of dressers, enclosed cabinets. These are represented by a 2 in. thick slab of wood twice as large as the conditioned floor area, exposed to the room on both sides.	Horizontal wood slab exposed to the zone on both sides

Item	Description	Simulation Object
Light and thin contents	Contents of the conditioned zone that have a large surface area compared to weight, for example, clothing on hangers, curtains, pots, and pans. These are assumed to be 2 Btu per square foot of conditioned floor area.	Air heat capacity ( $C_{air}$ ) = CFA * 2

Source: California Energy Commission

**PROPOSED DESIGN**

The proposed design has standard conditioned zone thermal mass objects (such as gypsum board in walls, cabinets, sinks, and tubs) that are not user-editable and are not a compliance variable. If the proposed design includes specific interior thermal mass elements that are significantly different from what is included in typical wood-frame production housing, such as masonry partition walls, the user may include them. See also Chapter 6.10.6.4 Exterior Thermal Mass.

**STANDARD DESIGN**

The standard design has standard conditioned zone thermal mass objects.

**6.10.4.2 Thermostats and Schedules**

Thermostat settings are shown in Table 37. The values for cooling, venting, and standard heating apply to the standard design run and are the default for the proposed design run. See the explanation later in this chapter regarding the values for zonal control.

Heat pumps equipped with supplementary electric resistance heating are assumed to meet mandatory control requirements specified in §110.2(b) and (c).

Systems with no setback required by §110.2(c) (gravity gas wall heaters, gravity floor heaters, gravity room heaters, noncentral electric heaters, fireplaces or decorative gas appliances, wood stoves, room air-conditioners, and room air-conditioner heat pumps) are assumed to have a constant heating set point of 68 degrees Fahrenheit. The cooling set point from Table 37 is assumed in both the proposed design and standard design.

**PROPOSED DESIGN**

The proposed design assumes a mandatory setback thermostat meeting the requirements of §110.2(c). Systems exempt from the requirement for a setback thermostat are assumed to have no setback capabilities.

**STANDARD DESIGN**

The standard design has setback thermostat conditions based on the mandatory requirement for a setback thermostat. For equipment exempt from the setback thermostat requirement, the standard design has no setback thermostat capabilities.

#### **6.10.4.3 Determining Heating Mode vs. Cooling Mode**

When the building is in the heating mode, the heating setpoints for each hour are set to the "heating" values in Table 37, the cooling setpoint is a constant 78 degrees Fahrenheit (°F), and the ventilation setpoint is set to a constant 77°F. When the building is in the cooling mode, the heating setpoint is a constant 60°F, and the cooling and venting setpoints are set to the values in Table 37

The mode depends upon the outdoor temperature averaged over hours 1 through 24 of eight days prior to the current day through two days prior to the current day. (For example, if the current day is June 21, the mode is based on the average temperature for June 13 through 20.) When this running average temperature is equal to or less than 60°F, the building is in a heating mode. When the running average is greater than 60°F, the building is in a cooling mode.

#### **6.10.5 Internal Gains**

Internal gains assumptions are included in Appendix E and consistent with the CASE report on plug loads and lighting (Rubin 2016, see Appendix F). The internal gains assumptions for the standard design building is the same as the proposed design.

#### **6.10.6 Exterior Surfaces**

The user enters exterior surfaces to define the envelope of the proposed design. The areas, construction assemblies, orientations, and tilts modeled are consistent with the actual building design and shall equal the overall roof/ceiling area with conditioned space on the inside and unconditioned space on the other side.

##### **6.10.6.1 Ceilings Below Attics**

Ceilings below attics are horizontal surfaces between conditioned zones and attics. The area of the attic floor is determined by the total area of ceilings below attics defined in conditioned zones.

#### **PROPOSED DESIGN**

The software allows the user to define ceilings below attic, enter the area, and select a construction assembly for each.

#### **STANDARD DESIGN**

The standard design for newly constructed buildings has the same ceiling below attic area as the proposed design. The standard design is a high-performance attic with a ceiling constructed with 2x4 framed trusses and insulated with the R-values specified in §170.2 and Table 170.2-A for the applicable climate zone. The roof surface is a 10 lbs/ft<sup>2</sup> tile roof with an air space when the proposed roof is steep slope or a lightweight roof when the proposed roof is low slope.

Multifamily dwelling units: Below roof-deck insulation has R-0 in Climate Zones 1-3 and 5-7, R-13 in Climate Zones 10 and 16, and R-19 in Climate Zones 4, 8, 9 and 11-15. Insulation on the ceiling has R-38 in Climate Zones 1, 2, 4 and 8-16, and R-30 insulation on the ceiling in Climate Zones 3 and 5-7. Climate Zones 2, 3, and 5-7 have a radiant barrier, and Climate Zones 1, 4, and 8-16 have no radiant barrier.

#### **VERIFICATION AND REPORTING**

Ceiling below attic area and constructions are reported on the LMCC. SIP assemblies are reported as a special feature on the LMCC.

#### **6.10.6.2 Non-Attic (Cathedral) Ceiling and Roof**

Non-attic ceilings, also known as cathedral ceilings, are surfaces with roofing on the outside and finished ceiling on the inside but without an attic space.

#### **PROPOSED DESIGN**

The software allows the user to define cathedral ceilings, enter the area, and select a construction assembly for each. The user also enters the roof characteristics of the surface.

#### **STANDARD DESIGN**

The standard design has the same area as the proposed design cathedral ceiling modeled as ceiling below attic with the features from §170.2 and Table 170.2-A or for the applicable climate zone.

The standard design building has an area of ceiling below attic equal to the non-attic ceiling/roof areas of the proposed design. The standard design roof and ceiling surfaces are modeled with the same construction assembly and characteristics, aged reflectance, and emittance as §170.2, Table 170.2-A for the applicable climate zone.

#### **VERIFICATION AND REPORTING**

Non-attic ceiling/roof area and constructions are reported on the LMCC. SIP assemblies are reported as a special feature on the LMCC.

### 6.10.6.3 Exterior Walls

#### PROPOSED DESIGN

The software allows the user to define walls, enter the gross area, and select a construction assembly for each. The user also enters the plan orientation (front, left, back, or right) or plan azimuth (value relative to the front, which is represented as zero degrees) and tilt of the wall.

The wall areas modeled are consistent with the actual building design, and the total wall area is equal to the gross wall area with conditioned space on the inside and unconditioned space or exterior conditions on the other side. Underground mass walls are defined with inside and outside insulation and the number of feet below grade. Walls adjacent to unconditioned spaces with no solar gains (such as knee walls or garage walls) are entered as an interior wall with the zone on the other side specified as attic, garage, or another zone, and the compliance manager treats that wall as a demising wall. An attached unconditioned space is modeled as an unconditioned zone.

#### STANDARD DESIGN

The standard design building has high-performance walls modeled with the same area of framed walls as is in the proposed design separating conditioned space and the exterior, with a U-factor equivalent to that as specified in §170.2 and Table 170.2-A for the applicable climate zone.

**Dwellings:** Above-grade framed walls in Climate Zones 1-5 and 8-16 have 2x6 16-in. on center wood framing with R-21 insulation between framing and R-4 continuous insulation (0.051 U-factor). Climate Zones 6-7 above-grade framed walls have 2x4 16 in. on center wood framing with R-15 insulation between framing and R-4 continuous insulation (0.065 U-factor). Walls adjacent to unconditioned space, such as garage walls, are treated the same as exterior walls, except there is no continuous insulation.

Above-grade mass walls are 6-inch concrete with R-13 interior insulation in 3.5-inch wood furring in Climate Zones 1-15 and R-17 in Climate Zone 16. Below-grade mass walls in Climate Zones 1-15 have R-13, and Climate Zone 16 has R-15 interior insulation in 3.5-inch wood furring. When the proposed design is a wall type such as SIP, straw bale, or other construction type not specifically mentioned above, the standard design wall is a wood-framed wall meeting the requirements of §170.2 and Table 170.2-A.

The total gross exterior wall area in the standard design is equal to the total gross exterior wall area of the proposed design for each wall type. The gross exterior wall area of framed walls in the standard design (excluding demising walls) is equally divided among the four main compass points -- north, east, south, and west. The gross

exterior wall area of mass walls in the standard design (excluding demising walls and below grade walls) is equally divided among these four main compass points. Window and door areas are subtracted from the gross wall area to determine the net wall area in each orientation.

#### **VERIFICATION AND REPORTING**

Exterior wall area and construction details are reported on the LMCC. Metal-framed and SIP assemblies are reported as a special feature on the LMCC.

#### **6.10.6.4 Exterior Thermal Mass**

Constructions for standard exterior mass are supported but not implemented beyond the assumptions for typical mass.

The performance approach assumes that both the proposed design and standard design building have a minimum mass as a function of the conditioned area of slab floor and non-slab-floor. (See [Chapter 6.10.4.1](#) Internal Thermal Mass.)

Mass such as concrete slab floors, masonry walls, double gypsum board, and other special mass elements can be modeled. When the proposed design has more than the typical assumptions for mass in a building, then each element of heavy mass is modeled in the proposed design, otherwise; the proposed design is modeled with the same thermal mass as the standard design.

#### **PROPOSED DESIGN**

The proposed design may be modeled with the default 20 percent exposed mass/80 percent covered mass or with actual mass areas modeled as separate covered and exposed mass surfaces. Exposed mass surfaces covered with flooring material that is in direct contact with the slab can be modeled as exposed mass. Examples of such materials are tile, stone, vinyl, linoleum, and hard-wood.

#### **STANDARD DESIGN**

The conditioned slab floor in the standard design is assumed to be 20 percent exposed slab and 80 percent slab covered by carpet or casework. Interior mass assumptions as described in [Chapter 6.10.4.1](#) Internal Thermal Mass are also assumed. No other mass elements are modeled in the standard design. The standard design mass is modeled with the following characteristics:

- The conditioned slab floor area (slab area) shall have a thickness of 3.5 inches, a volumetric heat capacity of 28 Btu/ft<sup>3</sup>-° F, and a conductivity of 0.98 Btu-in/hr-ft<sup>2</sup>-° F. The exposed portion shall have a surface conductance of 1.3 Btu/h-ft<sup>2</sup>-°

F (no thermal resistance on the surface), and the covered portion shall have a surface conductance of  $0.50 \text{ Btu/h-ft}^2\text{-}^\circ \text{ F}$ , typical of a carpet and pad.

- The “exposed” portion of the conditioned non-slab floor area shall have a thickness of 2.0 inches, a volumetric heat capacity of  $28 \text{ Btu/ft}^3\text{-}^\circ \text{ F}$ , a conductivity of  $0.98 \text{ Btu-in/hr- ft}^2\text{-}^\circ \text{ F}$ ; and a surface conductance of  $1.3 \text{ Btu/h- ft}^2\text{-}^\circ \text{ F}$  (no added thermal resistance on the surface). These thermal mass properties apply to the “exposed” portion of non-slab floors for both the proposed design and standard design. The covered portion of non-slab floors is assumed to have no thermal mass.

### **VERIFICATION AND REPORTING**

Exposed mass greater than 20 percent exposed slab on grade, and any other mass modeled by the user is reported as a special feature on the LMCC.

#### **6.10.6.5 Doors**

Doors are defined as an opening in a building envelope. If the rough opening of a door includes fenestration equal to 25 percent or more of glass or fenestration, it is fenestration. (See [Chapter 6.10.6.6 Fenestration](#).) Doors with less than 25 percent fenestration are considered an opaque door.

### **PROPOSED DESIGN**

The compliance software shall allow users to enter doors specifying the U-factor, area, and orientation. Doors to the exterior or to unconditioned zones are modeled as part of the conditioned zone. For doors with less than 25 percent glass area, the U-factor shall come from Reference Appendices, Joint Appendix *JA4, Table 4.5.1* (default U-factor 0.20) or from National Fenestration Rating Council (NFRC) certification data for the entire door. For unrated doors, the glass area of the door, calculated as the sum of all glass surfaces plus 2 inches on all sides of the glass (to account for a frame), is modeled under the rules for fenestrations; the opaque area of the door is considered the total door area minus this calculated glass area. Doors with 25 percent or more glass area are modeled under the rules for fenestrations using the total area of the door.

When modeling a garage zone, large garage doors (metal roll-up or wood) are modeled with a 1.0 U-factor.

### **STANDARD DESIGN**

The standard design has the same door area for each dwelling unit as the proposed design. The standard design door area is distributed equally among the four main

compass points--north, east, south, and west. The U-factor for the standard design is taken from §170.2 and Table 170.2-A. All swinging opaque doors are assumed to have a U-factor of 0.20. The net opaque wall area is reduced by the door area in the standard design.

### **VERIFICATION AND REPORTING**

Door area and U-factor are reported on the LMCC.

#### **6.10.6.6 Fenestration**

Fenestration is modeled with a U-factor and solar heat gain coefficient (SHGC). Acceptable sources of these values are National Fenestration Rating Council (NFRC), default tables from §110.6 of the Energy Code, and *Reference Appendices, Nonresidential Appendix NA6*.

In limited cases for certain site-built fenestration that is field fabricated, the performance factors (U-factor, SHGC) may come from *Reference Appendices, Nonresidential Appendix NA6* as described in Exception 3 to §170.2(a)3Aii.

There is no detailed model of chromogenic fenestration available. As allowed by Exception 2 to §170.2(a)3Aii, the lower-rated labeled U-factor and SHGC may be used only when installed with automatic controls as noted in the exception. Chromogenic fenestration cannot be averaged with nonchromogenic fenestration.

### **PROPOSED DESIGN**

The compliance software allows users to enter individual skylights and fenestration types, the U-factor, SHGC, area, orientation, and tilt.

Performance datum (U-factors and SHGC) are from NFRC values or from the CEC default tables from §110.6 of the Energy Code. In spaces other than sunspaces, solar gains from windows or skylights use the California Simulation Engine (CSE) default solar gain targeting.

Skylights are a fenestration with a slope of 60 degrees or more. Skylights are modeled as part of a roof.

### **STANDARD DESIGN**

If the proposed design fenestration area is less than 20 percent of the conditioned floor area, the standard design fenestration area is set equal to the proposed design fenestration area. Otherwise, the standard design fenestration area is set equal to 20 percent of the conditioned floor area. The standard design fenestration area is distributed equally among the four main compass points—north, east, south, and west.



The standard design has no skylights.

The net wall area on each orientation is reduced by the fenestration area and door area on each façade. The U-factor and SHGC performance factors for the standard design are taken from §170.2 and Table 170.2-A, which is 0.30 U-factor in all climate zones. SHGC is 0.23 in Climate Zones 2, 4, and 6-15. Where there is no prescriptive requirement (Climate Zones 1, 3, 5, and 16), the SHGC is set to 0.35.

## VERIFICATION AND REPORTING

Fenestration area, U-factor, SHGC, orientation, and tilt are reported on the LMCC.

### 6.10.6.7 Overhangs and Sidefins

#### PROPOSED DESIGN

Software users enter a set of basic parameters for a description of an overhang and sidefin for each individual fenestration or window area entry. The basic parameters include fenestration height, overhang/sidefin length, and overhang/sidefin height. Compliance software user entries for overhangs may also include fenestration width, overhang left extension, and overhang right extension. Compliance software user entries for sidefins may also include fin left extension and fin right extension for both left and right fins. Walls at right angles to windows may be modeled as sidefins.

**Figure 14: Overhang Dimensions**

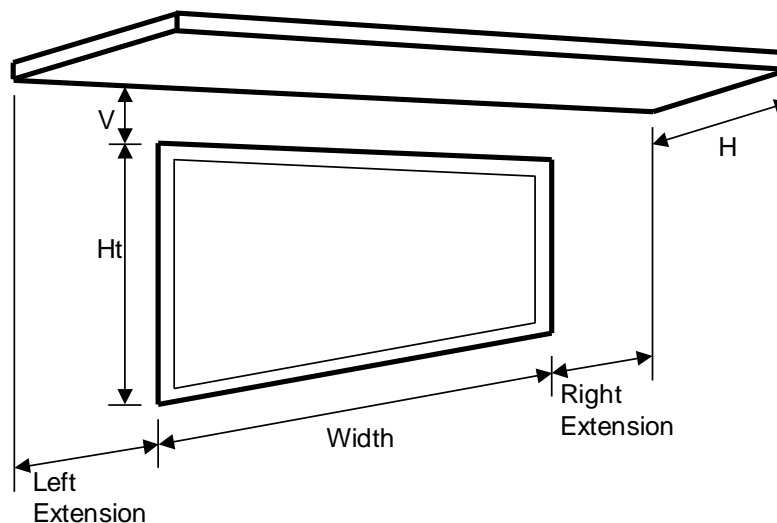

Source: California Energy Commission

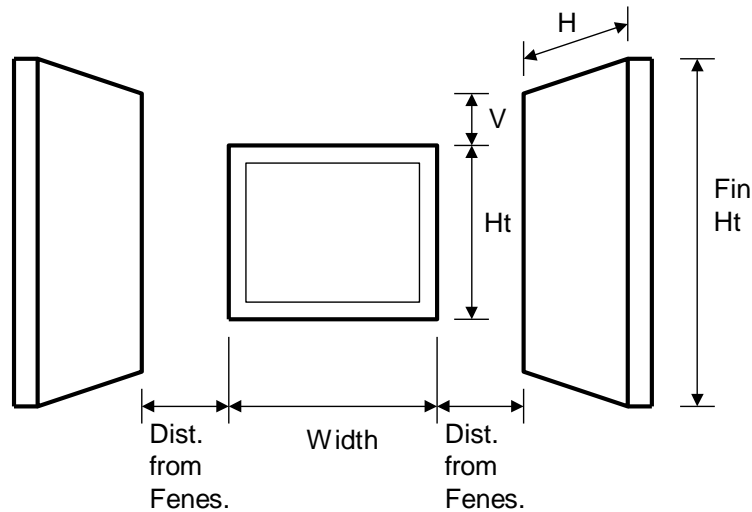
**Figure 15: Sidefin Dimensions**

Source: California Energy Commission

### **STANDARD DESIGN**

The standard design does not have overhangs or sidefins.

### **VERIFICATION AND REPORTING**

Overhang and fin dimensions are reported on the LMCC.

#### **6.10.6.8 Interior Shading Devices**

For both the proposed and standard design, all windows are assumed to have draperies, and skylights are assumed to have no interior shading. Window medium drapes are closed at night and half open in the daytime hours. Interior shading is not a compliance variable and is not user-editable.

#### **6.10.6.9 Exterior Shading**

For both the proposed and standard design, all windows are assumed to have bug screens, and skylights are assumed to have no exterior shading. Exterior shading is modeled as an additional glazing system layer using the ASHRAE Window Attachment (ASHWAT) calculation.

### **PROPOSED DESIGN**

The compliance software shall require the user to accept the default exterior shading devices, which are bug screens for windows and none for skylights. Credit for shading devices that are allowable for prescriptive compliance are not allowable in performance compliance.

### **STANDARD DESIGN**

The standard design shall assume bug screens. The standard design does not have skylights.

#### **6.10.6.10 Slab on Grade Floors**

##### **PROPOSED DESIGN**

The software allows users to enter areas and exterior perimeter of slabs that are heated or unheated, covered, or exposed, and with or without slab-edge insulation. Perimeter is the length of wall between conditioned space and the exterior, but it does not include edges that cannot be insulated, such as between the house and the garage. The default condition for the proposed design is that 80 percent of each slab area is carpeted or covered by walls and cabinets, and 20 percent is exposed. Inputs other than the default condition require that carpet and exposed slab conditions are documented on the construction plans.

When the proposed heating distribution is radiant floor heating (heated slab), the software user will identify that the slab is heated and model the proposed slab edge insulation. The mandatory minimum requirement is R-5 insulation in Climate Zones 1-15 and R-10 in Climate Zone 16 (§110.8[g], Table 110.8-A).

##### **STANDARD DESIGN**

The standard design perimeter lengths and slab on grade areas are the same as the proposed design. 80 percent of standard design slab area is carpeted, and 20 percent is exposed. For the standard design, an unheated slab edge has no insulation with the exception of Climate Zone 16, which assumes R-7 to a depth of 16 inches. The standard design for a heated slab is a heated slab with the mandatory slab edge insulation of R-5 in Climate Zones 1-15 and R-10 in Climate Zone 16.

##### **VERIFICATION AND REPORTING**

Slab areas, perimeter lengths, and inputs of other than the default condition are reported on the LMCC.

#### **6.10.6.11 Underground Floors**

##### **PROPOSED DESIGN**

The software allows users to enter areas and depth below grade of slab floors occurring below grade. Unlike slab-on-grade floors, there is no perimeter length associated with underground floors.

##### **STANDARD DESIGN**

The standard design underground floor areas are the same as the proposed design.

### 6.10.6.12 Raised Floors

#### PROPOSED DESIGN

The software allows the user to input floor areas and constructions for raised floors over a crawl space, over exterior (garage or unconditioned), and concrete raised floors. The proposed floor area and constructions are consistent with the actual building design.

#### STANDARD DESIGN

The standard design has the same area and type of construction as the proposed design. The thermal characteristics meet §170.2 and Table 170.2-A. For floor areas that are framed construction, the standard design floor has R-19 in 2x6 wood framing, 16-in. on center (0.037 U-factor). For floor areas that are concrete raised floors, the standard design floor is 6 inches of normal weight concrete with R-8 continuous insulation in Climate Zones 1, 2, 11, 13, 14, 16; Climate Zones 12 and 15 have R-4; Climate Zones 3-10 have R-0.

#### VERIFICATION AND REPORTING

Raised floor areas and constructions are reported on the LMCC.

## 6.11 Attics

The compliance software models attics as a separate thermal zone and includes the interaction with the air distribution ducts, infiltration exchange between the attic and the house, the solar gains on the roof deck, and other factors. These interactions are illustrated in Figure 19.

Figure 16: Attic Model Components

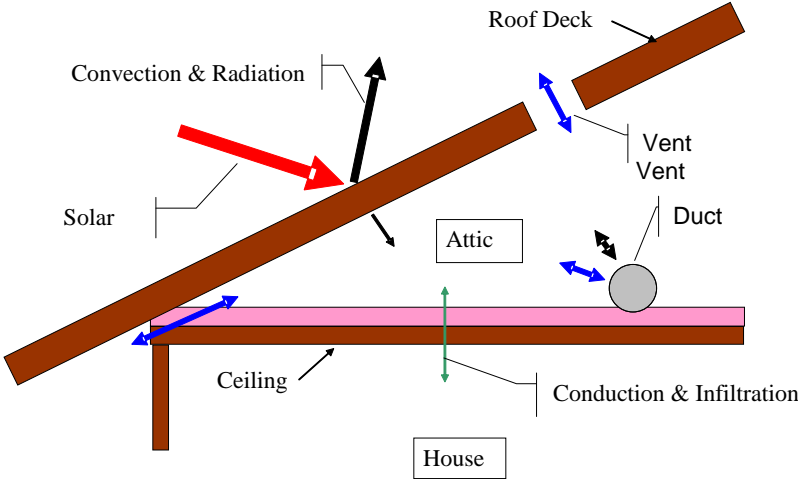

Source: California Energy Commission

## **6.11.1 Attic Components**

### **6.11.1.1 Roof Rise**

The roof rise is the ratio of rise to run (or pitch) and refers to the number of feet the roof rises vertically for every 12 feet horizontally. For roofs with multiple pitches, the roof rise that makes up the largest roof area is used.

### **6.11.1.2 Vent Area**

This value is the vent area as a fraction of attic floor area. This value is not a compliance variable and is assumed set equal to attic floor area divided by 300.

### **6.11.1.3 Fraction High**

The fraction of the vent area that is high due to the presence of ridge, roof, or gable end-mounted vents. Soffit vents are considered low ventilation. The default value is zero for attics with standard ventilation. Attics with radiant barriers are required to have a vent high fraction of at least 0.3.

### **6.11.1.4 Roof Deck/Surface Construction**

Typical roof construction types are concrete or clay tile, metal tile, gravel, ballast, or other steep- or low-sloped roofing types.

### **6.11.1.5 Solar Reflectance**

This input is a fraction that specifies the certified aged reflectance of the roofing material or 0.1 default value for uncertified materials. The installed value must be equal to or higher than the value specified in the proposed model. Roof construction with a roof membrane mass of at least 25 lbs/ft<sup>2</sup>, or a roof area that has integrated solar collectors, is assumed to meet the minimum solar reflectance.

### **6.11.1.6 Thermal Emittance**

Thermal emittance is the certified aged thermal emittance (or emissivity) of the roofing material, or a default value. Unless a default value is modeled, the installed value must be equal to or greater than the value modeled. The default value is 0.85 if certified aged thermal emittance value is not available from the [Cool Roof Rating Council \(CRRC\)](http://www.coolroofs.org), [www.coolroofs.org](http://www.coolroofs.org). Roof construction with a roof membrane mass of at least 25 lbs/ft<sup>2</sup> or roof area incorporated integrated solar collectors is assumed to meet the minimal, default, thermal emittance.

## **PROPOSED DESIGN**

The conditioning is either ventilated or unventilated. Each characteristic of the roof is modeled to reflect the proposed construction. Values for solar reflectance and thermal emittance shall be default or from the CRRC.

Roofs with solar collectors or with thermal mass over the roof membrane with a weight of at least 25 lbs/ft<sup>2</sup> may model the prescriptive values for solar reflectance and thermal emittance.

### **STANDARD DESIGN**

The standard design depends on the variables of the climate zone and roof slope. Low-sloped roofs (with a roof rise of 2 feet in 12 or less) in Climate Zones 13 and 15 will have a standard design aged solar reflectance of 0.63 and a thermal emittance of 0.85.

Steep-sloped roofs in Climate Zones 10-15 will have a standard design roof with an aged solar reflectance of 0.20 and a minimum thermal emittance of 0.85.

Roofs with solar collectors or with thermal mass over the roof membrane with a weight of at least 25 lbs/ft<sup>2</sup> are assumed to meet the standard design values for solar reflectance and thermal emittance.

### **VERIFICATION AND REPORTING**

A reflectance of 0.20 or higher is reported as a cool roof. A value higher than the default but less than 0.20 is reported as a non-standard roof reflectance value.

## **6.11.2 Ceiling Below Attic**

### **PROPOSED DESIGN**

For each conditioned zone, the user enters the area and construction of each ceiling surface that is below an attic space. The compliance software shall allow a user to enter multiple ceiling constructions. Surfaces that tilt 60 degrees or more are treated as knee walls and are not included as ceilings. The sum of areas shall equal the overall ceiling area with conditioned space on the inside and unconditioned attic space on the other side.

The compliance software creates an attic zone with a floor area equal to the sum of the areas of all the user input ceilings below an attic in the building. The user specifies the framing and spacing, the materials of the frame path, and the R-value of the insulation path for each ceiling construction.

The user inputs the proposed insulation R-value rounded to the nearest whole R-value. For simulation, all ceiling below attic insulation is assumed to have nominal properties of R-2.6 per inch, a density of 0.5 lb/ft<sup>3</sup>, and a specific heat of 0.2 Btu/lb.

**STANDARD DESIGN**

The standard design shall have the same area of ceiling below attic as the proposed design. The ceiling/framing construction is based on the prescriptive requirement and standard framing is assumed to be 2x4 wood trusses at 24 inches on center.

**VERIFICATION AND REPORTING**

The area, insulation R-value, and layer of each construction are reported on the LMCC.

**6.11.3 Attic Roof Surface and Pitch****PROPOSED DESIGN**

The roof pitch is the ratio of rise to run, (for example, 4:12 or 5:12). If the proposed design has more than one roof pitch, the pitch of the largest area is used.

The compliance software creates an attic zone roof. The roof area is calculated as the ceiling below attic area divided by the cosine of the roof slope where the roof slope is an angle in degrees from the horizontal. The roof area is then divided into four equal sections with each section sloping in one of the cardinal directions (north, east, south, and west). Gable walls, dormers, or other exterior vertical surfaces that enclose the attic are ignored.

If the user specifies a roof with a pitch less than 2:12, the compliance software creates an attic with a flat roof that is 30 inches above the ceiling.

**STANDARD DESIGN**

The standard design shall have the same roof pitch, roof surface area, and orientations as the proposed design.

**VERIFICATION AND REPORTING**

The roof pitch is reported on the LMCC.

**6.11.4 Attic Conditioning**

Attics may be ventilated or unventilated. Insulation in a ventilated attic must be installed at the ceiling level. Unventilated attics usually have insulation at the roof deck and sometimes on the ceiling (§160.1[a]).

In an unventilated attic, the roof system becomes part of the insulated building enclosure. Local building jurisdictions may impose additional requirements.

**PROPOSED DESIGN**

A conventional attic is modeled as ventilated. When an attic will not be vented, attic conditioning is modeled as unventilated.

**STANDARD DESIGN**

Attic ventilation is set to ventilated for the standard design.

**VERIFICATION AND REPORTING**

The attic conditioning (ventilated or unventilated) is reported on the LMCC.

**6.11.5 Attic Edge**

With a standard roof truss (Figure 20), the depth of the ceiling insulation is restricted to the space left between the roof deck and the wall top plate for the insulation path, and the space between the bottom and top chord of the truss in the framing path. If the modeled insulation completely fills this space, there is no attic air space at the edge of the roof. Heat flow through the ceiling in this attic edge area is directly to the outside both horizontally and vertically, instead of to the attic space. Measures that depend on an attic air space, such as radiant barriers or ventilation, do not affect the heat flows in the attic edge area.

**Figure 17: Section at Attic Edge with Standard Truss**

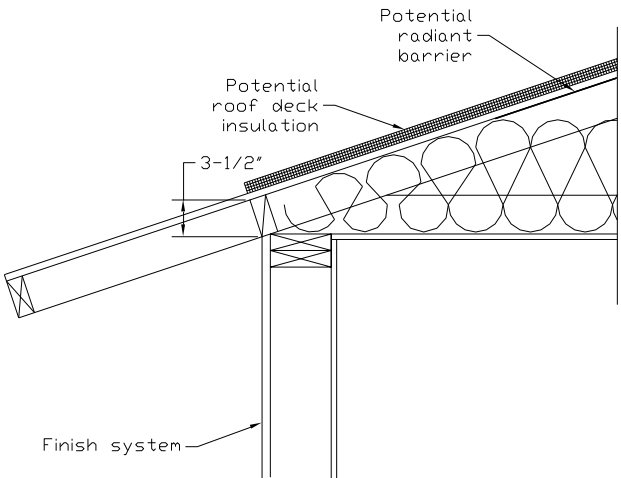

Source: California Energy Commission

A raised heel truss (Figure 21) provides additional height at the attic edge that, depending on the height Y and the ceiling insulation R, can either reduce or eliminate the attic edge area and its thermal impact.



**Figure 18: Section at Attic Edge with a Raised Heel Truss**

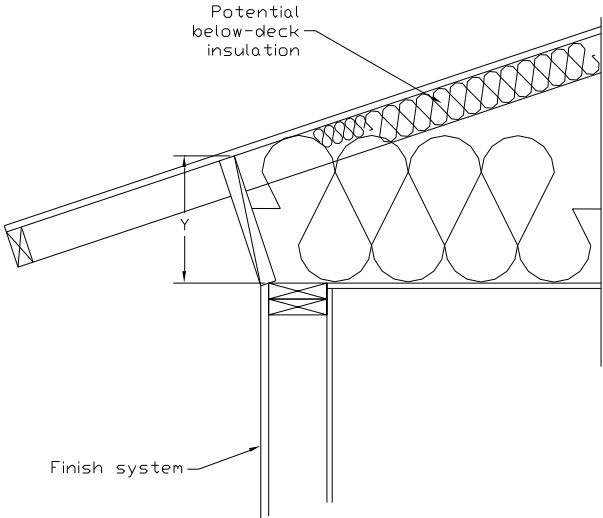

Source: California Energy Commission

For cases where the depth of insulation (including below-deck insulation depth) is greater than the available height at the attic edge, the compliance software automatically creates cathedral ceiling surfaces to represent the attic edge area and adjusts the dimensions of the attic air space using the algorithms contained in Appendix G. If above-deck insulation is modeled, it is included in the attic edge cathedral ceiling constructions, but radiant barriers below the roof deck are not.

**PROPOSED DESIGN**

The compliance software shall allow the user to specify that a raised heel truss will be used (as supported by construction drawings), with the default being a standard truss as shown in Figure 20. If the user selects a raised heel truss, the compliance software will require the user to specify the vertical distance between the wall top plate and the bottom of the roof deck (Y in Figure 21).

**STANDARD DESIGN**

The standard design shall have a standard truss with the default vertical distance of 3.5 inches between wall top plate and roof deck.

**VERIFICATION AND REPORTING**

A raised heel truss is a special feature, and the vertical height above the top plate will be included on the LMCC.

### 6.11.6 The Roof Deck

The roof deck is the construction at the top of the attic and includes the solar optic properties of the exterior surface, the roofing type, the framing, insulation, air gaps, and other features. These are illustrated in Figure 22, which shows a detailed section through the roof deck.

**Figure 19: Components of the Attic Through Roof Deck**

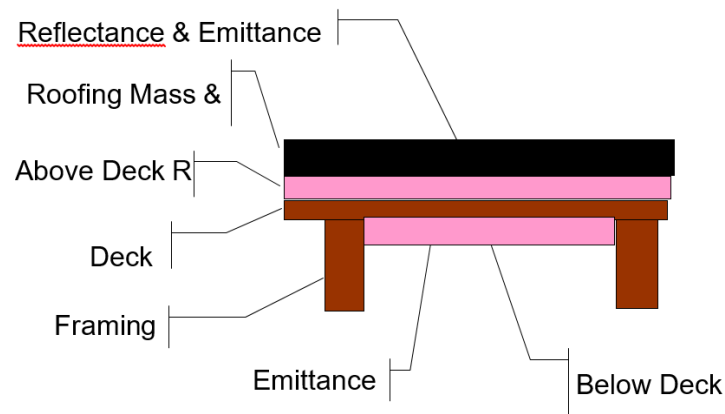

Source: California Energy Commission

#### 6.11.6.1 Radiant Barrier

Radiant barriers are used to reduce heat flow at the bottom of the roof deck in the attic. A 0.05 emittance is modeled at the bottom surface of the roof deck if radiant barriers are used. If no radiant barrier is used, the value modeled is 0.9. If radiant barrier is installed over existing skip sheathing in a reroofing application, 0.5 is modeled.

#### PROPOSED DESIGN

The user shall specify whether the proposed design has:

- A radiant Barrier
- No Radiant Barrier

#### STANDARD DESIGN

The standard design shall have a radiant barrier if required by the prescriptive Energy Code (§170.2 and Table 170.2-A) for the applicable climate zone.

#### VERIFICATION AND REPORTING

Radiant barriers are reported as a special feature on the LMCC.

### **6.11.6.2 Below Deck Insulation**

Below-deck insulation is insulation that will be installed below the roof deck between the roof trusses or rafters.

#### **PROPOSED DESIGN**

The compliance software shall allow the user to specify the R-value of insulation that will be installed below the roof deck between the roof trusses or rafters. The default is an uninsulated roof deck.

#### **STANDARD DESIGN**

The standard design has below-deck insulation as specified in [Chapter 6.11.2 Ceilings Below Attics](#).

#### **VERIFICATION AND REPORTING**

The R-value of any below-deck insulation is reported as a special feature on the LMCC.

### **6.11.6.3 Roof Deck and Framing**

The roof deck is the structural surface that supports the roofing. The compliance software assumes a standard wood deck, and this is not a compliance variable. The size, spacing, and material of the roof deck framing are compliance variables.

#### **PROPOSED DESIGN**

The roof deck is wood siding/sheathing/decking. The compliance software shall default the roof deck framing to 2x4 trusses at 24 in. on center. The compliance software shall allow the user to specify alternative framing size, material, and framing spacing.

#### **STANDARD DESIGN**

The standard design is 2x4 trusses at 24 in. on center.

#### **VERIFICATION AND REPORTING**

Nonstandard roof deck framing or spacing is reported as a special feature on the LMCC.

### **6.11.6.4 Above Deck Insulation**

Above-deck insulation represents the insulation value of the air gap in "concrete or clay tile" or "metal tile or wood shakes." The R-value of any user modeled insulation layers between the roof-deck and the roofing is added to the air gap value.

#### **PROPOSED DESIGN**

This input defaults to R-0.85 for "concrete or clay tile" or for "metal tile or wood shakes" to represent the benefit of the air gap but no additional insulation. The

compliance software shall allow the user to specify the R-value of additional above-deck insulation in any roof-deck construction assembly.

### **STANDARD DESIGN**

The standard design accounts for the air gap based on roofing type but has no additional above-deck insulation.

### **VERIFICATION AND REPORTING**

Above-deck insulation R-value is reported as a special feature on the LMCC.

### **6.11.6.5 Roofing Type and Mass**

#### **PROPOSED DESIGN**

The choice of roofing type determines the air gap characteristics between the roofing material and the deck and establishes whether other inputs are needed, as described below. The choices for roof type are shown below.

- Concrete or clay tile. Both types have significant thermal mass and an air gap between the deck and the tiles.
- Metal tile or wood shakes. These are lightweight with an air gap between the tiles or shakes and the deck. Note that tapered cedar shingles do not qualify and are treated as a conventional roof surface.
- Other steep-slope roofing types. These include asphalt and composite shingles and tapered cedar shingles. These products have no air gap between the shingles and the structural roof deck.
- Low-slope membranes. These are basically flat roofs with a slope of less than 2:12.
- Above-deck mass. The above-deck mass depends on the roofing type. The mass is 10 lbs/ft<sup>2</sup> for concrete and clay tile and 5 lbs/ft<sup>2</sup> for metal tile, wood shakes, or other steep-slope roofing types. For low-slope roofs, the additional thermal mass is assumed to be gravel or stone, and the user chooses one of the following inputs that is less than or equal to the weight of the material being installed above the roof deck:
  - No mass (asphalt)
  - 5 lbs/ft<sup>2</sup>
  - 10 lbs/ft<sup>2</sup>
  - 15 lbs/ft<sup>2</sup>

- 25 lbs/ft<sup>2</sup>

### **STANDARD DESIGN**

The roof slope shall match the proposed design. The roof type for a steep slope roof is 10 lbs/ft<sup>2</sup> tile. The roof type for low-slope roof is lightweight roof.

### **VERIFICATION AND REPORTING**

The roof type is reported on the LMCC.

## **6.11.6.6 Solar Reflectance and Thermal Emittance**

### **PROPOSED DESIGN**

The compliance software shall allow the user to default the solar reflectance and thermal emittance of the roofing. The solar reflectance product default is 0.10 for all roof types. The thermal emittance default is 0.85.

The compliance software shall allow the user to input aged solar reflectance and thermal emittance of roofing material that are rated by the CRRC. The installed value must be equal to or higher than the value specified here. Roof construction with a roof membrane mass of at least 25 lbs/ft<sup>2</sup> or roof area incorporated integrated solar collectors are assumed to meet the minimal solar reflectance.

### **STANDARD DESIGN**

The solar reflectance and thermal emittance of the standard design roofing are as specified in the prescriptive standards.

### **VERIFICATION AND REPORTING**

Thermal emittance and solar reflectance shall be reported on the LMCC. A reflectance of 0.20 or higher is reported as a cool roof. A value higher than the default but less than 0.20 is reported as a nonstandard roof reflectance value.

---

## **6.12 Domestic Hot Water (DHW)**

Water heating energy use is based on the number of dwelling units, number of bedrooms, fuel type, distribution system, water heater type, and conditioned floor area. Detailed calculation information is included in Appendix B.

### **PROPOSED DESIGN**

The water heating system is defined by the heater type (gas, electric resistance, or heat pump), tank type, dwelling-unit distribution type, efficiency (either UEF or recovery efficiency with the standby loss), tank volume, exterior insulation R-value (only for indirect), rated input, and tank location (for electric resistance and heat pump water heater only).

Heat pump water heaters are defined by energy factor, volume, and tank location or, for Northwest Energy Efficiency Alliance (NEEA) rated heat pumps, by selecting the specific heater brand, model, and tank location.

Water heater and tank types include:

- Consumer storage:  $\leq 75,000$  Btu/h gas/propane,  $\leq 12$  kW electric, or  $\leq 24$  amps heat pump, rated with UEF.
- Consumer instantaneous:  $\leq 200,000$  Btu/h gas or propane, or  $\leq 12$  kW electric. An instantaneous water heater is a water heater with an input rating of  $\geq 4,000$  Btu/h/gallon of stored water, rated with a UEF.
- Residential-duty commercial storage:  $> 75,000$  Btu/h,  $\leq 105,000$  Btu/h gas/propane,  $\leq 12$  kW electric,  $\leq 24$  amps heat pump, and rated storage volume  $< 120$  gallons, rated with a UEF.
- Residential-duty commercial instantaneous:  $\leq 200,000$  Btu/h gas/propane,  $\leq 58.6$  kW electric, rated storage volume  $\leq 2$  gallons, rated with a UEF.
- Commercial storage:  $> 75,000$  Btu/h gas/propane,  $> 105,000$  Btu/h oil, or  $> 12$  kW electric, rated with thermal efficiency and standby loss.
- Commercial instantaneous:  $> 200,000$  Btu/h gas/propane,  $> 12$  kW electric. Instantaneous water heater is a water heater with an input rating of  $\geq 4,000$  Btu/h per gallon of stored water, rated with thermal efficiency.
- Heat pump water heater:  $\leq 24$  amps NEEA rating or rated with UEF.
- Mini-tank (modeled only in conjunction with an instantaneous gas water heater): a small electric storage buffering tank that may be installed downstream of an instantaneous gas water heater to mitigate delivered water temperatures (e.g., cold water sandwich effect). If the standby loss of this aftermarket tank is not listed in the [CEC appliance database](#), a standby loss of 35 W must be assumed.
- Indirect: a tank with no heating element or combustion device used in combination with a boiler or other device serving as the heating element.
- Boiler: a water boiler that supplies hot water, rated with thermal efficiency or AFUE.

Heater element type includes:

- Electric resistance.
- Gas.
- Heat pump.

Dwelling unit distribution system types for systems serving individual dwelling units include:

- Standard (all distribution pipes insulated).

Point of use.

Central parallel piping.

- Recirculation with nondemand control (continuous pumping).
- Recirculation with demand control, push button.
- Recirculation with demand control, occupancy/motion sensor.
- HERS-required pipe insulation, all lines.
- HERS-required central parallel piping.
- HERS-required recirculation, demand control, push button.
- HERS-required recirculation with demand control, occupancy/motion sensor.

When a multifamily building has central water heating, both a dwelling unit and a central system distribution type must be specified. Dwelling unit distribution types for this case include:

- Standard (all distribution pipes insulated).
- HERS required pipe insulation, all lines.

Multifamily central hot water heating central system distribution types include:

- No loops or recirculation system pump.
- Recirculation with no control (continuous pumping).

Some distribution systems have an option to increase the amount of credit received if the option for HERS verification is selected. See Appendix B for the amount of credit and *Reference Appendices, Residential Appendix Table RA2-1* for a summary of inspection requirements.

#### **6.12.1.1 Distribution Compactness**

Applicable to single dwelling units or multifamily with individual water heater in each dwelling unit. Distribution compactness identifies the proximity between the water heater and use points. The distribution compactness of the water heating system must be specified. The choices include:

- None.
- Compact distribution basic credit.

- Compact distribution expanded credit (HERS).

For both compact distribution basic credit and expanded credit, the plan view distance from the water heater to the master bedroom, the kitchen, and the furthest fixture must be specified. The software will determine if the distances qualify for the credit.

### **6.12.1.2 Drain Water Heat Recovery**

Drain water heat recovery (DWHR) is a system where the waste heat from shower drains is used to preheat the cold inlet water. The preheat water can be routed to the served shower, water heater, or both.

The user specifies the DHWR device for the water heating system. The rated efficiency of the DWHR device, the number of shower(s) served, and the configuration must be specified. The configuration choices include:

- Equal flow to shower and water heater: The potable-side heat exchanger output feeds both the fixture and the water heater inlet. Potable and drain flow rates are equal, assuming no other simultaneous hot water draws.
- Unequal flow to shower: The potable-side heat exchanger output feeds the inlet(s) of the water heater(s) that are part of the parent DHW system. (The inlet temperature is adjusted to reflect recovered heat.)
- Unequal flow to water heater: The potable-side heat exchanger output feeds only the associated fixture.

Multiple DHWR devices can be used for a water heater system.

Drain water heat recovery is a HERS-verified measure.

### **6.12.2 Individual Dwelling Units**

The standard design is a single heat pump water heater with a 2.0 UEF. with compact distribution basic credit in Climate Zones 1 and 16, and a drain water heat recovery system in Climate Zone 16. In Climate Zone 16, the standard design DWHR has an exchanger efficiency of 0.65, serving 100 percent of showers, with an equal shower configuration.

If the proposed building has an attached garage, then the standard design HPWH location is the garage. If the proposed building does not have an attached garage, then the standard design HPWH location is in the conditioned space with the air inlet and outlet ducted to the outside.

In Climate Zones 3, 4, 13, and 14, if the proposed design is gas, then the standard design is a single gas or propane consumer instantaneous water heater for each dwelling unit. The single consumer instantaneous water heater is modeled with an input



of 200,000 Btu/h, a tank volume of zero gallons, a high draw pattern, and a UEF meeting the minimum federal standards. The current minimum federal standard for a high-draw-pattern instantaneous water heater is 0.81 UEF.

### 6.12.3 Multiple Dwelling Units – Central Water Heating

When the proposed design is a central water heating system, the standard design consists of the water heating devices, a recirculation system, and solar systems as follows:

**Water-heating device.** If the proposed water-heating system has no recirculating loops, then the standard design is a heat pump water heater with 2.0 UEF. This is only allowed for a central system serving eight or fewer dwelling units.

If the proposed central water-heating device has recirculating loops, then the standard design is a natural gas or propane commercial packaged boiler, 80 percent thermal efficiency, with a tank volume based on the proposed building floor area.

The appropriate efficiencies and standby losses for each standard water-heating device are then assigned to match the minimum federal requirements. The standards for consumer water heaters, as defined by 42 U.S.C 6291(16), are specified in 10 CFR 430.32(d); the standards for commercial water heaters, as defined by 42 U.S.C 6291(16), are specified in 10 CFR 431.110.

**Recirculating system.** If the central water-heating system has recirculation loops, the standard design includes a recirculation system with no controls and one recirculation loop.

**Solar thermal water-heating system.** The standard design has a solar water heating system meeting the installation criteria specified in *Reference Residential Appendix RA4* and with a minimum solar savings fraction of 0.20 in Climate Zones 1-9, or 0.35 in Climate Zones 10-16.

#### VERIFICATION AND REPORTING

All modeled features and the number of devices modeled for the water heating system are reported on the LMCC. Electric resistance and heat pump water heaters indicate the location of the water heater. NEEA-rated heat pumps are identified by the brand and model, which must be verified by the building inspector.

Where water heating system features or distribution systems specify or require HERS verification, those features are listed in the HERS required verification listings on the LMCC.

#### **6.12.4 Solar Thermal Water Heating Credit**

When a water heating system has a solar thermal system to provide part of the water heating, the user enters information about the Solar Rating and Certification Corporation approved collector (manufacturer, brand, model number), including details of the installation (azimuth, tilt),

Alternatively, the solar fraction (SF) is determined using the CEC Solar Water Heating Calculator, OG-100 calculation method, or the certified OG-300 rating. The calculation method requires that the user specify the climate zone and conditioned floor area, in addition to published data for the solar thermal water heating system.

---

### **6.13 Additions/Alterations**

Addition and alteration compliance is based on Energy Code, §180.0, §180.1, §180.2, and §180.3. The energy budget for additions and alterations is based on TDV energy. Alterations must model the entire dwelling unit. Additions may be modeled as addition alone, as “existing+addition+alteration,” or the entire building may be modeled as an entirely new building.

Additions that are 1,000 ft<sup>2</sup> or less and junior accessory dwelling units are not required to comply with whole-dwelling unit ventilation airflow specified in §160.2(b)2Aiv or §160.2(b)2Av. When an addition to any building creates a new dwelling unit, this exception does not apply.

The standard design does not include:

- Cool roof when an addition is 300 ft<sup>2</sup> or less.
- Ventilation cooling for additions that are 1,000 ft<sup>2</sup> or less.
- Solar generation/PV requirements.

#### **6.13.1 Whole Building**

The entire proposed building, including all additions or alterations or both, is modeled the same as a newly constructed building. The building complies if the proposed design uses equal or less energy than the standard design.

#### **6.13.2 Alteration-Along Approach**

The proposed alteration alone floor area is modeled. The alteration requirements of §180.2 are applied to any features that do not exist.

### 6.13.3 Addition-Alone Approach

The proposed addition alone is modeled the same as a newly constructed building except that the internal gains are prorated based on the size of the dwelling. None of the exceptions included for prescriptive additions, which are implemented in the existing plus addition plus alteration compliance approach ([Chapter 6.13.4 Existing+ Addition\\_ Alteration Approach](#)), are given the addition alone approach. (See Energy Code, §180.1[b]2.) The addition complies if the proposed design uses equal or less space heating, space cooling, and water heating TDV energy than the standard design.

The addition-alone approach shall not be used when alterations to the existing building are proposed. Modifications to any surfaces between the existing building and the addition are part of the addition and are not considered alterations.

#### PROPOSED DESIGN

The user shall indicate that an addition alone is being modeled and enter the conditioned floor area of the addition. Any surfaces that are between the existing building and the addition are not modeled or are treated as adiabatic surfaces. All other features of the addition shall be modeled the same as a newly constructed building.

When an existing HVAC system is extended to serve the addition, the standard design shall assume the same efficiency for the HVAC equipment as the proposed design. (See [Chapter 6.9.1 Heating Subsystems](#) and [Chapter 6.9.2 Cooling Subsystems](#).)

When a dual-glazed greenhouse or garden window is installed in an addition or alteration, the proposed design U-factor can be assumed to be 0.30.

#### STANDARD DESIGN

The addition alone is modeled the same as a newly constructed building, with the following exceptions:

- A. When roofing requirements are included in Table 170.2-A, they are included in the standard design if the added conditioned floor area is greater than 300 ft<sup>2</sup>.
- B. When ventilation cooling (whole-house fan) is required by Table 170.2-K, it is included in the standard design when the added conditioned floor area is greater than 1,000 ft<sup>2</sup>. The capacity shall be based on 1.5 CFM/ft<sup>2</sup> of conditioned floor area for the entire dwelling unit conditioned floor area.
- C. When compliance with IAQ requirements of §160.2 apply to an addition with greater than 1,000 ft<sup>2</sup> added, the conditioned floor area of the entire dwelling unit shall be used to determine the required ventilation airflow. For additions with 1,000 ft<sup>2</sup> or less of added conditioned floor area, no IAQ requirements apply.

- D. PV requirements are not included.
- E. For multifamily buildings with three habitable stories or less in Climate Zones 1-15 the space conditioning system is a heat pump. For multifamily buildings with three habitable stories or less in Climate Zone 16 the space conditioning system is an air conditioner with furnace. For multifamily buildings with more than three habitable stories in Climate Zones 2-15 the space conditioning system is a heat pump. For multifamily buildings with more than three habitable stories in Climate Zones 1 and 16 the space conditioning system is a dual-fuel heat pump. See Chapter 6.9.1 Heating Subsystems for equipment efficiencies and operating details for each type of system. The cooling system for the standard design building is a nonzonal control system, split-system ducted cooling system, meeting the minimum requirements of the Appliance Efficiency Regulations. See Chapter 6.9.2 Cooling Subsystems for equipment efficiencies and operating details for each type of system.
- F. For dwelling units with water heaters serving individual dwelling units, the standard design DHW system is a heat pump water heater with a 2.0 UEF. In climate zones 3, 4, 13 and 14, if the proposed design is gas, the standard design DHW system is a natural gas tankless (or propane if natural gas is not available) water heating system. See Chapter 6.12.2 Individual Dwelling Units for equipment efficiencies and operating details for each type of water heater.

#### **6.13.4 Existing + Addition + Alteration Approach**

Energy Code §180.1 contains the provisions for additions and §180.2 for alterations when the existing building is included in the calculations. These provisions are the “Existing + Addition + Alteration” (or “E+A+A”) performance approach.

##### **PROPOSED DESIGN**

The proposed design is modeled by identifying each energy feature as part of the existing building (as existing, altered, or new), or as part of the addition. The compliance software uses this information to create an E+A+A standard design using the rules in the standards that take into account whether altered components meet or exceed the threshold at which they receive a compliance credit and whether any related measures are triggered by altering a given component.

For building surfaces and systems designated below, all compliance software must provide an input field with labels for the proposed design, which define how the standard design requirements are established based on the option selected by the software user:

- Existing: The surface or system remains unchanged within the proposed design. (Both standard design and proposed design have the same features and characteristics.)
- Altered: the surface or system is altered in the proposed design. No verification of existing conditions is assumed with this designation.
- Verified Altered: the surface or system is altered in the proposed design, and the original condition is verified by a HERS rater (an optional selection).
- New: a new surface or system is added in the proposed design (may be in the existing building or the addition).

Deleted features are not included in the proposed design.

§180.2, Table 180.2-B specifies the details of the standard design for altered components based on whether verification of existing conditions is selected or not:

**Altered** with no third-party verification of existing conditions (the default selection). This compliance path does not require an on-site inspection of existing conditions prior to the start of construction. The attributes of the existing condition are undefined, with the standard design for altered components based on §180.2, Table 180.2-B, and the climate zone. Energy compliance credit or penalty is a function of the difference between the value for that specific feature allowed in Table 180.2-B and the modeled/installed efficiency of the feature.

**Verified Altered** existing conditions. This compliance path requires that a HERS rater perform an on-site inspection of pre-alteration conditions prior to construction. If an altered component or system meets or exceeds the prescriptive alteration requirements, the compliance software uses the user-defined and verified existing condition as the standard design value. Energy compliance credit is then based on the difference between the verified existing condition for that altered feature and the modeled/installed efficiency of the proposed design.

#### 6.13.4.1 QII

##### STANDARD DESIGN

The standard design includes QII for additions greater than 700 ft<sup>2</sup> in multifamily building in Climate Zones 1-6 and 8-16 (§180.1[a]1Bv).

The provisions of §180.1(a)1Aiv, as applied to converting an existing unconditioned space to conditioned space, are accommodations made by the HERS rater in the field. No adjustments to the energy budget are made.

**6.13.4.2 PV**

**STANDARD DESIGN**

The standard design does not include PV for additions and alterations.

**6.13.4.3 Roof/Ceilings**

**STANDARD DESIGN**

The standard design roof/ceiling construction assembly is based on the proposed design assembly type as shown in Table 39. For additions less than or equal to 700 ft<sup>2</sup>, radiant barrier requirements follow Option C (§170.2[a]1Bii). The standard design for unaltered ceilings and roofs is the existing condition.

**Table 39: Standard Design for Roofs/Ceilings**

<b>Proposed Design Roof/Ceiling Types</b>	<b>Addition ≤ 300 ft<sup>2</sup></b>	<b>Addition &gt; 300 ft<sup>2</sup> and ≤ 700 ft<sup>2</sup></b>	<b>Addition &gt; 700 ft<sup>2</sup></b>	<b>Altered</b>	<b>Verified Altered</b>
Roof Deck Insulation (below-deck, where required) at vented attic	NR	NR	CZ 8, 9, 11-15 = R-19, CZ 10, 16 = R-13	CZ 8, 9, 11-15 = R-19, CZ 10, 16 = R-13	Existing
Ceilings Below Attic	CZ 1, 2, 8-16 = R-38 CZ 3, 5-7 = R-30	CZ 1, 2, 4, 8-16 = R-38 CZ 3, 5-7 = R-30	CZ 1, 2, 4, 8-16 = R-38 CZ 3, 5-7 = R-30	CZ 5-7 = R-19 CZ 1-4, 8-16 = R-49	Existing
Non-Attic (Cathedral) Ceilings and Roofs	R-22/U-0.043	R-22/U-0.043	Same as above	R-19/U-0.054	Existing
Radiant Barrier	CZ 2-15 REQ CZ 1, 16 NR	CZ 2-15 REQ CZ 1, 16 NR	CZ 2, 3, 5-7 REQ CZ 1, 4, 8-16 NR	NR	Existing
Roofing Surface	NR	CZ 10-15 =0.20	CZ 10-15 =0.20	CZ 4, 8-15 =0.20	Existing

<b>Proposed Design Roof/Ceiling Types</b>	<b>Addition ≤ 300 ft<sup>2</sup></b>	<b>Addition &gt; 300 ft<sup>2</sup> and ≤ 700 ft</b>	<b>Addition &gt; 700 ft<sup>2</sup></b>	<b>Altered</b>	<b>Verified Altered</b>
(Cool Roof) Steep-Sloped		Reflectance, =0.75 Emittance	Reflectance, =0.75 Emittance	Reflectance =0.75 Emittance	
Roofing Surface (Cool Roof) Low Slope	NR	CZ 13, 15 = 0.63 Reflectance, =0.75 Emittance	CZ 13, 15 = 0.63 Reflectance, =0.75 Emittance	CZ 4, 6-15 =0.63 Reflectance =0.75 Emittance	Existing
Above Deck Insulation, Low-Sloped	NR	NR	NR	CZ 1, 2, 4, 8-16 R-14 continuous	Existing

Source: California Energy Commission

**6.13.4.4 Exterior Walls and Doors**

The software allows the user to indicate whether a new wall in an addition is an extension of an existing wood-framed wall and, if so, the dimensions of the existing wall. The standard design exterior wall construction assembly is based on a wood-framed wall with R-15 cavity insulation for existing 2x4 walls or R-21 cavity insulation for existing 2x6 walls.

The software allows the user to indicate if a wall is existing, where siding is not removed or replaced. The user also identifies if the walls have 2x4 or 2x6 framing. The standard design exterior wall construction assembly is based on a wood-framed wall with R-15 cavity insulation for existing 2x4 walls or R-21 cavity insulation for existing 2x6 walls.

**PROPOSED DESIGN**

Existing structures with insulated wood-framed walls that are being converted to conditioned space using an E+A+A approach are allowed to show compliance using the existing wall framing, without having to upgrade to current prescriptive continuous insulation requirements. The walls are modeled as an assembly with the existing framing and either R-15 (in 2x4 framing) or R-21 (in 2x6 framing) insulation (Exception to §160.1[b] and §180.1[a]1).

**STANDARD DESIGN**

The areas, orientation, and tilt of existing, new, and altered net exterior wall areas (with windows and doors subtracted) are the same in the existing and addition portions of standard design as in the proposed design.

If the proposed wall area is framed, the gross exterior wall area (excluding knee walls) is equally divided among the four building orientations: front, left, back and right. The gross exterior wall area of any unframed walls is also equally divided among the four orientations in the standard design.

The standard design exterior wall construction assembly is based on the proposed design assembly type as shown in Table 40. Framed walls are modeled as 16-in. on center wood framing. The standard design for unaltered walls is the existing condition.

The standard design for exterior opaque or swinging doors is 0.20 U-factor. Fire-rated doors (from the house to garage) use the proposed design door U-factor as the standard design U-factor.

**Table 40: Addition Standard Design for Walls and Doors**

<b>Proposed Design Exterior Wall Assembly Type or Door</b>	<b>Addition</b>	<b>Altered</b>	<b>Verified Altered</b>
Framed & Non-Mass Exterior Walls	CZ 1-5, 8016 = R-21+R-4 in 2x6 (U-0.051) CZ 6-7 = R-15+R-4 in 2x4 (U-0.065)	R-13 in 2x4 R-20 in 2x6	Existing
Wood framed existing walls where siding is not removed Extension of an existing wall	R-15 in 2x4 R-21 in 2x6	R-13 in 2x4 R-20 in 2x6	Existing
Framed Wall Adjacent to Unconditioned (e.g., Demising or Garage Wall)	R-15 in 2x4 R-21 in 2x6	R-13 in 2x4 R-20 in 2x6	Existing



<b>Proposed Design Exterior Wall Assembly Type or Door</b>	<b>Addition</b>	<b>Altered</b>	<b>Verified Altered</b>
Above Grade Mass Interior Insulated	CZ 1-15 = R-13 (0.077) CZ 16 = R-17 (0.059)	N/R Mandatory requirements have no insulation for mass walls	Existing
Below Grade Mass Interior Insulation	CZ 1-15 = R-13 CZ 16 = R-15	N/R Mandatory requirements have no insulation for mass walls	Existing
Swinging Doors	0.20	0.20	Existing

Source: California Energy Commission

**6.13.4.5 Fenestration**

**PROPOSED DESIGN**

Fenestration areas are modeled in the addition as new. In an existing building, they may be existing, altered, or new. Altered (replacement) fenestration is defined in §180.2(b)1.C as “existing fenestration area in an existing wall or roof [which is] replaced with a new manufactured fenestration product... Up to the total fenestration area removed in the existing wall or roof...” Altered also includes fenestration installed in the same existing wall, even if in a different location on that wall. Added fenestration area in an existing wall or roof is fenestration that did not previously exist and is modeled as new.

**STANDARD DESIGN**

Standard design fenestration U-factor and SHGC are based on the values shown in Table 41. Vertical glazing includes all fenestration in exterior walls such as windows, clerestories, and glazed doors. Skylights include all glazed openings in roofs and ceilings.

New fenestration in an alteration is modeled with the same U-factor and SHGC as required for an addition.

West-facing limitations are combined with the maximum fenestration allowed and are not an additional allowance.

The standard design is set for fenestration areas and orientations as shown in Table 41:

- Proposed design  $\leq$  allowed percentage of total fenestration area:

In the existing building, the standard design uses the same area and orientation of each existing or altered fenestration area (in the respective existing or altered wall or roof.)

In the addition, new fenestration is divided equally among the four project compass points similar to new gross wall areas in the addition described above.

- Proposed design  $>$  allowed percentage of total fenestration area:

The standard design first calculates the allowed total fenestration area as the total existing and altered fenestration area in existing or altered walls and roofs. Added to this is the percent of fenestration allowed in the addition, based on the conditioned floor area of the addition.

**Table 41: Standard Design for Fenestration (in Walls and Roofs)**

<b>Proposed Design Fenestration Type</b>	<b>Addition <math>\leq</math> 400 ft<sup>2</sup></b>	<b>Addition <math>&gt;</math> 400 and <math>\leq</math> 700 ft<sup>2</sup></b>	<b>Addition <math>&gt;</math> 700 ft<sup>2</sup></b>	<b>Altered</b>	<b>Verified Altered</b>
Vertical Glazing: Area and Orientation	75 ft <sup>2</sup> or 30%	120 ft <sup>2</sup> or 25%	175 ft <sup>2</sup> or 20%	See full description below.	Existing
West Facing Maximum Allowed	CZ 2, 4, 6 - 15=60 ft <sup>2</sup>	CZ 2, 4, 6 - 15=60 ft <sup>2</sup>	CZ 2, 4, 6 - 15=70 ft <sup>2</sup> or 5%	NR	NR
Vertical Glazing: U-Factor	0.30	0.30	0.30	0.40	See below
Vertical Glazing: SHGC	CZ 2, 4, 6-15=0.23 CZ 1,3, 5 & 16=0.35	CZ 2, 4, 6-15=0.23 CZ 1,3, 5 & 16=0.35	CZ 2, 4, 6-15=0.23 CZ 1,3, 5 & 16=0.35	CZ 2, 4, 6-15=0.35 CZ 1,3, 5 & 16=0.35	Existing
Skylight: Area and Orientation	No skylight area in the standard design	No skylight area in the standard design	No skylight area in the standard design	NR	Existing

<b>Proposed Design Fenestration Type</b>	<b>Addition ≤ 400 ft<sup>2</sup></b>	<b>Addition &gt; 400 and ≤ 700 ft<sup>2</sup></b>	<b>Addition &gt; 700 ft<sup>2</sup></b>	<b>Altered</b>	<b>Verified Altered</b>
Skylight: U-Factor	0.30	0.30	0.30	0.55	Existing
Skylight: SHGC	CZ 2, 4, 6 - 15=0.23 CZ 1,3 5 & 16=0.35	CZ 2, 4, 6 - 15=0.23 CZ 1,3 5 & 16=0.35	CZ 2, 4, 6 - 15=0.23 CZ 1,3 5 & 16=0.35	CZ 2, 4, 6 - 15=0.30 CZ 1,3 5 & 16=0.35	Existing

Source: California Energy Commission

**6.13.4.6 Overhangs, Sidesfins and Other Exterior Shading**  
**STANDARD DESIGN**

The standard design for a proposed building with overhangs, sidesfins, and exterior shades is shown in Table 42 Exterior shading (limited to bug screens) is treated differently than fixed overhangs and sidesfins, as explained in [Chapter 6.10.6.9](#) Exterior Shading.

**Table 42: Standard Design for Overhangs, Sidesfins, and Other Exterior Shading**

<b>Proposed Design Shading Type</b>	<b>Addition</b>	<b>Altered</b>	<b>Verified Altered</b>
Overhangs and Sidesfins	No overhangs or sidesfins	Proposed altered condition	Same as altered
Exterior Shading	Standard (bug screens on fenestration, none on skylights)	Proposed altered condition	Existing exterior shading
Window Film	No window film	Proposed altered condition	Existing exterior shading

Source: California Energy Commission

**6.13.4.7 Window Film**  
**PROPOSED DESIGN**

A window film must have at least a 15-year warranty and is treated as a window replacement. The values modeled are either the default values from Tables 110.6-A and 110.6-B or the NFRC Window Film Energy Performance Label.

### 6.13.4.8 Floors

#### STANDARD DESIGN

The standard design for floors is shown in Table 43.

**Table 43: Standard Design for Floors**

<b>Proposed Design Floor Type</b>	<b>Addition</b>	<b>Altered (mandatory)</b>	<b>Verified Altered</b>
Raised Floor Over Awl Space or Over Exterior	R-19 in 2x6 16" o.c. wood framing	R-19 in 2x6 16" o.c. wood framing	If proposed $U \leq 0.037$ , standard design = existing raised; if proposed $U > 0.037$ , standard design = 0.037
Slab-on-Grade: Unheated	CZ1-15: R-0 CZ16: R-7 16" vertical	R-0	Existing unheated slab-on-grade
Slab-on-Grade: Heated	CZ1-15: R-5 16" vertical CZ 16: R-10 16" vertical	CZ1-15: R-5 16" vertical CZ 16: R-10 16" vertical	Existing heated slab-on-grade
Raised Concrete Slab	CZ1,2,11,13,14,16: R-8 CZ3-10: R-0 CZ12,15: R-4	R-0	Existing raised concrete slab

Source: California Energy Commission

### 6.13.4.9 Thermal Mass

#### STANDARD DESIGN

The standard design for thermal mass in existing plus addition plus alteration calculations is the same as for all newly constructed buildings as explained in [Chapter 6.10.4.1 Internal Thermal Mass](#).

6.13.4.10 Air Leakage and Infiltration

STANDARD DESIGN

Standard design air leakage and infiltration is shown in Table 44.

Table 44: Standard Design for Air Leakage and Infiltration

Proposed Air Leakage and Infiltration	Addition	Altered	Verified Altered
Multifamily Buildings	7 ACH50	7 ACH50	7 ACH50

Source: California Energy Commission

6.13.4.11 Space Conditioning System

STANDARD DESIGN

The standard design for space-conditioning systems is shown in Table 45.

When cooling ventilation (whole-house fan) is required by §170.1, the capacity is 1.5 CFM/ft<sup>2</sup> of conditioned floor area for the entire dwelling unit.

When compliance with IAQ requirements of §160.2 apply to an addition with greater than 1,000 ft<sup>2</sup> added, the conditioned floor area of the entire dwelling unit is used to determine the required ventilation airflow. For additions with 1,000 ft<sup>2</sup> or less of added conditioned floor area, no IAQ requirements shall apply.

Table 45: Standard Design for Space Conditioning Systems

Proposed Design Space-Conditioning System Type	Addition	Altered	Verified Altered
Heating System	See Chapter 6.13.3 Addition-Alone Approach and 2015 Federal Appliance Stds. based on fuel source and equipment type	Same as Addition	Existing heating fuel type and equipment type/efficiency If the existing equipment is electric resistance and none of the exceptions to §180.2(b)2Av are met the Standard Design system shall be a heat pump meeting the requirements

<b>Proposed Design Space-Conditioning System Type</b>	<b>Addition</b>	<b>Altered</b>	<b>Verified Altered</b>
			of Chapter 6.13.3 Addition-Alone Approach.
Cooling System	See Chapter 6.13.3 Addition-Alone Approach and 2015 Federal Appliance Standards based on fuel source and equipment type	Same as Addition	Existing cooling equipment type/efficiency
Refrigerant Charge	CZ 2, 8-15: Yes CZ 1, 3-7: No	Same as Addition	Existing
Whole-House Fan (WHF) applies only if addition > 1,000 ft <sup>2</sup>	CZ 8-14; 1.5 CFM/ft <sup>2</sup>	N/A	Existing condition. To count as Existing the WHF must be ≥ 1.5 CFM/ft <sup>2</sup> and be CEC-rated
Indoor Air Quality applies only if addition > 1,000 ft <sup>2</sup> or if addition is a dwelling unit	Meet mandatory ventilation for entire dwelling	Same as Addition	Existing

Source: California Energy Commission

**6.13.4.12 Duct System**

**PROPOSED DESIGN**

Duct insulation shall be based on the new or replacement R-value input by the user. Duct leakage shall be based on the tested duct leakage rate entered by the user or a default rate of 30 percent. [Not Yet Implemented]



**STANDARD DESIGN**

**Table 46: Standard Design for Duct Systems**

<b>Proposed Design Duct System Type</b>	<b>No Verification of Existing Conditions</b>	<b>Verified Existing Conditions</b>
Altered or Extended Ducts >25 ft	CZ 1-2, 4, 8-16: Duct insulation R-8 and duct leakage of 10% CZ 3, 5-7: Duct insulation R-6 and duct leakage of 10%	Existing duct R-value and duct leakage the lesser of 30% or the existing leakage rate
New Ducts	CZ 1-2, 4, 8-16: Duct insulation R-8 and duct leakage of 5% CZ 3, 5-7: Duct insulation R-6 and duct leakage of 5%	N/A

Based on Table 180.2-C

Note 1: Refer to §180.2(b)2Aii for definition of an “Entirely New or Complete Replacement Duct System.”

Source: California Energy Commission

**6.13.4.13 Water Heating System**

**STANDARD DESIGN**

**Table 47: Standard Design for Water Heater Systems**

<b>Proposed Design Water Heating System Type</b>	<b>Addition (adding water heater)</b>	<b>Altered</b>	<b>Verified Altered</b>
Multifamily Individual Water Heater for Each Dwelling Unit	Prescriptive water heating system for each dwelling unit (see Chapter 6.12)	Existing fuel type, proposed tank type, mandatory requirements (excluding any solar)	Existing water heater type(s), efficiency, distribution system
Multifamily Central Water Heating System	Central water heating system (see Chapter 6.12)	Mandatory and prescriptive requirements (excluding any solar)	Existing water heater type(s), efficiency, distribution system

Source: California Energy Commission

## **6.14 Documentation**

The software shall be capable of displaying and printing an output of the energy use summary and a text file of the building features. These are the same features as shown on the LMCC when generated using the report manager.

See public domain software user guide or vendor software guide for detailed modeling guidelines.