

**DOCKETED**

<b>Docket Number:</b>	19-AB-2127
<b>Project Title:</b>	Implementation of AB 2127 Electric Vehicle Charging Infrastructure Assessments
<b>TN #:</b>	238032
<b>Document Title:</b>	Assembly Bill 2127 Electric Vehicle Charging Infrastructure Assessment (Revised Staff Report)
<b>Description:</b>	*** This Document Supersedes TN: 238005***
<b>Filer:</b>	Spencer Kelley
<b>Organization:</b>	California Energy Commission
<b>Submitter Role:</b>	Commission Staff
<b>Submission Date:</b>	5/28/2021 10:54:39 AM
<b>Docketed Date:</b>	5/28/2021



**CALIFORNIA  
ENERGY COMMISSION**



**CALIFORNIA  
natural  
resources  
AGENCY**

California Energy Commission

## **REVISED STAFF REPORT**

### **Assembly Bill 2127**

# **Electric Vehicle Charging Infrastructure Assessment**

**Analyzing Charging Needs to Support  
Zero-Emission Vehicles in 2030**

**May 2021 | CEC-600-2021-001-REV**



# California Energy Commission

Matt Alexander

Noel Crisostomo

Wendell Krell

Jeffrey Lu

Raja Ramesh

**Primary Authors**

Kiel Pratt

**Project Manager**

Charles Smith

**Office Manager**

**TRANSPORTATION POLICY AND ANALYSIS OFFICE**

Hannon Rasool

**Deputy Director**

**FUELS AND TRANSPORTATION DIVISION**

Drew Bohan

**Executive Director**

## **DISCLAIMER**

**Staff members of the California Energy Commission (CEC) prepared this report. As such, it does not necessarily represent the views of the CEC, its employees, or the State of California. The CEC, the State of California, its employees, contractors and subcontractors make no warrant, express or implied, and assume no legal liability for the information in this report; nor does any party represent that the uses of this information will not infringe upon privately owned rights. This report has not been approved or disapproved by the CEC nor has the Commission passed upon the accuracy or adequacy of the information in this report.**

## ACKNOWLEDGEMENTS

The following California Energy Commission staff members contributed to developing this *Assembly Bill 2127 Electric Vehicle Charging Infrastructure Assessment*: Jennifer Allen, Aniss Bahreinian, Messay Betru, Peter Chen, Kyle Corrigan, Jesse Gage, Tiffany Hoang, Madison Jarvis, Elizabeth John, Alex Lonsdale, Thanh Lopez, Lynn Marshall, Bob McBride, Tim Olson, Mark Palmere, Marc Perry, Sharon Purewal, Shaun Ransom, Larry Rillera, Ben Wender, and Micah Wofford.

The authors appreciate the analytical expertise of these research collaborators: Eric Wood, Dong-Yeon Lee, Matteo Muratori, Ria Kontou, Nick Reinecke, and Yanbo Ge (National Renewable Energy Laboratory); Bin Wang, Cong Zhang, Fan Tong, and Doug Black (Lawrence Berkeley National Laboratory); Gil Tal, Alan Jenn, and Adam Davis (University of California at Davis); and coordination with the efforts of Siobhan Powell and Ram Rajagopal (Stanford University), Siddharth Sridhar and Michael Kintner-Meyer (Pacific Northwest National Laboratory), and Jason Harper (Argonne National Laboratory).

The authors value the ongoing interagency coordination on infrastructure efforts and the input and feedback from Carolyn Sisto, Audrey Neuman, Michael Truax, Ed Pike, and Sulekha Chattopadhyay (California Public Utilities Commission); Joshua Cunningham, Nicole Dolney, Kathy Jaw, Sara Forestieri, Fang Yan, Paul Arneja, Brandon Rose, Katherine Garrison, Ryan Hart, and Melanie Zauscher (California Air Resources Board); Janette Ramirez, Eric Fredericks, and Kalin Pacheco (Caltrans); and Ian Macmillan (South Coast Air Quality Management District).

Finally, the authors appreciate the comments and feedback provided by various stakeholders, including Adopt A Charger, Advanced Energy Economy, Alliance for Automotive Innovation, American Honda Company, Ample, Amply Power, Arrival, Beam, Blink Charging, BMW of North America, BTC Power, California Electric Transportation Coalition, CalStart, Chargepoint, City of Sacramento, Cruise, Daimler, Engie Impact, Electric Auto Association, Electric Vehicle Charging Association, Electriphi, Enel X, Environmental Defense Fund, EVBox, EVgo, ev.energy, EV Connect, Fermata Energy, Flo, Ford Motor Company, FreeWire, General Motors Company, Greenlots, Hsubject, IoTecha, Kitu Systems, Lightning Motors, Lion Electric Company, Los Angeles Cleantech Incubator, Los Angeles Department of Water and Power, Lucid, Mercedes-Benz Automotive Group, Mitsubishi Motors R&D of America, Mobility House, Natural Resources Defense Council, next-dimension, Nikola Corporation, Nissan Technical Center North America, Nuvve, Orange Charger, Oxygen Initiative, Pacific Gas and Electric Company, Plug In America, Powerflex-EDF Renewables, Rhombus Energy Solutions, Rivian, Robert L. Graham, Sacramento Municipal Utilities District, San Diego Gas and Electric Company, SemaConnect, Siemens, Sierra Club California, Southern California Edison, Stellantis, Toyota Motor North America, Tritium, The Utility Reform Network, Veloce Energy, Vinfast, and Volvo Group.

# ABSTRACT

This inaugural *Assembly Bill (AB) 2127 Electric Vehicle Charging Infrastructure Assessment* examines charging needs to support California's plug-in electric vehicles (PEVs) in 2030. Under AB 2127, the California Energy Commission (CEC) is required to publish a biennial report on the charging needs of 5 million zero emission vehicles (ZEVs) by 2030. In September 2020, Governor Gavin Newsom issued Executive Order N-79-20, which directed the Commission to update this assessment to support expanded ZEV adoption targets.

In 2018, Executive Order B-48-18 set a goal of having 250,000 chargers (including 10,000 direct current fast chargers) by 2025. As of January 4, 2021, California has installed more than 70,000 public and shared chargers, including nearly 6,000 direct current fast chargers. This report finds that an additional 123,000 are planned, of which about 13,600 are fast chargers, which leaves a gap of about 57,000 installations, including 430 fast chargers, from the 250,000 chargers goal.

For passenger vehicle charging in 2030, this report projects over 700,000 public and shared private chargers are needed to support 5 million ZEVs, and nearly 1.2 million to support about 8 million ZEVs anticipated under Executive Order N-79-20. An additional 157,000 chargers are needed to support 180,000 medium- and heavy-duty vehicles anticipated for 2030.

A portfolio of charging solutions is needed to address site-specific real estate and grid constraints. To maximize grid integration, energy resilience, and ease of use, charging equipment hardware and software should use common connector and communication standards.

Charging businesses are evolving beyond a model of only selling electricity, which alone may be insufficient for sustainable operations. Rather, innovative business models are prioritizing higher utilization, diversified revenues, and adaptation to local environments. This report outlines needs for continued government support and funding, increased private funding, and a flexible and scalable framework to accommodate the growing charging market.

**Keywords:** Charging, infrastructure, transportation electrification, electric vehicle, network planning

Please use the following citation for this report:

Alexander, Matt, Noel Crisostomo, Wendell Krell, Jeffrey Lu, and Raja Ramesh. May 2021. *Assembly Bill 2127 Electric Vehicle Charging Infrastructure Assessment: Analyzing Charging Needs to Support Zero-Emission Vehicles in 2030 – Revised Staff Report*. California Energy Commission. Publication Number: CEC-600-2021-001-REV.

# TABLE OF CONTENTS

	Page
Acknowledgements .....	i
Abstract .....	ii
Table of Contents .....	iii
List of Figures .....	v
List of Tables.....	vi
Executive Summary .....	1
Light-Duty Plug-In Electric Vehicles Will Need Nearly 1.2 Million Shared Chargers by 2030 ...	2
Continued Public Funding for Charger Deployment Is Essential to Meeting State ZEV Goals..	3
Electrification of Medium- and Heavy-Duty Vehicles Is Accelerating .....	5
Charging Solutions Must Be Tailored to Local and Community Needs to Ensure ZEV Access for All Californians.....	6
Prioritize Charging Standards and Innovation .....	6
The Road Ahead .....	7
CHAPTER 1: Background .....	9
CHAPTER 2: Existing Charging Infrastructure .....	12
Charger Types and Definitions .....	12
Counting Chargers .....	13
Analysis Shows Gaps in Geographic Distribution of Chargers.....	14
CHAPTER 3: Current Transportation Trends .....	18
Transportation Greenhouse Gas Emissions Continue to Rise .....	18
Californians Are Driving More.....	19
Growing Demand and Charging Needs for Ride-Hailing Services .....	19
Light-Duty ZEV Sales Are Growing as Battery Costs Decline .....	21
Growing Electrification of the Medium- and Heavy-Duty Sectors.....	25
CHAPTER 4: Modeling California’s Charger Needs .....	28
Near-Term Gap in Charging Infrastructure .....	28
Shared and Public Charging Are Key to Enabling Electrification .....	28

EVI-Pro 2 .....	30
Modeling Results .....	31
Policy Implications.....	38
EVI-RoadTrip.....	40
Modeling Results .....	40
Policy Implications.....	43
WIRED.....	44
Modeling Results .....	44
Policy Implications and Future Refinements.....	47
HEVI-LOAD .....	47
Modeling Results .....	48
Future Refinements and Policy Implications.....	50
EVSE Deployment and Grid Evaluation Model .....	50
Modeling Results .....	51
Policy Implications.....	54
Summary of Quantitative Modeling .....	54
CHAPTER 5: Meeting California’s Technological Needs for Charging Infrastructure .....	57
Pursue Greater Vehicle-Grid Integration to Support Grid Reliability, Provide Energy Resiliency, and Minimize Cost.....	57
Smart Charging .....	57
Bidirectional Charging.....	59
Prioritize Standardized and Interoperable Charger Connectors and Communications.....	61
Prioritize Standard Charger Connectors.....	62
Charger Communication Protocols.....	65
CHAPTER 6: Planning for California’s Local and Community Charging Infrastructure Needs ...	74
Tailor Charging Solutions So That Form Factors Match Local Needs.....	74
Use Community-Centric Planning to Serve Local and Community Needs and Foster Equitable Outcomes.....	75
Building Codes Are a Crucial Policy Tool to Deploy Sufficient Charging Infrastructure.....	77
Recognize and Prepare for Greater Complexities With Medium- and Heavy-Duty Infrastructure Planning.....	78
Continue Streamlining Local Permitting Ordinances.....	81
Publicly Owned Utilities Should Continue to Enhance Their Preparedness for Electrification	82

Develop a Workforce to Support Charging Infrastructure Deployment .....	83
CHAPTER 7: Financing California’s Charging Infrastructure Needs.....	87
Continued Public Support for Charger Deployment Is Essential to Meeting State ZEV Goals	87
Mandates and Infrastructure Incentives Have Driven Charging Infrastructure Growth .....	89
Promoting Private Investment Will Lead to Self-Sustaining Industry .....	94
Exploring Innovative Programs, Financial Instruments, and Process Improvements Could Increase Private Sector Investment .....	98
CHAPTER 8: The Road Ahead .....	103
GLOSSARY .....	105
APPENDIX A: List of Related Public Workshops.....	A-1
APPENDIX B: EVI-Pro 2 Inputs and Parameters.....	B-1
APPENDIX C: EVI-Pro 2 Detailed Results.....	C-1
APPENDIX D: EVI-Pro 2 Alternative Futures Scenarios .....	D-1
APPENDIX E: EVI-RoadTrip County Results .....	E-1

## **LIST OF FIGURES**

	Page
Figure 1: Projected 2030 Charger Counts to Support 5 Million and 8 Million Light-Duty Zero-Emission Vehicles .....	3
Figure 2: Projected Statewide Power for Light-Duty Charging for 8 Million ZEVs on a Typical 2030 Weekday .....	5
Figure 3: CEC’s Analyses Cover Multiple Facets of Charging Infrastructure.....	11
Figure 4: Installed and Projected Charger Counts Compared With Charger Needs for 1.5 Million Light-Duty ZEVs in 2025 and 8 Million Light-Duty ZEVs in 2030 .....	14
Figure 5: Population Density, PEV Density, and Public Chargers by County .....	15
Figure 6: Public Charger Counts by Census Tract Population Density.....	16
Figure 7: Public Level 2 and DC Fast Chargers Per Capita by Income .....	17
Figure 8: Transportation-Related Emissions Accounted for More Than Half of the State’s GHG Emissions in 2018.....	19
Figure 9: California Light-Duty Vehicle Miles Traveled (in Billions) .....	19
Figure 10: Daily Charging Profile of TNC and Non-TNC Drivers in Los Angeles.....	21



Figure 11: ZEV Adoption Trajectories .....	23
Figure 12: U.S. SUV Segment Price and Share of Battery Cost.....	24
Figure 13: Projected 2030 Statewide PEV Charging Load for Intraregional Travel of 8 Million Light-Duty ZEVs in EVI-Pro 2 .....	35
Figure 14: Difference in Alternative Future Network Results Compared to the Standard Scenario .....	37
Figure 15: Station Locations to Support 2030 Interregional Electric Travel for BEVs.....	42
Figure 16: Projected 2030 Load Curve for Interregional DC Fast Charging .....	43
Figure 17: DC Fast Chargers Needed to Support TNC PEVs (2023–2030).....	45
Figure 18: DC Fast Chargers Needed to Support TNC PEVs in 2030 by Region .....	46
Figure 19: Projected 2030 Load Curve for TNC DC Fast Charging.....	46
Figure 20: Projected On-Road Medium- and Heavy-Duty Vehicle Charging Load.....	50
Figure 21: EDGE Capacity Analysis and Data Gaps.....	53
Figure 22: Grid-Integrated Charging Equipment Design Archetype.....	73
Figure 23: Examples of Different Charger Form Factors Based on the Local Environment.....	75
Figure 24: Project Milestone Activities and Key Occupations for Electric Vehicle Charging Infrastructure.....	84
Figure 25: Charging “Beyond the Grid” .....	93
Figure 26: Serving a Broader Driver Market .....	93
Figure 27: Challenging the Presumption That Networks Must “Charge for Charging”.....	94

## **LIST OF TABLES**

	Page
Table 1: Types of Chargers.....	12
Table 2: Definitions of Common Charging Terms .....	13
Table 3: Statewide Counts of Level 2 and DC Fast Chargers, and Projected Charger Gap for 1.5 Million ZEVs by 2025 and 8 Million by 2030.....	14
Table 4: Summary of CEC Charging Infrastructure Quantitative Analyses .....	30
Table 5: Comparison of Primary Input Parameters for EVI-Pro 1 and 2.....	31
Table 6: Comparison of EVI-Pro 2 Draft and Final AB 2127 Analysis.....	32
Table 7: Projected Chargers Needed to Support Intraregional Travel for 8 Million Light-Duty ZEVs in 2030.....	34

Table 8: Summary of Alternative Future Scenarios.....	36
Table 9: DC Fast Charging Infrastructure Needed to Support 2030 Interregional Electric Travel for BEVs.....	41
Table 10: Comparison of Primary Input Parameters for HEVI-LOAD .....	48
Table 11: EDGE Domain Data Sources and Evaluation Criteria .....	51
Table 12: Summary of Quantitative Modeling Results.....	55
Table 13: Existing and Upcoming Charging Connector Standards.....	64

# EXECUTIVE SUMMARY

With transportation accounting for more than 50 percent of the state's greenhouse gas (GHG) emissions, more than 80 percent of smog-forming nitrogen oxide pollution, and 95 percent of toxic diesel particulate matter, the full transition to ZEVs is a critical step toward carbon neutrality, equal balance of GHGs emitted into and removed from the atmosphere, by 2045 and improved public health and air quality. The State is taking many steps to help California achieve this transition, including those described below.

On September 23, 2020, Governor Gavin Newsom signed Executive Order N-79-20, setting the following targets for zero-emission vehicles (ZEVs):

- By 2035, 100 percent ZEV sales for new passenger vehicles, 100 percent ZEV operations for drayage trucks, and 100 percent ZEV operations for off-road vehicles and equipment where feasible
- By 2045, 100 percent ZEV operations for medium- and heavy-duty vehicles, where feasible

Assembly Bill 2127 (Ting, Chapter 365, Statutes of 2018) requires the California Energy Commission (CEC) to prepare a statewide assessment of the charging infrastructure needed to achieve the goal of 5 million ZEVs on the road by 2030 and reducing emissions of greenhouse gases to 40 percent below 1990 levels by 2030. Executive Order N-79-20 directed the CEC to expand this assessment to support the levels of electric vehicle adoption required by the executive order.

Analysis from the California Air Resources Board (CARB) estimates that 8 million light-duty ZEVs and 180,000 medium- and heavy-duty ZEVs will be needed in 2030 to meet the new goal. For passenger vehicles, this report projects that over 700,000 chargers are needed to support 5 million ZEVs and nearly 1.2 million public and shared private chargers are needed to support almost 8 million ZEVs in 2030. For medium- and heavy-duty charging in 2030, modeling analysis suggests that 157,000 chargers are needed to support 180,000 ZEVs. The passenger vehicle charging projections are updated from the original staff report version of this document.

The updated projection reflects stakeholder input and is primarily the result of more aggressive vehicle attributes, including longer ranges, larger batteries, and higher charging powers of EVs coming to market. The rapid improvements in battery prices and vehicle range allow for fewer chargers because drivers will not have to charge as often.

Future reports will reassess charging infrastructure needs through 2035 and potentially project longer-term needs through 2045 as envisioned by Executive Order N-79-20.

Informed by data and input from stakeholders, this report identifies trends and market, technical, and policy solutions that would advance transportation electrification to benefit all Californians. This report outlines a vision where charging is accessible, smart, widespread, and easier than a trip to the gas station.

## **Light-Duty Plug-In Electric Vehicles Will Need Nearly 1.2 Million Shared Chargers by 2030**

California's cumulative ZEV sales reached 862,874 through the first quarter of 2021, including more than 60 percent battery-electric vehicles (BEVs), more than 38 percent plug-in hybrid vehicles (PHEVs), and more than 1 percent hydrogen fuel cell electric vehicles (FCEVs). Industry forecasts from Bloomberg New Energy Finance find that BEVs may achieve purchase cost parity with internal combustion engine counterparts as early as 2022 in select vehicle segments. With vehicle costs decreasing and consumer acceptance growing, access to convenient charging infrastructure is critical in generating the exponential growth needed to achieve 100 percent ZEV passenger vehicle new sales by 2035.

As of January 4, 2021, there are more than 70,000 public and shared private chargers available across the state. This report finds that an additional 123,000 chargers are planned (through state grants, approved utility investments, and settlement agreements), bringing the total to 193,000 chargers. To meet the 2025 goal of 250,000 public and shared chargers, the state will need about 57,000 more than are already installed or planned.

Modeling results in this report project that the state will need nearly 1.2 million public and shared private chargers in 2030 to support the number of light-duty vehicles needed to achieve the goals of the Executive Order N-79-20. Figure 1 illustrates the projected breakdown of charger type and count. Green bars indicate the charger need for 5 million ZEVs as called for in AB 2127, blue bars represent the additional charger need for 8 million ZEVs, and text labels at the rightmost end of each bar indicate the total charger need for 8 million ZEVs.

**Figure 1: Projected 2030 Charger Counts to Support 5 Million and 8 Million Light-Duty Zero-Emission Vehicles**

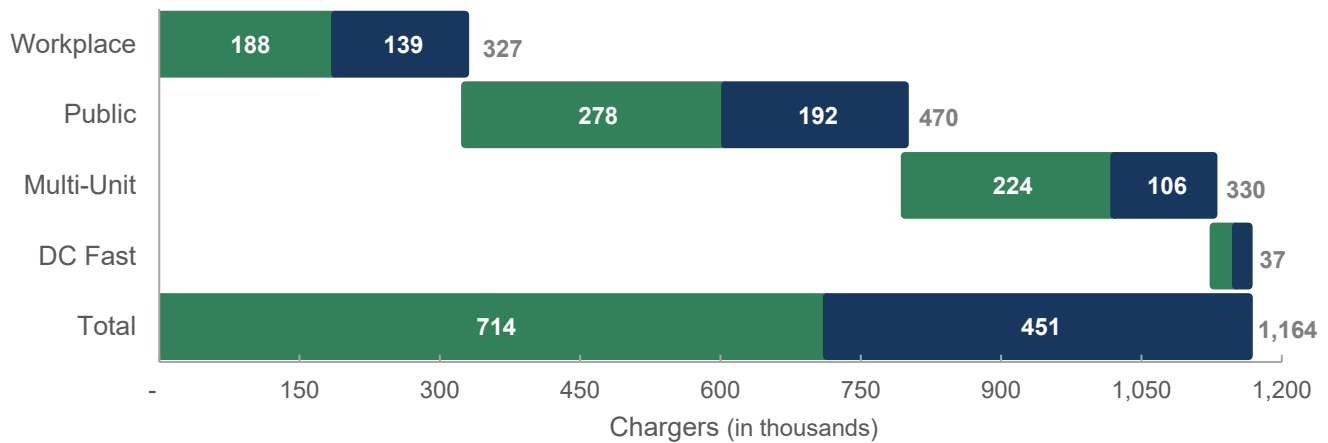

**Models project that California will need more than 700,000 shared private and public chargers in 2030 to support 5 million ZEVs as called for in AB 2127 and nearly 1.2 million chargers to support 8 million ZEVs to achieve the goals of the Executive Order N-79-20. Counts for chargers at workplaces, public destinations, and multiunit dwellings generally indicate the number of Level 2 chargers needed. In some cases, Level 1 chargers may be sufficient at select multiunit dwellings. These values do not include chargers at single-family homes.**

Source: CEC and National Renewable Energy Laboratory

## **Continued Public Funding for Charger Deployment Is Essential to Meeting State ZEV Goals**

Continued growth in the PEV market will depend on driver confidence in charging infrastructure. Widely available charging will reduce range anxiety and give drivers confidence that PEVs are as convenient to fuel as conventional vehicles. The state must continue to invest in charging infrastructure to achieve its ZEV goals. As demonstrated by the sheer number of chargers needed by 2030, the immediate need is great. The CEC’s California Electric Vehicle Infrastructure Project (CALeVIP), which provides incentives for the purchase and installation of public chargers throughout California, is oversubscribed by hundreds of millions of dollars. During the project, applicants have requested more than \$300 million in rebates, but only about one-third of those could be funded with available CEC and partner funds. While the public investment share will fall as PEV numbers increase and the private market becomes financially viable, significant public investment is needed now.

Electricity sales alone may be insufficient to maintain sustainable business operations or cover capital costs for planning and constructing charging stations. Many companies have introduced or are exploring models that include complementary revenue streams, for example, through coordinating the charging of many vehicles to support grid stability, integration with local retail and marketing, or subscription-based business models. Public investments in charging infrastructure, including through CALeVIP, will remain critical to encouraging continued market experimentation, growth, and maturation. Public investments have already attracted large

amounts of private follow-up capital. Policy makers can encourage greater private investment and business model innovation by exploring financing mechanisms that offer incentives for high charger use, diverse revenue streams, reduced charger costs, and minimization of grid upgrades.

## **The State Must Seek to Align PEV Charging With Renewable Energy Generation**

Charging millions of PEVs will introduce significant new load onto the electric grid. CEC models project that electricity consumption in 2030 from light-duty vehicle charging will reach around 5,500 megawatts (MW) around midnight and 4,600 MW around 10 a.m. on a typical weekday, increasing electricity demand by up to 25 and 20 percent at those times, respectively (Figure 2). While current results indicate that nonresidential charging demand will generally align with daytime solar generation, more than 60 percent of total charging energy will still be demanded when sunshine is not abundantly available. Further, a projected surge of charging demand around midnight when off-peak electricity rates take effect may strain local distribution infrastructure. To fully realize the economic, air quality, and climate benefits of electrification, California must pursue greater vehicle-grid integration, or coordination of charging with grid needs, to ensure that charging is better aligned with clean, renewable electricity without sacrificing driver convenience.

**Figure 2: Projected Statewide Power for Light-Duty Charging for 8 Million ZEVs on a Typical 2030 Weekday**

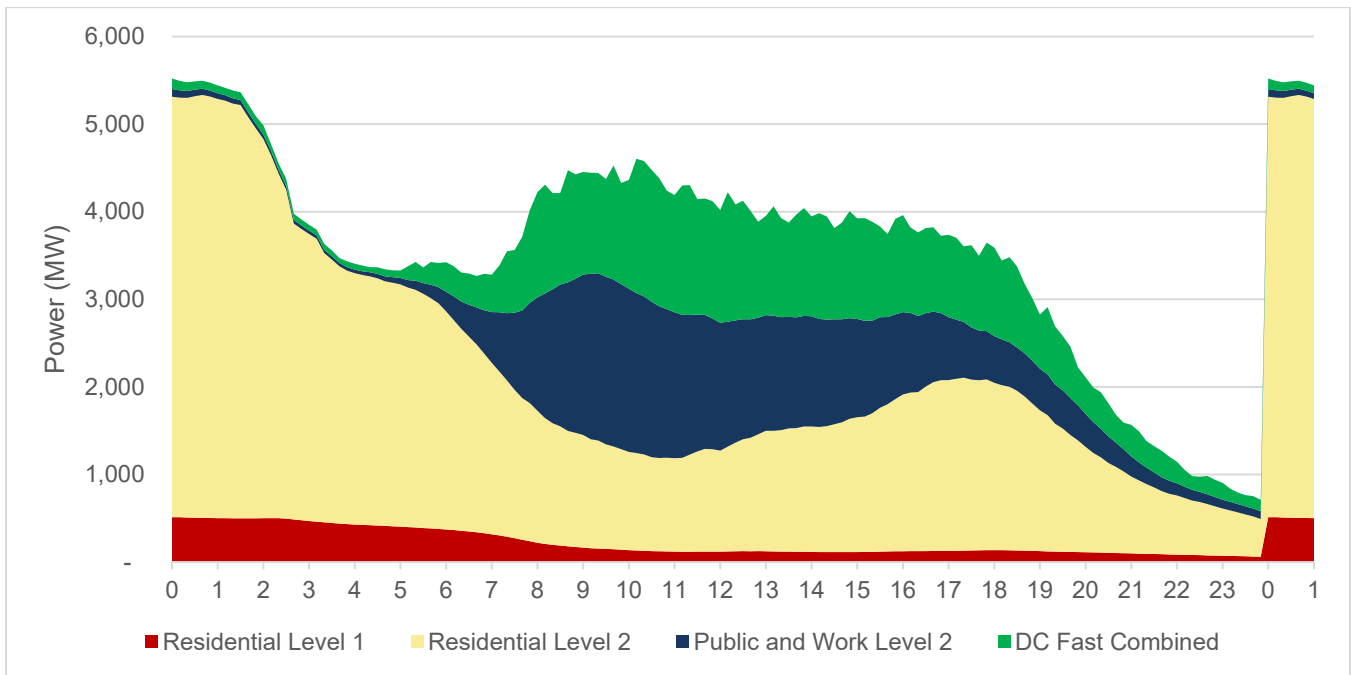

**Charging management strategies beyond time-of-use rates, including those that reflect wholesale prices and carbon intensity, will be needed to align electric vehicle loads with daytime solar generation. Demand for DC fast charging, as well as public and work Level 2 charging occurs mostly during the day. Residential charging technologies should be coordinated with distribution systems to lessen the impact of charging timed to begin at midnight, illustrated with a 25<sup>th</sup> hour on the right.**

Source: CEC, National Renewable Energy Laboratory, and UC Davis

## **Electrification of Medium- and Heavy-Duty Vehicles Is Accelerating**

Medium- and heavy-duty vehicles and equipment are critical to California’s businesses, freight operations, and transit systems, but they are also responsible for 68 percent of the nitrogen oxide emissions and 91 percent of the diesel soot statewide. Electrifying the state’s medium- and heavy-duty sectors will be crucial to meeting the state’s climate goals and improving air quality, especially in disadvantaged communities.

In the next five years, medium- and heavy-duty vehicles such as delivery vans, Class 8 trucks, and cargo handling equipment will rapidly electrify because of market developments, regional air quality implementation plans, and state ZEV goals. While private light-duty vehicles typically see extended periods of downtime that allow flexible charging patterns, medium- and heavy-duty vehicles tend to adhere to rigid operating schedules, making infrastructure planning for these vehicles unique. While set operating schedules may ease infrastructure planning and present opportunities for vehicle-grid integration, less downtime and the resultant need for higher-power charging also present challenges.

CARB's *Draft 2020 Mobile Source Strategy* projects that the state will need 180,000 medium- and heavy-duty ZEVs in 2030 to achieve state climate and air quality goals and comply with Executive Order N-79-20. Preliminary modeling, which considered 50-kilowatt (kW) and 350-kW charging power levels, suggests that to charge these vehicles, 157,000 DC fast chargers will be needed, of which 141,000 are 50 kW and 16,000 are 350 kW.

Although there is significant variation in energy demand timing among vehicle types, this charging network corresponds with a load in excess of 2,000 MW around 5 p.m. on a typical weekday, highlighting the importance of concerted effort to manage load. Among off-road applications, significant infrastructure planning and investment are needed to support near-term electrification of transport refrigeration units, cargo-handling equipment, and airport ground-support equipment.

## **Charging Solutions Must Be Tailored to Local and Community Needs to Ensure ZEV Access for All Californians**

While this report provides a high-level view of the infrastructure required to support California's ZEV future, charger deployment projects must be thoughtfully tailored to local needs. Effective charging solutions depend greatly on community needs, land use, space constraints, grid capacity, vehicle duty cycles, and other factors. Simply put, there is no one-size-fits-all solution for how charging should fit into the built environment. Planning charging infrastructure for medium- and heavy-duty vehicles introduces additional complexities given the broad range of vehicle uses and often-inflexible operating patterns.

Historically, transportation planning and projects have insufficiently considered the needs of local communities, particularly low-income and disadvantaged communities suffering disproportionate health impacts. To ensure the benefits of electrification are equitably distributed, policy makers must involve communities in identifying and planning high-quality charging solutions that address community transportation needs and yield direct local benefits, including through strategies such as participatory budgeting, inclusive community outreach, and communitycentric planning.

Policy makers and electric vehicle stakeholders recognize that electrifying California's diverse mobility landscape requires solutions fitted to local constraints and needs, and that effective infrastructure deployment requires various charging solutions and metrics. Charger funding programs should include those that address or avoid the need for grid upgrades, improve resiliency, enable high charger usage, or are uniquely suited to particular built environments.

## **Prioritize Charging Standards and Innovation**

Charger connectors, which determine whether a vehicle can charge when it arrives at a charging station, remain fragmented across all PEV sectors. DC fast charging connectors for passenger cars are split among three designs, and lack of connector standardization is even more prevalent among medium- and heavy-duty vehicles. Encouraging greater standardization of charging connectors promotes greater driver convenience and helps ensure that chargers installed today are not stranded in the future.



Beyond the physical connector, for networked charging, deploying chargers with the capability to speak a common “language” with vehicles will ensure that chargers and vehicles can exchange necessary information to realize critical customer and electricity system benefits at scale. These benefits include automatically aligning charging with surplus renewable energy generation to save customers money and integrate more renewable energy into the grid, enabling plug-in vehicles to power homes and businesses during outages to improve resilience, and streamlining the charging experience for the driver.

## **The Road Ahead**

Widespread, accessible, and convenient charging infrastructure is critical to transportation electrification and California’s ability to address climate change and air pollution. The state will need more than 1.3 million public and shared chargers by 2030 (for passenger vehicles and medium- and heavy-duty vehicles), necessitating significant public support and investment. Industry, working closely with the CEC, state agencies, and local governments, must quickly close the gap to provide drivers and fleets confidence that their mobility needs can be served by electric vehicles.

This report identifies several actions to support the widespread deployment of charging infrastructure:

- Continue public support for charger deployment, using public funds to leverage private funds, and eventually transition to a self-sustaining private market.
- Continue modeling efforts to project the quantities, locations, and load curves of chargers needed to meet statewide travel demand.
- Support innovative charging solutions and financing mechanisms.
- Support local efforts to prepare for transportation electrification.
- Ensure equitable distribution of charger deployment throughout the state.
- Align charging with renewable generation and grid needs.
- Prioritize standardized charger connectors and, for networked charging, prioritize hardware capable of standardized communications protocols.



# CHAPTER 1:

## Background

---

Despite progress reducing statewide greenhouse gas (GHG) emissions, California's transportation-related emissions now contribute more than half of the state's GHG emissions and have been trending up since 2012. Transportation is a major source of the state's air pollution, contributing nearly 80 percent of smog-forming nitrogen oxides (NOx) and 95 percent of toxic diesel particulate matter.<sup>1</sup> To achieve the state's long-term air quality and GHG emissions reduction goals, California must rapidly transition toward the widespread use of zero-emission vehicles (ZEVs) powered by clean energy. In support of this transition, in September 2020, Governor Gavin Newsom issued Executive Order N-79-20,<sup>2</sup> which calls for:

- All in-state sales of new passenger cars and trucks to be zero-emission by 2035.
- All drayage trucks operating in the state to be zero-emission by 2035.
- All medium- and heavy-duty vehicles operating in the state to be zero-emission by 2045, where feasible.
- All off-road vehicles and equipment to be zero-emission by 2035, where feasible.

Preceding N-79-20, former Governor Edmund G. Brown Jr. issued Executive Order B-48-18,<sup>3</sup> which directed California to install 250,000 electric vehicle chargers, including 10,000 direct current (DC) fast chargers, to support 1.5 million ZEVs statewide by 2025. B-48-18 further established a target of 5 million ZEVs statewide by 2030. The 5 million ZEVs goal represents level of vehicle adoption consistent with ensuring that statewide greenhouse gas emissions are reduced to 40% below the 1990 level by 2030<sup>4</sup>. In 2018, Assembly Bill (AB) 2127<sup>5</sup> codified this

---

1 California Energy Commission staff. 2019. [2019 Integrated Energy Policy Report](#). California Energy Commission. Publication Number: CEC-100-2019-001-CMF. Available at <https://www.energy.ca.gov/data-reports/reports/integrated-energy-policy-report/2019-integrated-energy-policy-report>.

2 Governor Gavin Newsom. [Executive Order N-79-20](#). Issued September 23, 2020. <https://www.gov.ca.gov/wp-content/uploads/2020/09/9.23.20-EO-N-79-20-text.pdf>.

3 Governor Edmund G. Brown, Jr. [Executive Order B-48-18](#). Issued January 26, 2018. <https://www.ca.gov/archive/gov39/2018/01/26/governor-brown-takes-action-to-increase-zero-emission-vehicles-fund-new-climate-investments/index.html>.

4 California Air Resources Board staff. 2021. *Revised Draft 2020 Mobile Source Strategy*. California Air Resources Board.

5 [Assembly Bill 2127 \(Ting\), Statutes of 2018, Chapter 365](#). [https://leginfo.ca.gov/faces/billTextClient.xhtml?bill\\_id=201720180AB2127](https://leginfo.ca.gov/faces/billTextClient.xhtml?bill_id=201720180AB2127).

2030 ZEV target and tasked the California Energy Commission (CEC) with preparing biennial assessments of the charging infrastructure needed to meet these goals. While vehicles fueled by electricity or hydrogen are considered ZEVs, these assessments focus exclusively on plug-in electric vehicles (PEVs), which include battery-electric vehicles (BEVs) and plug-in hybrid electric vehicles (PHEVs).

As directed by AB 2127, this document examines existing and future charging infrastructure needs throughout California, including the chargers, make-ready<sup>6</sup> electrical equipment, supporting hardware and software, and other programs for on-road and off-road vehicle categories. In assembling this analysis, CEC staff regularly sought input from stakeholders including state agencies, utilities, transit agencies, charging infrastructure companies, environmental groups, and automakers.<sup>7</sup>

This report discusses several analyses of California's existing chargers, trends affecting charger deployment, and quantitative modeling of projected charger demand. It outlines several actions to ensure that charging is accessible, convenient, and available to meet the needs of all Californians. Figure 3 illustrates the breadth of this assessment, with vehicle categories spanning the horizontal axis in different colors, and areas of analysis spanning the vertical axis. Specific CEC analyses are shown in the colored boxes with on-road light-duty vehicles in blue, medium- and heavy-duty vehicles in red, and off-road, port, and airport electrification applications in green.

---

6 "Make-ready" refers to the electrical infrastructure required to operate a charger, such as transformers or wiring.

7 Appendix A includes a list of relevant public workshops.

**Figure 3: CEC’s Analyses Cover Multiple Facets of Charging Infrastructure**

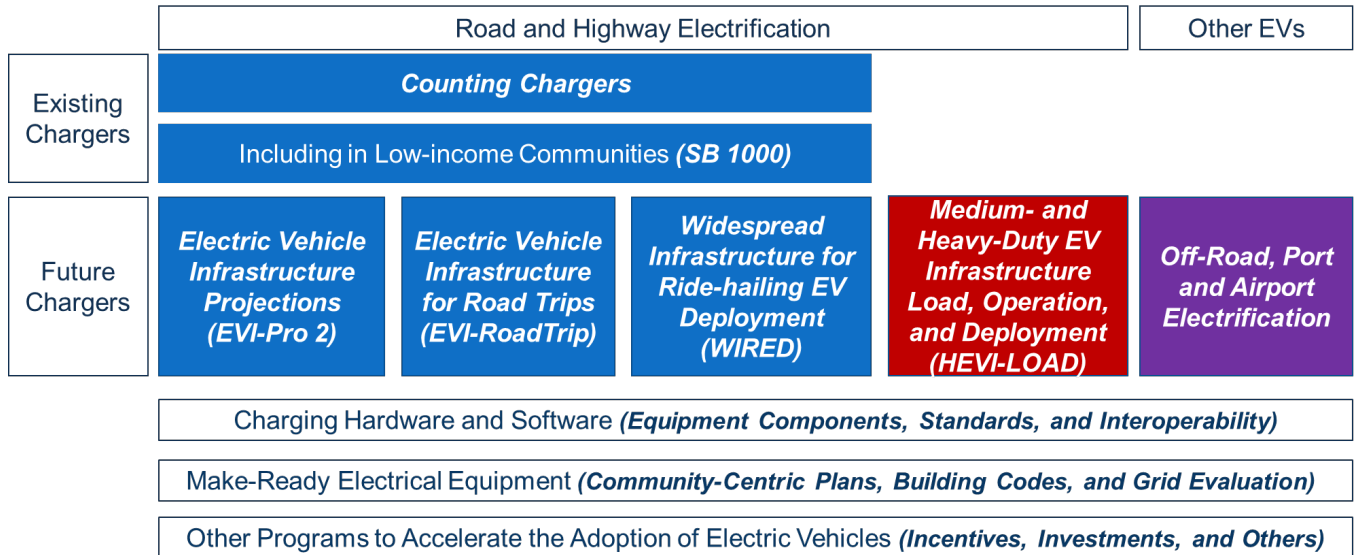

**AB 2127 directs the CEC to examine existing and future charging infrastructure needs, which include the chargers, hardware and software, make-ready electrical equipment, and other programs to accelerate the adoption of electric vehicles for light-, medium-, and heavy-duty vehicles operating on roads and highways, as well as off-road, port, and airport electrification applications. CEC has several concurrent analysis and modeling efforts covering these identified areas.**

Source: CEC

# CHAPTER 2:

## Existing Charging Infrastructure

---

### Charger Types and Definitions

Chargers, sometimes referred to as electric vehicle supply equipment (EVSE), are manufactured appliances that safely deliver electricity to charge a PEV. As summarized in Table 1, three categories are used to describe light-duty PEV chargers: Level 1, Level 2, and DC fast charging. Level 1 and Level 2 chargers deliver alternating current (AC) electricity to the vehicle and use the Society of Automotive Engineering (SAE) J1772 standard connector. While all PEVs can use the SAE J1772 connector,<sup>8</sup> not all have a separate charging port compatible with DC fast charging. DC fast chargers deliver DC electricity to the vehicle. Three types of connectors are used for DC fast charging in the North American market: CHAdeMO, Combined Charging System (CCS), and Tesla. The charging inlet of a PEV determines the type of DC fast charging connector the vehicle can use.

**Table 1: Types of Chargers**

Parameter	Level 1	Level 2	DC Fast Charger
<b>Voltage</b>	120 Volts AC	208-240 Volts AC	200-1000 Volts DC
<b>Maximum power output in kilowatts (kW)</b>	1.9 kW	19.2 kW	450 kW
<b>Typical added range per hour of charging*</b>	~4 miles at 1.44 kW	~23 miles at 7.2 kW	~90 miles in 30 mins at 55 kW ~204 miles in 30 mins at 150 kW

\* Range estimates based on a 110 MPG-equivalent vehicle

Source: CEC, National Renewable Energy Laboratory, CharIN

When discussing chargers, the CEC uses precise nomenclature to avoid confusion between common terms such as “charger” and “charging station.” These definitions are summarized in Table 2.

---

<sup>8</sup> Tesla vehicles require an adapter supplied at purchase to use the J1772 connector.

**Table 2: Definitions of Common Charging Terms**

<b>Charger</b>	A manufactured appliance that delivers electricity to charge a PEV; also called “EVSE.”
<b>Connector</b>	A physical socket with a specified pin configuration. A charger may have one or multiple connectors.
<b>Charging Station</b>	A charging station is a physical address where one or more chargers are available for use. This is the same usage as for “gas station.” A charging station can be public, shared private, or private.
<b>Public</b>	A public charging station has parking space(s) designated by a property owner or lessee to be available to and accessible by the public for any period.
<b>Shared Private</b>	A shared private charging station has parking space(s) designated by a property owner or lessee to be available to and accessible by employees, tenants, visitors, and/or residents. Parking spaces are not dedicated to individual drivers or vehicles.
<b>Private</b>	A private charging station has parking space(s) that are privately owned and operated, often dedicated for a specific driver or vehicle (for example, a charger installed in the garage of a single-family home).

Source: CEC

## Counting Chargers

The CEC gathers statewide counts of light-duty shared private chargers through quarterly voluntary surveys with California’s electric vehicle service providers (EVSPs), utilities, and public agencies. CEC staff aggregates charger counts from the surveys with public charger counts from the Alternative Fuels Data Center database to determine progress toward achieving the state’s goal of 250,000 public and shared private chargers by 2025. These counts do not categorize chargers by market segment (workplace, public, fleet, and so forth) or include dedicated private chargers such as those installed for personal use at single-family homes. As shown in Figure 4 and Table 3, California has more than 70,000 public and shared private chargers as of January 4, 2021.

In addition to tallying deployed chargers, Figure 4 and Table 3 also indicate the number of projected charger installations that will occur through 2025 based on funding allocated through state programs, ratepayer-funded programs, and settlement agreements. By combining the existing and projected charger counts, the CEC estimates that the state will need an additional 57,000 Level 2 chargers and 430 DC fast chargers to achieve the 2025 goal of 250,000 chargers, of which 10,000 are DC fast chargers. Deployment of Level 2 chargers lags more significantly, with the 57,000-charger gap translating to around 24 percent of the 2025 goal, whereas the DC fast charger gap is only around 4 percent of the corresponding 2025 goal.

Finally, Figure 4 and Table 3 also show the gap between the projected number of light-duty chargers in 2025 and the projected charger need for 8 million ZEVs in 2030. CEC models (discussed in Chapter 4) project that the state will need between 1,090,000 and 1,238,000 public and shared private chargers at public destinations, workplaces, and multiunit dwellings (MUDs) in 2030, with an average projection of 1,164,000 chargers. Based on these estimates, the state will need an additional 972,000 chargers beyond the current 2025 projection to meet anticipated charging needs for 2030.

**Figure 4: Installed and Projected Charger Counts Compared With Charger Needs for 1.5 Million Light-Duty ZEVs in 2025 and 8 Million Light-Duty ZEVs in 2030**

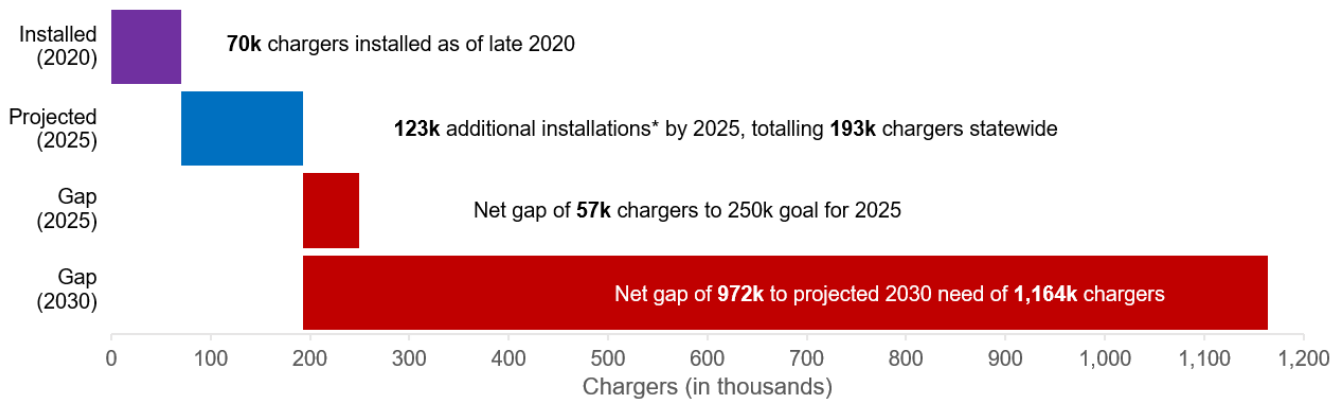

\* Based on allocated funding through 2025 as of February 2021

Source: CEC and National Renewable Energy Laboratory

**Table 3: Statewide Counts of Level 2 and DC Fast Chargers, and Projected Charger Gap for 1.5 Million ZEVs by 2025 and 8 Million by 2030**

Metric	Level 2 Chargers	DC Fast Chargers	Level 2 + DC
Public (2020)	24,880	5,404	30,284
Shared Private (2020)	39,201	559	39,760
Total Installed (2020)	64,081	5,963	70,044
Projected Additional Installations (2025)*	118,950	3,607	122,557
Projected Total (2025)*	183,031	9,570	192,601
Gap to 2025 Need	56,969	430	57,399
Gap to 2030 Need	943,824**	27,891	971,715

\* Based on allocated funding through 2025 as of February 2021

\*\* May include Level 1 charging at MUDs

Source: CEC and National Renewable Energy Laboratory

### Analysis Shows Gaps in Geographic Distribution of Chargers

Senate Bill 1000 (Leyva, Chapter 587, Statutes of 2016) directs the CEC to assess whether light-duty charging infrastructure is disproportionately distributed with respect to population density, geographical area, or income, including low-, middle-, and high-income levels. Such findings are discussed in greater detail in *California Electric Vehicle Infrastructure Deployment*



*Assessment: Senate Bill 1000 Report.*<sup>9</sup> Results will inform future Clean Transportation Program investments.

Preliminary county-level analysis indicates that chargers are generally deployed where there are high concentrations of people and PEVs, as shown in Figure 5. Regionally, air district-level analysis indicates that nearly three-quarters of public Level 2 chargers, and more than half of public DC fast chargers statewide are contained in the South Coast and Bay Area Air Quality Management Districts alone.

**Figure 5: Population Density, PEV Density, and Public Chargers by County**

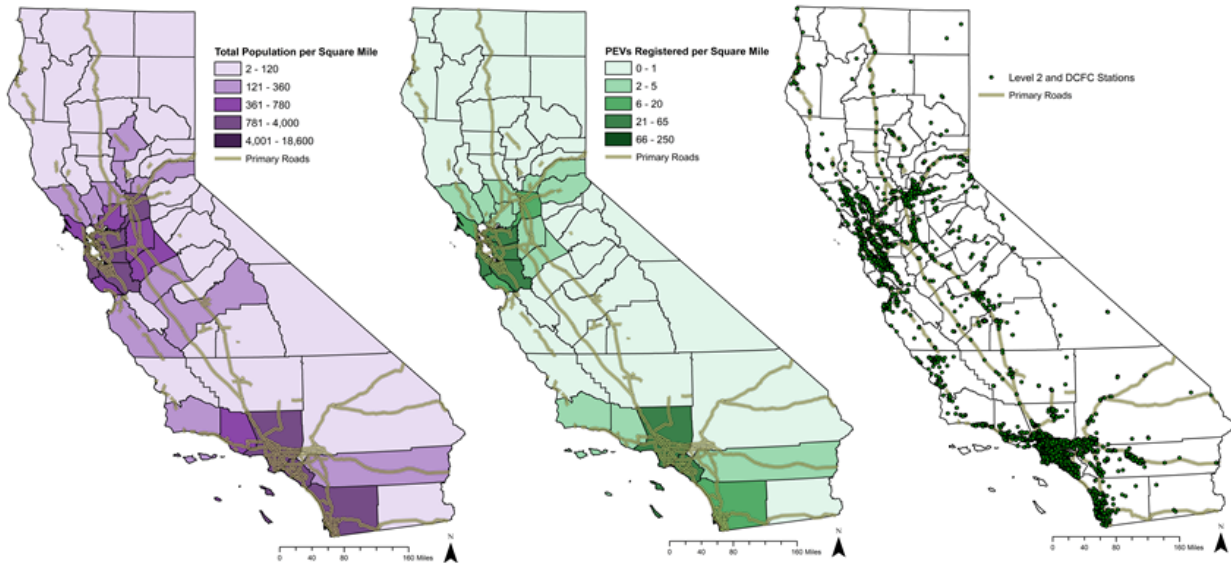

**At the county level, existing chargers are generally found in areas with high concentrations of people and PEVs, particularly those in the Bay Area and South Coast.**

Source: CEC

At a finer scale, however, factors other than population and PEV density appear to play a larger role in existing charger distribution. Staff evaluated charger deployment by census tract population density for a neighborhood-level analysis. At this census tract level, more chargers appear in census tracts with low population density than in tracts with high population density, as shown in Figure 6. Land use and area contribute to this observation. Staff found that census tracts with high population density generally cover less area and are predominantly residential. Chargers are mostly absent or low in these dense urban residential census tracts. The census tracts neighboring these, with large commercial areas and more roads, generally

---

<sup>9</sup> Hoang, Tiffany. 2020. [California Electric Vehicle Infrastructure Deployment Assessment: Senate Bill 1000 Report](#). California Energy Commission. Publication Number: CEC-600-2020-153.

contain more public chargers. Indeed, staff found that census tracts with low population densities and high numbers of chargers are usually larger tracts that contain land uses like large commercial areas and airports.

**Figure 6: Public Charger Counts by Census Tract Population Density**

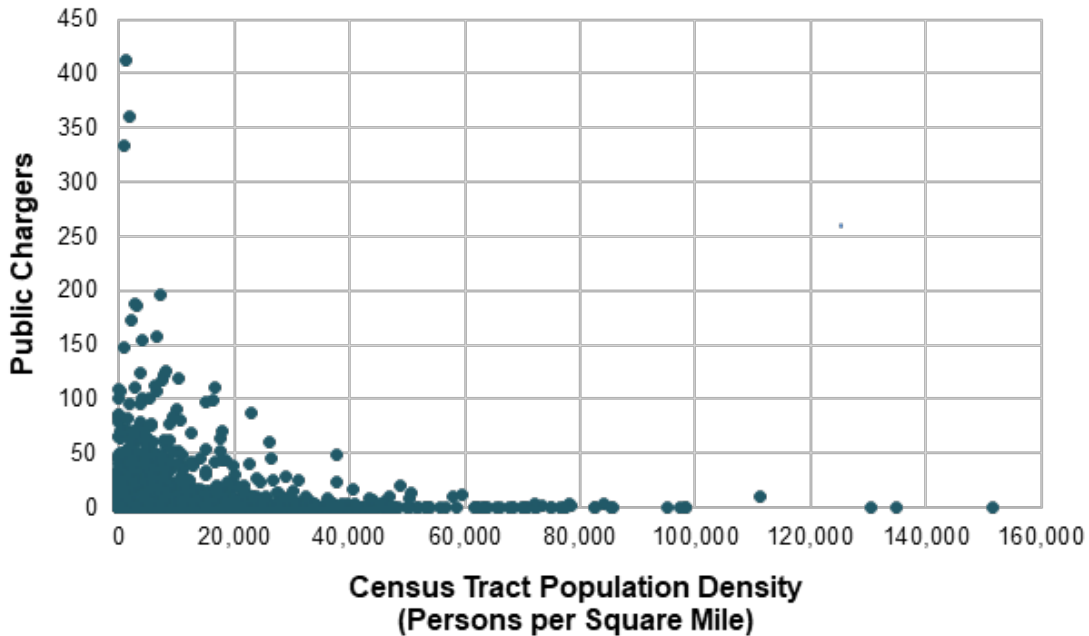

**More chargers appear in census tracts with low population density than in high-population-density tracts. Staff found that chargers tend to be absent or rare in dense urban residential tracts.**

Source: CEC

Staff also found differences in per capita numbers for public Level 2 and DC fast chargers across low-, middle-, and high-income communities, as shown by Figure 7. Generally, low-income census tract communities throughout the state have slightly fewer public chargers per capita than middle- and high-income communities, although about half of all public Level 2 and DCFCs in the state are installed in low-income communities. DC fast chargers do not show a correlation to income level.

**Figure 7: Public Level 2 and DC Fast Chargers Per Capita by Income**

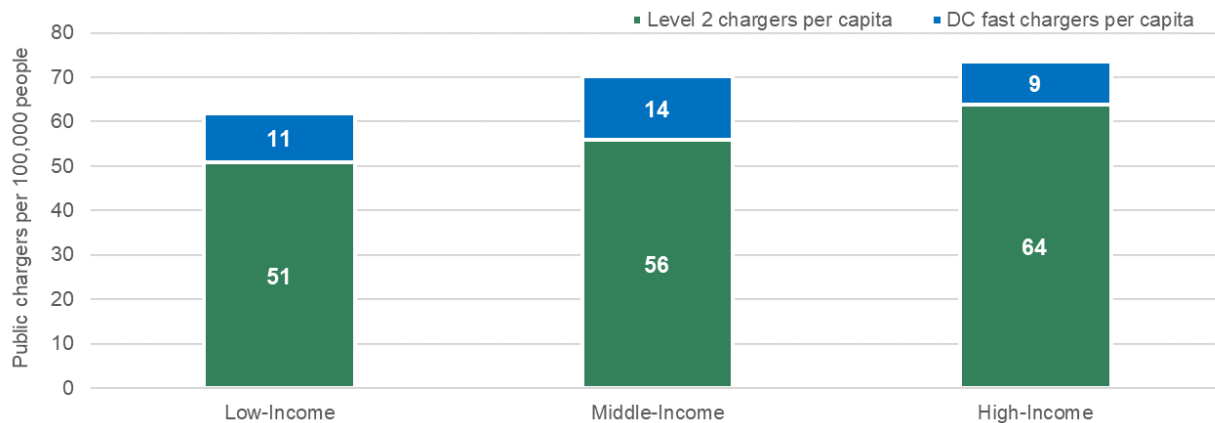

Source: CEC analysis of U.S. Department of Energy Alternative Fuels Data Center (July 23, 2020) and U.S. Census Bureau American Community Survey 2014 – 2018 5-Year Estimates

Taken as a whole, this preliminary analysis provides an overview of existing charger distribution and indicates that more public charging investments may need to be targeted toward low-income communities and high-population-density neighborhoods to enable more proportionate charging infrastructure distribution throughout the state. However, data gaps and limitations exist. To the best of staff’s knowledge, current data, including spatial data, on Level 1, shared private, and private chargers are limited even though these chargers may account for a significant portion of statewide charging infrastructure. For example, shared private chargers accounted for nearly 40,000 of California’s chargers as of September 30, 2020. Furthermore, a *charger distribution* analysis alone does not present a full picture. For future SB 1000 assessments, staff plan to use new data as they become available to evaluate components of *charger access*, which include factors such as housing and occupancy types, the distribution of BEVs and PHEVs, and charger power capacity. Moreover, staff plans to evaluate public charger distribution and access across urban and rural communities and conduct additional land-use analysis to investigate factors beyond location that affect charging access.

# CHAPTER 3:

## Current Transportation Trends

---

### Transportation Greenhouse Gas Emissions Continue to Rise

Transportation is the largest source of GHG emissions in California. It directly contributes around 40 percent of the state’s GHG emissions according to 2018 data from the California Air Resources Board (CARB) and more than 50 percent when accounting for oil and gas production and refining (Figure 8).<sup>10</sup> Despite a declining trend in statewide emissions, transportation emissions have seen an increasing trend since 2010 because of factors including rising vehicle ownership,<sup>11</sup> increased vehicle miles traveled, the growth of ride-hailing services, and consumer preferences for larger vehicles. These factors highlight the necessity of ZEV adoption, including vehicle electrification, to help achieve reductions in emissions.

---

10 California Energy Commission staff. 2019. [2019 Integrated Energy Policy Report](https://www.energy.ca.gov/data-reports/reports/integrated-energy-policy-report/2019-integrated-energy-policy-report). California Energy Commission. Publication Number: CEC-100-2019-001-CMF. Available at <https://www.energy.ca.gov/data-reports/reports/integrated-energy-policy-report/2019-integrated-energy-policy-report>.

11 California Department of Motor Vehicles 2019. [“Estimated Vehicles Registered by County.”](https://www.dmv.ca.gov/portal/uploads/2020/06/2019-Estimated-Vehicles-Registered-by-County-1.pdf) Available at <https://www.dmv.ca.gov/portal/uploads/2020/06/2019-Estimated-Vehicles-Registered-by-County-1.pdf>.

**Figure 8: Transportation-Related Emissions Accounted for More Than Half of the State’s GHG Emissions in 2018**

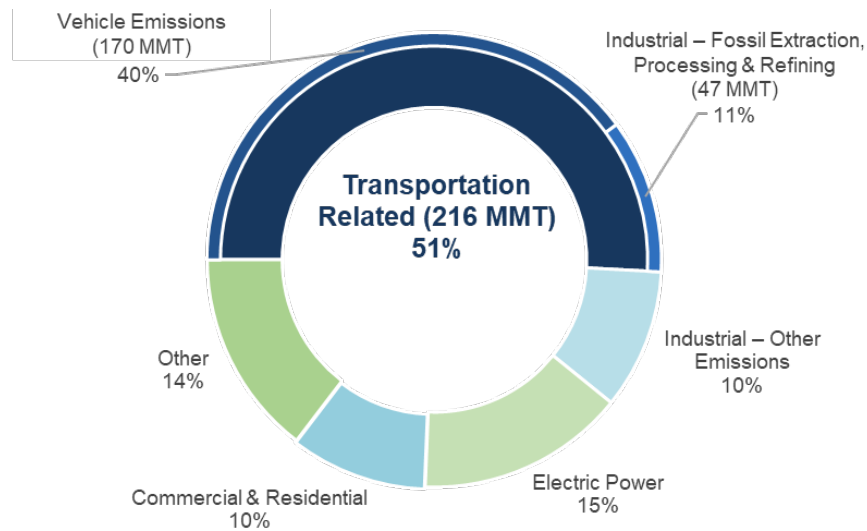

Data Source: CARB 2018 GHG Emission Data Inventory

### Californians Are Driving More

Transitioning to ZEVs will be critical to reducing GHG emissions from transportation, especially as Californians have increasingly relied on automobile transport in recent years. Figure 9 shows that vehicle miles traveled in California has increased by 50 billion miles, or about 17 percent, from 2012 to 2016.

**Figure 9: California Light-Duty Vehicle Miles Traveled (in Billions)**

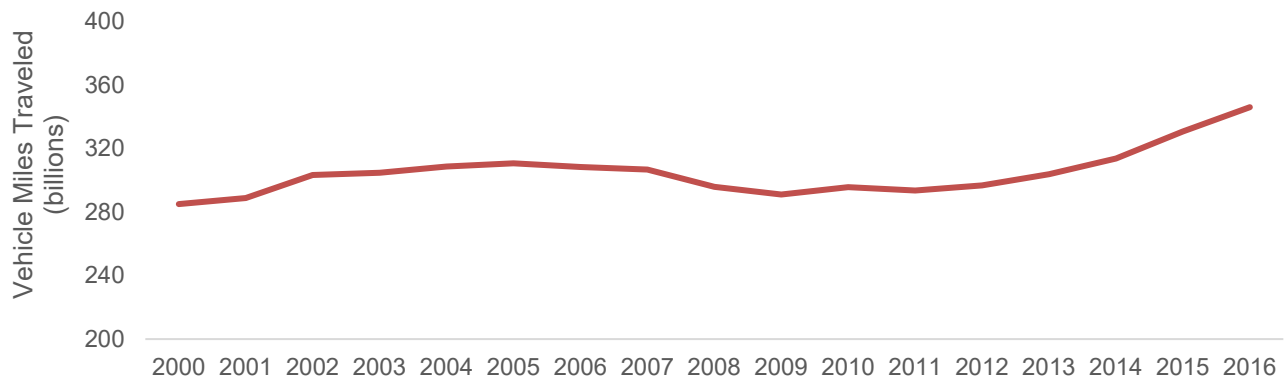

**Light-duty vehicle miles traveled in California was roughly constant from 2000 to 2012, then increased by 50 billion or roughly 17 percent from 2012 to 2016.**

Source: CARB Emission Factor Tool 2017

### Growing Demand and Charging Needs for Ride-Hailing Services

Rising transportation emissions can be partly attributed to the growing use of ride-hailing transportation network company (TNC) services such as Uber and Lyft. Since the inception of

the modern ride-hailing model in 2009, Uber and Lyft have gained more than 50 million users and provided 5.5 billion rides worldwide.<sup>12</sup> CARB estimates that California TNC vehicles accounted for 1.2 percent of all light-duty vehicle miles traveled in 2018. Furthermore, TNC vehicle emissions per passenger mile were roughly 50 percent higher than the statewide passenger vehicle average, largely due to miles driven with no passengers in the car.<sup>13</sup> The rapid growth of TNCs and associated emissions necessitate targeted regulatory action to help California meet statewide emissions goals.

In 2018, the CPUC and the CARB began implementing the nation's first bill requiring TNCs to reduce emissions. Senate Bill 1014 (Skinner, Chapter 369, Statutes of 2018), the Clean Miles Standard, requires TNCs to reduce GHG emissions on a per-passenger-mile basis. The bill sets annual targets for electric vehicle miles traveled, starting with 2 percent in 2023 and increasing to 90 percent by 2030,<sup>14</sup> and directs TNCs to provide ZEVs for their fleets. Because of the high usage of TNC vehicles, replacing a gasoline TNC vehicle with a ZEV eliminates three times more emissions than replacing a personally driven (non-TNC) vehicle. Further, recent data indicate that ZEVs can replace gasoline TNC vehicles while maintaining identical levels of service.<sup>15</sup>

ZEV adoption presents opportunities for TNCs to reduce emissions but raises questions about the effect on public charging infrastructure. In 2018, ZEVs serving in TNC fleets represented fewer than 0.5 percent of all ZEVs in California, but TNC ZEVs accounted for 35 percent of non-Tesla public charging on an energy basis. Furthermore, TNC ZEV drivers on average visit a DC fast charger 2.5 times a day and charge on average 20 kilowatt-hours

---

12 Jenn, Alan. 2020. "[Emissions Benefits of Electric Vehicles in Uber and Lyft Ride-Hailing Services.](https://www.nature.com/articles/s41560-020-0632-7)" *Nature Energy*. <https://www.nature.com/articles/s41560-020-0632-7>.

13 CARB staff. 2018. [Senate Bill 1014 Emissions Inventory](https://ww2.arb.ca.gov/sites/default/files/2019-12/SB%201014%20-%20Base%20year%20Emissions%20Inventory_December_2019.pdf). [https://ww2.arb.ca.gov/sites/default/files/2019-12/SB%201014%20-%20Base%20year%20Emissions%20Inventory\\_December\\_2019.pdf](https://ww2.arb.ca.gov/sites/default/files/2019-12/SB%201014%20-%20Base%20year%20Emissions%20Inventory_December_2019.pdf).

14 CARB. 2020. "[Clean Miles Standard Workshop - Proposed Regulation Targets, presentation.](https://ww2.arb.ca.gov/sites/default/files/2020-11/CMS%20Workshop%206_public%20%28002%29.pdf)" [https://ww2.arb.ca.gov/sites/default/files/2020-11/CMS%20Workshop%206\\_public%20%28002%29.pdf](https://ww2.arb.ca.gov/sites/default/files/2020-11/CMS%20Workshop%206_public%20%28002%29.pdf).

15 Jenn, Alan. 2020. "[Emissions Benefits of Electric Vehicles in Uber and Lyft Ride-Hailing Services.](https://www.nature.com/articles/s41560-020-0632-7)" *Nature Energy*. <https://www.nature.com/articles/s41560-020-0632-7>.

(kWh) per session,<sup>16</sup> whereas typical ZEV drivers generally do not use DC fast chargers regularly.<sup>17</sup>

Figure 10 illustrates the charging habits of TNC drivers compared to non-TNC drivers in Los Angeles. TNC drivers have a substantially higher propensity to charge between 12 a.m. and 10 a.m. There is also a noticeable dip in charging events for TNC drivers around 8 p.m., whereas this is the busiest charging time for non-TNC drivers. Charging behavior data from San Francisco and San Diego showed similar patterns.<sup>18</sup>

**Figure 10: Daily Charging Profile of TNC and Non-TNC Drivers in Los Angeles**

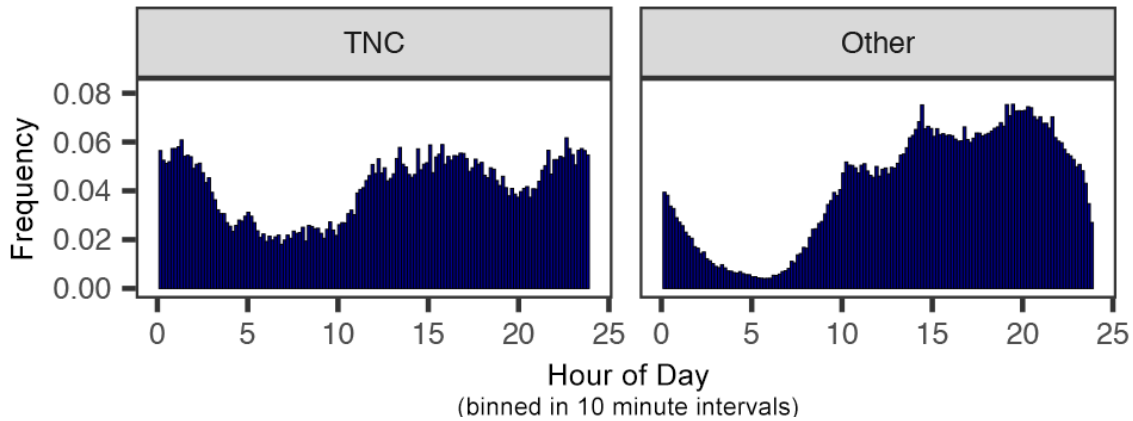

Source: Alan Jenn, UC Davis

## Light-Duty ZEV Sales Are Growing as Battery Costs Decline

Light-duty ZEVs continue to gain popularity in California, with growing sales driven in part by vehicle incentives and declining battery prices. Still, the CEC’s 2020 IEPR Update Forecast anticipates only 3.3 million light-duty ZEVs by 2030 in its mid case and 4.8 million in its aggressive case, both short of California’s goal of 5 million ZEVs by 2030.<sup>19</sup>

---

16. Ibid.

17 Eighty-three percent of California PEV drivers reside in detached houses, and these drivers charge primarily ( $\geq 84$  percent) at home. Nicholas et al. (2019). [Quantifying the Electric Vehicle Charging Infrastructure Gap Across U.S. Markets](#). The International Council on Clean Transportation. [https://theicct.org/sites/default/files/publications/US\\_charging\\_Gap\\_20190124.pdf](https://theicct.org/sites/default/files/publications/US_charging_Gap_20190124.pdf).

18 Jenn, Alan. 2020. [Presentation — Optimizing Charging Infrastructure Buildout for TNC Electrification.](#) <https://efiling.energy.ca.gov/getdocument.aspx?tn=234210>.

19 Bahreinian, Aniss and Mark Palmere. 2020. [Light-Duty Vehicle Forecast 2020 IEPR Update](#). California Energy Commission. <https://www.energy.ca.gov/media/4717>.

Figure 11 compares the CARB's *2020 Draft 2020 Mobile Source Strategy*<sup>20</sup> planning scenario with the CEC's IEPR midcase forecast. CARB's Draft 2020 Mobile Source Strategy planning scenario takes a policy achievement approach and projects the necessary vehicle population to meet state air quality and climate policy goals, including 100 percent zero-emission new passenger car sales by 2035 per Executive Order N-79-20. The CEC's IEPR mid case forecast is based on transportation demand and reflects market conditions.

Despite growing market interest, the CEC's projections indicate that California must support ZEV adoption more aggressively to achieve 5 million ZEVs by 2030 (per Executive Order B-48-18 and AB 2127), let alone 8 million (per Executive Order N-79-20). Charging infrastructure needs are affected by broader trends in the ZEV market, like those described above, and can affect ZEV adoption rates. However, insufficient charging infrastructure continues to be a significant barrier to accelerated adoption. Public investments will help increase ZEV adoption and support equitable access.

---

20 CARB staff. 2020. [Draft 2020 Mobile Source Strategy](https://ww2.arb.ca.gov/resources/documents/2020-mobile-source-strategy). <https://ww2.arb.ca.gov/resources/documents/2020-mobile-source-strategy>.



**Figure 11: ZEV Adoption Trajectories**

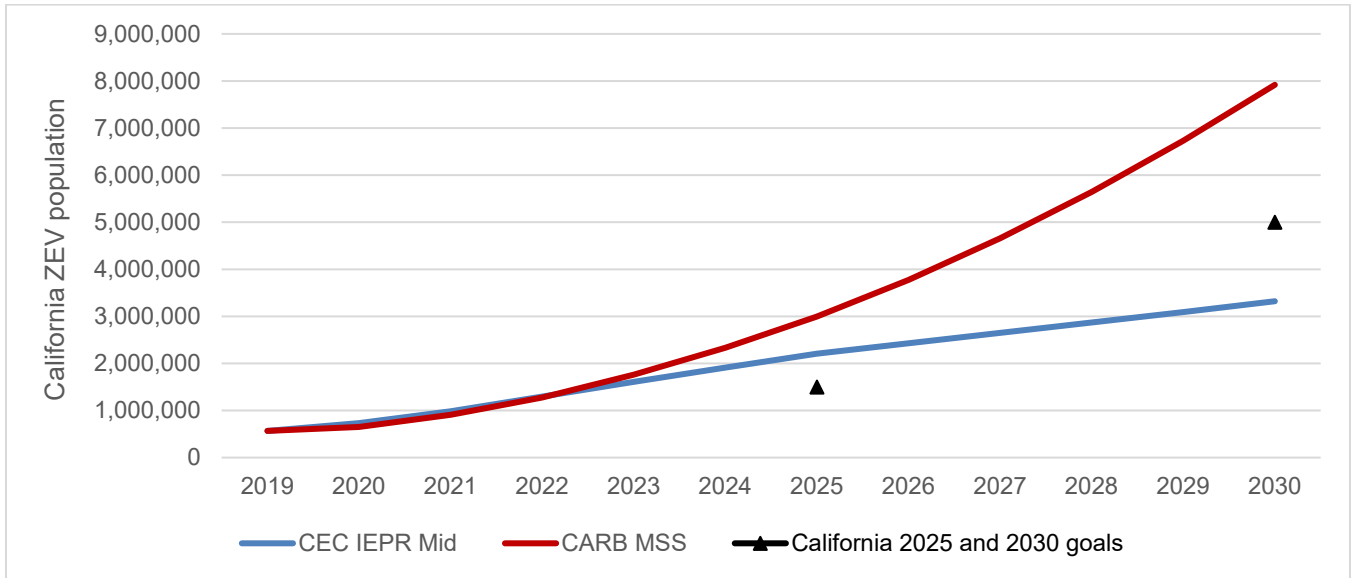

**The CEC’s 2020 Transportation Energy Demand Forecast mid case forecast offers a scenario of ZEV adoption through 2030, with 2.2 million ZEVs in 2025 and 3.3 million in 2030. CARB’s *Draft 2020 Mobile Source Strategy* scenario shows the rate of ZEV adoption needed through 2030 to meet California’s climate and air quality goals. The black triangles show California’s 2025 and 2030 ZEV adoption goals, for reference.**

Source: CEC and CARB staff

At the end of 2020, nearly 636,000 ZEVs were registered in California, including more than 369,000 battery-electric vehicles, 259,000 plug-in hybrid electric vehicles, and 7,000 fuel cell electric vehicles. While ZEVs accounted for nearly 8 percent of California’s new car sales in 2020,<sup>21</sup> adoption was uneven throughout the state. The CEC’s most recent *Energy Equity Indicators* report,<sup>22</sup> which tracks recommendations outlined in the *SB 350 Low-Income Barriers Study*,<sup>23</sup> shows that ZEV adoption varied widely by county and that participation in the state’s Clean Vehicle Rebate Project was especially low in some Central Valley and Inland Empire communities. These findings indicate the potential for more widespread ZEV adoption upon additional investment to promote and support ZEVs in these communities.

21 CEC. 2021. [California Energy Commission Zero Emission Vehicle and Infrastructure Statistics](https://www.energy.ca.gov/zevstats). Data last updated August 28, 2020. Retrieved April 26, 2021 from <https://www.energy.ca.gov/zevstats>.

22 CEC. 2018. [Energy Equity Indicators Tracking Progress](https://www.energy.ca.gov/sites/default/files/2019-12/energy_equity_indicators_ada.pdf). [https://www.energy.ca.gov/sites/default/files/2019-12/energy\\_equity\\_indicators\\_ada.pdf](https://www.energy.ca.gov/sites/default/files/2019-12/energy_equity_indicators_ada.pdf).

23 CEC. 2016. [Low-Income Barriers Study, Part A](https://efiling.energy.ca.gov/getdocument.aspx?tn=214830&usg=AOvVaw3DzKXFOzCAiOjGLEIAxdYn). <https://efiling.energy.ca.gov/getdocument.aspx?tn=214830&usg=AOvVaw3DzKXFOzCAiOjGLEIAxdYn>.

Advancements in vehicle batteries are also driving vehicle price reductions and ZEV adoption. Improved battery cell designs, higher-energy density cathodes, and economies of scale will contribute to steadily declining battery prices through the 2020s. ZEVs will become more affordable as the cost of batteries continues to decline. Bloomberg New Energy Finance forecasts that BEVs will achieve purchase cost parity with internal combustion engine vehicles in the United States. SUV segment as early as 2022–2023 (Figure 12).

**Figure 12: U.S. SUV Segment Price and Share of Battery Cost**

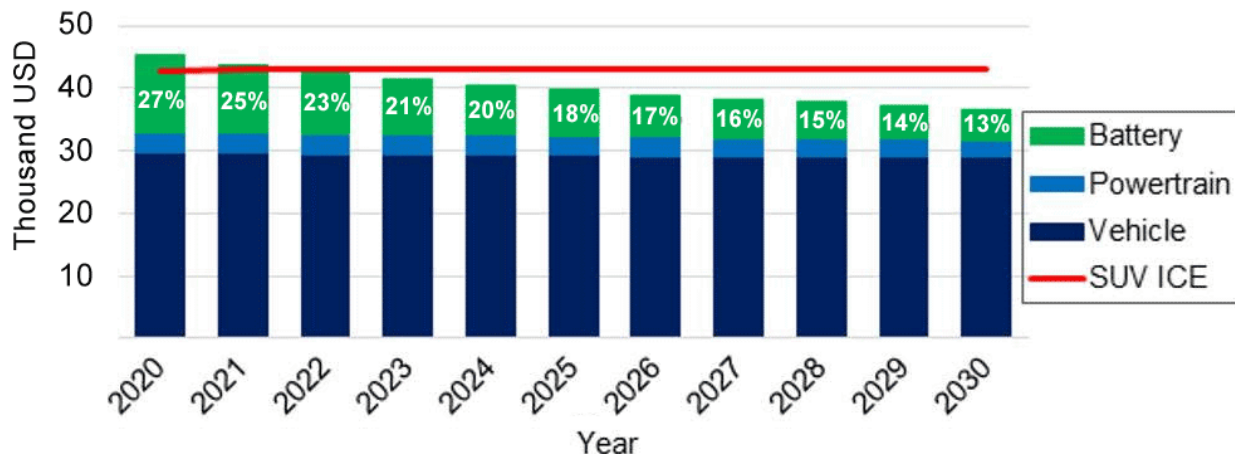

**Forecasted pretax vehicle costs for battery-electric vehicles and internal combustion engine vehicles.**

Source: Bloomberg New Energy Finance

The ZEV market share of new vehicle sales continued steadily increasing to a high of 7.78 percent in 2020.<sup>24</sup> Furthermore, COVID-19 has spurred several behavioral changes that may affect ZEV adoption. A sustained shift toward remote work may reduce sales of light-duty vehicles, including ZEVs. Conversely, increased demand for groceries and delivered goods may accelerate adoption of electrified commercial vehicles, the sales of which Bloomberg New Energy Finance expects to reach prepandemic levels before other vehicle sectors.<sup>25</sup> It is unclear whether these behavior changes will be permanent, and it is difficult to draw long-term conclusions based on recent sales figures given the volatility and seasonality of ZEV sales and the limited data available.

24 California Energy Commission staff. 2020. "[Light-Duty Vehicle Forecast Update.](#)" *Transportation Energy Demand Forecast Update — Commissioner Workshop on Updates to the California Energy Demand 2019-2030 Forecast*. California Energy Commission. <https://efiling.energy.ca.gov/getdocument.aspx?tn=235838>.

25 McKerracher, Colin, Ali Izadi-Najafabadi, Aleksandra O'Donovan, Nick Albanese, Dr. Nikolas Soulopolous, David Doherty, Milo Boers, et al. Bloomberg New Energy Finance. 2020. [Electric Vehicle Outlook 2020](#). <https://about.bnef.com/electric-vehicle-outlook/>.

## Growing Electrification of the Medium- and Heavy-Duty Sectors

Beyond light-duty passenger cars, CEC staff expects rapid electrification of the state's medium- and heavy-duty (MD/HD) vehicles and equipment in the next decade. A combination of expanded offerings from manufacturers and new regulations will drive adoption of zero-emissions options across the MD/HD sectors, which includes on-road trucks and buses as well as off-road mobile equipment (such as transportation refrigeration units and cargo-handling equipment).

While MD/HD vehicles and equipment are critical to California's businesses, freight operations, and transit systems, they are responsible for 68 percent of NOx emissions and 91 percent of diesel particulate matter statewide.<sup>26</sup> These pollutants contribute to toxic air and disproportionately harm communities near ports, railyards, distribution centers, and major freight corridors. These findings are especially true in California's South Coast region and San Joaquin Valley, which suffer some of the worst air pollution in the nation.<sup>27</sup> Planning and installing charging infrastructure to support the state's rapidly electrifying MD/HD sectors will be crucial to improving air quality in disadvantaged communities and achieving the state's long-term climate goals.

Recent regulations approved by CARB target increasing levels of electrification among on-road MD/HD vehicles. The Advanced Clean Trucks regulation establishes rising manufacturer ZEV sales targets for Class 2b to Class 8 trucks,<sup>28</sup> with implementation beginning with Model Year 2024.<sup>29</sup> Other regulations developed by CARB, such as Innovative Clean Transit,<sup>30</sup> Zero-

---

26 CARB. 2019. [Regulatory Drivers for Transportation Electrification of Freight and Off-Road Equipment](https://efiling.energy.ca.gov/GetDocument.aspx?tn=228048&DocumentContentId=59334). <https://efiling.energy.ca.gov/GetDocument.aspx?tn=228048&DocumentContentId=59334>.

27 In particular, the San Joaquin Valley consistently suffers the nation's worst air quality. The American Lung Association's 2020 State of the Air report found that the top three cities most polluted by year-round particle pollution were all located in the San Joaquin Valley. American Lung Association. (2020). [State of the Air 2020](https://www.stateoftheair.org/assets/SOTA-2020.pdf). <https://www.stateoftheair.org/assets/SOTA-2020.pdf>.

28 Trucks are classified by their gross vehicle weight rating (GVWR). Class 2b includes trucks with a GVWR of 8,501–10,000 pounds. Class 8 includes all trucks with a GVWR of over 33,000 pounds. Advanced Clean Trucks regulates all truck classes between classes 2b and 8.

29 CARB. 2020. "[Advanced Clean Trucks Fact Sheet](https://ww2.arb.ca.gov/resources/fact-sheets/advanced-clean-trucks-fact-sheet)." <https://ww2.arb.ca.gov/resources/fact-sheets/advanced-clean-trucks-fact-sheet>.

30 CARB. 2019. "[Innovative Clean Transit Regulation](https://ww2.arb.ca.gov/sites/default/files/2019-10/ictfro-Clean-Final_0.pdf)." [https://ww2.arb.ca.gov/sites/default/files/2019-10/ictfro-Clean-Final\\_0.pdf](https://ww2.arb.ca.gov/sites/default/files/2019-10/ictfro-Clean-Final_0.pdf)

Emission Airport Shuttle,<sup>31</sup> and Advanced Clean Fleets,<sup>32</sup> target earlier transitions to zero-emissions trucks and buses for select fleets.

Executive Order N-79-20 directs the state to target 100 percent zero-emission operation of the state's drayage trucks by 2035 and of all medium- and heavy-duty vehicles by 2045, where feasible. A growing portfolio of electrified MD/HD vehicle offerings, including from Daimler, Lion Electric, Proterra, Volvo, and many others, will support this transition.

CEC staff also expects significant growth of zero-emission equipment use in off-road applications. Executive Order N-79-20 directs the state to target 100 percent zero-emission off-road vehicles and equipment by 2035, where feasible. CARB has proposed new transportation refrigeration unit regulations that will require truck operators to begin transitioning to zero-emission truck transport refrigeration units beginning in 2023.<sup>33</sup> A similar regulation for cargo-handling equipment at seaports and railyards is slated for board consideration in 2022, with implementation beginning in 2026.<sup>34</sup> Separately, the San Pedro Bay Ports have announced an ambitious plan to completely transition to zero-emissions cargo-handling equipment by 2030,<sup>35</sup> and the Port of Oakland has announced plans to accelerate the transition to zero-emissions cargo-handling equipment.<sup>36</sup> Several airports across the state, including San Jose International Airport<sup>37</sup> and Los Angeles International Airport,<sup>38</sup> identify electrification of ground-support equipment as part of their clean air plans. Finally, increasing commercial availability of electrified construction equipment may spur modest uptake in the

---

31 CARB. 2019. "[Zero-Emission Airport Shuttle Regulation](https://ww3.arb.ca.gov/regact/2019/asb/fro.pdf)." <https://ww3.arb.ca.gov/regact/2019/asb/fro.pdf>.

32 CARB. 2020. "[Advanced Clean Fleets](https://ww2.arb.ca.gov/our-work/programs/advanced-clean-fleets/about)." <https://ww2.arb.ca.gov/our-work/programs/advanced-clean-fleets/about>.

33 CARB. 2020. "[Transportation Refrigeration Unit Rulemaking](https://ww2.arb.ca.gov/our-work/programs/transport-refrigeration-unit)." <https://ww2.arb.ca.gov/our-work/programs/transport-refrigeration-unit>.

34 CARB. 2018. [Concepts to Minimize the Community Health Impacts from Large Freight Facilities](https://ww2.arb.ca.gov/sites/default/files/2020-07/Revised%20Advance%20Materials%20-%2010-10-2019%20ADA%20Final.pdf). <https://ww2.arb.ca.gov/sites/default/files/2020-07/Revised%20Advance%20Materials%20-%2010-10-2019%20ADA%20Final.pdf>

35 San Pedro Bay Ports. 2017. [Clean Air Action Plan](https://cleanairactionplan.org/documents/final-2017-clean-air-action-plan-update.pdf). <https://cleanairactionplan.org/documents/final-2017-clean-air-action-plan-update.pdf>.

36 Port of Oakland. 2019. [Seaport Air Quality 2020 and Beyond Plan](https://www.portofoakland.com/files/PDF/Volume%20I.pdf). <https://www.portofoakland.com/files/PDF/Volume%20I.pdf>.

37 San Jose International Airport. 2020. [Sustainability Management Plan](https://www.flysanjose.com/sites/default/files/commission/2020_0121_Final%20SMP.PDF). [https://www.flysanjose.com/sites/default/files/commission/2020\\_0121\\_Final%20SMP.PDF](https://www.flysanjose.com/sites/default/files/commission/2020_0121_Final%20SMP.PDF).

38 Los Angeles World Airports. 2019. "[LAX Ground Support Equipment Emissions Reduction Policy](https://www.lawa.org/-/media/lawa-web/environment/files/lax_gse_emission_reduction_policy_boac.ashx)." [https://www.lawa.org/-/media/lawa-web/environment/files/lax\\_gse\\_emission\\_reduction\\_policy\\_boac.ashx](https://www.lawa.org/-/media/lawa-web/environment/files/lax_gse_emission_reduction_policy_boac.ashx).

construction industry. To underscore the importance of the off-road sector, a 2019 analysis by CEC indicates that electricity consumption from off-road vehicles and equipment will more than double between 2019 and 2030 even without considering Executive Order N-79-20.<sup>39</sup>

In many cases, MD/HD vehicles and equipment will need to charge as quickly as possible, which will create new multimegawatt loads. Charging infrastructure planning will be especially important and must address grid constraints, resilience, and compatibility with existing operating schedules. The lack of a unified charging connector standard for MD/HD vehicles and equipment works against driver convenience and increases the likelihood that chargers installed today will potentially be stranded assets in the future. Electric distribution and transmission system planners are beginning to anticipate large public charging loads,<sup>40</sup> but more detailed analysis is necessary to prepare for the rollout of charging infrastructure to support this transition.

---

<sup>39</sup> Off-road electricity consumptions is projected to rise from 1,806 GWh in 2019 to 3,799 GWh in 2030. Miller, Marshall R. UC Davis Institute of Transportation and Aspen Environmental Group, 2019. *California Off-Road Transportation Electrification Demand Forecast*. California Energy Commission.

<sup>40</sup> West Coast Clean Transit Corridor Initiative. 2020. [West Coast Clean Transit Corridor Initiative Study](https://www.westcoastcleantransit.com/). <https://www.westcoastcleantransit.com/>.

# CHAPTER 4:

## Modeling California's Charger Needs

---

This chapter explores the number of chargers that will be needed to meet California's ZEV goals. The modeling results presented here project that California will need more than 1.3 million chargers to support 8 million light-duty and 180,000 medium- and heavy-duty ZEVs by 2030. This total has decreased compared to the January 2021 publication of the AB 2127 Staff Report primarily because of improvements in modeling, including incorporation of stakeholder feedback. The improved model better reflects current and future market conditions, which see EVs with longer ranges, larger batteries, and higher charging powers that do not require as much charging. Further details on modeling updates are presented in the remainder of this chapter.

### Near-Term Gap in Charging Infrastructure

California is on track to surpass its goal of 1.5 million ZEVs on state roadways by 2025 but is behind in providing the charging infrastructure needed to support the growing PEV population. To meet the 2025 goal of 250,000 public and shared chargers, the state needs about 57,000 more than are currently planned, representing a 24 percent shortfall of Level 2 chargers and a 4 percent shortfall of DC fast chargers. Charging infrastructure deployment is lagging vehicle sales, and this gap may stymie progress toward 5 million and 8 million ZEVs by 2030.

### Shared and Public Charging Are Key to Enabling Electrification

While most PEV drivers today charge at single-family homes,<sup>41</sup> shared and public charging infrastructure will be increasingly critical as PEV adoption spreads beyond early adopters. Even with declining vehicle sticker prices, several<sup>42</sup> recent reports<sup>43</sup> emphasize that continued growth in the PEV market will depend on driver confidence in charging infrastructure. Drivers

---

41 Eighty-three percent of California PEV drivers reside in detached houses, and these drivers charge primarily (≥84 percent) at home. Nicholas et al. (2019). [Quantifying the Electric Vehicle Charging Infrastructure Gap Across U.S. Markets](https://theicct.org/sites/default/files/publications/US_charging_Gap_20190124.pdf). The International Council on Clean Transportation. [https://theicct.org/sites/default/files/publications/US\\_charging\\_Gap\\_20190124.pdf](https://theicct.org/sites/default/files/publications/US_charging_Gap_20190124.pdf).

42 A survey by Autolist indicated that lack of charging infrastructure was among the top three concerns among prospective buyers. Autolist. August 2019. "[Survey: Price, Range and Weak Charging Network Are Top Reasons Consumers Avoid EVs](https://www.autolist.com/news-and-analysis/survey-electric-vehicles)." <https://www.autolist.com/news-and-analysis/survey-electric-vehicles>.

43 Separately, a study conducted by the Harris Poll on behalf of Volvo found that lack of charging infrastructure was the second largest concern among drivers. Volvo Car USA. February 2019. "[The State of Electric Vehicles in America](https://www.media.volvocars.com/us/en-us/download/249123)." <https://www.media.volvocars.com/us/en-us/download/249123>.

who lack reliable charging at home or work will rely on public charging for their mobility needs. Indeed, shared and public charging can allow all Californians to enjoy the benefits of PEVs. A 2020 National Renewable Energy Laboratory study found that public charging provided several thousand dollars' worth of tangible value to PEV-driving households.<sup>44</sup> The study found that public charging:

- Enables greater inter-regional BEV travel with public DC fast chargers.
- Provides fuel cost savings to PHEV drivers by enabling drivers to substitute electric miles for what otherwise would have been gasoline miles.
- Substantially decreases the perceived risk of "limited range and long recharging time, thereby increasing the likelihood of purchase" of a BEV.
- Increases the public visibility of electric vehicles and creates "confidence in their viability and permanence."

As the state continues building infrastructure to support its growing PEV population, policy makers and electric vehicle stakeholders must recognize that meeting the diverse electric mobility needs of Californians cannot be achieved through one-size-fits-all solutions.

Thoughtful charger deployment is a significant undertaking that demands careful attention to driver behavior, the local built environment, equity, resiliency, grid capacity, technical standards, and scalability for an assortment of charging solutions. To quantify California's charging needs, the CEC has partnered with the National Renewable Energy Laboratory, Lawrence Berkeley National Laboratory, and the University of California, Davis, to develop quantitative analysis tools covering various vehicle classes, use cases, and local conditions. These analyses are summarized in Table 4 and described in greater detail in the following sections.

Because of the state's ambitious ZEV adoption, climate, and air quality goals, modeling results presented in this chapter focus on CARB's *Draft 2020 Mobile Source Strategy* planning scenario as the priority for the state. CARB's *Draft 2020 Mobile Source Strategy* illustrates the trajectory needed to achieve the Executive Order N-79-20 target of 100 percent light-duty ZEV sales by 2035, as well as other key climate and air quality goals.

For light-duty infrastructure needs, modeling was also conducted for two scenarios from the CEC's *2020 IEPR Transportation Energy Demand Forecast* update: the low and aggressive forecasts. Results, additional details, and discussion about these two scenarios can be found in Appendices C and E. The *IEPR Transportation Energy Demand Forecast* scenarios are

---

44 Greene, David L., Matteo Muratori, Eleftheria Kontou, Brennan Borlaug, Marc Melaina, and Aaron Brooker (National Renewable Energy Laboratory). 2020. [Quantifying the Tangible Value of Public Electric Vehicle Charging Infrastructure](https://efiling.energy.ca.gov/getdocument.aspx?tn=233987). California Energy Commission. Publication Number: CEC-600-2020-004. <https://efiling.energy.ca.gov/getdocument.aspx?tn=233987>.



fundamentally different from CARB’s *Draft 2020 Mobile Source Strategy* in that the former are forecasts, whereas the latter is a planning scenario. The IEPR forecasts project ZEV adoption under varying market, economic, and consumer choice conditions. In contrast, CARB’s *Draft 2020 Mobile Source Strategy* identifies the level of ZEV adoption needed to meet climate, air quality, and transportation electrification goals.

**Table 4: Summary of CEC Charging Infrastructure Quantitative Analyses**

Model	Description
Electric Vehicle Infrastructure Projections (EVI-Pro) 2	Projects charging infrastructure needs to enable electrified short-distance intraregional travel for vehicles with a gross vehicle weight rating (GVWR) of 10,000 pounds or less.
Electric Vehicle Infrastructure for Road Trips (EVI-RoadTrip)	Projects charging infrastructure needs to enable all-electric long-distance (>100 mi.) interregional travel for light-duty vehicles.
Widespread Infrastructure for Ride-hailing EV Deployment (WIRED)	Projects charging infrastructure needs to enable electrification of ride-hailing services via transportation network companies.
Medium- and Heavy-Duty Electric Vehicle Infrastructure Load, Operation, and Deployment (HEVI-LOAD)	Projects charging infrastructure needs to enable electrification of on-road MD/HD vehicles with a GVWR of 10,001 pounds and above.
EVSE Deployment and Grid Evaluation (EDGE) Model	Geospatially analyzes and tracks local grid capacity, air quality, travel demand, and equity considerations.

Source: CEC

## **EVI-Pro 2**

The latest version of the Electric Vehicle Infrastructure Projection tool (EVI-Pro 2) is a simulation model that helps determine the number, locations, and types of chargers required to meet the needs of California’s light-duty PEV drivers. Using a two-step approach, EVI-Pro estimates the charging demand from light-duty PEVs and designs a supply of residential (including MUDs), workplace, and public charging infrastructure capable of meeting the demand. The original EVI-Pro 1 model, developed in 2016 through a collaboration between the



CEC and the National Renewable Energy Laboratory, set the standard for charging infrastructure assessments in California<sup>45</sup> and across the United States.<sup>46</sup>

The EVI-Pro 1 analysis formed the basis for the Executive Order B-48-18 target of 250,000 electric vehicle chargers statewide by 2025, including 10,000 DC fast chargers.<sup>47</sup> An update to the model, EVI-Pro 2, expands infrastructure projections to support nearly 8 million ZEVs by 2030 and incorporates evolving technology and market conditions. This level of ZEV adoption is derived from CARB’s *Draft 2020 Mobile Source Strategy*<sup>48</sup> and is the trajectory needed to achieve the Executive Order N-79-20 target of 100 percent light-duty ZEV sales by 2035.

Table 5 outlines critical differences between EVI-Pro 1 and EVI-Pro 2. In addition, Appendix B details the key parameters and inputs used in EVI-Pro 2.

**Table 5: Comparison of Primary Input Parameters for EVI-Pro 1 and 2**

Input	EVI-Pro 1	EVI-Pro 2
ZEV Population	1.5 million in 2025	7.9 million in 2030
PEV / Hydrogen Fuel Cell Electric Vehicle Split	87%/13% in 2025	95%/5% in 2030
Within PEVs, PHEV / BEV Split	45%/55% in 2025	30%/70% in 2030
Charging Behavior Objective	Maximize electric vehicle miles traveled	Mirror observed behavior
PEVs w/ Home Charging	92%	67%
Time-of-Use Rate Participation	Not included	67% in 2030
Infrastructure Utilization	Assumed	Observed

Source: CEC and National Renewable Energy Laboratory

## Modeling Results

---

45 Bedir, Abdulkadir, Noel Crisostomo, Jennifer Allen, Eric Wood, and Clément Rames. 2018. *California Plug-In Electric Vehicle Infrastructure Projections: 2017-2025*. California Energy Commission. Publication Number: CEC-600-2018-001.

46 Electric Vehicle Infrastructure Projection Tool (EVI-Pro) Lite. U.S. Department of Energy Alternative Fuels Data Center, November 30, 2020. <https://afdc.energy.gov/evi-pro-lite>.

47 California Energy Commission staff. 2018. "California Plug-In Electric Vehicle Infrastructure Projections: 2017-2025." California Energy Commission. Publication Number: CEC-600-2018-001.

48 CARB staff. 2021. [Revised Draft 2020 Mobile Source Strategy](https://ww2.arb.ca.gov/resources/documents/2020-mobile-source-strategy). <https://ww2.arb.ca.gov/resources/documents/2020-mobile-source-strategy>.

Since the January 2021 publication of the AB 2127 Staff Report, the EVI-Pro 2 analysis has been updated to incorporate final inputs, assumptions, methodologies, and scenarios. Stakeholders responded to the January 2021 Staff Draft by submitting comment letters. Several of these letters<sup>49</sup> suggested revisions to modeling assumptions, which were incorporated along with additional modifications to the model. All changes are summarized in Table 6 and led to the final results presented below in this chapter.

**Table 6: Comparison of EVI-Pro 2 Draft and Final AB 2127 Analysis**

EVI-Pro 2 Update	Description
Vehicle Attributes	<p>More aggressive vehicle attributes (e.g. greater range increases over time) have been incorporated to better reflect market trends for 2030.</p> <p><b>Impact:</b> Significant decrease in public charging infrastructure needed.</p>
Treatment of PHEV Travel	<p>PHEV charging behavior has been revised to allow more frequent charging away from home on high mileage travel days.</p> <p><b>Impact:</b> More public PHEV charging, increase in Level 2 network size and load contribution.</p>
Nonresidential Charging Plug-In/Out Assumptions	<p>BEVs and PHEVs now only charge in nonresidential locations once they reach 80 or 30 e-miles of remaining range or less, respectively. BEVs using DC fast charging are also forced to stop charging once they reach 85% state-of-charge (SOC), which maximizes charging speed and increases battery life. Before, there were no DC fast charging SOC restrictions.</p> <p><b>Impact:</b> Fewer and longer charging events, decrease in nonresidential network size (particularly DC fast chargers).</p>
Residential Plug-In Assumption	<p>BEVs and PHEVs only charge at home once they reach 160 or 60 e-miles of remaining range or less, respectively. Before, there was no restriction.</p> <p><b>Impact:</b> Residential charging load decreased, insignificant change to network results.</p>
Residential Charging Assignment	<p>Vehicles with access to home charging are assigned a Level 1 or Level 2 home charger based on average daily VMT of the vehicle.</p> <p><b>Impact:</b> Replaced large amount of Level 1 charging with Level 2.</p>
Residential Charging Behavior	<p>The final analysis assumes that half of drivers participating in time-of-use (TOU) rates set a timer to charge at midnight, while the other half delay charging to reach</p>

49 Comment letters from California Electric Transportation Coalition, Engie Impact, Environmental Defense Fund, Los Angeles Cleantech Incubator, Natural Resources Defense Council, Pacific Gas and Electric Company, San Diego Gas and Electric Company, Sierra Club California, and The Utility Reform Network (TURN) particularly focused on the CEC’s modeling efforts. These comment letters informed the updates presented in this chapter.

	<p>the needed SOC when they depart in the morning. Before, the model simulated 100% of TOU rate customers initiating charging at midnight.</p> <p><b>Impact:</b> Change to residential load profile, insignificant change to network results.</p>
DCFC Load Calculation	<p>The precision of statewide charging load profiles has been improved by derating load aggregations based on the start and end time of individual charging events.</p> <p><b>Impact:</b> Updated load profiles lessen the contribution of DCFC, no change to network results.</p>
TOU Implementation	<p>TOU participation was originally implemented through a post-processing step to shift residential charging load. It is now built into the model to inform charging decisions.</p> <p><b>Impact:</b> Minor changes to network and load results.</p>

Source: CEC and National Renewable Energy Laboratory

Table 7 shows the charging infrastructure needed to support nearly 8 million ZEVs in 2030. EVI-Pro 2 projects that the state will need 791,000 to 803,000 Level 2 chargers at public destinations (for example, shopping centers) and workplaces and 30,200 to 31,000 public DC fast chargers. These DC fast chargers are modeled to support travel within a region, while EVI-RoadTrip (discussed in the next section) models the need for additional DC fast chargers to support travel between regions. While in practice, some DC fast chargers will be used for both intraregional and interregional travel, the estimates tabulated below do not reflect this synergy and therefore may slightly overestimate the number of needed DC fast chargers. An additional 265,000 to 395,000 Level 1 and Level 2 chargers are required to support MUDs.

Modeling efforts capture specific scenarios using best available data to quantify the required infrastructure needed to support California’s public health and ZEV goals. However, actual deployments are influenced by various dynamics. If additional chargers of a certain plug type are available, the need for chargers of other plug types may be reduced, although not necessarily in a one-to-one relationship. For example, additional Level 1 and Level 2 chargers at MUDs beyond the 265,000–395,000 projections may reduce the number of work and public chargers needed. These MUD chargers will provide the added benefit of convenient at-home charging with potentially more favorable electricity rates that could also serve other nonresidential charging needs during the day.

In total, EVI-Pro 2 projects that California will need between 1,086,000 to 1,229,000 chargers to support almost 8 million light-duty ZEVs in 2030, with an average projection of nearly 1,157,000 chargers.

Notably, EVI-Pro 2 analysis has been expanded to look beyond 2030 for CARB’s *Draft 2020 Mobile Source Strategy*, with annual infrastructure results for 2020 to 2035 presented in Appendix C. Because of the exponential increase of ZEVs in CARB’s *Draft 2020 Mobile Source Strategy* needed to meet the Executive Order N-79-20 targets by 2035, EVI-Pro 2 projects a rapid scaling in charging infrastructure to serve the state’s goals.

**Table 7: Projected Chargers Needed to Support Intraregional Travel for 8 Million Light-Duty ZEVs in 2030**

Plug Type	Staff Report (Draft) Results (1000 plugs)			Revised Staff Report Results (1000 plugs)		
	Low	Average	High	Low	Average	High
MUDs (Level 1+2)	258	287	316	265	330	395
Work (Level 2)	556	572	588	324	327	330
Public (Level 2)	600	617.5	635	466	470	474
All Level 1 and 2	1,414	1,476.5	1,539	1,055	1,127	1,199
Public (DC fast chargers)	53.1	54.5	55.9	30.2	30.6	31
Total Chargers	1,467.1	1,531	1,594.9	1,085.2	1,157.6	1,230

Source: CEC and National Renewable Energy Laboratory

As shown in Figure 13, EVI-Pro 2 also suggests that charging demand in 2030 will result in a peak load of about 5.4 GW at midnight from residential charging, adding up to 25 percent to total electric load during that period on weekdays and weekends.<sup>50</sup> Nonresidential charging contributes to a daytime peak load of about 4.4 GW around 10 a.m., adding up to 20 and 23 percent to total electric load during that period on weekdays and weekends, respectively. Finally, charging load from EVI-Pro 2 would add up to 7 and 8 percent to the total system electric load at 8 p.m. on weekdays and weekends, respectively. The load profile is distinct from that of EVI-Pro 1, with a noticeable shift from an early evening ramp in load in EVI-Pro 1 to three residential peaks in EVI-Pro 2. This shift is due to the incorporation of time-of-use (TOU) rate participation in EVI-Pro 2.

Residential TOU rate participation is based on the accelerated enrollment assumed in the CEC’s California Electricity Demand analyses, described in more detail in Appendix B.<sup>51</sup> EVI-Pro 2 assumes that drivers with access to home charging and are not on a TOU rate will charge according to the same behavior seen in EVI-Pro 1. This behavior is simply to plug in to charge upon arriving home from work, resulting in the typical early evening peak in residential load. For residential TOU rates in the EVI-Pro 2 analysis, drivers with access to residential charging who are on a TOU rate are split into two equal groups. The first group of drivers is assumed to

50 Cumulative load from LD EV charging peaks at 5.4 GW at midnight. This is projected to be up to 25 percent of projected load on April 2, 2030 (likely the lowest weekday midnight load that year) and March 31, 2030 (likely the lowest weekend midnight load that year).

51 CEC staff-developed participation rates for the [Transportation Energy Demand Forecast for the 2020 IEPR Update, Transportation Energy Demand Forecast Update - Commissioner Workshop on Updates to the California Energy Demand 2019-2030 Forecast, December 3, 2020](https://www.energy.ca.gov/event/workshop/2020-12/session-1-transportation-energy-demand-forecast-update-commissioner-workshop). <https://www.energy.ca.gov/event/workshop/2020-12/session-1-transportation-energy-demand-forecast-update-commissioner-workshop>.

set a timer to begin charging their vehicle at midnight, while the other group delays charging (presumably with the use of a smart charging system) to meet their daily energy needs by the time they need to start driving. Both of these behaviors benefit from cheaper TOU charging.

This approach illustrates the impact that different charging behaviors and technology can have on the grid: 1) the early evening peak demonstrates inefficiencies from unmanaged charging right as solar generation drops off; 2) the timed midnight peak demonstrates a step forward in managed charging that could be achieved simplistically but has the potential for a significant instantaneous loading of distribution circuits; and 3) the early morning peak represents a more optimized gradual increase in charging load that smart charging could accomplish. Future work will continue to investigate the potential benefits of more advanced smart charging.

**Figure 13: Projected 2030 Statewide PEV Charging Load for Intraregional Travel of 8 Million Light-Duty ZEVs in EVI-Pro 2**

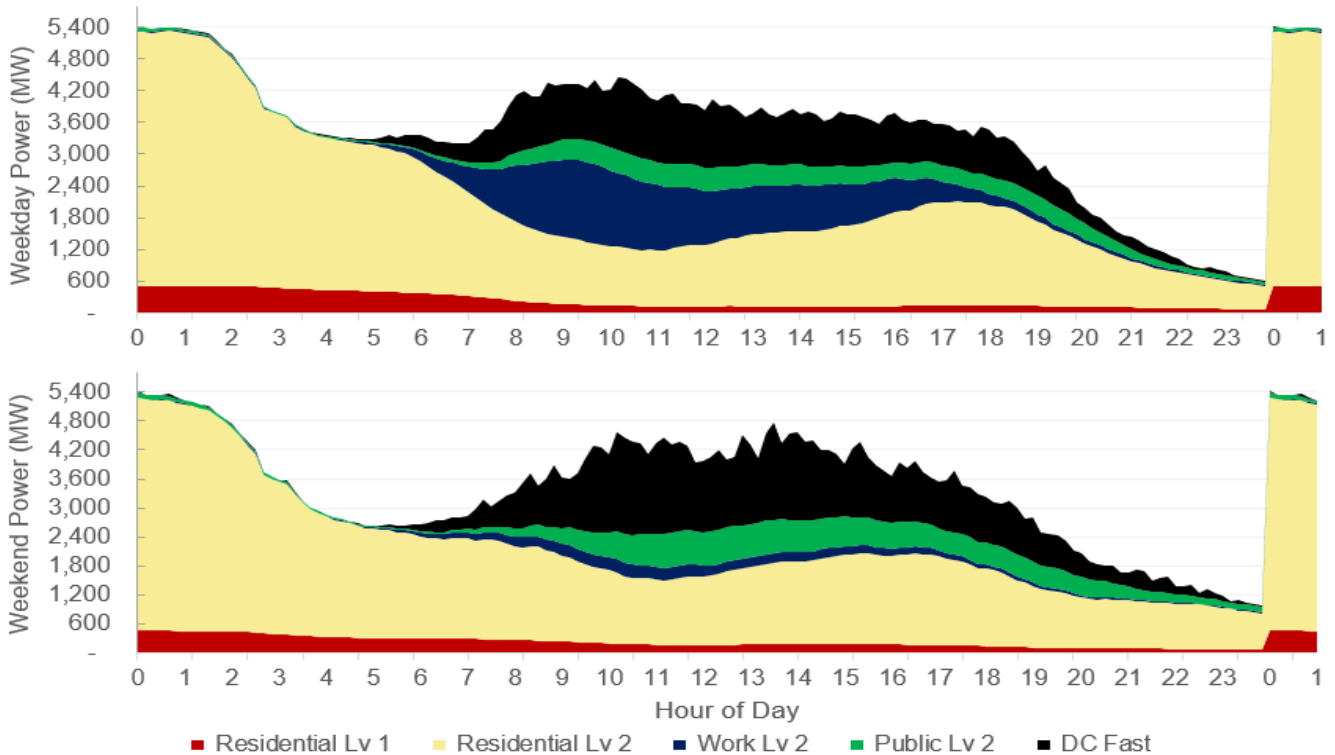

The projected statewide load profiles indicate a peak load of around 5.4 GW around 12 a.m. from the charging of nearly 8 million light-duty ZEVs for intraregional travel in 2030. These results suggest that, with some residential charging management strategies, a large amount of charging load will align with daytime solar generation. However, more than half of total charging energy demand still occurs outside solar generation hours (9 a.m. to 5 p.m.). Further, the sudden spike in charging load at midnight due to the simultaneous response to off-peak time-of-use rates may overload distribution equipment and affect power quality. The load profiles add a 25<sup>th</sup> hour on the right to illustrate the impact of timed midnight charging.

Source: CEC and National Renewable Energy Laboratory

It is important to emphasize uncertainties in projecting infrastructure needs 10 or more years out into the future. To address this, CEC staff and NREL developed “alternative future”

scenarios to illustrate potential futures given the uncertainty of how the transportation landscape may evolve in the next decade. Each scenario, described in Table 8, makes a modification to the inputs and assumptions in EVI-Pro 2 to generate a new set of network infrastructure and load profile results. The set of scenarios has been expanded since the January 2021 publication of the AB 2127 Staff Report to incorporate additional relevant scenarios. Load profile results and additional discussion about these scenarios can be found in Appendix C.

**Table 8: Summary of Alternative Future Scenarios**

Scenario Name	EVI-Pro 2 Modification Compared to Standard Scenario
Unconstrained Residential Load	No TOU participation is assumed.
Low Residential Access	50% of vehicles have access to overnight charging.
High Residential Access	95% of vehicles have access to overnight charging.
Low Energy Demand	Energy demand of charging is decreased by 30%.
High Energy Demand	Energy demand of charging is increased by 30%.
Low-Range PEVs	Vehicles maintain the same attributes used in the AB 2127 Staff Report analysis.
Gas Station Model	Vehicles without access to home charging prefer DCFC charging above work L2 charging.
EV Happy Hour	Vehicles with access to home charging prefer work L2 charging above home charging.
Level 1 Access	Level 1 charging is enabled as an option for public and workplace charging.
Lazy PHEVs	PHEVs with access to overnight charging never use public or workplace charging.
Widespread Topping Off	BEV and PHEV e-mile plug-in requirements are doubled, resulting in smaller and more frequent charging events.

Source: CEC and National Renewable Energy Laboratory

Figure 14 shows the differences in network results for each alternative future compared to the standard scenario discussed earlier in this chapter. Scenarios result in decreases and increases in different types of charging infrastructure, and the net change for each scenario is provided on the right side of the figure.

**Figure 14: Difference in Alternative Future Network Results Compared to the Standard Scenario**

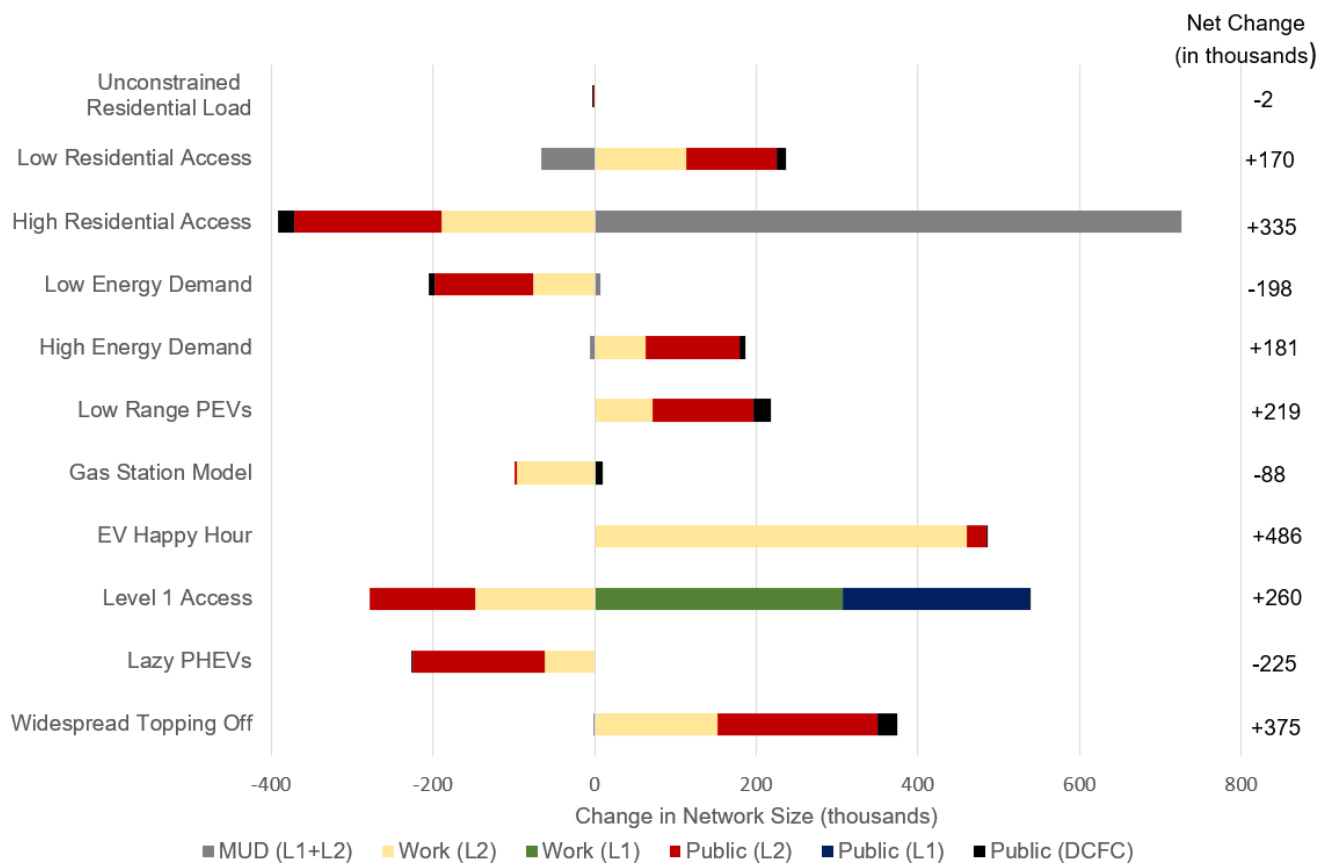

**The alternative future scenarios result in decreases and increases in different types of charging infrastructure. The net change in the network size for each scenario is shown on the right side.**

Source: CEC and National Renewable Energy Laboratory

Several key takeaways emerge from these alternative future scenarios:

**1) Residential charging access is a key determinant of charging infrastructure needs.**

Similarly, while the impact of varying residential charging access is not surprising, it emphasizes the importance of this factor on public charging needs. Achieving the most optimistic residential charging access through electrical or charging infrastructure installations or both coupled with changes in parking behavior could decrease the public charging need by more than a third. In the more conservative residential charging access scenario, decreasing home charging access leads to a notable increase in daytime DC fast charging demand (37 percent increase in DCFC network and 8 percent increase in DCFC load contribution) as drivers replace long-duration overnight charging with fast public charging to meet their travel needs. While access to home charging should still be a priority, and remains one of the key benefits and incentives of owning an EV, the potential for a properly sized and distributed DC fast charging network to act

as an alternative to home charging presents an opportunity for further EV penetration and increased alignment with solar generation.

**2) Lower energy demand requires fewer chargers.**

As expected, scenarios with lower charging energy demand correspond with a need for less charging infrastructure. Variation in energy demand could result from several factors, such as vehicle efficiency (through technology advancements or different weather conditions throughout the state) and behaviors change with drivers increasing or decreasing their daily vehicle miles traveled.

**3) Vehicle attributes strongly impact charging infrastructure needs.**

More conservative assumptions in range, battery size, and charging power necessitate a larger public infrastructure network to satisfy travel requirements. It will be important to track vehicle technology advancements to inform installation of a sufficient infrastructure network for vehicles that enter the market.

**4) Charging preferences should be considered when evaluating charging infrastructure needs**

For example, the Gas Station Model notably increases the needed DCFC network when drivers prefer DC fast charging over workplace charging. Furthermore, the EV Happy Hour scenario, while successful in aligning daytime workplace charging with solar generation, results in the largest net infrastructure increase for chargers (42 percent) out of any scenario. Cost-benefit analyses will be critical as EV adoption increases, and certain charging patterns may be encouraged and desired more than others.

**5) Nonresidential Level 1 charging is a feasible, but not ideal, alternative to Level 2 charging.**

Including Level 1 charging as an additional option for public and workplace charging has the potential to accommodate low-energy charge sessions and reduce the number of Level 2 chargers needed, but this does not come as a one-to-one replacement. The resulting Level 1 and Level 2 network requires more than 250,000 additional chargers compared to the standard Level 2-only network.

**6) The charging behavior of drivers can have a significant impact on the overall charging infrastructure network requirements**

Finally, charging behavior is one of the most impactful factors influencing network size. The Lazy PHEVs scenario demonstrates the large demand PHEVs place on the public and workplace Level 2 network, which may necessitate cost-benefit analysis to weigh the reduced emissions via electric PHEV travel against the additional chargers needed to serve those vehicles. Meanwhile, the Widespread Topping Off scenario emphasizes the massive inefficiencies of frequent and small charge sessions.

## **Policy Implications**

Results from EVI-Pro 2 suggest that California will need between 1,086,000 to 1,229,000 chargers to support the intraregional travel demands of nearly 8 million ZEVs in 2030, with an average projection of about 1,157,000 chargers. When accounting for planned future



installations, current estimates indicate that there will be 193,000 chargers statewide in 2025, meaning that by 2030, California will need almost 1 million additional chargers to meet charging demand modeled by EVI-Pro 2.

These results also illustrate the potential of TOU rates to shift EV home charging load from an early evening ramp, which problematically coincides with the total electricity system peak, to later in the evening or in the early morning. The implications to system electricity load of TOU participation and automated charging management should be considered as TOU rate structures evolve and become more widely adopted. While TOU rates can shift load to more beneficial times, smart charging protocols beyond TOU rates will be needed to optimally manage EV charging load and protect distribution grid infrastructure, as demonstrated by the “timer spike” in load contrasted with the effect of drivers “charging for departure” and spreading charging load throughout the early morning. The significant amount of power demanded by PEVs highlights a critical need for incentives, rate structures, advanced technologies, and other tools working in conjunction to enable and encourage smart charging and vehicle-grid integration.

The alternative futures analyses illustrate the large uncertainty associated with modeling infrastructure needs far into the future. It is challenging to predict how technologies, preferences, behaviors, policies, and markets will unfold in the next decade. Thus, it will be critical to continue evaluating infrastructure needs and considering scenarios as new data, information, and trends become available.

Annual EVI-Pro 2 results broken down to the county level can be found in Appendix C. These detailed results will help inform an assortment of planning needs, CEC and industry investments, and programs to address charging use cases including in MUDs and low-income communities. At the electricity distribution system level, these results will be critical for planning entities to prepare for growing PEV adoption and charging demand and successfully install infrastructure using the most effective charging solution for particular built environments and use cases. At the statewide bulk power level, these results will be coordinated with analyses of possible transmission system congestion.<sup>52</sup> Future work will aim to enhance geographic resolution to obtain results at finer than the county level.

---

52 Kintner-Meyer, M., S. Davis, S. Sridhar, D. Bhatnagar, S. Mahserejian, and M. Ghosal (Pacific Northwest National Laboratory). 2020. *Electric Vehicles at Scale – Phase I Analysis: High EV Adoption Impacts on the Western U.S. Power Grid*. [https://www.pnnl.gov/sites/default/files/media/file/EV-AT-SCALE\\_1\\_IMPACTS\\_final.pdf](https://www.pnnl.gov/sites/default/files/media/file/EV-AT-SCALE_1_IMPACTS_final.pdf).

Future work will also continue to investigate scenarios with greater charging load management.<sup>53</sup> In addition, staff will work with partner agencies to continue updating EVI-Pro 2 as newer vehicle population scenarios become available.

A report discussing EVI-Pro 2 findings is expected by the end of the third quarter of 2021 and will include further detail on the inputs used in the model, the associated method, and additional scenarios and sensitivities.

## **EVI-RoadTrip**

The Electric Vehicle Infrastructure for Road Trips (EVI-RoadTrip) model projects the number and locations of DC fast chargers needed to enable electrified road trips within and across California's borders. EVI-RoadTrip differs from EVI-Pro 2 in the scope of the analysis: EVI-RoadTrip focuses on long-distance interregional (100+ mile) trips, while EVI-Pro 2 focuses on short-distance intraregional trips for daily routines. Further, EVI-RoadTrip analyzes DC fast chargers to support BEVs only, while EVI-Pro 2 also considers Level 1 and Level 2 chargers to support BEVs and PHEVs.

EVI-RoadTrip follows four key steps: trip data generation, energy and charging simulation, station siting and sizing, and grid hosting capacity analysis. The model simulates interregional and out-of-state road trips by BEVs, estimates energy use and charging demand along the road trip routes, calculates geographic clusters of charging demand, and simulates the existence of charging stations to serve those clusters, locating them in preferred areas (such as retail and shopping areas) with appropriate chargers.

## **Modeling Results**

Table 9 shows the number of needed DC fast chargers and stations in 2030 to support the BEV fleet of more than 5 million vehicles per CARB's *Draft 2020 Mobile Source Strategy*.<sup>54</sup> These results show that California will need between 2,108 and 7,408 DC fast chargers (average of 4,758) located at 1,039 to 1,338 stations (average of 1,189) to support electric interregional travel. These numbers assume drivers will unplug their vehicle from DC fast chargers when the battery reaches around 80 percent state of charge, as charging power (in other words, charging speed) diminishes significantly once the battery reaches higher states of charge.

---

53 Wood, Eric, Dong-Yeon (D-Y) Lee, Nicholas Reinicke, Yanbo Ge, and Erin Burnell (National Renewable Energy Laboratory). 2020. "Presentation — Electric Vehicle Infrastructure Projection Tool (EVI-Pro)." Integrated Energy Policy Report August 6, 2020, Workshop. <https://efiling.energy.ca.gov/getdocument.aspx?tn=234215>.

54 CARB's *Draft 2020 Mobile Source Strategy* calls for nearly 8 million ZEVs in 2030. Of this total, more than 5.2 million are BEVs, and EVI-RoadTrip models only the DC fast charging needs to enable long-distance interregional travel for these BEVs.

**Table 9: DC Fast Charging Infrastructure Needed to Support 2030 Interregional Electric Travel for BEVs**

Result	Low	Average	High
<b>DC Fast Charge Stations</b>	1,039	1,189	1,338
<b>DC Fast Chargers</b>	2,108	4,758	7,408

Source: CEC and National Renewable Energy Laboratory

While EVI-RoadTrip addresses a unique use case and a unique charger fleet compared to EVI-Pro 2, in practice some DC fast chargers could be used for intraregional and interregional purposes. The estimates shown above do not reflect this synergy and, therefore, may slightly overestimate the number of needed DC fast chargers. Future work will aim to harmonize the modeling results of EVI-RoadTrip and EVI-Pro 2.

EVI-RoadTrip also models the locations of needed fast charging infrastructure based on existing land use data and the simulated clusters of charging demand (Figure 15, at right). Modeling results indicate that most these stations would be at retail and shopping areas (55 percent), with most of the remaining stations at recreation and park areas (30 percent), gas stations (13 percent), and airports (2 percent). EVI-RoadTrip places some stations outside California to accommodate trips with routes that include out-of-state segments.

Comparing these results against a list of existing DC fast charging stations published by the Alternative Fuels Data Center (AFDC) yields a few notable takeaways (Figure 16, at left). Existing stations are largely concentrated in the major metropolitan areas of the state, with a sparser distribution along major highways. The EVI-RoadTrip results indicate that by 2030, stations need to more thoroughly cover California’s road network to enable long-distance travel. In addition, many of the EVI-RoadTrip stations are in rural and less-trafficked areas that have so far not been targeted in the market. Moreover, a notable caveat is that an existing fast charging station on the AFDC list may not be a suitable substitute for a projected nearby EVI-RoadTrip station; for example, it may not have enough chargers. It will be important to consider the evolution, both in terms of the number of chargers at stations and related power levels, to support the travel demand modeled in EVI-RoadTrip.

**Figure 15: Station Locations to Support 2030 Interregional Electric Travel for BEVs**

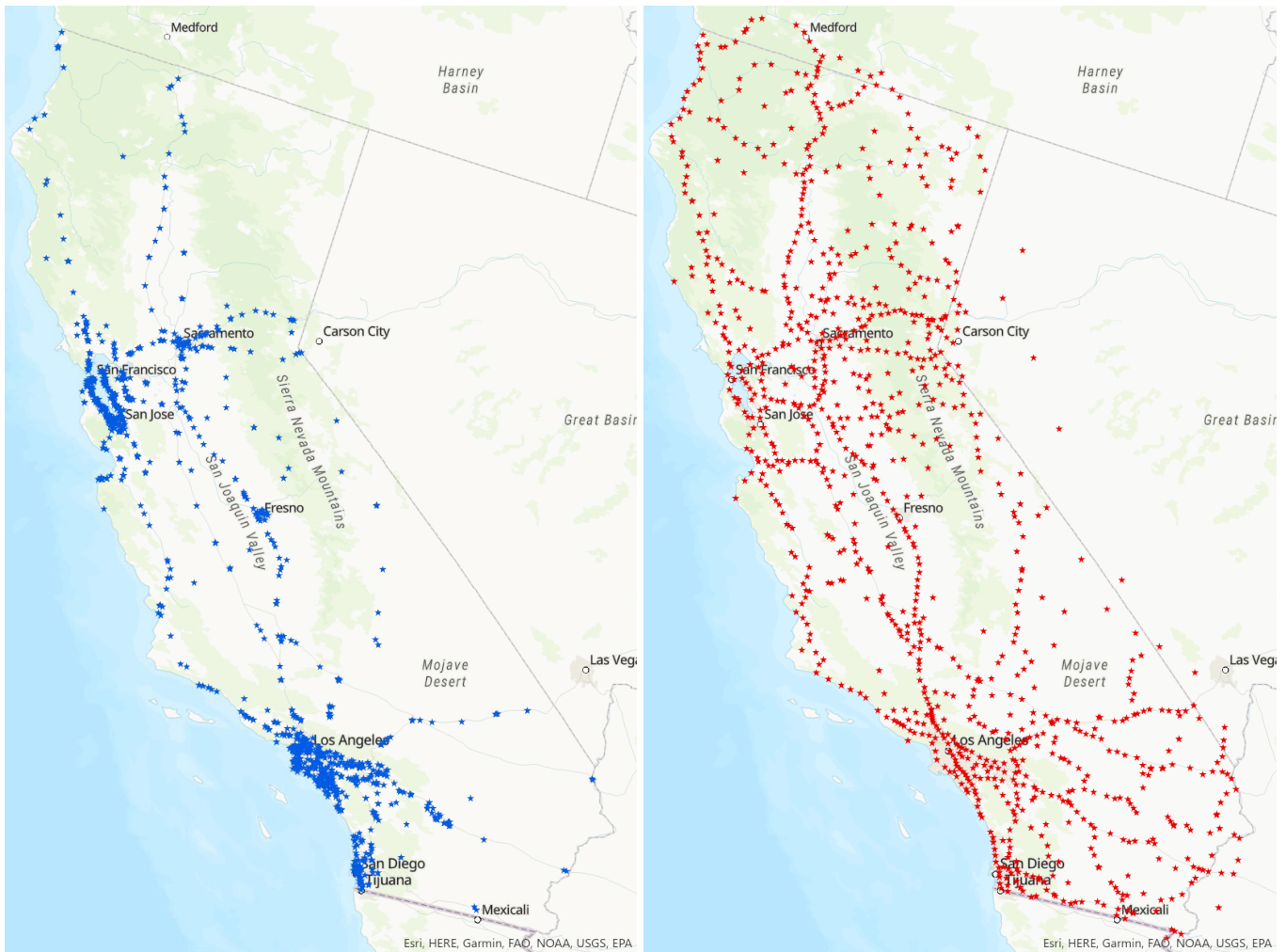

**The left map shows the existing DC fast charging station locations in California listed by the Alternative Fuels Data Center (retrieved April 2, 2021). The right map shows the simulated locations of needed fast charging infrastructure in 2030 to support long-distance interregional travel for more than 5 million BEVs (out of almost 8 million ZEVs) in EVI-RoadTrip.**

Source: CEC, National Renewable Energy Laboratory, and Alternative Fuels Data Center

The typical weekday load profile projected by EVI-RoadTrip (Figure 16) indicates that power demand from interregional DC fast charging will peak at 60 megawatts (MW) between 2 and 3 p.m. in 2030. The load profile assumes that drivers will unplug once the battery nears 80 percent state of charge, and different charging behaviors would alter systemwide demand. For example, EVI-RoadTrip estimates that if all drivers always charge to 99 percent state of charge, peak power demand from interregional DC fast charging will more than double to more than 145 MW between 2 and 3 p.m. An analysis of Southern California Edison's territory using the CEC's EDGE tool (discussed later in this chapter) indicates that current grid capacity could accommodate charging demand from these road trips.

**Figure 16: Projected 2030 Load Curve for Interregional DC Fast Charging**

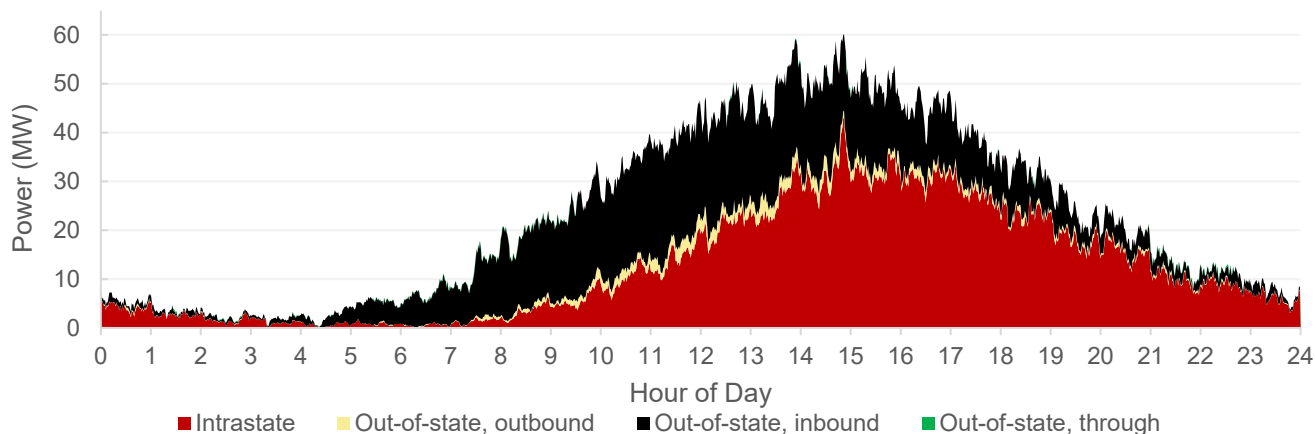

**EVI-RoadTrip projects that DC fast charging to support interregional BEV travel will peak at 60 MW in the midafternoon around 2-3 p.m.**

Source: CEC and National Renewable Energy Laboratory

A report discussing EVI-RoadTrip findings is expected by the end of the third quarter of 2021. The report will include further detail on the inputs used in the model, the method, and a robust sensitivity analysis.

## Policy Implications

Several policy implications emerge from EVI-RoadTrip. The results, in combination with a case study from SCE's territory using the EDGE tool, indicate that road trip charging demand may be accommodated by the current grid infrastructure. However, the CEC recognizes the need to continue working and engaging with the utilities on the EDGE tool to accurately reflect grid conditions and the impact of future load, as described later. In addition, the charging load associated with other types of trips and vehicles may require significant grid upgrades or impact reduction using distributed energy resources, smart charging (discussed in greater detail in Chapter 5), or other measures.

Even with a growing BEV population, EVI-RoadTrip finds that technology improvements such as longer-range vehicles and higher charging power will moderate the growth in the needed number of stations and plugs for 2030, highlighting the importance of future-proofing equipment and encouraging the interoperability of charging connectors today. Further, the model identifies several station sites in neighboring states to accommodate routes that include portions of out-of-state travel, highlighting the need for interstate collaboration.

Finally, as this analysis is based on assumptions surrounding travel demand, driver behavior, and charging session characteristics, it highlights the need for high-quality data on travel behavior and charging session-level profiles to improve model accuracy.

## WIRED

The Widespread Infrastructure for Ride-Hailing EV Deployment (WIRED) model, developed by UC Davis, assesses the need for charging infrastructure demanded by TNC vehicles, initially in three major California regions: San Diego County, the Greater Los Angeles region, and the San Francisco Bay Area. Understanding the charging infrastructure needs of TNC vehicles is especially important in light of CARB's Draft Clean Miles Standard, enacted by SB 1014, which calls for TNCs to electrify 50 percent of vehicle miles traveled by 2027 and 90 percent by 2030.<sup>55</sup> In addition, the emissions benefits of electrifying a vehicle in a TNC fleet are nearly three times greater than the benefits for electrifying a privately-owned vehicle, due largely to greater average miles traveled and passenger occupancy of a TNC vehicle.<sup>56</sup>

WIRED uses empirical data from Lyft and Uber trips and aims to minimize charger equipment cost, network installation size, driver use cost, travel time, and charging time. The model outputs the number of chargers needed at an aggregated census tract level across the three major metropolitan regions mentioned above. This analysis assumes that 80 percent of the 333,000 ZEVs projected to be in TNC fleets in California by 2030<sup>57</sup> are operating in these regions. These vehicles were modeled as BEVs or PHEVs based on the yearly projection used in EVI-Pro 2. In the previous staff report version of this report, TNC PEVs were assumed to rely completely on public charging, with no use of overnight charging. However, the results presented in this revised staff report incorporate the assumption that 40 percent of TNC PEVs have access to overnight charging, a change that decreases the need for public charging.

### Modeling Results

In the previous staff report version, the WIRED analysis was completely independent from the other light-duty infrastructure models described earlier in this chapter. The siloed nature of these models meant that projected charging infrastructure, particularly DC fast chargers, may have been overestimated. Modeling updates since the January 2021 publication of the staff report allow WIRED to consider the projected charging infrastructure modeled in EVI-Pro 2 and EVI-RoadTrip to determine the net additional chargers needed to support TNC charging needs.

WIRED projects a steady increase in the number of DC fast chargers required in each city, especially in the Los Angeles and San Francisco regions. Figure 17 shows this increase over

---

55 CARB Staff. 2020. [Draft Regulation Order — Clean Miles Standard](https://ww2.arb.ca.gov/sites/default/files/2020-11/CMS%20Draft%20Regulation%20Order.pdf).  
<https://ww2.arb.ca.gov/sites/default/files/2020-11/CMS%20Draft%20Regulation%20Order.pdf>.

56 Jenn, Alan. 2019. *National Center for Sustainable Transportation*. "[Emissions Benefits of Electric Vehicles in Uber and Lyft Services](https://escholarship.org/uc/item/15s1h1kn)." UC Davis Institute of Transportation Studies. <https://escholarship.org/uc/item/15s1h1kn>.

57 CARB Staff. November 19, 2020. *Clean Miles Standard Workshop*. "Proposed Regulation Targets."  
[https://ww2.arb.ca.gov/sites/default/files/2020-11/CMS%20Workshop%206\\_public%20%28002%29.pdf](https://ww2.arb.ca.gov/sites/default/files/2020-11/CMS%20Workshop%206_public%20%28002%29.pdf).

time, while Figure 18 shows the different needs for charging infrastructure in the regions studied, based on differences in energy demanded to power their fleets. By 2030, more than 2,100 DC fast chargers will be needed across the three regions to serve TNCs. Notably, TNC charging infrastructure needs have decreased compared to the AB 2127 Staff Report. This decrease is due to the inclusion of home charging access and the incorporation of EVI-Pro 2 and EVI-RoadTrip results described above. Residential charging access among TNC drivers is still a large unknown, especially looking into the future. The current assumption that 40 percent of TNC drivers have access to overnight charging may be an underestimate or overestimate, and it should be recognized that public infrastructure needs are noticeably impacted by this factor. The inclusion of EVI-Pro 2 and EVI-RoadTrip results in this analysis represents a step forward in the harmonization of the CEC’s modeling. While the chargers projected by the other two models are able to fulfill some of the TNC charging demand (in particular, previous Level 1 and 2 charging), WIRED still identifies areas where additional infrastructure is necessary to serve the unique charging requirements of TNCs.

**Figure 17: DC Fast Chargers Needed to Support TNC PEVs (2023–2030)**

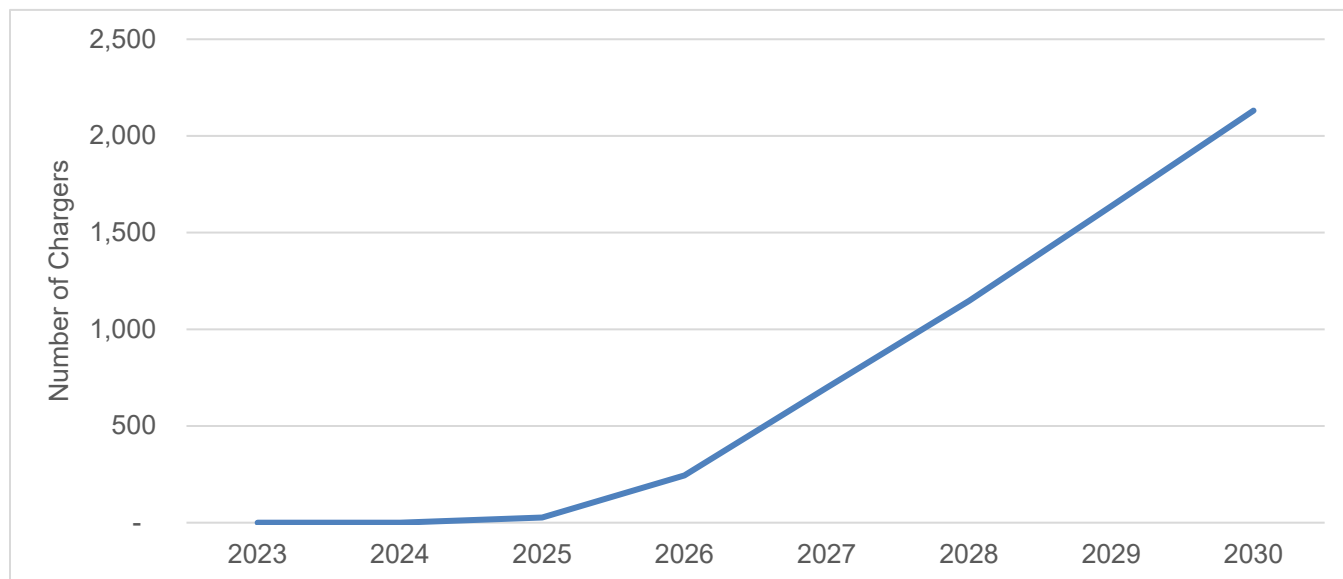

**Aggregated DC fast charging infrastructure needs modeled by WIRED in the Greater Los Angeles region, San Diego County, and the San Francisco Bay Area.**

Source: UC Davis

**Figure 18: DC Fast Chargers Needed to Support TNC PEVs in 2030 by Region**

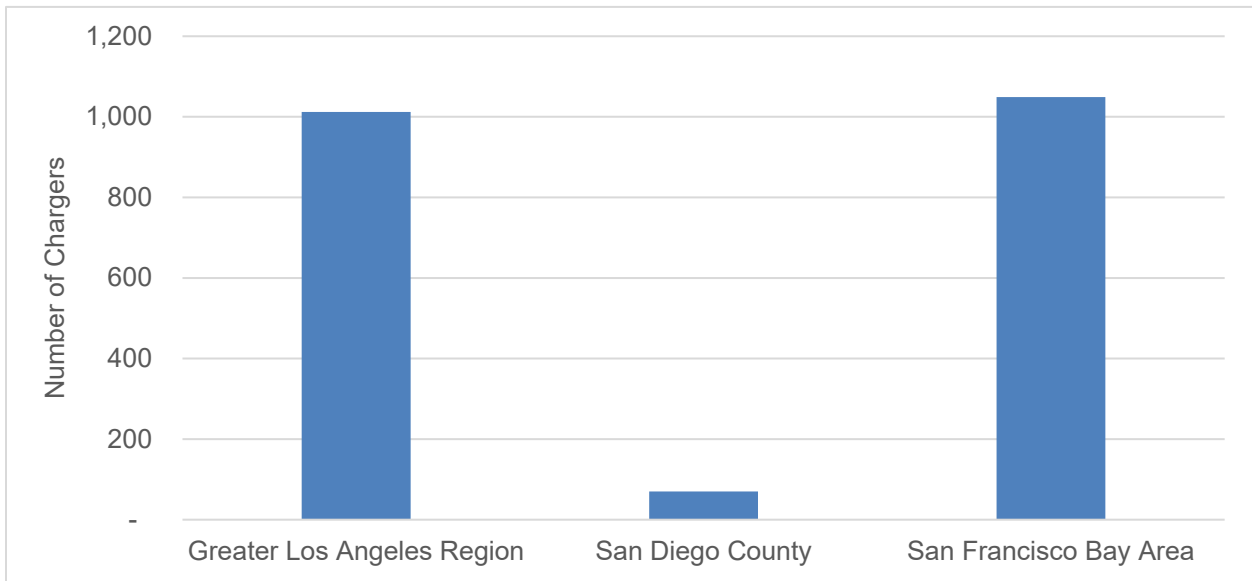

**WIRED models transportation network company infrastructure requirements, illustrating how travel patterns in the different regions affect the resulting network design.**

Source: UC Davis

Figure 19 shows the projected load from TNC fast charging in 2030. The peak charging load of nearly 140 MW occurs in the middle of the day between 11 a.m. and 2 p.m. WIRED outputs load at an hourly resolution, and the load between hours has been estimated through linear interpolation.

**Figure 19: Projected 2030 Load Curve for TNC DC Fast Charging**

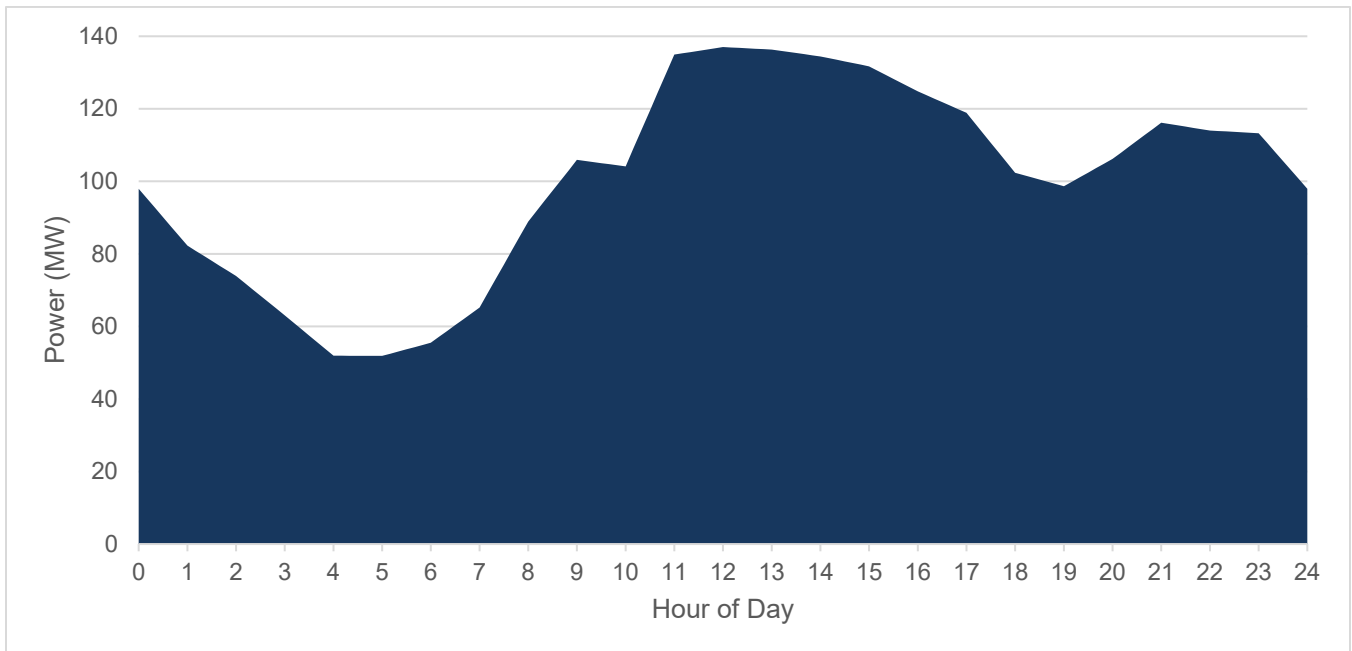



**WIRED models the load from TNC fast charging, with a peak load in 2030 of nearly 140 MW between 11 a.m. and 2 p.m. across Greater Los Angeles, San Diego County, and San Francisco Bay Area.**

Source: UC Davis

## **Policy Implications and Future Refinements**

The results indicate that the average TNC PEV demands more DC fast chargers than a PEV that is not part of a fleet.<sup>58</sup> Furthermore, TNC charging demand is most significant near airports and downtown areas. Finally, access to overnight charging for TNC PEV drivers can decrease public charging demand significantly. Policy makers should consider these factors when crafting TNC fleet electrification policies.

Future work will continue improving the harmonization of WIRED with EVI-Pro 2 and EVI-RoadTrip. In addition, the analysis may also extend beyond the three regions it currently considers.

## **HEVI-LOAD**

The Medium- and Heavy-Duty Electric Vehicle Infrastructure Load, Operations, and Deployment (HEVI-LOAD) model aims to characterize regional charging infrastructure needs in 2030 for public, shared private, and private charging for on-road medium- and heavy-duty electric vehicles. The goal of the model is to determine the number, locations, and types of charger deployments and examine suitable power levels ranging from overnight charging (<50 kW) to public fast charging (multimegawatt) for the range of applications envisioned in California's transition to ZEVs. HEVI-LOAD began development in 2020 under a collaboration between Lawrence Berkeley National Laboratory and the CEC.

The current approach for HEVI-LOAD uses three steps: vehicle projection, trip disaggregation, and infrastructure assessment.<sup>59</sup> Medium- and heavy-duty vehicle energy consumption is derived from a vehicle powertrain physics model that is informed by a CARB truck electrification viability analysis<sup>60</sup> and the emission factor (EMFAC) tool.<sup>61</sup> Future electric vehicle penetrations are derived from a truck choice model used for the CEC's Transportation Energy

---

58 Jenn, Alan. 2020. *Transportation Research Board* (accepted conference paper). "Charging Forward: Deploying EV Infrastructure for Uber and Lyft in California."

59 Wang, Bin, Doug Black, Fan Tong, and Cong Zhang (Lawrence Berkeley National Laboratory). 2020. "[Presentation — Medium- and Heavy-Duty Electric Vehicle Infrastructure Projections \(HEVI-Pro\).](#)" Integrated Energy Policy Report August 6th, 2020 workshop. <https://efiling.energy.ca.gov/getdocument.aspx?tn=234209>.

60 CARB. [Advanced Clean Truck Market Segment Analysis, February 22, 2019.](#) <https://ww2.arb.ca.gov/sites/default/files/2019-02/190225actmarketanalysis.xlsx>.

61 CARB. [EMFAC.](#) <https://arb.ca.gov/emfac/>.

Demand Forecast (TEDF) as lower bounds.<sup>62</sup> The scenario of CARB's *Draft 2020 Mobile Source Strategy*, which supports near-term air quality improvement and long-term decarbonization, serve as an upper bound.<sup>63</sup>

HEVI-LOAD considers more than 70 vehicle types aligned with the tools above, which are collected for simplicity into the nine categories in Figure 1921. Vehicle energy storage density improves annually across all EV types.<sup>64</sup>

Energy consumption for the vehicles are allocated into individual trips, with an activity model calculated based on the payload of the vehicle type and informed by surveyed usage data.<sup>65</sup> These data inform vehicle-specific models of driving and resting periods and the probability that a vehicle will need to recharge.

**Table 10: Comparison of Primary Input Parameters for HEVI-LOAD**

Scenario	Preliminary (August 2020)	Medium Charging Demand	High Charging Demand	Mobile Source Strategy
BEV Population	130,000 in 2030	75,000 in 2030	81,000 in 2030	180,000 in 2030
Regional Populations Enhanced for Air Quality Attainment	South Coast Air Quality Management District Counties	Not Specified	Not Specified	Not Specified
Payload Associated with Vehicle Type	N/A (Assumed Electricity Consumption Rates)	3 choices, based on the relevant Weight Classes	Maximum GVWR for the relevant Weight Classes	Maximum GVWR for the relevant Weight Classes
Battery Energy Density Improvement (%/year)	None	7.2%	5.2%	5.2%

Source: CEC and Lawrence Berkeley National Laboratory

## Modeling Results

---

62 Populations for the Medium- and High Charging Demand cases within Table 10 reflect a modification to the December 3, 2020, draft Transportation Energy Demand Forecast cases, in which the catenary (direct electric) fuel type is excluded. Instead, trucks choose among zero-emission fuel types: battery or fuel cell EV.

63 CARB. DRAFT Mobile Emissions Toolkit for Analysis (META), October 2, 2020. [https://ww3.arb.ca.gov/planning/sip/2020mss/draft\\_META.zip](https://ww3.arb.ca.gov/planning/sip/2020mss/draft_META.zip).

64 Annual growth rates in gravimetric and volumetric energy densities are derived from [Bloomberg](#), [Tesla](#), and [Sila Nano](#).

65 This includes time-based activity distributions from vehicles tested with portable activity monitoring systems in Southern California by the University of California, Riverside, for Energy Commission [agreement 500-15-002 with South Coast Air Quality Management District](#). More information is available at <https://ww2.energy.ca.gov/2019publications/CEC-500-2019-057/CEC-500-2019-057-AP.pdf>.

CEC and LBNL built upon a preliminary August 2020 analysis to estimate a range of charging infrastructure needs in 2030. The Medium Charging Demand scenario reflects a lower end of need as it combines BEV populations from the Mid Case TEDF, an optimistic rate of improvement in battery technology, and typical loading characteristics. In contrast, the High Charging Demand and CARB's *Draft 2020 Mobile Source Strategy* scenarios reflect the potential for more extensive charging requirements resulting from heavily loaded operations and more conservative improvements in battery technology. These latter two scenarios differ in the method to derive the 2030 population, with High Charging Demand case using an economic choice model and CARB's *Draft 2020 Mobile Source Strategy* case using a scenario planning tool with the objective of reducing a certain volume of emissions. In the current structure of HEVI-LOAD, vehicles are provided two options: to charge overnight at 50 kilowatts (kW) or during the daytime at 350 kW, which is the maximum DC charging power supported by the CCS connector standard without liquid cooling.

For CARB's *Draft 2020 Mobile Source Strategy* scenario, the 180,000 MD/HD vehicles expected to be deployed as of 2030<sup>66</sup> would require about 141,000 50 kW chargers and 16,000 350 kW chargers to complete trips. Following the AB 2127 directive to analyze meeting the state's ambient air quality standards and climate change goals, Figure 20 features the hourly charging load profiles of the nine aggregated vehicle categories for CARB's *Draft 2020 Mobile Source Strategy* scenario. Charging profiles at the county-level indicate high variability in regional travel requirements and use cases.

---

66 The approximate population is derived from CARB's *Draft 2020 Mobile Source Strategy* populations of the following segments: 31,819 Light-Heavy-Duty Trucks (8,501-10,000 lbs.); 8,969 Light-Heavy-Duty Trucks (10,001-14,000 lbs.); and 171,887 Heavy-Duty Vehicles.

**Figure 20: Projected On-Road Medium- and Heavy-Duty Vehicle Charging Load**

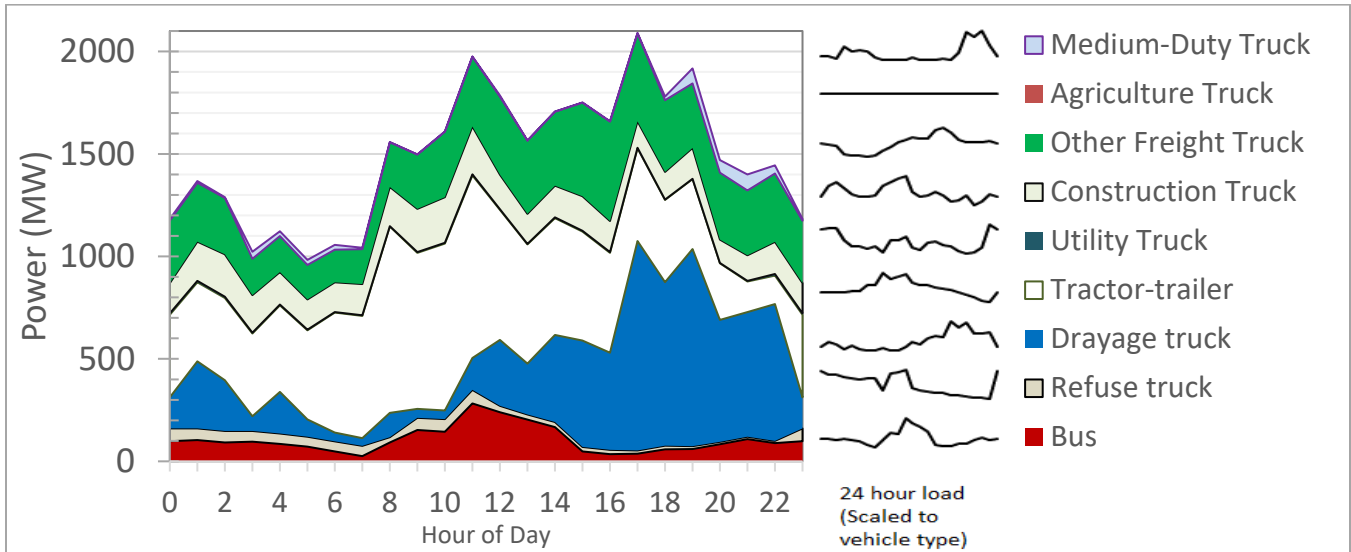

**CARB’s Draft 2020 Mobile Source Strategy scenario of the Medium- and Heavy-Duty Electric Vehicle Infrastructure Load, Operations, and Deployment (HEVI-LOAD) Tool illustrates the wide variation in the on-road vehicle duties and the potential for two gigawatts of evening charging requirements.**

Source: CEC and Lawrence Berkeley National Laboratory

### Future Refinements and Policy Implications

CEC and LBNL continue to refine the HEVI-LOAD tool, including additional vehicle technology parameters, higher charging power options, and localized parameters for planning, including truck parking and routes. Further, analysis of higher adoption within the South Coast Air Basin and San Joaquin Valley will be tailored toward faster adoption of ZEVs to meet more significant regulatory air quality targets, using a method that accounts for how incentives and technology options affect vehicle choices. Future studies will examine specific requirements for commercial route schedules using a type of bottom-up analysis, agent-based activity simulation, at the subhourly level to determine interactions between the trucks and the road network. This analysis will enable more granular exploration of grid infrastructure upgrade requirements and the potential for load flexibility with smart charging and time-variant rates. Along with EVI-Pro, HEVI-LOAD will be critical to identifying and preparing for distribution or transmission grid constraints. A report discussing HEVI-LOAD findings is expected by the third quarter of 2021. The report will include county-level resolution of charger need. It will also include further detail on the inputs used in the model, the model method, and additional forecast scenarios out to 2035.

### EVSE Deployment and Grid Evaluation Model

To properly launch the PEV charging infrastructure necessary to meet California’s ZEV adoption goals, it is important to identify enough geographically dispersed locations that can economically host charging stations. The EDGE model is designed to help users focus charger deployment strategies and plan infrastructure investments to:

- Meet PEV travel demand charging needs.
- Achieve regional air quality improvement targets.
- Minimize charging-related impacts to the electric grid.
- Ensure the equitable distribution of PEV chargers throughout the state.

As an analytical end point for CEC charging infrastructure analyses, EDGE will combine metrics and output results from several data sources and models within four assessment domains: grid conditions, air quality, travel demand, and equity considerations. Each domain contains distinct barriers with complex relationships at the local level that highlight the need for unique infrastructure deployment solutions. As a foundation, charger quantities by type, geographic area, and power level derived from the CEC’s infrastructure models are used as the primary basis upon which data and analysis outputs from other domains are layered. Table 11 lists the evaluation criteria and data sources for each assessment domain within EDGE.

**Table 11: EDGE Domain Data Sources and Evaluation Criteria**

Domain	Data	Evaluation Criteria
G – Grid Conditions	IOU Integration Capacity Analysis (ICA) maps	Existing grid assets and integration capacity
A – Air Quality	California Department of Motor Vehicles populations, CEC GHG emission factors, CalEnviroScreen pollution data	Transportation GHG emission profiles
T – Travel Demand	EVI-Pro, California Statewide Travel Demand Model, Alternative Fuels Data Center	Electric vehicle trip density and travel-demanded charging
E – Equity Considerations	Senate Bill 1000 analysis, Location Affordability Index	Distribution of EVSEs within disadvantaged communities

Source: CEC

In terms of regional grid planning, EDGE will act as an “early warning system.” The algorithmic approach compares the load contributions from the CEC’s infrastructure model results to the capacities of existing distribution grids in the state to host new electricity loads. Where there is insufficient capacity to host new loads, this comparison shows a net capacity deficit. If there is a capacity deficit in a location, EDGE flags that location as needing an infrastructure upgrade.

## Modeling Results

Initial EDGE modeling focused on the grid conditions domain, and future iterations will incorporate air quality, travel demand, and equity domains. Preliminary results (Figure 21) based on IOU Integration Capacity Analysis (ICA) maps show large areas of the grid with little to no excess capacity. They also show significant gaps in available utility grid data, largely in publicly owned utility (POU) territories. This analysis and the accompanying maps can be updated as more utility distribution grid capacity information becomes available. For instance, recognizing that the ICA maps represent a monthly snapshot of a distribution system that frequently changes (for example, with switching, reconfiguration, and constant work to

prepare upgrades), staff is incorporating additional data from the Grid Needs Assessment Reports that consider loading and generation conditions over a longer time frame, as well as pending updates to the Uniform Load results.<sup>67</sup> EDGE can similarly be used to compare information from the CEC's infrastructure model results to assess progress toward various targets and could be one indicator of where to focus charger deployment or capital investments.

---

67 CPUC. [Administrative Law Judge's Ruling on Joint Parties' Motion for an Order Requiring Refinements to the Integration Capacity Analysis](https://docs.cpuc.ca.gov/PublishedDocs/Efile/G000/M361/K810/361810169.PDF), Rulemaking 14-08-013, January 27, 21, <https://docs.cpuc.ca.gov/PublishedDocs/Efile/G000/M361/K810/361810169.PDF>



**Figure 21: EDGE Capacity Analysis and Data Gaps**

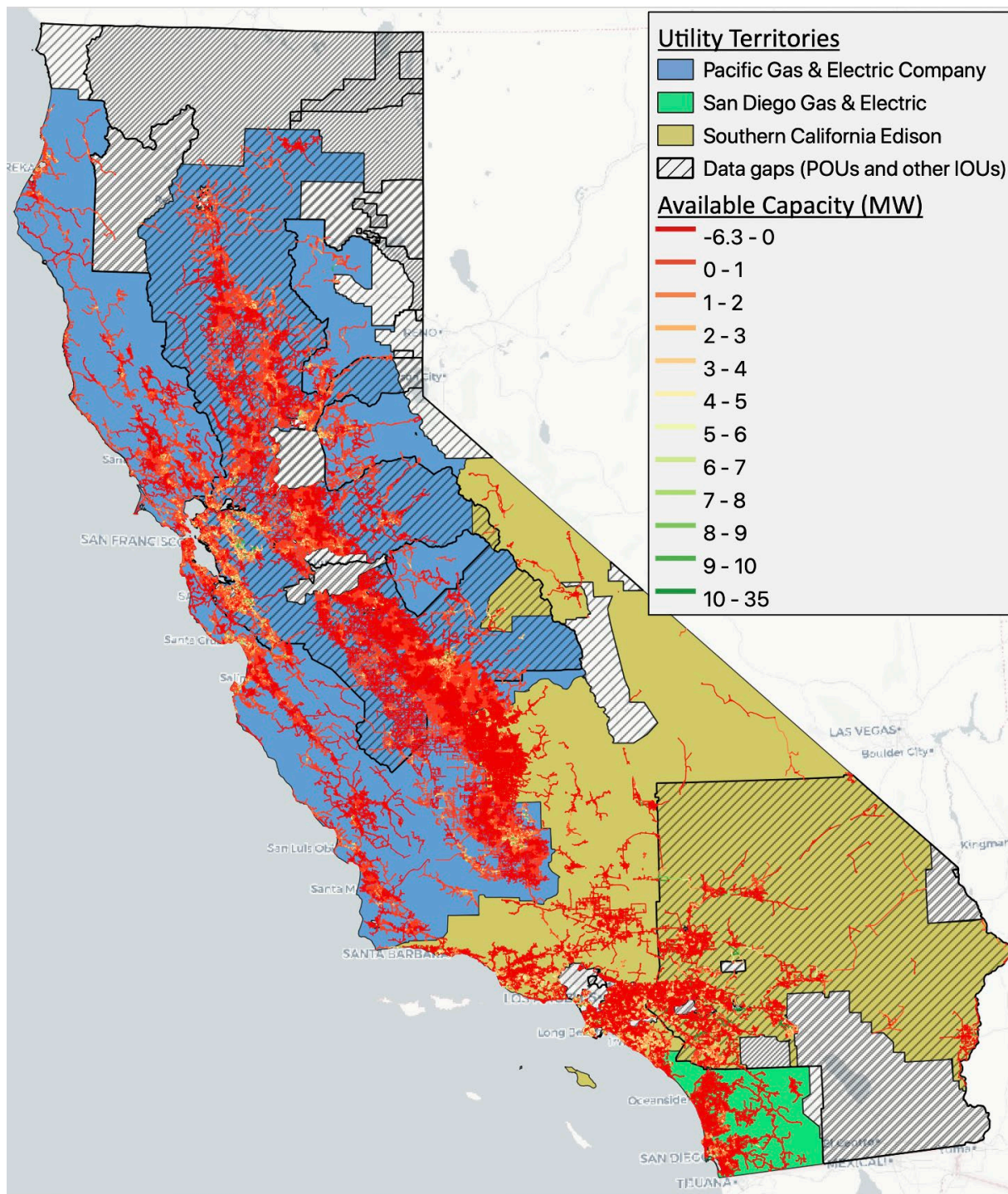

Red lines indicate areas where the grid cannot accommodate additional load without any thermal or voltage violations. Grey hatched areas indicate regions where gaps in utility grid data exist (mostly in POU service areas). Colored lines, keyed in the legend, indicate the available circuit capacity in megawatts.

Source: CEC

## **Policy Implications**

EDGE and other CEC modeling indicate that the necessary make-ready infrastructure to support EVSEs requires special attention and investment. The costs that make up this investment include transformers, meters, breakers, wires, conduit, and associated civil engineering work. These costs and time frames can be highly variable and difficult to predict. The extent of utility involvement is also an important factor.

Moreover, as medium- and heavy-duty electrification progresses (especially with CARB's new Advanced Clean Trucks and Innovative Clean Transit rules), existing make-ready infrastructure may need to serve higher-than-anticipated levels of charging load. Preliminary research suggests that most electric utilities in California have enough capacity in urban areas along the Interstate 5 corridor to support new medium-duty vehicle charging, but many rural areas and most heavy-duty charging stations will require local distribution grid upgrades, often including dedicated substations.<sup>68</sup> As an "early warning system" to help pinpoint the needs for these upgrades, EDGE can provide valuable assistance to transportation electrification planners.

## **Summary of Quantitative Modeling**

The CEC's array of modeling analyzes statewide charger needs for the widespread electrification of light-duty intraregional and interregional travel, TNC vehicles, and MD/HD vehicles. They also track local grid capacity, air quality, travel demand, and equity considerations. Table 12 summarizes the results from these quantitative models in support of CARB's *Draft 2020 Mobile Source Strategy* planning scenario. As mentioned throughout this chapter, the light-duty infrastructure models are not completely harmonized at this point. In particular, EVI-Pro 2 and EVI-RoadTrip do not account for chargers that can be used for multiple purposes (for example, short-distance and long-distance trips). However, WIRED does consider the results of EVI-Pro 2 and EVI-RoadTrip to estimate the additional chargers needed to support TNC charging. The overall effect of this is a potential overestimation of the needed charging infrastructure, particularly DC fast chargers. However, the impact of this is expected to be relatively minor since the models serve unique and distinct use cases. Future work will aim to increase the synergy between models.

---

68 West Coast Clean Transit Corridor Initiative. 2020.



**Table 12: Summary of Quantitative Modeling Results**

Model Name	Results
EVI-Pro 2	Between 1,086,000 and 1,229,000 chargers needed at MUDs, workplaces, and public locations to support electrified intraregional travel for nearly 8 million light-duty ZEVs in 2030. This estimate includes 265,000 to 395,000 Level 1 and Level 2 chargers at MUDs, 791,000 to 803,000 public and work Level 2 chargers, and 30,000 to 31,000 public DC fast chargers.
EVI-RoadTrip	Between 2,108 and 7,408 public DC fast chargers needed to support electrified interregional trips for more than 5 million light-duty BEVs (out of nearly 8 million light-duty ZEVs) in 2030.
WIRED	More than 2,100 public DC fast chargers needed in the Greater Los Angeles, San Diego County, and San Francisco Bay Area regions to support electrified TNC vehicles in 2030.
HEVI-LOAD	Around 141,000 50 kW and 16,000 350 kW DC fast chargers needed to support electrified travel for 180,000 battery-electric MD/HD vehicles in 2030.
EDGE	Figure 21 shows an analysis of existing IOU ICA maps.

Source: CEC

EVI-Pro 2, EVI-RoadTrip, and WIRED in concert project that California will need 1,127,000 Level 2 chargers and 37,500 DC fast chargers to support nearly 8 million light-duty ZEVs by 2030. In some cases, Level 1 chargers may be a sufficient substitute for Level 2 chargers serving MUDs.

Future work will make the modeling analyses and results presented in this chapter more publicly accessible. As noted earlier in this chapter, stand-alone reports for EVI-Pro 2, EVI-RoadTrip, and HEVI-LOAD are anticipated to be published in 2021 and will provide more details on the methods, inputs, assumptions, and sensitivities for each model. In addition, public-facing tools are planned to be updated and developed to create an interactive means of visualizing, engaging with, and leveraging these results. For example, the EVI-Pro Results Viewer<sup>69</sup> is planned to be updated this year to incorporate updated EVI-Pro 2 analysis and potentially show EVI-RoadTrip results as well.

The CEC’s modeling and collaboration with stakeholders shows a large need for additional infrastructure to support improvements in public health and reductions in GHG emissions. While modeling efforts are imprecise, all scenarios indicate the need for a ramp up of

---

<sup>69</sup> [EVI-Pro Results Viewer](https://maps.nrel.gov/cec/), <https://maps.nrel.gov/cec/>.

investments and charging infrastructure deployments. The targets and build-outs are achievable with continued collaboration and a focus on accessibility.

# **CHAPTER 5:**

## **Meeting California’s Technological Needs for Charging Infrastructure**

---

The previous chapter highlighted results from CEC models, which project that California will need nearly 1.2 million public and shared private chargers to meet the mobility demands of nearly 8 million light-duty ZEVs by 2030. Increasing electrification of MD/HD vehicles and equipment further necessitates rapid charger deployment throughout the state. Chapters 5, 6, and 7 will discuss how California can meet these charging infrastructure needs and ensure that charging is accessible, equitable, smart, and convenient for all.

### **Pursue Greater Vehicle-Grid Integration to Support Grid Reliability, Provide Energy Resiliency, and Minimize Cost**

As discussed in Chapter 4, charging millions of vehicles will introduce significant load onto California’s electric grid (Figure 13). Widespread vehicle-grid integration is necessary to support grid reliability and ensure that vehicles are charged with the cleanest and cheapest electricity possible. Vehicle-grid integration, which encompasses a suite of economic and technological tools to enhance the charging behavior of PEVs, will help minimize driver charging costs, align charging with renewable energy generation, and even empower vehicles to supply the stored energy to homes, businesses, or the grid.

#### **Smart Charging**

Smart charging, a basic form of vehicle-grid integration, involves reducing the power or shifting the timing of charging based on electricity pricing, carbon intensity,<sup>70</sup> demand response, or other grid signals, while ensuring that a driver’s range and departure time requests are met. Results from EVI-Pro 2 show that a significant portion of 2030 PEV charging will not naturally align with daytime solar generation. While current projections indicate that nonresidential charging demand will generally align with solar generation, more than 60 percent of total charging energy will still be demanded when sunshine is not abundantly available (between 5 p.m. and 9 a.m.).<sup>71</sup> Further, model results suggest that electricity

---

70 Carbon intensity refers to the level of carbon emissions associated with an activity, such as electricity generation. Low-carbon intensity electricity means electricity which was generated with low levels of carbon emissions.

71 EVI-Pro 2 projects that only 38 percent of total charging energy will be demanded between 9 a.m. and 5 p.m. on weekdays, when solar generation is widely available.

demand from vehicle charging will surge at the late-night hours (typically midnight) when off-peak electricity rates take effect and charging timers simultaneously switch on. Despite the time flexibility afforded by nighttime charging, such an instantaneous spike in electricity demand may compromise local grid reliability and necessitate investments in grid upgrades, particularly in urban areas.<sup>72</sup> Smart charging can address these “timer spikes” by enabling vehicles to automatically shift or reduce charging based on local or system capacity<sup>73</sup> while still ensuring the battery is sufficiently charged to meet the driver’s mobility needs. Further, smart charging can enable drivers to receive compensation for participating in such demand response programs.<sup>74</sup>

In addition to promoting grid reliability, smart charging can help integrate California’s growing renewable energy sources by aligning charging to times when solar or wind generation is abundant. Balancing authorities throughout the state, such as the California Independent System Operator (California ISO), must balance real-time electricity generation and demand across the power system. Occasionally, renewable sources generate more power than is demanded by the grid, and these sources are temporarily shut off to prevent overloading the grid. For example, data from May 2019 indicate that the California ISO curtailed enough solar and wind generation to cover all the charging needs for every plug-in passenger car in California for the entire month.<sup>75</sup> Given that more than 70 percent of vehicles are parked at home or work at noontime,<sup>76</sup> smart charging has the potential to promote greater coordination between vehicle charging and surplus renewable energy. In a future with widespread smart charging, utilities and service providers that aggregate and manage EV load can use hourly pricing and carbon intensity signals to encourage vehicles to charge during periods of excess

---

72 In their joint smart charging project report, BMW and PG&E noted that “Nighttime charging can be more beneficial if the ‘timer peak’ is eliminated,” and that timer peaks “could increase the risk of grid instability,” particularly in urban areas. BMW and PG&E. (2017). “[BMW i ChargeForward: PG&E’s Electric Vehicle Smart Charging Pilot](https://efiling.energy.ca.gov/GetDocument.aspx?tn=221489&DocumentContentId=29450).” <https://efiling.energy.ca.gov/GetDocument.aspx?tn=221489&DocumentContentId=29450>

73 The CPUC’s proposed decision concerning implementation of SB 676 identifies EV participation in demand response as a near-term policy action with broad support, and notes that “EV charging load’s demand responsiveness could be a source of local or system capacity ... through either a tariff-based mechanism or by allowing EVs to bid into resource adequacy markets.” CPUC. (November 2020). “[Proposed Decision Concerning Implementation of Senate Bill 676 and Vehicle-To-Grid Integration Strategies](https://docs.cpuc.ca.gov/PublishedDocs/Efile/G000/M350/K963/350963223.PDF).” <https://docs.cpuc.ca.gov/PublishedDocs/Efile/G000/M350/K963/350963223.PDF>

74 Ibid.

75 Based on CEC analysis of CEC, DOT, and DOE vehicle data.

76 California Public Utilities Commission Energy Division, [Vehicle - Grid Integration: A Vision for Zero-Emission Transportation Interconnected throughout California’s Electricity System](#), March 2014.

renewable generation automatically and seamlessly and thereby maximize the use of local clean energy.<sup>77</sup>

Finally, smart charging can yield significant cost savings for drivers. By considering local electricity rates and the driver's range requirements, a smart charging algorithm can automatically align charging with the lowest electricity prices while ensuring that the battery is sufficiently charged by the driver-set departure time. These savings are not trivial: for a San Diego driver who would normally plug in at 5 p.m. after work, shifting all charging to San Diego Gas & Electric's (SDG&E) "Super Off-Peak" hours can slash electricity costs by more than half.<sup>78</sup> While drivers can look up local electricity rates and manually set charging timers, or plug and unplug their vehicles at the appropriate times, smart charging achieves the same cost savings automatically and consistently.

In certain settings, smart charging has additional cost-saving features. For public or workplace charging where the commercial or industrial electricity rate includes a demand charge based on peak power use for the month, these algorithms can dynamically coordinate charging with other loads at the site to minimize electricity costs.

Smart charging will be increasingly important as California plugs in millions more PEVs in the coming years and continues expanding renewable electricity generation. Convenient and widespread smart charging will depend on chargers that can easily communicate with vehicles and the grid; these enabling technologies are discussed later in this chapter.

### **Bidirectional Charging**

Beyond smart charging, California should also encourage bidirectional technologies that allow PEVs to safely export stored battery energy. Most PEVs today are not equipped with bidirectional hardware, but bidirectional-capable vehicles — such as the recently announced

---

<sup>77</sup> Herter, Karen and Gavin Situ. 2020. [Analysis of Potential Amendments to the Load Management Standards: Load Management Rulemaking](#), Docket Number 19-OIR-01. California Energy Commission. Publication Number: CEC-400-2021-003-SD. <https://efiling.energy.ca.gov/GetDocument.aspx?tn=237306&DocumentContentId=70488>.

<sup>78</sup> Based on SDG&E's TOU-DR1 rate schedule as of July 2020.

Lucid Air,<sup>79</sup> Ford F-150 Lightning,<sup>80</sup> and Rivian R1S and R1T<sup>81</sup> — could open new opportunities for cars to power homes and businesses and provide grid support services in exchange for payment. Cleanly and quietly powering homes using a portion of the significant onboard battery energy of a vehicle can provide vital resiliency during grid outages, especially for communities affected by public safety power shutoffs.<sup>82</sup> While the technologies to support such a setup exist, stakeholders must address several barriers before commercial vehicle-to-home solutions can become widely available. These barriers include vehicle-charger communication protocols, the creation of a protocol for metering the reverse flow of electricity through an EVSE<sup>83</sup>, considerations for vehicle warranty agreements, and updated utility interconnection rules, among others. In the immediate term, the CEC should support bidirectional charging by confirming interconnection paths for inverters designed for “mobile energy storage,” including possibly leveraging the Energy Commission’s Solar Equipment Lists, used to provide information and data that support existing solar incentive programs, utility grid connection services, consumers and state and local programs.<sup>84</sup> Creating streamlined

---

79 The Lucid Air will feature “full bi-directionality for advanced Vehicle-to-Everything (V2X).” Lucid Motors. Accessed November 2020. “[Lucid Air to be the Fastest Charging EV, Featuring a 900V+ Architecture Delivering a Charging Rate of up to 20 Miles Per Minute.](https://www.lucidmotors.com/media-room/lucid-air-fastest-charging-ev/)” <https://www.lucidmotors.com/media-room/lucid-air-fastest-charging-ev/>.

80 The Ford F-150 will feature bidirectional power transfer. Wall Howard, Phoebe, “[Ford reveals plan for \\$700M plant, jobs at Rouge plus all-electric Ford F-150 secrets,](https://www.freep.com/story/money/cars/ford/2020/09/17/ford-invests-rouge-electric-f-150-uaw/5819541002/)” *Detroit Free Press*, September 17, 2020. <https://www.freep.com/story/money/cars/ford/2020/09/17/ford-invests-rouge-electric-f-150-uaw/5819541002/> and “[How the 2022 Ford F-150 Lightning can power your house for days,](https://www.cnet.com/roadshow/news/2022-ford-f-150-lightning-intelligent-backup-power/)” Road Show by CNET, May 19, 2021. <https://www.cnet.com/roadshow/news/2022-ford-f-150-lightning-intelligent-backup-power/>.

81 Rivian vehicles will be capable of “Rivian-to-Rivian” charging. Evans, Sean. “[The Drive Interview: Rivian Automotive Founder and CEO RJ Scaringe,](https://www.thedrive.com/tech/28323/the-drive-interview-rivian-automotive-founder-and-ceo-rj-scaringe/)” June 5, 2019. [https://www.thedrive.com/tech/28323/the-drive-interview-rivian-automotive-founder-and-ceo-rj-scaringe](https://www.thedrive.com/tech/28323/the-drive-interview-rivian-automotive-founder-and-ceo-rj-scaringe/).

82 California Energy Commission. [Staff Workshop - Vehicle-to-Building \(V2B\) for Resilient Backup Power](https://www.energy.ca.gov/event/workshop/2021-01/staff-workshop-vehicle-building-v2b-resilient-backup-power), January 25, 2021. <https://www.energy.ca.gov/event/workshop/2021-01/staff-workshop-vehicle-building-v2b-resilient-backup-power>.

83 AC EVSE being deployed in 2021 and DC EVSE in 2023 may have enabling technologies for this purpose. In 2020, the California Division of Measurement Standards (DMS) adopted regulations (<https://www.cdfa.ca.gov/dms/programs/zevfuels/>) pertaining to the accuracy of AC and DC EVSE that transfer electricity to a vehicle for a fee. The DMS regulation comprises the requirements in the National Institute of Standards and Technology (NIST) Handbook 44, Section 3.40. Electric Vehicle Fueling Systems, which include requirements for 1.0 percent acceptance tolerances for both types of EVSE as defined in [Table T.2.](#) of the regulation text and the [Final Statement of Reasons](https://www.cdfa.ca.gov/dms/pdfs/regulations/EVSE-FSOR.pdf) (<https://www.cdfa.ca.gov/dms/pdfs/regulations/EVSE-FSOR.pdf>).

84 The CEC’s Solar Equipment Lists include equipment that meets established national safety and performance standards.

interconnection pathways that accommodate AC<sup>85</sup> and DC<sup>86</sup> vehicle discharge will promote rapid growth of bidirectional technologies and help unlock the potential for EVs to be a power source for homes and businesses.

In addition to offering energy resiliency, bidirectional charging solutions enable more continuous monetization of this flexible energy resource via controlled and repeated charge and discharge cycles. This capability sets it apart from smart charging, whose beneficial grid interaction ends once the car batteries are charged. Thus, bidirectional technologies unlock greater revenue-generating opportunities for vehicles to aid and support the grid. For example, a utility program could offer bill credits in exchange for responding to signals requesting that vehicles discharge power to the grid alleviate local power constraints. Another program could compensate homeowners for switching from grid power to vehicle battery power during periods of extreme electricity demand. Such programs could significantly reduce vehicle ownership costs for drivers while reducing grid infrastructure upgrade costs and improving system reliability. As transportation electrification grows, California will need to continue work on enabling a market that liberates the cost savings from grid-integrated charging for all stakeholders. The CEC is developing an update to the *Vehicle-Grid Integration Roadmap* that will discuss the necessary policy and technological steps to realize a future where programs, vehicles, and infrastructure supporting vehicle-grid integration are widely available.

## **Prioritize Standardized and Interoperable Charger Connectors and Communications**

Despite years of market experimentation, charger connectors and communication protocols remain fragmented across all PEV types. This lack of consistency inconveniences PEV drivers, increases confusion among prospective PEV buyers, and threatens to hinder widespread vehicle-grid integration. Accelerating market unification around interoperable connectors, as well as around communication protocols where networked charging makes sense, will help unlock the value of flexible charging at an immense scale and bring down the cost of charging

---

85 On AC V2G, the *2019 IEPR* at page 112 notes that CPUC's Vehicle-to-Grid Alternating Current Subgroup recommends exploring the development of lists to authenticate and authorize certified PEVs to safely discharge to the grid and analyze policy implications of multiutility and cross-state electrical and inverter certification issues. CEC. 2019. *2019 Integrated Energy Policy Report*. <https://www.energy.ca.gov/data-reports/reports/integrated-energy-policy-report/2019-integrated-energy-policy-report>.

86 On DC V2G, ordering paragraphs 38-39 of CPUC Decision 20-09-035 clarify that "Rule 21 applies to the interconnection of stationary and mobile energy storage systems," and that "equipment with stationary inverter for direct current charging of vehicles may be interconnected under the current Rule 21 language if the EVSE meets Rule 21 requirements." CPUC. September 2020. "[D.20-09-035](https://docs.cpuc.ca.gov/PublishedDocs/Published/G000/M347/K953/347953769.PDF)." <https://docs.cpuc.ca.gov/PublishedDocs/Published/G000/M347/K953/347953769.PDF>.

an EV. This market unification would foster a more efficient and understandable charging network and could deliver more value and convenience to drivers and site hosts who use networked charging. Hardware capable of advanced functions can provide cost savings and greater convenience to drivers while enhancing a site host's freedom to choose the best equipment solutions without being locked into a single provider. Where appropriate, state agencies and policy makers should leverage procurement requirements, funding opportunities, or other market signals to accelerate market unification around interoperable connectors and communication protocols.

### **Prioritize Standard Charger Connectors**

Charging connectors are the most prominent and readily apparent example of PEV charging market fragmentation. DC fast charging connectors for passenger cars are split among three designs — CCS, CHAdeMO, and Tesla — even though all effectively serve the same purpose. For a driver, this fragmentation means that fast charging requires that a driver not only find a nearby station, but verify whether that charging station has a connector compatible with their vehicle. Alternatively, some drivers may be able to purchase adapters to fast charge using other connector standards, but these adapters can cost several hundred dollars. This expense exists only because of market fragmentation.

The presence of several fast charging connector standards also increases the hardware complexity of charging stations and impedes high charger usage. Indeed, models such as EVI-Pro 2 and EVI-RoadTrip assume a unified fast charging standard such that any vehicle can use any fast charger. In the real world, the lack of connector standardization increases the number of fast chargers needed to meet California's mobility demands<sup>87</sup> and necessitates more financial investment, more planning, and more time — yet yields no additional emissions reductions, electric miles, or any tangible benefit to drivers or site hosts. Unification around a common connector standard will reduce overall network cost, improve convenience, and maximize access to charging, regardless of the driver's vehicle make or model.

Fortunately, North American market players appear to be rapidly unifying around CCS,<sup>88</sup> with Nissan announcing that its upcoming electric crossover will be equipped with a CCS inlet rather

---

87 Li, Jing. [Compatibility and Investment in the U.S. Electric Vehicle Market](https://www.mit.edu/~lijing/documents/papers/li_evcompatibility.pdf), MIT Sloan School of Management, January 27, 2019. At 28, [https://www.mit.edu/~lijing/documents/papers/li\\_evcompatibility.pdf](https://www.mit.edu/~lijing/documents/papers/li_evcompatibility.pdf).

88 Analysis by CARB shows that by Model Year 2022, 51 of the 59 BEV models expected to be available in California will use CCS. CARB. 2020. "[Public Workshop Advanced Clean Cars II](https://ww2.arb.ca.gov/sites/default/files/2020-09/ACC%20II%20Sept%202020%20Workshop%20Presentation%20%28Updated%29.pdf)." <https://ww2.arb.ca.gov/sites/default/files/2020-09/ACC%20II%20Sept%202020%20Workshop%20Presentation%20%28Updated%29.pdf>.



than CHAdeMO.<sup>89</sup> Separately, CARB staff announced a proposal to begin developing rules that would require light-duty vehicles with fast charging capability sold in California to be compatible with the CCS connector, beginning with Model Year 2026.<sup>90</sup> The CEC and other funders of charging infrastructure should align connector requirements for applicable programs and funding opportunities with the market's direction.

The lack of connector standardization is even more prevalent among MD/HD vehicles. However, the nascency of the MD/HD market may present opportunities to encourage standardization more aggressively earlier on. Many manufacturers of plug-in MD/HD vehicles use proprietary connectors that are incompatible between different vehicles, and vehicle operators have repeatedly voiced frustration about the lack of interoperability and the need to coordinate specific vehicles with specific chargers.<sup>91</sup> These concerns are especially pronounced for fleets that operate multiple equipment types, such as in cargo-handling environments where several types of vehicles from different manufacturers may be operating on a given day. While some manufacturers repurpose light-duty connectors such as CCS for use with MD/HD vehicles, many high-power standards designed specifically for the MD/HD sectors remain under development, including CharIN's conductive connector for megawatt-level charging<sup>92</sup> and SAE's J2954 for wireless charging.<sup>93</sup> While MD/HD vehicles will likely use a wide array of charging interfaces (for example, conductive connector, automated pantograph, or wireless), wherever appropriate, the state should prioritize charger deployments that use standardized and interoperable implementations.

Table 13 shows a selection of existing and under-development charging connector standards for light-duty and MD/HD applications.

---

89 Goodwin, A. July 15, 2020. "[Nissan Adopts CCS Fast-Charging With New Ariya Electric SUV.](https://www.cnet.com/roadshow/news/nissan-ariya-electric-suv-adopts-ccs-fast-charging/)" Road Show by C|Net. <https://www.cnet.com/roadshow/news/nissan-ariya-electric-suv-adopts-ccs-fast-charging/>.







90 CARB. 2020. "[Public Workshop Advanced Clean Cars II.](https://ww2.arb.ca.gov/sites/default/files/2020-09/ACC%20II%20Sept%202020%20Workshop%20Presentation%20%28Updated%29.pdf)" <https://ww2.arb.ca.gov/sites/default/files/2020-09/ACC%20II%20Sept%202020%20Workshop%20Presentation%20%28Updated%29.pdf>.

91 Panel discussion. May 2020. "[IEPR Workshop on Heavy-Duty Zero-Emission Vehicle Market Trends.](https://efiling.energy.ca.gov/getdocument.aspx?tn=233610)" <https://efiling.energy.ca.gov/getdocument.aspx?tn=233610>.

92 The National Renewable Energy Laboratory recently hosted a test event for the Megawatt Charging System. Source: NREL. October 12, 2020. [NREL-Hosted Event Supports Industry Development of Megawatt Charging System Connectors.](https://www.nrel.gov/news/program/2020/nrel-hosted-event-supports-industry-development-megawatt-charging-system-connectors.html) <https://www.nrel.gov/news/program/2020/nrel-hosted-event-supports-industry-development-megawatt-charging-system-connectors.html>.

93 SAE J2954-2 for heavy-duty vehicles is a work in progress. Source: SAE International. October 25, 2013. [Wireless Power Transfer of Heavy Duty Plug-In Electric Vehicles and Positioning Communication.](https://www.sae.org/standards/content/j2954/2/) <https://www.sae.org/standards/content/j2954/2/>.

**Table 13: Existing and Upcoming Charging Connector Standards**

Diagram	Connector Standard	Maximum Output Power	Application Notes
	SAE J1772	19.2 kW AC <sup>94</sup>	Used for Level 1 and Level 2 charging in North America. Commonly found on home, workplace, and public chargers.
	CCS	450 kW DC <sup>95</sup>	Used for DC fast charging most vehicle models in North America. Generally installed at public charging stations.
	CHAdeMO	400 kW DC <sup>96</sup>	Used for DC fast charging select vehicles models in North America. Generally installed at public charging stations.
	Tesla	22 kW AC <sup>97</sup> 250 kW DC <sup>98</sup>	Used for both AC and DC fast charging for Tesla models only.
	SAE J2954	22 kW light-duty, 200 kW MD/HD <sup>99</sup>	Wireless power transfer. The standard for MD/HD vehicles is under development.
	SAE J3105	>1 MW <sup>100</sup>	Automated connection device to charge MD/HD vehicles. Variants include pantograph “up” or “down” and pin-and-socket.
	CharIN Megawatt Charging System	4 MW <sup>101</sup>	Conductive MW-level charging for MD/HD road vehicles, ships and planes. The technical specification is under development and will undergo standardization.

Source: CEC

94 U.S Department of Energy Alternative Fuels Data Center. “[Developing Infrastructure to Charge Plug-In Electric Vehicles.](https://afdc.energy.gov/fuels/electricity_infrastructure.html)” [https://afdc.energy.gov/fuels/electricity\\_infrastructure.html](https://afdc.energy.gov/fuels/electricity_infrastructure.html).

## Charger Communication Protocols

Beyond efforts to harmonize the physical connector, there is continued stakeholder debate on the usefulness of managing charging infrastructure using network communications and software within the charger.<sup>102</sup> A substantial and unknown number of “non-networked” chargers have supported EV deployments to date<sup>103</sup> and tend to be less expensive than networked alternatives with respect to certain cost categories. However, some stakeholders contend that non-networked chargers may be insufficient to serve the broader range of needs of future EV adopters and the grid. While non-networked EVSE may continue to meet the basic needs for some segments of the growing driver population, these stakeholders emphasize the importance of leveraging network technologies to aid drivers with a variety of applications beyond basic charging.<sup>104</sup>

Even in situations where networked charging is used, a second question arises: Whether networked chargers should include certain hardware components to potentially future-proof

---

95 CharIn. 2020. “[Mapping Standards for Low- and Zero-Emission Electric Heavy-Duty Vehicles](#),” presentation. International Transportation Forum February 18-20, 2020 Workshop. <https://www.itf-oecd.org/sites/default/files/docs/charging-infrastructure-standardisation-developments-bracklo.pdf>.

96 CHAdeMO. “[Technology Overview](#).” <https://www.chademo.com/technology/technology-overview/>.

97 Tesla Motors. 2015. [Form 10-K](#). Edgar Online. <http://large.stanford.edu/courses/2015/ph240/romanowicz2/docs/tesla-annual.pdf>.

98 Tesla Motors. 2019. “[Introducing V3 Supercharging](#).” <https://www.tesla.com/blog/introducing-v3-supercharging>.

99 SAE. 2013. “[Wireless Power Transfer of Heavy Duty Plug-In Electric Vehicles and Positioning Communication J2954/2 Standard](#)”. <https://www.sae.org/standards/content/j2954/2/>.

100 CharIn. 2020. “[Mapping Standards for Low- and Zero-Emission Electric Heavy-Duty Vehicles](#),” presentation. International Transportation Forum February 18-20, 2020 Workshop. <https://www.itf-oecd.org/sites/default/files/docs/charging-infrastructure-standardisation-developments-bracklo.pdf> and CharIn. 2021. [Megawatt Charging System](#), <https://www.charin.global/technology/mcs/>.

101 Ibid.

102 A [comment](#) submitted by the California Electric Transportation Coalition (CalETC) indicated that networked charging and standardized charger-to-vehicle communication may not be appropriate in many instances.

103 A comprehensive accounting of non-networked chargers is unavailable for private chargers, especially in the residential segment, and those installed independently from incentive programs. Lopez, Thanh. California Energy Commission “[Counting Electric Vehicle Chargers in California](#).” 20-TRAN-03, Workshop, June 10, 2020, page 15-16. <https://efiling.energy.ca.gov/GetDocument.aspx?tn=233391&DocumentContentId=65903>

104 Detailed below, automotive manufacturers, charging equipment manufacturers, charging service providers, technology consultants, and environmental advocates.

installations to support communication with upcoming electric vehicle models. It is important to emphasize that there are two separate questions. One is whether networked chargers are appropriate for each use case and market segment. The other is, when a charger is network capable, whether it should also include certain hardware to be capable to support a certain communication protocol, which in this case is the International Organization for Standardization (ISO) 15118 standard.

ISO 15118 has proponents who believe that it has the potential to create a unifying baseline for communication and interoperability across different EVSEs and vehicles. However, others contend that ISO 15118 is not ready for broad implementation and could be more costly than their preferred alternatives. To further complicate the debate, because ISO 15118 may have the potential to support many different use cases, there are those who believe ISO 15118 is well suited for some use cases but not other uses cases.

In cases where networked chargers have been deployed, the market has been slow to implement standardized communication protocols between the vehicle and charger, and between the charger and network. All chargers equipped with a J1772 connector for AC charging today are capable of rudimentary vehicle-to-charger “low-level” communications using a pulse-width modulated signal over the electrical connection via IEC 61851. IEC 61851 communicates basic information, such as requested and available charge current, but it is not capable of valuable functions enabled by secure “high-level” communications such as accounting for the driver’s mobility needs, scheduling, electricity pricing, vehicle discharge commands, or authentication and billing. Therefore, current methods for charge session payment and vehicle-grid integration are handled through external means. These external methods can require a separate smartphone app, membership card, manual input from the driver, or vehicle telematics. This situation may be exacerbated by the growing number of EVSE and vehicle options if they each rely solely on proprietary communication pathways.

While these external methods provide a basic level of service, the customer experience varies widely by vehicle make and charging network.<sup>105</sup> These methods may have limited potential for grid-integrated charging in the long term.

This assessment describes two key communication protocols that can enable progress in this area. While these are not the only communication protocols available to EVSPs and vehicle manufacturers, they show promise in unifying disparate pathways, supporting grid-integrated charging, and improving the customer experience.

## **Open Charge Point Protocol and Open, Standards-based Network Communications**

---

<sup>105</sup> Improving the convenience and driver satisfaction with charging will help increase mass adoption of electric vehicles. See John Voelcker, “[Range Anxiety Is Very Real, New J.D. Power EVs Survey Finds](#),” Forbes, January 20, 2021, with reference to J.D. Power, “[Electric Vehicle Experience \(EVX\) Public Charging Study](#),” 2021.

Charger-to-network communications using the Open Charge Alliance’s Open Charge Point Protocol (OCPP) can provide charger operators and site hosts greater flexibility, choice, and control over their chargers. Network management systems provide site hosts a centralized way to connect and communicate with portfolios of chargers. Using network management software, hosts can monitor charger status, connect chargers to signals for local electricity pricing and demand response, and even set up reservation systems to allocate time slots for users. OCPP provides a common language to promote this communication between chargers and network management systems, and is already the de-facto standard for much of charger-network communication.<sup>106</sup>

Generally, any charger that is OCPP-compliant will work with any back-end network that is also OCPP-compliant.<sup>107</sup> With widespread charger-network interoperability, site hosts are free to manage a mixed portfolio of charging hardware under a single networking solution, regardless of the model or manufacturer of each charger. Furthermore, site hosts can “shop around” for back-end network solutions based on features, convenience, or price. This two-way flexibility ensures that site hosts are never locked into any single back-end network or charger manufacturer, minimizing the risk of stranded assets and spurring marketplace competition and lowering costs.

For these reasons, many stakeholders support the implementation of OCPP for network communications,<sup>108</sup> with some specifically preferring immediate implementation of OCPP 2.0 accompanied by third-party certification.<sup>109</sup> Parties also highlighted the continued development of the successor to OCPP,<sup>110</sup> IEC 63110, which is designed to operate alongside charger-to-vehicle communications.<sup>111</sup>

---

106 Neaimah, M., Andersen, P.B. [Mind the gap- open communication protocols for vehicle grid integration](https://energyinformatics.springeropen.com/articles/10.1186/s42162-020-0103-1). Energy Inform 3, 1 (2020). <https://energyinformatics.springeropen.com/articles/10.1186/s42162-020-0103-1>

107 Under the Open Charge Alliance’s certification program, a charger is OCPP-compliant only if it successfully communicates with at least two OCPP-compliant networks. Source: Siemens. “[Charging With OCPP Standards](https://assets.new.siemens.com/siemens/assets/api/uid:11c56240-64b2-4977-8f8c-0e418dfb2a33/sids-t40036-00-4aus-lo-res.pdf).” <https://assets.new.siemens.com/siemens/assets/api/uid:11c56240-64b2-4977-8f8c-0e418dfb2a33/sids-t40036-00-4aus-lo-res.pdf>.

108 Comments filed in the 19-AB-2127 docket from [Environmental Defense Fund and Natural Resources Defense Council](#), [EVBox](#), [Siemens and Veloce Energy](#) support OCPP.

109 Comments from [Greenlots](#) highlight the OCA’s third-party certification process.

110 Comments from [ChargePoint](#) emphasize the potential to offer network management features beyond those scoped in OCPP that are in development within IEC 63110.

111 Comments from [Mercedes-Benz](#) noted the potential for enhanced charging security from IEC 63110 working with ISO 15118.

As shown in Figure 22 below, grid-responsive charging requires coordination and negotiation among many stakeholders: Utilities providing electricity, charger networks and automakers serving as aggregators, energy management systems (EMS) optimizing charging among local loads, and vehicles acting as intelligent agents on behalf of the respective drivers.<sup>112</sup> OCPP and IEC 63110 are among several open, standards-based charger-to-network “back-end” communication technologies that continue to evolve and can enable stakeholders to build an integrated ecosystem around the driver.<sup>113</sup> For “front-end” communications between the vehicle and charger, the ISO 15118 standard described below could provide a key communication link.

### **International Organization for Standardization 15118 and Alternatives**

The ISO 15118 standard defines digital communication between the vehicle and charger and provides a “language” to securely exchange information for authentication, billing, and charging parameters. Portions of ISO 15118 are widely used to control DC charging today, and some automakers and charging networks have signaled their intention to expand the use of ISO 15118 to enable more convenient, grid-integrated, and cybersecure AC charging.<sup>114</sup> However, there is ongoing debate in California on the extent to which ISO 15118 should be used to help reach the end goal of a seamless driver experience. This is discussed in additional detail below.

An optional feature of ISO 15118 is “Plug and Charge,” which allows drivers charging away from home to initiate and securely pay for a charging session simply by plugging in their

---

112 The pathways depicted in Figure 21 are derived from implementing a recommendation within Table 5 of the [VGI Communication Protocol Working Group](#), CPUC Energy Division Staff Report, February 2018, at page 25 involving “a combination of the following” protocols listed 1. OpenADR 2.0b, 2. IEEE 2030.5, and 3. OCPP between the power flow entity and the EVSE and “one of the following” EVSE-EV protocols, listed 1. ISO 15118. Within Docket 17-EVI-01 CEC sought manufacturers’ feedback upon this proposal in [June 2018](#) at pages 11-27, which was revised in [November 2019](#) at pages 47-54. The CPUC Energy Division refers to and aligns with the CEC November 2019 proposal within the Draft [Transportation Electrification Framework](#), February 2020, page 82, footnote 201.

113 To elaborate, the “driver” in this case is a person charging their EV that can be, simultaneously, a driver of an automotive OEM, an owner of a smart EVSE, a participant in a charging service provider’s load aggregation, and a retail customer of an electric utility. Flexibility in network communication can enable innovation for vehicle-grid integration across California’s energy markets without reducing interoperability for a *shared* customer like this.

114 Audi, BMW, Daimler, Ford, Lucid, Porsche, Volvo and Volkswagen have stated their intention to implement ISO 15118 for AC and DC charger communications. Source: OEM Group. January 13, 2017. “[OEM Consolidated Comment to CEC VGI Communications Standard Workshop 7 December 2016.](#)” <https://efiling.energy.ca.gov/GetDocument.aspx?tn=215326&usg=AOvVaw2ECiPPrOLaFkr8K55QBlaG>.

vehicle.<sup>115</sup> When a network connection is available, user authentication and billing are processed automatically in the background without the need to scan a membership card, tap through app menus, or swipe a credit card. The critical importance of this driver-friendly feature increases with market expansion. Numerous automakers have already introduced or will introduce U.S. vehicles that can support Plug and Charge, including Audi,<sup>116</sup> BMW, Daimler, Porsche, Volkswagen, Lucid Motors, Ford,<sup>117</sup> Hyundai,<sup>118</sup> Rivian, Volvo, and others. As the number of electric vehicle models coming to market increases, so will the need for an effortless way to authenticate and charge at work and in public settings, especially for Californians who lack access to home chargers.

In addition to improving the convenience of charging, ISO 15118 can also provide a common and user-friendly way for vehicles and chargers to communicate the necessary information for the smart and bidirectional charging capabilities described earlier. ISO 15118 algorithms rely on the driver's requested range and desired departure time, and optimize around electricity rates, local power availability, demand response events, and other dynamic information. This process can minimize charging costs and grid impacts without inconveniencing the driver. The potential of this enabling technology to improve convenience and drivers' confidence indicates

---

115 Electrify America in implementing the [Volkswagen Zero Emission Vehicle Investment Commitment](#) in California, is one of the first charging networks that has enabled Plug and Charge. Electrify America, 2020 Annual Report to California Air Resources Board, Public Version, May 3, 2021.

<https://media.electrifyamerica.com/assets/documents/original/681-2020ElectrifyAmericaCaliforniaAnnualReportPublic.pdf>.

Separately, Tritium – whose [RT50 DC fast charger is whitelabeled](#) for deployment within several other charging providers (including EnelX and Siemens) – is rolling out software updates to enable Plug and Charge on its charging hardware. Tritium. "[Tritium Launches Software Update for RT50 Chargers to Unlock Plug and Charge Capabilities](#)," March 16, 2021. <https://tritiumcharging.com/tritium-launches-software-update-for-rt50-chargers-to-unlock-plug-and-charge-capabilities/>

116 In a [joint comment](#) to the CPUC, Audi, BMW, Daimler, Lucid, Porsche, and VW stated their intention to implement ISO 15118 on their future vehicles, including the Plug and Charge feature.

<https://www.cpuc.ca.gov/WorkArea/DownloadAsset.aspx?id=6442457082&usg=AOvVaw397WEvjy9d6c7n-6nZhrFY>.

117 Ford's Mustang Mach-E features Plug and Charge. Source: Ford. [Convenience on the Road](#).

<https://www.ford.com/buy-site-wide-content/overlays/mach-e-overlays/convenience-on-the-road/>.

118 Hyundai's upcoming IONIQ 5 will feature Plug and Charge. [Hyundai press release translated from Korean](#).

<https://news.hmgjournal.com/MediaCenter/News/Press-Releases/%ED%98%84%EB%8C%80%EC%9E%90%EB%8F%99%EC%B0%A8-%EC%95%84%EC%9D%B4%EC%98%A4%EB%8B%89-5-%EC%84%B8%EA%B3%84-%EC%B5%9C%EC%B4%88-%EA%B3%B5%EA%B0%9C>



that “implementing the 15118 standard may increase the driver’s willingness to participate in controlled charging programs,” according to one major charging infrastructure provider.<sup>119</sup>

The ISO 15118 standard is evolving to incorporate additional features. An update to ISO 15118 later in 2021 will expand the standard to include bidirectional charging, enabling vehicles and chargers to communicate power limits, power transfer method (such as AC, DC, or wireless), and local grid parameters for features such as vehicle-to-home.<sup>120</sup>

Given the capabilities of ISO 15118, deploying ISO 15118-ready equipment in new networked charger installations could help ensure that the greatest number of new vehicles can securely exchange the information necessary for efficient coordination with the grid. “ISO 15118-ready equipment” is charging equipment with the necessary hardware components to implement the standard. Today, many chargers are not equipped with the transceiver chip (estimated to cost less than \$10 per EVSE<sup>121</sup>) and hardware security module<sup>122</sup> that enable ISO 15118 communication and secure payment processing. As a result, automakers are already exploring some vehicle-grid integration capabilities using vehicle telematics as an alternative path.<sup>123</sup> Some may continue to prefer supporting these features using brand-specific solutions, such as the exclusive use of vehicle telematics. As ISO 15118-ready chargers become increasingly

---

119 Patadia, Shana and Rodine, Craig (ChargePoint). 2019. *Next-Generation Grid Communications for Residential PEV*. California Energy Commission. Publication Number: [CEC-500-2019-009](#) at page 3.

120 ISO/DIS 15118-20 [Road vehicles — Vehicle to grid communication interface — Part 20: 2nd generation network and application protocol requirements](#). <https://www.iso.org/standard/77845.html?browse=tc> As of May 6, 2021, ISO 15118-20 is in the final stage of [Enquiry](#), with a “Full report circulated: Draft International Standard (DIS) approved for registration as Final Draft International Standard (FDIS),” prior to approval.

121 [IoTecha](#) estimates the hardware to enable ISO 15118 to be on the order of \$5 for a powerline carrier transceiver or \$7 with a filter. IoTecha. Accelerating EV Adoption Leveraging the Economy of Scale, Presentation to California Public Utilities Commission, May 29, 2017, <https://www.cpuc.ca.gov/WorkArea/DownloadAsset.aspx?id=6442454191b>. This estimate is corroborated by Energy Commission staff analysis identifying transceivers from [Qualcomm](#) and [ST](#): Fauble, Brian and Crisostomo, Noel. California Energy Commission. “[Future Equipment Requirements for CALeVIP](#).” 17-EVI-01 California Electric Vehicle Infrastructure Workshop, November 18, 2019, page 52-53. <https://efiling.energy.ca.gov/GetDocument.aspx?tn=230794&DocumentContentId=62410>. [Lumissil](#) and [MediaTek](#) announced additional transceivers, in February 2021 and July 2020, respectively.

122 Some EVSEs include a hardware security module for cryptography. Cost estimates are unavailable.

123 Many vehicles are equipped with telematics systems (also referred to as telemetry). Telematics systems are generally proprietary to each automaker, and enable automakers to monitor and communicate with vehicles. Some automakers have demonstrated limited vehicle-grid integration capabilities using telematics.



common, other automakers may begin implementing ISO 15118 use cases that work in conjunction with their vehicle telematics,<sup>124</sup> infotainment systems,<sup>125</sup> and mobile applications.

In response to the discussion of ISO 15118 in the January 2021 Staff Report version of this assessment, the CEC received numerous comments from stakeholders. Several stakeholders emphasized the need to address existing charger communication fragmentation and encourage greater standardization.<sup>126</sup> A coalition of charging providers highlighted the need for increased information sharing among automakers and charging providers to guide implementation of ISO 15118 use cases,<sup>127</sup> and several emphasized the need to future-proof state investments with ISO 15118-ready equipment.<sup>128</sup> One automaker highlighted the role of ISO 15118 in a cybersecure charging ecosystem.<sup>129</sup> Providers of bidirectional chargers noted a convergence toward CCS and ISO 15118, but clarified that custom software extensions would be necessary to enable bidirectionality until the ISO 15118-20 update is issued.<sup>130</sup> A joint comment submitted by a coalition of vehicle manufacturers, charger hardware and software providers, advanced transportation consortia, and an environmental organization emphasized that the CEC should signal to the market an intention to utilize ISO 15118 for state investments, in order to enable an adequate phase-in timeframe.<sup>131</sup>

In contrast, other commenters stated that it is premature to implement ISO 15118 hardware specifications, with some pointing to costs of operating a network and pending cybersecurity efforts.<sup>132</sup> A separate joint comment submitted by a coalition of numerous automakers and utilities also expressed concern that ISO 15118 may slow infrastructure deployment, and

---

124 For example, BMW notes the use of telematics and ISO 15118 for various VGI capabilities on slides 2-3. Working Group CPUC, July 24, 2017, <https://www.cpuc.ca.gov/WorkArea/DownloadAsset.aspx?id=6442454207>.

125 The infotainment system generally appears on the vehicle's center screen, and is how the driver controls the radio, audio system, phone connections, navigation, apps, and other settings.

126 These include comments submitted by [Cruise](#), [Environmental Defense Fund](#), [Natural Resources Defense Council](#), [Sierra Club](#), and [Volvo](#).

127 The need for greater information sharing was noted by both the [Electric Vehicle Charging Association](#) (a coalition of 13 charging providers) and [Flo](#).

128 [EVBox](#), [Greenlots](#), [Hubeject](#), [IoTecha](#), [Next Dimension](#) and [Oxygen Initiative](#) emphasized the need to future-proof state charger deployments by investing in ISO 15118 capable equipment.

129 [Mercedes-Benz Research & Development North America](#) stated "ISO 15118 is a vital building block of a comprehensive cybersecurity architecture for electric charging systems."

130 These include comments submitted by [Fermata Energy](#), [Nuvve](#), and [Rhombus Energy Solutions](#).

131 A joint comment submitted by [Veloce Energy \(with 32 co-signers\)](#) highlighted the need for interoperability, standardization, and networked chargers to meet California's clean mobility and grid integration goals.

132 The [Alliance for Automotive Innovation](#), [CalETC](#) (with 20 co-signers), [ChargePoint](#), [PG&E](#), and [SDG&E](#) cautioned that ISO 15118 could raise costs. CalETC and ChargePoint noted that the SAE PKI project is ongoing.

suggested further cost-benefit analysis efforts, further consideration of the topic within the development of an update to the VGI Roadmap, and a technology-neutral approach.<sup>133</sup>

With or without ISO 15118-ready hardware, automakers and charging providers may seek to implement some vehicle-grid integration capabilities using custom-designed solutions with brand-specific mobile applications or protocols. However, such custom implementations may prove incompatible among different vehicle or charger models. There is the potential to progress toward interoperability through other means such as relying more extensively on “back-end” cloud-based solutions. While automakers and charging providers could leverage existing cloud solutions, this approach may require greater reliance on manual user interaction.

Regardless of the communication pathway, stakeholders should strive toward interoperability and create an environment where consumers have the ability to adopt new technologies, regardless of which EVSE or vehicle they use. Consumers should not be locked into certain products. Further, pathways should focus on cost-effective solutions that enhance the consumer experience. ISO 15118 has the potential to serve as a common language for interoperable vehicle-grid integration. Given the growing use of ISO 15118 globally among automakers and charger networks,<sup>134</sup> and continued stakeholder interest in this topic, the CEC will further examine opportunities to – if and when appropriate – advance the deployment of ISO 15118-capable charging hardware to ensure maximum preparedness for future electric vehicles and for widespread vehicle-grid integration. Investing in low-cost solutions by way of hardware readiness today could help future-proof EVSE<sup>135</sup> and ensure that all EV drivers have the opportunity to benefit from smart and bidirectional charging.

---

133 In a letter signed by multiple stakeholders, [CalEVC](#) suggested the interagency effort to update the VGI roadmap should “examine the issues around VGI and charging station payment for each charging market segment and make recommendations including ranking of competing principles and priorities.”

134 A nonexhaustive search indicates that [BTC Power](#), [Siemens](#), and [Nuvve](#) have or are developing AC Level 2 EVSE aligned with the Grid Integrated Charging Equipment Design, shown in Figure 22.

135 ISO 15118-ready chargers would be backward-compatible with vehicles using basic charging communication. Further, for maximum interoperability, chargers with the forthcoming ISO 15118-20 could be capable of supporting previous versions of ISO 15118, IEC 61851-1 Edition 3, and for DC charging DIN 70121. [CharIN comments](#) regarding Future Equipment Requirements for CALeVIP, 17-EVI-01, December 13, 2019. <https://efiling.energy.ca.gov/GetDocument.aspx?tn=231211&DocumentContentId=62857>

**Figure 22: Grid-Integrated Charging Equipment Design Archetype**

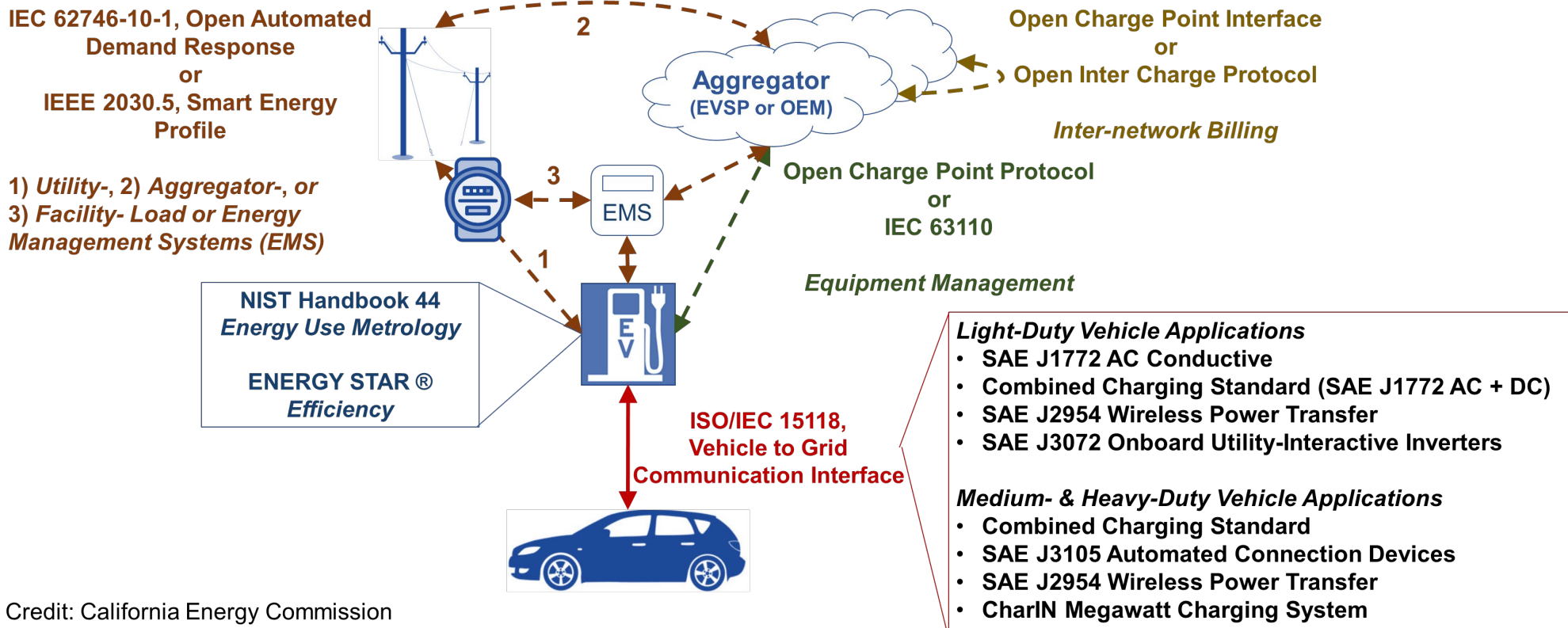

**Interoperable charging hardware may enhance and support a user-friendly and grid-responsive charging. ISO 15118 may provide a standard vehicle-charger communication language, and OCPP may provide a standard charger-network language. Widespread deployment of chargers that “speak” these languages can ensure that California is prepared for vehicle-grid integration, as well as future vehicle and charger features.**

Source: CEC

# CHAPTER 6:

## Planning for California’s Local and Community Charging Infrastructure Needs

---

### Tailor Charging Solutions So That Form Factors Match Local Needs

While all charging should incorporate standardized connectors, and networked charging should use standardized communication protocols, charger deployments must also meet the needs of the local community, built environment, and use case. There is no one-size-fits-all charging solution. Local land use, available electrical capacity, expected charger use, space constraints, the presence of distributed energy resources, and many other factors determine the most appropriate solution for a charging installation. Generally, the “best fit” charging solution maximizes the electric miles enabled at the lowest overall cost while reflecting local needs and constraints.

For instance, today grid-tied pedestal chargers may be commonplace in office parks and suburban malls. As charging is deployed in more challenging settings, for example, at a parking deck where electrical upgrades would be cost-prohibitive, a mobile unit capable of charging multiple vehicles throughout the day could be the optimal solution. And in remote areas with no or limited grid service, or for hosts who want to avoid construction permitting, a drop-in charger canopy with integrated solar and battery storage can offer the cheapest and fastest way to provide charging. Examples of chargers suited to each of these situations are illustrated in Figure 23. These innovative and unique charging products may offer significant avoided cost benefits that are not apparent when simply comparing products based on upfront cost. However, such products often do not fit neatly into existing charging infrastructure funding programs. The CEC is exploring funding approaches that better recognize and account for avoided cost benefits. Indeed, the CEC’s BESTFIT Innovative Charging Solutions solicitation demonstrated the significant demand and interest for these types of solutions, with 55 applicants requesting nearly \$60 million in CEC funding and providing more than \$37 million in match funding for light-duty and medium- and heavy-duty projects.<sup>136</sup> The proposed awardees consist of a diverse set of projects, including leveraging existing utility assets to install public curbside charging, installing shared and reservable chargers at MUDs, developing mobile chargers, electrifying a transit route with wireless chargers, demonstrating VGI with light-duty vehicles and electric school buses, and building the nation’s first dedicated truck stop for medium- and heavy-duty EVs.

---

136 CEC. “[GFO-20-605 — BESTFIT Innovative Charging Solutions.](https://www.energy.ca.gov/solicitations/2020-08/gfo-20-605-bestfit-innovative-charging-solutions)”  
<https://www.energy.ca.gov/solicitations/2020-08/gfo-20-605-bestfit-innovative-charging-solutions>.

**Figure 23: Examples of Different Charger Form Factors Based on the Local Environment**



The best-fit charging solution depends on the needs of the local community, built environment, and use case. Pedestal chargers (left) are common today and generally require a grid connection and construction permitting. FreeWire’s Mobi chargers (middle) can move about and charge multiple vehicles throughout the day and can be recharged on a standard 240 VAC outlet when not in use. Beam’s charging canopy (right) integrates solar and battery storage and can be fitted on existing parking spaces without any electrical infrastructure or permitting.

Source: CEC, FreeWire Technologies, Beam Global

## **Use Community-Centric Planning to Serve Local and Community Needs and Foster Equitable Outcomes**

Historically, transportation planning and projects have insufficiently considered the needs of the local community, particularly low-income and disadvantaged communities suffering disproportionate health impacts.<sup>137</sup> To ensure that the benefits of electrification are equitably distributed, policy makers must directly involve communities in identifying and planning high-quality charging solutions that meet local needs and yield direct community benefits. In its 2019 *Mobility Equity Framework*,<sup>138</sup> the Greenlining Institute recommends that planners involve communities via strategies such as participatory budgeting<sup>139</sup> and ensuring that community members have decision-making authority throughout the project. Furthermore, to ensure broad community inclusion and participation, CARB recommends providing financial

---

137 Greenlining Institute. (2018). [Mobility Equity Framework](https://greenlining.org/wp-content/uploads/2019/01/MobilityEquityFramework_8.5x11_v_GLI_Print_Endnotes-march-2018.pdf). [https://greenlining.org/wp-content/uploads/2019/01/MobilityEquityFramework\\_8.5x11\\_v\\_GLI\\_Print\\_Endnotes-march-2018.pdf](https://greenlining.org/wp-content/uploads/2019/01/MobilityEquityFramework_8.5x11_v_GLI_Print_Endnotes-march-2018.pdf).

138 Ibid.

139 According to the Greenlining Institute, “In participatory budgeting, community members democratically decide how to spend part of a public budget. Because the process facilitates residents brainstorming project ideas to address their needs, this is generally more robust than other community needs assessments.”

compensation to those attending community outreach events, providing transportation to such events where appropriate, and engaging in targeted outreach to hard-to-reach residents.<sup>140</sup>

One key tool to identify local needs and challenges and to promote equitable charging infrastructure deployment is an EV community blueprint. Local governments or similar jurisdictions gathered teams that often included community-based organizations to apply for CEC-funded grants for up to \$200,000 to develop EV community blueprints. These blueprints outline local policies, actions, and measures to prepare for and accelerate widespread vehicle electrification. The CEC has awarded grant funding for EV blueprint development to several jurisdictions throughout the state, including the City of Sacramento, the County of Los Angeles, and the Port of Long Beach.

To highlight one example, Ventura County brought together “over 25 stakeholders representing local governments, Port of Hueneme, workforce development interests, affordable housing authorities, commercial property management companies, community-based organizations, and nonprofit advocates.”<sup>141</sup> The coalition reached out to hundreds of employers, property managers, county employees, and members of the public, including Spanish speakers and parents of school-age children. Across the blueprints, public outreach (ranging from workshops to surveys to ride-and-drive events where participants can get inside an EV) emerged as a key tool to understand community needs and inform members of available incentives, rebates, and charging accessibility.

Fresno’s EV community blueprint, developed by a team led by Tierra Resource Consultants, focused on the charging infrastructure needs of those who live in multiunit dwellings (MUDs). There is much less access to residential charging at MUDs,<sup>142</sup> which account for about 40 percent of California’s housing stock and where its low-income residents are most likely to live.<sup>143</sup> Along with identifying market, policy, and economic barriers to ZEV adoption for low-income or MUD tenant Californians or both, the blueprint identifies a community engagement framework to support the ability of communities to drive the development process to install

---

140 CARB. “[STEP Community Inclusion Guidance](https://ww3.arb.ca.gov/msprog/step/step_community_inclusion_guidance.pdf).”  
[https://ww3.arb.ca.gov/msprog/step/step\\_community\\_inclusion\\_guidance.pdf](https://ww3.arb.ca.gov/msprog/step/step_community_inclusion_guidance.pdf).

141 VCREA, Community Environmental Council, and EV Alliance staff. 2019. [Ventura County Electric Vehicle Ready Blueprint](https://s29552.pcdn.co/wp-content/uploads/Ventura-County-EV-Ready-Blueprint_July-2019.pdf). [https://s29552.pcdn.co/wp-content/uploads/Ventura-County-EV-Ready-Blueprint\\_July-2019.pdf](https://s29552.pcdn.co/wp-content/uploads/Ventura-County-EV-Ready-Blueprint_July-2019.pdf).

142 Nicholas, Michael, Dale Hall, Nic Lutsey. 2019. [Quantifying The Electric Vehicle Charging Infrastructure Gap Across U.S. Markets](https://theicct.org/sites/default/files/publications/US_charging_Gap_20190124.pdf). [https://theicct.org/sites/default/files/publications/US\\_charging\\_Gap\\_20190124.pdf](https://theicct.org/sites/default/files/publications/US_charging_Gap_20190124.pdf).

143 Keneipp, Floyd, Nicholas Synder, Natalie Mezaki, Cory Welch. 2019. *EV Ready Low-Income Multifamily Community Blueprint*.



chargers at their homes or nearby commercial locations. This type of community-centric demand development is a crucial complement to the modeling detailed in Chapter 4.

Many blueprints identified the need for multimodal transportation hubs that provide EV charging alongside existing bus terminals, park-and-ride lots, and commuter trains to encourage EV usage and adoption. Other tools featured in the blueprints include local and regional government procurement of EVs and setting local goals that align with those of the state.

The second phase of the CEC's Electric Vehicle Ready Communities Blueprint solicitation is providing \$7.5 million for communities to implement the projects they describe in their blueprints, such as those discussed in the paragraphs above.<sup>144</sup>

## **Building Codes Are a Crucial Policy Tool to Deploy Sufficient Charging Infrastructure**

Building codes are often a cost-effective tool to support state policy, ensure equitable outcomes, and reduce barriers to EV adoption. Increased charging options at MUDs are needed to ensure that all Californians have access to convenient charging. This objective is too often a challenge at apartments and condos and for renters where the financial incentives of tenants and landlords do not always align. Building codes that address new construction as well as major renovations to existing buildings (such as when new parking is added or during repaving of an existing parking lot) can materially address the EV charging infrastructure gap identified from the modeling in Chapter 4.

Again, modeling efforts capture specific scenarios using best available data to quantify the required infrastructure needed to support California's public health and ZEV goals. However, actual deployments are influenced by various dynamics. If additional chargers of a certain plug type are available, the need for chargers of other plug types may be reduced. For example, additional Level 1 and Level 2 chargers at MUDs beyond the 265,000–395,000 projection will likely reduce the number of work and public chargers needed. These MUD chargers will provide the added benefit of convenient at-home charging with potentially more favorable electricity rates that could also serve other nonresidential charging needs during the day.

Many city and county governments are using their authority over building codes to increase EV adoption and decrease the cost of charging infrastructure. They can be either "reach" goals or mandated. Building codes are an important tool in supporting Executive Order N-79-20 and

---

144 CEC. "[GFO-19-603 - Electric Vehicle Ready Communities Phase II- Blueprint Implementation.](https://www.energy.ca.gov/solicitations/2020-08/gfo-19-603-electric-vehicle-ready-communities-phase-ii-blueprint)" <https://www.energy.ca.gov/solicitations/2020-08/gfo-19-603-electric-vehicle-ready-communities-phase-ii-blueprint>.

should be updated to ensure broad access to ZEV infrastructure for all Californians. Some local codes have already incorporated items such as:

- Distribution-level grid upgrades to make parking spaces “EV-ready” during new construction, particularly for multiunit dwellings (mandatory and reach).
- Charger or make-ready installations, particularly at multiunit dwellings (mandatory and reach).
- Load-management systems that allow multiple chargers to share one electrical connection (reach).

As recognized in assessments by state agencies, it may not be enough to focus solely on new buildings. Codes that address alterations and additions of existing buildings would likely result in significantly better availability of charging infrastructure.<sup>145</sup> Only about 10 percent of nonresidential buildings are projected to be EV capable by 2030 if building standards are limited to new construction.<sup>146</sup>

## **Recognize and Prepare for Greater Complexities With Medium- and Heavy-Duty Infrastructure Planning**

While private light-duty vehicles typically see extended periods of downtime and have flexible usage requirements, medium- and heavy-duty vehicles often adhere to demanding operation patterns that make infrastructure planning a unique challenge. California’s medium- and heavy-duty vehicles cover a broad spectrum of duty cycles and use cases, including passenger travel, goods movement, port cargo handling, long-distance transport of refrigerated goods, and urban delivery, among many others. Electrifying the medium- and heavy-duty sectors is especially critical because of the toxic air pollution from diesel exhaust that disproportionately impacts communities near ports and major trucking corridors. Improving these conditions will require solutions beyond simply scaling up the model for light-duty charging. Charging infrastructure planning for the medium- and heavy-duty sectors requires close attention to the specific vehicle duties and environments, impacts of high-power charging demand, lack of consistency in charging connectors, limitations on available truck parking,<sup>147</sup> and landlord-tenant relationships.

Each vehicle operator’s requirements for power, uninterrupted runtime, duty type, and downtime available for refueling directly affect the design and sizing of the appropriate

---

145 California Public Utilities Commission, *Draft Transportation Electrification Framework*, page 122.

146 California Air Resources Board staff. 2019. *EV Charging Infrastructure: Nonresidential Building Standards*. California Air Resources Board.

147 Caltrans. [California Freight Mobility Plan 2020](https://www.caltrans-itsp2021.org/files/managed/Document/120/final-cfmp-2020-appendix-remediated-a11y.pdf) at page 447. <https://www.caltrans-itsp2021.org/files/managed/Document/120/final-cfmp-2020-appendix-remediated-a11y.pdf>.



hardware. A charger to deliver energy to a school bus overnight would be insufficient for a heavy-duty forklift with only a few hours of downtime each day. Furthermore, the operating site for the vehicle may introduce unique constraints to charger selection, such as spacing and clearance concerns, work rules governing plugging and unplugging vehicles, and limitations on available grid electrical capacity for charging. The result of such operator-specific complexities is that the most appropriate charger type — whether a conductive connector charger, pantograph, or wireless charger — may vary significantly from site to site, even for ostensibly similar vehicles.

To illustrate this point, in 2017, the CEC awarded around \$8 million each to the Port of Long Beach and the Port of Los Angeles for charging infrastructure installations to support new battery-electric yard tractors. While both projects received roughly the same amount of funding for charging infrastructure, each project allocated funds differently to match their operating demands. The Port of Long Beach spent \$6.7 million on construction and service upgrades alone, while the Port of Los Angeles spent only about \$2 million in construction costs and used a more significant portion of funding to purchase charger hardware itself. These projects illustrate how vehicle duty cycles and site-specific needs drastically affect charging infrastructure costs, and how costs can vary widely even when the environment or goals appear similar. Policy makers must recognize that while one particular deployment solution could be scaled to meet the energy needs of select medium- and heavy-duty vehicles, meeting the broad needs of all fleets statewide requires a diverse range of chargers to accommodate different power levels, geometries, and duty cycles. Recognizing this fact, in July 2020, the CEC announced \$3 million in funding to help entities in California develop blueprints that identify needs, actions, and milestones for medium- and heavy-duty charging infrastructure deployment.<sup>148</sup>

Medium- and heavy-duty vehicles, being more massive than the light-duty counterparts, generally use more energy to operate and require higher charging power. Power levels to charge these vehicles may reach several megawatts, potentially imposing significant challenges to local distribution grids and vehicle operators who may face costly facility upgrades. For comparison, charging one heavy-duty vehicle at 2 MW uses as much power as simultaneously fast-charging 10–20 light-duty vehicles. A preliminary analysis using the CEC’s EDGE tool found that California’s IOUs should proactively plan to accommodate MD/HD fleets, including through grid upgrades or other mitigative action.<sup>149</sup> This finding indicates that

---

148 CEC. “[GFO-20-601 — Blueprints for Medium- and Heavy-Duty Zero-Emission Vehicle Infrastructure.](https://www.energy.ca.gov/solicitations/2020-07/gfo-20-601-blueprints-medium-and-heavy-duty-zero-emission-vehicle)” <https://www.energy.ca.gov/solicitations/2020-07/gfo-20-601-blueprints-medium-and-heavy-duty-zero-emission-vehicle>.

149 Publicly owned utilities should also plan for high-powered charging deployments, but capacity maps for POUs are unavailable online and have not yet been incorporated into EDGE.

charger deployments for larger vehicles may frequently require new utility grid hardware in addition to the charger itself. Furthermore, in some off-road applications such as construction and agriculture, access to the grid may be nonexistent.

Even if additional electrical capacity is available from the grid and at the facility, depending on the utility rate structure, charger site hosts or vehicle operators could face costly demand charges based on peak power demand. Some sites can install distributed energy resources (including local generation and stationary storage) to limit facility peak demand and enable charging power levels that would otherwise be too costly or require grid upgrades. Where operational requirements allow, smart charging and other managed charging strategies can help limit instantaneous power demand and minimize long-term charging expenses.<sup>150</sup> The CEC is funding research and demonstration projects in these areas through solicitations under the Electric Program Investment Charge (EPIC)<sup>151</sup> and the Clean Transportation Program.<sup>152</sup>

As discussed earlier, charger interoperability is a crucial concern among early adopters of electrified medium- and heavy-duty vehicles and equipment, particularly in cargo-handling environments where several equipment types from numerous manufacturers are present. Some manufacturers repurpose connectors originally designed for the light-duty segment, while others often use proprietary connectors incompatible with other vehicles or equipment types. At a May 2020 workshop, BNSF noted that some of its chargers were not interoperable, even among vehicle models from the same manufacturer.<sup>153</sup> On the other hand, as electrification of the medium- and heavy-duty sectors continues, power transfer methods will likely expand beyond conductive connectors. While charging with a plug may remain the default choice, some vehicles may automate plug-based charging or include other methods such as wireless charging or automated pantograph charging<sup>154</sup> for certain use cases. Regardless of the power transfer method, the CEC should prioritize interoperable implementations that conform to

---

150 Santa Clara Valley Transportation Authority. July 9, 2019. "[VTA Supports the LACI Feedback for Managed Electrified Fleet Charging Especially for Transit Bus Fleets.](https://efiling.energy.ca.gov/GetDocument.aspx?tn=228926)" <https://efiling.energy.ca.gov/GetDocument.aspx?tn=228926>.

151 CEC. "[GFO-20-304 — Evaluating Bi-Directional Energy Transfers and Distributed Energy Resource Integration for Medium- and Heavy-Duty Fleet Electrification.](https://www.energy.ca.gov/solicitations/2020-09/gfo-20-304-evaluating-bi-directional-energy-transfers-and-distributed-energy)" <https://www.energy.ca.gov/solicitations/2020-09/gfo-20-304-evaluating-bi-directional-energy-transfers-and-distributed-energy>.

152 CEC. "[GFO-20-605 — BESTFIT Innovative Charging Solutions.](https://www.energy.ca.gov/solicitations/2020-08/gfo-20-605-bestfit-innovative-charging-solutions)" <https://www.energy.ca.gov/solicitations/2020-08/gfo-20-605-bestfit-innovative-charging-solutions>.

153 Comments by Amanda Marruffo (BNSF) at Integrated Energy Policy Report Commissioner Workshop on Heavy-Duty Zero-Emission Vehicle Market Trends on May 20, 2020.

154 Pantograph charging uses as a moveable arm to connect charging conductors on top of a vehicle to an overhead charger. These are visually similar to the overhead catenary system found on many light rail systems.

existing and in-development standards from CharIN<sup>155</sup> and the Society of Automotive Engineers.

Landlord-tenant relationships further complicate MD/HD vehicle charging infrastructure planning. Infrastructure may be supplied by a different party than the vehicle or equipment operator, as is often the case at California's seaports and airports, where private terminal operators own and operate equipment but are usually not responsible for major site improvements such as electrical infrastructure. Such relationships may complicate financial responsibility and require greater coordination for infrastructure deployment, but these challenges are not insurmountable. The Port of Long Beach's EV Blueprint, for example, outlines steps encouraging collaboration between the port and the terminal operators for new equipment and charging infrastructure deployment. As part of its effort to involve operators in infrastructure preparation, the port has developed an energy forecasting tool to help operators estimate the power and energy demands based on their existing equipment duty cycles. The CEC should encourage development of similar tools and partnerships and ensure that any funding or program requirements accommodate landlord-tenant and other multiparty ownership arrangements. Further, clear state policy and regulations can provide strong signals to encourage all stakeholders at a given site to work collaboratively toward a common outcome.

## **Continue Streamlining Local Permitting Ordinances**

As with most types of construction, charging infrastructure installation must comply with local building, safety, and permitting regulations. In 2015, in response to complaints that existing permitting processes were cumbersome and inconsistent across municipalities, the Legislature passed Assembly Bill 1236 (Chiu, Chapter 598, Statutes of 2015), which required cities and counties to simplify permitting for charger installations. The bill required local governments to adopt ordinances streamlining and clarifying charger permitting and prohibited unreasonable barriers to installation, such as aesthetic reviews. While AB 1236 set a compliance deadline of September 2017, as of October 2020, only half of the 540 jurisdictions tracked by the Governor's Office of Business and Economic Development (GO-Biz) had streamlined or were streamlining charger permitting ordinances. Of the jurisdictions tracked, 269 had no streamlining efforts.<sup>156</sup>

---

155 The CEC is partly funding the development of [CharIN's Megawatt Charging System](https://www.charin.global/technology/mcs/) <https://www.charin.global/technology/mcs/> (formerly High Power Charging for Commercial Vehicles) connector standard under [Contract 600-15-001](https://ww2.energy.ca.gov/business_meetings/2020_packets/2020-04-08/Item_01c_600-15-001-04%20DOE%20National%20Renewable%20Energy%20Laboratory_ADA.pdf) [https://ww2.energy.ca.gov/business\\_meetings/2020\\_packets/2020-04-08/Item\\_01c\\_600-15-001-04%20DOE%20National%20Renewable%20Energy%20Laboratory\\_ADA.pdf](https://ww2.energy.ca.gov/business_meetings/2020_packets/2020-04-08/Item_01c_600-15-001-04%20DOE%20National%20Renewable%20Energy%20Laboratory_ADA.pdf).

156 California Governor's Office of Business and Economic Development (GO-Biz) staff. 2020. "[Plug-in Electric Vehicle Charging Station Readiness](https://business.ca.gov/industries/zero-emission-vehicles/plug-in-readiness/)." <https://business.ca.gov/industries/zero-emission-vehicles/plug-in-readiness/>.

Electric vehicle service providers have continued raising concerns that AB 1236 noncompliance presents a significant hurdle for charger deployment. During a June 2020 presentation, Electrify America indicated that its California projects cost 24 percent more and took 59 percent longer than its national average, and that soft costs such as permitting remain major challenges in the state.<sup>157</sup> Burdensome permitting processes continue to needlessly delay charger installation and pose a barrier to California’s charger deployment goals. GO-Biz has assembled resources, such as example ordinances and a permitting guidebook, and tracks AB 1236 progress across California using an eight-part scorecard. The CEC should continue supporting GO-Biz’s efforts to achieve statewide AB 1236 compliance.

## **Publicly Owned Utilities Should Continue to Enhance Their Preparedness for Electrification**

California’s POU, which are generally smaller than its IOUs, are well-positioned to assess their unique regional grid operations and establish charging infrastructure strategies addressing their local needs and statewide goals. Following Public Utilities Code Sections 9621 and 9622, POU with annual electrical demand exceeding 700 gigawatt-hours are required to adopt integrated resource plans that address topics including transportation electrification, and to submit these plans to the CEC.<sup>158</sup> A recent CEC staff review of these plans<sup>159</sup> found that many POU were developing investment and outreach programs to promote PEV adoption, and several had existing or anticipated charger incentive programs. Several POU also highlighted aspects of their investment plans that aligned with air pollution and ZEV goals, and some discussed the impact of transportation electrification on disadvantaged communities.

However, the integrated resource plans could be improved with regard to transportation electrification program planning. For example, the guidelines encouraged utilities to describe efforts to coordinate preparations for transportation electrification with neighboring utilities.<sup>160</sup> However, only 3 of the 16 utilities (Burbank Water and Power, Anaheim Public Utilities, and

---

157 Nelson, Matthew. 2020. "[Presentation — Electrify America.](https://efiling.energy.ca.gov/GetDocument.aspx?tn=233622&DocumentContentId=66202)"  
<https://efiling.energy.ca.gov/GetDocument.aspx?tn=233622&DocumentContentId=66202>.

158 Vidaver, David, Melissa Jones, Paul Deaver, and Robert Kennedy. 2018. [Publicly Owned Utility Integrated Resource Plan Submission and Review Guidelines – Revised Second Edition](https://efiling.energy.ca.gov/GetDocument.aspx?tn=224889&DocumentContentId=55481). California Energy Commission. Publication Number: CEC-200-2018-004- CMF.  
<https://efiling.energy.ca.gov/GetDocument.aspx?tn=224889&DocumentContentId=55481>.

159 Available in docket log for [18-IRP-01](https://efiling.energy.ca.gov/Lists/DocketLog.aspx?docketnumber=18-IRP-01) <https://efiling.energy.ca.gov/Lists/DocketLog.aspx?docketnumber=18-IRP-01>.

160 For example, the POU IRP Submission and Review Guidelines at 10 included “7. Plans to coordinate with adjacent or similarly situated utilities to meet broader community or regional infrastructure needs and ensure harmonious inter-territory operations of electric transportation technologies.”

the Los Angeles Department of Water and Power) discussed their efforts to harmonize programs and initiatives.<sup>161</sup> Improving this coordination may prove important to supporting driver-friendly charging network development. Furthermore, while many POUs acknowledged that transportation electrification would increase overall electricity consumption, most of their plans did not discuss the costs or operational impacts of this added load. Given that PEV adoption is growing across California, POUs should seek to sharpen their analysis of and preparedness for the impacts of increased electricity demand from vehicle charging. Integrated resource plans should discuss the charging load impacts in greater detail and identify possible grid upgrade needs in POU territory and neighboring regions. Moreover, POUs should work with the CEC to incorporate their data into the CEC’s modeling efforts, including the EDGE tool. This incorporation will help identify strategies to minimize or address grid impacts within and across service territories.

## **Develop a Workforce to Support Charging Infrastructure Deployment**

California’s EV charger supply chain is an emerging industry. In-state manufacturers have cultivated supply chain partners to meet domestic and global demand for their charging products. About 14,100 Californians are employed across 34 ZEV-related manufacturers.<sup>162</sup> There are hundreds of ZEV-related companies in California.

The state has contributed to the development of these companies and technologies through policies, investments, and fleet preferences.<sup>163</sup> California’s charger incentive programs<sup>164</sup> use funding to accelerate charger installations across the state. These funding programs have relied, in part, on the availability of a workforce possessing key occupational skillsets, including utility make-ready designs, construction, and charging infrastructure maintenance. Figure 24 identifies the sequence of project milestone activities and lists key occupations. To date, workforce training and development have occurred through a mix of employer on-the-job training and institutions such as the CEC’s Clean Transportation Program, California community colleges, other state entities, regional workforce investment boards, the Electric Vehicle

---

161 Both Anaheim and LADWP reports mention active coordination with other POUs via the EV Working Group of the Southern California Public Power Authority (SCPPA), while Burbank’s report states working within LADWP’s balancing authority.

162 Based on CEC staff research.

163 Examples include CAEATFA Sales and Use Tax Exclusion, Clean Transportation Program funding, and the California Competes Tax Credit.

164 Examples include CALeVIP, Electrify America, and CPUC’s Senate Bill 350 Transportation Electrification Programs.

Infrastructure Training Program,<sup>165</sup> and the California Transit Training Consortium, to name a few.

**Figure 24: Project Milestone Activities and Key Occupations for Electric Vehicle Charging Infrastructure**

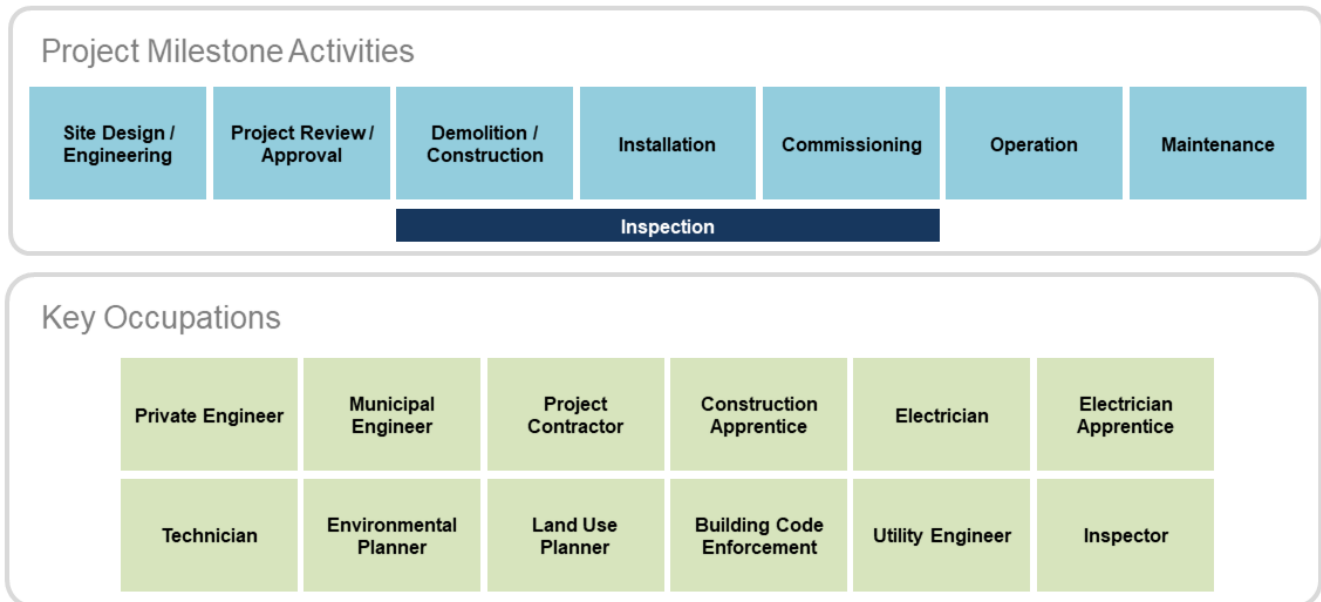

Source: CEC

Several state agencies are engaged in ensuring that a robust workforce is prepared to support ZEV infrastructure deployment. In December 2018, the CPUC issued an order instituting rulemaking to continue the development of rates and infrastructure for vehicle electrification (DRIVE OIR 18-12-006).<sup>166</sup> The rulemaking continues the CPUC’s implementation and administration of transportation electrification programs, tariffs, and policies and “seeks to develop a comprehensive framework to guide the CPUC’s role in the electrification of California’s transportation sector.” The CPUC’s *Draft Transportation Electrification Framework* seeks to address equity — the disproportionate burden of air quality and climate change impacts — and widespread transportation electrification, including workforce training and development. The framework notes that IOUs should consider whether any incremental

165 CEC. [Joint Workshop with the California Energy Commission and California Public Utilities Commission to discuss the Electric Vehicle Infrastructure Training Program](https://www.energy.ca.gov/event/workshop/2021-04/joint-workshop-california-energy-commission-and-california-public-utilities), April 16, 2021, <https://www.energy.ca.gov/event/workshop/2021-04/joint-workshop-california-energy-commission-and-california-public-utilities>.

166 CPUC staff. 2018. [R.18-12-006 Development of Rates and Infrastructure for Vehicle Electrification](https://docs.cpuc.ca.gov/SearchRes.aspx?DocFormat=ALL&DocID=252025566). <https://docs.cpuc.ca.gov/SearchRes.aspx?DocFormat=ALL&DocID=252025566>.

workforce training is needed to support the scale of transportation electrification infrastructure deployment expected in their transportation electrification plans.

In July 2020, the CEC held a public workshop to discuss the potential training and certification requirements for inclusion in CALeVIP. At the workshop, the Contractors State License Board provided an overview of the certification process for electricians. California Labor Code Section 108 specifies that “certification is required only for those persons who perform work as electricians for contractors licensed as Class C-10 electrical licensed contractors under the Contractors’ State License Board rules and regulations.” The Contractors State License Board explained that during the past decade, the number of C-10 license holders in California has averaged slightly more than 25,000. Stakeholder comments during the workshop and in the docket<sup>167</sup> expressed agreement with the safety imperative for EVSE installation and operations, the value of certified electricians with specific EVSE installation knowledge, and the need to better understand workforce projections needed to meet the state’s ZEV infrastructure goals through 2025 and beyond.

CARB has identified a suite of mobile source zero-emission measures<sup>168</sup> designed to help meet the state’s air quality goals, including the Innovative Clean Transit Rule, the Advanced Clean Trucks regulation, the Transportation Refrigeration Units regulation, and the Cargo Handling Equipment regulation. As part of assessing charging infrastructure needs, the CEC will continue to evaluate the requisite infrastructure for these ZEV deployments and related workforce impacts. CARB has also articulated a plan to embed equity and engagement in accompanying implementation of their measures. Disadvantaged and low-income communities can realize environmental and economic benefits, including the creation of good jobs, if inclusion during implementation is intentional, starting with workforce training, support for career pathways, and resource alignment. As these measures receive CARB approval, it will be important to assess and monitor workforce issues associated with scaling up deployment of all on- and off-road electric transportation infrastructure.

The California ZEV and ZEV infrastructure supply chain, as an emerging industry, constantly reassesses suppliers, workforce needs, and market demand for products not only in California, but nationally and globally. Companies in this supply chain are driven to innovate technologies and grow to scale in response to CARB regulations and California’s demand for these products and services. The state should evaluate the workforce needs for EV infrastructure in terms of workload capacity, training and certification, job quality, and regional differences. Given that the occupations shown in Figure 24 encompass a scope that extends beyond charging

---

167 CEC. “[Block Grant for Electric Vehicle Charger Incentive Projects.](#)” Docket 17-EVI-01. <https://efiling.energy.ca.gov/Lists/DocketLog.aspx?docketnumber=17-EVI-01>.

168 CARB. March 25, 2020. “[2020 Mobile Source Strategy: A Vision for Clean Air.](#)” Public Webinar. [https://ww3.arb.ca.gov/planning/sip/2020mss/pres\\_marwbnr.pdf](https://ww3.arb.ca.gov/planning/sip/2020mss/pres_marwbnr.pdf).

infrastructure, the state should also evaluate this workforce for applications beyond charging infrastructure that are relevant to implementing the suite of aggressive zero-emissions measures described above.



# CHAPTER 7:

## Financing California’s Charging Infrastructure Needs

---

To achieve California’s 2035 ZEV sales and deployment goals, the electric vehicle and charger markets will need to become self-sustaining. While PEVs are projected to reach cost parity with internal combustion vehicles in the next few years, there is more uncertainty about the path to self-sufficiency for the charging market. Electricity sales alone may not be enough to maintain sustainable business operations or cover capital costs for planning and constructing charging infrastructure. Continued deployment incentives and innovation-enabling policies are critical to promoting private investment and a sustainable industry.

### **Continued Public Support for Charger Deployment Is Essential to Meeting State ZEV Goals**

Deploying the charging infrastructure needed to support California’s ZEV adoption, decarbonization, and air quality goals will require clear planning and fast deployment of accessible financing to help the charging industry scale up. The CEC has led on both fronts for the state through the modeling and planning analyses described in this report, as well as through its Clean Transportation Program that invests up to \$100 million annually in a broad portfolio of transportation and fuel-related projects throughout the state. Since the inception of the Clean Transportation Program in 2009, the state has invested nearly \$899 million in key projects across California. Around 49 percent of the project funds for the program were awarded to projects within disadvantaged or low-income communities. When excluding statewide projects and those without an applicable site, this number was around 69 percent.<sup>169</sup>

California’s network of more than 70,000 public and shared private chargers has been supported by state programs, ratepayer funds, and settlement agreements. The CEC’s Clean Transportation Program has invested \$194 million in public and shared private light-duty vehicle charging infrastructure over the past 13 years.

The California Electric Vehicle Infrastructure Project (CALeVIP) is the CEC’s flagship incentive program for light-duty charging infrastructure. CALeVIP uses the EVI-Pro tool described in Chapter 4 to estimate where local and regional gaps in charger deployment exist, and then

---

169 Brecht, Patrick. 2021. [2021–2023 Investment Plan Update for the Clean Transportation Program](https://efiling.energy.ca.gov/getdocument.aspx?tn=237454). California Energy Commission. Publication Number: CEC-600-2021-026-SD. Available at: <https://efiling.energy.ca.gov/getdocument.aspx?tn=237454>

targets funding to address those gaps.<sup>170</sup> As of April 30, 2021, CALeVIP has launched nine regional incentive projects totaling \$124.9 million in rebate funding, potentially deploying 5,300 Level 2 connectors and 1,500 DC fast chargers. Illustrating the immense popularity of the program, CALeVIP incentives are oversubscribed by \$270 million, representing roughly 7,800 Level 2 connectors and 23,700 DC fast chargers. While most of the CALeVIP incentive projects are required to invest at least 25 percent of available rebates in disadvantaged or low-income communities, many of the projects achieve upward of 35–50 percent.

Preliminary data from a subset of projects completed through February 28, 2021, show that CALeVIP provides an average rebate of \$589/kW for Level 2 connectors and \$1,300/kW for DC fast chargers. Notably, this investment is leveraged with additional funds from the project developer and customer, such that completed projects have an average total cost of \$1,332/kW for Level 2 connectors and \$2,000/kW for DC fast chargers — representing a leveraged funding share of 60 percent and 35 percent, respectively.<sup>171</sup>

The CALeVIP design intentionally incorporates flexibility in approaches to asset ownership and charging business models (by supporting a variety of site types), as well as to administratively qualifying EVSPs (including 23 manufacturers of charging equipment) into the program. This flexibility has enabled the state to increase charger deployment quickly and cost-effectively in key areas that lack needed infrastructure. A key feature of the success of CALeVIP has been working closely with regional governments to enter markets upon ensuring that permitting processes have been streamlined.<sup>172</sup> The administrative simplicity of the CALeVIP platform has resulted in partner funding contributions on the order of \$32.3 million (as of April 30, 2021) from community choice retail energy providers, air quality management districts, and metropolitan planning organizations.<sup>173</sup> The success of CALeVIP as a model for infrastructure program design is illustrated by efforts to emulate the implementation in New York<sup>174</sup> and

---

170 CALeVIP. [Incentive Project Planning](https://calevip.org/incentive-project-planning). <https://calevip.org/incentive-project-planning>.

171 Data to be published at <https://www.energy.ca.gov/programs-and-topics/programs/clean-transportation-program/california-electric-vehicle>.

172 August 30, 2019 CALeVIP Permitting Workshop presentations from the Energy Commission ([Clean Transportation Program](#)), GO-Biz ([Electric Vehicle Charging Station Permitting Guidebook](#)) and Division of the State Architect ([Electric Vehicle Charging Stations](#)).

173 Future projects beginning with Peninsula-Silicon Valley in December 2020 will include more than \$30 million in partner funds.

174 New York State Energy Research and Development Authority. "[Charge Ready NY](#)." <https://www.nyserda.ny.gov/All-Programs/Programs/ChargeNY/Charge-Electric/Charging-Station-Programs/Charge-Ready-NY>.

ongoing discussion on project design with counterpart staff who is developing initiatives in three other states.

## **Mandates and Infrastructure Incentives Have Driven Charging Infrastructure Growth**

Executive orders and legislation have established California's interest in economic growth supported by the ZEV and charging industries. Executive Order B-16-2012 ordered state agencies to establish benchmarks to help grow private sector investment in ZEV infrastructure by 2015 and targeted a strong and sustainable ZEV industry as part of California's economy by 2025.<sup>175</sup> In 2015, Senate Bill 350 (De León, Chapter 547, Statutes of 2015) expanded the roles of electric utilities in supporting transportation electrification, and the Legislature declared that "electrification should stimulate innovation and competition, enable consumer options in charging equipment and services, attract private capital investments, and create high-quality jobs for Californians, where technologically feasible."<sup>176</sup> Specifically, SB 350 stated that utility transportation electrification programs should not unfairly compete with nonutility enterprises.<sup>177</sup>

A critical enabler of early-stage charging infrastructure growth has been the CPUC's decisions<sup>178</sup> concluding that charging service providers are not classified as public utilities, in accordance with the Legislature's intentions to encourage the development of business models for transportation electrification. While companies have demonstrated success in using charging solutions that require little or no ratepayer or public funding support, at present, many charging service providers have not found a self-sustaining business model operable at the scale necessary for California to achieve widespread electrification.

Based on responses to a February 2020 request for information for "Strategies to Attract Private Investment in Zero Emission Vehicle Charging Infrastructure and Other Clean Transportation," as well as further conversations with investors, CEC staff identified important

---

175 Governor Edmund G. Brown Jr. March 23, 2012. [Executive Order B-16-2012](https://www.ca.gov/archive/gov39/2012/03/23/news17472/index.html).  
<https://www.ca.gov/archive/gov39/2012/03/23/news17472/index.html>.

176 Public Utilities Code Section 740.12(b).

177 Public Utilities Code Section 740.3(c).

178 California Public Utilities Commission. Decision in Phase 1 on Whether a Corporation or Person That Sells Electric Vehicle Charging Services to the Public is a Public Utility ([D.10-07-044](#)) and Decision Clarifying Status of Electric Vehicle Charging Service Providers as Public Utilities ([D.20-09-025](#)).

insights relating to a sustainable charging market.<sup>179</sup> These insights confirmed that vehicle mandates and infrastructure incentives have driven early opportunities for growth in the industry. Listed below are supporting regulations that have seeded growth for the nascent charging infrastructure market.

- The CPUC’s decisions to not regulate charging service providers as utilities, described above, have enabled the market to introduce a broad range of business models that independently deliver electricity as a fuel.<sup>180</sup> These CPUC decisions have been foundational in driving competition, market experimentation, and private investment in charging services.
- Incentives funded by utilities,<sup>181</sup> state programs,<sup>182</sup> and settlement funds<sup>183</sup> have helped reduce cost barriers to charger installation. These programs have been necessary to support the market. However, these funding sources alone cannot support the long-term market transformation that is required to meet state goals. Further, these funds are limited. Companies investing in charging projects highlighted that uncertainty regarding the future availability of funds jeopardizes their ability to plan deployments effectively.
- The Low Carbon Fuel Standard,<sup>184</sup> which offers a combination of capacity credits, base fuel credits, and incremental fuel credits, created greater financial certainty for new charger deployments and encouraged the delivery of electricity as a fuel. This regulation provides capacity credits for new fast-charger deployments,<sup>185</sup> base credits

---

179 Comments and subsequent discussion with stakeholders participating in Docket No. [20-FINANCE-01](#), Strategies to Attract Private Investment In Zero Emission Vehicle Charging Infrastructure and Other Clean Transportation Projects <https://efiling.energy.ca.gov/Lists/DocketLog.aspx?docketnumber=20-FINANCE-01>.

180 Specifically, D.10-07-044 determined that charging services for light-duty vehicles are not subject to regulation as utility, and D.20-09-025 clarified that this exemption includes charging services for MD/HD vehicles.

181 CPUC. 2020. "[Transportation Electrification Activities Pursuant to Senate Bill 350](#)." <https://www.cpuc.ca.gov/sb350te/>.

182 Such as the CEC’s [Clean Transportation Program](#). More information is available at <https://www.energy.ca.gov/programs-and-topics/programs/clean-transportation-program>.

183 In 2012 and 2015, California negotiated legal agreements with NRG and Volkswagen to install charging infrastructure to settle harms resulting from the 2001 electricity crisis and excessive diesel combustion emissions from Volkswagen vehicles, respectively.

184 CARB. 2020. [Low Carbon Fuel Standard Regulation](#). [https://ww2.arb.ca.gov/sites/default/files/2020-07/2020\\_lcfs\\_fro\\_oal-approved\\_unofficial\\_06302020.pdf](https://ww2.arb.ca.gov/sites/default/files/2020-07/2020_lcfs_fro_oal-approved_unofficial_06302020.pdf).

185 Section 95486.2 of the regulation describes capacity credits for new fast charger deployments, which decrease as charger usage increases.

for delivery of electricity as a fuel, and incremental credits to encourage smart charging.<sup>186</sup>

- State and local building codes have encouraged or required the installation of charger make-ready equipment. The 2016 Green Building Standards (CALGreen) Code, Title 24, Part 11,<sup>187</sup> requires builders to provide capacity for electric vehicle charging for many types of new construction, thereby avoiding the substantial costs that would otherwise be incurred as major retrofits to later install infrastructure. Building codes are crucial to ensuring cost-effectively that California meets its zero-emission vehicles goals. Building codes may prove essential to support residents of multiunit dwellings and must keep pace to ensure broad access to ZEV infrastructure.
- In 2018, updates to the SB 375 GHG Emissions Reduction Targets introduced greater regulatory flexibility and included charging infrastructure as a compliance pathway for Sustainable Communities Strategies.<sup>188</sup> Metropolitan planning organizations, as a transportation measure within their Sustainable Communities Strategies, can invest in regional charging infrastructure beyond existing and future state programs.

In progressing toward the state's 2035 goals, market-based expansion will rely on regulatory policy certainty, in concert with the flexibility that the industry and technology development afford to reach California's transportation and emissions reduction goals.

California is home to 34 ZEV-related companies (including manufacturers of ZEVs, ZEV components, and ZEV infrastructure) with an estimated market capitalization of more than \$500 billion.<sup>189</sup> In 2020, an assessment conducted for the U.S. Department of Energy concluded that the light-duty charging infrastructure supply chain in California represented more than one-third of the U.S. market. The assessment emphasized that charging has high vitality and numerous players and is meeting current needs, but should improve "the design

---

186 Section 95486.1 describes credits for fuel delivery, including incremental credits that encourage smart charging when electricity carbon intensity is low.

187 [2016 California Green Building Standards Code](https://codes.iccsafe.org/content/CAGBSC2016S0819PA/chapter-4-residential-mandatory-measures), Part 11, Chapter 4 Residential Mandatory Measures, Section 4.106.4.1, 4.106.4.2, and 4.106.4.3. <https://codes.iccsafe.org/content/CAGBSC2016S0819PA/chapter-4-residential-mandatory-measures>.

188 CARB. 2018. [Proposed Update to the SB 375 GHG Emissions Reduction Targets](https://ww3.arb.ca.gov/cc/sb375/sb375_target_update_final_ea.pdf). [https://ww3.arb.ca.gov/cc/sb375/sb375\\_target\\_update\\_final\\_ea.pdf](https://ww3.arb.ca.gov/cc/sb375/sb375_target_update_final_ea.pdf).

189 Market capitalization of ZEV manufacturers and related entities, as of December 2020.

thinking around technology” to accelerate the market and overcome business model challenges.<sup>190</sup>

The EV charging industry uses a variety of business models. Many companies are leveraging advanced technology and consumer-oriented designs around chargers to address the issues stemming from constrained electrical capacity and expensive real estate.

This interest in innovation was further demonstrated by the creation of and the response to a \$7.5 million funding solicitation issued by the CEC in November 2020, where 45 teams of companies bid 55 projects to demonstrate new charging solutions that reduce costs, improve the customer experience, and increase the use of infrastructure for all sectors of on-road vehicles.<sup>191</sup> The set of proposals that received a passing score represents a demand on the order of \$60 million for Clean Transportation Program investments and emphasizes the importance of the state pursuing transformative charging infrastructure technologies in partnership with private sector entrepreneurs.

Highlighted in Figure 25, Figure 26, and Figure 27 are examples of EV service providers who are innovating their charging services to expand the locations where charging can be cost-effectively installed.

---

190 Market share represented as the number of EVSE supply chain companies with headquarters in the United States in Figure 3. Synthesis Partners. 2020. [North American \(NA\) Light-duty Electric Vehicle \(LDEV\) Supplier Equipment Market and Supply Chain Gap Intelligence](https://synthesispartners.files.wordpress.com/2020/06/na-ldev-evse-supply-chain-assessment-and-gap-intelligence-final-public-report-issued-april-2020.pdf). <https://synthesispartners.files.wordpress.com/2020/06/na-ldev-evse-supply-chain-assessment-and-gap-intelligence-final-public-report-issued-april-2020.pdf>.

191 CEC. [GFO-20-605 - BESTFIT Innovative Charging Solutions](https://www.energy.ca.gov/sites/default/files/2020-11/GFO-20-605%20NOPAR_ADA.docx). [https://www.energy.ca.gov/sites/default/files/2020-11/GFO-20-605%20NOPAR\\_ADA.docx](https://www.energy.ca.gov/sites/default/files/2020-11/GFO-20-605%20NOPAR_ADA.docx).

**Figure 25: Charging “Beyond the Grid”**



San Leandro-based FreeWire Technologies integrates lithium-ion batteries into small-footprint chargers to provide charging solutions with minimal grid impact. The Mobi charger, a mobile charging unit with a built-in 80 kWh battery, can move around a parking area to charge up to 10 vehicles per day at up to 11 kW. Customers can charge the Mobi overnight in preparation for the next day’s charging needs, avoiding peak demand. The Mobi offers a quick, low-impact solution for charging vehicles without needing extensive permitting, engineering, construction, or displacement of any parking. The stationary Boost Charger, shown above with internal components, is a 120 kW DC fast charger with a built-in 160 kWh battery. The onboard battery enables DC fast charging from lower-voltage inputs (208–240 volts alternating current ) from the facility and eliminates the need for costly and bulky make-ready equipment typical of most DC fast charger deployments.

Photo: FreeWire Technologies

**Figure 26: Serving a Broader Driver Market**

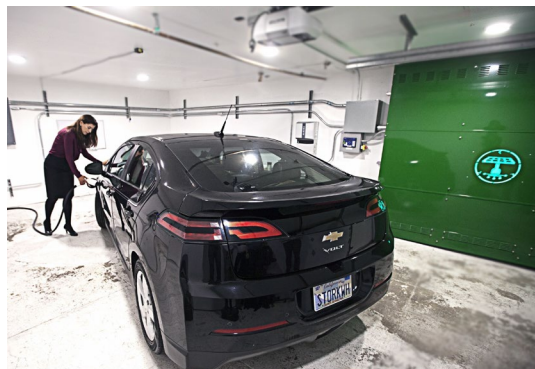

San Francisco-based Powertree Services offers monthly subscriptions to chargers installed at multiunit dwellings that serve tenants *and* nearby residents. Powertree works with apartment owners and developers to build charging stations that incorporate EV access control and are supported by photovoltaics, stationary batteries, and an energy management system that together minimize or eliminate the need for transformer or service upgrades. Powertree overcomes low initial charger use, the cost of “lost” parking spaces, and the uncertainty of tenant turnover by allowing residents and neighbors to share access to a single charger for all vehicle types, and a system that provides clean electricity and backup power during emergencies. Together, it creates a valuable asset for the building owner.

Photo: Powertree



## Figure 27: Challenging the Presumption That Networks Must “Charge for Charging”



**San Francisco-based Volta Charging installs and operates a network of free public chargers chiefly near the entrances of anchor tenants of commercial retail centers. Prominent placement maximizes charger usage and improves confidence among prospective PEV drivers in the community. The large displays show messages from tenants or third-party sponsors. Charging as an amenity helps retailers attract and retain visitors, which can be more valuable than the cost of the installation or the electricity. More than 90 percent of Volta’s nearly 200 stations in California are small, having four or fewer Level 2 chargers, which limits the need for immediate grid upgrades. Volta is also expanding its network to include 50 kW DC fast chargers with load management.**

Photo: CEC staff

Notably, the preceding examples of innovative charging solutions (FreeWire Technologies, Powertree Services, and Volta Charging) are attracting private capital to scale up deployment, with limited Clean Transportation Program demonstration<sup>192</sup> and manufacturing<sup>193</sup> grants. These entities and their competitors are trying to grow and serve more infrastructure needs while adapting to industry dynamics, regulatory directives, and consumer uncertainty. However, as new markets open and demand the services of these companies, new challenges arise that can limit growth.

## Promoting Private Investment Will Lead to Self-Sustaining Industry

Facilitating a policy and financial environment conducive to scaling up charging infrastructure is critical to realizing the transformation to carbon neutrality by 2045. Success will be contingent upon the expansion and certainty of incentives, especially in the near- and midterm. With continued planning through efforts like those described in the AB 2127 legislation, and through public financing via initiatives like the Clean Transportation Program, the state can accelerate progress toward achieving California’s ZEV goals until sustainable business models are feasible and widespread in the charging industry.

---

192 California Energy Commission Agreement ARV-13-057 with Powertree Services, for \$500,000.

193 California Energy Commission Agreement ARV-19-072 with Freewire Technologies, Inc. for \$1.98 million.



Following the AB 2127 directive to “consider all necessary charging infrastructure” and “programs to accelerate the adoption of electric vehicles,” the CEC identified several factors as critical to spurring self-sustaining growth.<sup>194</sup> Successful private investment in charging infrastructure could be promoted by fostering several conditions:

### **1. Coordinated Government and Regulatory Actions Supporting the Need for 100 Percent ZEVs**

Reaching 100 percent ZEV outcomes will require sending clear market signals to market participants and investors. Public agency quantitative modeling to understand technical needs and geographic gaps in charging through a stakeholder process will help support and direct the market. Further, programs and funding to encourage solutions tailored to local needs that reduce total operational costs will enable EVSPs to better serve harder-to-reach customer segments facing financial or grid constraints. The public may need to invest to solve industry-wide constraints, particularly in areas such as interoperability<sup>195</sup> and functional testing capacity,<sup>196</sup> so that first-mover companies do not need to bear disproportionate startup costs. Investments that enable growth among multiple equipment manufacturers or EVSPs in California and beyond can confirm to investors that opportunity extends to grow the ZEV market well beyond the state and achieve nationwide<sup>197</sup> and global ZEV targets.<sup>198</sup>

### **2. Maturation of Charging Technologies and Companies to Raise Investor Confidence**

---

194 Comments and subsequent discussion with stakeholders participating in Docket No. [20-FINANCE-01](#), Strategies to Attract Private Investment In Zero Emission Vehicle Charging Infrastructure and Other Clean Transportation Projects <https://efiling.energy.ca.gov/Lists/DocketLog.aspx?docketnumber=20-FINANCE-01>.

195 For example, the California Energy Commission recently amended an existing technical support contract to perform functional evaluations of charging systems to support interoperability for MD/HD vehicles. ([Amendment 4 to Agreement 600-15-001 with the National Renewable Energy Laboratory](#)) More information is available at [https://ww2.energy.ca.gov/business\\_meetings/2020\\_packets/2020-04-08/Item\\_01c\\_600-15-001-04%20DOE%20National%20Renewable%20Energy%20Laboratory\\_ADA.pdf](https://ww2.energy.ca.gov/business_meetings/2020_packets/2020-04-08/Item_01c_600-15-001-04%20DOE%20National%20Renewable%20Energy%20Laboratory_ADA.pdf).

196 Several charging equipment providers including EVBox, Freewire, Hubject, ChargePoint, Siemens, EnelX, Greenlots, Electrify America, IoTecha, Nuvve, Flo, and those represented by CharIN and EV Charging Association responded to the [November 11, 2019 workshop](#) in docket [17-EVI-01](#), describing the cost, time, and technical challenges with equipment certification. CEC. “[Staff Solicitation Scoping Workshop — Pre-Solicitation Concept for Vehicle-Grid Innovation Lab \(ViGIL\)](#).” <https://www.energy.ca.gov/event/workshop/2020-05/staff-solicitation-scoping-workshop-pre-solicitation-concept-vehicle-grid>.

197 Multi-State Zero Emission Vehicle Task Force. *Multi-State ZEV Action Plan, 2018-2021*. <https://www.nescaum.org/topics/zero-emission-vehicles/multi-state-zev-action-plan-2018-2021-accelerating-the-adoption-of-zero-emission-vehicles>

198 International ZEV Alliance. The ZEV Alliance Participation Statement. <http://www.zevalliance.org/members/>

Transitioning an EVSP – from start-up operations backed with initial capital, through first demonstrations with customers, to offering more commercial projects across electrification applications or geographies – depends on the ability of the EVSP to raise successive rounds of funding. Investors may examine the charging company’s intended role in the electrification ecosystem and analyze its potential to meet the needs of their addressable market competitively. The investor’s due diligence on the company’s financial statements, supply chain, and need for partners to complete projects will depend on whether the company is specialized (for example, the manufacturer of a charger component) or has broad scope (for example, the operator of a network of chargers). Corporate strategies in the charging industry to raise capital include strategic investments by automotive manufacturers undertaking electrification, mergers among niche companies (for example, hardware and controls manufacturers), acquisition by global electric utilities or conventional fueling providers, or alliances to share technical resources. As companies grow, their ability to take risks implementing large commercial projects in new market segments can increase, permitting them to use additional mechanisms to complement public investment, including project finance, asset finance, and asset management.

### **3. Cost Transparency to Improve Construction Project Budgeting and Measure Advances in EVSE Functionality**

Comparative analysis of public and utility-funded infrastructure programs has been challenged by a lack of generally accepted principles for recording and disclosing the costs of installing infrastructure. This challenge stems from the nonstandard ways of invoicing items and tasks in bills of materials, variations in labor rates and permitting costs, site-specificity of project designs, the cost of delays due to issues outside the project developer’s control, and varied business strategies among EVSPs.<sup>199</sup> Further, restrictions and limitations on data disclosure prevent detailed analysis of cost drivers that could inform the design of new technological solutions or identify triggers for needed policy intervention. The prices of EVSE are readily available when sold at retail and can help illustrate the order-of-magnitude of savings from economies of scale. Importantly, as EVSEs rapidly undergo feature enhancements, the related costs can be benchmarked according to functions offered over time.<sup>200</sup> Absent perfect data,

---

199 EVgo. June 1, 2020. [Strategies to Attract Private Investment in Zero Emission Vehicle Charging Infrastructure and Other Clean Transportation Projects](https://efiling.energy.ca.gov/GetDocument.aspx?tn=233276&DocumentContentId=65762).

<https://efiling.energy.ca.gov/GetDocument.aspx?tn=233276&DocumentContentId=65762> and CA Governor's Office of Business and Economic Development. June 1 2020. ["Strategies to Attract Private Investment in Zero Emission Vehicle Charging Infrastructure and Other Clean Transportation Projects."](https://efiling.energy.ca.gov/GetDocument.aspx?tn=233255&DocumentContentId=65739)  
<https://efiling.energy.ca.gov/GetDocument.aspx?tn=233255&DocumentContentId=65739>

200 Crisostomo, Noel. California Energy Commission. "Electric Vehicle Charging Load," 19-OIR-01 Load Management Rulemaking January 14, 2020 Workshop, Panel 3: Responding to Hourly and Sub-Hourly Grid Signals, page 5. <https://efiling.energy.ca.gov/GetDocument.aspx?tn=231541&DocumentContentId=63354>

market participants can create higher-level benchmarks<sup>201</sup> by which public and, increasingly, private investors can compare the costs to provision charging services.

#### **4. Diversification of Revenue Streams That Support Financial Stability and Improve the Certainty of Returns for Investors**

Beyond the basic revenue model of selling charging by marking up the retail price of electricity, investors highlighted their intention to pursue a variety of revenue streams to diversify their business. A (non-exhaustive) selection of additional revenue opportunities from charging include 1) aggregating charging to provide a grid asset that system operators can manage<sup>202</sup>; 2) monetizing emission reduction value in regulatory programs or in support of corporate sustainability policies; 3) unlocking financial benefits to the site host, such as increasing employee retention or attracting additional sales at a retail location; and 4) enhancing asset value or minimizing compliance costs for building construction.

Clarifying revenue models will be critical to determine the viability of projects, understand the effects of policies on viability, and understand the milestones at which private capital would participate.<sup>203</sup> As a starting point, the Electric Infrastructure Financial Analysis Tool (E-FAST) developed by the National Renewable Energy Laboratory for the Energy Commission can calculate breakeven electricity prices and profitability indices over time according to charging behavior projections by EVI-Pro.<sup>204</sup>

#### **5. Enabling Liquidity of Capital and Commodity Transactions in the Long Term**

Several investors described a willingness to furnish capital to build projects if public incentives help support operations and increase the certainty of generating revenue in excess of operational expenses. Working in tandem, the prior recommendations improve liquidity and ensure that revenues sufficiently cover operational expenses. One mechanism several EVSPs use to improve liquidity is a “shared savings” business model in which a charging company builds, operates, and sells infrastructure as a service to another company’s fleet, or to a group of customers. The EVSP shares a portion of the fleet’s or group’s cost savings from avoiding

---

201 Comments of Patrick Kelly, EDF Renewables/Powerflex at November 19, 2019 staff workshop on CALeVIP Future Equipment Technology.

202 For example, see detailed comments referenced below from Amply, Enel X, Freewire, Clean Energy Works, and Princeton Energy Systems.

203 CA Governor's Office of Business and Economic Development. June 1 2020. “Strategies to Attract Private Investment in Zero Emission Vehicle Charging Infrastructure and Other Clean Transportation Projects.” <https://efiling.energy.ca.gov/GetDocument.aspx?tn=233255&DocumentContentId=65739>

204 Kontou, Eleftheria and Eric Wood. July 2020. *Financial Feasibility of High-Power Fast Charging Stations: Case Study in San Diego, California*. <https://efiling.energy.ca.gov/getdocument.aspx?tn=233876>.

gasoline purchases or utility costs that these customers would have otherwise incurred.<sup>205</sup> These shared models may take the form of energy service contracts, the bundling of vehicle acquisition services (such as purchases or leases), or infrastructure subscription services. These models can unlock options for multi-year supply-and-demand contracts that provide the revenue certainty to access mainstream financing through private equity, investment bank bond investment, publicly-traded stock company formation<sup>206</sup>, and commercial banks.

## **Exploring Innovative Programs, Financial Instruments, and Process Improvements Could Increase Private Sector Investment**

As legislation and executive orders envision, private investments should drive the expansion to widespread transportation electrification in the long term. However, until the enabling conditions described above have created a sustainable approach to public-private partnerships, public investment is a critical stopgap to continue the transition, particularly in harder-to-reach market segments.

Stakeholder interviews raised the importance of vehicle and infrastructure incentives for customers and fleets. Given their experience across the variety of utility, state, and local initiatives, these interviews highlighted how potential improvements could ease the transactions to access funding, and therefore spur project completion while increasing funds from the private sector. Considering the following design elements can improve the implementation of additional programs:

- **Program Navigability.** Displaying incentives for both vehicle and infrastructure at a “one-stop shop” could help applicants to identify appropriate funds from federal, state, local, and utility programs.<sup>207</sup> Consistent eligibility requirements – both policy-driven and technical – across programs could reduce the transaction costs for EVSPs by enabling broader access while improving competition.
- **Pairing Vehicles and Chargers.** Vehicle purchase incentives could be paired with a corresponding infrastructure incentives. This pairing is important for cases where the customer’s use of vehicles requires dedicated infrastructure that would not be supported by other project finance initiatives.
- **Terms of Asset Use and Operation.** Incentives should accommodate varied asset usage and business models for vehicles and infrastructure. Fleet owners may be distinct

---

205 Amply. May 27, 2020. [“Comments on Clean Transportation Financing and Investment.”](https://efiling.energy.ca.gov/GetDocument.aspx?tn=233188&DocumentContentId=65672)  
<https://efiling.energy.ca.gov/GetDocument.aspx?tn=233188&DocumentContentId=65672>

206 Root, Al. “Is There Enough Electricity for EVs? Yes. Here’s Who Will Charge Them,” Barrons, November 14, 2020. <https://www.barrons.com/articles/theres-enough-electricity-in-the-world-for-electric-vehicles-heres-who-will-charge-them-51605368406>

207 Comments from Volvo Group North America, May 20-21, 2020, IEPR Workshop on Heavy Duty Zero-Emission Vehicle Market Trends.

from vehicle operators, and infrastructure hosts may be distinct from the owners of the real estate where the infrastructure is sited. Programs that use agreeable contract terms to overcome principal-agency problems for issues such as physical access to a charger or the timing of charging are critical.<sup>208</sup>

- **Flexible Build Timelines.** Exacting timelines for purchases or commissioning installations may be deal breakers, particularly if a project is subject to permitting, electrical study, or utility load service constraints outside the developer's control.<sup>209</sup> Deployment approaches that balance viability milestones with flexibility to complete the project are useful, especially if structural changes are needed in a region.
- **Market- or Performance-Based Allocation.** To enable innovation that may not fit into existing frameworks, investment allocations should be set in consideration of the potential for market growth. For example, new infrastructure providers whose approach includes customer agreements or installation designs that do not comport with existing requirements may warrant modifications to program terms to enable more participation.<sup>210</sup> In addition, serving hard-to-reach market segments may require higher or more sustained incentives, if cost reductions realized in the industry as a whole are not evenly realized across customer segments.
- **New Technologies.** As electrification technologies rapidly advance, incentive programs should be structured to additionally consider pilot tests that promote commercial introduction. Charging technologies such as wireless or automated chargers should be funded to encourage diversity. Positive demonstration results can spur further commercialization, given the potential for rapid shifts in usage as customer behaviors change and new charging use cases arise.

CEC initiatives may serve as forums to explore new strategies to improve customer uptake and accelerate deployment. These initiatives are intended to work in concert and support the simultaneous expansion of incentives needed to support widespread adoption. In coordination with program improvements that the CPUC and other public funding agencies are considering,

---

208 Powertree Services. March 28, 2020. [Observation and Recommendations for Activating Private \(Non-State\) Capital in Support of Renewable and Clean Energy Infrastructure](https://efiling.energy.ca.gov/GetDocument.aspx?tn=232575&DocumentContentId=64603).  
<https://efiling.energy.ca.gov/GetDocument.aspx?tn=232575&DocumentContentId=64603>.

209 Trillium. April 10, 2020. [Strategies to Attract Private Investment in Zero Emission Vehicle Charging Infrastructure and Other Clean Transportation Projects](https://efiling.energy.ca.gov/GetDocument.aspx?tn=232700&DocumentContentId=64761).  
<https://efiling.energy.ca.gov/GetDocument.aspx?tn=232700&DocumentContentId=64761>.

210 For example, fleet equipment serving a transportation service available for use by riders of the general population is not considered "public" charging infrastructure and is ineligible from utility or publicly-administered funds, limiting the potential benefit to benefit drivers. Nadia Anderson. July 2020. [Cruise's Approach to Automated, Shared, and Electric Transportation](https://efiling.energy.ca.gov/GetDocument.aspx?tn=233861&DocumentContentId=66636).  
<https://efiling.energy.ca.gov/GetDocument.aspx?tn=233861&DocumentContentId=66636>.

the CEC initiatives can foster the above-mentioned market conditions to support greater private investment.

At workshops in June<sup>211</sup> and August<sup>212</sup> 2020, staff presented a concept<sup>213</sup> for a policy and economic model to accelerate widespread transportation electrification while leveraging limited public funds with private capital. The concept measures the cost to enable charging through public investment and aims to signal market competition among diverse solutions. It measures how a charging solution’s request for funding leverages private dollars and compares to the benefit of the electric miles traveled it enables, with e-miles derived from the charger power (kW), the measured or projected duration of service (h), and the speed of deployment. This metric can be calculated<sup>214</sup> for a project serving a need over one year or more, and is the core of a five-step process:

1. Assess and confirm charging infrastructure-associated energy needs in a region with CEC’s models and identify locally-appropriate projects with EV community blueprints.
2. Conduct reverse auctions to quantify the cost of charging. EVSPs would bid to supply the assessed energy needs, competing to provide the charging services at the lowest public cost by supporting their bid with private capital.
3. Budget the required public investment to supply enough charging infrastructure.
4. Select EVSPs and tailor awards according to their challenges to market scale-up.
5. Utilities serve sufficient load as modeled and offering economical rates.

This funding concept would not be predetermined by a specific approach to constructing infrastructure. Rather, it encourages charging innovations that are best fit for unique settings, while maintaining efficiency, safety, and grid integration standards. Additionally, this allows costs to “float” according to the regional market served to ensure that sufficient investment

---

211 Crisostomo, Noel. 2020. "[Lessons Learned From Electricity Policy for Transportation Electrification.](#)" Integrated Energy Policy Report June 24, 2020, Workshop. <https://efiling.energy.ca.gov/getdocument.aspx?tn=233635>.

212 Crisostomo, Noel. 2020. "[Assembly Bill 2127 Charging Infrastructure: Other Programs to Accelerate EV Adoption.](#)" Integrated Energy Policy Report August 4, 2020, Workshop. <https://efiling.energy.ca.gov/getdocument.aspx?tn=234173>.

213 Formerly known as the Transportation Electrification Regulatory Policies Act (TERPA)

214

$$\text{Cost of Enabled Charging} \left( \frac{\$}{\text{kWh/year}} \right) = \frac{\text{Public Investment}}{\frac{\text{kW} * (h_{\text{measured}} + h_{\text{projected}})}{\text{Station}} * \frac{\text{Stations Installed}}{\text{Year}}}$$



flows 1) to harder-to-reach customers (such as disadvantaged or rural communities) and 2) over time to ensure full fleet decarbonization.<sup>215</sup>

With the potential to leverage existing public, ratepayer, and other funding while opening private investment channels, several stakeholders including multiple EVSPs<sup>216</sup> expressed support for this model. While other stakeholders expressed uncertainty over implementation ease relative to other programs. CEC staff have already incorporated some of the elements of the model into principles guiding future programs and projects.

The CEC has also requested proposals for a variety of financing mechanisms, with the goal of increasing the ratio of private capital to public funds.<sup>217</sup> Experimentation with developers to configure investment programs is critical to understanding the market conditions for expanding infrastructure in the long term with less funding from government and utility programs. Suggestions from stakeholders include initiatives to:

1. Structure low-interest revolving loan programs to enable repayment of the principal provided by the state via revenue generated by (or fuel and operational expense savings to) the site.<sup>218</sup> A loan could be complemented with policies that improve the prospect for a variety of revenue streams (as described above), including increased revenue from properties surrounding the site host.<sup>219</sup> Revenue-based loan repayment

---

215 Further, deployments in equity communities could be exceeded. For example, each bidder could be required to serve at least a certain amount of energy in a socioeconomic- or pollution- geo-targeted area.

216 [TURN](#), [Sierra Club](#), [Earth Justice](#), [Center for Sustainable Energy](#), [Enel X](#), [Freewire](#), [Powertree](#), and [EV Charging Association](#) comments in [Docket 20-IEPR-02](#) <https://efiling.energy.ca.gov/Lists/DocketLog.aspx?docketnumber=20-IEPR-02> regarding the June 24 and August 4, 2020 Workshops.

217 CEC. [Revised Notice of Availability](#) <https://efiling.energy.ca.gov/GetDocument.aspx?tn=232830&DocumentContentId=65264>, Request for Information - Strategies to Attract Private Investment in Zero Emission Vehicle Charging Infrastructure and Other Clean Transportation Projects – February 2020 and comments of [Clean Energy Works](#) <https://efiling.energy.ca.gov/GetDocument.aspx?tn=232725&DocumentContentId=64796> in Docket 20-FINANCE-02.

218 Princeton Energy Systems. May 13, 2020. Strategies to Attract Private Investment in Zero Emission Vehicle Charging Infrastructure. <https://efiling.energy.ca.gov/GetDocument.aspx?tn=232972&DocumentContentId=65424>

219 FreeWire Technologies. August 7, 2020. [Strategies to Attract Private Investment in Zero Emission Vehicle Charging Infrastructure](#). <https://efiling.energy.ca.gov/GetDocument.aspx?tn=234254&DocumentContentId=67099> and Tesla. June 1, 2020. "[Strategies to Attract Private Investment in Zero Emission Vehicle Charging Infrastructure and Other Clean Transportation Projects](#)." <https://efiling.energy.ca.gov/GetDocument.aspx?tn=233272&DocumentContentId=65758>.

could reduce operating risk for the EVSP, while ensuring that the site developer shares the incentive for high charger utilization.

2. Create policies to establish long-term offtake agreements<sup>220</sup> that reduce barriers to high-usage cases (such as commercial, institutional, or industrial fleets, or transportation network company charging<sup>221</sup>) by holistically addressing vehicle purchases, infrastructure installation capital, and operational risks that challenge an EVSP's willingness to engage in project financing.<sup>222</sup>
3. Work with industry to establish consensus "pro forma" standard contracting terms and conditions to enable the rapid execution of agreements between infrastructure developers and fully- or partially-subsidized infrastructure programs. One form could include the use of utility tariff on-bill financing in which the utility capitalizes on an investment in charging infrastructure. The costs of the charging could be recovered through a monthly charge to the EV customer.<sup>223</sup> Alternatively, utilities could enter a long-term, fixed-price contracts with standard offer or feed-in-tariffs to enable participation in ancillary services.<sup>224</sup>
4. Coordinate the design of incentives with state or local investment tax credits and federal tax credits, advanced technology manufacturing initiatives, and specifically targeted state investments in areas in need of economic recovery, including Qualified Opportunity Zones.<sup>225</sup>

---

220 An offtake agreement would define the terms between an electric vehicle service provider and an electric vehicle customer for the respective sale and purchase of the EVSP's product or services. An offtake agreement would be negotiated prior to the construction of the charging facilities to secure future revenues for the EVSP.

221 Cruise. June 1, 2020. "[Cruise LLC Response to ZEV Charging RFI.](https://efiling.energy.ca.gov/GetDocument.aspx?tn=233262&DocumentContentId=65745)"  
[https://efiling.energy.ca.gov/GetDocument.aspx?tn=233262&DocumentContentId=65745.](https://efiling.energy.ca.gov/GetDocument.aspx?tn=233262&DocumentContentId=65745)

222 Enel X E-Mobility. April 10, 2020. "[Strategies to Attract Private Investment in Zero Emission Vehicle Charging Infrastructure and Other Clean Transportation Projects.](https://efiling.energy.ca.gov/GetDocument.aspx?tn=232724&DocumentContentId=64795)"  
<https://efiling.energy.ca.gov/GetDocument.aspx?tn=232724&DocumentContentId=64795>

223 Clean Energy Works. April 10, 2020. "[Response to RFI on Strategies to Attract Private Investment in Zero Emission Vehicle Charging Infrastructure and Other Clean Transportation Projects.](https://efiling.energy.ca.gov/GetDocument.aspx?tn=232725&DocumentContentId=64796)"  
<https://efiling.energy.ca.gov/GetDocument.aspx?tn=232725&DocumentContentId=64796>

224 Enel X E-Mobility. April 10, 2020. "Strategies to Attract Private Investment in Zero Emission Vehicle Charging Infrastructure and Other Clean Transportation Projects."  
<https://efiling.energy.ca.gov/GetDocument.aspx?tn=232724&DocumentContentId=64795>

225 Internal Revenue Service. "[Opportunity Zones.](https://www.irs.gov/credits-deductions/businesses/opportunity-zones)" [https://www.irs.gov/credits-deductions/businesses/opportunity-zones.](https://www.irs.gov/credits-deductions/businesses/opportunity-zones)



# CHAPTER 8:

## The Road Ahead

---

Widespread, accessible, and convenient charging infrastructure is critical to transportation electrification and California's ability to address climate change and air pollution. Significant public investment is needed to meet the need for over 1.3 million shared and public chargers by 2030. Industry, working closely with the CEC, state agencies, and local governments, must quickly close the gap to provide drivers and fleets confidence that their mobility needs can be served by electric vehicles.

This report identifies several actions to support the widespread deployment of charging infrastructure:

1. **Continue public support for charger deployment, using public funds to leverage private funds, and eventually transition to a self-sustaining private market.** The charging market has introduced diverse and novel business models. The state must continue to invest in charging infrastructure deployment to achieve its ZEV goals. Public investments in charging infrastructure, including through the successful California Electric Vehicle Infrastructure Project, will remain critical to encouraging continued market experimentation, growth, and maturation.
2. **Continue the modeling efforts to project the quantities, locations, and load curves of chargers needed to meet statewide travel demand, including for MD/HD vehicles.** Work with partner agencies to incorporate updated electrification and vehicle population scenarios as they become available. Communicate results with load-serving entities and other stakeholders to increase efficacy of infrastructure deployment.
3. **Support innovative charging solutions and financing mechanisms.** Explore solutions that can generate new revenue streams, reduce charger costs, improve usage, address the need for grid upgrades, improve resiliency, or be uniquely well-suited to specific environments. Consider innovative financing mechanisms.
4. **Support local efforts to prepare for transportation electrification.** Recognize that there is no one-size-fits-all charger, and that local conditions will determine the most appropriate solution. Support local efforts to prepare for transportation electrification, including through community EV blueprints, streamlined permitting ordinances, utility integrated resource plans, and workforce training.
5. **Ensure equitable distribution of charger deployment throughout the state.** Maintain ongoing analyses, such as those called for by Senate Bill 1000, intended to ensure that chargers are equitably and proportionately deployed throughout California.
6. **Align charging with renewable generation and grid needs.** Pursue greater vehicle-grid integration, as charging millions of vehicles will introduce significant new

load onto the grid. Smart charging will help automatically align charging with renewable energy generation, and bidirectional technologies improve resilience and will enable vehicles to supply stored electricity to homes, buildings, other vehicles, or the grid to earn revenue.

7. **Prioritize standardized charger connectors, and for networked charging, prioritize hardware capable of standardized communications protocols.** These standards will promote greater driver convenience, interoperability, and grid-integrated charging at the necessary massive scale.

## GLOSSARY

**ALTERNATING CURRENT (AC)** — Flow of electricity that constantly changes direction. Almost all power produced by electric utilities in the United States moves in current that shifts direction at a rate of 60 times per second.

**BATTERY-ELECTRIC VEHICLE (BEV)** — Also known as an “all-electric” vehicle, BEVs use energy that is stored in rechargeable battery packs. BEVs sustain power through the batteries and therefore must be plugged into an external electricity source to recharge.

**BUILT ENVIRONMENT** — Man-made structures, features, and facilities viewed collectively as the patterns of land use within a community, the design and construction of spaces and buildings within a community, and the transportation systems that connect people to places.<sup>226</sup>

**CALIFORNIA AIR RESOURCES BOARD (CARB)** — The state's lead air quality agency consisting of an 11-member board appointed by the Governor and more than 1,000 employees. CARB is responsible for attainment and maintenance of the state and federal air quality standards, California climate change programs, and motor vehicle pollution control. It oversees county and regional air pollution management programs.

**CALIFORNIA ENERGY COMMISSION (CEC)**—The state agency established by the Warren-Alquist State Energy Resources Conservation and Development Act in 1974 (Public Resources Code, Sections 25000 et seq.) responsible for energy policy. The CEC's five major areas of responsibilities are forecasting future statewide energy needs; licensing power plants sufficient to meet those needs; promoting energy conservation and efficiency measures; developing renewable and alternative energy resources, including providing assistance to develop clean transportation fuels and infrastructure; and planning for and directing state response to energy emergencies.

**CALIFORNIA PUBLIC UTILITIES COMMISSION (CPUC)** — A state agency created by a California constitutional amendment in 1911 to regulate the rates and services of more than 1,500 privately owned utilities and 20,000 transportation companies. The CPUC is an administrative agency that exercises legislative and judicial powers; its decisions and orders may be appealed only to the California Supreme Court. The major duties of the CPUC are to regulate privately owned utilities, securing adequate service to the public at rates that are just and reasonable to customers and shareholders of the utilities; and the oversight of electricity transmission lines and natural gas pipelines. The CPUC also provides electricity and natural gas forecasting, and analysis and planning of energy supply and resources. Its headquarters are in San Francisco.

---

226 Adapted from the [Oxford University Press](#) and the [California Institute for Local Government](#)

CHAdeMO — A connector standard for fast charging of electric vehicles that can provide up to 62.5 kilowatts of power.

COMBINED CHARGING SYSTEM (CCS) — A connector standard for fast charging of electric vehicles that can provide up to 350 kilowatts of power.

DIRECT CURRENT (DC) — A current of electricity that flows in one direction and is the type of power that comes from a battery.

ELECTRIC VEHICLE (EV) — A broad category that includes all vehicles that can be fully powered by electricity or an electric motor.

ELECTRIC VEHICLE CHARGING STATION — A location where one or more EVSEs are installed to charge EVs.

ELECTRIC VEHICLE SUPPLY EQUIPMENT (EVSE) -- Equipment designed to supply power to EVs. Most EVSEs can charge BEVs and PHEVs.

GREENHOUSE GAS (GHG) — Any gas that absorbs infrared radiation in the atmosphere. Greenhouse gases include water vapor, carbon dioxide (CO<sub>2</sub>), methane (CH<sub>4</sub>), nitrous oxide (NO<sub>x</sub>), halogenated fluorocarbons (HCFCs), ozone (O<sub>3</sub>), perfluorinated carbons (PFCs), and hydrofluorocarbons (HFCs).

HYBRID AND ZERO-EMISSION TRUCK AND BUS VOUCHER INCENTIVE PROJECT (HVIP) — A project launched in 2009 by the CARB in partnership with CALSTART, a transportation nonprofit, to accelerate the purchase of cleaner, more efficient trucks and buses in California.

KILOWATT (kW) — One thousand watts, a measure of power. On a hot summer afternoon, a typical home — with central air conditioning and other equipment in use — might have a power demand of 4 kW.

KILOWATT-HOUR (kWh) — One kilowatt of electricity supplied for one hour, that is, a measure of energy. It is the most used unit of measure telling the amount of electricity consumed over time.

LEVEL 1 (L1) CHARGING — Electric vehicle charging at 120 volts.

LEVEL 2 (L2) CHARGING — Electric vehicle charging at 240 volts.

MEGAWATT (MW) — A unit of power equal to 1 million watts.

NITROGEN OXIDES (OXIDES OF NITROGEN, NO<sub>x</sub>) — A general term for compounds of nitric oxide (NO), nitrogen dioxide (NO<sub>2</sub>), and other oxides of nitrogen. Nitrogen oxides are typically created during combustion and are major contributors to smog formation and acid deposition. NO<sub>2</sub> is a criteria air pollutant and may result in numerous adverse health effects.

PLUG-IN ELECTRIC VEHICLE (PEV) — A general term for any car that runs at least partially on battery power and is recharged from the electricity grid. There are two types of PEVs: pure battery-electric and plug-in hybrid electric vehicles.

PLUG-IN HYBRID ELECTRIC VEHICLE (PHEV) — PHEVs are powered by an internal combustion engine and an electric motor that uses energy stored in a battery. The vehicle can be plugged

in to an electric power source to charge the battery. Some can travel nearly 100 miles on electricity alone, and all can operate solely on gasoline (like a conventional hybrid).

**SOCIETY OF AUTOMOTIVE ENGINEERS (SAE)** — A global association of more than 128,000 engineers and related technical experts in the aerospace, automotive, and commercial vehicle industries. It is the leader in connecting and educating mobility professionals to enable safe, clean, and accessible mobility solutions.<sup>227</sup>

**TRANSPORTATION NETWORK COMPANY (TNC)** — A company that provides prearranged transportation services for compensation using an online-enabled application or platform (such as smartphone apps) to connect drivers using their personal vehicles with passengers.

**VEHICLE-GRID INTEGRATION (VGI)** — Methods to align electric vehicle charging with the needs of the electric grid. To do this, electric vehicles must have capabilities to manage charging or support two-way communication between vehicles and the grid.<sup>228</sup>

**ZERO-EMISSION VEHICLE (ZEV)** — Vehicles that produce no emissions from the onboard source of power (for example, hydrogen fuel cell vehicles and electric vehicles).

---

227 [Society of Automotive Engineers](https://www.sae.org/about/) (https://www.sae.org/about/).

228 [California Public Utilities Commission](https://www.cpuc.ca.gov/General.aspx?id=6442454110) (https://www.cpuc.ca.gov/General.aspx?id=6442454110).

# APPENDIX A:

## List of Related Public Workshops

---

March 11, 2019: The CEC, CARB, and CPUC conducted a joint workshop regarding light-duty electric vehicle charging infrastructure needs.<sup>229</sup>

May 2, 2019: The CEC, CARB, and CPUC conducted a joint workshop regarding medium- and heavy-duty, off-road, port and airport charging infrastructure needs.<sup>230</sup>

May 20-21, 2020: The CEC hosted a workshop with stakeholder presentations regarding port and off-road equipment and medium- and heavy-duty vehicles used for moving freight goods and mass transportation.<sup>231</sup>

June 4, 2020: CEC staff hosted a public workshop to solicit feedback on the CEC's proposed methodology and preliminary analysis for the Senate Bill 1000 Electric Vehicle Charging Infrastructure Deployment Assessment.<sup>232</sup>

June 10, 2020: CEC staff hosted a workshop to solicit feedback on methods to count public and shared private electric vehicle chargers in California.<sup>233</sup>

June 22, 2020: The CEC and CPUC conducted a joint workshop regarding vehicle-grid integration and charging infrastructure.<sup>234</sup>

---

229 [March 11 and May 2, 2019, workshop sessions](https://www.energy.ca.gov/data-reports/reports/integrated-energy-policy-report/2019-integrated-energy-policy-report/2019-iepr): <https://www.energy.ca.gov/data-reports/reports/integrated-energy-policy-report/2019-integrated-energy-policy-report/2019-iepr>.

230 Ibid.

231 May 20-21, 2020: workshops [session 1](https://www.energy.ca.gov/event/workshop/2020-05/iepr-commissioner-w%E2%80%A2May%2020-21,%202020orkshop-heavy-duty-zero-emission-vehicle-market-trends)- <https://www.energy.ca.gov/event/workshop/2020-05/iepr-commissioner-w%E2%80%A2May%2020-21,%202020orkshop-heavy-duty-zero-emission-vehicle-market-trends>, [session 2](https://www.energy.ca.gov/event/workshop/2020-05/iepr-commissioner-workshop-heavy-duty-zero-emission-vehicle-market-trends-0)- <https://www.energy.ca.gov/event/workshop/2020-05/iepr-commissioner-workshop-heavy-duty-zero-emission-vehicle-market-trends-0>.

232 [June 4, 2020: workshop](https://www.energy.ca.gov/event/2020-06/senate-bill-1000-workshop)- <https://www.energy.ca.gov/event/2020-06/senate-bill-1000-workshop>.

233 [June 10, 2020: workshop](https://www.energy.ca.gov/event/2020-06/staff-workshop-counting-electric-vehicle-chargers-california)- <https://www.energy.ca.gov/event/2020-06/staff-workshop-counting-electric-vehicle-chargers-california>.

234 [June 22, 2020: workshop session 1](https://www.energy.ca.gov/event/workshop/2020-06/session-1-joint-agency-workshop-vehicle-grid-integration-and-charging)- <https://www.energy.ca.gov/event/workshop/2020-06/session-1-joint-agency-workshop-vehicle-grid-integration-and-charging>.

August 4 and 6, 2020: The CEC, CARB, and CPUC conducted a joint workshop and presented preliminary results on needed chargers, hardware and software, grid capacity analysis, and deployments in low-income communities.<sup>235</sup>

February 4 and 5, 2021: The CEC conducted a workshop and presented the AB 2127 Electric Vehicle Charging Infrastructure Assessment (Staff Report).<sup>236</sup>

April 16, 2021: The CEC and CPUC conducted a joint workshop on the Electric Vehicle Infrastructure Training Program.<sup>237</sup>

---

235 August 4-6, 2020: workshops [session 1-](https://www.energy.ca.gov/event/workshop/2020-08/session-1-engagement-and-outreach-enhancing-charging-infrastructure) <https://www.energy.ca.gov/event/workshop/2020-08/session-1-engagement-and-outreach-enhancing-charging-infrastructure>, [session 2-](https://www.energy.ca.gov/event/workshop/2020-08/session2-charging-infrastructure-technology-and-markets-commissioner) <https://www.energy.ca.gov/event/workshop/2020-08/session2-charging-infrastructure-technology-and-markets-commissioner>, [session 3-](https://www.energy.ca.gov/event/workshop/2020-08/session3-modeling-and-projecting-charging-infrastructure-commissioner) <https://www.energy.ca.gov/event/workshop/2020-08/session3-modeling-and-projecting-charging-infrastructure-commissioner>, [session 4-](https://www.energy.ca.gov/event/workshop/2020-08/session-4-examining-needs-infrastructure-development-commissioner-workshop) <https://www.energy.ca.gov/event/workshop/2020-08/session-4-examining-needs-infrastructure-development-commissioner-workshop>.

236 February 4-5, 2021: workshops [session 1-](https://www.energy.ca.gov/event/workshop/2021-02/session-1-lead-commissioner-workshop-assembly-bill-2127-electric-vehicle) <https://www.energy.ca.gov/event/workshop/2021-02/session-1-lead-commissioner-workshop-assembly-bill-2127-electric-vehicle>, [session 2-](https://www.energy.ca.gov/event/workshop/2021-02/session-2-lead-commissioner-workshop-assembly-bill-2127-electric-vehicle) <https://www.energy.ca.gov/event/workshop/2021-02/session-2-lead-commissioner-workshop-assembly-bill-2127-electric-vehicle>.

237 April 16, 2021 [workshop](https://www.energy.ca.gov/event/workshop/2021-04/joint-workshop-california-energy-commission-and-california-public-utilities): <https://www.energy.ca.gov/event/workshop/2021-04/joint-workshop-california-energy-commission-and-california-public-utilities>

# APPENDIX B:

## EVI-Pro 2 Inputs and Parameters

The data below highlights several key inputs and parameters used for the EVI-Pro 2 analysis discussed in this report.

Table B-1 illustrates the share of BEVs and PHEVs in each calendar year for CARB’s *Draft 2020 Mobile Source Strategy* from 2020 to 2030. The CEC’s IEPR low scenario (around 2 million ZEVs) results in a 2030 BEV share of 62% and PHEV share of 38%, while the aggressive scenario (5 million ZEVs) results in a 70% BEV share and 30% PHEV share.

**Table B-1: BEV/PHEV Shares for 8 Million ZEVs in EVI-Pro 2**

PEV Share	2020	2021	2022	2023	2024	2025	2026	2027	2028	2029	2030
BEVs	61%	63%	64.5%	65.5%	66.5%	67%	68%	68.5%	69%	69.5%	70%
PHEVs	39%	37%	35.5%	34.5%	33.5%	33%	32%	31.5%	31%	30.5%	30%

Source: CEC and National Renewable Energy Laboratory

Figure B-1 and Figure B-2 show the breakdown of BEV and PHEV populations, respectively, by vehicle classification for CARB’s *Draft 2020 Mobile Source Strategy* planning scenario. EVI-Pro 2 simulates seven different vehicle classifications, which are different than the classifications used by CARB in their analyses. As a result, assumptions have been made to convert CARB’s vehicle populations into the appropriate EVI-Pro 2 vehicle classifications.

**Figure B-1: BEV Population Breakdown by Vehicle Classification for CARB’s *Draft 2020 Mobile Source Strategy* (8 Million ZEVs)**

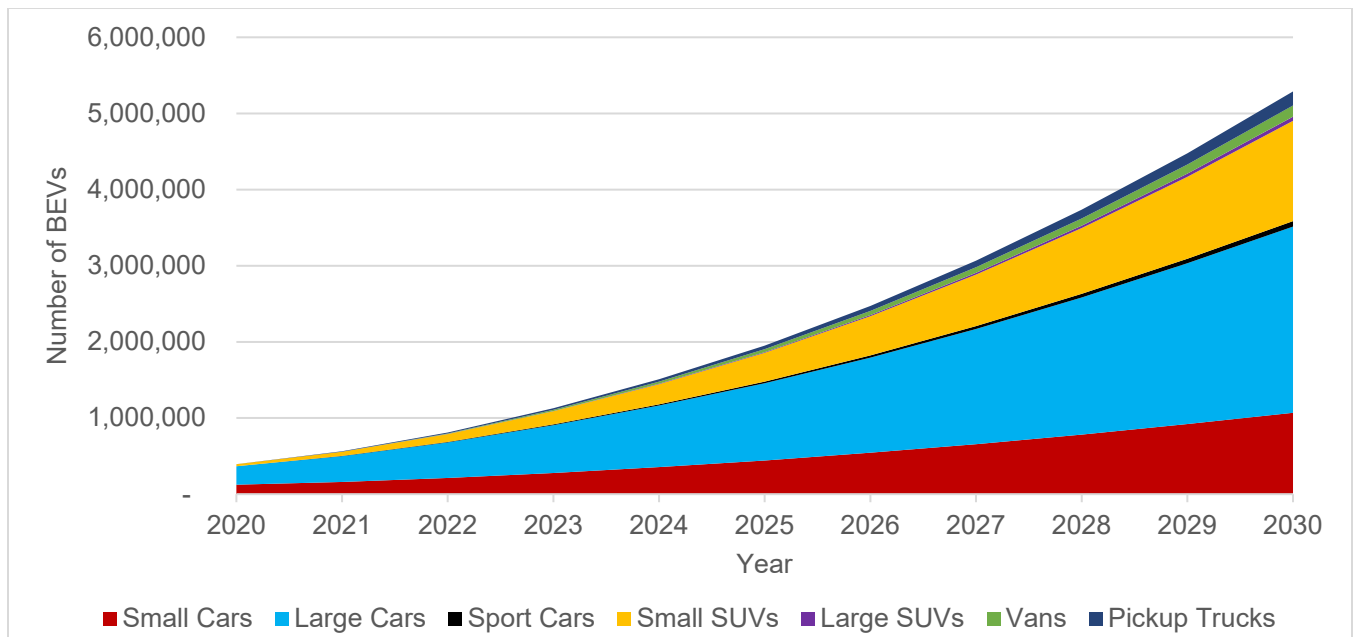



**CARB's Draft 2020 Mobile Source Strategy** planning scenario consists of a BEV market dominated by large cars, which make up 46% of the 2030 fleet, along with small cars and small SUVs, which combine to make up another 45% of the 2030 fleet. The remaining vehicle classifications make up a combined 8% of the 2030 fleet. Note that assumptions have been made to translate the vehicle classifications used in CARB's *Draft 2020 Mobile Source Strategy* to those used in EVI-Pro 2.

Source: CEC and CARB

**Figure B-2: PHEV Population Breakdown by Vehicle Classification for CARB's Draft 2020 Mobile Source Strategy (8 Million ZEVs)**

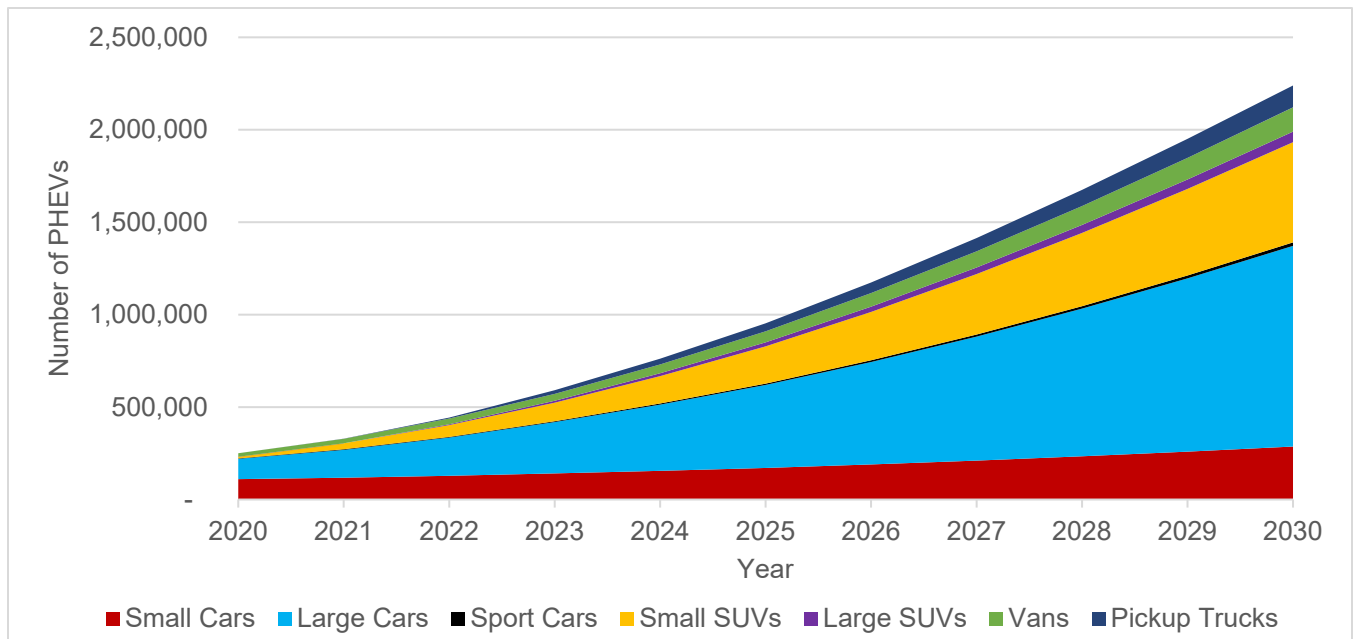

**CARB's Draft 2020 Mobile Source Strategy** planning scenario consists of a PHEV market dominated by large cars, which make up 48% of the 2030 fleet, along with small cars and small SUVs, which combine to make up another 37% of the 2030 fleet. The remaining vehicle classifications make up a combined 15% of the 2030 fleet. Note that assumptions have been made to translate the vehicle classifications used in CARB's *Draft 2020 Mobile Source Strategy* to those used in EVI-Pro 2.

Source: CEC and CARB

Table B-2 and Table B-3 show the electric range values for BEVs and PHEVs, respectively, by vehicle classification and simulation year for CARB's *Draft 2020 Mobile Source Strategy*. It is important to note that these values are "on the road" fleet averages in each year. This means that BEV range values shown for simulation year 2030 do not represent the range values for model year 2030 vehicles; instead this is a fleet-wide average range value that factors in older vehicles still on the road in the year 2030. In addition, a zero in the table indicates that there are no vehicles in that classification forecasted to be on the road in that year. For example, Table B-2 shows that there are no BEV pickup trucks forecasted in 2020 because the electric range equals zero.

**Table B-2: Fleet-Average BEV Electric Range by Vehicle Classification and Year**

Electric Range (miles)	2020	2021	2022	2023	2024	2025	2026	2027	2028	2029	2030
Small Cars	100	120	140	160	180	200	220	240	260	280	300
Large Cars	100	150	200	250	300	350	400	450	500	550	600
Sport Cars	0	0	0	0	0	0	0	0	0	0	0
Small SUVs	0	0	0	0	0	0	0	0	0	0	0
Large SUVs	0	0	0	0	0	0	0	0	0	0	0
Vans	0	0	0	0	0	0	0	0	0	0	0
Pickup Trucks	0	0	0	0	0	0	0	0	0	0	0

Small Cars	142	157	172	184	192	201	209	215	221	226	232
Large Cars	263	263	263	263	263	263	263	263	263	263	263
Sport Cars	204	209	223	233	247	259	268	274	280	284	288
Small SUVs	257	270	275	278	281	282	284	284	284	284	285
Large SUVs	239	239	240	240	242	242	245	247	248	250	251
Vans	148	148	211	214	214	214	214	214	214	214	214
Pickup Trucks	0	245	250	257	266	275	278	280	281	281	281

Source: CEC and National Renewable Energy Laboratory

**Table B-3: Fleet-Average PHEV Electric Range by Vehicle Classification and Year**

Electric Range (miles)	2020	2021	2022	2023	2024	2025	2026	2027	2028	2029	2030
Small Cars	32	32	32	32	35	35	35	38	38	41	41
Large Cars	42	42	45	45	48	48	48	51	51	51	51
Sport Cars	40	40	40	40	43	43	43	43	43	43	43
Small SUVs	42	45	45	45	45	45	45	45	48	49	49
Large SUVs	0	43	43	46	46	46	46	46	48	48	48
Vans	41	41	44	44	46	46	49	49	51	51	51
Pickup Trucks	0	44	45	45	45	46	46	46	46	46	46

Source: CEC and National Renewable Energy Laboratory

Table B-4 and Table B-5 show the battery size for BEVs and PHEVs, respectively, by vehicle classification and simulation year for CARB's *Draft 2020 Mobile Source Strategy*. Once again, these are "on the road" fleet averages for each year.

**Table B-4: Fleet-Average BEV Battery Size by Vehicle Classification and Year**

Battery Size (kWh)	2020	2021	2022	2023	2024	2025	2026	2027	2028	2029	2030
Small Cars	42	47	52	56	59	62	65	67	69	71	73
Large Cars	92	92	92	92	92	92	92	92	92	92	92
Sport Cars	76	78	84	89	95	101	105	108	111	113	115
Small SUVs	119	129	133	135	137	138	139	139	139	139	139
Large SUVs	119	119	120	120	121	121	123	124	125	126	127
Vans	58	58	87	88	88	88	88	88	88	88	88
Pickup Trucks	0	151	154	158	163	168	169	169	168	166	163

Source: CEC and National Renewable Energy Laboratory

**Table B-5: Fleet-Average PHEV Battery Size by Vehicle Classification and Year**

Battery Size (kWh)	2020	2021	2022	2023	2024	2025	2026	2027	2028	2029	2030
Small Cars	8	8	8	8	9	9	9	10	10	11	11
Large Cars	11	11	12	12	13	13	13	14	14	14	14
Sport Cars	11	11	11	11	12	12	12	12	12	12	12
Small SUVs	15	16	16	16	16	16	16	16	17	17	17
Large SUVs	0	16	16	17	17	17	17	17	18	18	18
Vans	14	14	15	15	16	16	17	17	18	18	18
Pickup Trucks	0	18	18	18	18	18	18	18	18	18	18

Source: CEC and National Renewable Energy Laboratory

Table B-6 and shows the residential AC charge power for BEVs in CARB's *Draft 2020 Mobile Source Strategy*. It is assumed that the AC charge power for public and workplace charging is limited to 6.6 kW for all vehicle classifications in all years.

**Table B-6: Fleet-Average BEV Residential AC Charge Power by Vehicle Classification and Year**

Charge Power (kW)	2020	2021	2022	2023	2024	2025	2026	2027	2028	2029	2030
Small Cars	7.7	8.5	9.3	10.0	10.4	10.9	11.3	11.7	12.0	12.0	12.0
Large Cars	12.0	12.0	12.0	12.0	12.0	12.0	12.0	12.0	12.0	12.0	12.0
Sport Cars	11.1	11.3	12.0	12.0	12.0	12.0	12.0	12.0	12.0	12.0	12.0
Small SUVs	12.0	12.0	12.0	12.0	12.0	12.0	12.0	12.0	12.0	12.0	12.0
Large SUVs	12.0	12.0	12.0	12.0	12.0	12.0	12.0	12.0	12.0	12.0	12.0
Vans	8.0	8.0	11.5	11.6	11.6	11.6	11.6	11.6	11.6	11.6	11.6
Pickup Trucks	0	12.0	12.0	12.0	12.0	12.0	12.0	12.0	12.0	12.0	12.0

Source: CEC and National Renewable Energy Laboratory

Figure B-3 illustrates the charge curves that were used in EVI-Pro 2 and EVI-RoadTrip simulations for DC fast charging. Charge curves show the vehicle charging power (kW) as a function of battery state-of-charge (SOC). A common trend seen in these curves is a significant drop-off in charging power once a vehicle reaches around 80 to 85 percent SOC, highlighting the inefficiency of fully charging vehicles to 100 percent SOC at a fast charger. For simplicity, charge curves were developed for three broad vehicle classes: short-range cars (SR-Car), long-range cars (LR-Car), and SUVs. These vehicle classes match those simulated in EVI-RoadTrip, but aggregate the wider diversity of vehicles simulated in EVI-Pro 2. Charge curves were developed on a 5-year interval, with each curve representing the charging characteristics of model year vehicles (i.e., the 2030 SR-Car charge curve represents the charging characteristics for a model year 2030 SR-Car, not the fleet-wide average for all vehicles in calendar year 2030).

**Figure B-3: DCFC Charging Power (kW) as a Function of Battery State-of-Charge (SOC)**

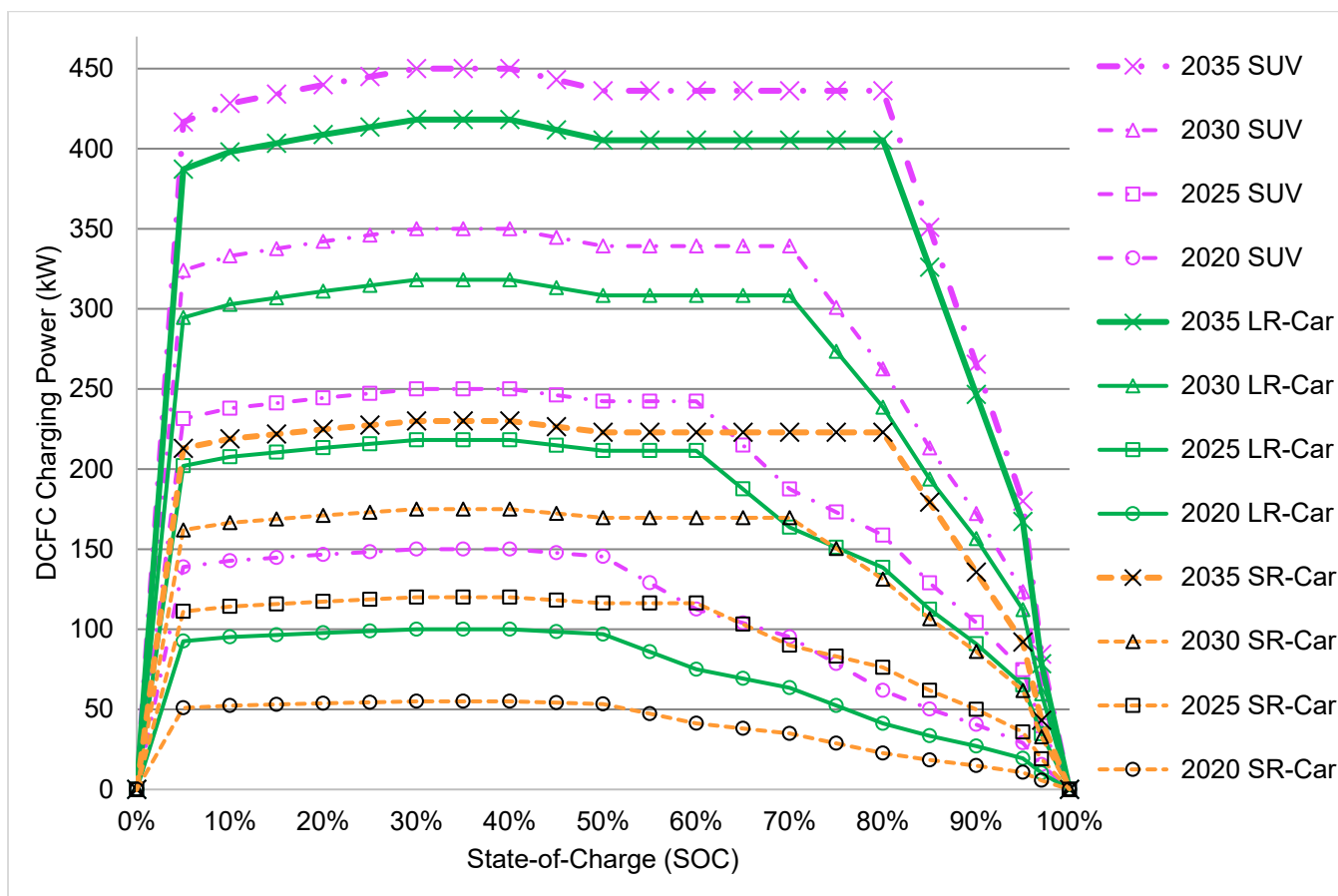

Charge curves illustrate how the vehicle charging power (kW) changes as a function of battery state-of-charge (SOC). These DCFC charge curves were developed for three classes of vehicles on five-year intervals for model years. In general, charging power drops significantly around 80 to 85 percent SOC, and vehicles simulated in EVI-Pro 2 are forced to plug out at 85 percent SOC to avoid inefficient charging.

Source: CEC and National Renewable Energy Laboratory

Table B-7 illustrates how EVI-Pro 2 vehicle classes were aggregated into the three classes shown in Figure B-3, as there are only three distinct sets of charge powers. In contrast to Figure B-3, Table B-7 shows the fleet-wide average DC charge power in each calendar year. For example, the average DC charge power in the year 2030 includes older vehicles as well, resulting in an average charge power lower than what might be expected just by looking at the charge curves in Figure B-3. Average DC charge power is calculated between the 35 to 85 percent SOC window.

**Table B-7: Fleet-Average BEV DC Charge Power by Vehicle Classification and Year**

Charge Power (kW)	2020	2021	2022	2023	2024	2025	2026	2027	2028	2029	2030
Small Cars	42.9	55.2	67.6	80.0	92.3	104.6	116.1	127.6	139.1	150.6	162.1
Large Cars	78.1	100.5	122.9	145.4	167.8	190.2	211.1	232.0	252.8	273.7	294.6

Sport Cars	78.1	100.5	122.9	145.4	167.8	190.2	211.1	232.0	252.8	273.7	294.6
Small SUVs	117.1	137.3	157.5	177.6	197.8	218.0	239.2	260.4	281.7	302.9	324.1
Large SUVs	117.1	137.3	157.5	177.6	197.8	218.0	239.2	260.4	281.7	302.9	324.1
Vans	117.1	137.3	157.5	177.6	197.8	218.0	239.2	260.4	281.7	302.9	324.1
Pickup Trucks	0	137.3	157.5	177.6	197.8	218.0	239.2	260.4	281.7	302.9	324.1

Source: CEC and National Renewable Energy Laboratory

Table B-8 shows the AC charge power of PHEVs for CARB’s *Draft 2020 Mobile Source Strategy*. It is assumed that residential, public, and workplace charge powers are all the same.

**Table B-8: Fleet-Average PHEV AC Charge Power by Vehicle Classification and Year**

Charge Power (kW)	2020	2021	2022	2023	2024	2025	2026	2027	2028	2029	2030
Small Cars	3.9	3.9	3.9	3.9	4.3	4.3	4.3	4.6	4.6	5.0	5.0
Large Cars	5.1	5.1	5.5	5.5	5.8	5.7	5.7	6.2	6.2	6.2	6.2
Sport Cars	4.9	4.9	4.9	4.9	5.2	5.2	5.2	5.2	5.2	5.2	5.2
Small SUVs	5.1	5.5	5.5	5.5	5.5	5.5	5.5	5.5	5.8	5.9	5.9
Large SUVs	0.0	5.2	5.2	5.6	5.6	5.6	5.6	5.6	5.8	5.8	5.8
Vans	5.0	5.0	5.3	5.3	5.6	5.6	5.9	5.9	6.2	6.2	6.2
Pickup Trucks	0.0	5.3	5.5	5.5	5.5	5.6	5.6	5.6	5.6	5.6	5.6

Source: CEC and National Renewable Energy Laboratory

The charger utilization assumptions have also been changed in EVI-Pro 2 compared to EVI-Pro 1. In EVI-Pro 2, network size for non-residential Level 2 and DC fast charging is calculated as a function of simulated charging demand using results of linear regression analysis that leveraged over 5 million observed charging events from EVSPs operating in California. Network size is estimated based on the number of observed charging events per month along with county-specific socioeconomic variables such as population and income level. The model identifies a strong correlation between the supply of infrastructure and charging demand, resulting in statewide averages of close to 1 event per Level 2 plug per day and over 8 events per DC fast charger plug per day in 2030. It is important to note that these are statewide averages for reporting purposes, but county-level variation for charger utilization is observed and incorporated in the model. The lower and upper bounds for statewide average charger utilization used in EVI-Pro 2 are determined through the confidence intervals from this regression analysis. These refined charger utilization inputs result in a narrower gap between the lower and upper bounds for EVI-Pro 2 charger counts seen in Chapter 4 compared to what was observed in EVI-Pro 1 results.

Finally, as described in Chapter 4, EVI-Pro 2 uses time-of-use participation rates as an input to influence residential charging. Table B-9 shows these inputs, which are broken down for key utility territories. TOU participation rates were developed by CEC staff for the Transportation Energy Demand Forecast for the 2020 IEPR Update. EVI-Pro 2 uses the participation rates for

the mid case scenario. For the investor-owned utility areas, participation rates were based on current estimates of EV owner enrollment and the effects of the transition of a majority of residential households onto a default TOU rate. San Diego Gas and Electric (SDGE) has completed this process, and now has 70 percent of all households on a TOU rate. Since some EV owners were already on TOU, staff estimates that now 76 percent of EV owners are on a TOU rate. Southern California Edison (SCE) and Pacific Gas and Electric (PGE) will complete this process by 2023, increasing assumed EV enrollment rates from less than a third to about 80 percent. After the default transition period, the enrollment rate increases at 1 percent annually through 2030. Sacramento Municipal Utilities District (SMUD) reports that 99 percent of all households are on its Time of Day rate, so the same assumption is used for EV owners. In Burbank Water and Power and Glendale Water and Power (combined to BUGL) and Los Angeles Department of Water and Power (LADWP), where customers must opt in to a TOU rate, participation is assumed to escalate at 2.5 percent annually as utilities expand rate offerings and marketing and education efforts. From 2030 to 2035, all participation rates remain constant, except for BUGL and LADWP, which continue to increase by 2.5 percent.

**Table B-9: Time-of-Use Participation Rates by Utility Territory Used in EVI-Pro 2**

Year	PGE	SCE	SDGE	BUGL	LADWP	SMUD
2020	38%	22%	76%	15%	20%	98%
2021	41%	26%	77%	15%	21%	98%
2022	81%	76%	77%	16%	21%	98%
2023	81%	76%	78%	16%	22%	98%
2024	81%	77%	79%	17%	22%	99%
2025	82%	78%	80%	17%	23%	99%
2026	83%	79%	80%	17%	23%	99%
2027	84%	79%	81%	18%	24%	99%
2028	85%	80%	82%	18%	24%	99%
2029	85%	81%	83%	19%	25%	99%
2030	86%	82%	84%	19%	26%	99%
2031	86%	82%	84%	20%	26%	99%
2032	86%	82%	84%	20%	27%	99%
2033	86%	82%	84%	21%	28%	99%
2034	86%	82%	84%	21%	28%	99%
2035	86%	82%	84%	22%	29%	99%

# APPENDIX C:

## EVI-Pro 2 Detailed Results

This appendix expands upon the EVI-Pro 2 results presented in Chapter 4, which focused on CARB’s *Draft 2020 Mobile Source Strategy* planning scenario with nearly 8 million ZEVs in 2030. EVI-Pro 2 analysis was also conducted for the low and aggressive forecasts from the CEC’s 2020 IEPR scenarios. As a reminder, the IEPR aggressive ZEV forecast was scaled up slightly to 5 million ZEVs in 2030. Table C-1 illustrates the differences between these three scenarios.

**Table C-1: Summary of EVI-Pro 2 Scenario Assumptions in 2030**

Input	CEC IEPR Low Forecast	CEC IEPR Aggressive Forecast	CARB Mobile Source Strategy
ZEV Population	1.9 million in 2030	5.0 million in 2030	7.9 million in 2030
PEV / Hydrogen Fuel Cell Electric Vehicle Split	95/5% in 2030	96/4% in 2030	95/5% in 2030
Within PEVs, PHEV / BEV Split	38/62% in 2030	30/70% in 2030	30/70% in 2030
PEVs w/ Home Charging	81%	72%	67%
Time-of-Use Rate Participation	67% in 2030	67% in 2030	67% in 2030

Source: CEC and National Renewable Energy Laboratory

Tables C-2, C-3, and C-4 show the annual statewide EVI-Pro 2 results for the IEPR low forecast, IEPR aggressive forecast, and CARB *Draft 2020 Mobile Source Strategy* planning scenario, respectively.

**Table C-2: Annual Statewide EVI-Pro 2 Results for the IEPR Low Forecast**

Year	MUDs (Level 1+2)		Work (Level 2)		Public (Level 2)		Public (DCFC)		Total Chargers	
	Low	High	Low	High	Low	High	Low	High	Low	High
2020	64,124	95,890	29,789	30,559	57,908	59,097	3,386	3,505	155,207	189,050
2021	70,908	106,124	34,387	35,227	64,932	66,222	3,949	4,081	174,176	211,654
2022	76,947	115,417	41,402	42,342	77,380	78,849	4,313	4,455	200,042	241,063
2023	80,972	121,480	49,157	50,213	90,383	92,041	4,801	4,953	225,312	268,688
2024	81,628	122,533	53,155	54,269	97,281	99,041	4,345	4,488	236,409	280,331
2025	83,546	125,491	58,413	59,602	106,032	107,919	4,657	4,807	252,648	297,819
2026	86,308	129,691	60,476	61,695	109,843	111,783	4,508	4,655	261,135	307,825
2027	88,558	133,123	61,313	62,546	109,922	111,863	4,967	5,125	264,761	312,657

2028	90,471	136,046	65,102	66,391	115,946	117,972	5,306	5,472	276,825	325,880
2029	92,107	138,558	65,808	67,108	116,760	118,794	5,504	5,674	280,178	330,135
2030	93,661	140,943	68,202	69,537	120,501	122,591	5,414	5,582	287,777	338,653

Source: CEC and National Renewable Energy Laboratory

Table C-3 presents the range of EVI-Pro 2 results for the IEPR Aggressive forecast, which corresponds to 5 million ZEVs by 2030. This scenario reflects the original statutory requirement of AB 2127 (Ting, 2018). This scenario includes about 3.4 million BEVs, 1.4 million PHEVs, and 180,000 FCEVs in 2030.

**Table C-3: Annual Statewide EVI-Pro 2 Results for the IEPR Aggressive Forecast (5 Million ZEVs by 2030)**

Year	MUDs (Level 1+2)		Work (Level 2)		Public (Level 2)		Public (DCFC)		Total Chargers	
	Low	High	Low	High	Low	High	Low	High	Low	High
2020	64,243	96,056	31,087	31,878	59,499	60,711	3,723	3,850	158,551	192,494
2021	71,891	106,419	44,065	45,141	81,442	83,065	5,297	5,467	202,694	240,092
2022	80,897	119,894	57,110	58,375	101,253	103,165	6,476	6,675	245,735	288,109
2023	87,778	130,166	75,263	76,796	128,814	131,127	7,943	8,177	299,798	346,266
2024	93,696	139,017	90,588	92,343	152,421	155,078	7,767	7,997	344,471	394,434
2025	102,554	152,280	102,022	103,950	164,356	167,190	9,374	9,642	378,306	433,062
2026	117,978	175,244	117,504	119,660	186,487	189,639	10,461	10,754	432,430	495,297
2027	133,257	197,996	136,052	138,478	211,393	214,907	12,565	12,908	493,267	564,288
2028	148,610	220,869	152,316	154,980	233,521	237,353	14,441	14,828	548,888	628,031
2029	164,107	243,960	172,689	175,649	260,197	264,419	16,416	16,849	613,409	700,876
2030	179,973	267,620	186,403	189,564	275,613	280,059	17,476	17,934	659,464	755,177

Source: CEC and National Renewable Energy Laboratory

Table C-4 presents the range of EVI-Pro 2 results for CARB’s Draft Mobile Source Strategy, which corresponds to 8 million ZEVs by 2030. This scenario reflects the goals set by Executive Order N-79-20. This scenario includes about 5.3 million BEVs, 2.2 million PHEVs, and 422,000 FCEVs in 2030.

**Table C-4: Annual Statewide EVI-Pro 2 Results for CARB Draft 2020 Mobile Source Strategy (8 Million ZEVs by 2030)**

Year	MUDs (Level 1+2)		Work (Level 2)		Public (Level 2)		Public (DCFC)		Total Chargers	
	Low	High	Low	High	Low	High	Low	High	Low	High
2020	60,482	90,455	26,051	26,767	49,672	50,741	3,423	3,542	139,627	171,505



2021	69,615	103,075	36,227	37,187	66,380	67,781	4,709	4,866	176,931	212,909
2022	79,699	118,214	47,998	49,130	86,050	87,734	5,807	5,991	219,555	261,069
2023	85,039	126,230	67,675	69,097	117,386	119,530	7,623	7,850	277,724	322,706
2024	96,199	142,897	86,904	88,606	144,557	147,099	8,276	8,518	335,936	387,120
2025	114,702	170,516	115,986	118,119	188,380	191,558	10,679	10,978	429,747	491,171
2026	133,655	198,796	149,555	152,179	238,594	242,502	12,834	13,183	534,638	606,660
2027	157,901	234,954	181,969	185,066	281,864	286,399	17,108	17,557	638,842	723,976
2028	190,555	283,685	225,442	229,172	337,427	342,773	22,245	22,815	775,669	878,445
2029	226,262	336,943	271,340	275,740	395,829	402,022	27,077	27,760	920,508	1,042,464
2030	264,949	394,706	324,425	329,598	466,404	473,626	30,193	30,950	1,085,972	1,228,880
2031	305,753	455,604	378,574	384,535	538,595	546,869	33,981	34,826	1,256,904	1,421,834
2032	335,053	499,378	437,966	444,794	611,488	620,827	40,573	41,572	1,425,080	1,606,571
2033	362,997	541,136	499,911	507,642	678,298	688,612	47,621	48,786	1,588,828	1,786,176
2034	389,087	580,206	556,542	565,099	747,185	758,501	54,498	55,824	1,747,312	1,959,629
2035	412,981	615,938	611,690	621,050	790,347	802,293	61,072	62,552	1,876,090	2,101,834

Source: CEC and National Renewable Energy Laboratory

Figure C-1 shows the trajectory of total public and shared private chargers needed in the state under each of these forecast and planning scenarios. Note that the CEC IEPR forecasts only project out to year 2030.

**Figure C-1: Total Statewide Public and Shared Private Charger Needs by Year**

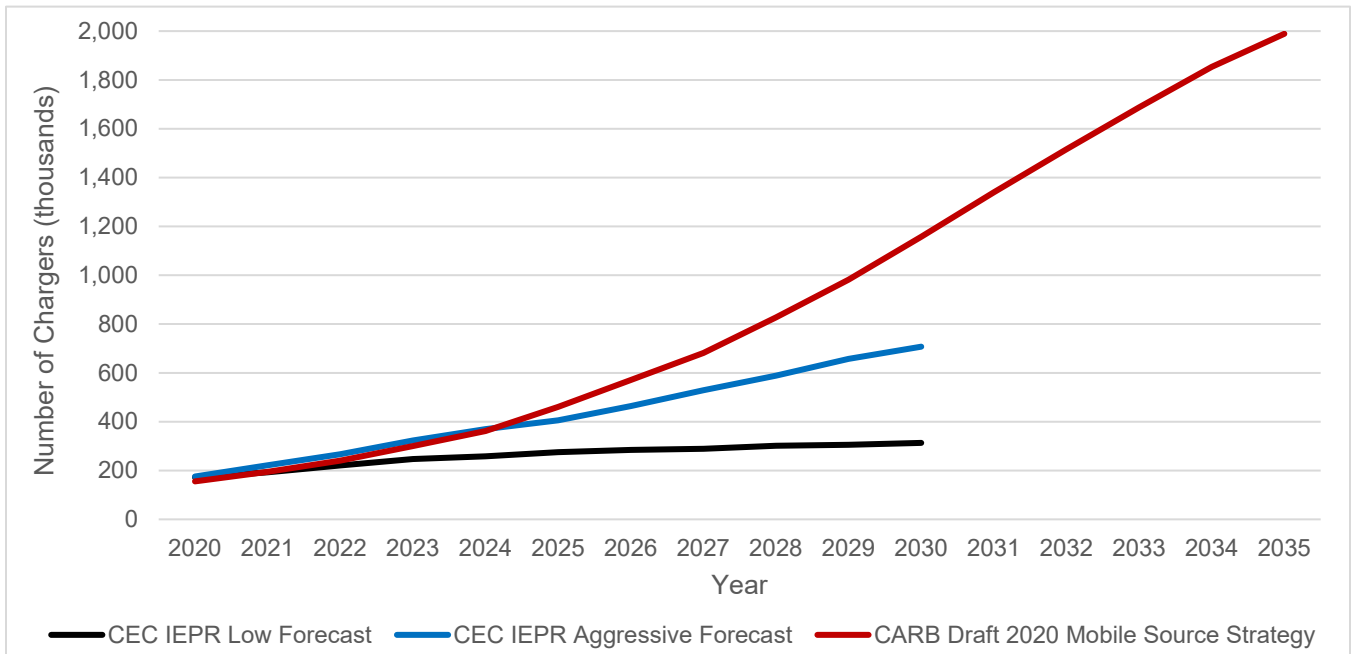

**Different vehicle forecast and planning scenarios result in varying charging infrastructure needs in**

**the state. The CARB Draft Mobile Source Strategy results in the largest infrastructure need, with nearly 1.2 million public and shared private chargers needed to support almost 8 million ZEVs in 2030. This increases to just under 2 million chargers by 2035, as the number of ZEVs increases rapidly to meet EO N-79-20 goals in this planning scenario. The CEC IEPR forecasts result in smaller charging infrastructure networks due to fewer ZEVs on the road. The IEPR aggressive scenario projects over 700,000 chargers needed to support 5 million ZEVs in 2030, while the IEPR low scenario projects a little over 300,000 chargers needed to support almost 2 million ZEVs in 2030. Note that the IEPR forecasts do not go beyond year 2030.**

Source: CEC and National Renewable Energy Laboratory

Tables C-5 to C-20 show the annual EVI-Pro 2 results broken down at the county level for CARB's *Draft 2020 Mobile Source Strategy* planning scenario. The charger counts shown are the average between the lower and upper bounds.

**Table C-5: County-Level EVI-Pro 2 Results for Year 2020 and CARB's *Draft 2020 Mobile Source Strategy***

County	MUDs (Level 1+2)	Work (Level 2)	Public (Level 2)	Public (DCFC)	Total
Alameda	3,343	1,251	1,810	136	6,541
Alpine	0	7	15	7	28
Amador	19	23	99	10	151
Butte	269	112	314	23	718
Calaveras	37	43	112	13	205
Colusa	22	38	66	9	135
Contra Costa	1,496	630	1,297	85	3,508
Del Norte	17	22	48	9	97
El Dorado	153	66	287	22	528
Fresno	1,355	463	1,249	69	3,137
Glenn	22	30	47	9	109
Humboldt	171	70	207	18	465
Imperial	338	156	247	23	764
Inyo	19	26	59	9	113
Kern	925	421	1,125	63	2,535
Kings	146	66	310	22	543
Lake	57	33	117	11	218
Lassen	17	27	72	9	125
Los Angeles	26,614	8,019	12,048	880	47,562
Madera	94	75	202	20	391
Marin	498	179	347	31	1,055
Mariposa	19	26	77	9	130
Mendocino	86	55	141	13	296
Merced	247	114	316	24	701
Modoc	0	10	12	7	28
Mono	0	14	12	7	33
Monterey	686	266	568	35	1,555
Napa	164	101	269	17	552
Nevada	52	37	121	14	224
Orange	7,536	2,433	4,347	300	14,616
Placer	380	181	563	35	1,159
Plumas	17	19	57	10	104

Riverside	2,205	984	3,164	181	6,534
Sacramento	2,354	948	1,730	115	5,147
San Benito	71	30	57	10	168
San Bernardino	2,810	1,412	2,545	146	6,912
San Diego	8,466	2,359	5,283	343	16,451
San Francisco	2,424	451	812	30	3,717
San Joaquin	717	426	864	48	2,055
San Luis Obispo	383	175	474	31	1,064
San Mateo	1,852	590	913	62	3,418
Santa Barbara	850	221	516	42	1,629
Santa Clara	4,027	1,829	2,240	159	8,255
Santa Cruz	386	101	295	28	810
Shasta	159	78	274	20	531
Sierra	0	1	15	7	23
Siskiyou	17	28	70	8	124
Solano	597	311	701	39	1,648
Sonoma	671	269	919	65	1,924
Stanislaus	488	239	603	34	1,364
Sutter	104	51	150	12	317
Tehama	45	35	93	11	184
Trinity	22	20	67	10	120
Tulare	372	224	514	28	1,138
Tuolumne	37	32	94	12	176
Ventura	1,169	394	937	65	2,565
Yolo	371	134	232	18	756
Yuba	69	52	80	10	211
<b>Total</b>	<b>75,468</b>	<b>26,409</b>	<b>50,207</b>	<b>3,482</b>	<b>155,566</b>

Source: CEC and National Renewable Energy Laboratory

**Table C-6: County-Level EVI-Pro 2 Results for Year 2021 and CARB's Draft 2020 Mobile Source Strategy**

County	MUDs (Level 1+2)	Work (Level 2)	Public (Level 2)	Public (DCFC)	Total
Alameda	3,825	1,731	2,398	173	8,126
Alpine	0	9	19	8	36
Amador	21	30	126	12	190
Butte	308	148	418	30	903
Calaveras	43	57	145	15	261
Colusa	26	49	85	10	170
Contra Costa	1,711	900	1,718	113	4,443
Del Norte	20	33	65	11	129
El Dorado	175	86	371	30	661
Fresno	1,551	637	1,619	95	3,902
Glenn	26	39	61	11	136
Humboldt	195	91	264	23	574
Imperial	387	217	338	30	972
Inyo	21	35	77	11	144
Kern	1,058	558	1,468	78	3,163
Kings	167	91	402	27	687
Lake	66	40	156	16	278
Lassen	20	32	95	11	157
Los Angeles	30,449	11,350	16,460	1,246	59,506

Madera	108	111	254	25	498
Marin	569	238	450	37	1,295
Mariposa	21	34	94	11	161
Mendocino	98	84	192	17	392
Merced	283	150	419	31	882
Modoc	0	14	15	8	36
Mono	0	18	18	8	43
Monterey	784	376	741	49	1,951
Napa	188	129	349	26	693
Nevada	60	42	159	17	278
Orange	8,623	3,327	5,762	431	18,142
Placer	435	244	741	45	1,465
Plumas	20	25	68	12	126
Riverside	2,523	1,385	4,113	234	8,254
Sacramento	2,693	1,266	2,308	160	6,427
San Benito	82	37	76	12	207
San Bernardino	3,215	1,914	3,435	206	8,770
San Diego	9,686	3,331	7,167	501	20,685
San Francisco	2,774	636	1,079	45	4,534
San Joaquin	821	565	1,129	62	2,576
San Luis Obispo	438	247	636	38	1,359
San Mateo	2,119	818	1,209	88	4,235
Santa Barbara	972	310	712	57	2,052
Santa Clara	4,607	2,513	3,036	222	10,378
Santa Cruz	442	140	398	38	1,018
Shasta	182	103	362	26	674
Sierra	0	1	18	8	27
Siskiyou	20	38	91	10	158
Solano	683	405	918	56	2,062
Sonoma	768	397	1,183	82	2,430
Stanislaus	558	335	804	48	1,745
Sutter	119	65	197	16	397
Tehama	51	48	121	13	233
Trinity	26	27	85	13	151
Tulare	425	318	688	37	1,469
Tuolumne	43	43	122	17	224
Ventura	1,337	563	1,252	95	3,247
Yolo	425	206	296	24	952
Yuba	79	70	96	12	258
<b>Total</b>	<b>86,345</b>	<b>36,707</b>	<b>67,080</b>	<b>4,788</b>	<b>194,920</b>

Source: CEC and National Renewable Energy Laboratory

**Table C-7: County-Level EVI-Pro 2 Results for Year 2022 and CARB's Draft 2020 Mobile Source Strategy**

County	MUDs (Level 1+2)	Work (Level 2)	Public (Level 2)	Public (DCFC)	Total
Alameda	4,384	2,279	3,068	212	9,943
Alpine	0	9	19	8	36
Amador	24	26	154	14	218
Butte	353	183	520	38	1,094
Calaveras	49	63	180	15	307
Colusa	29	58	106	11	204

Contra Costa	1,961	1,123	2,228	143	5,455
Del Norte	23	38	81	12	153
El Dorado	200	107	467	32	807
Fresno	1,777	843	2,073	118	4,811
Glenn	29	43	71	12	155
Humboldt	224	129	334	26	713
Imperial	444	266	412	37	1,158
Inyo	24	43	95	11	173
Kern	1,213	771	1,909	102	3,994
Kings	191	113	518	30	853
Lake	75	50	190	17	332
Lassen	23	32	114	13	182
Los Angeles	34,895	15,221	21,657	1,611	73,383
Madera	124	148	320	27	620
Marin	653	321	583	52	1,608
Mariposa	24	36	114	12	187
Mendocino	113	110	247	18	488
Merced	324	184	520	35	1,063
Modoc	0	14	15	8	36
Mono	0	18	15	8	41
Monterey	899	471	964	60	2,394
Napa	216	169	442	32	859
Nevada	68	52	199	19	338
Orange	9,881	4,503	7,392	519	22,296
Placer	498	312	935	53	1,798
Plumas	23	28	74	13	138
Riverside	2,891	1,794	5,404	284	10,374
Sacramento	3,086	1,682	2,964	189	7,922
San Benito	94	37	95	12	238
San Bernardino	3,684	2,465	4,443	267	10,859
San Diego	11,100	4,461	9,417	621	25,599
San Francisco	3,179	917	1,415	61	5,571
San Joaquin	940	734	1,446	77	3,198
San Luis Obispo	502	307	823	45	1,678
San Mateo	2,429	1,070	1,576	107	5,182
Santa Barbara	1,115	399	949	69	2,533
Santa Clara	5,280	3,348	3,961	263	12,852
Santa Cruz	506	178	525	42	1,251
Shasta	209	123	461	30	824
Sierra	0	1	19	8	28
Siskiyou	23	44	112	11	190
Solano	783	556	1,140	79	2,559
Sonoma	880	493	1,540	90	3,004
Stanislaus	640	432	995	63	2,130
Sutter	136	92	252	17	497
Tehama	59	59	149	14	280
Trinity	29	35	102	14	180
Tulare	488	432	845	43	1,807
Tuolumne	49	52	148	18	266
Ventura	1,532	744	1,594	114	3,984
Yolo	487	272	388	27	1,174
Yuba	91	76	113	14	294

<b>Total</b>	98,956	48,564	86,892	5,899	240,312
--------------	--------	--------	--------	-------	---------

Source: CEC and National Renewable Energy Laboratory

**Table C-8: County-Level EVI-Pro 2 Results for Year 2023 and CARB's *Draft 2020 Mobile Source Strategy***

<b>County</b>	<b>MUDs (Level 1+2)</b>	<b>Work (Level 2)</b>	<b>Public (Level 2)</b>	<b>Public (DCFC)</b>	<b>Total</b>
Alameda	4,680	3,150	4,167	276	12,271
Alpine	0	9	19	8	36
Amador	26	34	197	17	274
Butte	377	250	709	46	1,382
Calaveras	52	85	238	19	395
Colusa	31	75	137	11	255
Contra Costa	2,094	1,522	3,042	202	6,860
Del Norte	24	44	103	13	185
El Dorado	214	144	624	41	1,023
Fresno	1,897	1,173	2,817	145	6,033
Glenn	31	52	87	12	183
Humboldt	239	166	447	30	881
Imperial	474	387	588	41	1,489
Inyo	26	51	119	12	208
Kern	1,295	1,059	2,593	135	5,081
Kings	204	149	694	35	1,082
Lake	80	56	245	21	403
Lassen	24	36	149	13	223
Los Angeles	37,249	21,694	29,886	2,112	90,940
Madera	132	192	423	35	783
Marin	697	481	803	64	2,046
Mariposa	26	45	142	12	226
Mendocino	121	145	331	21	617
Merced	346	247	693	42	1,328
Modoc	0	15	15	8	38
Mono	0	18	16	8	42
Monterey	960	652	1,302	73	2,987
Napa	230	222	577	40	1,069
Nevada	73	62	263	22	420
Orange	10,548	6,371	10,102	728	27,749
Placer	532	424	1,240	74	2,270
Plumas	24	30	101	15	170
Riverside	3,086	2,468	7,275	395	13,223
Sacramento	3,295	2,305	4,066	257	9,923
San Benito	100	57	130	14	300
San Bernardino	3,933	3,495	5,985	346	13,759
San Diego	11,849	6,483	12,997	832	32,161
San Francisco	3,394	1,299	1,937	83	6,713
San Joaquin	1,004	1,038	1,911	93	4,046
San Luis Obispo	536	426	1,117	58	2,137
San Mateo	2,593	1,527	2,133	137	6,390
Santa Barbara	1,190	571	1,341	96	3,198
Santa Clara	5,636	4,823	5,377	348	16,184
Santa Cruz	541	242	697	54	1,534
Shasta	223	170	618	40	1,052

Sierra	0	1	16	8	25
Siskiyou	24	52	143	12	232
Solano	836	777	1,549	104	3,266
Sonoma	940	696	2,109	118	3,863
Stanislaus	683	587	1,339	77	2,687
Sutter	146	113	325	23	606
Tehama	63	67	199	16	344
Trinity	31	39	129	16	215
Tulare	521	562	1,134	56	2,272
Tuolumne	52	65	192	21	330
Ventura	1,636	1,010	2,185	150	4,981
Yolo	520	365	536	35	1,455
Yuba	97	105	149	19	369
<b>Total</b>	<b>105,635</b>	<b>68,386</b>	<b>118,458</b>	<b>7,736</b>	<b>300,215</b>

Source: CEC and National Renewable Energy Laboratory

**Table C-9: County-Level EVI-Pro 2 Results for Year 2024 and CARB's *Draft 2020 Mobile Source Strategy***

County	MUDs (Level 1+2)	Work (Level 2)	Public (Level 2)	Public (DCFC)	Total
Alameda	5,296	4,072	5,129	296	14,792
Alpine	0	7	19	8	33
Amador	30	40	238	17	324
Butte	426	312	858	46	1,641
Calaveras	59	91	252	18	420
Colusa	35	91	159	12	298
Contra Costa	2,369	2,016	3,656	201	8,242
Del Norte	28	49	116	14	207
El Dorado	242	191	779	45	1,257
Fresno	2,147	1,412	3,476	162	7,197
Glenn	35	59	96	14	204
Humboldt	271	235	537	31	1,074
Imperial	536	467	698	49	1,750
Inyo	30	58	141	13	241
Kern	1,465	1,447	3,264	154	6,331
Kings	231	177	852	38	1,298
Lake	91	71	292	21	475
Lassen	28	37	172	17	254
Los Angeles	42,154	28,230	37,354	2,293	110,030
Madera	150	238	510	41	939
Marin	789	628	975	69	2,461
Mariposa	30	61	181	15	286
Mendocino	136	175	394	25	730
Merced	391	307	876	57	1,631
Modoc	0	15	14	8	36
Mono	0	18	18	8	43
Monterey	1,086	831	1,578	81	3,576
Napa	260	256	711	47	1,275
Nevada	83	74	318	23	498
Orange	11,937	8,251	12,629	769	33,586
Placer	602	516	1,506	75	2,699
Plumas	28	34	128	17	206

Riverside	3,492	3,011	8,794	417	15,715
Sacramento	3,729	2,897	4,802	262	11,690
San Benito	113	67	158	15	353
San Bernardino	4,450	4,362	7,408	369	16,590
San Diego	13,409	8,414	15,995	934	38,752
San Francisco	3,841	1,720	2,376	96	8,032
San Joaquin	1,136	1,340	2,349	112	4,938
San Luis Obispo	607	528	1,372	60	2,567
San Mateo	2,935	1,965	2,644	160	7,704
Santa Barbara	1,347	757	1,659	98	3,861
Santa Clara	6,378	6,229	6,661	384	19,651
Santa Cruz	612	291	852	55	1,809
Shasta	252	204	735	39	1,230
Sierra	0	5	16	8	29
Siskiyou	28	56	171	13	268
Solano	946	1,008	1,869	125	3,949
Sonoma	1,064	870	2,542	138	4,613
Stanislaus	773	751	1,631	75	3,230
Sutter	165	133	383	24	705
Tehama	71	84	238	16	409
Trinity	35	35	168	18	257
Tulare	589	681	1,380	60	2,710
Tuolumne	59	75	230	23	387
Ventura	1,851	1,258	2,657	158	5,924
Yolo	589	426	639	39	1,692
Yuba	110	124	174	18	427
<b>Total</b>	<b>119,548</b>	<b>87,755</b>	<b>145,828</b>	<b>8,397</b>	<b>361,528</b>

Source: CEC and National Renewable Energy Laboratory

**Table C-10: County-Level EVI-Pro 2 Results for Year 2025 and CARB's Draft 2020 Mobile Source Strategy**

County	MUDs (Level 1+2)	Work (Level 2)	Public (Level 2)	Public (DCFC)	Total
Alameda	6,317	5,282	6,601	367	18,567
Alpine	0	5	19	8	32
Amador	35	52	299	18	403
Butte	509	422	1,143	59	2,132
Calaveras	71	107	321	23	522
Colusa	42	120	195	14	372
Contra Costa	2,827	2,749	4,832	271	10,679
Del Norte	33	63	149	17	262
El Dorado	289	266	1,027	63	1,644
Fresno	2,561	1,982	4,540	204	9,287
Glenn	42	85	124	15	267
Humboldt	323	317	712	42	1,394
Imperial	640	685	983	65	2,373
Inyo	35	71	174	16	296
Kern	1,748	2,079	4,224	190	8,241
Kings	276	237	1,080	42	1,636
Lake	108	106	378	28	621
Lassen	33	46	214	16	309
Los Angeles	50,284	36,998	48,488	2,953	138,722



Madera	179	302	652	47	1,179
Marin	941	814	1,281	87	3,123
Mariposa	35	78	230	18	361
Mendocino	163	250	514	35	962
Merced	467	387	1,124	72	2,050
Modoc	0	18	14	8	39
Mono	0	18	18	8	43
Monterey	1,296	1,141	2,072	104	4,613
Napa	311	358	929	63	1,661
Nevada	99	89	426	30	643
Orange	14,240	11,015	16,317	986	42,559
Placer	718	663	1,958	100	3,439
Plumas	33	46	162	20	261
Riverside	4,166	4,039	11,452	600	20,258
Sacramento	4,448	4,066	6,342	368	15,225
San Benito	135	80	199	21	435
San Bernardino	5,309	5,842	9,733	478	21,363
San Diego	15,995	11,039	21,011	1,179	49,224
San Francisco	4,582	2,213	3,005	133	9,933
San Joaquin	1,355	1,842	3,031	136	6,365
San Luis Obispo	724	714	1,785	82	3,305
San Mateo	3,501	2,589	3,389	212	9,691
Santa Barbara	1,607	1,025	2,179	127	4,938
Santa Clara	7,609	8,563	8,776	499	25,447
Santa Cruz	730	382	1,129	70	2,311
Shasta	301	281	970	52	1,604
Sierra	0	15	16	8	39
Siskiyou	33	74	213	13	333
Solano	1,129	1,301	2,442	148	5,020
Sonoma	1,269	1,206	3,220	158	5,853
Stanislaus	922	1,080	2,227	109	4,338
Sutter	197	175	507	28	907
Tehama	85	107	304	21	516
Trinity	42	56	212	22	332
Tulare	703	982	1,818	76	3,579
Tuolumne	71	103	291	27	491
Ventura	2,208	1,717	3,465	197	7,587
Yolo	702	544	829	50	2,125
Yuba	131	168	225	23	547
<b>Total</b>	<b>142,609</b>	<b>117,053</b>	<b>189,969</b>	<b>10,828</b>	<b>460,459</b>

Source: CEC and National Renewable Energy Laboratory

**Table C-11: County-Level EVI-Pro 2 Results for Year 2026 and CARB's Draft 2020 Mobile Source Strategy**

County	MUDs (Level 1+2)	Work (Level 2)	Public (Level 2)	Public (DCFC)	Total
Alameda	7,363	6,852	8,427	455	23,098
Alpine	0	5	19	8	32
Amador	41	72	376	22	510
Butte	593	581	1,468	74	2,716
Calaveras	83	139	410	26	658
Colusa	49	147	234	17	448

Contra Costa	3,295	3,620	6,216	341	13,472
Del Norte	38	69	192	17	317
El Dorado	337	351	1,292	63	2,043
Fresno	2,986	2,638	5,969	275	11,867
Glenn	49	101	155	17	322
Humboldt	377	409	895	50	1,730
Imperial	746	930	1,213	80	2,968
Inyo	41	100	231	17	390
Kern	2,037	2,605	5,326	225	10,193
Kings	322	284	1,324	59	1,989
Lake	127	141	463	32	762
Lassen	38	59	270	18	385
Los Angeles	58,610	47,236	60,874	3,510	170,229
Madera	208	387	818	57	1,470
Marin	1,097	1,038	1,654	101	3,890
Mariposa	41	109	285	24	459
Mendocino	190	298	646	31	1,165
Merced	544	500	1,401	83	2,528
Modoc	0	19	14	8	40
Mono	0	18	19	8	45
Monterey	1,511	1,516	2,645	122	5,794
Napa	362	451	1,143	71	2,027
Nevada	115	107	541	35	797
Orange	16,598	14,347	20,637	1,212	52,793
Placer	837	885	2,504	114	4,341
Plumas	38	60	195	21	314
Riverside	4,856	5,287	14,665	767	25,574
Sacramento	5,184	5,269	8,266	413	19,133
San Benito	158	121	238	23	540
San Bernardino	6,188	7,659	12,323	597	26,767
San Diego	18,644	14,090	26,397	1,352	60,483
San Francisco	5,341	2,820	3,770	161	12,092
San Joaquin	1,580	2,265	3,898	173	7,916
San Luis Obispo	844	949	2,244	100	4,136
San Mateo	4,080	3,404	4,294	247	12,025
Santa Barbara	1,873	1,317	2,745	140	6,075
Santa Clara	8,869	10,870	11,038	575	31,352
Santa Cruz	851	523	1,404	78	2,857
Shasta	351	406	1,243	66	2,067
Sierra	0	15	16	8	39
Siskiyou	38	95	265	17	415
Solano	1,315	1,673	3,066	195	6,250
Sonoma	1,479	1,663	4,144	212	7,498
Stanislaus	1,075	1,350	2,840	142	5,407
Sutter	229	240	631	36	1,135
Tehama	99	129	369	26	624
Trinity	49	64	269	22	404
Tulare	819	1,263	2,304	106	4,492
Tuolumne	83	126	355	29	592
Ventura	2,574	2,290	4,515	244	9,623
Yolo	819	706	1,062	60	2,647
Yuba	153	203	329	25	710

<b>Total</b>	166,225	150,867	240,548	13,009	570,649
--------------	---------	---------	---------	--------	---------

Source: CEC and National Renewable Energy Laboratory

**Table C-12: County-Level EVI-Pro 2 Results for Year 2027 and CARB's Draft 2020 Mobile Source Strategy**

<b>County</b>	<b>MUDs (Level 1+2)</b>	<b>Work (Level 2)</b>	<b>Public (Level 2)</b>	<b>Public (DCFC)</b>	<b>Total</b>
Alameda	8,701	8,291	9,904	615	27,511
Alpine	0	5	19	8	32
Amador	49	82	443	30	604
Butte	701	684	1,690	102	3,177
Calaveras	98	170	460	34	762
Colusa	58	176	281	16	532
Contra Costa	3,893	4,338	7,439	464	16,134
Del Norte	45	97	238	21	402
El Dorado	398	449	1,507	94	2,449
Fresno	3,528	3,415	6,860	384	14,187
Glenn	58	122	172	22	374
Humboldt	445	463	1,063	72	2,044
Imperial	881	1,128	1,391	94	3,494
Inyo	49	136	262	21	468
Kern	2,408	3,231	6,277	295	12,211
Kings	380	348	1,533	78	2,340
Lake	149	182	550	43	924
Lassen	45	64	311	22	443
Los Angeles	69,258	57,125	71,446	4,749	202,579
Madera	246	486	989	65	1,786
Marin	1,296	1,221	1,894	124	4,536
Mariposa	49	133	314	26	522
Mendocino	224	379	752	50	1,405
Merced	643	588	1,677	97	3,004
Modoc	0	19	12	8	39
Mono	0	19	19	8	46
Monterey	1,785	1,840	3,111	172	6,908
Napa	428	543	1,362	101	2,434
Nevada	136	174	670	40	1,020
Orange	19,613	17,524	24,856	1,515	63,509
Placer	989	1,103	2,956	157	5,206
Plumas	45	71	240	25	381
Riverside	5,738	6,510	17,666	980	30,894
Sacramento	6,126	6,424	9,687	547	22,785
San Benito	186	122	311	23	642
San Bernardino	7,312	9,346	14,714	807	32,179
San Diego	22,032	17,342	31,346	1,891	72,610
San Francisco	6,311	3,350	4,293	200	14,155
San Joaquin	1,867	2,732	4,613	224	9,436
San Luis Obispo	998	1,162	2,551	135	4,846
San Mateo	4,822	4,131	5,077	337	14,367
Santa Barbara	2,213	1,629	3,200	187	7,229
Santa Clara	10,480	12,897	12,945	777	37,099
Santa Cruz	1,006	640	1,716	104	3,466
Shasta	415	516	1,497	89	2,517

Sierra	0	15	14	8	36
Siskiyou	45	126	298	19	488
Solano	1,554	1,977	3,698	263	7,493
Sonoma	1,748	2,139	4,889	271	9,047
Stanislaus	1,270	1,618	3,310	177	6,375
Sutter	271	306	724	39	1,340
Tehama	117	158	447	35	757
Trinity	58	78	323	32	491
Tulare	968	1,517	2,748	133	5,366
Tuolumne	98	157	417	33	704
Ventura	3,042	2,907	5,345	353	11,647
Yolo	967	846	1,222	87	3,122
Yuba	181	264	380	34	859
<b>Total</b>	<b>196,427</b>	<b>183,518</b>	<b>284,132</b>	<b>17,333</b>	<b>681,409</b>

Source: CEC and National Renewable Energy Laboratory

**Table C-13: County-Level EVI-Pro 2 Results for Year 2028 and CARB's Draft 2020 Mobile Source Strategy**

County	MUDs (Level 1+2)	Work (Level 2)	Public (Level 2)	Public (DCFC)	Total
Alameda	10,504	10,007	11,695	780	32,986
Alpine	0	3	19	8	29
Amador	59	98	509	34	699
Butte	846	842	2,036	134	3,858
Calaveras	118	204	518	43	882
Colusa	71	228	348	24	670
Contra Costa	4,700	5,399	8,936	558	19,592
Del Norte	55	119	286	31	491
El Dorado	481	560	1,842	129	3,012
Fresno	4,259	4,303	8,448	520	17,529
Glenn	71	147	226	26	470
Humboldt	538	608	1,284	94	2,524
Imperial	1,064	1,467	1,624	137	4,292
Inyo	59	176	327	24	586
Kern	2,907	4,095	7,832	407	15,241
Kings	459	449	1,832	100	2,841
Lake	180	219	649	56	1,104
Lassen	55	82	371	24	531
Los Angeles	83,605	70,205	84,407	6,107	244,325
Madera	297	636	1,162	77	2,171
Marin	1,565	1,523	2,412	173	5,672
Mariposa	59	145	372	34	610
Mendocino	271	490	894	59	1,714
Merced	776	738	2,084	147	3,745
Modoc	0	19	11	8	38
Mono	0	19	19	8	46
Monterey	2,155	2,307	3,749	222	8,434
Napa	517	632	1,588	111	2,848
Nevada	164	231	834	61	1,290
Orange	23,676	21,686	29,801	1,945	77,109
Placer	1,194	1,392	3,526	203	6,315
Plumas	55	89	281	25	451

Riverside	6,927	8,360	21,344	1,278	37,909
Sacramento	7,395	8,007	11,755	727	27,884
San Benito	225	163	365	28	780
San Bernardino	8,827	11,497	17,796	1,043	39,164
San Diego	26,595	21,561	37,318	2,500	87,974
San Francisco	7,619	4,162	5,110	271	17,162
San Joaquin	2,254	3,343	5,386	274	11,257
San Luis Obispo	1,204	1,413	3,087	180	5,884
San Mateo	5,821	5,115	6,019	432	17,387
Santa Barbara	2,671	2,088	3,859	235	8,854
Santa Clara	12,651	16,023	15,776	1,093	45,544
Santa Cruz	1,214	810	2,038	138	4,200
Shasta	501	659	1,791	115	3,065
Sierra	0	14	14	7	34
Siskiyou	55	172	359	22	607
Solano	1,877	2,361	4,520	337	9,094
Sonoma	2,110	2,621	5,776	336	10,843
Stanislaus	1,534	2,045	3,954	235	7,767
Sutter	327	388	856	49	1,620
Tehama	141	185	565	47	938
Trinity	71	84	370	38	563
Tulare	1,169	1,984	3,365	177	6,695
Tuolumne	118	226	529	49	921
Ventura	3,672	3,578	6,368	468	14,086
Yolo	1,168	1,023	1,406	109	3,705
Yuba	218	306	453	36	1,013
<b>Total</b>	<b>237,120</b>	<b>227,307</b>	<b>340,100</b>	<b>22,530</b>	<b>827,057</b>

Source: CEC and National Renewable Energy Laboratory

**Table C-14: County-Level EVI-Pro 2 Results for Year 2029 and CARB's Draft 2020 Mobile Source Strategy**

County	MUDs (Level 1+2)	Work (Level 2)	Public (Level 2)	Public (DCFC)	Total
Alameda	12,474	11,821	13,806	933	39,035
Alpine	0	4	19	8	31
Amador	70	119	596	40	825
Butte	1,005	1,013	2,399	168	4,584
Calaveras	140	220	613	50	1,024
Colusa	84	239	402	24	749
Contra Costa	5,582	6,611	10,390	706	23,289
Del Norte	65	130	343	35	573
El Dorado	571	649	2,146	155	3,520
Fresno	5,058	5,254	9,992	654	20,958
Glenn	84	201	265	28	579
Humboldt	638	764	1,499	117	3,018
Imperial	1,264	1,644	1,959	167	5,033
Inyo	70	219	386	29	705
Kern	3,452	4,924	9,282	501	18,159
Kings	545	525	2,089	124	3,283
Lake	214	268	780	66	1,327
Lassen	65	107	417	27	615
Los Angeles	99,289	84,294	98,592	7,348	289,524

Madera	353	740	1,407	105	2,606
Marin	1,858	1,833	2,769	202	6,663
Mariposa	70	168	422	39	699
Mendocino	322	596	1,057	69	2,043
Merced	922	997	2,538	174	4,631
Modoc	0	19	11	8	38
Mono	0	19	18	8	45
Monterey	2,559	2,804	4,384	279	10,025
Napa	614	733	1,849	132	3,328
Nevada	195	274	970	76	1,515
Orange	28,118	25,904	35,115	2,338	91,475
Placer	1,419	1,693	4,094	245	7,451
Plumas	65	120	332	30	547
Riverside	8,226	10,497	24,968	1,549	45,239
Sacramento	8,783	9,650	14,034	891	33,358
San Benito	267	194	430	32	922
San Bernardino	10,483	14,100	20,927	1,308	46,818
San Diego	31,585	25,672	43,262	3,095	103,614
San Francisco	9,048	4,904	5,982	321	20,255
San Joaquin	2,676	4,111	6,390	334	13,512
San Luis Obispo	1,430	1,759	3,622	215	7,027
San Mateo	6,913	6,067	7,106	533	20,618
Santa Barbara	3,173	2,426	4,551	298	10,448
Santa Clara	15,024	19,313	18,443	1,318	54,098
Santa Cruz	1,442	988	2,465	174	5,068
Shasta	595	765	2,070	144	3,574
Sierra	0	14	15	8	36
Siskiyou	65	209	440	26	741
Solano	2,229	2,938	5,314	395	10,876
Sonoma	2,505	3,187	6,855	414	12,962
Stanislaus	1,821	2,443	4,723	288	9,276
Sutter	389	441	991	57	1,879
Tehama	168	214	675	59	1,116
Trinity	84	95	423	44	645
Tulare	1,388	2,453	4,045	225	8,111
Tuolumne	140	281	608	56	1,085
Ventura	4,361	4,253	7,466	575	16,655
Yolo	1,387	1,316	1,666	129	4,498
Yuba	259	344	511	41	1,156
<b>Total</b>	<b>281,603</b>	<b>273,540</b>	<b>398,925</b>	<b>27,418</b>	<b>981,486</b>

Source: CEC and National Renewable Energy Laboratory

**Table C-15: County-Level EVI-Pro 2 Results for Year 2030 and CARB's Draft 2020 Mobile Source Strategy**

County	MUDs (Level 1+2)	Work (Level 2)	Public (Level 2)	Public (DCFC)	Total
Alameda	14,610	14,140	16,354	1,071	46,176
Alpine	0	4	19	8	31
Amador	82	159	697	45	983
Butte	1,177	1,238	2,829	181	5,425
Calaveras	164	292	712	55	1,223
Colusa	98	295	458	29	879

Contra Costa	6,538	7,823	12,478	819	27,657
Del Norte	76	160	394	40	670
El Dorado	669	854	2,485	168	4,175
Fresno	5,924	6,081	11,922	718	24,645
Glenn	98	228	328	31	685
Humboldt	748	946	1,740	127	3,560
Imperial	1,480	1,980	2,220	167	5,847
Inyo	82	259	438	34	813
Kern	4,043	6,031	10,923	560	21,557
Kings	639	584	2,482	142	3,846
Lake	251	327	923	74	1,575
Lassen	76	164	509	31	779
Los Angeles	116,292	99,874	116,665	8,183	341,014
Madera	413	869	1,642	126	3,050
Marin	2,176	2,143	3,186	235	7,741
Mariposa	82	194	492	41	808
Mendocino	377	730	1,258	81	2,446
Merced	1,080	1,212	2,873	184	5,349
Modoc	0	19	15	8	42
Mono	0	19	16	8	43
Monterey	2,997	3,396	5,196	311	11,902
Napa	719	930	2,154	155	3,958
Nevada	228	361	1,141	90	1,820
Orange	32,933	30,757	41,193	2,609	107,492
Placer	1,661	2,053	4,807	275	8,797
Plumas	76	141	377	35	630
Riverside	9,635	12,508	29,633	1,776	53,551
Sacramento	10,287	11,782	16,580	984	39,633
San Benito	313	188	502	37	1,040
San Bernardino	12,278	16,609	24,491	1,488	54,866
San Diego	36,993	30,986	50,336	3,313	121,628
San Francisco	10,598	5,822	6,960	361	23,741
San Joaquin	3,135	4,796	7,510	389	15,829
San Luis Obispo	1,675	2,167	4,263	246	8,350
San Mateo	8,097	7,414	8,283	620	24,413
Santa Barbara	3,716	3,109	5,271	322	12,418
Santa Clara	17,597	23,335	21,930	1,445	64,307
Santa Cruz	1,689	1,219	2,907	189	6,005
Shasta	697	891	2,428	161	4,177
Sierra	0	14	15	8	36
Siskiyou	76	249	514	29	868
Solano	2,610	3,452	6,121	429	12,612
Sonoma	2,934	3,924	8,183	462	15,504
Stanislaus	2,133	2,932	5,544	342	10,951
Sutter	455	512	1,187	70	2,225
Tehama	196	262	790	65	1,312
Trinity	98	100	489	49	737
Tulare	1,626	2,950	4,934	259	9,769
Tuolumne	164	355	711	63	1,292
Ventura	5,107	5,185	8,927	627	19,847
Yolo	1,624	1,563	1,983	148	5,319
Yuba	304	427	600	47	1,378

<b>Total</b>	329,828	327,012	470,015	30,572	1,157,426
--------------	---------	---------	---------	--------	-----------

Source: CEC and National Renewable Energy Laboratory

**Table C-16: County-Level EVI-Pro 2 Results for Year 2031 and CARB's Draft 2020 Mobile Source Strategy**

<b>County</b>	<b>MUDs (Level 1+2)</b>	<b>Work (Level 2)</b>	<b>Public (Level 2)</b>	<b>Public (DCFC)</b>	<b>Total</b>
Alameda	16,863	16,721	19,008	1,231	53,823
Alpine	0	3	19	8	29
Amador	95	193	810	50	1,148
Butte	1,358	1,458	3,239	202	6,257
Calaveras	189	319	831	57	1,397
Colusa	113	308	519	31	971
Contra Costa	7,545	9,107	14,184	940	31,776
Del Norte	88	180	444	47	759
El Dorado	772	1,067	2,894	194	4,927
Fresno	6,838	7,419	13,476	807	28,539
Glenn	113	272	365	35	785
Humboldt	863	1,091	2,001	144	4,099
Imperial	1,708	2,378	2,653	181	6,920
Inyo	95	278	512	35	920
Kern	4,666	7,227	12,311	618	24,822
Kings	737	629	2,843	179	4,388
Lake	290	378	1,073	90	1,832
Lassen	88	223	580	33	925
Los Angeles	134,221	115,180	134,797	9,011	393,208
Madera	477	1,031	1,909	147	3,564
Marin	2,512	2,488	3,691	263	8,954
Mariposa	95	255	563	48	961
Mendocino	435	870	1,434	89	2,827
Merced	1,247	1,455	3,402	231	6,335
Modoc	0	18	15	8	40
Mono	0	19	16	8	43
Monterey	3,459	4,041	5,939	359	13,799
Napa	830	1,063	2,471	187	4,551
Nevada	263	431	1,291	92	2,078
Orange	38,010	34,938	47,209	2,930	123,087
Placer	1,918	2,426	5,560	311	10,215
Plumas	88	156	438	40	723
Riverside	11,120	14,473	34,884	2,087	62,564
Sacramento	11,873	14,025	19,465	1,122	46,485
San Benito	361	224	581	36	1,202
San Bernardino	14,171	19,100	28,145	1,684	63,100
San Diego	42,697	36,715	57,835	3,698	140,945
San Francisco	12,232	6,771	7,933	437	27,373
San Joaquin	3,618	5,672	8,890	418	18,598
San Luis Obispo	1,934	2,534	5,019	292	9,779
San Mateo	9,345	8,527	9,764	704	28,339
Santa Barbara	4,289	3,543	6,066	367	14,265
Santa Clara	20,310	27,410	25,133	1,592	74,446
Santa Cruz	1,949	1,373	3,430	216	6,967
Shasta	804	994	2,856	177	4,831



Sierra	0	15	14	8	36
Siskiyou	88	295	606	32	1,021
Solano	3,013	4,062	7,207	496	14,778
Sonoma	3,387	4,551	9,311	525	17,774
Stanislaus	2,462	3,523	6,376	379	12,740
Sutter	526	595	1,364	82	2,566
Tehama	227	295	901	75	1,497
Trinity	113	108	556	57	835
Tulare	1,876	3,787	5,677	297	11,638
Tuolumne	189	408	833	81	1,510
Ventura	5,895	6,556	10,409	710	23,570
Yolo	1,875	1,864	2,266	168	6,173
Yuba	350	512	714	57	1,634
<b>Total</b>	<b>380,679</b>	<b>381,554</b>	<b>542,732</b>	<b>34,404</b>	<b>1,339,369</b>

Source: CEC and National Renewable Energy Laboratory

**Table C-17: County-Level EVI-Pro 2 Results for Year 2032 and CARB's *Draft 2020 Mobile Source Strategy***

County	MUDs (Level 1+2)	Work (Level 2)	Public (Level 2)	Public (DCFC)	Total
Alameda	18,482	19,406	21,580	1,461	60,928
Alpine	0	3	19	8	29
Amador	104	206	909	56	1,274
Butte	1,488	1,611	3,711	238	7,048
Calaveras	207	395	916	74	1,592
Colusa	124	347	598	41	1,110
Contra Costa	8,270	10,638	16,481	1,124	36,512
Del Norte	96	199	485	48	829
El Dorado	846	1,215	3,332	227	5,620
Fresno	7,494	8,861	15,408	979	32,742
Glenn	124	334	417	42	918
Humboldt	946	1,204	2,233	167	4,550
Imperial	1,872	2,744	2,938	198	7,752
Inyo	104	313	587	39	1,042
Kern	5,114	8,531	14,209	753	28,606
Kings	808	702	3,158	188	4,857
Lake	318	429	1,224	107	2,078
Lassen	96	271	646	38	1,051
Los Angeles	147,103	133,850	152,804	10,788	444,545
Madera	523	1,162	2,067	157	3,909
Marin	2,753	2,978	4,049	307	10,088
Mariposa	104	290	670	61	1,124
Mendocino	476	1,037	1,664	104	3,281
Merced	1,366	1,562	3,838	272	7,039
Modoc	0	18	18	8	43
Mono	0	19	15	8	42
Monterey	3,792	4,658	6,694	429	15,572
Napa	910	1,290	2,792	225	5,217
Nevada	288	526	1,465	111	2,391
Orange	41,658	40,265	53,703	3,529	139,155
Placer	2,102	2,851	6,285	353	11,591
Plumas	96	191	510	42	839

Riverside	12,187	16,443	38,991	2,509	70,131
Sacramento	13,012	16,251	21,952	1,342	52,557
San Benito	396	246	693	48	1,382
San Bernardino	15,531	22,272	31,516	1,980	71,300
San Diego	46,795	42,375	66,630	4,404	160,204
San Francisco	13,406	7,728	9,009	509	30,651
San Joaquin	3,965	6,521	10,170	524	21,181
San Luis Obispo	2,119	2,893	5,686	342	11,040
San Mateo	10,242	9,797	11,049	823	31,911
Santa Barbara	4,701	4,121	7,003	440	16,265
Santa Clara	22,260	31,036	28,610	1,913	83,819
Santa Cruz	2,136	1,526	3,912	248	7,823
Shasta	881	1,204	3,319	211	5,615
Sierra	0	14	15	8	36
Siskiyou	96	344	692	41	1,173
Solano	3,302	4,837	8,028	592	16,760
Sonoma	3,712	5,290	10,486	646	20,134
Stanislaus	2,698	4,064	7,234	458	14,454
Sutter	576	719	1,551	110	2,957
Tehama	248	330	1,029	89	1,697
Trinity	124	162	637	63	986
Tulare	2,057	4,477	6,313	362	13,210
Tuolumne	207	488	936	91	1,721
Ventura	6,461	7,406	11,917	870	26,654
Yolo	2,055	2,107	2,560	200	6,922
Yuba	384	624	791	66	1,865
<b>Total</b>	<b>417,216</b>	<b>441,380</b>	<b>616,158</b>	<b>41,072</b>	<b>1,515,826</b>

Source: CEC and National Renewable Energy Laboratory

**Table C-18: County-Level EVI-Pro 2 Results for Year 2033 and CARB's Draft 2020 Mobile Source Strategy**

County	MUDs (Level 1+2)	Work (Level 2)	Public (Level 2)	Public (DCFC)	Total
Alameda	20,025	22,172	23,803	1,715	67,715
Alpine	0	1	19	8	28
Amador	112	224	998	68	1,402
Butte	1,613	1,864	4,148	288	7,913
Calaveras	225	435	977	86	1,723
Colusa	134	389	656	47	1,226
Contra Costa	8,960	12,305	18,195	1,296	40,756
Del Norte	105	201	565	57	928
El Dorado	916	1,443	3,650	269	6,279
Fresno	8,120	9,452	17,130	1,158	35,860
Glenn	134	343	476	45	998
Humboldt	1,025	1,360	2,480	194	5,059
Imperial	2,029	3,031	3,386	262	8,707
Inyo	112	356	643	43	1,154
Kern	5,541	9,403	15,471	860	31,275
Kings	875	814	3,490	219	5,398
Lake	344	476	1,335	116	2,271
Lassen	105	295	721	42	1,163
Los Angeles	159,390	152,899	169,662	12,781	494,732

Madera	567	1,283	2,280	177	4,307
Marin	2,983	3,331	4,675	374	11,363
Mariposa	112	305	760	70	1,247
Mendocino	516	1,199	1,823	120	3,658
Merced	1,480	1,746	4,202	289	7,717
Modoc	0	19	15	8	42
Mono	0	19	15	8	42
Monterey	4,108	5,204	7,460	487	17,259
Napa	986	1,491	3,096	264	5,836
Nevada	313	640	1,640	125	2,718
Orange	45,138	46,905	59,286	4,275	155,605
Placer	2,277	3,160	7,040	414	12,891
Plumas	105	197	552	49	902
Riverside	13,205	18,996	43,273	2,956	78,431
Sacramento	14,099	18,163	24,306	1,537	58,106
San Benito	429	294	779	57	1,559
San Bernardino	16,829	25,140	34,747	2,276	78,992
San Diego	50,703	49,185	73,986	5,140	179,014
San Francisco	14,525	9,043	9,977	610	34,155
San Joaquin	4,297	7,318	11,282	632	23,528
San Luis Obispo	2,296	3,274	6,252	400	12,223
San Mateo	11,097	11,191	12,434	957	35,680
Santa Barbara	5,093	4,783	7,828	517	18,222
Santa Clara	24,119	35,105	31,743	2,257	93,224
Santa Cruz	2,314	1,759	4,338	299	8,711
Shasta	955	1,356	3,606	227	6,144
Sierra	0	14	15	8	36
Siskiyou	105	386	740	46	1,276
Solano	3,578	5,589	8,988	665	18,820
Sonoma	4,022	6,062	11,702	783	22,570
Stanislaus	2,924	4,445	8,073	532	15,974
Sutter	624	799	1,749	117	3,289
Tehama	269	375	1,125	99	1,868
Trinity	134	218	698	63	1,114
Tulare	2,228	5,101	7,053	421	14,803
Tuolumne	225	548	1,070	107	1,950
Ventura	7,000	8,539	13,347	994	29,881
Yolo	2,227	2,437	2,841	217	7,722
Yuba	416	692	857	70	2,035
<b>Total</b>	<b>452,067</b>	<b>503,776</b>	<b>683,455</b>	<b>48,204</b>	<b>1,687,502</b>

Source: CEC and National Renewable Energy Laboratory

**Table C-19: County-Level EVI-Pro 2 Results for Year 2034 and CARB's Draft 2020 Mobile Source Strategy**

County	MUDs (Level 1+2)	Work (Level 2)	Public (Level 2)	Public (DCFC)	Total
Alameda	21,469	24,177	26,175	1,953	73,774
Alpine	0	1	19	8	28
Amador	120	255	1,082	77	1,535
Butte	1,729	2,098	4,571	324	8,723
Calaveras	241	494	1,113	93	1,941
Colusa	144	454	709	50	1,356

Contra Costa	9,606	13,713	20,049	1,466	44,834
Del Norte	112	247	610	63	1,031
El Dorado	982	1,597	3,980	317	6,877
Fresno	8,705	10,339	18,713	1,326	39,083
Glenn	144	411	499	51	1,105
Humboldt	1,099	1,719	2,767	224	5,809
Imperial	2,175	3,554	3,795	316	9,839
Inyo	120	387	710	50	1,267
Kern	5,941	10,869	17,053	1,010	34,873
Kings	938	916	3,893	253	6,000
Lake	369	544	1,454	132	2,499
Lassen	112	323	791	56	1,281
Los Angeles	170,877	170,287	186,195	14,638	541,998
Madera	608	1,514	2,599	202	4,922
Marin	3,198	4,004	5,113	417	12,732
Mariposa	120	332	818	73	1,343
Mendocino	553	1,302	2,030	137	4,023
Merced	1,587	1,939	4,612	346	8,484
Modoc	0	18	15	8	40
Mono	0	19	18	8	45
Monterey	4,404	5,900	8,290	576	19,170
Napa	1,057	1,593	3,394	297	6,341
Nevada	335	690	1,779	144	2,949
Orange	48,391	51,976	65,288	4,808	170,463
Placer	2,441	3,512	7,802	494	14,250
Plumas	112	212	590	54	967
Riverside	14,157	21,419	48,106	3,423	87,105
Sacramento	15,115	20,581	26,923	1,815	64,434
San Benito	460	296	847	67	1,670
San Bernardino	18,042	27,858	38,814	2,647	87,361
San Diego	54,358	53,646	81,815	5,744	195,563
San Francisco	15,572	9,970	10,910	688	37,141
San Joaquin	4,606	7,908	12,246	748	25,508
San Luis Obispo	2,462	3,684	6,840	456	13,441
San Mateo	11,897	12,569	13,632	1,084	39,181
Santa Barbara	5,461	5,314	8,631	584	19,989
Santa Clara	25,857	39,544	34,972	2,555	102,928
Santa Cruz	2,481	2,028	4,808	352	9,669
Shasta	1,024	1,473	3,977	284	6,758
Sierra	0	15	14	8	36
Siskiyou	112	416	814	59	1,401
Solano	3,836	6,257	9,871	775	20,738
Sonoma	4,312	6,838	12,719	883	24,752
Stanislaus	3,134	4,879	8,926	618	17,558
Sutter	669	870	1,903	138	3,581
Tehama	288	424	1,245	110	2,067
Trinity	144	290	751	67	1,253
Tulare	2,389	5,515	7,834	546	16,284
Tuolumne	241	601	1,192	118	2,151
Ventura	7,505	9,651	14,505	1,084	32,745
Yolo	2,387	2,604	3,111	251	8,353
Yuba	446	776	912	89	2,222

<b>Total</b>	484,647	560,821	752,843	55,161	1,853,471
--------------	---------	---------	---------	--------	-----------

Source: CEC and National Renewable Energy Laboratory

**Table C-20: County-Level EVI-Pro 2 Results for Year 2035 and CARB's *Draft 2020 Mobile Source Strategy***

<b>County</b>	<b>MUDs (Level 1+2)</b>	<b>Work (Level 2)</b>	<b>Public (Level 2)</b>	<b>Public (DCFC)</b>	<b>Total</b>
Alameda	22,789	25,914	27,850	2,276	78,829
Alpine	0	1	18	8	27
Amador	128	278	1,161	85	1,652
Butte	1,835	2,405	4,713	354	9,308
Calaveras	256	556	1,176	103	2,091
Colusa	153	474	740	50	1,416
Contra Costa	10,197	14,895	20,922	1,620	47,634
Del Norte	119	273	625	68	1,085
El Dorado	1,043	1,815	4,279	370	7,507
Fresno	9,240	11,575	19,826	1,473	42,114
Glenn	153	408	576	52	1,189
Humboldt	1,167	1,896	2,932	251	6,245
Imperial	2,309	3,940	4,055	340	10,644
Inyo	128	425	753	56	1,362
Kern	6,306	12,061	18,193	1,088	37,649
Kings	996	1,040	4,151	282	6,470
Lake	392	615	1,505	135	2,646
Lassen	119	367	814	65	1,366
Los Angeles	181,388	187,510	196,068	16,401	581,368
Madera	645	1,548	2,782	208	5,183
Marin	3,395	4,315	5,366	447	13,523
Mariposa	128	416	838	82	1,464
Mendocino	588	1,325	1,993	151	4,056
Merced	1,685	2,179	4,816	384	9,065
Modoc	0	18	16	8	42
Mono	0	19	16	8	43
Monterey	4,675	6,314	8,660	646	20,296
Napa	1,122	1,881	3,548	324	6,874
Nevada	356	755	1,989	169	3,268
Orange	51,368	57,511	68,400	5,550	182,829
Placer	2,592	3,766	8,132	581	15,071
Plumas	119	246	606	60	1,031
Riverside	15,028	22,877	50,585	3,827	92,316
Sacramento	16,045	23,200	28,615	2,006	69,866
San Benito	488	432	901	68	1,888
San Bernardino	19,151	30,385	40,970	2,849	93,356
San Diego	57,701	59,098	87,975	6,553	211,328
San Francisco	16,531	10,983	11,642	813	39,968
San Joaquin	4,890	8,662	13,270	774	27,595
San Luis Obispo	2,613	3,960	7,335	527	14,436
San Mateo	12,629	14,034	14,578	1,236	42,476
Santa Barbara	5,796	5,993	9,232	653	21,674
Santa Clara	27,448	42,623	36,380	2,834	109,285
Santa Cruz	2,634	2,455	5,082	399	10,570
Shasta	1,087	1,681	4,295	319	7,382

Sierra	0	18	14	8	39
Siskiyou	119	417	882	68	1,486
Solano	4,072	7,064	10,579	821	22,535
Sonoma	4,577	7,644	13,254	980	26,456
Stanislaus	3,327	5,514	9,521	692	19,055
Sutter	710	1,020	1,958	140	3,829
Tehama	306	459	1,318	128	2,211
Trinity	153	277	784	86	1,300
Tulare	2,536	5,924	8,318	587	17,364
Tuolumne	256	623	1,251	133	2,263
Ventura	7,966	10,564	15,829	1,250	35,610
Yolo	2,534	2,801	3,237	274	8,846
Yuba	474	921	991	94	2,480
<b>Total</b>	514,459	616,370	796,320	61,812	1,988,962

Source: CEC and National Renewable Energy Laboratory

# APPENDIX D:

## EVI-Pro 2 Alternative Futures Scenarios

---

As described in Chapter 4, staff investigated “alternative future” scenarios, which each make a single adjustment to the assumptions or preferences in EVI-Pro 2. These scenarios, described again in Table D-1, are meant to illustrate potential futures given the uncertainty of how the electric transportation landscape may evolve in the next decade.

**Table D-1: Summary of Alternative Future Scenarios**

Scenario Name	EVI-Pro 2 Modification Compared to Standard Scenario
Unconstrained Residential Load	No TOU participation is assumed
Low Residential Access	50% of vehicles have access to overnight charging
High Residential Access	95% of vehicles have access to overnight charging
Low Energy Demand	Energy demand of charging is decreased by 30%
High Energy Demand	Energy demand of charging is increased by 30%
Low Range PEVs	Vehicles maintain the same attributes used in the AB 2127 Staff Report analysis
Gas Station Model	Vehicles without access to home charging prefer DCFC charging above work L2 charging
EV Happy Hour	Vehicles with access to home charging prefer work L2 charging above home charging
Level 1 Charging	Level 1 charging is enabled as an option for public and workplace charging
Lazy PHEVs	PHEVs with access to overnight charging never use public or workplace charging
Widespread Topping Off	BEV and PHEV e-mile plug-in requirements are doubled, resulting in smaller and more frequent charging events

Source: CEC and National Renewable Energy Laboratory

Shown below are 2030 weekday load curve results for the alternative future scenarios. As stated above, these results are for CARB’s *Draft 2020 Mobile Source Strategy*, with a fleet size of nearly 8 million ZEVs in 2030.

Figure D-1 shows the Unconstrained Residential Load profile. As mentioned before, the only difference in this scenario compared to the standard scenario is the removal of TOU participation. This results in the removal of the timed midnight and early morning residential peaks, instead shifting this charging to the early evening when drivers plug in their vehicles

upon arriving home from work. The evening ramp in residential charging peaks around 7 p.m. at nearly 6.6 GW. This unconstrained load profile shape is very similar to the original EVI-Pro 1 load profile.

**Figure D-1: Projected 2030 Weekday Load Curve for the Unconstrained Alternative Future**

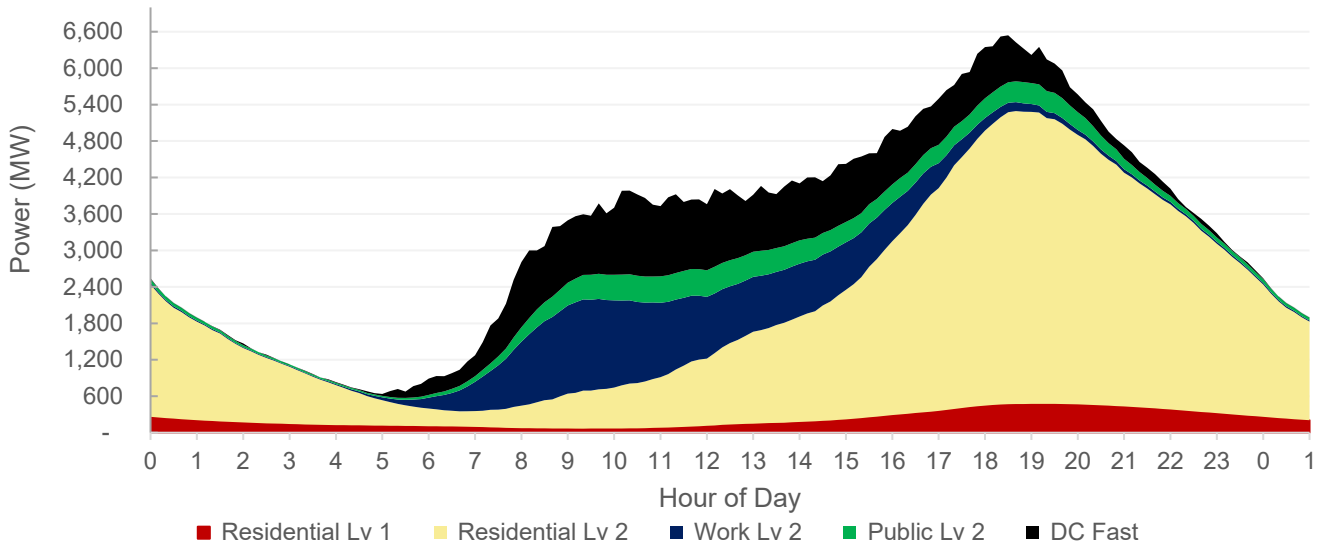

**The unconstrained scenario results in a load profile similar to previous EVI-Pro results, with an evening ramp in residential charging peaking around 7 p.m. to nearly 6.6 GW in 2030. The load profile adds a 25<sup>th</sup> hour on the right to illustrate how the lack of TOU participation removes the timed midnight and early morning residential charging peaks.**

Source: CEC and National Renewable Energy Laboratory

Figure D-2 shows the Low Residential Access load profile. The decrease in residential charging access from 67 percent to 50 percent results in smaller amount of residential charging compared to the standard scenario, shifting this load instead to the daytime hours at public and workplace chargers. This drives the daytime peak load from 4.2 GW at 10 a.m. in the standard scenario to 5.4 GW at 10 a.m. in this alternative future. Meanwhile, the timed midnight residential charging peak drops by about 1.2 GW.



**Figure D-2: Projected 2030 Weekday Load Curve for the Low Residential Access Alternative Future**

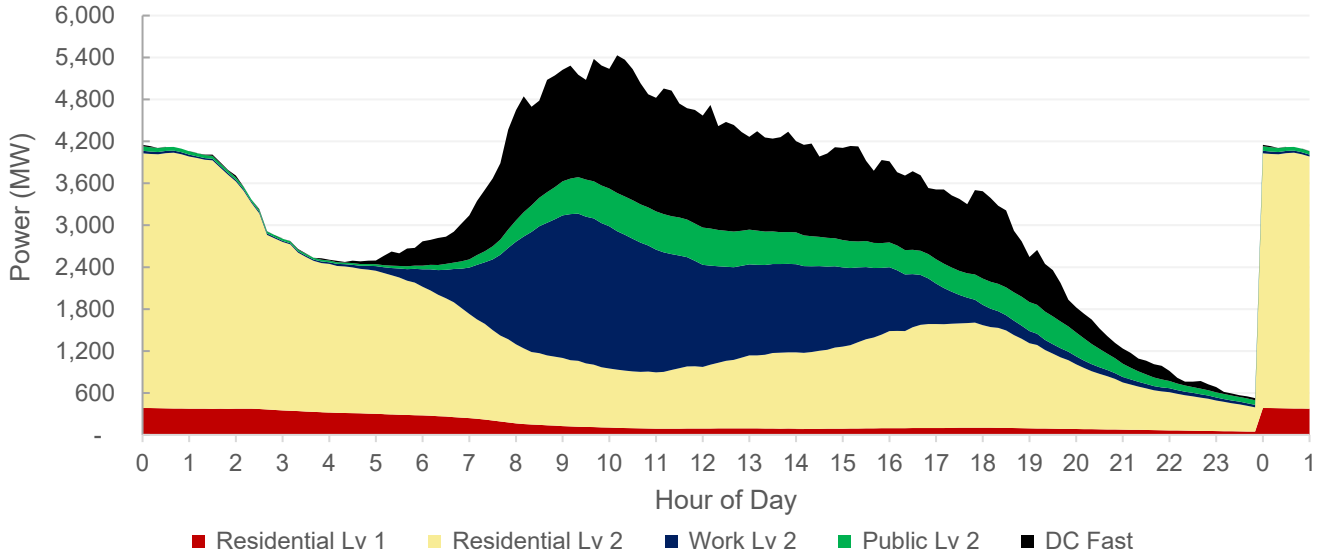

**The Low Residential Access alternative future results in a significant shift of residential charging load to public and workplace load compared to the standard scenario. This shifts the peak load from midnight to 10 a.m., with the load at 10 a.m. rising from 4.2 GW to 5.4 GW. The load profile adds a 25<sup>th</sup> hour on the right to illustrate the timed midnight charging spike.**

Source: CEC and National Renewable Energy Laboratory

Figure D-3 shows the High Residential Access load profile. The increase in residential charging access from 67 percent to 95 percent results in much larger amount of residential charging, reducing the charging demand at public and workplace chargers during the daytime. This in turn increases the peak load at midnight to 7.2 GW.

**Figure D-3: Projected 2030 Weekday Load Curve for the High Residential Access Alternative Future**

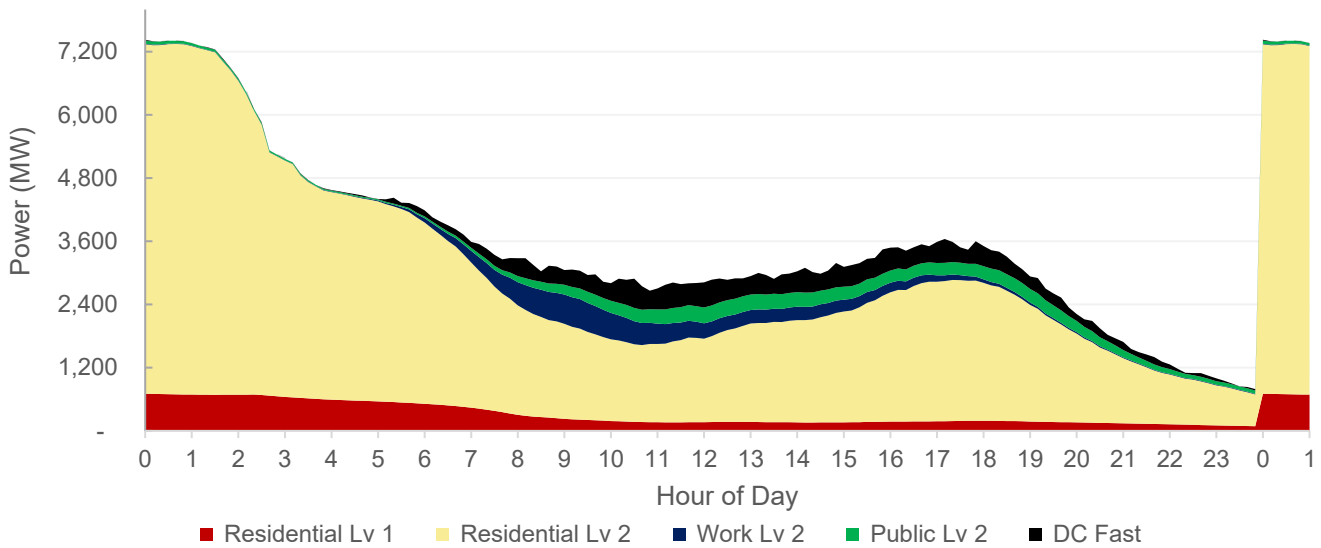

**The High Residential Access alternative future results in a significant shift of public and workplace charging load to residential load compared to the standard scenario, with the residential load share increasing by 20 percent. This pushes the midnight peak load from 5.4 GW to 7.2 GW . The load profile adds a 25<sup>th</sup> hour on the right to illustrate the timed midnight charging spike.**

Source: CEC and National Renewable Energy Laboratory

Figure D-4 shows the Low Energy Demand load profile. The 30 percent decrease in energy demand in this alternative future does not alter the shape of the load profile much compared to the standard scenario. However, as would be expected, it results in an approximately 30 percent decrease in total energy for charging, with a decrease in load across all hours. This drops the midnight peak load by about 1.8 GW.

**Figure D-4: Projected 2030 Weekday Load Curve for the Low Energy Demand Alternative Future**

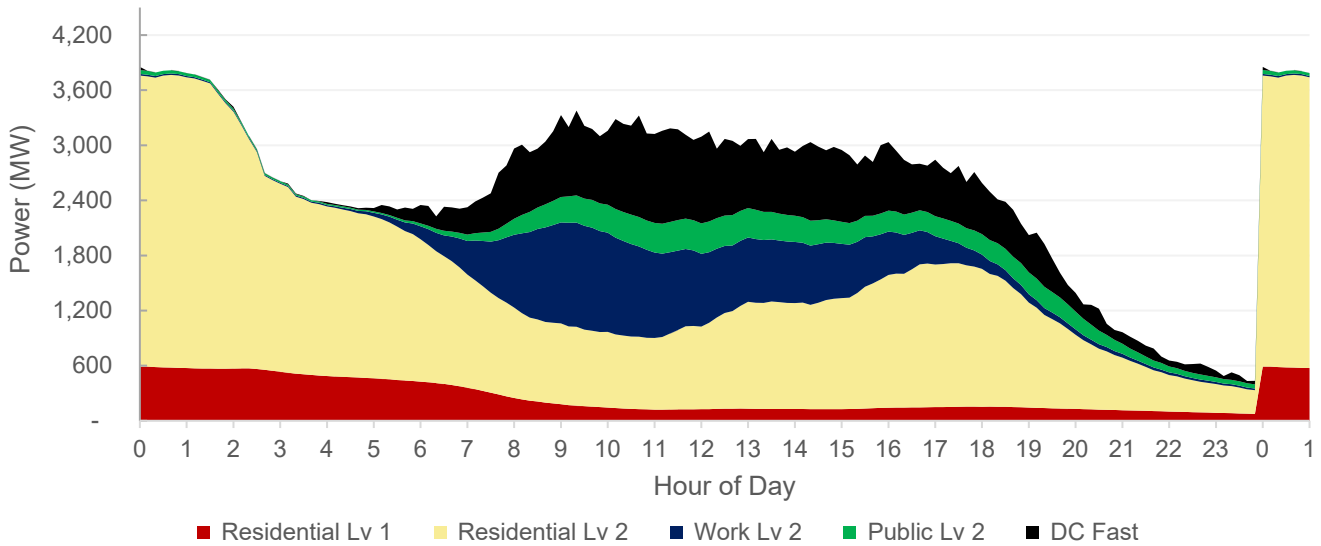

**The Low Energy Demand alternative future results in a similarly shaped load profile compared to the standard scenario, but with approximately 30 percent less total energy for charging and decreased load across all hours. This decreases the midnight peak load from 5.4 GW to 3.6 GW. The load profile adds a 25<sup>th</sup> hour on the right to illustrate the timed midnight charging spike.**

Source: CEC and National Renewable Energy Laboratory

Figure D-5 shows the High Energy Demand load profile. This alternative future, which raises the energy demand by 30 percent, has the opposite effect of the Low Energy Demand alternative future shown above. While the shape of the load profile remains largely the same as the standard scenario, the total energy for charging rises by about 30 percent and the load the load is increased across all hours. This raises the midnight peak load by about 1.4 GW.

**Figure D-5: Projected 2030 Weekday Load Curve for the High Energy Demand Alternative Future**

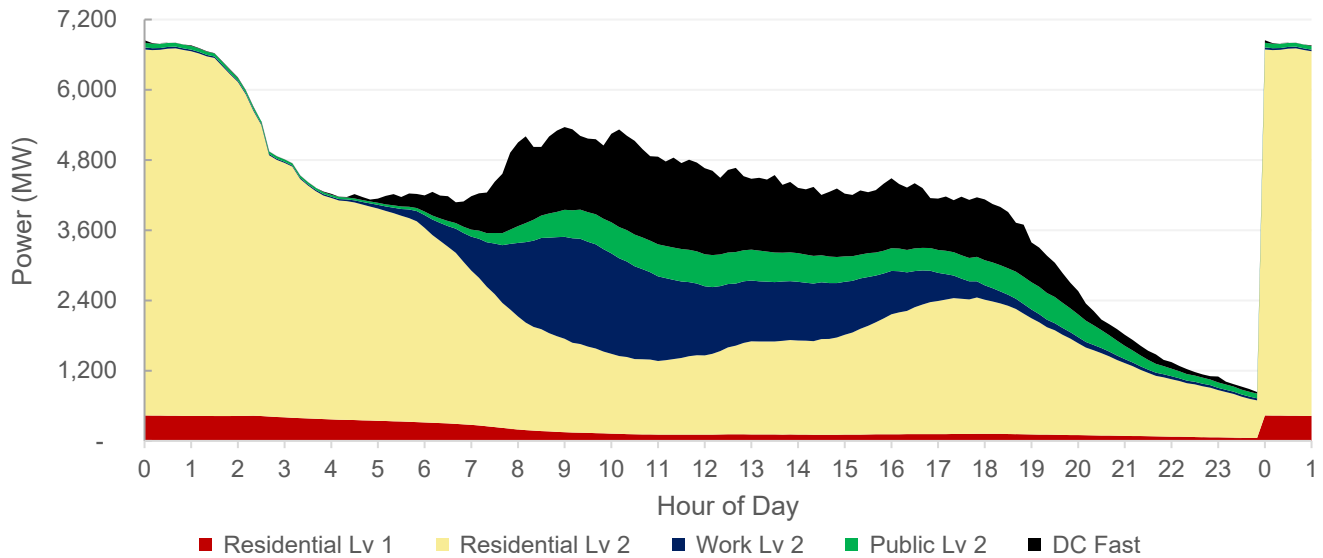

**The High Energy Demand alternative future results in a similarly shaped load profile compared to the standard scenario, but with approximately 30 percent more total energy for charging and increased load across all hours. This raises the midnight peak load from 5.4 GW to 6.8 GW. The load profile adds a 25<sup>th</sup> hour on the right to illustrate the timed midnight charging spike.**

Source: CEC and National Renewable Energy Laboratory

Figure D-6 shows the Low Range PEVs load profile. More conservative vehicle attributes in this alternative future result in interesting changes to the load profile. The total energy for charging decreases by 20 percent compared to the standard scenario. This is due to vehicles within high mileage travel days being unable to satisfy driving needs with smaller-ranged BEVs (without modifying travel plans). This reflects less utility for short-range BEVs that may be left at home for longer travel days, or not purchased to begin with due to the travel needs of drivers. Furthermore, the smaller ranges lead to vehicles that are more likely to charge daily, rather than just a few times a week as in the standard scenario. This increases the coincidence of charging at midnight, raising the peak load from 5.4 GW to nearly 6 GW. Finally, the shape of the residential charging load is noticeably different compared to the standard scenario. Due to the updated residential plug-in requirements shown in Table 6 in Chapter 4, which are based on remaining electric range, PEVs are more likely to plug in at a high SOC in this alternative future. This results in shorter charging durations and an almost immediate decline in residential load after the timed midnight spike, compared to the standard scenario which shows longer charging sessions and a sustained residential load for the first few morning hours before decreasing.

**Figure D-6: Projected 2030 Weekday Load Curve for the Low Range PEVs Alternative Future**

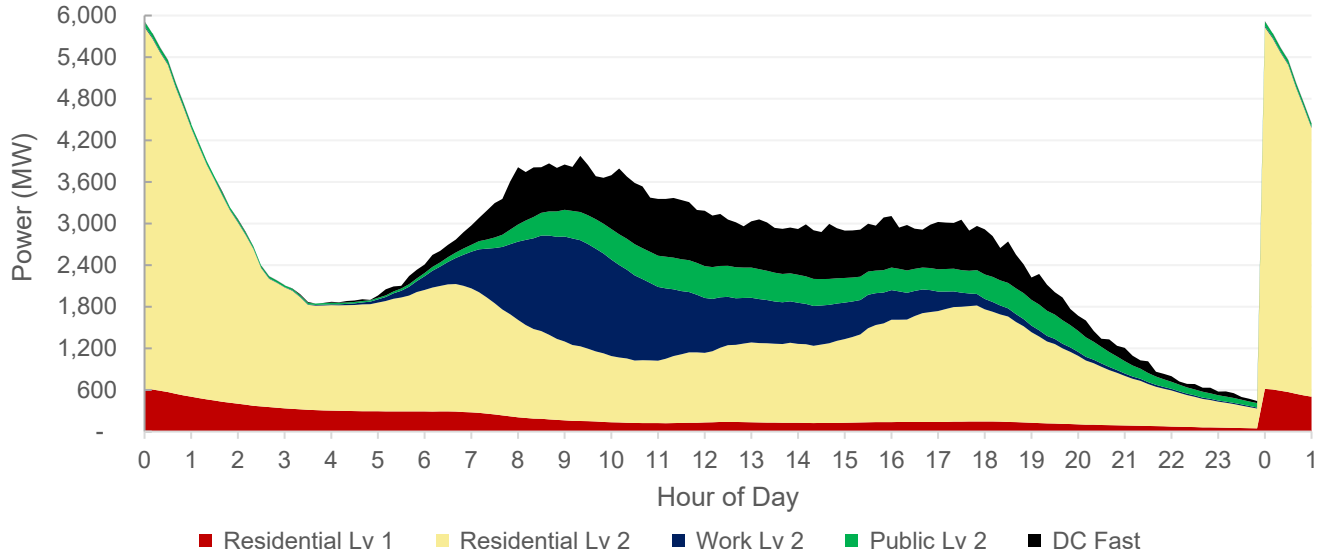

**The Low Range PEVs alternative future results in a number of differences in the load profile compared to the standard scenario. The overall energy from charging is smaller compared to the standard scenario since many low-range PEVs cannot meet the travel requirements of drivers. Furthermore, low-range PEVs are more likely to charge on a daily basis, leading to more coincidence in residential charging that increases the timed midnight peak from 5.4 GW to 6 GW. The load profile adds a 25<sup>th</sup> hour on the right to illustrate the timed midnight charging spike.**

Source: CEC and National Renewable Energy Laboratory

Figure D-7 shows the Gas Station Model load profile. The swap in driver preference to favor DC fast charging before work Level 2 charging results in a 6 percent increase in DC fast charging load share. This alternative future also subtly decreases the daytime peak load from above 4.2 GW to just below 4.2 GW around 10 a.m.

**Figure D-7: Projected 2030 Weekday Load Curve for the Gas Station Model Alternative Future**

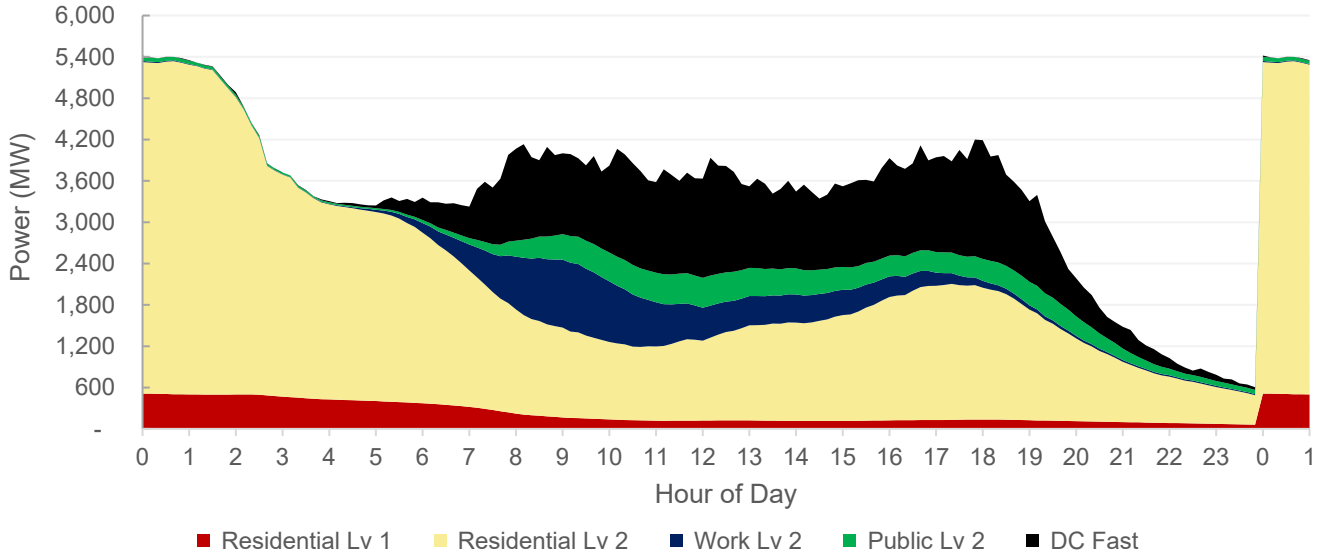

**The Gas Station Model alternative future results in a 6 percent increase in DC fast charging load as it replaces workplace charging demand. This also results in a subtle decrease in the daytime peak load to below 4.2 GW. The load profile adds a 25<sup>th</sup> hour on the right to illustrate the timed midnight charging spike.**

Source: CEC and National Renewable Energy Laboratory

Figure D-8 shows the EV Happy Hour load profile. The swap in preference to favor workplace charging before home charging results in a significantly different load profile than the standard scenario. Workplace charging dominates during the daytime hours, and its overall load share increases by about 22 percent (replacing residential charging load) to make up 35 percent of the total load. This in turn shifts the peak load from 5.4 GW at midnight in the standard scenario to 6.5 GW around 10 a.m. This suggests that encouraging more workplace charging could indeed align more EV charging with solar generation, although this alternative future also results in the largest net increase to the network size as shown in Chapter 4.

**Figure D-8: Projected 2030 Weekday Load Curve for the EV Happy Hour Alternative Future**

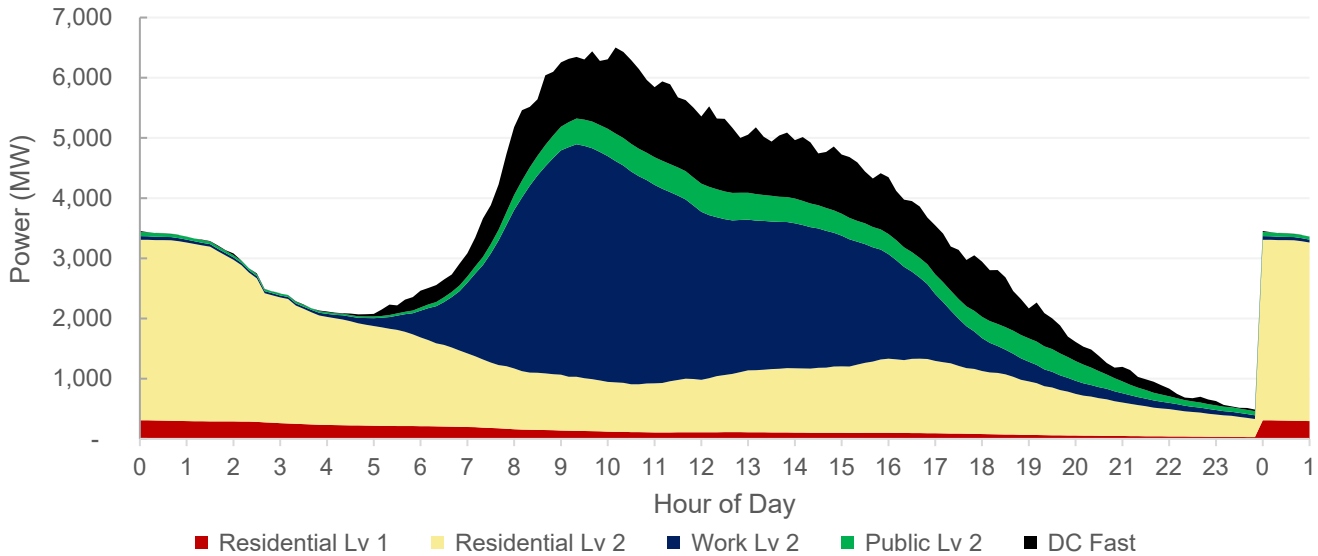

**The EV Happy Hour alternative future results in a 22 percent increase in workplace charging load that replaces residential charging. This shifts the peak load from 5.4 GW at midnight to 6.5 GW around 10 a.m. a.m., further aligning EV charging with daytime solar generation. The load profiles adds a 25<sup>th</sup> hour on the right to illustrate the timed midnight charging spike.**

Source: CEC and National Renewable Energy Laboratory

Figure D-9 shows the Level 1 Charging load profile. Allowing Level 1 chargers in public and work locations enables this type of charging to replace about 7 percent of Level 2 charging load, primarily workplace charging due to longer dwell times. This reduces the daytime peak load from about 4.2 GW to 3.5 GW at 10 a.m. due to the low-powered charging. However, as seen in Figure 15 in Chapter 4, this alternative future does not result in a one to one replacement of Level 1 and 2 chargers, instead leading to a net increase of over 250,000 additional chargers required to meet the charging demand.

**Figure D-9: Projected 2030 Weekday Load Curve for the Level 1 Charging Alternative Future**

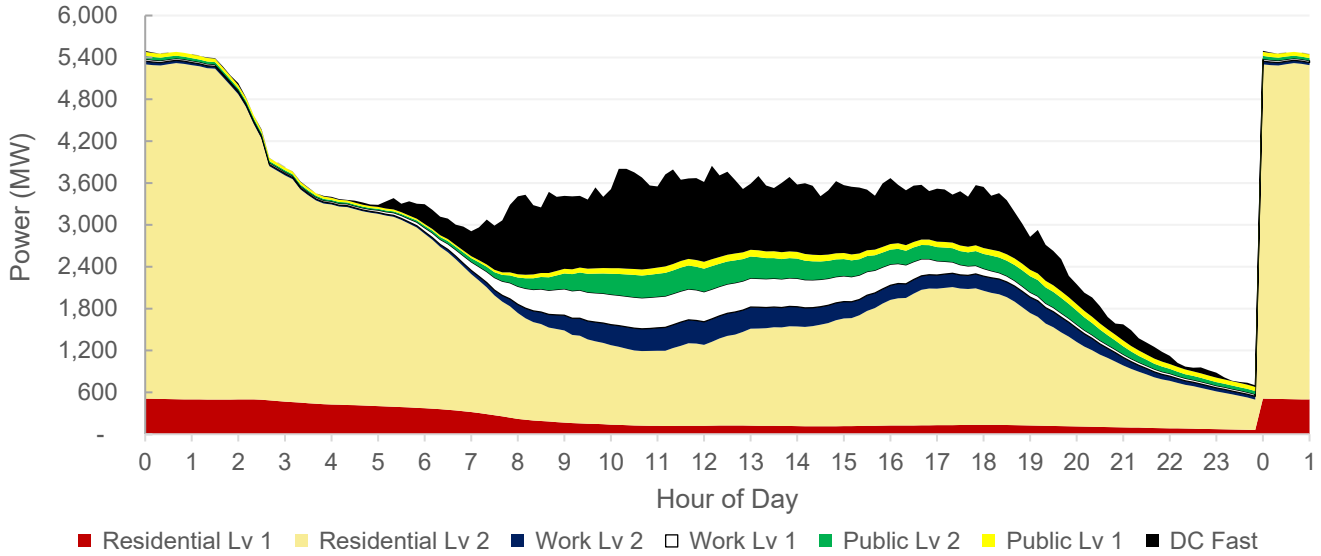

**The Level 1 Charging alternative future demonstrates that Level 1 charging can accommodate a large amount of Level 2 charging sessions (particularly workplace events), making up 7 percent of the total load share. However, the network results indicate that this requires a significantly larger amount of chargers overall. The load profile adds a 25<sup>th</sup> hour on the right to illustrate the timed midnight charging spike.**

Source: CEC and National Renewable Energy Laboratory

Figure D-10 shows the Lazy PHEVs load profile. Interestingly, forbidding PHEVs with residential charging access to charge in public or work locations does not alter the load profile significantly compared to the standard scenario. The public Level 2 load decreases by about 2 percent and is replaced by residential charging, but otherwise the load results are largely unchanged compared to the standard scenario. However, Figure 14 in Chapter 4 showed that this alternative future resulted in a net decrease of 225,000 chargers. This highlights the impact PHEVs have on the network size despite their relatively low contribution to charging load overall.



**Figure D-10: Projected 2030 Weekday Load Curve for the Lazy PHEVs Alternative Future**

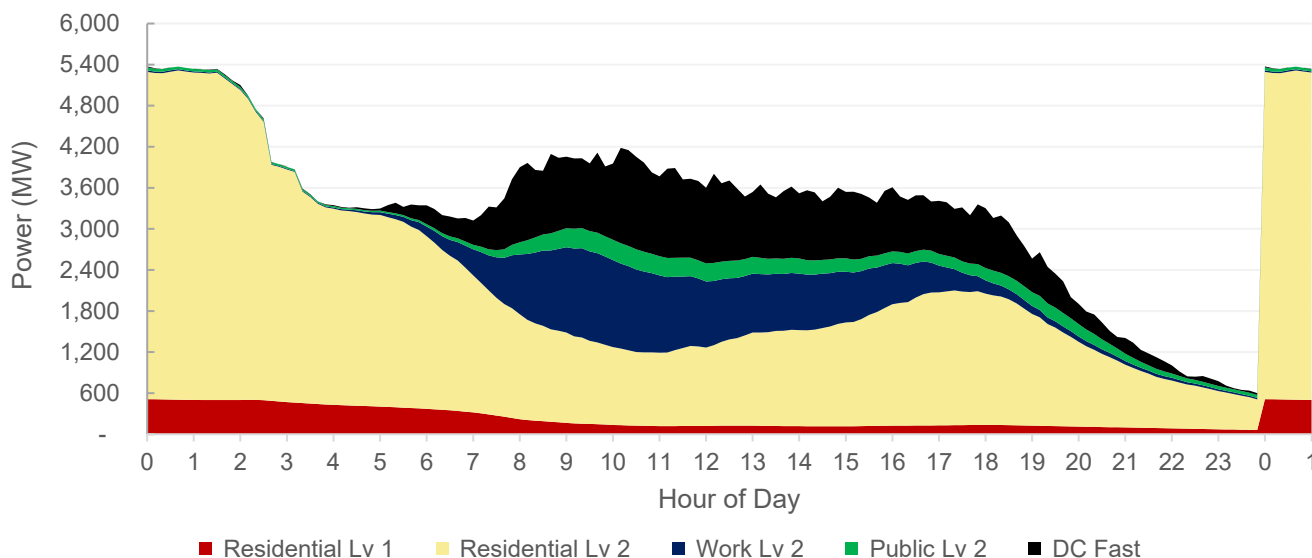

**The Lazy PHEVs alternative future results in an almost identical load profile compared to the standard case. This indicates that PHEVs make a relatively small contribution to charging load, but are a major driver for infrastructure demanded to serve frequent small charging sessions. The load profile adds a 25<sup>th</sup> hour on the right to illustrate the timed midnight charging spike.**

Source: CEC and National Renewable Energy Laboratory

Figure D-11 shows the Widespread Topping Off load profile. This alternative future results in perhaps the starkest change compared to the standard scenario. Doubling the e-mile plug-in thresholds leads to much more frequent charging events, increasing the probability that vehicles are charging daily or almost daily. The most notable impact of this is the spike in midnight charging load from 5.4 GW to 13 GW due to the large increase in drivers simultaneously plugging in their vehicles at midnight. However, this charging load drops off dramatically as vehicles plug in at high SOC and quickly complete their charging. This alternative future highlights the inefficiencies, and potentially extremely harmful effects, of drivers frequently topping off their vehicles.

**Figure D-11: Projected 2030 Weekday Load Curve for the Widespread Topping Off Alternative Future**

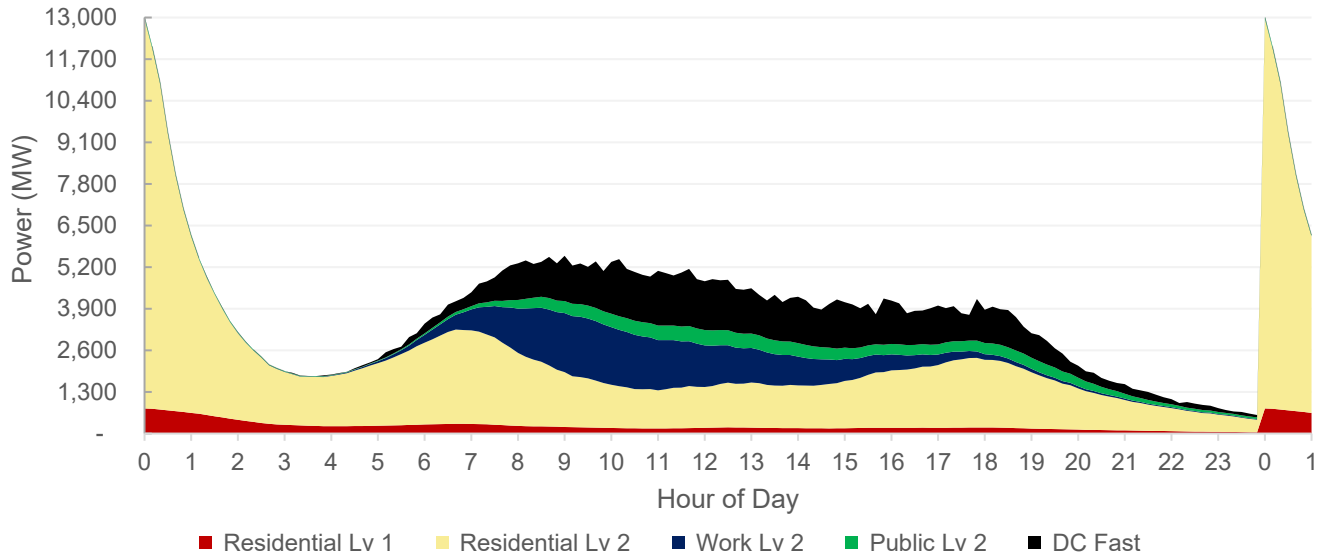

**The Widespread Topping Off alternative future results in a dramatic increase in charging load compared to the standard case at midnight, with the peak load rising from 5.4 GW to 13 GW. Encouraging frequent charging events leads to a massive coincidence in charging load from the timed midnight charging effect, highlighting the harmful effects of this type of behavior. The load profile adds a 25<sup>th</sup> hour on the right to illustrate the timed midnight charging spike.**

Source: CEC and National Renewable Energy Laboratory

# APPENDIX E:

## EVI-RoadTrip County Results

---

This appendix expands upon the EVI-RoadTrip results presented in Chapter 4, which focused on CARB's *Draft 2020 Mobile Source Strategy* planning scenario with about 8 million ZEVs in 2030. EVI-RoadTrip analysis was also conducted for the low and aggressive forecasts from the CEC's Energy Assessments Divisions 2020 IEPR scenarios.

Tables E-1 to E-4 show the county-level EVI-RoadTrip results tied to CARB's Draft Mobile Source Strategy planning scenario for the years 2020, 2025, 2030, and 2035. This includes both the chargers needed in each county (broken down by power level), as well as the total number of stations. The lower bound for chargers assumes a 100 percent utilization rate, while the upper bound assumes a 25 percent utilization rate. The exception to this upper bound rule is if the station only has one charger in the lower bound, in which case the upper bound is increased to two chargers, assuming a 50 percent utilization rate. The lower bound for stations does not set any restrictions on the size of a station, while the upper bound sets a maximum of 10 chargers per station. Note that for tabulation purposes, these charger and station counts are aggregated to the county level, but EVI-RoadTrip does generate geolocations for modeled stations, as seen in Figure 15 in Chapter 4.

**Table E-1: County-Level EVI-RoadTrip Results for Year 2020 for CARB's *Draft 2020 Mobile Source Strategy***

County	50 kW Chargers		150 kW Chargers		250 kW Chargers		350 kW Chargers		Stations	
	Low	High	Low	High	Low	High	Low	High	Low	High
Alameda	0	0	8	28	0	0	0	0	5	5
Alpine	0	0	4	8	0	0	0	0	4	4
Amador	0	0	1	2	0	0	0	0	1	1
Butte	0	0	2	4	0	0	0	0	2	2
Calaveras	0	0	0	0	0	0	0	0	0	0
Colusa	0	0	11	38	0	0	0	0	7	7
Contra Costa	0	0	9	36	0	0	0	0	4	5
Del Norte	0	0	6	16	0	0	0	0	5	5
El Dorado	0	0	12	32	0	0	0	0	10	10
Fresno	4	16	60	228	0	0	0	0	21	35
Glenn	2	8	4	12	0	0	0	0	4	4
Humboldt	1	4	11	28	0	0	0	0	10	10
Imperial	0	0	29	88	1	4	0	0	22	22
Inyo	0	0	13	26	0	0	0	0	13	13
Kern	6	24	110	412	0	0	1	4	39	64
Kings	1	4	13	50	0	0	0	0	4	7
Lake	0	0	2	4	0	0	0	0	2	2

Lassen	0	0	7	14	0	0	0	0	7	7
Los Angeles	2	8	78	286	0	0	0	0	33	48
Madera	0	0	8	24	0	0	0	0	6	6
Marin	0	0	3	6	0	0	0	0	3	3
Mariposa	0	0	1	2	0	0	0	0	1	1
Mendocino	1	4	8	18	0	0	0	0	8	8
Merced	2	8	52	196	0	0	0	0	20	31
Modoc	0	0	7	14	0	0	0	0	7	7
Mono	0	0	10	24	0	0	0	0	9	9
Monterey	0	0	15	44	0	0	0	0	11	12
Napa	0	0	3	6	0	0	0	0	3	3
Nevada	0	0	11	40	0	0	0	0	6	7
Orange	0	0	23	84	0	0	0	0	12	15
Placer	0	0	20	74	0	0	0	0	10	12
Plumas	0	0	3	6	0	0	0	0	3	3
Riverside	3	12	73	262	0	0	0	0	41	47
Sacramento	0	0	12	30	0	0	0	0	10	11
San Benito	0	0	1	2	0	0	0	0	1	1
San Bernardino	11	44	130	452	0	0	3	10	75	95
San Diego	0	0	42	144	2	4	0	0	27	30
San Francisco	0	0	1	2	0	0	0	0	1	1
San Joaquin	0	0	16	56	0	0	0	0	10	10
San Luis Obispo	0	0	10	24	0	0	0	0	9	9
San Mateo	0	0	1	2	0	0	0	0	1	1
Santa Barbara	0	0	18	64	0	0	0	0	10	12
Santa Clara	0	0	12	36	0	0	0	0	9	9
Santa Cruz	0	0	0	0	0	0	0	0	0	0
Shasta	0	0	12	36	0	0	0	0	9	9
Sierra	0	0	0	0	0	0	0	0	0	0
Siskiyou	1	4	19	58	0	0	0	0	14	15
Solano	0	0	16	56	0	0	0	0	9	10
Sonoma	0	0	6	12	0	0	0	0	6	6
Stanislaus	1	4	14	52	0	0	0	0	7	10
Sutter	0	0	3	6	0	0	0	0	3	3
Tehama	2	8	11	36	0	0	0	0	8	9
Trinity	0	0	6	16	0	0	0	0	5	5
Tulare	0	0	13	48	0	0	0	0	6	9
Tuolumne	0	0	8	20	0	0	0	0	7	7
Ventura	1	4	14	48	0	0	0	0	9	10
Yolo	1	4	16	58	0	0	0	0	9	11
Yuba	0	0	5	16	0	0	0	0	3	4
<b>Total Inside California</b>	39	156	1,003	3,386	3	8	4	14	581	702
<b>Total Outside California</b>	0	0	20	50	0	0	0	0	17	18
<b>Total Overall</b>	39	156	1,023	3,436	3	8	4	14	598	720

Source: CEC and National Renewable Energy Laboratory

**Table E-2: County-Level EVI-RoadTrip Results for Year 2025 for CARB's *Draft 2020 Mobile Source Strategy***

County	150 kW Chargers		250 kW Chargers		350 kW Chargers		Stations	
	Low	High	Low	High	Low	High	Low	High
Alameda	7	26	14	54	0	0	10	13
Alpine	2	6	3	8	0	0	4	4
Amador	0	0	4	8	0	0	4	4
Butte	2	4	4	8	0	0	6	6
Calaveras	1	2	2	4	0	0	3	3
Colusa	11	42	6	20	0	0	8	11
Contra Costa	5	18	7	26	0	0	7	7
Del Norte	1	4	8	22	0	0	7	7
El Dorado	9	36	11	36	0	0	11	13
Fresno	43	166	37	134	0	0	25	44
Glenn	6	22	4	16	0	0	5	6
Humboldt	11	30	9	22	0	0	17	17
Imperial	8	30	35	110	1	2	30	31
Inyo	10	20	10	20	0	0	20	20
Kern	80	298	48	170	0	0	46	73
Kings	11	40	4	16	0	0	5	8
Lake	2	4	3	6	0	0	5	5
Lassen	4	8	9	18	0	0	13	13
Los Angeles	57	208	65	238	2	8	51	74
Madera	7	22	4	14	0	0	7	8
Marin	1	2	2	4	0	0	3	3
Mariposa	3	6	0	0	0	0	3	3
Mendocino	14	44	6	14	0	0	15	16
Merced	31	116	27	102	0	0	20	34
Modoc	3	6	7	14	0	0	10	10
Mono	7	18	6	12	0	0	12	12
Monterey	17	58	9	26	0	0	16	19
Napa	2	4	2	4	0	0	4	4
Nevada	4	16	16	60	0	0	8	13
Orange	9	34	17	62	0	0	14	16
Placer	15	58	21	78	0	0	15	22
Plumas	2	6	5	12	0	0	6	6
Riverside	40	146	62	216	0	0	51	65
Sacramento	8	30	12	38	0	0	13	13
San Benito	2	8	2	8	0	0	2	2
San Bernardino	74	268	122	406	0	0	99	124
San Diego	27	102	36	128	0	0	33	40
San Francisco	1	2	0	0	0	0	1	1
San Joaquin	9	34	25	88	0	0	18	22
San Luis Obispo	14	42	3	8	0	0	13	13

San Mateo	2	4	1	2	0	0	3	3
Santa Barbara	11	42	9	30	0	0	12	12
Santa Clara	5	18	17	58	0	0	14	14
Santa Cruz	1	2	1	2	0	0	2	2
Shasta	5	12	16	44	0	0	17	18
Sierra	0	0	1	2	0	0	1	1
Siskiyou	7	20	24	74	0	0	23	23
Solano	12	46	9	32	0	0	9	13
Sonoma	5	14	6	16	0	0	9	9
Stanislaus	9	30	18	66	0	0	14	17
Sutter	3	8	4	10	0	0	6	6
Tehama	6	22	6	20	0	0	7	8
Trinity	3	6	3	6	0	0	6	6
Tulare	13	48	5	18	0	0	9	11
Tuolumne	2	4	5	10	0	0	7	7
Ventura	13	42	3	8	0	0	11	12
Yolo	10	38	6	22	0	0	8	10
Yuba	3	10	3	10	0	0	4	4
<b>Total Inside California</b>	<b>670</b>	<b>2,352</b>	<b>804</b>	<b>2,660</b>	<b>3</b>	<b>10</b>	<b>802</b>	<b>981</b>
<b>Total Outside California</b>	<b>18</b>	<b>48</b>	<b>32</b>	<b>86</b>	<b>0</b>	<b>0</b>	<b>39</b>	<b>41</b>
<b>Total Overall</b>	<b>688</b>	<b>2,400</b>	<b>836</b>	<b>2,746</b>	<b>3</b>	<b>10</b>	<b>841</b>	<b>1,022</b>

Source: CEC and National Renewable Energy Laboratory

**Table E-3: County-Level EVI-RoadTrip Results for Year 2030 for CARB's Draft 2020 Mobile Source Strategy**

County	150 kW Chargers		250 kW Chargers		350 kW Chargers		Stations	
	Low	High	Low	High	Low	High	Low	High
Alameda	0	0	5	20	22	82	12	17
Alpine	1	4	2	8	9	30	7	8
Amador	0	0	3	6	4	8	7	7
Butte	0	0	5	10	9	22	13	13
Calaveras	3	6	2	4	2	4	7	7
Colusa	0	0	4	16	11	40	8	9
Contra Costa	0	0	2	6	11	44	6	8
Del Norte	0	0	0	0	15	54	9	9
El Dorado	0	0	0	0	25	86	15	17
Fresno	4	12	36	142	45	172	24	42
Glenn	0	0	5	20	8	32	4	7
Humboldt	0	0	4	8	16	40	18	18
Imperial	0	0	5	16	53	192	28	38
Inyo	3	10	9	18	12	24	23	23
Kern	14	52	84	316	74	280	54	92
Kings	2	4	9	32	10	40	9	12
Lake	0	0	1	2	6	16	6	6

Lassen	0	0	4	8	15	34	18	18
Los Angeles	3	8	47	182	120	446	61	95
Madera	0	0	6	22	8	30	6	9
Marin	0	0	1	2	4	12	4	4
Mariposa	3	6	2	4	0	0	5	5
Mendocino	3	10	14	46	7	18	17	18
Merced	0	0	18	66	55	214	21	38
Modoc	3	8	2	6	10	20	14	14
Mono	2	8	8	22	10	30	15	15
Monterey	5	14	9	36	18	64	19	20
Napa	0	0	2	4	2	8	3	3
Nevada	0	0	6	20	33	128	16	25
Orange	1	2	6	22	29	110	17	21
Placer	0	0	11	38	37	142	20	29
Plumas	1	2	2	4	9	18	12	12
Riverside	2	6	30	118	113	426	57	84
Sacramento	0	0	2	6	30	112	16	20
San Benito	0	0	2	6	5	20	4	4
San Bernardino	5	12	60	222	225	806	129	173
San Diego	2	4	16	58	82	306	49	66
San Francisco	0	0	0	0	1	2	1	1
San Joaquin	1	4	8	30	40	152	19	28
San Luis Obispo	4	12	14	48	6	20	16	16
San Mateo	1	2	0	0	3	6	4	4
Santa Barbara	0	0	13	52	16	60	12	18
Santa Clara	0	0	2	8	31	114	16	21
Santa Cruz	0	0	2	4	2	4	4	4
Shasta	0	0	6	16	21	68	19	20
Sierra	0	0	2	4	1	2	3	3
Siskiyou	0	0	3	8	44	146	30	33
Solano	0	0	7	26	14	50	11	13
Sonoma	3	10	11	32	2	4	12	13
Stanislaus	1	4	14	46	22	86	14	21
Sutter	1	2	2	8	5	16	5	6
Tehama	0	0	2	6	13	50	8	9
Trinity	0	0	5	10	4	8	9	9
Tulare	3	10	11	42	6	22	10	13
Tuolumne	0	0	7	16	11	28	16	16
Ventura	3	10	11	42	9	26	14	15
Yolo	0	0	8	28	14	52	11	14
Yuba	1	4	3	8	7	26	7	7
<b>Total Inside California</b>	75	226	555	1,950	1,416	5,052	994	1,290
<b>Total Outside California</b>	5	12	11	32	46	136	45	48
<b>Total Overall</b>	80	238	566	1,982	1,462	5,188	1,039	1,338

Source: CEC and National Renewable Energy Laboratory

**Table E-4: County-Level EVI-RoadTrip Results for Year 2035 for CARB's *Draft 2020 Mobile Source Strategy***

County	150 kW Chargers		250 kW Chargers		350 kW Chargers		450 kW Chargers		Stations	
	Low	High	Low	High	Low	High	Low	High	Low	High
Alameda	0	0	4	16	6	22	24	94	15	20
Alpine	0	0	0	0	2	4	11	34	10	10
Amador	0	0	2	4	1	2	4	8	7	7
Butte	0	0	3	6	0	0	10	28	11	11
Calaveras	1	2	1	2	1	2	3	6	6	6
Colusa	0	0	2	6	3	12	16	56	12	14
Contra Costa	0	0	2	6	1	4	17	58	11	14
Del Norte	0	0	0	0	1	4	18	68	10	11
El Dorado	0	0	1	2	0	0	35	128	19	24
Fresno	0	0	22	82	40	158	55	202	34	62
Glenn	0	0	1	2	4	16	7	28	5	7
Humboldt	0	0	1	2	2	8	26	66	24	25
Imperial	1	2	1	4	13	48	71	270	35	53
Inyo	1	2	6	14	3	6	18	42	26	26
Kern	1	4	85	302	68	266	86	310	81	134
Kings	0	0	3	6	7	26	7	28	7	11
Lake	0	0	4	8	0	0	8	24	10	10
Lassen	0	0	4	8	3	6	22	56	26	26
Los Angeles	0	0	19	68	53	208	136	514	68	117
Madera	0	0	1	2	3	10	12	46	9	10
Marin	0	0	0	0	1	4	6	20	4	5
Mariposa	0	0	3	6	1	2	8	20	11	11
Mendocino	0	0	10	32	7	22	9	32	17	18
Merced	2	4	6	20	28	112	47	186	22	44
Modoc	0	0	1	2	2	6	18	42	19	19
Mono	0	0	1	2	7	14	13	26	21	21
Monterey	0	0	12	44	7	26	23	82	24	25
Napa	0	0	1	2	0	0	5	10	6	6
Nevada	0	0	2	4	8	32	37	146	16	25
Orange	0	0	1	2	11	42	35	136	18	27
Placer	1	2	1	2	8	32	43	170	19	31
Plumas	0	0	0	0	2	8	7	14	8	8
Riverside	0	0	6	16	31	124	122	458	60	90
Sacramento	0	0	0	0	2	8	37	136	19	25
San Benito	0	0	0	0	0	0	5	14	4	4
San Bernardino	0	0	12	34	79	298	267	994	139	210
San Diego	2	4	2	4	22	80	97	354	62	83
San Francisco	0	0	0	0	0	0	1	2	1	1
San Joaquin	0	0	0	0	13	48	51	196	24	37



San Luis Obispo	0	0	16	54	3	12	10	28	19	21
San Mateo	0	0	2	4	1	2	4	8	7	7
Santa Barbara	0	0	12	44	13	52	13	48	16	24
Santa Clara	0	0	3	10	4	16	30	112	16	24
Santa Cruz	0	0	0	0	0	0	5	10	5	5
Shasta	0	0	1	2	4	10	26	84	22	23
Sierra	0	0	1	2	0	0	2	4	3	3
Siskiyou	0	0	3	8	9	34	51	180	34	42
Solano	0	0	1	4	9	34	17	66	10	16
Sonoma	1	2	1	4	1	2	12	34	12	12
Stanislaus	1	2	2	8	10	38	38	140	19	29
Sutter	0	0	2	6	0	0	5	16	5	5
Tehama	1	2	1	2	0	0	18	64	13	13
Trinity	1	2	3	6	0	0	4	12	7	7
Tulare	0	0	18	64	6	22	7	26	14	20
Tuolumne	1	2	4	12	2	6	11	32	14	14
Ventura	1	2	11	42	7	24	10	30	17	20
Yolo	0	0	9	34	4	16	9	32	11	14
Yuba	0	0	1	2	3	12	11	42	8	9
<b>Total Inside California</b>	15	32	311	1,018	516	1,940	1,700	6,072	1,172	1,596
<b>Total Outside California</b>	0	0	10	20	9	22	54	158	58	60
<b>Total Overall</b>	15	32	321	1,038	525	1,962	1,754	6,230	1,230	1,656

Source: CEC and National Renewable Energy Laboratory

Tables E-5 and E-6 show EVI-RoadTrip results for the CEC’s IEPR aggressive and low forecasts, respectively. Note that these forecasts only go up to the year 2030.

**Table E-5: DCFC Infrastructure Needed for the CEC’s IEPR Aggressive Forecast**

Result	2020		2025		2030	
	Low	High	Low	High	Low	High
Total Chargers	1,034	3,424	1,657	5,842	1,849	6,496
Total Stations	600	714	818	1,051	907	1,181

Source: CEC and National Renewable Energy Laboratory

**Table E-6: DCFC Infrastructure Needed for the CEC’s IEPR Low Forecast**

Result	2020		2025		2030	
	Low	High	Low	High	Low	High
Total Chargers	1,080	3,644	1,274	4,298	1,364	4,580
Total Stations	610	728	711	860	788	932

Source: CEC and National Renewable Energy Laboratory