

DOCKETED

| | |
|-------------------------|---|
| Docket Number: | 23-OPT-01 |
| Project Title: | Fountain Wind Project |
| TN #: | 254794 |
| Document Title: | fwp_project_description_2024_update_redline |
| Description: | N/A |
| Filer: | Caitlin Barns |
| Organization: | Stantec Consulting Services, Inc. |
| Submitter Role: | Applicant Consultant |
| Submission Date: | 3/4/2024 10:49:47 AM |
| Docketed Date: | 3/4/2024 |



March 4, 2024

Project/File: Fountain Wind Project (23-OPT-01)

Lon Payne
California Energy Commission
1516 9th Street
Sacramento, CA 95814

Dear Lon Payne,

Reference: Fountain Wind Project Updated Project Description

Attached please find the updated project description for the Fountain Wind Project. The updates reflect additional project details unavailable prior to these revisions, and clarifications compiled during the data compilation phase. Additions include revisions to a table of project component dimensions; a table of colors, finishes, and materials for major project components; and additional detail regarding turbine deliveries, total construction truck trips, transportation management during construction, water supply during construction and operations, and a distribution line connecting the O&M building and the substation.

Sincerely,

STANTEC CONSULTING SERVICES INC.

A handwritten signature in black ink that reads 'Caitlin M. Barns'.

Caitlin Barns
Senior Environmental Planner
Phone: (503) 207-4368
caitlin.barns@stantec.com

Attachment: Fountain Wind Project Updated Project Description



FOUNTAIN WIND ENERGY PROJECT

Project Description

~~July 10, 2023~~

March 1, 2024

Prepared for:
Fountain Wind LLC
1001 McKinney, Suite 700
Houston, TX 77002

Prepared by:
Stantec Consulting Services Inc.
601 SW Second Avenue, Suite 1400
Portland, OR 97204

TABLE OF CONTENTS

Executive Summary **ii**

1 Project Overview **1**

1.1 Project Overview 1

1.2 Project Schedule 1

1.3 Project Location 2

2 Generation Facility Description, Design, and Operation **2**

2.1 Wind Turbine Generators 4

3 Collection Line Description, Design, and Operation **6**

3.1 Electrical Collector System and Communication System 6

3.1.1 Underground Collector System 6

3.1.2 Overhead Collector System 6

3.2 Project Substation, Switching Station, and Interconnection Facilities 7

3.3 Other Infrastructure 8

3.3.1 Access Roads 8

3.3.2 Temporary Construction and Equipment Areas 8

3.3.3 Operation and Maintenance Facility 9

3.3.4 Meteorological Equipment 9

3.4 Site Preparation and Construction 11

3.4.1 Site Preparation 11

3.4.2 Construction Sequence 12

3.4.3 Construction Schedule and Workforce 14

3.4.4 Stormwater Control 16

3.4.5 Operation and Maintenance 16

3.4.6 Decommissioning and Site Restoration 17

3.4.7 Water, Wastewater, Waste, and Hazardous Materials 18

4 Project Permits **21**

5 References **24**

LIST OF TABLES

Table 1. Project Assessor’s Parcel Numbers 2

Table 2. Project Components and Associated Impact Footprints 3

Table 3. Project Component Dimensions 4

Table 4. Approximate Dimensions and Colors, Materials, and Finishes of Major Project Components 10

Table 5. Construction Equipment List 14

Table 6. Hazardous Materials 19

Table 7. List of Potential Permits and Status 21

LIST OF FIGURES

Figure 1. Project Region

Figure 2. Project Site Aerial

Figure 3. Zoning

Figure 4. Generic (non-project-specific) Turbine Profiles

Figure 5. Conceptual Design

Figure 6. Preliminary Substation Designs

Figure 7. Preliminary Switching Station Designs

Figure 8. Operation and Maintenance Facility



Executive Summary

The Fountain Wind Energy Project (Project) is a wind energy generation development proposed by Fountain Wind LLC (Applicant) in unincorporated Shasta County. The proposed Project is located approximately 1 mile west of the existing Hatchet Ridge Wind Project, 6 miles west of Burney, 35 miles northeast of Redding, and immediately ~~north and~~ south of State Route 299. The project would be located entirely on private property, managed for timber production and harvesting, where public access is currently restricted. The Project Area includes ~~thirty-seven~~ 37 parcels in which the project components will be sited and encompasses approximately 16,108 acres. The Project Site Boundary encompasses approximately 2,855 acres within the Project Area and includes where all infrastructure would be sited and where potential temporary and permanent disturbance activities may occur including associated construction and maintenance corridors.

As further described below, the primary project components are:

- Up to 48 wind turbines with a nameplate generating capacity of up to 7.2 megawatts (MW) each (for a total nameplate capacity of up to 205 MW).
- Underground and overhead collection lines.
- Access roads, temporary construction laydown areas, an operation and maintenance facility, permanent meteorological evaluation towers, storage sheds, and up to three temporary concrete batch plants.
- A substation and switchyard to interconnect to the existing Pacific Gas and Electric Company (PG&E) 230 kilovolt line (from Pit #1 Dam to the Cottonwood Substation) and a relay microwave tower or overhead fiber optic communication circuits.

The Applicant is applying for site certification and project approval under the California Energy Commission's "opt-in" provisions pursuant to Public Resources Code §25545 et seq. These opt-in provisions grant the Commission exclusive permitting authority (with some exceptions) over qualifying non-thermal energy production "facilities," including a "terrestrial wind electrical generating powerplant with a generating capacity of 50 megawatts or more and any facilities appurtenant thereto." The project qualifies as a "facility" under Public Resources Code §25545(a)(1) because it is a terrestrial wind electrical generating powerplant with a generating capacity of more than 50 MW.

Project construction is expected to last 24 to 28 months and require up to approximately 200 workers at peak construction. Project operations would require up to 10 full-time employees, depending on the final turbine technology that is selected for the Project. Routine maintenance activities are expected to include checking torque on tower bolts and anchors; checking for signs of stress on the turbines or leakage of lubricants, hydraulic fluids, or other hazardous materials; inspecting the grounding cables, wire ropes and clips, and surge arrestors; cleaning; and repainting.

The life of the project is assumed to be 35 years. Proposed decommissioning of existing facilities would require approximately 18 to 24 months. Decommissioning would involve dismantling project infrastructure components to a depth of 3 three feet below grade and removing them from the project site. Underground cables would be abandoned in place. The project site would be revegetated to be consistent with the area's ecological setting and the landowner's current and future land use practices.



1 Project Overview

1.1 Project Overview

The Fountain Wind Energy Project (Project) is a wind energy generation development proposed by Fountain Wind LLC (Applicant), in an unincorporated area of Shasta County. Overall, the project would have a total nameplate generating capacity of up to 205 megawatts (MW).¹ Associated infrastructure and facilities would include:

- Up to 48 wind turbine generators;
- 34.5-kilovolt (kV) overhead and underground electrical collector system;
- an on-site substation to receive electricity from the turbines via the electrical collector system;
- overhead and underground fiber-optic communication lines and/or a microwave relay system;
- an onsite switching station to connect the project to the existing regional grid operated by the Pacific Gas and Electric Company (PG&E);
- a temporary 10-acre construction and equipment laydown area;
- up to nine (9) temporary 2-acre laydown areas distributed throughout the project site to store and stage building materials and equipment;
- up to three (3) permanent meteorological evaluation towers (METs);
- temporary, episodic deployment of mobile Sonic Detection and Ranging (SoDAR) or Light Detection and Ranging (LiDAR) systems within identified disturbance areas (e.g., at MET locations);
- two (2) storage sheds;
- up to three (3) temporary five (5) acre concrete batch plants; and
- an operation and maintenance (O&M) facility with employee parking, including a septic system and the potential for a new domestic operational water supply well

New access roads would be constructed within the project site, and existing roads would be improved. See Figures 1 and 2, which show the project region and proposed layout of project components. The project would operate year-round.

1.2 Project Schedule

Project construction is expected to last 24 to 28 months. The calendar dates of project construction will depend on the timing of receipt of regulatory approvals.

¹ “Nameplate capacity” is the amount of power that would be generated under ideal conditions. Actual output can differ from nameplate capacity for a number of reasons, including wind speeds and other weather conditions or equipment maintenance.



1.3 Project Location

The Project [site](#) is located approximately 1 mile west of the existing Hatchet Ridge Wind Project, 6 miles west of Burney, 35 miles northeast of Redding, and immediately south of State Route (SR) 299. Other communities near the project site include Montgomery Creek, Round Mountain, Wengler, and Big Bend. Access to the project site is provided locally by SR 299, ~~Moose Camp Road, as well as three~~ [via two](#) existing, gated, private logging roads, and would be provided regionally by highways that provide access to SR 299, including Interstate 5, which is approximately 35 miles to the west of the project site, and SR 139, which is approximately 60 miles to the east of the project site. The Assessor’s Parcel Numbers associated with the project are included in Table 1.

Table 1. Project Assessor’s Parcel Numbers

| | | | | | |
|--------------|--------------|--------------|--------------|--------------|--------------|
| 027130046000 | 027220001000 | 029190013000 | 029210009000 | 029250010000 | 030080014000 |
| 027140028000 | 029170006000 | 029190014000 | 029210019000 | 030080005000 | 034010003000 |
| 027160020000 | 029170008000 | 029190016000 | 029210020000 | 030080006000 | 034010004000 |
| 027160027000 | 029190010000 | 029190017000 | 029210021000 | 030080007000 | 034010008000 |
| 027160047000 | 029190011000 | 029200043000 | 029220006000 | 030080008000 | 034010016000 |
| 027160049000 | 029190012000 | 029210001000 | 029250001000 | 030080013000 | 034010017000 |
| 027210006000 | | | | | |

The project site is located within the southern end of the Cascade Range with topography characterized by buttes and peaks separated by small valleys. The Lassen National Forest lies to the southeast, and the Shasta-Trinity National Forest is to the north. Other surrounding lands are privately owned; many are used for timber harvesting purposes. Elevations within the project site range from 3,000 to 6,000 feet above sea level. Little Cow Creek and the south fork of Montgomery Creek cross the project site from east to west. Other small tributaries run through the valleys. Northern portions of the ~~leasehold project site~~ were affected by the 1992 Fountain Fire as evidenced by burn scars. The Shasta County General Plan designates the project ~~site's use~~ as Timber (T); the zoning designation is Timber Production (TP) (see Figure 3). The existing land use within the project site consists exclusively of managed timber lands. Logging roads and transmission lines cross the project site. Moose Camp, an approximately 50-cabin, 146-acre private recreational facility, is located [approximately 300 feet](#) east of the main Project access road.

2 Generation Facility Description, Design, and Operation

The project consists of three major components included within the approximately 2,855-acre Project Site boundary:

- Up to 48 turbines, including associated concrete foundations, pads, and temporary construction areas
- 34.5 kV overhead and underground collector lines and fiber optic communication cabling
- An on-site substation and switching station for connecting the project into the existing PG&E transmission line (Figures 5 and 6)



The elements of each of these major components are described in more detail in Table 2 and 3 below. Ancillary facilities and infrastructure would also be required, including access roads, temporary construction laydown areas, an O&M facility, up to three (3) permanent METs, two (2) storage sheds, and up to three (3) temporary concrete batch plants.

Table 2. Project Components and Associated Impact Footprints

| Project Component | Quantity | Temporary Impact Description | Permanent Impact Description |
|--------------------------------|--|--|--|
| Turbines | Up to 48 | Approximately 5 acres each (250 ft. radius) | Approximately 2.5 acres each (186 ft. radius) |
| Access Roads | Up to 19 miles new and 19 miles widening of existing roads | Up to 200 ft. wide cleared corridor | Up to 40 ft. wide corridor (20 ft. wide drivable surface with up to 10 ft. of cleared area on either side) |
| Batch Plant | 3 | Approximately 5 acres each (466 ft. x 466 ft.) | -- |
| O&M Building | 1 | -- | Approximately 5 acres (466 ft. x 466 ft.) |
| Staging Areas | 9 | Approximately 2 acres each (295 ft. x 295 ft.) | -- |
| MET Tower | 3 | Approximately 1.5 acres each (144 ft. radius) | Approximately 0.75 acres each (102 ft. radius) |
| Underground Collector | Up to 39 miles | Up to 50 ft. wide cleared corridor | Up to 30 ft. wide cleared corridor |
| Overhead Collector | Up to 6 miles | Up to 100 ft. wide cleared corridor | Up to 80 ft. wide cleared corridor |
| Substation | 1 | Approximately 7 acres | Approximately 5 acres |
| Switching Station | 1 | Approximately 12 acres | Approximately 8 acres |
| Microwave Tower ¹ | 1 | -- | -- |
| Storage Shed ² | 2 | -- | -- |
| <u>Water Tanks³</u> | <u>3</u> | <u>--</u> | <u>--</u> |
| Total Disturbance | -- | Approximately 548 acres | Approximately 510 acres |

Notes:

Because the disturbance footprints of numerous components overlap, total disturbance will not equate to the sum of the disturbance acreage for each component.

1 – the microwave tower is within the substation / switchyard permanent impact footprint

2 – the storage shed(s) are within the turbine, ~~and~~ MET tower, or access road permanent impact footprints and are anticipated to be approximately 10 feet by 20 feet.

3 – the water tanks are within the temporary impact footprint of access roads or staging areas; permanent dimensions are similar to those of the storage sheds (10-12 feet in diameter). Water tanks would have a negligible effect on total permanent disturbance.



Table 3. Project Component Dimensions

| Project Component | Dimensions (approximate) |
|---|---|
| Turbine | Up to 610 ft. |
| Nacelle | Height: 13 ft. Width: 21 ft. Length: 42 ft. |
| Hub ¹ | Height: 16 ft. Width: 14 ft. Length: 16 ft. Base to hub height: up to 342 3 ft. |
| Blade ¹ | Height: 11 ft. Width: 14 ft. Length: 264 3 ft. |
| Tower Sections | Height: between 31 and 75 ft. each |
| MET Tower | Height: up to 394 ft. Width (Base): 30 ft. |
| Overhead Collector Line Poles | Height: up to 90 ft. |
| Overhead Collector Line Conductor | Ground clearance: 20 – 30 ft. |
| Microwave Tower (within Substation) | Area: 25 ft. x 25 ft. Height: 150 ft. |
| Storage Shed (within turbine, MET tower, or access road permanent impact footprint) | Area: 10 ft. x 20 ft. Height: 10 ft. |
| <u>Note: these represent the maximum potential dimensions for these components</u> | |

2.1 Wind Turbine Generators

Figure 2 depicts 48 turbine sites that are being considered as part of the project. Final design may include fewer than 48 turbine sites. The 48 turbine sites represent feasible locations for a range of turbine models, each with different dimensions, generating capacity, and layout requirements. Prior to construction, the Applicant would determine which model would be installed based on component availability from the manufacturer, data on on-site wind resources, and other project-specific factors. Regardless of the model ultimately selected, the project would not exceed the proposed maximum 205 MW nameplate generating capacity and total tip height of each turbine would not exceed approximately 610 feet above ground level.

The project would construct, operate, maintain, and decommission up to 48 wind turbines, each with a nameplate generating capacity of up to 7.2 MW, to convert wind energy directly to electrical power to supply the existing electrical grid. The project would use three-bladed, horizontal-axis turbines, meaning the rotor shaft and nacelle, which contains the electrical generator, would be mounted at the top of a cylindrical tower. A range of turbine heights are being considered; however, the maximum possible height would be 610 feet from ground level to the vertical turbine blade tip. Each turbine tower would be mounted on a concrete pedestal supported by a permanent foundation. Representative (non-project-specific) turbine profiles are shown in Figure 4.

A commercial-scale wind turbine is made up of three main parts: tower, nacelle, and rotor that is made up of three ~~(3)~~ blades mounted to a hub. The rotor is attached to the nacelle, which houses the generating components within a wind turbine, including the drive shaft, gearbox, generator, and controls. The tower provides the vertical support



for the nacelle and rotor. Each turbine tower would be mounted on a concrete pedestal supported by a foundation. Spread footing foundations, which have a wide base that spreads the weight of the structure over a larger subsurface area for greater stability, are likely to be used for the foundation design. This type of foundation is buried underground to a depth of approximately 10 to 15 feet with a pedestal that extends approximately 1-foot above ground.

Turbine foundations would be designed based on the findings of a project-specific, site-specific geotechnical investigation that would be prepared once final turbine locations have been verified. California Building Code Section 1803 specifies the required content of geotechnical reports. Existing law requires that the geotechnical investigation be conducted by a registered design professional and in accordance with the provisions of California Building Code Section 1803, as may be amended from time to time, and in effect at the time the investigation is conducted. Prior to finalizing the location of each turbine, soil borings would be collected to an approximately 50-foot depth, or as appropriate, to verify soil and rock characteristics and to check that there is sufficient soil strength and bearing capacity to provide a stable foundation for the turbine.

Depending on the final turbine model selected, the widest underground portion of the turbine spread footing foundation would be between 60 and 80 feet in diameter. The aboveground, visible portion of the foundation is anticipated to be similar in diameter to the turbine tower, up to approximately 16 feet in diameter. A step-up transformer would be located either within the turbine nacelle or within a 9-foot by 9-foot reinforced concrete box pad located approximately five feet from the tower foundation ~~(Figure 3).~~

Designated turbines and METs would have flashing red lights installed to improve visibility for aviation and that comply with Federal Aviation Administration (FAA) standards and Advisory Circular 70/7460-1L (FAA 2016). In accordance with these standards, the Applicant would prepare a lighting plan for the project and obtain FAA approval that would specify the installation of flashing red lights on designated turbines and METs to improve visibility for aviation. Because the height of the proposed turbines would be greater than 500 feet, it is expected that each would need to be lit with two lights.

During construction, a temporary construction work area of up to approximately five ~~(5)~~ acres would be cleared around each turbine site. This work area would encompass the area needed for grading, foundation excavation and construction, and turbine delivery, assembly, and erection. The final size and configuration of each construction work area would depend on the turbine site's terrain. Each construction work area would generally require a 250-foot by 350-foot designated space for staging the construction crane, which would be used to unload turbine components from delivery trucks and to hoist turbine sections in to place during turbine assembly. Within each work area a crane pad would be constructed of compacted soil leveled to approximately two percent slope or less to provide a stable area sufficient to support the weight of the crane during turbine component installation. The size and location of each crane pad would be determined by the final turbine technology that is selected and the requirements for the specific crane that is used for turbine component installation. The crane pad would likely be left in place after construction and used for turbine repair or during decommissioning of the project.

Post-construction, a permanent, 15-foot-wide gravel ring would be placed around the base of the ~~foundation~~turbine to provide a stable surface for maintenance vehicles and to minimize surface erosion and runoff. ~~The permanent turbine pads would be between 65 and 95 feet in diameter, depending on the site conditions and final turbine model constructed.~~ An area up to an additional approximately 2.5 acres around the ~~permanent turbine pad~~turbines would be removed from timber production and maintained as a defensible space containing low-growing vegetation.



3 Collection Line Description, Design, and Operation

3.1 Electrical Collector System and Communication System

A combination of overhead and underground 34.5 kV electrical collector lines would collect energy generated by the turbines and deliver it to an on-site substation. A communication system also would be installed within the same footprint. The communication system consists of fiber optic communication cabling for the Supervisory Control and Data Acquisition (SCADA) system, which provides communication capabilities between turbine locations, substation, and O&M facilities. Most of the collector system would be located underground and adjacent to on-site access roads. However, portions of the collector system may be constructed overhead in response to environmental and engineering constraints such as:

- a large distance from generators to the substation;
- meeting the electrical transmission limits of underground cable (20 to 28 MW);
- steep terrain where the use of a backhoe or trenching machine is infeasible or unsafe;
- stream and wetland crossings or cultural resource sites, where an overhead line would avoid or minimize an impact to the resource; or
- the presence of soils with low thermal conductivity or rocky conditions which that could significantly increase trenching costs.

See also Figure 5, which shows conceptual design details of the proposed overhead collector system poles.

3.1.1 UNDERGROUND COLLECTOR SYSTEM

The underground collector system would consist of insulated cables buried in trenches that are 46 inches deep and at least 12 inches wide. Each trench would contain power cables, a ground wire, a fiber optic communication cable, and a marker tape above the cables. Cables generally would be co-located with turbine access roads to minimize ground disturbance. In areas where the underground collector system would be co-located with both new and existing access roads, no additional ground disturbance would be required to install the underground electrical collection system beyond that which is disclosed in the impacts for the widening of the road. Where cable trenches cannot be co-located with access roads, a temporary, 50-foot-wide disturbance area would be required to install each cable. During operations, a permanent, 30-foot-wide corridor centered on each buried cable would be maintained clear of woody vegetation. The cables would terminate at individual turbines; the cables would connect from there to junction boxes, overhead power lines, or at the on-site substation. Junction boxes also would be installed on long collector runs between turbine strings. Blasting may be required prior to trenching in rocky areas.

3.1.2 OVERHEAD COLLECTOR SYSTEM

The 34.5 kV overhead electrical collector system would be installed on wood poles with a maximum height of 90 feet and wire heights between approximately 20 to 30 feet above the ground depending on the span (Figure 5); however, special circumstances could require greater wire clearances. Installation of the overhead collector line could require a temporary workspace consisting of an approximately 100-foot-wide corridor centered on the



center line of the overhead line. An approximately 80-foot-wide corridor would be maintained during the operations phase. This area would be kept clear of taller woody vegetation to provide for safe operations and allow access for equipment inspections, vegetation control, and maintenance. All overhead collector lines would be designed in accordance with the Avian Protection Plan Guidelines prepared by the U.S. Fish and Wildlife Service (USFWS 2005), and the Edison Electric Institute's Avian Power Line Interaction Committee (APLIC) guidance for reducing avian electrocution risk (APLIC 2006) and risk of collisions with power lines (APLIC 2012).

Riser poles used to transition underground lines to overhead collectors would be constructed consistent with APLIC guidance for power pole configurations at wind energy projects (APLIC 2019). All electrical infrastructure would be built according to relevant state and federal building codes and fire safety requirements.

3.2 Project Substation, Switching Station, and Interconnection Facilities

As described above, an on-site substation and switching station would increase the voltage of the electricity from the collection system's 34.5 kV to 230 kV to match the voltage of the existing PG&E 230 kV line. The preliminary substation and switching station designs are depicted in Figures 6 and 7, respectively. The basic elements of the substation facilities include a control house, a bank of one or two main transformers, outdoor breakers, capacitor banks, relaying equipment, high-voltage bus work, steel support structures, an underground grounding grid, a back-up generator, and overhead lightning-suppression conductors. The Project substation would require distribution level (i.e. approximately 12 kV) power from the local PG&E distribution grid to provide power the control house. The distribution line is anticipated to run between the O&M building and the substation alongside the access road (up to approximately 5.5 miles) via above ground wooden distribution poles or it could also be installed underground similar to the underground collector system. In the event of a local power outage, the Project would utilize a back-up generator to provide power to the control house, which would maintain communications and control of the Project. The main outdoor electrical equipment and control enclosure would be installed on concrete foundations. The Project substation will be co-located with the switching station, and they would be connected to the grid via an above ground tap line and electrical switch.

The switching station would be located next adjacent to the project substation existing PG&E 230 kV Cottonwood-to-Pit 1 transmission line and would facilitate the interconnection between the project's generated electricity and the PG&E transmission lines. The Applicant will construct the switching station on behalf of PG&E, and PG&E will own the infrastructure upon completion of construction. The project would tap into the existing PG&E 230 kV line via an aboveground line tap located directly adjacent to the switching station. To complete the interconnection, an existing pole To complete the interconnection, a single transmission tower will be removed from PG&E's 230 kV Cottonwood-to-Pit 1 transmission line and replaced with four tubular steel poles, and the approximately 125 feet in height. The 230 kV conductor would be routed to and from the switching station along the four new poles and into. The Applicant will construct the switching station to connect to on behalf of PG&E, and PG&E will own and operate the project's substation infrastructure upon completion of construction.

Additionally, a relay microwave tower or overhead fiber optic communication circuits could be required. If required, the microwave relay tower would be up to 150 feet tall and would be located within the switching station permanent footprint. The tower would be a self-supporting lattice or lattice mast design and would require either a reinforced concrete slab foundation or a drilled pier foundation. A reinforced concrete slab foundation can be up to approximately 42 inches thick, covering a 25- by-25-foot area. A drilled pier foundation can be approximately 40 feet deep. An antenna system would be mounted on the tower and oriented for optimal communication with PG&E's control and communication system.



Together, construction of the substation, switching station, and interconnection facilities would temporarily disturb up to approximately 19 acres; the permanent area of disturbance would be approximately 5 acres for the collector substation and 8 acres for the switching station. The permanent footprint of the substation and switching station would include a graveled parking area for maintenance vehicles. The substation and switching station would be enclosed with a chain-link fence. Appropriate safety signs would be posted along roads and around towers, transformers, and other high-voltage facilities in conformance with applicable regulations.

3.3 Other Infrastructure

3.3.1 ACCESS ROADS

The project site would be accessed from two existing, gated private logging roads located off SR 299. Existing gates may be replaced or reinforced during project construction. During construction, workers would access the project site using the two access points and would park at the O&M facility or at a laydown area. The proposed road system is shown in Figure 2. The road layout may be modified as final project designs are developed to maximize the use of existing roads. Access road cross section details are shown in Figure 7. As new roads are built and existing roads are modified, existing culverts would be replaced as needed with wider, stronger culverts to maintain a functional stormwater drainage system. Drainage improvements would be made in accordance with the project's erosion control plan pursuant to the National Pollution Discharge Elimination System (NPDES) permit. During operation and maintenance activities, the access roads would continue to be used by service vehicles and equipment.

3.3.2 TEMPORARY CONSTRUCTION AND EQUIPMENT AREAS

Construction would require ~~an approximately a temporary laydown area of up to 10-acre acres of~~ cleared, graded, and compacted gravel ~~pad for use as a temporary laydown area anticipated to be at the location of the O&M area or concrete batch plant (Figure 2).~~ This laydown area would be the main construction staging area to store equipment and materials, host construction trailers, refuel equipment, and store construction waste temporarily (i.e., for up to 14 days). ~~Construction waste would be removed weekly or biweekly by a local waste management company.~~

~~Construction waste would be removed weekly or biweekly by a local waste management company.~~ This area would also provide temporary parking, construction office space (mobile office trailers), and temporary sanitary facilities. A vendor-supplied fuel truck would make daily or weekly deliveries to approved storage tanks, which would then be used to refuel construction vehicles. Fuel tank storage capacity would be determined by the construction contractor. Fuel tanks would be maintained and operated according to all local, state, and federal regulations during construction and operation, and hazardous material storage would be detailed in the Spill Prevention, Countermeasure, and Control (SPCC) Plan.

Refueling and general maintenance for construction equipment, such as changing fluids and lubricating parts, would occur within this temporary construction and equipment area or other outdoor locations with sufficient containment capabilities and according to measures outlined in the SPCC Plan. Post-construction, the portions of the staging and laydown area not used for permanent operation and maintenance activities would be restored to preconstruction conditions in accordance with applicable plans, such as a Habitat Restoration Plan, Vegetation Management Plan, and/or Invasive Species Management Plan. These plans would be developed by the Applicant prior to initiating on-site activities and would outline the procedures to be implemented upon the completion of



construction to restore and revegetate areas of temporary disturbance and performance standards to measure revegetation success.

Additionally, during construction, up to nine (9) 2-acre laydown (staging) areas would be located throughout the project site to stage building materials and equipment. The final dimensions of each laydown area would be based on site topography and may be graded and compacted or graveled depending on construction needs and soil conditions. Following construction, the laydown areas would be restored in accordance with the Applicant-proposed Habitat Restoration Plan and Vegetation Management Plan within one year following the conclusion of construction. Restoration may occur on a rolling basis as construction is completed in the locations served by each laydown area.

3.3.3 OPERATION AND MAINTENANCE FACILITY

A permanent, 7,000-square-foot O&M facility, storage yard, and parking area would be located within an approximately 5-acre fenced area near SR 299 (Figures 8a, b, and c). During the project's operation and maintenance phase, maintenance equipment would be staged in the O&M storage yard. The O&M facility would be served by a new ~~or existing domestic wells or~~ water supply well and water storage tank and an on-site septic system in accordance with the rules and regulations of the Shasta County Department of Resource Management's Environmental Health Division. Water may also be trucked to the Project site from Redding or Burney for use during operations. The septic tank would be pumped on a regular basis by a company licensed to pump, transport, and dispose of septic wastewater. If a leach field is utilized, it would rely on effluent absorption and purification to treat the wastewater before it enters groundwater. Wastewater would not be discharged into surface water.

3.3.4 METEOROLOGICAL EQUIPMENT

Up to three (3) permanent METs would be constructed within the project site to measure and record meteorological data to assess the performance of turbines and guide project operation (Figure 2). These METs would be un-guyed and freestanding to minimize impacts on avian species, would be up to 394 feet tall, and would comply with FAA lighting regulations. The Applicant would develop an FAA-approved lighting plan that is expected to specify the installation of flashing red lights on designated METs to improve visibility.

Mobile meteorological equipment, such as LiDAR and SoDAR systems, also may temporarily be deployed on-site during operation to supplement wind resource data gathered by the permanent METs. No ground disturbance would result from the use of these mobile units. Table 4 below outlines dimensions and finishes for aboveground components.



Table 4. Approximate Dimensions and Colors, Materials, and Finishes of Major Project Components

| <u>Component</u> | <u>Turbines</u> | | | | <u>Overhead Collector Line</u> | | <u>Aboveground Facilities</u> | | | | | | | |
|-----------------------------|---|--|---|-------------------------------------|--------------------------------|---|---|--------------------|--------------------------|-------------------------|----------------------|-----------------------------|--|--|
| <u>Subcomponent</u> | <u>Nacelle</u> | <u>Hub</u> | <u>Blade</u> | <u>Tower (sections)</u> | <u>Poles</u> | <u>Conductor</u> | <u>MET</u> | <u>Substation</u> | <u>Switching Station</u> | <u>O&M Facility</u> | <u>Storage Sheds</u> | <u>Concrete Batch Plant</u> | <u>Microwave Relay Tower (if required)</u> | <u>Access Roads</u> |
| <u>Dimensions</u> | Height: 3.8 m Width: 6.5 m Length: 12.7 m | Height: 4.9 m Width: 4.4 m Length: 4.9 m | Height: 3.2 m Width: 4.4 m Length: 79.6 m | Height: between 9.5 and 22.9 m each | Height: up to 90 feet | Height: 20 – 30 feet Length: up to 5 miles | Height: up to 394 feet Width (Base): 30 feet | 5 acres | 8 acres | 5 acres | 10 feet by 20 feet | 15 acres (temporary) | Height: 150 feet | Width: 16 feet Length: up to 19 miles |
| <u>Color</u> | white | white | white | white | brown or gray | gray | aviation-safe orange and white | gray | gray | white and gray | multi | -- | gray | gray |
| <u>Materials</u> | fiberglass | cast iron | fiberglass, carbon fiber, metal | steel | wood or steel | aluminum | steel | metal and concrete | metal and concrete | steel and concrete | painted steel | -- | steel | gravel or dirt |
| <u>Finish (reflectance)</u> | moderate | moderate | low | low | low to moderate | low | moderate | low to moderate | low to moderate | low to moderate | moderate | -- | moderate | low |



3.4 Site Preparation and Construction

3.4.1 SITE PREPARATION

3.4.1.1 Fencing and Site Security

The project would be located entirely on private property where public access is currently restricted. The on-site switching station and substation would be surrounded by a chain-link fence. Where necessary, safety and “No Trespassing” signs would be posted around towers, transformers, other high-voltage facilities, and along roads in accordance with federal and state regulations. ~~Roads diverging~~ Site access roads that diverge from public access points such as SR 299 would be gated, locked, and set back from SR 299 at least 50 feet with a paved apron.

3.4.1.2 Timber Clearance and Harvesting

Existing commercial and pre-commercial timber would be harvested, treated, and/or removed from the project site to allow development of the project. Areas that would be removed from timber production would be harvested in accordance with requirements set forth in the Forest Practice Act and CAL FIRE's Forest Practice Rules (CAL FIRE 2022) and according to a plan prepared by a Registered Professional Forester and carried out by licensed timber operators.

3.4.1.3 Ground-Disturbing Activities

Construction would include ground-disturbing activities such as clearing and grubbing; topsoil stripping; grading; compaction; utility trenching; soil borings; well-drilling; and placement of turbine foundations, pads, and aggregate surfacing. Grading activities would include the removal, storage, and disposal of soil, gravel, vegetation, organic matter, loose rock, and debris. Native soil excavated in one part of the project site would be used as fill in another area to minimize soil import and export. Cut and fill dimensions would be finalized along with final engineering designs. Project disturbance areas are summarized in Table 2.

Blasting may be necessary to loosen rock before excavation. If blasting is necessary, the Applicant would prepare a Blasting Plan that identifies the locations where blasting is anticipated to be needed and all applicable regulations for blasting procedures. The Blasting Plan would also specify the times and distances where explosives would be permitted to avoid impacts on sensitive environmental receptors and the human environment. Emergency responders would be notified at least 24 hours in advance of blasting. All blasting activities would be conducted in compliance with applicable federal, state, and local laws, and appropriate safety and environmental protection measures would be implemented, including weather restrictions related to wildfire risk.

3.4.1.4 Road Construction and Improvement

The Project would be accessed via two existing, gated logging roads located off SR 299. Existing gates may be replaced or reinforced, and the roads would be graveled. Access roads are designed to have a 20-foot-wide drivable surface plus a 10-foot buffer on either side for road shoulders and appropriate drainage features, resulting in an approximately 40-foot-wide permanent disturbance area. During construction, some areas could be cleared up to 200 feet wide to accommodate necessary cut-and-fill, stormwater controls, grading, crane travel, and blade-delivery-vehicle turning radii. The Project Area includes an existing network of logging roads, some of



which will be used for the Project. Existing logging roads would be widened and modified according to the aforementioned specifications to safely accommodate turbine component delivery vehicles and construction equipment. Road widening details are provided in Table 2. Fugitive dust control during construction would include the application of appropriate dust suppressants, as necessary, such as water or surfactants approved for use in the State of California.

As new roads are built and existing roads are modified, existing culverts would be upgraded or replaced as needed to maintain a functional stormwater drainage system and meet fire safety and access standards. Individual crossings and culverts would follow appropriate BMPs and comply with all applicable requirements of the U.S. Army Corps of Engineers-, the California Department of Fish and Wildlife and the Regional Water Quality Control Board. Drainage improvements would be made in accordance with the project's erosion control plan pursuant to the NPDES permit.

During operation, access roads would continue to be used by service vehicles and equipment for Project maintenance activities as well as continued timber management and the Project operator and timber operator would share responsibility for road maintenance. Access road maintenance would include periodically grading and compacting of roads, and placement of additional gravel as needed, to minimize erosion. Drainage features such as roadway ditches, and culverts would also be inspected, cleaned, and maintained regularly. Maintenance would be done at a frequency dictated by environmental conditions on-site.

3.4.1.5 DomesticWater Supply Well Installation

~~New~~ A new water wellsupply well may be required during ~~construction and operation~~. Domestic well operations. Well installation, ~~if determined by the Applicant to be needed or desirable for project purposes~~, would occur at the location of the proposed O&M facility and be performed using typical truck mounted drilling equipment in accordance with the rules and regulations of the Shasta County Department of Resource Management's Environmental Health Division (Shasta County EHD 2019). ~~The number of new wells to be installed would be determined based on an agreement with the landowner. The project's estimated water demand is discussed in the Water Supply Report (Stantec 2024). Alternatively, water for operations may be trucked in from Redding or from Burney.~~

~~Alternatively, the Burney Water District could supply domestic water to serve project needs. The project's estimated water demand is discussed in the Water Supply Assessment (TN# 248320-1).~~

3.4.2 CONSTRUCTION SEQUENCE

Initial construction activities would include widening existing access roads and constructing new access roads. Temporary construction staging and laydown areas would also be established to store turbine components materials delivered to the project and other project equipment. An area of up to 5-acres would be cleared around each turbine location to create a crane pad, construction laydown area, and gearbox assembly area. Once turbine foundations are constructed, the turbines would be assembled and erected using forklifts and cranes. Construction of the substation, switching station, underground and overhead collection system, and O&M building would be concurrent with turbine installation. Upon the conclusion of construction, final testing would begin to see that that all systems are functioning properly. As construction activities are completed, temporary staging and laydown areas would be restored to preconstruction conditions. As part of a final site cleanup, all waste materials would be removed from the project site. See Section 3.4.6 below for a description of decommissioning and site restoration procedures.



Throughout construction, all construction activities would be implemented consistent with NPDES permit requirements, and the Storm Water Pollution Prevention Plan (SWPPP), and the Temporary Erosion and Sediment Control (TESC) Plan.

3.4.2.1 Materials Delivery

Delivery of project components would be coordinated through the California Department of Transportation (Caltrans) and timed to minimize traffic disruptions. Coordination would include topics such as final trailer configuration, clearance requirements, emergency service access, lane closures (if necessary), California Highway Patrol escort (if required), and transportation times. For the purposes of this analysis, all materials would be delivered to the project site by truck.

Turbines

Delivery plans would be finalized once a final turbine model and supplier is selected. A Transportation Management Plan would be prepared to minimize impacts from the transportation of oversized loads and to direct deliveries to off-peak hours. Oversized loads may be required to travel over bridges and overpasses. A logistical route analysis that focuses on geometrics and bridge capacity will be performed following the final turbine supplier and turbine model selection. In addition, Caltrans will require preparation of a "Swept Path Analysis" that shows turn-by-turn impacts that might be experienced by the oversized loads along SR 299 or at side road intersections. California Highway Patrol will likely be required to escort oversize loads.

Based on the fact that the Hatchet Ridge Wind Project delivered similarly oversized components along SR299, the existing highway and bridge geometrics are anticipated to be able to accommodate the planned deliveries. In addition, although the Project may utilize longer blade lengths than were used for the Hatchet Ridge project, the haul trucks will include rear-axle steering capabilities, thereby addressing many turning constraints. In general, towers are expected to be delivered in three to six sections. Turbine components such as blades, nacelles, rotors, controllers, ladders and platforms, pad-mounted transformers, pad-mounted transformer vaults, and turbine switchgear would be delivered separately. Up to 15 separate delivery loads would be needed for each turbine. Of these, approximately nine deliveries would be classified as oversized for highway transportation according to California Vehicle Code Division 15, Size, Weight, and Load. These deliveries would require oversize vehicle permits and/or variances from Caltrans. Turbine component delivery vehicles would conform to road weight limits, and any deviations from these weight limits would be specified in oversize permit applications submitted to Caltrans. Additionally, cranes used to assemble turbine components would be delivered in multiple loads and assembled on-site.

Aggregate

Up to three temporary concrete batch plants, each consisting of up to 5 acres, may be located within the Project site to facilitate cement delivery for foundations. Aggregate is expected to be sourced locally from the immediate Project area but could be supplied from Redding. The batch plants would be removed following construction. Each batch plant would require a stand-alone generator as well as fuel, aggregate, cement, sand, and water for operation. Stockpiles of sand and aggregate, which would be delivered by truck, would be located near each batch plant in a location that would minimize exposure to wind. Cement would be discharged via screw conveyor directly into an elevated storage silo without outdoor storage. The construction managers and crew would use BMPs and standard operating procedures to keep the plant, storage, and stockpile areas clean and to minimize the buildup of fine materials that could result in fugitive dust or offsite sedimentation.



Project construction is anticipated to generate ~~approximately 47,037 total~~ up to 88,447 two-way material delivery truck trips (Westwood ~~2023~~-2024) assuming that cement would be hauled in from an off-site supplier rather than batched on site. Material delivery trucks would carry aggregate, turbine-related components, concrete components, water, and other construction-related materials. The Applicant anticipates that the bulk of materials would be delivered by truck from locations no more than 50 miles from the project site. Prior to arrival on-site, large components such as turbine blades are likely to be delivered by truck, barge, or rail to existing regional storage yards.

Construction Equipment

Equipment types and use assumptions by phase to construct the project are identified in Table 45 below.

Water

Non-potable water will be purchased from commercial water suppliers and trucked to the Project site from Redding or Burney for use during construction. Water would be used for dust control, concrete preparation (for turbine and building foundations), soil compaction, and filling and maintenance of the project's three 5,000-gallon water tanks (for fire suppression). Details are provided in the Water Supply Report (Stantec 2024).

3.4.3 CONSTRUCTION SCHEDULE AND WORKFORCE

Project construction is expected to last 24 to 28 months. Generally, construction would occur during daylight hours from 7 am to 5 pm but could vary during summer or winter months, to accommodate specific construction needs or site conditions, to avoid traffic or high winds, or to facilitate the project schedule. The project would require up to 200 workers at peak construction, most of whom are anticipated to be local workers, and others would be specialized workers that may reside outside the local area. Non-local workers would stay at local hotels or RV parks and commute to the project site. No new temporary worker lodging is expected to be constructed as part of the project. Workers would most likely commute from Redding, Burney, Fall River Mills, or McArthur (Westwood 2023³⁴).

Table 5. Construction Equipment List

| Phase | Workdays | Equipment Type | Number | Hours/day |
|------------------------------|----------|--------------------------|--------|-----------|
| Timber Removal and Grubbing | 55 | Feller Buncher (logging) | 2 | 10 |
| | | Logging Trucks | 8 | 10 |
| | | Skidder | 2 | 10 |
| | | Pickups | 8 | 10 |
| | | Hydro Axe | 2 | 10 |
| Grading and Access Road Work | 126 | Road Grader | 3 | 10 |
| | | Scraper | 4 | 10 |
| | | Bulldozer (medium) | 6 | 10 |
| | | Drum Compactor | 4 | 10 |
| | | Rock Trucks | 8 | 10 |
| | | Pickups | 16 | 10 |
| | | Water Truck | 6 | 10 |



| Phase | Workdays | Equipment Type | Number | Hours/day |
|---|----------|--|--------|-----------|
| Concrete Batch Plants | 70 | Concrete Pump Truck | 2 | 10 |
| | | Mixer | 10 | 10 |
| | | Generator | 3 | 10 |
| | | Skid Steer Loader | 3 | 10 |
| | | Pickups | 6 | 10 |
| | | Water Truck | 3 | 10 |
| Turbine, Transformer, Substation, and O&M Foundations | 70 | Excavator | 3 | 10 |
| | | Bulldozer (medium) | 3 | 10 |
| | | Drum Compactor | 4 | 10 |
| | | Skid Steer Loader | 3 | 10 |
| | | Pickups | 10 | 10 |
| | | Mobile Hydraulic Crane | 3 | 10 |
| Turbine and Transformer Installation | 66 | Mobile Hydraulic Crane | 6 | 10 |
| | | Bulldozer (medium) | 2 | 10 |
| | | Rubber Tired Forklifts | 10 | 10 |
| | | Large Crawler Crane | 4 | 10 |
| | | Pickups | 20 | 10 |
| | | Turbine Delivery Vehicles | 8 | 10 |
| | | Generator | 4 | 10 |
| Substation and O&M Building Installation | 160 | Mobile Hydraulic Crane | 2 | 10 |
| | | Skid Steer Loader | 2 | 10 |
| | | Pickups | 8 | 10 |
| | | Rubber Tired Forklift | 3 | 10 |
| Underground Collector System | 95 | Trenching Equipment | 4 | 10 |
| | | Rubber Tired Forklift | 4 | 10 |
| | | Pickups | 12 | 10 |
| | | Bulldozer (medium) | 1 | 10 |
| | | Skid Steer Loader | 4 | 10 |
| Overhead Collection System | 40 | Backhoe Loader (includes setting collector system poles) | 4 | 10 |
| | | Cable Reel Truck (includes auger for pole foundations) | 3 | 10 |
| | | Mobile Hydraulic Crane | 2 | 10 |
| | | Pickups | 10 | 10 |
| | | Bulldozer (medium) | 1 | 10 |
| | | Boom Lift | 6 | 10 |
| Substation Aggregate and Security Fence | 15 | Skid Steer Loader | 1 | 10 |



| Phase | Workdays | Equipment Type | Number | Hours/day |
|------------------------------|----------|--|--------|-----------|
| Transmission Line Connection | 20 | Mobile Hydraulic Crane | 6 | 10 |
| | | Cable Reel Truck (includes auger for pole foundations) | 4 | 10 |
| | | Boom Lift | 6 | 10 |
| | | Pickups | 8 | 10 |
| | | Bulldozer (medium) | 1 | 10 |
| | | Excavator | 2 | 10 |

Source: Fountain Wind, LLC 2023

3.4.4 STORMWATER CONTROL

To minimize impacts on drainage and runoff, the project would maintain on-site surface drainage patterns to the extent possible. Newly constructed access roads would be designed to follow natural contours and minimize hill cuts. Ditches and culverts would be incorporated into road design to capture and convey storm water runoff. Except in areas where permanent recontouring is required, disturbed areas would be restored to preconstruction conditions.

In accordance with the Construction General Permit (USEPA 2017), the Applicant would prepare a site-specific SWPPP for the project that would identify BMPs to be used to minimize or eliminate pollution, erosion, and sedimentation. ~~The Applicant also would prepare a TESC Plan, which would be implemented and maintained by the construction contractor throughout operation to further reduce the potential for erosion. Measures included in the TESC Plan would be comparable in effect to those described by the Center for Environmental Excellence by the American Association of State Highway and Transportation Officials (AASHTO 2019).~~

3.4.5 OPERATION AND MAINTENANCE

Although upgrading and replacing equipment could extend the operating life of the wind energy facility indefinitely, for purposes of the California Environmental Quality Act (CEQA), the life of the project is assumed to be approximately 35 years.

The Applicant would prepare a project-specific Fire Prevention Plan (FPP) prior to the commencement of on-site activities that would remain in place for the life of the project. The FPP would include procedures for emergency response, evacuation, fire agency notification, and fire prevention. Tree removal and maintenance of fire breaks would be undertaken. The FPP would require the Applicant’s and construction contractors’ vehicles and personnel to be equipped with fire suppression equipment, radio and cellular access, and pertinent telephone numbers for reporting a fire. The Applicant’s FPP would be prepared consistent with the directives in the Shasta County Fire Safety Standards (Shasta County 2017), the Forest Practice Rules (CAL FIRE 2019), and CAL FIRE’s Shasta-Trinity Unit Strategic Fire Plan (CAL FIRE 2017).

Project operation would require up to 10 full-time employees. Operation and maintenance activities would occur from Monday to Friday during normal working hours. Potable water for operations employees would be provided by a new water supply well and water storage tank at the site of the O&M building. Water may also be trucked to the Project site from Redding or Burney for use during operation. Operational employees would be on-call outside of regular working hours on an as-needed basis. The project operator would also monitor the turbines through the SCADA monitoring system 24 hours a day, 7 days a week, 365 days a year via a Remote Operation Control



Center (ROCC). The SCADA system would allow the ROCC to perform self-diagnostic tests and would allow a remote operator to perform system checks, establish operating parameters, identify operating problems, and see that the turbines are operating at peak performance.

Maintenance of turbines and associated infrastructure includes a wide variety of activities. The Applicant would develop an operation and maintenance protocol to be implemented throughout project operation. This protocol would specify routine turbine maintenance and operation in accordance with the maintenance requirements prescribed by the turbine manufacturer. Some unscheduled maintenance and repair would be necessary. Routine maintenance activities are expected to include, but not be limited to the following:

- ~~C~~checking torque on tower bolts and foundation anchor bolts;
- checking for cracks and other signs of stress on the turbine tower and other turbine components;
- inspecting for leakage of lubricants, hydraulic fluids and other hazardous materials, and replacing them as necessary;
- inspecting the grounding cables, wire ropes and clips, and surge arrestors;
- cleaning; and
- repainting

Most routine maintenance activities would occur within and around the tower and the nacelle. Cleanup from routine maintenance activities would be performed at the time maintenance is performed. While performing most routine maintenance activities, operations and maintenance staff would travel via pickup or other light-duty trucks.

Scheduled maintenance activities would include servicing the turbines twice a year or more often as needed. Turbine servicing would require maintenance staff to climb towers and perform activities such as replacing bearings, applying lubricants, and replacing hydraulic fluids. Non-routine maintenance such as repair or replacement of blades or other major components, if needed, could involve use of one or more cranes and equipment transport vehicles. Project access roads would be periodically graded and compacted in order to minimize erosion. Catch basins, roadway ditches, and culverts would be cleaned and maintained regularly.

3.4.6 DECOMMISSIONING AND SITE RESTORATION

~~Proposed decommissioning~~Decommissioning of existing facilities and infrastructure and restoration of the project site would require approximately 18 to 24 months. Decommissioning refers to the dismantling and removal of the project's facilities, including power generation equipment. Removal of turbine components and related infrastructure would include dismantling the turbines, support towers, transformers, substation, switching station, and foundations; excavating them to a depth of approximately ~~3~~three feet below grade; and removing them from the project site to be reused, recycled, or sold. Once turbines have been dismantled and removed, roads no longer needed to access those locations would be allowed to naturally revegetate. If a ~~domestic~~water supply well(~~s~~) is installed, it would remain on-site, or would be properly abandoned according to regulatory requirements. Underground collection and communication cables would be abandoned in place.

The types of equipment, vehicles, and workforce necessary to decommission the project would be generally similar to the requirements for construction, except considerably less intensive in that no concrete batch plant(s), cable delivery, or concrete trucks would be required, and no cable trenching or similar work would occur. Moreover, existing Project access roads would be used; no new access roads or road widening would be required. All management plans and BMPs developed for project construction would also apply during the decommissioning phase of the project.



Site restoration refers to recontouring and revegetating the site upon completion of the project's operational life to be as similar to ~~preconstruction~~ surrounding conditions as possible. In coordination with the landowner, disturbed areas would be replanted with trees or other appropriate vegetation. The goal of site revegetation would be to develop vegetation cover, composition, and diversity similar to the area's ecological setting and consistent with the landowner's current and future land use practices.

Prior to operation of the project, the Applicant would prepare a Draft Decommissioning Plan that details a restoration plan and how project facilities and infrastructure would be removed. The Draft Decommissioning Plan would be revised and finalized prior to project operations. The Applicant or its contractor would implement the Final Decommissioning Plan upon cessation of project operations and would include plans and procedures for facility dismantling and removal, disposal and recycling, site restoration, and habitat restoration and monitoring. The Decommissioning Plan would be developed in compliance with standards and requirements at the time of site decommissioning. The Applicant would also be required to post and update a financial assurance mechanism to cover the cost of the annual decommissioning cost estimate. This financial assurance will also address facility closure in the event of unexpected cessation of operations.

3.4.7 WATER, WASTEWATER, WASTE, AND HAZARDOUS MATERIALS

3.4.7.1 Water and Wastewater

~~As discussed in the Water Supply Report, nonpotable water will be trucked to the Project site from Redding or Burney for use during construction and long-term operation includes the use of potable water from one or more new on-site water supply wells to be drilled at the O&M facility location or from the importation of water by truck from the Burney Water District, which is located approximately six miles east-northeast of. Water may also be trucked to the project site. Any wells installed on Project site from Redding or Burney for use during operation. The onsite well~~ would be constructed in accordance with the rules and regulations of the Shasta County Department of Resource Management's Environmental Health Division. ~~A Water Supply Assessment has been prepared for the project in accordance with Water Code requirements (TN# 248320-1) For further information on water supply, refer to the Water Supply Report (Stantec 2024).~~

Project construction would require up to ~~52,310~~ 52,310 acre-feet of water for dust control, soils compaction, ~~and~~ concrete manufacture, emergency fire suppression, and other activities. ~~Out over a two-year period. Water would also be used to fill and maintain three 5,000-gallon tanks through the life of the 47,037 total material delivery trips, approximately 8,418 are estimated Project for the delivery purposes of water during construction. (Westwood 2023)-fire suppression.~~

Operation and maintenance of the project would require up to 5.6 acre-feet of water per year (approximately 5,000 gallons per day) for vehicle and equipment washing and maintenance, potable water supplies for up to 10 full-time employees, and water storage to meet Shasta County fire flow requirements. Water for the O&M building would be supplied ~~either~~ by an on-site well ~~or by~~ and storage tank located at the O&M building that ~~would~~ may be periodically filled by a water truck. Water use during decommissioning and site restoration would be limited to use for fire protection and dust suppression.

During construction, portable toilets would be provided for the construction workforce. These facilities would be serviced on a regular basis by a contractor who would dispose of sanitary wastewater pursuant to applicable regulations. Wastewater from the O&M facility would be processed using an on-site septic system. ~~or an above-~~



ground tank system that would be serviced periodically. Total maximum daily wastewater discharge would be approximately 160 gallons/day.

The project would comply with applicable fire flow requirements in the Shasta County Code of Ordinances, Title 16 Buildings and Construction, Chapter 16.04.130 Fire Standards and Equipment (Ordinance No. 2019-06 [2019]) and the 2019 California Fire Code (24 Cal. Code Regs. Part 9).

3.4.7.2 Waste

During construction, approximately 10,000 pounds of solid waste would be generated per week. Construction debris (e.g., scrap lumber and metal) and operational debris (e.g., office waste) would be collected by either the construction contractor or Burney Disposal Inc. Waste would be transported to the Burney Transfer Station and ultimately disposed of or recycled at the Anderson Landfill or other landfills in the region in accordance with federal, state, and local solid waste regulations. Decommissioning and restoration would generate the same amount of solid waste as the construction phase (10,000 pounds per week). The Applicant would handle and dispose of solid waste in accordance with all regulatory requirements and would implement standard BMPs with regard to solid waste.

3.4.7.3 Hazardous Materials

Table 56, Hazardous Materials, describes the types, uses, and quantities of hazardous materials that are expected to be used during the site preparation and construction, operation, maintenance, decommissioning, and site restoration phases of the project.

During all project phases, activities may involve the transportation, use, or storage of a variety of hazardous materials, including batteries, hydraulic fluid, diesel fuel, gasoline, propane, antifreeze, dielectric fluids, explosives, herbicides, grease, lubricants, paints, solvents, and adhesives.

During construction, waste disposal and collection receptacles would be located on-site for proper disposal of hazardous materials. Operation and maintenance of the project would not require as many hazardous materials as construction or decommissioning. During operation, hazardous materials would be stored in the O&M facility and storage sheds. Monthly inspections of each of these facilities would occur to check for leaks and spills.

Table 6. Hazardous Materials

| Hazardous Material | Uses | Typical Quantities |
|----------------------|---|--|
| Diesel ^a | Fuel for construction and transportation equipment during construction and decommissioning. Used to power an emergency generator during operation, if needed. | Over 5,000 gallons would be stored in aboveground tanks during construction and operation. The amount of diesel to be stored onsite during decommissioning is unknown at this time but is assumed be similar to that of construction. ^b |
| Gasoline | Some construction equipment and transportation vehicles. | Gasoline would not be stored onsite <u>in temporary aboveground storage tanks during any phase of the Projectproject construction.</u> |
| Propane ^a | Ambient heating of the O&M building. | Approximately 500 to 1,000 gallons stored in an aboveground propane storage vessel. |



| Hazardous Material | Uses | Typical Quantities |
|--|---|---|
| Lubricating oils/grease/hydraulic fluids/gear oils | Lubricating oil would be present in some turbine components, in the diesel engine of the emergency generator, and in engines of construction and transportation equipment. | Limited quantities would be stored in portable containers (capacity of 55 gallons or less) and maintained onsite during all phases of the Project. |
| Glycol-based antifreeze | Used in wind turbine components for cooling (approximately 5 to 10 gallons are present in the cooling system for the transmission. Used in the diesel engine for the emergency generator. | Limited quantities (10 to 20 gallons of concentrate) would be stored onsite during each phase of the project. |
| Lead-acid storage batteries and electrolyte solution | Present in construction and transportation equipment. Backup power source for control equipment, tower lighting, and signal transmitters. | Limited quantities of electrolyte solution (<20 gallons) for maintenance of construction and transportation equipment during construction and decommissioning. |
| Other batteries (e.g., nickel-cadmium batteries) | Used in some control equipment and signal-transmitting equipment. | These batteries would not be maintained onsite. |
| Cleaning solvents | Organic solvents would be used for equipment cleaning and maintenance when water-based cleaning and degreasing solvents cannot be used. | Limited quantities of organic solvents (<55 gallons) would be stored onsite during construction and decommissioning to maintain construction and transportation equipment. Limited quantities (<10 gallons) of water-based cleaning solvents would be stored onsite during operation. |
| Paints and coatings ^c | Used for corrosion control on exterior surfaces of turbine towers. | Limited quantities would be used for touch-up painting during construction (<50 gallons) and for maintenance during operations (<20 gallons). |
| Dielectric fluids ^d | Used in electrical transformers, bushings, and other electric power management devices as an electrical insulator. | Some transformers may contain more than 500 gallons of dielectric fluid. Onsite transformers each contain approximately 10,000 gallons of mineral oil. |
| Explosives | May be necessary for excavation of tower foundations in bedrock or creating construction access, onsite roads, or grade alterations. | Limited quantities necessary to complete the task would be stored onsite. Onsite storage is expected to occur only for limited periods of time and as needed for specific construction activities. |
| Herbicides | May be used for vegetation control around facilities for fire safety. | If deemed necessary, herbicides would be brought to the site and applied by a licensed applicator. |

SOURCE: Fountain Wind, LLC 2023

NOTES:

- a. Diesel fuel and propane would be replenished onsite by commercial vendors as necessary.
- b. These values represent the total onsite storage capacity, not the total amount of fuel ~~which~~that would be consumed during Project construction.
- c. It is presumed that all wind turbine components, nacelles, and support towers would be painted at their respective points of manufacture. No wholesale painting would occur onsite; only limited amounts would be used for touch-up purposes during construction and maintenance phases. It is assumed that the coatings applied by the manufacturer during fabrication would be sufficiently durable to last throughout the equipment's operational period and that no wholesale repainting would occur.
- d. It is assumed that the majority of transformers, bushings, and other electrical devices that rely on dielectric fluids would have those fluids added during fabrication and would not require dielectric fluid to be added onsite. It is assumed that servicing of electrical devices that involves wholesale removal and replacement of dielectric fluids would not occur onsite and that equipment requiring such servicing would be removed from the site and replaced. New transformers, bushings, or electrical devices are expected to contain mineral oil-based, or synthetic dielectric fluids that are free of polychlorinated biphenyls. Some equipment may instead contain gaseous dielectric agents (e.g., sulfur hexafluoride) rather than liquid dielectric fluids.

In accordance with requirements contained in the Health and Safety Code and the California Code of Regulations, the Applicant would prepare a Hazardous Materials Business Plan/Spill Prevention Control and



Countermeasures Plan (HMBP/SPCC) prior to construction. The HMBP would include BMPs for the transport, storage, use, and disposal of hazardous materials and waste. The HMBP would also include information regarding construction activities, worker training procedures, and hazardous materials inventory procedures. Prior to operation, the Applicant would update the HMBP (including the BMPs) with information about the types of hazardous materials that would be used during operation. The HMBP/SPCC would comply with the requirements of these federal, state, and local requirements (e.g., 40 CFR Part 112).

During construction, operation, and decommissioning, all fuels, waste oils, and solvents would be collected and stored in tanks or drums within a secondary containment area consisting of an impervious floor and bermed sidewalls. Fuel would be stored in aboveground storage tanks.

These tanks may have either a double wall or would be placed within temporary, lined, earthen berms for spill containment. Upon the conclusion of construction and decommissioning phases, excess fuels would be removed from the site and any surface contamination resulting from fuel handling operations would be remediated.

All equipment (particularly equipment operating in or near a drainage or in a basin) would be maintained in good working condition and free of leaks. All vehicles would be equipped with drip pans during storage to contain minor spills and drips. No refueling or storage would take place within 100 feet of a drainage channel or other sensitive resource. Spill kits would be located on-site and in vehicles for use in spill response. In addition, all maintenance crews working with heavy equipment would be trained in spill containment and response.

4 Project Permits

In the absence of CEC opt-in jurisdiction, the permits in Table 7 would be required for the development of the project. Those that would be superseded by a CEC authorization are marked with an asterisk.

Table 7. List of Potential Permits and Status

| Agency | Permit/Approval Required | Status |
|--|--|---|
| Federal | | |
| Federal Aviation Administration (FAA) | Notice of Proposed Construction or Alteration; Determination of No Hazard. | Received July 20, 2020 and extended on January 17, 2023. |
| U.S. Army Corps of Engineers (USACE) | Clean Water Act, Section 404 Nationwide Permit if jurisdictional waters of the U.S. could be affected by construction or operation of the project. | Preconstruction Notification (PCN) to be obtained prior to CEC action. |
| State | | |
| California Department of Forestry & Fire Protection (CAL FIRE) | Application for conversion* (Pub. Res. Code §4621 et seq.); approval of a timber harvesting plan (Pub. Res. Code §4582) | Timber Conversion Permit Application submitted April 23, 2021, and provided to CEC (TN# 248312). Permit will be submitted prior to <u>superseded by CEC action-Certification</u> |



| Agency | Permit/Approval Required | Status |
|--|---|--|
| State and/or Regional Water Resources Control Board (SWRCB and/or RWQCB) | Construction Stormwater General Permit; Notice of Intent to Comply with Section 402 of the Clean Water Act, SWPPP and SPCC Plan; Industrial Stormwater General Permit; Coverage under General Order of Waste Discharge Requirements for Timberland Management Activities on Non-Federal and Federal Lands; Waste Discharge Requirements ; Approval of O&M SWPPP and SPCC Plan. Section 401 Certification if USACE determines jurisdictional waters of the U.S. would require a Clean Water Act Section 404 permit. | If required , Notice of Intent will be filed by EPC contractor prior to CEC action. |
| California Department of Fish and Wildlife (CDFW) | Streambed Alteration Agreement* (Fish & Game Code §1600 et seq.); consultation with CDFW would be needed to address potential effects to State-listed species under Section 2081 of the California Fish and Game Code. | Submitted application on May 13, 2021 (EPIMS No. 18805); per Opt-in procedures, authorization will be superesed by CEC Certification. |
| California Department of Transportation | Oversize load permit(s) and variances* for loads with a width over 15 feet and/or length over 135 feet (i.e., "superloads"); Encroachment Permit for utility line crossing state right-of-way; Notification of Transportation of Oversize/Overweight Loads* . | Will if required, will be obtained prior to construction. |
| California Highway Patrol | Notification of Transportation of Oversize/Overweight Loads* Hazardous materials transportation license | If required, will be obtained prior to construction. |
| California Public Utilities Commission | Approval of construction of switching station for transfer to PG&E (i.e., General Order 131-D) | If required, PG&E will be applicant to CPUC for these facilities. |
| Local | | |
| Shasta County Air Quality Management District | Authority to Construct and/or Permit to Operate* as needed | Permit application for Authority to Construct submitted to AQMD on July 5, 2023. Water SWater |
| Shasta County | Use Permit or other zoning entitlement | Permit No. 16-007 denied October 26, 2021; utility-scale wind energy now prohibited by ordinance in Shasta County; local authorization now superesed by CEC Certification per Opt-In procedures. |
| Shasta County Department of Resource Management, Environmental Health Division | Hazardous Materials Business Plan*, septic system permit*, well permit* | Superesed by CEC Certification |
| Shasta County Building Division | Building and grading permits* | Superesed by CEC Certification |
| Shasta County Hazardous Materials Program, CUPA | Hazardous Materials Business Plan and Permit* for handling hazardous materials above threshold quantities (includes hazardous waste management). | Superesed by CEC Certification |
| Shasta County, Public Works Department | Encroachment Permit* | Superesed by CEC Certification |



Fountain Wind Energy Project: Project Description

| Agency | Permit/Approval Required | Status |
|--------|--------------------------|--------|
|--------|--------------------------|--------|

* Indicates that permit would be superseded by CEC approval of the project under the opt-in program.



5 References

- Avian Power Line Interaction Committee (APLIC). 2006. Suggested Practices for Avian Protection on Power Lines: The State of the Art in 2006. Edison Electric Institute, APLIC, and the California Energy Commission. Washington, DC and Sacramento, CA.
- APLIC. 2012. Reducing Avian Collisions with Power Lines: The State of the Art in 2012. Edison Electric Institute and APLIC. Washington, DC. Available ~~online at:~~ http://www.aplic.org/uploads/files/11218/Reducing_Avian_Collisions_2012watermarkLR.pdf.
- APLIC. 2019. APLIC Recommendations for Power Pole Configurations at Wind Energy Projects. Available ~~online at:~~ <https://www.aplic.org/riser-poles-wind.php>.
- California Department of Forestry and Fire Protection (CAL FIRE). 2017. Shasta–Trinity Unit Strategic Fire Plan. Available ~~online at:~~ <http://cdfdata.fire.ca.gov/pub/fireplan/fpupload/fpppdf1597.pdf>.
- CAL FIRE. 2022. California Forest Practice Rules 2022. Available ~~online: chrome-extension://efaidnbmnnnibpcajpcglclefindmkaj/at:~~ https://bof.fire.ca.gov/media/y5rfw50b/2022-fpr-and-fpa_ada.pdf February 2019.
- Center for Environmental Excellence by the American Association of State Highway and Transportation Officials (AASHTO). 2019. Chapter 4: Construction Practices for Environmental Stewardship. Available ~~online: chrome-extension://efaidnbmnnnibpcajpcglclefindmkaj/at:~~ https://www.epa.gov/sites/default/files/2015-11/documents/25-25-4-_fr.pdf
- Federal Aviation Administration (FAA). 2016. Advisory Circular No. 70/7460-1L, Obstruction Marking and Lighting with Change 2. Available ~~online at:~~ https://www.faa.gov/documentLibrary/media/Advisory_Circular/AC_70_7460-1L_-_Obstruction_Marking_and_Lighting_-_Change_2.pdf.
- Shasta County Department of Resource Management, Department of Environmental Health (Shasta County EHD), 2019. Wells and Public Water Systems. ~~Available at:~~ https://www.co.shasta.ca.us/index/drm_index/eh_index/ehd_programs/wells.aspx ~~Available online:~~ https://www.co.shasta.ca.us/index/drm_index/eh_index/ehd_programs/wells.aspx.
- Shasta County Department of Public Works. Rev. 2017. Development Standards Manual Chapter 6: Fire Safety Standards. ~~Available online:~~ https://www.shastacounty.gov/sites/default/files/fileattachments/public_works/page/2823/sc-development-standards-manual3a2cc3226bfb69248dc7ff0000cdcf8f.pdf ~~Available at:~~ https://www.shastacounty.gov/sites/default/files/fileattachments/public_works/page/2823/sc-development-standards-manual3a2cc3226bfb69248dc7ff0000cdcf8f.pdf
- [Stantec Consulting Services, Inc. \(Stantec\) 2024. Water Supply Report for the Fountain Wind Project. March 1, 2024.](#)
- U.S. Environmental Protection Agency (USEPA). 2017. National Pollutant Discharge Elimination System General Permit for Discharges from Construction Activities. ~~Available online:~~ <https://www.epa.gov/npdes/stormwater-discharges-construction-activities> ~~Available at:~~ <https://www.epa.gov/npdes/stormwater-discharges-construction-activities>
- U.S. Fish and Wildlife Service (USFWS). 2005. Avian Protection Plan Guidelines. Available ~~online at:~~ <https://ecos.fws.gov/ServCat/DownloadFile/104185?Reference=60102>



Fountain Wind Energy Project: Project Description

Westwood. 2023~~4~~. Traffic Study: Fountain Wind ~~Power~~Project, Shasta County, California. ~~June 10, 2023~~March 1, 2024.



FIGURES



Figure 1. Project Region

Figure 2. Project Site Aerial

Figure 3. Zoning

Figure 4. Generic (non-project-specific) Turbine Profiles

Figure 5. Conceptual Design

Figure 6. Preliminary Substation Designs

Figure 7. Preliminary Switching Station Designs

Figure 8. Operation and Maintenance Facility



V:\1956\active\Task_Owner and other Non-BCI 956_Jobs\185703743\03_data\gis_cad\gis\mxd\2023\Fig1_ProjectRegionalAerial.mxd Revised: 2023-07-06 By: gcarpenter



- Legend
- Turbine Location
 - Project Area
 - County Boundary



0 8 Miles
 (At original document size of 11x17)
 1:506,880

- Notes
1. Coordinate System: NAD 1983 StatePlane California I FIPS 0401 Feet
 2. Data Sources: Shasta County GIS Division
 3. Background: 2020 NAIP Orthoimagery

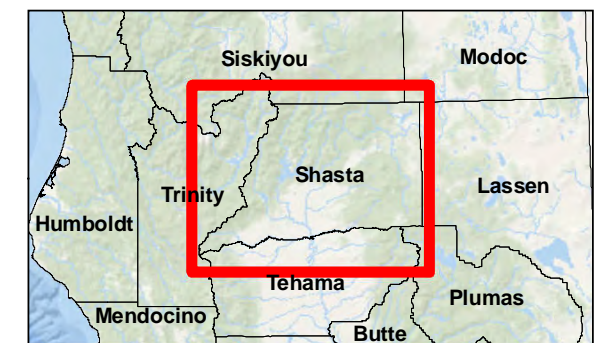

Project Location
 Shasta County
 California

Prepared by GC on 2023-07-06
 TR Review by DA on 2023-07-05
 IR Review by CB on 2023-07-05

Client/Project
 Fountain Wind LLC
 Fountain Wind Project

203723159

Figure No.
1

Title
Regional Overview

DRAFT

V:\1956\active\Task Owner and other Non-BC1956_Jobs\185703743\03_data\gis_cad\gis\mxd\2023\Fig2_ProjectSiteAerial.mxd Revised: 2023-07-07 By: gcarpentier

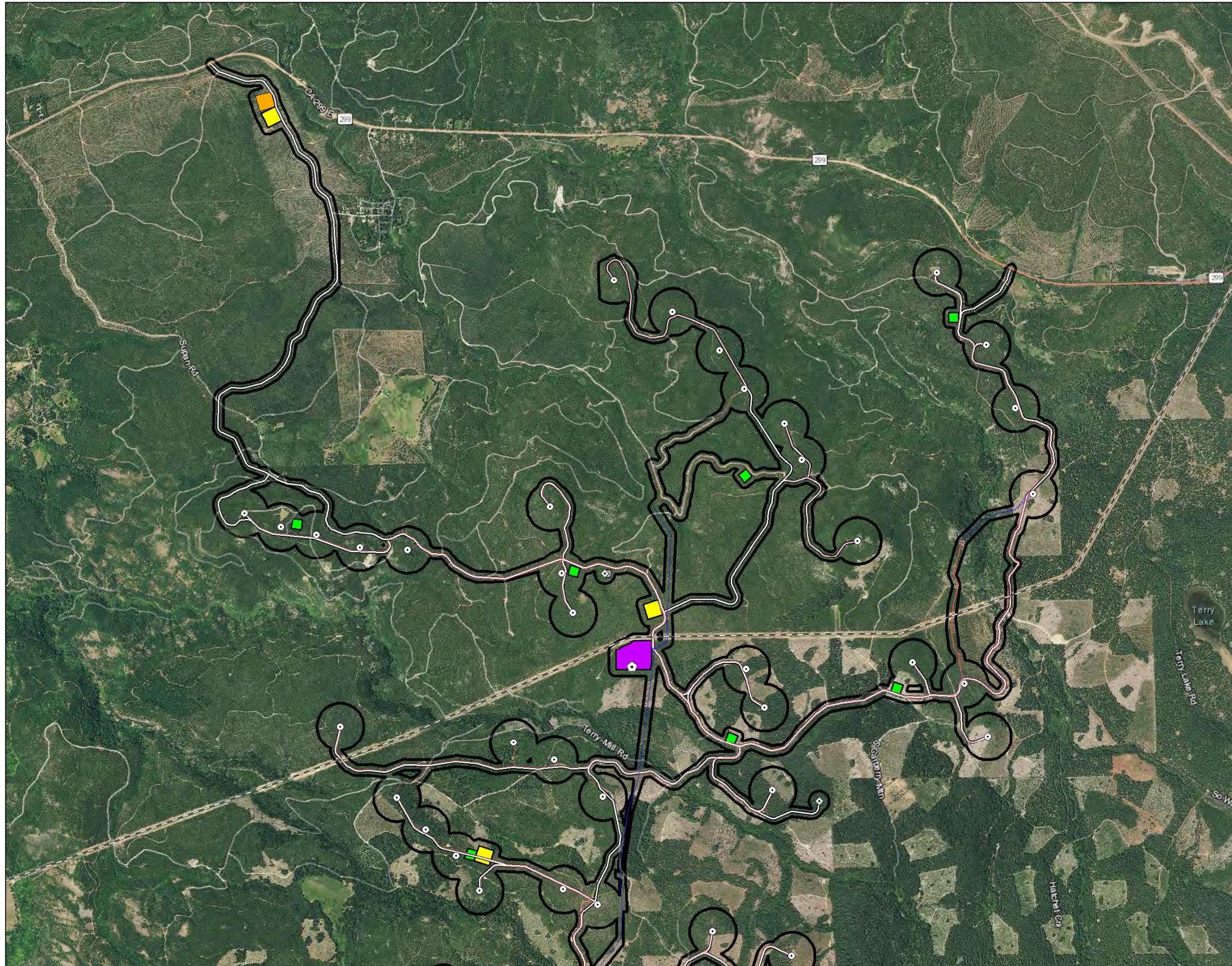

Legend

- Turbine Location
- ◇ Met Tower Location
- ⬠ Microwave Tower Location
- Storage Shed Location
- Overhead Collection
- Underground Collection
- Access Road
- Batch Plant
- O&M Facility
- Staging Area
- Substation/Switchyard Site
- ▭ Project Site Boundary
- PG&E Transmission Line

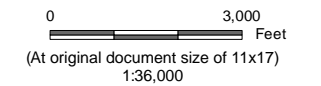

Notes

1. Coordinate System: NAD 1983 UTM Zone 10N
2. Data Sources: Shasta County GIS Division
3. Background: 2020 NAIP Orthoimagery



Project Location
Shasta County
California

Prepared by GC on 2023-07-06
TR Review by ES on 2023-07-06
IR Review by CB on 2023-07-06

Client/Project
Fountain Wind LLC
Fountain Wind Project

203723159

Figure No.

2

Title

Project Overview
Map 1 of 2

V:\1956\active\Task_Owner and other Non-BC1956_Jobs\185703743\03_data\gis_cad\gis\mxd\2023\Fig2_ProjectSiteAerial.mxd Revised: 2023-07-07 By: gcarpenter

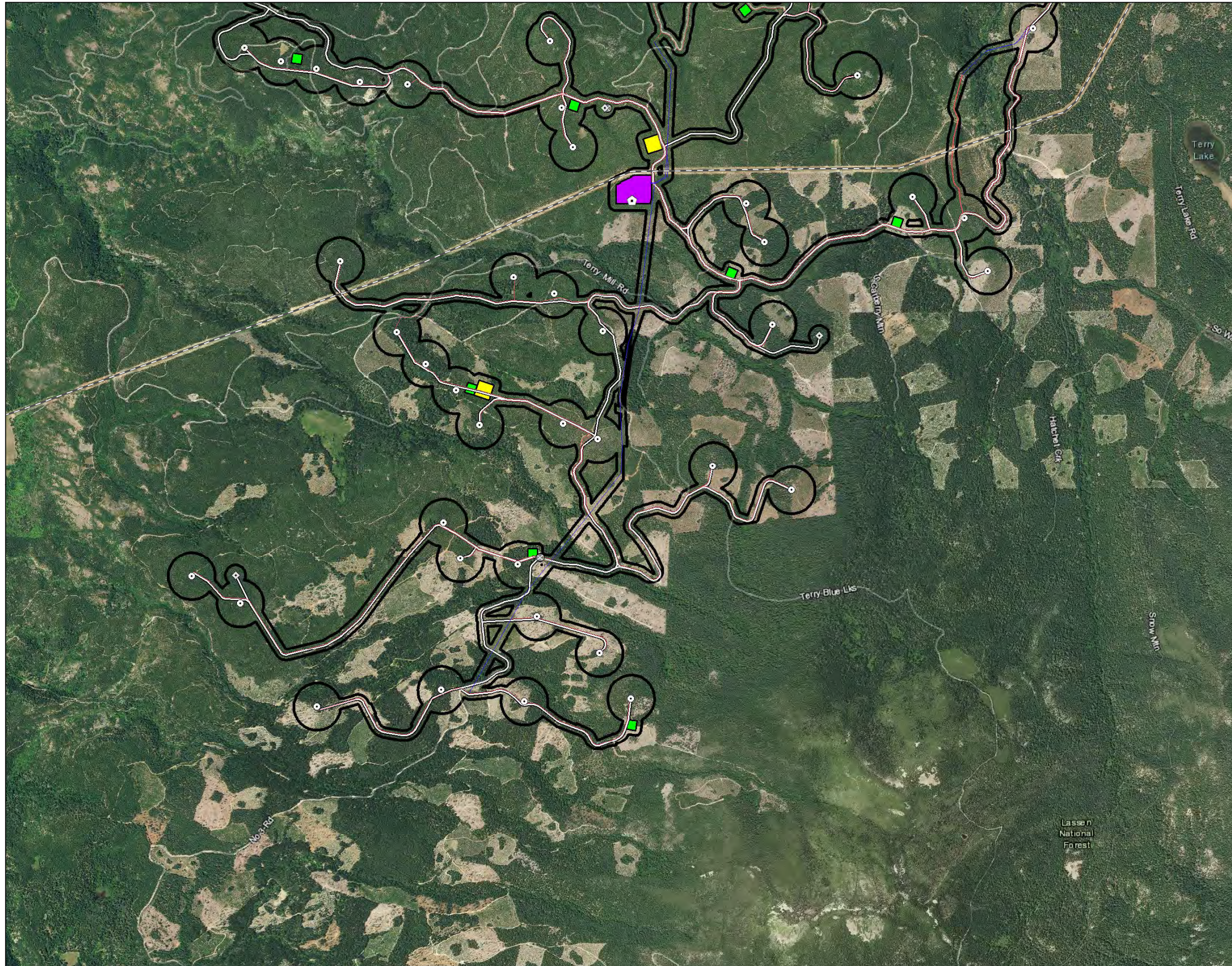

Legend

- Turbine Location
- ◇ Met Tower Location
- ⬠ Microwave Tower Location
- Storage Shed Location
- Overhead Collection
- Underground Collection
- Access Road
- Batch Plant
- O&M Facility
- Staging Area
- Substation/Switchyard Site
- ▭ Project Site Boundary
- PG&E Transmission Line

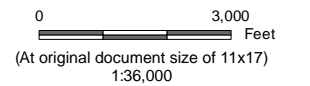

Notes

1. Coordinate System: NAD 1983 UTM Zone 10N
2. Data Sources: Shasta County GIS Division
3. Background: 2020 NAIP Orthoimagery



Project Location
Shasta County
California

Prepared by GC on 2023-07-06
TR Review by ES on 2023-07-06
IR Review by CB on 2023-07-06

Client/Project
Fountain Wind LLC
Fountain Wind Project

203723159

Figure No.

2

Title

Project Overview
Map 2 of 2

V:\11956\active\Task_Owner and other Non-BCI\956_Jobs\1185703743\03_data\gis_cad\gis\mxd\2023\Fig3_Zoning.mxd Revised: 2023-07-05 By: gcapentier

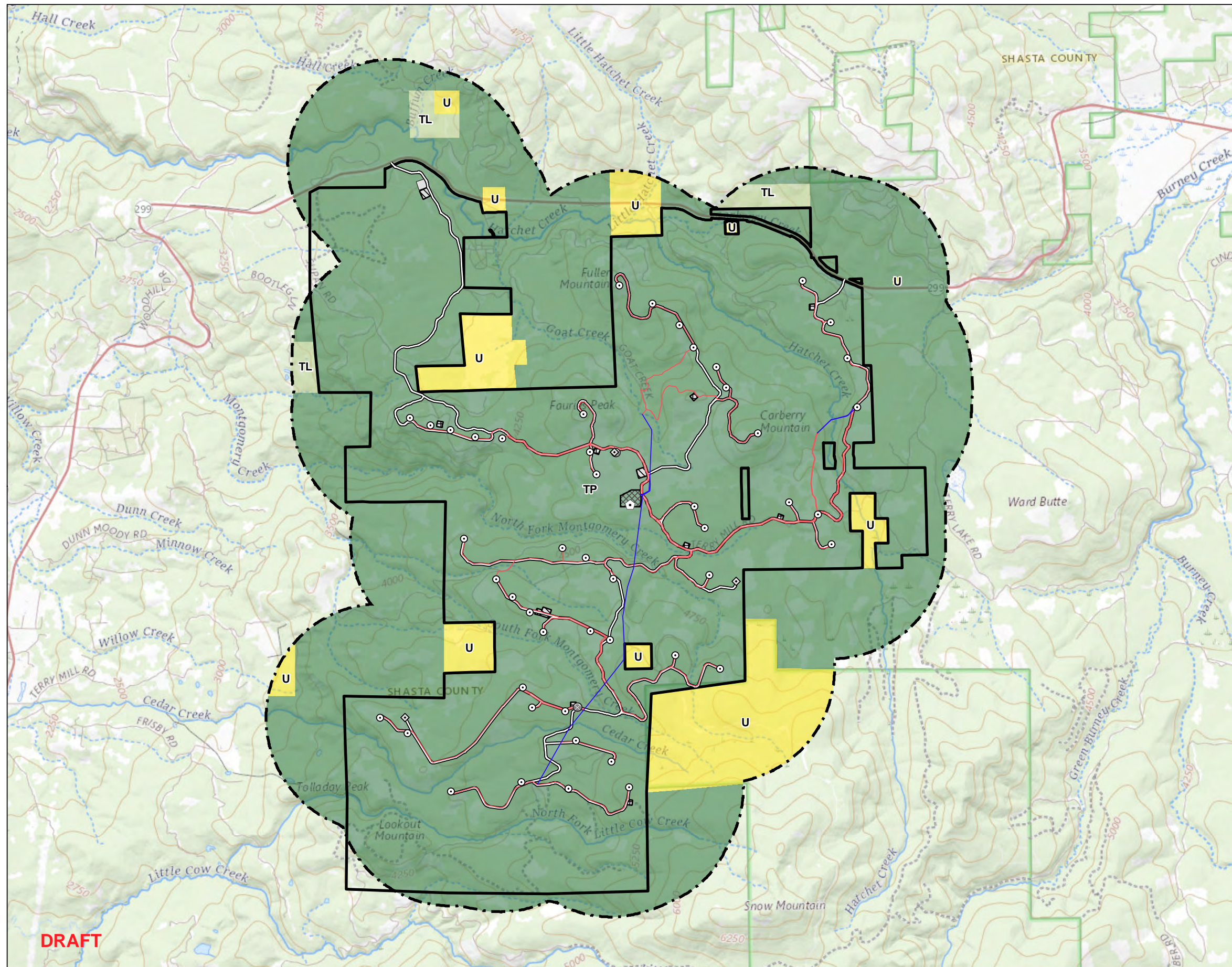

Legend

- Turbine Location
 - ◇ Met Tower Location
 - ⬠ Microwave Tower Location
 - Storage Shed Location
 - Overhead Collection
 - Underground Collection
 - Access Road
 - ▨ Batch Plant
 - ▭ O&M Facility
 - ▩ Staging Area
 - ▩ Substation/Switchyard Site
 - ▭ Project Area
 - ⬢ 1 mile from the Project Site
- Shasta County Zoning
- TL Timberland District (TL)
 - TP Timber Production District (TP)
 - U Unclassified District (U)

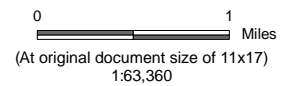

- Notes
1. Coordinate System: NAD 1983 StatePlane California I FIPS 0401 Feet
 2. Data Sources: Shasta County GIS Division
 3. Background: The USGS National Map



Project Location
Shasta County
California

Client/Project
Fountain Wind LLC
Fountain Wind Project

Prepared by GC on 2023-07-05
TR Review by DA on 2023-07-05
IR Review by CB on 2023-07-05

203723159

Figure No.

3

Title

Zoning

DRAFT

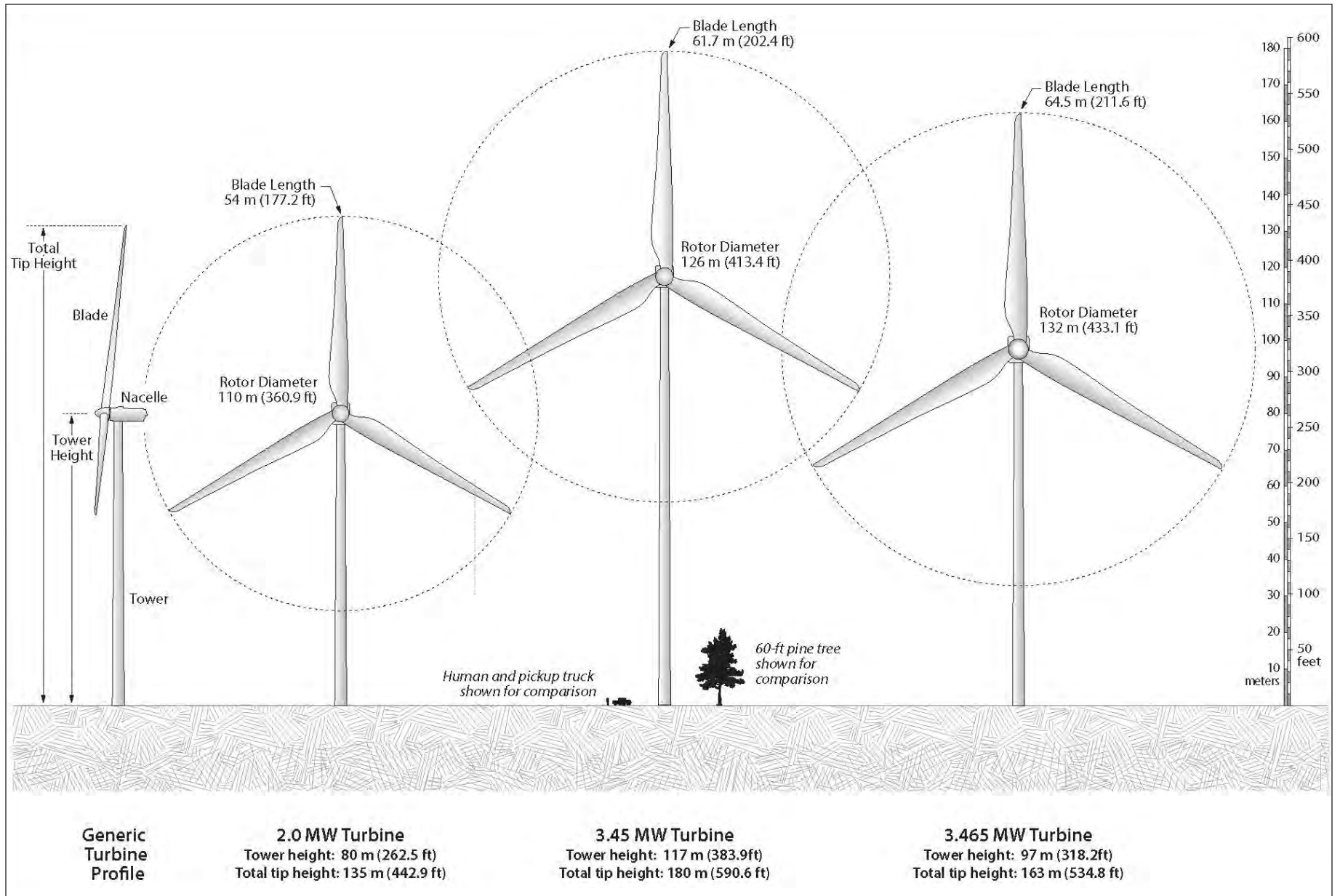

SOURCE: Pacific Wind Development, LLC.

NOTE: Generic turbine profiles are shown, not the specific turbines proposed for this Project. Dimensions of the proposed turbines are as described in the Project Description.

Fountain Wind

Figure 4
Typical Wind Turbine

Figure 5 Typical Overhead Collector Line Pole

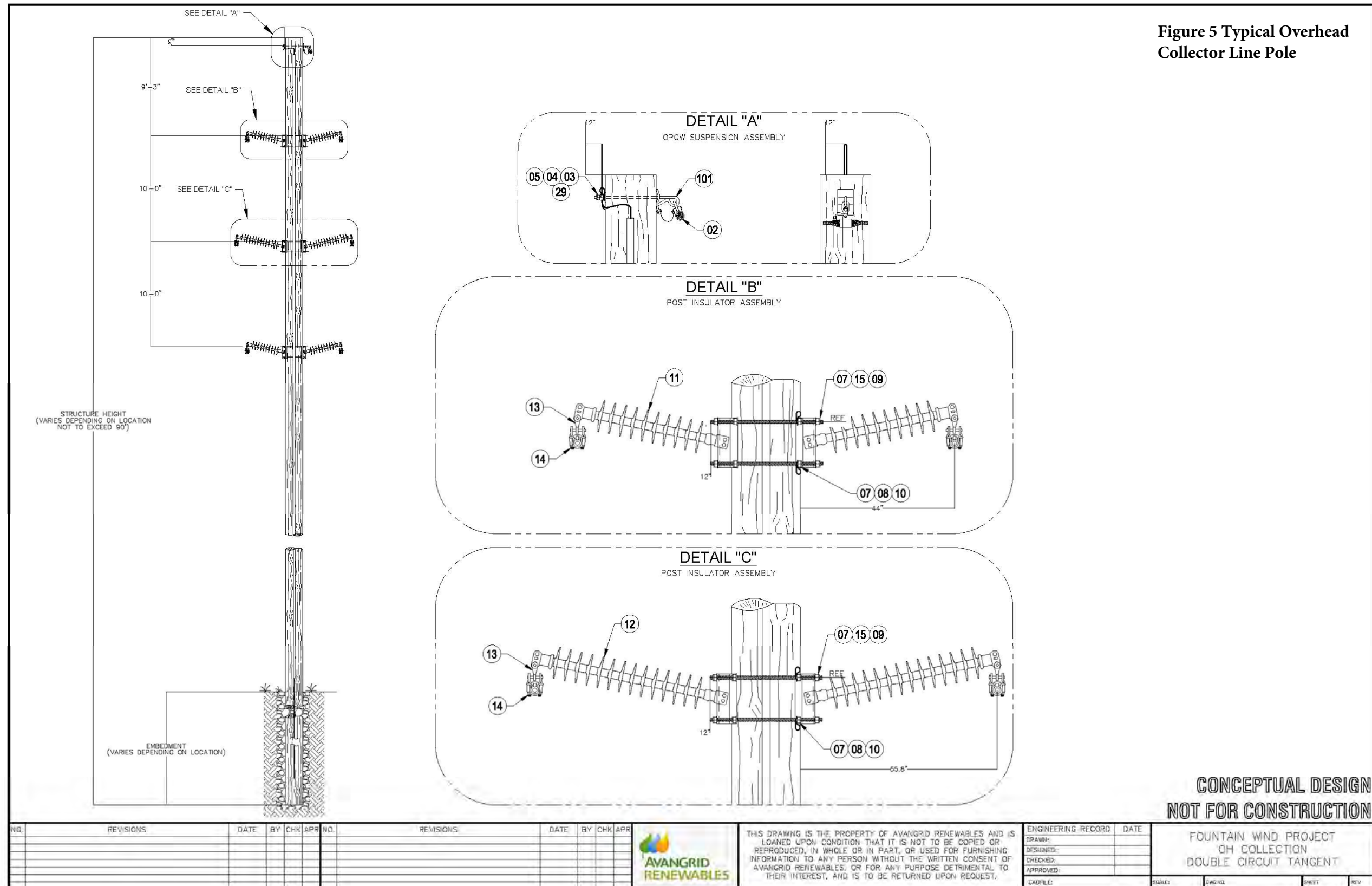

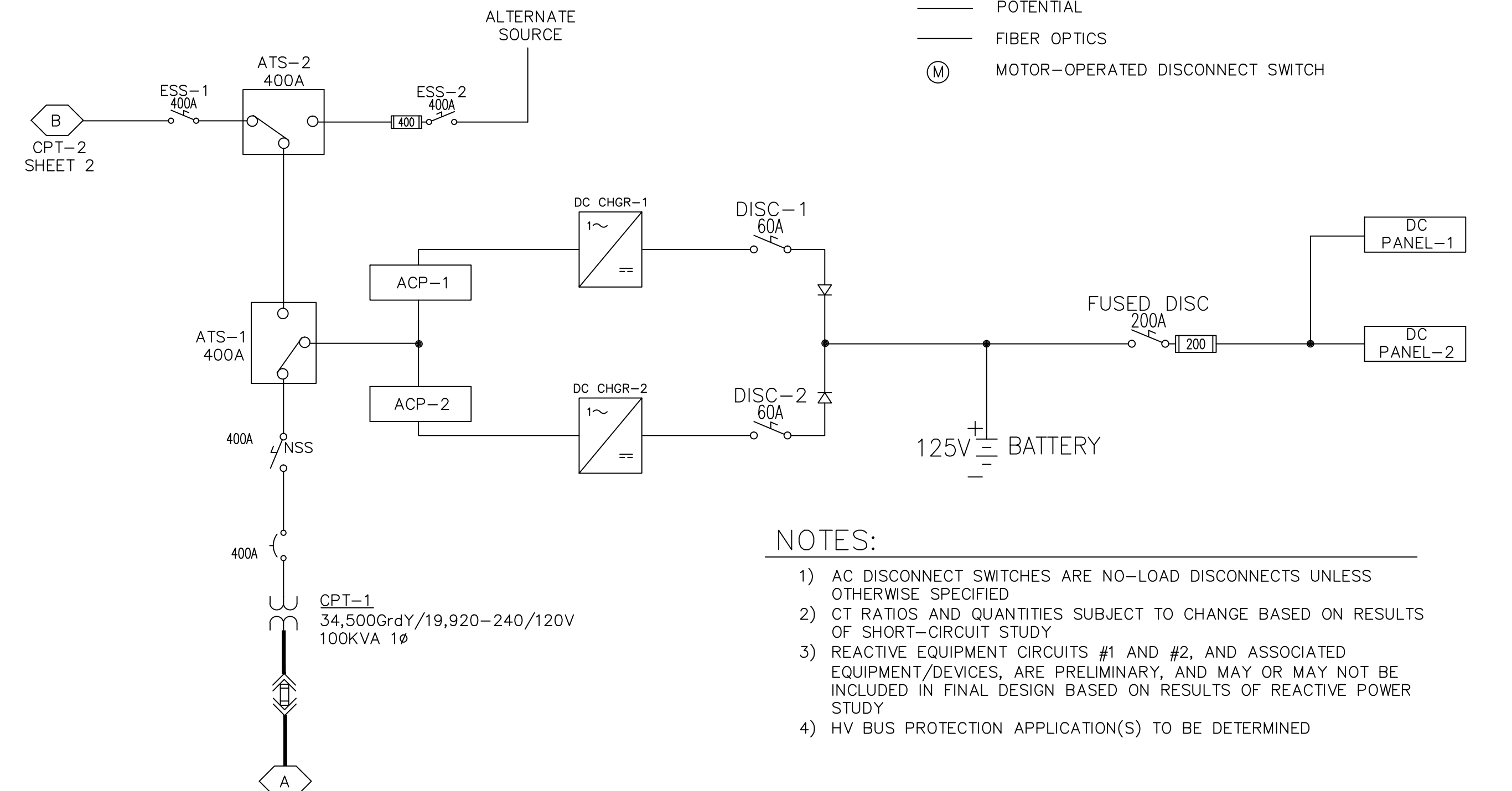
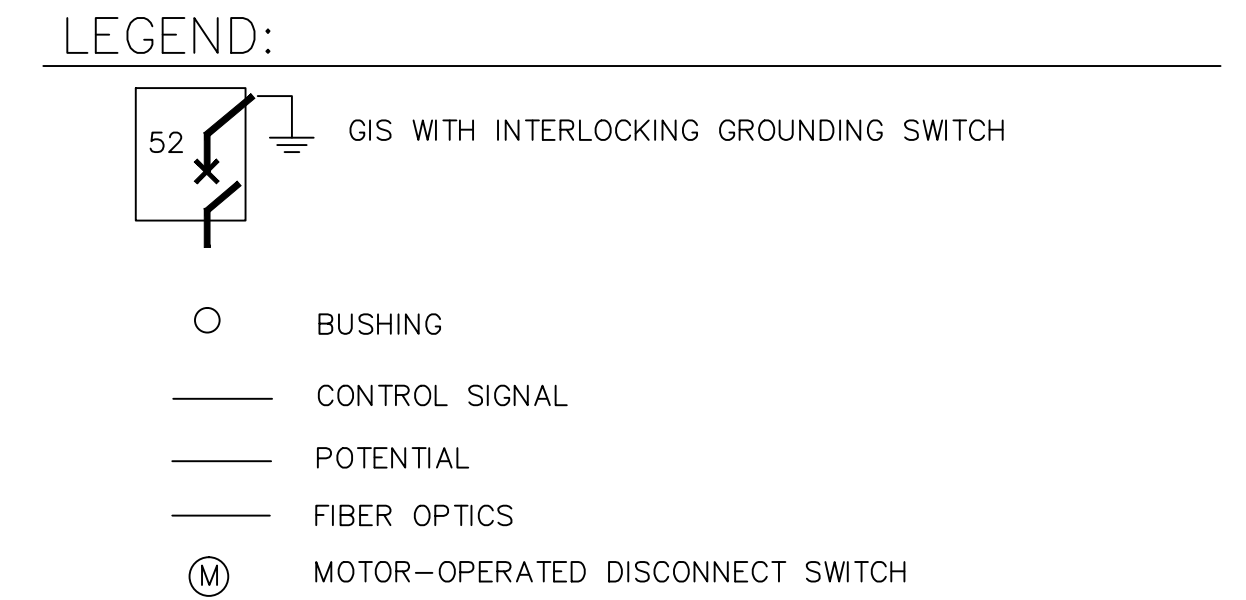
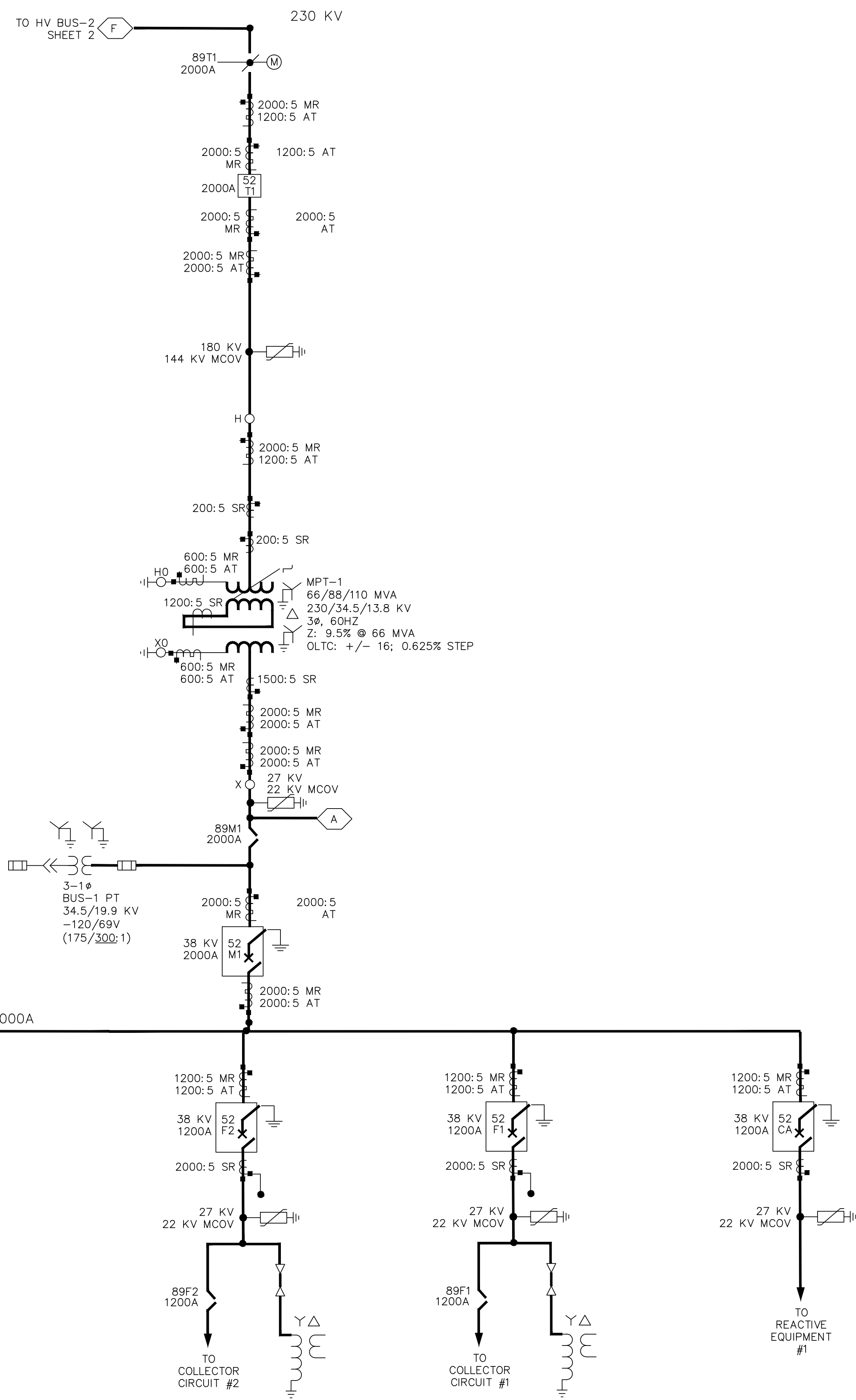
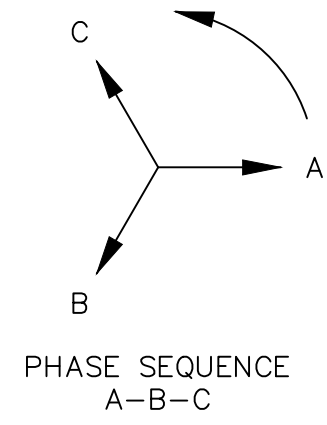

- NOTES:
- 1) AC DISCONNECT SWITCHES ARE NO-LOAD DISCONNECTS UNLESS OTHERWISE SPECIFIED
 - 2) CT RATIOS AND QUANTITIES SUBJECT TO CHANGE BASED ON RESULTS OF SHORT-CIRCUIT STUDY
 - 3) REACTIVE EQUIPMENT CIRCUITS #1 AND #2, AND ASSOCIATED EQUIPMENT/DEVICES, ARE PRELIMINARY, AND MAY OR MAY NOT BE INCLUDED IN FINAL DESIGN BASED ON RESULTS OF REACTIVE POWER STUDY
 - 4) HV BUS PROTECTION APPLICATION(S) TO BE DETERMINED

CONCEPTUAL- NOT FOR CONSTRUCTION

| NO. | REVISIONS | DATE | BY | CHK | APR | NO. | REVISIONS | DATE | BY | CHK | APR |
|-----|-----------|------|----|-----|-----|-----|-----------|------|----|-----|-----|
| | | | | | | | | | | | |
| | | | | | | | | | | | |
| | | | | | | | | | | | |
| | | | | | | | | | | | |
| | | | | | | | | | | | |



THIS DRAWING IS THE PROPERTY OF AVANGRID RENEWABLES AND IS LOANED UPON CONDITION THAT IT IS NOT TO BE COPIED OR REPRODUCED, IN WHOLE OR IN PART, OR USED FOR FURNISHING INFORMATION TO ANY PERSON WITHOUT THE WRITTEN CONSENT OF AVANGRID RENEWABLES, OR FOR ANY PURPOSE DETRIMENTAL TO THEIR INTEREST, AND IS TO BE RETURNED UPON REQUEST.

| ENGINEERING RECORD | DATE |
|--------------------|------|
| DRAWN: | |
| DESIGNED: | |
| CHECKED: | |
| APPROVED: | |
| CADFILE: | |

FOUNTAIN WIND PROJECT
230-34.5KV COLLECTOR SUBSTATION SWITCHING DIAGRAM

SCALE: 1"=25'-0" DWG.NO. SHEET 1 OF 2 REV

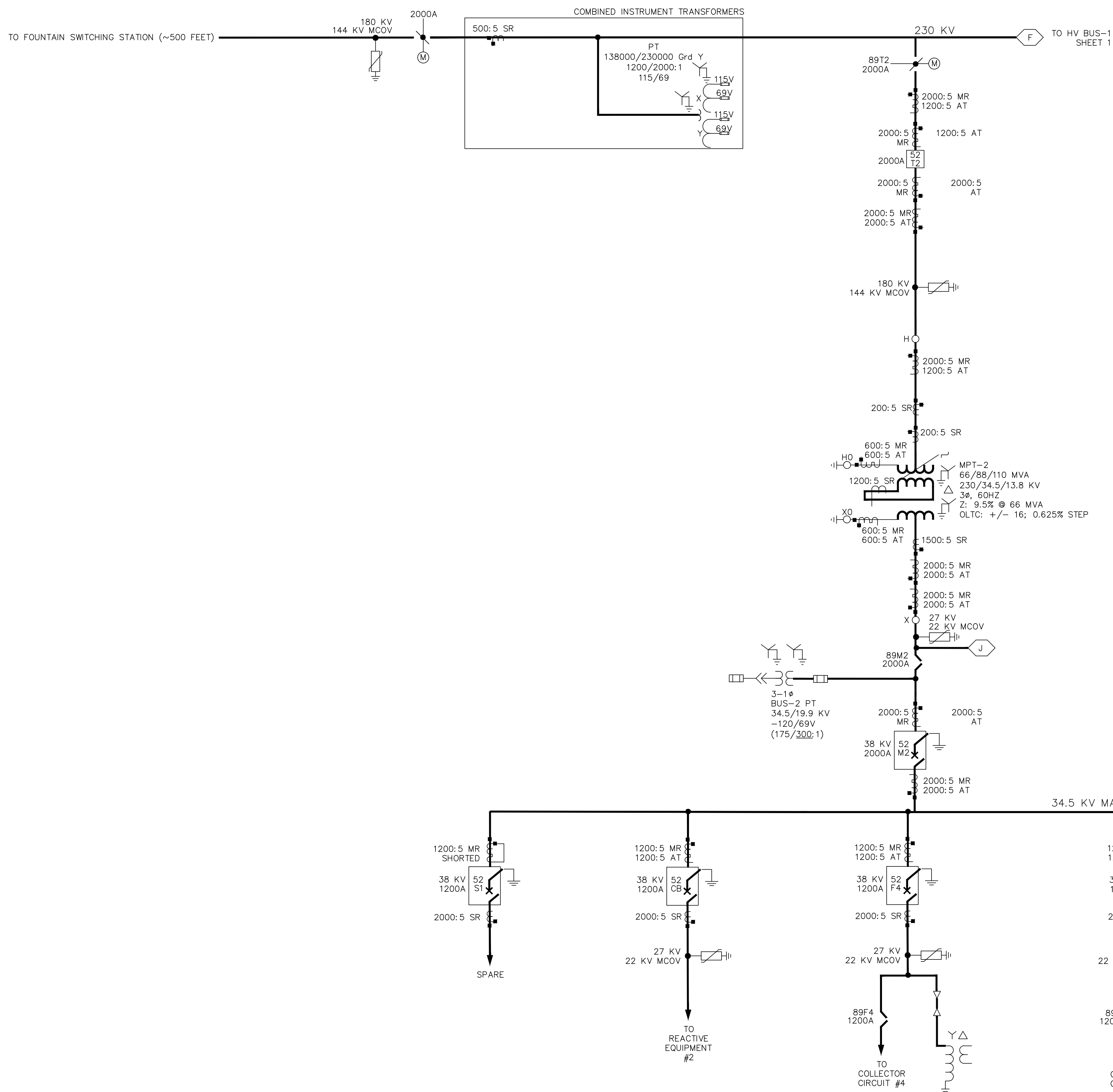

LEGEND:
SEE SHEET 1

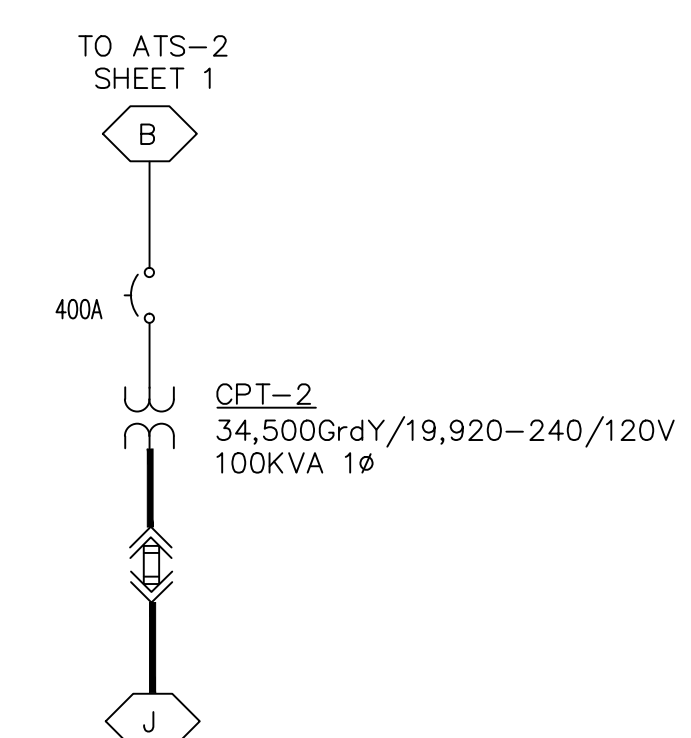

CONCEPTUAL- NOT FOR CONSTRUCTION

| NO. | REVISIONS | DATE | BY | CHK | APR | NO. | REVISIONS | DATE | BY | CHK | APR |
|-----|-----------|------|----|-----|-----|-----|-----------|------|----|-----|-----|
| | | | | | | | | | | | |
| | | | | | | | | | | | |
| | | | | | | | | | | | |
| | | | | | | | | | | | |
| | | | | | | | | | | | |
| | | | | | | | | | | | |
| | | | | | | | | | | | |
| | | | | | | | | | | | |
| | | | | | | | | | | | |



THIS DRAWING IS THE PROPERTY OF AVANGRID RENEWABLES AND IS LOANED UPON CONDITION THAT IT IS NOT TO BE COPIED OR REPRODUCED, IN WHOLE OR IN PART, OR USED FOR FURNISHING INFORMATION TO ANY PERSON WITHOUT THE WRITTEN CONSENT OF AVANGRID RENEWABLES, OR FOR ANY PURPOSE DETRIMENTAL TO THEIR INTEREST, AND IS TO BE RETURNED UPON REQUEST.

| ENGINEERING RECORD | DATE |
|--------------------|------|
| DRAWN: | |
| DESIGNED: | |
| CHECKED: | |
| APPROVED: | |
| CADFILE: | |

FOUNTAIN WIND PROJECT
230-34.5KV COLLECTOR SUBSTATION
GENERAL ARRANGEMENT

| KV | BIL | MINIMUM METAL-TO-METAL DISTANCE FOR RIGID BUS PHASE-TO-PHASE | MINIMUM CENTERLINE TO CENTERLINE PHASE SPACING FOR RIGID BUS | MINIMUM CREEPAGE DISTANCE | MINIMUM PHASE TO GROUND SPACING | MINIMUM CLEARANCE BETWEEN LIVE PARTS TO FENCE | MINIMUM CLEARANCE PHASE TO SUBSTATION GRADE | MINIMUM CLEARANCE PHASE TO SUBSTATION ROADWAY |
|------|------|--|--|---------------------------|---------------------------------|---|---|---|
| | | | | | | | | |
| 230 | 1050 | 7'-2" | 13'-0" | 195" | 6'-7" | 16'-5" | 16'-0" | 28'-0" |
| 34.5 | 250 | 1'-9" | 4'-0" | 37" | 1'-7" | 10'-11" | 10'-0" | 22'-0" |

NOTE:
1050KV BIL COMES FROM REQUIRED 900KV BIL X ALTITUDE FACTOR
250KV BIL COMES FROM REQUIRED 200KV BIL X ALTITUDE FACTOR

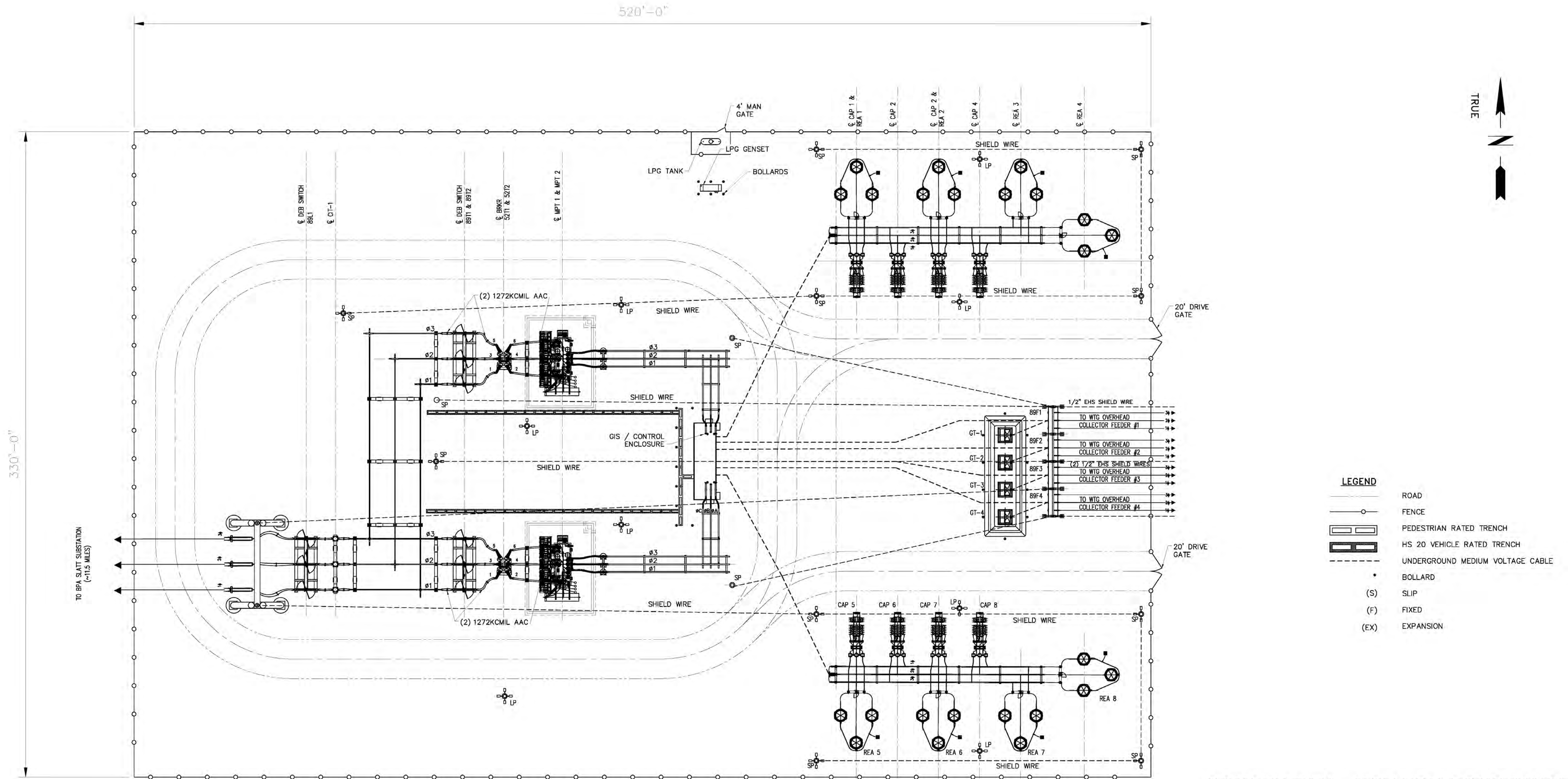

LEGEND

| | |
|------|----------------------------------|
| | ROAD |
| | FENCE |
| | PEDESTRIAN RATED TRENCH |
| | HS 20 VEHICLE RATED TRENCH |
| | UNDERGROUND MEDIUM VOLTAGE CABLE |
| | BOLLARD |
| (S) | SLIP |
| (F) | FIXED |
| (EX) | EXPANSION |

CONCEPTUAL- NOT FOR CONSTRUCTION

| NO. | REVISIONS | DATE | BY | CHK | APR | NO. | REVISIONS | DATE | BY | CHK | APR |
|-----|-----------|------|----|-----|-----|-----|-----------|------|----|-----|-----|
| | | | | | | | | | | | |



THIS DRAWING IS THE PROPERTY OF AVANGRID RENEWABLES AND IS LOANED UPON CONDITION THAT IT IS NOT TO BE COPIED OR REPRODUCED, IN WHOLE OR IN PART, OR USED FOR FURNISHING INFORMATION TO ANY PERSON WITHOUT THE WRITTEN CONSENT OF AVANGRID RENEWABLES, OR FOR ANY PURPOSE DETRIMENTAL TO THEIR INTEREST, AND IS TO BE RETURNED UPON REQUEST.

| | |
|--------------------|------|
| ENGINEERING RECORD | DATE |
| DRAWN: | |
| DESIGNED: | |
| CHECKED: | |
| APPROVED: | |
| CADFILE: | |

FOUNTAIN WIND PROJECT
230-34.5KV COLLECTOR SUBSTATION
GENERAL ARRANGEMENT

| | | | |
|------------------|---------|----------|-----|
| SCALE: 1"=25'-0" | DWG.NO. | SHEET OF | REV |
|------------------|---------|----------|-----|

| VOLTAGE | | MINIMUM METAL-TO-METAL DISTANCE FOR RIGID BUS PHASE-TO-PHASE | MINIMUM CENTERLINE TO CENTERLINE PHASE SPACING FOR RIGID BUS | MINIMUM CREEPAGE DISTANCE | MINIMUM PHASE TO GROUND SPACING | MINIMUM CLEARANCE BETWEEN LIVE PARTS TO FENCE | MINIMUM CLEARANCE PHASE TO SUBSTATION GRADE | MINIMUM CLEARANCE PHASE TO SUBSTATION ROADWAY |
|---------|------|--|--|---------------------------|---------------------------------|---|---|---|
| KV | BIL | | | | | | | |
| 230 | 1050 | 7'-2" | 13'-0" | 195" | 6'-7" | 16'-5" | 16'-0" | 28'-0" |
| 34.5 | 250 | 1'-9" | 4'-0" | 37" | 1'-7" | 10'-11" | 10'-0" | 22'-0" |
| | | | | | | | | |

NOTE:
 1050KV BIL COMES FROM REQUIRED 900KV BIL X ALTITUDE FACTOR
 250KV BIL COMES FROM REQUIRED 200KV BIL X ALTITUDE FACTOR

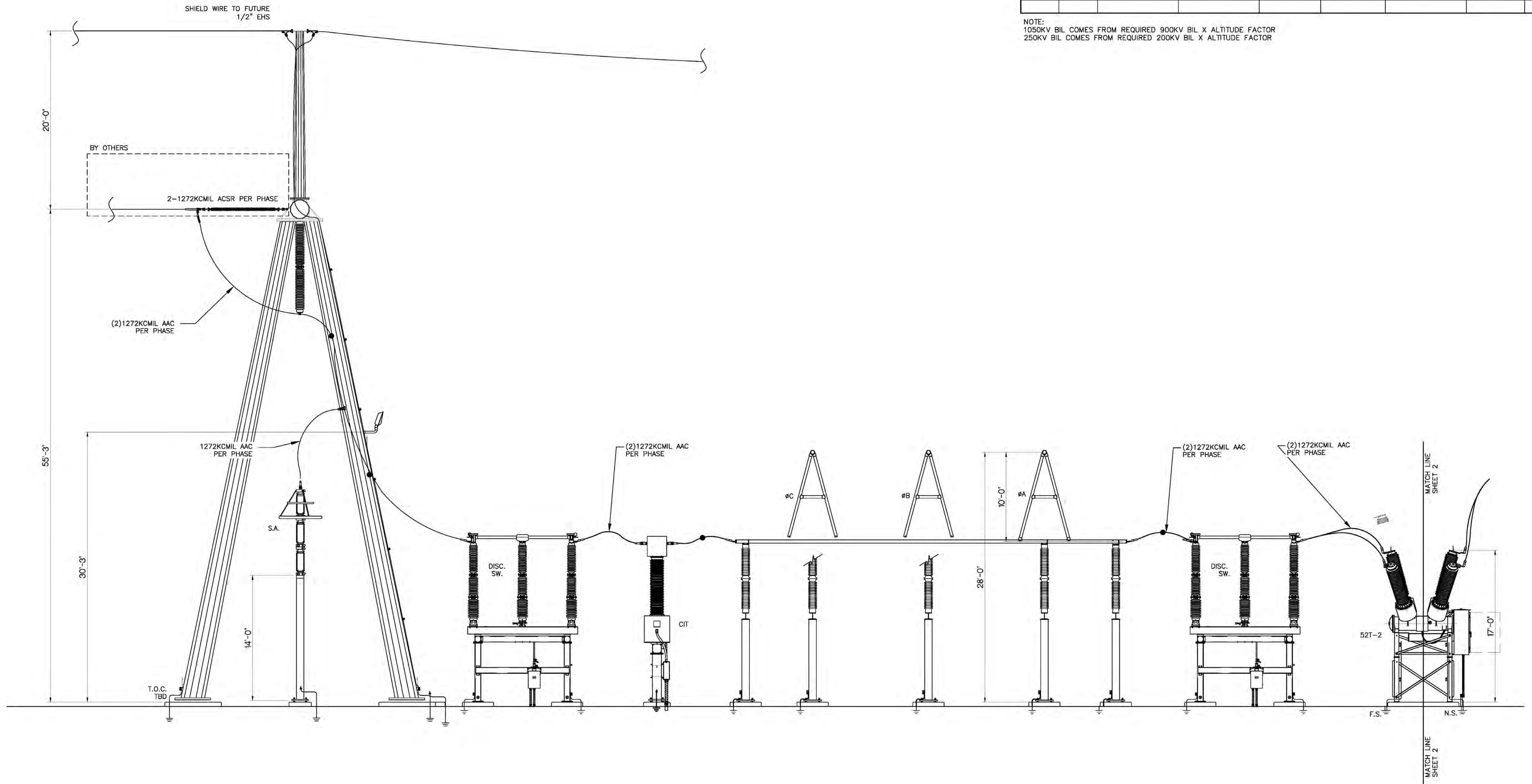

CONCEPTUAL- NOT FOR CONSTRUCTION

| NO. | REVISIONS | DATE | BY | CHK | APR | NO. | REVISIONS | DATE | BY | CHK | APR |
|-----|-----------|------|----|-----|-----|-----|-----------|------|----|-----|-----|
| | | | | | | | | | | | |
| | | | | | | | | | | | |
| | | | | | | | | | | | |



THIS DRAWING IS THE PROPERTY OF AVANGRID RENEWABLES AND IS LOANED UPON CONDITION THAT IT IS NOT TO BE COPIED OR REPRODUCED, IN WHOLE OR IN PART, OR USED FOR FURNISHING INFORMATION TO ANY PERSON WITHOUT THE WRITTEN CONSENT OF AVANGRID RENEWABLES, OR FOR ANY PURPOSE DETRIMENTAL TO THEIR INTEREST, AND IS TO BE RETURNED UPON REQUEST.

| ENGINEERING RECORD | DATE |
|--------------------|------|
| DRAWN: | |
| DESIGNED: | |
| CHECKED: | |
| APPROVED: | |
| GADFILE: | |

| FOUNTAIN WIND PROJECT | |
|--|----------|
| 230-34.5KV COLLECTOR SUBSTATION ELEVATIONS | |
| SCALE: 1"=25'-0" | DWG. NO. |
| SHEET 1 OF 2 | REV |

| VOLTAGE | | MINIMUM METAL-TO-METAL DISTANCE FOR RIGID BUS PHASE-TO-PHASE | MINIMUM CENTERLINE TO CENTERLINE PHASE SPACING FOR RIGID BUS | MINIMUM CREEPAGE DISTANCE | MINIMUM PHASE TO GROUND SPACING | MINIMUM CLEARANCE BETWEEN LIVE PARTS TO FENCE | MINIMUM CLEARANCE PHASE TO SUBSTATION GRADE | MINIMUM CLEARANCE PHASE TO SUBSTATION ROADWAY |
|---------|------|--|--|---------------------------|---------------------------------|---|---|---|
| KV | BIL | | | | | | | |
| 230 | 1050 | 7'-2" | 13'-0" | 195" | 6'-7" | 16'-5" | 16'-0" | 28'-0" |
| 34.5 | 250 | 1'-9" | 4'-0" | 37" | 1'-7" | 10'-11" | 10'-0" | 22'-0" |
| | | | | | | | | |

NOTE:
 1050KV BIL COMES FROM REQUIRED 900KV BIL X ALTITUDE FACTOR
 250KV BIL COMES FROM REQUIRED 200KV BIL X ALTITUDE FACTOR

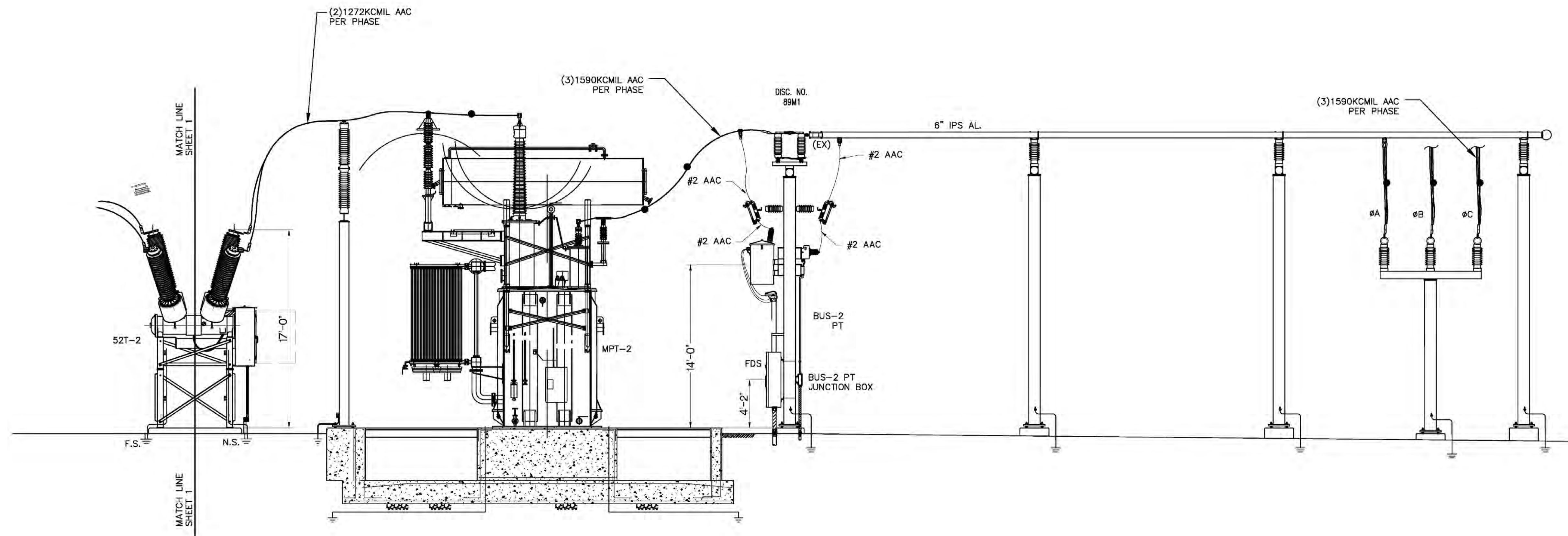

CONCEPTUAL- NOT FOR CONSTRUCTION

| NO. | REVISIONS | DATE | BY | CHK | APR | NO. | REVISIONS | DATE | BY | CHK | APR |
|-----|-----------|------|----|-----|-----|-----|-----------|------|----|-----|-----|
| | | | | | | | | | | | |
| | | | | | | | | | | | |
| | | | | | | | | | | | |



THIS DRAWING IS THE PROPERTY OF AVANGRID RENEWABLES AND IS LOANED UPON CONDITION THAT IT IS NOT TO BE COPIED OR REPRODUCED, IN WHOLE OR IN PART, OR USED FOR FURNISHING INFORMATION TO ANY PERSON WITHOUT THE WRITTEN CONSENT OF AVANGRID RENEWABLES, OR FOR ANY PURPOSE DETRIMENTAL TO THEIR INTEREST, AND IS TO BE RETURNED UPON REQUEST.

| ENGINEERING RECORD | DATE |
|--------------------|------|
| DRAWN: | |
| DESIGNED: | |
| CHECKED: | |
| APPROVED: | |
| GADFILE: | |

| FOUNTAIN WIND PROJECT | |
|--|----------|
| 230-34.5KV COLLECTOR SUBSTATION ELEVATIONS | |
| SCALE: 1"=25'-0" | DWG. NO. |
| SHEET 2 OF 2 | REV |

PREPARED FOR:

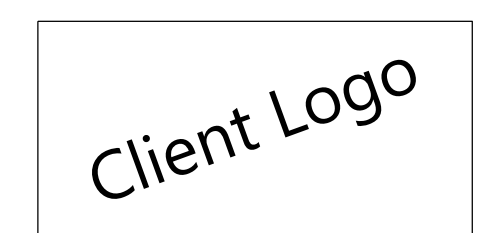

Client Address
 City, ST Zip code

REVISIONS:

| # | DATE | COMMENT |
|---|------|---------|
| | | |
| | | |
| | | |
| | | |
| | | |
| | | |
| | | |
| | | |
| | | |
| | | |

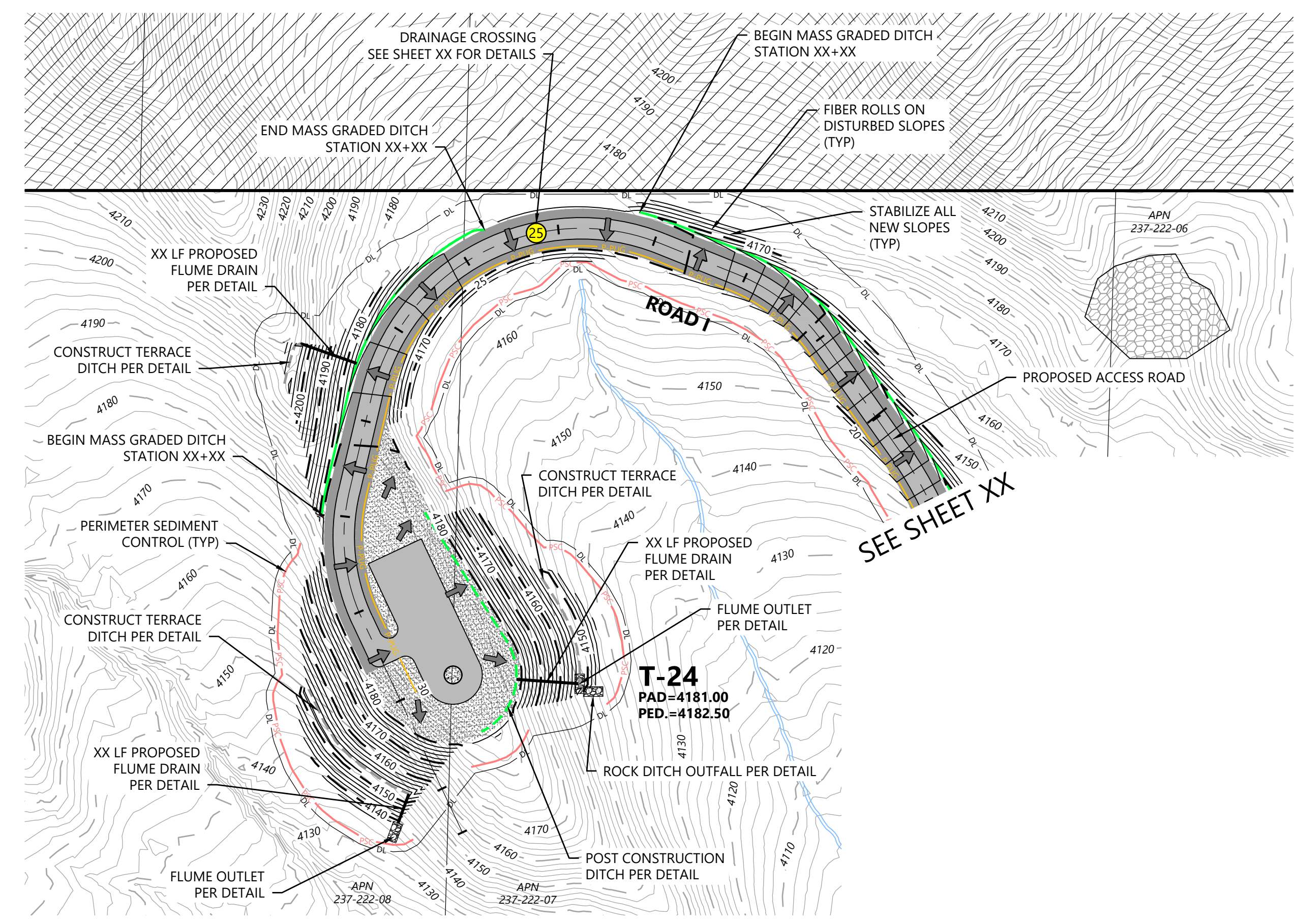

- LEGEND:**
- T-#** TURBINE LOCATION
 - PROPOSED ACCESS ROAD
 - PROPOSED ACCESS ROAD WITH CRANE PATH
 - PROPOSED GRADED PAD AREA
 - PROPOSED GRAVEL AREA
 - PROPOSED UNDERGROUND COLLECTION*
 - PROPOSED OVERHEAD TRANSMISSION*
 - DISTURBANCE LIMITS
 - PERIMETER SEDIMENT CONTROL
 - PROPOSED INDEX CONTOUR
 - PROPOSED INTERVAL CONTOUR
 - PROPOSED CULVERT
 - PROPOSED MASS GRADED DITCH
 - PROPOSED POST CONSTRUCTION DITCH/BERM
 - PROPOSED TERRACE DITCH
 - PROPOSED ROAD/PAD CROSS SLOPE DIRECTION
 - PROPOSED DRAINAGE CROSSING
 - PROPOSED RIPRAP
 - NON-PARTICIPATING LAND
 - SECTION LINES
 - RIGHT-OF-WAY LINES
 - EASEMENT LINES
 - PARCEL LINES
 - EX. INDEX CONTOUR
 - EX. INTERVAL CONTOUR
 - EX. TREELINE
 - EX. PAVED ROAD
 - EX. GRAVEL ROAD
 - EX. FENCE
 - EX. CULVERT
 - EX. OVERHEAD POWER
 - EX. UNDERGROUND POWER
 - EX. FIBER OPTIC LINE
 - EX. GAS PIPELINE
 - EX. TELEPHONE LINE
 - EX. WATER LINE
 - EX. STREAM CHANNEL (PUBLIC DATA)
 - EX. WETLAND (PUBLIC DATA)
 - DELINEATED WETLAND/STREAM
 - FEMA FLOOD ZONE
 - ENVIRONMENTALLY SENSITIVE AREA (ESA)
- *SEE ELECTRICAL PLAN SET FOR DETAILS

Road I - Sta. 20+00 to End

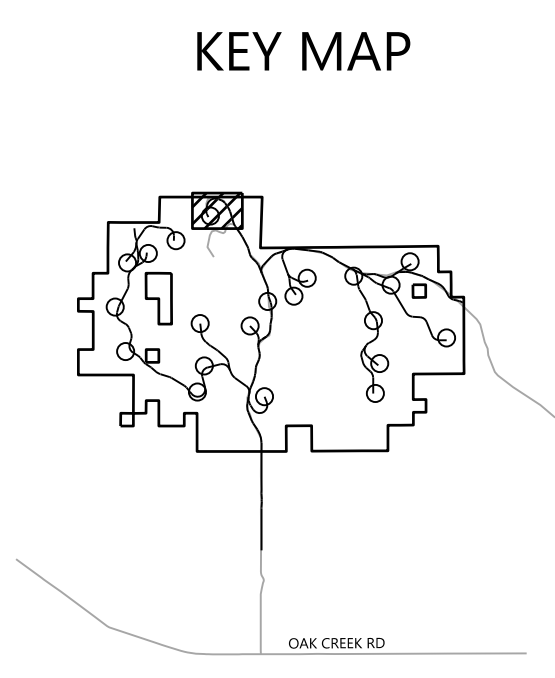
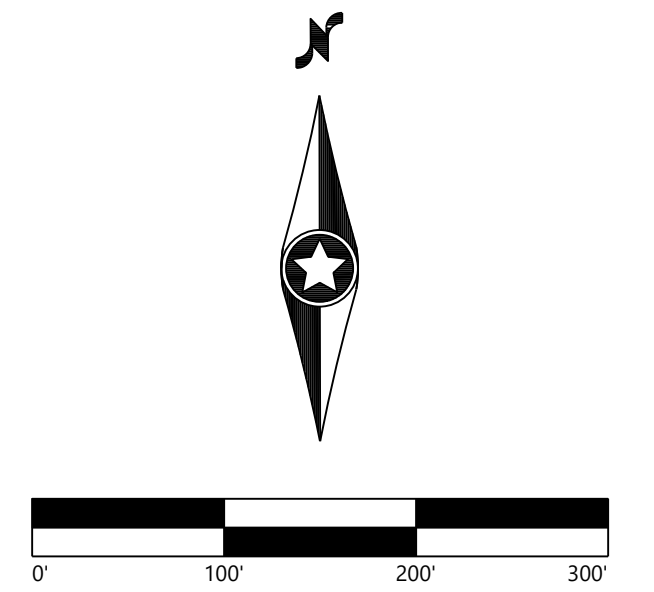
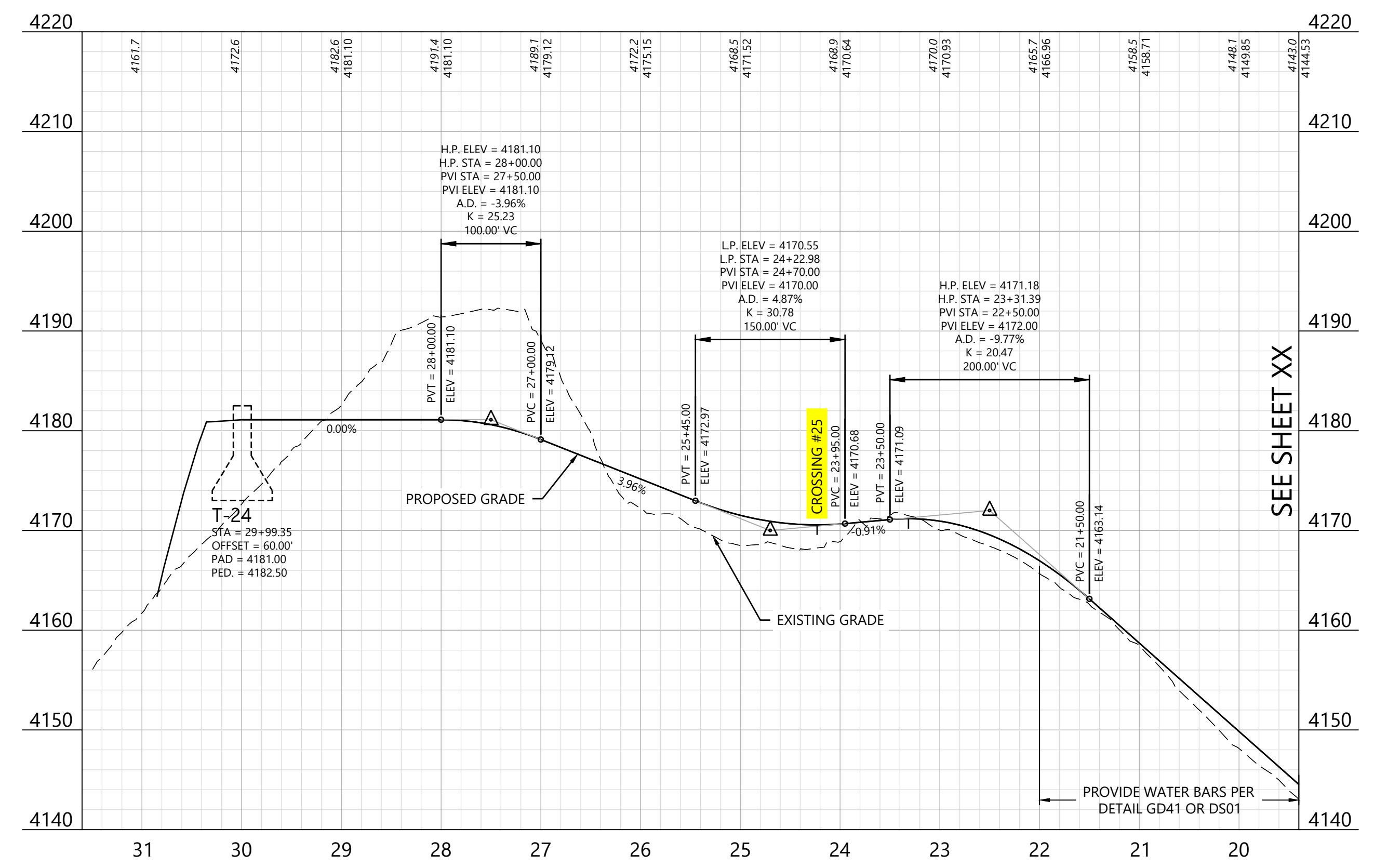

Project Name
Project Name
 County, State
 County, State

Road I - Sta. 20+00
 to End

SAMPLE DRAWING

DATE: XX/XX/XXXX

SHEET: XX

LINE NAMES CHECKED BY CH DATE

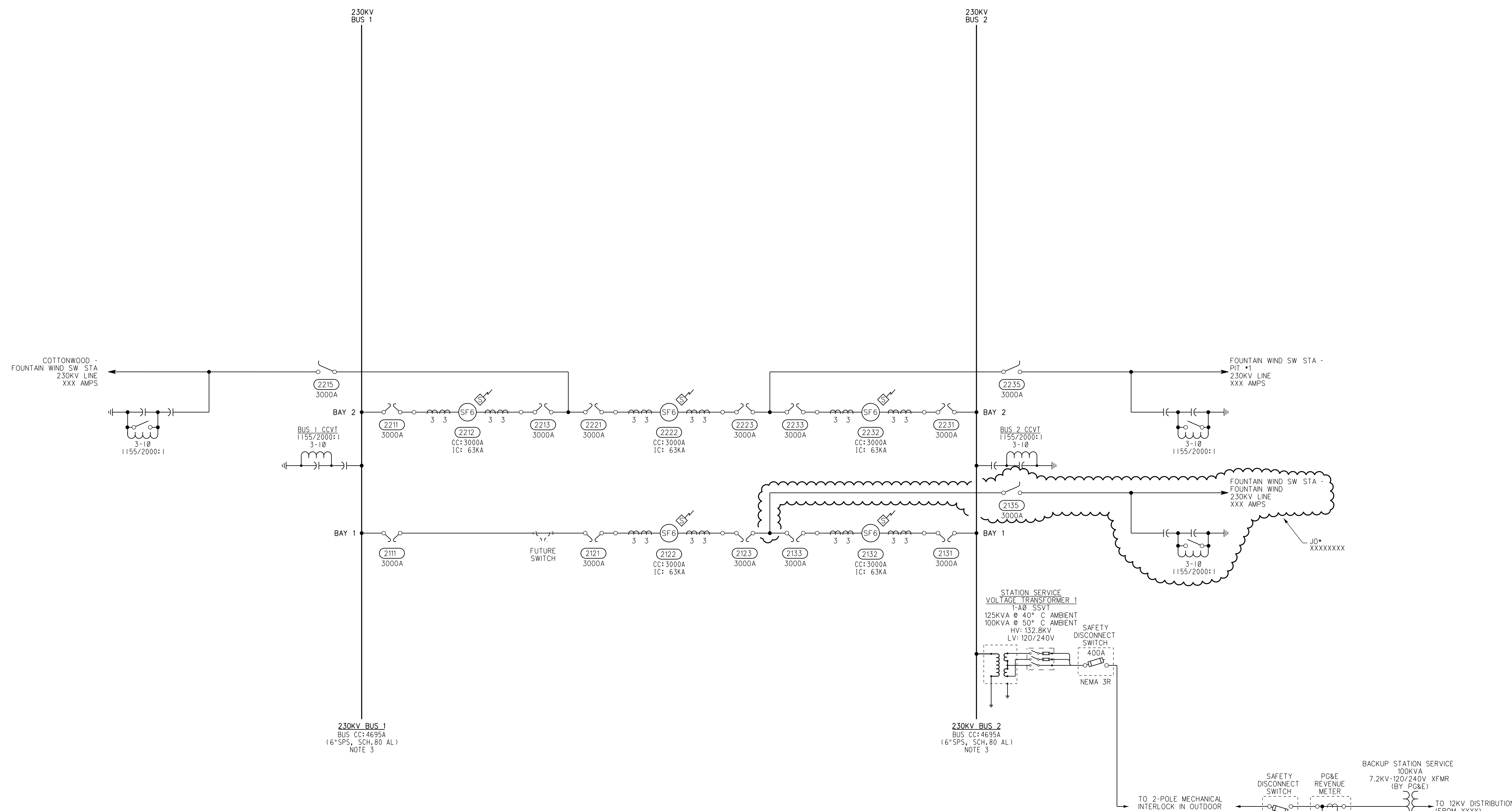

LEGEND

- (SF6) - 230KV CIRCUIT BREAKER
CC: 3000A IC: 63KA
- (C) - 230KV CENTER BREAK DISCONNECT SWITCH
CC: 3000A IC: 63KA
- (V) - 230KV VERTICAL BREAK DISCONNECT SWITCH
CC: 3000A IC: 63KA
- (XXXX) - EQUIPMENT NUMBER
- IC - INTERRUPTING CAPACITY
- CC - CONTINUOUS CURRENT
- ◇ - SUPERVISORY CONTROL
- - FUTURE

NOTES

1. PG&E STANDARD IS EVOLVING TO NO WAVETRAPS ON 230KV LINES.
2. TRANSMISSION LINE RATINGS SHOWN DEPICT SUMMER NORMAL OPERATING CONDITION WITHIN SUBSTATION FENCE ONLY.
3. TO BE DE-RATED FOR ALTITUDE CORRECTION ONCE THE SITE LOCATION IS FINALIZED.

REFERENCES

| REFERENCES | DWG NO. |
|---------------------------------------|----------|
| ULTIMATE SINGLE LINE DIAGRAM | ULT SLD |
| GENERAL ARRANGEMENT OUTDOORS | GAO |
| ULTIMATE GENERAL ARRANGEMENT OUTDOORS | ULT GAO |
| PROPERTY PLAN | PROP PLN |

SWITCHING STATION NAME TO BE PROVIDED BY PG&E

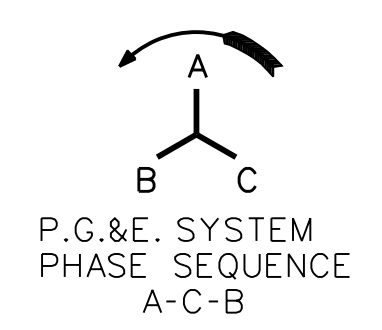

CAD USER: JME DATE: 05-07-21
VECTOR: SLD.DGN
RASTER:

| SUBSTATION & TRANSMISSION | | | | SWITCHING STATION | | | | ELECTRICAL | | | | FOUNTAIN WIND SWITCHING STATION | | | | ARRANGEMENT | | | | ACTIVE | | | | PROJECT | | | | SUBSTATION | | | | 230KV | | | | | | | | | | | | | | | | | | | |
|--|------|-------------|--------|-------------------|------|------|------|------------|------|-------------|--------|---------------------------------|------|------|------|--------------|------------|------|--|--------|--|--|--|----------|--|--|--|-----------------------------|--|--|--|-------|--|--|--|------|--|--|--|----------------|--|--|--|------|--|--|--|-----------------|--|--|--|
| BUSINESS LINE | | | | FACILITY TYPE | | | | DISCIPLINE | | | | FACILITY NAME | | | | DRAWING TYPE | | | | STATUS | | | | PROJECT | | | | FACILITY COMPONENT | | | | UNIT | | | | | | | | | | | | | | | | | | | |
| ELECTRIC TRANSMISSION ENGINEERING & CONSTRUCTION | | | | | | | | | | | | | | | | | | | | W.O. | | | | REV. 1 | | | | DSG J. EMERT | | | | DWN | | | | CHKD | | | | SUPV R. KODURU | | | | APVD | | | | DATE 09/03/2020 | | | |
| FOR QUESTIONS ON REV. B OF THIS DWG | | | | | | | | | | | | | | | | | | | | B | | | | 05/10/21 | | | | UPDATED PER IDP COMMENTS | | | | JME | | | | RKK | | | | | | | | | | | | | | | |
| Call DASHIELL- at | | | | | | | | | | | | | | | | | | | | - | | | | - | | | | RECEIVED ON 04/28/2021 | | | | - | | | | - | | | | - | | | | - | | | | | | | |
| Call DASHIELL-RAJA KODURU at 713-578-6218 | | | | | | | | | | | | | | | | | | | | A | | | | 09/03/20 | | | | APPROVED FOR CONSTRUCTION | | | | JME | | | | RKK | | | | | | | | | | | | | | | |
| | | | | | | | | | | | | | | | | | | | | - | | | | - | | | | REFERENCE EDS 4042042 REV 4 | | | | - | | | | - | | | | - | | | | - | | | | | | | |
| REV | DATE | DESCRIPTION | JOB NO | USG | CHKD | SUPV | APVD | REV | DATE | DESCRIPTION | JOB NO | USG | CHKD | SUPV | APVD | DATE | 09/03/2020 | PG&E | | | | | | | | SINGLE LINE DIAGRAM FOUNTAIN WIND SWITCHING STATION DEPARTMENT OF ENGINEERING PACIFIC GAS AND ELECTRIC COMPANY SAN FRANCISCO, CALIFORNIA | | | | | | | | | | | | | | | | | | | | | | | | | |

| | |
|--------------|--------|
| SCAN | IC |
| BILL OF MATL | |
| DWG LIST | |
| SUPDS | |
| SUPDS BY | |
| SHEET NO | SHEETS |
| SLD | REV |

LINE NAMES CHECKED BY CH DATE

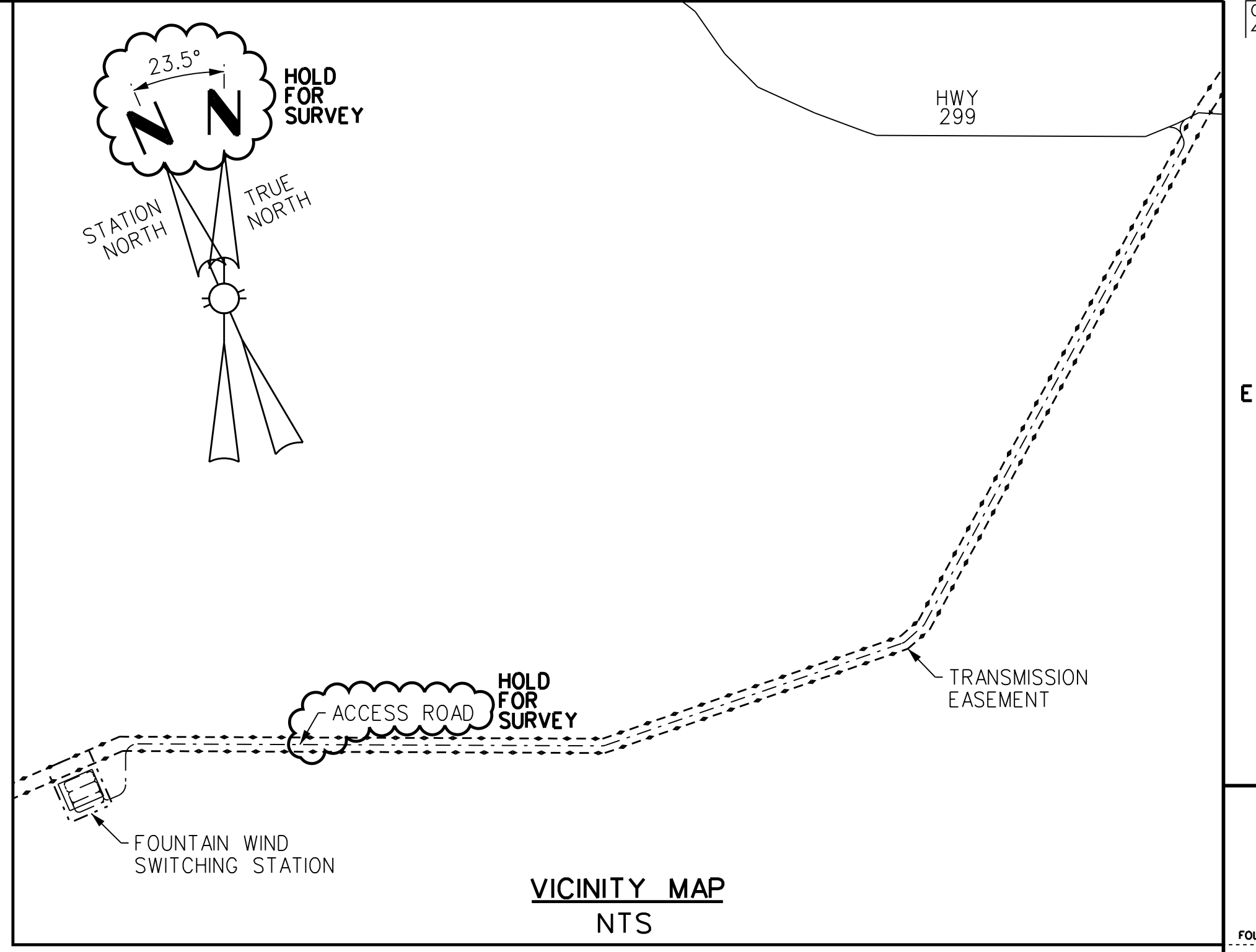
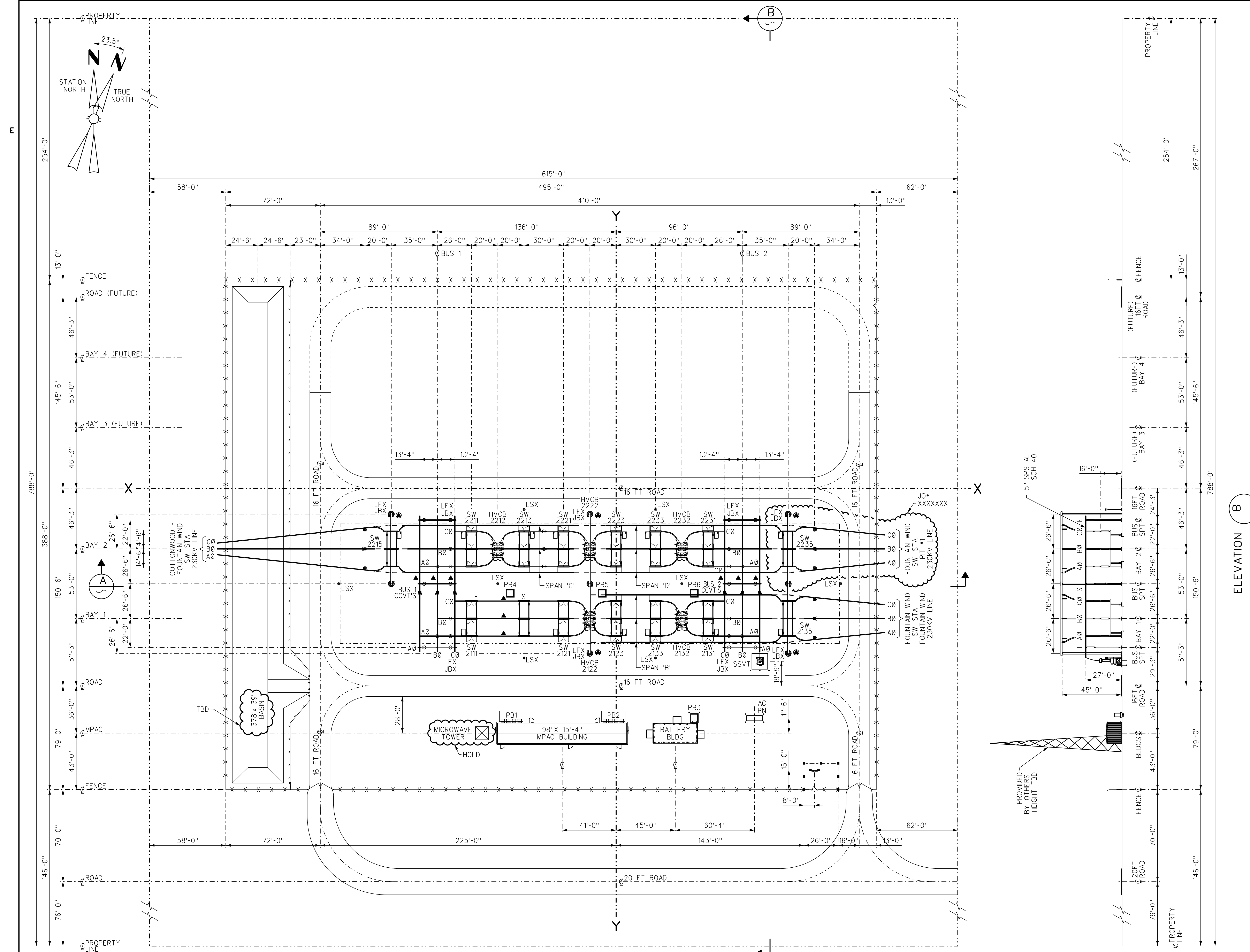

| SPAN 'A' | | | | SPAN 'B' | | | | SPAN 'D' | | | |
|--------------------------------------|------------|-------------|--|--------------------------------------|------------|-------------|--|--------------------------------------|------------|-------------|--|
| DEADEND-DEADEND | | | | DEADEND-DEADEND | | | | DEADEND-DEADEND | | | |
| 2-2300 KCMIL AAC CONDUCTOR 151' SPAN | | | | 2-2300 KCMIL AAC CONDUCTOR 151' SPAN | | | | 2-2300 KCMIL AAC CONDUCTOR 151' SPAN | | | |
| TEMP °F | TENSION LB | SAG FT - IN | | TEMP °F | TENSION LB | SAG FT - IN | | TEMP °F | TENSION LB | SAG FT - IN | |
| 30 | 659 | 9-11 | | 30 | 659 | 9-11 | | 30 | 659 | 9-11 | |
| 50 | 654 | 10-0 | | 50 | 654 | 10-0 | | 50 | 654 | 10-0 | |
| 70 | 646 | 10-2 | | 70 | 646 | 10-2 | | 70 | 646 | 10-2 | |
| 90 | 641 | 10-3 | | 90 | 641 | 10-3 | | 90 | 641 | 10-3 | |
| 110 | 635 | 10-4 | | 110 | 635 | 10-4 | | 110 | 635 | 10-4 | |

MAX. TENSION = 750# PER SUBCONDUCTOR @ 25° F, 8#WIND
 MAX. TENSION = 750# PER SUBCONDUCTOR @ 25° F, 8#WIND
 MAX. TENSION = 750# PER SUBCONDUCTOR @ 25° F, 8#WIND

ELEVATION B

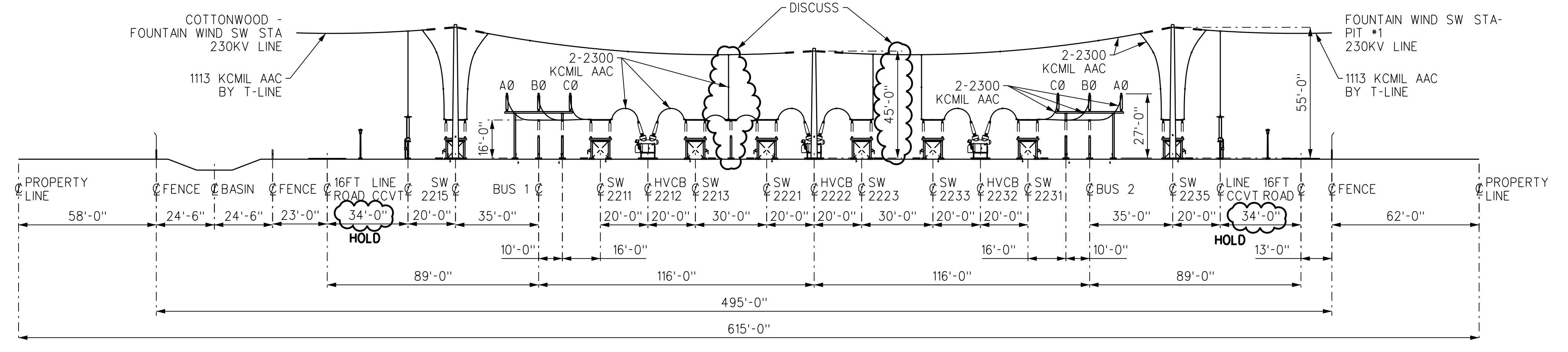
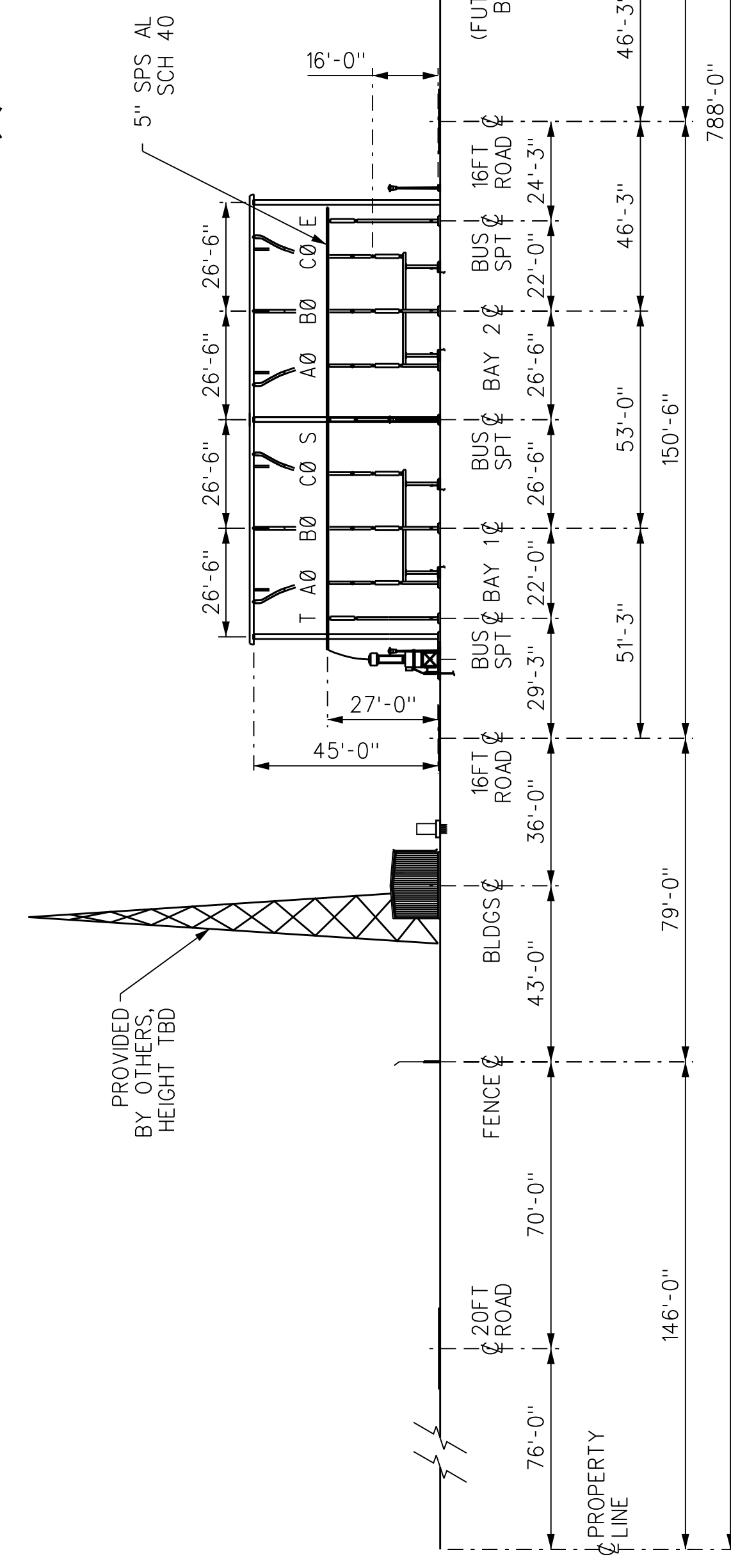

ELEVATION A

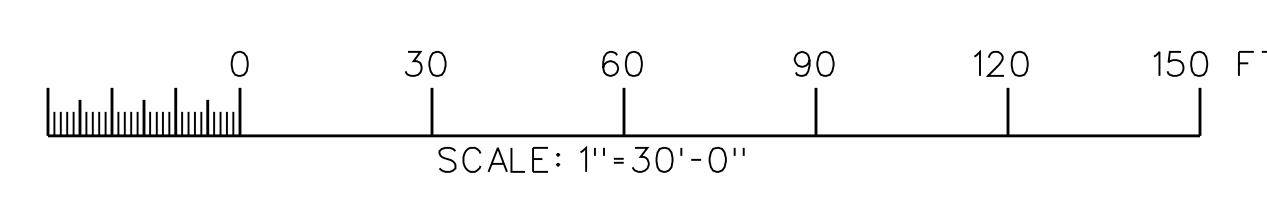

LEGEND

- LS — LIGHT STAND
- JB — JUNCTION BOX
- LF — LIGHT FIXTURE
- PB — PULL BOX
- SW — SWITCH
- HVCB — HIGH VOLTAGE CIRCUIT BREAKER
- CCVT — COUPLING CAPACITOR VOLTAGE TRANSFORMER
- E — EXPANSION BUS SUPPORT
- T — TIGHT FIT BUS SUPPORT
- S — SLIP FIT BUS SUPPORT
- ▲ — INSERT 397.5 KCMIL ACSR CABLE INTO 4" SPS AL TUBING AND 795 KCMIL ACSR CABLE INTO 6" SPS AL TUBING WHERE THE UNSUPPORTED SPAN IS 20 FEET OR GREATER FOR WIND VIBRATION DAMPING. (EDS 052646)
- — 120V-15A & 240V-20A SINGLE PHASE RECEPTACLES
- — NON-CONDUCTIVE FENCE
- - - — VINYL FENCE
- x - x - x — SUBSTATION FENCE
- - - - - — BARRIER FENCE AND CHAIN
- • • • • — REMOVABLE BOLLARDS
- - - - - — PROPERTY LINE

ELECTRICAL CLEARANCES (ES 067908 REV 5)

| | |
|--|-------------|
| PHASE TO PHASE (METAL TO METAL) | 7'-5"(MIN) |
| PHASE TO GROUND | 5'-11"(MIN) |
| VERTICAL CLEARANCE TO UNGUARDED LIVE PARTS (RECOMMENDED) | 15'-0" |
| SWITCHING STATION SHORT CIRCUIT INTERRUPTING RATING | 63KA |

- NOTES**
- 1/4" WEEP HOLES ARE INCLUDED IN THE LOW POINT OF ALL TUBULAR BUS UNITS.
 - BOND ALL SWITCH OPERATING PLATFORMS PER ES 067910.
 - IN NO CASE SHALL THE ELECTRICAL CLEARANCES BETWEEN PHASE TO PHASE AND PHASE TO GROUND BE LESS THAN SHOWN IN TABLE 3 COLUMN 4 AND TABLE 1 COLUMN 5 ON EDS 067908 RESPECTIVELY.
 - MAKE UP ALUMINUM-TO-ALUMINUM AND ALUMINUM-TO-COPPER CONNECTIONS PER ES 037788.
- REFERENCES**
- | | |
|---|---------|
| SINGLE LINE DIAGRAM | SLD |
| ULTIMATE SINGLE LINE DIAGRAM | ULTSLD |
| ULTIMATE GENERAL ARRANGEMENT OUTDOORS | ULTGAO |
| PROPERTY PLAN | PROPPLN |

SWITCHING STATION NAME TO BE PROVIDED BY PG&E

| SUBSTATION & TRANSMISSION BUSINESS LINE | | SWITCHING STATION FACILITY TYPE | | ELECTRICAL DISCIPLINE | | FOUNTAIN WIND SWITCHING STATION FACILITY NAME | | ARRANGEMENT DRAWING TYPE | | ACTIVE STATUS | | SUBSTATION FACILITY COMPONENT | | 230KV UNIT | |
|---|----------|---------------------------------|--------|-----------------------|------|---|-----|--------------------------|-------------|---------------|------|-------------------------------|------|------------|------|
| REV | DATE | DESCRIPTION | JOB NO | CHKD | SUPV | APVD | REV | DATE | DESCRIPTION | JOB NO | CHKD | SUPV | APVD | DATE | UNIT |
| B | 05/14/21 | UPDATED PER IDP COMMENTS | | | | | | | | | | | | | |
| - | - | RECEIVED ON 04/28/2021 | | | | | | | | | | | | | |
| A | 09/03/20 | APPROVED FOR CONSTRUCTION | | | | | | | | | | | | | |
| - | - | REFERENCE EDS 4042042 REV 4 | | | | | | | | | | | | | |

ELECTRIC TRANSMISSION ENGINEERING & CONSTRUCTION
 FOR QUESTIONS ON REV B OF THIS DWG
 Call DASHIELL at xxx-xxx-xxxx
 Call DASHIELL-RAJA KODURU at 713-578-6218

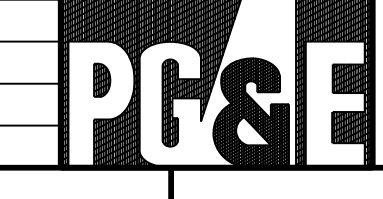

GENERAL ARRANGEMENT OUTDOORS
 FOUNTAIN WIND SWITCHING STATION
 DEPARTMENT OF ENGINEERING
 PACIFIC GAS AND ELECTRIC COMPANY
 SAN FRANCISCO, CALIFORNIA

| | |
|--------------|--------|
| SCAN | IC |
| BILL OF MATL | |
| DWG LIST | |
| SUPDS | |
| SUPSD BY | |
| SHEET NO | SHEETS |
| GAO | REV |

LINE NAMES CHECKED BY CH DATE

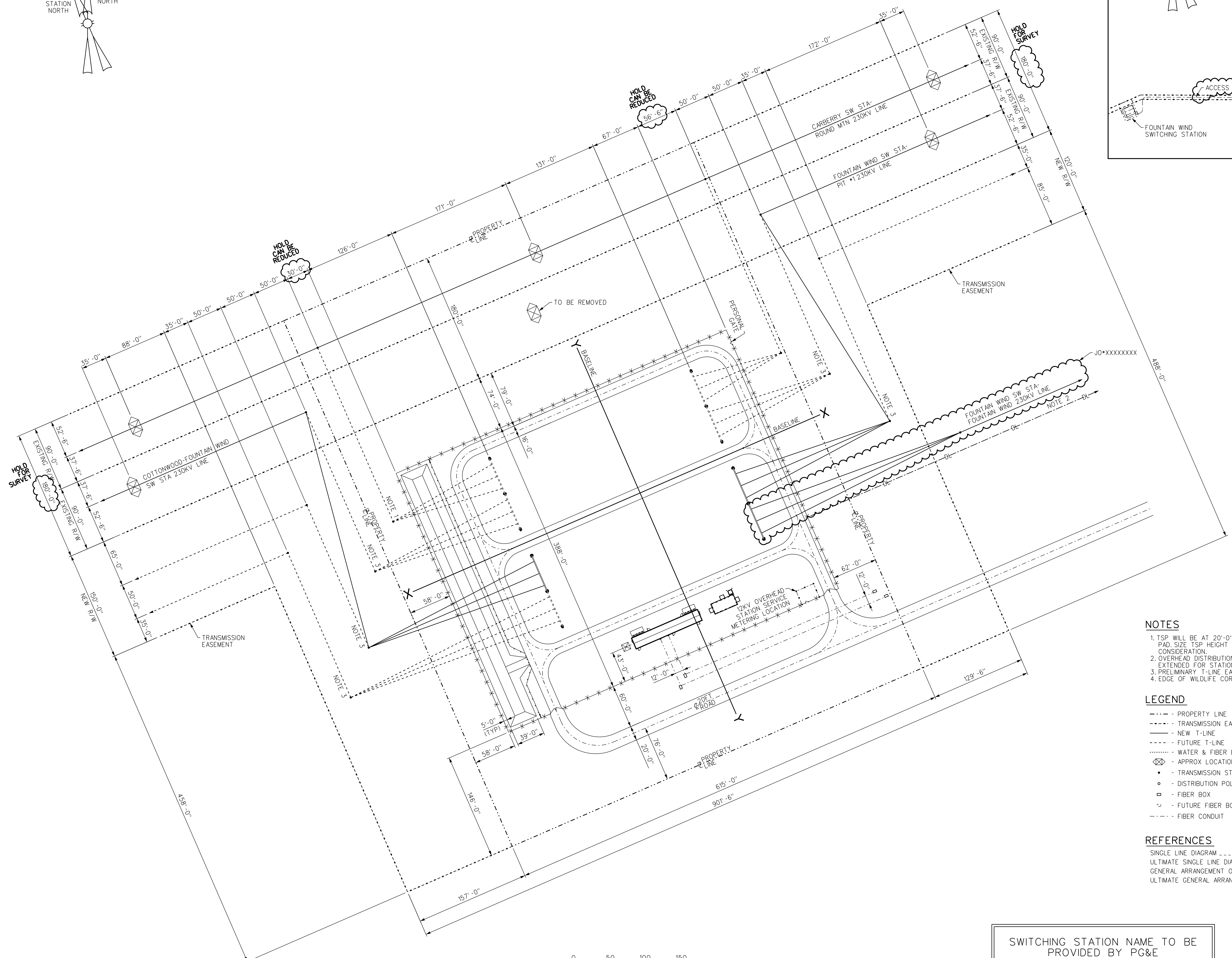
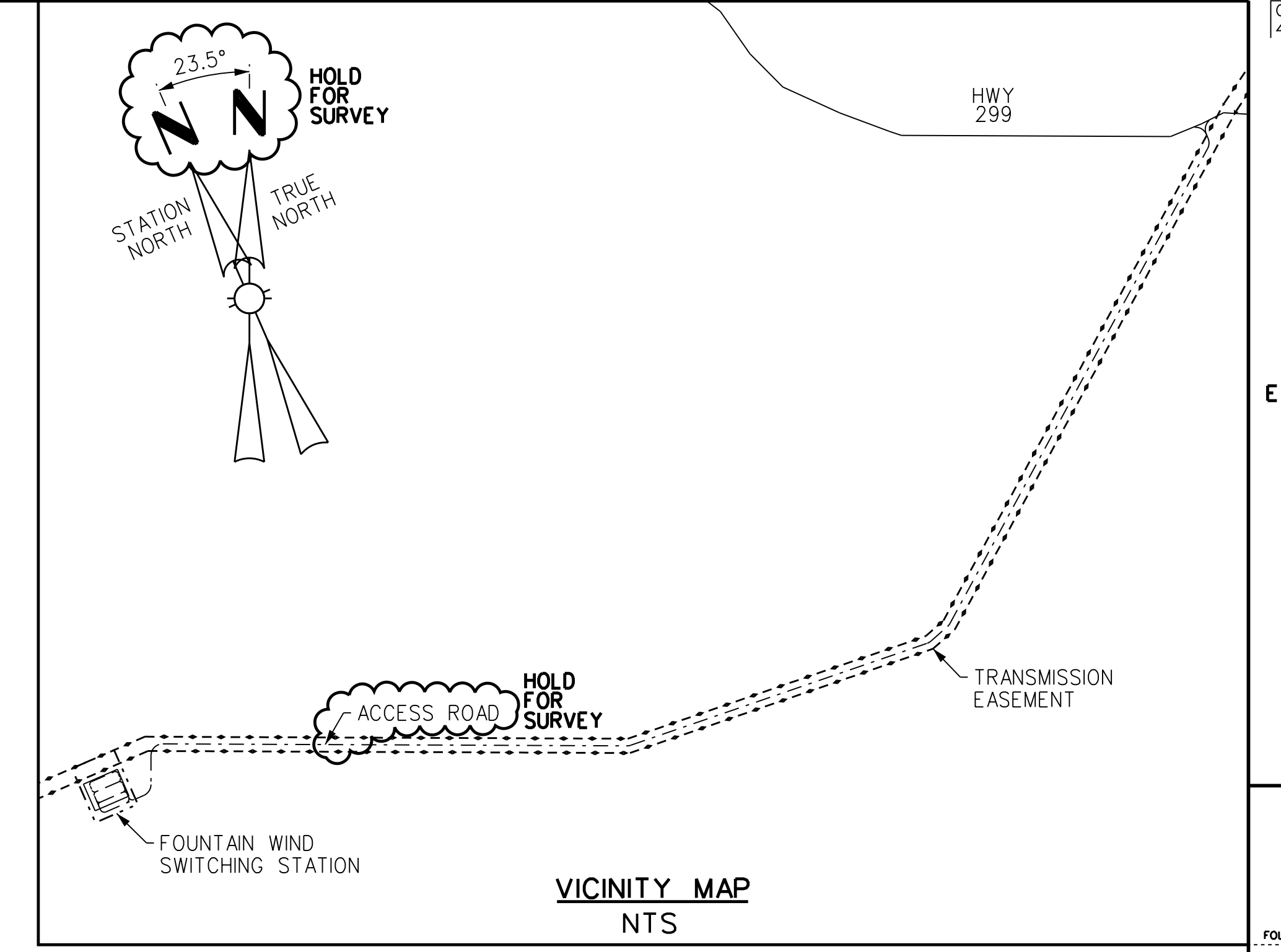
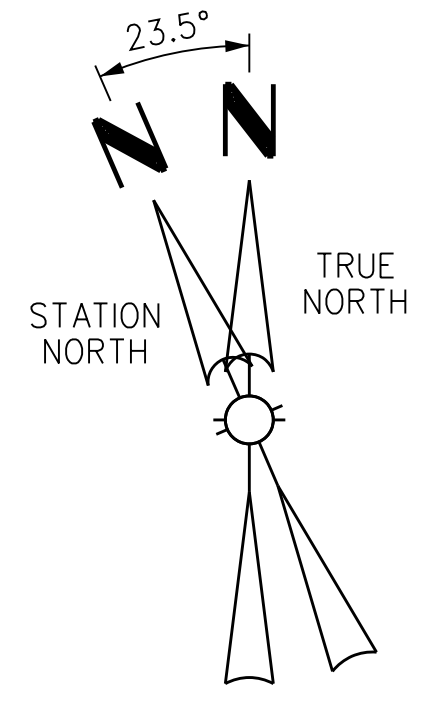

- NOTES**
- TSP WILL BE AT 20'-0" BELOW STATION PAD. SIZE TSP HEIGHT WITH THIS CONSIDERATION.
 - OVERHEAD DISTRIBUTION LINE TO BE EXTENDED FOR STATION SERVICE.
 - PRELIMINARY T-LINE EASEMENT SHOWN.
 - EDGE OF WILDLIFE CORRIDOR.

- LEGEND**
- PROPERTY LINE
 - - - TRANSMISSION EASEMENTS
 - NEW T-LINE
 - - - FUTURE T-LINE
 - WATER & FIBER EASEMENT
 - ⊗ APPROX LOCATION OF 230KV TOWERS
 - TRANSMISSION STEEL POLE
 - DISTRIBUTION POLE
 - FIBER BOX
 - ▭ FUTURE FIBER BOX
 - - - FIBER CONDUIT

REFERENCES

| | |
|---------------------------------------|--------|
| SINGLE LINE DIAGRAM | SLD |
| ULTIMATE SINGLE LINE DIAGRAM | ULTSLD |
| GENERAL ARRANGEMENT OUTDOORS | GAO |
| ULTIMATE GENERAL ARRANGEMENT OUTDOORS | ULTGAO |

SWITCHING STATION NAME TO BE PROVIDED BY PG&E

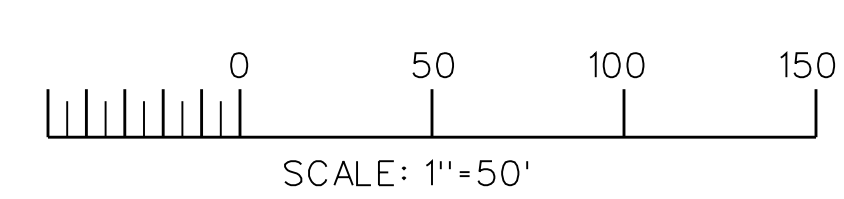

| SUBSTATION & TRANSMISSION BUSINESS LINE | | SWITCHING STATION FACILITY TYPE | CIVIL DISCIPLINE | FOUNTAIN WIND SWITCHING STATION FACILITY NAME | | ARRANGEMENT DRAWING TYPE | ACTIVE STATUS | PROJECT | SUBSTATION FACILITY COMPONENT | | 230KV UNIT | | | |
|---|----------|---------------------------------|------------------|---|------|--------------------------|---------------|---------|-------------------------------|--------|------------|------|------|------|
| REV | DATE | DESCRIPTION | JOB NO | CHKD | SUPV | APVD | REV | DATE | DESCRIPTION | JOB NO | CHKD | SUPV | APVD | DATE |
| B | 05/14/21 | UPDATED PER IDP COMMENTS | | | | | JME | RKK | | | | | | |
| - | - | RECEIVED ON 04/28/2021 | | | | | | | | | | | | |
| A | 09/03/20 | APPROVED FOR CONSTRUCTION | | | | | JME | RKK | | | | | | |
| - | - | REFERENCE EDS 4042042 REV 4 | | | | | | | | | | | | |

ELECTRIC TRANSMISSION ENGINEERING & CONSTRUCTION
 FOR QUESTIONS ON REV. B OF THIS DWG
 Call DASHIELL at xxx-xxx-xxxx
 Call DASHIELL-RAJA KODURU at 713-578-6218

PROPERTY PLAN
 FOUNTAIN WIND SWITCHING STATION
 DEPARTMENT OF ENGINEERING
 PACIFIC GAS AND ELECTRIC COMPANY
 SAN FRANCISCO, CALIFORNIA

| | |
|--------------|--------|
| SCAN | IC |
| BILL OF MATL | |
| DWG LIST | |
| SUPDS | |
| SUPSD BY | |
| SHEET NO | SHEETS |
| PROPLN | REV |

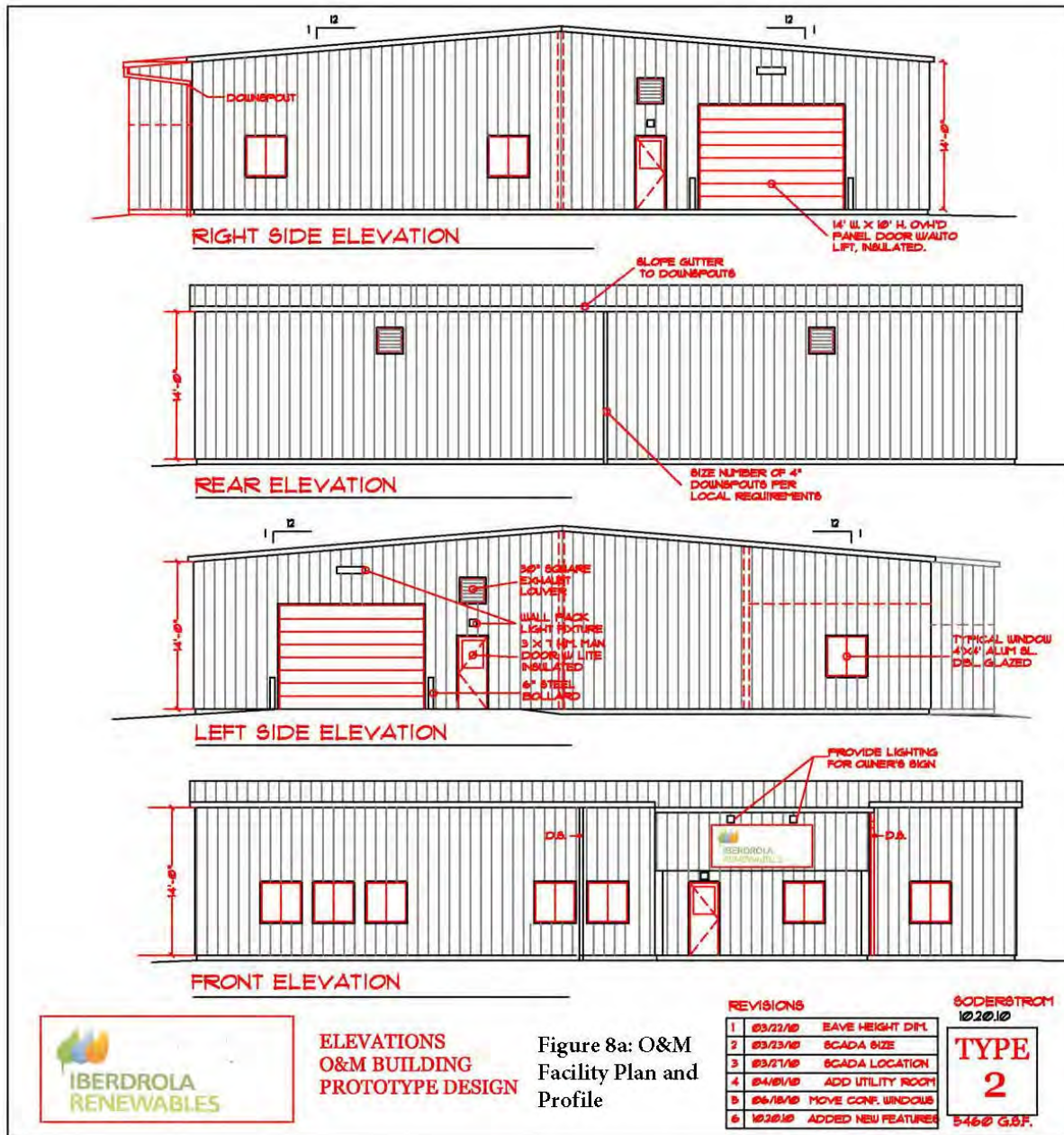

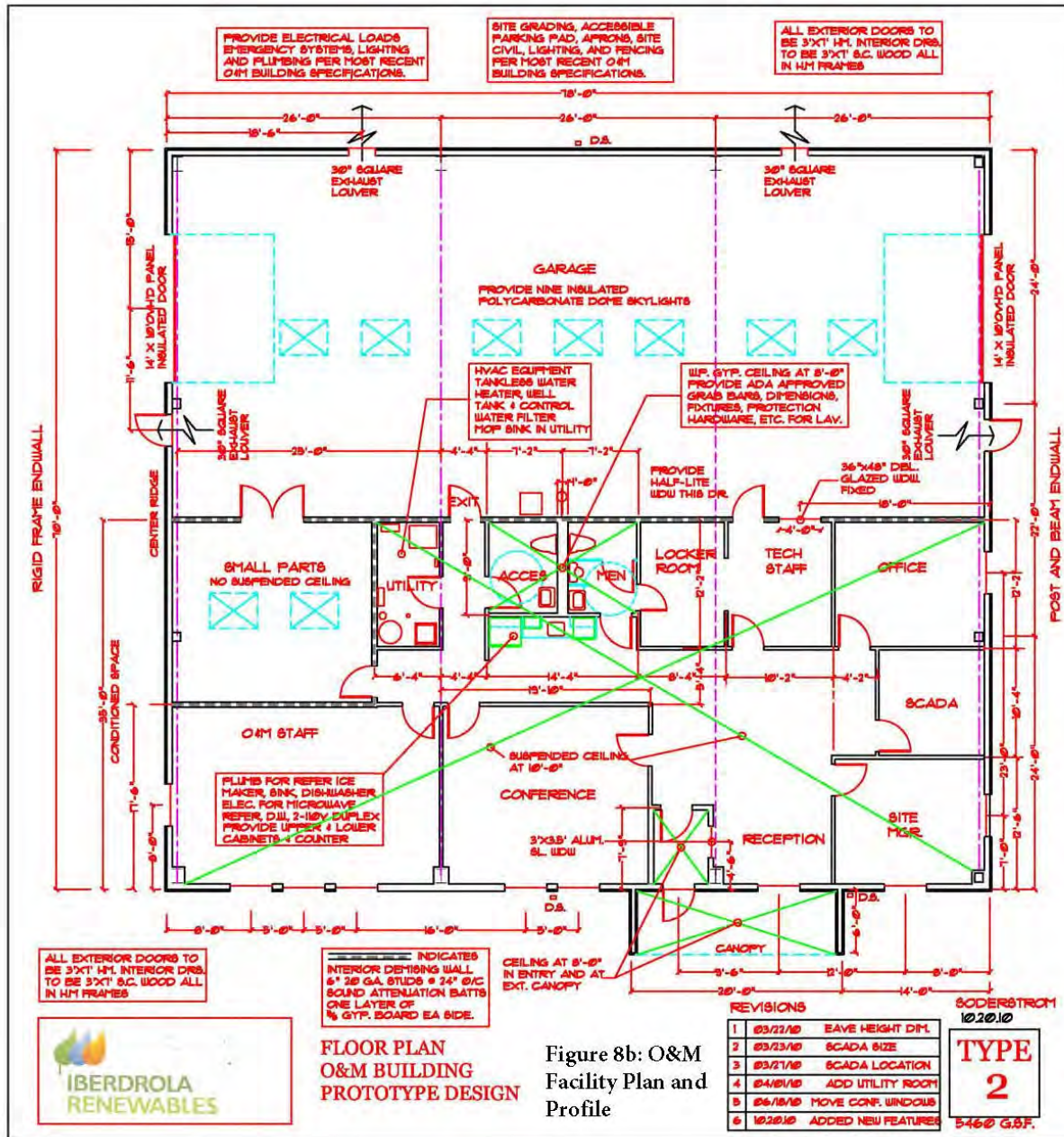

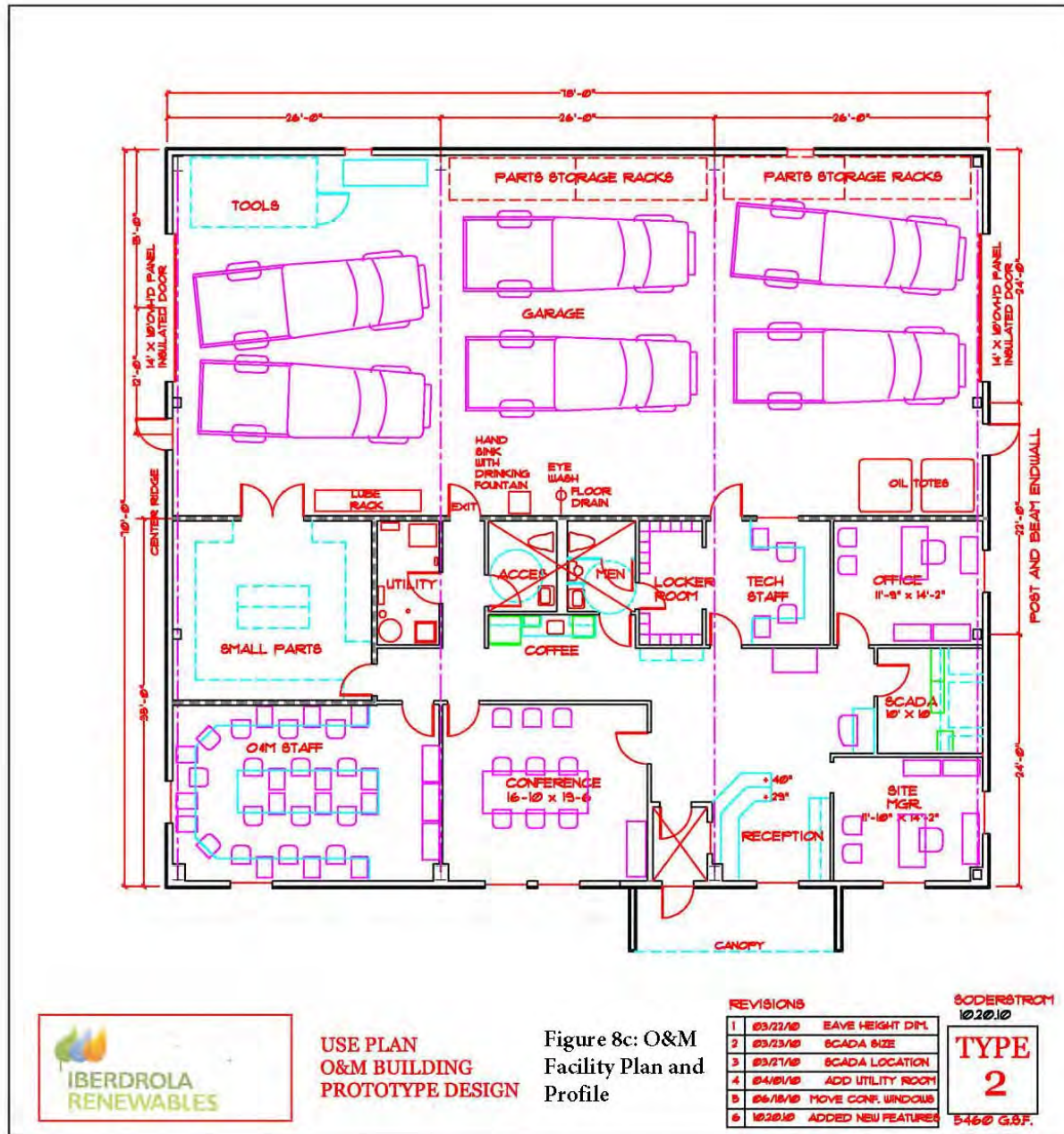



Westwood
 Phone (852) 837-5150 7688 Avogram Drive
 Fax (852) 837-5522 Eden Prairie, MN 55344
 TollFree (888) 837-5150 westwoodps.com
 Westwood Professional Services, Inc.

Figure 9: Site Plan O&M Facility

Designed: _____
 Checked: _____
 Drawn: _____
 Record Drawing by/date: _____

| Revisions # | DATE | DESCRIPTION |
|-------------|------|-------------|
| | | |
| | | |
| | | |

Prepared for:

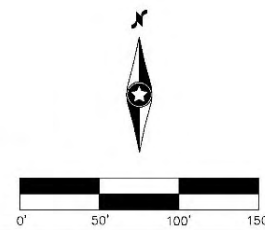

Fountain Wind Project
 Shasta County, California

O&M Exhibit

NOT FOR CONSTRUCTION

Date: 09/05/17
 Sheet: 1 OF 1

001_269-12-01.dwg