

**DOCKETED**

<b>Docket Number:</b>	17-MISC-01
<b>Project Title:</b>	California Offshore Renewable Energy
<b>TN #:</b>	254038
<b>Document Title:</b>	California Energy Commission Draft Commission Report
<b>Description:</b>	Draft_Vol III_Appendices for AB 525 Strategic Plan
<b>Filer:</b>	susan fleming
<b>Organization:</b>	California Energy Commission
<b>Submitter Role:</b>	Commission Staff
<b>Submission Date:</b>	1/19/2024 4:20:05 PM
<b>Docketed Date:</b>	1/19/2024



**CALIFORNIA  
ENERGY COMMISSION**



**CALIFORNIA  
NATURAL  
RESOURCES  
AGENCY**

California Energy Commission

## **DRAFT COMMISSION REPORT**

# **AB 525 Offshore Wind Strategic Plan**

Volume III: Appendices

**Gavin Newsom, Governor**

**January 2024 | CEC-700-2023-009-V3-AP**

# California Energy Commission

David Hochschild  
**Chair**

Siva Gunda  
**Vice Chair**

## **Commissioners**

J. Andrew McAllister, Ph.D.  
Patty Monahan  
Noemí Otilia Osuna Gallardo, J.D.

Melissa Jones  
Jim Bartridge  
Lorelei Walker  
**Primary Author(s)**

Rachel MacDonald  
**Project Manager**

Elizabeth Huber  
**Director**  
**SITING, TRANSMISSION, AND ENVIRONMENTAL PROTECTION  
DIVISION**

Drew Bohan  
**Executive Director**

## **DISCLAIMER**

Staff members of the California Energy Commission (CEC) prepared this report. As such, it does not necessarily represent the views of the CEC, its employees, or the State of California. The CEC, the State of California, its employees, contractors, and subcontractors make no warrant, express or implied, and assume no legal liability for the information in this report; nor does any party represent that the uses of this information will not infringe upon privately owned rights. This report has not been approved or disapproved by the CEC nor has the Commission passed upon the accuracy or adequacy of the information in this report.

# **ACKNOWLEDGEMENTS**

## **California Energy Commission**

Rachel MacDonald  
Susan Fleming  
Carol Robinson  
Katerina Robinson  
Elizabeth Barminski  
Danielle Mullany  
Scott Flint  
Raechel Damiani  
Kristy Chew  
Eli Harland  
Paul Deaver  
Paul Marshall

## **California State Lands Commission**

Jennifer Mattox  
Katie Robinson-Flipp  
Matt Koller  
Amy Vierra  
Nicole Dobroski

## **California Coastal Commission**

Holly Wyer  
Kate Huckelbridge  
Heather McNair  
Javier Padilla Reyes

## **California Department of Fish and Wildlife**

Becky Ota  
Eric Wilkins  
Brian Owens  
Christopher Potter  
Crystal D'Souza  
Victoria Lake  
Margarita McInnis  
Jay Staton

## **California Public Utilities Commission**

Trevor Pratt  
David Withrow  
Tommy Alexander

**California Ocean Protection Council**

Justine Kimball  
Jenn Eckerle  
Yi-Hui Wang  
Maria Rodriguez

**Bureau of Ocean Energy Management**

Sara Gultinan  
Jennifer Miller  
John Bain  
Necy Sumait

The agencies would like to acknowledge the contributions of the following contractors.

Aspen Environmental: Susan Lee, Vida Strong, Brewster Birdsall

Guidehouse: Claire Huang, Lily Busse, Amul Sathe, Robert Baker

Catalyst Environmental Solutions: Ben Pogue, Adrian Gonzalez

Greene Economics: Gretchen Greene, Jeri Sawyer

Schatz Energy Research Center: Arne Jacobson, James Zoellick, Greyson Adams

Moffatt & Nichol: Matt Trowbridge, Jennifer Lim

## ABSTRACT

Assembly Bill 525 (Chiu, Chapter 231, Statutes of 2021) directs the California Energy Commission (CEC) to complete and submit a strategic plan for offshore wind development in federal waters off the California coast to the California Natural Resources Agency and the relevant fiscal and policy committees of the Legislature.

This strategic plan is the last of four work products the CEC is directed to prepare by AB 525. The strategic plan consists of three volumes: **Volume I** is an overview report, **Volume II** is the main report, and **Volume III** contains the technical appendices.

In preparing the strategic plan, the CEC coordinated with federal, state, and local agencies and a wide variety of stakeholders. As required by AB 525, this strategic plan identifies suitable sea space to accommodate the offshore wind planning goals, develops a plan to improve ports and waterfront facilities to achieve economic and workforce benefits, and assesses transmission investments, upgrades, and associated costs. In addition, this strategic plan addresses the permitting processes for offshore wind facilities and identifies potential impacts on coastal resources, fisheries, Native American and Indigenous peoples, underserved communities, and national defense. The plan also outlines strategies for addressing those potential impacts such as avoidance, minimization, monitoring, mitigation, and adaptive management.

**Keywords:** Offshore wind energy, floating offshore wind, offshore energy, offshore development, offshore wind planning goals, decarbonization, coastal, cultural and environmental resources, renewable energy, reliability, transmission, infrastructure planning, ports and waterfront facilities, workforce, economic benefits, sea space, fisheries, floating, Assembly Bill 525, Senate Bill 100.

Please use the following citation for this report:

Jones, Melissa, Jim Bartridge, and Lorelei Walker. 2024. *Assembly Bill 525 Offshore Wind Strategic Plan*. California Energy Commission. Publication Number: CEC-700-2023-009-V3-AP

*Note: If needed, insert a blank page so that the Table of Contents begins on the right.*

# TABLE OF CONTENTS

	Page
AB 525 Offshore Wind Strategic Plan.....	i
Table of Contents.....	v
List of Figures.....	ix
List of Tables.....	x
<b>APPENDIX A: Floating Offshore Wind Technology .....</b>	<b>1</b>
<b>Floating Offshore Wind Turbine Designs .....</b>	<b>1</b>
Spar Type .....	1
Hybrid Spar Type.....	3
Semi-Submersible Type.....	3
Barge Type .....	5
Tension Leg Platform Type .....	6
Multi-Turbine Platform Type .....	7
<b>Floating Offshore Wind Mooring Systems.....</b>	<b>8</b>
<b>Anchoring Systems for Floating Offshore Wind.....</b>	<b>10</b>
<b>Transmission Cables for Floating Offshore Wind.....</b>	<b>12</b>
<b>Geohazard Considerations for Floating Offshore Wind Turbines.....</b>	<b>14</b>
<b>APPENDIX B: Floating Offshore Wind Development: Potential Impacts and Mitigation Strategies.....</b>	<b>16</b>
<b>Introduction.....</b>	<b>16</b>
Beneficial Impacts .....	16
Outreach and Collaboration .....	17
<b>Organization of Appendix B.....</b>	<b>17</b>
<b>Biological Resources .....</b>	<b>17</b>
Offshore Impacts.....	17
Onshore Impacts.....	18
<b>Biological Resource Mitigation Strategies .....</b>	<b>19</b>
Siting Surveys .....	19
Bird and Bat Conservation Strategy .....	19
Avoidance .....	20
Seasonal Restrictions .....	20
Noise.....	20
Monitoring and Adaptive Management.....	21
Marine Vessel Use, Speed, and Location Restrictions.....	21
Electric and Magnetic Fields.....	22
Minimizing Marine Entanglement.....	22
Cable Burial.....	22



Perching and Haul Out Barriers .....	22
Protect Seabed from Derelict Fishing Gear .....	23
Offshore Contamination from Construction.....	23
Protect Coastal Water Quality .....	23
<b>Fisheries – Commercial and Recreational .....</b>	<b>23</b>
Offshore Impacts.....	23
Ports and Harbors Impacts .....	24
Onshore Impacts .....	24
<b>Fisheries Mitigation Strategies.....</b>	<b>24</b>
Establish Coordination and Communication Processes .....	24
Monitor Fisheries Impacts.....	25
Maximize Access to Productive Fishing Grounds and Aquaculture Production Areas.....	25
Provide Compensatory Mitigation .....	26
Minimize Obstructions of Port Facilities Usage .....	27
Minimize Conflicts within Shipping Lanes and Transit Corridors .....	28
<b>Department of Defense Operations .....</b>	<b>29</b>
Offshore Impacts.....	29
Ports and Harbors Impacts .....	29
Onshore Impacts .....	29
Department of Defense Operations Mitigation Strategies .....	29
<b>Atmospheric and Oceanographic Processes.....</b>	<b>30</b>
Offshore Impacts.....	30
Ports and Harbors Impacts .....	30
Atmospheric and Oceanographic Processes Mitigation Strategies.....	30
<b>Climate Change.....</b>	<b>31</b>
Offshore Impacts.....	31
Ports and Harbors Impacts .....	31
Onshore Impacts .....	31
Climate Change Mitigation Strategies.....	31
<b>Cultural and Tribal Cultural Resources .....</b>	<b>31</b>
Offshore Impacts.....	31
Ports and Harbors Impacts .....	32
Onshore Impacts .....	32
Mitigation Strategies- Cultural and Tribal Cultural Resources.....	33
<b>Aesthetics .....</b>	<b>35</b>
Offshore Impacts.....	35
Ports and Harbors Impacts .....	35
Onshore Impacts .....	35
Aesthetics Mitigation Strategies.....	36
<b>Air Quality and Greenhouse Gas Emissions .....</b>	<b>36</b>
Offshore Impacts.....	36
Ports and Harbors Impacts .....	36

Onshore Impacts .....	36
Air Quality and Greenhouse Gas Emissions Mitigation Strategies .....	37
<b>Aquaculture, Agriculture, and Forestry Resources.....</b>	<b>37</b>
Offshore Impacts .....	37
Ports and Harbors Impacts .....	37
Onshore Impacts .....	38
Aquaculture, Agriculture, and Forestry Resources Mitigation Strategies .....	38
<b>Environmental Justice and Socioeconomics .....</b>	<b>39</b>
Offshore Impacts .....	39
Ports and Harbors Impacts .....	39
Onshore Impacts .....	39
Environmental Justice and Socioeconomics Mitigation Strategies .....	39
<b>Geology, Soils, and Paleontological Resources Impacts .....</b>	<b>40</b>
Offshore Impacts .....	40
Ports and Harbors Impacts .....	41
Onshore Impacts .....	41
Geology, Soils, and Paleontological Resources Mitigation Strategies.....	41
<b>Hazards, Safety, and Hazardous Materials.....</b>	<b>42</b>
Offshore Impacts .....	42
Ports and Harbors Impacts .....	42
Onshore Impacts .....	42
Hazards, Safety, and Hazardous Materials Mitigation Strategies .....	42
<b>Hydrology and Water Quality .....</b>	<b>43</b>
Offshore Impacts .....	43
Ports and Harbors Impacts .....	43
Onshore Impacts .....	43
Hydrology and Water Quality Mitigation Strategies.....	43
<b>Land Use and Planning .....</b>	<b>44</b>
Ports and Harbors Impacts .....	44
Onshore Impacts .....	44
Land Use and Planning Mitigation Strategies .....	44
<b>Mineral Resources .....</b>	<b>45</b>
Offshore Impacts .....	45
Ports and Harbors Impacts .....	45
Onshore Impacts .....	45
Mineral Resources Mitigation Strategies .....	45
<b>Noise and Vibration .....</b>	<b>45</b>
Offshore Impacts .....	45
Ports and Harbors Impacts .....	46
Onshore Impacts .....	46
Noise and Vibration Mitigation Strategies .....	46

<b>Population and Housing</b> .....	<b>46</b>
Onshore Impacts .....	46
Population and Housing Mitigation Strategies .....	47
<b>Public Services</b> .....	<b>47</b>
Offshore Impacts .....	47
Ports and Harbors Impacts .....	47
Onshore Impacts .....	47
Public Services Mitigation Strategies .....	47
<b>Recreation and Tourism Impacts</b> .....	<b>48</b>
Offshore Impacts .....	48
Ports and Harbors Impacts .....	48
Onshore Impacts .....	48
Recreation and Tourism Mitigation Strategies .....	48
<b>Transportation – Offshore and Onshore</b> .....	<b>49</b>
Offshore Impacts .....	49
Ports and Harbors Impacts .....	49
Onshore Impacts .....	50
Transportation Mitigation Strategies .....	50
<b>Utilities and Service Systems</b> .....	<b>51</b>
Ports and Harbors Impacts .....	51
Onshore Impacts .....	51
Utilities and Service Systems Mitigation Strategies .....	51
<b>Wildfire Impacts</b> .....	<b>52</b>
Onshore Impacts .....	52
Mitigation Strategies .....	52
<b>APPENDIX C: Offshore Wind Sea Space Assessment</b> .....	<b>53</b>
<b>Additional Information: Background and Identification Methods</b> .....	<b>53</b>
Assumptions and Methods .....	54
State Policy Assumptions Identified from Previous Work .....	55
General Overview of Assessment Approach .....	55
Assessment Methods .....	59
<b>Additional Information: Identification of Offshore Wind Resource and Technical Characteristics</b> .....	<b>60</b>
Wind Resource .....	60
<b>Additional Information: Screening for Marine Biological Resource Conflicts</b> ....	<b>63</b>
Marine Birds .....	63
Marine Mammals .....	66
<b>Additional Information: Characterization of Sea Space</b> .....	<b>71</b>
Del Norte Area_1 .....	74
Humboldt Area_1 .....	75
Humboldt Area_2 .....	76

Mendocino Area_1 .....	78
Mendocino Area_2 .....	79
Monterey Area_1 .....	80
<b>Additional Information: Next Steps.....</b>	<b>82</b>
BOEM Environmental Assessment.....	82
<b>Sea Space Identification Datasets.....</b>	<b>88</b>
<b>APPENDIX D: Offshore Wind Transmission .....</b>	<b>104</b>
<b>Transmission Permitting .....</b>	<b>104</b>
Investor-Owned Utility Transmission Projects .....	104
CPUC Environmental Review .....	105
Publicly Owned Utility or Merchant Transmission Projects .....	106
Federal Approval of Transmission Infrastructure Projects.....	107
<b>Transmission Alternatives Schematics.....</b>	<b>108</b>

## **LIST OF FIGURES**

	Page
Figure A-1: Hywind Spar Design Concept.....	2
Figure A-2: Toda Hybrid Spar Design Concept .....	3
Figure A-3: WindFloat Semi-Submersible Design Concept .....	4
Figure A-4: Floatgen Barge Concept.....	5
Figure A-5: SBM Tension Leg Platform Concept .....	6
Figure A-6: Hexicon Multi-Turbine Semi-Submersible Concept.....	7
Figure A-7: Catenary and Taut Mooring Lines .....	8
Figure A-8: Offshore Wind Anchoring Concepts.....	11
Figure A-9: Dynamic Cable System Concept.....	13
Figure C-1: Mean Annual Wind Resource for the Outer Continental Shelf.....	61
Figure C-2: Offshore Wind by Capacity Factor .....	62
Figure C-3: Marine Birds Map.....	64
Figure C-4: Important Bird Areas Map .....	65
Figure C-5: Marine Mammals Map .....	67
Figure C-6: Humpback Whale Habitat-Based Density Map.....	69
Figure C-7: Blue Whale Habitat-Based Density Map.....	70

Figure C-8: Gray Whale Important Biological Areas Map .....	71
Figure C-9: AB 525 Suitable Sea Space Identified for Further Analysis .....	73
Figure D-1: North Coast Transmission Alternative 7.2a Schematic .....	108
Figure D-2: North Coast Transmission Alternative 7.2b Schematic .....	109
Figure D-3: North Coast Transmission Alternative 12.4c Schematic .....	110
Figure D-4: North Coast Transmission Alternative 12.4d Schematic .....	111
Figure D-5: North Coast Transmission Alternative 25.8a Schematic .....	112

## **LIST OF TABLES**

	Page
Table A-1: Summary of Floating Offshore Wind Turbine Designs .....	8
Table A-2: Mooring System Comparison .....	9
Table A-3: Characteristics of Floating Offshore Wind Anchoring Systems .....	11
Table C-1: Characterization Summary for Del Norte Area_1 .....	74
Table C-2: Characterization Summary for Humboldt Area_1 .....	75
Table C-3: Characterization Summary for Humboldt Area_2 .....	77
Table C-4: Characterization Summary for Mendocino Area_1 .....	78
Table C-5: Characterization Summary for Mendocino Area_2 .....	79
Table C-6: Characterization Summary for Monterey Area_1 .....	80
Table C-8: Sea Space Identification Data .....	88

# APPENDIX A:

## Floating Offshore Wind Technology

---

This appendix provides a summary of the types of floating offshore wind turbines, foundation and mooring designs, and cables used to anchor them. A limited discussion of geotechnical issues that drive design of the systems is also included. Parameters include project turbine design, location, mooring system, distance from shore, and water depths for turbine operation. A more thorough discussion of these projects and additional offshore wind turbine design concepts can be found in the ABS Group report *Floating Offshore Wind Turbine Development Assessment*.<sup>1</sup>

### Floating Offshore Wind Turbine Designs

The three primary types of floating offshore wind turbine designs that are currently in use are: spar, tension leg platform (TLP), and semi-submersible. Additional hybrid forms of the primary turbine types and other designs such as barge and multi-turbine platforms are also under development. Examples of these turbine designs are provided below. There are other examples of these designs, but these have been chosen for general illustrative purposes. These floating offshore wind turbine designs are detailed in a summary table at the end of this section.

#### Spar Type

**Figure A-1** shows an Equinor-designed Hywind floating wind turbine based on a single floating cylindrical spar buoy moored by cables or chains to the seabed. The hull is made of steel or concrete, the substructure is ballasted so that the entire construction floats upright, and the spar design utilizes a spread mooring system.

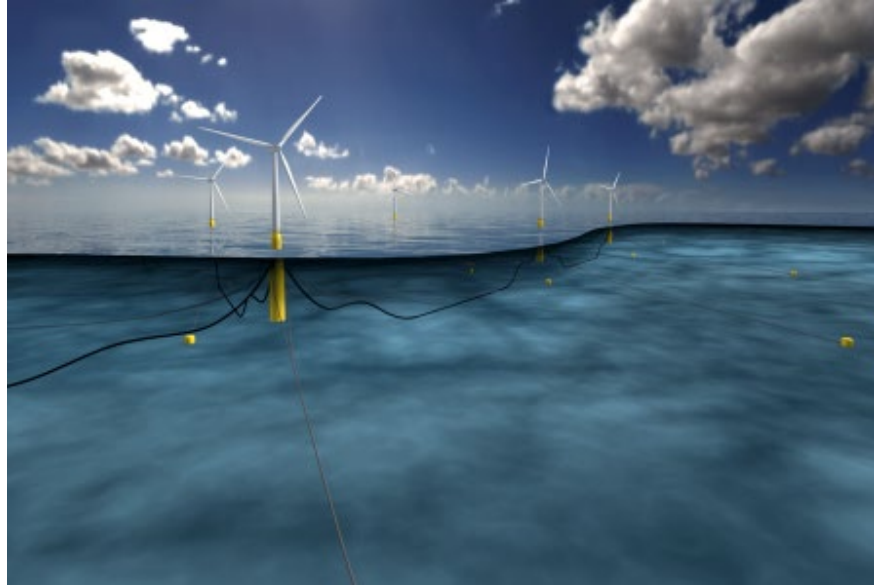
Hywind combines familiar technologies from the offshore and wind power industries into a new design. This design is being applied to the following project(s):

- Hywind Demo – 2.3-megawatt (MW) Capacity (Installed)
- Hywind Scotland – 30 MW Capacity (Installed)
- Hywind Tampen – 88 MW Capacity (Under development)
- Korea National Oil Corporation (KNOC) (Donghae 1) – 200 MW Capacity (Under development)

---

<sup>1</sup> ABS Group Consulting Inc. March 2021. [Floating Offshore Wind Turbine Development Assessment: Final Report and Technical Summary](https://www.boem.gov/sites/default/files/documents/renewable-energy/studies/Study-Number-Deliverable-4-Final-Report-Technical-Summary.pdf). OCS Study BOEM 2021-030, Task Order 140M0120F002. Available at <https://www.boem.gov/sites/default/files/documents/renewable-energy/studies/Study-Number-Deliverable-4-Final-Report-Technical-Summary.pdf>.

**Figure A-1: Hywind Spar Design Concept**



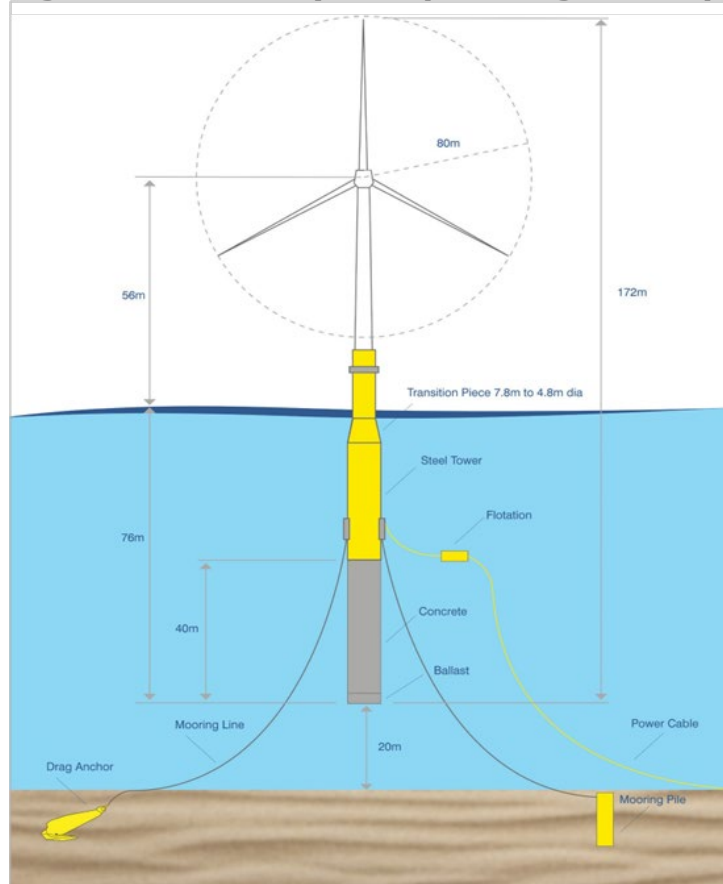
Source: ABS Group Consulting Inc. 2021.

## Hybrid Spar Type

**Figure A-2** shows a Toda-designed hybrid spar turbine, which is a hybrid spar-type floating platform consisting of a lower section of prestressed concrete and an upper section of steel. The figure provides a schematic of the spar with the concrete lower section (gray) and the upper steel section (yellow). The Toda spar design utilizes a spread mooring system. This design is being applied to the following project(s):

- Sakiyama – 2 MW Capacity (Installed)

**Figure A-2: Toda Hybrid Spar Design Concept**



Source: ABS Group Consulting Inc. 2021.

## Semi-Submersible Type

**Figure A-3** shows the Principle Power-designed WindFloat semi-submersible design which consists of three columns, heave plates at the base of each column, and an integrated wind turbine situated atop one of the three columns. The innovative features of the WindFloat dampen wave and turbine induced motion, enabling wind turbines to be sited in rougher and deeper waters. The hull is made of steel and this semi-submersible turbine design utilizes a spread mooring system. In **Figure A-3**, the red portion would be submerged, and the remaining white portion would be above water.



The Principle Power semi-submersible WindFloat design is being applied to the following project(s):

- WindFloat 1 (WF1) – 2 MW Capacity (Installed)
- WindFloat Atlantic (WFA) – 25 MW Capacity (Installed)
- Kincardine – 50 MW Capacity (Under construction)
- Les Éoliennes Flottantes du Golfe de Lion (EFGL) – 30 MW Capacity (Under development)<sup>2</sup>
- Erebus – 96 MW Capacity (Under development)
- Korea Floating Wind (KFWind) – 1,300 MW Capacity (Under development)<sup>3</sup>

**Figure A-3: WindFloat Semi-Submersible Design Concept**



Source: ABS Group Consulting Inc. 2021.

---

<sup>2</sup> Principle Power. 2023. "[Projects](https://www.principlepower.com/projects)." Available at <https://www.principlepower.com/projects>.

<sup>3</sup> Ibid.

## Barge Type

**Figure A-4** shows the Ideol Floatgen Damping Pool barge technology. The hull is a square ring-shaped foundation with a patented central opening system (Damping Pool). The shallow draft hull, made of concrete or steel, is applicable to deep offshore waters and starting at depths as shallow as 30 meters and utilizes a spread mooring system. This design is being applied to the following project(s):

- Floatgen – 2 MW Capacity (Installed)
- Hibiki – 3 MW Capacity (Installed)
- EolMed – 25 MW Capacity (Under development)
- Atlantis Ideol – 100 MW Capacity (Under development)
- Acacia – MW N/A

**Figure A-4: Floatgen Barge Concept**



Source: ABS Group Consulting Inc. 2021

## Tension Leg Platform Type

**Figure A-5** shows the SBM Offshore Tension Leg Platform (TLP) design, which is a modularized design that requires no construction or port infrastructure. The hull material is made of steel and the TLP design utilizes a tension leg mooring system. With the tension legs anchored to the seabed, the floater has a reduced seabed footprint. This design is being applied to the following project(s):

- Provence Grand Large (PGL) – 24 MW Capacity (Under development)
- CADEMO – 24 MW Capacity (Under development)

**Figure A-5: SBM Tension Leg Platform Concept**



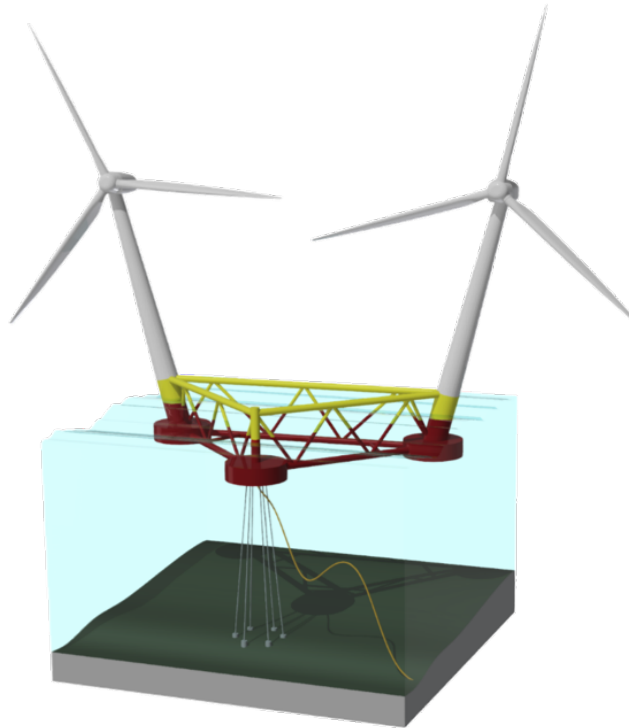
Source: ABS Group Consulting Inc. 2021.

## Multi-Turbine Platform Type

**Figure A-6** shows the Hexicon multi-turbine platform that is based on a semi-submersible design with three columns connected to a truss structure. The hull material is steel and the turret mooring system allows the platform to weathervane and passively align with the wind direction. The second-generation Hexicon design (as seen in **Figure A-6**) reduced the weight of the platform, introduced a new mooring system that optimizes seabed usage, reduced capital expenditure (CAPEX), and reduced operational expenditure (OPEX).<sup>4</sup> This design is being applied to the following project(s):

- Hexicon Dounreay Tri project – 10 MW Capacity (Under development)
- Donghae TwinWind – 200 MW Capacity (Under development)

**Figure A-6: Hexicon Multi-Turbine Semi-Submersible Concept**



Source: ABS Group Consulting Inc. 2021.

---

<sup>4</sup> Wunder Hexicon. "[Technology](https://www.wunderhexicon.es/technology)." Available at <https://www.wunderhexicon.es/technology>.

**Table A-1** is a summary of the various floating offshore wind turbine types presented in this appendix by design type. The table shows the designer, hull material, mooring system utilized, and the current estimated project capacity as of publication.

**Table A-1: Summary of Floating Offshore Wind Turbine Designs**

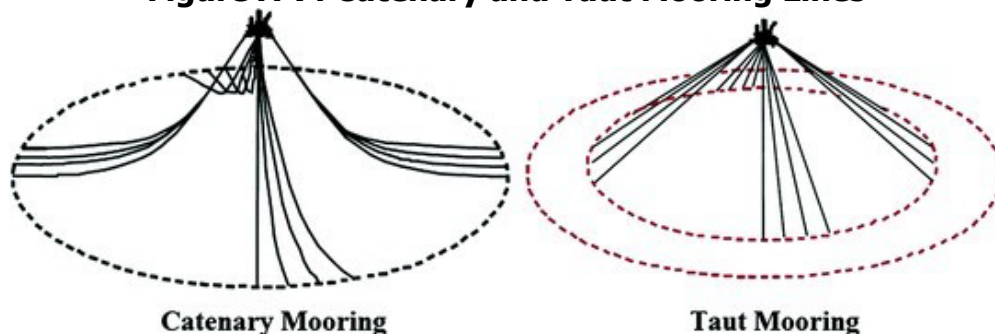
Floating Turbine Type	Designer	Hull Material(s)	Mooring System	Estimated Project Capacity (MW)
Spar	Equinor	Steel or concrete	Spread	320
Hybrid spar	Toda	Steel and concrete hybrid	Spread	2
Semi-submersible	Principle Power	Steel	Spread	1,503
Barge	Ideol	Steel or concrete	Spread	130
Tension leg platform	SBM Offshore	Steel	Tension leg	48
Multi-turbine platform	Hexicon AB	Steel	Turret	210

Source: CEC. 2023

## Floating Offshore Wind Mooring Systems

Catenary and taut mooring lines, shown in **Figure A-7**, are the most common mooring configurations utilized to keep the floating offshore wind turbine foundations in position with drag or suction anchors.<sup>5</sup> These mooring systems are similar to systems used in the oil and gas industry.

**Figure A-7: Catenary and Taut Mooring Lines**



Source: Corewind. 2020.

<sup>5</sup> Ikhennecheu, Maria, Mattias Lynch, Siobhan Doole, Friedemann Borisade, Denis Matha, Jose Domiguez, Ruben Vicente, et al. February 2020. [D2.1 Review of the state of the art of mooring and anchoring designs, technical challenges and identification of relevant DLCs](https://corewind.eu/wp-content/uploads/files/delivery-docs/D2.1.pdf). Corewind. Grant agreement No. 815083. Available at <https://corewind.eu/wp-content/uploads/files/delivery-docs/D2.1.pdf>.

Catenary mooring systems, which are used with spar-buoy and semi-submersible platforms, consist of free hanging lines. The motions of the floating turbines are limited by the weight of the lower sections of mooring chain that rests on the seafloor. These systems provide restoring forces through the suspended weight of the mooring lines, which terminate at the seabed horizontally. The anchor point is only subjected to horizontal forces at the seabed.

Taut leg systems are used with TLPs and have mooring lines that are pre-tensioned until they are stretched. The stability of the floating turbines is maintained by the high tension in the cables. These systems terminate at a 30° - 45° angle at the seabed. As a result, the anchor points are loaded by both horizontal and vertical forces.

Different mooring line materials can be used based on turbine design and water depths:<sup>6</sup>

- Conventional materials, such as chain and wire rope, are applied in tension leg system for tension leg platform (TLP)-type floating offshore wind turbines. This type of application is new for TLP.
- New materials such as polyamide (nylon) ropes are used in the design, especially for shallow water mooring systems.
- New configurations with a combination of chain, wire rope, fiber ropes, clump weight, and buoys are used to design the mooring system in shallow water.

**Table A-2** describes the two types of configurations and associated advantages and drawbacks:<sup>7</sup>

**Table A-2: Mooring System Comparison**

	<b>Catenary Mooring</b>	<b>Taut Mooring</b>
<b>Connection to seabed</b>	Horizontal	Horizontal and vertical
<b>Loads on the anchor</b>	Reduced	Large, subjected to both horizontal and vertical forces
<b>Generation of the restoring force</b>	Weight of the mooring line	Elasticity of the mooring line
<b>Degrees of freedom</b>	Some degree of horizontal movement	Limited horizontal movement
<b>Seabed disruption</b>	Lower section of chain rests on the seabed, resulting in more disruption	Low disruption
<b>Common material(s)</b>	Long steel chains and/or wires	Synthetic fibers or wires

6 ABS Group Consulting Inc. March 2021. [Floating Offshore Wind Turbine Development Assessment: Final Report and Technical Summary](https://www.boem.gov/sites/default/files/documents/renewable-energy/studies/Study-Number-Deliverable-4-Final-Report-Technical-Summary.pdf). OCS Study BOEM 2021-030, Task Order 140M0120F002. Available at <https://www.boem.gov/sites/default/files/documents/renewable-energy/studies/Study-Number-Deliverable-4-Final-Report-Technical-Summary.pdf>.

7 Ibid.

	<b>Catenary Mooring</b>	<b>Taut Mooring</b>
<b>Usual applications</b>	Spar-buoy Semi-submersible platforms	Tension leg platforms
<b>Main advantages</b>	Low cost of anchors	Small footprint Adapted to higher depth (less mooring line needed)
<b>Main drawbacks</b>	Larger footprint	High cost of anchor
<b>Industry example</b>	Hywind	Floatgen (Ideol)

Source: Corewind. 2020.

## **Anchoring Systems for Floating Offshore Wind**

Various anchoring systems can be utilized based on the mooring system, seabed conditions, and the holding capacity. The catenary mooring system is usually used with drag-embedded anchors, and taut leg mooring systems use drive piles, anchor piles, or gravity anchors. The attributes of the different kind of anchoring systems are summarized in **Table A-3**.<sup>8</sup> Photos and illustration of the different types of anchors are also shown in **Figure A-8**. These systems have been used extensively in the oil and gas industries.

The embedment depth of the anchor depends on the various factors such as the unit weight of the soil, ultimate pullout capacity and the area of the anchor. The properties and configuration of the station-keeping system of floating offshore wind turbine depends on various features of its mooring system. These characteristics are:

- Type of mooring/tendon system
- Arrangement and number of mooring lines
- Type of material used for constructing mooring/tendon line components, especially elasticity of the mooring line
- Length of mooring line
- Pretension
- Anchor type along with its size and holding capacity
- Linking between the hull and the station-keeping system
- Types, properties, and fatigue resistance of other components of mooring system such as windlass, winches, fairleads, inline buoys, clamp weights, chain stoppers, etc.

---

<sup>8</sup> James, Rhordi and Marc Costa Ros (The Carbon Trust). June 2015. *Floating Offshore Wind: Market and Technology review*. Available at <https://www.carbontrust.com/our-work-and-impact/guides-reports-and-tools/floating-offshore-wind-market-technology-review>.



**Table A-3: Characteristics of Floating Offshore Wind Anchoring Systems**

	<b>Drag-embedded</b>	<b>Driven pile</b>	<b>Suction pile</b>	<b>Gravity anchor</b>
<b>Seabed suitability</b>	Mostly applicable to cohesive sediments	Suitable for a wide range of soil condition	Limited application due to right soil conditions; not suited in loose sandy soils or stiff soils	Needs medium to hard seabed condition
<b>Type of load handling</b>	Horizontal	Vertical or horizontal	Vertical or horizontal	Usually vertical, but also horizontal
<b>Difficulty of installation</b>	Simple installation process	Because of hammer piling, creates noise during installation	Relatively simple installation process	Can have higher installation cost
<b>Recovery</b>	Recoverable during decommissioning process	Difficult to remove during decommissioning	Easy to remove during decommissioning	Difficult to remove during decommissioning
<b>Mooring system suitability</b>	Mostly used by catenary mooring system	Applicable to taut leg mooring system because of its capability to handle vertical loading		

Source: James and Ros. 2015.

**Figure A-8: Offshore Wind Anchoring Concepts**



Suction Anchor

Driven Pile





Drag Embedded Anchor



Gravity Base Anchor

Source: Floating Wind Turbines.

## Transmission Cables for Floating Offshore Wind

The power transmission systems for floating offshore wind turbines are another critical part of the technology which need to be carefully analyzed. When considering the size of substations and the severe impact of power outages, a conservative methodology is needed to select appropriate cable materials. Different methodology and concepts have been proposed for power transmission of floating offshore wind turbines due to their frequent motion, and also subjectivity to crossing faults. **Figure A-9** shows a schematic of the various types of motion and forces cables may undergo.

For power transmission from turbine to shore, export cables are used that will have copper or aluminum conductors insulated by cross-linked polyethylene or ethylene propylene rubber. The insulation is covered with a lead alloy sheath, which works as an insulation screen and makes the insulation watertight. When export cables come ashore from the offshore floating substations, it will be important to determine the optimal layout and distance of exposed versus buried cables. Dounreay Tri Limited suggested that 80% of the export cable length should be buried to water depths between 1m and 2m using ploughing and/or jetting installation techniques.<sup>9</sup> The rest of the export cable length may require protection through concrete mattresses or rock dump.

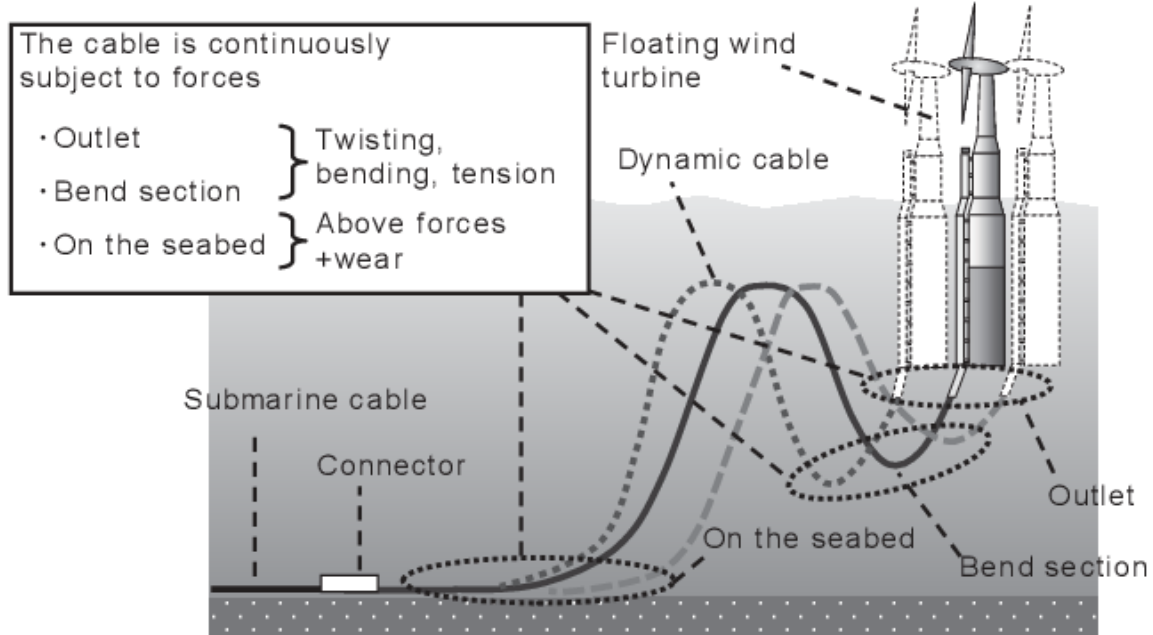
The maximum width and depth of cable protection will be 8m and 0.5m, respectively. One study noted that power cables for floating offshore wind turbines might need to be different than the cables used with fixed foundation turbines, as floating offshore wind turbines are

---

<sup>9</sup> Dounreay Tri Limited. September 2016. [Environmental Statement: Dounreay Tri Floating Wind Demonstration Project](https://marine.gov.scot/sites/default/files/environmental_statement_0.pdf). Available at [https://marine.gov.scot/sites/default/files/environmental\\_statement\\_0.pdf](https://marine.gov.scot/sites/default/files/environmental_statement_0.pdf).

subjected to frequent motion.<sup>10</sup> This researcher suggested copper might be the preferred material for sheathing of floating offshore wind turbine electrical cable design since it is resistant to fatigue, malleable, and more tolerant to large bending deflection than lead. **Volume I, Chapter 8** on transmission also discussed the status of transmission cable technology for offshore wind, as does the detailed *Guidehouse Assessment* commissioned by CEC to support the AB 525 strategic plan development.<sup>11</sup>

**Figure A-9: Dynamic Cable System Concept**



Source: Semantic Scholar.

10 Sharples, Malcolm. November 2011. [Offshore Electrical Cable Burial for Wind Farms: State of the Art, Standards and Guidance & Acceptable Burial Depths, Separation Distances and Sand Wave Effect](https://www.bsee.gov/sites/bsee.gov/files/tap-technical-assessment-program/final-report-offshore-electrical-cable-burial-for-wind-farms.pdf). U. S. Bureau of Safety and Environmental Enforcement, Project No. 671, Contract M10PC00102. Available at <https://www.bsee.gov/sites/bsee.gov/files/tap-technical-assessment-program/final-report-offshore-electrical-cable-burial-for-wind-farms.pdf>.

11 Huang, Claire, Lily Busse, and Robert Baker (Guidehouse Inc.). June 2023. [Offshore Wind Transmission Technologies Assessment: Overview of Existing and Emerging Transmission Technologies](https://efiling.energy.ca.gov/GetDocument.aspx?tn=250520&DocumentContentId=85289). California Energy Commission, No. 223437. Available at <https://efiling.energy.ca.gov/GetDocument.aspx?tn=250520&DocumentContentId=85289>.

## Geohazard Considerations for Floating Offshore Wind Turbines

Environmental conditions affect the installation, commissioning, performance, and decommissioning of floating offshore wind turbine developments. To ensure the safe operation of turbines, it is important to understand the effects of geohazards on the floating structure that supports the turbine along with its mooring system and power transmission system to the grid.<sup>12</sup> Seismic activities can impact floating offshore wind turbines in the form of ground motions as well as by associated sudden wave loading. These loads can cause failure of mooring line, scouring of the foundation and damages to the power transmission cable. As floating offshore wind turbines may be deployed in areas susceptible to earthquakes, the design of the turbines must consider the fault conditions relevant to the power transmission system, the seabed condition at the site, and the liquefaction or mud failure and consequent scour effects on the mooring.

In addition, the loads generated by seismic activity on the mooring system and buried cables should be investigated. The impacts of earthquake triggered tsunamis on the floating offshore wind turbines should be considered as environmental loads beyond normal conditions. The range of expected variations of environmental conditions should be calculated by statistical models and probabilistic methods.

In addition to earthquake and tsunami loads, there are other environmental loads that are variable in magnitude and direction over time. Landslide and slope stability require investigations based on the conditions of a specific site. While finalizing the siting and design of floating offshore wind developments, wind loads; hydrodynamic loads induced by waves and current, including drag and inertia forces; tidal effects; marine growth; and snow and ice loads should also be taken into account.

There are several standards and studies that have addressed different aspects of external forces caused by tsunami waves on floating offshore wind turbines components. While analyzing tsunami wave loading for a floating offshore wind turbine, International Organization for Standardization (ISO) requirements for offshore structures (19901-1:2015)<sup>13</sup> suggested emphasis should be given to the exposure of the floating offshore wind turbine site to the

---

12 Tajalli, Tayebah, Mahmud Monim, Kent Simpson, Tony Lapierre, Jason Dahl, Jill Rowe, and Malcolm Spaulding. May 2020. *Potential Earthquake, Landslide, Tsunami and Geo-Hazards for the U.S. Offshore Pacific Wind Farms*. OCS Study BOEM 2020-04, Task Order 140M0119C0004. Available at <https://www.boem.gov/environment/final-report-geohazards>.

13 International Organization for Standardization (ISO) 19901-1:2015 establishes general requirements for the determination and use of meteorological and oceanographic (metocean) conditions for the design, construction and operation of offshore structures of all types used in the petroleum and natural gas industries.

More information on the <https://www.iso.org/standard/60183.html> International Organization for Standardization 19901-1:2015 is available at <https://www.iso.org/standard/60183.html>.

potential directions of tsunami wave approach and related earthquake-induced currents. Although for most offshore structures, the environmental loads are dictated by extreme wind-generated waves, the very long periods of tsunami waves can have a significant impact on moored floating structures.

# **APPENDIX B:**

## **Floating Offshore Wind Development: Potential Impacts and Mitigation Strategies**

---

### **Introduction**

This appendix was developed by Aspen Environmental Group under contract to the CEC. It identifies the types of potential impacts anticipated to arise from the development and operation of offshore wind projects off the California coast. For each resource category, the discussion identifies potential impacts across the three spatial areas that would be affected – offshore, ports and harbors, and onshore. The list of impacts for each resource topic is followed by a discussion of the mitigation strategies that could be employed or adopted to address these impacts.

There is considerable ongoing academic and industry research underway on how offshore wind activities may affect environmental resources. In addition, research into the design of floating offshore wind facilities is ongoing. This research, data collection, modeling, and monitoring efforts will more fully characterize the nature and potential severity of impacts, identify impacts that are currently unanticipated, and help identify appropriate approaches to mitigating project-specific impacts. Over the next several years, the results of these efforts will produce information that will help decision makers and project proponents in identify more finely tuned project designs and strategies to minimize potential impacts.

The descriptions in this appendix of impacts and mitigation strategies are general in nature, describing the overall characteristics of potential impacts (grouped by environmental resource) and the approaches that may be taken to mitigate their effects. These are based on current knowledge of and experience with offshore and onshore development.

### **Beneficial Impacts**

The impacts defined in the remainder of this appendix are adverse impacts. However, the development of offshore wind would also have important beneficial effects:

- Renewable power generation reduces the need for fossil fuel plants that emit greenhouse gases (GHG) and other pollutants, thereby reducing GHG emissions. In addition to the reduction of these air emissions that have specific negative health effects, the reduction of GHG emissions is being targeted in order to reduce the effects of climate change, including storm intensity, wildfires, and sea level rise.
- The manufacturing, construction, and operation of offshore wind facilities and ports can create training and employment opportunities for disadvantaged and underserved communities, as well as high paying jobs. This is a beneficial impact that is expected to result from the development of this new industry in California.

## **Outreach and Collaboration**

Another activity that spans all disciplines is the implementation of collaborative outreach, coordination, and communication programs involving project proponents, key public agencies, Native American tribal groups, special interest groups, economic sector representatives, and affected communities. A robust level of engagement and collaboration will help decision makers identify issues and suggest paths to address issues and mitigate impacts.

## **Organization of Appendix B**

The remainder of this appendix is organized as follows:

- Impacts are identified for each resource type (e.g., biological resources, fisheries, cultural resources, etc.).
- Within each resources type, impacts are defined for the location of offshore wind-related activities and facilities (i.e., offshore, ports and harbors, and onshore). The type and potential intensity of impacts that may occur during development and operation of any particular offshore wind project will depend on the physical and operational characteristics of the project's equipment, its construction methods, and the nature of the environmental resources found at the locations where each offshore wind component would be assembled or installed.
- Mitigation strategies are then presented to minimize potential impacts. The mitigation strategies presented here are a compilation of recommended measures to reduce or eliminate impacts based on BOEM and State environmental documents, technical studies, and stakeholder and public input. Like impacts, the application and type of mitigation strategies will be dependent upon individual project design and construction characteristics and location specific environmental resources.

## **Biological Resources**

### **Offshore Impacts**

- Seabed habitats and sensitive species disturbed during offshore site investigations using remotely operated vehicles (ROVs) or other means.
- Aquatic habitats and species that utilize these habitats and associated benthic assemblages or aquatic vegetation disturbed by drilling, trenching, dredging, and turbine platform mooring.
- Local seafloor habitat at tower anchor sites and along electric cable routes being temporarily or permanently altered.
- Injury, mortality or alteration of behavior of various aquatic species (e.g., marine mammals, sea turtles, birds, and fish) due to vessel strikes and traffic, spills, debris, and noise, as well as light from vessel and turbine operation.
- Entanglement with monitoring survey equipment, and collisions with turbine mooring lines and electric cables.

- Secondary entanglement of marine species in derelict fishing gear snagged on projects' underwater components.
- Bird and bat collisions with turbine blades due to flight patterns or attraction to towers.
- Underwater noise and vibration during construction and operation altering marine mammal navigation, foraging, and other behaviors.
- Electromagnetic fields (EMF) from inter-array cables between turbines or subsea transmission cables to shore affecting behavior of marine species.
- Changes in wind, currents, waves, and sediment transport due to presence of wind turbines creating changes in marine animal behavior, ocean upwelling, nutrient availability, and larval transport.
- Introduction of nonindigenous marine species as a result of vessel ballast discharge or hull biofouling
- Operating turbines altering microclimatic conditions such as surface temperature, wind speed, and fog dispersion.
- Disturbance of seafloor habitat and associated fauna resulting from biofouling or damage from shallow water structural components

### **Ports and Harbors Impacts**

Coastal, terrestrial, and marine habitats and sensitive species disturbed during site investigations, port construction, and ongoing harbor activities include:

- Shoreline reconfiguration, and/or dredging disturbing aquatic and bottom habitats and the species using these habitats and associated biotic assemblages.
- Dredging, vessel strikes or traffic, spills, debris, and noise impacts from pile driving, construction/demolition, vessels operation causing injury, mortality or alteration of behavior of aquatic species (e.g., marine mammals, sea turtles, and marine/coastal birds, fish).
- Physiological or behavioral effects on marine species from EMF.
- Vessel hull biofouling or ballast water discharge introducing nonindigenous marine species.
- Port improvements resulting in loss of eelgrass and other shallow water biota and/or habitat.
- Damage to mudflats, shorelines, coastal wetlands, and submerged vegetation from vessel wake.

### **Onshore Impacts**

- Facility development disturbing or filling of wetlands.
- Human presence and construction disturbing or attracting attract wildlife.
- Project construction or operation displacing, harassing, injuring, or killing wildlife.
- Vegetation removal and grading during construction of onshore facilities, roads, housing, commercial services, utilities, etc. resulting in loss and fragmentation of habitat.
- Disturbed lands being colonized by invasive vegetation.



- Construction interfering with the movement of resident or migratory fish or wildlife species, affecting migratory wildlife corridors, or impeding the use of native wildlife nursery sites.
- Construction activities causing disturbance of anadromous fish migration and spawning success.
- Human presence and noise and light altering animal behavior.
- Construction resulting in take of protected nesting birds by disturbance or direct loss of nests.
- Presence of transmission lines creating collision risk for birds or bats.

## **Biological Resource Mitigation Strategies**

Broad protective measures would typically be applied by BOEM (offshore) and land management agencies (nearshore and onshore), including requirements for the following:

- Develop and implement an Adaptive Management Framework to guide evaluation of monitoring results, identification of unanticipated adverse effects, and implementation or modification of response actions (which may include additional mitigation or revised monitoring requirements). These actions would be taken in consultation with resource agencies: National Marine Fisheries Service (NMFS), US Fish and Wildlife Service (USFWS), and the California Department of Fish and Wildlife (CDFW).
- Develop a decommissioning plan to remove project facilities and restore the site in the future.

## **Siting Surveys**

Surveys would need to be conducted prior to and as part of project design to establish baseline conditions within the proposed turbine array area and cable routes, as well as proposed routes for support vessels transiting to/from the project area. These surveys would characterize existing conditions, identify resources potentially at risk, and be used to develop the project design in a manner that minimizes impacts.

Onshore, port, and harbor areas proposed for project-related disturbance would be surveyed to identify plants and animals that could be adversely affected by the project.

Siting surveys would also allow minimization of disturbance impacts of mooring and anchoring floating platforms on the seafloor, resulting in avoidance of hard bottom or deep-sea coral/sponge substrate or other sensitive habitats. Surveys would inform design that minimizes the areas of disturbance.

## **Bird and Bat Conservation Strategy**

Develop a Bird and Bat Conservation Strategy (BBCS) Plan to minimize adverse impacts to birds and bats. Define suitable breeding habitat and flight heights for affected species through surveys and protect such zones from intensive development. The BBCS should also examine the benefits of using low-intensity flashing lights and bird-friendly wavelengths on project structures to minimize seabird attraction based on specifications for project lighting, developed in consultation with the USFWS and U.S. Coast Guard (USCG). To reduce bird and bat impacts,



offshore lighting would be minimal, low intensity, and directed only onto the platform and not illuminate adjacent waters. Turbine lighting would be designed to not attract migrating marine birds, while being consistent with Federal Aviation Administration (FAA) requirements. Night lighting on service and support vessels should be minimized to reduce the potential for seabird attraction.

## **Avoidance**

Based on survey results and the experiences of other projects in offshore environments, specific siting plans would be developed to identify turbine locations and cable routes to avoid and minimize adverse impacts to sensitive habitats. Expansion of existing ports and harbors would also consider surveys that define sensitive habitats; design would avoid sensitive habitats to the extent feasible.

Sensitive marine habitats and biota (including hard substrate, submerged aquatic vegetation, Habitat Areas of Particular Concern, and Essential Fish Habitat) would be protected through avoidance, the establishment of buffer zones, and use of construction methods that do not create impacts (such as horizontal directional drilling for shore cable landings). Where sensitive habitat cannot be avoided, mitigation strategies would include habitat restoration, the creation and maintenance of comparable habitat, or payments to appropriate approved mitigation funds.

## **Seasonal Restrictions**

In-water construction (such as pile driving, slope stabilization, dredging, shoreline reconfiguration, and cofferdam installation and removal for work in ports and harbors) would be conducted within work windows established to avoid seasonal restrictions designed to protect listed species that might be present. When and how these in-water methods would be deployed would be identified through formal consultation with the NMFS, USFWS, and the CDFW.

Where appropriate, seasonal restrictions may be imposed on site development and operations activities. Areas to be protected would be identified. While offshore wind turbines would be widely spaced, operational adjustments to seasonal or time-of-day operation could be made to reduce impacts to migratory birds if studies indicate a substantial impact.

If protection is infeasible, alternative habitat would be identified and protected, or fees paid to an established mitigation bank. Required permits would be obtained for impacts to protected species.

## **Noise**

Coordination with NMFS to establish and implement actions and protocols to maintain an appropriate acoustic zone of influence in accordance with NMFS's published harassment threshold of 120 decibels (dB) during construction and operations activities to minimize behavioral disturbance and protect marine resources. Actions may include posting qualified marine mammal observers on vessels during daylight hours, then reducing noise where feasible during construction if a mammal approaches the acoustic zone of influence. In

addition, it would be beneficial to conduct noise-generating activities during daylight hours when feasible to ensure observations may be carried out.

### **Monitoring and Adaptive Management**

Pre-construction surveys and sampling could be conducted to characterize existing conditions prior to the start of construction. Throughout construction, ongoing monitoring and surveying of the project area could identify changes and how biological organisms, marine and terrestrial, are interacting with the project or are affected by it, including resident and migratory species and benthic communities. This strategy would allow for adaptive management, determining what are adverse and beneficial outcomes and adjusting or introducing measures that reduce adverse effects and support beneficial effects.

Qualified biological or protected species observers (BO/PSO) would perform monitoring duties during construction, maintenance, or operation elements. A monitoring plan would establish monitoring protocols and define exclusion or monitoring zones and define methods to use to dissuade marine mammals and turtles from entering active work areas. Advancements in monitoring technology should be considered to enhance human efforts.

For any in-water pile driving, a sound monitoring plan would be implemented to protect sensitive marine species and marine mammals. To address the uncertainty regarding acoustic impacts on marine life, an adaptive management approach would be used that monitors acoustic sources both before and during project implementation to determine the acoustic impacts of offshore construction and operations. This strategy could also be used to identify acoustic calls from marine mammals and determine their use of the project area and if there are significant pre- and post-project changes.

Ongoing monitoring would determine effects of seabed disturbance on sediment transport that may result in scour or aggradation.

Measures to prevent the introduction and spread of nonnative invasive species would be implemented with respect to hull cleaning, inspection of vessels from outside the region prior to use on the project, and compliance with ballast water discharge requirements.

For dredging or shoreline reconfiguration, Best Management Practices (BMPs) would typically include completion of pre- and post-construction bathymetric surveys, procedures to ensure material is properly dredged and disposed, sediment dispersion is minimized, and that the fill achieves design requirements and specifications.

### **Marine Vessel Use, Speed, and Location Restrictions**

In sensitive areas, or where marine mammals are present, restrictions would be imposed on vessel speed and separation distances defined and maintained by vessels. Crews responsible for navigation or monitoring would be trained on species sighting and reporting as well as vessel strike avoidance measures. Coordinating with NMFS when using Dynamic Positioning Vessels to install project facilities or other equipment ensures compliance with published thresholds for minimizing injury to marine mammals.

## **Electric and Magnetic Fields**

Minimize EMF impacts by using shielding on subsea cables and other electrical infrastructure, to the maximum extent practicable. Other potential adverse effects of EMF from electric cables on different species of marine life would be evaluated based on the results of ongoing studies and evaluations. This pre-construction information would be used to identify and implement mitigation that reduces the level of EMF exposure if demonstrated to have an adverse effect.

## **Minimizing Marine Entanglement**

Best management practices would be established to minimize entanglement of marine life in project-related equipment. These methods would include use of best available mooring systems and use of shortest practicable line lengths, rubber sleeves, chains, cables, or similar equipment that prevents lines from loping, wrapping, or entrapping protected species. Periodic monitoring for entangled derelict fishing gear and a strategy for removal can be tied to routine monitoring for mooring integrity or biotic surveys. A monitoring strategy would incorporate timing of the presence of species with a high risk of entanglement (e.g., baleen whales). Inter-array electrical cable depths and deployment design could be determined through an improved understanding of secondary entanglement (e.g., modeling, survey data/monitoring), in an adaptive management framework. One mitigation strategy to reduce entanglement risk could include rewarding boaters for retrieving and bring any debris that could entangle marine life to a collection area on land for proper disposal. Another mitigation strategy to reduce or offset entanglement risk would be to provide funding for the commercial crab fisheries community to switch to ropeless gear.

## **Cable Burial**

Nearshore landing of undersea transmission cables would be through horizontal directional drilled (HDD)<sup>14</sup> conduits. In deeper water, inter-array electrical cables between offshore turbines and substations and undersea transmission cables between substations and the nearshore could be buried, suspended, or a combination of these two methods. Mitigation strategies would need to identify the impacts of each approach, considering such potential adverse effects on bottom substrates and habitats, risk to/from fishing gear and dragging anchors, and potential for adverse interactions between cables and large marine animals or submersed craft.

## **Perching and Haul Out Barriers**

To reduce the attractiveness of structures to some marine mammals and birds, a mitigation strategy would be to minimize potential perching or haul out surfaces by designs or installation of barriers, if this is determined to be a concern.

---

<sup>14</sup> HDD is a trenchless method of installing underground conduits, avoiding surface disruption. Use of HDD for coastal landings of cables would avoid disturbance of shoreline and near shore environments subject to tidal and wave action.

## **Protect Seabed from Derelict Fishing Gear**

To reduce seafloor impacts from derelict fishing gear, a mitigation approach that addresses debris and equipment loss would be implemented, including the marking of equipment for identification, cleanup, and recovery procedures.

## **Offshore Contamination from Construction**

Preparation and implementation of a Spill Prevention, Contingency and Countermeasures (SPCC) Plan that identifies the largest accidental release possible at location and for an activity would identify response actions and the need for sufficient spill response equipment and booms to be on-site or readily deployed to address a release of oil, debris, or other material. Fueling of equipment would occur using proper fuel transfer procedures per US Coast Guard (USCG) regulations, spill containment, and the location will be inspected after fueling to document that no spills have occurred. Any spills will be cleaned up immediately using spill response equipment as identified in the SPCC Plan. Implementation of a materials handling, storage, and disposal plan would ensure that all hazardous materials and all waste and debris are transported, handled, stored, and disposed of consistent with State and federal regulation and are prevented from entering the ocean or contaminating the land.

## **Protect Coastal Water Quality**

Use of horizontal directional drilled (HDD) coastal landings for subsea transmission cables minimizes disturbance of sensitive coastal resources. HDD operations would develop a Drilling Fluid Monitoring and Contingency Plan that incorporates accidental drilling fluid release monitoring of coastal waters during HDD activities.

To protect water quality and the aquatic environment, silt curtains would be deployed whenever in-water construction cannot be contained within a cofferdam or when dredging activities would increase turbidity and resuspend sediment above ambient conditions in the water column. Machinery or construction materials not essential for project-related work would not be allowed in the intertidal zone.

## **Fisheries – Commercial and Recreational**

### **Offshore Impacts**

- Prohibition of offshore fishing activities due to potential conflict with offshore wind construction activities or operation.
- Interference with or restriction of commercial and recreational fishing due to presence of floating turbines or substations, undersea electric cables, anchors, and mooring cables.
- Hazards to navigation from increased vessel traffic.
- Potential snagging or loss of fishing gear due to offshore wind project vessels passing through area and losing or dropping materials into the sea.
- Interference with fishing success due to electromagnetic cables and depressed fish catches in the vicinity of offshore wind operations.

## **Ports and Harbors Impacts**

- Uncertainty as to possible reduction in fishing ground access adversely affects fishing industry and fishing community investment decisions.
- Increased navigational hazards due to increased vessel traffic and mooring of vessels, barges, and offshore wind components and from competition for access to the harbor entrance during favorable tides, seas, and weather.
- Dredging and deepening of channels or shoreline reconfiguration could impact bedforms and currents resulting in increased hazardous conditions for fishing vessels entering and existing port facilities.
- Development of port facilities to support offshore wind could displace fishing fleets due to competition for berths, vessel and gear storage, and marine services.
- Fish processing and wholesale/retail facilities may be disrupted or displaced by construction.
- Displacement of or restrictions on in-harbor fishing or seining for live bait.

## **Onshore Impacts**

- Transmission line or industrial facility construction may interfere with the movement of resident or migratory fish species, or reduce the habitat for fish species, affecting fisheries.

## **Fisheries Mitigation Strategies**

The goal of mitigation strategies for fisheries is the successful coexistence of viable offshore wind facilities with sustainable commercial and recreational fisheries, both of which would support thriving communities in coastal regions of California.

### **Establish Coordination and Communication Processes**

Develop effective and adaptive coordination, communication, and information flow among fishing industry participants, the offshore wind energy industry, relevant federal, state, and local government, coastal communities, and Native American tribes. The process would provide information regarding the locations of offshore wind data collection instrumentation and structures, area closures, and navigation restrictions. Electronic chart information would be provided to the fishing community and other mariners showing the as-built location of project infrastructure. Specifically, the following processes could be implemented:

- Implementation consultation to identify fisheries locations. Prior to construction the types, seasons, and geographic extent of commercial and recreational fisheries activities occurring in the offshore project area and between the project area and ports and harbors to be used would be identified. To minimize or avoid displacement of key fisheries facilities by offshore wind development, the fishing community would be consulted regarding the size and location of ports and harbors used by commercial and recreational fishermen and the locations of existing berths, storage areas, marine services, and processing facilities that are used.
- Develop a Fisheries/Mariners Communications Plan in which a fisheries liaison would be established to coordinate with the U.S. Coast Guard (USCG) and representatives of local

fisheries groups to publicize relevant information through local notices to mariners and to harbor masters or other port authorities as well as through project websites, social media, postings at nearby port facilities, and other appropriate means. Development of a fisheries communication plan is required by BOEM. The fisheries liaison would coordinate with commercial and recreational fishing interests to identify optimal times/seasons for fishery operations, identify types of offshore wind project activities that may conflict with such operations, and work to minimize conflicts.

- Develop memoranda of understanding and similar coordination agreements between relevant federal, state, and local agencies to prioritize and accelerate mitigation efforts.

### **Monitor Fisheries Impacts**

With cooperation from the CDFW, the Pacific States Marine Fisheries Commission, and the Pacific Fishery Management Council, utilize habitat suitability or other appropriate modeling as input to configuration of offshore wind farms, and implement effective ongoing monitoring and reporting on impacts to fisheries.

### **Maximize Access to Productive Fishing Grounds and Aquaculture Production Areas**

Specific mitigation options are as follows:

- Design floating-platform mooring systems, inter-array electrical cables, and associated aids to navigation that stabilize and gather energy from floating offshore wind energy turbines and associated equipment, while minimizing potential for gear entanglement on the periphery of wind farm areas.
- To the extent feasible, a project's design and layout would be designed to accommodate commercial and recreational fishing requirements. The orientation of turbines, cable arrays, and other project structures would attempt to accommodate local trawl tow directionality, if applicable, and to avoid specific areas of important fisheries. This would include limiting the geographic extent of exclusion areas and lost fishing grounds where possible. Turbine anchor points, foundations, scour protection, and cable protection (if required) that alter habitat important to fisheries would be minimized. The duration and location of ocean area closures required to accommodate offshore wind-related construction and activities would be minimized consistent with safety and conflict avoidance needs.
- Design of port and harbor facilities should consider whether filling, dredging and deepening of port, harbor, and channels could create new tidal and current impacts that would adversely affect access and safety for fishing industry vessels and small craft.
- To the extent feasible, subsea transmission and inter-array electrical cables would be buried, and their locations communicated to the fisheries community. Any seafloor cable protection would be designed to not introduce new snag points for mobile fishing gear and would be consistent with the existing benthic environment. Where feasible and appropriate, shore-bound subsea transmission cables would be located adjacent to existing buried undersea cables.

## **Provide Compensatory Mitigation**

When access to fishing grounds is impaired or reduced, participants should be compensated for their lost revenue. Specifically:

- Establish and fund a gear loss/damage compensation plan, including standardized, neutrally arbitrated processes to address fishing gear interactions with offshore wind energy structures. Establish a Gear Replacement Fund, including defining the basis for making claims. Mechanisms would be established to create inclusive and predictable plans for distributing compensatory mitigation payments associated with offshore wind energy development, including the loss of productive fishing grounds, cost of transit to more distant grounds, relevant transitional vessel and gear costs, and permits.
- Where in-bay or near-bay fisheries activities (such as seining for live bait, nearshore fisheries, or aquaculture production) are displaced by offshore wind project needs, alternative sites or other compensatory mitigation would be provided.
- Complete periodic surveys of offshore wind infrastructure during operation, including mooring anchors and cables. Any entangled or derelict fishing gear that could contribute to secondary entanglement of fishes, invertebrates, and marine mammals would be removed and disposed on onshore. To reduce conflicts, instrumentation, devices, or structures would be removed when no longer needed.
- Consider full funding of decommissioning accounts early in project life, rather than an incremental funding scenario that extends funding over a longer period of time.

The following additional strategies were identified through engagement with fisheries and fishing communities include to help understand and address impacts, including:

- BOEM should keep an active list of impacts in a 'living' document to be amended as more information becomes available.
- Fishing industry representatives provided an example of a Fishing Community Benefit Agreement (FCBA) template. The FCBA would:
  - Provide a mechanism for claims to be evaluated and paid for fishing gear damaged or lost due to offshore wind structures or activities.
  - Provide an annually funded fishing community fund, based on a percentage of the offshore wind lease sales (or another formula to be determined) that will enable local-level projects and programs to provide economic resilience and sustainability to the region's fisheries and related businesses. Annual funding would begin at the site-assessment phase and continue for the life of the lease.
  - The fishing community fund may also support larger state-wide industry-led organizations which work to benefit and sustain in-state wild-capture fishing communities and seafood. This work is essential to California's food security, thereby benefitting all California fishermen and related businesses.



- Establish a long-term constructive relationship between offshore wind companies, fishermen, and impacted communities. Funding would be adjusted for inflation annually.
- The first five California leases should serve as a demonstration project, allowing sufficient time to study the performance and environmental and socioeconomic effects of these wind farms. This will allow adaptive management and avoidance of future problems.
- For impacts to fishermen, deck hands, supporting businesses, and their communities, a robust, annually funded resiliency fund must be established for the duration of the leases. The fund could be based on a percentage of annual power sales (with a guaranteed minimum amount), or on an amount per turbine, or per acre, for each offshore wind lease, and adjusted annually for inflation.
  - Examples of the uses for this fund may include providing low-cost quality ice, refrigerated storage buildings, low-cost fuel, assistance with federal observer requirements and deckhand insurance costs, support for fishermen’s costs in participating in fisheries management.
  - Initial, one-time direct payments to fishermen affected by offshore wind leases, with larger payments going to any fisherman who can verify fishing activity in the WEA and cable route(s) to shore.

### **Minimize Obstructions of Port Facilities Usage**

To ensure shared use of facilities and to reduce future cumulative effects of development of offshore wind facilities, all port facilities (including wet storage and staging sites, turning basins, and navigable ship channels) should be designed to allow shared use of facilities by commercial and recreational fishing, aquaculture, and the offshore wind industry. Specific mitigation concepts include:

- Spatially separate offshore wind energy industry and fishing industry port and shore-side facilities, as well as aquaculture production and processing sites.
- Make preemptive investments and improvements to marina infrastructure, shore-side fishing gear and equipment storage sites, and anticipated direct adaptation costs that would be borne by fishery and aquaculture participants when proposed offshore wind facilities affect existing fishery gear or storage sites.
- Require offshore wind site bidders receiving a bid credit for a Lease Area Use Community Benefit Agreement (CBA) should be encouraged or required to expend a significant portion of the bid credit within those communities. BOEM has a dual approach to CBAs. One is for a Lease Area Use CBA to be established with a community or stakeholder group whose use of the lease area is directly impacted by the potential offshore wind development. The other is a bidding credit for committing to make monetary contributions to programs that support



workforce training for the offshore wind industry, develop a U.S. domestic supply chain for offshore wind, or both.<sup>15</sup>

- Create protocols for coordinated joint use of shared navigable channels, turning basins, and entrance channels as needed to minimize congestion and delays.
- Where appropriate, designate and maintain “bypass channels” with navigational aids for shallow-draft fishing and other vessels potentially delayed by offshore wind equipment transport in navigation channels.
- Provide alternative sites or other mitigation options to compensate for displaced bay uses such as aquaculture production resulting from bay waters being converted to floating storage and staging areas for floating turbines.
- In designing and developing port and harbor facilities, studies will be undertaken to identify whether dredging and deepening of channels at and near ports could create tidal and current impacts that would adversely affect access and safety for fishing industry vessels and small craft.

### **Minimize Conflicts within Shipping Lanes and Transit Corridors**

Provide safe offshore access to port facilities with minimal preventable hazards and minimize gear entanglement risk from electric transmission cables running from lease areas to landfall.

- Develop and implement coordination agreements for safe joint use of shared sea lanes and transit routes as needed to minimize congestion, conflicts, hazards, and delays.
- Align shore-bound wind energy electric transmission cables adjacent to existing buried undersea broadband fiber-optic and other shore-bound cables, consistent with existing fishery organization site agreements (where feasible).
- Develop effective navigational aids through collaborative discussion. Include consideration of lighting and markings to address navigation impacts and consider radar equipment functionality and visibility.
- Create a jobs training program for those in the fishing community seeking to develop skills need for employment on the offshore wind project, if the fishing industry may become substantially impaired by the offshore wind activity. This includes the potential for fisheries crew to transition to offshore wind support operations on marine vessels or onshore.

---

<sup>15</sup> The BOEM Pacific Wind Lease Sale 1 (PACW-1) [Draft Conceptual Strategy for Bidding Credits](https://www.boem.gov/sites/default/files/documents/renewable-energy/state-activities/CA%20BFF%20Addendum.pdf) is available at <https://www.boem.gov/sites/default/files/documents/renewable-energy/state-activities/CA%20BFF%20Addendum.pdf>.

## **Department of Defense Operations**

### **Offshore Impacts**

- Alteration of radar signals by wind turbine blade rotation (doppler effect).
- Risk of aircraft and ship collisions with turbine blades and/or turbine bases.
- Risk of ship and submarine collisions with underwater mooring cables and transmission cables.
- Loss of availability of wind project area for training and exercises.
- Risk of anchor snagging on underwater mooring cables or electrical cables by U.S. Department of Defense (DOD) vessels.
- Potential conflict from electromagnetic emissions from electric cables with DoD operations.
- Construction and activity and vessel traffic may interfere with training and exercises.
- Potentially increased need for USCG search and rescue services.

### **Ports and Harbors Impacts**

- Risk of anchor snagging of underwater electrical cables by DOD vessels.
- Potential competition for port facilities (e.g., Navy and USCG).

### **Onshore Impacts**

- Presence of additional transmission lines can create obstructions or hazards to DOD activities (including low altitude flights).

### **Department of Defense Operations Mitigation Strategies**

Measures to avoid conflict with DOD coastal, marine, and air operations would require BOEM and/or offshore wind project proponents to coordinate directly with the DOD during the leasing, siting, and design activities to ensure that the project does not interfere with DOD operations. Mitigation of effects on DOD operations would be primarily based on avoidance of conflicts, considering potential interference with navigational radar, risk of collisions with infrastructure (including anchoring systems and floating turbine structures), risk of electromagnetic emissions conflict, and risk of snagging or being entangled with underwater cables.

Construction and operation of offshore wind facilities would create the potential for an increased need for vessel lane management, law enforcement, and search and rescue activities by the USCG. This could be coordinated with the USCG through a communications plan and identification of routes for vessels and structures transiting between port and the project site. Port and harbor development would be designed to accommodate USCG facilities and transit requirements.

## **Atmospheric and Oceanographic Processes**

### **Offshore Impacts**

- Major storms could damage marine vessels or floating turbine components in deepwater environments resulting in the potential for lost materials entering the water column or being deposited on the seabed, posing risks to aquatic life, habitats, and vessels.
- Potential detrimental alteration of currents, upwelling, and sediment transport due to presence and operation of floating wind structures.
- Turbine operation may affect air currents, potentially resulting in alteration of wind patterns and wind intensity, precipitation patterns, and air and ocean surface temperatures.

### **Ports and Harbors Impacts**

- Tsunami and storm surge could damage coastal and onshore facilities, resulting in materials being introduced into the water column and being deposited on ocean floor, adversely affecting marine life and habitats and posing hazards to shipping.
- Potential detrimental alteration of currents and sediment transport due to dredging, shoreline reconfiguration, or trenching, resulting in alteration or loss of habitat.

### **Atmospheric and Oceanographic Processes Mitigation Strategies**

The designs for port and harbor facility development or alteration, including channel deepening, breakwaters, piers, turning basins, and shoreline fill would be evaluated for potential detrimental alterations of currents and sediment transport. Ports and harbors where project components would be assembled, and from where operations and maintenance would occur, would be designed to withstand anticipated effects of sea level rise, storm surge, and tsunamis. Designs would be informed by pre-installation data collection of pertinent physical and biological parameters in and adjacent to the offshore wind operations area. Data characterizing the project area (both physically and in terms of existing facilities such as communication cables) would be used to identify the most appropriate locations for offshore wind turbine anchoring.

For safety, during construction and installation activities weather forecasts would be monitored and operations halted in the event of dangerous conditions being predicted. During installation of individual turbines or facilities, marine restricted zones would be established for the time required to complete the work.

Post-installation monitoring would characterize the effects of the project's offshore elements on currents, upwelling and sediment transport. Water chemistry and physical conditions of the sea floor would be periodically monitored or sampled to identify any changes over time. Offshore wind project operators would periodically inspect and maintain structures on the seabed and in ports and harbors to ensure their integrity and designed performance under adverse conditions.

If needed, a mitigation plan to reduce radar effects would be developed in coordination with the National Oceanographic and Atmospheric Administration (NOAA) U.S. Integrated Ocean

Observing System (IOOS) Office's Surface Currents Program. Such a program may include measures to correct for radar impacts of offshore wind turbines on data collection. The offshore wind project would collect and share with the Surface Currents Program real-time telemetry of surface currents, waves, and other oceanographic data.

## **Climate Change**

### **Offshore Impacts**

- Potential damage to offshore wind facility components from major storm events may result in materials being introduced into the water column and being deposited on the ocean floor, adversely affecting marine life and habitats and posing hazards to shipping.
- More frequent and intense storm events could increase the downtime of offshore wind farms, reducing generation capacity.
- Changing environmental conditions could affect the distribution patterns of marine life, affecting their susceptibility to the effects of offshore wind development.

### **Ports and Harbors Impacts**

- Risk to project infrastructure and structures from storm events and sea level rise exacerbated by climate change.

### **Onshore Impacts**

- Wildfires, extreme storms, and floods are exacerbated by climate change and could create risk to transmission infrastructure and manufacturing facilities.

### **Climate Change Mitigation Strategies**

All offshore facilities and equipment (e.g., floating turbines, anchoring systems, inter-array electrical and subsea transmission cables, and substations) and port and harbor facilities (e.g., channels, breakwaters, piers, wharfs, warehouses, and laydown/storage areas) would be designed to consider sea level rise, alterations in storm severity and frequency, and currents anticipated to arise from climate change. Port and other onshore facilities may be designed to be protected from wildfire and flooding risks that may increase with climate change. Support for long-term monitoring programs to track changes in marine life and habitats that can help untangle the effects of climate change from those of offshore wind development.

## **Cultural and Tribal Cultural Resources**

### **Offshore Impacts**

- Introduction of structures and activities in seascape areas that are culturally and spiritually important to tribes would introduce visual or noise disturbance, degrading the overall setting and feeling of a sacred area.

- Construction and operation could result in disturbance of Tribal Cultural Resources that may be located in coastal waters.<sup>16</sup> Geophysical surveys may identify offshore resources showing evidence of a pre-contact archaeological site (e.g., stone tools, pottery or other pre-contact artifacts).
- Shipwrecks or other historic resources on the seabed may be disturbed by dredging, cable installation, anchoring, or vessel traffic. Resources may include an iron, steel, or wooden hull, wooden timbers, anchors, concentrations of historic objects, piles of ballast rock or evidence of a pre-contact archaeological site (e.g., stone tools, pottery or other pre-contact artifacts).

### **Ports and Harbors Impacts**

- Introduction of noise, traffic, and visual changes in shorelines and landscapes that are culturally and spiritually important to tribes could degrade the overall setting and feeling of a sacred area.
- Construction activities could result in direct disturbance of Tribal Cultural Resources, including burials, that may be located within port areas and could result in the loss of access to traditional cultural materials and sacred areas.
- Construction and operation of port facilities could kill or harm important living resources (e.g., condors, salmon) culturally important to tribes.
- Construction activities in ports and harbors may disturb or destroy archaeological and cultural resources.
- Shipwrecks and other submerged cultural resources in harbors may be disturbed or destroyed by dredging, cable installation, anchoring, and vessel traffic.

### **Onshore Impacts**

- Introduction of noise, traffic, and visual changes in landscapes culturally and spiritually important to tribes could degrade the overall setting and feeling of a sacred area and could result in direct disturbance Tribal Cultural Resources that may be located onshore.
- Construction and operation of port facilities could result in the loss of access to traditional cultural materials and sacred areas onshore.
- Construction activities could result in direct disturbance of Tribal Cultural Resources, including burials, that may be located within transmission line or manufacturing areas.
- Ground disturbing construction and presence of new facilities may disturb or degrade archaeological and cultural resources.

---

16 Tribal Cultural Resources are defined and established in Assembly Bill 52 (Chapter 532, Statutes 2014) to comply with the California Environmental Quality Act (CEQA). [Assembly Bill 52](https://leginfo.ca.gov/faces/billNavClient.xhtml?bill_id=201320140AB52&search_keywords=) is available at [https://leginfo.ca.gov/faces/billNavClient.xhtml?bill\\_id=201320140AB52&search\\_keywords=](https://leginfo.ca.gov/faces/billNavClient.xhtml?bill_id=201320140AB52&search_keywords=).

## **Mitigation Strategies- Cultural and Tribal Cultural Resources**

### **Government-to-Government Consultation**

Pre-construction mitigation strategies include early and ongoing consultation with Native American tribes to identify sacred and Tribal Cultural Resources/Traditional Cultural Properties that may be impacted by a project and to define any recommended project-specific mitigation measures. Compliance with AB 52 (defining consultation with affected tribes to identify Tribal Cultural Resources) is required as the first step of any California Environmental Quality Act (CEQA) process, as well as compliance with the National Historic Preservation Act Section 106 in conjunction with the National Environmental Policy Act (NEPA) process.

### **Complete Surveys**

After consultation to identify Native American concerns, surveys would be completed. Native American tribal members could participate in surveys, if desired. The Work Plan package for survey methodology and findings of surveys would be shared with consulting tribes and development of mitigation strategies would be based on consultation.

For both cultural and tribal cultural resources, surveys would include complete survey coverage of a project's area of potential effect (APE) by qualified terrestrial archaeologists, or marine archaeologists with experience analyzing marine geophysical data. They must meet the Secretary of the Interior's Professional Qualifications Standards for their respective disciplines (48 Federal Register (Fed. Reg.) 44738–44739). Surveys would follow BOEM, CLSC, and land manager standards, as applicable.

### **Avoidance of Anticipated Resources**

Mitigation strategies during construction would include establishing avoidance areas with appropriate buffers to protect significant Cultural and Tribal Cultural Resources. If avoidance is not feasible, additional investigations to determine if the resource is eligible for listing in the National Register of Historic Places and/or the California Register of Historical Resources would be required. If any resource is determined eligible for listing and cannot be avoided, a historic properties treatment plan and/or data recovery plan would be required.

### **Plan for Discovery of Unanticipated Resources**

Plans should be developed to define a process for discovery of unanticipated resources. The inadvertent discovery of human remains would require compliance with applicable laws, including the identification of the most likely Tribal ancestor group if the remains are determined to be Native American.

Any identified cultural resource would be avoided, or if avoidance is not feasible, additional investigations would be made. Investigations would determine if a resource is eligible for listing in the National Register of Historic Places and/or the California Register of Historical Resources. If any resource is determined eligible for listing and cannot be avoided, a historic properties treatment plan and/or data recovery plan would be required.

Mitigation strategies during construction would include establishing avoidance areas with appropriate buffers to protect significant cultural resources. Unanticipated Discovery Plans and Construction Monitoring Plans would be implemented.

### **Protection of Resources During Operation and Maintenance**

Depending on the nature and significance of any identified Cultural or Tribal Cultural Resource that may be affected by operations and maintenance, a long-term protection plan may be required. Additionally, any repairs, maintenance, or new construction that may be needed after initial construction of the project, should occur within the surveyed area of potential effect. New surveys would be required for areas not within the original area of potential effect.

### **Strategies for Addressing Impacts Identified by Native American Tribes and Indigenous Peoples**

These strategies were informed by formal government-to-government consultations, roundtable sessions, and other meetings between the state and California Native American tribes:

- Collaboratively co-create with California Native American tribes appropriate avoidance and mitigation strategies for impacts to tribal cultural resources and interests.
  - Continue to study and consult with tribes on the impacts of the size and timing of opening additional sea space for offshore wind development.
- Leverage existing programs and explore additional funding opportunities to compensate tribal representatives' participation in tribal consultations, meetings, and work group sessions.
- Establish strong, legally binding, tribal community benefits agreements.
  - Consider standard conditions for tribal community benefit agreements, which may include funding towards tribal roads, housing, energy reliability, tribal energy generation, microgrids, transmission line development and improvements, food sovereignty, public health, subsistence and commercial fishing, and workforce training and development.
  - Develop a template tribal community benefits agreement with baseline requirements and additional options for consideration between tribes and developers.
- Study and develop public safety measures to reduce violent crime and sexual and gender-based violence against Native American and other vulnerable populations.
  - Measures to consider include, but not limited to, community coordinator position(s) and trainings for offshore wind employees and contractors, public safety personnel, and police officers.



- In consultation with California Native American tribes, understand and identify locations and significance of Tribal Cultural Resources and develop appropriate avoidance and mitigation measures for the protection of Tribal Cultural Resources.
  - Complete pedestrian surveys (on land) and geophysical surveys (offshore) in partnership with California Native American tribes' tribal cultural resource experts.
  - Investigate if Tribal Cultural Resources are eligible for listing in the National Register of Historic Places or the California Register of Historical Resources.
  - In consultation with California Native American tribes, develop appropriate mitigation measures for inadvertent discovery of human remains and Tribal Cultural Resources.
  - Develop appropriate mitigation measures to prevent cumulative impacts to Tribal Cultural Resources, including the purchase and return of ancestral lands, cultural easements, co-management agreements, joint powers agreements, and other legal mechanisms.

## **Aesthetics**

### **Offshore Impacts**

- Visibility of offshore turbines and substations may alter scenic seascape vistas from valued coastal areas.
- Lighting on offshore turbines or substations (required for aviation and vessel safety) may be visible from onshore locations, detracting from night sky views.

### **Ports and Harbors Impacts**

- Construction of large port facilities may degrade the quality of scenic coastal areas.
- Night lighting required for 24-hour operations at port facilities and for security at facilities may degrade night sky viewsheds and create glare or nuisance effects.
- Potential conflict with zoning or other regulations governing scenic quality (e.g., designated State Scenic Highways and Scenic Corridors along the coast).

### **Onshore Impacts**

- Industrial facilities (construction yards, transmission lines, substations, warehouses, commercial buildings, new roads and infrastructure) may create contrast with undeveloped or natural landforms.
- Construction disturbance for development of access roads, grading, construction yards, and transmission tower pads may create scars visible across long distances.
- Night lighting required for 24-hour operations at substations or manufacturing facilities may degrade night sky viewsheds and create glare or nuisance effects.



- Potential conflict with zoning or other regulations governing scenic quality (e.g., designated State Scenic Highways and Scenic Corridors along the coast).

### **Aesthetics Mitigation Strategies**

Strategies to mitigate the visual impacts of offshore facilities viewed from onshore would be limited by safety requirements. The location, color, and height of turbines or floating substations would determine their visibility during daylight, while the need for aviation and vessel safety lighting would determine their nighttime visibility. The safety lighting and color treatments for offshore turbines would be subject to BOEM and USCG guidelines and Federal Aviation Administration regulatory requirements, and any modifications to reduce visual effects would require coordination with these agencies. Further, the location of offshore wind facilities would be restricted to identified wind energy areas in federal waters as defined by BOEM and the State of California.

Mitigation strategies for visual impacts at ports, harbors and onshore facilities include locating facilities outside of the viewshed of a scenic vista or other designated scenic resource to the extent feasible. Onshore facilities would be screened with vegetation and designed (i.e., size, color, texture) to minimize the visual contrast with surrounding land uses.

Paint treatments on all surfaces could be non-reflective to avoid glare. A Lighting Plan would be developed for offshore, port and harbor, and onshore facilities to minimize nighttime lighting impacts, with the requirements that outdoor lighting be directed downward and shielded, that lighting does not blink or flash, and that lighting must not exceed the maximum illumination to the extent feasible as permitted by the zoning requirements applicable to the site and regulatory safety requirements.

## **Air Quality and Greenhouse Gas Emissions**

### **Offshore Impacts**

- Construction and activities creating air pollutants and GHG emissions from equipment, marine vessels, and helicopters.

### **Ports and Harbors Impacts**

- Construction and operation and maintenance activity creating air pollutants and GHG emissions from construction vehicles, equipment, vessels, and helicopters for transporting workers and materials to the sites.
- Construction and grading/filling creating fugitive dust.
- Pollutant emissions exposing sensitive populations near port sites to substantial air pollutant concentrations.

### **Onshore Impacts**

- Construction vehicles, equipment, and workers creating criteria air pollutants and GHG emissions.

- Increased air pollutants obstructing local implementation of applicable air quality management plans or standards.
- Pollutant emissions exposing sensitive populations near inland sites to substantial air pollutant concentrations.

### **Air Quality and Greenhouse Gas Emissions Mitigation Strategies**

Strategies to mitigate the air quality and greenhouse gas emissions of offshore wind development would focus on reducing the direct emissions of fueled equipment and transportation modes, including vehicles, vessels, and helicopters. Specific strategies could include:

- Offshore, for equipment and vessels where onboard construction equipment would use diesel engines, the use of ultra-low sulfur fuel, with a maximum sulfur content of 15 parts per million, would be required, if feasible. This fuel type would be mandatory onshore.
- The use of “bunker fuel” in some larger construction vessels would be limited to a maximum fuel sulfur content requirement of 0.10 percent sulfur (1,000 parts per million sulfur), as established within U.S. EPA-designated Emission Control Areas, if feasible.
- Strategies may also include fleet wide requirements for engines to achieve Tier 4 standards, for onshore equipment (40 Code of Federal regulations (CFR) 1039) and for marine engines (40 CFR 1042).
- Renewable diesel fuel and low carbon fuels for marine vessels would reduce the impacts of GHG emissions directly caused by construction and maintenance operations.
- Permit conditions could require each project to collect information needed to determine and track actual emissions from project-related vessels, helicopters, and onshore activities. Based on the tracked actual emissions of construction activities, projects could be required to offset ozone precursor or particulate matter emissions by acquiring emissions offsets or by sponsoring emissions reduction programs onshore.
- Fugitive dust generated during construction of onshore facilities and project components would be managed in accordance with a fugitive dust control plan.
- Onshore and in State waters, stationary sources would be required to use Best Available Control Technology and achieve Lowest Achievable Emission Rate limits set by local air permitting jurisdictions.

### **Aquaculture, Agriculture, and Forestry Resources**

There would be no impacts to these resources from offshore project components and activities.

### **Offshore Impacts**

#### **Ports and Harbors Impacts**

- Construction and operation of large port facilities could limit operation of aquaculture sites and facilities, potentially requiring relocation of specific fisheries (e.g., oyster culture and

hagfish staging areas in Humboldt Bay) and limiting opportunities for development of new aquaculture sites.

### **Onshore Impacts**

- Construction of industrial facilities or transmission lines may result in loss of farmland or productive forests.
- Construction of industrial facilities or transmission lines may result in conversion of Prime Farmland, Farmland of Statewide Importance, Unique Farmland, Farmland of Local Importance, or Grazing Land to nonagricultural uses.
- Construction of industrial facilities or transmission lines may create conflict with zoning for agricultural use or Williamson Act, forest land, or Timberland Production Zones.
- Presence of industrial facilities or transmission lines may interfere with agricultural operations or convert agricultural land to non-agricultural uses.
- Transmission lines in new corridors may create a need for new easements and rights-of-way through agricultural or timber-producing areas.

### **Aquaculture, Agriculture, and Forestry Resources Mitigation Strategies**

Mitigation strategies to address the potential requirement to relocate certain aquaculture or farming facilities would include project proponents working with port and local/regional government entities on establishing and funding a relocation assistance program. The purpose of such a program would be to ensure that entities (e.g., aquaculture facilities operating in the tidal/near shore zone) would remain economically viable even if displaced by development of offshore wind infrastructure. The relocation assistance program could support staff that would help identify alternative locations, and the program would be a source of compensation for relocation costs.

Onshore construction and operational activity may result in the conversion and loss of farmland and/or timberland to non-agricultural use. Mitigation for the conversion and loss of farmland and/or timberland may occur through project proponents providing compensation funds to an agricultural land or timberland preservation trust recognized and approved by the applicable city or county. The city or county would specify the amount of the compensation amount based on the productivity of the farmland and related history of irrigation water availability, and the productivity of the timberland. In the event of a conflict with agricultural zoning or a Timberland Production Zone designation, the project proponent would need to initiate an application with the city or county for a change in zoning.

In the event of a conflict with a Williamson Act Agricultural Preserve designation and related contract, the project proponent would need to initiate a Williamson Act Non-Renewal process, or a Williamson Act Cancellation process. The offshore wind project proponent would also negotiate with farmland and/or timberland owners for the compensatory value of any easements required for transmission lines developed by the project proponent that cross the farm or timberland.

## **Environmental Justice and Socioeconomics**

### **Offshore Impacts**

- Offshore construction and operation may affect fisheries workers if offshore wind operations created limitations to or additional costs imposed on commercial fisheries activities, resulting in loss of employment.

### **Ports and Harbors Impacts**

- Construction activities at ports and harbors may create air emissions or releases of hazardous materials that may disproportionately affect nearby disadvantaged populations.
- Increases in noise, lighting, and traffic related to 24-hour offshore wind construction activities may disproportionately affect disadvantaged populations near port sites.

### **Onshore Impacts**

- Project implementation may create economic and social conditions in local communities that disproportionately affect disadvantaged populations, fisheries industry workers, less skilled workers, and tribal members.
- Underserved and disadvantaged populations may be displaced due to increased competition for housing and rising housing costs due to an influx of new workers.
- Disadvantaged populations near and on routes to project sites may be subject to disproportionate increases in noise and traffic related to 24-hour offshore wind construction activities.

## **Environmental Justice and Socioeconomics Mitigation Strategies**

Strategies to offset impacts to disadvantaged populations near ports include methods to reduce environmental impacts in general and the implementation of assistance programs to address impacts to disadvantaged communities. Examples of assistance include the following:

- Implementing a Community Partnership Program or a Local Community and Minority-Owned Business Enterprise (MBE) Program. These programs could help ensure diversity among a project proponent's contractors and subcontractors and emphasize local training and hiring practices. A Community Partnership Program could be set up to develop and foster job training and mentorship/apprentice programs, identify job opportunities through a collaborative labor needs database, operate a job training center, and assist community-based organizations in developing and implementing Business Impact Mitigation Plans to identify any adverse impacts on existing local businesses and to identify opportunities to support project needs for goods and services.
- Creation of an accessible computer communications network (e.g., at libraries and community centers) with Wi-Fi access and workstations to allow users to identify and apply for job and housing opportunities.
- Establishing a Local and Minority Business Enterprise Hiring Program to encourage maximum use of local workers firms for job categories specific to offshore wind construction and operation activities.

- Meaningfully engage with affected underserved communities to listen to concerns and suggestions for how best to address concerns raised.
- Engage with potentially affected underserved communities to explore community benefit agreements.

## **Geology, Soils, and Paleontological Resources Impacts**

### **Offshore Impacts**

- Earthquakes may cause seabed slumping or subsidence, resulting in damage to seafloor cables, anchors, or mooring facilities.

## **Ports and Harbors Impacts**

- Earthquakes may damage port facilities due to ground shaking, land slippage, or subsidence.
- Construction may result in soil erosion, slope instability, or migration of sediments offsite.
- Adverse soil and geologic characteristics may constrain development of facility foundations.
- Excavation or grading may result in disturbance or loss of unique paleontological resources.

## **Onshore Impacts**

- Earthquakes may damage facilities from ground shaking, land slippage, or subsidence.
- Construction may result in soil erosion, slope instability, or migration of sediments offsite.
- Adverse soil or geologic characteristics may constrain development of facility foundations.
- Excavation or grading may result in disturbance or loss of unique paleontological resources.

## **Geology, Soils, and Paleontological Resources Mitigation Strategies**

Strategies include the following:

- Geotechnical surveys completed prior to final design and construction would determine the characteristics of seafloor and substrate in areas of potential offshore disturbance, including their suitability for anchors or foundations, susceptibility to scour, and mobility of sediments. Geotechnical surveys would also be completed in ports and harbors, and other onshore project locations to characterize existing geologic and soils conditions to inform the design of these facilities.
- Implementation of scour protection methods to avoid development of scour holes at foundations and anchor points. Periodic inspection of the areas around anchor points and foundations would be required to assess their condition and make appropriate repairs as needed.
- Use of HDD for coastal landings of electrical cables and for crossings of waterways for underground electrical cables onshore.
- Ensure that subsea transmission cables and inter-array electrical cables are buried sufficiently to guard against erosion.
- Best management practices would be identified and implemented to minimize sediment mobilization during dredging, filling, and component installation activities.
- Paleontological surveys completed prior to project design in onshore and nearshore areas that will be disturbed by project activities should be conducted, and any identified resources protected or documented and conserved. A monitoring plan would be developed for any areas identified as having a high potential for paleontological resources that will be disturbed by construction.

## **Hazards, Safety, and Hazardous Materials**

### **Offshore Impacts**

- Accidental spill or discharge of hazardous material, trash, or debris to marine environment from turbines and vessels could contaminate seawater.
- Ballast discharge from vessels could contaminate seawater.
- Increased intensity of marine vessel use may result in collisions and loss of materials into the marine environment.
- Fires or blade loss at floating turbine may cause injury or death and loss of materials into the marine environment.
- Workers could be injured or killed in work site accidents.

### **Ports and Harbors Impacts**

- Accidental spill or discharge of hazardous material, trash, or debris in ports could contaminate coastal environments.
- Industrial development could result in increased risk of structure fires.
- New facilities could cause release of in areas with known or unknown hazardous materials in soils or coastal sediments if not properly contained.
- Increased roadway traffic may result in a greater frequency of accidents; vessel collisions may occur during transit in and out of port facilities.
- Workers could be injured or killed in work site accidents.
- Construction could create a hazard to the public or workers due to encounters with unexploded ordnance.

### **Onshore Impacts**

- Accidental spill or discharge of hazardous material in terrestrial or stream and river environments may contaminate waterways or soils.
- New industrial or transmission construction may increase the risk of structure fires.
- Construction of new facilities may release hazardous materials in soils if they are not properly contained.
- Transmission lines may create interference with radio, television, communications, electronic equipment, or cardiac pacemakers, and can create induced currents or shocks.
- Construction activities could create a hazard to the public or workers due to disturbance of unexploded ordnance.
- Construction or operational traffic could impair emergency response or evacuation plans.
- Workers could be injured or killed in work site accidents.

### **Hazards, Safety, and Hazardous Materials Mitigation Strategies**

Major construction projects typically include development and implementation of a Worker Environmental Awareness Program (WEAP) to instruct all workers on environmental and safety issues, and project-specific work requirements. The WEAP would include instruction on safety

requirements for onshore, ports and harbors, and offshore areas, including the wearing of safety gear and procedures for fire and vehicle movement safety protocols. Operators would be required to comply with Bureau of Safety and Environmental Enforcement (BSEE) Notice to Lessees and Operators, including requirements in "Marine Trash and Debris Awareness and Elimination."

To reduce the potential for hazardous materials to be discharged onshore, in ports and harbors, or in offshore areas, major construction projects can implement a Hazardous Materials Management Plan consistent with State and federal requirements. All areas of ground disturbance would be evaluated for the potential presence of hazardous wastes.

Traffic to and from construction areas may be subject to a Transportation Management Plan that identifies potential safety concerns, defines measures to reduce traffic volumes, and establishes material delivery schedules to minimize risks.

All vessels working on the project would be required to comply with USCG and port requirements regarding navigation lanes, vessel speed, lighting, communications, and other aspects of good seamanship. Vessel operators would be required to comply with State and federal regulations regarding management and discharge of ballast and the use of antibiofouling materials.

## **Hydrology and Water Quality**

### **Offshore Impacts**

- Seabed construction activities may cause short-term changes in water quality due to turbidity and sediment deposition.
- Anti-biofouling and corrosion protection measures and ballast discharge may adversely affect water quality.

### **Ports and Harbors Impacts**

- Port construction may cause turbidity or suspension of sediments, which reduces marine water quality.
- Off-site migration of stormwater runoff and silt during port construction may reduce water quality both onshore and in the marine environment.
- Anti-biofouling and vessel corrosion protection measures may introduce contaminants to seawater.

### **Onshore Impacts**

- Construction and grading activities may cause erosion and stormwater runoff affecting adjacent properties and waterbodies.

### **Hydrology and Water Quality Mitigation Strategies**

Construction methods can be developed and implemented to minimize turbidity and sediment deposition during seabed disturbing activities. Vessels involved in offshore and port and harbor construction and activities would be required to comply with applicable local, State, USCG, and



EPA permits and regulatory requirements of for vessel discharges and material handling, including ballast water discharges, sanitary discharges, handling of waste materials, and use of anti-biofouling and corrosion protection measures.

At onshore areas and at ports and harbors where construction activities would occur, development and implementation of stormwater pollution prevention plans (SWPPPs) would be required to minimize pollution of waterways and control sediment erosion and migration.

## **Land Use and Planning**

### **Offshore Impacts**

- Construction vessels and practices may result in inconsistency with maritime regulations and designations.

### **Ports and Harbors Impacts**

- Port facilities may be inconsistent with Local Coastal Programs, Port Master Plans, and other applicable planning and zoning regulations, requiring plan or zoning amendments.
- Sensitive land uses (residences, schools, etc.) adjacent to ports may be subject to increased noise, dust, traffic, or air emissions during construction and operation.
- Competition for port facilities and ongoing general Port expansions/improvements may constrain access to these facilities by other users.

### **Onshore Impacts**

- New construction may be inconsistent with applicable local planning and zoning regulations, requiring plan or zoning amendments.
- Construction of new facilities may result in long-term conversion of land or open space for industrial use, including cable landing areas, new transmission or substation facilities, and facilities.
- New construction may permanently establish new industrial use, converting lands from previous uses.
- Sensitive land uses located near future construction and sites and transportation routes may be subject to increased noise, dust, traffic, lighting, or air emissions during construction and operation.

### **Land Use and Planning Mitigation Strategies**

Mitigation strategies to offset such nuisance effects as air emissions, noise, lighting, and traffic on surrounding land uses, including sensitive receptors such as residences, hospitals, recreational uses are defined in this appendix under those resource categories.

Mitigation strategies for transportation impacts affecting sensitive receptors are addressed in the Transportation section; they include development of both a Traffic Management Plan (TMP) and a Construction Management Plan (CMP) prior to construction. A CMP can minimize construction nuisance effects on neighboring land uses by scheduling work activities outside of major events taking place onshore; monitoring onshore construction during peak tourist

season to minimize adverse effects; and specifying measures to minimize noise, vibration, and fugitive dust emissions that would affect the enjoyment of neighboring land uses. Additionally, safety zones may be implemented around construction activities to ensure public safety.

Onshore operations and maintenance activities may be inconsistent with general plan or zoning designations applicable to the site or are incompatible surrounding land uses. In this case, project proponents may be required to seek a land use plan or zone amendment. If development of an onshore site requires long-term or permanent displacement of an existing land use (e.g., residences, businesses, etc.), implementation of a relocation assistance program (including purchase of properties and funds to cover relocation) for affected land uses may be a suitable mitigation strategy.

All vessels working on each project would be required to comply with USCG and port requirements regarding navigation lanes, vessel speed, lighting, communications, and other aspects of good seamanship.

## **Mineral Resources**

### **Offshore Impacts**

- Presence of offshore turbines and associated structures may prevent access to marine mineral deposits.

### **Ports and Harbors Impacts**

- Construction or presence of a port facility may prevent access to mineral deposits (e.g., sand and gravel).

### **Onshore Impacts**

- Construction or presence of a transmission line or industrial facility may prevent access to mineral deposits.

## **Mineral Resources Mitigation Strategies**

The location of onshore facilities (including manufacturing facilities, transmission lines and access roads), ports and harbors, and offshore facilities and their proximity to important mineral resources or active extraction operations would be identified in CEQA and NEPA documents. After their identification, proposed facilities and access roads would be adjusted, where feasible, to allow continued access to important mineral resources. If avoidance is not feasible, a compensation plan would be developed for effects on existing extraction operations or resources that are made unrecoverable.

## **Noise and Vibration**

### **Offshore Impacts**

- Underwater noise and vibration from equipment, marine vessel, and helicopter use during construction and operation could alter marine mammal and fish ecology [See Biological Resources for impacts to marine resources].

## **Ports and Harbors Impacts**

- Noise and vibration associated with port facility construction, project component assembly activities may disturb nearby residents or recreational visitors.
- Noise and vibration associated with operation and maintenance activities, including vehicle, equipment, vessel, and helicopter use, may disturb nearby residents or recreational visitors.

## **Onshore Impacts**

- Construction noise and vibration (e.g., directional drilling for subsea transmission cable landing and development of electrical grid interconnection facilities) may disturb nearby residents or recreational visitors.
- Transmission line corona noise may be noticeable near operating lines during some weather conditions.
- Operation and maintenance activities (e.g., vehicle, equipment, and helicopter use) may cause noise and vibration at levels that could disturb nearby residents or occupants.

## **Noise and Vibration Mitigation Strategies**

Strategies to mitigate noise and vibration effects onshore and at ports and harbors rely on minimization techniques and ensuring compliance with any local noise regulations. Noise and vibration from marine vessel and motor vehicle traffic can be reduced by restricting hours of operation for helicopters and other loud equipment, using equipment silencers for pumps and drilling rigs, and isolating or enclosing stationary equipment that causes noise and vibration onshore. These are also examples of techniques that should be used to avoid or minimize noise and vibration impacts to residents or recreational visitors near project activities.

Construction methods and project design should incorporate efforts to minimize the intensity and duration of noise and vibration sources. For example, avoiding or minimizing pile driving, reducing the intensity of noise from dredging, and using low-noise techniques for geophysical surveys should be considered as project design features for activities offshore and near ports and harbors.

See the discussion of mitigation for Biological Resources for impacts to marine resources.

## **Population and Housing**

There are no direct impacts related to offshore development, and effects related to ports and harbors are addressed under Onshore Impacts.

## **Onshore Impacts**

- An influx of a new workforce to support construction and operation may increase the demand for temporary housing, potentially displacing existing renters.
- An influx of a new workforce to support offshore wind construction and operation may increase the demand for permanent housing, requiring local communities to plan for future housing development.

## **Population and Housing Mitigation Strategies**

Project proponents may fund the establishment and administration of a relocation assistance program, should it become necessary to help the workforce locate temporary and permanent housing. This would be done in a manner that does not displace existing residents.

An increased demand for temporary and permanent housing would require that local communities plan for and construct various types of new residential development. Port developers and/or project proponents could provide mitigation by funding the added costs to communities of planning and approving residential development (e.g., by funding the hiring of additional planning and plan review staff).

## **Public Services**

### **Offshore Impacts**

- Construction and operation activities may create an increased need for search and rescue services.

### **Ports and Harbors Impacts**

- Competition for port facilities may displace existing port services.
- Increased port facility size and employment may increase demand for public services within local communities (e.g., police, fire, libraries, schools).

### **Onshore Impacts**

- An influx of a new workforce to support and construction and operation may increase demand for public services within port local communities (e.g., police, fire, libraries, schools).
- Construction and operation activities may create an increased need for emergency response services or firefighting.

## **Public Services Mitigation Strategies**

To mitigate the potential need for increased search and rescue services that may result from construction of and support for either onshore, port and harbor, or offshore activities, a project proponent would coordinate with the USCG, Cal Fire, local agencies, and other recognized search and rescue units to assess the level of additional services that maybe be required. Mitigation may include a determination of the project's fair share of increased expenses that may be required to provide the required services.

Long-range processes funded by transmission, port, or project proponents may include working with responsible agencies to identify any need for expanded or new public facilities, such as fire and police stations, schools, and libraries, and their associated equipment and material needs arising for project-induced population increases. The process would identify fair-share contributions from the project proponent and those costs reasonably borne by the local community through expanded tax revenues and grants.

## **Recreation and Tourism Impacts**

Please see also the discussion of Aesthetics, because effects that may reduce the perceived scenic nature of the coast may also reduce tourism. However, the development of the industry could also create tourism opportunities for people interested in seeing the operation of these large-scale facilities.

### **Offshore Impacts**

- The presence of offshore turbines and associated structures and increased vessel traffic may contribute to a decline in tourist activities or opportunities (e.g., recreational fishing/boating and whale watching).
- Turbine structures, inter-array cables, electrical cables, or vessel traffic may create conflicts with recreational users.

### **Ports and Harbors Impacts**

- The proximity of port industrial facilities to a recreation area may diminish the value or character of that recreation area due to the change in visual setting, or due to construction and operational noise, dust, or other emissions.
- Increased competition for port facilities and services may constrain access for recreational boaters, whale tour boats, and party fishing boats.
- New port construction and development may interfere with public coastal access to beaches and shorelines.

### **Onshore Impacts**

- Transmission lines and industrial facilities may occupy lands designated or currently used for recreation, or obstruct access to a recreation site, reducing access or visitation.
- The proximity of industrial facilities to a recreation area may diminish the value or character of that recreation area.
- The influx of a new workforce to support construction and operation may increase demand for local parks and recreation areas.
- New construction and industrial development along coastal areas may contribute to a decline in existing tourism and interfere with public coastal access.

## **Recreation and Tourism Mitigation Strategies**

Mitigation strategies for recreation and tourism impacts are similar to those applicable to land use and planning (see Section A.16.2 above) because recreation is considered a sensitive land use. To reduce potential conflicts with recreation and tourism, a port, transmission, or project proponent could formally coordinate with local tourism and economic development agencies and organizations to identify ways to avoid or reduce adverse impacts, ensure adequate coastal access, and devise mutually beneficial strategies to enhance visitor experiences. This collaboration would also identify the need for any additional recreational facilities in the community and region as a result of population growth attributable to activities in general.

To avoid preclusion or curtailment of recreational activities due to construction at ports and harbors and onshore, mitigation could include development of a TMP and a CMP. Both plans should be coordinated with and reviewed and/or approved by the public agencies with jurisdiction over the affected roads (i.e., Caltrans and local road agencies) and recreation resources (i.e., federal, State, and local parks and recreation agencies). Implementation of a TMP could minimize disruptions to recreation and tourism activities by encouraging worker carpooling, remote parking, and use of alternate transportation modes and planning construction activities to avoid periods of high visitor traffic volumes. A CMP could minimize effects on neighboring recreational areas by scheduling potentially disruptive work activities outside of times when major recreation or tourist events take place onshore or offshore. A CMP may also prescribe specific measures to minimize noise, vibration, and fugitive dust emissions in order to allow continued enjoyment of nearby recreational and tourist areas.

To minimize offshore conflicts, project structures would be marked with appropriate navigation aids, as required by the USCG. Outreach would be conducted to inform mariners of project structures or activities to be avoided in the area (e.g., Notice to Mariners, flyers posted at marinas and docks). Subsurface floats could be installed at sufficient depth to avoid potential vessel strike. Developers would work cooperatively with commercial, charter, and recreational fishing entities and interests to avoid and minimize potential space-use conflicts with commercial and recreational interests during construction and operation.

During the transportation of offshore components from port and harbor facilities to their offshore installation sites, mitigation strategies may include public notifications and safety measures to preclude impacts to recreational boating. This effort may require establishing safety zones along transport routes and locations where foundations, turbines, and the offshore subsea transmission and inter-array electrical cables are installed.

## **Transportation – Offshore and Onshore**

### **Offshore Impacts**

- Increased marine vessel traffic during pre-construction surveys, construction, and could increase risk of collision.

### **Ports and Harbors Impacts**

- Port operation supporting activities may result in collisions with vessels and port facilities or port access issues when turbines are being towed out of port.
- Increased port employment may result in traffic congestion and increased demand for parking at and near the port.
- Temporary mooring for boats and barges or wet storage of turbines or components may create hazards to vessels transiting the port area.

## **Onshore Impacts**

- Construction or operation of an industrial facility or transmission line may conflict with a program, plan, ordinance, or policy addressing the circulation system, including transit, roadway, bicycle, and pedestrian facilities.
- Operation of a large industrial facility may disrupt performance of the circulation system or conflict with CEQA Guidelines section 15064.3, subdivision (b), pertaining to vehicle miles travelled.
- Project construction or operation may require temporary closure of lanes or roadways that would substantially restrict the movement of emergency vehicles or create other hazards.
- Project construction may require use of heavy construction vehicles that damage to road surfaces.
- Because of topography, land availability, or other locational considerations, project construction may require location of some facilities within an airport land use plan area, within two miles of a public airport, or within areas of active military flights.
- Project construction and operation may create a hazard to the public or the environment due to the transport of heavy loads on highways or with helicopters.

## **Transportation Mitigation Strategies**

Mitigation practices for marine vessels would rely primarily on existing USCG regulations and port regulations. Project vessels operating offshore and in ports and harbors would be required to comply with these requirements regarding vessel operation and safety, including use of designated traffic lanes and maintaining required communications and radar contact. Where shipping lanes have been established, project vessels would be required to comply with applicable requirements, such as communications, vessel right of way, and speed restrictions. Because of the increased amount of vessel traffic, especially during installation of offshore facilities, specific shipping lanes or advisories may be established by the USCG to ensure safe transit between harbors and the site. Other mitigation strategies include the following:

- Marine and vessel safety would also be enhanced through a staff and crew training program that would be part of a broader Worker Environmental Awareness Plan. Such a plan would address work site and navigation safety practices related to vessel and vehicle use and the securing of equipment and materials to prevent overboard loss.
- A Mariner Communication and Outreach Plan that facilitates coordination with all mariners would be developed and implemented throughout the life of a port or project, including use of Local Notices to Mariners that identify locations of partially installed offshore facilities. A 24-hour manned operations center may be established to ensure direct communications with the USCG and the ability to monitor project vessel movements during construction and activities.
- For safety, offshore structures would have unique letter/number markings and any FAA-required safety lights and this information would be provided to the USCG and mariners to facilitate general navigation and search and rescue activities. The operator would work with NOAA to ensure nautical charts include structure locations and identification information.



The operator would coordinate with the USCG to establish protocols for braking turbine generators during search and rescue operations or other emergencies. The communications and shut down procedures, including the brake systems, will be tested at an agreed upon frequency.

To ensure safety for pedestrians and vehicles operating onshore and in ports and harbors, a TMP would be implemented to address parking and congestion, including the use of van pools and carpools, ensuring bicycle and pedestrian safety, the need for temporary or permanent traffic controls, and the timing of work shifts and material deliveries to reduce peak AM/PM hour traffic impacts.

Mitigation strategies for onshore and port and harbor effects may also require development of CMP prior to construction. A CMP could further minimize nuisance effects on neighboring land uses by scheduling work activities outside of major events taking place onshore; monitoring onshore construction during peak tourist season to minimize adverse effects; and specifying measures to minimize noise, vibration, and fugitive dust emissions that would affect the enjoyment of neighboring land uses. Additionally, safety zones may be implemented around construction activities to ensure public safety.

## **Utilities and Service Systems**

There are no impacts related to utilities and service systems associated with offshore development.

### **Ports and Harbors Impacts**

- Major port development would increase demand and competition for water, sewer, gas, and electric utilities at the port.
- Major port development may result in increased taxes, fees, charges, or port indebtedness to expand or upgrade utilities and other services.

### **Onshore Impacts**

- Construction of transmission and industrial facilities may disrupt utility systems and pipelines, or put excess pressure on waste treatment or disposal facilities.
- Construction or operation of transmission and industrial facilities may require water supplies in excess of available services.
- Facility construction or expansion may result in increased taxes, fees, charges, or indebtedness to expand or upgrade utilities.

### **Utilities and Service Systems Mitigation Strategies**

Port, manufacturing, and offshore wind project proponents would consult with service providers to determine if there is adequate capacity in existing utility and service systems to support the anticipated workforce and project needs or if expansions are needed. Ongoing consultation would determine if any existing service lines (electric transmission, water, wastewater, sewer) would need to be moved, enlarged, or abandoned.



Mitigation for long term increased demand for additional or new utility services and infrastructure may be addressed by establishing a port or offshore wind utility assessment district. Port and offshore wind project proponents would work with the local/regional authorities and entities which provide utilities on formation of a specialized assessment district, which would ensure adequate funding of utility services. Administration of the district, and any upgrades, expansion, or construction of new utility infrastructure would be funded by offshore wind project proponents in accordance with accepted utility practices for provision of public goods and services. An additional future offshore wind projects would pay utility district assessment fees on a prorated basis.

## **Wildfire Impacts**

There are no wildfire impacts associated with offshore or ports/harbors development.

### **Onshore Impacts**

- Construction of or for transmission lines in remote areas could lead to a risk of property or facility loss, injury, or death involving wildland fires.
- The potential expansion of populated areas (especially if expansions occur in areas of the wildland/urban interface) may create increased risk of loss of life and property in wildfire events.
- Operating transmission lines can create sources of wildfire ignition, and the presence of transmission lines can obstruct fire suppression efforts.

### **Mitigation Strategies**

Mitigation strategies for preventing wildfires or minimizing loss of life and property damage from wildfire include locating facilities in areas not prone to wildfire, creation of defensible space around facilities, and implementation of safety protocols when using methods that could ignite a fire (such as welding). Use of fire-resistant building materials would also help reduce the risk from wildfire. Project facilities that are proposed be located in fire prone areas would be required to implement local and State mandated procedures and methods for reducing fire risk.

# APPENDIX C:

## Offshore Wind Sea Space Assessment

---

This appendix contains additional information related to the sea space assessment in **Volume II, Chapter 5** including background and identification methods, wind resource identification, conflict screening for marine biological resources (marine birds and marine mammals), sea space characterization tables, and next steps in the sea space identification process. Also included is the sea space identification dataset table listing the datasets used in this assessment.

### **Additional Information: Background and Identification Methods**

In 2016 the Bureau of Ocean Energy Management (BOEM), established the BOEM California Intergovernmental Renewable Energy Task Force (Task Force) as a partnership of federal, state, and local agencies, and federally recognized tribal governments. The Task Force collaborated to assess the potential for offshore wind developments and to inform BOEM's decision making process for identifying potential areas for offshore renewable energy development. In 2018, with input from the Task Force, BOEM issued a Call for Information and Nominations for three Call Areas off the coast of California.

The Task Force utilized a process to establish the 2018 Call Areas that involved robust outreach and engagement with members of coastal communities, fishing communities, Native American tribes, local, state, and federal agencies, academics and scientists, environmental organizations, and renewable energy developers for the purpose of data gathering. The data received throughout the outreach and engagement process was used to establish the California Offshore Wind Energy Gateway and, at the time of the Call Area establishment, included over 660 datasets. This tool, in coordination with continued engagement through the Task Force meetings, was used to support BOEM in issuing the 2018 Call Areas. The Humboldt and Morro Bay Call Areas advanced to Wind Energy Areas. The lease sale for the Morro Bay Wind Energy Area and the Humboldt Wind Energy Area was held on December 6, 2022.

For sea space identification required by AB 525, the CEC built off work previously done in coordination with BOEM and the Task Force. The CEC continues to work with BOEM and others to review the data, technical work, sea space areas, and screening results to ensure identified sea space supports a future phase of offshore wind leasing to accommodate both the national offshore wind energy goals and California's floating offshore wind planning goal of 25 gigawatts (GW) by 2045. The CEC collected and used new and updated data and information from the latest research and studies to identify initial BOEM Call Areas. This new body of work is the collective effort of state and federal agencies, academic institutions, environmental and conservation stakeholders, and other parties interested and following planning and development activities for floating offshore wind in California.

AB 525 directs the CEC to identify sea space in two primary steps. First, identify the sea space established by the federal Bureau of Ocean Energy Management (BOEM) in its 2018 Call for Nominations, as published in the Federal Register, Volume 83, Number 203, on October 19, 2018, and any other relevant information necessary to achieve the 2030 offshore wind planning goal established pursuant to Section 25991.1. Second, identify suitable sea space for a future phase of offshore wind leasing to accommodate the 2045 offshore wind planning goal established pursuant to Section 25991.1.

For the purposes of AB 525, CEC has defined suitable sea space to mean ocean areas identified off California that could support the commercial deployment of floating offshore wind generation technologies and, based on available information, avoids or reduces (minimizes) potential conflicts to help ensure the protection of cultural and biological resources and existing ocean uses. Suitable sea space must also be located in federal waters to facilitate future (BOEM) leasing activities and sufficient to accommodate the AB 525 planning goals.

### **Assumptions and Methods**

To meet the AB 525 requirements, specifically detailing the need for the CEC to work with other state agencies, an interagency working group was formed to coordinate efforts around sea space identification. The interagency working group includes representatives from the California Department of Fish and Wildlife (CDFW), California Coastal Commission (CCC), California State Lands Commission (CSLC), Ocean Protection Council (OPC), and California Public Utilities Commission (CPUC), in addition to subject matter experts from the CEC. Sea space identification includes the spatial mapping of locations potentially suitable for floating offshore wind.

With input from the interagency working group, the CEC applied best available data and information in consideration of the following specific direction in AB 525 that suitable sea space is:

- Located in Federal Waters (3-200 miles offshore)
- Sufficient to accommodate the AB 525 offshore wind planning goals for 2030 and 2045
- In identifying suitable sea space, the Commission shall consider all the following:
  - Existing data and information on offshore wind resource potential and commercial viability.
  - Existing and necessary transmission and port infrastructure.
  - Protection of cultural and biological resources with the goal of prioritizing least-conflict ocean areas.

In addition, AB 525 requires the CEC to:

- Incorporate the information developed by BOEM's California Intergovernmental Renewable Energy Task Force (Task Force).
- Use the California Offshore Wind Energy Gateway, or a functionally equivalent internet website, to provide relevant information developed under this section to the public.

- Coordinate with agencies (noted above) to make recommendations regarding potential significant adverse environmental impacts and use conflicts, such as avoidance, minimization, monitoring, mitigation, and adaptive management, consistent with California’s long-term renewable energy, greenhouse gas emission reduction, and biodiversity goals.

### **State Policy Assumptions Identified from Previous Work**

In addition to the AB 525 requirements identified above, the planning assumptions for identifying suitable sea space include the following:

- BOEM lessees can develop projects that generate up to a total of 4.5 to 7 GW from the BOEM wind lease areas and that this amount of generation would fulfill the CEC AB 525 OSW 2030 planning goal.
- Defer to Department of Defense (DOD) operational concerns south of San Francisco Bay and limit additional planning for offshore wind on the Southern and South-Central Coast
  - BOEM Diablo Canyon Call Area remains undeveloped (this area is also in conflict with the proposed Chumash Heritage National Marine Sanctuary)
  - New offshore wind areas are located north of San Francisco Bay and one area is located north of Morro Bay
- Maintain integrity of National Marine Sanctuaries to achieve:
  - Marine conservation as part of the California 30x30 goals
  - Reduce and minimize potential conflict with commercial fishing, marine species and habitats, marine research, and conservation activities.

### **General Overview of Assessment Approach**

To meet the specific policy mandates of AB 525 for sea space identification, CEC and partner agencies performed the following activities:

- Identified the BOEM Call Areas and the current BOEM leasing areas, summarized the range of floating offshore wind generation technical potential from these areas, and describe how the Call Areas will contribute to California’s floating offshore wind goals.
- Identified and mapped new areas of suitable sea space for floating offshore wind, estimated the range of floating offshore wind generation potential from these mapped areas, and described how the mapped areas would contribute to California’s floating offshore wind goals.
- Summarized attributes that help describe, characterize, and compare identified sea space areas and their potential to support the deployment of floating offshore wind generation technology.

- Used existing datasets to screen and assess the sea space to identify and describe potential biological, ecological, and ocean use conflicts that may occur.
- Determined how avoidance or minimization of conflicts might affect the floating offshore wind generation potential within the identified suitable sea space.
- Identified data gaps and the ongoing research that will become available to further assess identified suitable sea space.
- Developed recommendations for further data collection and additional research to help fill remaining data gaps in the future.
- Engaged tribal governments on specific tribal issues related to the suitable sea space and continue that engagement through Tribal Working Groups.
- Continue to engage all affected ocean users and stakeholders in public processes conducted in support of AB 525 to share, discuss, review and comment on the identified suitable sea space for wind energy areas in federal waters sufficient to accommodate the offshore wind planning goals for 2030 and 2045.

### **Study Area**

The Exclusive Economic Zone (EEZ) for California was selected as the boundary to assess offshore wind resources. The EEZ delineates federal waters, starting at the California 3-mile jurisdictional limit and extending to 200 miles into the Pacific Ocean. The study area was selected because the entire EEZ contains significant wind resources, and it helped narrow the sea space locations from a state-wide point of view. Several available datasets representing modeled wind speeds cover the entire EEZ were useful in characterizing the offshore wind resource.

### **Available Datasets**

Working with BOEM and the Conservation Biology Institute (CBI), CEC and state partner agencies have collected available data useful for examining various aspects of the wind resource, ocean uses, and environmental information. This data is categorized, described, and available for viewing in the California Offshore Wind Energy Gateway on Data Basin. The CEC and partner agencies worked with CBI to identify the key datasets for offshore wind energy planning from approximately 660 datasets available on the California Offshore Wind Energy Gateway. These datasets were evaluated for completeness, accuracy, and relevance in supporting planning activities for offshore wind.

Available spatial datasets were assembled into the following categories for this assessment:

- Offshore wind resource
- Existing infrastructure
- Ocean uses
- Protected Areas

- Marine birds
- Marine mammals
- Marine turtles
- Benthic (ocean bottom) habitats

The best available data that represents marine species and important habitat areas were collected in a scientific manner, but they vary in the type of information represented. Best available data may provide information in the following general categories:

- Presence/Absence
- Densities
- Sensitive groups
- Extent of Sensitive Habitat or Important Biological Areas
- Migratory information

CEC and partner agencies examined the best available attributes for each individual or group of species. When identifying potential conflicts in sea space areas, this assessment discusses and reports out as needed for each type of data available.

### **Supporting Data and Studies**

Data and studies available to help identify suitable sea space include:

- Environmental and ocean use datasets, cataloged and publicly available on the Conservation Biology Institute's (CBI) Data Basin platform in the California Offshore Wind Energy Gateway, including Marine Cadastre, CDFW, BOEM, NOAA, NMFS and US Geologic Survey (USGS).
- Technical reports and datasets from National Renewable Energy Laboratory (NREL) on floating offshore wind technical potential off the California coast.
- Technical reports and datasets from Cal Poly Humboldt on floating offshore wind technical potential, environmental effects, and transmission infrastructure off the California North Coast.
- Draft and final technical reports, datasets, and modeling results from CEC and OPC funded studies such as those conducted by CBI, Point Blue Conservation Science (Point Blue), and BOEM.
- CCC staff report and findings for BOEM Wind Energy Area Consistency Determinations.
- Transmission reports from the CPUC's Integrated Resource Plan and Long-Term Procurement Plan, and the California ISO 20-year Transmission Outlook.
- BOEM and CSLC reports on port infrastructure and location.

- In addition, CEC will consider and use ongoing input from CSLC, CCC, CDFW, CPUC, OPC, Native American tribes, federal and local governments, stakeholders, and fisheries.

### **Data Analysis Tools**

CEC uses spatial data to assess offshore wind energy planning options. Below is a list of data analysis tools used throughout this process:

**California Offshore Wind Energy Gateway on Data Basin:** The California Offshore Wind Energy Gateway is an authoritative platform to support offshore wind planning efforts by assembling geospatial information on ocean wind energy potential, ecological and natural resources, ocean commercial and recreational uses, and community values.<sup>17</sup> The California Offshore Wind Energy Gateway is powered by Data Basin technology; the spatial datasets are organized into thematic galleries and topical maps. This platform allows decision makers and stakeholders to access, view, map, collate, and contribute data. It also supports public and private collaboration and integration with online tools.

**California Offshore Wind Energy Modeling Platform:** The Conservation Biology Institute (CBI) used data from the California Offshore Wind Energy Gateway to produce a robust set of spatial models, designed to synthesize information to help stakeholders and decision-makers assess the suitability of offshore wind energy development in federal waters off the coast of California.<sup>18</sup> These models are created using the Environmental Evaluation Modeling System (EEMS) with 295 input datasets and provide a transparent and data-driven means for assessing a range of considerations at a given location, such as energy potential, deployment feasibility, ocean uses, fisheries, and marine life occurrence.

Each model has a hierarchical structure with multiple components and data that can be examined in detail. Models depict where any given location falls on a continuum of values generated for federal waters off the California coast. Each of the models depicts a composite index representing the four offshore wind considerations (described below) and individual scores for all components, based on the available input data:

- **Wind Energy Potential:** This model estimates energy potential by considering annual, monthly, and evening components of the offshore wind energy resource.
- **Offshore Wind Infrastructure Deployment Feasibility:** This model estimates offshore wind infrastructure deployment feasibility by considering proximity to ports and electrical grid connections, physical constraints of seafloor slope and depth, and infrastructure avoidance.

---

17 The [California Offshore Wind Energy Gateway](https://caoffshorewind.databasin.org/) is available at <https://caoffshorewind.databasin.org/>.

18 The [California Offshore Wind Energy Modeling Platform](https://osw.eemsonline.org/) is available at <https://osw.eemsonline.org/>.



- **Ocean Use:** This model estimates the amount of ocean use at a given location by considering commercial fishing activity, vessel traffic and navigation, recreation, cultural and historical resources, and ocean disposal sites.
- **Environmental Considerations:** This model estimates an index of marine life present at a given location by considering the occurrence, activity, density, and/or habitat of marine species. These species include marine mammals such as whales and pinnipeds, seabirds, leatherback sea turtles; highly migratory species such as sharks, albacore and swordfish; and prey species such as krill, anchovies, squid, and sardines. Species with a protected status, (e.g. threatened or endangered), were weighted more heavily in the model.

Links to all input datasets can be found via the model interface and can be accessed through Data Basin’s California Offshore Wind Energy Gateway and are available for public use, further investigation, and/or to display customizable maps.

**ESRI ArcGIS:** The CEC develops, maintains, and uses geographic information system (GIS) data for a wide range of activities related to offshore wind planning. GIS software creates, manages, analyzes, and maps all types of data. Visual analysis is completed with a graphic diagram, alongside the mapped results.

## Assessment Methods

Energy Commission staff used the following preliminary approach to apply best available information to identify suitable sea space:

1. Identify wind and technical characteristics, map locations of wind potential considering or measuring the following specific attributes:
  - Wind speed and consistency
  - Wind capacity factor<sup>19</sup>
  - Ocean bottom depth and slope
  - Distance to transmission and port facilities
2. Identify areas that are exclusions from consideration for development activities:
  - National Marine Sanctuaries
  - Designated habitat areas
  - Escarpments and canyons

---

<sup>19</sup> Capacity Factor is defined as the ratio of actual annual output to output at rated capacity for an entire year, using a long-term average over the lifetime of an asset, without curtailment for renewable generation.



3. Identify and categorize data and information to assess and screen sites for conflicts. Specific elements and activities from available data sets that were assessed to determine conflicts include:
  - Existing infrastructure: cables, pipelines, platforms, existing leases, or rights-of-ways
  - Ocean uses: commercial fishing activity, recreational fishing activity, shipping lanes, shipping traffic, and military operations
  - Native American and Indigenous People: cultural significance and cultural landscapes
  - Protected Areas: California Marine Protected Areas, Essential Fish Habitat, and Habitat Areas of Particular Concern
  - Marine mammals: species density, migratory routes, Important Biological Areas (feeding, habitat, breeding)
  - Marine birds: species density, occurrence of sensitive species groups
  - Marine turtles: species distribution, critical habitat
  - Benthic (ocean bottom) habitats: seamounts, hard bottom areas, deep sea corals and sponges
4. Analyze and summarize results. CEC and the interagency working group examined the available datasets and completed the following tasks to identify suitable sea space for the purposes of informing the AB 525 Strategic Plan:
  - Mapped locations of floating offshore wind potential
  - Calculated amount of potential energy capacity
  - Identified and described potential conflicts
  - Summarized the potential conflicts and effects of those conflicts on energy generation capacity

## **Additional Information: Identification of Offshore Wind Resource and Technical Characteristics**

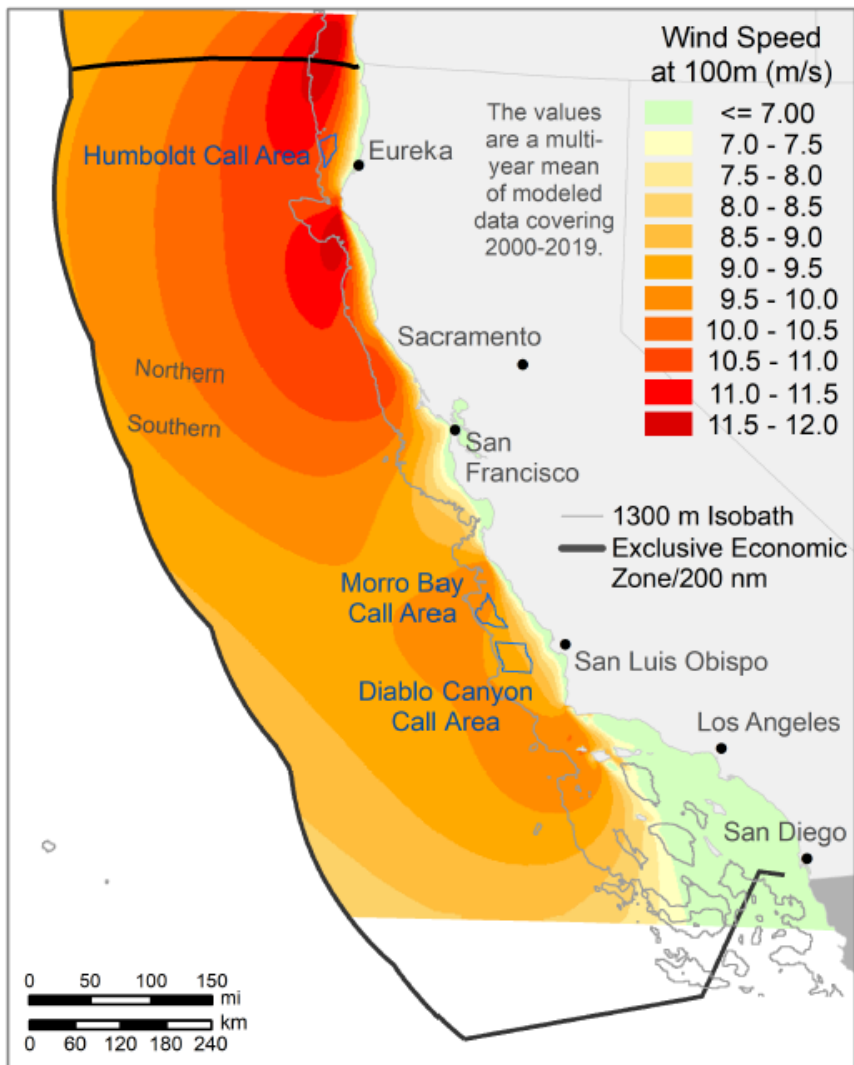
### **Wind Resource**

The wind resources off California extend from approximately 3 miles offshore out to the 200-mile boundary of the California EEZ. Winds offshore blow stronger and more consistently than any winds onshore. In general, the winds blow consistently in the evening at about the same time that solar generation is declining due to approaching sunset.

NREL, BOEM, and the offshore wind industry generally consider a wind speed of 7 meters per second (m/s) or greater at a 100-meter hub height as feasible for commercial offshore wind energy generation development. **Figure C-1** displays a map of wind resource data from an

NREL study showing wind speed ranging from less than 7 m/s to approximately 12 m/s. The red areas of the map have wind speeds greater than 10m/s and orange areas are greater than 7 m/s, green areas are less than 7 m/s and are not considered feasible for development currently.

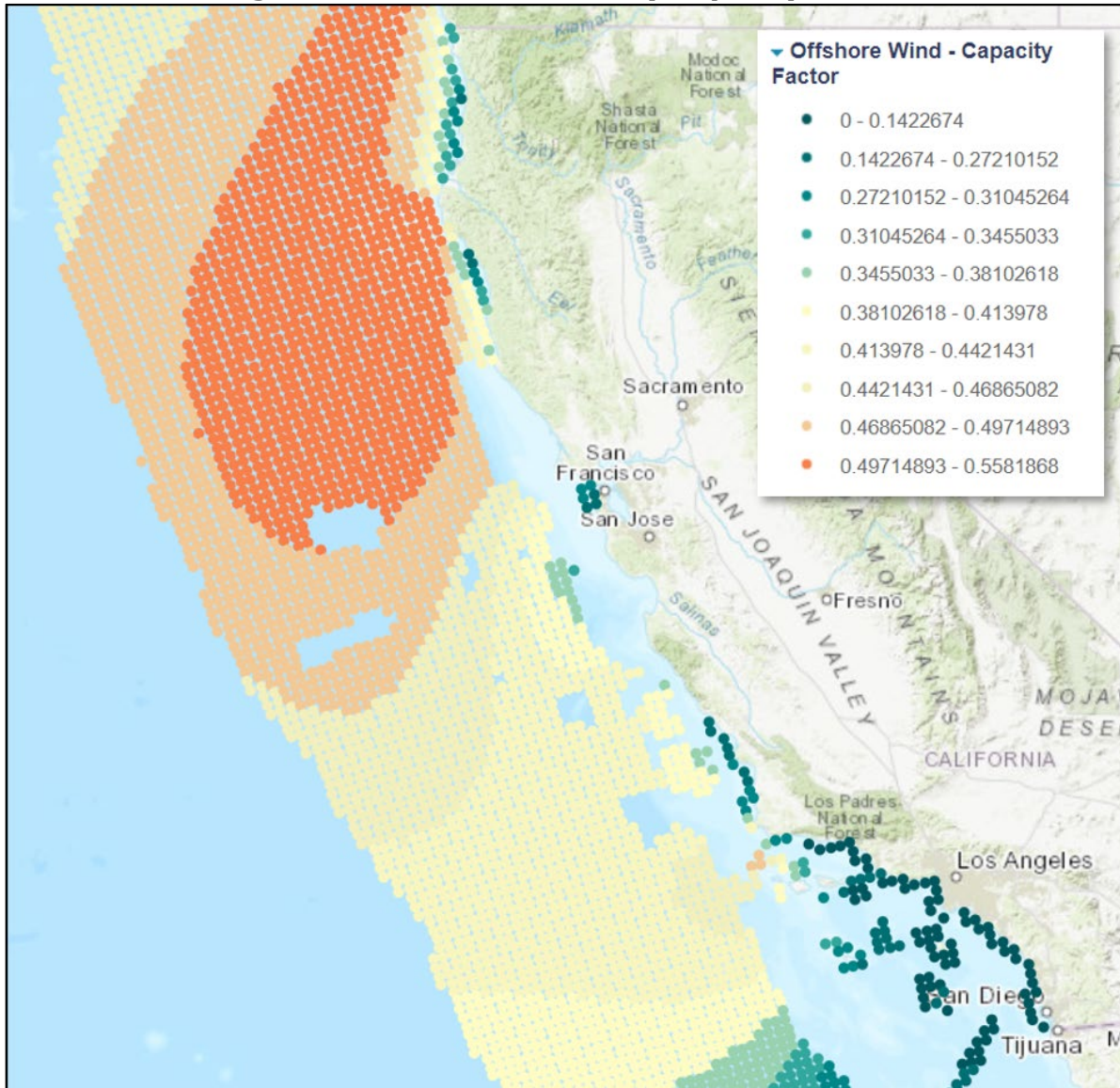
**Figure C-1: Mean Annual Wind Resource for the Outer Continental Shelf**



Source: NREL. 2020

**Figure C-2** shows a map of offshore wind by capacity factor. Capacity factor is a measure of how much energy is produced by a plant compared with its maximum rated output, with larger values indicating more energy generation. This map represents NREL data from 2021 and displays the highest capacity factors in dark orange. Offshore wind capacity factor was assessed to help identify locations with the best wind resource. The North Coast has the highest capacity factors, making it more feasible for offshore wind development.

**Figure C-2: Offshore Wind by Capacity Factor**



Source: CEC, Data Basin. 2023

Waters off the North Coast, including Del Norte, Humboldt, and Mendocino counties, have the highest wind resources and are more desirable for offshore wind development from a wind resource perspective. Waters off the Central Coast have moderate wind resources still suitable for offshore wind deployment, while waters off the South Coast have the lowest offshore wind energy generation potential.

## Additional Information: Screening for Marine Biological Resource Conflicts

### Marine Birds

Marine birds have the potential to be negatively affected by offshore wind energy development. Spatial mapping of marine bird abundance, distribution, and density are important for siting offshore wind infrastructure and evaluating environmental effects.

**Figure C-3** depicts marine bird relative density in the California Offshore Wind Energy Modeling Platform, a publicly available set of spatial models designed to synthesize information of offshore wind energy development. The model estimates an index of marine life presence by considering the occurrence, activity, density, and habitat of sensitive marine species. Species with a higher protected status (such as endangered) were weighted more heavily in the model.

The data shows marine bird species groups across multiple seasons. Marine birds include species of alcids, cormorants, grebes, gulls and terns, jaegers and skuas, loons, brown pelican, phalaropes, scoters, and tubenoses (albatrosses, storm-petrels, and petrels and shearwaters).<sup>20</sup> The dark green color shows areas where there is high marine bird presence and yellow areas show less marine bird presence. Data from this study demonstrates that higher marine bird activity takes place closer to shore. Farther from shore, there is less activity for marine bird species in general, however, certain species continue to use extensive areas of the ocean surface.

Depicted in **Figure C-4** are pelagic Important Bird Areas. Designated by the National Audubon Society and BirdLife International, Important Bird Areas (IBAs) are based on an established program that uses standardized criteria to identify essential habitats, which are areas that hold a significant proportion of the population of one or more bird species.<sup>21</sup> Pelagic IBAs are identified along the California Coast closer to shore, generally within 20 miles from the shoreline. Data from this study demonstrates that higher marine bird activity takes place closer to shore.

---

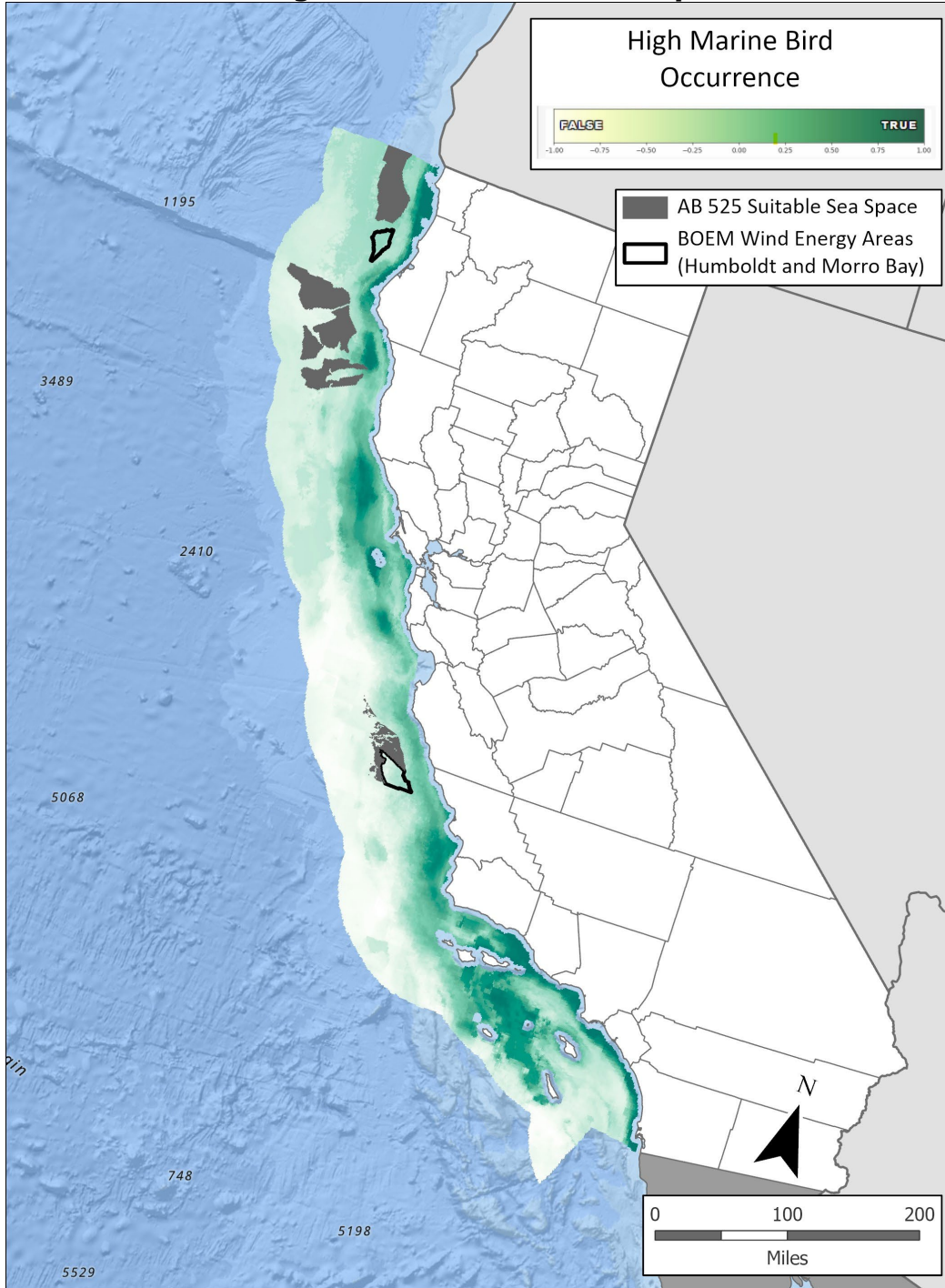
20 Degagne, Rebecca, Mike Gough, Gladwin Joseph, Declan Pizzino, Charlotte Smith, and James Strittholt. October 2022. [Spatial Modeling to Support Sustainable Offshore Wind Energy Development for California](https://consbio.org/wp-content/uploads/2022/05/CA-OSW-EEMS-Modeling-Report-October-2022.pdf). Conservation Biology Institute. Available at <https://consbio.org/wp-content/uploads/2022/05/CA-OSW-EEMS-Modeling-Report-October-2022.pdf>.

21 [Audubon California](http://ca.audubon.org/) is available at <http://ca.audubon.org/>.

The [Pelagic Important Bird Areas](https://caoffshorewind.databasin.org/datasets/8771568e581740d39c7d266e35f5638b/) are available at <https://caoffshorewind.databasin.org/datasets/8771568e581740d39c7d266e35f5638b/>.

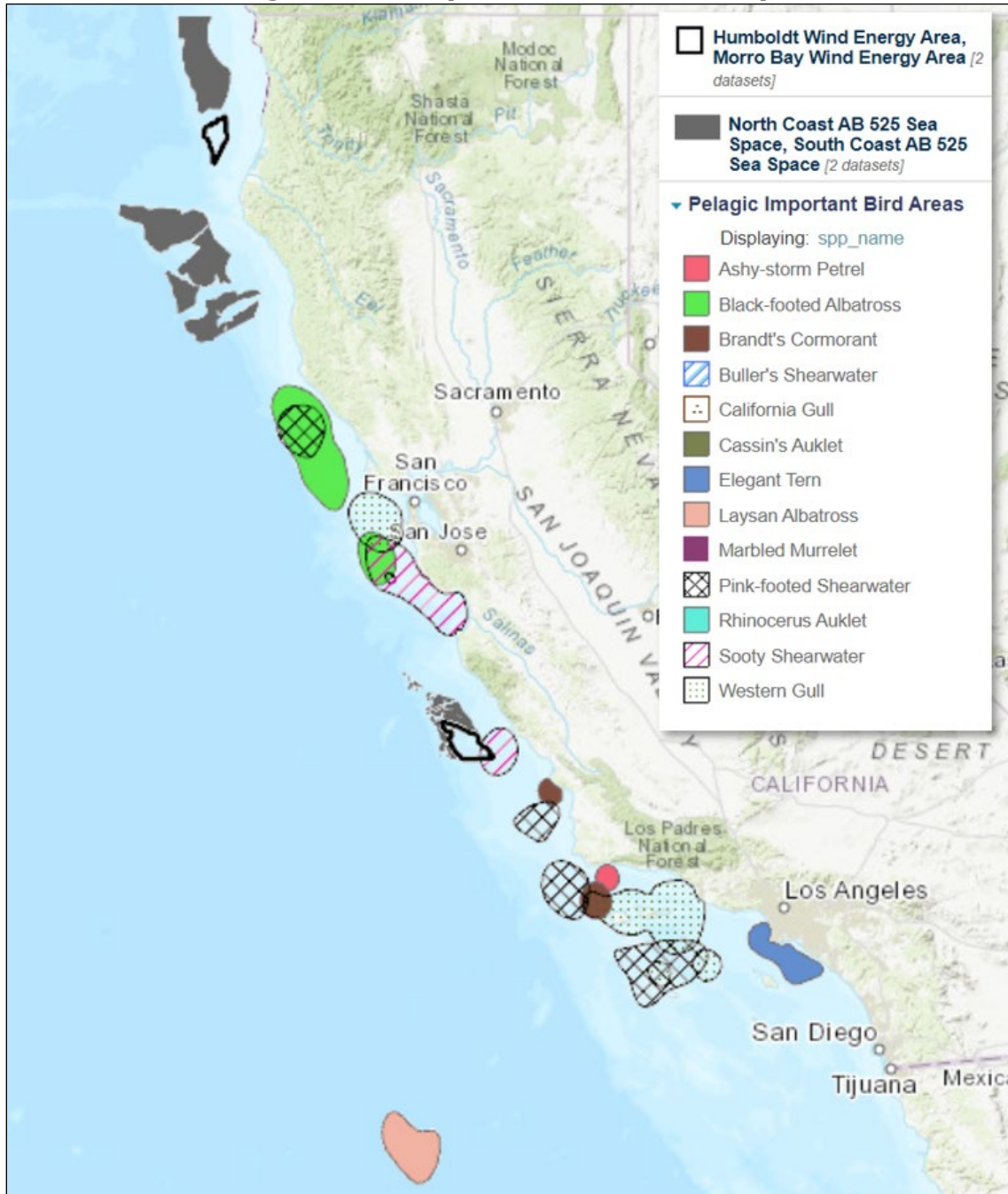


**Figure C-3: Marine Birds Map**



Source: CEC, California Offshore Wind Energy Modeling Platform. 2023

**Figure C-4: Important Bird Areas Map**



Source: CEC, Data Basin. 2023

## Marine Mammals

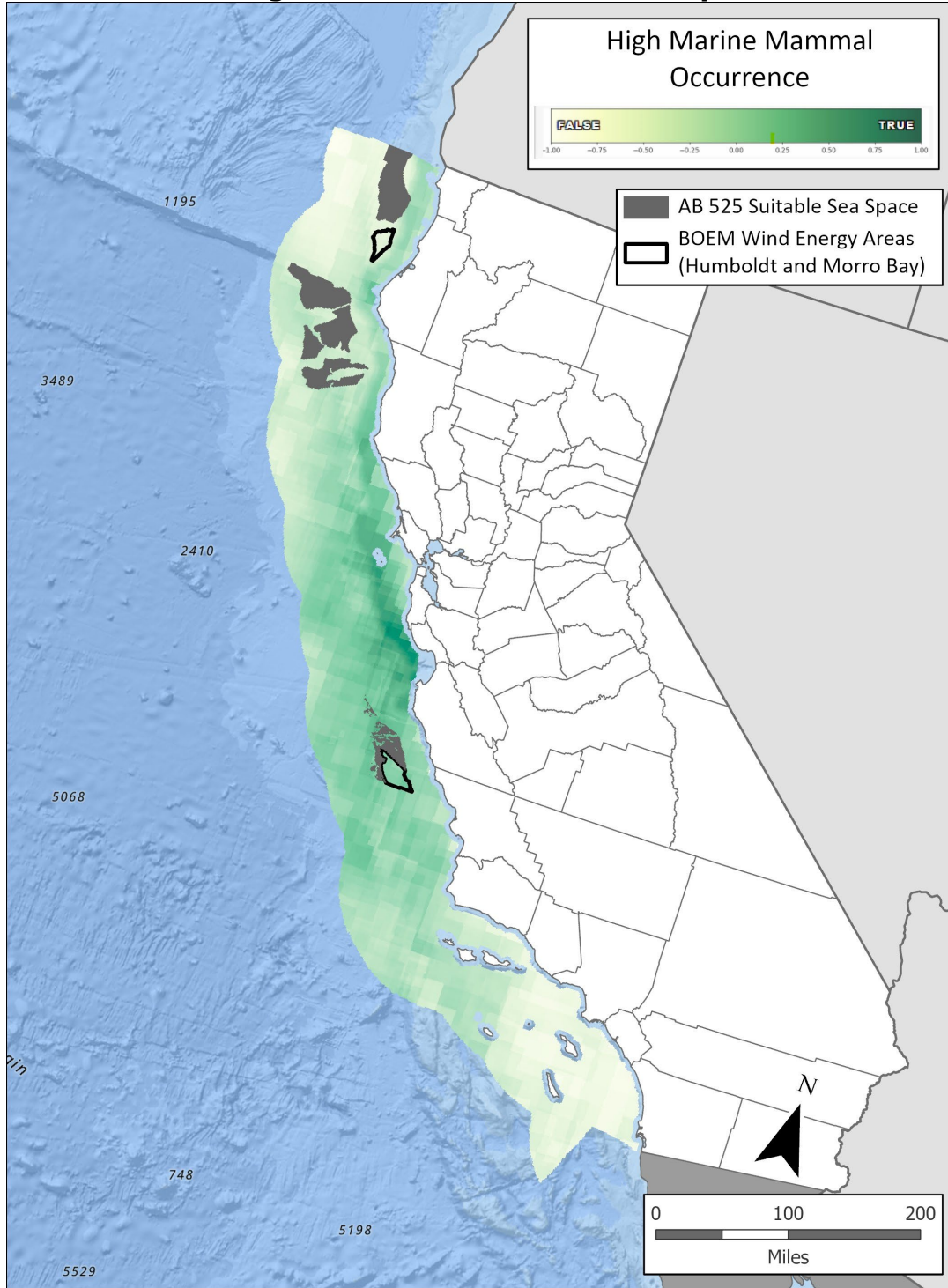
Marine mammals have the potential to be affected by offshore wind energy development. The best available species distribution models were used to examine the density and distribution of marine mammals and to identify potential interaction with offshore wind energy infrastructure development. In **Figure C-5**, data from the California Offshore Wind Energy Modeling Platform shows the total marine mammals species density and distribution. Marine mammals include toothed whales (southern resident killer whale, sperm whale, beaked whale, dolphin, porpoise), baleen whales (humpback whale, fin whale, blue whale, gray whale, minke whale), and pinnipeds (California sea lion, northern elephant seal, Guadalupe fur seal).

Findings show areas closer to shore have higher marine mammal density and there is generally higher activity off the Central Coast. The distribution of whales extends into deeper waters, with higher density closer to shore. Pinniped distribution data shows higher density off the Central Coast in comparison to the North Coast.<sup>22</sup>

---

<sup>22</sup> Ibid.

**Figure C-5: Marine Mammals Map**



Source: CEC, California Offshore Wind Energy Modeling Platform. 2023



**Figures C-6 and C-7** depict habitat-based density estimates in the California Current Ecosystem for the humpback whale and blue whale, respectively. These models provide multi-year average densities for summer and fall periods using data collected between 1991 and 2018.<sup>23</sup> This data demonstrates the humpback whale and blue whale predicted mean density is highest closer to shore. Also displayed in the maps are important feeding areas for the humpback and blue whales. These areas are shown in orange and are primarily located closer to shore.

**Figure C-8** shows a map of biologically important areas for the gray whale. Important feeding areas are shown in orange, migratory corridor shown in purple, and potential species presence shown in yellow on the map. Migratory corridor data is representative of spring and fall periods and indicates that the migration corridors used by most gray whales are within 10 kilometers of the U.S. West Coast.<sup>24</sup>

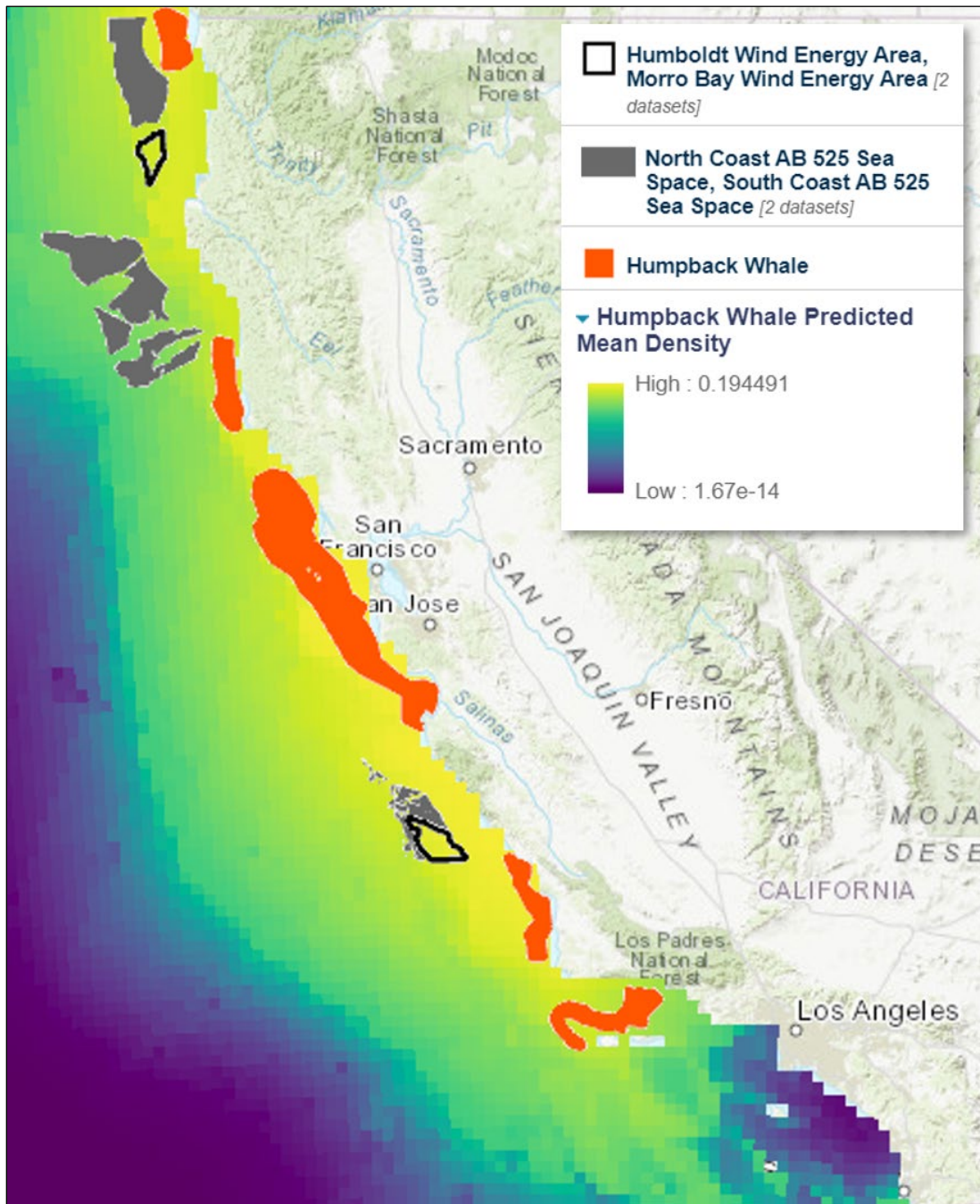
These maps are examples of species-specific spatial data that was assessed for marine mammals. In these examples, Important Biological Areas are located closer to shore. Identifying AB 525 sea space a minimum distance of 20 miles from shore helps to avoid conflicts and minimize potential impacts. It is important to note that the subsea transmission cables going to shore may increase risk for marine mammals, more information on impacts and strategies to address them are described in **Volume II, Chapter 4**.

---

23 Becker, Elizabeth, Karin Forney, David Miller, Paul Fiedler, Jay Barlow, and Jeff Moore. December 2020. [Habitat-based density estimates for cetaceans in the California Current Ecosystem based on 1991-2018 survey data](https://repository.library.noaa.gov/view/noaa/27826). NOAA Fisheries. NOAA Technical Memorandum NMFS-SWFSC-638. Available at <https://repository.library.noaa.gov/view/noaa/27826>.

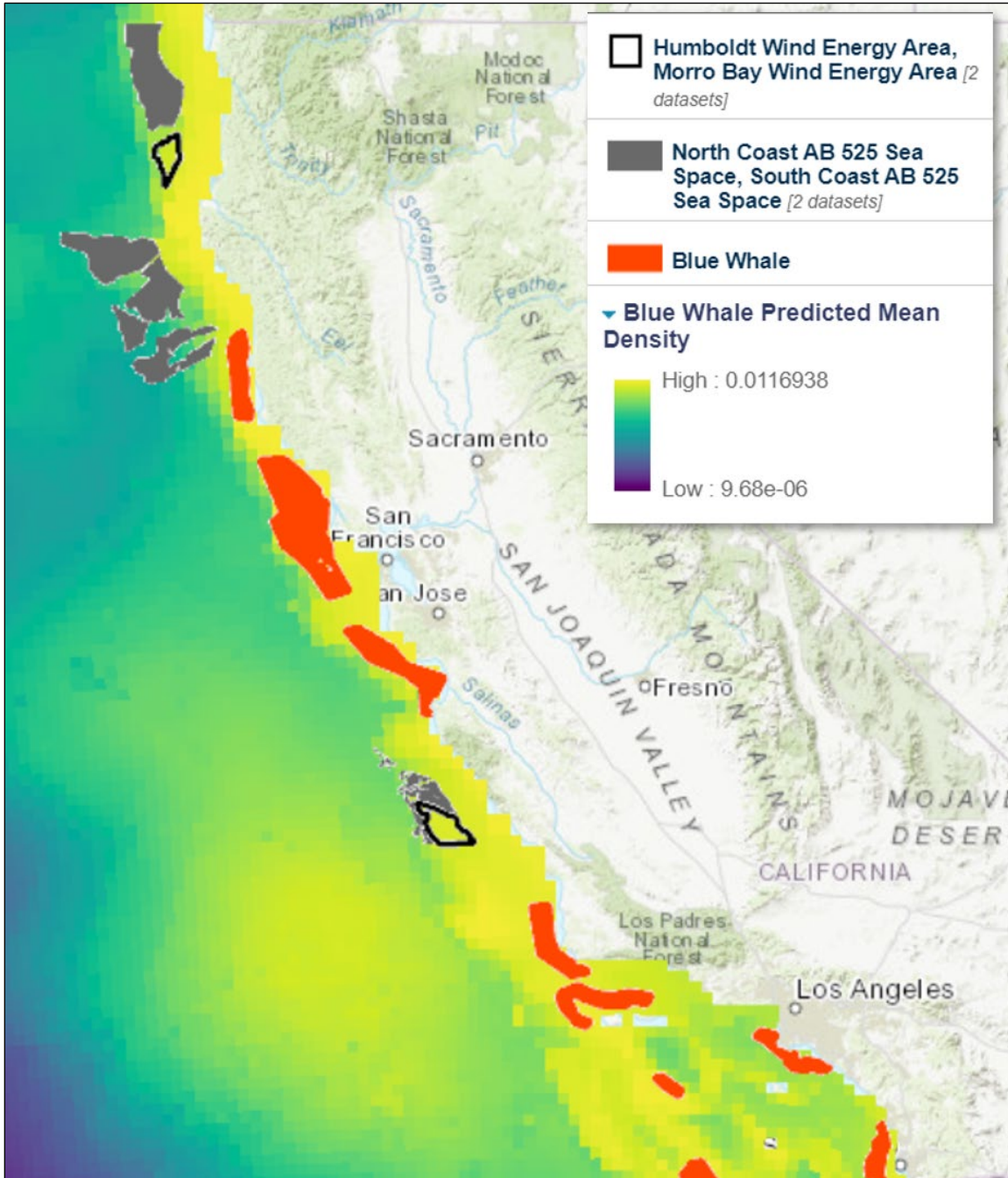
24 Ferguson, Megan, Corrie Curtice, Jolie Harrison, and Sofie Van Parijs. 2015. [Biologically important areas for cetaceans within U.S. waters](https://www.aquaticmammalsjournal.org/wp-content/uploads/2015/02/AM_41.1_Complete_Issue.pdf). Aquatic Mammals, 41(1), 1-128. Available at [https://www.aquaticmammalsjournal.org/wp-content/uploads/2015/02/AM\\_41.1\\_Complete\\_Issue.pdf](https://www.aquaticmammalsjournal.org/wp-content/uploads/2015/02/AM_41.1_Complete_Issue.pdf).

**Figure C-6: Humpback Whale Habitat-Based Density Map**



Source: CEC, Data Basin. 2023

**Figure C-7: Blue Whale Habitat-Based Density Map**



Source: CEC, Data Basin. 2023



**Figure C-8: Gray Whale Important Biological Areas Map**



Source: CEC, Data Basin. 2023

### **Additional Information: Characterization of Sea Space**

Using the results of the wind resource identification and conflict screening exercises, the CEC further refined sea space areas to identify areas with lower potential conflict. These areas are shown in **Figure C-9** in more defined shapes within the ovals. Each sea space location is characterized by wind speed greater than 7 meters per second, average water depth of 2,600 meters or less, ocean bottom slope of 10 percent or less, and a minimum distance of 20 miles

from shore.<sup>25</sup> By examining the potential conflict data, locations were identified that could avoid or help to reduce some potential conflicts, and therefore the project specific impacts, because species use or existing ocean use activities occur less frequently. These locations are considered lower conflict, or least conflict for potential offshore wind generation development, based on existing but limited information.

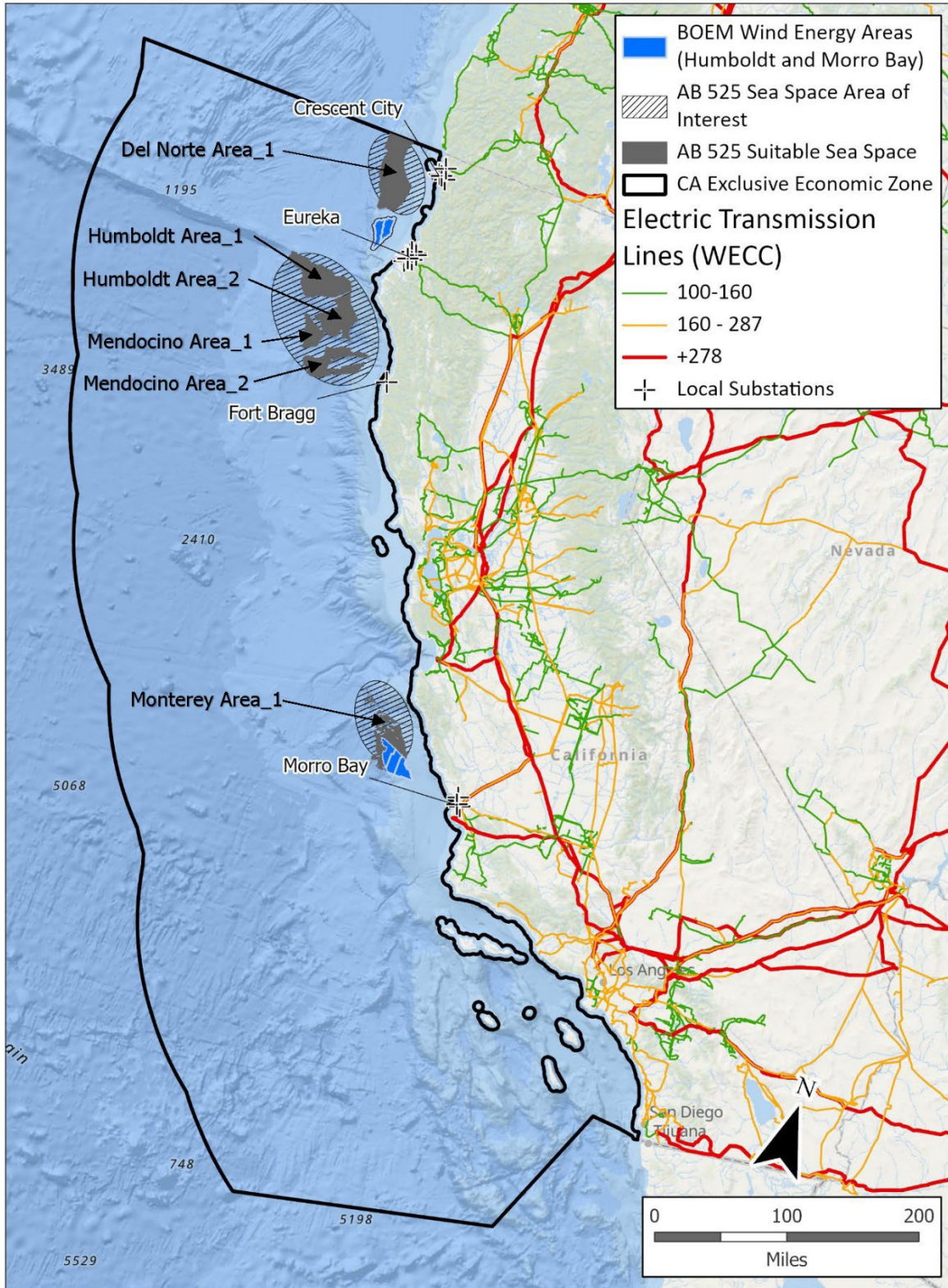
Based on existing information, this AB 525 suitable sea space should be considered as areas to focus research on for understanding impacts of offshore wind deployment. These locations should be considered areas for additional data gathering, research, and feasibility analysis to lessen conflicts and help minimize impacts of offshore wind development.

All six sea space locations are characterized in the summary tables below. The characterization tables provide location specific details regarding wind resource, existing ocean uses, environmental resources, and ocean characteristics occurring in that area. Five areas are located off the North Coast of California and one area is located off the south-central coast of California, just north of the current Morro Bay lease area as shown in **Figure C-9**. The naming convention used correlates with California counties. The installation capacity ranges are based on a generation density of 3 megawatt per square kilometer (MW/KM<sup>2</sup>) (low estimate) and 5 MW/KM<sup>2</sup> (high estimate).

---

<sup>25</sup> Mendocino Area\_1 has an average water depth greater than 2,600 meters due to the inclusion of an area with a gradual increase in ocean bottom slope and low conflicts, making that area more suitable for offshore wind deployment.

**Figure C-9: AB 525 Suitable Sea Space Identified for Further Analysis**



Source: CEC. 2023



## Del Norte Area\_1

Area Del Norte Area\_1 is the northernmost option identified within the study area of the exclusive economic zone, located off Del Norte County. The 1,062 square mile area is located approximately 33 miles from shore. The average depth across the area is 978 meters, with a maximum depth of 1,309 meters and a minimum depth of 277 meters. The closest electrical substation is in Crescent City, approximately 30 miles from the midpoint of the landward side of the sea space. The energy installation capacity range for this area is estimated to be 8.3 GW to 13.8 GW, as shown in **Table C-1** and **Figure C-9**.

**Table C-1: Characterization Summary for Del Norte Area\_1**

Data Category	Value
<b>Logistics</b>	
Area (sq miles)	1,062
Average Distance to shore (mi)	33
Depth (meters) (minimum, maximum, mean)	Min- 277 Max- 1,309 Mean- 978
Approximate Distance to Substations (mi)	30
Installation Capacity Range (GW)	8.3-13.8
<b>Wind Resource</b>	
Average annual wind speed (m/s)	>10
<b>Shipping</b>	
AIS Vessel Traffic- Number of Vessels	26-100
<b>Fisheries</b>	
North Coast Fisheries	Chinook Salmon Dungeness Crab Groundfish Hagfish Pink Shrimp Pacific Halibut Highly Migratory Species: Albacore, Bluefin Tuna, Pacific Bonito, Louvar, Swordfish
NOAA Observed Fishing Effort in U.S. Pacific Coast Groundfish Fisheries	At-Sea Midwater Trawl Mothership Catch Shares Bottom Trawl Limited-Entry Bottom Trawl Non-catch Shares Hook-and-Line
Catch of Commercial Fish	Commercial Salmonids Commercial Groundfish Commercial Highly Migratory Species
Average Quarterly Species Distribution Predictions	Anchovy Sardine Clubhook Squid Albacore

Data Category	Value
<b>Environmental</b>	
Marine Birds- Species Overlap	Pink-footed Shearwater Ashy Storm-Petrel Tufted Puffin Black-vented Shearwater Brown Pelican Marbled Murrelet
Marine Mammals- Species Overlap	Blue Whale Fin Whale Humpback Whale Sperm Whale Gray Whale
Pinnipeds- Species Overlap	Northern Elephant Seal California Sea Lion Guadalupe Fur Seal
Benthic Habitat	Deep-Sea Corals and Sponges
Protected Areas	Essential fish habitat conservation areas for Pacific Groundfish
<b>Geophysical</b>	
Earthquake epicenter density	Located in earthquake epicenter zone
Seamounts and knolls	1 knoll

### Humboldt Area\_1

Humboldt Area\_1 is located off Humboldt County. The 869 square mile area is located approximately 47 miles from shore. The average depth across the area is 1,657 meters, with a maximum depth of 2,640 meters and a minimum depth of 457 meters. The closest electrical substation is in Eureka, approximately 50 miles from the midpoint of the landward side of the sea space. The energy installation capacity range for this area is estimated to be 6.8 GW to 11.3 GW, as shown in **Table C-2 and Figure C-9**.

**Table C-2: Characterization Summary for Humboldt Area\_1**

Data Category	Value
<b>Logistics</b>	
Area (sq miles)	869
Average Distance to shore (mi)	47
Depth (meters) (minimum, maximum, mean)	Min- 457 Max- 2,640 Mean-1,657
Approximate Distance to Substations (mi)	50
Installation Capacity Range (GW)	6.8-11.3
<b>Wind Resource</b>	
Average annual wind speed (m/s)	>10
<b>Shipping</b>	



<b>Data Category</b>	<b>Value</b>
AIS Vessel Traffic- Number of Vessels	26-200
<b>Fisheries</b>	
North Coast Fisheries	Chinook Salmon Groundfish Highly Migratory Species: Albacore, Bluefin Tuna, Pacific Bonito, Louvar, Swordfish
NOAA Observed Fishing Effort in U.S. Pacific Coast Groundfish Fisheries	Catch Shares Bottom Trawl Limited-Entry Bottom Trawl
Catch of Commercial Fish	Commercial Salmonids Commercial Groundfish Commercial Highly Migratory Species
Average Quarterly Species Distribution Predictions	Anchovy Sardine Clubhook Squid Albacore
<b>Environmental</b>	
Marine Birds- Species Overlap	Pink-footed Shearwater Ashy Storm-Petrel Tufted Puffin Black-vented Shearwater Brown Pelican
Marine Mammals- Species Overlap	Blue Whale Fin Whale Humpback Whale Sperm Whale Gray Whale
Pinnipeds- Species Overlap	Northern Elephant Seal California Sea Lion Guadalupe Fur Seal
Benthic Habitat	Deep-Sea Corals and Sponges
Protected Areas	Habitat Areas of Particular Concern for Pacific Groundfish Essential fish habitat conservation areas for Pacific Groundfish
<b>Geophysical</b>	
Earthquake epicenter density	Located in earthquake epicenter zone
Seamounts and knolls	Proximal along northern edge

## **Humboldt Area\_2**

Humboldt Area\_2 is located off Humboldt County. The 634 square mile area is located approximately 34 miles from shore. The average depth across the area is 1,394 meters, with a maximum depth of 2,149 meters and a minimum depth of 837 meters. The closest electrical substation is in Eureka, approximately 58 miles from the midpoint of the landward side of the

sea space. The energy installation capacity range for this area is estimated to be 4.9 GW to 8.2 GW, as shown in **Table C-3 and Figure C-9**.

**Table C-3: Characterization Summary for Humboldt Area\_2**

Data Category	Value
<b>Logistics</b>	
Area (sq miles)	634
Average Distance to shore (mi)	34
Depth (meters) (minimum, maximum, mean)	Min- 837 Max-2,149 Mean-1,394
Approximate Distance to Substations (mi)	58
Installation Capacity Range (GW)	4.9-8.2
<b>Wind Resource</b>	
Average annual wind speed (m/s)	>10
<b>Shipping</b>	
AIS Vessel Traffic- Number of Vessels	26-200
<b>Fisheries</b>	
North Coast Fisheries	Chinook Salmon Groundfish Highly Migratory Species: Albacore, Bluefin Tuna, Pacific Bonito, Louvar, Swordfish
NOAA Observed Fishing Effort in U.S. Pacific Coast Groundfish Fisheries	Catch Shares Bottom Trawl Limited-Entry Bottom Trawl
Catch of Commercial Fish	Commercial Salmonids Commercial Groundfish Commercial Highly Migratory Species
Average Quarterly Species Distribution Predictions	Anchovy Sardine Clubhook Squid Albacore
<b>Environmental</b>	
Marine Birds- Species Overlap	Pink-footed Shearwater Ashy Storm-Petrel Tufted Puffin Black-vented Shearwater Brown Pelican
Marine Mammals- Species Overlap	Blue Whale Fin Whale Humpback Whale Sperm Whale Gray Whale

Data Category	Value
Pinnipeds- Species Overlap	Northern Elephant Seal California Sea Lion Guadalupe Fur Seal
Benthic Habitat	Deep-Sea Corals and Sponges
<b>Geophysical</b>	
Earthquake epicenter density	Located in earthquake epicenter zone

## Mendocino Area\_1

Mendocino Area\_1 is located off Mendocino County. The 260 square mile area is located approximately 57 miles from shore. The average depth across the area is 2,860 meters, with a maximum depth of 3,224 meters and a minimum depth of 2,235 meters. The closest electrical substation is in Fort Bragg, approximately 58 miles from the midpoint of the landward side of the sea space. The energy installation capacity range for this area is estimated to be 2 GW to 3.4 GW, as shown in **Table C-4 and Figure C-9**.

**Table C-4: Characterization Summary for Mendocino Area\_1**

Data Category	Value
<b>Logistics</b>	
Area (sq miles)	260
Average Distance to shore (mi)	57
Depth (meters) (minimum, maximum, mean)	Min-2,235 Max-3,224 Mean-2,860
Approximate Distance to Substations (mi)	58
Installation Capacity Range (GW)	2-3.4
<b>Wind Resource</b>	
Average annual wind speed (m/s)	>10
<b>Shipping</b>	
AIS Vessel Traffic- Number of Vessels	26-50
<b>Fisheries</b>	
North Coast Fisheries	Highly Migratory Species: Albacore, Bluefin Tuna, Pacific Bonito, Louvar, Swordfish
Catch of Commercial Fish	Commercial Salmonids Commercial Highly Migratory Species
Average Quarterly Species Distribution Predictions	Anchovy Sardine Clubhook Squid Albacore
<b>Environmental</b>	

Data Category	Value
Marine Birds- Species Overlap	Pink-footed Shearwater Ashy Storm-Petrel Tufted Puffin Black-vented Shearwater Brown Pelican
Marine Mammals- Species Overlap	Blue Whale Fin Whale Humpback Whale Sperm Whale
Pinnipeds- Species Overlap	Northern Elephant Seal California Sea Lion Guadalupe Fur Seal
<b>Geophysical</b>	
Earthquake epicenter density	Located in earthquake epicenter zone

## Mendocino Area\_2

Mendocino Area\_2 is located off Mendocino County. The 636 square mile area is located approximately 43 miles from shore. The average depth across the area is 2,348 meters, with a maximum depth of 3,174 meters and a minimum depth of 1,120 meters. The closest electrical substation is in Fort Bragg, approximately 22 miles from the midpoint of the landward side of the sea space. The energy installation capacity range for this area is estimated to be 4.9 GW to 8.2 GW, as shown in **Table C-5 and Figure C-9**.

**Table C-5: Characterization Summary for Mendocino Area\_2**

Data Category	Value
<b>Logistics</b>	
Area (sq miles)	636
Average Distance to shore (mi)	43
Depth (meters) (minimum, maximum, mean)	Min-1,120 Max- 3,174 Mean- 2,348
Approximate Distance to Substations (mi)	22
Installation Capacity Range (GW)	4.9-8.2
<b>Wind Resource</b>	
Average annual wind speed (m/s)	>10
<b>Shipping</b>	
AIS Vessel Traffic- Number of Vessels	26-200
<b>Fisheries</b>	

Data Category	Value
North Coast Fisheries	Chinook Salmon Groundfish Highly Migratory Species: Albacore, Bluefin Tuna, Pacific Bonito, Louvar, Swordfish
NOAA Observed Fishing Effort in U.S. Pacific Coast Groundfish Fisheries	Catch Shares Bottom Trawl Limited-Entry Bottom Trawl
Catch of Commercial Fish	Commercial Salmonids Commercial Groundfish Commercial Highly Migratory Species
Average Quarterly Species Distribution Predictions	Anchovy Sardine Clubhook Squid Albacore
<b>Environmental</b>	
Marine Birds- Species Overlap	Pink-footed Shearwater Ashy Storm-Petrel Tufted Puffin Black-vented Shearwater Brown Pelican
Marine Mammals- Species Overlap	Blue Whale Fin Whale Humpback Whale Sperm Whale Gray Whale
Pinnipeds- Species Overlap	Northern Elephant Seal California Sea Lion Guadalupe Fur Seal
Benthic Habitat	Deep-Sea Corals and Sponges

## Monterey Area\_1

Monterey Area\_1 is the southernmost newly identified sea space area, located north of the Morro Bay lease area off Monterey County. The 564 square mile area is located approximately 30 miles from shore. The average depth across the area is 1,463 meters, with a maximum depth of 2,536 meters and a minimum depth of 895 meters. The closest electrical substation is in Morro Bay, approximately 63 miles from the midpoint of the landward side of the sea space. The energy installation capacity range for this area is estimated to be 4.4 GW to 7.3 GW, as shown in **Table C-6 and Figure C-9**.

**Table C-6: Characterization Summary for Monterey Area\_1**

Data Category	Value
<b>Logistics</b>	
Area (sq miles)	564

<b>Data Category</b>	<b>Value</b>
Average Distance to shore (mi)	30
Depth (meters) (minimum, maximum, mean)	Min- 895 Max- 2,536 Mean- 1,463
Approximate Distance to Substations (mi)	63
Installation Capacity Range (GW)	4.4-7.3
<b>Wind Resource</b>	
Average annual wind speed (m/s)	>8
<b>Shipping</b>	
AIS Vessel Traffic- Number of Vessels	26-300
<b>Fisheries</b>	
Central Coast Fisheries	Albacore Tuna Swordfish Louvar Opah Bluefin Tuna Thresher Shark Blackcod/Sablefish Bocaccio Canary Chilipepper Rockfish Thornyhead Rockfish
NOAA Observed Fishing Effort in U.S. Pacific Coast Groundfish Fisheries	Catch Shares Hook-and-Line Catch Shares Pot
Average Quarterly Species Distribution Predictions	Albacore Clubhook Squid Anchovy Sardine
<b>Environmental</b>	
Marine Birds- Species Overlap	Pink-Footed Shearwater Ashy Storm-Petrel Tufted Puffin Black-Vented Shearwater Brown Pelican Scripps, Guadalupe, and Craveri's Murrelet
Marine Mammals- Species Overlap	Blue Whale Fin Whale Humpback Whale Sperm Whale Gray Whale

Data Category	Value
Pinnipeds- Species Overlap	Northern Elephant Seal California Sea Lion Guadalupe Fur Seal
Benthic Habitat	Deep-Sea Corals and Sponges
Sea Turtles- Species Overlap	Leatherback sea turtle
Protected Areas	Habitat Areas of Particular Concern for Pacific Groundfish Essential fish habitat conservation areas for Pacific Groundfish

## Additional Information: Next Steps

The AB 525 suitable sea space identified in this report is intended to inform BOEM offshore wind Call(s) for additional California offshore wind lease areas. Throughout the AB 525 process, existing and readily mappable data provided a basis for understanding potential suitable areas and potential conflicts. It is expected that BOEM’s process of determining suitability will include newer data and more technical modeling to determine offshore wind suitability. The CEC recommends that BOEM consider the areas identified in this chapter in future offshore wind Call Areas. The CEC also strongly recommends the Call Areas begin at a minimum of 20 miles from shore as these areas are demonstrated to have lower conflict for some species and existing ocean uses.

After identifying sea space in its process, BOEM will initiate a series of environmental reviews. These processes narrow the area within which leasing and development of offshore wind facilities could take place, and define the potential impacts of related offshore wind activities. These processes typically begin with the BOEM Call for Information and Nominations, which is followed by a public comment period and industry nominations of specific portions of the Call Areas for which they wish to obtain a commercial lease.

After BOEM considers the information it receives, a WEA is identified, and an environmental assessment process begins. The primary agencies involved in these environmental assessments of potential lease areas are BOEM, NOAA’s National Marine Fisheries Service (NMFS), and the CCC. The NMFS and CCC processes occur generally concurrently, and both processes result in definition of requirements for protection of marine resources with which offshore wind development must conform.

### BOEM Environmental Assessment

Prior to holding a lease sale, BOEM prepares an Environmental Assessment (EA), which is a NEPA document that assesses the potential impacts of the issuance of commercial and research leases within the identified Wind Energy Areas (WEAs).

The EA considers potential environmental consequences of site characterization activities (i.e., biological, archeological, geological, and geophysical surveys and core samples) and site

assessment activities (i.e., installation of meteorological buoys).<sup>26</sup> The EA also considers project easements associated with each potential lease issued and grants for subsea cable corridors from the WEA through federal waters.

The EA prepared for a WEA addresses the purpose and need for the issuance of leases, the alternatives to issuing the leases, the affected environment and environmental impacts of the action, and the public involvement and consultation processes.

In addition to resource-specific impact assessment discussions, BOEM EAs include an appendix defining specific mitigation measures and best management practices intended to minimize resource effects.<sup>27</sup> BOEM directs lessees to incorporate these best management practices into their development plans. Examples of these mitigation requirements include measures that would:

- Protect water quality by addressing impacts from vessel discharges and debris.
- Protect marine mammals and sea turtles by addressing impacts from noise, vessel strikes, and entanglement.
- Reduce effects on birds and bats from lighting, trash and debris attraction.
- Protect commercial fishing vessels from debris and enhance marine navigation safety.
- Identify and protect potential archaeological resources in the area.

The EA mitigation appendix also details mitigation requirements for the following concerns:

- Typical mitigation measures for protected marine species (including a survey monitoring plan, requirements to minimize vessel interactions with listed species, entanglement avoidance, requirements for protected species observers, and reporting requirements)
- Measures to minimize potential adverse impacts to birds.
- Measures to minimize potential adverse impacts to historic properties.
- Measures to minimize trash and debris.

### **NMFS Endangered Species Act Compliance**

Before BOEM can proceed with a lease sale, it must comply with the requirements of the Endangered Species Act (ESA) and evaluate potential effects on endangered species and their habitats through formal consultation with the NMFS. The process begins with BOEM submitting

---

26 An example of a [BOEM Final Environmental Assessment and Appendices](https://www.boem.gov/renewable-energy/state-activities/humboldt-wind-energy-final-ea) is available at <https://www.boem.gov/renewable-energy/state-activities/humboldt-wind-energy-final-ea>.

27 An example of a [Typical Environmental Protection Mitigation Measures and Best Management Practices](https://www.boem.gov/renewable-energy/state-activities/appendix-d-typical-mitigation-measures-bmps) is available at <https://www.boem.gov/renewable-energy/state-activities/appendix-d-typical-mitigation-measures-bmps>.



a Biological Assessment (BA) to NMFS, defining the potential effects of the lease sale on threatened or endangered species that may be affected.<sup>28</sup>

NMFS then evaluates whether the BOEM proposed issuance of offshore wind leases, site characterization, and assessment activities is likely to adversely affect species listed as threatened or endangered or critical habitats designated under the ESA.

NMFS considers the information provided in the BA and the BOEM EA and prepares an ESA Concurrence Letter that defines its conclusions.<sup>29</sup> The NMFS concurrence letter evaluates the BOEM mitigation requirements to avoid and minimize the potential environmental risks to or conflicts with protected resources. NMFS references the EA mitigation appendix, which includes the specific project design criteria and best management practices intended to minimize effects to ESA-listed species and EFH for site characterization and assessment activities to support offshore wind development.

Categories of protective measure that are most relevant to NMFS include:

- Hard Bottom Avoidance and Metocean Buoy Anchoring Plan
- Marine Debris Awareness and Prevention
- Minimize Interactions with ESA-listed species during Geophysical Survey Operations
- Minimize Vessel Interactions with ESA-listed species
- Minimize Risk During ROV Usage, Buoy Deployment, Operations, and Retrieval
- Protected Species Observers
- Reporting Requirements
- Prohibition of Trawling for During Project Activities

### **CCC Consistency Authority**

The CCC also has a role in coastal resource protection related to the development of offshore wind energy in federal waters offshore of California. The CCC evaluates proposed offshore wind leasing and development in federal waters through its federal consistency authority under the Coastal Zone Management Act (CZMA) and state regulatory authority under the California Coastal Act (CCA) for portions of the projects in state waters.

---

28 An example of a [Biological Assessment submitted by BOEM to NMFS](https://www.boem.gov/renewable-energy/state-activities/final-ca-ren-lease-issuance-baefh07222022clean508-compliant-final) is available at <https://www.boem.gov/renewable-energy/state-activities/final-ca-ren-lease-issuance-baefh07222022clean508-compliant-final>.

29 An example of a [NMFS Letter of Concurrence](https://www.boem.gov/renewable-energy/state-activities/loc-efh-osw-leases-ca) is available at <https://www.boem.gov/renewable-energy/state-activities/loc-efh-osw-leases-ca>.

The CCC has two opportunities to weigh in on offshore wind development in federal waters. The CCC first opportunity for review occurs prior to a BOEM lease sale. At this stage, the CCC assesses whether the leasing process, including any reasonably foreseeable development within a proposed lease area, is consistent with Chapter 3 policies of the Coastal Act. This process starts with a BOEM submittal of a Consistency Determination (CD), in compliance with Section 930.34 et seq. of the NOAA Federal Consistency Regulations (Title 15 Code of Federal Regulations (CFR) part 930 Subpart C).<sup>30</sup> The BOEM CD analyzes the consistency of the proposed lease sale with the Chapter 3 policies of the California Coastal Act addressing public access, recreation, marine resources, land resources, and development.

For the CCC to evaluate whether it should concur with the BOEM CD, it conducts a federal consistency review to evaluate the proposed development actions. Offshore wind development must be planned and implemented in a manner that protects coastal resources. Review of the BOEM CD for proposed leasing is the state's opportunity to examine the impacts of offshore wind development at a high level and to assess whether the WEAs are appropriate places to site offshore wind in California. The CCC review also allows identification of future data and information needs for subsequent federal consistency review of individual projects' Construction and Operations Plans (COPs).

In reviewing leasing proposals (or subsequent specific projects), the CCC assesses the impacts that floating offshore wind may have on the following resources, activities, or communities: Marine Resources and Water Quality, Commercial and Recreational Fishing, Oil Spills, Coastal Hazards, Scenic and Visual Resources, Public Access and Recreation, Tribal and Cultural Resources, Environmental Justice Communities, and Air Quality. The review of future development during this stage is done at a siting level, rather than a project-specific level. This review under the Coastal Zone Management Act sets up a partnership between the state and federal government to address coastal impacts from leasing of the WEAs. During this review the CCC and BOEM negotiate conditions to ensure the leasing of the WEA is consistent with the Chapter 3 policies of the Coastal Act. At this phase, the CCC action is to either concur with or object to the BOEM Consistency Determination, depending on the outcomes of that negotiation.

The CCC second opportunity for review of offshore wind projects occurs after specific projects are proposed, during the COP phase. BOEM lessees are required to submit Consistency Certifications to the CCC during their NEPA review process. In response to the Consistency

---

<sup>30</sup> The CCC website for Offshore Wind presents documentation and resources related to its process. The [CCC Offshore Wind website](https://www.coastal.ca.gov/upcoming-projects/offshore-wind/) is available at <https://www.coastal.ca.gov/upcoming-projects/offshore-wind/>.

Certification, the CCC implements a more detailed review that considers whether projects are consistent with Chapter 3 of the Coastal Act. This process is not further defined in this report.<sup>31</sup>

### **Offshore Wind Research: Ocean Protection Council**

Acknowledging the multitude of unknowns surrounding the potential impacts of offshore wind development in California, the Ocean Protection Council (OPC) working with other state partner agencies is spearheading efforts to support projects aimed at filling data and knowledge gaps. OPC is a cabinet-level state agency dedicated to protecting and conserving California's coastal and ocean ecosystems and the communities that rely on them. OPC's primary role on offshore wind is to ensure that planning and implementation decisions are based on the best available science - with the goal of minimizing adverse effects on marine life, habitats, fisheries, cultural resources, and coastal communities while advancing California's ambitious offshore wind energy goals. OPC plays a critical role in convening and coordinating agency and external partners, including California Native American tribes, environmental non-profits, and fishermen and has been leading coordinated state agency efforts to identify key environmental considerations, including priority management questions and research and monitoring needs.

Recently, OPC has made accelerated targeted investments close to \$2 million to support a comprehensive planning approach for offshore wind development that facilitates science-based decision-making and policies. These investments have funded several studies aimed at understanding patterns of marine life, habitats, and different ocean uses off the California coast. The findings from these studies have been instrumental in identifying potential areas of conflicts with offshore wind development in the sea space analysis led by the CEC. The completed projects have made valuable spatial information publicly available. Examples of these resources include the California Offshore Wind Energy Modeling Platform, and the fishing ground mapping tool for the northern and the central coasts of California based on inputs from local fishing communities.<sup>32, 33, 34</sup>

---

31 The California Coastal Commission [Consistency Determination for Morro Bay](https://documents.coastal.ca.gov/assets/upcoming-projects/offshore-wind/W7a-6-2022-AdoptedFindings.pdf) is available at <https://documents.coastal.ca.gov/assets/upcoming-projects/offshore-wind/W7a-6-2022-AdoptedFindings.pdf>.

The California Coastal Commission [Consistency Determination for Humboldt](https://documents.coastal.ca.gov/reports/2022/4/Th8a/Th8a-4-2022%20staffreport.pdf) is available at <https://documents.coastal.ca.gov/reports/2022/4/Th8a/Th8a-4-2022%20staffreport.pdf>.

32 The [California Offshore Wind Energy Modeling Platform](https://osw.eemsonline.org/) is available at <https://osw.eemsonline.org/>.

33 The [North Coast Fisheries Mapping Project](https://storymaps.arcgis.com/stories/ec90562aada545acb6bb1bf6f3c8f228) is available at <https://storymaps.arcgis.com/stories/ec90562aada545acb6bb1bf6f3c8f228>.

34 The [Central Coast Fisheries Web App](https://experience.arcgis.com/experience/0aefe2155de3457b9709c9303762664f/) is available at <https://experience.arcgis.com/experience/0aefe2155de3457b9709c9303762664f/>.

OPC is currently supporting ongoing studies that will further enhance our understanding of suitable sea space for offshore wind development. One such study, conducted by Point Blue, is to develop offshore wind energy siting models to identify the areas with maximum power generation benefits while minimizing negative impacts. Another study, conducted by the California Polytechnic State University San Luis Obispo and primarily funded by BOEM with additional support from OPC, aims to display high-resolution fishing activity patterns along the U.S. West Coast.

In May 2023, OPC released a competitive solicitation for proposals to develop a comprehensive environmental monitoring guidance for offshore wind. The monitoring guidance will identify priorities for environmental monitoring across various spatial scales and throughout different phases of offshore wind development. The guidance will also provide recommendations for study designs and data collection. The guidance will serve as a clear and practical resource for regulators, developers, and other stakeholders involved in offshore wind projects in California to ensure that environmental impacts of offshore wind development are properly monitored, evaluated, and mitigated throughout the project lifecycle. Guidance development is anticipated to begin in Fall 2023 and completed within two years.

While efforts have been made to address patterns of different ocean uses, significant data and knowledge gaps persist that should be addressed to improve decision making of future offshore wind development. Currently, one of key priorities for near-term investment is to collect more high-quality baseline information within and near existing lease areas in California before the construction of the first offshore wind farm begins. As most of the existing monitoring programs were not specifically designed to understand the impacts of offshore wind development, observational data in the deep ocean further offshore is sparser than near-shore areas. Therefore, it is imperative to gain a better understanding of where, when, and how important marine species use current lease areas and their surroundings. This can be achieved more effectively by leveraging existing monitoring programs and survey efforts from lessees during the site assessment phase.

In addition to prioritizing environmental monitoring, another near-term investment focus is to simulate and assess the impact of offshore wind development on oceanic processes, especially upwelling, which provides abundant nutrients to sustain diverse marine life, through comprehensive modeling. While previous investments have modeled the impact of offshore wind development on upwelling, additional modeling on how these impacts propagate through marine species across the food web and fisheries will improve understanding of the scale and magnitude of impacts that offshore wind development may have on marine ecosystems and fishing communities. Moreover, models serve as useful tools for shedding light on how potential impacts of offshore wind development vary with different layouts, foundations, and anchoring types, and untangling the contribution of offshore wind from other factors, such as climate change, in relation to changes observed in marine life and habitats.

Some efforts have been made to test smart technologies that enable real-time monitoring of floating offshore wind structures and address mitigation strategies from existing projects. Once baseline information is better understood, cost-effective real-time monitoring technologies are

developed, and effective mitigation strategies are identified, the state will need to establish an adaptive management framework. This framework will provide clear guidelines and rules for implementing necessary actions and strategies when real-time environmental monitoring detects negative impacts that deviate from long-term averages.

To account for the potential cumulative impacts of offshore wind development extending beyond California’s borders and the need for infrastructure development across multiple states, the establishment of a regional coordination group comprised of both federal and state governments and stakeholders will be necessary. While the monitoring guidance will serve as a foundation, it would be ideal to establish a longer-term regional collaborative group that can reach a shared understanding of research and monitoring priorities and needs to avoid duplicated efforts and adopt transparent and sustained funding mechanisms to support priority investments.

### Sea Space Identification Datasets

Data description table of all data considered in analysis of sea space identification. Each dataset is located the Offshore Wind Energy Gateway on Data Basin and is linked to the webpage for additional information.<sup>35</sup>

**Table C-8: Sea Space Identification Data**

Input	Data Description	Data Provider	Link to Data
<b>Logistics</b>			
California Exclusive Economic Zone (EEZ)	The EEZ of the U.S. extends 200 nautical miles from the territorial sea baseline and is adjacent to the 12 nm territorial sea of the U.S., overlapping the 12-24nm contiguous zone.	NOAA	<a href="#">California Exclusive Economic Zone (EEZ)</a>
<b>Wind Resource</b>			
Offshore Wind Capacity Factor	Offshore wind supply curve 2021 data provided by the National Renewable Energy Laboratory (NREL). Data includes latitude, longitude, available area, capacity potential, generation potential, generator capacity factor, and distance to interconnect.	NREL	<a href="#">Offshore Wind Capacity Factor</a>

35 The [California Offshore Wind Energy Gateway](https://caoffshorewind.databasin.org/) is available at <https://caoffshorewind.databasin.org/>.

Input	Data Description	Data Provider	Link to Data
Offshore Wind Variables Summarized by Aliquot	The wind speed dataset is based on the NREL 2020 modeled wind speed at 110 meters above the sea surface for California, Oregon, and Washington. The Center for Geospatial Science & Technology (CGST) from California State University Northridge summarized the data by BOEM aliquot for annual average wind speed and number of months with wind speeds above 7 meters per second.	California State University Northridge, BOEM, NREL; Optis et al. 2020	<a href="#">Offshore Wind Variables Summarized by Aliquot</a>
<b>Ocean Use</b>			
2020 Automatic Identification System (AIS) Vessel Traffic by Type	AIS are a navigation safety device that transmits and monitors the location and characteristics of many vessels in US and international waters in real-time. This dataset counts and aggregates the number of ships passing through each aliquot grid cell off the Western USA.	California State University Northridge, BOEM	<a href="#">2020 AIS Vessel Traffic by Type</a>
United States Coast Guard (USCG) Pacific Coast Port Access Route Study (PAC-PARS)- Proposed Shipping Fairways	The PAC-PARS final report published the proposed shipping fairways in the Port Access Route Study: The Pacific Coast from Washington to California. Data sourced from Appendix II: Proposed District Eleven (D11) Fairways Post-Adjudication.	USCG	<a href="#">PAC-PARS Proposed Shipping Fairways</a>
<b>Fisheries</b>			
North Coast Fisheries	Commercial Fishing Grounds West of Del Norte, Humboldt, and Mendocino Counties. Collaborative effort by three Northern California Commercial Fishermen's Associations to map community fishing grounds by species/species complex, gear type, depth, seafloor substrate and season.	The underlying data was collected by the Humboldt Fishermen's Marketing Association, Salmon Trollers Marketing Association, and Crescent City Commercial Fishermen's Association.	<a href="#">North Coast Fisheries</a>

Input	Data Description	Data Provider	Link to Data
Central Coast Fisheries	<p>These data are the result of a collaborative effort led by the Morro Bay Commercial Fishermen's Organization, involving fishermen from San Diego to Santa Cruz, to map commercial fishing grounds between Point Sur and Point Conception, California.</p>	<p>The underlying data were collected by the Morro Bay Commercial Fishermen's Organization (MBCFO) in collaboration with Dr. Carrie Pomeroy and Brianna Haugen at UCSC, with additional assistance from Steve Scheiblaue (Marine Alliances Consulting). The spatial dataset was developed by GHD in partnership with MBCFO, Pomeroy and Haugen.</p>	<p><a href="#">Central Coast Fisheries</a></p>
NOAA Observed Fishing Effort in the 2002-2017 U.S. Pacific Coast Groundfish Fisheries: At-Sea Midwater Trawl Mothership (2002-2017)	<p>The main purpose of these data layers is to help inform the National Marine Fisheries Service Biological Opinion on Continuing Operation of the Pacific Coast Groundfish Fishery. In the shoreside bottom trawl fishery, permit holders with individual fish quotas (IFQ) and a trawl endorsement can use multiple gear types (although not within the same trip), including bottom trawl, midwater trawl, hook-and-line gear, and pot gear. These management changes could impact fishing effort in trawl sectors, as well as alter fixed gear fishing effort by providing a new opportunity for fixed gear fishing activity and potential competition between IFQ and other fixed gear sectors. This data layer displays fishing effort to assess these potential changes.</p>	<p>NOAA Fisheries, Northwest Fisheries Science Center (NWFSC), Fishery Resource Analysis and Monitoring Division; Somers et al. 2020</p>	<p><a href="#">NOAA Observed Fishing Effort in the 2002-2017 U.S. Pacific Coast Groundfish Fisheries: At-Sea Midwater Trawl Mothership (2002-2017)</a></p>
NOAA Observed Fishing Effort in the 2002-2017 U.S. Pacific Coast Groundfish Fisheries: Limited Entry Bottom Trawl (2002-2010)			<p><a href="#">NOAA Observed Fishing Effort in the 2002-2017 U.S. Pacific Coast Groundfish Fisheries: Limited Entry Bottom Trawl (2002-2010)</a></p>
NOAA Observed Fishing Effort in the 2002-2017 U.S. Pacific Coast Groundfish Fisheries: Catch Shares Hook-and-Line (2011-2017)			<p><a href="#">NOAA Observed Fishing Effort in the 2002-2017 U.S. Pacific Coast Groundfish Fisheries: Catch Shares Hook-and-Line (2011-2017)</a></p>
NOAA Observed Fishing Effort in the 2002-2017 U.S. Pacific Coast Groundfish Fisheries: Catch Shares Bottom Trawl (2011-2017)			<p><a href="#">NOAA Observed Fishing Effort in the 2002-2017 U.S. Pacific Coast Groundfish Fisheries: Catch Shares Bottom Trawl (2011-2017)</a></p>
NOAA Observed Fishing Effort in the 2002-2017 U.S. Pacific Coast Groundfish Fisheries: At-Sea Midwater Trawl Catcher-Processor (2002-2017)			<p><a href="#">NOAA Observed Fishing Effort in the 2002-2017 U.S. Pacific Coast Groundfish Fisheries: At-Sea Midwater Trawl Catcher-Processor (2002-2017)</a></p>



Input	Data Description	Data Provider	Link to Data
NOAA Observed Fishing Effort in the 2002-2017 U.S. Pacific Coast Groundfish Fisheries: Non-Catch Shares Pot (2002-2017)			<a href="#">NOAA Observed Fishing Effort in the 2002-2017 U.S. Pacific Coast Groundfish Fisheries: Non-Catch Shares Pot (2002-2017)</a>
NOAA Observed Fishing Effort in the 2002-2017 U.S. Pacific Coast Groundfish Fisheries: Non-Catch Shares Hook-and-Line (2002-2017)			<a href="#">NOAA Observed Fishing Effort in the 2002-2017 U.S. Pacific Coast Groundfish Fisheries: Non-Catch Shares Hook-and-Line (2002-2017)</a>
NOAA Observed Fishing Effort in the 2002-2017 U.S. Pacific Coast Groundfish Fisheries: Catch Shares Pot (2011-2017)			<a href="#">NOAA Observed Fishing Effort in the 2002-2017 U.S. Pacific Coast Groundfish Fisheries: Catch Shares Pot (2011-2017)</a>
NOAA Observed Fishing Effort in the 2002-2017 U.S. Pacific Coast Groundfish Fisheries: Shoreside Midwater Trawl for Rockfish (2011-2017)			<a href="#">NOAA Observed Fishing Effort in the 2002-2017 U.S. Pacific Coast Groundfish Fisheries: Shoreside Midwater Trawl for Rockfish (2011-2017)</a>
NOAA Observed Fishing Effort in the 2002-2017 U.S. Pacific Coast Groundfish Fisheries: Shoreside Midwater Trawl for Hake (2011-2017)			<a href="#">NOAA Observed Fishing Effort in the 2002-2017 U.S. Pacific Coast Groundfish Fisheries: Shoreside Midwater Trawl for Hake (2011-2017)</a>
Catch of California Commercial Groundfish Fisheries 1931-2005	<p>This layer summarizes California Fish and Wildlife commercial groundfish catches from 1931-2005. Catches are reported on landing receipts (also known as 'fish tickets') and are recorded by fish dealers or processors at the port of landing. Summary catch statistics include market category, year, pounds landed, and spatial block. The time series includes species that are historically and/or currently important to the California fisheries economy and were binned into 4 broad groups based on depth: 0-200m-- sanddabs, flounders, soles, California halibut, cabezon, scorpionfish, other sculpins, and leopard sharks; 0-400m—lingcod, petrale sole, pacific halibut, and north pacific hake (whiting); 0-</p>	Miller, R.R.; Miller et al. 2017	<a href="#">Catch of California Commercial Groundfish Fisheries 1931-2005</a>



Input	Data Description	Data Provider	Link to Data
	<p>600m-- all rockfish spp.; 100-1200m—sablefish, spiny dogfish, Rex and Dover soles, and thornyheads.</p>		
<p>Catch of California Commercial Highly Migratory Species 1981-2005</p>	<p>This layer summarizes California Fish and Wildlife commercial Highly Migratory Species (HMS) catches from 1981-2005. Catches are reported on landing receipts (also known as 'fish tickets') and are recorded by fish dealers or processors at the port of landing. Summary catch statistics include market category, year, pounds landed, and spatial block. The time series includes species that are historically and/or currently important to the California fisheries economy and were binned into an HMS group and includes albacore, yellowfin, bluefin, other tuna, swordfish, and pelagic shark.</p>		<p><a href="#">Catch of California Commercial Highly Migratory Species 1981-2005</a></p>
<p>Catch of Commercial Salmonids 1981-2005</p>	<p>This layer summarizes California Fish and Wildlife commercial Salmonid catches from 1981-2005. Catches are reported on landing receipts (also known as 'fish tickets') and are recorded by fish dealers or processors at the port of landing. Summary catch statistics include market category, year, pounds landed, and spatial block. The time series includes species that are historically and/or currently important to the California fisheries economy and were binned into a</p>		<p><a href="#">Catch of Commercial Salmonids 1981-2005</a></p>

Input	Data Description	Data Provider	Link to Data
	Salmonid group and includes Chinook, coho, pink, and unspecified salmon.		
Average, Quarterly Predictions for Anchovy ( <i>Engraulis mordax</i> ), California Current System, 1995-2018	Average, quarterly species distribution predictions for anchovy ( <i>Engraulis mordax</i> ) in the California Current System, 1995-2018. Predicted probabilities of occurrence are from NOAA SWFSC trawl surveys.	Muhling BA; Muhling et al. 2019	<a href="#">Average, Quarterly Predictions for Anchovy (<i>Engraulis mordax</i>), California Current System, 1995-2018</a>
Average, Quarterly Predictions for Sardine ( <i>Sardinops sagax</i> ), California Current System, 1995-2018	Average, quarterly species distribution predictions for sardine ( <i>Sardinops sagax</i> ) in the California Current System, 1995-2018. Predicted probabilities of occurrence are from NOAA SWFSC trawl surveys.		<a href="#">Average, Quarterly Predictions for Sardine (<i>Sardinops sagax</i>), California Current System, 1995-2018</a>
Average, Quarterly Predictions for Clubhook Squid ( <i>Onychoteuthis borealijaponica</i> ), California Current System, 1995-2018	Average, quarterly species distribution predictions for clubhook squid ( <i>Onychoteuthis borealijaponica</i> ) in the California Current System. Predicted probabilities of occurrence are from NOAA SWFSC trawl surveys.		<a href="#">Average, Quarterly Predictions for Clubhook Squid (<i>Onychoteuthis borealijaponica</i>), California Current System, 1995-2018</a>
Average, Quarterly Predictions for Albacore ( <i>Thunnus alalunga</i> ), California Current System, 1995-2018	Average, quarterly species distribution predictions for albacore ( <i>Thunnus alalunga</i> ) in the California Current System, 1995-2018. The albacore SDM predicts (log10) catch per unit effort as fish/vessel/day from industry logbooks. The albacore SDMs can best be thought of as "potential habitat", as albacore presence is strongly impacted by migration rates and routes, particularly off California.		<a href="#">Average, Quarterly Predictions for Albacore (<i>Thunnus alalunga</i>), California Current System, 1995-2018</a>
Point Density of North Pacific Albacore Trolling Fleet Logbook (1995-1999)	This logbook is maintained to track catch and effort of albacore using hook and line gear, particularly by trolling. The logbook		NMFS via CDFW

Input	Data Description	Data Provider	Link to Data
Point Density of North Pacific Albacore Trolling Fleet Logbook (2000-2005)	data records catch and effort at discrete latitude/longitude points for each set made. Using the discrete points, a raster layer was created using the Point Density tool in ArcGIS to create a map of where the points reported in logbooks are more and less dense.		<a href="#">Point Density of North Pacific Albacore Trolling Fleet Logbook (2000-2005)</a>
Point Density of North Pacific Albacore Trolling Fleet Logbook (2006-2010)			<a href="#">Point Density of North Pacific Albacore Trolling Fleet Logbook (2006-2010)</a>
Point Density of North Pacific Albacore Trolling Fleet Logbook (2011-2016)			<a href="#">Point Density of North Pacific Albacore Trolling Fleet Logbook (2011-2016)</a>
VMS Salmon 2010-2017 (BOEM)	Vessel Monitoring System (VMS) data were used from the NOAA Office of Law Enforcement to create this fishing effort dataset for the U.S. West Coast. The dataset was generated using VMS points at fishing speeds to create fishing tracks. Tracks were joined to the BOEM aliquot grid (1.2x1.2 km) to create heat maps of fishing effort for various fisheries based on individual and combined declaration codes.	BOEM, California State Polytechnic University	<a href="#">VMS Salmon 2010-2017 (BOEM)</a>
Total Days Spent Trolling for Albacore (1985-2016)	This logbook is maintained to track catch and effort of albacore using hook and line gear, particularly by trolling. Catches are expressed in number of fish and effort is expressed as vessel-days.	CDFW	<a href="#">Total Days Spent Trolling for Albacore (1985-2016)</a>
Total Fish Caught by North Pacific Albacore Trolling Fleet (1985-2016)			<a href="#">Total Fish Caught by North Pacific Albacore Trolling Fleet (1985-2016)</a>
<b>Environmental</b>			
Tufted Puffin Predicted At-Sea Density, U.S. West Coast	This dataset provides seasonal spatial rasters of predicted long-term (1980-2017) density throughout the Pacific Outer Continental Shelf (OCS) and adjacent waters off the contiguous United States at 2-km spatial resolution. The maps represent model-derived spatial predictions of long-term average density, in units of individuals per km <sup>2</sup> . The maps do not provide predictions of the actual number of individuals of a given species or taxonomic group that would be expected in a given area; they only indicate where a	Jeffery B. Leirness, CSS Inc., NOAA, BOEM; Leirness et al. 2021	<a href="#">Tufted Puffin Predicted At-Sea Density, U.S. West Coast</a>
Brown Pelican Predicted At-Sea Density, U.S. West Coast			<a href="#">Brown Pelican Predicted At-Sea Density, U.S. West Coast</a>
Scripps's, Guadalupe, and Craveri's Murrelet Predicted At-Sea Density, U.S. West Coast			<a href="#">Scripps's, Guadalupe, and Craveri's Murrelet Predicted At-Sea Density, U.S. West Coast</a>
Marbled Murrelet Predicted At-Sea Density, U.S. West Coast			<a href="#">Marbled Murrelet Predicted At-Sea Density, U.S. West Coast</a>
Ashy Storm-Petrel Predicted At-Sea Density, U.S. West Coast			<a href="#">Ashy Storm-Petrel Predicted At-Sea Density, U.S. West Coast</a>

Input	Data Description	Data Provider	Link to Data
Black-vented Shearwater Predicted At-Sea Density, U.S. West Coast	given species/group may be more or less abundant.		<a href="#">Black-vented Shearwater Predicted At-Sea Density, U.S. West Coast</a>
Pink-footed Shearwater Predicted At-Sea Density, U.S. West Coast			<a href="#">Pink-footed Shearwater Predicted At-Sea Density, U.S. West Coast</a>
Pelagic Important Bird Areas	Important Bird Areas (IBAs) are based on an established program that uses standardized criteria to identify essential habitats, which are areas that hold a significant proportion of the population of one or more bird species. To qualify as a globally significant IBA, a proposed site must hold a significant number of a globally threatened species, or a significant percentage of a global population, as evidenced by documented, repeated observation of substantial congregations in an area. This layer represents individual colony locations. The following species are represented in this dataset: Ashy Storm-Petrel, Black-footed Albatross, Brandt's Cormorant, Elegant Tern, Pink-footed Shearwater, Sooty Shearwater, and Western Gull.	Audubon California	<a href="#">Pelagic Important Bird Areas</a>
California Current System predicted seabird abundance, Winter	To support the planning and establishment of MPAs and inform marine spatial planning, we identified areas that may support aggregations of foraging seabirds ("hotspots") in the California Current System, a highly productive, large marine ecosystem on the west coast of North America. We developed habitat-association models for 16 species using information from at-sea observations collected over an 11-year period (1997-2008), bathymetric data, and remotely sensed oceanographic data.	Point Blue Conservation Science	<a href="#">California Current System predicted seabird abundance, Winter</a>
California Current System predicted seabird abundance, Summer			<a href="#">California Current System predicted seabird abundance, Summer</a>
California Current System predicted seabird abundance, Spring			<a href="#">California Current System predicted seabird abundance, Spring</a>
California Current System predicted seabird abundance, Fall			<a href="#">California Current System predicted seabird abundance, Fall</a>
Leatherback Sea Turtle ( <i>Dermochelys coriacea</i> ) Critical Habitat	This dataset depicts designated critical habitat for the leatherback sea turtle ( <i>Dermochelys coriacea</i> ) in California as designated by the National Oceanic and Atmospheric Administration	NOAA Office for Coastal Management	<a href="#">Leatherback Sea Turtle Critical Habitat</a>

Input	Data Description	Data Provider	Link to Data
	(NOAA), National Marine Fisheries Service, under the Endangered Species Act.		
Leatherback Sea Turtle ( <i>Dermochelys coriacea</i> ) Utilization Distribution, California Current	Leatherback Sea Turtle ( <i>Dermochelys coriacea</i> ) utilization distribution (UD) in the California Current. Utilization Distribution is the probability of an animal being found in a given location. In this study, satellite and light-based geolocation tracking data from the Tagging of Pacific Predators (TOPP) project were used to determine the distribution and key habitats of eight protected predator species across three taxa groups within the US waters of the California Current System.	Sara Maxwell, TOPP (Tagging of Pacific Predators) Program; Maxwell et al. 2013	<a href="#">Leatherback Sea Turtle Utilization Distribution, California Current</a>
California Sea Lion ( <i>Zalophus californianus</i> ) Utilization Distribution, California Current	California Sea Lion ( <i>Zalophus californianus</i> ) utilization distribution (UD) in the California Current. A utilization distribution is the probability of an animal being found in a given location. In this study, satellite and light-based geolocation tracking data from the Tagging of Pacific Predators (TOPP) project were used to determine the distribution and key habitats of the California sea lion within the US waters of the California Current System.		<a href="#">California Sea Lion Utilization Distribution, California Current</a>
Northern Elephant Seal ( <i>Mirounga angustirostris</i> ) Utilization Distribution, California Current	Northern Elephant Seal ( <i>Mirounga angustirostris</i> ) utilization distribution (UD) in the California Current. A utilization distribution is the probability of an animal being found in a given location. In this study, satellite and light-based geolocation tracking data from the Tagging of Pacific Predators (TOPP) project were used to determine the distribution and key habitats of the Northern elephant seal within the US waters of the California Current System.		<a href="#">Northern Elephant Seal Utilization Distribution, California Current</a>

Input	Data Description	Data Provider	Link to Data
<p>Guadalupe Fur Seal (<i>Arctocephalus townsendi</i>) Utilization Distributions, 2018-2019, and 2020</p>	<p>This dataset contains utilization distributions for all tagged Guadalupe fur seals (<i>Arctocephalus townsendi</i>) in 2018-2019, and 2020 in the California Current Ecosystem. As part of this study, censuses were performed at Guadalupe Island, México and San Benito Archipelago, México in summer 2018 and 2019. Satellite-linked time depth recorders were deployed on adult females (n = 30, 15 per year), juvenile females (n = 20, 10 per year) and juvenile males (n = 20, 10 per year) at Guadalupe Island in November 2018 and March 2020, and satellite location-only transmitters were deployed on pups (n = 30) at Guadalupe Island in March 2020.</p>	<p>Tenaya Norris, Fernando Elorriaga-Verplancken, Michael Ziccardi, UC Davis; Norris et al. 2020, Norris et al. 2019</p>	<p><a href="#">Guadalupe Fur Seal Utilization Distributions, 2018-2019, and 2020</a></p>
<p>Blue Whale (<i>Balaenoptera musculus</i>) Utilization Distribution, California Current</p>	<p>Utilization distribution (UD) in the California Current. Utilization Distribution is the probability of an animal being found in a given location. In this study, satellite and light-based geolocation tracking data from the Tagging of Pacific Predators (TOPP) project were used to determine the distribution and key habitats of eight protected predator species across three taxa groups within the US waters of the California Current System.</p>	<p>Sara Maxwell, TOPP (Tagging of Pacific Predators) Program; Maxwell et al. 2013</p>	<p><a href="#">Blue Whale Utilization Distribution, California Current</a></p>
<p>Humpback Whale (<i>Megaptera novaeangliae</i>) Utilization Distribution, California Current</p>			<p><a href="#">Humpback Whale Utilization Distribution, California Current</a></p>
<p>Biologically Important Areas for Cetaceans - Small and Resident</p>	<p>The Cetacean Density and Distribution Mapping Working Group identified Biologically Important Areas (BIAs) for 24 cetacean species, stocks, or populations in seven regions (US East Coast, Gulf of Mexico, West Coast, Hawaiian Islands, Gulf of Alaska, Aleutian Islands and Bering Sea, and Arctic (encompassing the northeastern Chukchi and western Beaufort seas)) within US waters. BIAs are reproductive areas, feeding areas, migratory corridors, and areas in which small and resident populations are concentrated. BIAs are region-, species-, and time-specific.</p>	<p>Marine Geospatial Ecology Lab, Duke University; Van Parijs et al. 2015; Calambokidis et al. 2015</p>	<p><a href="#">Biologically Important Areas for Cetaceans - Small and Resident</a></p>
<p>Biologically Important Areas for Cetaceans - Feeding</p>			<p><a href="#">Biologically Important Areas for Cetaceans - Feeding</a></p>
<p>Biologically Important Areas for Gray Whale - Migratory Corridor</p>			<p><a href="#">Biologically Important Areas for Gray Whale - Migratory Corridor</a></p>
<p>Biologically Important Areas for Blue Whales on the US West Coast</p>			<p><a href="#">Biologically Important Areas for Blue Whales on the US West Coast</a></p>
<p>Biologically Important Areas for Humpback Whales on the US West Coast</p>			<p><a href="#">Biologically Important Areas for Humpback Whales on the US West Coast</a></p>

Input	Data Description	Data Provider	Link to Data
Southern Resident Killer Whale Critical Habitat	A geospatial dataset depicting the boundaries of marine areas designated as critical habitat under the Endangered Species Act (ESA) for Southern Resident killer whales (SRKW). The layer displays SRKW critical habitat as the area from the US Canada Border in the north to just below Point Sur, approximately 20 miles south of Monterey, CA., and between the -6.1 meter (-20 ft) isobath, relative to mean higher water (MHW) and the -200 meter (-656 ft) isobath.	NOAA, National Marine Fisheries Service, West Coast Region	<a href="#">Southern Resident Killer Whale Critical Habitat</a>
Humpback Whale ( <i>Megaptera novaeangliae</i> ) Summer/Fall Habitat-based Density, California Current	Humpback Whale ( <i>Megaptera novaeangliae</i> ) habitat-based density estimates in the California Current Ecosystem (CCE). Habitat-based density models were developed for 14 species and one guild (Mesoplodonts and Cuvier's beaked whale) using 92,214 km of on-effort survey data collected between 1991 and 2018 within the CCE study area. To generate average density surfaces, predictions were made on daily grids encompassing the 1996-2018 surveys (late June - early December). Models thus provide "multi-year average density surfaces" representative of the summer/fall period.	Elizabeth A. Becker, NOAA; Becker et al. 2020	<a href="#">Humpback Whale Summer/Fall Habitat-based Density, California Current</a>
Fin Whale ( <i>Balaenoptera physalus</i> ) Summer/Fall Habitat-based Density, California Current	Fin Whale ( <i>Balaenoptera physalus</i> ) habitat-based density estimates in the California Current Ecosystem (CCE). Habitat-based density models were developed for 14 species and one guild (Mesoplodonts and Cuvier's beaked whale) using 92,214 km of on-effort survey data collected between 1991 and 2018 within the CCE study area. To generate average density surfaces, predictions were made on daily grids encompassing the 1996-2018 surveys (late June - early December). Models thus provide "multi-year average density surfaces" representative of the summer/fall period.		<a href="#">Fin Whale Summer/Fall Habitat-based Density, California Current</a>



Input	Data Description	Data Provider	Link to Data
Sperm Whale ( <i>Physeter macrocephalus</i> ) Summer/Fall Density, California Current	Sperm Whale ( <i>Physeter macrocephalus</i> ) density map created by the California Current Marine Mammal Assessment Program at NOAA's Southwest Fisheries Science Center. Predictive habitat-based models of cetacean density were developed based on seven shipboard cetacean surveys conducted during summer and fall between 1991 and 2009 in the California Current Ecosystem.		<a href="#">Sperm Whale Summer/Fall Density, California Current</a>
Blue Whale ( <i>Balaenoptera musculus</i> ) Summer/Fall Habitat-based Density, California Current	Blue Whale ( <i>Balaenoptera musculus</i> ) habitat-based density estimates in the California Current Ecosystem. Habitat-based density models were developed for 14 species and one guild (Mesoplodonts and Cuvier's beaked whale) using 92,214 km of on-effort survey data collected between 1991 and 2018 within the CCE study area. To generate average density surfaces, predictions were made on daily grids encompassing the 1996-2018 surveys (late June - early December). Models thus provide "multi-year average density surfaces" representative of the summer/fall period.		<a href="#">Blue Whale Summer/Fall Habitat-based Density, California Current</a>
Deep-Sea Coral and Sponge Habitat Suitability, U.S. West Coast	The maps produced in this study identify areas where deep-sea corals, sponges, and benthic macrofauna are more likely and less likely to occur and can be used in regional ocean planning efforts and assessments for offshore energy, ground fishing, conservation, and other activities that could impact these sensitive benthic biota, as well as to identify targets for future ocean exploration.	Matthew Poti, National Centers for Coastal Ocean Science (NCCOS).	<a href="#">Deep-Sea Coral and Sponge Habitat Suitability, U.S. West Coast</a>
<b>Marine Protected Areas</b>			
California National Marine Sanctuaries	NOAA manages four designated national marine sanctuaries off California's coast: Channel Islands, Cordell Bank, Greater Farallones, and Monterey Bay.	NOAA	<a href="#">California National Marine Sanctuaries</a>

Input	Data Description	Data Provider	Link to Data
<p>Deep-Sea Ecosystem Conservation Area (DECA; v20191107)</p>	<p>Deep-Sea Ecosystem Conservation Area (DECA) for NMFS' Final Rule Implementing Amendment 28 to the Pacific Coast Groundfish Fishery Management Plan.</p> <p>These data delineate areas of the exclusive economic zone (EEZ) deeper than 3,500 m water depth that were not designated as Pacific Coast groundfish essential fish habitat (EFH). Although outside of EFH, the Pacific Fishery Management Council (PFMC) felt these areas included sensitive deep-water habitats, including deep-sea corals, that warranted protection. The Council recommended that this area be closed to fishing with bottom contacting gears using discretionary authority under the Magnuson-Stevens Act. Bottom contacting gears is a defined term at 50 CFR 660.12.</p>	<p>NOAA Fisheries, West Coast Region, Sustainable Fisheries Division, NOAA Fisheries, Northwest Fisheries Science Center</p>	<p><a href="#">Deep-Sea Ecosystem Conservation Area (DECA; v20191107)</a></p>
<p>Pacific Groundfish Essential Fish Habitat and HAPCs</p>	<p>These layers depict essential fish habitat (EFH), EFH conservation areas, and habitat areas of particular concern (HAPC) for Pacific groundfish. The National Oceanic and Atmospheric Administration's (NOAA) National Marine Fisheries Service (Fisheries) works with the regional fishery management councils to identify the essential habitat for every life stage of each federally managed species using the best available scientific information.</p>	<p>NOAA Fisheries with post-processing by the Conservation Biology Institute</p>	<p><a href="#">Pacific Groundfish Essential Fish Habitat and HAPCs</a></p>
<p>Essential Fish Habitat</p>	<p>These data depict Essential Fish Habitat (EFH) boundaries off Washington, Oregon, and California. The coordinate locations are from the NMFS Final Rule to implement Amendment 19 to the Pacific Coast Groundfish Fishery Management Plan (71 Fed. Reg. 27408; May 11, 2006).</p>	<p>National Oceanic and Atmospheric Administration, National Marine Fisheries Service, Northwest Regional Office</p>	<p><a href="#">Essential Fish Habitat</a></p>
<p>California Department of Fish and Wildlife Managed Marine Protected Areas</p>	<p>These data include all of California's marine protected areas (MPAs) as of March 1, 2016. These areas are managed by the California Department of Fish and Wildlife.</p>	<p>State of California Department of Fish and Wildlife, Marine Region GIS Lab</p>	<p><a href="#">California Department of Fish and Wildlife Managed Marine Protected Areas</a></p>

Input	Data Description	Data Provider	Link to Data
<b>Geophysical</b>			
Earthquake Epicenter Location and Density, 1900-2021, U.S. Pacific EEZ	<p>These data show earthquake epicenters and epicenter density (weighted by earthquake magnitude) for all earthquakes of magnitude greater than 4.5, from 1900-01-01 to 2021-06-15, within the geographic bounds of the U.S. Pacific Exclusive Economic Zone. Data representing earthquake epicenters was acquired from the USGS Earthquake Catalog. The earthquake epicenter density layer was created by the Conservation Biology Institute.</p>	USGS with post-processing by the Conservation Biology Institute	<a href="#">Earthquake Epicenter Location and Density, 1900-2021, U.S. Pacific EEZ</a>
100m Depth Contours	<p>This is a subset of the USGS CAORWALL Bathymetry for the California, Oregon, Washington EEZ. Contour lines of 1500 meters or less are included.</p>	U.S. Geological Survey (USGS)	<a href="#">100m Depth Contours</a>
Seafloor Geomorphology, US West Coast	<p>The Seafloor Geomorphology, US West Coast dataset contains a digital seafloor geomorphic features map (GSFM) of the ocean within the Exclusive Economic Zone of the West Coast, USA. This dataset is a subset of a global dataset that includes global spatial data layers for 29 categories of geomorphic features, defined by the International Hydrographic Organisation and other sources.</p>	<p>Seafloor Geomorphic Features Map by Harris, P.T., Macmillan-Lawler, M., Rupp, J. and Baker, E.K. 2014. Geomorphology of the oceans. Marine Geology, 352: 4-24.</p>	<a href="#">Seafloor Geomorphology, US West Coast</a>
Seafloor Geology (GLORIA)	<p>The GLORIA image of the Exclusive Economic Zone (EEZ) off California, Oregon, and Washington covers about 830,000 square kilometers (sq km) of sea floor. Many geologic features visible on the imagery are representative of a tectonically active continental margin: volcanic ridges and seamounts, faults, crustal lineaments, channels, levees, slump scars, large sediment bedforms, and varying sediment types. This data layer provides a geologic interpretation of the Geologic LO-Range Inclined Asdic (GLORIA) data for the US Pacific Coast.</p>	U.S. Geological Survey (USGS)	<a href="#">Seafloor Geology (GLORIA)</a>

Input	Data Description	Data Provider	Link to Data
Submerged Landforms Model, California	<p>This dataset was developed as a predictive model for locating potential archaeological sites along the California coastline. The model is based on NOAA's National Geophysical Data Center's (NGDC) high-resolution digital elevation models (DEMs) created for select US coastal regions. Submerged lands probability is on a scale of 1-6, low to high.</p>	<p>BOEM, National Geophysical Data Center, NOAA; ICF International et al. 2013</p>	<p><a href="#">Submerged Landforms Model, California</a></p>
GEBCO 2020 Bathymetric Grid, Pacific EEZ	<p>Depth of the ocean floor, in meters. The GEBCO 2020 Grid is the latest global bathymetric product released by the General Bathymetric Chart of the Oceans (GEBCO) and has been developed through the Nippon Foundation-GEBCO Seabed 2030 Project.</p>	<p>GEBCO Compilation Group</p>	<p><a href="#">GEBCO 2020 Bathymetric Grid, Pacific EEZ</a></p>
Global Distribution of Seamounts and Knolls (2011)	<p>This dataset shows the global distribution of seamounts and knolls identified using global bathymetric data at 30 arc-sec resolution. A total of 33,452 seamounts and 138,412 knolls were identified, representing the largest global set of identified seamounts and knolls to date. The research leading to these results received funding from the European Community's Seventh Framework Programme, and from the International Union for Conservation of Nature (IUCN).</p>	<p>Yesson C, Clark MR, Taylor M, Rogers AD (2011). The global distribution of seamounts based on 30-second bathymetry data. Deep Sea Research Part I: Oceanographic Research Papers 58: 442-453.</p>	<p><a href="#">Global Distribution of Seamounts and Knolls (2011)</a></p>
Bathymetry, backscatter intensity, and benthic habitat offshore of Morro Bay, California	<p>This part of USGS Data Series 781 presents substrate, geomorphic, and geologic attributed polygons in the Offshore of Morro Bay, California, map area, one of 83 map areas of the California State Waters Map Series. Multibeam echosounder (MBES) data used to derive this data were generated from bathymetry and backscatter data collected by Fugro Pelagos in 2008. The surveys were conducted to map surficial geology and benthic habitat as part of the USGS California Seafloor Mapping Program, a collaboration with California State University Monterey Bay (CSUMB, 2016) and the</p>	<p>Guy R. Cochrane, USGS California Seafloor Mapping Program; Cochrane et al. 2022</p>	<p><a href="#">Bathymetry, backscatter intensity, and benthic habitat offshore of Morro Bay, California</a></p>

Input	Data Description	Data Provider	Link to Data
	National Oceanic and Atmospheric Administration (NOAA).		
Bathymetry, backscatter intensity, and benthic habitat offshore of Point Estero, California	Surveys offshore of Point Estero, California, were conducted to map surficial geology and benthic habitat as part of the USGS California Seafloor Mapping Program, a collaboration with California State University Monterey Bay (CSUMB) and the National Oceanic and Atmospheric Administration (NOAA). These data are intended to provide regional bathymetric information in California State waters for offshore resource and ecosystem management.		<a href="#">Bathymetry, backscatter intensity, and benthic habitat offshore of Point Estero, California</a>

# APPENDIX D:

## Offshore Wind Transmission

---

This appendix provides additional information on permitting processes for transmission and schematics of the transmission alternatives identified in **Volume II, Chapters 8 and 9**.

### Transmission Permitting

As previously described, permitting of transmission infrastructure in the state generally depends on the type of entity developing the transmission infrastructure: investor-owned utilities (IOUs), publicly owned utilities (POUs), and merchant or independent developers. These developers go through different processes for planning and determining whether transmission upgrades or new transmission lines are needed, as well as for permitting and environmental reviews. The following sections describe the current processes.

### Investor-Owned Utility Transmission Projects

The following is a brief description of the transmission development and approval process when a transmission project is proposed by IOUs. The CPUC regulates IOUs including evaluating the need for transmission projects, issuing permits for construction, and performing the environmental review under CEQA. The IOUs' bulk transmission lines, which are high voltage lines (generally 200 kilovolts or greater);<sup>36</sup> are operated by the California ISO under the regulation of FERC. As a FERC-regulated entity, the California ISO ensures open access to transmission at just and reasonable rates and is responsible for planning for transmission expansion based on reliability, economic, and policy driven needs.

The California ISO conducts an annual transmission planning process (TPP) to identify transmission needs over a 10-year horizon and takes projects to the California Board of Governors for approval.<sup>37</sup> Two major inputs to the California ISO TPP process are the CEC's Integrated Energy Policy Report (IEPR) demand forecast and the CPUC's optimal resource portfolio that meets California's clean energy goals in a reliable and cost-effective manner, developed as part a two-year Integrated Resource Plan (IRP) process. Once a transmission

---

36 The CPUC defines a transmission line in [General Order 131-D](#) as a line designed to operate at or above 200 kilovolts (kv) and requires a Certificate of Public Necessity and Convenience (CPCN). A power line is defined as a line that operates between 50 and 200 kV and requires a Permit to Construct (PTC). A distribution line defined as a line designed to operate under 50 kV and does not require a CPCN or PTC, but investments in distribution lines are included in rate cases.

37 The California ISO is not limited to a 10-year planning horizon. Recent legislation, Senate Bill 887 (Becker, Chapter 358, Statutes of 2022,) requires the CPUC and CEC to provide 15-year projections of loads, resources, and other planning inputs for use by the California ISO in its transmission planning process.

line is approved by California ISO, it goes out for competitive bid. IOUs or merchant transmission developers can bid to develop the project.

If successful in winning a bid for a bulk transmission project (200 kV or above), an IOU must then obtain a certificate of public necessity and convenience (CPCN) from the CPUC, which again examines the need for the bulk transmission project.<sup>38</sup> The process of determining whether a transmission project receives a CPCN is one of deciding whether the project is needed. Usually, the environmental analysis and the review of need and costs through the CPCN process are done concurrently.<sup>39</sup> A bulk transmission project is generally found needed because it meets at least one of the following three criteria:

- The project is required to ensure that electricity is reliably transmitted to customers.
- The project reduces the cost of providing electricity to customers.
- The project allows the state to meet mandated legislative or policy requirements.

The IOUs operate their own lower voltage power lines and distribution systems under CPUC regulation. Upgrades and new facilities to those systems must be approved by the CPUC. For smaller power lines (between 50 and 200 kV), an IOU must obtain a Permit to Construct (PTC) from the CPUC. The CPUC process requires environmental review but generally does not analyze the need for or economics of these smaller transmission projects.

Merchant or private transmission developers can develop transmission infrastructure in the California ISO balancing authority footprint, but essentially become utilities under CPUC jurisdiction if they do and are responsible for obtaining necessary permits for construction and other approvals. Merchant transmission lines outside the California ISO footprint are regulated by FERC, not the CPUC.<sup>40</sup>

## **CPUC Environmental Review**

The CPUC serves as the lead agency for the environmental review of transmission facilities pursuant to CEQA. As noted above, for large transmission facilities, an IOU must obtain a

---

38 California Public Utilities Code Section 1001 prohibits construction without the electric utility obtaining a certificate from the CPUC certifying that "...present or future public convenience and necessity require or will require such construction."

39 A detailed description of [Electric Transmission Siting at the CPUC](https://www.cpuc.ca.gov/-/media/cpuc-website/files/legacyfiles/t/5073-transmission-siting-flow-chart.pdf) is available at <https://www.cpuc.ca.gov/-/media/cpuc-website/files/legacyfiles/t/5073-transmission-siting-flow-chart.pdf>.

40 The Energy Policy Act of 2005 directed the Federal Energy Regulatory Commission to develop incentive-based rate treatments for transmission of electric energy in interstate commerce, adding a new section 219 to the Federal Power Act.

More information on the [Energy Policy Act of 2005 Credit Risk Management Rule](https://www.ferc.gov/electric-transmission) is available at <https://www.ferc.gov/electric-transmission>.



CPCN from the CPUC, while a PTC is required for smaller projects.<sup>41</sup> The CPUC often has concurrent processes for the CPCN or PTC and the environmental review. The CPUC may also perform the environmental review for a merchant transmission developer project, although a CPCN or PTC is not required for merchant projects.

Generally, the project proponent IOU or merchant transmission developer files an environmental analysis with the CPUC called the Proponent's Environmental Assessment. The CPUC as the permitting agency then prepares their own assessment of the environmental impacts of the project. The assessment includes input from several state agencies, plus any cities, counties, or tribes that a proposed transmission line might impact. This process includes the preparation of and an EIR pursuant to CEQA for the portions affecting state lands. The planning and permitting process for transmission projects under the California ISO and CPUC approval process can take several years.

### **Publicly Owned Utility or Merchant Transmission Projects**

POUs, such as the SMUD and LADWP, JPAs such as TANC, and other public agencies such as the federal Western Area Power Administration act as both the project developer and the lead agency for the permitting of their transmission facilities. Because these POUs and JPAs are public utilities directly responsible to their customers and not to investors or shareholders, it is presumed that decisions are made in the best interests of their customers and no independent oversight through a separate state agency, like the CPUC, is necessary or even permitted.<sup>42</sup> POUs and federal agencies have their own approval processes for transmission projects, which differ by agency.

When considering the approval of transmission projects, the POUs or JPAs are required to consider the environmental impacts and are the lead agency pursuant to CEQA. For any transmission project that impacts federal lands, coordination with and approval by the appropriate federal agencies is required.

Merchant transmission developers rely on relevant federal, state, and local agencies to act as the lead agency for environmental reviews for their projects depending on where the transmission project is being developed. A JPA may also rely on federal, state, or local state agencies to serve as lead agency for environmental reviews of a transmission project.

---

41 Senate Bill 529 (Hertzberg, Chapter 357, Statutes of 2022) requires the CPUC, by January 1, 2024, to update its [General Order 131-D](#) to allow IOUs the use of the PTC process or claim an exemption, rather than a CPCN, for extension, expansion, upgrade, or other modification to its existing electrical transmission facilities, including electric transmission lines and substations within existing transmission easements, rights of way, or franchise agreements, even if the facility is above a 200-kilovolt voltage level.

42 Pursuant to Public Utilities Code sections 224.3 and 10001-10303, publicly owned utilities have sole decision authority over activities including the construction, procurement, and operation of electric generation resources and transmission infrastructure.

## **Federal Approval of Transmission Infrastructure Projects**

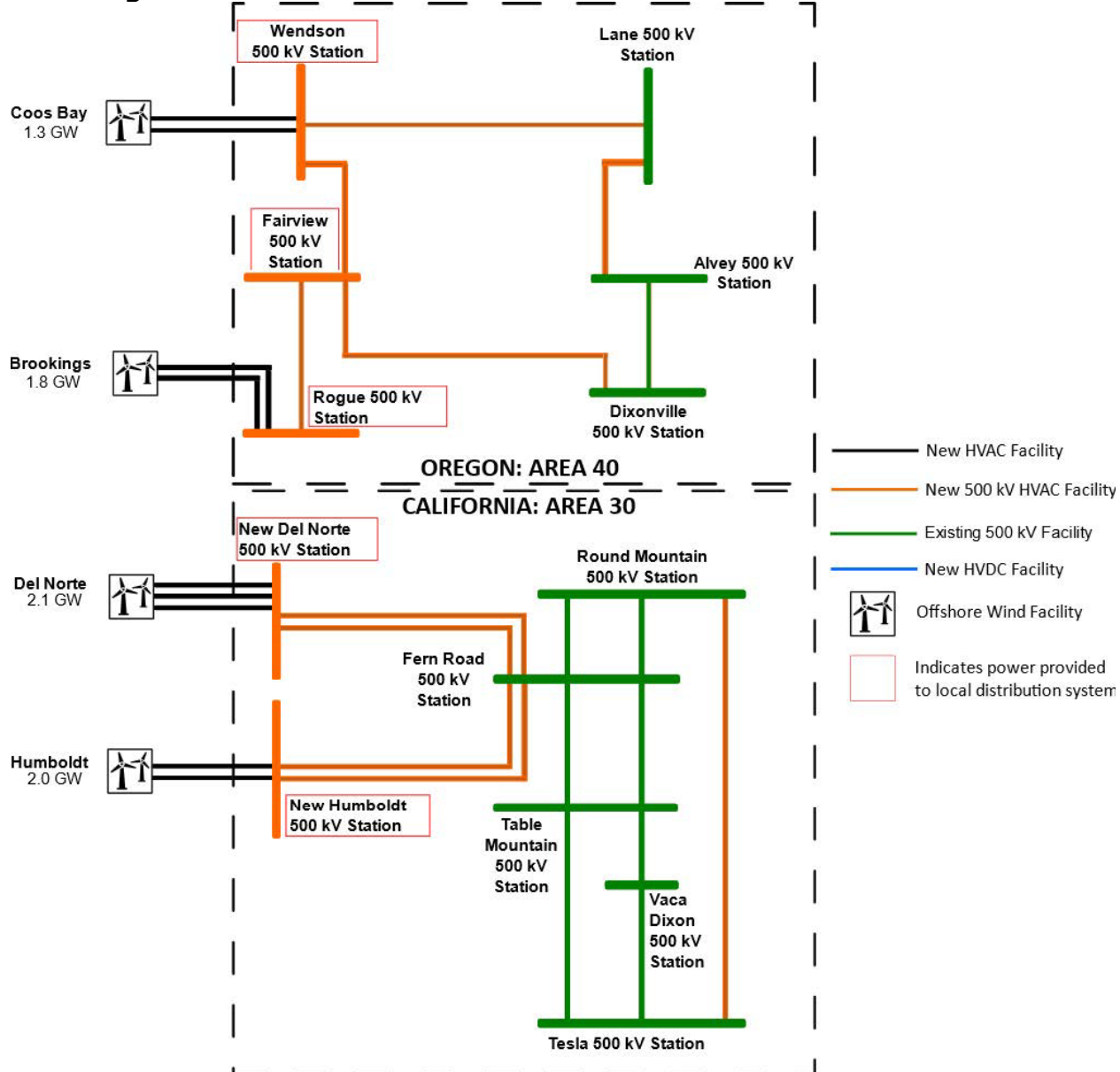
With the federal government owning approximately 45 percent of the land in California and the location of state's major transmission infrastructure, it is likely that transmission lines from an offshore wind project may cross federally owned land (for example, U.S. Forest Service, Bureau of Land Management), requiring federal approval.<sup>43</sup> Alternately, even if a transmission project does not cross federal land, a federal permit may still be required (for example, impacts a federally listed endangered species or impacts Waters of the U.S.). A federal action, such as approving a transmission line on federal land or a federal permit would require environmental review pursuant to NEPA.

---

<sup>43</sup> More information on [Federal land ownership by state](https://ballotpedia.org/Federal_land_ownership_by_state) is available at [https://ballotpedia.org/Federal\\_land\\_ownership\\_by\\_state](https://ballotpedia.org/Federal_land_ownership_by_state).

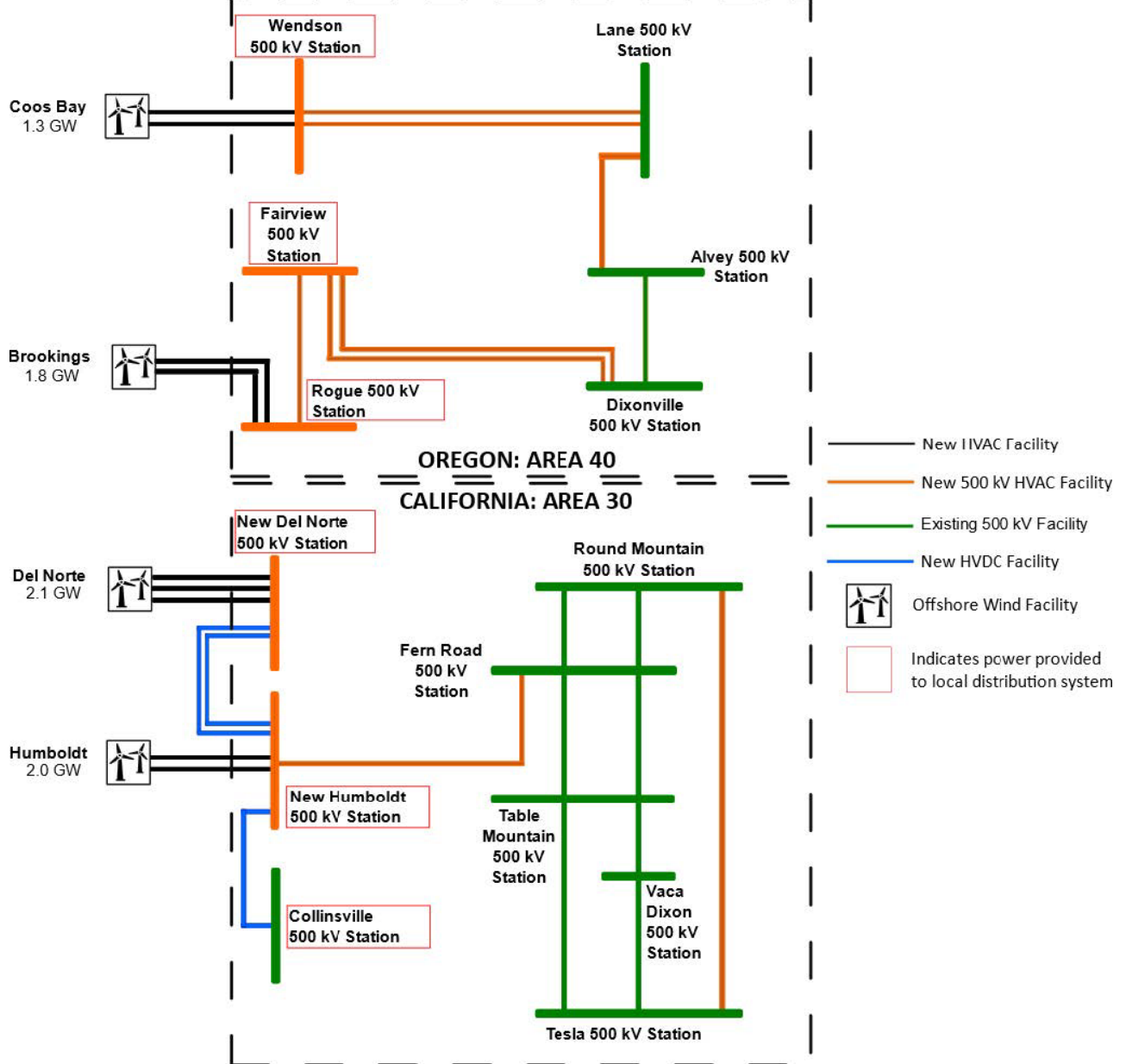
# Transmission Alternatives Schematics

**Figure D-1: North Coast Transmission Alternative 7.2a Schematic**



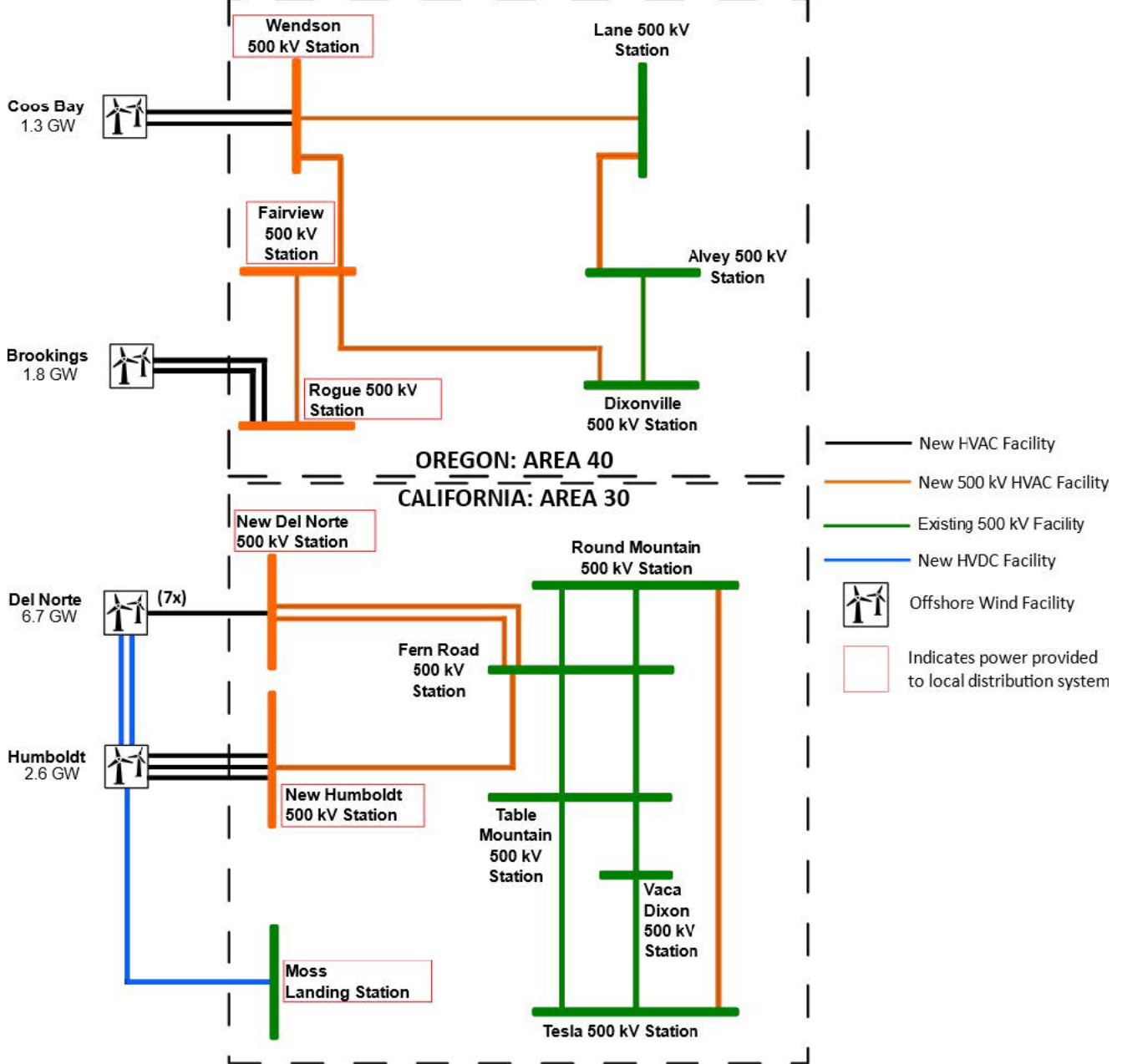
Source: Schatz. 2023

**Figure D-2: North Coast Transmission Alternative 7.2b Schematic**



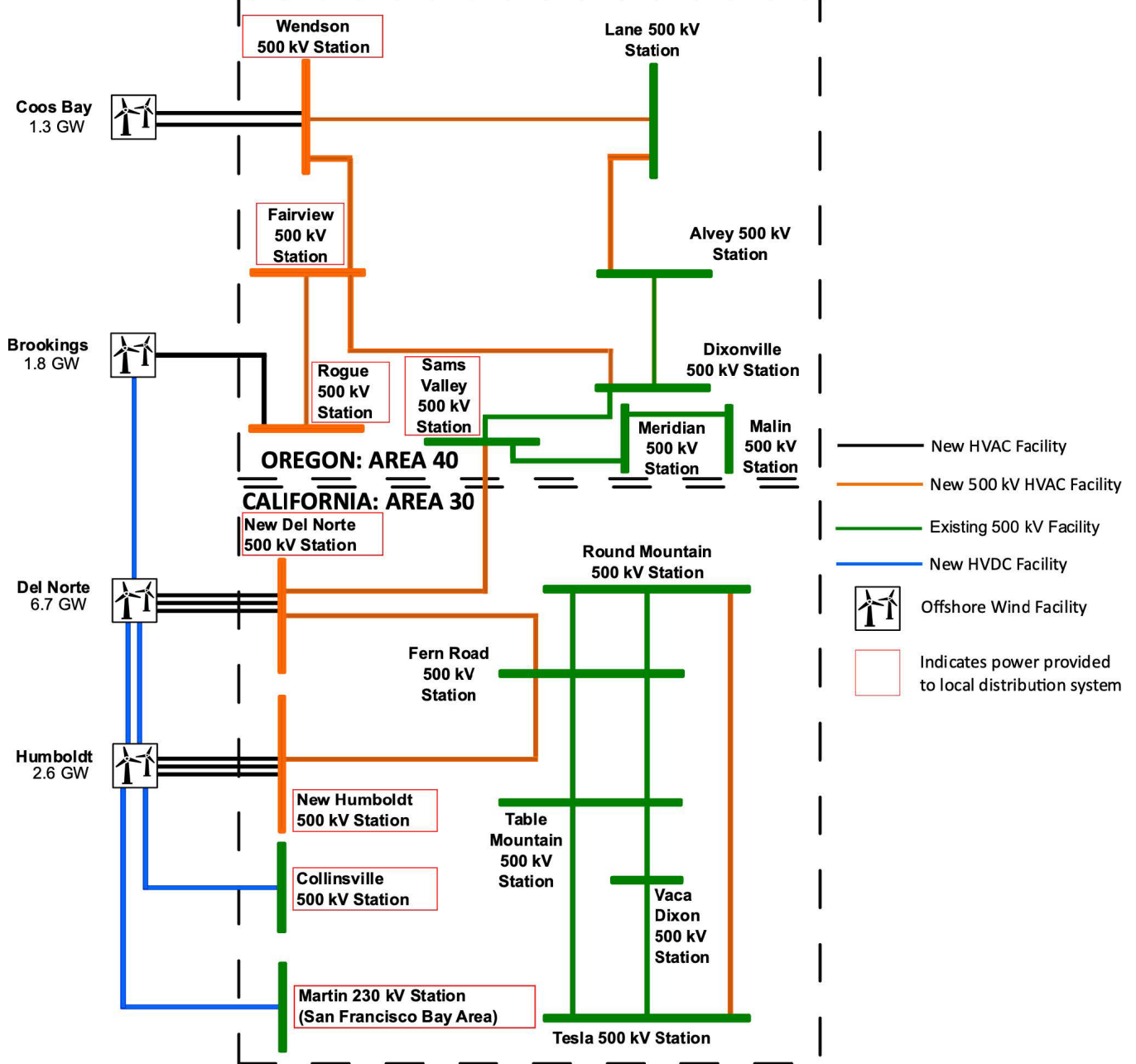
Source: Schatz. 2023

**Figure D-3: North Coast Transmission Alternative 12.4c Schematic**



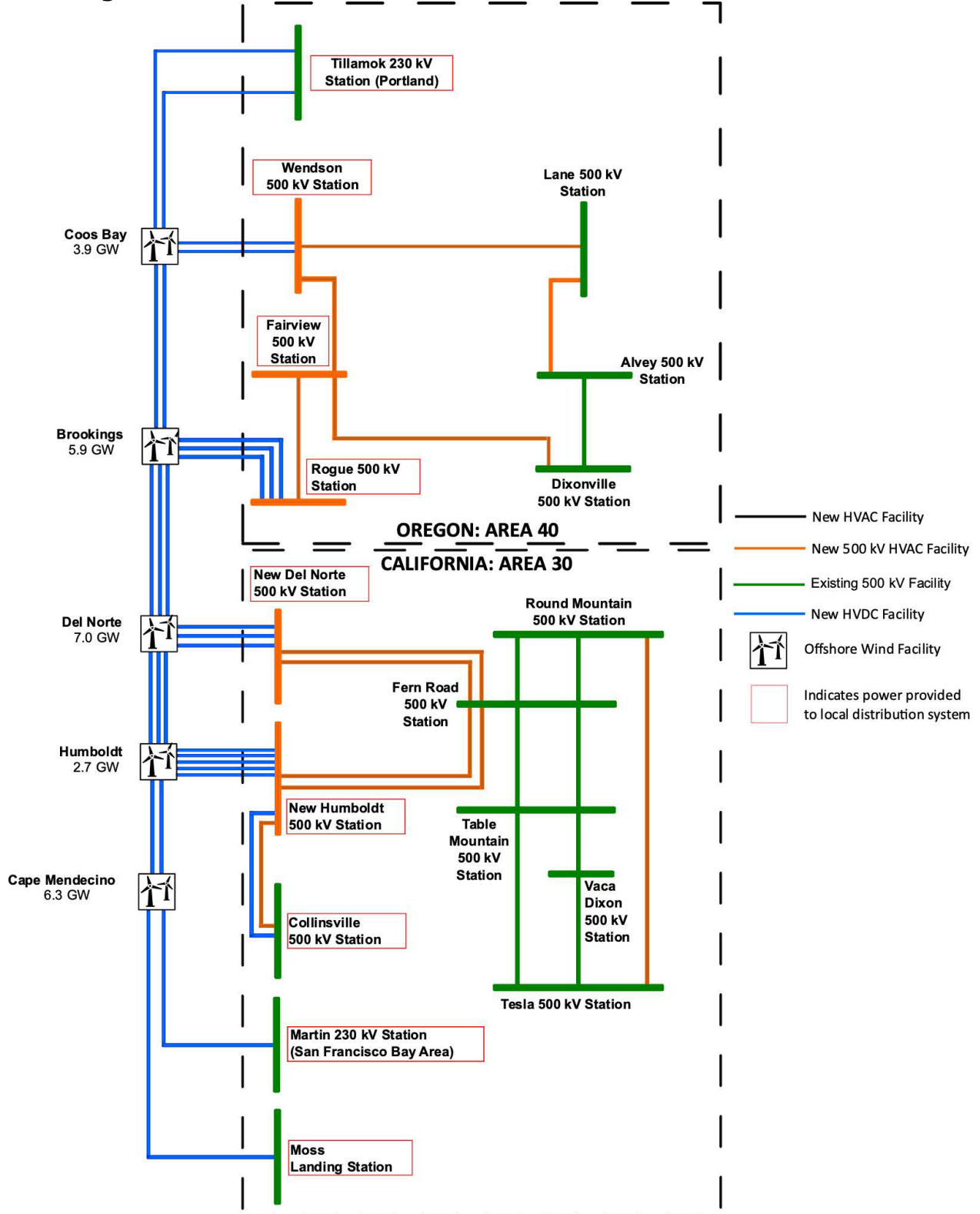
Source: Schatz. 2023

**Figure D-4: North Coast Transmission Alternative 12.4d Schematic**



Source: Schatz. 2023

**Figure D-5: North Coast Transmission Alternative 25.8a Schematic**



Source: Schatz. 2023