

DOCKETED

Docket Stamp Updated:	10/13/2023 3:11:15 PM
Docket Number:	22-BSTD-01
Project Title:	2025 Energy Code Pre-Rulemaking
TN #:	252600
Document Title:	CA Statewide Utility Codes and Standards Enhancement Team Comments - Final CASE Report- Revised October 13,2023, Nonresidential HVAC Space Heating
Description:	**** THIS DOCUMENT SUPERSEDES TN 251499 ****
Filer:	System
Organization:	CA Statewide Utility Codes and Standards Enhancement Team
Submitter Role:	Public
Submission Date:	10/13/2023 3:02:41 PM
Docketed Date:	10/13/2023

DOCKETED	
Docket Stamp Updated:	10/13/2023 3:07:18 PM
Docket Number:	22-BSTD-01
Project Title:	2025 Energy Code Pre-Rulemaking
TN #:	252600
Document Title:	CA Statewide Utility Codes and Standards Enhancement Team Comments - Final CASE Report- Revised October 13,2023, Nonresidential HVAC Space Heating
Description:	*** THIS DOCUMENT SUPERSEDES TN 251499 ***
Filer:	System
Organization:	CA Statewide Utility Codes and Standards Enhancement Team
Submitter Role:	Public
Submission Date:	10/13/2023 3:02:41 PM
Docketed Date:	10/13/2023

DOCKETED	
Docket Number:	22-BSTD-01
Project Title:	2025 Energy Code Pre-Rulemaking
TN #:	252600
Document Title:	CA Statewide Utility Codes and Standards Enhancement Team Comments - Final CASE Report- Revised October 13,2023, Nonresidential HVAC Space Heating
Description:	*** THIS DOCUMENT SUPERSEDES TN 25499 ***
Filer:	System
Organization:	CA Statewide Utility Codes and Standards Enhancement Team
Submitter Role:	Public
Submission Date:	10/13/2023 12:58:50 PM
Docketed Date:	10/13/2023

Comment Received From: CA Statewide Utility Codes and Standards Enhancement Team

Submitted On: 10/13/2023

Docket Number: 22-BSTD-01

Final CASE Report- Revised October 13,2023, Nonresidential HVAC Space Heating

*** This document supersedes TN 251499 ***, and contains the following revisions: (1) Minor revisions and reorganization to address editorial issues and values in tables; (2) Created new Appendix J to include new analysis using updated heat pump baselines; and (3) updated tables in section 4 to direct readers to Appendix J for details.

Additional submitted attachment is included below.

Nonresidential HVAC Space Heating



Category Name: Nonresidential HVAC
Bryan Boyce and Shaojie Wang, Energy Solutions
Jeff Stein and Hwakong Cheng, Taylor Engineers

Revised October 2023
Original Version: July 2023
Final CASE Report

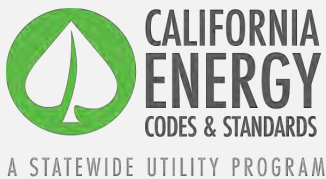

This report was prepared by the California Statewide Codes and Standards Enhancement (CASE) Program that is funded, in part, by California utility customers under the auspices of the California Public Utilities Commission.

Copyright 2023 Pacific Gas and Electric Company, Southern California Edison, San Diego Gas & Electric Company, Los Angeles Department of Water and Power, and Sacramento Municipal Utility District. All rights reserved, except that this document may be used, copied, and distributed without modification.

Neither Pacific Gas and Electric Company, Southern California Edison, San Diego Gas & Electric Company, Los Angeles Department of Water and Power, Sacramento Municipal Utility District or any of its employees makes any warranty, express or implied; or assumes any legal liability or responsibility for the accuracy, completeness or usefulness of any data, information, method, product, policy or process disclosed in this document; or represents that its use will not infringe any privately-owned rights including, but not limited to, patents, trademarks or copyrights.

Document Information

Category:	Codes and Standards
Keywords:	Statewide Codes and Standards Enhancement (CASE) Initiative; California Statewide Utility Codes and Standards Team; Codes and Standards Enhancements; 2025 California Energy Code; 2025 Title 24, Part 6; California Energy Commission; energy efficiency; boiler; electric resistance heating; heat pump; heat recovery; hydronic heating; HVAC; thermal energy storage
Authors:	Bryan Boyce, Shaojie Wang (Energy Solutions); Jeff Stein, Hwakong Cheng (Taylor Engineers)
Prime Contractor:	Energy Solutions
Project Management:	California Statewide Utility Codes and Standards Team: Pacific Gas and Electric Company, Southern California Edison, San Diego Gas & Electric Company, Sacramento Municipal Utility District, and Los Angeles Department of Water and Power.
Revisions as of October 2023	<ol style="list-style-type: none">1. At CEC's request, added Appendix J that presents the energy impacts and cost effectiveness relative to the baseline that CEC presented at their July 27, 2023 Heat Pump Baseline workshop. Tables in Section 4 were relabeled and language added to direct readers to updated tables in Appendix J.2. Minor updates to values in Table 32, Table 39, Table 40, and Table 41.3. In Table 70 added "\$" in column headers for 'Labor Income', 'Total Added Value', and 'Output'. Values in the table did not change.4. Updated values in Table 125.5. Updated material impacts information in Section 5.5.4 Statewide Material Impacts, added Table 147: First-Year Statewide Impacts on Material Use, and updated Appendix D with embodied carbon impacts.6. Table 8: removed "million" from column headers for 'Labor Income', 'Total Added Value', and 'Output'. Values in table did not change.7. Updated table numbers.

Table of Contents

Executive Summary	xvi
1. Introduction	1
2. Addressing Energy Equity and Environmental Justice	6
2.1 General Equity Impacts	6
2.2 Specific Impacts of the Proposal	10
3. Hot Water Supply Temperature Limit	11
3.1 Measure Description	11
3.2 Market Analysis	16
3.3 Energy Savings	27
3.4 Cost and Cost Effectiveness	40
3.5 First-Year Statewide Impacts	64
3.6 Addressing Energy Equity and Environmental Justice	70
4. Mechanical Heat Recovery and Thermal Energy Storage	72
4.1 Measure Description	72
4.2 Market Analysis	77
4.3 Energy Savings	111
4.4 Cost and Cost Effectiveness	122
4.5 First-Year Statewide Impacts	141
4.6 Addressing Energy Equity and Environmental Justice	150
5. Electric Resistance Heating	151
5.1 Measure Description	151
5.2 Market Analysis	169
5.3 Energy Savings	180
5.4 Cost and Cost Effectiveness	186
5.5 First-Year Statewide Impacts	199
5.6 Addressing Energy Equity and Environmental Justice	206
6. Proposed Revisions to Code Language	207
6.1 Guide to Markup Language	207
6.2 Standards	207
6.3 Reference Appendices	210
6.4 ACM Reference Manual	210
6.5 Compliance Forms	213
7. Bibliography	215
Appendix A : Statewide Savings Methodology	220
Appendix B : Embedded Electricity in Water Methodology	225

Appendix C : California Building Energy Code Compliance (CBECC) Software Specification	226
C.1 Hot Water Supply Temperature Limit.....	226
C.2 Mechanical Heat Recovery	229
C.3 Revisit Exceptions to Prescriptive Electric Resistance Ban.....	240
Appendix D : Environmental Analysis	247
Appendix E : Discussion of Impacts of Compliance Process on Market Actors	251
Appendix F : Summary of Stakeholder Engagement	253
Appendix G : Energy Cost Savings in Nominal Dollars	256
Appendix H : TIER Compliance Modeling Procedure Memorandum	259
Appendix I : Memo Discussing All-Electric Plant Options for a Large Office	268
Appendix J : Updated Savings Tables for Mechanical Heat Recovery (October 2023)	273

List of Tables

Table 1: Scope of Code Change Proposal—Limit HWST.....	xvii
Table 2: Scope of Code Change Proposal — HR + TES.....	xviii
Table 3: Scope of Code Change Proposal—ER Heating	xx
Table 4: California Construction Industry, Establishments, Employment, and Payroll in 2022 (Estimated).....	18
Table 5: Specific Subsectors of the California Commercial Building Industry Impacted by Proposed Change to Code/Standard by Subsector in 2022 (Estimated)	19
Table 6: California Building Designer and Energy Consultant Sectors in 2022 (Estimated)	20
Table 7: Employment in California State and Government Agencies with Building Inspectors in 2022 (Estimated).....	22
Table 8: Estimated Impact that Adoption of the Proposed Measure would have on the California Commercial Construction Sector.....	23
Table 9: Net Domestic Private Investment and Corporate Profits, U.S.....	25
Table 10: Summary of Assumptions Used in Limit HWST Analysis.....	28
Table 11: Prototype Buildings Used for Energy, Demand, Cost, and Environmental Impacts Analysis	33
Table 12: Modifications Made to Standard Design in Each Prototype to Simulate Proposed Code Change.....	35
Table 13: First Year Natural Gas Savings (kBtu) Per Square Foot—Hot Water Supply Temperature Limit (Gas Baseline)	37

Table 14: First Year Source Energy Savings (kBtu) Per Square Foot—Hot Water Supply Temperature Limit (Gas Baseline)	37
Table 15: First Year LSC Energy Savings (\$) Per Square Foot—Hot Water Supply Temperature Limit (Gas Baseline)	37
Table 16: First Year Electricity Savings (kWh) Per Square Foot—Hot Water Supply Temperature Limit (Electric Baseline)	38
Table 17: First Year Peak Demand Reduction (W) Per Square Foot—Hot Water Supply Temperature Limit (Electric Baseline)	38
Table 18: First Year Source Energy Savings (kBtu) Per Square Foot—Hot Water Supply Temperature Limit (Electric Baseline)	38
Table 19: First Year LSC Energy Savings (\$) Per Square Foot—Hot Water Supply Temperature Limit (Electric Baseline)	39
Table 20: 2026 PV LSC Cost Savings Over 30-Year Period of Analysis – Per Square Foot – New Construction and Additions– HighRiseMixedUse – Hot Water Supply Temperature Limit (Gas Baseline)	41
Table 21: 2026 PV LSC Savings Over 30-Year Period of Analysis – Per Square Foot – New Construction and Additions – Hospital – Hot Water Supply Temperature Limit (Gas Baseline)	41
Table 22: 2026 PV LSC Savings Over 30-Year Period of Analysis – Per Square Foot – New Construction and Additions – HotelSmall – Hot Water Supply Temperature Limit (Gas Baseline).....	42
Table 23: 2026 PV LSC Savings Over 30-Year Period of Analysis – Per Square Foot – New Construction and Additions –OfficeLarge – Hot Water Supply Temperature Limit (Gas Baseline).....	42
Table 24: 2026 PV LSC Savings Over 30-Year Period of Analysis – Per Square Foot – New Construction and Additions – OfficeMedium – Hot Water Supply Temperature Limit (Gas Baseline).....	43
Table 25: 2026 PV LSC Savings Over 30-Year Period of Analysis – Per Square Foot – New Construction and Additions – SchoolLarge – Hot Water Supply Temperature Limit (Gas Baseline).....	43
Table 26: 2026 PV LSC Savings Over 30-Year Period of Analysis – Per Square Foot – New Construction and Additions – All Prototypes– Hot Water Supply Temperature Limit (Gas Baseline).....	44
Table 27: 2026 PV LSC Savings Over 30-Year Period of Analysis – Per Square Foot – Alterations – HighRiseMixedUse – Hot Water Supply Temperature Limit (Gas Baseline).....	44
Table 28: 2026 PV LSC Savings Over 30-Year Period of Analysis – Per Square Foot – Alterations – Hospital – Hot Water Supply Temperature Limit (Gas Baseline).....	45

Table 29: 2026 PV LSC Savings Over 30-Year Period of Analysis – Per Square Foot – Alterations – HotelSmall – Hot Water Supply Temperature Limit (Gas Baseline) ...	45
Table 30: 2026 PV LSC Savings Over 30-Year Period of Analysis – Per Square Foot – Alterations –OfficeLarge – Hot Water Supply Temperature Limit (Gas Baseline) ...	46
Table 31: 2026 PV LSC Cost Savings Over 30-Year Period of Analysis – Per Square Foot – Alterations – OfficeMedium – Hot Water Supply Temperature Limit (Gas Baseline).....	46
Table 32: 2026 PV LSC Cost Savings Over 30-Year Period of Analysis – Per Square Foot – Alterations – OfficeMedium – Hot Water Supply Temperature Limit (Gas Baseline).....	47
Table 33: 2026 PV LSC Savings Over 30-Year Period of Analysis – Per Square Foot – Alterations – All Prototypes– Hot Water Supply Temperature Limit (Gas Baseline)	47
Table 34: 2026 PV LSC Cost Savings Over 30-Year Period of Analysis – Per Square Foot – New Construction and Additions– HighRiseMixedUse – Hot Water Supply Temperature Limit (Electric Baseline)	48
Table 35: 2026 PV LSC Savings Over 30-Year Period of Analysis – Per Square Foot – New Construction and Additions – Hospital – Hot Water Supply Temperature Limit (Electric Baseline)	48
Table 36: 2026 PV LSC Savings Over 30-Year Period of Analysis – Per Square Foot – New Construction and Additions – HotelSmall – Hot Water Supply Temperature Limit (Electric Baseline).....	49
Table 37: 2026 PV LSC Savings Over 30-Year Period of Analysis – Per Square Foot – New Construction and Additions –OfficeLarge – Hot Water Supply Temperature Limit (Electric Baseline).....	49
Table 38: 2026 PV LSC Savings Over 30-Year Period of Analysis – Per Square Foot – New Construction and Additions – SchoolLarge – Hot Water Supply Temperature Limit (Electric Baseline).....	50
Table 39: 2026 PV LSC Savings Over 30-Year Period of Analysis – Per Square Foot – New Construction and Additions – OfficeMedium – Hot Water Supply Temperature Limit (Electric Baseline).....	50
Table 40: 2026 PV LSC Savings Over 30-Year Period of Analysis – Per Square Foot – New Construction and Additions – All Prototypes– Hot Water Supply Temperature Limit (Electric Baseline).....	51
Table 41: 2026 PV LSC Savings Over 30-Year Period of Analysis – Per Square Foot – Alterations – HighRiseMixedUse – Hot Water Supply Temperature Limit (Electric Baseline).....	51
Table 42: 2026 PV LSC Savings Over 30-Year Period of Analysis – Per Square Foot – Alterations – Hospital – Hot Water Supply Temperature Limit (Electric Baseline) ..	52

Table 43: 2026 PV LSC Savings Over 30-Year Period of Analysis – Per Square Foot – Alterations – HotelSmall – Hot Water Supply Temperature Limit (Electric Baseline)	52
Table 44: 2026 PV LSC Savings Over 30-Year Period of Analysis – Per Square Foot – Alterations –OfficeLarge – Hot Water Supply Temperature Limit (Electric Baseline)	53
Table 45: 2026 PV LSC Savings Over 30-Year Period of Analysis – Per Square Foot – Alterations – OfficeMedium – Hot Water Supply Temperature Limit (Electric Baseline).....	53
Table 46: 2026 PV LSC Savings Over 30-Year Period of Analysis – Per Square Foot – Alterations – SchoolLarge – Hot Water Supply Temperature Limit (Electric Baseline)	54
Table 47: 2026 PV LSC Savings Over 30-Year Period of Analysis – Per Square Foot – Alterations – All Prototypes– Hot Water Supply Temperature Limit (Electric Baseline).....	54
Table 48. HW Pipe Cost Data from Mechanical Contractors	55
Table 49: Boiler Cost Data	57
Table 50: Cost Effectiveness Results for Selected Climate Zones (Large Office – Gas Baseline).....	59
Table 51: Cost Effectiveness Results for Selected Climate Zones (Large Office – Elec Baseline).....	59
Table 52: Cost Effectiveness Results for Selected Climate Zones (Medium Office – Gas Baseline).....	60
Table 53: Cost Effectiveness Results for Selected Climate Zones (Medium Office – Elec Baseline).....	60
Table 54: 30-Year Cost-Effectiveness Summary Per Square Foot – New Construction/Additions – Hot Water Supply Temperature Limit (Gas Baseline).....	62
Table 55: 30-Year Cost-Effectiveness Summary Per Square Foot – Alterations – Hot Water Supply Temperature Limit (Gas Baseline)	62
Table 56: 30-Year Cost-Effectiveness Summary Per Square Foot – New Construction/Additions – Hot Water Supply Temperature Limit (Electric Baseline)	63
Table 57: 30-Year Cost-Effectiveness Summary Per Square Foot – Alterations – Hot Water Supply Temperature Limit (Electric Baseline)	63
Table 58: Statewide Energy and Energy Cost Impacts – New Construction and Additions (Gas Baseline).....	65
Table 59: Statewide Energy and Energy Cost Impacts – Alterations (Gas Baseline) ...	66

Table 60: Statewide Energy and Energy Cost Impacts – New Construction, Additions, and Alterations (Gas Baseline).....	66
Table 61: Statewide Energy and Energy Cost Impacts – New Construction and Additions (Electric Baseline)	67
Table 62: Statewide Energy and Energy Cost Impacts – Alterations (Electric Baseline)	68
Table 63: Statewide Energy and Energy Cost Impacts – New Construction, Additions, and Alterations (Electric Baseline)	68
Table 64: First-Year Statewide GHG Emissions Impacts	69
Table 65: California Construction Industry, Establishments, Employment, and Payroll in 2022 (Estimated).....	102
Table 66: Specific Subsectors of the California Commercial Building Industry Impacted by Proposed Change to Code/Standard by Subsector in 2022 (Estimated)	103
Table 67: California Building Designer and Energy Consultant Sectors in 2022 (Estimated)	104
Table 68: Employment in California State and Government Agencies with Building Inspectors in 2022 (Estimated).....	106
Table 69: Estimated Impact that Adoption of the Proposed Measure would have on the California Commercial Construction Sector.....	107
Table 70: Estimated Impact that Adoption of the Proposed Measure would have on the California Building Designers and Energy Consultants Sectors	108
Table 71: Net Domestic Private Investment and Corporate Profits, U.S.....	109
Table 72: Prototype Buildings Used for Energy, Demand, Cost, and Environmental Impacts Analysis	117
Table 73: Lookup Table for Mechanical Heat Recovery Submeasures	119
Table 74: First Year Electricity Savings (kWh) Per Square Foot – Simultaneous Cooling and Heating (AWHP Baseline)	120
Table 75: First Year Peak Demand Reduction (W) Per Square Foot.....	120
Table 76: First Year Natural Gas Savings (kBtu) Per Square Foot.....	120
Table 77: First Year Source Energy Savings (kBtu) Per Square Foot	121
Table 78: First Year LSC Energy Savings (\$) Per Square Foot.....	121
Table 79: 2026 PV LSC Savings Over 30-Year Period of Analysis – Per Square Foot – New Construction and Additions – Hospital (Simultaneous Cooling and Heating)	123
Table 80: 2026 PV LSC Savings Over 30-Year Period of Analysis – Per Square Foot – New Construction and Additions – Large Office (Thermal Energy Storage – AWHP Baseline).....	124

Table 81: 2026 PV LSC Savings Over 30-Year Period of Analysis – Per Square Foot – New Construction and Additions – Large Office (Thermal Energy Storage – Gas Baseline).....	124
Table 82: 2026 PV LSC Savings Over 30-Year Period of Analysis – Per Square Foot – New Construction and Additions – Large Office (Heat Recovery for Service Water Heating)	125
Table 83: 2026 PV LSC Savings Over 30-Year Period of Analysis – Per Square Foot – New Construction and Additions – Large School (Heat Recovery for Service Water Heating)	125
Table 84: 2026 PV LSC Savings Over 30-Year Period of Analysis – Per Square Foot – New Construction and Additions – Large Office (Simultaneous Heat Recovery for Space Heating and Service Water Heating Scenario A).....	126
Table 85: 2026 PV LSC Savings Over 30-Year Period of Analysis – Per Square Foot – New Construction and Additions – Large Office (Simultaneous Heat Recovery for Space Heating and Service Water Heating Scenario B).....	126
Table 86: Incremental First Cost and Maintenance Cost for 4-pipe vs 2-pipe AWHP .	128
Table 87: Incremental Cost of Simultaneous Heat Recovery	130
Table 88: TIER Plant Incremental Cost Savings	131
Table 89: Detailed Pricing for TIER vs AWHP - San Jose Site.....	132
Table 90: Incremental Cost for Conversion of All-Electric HW Plant to Gas Heat.....	134
Table 91: Pricing for SWH Heat Recovery	135
Table 92: 30-Year Cost-Effectiveness Summary Per Square Foot – New Construction/Additions – Hospital (Simultaneous Cooling and Heating).....	137
Table 93: 30-Year Cost-Effectiveness Summary Per Square Foot – New Construction/Additions – Large Office (Thermal Energy Storage - AWHP Baseline)	138
Table 94: 30-Year Cost-Effectiveness Summary Per Square Foot – New Construction/Additions – Large Office (Thermal Energy Storage - Gas Baseline)	138
Table 95: 30-Year Cost-Effectiveness Summary Per Square Foot – New Construction/Additions – Large Office (Heat Recovery for Service Water Heating)	139
Table 96: 30-Year Cost-Effectiveness Summary Per Square Foot – New Construction/Additions – Large Office (Simultaneous Heat Recovery for Space Heating and Service Water Heating Scenario A).....	140
Table 97: 30-Year Cost-Effectiveness Summary Per Square Foot – New Construction/Additions – Large Office (Simultaneous Heat Recovery for Space Heating and Service Water Heating Scenario B).....	140

Table 98: Statewide Energy and Energy Cost Impacts – New Construction and Additions – Hospital – Simultaneous Cooling and Heating	142
Table 99: Statewide Energy and Energy Cost Impacts – New Construction and Additions - Large Office – Thermal Energy Storage (AWHP Baseline).....	143
Table 100: Statewide Energy and Energy Cost Impacts – New Construction and Additions - Large Office – Thermal Energy Storage (Gas Baseline).....	144
Table 101: Statewide Energy and Energy Cost Impacts – New Construction and Additions - Large Office – Heat Recovery for Service Water Heating	145
Table 102: Statewide Energy and Energy Cost Impacts – New Construction and Additions - Large Office – Simultaneous Heat Recovery for Space Heating and Service Water Heating Scenario A	146
Table 103: Statewide Energy and Energy Cost Impacts – New Construction and Additions - Large Office – Simultaneous Heat Recovery for Space Heating and Service Water Heating Scenario B.....	147
Table 104: First-Year Statewide GHG Emissions Impacts	148
Table 105: Water Savings for Heat Recovery + Thermal Energy Storage Measure – Large Office	149
Table 106: California Construction Industry, Establishments, Employment, and Payroll in 2022 (Estimated)	171
Table 107: Specific Subsectors of the California Commercial Building Industry Impacted by Proposed Change to Code/Standard by Subsector in 2022 (Estimated)	172
Table 108: California Building Designer and Energy Consultant Sectors in 2022 (Estimated)	173
Table 109: Employment in California State and Government Agencies with Building Inspectors in 2022 (Estimated).....	174
Table 110: Estimated Impact that Adoption of the Proposed Measure would have on the California Commercial Construction Sector.....	176
Table 111: Net Domestic Private Investment and Corporate Profits, U.S.....	178
Table 112: Prototype Buildings Used for Energy, Demand, Cost, and Environmental Impacts Analysis	181
Table 113: First Year Electricity Savings (kWh) Per Square Foot – Electric Resistance Heating (Gas Baseline)	184
Table 114: First Year Peak Demand Reduction (W) Per Square Foot – Electric Resistance Heating (Gas Baseline)	184
Table 115: First Year Natural Gas Savings (kBtu) Per Square Foot – Electric Resistance Heating (Gas Baseline)	184

Table 116: First Year Source Energy Savings (kBtu) Per Square Foot – Electric Resistance Heating (Gas Baseline)	184
Table 117: First Year LSC Energy Savings (\$) Per Square Foot – Electric Resistance Heating (Gas Baseline)	184
Table 118: First Year Electricity Savings (kWh) Per Square Foot – Electric Resistance Heating (AWHP Baseline)	185
Table 119: First Year Peak Demand Reduction (W) Per Square Foot – Electric Resistance Heating (AWHP Baseline)	185
Table 120: First Year Source Energy Savings (kBtu) Per Square Foot – Electric Resistance Heating (AWHP Baseline)	185
Table 121: First Year LSC Energy Savings (\$) Per Square Foot – Electric Resistance Heating (AWHP Baseline)	185
Table 122: 2026 PV LSC Savings Over 30-Year Period of Analysis – Per Square Foot – New Construction and Additions – OfficeLarge – Electric Resistance Heating (Gas Baseline)	187
Table 123: 2026 PV LSC Savings Over 30-Year Period of Analysis – Per Square Foot – New Construction and Additions–OfficeMedium – Electric Resistance Heating (Gas Baseline)	187
Table 124: 2026 PV LSC Savings Over 30-Year Period of Analysis – Per Square Foot – New Construction and Additions–SchoolLarge – Electric Resistance Heating (Gas Baseline)	188
Table 125: 2026 PV LSC Savings Over 30-Year Period of Analysis – Per Square Foot – New Construction and Additions–All Prototypes – Electric Resistance Heating (Gas Baseline)	188
Table 126: 2026 PV LSC Savings Over 30-Year Period of Analysis – Per Square Foot – Alterations– OfficeLarge – Electric Resistance Heating (Gas Baseline)	189
Table 127: 2026 PV LSC Savings Over 30-Year Period of Analysis – Per Square Foot – Alterations–OfficeMedium – Electric Resistance Heating (Gas Baseline)	189
Table 128: 2026 PV LSC Savings Over 30-Year Period of Analysis – Per Square Foot – Alterations–SchoolLarge – Electric Resistance Heating (Gas Baseline)	190
Table 129: 2026 PV LSC Savings Over 30-Year Period of Analysis – Per Square Foot – Alterations–All Prototypes – Electric Resistance Heating (Gas Baseline)	190
Table 130: 2026 PV LSC Savings Over 30-Year Period of Analysis – Per Square Foot – New Construction and Additions–OfficeLarge – Electric Resistance Heating (AWHP Baseline)	191
Table 131: 2026 PV LSC Savings Over 30-Year Period of Analysis – Per Square Foot – New Construction and Additions –OfficeMedium – Electric Resistance Heating (AWHP Baseline)	191

Table 132: 2026 PV LSC Savings Over 30-Year Period of Analysis – Per Square Foot – New Construction and Additions –SchoolLarge – Electric Resistance Heating (AWHP Baseline)	192
Table 133: 2026 PV LSC Savings Over 30-Year Period of Analysis – Per Square Foot – New Construction and Additions –All Prototypes – Electric Resistance Heating (AWHP Baseline)	192
Table 134: Building Data for ER Heating Measure Costing	193
Table 135: Gas Hydronic Baseline Cost Data	194
Table 136: Electric (AWHP) Hydronic Baseline Cost Data	195
Table 137: ER Heating Proposed Design Cost Data	195
Table 138: 30-Year Cost-Effectiveness Summary Per Square Foot – New Construction/Additions – Gas Baseline	197
Table 139: 30-Year Cost-Effectiveness Summary Per Square Foot – Alterations – Gas Baseline	198
Table 140: 30-Year Cost-Effectiveness Summary Per Square Foot – New Construction/Additions – AWHP Baseline	199
Table 141: Statewide Energy and Energy Cost Impacts – New Construction and Additions (Gas Baseline).....	200
Table 142: Statewide Energy and Energy Cost Impacts – Alterations (Gas Baseline)	201
Table 143: Statewide Energy and Energy Cost Impacts – New Construction and Additions (AWHP Baseline)	202
Table 144: Statewide Energy and Energy Cost Impacts – New Construction, Additions, and Alterations (Gas Baseline).....	203
Table 145: Statewide Energy and Energy Cost Impacts – New Construction, Additions, and Alterations (AWHP Baseline)	203
Table 146: First-Year Statewide GHG Emissions Impacts	204
Table 147: First-Year Statewide Impacts on Material Use.....	205
Table 148: Estimated New Nonresidential Construction in 2026 (Million Square Feet)	222
Table 149: Estimated Existing Floorspace in 2026 (Million Square Feet)	223
Table 150: Percentage of Nonresidential Floorspace Impacted by Proposed Code Change in 2026, by Building Type	224
Table 151: EnergyPlus Input Variables Relevant to Hotwater Supply Temperature Limit	227
Table 152: EnergyPlus Input Variables Relevant to Mechanical Heat Recovery	230

Table 153: EnergyPlus Input Variables Relevant to Revisit Exceptions to Prescriptive Electric Resistance Ban	241
Table 154: First-Year Embodied Carbon Impacts	250
Table 155: Roles of Market Actors in the Proposed Compliance Process	252
Table 156: Utility-Sponsored Stakeholder Meetings.....	254
Table 157: Engaged Stakeholders	255
Table 158: Nominal LSC Over 30-Year Period of Analysis – Per Square Foot – New Construction, Additions, and Alterations – Limit HWST (Gas Baseline).....	257
Table 159: Nominal LSC Savings Over 30-Year Period of Analysis – Per Square Foot – New Construction, Additions, and Alterations – Limit HWST (AWHP Baseline) ...	257
Table 160: Nominal LSC Savings Over 30-Year Period of Analysis – Per Square Foot – New Construction – Simultaneous Cooling and Heating	257
Table 161: Nominal LSC Savings Over 30-Year Period of Analysis – Per Square Foot – New Construction – Thermal Energy Storage – AWHP Baseline	257
Table 162: Nominal LSC Savings Over 30-Year Period of Analysis – Per Square Foot – New Construction – Thermal Energy Storage – Gas Baseline	257
Table 163: Nominal LSC Savings Over 30-Year Period of Analysis – Per Square Foot – New Construction – Heat Recovery for Service Water Heating.....	258
Table 164: Nominal LSC Savings Over 30-Year Period of Analysis – Per Square Foot – New Construction – Simultaneous Heat Recovery for Space Heating and Service Water Heating Scenarios A.....	258
Table 165: Nominal LSC Savings Over 30-Year Period of Analysis – Per Square Foot – New Construction – Simultaneous Heat Recovery for Space Heating and Service Water Heating Scenarios B.....	258
Table 166: Nominal LSC Savings Over 30-Year Period of Analysis – Per Square Foot – New Construction – ER Heating (Gas Baseline)	258
Table 167: Nominal LSC Savings Over 30-Year Period of Analysis – Per Square Foot – New Construction – ER Heating (AWHP Baseline)	258
Table 168: Lookup Table for Mechanical Heat Recovery Submeasures	273
Table 169: First Year Electricity Savings (kWh) Per Square Foot – Simultaneous Cooling and Heating (AWHP Baseline)	274
Table 170: First Year Peak Demand Reduction (W) Per Square Foot.....	274
Table 171: First Year Source Energy Savings (kBtu) Per Square Foot	274
Table 172: First Year LSC Energy Savings (\$) Per Square Foot.....	274
Table 173: 2026 PV LSC Savings Over 30-Year Period of Analysis – Per Square Foot – New Construction and Additions – Large Office (Heat Recovery for Service Water Heating)	275

Table 174: 2026 PV LSC Savings Over 30-Year Period of Analysis – Per Square Foot – New Construction and Additions – Large Office (Simultaneous Heat Recovery for Space Heating and Service Water Heating Scenario A).....	275
Table 175: 30-Year Cost-Effectiveness Summary Per Square Foot – New Construction/Additions – Large Office (Heat Recovery for Service Water Heating)	276
Table 176: 30-Year Cost-Effectiveness Summary Per Square Foot – New Construction/Additions – Large Office (Simultaneous Heat Recovery for Space Heating and Service Water Heating Scenario A).....	276
Table 177: Statewide Energy and Energy Cost Impacts – New Construction and Additions – Heat Recovery for Service Water Heating	277
Table 178: Statewide Energy and Energy Cost Impacts – New Construction and Additions - Large Office – Simultaneous Heat Recovery for Space Heating and Service Water Heating Scenario A.....	277
Table 179: First-Year Statewide GHG Emissions Impacts	278

List of Figures

Figure 1: Typical VAV Box Coil Selections (55 EAT).....	29
Figure 2: Typical VAV Box Coil Selections (65 EAT).....	29
Figure 3: UC Berkeley CBE HW Piping Loss Data (with year each building was built) .	30
Figure 4: Histogram of HW System Operating Hours (ref: UCB CBE)	31
Figure 5: Boiler Efficiency Curve	32
Figure 6: Pipe Cost (\$/linear ft) vs Flow (gpm)	55
Figure 7: 2nd Floor of 2-Story, 40,000 ft2 Medium Office Building	56
Figure 8: Typical Floor of 5-Story, 200,000 ft2 Large Office Building.....	57
Figure 9: Schematic of Ice Storage TES System	82
Figure 10: Schematic of CHW+HW Storage TES System.....	82
Figure 11: TIER Schematic	83
Figure 12: Water-Cooled VRF with TES.....	84
Figure 13: WSHP with TES Schematic	85
Figure 14: WSHP with TES Detailed Schematic	86
Figure 15: Cool Day Morning Operation of a Condenser Water TIER System	87
Figure 16: Cool Day Afternoon Operation of a Condenser Water TIER System.....	88
Figure 17: Warm Day Afternoon Operation of a Condenser Water TIER System.....	89
Figure 18: Demonstration of TES Tank Size Relative to Building	90

Figure 19: Schematic Showing TES Tank Elevation View	90
Figure 20: Schematic Showing TIER Plant Equipment.....	91
Figure 21: Control Schematic for SWH Heat Exchanger	92
Figure 22: Typical Plumbing Drawings Showing EWH Location and Schedule	93
Figure 23: Typical Mechanical Drawings Showing DHW HX Incremental Piping and Equipment Schedule.....	93
Figure 24: San Jose Building "A" Mechanical Drawing Level 6	94
Figure 25: San Jose Building "A" Plumbing Drawing Level 6	95
Figure 26: San Jose Building "A" Mechanical Drawing Level 18	95
Figure 27. Partial Piping Schematic of CHW Plant with Four Air Cooled Chillers and One Heat Recovery Chiller	97
Figure 28. Partial Piping Schematic of CHW Plant with Four Heat Recovery Chillers ..	98
Figure 29. Piping Schematic of CHW Plant with Two Heat Recovery Chillers	99
Figure 30. Schematic of Small HR Chiller Added to Existing CHW/Boiler Plant	100
Figure 31. Plan View of Small HR Chiller Added to Existing CHW/Boiler Plant	101
Figure 32: Typical CHW/HW Plant with 2-Pipe and 4-Pipe AWHPs	127
Figure 33. Schematic for Conversion of Standard Chiller to HR Chiller.....	129
Figure 34. Plan View for Conversion of Standard Chiller to HR Chiller.....	130
Figure 35: Conversion of All-Electric HW Plant to Gas Heat	133
Figure 36: Markup Illustrating Occupied Standby Requirements in Table 120.1-A (Top of Table)	154
Figure 37: Markup Illustrating Occupied Standby Requirements in Table 120.1-A (Middle of Table, 1 of 2)	155
Figure 38: Markup Illustrating Occupied Standby Requirements in Table 120.1-A (Middle of Table, 2 of 2)	156
Figure 39: Markup Illustrating Occupied Standby Requirements in Table 120.1-A (Bottom of Table)	157
Figure 40: Data Center Office Space with Heat Recovery to Fan Powered Boxes	159
Figure 41: Data Center Dual Fan Dual Duct Heat Recovery Schematic.....	159
Figure 42: Office Computer Room Without Transfer Air	160
Figure 43: Office Computer Room with Transfer Air.....	161
Figure 44: Typical Office Computer Room showing Heat Recovery Opportunity, Example 1	162
Figure 45: Typical Office Computer Room showing Heat Recovery Opportunity, Example 2.....	163

Figure 46: Typical Office Computer Room showing Heat Recovery Opportunity,
Example 3..... 164

Executive Summary

This CASE Report presents justifications for code changes to HVAC requirements that refine and build on prior code changes to Title 24, Part 6 approved by the CEC. These proposed code changes address the challenges commercial buildings face in electrifying and continue to drive increases in efficiency in the following areas:

- Limiting hot water supply temperature in hydronic systems to increase current efficiency and prepare for future electrification.
- Requirements for mechanical heat recovery and thermal energy storage in new construction, yielding large per unit energy savings for the mechanical heat recovery plus thermal energy storage (HR + TES) measure.
- Refinements to electric resistance heating that were found to be cost effective in most climate zones and small-to-medium building prototypes.

Three California investor-owned utilities (IOUs)—Pacific Gas and Electric Company, San Diego Gas & Electric, and Southern California Edison—and two publicly-owned utilities—Los Angeles Department of Water and Power, and Sacramento Municipal Utility District (herein referred to as the Statewide CASE Team when including the CASE Author)—sponsored this effort. The program goal is to prepare and submit proposals that would result in cost-effective enhancements to improve energy efficiency and energy performance in California buildings.

The Statewide CASE Team submits code change proposals to the CEC, the state agency that has authority to adopt revisions to Title 24, Part 6. The CEC will evaluate proposals submitted by the Statewide CASE Team and other stakeholders. The CEC may revise or reject proposals. See the CEC’s 2025 Title 24 website for information about the rulemaking schedule and how to participate in the process:

<https://www.energy.ca.gov/programs-and-topics/programs/building-energy-efficiency-standards/2025-building-energy-efficiency>.

Limit Hot Water Supply Temperature

Proposed Code Change

This proposed measure would mandate a limit of 130 °F on hot water supply temperatures (HWST) in space heating design in new construction, additions, or alterations. It would apply to all nonresidential buildings using either gas boilers or electric systems to provide comfort space heating and reheating. Efficiency will increase because for condensing boilers, it is preferable to design for lower HWST to ensure the boiler

operates in condensing mode. Lower supply temperatures also facilitate all-electric hydronic designs.

A major driver for this measure is “electrification readiness,” since hydronic heat pumps are generally incapable of providing HWST equal to what gas boilers can provide. Even if a site continued to meet its space heating needs with gas boilers, were this measure to be added to Part 6, then the future retrofit to heat pumps would be more cost effective. The purpose of this measure will be to ensure that starting with the 2025 edition of Title 24 Part 6, the state does not continue adding hydronic systems with HWST above 140 °F to the building stock. Detailed descriptions of the opportunity and efficiencies can be found in Section 3.1.

This proposal would necessitate a modification to the Alternative Calculation Method (ACM) Reference Manual since it is currently assumed that hydronic systems deliver 160 °F water as well as an update to Section 4.6 of the Nonresidential Compliance Manual. This proposal aligns with a parallel effort by the International Energy Conservation Code (IECC).

Table 1: Scope of Code Change Proposal—Limit HWST

Proposal Name	Limit HWST
Type of Requirement	Mandatory
Applicable Climate Zones	All
Modified Sections of Title 24, Part 6	120.2(l) (new)
Modified Title 24, Part 6 Appendices	No
Would Compliance Software Be Modified	Yes; 5.8.1
Modified Compliance Document(s)	NRCC-MCH-01-E, 2022-NRCI-MCH-E

Cost Effectiveness

The proposed code changes were found to be cost effective for all climate zones where it is proposed to be required. Additions and alterations are slightly less cost effective than new construction.

For the limit HWST measure, the benefit-to-cost (B/C) ratio over the 30-year period of analysis ranged between 0.89 and 25.9 depending on climate zone. See more details in Section 3.4.5.¹ Limiting HWST is cost effective to different degrees in all climate zones and building types except for Climate Zone 16. Analysis shows electric and gas savings as well as GHG emissions reductions. Water use is not reduced. See Section 3.5 for metrics, analysis, and full potential impacts.

¹ The benefit-to-cost (B/C) ratio compares the benefits or cost savings to the costs over the 30-year period of analysis. Proposed code changes that have a B/C ratio of 1.0 or greater are cost-effective. The larger the B/C ratio, the faster the measure pays for itself from energy cost savings.

Mechanical Heat Recovery and Thermal Energy Storage

As the trend toward all-electric space heating accelerates, large buildings will face challenges meeting their space heating needs solely with air source heat pumps due to space, cost, and efficiency barriers. Depending on how well the cooling and heating loads overlap, requirements for thermal energy storage and heat recovery equipment can mitigate heat pump challenges. For buildings with low overlapping loads, the thermal energy storage requirement is intended to store waste heat when the building is in cooling mode to use later when the building is in heating mode. The requirement is fuel neutral and applies equally to gas or electric space heating.

This measure is being pursued as a prescriptive addition to Section 140.4(r) and will improve the space heating energy efficiency of large buildings with the goal of ensuring that building waste heat is leveraged to minimize the installed capacity of heating equipment. The full measure description is in Section 4.1.

The purpose is to require heat recovery in large nonresidential buildings. The recovered heat would be applied to the building's space and domestic hot water. Buildings with misaligned cooling and heating loads would also be required to include thermal energy storage, enabling the recovered heat to be used later.

Table 2: Scope of Code Change Proposal — HR + TES

Proposal Name	HR + TES
Type of Requirement	Prescriptive, Performance (Compliance Option)
Applicable Climate Zones	All
Modified Section(s) of Title 24, Part 6	140.4(r) (new)
Modified Title 24, Part 6 Appendices	No
Would Compliance Software Be Modified	Yes; 5.8.8, and 5.8.9 (new section)
Modified Compliance Document(s)	NRCC-MCH-01-E, 2022-NRCI-MCH-E, NRCA-MCH-15-A

Cost Effectiveness

The mechanical HR and TES measure is expected to result in water savings as well as energy savings due to reduced cooling tower runtime for systems using condenser water TES. For the heat recovery and thermal energy storage measure, the benefit-to-cost (B/C) ratio over the 30-year period of analysis ranged between 1.06 and infinite, which occurs when the proposed design costs less than the baseline design and results in immediate payback, depending on climate zone and measure (i.e., heat recovery with or without thermal energy storage). See more details in Section 4.4.5.

Estimated impacts show that in the electric-to-electric case, the analysis for the mechanical heat recovery and thermal energy storage measure indicated a lower up-front cost and positive Long-term Systemwide Cost (LSC) savings, yielding an immediate payback. Per unit energy savings are large for the mechanical HR + TES measure but savings are limited since we only claim new construction. The gas-to-gas cases provide further savings.

The mechanical HR + TES measure is expected to result in water savings due to reduced cooling tower runtime for systems using condenser water TES. See Section 4.5 for more details on the first-year statewide impacts. Section 4.3.2 contains details on the per unit energy savings.

Electric Resistance Heating

This measure proposes updates to prescriptive language limiting electric resistance (ER) for space heating. Recent research pointing to the inefficiencies in the hydronic system distribution network and a steady shift toward cleaner electricity have resulted in a need to revisit the tradeoff between hydronic and ER heating. The current ban on ER heating is wide ranging and includes electric boilers, electric furnaces except as backup for heat pumps, and electric resistance variable air volume (VAV) reheat. There are currently six exceptions allowing various configurations that presumably do not consume significant electric resistance heating energy. The Statewide CASE Team proposes to preserve the prescriptive ban on electric boilers and unitary furnaces, and to update the code to allow electric resistance heat for spaces with decoupled ventilation, assuming certain energy efficient conditions are met. The proposal includes some editorial cleanup to the remainder of the exceptions as follows.

Section 140.4(g) — Electric resistance heating (new construction): The purpose of this change is to add a new exception that would allow electric resistance heating in spaces with very low space heating needs by minimizing heating loads through demand-controlled ventilation and occupied standby controls where possible, decoupling ventilation from space heating, and recovering heat from nearby computer rooms.

Section 141.0(a) Electric resistance heating (additions): The purpose of this change is to delete exception 2 in 141.0(a), which aligns requirements for additions with those proposed for new construction.

Section 141.0(b) Electric resistance heating (alterations): The purpose of this change is to add an exception (exception 6) to Section 141.0(b)2C, which would mean that buildings pursuing exception 7 to 140.4(g) would have to ensure the building envelope complies with prescriptive requirements for new construction and that the site appropriately leverages exhaust air heat recovery as specified in 140.4(q).

For a full measure description see Section 5.1. Limitations to hydronic systems driving the renewed examination of electric resistance heating are described in greater detail in Section 5.1.2.2.

Table 3: Scope of Code Change Proposal—ER Heating

Proposal Name	ER Heating
Type of Requirement	Alternative to Prescriptive Requirements
Applicable Climate Zones	All
Modified Section(s) of Title 24, Part 6	140.4(g), 141.0(a)
Modified Title 24, Part 6 Appendices	No
Would Compliance Software Be Modified	Yes
Modified Compliance Document(s)	NRCC-MCH-01-E

Cost Effectiveness

The ER heating measure includes negative electricity savings mainly stemming from the assumption that the system uses a natural gas boiler in the base case, so the impact of switching to electric heating results in negative electricity savings but positive natural gas savings. Shifting from an AWHP hydronic base case to the ER zone heating measure would result in negative electric savings as well, due to the reduction in system coefficient of performance. The proposed ER heating case includes a much lower incremental measure cost, which offsets the increase in electric energy consumption. When compared against a gas baseline, the ER heating measure shows positive source energy savings, a metric that compares changes to gas and electric energy consumption. Furthermore, the ER heating energy savings analysis is currently conservative and does not capture all elements of the measure case, such as the computer room heat recovery clause.

For the ER heating measure, the benefit-to-cost (B/C) ratio over the 30-year period of analysis ranged between 0.77 and infinite depending on climate zone. See more details in Section 5.4.5.

Avoided GHG emissions for embodied carbon in ER measures was also calculated, to inform the market that forgoing a hydronic space heating system in favor of zonal electric resistance heating results in a significant reduction in materials.

Addressing Energy Equity and Environmental Justice

The Statewide CASE Team assessed the potential impacts of the proposed measure, and based on a preliminary review, the measure is unlikely to have significant impacts on energy equity or environmental justice, therefore reducing the impacts of disparities in DIPs. The Statewide CASE Team does not recommend further research or action at

this time, but it is open to receiving feedback and data that may prove otherwise. Please reach out to Bryan Boyce (bboyce@energy-solution.com) and Marissa Lerner (mlerner@energy-solution.com) for further engagement. These measures are primarily intended to impact large buildings, which are typically not thought to significantly impact DIPs. However, our assessment is that although minor, impacts to DIPs are likely to be positive overall. Full details addressing energy equity and environmental justice can be found in Sections 2, 3.6, 4.6 and 5.6 of this report.

1. Introduction

The Codes and Standards Enhancement (CASE) initiative presents recommendations to support the California Energy Commission’s (CEC’s) efforts to update California’s Energy Code (Title 24, Part 6) to include new requirements or to upgrade existing requirements for various technologies. The three California Investor-Owned Utilities (IOUs)—Pacific Gas and Electric Company, San Diego Gas and Electric, and Southern California Edison – and two Publicly Owned Utilities—Los Angeles Department of Water and Power and Sacramento Municipal Utility District (herein referred to as the Statewide CASE Team when including the CASE Author)—sponsored this effort. The program goal is to prepare and submit proposals that would result in cost-effective enhancements to improve energy efficiency and energy performance in California buildings. This report and the code change proposal presented herein are a part of the effort to develop technical and cost-effectiveness information for proposed requirements on building energy-efficient design practices and technologies.

The CEC is the state agency that has authority to adopt revisions to Title 24, Part 6. One of the ways the Statewide CASE Team participates in the CEC’s code development process is by submitting code change proposals to the CEC for consideration. CEC will evaluate proposals the Statewide CASE Team and other stakeholders submit and may revise or reject proposals. See [the CEC’s 2025 Title 24 website](#) for information about the rulemaking schedule and how to participate in the process.

The goal of this CASE Report is to present a code change proposal regarding nonresidential space heating energy efficiency. The report contains pertinent information supporting the proposed code change.

When developing the code change proposal and associated technical information presented in this report, the Statewide CASE Team worked with industry stakeholders including manufacturers, distributors, contractors, builders, utility incentive program managers, Title 24 energy analysts, and others involved in the code compliance process. The proposal incorporates feedback received during public stakeholder workshops that the Statewide CASE Team held on February 27, 2023 and May 18, 2023.

The following is a summary of the contents of this report:

Section 2 – Addressing Energy Equity and Environmental Justice describes the potential impacts of this code change measure package on DIPs.

Section 3 – Hot Water Supply Temperature Limit

- Section 3.1 – Measure Description of this CASE Report provides a description of the measure and its background. This section also presents a detailed description of how this code change is accomplished in the various sections and documents that make up the Title 24, Part 6 Standards.
- Section 3.2 – Market Analysis includes a review of the current market structure. Section 3.2.2 describes the feasibility issues associated with the code change, including whether the proposed measure overlaps or conflicts with other portions of the building standards, such as fire, seismic, and other safety standards, and whether technical, compliance, or enforceability challenges exist.
- Section 3.3 – Energy Savings presents the per unit energy, demand reduction, and energy cost savings associated with the proposed code change. This section also describes the methodology that the Statewide CASE Team used to estimate per unit energy, demand reduction, and energy cost savings.
- Section 3.4 – Cost and Cost Effectiveness presents the lifecycle cost and cost-effectiveness analysis. This includes a discussion of the materials and labor required to implement the measure and a quantification of the incremental cost. It also includes estimates of incremental maintenance costs, i.e., equipment lifetime and various periodic costs associated with replacement and maintenance during the period of analysis.
- Section 3.5 – First-Year Statewide Impacts presents the statewide energy savings and environmental impacts of the proposed code change for the first year after the 2025 code takes effect. This includes the amount of energy that would be saved by California building owners and tenants and impacts (increases or reductions) on material with emphasis placed on any materials that are considered toxic. Statewide water consumption impacts are also reported in this section.
- Section 3.6 – Addressing Energy Equity and Environmental Justice presents the potential impacts of proposed code changes on disproportionately impacted populations (DIPs), as well as a summary of research and engagement methods.

Section 4 – Mechanical Heat Recovery and Thermal Energy Storage

- Section 4.1 – Measure Description of this CASE Report provides a description of the measure and its background. This section also presents a detailed description of how this code change is accomplished in the various sections and documents that make up the Title 24, Part 6 Standards.
- Section 4.2 – Market Analysis includes a review of the current market structure. Section 4.2.2 describes the feasibility issues associated with the code change, including whether the proposed measure overlaps or conflicts with other portions

of the building standards, such as fire, seismic, and other safety standards, and whether technical, compliance, or enforceability challenges exist.

- Section 4.3 – Energy Savings presents the per unit energy, demand reduction, and energy cost savings associated with the proposed code change. This section also describes the methodology that the Statewide CASE Team used to estimate per unit energy, demand reduction, and energy cost savings.
- Section 4.4 – Cost and Cost Effectiveness presents the lifecycle cost and cost-effectiveness analysis. This includes a discussion of the materials and labor required to implement the measure and a quantification of the incremental cost. It also includes estimates of incremental maintenance costs, i.e., equipment lifetime and various periodic costs associated with replacement and maintenance during the period of analysis.
- Section 4.5 – First-Year Statewide Impacts presents the statewide energy savings and environmental impacts of the proposed code change for the first year after the 2025 code takes effect. This includes the amount of energy that would be saved by California building owners and tenants and impacts (increases or reductions) on material with emphasis placed on any materials that are considered toxic. Statewide water consumption impacts are also reported in this section.
- Section 4.6 – Addressing Energy Equity and Environmental Justice presents the potential impacts of proposed code changes on disproportionately impacted populations (DIPs), as well as a summary of research and engagement methods.

Section 5 – Electric Resistance Heating

- Section 5.1 – Measure Description of this CASE Report provides a description of the measure and its background. This section also presents a detailed description of how this code change is accomplished in the various sections and documents that make up the Title 24, Part 6 Standards.
- Section 5.2 – Market Analysis includes a review of the current market structure. Section 5.2.2 describes the feasibility issues associated with the code change, including whether the proposed measure overlaps or conflicts with other portions of the building standards, such as fire, seismic, and other safety standards, and whether technical, compliance, or enforceability challenges exist.
- Section 5.3 – Energy Savings presents the per unit energy, demand reduction, and energy cost savings associated with the proposed code change. This section also describes the methodology that the Statewide CASE Team used to estimate per unit energy, demand reduction, and energy cost savings.
- Section 5.4 – Cost and Cost Effectiveness presents the lifecycle cost and cost-effectiveness analysis. This includes a discussion of the materials and labor

required to implement the measure and a quantification of the incremental cost. It also includes estimates of incremental maintenance costs, i.e., equipment lifetime and various periodic costs associated with replacement and maintenance during the period of analysis.

- Section 5.5 – First-Year Statewide Impacts presents the statewide energy savings and environmental impacts of the proposed code change for the first year after the 2025 code takes effect. This includes the amount of energy that would be saved by California building owners and tenants and impacts (increases or reductions) on material with emphasis placed on any materials that are considered toxic. Statewide water consumption impacts are also reported in this section.
- Section 5.6 – Addressing Energy Equity and Environmental Justice presents the potential impacts of proposed code changes on disproportionately impacted populations (DIPs), as well as a summary of research and engagement methods.

Section 6 – Proposed Revisions to Code Language concludes the report with specific recommendations with ~~strikeout~~ (deletions) and underlined (additions) language for the Standards, Reference Appendices, and Alternative Calculation Manual (ACM) Reference Manual. Generalized proposed revisions to sections are included for the Compliance Manual and compliance forms.

Section 7 – Bibliography presents the resources that the Statewide CASE Team used when developing this report.

Appendix A: Statewide Savings Methodology presents the methodology and assumptions used to calculate statewide energy impacts.

Appendix B: Embedded Electricity in Water Methodology presents the methodology and assumptions used to calculate the electricity embedded in water use (e.g., electricity used to draw, move, or treat water) and the energy savings resulting from reduced water use.

Appendix C: California Building Energy Code Compliance (CBECC) Software Specification presents relevant proposed changes to the compliance software.

Appendix D: Environmental Analysis presents the methodologies and assumptions used to calculate impacts on GHG emissions and water use and quality.

Appendix E: Discussion of Impacts of Compliance Process on Market Actors presents how the recommended compliance process could impact identified market actors.

Appendix F: Summary of Stakeholder Engagement documents the efforts made to engage and collaborate with market actors and experts.

Appendix G: Energy Cost Savings in Nominal Dollars presents energy cost savings over the period of analysis in nominal dollars.

Appendix H: TIER Compliance Modeling Procedure Memorandum provides an in-depth step-by-step procedure for modeling TIER plant energy consumption since this system has not yet been modeled in EnergyPlus.

Appendix I: Memo Discussing All-Electric Plant Options for a Large Office reproduces a narrative developed to assist with system selection for a building deciding which all-electric option to pursue.

The California IOUs offer free energy code training, tools, and resources for those who need to understand and meet the requirements of Title 24, Part 6. The program recognizes that building codes are one of the most effective pathways to achieve energy savings and GHG reductions from buildings – and that well-informed industry professionals and consumers are key to making codes effective. With that in mind, the California IOUs provide tools and resources to help both those who enforce the code, as well as those who must follow it. Visit [EnergyCodeAce.com](https://www.energycodeace.com) to learn more and to access content, including a glossary of terms.

2. Addressing Energy Equity and Environmental Justice

2.1 General Equity Impacts

The Statewide CASE Team recognizes, acknowledges, and accounts for a history of prejudice and inequality in disproportionately impacted populations (DIPs) and the role this history plays in the environmental justice issues that persist today. While the term disadvantaged communities (DACs) is often used in the energy industry and state agencies, the Statewide CASE Team chose to use terminology that is more acceptable to and less stigmatizing for those it seeks to describe (DC Fiscal Policy Institute 2017). Similar to the California Public Utilities Commission (CPUC) definition, DIPs refer to the populations throughout California that “most suffer from a combination of economic, health, and environmental burdens. These burdens include poverty, high unemployment, air and water pollution, presence of hazardous wastes, as well as high incidence of asthma and heart disease” (CPUC n.d.). DIPs also incorporate race, class, and gender since these intersecting identity factors affect how people frame issues, interpret, and experience the world.²

Including impacted communities in the decision-making process, ensuring that the benefits and burdens of the energy sector are evenly distributed, and facing the unjust legacies of the past all serve as critical steps to achieving energy equity. Recognizing the importance of engaging DIPs and gathering their input to inform the code change process and proposed measures, the Statewide CASE Team is working to build relationships with community-based organizations (CBOs) to facilitate meaningful engagement. A participatory approach allows individuals to address problems, develop innovative ideas, and bring forth a different perspective. Please reach out to Bryan Boyce (bboyce@energy-solution.com) and Marissa Lerner (mlerner@energy-solution.com) for further engagement.

Energy equity and environmental justice (EEEJ) is a newly emphasized component of the Statewide CASE Team’s work and is an evolving dialogue within California and

² Environmental disparities have been shown to be associated with unequal harmful environmental exposure correlated with race/ethnicity, gender, and socioeconomic status. For example, chronic diseases, such as respiratory diseases, cardiovascular disease, and cancer, associated with environmental exposure have been shown to occur in higher rates in the LGBTQ+ population than in the cisgender, heterosexual population (Goldsmith L 2022). Socioeconomic inequities, climate, energy, and other inequities are inextricably linked and often mutually reinforcing.

beyond.³ To minimize the risk of perpetuating inequity, code change proposals are being developed with intentional consideration of the unintended consequences of proposals on DIPs. The Statewide CASE Team identified potential impacts via research and stakeholder input. While the listed potential impacts should be comprehensive, they may not yet be exhaustive. As the Statewide CASE Team continues to build relationships with CBOs, these partnerships will inform and further improve the identification of potential impacts. The Statewide CASE Team is open to additional peer-reviewed studies that contribute to or challenge the information on this topic presented in this report. The Statewide CASE Team is currently continuing outreach with CBOs and EEEJ partners. Results of that outreach as well as a summary of the 2025 code cycle EEEJ activities will be documented in the 2025 EEEJ Summary Report that is expected to be published on title24stakeholders.com by the end of 2023.

2.1.1 Procedural Equity and Stakeholder Engagement

As mentioned, representation from DIPs is crucial to considering factors and potential impacts that may otherwise be missed or misinterpreted. The Statewide CASE Team is committed to engaging with representatives from as many affected communities as possible. This code cycle, the Statewide CASE Team is focused on building relationships with CBOs and representatives of DIPs across California. To achieve this end, the Statewide CASE Team is prioritizing the following activities:

- Identification and outreach to relevant and interested CBOs
- Holding a series of working group meetings to solicit feedback from CBOs on code change proposals
- Developing a 2025 EEEJ Summary Report

In support of these efforts, the Statewide CASE team is also working to secure funds to provide fair compensation to those who engage with the Statewide CASE Team. While the 2025 code cycle will come to an end, the Statewide CASE Team's EEEJ efforts will continue, as this is not an effort that can be "completed" in a single or even multiple code cycles. In future code cycles, the Statewide CASE Team is committed to furthering relationships with CBOs and inviting feedback on proposed code changes with a goal of

³ The CEC defines energy equity as "the quality of being fair or just in the availability and distribution of energy programs" (CEC 2018). American Council for an Energy-Efficient Economy (ACEEE) defines energy equity as that which "aims to ensure that disadvantaged communities have equal access to clean energy and are not disproportionately affected by pollution. It requires the fair and just distribution of benefits in the energy system through intentional design of systems, technology, procedures and policies" (ACEEE n.d.). Title 7, Planning and Land Use, of the California Government Code defines environmental justice as "the fair treatment and meaningful involvement of people of all races, cultures, incomes, and national origins, with respect to the development, adoption, implementation, and enforcement of environmental laws, regulations, and policies" (State of California n.d.).

engagement with these organizations representing DIPs throughout the code cycle. Several strategies for future code cycles are being considered, including:

- Creating an advisory board of trusted CBOs that may provide consistent feedback on code change proposals throughout the development process
- Establishing a robust compensation structure that enables participation from CBOs and DIPs in the Statewide CASE Team’s code development process
- Holding equity-focused stakeholder meetings to solicit feedback on code change proposals that seem more likely to have strong potential impacts

2.1.2 Potential Impacts on DIPs in Nonresidential Buildings

To assess potential inequity of proposals for nonresidential buildings the Statewide CASE Team considered which building types are used by DIPs most frequently and evaluated the allocation of impacts related to the following areas among all populations.

- **Cost:** People historically impacted by poverty and other historic systems of wealth distribution can be affected more severely by the incremental first cost of proposed code changes. Costs can also create an economic burden for DIPs that does not similarly affect other populations. See Section 4.4 for an estimate of energy cost savings from the current proposals.
- **Health:** Any potential health burdens from proposals could more severely affect DIPs that can have limited access to healthcare and live in areas affected by environmental and other health burdens. Several of the potential negative health impacts from buildings on DIPs are addressed by energy efficiency (Norton 2014., Cluett 2015, Rose 2020). For example, indoor air quality (IAQ) improvements through ventilation or removal of combustion appliances can lessen the incidents of asthma, chronic obstructive pulmonary disease (COPD), and some heart problems. Black and Latinx people are 56 percent and 63 percent more likely to be exposed to dangerous air pollution than white people, respectively (Tessum, et al. 2019). Water heating and building shell improvements can reduce stress levels associated with energy bills by lowering utility bill costs. Electrification can reduce the health consequences resulting from NOx, SO2, and PM2.5.
- **Resiliency:** DIPs are more vulnerable to the negative consequences of natural disasters, extreme temperatures, and weather events due to climate change. Black Americans are 40 percent more likely to currently live in areas with the highest projected increases in extreme heat related mortality rates, compared to other groups (EPA 2021). Similarly, natural disasters affect DIPs differently. Race and wealth affect the ability to evacuate for a natural disaster, as evidenced during Hurricane Harvey wherein White and wealthy residents were overrepresented by 19.8 percent among evacuees (Deng, et al. 2021) Proposals

that improve buildings' resiliency to natural disasters and extreme weather could positively impact DIPs. For example, buildings with more insulation and tighter envelopes can reduce the health impacts of infiltration of poor quality air, reduce risk of moisture damage and related health impacts (mildew and mold), and help maintain thermal comfort during extreme weather events.

- **Comfort:** Thermal comfort and proper lighting are important considerations for any building where people work, though impacts are not proportional across all populations. Thermal comfort can also have serious health effects as heat related illness is on the rise in California. DIPs are at a greater risk for heat illness due in part to socioeconomic factors. From 2005 to 2015 the number of emergency room visits for heat related illness in California rose 67 percent for Black people, 53 percent for Asian-Americans, and 63 percent for Latinx people (Abualsaud, Ostrovskiy and Mahfoud 2019). Studies have shown that not only do the effects of urban heat islands lead to higher mortality during heat waves, but those in large buildings are disproportionately affected (Smargiassi 2008, Laaidi 2012). These residents tend to be the elderly, people of color, and low-income households (Drehobl 2020, Blankenship 2020, IEA 2014). Comfort is not only a nice quality to have in workplaces, schools, etc., but it also has real world health impacts on people's health.

2.1.2.1 Potential Impacts by Building Type

Proposals for the following building types would not have disproportionate impacts because all populations use the buildings with the same relative frequency. While there may be impacts on costs, health, resiliency, or comfort, DIPs would not be affected more or less than any other population. It is unlikely that DIPs would pay a disparate share of the incremental first costs.

- Office buildings of all sizes
- Retail buildings of all sizes
- Non-refrigerated buildings
- Laboratories
- Open air parking garage
- Vehicle service

Below is a description of how the proposed code changes might impact DIPs by building type.

Schools (Small and Large)

Incremental costs could have a larger impact on DIPs than the general population because school funding is linked with race and income in the United States (U.S.). Jurisdictions with lower income populations where the tax base, funding, and capital improvement budgets may be more constrained may find it more challenging to

accommodate the incremental first costs. Costs can affect educational quality, as incremental costs present a significant burden for schools with lower budgets. Analysis from the U.S. Government Accountability Office shows that students in poorer and smaller schools tend to have less access to college-prep courses and 80 percent of the students in these poorest schools were Black and Latinx (United States Government Accountability Office 2018). Incremental costs can deepen these educational inequalities by burdening schools with low budgets. Proposals will impact individuals attending and working at schools including those from DIPs. Proposals that impact health, resiliency, and comfort all have the potential to disproportionately impact those who attend or work in majority DIP schools, as those schools can less often afford considerations for those criteria.

Hotel

Proposals that impact health and resiliency have the potential to disproportionately impact those working or residing in hotels. California has used hotels for temporary housing, and many unhoused people rely on these buildings for shelter on a regular basis and during extreme weather events. California's Project Roomkey offered temporary hotel housing for more than 42,000 unhoused Californians in the COVID-19 crisis (California Governor's Office of Emergency Services 2021). More than 1.6 million people are employed year-round in accommodation and food services with more than 49 percent of that industry identifying as Black, Asian American, or Latinx (U.S. BUREAU OF LABOR STATISTICS 2023). While the costs may increase for this nonresidential building type, the burden of that cost is unlikely to be disproportionate.

Hospital

Increased incremental costs for hospitals can present challenges to jurisdictions with lower income populations where the tax base, funding, and budgets may be more constrained. Proposed measures that impact health and resiliency have the potential to disproportionately impact those who attend or work in hospitals.

2.2 Specific Impacts of the Proposal

Overall, the Space Heating measures are expected to benefit DIPs. The measures are geared toward improving efficiency, reducing on-site natural gas usage (which will bring IAQ benefits), and in the case of electric resistance heating, providing a low upfront cost option for electric space heating. Refer to Sections 3.6, 4.6, and 5.6 for further discussion of impacts by measure.

3. Hot Water Supply Temperature Limit

3.1 Measure Description

3.1.1 Proposed Code Change

The purpose of this measure is to place a mandatory limit on design space heating hot water supply temperatures (HWST) of 130 °F for new construction and additions and alterations. The measure would apply to all nonresidential buildings that use hydronics to provide comfort space heating and reheat. This proposal would apply to systems that use gas boilers as well as all-electric designs.

This proposal would necessitate a modification to the ACM Reference Manual since it is currently assumed that hydronic systems deliver 160 °F water. The ACM Reference Manual would be adjusted to reflect the new requirement of 130 °F supply hot water. The baseline design hot water return temperature would also be lowered from 120 °F to 105 °F.

This requirement is proposed to be included in section 120.2, “Required Controls for Space-Conditioning Systems.” See Section 6 of this report for marked-up code language.

3.1.2 Justification and Background Information

3.1.2.1 Justification

This measure is being pursued to ensure hydronic space heating “electric readiness.” Historically, hydronic hot water systems were designed around a supply temperature of 180 °F. As described below, this was needed to protect noncondensing boilers from experiencing condensation in the exhaust gas stream. Today, within hydronic space heating, the design trend has been toward lower supply hot water temperatures. This is because for condensing boilers, it is preferable to design for lower supply hot water temperatures to ensure the boiler operates in condensing mode. And second, lower supply temperatures facilitate all-electric hydronic designs. This is because most hydronic heat pump equipment is currently limited from producing supply hot water temperatures above roughly 140 °F. As was found in the Code Readiness Electrification Designer Interview report, all design engineers implementing hydronic heat pump systems were actively designing systems and distribution to meet 140 °F or lower supply temperatures throughout multiple buildings in California (Bulger 2023). The purpose of this measure will be to ensure that starting with the 2025 edition of Title 24 Part 6, the state does not continue adding hydronic space heating systems to the building stock designed around hot water supply temperatures that cannot be achieved by hydronic heat pump equipment.

In addition to the electric-readiness goal, there are energy efficiency reasons to pursue this proposal. As noted, for gas boiler systems using condensing equipment, lower supply and return temperatures are desirable since they ensure the boiler operates in condensing mode most of the time. At lower supply water temperatures, the heat lost through the distribution system will be reduced.

Even more than boilers, heat pump efficiency is very sensitive to hot water supply temperature. The same heat pump will be more efficient when operated at 130 °F compared to 140 °F.

Lowering the hot water supply temperature (HWST) results in lower waterside delta T (ΔT or dT) across the heating coils. For example, systems designed for 180°F HWST are typically designed for a 40 °F dT across the hot water coils. Using the same hot water coils with a 130 °F HWST reduces the dT to about 25 °F (see Section 3.3.1.1 for a detailed discussion of the interplay between flow rate and temperature difference in a hydronic space heating system). This means that flow rates and pipe sizes will increase as will pump sizes and pump energy. As documented in this report, the energy savings of 130 °F HWST are more than enough to compensate for the increased first cost.

3.1.2.2 Additions and Alterations

The HWST limit proposal applies to additions and alterations. The economics are different for additions and alterations versus new construction, but they are still compelling. There are several scenarios of additions and alterations that should be considered. One scenario is an addition or alteration that includes a new hot water (HW) plant and new zoning. In this case the system would be able to operate at the new HWST from the first day, and the economics would be the same as new construction. Another scenario is an addition or alteration that includes new zoning to be served by an existing HW plant with noncondensing boilers that also serves existing-to-remain zones sized for 180 °F. This is a common scenario for high-rise office buildings when a new tenant moves into one floor. In this case, the only cost impact would be that the piping to the new zones would need to be upsized to accommodate the lower HWST of 130 °F, but the plant would still need to operate at 180 °F until at least one boiler is replaced with a noncondensing boiler. With the upsized piping, the coils would not need to be upsized. Even then the plant might need to operate above 130 °F some of the time to satisfy the existing zones. So therefore, there would be no energy savings at first. Most, but not necessarily all the savings, would not occur until the boiler is replaced. Note that upsizing the piping is only about 20 percent of the total first cost for this measure, while upgrading from noncondensing to condensing boilers is about 75 percent of the total first cost. Therefore, in this case, most of the cost is not incurred until the boilers are replaced.

A parametric analysis of the gas baseline for medium and large offices in all climate zones was performed. In the analysis the incremental cost for larger piping is incurred in year zero but the incremental cost for condensing boilers and larger pumps is not incurred until year 15 and the energy savings do not begin until year 15. The B/C ratio is still > 1.0 in all climate zones. Assuming the boiler is upgraded to condensing in year 15 is a conservative assumption. The typical lifespan for a boiler is 20 to 30 years, the average boiler is 10 to 15 years old, and it will be replaced in 10 to 15 years. Furthermore, many existing boilers are already condensing. One reason is because air quality management districts, (e.g., the Bay Area Air Quality Management District and South Coast Air Quality Management District), have promulgated regulations limiting boiler NO_x and SO_x emissions, and the regulations are retroactive to existing buildings (e.g., [BAAQMD Reg 9 Rule 6](#) and [SCAQMD Rule 1146.2](#)). Typically, only condensing boilers can meet the requirements. Thus, hundreds of existing boilers have been replaced with condensing boilers to comply with these regulations. In addition, prescriptive language added to Title 24 Part 6 section 140.4(k)8 in 2022 requiring condensing boilers for systems between 1 and 10 MMBtu/h in most California climate zones further increases the likelihood that existing gas boilers will be condensing by the time this measure takes effect in 2026.

3.1.2.3 Background Information

Design supply hot water temperatures of 180 °F were the norm in the era when atmospheric noncondensing boilers were the dominant equipment type used to provide hot water in buildings. High supply water temperatures were needed to ensure that return hot water temperatures were above the dew point of boiler exhaust gases, which is roughly at 135 °F. If condensation occurred in noncondensing boilers, then damage could occur to the boiler system, so high supply and return water temperatures were needed to avoid this possibility. There was never a space conditioning need to have such high temperatures. Today, condensing boilers are much more commonly specified for sites with natural gas boilers, and lower supply hot water temperatures will provide a substantial energy efficiency benefit since it will be all but guaranteed that the equipment will continuously operate in condensing mode when the supply hot water temperature is 130 °F. Note that this measure would not preempt noncondensing boilers since the intention is to ensure the distribution network and space heating coils are optimized around “heat pump friendly” temperatures. Higher boiler temperatures would be allowed if there is a secondary distribution network designed to comply with the 130 °F limit.

3.1.3 Summary of Proposed Changes to Code Documents

The sections below summarize how the standards, Reference Appendices, Alternative Calculation Method (ACM) Reference Manuals, and compliance forms would be

modified by the proposed change.⁴ See Section 6 of this report for detailed proposed revisions to code language.

3.1.3.1 Specific Purpose and Necessity of Proposed Code Changes

Each proposed change to language in Title 24, Part 1 and Part 6 as well as the reference appendices to Part 6 are described below. See Section 6.2 of this report for marked-up code language.

Section: 120.2

Specific Purpose: The specific purpose of the addition to 120.2 is to limit hot water supply temperatures for space heating hydronic systems to 130°F or lower.

Necessity: This addition is necessary to increase energy efficiency via cost-effective building design standards, as mandated by the California Public Resources Code, Sections 25213 and 25402.

3.1.3.2 Specific Purpose and Necessity of Changes to the Nonresidential ACM Reference Manual

The purpose and necessity of proposed changes to the Nonresidential ACM Reference Manual are described below. See Section 6.4 of this report for the detailed proposed revisions to the text of the ACM Reference Manual.

This measure would result in several changes to the ACM Reference Manual to ensure that the standard design reflects the mandatory code requirements being recommended by this measure. The changes would be focused on adjusting the hot water supply temperature and hot water temperature difference in the standard design under section 5.8.1.

Section: 5.8.1

Specific Purpose: The specific purpose is to modify the standard design to reflect the mandatory code changes being recommended in this measure. The changes would be to modify the “Hot Water Supply Temperature” from 160 °F to 130 °F, to modify the “Hot Water Temperature Difference” from 40 °F to 25 °F, and finally to modify the “Hot Water Supply Temperature Reset” from fixed at 160 °F to 130 °F in the standard design.

Necessity: These changes are necessary to ensure the standard design in the ACM Reference Manual accurately matches the new language being added to Title 24 Part 6.

⁴ Visit [EnergyCodeAce.com](https://www.energycodeace.com) for training, tools, and resources to help people understand existing code requirements.

3.1.3.3 Summary of Changes to the Nonresidential Compliance Manual

Chapter 4 of the Nonresidential Compliance Manual would need to be revised. We recommend focusing the updates on Section 4.6, “HVAC System Control Requirements.” A discussion of how different types of boilers would be able to comply with the measure should be included. For example, specific considerations for noncondensing boilers, condensing boilers, and air-to-water heat pump systems should be described in the compliance manual. In addition, it will be critical to include a discussion of how retrofit situations would be able to comply.

3.1.3.4 Summary of Changes to Compliance Forms

The compliance forms would need to be updated to ensure that the design HWST is 130 °F or less. A similar approach to how the current prescriptive return water temperature limit of 120 °F (found at section 140.4(k)8B) is checked would be appropriate.

3.1.4 Regulatory Context

3.1.4.1 Determination of Inconsistency or Incompatibility with Existing State Laws and Regulations

There are no relevant state or local laws or regulations.

3.1.4.2 Duplication or Conflicts with Federal Laws and Regulations

There are no relevant state or local laws or regulations.

3.1.4.3 Difference From Existing Model Codes and Industry Standards

The Statewide CASE Team is aware of a parallel effort in IECC to also set a limit to HWSTs. The limit being discussed in that standard is also 130 °F. The intent of this proposal is to align with that effort.

3.1.5 Compliance and Enforcement

When developing this proposal, the Statewide CASE Team considered methods to streamline the compliance and enforcement process and how negative impacts on market actors that are involved in the process could be mitigated or reduced. This section describes how to comply with the proposed code change. It also describes the compliance verification process. Appendix E presents how the proposed changes could impact various market actors.

The compliance verification activities related to this measure that need to occur during each phase of the project are described below:

- **Design Phase:** Small, incremental changes anticipated to comply with HWST Limit.

- **Permit Application Phase:** No changes are anticipated because of this measure.
- **Construction Phase:** Equipment and hydronic distribution networks will be familiar to contractors.
- **Inspection Phase:** Inspection would be similar to the process currently in place to ensure HWRTs are below 120 °F, which is a requirement in 140.4(k)8B.

3.2 Market Analysis

3.2.1 Current Market Structure

The Statewide CASE Team performed a market analysis with the goals of identifying current technology availability, current product availability, and market trends. It then considered how the proposed standard may impact the market in general as well as individual market actors. Information was gathered about the incremental cost of complying with the proposed measure. Estimates of market size and measure applicability were identified through research and outreach with stakeholders including utility program staff, CEC staff, and a wide range of industry actors. In addition to conducting personalized outreach, the Statewide CASE Team discussed the current market structure and potential market barriers during a public stakeholder meeting that the Statewide CASE Team held on February 27, 2023.

The market structure is consistent with how standard boiler systems are developed today. Based on a communication with a Bay Area boiler distributor in December 2022, 90 percent of boilers sales are condensing (i.e., 88 percent or greater thermal efficiency) in California. The typical HWST for condensing boilers is 140 °F but there are no issues with operating them at the proposed HWST of 130 °F. The remaining ten percent of boilers that are still noncondensing are generally installed at 180 °F.

The market actors involved in implementing this measure encompass:

- Building Owners
- Architects
- Mechanical Designers
- Electrical Designers
- Controls Designers
- Plumbing Designers
- Energy Consultants
- Builders
- Installers

- Plans Examiners
- Building Inspectors
- Manufacturers
- Commissioning Agents

3.2.2 Technical Feasibility and Market Availability

Designing new buildings with hydronic hot water supply temperatures of 130 °F or less is technically feasible. The primary barrier to universal adoption of this design practice is the fact that much higher HWSTs were historically the norm, and some segments of the industry have not yet evolved to use lower temperatures.

A design change from higher to lower HWSTs does not involve a large-scale redesign of the entire hydronic plant. Instead, some adjustments are needed to some aspects of the system to account for the reduced heat per unit volume of water being delivered to the zones. These adjustments may include wider pipe diameters, more powerful pumps due to the higher water flow rate at lower HWST, and deeper coils at the terminal units, though our analysis shows that deeper coils are not needed to comply with the proposed 130 °F limit. Some or all of these aspects could be impacted by this proposal. It would be up to the designer to determine how the system is configured at the new design HWST. These changes are incremental relative to previous design practices. The necessary equipment and market actors would not change as a result of this measure. Only the capacity and size of aspects such as the piping and pumps of the hydronic system would change. Refer to Section 3.3.1.1 for an in-depth discussion of the impacts that a lower HWST would have on the different aspects of the hydronic distribution system.

This measure ensures that California does not continue to add buildings using high HWSTs to the stock. The savings claimed by this measure are expected to persist over time, since the building infrastructure would be optimized at lower HWSTs that would not be easily revised upward. There are not expected to be any adverse occupant comfort impacts, since presumably the hot water distribution system would still be designed to furnish the necessary heat to satisfy the anticipated building loads.

The Statewide CASE Team reviewed a recently published data brief prepared by the PG&E Code Readiness team (Weitze and Gantley 2023). The data brief summarized five recently retrofitted or new construction sites with hydronic heat pump space heating systems. In all cases, the hot water supply temperatures were below 130 °F, at one site it is 90 °F. No instances of occupant discomfort or inability to meet zone heating setpoints were reported in the data brief.

3.2.3 Market Impacts and Economic Assessments

3.2.3.1 Impact on Builders

Builders of commercial structures are directly impacted by many of the measures proposed by the Statewide CASE Team for the 2025 code cycle. It is within the normal practices of these businesses to adjust their building practices to changes in building codes. When necessary, builders engage in continuing education and training to remain compliant with changes to design practices and building codes.

California’s construction industry comprises approximately 93,000 business establishments and 943,000 employees (see Table 4). For 2022, total estimated payroll will be about \$78 billion. Nearly 72,000 of these business establishments and 473,000 employees are engaged in the residential building sector, while another 17,600 establishments and 369,000 employees focus on the commercial sector. The remainder of establishments and employees work in industrial, utilities, infrastructure, and other heavy construction roles (the industrial sector).

Table 4: California Construction Industry, Establishments, Employment, and Payroll in 2022 (Estimated)

Building Type	Construction Sectors	Establishments	Employment	Annual Payroll (Billions \$)
Residential	All	71,889	472,974	31.2
Residential	Building Construction Contractors	27,948	130,580	9.8
Residential	Foundation, Structure, & Building Exterior	7,891	83,575	5.0
Residential	Building Equipment Contractors	18,108	125,559	8.5
Residential	Building Finishing Contractors	17,942	133,260	8.0
Commercial	All	17,621	368,810	35.0
Commercial	Building Construction Contractors	4,919	83,028	9.0
Commercial	Foundation, Structure, & Building Exterior	2,194	59,110	5.0
Commercial	Building Equipment Contractors	6,039	139,442	13.5
Commercial	Building Finishing Contractors	4,469	87,230	7.4
Industrial, Utilities, Infrastructure, & Other (Industrial+)	All	4,206	101,002	11.4
Industrial+	Building Construction	288	3,995	0.4
Industrial+	Utility System Construction	1,761	50,126	5.5
Industrial+	Land Subdivision	907	6,550	1.0
Industrial+	Highway, Street, and Bridge Construction	799	28,726	3.1
Industrial+	Other Heavy Construction	451	11,605	1.4

Source: (State of California Employment Development Department 2022)

The proposed change to limit hot water supply temperatures would likely affect commercial builders but would not impact firms that focus on construction and retrofit of industrial buildings, utility systems, public infrastructure, or other heavy construction. The effects on the commercial building industry would not be felt by all firms and workers, but rather would be concentrated in specific industry subsectors. Table 5 shows the commercial building subsectors the Statewide CASE Team expects to be impacted by the changes proposed in this report. Electrical contractors and plumbing & HVAC contractors will be impacted very slightly by the different designs based on higher water flow rates and lower temperature differences (a.k.a. ΔT or dT) that will result from this measure. The Statewide CASE Team’s estimates of the magnitude of these impacts are shown in Section 3.2.4 Economic Impacts.

Table 5: Specific Subsectors of the California Commercial Building Industry Impacted by Proposed Change to Code/Standard by Subsector in 2022 (Estimated)

Construction Subsector	Establishments	Employment	Annual Payroll (Billions \$)
Nonresidential Electrical Contractors	3,137	74,277	7.0
Nonresidential plumbing & HVAC contractors	2,346	55,572	5.5

Source: (State of California Employment Development Department 2022)

3.2.3.2 Impact on Building Designers and Energy Consultants

Adjusting design practices to comply with changing building codes is within the normal practices of building designers. Building codes (including Title 24, Part 6) are typically updated on a three-year revision cycle and building designers and energy consultants engage in continuing education and training to remain compliant with changes to design practices and building codes.

Businesses that focus on residential, commercial, institutional, and industrial building design are contained within the Architectural Services sector (North American Industry Classification System, or NAICS,⁵ 541310). Table 6 shows the number of establishments, employment, and total annual payroll for Building Architectural Services. The proposed code changes would potentially impact all firms within the Architectural Services sector. The Statewide CASE Team anticipates the impacts for

⁵ NAICS is the standard used by federal statistical agencies in classifying business establishments for the purpose of collecting, analyzing, and publishing statistical data related to the U.S. business economy. NAICS was developed jointly by the U.S. Economic Classification Policy Committee (ECPC), Statistics Canada, and Mexico's Instituto Nacional de Estadística y Geografía, to allow for a high level of comparability in business statistics among the North American countries. NAICS replaced the Standard Industrial Classification (SIC) system in 1997.

hot water supply temperature limit to affect firms that focus on nonresidential construction.

There is not a NAICS code specific to energy consultants. Instead, businesses that focus on consulting related to building energy efficiency are contained in the Building Inspection Services sector (NAICS 541350), which is comprised of firms primarily engaged in the physical inspection of residential and nonresidential buildings.⁶ It is not possible to determine which business establishments within the Building Inspection Services sector are focused on energy efficiency consulting. The information shown in Table 6 provides an upper bound indication of the size of this sector in California.

Table 6: California Building Designer and Energy Consultant Sectors in 2022 (Estimated)

Sector	Establishments	Employment	Annual Payroll (Millions \$)
Architectural Services^a	4,134	31,478	3,623.3
Building Inspection Services^b	1,035	3,567	280.7

Source: (State of California Employment Development Department 2022)

- a. Architectural Services (NAICS 541310) comprises private-sector establishments primarily engaged in planning and designing residential, institutional, leisure, commercial, and industrial buildings and structures.
- b. Building Inspection Services (NAICS 541350) comprises private-sector establishments primarily engaged in providing building (residential & nonresidential) inspection services encompassing all aspects of the building structure and component systems, including energy efficiency inspection services.

3.2.3.3 Impact on Occupational Safety and Health

The proposed code change does not alter any existing federal, state, or local regulations pertaining to safety and health, including rules enforced by the California Division of Occupational Safety and Health (DOSH). All existing health and safety rules would remain in place. Complying with the proposed code change is not anticipated to have adverse impacts on the safety or health of occupants or those involved with the construction, commissioning, and maintenance of the building.

⁶ Establishments in this sector include businesses primarily engaged in evaluating a building's structure and component systems and includes energy efficiency inspection services and home inspection services. This sector does not include establishments primarily engaged in providing inspections for pests, hazardous wastes or other environmental contaminants, nor does it include state and local government entities that focus on building or energy code compliance/enforcement of building codes and regulations.

3.2.3.4 Impact on Building Owners and Occupants

Commercial Buildings

The commercial building sector includes a wide array of building types, including offices, restaurants, lodging, retail, mixed-use establishments, and warehouses (including refrigerated) (Kenney M 2019). Energy use by occupants of commercial buildings also varies considerably, with electricity used primarily for lighting, space cooling and conditioning, and refrigeration, while natural gas is used primarily for water heating and space heating. According to information published in the 2019 California Energy Efficiency Action Plan, there is more than 7.5 billion square feet of commercial floor space in California consuming 19 percent of California's total annual energy use (Kenney M 2019). The diversity of building and business types within this sector creates a challenge for disseminating information on energy and water efficiency solutions, as does the variability in sophistication of building owners and the relationships between building owners and occupants.

Estimating Impacts

Building owners and occupants would benefit from lower energy bills. As discussed in Section 3.2.4.1, when building occupants save on energy bills, they tend to spend it elsewhere in the economy thereby creating jobs and economic growth for the California economy. The Statewide CASE Team does not expect the proposed code change for the 2025 code cycle to impact building owners or occupants adversely.

3.2.3.5 Impact on Building Component Retailers (Including Manufacturers and Distributors)

As noted above, this measure is expected to produce incremental changes to hot water system design elements in that sizing of pipes, fittings, pumps, and coils, but the systems as a whole will largely resemble higher temperature systems. Therefore, the Statewide CASE Team anticipates the proposed change would have no material impact on California component retailers.

3.2.3.6 Impact on Building Inspectors

Table 7 shows employment and payroll information for state and local government agencies in which many inspectors of residential and commercial buildings are employed. Building inspectors participate in continuing education and training to stay current on all aspects of building regulations, including energy efficiency. The Statewide CASE Team, therefore, anticipates the proposed change would have no impact on employment of building inspectors or the scope of their role conducting energy efficiency inspections.

Table 7: Employment in California State and Government Agencies with Building Inspectors in 2022 (Estimated)

Sector	Govt.	Establishments	Employment	Annual Payroll (Million \$)
Administration of Housing Programs ^a	State	18	265	29.0
	Local	38	3,060	248.6
Urban and Rural Development Admin ^b	State	38	764	71.3
	Local	52	2,481	211.5

Source: (State of California Quarterly Census of Employment and Wages 2010)

- a. Administration of Housing Programs (NAICS 925110) comprises government establishments primarily engaged in the administration and planning of housing programs, including building codes and standards, housing authorities, and housing programs, planning, and development.
- b. Urban and Rural Development Administration (NAICS 925120) comprises government establishments primarily engaged in the administration and planning of the development of urban and rural areas. Included in this industry are government zoning boards and commissions.

3.2.3.7 Impact on Statewide Employment

As described in Sections 3.2.3.1 through 3.2.3.6, the Statewide CASE Team does not anticipate significant employment or financial impacts to any particular sector of the California economy. This is not to say that the proposed change would not have modest impacts on employment in California. In Section 3.2.4, the Statewide CASE Team estimated the proposed change in hot water supply temperatures would affect statewide employment and economic output directly and indirectly through its impact on builders, designers, and energy consultants, and building inspectors. In addition, the Statewide CASE Team estimated how energy savings associated with the proposed change in hot water supply temperatures would lead to modest ongoing financial savings for California businesses, which would then be available for other economic activities.

3.2.4 Economic Impacts

For the 2025 code cycle, the Statewide CASE Team used the IMPLAN model software⁷, along with economic information from published sources, and professional judgement to develop estimates of the economic impacts associated with each of the proposed code changes. Conceptually, IMPLAN estimates jobs created as a function of incoming cash flow in different sectors of the economy, due to implementing a code or a standard. The jobs created are typically categorized into direct, indirect, and induced employment. For example, cash flow into a manufacturing plant captures direct employment (jobs created in the manufacturing plant), indirect employment (jobs

⁷ IMPLAN employs economic data and advanced economic impact modeling to estimate economic impacts for interventions like changes to the California Title 24, Part 6 code. For more information on the IMPLAN modeling process, see www.IMPLAN.com.

created in the sectors that provide raw materials to the manufacturing plant) and induced employment (jobs created in the larger economy due to purchasing habits of people newly employed in the manufacturing plant). Eventually, IMPLAN computes the total number of jobs created due to a code. The assumptions of IMPLAN include constant returns to scale, fixed input structure, industry homogeneity, no supply constraints, fixed technology, and constant byproduct coefficients. The model is also static in nature and is a simplification of how jobs are created in the macro-economy.

The economic impacts developed for this report are only estimates and are based on limited and to some extent speculative information. The IMPLAN model provides a relatively simple representation of the California economy and, though the Statewide CASE Team is confident that the direction and approximate magnitude of the estimated economic impacts are reasonable, it is important to understand that the IMPLAN model is a simplification of extremely complex actions and interactions of individual, businesses, and other organizations as they respond to changes in energy efficiency codes. In all aspects of this economic analysis, the CASE Authors rely on conservative assumptions regarding the likely economic benefits associated with the proposed code change. By following this approach, the economic impacts presented below represent lower bound estimates of the actual benefits associated with this proposed code change.

Adoption of this code change proposal would result in relatively modest economic impacts through the additional direct spending by those in the commercial building industry, architects, energy consultants, and building inspectors, as shown in Table 8. The Statewide CASE Team does not anticipate that money saved by commercial building owners or other organizations affected by the proposed 2025 code cycle regulations would result in additional spending by those businesses.

Table 8: Estimated Impact that Adoption of the Proposed Measure would have on the California Commercial Construction Sector

Type of Economic Impact	Employment (Jobs)	Labor Income	Total Value Added	Output
Direct Effects (Additional spending by Commercial Builders)	153.9	\$11,954,319	\$13,815,434	\$23,530,561
Indirect Effect (Additional spending by firms supporting Commercial Builders)	37.6	\$3,256,432	\$5,109,944	\$9,410,297
Induced Effect (Spending by employees of firms experiencing “direct” or “indirect” effects)	64.0	\$4,367,720	\$7,820,045	\$12,446,563
Total Economic Impacts	255.5	\$19,578,472	\$26,745,422	\$45,387,421

Source: CASE Team analysis of data from the IMPLAN modeling software. (IMPLAN Group LLC 2020)

3.2.4.1 Creation or Elimination of Jobs

The Statewide CASE Team does not anticipate that the measures proposed for the 2025 code cycle regulation would lead to the creation of new *types* of jobs or the elimination of *existing* types of jobs. In other words, the Statewide CASE Team’s proposed change would not result in economic disruption to any sector of the California economy. Rather, the estimates of economic impacts discussed in Section 3.2.4 would lead to modest changes in employment of existing jobs.

3.2.4.2 Creation or Elimination of Businesses in California

As stated in Section 3.2.4.1, the Statewide CASE Team’s proposed change would not result in economic disruption to any sector of the California economy. The proposed change represents a modest change to hydronic system design practices, which would not excessively burden or competitively disadvantage California businesses – nor would it necessarily lead to a competitive advantage for California businesses. Therefore, the Statewide CASE Team does not foresee any new businesses being created, nor does the Statewide CASE Team think any existing businesses would be eliminated due to the proposed code changes.

3.2.4.3 Competitive Advantages or Disadvantages for Businesses in California

The proposed code changes would apply to all businesses incorporated in California, regardless of whether the business is located inside or outside of the state.⁸ Therefore, the Statewide CASE Team does not anticipate that these measures proposed for the 2025 code cycle regulation would have an adverse effect on the competitiveness of California businesses. Likewise, the Statewide CASE Team does not anticipate businesses located outside of California would be advantaged or disadvantaged.

3.2.4.4 Increase or Decrease of Investments in the State of California

The Statewide CASE Team analyzed national data on corporate profits and capital investment by businesses that expand a firm’s capital stock (referred to as net private domestic investment, or NPDI).⁹ As Table 9 shows, between 2017 and 2021, NPDI as a percentage of corporate profits ranged from a low of 18 in 2020 due to the worldwide economic slowdowns associated with the COVID 19 pandemic to a high of 35 percent in 2019, with an average of 26 percent. While only an approximation of the proportion of business income used for net capital investment, the Statewide CASE Team believes it

⁸ Gov. Code, §§ 11346.3(c)(1)(C), 11346.3(a)(2); 1 CCR § 2003(a)(3) Competitive advantages or disadvantages for California businesses currently doing business in the state.

⁹ Net private domestic investment is the total amount of investment in capital by the business sector that is used to expand the capital stock, rather than maintain or replace due to depreciation. Corporate profit is the money left after a corporation pays its expenses.

provides a reasonable estimate of the proportion of proprietor income that would be reinvested by business owners into expanding their capital stock.

Table 9: Net Domestic Private Investment and Corporate Profits, U.S.

Year	Net Domestic Private Investment by Businesses, Billions of Dollars	Corporate Profits After Taxes, Billions of Dollars	Ratio of Net Private Investment to Corporate Profits (Percent)
2017	518.473	1882.460	28
2018	636.846	1977.478	32
2019	690.865	1952.432	35
2020	343.620	1908.433	18
2021	506.331	2619.977	19
5-Year Average	539.227	2068.156	26

Source: (Federal Reserve Economic Data, FRED 2022)

The Statewide CASE Team does not anticipate that the economic impacts associated with the proposed measure would lead to significant change (increase or decrease) in investment, directly or indirectly, in any affected sectors of California’s economy. Nevertheless, the Statewide CASE Team can derive a reasonable estimate of the change in investment by California businesses based on the estimated change in economic activity associated with the proposed measure and its expected effect on proprietor income, which was used a conservative estimate of corporate profits, a portion of which was assumed to be allocated to net business investment.¹⁰

3.2.4.5 Incentives for Innovation in Products, Materials, or Processes

The HVAC industry is trending toward all-electric space heating designs. The purpose of this measure is to support this trend by further solidifying the notion that all hydronic systems will be installed with the maximum hot water supply temperature that can easily facilitate future air to water heat pump system retrofits. This measure is not expected to limit innovation in the nonresidential HVAC industry.

3.2.4.6 Effects on the State General Fund, State Special Funds, and Local Governments

The Statewide CASE Team does not expect the proposed code changes would have a measurable impact on California’s General Fund, any state special funds, or local government funds.

¹⁰ 26 percent of proprietor income was assumed to be allocated to net business investment; see Table 9.

Cost of Enforcement

Cost to the State: State government already has budget for code development, education, and compliance enforcement. While state government will be allocating resources to update the Title 24, Part 6 Standards, including updating education and compliance materials and responding to questions about the revised requirements, these activities are already covered by existing state budgets. The costs to state government are small when compared to the overall costs savings and policy benefits associated with the code change proposals. To the extent that new state buildings are still being designed with gas boilers, this proposal would require that they be limited to 130 °F HWSTs.

Cost to Local Governments: All proposed code changes to Title 24, Part 6 would result in changes to compliance determinations. Local governments would need to train building department staff on the revised Title 24, Part 6 Standards. While this retraining is an expense to local governments, it is not a new cost associated with the 2025 code change cycle. The building code is updated on a triennial basis, and local governments plan and budget for retraining every time the code is updated. There are numerous resources available to local governments to support compliance training that can help mitigate the cost of retraining, including tools, training and resources provided by the IOU Codes and Standards program (such as Energy Code Ace). As noted in Section 3.1.5 and Appendix E, the Statewide CASE Team considered how the proposed code change might impact various market actors involved in the compliance and enforcement process and aimed to minimize negative impacts on local governments.

3.2.4.7 Impacts on Specific Persons

While the objective of any of the Statewide CASE Team’s proposal is to promote energy efficiency, the Statewide CASE Team recognizes that there is the potential that a proposed code change may result in unintended consequences. This code change proposal is not expected to impact specific persons. Refer to Section 3.6 for more details addressing energy equity and environmental justice.

3.2.5 Fiscal Impacts

3.2.5.1 Mandates on Local Agencies or School Districts

There are no relevant mandates to local agencies or school districts to our knowledge.

3.2.5.2 Costs to Local Agencies or School Districts

There are no costs to local agencies or school districts.

3.2.5.3 Costs or Savings to Any State Agency

There are no costs or savings to any state agencies.

3.2.5.4 Other Non-Discretionary Cost or Savings Imposed on Local Agencies

There are no added non-discretionary costs or savings to local agencies.

3.2.5.5 Costs or Savings in Federal Funding to the State

There are no costs or savings to federal funding to the state.

3.3 Energy Savings

The Statewide CASE Team gathered stakeholder input to inform the energy savings analysis. Since CBECC does not model distribution system losses, a collaboration was formed with the UC Berkeley Center for the Built Environment (CBE) to utilize their analysis on hot water distribution losses. These values are critical inputs to help understand the costs and benefits of lower HWSTs. In addition, to develop incremental first costs, the Statewide CASE Team conducted market outreach to Bay Area distributors (for boiler costs) and contractors (for piping costs). See Appendix F for a summary of stakeholder engagement.

Energy savings benefits may have potential to disproportionately impact DIPs. Refer to Section 3.6 for more details addressing energy equity and environmental justice.

3.3.1 Energy Savings Methodology

3.3.1.1 Key Assumptions for Energy Savings Analysis

To model the energy savings for the 130 °F HWST limit, the Statewide CASE Team used applicable prototypes provided by the Energy Commission, specifically, those that make use of hydronic heating. These include medium office, large office, large school, high-rise mixed use, hotel, and hospital.

A significant portion of the energy savings come from reduced piping losses. Unfortunately, CBECC assumes adiabatic pipes and does not have a way to capture pipe losses. Therefore, a combination of CBECC modeling and spreadsheet post-processing was used.

CBECC was used to determine the total hourly heating load for each of the prototype models. Two baselines/proposed cases were then modeled outside of CBECC using Excel-based post-processing techniques. These cases, along with several key assumptions that impact energy performance, are summarized in Table 10.

Table 10: Summary of Assumptions Used in Limit HWST Analysis

Parameter	Gas Baseline	Gas Proposed	Elec Baseline	Elec Proposed
Equipment Type and Efficiency	Non-condensing, 85% TE ^a	Condensing, 94% TE	AWHP, 2.31 COP ^b	AWHP, 2.54 COP ^b
HWST (°F)	180	130	140	130
dT (°F)	40	25	30	25
VAV Box	Standard 2-row	Standard 2-row	Standard 2-row	Standard 2-row
Operating Hours Criteria	OAT<65 °F and building is occupied	OAT<65 °F and building is occupied	OAT<65 °F and building is occupied	OAT<65 °F and building is occupied

- a. The decision to use a non-condensing boiler in the base case and a condensing boiler in the proposed case was intended to bound the analysis by choosing the lowest first cost option possible (e.g., smallest pipe, least expensive boiler, smallest pump), resulting in the largest incremental cost hurdle to be overcome. This does not imply that non-condensing boilers cannot comply with the proposal.
- b. Air to water heat pump (AWHP) COPs taken from Title 24 Part 6 2022 Table 110.2-N. COP at 130 °F is the interpolated value between 120 and 140 °F.

Delta-T (dT) Data: The analysis is sensitive to the dT because this drives the pipe sizing and piping costs. Lowering the HWST results in a lower dT (which has the consequence of higher water flow rates and thus, larger pipes). The relationship between HWST and dT depends on the coil selection. Figure 1 shows typical VAV box coil performance data derived from a major VAV box manufacturer’s coil selection software. It shows performance for a standard 2 row coil (which is by far the most commonly selected VAV box coil) and an oversized (OS) 2 row coil. This figure shows that at 130 °F HWST the standard coil has a dT of about 30 °F and the oversized coil has a dT of about 35 °F. The coil dT is sensitive to the design entering air temperature (EAT), i.e., the temperature entering the coil at the peak heating condition. Figure 1 assumes a 55 °F EAT which is a typical EAT when the building is occupied and minimum ventilation (cold outside air) is required. The Statewide CASE Team’s assumption is that that the peak heating condition is during morning warmup, before occupancy, when no outside air is required. Figure 2 shows similar VAV box reheat coil performance at 65 °F, which is more typical for morning warmup. This figure gives the more conservative result of 25 °F dT for a standard coil at 130 °F HWST. This more conservative assumption is used in our analysis.

While standard 2-row coils are by far the most common, some engineers use oversized and/or high-capacity coils (12 fins/inch versus 10 fins/inch for standard) to increase the dT. For simplicity, this analysis assumes standard 2-row coils in the base case and proposed case. The Statewide CASE Team also could have analyzed oversized and/or high-capacity coils in the proposed case to increase dT (and reduce incremental piping costs) but then it would have been necessary to include the incremental coil costs. Note that Figure 1 and Figure 2 both show that a standard coil can accommodate higher than

a 40 °F dT at 180 °F. However, a design dT of 40 °F (or lower) is industry standard practice for 180 °F HWST and is therefore used in Baseline 1.

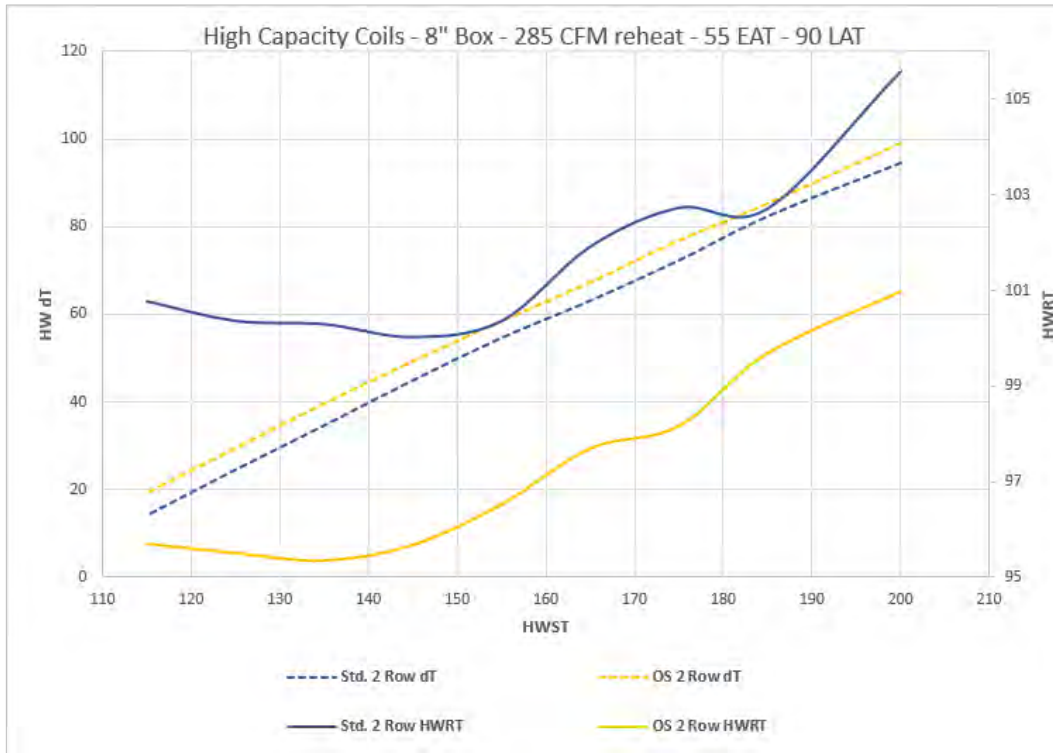

Figure 1: Typical VAV Box Coil Selections (55 EAT)

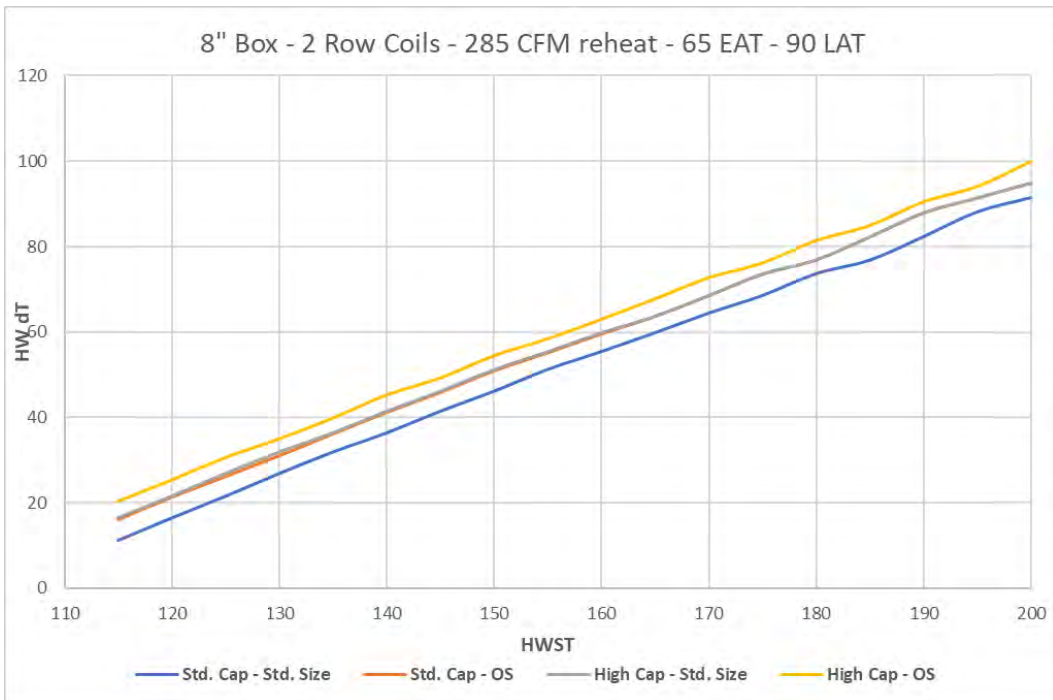

Figure 2: Typical VAV Box Coil Selections (65 EAT)

Piping Loss Data: The UC Berkeley Center for the Built Environment is wrapping up a major study on heating hot water system efficiency (Raftery 2018). That soon to be published study, collected measured piping loss data from several buildings (Figure 3). This data was used to develop a regression of typical piping losses as a function of HWST from 130 °F to 180 °F.

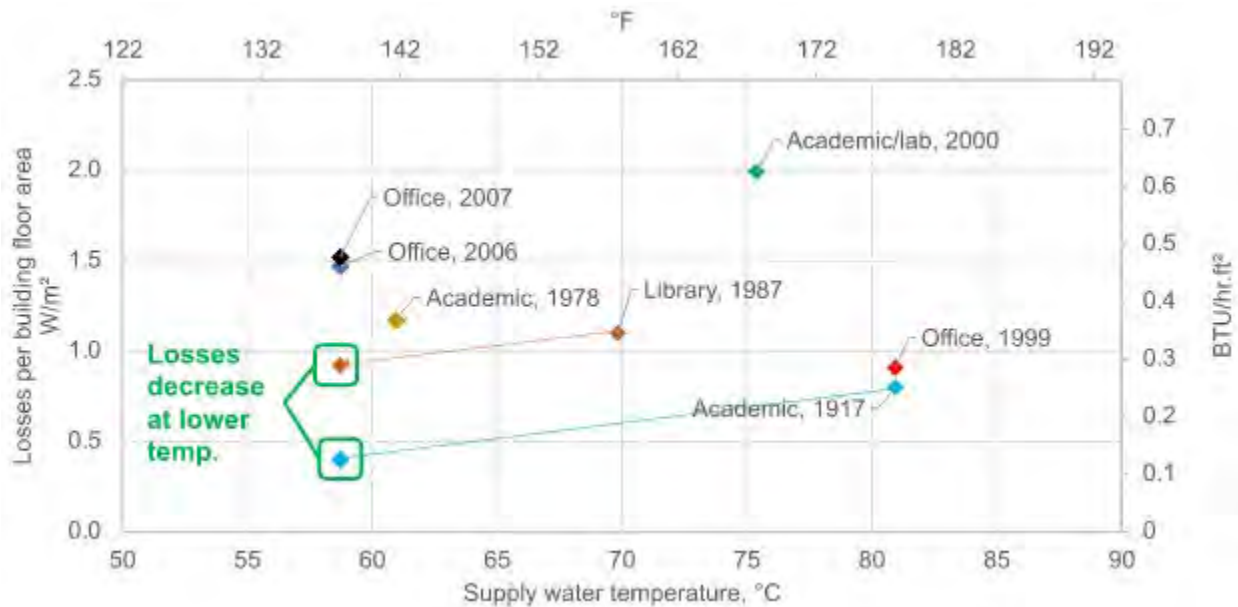

Figure 3: UC Berkeley CBE HW Piping Loss Data (with year each building was built)

The CBE study also included a survey of several hundred existing buildings and found that the median HW system operates 78 percent of the time (i.e., 19 hours/day for every day of the year). See Figure 4 for a histogram demonstrating the fraction of operating hours of buildings in the CBE study. This is considerably more hours than what is assumed for the CBECC prototypes. For example, the large office prototype model in Climate Zone 3 assumes the HW system operates for only 44 percent of the year. There are several reasons for this discrepancy. One reason is that building operators have a habit of operating buildings far longer than they are typically occupied to minimize the risk of hot/cold complaints when someone comes in after-hours. Another reason is that the prototype models assume uniform load/occupancy profiles (which is not realistic) and do not include “rogue zones” (meaning, zones where the HVAC system does not operate as expected due to factors such as malfunctioning controls, errors during construction, or poor design). Unfortunately, most buildings have some form of rogue zones that can cause the entire hot system to operate (and trigger nearly all the piping losses) when most zones do not need heat. For example, if the minimum flow rate is set higher than necessary in an interior zone then that zone will likely be over-cooled, even when the outside air temperature is 90 °F and one would expect the heating system to be off. When over-cooling occurs, then the space heating system

must be activated to offset the over-cooling to bring the temperature of the conditioned space back up to the given setpoint.

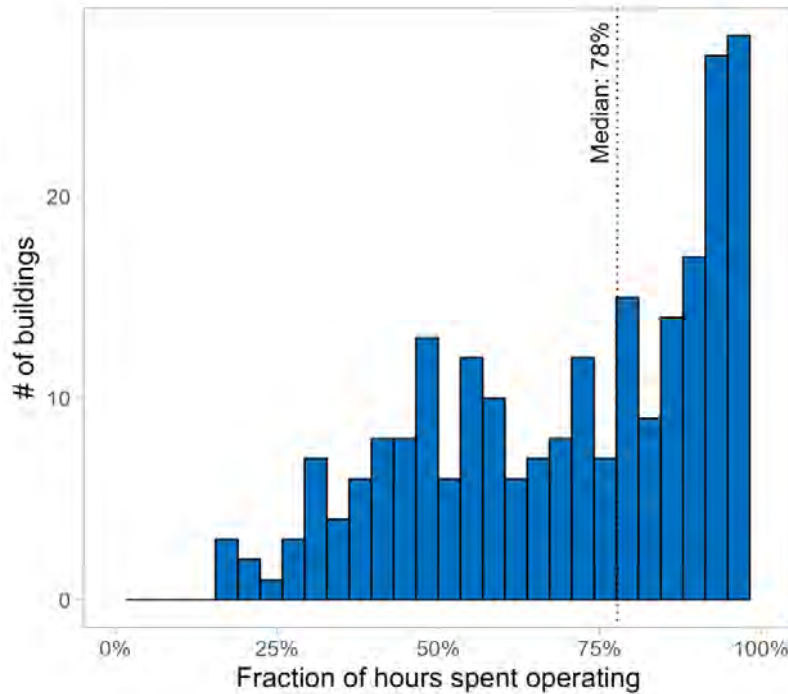

Figure 4: Histogram of HW System Operating Hours (ref: UCB CBE)

The analysis assumes the HW system is running when the following three conditions are met:

1. CBECC indicates a HW load,
2. the building is in occupied mode, and
3. the outside air temperature is below 65 °F.

This was done to account for the discrepancy in runtime hours between the prototype and the real world and to more accurately capture the piping losses. For Climate Zone 3 large office, this increased the HW system hours of operation from 44 to 63 percent (still well below the median of 78 percent from the CBE survey).

Boiler Efficiency: Boiler energy consumption was post-processed using the boiler performance curves used by DOE-2.2 and EnergyPlus. This curve determines the boiler efficiency as a function of the part load ratio and the boiler entering water temperature, with the curve normalized to the nominal efficiency at 100 percent full-load and 80 °F EWT. These curves were validated by PG&E/Taylor Engineers research projects that tested several boilers using the ASHRAE 155P Method of Test (PG&E 2012a) (PG&E 2012b). The curves are valid for both condensing and non-condensing boilers.

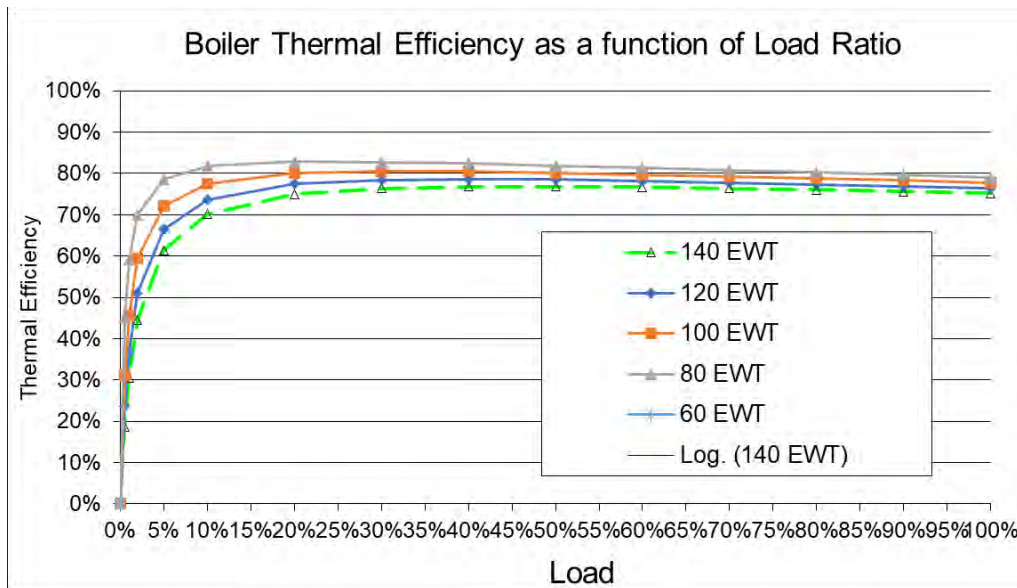

Figure 5: Boiler Efficiency Curve

Nominal condensing and non-condensing boiler efficiencies were determined based on a survey of boiler manufacturers of both types of boilers. The average nominal non-condensing boiler efficiency was 85 percent, and the average condensing boiler efficiency was 94 percent in steady conditions after the heating load steadies at more than 20 percent.

AWHP Efficiency: AWHP efficiency was assumed to match the minimum efficiencies listed in Title 24-2022 Table 110.2-N (minimum efficiencies for heat pumps).

3.3.1.2 Energy Savings Methodology per Prototypical Building

The Statewide CASE Team measured per unit energy savings expected from the proposed code changes in several ways to quantify key impacts. First, savings are calculated by fuel type. Electricity savings are measured in terms of both energy use and peak demand reduction. Natural gas savings are quantified in terms of energy use. Second, the Statewide CASE Team calculated source energy savings. Source energy represents the total amount of raw fuel required to operate a building. In addition to all energy used from on-site production, source energy incorporates all transmission, delivery, and production losses. The hourly source energy values provided by CEC are proportional to GHG emissions. Finally, the Statewide CASE Team calculated Long-term Systemwide Cost (LSC) savings, formerly known as Time Dependent Value (TDV) energy cost savings. LSC savings are calculated using hourly energy cost metrics for both electricity and natural gas provided by the CEC. These LSC hourly factors are projected over the 30-year life of the building. The LSC factors incorporate the hourly cost of marginal generation, transmission and distribution, fuel, capacity, losses, and cap-and-trade-based CO2 emissions. More information on source energy and LSC

hourly factors is available in the [March 2020 CEC Staff Workshop on Energy Code Compliance Metrics](#) and the [July 2022 CEC Staff Workshop on Energy Code Accounting for the 2025 Building Energy Efficiency Standards](#).

The CEC directed the Statewide CASE Team to model the energy impacts using specific prototypical building models that represent typical building geometries for different types of buildings (California Energy Commission 2022). The prototype buildings that the Statewide CASE Team used in the analysis are presented in Table 11.

Table 11: Prototype Buildings Used for Energy, Demand, Cost, and Environmental Impacts Analysis

Prototype Name	Number of Stories	Floor Area (Square Feet)	Description
HighRiseMixedUse	10	125,400	10-story (9-story residential, 1-story commercial), 117-unit building. Avg dwelling unit size: 850 ft ² . Central gas storage DHW.
Hospital	5	241,501	5-Story Hospital plus basement. Source: DOE Standard 90.1 Hospital prototype and scorecard. The prototype contains Title 24, Part 6, minimally compliant envelope features and lighting. For HVAC systems, the AIA guidelines recommended using VAV systems wherever possible.
HotelSmall	4	42,554	4 story Hotel with 77 guest rooms. WWR-11%
OfficeLarge	12	498,589	12 story + 1 basement office building with 5 zones and a ceiling plenum on each floor. WWR-0.40.
OfficeMedium	3	53,628	3 story office building with 5 zones and a ceiling plenum on each floor. WWR-0.33
SchoolLarge	2	210,866	High school with WWR of 35% and SRR 1.4%

The Statewide CASE Team estimated LSC energy and energy cost savings, source energy, electricity, natural gas, peak demand, and GHG impacts by simulating the proposed code change in EnergyPlus using prototypical buildings and rulesets from the 2025 Research Version of the California Building Energy Code Compliance (CBECC) software.

CBECC generates two models based on user inputs: the Standard Design and the Proposed Design. The Standard Design represents the geometry of the prototypical building and a design that uses a set of features that result in a LSC energy budget and Source energy budget that is minimally compliant with 2022 Title 24, Part 6 code

requirements. Features used in the Standard Design are described in the 2022 Nonresidential ACM Reference Manual. The Proposed Design represents the same geometry as the Standard Design, but it assumes the energy features that the software user describes with user inputs.

Although CBECC gives the user the ability to alter HWSTs, this functionality was not used for this analysis due to the inability for CBECC to model pipe distribution losses. This limitation rendered CBECC inadequate other than as a source for heating and cooling load profiles for each prototype. The Statewide CASE Team exported the building loads for each applicable prototype in 16 climate zones and then performed post-processing on this data consistent with the methodology described in Section 3.3.1.1, Key Assumptions for Energy Savings Analysis. For example, piping losses as a function of temperature were applied to both the baseline and proposed cases, which then impacted the demand on the boiler or air to water heat pump. In addition, the boiler performance curves developed as part of the ASHRAE 155P research project were used instead of the CBECC default curves. The implication of these types of changes is that the standard design is less efficient than an unaltered CBECC prototype made to match the 2022 code requirements. However, since capturing distribution losses is an important aspect of the cost-effectiveness analysis for this measure, this change was necessary.

As noted above, the Statewide CASE Team created two separate savings estimates, one meant to capture sites using gas heating, and another to capture sites using heat pump hydronics. This drove the need to further modify the standard design from gas to electric. This is because the Statewide CASE Team was interested in estimating the savings and demonstrating cost-effectiveness for buildings using an all-electric space heating hydronic system. To accomplish this, the gas boiler was changed to an AWHP with a 140 °F HWST in the standard design.

The Proposed Design was identical to the Standard Design in all ways except for the revisions that represent the proposed changes to the code. Table 12 presents precisely which parameters were modified and what values were used in the Standard Design and Proposed Design. Section 3.3.1.1, Key Assumptions for Energy Savings Analysis, describes the changes between the baseline and proposed cases in detail.

Table 12: Modifications Made to Standard Design in Each Prototype to Simulate Proposed Code Change

Prototype ID	Climate Zone	Objects Modified	Parameter Name	Standard Design Parameter Value	Proposed Design Parameter Value
HighRiseMixedUse	All	Boiler or AWHP	HWST	G: 180 °F; E: 140 °F	G & E: 130 °F
Hospital	All	Boiler or AWHP	HWST	G: 180 °F; E: 140 °F	G & E: 130 °F
HotelSmall	All	Boiler or AWHP	HWST	G: 180 °F; E: 140 °F	G & E: 130 °F
OfficeLarge	All	Boiler or AWHP	HWST	G: 180 °F; E: 140 °F	G & E: 130 °F
OfficeMedium	All	Boiler or AWHP	HWST	G: 180 °F; E: 140 °F	G & E: 130 °F
SchoolLarge	All	Boiler or AWHP	HWST	G: 180 °F; E: 140 °F	G & E: 130 °F

CBECC calculates whole-building energy consumption for every hour of the year measured in kilowatt-hours per year (kWh/y) and therms per year (Therms/y). It then applies the 2025 LSC hourly factors to calculate LSC energy use in kilo British thermal units per year (kBtu/y), Source Energy factors to calculate Source Energy Use in kilo British thermal units per year (kBtu/y), and hourly GHG emissions factors to calculate annual GHG emissions in metric tons of carbon dioxide emissions equivalent (MT or “tonnes” CO₂e/y) (California Energy Commission 2022). CBECC also generates LSC savings values measured in 2026 present value dollars (2026 PV\$) and nominal dollars. CBECC also calculates annual peak electricity demand measured in kilowatts (kW).

The energy impacts of the proposed code change do vary by climate zone. The Statewide CASE Team simulated the energy impacts in every climate zone and applied the climate-zone specific LSC hourly factors when calculating energy and energy cost impacts.

Per unit energy impacts for nonresidential buildings are presented in savings per square foot. Annual energy, GHG, and peak demand impacts for each prototype building were translated into impacts per square foot by dividing by the floor area of the prototype building. This step allows for an easier comparison of savings across different building types and enables a calculation of statewide savings using the construction forecast that is published in terms of floor area by building type.

3.3.1.3 Statewide Energy Savings Methodology

The per unit energy impacts were extrapolated to statewide impacts using the statewide construction forecasts that the CEC provided. The statewide construction forecasts estimate new construction/additions that would occur in 2026, the first year that the 2025 Title 24, Part 6 requirements are in effect. They also estimate the amount of total existing building stock in 2026, which the Statewide CASE Team used to approximate savings from building alterations (California Energy Commission 2022). The

construction forecast provides construction (new construction/additions and existing building stock) by building type and climate zone, as shown in Appendix A.

For this measure, a “gas-to-gas” and “electric-to-electric” baseline to proposed design framework was used. This means that the measure was separately analyzed for systems that use a gas boiler and air to water heat pump hydronic system. The gas-to-gas analysis results in natural gas (i.e., therms) savings and the electric-to-electric analysis results in electric (i.e., kWh) savings. To ensure that impacts are not over counted, the construction forecast was adjusted to account for the estimated number of buildings using electric vs. gas for space heating. The Statewide CASE Team assumed that the fraction of electric buildings statewide would be consistent with the number of local jurisdictions that have adopted all-electric reach codes.

Appendix A presents additional information about the methodology and assumptions used to calculate statewide energy impacts.

3.3.2 Per unit Energy Impacts Results

Energy savings and peak demand reductions per unit and by climate zone are presented in Table 13 through Table 19. Savings are presented for new construction and additions. The per unit energy savings figures do not account for naturally occurring market adoption or compliance rates. Per unit savings for the first year are expected to range from 0.01 to 0.43 kWh/y (using the electric baseline) and 0.41 to 8.61 kBtu/y (using the gas baseline) depending upon climate zone. Demand reductions/increases are expected to range between 0.002 W and 0.065 W (using the electric baseline) depending on the climate zone.

Table 13: First Year Natural Gas Savings (kBtu) Per Square Foot—Hot Water Supply Temperature Limit (Gas Baseline)

Prototype	CZ 1	CZ 2	CZ 3	CZ 4	CZ 5	CZ 6	CZ 7	CZ 8	CZ 9	CZ 10	CZ 11	CZ 12	CZ 13	CZ 14	CZ 15	CZ 16
Highrisemixeduse	1.83	1.22	1.41	1.09	1.27	0.89	0.82	0.67	0.74	0.70	0.93	1.04	0.85	0.94	0.41	1.37
Hospital	8.61	8.24	7.90	7.94	7.98	7.15	7.06	7.31	7.17	7.27	7.75	7.83	7.49	7.32	6.87	7.31
Hotelsmall	3.71	2.94	2.93	2.67	2.93	1.72	1.56	1.54	1.71	1.77	2.19	2.50	1.90	2.14	0.96	3.01
Officelarge	4.41	3.28	3.40	2.99	3.20	1.93	1.71	1.65	1.78	1.79	2.69	2.73	2.17	2.62	1.02	3.88
Officemedium	4.51	3.25	3.31	2.84	3.12	1.68	1.53	1.41	1.65	1.60	2.76	2.84	2.24	2.70	1.06	4.01
SchoolLarge	4.57	3.57	3.91	3.46	3.69	2.71	2.68	2.65	2.70	2.46	3.44	3.42	2.81	3.13	1.76	4.04

Table 14: First Year Source Energy Savings (kBtu) Per Square Foot—Hot Water Supply Temperature Limit (Gas Baseline)

Prototype	CZ 1	CZ 2	CZ 3	CZ 4	CZ 5	CZ 6	CZ 7	CZ 8	CZ 9	CZ 10	CZ 11	CZ 12	CZ 13	CZ 14	CZ 15	CZ 16
Highrisemixeduse	1.65	1.11	1.28	0.99	1.15	0.80	0.73	0.60	0.67	0.63	0.84	0.94	0.77	0.85	0.37	1.23
Hospital	7.79	7.46	7.15	7.19	7.23	6.43	6.33	6.58	6.45	6.54	7.02	7.09	6.78	6.58	6.18	6.57
Hotelsmall	3.36	2.66	2.65	2.42	2.65	1.55	1.40	1.39	1.54	1.59	1.98	2.26	1.72	1.93	0.86	2.71
Officelarge	4.00	2.97	3.08	2.71	2.89	1.74	1.53	1.48	1.60	1.61	2.44	2.47	1.96	2.36	0.92	3.49
Officemedium	4.09	2.94	3.00	2.57	2.82	1.51	1.37	1.27	1.49	1.44	2.50	2.57	2.03	2.43	0.95	3.60
SchoolLarge	4.13	3.23	3.54	3.13	3.34	2.44	2.40	2.38	2.43	2.21	3.12	3.09	2.54	2.81	1.59	3.63

Table 15: First Year LSC Energy Savings (\$) Per Square Foot—Hot Water Supply Temperature Limit (Gas Baseline)

Prototype	CZ 1	CZ 2	CZ 3	CZ 4	CZ 5	CZ 6	CZ 7	CZ 8	CZ 9	CZ 10	CZ 11	CZ 12	CZ 13	CZ 14	CZ 15	CZ 16
Highrisemixeduse	0.98	0.68	0.78	0.62	0.70	0.51	0.48	0.39	0.43	0.41	0.55	0.60	0.50	0.56	0.26	0.78
Hospital	4.63	4.43	4.27	4.29	4.30	3.87	3.84	3.98	3.90	3.96	4.20	4.24	4.06	4.00	3.73	3.98
Hotelsmall	2.00	1.62	1.61	1.50	1.60	0.99	0.92	0.91	0.99	1.03	1.28	1.42	1.12	1.26	0.59	1.71
Officelarge	2.40	1.82	1.88	1.70	1.76	1.10	0.99	0.97	1.03	1.05	1.58	1.57	1.29	1.56	0.63	2.22
Officemedium	2.47	1.83	1.84	1.62	1.72	0.96	0.90	0.83	0.97	0.94	1.63	1.64	1.33	1.62	0.66	2.30
SchoolLarge	2.51	1.98	2.15	1.94	2.02	1.49	1.47	1.48	1.52	1.39	1.97	1.92	1.61	1.83	1.04	2.29

Table 16: First Year Electricity Savings (kWh) Per Square Foot—Hot Water Supply Temperature Limit (Electric Baseline)

Prototype	CZ 1	CZ 2	CZ 3	CZ 4	CZ 5	CZ 6	CZ 7	CZ 8	CZ 9	CZ 10	CZ 11	CZ 12	CZ 13	CZ 14	CZ 15	CZ 16
Highrisemixeduse	0.05	0.03	0.04	0.03	0.04	0.02	0.02	0.02	0.02	0.02	0.03	0.03	0.02	0.03	0.01	0.04
Hospital	0.43	0.40	0.38	0.38	0.38	0.31	0.31	0.33	0.32	0.33	0.36	0.37	0.35	0.33	0.30	0.34
Hotelsmall	0.12	0.09	0.09	0.08	0.09	0.05	0.04	0.04	0.05	0.05	0.07	0.08	0.06	0.07	0.03	0.10
Officelarge	0.13	0.11	0.10	0.10	0.10	0.05	0.04	0.05	0.05	0.05	0.09	0.09	0.07	0.09	0.03	0.13
Officemedium	0.14	0.10	0.09	0.09	0.09	0.04	0.04	0.04	0.05	0.05	0.09	0.09	0.07	0.09	0.03	0.14
SchoolLarge	0.17	0.12	0.12	0.11	0.11	0.08	0.08	0.07	0.07	0.07	0.11	0.11	0.09	0.10	0.05	0.13

Table 17: First Year Peak Demand Reduction (W) Per Square Foot—Hot Water Supply Temperature Limit (Electric Baseline)

Prototype	CZ 1	CZ 2	CZ 3	CZ 4	CZ 5	CZ 6	CZ 7	CZ 8	CZ 9	CZ 10	CZ 11	CZ 12	CZ 13	CZ 14	CZ 15	CZ 16
Highrisemixeduse	0.003	0.002	0.002	0.002	0.002	0.002	0.001	0.002	0.002	0.002	0.002	0.002	0.002	0.002	0.002	0.003
Hospital	0.065	0.063	0.065	0.062	0.061	0.052	0.050	0.057	0.058	0.057	0.064	0.062	0.061	0.057	0.054	0.053
Hotelsmall	0.015	0.014	0.013	0.014	0.013	0.008	0.007	0.009	0.009	0.010	0.013	0.014	0.012	0.013	0.008	0.014
Officelarge	0.018	0.017	0.016	0.018	0.016	0.008	0.006	0.009	0.010	0.011	0.018	0.017	0.015	0.019	0.008	0.021
Officemedium	0.020	0.016	0.015	0.017	0.015	0.007	0.006	0.008	0.009	0.009	0.018	0.017	0.014	0.018	0.008	0.020
SchoolLarge	0.014	0.012	0.012	0.012	0.011	0.007	0.006	0.008	0.008	0.008	0.014	0.013	0.012	0.014	0.007	0.016

Table 18: First Year Source Energy Savings (kBtu) Per Square Foot—Hot Water Supply Temperature Limit (Electric Baseline)

Prototype	CZ 1	CZ 2	CZ 3	CZ 4	CZ 5	CZ 6	CZ 7	CZ 8	CZ 9	CZ 10	CZ 11	CZ 12	CZ 13	CZ 14	CZ 15	CZ 16
Highrisemixeduse	0.08	0.06	0.07	0.06	0.06	0.04	0.04	0.04	0.04	0.04	0.06	0.06	0.05	0.06	0.03	0.07
Hospital	0.88	0.83	0.80	0.78	0.79	0.65	0.68	0.69	0.68	0.69	0.77	0.78	0.74	0.71	0.62	0.70
Hotelsmall	0.23	0.20	0.19	0.19	0.18	0.11	0.12	0.11	0.12	0.12	0.18	0.19	0.16	0.18	0.09	0.22
Officelarge	0.26	0.24	0.22	0.24	0.22	0.12	0.13	0.12	0.13	0.14	0.24	0.22	0.19	0.24	0.09	0.30
Officemedium	0.31	0.25	0.21	0.23	0.21	0.11	0.13	0.11	0.13	0.13	0.25	0.24	0.20	0.25	0.10	0.32
SchoolLarge	0.30	0.24	0.25	0.23	0.22	0.16	0.16	0.16	0.16	0.15	0.25	0.24	0.20	0.23	0.12	0.27

Table 19: First Year LSC Energy Savings (\$) Per Square Foot—Hot Water Supply Temperature Limit (Electric Baseline)

Prototype	CZ 1	CZ 2	CZ 3	CZ 4	CZ 5	CZ 6	CZ 7	CZ 8	CZ 9	CZ 10	CZ 11	CZ 12	CZ 13	CZ 14	CZ 15	CZ 16
Highrisemixeduse	0.28	0.21	0.22	0.17	0.20	0.13	0.11	0.10	0.11	0.11	0.15	0.16	0.14	0.15	0.07	0.22
Hospital	2.57	2.43	2.31	2.23	2.29	1.90	1.95	1.98	1.95	1.98	2.17	2.21	2.08	1.99	1.80	2.03
Hotelsmall	0.71	0.57	0.54	0.50	0.52	0.28	0.30	0.27	0.30	0.30	0.44	0.47	0.38	0.43	0.18	0.62
Officelarge	0.79	0.67	0.62	0.60	0.61	0.30	0.32	0.30	0.32	0.34	0.56	0.54	0.44	0.56	0.20	0.82
Officemedium	0.90	0.67	0.58	0.57	0.56	0.27	0.30	0.26	0.30	0.29	0.57	0.56	0.46	0.57	0.19	0.86
SchoolLarge	0.98	0.73	0.76	0.63	0.65	0.45	0.43	0.43	0.43	0.40	0.64	0.64	0.52	0.56	0.28	0.78

3.4 Cost and Cost Effectiveness

3.4.1 Energy Cost Savings Methodology

Energy cost savings were calculated by applying the LSC hourly factors to the energy savings estimates that were derived using the methodology described in Section 3.3.1. LSC hourly factors are a normalized metric to calculate energy cost savings that accounts for the variable cost of electricity and natural gas for each hour of the year, along with how costs are expected to change over the period of analysis. In this case, 30 years period was used for the analysis.

The CEC requested energy cost savings over the 30-year period of analysis in both 2026 present value dollars (2026 PV\$) and nominal dollars. The cost effectiveness analysis uses energy cost values in 2026 PV\$. Costs and cost effectiveness using and 2026 PV\$ are presented in Section 3.4 of this report. CEC uses results in nominal dollars to complete the Economic and Fiscal Impacts Statement (From 399) for the entire package of proposed change to Title 24, Part 6. Appendix G presents energy cost savings results in nominal dollars.

3.4.2 Energy Cost Savings Results

Per unit energy cost savings for newly constructed buildings, additions, and alterations that are realized over the 30-year period of analysis are presented 2026 present value dollars (2026 PV\$) in Table 20 through Table 47.

The LSC hourly factors methodology allows peak electricity savings to be valued more than electricity savings during non-peak periods. Discuss the peak savings attributed to the code change (e.g., what percentage of the savings occur during peak periods?).

Any time code changes impact cost, there is potential to disproportionately impact certain populations. Refer to Section 3.6 for more details addressing energy equity and environmental justice.

The Statewide CASE Team is presenting the electric and natural gas LSC values together in Table 20 through Table 47 for simplicity. However, the electrical and gas savings are separate and depend on which type of fuel the building uses for space heating. Any row with “NA” indicates that the given climate zone does not have any construction forecast over the period of analysis.

Table 20: 2026 PV LSC Cost Savings Over 30-Year Period of Analysis – Per Square Foot – New Construction and Additions– HighRiseMixedUse – Hot Water Supply Temperature Limit (Gas Baseline)

Climate Zone	30-Year LSC Electricity Savings (2026 PV\$)	30-Year LSC Natural Gas Savings (2026 PV\$)	Total 30-Year LSC Savings (2026 PV\$)
1	0.00	0.98	0.98
2	0.00	0.68	0.68
3	0.00	0.78	0.78
4	0.00	0.62	0.62
5	0.00	0.70	0.70
6	0.00	0.51	0.51
7	0.00	0.48	0.48
8	0.00	0.39	0.39
9	0.00	0.43	0.43
10	0.00	0.41	0.41
11	0.00	0.55	0.55
12	0.00	0.60	0.60
13	0.00	0.50	0.50
14	0.00	0.56	0.56
15	0.00	0.26	0.26
16	0.00	0.78	0.78

^a “NA” refers to the fact that the CEC forecasts 0 square feet of construction activity in this climate zone for this building type in 2026.

Table 21: 2026 PV LSC Savings Over 30-Year Period of Analysis – Per Square Foot – New Construction and Additions – Hospital – Hot Water Supply Temperature Limit (Gas Baseline)

Climate Zone	30-Year LSC Electricity Savings (2026 PV\$)	30-Year LSC Natural Gas Savings (2026 PV\$)	Total 30-Year LSC Savings (2026 PV\$)
1	0.00	4.63	4.63
2	0.00	4.43	4.43
3	0.00	4.27	4.27
4	0.00	4.29	4.29
5	0.00	4.30	4.30
6	0.00	3.87	3.87
7	0.00	3.84	3.84
8	0.00	3.98	3.98
9	0.00	3.90	3.90
10	0.00	3.96	3.96
11	0.00	4.20	4.20
12	0.00	4.24	4.24
13	0.00	4.06	4.06
14	0.00	4.00	4.00
15	0.00	3.73	3.73
16	0.00	3.98	3.98

Table 22: 2026 PV LSC Savings Over 30-Year Period of Analysis – Per Square Foot – New Construction and Additions – HotelSmall – Hot Water Supply Temperature Limit (Gas Baseline)

Climate Zone	30-Year LSC Electricity Savings (2026 PV\$)	30-Year LSC Natural Gas Savings (2026 PV\$)	Total 30-Year LSC Savings (2026 PV\$)
1	0.00	2.00	2.00
2	0.00	1.62	1.62
3	0.00	1.61	1.61
4	0.00	1.50	1.50
5	0.00	1.60	1.60
6	0.00	0.99	0.99
7	0.00	0.92	0.92
8	0.00	0.91	0.91
9	0.00	0.99	0.99
10	0.00	1.03	1.03
11	0.00	1.28	1.28
12	0.00	1.42	1.42
13	0.00	1.12	1.12
14	0.00	1.26	1.26
15	0.00	0.59	0.59
16	0.00	1.71	1.71

Table 23: 2026 PV LSC Savings Over 30-Year Period of Analysis – Per Square Foot – New Construction and Additions –OfficeLarge – Hot Water Supply Temperature Limit (Gas Baseline)

Climate Zone	30-Year LSC Electricity Savings (2026 PV\$)	30-Year LSC Natural Gas Savings (2026 PV\$)	Total 30-Year LSC Savings (2026 PV\$)
1	NA	NA	NA
2	NA	NA	NA
3	0.00	1.88	1.88
4	0.00	1.70	1.70
5	NA	NA	NA
6	0.00	1.10	1.10
7	0.00	0.99	0.99
8	0.00	0.97	0.97
9	0.00	1.03	1.03
10	0.00	1.05	1.05
11	0.00	1.58	1.58
12	0.00	1.57	1.57
13	NA	NA	NA
14	0.00	1.56	1.56
15	0.00	0.63	0.63
16	0.00	2.22	2.22

Table 24: 2026 PV LSC Savings Over 30-Year Period of Analysis – Per Square Foot – New Construction and Additions – OfficeMedium – Hot Water Supply Temperature Limit (Gas Baseline)

Climate Zone	30-Year LSC Electricity Savings (2026 PV\$)	30-Year LSC Natural Gas Savings (2026 PV\$)	Total 30-Year LSC Savings (2026 PV\$)
1	0.00	2.47	2.47
2	0.00	1.83	1.83
3	0.00	1.84	1.84
4	0.00	1.62	1.62
5	0.00	1.72	1.72
6	0.00	0.96	0.96
7	0.00	0.90	0.90
8	0.00	0.83	0.83
9	0.00	0.97	0.97
10	0.00	0.94	0.94
11	0.00	1.63	1.63
12	0.00	1.64	1.64
13	0.00	1.33	1.33
14	0.00	1.62	1.62
15	0.00	0.66	0.66
16	0.00	2.30	2.30

Table 25: 2026 PV LSC Savings Over 30-Year Period of Analysis – Per Square Foot – New Construction and Additions – SchoolLarge – Hot Water Supply Temperature Limit (Gas Baseline)

Climate Zone	30-Year LSC Electricity Savings (2026 PV\$)	30-Year LSC Natural Gas Savings (2026 PV\$)	Total 30-Year LSC Savings (2026 PV\$)
1	0.00	2.51	2.51
2	0.00	1.98	1.98
3	0.00	2.15	2.15
4	0.00	1.94	1.94
5	0.00	2.02	2.02
6	0.00	1.49	1.49
7	0.00	1.47	1.47
8	0.00	1.48	1.48
9	0.00	1.52	1.52
10	0.00	1.39	1.39
11	0.00	1.97	1.97
12	0.00	1.92	1.92
13	0.00	1.61	1.61
14	0.00	1.83	1.83
15	0.00	1.04	1.04
16	0.00	2.29	2.29

^a “NA” refers to the fact that the CEC forecasts 0 square feet of construction activity in this climate zone.

Table 26: 2026 PV LSC Savings Over 30-Year Period of Analysis – Per Square Foot – New Construction and Additions – All Prototypes– Hot Water Supply Temperature Limit (Gas Baseline)

Climate Zone	30-Year LSC Electricity Savings (2026 PV\$)	30-Year LSC Natural Gas Savings (2026 PV\$)	Total 30-Year LSC Savings (2026 PV\$)
1	0.00	2.71	2.71
2	0.00	2.29	2.29
3	0.00	2.17	2.17
4	0.00	2.02	2.02
5	0.00	2.08	2.08
6	0.00	1.35	1.35
7	0.00	1.58	1.58
8	0.00	1.24	1.24
9	0.00	1.31	1.31
10	0.00	1.77	1.77
11	0.00	2.08	2.08
12	0.00	2.04	2.04
13	0.00	1.87	1.87
14	0.00	1.96	1.96
15	0.00	1.32	1.32
16	0.00	2.48	2.48

Table 27: 2026 PV LSC Savings Over 30-Year Period of Analysis – Per Square Foot – Alterations – HighRiseMixedUse – Hot Water Supply Temperature Limit (Gas Baseline)

Climate Zone	30-Year LSC Electricity Savings (2026 PV\$)	30-Year LSC Natural Gas Savings (2026 PV\$)	Total 30-Year LSC Savings (2026 PV\$)
1	0.00	0.98	0.98
2	0.00	0.68	0.68
3	0.00	0.78	0.78
4	0.00	0.62	0.62
5	NA	NA	NA
6	0.00	0.51	0.51
7	0.00	0.48	0.48
8	0.00	0.39	0.39
9	0.00	0.43	0.43
10	0.00	0.41	0.41
11	0.00	0.55	0.55
12	0.00	0.60	0.60
13	0.00	0.50	0.50
14	0.00	0.56	0.56
15	0.00	0.26	0.26
16	0.00	0.78	0.78

Table 28: 2026 PV LSC Savings Over 30-Year Period of Analysis – Per Square Foot – Alterations – Hospital – Hot Water Supply Temperature Limit (Gas Baseline)

Climate Zone	30-Year LSC Electricity Savings (2026 PV\$)	30-Year LSC Natural Gas Savings (2026 PV\$)	Total 30-Year LSC Savings (2026 PV\$)
1	0.00	4.63	4.63
2	0.00	4.43	4.43
3	0.00	4.27	4.27
4	0.00	4.29	4.29
5	0.00	4.30	4.30
6	0.00	3.87	3.87
7	0.00	3.84	3.84
8	0.00	3.98	3.98
9	0.00	3.90	3.90
10	0.00	3.96	3.96
11	0.00	4.20	4.20
12	0.00	4.24	4.24
13	0.00	4.06	4.06
14	0.00	4.00	4.00
15	0.00	3.73	3.73
16	0.00	3.98	3.98

Table 29: 2026 PV LSC Savings Over 30-Year Period of Analysis – Per Square Foot – Alterations – HotelSmall – Hot Water Supply Temperature Limit (Gas Baseline)

Climate Zone	30-Year LSC Electricity Savings (2026 PV\$)	30-Year LSC Natural Gas Savings (2026 PV\$)	Total 30-Year LSC Savings (2026 PV\$)
1	0.00	2.00	2.00
2	0.00	1.62	1.62
3	0.00	1.61	1.61
4	0.00	1.50	1.50
5	0.00	1.60	1.60
6	0.00	0.99	0.99
7	0.00	0.92	0.92
8	0.00	0.91	0.91
9	0.00	0.99	0.99
10	0.00	1.03	1.03
11	0.00	1.28	1.28
12	0.00	1.42	1.42
13	0.00	1.12	1.12
14	0.00	1.26	1.26
15	0.00	0.59	0.59
16	0.00	1.71	1.71

Table 30: 2026 PV LSC Savings Over 30-Year Period of Analysis – Per Square Foot – Alterations –OfficeLarge – Hot Water Supply Temperature Limit (Gas Baseline)

Climate Zone	30-Year LSC Electricity Savings (2026 PV\$)	30-Year LSC Natural Gas Savings (2026 PV\$)	Total 30-Year LSC Savings (2026 PV\$)
1	0.00	2.40	2.40
2	0.00	1.82	1.82
3	0.00	1.88	1.88
4	0.00	1.70	1.70
5	0.00	1.76	1.76
6	0.00	1.10	1.10
7	0.00	0.99	0.99
8	0.00	0.97	0.97
9	0.00	1.03	1.03
10	0.00	1.05	1.05
11	0.00	1.58	1.58
12	0.00	1.57	1.57
13	0.00	1.29	1.29
14	0.00	1.56	1.56
15	0.00	0.63	0.63
16	0.00	2.22	2.22

Table 31: 2026 PV LSC Cost Savings Over 30-Year Period of Analysis – Per Square Foot – Alterations – OfficeMedium – Hot Water Supply Temperature Limit (Gas Baseline)

Climate Zone	30-Year LSC Electricity Savings (2026 PV\$)	30-Year LSC Natural Gas Savings (2026 PV\$)	Total 30-Year LSC Savings (2026 PV\$)
1	0.00	2.47	2.47
2	0.00	1.83	1.83
3	0.00	1.84	1.84
4	0.00	1.62	1.62
5	0.00	1.72	1.72
6	0.00	0.96	0.96
7	0.00	0.90	0.90
8	0.00	0.83	0.83
9	0.00	0.97	0.97
10	0.00	0.94	0.94
11	0.00	1.63	1.63
12	0.00	1.64	1.64
13	0.00	1.33	1.33
14	0.00	1.62	1.62
15	0.00	0.66	0.66
16	0.00	2.30	2.30

Table 32: 2026 PV LSC Cost Savings Over 30-Year Period of Analysis – Per Square Foot – Alterations – OfficeMedium – Hot Water Supply Temperature Limit (Gas Baseline)

Climate Zone	30-Year LSC Electricity Savings (2026 PV\$)	30-Year LSC Natural Gas Savings (2026 PV\$)	Total 30-Year LSC Savings (2026 PV\$)
1	0.00	2.47	2.47
2	0.00	1.83	1.83
3	0.00	1.84	1.84
4	0.00	1.62	1.62
5	0.00	1.72	1.72
6	0.00	0.96	0.96
7	0.00	0.90	0.90
8	0.00	0.83	0.83
9	0.00	0.97	0.97
10	0.00	0.94	0.94
11	0.00	1.63	1.63
12	0.00	1.64	1.64
13	0.00	1.33	1.33
14	0.00	1.62	1.62
15	0.00	0.66	0.66
16	0.00	2.30	2.30

Table 33: 2026 PV LSC Savings Over 30-Year Period of Analysis – Per Square Foot – Alterations – All Prototypes– Hot Water Supply Temperature Limit (Gas Baseline)

Climate Zone	30-Year LSC Electricity Savings (2026 PV\$)	30-Year LSC Natural Gas Savings (2026 PV\$)	Total 30-Year LSC Savings (2026 PV\$)
1	0.00	2.88	2.88
2	0.00	2.26	2.26
3	0.00	2.19	2.19
4	0.00	2.03	2.03
5	0.00	2.20	2.20
6	0.00	1.44	1.44
7	0.00	1.40	1.40
8	0.00	1.35	1.35
9	0.00	1.41	1.41
10	0.00	1.54	1.54
11	0.00	2.24	2.24
12	0.00	2.07	2.07
13	0.00	2.01	2.01
14	0.00	1.93	1.93
15	0.00	1.19	1.19
16	0.00	2.50	2.50

Table 34: 2026 PV LSC Cost Savings Over 30-Year Period of Analysis – Per Square Foot – New Construction and Additions– HighRiseMixedUse – Hot Water Supply Temperature Limit (Electric Baseline)

Climate Zone	30-Year LSC Electricity Savings (2026 PV\$)	30-Year LSC Natural Gas Savings (2026 PV\$)	Total 30-Year LSC Savings (2026 PV\$)
1	0.28	0.00	0.28
2	0.21	0.00	0.21
3	0.22	0.00	0.22
4	0.17	0.00	0.17
5	0.20	0.00	0.20
6	0.13	0.00	0.13
7	0.11	0.00	0.11
8	0.10	0.00	0.10
9	0.11	0.00	0.11
10	0.11	0.00	0.11
11	0.15	0.00	0.15
12	0.16	0.00	0.16
13	0.14	0.00	0.14
14	0.15	0.00	0.15
15	0.07	0.00	0.07
16	0.22	0.00	0.22

^a “NA” refers to the fact that the CEC forecasts 0 square feet of construction activity in this climate zone for this building type in 2026.

Table 35: 2026 PV LSC Savings Over 30-Year Period of Analysis – Per Square Foot – New Construction and Additions – Hospital – Hot Water Supply Temperature Limit (Electric Baseline)

Climate Zone	30-Year LSC Electricity Savings (2026 PV\$)	30-Year LSC Natural Gas Savings (2026 PV\$)	Total 30-Year LSC Savings (2026 PV\$)
1	2.57	0.00	2.57
2	2.43	0.00	2.43
3	2.31	0.00	2.31
4	2.23	0.00	2.23
5	2.29	0.00	2.29
6	1.90	0.00	1.90
7	1.95	0.00	1.95
8	1.98	0.00	1.98
9	1.95	0.00	1.95
10	1.98	0.00	1.98
11	2.17	0.00	2.17
12	2.21	0.00	2.21
13	2.08	0.00	2.08
14	1.99	0.00	1.99
15	1.80	0.00	1.80
16	2.03	0.00	2.03

Table 36: 2026 PV LSC Savings Over 30-Year Period of Analysis – Per Square Foot – New Construction and Additions – HotelSmall – Hot Water Supply Temperature Limit (Electric Baseline)

Climate Zone	30-Year LSC Electricity Savings (2026 PV\$)	30-Year LSC Natural Gas Savings (2026 PV\$)	Total 30-Year LSC Savings (2026 PV\$)
1	0.71	0.00	0.71
2	0.57	0.00	0.57
3	0.54	0.00	0.54
4	0.50	0.00	0.50
5	0.52	0.00	0.52
6	0.28	0.00	0.28
7	0.30	0.00	0.30
8	0.27	0.00	0.27
9	0.30	0.00	0.30
10	0.30	0.00	0.30
11	0.44	0.00	0.44
12	0.47	0.00	0.47
13	0.38	0.00	0.38
14	0.43	0.00	0.43
15	0.18	0.00	0.18
16	0.62	0.00	0.62

Table 37: 2026 PV LSC Savings Over 30-Year Period of Analysis – Per Square Foot – New Construction and Additions –OfficeLarge – Hot Water Supply Temperature Limit (Electric Baseline)

Climate Zone	30-Year LSC Electricity Savings (2026 PV\$)	30-Year LSC Natural Gas Savings (2026 PV\$)	Total 30-Year LSC Savings (2026 PV\$)
1	NA	NA	NA
2	NA	NA	NA
3	0.62	0.00	0.62
4	0.60	0.00	0.60
5	NA	NA	NA
6	0.30	0.00	0.30
7	0.32	0.00	0.32
8	0.30	0.00	0.30
9	0.32	0.00	0.32
10	0.34	0.00	0.34
11	0.56	0.00	0.56
12	0.54	0.00	0.54
13	NA	NA	NA
14	0.56	0.00	0.56
15	0.20	0.00	0.20
16	0.82	0.00	0.82

Table 38: 2026 PV LSC Savings Over 30-Year Period of Analysis – Per Square Foot – New Construction and Additions – SchoolLarge – Hot Water Supply Temperature Limit (Electric Baseline)

Climate Zone	30-Year LSC Electricity Savings (2026 PV\$)	30-Year LSC Natural Gas Savings (2026 PV\$)	Total 30-Year LSC Savings (2026 PV\$)
1	0.98	0.00	0.98
2	0.73	0.00	0.73
3	0.76	0.00	0.76
4	0.63	0.00	0.63
5	0.65	0.00	0.65
6	0.45	0.00	0.45
7	0.43	0.00	0.43
8	0.43	0.00	0.43
9	0.43	0.00	0.43
10	0.40	0.00	0.40
11	0.64	0.00	0.64
12	0.64	0.00	0.64
13	0.52	0.00	0.52
14	0.56	0.00	0.56
15	0.28	0.00	0.28
16	0.78	0.00	0.78

Table 39: 2026 PV LSC Savings Over 30-Year Period of Analysis – Per Square Foot – New Construction and Additions – OfficeMedium – Hot Water Supply Temperature Limit (Electric Baseline)

Climate Zone	30-Year LSC Electricity Savings (2026 PV\$)	30-Year LSC Natural Gas Savings (2026 PV\$)	Total 30-Year LSC Savings (2026 PV\$)
1	0.90	0.00	0.90
2	0.67	0.00	0.67
3	0.58	0.00	0.58
4	0.57	0.00	0.57
5	0.56	0.00	0.56
6	0.27	0.00	0.27
7	0.30	0.00	0.30
8	0.26	0.00	0.26
9	0.30	0.00	0.30
10	0.29	0.00	0.29
11	0.57	0.00	0.57
12	0.56	0.00	0.56
13	0.46	0.00	0.46
14	0.57	0.00	0.57
15	0.19	0.00	0.19
16	0.86	0.00	0.86

Table 40: 2026 PV LSC Savings Over 30-Year Period of Analysis – Per Square Foot – New Construction and Additions – All Prototypes– Hot Water Supply Temperature Limit (Electric Baseline)

Climate Zone	30-Year LSC Electricity Savings (2026 PV\$)	30-Year LSC Natural Gas Savings (2026 PV\$)	Total 30-Year LSC Savings (2026 PV\$)
1	1.10	0.00	1.10
2	0.96	0.00	0.96
3	0.82	0.00	0.82
4	0.78	0.00	0.78
5	0.78	0.00	0.78
6	0.44	0.00	0.44
7	0.61	0.00	0.61
8	0.43	0.00	0.43
9	0.45	0.00	0.45
10	0.69	0.00	0.69
11	0.80	0.00	0.80
12	0.78	0.00	0.78
13	0.73	0.00	0.73
14	0.75	0.00	0.75
15	0.51	0.00	0.51
16	0.99	0.00	0.99

Table 41: 2026 PV LSC Savings Over 30-Year Period of Analysis – Per Square Foot – Alterations – HighRiseMixedUse – Hot Water Supply Temperature Limit (Electric Baseline)

Climate Zone	30-Year LSC Electricity Savings (2026 PV\$)	30-Year LSC Natural Gas Savings (2026 PV\$)	Total 30-Year LSC Savings (2026 PV\$)
1	0.28	0.00	0.28
2	0.21	0.00	0.21
3	0.22	0.00	0.22
4	0.17	0.00	0.17
5	0.20	0.00	0.20
6	0.13	0.00	0.13
7	0.11	0.00	0.11
8	0.10	0.00	0.10
9	0.11	0.00	0.11
10	0.11	0.00	0.11
11	0.15	0.00	0.15
12	0.16	0.00	0.16
13	0.14	0.00	0.14
14	0.15	0.00	0.15
15	0.07	0.00	0.07
16	0.22	0.00	0.22

Table 42: 2026 PV LSC Savings Over 30-Year Period of Analysis – Per Square Foot – Alterations – Hospital – Hot Water Supply Temperature Limit (Electric Baseline)

Climate Zone	30-Year LSC Electricity Savings (2026 PV\$)	30-Year LSC Natural Gas Savings (2026 PV\$)	Total 30-Year LSC Savings (2026 PV\$)
1	2.57	0.00	2.57
2	2.43	0.00	2.43
3	2.31	0.00	2.31
4	2.23	0.00	2.23
5	2.29	0.00	2.29
6	1.90	0.00	1.90
7	1.95	0.00	1.95
8	1.98	0.00	1.98
9	1.95	0.00	1.95
10	1.98	0.00	1.98
11	2.17	0.00	2.17
12	2.21	0.00	2.21
13	2.08	0.00	2.08
14	1.99	0.00	1.99
15	1.80	0.00	1.80
16	2.03	0.00	2.03

Table 43: 2026 PV LSC Savings Over 30-Year Period of Analysis – Per Square Foot – Alterations – HotelSmall – Hot Water Supply Temperature Limit (Electric Baseline)

Climate Zone	30-Year LSC Electricity Savings (2026 PV\$)	30-Year LSC Natural Gas Savings (2026 PV\$)	Total 30-Year LSC Savings (2026 PV\$)
1	0.71	0.00	0.71
2	0.57	0.00	0.57
3	0.54	0.00	0.54
4	0.50	0.00	0.50
5	0.52	0.00	0.52
6	0.28	0.00	0.28
7	0.30	0.00	0.30
8	0.27	0.00	0.27
9	0.30	0.00	0.30
10	0.30	0.00	0.30
11	0.44	0.00	0.44
12	0.47	0.00	0.47
13	0.38	0.00	0.38
14	0.43	0.00	0.43
15	0.18	0.00	0.18
16	0.62	0.00	0.62

Table 44: 2026 PV LSC Savings Over 30-Year Period of Analysis – Per Square Foot – Alterations –OfficeLarge – Hot Water Supply Temperature Limit (Electric Baseline)

Climate Zone	30-Year LSC Electricity Savings (2026 PV\$)	30-Year LSC Natural Gas Savings (2026 PV\$)	Total 30-Year LSC Savings (2026 PV\$)
1	0.79	0.00	0.79
2	0.67	0.00	0.67
3	0.62	0.00	0.62
4	0.60	0.00	0.60
5	0.61	0.00	0.61
6	0.30	0.00	0.30
7	0.32	0.00	0.32
8	0.30	0.00	0.30
9	0.32	0.00	0.32
10	0.34	0.00	0.34
11	0.56	0.00	0.56
12	0.54	0.00	0.54
13	0.44	0.00	0.44
14	0.56	0.00	0.56
15	0.20	0.00	0.20
16	0.82	0.00	0.82

Table 45: 2026 PV LSC Savings Over 30-Year Period of Analysis – Per Square Foot – Alterations – OfficeMedium – Hot Water Supply Temperature Limit (Electric Baseline)

Climate Zone	30-Year LSC Electricity Savings (2026 PV\$)	30-Year LSC Natural Gas Savings (2026 PV\$)	Total 30-Year LSC Savings (2026 PV\$)
1	0.90	0.00	0.90
2	0.67	0.00	0.67
3	0.58	0.00	0.58
4	0.57	0.00	0.57
5	0.56	0.00	0.56
6	0.27	0.00	0.27
7	0.30	0.00	0.30
8	0.26	0.00	0.26
9	0.30	0.00	0.30
10	0.29	0.00	0.29
11	0.57	0.00	0.57
12	0.56	0.00	0.56
13	0.46	0.00	0.46
14	0.57	0.00	0.57
15	0.19	0.00	0.19
16	0.86	0.00	0.86

Table 46: 2026 PV LSC Savings Over 30-Year Period of Analysis – Per Square Foot – Alterations – SchoolLarge – Hot Water Supply Temperature Limit (Electric Baseline)

Climate Zone	30-Year LSC Electricity Savings (2026 PV\$)	30-Year LSC Natural Gas Savings (2026 PV\$)	Total 30-Year LSC Savings (2026 PV\$)
1	0.98	0.00	0.98
2	0.73	0.00	0.73
3	0.76	0.00	0.76
4	0.63	0.00	0.63
5	0.65	0.00	0.65
6	0.45	0.00	0.45
7	0.43	0.00	0.43
8	0.43	0.00	0.43
9	0.43	0.00	0.43
10	0.40	0.00	0.40
11	0.64	0.00	0.64
12	0.64	0.00	0.64
13	0.52	0.00	0.52
14	0.56	0.00	0.56
15	0.28	0.00	0.28
16	0.78	0.00	0.78

Table 47: 2026 PV LSC Savings Over 30-Year Period of Analysis – Per Square Foot – Alterations – All Prototypes– Hot Water Supply Temperature Limit (Electric Baseline)

Climate Zone	30-Year LSC Electricity Savings (2026 PV\$)	30-Year LSC Natural Gas Savings (2026 PV\$)	Total 30-Year LSC Savings (2026 PV\$)
1	1.25	0.00	1.25
2	0.97	0.00	0.97
3	0.85	0.00	0.85
4	0.81	0.00	0.81
5	0.88	0.00	0.88
6	0.50	0.00	0.50
7	0.55	0.00	0.55
8	0.50	0.00	0.50
9	0.52	0.00	0.52
10	0.59	0.00	0.59
11	0.93	0.00	0.93
12	0.83	0.00	0.83
13	0.84	0.00	0.84
14	0.75	0.00	0.75
15	0.46	0.00	0.46
16	1.01	0.00	1.01

3.4.3 Incremental First Cost

Piping Cost Data: Piping cost data was provided by two large Bay Area mechanical contractors. See Table 48. These are fully installed costs and include materials, labor, allowances for elbows, valves, fittings, insulation, etc. Copper pipes are assumed for 2” and smaller, black steel for 3” and 4”.

Table 48. HW Pipe Cost Data from Mechanical Contractors

Pipe Size	\$/linear foot	Max Flow Rate (gpm)
3/4	\$ 105.05	4.6
1"	\$ 110.97	8.9
1-1/4"	\$ 121.18	15
1-1/2"	\$ 131.15	24
2"	\$ 149.72	51
3"	\$ 223.56	140
4"	\$ 272.50	280

3.4.3.1 Pipe Sizing Methodology

Taylor Engineers has developed a publicly available [tool](#) for optimally sizing HW pipes based on pipe cost, pump energy cost, noise considerations, erosion considerations, etc. Using this tool, the Statewide CASE Team derived the maximum water flow rates (in gallons per minute or gpm) listed in Table 48. These flow rates and pipe costs were then used to derive a regression for pipe cost as a function of gpm (Figure 6).

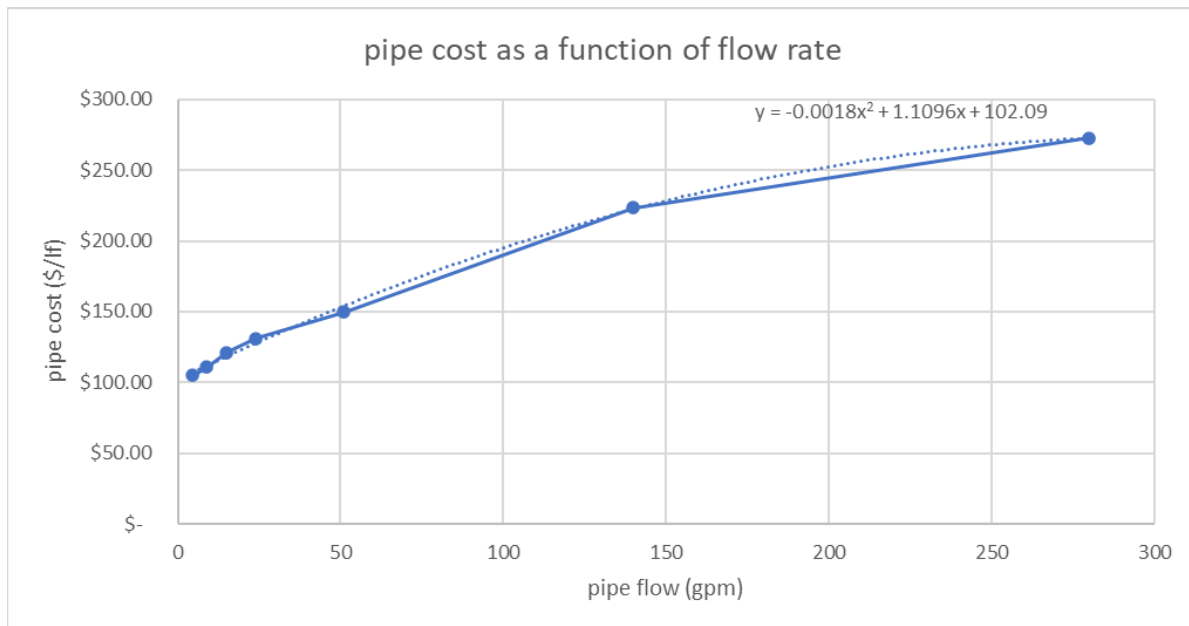

Figure 6: Pipe Cost (\$/linear ft) vs Flow (gpm)

The Statewide CASE Team took the drawings for two real office buildings (see Figure 7 and Figure 8) with HW reheat systems and measured the linear feet of all the pipes in the building and the calculated the design heating capacity in Btuh of each segment of pipe based on the design gpm and design dT. We then determined the new gpm in each pipe segment based on the new dT. The regression equation from Figure 6 was then used to determine the new pipe cost if for each segment which was multiplied by the segment length to determine the new pipe cost for each segment. Since the two real buildings did not exactly match the areas of the prototype models, the incremental piping costs from the real buildings were normalized to \$/ft² so they could be applied to the energy results from the prototype models based on each prototype’s floor area.

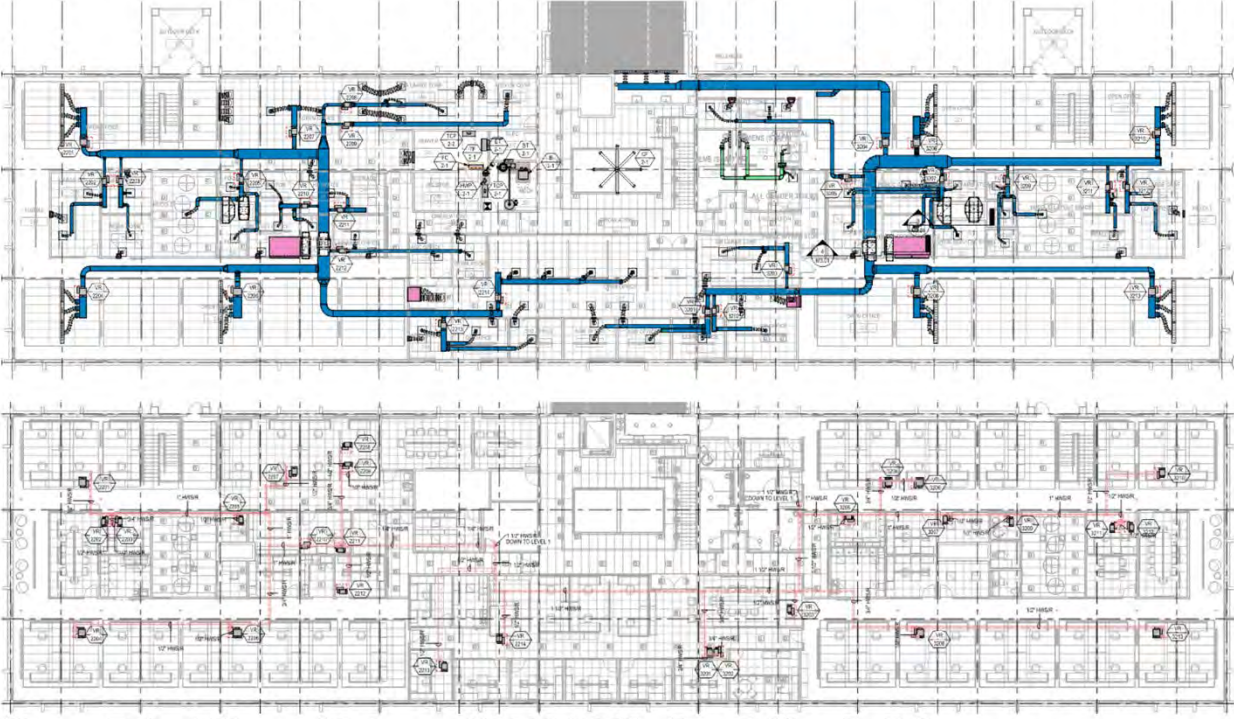

Figure 7: 2nd Floor of 2-Story, 40,000 ft² Medium Office Building

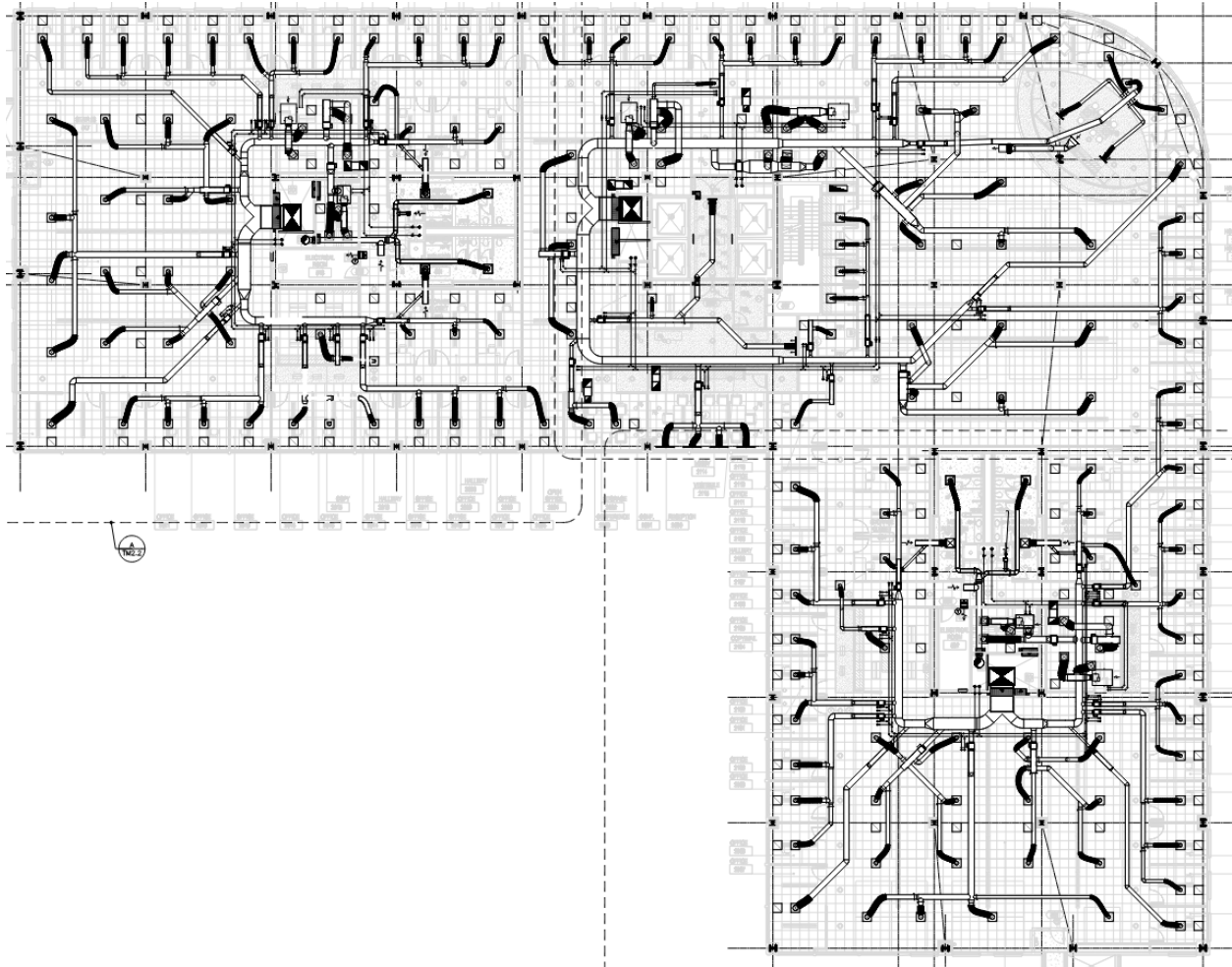

Figure 8: Typical Floor of 5-Story, 200,000 ft² Large Office Building

3.4.3.2 Boiler Cost Data

We solicited boiler price data from two Bay Area boiler representatives for boilers representing a range of types, sizes, and manufacturers. The data was then averaged to arrive at the equipment costs shown in Table 49.

Table 49: Boiler Cost Data

Boiler type	Avg equip cost (\$/kBtuh)
Non-condensing	\$29.45
Condensing	\$39.81
Equipment Incremental Cost	\$10.36

The mechanical contractor advised that an installed cost multiplier of 2.0 could reasonably be applied to the equipment incremental cost of \$10.36/kBtuh to arrive at the installed incremental cost of switching from non-condensing in Baseline 1 to condensing in Proposed 1 of \$20.72/kBtuh. The peak loads determined by the CBECC

prototype models for each climate zone were on the order of 8-11 Btuh/ft², which is well below typical engineer boiler sizing.¹¹ To be conservative the Statewide CASE Team doubled the CBECC peak loads to determine the loads for the study buildings and thus the incremental boiler costs. This assumption is conservative because it increases the size of the boilers and pumps and thus the incremental costs. Doubling the CBECC peak loads was consistent with the actual sizing of the boiler plants for the two study buildings.

3.4.3.3 Pump Cost Data

Similarly pump cost data was solicited from Bay Area pump representatives for pumps representing the range of flows seen in the two office buildings above. This survey provided an incremental installed cost of \$80/gpm. The new gpm for each building was determined based on the estimated peak loads in each climate and the new dT.

3.4.4 Incremental Maintenance and Replacement Costs

Incremental maintenance cost is the incremental cost of replacing the equipment or parts of the equipment, as well as periodic maintenance required to keep the equipment operating relative to current practices over the 30-year period of analysis. The present value of equipment maintenance costs (or savings) was calculated using a three percent discount rate (d), which is consistent with the discount rate used when developing the 2025 LSC hourly factors. The present value of maintenance costs that occurs in the nth year is calculated as follows:

$$\textit{Present Value of Maintenance Cost} = \textit{Maintenance Cost} \times \left[\frac{1}{1 + d} \right]^n$$

This measure is not expected to result in different maintenance costs relative to the base case.

3.4.5 Cost Effectiveness

Table 50, Table 51, Table 52, and Table 53 summarize the cost-effectiveness calculations for a representative sample of climate zones for large and medium office buildings for both Baseline 1 (gas boilers) and Baseline 2 (AWHPs). In all cases the benefit-to-cost ratio is above 1.0, indicating that the measure is cost-effective in all cases.

¹¹ This assertion is based on professional judgement and past informal surveys of real designs.

Table 50: Cost Effectiveness Results for Selected Climate Zones (Large Office – Gas Baseline)

Parameter	CZ01	CZ03	CZ06	CZ07	CZ09	CZ12
Plant capacity (Btuh/sf)	22.0	20.9	17.1	15.6	17.8	21.1
Plant capacity (KBH)	10,977	10,439	8,515	7,790	8,884	10,524
Incremental boiler cost (\$/KBH)	\$20.72	\$20.72	\$20.72	\$20.72	\$20.72	\$20.72
Incremental boiler cost (\$)	\$227,395	\$216,253	\$176,395	\$161,391	\$184,045	\$218,029
Incremental boiler cost (\$/ft2)	\$0.46	\$0.43	\$0.35	\$0.32	\$0.37	\$0.44
Incremental gpm	329	313	255	234	267	316
Incremental pump cost (\$/gpm)	\$80	\$80	\$80	\$80	\$80	\$80
Incremental pump cost (\$)	\$26,384	\$25,091	\$20,467	\$18,726	\$21,354	\$25,297
Incremental pump cost (\$/ft2)	\$0.05	\$0.05	\$0.04	\$0.04	\$0.04	\$0.05
Incremental pipe cost 40dT to 25dT (\$/ft2)	\$0.19	\$0.19	\$0.19	\$0.19	\$0.19	\$0.19
Total incremental cost (\$/ft2)	\$0.70	\$0.67	\$0.59	\$0.55	\$0.60	\$0.68
Energy savings (\$/ft2)	\$2.40	\$1.88	\$1.10	\$0.99	\$1.03	\$1.57
Net lifecycle savings (\$/ft2)	\$1.70	\$1.21	\$0.51	\$0.44	\$0.43	\$0.89
Benefit-to-Cost Ratio	3.4	2.8	1.9	1.8	1.7	2.3

Table 51: Cost Effectiveness Results for Selected Climate Zones (Large Office – Elec Baseline)

Parameter	CZ01	CZ03	CZ06	CZ07	CZ09	CZ12
Plant capacity (Btuh/sf)	22.0	20.9	17.1	15.6	17.8	21.1
Incremental gpm	146	139	114	104	118	140
Incremental pump cost (\$/gpm)	\$80	\$80	\$80	\$80	\$80	\$80
Incremental pump cost (\$)	\$11,726	\$11,152	\$9,096	\$8,322	\$9,491	\$11,243
Incremental pump cost (\$/ft2)	\$0.02	\$0.02	\$0.02	\$0.02	\$0.02	\$0.02
Incremental pipe cost 30dT to 25dT (\$/ft2)	\$0.08	\$0.08	\$0.08	\$0.08	\$0.08	\$0.08
Total incremental cost (\$/ft2)	\$0.10	\$0.10	\$0.10	\$0.10	\$0.10	\$0.10
Energy savings (\$/ft2)	\$0.79	\$0.62	\$0.30	\$0.25	\$0.32	\$0.54
Net lifecycle savings (\$/ft2)	\$0.69	\$0.52	\$0.20	\$0.15	\$0.22	\$0.43
Benefit-to-Cost Ratio	7.6	6.1	3.1	2.6	3.3	5.2

Table 52: Cost Effectiveness Results for Selected Climate Zones (Medium Office – Gas Baseline)

Parameter	CZ01	CZ03	CZ06	CZ07	CZ09	CZ12
Plant capacity (Btuh/sf)	22.8	21.4	15.0	12.8	17.1	22.7
Plant capacity (KBH)	1,224	1,148	806	687	915	1,218
Incremental boiler cost (\$/KBH)	\$20.72	\$20.72	\$20.72	\$20.72	\$20.72	\$20.72
Incremental boiler cost (\$)	\$25,362	\$23,789	\$16,698	\$14,235	\$18,956	\$25,232
Incremental boiler cost (\$/ft2)	\$0.47	\$0.44	\$0.31	\$0.27	\$0.35	\$0.47
Incremental gpm	37	34	24	21	27	37
Incremental pump cost (\$/gpm)	\$136	\$136	\$136	\$136	\$136	\$136
Incremental pump cost (\$)	\$5,010	\$4,699	\$3,298	\$2,812	\$3,744	\$4,984
Incremental pump cost (\$/ft2)	\$0.09	\$0.09	\$0.06	\$0.05	\$0.07	\$0.09
Incremental pipe cost 40dT to 25dT (\$/ft2)	\$0.16	\$0.16	\$0.16	\$0.16	\$0.16	\$0.16
Total incremental cost (\$/ft2)	\$0.73	\$0.69	\$0.53	\$0.48	\$0.58	\$0.72
Energy savings (\$/ft2)	\$2.43	\$1.75	\$0.96	\$0.87	\$0.96	\$1.57
Net lifecycle savings (\$/ft2)	\$1.71	\$1.06	\$0.42	\$0.39	\$0.37	\$0.85
Benefit-to-Cost Ratio	3.3	2.5	1.8	1.8	1.6	2.2

Table 53: Cost Effectiveness Results for Selected Climate Zones (Medium Office – Elec Baseline)

Parameter	CZ01	CZ03	CZ06	CZ07	CZ09	CZ12
Plant capacity (Btuh/sf)	22.8	21.4	15.0	12.8	17.1	22.7
Incremental gpm	16	15	11	9	12	16
Incremental pump cost (\$/gpm)	\$136	\$136	\$136	\$136	\$136	\$136
Incremental pump cost (\$)	\$2,227	\$2,088	\$1,466	\$1,250	\$1,664	\$2,215
Incremental pump cost (\$/ft2)	\$0.04	\$0.04	\$0.03	\$0.02	\$0.03	\$0.04
Incremental pipe cost 30dT to 25dT (\$/ft2)	\$0.07	\$0.07	\$0.07	\$0.07	\$0.07	\$0.07
Total incremental cost (\$/ft2)	\$0.11	\$0.11	\$0.10	\$0.09	\$0.10	\$0.11
Energy savings (\$/ft2)	\$0.89	\$0.58	\$0.27	\$0.22	\$0.30	\$0.56
Net lifecycle savings (\$/ft2)	\$0.78	\$0.47	\$0.17	\$0.13	\$0.19	\$0.44
Benefit-to-Cost Ratio	8.0	5.3	2.7	2.4	2.9	5.0

This measure proposes a mandatory requirement. As such, a cost analysis is required to demonstrate that the measure is cost-effective over the 30-year period of analysis.

The CEC establishes the procedures for calculating cost-effectiveness. The Statewide CASE Team collaborated with CEC staff to confirm that the methodology in this report is consistent with their guidelines, including which costs were included in the analysis. The incremental first cost and incremental maintenance costs over the 30-year period of analysis were included. The LSC savings from electricity and natural gas savings were also included in the evaluation. Design costs were not included nor were the incremental costs of code compliance verification.

According to the CEC's definitions, a measure is cost-effective if the benefit-to-cost (B/C) ratio is greater than 1.0. The B/C ratio is calculated by dividing the cost benefits realized over 30 years by the total incremental costs, which includes maintenance costs for 30 years. The B/C ratio was calculated using 2026 PV costs and cost savings.

Results of the per unit cost-effectiveness analyses are presented in Table 54 and Table 55 for new construction/additions and alterations for the gas baseline, respectively.

Table 56 and Table 57 show per unit cost-effectiveness results for the new construction/additions and alterations for the AWHP baseline, respectively.

The proposed measure saves money over the 30-year period of analysis relative to the existing conditions. The proposed code change is cost-effective in every climate zone. Benefits and costs are defined as follows:

- **Benefits: LSC Savings + Other PV Savings:** Benefits include LSC Savings over the period of analysis (California Energy Commission 2022). Other savings are discounted at a real (nominal – inflation) three percent rate. Other PV savings include incremental first-cost savings if proposed first cost is less than current first cost, incremental PV maintenance cost savings if PV of proposed maintenance costs is less than PV of current maintenance costs, and incremental residual value if proposed residual value is greater than current residual value at end of the CASE analysis period.
- **Costs: Total Incremental Present Valued Costs:** Costs include incremental equipment, replacement, and maintenance costs over the period of analysis. Costs are discounted at a real (inflation-adjusted) three percent rate and if PV of proposed maintenance costs is greater than PV of current maintenance costs. If incremental maintenance cost is negative, it is treated as a positive benefit. If there are no total incremental PV costs, the benefit-to-cost ratio is infinite.

Table 54: 30-Year Cost-Effectiveness Summary Per Square Foot – New Construction/Additions – Hot Water Supply Temperature Limit (Gas Baseline)

Climate Zone	Benefits LSC Savings + Other PV Savings (2026 PV\$)	Costs Total Incremental PV Costs (2026 PV\$)	Benefit-to-Cost Ratio
1	2.71	0.64	4.21
2	2.29	0.64	3.58
3	2.17	0.65	3.33
4	2.02	0.67	3.00
5	2.08	0.66	3.17
6	1.35	0.55	2.46
7	1.58	0.54	2.91
8	1.24	0.57	2.17
9	1.31	0.60	2.19
10	1.77	0.62	2.86
11	2.08	0.75	2.78
12	2.04	0.70	2.89
13	1.87	0.69	2.70
14	1.96	0.70	2.80
15	1.32	0.62	2.12
16	2.48	0.72	3.44

Table 55: 30-Year Cost-Effectiveness Summary Per Square Foot – Alterations – Hot Water Supply Temperature Limit (Gas Baseline)

Climate Zone	Benefits LSC Savings + Other PV Savings (2026 PV\$)	Costs Total Incremental PV Costs (2026 PV\$)	Benefit-to-Cost Ratio
1	2.88	0.63	4.55
2	2.26	0.67	3.38
3	2.19	0.66	3.30
4	2.03	0.68	2.99
5	2.20	0.66	3.34
6	1.44	0.56	2.57
7	1.40	0.53	2.63
8	1.35	0.58	2.32
9	1.41	0.61	2.33
10	1.54	0.63	2.44
11	2.24	0.74	3.02
12	2.07	0.70	2.96
13	2.01	0.68	2.94
14	1.93	0.70	2.74
15	1.19	0.65	1.83
16	2.50	0.72	3.47

Table 56: 30-Year Cost-Effectiveness Summary Per Square Foot – New Construction/Additions – Hot Water Supply Temperature Limit (Electric Baseline)

Climate Zone	Benefits LSC Savings + Other PV Savings (2026 PV\$)	Costs Total Incremental PV Costs (2026 PV\$)	Benefit- to-Cost Ratio
1	1.10	0.10	10.87
2	0.96	0.10	9.51
3	0.82	0.10	8.04
4	0.78	0.10	7.56
5	0.78	0.10	7.70
6	0.44	0.10	4.55
7	0.61	0.10	6.33
8	0.43	0.10	4.36
9	0.45	0.10	4.52
10	0.69	0.10	6.86
11	0.80	0.11	7.55
12	0.78	0.10	7.52
13	0.73	0.10	7.03
14	0.75	0.10	7.23
15	0.51	0.10	5.05
16	0.99	0.10	9.40

Table 57: 30-Year Cost-Effectiveness Summary Per Square Foot – Alterations – Hot Water Supply Temperature Limit (Electric Baseline)

Climate Zone	Benefits LSC Savings + Other PV Savings (2026 PV\$)	Costs Total Incremental PV Costs (2026 PV\$)	Benefit- to-Cost Ratio
1	1.25	0.10	12.51
2	0.97	0.10	9.49
3	0.85	0.10	8.35
4	0.81	0.10	7.86
5	0.88	0.10	8.70
6	0.50	0.10	5.18
7	0.55	0.10	5.72
8	0.50	0.10	5.11
9	0.52	0.10	5.24
10	0.59	0.10	5.85
11	0.93	0.11	8.87
12	0.83	0.10	8.00
13	0.84	0.10	8.20
14	0.75	0.10	7.22
15	0.46	0.10	4.50
16	1.01	0.10	9.70

3.5 First-Year Statewide Impacts

3.5.1 Statewide Energy and Energy Cost Savings

The Statewide CASE Team calculated the first-year statewide savings for new construction and additions by multiplying the per unit savings, which are presented in Section 3.3.2, by assumptions about the percentage of newly constructed buildings that would be impacted by the proposed code. The statewide new construction forecast for 2026 is presented in Appendix A, as are the Statewide CASE Team's assumptions about the percentage of new construction that would be impacted by the proposal (by climate zone and building type). As noted above, since both an electric and gas baseline were analyzed, it was assumed that the statewide construction forecast would be split in a manner consistent with the percentage of local jurisdictions that have adopted all-electric reach codes, which is approximately 20 percent of the state as of early 2023.

The methodology for estimating savings in alterations is the same as for new construction. The main driver of savings, i.e., the reduced losses in the distribution network from a lower HWST, is consistent across NC and alterations.

The first-year energy impacts represent the first-year annual savings from all buildings that were completed in 2026. The 30-year energy cost savings represent the energy cost savings over the entire 30-year analysis period. The statewide savings estimates do not take naturally occurring market adoption or compliance rates into account.

The tables below presents the first-year statewide energy and energy cost savings from newly constructed buildings and additions (Table 58) and alterations (Table 59) by climate zone for the gas baseline. Table 60 presents first-year statewide savings from new construction, additions, and alterations for the gas baseline. This data is repeated for the electric baseline in Table 61, Table 62, and Table 63. The natural gas and electric cases are combined in these tables. The Statewide CASE Team assumed that since 30 percent of the state population lives within jurisdictions that require all-electric space heating (due to local all-electric reach code adoptions, calculated using localenergycodes.com), 30 percent of the floor area would apply to the electric case and 60 percent of the floor area would apply to the gas case (we assumed that the remaining 10 percent of floor area for in-scope prototypes would not use hydronics). Since the gas case only includes natural gas savings and the electric case only includes electricity and peak demand savings, these columns in the tables only reflect the impacts of each respective modeling case. Source energy and energy cost savings are combined.

While a statewide analysis is crucial to understanding broader effects of code change proposals, there is potential to disproportionately impact specific populations that needs to be considered. Refer to Section 3.6 for more details addressing energy equity and environmental justice.

Table 58: Statewide Energy and Energy Cost Impacts – New Construction and Additions (Gas Baseline)

Climate Zone	Statewide New Construction & Additions Impacted by Proposed Change in 2026 (Million Square Feet)	First-Year ^a Electricity Savings (GWh)	First-Year Peak Electrical Demand Reduction (MW)	First-Year Natural Gas Savings (Million Therms)	First-Year Source Energy Savings (Million kBtu)	30-Year Present Valued Energy Cost Savings (Million 2026 PV\$)
1	126,822	0	0	0.01	1	\$0.34
2	621,893	0	0	0.03	2	\$1.42
3	4,319,508	0	0	0.17	15	\$9.38
4	2,195,688	0	0	0.08	7	\$4.45
5	372,121	0	0	0.01	1	\$0.78
6	2,409,168	0	0	0.06	5	\$3.25
7	1,957,458	0	0	0.06	5	\$3.09
8	3,544,528	0	0	0.08	7	\$4.41
9	6,258,483	0	0	0.14	13	\$8.21
10	2,316,511	0	0	0.07	7	\$4.11
11	613,164	0	0	0.02	2	\$1.28
12	3,718,212	0	0	0.13	12	\$7.58
13	1,040,254	0	0	0.03	3	\$1.94
14	596,615	0	0	0.02	2	\$1.17
15	375,257	0	0	0.01	1	\$0.50
16	187,418	0	0	0.01	1	\$0.46
Total	30,653,103	0	0	0.93	84	\$52.36

a. First-year savings from all buildings completed statewide in 2026.

Table 59: Statewide Energy and Energy Cost Impacts – Alterations (Gas Baseline)

Climate Zone	Statewide New Construction & Additions Impacted by Proposed Change in 2026 (Million Square Feet)	First-Year ^a Electricity Savings (GWh)	First-Year Peak Electrical Demand Reduction (MW)	First-Year Natural Gas Savings (Million Therms)	First-Year Source Energy Savings (Million kBtu)	30-Year Present Valued Energy Cost Savings (Million 2026 PV\$)
1	158,048	0	0	0.01	1	\$0.45
2	1,274,440	0	0	0.05	5	\$2.89
3	6,997,001	0	0	0.28	25	\$15.34
4	3,559,600	0	0	0.13	12	\$7.24
5	545,780	0	0	0.02	2	\$1.20
6	4,689,200	0	0	0.12	11	\$6.75
7	3,978,600	0	0	0.10	9	\$5.58
8	6,947,201	0	0	0.17	15	\$9.40
9	11,978,201	0	0	0.30	27	\$16.93
10	5,157,400	0	0	0.14	13	\$7.95
11	960,120	0	0	0.04	3	\$2.15
12	6,548,001	0	0	0.24	22	\$13.52
13	1,928,480	0	0	0.07	6	\$3.88
14	1,249,360	0	0	0.04	4	\$2.41
15	664,300	0	0	0.01	1	\$0.79
16	359,760	0	0	0.02	1	\$0.90
Total	56,995,493	0	0	1.73	157	\$97.39

a. First-year savings from all buildings completed statewide in 2026.

Table 60: Statewide Energy and Energy Cost Impacts – New Construction, Additions, and Alterations (Gas Baseline)

Construction Type	First-Year Electricity Savings (GWh)	First-Year Peak Electrical Demand Reduction (MW)	First -Year Natural Gas Savings (Million Therms)	First-Year Source Energy Savings (Million kBtu)	30-Year Present Valued Energy Cost Savings (PV\$ Million)
New Construction & Additions	0	0	0.93	84.18	52.36
Alterations	0	0	1.73	156.52	97.39
Total	0	0	2.67	240.70	149.74

Table 61: Statewide Energy and Energy Cost Impacts – New Construction and Additions (Electric Baseline)

Climate Zone	Statewide New Construction & Additions Impacted by Proposed Change in 2026 (Million Square Feet)	First-Year^a Electricity Savings (GWh)	First-Year Peak Electrical Demand Reduction (MW)	First-Year Natural Gas Savings (Million Therms)	First-Year Source Energy Savings (Million kBtu)	30-Year Present Valued Energy Cost Savings (Million 2026 PV\$)
1	60,179	0.01	0.00	0	0.02	\$0.07
2	291,757	0.05	0.01	0	0.10	\$0.28
3	2,067,536	0.27	0.04	0	0.59	\$1.69
4	1,050,299	0.14	0.02	0	0.31	\$0.82
5	176,736	0.02	0.00	0	0.05	\$0.14
6	1,161,103	0.09	0.01	0	0.19	\$0.51
7	928,157	0.09	0.01	0	0.21	\$0.57
8	1,711,890	0.12	0.02	0	0.29	\$0.73
9	3,032,086	0.22	0.04	0	0.53	\$1.36
10	1,090,449	0.12	0.02	0	0.28	\$0.75
11	291,877	0.04	0.01	0	0.09	\$0.23
12	1,779,149	0.23	0.04	0	0.54	\$1.39
13	494,165	0.06	0.01	0	0.14	\$0.36
14	284,605	0.03	0.01	0	0.09	\$0.21
15	175,835	0.01	0.00	0	0.03	\$0.09
16	89,188	0.01	0.00	0	0.03	\$0.09
Total	14,685,012	1.51	0.25	0	3.49	\$9.28

Table 62: Statewide Energy and Energy Cost Impacts – Alterations (Electric Baseline)

Climate Zone	Statewide New Construction & Additions Impacted by Proposed Change in 2026 (Million Square Feet)	First-Year ^a Electricity Savings (GWh)	First-Year Peak Electrical Demand Reduction (MW)	First-Year Natural Gas Savings (Million Therms)	First-Year Source Energy Savings (Million kBtu)	30-Year Present Valued Energy Cost Savings (Million 2026 PV\$)
1	79,033	0.02	0.00	0	0.03	\$0.10
2	637,273	0.10	0.02	0	0.22	\$0.62
3	3,498,777	0.48	0.08	0	1.04	\$2.97
4	1,779,944	0.24	0.04	0	0.54	\$1.43
5	272,913	0.04	0.01	0	0.09	\$0.24
6	2,344,761	0.20	0.03	0	0.43	\$1.18
7	1,989,454	0.16	0.02	0	0.41	\$1.09
8	3,473,858	0.29	0.05	0	0.67	\$1.74
9	5,989,659	0.51	0.09	0	1.19	\$3.11
10	2,578,865	0.25	0.04	0	0.57	\$1.51
11	480,103	0.07	0.01	0	0.17	\$0.45
12	3,274,236	0.45	0.08	0	1.03	\$2.70
13	964,319	0.13	0.02	0	0.31	\$0.81
14	624,722	0.08	0.01	0	0.19	\$0.47
15	332,171	0.02	0.00	0	0.06	\$0.15
16	179,894	0.03	0.00	0	0.06	\$0.18
Total	28,499,979	3.06	0.52	0	7.02	\$18.76

a. First-year savings from all buildings completed statewide in 2026.

Table 63: Statewide Energy and Energy Cost Impacts – New Construction, Additions, and Alterations (Electric Baseline)

Construction Type	First-Year Electricity Savings (GWh)	First-Year Peak Electrical Demand Reduction (MW)	First-Year Natural Gas Savings (Million Therms)	First-Year Source Energy Savings (Million kBtu)	30-Year Present Valued Energy Cost Savings (PV\$ Million)
New Construction & Additions	1.51	0.25	0.00	3.49	\$9.28
Alterations	3.06	0.52	0.00	7.02	\$18.76
Total	4.58	0.77	0.00	10.50	\$28.04

3.5.2 Statewide Greenhouse Gas (GHG) Emissions Reductions

The Statewide CASE Team calculated avoided GHG emissions associated with energy consumption using the hourly GHG emissions factors that CEC developed along with the 2025 LSC hourly factors and an assumed cost of \$123.15 per metric tons of carbon dioxide equivalent emissions (metric tons CO₂e) (California Energy Commission 2022).

The 2025 LSC hourly factors used in the lifecycle cost-effectiveness analysis include the monetary value of avoided GHG emissions based on a proxy for permit costs (not social costs).¹² The Cost-Effectiveness Analysis presented in Section 3.4 of this report does not include the cost savings from avoided GHG emissions. To demonstrate the cost savings of avoided GHG emissions, the Statewide CASE Team disaggregated the value of avoided GHG emissions from the other economic impacts. The authors used the same monetary values that are used in the LSC hourly factors.

Table 64 presents the estimated first-year avoided GHG emissions of the proposed code change. During the first year, GHG emissions of 15,130 (metric tons CO₂e) would be avoided.

Table 64: First-Year Statewide GHG Emissions Impacts

Measure	Electricity Savings ^a (GWh/y)	Reduced GHG Emissions from Electricity Savings ^a (Metric Tons CO ₂ e)	Natural Gas Savings ^a (Million Therms/y)	Reduced GHG Emissions from Natural Gas Savings ^a (Metric Tons CO ₂ e)	Total Reduced GHG Emissions ^b (Metric Ton CO ₂ e)	Total Monetary Value of Reduced GHG Emissions ^c (\$)
Limit HWST – G to G	0	0	2.67	14,574	14,574	1,794,756
Limit HWST – E to E	4.58	556	0.00	0.00	556	68,427
TOTAL	4.21	556	2.67	14,574	15,130	1,863,183

- First-year savings from all buildings completed statewide in 2026.
- GHG emissions savings were calculated using hourly GHG emissions factors are published alongside the in the LSC hourly factors and Source Energy factors by CEC here: <https://www.energy.ca.gov/files/2025-energy-code-hourly-factors>
- The monetary value of avoided GHG emissions is based on a proxy for permit costs (not social costs) derived from the 2022 TDV Update Model published by CEC here: <https://www.energy.ca.gov/files/tdv-2022-update-model>

¹² The permit cost of carbon is equivalent to the market value of a unit of GHG emissions in the California Cap-and-Trade program, while social cost of carbon is an estimate of the total economic value of damage done per unit of GHG emissions. Social costs tend to be greater than permit costs. See more on the Cap-and-Trade Program on the California Air Resources Board website: <https://ww2.arb.ca.gov/our-work/programs/cap-and-trade-program>.

3.5.3 Statewide Water Use Impacts

The proposed code change will not result in water savings.

3.5.4 Statewide Material Impacts

This measure is not expected to result in a meaningful change to materials. Building hydronic distribution systems would be expected to include slightly more material (e.g., steel, iron, copper) to account for larger pipe diameter were this measure to be adopted.

3.5.5 Other Non-Energy Impacts

This measure is not expected to result in any non-energy impacts.

3.6 Addressing Energy Equity and Environmental Justice

3.6.1 Research Methods and Engagement

The Statewide CASE Team considered the impacts of the proposal on DIPs using four criteria: cost, health, resiliency, and comfort. The details of these criteria and more examples can be found in Section 2.1.2.

3.6.2 Potential Impacts

The intent of this measure is to facilitate all-electric space heating through the requirement of lower HWSTs, the overriding viewpoint is that this measure will positively impact all building occupants including DIPs through the reduction of on-site pollution emissions caused by natural gas combustion (refer to Section 3.5.2 for more information regarding greenhouse gas emissions impacts).

This measure would require lower hot water supply temperatures in hydronic space heating applications. The proposal would likely impact piping and pump firsts costs, but these costs would be offset by ongoing energy efficiency benefits through the reduction in thermal losses in the distribution network. As noted, the purpose of the measure is to facilitate all-electric space heating, which again, is viewed as having positive benefits to all building occupants.

There are incremental costs for the proposals (e.g., larger diameter pipes and larger coils which cost more, though recall that our analysis showed that larger coils are not necessary), but there are also energy efficiency benefits (e.g., reduced thermal losses through the hot water pipe network). Both these costs and energy cost savings benefits are relatively minor, and DIPs most likely will not be adversely impacted by this proposal.

Impacts may vary by building type. Offices of all sizes, for example, are expected to be used by all people equally and DIPs are not more or less likely to occupy office spaces

than any other population. So, the proposed change is not expected to have an unequal impact on DIPs. The Statewide CASE Team identified schools and hotels as building types that may have disproportional impacts. The impacts of proposed measures on building types are discussed in more detail in Section 2.1.2.

4. Mechanical Heat Recovery and Thermal Energy Storage

4.1 Measure Description

4.1.1 Proposed Code Change

The measure is being pursued as a prescriptive addition to Section 140.4(r) and would apply to newly constructed large buildings with large simultaneous or diurnal heating and cooling loads. The new prescriptive code language is needed to ensure that large buildings pursuing all-electric space heating do so efficiently, with the specific goal of ensuring that building waste heat is leveraged in a way to minimize the installed capacity of air source heat pump equipment. Large buildings would have challenges meeting their space heating needs solely with air source heat pumps due to space, cost, and efficiency barriers. The proposal includes requirements for thermal energy storage and/or heat recovery equipment depending on how well that cooling and heating loads overlap. For buildings with low overlapping loads, the thermal energy storage requirement is intended to store waste heat from when the building is in cooling mode so that it can be re-used later when the building is in heating mode. When applied to buildings using gas for space heating, the measure can be considered “electric readiness.” This is because thermal energy storage and/or heat recovery equipment being present at the building (along with a trim gas boiler used to provide heating when recovered heat is insufficient to meet space heating loads) will most likely reduce the needed ASHP equipment when the building eventually electrifies its space heating by replacing its gas boiler with ASHPs.

The measure also proposes changes to the ACM Reference Manual rulesets to accommodate the new prescriptive requirements being proposed. For example, the ACM Reference Manual currently does not contain rulesets to model dedicated heat recovery chillers or thermal energy storage oriented toward space heating.

4.1.2 Justification and Background Information

4.1.2.1 Justification

For small and medium size commercial buildings, a variety of existing heat pump-based solutions exist on the market. These options include unitary single zone ASHPs and variable refrigerant flow systems. PG&E’s Code Readiness Program has conducted research at small and medium commercial buildings and has found that many projects are now utilizing DOAS with VRF as a cost-effective solution to fully electrify space heating (Bulger 2023). However, large commercial buildings have been considered harder to electrify due to space and equipment capacity issues. A simple but relatively

inefficient all-electric hydronic system that is currently allowed by code consists of air-to-water heat pumps supplying hot water sized to meet the building's peak heating load. Even if legacy design practices around space heating – including designing to ultra-hot water temperatures (e.g., 140 °F or higher) and oversizing the system design capacity, as was commonly done with natural gas boilers – are overcome, the resulting system is still unattractive for several reasons. First, the space requirement for ASHPs (of which AWHPs are a subcategory) is typically significant and may be hard to achieve in dense urban areas. Second, the efficiency of an AWHP delivering a HWST of 120 °F is in the 2.0 to 2.5 COP range at a heating design temperature of 30 °F (this would be even lower in climate zone 16 where design temperatures are generally lower than 20 °F). Third, an AWHP system sized to meet heating demand is expensive.

Despite its drawbacks, AWHP systems serving hydronic reheat are being promoted as an all-electric option for large buildings. The Code Readiness Electrification Designer Interview report found that multiple design engineers use configurations of multi-zone VAV systems with AWHPs supplying zone heating and reheat coils (Bulger 2023). This measure seeks to improve upon the default AWHP system that is typically installed in large buildings when all-electric solutions are pursued. The Statewide CASE Team surveyed the literature and market of available designs and have concluded that the inclusion of concepts such as condenser water thermal energy storage and dedicated heat recovery chillers are critical components of an efficient and cost-effective hydronic system design. Determining the specific requirements and triggers around heat recovery chiller sizing and when a TES tank should be specified was the focus of this measure.

4.1.2.2 Background Information

Interest in all-electric HVAC systems for commercial new construction has been sharply growing in recent years. Evidence of this trend can be found in the adoption of all-electric reach codes by local jurisdictions. Based on localenergycodes.com, between 2019 and early 2023, jurisdictions representing roughly 11 million Californians, or 28 percent of the state population have enacted all-electric reach codes. Most of this activity is centered around the Bay Area (including San Francisco) and southern California (including Los Angeles), making this a statewide trend. In addition, indications from government agencies such as the California Air Resources Board (CARB) have indicated potential upcoming regulations to set emissions-based standards for residential space heating appliances by 2030 (i.e., a zero on-site emissions limit, which would only be achievable with electric-powered equipment), with commercial equipment likely following at a later date (California Air Resources Board 2022). The underlying message is clear: all-electric space heating systems are poised to become extremely popular in California in the coming years. Large buildings face unique challenges when pursuing all-electric space heating due to the need for significant space requirements of

air to water heat pump (when serving hydronic heating) or other types of air source heat pumps if other systems are used. System configurations that include heat recovery and thermal energy storage can effectively shrink the capacity of air source equipment. This can save significant roof space and reduce upfront costs due to reduced ASHP equipment capacity needs. In addition, the plant efficiency (including chillers, heaters, heat rejection, and pumping) can increase by 20-40 percent relative to an all two-pipe AWHP and water-cooled chiller (WCC) system. The result is that Title 24 Part 6 has a unique opportunity to steer designers and installers toward the most efficient and cost-effective options available on the market, as the all-electric commercial building stock is starting to be constructed.

4.1.3 Summary of Proposed Changes to Code Documents

The sections below summarize how the standards, Reference Appendices, Alternative Calculation Method (ACM) Reference Manuals, and compliance forms would be modified by the proposed change.¹³ See Section 6 of this report for detailed proposed revisions to code language.

4.1.3.1 Specific Purpose and Necessity of Proposed Code Changes

Each proposed change to language in Title 24, Part 1 and Part 6 as well as the reference appendices to Part 6 are described below. See Section 6.2 of this report for marked-up code language.

Section: 140.4(r)1

Specific Purpose: The specific purpose is to require the use of heat recovery for large buildings with significant simultaneous cooling and heating loads. Large buildings with significant overlapping cooling and heating loads can leverage cooling waste energy for heating, resulting in energy efficiency benefits and potentially enable equipment installed capacity reductions as well.

Necessity: This addition is necessary to increase energy efficiency via cost-effective building design standards, as mandated by the California Public Resources Code, Sections 25213 and 25402.

Section: 140.4(r)2

Specific Purpose: The specific purpose is to require the use of heat recovery and thermal energy storage for large buildings with significant diurnal cooling and heating loads. Thermal energy storage is needed to capture waste heat in buildings without

¹³ Visit [EnergyCodeAce.com](https://www.energycodeace.com) for trainings, tools, and resources to help people understand existing code requirements.

significant overlapping cooling and heating loads. Waste heat is stored and re-used for space or service water heating later. This practice results in energy efficiency and is likely to result in equipment installed capacity reductions as well.

Necessity: This addition is necessary to increase energy efficiency via cost-effective building design standards, as mandated by the California Public Resources Code, Sections 25213 and 25402.

Section: 140.4(r)3

Specific Purpose: The specific purpose is to require heat recovery be used for service hot water end-uses when above a certain threshold of service hot water capacity.

Necessity: This addition is necessary to increase energy efficiency via cost-effective building design standards, as mandated by the California Public Resources Code, Sections 25213 and 25402.

4.1.3.2 Specific Purpose and Necessity of Changes to the Nonresidential ACM Reference Manual

The purpose and necessity of proposed changes to the Nonresidential ACM Reference Manual are described below. See Section 6.4 of this report for the detailed proposed revisions to the text of the ACM Reference Manual.

Section: 5.8.2

Specific Purpose: The specific purpose is to modify the chiller section to the ACM Reference Manual to enable hydronic heat recovery chiller capabilities.

Necessity: These changes are necessary to add functionality to the ACM Reference Manual that would allow designers to take advantage of this technology when seeking compliance for space heating systems.

Section: 5.8.9 (new section)

Specific Purpose: The specific purpose is to add a section describing thermal energy storage. Currently, the TES section is geared toward cooling peak reduction. The use of TES for space heating is not described in the ACM Reference Manual.

Necessity: These changes are necessary to add functionality to the ACM Reference Manual that would allow designers to take advantage of this technology when seeking compliance for space heating systems.

Section: 5.9.1.2

Specific Purpose: The specific purpose is to modify the water heating section to add capabilities for service water heating heat recovery from the mechanical HVAC system.

Necessity: These changes are necessary to add functionality to the ACM Reference Manual that would allow designers to take advantage of this technology when seeking compliance for their designs.

4.1.3.3 Summary of Changes to the Nonresidential & Multifamily Compliance Manual

Nonresidential and Multifamily Chapter 4 (Section 4.7 HVAC System Requirements) of the Nonresidential Compliance Manual would need to be revised. All-electric hydronic space heating systems are currently a less familiar option to many designers. The compliance manual would be updated in a way that contextualizes the new requirements being added in 140.4(r). The two new subsections are intended to separate out large building hydronic systems into two categories: those with large simultaneous cooling and heating loads, and those without. The prescriptive text should give designers all the tools needed to determine whether thermal energy storage is required for their design, but the compliance manual would further contextualize these requirements along with providing some example scenarios. The examples would touch space heating and service water heating to clearly illustrate the new prescriptive requirements and when they are triggered.

4.1.3.4 Summary of Changes to Compliance Forms

The proposed code change would most likely result in some modifications to the compliance forms. These changes include fields to determine whether the proper amount of thermal energy storage and/or if the correct amount of heat recovery capacity is specified in the design. Examples of the revised forms are presented in Section 6.5.

4.1.4 Regulatory Context

4.1.4.1 Determination of Inconsistency or Incompatibility with Existing State Laws and Regulations

There are no relevant state or local laws or regulations.

4.1.4.2 Duplication or Conflicts with Federal Laws and Regulations

There are no relevant federal laws or regulations.

4.1.4.3 Difference From Existing Model Codes and Industry Standards

ASHRAE 90.1-2022 includes two prescriptive measures that are related to this proposal. These measures are 6.5.6.2 Heat Recovery for Service Water Heating and 6.5.6.3 Heat Recovery for Space Conditioning. Our heat recovery measure is intended to cover a broader range of cases than what is specified in these measures. For example, 6.5.6.3 covers hydronic heat recovery for acute inpatient hospitals, whereas

our measure sets a condition of simultaneous cooling and heating loads and then any building type that meets it would be covered.

4.1.5 Compliance and Enforcement

When developing this proposal, the Statewide CASE Team considered methods to streamline the compliance and enforcement process and how negative impacts on market actors who are involved in the process could be mitigated or reduced. This section describes how to comply with the proposed code change. It also describes the compliance verification process. Appendix E presents how the proposed changes could impact various market actors.

The compliance verification activities related to this measure that need to occur during each phase of the project are described below:

- **Design Phase:** The requirement for hydronic heat recovery and thermal energy storage would require new design strategies. Workforce education around equipment sizing and HVAC controls configuration would be needed.
- **Permit Application Phase:** The design phase changes affect the energy consultant and the permit application process. Energy consultants often inform the design team of these requirements and work with them on how best to incorporate into their design. Energy Consultants also need training to understand the energy code changes. Documentation will need to be revised to properly demonstrate compliance.
- **Construction Phase:** Minor changes to this phase are expected from this measure. The novelty of this measure is not with the types of equipment being required but instead their configuration. Most aspects of construction would look the same before and after this measure. Large volume thermal energy storage tanks to reduce peak space heating demand are not common today but are relatively straightforward pieces of equipment to install.
- **Inspection Phase:** Changes to the inspection phase are expected to be minor. Inspectors would need to check that the necessary equipment has been installed as indicated by the prescriptive heat recovery and thermal energy storage requirements included in this measure.

4.2 Market Analysis

4.2.1 Current Market Structure

The Statewide CASE Team performed a market analysis with the goals of identifying current technology availability, current product availability, and market trends. It then considered how the proposed standard may impact the market in general as well as

individual market actors. Information was gathered about the incremental cost of complying with the proposed measure. Estimates of market size and measure applicability were identified through research and outreach with stakeholders including utility program staff, CEC staff, and a wide range of industry actors. In addition to conducting personalized outreach, the Statewide CASE Team discussed the current market structure and potential market barriers during a public stakeholder meeting that the Statewide CASE Team held on February 27, 2023.

The market structure of heat recovery systems and thermal energy storage systems can be considered separately, though both trends reinforce each other, and the best examples of projects leverage both techniques.

The most compelling system configuration is one that draws both from thermal energy storage and heat recovery. The principle is that large buildings tend to generate reasonable to significant amounts of heat year round, even in the winter. This internal building load generation in commercial buildings tends to be high. Daytime heating loads from people, data centers, and other processes can be stored overnight to be used for the next morning warm-up period. This diurnal trend should suffice to provide most of the heating loads in many California nonresidential buildings, with some ASHP backup for peak periods.

The California State University (CSU) system has committed to incorporating thermal energy storage and/or heat recovery into its campuses for decarbonization and teaching purposes (CSU 2019). The educational benefit of these actions far outweighs the efficiency benefits because thousands of engineering students statewide are being exposed to heat recovery and thermal energy storage concepts in their own buildings, making them familiar and comfortable with this technology when entering their careers. Many other university campuses throughout the state make sure of heat recovery in their campus HVAC systems as well.

Heat recovery without thermal energy storage has also gained traction. Over the past five years, key California HVAC distributors and designers have observed that the installation rate of heat recovery chillers has increased from almost negligible to a common occurrence, driven mainly by local all-electric reach code requirements and corporate and institutional decarbonization goals.

Based on early feedback from CEC regarding market readiness for thermal energy storage when applied to space heating, the Statewide CASE team aggressively pursued stakeholder outreach to learn about the current TES market in Spring 2023. It is the case that TES applied to space heating is a relatively new concept in the market, so in response, the Statewide CASE Team made a concerted effort to connect with key manufacturers and distributors to discuss the TES market. The Statewide CASE Team conducted stakeholder outreach with the following entities:

Manufacturers:

- Trane/CALMAC
- Baltimore Aircoil Company (BAC)

Distributors:

- Sigler
- Norman S Wright
- California Hydronics

Model energy code:

- ASHRAE 90.1 MSC

All entities collectively confirmed that the current market penetration of TES for space heating is relatively small (on a total building stock basis) but rapidly growing (meaning that many ongoing projects are leveraging the technology). However, despite the market currently being small, numerous statements and perspectives from market actors gave the Statewide CASE Team confidence that space heating TES measures are appropriate (particularly because 2025 Title 24 Part 6 would take effect in 2026, giving the market additional time to prepare for a TES requirement). BAC noted an uptick in interest in using TES for space heating over the past couple of years, with Mark MacCracken’s ASHRAE Journal article regarding ice TES’s potential for all-electric space heating (MacCracken 2020) being cited as a key driver. CALMAC, a manufacturer that developed ice TES in the early 1980s, was bought by Trane in the late 2010s. Both BAC and Trane/CALMAC noted thousands of successful ice TES installations worldwide, with some units still in operation after 30 years.

Ice TES equipment has traditionally been leveraged for chiller peak cooling load shifting purposes. This equipment added value to the building by reducing the required amount of chiller equipment and reducing utility peak demand charges for the building’s electric service. The technology benefits the electrical grid and society by helping avoid the need for inefficient “peaker plants” that would otherwise be needed on peak summer cooling days. As noted, ice TES manufacturers have mature product offerings dedicated to this use case of TES and have a proven track record of successful and long-lasting installations.

Ice TES for space heating is simply a twist on its application for space cooling. When used for space cooling on warm summer days, the ice TES system “discharges” (i.e., rejects heat from the tank to form ice) overnight and “charges” (i.e., accepts heat from the building zones) during the subsequent afternoon. Historically, when using ice TES only for cooling peak load shifting in the summer, the building would have little need for the thermal energy leaving the ice TES tank during discharging. Therefore, ice TES typically would reject heat to a cooling tower during the discharging period (which again,

occurs overnight). When used for space heating, ice TES discharges during the warm-up period of a cool winter morning and charges during the subsequent afternoon. The two minor differences between ice TES for space cooling & space heating are: 1) the timing of when the ice TES tank is discharged (overnight for space cooling, during morning warm-up for space heating) and 2) in space cooling mode, the thermal energy leaving the ice TES tank is rejected to the ambient environment, and in space heating mode, the thermal energy leaving the ice TES tank is used to warm up the building. There are obviously additional differences related to controls, hydronic piping, and the need for a water-to-water heat pump (a.k.a. a heat recovery chiller or “chiller-heater” in some product literature) in the space heating case, but ultimately these are minor differences that engineers and contractors routinely deal with on a case-by-case basis. The proven track record of the ice TES technology and significant number of long-lasting successful installations gives the Statewide CASE Team confidence that the technology is mature and can be straightforwardly adapted for use in space heating.

Distributors noted familiarity with chilled, condenser, and hot water TES.

- The Bay Area distributor Norman S Wright noted that they have seen condenser water or hot water TES for space heating. Norman S Wright frequently encounters hot water TES with a design setpoint of 120 °F.
- Sigler has experience with chilled water and hot water TES. Sigler noted that their projects have included both chilled water and hot water TES in the same building (likely to enable both cooling and heating peak load shifting).

Both distributors were highly familiar with the concept of space heating TES and did not object to the idea of including it in the prescriptive section of Title 24 Part 6. Cal Hydro has seen less TES in its business but noted the increase in wastewater heat recovery systems, which is included as an exception to 140.4(r) if the system can offset 25 percent of the combined SWH and space heating design capacity, since this technology would reduce the needed capacity of space heating equipment.

In addition to outreach with distributors and manufacturers, the Statewide CASE Team also presented its proposals to the ASHRAE 90.1 mechanical subcommittee’s (MSC) hydronics working group and the full MSC at the summer ASHRAE conference in Tampa, FL. The 90.1 MSC had a positive reception to the proposal to include space heating TES and noted plans to leverage the Statewide CASE Team’s work for a future addendum to 90.1.

The outreach also included discussions around heat recovery without TES. In all meetings, the market expressed high levels of confidence that the market is ready for prescriptive heat recovery code measures. The practice of converting a portion of the cooling/heating chiller/heat pump equipment from 2-pipe to 4-pipe to meet simultaneous cooling and heating loads is commonplace, according to the market actors. There was

no pushback from any group on the idea of requiring this technology in the prescriptive section of Title 24 Part 6.

In summary, all entities contacted expressed a positive reaction to the idea of prescriptively requiring TES to offset peak space heating equipment needs and noted that heat recovery equipment has become very common in newly constructed nonresidential buildings. The market for space heating TES is rapidly growing in parallel with the push for all-electric space heating. The market expressed readiness for such a proposal due to the overall familiarity with the concept of TES (which has historically been more focused on space cooling, but as described, the application for space heating is similar and easily understood by engineers and contractors).

The Statewide CASE Team reviewed recent publications regarding hydronic all-electric systems including a PG&E Code Readiness data brief summarizing field sites with all-electric space heating, including hydronic heat recovery (Weitze and Gantley 2023). Although the sites all fell below the capacity thresholds established for this measure (see the proposed code language for mechanical heat recovery at 140.4(r) in section 6.2), the data brief did provide some useful insights regarding the viability of heat recovery at different types of sites. For example, a site in Berkeley with process cooling loads was shown to provide a significant heat recovery opportunity. A site in Merced with low space heating needs (partially due to its decoupled ventilation system) received a heat recovery machine but it turned out to not pay back due to the limited overlapping cooling & heating loads. As noted, because this site would not have triggered the heat recovery requirements that we're proposing (due to its cooling/heating equipment capacities being below the thresholds), we view this as a positive since it supports our decision to exclude sites that are smaller and/or are without significant process loads.

4.2.2 Technical Feasibility and Market Availability

All-electric hydronic space heating with condenser water storage is growing but is not yet widespread. Other types of commonly used TES systems include ice storage (see Figure 9), chilled water storage and hot water storage (see Figure 10). The different options have pros and cons. CALMAC produces a commercially available ice storage option that has been commercially available for decades, with [thousands of successful installations](#). Ice thermal storage has the advantage of a lower footprint due to the latent capacity boost from freezing water (MacCracken 2020). Condenser water storage is an appealing option in the mild California climate (Gill 2021). Condenser water storage, ice storage and CHW/HW storage systems would all meet the proposed requirement.

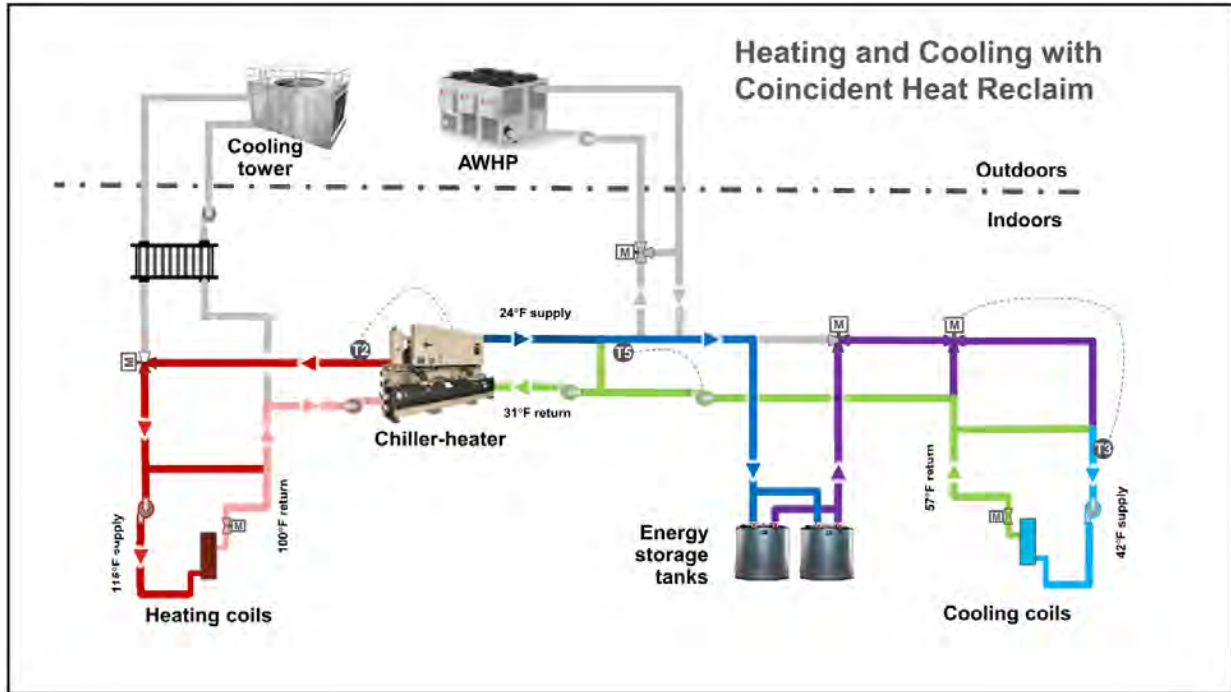

Figure 9: Schematic of Ice Storage TES System

Source: Trane seminar on Electrification of Cooling and Heating with Thermal Energy Storage, used with permission.

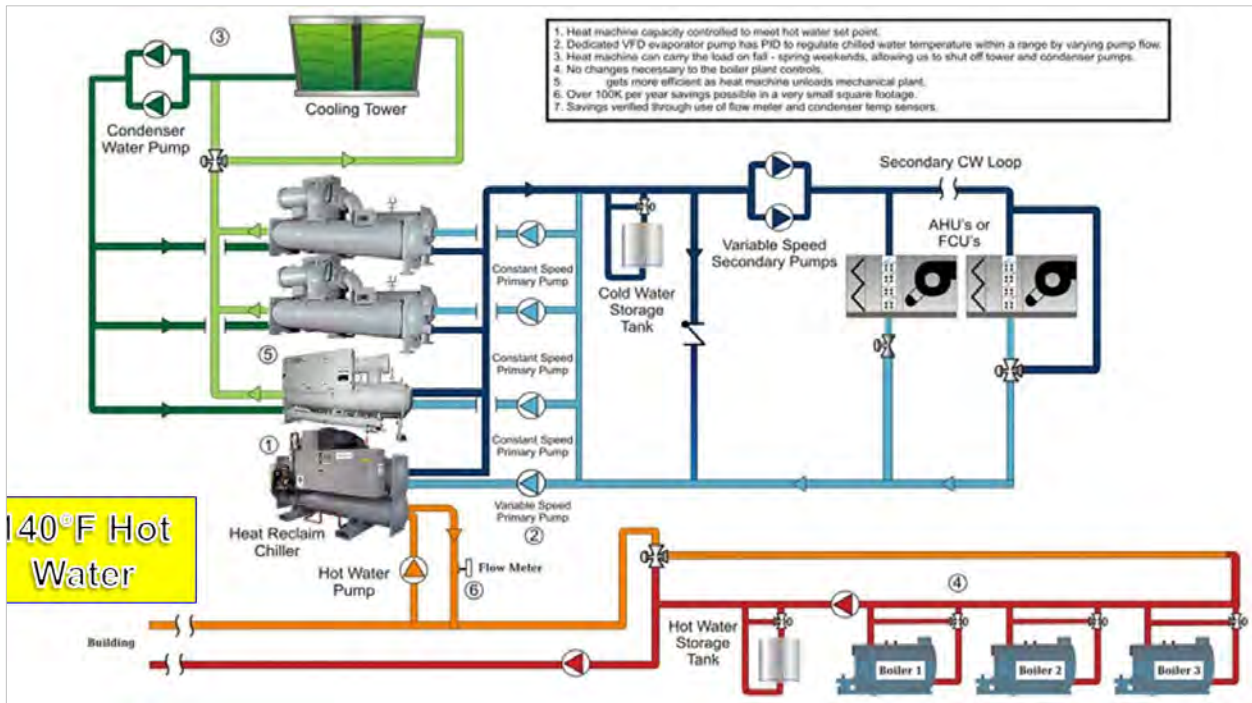

Figure 10: Schematic of CHW+HW Storage TES System

Source: Carrier seminar on All Electric Central Plant Design, used with permission

There are several types of condenser water storage systems that would meet the proposed TES requirement including:

1. TIER (Time Independent Energy Recovery)
2. Water-cooled VRF with TES
3. Water-source heat pumps (WSHP) with TES

These are all described in more detail below.

TIER systems: TIER systems typically include chilled water air handlers, VAV boxes with hot water reheat, and water-cooled heat recovery chillers. See Figure 11. Additional heating is typically provided by air source heat pumps, though gas boilers can be used as well. Additional heat rejection is typically provided by water-cooled chillers served by cooling towers.

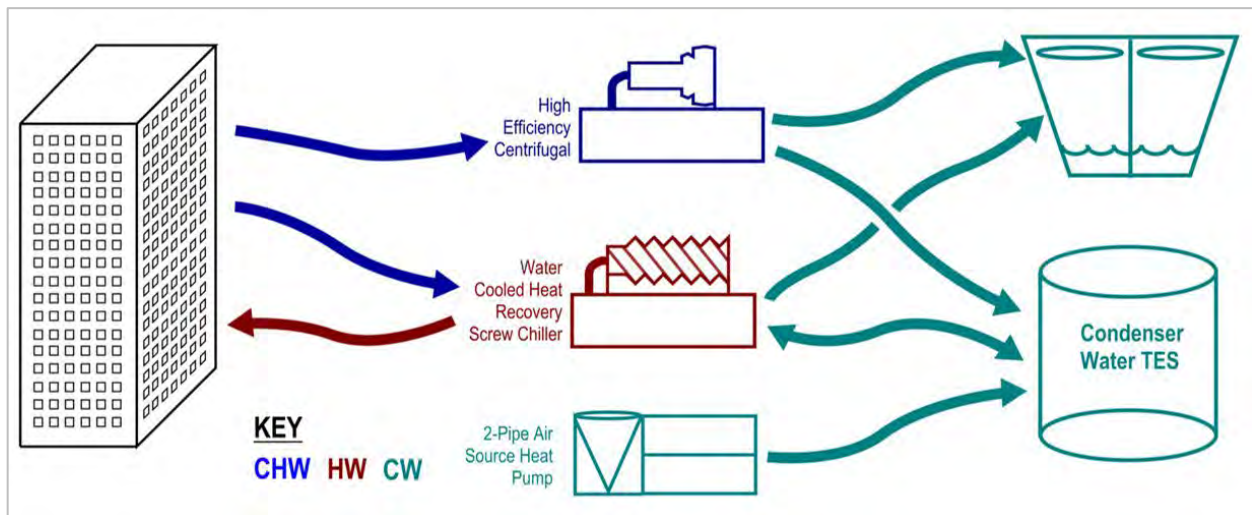

Figure 11: TIER Schematic

Source: (Gill 2021)

Water-cooled VRF with TES: Water-cooled VRF with TES (see Figure 12 for an example schematic) typically consists of VRF fan coils at each zone, water-cooled condensing units serving the fan coils, boilers or AWHPs to add heat to the tank, and fluid coolers, dry-coolers, or AWHPs to provide heat rejection.

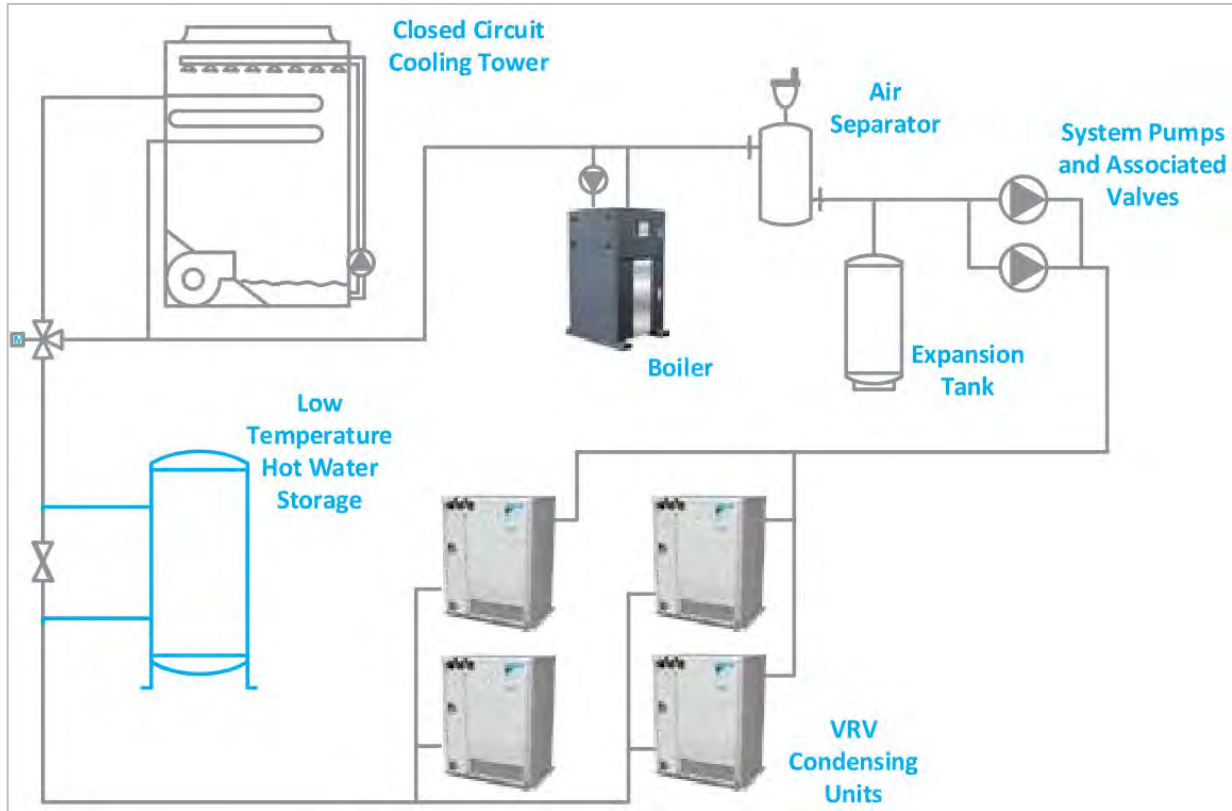

Figure 12: Water-Cooled VRF with TES

Source: Daikin, used with permission

Water-source heat pumps (WSHP) with TES

Water-source heat pumps (WSHP) with TES typically include water-source heat pumps at each zone served by a closed condenser water loop (CCW), boilers or AWHPs to provide heat, and AWHPs and/or cooling towers to provide heat rejection. Refer to Figure 13 and Figure 14 for schematics for this system type. Thousands of WSHP systems are in service throughout the state. Adding an additional thermal energy storage tank to this design is a minor tweak to the system, and simply adds some thermal buffer to the water loop.

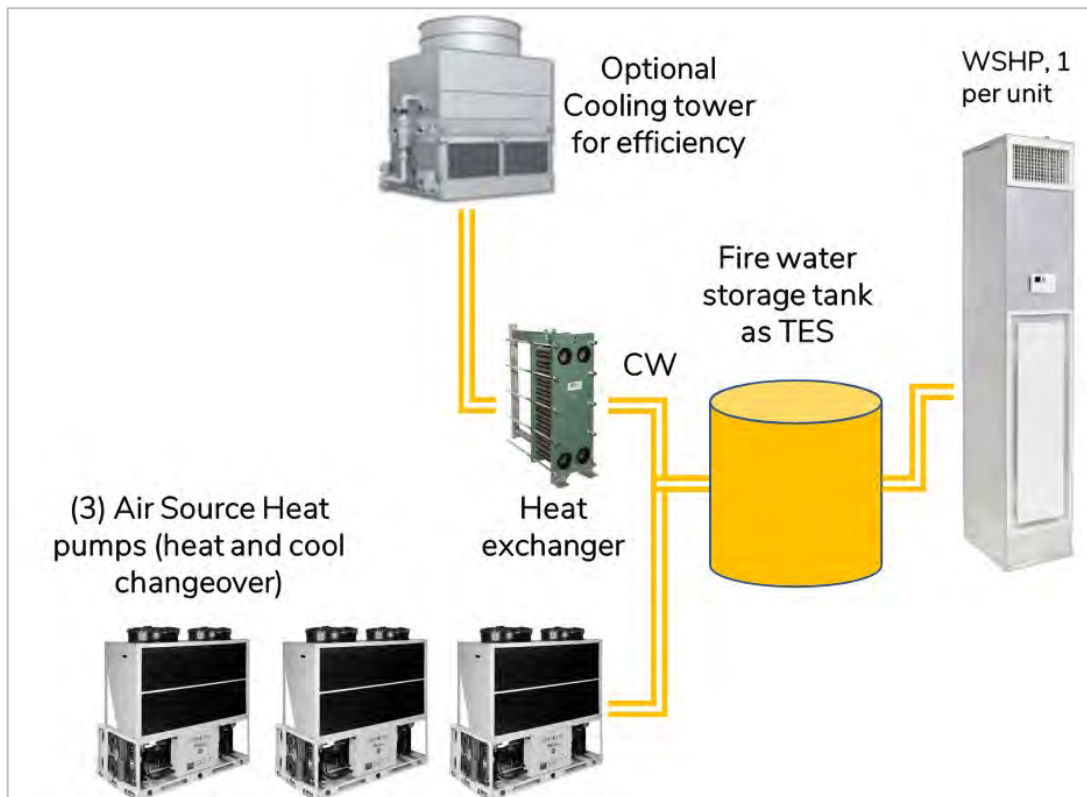

Figure 13: WSHP with TES Schematic

Source: Taylor Engineers

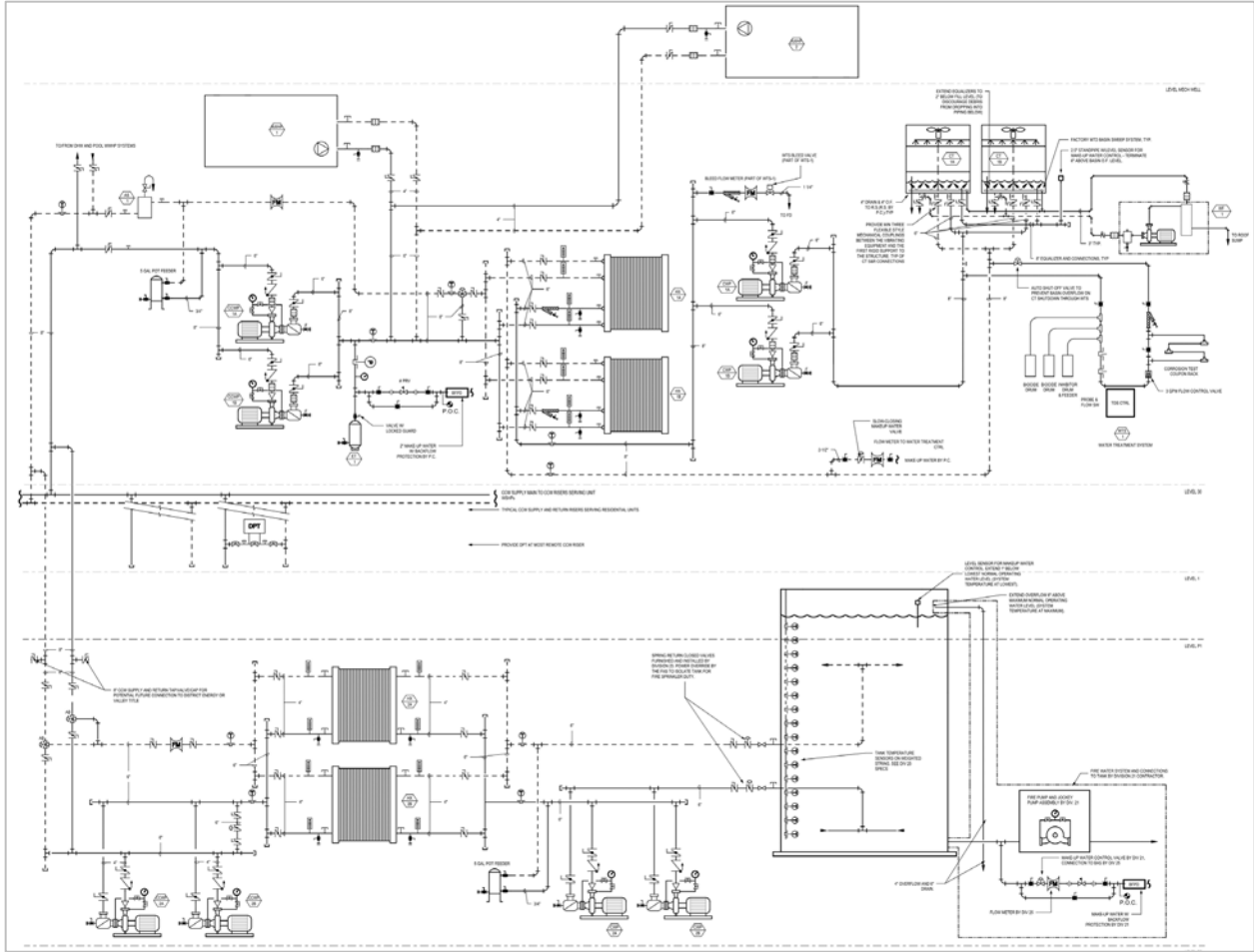

Figure 14: WSHP with TES Detailed Schematic

Source: Taylor Engineers

Note: This screenshot of a design drawing is high resolution and is intended to be viewed using the zoom function of PDF software. This guidance applies to all design drawings included in this report.

4.2.2.1 Understanding Condenser Water TIER

Condenser water TIER plants take heat rejected from cooling loads via high efficiency, low lift, centrifugal chillers and stores it in a TES tank at tepid temperatures between 60 °F (16 °C) and 80 °F (27 °C). Tank temperature excursions down to 40 °F (4.4 °C) are allowed on peak heating days to minimize tank size. When energy is needed for building heating, heat is extracted from the tank using water-to-water heat recovery chillers. In effect, the cooling chillers and heat recovery chillers are placed in a cascade configuration: the cooling chillers have a lift envelope of 40 °F chilled water supply temperature to 80 °F (27 °C) condenser water leaving temperature, while the heat recovery chillers have a lift envelope of 60 °F (16 °C) evaporator supply temperature to the active hot water supply temperature setpoint, typically 110 °F (43 °C) to 140 °F (60 °C) for all-electric designs.

During most days in California’s mild climate zones the energy recovered from cooling loads alone can satisfy heating loads. During the small fraction of the year when heat recovery alone cannot satisfy heating demand, trim ASHPs are used to charge the storage tank.

The schematics below show an example plant in a few typical modes of operation to illustrate the design concept. Flow paths for chilled water, condenser water, and hot water are traced in each.

Figure 15 illustrates a typical cold morning operation condition during which the TES tank discharges. All the red heat recovery chillers are in operation, supplying hot water to the building at 130 °F (54 °C) on the condenser side while extracting heat from the TES tank on the evaporator side. Any cooling loads that the building might have—e.g., due to 24/7 IT spaces, data centers, lab equipment, etc.—are concurrently addressed by a blue variable speed “cooling-only” machine. The condenser water rejected from this machine, which is 70 °F (21 °C) in this example, is then passed through the trim air source heat pumps, which act to boost the condenser water charging the top of the tank to 80 °F (27 °C). The amount of heat the blue cooling only chiller and the ASHPs are adding to the tank is less than the amount of heat the red heat recovery chillers are removing from the tank so on balance the tank is discharging (decreasing in temperature).

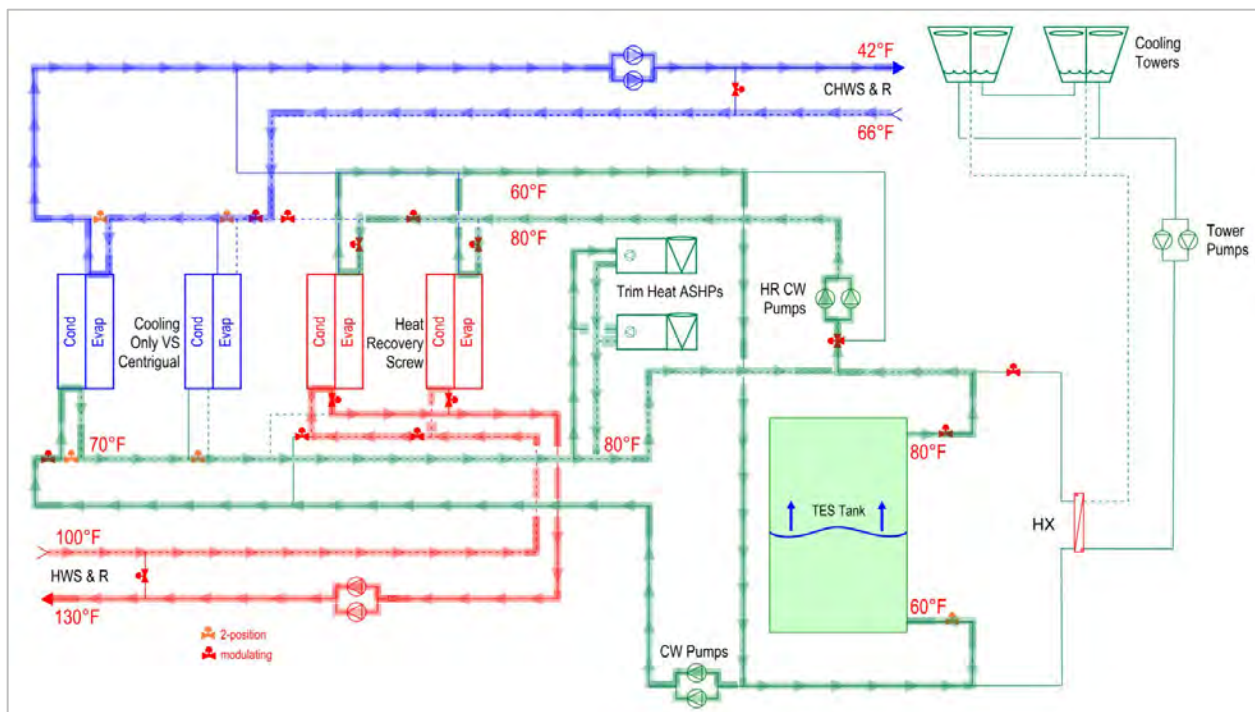

Figure 15: Cool Day Morning Operation of a Condenser Water TIER System

Later during the same day, when heating loads decrease and cooling loads increase, the net result is that the tank charges (increasing in temperature). During the example condition in Figure 16, only one red heat recovery chiller is providing heating while drawing energy from the TES tank. Two-cooling only blue chillers are cooling the building in a series configuration while head pressure control on the condenser side is modulating flow through the cooling-only machines' condenser barrels to achieve the target condenser water leaving temperature of 80 °F (27 °C) needed to charge the tank. The air-source heat pumps are off because building automation system (BAS) logic has determined that heat rejection loads alone will be sufficient to charge the tank by the end of the business day, i.e., bring the tank up to an average temperature of about 80 °F.

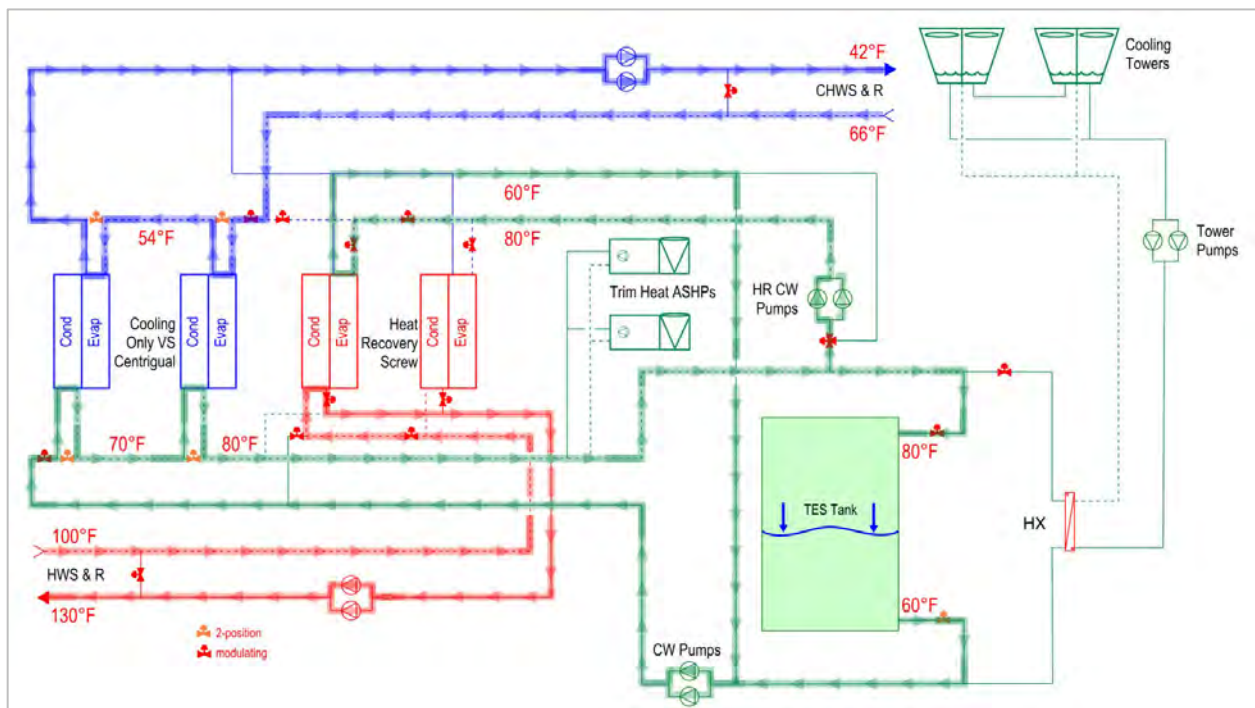

Figure 16: Cool Day Afternoon Operation of a Condenser Water TIER System

Figure 17 shows a high cooling load condition as might occur during the afternoon of a warm day. In this scenario, one of the red heat recovery chillers has been indexed into “cooling mode” and is connected on the evaporator side to the chilled water loop while rejecting heat at low lift to the condenser water loop. Any building heating loads are served by the one remaining heat recovery chiller indexed to the hot water loop. A mixing valve upstream of the heat recovery chiller evaporator inlets (shown in yellow) prevents water warmer than 80 °F (27 °C) from entering the heating heat recovery chiller’s evaporator barrel as is required by many chiller manufacturers for continuous operation. Since the day is warm, morning heating loads were small, meaning the tank is already fully charged by early afternoon. Therefore, all excess heat is rejected

through the cooling towers, which are isolated with a heat exchanger to prevent dirty tower water from entering the tank or the chilled or hot water loops.

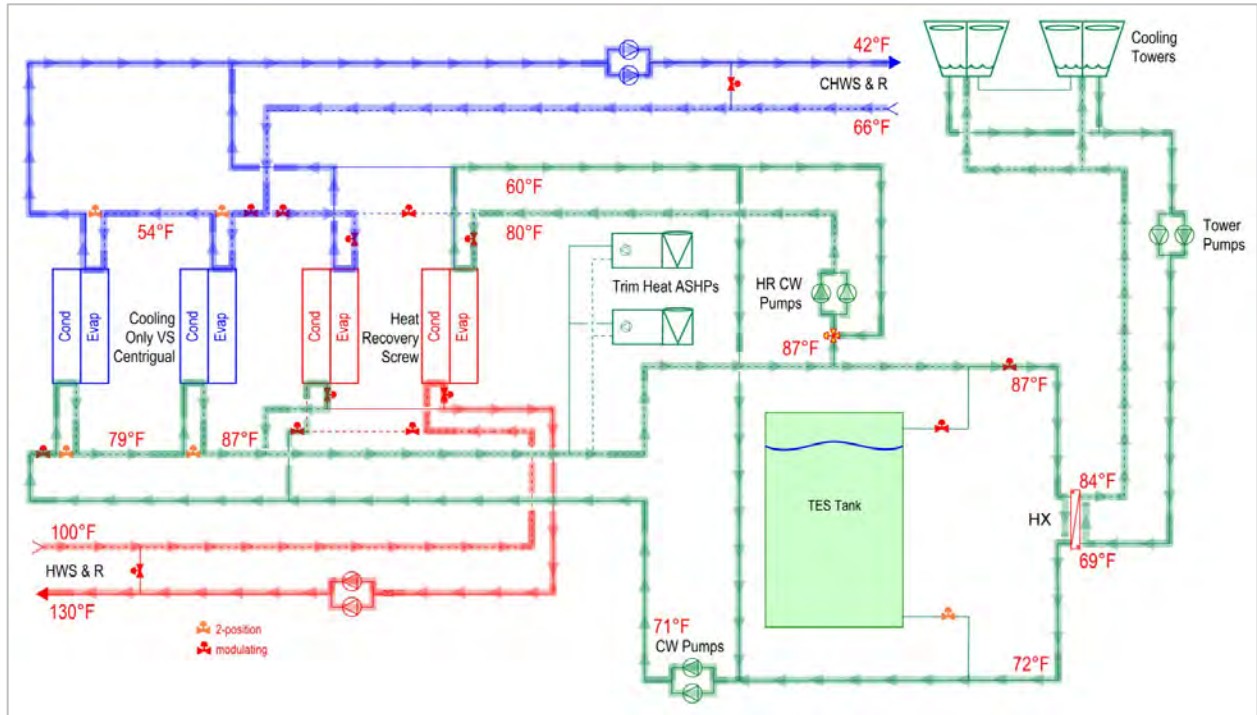

Figure 17: Warm Day Afternoon Operation of a Condenser Water TIER System

Figure 18, Figure 19, and Figure 20 are included to provide additional visual context regarding how CW TES fits into a building design. The purpose of including these figures is to show that while CW TES does take up space in the building, it can be effectively factored into the building design without becoming an overly prominent aspect of the building architecture. Note that other TIER projects have located the TES tank inside parking structures or basements.



Figure 18: Demonstration of TES Tank Size Relative to Building

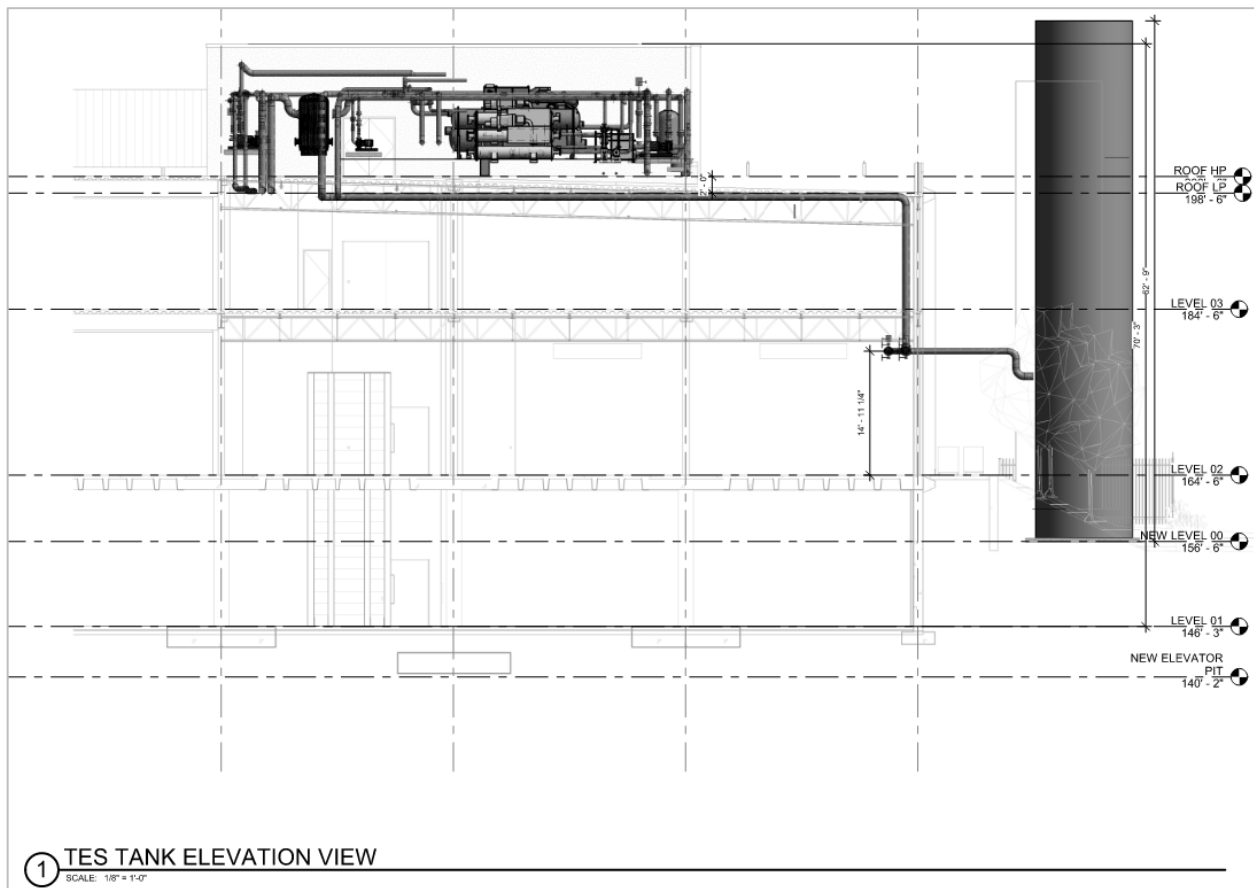

Figure 19: Schematic Showing TES Tank Elevation View

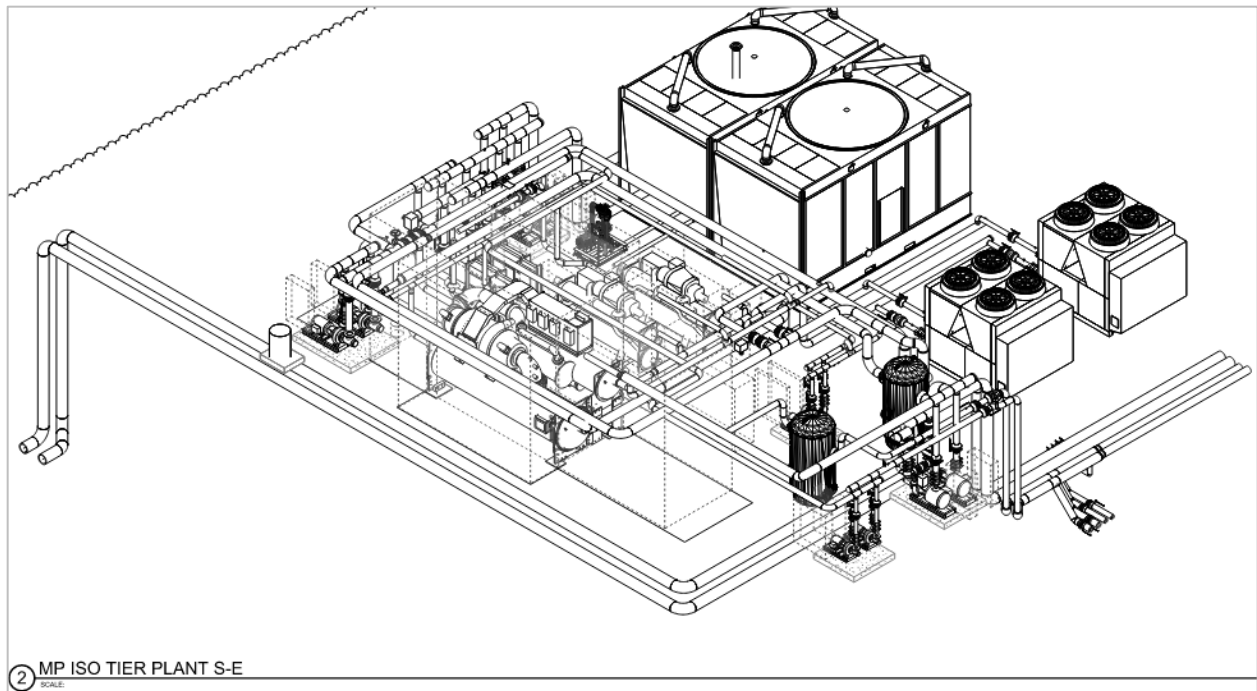

Figure 20: Schematic Showing TIER Plant Equipment

4.2.2.2 Service Hot Water Heat Recovery

Adding service water heating (SWH, a.k.a. domestic hot water or DHW) heat recovery to a building that uses heat recovery for hydronic space heating is straightforward and common. A heat exchanger (HX) is added upstream of the service hot water heater(s), referred to as electric water heaters (EWH) in the figures. The heating hot water (HHW) flow through the heat exchanger is modulated to preheat the domestic cold water (DCW) before it goes to the EWH. When the DCW flow switch indicates there is no DHW load then the control valve is closed. To the heating hot water system, the HX is just another HW load, like a VAV reheat coil. Note that the HHW system does not need to be sized for the capacity of the SWH HX. If the HHW system is at peak capacity serving space heating needs then the SWH HX valve can simply be shut, as the EWH is already sized to meet the entire SWH (DHW) load.

Figure 21 shows the control points for a typical SWH Heat Exchanger.

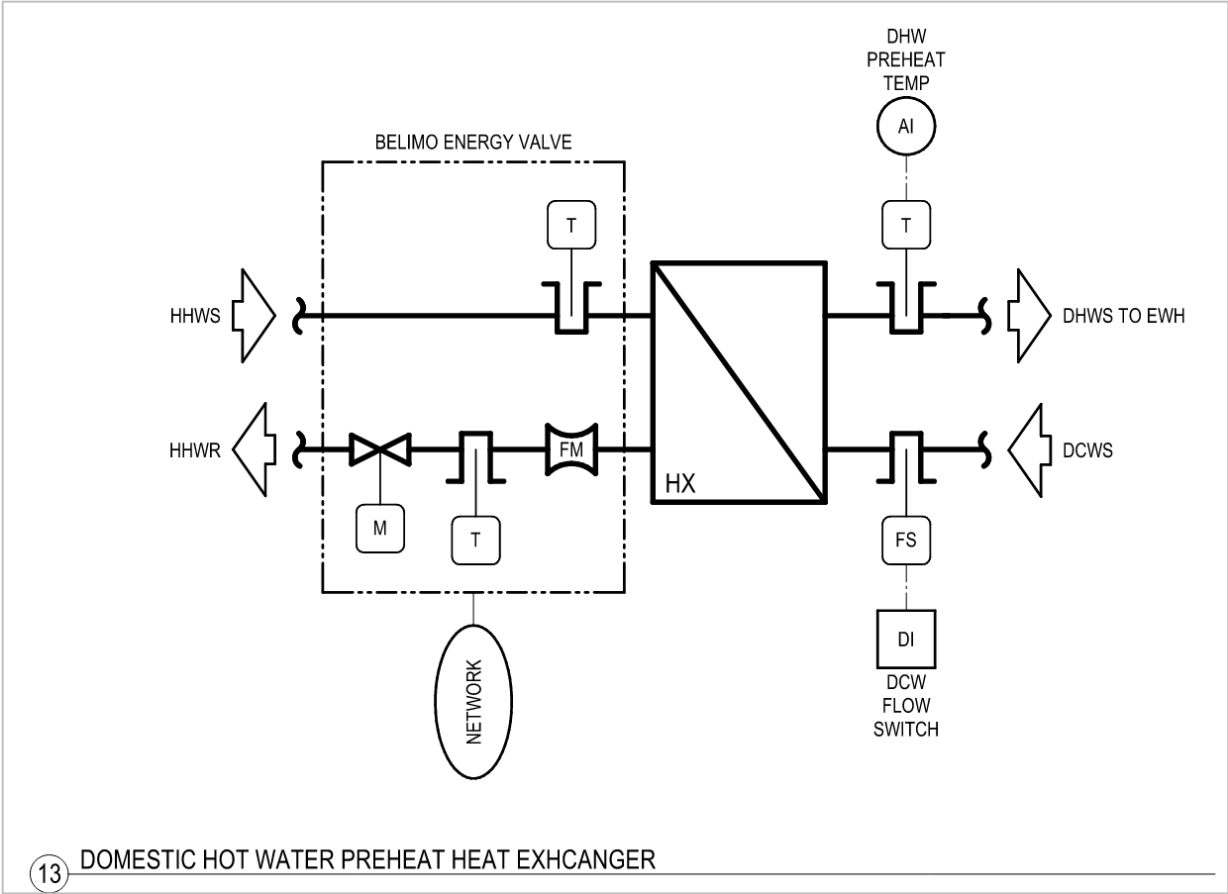

Figure 21: Control Schematic for SWH Heat Exchanger

Figure 22 shows the plumbing schedule for a Sunnyvale office building with SWH heat recovery. The schedule shows the electric water heaters (EWH) and the location of one of the EWH on level 1 (EWH-01-02). Figure 23 shows the HX schedule for the same building and the location of HX-2-1 corresponding to the EWH in Figure 22. The red lines in Figure 23 show the additional HW piping needed to serve this HX.

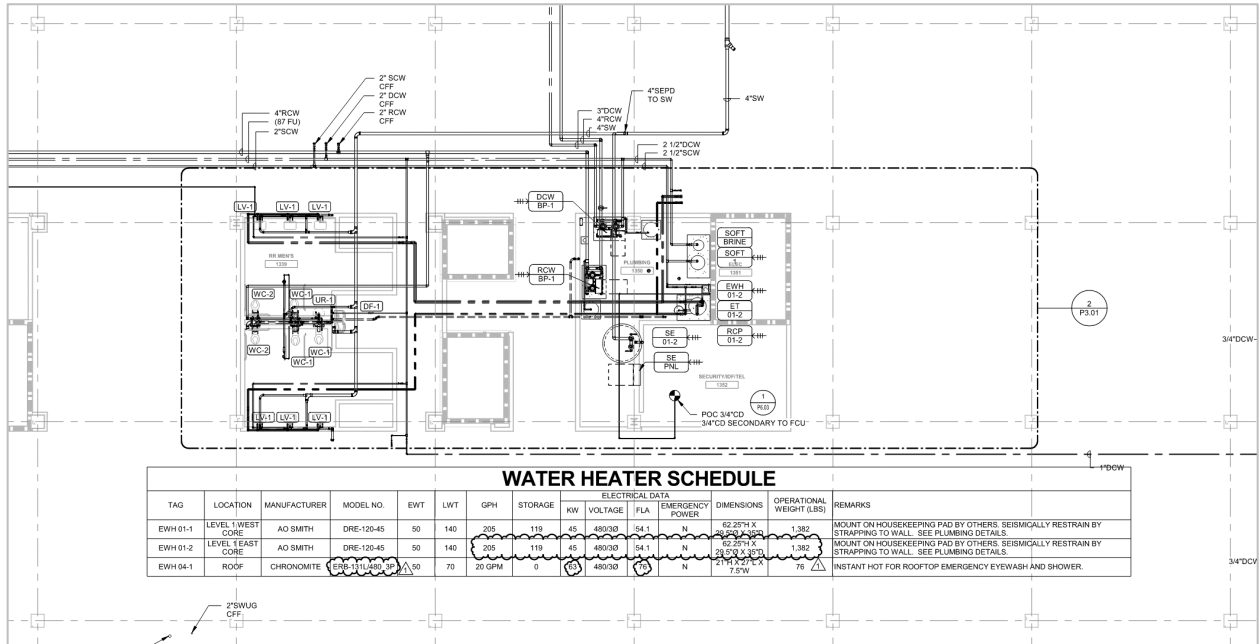

Figure 22: Typical Plumbing Drawings Showing EWH Location and Schedule

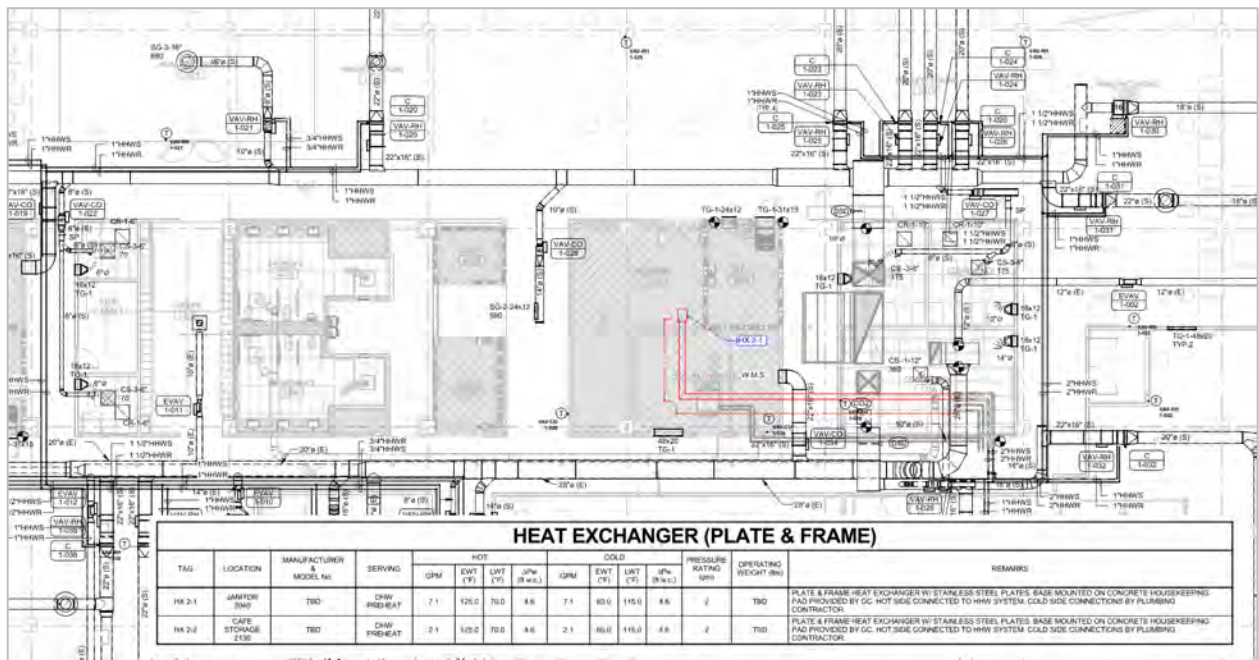

Figure 23: Typical Mechanical Drawings Showing DHW HX Incremental Piping and Equipment Schedule

Figure 24, Figure 25, and Figure 26 are from a large office building “A” in San Jose. This building has several 4-pipe AWHPs that use their condenser heat recovery for space heating and SWH preheat. Building “A” has a peak cooling capacity of 2,000 tons, a peak heating capacity of about 10,000 kBtuh. It also has two kitchens with a total SWH load of 1,600 kBtuh, and HX’s with a SWH preheat capacity of 800 kBtuh, i.e., the ability to use heat recovery to meet 50 percent of the peak SWH load. Figure 24 shows the incremental piping needed to serve one of the HX. Figure 25 shows the location of three of the EWHs. Figure 26 shows the incremental piping needed to serve another HX. Incremental piping from these and other HXs were averaged to arrive at an average incremental cost for SWH HR.

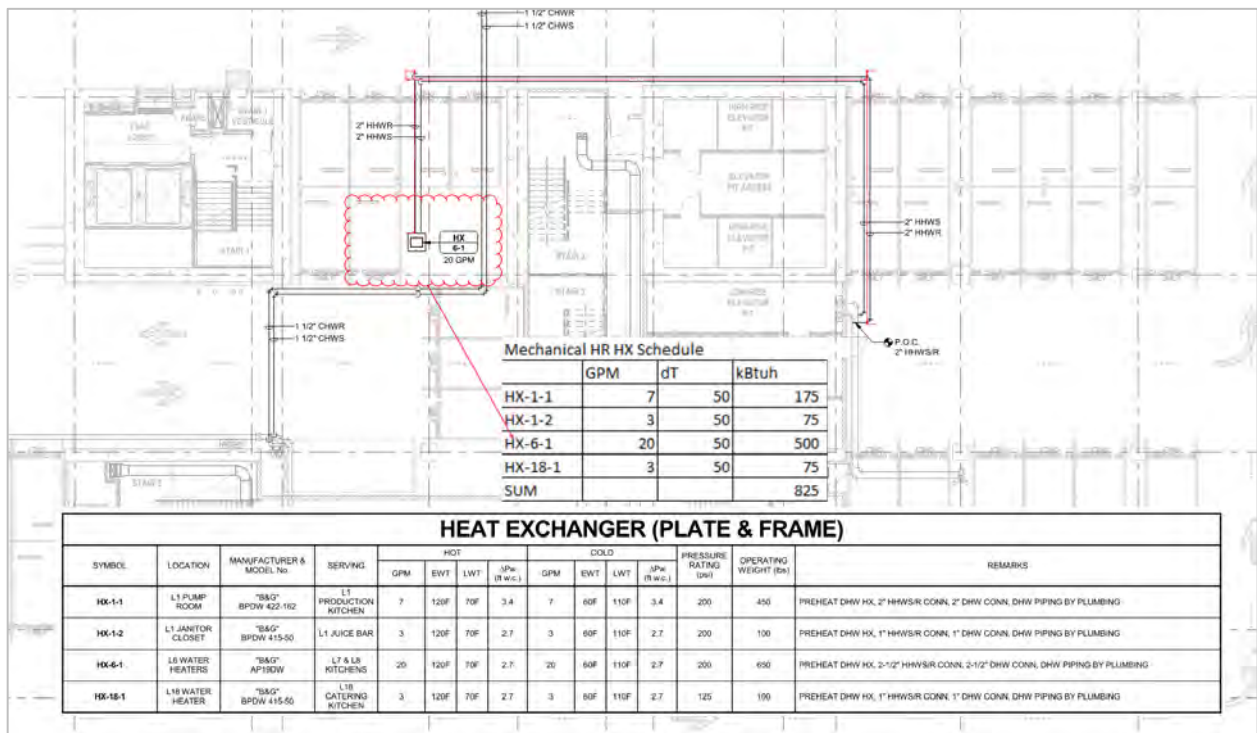

Figure 24: San Jose Building "A" Mechanical Drawing Level 6

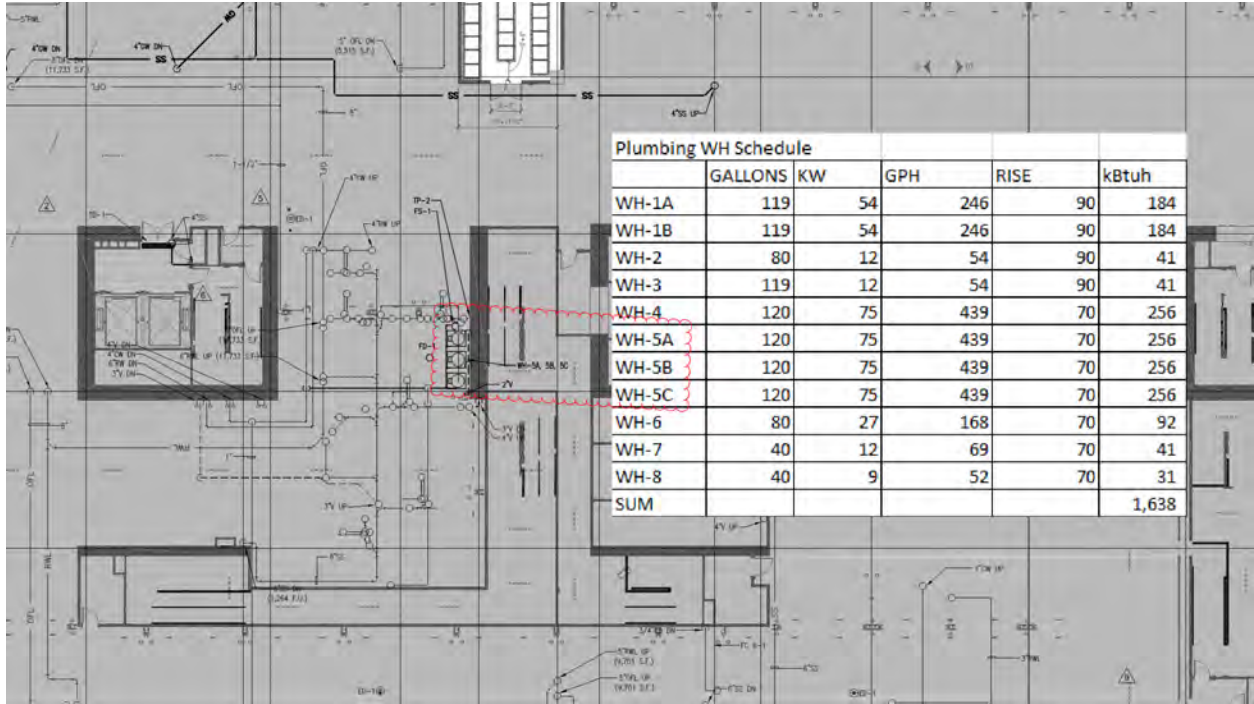

Figure 25: San Jose Building "A" Plumbing Drawing Level 6

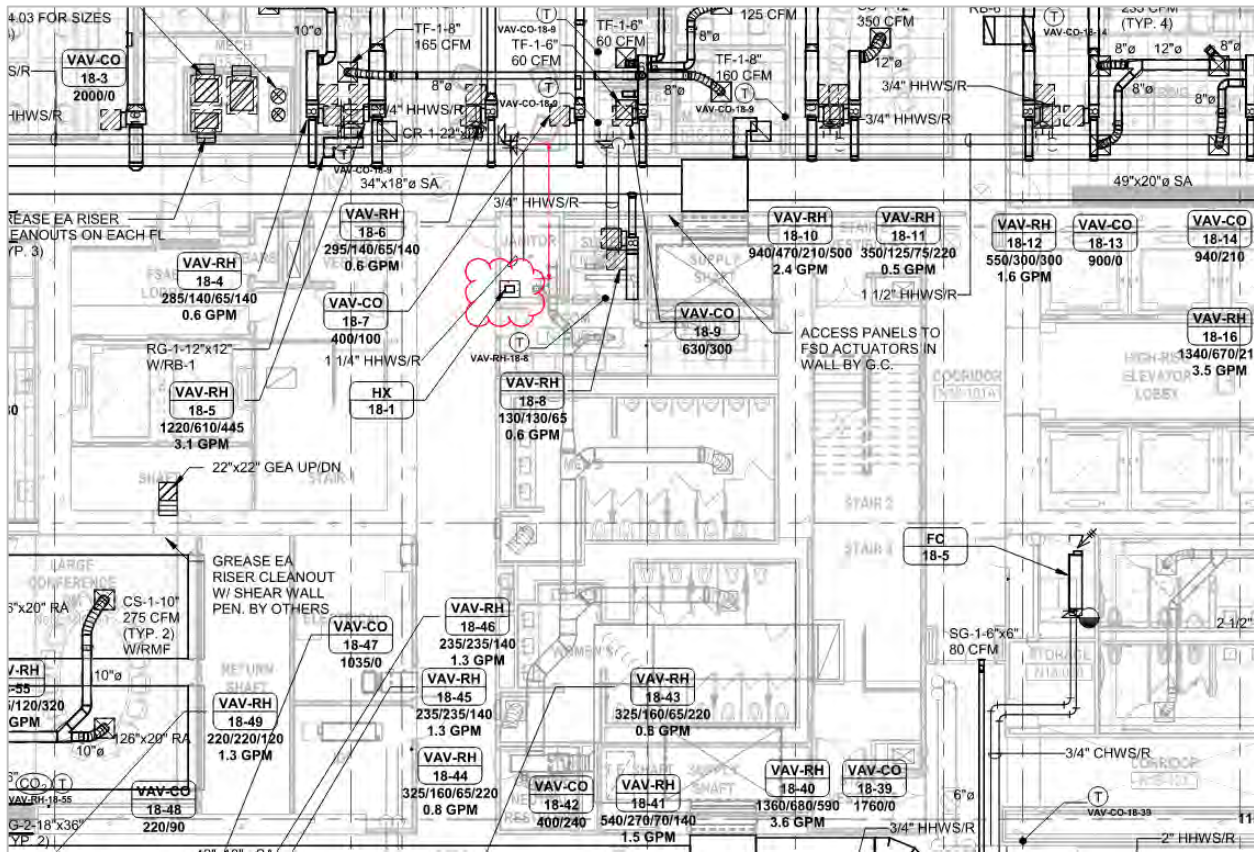

Figure 26: San Jose Building "A" Mechanical Drawing Level 18

4.2.2.3 Heat Recovery and TES with Gas Heat

Most of the examples above of heat recovery and thermal storage are all-electric designs, however, heat recovery and TES are just as compatible with gas heat. A common way to incorporate heat recovery into a conventional plant with boilers is with one or more water-to-water heat recovery chillers. Figure 27 is an example of a plant where one of the five chillers is a water-to-water heat recovery chiller. Figure 28 is an example of a plant where all four of the chillers are water-to-water heat recovery chillers. Figure 29 is another example a plant where both chillers are water-to-water heat recovery chillers. In all these examples the heat recovery chillers are part of the design capacity and are required to operate at peak cooling load either in heat recovery mode or in cooling only mode. Heat recovery chillers do not have to be part of the design capacity. For example, a small HR chiller can be added to a plant as an energy and water saving feature. Figure 30 and Figure 31 is an example of a how a small (50-200 ton) HR chiller can be added to an existing 630 ton chiller plant.

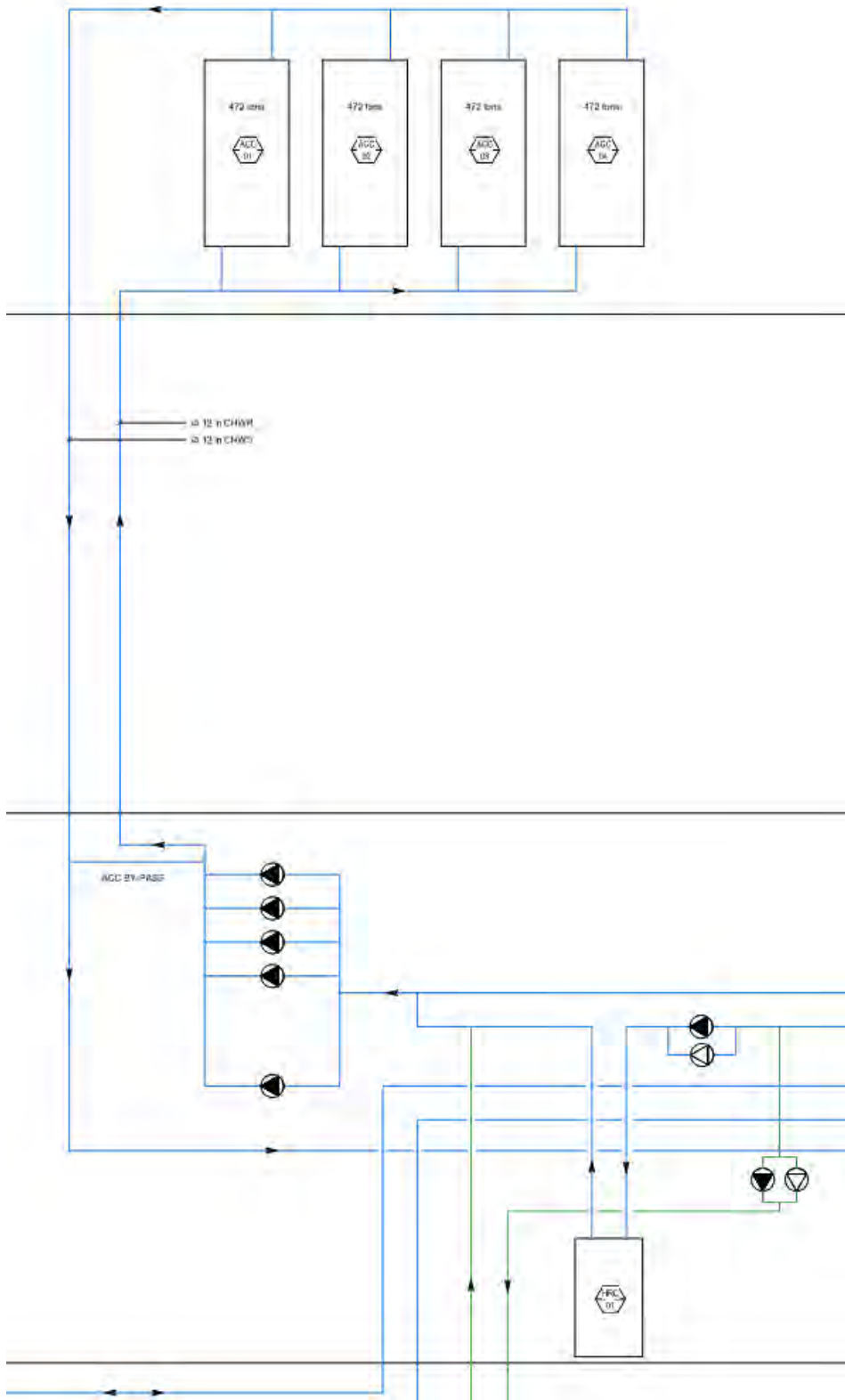

Figure 27. Partial Piping Schematic of CHW Plant with Four Air Cooled Chillers and One Heat Recovery Chiller

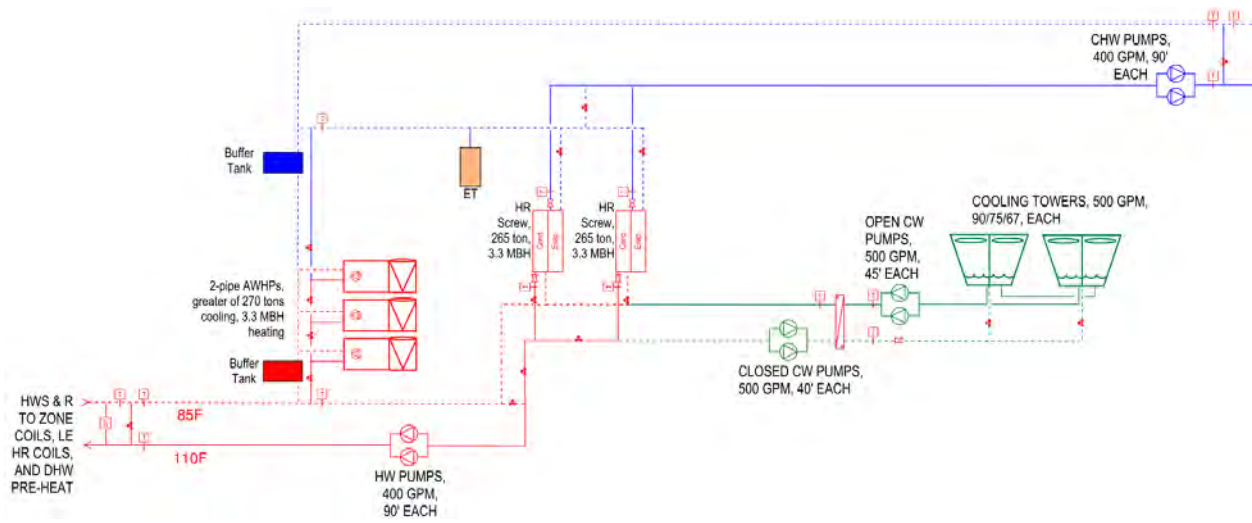

Figure 29. Piping Schematic of CHW Plant with Two Heat Recovery Chillers

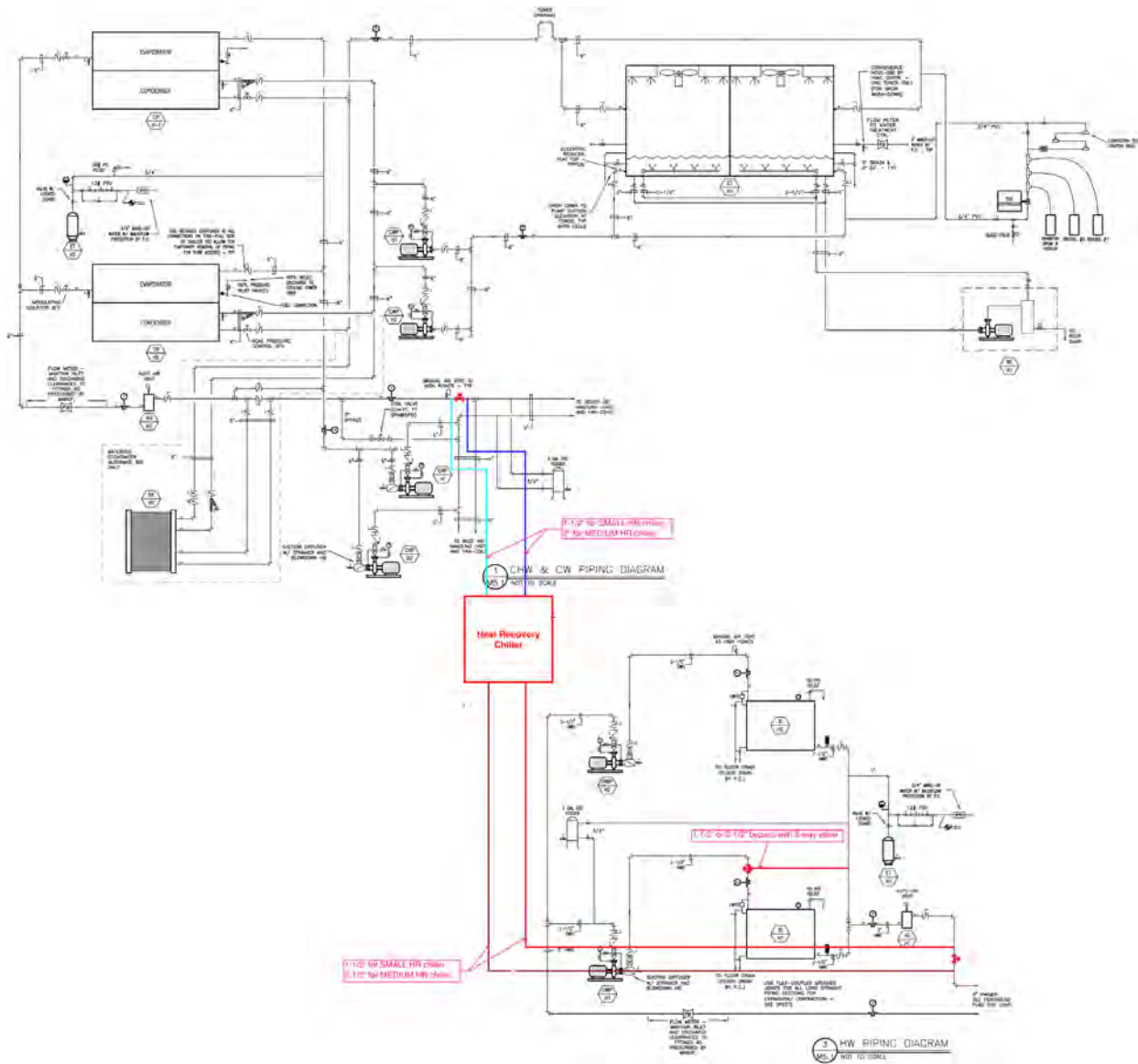

Figure 30. Schematic of Small HR Chiller Added to Existing CHW/Boiler Plant

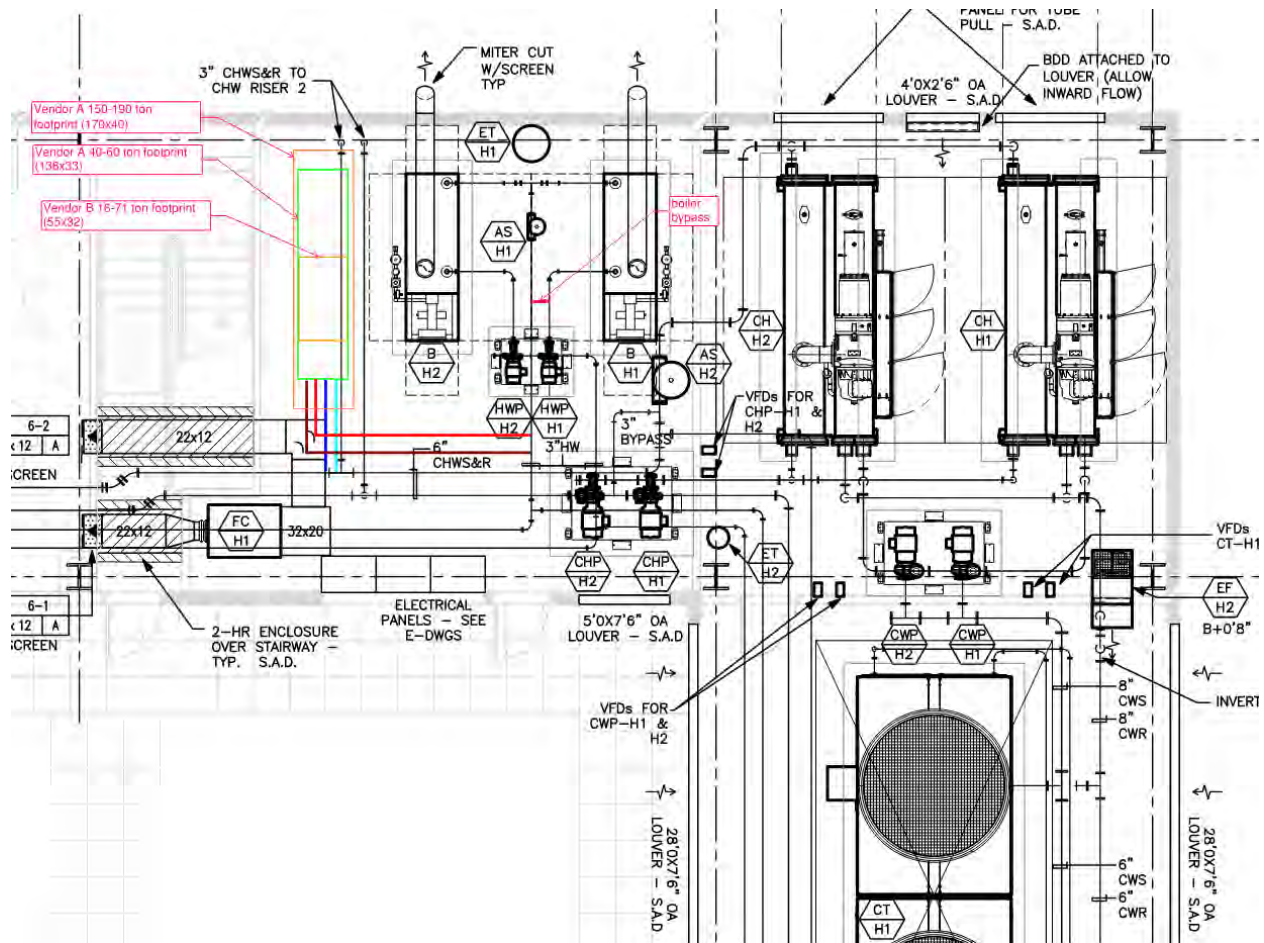

Figure 31. Plan View of Small HR Chiller Added to Existing CHW/Boiler Plant

4.2.3 Market Impacts and Economic Assessments

4.2.3.1 Impact on Builders

Builders of residential and commercial structures are directly impacted by many of the measures proposed by the Statewide CASE Team for the 2025 code cycle. It is within the normal practices of these businesses to adjust their building practices to changes in building codes. When necessary, builders engage in continuing education and training to remain compliant with changes to design practices and building codes.

California's construction industry comprises approximately 93,000 business establishments and 943,000 employees (see Table 65). For 2022, total estimated payroll will be about \$78 billion. Nearly 72,000 of these business establishments and 473,000 employees are engaged in the residential building sector, while another 17,600 establishments and 369,000 employees focus on the commercial sector. The remainder of establishments and employees work in industrial, utilities, infrastructure, and other heavy construction roles (the industrial sector).

Table 65: California Construction Industry, Establishments, Employment, and Payroll in 2022 (Estimated)

Building Type	Construction Sectors	Establishments	Employment	Annual Payroll (Billions \$)
Residential	All	71,889	472,974	31.2
Residential	Building Construction Contractors	27,948	130,580	9.8
Residential	Foundation, Structure, and Building Exterior	7,891	83,575	5.0
Residential	Building Equipment Contractors	18,108	125,559	8.5
Residential	Building Finishing Contractors	17,942	133,260	8.0
Commercial	All	17,621	368,810	35.0
Commercial	Building Construction Contractors	4,919	83,028	9.0
Commercial	Foundation, Structure, and Building Exterior	2,194	59,110	5.0
Commercial	Building Equipment Contractors	6,039	139,442	13.5
Commercial	Building Finishing Contractors	4,469	87,230	7.4
Industrial, Utilities, Infrastructure, & Other (Industrial+)	All	4,206	101,002	11.4
Industrial+	Building Construction	288	3,995	0.4
Industrial+	Utility System Construction	1,761	50,126	5.5
Industrial+	Land Subdivision	907	6,550	1.0
Industrial+	Highway, Street, and Bridge Construction	799	28,726	3.1
Industrial+	Other Heavy Construction	451	11,605	1.4

Source: (State of California Employment Development Department 2022)

The proposed change to hydronic space heating designs would likely affect commercial builders but would not impact firms that focus on construction and retrofit of industrial buildings, utility systems, public infrastructure, or other heavy construction. The effects on the residential and commercial building industry would not be felt by all firms and workers, but rather would be concentrated in specific industry subsectors. Table 66 shows the commercial building subsectors the Statewide CASE Team expects to be impacted by the changes proposed in this report. As noted above, this proposal includes requirements for heat recovery and thermal energy storage which will impact electrical and mechanical contractors. The Statewide CASE Team’s estimates of the magnitude of these impacts are shown in Section 4.2.4 Economic Impacts.

Table 66: Specific Subsectors of the California Commercial Building Industry Impacted by Proposed Change to Code/Standard by Subsector in 2022 (Estimated)

Construction Subsector	Establishments	Employment	Annual Payroll (Billions \$)
Other Nonresidential Exterior contractors	277	3,006	0.2
Nonresidential Electrical Contractors	3,137	74,277	7.0
Nonresidential plumbing & HVAC contractors	2,346	55,572	5.5

Source: (State of California Employment Development Department 2022)

4.2.3.2 Impact on Building Designers and Energy Consultants

Adjusting design practices to comply with changing building codes is within the normal practices of building designers. Building codes (including Title 24, Part 6) are typically updated on a three-year revision cycle, and building designers and energy consultants engage in continuing education and training to remain compliant with changes to design practices and building codes.

In the coming years, all-electric space heating is expected to become the default option for most buildings. This proposal seeks to ensure that heat recovery and thermal energy storage are included in designs when appropriate. The current default approach to space heating in large nonresidential buildings essentially amounts to a simple load calculation to determine the design day heating loads and then a corresponding gas boiler selection (typically with some oversizing) with capacity to meet this heating load. This proposal argues that for all-electric designs, this approach (except with swapping out 2-pipe air to water heat pumps for the gas boiler) is insufficient. AWHPs consume too much real estate in the building and are also not particularly efficient options by themselves. In the absence of this measure, over time, it is probable that industry to conclude that heat recovery and TES are essential elements to an all-electric space heating designs. This measure essentially seeks to accelerate the adoption of these cost-effective and efficient aspects into all-electric hydronic space heating designs. The Statewide CASE Team intends to work with the market leaders to ensure that these best practices are widely disseminated throughout the HVAC designer community in California.

Businesses that focus on residential, commercial, institutional, and industrial building design are contained within the Architectural Services sector (North American Industry Classification System 541310). Table 67 shows the number of establishments, employment, and total annual payroll for Building Architectural Services. The proposed code changes would potentially impact all firms within the Architectural Services sector. The Statewide CASE Team anticipates the impacts for Hydronic Heat Recovery and Thermal Energy Storage to affect firms that focus on nonresidential construction.

There is not a North American Industry Classification System (NAICS)¹⁴ code specific to energy consultants. Instead, businesses that focus on consulting related to building energy efficiency are contained in the Building Inspection Services sector (NAICS 541350), which is comprised of firms primarily engaged in the physical inspection of residential and nonresidential buildings.¹⁵ It is not possible to determine which business establishments within the Building Inspection Services sector are focused on energy efficiency consulting. The information shown in Table 67 provides an upper bound indication of the size of this sector in California.

Table 67: California Building Designer and Energy Consultant Sectors in 2022 (Estimated)

Sector	Establishments	Employment	Annual Payroll (Millions \$)
Architectural Services^a	4,134	31,478	3,623.3
Building Inspection Services^b	1,035	3,567	280.7

Source: (State of California Employment Development Department 2022)

- a. Architectural Services (NAICS 541310) comprises private-sector establishments primarily engaged in planning and designing residential, institutional, leisure, commercial, and industrial buildings and structures.
- b. Building Inspection Services (NAICS 541350) comprises private-sector establishments primarily engaged in providing building (residential & nonresidential) inspection services encompassing all aspects of the building structure and component systems, including energy efficiency inspection services.

4.2.3.3 Impact on Occupational Safety and Health

The proposed code change does not alter any existing federal, state, or local regulations pertaining to safety and health, including rules enforced by the California Division of Occupational Safety and Health (DOSH). All existing health and safety rules would remain in place. Complying with the proposed code change is not anticipated to have adverse impacts on the safety or health of occupants or those involved with the construction, commissioning, and maintenance of the building.

¹⁴ NAICS is the standard used by federal statistical agencies in classifying business establishments for the purpose of collecting, analyzing, and publishing statistical data related to the U.S. business economy. NAICS was developed jointly by the U.S. Economic Classification Policy Committee (ECPC), Statistics Canada, and Mexico's Instituto Nacional de Estadística y Geografía, to allow for a high level of comparability in business statistics among the North American countries. NAICS replaced the Standard Industrial Classification (SIC) system in 1997.

¹⁵ Establishments in this sector include businesses primarily engaged in evaluating a building's structure and component systems and includes energy efficiency inspection services and home inspection services. This sector does not include establishments primarily engaged in providing inspections for pests, hazardous wastes or other environmental contaminants, nor does it include state and local government entities that focus on building or energy code compliance/enforcement of building codes and regulations.

4.2.3.4 Impact on Building Owners and Occupants

Commercial Buildings

The commercial building sector includes a wide array of building types, including offices, restaurants and lodging, retail, and mixed-use establishments, and warehouses (including refrigerated) (Kenney M 2019). Energy use by occupants of commercial buildings also varies considerably, with electricity used primarily for lighting, space cooling and conditioning, and refrigeration, while natural gas is used primarily for water heating and space heating. According to information published in the 2019 California Energy Efficiency Action Plan, there is more than 7.5 billion square feet of commercial floor space in California consuming 19 percent of California’s total annual energy use (Kenney M 2019). The diversity of building and business types within this sector creates a challenge for disseminating information on energy and water efficiency solutions, as does the variability in sophistication of building owners and the relationships between building owners and occupants.

Estimating Impacts

Building owners and occupants would benefit from lower energy bills. As discussed in Section 4.2.4.1, when building occupants save on energy bills, they tend to spend it elsewhere in the economy thereby creating jobs and economic growth for the California economy. The Statewide CASE Team does not expect the proposed code change for the 2025 code cycle to impact building owners or occupants adversely.

4.2.3.5 Impact on Building Component Retailers (Including Manufacturers and Distributors)

The Statewide CASE Team anticipates the proposed change would have minimal material impact on California component retailers. All measures being proposed at Section 140.4(r) are achievable with existing commercially available equipment. Water storage tanks, for example, are commonly used for many applications such as data center makeup water storage. AWHP sales are poised to sharply increase in the coming years as all-electric reach codes expand. Our measure would encourage a portion of those units to be 4-pipe rather than 2-pipe, which would have a negligible impact on AWHP manufacturers, since it’s common for the same manufacturer to produce both styles. Impact on Building Inspectors

Table 68 shows employment and payroll information for state and local government agencies in which many inspectors of residential and commercial buildings are employed. Building inspectors participate in continuing education and training to stay current on all aspects of building regulations, including energy efficiency. The Statewide CASE Team, therefore, anticipates the proposed change would have no impact on employment of building inspectors or the scope of their role conducting energy efficiency inspections.

Table 68: Employment in California State and Government Agencies with Building Inspectors in 2022 (Estimated)

Sector	Govt.	Establishments	Employment	Annual Payroll (Million \$)
Administration of Housing Programs ^a	State	18	265	29.0
	Local	38	3,060	248.6
Urban and Rural Development Admin ^b	State	38	764	71.3
	Local	52	2,481	211.5

Source: (State of California Employment Development Department 2022)

Administration of Housing Programs (NAICS 925110) comprises government establishments primarily engaged in the administration and planning of housing programs, including building codes and standards, housing authorities, and housing programs, planning, and development.

- a. Urban and Rural Development Administration (NAICS 925120) comprises government establishments primarily engaged in the administration and planning of the development of urban and rural areas. Included in this industry are government zoning boards and commissions.

4.2.3.6 Impact on Statewide Employment

As described in Sections 4.2.3.1 through 4.2.3.6, the Statewide CASE Team does not anticipate significant employment or financial impacts to any particular sector of the California economy. This is not to say that the proposed change would not have modest impacts on employment in California. In Section 4.2.4, the Statewide CASE Team estimated the proposed change in Hydronic Heat Recovery and Thermal Energy Storage would affect statewide employment and economic output directly and indirectly through its impact on builders, designers, and energy consultants, and building inspectors. In addition, the Statewide CASE Team estimated how energy savings associated with the proposed change in Hydronic Heat Recovery and Thermal Energy Storage would lead to modest ongoing financial savings for California residents, which would then be available for other economic activities.

4.2.4 Economic Impacts

For the 2025 code cycle, the Statewide CASE Team used the IMPLAN model software¹⁶, along with economic information from published sources, and professional judgement to develop estimates of the economic impacts associated with each of the proposed code changes. Conceptually, IMPLAN estimates jobs created as a function of incoming cash flow in different sectors of the economy, due to implementing a code or a standard. The jobs created are typically categorized into direct, indirect, and induced employment. For example, cash flow into a manufacturing plant captures direct employment (jobs created in the manufacturing plant), indirect employment (jobs

¹⁶ IMPLAN employs economic data and advanced economic impact modeling to estimate economic impacts for interventions like changes to the California Title 24, Part 6 code. For more information on the IMPLAN modeling process, see www.IMPLAN.com.

created in the sectors that provide raw materials to the manufacturing plant) and induced employment (jobs created in the larger economy due to purchasing habits of people newly employed in the manufacturing plant). Eventually, IMPLAN computes the total number of jobs created due to a code. The assumptions of IMPLAN include constant returns to scale, fixed input structure, industry homogeneity, no supply constraints, fixed technology, and constant byproduct coefficients. The model is also static in nature and is a simplification of how jobs are created in the macro-economy.

The economic impacts developed for this report are only estimates and are based on limited and to some extent speculative information. The IMPLAN model provides a relatively simple representation of the California economy and, though the Statewide CASE Team is confident that the direction and approximate magnitude of the estimated economic impacts are reasonable, it is important to understand that the IMPLAN model is a simplification of extremely complex actions and interactions of individual, businesses, and other organizations as they respond to changes in energy efficiency codes. In all aspects of this economic analysis, the CASE Authors rely on conservative assumptions regarding the likely economic benefits associated with the proposed code change. By following this approach, the economic impacts presented below represent lower bound estimates of the actual benefits associated with this proposed code change.

Adoption of this code change proposal¹⁷ would result in relatively modest economic impacts through the additional direct spending by those in the commercial building industry, architects, energy consultants, and building inspectors. The Statewide CASE Team does not anticipate that money saved by commercial building owners or other organizations affected by the proposed 2025 code cycle regulations would result in additional spending by those businesses.

Table 69: Estimated Impact that Adoption of the Proposed Measure would have on the California Commercial Construction Sector

Type of Economic Impact	Employment (Jobs)	Labor Income (Million)	Total Value Added (Million)	Output (Million)
Direct Effects (Additional spending by Commercial Builders)	136.4	\$10.6	\$12.2	\$20.9
Indirect Effect (Additional spending by firms supporting Commercial Builders)	33.4	\$2.9	\$4.5	\$8.3
Induced Effect (Spending by employees of firms experiencing “direct” or “indirect” effects)	56.7	\$3.9	\$6.9	\$11.0
Total Economic Impacts	226.5	\$17.4	\$23.7	\$40.2

Source: CASE Team analysis of data from the IMPLAN modeling software. (IMPLAN Group LLC 2020)

Table 70: Estimated Impact that Adoption of the Proposed Measure would have on the California Building Designers and Energy Consultants Sectors

Type of Economic Impact	Employment (Jobs)	Labor Income (Million)	Total Value Added (Million)	Output (Million)
Direct Effects (Additional spending by Building Designers & Energy Consultants)	3.7	\$0.4	\$0.4	\$0.6
Indirect Effect (Additional spending by firms supporting Bldg. Designers & Energy Consultants)	1.5	\$0.1	\$0.2	\$0.3
Induced Effect (Spending by employees of firms experiencing “direct” or “indirect” effects)	2.2	\$0.2	\$0.3	\$0.4
Total Economic Impacts	7.4	\$0.7	\$0.8	\$1.3

Source: CASE Team analysis of data from the IMPLAN modeling software.

4.2.4.1 Creation or Elimination of Jobs

The Statewide CASE Team does not anticipate that the measures proposed for the 2025 code cycle regulation would lead to the creation of new *types* of jobs or the elimination of *existing* types of jobs. In other words, the Statewide CASE Team’s proposed change would not result in economic disruption to any sector of the California economy. Rather, the estimates of economic impacts discussed in Section 4.2.4 would lead to modest changes in employment of existing jobs.

4.2.4.2 Creation or Elimination of Businesses in California

As stated in Section 4.2.4.1, the Statewide CASE Team’s proposed change would not result in economic disruption to any sector of the California economy. The proposed change represents a modest change to the design strategy to provide space heating in nonresidential buildings, which would not excessively burden or competitively disadvantage California businesses – nor would it necessarily lead to a competitive advantage for California businesses. Therefore, the Statewide CASE Team does not foresee any new businesses being created, nor does the Statewide CASE Team think any existing businesses would be eliminated due to the proposed code changes.

4.2.4.3 Competitive Advantages or Disadvantages for Businesses in California

The proposed code changes would apply to all businesses incorporated in California, regardless of whether the business is located inside or outside of the state.¹⁸ Therefore, the Statewide CASE Team does not anticipate that these measures proposed for the 2025 code cycle regulation would have an adverse effect on the competitiveness of

¹⁸ Gov. Code, §§ 11346.3(c)(1)(C), 11346.3(a)(2); 1 CCR § 2003(a)(3) Competitive advantages or disadvantages for California businesses currently doing business in the state.

California businesses. Likewise, the Statewide CASE Team does not anticipate businesses located outside of California would be advantaged or disadvantaged.

4.2.4.4 Increase or Decrease of Investments in the State of California

The Statewide CASE Team analyzed national data on corporate profits and capital investment by businesses that expand a firm’s capital stock (referred to as net private domestic investment, or NPDI).¹⁹ As Table 71 shows, between 2017 and 2021, NPDI as a percentage of corporate profits ranged from a low of 18 in 2020 due to the worldwide economic slowdowns associated with the COVID 19 pandemic to a high of 35 percent in 2019, with an average of 26 percent. While only an approximation of the proportion of business income used for net capital investment, the Statewide CASE Team believes it provides a reasonable estimate of the proportion of proprietor income that would be reinvested by business owners into expanding their capital stock.

Table 71: Net Domestic Private Investment and Corporate Profits, U.S.

Year	Net Domestic Private Investment by Businesses, Billions of Dollars	Corporate Profits After Taxes, Billions of Dollars	Ratio of Net Private Investment to Corporate Profits (Percent)
2017	518.473	1882.460	28
2018	636.846	1977.478	32
2019	690.865	1952.432	35
2020	343.620	1908.433	18
2021	506.331	2619.977	19
5-Year Average	539.227	2068.156	26

Source: (Federal Reserve Economic Data, FRED 2022)

The Statewide CASE Team does not anticipate that the economic impacts associated with the proposed measure would lead to significant change (increase or decrease) in investment, directly or indirectly, in any affected sectors of California’s economy. Nevertheless, the Statewide CASE Team can derive a reasonable estimate of the change in investment by California businesses based on the estimated change in economic activity associated with the proposed measure and its expected effect on proprietor income, which was used a conservative estimate of corporate profits, a portion of which would likely be allocated to net business investment.²⁰

¹⁹ Net private domestic investment is the total amount of investment in capital by the business sector that is used to expand the capital stock, rather than maintain or replace due to depreciation. Corporate profit is the money left after a corporation pays its expenses.

²⁰ 26 percent of proprietor income was assumed to be allocated to net business investment; see Table 9.

4.2.4.5 Incentives for Innovation in Products, Materials, or Processes

The HVAC industry is trending toward all-electric space heating designs. The purpose of this measure is to support this trend by further solidifying the notion that all-electric hydronic systems should be designed with appropriate amounts of thermal energy storage and hydronic heat recovery to maximize efficiency and limit upfront costs. When applied to gas sites, this measure is intended to improve energy efficiency and facilitate future all-electric retrofits. This measure is expected to drive innovation in the nonresidential HVAC industry.

4.2.4.6 Effects on the State General Fund, State Special Funds, and Local Governments

The Statewide CASE Team does not expect the proposed code changes would have a measurable impact on California's General Fund, any state special funds, or local government funds.

Cost of Enforcement

Cost to the State: State government already has budget for code development, education, and compliance enforcement. While state government will be allocating resources to update the Title 24, Part 6 Standards, including updating education and compliance materials and responding to questions about the revised requirements, these activities are already covered by existing state budgets. The costs to state government are small when compared to the overall costs savings and policy benefits associated with the code change proposals. The proposed code change is expected to impact state buildings in an equal manner to all other nonresidential buildings. This proposal has been found to be cost-effective.

Cost to Local Governments: All proposed code changes to Title 24, Part 6 would result in changes to compliance determinations. Local governments would need to train building department staff on the revised Title 24, Part 6 Standards. While this re-training is an expense to local governments, it is not a new cost associated with the 2025 code change cycle. The building code is updated on a triennial basis, and local governments plan and budget for retraining every time the code is updated. There are numerous resources available to local governments to support compliance training that can help mitigate the cost of retraining, including tools, training and resources provided by the IOU Codes and Standards program (such as Energy Code Ace). As noted in Section 4.1.5 and Appendix E, the Statewide CASE Team considered how the proposed code change might impact various market actors involved in the compliance and enforcement process and aimed to minimize negative impacts on local governments.

4.2.4.7 Impacts on Specific Persons

While the objective of any of the Statewide CASE Team’s proposal is to promote energy efficiency, the Statewide CASE Team recognizes that there is the potential that a proposed code change may result in unintended consequences. This code change proposal is not expected to impact specific persons. Refer to Section 4.6 for more details addressing energy equity and environmental justice.

4.2.5 Fiscal Impacts

4.2.5.1 Mandates on Local Agencies or School Districts

There are no relevant mandates to local agencies or school districts.

4.2.5.2 Costs to Local Agencies or School Districts

There are no costs to local agencies or school districts.

4.2.5.3 Costs or Savings to Any State Agency

There are no costs or savings to any state agencies.

4.2.5.4 Other Non-Discretionary Cost or Savings Imposed on Local Agencies

There are no added non-discretionary costs or savings to local agencies.

4.2.5.5 Costs or Savings in Federal Funding to the State

There are no costs or savings to federal funding to the state.

4.3 Energy Savings

The Statewide CASE Team gathered stakeholder input to inform the energy savings analysis. We researched manufacturer product literature for heat recovery and thermal energy storage equipment to inform technical efficiency and capacity assumptions in the analysis. See Appendix F for a summary of stakeholder engagement.

Energy savings benefits may have potential to disproportionately impact DIPs. Refer to Section 3.6 for more details addressing energy equity and environmental justice.

4.3.1 Energy Savings Methodology

4.3.1.1 Key Assumptions for Energy Savings Analysis

Simultaneous Cooling and Heating

The purpose of this measure is to ensure hydronic heat recovery occurs when significant overlapping cooling and heating loads are present. Heating loads can be either space heating hydronics or domestic hot water. To demonstrate energy savings,

the Hospital prototype was modeled since it includes significant overlapping cooling and heating loads.

The base case for this measure is an all-electric building whose heating loads are entirely satisfied with air-to-water heat pumps (AWHPs). This was chosen to reflect local jurisdictions requiring all-electric designs via reach codes. Currently, the prototypes that use hydronic heating are served by gas boilers. The standard design prototypes were modified within CBECC to replace the gas boilers with the CBECC AWHP object. These modified models became the base case for this measure.

The measure case was modified to replace 30 percent of the AWHP equipment with 4-pipe dedicated heat recovery chillers to satisfy the overlapping cooling and heating loads. As a result of the conversion of 30 percent of the AWHPs to DRHCs, the WCC system was able to be downsized as well.

To produce initial results, the all-electric baseline prototype load profiles were exported from CBECC and then modified in Excel to model a dedicated heat recovery chiller system. Since heat recovery chillers are most appropriate for buildings with large overlapping cooling and heating loads, this measure is tailored for buildings with this characteristic.

Thermal Energy Storage

Many large buildings have low overlapping cooling and heating loads, making chilled water to hot water heat recovery chiller units impractical. However, the buildings may still have a significant peak heating load, necessitating a large AWHP system if the building is all-electric. These buildings are good candidates for thermal energy storage of day-before cooling waste heat for the next morning warm-up heating needs. This allows the building to downsize the AWHP capacity.

This measure's base case, similar to the simultaneous cooling and heating measure, consists of an all-electric building fully satisfied with AWHPs supplying hot water. The impacted prototypes include large office and secondary school.

We modeled this measure using condenser water (CW) TES (in essence, the TIER system), which provides several EE benefits. CW TES systems operate the AWHP and HRC in low-lift conditions. In the TIER system, the AWHP is configured to deliver CW temperatures (drawing heat from ambient air at design heating conditions, which is typically 30 °F in most California climates) and the heat recovery chiller operates between CW and HW temperatures. The more limited operating envelopes increase efficiency due to the compressor not having to work as hard as it would if the AWHP were configured to deliver HW temperatures, or the heat recovery chiller operated between CHW and HW temperature ranges.

The measure case was modeled outside of CBECC (and EnergyPlus) according to detailed specification prepared by Taylor Engineers in a memo to the Oakland Building Department. This memo is reproduced in Appendix H. The all-electric baseline prototype IDF files were exported from CBECC and then post-processed according to the Taylor Engineers specification.

Simultaneous Heat Recovery for Space Heating and Service Water Heating (All-Electric Baseline)

Energy savings for this measure were calculated by first simulating the Large Office prototype in CBECC in all 16 climate zones. The airside economizer in this model was disabled to accurately represent all potential condenser heat available for heat recovery. The peak heating, cooling, and SWH loads were then exported to Excel, along with the hourly load profile PLR (part load ratio) for CHW load, HW load, and SWH load.

Excel was then used to post-process the results on an 8760 hourly basis. Adjustable inputs were added to the spreadsheet for process cooling loads (e.g., a data center). This represents the $\text{Cooling}_{\text{HL}}$ referenced in the proposed language. An adjustable process SWH load was also added (e.g., kitchen, laundry, fitness center, etc.). This represents the SWH_{cap} referenced in the proposed language. The adjustable process the peak heating/cooling loads and the process inputs for $\text{Cooling}_{\text{HL}}$ and SWH_{cap} were then scaled to represent the different thresholds for simultaneous heat recovery in 140.4r(1) and for SWH heat recovery in 140.4r(3). The spreadsheet also includes adjustable values for heat recovery chiller capacity and SWH heat recovery capacity, representing the minimum capacity for each as specified in the proposed language. A fixed process cooling PLR of 0.5 was assumed. This is conservative and consistent with the ACM load profile for computer rooms, which is 0.25 for 25 percent of the time, 0.5 for 25 percent of the time, 0.75 for 25 percent of the time and 1.0 for 25 percent of the time (average of 62 percent). The SWH PLR from the prototype models was used for the process SWH_{cap} PLR.

For each hour the scaled cooling load from the model and the scaled process cooling load were added to determine the total hourly cooling load. A fixed water-to-water heat recovery chiller COP of 4.5 was assumed to approximate the chiller waste heat. The cooling load plus chiller waste heat represents the available condenser heat rejection available for heat recovery. The model then compares the available heat rejection, the current HHW load and the heat recovery chiller capacity and takes the smallest of these three to determine how much heat is recovered in that hour for HHW. The HHW energy savings for that hour are then calculated by assuming a fixed COP of 4.5 for the heat recovery chiller versus a fixed COP of 3.3 for a baseline AWHP.

The spreadsheet also accounts for the fact that a 4-pipe AWHP heat recovery chiller is less efficient in cooling-only mode than a 2-pipe AWHP in cooling-only mode. The hourly PLR is compared to the fraction of chiller capacity that is 2-pipe vs 4-pipe.

Whatever capacity the 2-pipe cannot satisfy must be met by the 4-pipe. The energy penalty for running the 4-pipe in cooling only mode is then calculated based on a fixed COP for 2-pipe of 4.5 and a fixed COP for 4-pipe of 3.5. Net kW savings are then multiplied by the electric rate in that climate for that hour to determine the hourly \$ savings.

The heat recovered for HHW is then subtracted from the condenser heat available to determine the remaining heat available for SWH heat recovery. This is then compared to the SWH load in that hour to determine the amount of SWH heat recovery in that hour. The SWH energy savings for that hour are then calculated by assuming a fixed COP of 4.5 for the heat recovery chiller versus a fixed COP of 1.0 for a baseline electric water heater. These kW savings are then multiplied by the electric rate in that climate for that hour to determine the hourly dollar savings.

Note that this analysis is highly conservative because it does not take credit for cooling energy savings, only heating energy savings. It assumes that if the air economizer were enabled there would be no simultaneous heating and cooling. This is obviously not always true, particularly if there is a significant SWH load or if there is a data center without a direct air economizer or the data center is not operated at elevated supply and return temperatures (e.g., 75 SAT, 95 RAT). A more accurate analysis would take credit for cooling savings by also determining the Cooling PLR with the economizer enabled and comparing this to the calculated heat recovery. The smaller of the current required cooling and the current heat recovery would be free cooling load, since the HR chiller energy is already accounted for as part of the incremental heating energy savings. This free cooling load would be compared to the energy a 2-pipe AWHP would use to meet this load to determine the free cooling KW savings. Since the B/C ratio is already > 1 in all climates it was not necessary to capture the cooling energy savings.

Incremental cost functions for heat recovery chiller capacity and SWH heat recovery capacity on a per kBtuh basis were developed based on the Incremental Costs in Section 4.4.3. These cost functions were then applied to the adjustable values for heat recovery chiller capacity and SWH heat recovery capacity to determine the total incremental cost for the current spreadsheet assumptions. These are compared to the total \$ savings to determine the B/C ratio for the current spreadsheet assumptions. The adjustable variables in the spreadsheet were then run through a wide range of parametric analysis to demonstrate cost-effectiveness under a wide range of assumptions for building loads, process loads, HR chiller sizing, and SWH sizing.

Simultaneous Heat Recovery for Space Heating and Service Water Heating (Gas Baseline)

The methodology for the gas baseline is basically the same as the methodology for the all-electric baseline, as described in the preceding section. Hourly load profiles for the Large Office prototype for all climate zones were exported to Excel for post-processing.

Excel was then used to post-process the results on an 8760 hourly basis. Adjustable inputs were added to the spreadsheet for process cooling loads (e.g., a data center). This represents the $\text{Cooling}_{\text{HL}}$ referenced in the proposed language. An adjustable process SWH load was also added (e.g., kitchen, laundry, fitness center, etc.). This represents the SWH_{cap} referenced in the proposed language. The process peak heating/cooling loads and the process inputs for $\text{Cooling}_{\text{HL}}$ and SWH_{cap} were then scaled to represent the different thresholds for simultaneous heat recovery in 140.4r(1) and for the SWH heat recovery submeasure in 140.4r(3). The spreadsheet also includes adjustable values for heat recovery chiller capacity and SWH heat recovery capacity, representing the minimum capacity for each as specified in the proposed language. Since cost data was based on the plant described in Section 4.4.3.2, we assumed that the plant consists of two equally sized chillers in the base case and proposed case but in the proposed case one of these chillers can operate in heat recovery mode. When in heat recovery mode the maximum cooling capacity of this chiller is only 50 percent of its capacity in cooling-only mode (this is based on input from the chiller vendor). This is because the chiller kW/ton in HR mode is roughly double the kW/ton in cooling-only mode (due to the higher compressor lift demanded of the chiller to supply both chilled and hot water). To avoid exceeding the available electrical capacity (i.e., the maximum input power of the chiller regardless of its mode of operation) the chiller capacity is thus limited to 50 percent in HR mode.

To determine the baseline cooling energy use, for each hour the scaled cooling load with the economizer enabled is divided by the average cooling-only chiller plant COP of 6.39 (based on chiller performance data from the vendor of the chillers described in Section 4.4.3.2). We also assume each chiller operates hot gas bypass (HGB) when chiller load is below 5 percent of design load, i.e., kW is fixed from five percent to zero percent load.

The baseline assumes service water heating is electric resistance. For space heating, an average gas boiler efficiency of 70 percent is assumed.

For the proposed case:

1. We first determine if the cooling load, with economizer enabled, is too high to recover heat (since heat recovery derates the chiller, as described above). If so, then the HR chiller operates in cooling-only (CO) mode and no heat is recovered.
2. If heat can be recovered, then we determine the maximum possible CHW load with the economizer disabled. This is compared to the space heat load, the SWH load and the SWH max HR capacity to determine the max HHW+SWH load that could be served by HR. If the SWH process load is < 500 kBTU/h then the SWH max HR capacity is zero. If the SWH process load is > 500 kBTU/h then the SWH max HR capacity is the smaller of 30 percent of peak heat rejection capacity or 30 percent of peak SWH process load.

3. The max available heat rejection is then determined from the max cooling load with economizer disabled, the maximum heating capacity of the HR chiller, and an average COP of 3.52 for the plant in HR mode (based on chiller performance data from the vendor of the chillers described in Section 4.4.3.2 operating in HR mode)
4. The smaller of the loads in steps 2 and 3 is the amount of heat transferred to HHW or SWH.
5. If the HHW load is greater than the amount of heat transferred then the remaining HHW load is met by the gas boiler using the same boiler efficiency as the base case.
6. If the HHW load is less than the amount of heat transferred then the remaining heat transferred is used to meet part of the SWH load.
7. The SWH load not met by heat transfer is met by electric resistance, like the base case.
8. If there is any cooling load not met by the HR chiller in HR mode or by the economizer then it is met by the CO chiller up to the max capacity of the CO chiller, using same CO chiller plant COP and HGB assumptions as the baseline.
9. If there is any remaining cooling load that cannot be met by the CO-chiller at max capacity then it is met by the HR chiller in hybrid mode (some heat rejected by the HR chiller is recovered, the rest is rejected to the cooling towers).
10. The loads from steps 4 and 9 determine the total cooling load on the HR chiller. The HR chiller energy is based on the COP described in step 3. We also assume the HR chiller operates hot gas bypass (HGB) when chiller load is below five percent of design load, i.e. kW is fixed from five percent to zero percent load.

4.3.1.2 Energy Savings Methodology per Prototypical Building

The Statewide CASE Team measured per unit energy savings expected from the proposed code changes in several ways to quantify key impacts. First, savings are calculated by fuel type. Electricity savings are measured in terms of both energy usage and peak demand reduction. Natural gas savings are quantified in terms of energy usage. Second, the Statewide CASE Team calculated source energy savings. Source energy represents the total amount of raw fuel required to operate a building. In addition to all energy used from on-site production, source energy incorporates all transmission, delivery, and production losses. The hourly Source Energy values provided by CEC are proportional to GHG emissions. Finally, the Statewide CASE Team calculated Long-term Systemwide Cost (LSC) savings, formerly known as Time Dependent Value (TDV) Energy Cost Savings. LSC savings are calculated using hourly energy cost metrics for both electricity and natural gas provided by the CEC. These LSC hourly factors are projected over the 30-year life of the building. The LSC hourly factors incorporate the

hourly cost of marginal generation, transmission and distribution, fuel, capacity, losses, and cap-and-trade-based CO2 emissions. More information on source energy and LSC hourly factors is available in the [March 2020 CEC Staff Workshop on Energy Code Compliance Metrics](#) and the [July 2022 CEC Staff Workshop on Energy Code Accounting for the 2025 Building Energy Efficiency Standards](#).

The CEC directed the Statewide CASE Team to model the energy impacts using specific prototypical building models that represent typical building geometries for different types of buildings (California Energy Commission 2022). The prototype buildings that the Statewide CASE Team used in the analysis are presented in Table 72.

Table 72: Prototype Buildings Used for Energy, Demand, Cost, and Environmental Impacts Analysis

Prototype Name	Number of Stories	Floor Area (Square Feet)	Description
Hospital	5	241,501	5-Story Hospital plus basement. Source: DOE Standard 90.1 Hospital prototype and scorecard. The prototype contains Title 24, Part 6, minimally compliant envelope features and lighting. For HVAC systems, the AIA guidelines recommended using VAV systems wherever possible.
OfficeLarge	12	498,589	12 story + 1 basement office building with 5 zones and a ceiling plenum on each floor. WWR-0.40.
SchoolLarge	2	210,866	High school with WWR of 35% and SRR 1.4%

The Statewide CASE Team estimated LSC energy, source energy, electricity, natural gas, peak demand, and GHG impacts by simulating the proposed code change in EnergyPlus using prototypical buildings and rulesets from the 2025 Research Version of the California Building Energy Code Compliance (CBECC) software.

CBECC generates two models based on user inputs: the Standard Design and the Proposed Design. The Standard Design represents the geometry of the prototypical building and a design that uses a set of features that result in a lifecycle energy budget and Source energy budget that is minimally compliant with 2022 Title 24, Part 6 code requirements. Features used in the Standard Design are described in the 2022 Nonresidential ACM Reference Manual. The Proposed Design represents the same geometry as the Standard Design, but it assumes the energy features that the software user describes with user inputs. To develop savings estimates for the proposed code changes, the Statewide CASE Team created a Standard Design for each prototypical building representing compliance with 2022 code and then modified the space heating system to convert it from a natural gas boiler to an electric AWHP sized to meet peak design loads. This system represents the baseline conditions against which the

measures were compared. For this measure, the standard design uses a 2-pipe AWHP because our baseline condition is assumed to be a design minimally complying with the code in a local jurisdiction that has adopted an all-electric energy code.

The Proposed Design was identical to the Standard Design in all ways except for the revisions that represent the proposed changes to the code. This measure contains two subcategories: heat recovery with or without thermal energy storage in the proposed design. Most prototypes would fall under the category of requiring thermal energy storage, so their proposed design configurations included heat recovery and thermal energy storage. The Hospital prototype would comply without thermal energy storage, so it was modified to only include hydronic heat recovery. The changes between the standard and proposed designs are further described in Section 4.3.1.1.

CBECC calculates whole-building energy consumption for every hour of the year measured in kilowatt-hours per year (kWh/y) and therms per year (Therms/y). It then applies the 2025 LSC hourly factors to calculate lifecycle energy use in kilo British thermal units per year (kBtu/y), Source Energy factors to calculate Source Energy Use in kilo British thermal units per year (kBtu/y), and hourly GHG emissions factors to calculate annual GHG emissions in metric tons of carbon dioxide emissions equivalent (MT or “tonnes” CO₂e/y) (California Energy Commission 2022). CBECC also generates LSC savings values measured in 2026 present value dollars (2026 PV\$) and nominal dollars. CBECC also calculates annual peak electricity demand measured in kilowatts (kW).

The energy impacts of the proposed code change do vary by climate zone. The Statewide CASE Team simulated the energy impacts in every climate zone and applied the climate-zone specific LSC hourly factors when calculating energy and energy cost impacts.

Per unit energy impacts for nonresidential buildings are presented in savings per square foot. Annual energy, GHG, and peak demand impacts for each prototype building were translated into impacts per square foot by dividing by the floor area of the prototype building. This step allows for an easier comparison of savings across different building types and enables a calculation of statewide savings using the construction forecast that is published in terms of floor area by building type.

4.3.1.3 Statewide Energy Savings Methodology

The per unit energy impacts were extrapolated to statewide impacts using the statewide construction forecasts that the CEC provided. The statewide construction forecasts estimate new construction/additions that would occur in 2026, the first year that the 2025 Title 24, Part 6 requirements are in effect. They also estimate the amount of total existing building stock in 2026, which the Statewide CASE Team used to approximate savings from building alterations (California Energy Commission 2022). The

construction forecast provides construction (new construction/additions and existing building stock) by building type and climate zone, as shown in Appendix A.

Appendix A presents additional information about the methodology and assumptions used to calculate statewide energy impacts.

4.3.2 Per unit Energy Impacts Results

Energy savings and peak demand reductions per unit are presented in Table 74 through Table 78. The measure IDs presented in Table 73 apply to each of the five savings tables that follow. This measure would only apply to new construction/additions, not alterations. The per unit energy savings figures do not account for naturally occurring market adoption or compliance rates. Per unit savings for the first year are expected to range from -0.64 to 1.10 kWh/y depending upon climate zone. Demand reductions are expected to range between -0.08 W and 0.23 W depending on climate zone.

After the Final CASE Report was published in July 2023, CEC requested that the Statewide CASE Team present the energy impacts relative to a baseline that is in alignment with what CEC presented at their July 27, 2023 Heat Pump Baseline workshop. Please refer to Appendix J for the final savings numbers. The original values from the July 2023 Final CASE Report are still presented below for reference purposes.

Table 73: Lookup Table for Mechanical Heat Recovery Submeasures

Measure Name	Measure ID
Simultaneous Cooling and Heating (AWHP Baseline)	A
Thermal Energy Storage (AWHP Baseline)	B
Thermal Energy Storage (Gas Baseline)	C
Heat Recovery for Service Water Heating	D
Simultaneous Heat Recovery for Space Heating and Service Water Heating Scenario A	E
Simultaneous Heat Recovery for Space Heating and Service Water Heating Scenario B	F

Table 74: First Year Electricity Savings (kWh) Per Square Foot – Simultaneous Cooling and Heating (AWHP Baseline)

Measure ID	Prototype	CZ 1	CZ 2	CZ 3	CZ 4	CZ 5	CZ 6	CZ 7	CZ 8	CZ 9	CZ 10	CZ 11	CZ 12	CZ 13	CZ 14	CZ 15	CZ 16
A	Hospital	0.94	0.89	0.78	0.98	0.83	0.74	0.66	0.73	0.74	0.74	0.74	0.85	0.72	0.91	NA	1.10
B	OfficeLarge	0.34	0.47	0.17	0.49	0.27	0.26	0.28	0.31	0.27	0.28	0.46	0.46	0.41	0.68	0.31	0.94
C	OfficeLarge	(0.10)	0.06	0.02	0.10	0.04	0.22	0.26	0.24	0.20	0.18	0.12	0.11	0.15	0.10	0.27	0.03
D	OfficeLarge	0.19	0.17	0.17	0.15	0.16	0.17	0.18	0.17	0.17	0.16	0.14	0.16	0.15	0.15	NA	0.12
D	SchoolLarge	0.58	0.49	0.34	0.41	0.32	0.38	0.41	0.38	0.34	0.40	0.43	0.45	0.40	0.38	NA	0.36
E	OfficeLarge	(0.48)	(0.52)	(0.46)	(0.54)	(0.49)	(0.22)	(0.19)	(0.28)	(0.32)	(0.37)	(0.52)	(0.47)	(0.44)	(0.54)	NA	(0.64)
F	OfficeLarge	0.10	0.09	0.14	0.10	0.16	0.15	0.17	0.14	0.13	0.11	0.06	0.07	0.06	0.04	NA	0.08

Table 75: First Year Peak Demand Reduction (W) Per Square Foot

Measure ID	Prototype	CZ 1	CZ 2	CZ 3	CZ 4	CZ 5	CZ 6	CZ 7	CZ 8	CZ 9	CZ 10	CZ 11	CZ 12	CZ 13	CZ 14	CZ 15	CZ 16
A	Hospital	0.15	0.14	0.09	0.17	0.14	0.13	0.12	0.16	0.15	0.12	0.12	0.13	0.09	0.20	NA	0.17
B	OfficeLarge	0.09	0.10	0.04	0.11	0.07	0.01	0.00	0.02	0.02	0.04	0.14	0.12	0.09	0.21	0.02	0.23
C	OfficeLarge	(0.01)	(0.01)	(0.01)	(0.00)	(0.01)	(0.00)	(0.00)	(0.00)	(0.00)	(0.00)	(0.00)	(0.00)	(0.01)	0.00	(0.00)	(0.00)
D	OfficeLarge	0.01	0.01	0.01	0.00	0.00	0.00	0.00	0.00	0.00	0.00	0.00	0.00	0.00	0.00	NA	0.00
D	SchoolLarge	0.02	0.02	0.01	0.00	0.00	0.00	0.00	0.00	0.00	0.00	0.00	0.00	0.00	0.00	NA	0.00
E	OfficeLarge	(0.08)	(0.07)	(0.08)	0.00	0.00	0.00	0.00	0.00	0.00	0.00	0.00	0.00	0.00	0.00	NA	0.00
F	OfficeLarge	(0.02)	(0.01)	(0.01)	0.00	0.00	0.00	0.00	0.00	0.00	0.00	0.00	0.00	0.00	0.00	NA	0.00

Table 76: First Year Natural Gas Savings (kBtu) Per Square Foot

Measure ID	Prototype	CZ 1	CZ 2	CZ 3	CZ 4	CZ 5	CZ 6	CZ 7	CZ 8	CZ 9	CZ 10	CZ 11	CZ 12	CZ 13	CZ 14	CZ 15	CZ 16
A	Hospital	NA	NA	NA	NA	NA	NA	NA	NA	NA	NA	NA	NA	NA	NA	NA	NA
B	OfficeLarge	NA	NA	NA	NA	NA	NA	NA	NA	NA	NA	NA	NA	NA	NA	NA	NA
C	OfficeLarge	6.67	4.94	4.33	3.46	4.44	1.68	1.37	1.88	2.04	2.43	3.78	4.29	3.49	4.23	1.35	3.75
D	OfficeLarge	NA	NA	NA	NA	NA	NA	NA	NA	NA	NA	NA	NA	NA	NA	NA	NA
D	SchoolLarge	NA	NA	NA	NA	NA	NA	NA	NA	NA	NA	NA	NA	NA	NA	NA	NA
E	OfficeLarge	10.13	10.17	9.71	9.97	10.21	4.01	3.35	4.08	4.78	5.40	9.05	8.55	7.12	9.38	NA	13.18
F	OfficeLarge	2.79	1.76	1.75	1.17	1.38	1.07	1.06	0.80	0.89	1.02	1.31	1.74	1.31	1.85	NA	1.55

Table 77: First Year Source Energy Savings (kBtu) Per Square Foot

Measure ID	Prototype	CZ 1	CZ 2	CZ 3	CZ 4	CZ 5	CZ 6	CZ 7	CZ 8	CZ 9	CZ 10	CZ 11	CZ 12	CZ 13	CZ 14	CZ 15	CZ 16
A	Hospital	2.15	2.17	1.66	2.34	1.89	1.68	1.47	1.62	1.63	1.67	1.85	1.96	1.63	2.57	NA	2.76
B	OfficeLarge	1.04	1.31	0.45	1.32	0.68	0.21	0.19	0.31	0.33	0.39	1.37	1.17	0.94	2.03	0.41	2.59
C	OfficeLarge	5.87	4.43	3.81	3.15	3.94	1.60	1.34	1.77	1.91	2.23	3.42	3.86	3.17	3.82	1.42	3.33
D	OfficeLarge	0.21	0.17	0.17	0.16	0.16	0.18	0.19	0.18	0.17	0.18	0.15	0.17	0.16	0.18	NA	0.14
D	SchoolLarge	0.70	0.60	0.27	0.45	0.24	0.35	0.41	0.35	0.29	0.47	0.51	0.55	0.51	0.46	NA	0.41
E	OfficeLarge	8.07	8.06	7.68	7.86	8.12	3.07	2.54	3.06	3.61	4.11	6.98	6.67	5.47	7.20	NA	10.39
F	OfficeLarge	2.42	1.53	1.55	1.05	1.26	1.04	1.04	0.79	0.85	0.96	1.11	1.51	1.12	1.58	NA	1.33

Table 78: First Year LSC Energy Savings (\$) Per Square Foot

Measure ID	Prototype	CZ 1	CZ 2	CZ 3	CZ 4	CZ 5	CZ 6	CZ 7	CZ 8	CZ 9	CZ 10	CZ 11	CZ 12	CZ 13	CZ 14	CZ 15	CZ 16
A	Hospital	5.96	5.77	4.69	5.97	5.28	4.62	3.93	4.56	4.54	4.52	4.56	5.09	4.25	5.91	NA	7.15
B	OfficeLarge	2.39	3.04	1.02	3.08	1.69	1.21	1.24	1.46	1.35	1.47	3.02	2.82	2.45	4.55	1.67	6.43
C	OfficeLarge	3.11	2.91	2.38	2.31	2.56	1.93	1.91	2.15	2.07	2.21	2.68	2.85	2.63	2.97	2.14	2.23
D	OfficeLarge	0.89	0.77	0.77	0.72	0.75	0.82	0.87	0.82	0.79	0.79	0.70	0.76	0.73	0.75	NA	0.60
D	SchoolLarge	2.94	2.49	1.50	1.98	1.45	1.77	1.91	1.76	1.57	1.94	2.09	2.19	2.00	1.87	NA	1.79
E	OfficeLarge	2.67	2.53	2.52	2.60	2.73	0.99	0.93	0.84	1.03	1.17	2.35	2.24	1.73	2.48	NA	3.65
F	OfficeLarge	1.71	1.20	1.42	1.05	1.36	1.26	1.41	1.07	1.07	1.04	0.94	1.18	0.95	1.16	NA	1.11

4.4 Cost and Cost Effectiveness

4.4.1 Energy Cost Savings Methodology

Energy cost savings were calculated by applying the LSC hourly factors to the energy savings estimates that were derived using the methodology described in Section 4.3.1. LSC hourly factors are a normalized metric to calculate energy cost savings that accounts for the variable cost of electricity and natural gas for each hour of the year, along with how costs are expected to change over the period of analysis. In this case, the period of analysis used is 30 years.

The CEC requested energy cost savings over the 30-year period of analysis in both 2026 present value dollars (2026 PV\$) and nominal dollars. The cost-effectiveness analysis uses energy cost values in 2026 PV\$. Costs and cost effectiveness using and 2026 PV\$ are presented in Section 4.4 of this report. CEC uses results in nominal dollars to complete the Economic and Fiscal Impacts Statement (From 399) for the entire package of proposed change to Title 24, Part 6. Appendix G presents energy cost savings results in nominal dollars. After this CASE Report was finalized in July 2023, CEC requested updated savings and cost-effectiveness values to reflect their proposed all-electric HVAC baselines for large schools and large offices. Please refer to Appendix J for the final values.

4.4.2 Energy Cost Savings Results

Per unit energy cost savings for newly constructed buildings that are realized over the 30-year period of analysis are presented 2026 present value dollars (2026 PV\$) in Table 79 through Table 85.

The LSC hourly factors methodology allows peak electricity savings to be valued more than electricity savings during non-peak periods. This measure is expected to have an impact on heating peak demand, as well as potentially on cooling peak demand depending on how the thermal energy storage tank is configured.

Any time code changes impact cost, there is potential to disproportionately impact DIPs. Refer to Section 4.6 for more details addressing energy equity and environmental justice.

Table 79: 2026 PV LSC Savings Over 30-Year Period of Analysis – Per Square Foot – New Construction and Additions – Hospital (Simultaneous Cooling and Heating)

Climate Zone	30-Year LSC Electricity Savings (2026 PV\$)	30-Year LSC Natural Gas Savings (2026 PV\$)	Total 30-Year LSC Savings (2026 PV\$)
1	5.96	0.00	5.96
2	5.77	0.00	5.77
3	4.69	0.00	4.69
4	5.97	0.00	5.97
5	5.28	0.00	5.28
6	4.62	0.00	4.62
7	3.93	0.00	3.93
8	4.56	0.00	4.56
9	4.54	0.00	4.54
10	4.52	0.00	4.52
11	4.56	0.00	4.56
12	5.09	0.00	5.09
13	4.25	0.00	4.25
14	5.91	0.00	5.91
15	NA	NA	NA
16	7.15	0.00	7.15

^a “NA” refers to the fact that the CEC forecasts 0 square feet of construction activity in this climate zone for this building type in 2026.

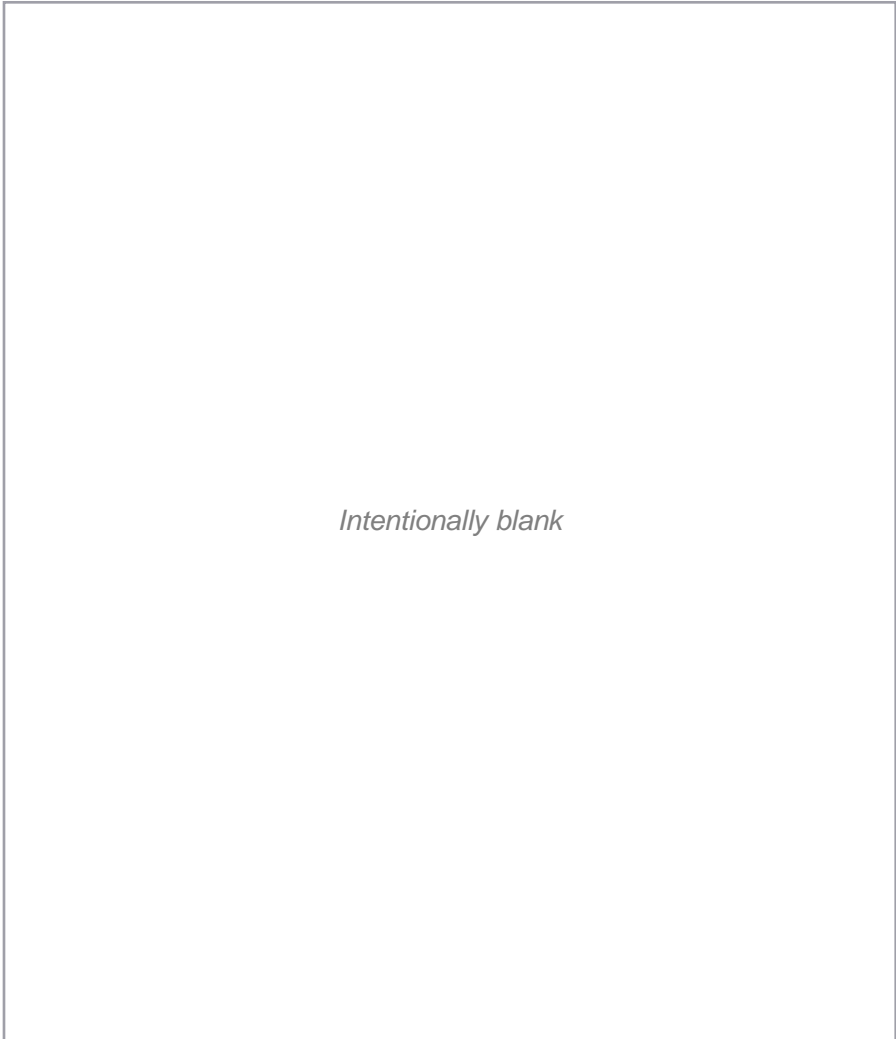

Table 80: 2026 PV LSC Savings Over 30-Year Period of Analysis – Per Square Foot – New Construction and Additions – Large Office (Thermal Energy Storage – AWHP Baseline)

Climate Zone	30-Year LSC Electricity Savings (2026 PV\$)	30-Year LSC Natural Gas Savings (2026 PV\$)	Total 30-Year LSC Savings (2026 PV\$)
1	NA	NA	NA
2	NA	NA	NA
3	1.02	0.00	1.02
4	3.08	0.00	3.08
5	NA	NA	NA
6	1.21	0.00	1.21
7	1.24	0.00	1.24
8	1.46	0.00	1.46
9	1.35	0.00	1.35
10	1.47	0.00	1.47
11	3.02	0.00	3.02
12	2.82	0.00	2.82
13	NA	NA	NA
14	4.55	0.00	4.55
15	1.67	0.00	1.67
16	6.43	0.00	6.43

Table 81: 2026 PV LSC Savings Over 30-Year Period of Analysis – Per Square Foot – New Construction and Additions – Large Office (Thermal Energy Storage – Gas Baseline)

Climate Zone	30-Year LSC Electricity Savings (2026 PV\$)	30-Year LSC Natural Gas Savings (2026 PV\$)	Total 30-Year LSC Savings (2026 PV\$)
1	NA	NA	NA
2	NA	NA	NA
3	-0.09	2.47	2.38
4	0.36	1.95	2.31
5	NA	NA	NA
6	0.94	1.00	1.93
7	1.08	0.83	1.91
8	1.00	1.15	2.15
9	0.84	1.23	2.07
10	0.75	1.46	2.21
11	0.43	2.25	2.68
12	0.34	2.51	2.85
13	NA	NA	NA
14	0.43	2.54	2.97
15	1.30	0.84	2.14
16	0.07	2.17	2.23

Table 82: 2026 PV LSC Savings Over 30-Year Period of Analysis – Per Square Foot – New Construction and Additions – Large Office (Heat Recovery for Service Water Heating)

Climate Zone	30-Year LSC Electricity Savings (2026 PV\$)	30-Year LSC Natural Gas Savings (2026 PV\$)	Total 30-Year LSC Savings (2026 PV\$)
1	NA	NA	NA
2	NA	NA	NA
3	0.77	0.00	0.77
4	0.72	0.00	0.72
5	NA	NA	NA
6	0.82	0.00	0.82
7	0.87	0.00	0.87
8	0.82	0.00	0.82
9	0.79	0.00	0.79
10	0.79	0.00	0.79
11	0.70	0.00	0.70
12	0.76	0.00	0.76
13	NA	NA	NA
14	0.75	0.00	0.75
15	NA	NA	NA
16	0.60	0.00	0.60

Table 83: 2026 PV LSC Savings Over 30-Year Period of Analysis – Per Square Foot – New Construction and Additions – Large School (Heat Recovery for Service Water Heating)

Climate Zone	30-Year LSC Electricity Savings (2026 PV\$)	30-Year LSC Natural Gas Savings (2026 PV\$)	Total 30-Year LSC Savings (2026 PV\$)
1	2.94	0.00	2.94
2	2.49	0.00	2.49
3	1.50	0.00	1.50
4	1.98	0.00	1.98
5	1.45	0.00	1.45
6	1.77	0.00	1.77
7	1.91	0.00	1.91
8	1.76	0.00	1.76
9	1.57	0.00	1.57
10	1.94	0.00	1.94
11	2.09	0.00	2.09
12	2.19	0.00	2.19
13	2.00	0.00	2.00
14	1.87	0.00	1.87
15	NA	NA	NA
16	1.79	0.00	1.79

Table 84: 2026 PV LSC Savings Over 30-Year Period of Analysis – Per Square Foot – New Construction and Additions – Large Office (Simultaneous Heat Recovery for Space Heating and Service Water Heating Scenario A)

Climate Zone	30-Year LSC Electricity Savings (2026 PV\$)	30-Year LSC Natural Gas Savings (2026 PV\$)	Total 30-Year LSC Savings (2026 PV\$)
1	NA	NA	NA
2	NA	NA	NA
3	(3.01)	5.52	2.52
4	(3.15)	5.75	2.60
5	NA	NA	NA
6	(1.38)	2.37	0.99
7	(1.10)	2.03	0.93
8	(1.65)	2.49	0.84
9	(1.85)	2.88	1.03
10	(2.08)	3.25	1.17
11	(3.06)	5.40	2.35
12	(2.76)	5.00	2.24
13	NA	NA	NA
14	(3.16)	5.64	2.48
15	NA	NA	NA
16	(4.06)	7.71	3.65

Table 85: 2026 PV LSC Savings Over 30-Year Period of Analysis – Per Square Foot – New Construction and Additions – Large Office (Simultaneous Heat Recovery for Space Heating and Service Water Heating Scenario B)

Climate Zone	30-Year LSC Electricity Savings (2026 PV\$)	30-Year LSC Natural Gas Savings (2026 PV\$)	Total 30-Year LSC Savings (2026 PV\$)
1	NA	NA	NA
2	NA	NA	NA
3	1.42	0.84	1.70
4	1.05	0.84	1.26
5	NA	NA	NA
6	1.26	0.84	1.51
7	1.41	0.84	1.69
8	1.07	0.84	1.28
9	1.07	0.84	1.27
10	1.04	0.84	1.25
11	0.94	0.84	1.12
12	1.18	0.84	1.41
13	NA	NA	NA
14	1.16	0.84	1.38
15	NA	NA	NA
16	1.11	0.84	1.33

4.4.3 Incremental First Cost

4.4.3.1 Simultaneous Heat Recovery – Electric Baseline

The incremental cost for simultaneous heat recovery was determined by starting with an all-electric design without heat recovery and upgrading the design to include heat recovery. A typical all-electric central plant without heat recovery consists of all 2-pipe air to water heat pumps (AWHP, sometimes labeled ATWHP, and sometimes more generally referred to as air source heat pumps or ASHP). 2-pipe AWHPs can provide chilled water or hot water, but not at the same time. In cooling mode, heat is rejected to the ambient air. In heating mode, heat is extracted from ambient air. 4-pipe AWHPs can provide both heating and cooling at the same time by recovering condenser waste heat. The net heat that is not recovered is rejected to ambient air. Figure 32 shows a typical plant with a combination of 2-pipe and 4-pipe AWHPs. These AWHPs all have a cooling capacity of approximately 130 tons. The two pipes leaving the 2-pipe AWHPs have four control valves such that when the 2-pipe AWHP is needed for cooling it is connected to the CHW system and when the 2-pipe AWHP is needed for heating it is connected to the HW system. The 4-pipe AWHPs do not have these control valves as they are always connected to both the CHW and HW system.

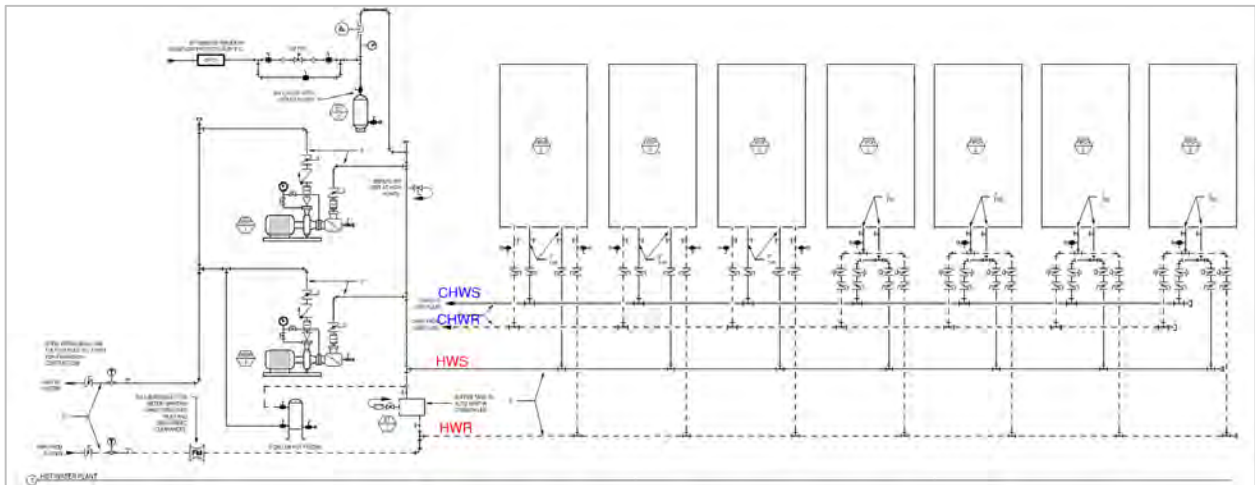

Figure 32: Typical CHW/HW Plant with 2-Pipe and 4-Pipe AWHPs

The incremental cost of simultaneous heat recovery is the additional cost to upgrade one 2-pipe AWHP to a 4-pipe AWHP. A Bay Area mechanical contractor provided the full incremental cost to upgrade one of the 130-ton AWHP in this plant from a 2-pipe AWHP to a 4-pipe AWHP. As shown in Table 86, the 4-pipe AWHP costs \$65,000 more than the 2-pipe and has slightly higher maintenance, but the 4-pipe is less expensive to install and has a lower controls cost, mostly because it does not require the 4-way

control valves. The net result is an incremental cost of \$565/ton of heat recovery capacity.

Table 86: Incremental First Cost and Maintenance Cost for 4-pipe vs 2-pipe AWHP

Parameter	Value
Representative AWHP capacity (tons)	130
Incremental equipment cost (\$/ton)	\$500
Incremental equipment cost (\$/AWHP)	\$65,000
Incremental piping (\$/AWHP)	(\$15,000)
Incremental piping (\$/ton)	(\$115)
Incremental controls (\$/AWHP)	(\$17,500)
Incremental controls (\$/ton)	(\$135)
Incremental maintenance cost (\$/y/AWHP)	\$250
Incremental maintenance cost (\$/y/ton)	\$1.92
NPV multiplier for annual maintenance	19.6
NPV of annual maintenance \$/ton	\$38
Expected life of AWHP (years)	20
Replacement cost multiplier	0.55
Incremental replacement cost (\$/ton)	\$277
Net incremental cost for 4-pipe (\$/AWHP)	\$73,389
Net incremental cost for 4-pipe (\$/ton)	\$565
HR Chiller capacity in prototype (tons)	368
Incremental cost for prototype (\$)	\$207,977

4.4.3.2 Simultaneous Heat Recovery – Gas Baseline

The incremental cost for a gas baseline was determined by starting with an existing office building with gas heat and no HR and redesigning and repricing the system to add heat recovery. The existing building was built in 2010 in Pleasanton CA and is roughly 100,000 ft². The central plant includes (2) 310 ton water-cooled screw chillers and (2) 2,000 kbtuh gas boilers. Figure 33 and Figure 34 illustrate the modifications needed to allow condenser heat from one of the chillers to be rejected to the hot water system.

These modifications include:

- Addition of a water-water heat exchanger (HX) to isolate the HR chiller from the open condenser water loop to/from the cooling towers. This HX prevents the dirty open loop CW from potentially fouling the hot water reheat coils (another example of such a HX is shown in Figure 29). The HX is sized for the flow and capacity of the associated chiller and a 3 degree approach, i.e. adding the HX increases the temperature of the condenser water entering the chiller by 3°F at

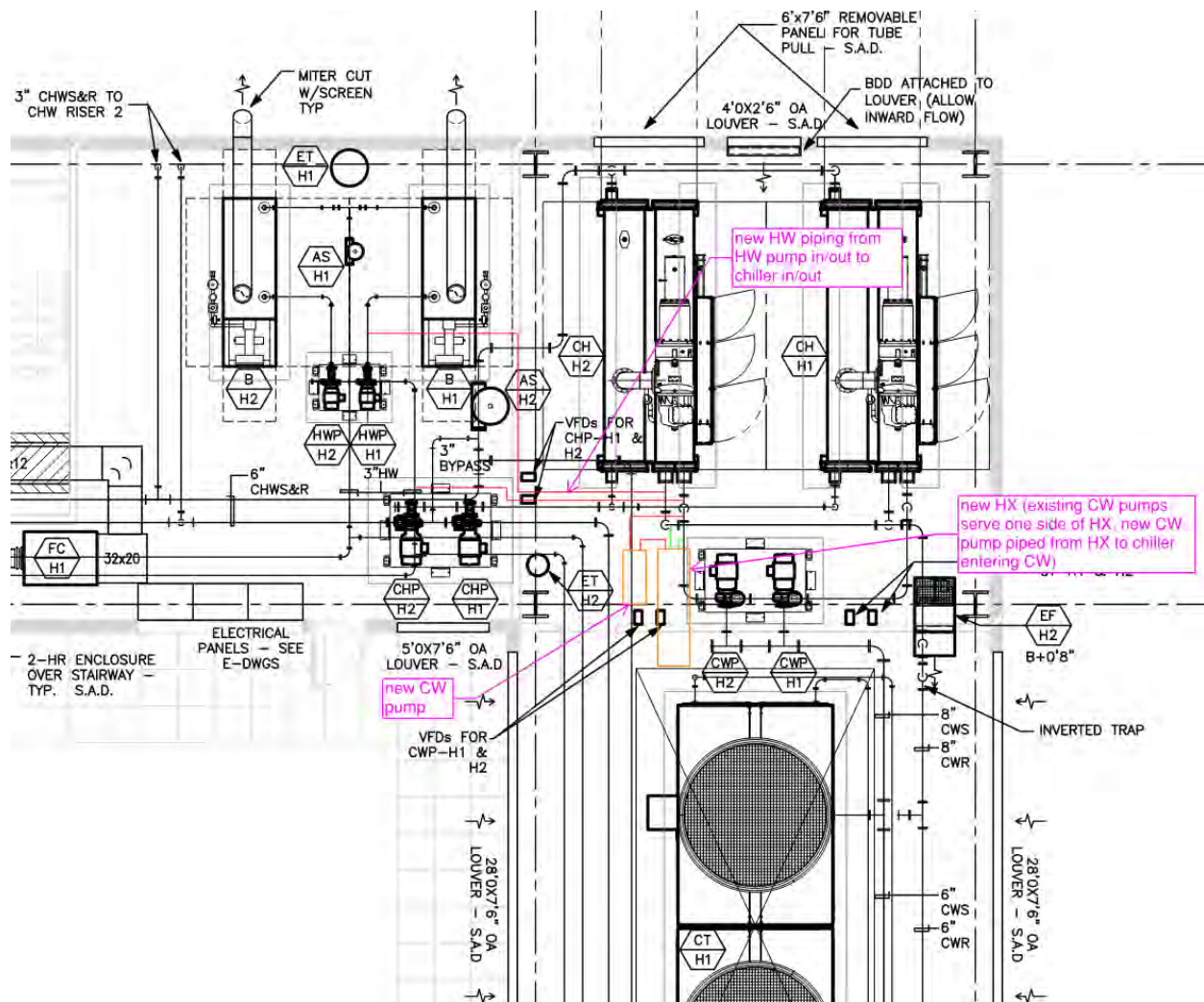

Figure 34. Plan View for Conversion of Standard Chiller to HR Chiller

Pricing for the HX and pump were provided by a Bay Area HX and pump vendor. Full incremental installed costs for the conversion were then provided by a Bay Area mechanical contractor and are summarized in Table 87. In order to extrapolate this incremental cost to other chiller sizes we assumed 90 percent of the cost was fixed, with only ten percent of this cost varying by chiller size. We also assumed that the cost for any chiller less than 200 tons was the same as the cost for a 200 ton chiller.

Table 87: Incremental Cost of Simultaneous Heat Recovery

Parameter	Value
Chiller cooling capacity in cooling-only mode	310 tons
Chiller cooling capacity in HR mode	155 tons
HX cost, including installation	\$109,300
CW pump + VFD cost, including installation	\$11,200

Parameter	Value
Piping (material & labor)	\$70,500
Insulation	\$12,000
Electrical	\$18,000
Controls	\$24,000
Subtotal	\$245,000
Incremental Annual Maintenance Cost	\$1,000
NPV of Incremental Maintenance Cost	\$19,600
Incremental Cost	\$264,600
Cost/ton based on cooling-only tons	\$854
Cost/ton based on heat recovery tons	\$1,707

4.4.3.3 Thermal Energy Storage (TES) – Electric Baseline

Condenser water Time Independent Energy Recovery (TIER) is a form of TES that uses condenser water for thermal storage. It was bid as an alternate system design option versus AWHPs on four recent Bay Area new construction projects. See Table 88 and Appendix I for a reproduction of a technical memo developed by Taylor Engineers comparing several all-electric hydronic design options, including TIER. Pricing was provided by each individual project’s General Contractor and thus represents the total net cost to the owner. In all cases TIER costs less than the base case all-electric design.

Table 88: TIER Plant Incremental Cost Savings

Location	Santa Clara	Sunnyvale	San Jose	Oakland
Stories	3	3	6	27
Building area (ft ²)	314,000	1,100,000	1,022,981	718,000
CHWcap (tons)	780	2,660	1,800	1,200
SWHcap (kBtuh)	307	N/A	553	N/A
Hwcap (kBtuh)	5,000	18,986	11,896	10,215
Tank capacity (kBtu)	12,125	45,807	**	34,436
Tank capacity (gallons)	35,000	141,000	**	53,000
Tank doubles as fire water storage?	No	Yes	Yes	Yes
First Cost Savings (\$)	*	1,500,000	6,725,003	2,200,000
First cost savings (\$/ft ²)	*	\$ 1.36	\$ 6.57	\$ 3.06

*For the Santa Clara site, TIER was the base bid. The GC indicated that AWHPs was a net cost add but did not provide a hard bid, i.e., TIER was lower cost. The owner opted for TIER since it was lower cost, lower energy use, and lower maintenance.

**Tank size TBD.

Table 89: Detailed Pricing for TIER vs AHP - San Jose Site

All-In System Costs (options)	ASHPs - Heating Only \$	ASHPs - Heating Only \$/sf	ASHP/Chilled Water \$	ASHP/Chilled Water \$/sf	TIER Plant \$	TIER Plant \$/sf
General Conditions	481,226	\$0.47	481,226	\$0.47	481,226	\$0.47
Staking	5,000	\$0.00	5,000	\$0.00	5,000	\$0.00
Concrete	0	\$0.00	0	\$0.00	156,741	\$0.15
Rebar	0	\$0.00	0	\$0.00	37,425	\$0.04
Structural Steel	500,000	\$0.49	500,000	\$0.49	210,000	\$0.21
Misc. Metal	75,000	\$0.07	75,000	\$0.07	32,000	\$0.03
Below Grade Waterproofing	0	\$0.00	0	\$0.00	5,000	\$0.00
Signage	1,000	\$0.00	1,000	\$0.00	1,000	\$0.00
Fire Sprinklers	0	\$0.00	0	\$0.00	26,600	\$0.03
Plumbing	320,000	\$0.31	320,000	\$0.31	320,000	\$0.31
HVAC	17,791,154	\$17.39	17,199,508	\$16.81	11,118,477	\$10.87
Electrical	3,000,000	\$2.93	3,000,000	\$2.93	3,028,623	\$2.96
Design	320,327	\$0.31	320,327	\$0.31	320,327	\$0.31
Subtotal	22,493,707	\$21.99	21,902,061	\$21.41	15,742,419	\$15.39
Contingency	1,124,685	\$1.10	1,095,103	\$1.07	787,121	\$0.77
SDI	236,184	\$0.23	229,972	\$0.22	165,295	\$0.16
Fee	703,710	\$0.69	685,201	\$0.67	492,498	\$0.48
Total	24,558,286	\$24.01	23,912,336	\$23.38	17,187,333	\$16.80

4.4.3.4 Thermal Energy Storage (TES) – Gas Baseline

The incremental cost for TES with a gas baseline was determined via the following steps.

1. First starting with the incremental cost of a TIER system versus an all-electric ASHP baseline. This pricing averages minus \$3.67/ft² and is described above in Table 88 (i.e., TIER costs less than all-electric).
2. We then worked with a mechanical contractor to redesign/reprice the all-electric ASHP baseline for one of the TIER sites to a conventional gas boiler system (basically ACM System 6). This included deleting ASHPs, deleting primary HWP, deleting buffer tanks, adding boilers, and adding new gas service to boilers on the roof. These changes are illustrated in Figure 35 and summarized in Table 93. This exercise indicated that the cost to upgrade from gas boilers to all-electric ASHPs is \$6.74/ft² and \$575/kbtuh.

3. $\$6.74 - \$3.67 = \$3.07/\text{ft}^2 =$ cost to go from System 6 (gas boiler baseline) to TIER w/ ASHP.
4. We then averaged the heating capacity of the 4 TIER sites to arrive at 3.86 btuh/ft² of boiler/ASHP heating capacity for TIER plants (compared to about 12 btuh/ft² without TIER TES).
5. Multiplying the $\$575/\text{kbtuh}$ times 3.86 btuh/ft² indicates that a TIER plant with ASHP costs $\$2.22/\text{ft}^2$ more than a TIER plant with gas boilers.
6. $\$3.07/\text{ft}^2 - \$2.22/\text{ft}^2 = \$0.85/\text{ft}^2 =$ cost to go from System 6 (gas boiler baseline) to TIER w/ gas boilers.

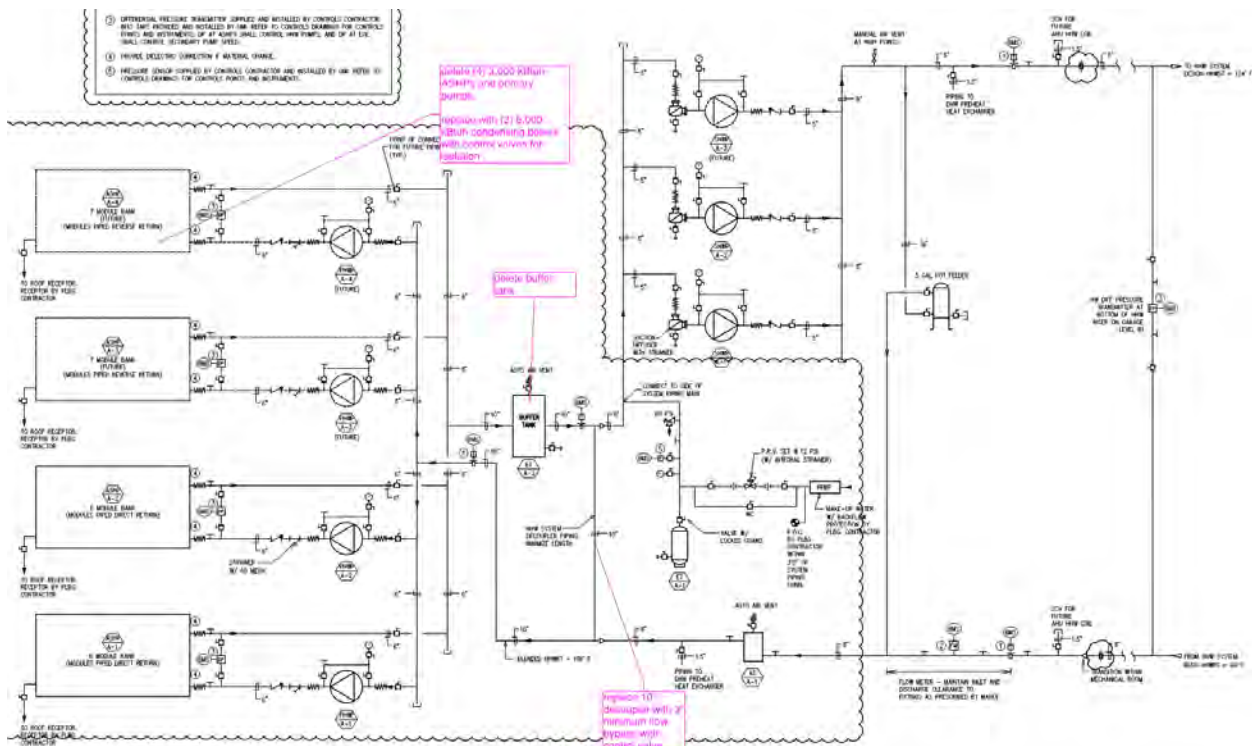

Figure 35: Conversion of All-Electric HW Plant to Gas Heat

Table 90: Incremental Cost for Conversion of All-Electric HW Plant to Gas Heat

Description	Equipment Cost	Other Mech Contractor Cost	Plumbing Contractor Cost	Elec Contractor Cost	Controls Contractor Cost	Total
Delete (2) 420-ton Climacool ASHP (6 modules each)	(\$3,187,800)	(\$24,000)	\$0	(\$100,000)	(\$39,600)	(\$3,351,400)
Delete (2) 490-ton Climacool ASHP (7 modules each)	(\$3,719,100)	(\$24,000)	\$0	(\$100,000)	(\$39,600)	(\$3,882,700)
Add (2) 6,000 MBH condensing boilers such as Aerco Benchmark 6000 or Lochinvar Crest FB6001	\$379,500	\$60,000	0	\$0	\$55,000	\$494,500
Delete (4) primary hot water pumps	(\$48,576)	(\$16,000)	\$0	(\$10,000)	(\$35,200)	(\$109,776)
Delete HHW buffer tank	(\$12,650)	(\$2,000)	\$0	\$0	\$0	(\$14,650)
Add new gas service to boilers on roof	\$0	\$0	\$100,000	\$0	\$0	\$100,000
Add/deduct for HW piping changes (boiler control valves, min flow bypass valve, etc.)	\$0	(\$130,000)	\$0	\$0	\$0	(\$130,000)
Total Costs	(\$6,588,626)	(\$136,000)	\$100,000	(\$210,000)	(\$59,400)	(\$6,894,026)
Building Area (ft2)	N/A	N/A	N/A	N/A	N/A	1,022,981
Normalized Total (\$/ft2)	N/A	N/A	N/A	N/A	N/A	(\$6.74)

4.4.3.5 Incremental Cost for SWH Heat Recovery

Bay Area equipment reps, mechanical contractors, controls contractors and service contractors provided incremental cost data to add SWH heat recovery on a \$/kBtuh of HR capacity basis, shown in Table 91.

Table 91: Pricing for SWH Heat Recovery

Parameter	Value
HX 2-1 gpm	7.1
HX dT	55
HX kbtuh	195
Pipe size	1"
Pipe cost (\$/LF)	\$111
LF of pipe mech	104
LF of pipe plumbing	20
LF of pipe	124
Cost of piping	\$13,764
Cost of HX	\$6,540
Install cost of HX, excluding piping above	\$1,200
Incremental controls per HX (see pts and SOO below)	\$6,500
Incremental annual maintenance cost per HX	\$0
Maintenance multiplier	19.60
NPV of maintenance	\$0
Incremental cost	\$28,004
Incremental cost \$/kBtuh of HR capacity	\$143

4.4.4 Incremental Maintenance and Replacement Costs

Incremental maintenance cost is the incremental cost of replacing the equipment or parts of the equipment, as well as periodic maintenance required to keep the equipment operating relative to current practices over the 30-year period of analysis. The present value of equipment maintenance costs (or savings) was calculated using a three percent discount rate (d), which is consistent with the discount rate used when developing the 2025 LSC hourly factors. The present value of maintenance costs that occurs in the nth year is calculated as follows:

$$\text{Present Value of Maintenance Cost} = \text{Maintenance Cost} \times \left[\frac{1}{1+d} \right]^n$$

The incremental maintenance and replacement costs for Simultaneous Heat Recovery were provided by a Bay Area mechanical and service contractor and are listed in Table 86.

For heat recovery with TES, maintenance and replacement costs are expected to be lower for the proposed case because there are fewer AWHPs to maintain and replace. Incremental maintenance costs for this measure were not quantified. This aspect is not needed to demonstrate cost effectiveness since the proposed case has lower first costs, lower energy costs and lower maintenance/replacement costs than the base case.

4.4.5 Cost Effectiveness

This measure proposes a prescriptive requirement for builders who have chosen to pursue an all-electric design. As such, a cost analysis is required to demonstrate that the measure is cost effective over the 30-year period of analysis.

The CEC establishes the procedures for calculating cost effectiveness. The Statewide CASE Team collaborated with CEC staff to confirm that the methodology in this report is consistent with their guidelines, including which costs were included in the analysis. The incremental first cost and incremental maintenance costs over the 30-year period of analysis were included. The LSC savings from electricity savings were also included in the evaluation. Design costs were not included nor were the incremental costs of code compliance verification.

According to the CEC's definitions, a measure is cost effective if the benefit-to-cost (B/C) ratio is greater than 1.0. The B/C ratio is calculated by dividing the cost benefits realized over 30 years by the total incremental costs, which includes maintenance costs for 30 years. The B/C ratio was calculated using 2026 PV costs and cost savings.

Results of the per unit cost-effectiveness analyses are presented in Table 92 for new construction/addition for the condition of heat recovery without thermal energy storage (represented by the hospital prototype). Results of the per unit cost-effectiveness analyses are presented in Table 93 for new construction/addition for the condition of heat recovery with thermal energy storage (represented by the large office prototype) with an electric baseline and Table 94 for the gas baseline case. The B/C ratio is infinite (implying immediate payback) due to the fact that the incremental first cost is negative relative to the baseline design without heat recovery or thermal energy storage. Table 95 shows the cost effectiveness for heat recovery for service hot water. Table 96 and Table 97 show cost effectiveness for scenarios "A" and "B" of the simultaneous cooling and heating measure. Benefits and costs are defined as follows:

- **Benefits: LSC Savings + Other PV Savings:** Benefits include LSC Savings over the period of analysis (California Energy Commission 2022). Other savings are discounted at a real (nominal – inflation) three percent rate. Other PV savings

include incremental first-cost savings if proposed first cost is less than current first cost, incremental PV maintenance cost savings if PV of proposed maintenance costs is less than PV of current maintenance costs, and incremental residual value if proposed residual value is greater than current residual value at end of the CASE analysis period.

- Costs:** Total Incremental Present Valued Costs: Costs include incremental equipment, replacement, and maintenance costs over the period of analysis. Costs are discounted at a real (inflation-adjusted) three percent rate and if PV of proposed maintenance costs is greater than PV of current maintenance costs. If incremental maintenance cost is negative, it is treated as a positive benefit. If there are no total incremental PV costs, the benefit-to-cost ratio is infinite.

Table 92: 30-Year Cost-Effectiveness Summary Per Square Foot – New Construction/Additions – Hospital (Simultaneous Cooling and Heating)

Climate Zone	Benefits LSC Savings + Other PV Savings (2026 PV\$)	Costs Total Incremental PV Costs (2026 PV\$)	Benefit-to-Cost Ratio
1	5.96	0.41	14.39
2	5.77	0.41	13.93
3	4.69	0.41	11.32
4	5.97	0.41	14.43
5	5.28	0.41	12.74
6	4.62	0.41	11.16
7	3.93	0.41	9.48
8	4.56	0.41	11.01
9	4.54	0.41	10.96
10	4.52	0.41	10.91
11	4.56	0.41	11.01
12	5.09	0.41	12.29
13	4.25	0.41	10.26
14	5.91	0.41	14.27
15	3.42	0.41	8.25
16	NA	NA	NA
Total	4.76	0.41	11.49

Table 93: 30-Year Cost-Effectiveness Summary Per Square Foot – New Construction/Additions – Large Office (Thermal Energy Storage - AHP Baseline)

Climate Zone	Benefits LSC Savings + Other PV Savings (2026 PV\$)	Costs Total Incremental PV Costs (2026 PV\$)	Benefit-to-Cost Ratio
1	-	-	-
2	-	-	-
3	1.02	(3.66)	Infinite
4	3.08	(3.66)	Infinite
5	-	-	-
6	1.21	(3.66)	Infinite
7	1.24	(3.66)	Infinite
8	1.46	(3.66)	Infinite
9	1.35	(3.66)	Infinite
10	1.47	(3.66)	Infinite
11	3.02	(3.66)	Infinite
12	2.82	(3.66)	Infinite
13	-	-	-
14	4.55	(3.66)	Infinite
15	1.67	(3.66)	Infinite
16	6.43	(3.66)	Infinite
Total	1.59	(3.66)	Infinite

Table 94: 30-Year Cost-Effectiveness Summary Per Square Foot – New Construction/Additions – Large Office (Thermal Energy Storage - Gas Baseline)

Climate Zone	Benefits LSC Savings + Other PV Savings (2026 PV\$)	Costs Total Incremental PV Costs (2026 PV\$)	Benefit-to-Cost Ratio
1	-	(0.85)	-
2	-	(0.85)	-
3	2.38	(0.85)	Infinite
4	2.31	(0.85)	Infinite
5	-	(0.85)	-
6	1.93	(0.85)	Infinite
7	1.91	(0.85)	Infinite
8	2.15	(0.85)	Infinite
9	2.07	(0.85)	Infinite
10	2.21	(0.85)	Infinite
11	2.68	(0.85)	Infinite

Climate Zone	Benefits LSC Savings + Other PV Savings (2026 PV\$)	Costs Total Incremental PV Costs (2026 PV\$)	Benefit-to-Cost Ratio
12	2.85	(0.85)	Infinite
13	-	(0.85)	-
14	2.97	(0.85)	Infinite
15	2.14	(0.85)	Infinite
16	2.23	(0.85)	Infinite
Total	2.20	(0.85)	Infinite

Table 95: 30-Year Cost-Effectiveness Summary Per Square Foot – New Construction/Additions – Large Office (Heat Recovery for Service Water Heating)

Climate Zone	Benefits LSC Savings + Other PV Savings (2026 PV\$)	Costs Total Incremental PV Costs (2026 PV\$)	Benefit-to-Cost Ratio
1	-	-	-
2	-	-	-
3	0.78	0.27	2.87
4	0.73	0.32	2.32
5	-	-	-
6	0.83	0.25	3.36
7	0.87	0.23	3.80
8	0.83	0.24	3.39
9	0.80	0.25	3.20
10	0.80	0.26	3.11
11	0.70	0.29	2.41
12	0.76	0.28	2.73
13	-	-	-
14	0.76	0.28	2.73
15	NA	NA	NA
16	0.61	0.29	2.11
Total	0.80	0.29	2.94

Table 96: 30-Year Cost-Effectiveness Summary Per Square Foot – New Construction/Additions – Large Office (Simultaneous Heat Recovery for Space Heating and Service Water Heating Scenario A)

Climate Zone	Benefits LSC Savings + Other PV Savings (2026 PV\$)	Costs Total Incremental PV Costs (2026 PV\$)	Benefit-to-Cost Ratio
1	-	-	-
2	-	-	-
3	2.52	0.78	3.22
4	2.60	0.79	3.28
5	-	-	-
6	0.99	0.78	1.27
7	0.93	0.79	1.18
8	0.84	0.79	1.06
9	1.03	0.79	1.30
10	1.17	0.79	1.47
11	2.35	0.79	2.96
12	2.24	0.79	2.84
13	-	0.79	-
14	2.48	0.79	3.16
15	NA	NA	NA
16	3.65	0.77	4.72
Total	2.48	0.79	3.16

Table 97: 30-Year Cost-Effectiveness Summary Per Square Foot – New Construction/Additions – Large Office (Simultaneous Heat Recovery for Space Heating and Service Water Heating Scenario B)

Climate Zone	Benefits LSC Savings + Other PV Savings (2026 PV\$)	Costs Total Incremental PV Costs (2026 PV\$)	Benefit-to-Cost Ratio
1	-	0.84	-
2	-	0.84	-
3	1.42	0.84	1.70
4	1.05	0.84	1.26
5	-	0.84	-
6	1.26	0.84	1.51
7	1.41	0.84	1.69
8	1.07	0.84	1.28
9	1.07	0.84	1.27

Climate Zone	Benefits LSC Savings + Other PV Savings (2026 PV\$)	Costs Total Incremental PV Costs (2026 PV\$)	Benefit-to-Cost Ratio
10	1.04	0.84	1.25
11	0.94	0.84	1.12
12	1.18	0.84	1.41
13	-	0.84	-
14	1.16	0.84	1.38
15	NA	NA	NA
16	1.11	0.84	1.33
Total	1.18	0.84	1.41

4.4.5.1 Cost Effectiveness: Simultaneous Heat Recovery (Gas Baseline)

The energy savings methodology described in Section 4.3.1 was combined with the incremental cost data described in Section 4.4.3.2 to determine the cost effectiveness of the proposed 140.4(r)1 requirement. Parametric analyses were run for Scenario A ($\text{Cooling}_{HL} + 0.1 * \text{Cooling}_{LL} \geq 200 \text{ tons and } \text{SWH}_{cap} + \text{Heating}_{cap} \geq 2200 \text{ kBtu/h}$) and for Scenario B ($\text{Cooling}_{cap} \geq 300 \text{ tons and } \text{SWH}_{cap} + 0.1 * \text{Heating}_{cap} \geq 700 \text{ kBtu/h}$). As shown in Table 95 and Table 96, the measure is cost-effective for both scenarios in all climate zones except Climate Zone 15. This caused us to add Exception 3 to Section 140.4(r)1, which excludes Climate Zone 15 from the requirements unless the building’s peak service water heating loads are greater than 600 kBtu/h, which is roughly the breakeven point for cost-effectiveness based on our parametric analysis.

4.5 First-Year Statewide Impacts

4.5.1 Statewide Energy and Energy Cost Savings

The Statewide CASE Team calculated the first-year statewide savings for new construction and additions by multiplying the per unit savings, which are presented in Section 4.3.2, by assumptions about the percentage of newly constructed buildings that would be impacted by the proposed code. The statewide new construction forecast for 2026 is presented in Appendix A, as are the Statewide CASE Team’s assumptions about the percentage of new construction that would be impacted by the proposal (by climate zone and building type).

The first-year energy impacts represent the first-year annual savings from all buildings that were completed in 2026. The 30-year energy cost savings represent the energy cost savings over the entire 30-year analysis period. The statewide savings estimates do not take naturally occurring market adoption or compliance rates into account.

Table 98 through Table 103 presents the first-year statewide energy and energy cost savings from newly constructed buildings and additions by climate zones.

Table 98: Statewide Energy and Energy Cost Impacts – New Construction and Additions – Hospital – Simultaneous Cooling and Heating

Climate Zone	Statewide New Construction & Additions Impacted by Proposed Change in 2026	First-Year ^a Electricity Savings (GWh)	First-Year Peak Electrical Demand Reduction (MW)	First-Year Natural Gas Savings (Million Therms)	First-Year Source Energy Savings (Million kBtu)	30-Year Present Valued Energy Cost Savings (Million 2026 PV\$)
1	8,524	0.01	0.00	-	0.02	\$0.05
2	50,641	0.05	0.01	(0.00)	0.11	\$0.29
3	244,098	0.19	0.02	-	0.40	\$1.14
4	126,400	0.12	0.02	-	0.30	\$0.76
5	23,122	0.02	0.00	-	0.04	\$0.12
6	95,278	0.07	0.01	-	0.16	\$0.44
7	159,232	0.10	0.02	-	0.23	\$0.63
8	127,966	0.09	0.02	-	0.21	\$0.58
9	228,958	0.17	0.03	0.00	0.37	\$1.04
10	235,745	0.18	0.03	-	0.39	\$1.06
11	42,317	0.03	0.01	-	0.08	\$0.19
12	239,371	0.20	0.03	-	0.47	\$1.22
13	79,152	0.06	0.01	-	0.13	\$0.34
14	41,099	0.04	0.01	0.00	0.11	\$0.24
15	NA	NA	NA	NA	NA	NA
16	13,960	0.02	0.00	-	0.04	\$0.10
Total	1,716,137	1.34	0.22	0.00	3.06	\$8.21

a. First-year savings from all buildings completed statewide in 2026.

Table 99: Statewide Energy and Energy Cost Impacts – New Construction and Additions - Large Office – Thermal Energy Storage (AWHP Baseline)

Climate Zone	Statewide New Construction & Additions Impacted by Proposed Change in 2026	First-Year^a Electricity Savings (GWh)	First-Year Peak Electrical Demand Reduction (MW)	First-Year Natural Gas Savings (Million Therms)	First-Year Source Energy Savings (Million kBtu)	30-Year Present Valued Energy Cost Savings (Million 2026 PV\$)
1	0	0.00	0.00	0.00	0.00	\$0.00
2	0	0.00	0.00	0.00	0.00	\$0.00
3	870,269	0.15	0.04	0.00	0.39	\$0.89
4	424,640	0.21	0.05	0.00	0.56	\$1.31
5	0	0.00	0.00	0.00	0.00	\$0.00
6	382,660	0.10	0.00	0.00	0.08	\$0.46
7	222,008	0.06	0.00	0.00	0.04	\$0.28
8	615,701	0.19	0.01	0.00	0.19	\$0.90
9	1,117,303	0.31	0.02	0.00	0.37	\$1.51
10	105,380	0.03	0.00	0.00	0.04	\$0.16
11	29,278	0.01	0.00	0.00	0.04	\$0.09
12	154,652	0.07	0.02	0.00	0.18	\$0.44
13	0	0.00	0.00	0.00	0.00	\$0.00
14	53,874	0.04	0.01	0.00	0.11	\$0.24
15	3,506	0.00	0.00	0.00	0.00	\$0.01
16	13,442	0.01	0.00	0.00	0.03	\$0.09
Total	3,992,712	1.18	0.16	0.00	2.04	\$6.36

a. First-year savings from all buildings completed statewide in 2026.

Table 100: Statewide Energy and Energy Cost Impacts – New Construction and Additions - Large Office – Thermal Energy Storage (Gas Baseline)

Climate Zone	Statewide New Construction & Additions Impacted by Proposed Change in 2026	First-Year^a Electricity Savings (GWh)	First-Year Peak Electrical Demand Reduction (MW)	First-Year Natural Gas Savings (Million Therms)	First-Year Source Energy Savings (Million kBtu)	30-Year Present Valued Energy Cost Savings (Million 2026 PV\$)
1	0	0.00	0.00	0.00	0.00	\$0.00
2	0	0.00	0.00	0.00	0.00	\$0.00
3	1,450,449	0.02	-0.02	0.06	5.52	\$3.45
4	707,733	0.07	0.00	0.02	2.23	\$1.64
5	0	0.00	0.00	0.00	0.00	\$0.00
6	637,767	0.14	0.00	0.01	1.02	\$1.23
7	370,013	0.10	0.00	0.01	0.50	\$0.71
8	1,026,168	0.25	0.00	0.02	1.82	\$2.20
9	1,862,172	0.38	0.00	0.04	3.55	\$3.85
10	175,633	0.03	0.00	0.00	0.39	\$0.39
11	48,797	0.01	0.00	0.00	0.17	\$0.13
12	257,753	0.03	0.00	0.01	0.99	\$0.74
13	0	0.00	0.00	0.00	0.00	\$0.00
14	89,790	0.01	0.00	0.00	0.34	\$0.27
15	5,844	0.00	0.00	0.00	0.01	\$0.01
16	22,403	0.00	0.00	0.00	0.07	\$0.05
Total	6,654,520	1.03	-0.03	0.18	16.61	\$14.66

a. First-year savings from all buildings completed statewide in 2026.

Table 101: Statewide Energy and Energy Cost Impacts – New Construction and Additions - Large Office – Heat Recovery for Service Water Heating

Climate Zone	Statewide New Construction & Additions Impacted by Proposed Change in 2026	First-Year^a Electricity Savings (GWh)	First-Year Peak Electrical Demand Reduction (MW)	First-Year Natural Gas Savings (Million Therms)	First-Year Source Energy Savings (Million kBtu)	30-Year Present Valued Energy Cost Savings (Million 2026 PV\$)
1	571	0.00	0.00	0.00	0.00	\$0.00
2	11,215	0.01	0.00	0.00	0.01	\$0.03
3	367,274	0.07	0.00	0.00	0.07	\$0.34
4	180,469	0.04	0.00	0.00	0.04	\$0.18
5	3,203	0.00	0.00	0.00	0.00	\$0.00
6	179,894	0.04	0.00	0.00	0.04	\$0.20
7	127,603	0.04	0.00	0.00	0.04	\$0.17
8	284,982	0.07	0.00	0.00	0.06	\$0.31
9	497,625	0.10	0.00	0.00	0.10	\$0.49
10	110,320	0.04	0.00	0.00	0.04	\$0.17
11	40,991	0.01	0.00	0.00	0.02	\$0.07
12	153,042	0.05	0.00	0.00	0.06	\$0.26
13	54,173	0.02	0.00	0.00	0.03	\$0.11
14	32,591	0.01	0.00	0.00	0.01	\$0.04
15	NA	NA	NA	NA	NA	NA
16	10,480	0.00	0.00	0.00	0.00	\$0.01
Total	2,054,431	0.50	0.00	0.00	0.53	\$2.39

a. First-year savings from all buildings completed statewide in 2026.

Table 102: Statewide Energy and Energy Cost Impacts – New Construction and Additions - Large Office – Simultaneous Heat Recovery for Space Heating and Service Water Heating Scenario A

Climate Zone	Statewide New Construction & Additions Impacted by Proposed Change in 2026	First-Year ^a Electricity Savings (GWh)	First-Year Peak Electrical Demand Reduction (MW)	First-Year Natural Gas Savings (Million Therms)	First-Year Source Energy Savings (Million kBtu)	30-Year Present Valued Energy Cost Savings (Million 2026 PV\$)
1	0	0.00	0.00	0.00	0.00	\$0.00
2	0	0.00	0.00	0.00	0.00	\$0.00
3	145,045	(0.07)	(0.01)	0.01	1.11	\$0.37
4	70,773	(0.04)	0.00	0.01	0.56	\$0.18
5	0	0.00	0.00	0.00	0.00	\$0.00
6	63,777	(0.01)	0.00	0.00	0.20	\$0.06
7	37,001	(0.01)	0.00	0.00	0.09	\$0.03
8	102,617	(0.03)	0.00	0.00	0.31	\$0.09
9	186,217	(0.06)	0.00	0.01	0.67	\$0.19
10	17,563	(0.01)	0.00	0.00	0.07	\$0.02
11	4,880	(0.00)	0.00	0.00	0.03	\$0.01
12	25,775	(0.01)	0.00	0.00	0.17	\$0.06
13	0	0.00	0.00	0.00	0.00	\$0.00
14	8,979	(0.00)	0.00	0.00	0.06	\$0.02
15	NA	NA	NA	NA	NA	NA
16	2,240	(0.00)	0.00	0.00	0.02	\$0.01
Total	664,868	(0.24)	(0.01)	0.04	3.31	\$1.04

a. First-year savings from all buildings completed statewide in 2026.

Table 103: Statewide Energy and Energy Cost Impacts – New Construction and Additions - Large Office – Simultaneous Heat Recovery for Space Heating and Service Water Heating Scenario B

Climate Zone	Statewide New Construction & Additions Impacted by Proposed Change in 2026	First-Year ^a Electricity Savings (GWh)	First-Year Peak Electrical Demand Reduction (MW)	First-Year Natural Gas Savings (Million Therms)	First-Year Source Energy Savings (Million kBtu)	30-Year Present Valued Energy Cost Savings (Million 2026 PV\$)
1	0	0.00	0.00	0.00	0.00	\$0.00
2	0	0.00	0.00	0.00	0.00	\$0.00
3	145,045	0.02	0.00	0.00	0.23	\$0.21
4	70,773	0.01	0.00	0.00	0.07	\$0.07
5	0	0.00	0.00	0.00	0.00	\$0.00
6	63,777	0.01	0.00	0.00	0.07	\$0.08
7	37,001	0.01	0.00	0.00	0.04	\$0.05
8	102,617	0.01	0.00	0.00	0.08	\$0.11
9	186,217	0.02	0.00	0.00	0.16	\$0.20
10	17,563	0.00	0.00	0.00	0.02	\$0.02
11	4,880	0.00	0.00	0.00	0.01	\$0.00
12	25,775	0.00	0.00	0.00	0.04	\$0.03
13	0	0.00	0.00	0.00	0.00	\$0.00
14	8,979	0.00	0.00	0.00	0.01	\$0.01
15	NA	NA	NA	NA	NA	NA
16	NA	NA	NA	NA	NA	NA
Total	664,868	0.09	0.00	0.01	0.72	\$0.79

a. First-year savings from all buildings completed statewide in 2026.

4.5.2 Statewide Greenhouse Gas (GHG) Emissions Reductions

The Statewide CASE Team calculated avoided GHG emissions associated with energy consumption using the hourly GHG emissions factors that CEC developed along with the 2025 LSC hourly factors and an assumed cost of \$123.15 per metric tons of carbon dioxide equivalent emissions (metric tons CO₂e).

The 2025 LSC hourly factors used in the lifecycle cost-effectiveness analysis include the monetary value of avoided GHG emissions based on a proxy for permit costs (not

social costs).²¹ The Cost-Effectiveness Analysis presented in Section 4.4 of this report does not include the cost savings from avoided GHG emissions. To demonstrate the cost savings of avoided GHG emissions, the Statewide CASE Team disaggregated the value of avoided GHG emissions from the other economic impacts. The authors used the same monetary values that are used in the LSC hourly factors.

Table 104 presents the estimated first-year avoided GHG emissions of the proposed code change. During the first year, GHG emissions of 1,550 (metric tons CO₂e) would be avoided.

Table 104: First-Year Statewide GHG Emissions Impacts

Measure	Electricity Savings ^a (GWh/yr)	Reduced GHG Emissions from Electricity Savings ^a (Metric Tons CO ₂ e)	Natural Gas Savings ^a (Million Therms/yr)	Reduced GHG Emissions from Natural Gas Savings ^a (Metric Tons CO ₂ e)	Total Reduced GHG Emissions ^b (Metric Ton CO ₂ e)	Total Monetary Value of Reduced GHG Emissions ^c (\$)
Simultaneous cooling and heating	1.34	162	0	0	162	19,930
Thermal Energy Storage	2.21	117	0	995	1,112	136,931
Heat Recovery for Service Water Heating	0.35	-0.45	0.05	276	276	33,966
TOTAL	3.90	279	0.05	1,271	1,550	156,895

- a. First-year savings from all buildings completed statewide in 2026.
- b. GHG emissions savings were calculated using hourly GHG emissions factors are published alongside the in the LSC hourly factors and Source Energy factors by CEC here: <https://www.energy.ca.gov/files/2025-energy-code-hourly-factors>
- c. The monetary value of avoided GHG emissions is based on a proxy for permit costs (not social costs) derived from the 2022 TDV Update Model published by CEC here: <https://www.energy.ca.gov/files/tdv-2022-update-model>

4.5.3 Statewide Water Use Impacts

Systems configured to reject heat to a thermal energy storage tank instead of a cooling tower will likely experience water savings due to the reduced runtime hours of the cooling towers. The Statewide CASE Team quantified this impact per prototype building. Since energy use of the proposed design was calculated using spreadsheet-

²¹ The permit cost of carbon is equivalent to the market value of a unit of GHG emissions in the California Cap-and-Trade program, while social cost of carbon is an estimate of the total economic value of damage done per unit of GHG emissions. Social costs tend to be greater than permit costs. See more on the Cap-and-Trade Program on the California Air Resources Board website: <https://ww2.arb.ca.gov/our-work/programs/cap-and-trade-program>.

based calculation instead of EnergyPlus, water use was also calculated in a spreadsheet and was estimated based on the energy rejected through the cooling tower. The methodology included multiplying the heat rejection energy by 970 Btu/lb of water, then converting this to volume using the conversion factor of 8.33 gallons/lb. In this calculation, it was assumed that the cooling tower operated at three cycles of concentration, which resulted in two-thirds of the water being evaporated and one-third being bled by the system. The water consumption in the baseline design was automatically calculated by EnergyPlus. The water savings for large office are shown in Table 105.

Table 105: Water Savings for Heat Recovery + Thermal Energy Storage Measure – Large Office

Climate Zone	Baseline Design (2-pipe AWP) Water Consumption (gal)	Proposed Design (HR+TES) Water Consumption (gal)	Water Savings (gal)	Water Savings per square foot (gal/sf)	Water Savings (%)
1	275,808	52,376	223,431	0.45	81%
2	2,486,360	1,922,472	563,889	1.13	23%
3	1,228,853	769,926	458,926	0.92	37%
4	3,775,740	2,946,546	829,194	1.66	22%
5	1,591,649	1,094,418	497,230	1.00	31%
6	2,885,407	2,332,422	552,985	1.11	19%
7	3,095,797	2,352,232	743,565	1.49	24%
8	4,656,727	3,872,690	784,037	1.57	17%
9	4,462,902	3,615,566	847,336	1.70	19%
10	5,237,088	4,273,836	963,252	1.93	18%
11	5,163,694	3,799,292	1,364,401	2.74	26%
12	3,669,018	2,770,798	898,219	1.80	24%
13	5,415,562	3,980,302	1,435,260	2.88	27%
14	4,847,060	3,833,080	1,013,980	2.03	21%
15	9,824,976	7,010,338	2,814,639	5.64	29%
16	1,823,684	1,414,014	409,670	0.82	22%

4.5.4 Statewide Material Impacts

This measure is expected to result in small changes to materials. The simultaneous cooling and heating measure (140.4(r)1) would result in a minor change in hydronic equipment configuration. The Thermal Energy Storage measure (140.4(r)2) would result in additional thermal energy storage equipment specification which would be offset by reduced AWP equipment specifications. Material impacts have not been quantified.

4.5.5 Other Non-Energy Impacts

This measure is not expected to result in any non-energy impacts.

4.6 Addressing Energy Equity and Environmental Justice

4.6.1 Research Methods and Engagement

The Statewide CASE Team considered the impacts of the proposal on DIPs using four criteria: cost, health, resiliency, and comfort. The details of these criteria and more examples can be found in Section 2.1.2.

4.6.2 Potential Impacts

The purpose of this code change is to guide mechanical designers toward efficient system configurations for all-electric designs in large buildings. Future revisions to the code language being proposed may target smaller buildings, but for this cycle, the Statewide CASE Team intends to only target the largest and most complex buildings being constructed. The new requirements of thermal energy storage and heat recovery are complex and major changes to current practice, but because it only impacts large buildings, this will reduce the impact on DIPs since there are relatively few large buildings constructed. Furthermore, our analysis shows that inclusion of thermal energy storage reduces upfront construction costs (at the expense of a more complex system), which is a benefit to all practitioners, including DIPs.

Furthermore, the proposal only applies to buildings that are already pursuing all-electric space heating, so the requirements will only apply to the largest all-electric buildings in the state. This gives the Statewide CASE Team reason to believe that DIPs will not be adversely impacted by this measure. Furthermore, the requirements in this measure are cost-effective and with the inclusion of thermal energy storage, also reduce first costs.

Impacts may vary by building type. Offices of all sizes, for example, are expected to be used by all people equally and DIPs are not more or less likely to occupy office spaces than any other population. So, the proposed change is not expected to have an unequal impact on DIPs. The Statewide CASE Team identified schools and hotels as building types that may have disproportional impacts. The impact of the proposed code changes on building types are discussed in Section 2.1.2.1.

5. Electric Resistance Heating

5.1 Measure Description

5.1.1 Proposed Code Change

This measure proposes updates to prescriptive language limiting electric resistance for space heating at 140.4(g). The current ban on electric resistance heating is wide ranging and includes electric boilers, electric furnaces (except as backup for heat pumps) and electric resistance VAV reheat. There are currently six exceptions allowing various configurations that presumably don't consume much resistance electricity. The prescriptive ban on electric boilers and unitary furnaces would remain, but the code would be updated to allow electric resistance heat for spaces with decoupled ventilation, assuming certain energy efficient conditions are met. The proposal includes some editorial cleanup to the remainder of the exceptions to 140.4(g).

For additions, Exception 2 to 141.0(a) would be deleted. This exception allowed electric resistance heat for a narrow range of conditions, and our intent is to broaden its applicability. The requirements specified in the new exception to 140.4(g) that would ensure the existing building would not consume too much electric reheat energy would be preserved.

5.1.2 Justification and Background Information

5.1.2.1 Justification

Recent research conducted by the UC Berkeley Center for the Built Environment (CBE) has demonstrated a low rate of delivery of input boiler energy to useful heating at the occupied zone level (Rafferty 2018). This study put the fraction at [17 percent of input energy](#). It is likely that a newly constructed hydronic system with Title 24 compliant HVAC controls and a condensing boiler would perform better than an existing building with higher operating hours and a less efficient boiler, making the example where 17 percent of input energy is delivered to zones as useful heating somewhat of an extreme example. However, due to the significantly lower upfront costs and increasingly clean electric grid, electric resistance heating is appealing as an alternative to installing a hydronic system altogether, if the heating loads are small enough.

5.1.2.2 Background Information

Electric resistance heating has long been prescriptively banned in Section 140.4(g). However, recent research pointing to the inefficiencies in the hydronic system distribution network (Rafferty 2018) and a steady shift toward cleaner electricity (spurred by [utility renewables portfolio standards](#) and legislation such as [SB 32](#) and [SB 100](#))

have resulted in a need to revisit the tradeoff between hydronic and electric resistance (ER) heating. Electric boilers retain the least attractive characteristics of hydronic heating (i.e., expensive piping networks and distribution losses which reduce efficiency) and deserve to remain prescriptively banned, however, airside electric resistance heating at the zone level can be a compelling alternative to hydronic heating systems. This is because zone-level ER heating avoids the thermal distribution losses from an ER boiler hydronic system and is cheaper as well. The inherent drawback to any resistance heating is the fact that the efficiency is capped at a 1.0 COP, which is easily surpassed by heat pumps. However, as demonstrated by UC Berkeley CBE research, a gas fired boiler hydronic space heating system falls well short of its traditionally assumed efficiency level for several reasons: the greater runtime hours of hydronic space heating systems than assumed, distribution system thermal losses when the building is economizing or in mechanical cooling mode, and poor gas boiler efficiency encountered in low part-load conditions. These factors are described in greater detail in Section 3.3.1.1 to support the Limit HWST energy savings but they are pertinent to this measure as well.

These significant downsides to hydronic systems present an opportunity to allow designers to bypass the need for a hydronic distribution system in favor of a zone-level ER heating system. The zone-level ER system option should only be pursued for sites with a relatively minimal heating load, otherwise the inefficient resistance heating (relative to heat pump hydronics) becomes too expensive to be justified. However, if heating loads can be sufficiently minimized, the lower upfront cost of the zone-level ER heating system design can be cost-effective. Adding an exception to 140.4(g) to allow zone-level ER heating with conditions to ensure low heating loads would provide a cost-effective all-electric space heating option for designers. Buildings could leverage a combination of hydronic and ER zones, since the requirement is intended to apply at the zone level. A building comprising VRF or some form of hydronic heat pumps (e.g., radiant AWHP, WSHP, TIER) in high heating load zones and then ER in low heating load zones could comply if all clauses are met.

The PG&E Code Readiness team conducted a series of designer interviews with a focus on understanding current space heating electrification options (Bulger 2023). In the report, designers cited the opportunity of electric resistance heating but noted that it is generally only viable when paired with an efficient building envelope and other measures such as energy recovery ventilation to assist with shrinking the space heating loads.

5.1.2.3 Reducing Heating Loads

The proposed Exception 7 to Section 140.4(g) minimizes heating loads in several ways (the quotes are the actual proposed code language):

- a) “the zone is not served by a hydronic heating system” – this eliminates the piping losses described in detail in Section 3.3.1.1.
- b) “Each heating zone serves no more than one cooling zone and each cooling zone serves no more than one heating zone” – This one-to-one relationship between heating/cooling zones minimizes simultaneous heating/cooling and fighting, which can occur with large heating zones that overlap with multiple smaller cooling zones – e.g., a perimeter heating system with one zone per exposure or a radiant floor heating system with large zones.
- c) “The primary airflow delivered to the zone at design heating conditions does not exceed the minimum required for ventilation.” This further minimizes reheat by requiring equipment like fan-powered boxes or radiant heat in perimeter zones. It effectively prohibits single duct VAV reheat boxes with electric resistance in perimeter zones because the primary airflow needed to be reheated to meet the peak heating load would exceed the ventilation minimum. A fan-powered VAV box, on the other hand, can deliver just the ventilation minimum while heating secondary/return air to meet the peak heating load. Note that this does not prohibit single duct VAV reheat boxes with electric resistance in interior zones because the peak heating load in interior zones can be satisfied by just reheating the minimum ventilation.
- d) “All spaces with Note F in Table 120.1-A have occupant sensor ventilation controls meeting 120.1(d)5.A to G.” Figure 36 through Figure 39 include Table 120.1-A along with markup and commentary to illustrate the opacity of complying with occupied standby requirements. Note F designates the space types that are allowed to reduce ventilation to zero in occupied-standby mode. There are 28 space types in Table 120.1-A where occupied-standby ventilation is allowed. Section 120.1(d)5 requires occupied-standby ventilation where the lighting sections 130.1(c)5, 6 and 7 require occupancy sensors. These lighting sections effectively only require occupied standby in about 6 of the 28 space types where occupied standby is allowed (shaded pink in the Title 24 Table 120.1-A below). This clause would require occupied-standby in the other 22 space types where it is currently not required, including break rooms, coffee stations, bedroom/living room, barracks sleeping areas, lobbies/pre-function, large multipurpose rooms, public assembly spaces such as religious worship, courtrooms, and museums, malls, supermarkets, sports spectator areas, and entertainment stages (see yellow highlights below). We also expect that this clause will draw attention to the existing occupied standby requirement and thus improve compliance and enforcement for the six space types where it is already required.
- e) “The zone does not have continuous exhaust makeup air or pressurization requirements that require an outdoor air rate greater than 0.15 cfm/ft²”. This excludes spaces like kitchens and labs that have outdoor air rates and thus high

heating loads. Note that spaces with high exhaust rates like kitchens and labs do not necessarily require high outdoor air rates if there is a significant amount of transfer air available for exhaust makeup. We expect this will improve compliance and enforcement of the existing transfer air requirements in Sections 140.4(o) and 140.9(b)2.

TABLE 120.1-A– Minimum Ventilation Rates

Occupancy Category	Total Outdoor Air Rate ¹ R _t (cfm/ft ²)	Min Ventilation Air Rate for DCV R _v (cfm/ft ²)	Air Class	Notes
Educational Facilities				
Daycare (through age 4)	0.21	0.15	2	
Daycare sickroom	0.15		3	
Classrooms (ages 5-8)	0.38	0.15	1	
Classrooms (age 9 -18)	0.38	0.15	1	
Lecture/postsecondary classroom	0.38	0.15	1	F
Lecture hall (fixed seats)	-	0.15	1	F
Art classroom	0.15		2	
Science laboratories	0.15		2	
University/college laboratories	0.15		2	
Wood/metal shop	0.15		2	
Computer lab	0.15		1	
Media center	0.15		1	A
Music/theater/dance	1.07	0.15	1	F
Multipurpose assembly	0.5	0.15	1	F

PINK ones are required to have occ sensors in 130.1.c.5,6,7

130.1.c.5 just says "classrooms of any size". Is a lecture hall a classroom or an assembly space?

YELLOW ones are NOT required to have occ sensors in 130.1.c.5,6,7

130.1.c.5 only requires for multipurpose rooms < 1,000 sf

Figure 36: Markup Illustrating Occupied Standby Requirements in Table 120.1-A (Top of Table)

Occupancy Category	Total Outdoor Airflow Rate ¹ R _t cfm/ft ²	Min Ventilation Air Rate for DCV R _v (cfm/ft ²)	Air Class	Notes
Food and Beverage Service				
Restaurant dining rooms	0.5	0.15	2	
Cafeteria/fast-food dining	0.5	0.15	2	
Bars, cocktail lounges	0.5	0.2	2	
Kitchen (cooking)	0.15		2	
General				
Break rooms	0.5	0.15	1	F
Coffee Stations	0.5	0.15	1	F
Conference/meeting	0.5	0.15	1	F
Corridors	0.15		1	F
Occupiable storage rooms for liquids or gels	0.15		2	B
Hotels, Motels, Resorts, Dormitories				
Bedroom/living room	0.15		1	F
Barracks sleeping areas	0.15		1	F
Laundry rooms, central	0.15		2	
Laundry rooms within dwelling units	0.15		1	
Lobbies/pre-function	0.5	0.15	1	F
Multipurpose assembly	0.5		1	F
Office Buildings				
Breakrooms	0.5	0.15	1	
Main entry lobbies	0.5	0.15	1	F
Occupiable storage rooms for dry materials	0.15		1	
Office space	0.15		1	F
Reception areas	0.15		1	F
Telephone/data entry	0.15		1	F
Miscellaneous Spaces				
Bank vaults/safe deposit	0.15		2	F
Banks or bank lobbies	0.15		1	F
Computer (not printing)	0.15		1	F
Freezer and refrigerated spaces (<50oF)	-		2	E
General manufacturing (excludes heavy industrial and process using chemicals)	0.15		3	

130.1 only lists multipurpose < 1,000 sf

Figure 37: Markup Illustrating Occupied Standby Requirements in Table 120.1-A (Middle of Table, 1 of 2)

Occupancy Category	Total Outdoor Airflow Rate ¹ R _t cfm/ft ²	Min Ventilation Air Rate for DCV R _v (cfm/ft ²)	Air Class	Notes
Pharmacy (prep. Area)	0.15		2	
Photo studios	0.15		1	
Shipping/receiving	0.15		2	B
Sorting, packing, light assembly	0.15		2	
Telephone closets	0.15		1	
Transportation waiting	0.5	0.15	1	F
Warehouses	0.15		2	B
All others	0.15		2	
Public Assembly Spaces				
Auditorium seating area	1.07	0.15	1	F
Places of religious worship	1.07	0.15	1	F
Courtrooms	0.19	0.15	1	F
Legislative chambers	0.19	0.15	1	F
Libraries (reading rooms and stack areas)	0.15		1	
Lobbies	0.5	0.15	1	F
Museums (children's)	0.25	0.15	1	
Museums/galleries	0.25	0.15	1	F
Residential				
Common corridors	0.15		1	F
Retail				
Sales (except as below)	0.25	0.2	2	
Mall common areas	0.25	0.15	1	F
Barbershop	0.4		2	
Beauty and nail salons	0.4		2	
Pet shops (animal areas)	0.25	0.15	2	
Supermarket	0.25	0.2	1	F
Coin-operated laundries	0.3		2	
Sports and Entertainment				
Gym, sports arena (play area)	0.5	0.15	2	E
Spectator areas	0.5	0.15	1	F
Swimming (pool)	0.15		2	C

Figure 38: Markup Illustrating Occupied Standby Requirements in Table 120.1-A (Middle of Table, 2 of 2)

Occupancy Category	Total Outdoor Airflow Rate ¹ R _t cfm/ft ²	Min Ventilation Air Rate for DCV R _v (cfm/ft ²)	Air Class	Notes
Swimming (deck)	0.5	0.15	2	C
Disco/dance floors	1.5	0.15	2	F
Health club/aerobics room	0.15		2	
Health club/weight rooms	0.15		2	
Bowling alley (seating)	1.07	0.15	1	
Gambling casinos	0.68	0.15	1	
Game arcades	0.68	0.15	1	
Stages, studios	0.5	0.15	1	D, F

General footnotes for Table 120.1-A:

¹ R_t is determined as being the larger of the area method and the default per person method. The occupant density used in the default per person method is one half of the maximum occupant load assumed for egress purposes in the CBC.

Specific Notes:

A – For high-school and college libraries, the values shown for “Public Assembly Spaces – Libraries” shall be used.

B – Rate may not be sufficient where stored materials include those having potentially harmful emissions.

C – Rate does not allow for humidity control. “Deck area” refers to the area surrounding the pool that is capable of being wetted during pool use or when the pool is occupied. Deck area that is not expected to be wetted shall be designated as an occupancy category.

D – Rate does not include special exhaust for stage effects such as dry ice vapors and smoke.

E – Where combustion equipment is intended to be used on the playing surface or in the space, additional dilution ventilation, source control, or both shall be provided.

F – Ventilation air for this occupancy category shall be permitted to be reduced to zero when the space is in occupied-standby mode.

Figure 39: Markup Illustrating Occupied Standby Requirements in Table 120.1-A (Bottom of Table)

- f) “All spaces with R_t ≥ 0.3 in Table 120.1-A have demand control ventilation meeting 120.1(d)4.” This basically requires DCV in the same space types where DCV is required by section 120.1(d)3 but 120.1(d)3 has several exceptions,

including systems with no economizer, no modulating OA control, and OA < 3,000 cfm. This clause removes the exceptions to DCV. Not only does this expand coverage of DCV but the Statewide CASE Team expects that tying it to the ER exception will also improve compliance and enforcement of the existing DCV requirements.

- g) “Computer room hot aisle air shall be transferred to the zone in heating.”
Computer room hot aisle air is considered “available” if there is a computer room with a design equipment load > 12 kW on the same floor and within 30 feet of the zone and > 50 percent of the heat from the computer room is not otherwise being recovered for space heating. Computer rooms are a tremendous and largely untapped sources of free heat for space heating. There are many ways to recover heat from computer rooms for space heat. One of the simplest and most efficient ways is to directly transfer air from the computer room hot aisle to spaces in heating. Title 24 Part 6 requires hot/cold aisle containment for computer rooms over 10 kW. With containment the hot aisle air is typically 90-100 °F, which is the perfect temperature for space heating.

Data centers, which are just very large computer rooms, always have office spaces that require heating. It is common to use a dual fan dual duct system in a data center to meet all the office heating needs but it is also common to have backup electric resistance heat to serve the office while the data center is being populated or when the data center is offline (e.g., during a major refresh). Figure 40 is from a data center office space that uses VAV boxes with electric resistance heat in the building interior. The perimeter uses fan powered boxes with secondary air ducted from the data center hot aisle and backup electric resistance heat. Figure 41 is the schematic from a data center office space that uses a dual fan dual duct system. The data center provides all the heat in normal operation but the hot deck air handler includes a backup electric resistance heating coil for periods when the data center is offline. The figures are meant to show where ER could be used and where computer room waste heat could satisfy a portion of the space heating load, thus offsetting the ER heating demand.

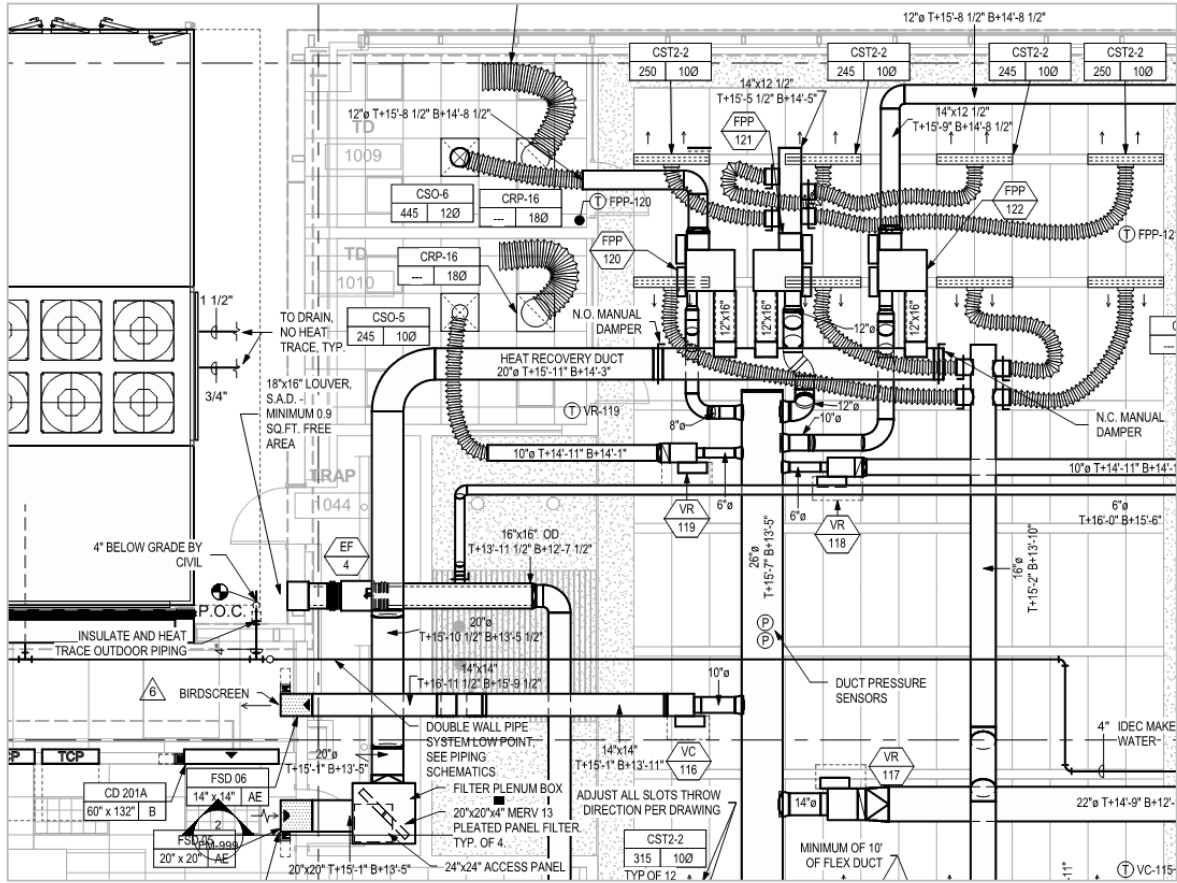

Figure 40: Data Center Office Space with Heat Recovery to Fan Powered Boxes

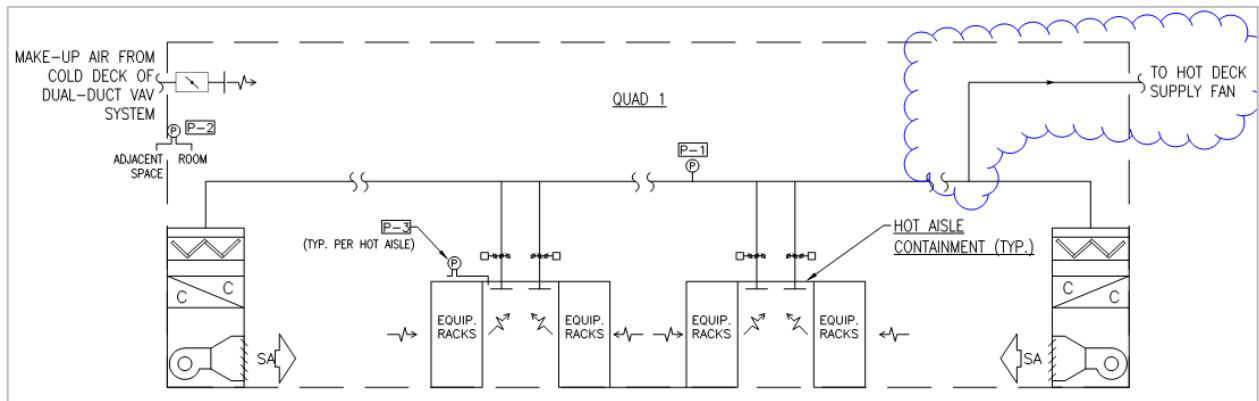

Figure 41: Data Center Dual Fan Dual Duct Heat Recovery Schematic

Just as all data centers have an office component, many offices and other commercial buildings have a computer room component that can satisfy a significant fraction of the office's space heating needs. An informal survey of 10 office buildings indicates that about half of them have computer rooms over 10 kW with available transfer air.

Figure 42 is a section of an office floor plan with an individual distribution frame (IDF) computer room. This computer room is served by a 6-ton (20 kW) fan coil. It is also served by a cooling-only VAV box to provide economizer cooling as required for computer rooms by Exception 2 to Section 140.9(a)1. The surrounding office spaces are served by VAV boxes with HW reheat.

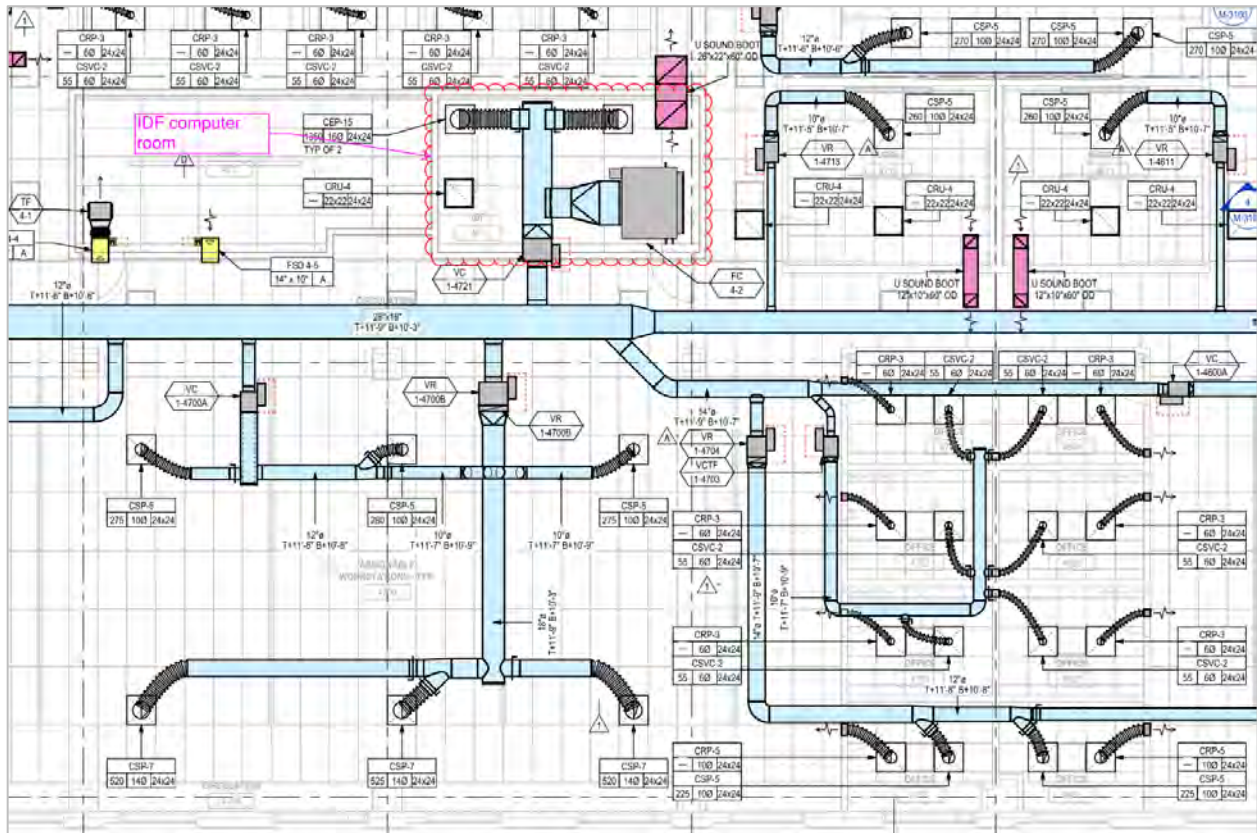

Figure 42: Office Computer Room Without Transfer Air

Figure 43 is the same office space converted to electric resistance heat. The interior reheat boxes are single duct electric reheat boxes. The perimeter boxes are changed to parallel fan powered boxes with electric heat. The fan boxes near the computer room draw their secondary air from the ceiling space of the computer room. The computer room ceiling space is connected to the computer room hot aisle by the return grille in the computer room ceiling. If the computer room load is low and there is minimal available transfer air, then the fan boxes simply pull return air through the computer room return air sound boot and modulate their electric resistance coils as needed. Note that one of the keys to heating with computer room transfer air is making sure the hot aisle stays hot, even at low load. In this case that is accomplished by locating the computer room VAV box and fan coil thermostats in the cold aisle and maintaining the cold aisle at 75 °F (VAV box) and 78 °F (fan coil). The fan coil speed is modulated to

maintain the cold/hot aisle differential pressure at 0.01". This ensures the computer servers do not pull the cold aisle air into negative pressurization and minimizes bypass from cold to hot, thus keeping the air entering the servers cold and keeping the hot aisle hot.

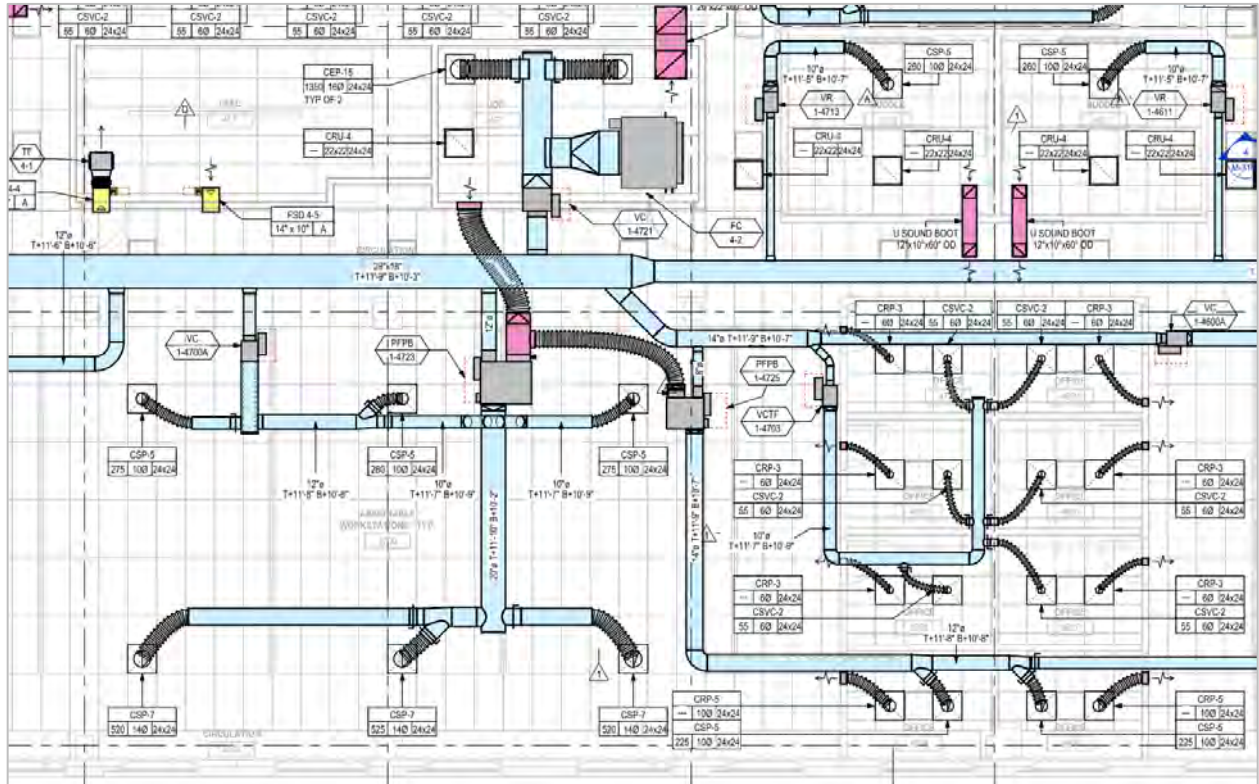

Figure 43: Office Computer Room with Transfer Air

Figure 44, Figure 45, and Figure 46 show typical office floor plans that include computer rooms over 10 kW. These figures also show the portions of those floor plans that have available transfer air and could be completely heated by the nearby computer rooms. As the figures indicate, significant amounts of floor plan space heating needs can be satisfied using available computer room waste heat.



Figure 44: Typical Office Computer Room showing Heat Recovery Opportunity, Example 1

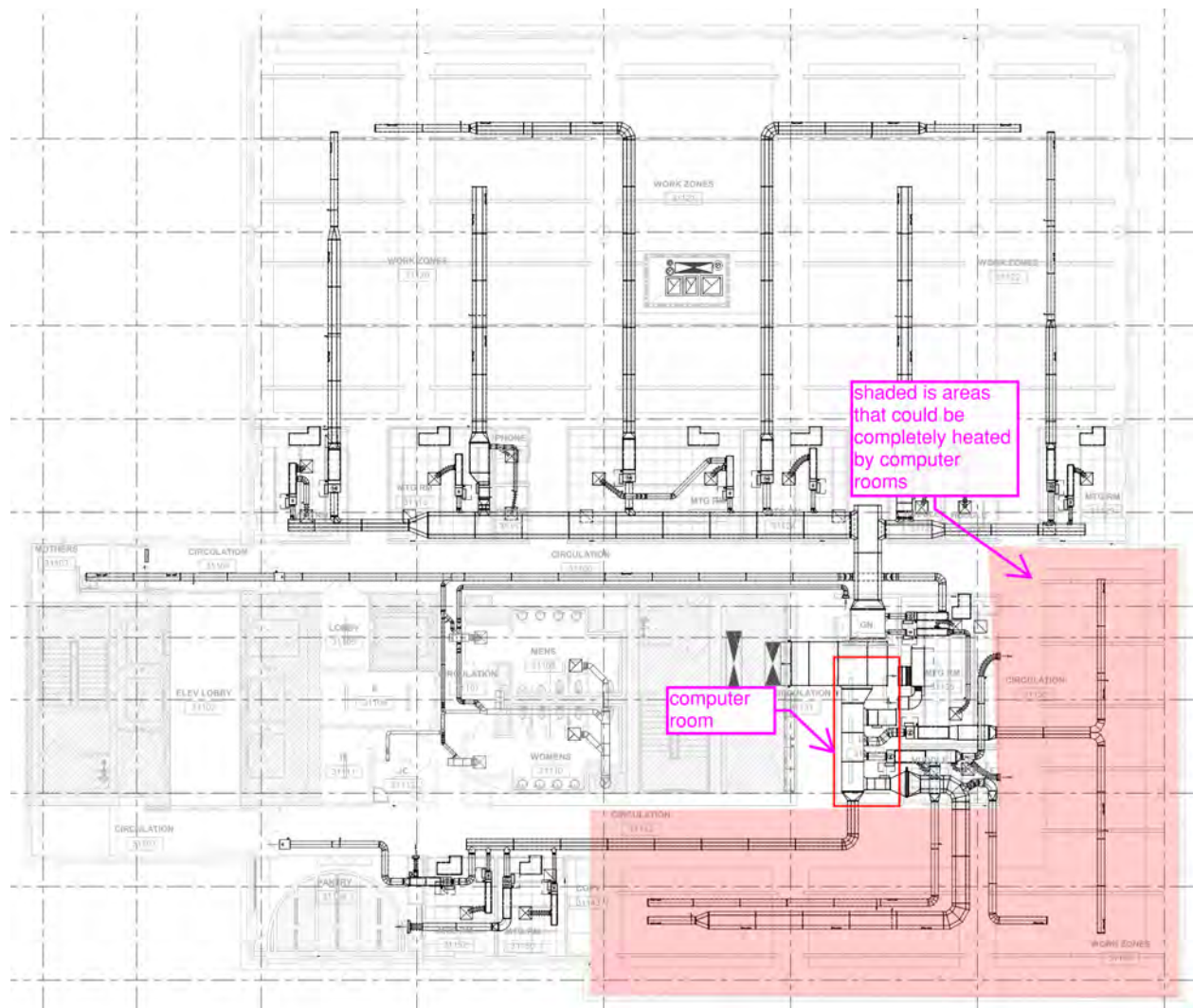

Figure 45: Typical Office Computer Room showing Heat Recovery Opportunity, Example 2

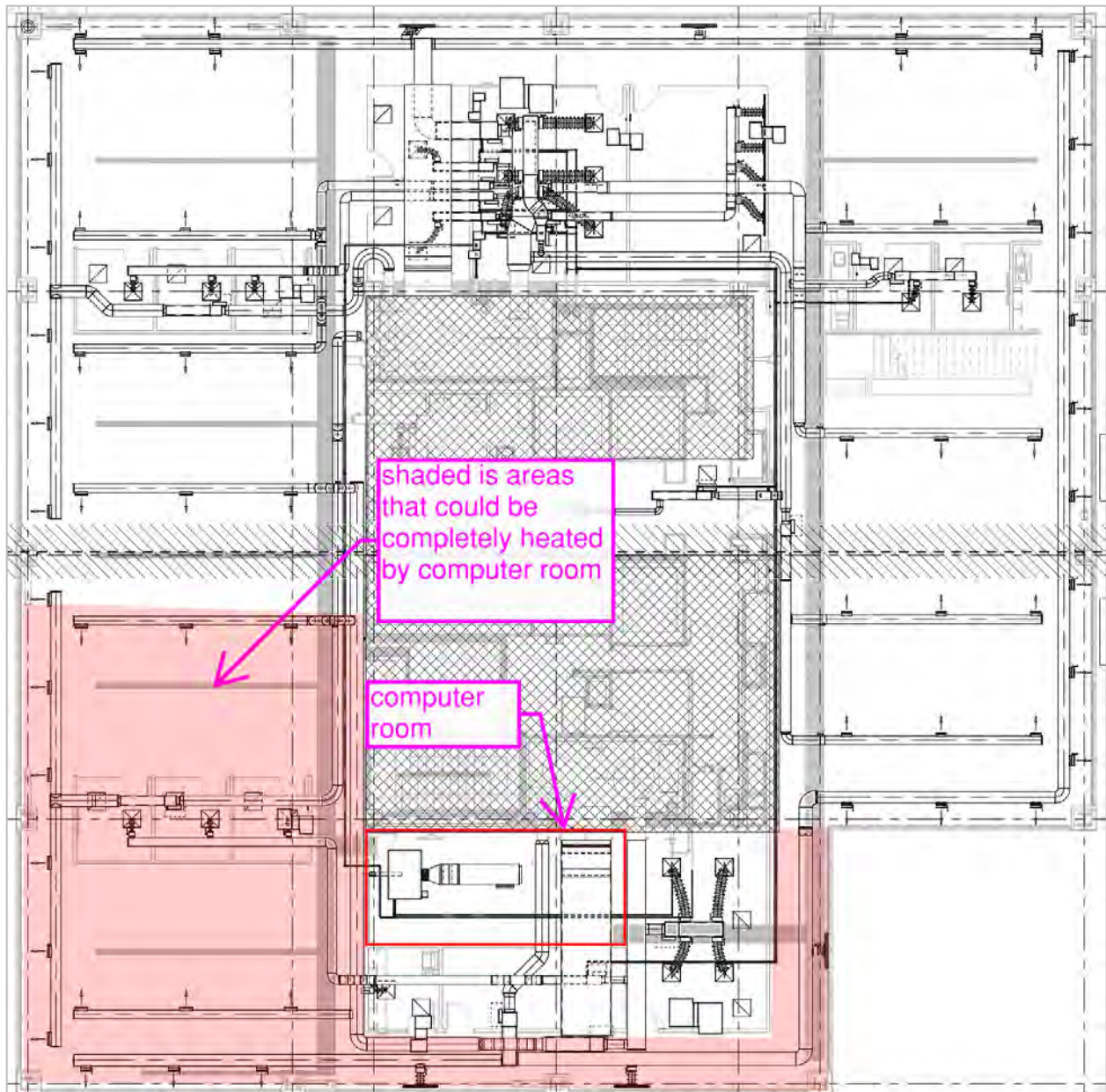

Figure 46: Typical Office Computer Room showing Heat Recovery Opportunity, Example 3

- h) “Has the capability to detect failure of the heater in the ON position. Capabilities include manual reset thermal cutout or discharge air temperature sensor with associated fault detection logic.” This clause ensures that the building DDC is able to detect if the electric resistance heater has failed in the ON position so that corrective actions can be taken to ensure that energy is not wasted.

5.1.2.4 True Energy Costs vs Modeled Energy Costs

As described below in Sections 5.3 and 5.4, the proposed exception for electric resistance heating is lifecycle cost-effective because the first cost savings are greater

than the incremental lifecycle energy costs. The lifecycle energy costs of buildings with electric resistance are about 10 percent higher than buildings with either baseline system (gas boilers or AWHPs). It is important to recognize, however, that the analysis in Sections 5.3 and 5.4 does not take credit for any of the following:

- reduced simultaneous heating/cooling and fighting (clause (b))
- increased use of occupied standby (clause (d))
- increased use of transfer air for kitchens, labs, and other high exhaust spaces (clause (e))
- increased use of demand-controlled ventilation (clause (f))
- increased use of computer room heat recovery (clause (g))

The analysis does not account for any of these because they are not readily modeled in the prototype models and because the proposal is already cost-effective.

5.1.2.5 Other Benefits of Electric Resistance

It is also important to understand that the lifecycle cost analysis does not take credit for any of these other important benefits of electric resistance heat:

- Prescriptive code benefits – The first cost savings of electric resistance will encourage many projects to switch from performance compliance to prescriptive compliance. This has many benefits because there are many valuable prescriptive requirements that are not properly accounted for in the performance compliance software, including:
 - Prescriptive envelope – Many, if not most buildings that use the performance approach have too high a window-wall ratio to comply prescriptively. Theoretically, the software requires the design to compensate with improved HVAC and lighting. In practice, limitations of the software and enforcement mean that HVAC and lighting often do not compensate. Furthermore, envelope savings are more reliable and durable than HVAC and lighting savings, which require good design, good commissioning, and good long-term O&M.
 - Window switches – HVAC interlocks for operable windows is a prescriptive requirement. The ACM Reference Manual does include a methodology for penalizing a project without the required switches, but the methodology is conservative and almost certainly underestimates the true benefit of the interlocks.
 - PV and batteries are prescriptive requirements.
- Refrigerant Leakage – Other electric heating options such as AWHPs or VRF require refrigerants which are powerful global warming gases. In addition to the environmental consequences, refrigerants can also pose significant health and

safety risks, particularly VRF systems where a leak can result in dangerous levels of refrigerant in occupied spaces. Note that the lifecycle cost analysis also did not take credit for eliminating the cost of refrigerant monitoring systems.

- Gas Leakage – Natural gas (methane) is also a powerful greenhouse gas.
- Embodied Carbon – Electric resistance has a much smaller embodied carbon footprint compared to gas boilers, AWHPs, VRF, etc. Gas boilers, for example, are large pieces of equipment and require lots of copper and steel piping throughout the building, pipe insulation, pumps, equipment bases, structural supports, expansion tanks, storage tanks, control valves, isolation valves, etc. AWHPs are much bigger than gas boilers. VRF also requires lots of piping and pipe insulation. As the electricity grid gets greener, the embodied carbon penalty for these other systems will only tilt the scales further in favor of electric resistance. Although not accounted for in the lifecycle analysis, material impacts are quantified and discussed in Section 5.5.4.

5.1.2.6 Impact on Other Title 24 Requirements

It is also important to recognize that the proposed exception for electric resistance does not allow a project to avoid the proposed requirements herein for mechanical heat recovery and thermal energy storage or any other current or future requirements in Title 24, Part 6, like the heat pump requirement for most single zone systems in most climate zones. The proposal is an exception to the electric resistance ban that allows electric resistance in some cases. It does not require electric resistance in any cases. If a project had enough process loads and enough simultaneous heating and cooling to trigger the mechanical heat recovery requirement, or the project were large enough to trigger the TES requirement, then the project would need to include heat pumps (e.g., AWHP, WSHP, VRF).

5.1.2.7 Impact on Reach Codes

Another benefit of this proposal allowing electric resistance is that it may encourage additional jurisdictions in California to adopt all-electric reach codes. Currently, as demonstrated by the incremental costs for this measure (see Section 5.4.3), going all-electric is significantly more expensive for many building types than gas heat (e.g., large office). Allowing electric resistance makes going all-electric the lowest cost option for many of these building types, rather than the most expensive option.

5.1.3 Summary of Proposed Changes to Code Documents

The Sections below summarize how the standards, Reference Appendices, Alternative Calculation Method (ACM) Reference Manuals, and compliance forms would be

modified by the proposed change.²² See Section 6 of this report for detailed proposed revisions to code language.

5.1.3.1 Specific Purpose and Necessity of Proposed Code Changes

Each proposed change to language in Title 24, Part 1 and Part 6 as well as the reference appendices to Part 6 are described below. See Section 6.2 of this report for marked-up code language.

Section: 140.4(g) Exception 5

Specific Purpose: This exception is deleted because the new Exception 7 can be cost-effectively applied to any building that would have qualified to use Exception 5. Exception 7 is also more energy efficient than Exception 5.

Necessity: These changes are necessary to increase energy efficiency via cost-effective building design standards, as mandated by California Public Resources Code, Sections 25213 and 25402.

Section: 140.4(g) Exception 7

Specific Purpose: The specific purpose is to add an exception to the prescriptive ban on electric resistance heating. This exception would allow electric resistance heating at the zone level.

Necessity: These changes are necessary to increase energy efficiency via cost-effective building design standards, as mandated by California Public Resources Code, Sections 25213 and 25402.

Section: 141.0(a) Exception 2

Specific Purpose: The new Exception 7 to 140.4(g) provides a feasible and cost-effective option for additions that might use 141.0(a) Exception 2 and is more energy efficient than 141.0(a) Exception 2.

Necessity: These changes are necessary to increase energy efficiency via cost-effective building design standards, as mandated by California Public Resources Code, Sections 25213 and 25402.

Section 141.0(b)2C Exception 6

Specific Purpose: The purpose of this new exception is to ensure that existing buildings pursuing exception 7 to 140.4(g) would have to upgrade their building

²² Visit [EnergyCodeAce.com](https://www.energycodeace.com) for trainings, tools, and resources to help people understand existing code requirements.

envelopes to comply with prescriptive requirements for new construction and that the site appropriately leverages exhaust air heat recovery as specified in 140.4(q).

Necessity: These changes are necessary to increase energy efficiency via cost-effective building design standards, as mandated by California Public Resources Code, Sections 25213 and 25402.

5.1.3.2 Specific Purpose and Necessity of Changes to the Nonresidential ACM Reference Manual

The proposed code change would not modify the ACM Reference Manual.

5.1.3.3 Summary of Changes to the Nonresidential Compliance Manual

Chapter 4 (Section 4.7 HVAC System Requirements) of the Nonresidential Compliance Manual would need to be revised. This proposal to add an exception to 140.4(g) contains several specific conditions and triggers that must be met to ensure that space heating loads are absolutely minimized to allow electric resistance heating at the zone level. Additional clarification and several examples should be added to the compliance manual to explain these triggers and conditions in further detail than what is reasonable to include in the prescriptive code itself. The Statewide CASE Team has found that this draft language has been difficult to understand by stakeholders so a large amount of focus will be placed on making sure that the conditions are clearly explained in plain language in the compliance manual.

5.1.3.4 Summary of Changes to Compliance Forms

The Statewide CASE Team proposes a checklist for the compliance form to ensure that all clauses of the proposed exception are valid. Refer to Section 6.5 for more detail.

5.1.4 Regulatory Context

5.1.4.1 Determination of Inconsistency or Incompatibility with Existing State Laws and Regulations

There are no relevant state or local laws or regulations.

5.1.4.2 Duplication or Conflicts with Federal Laws and Regulations

There are no relevant federal laws or regulations.

5.1.4.3 Difference From Existing Model Codes and Industry Standards

There are no relevant industry standards or model codes.

5.1.5 Compliance and Enforcement

When developing this proposal, the Statewide CASE Team considered methods to streamline the compliance and enforcement process and how negative impacts on market actors who are involved in the process could be mitigated or reduced. This section describes how to comply with the proposed code change. It also describes the compliance verification process. Appendix E presents how the proposed changes could impact various market actors.

The compliance verification activities related to this measure that need to occur during each phase of the project are described below:

- **Design Phase:** A designer would be able to comply with code using zone-level ER heating prescriptively were this measure to be enacted. In the past, the designer would have had to pursue the performance path. Adding this exception would simplify the compliance process by enabling more buildings to comply prescriptively.
- **Permit Application Phase:** A compliance checklist is proposed for buildings that intend to use this exception. The checklist will ensure that all applicable clauses within the exception are true.
- **Construction Phase:** Construction would be simpler for buildings installing zone-level ER heating as compared to those with hydronic distribution systems. The electrical system impacts would be relatively minimal.
- **Inspection Phase:** Inspecting for correctly installed HVAC controls would be imperative for realizing the system efficiency that makes this design choice cost-effective. However, these and other prescriptive requirements are already familiar measures for building inspectors and no changes are anticipated as a result of this measure.

5.2 Market Analysis

5.2.1 Current Market Structure

The Statewide CASE Team performed a market analysis with the goals of identifying current technology availability, current product availability, and market trends. It then considered how the proposed standard may impact the market in general as well as individual market actors. Information was gathered about the incremental cost of complying with the proposed measure. Estimates of market size and measure applicability were identified through research and outreach with stakeholders including utility program staff, CEC staff, and a wide range of industry actors. In addition to conducting personalized outreach, the Statewide CASE Team discussed the current

market structure and potential market barriers during a public stakeholder meeting that the Statewide CASE Team held on February 27, 2023.

Currently, very few nonresidential buildings are constructed in California with ER heating due to the prescriptive ban at 140.4(g).

5.2.2 Technical Feasibility and Market Availability

The use of zone-level ER for space heating is technically feasible but has been prescriptively limited for quite some time. Decades ago, this ban made sense due to the high carbon intensity of the electric grid and less sophisticated HVAC controls capable of limiting heating demand. However, these former challenges for ER heating have been mitigated by progress in recent years. Today, it is possible to design a system with very low heating loads if the prescriptive code were to be followed along with some additional EE strategies that are included in this measure. These criteria include the low prescriptive window-wall ratios, prohibiting hot water piping, minimizing ventilation loads with CO₂ and occupant sensing ventilation resets, heat recovery from computer rooms, and largely eliminating reheat by using parallel fan-powered boxes (FPB) or other systems that decouple heating and primary air. All of the above listed strategies are technically feasible and widely implemented in nonresidential buildings.

The Statewide CASE Team reviewed recently published research by the PG&E Code Readiness team which reported out on all-electric hydronic space heating site attributes (Weitze and Gantley 2023). The field studies are focused on hydronic heat pumps, but the building loads demonstrate an important point related to this measure. Specifically, the study includes two buildings, one with an 80-year-old building envelope (located in climate zone 12) and another with a <10-year-old envelope (located in climate zone 2). The difference in heating energy use intensity for the two sites was significant, with the older building consuming 26.5 kBtu/ft²/y and the newer building consuming 1.4 kBtu/ft²/y. There are a variety of factors that can drive the difference in heating energy use intensity, but the magnitude of this difference speaks to the importance of an efficient building envelope as a mechanism that can assist in shrinking heating loads.

5.2.3 Market Impacts and Economic Assessments

5.2.3.1 Impact on Builders

Builders of residential and commercial structures are directly impacted by many of the measures proposed by the Statewide CASE Team for the 2025 code cycle. It is within the normal practices of these businesses to adjust their building practices to changes in building codes. When necessary, builders engage in continuing education and training to remain compliant with changes to design practices and building codes.

California’s construction industry comprises approximately 93,000 business establishments and 943,000 employees (see Table 106). For 2022, total estimated payroll will be about \$78 billion. Nearly 72,000 of these business establishments and 473,000 employees are engaged in the residential building sector, while another 17,600 establishments and 369,000 employees focus on the commercial sector. The remainder of establishments and employees work in industrial, utilities, infrastructure, and other heavy construction roles (the industrial sector).

Table 106: California Construction Industry, Establishments, Employment, and Payroll in 2022 (Estimated)

Building Type	Construction Sectors	Establishments	Employment	Annual Payroll (Billions \$)
Residential	All	71,889	472,974	31.2
Residential	Building Construction Contractors	27,948	130,580	9.8
Residential	Foundation, Structure, & Building Exterior	7,891	83,575	5.0
Residential	Building Equipment Contractors	18,108	125,559	8.5
Residential	Building Finishing Contractors	17,942	133,260	8.0
Commercial	All	17,621	368,810	35.0
Commercial	Building Construction Contractors	4,919	83,028	9.0
Commercial	Foundation, Structure, & Building Exterior	2,194	59,110	5.0
Commercial	Building Equipment Contractors	6,039	139,442	13.5
Commercial	Building Finishing Contractors	4,469	87,230	7.4
Industrial, Utilities, Infrastructure, & Other (Industrial+)	All	4,206	101,002	11.4
Industrial+	Building Construction	288	3,995	0.4
Industrial+	Utility System Construction	1,761	50,126	5.5
Industrial+	Land Subdivision	907	6,550	1.0
Industrial+	Highway, Street, and Bridge Construction	799	28,726	3.1
Industrial+	Other Heavy Construction	451	11,605	1.4

Source: (State of California Employment Development Department 2022)

The proposed change to the prescriptive ban to electric resistance heating would likely affect commercial builders but would not impact firms that focus on construction and retrofit of industrial buildings, utility systems, public infrastructure, or other heavy construction. The effects on the residential and commercial building industry would not be felt by all firms and workers, but rather would be concentrated in specific industry subsectors. Table 107 shows the commercial building subsectors the Statewide CASE Team expects to be impacted by the changes proposed in this report. Electrical, plumbing, and HVAC contractors would be slightly impacted by a potential shift away

from hydronic to ER-based space heating designs. The Statewide CASE Team’s estimates of the magnitude of these impacts are shown in Section 5.2.4 Economic Impacts.

Table 107: Specific Subsectors of the California Commercial Building Industry Impacted by Proposed Change to Code/Standard by Subsector in 2022 (Estimated)

Construction Subsector	Establishments	Employment	Annual Payroll (Billions \$)
Nonresidential Electrical Contractors	3,137	74,277	7.0
Nonresidential plumbing & HVAC contractors	2,346	55,572	5.5

Source: (State of California Quarterly Census of Employment and Wages 2010)

5.2.3.2 Impact on Building Designers and Energy Consultants

Adjusting design practices to comply with changing building codes is within the normal practices of building designers. Building codes (including Title 24, Part 6) are typically updated on a three-year revision cycle, and building designers and energy consultants engage in continuing education and training to remain compliant with changes to design practices and building codes.

The market will benefit from this exception being added to the prescriptive code due to the wider number of all-electric space heating options available. The designer will have more flexible options to prescriptive comply with the code. The building owner will have an additional cost-effective and cheaper up-front cost option to choose from. Energy consultants will also benefit from the added all-electric space heating option.

Businesses that focus on residential, commercial, institutional, and industrial building design are contained within the Architectural Services sector (NAICS 541310). Table 108 shows the number of establishments, employment, and total annual payroll for Building Architectural Services. The proposed code changes would potentially impact all firms within the Architectural Services sector. The Statewide CASE Team anticipates the impacts for the added exception to the ban on ER heating to affect firms that focus on nonresidential construction.

There is not a North American Industry Classification System (NAICS)²³ code specific to energy consultants. Instead, businesses that focus on consulting related to building

²³ NAICS is the standard used by federal statistical agencies in classifying business establishments for the purpose of collecting, analyzing, and publishing statistical data related to the U.S. business economy. NAICS was developed jointly by the U.S. Economic Classification Policy Committee (ECPC), Statistics Canada, and Mexico's Instituto Nacional de Estadística y Geografía, to allow for a high level of comparability in business statistics among the North American countries. NAICS replaced the Standard Industrial Classification (SIC) system in 1997.

energy efficiency are contained in the Building Inspection Services sector (NAICS 541350), which is comprised of firms primarily engaged in the physical inspection of residential and nonresidential buildings.²⁴ It is not possible to determine which business establishments within the Building Inspection Services sector are focused on energy efficiency consulting. The information shown in Table 108 provides an upper bound indication of the size of this sector in California.

Table 108: California Building Designer and Energy Consultant Sectors in 2022 (Estimated)

Sector	Establishments	Employment	Annual Payroll (Millions \$)
Architectural Services^a	4,134	31,478	3,623.3
Building Inspection Services^b	1,035	3,567	280.7

Source: (State of California Employment Development Department 2022)

- a. Architectural Services (NAICS 541310) comprises private-sector establishments primarily engaged in planning and designing residential, institutional, leisure, commercial, and industrial buildings and structures.
- b. Building Inspection Services (NAICS 541350) comprises private-sector establishments primarily engaged in providing building (residential & nonresidential) inspection services encompassing all aspects of the building structure and component systems, including energy efficiency inspection services.

5.2.3.3 Impact on Occupational Safety and Health

The proposed code change does not alter any existing federal, state, or local regulations pertaining to safety and health, including rules enforced by the California Division of Occupational Safety and Health (DOSH). All existing health and safety rules would remain in place. Complying with the proposed code change is not anticipated to have adverse impacts on the safety or health of occupants or those involved with the construction, commissioning, and maintenance of the building.

5.2.3.4 Impact on Building Owners and Occupants

Commercial Buildings

The commercial building sector includes a wide array of building types, including offices, restaurants and lodging, retail, and mixed-use establishments, and warehouses (including refrigerated) (Kenney M 2019). Energy use by occupants of commercial

²⁴ Establishments in this sector include businesses primarily engaged in evaluating a building's structure and component systems and includes energy efficiency inspection services and home inspection services. This sector does not include establishments primarily engaged in providing inspections for pests, hazardous wastes or other environmental contaminants, nor does it include state and local government entities that focus on building or energy code compliance/enforcement of building codes and regulations.

buildings also varies considerably, with electricity used primarily for lighting, space cooling and conditioning, and refrigeration, while natural gas is used primarily for water heating and space heating. According to information published in the 2019 California Energy Efficiency Action Plan, there is more than 7.5 billion square feet of commercial floor space in California consuming 19 percent of California’s total annual energy use (Kenney M 2019). The diversity of building and business types within this sector creates a challenge for disseminating information on energy and water efficiency solutions, as does the variability in sophistication of building owners and the relationships between building owners and occupants.

Estimating Impacts

Building owners and occupants would benefit from lower energy bills. As discussed in Section 5.2.4.1, when building occupants save on energy bills, they tend to spend it elsewhere in the economy thereby creating jobs and economic growth for the California economy. The Statewide CASE Team does not expect the proposed code change for the 2025 code cycle to impact building owners or occupants adversely.

5.2.3.5 Impact on Building Component Retailers (Including Manufacturers and Distributors)

The Statewide CASE Team anticipates the proposed change would have no material impact on California component retailers.

5.2.3.6 Impact on Building Inspectors

Table 109 shows employment and payroll information for state and local government agencies in which many inspectors of residential and commercial buildings are employed. Building inspectors participate in continuing education and training to stay current on all aspects of building regulations, including energy efficiency. The Statewide CASE Team, therefore, anticipates the proposed change would have no impact on employment of building inspectors or the scope of their role conducting energy efficiency inspections.

Table 109: Employment in California State and Government Agencies with Building Inspectors in 2022 (Estimated)

Sector	Govt.	Establishments	Employment	Annual Payroll (Million \$)
Administration of Housing Programs ^a	State	18	265	29.0
	Local	38	3,060	248.6
Urban and Rural Development Admin ^b	State	38	764	71.3
	Local	52	2,481	211.5

Source: (State of California Quarterly Census of Employment and Wages 2010)

- a. Administration of Housing Programs (NAICS 925110) comprises government establishments primarily engaged in the administration and planning of housing programs, including building codes and standards, housing authorities, and housing programs, planning, and development.
- b. Urban and Rural Development Administration (NAICS 925120) comprises government establishments primarily engaged in the administration and planning of the development of urban and rural areas. Included in this industry are government zoning boards and commissions.

5.2.3.7 Impact on Statewide Employment

As described in Sections 5.2.3.1 through 5.2.3.6, the Statewide CASE Team does not anticipate significant employment or financial impacts to any particular sector of the California economy. This is not to say that the proposed change would not have modest impacts on employment in California. In Section 5.2.4, the Statewide CASE Team estimated the proposed change in the exceptions to the prescriptive ban on electric resistance heating would affect statewide employment and economic output directly and indirectly through its impact on builders, designers, and energy consultants, and building inspectors. In addition, the Statewide CASE Team estimated how energy savings associated with the proposed change in the exceptions to the prescriptive ban on electric resistance heating would lead to modest ongoing financial savings for California residents, which would then be available for other economic activities.

5.2.4 Economic Impacts

For the 2025 code cycle, the Statewide CASE Team used the IMPLAN model software²⁵, along with economic information from published sources, and professional judgement to develop estimates of the economic impacts associated with each of the proposed code changes. Conceptually, IMPLAN estimates jobs created as a function of incoming cash flow in different sectors of the economy, due to implementing a code or a standard. The jobs created are typically categorized into direct, indirect, and induced employment. For example, cash flow into a manufacturing plant captures direct employment (jobs created in the manufacturing plant), indirect employment (jobs created in the sectors that provide raw materials to the manufacturing plant) and induced employment (jobs created in the larger economy due to purchasing habits of people newly employed in the manufacturing plant). Eventually, IMPLAN computes the total number of jobs created due to a code. The assumptions of IMPLAN include constant returns to scale, fixed input structure, industry homogeneity, no supply constraints, fixed technology, and constant byproduct coefficients. The model is also static in nature and is a simplification of how jobs are created in the macro-economy.

²⁵ IMPLAN employs economic data and advanced economic impact modeling to estimate economic impacts for interventions like changes to the California Title 24, Part 6 code. For more information on the IMPLAN modeling process, see www.IMPLAN.com.

The economic impacts developed for this report are only estimates and are based on limited and to some extent speculative information. The IMPLAN model provides a relatively simple representation of the California economy and, though the Statewide CASE Team is confident that the direction and approximate magnitude of the estimated economic impacts are reasonable, it is important to understand that the IMPLAN model is a simplification of extremely complex actions and interactions of individual, businesses, and other organizations as they respond to changes in energy efficiency codes. In all aspects of this economic analysis, the CASE Authors rely on conservative assumptions regarding the likely economic benefits associated with the proposed code change. By following this approach, the economic impacts presented below represent lower bound estimates of the actual benefits associated with this proposed code change. Adoption of this code change proposal would result in relatively modest economic impacts through the additional direct spending by those in the commercial building industry, architects, energy consultants, and building inspectors. The Statewide CASE Team does not anticipate that money saved by commercial building owners or other organizations affected by the proposed 2025 code cycle regulations would result in additional spending by those businesses.

Table 110: Estimated Impact that Adoption of the Proposed Measure would have on the California Commercial Construction Sector

Type of Economic Impact	Employment (Jobs)	Labor Income (Million)	Total Value Added (Million)	Output (Million)
Direct Effects (Additional spending by Commercial Builders)	164.3	\$12.8	\$14.8	\$25.1
Indirect Effect (Additional spending by firms supporting Commercial Builders)	40.2	\$3.5	\$5.5	\$10.0
Induced Effect (Spending by employees of firms experiencing “direct” or “indirect” effects)	68.3	\$4.7	\$8.4	\$13.3
Total Economic Impacts	272.9	\$20.9	\$28.6	\$48.5

Source: CASE Team analysis of data from the IMPLAN modeling software (IMPLAN Group LLC 2020).

5.2.4.1 Creation or Elimination of Jobs

The Statewide CASE Team does not anticipate that the measures proposed for the 2025 code cycle regulation would lead to the creation of new *types* of jobs or the elimination of *existing* types of jobs. In other words, the Statewide CASE Team’s proposed change would not result in economic disruption to any sector of the California economy. Rather, the estimates of economic impacts discussed in Section 5.2.4 would lead to modest changes in employment of existing jobs.

5.2.4.2 Creation or Elimination of Businesses in California

As stated in Section 5.2.4.1, the Statewide CASE Team’s proposed change would not result in economic disruption to any sector of the California economy. The proposed change represents a modest change to options available to nonresidential building designers to prescriptively provide space heating, which would not excessively burden or competitively disadvantage California businesses – nor would it necessarily lead to a competitive advantage for California businesses. Therefore, the Statewide CASE Team does not foresee any new businesses being created, nor does the Statewide CASE Team think any existing businesses would be eliminated due to the proposed code changes.

5.2.4.3 Competitive Advantages or Disadvantages for Businesses in California

The proposed code changes would apply to all businesses incorporated in California, regardless of whether the business is located inside or outside of the state (IMPLAN Group LLC 2020). Therefore, the Statewide CASE Team does not anticipate that these measures proposed for the 2025 code cycle regulation would have an adverse effect on the competitiveness of California businesses. Likewise, the Statewide CASE Team does not anticipate businesses located outside of California would be advantaged or disadvantaged.

5.2.4.4 Increase or Decrease of Investments in the State of California

The Statewide CASE Team analyzed national data on corporate profits and capital investment by businesses that expand a firm’s capital stock (referred to as net private domestic investment, or NPDI).²⁶ As Table 111 shows, between 2017 and 2021, NPDI as a percentage of corporate profits ranged from a low of 18 in 2020 due to the worldwide economic slowdowns associated with the COVID 19 pandemic to a high of 35 percent in 2019, with an average of 26 percent. While only an approximation of the proportion of business income used for net capital investment, the Statewide CASE Team believes it provides a reasonable estimate of the proportion of proprietor income that would be reinvested by business owners into expanding their capital stock.

²⁶ Net private domestic investment is the total amount of investment in capital by the business sector that is used to expand the capital stock, rather than maintain or replace due to depreciation. Corporate profit is the money left after a corporation pays its expenses.

Table 111: Net Domestic Private Investment and Corporate Profits, U.S.

Year	Net Domestic Private Investment by Businesses, Billions of Dollars	Corporate Profits After Taxes, Billions of Dollars	Ratio of Net Private Investment to Corporate Profits (Percent)
2017	518.473	1882.460	28
2018	636.846	1977.478	32
2019	690.865	1952.432	35
2020	343.620	1908.433	18
2021	506.331	2619.977	19
5-Year Average	539.227	2068.156	26

Source: (Federal Reserve Economic Data, FRED 2022)

The Statewide CASE Team does not anticipate that the economic impacts associated with the proposed measure would lead to significant change (increase or decrease) in investment, directly or indirectly, in any affected sectors of California’s economy. Nevertheless, the Statewide CASE Team is able to derive a reasonable estimate of the change in investment by California businesses based on the estimated change in economic activity associated with the proposed measure and its expected effect on proprietor income, which was used conservative estimate of corporate profits, a portion of which is assumed to be allocated to net business investment.²⁷

5.2.4.5 Incentives for Innovation in Products, Materials, or Processes

This proposal is not expected to drive, lead to, or incentivize innovation in building materials, components, or processes, nor is it expected to stifle innovation.

5.2.4.6 Effects on the State General Fund, State Special Funds, and Local Governments

The Statewide CASE Team does not expect the proposed code changes would have a measurable impact on California’s General Fund, any state special funds, or local government funds.

Cost of Enforcement

Cost to the State: State government already has budget for code development, education, and compliance enforcement. While state government will be allocating resources to update the Title 24, Part 6 Standards, including updating education and compliance materials and responding to questions about the revised requirements, these activities are already covered by existing state budgets. The costs to state government are small when compared to the overall costs savings and policy benefits associated with the code change proposals. As a nonresidential measure, there may be

²⁷ 26 percent of proprietor income was assumed to be allocated to net business investment; see Table 9.

impacts to state buildings (new construction/additions or alterations), but the Statewide CASE Team’s analysis has found that the proposed code changes are cost-effective.

Cost to Local Governments: All proposed code changes to Title 24, Part 6 would result in changes to compliance determinations. Local governments would need to train building department staff on the revised Title 24, Part 6 Standards. While this re-training is an expense to local governments, it is not a new cost associated with the 2025 code change cycle. The building code is updated on a triennial basis, and local governments plan and budget for retraining every time the code is updated. There are numerous resources available to local governments to support compliance training that can help mitigate the cost of retraining, including tools, training and resources provided by the IOU Codes and Standards program (such as Energy Code Ace). As noted in Section 5.1.5 and Appendix E, the Statewide CASE Team considered how the proposed code change might impact various market actors involved in the compliance and enforcement process and aimed to minimize negative impacts on local governments.

5.2.4.7 Impacts on Specific Persons

While the objective of any of the Statewide CASE Team’s proposal is to promote energy efficiency, the Statewide CASE Team recognizes that there is the potential that a proposed code change may result in unintended consequences. This proposal would not impact any specific group or groups of persons differently from impacts to persons generally. Refer to Section 5.6 for more details addressing energy equity and environmental justice.

5.2.5 Fiscal Impacts

5.2.5.1 Mandates on Local Agencies or School Districts

There are no relevant mandates to local agencies or school districts.

5.2.5.2 Costs to Local Agencies or School Districts

There are no costs to local agencies or school districts.

5.2.5.3 Costs or Savings to Any State Agency

There are no costs or savings to any state agencies.

5.2.5.4 Other Nondiscretionary Cost or Savings Imposed on Local Agencies

There are no added nondiscretionary costs or savings to local agencies.

5.2.5.5 Costs or Savings in Federal Funding to the State

There are no costs or savings to federal funding to the state.

5.3 Energy Savings

The code change proposal would not modify the stringency of the existing California Energy Code, so there would be no savings on a per unit basis. Section 5.3 of the CASE Report, which typically presents the methodology, assumptions, and results of the per unit energy impacts, has been truncated for this proposal. The Statewide CASE Team completed an analysis of a prescriptively complying standard design (with piping distribution losses added) with an ER heating system meeting all conditions included in the added exception. The baseline was developed for both a natural gas boiler and an electric 2-pipe AWHP system.

The Statewide CASE Team gathered stakeholder input to inform the energy savings analysis. See Appendix F for a summary of stakeholder engagement.

Energy savings benefits may have potential to disproportionately impact DIPs. Refer to Section 5.6 for more details addressing energy equity and environmental justice.

5.3.1 Energy Savings Methodology

5.3.1.1 Key Assumptions for Energy Savings Analysis

Electric resistance has long been disallowed by the prescriptive code at 140.4(g). Recent Center for the Built Environment research has indicated that approximately 20 percent of the input boiler energy is delivered to zone heating. This research points to the potential for zone-level electric resistance heating, which would avoid the low-efficiency boilers (when in part load) and distribution system losses (when the building is in economizing or cooling mode).

The modeled prototypes include those with hydronic space heating. This includes Large Office, Medium Office, Large School, and Hospital.

For this measure, the base case is a CBECC model for each of the applicable prototypes with a gas boiler for space heating. Pipe losses were included in the baseline system according to heat loss estimates developed with CBE research. In addition, the HWST was modified to 130 °F to align with the HWST limit measure.

The measure case is altered such that the gas boiler (and associated distribution losses) is removed from the model and each zone's hourly heating demand is assumed to be satisfied by a 1.0 COP electric resistance heater.

5.3.1.2 Energy Savings Methodology per Prototypical Building

The Statewide CASE Team measured per unit energy savings expected from the proposed code changes in several ways to quantify key impacts. First, savings are calculated by fuel type. Electricity savings are measured in terms of both energy usage and peak demand reduction. Natural gas savings are quantified in terms of energy

usage. Second, the Statewide CASE Team calculated Source Energy Savings. Source Energy represents the total amount of raw fuel required to operate a building. In addition to all energy used from on-site production, source energy incorporates all transmission, delivery, and production losses. The hourly Source Energy values provided by CEC are proportional to GHG emissions. Finally, the Statewide CASE Team calculated LSC Savings, formerly known as Time Dependent Value (TDV) Energy Cost Savings. LSC Savings are calculated using hourly energy cost metrics for both electricity and natural gas provided by the CEC. These LSC hourly factors are projected over the 30-year life of the building. The LSC hourly factors incorporate the hourly cost of marginal generation, transmission and distribution, fuel, capacity, losses, and cap-and-trade-based CO2 emissions. More information on Source Energy and LSC hourly factors is available in the [March 2020 CEC Staff Workshop on Energy Code Compliance Metrics](#) and the [July 2022 CEC Staff Workshop on Energy Code Accounting for the 2025 Building Energy Efficiency Standards](#).

The CEC directed the Statewide CASE Team to model the energy impacts using specific prototypical building models that represent typical building geometries for different types of buildings (California Energy Commission 2022). The prototype buildings that the Statewide CASE Team used in the analysis are presented in Table 112.

Table 112: Prototype Buildings Used for Energy, Demand, Cost, and Environmental Impacts Analysis

Prototype Name	Number of Stories	Floor Area (Square Feet)	Description
OfficeLarge	12	498,589	12 story + 1 basement office building with 5 zones and a ceiling plenum on each floor. WWR-0.40.
OfficeMedium	3	53,628	3 story office building with 5 zones and a ceiling plenum on each floor. WWR-0.33
SchoolLarge	2	210,866	High school with WWR of 35% and SRR 1.4%

The Statewide CASE Team estimated LSC energy, source energy, electricity, natural gas, peak demand, and GHG impacts by simulating the proposed code change in EnergyPlus using prototypical buildings and rulesets from the 2025 Research Version of the California Building Energy Code Compliance (CBECC) software.

CBECC generates two models based on user inputs: the Standard Design and the Proposed Design.²⁸ The Standard Design represents the geometry of the prototypical

²⁸ CBECC-Res creates a third model, the Reference Design, that represents a building similar to the Proposed Design, but with construction and equipment parameters that are minimally compliant with the 2006 International Energy Conservation Code (IECC). The Statewide CASE Team did not use the Reference Design for energy impacts evaluations.

building and a design that uses a set of features that result in a LSC energy budget and source energy budget that is minimally compliant with 2022 Title 24, Part 6 code requirements. Features used in the Standard Design are described in the 2022 Nonresidential ACM Reference Manual. The Proposed Design represents the same geometry as the Standard Design, but it assumes the energy features that the software user describes with user inputs. To develop savings estimates for the proposed code changes, the Statewide CASE Team created a Standard Design and Proposed Design for each prototypical building with the Standard Design representing compliance with 2022 code and the Proposed Design representing compliance with the proposed requirements. Comparing the energy impacts of the Standard Design to the Proposed Design reveals the impacts of the proposed code change relative to a building that is minimally compliant with the 2022 Title 24, Part 6 requirements.

There is an existing Title 24, Part 6 requirement that covers the building system in question and applies to both new construction/additions and alterations, so the Standard Design is minimally compliant with the 2022 Title 24 requirements. The standard design space heating system was modified from the default gas boiler space heating system to a 2-pipe AWHP system in CBECC. For both standard design fuel types, the HWST was set to 130 °F.

CBECC calculates whole-building energy consumption for every hour of the year measured in kilowatt-hours per year (kWh/y) and therms per year (Therms/y). It then applies the 2025 LSC hourly factors to calculate LSC energy use in kilo British thermal units per year (kBtu/y), Source Energy factors to calculate Source Energy Use in kilo British thermal units per year (kBtu/y), and hourly GHG emissions factors to calculate annual GHG emissions in metric tons of carbon dioxide emissions equivalent (MT or “tonnes” CO₂e/y) (California Energy Commission 2022). CBECC also generates LSC Savings values measured in 2026 present value dollars (2026 PV\$) and nominal dollars. CBECC also calculates annual peak electricity demand measured in kilowatts (kW).

The energy impacts of the proposed code change vary by climate zone. The Statewide CASE Team simulated the energy impacts in every climate zone and applied the climate-zone specific LSC hourly factors when calculating energy and energy cost impacts.

Per unit energy impacts for nonresidential buildings are presented in savings per square foot. Annual energy, GHG, and peak demand impacts for each prototype building were translated into impacts per square foot by dividing by the floor area of the prototype building. This step allows for an easier comparison of savings across different building types and enables a calculation of statewide savings using the construction forecast that is published in terms of floor area by building type.

5.3.1.3 Statewide Energy Savings Methodology

The per unit energy impacts were extrapolated to statewide impacts using the statewide construction forecasts that the CEC provided. The statewide construction forecasts estimate new construction/additions that would occur in 2026, the first year that the 2025 Title 24, Part 6 requirements are in effect. They also estimate the amount of total existing building stock in 2026, which the Statewide CASE Team used to approximate savings from building alterations (California Energy Commission 2022). The construction forecast provides construction (new construction/additions and existing building stock) by building type and climate zone, as shown in Appendix A. Appendix A presents additional information about the methodology and assumptions used to calculate statewide energy impacts.

5.3.2 Per unit Energy Impacts Results

Energy savings and peak demand reductions per unit are presented in Table 113 through Table 121. The per unit energy savings figures do not account for naturally occurring market adoption or compliance rates. For the scenario comparing a gas boiler-powered hydronic system to the ER heating system, per unit savings for the first year are expected to range from -2.22 to -0.25 kWh/y and 0.14 to 11.7982 kBtu/y depending upon climate zone. Demand increases are expected to range between -0.39 and -0.10 kW depending on climate zone. Keep in mind that this version of the analysis is fuel substitution, so large natural gas and negative electric “savings” are expected. For the scenario comparing an electric AWHP hydronic system to the ER heating system, per unit savings for the first year are expected to range from -0.84 to 0.00 kWh/y depending upon climate zone. Demand increases are expected to range between -0.11 and -0.02 W depending on climate zone.

Table 113: First Year Electricity Savings (kWh) Per Square Foot – Electric Resistance Heating (Gas Baseline)

Prototype	CZ 1	CZ 2	CZ 3	CZ 4	CZ 5	CZ 6	CZ 7	CZ 8	CZ 9	CZ 10	CZ 11	CZ 12	CZ 13	CZ 14	CZ 15	CZ 16
OfficeLarge	(1.34)	(1.29)	(1.12)	(1.32)	(1.12)	(0.62)	(0.56)	(0.68)	(0.73)	(0.79)	(1.33)	(1.15)	(1.01)	(1.36)	(0.62)	(2.05)
OfficeMedium	(1.33)	(1.03)	(0.79)	(0.97)	(0.76)	(0.30)	(0.26)	(0.33)	(0.36)	(0.46)	(1.07)	(0.90)	(0.72)	(1.07)	(0.25)	(1.90)
SchoolLarge	(2.22)	(1.55)	(1.67)	(1.41)	(1.59)	(0.77)	(0.63)	(0.74)	(0.84)	(0.75)	(1.48)	(1.46)	(1.18)	(1.23)	(0.47)	(1.85)

Table 114: First Year Peak Demand Reduction (W) Per Square Foot – Electric Resistance Heating (Gas Baseline)

Prototype	CZ 1	CZ 2	CZ 3	CZ 4	CZ 5	CZ 6	CZ 7	CZ 8	CZ 9	CZ 10	CZ 11	CZ 12	CZ 13	CZ 14	CZ 15	CZ 16
OfficeLarge	(0.24)	(0.25)	(0.24)	(0.29)	(0.23)	(0.13)	(0.10)	(0.16)	(0.18)	(0.19)	(0.33)	(0.28)	(0.26)	(0.34)	(0.16)	(0.39)
OfficeMedium	(0.26)	(0.22)	(0.19)	(0.22)	(0.21)	(0.07)	(0.06)	(0.09)	(0.11)	(0.13)	(0.26)	(0.22)	(0.21)	(0.26)	(0.09)	(0.30)
SchoolLarge	(0.20)	(0.18)	(0.20)	(0.18)	(0.22)	(0.12)	(0.10)	(0.14)	(0.14)	(0.13)	(0.20)	(0.18)	(0.17)	(0.16)	(0.11)	(0.20)

Table 115: First Year Natural Gas Savings (kBtu) Per Square Foot – Electric Resistance Heating (Gas Baseline)

Prototype	CZ 1	CZ 2	CZ 3	CZ 4	CZ 5	CZ 6	CZ 7	CZ 8	CZ 9	CZ 10	CZ 11	CZ 12	CZ 13	CZ 14	CZ 15	CZ 16
OfficeLarge	10.43	8.49	7.71	8.07	7.84	3.52	2.95	3.54	3.91	4.16	7.35	7.01	5.63	7.30	2.22	10.74
OfficeMedium	11.79	8.55	7.15	7.63	7.23	3.00	2.58	3.01	3.53	3.57	7.69	7.44	6.02	7.56	2.20	11.63
SchoolLarge	10.13	5.83	6.27	5.00	5.23	2.15	1.97	1.92	2.06	1.55	5.10	5.13	3.31	3.81	0.14	6.29

Table 116: First Year Source Energy Savings (kBtu) Per Square Foot – Electric Resistance Heating (Gas Baseline)

Prototype	CZ 1	CZ 2	CZ 3	CZ 4	CZ 5	CZ 6	CZ 7	CZ 8	CZ 9	CZ 10	CZ 11	CZ 12	CZ 13	CZ 14	CZ 15	CZ 16
OfficeLarge	6.26	4.24	3.86	3.59	4.15	1.40	1.21	1.11	1.38	1.54	2.58	3.10	2.23	2.48	0.28	4.04
OfficeMedium	7.57	4.96	4.46	4.51	4.89	1.94	1.84	2.02	2.24	2.15	3.92	4.21	3.46	4.18	1.24	6.19
SchoolLarge	8.54	5.11	4.96	4.42	4.16	3.13	3.27	2.62	2.52	2.42	3.93	4.29	3.19	3.45	1.26	5.24

Table 117: First Year LSC Energy Savings (\$) Per Square Foot – Electric Resistance Heating (Gas Baseline)

Prototype	CZ 1	CZ 2	CZ 3	CZ 4	CZ 5	CZ 6	CZ 7	CZ 8	CZ 9	CZ 10	CZ 11	CZ 12	CZ 13	CZ 14	CZ 15	CZ 16
OfficeLarge	(2.75)	(3.57)	(3.07)	(3.73)	(2.76)	(2.00)	(1.63)	(2.38)	(2.48)	(2.65)	(4.34)	(3.34)	(3.20)	(4.56)	(2.74)	(7.19)
OfficeMedium	(2.40)	(2.18)	(1.57)	(1.94)	(0.96)	(0.24)	(0.00)	(0.45)	(0.38)	(0.98)	(2.61)	(1.63)	(1.36)	(2.55)	(0.50)	(5.88)
SchoolLarge	(7.72)	(6.62)	(7.50)	(5.38)	(6.84)	(3.41)	(2.64)	(3.43)	(3.84)	(3.56)	(5.80)	(5.53)	(5.10)	(4.89)	(2.93)	(7.51)

Table 118: First Year Electricity Savings (kWh) Per Square Foot – Electric Resistance Heating (AWHP Baseline)

Prototype	CZ 1	CZ 2	CZ 3	CZ 4	CZ 5	CZ 6	CZ 7	CZ 8	CZ 9	CZ 10	CZ 11	CZ 12	CZ 13	CZ 14	CZ 15	CZ 16
OfficeLarge	(0.32)	(0.35)	(0.46)	(0.35)	(0.37)	(0.35)	(0.32)	(0.39)	(0.40)	(0.43)	(0.50)	(0.38)	(0.40)	(0.36)	(0.44)	(0.29)
OfficeMedium	(0.11)	(0.02)	(0.17)	(0.00)	(0.07)	(0.06)	(0.06)	(0.08)	(0.05)	(0.13)	(0.18)	(0.04)	(0.05)	(0.02)	(0.07)	(0.13)
SchoolLarge	(0.84)	(0.57)	(0.82)	(0.45)	(0.78)	(0.34)	(0.21)	(0.32)	(0.38)	(0.33)	(0.57)	(0.56)	(0.47)	(0.32)	(0.20)	(0.29)

Table 119: First Year Peak Demand Reduction (W) Per Square Foot – Electric Resistance Heating (AWHP Baseline)

Prototype	CZ 1	CZ 2	CZ 3	CZ 4	CZ 5	CZ 6	CZ 7	CZ 8	CZ 9	CZ 10	CZ 11	CZ 12	CZ 13	CZ 14	CZ 15	CZ 16
OfficeLarge	(0.06)	(0.06)	(0.11)	(0.07)	(0.07)	(0.07)	(0.06)	(0.09)	(0.10)	(0.10)	(0.09)	(0.07)	(0.09)	(0.04)	(0.10)	(0.03)
OfficeMedium	(0.06)	(0.04)	(0.07)	(0.02)	(0.06)	(0.02)	(0.02)	(0.04)	(0.06)	(0.06)	(0.04)	(0.02)	(0.06)	(0.04)	(0.04)	(0.04)
SchoolLarge	(0.04)	(0.04)	(0.09)	(0.04)	(0.09)	(0.07)	(0.05)	(0.08)	(0.08)	(0.06)	(0.04)	(0.03)	(0.06)	0.04	(0.06)	0.06

Table 120: First Year Source Energy Savings (kBtu) Per Square Foot – Electric Resistance Heating (AWHP Baseline)

Prototype	CZ 1	CZ 2	CZ 3	CZ 4	CZ 5	CZ 6	CZ 7	CZ 8	CZ 9	CZ 10	CZ 11	CZ 12	CZ 13	CZ 14	CZ 15	CZ 16
OfficeLarge	(0.70)	(0.67)	(1.15)	(0.76)	(0.86)	(0.85)	(0.71)	(0.93)	(0.95)	(1.02)	(1.08)	(0.80)	(0.86)	(0.63)	(1.02)	(0.51)
OfficeMedium	(0.39)	(0.12)	(0.62)	(0.14)	(0.33)	(0.27)	(0.20)	(0.32)	(0.23)	(0.47)	(0.45)	(0.24)	(0.32)	(0.19)	(0.32)	(0.39)
SchoolLarge	(1.48)	(1.18)	(1.97)	(1.10)	(1.88)	(1.07)	(0.78)	(1.15)	(1.18)	(1.04)	(1.22)	(1.30)	(1.26)	(0.55)	(0.87)	(0.11)

Table 121: First Year LSC Energy Savings (\$) Per Square Foot – Electric Resistance Heating (AWHP Baseline)

Prototype	CZ 1	CZ 2	CZ 3	CZ 4	CZ 5	CZ 6	CZ 7	CZ 8	CZ 9	CZ 10	CZ 11	CZ 12	CZ 13	CZ 14	CZ 15	CZ 16
OfficeLarge	(2.00)	(2.13)	(3.11)	(2.18)	(2.33)	(2.32)	(2.02)	(2.58)	(2.66)	(2.79)	(3.06)	(2.32)	2.47)	(2.09)	(2.80)	(1.67)
OfficeMedium	(0.86)	(0.31)	(1.44)	(0.16)	(0.54)	(0.49)	(0.39)	(0.62)	(0.47)	(0.99)	(1.16)	(0.39)	(0.58)	(0.26)	(0.62)	(0.83)
SchoolLarge	(5.07)	(3.81)	(5.69)	(2.72)	(4.87)	(2.22)	(1.54)	(2.22)	(2.49)	(2.14)	(3.32)	(3.27)	(2.94)	(1.60)	(1.52)	(1.21)

5.4 Cost and Cost Effectiveness

5.4.1 Energy Cost Savings Methodology

Energy cost savings were calculated by applying the LSC hourly factors to the energy savings estimates that were derived using the methodology described in Section 3.3.1. LSC hourly factors are a normalized metric to calculate energy cost savings that accounts for the variable cost of electricity and natural gas for each hour of the year, along with how costs are expected to change over the period of analysis. In this case, the period of analysis used is 30 years.

The CEC requested energy cost savings over the 30-year period of analysis in both 2026 present value dollars (2026 PV\$) and nominal dollars. The cost-effectiveness analysis uses energy cost values in 2026 PV\$. Costs and cost-effectiveness using and 2026 PV\$ are presented in Section 5.4 of this report. CEC uses results in nominal dollars to complete the Economic and Fiscal Impacts Statement (From 399) for the entire package of proposed change to Title 24, Part 6. Appendix G presents energy cost savings results in nominal dollars.

The methodology for additions and alterations was the same as for new construction. This is a conservative estimate as it assumed the perfect operation of HVAC controls and an efficient envelope in the baseline system.

5.4.2 Energy Cost Savings Results

Per unit energy cost savings for newly constructed buildings, additions, and alterations that are realized over the 30-year period of analysis are presented 2026 present value dollars (2026 PV\$) in Table 122 through Table 133.

The LSC hourly factors methodology allows peak electricity savings to be valued more than electricity savings during non-peak periods. This measure has the potential to increase winter morning peak electric demand, particularly if a natural gas boiler is in the Baseline. Summer afternoon/evening peak impacts are expected to be minimal.

Any time code changes impact cost, there is potential to disproportionately impact DIPs. Refer to Section 5.6 for more details addressing energy equity and environmental justice.

Table 122: 2026 PV LSC Savings Over 30-Year Period of Analysis – Per Square Foot – New Construction and Additions – OfficeLarge – Electric Resistance Heating (Gas Baseline)

Climate Zone	30-Year LSC Electricity Savings (2026 PV\$)	30-Year LSC Natural Gas Savings (2026 PV\$)	Total 30-Year LSC Savings (2026 PV\$)
1	NA ^a	NA	NA
2	NA	NA	NA
3	(7.44)	4.36	(3.07)
4	(8.39)	4.66	(3.73)
5	NA	NA	NA
6	(4.05)	2.05	(2.00)
7	(3.38)	1.75	(1.63)
8	(4.50)	2.12	(2.38)
9	(4.80)	2.32	(2.48)
10	(5.14)	2.49	(2.65)
11	(8.71)	4.37	(4.34)
12	(7.43)	4.10	(3.34)
13	NA	NA	NA
14	(8.95)	4.39	(4.56)
15	(4.12)	1.38	(2.74)
16	(13.44)	6.25	(7.19)

^a “NA” refers to the fact that the CEC forecasts 0 square feet of construction activity in this climate zone for this building type in 2026.

Table 123: 2026 PV LSC Savings Over 30-Year Period of Analysis – Per Square Foot – New Construction and Additions–OfficeMedium – Electric Resistance Heating (Gas Baseline)

Climate Zone	30-Year LSC Electricity Savings (2026 PV\$)	30-Year LSC Natural Gas Savings (2026 PV\$)	Total 30-Year LSC Savings (2026 PV\$)
1	(9.04)	6.64	(2.40)
2	(7.10)	4.92	(2.18)
3	(5.68)	4.11	(1.57)
4	(6.41)	4.47	(1.94)
5	(5.06)	4.10	(0.96)
6	(2.01)	1.77	(0.24)
7	(1.56)	1.56	(0.00)
8	(2.28)	1.83	(0.45)
9	(2.51)	2.13	(0.38)
10	(3.14)	2.16	(0.98)
11	(7.22)	4.61	(2.61)
12	(6.05)	4.42	(1.63)
13	(4.99)	3.63	(1.36)
14	(7.15)	4.60	(2.55)
15	(1.87)	1.37	(0.50)
16	(12.70)	6.82	(5.88)

^a “NA” refers to the fact that the CEC forecasts 0 square feet of construction activity in this climate zone for this building type in 2026.

Table 124: 2026 PV LSC Savings Over 30-Year Period of Analysis – Per Square Foot – New Construction and Additions–SchoolLarge – Electric Resistance Heating (Gas Baseline)

Climate Zone	30-Year LSC Electricity Savings (2026 PV\$)	30-Year LSC Natural Gas Savings (2026 PV\$)	Total 30-Year LSC Savings (2026 PV\$)
1	(13.48)	5.75	(7.72)
2	(10.08)	3.46	(6.62)
3	(11.21)	3.71	(7.50)
4	(8.47)	3.09	(5.38)
5	(9.92)	3.08	(6.84)
6	(4.75)	1.34	(3.41)
7	(3.88)	1.24	(2.64)
8	(4.73)	1.29	(3.43)
9	(5.24)	1.40	(3.84)
10	(4.68)	1.12	(3.56)
11	(9.04)	3.24	(5.80)
12	(8.72)	3.19	(5.53)
13	(7.31)	2.21	(5.10)
14	(7.44)	2.55	(4.89)
15	(3.27)	0.33	(2.93)
16	(11.37)	3.86	(7.51)

^a “NA” refers to the fact that the CEC forecasts 0 square feet of construction activity in this climate zone for this building type in 2026.

Table 125: 2026 PV LSC Savings Over 30-Year Period of Analysis – Per Square Foot – New Construction and Additions–All Prototypes – Electric Resistance Heating (Gas Baseline)

Climate Zone	30-Year LSC Electricity Savings (2026 PV\$)	30-Year LSC Natural Gas Savings (2026 PV\$)	Total 30-Year LSC Savings (2026 PV\$)
1	(9.22)	6.60	(2.62)
2	(7.67)	4.64	(3.03)
3	(7.54)	4.20	(3.34)
4	(7.82)	4.36	(3.46)
5	(5.45)	4.02	(1.43)
6	(3.36)	1.81	(1.54)
7	(2.80)	1.54	(1.26)
8	(3.73)	1.87	(1.86)
9	(3.97)	2.10	(1.87)
10	(3.96)	1.87	(2.09)
11	(8.27)	3.94	(4.33)
12	(6.84)	4.09	(2.75)
13	(6.11)	2.95	(3.16)
14	(7.69)	4.10	(3.59)
15	(2.25)	1.15	(1.10)
16	(12.47)	5.84	(6.63)

^a “NA” refers to the fact that the CEC forecasts 0 square feet of construction activity in this climate zone for this building type in 2026.

Table 126: 2026 PV LSC Savings Over 30-Year Period of Analysis – Per Square Foot – Alterations– OfficeLarge – Electric Resistance Heating (Gas Baseline)

Climate Zone	30-Year LSC Electricity Savings (2026 PV\$)	30-Year LSC Natural Gas Savings (2026 PV\$)	Total 30-Year LSC Savings (2026 PV\$)
1	(8.50)	5.75	(2.75)
2	(8.35)	4.78	(3.57)
3	(7.44)	4.36	(3.07)
4	(8.39)	4.66	(3.73)
5	(7.16)	4.40	(2.76)
6	(4.05)	2.05	(2.00)
7	(3.38)	1.75	(1.63)
8	(4.50)	2.12	(2.38)
9	(4.80)	2.32	(2.48)
10	(5.14)	2.49	(2.65)
11	(8.71)	4.37	(4.34)
12	(7.43)	4.10	(3.34)
13	(6.58)	3.37	(3.20)
14	(8.95)	4.39	(4.56)
15	(4.12)	1.38	(2.74)
16	(13.44)	6.25	(7.19)

Table 127: 2026 PV LSC Savings Over 30-Year Period of Analysis – Per Square Foot – Alterations–OfficeMedium – Electric Resistance Heating (Gas Baseline)

Climate Zone	30-Year LSC Electricity Savings (2026 PV\$)	30-Year LSC Natural Gas Savings (2026 PV\$)	Total 30-Year LSC Savings (2026 PV\$)
1	(9.04)	6.64	(2.40)
2	(7.10)	4.92	(2.18)
3	(5.68)	4.11	(1.57)
4	(6.41)	4.47	(1.94)
5	(5.06)	4.10	(0.96)
6	(2.01)	1.77	(0.24)
7	(1.56)	1.56	(0.00)
8	(2.28)	1.83	(0.45)
9	(2.51)	2.13	(0.38)
10	(3.14)	2.16	(0.98)
11	(7.22)	4.61	(2.61)
12	(6.05)	4.42	(1.63)
13	(4.99)	3.63	(1.36)
14	(7.15)	4.60	(2.55)
15	(1.87)	1.37	(0.50)
16	(12.70)	6.82	(5.88)

Table 128: 2026 PV LSC Savings Over 30-Year Period of Analysis – Per Square Foot – Alterations–SchoolLarge – Electric Resistance Heating (Gas Baseline)

Climate Zone	30-Year LSC Electricity Savings (2026 PV\$)	30-Year LSC Natural Gas Savings (2026 PV\$)	Total 30-Year LSC Savings (2026 PV\$)
1	(13.48)	5.75	(7.72)
2	(10.08)	3.46	(6.62)
3	(11.21)	3.71	(7.50)
4	(8.47)	3.09	(5.38)
5	(9.92)	3.08	(6.84)
6	(4.75)	1.34	(3.41)
7	(3.88)	1.24	(2.64)
8	(4.73)	1.29	(3.43)
9	(5.24)	1.40	(3.84)
10	(4.68)	1.12	(3.56)
11	(9.04)	3.24	(5.80)
12	(8.72)	3.19	(5.53)
13	(7.31)	2.21	(5.10)
14	(7.44)	2.55	(4.89)
15	(3.27)	0.33	(2.93)
16	(11.37)	3.86	(7.51)

Table 129: 2026 PV LSC Savings Over 30-Year Period of Analysis – Per Square Foot – Alterations–All Prototypes – Electric Resistance Heating (Gas Baseline)

Climate Zone	30-Year LSC Electricity Savings (2026 PV\$)	30-Year LSC Natural Gas Savings (2026 PV\$)	Total 30-Year LSC Savings (2026 PV\$)
1	(9.81)	6.45	(3.36)
2	(7.76)	4.63	(3.13)
3	(7.41)	4.20	(3.21)
4	(7.74)	4.43	(3.32)
5	(5.87)	4.01	(1.86)
6	(3.61)	1.86	(1.75)
7	(2.88)	1.61	(1.28)
8	(4.04)	1.92	(2.12)
9	(4.44)	2.14	(2.30)
10	(4.26)	1.94	(2.32)
11	(7.97)	4.12	(3.85)
12	(7.12)	4.03	(3.09)
13	(6.24)	2.97	(3.26)
14	(8.02)	3.97	(4.06)
15	(2.79)	1.02	(1.77)
16	(12.59)	5.74	(6.85)

Table 130: 2026 PV LSC Savings Over 30-Year Period of Analysis – Per Square Foot – New Construction and Additions–OfficeLarge – Electric Resistance Heating (AWHP Baseline)

Climate Zone	30-Year LSC Electricity Savings (2026 PV\$)	30-Year LSC Natural Gas Savings (2026 PV\$)	Total 30-Year LSC Savings (2026 PV\$)
1	NA	NA	NA
2	NA	NA	NA
3	(3.11)	0.00	(3.11)
4	(2.18)	0.00	(2.18)
5	NA	NA	NA
6	(2.32)	0.00	(2.32)
7	(2.02)	0.00	(2.02)
8	(2.58)	0.00	(2.58)
9	(2.66)	0.00	(2.66)
10	(2.79)	0.00	(2.79)
11	(3.06)	0.00	(3.06)
12	(2.32)	0.00	(2.32)
13	NA	NA	NA
14	(2.09)	0.00	(2.09)
15	(2.80)	0.00	(2.80)
16	(1.67)	0.00	(1.67)

Table 131: 2026 PV LSC Savings Over 30-Year Period of Analysis – Per Square Foot – New Construction and Additions –OfficeMedium – Electric Resistance Heating (AWHP Baseline)

Climate Zone	30-Year LSC Electricity Savings (2026 PV\$)	30-Year LSC Natural Gas Savings (2026 PV\$)	Total 30-Year LSC Savings (2026 PV\$)
1	(0.86)	0.00	(0.86)
2	(0.31)	0.00	(0.31)
3	(1.44)	0.00	(1.44)
4	(0.16)	0.00	(0.16)
5	(0.54)	0.00	(0.54)
6	(0.49)	0.00	(0.49)
7	(0.39)	0.00	(0.39)
8	(0.62)	0.00	(0.62)
9	(0.47)	0.00	(0.47)
10	(0.99)	0.00	(0.99)
11	(1.16)	0.00	(1.16)
12	(0.39)	0.00	(0.39)
13	(0.58)	0.00	(0.58)
14	0.26	0.00	0.26
15	(0.62)	0.00	(0.62)
16	0.83	0.00	0.83

Table 132: 2026 PV LSC Savings Over 30-Year Period of Analysis – Per Square Foot – New Construction and Additions –SchoolLarge – Electric Resistance Heating (AWHP Baseline)

Climate Zone	30-Year LSC Electricity Savings (2026 PV\$)	30-Year LSC Natural Gas Savings (2026 PV\$)	Total 30-Year LSC Savings (2026 PV\$)
1	(5.07)	(0.00)	(5.07)
2	(3.81)	(0.00)	(3.81)
3	(5.69)	(0.00)	(5.69)
4	(2.72)	(0.00)	(2.72)
5	(4.87)	(0.00)	(4.87)
6	(2.22)	(0.00)	(2.22)
7	(1.54)	(0.00)	(1.54)
8	(2.22)	(0.00)	(2.22)
9	(2.49)	(0.00)	(2.49)
10	(2.14)	(0.00)	(2.14)
11	(3.32)	(0.00)	(3.32)
12	(3.27)	(0.00)	(3.27)
13	(2.94)	(0.00)	(2.94)
14	(1.60)	(0.00)	(1.60)
15	(1.52)	(0.00)	(1.52)
16	(1.21)	(0.00)	(1.21)

Table 133: 2026 PV LSC Savings Over 30-Year Period of Analysis – Per Square Foot – New Construction and Additions –All Prototypes – Electric Resistance Heating (AWHP Baseline)

Climate Zone	30-Year LSC Electricity Savings (2026 PV\$)	30-Year LSC Natural Gas Savings (2026 PV\$)	Total 30-Year LSC Savings (2026 PV\$)
1	(1.04)	0.00	(1.04)
2	(0.97)	0.00	(0.97)
3	(3.05)	0.00	(3.05)
4	(1.67)	0.00	(1.67)
5	(0.89)	0.00	(0.89)
6	(1.57)	0.00	(1.57)
7	(1.26)	0.00	(1.26)
8	(1.80)	0.00	(1.80)
9	(1.78)	0.00	(1.78)
10	(1.65)	0.00	(1.65)
11	(2.43)	0.00	(2.43)
12	(1.29)	0.00	(1.29)
13	(1.71)	0.00	(1.71)
14	(0.77)	0.00	(0.77)
15	(0.89)	0.00	(0.89)
16	(0.30)	0.00	(0.30)

5.4.3 Incremental First Cost

A real 40,000 ft² Bay Area office building that was recently built has a VAV HW reheat system served by a gas boiler. The piping was designed for a design HWST of 160 °F. To account for the proposed maximum HWST of 130 °F, the Gas Baseline design was slightly modified to include larger pumps and piping needed for 130 °F HWST. To develop the AWHP baseline the Statewide CASE Team redesigned the mechanical system with an AWHP instead of a boiler and then redesigned it with fan-powered VAV boxes with electric resistance heat, instead of hydronic heating. Thus, there were 3 full designs: Gas Baseline, AWHP Baseline and Electric Resistance.

Contractor pricing for the mechanical equipment for each case was solicited from Bay Area HVAC equipment representatives. Pricing was provided for boilers, AWHPs, HW reheat boxes, fan power boxes with electric resistance, and single duct VAV boxes with electric resistance (interior zones can meet the criteria without fan boxes). Incremental pricing for a complete installation was then solicited from Bay Area mechanical and electrical contractors. This pricing includes all miscellaneous costs associated with a hydronic system such as expansion tanks and water treatment. It also includes a sound boot on the inlet of each of the fan-powered boxes. It also included the cost for the electrical contractor to power the AWHP and each of the fan-powered boxes. Detailed incremental costs are shown in Table 134 through Table 137.

Table 134: Building Data for ER Heating Measure Costing

Metric	Data	Source (if applicable)
Area (ft ²)	40,000	Real Building Drawings
Peak load (Btuh/ft ²)	18	Real Building Drawings
Peak load (Btuh)	720,000	Real Building Drawings
Total zones	53	Real Building Drawings
Interior zones	16	Real Building Drawings
Avg ft ² /box	754.72	Real Building Drawings
Discount rate for annual costs	3%	MeasureSET
Study period (years)	30	MeasureSET
PV multiplier	19.60	calculation

Table 135: Gas Hydronic Baseline Cost Data

Baseline: Gas Boiler serving HW Reheat Boxes	Data	Source (if applicable)
Avg cost/reheat box	\$345	Bay Area equip. rep.
Cost of reheat boxes	\$18,282	Bay Area equip. rep.
Mech installation cost for typical HW reheat box (\$/box)	\$5,000	Bay Area mech. Contractor
Mech installation cost for reheat boxes (\$)	\$265,000	Calculation
Boiler cost - installed (\$/Btuh)	0.1	Bay Area equip. reps
Boiler cost - installed (\$)	\$72,000	Calculation
HW piping cost \$/ft2 (does not include box piping)	5.68	Bay Area mech. Contractor
HW piping cost \$ (does not include box piping)	\$227,200	Calculation
Pump cost \$/gpm installed	170.5	Bay Area equip. reps
Gpm	86	Calculation
Pump cost \$	\$14,663	Calculation
Misc. hydronics cost \$ (ET, TES, WTS, etc.)	\$30,000	Bay Area mech. Contractor
Boiler/HW incremental controls \$	\$15,000	Bay Area mech. Contractor
Gas service to building and to boiler	\$20,000	Bay Area mech. Contractor
Plumbing for boiler \$ (MUW, drain, etc.)	\$10,000	Bay Area mech. Contractor
Structural/arch for boiler (pad, roof screen, mech room, etc.)	0	Bay Area mech. Contractor
Annual maintenance for HW system, incl boiler (\$/y)	\$1,000	Bay Area service Contractor
Other first costs	\$12,500	Bay Area mech. Contractor
Total first cost	\$684,645	Calculation
Total annual costs	\$1,000	Bay Area service Contractor
PV of annual	\$19,600	Calculation
Boiler expected life (years)	30	ASHRAE database
Boiler replacement cost	0	Calculation
NPV	\$704,246	Calculation
Savings/ft2 vs Gas Baseline	\$5.91	Calculation

Table 136: Electric (AWHP) Hydronic Baseline Cost Data

Baseline: AWHP serving HW Reheat Boxes	Data	Source (if applicable)
Avg cost/reheat box	\$345	Bay Area equip. rep.
Cost of reheat boxes	\$18,282	Bay Area equip. rep.
Mech installation cost for typical HW reheat box (\$/box)	\$5,000	Bay Area mech. Contractor
Mech installation cost for reheat boxes (\$)	\$265,000	Calculation
AWHP cost - installed (\$/Btuh)	\$0.28	Bay Area mech. Contractor
AWHP cost - installed (\$)	\$201,600	Calculation
HW piping cost \$/ft2 (does not include box piping)	\$5.68	Bay Area mech. Contractor
HW piping cost \$ (does not include box piping)	\$227,200	Calculation
Pump cost \$/gpm installed	\$171	Bay Area equip. reps
Gpm	86	calculated
Pump cost \$	\$14,663	calculated
Misc. hydronics cost \$ (ET, TES, WTS, etc.)	\$30,000	Bay Area mech. Contractor
AWHP/HW incremental controls \$	\$15,000	Bay Area mech. Contractor
Electrical service to AWHP	\$30,280	Bay Area elec. Contractor
Plumbing for AWHP \$ (MUW, drain, etc.)	\$10,000	Bay Area mech. Contractor
Structural/arch for AWHP (pad, roof screen, mech room, etc.)	0	Bay Area mech. Contractor
Annual maintenance for HW system, incl AWHP (\$/year)	\$1,000	Bay Area service Contractor
Other first costs	\$12,500	Bay Area mech. Contractor
Total first cost	\$824,525	Calculated
Total annual costs	\$1,000	Calculated
PV of annual	\$19,600	Calculated
AWHP expected life (years)	20	ASHRAE database
AWHP replacement cost	\$111,621	Calculated
NPV	\$955,747	Calculated

Table 137: ER Heating Proposed Design Cost Data

Proposed: Electric Resistance Heat	Data	Source (if applicable)
Interior zones	16	Real Building Drawings
Perimeter zones	37	Real Building Drawings
Single duct avg cost/box	\$1,033	Bay Area equip. rep.
Fan box avg cost/box	\$1,789	Bay Area equip. rep.
Cost of electric resistance boxes (SD + FPB)	\$82,721	Calculated
Mechanical installation cost of typical single duct box with electric resistance (\$/box)	\$2,000	Bay Area mech. Contractor

Mechanical installation cost of typical FPB with electric resistance (\$/box)	\$3,000	Bay Area mech. Contractor
Mechanical installation cost for boxes	\$143,000	Calculated
Electrical service to FPBs	\$1,820	Bay Area elec. Contractor
Electrical install for boxes	\$96,460	Calculated
Unit price of filter change for FPB (\$/box)	150	Bay Area mech. Contractor
Sound boot per box (\$/box)	1,000	Bay Area mech. Contractor
Percent of FPB with sound boots	100%	Conservative estimate
Sound boot cost	\$37,000	Calculated
Total first cost	\$359,181	Calculated
Total annual costs	\$5,550	Calculated
PV of annual	\$108,782	Calculated
NPV	\$467,963	Calculated
Savings/ft2 vs AWHP baseline	\$12.19	Calculated

5.4.4 Incremental Maintenance and Replacement Costs

Incremental maintenance cost was provided by Bay Area service contractors based on the three designs described above and is included in the table above. Surprisingly, the electric resistance case has the highest maintenance cost, even though it has no central heating plant equipment and no moving parts in the heating system. The high maintenance cost for the Electric Resistance measure is for filter replacements as Title 24, Part 6 requires filters in fan powered boxes. There are other types of electric resistance heating systems that would comply with the proposal and not require filter changes, such as baseboard radiators or radiant panels.

The only replacement cost included in the analysis is for replacement of the AWHP after 20 years. All other equipment has an expected life of 30 years or longer.

5.4.5 Cost Effectiveness

This measure proposes a prescriptive option. As such, a cost analysis is required to demonstrate that the measure is cost-effective over the 30-year period of analysis.

The CEC establishes the procedures for calculating cost-effectiveness. The Statewide CASE Team collaborated with CEC staff to confirm that the methodology in this report is consistent with their guidelines, including which costs were included in the analysis. The incremental first cost and incremental maintenance costs over the 30-year period of analysis were included. The LSC Savings from electricity and natural gas savings were also included in the evaluation. Design costs were not included nor were the incremental costs of code compliance verification.

According to the CEC’s definitions, a measure is cost-effective if the benefit-to-cost (B/C) ratio is greater than 1.0. The B/C ratio is calculated by dividing the cost benefits realized over 30 years by the total incremental costs, which includes maintenance costs for 30 years. The B/C ratio was calculated using 2026 PV costs and cost savings.

Results of the per unit cost-effectiveness analyses are presented in Table 138 and Table 139 for new construction/additions and alterations, respectively. Results are shown for the condition with a gas boiler in the baseline. Results are presented for the AWHP baseline in new construction in Table 140.

The proposed measure saves money over the 30-year period of analysis relative to the existing conditions. The proposed code change is cost-effective in every climate zone except for Climate Zone 16. Benefits and costs are defined as follows:

- **Benefits: LSC Savings + Other PV Savings:** Benefits include LSC Savings over the period of analysis (California Energy Commission 2022). Other savings are discounted at a real (nominal – inflation) three percent rate. Other PV savings include incremental first-cost savings if proposed first cost is less than current first cost, incremental PV maintenance cost savings if PV of proposed maintenance costs is less than PV of current maintenance costs, and incremental residual value if proposed residual value is greater than current residual value at end of the CASE analysis period.
- **Costs: Total Incremental Present Valued Costs:** Costs include incremental equipment, replacement, and maintenance costs over the period of analysis. Costs are discounted at a real (inflation-adjusted) three percent

Table 138: 30-Year Cost-Effectiveness Summary Per Square Foot – New Construction/Additions – Gas Baseline

Climate Zone	Benefits LSC Savings + Other PV Savings (2026 PV\$)	Costs Total Incremental PV Costs (2026 PV\$)	Benefit-to-Cost Ratio
1	(2.62)	(5.91)	2.26
2	(3.03)	(5.91)	1.95
3	(3.34)	(5.91)	1.77
4	(3.46)	(5.91)	1.71
5	(1.43)	(5.91)	4.14
6	(1.54)	(5.91)	3.83
7	(1.26)	(5.91)	4.69
8	(1.86)	(5.91)	3.18
9	(1.87)	(5.91)	3.16
10	(2.09)	(5.91)	2.83

Climate Zone	Benefits LSC Savings + Other PV Savings (2026 PV\$)	Costs Total Incremental PV Costs (2026 PV\$)	Benefit-to-Cost Ratio
11	(4.33)	(5.91)	1.37
12	(2.75)	(5.91)	2.15
13	(3.16)	(5.91)	1.87
14	(3.59)	(5.91)	1.65
15	(1.10)	(5.91)	5.39
16	(6.63)	(5.91)	0.89

Table 139: 30-Year Cost-Effectiveness Summary Per Square Foot – Alterations – Gas Baseline

Climate Zone	Benefits LSC Savings + Other PV Savings (2026 PV\$)	Costs Total Incremental PV Costs (2026 PV\$)	Benefit-to-Cost Ratio
1	(3.36)	(5.91)	1.76
2	(3.13)	(5.91)	1.89
3	(3.21)	(5.91)	1.84
4	(3.32)	(5.91)	1.78
5	(1.86)	(5.91)	3.18
6	(1.75)	(5.91)	3.38
7	(1.28)	(5.91)	4.62
8	(2.12)	(5.91)	2.79
9	(2.30)	(5.91)	2.57
10	(2.32)	(5.91)	2.55
11	(3.85)	(5.91)	1.53
12	(3.09)	(5.91)	1.91
13	(3.26)	(5.91)	1.81
14	(4.06)	(5.91)	1.46
15	(1.77)	(5.91)	3.33
16	(6.85)	(5.91)	0.86

Table 140: 30-Year Cost-Effectiveness Summary Per Square Foot – New Construction/Additions – AHP Baseline

Climate Zone	Benefits LSC Savings + Other PV Savings (2026 PV\$)	Costs Total Incremental PV Costs (2026 PV\$)	Benefit-to-Cost Ratio
1	(1.04)	(12.19)	11.71
2	(0.97)	(12.19)	12.52
3	(3.05)	(12.19)	4.00
4	(1.67)	(12.19)	7.28
5	(0.89)	(12.19)	13.75
6	(1.57)	(12.19)	7.78
7	(1.26)	(12.19)	9.65
8	(1.80)	(12.19)	6.77
9	(1.78)	(12.19)	6.84
10	(1.65)	(12.19)	7.40
11	(2.43)	(12.19)	5.02
12	(1.29)	(12.19)	9.43
13	(1.71)	(12.19)	7.13
14	(0.77)	(12.19)	15.80
15	(0.89)	(12.19)	13.71
16	(0.30)	(12.19)	40.30

5.5 First-Year Statewide Impacts

5.5.1 Statewide Energy and Energy Cost Savings

The Statewide CASE Team calculated the first-year statewide savings for new construction and additions by multiplying the per unit savings, which are presented in Section 5.3.2, by assumptions about the percentage of newly constructed buildings that would be impacted by the proposed code. The statewide new construction forecast for 2026 is presented in Appendix A, as are the Statewide CASE Team’s assumptions about the percentage of new construction that would be impacted by the proposal (by climate zone and building type). The Statewide CASE Team used the same savings methodology for alterations.

The first-year energy impacts represent the first-year annual savings from all buildings that were completed in 2026. The 30-year energy cost savings represent the energy cost savings over the entire 30-year analysis period. The statewide savings estimates do not take naturally occurring market adoption or compliance rates into account.

The tables below presents the first-year statewide energy and energy cost savings from newly constructed buildings and additions for the gas baseline (Table 141) and the electric baseline (Table 143) by climate zone. Table 142 presents the first-year statewide savings from alterations for the gas baseline. Table 144 and Table 145 presents a summary of first-year statewide savings from new construction, additions, and alterations for the two baselines.

While a statewide analysis is crucial to understanding broader effects of code change proposals, there is potential to disproportionately impact DIPs that needs to be considered. Refer to Section 5.6 for more details addressing energy equity and environmental justice.

Table 141: Statewide Energy and Energy Cost Impacts – New Construction and Additions (Gas Baseline)

Climate Zone	Statewide New Construction & Additions Impacted by Proposed Change in 2026 (Million Square Feet)	First-Year ^a Electricity Savings (GWh)	First-Year Peak Electrical Demand Reduction (MW)	First-Year Natural Gas Savings (Million Therms)	First-Year Source Energy Savings (Million kBtu)	30-Year Present Valued Energy Cost Savings (Million 2026 PV\$)
1	9,513	(0.01)	(0.00)	0.00	0.07	(\$0.02)
2	41,178	(0.05)	(0.01)	0.00	0.21	(\$0.12)
3	353,132	(0.39)	(0.08)	0.03	1.48	(\$1.18)
4	178,422	(0.22)	(0.05)	0.01	0.71	(\$0.62)
5	28,177	(0.02)	(0.01)	0.00	0.14	(\$0.04)
6	209,996	(0.11)	(0.02)	0.01	0.40	(\$0.32)
7	145,644	(0.07)	(0.01)	0.00	0.29	(\$0.18)
8	314,707	(0.18)	(0.04)	0.01	0.54	(\$0.58)
9	571,217	(0.34)	(0.08)	0.02	1.08	(\$1.07)
10	159,404	(0.10)	(0.02)	0.00	0.34	(\$0.33)
11	47,489	(0.06)	(0.01)	0.00	0.18	(\$0.21)
12	303,059	(0.32)	(0.07)	0.02	1.24	(\$0.83)
13	78,934	(0.07)	(0.01)	0.00	0.26	(\$0.25)
14	47,188	(0.06)	(0.01)	0.00	0.17	(\$0.17)
15	24,508	(0.01)	(0.00)	0.00	0.03	(\$0.03)
16	14,476	(0.03)	(0.00)	0.00	0.08	(\$0.10)
Total	2,527,044	(2.04)	(0.44)	0.12	7.21	(\$6.06)

a. First-year savings from all buildings completed statewide in 2026.

Table 142: Statewide Energy and Energy Cost Impacts – Alterations (Gas Baseline)

Climate Zone	Statewide New Construction & Additions Impacted by Proposed Change in 2026 (Million Square Feet)	First-Year^a Electricity Savings (GWh)	First-Year Peak Electrical Demand Reduction (MW)	First-Year Natural Gas Savings (Million Therms)	First-Year Source Energy Savings (Million kBtu)	30-Year Present Valued Energy Cost Savings (Million 2026 PV\$)
1	42,654	(0.06)	(0.01)	0.00	0.33	(\$0.14)
2	421,120	(0.48)	(0.09)	0.03	2.08	(\$1.32)
3	2,534,200	(2.76)	(0.56)	0.19	10.63	(\$8.14)
4	1,285,800	(1.56)	(0.33)	0.10	5.12	(\$4.27)
5	172,230	(0.15)	(0.04)	0.01	0.81	(\$0.32)
6	1,757,200	(0.99)	(0.20)	0.06	3.21	(\$3.07)
7	1,391,200	(0.66)	(0.12)	0.04	2.42	(\$1.78)
8	2,646,200	(1.62)	(0.37)	0.08	4.11	(\$5.60)
9	4,630,200	(3.14)	(0.74)	0.16	7.96	(\$10.66)
10	1,811,800	(1.19)	(0.27)	0.06	3.69	(\$4.20)
11	296,780	(0.37)	(0.07)	0.02	1.13	(\$1.14)
12	2,336,900	(2.60)	(0.54)	0.16	9.01	(\$7.23)
13	608,540	(0.59)	(0.12)	0.03	1.92	(\$1.99)
14	456,600	(0.57)	(0.12)	0.03	1.48	(\$1.85)
15	223,050	(0.09)	(0.03)	0.00	0.24	(\$0.40)
16	123,150	(0.24)	(0.04)	0.01	0.63	(\$0.84)
Total	20,737,624	(17.07)	(3.65)	0.98	54.76	(\$52.96)

a. First-year savings from all buildings completed statewide in 2026.

Table 143: Statewide Energy and Energy Cost Impacts – New Construction and Additions (AWHP Baseline)

Climate Zone	Statewide New Construction & Additions Impacted by Proposed Change in 2026 (Million Square Feet)	First-Year^a Electricity Savings (GWh)	First-Year Peak Electrical Demand Reduction (MW)	First-Year Natural Gas Savings (Million Therms)	First-Year Source Energy Savings (Million kBtu)	30-Year Present Valued Energy Cost Savings (Million 2026 PV\$)
1	4,077	(0.00)	(0.00)	(0.00)	(0.00)	(\$0.00)
2	17,648	(0.00)	(0.00)	(0.00)	(0.01)	(\$0.02)
3	151,342	(0.07)	(0.01)	(0.00)	(0.17)	(\$0.46)
4	76,467	(0.02)	(0.00)	(0.00)	(0.05)	(\$0.13)
5	12,076	(0.00)	(0.00)	(0.00)	(0.01)	(\$0.01)
6	89,998	(0.02)	(0.00)	(0.00)	(0.06)	(\$0.14)
7	62,419	(0.01)	(0.00)	(0.00)	(0.03)	(\$0.08)
8	134,875	(0.04)	(0.01)	(0.00)	(0.10)	(\$0.24)
9	244,807	(0.06)	(0.02)	(0.00)	(0.17)	(\$0.44)
10	68,316	(0.02)	(0.00)	(0.00)	(0.05)	(\$0.11)
11	20,352	(0.01)	(0.00)	(0.00)	(0.02)	(\$0.05)
12	129,883	(0.03)	(0.00)	(0.00)	(0.07)	(\$0.17)
13	33,829	(0.01)	(0.00)	(0.00)	(0.03)	(\$0.06)
14	20,223	(0.00)	0.00	(0.00)	(0.00)	(\$0.02)
15	10,503	(0.00)	(0.00)	(0.00)	(0.00)	(\$0.01)
16	6,204	(0.00)	0.00	(0.00)	0.00	(\$0.00)
Total	1,083,019	(0.29)	(0.07)	(0.00)	(0.77)	(\$1.94)

a. First-year savings from all buildings completed statewide in 2026.

Table 144: Statewide Energy and Energy Cost Impacts – New Construction, Additions, and Alterations (Gas Baseline)

Construction Type	First-Year Electricity Savings (GWh)	First-Year Peak Electrical Demand Reduction (MW)	First -Year Natural Gas Savings (Million Therms)	First-Year Source Energy Savings (Million kBtu)	30-Year Present Valued Energy Cost Savings (PV\$ Million)
New Construction & Additions	(2.04)	(0.44)	0.12	7.21	(6.06)
Alterations	(17.07)	(3.65)	0.98	54.76	(52.96)
Total	(19.11)	(4.09)	1.11	61.97	(59.02)

Table 145: Statewide Energy and Energy Cost Impacts – New Construction, Additions, and Alterations (AWHP Baseline)

Construction Type	First-Year Electricity Savings (GWh)	First-Year Peak Electrical Demand Reduction (MW)	First -Year Natural Gas Savings (Million Therms)	First-Year Source Energy Savings (Million kBtu)	30-Year Present Valued Energy Cost Savings (PV\$ Million)
New Construction & Additions	(0.29)	(0.07)	(0.00)	(0.77)	(1.94)
Alterations	0	0	0	0	0
Total	(0.29)	(0.07)	(0.00)	(0.77)	(1.94)

a. First-year savings from all alterations completed statewide in 2026.

5.5.2 Statewide Greenhouse Gas (GHG) Emissions Reductions

The Statewide CASE Team calculated avoided GHG emissions associated with energy consumption using the hourly GHG emissions factors that CEC developed along with the 2025 LSC hourly factors and an assumed cost of \$123.15 per metric tons of carbon dioxide equivalent emissions (metric tons CO₂e).

The 2025 LSC hourly factors used in the lifecycle cost-effectiveness analysis include the monetary value of avoided GHG emissions based on a proxy for permit costs (not social costs).²⁹ The Cost-Effectiveness Analysis presented in Section 5.4 of this report does not include the cost savings from avoided GHG emissions. To demonstrate the cost savings of avoided GHG emissions, the Statewide CASE Team disaggregated the

²⁹ The permit cost of carbon is equivalent to the market value of a unit of GHG emissions in the California Cap-and-Trade program, while social cost of carbon is an estimate of the total economic value of damage done per unit of GHG emissions. Social costs tend to be greater than permit costs. See more on the Cap-and-Trade Program on the California Air Resources Board website: <https://ww2.arb.ca.gov/our-work/programs/cap-and-trade-program>.

value of avoided GHG emissions from the other economic impacts. The authors used the same monetary values that are used in the LSC hourly factors.

Table 146 presents the estimated first-year avoided GHG emissions of the proposed code change. During the first year, GHG emissions of 3,261 (metric tons CO₂e) would be avoided.

Table 146: First-Year Statewide GHG Emissions Impacts

Measure	Electricity Savings ^a (GWh/yr)	Reduced GHG Emissions from Electricity Savings ^a (Metric Tons CO ₂ e)	Natural Gas Savings ^a (Million Therms/yr)	Reduced GHG Emissions from Natural Gas Savings ^a (Metric Tons CO ₂ e)	Total Reduced GHG Emissions ^b (Metric Ton CO ₂ e)	Total Monetary Value of Reduced GHG Emissions ^c (\$)
Gas boiler to ER heat	(19.11)	(2,742)	1.11	6,045	3,303	406,741
AWHP to ER heat	(0.29)	(42.27)	0.00	0.00	(42.27)	(5,205)
Total	(19.40)	(2,784)	1.11	6,045	3,261	401,536

- a. First-year savings from all buildings completed statewide in 2026.
- b. GHG emissions savings were calculated using hourly GHG emissions factors are published alongside the in the LSC hourly factors and Source Energy factors by CEC here: <https://www.energy.ca.gov/files/2025-energy-code-hourly-factors>
- c. The monetary value of avoided GHG emissions is based on a proxy for permit costs (not social costs) derived from the 2022 TDV Update Model published by CEC here: <https://www.energy.ca.gov/files/tdv-2022-update-model>

5.5.3 Statewide Water Use Impacts

The proposed code change will not result in water savings.

5.5.4 Statewide Material Impacts

The proposed code change is expected to result in significant material impacts due to avoided boiler, AWHP and hydronic distribution system pipe materials if building designers choose to pursue electric resistance heating instead of hydronic systems.

The Statewide CASE Team calculated material impacts by assuming two potential base cases with electric resistance heating being the proposed case. Base case one assumed a boiler and associated piping materials would be installed. Base case two assumed an AWHP and associated piping materials would be installed. In both scenarios, the proposed case is no boilers/AWHP and associated piping materials. For the boiler scenario, the Statewide CASE Team used a lifecycle assessment that was conducted on residential gas boilers to develop estimates of material quantities for boilers. (Vignali 2017) Residential gas boilers differ from boilers used in commercial applications, but the analysis simply used the percentage of weight of different materials

to total weight of the boiler and applied them to a commercial boiler, which should provide a reasonable estimate on the breakdown of materials. After determining the percentage of materials and applying to a commercial boiler with the appropriate capacity, the Statewide CASE Team was able to determine the weight of each material. The Statewide CASE Team then applied these weights to statewide construction forecasts to develop total statewide material impacts for the boiler scenario.

For the AWHP scenario, the Statewide CASE Team followed the same steps by using a lifecycle assessment for a residential AWHP to determine ratios of materials total weight and applied to a commercial AWHP of the proper capacity. (Naumann, Schropp and Gaderer 2022) Likewise, these values were multiplied with statewide construction forecasts to determine total statewide material impacts for the AWHP scenario.

Finally, the Statewide CASE Team determined total piping that would be associated with both systems. The Statewide CASE Team conducted an analysis which provided a total linear foot estimate of pipe for a building and also included pipe diameter. The same buildings and piping layouts that were detailed in section 3.4.3.1 were also used for this analysis. The Statewide CASE Team then used a standardized pipe sizing to weight per linear foot to determine total weight of the piping. The Statewide CASE Team assumed all pipe to be steel. This weight was then applied to statewide construction forecasts for both the boiler and AWHP scenario to determine impacts of the piping for both scenarios.

The Statewide CASE Team did not calculate material impacts to for alterations, only for new construction. This is calculation does not apply to alterations because in an alteration scenario, a boiler or AWHP (and associated piping) would already be installed in an existing building so switching to electric resistance would not reduce the materials associated with those products. Our analysis showed that on a normalized basis (per square foot) the piping material is a significant portion (in terms of weight) as compared to heating equipment material in the building. So, if the piping is assumed to be left in place, then it can be assumed that the material impacts of simply removing the boiler or AWHP would be significantly reduced. In new construction, choosing electric resistance means a boiler or AWHP and piping would not need to be installed in the building, which results in significant material savings for the building.

The results of this analysis are presented in Table 147 below. See Appendix D for additional information.

Table 147: First-Year Statewide Impacts on Material Use

Equipment	Material	Impact	Per-Unit Impacts (Pounds per Square Feet)	First-Year ^a Statewide Impacts (Pounds)
Gas Boiler	Copper	Decrease	-0.00	-1,025

Gas Boiler	Steel	Decrease	-0.07	-182,430
Gas Boiler	Plastic	Decrease	-0.00	-284
AWHP	Copper	Decrease	-0.02	-25,847
AWHP	Steel	Decrease	-0.17	-182,388
AWHP	Plastic	Decrease	-0.00	-1,130
Combined	Copper	Decrease	-0.02	-26,872
Combined	Steel	Decrease	-0.24	-364,818
Combined	Plastic	Decrease	-0.00	-1,414

a. First-year savings from all buildings completed statewide in 2026.

5.5.5 Other Non-Energy Impacts

This measure is not expected to result in any non-energy impacts.

5.6 Addressing Energy Equity and Environmental Justice

5.6.1 Research Methods and Engagement

The Statewide CASE Team considered the impacts of the proposal on DIPs using four criteria: cost, health, resiliency, and comfort. The details of these criteria and more examples can be found in Section 2.1.2.

5.6.2 Potential Impacts

As noted throughout this proposal, this proposal is cost-effective and in addition the initial cost costs for an electric resistance heating system is expected to be lower than compared to a hydronic system. The system being described in this measure is also simpler than a hydronic space heating system. The proposal is likely to induce projects to select electric heating systems instead of natural gas boiler-based systems, which would result in a decrease in on-site pollution emissions, which will benefit all building occupants including DIPs.

A conceivable adverse impact to DIPs would be the potential for increased electricity consumption over the lifetime of the building, as noted throughout Section 5.5. Up-front costs, natural gas emissions, and system complexity are all anticipated to be reduced because of this proposal. Furthermore, this measure does not particularly target DIPs relative to other groups. For more details on how the proposed code changes impact building types, see Section 2.1.2.1.

The cumulative effect of these factors leads the Statewide CASE Team to conclude that the measure will not adversely impact DIPs and if anything, will likely benefit them.

6. Proposed Revisions to Code Language

6.1 Guide to Markup Language

The proposed changes to the standards, Reference Appendices, and the ACM Reference Manuals are provided below. Changes to the 2022 documents are marked with red underlining (new language) and ~~strikethroughs~~ (deletions).

6.2 Standards

SECTION 120.2 – REQUIRED CONTROLS FOR SPACE-CONDITIONING SYSTEMS

(l) HVAC Hot Water Temperature. Zones that use hot water for space heating shall be designed for a hot water supply temperature of no greater than 130 °F.

SECTION 140.4 – PRESCRIPTIVE REQUIREMENTS FOR SPACE CONDITIONING SYSTEMS

(g) Electric resistance heating. Electric resistance heating systems shall not be used for space heating.

Exception 1 to Section 140.4(g): Where an electric resistance heating system supplements a heating system in which at least 60 percent of the annual heating energy requirement is supplied by site-solar or recovered energy.

Exception 2 to Section 140.4(g): Where an electric resistance heating system supplements a heat pump heating system, and the heating capacity of the heat pump is more than 75 percent of the design heating load calculated in accordance with Section 140.4(a) at the design outdoor temperature specified in Section 140.4(b)4.

Exception 3 to Section 140.4(g): Where the total capacity of all electric resistance heating systems serving the entire building is less than 10 percent of the total design output capacity of all heating equipment serving the entire building.

Exception 4 to Section 140.4(g): Where the total capacity of all electric resistance heating systems serving the entire building, excluding those allowed under Exception 2, is no more than 3 kW.

~~**Exception 5 to Section 140.4(g):** Where an electric resistance heating system serves an entire building that is not a hotel/motel building; and has a conditioned floor area no greater than 5,000 square feet; and has no mechanical cooling; and is in an area where natural gas is not currently available.~~

Exception 6 to Section 140.4(g): Heating systems serving as emergency backup to gas or heat pump heating equipment.

Exception 7 to Section 140.4(g): wire-to-air electric resistance heating is allowed in zones where all of the following clauses enumerated below are true. Note that clause (g) only applies to zones that meet the conditions described therein.

(a) the zone is not served by a hydronic heating system

(b) each heating zone serves no more than one cooling zone and each cooling zone serves no more than one heating zone

(c) the primary airflow delivered to the zone at design heating conditions does not exceed the minimum required for ventilation

(d) the zone does not have continuous exhaust makeup air or pressurization requirements that require an outdoor air rate greater than 0.15 cfm/ft².

(e) All spaces with Note F in Table 120.1-A have occupant sensor ventilation controls meeting 120.1(d)5.A to G

(f) All spaces with $R_t \geq 0.3$ in Table 120.1-A have demand control ventilation meeting 120.1(d)4

(g) if the zone meets the following conditions, then hot aisle air from the computer room shall be transferred to the zone in heating. If the zone does not meet these conditions then computer room transfer air is not required. Conditions: the zone is on the same floor as, and within 30 feet of, a computer room with a design equipment load > 12 kW and at least 50% of the heat from the computer room at design conditions is not otherwise being recovered for space heating (e.g., mechanical heat recovery),

If computer room transfer air is required then the transfer system shall be sized for at least:

1. 50% of the design equipment load of the computer room, or
2. 50% of the design heating load of the zone

(h) has the capability to detect failure of the heater in the ON position. Capabilities include manual reset thermal cutout or discharge air temperature sensor with associated fault detection logic.

....

(r) Mechanical Heat Recovery

1. Simultaneous Mechanical Heat Recovery is required for new buildings that meet either A or B:

- A. $\text{Cooling}_{HL} + 0.1 * \text{Cooling}_{LL} \geq 200$ tons and $\text{SWH}_{cap} + \text{Heating}_{cap} \geq 2200$ kBtuh, or
- B. $\text{Cooling}_{cap} \geq 300$ tons and $\text{SWH}_{cap} + 0.1 * \text{Heating}_{cap} \geq 700$ kBtuh

- Cooling_{cap} = design capacity of all mechanical cooling systems
- Cooling_{HL} = coincident peak cooling load of all spaces with a design equipment power density > 5 watts/ft² and a minimum outdoor airflow requirement < 0.5 cfm/ft², i.e., high load spaces.
- Cooling_{LL} = Cooling_{cap} - Cooling_{HL}. If the design includes capacity for future cooling systems, then assume 20% of future systems serve high load spaces.
- SWH_{cap} = design capacity of all service water heating (SWH) systems, excluding systems expected to operate less than 5 hours/week, such as instant-hot for emergency eyewash.
- Heating_{cap} = design capacity of all space heating systems

The heat recovery system shall include a heat recovery chiller, or other means, capable of transferring the lesser of the following from spaces in cooling to spaces in heating and/or to the SWH system:

- 25% of the peak heat rejection of the cooling system
- 25% of (SWH_{cap} + Heating_{cap})

EXCEPTION 1 to Section 140.4(r)1: Buildings that include thermal energy storage meeting 140.4(r)2

EXCEPTION 2 to Section 140.4(r)1: Laboratory buildings with exhaust air heat recovery systems meeting 140.9(c)6.

EXCEPTION 3 to Section 140.4(r)1: Buildings in Climate Zone 15 with SWH_{cap} < 600 kBtuh

2. Thermal Energy Storage is required for new buildings that meet both A and B:

- A. Cooling_{cap} ≥ 800 tons
- B. SWH_{cap} + Heating_{cap} ≥ 4,000 kBtuh

The thermal energy storage systems shall include both:

1. a water storage tank, or other means, capable of storing not less than 2 hours multiplied by (SWH_{cap} + Heating_{cap}), and
2. water-to-water chillers or other means of heat recovery to extract heat from the storage system while heating and reject heat to the storage system while cooling.

3. Heat Recovery for Service Water Heating.

If the building is required to have simultaneous mechanical heat recovery by 140.4(r)1 or thermal energy storage by 140.4(r)2, and SWH_{cap} ≥ 500 kBtuh, then the heat recovery system shall also heat or preheat the service hot water. The heat recovery system shall have the capacity to transfer the smaller of:

- 30% of the peak heat rejection of the cooling system
- 30% of SWH_{cap}

EXCEPTION 1 to Section 140.4(r): Buildings with a computer room heat recovery

system or wastewater heat recovery system capable of providing not less than 25% of $SWH_{cap} + Heating_{cap}$.

SECTION 141.0 – ADDITIONS, ALTERATIONS, AND REPAIRS TO EXISTING NONRESIDENTIAL

(a) Additions

~~**Exception 2 to Section 141.0(a):** Where an existing system with electric reheat is expanded by adding variable air volume (VAV) boxes to serve an addition, total electric reheat capacity may be expanded so that the total capacity does not exceed 150 percent of the existing installed electric heating capacity in any one permit, and the system need not comply with Section 140.4(g). Additional electric reheat capacity in excess of 150 percent of the existing installed electric heating capacity may be added subject to the requirements of Section 140.4(g).~~

(b) Alterations

2. Prescriptive approach.

C. New or Replacement Space-Conditioning Systems or Components other than new or replacement space-conditioning system ducts shall meet the requirements of Section 140.4 applicable to the systems or components being altered.

Exception 6 to Section 141.0(b)2C: Exception 7 to Section 140.4(g) (allowing electric resistance heating) only applies to spaces meeting the prescriptive envelope requirements in section 140.3 and systems meeting the exhaust air heat recovery requirements in section 140.4(g).

6.3 Reference Appendices

NA7.5.14 Thermal Energy Storage (TES) Systems

- Add choices for condenser water and hot water energy storage
- Add criteria to collect information for AWHP and HR chiller performance data
- Add to functional testing for TES used in heating load shifting mode

6.4 ACM Reference Manual

5. Nonresidential Building Descriptors Reference

5.1 Overview

...

5.7 HVAC Secondary Systems

...

5.7.7 Exhaust Air Heat Recovery

...

5.8 HVAC Primary Systems

5.8.1 Boilers

...

HOT WATER SUPPLY TEMPERATURE

Applicability: All boilers and air to water heat pumps.

Definition: The temperature of the water produced by the boiler and supplied to the hot water loop.

Units: Degrees Fahrenheit (°F).

Input Restrictions: ~~As designed.~~ ≤ 130 °F.

Standard Design: ~~For healthcare facilities, same as the Proposed Design. For all others,~~
Use ~~180~~130 °F for standard design boiler.

HOT WATER TEMPERATURE DIFFERENCE

Applicability: All boilers and air to water heat pumps.

Definition: The difference between the temperature of the water returning to the boiler from the hot water loop and the temperature of the water supplied to the loop.

Units: Degrees Fahrenheit (°F).

Input Restrictions: As designed.

Standard Design: ~~For healthcare facilities, same as the Proposed Design. For all others,~~
Use ~~40~~25 °F for standard design boiler.

HOT WATER SUPPLY TEMPERATURE RESET

Applicability: All boilers and air to water heat pumps.

Definition: Variation of the hot water supply temperature with outdoor air temperature.

Units: Degrees Fahrenheit (°F).

Input Restrictions: As designed (not allowed for non-condensing boilers).

Standard Design: ~~For healthcare facilities, same as the Proposed Design. For all others,~~
the hot water supply temperature is fixed at ~~160~~130 °F.

...

5.8.2 Chillers

CHILLER TYPE

Standard Design: For healthcare facilities, same as the Proposed Design. For all others, Chillers are only designated when the standard design system uses chilled water. In addition, if the proposed design meets the criteria for “Simultaneous Mechanical Heat Recovery” per 140.4(r)1 (determined automatically by the software based on design

capacity of cooling systems, heating systems, service water heating systems, and equipment power density) then the chiller plant will include a heat recovery chiller sized per 140.4(r)1.

5.8.8 Thermal Energy Storage (Cooling Mode)

...

5.8.9 Thermal Energy Storage (Heating Mode)

The compliance model inputs below document the requirements to model a thermal energy storage system for space heating with compliance software.

THERMAL ENERGY STORAGE SYSTEMS NAME

Applicability: All thermal energy storage systems.

Definition: A unique descriptor for thermal energy storage systems.

Units: Text, unique.

Input Restrictions: Where applicable, this should match the tags that are used on the plans such that a plan reviewer can make a connection.

Standard Design: Systems greater than 800 tons of cooling and 4 MMBtu of heating

THERMAL ENERGY STORAGE SYSTEMS TYPE

Applicability: All thermal energy storage systems.

Definition: The type of thermal energy storage system being used.

Units: Ice, chilled water, condenser water, hot water.

Input Restrictions: As designed.

Standard Design: Condenser water (when 140.4(r)2 conditions are met).

Additional fields will be needed to further describe TES performance. The Statewide CASE Team can collaborate with CEC as needed.

The ACM Reference Manual does not currently include provisions for SWH pre-heat from the central HW plant. The ACM Reference Manual does include provisions for drain water heat recovery (see below). Similar provisions need to be added for SWH pre-heat from the central HW plant. The standard design will include heat recovery for SWH if the criteria for 140.4(r)3 are met. The software should be able to make this determination based on the System Type and calculated SWH capacity. The SWH heat recovery system in the standard design shall be sized per the minimum capacity listed in 140.4(r)3.

6.12.1.2 Drain Water Heat Recovery

Drain water heat recovery (DWHR) is a system where the waste heat from shower drains is used to preheat the cold inlet water. The preheat water can be routed to the served shower, water heater, or both.

5.9.1.2 Water Heaters

...

Service Water Heating Heat Recovery

Applicability: Water heating systems with heat recovery from the mechanical cooling system.

Definition: SHW heat recovery is the process by which recovered waste heat from the cooling system is used to pre-heat or heat the SHW system.

Units: None.

Input Restrictions: As designed.

Standard Design: The Standard Design will include SHW heat recovery if the conditions of 140.4(r)3 are met.

Standard Design: Existing Buildings: Not applicable.

6.5 Compliance Forms

Certificate of Compliance

NRCC-MCH-01-E

- Add field to confirm 130 F HWST
- Fields for capacity, setpoints, other performance data of thermal energy storage, AWHP, and HR chiller equipment
- Fields to determine Cooling_{HL}
- Space heating system coefficient of performance (including fields to verify 110.2 hydronic heat pump ratings), both component COP and entire system COP
- Fields to confirm compliance with clauses in newly proposed exception to 140.4(g). A checklist will be developed that captures each of the individual clauses in the proposed exception to ensure compliance.

Certificate of Installation

2022-NRCI-MCH-E

Modifications expected to add air to water heat pump, heat recovery chiller, thermal energy storage equipment (add fields for items such as model number, rated performance, capacity).

Certificate of Acceptance

NRCA-MCH-15-A Thermal Energy Storage

- Need to modify this form so that it can be used to confirm thermal energy storage applicability to space heating in addition to or instead of space cooling. The current description is based on TES that complements space cooling only.
- Base modifications off of changes to NA7.5.14 Thermal Energy Storage

Certificate of Verification

No changes anticipated

7. Bibliography

- Abualsaud, Rana, Grigory Ostrovskiy, and Ziyad Mahfoud. 2019. "Ethnicity-Based Inequality in Heat-Related Illness Is on the Rise in California." *Wilderness & Environmental Medicine* 100-103.
- ACEEE. n.d. "Energy Equity." *ACEEE.org*. Accessed 2023. <https://www.aceee.org/topic/energy-equity>.
- Blankenship, Britney; J Renner, H Werner, M Lerner, K Cunningham. 2020. *Hand-in-Hand: Environmental and Social Justice Communities and California Energy Code*. ACEEE Summer Study on Energy Efficiency in Buildings.
- Bulger, Neil. 2023. *PG&E Code Readiness Program Electrification of Nonresidential Space Heating: Designer Interview Report*. ETCC. <https://www.etcc-ca.com/reports/code-readiness-electrification-nonresidential-space-heating-designer-interview-report>.
- California Air Resources Board. 2022. "2022 State Strategy for the State Implementation Plan." https://ww2.arb.ca.gov/sites/default/files/2022-08/2022_State_SIP_Strategy.pdf.
- California Energy Commission . 2022. "2025 Building Energy Efficiency Standards." *2025 Energy Code Hourly Factors*. Prepared for the California Energy Commission. Accessed March 21, 2023. <https://efiling.energy.ca.gov/getdocument.aspx?tn=239439>.
- California Energy Commission. 2022. "2025 California Energy Code Measure Proposal to the California Energy Commission." <https://www.energy.ca.gov/media/3538>.
- . 2022. *2025 Energy Code Hourly Factors*. November 10. Accessed March 21, 2023. <https://www.energy.ca.gov/files/2025-energy-code-hourly-factors>.
2022. "California Energy Commission Energy Code Data for Measure Proposals."
2022. "California Energy Commission Housing and Commercial Construction Data - Excel." https://ww2.energy.ca.gov/title24/documents/2022_Energy_Code_Data_for_Measure_Proposals.xlsx.
- California Energy Commission. 2018. "Impact Analysis: 2019 Update to the California Energy Efficiency Standards for Residential and Non-Residential Buildings." *energy.ca.gov*. June 29. https://www.energy.ca.gov/title24/2019standards/post_adoption/documents/2019_Impact_Analysis_Final_Report_2018-06-29.pdf.

- California Governor's Office of Emergency Services. 2021. *Cal OES News*. August 3. Accessed 2023. <https://news.caloes.ca.gov/project-roomkey-impact-to-date-and-looking-ahead/>.
- CEC. 2018. "Energy Equity Indicators Tracking Progress." *Energy.ca.gov*. June 25. Accessed 2023. https://www.energy.ca.gov/sites/default/files/2019-12/energy_equity_indicators_ada.pdf.
- Cluett, Rachel, J Amann. 2015. "Multiple Benefits of Multifamily Energy Efficiency for Cost-Effectiveness Screening." *American Council for an Energy-Efficiency Economy*.
- Commission, California Public Utilities. 2015a. "Water/Energy Cost-Effectiveness Analysis: Errata to the Revised Final Report." *California Public Utilities Commission*. Prepared by Navigant Consulting, Inc. . <http://www.cpuc.ca.gov/WorkArea/DownloadAsset.aspx?id=5350>.
- . 2015b. "Water/Energy Cost-Effectiveness Analysis: Revised Final Report." *California Public Utilities Commission (CPUC)*. Prepared by Navigant Consulting, Inc. <http://www.cpuc.ca.gov/WorkArea/DownloadAsset.aspx?id=5360>.
- CPUC. n.d. "Disadvantaged Communities." Accessed 2023. <https://www.cpuc.ca.gov/industries-and-topics/electrical-energy/infrastructure/disadvantaged-communities#:~:text=What%20is%20a%20Disadvantaged%20Community,%2C%20health%2C%20and%20environmental%20burdens>.
- CSU. 2019. "CSU Decarbonization Framework: Simultaneous Cooling and Heating Study." <https://www.calstate.edu/csu-system/doing-business-with-the-csu/capital-planning-design-construction/operations-center/Documents/resources/5.%20CSU%20Bldg%20Decarb%20Simultaneous%20Heating%20Cooling.pdf>.
- DC Fiscal Policy Institute. 2017. "Style Guide for Inclusive Language." *DCFPI*. December. https://www.dcfpi.org/wp-content/uploads/2017/12/Style-Guide-for-Inclusive-Language_Dec-2017.pdf.
- Deng, Hengfang, Daniel P Aldrich, Michael M Danziger, Jianxi Gao, Nolan E Phillips, Sean P Cornelius, and Qi Ryan Wang. 2021. "High-resolution human mobility data reveal race and wealth disparities in disaster evacuation patterns." *Humanities & Social Sciences Communications*.
- Drehobl, Ariel; L Ross; R Ayala. 2020. *How High are Household Energy Burdens? An Assessment of National and Metropolitan Energy Burden Across the United States*. American Council for an Energy-Efficiency Economy.

- Editors of E. 2019. "Earth Talk—Climate gentrification." *Santa Monica Daily Press*. December 9. Accessed March 21, 2023. <https://smdp.com/2019/12/09/climate-gentrification/>.
- EPA. 2021. *Climate Change and Social Vulnerability in the United States: A Focus on Six Impacts*. U.S. Environmental Protection Agency, EPA.
- Ettenson L, Heavey C. 2015. *California's Golden Energy Efficiency Opportunity: Ramping Up Success to Save Billions and Meet Climate Goals*. Natural Resources Defense Council & Environmental Entrepreneurs (E2).
- Federal Reserve Economic Data, FRED. 2022. *Net Domestic Private Investment, Corporate Profits After Taxes*. St. Louis Federal Reserve Bank. Accessed September 18, 2022. <https://fred.stlouisfed.org>.
- Gill, B. 2021. "Solving the Large Building All-Electric Heating Problem." *ASHRAE Journal* (ASHRAE) 63 (10): 16.
- Goldsmith L, Bell M. 2022. "Queering Environmental Justice: Unequal Environmental Health Burden on the LGBTQ+ Community." *American Journal of Public Health* (American Public Health Association) 112 (1): 79-87. <https://ajph.aphapublications.org/doi/10.2105/AJPH.2021.306406>.
- IEA. 2014. *Capturing the Multiple Benefits of Energy Efficiency*. International Energy Agency.
- IMPLAN Group LLC. 2020. *Economic Impact Analysis*. Accessed 2023. <https://implan.com/>.
- Katz, C. 2012. "People in Poor Neighborhoods Breathe More Hazardous Particles." *Scientific American*. November 1. Accessed March 21, 2023. <https://www.scientificamerican.com/article/people-poor-neighborhoods-breathe-more-hazardous-particles/>.
- Kenney M, Bird H, and Rosales H. 2019. *2019 California Energy Efficiency Action Plan*. Publication Number: CEC- 400-2019-010-CMF, California Energy Commission. Kenney, Michael, Heather Bird, and Heriberto Rosales. 2019. 2019 California Energy Efficiency Action Plan. California Energy Commission. Publication Number: CEC- 400-2019-010-CMF .
- Laaidi, Karine: A Zeghnoun: B Dousset: P Bretin: S Vandentorren: E Giraudet: P Beaudeau. 2012. "The Impact of Heat Islands on Mortality in Paris during the August 2003 Heat Wave." *Environmental Health Perspectives*.
- MacCracken, M. 2020. "Electrification, Heat Pumps and Thermal Energy Storage." *ASHRAE Journal* 32-39. <https://www.calmac.com/stuff/contentmgr/files/0/7a1a97ca8602d53f7f054875ce3>

ecd6c/pdf/electrification_heatpumps_and_thermal_energy_storage_ashrae_journal.pdf.

- Ming, Z, V Clark, S Price, B Conlon, H Staver, B Horii, E Cutter, N Kapur, and D Contoyannis. 2016. "California Energy Commission." *Time Dependent Valuation of Energy for Developing Building Efficiency Standards*. July. Accessed March 21, 2023. http://docketpublic.energy.ca.gov/PublicDocuments/16-BSTD-06/TN212524_20160801T120224_2019_TDV_Methodology_Report_7222016.pdf.
- Norton, Ruth Ann, & B Brown. 2014. "Green & Healthy Homes Initiative: Improving Health, Economic, and Social Outcomes Through Integrated Housing Intervention." *Environmental Justice* Vol. 7 (Nbr. 6.).
- Olson, A. 2022. "What is Climate Gentrification and Why is it Different?" *GreenLaw Blog of the Pace Environmental Law Programs*. January 18. Accessed March 21, 2023. <https://greenlaw.blogs.pace.edu/2022/01/18/what-is-climate-gentrification-and-why-is-it-different/#:~:text=For%20example%2C%20in%20Miami%2C%20Florida,are%20often%20lower%2Dincome%20neighborhoods.>
- PG&E. 2012b. "Boiler Research Project - ASHRAE Standard 155P - Phase II." Accessed July 2023. <https://www.etcc-ca.com/reports/boiler-research-project-ashrae-standard-155p-%E2%80%93-phase-ii>.
- PG&E. 2012a. "Boiler Research Project - ASHRAE Standard 155P." Accessed July 2023. https://www.etcc-ca.com/sites/default/files/OLD/images/boiler_research_project_-_ats-te_final_report_pcb_05092012.pdf.
- Rafferty, P., A. Geronazzo, H. Cheng, and G. Paliaga. 2018. "Quantifying energy losses in hot water reheat systems." *Energy and Buildings* 179: 183-199. <https://escholarship.org/uc/item/3qs8f8qx>.
- Rose, Erin; Hawkins, Beth. 2020. *Background Data and Statistics on Low- Income Energy Use and Burden for the Weatherization Assistance Program: Update for Fiscal Year 2020*. Oak Ridge National Laboratory.
- SBW Consulting, Inc. 2022. *Water-Energy Calculator 2.0 Project Report*. Project Report, San Francisco: California Public Utility Commission.
- Smargiassi, Audrey; M Fournier; C Griot; Y Baudouin; T Kosatsky. 2008. "Prediction of the indoor temperatures of an urban area with an in-time regression mapping approach." *Journal of Exposure Science and Environmental Epidemiology*.
- State of California Employment Development Department. 2022. *Quarterly Census of Employment and Wages*. Accessed September March 21, 2023, 2023.

<https://www.labormarketinfo.edd.ca.gov/cgi/dataanalysis/areaselection.asp?table name=industry>.

State of California. n.d. "Government Code Title 7 Division 1 Chapter 1.5 Article 4." *California Legislative Information*. Accessed 2023. https://leginfo.legislature.ca.gov/faces/codes_displaySection.xhtml?sectionNum=65040.12.&lawCode=GOV.

2010. *State of California Quarterly Census of Employment and Wages*. State of California. Accessed September 1, 2022. <https://www.labormarketinfo.edd.ca.gov/cgi/dataanalysis/areaselection.asp?table name=industry>.

Tessum, Christopher W., Joshua S. Apte, Andrew L. Goodkind, Nicholas Z. Muller, Kimberley A. Mullins, David A. Paoella, Stephen Polasky, et al. 2019. "Inequity in consumption of goods and services adds to racial–ethnic disparities in air pollution exposure." *PNSA* 113 (13). <https://doi.org/10.1073/pnas.1818859116>.

U.S. BUREAU OF LABOR STATISTICS. 2023. *U.S. Bureau of Labor Statistics*. January 25. Accessed 2023. <https://www.bls.gov/cps/cpsaat18.htm>.

United States Government Accountability Office . 2018. *K-12 EDUCATION Public High Schools with More Students in Poverty and Smaller Schools Provide Fewer Academic Offerings to Prepare for College*. United States Government Accountability Office .

Weitze, Hillary, and Maya Gantley. 2023. *PG&E's Code Readiness Program: Hydronic Heat Pump Field Assessment Data Brief*. ETCC.

Appendix A: Statewide Savings Methodology

The Statewide CASE Team estimated statewide impacts for the first year by multiplying per unit savings estimates by statewide construction forecasts that the CEC provided (California Energy Commission Housing and Commercial Construction Data - Excel 2022, California Energy Commission 2022). The CEC provided the construction estimates on March 27, 2023.

To calculate first-year statewide savings, the Statewide CASE Team multiplied the per unit savings by statewide construction estimates for the first year the standards will be in effect (2026). The nonresidential new construction forecast is presented in Table 148 and nonresidential existing statewide building stock is presented in (California Energy Commission 2022)Table 149.

The projected nonresidential new construction that will be impacted by the proposed code change in 2026 is presented in Table 148. The projected nonresidential existing statewide building stock that will be impacted by the proposed code change as a result of alterations in 2026 is presented in Table 149. This section describes how the Statewide CASE Team developed these estimates.

The CEC Building Standards Office provided the nonresidential construction forecast, which is available for public review on the CEC's website:

<https://www.energy.ca.gov/media/3538>.

The construction forecast presents the total floorspace of newly constructed buildings in 2026 by building type and climate zone. The building types included in the CECs' forecast are summarized in Table 148.

The Statewide CASE Team made assumptions about the percentage of newly constructed floorspace that would be impacted by the proposed code change. Table 150 presents the assumed percentage of floorspace that would be impacted by the proposed code change by building type. If a proposed code change does not apply to a specific building type, it is assumed that zero percent of the floorspace would be impacted by the proposal. If the assumed percentage is non-zero, but less than 100 percent, it is an indication that some but not all buildings would be impacted by the proposal. The Statewide CASE Team assumed that impacted floor area does not vary by climate zone.

The measures presented in this CASE Report are to some extent mutually exclusive. For example, a site cannot install both a hydronic space heating and zone-level electric resistance space heating system (though it is true that buildings can mix resistance heating and hydronic heating in different zones, we did not assume this for any of the analysis). So, the percentage of the construction forecast for each measure was

estimated to account for this. In terms of the percentage of the building stock pursuing all-electric space heating designs, the Statewide CASE Team followed the data indicated by jurisdictions that have passed all-electric reach codes (by analyzing localreachcodes.com and associating each jurisdiction that passed an all-electric reach code with its population). This led us to estimate 30 percent of the state is living in an all-electric region. This assumption is conservative since it is done in 2023 and these measures wouldn't take effect until 2026. To factor in the momentum toward all-electric, the Statewide CASE Team added 10 percent of the floor area to electric measures. The rest of the floor area is assumed to apply to the gas version of each measure.

Regarding the building types themselves, the focus was on the prototypes that include a gas boiler. These are the large office, medium office, large school, hospital, and hotel prototypes. The presence of the gas boiler in the prototype indicated that the building would be a candidate for the measures presented in this proposal.

Table 148: Estimated New Nonresidential Construction in 2026 (Million Square Feet)

Building Type	CZ 1	CZ 2	CZ 3	CZ 4	CZ 5	CZ 6	CZ 7	CZ 8	CZ 9	CZ 10	CZ 11	CZ 12	CZ 13	CZ 14	CZ 15	CZ 16	All CZs
Large Office	0.0000	0.0000	2.9009	1.4155	0.0000	1.2755	0.7400	2.0523	3.7243	0.3513	0.0976	0.5155	0.0000	0.1796	0.0117	0.0448	13.3090
Medium Office	0.1302	0.4761	1.3720	0.7442	0.3705	1.2010	0.8046	1.6460	3.1840	1.1740	0.2685	2.7990	0.5859	0.3482	0.2629	0.1020	15.4691
Small Office	0.0129	0.4330	0.1852	0.0200	0.0637	0.1468	0.2318	0.1580	0.3568	0.4130	0.0925	0.5394	0.3817	0.0436	0.1042	0.0328	3.2152
Large Retail	0.0000	0.0000	1.0970	0.5497	0.1491	0.6978	0.3746	0.8316	1.6640	0.6327	0.2997	1.3030	0.3564	0.1442	0.1803	0.0555	8.3356
Medium Retail	0.0842	0.3480	0.7947	0.4459	0.0857	0.6027	0.2856	0.8641	1.4240	0.8224	0.1420	0.6274	0.3790	0.1800	0.1242	0.0812	7.2912
Strip Mall	0.0011	0.1543	0.5040	0.2256	0.0074	0.5629	0.4878	0.9855	1.0650	1.3450	0.0716	0.5928	0.3253	0.3206	0.1001	0.0602	6.8093
Mixed-use Retail	0.0000	0.0000	0.0000	0.0000	0.0000	0.0000	0.0000	0.0000	0.0000	0.0000	0.0000	0.0000	0.0000	0.0000	0.0000	0.0000	0.0000
Large School	0.0057	0.1122	0.7718	0.3892	0.0320	0.5234	0.5360	0.7975	1.2519	0.7519	0.3123	1.0149	0.5417	0.1463	0.0755	0.0600	7.3225
Small School	0.0665	0.2698	0.4566	0.2294	0.1395	0.3155	0.2944	0.3516	0.6581	0.3481	0.0988	0.7763	0.3025	0.1070	0.0373	0.0449	4.4963
Non-refrigerated Warehouse	0.0618	0.3672	2.1600	1.1180	0.1776	1.3630	0.7108	1.9480	3.0100	1.3600	0.6315	2.8440	0.8203	0.3618	0.3673	0.1381	17.4394
Hotel	0.0363	0.2154	1.0330	0.5306	0.1095	0.5527	0.4822	0.7835	1.1830	0.5716	0.1534	0.8029	0.2557	0.1375	0.1248	0.0440	7.0160
Assembly	0.0103	0.3935	1.5830	0.5574	0.0587	0.7868	0.7991	1.4310	1.8240	1.1440	0.1669	1.4140	0.3043	0.2453	0.1180	0.0843	10.9206
Hospital	0.0284	0.1688	0.8137	0.4213	0.0771	0.3176	0.5308	0.4266	0.7632	0.7858	0.1411	0.7979	0.2638	0.1370	0.1112	0.0465	5.8307
Laboratory	0.0074	0.1919	1.2920	0.7133	0.0727	0.4164	0.2682	0.4612	0.8426	0.3493	0.1278	0.4340	0.1160	0.0806	0.0396	0.0313	5.4443
Restaurant	0.0139	0.0826	0.3269	0.1667	0.0340	0.3365	0.2036	0.4933	0.8189	0.4129	0.0710	0.3135	0.1414	0.1015	0.0474	0.0296	3.5937
Enclosed Parking Garage	0.0002	0.0091	1.8300	1.2450	0.0046	2.5850	0.7059	2.2650	1.5270	0.0505	0.0016	0.0412	0.0030	0.0152	0.0037	0.0072	10.2942
Open Parking Garage	0.0023	0.1182	2.4740	1.6820	0.0589	3.6480	1.2010	3.1970	2.1550	0.6535	0.0205	0.5323	0.0384	0.1965	0.0477	0.0937	16.1191
Grocery	0.0069	0.0451	0.1048	0.0618	0.0119	0.0465	0.0172	0.0519	0.0915	0.0494	0.0089	0.0388	0.0228	0.0108	0.0076	0.0060	0.5817
Refrigerated Warehouse	0.0000	0.0000	0.0610	0.0507	0.0143	0.0220	0.0000	0.0068	0.0132	0.0387	0.0000	0.0685	0.1181	0.0076	0.0079	0.0052	0.4141
Controlled-environment Horticulture	0.0927	0.0775	0.3197	0.0399	0.2021	0.2578	0.0015	0.0234	0.0261	0.2780	0.3027	0.3053	0.0901	0.0108	0.0480	0.0047	2.0801
Vehicle Service	0.0019	0.0775	0.5473	0.3582	0.0291	0.5513	0.3416	0.7989	1.8090	0.5735	0.0215	0.3892	0.2476	0.1954	0.0567	0.0491	6.0478
Manufacturing	0.0009	0.0190	0.2098	0.0711	0.0155	0.0147	0.0510	0.1075	0.0000	0.0000	0.0000	0.0000	0.0000	0.0000	0.0002	0.0000	0.4897
Unassigned	0.0000	0.0000	0.0003	0.4212	0.0000	0.0000	0.0000	0.0000	0.0000	0.0000	0.0000	0.0008	0.0000	0.0000	0.0000	0.0000	0.4222
TOTAL	0.5635	3.5591	20.8376	11.4566	1.7140	16.2239	9.0676	19.6806	27.3915	12.1056	3.0298	16.1506	5.2941	2.9696	1.8762	1.0211	152.9416

Source: (California Energy Commission 2022)

Table 149: Estimated Existing Floorspace in 2026 (Million Square Feet)

Building Type	CZ 1	CZ 2	CZ 3	CZ 4	CZ 5	CZ 6	CZ 7	CZ 8	CZ 9	CZ 10	CZ 11	CZ 12	CZ 13	CZ 14	CZ 15	CZ 16	All CZs
Large Office	0.1275	3.1020	139.8000	72.3500	1.8320	99.5400	72.7100	162.6000	303.1000	58.4800	2.6080	78.6100	9.2640	20.2700	4.4340	4.6630	1033.4905
Medium Office	3.3790	30.9900	78.7900	42.2800	13.3200	47.8100	43.8700	59.1100	86.3400	66.6900	16.9400	101.7000	25.1800	13.3300	10.2500	4.0630	644.0420
Small Office	4.1780	12.7500	22.1900	11.3300	7.5040	13.2200	8.5160	13.2800	20.8800	24.4300	10.6000	43.9400	21.4700	4.9870	6.1810	2.6760	228.1320
Large Retail	1.0020	8.6650	58.6800	26.9000	4.2000	31.9600	25.3400	43.4600	66.5300	53.3100	11.4000	58.1600	22.5100	10.9100	9.4020	3.2070	435.6360
Medium Retail	1.1760	13.1100	44.5200	25.7400	5.4330	44.2700	34.6600	66.7200	108.2000	66.8900	10.3700	60.5000	24.1500	15.5300	8.7690	5.1700	535.2080
Strip Mall	3.3360	9.8420	37.4200	18.4300	5.0950	40.2300	28.2900	55.7600	83.7000	66.9200	12.2500	48.3700	24.1800	15.2700	8.6960	4.5910	462.3800
Mixed-use Retail	0.0000	0.0000	0.0000	0.0000	0.0000	0.0000	0.0000	0.0000	0.0000	0.0000	0.0000	0.0000	0.0000	0.0000	0.0000	0.0000	0.0000
Large School	0.7589	8.0200	34.8300	13.9500	2.0710	28.3700	22.5400	42.9100	73.5800	56.0100	10.1300	53.3800	26.4100	12.0600	7.6210	3.5890	396.2299
Small School	2.2300	11.1300	25.5700	9.9790	6.0600	25.6900	14.9600	34.4400	54.3100	33.0300	13.5000	42.0800	23.4400	8.7200	4.2510	3.6450	313.0350
Non-refrigerated Warehouse	3.3300	20.2200	108.3000	53.4300	9.8020	89.9800	51.4800	128.4000	207.3000	182.7000	33.7300	148.3000	51.0800	38.8700	29.0500	11.6300	1167.6020
Hotel	1.7710	10.5200	48.1000	24.7300	5.0110	30.4900	32.6600	41.9700	66.0100	37.0900	7.2180	40.5300	13.0800	8.0060	5.8760	2.4390	375.5010
Assembly	4.3280	18.1800	91.3400	45.0600	6.5940	57.2500	40.9000	89.1400	120.2000	91.7500	16.3500	69.7200	30.1300	18.9500	11.8300	6.4390	718.1610
Hospital	1.8660	11.0900	48.3300	24.6700	5.0550	28.2500	27.1500	40.7700	69.8800	39.6000	11.1100	53.1800	22.4900	8.8020	5.0340	3.2340	400.5110
Laboratory	0.1782	4.0100	36.9300	28.0600	1.5310	12.2100	17.1900	15.6100	19.3100	10.8100	0.6790	12.1400	4.3960	1.7230	0.3870	0.5716	165.7358
Restaurant	0.6087	3.6160	14.7200	7.4940	1.5460	16.4600	10.7300	23.7800	40.0000	32.4100	3.5150	16.9500	7.7420	6.8590	3.4530	1.8970	191.7807
Enclosed Parking Garage	0.0170	0.5432	40.7100	30.9400	0.2988	29.1500	20.6700	58.4100	72.5300	2.6730	0.3450	3.0900	0.4883	0.8543	0.1666	0.4343	261.3205
Open Parking Garage	0.2193	7.0240	55.0300	41.8200	3.8640	41.1400	35.1700	82.4400	102.4000	34.5700	4.4610	39.9600	6.3140	11.0500	2.1550	5.6160	473.2333
Grocery	0.0960	1.7000	5.8690	3.5640	0.7523	3.4150	2.0820	4.0080	6.9510	4.0180	0.6502	3.7370	1.4500	0.9323	0.5386	0.3846	40.1480
Refrigerated Warehouse	0.0047	0.4556	0.9104	0.2123	0.3863	0.4566	0.0233	0.4213	0.7865	0.6521	0.2629	2.1460	3.9070	0.1842	0.1939	0.1444	11.1476
Controlled-environment Horticulture	0.6988	0.4569	2.6200	1.0720	6.3270	8.2640	1.0720	0.7413	1.5990	3.6090	2.5130	4.5330	5.3600	0.4681	0.6443	0.2349	40.2133
Vehicle Service	0.9073	6.1840	33.6500	15.9800	2.9710	33.7300	23.0800	49.5200	81.7800	56.5400	6.2960	38.3200	18.2400	15.0900	6.1800	3.5430	392.0113
Manufacturing	4.1050	16.8900	61.9300	79.5500	5.5900	73.3300	33.2700	122.7000	168.1000	49.5800	12.8600	57.0100	25.9700	16.9800	5.1460	9.2730	742.2840
Unassigned	0.3582	6.5750	9.0250	6.3180	0.2196	2.5750	0.7716	3.7780	7.8680	2.5510	3.3670	14.3500	2.9350	0.7699	0.4029	1.0260	62.8902
TOTAL	34.6756	205.0737	999.2644	583.8593	95.4630	757.7906	547.1349	1139.9686	1761.3545	974.3131	191.1551	990.7060	370.1863	230.6158	130.6613	78.4708	9090.6930

Source: (California Energy Commission 2022)

Table 150: Percentage of Nonresidential Floorspace Impacted by Proposed Code Change in 2026, by Building Type

Building Type	New Construction Impacted (Percent Square Footage) <i>(Measure 1/ Measure 2/ Measure 3^b)</i>	Existing Building Stock (Alterations) Impacted (Percent Square Footage)^a <i>(Measure 1/ Measure 2/ Measure 3^b)</i>
Large Office	90%/90%/10%	70%/0%/30%
Medium Office	90%/0%/10%	70%/0%/30%
Small Office	0%	0%
Large Retail	0%	0%
Medium Retail	0%	0%
Strip Mall	0%	0%
Mixed-use Retail	100%/0%/0%	100%/0%/0%
Large School	90%/90%/10%	70%/0%/30%
Small School	0%	0%
Non-refrigerated Warehouse	0%	0%
Hotel	100%/0%/0%	70%/0%/30%
Assembly	0%	0%
Hospital	100%/100%/0%	70%/0%/30%
Laboratory	0%	0%
Restaurant	0%	0%
Enclosed Parking Garage	0%	0%
Open Parking Garage	0%	0%
Grocery	0%	0%
Refrigerated Warehouse	0%	0%
Controlled-environment Horticulture	0%	0%
Vehicle Service	0%	0%
Manufacturing	0%	0%
Unassigned	0%	0%

- a. The percentages shown in the table indicate the breakout within the three measures. The Statewide CASE Team estimated that 1/30th of the existing building stock will be impacted in 2026 based on the estimate of a 30 year measure life.
- b. Limit HWST, 2. Mechanical heat recovery, 3. Electric resistance heating.

Appendix B: Embedded Electricity in Water Methodology

The Statewide CASE Team assumed the following embedded electricity in water values: 5,440 kWh/million gallons of water for indoor water use and 3,280 kWh/million gallons for outdoor water use (SBW Consulting, Inc. 2022). Embedded electricity use for indoor water use includes electricity used for water extraction, conveyance, treatment to potable quality, water distribution, wastewater collection, and wastewater treatment. Embedded electricity for outdoor water use includes all energy uses upstream of the customer; it does not include wastewater collection or wastewater treatment. The embedded electricity values do not include on-site energy consumption associated with water usage such as is the energy required for water heating or on-site pumping. On-site energy impacts are accounted for in the energy savings estimates presented in Section 3.3 of this report.

These embedded electricity values were derived from research conducted for CPUC Rulemaking 13-12-011. The CPUC study aimed to quantify the embedded electricity savings associated with IOU incentive programs that result in water savings, and the findings represent the most up-to-date research by the CPUC on embedded energy in water throughout California (Commission, Water/Energy Cost-Effectiveness Analysis: Errata to the Revised Final Report 2015a); (Commission, Water/Energy Cost-Effectiveness Analysis: Revised Final Report 2015b) This study resulted in the Water-Energy (W-E) Calculator 1.0, which was updated in February 2022 to Version 2.0 (SBW Consulting, Inc. 2022). The CPUC analysis was limited to evaluating the embedded electricity in water and does not include embedded natural gas in water. For this reason, this CASE Report does not include estimates of embedded natural gas savings associated with water reductions, though the embedded electricity values can be assumed to have the same associated emissions factors as grid-demanded electricity in general.

Appendix C: California Building Energy Code Compliance (CBECC) Software Specification

The purpose of this appendix is to present proposed revisions to CBECC for commercial buildings (CBECC) along with the supporting documentation that the CEC staff and the technical support contractors would need to approve and implement the software revisions.

This CASE Report recommends changes to prescriptive and mandatory code language that would result in changes to the ACM Reference Manual in several cases. The summary of the ACM Reference Manual changes is provided in the bulleted list below. See Section 6.4 for marked up language for the ACM Reference Manual.

- Revise the hot water supply temperature to 130 °F from the current ACM Reference Manual setpoint of 160 °F.
- Add a section describing 4-pipe dedicated heat recovery chiller and water-to-water heat pump objects to the ACM reference manual.
- Enhance the thermal energy storage object and ensure it can be configured to provide space heating, and also reflect different efficiency performance depending on if the TES tank uses ice, condenser water, or hot water. The Statewide CASE Team is working with DOE EnergyPlus developers and collaborating with CEC CBECC contractors to ensure that these capabilities are successfully added to CBECC in a timely fashion.
- Revise the Electric resistance reheat credit so that it is paired with decoupled ventilation (e.g., parallel fan powered boxes).

C.1 Hot Water Supply Temperature Limit

C.1.1 Technical Basis for Software Change

The current Standard Design specifies 160 °F hot water supply temperature in the ACM Reference Manual. The new mandatory limit for systems that use gas boilers as well as all-electric designs described in Section 6.2 modifies the hot water supply temperature for space heating of the Standard Design to 130 °F, and outlines other key variables needed to simulate the performance of these systems in energy modeling software.

C.1.2 Description of Software Change

Background Information for Software Change

This report describes how the design hot water supply temperature limit can be implemented in CBECC-Com for space heating.

Existing CBECC Building Energy Modeling Capabilities

CBECC-Com currently models the Standard Design hot water supply temperature and delta T based on 160 °F and 40 °F for natural gas boiler system.

Summary of Proposed Revisions to CBECC

The proposed change is described in Section 3 including primary building types, space types, climate zones, or systems that are predominantly affected by the measure. CBECC would need to be modified to adjust the Standard Design hot water supply and return temperatures.

C.1.3 User Inputs to CBECC

No changes to user inputs are needed to support this measure.

C.1.4 Simulation Engine Inputs

EnergyPlus/California Simulation Engine Inputs

Table 151 summarizes the relevant EnergyPlus input variable and corresponding variable name in CBECC. In EnergyPlus, this variable is located in the Sizing:Plant and Schedule:Day:Interval objects (see below).

Table 151: EnergyPlus Input Variables Relevant to Hotwater Supply Temperature Limit

Target EnergyPlus Object = Sizing:Plant			
EnergyPlus Field	CBECC user input/specified value (if applicable)	EnergyPlus Units	Notes
Name	created by OS		
Design Loop Exit Temperature {C}	54.44	°C	
Loop Design Temperature Difference {deltaC}	13.89	°C	
Sizing Option	NonCoincident		
Zone Timesteps in Averaging Window	1		
Coincident Sizing Factor Mode	None		
Target EnergyPlus Object = Schedule:Day:Interval			
EnergyPlus Field	CBECC user input/specified value (if applicable)	EnergyPlus Units	Notes
Name	created by OS		
Interpolate to Timestep	No		

Time 1 {hh:mm}	24:00		
Value Until Time 1	54.44	°C	

Sizing:Plant,

BaseHWSystem, !- Plant or Condenser Loop Name
Heating, !- Loop Type
54.44, !- Design Loop Exit Temperature {C}
13.89, !- Loop Design Temperature Difference {deltaC}
NonCoincident, !- Sizing Option
1, !- Zone Timesteps in Averaging Window
None; !- Coincident Sizing Factor Mode

Schedule:Day:Interval,

Schedule Day 2, !- Name
Temperature, !- Schedule Type Limits Name
No, !- Interpolate to Timestep
24:00, !- Time 1 {hh:mm}
54.44; !- Value Until Time 1

Calculated Values, Fixed Values, and Limitations

The existing algorithms for calculations, fixed values, and limitations are sufficient for the proposed measure. No changes are needed.

Alternate Configurations

There are no alternate configurations.

C.1.5 Simulation Engine Output Variables

CBECC generates hourly EnergyPlus simulation results to CSV files during analysis. These hourly simulation results can be used by the analyst to debug a building energy model. Variables of particular interest in this case would include:

- Boiler Inlet Temperature,hourly; !- HVAC Average [C]
- Boiler Outlet Temperature,hourly; !- HVAC Average [C]

C.1.6 Compliance Report

The existing compliance reports are sufficient for the proposed measure. No changes are needed.

C.1.7 Compliance Verification

The existing compliance reports are sufficient for the proposed measure. No changes are needed.

C.1.8 Testing and Confirming CBECC Building Energy Modeling

The existing testing and confirmation process are sufficient for the proposed measure. No changes are needed.

C.1.9 Description of Changes to ACM Reference Manual

This information is available in Section 6.4.

C.2 Mechanical Heat Recovery

C.2.1 Technical Basis for Software Change

The current Standard Design doesn't require heat recovery equipment in the ACM Reference Manual. The new prescriptive addition for large buildings with large simultaneous or diurnal heating and cooling loads established in Section 4 modifies the requirements for space heating of the Standard Design, and outlines other key variables needed to simulate the performance of these systems in energy modeling software.

C.2.2 Description of Software Change

Background Information for Software Change

This report describes how the mechanical heat recovery can be implemented in CBECC for space heating.

Existing CBECC Building Energy Modeling Capabilities

CBECC currently doesn't model the Standard Design with mechanical heat recovery.

Summary of Proposed Revisions to CBECC

The proposed change is described in Section 4 including primary building types, space types, climate zones, or systems that are predominantly affected by the measure. CBECC-Com would need to be modified to model mechanical heat recovery in the Standard Design.

C.2.3 User Inputs to CBECC

No changes to user inputs are needed to support this measure.

C.2.4 Simulation Engine Inputs

EnergyPlus/California Simulation Engine Inputs

Table 152 summarizes the relevant EnergyPlus input variable and corresponding variable name in CBECC. In EnergyPlus, this variable is located in the Sizing:Plant and Schedule:Day:Interval objects (Figure 4).

Table 152: EnergyPlus Input Variables Relevant to Mechanical Heat Recovery

Target EnergyPlus Object = Sizing:Plant			
EnergyPlus Field	CBECC user input, specified value, (if applicable)	EnergyPlus Units	Notes
Name	created by OS		
Design Loop Exit Temperature {C}	54.44444444444444	°C	
Loop Design Temperature Difference {deltaC}	13.88888888888889	°C	
Sizing Option	NonCoincident		
Zone Timesteps in Averaging Window	1		
Coincident Sizing actor Mode	None		
Target EnergyPlus Object = Schedule:Day:Interval			
EnergyPlus Field	CBECC user input, specified value, (if applicable)	EnergyPlus Units	Notes
Name	created by OS		
Interpolate to Timestep	No		
Time 1 {hh:mm}	24:00		
Value Until Time 1	54.44	°C	
Target EnergyPlus Object = Chiller:Electric:EIR			
EnergyPlus Field	CBECC user input, specified value, (if applicable)	EnergyPlus Units	Notes
Name	created by OS		
Design Heat Recovery Water Flow Rate {m3/s}	NA	m3/s	
Heat Recovery Inlet Node Name	Big Chiller Heat Rec Inlet Node		

Heat Recovery Outlet Node Name	Big Chiller Heat Rec Outlet Node		
Heat Recovery Leaving Temperature Setpoint Node Name	Big Chiller Heat Rec Outlet Node		
Target EnergyPlus Object = WaterHeater:Mixed			
EnergyPlus Field	CBECC user input, specified value, (if applicable)	EnergyPlus Units	Notes
Name	created by OS		
Tank Volume {m ³ }	NA	m ³	
Setpoint Temperature Schedule Name	Dummy Water Heater Setpoint		
Deadband Temperature Difference {deltaC}	0	°C	
Maximum Temperature Limit {C}	100	°C	
Heater Control Type	CYCLE		
Heater Maximum Capacity {W}	0	W	
Heater Fuel Type	Electricity		
Heater Thermal Efficiency	1		
Ambient Temperature Indicator	Outdoors		
Ambient Temperature Outdoor Air Node Name	Dummy Water Heater OA Node		
Off Cycle Loss Coefficient to Ambient Temperature {W/K}	0	W/K	
Off Cycle Loss Fraction to Zone	0		
On Cycle Loss Coefficient to Ambient Temperature {W/K}	0	W/K	
On Cycle Loss Fraction to Zone	0		
Use Side Inlet Node Name	BaseHWSystem-user Supply Inlet Pipe Node		
Use Side Outlet Node Name	Dummy Water Heater Use Side Outlet Node		
Use Side Effectiveness	1.0		
Source Side Inlet Node Name	Dummy Water Heater Source Side Inlet Node		
Source Side Outlet Node Name	Dummy Water Heater Source Side Outlet Node		
Source Side Effectiveness	1.0		
Use Side Design Flow Rate {m ³ /s}	Autosize		

Source Side Design Flow Rate {m ³ /s}	NA		
Target EnergyPlus Object = PlantLoop			
EnergyPlus Field	CBECC user input/specified value, (if applicable)	EnergyPlus Units	Notes
Name	created by OS		
Fluid Type	Water		
Plant Equipment Operation Scheme Name	Heat Recovery Loop Operation		
Loop Temperature Setpoint Node Name	Heat Recovery Supply Outlet Node		
Maximum Loop Temperature {C}	98		
Minimum Loop Temperature {C}	10		
Maximum Loop Flow Rate {m ³ /s}	autosize		
Minimum Loop Flow Rate {m ³ /s}	0		
Plant Loop Volume {m ³ }	autocalculate		
Plant Side Inlet Node Name	Heat Recovery Demand Inlet Node		
Plant Side Outlet Node Name	Heat Recovery Demand Outlet Node		
Plant Side Branch List Name	Heat Recovery Demand Side Branches		
Plant Side Connector List Name	Heat Recovery Demand Side Connectors		
Demand Side Inlet Node Name	Heat Recovery Supply Inlet Node		
Demand Side Outlet Node Name	Heat Recovery Supply Outlet Node		
Demand Side Branch List Name	Heat Recovery Supply Side Branches		
Demand Side Connector List Name	Heat Recovery Supply Side Connectors		
Load Distribution Scheme	Optimal		
Target EnergyPlus Object = PlantEquipmentList			
EnergyPlus Field	CBECC user input/specified value, (if applicable)	EnergyPlus Units	Notes
Name	created by OS		
Equipment 1 Object Type	WaterHeater:Mixed		
Equipment 1 Name	Dummy Water Heater		
Target EnergyPlus Object = PlantEquipmentOperation:HeatingLoad			

EnergyPlus Field		CBECC user input/specified value (if applicable)	Units	Notes
Name		created by OS		
Load Range 1 Lower Limit {W}		0	W	
Load Range 1 Upper Limit {W}		1000000000000000	W	
Range 1 Equipment List Name		Heat Recovery Plant Equipment List		
Target EnergyPlus Object = PlantEquipmentOperationSchemes				
EnergyPlus Field		CBECC user input/specified value (if applicable)	EnergyPlus Units	Notes
Name		created by OS		
Control Scheme 1 Object Type		PlantEquipmentOperation:HeatingLoad		
Control Scheme 1 Name		Dummy Water Heater Only		
Control Scheme 1 Schedule Name		PlantOnSched		
Target EnergyPlus Object = CondenserEquipmentOperationSchemes				
EnergyPlus Field		CBECC user input/specified value (if applicable)	EnergyPlus Units	Notes
Name		created by OS		
Control Scheme 1 Object Type		PlantEquipmentOperation:CoolingLoad		
Control Scheme 1 Name		BaseCWSsystem-user Cooling Operation Scheme		
Control Scheme 1 Schedule Name		Always On Discrete		
Target EnergyPlus Object = SetpointManager:Scheduled				
EnergyPlus Field	CBECC user input, specified value, (if applicable)	EnergyPlus Units	Notes	
Name	created by OS			
Control Variable	Temperature			
Schedule Name	Dummy Water			

Temperature, !- Schedule Type Limits Name
No, !- Interpolate to Timestep
24:00, !- Time 1 {hh:mm}
54.44; !- Value Until Time 1

WaterHeater:Mixed,

Dummy Water Heater, !- Name
0.0189271, !- Tank Volume {m3}
Dummy Water Heater Setpoint, !- Setpoint Temperature Schedule Name
0, !- Deadband Temperature Difference {deltaC}
100, !- Maximum Temperature Limit {C}
CYCLE, !- Heater Control Type
0, !- Heater Maximum Capacity {W}
, !- Heater Minimum Capacity {W}
, !- Heater Ignition Minimum Flow Rate {m3/s}
, !- Heater Ignition Delay {s}
Electricity, !- Heater Fuel Type
1, !- Heater Thermal Efficiency
, !- Part Load Factor Curve Name
, !- Off Cycle Parasitic Fuel Consumption Rate {W}
, !- Off Cycle Parasitic Fuel Type
, !- Off Cycle Parasitic Heat Fraction to Tank
, !- On Cycle Parasitic Fuel Consumption Rate {W}
, !- On Cycle Parasitic Fuel Type
, !- On Cycle Parasitic Heat Fraction to Tank

Outdoors, !- Ambient Temperature Indicator
 , !- Ambient Temperature Schedule Name
 , !- Ambient Temperature Zone Name
 Dummy Water Heater OA Node, !- Ambient Temperature Outdoor Air Node Name
 0, !- Off Cycle Loss Coefficient to Ambient Temperature {W/K}
 0, !- Off Cycle Loss Fraction to Zone
 0, !- On Cycle Loss Coefficient to Ambient Temperature {W/K}
 0, !- On Cycle Loss Fraction to Zone
 , !- Peak Use Flow Rate {m3/s}
 , !- Use Flow Rate Fraction Schedule Name
 , !- Cold Water Supply Temperature Schedule Name
 BaseHWSsystem-user Supply Inlet Pipe Node, !- Use Side Inlet Node Name
 Dummy Water Heater Use Side Outlet Node, !- Use Side Outlet Node Name
 1.0, !- Use Side Effectiveness
 Dummy Water Heater Source Side Inlet Node, !- Source Side Inlet Node Name
 Dummy Water Heater Source Side Outlet Node, !- Source Side Outlet Node Name
 1.0, !- Source Side Effectiveness
 autosize, !- Use Side Design Flow Rate {m3/s}
 0.007; !- Source Side Design Flow Rate {m3/s}

PlantLoop,

Heat Recovery Water Loop,!- Name

Water, !- Fluid Type

, !- User Defined Fluid Type

Heat Recovery Loop Operation, !- Plant Equipment Operation Scheme Name

Heat Recovery Supply Outlet Node, !- Loop Temperature Setpoint Node Name
98, !- Maximum Loop Temperature {C}
10, !- Minimum Loop Temperature {C}
autosize, !- Maximum Loop Flow Rate {m3/s}
0, !- Minimum Loop Flow Rate {m3/s}
autocalculate, !- Plant Loop Volume {m3}
Heat Recovery Demand Inlet Node, !- Plant Side Inlet Node Name
Heat Recovery Demand Outlet Node, !- Plant Side Outlet Node Name
Heat Recovery Demand Side Branches, !- Plant Side Branch List Name
Heat Recovery Demand Side Connectors, !- Plant Side Connector List Name
Heat Recovery Supply Inlet Node, !- Demand Side Inlet Node Name
Heat Recovery Supply Outlet Node, !- Demand Side Outlet Node Name
Heat Recovery Supply Side Branches, !- Demand Side Branch List Name
Heat Recovery Supply Side Connectors, !- Demand Side Connector List Name
Optimal; !- Load Distribution Scheme

PlantEquipmentList,

Heat Recovery Plant Equipment List, !- Name
WaterHeater:Mixed, !- Equipment 1 Object Type
Dummy Water Heater; !- Equipment 1 Name

PlantEquipmentOperation:HeatingLoad,

Dummy Water Heater Only, !- Name
0, !- Load Range 1 Lower Limit {W}
10000000000000000, !- Load Range 1 Upper Limit {W}
Heat Recovery Plant Equipment List; !- Range 1 Equipment List Name

PlantEquipmentOperationSchemes,

Heat Recovery Loop Operation, !- Name

PlantEquipmentOperation:HeatingLoad, !- Control Scheme 1 Object Type

Dummy Water Heater Only, !- Control Scheme 1 Name

PlantOnSched; !- Control Scheme 1 Schedule Name

CondenserEquipmentOperationSchemes,

BaseCWSsystem-user Operation Schemes, !- Name

PlantEquipmentOperation:CoolingLoad, !- Control Scheme 1 Object Type

BaseCWSsystem-user Cooling Operation Scheme, !- Control Scheme 1 Name

Always On Discrete; !- Control Scheme 1 Schedule Name

SetpointManager:Scheduled,

Dummy Water Heater Setpoint, !- Name

Temperature, !- Control Variable

Dummy Water Heater Setpoint, !- Schedule Name

Heat Recovery Supply Outlet Node; !- Setpoint Node or NodeList Name

SetpointManager:Scheduled,

Heat Recovery Water Loop Setpoint Manager, !- Name

Temperature, !- Control Variable

Heat Recovery Loop Temp Schedule, !- Schedule Name

Big Chiller Heat Rec Outlet Node; !- Setpoint Node or NodeList Name

Calculated Values, Fixed Values, and Limitations

The existing algorithms for calculations, fixed values and limitations are sufficient for the proposed measure. No changes are needed.

Alternate Configurations

There are no alternate configurations.

C.2.5 Simulation Engine Output Variables

CBEEC generates hourly EnergyPlus simulation results to CSV files during analysis. These hourly simulation results can be used by the analyst to debug a building energy model. Variables of particular interest in this case would include:

- Water Heater Heating Rate,timestep; !- HVAC Average [W]
- Water Heater Heating Energy,timestep; !- HVAC Sum [J]
- Chiller Evaporator Inlet Temperature,timestep; !- HVAC Average [C]
- Chiller Evaporator Outlet Temperature,timestep; !- HVAC Average [C]
- Chiller Evaporator Mass Flow Rate,timestep; !- HVAC Average [kg/s]
- Chiller Condenser Inlet Temperature,timestep; !- HVAC Average [C]
- Chiller Condenser Outlet Temperature,timestep; !- HVAC Average [C]
- Chiller Condenser Mass Flow Rate,timestep; !- HVAC Average [kg/s]
- Chiller Total Recovered Heat Rate,timestep; !- HVAC Average [W]
- Chiller Total Recovered Heat Energy,timestep; !- HVAC Sum [J]
- Chiller Heat Recovery Inlet Temperature,timestep; !- HVAC Average [C]
- Chiller Heat Recovery Outlet Temperature,timestep; !- HVAC Average [C]
- Chiller Heat Recovery Mass Flow Rate,timestep; !- HVAC Average [kg/s]
- Water Heater Use Side Mass Flow Rate,timestep; !- HVAC Average [kg/s]
- Water Heater Use Side Inlet Temperature,timestep; !- HVAC Average [C]
- Water Heater Use Side Outlet Temperature,timestep; !- HVAC Average [C]

- Water Heater Use Side Heat Transfer Rate,timestep; !- HVAC Average [W]
- Water Heater Use Side Heat Transfer Energy,timestep; !- HVAC Sum [J]
- Water Heater Source Side Mass Flow Rate,timestep; !- HVAC Average [kg/s]
- Water Heater Source Side Inlet Temperature,timestep; !- HVAC Average [C]
- Water Heater Source Side Outlet Temperature,timestep; !- HVAC Average [C]
- Water Heater Source Side Heat Transfer Rate,timestep; !- HVAC Average [W]
- Water Heater Source Side Heat Transfer Energy,timestep; !- HVAC Sum [J]

C.2.6 Compliance Report

The existing compliance reports are sufficient for the proposed measure. No changes are needed.

C.2.7 Compliance Verification

The existing compliance reports are sufficient for the proposed measure. No changes are needed.

C.2.8 Testing and Confirming CBECC Building Energy Modeling

Testing will need to be conducted after collaboration with DOE and LBNL to develop TES+HR rulesets and algorithms for CBECC.

C.2.9 Description of Changes to ACM Reference Manual

This information is available in Section 6.4.

C.3 Revisit Exceptions to Prescriptive Electric Resistance Ban

C.3.1 Technical Basis for Software Change

The current ban on electric resistance heating is wide ranging and includes electric boilers, electric furnaces, except as backup for heat pumps, and electric resistance VAV reheat. The new prescriptive requirements established in Section 5.1 allow electric

resistance heat for spaces with decoupled ventilation, and outlines other key variables needed to simulate the performance of these systems in energy modeling software.

C.3.2 Description of Software Change

Background Information for Software Change

This report describes how the fan powered box with electric reheat coil can be implemented in CBECC for space heating.

Existing CBECC Building Energy Modeling Capabilities

CBECC currently doesn't model the Standard Design with fan powered box with electric reheat coil for space heating.

Summary of Proposed Revisions to CBECC

The proposed change is described in Section 5 including primary building types, space types, climate zones, or systems that are predominantly affected by the measure. CBECC would need to be modified to adjust the Standard Design hot water supply and return temperatures.

C.3.3 User Inputs to CBECC

No changes to user inputs are needed to support this measure.

C.3.4 Simulation Engine Inputs

EnergyPlus/California Simulation Engine Inputs

Table 153 summarizes the relevant EnergyPlus input variable and corresponding variable name in CBECC. In EnergyPlus, this variable is located in the Sizing:Plant and Schedule:Day:Interval objects.

Table 153: EnergyPlus Input Variables Relevant to Revisit Exceptions to Prescriptive Electric Resistance Ban

Target EnergyPlus Object = AIRTERMINAL:SINGLEDUCT:PARALLELPIU:REHEAT			
EnergyPlus Field	CBECC user input, specified value, (if applicable)	EnergyPlus Units	Notes
Name	created by OS		
Availability Schedule Name	Always On Discrete		
Maximum Primary Air Flow Rate {m ³ /s}	Autosize	m ³ /s	
Maximum Secondary Air Flow Rate {m ³ /s}	Autosize	m ³ /s	

Minimum Primary Air Flow Fraction	0.2		
Fan On Flow Fraction	0.2		
Supply Air Inlet Node Name	NA		
Secondary Air Inlet Node Name	NA		
Outlet Node Name	NA		
Reheat Coil Air Inlet Node Name	NA		
Zone Mixer Name	NA		
Fan Name	NA		
Reheat Coil Object Type	Coil:Heating:Electric		
Reheat Coil Name	BaseVAVBox CoilHtg		
Maximum Hot Water or Steam Flow Rate {m ³ /s}	Autosize	m ³ /s	
Minimum Hot Water or Steam Flow Rate {m ³ /s}	0	m ³ /s	
Convergence Tolerance	0.001		
Target EnergyPlus Object = AirLoopHVAC:ZoneMixer			
EnergyPlus Field	CBECC user input/specified value (if applicable)	Units	Notes
Name	created by OS		
Outlet Node Name	NA		
Inlet 1 Node Name	NA		
Inlet 2 Node Name	NA		
Target EnergyPlus Object = Coil:Heating:Electric			
EnergyPlus Field	CBECC user input, specified value	EnergyPlus Units	Notes
Name	created by OS		
Availability Schedule Name	Always On Discrete		
Efficiency	1		
Nominal Capacity {W}	Autosize	W	
Air Inlet Node Name	NA		
Air Outlet Node Name	NA		
Target EnergyPlus Object = Fan:ConstantVolume			
EnergyPlus Field	CBECC user input, specified value, (if applicable)	EnergyPlus Units	Notes

Name	created by OS		
Availability Schedule Name	AllOnHVACAvail		
Fan Total Efficiency	0.4275		
Pressure Rise {Pa}	317.18980526	Pa	
Maximum Flow Rate {m3/s}	NA		
Motor Efficiency	0.855		
Motor In Airstream Fraction	1		
Air Inlet Node Name	NA		
Air Outlet Node Name	NA		

AirTerminal:SingleDuct:ParallelPIU:Reheat,

BaseVAVBox TrmlUnit, !- Name

Always On Discrete, !- Availability Schedule Name

Autosize, !- Maximum Primary Air Flow Rate {m3/s}

Autosize, !- Maximum Secondary Air Flow Rate {m3/s}

0.2, !- Minimum Primary Air Flow Fraction

0.2, !- Fan On Flow Fraction

VAV_1 Zone Splitter Outlet Node 1, !- Supply Air Inlet Node Name

Node 55, !- Secondary Air Inlet Node Name

BaseVAVBox TrmlUnit Outlet Node, !- Outlet Node Name

BaseVAVBox TrmlUnit Mixer Outlet, !- Reheat Coil Air Inlet Node Name

BaseVAVBox TrmlUnit Mixer, !- Zone Mixer Name

Fan 7, !- Fan Name

Coil:Heating:Electric, !- Reheat Coil Object Type

BaseVAVBox CoilHtg, !- Reheat Coil Name

Autosize, !- Maximum Hot Water or Steam Flow Rate {m3/s}

0, !- Minimum Hot Water or Steam Flow Rate {m3/s}

0.001; !- Convergence Tolerance

AirLoopHVAC:ZoneMixer,

BaseVAVTrmlUnit Mixer, !- Name

BaseVAVTrmlUnit Mixer Outlet, !- Outlet Node Name

BaseVAVTrmlUnit Fan Outlet, !- Inlet 1 Node Name

VAV_1 Zone Splitter Outlet Node 1; !- Inlet 2 Node Name

Coil:Heating:Electric,

BaseVAVReheatCoil, !- Name

Always On Discrete, !- Availability Schedule Name

1, !- Efficiency

57662.0261274549, !- Nominal Capacity {W}

BaseVAVTrmlUnit Mixer Outlet, !- Air Inlet Node Name

Basement TU Outlet Node; !- Air Outlet Node Name

Fan:ConstantVolume,

Fan, !- Name

AllOnHVACAvail, !- Availability Schedule Name

0.4275, !- Fan Total Efficiency

317.18980526, !- Pressure Rise {Pa}

9.4979422944, !- Maximum Flow Rate {m3/s}

0.855, !- Motor Efficiency

1, !- Motor In Airstream Fraction

Node 135, !- Air Inlet Node Name

Basement TU Fan Outlet; !- Air Outlet Node Name

Calculated Values, Fixed Values, and Limitations

The existing algorithms for calculations, fixed values and limitations are sufficient for the proposed measure. No changes are needed.

Alternate Configurations

There are no alternate configurations.

C.3.5 Simulation Engine Output Variables

CBECCE generates hourly EnergyPlus simulation results to CSV files during analysis. These hourly simulation results can be used by the analyst to debug a building energy model. Variables of particular interest in this case would include:

- Zone Air Terminal Sensible Heating Energy, hourly; !- HVAC Sum [J]
- Zone Air Terminal Sensible Cooling Energy, hourly; !- HVAC Sum [J]
- Zone Air Terminal Sensible Heating Rate, hourly; !- HVAC Average [W]
- Zone Air Terminal Sensible Cooling Rate, hourly; !- HVAC Average [W]
- Fan Electricity Rate, hourly; !- HVAC Average [W]
- Fan Rise in Air Temperature, hourly; !- HVAC Average [deltaC]
- Fan Heat Gain to Air, hourly; !- HVAC Average [W]
- Fan Electricity Energy, hourly; !- HVAC Sum [J]
- Fan Air Mass Flow Rate, hourly; !- HVAC Average [kg/s]
- Zone Air Terminal Primary Damper Position, hourly; !- HVAC Average []
- Zone Air Terminal Heating Rate, hourly; !- HVAC Average [W]
- Zone Air Terminal Heating Energy, hourly; !- HVAC Sum [J]

- Zone Air Terminal Outdoor Air Volume Flow Rate, hourly; !- HVAC Average [m3/s]
- Heating Coil Heating Energy, hourly; !- HVAC Sum [J]
- Heating Coil Heating Rate, hourly; !- HVAC Average [W]
- Heating Coil Electricity Energy, hourly; !- HVAC Sum [J]
- Heating Coil Electricity Rate, hourly; !- HVAC Average [W]

C.3.6 Compliance Report

The existing compliance reports are sufficient for the proposed measure. No changes are needed.

C.3.7 Compliance Verification

The existing compliance reports are sufficient for the proposed measure. No changes are needed.

C.3.8 Testing and Confirming CBECC Building Energy Modeling

The existing testing and confirmation process are sufficient for the proposed measure. No changes are needed.

C.3.9 Description of Changes to ACM Reference Manual

This information is available in Section 6.4.

Appendix D: Environmental Analysis

Potential Significant Environmental Effect of Proposal

The CEC is the lead agency under the California Environmental Quality Act (CEQA) for the 2025 Energy Code and must evaluate any potential significant environmental effects resulting from the proposed standards. A “significant effect on the environment” is “a substantial adverse change in the physical conditions which exist in the area affected by the proposed project.” (Cal. Code Regs., tit. 14, § 15002(g).)

The Statewide CASE Team has considered the environmental benefits and adverse impacts of its proposal including, but not limited to, an evaluation of factors contained in the California Code of Regulations, Title 14, section 15064 and determined that the proposal will not result in a significant effect on the environment.

Direct Environmental Impacts

Direct Environmental Benefits

Various aspects of this proposal are expected to result in energy savings, water savings, and GHG emission reductions. In addition, for the electric resistance heating measure, material reductions are anticipated from a shift to electric resistance zone heating that would result in embodied carbon emissions reductions (e.g., natural gas boilers or packaged air to water heat pumps, piping for hot water distribution). These benefits are further quantified throughout the body of this report.

Direct Adverse Environmental Impacts

This proposal is not expected to result in direct adverse environmental impacts, apart from the expected increase in electric load that may occur from the electric resistance heating measure. However, as discussed in this report, this increase in electric load is ideally minimized through the list of clauses that are being proposed to accompany the looser restriction on electric resistance heating. Further, nonresidential buildings prescriptively complying with code are going to be constructed with solar PV and battery storage, which should offset the increase in electric load from resistance heating.

Indirect Environmental Impacts

The measures in this proposal are not expected to result in indirect environmental benefits or adverse impacts.

Mitigation Measures

The Statewide CASE Team has considered opportunities to minimize the environmental impact of the proposal, including an evaluation of “specific economic, environmental, legal, social, and technological factors.” (Cal. Code Regs., tit. 14, § 15021.) The Statewide CASE Team did not determine whether this measure would result in significant direct or indirect adverse environmental impacts and therefore, did not develop any mitigation measures.

Water Use and Water Quality Impacts Methodology

The Statewide CASE Team anticipates water savings from the addition of thermal energy storage tanks in buildings. The reason for this is because unless it is fully charged, the TES tank receives waste heat instead of the cooling tower. The reduction in runtime hours of the cooling tower results in water savings due to the reduction in water evaporation and associated reduction in blowdown.

Embodied Carbon in Materials

Accounting for embodied carbon emissions is important for understanding the full environmental impacts picture of a proposed code change. The embodied carbon in materials analysis accounts specifically for emissions produced during the “cradle-to-gate” phase: emissions produced from material extraction, manufacturing, and transportation. Understanding these emissions ensures the proposed measure considers these early stages of materials production and manufacturing instead of emissions reductions from energy efficiency alone.

The Statewide CASE Team calculated emissions impacts associated with embodied carbon from the change in materials because of the proposed measures. The calculation builds off the materials impacts outlined in 3.5.4, 4.5.4, and 5.5.4; see these sections for more details on the materials impact analysis.

After calculating the materials impacts, the Statewide CASE Team applied average embodied carbon emissions for each material. The embodied carbon emissions are

based on industry-wide environmental product declarations (EPDs).^{30, 31} These industry-wide EPDs provide global warming potential (GWP) values per weight of specific materials.³² The Statewide CASE Team chose the industry-wide average for GWP values in the EPDs because the materials accounted for in the statewide calculation will have a range of embodied carbon; i.e. some materials like concrete have a wide range of embodied carbon depending on the manufacturer's processes, source of the materials, etc. The Statewide CASE Team assumes that most building projects will not specify low embodied carbon products. Therefore, an average is appropriate for a statewide estimate.

First year statewide impacts per material in pounds were multiplied by the GWP impacts for each material. This provides the total statewide embodied carbon impact for each material. If a material's use is increased, then there is an increase in embodied carbon impacts with additional emissions. If a material's use is decreased, then there is a decrease in embodied carbon impacts and emissions are reduced. Table 154 presents estimated first-year GHG emissions impacts associated with embodied carbon.

A comprehensive accounting of buildings' GHG emissions would include operational emissions (e.g., emissions from energy use) and embodied carbon. Title 24, Part 6 addresses energy use in buildings and results in reductions in operational GHG emissions. The Statewide CASE Team has provided embodied carbon impacts of the proposed code changes, which could support an informed dialogue on how operational emissions and embodied emissions be considered together in the future. The information provided in this report is an incomplete accounting of whole-building embodied carbon and does not account for interactive effects that the proposal may have on other elements of the building design or material use. There may be instances where a specific system or component may increase emissions through embodied

³⁰ EPDs are documents that disclose a variety of environmental impacts, including embodied carbon emissions. These documents are based on lifecycle assessments on specific products and materials. Industry-wide EPDs disclose environmental impacts for one product for all (or most) manufacturers in a specified area and are often developed through the coordination of multiple manufacturers and associations. A manufacturer specific EPD only examines one product from one manufacturer. Therefore, an industry-wide EPD discloses all the environmental impacts from the entire industry for a specific product or material, but a manufacturer specific EPD only factors one manufacturer.

³¹ An industry wide EPD was not used for mercury, lead, copper, plastics, and refrigerants. Global warming potential values of mercury, lead, and copper are based on data provided in a lifecycle assessment (LCA) conducted by Yale University in 2014. The GWP value for plastic is based on an LCA conducted by Franklin Associates, which captures roughly 59 percent of the U.S. total production of PVC and HDPE production. The GWP values for refrigerants are based on data provided by the Intergovernmental Panel on Climate Change (IPCC) Fourth Assessment Report.

³² GWP values for concrete and wood were in units of kg CO₂ equivalent by volume of the material rather than by weight. An average density of each material was used to convert volume to weight.

carbon but enable the building as a whole to have lower total emissions (operational plus building-wide embodied carbon).

Table 154: First-Year Embodied Carbon Impacts

Material	Impact	First-Year ^a Statewide Impacts (Pounds)	Embodied GHG Emissions Reductions (Metric Tons CO ₂ e)
Copper	Decrease	-26,872	-34.1
Steel	Decrease	-364,818	-200.7
Plastic	Decrease	-1,414	-1.2
Total	N/A	N/A	-236.0

a. First-year savings from all buildings completed statewide in 2026.

Appendix E: Discussion of Impacts of Compliance Process on Market Actors

This appendix discusses how the recommended compliance process, which is described in Sections 3.1.5, 4.1.5, and 5.1.5, could impact various market actors. Table 155 identifies the market actors who will play a role in complying with the proposed change, the tasks for which they are responsible, how the proposed code change could impact their existing workflow, and ways negative impacts could be mitigated. The information contained in Table 155 is a summary of key feedback the Statewide CASE Team received when speaking to market actors about the compliance implications of the proposed code changes. Appendix F summarizes the stakeholder engagement that the Statewide CASE Team conducted when developing and refining the code change proposal, including gathering information on the compliance process.

Each of the proposed measures will impact the building construction industry in some fashion. The measure to limit HWST will cause mechanical designers to specify larger diameter pipes or different coils. This change is minor. The mechanical heat recovery and thermal energy storage measure may present new strategies and requirements to mechanical designers and architects. The measure would impact only large buildings, so relatively few projects will be impacted, but for projects that qualify, it is the case that the new system requirements may be difficult to implement without workforce training in the runup to the new code taking effect. Integrating heat recovery and thermal energy storage for space heating is not an exceedingly common practice as of 2023, however, manufacturers are rapidly developing new options. Architects may appreciate the additional roof space available by the reduction in air source heat pump equipment needed due to the measure, but they may also need to newly integrate thermal energy storage tanks into building designs. The electric resistance heating measure would likely be simpler than current hydronic options and be welcomed by the building industry.

Table 155 identifies the market actors who will play a role in complying with the proposed change, the tasks for which they will be responsible, their objectives in completing the tasks, how the proposed code change could impact their existing workflow, and ways negative impacts could be mitigated.

Table 155: Roles of Market Actors in the Proposed Compliance Process

Market Actor	Task(s) in current compliance process relating to the CASE measure	How will the proposed measure impact the current task(s) or workflow?	How will the proposed code change impact compliance and enforcement?	Opportunities to minimize negative impacts of compliance requirement
HVAC Designer	<ul style="list-style-type: none"> Coordinate with architect and building owner to choose system type Develop layout, sizing, setpoints, and controls sequences for mechanical system 	<ul style="list-style-type: none"> Limit HWST: Designer would need to ensure that distribution system is sized to handle 130 °F or lower HWST for hydronic systems HR + TES: Designer may need to factor in new concepts to their design workflow, including hydronic heat recovery equipment and thermal energy storage. 	<ul style="list-style-type: none"> Modification to NCCC-MCH anticipated as a result of limit HWST and HR+TES measures. Designer may need to be educated on new strategies to incorporate TES into space heating systems 	<ul style="list-style-type: none"> Incorporate HR+TES sequences into ASHRAE Guideline 36 to alleviate controls development complexity on designer Training classes through ASHRAE local chapters and local utilities for HR+TES design strategies
Architect	<ul style="list-style-type: none"> Develop building function, layout, etc. 	<ul style="list-style-type: none"> Reduction in AWHP footprint frees up roof space Additional TES tank space needs ER Heating option frees up boiler, pipe distribution network, but requires a prescriptive envelope 	<ul style="list-style-type: none"> Work with mechanical designer 	<ul style="list-style-type: none"> Workforce education and training for new space heating requirements
ATT	<ul style="list-style-type: none"> Completes NA7.5 	<ul style="list-style-type: none"> NA7.5.14 proposed changes to TES testing 	<ul style="list-style-type: none"> Improve compliance with new TES measure for space heating 	<ul style="list-style-type: none"> ATT training to ensure tests are conducted properly for new requirements

Appendix F: Summary of Stakeholder Engagement

Collaborating with stakeholders that might be impacted by proposed changes is a critical aspect of the Statewide CASE Team’s efforts. The Statewide CASE Team aims to work with interested parties to identify and address issues associated with the proposed code changes so that the proposals presented to the CEC in this CASE Report are generally supported. Public stakeholders provide valuable feedback on draft analyses and help identify and address challenges to adoption including cost-effectiveness, market barriers, technical barriers, compliance and enforcement challenges, or potential impacts on human health or the environment. Some stakeholders also provide data that the Statewide CASE Team uses to support analyses.

This appendix summarizes the stakeholder engagement that the Statewide CASE Team conducted when developing and refining the recommendations presented in this report.

Utility-Sponsored Stakeholder Meetings

Utility-sponsored stakeholder meetings provide an opportunity to learn about the Statewide CASE Team’s role in the advocacy effort and to hear about specific code change proposals that the Statewide CASE Team is pursuing for the 2025 code cycle. The goal of stakeholder meetings is to solicit input on proposals from stakeholders early enough to ensure the proposals and the supporting analyses are vetted and have as few outstanding issues as possible. To provide transparency in what the Statewide CASE Team is considering for code change proposals, during these meetings the Statewide CASE Team asks for feedback on:

- Proposed code changes
- Draft code language
- Draft assumptions and results for analyses
- Data to support assumptions
- Compliance and enforcement
- Technical and market feasibility

The Statewide CASE Team hosted two stakeholder meetings for Space Heating via a webinar described in Table 156. See below for dates and links to event pages on [Title24Stakeholders.com](https://www.title24stakeholders.com). Materials from each meeting such as slide presentations, proposal summaries with code language, and meeting notes, are included in the bibliography section of this report.

Table 156: Utility-Sponsored Stakeholder Meetings

Meeting Name	Meeting Date	Event Page from Title24stakeholders.com
First Round of Nonresidential HVAC Space Heating Utility-Sponsored Stakeholder Meeting	Monday, February 27, 2023	https://title24stakeholders.com/event/hvac-controls-and-space-heating-utility-sponsored-stakeholder-meeting/
Second Round of Nonresidential HVAC Space Heating Utility-Sponsored Stakeholder Meeting	Thursday, May 18, 2023	https://title24stakeholders.com/event/pools-nonresidential-space-heating-and-commercial-kitchens-utility-sponsored-stakeholder-meeting/

The first round of utility-sponsored stakeholder meetings occurred from January to February 2023 and were important for providing transparency and an early forum for stakeholders to offer feedback on measures being pursued by the Statewide CASE Team. The objectives of the first round of stakeholder meetings were to solicit input on the scope of the 2025 code cycle proposals; request data and feedback on the specific approaches, assumptions, and methodologies for the energy impacts and cost-effectiveness analyses; and understand potential technical and market barriers. The Statewide CASE Team also presented initial draft code language for stakeholders to review.

The second round of utility-sponsored stakeholder meetings occurred from April to May 2023 and provided updated details on proposed code changes. The second round of meetings introduced early results of energy, cost-effectiveness, and incremental cost analyses, and solicited feedback on refined draft code language.

Utility-sponsored stakeholder meetings were open to the public. For each stakeholder meeting, two promotional emails were distributed from info@title24stakeholders.com. One email was sent to the entire Title 24 Stakeholders listserv, totaling over 3,000 individuals, and a second email was sent to a targeted list of individuals on the listserv depending on their subscription preferences. The Title 24 Stakeholders' website listserv is an opt-in service and includes individuals from a wide variety of industries and trades, including manufacturers, advocacy groups, local government, and building and energy professionals. Each meeting was posted on the Title 24 Stakeholders' LinkedIn page and cross-promoted on the CEC LinkedIn page two weeks before each meeting to reach out to individuals and larger organizations and channels outside of the listserv. The Statewide CASE Team conducted extensive personal outreach to stakeholders identified in initial work plans who had not yet opted into the listserv. Exported webinar meeting data captured attendance numbers and individual comments, and recorded outcomes of live attendee polls to evaluate stakeholder participation and support.

Statewide CASE Team Communications

The Statewide CASE Team held personal communications over email and phone with numerous stakeholders when developing this report, listed in Table 157. Market actors helped the Statewide CASE Team understand various aspects of standard practice in the construction industry, provide a sounding board for the viability of different aspects of the code change proposals, and provide technical data used for the analysis. Table 157 provides a snapshot of the organizations that were consulted. Note that this is not an exhaustive list.

Table 157: Engaged Stakeholders

Organization/Individual Name	Market Role
Center for the Built Environment, UC Berkeley	Researcher
ASHRAE 90.1 MSC including the hydronics working group	Model code development
California Hydronics	HVAC Distributor
Norman S Wright	HVAC Distributor
Nyle	HVAC Manufacturer
Glumac	HVAC Designer
NRDC	Energy Efficiency Advocate
Larson Energy Research	Researcher
Appropriate Designs	HVAC Designer
Trane/CALMAC	HVAC Manufacturer
Baltimore Aircoil Company	HVAC Manufacturer
Siglers	HVAC Distributor
PG&E Code Readiness Program	HVAC Researcher

Engagement with DIPs

Stakeholder outreach did not specifically target DIPs.

Appendix G: Energy Cost Savings in Nominal Dollars

The CEC requested energy cost savings over the 30-year period of analysis in both 2026 present value dollars (2026 PV\$) and nominal dollars. The cost-effectiveness analysis uses energy cost values in 2026 PV\$. Costs and cost-effectiveness 2026 PV\$ are presented in Sections 3.4, 4.4, and 5.4 of this report. This appendix presents energy cost savings in nominal dollars.

Table 158: Nominal LSC Over 30-Year Period of Analysis – Per Square Foot – New Construction, Additions, and Alterations – Limit HWST (Gas Baseline)

Prototype	CZ 1	CZ 2	CZ 3	CZ	CZ 5	CZ 6	CZ 7	CZ 8	CZ 9	CZ 10	CZ 11	CZ 12	CZ 13	CZ 14	CZ 15	CZ 16
HighRiseMixedUse	2.48	1.72	1.96	1.56	1.76	1.28	1.20	0.99	1.08	1.03	1.37	1.50	1.27	1.40	0.64	1.96
Hospital	11.65	11.16	10.76	10.80	10.82	9.75	9.66	10.00	9.81	9.96	10.59	10.68	10.23	10.06	9.38	10.01
HotelSmall	5.04	4.08	4.04	3.77	4.02	2.50	2.32	2.29	2.50	2.60	3.22	3.57	2.83	3.17	1.50	4.30
OfficeLarge	6.04	4.59	4.74	4.29	4.44	2.77	2.50	2.43	2.60	2.64	3.97	3.96	3.24	3.92	1.58	5.58
OfficeMedium	6.21	4.60	4.64	4.09	4.33	2.42	2.26	2.10	2.44	2.37	4.10	4.14	3.35	4.07	1.65	5.78
SchoolLarge	6.31	4.98	5.42	4.90	5.10	3.75	3.70	3.72	3.82	3.50	4.96	4.84	4.04	4.60	2.60	5.76

Table 159: Nominal LSC Savings Over 30-Year Period of Analysis – Per Square Foot – New Construction, Additions, and Alterations – Limit HWST (AWHP Baseline)

Prototype	CZ 1	CZ 2	CZ 3	CZ	CZ 5	CZ 6	CZ 7	CZ 8	CZ 9	CZ 10	CZ 11	CZ 12	CZ 13	CZ 14	CZ 15	CZ 16
HighRiseMixedUse	0.63	0.47	0.50	0.39	0.45	0.30	0.26	0.23	0.26	0.25	0.35	0.37	0.31	0.35	0.16	0.50
Hospital	5.80	5.49	5.22	5.04	5.16	4.29	4.40	4.47	4.40	4.48	4.89	5.00	4.69	4.50	4.05	4.58
HotelSmall	1.60	1.28	1.22	1.12	1.19	0.64	0.68	0.60	0.68	0.68	0.99	1.07	0.87	0.98	0.42	1.40
OfficeLarge	1.78	1.51	1.41	1.35	1.37	0.68	0.73	0.67	0.73	0.76	1.27	1.21	1.00	1.27	0.45	1.85
OfficeMedium	2.02	1.52	1.32	1.28	1.26	0.60	0.67	0.59	0.67	0.66	1.29	1.26	1.04	1.28	0.44	1.95
SchoolLarge	2.21	1.64	1.71	1.42	1.48	1.02	0.97	0.97	0.97	0.91	1.45	1.45	1.18	1.27	0.64	1.75

Table 160: Nominal LSC Savings Over 30-Year Period of Analysis – Per Square Foot – New Construction – Simultaneous Cooling and Heating

Prototype	CZ 1	CZ 2	CZ 3	CZ 4	CZ 5	CZ 6	CZ 7	CZ 8	CZ 9	CZ 10	CZ 11	CZ 12	CZ 13	CZ 14	CZ 15	CZ 16
Hospital	13.45	13.03	10.59	13.49	11.91	10.43	8.86	10.29	10.25	10.19	10.30	11.49	9.59	13.33	7.72	16.13

Table 161: Nominal LSC Savings Over 30-Year Period of Analysis – Per Square Foot – New Construction – Thermal Energy Storage – AWHP Baseline

Prototype	CZ 1	CZ 2	CZ 3	CZ 4	CZ 5	CZ 6	CZ 7	CZ 8	CZ 9	CZ 10	CZ 11	CZ 12	CZ 13	CZ 14	CZ 15	CZ 16
OfficeLarge	-	-	2.30	6.96	-	2.73	2.80	3.31	3.05	3.32	6.82	6.37	-	10.26	3.76	14.51

Table 162: Nominal LSC Savings Over 30-Year Period of Analysis – Per Square Foot – New Construction – Thermal Energy Storage – Gas Baseline

Prototype	CZ 1	CZ 2	CZ 3	CZ 4	CZ 5	CZ 6	CZ 7	CZ 8	CZ 9	CZ 10	CZ 11	CZ 12	CZ 13	CZ 14	CZ 15	CZ 16
OfficeLarge	-	-	6.02	5.73	-	4.62	4.53	5.14	4.98	5.38	6.63	7.09	-	7.36	5.05	5.60

Table 163: Nominal LSC Savings Over 30-Year Period of Analysis – Per Square Foot – New Construction – Heat Recovery for Service Water Heating

Prototype	CZ 1	CZ 2	CZ 3	CZ 4	CZ 5	CZ 6	CZ 7	CZ 8	CZ 9	CZ 10	CZ 11	CZ 12	CZ 13	CZ 14	CZ 15	CZ 16
OfficeLarge	-	-	1.75	1.64	-	1.85	1.95	1.85	1.79	1.79	1.57	1.71	-	1.69	-	1.35
SchoolLarge	6.63	5.63	3.39	4.46	3.28	3.99	4.31	3.98	3.54	4.37	4.71	4.95	4.51	4.23	-	4.04

Table 164: Nominal LSC Savings Over 30-Year Period of Analysis – Per Square Foot – New Construction – Simultaneous Heat Recovery for Space Heating and Service Water Heating Scenarios A

Prototype	CZ 1	CZ 2	CZ 3	CZ 4	CZ 5	CZ 6	CZ 7	CZ 8	CZ 9	CZ 10	CZ 11	CZ 12	CZ 13	CZ 14	CZ 15	CZ 16
OfficeLarge	-	-	7.13	7.36	-	2.86	2.62	2.54	3.06	3.47	6.71	6.36	-	7.07	-	10.23

Table 165: Nominal LSC Savings Over 30-Year Period of Analysis – Per Square Foot – New Construction – Simultaneous Heat Recovery for Space Heating and Service Water Heating Scenarios B

Prototype	CZ 1	CZ 2	CZ 3	CZ 4	CZ 5	CZ 6	CZ 7	CZ 8	CZ 9	CZ 10	CZ 11	CZ 12	CZ 13	CZ 14	CZ 15	CZ 16
OfficeLarge	-	-	3.46	2.55	-	3.00	3.35	2.55	2.54	2.51	2.32	2.90	-	2.89	-	2.74

Table 166: Nominal LSC Savings Over 30-Year Period of Analysis – Per Square Foot – New Construction – ER Heating (Gas Baseline)

Prototype	CZ 1	CZ 2	CZ 3	CZ 4	CZ 5	CZ 6	CZ 7	CZ 8	CZ 9	CZ 10	CZ 11	CZ 12	CZ 13	CZ 14	CZ 15	CZ 16
OfficeLarge	(4.72)	(6.81)	(5.80)	(7.21)	(5.09)	(3.98)	(3.22)	(4.81)	(4.99)	(5.34)	(8.67)	(6.47)	(6.35)	(9.15)	(5.83)	(14.61)
OfficeMedium	(3.68)	(3.65)	(2.46)	(3.21)	(1.10)	(0.09)	0.39	(0.55)	(0.31)	(1.66)	(4.69)	(2.53)	(2.13)	(4.56)	(0.76)	(11.49)
SchoolLarge	(15.94)	(14.03)	(15.96)	(11.35)	(14.64)	(7.34)	(5.63)	(7.41)	(8.31)	(7.74)	(12.26)	(11.66)	(10.95)	(10.39)	(6.53)	(15.96)

Table 167: Nominal LSC Savings Over 30-Year Period of Analysis – Per Square Foot – New Construction – ER Heating (AWHP Baseline)

Prototype	CZ 1	CZ 2	CZ 3	CZ 4	CZ 5	CZ 6	CZ 7	CZ 8	CZ 9	CZ 10	CZ 11	CZ 12	CZ 13	CZ 14	CZ 15	CZ 16
OfficeLarge	(4.51)	(4.81)	(7.02)	(4.93)	(5.25)	(5.23)	(4.55)	(5.83)	(6.02)	(6.30)	(6.90)	(5.25)	(5.58)	(4.71)	(6.33)	(3.76)
OfficeMedium	(1.95)	(0.69)	(3.25)	(0.37)	(1.22)	(1.09)	(0.87)	(1.41)	(1.07)	(2.23)	(2.62)	(0.88)	(1.30)	0.58	(1.40)	1.88
SchoolLarge	(11.46)	(8.60)	(12.85)	(6.13)	(11.00)	(5.01)	(3.47)	(5.01)	(5.63)	(4.83)	(7.51)	(7.37)	(6.63)	(3.62)	(3.44)	(2.74)

Appendix H: TIER Compliance Modeling Procedure Memorandum

The following memorandum was developed by Taylor Engineers to support an exceptional methods modeling procedure to achieve Title 24 compliance for a project using the Time Independent Energy Recovery (TIER) system design. This methodology formed the basis for the Statewide CASE Team's methodology for modeling the thermal energy storage and heat recovery measure.

To: City of Oakland Building Department
From: Brandon Gill, Taylor Engineering
Subject: TIER Plant Title 24 Exceptional Calculations Modeling Procedure
Date: November 7, 2021

This memo provides a step-by-step summary of the spreadsheet modeling approach used for completing Time Independent Energy Recovery (TIER) plant Title 24 exceptional calculations and accompanies the submitted spreadsheet.

EnergyPlus Model Modifications

Make the following modifications to the EnergyPlus/CBECC-Com model:

1. Eliminate plant energy use, including chilled water and hot water systems, from the energy model by setting devices input ratings to near zero. I.e., set chiller rated input power to 0.001 kW, all pump heads to 0.001', cooling tower fan power to 0.001 kW, etc. This approach shifts the associated energy use from these devices, and their TDV, to the exceptional calculations.
2. Lock out the main AHU's (AH-1) airside economizer during all hours. The analysis requires knowing the available load for heat recovery during each hour. The economizer will be "enabled" and the CHW load reduced in Excel post-processing for certain hours when heat recovery is not required.

Spreadsheet Analysis

Conduct the spreadsheet analysis as follows:

1. Structure the spreadsheet as an 8,760 model, not a bin analysis.
2. Export the following parameters from EnergyPlus/CBECC-Com on an 8,760 basis.
 - a. Ambient Dry Bulb
 - b. Ambient Wet Bulb
 - c. For the Main AHU
 - i. Return Air Dry Bulb Temperature
 - ii. Mixed Air Dry Bulb Temperature
 - iii. Mixed Air Wet Bulb Temperature (or RH, or Dew Point)
 - iv. Supply Air Dry Bulb Temperature
 - v. Supply Air Wet Bulb (or RH, or Dew Point)

- d. Hot water loop heating load (btu/h)
 - e. Hot water supply temperature
 - f. Hot water return temperature
 - g. Hot water flow rate
 - h. Chilled water loop load (btu/h)
 - i. Chilled water loop supply temperature
 - j. Chilled water return temperature
 - k. Chilled water loop flow rate
 - l. Net closed condenser water loop load (from first floor water source chiller/heat pump and aux WCAC/WSHPs under C&S scope) (btu/h)
 - m. Closed condenser water loop load from each typical floor (btu/h)
3. Adjust chilled water loop load output from the energy model to account for economizing.
- a. If the TES tanks are <95 percent charged, do not adjust the chilled water loop load (in other words, keep the economizer locked out to maximize heat recovery).
 - b. Else if, OAT > 75 °F or OAT > RAT, do not adjust the chilled water loop load.
 - c. Else, calculate mixed air enthalpy, outside air enthalpy, and supply air enthalpy from Enthalpy outputs. Calculate adjusted CHW load as the greatest of:
 - i. $(h_{OAT} - h_{SAT}) / (h_{MAT} - h_{SAT}) * (\text{EnergyPlus CHW Load})$
 - ii. $(OAT - SAT) / (MAT - SAT) * (\text{EnergyPlus CHW Load})$
 - iii. 0 btu/h
4. Identify operating chillers, and loop index of evaporators and condensers per the table below. In the table below, the left subscript denotes the index of the evaporator, and the right subscript denotes the index of the condenser.

		Chilled Water Load (tons)			
		0 – 250	250 – 575	575 – 850	850+
Hot Water Load (kBtu/h)	0 – 2500	CH-1 _{CHW-CW} HRC-1 _{CW-HW}	CH-1 _{CHW-CW} HRC-1 _{CW-HW} HRC-3 _{CHW-CW}	CH-1 _{CHW-CW} HRC-1 _{CW-HW} HRC-2 _{CHW-CW} HRC-3 _{CHW-CW}	CH-1 _{CHW-CW} HRC-1 _{CHW-HW} HRC-2 _{CHW-CW} HRC-3 _{CHW-CW}
	2500 – 5500	CH-1 _{CHW-CW} HRC-1 _{CW-HW} HRC-2 _{CW-HW}	CH-1 _{CHW-CW} HRC-1 _{CW-HW} HRC-2 _{CW-HW}	CH-1 HRC-1 _{CW-HW} HRC-2 _{CHW-HW}	—

			HRC-3 _{CHW-CW}	HRC-3 _{CHW-CW} *Marginal condition that should not occur in practice, but may occur in the energy model	
	5500 – 7500	CH-1 _{CHW-CW} HRC-1 _{CW-HW} HRC-3 _{CW-HW}	CH-1 HRC-1 _{CW-HW} HRC-3 _{CHW-HW} *Marginal condition that should not occur in practice, but may occur in the energy model	—	—
	7500+	CH-1 _{CHW-CW} HRC-1 _{CW-HW} HRC-2 _{CW-HW} HRC-3 _{CW-HW}	—	—	—

5. Heating and cooling loads shall be split among operating devices per the following rules:
- a. For all chillers, CH-1 through HRC-3, with their evaporators indexed to the CHW loop, split adjusted CHW load proportionally to chiller nominal capacity.
 - b. For any chillers, HRC-1 through HRC-3, with their evaporators indexed to the CHW loop and their condensers indexed to the HW loop, their heating output shall equal chiller cooling output + chiller compressor heat (chiller input energy) as calculated in subsequent steps.
 - c. For any chillers, HRC-1 through HRC-3, with their evaporators indexed to the CW loop and their condensers indexed to the HW loop, their heating output shall equal current hourly heating load less the heating output of the chillers covered by the chillers in the preceding clause. Where there are multiple such chillers, load shall be split proportionally to nominal chiller heating capacity.

6. Estimate the CWRT setpoint of chillers rejecting heat to the condenser water loop.
 - a. If the CW storage tank is currently cycled through to 62 °F at the top/44 °F at the bottom, assume chillers have a CWRT setpoint of 62 °F. (In practice the setpoint will either be 64 °F or 60 °F depending on whether the tank is charging or discharging, but at this point in the calculation we don't know that answer, and the error introduced by being off 2 °F is small.)
 - b. If the CW storage tank is currently cycled through to 82 °F at the top/62 °F at the bottom and not fully charged, assume chillers have a CWRT setpoint of 82 °F. (In practice the setpoint will either be 84 °F or 80 °F depending on whether the tank is charging or discharging, but at this point in the calculation we don't know that answer, and the error introduced by being off 2 °F is small.)
 - c. If the tank is fully charged, assume chillers have a CWRT setpoint that resets from a maximum of current CHWST setpoint + 50 °F at 700 tons of CHW load to a minimum of current CHWST setpoint + 20 °F at 120 tons of CHW load.
7. Determine the CHWST of chillers with evaporators indexed to the chilled water loop.
 - a. For CH-1, HRC-2, and HRC-3, CHWST setpoint will always equal the CHWST from the EnergyPlus file when indexed to the CHW loop.
 - b. For HRC-1, CHWST setpoint shall equal $(\text{CHWST setpoint} + \text{CHWRT})/2$ when indexed to the CHW loop (HRC-1 and HRC-2 evaporators are in series).
8. Determine the HWST setpoint of chillers with condensers indexed to the HW loop.
 - a. For HRC-1 and HRC-3, HWST setpoint will always equal the HWST from the EnergyPlus file when indexed to the HW loop.
 - b. For HRC-2, HWST setpoint shall equal $(\text{HWST setpoint} + \text{HWRT})/2$ when indexed to the HW loop (HRC-1 and HRC-2 condensers are in series).
9. Estimate the CHWST setpoint of chillers with evaporators indexed to the condenser water loop.
 - a. If the CW storage tank is currently cycled through to 62 °F at the top/44 °F at the bottom, HRC-2 and HRC-3 setpoint will equal 44 °F and HRC-1 setpoint will equal 53 °F.
 - b. Otherwise, assume all chillers have a CHWST setpoint of 60 °F.
10. Calculate power draw for chillers with condensers indexed to the CW loop given: current CHW load per chiller (see 5.a), CHWST and CWRT (see 6 and 7), full load chiller efficiency (see chiller table provided), and EnergyPlus chiller curves.
 - a. The model in section 14.3.10 of the [EnergyPlus Engineering Reference](#) shall be used. This model is also used in CBECC-com.
 - b. Normalize the chiller performance curves to the full load performance of the proposed design chillers.

11. Calculate power draw of chillers with condensers indexed to the HW loop.
 - a. For chillers with evaporators indexed to the CHW loop and condensers indexed to the HW loop, follow the same procedure as in 10, albeit use HWST as CWRT in the curves.
 - b. For chillers with evaporators indexed to the CW loop, calculations are complicated by the fact that chiller models take evaporator load as an input to calculate chiller power. In this case, we instead know *condenser* load per the procedure in 5.c, so the process is iterative as follows:
 - i. Guess that the chiller heating COP_{h0} equals 4 for HRC-1 and -2, and 4.5 for HRC-3.
 - ii. Using the heating load served by the chiller (see 5.c) and COP_h , estimate evaporator load as $\text{Condenser Load} - (\text{Condenser Load})/COP_h$
 - iii. Using the evaporator load estimate from the previous step, use the chiller model from 10 to estimate chiller power draw based on CHWST, HWST, full load chiller efficiency, and the Energy Plus chiller curves.
 - iv. Calculate iteration 1 COP_{h1} as $(\text{Evaporator load estimate} + \text{Chiller Power})/\text{Chiller Power}$.
 - v. Repeat 11.b.ii and 11.b.iii using COP_{h1} to determine heat removed from the condenser loop via evaporators and chiller power.
 - vi. This process could be continued until the power draw converges to within a couple percentage points, but our hunch is that this single iteration (which can be done easily in a spreadsheet without introducing circular references or VBA) is probably good enough.
12. Calculate excess heat dumped to the hot water loop that needs to be transferred to the CW loop.
 - a. There may be rare occasions when all chillers have evaporators indexed to the CHW loop (near cooling design condition) but there is still a small amount of heating load so HRC-1's condenser is indexed to the hot water loop. The amount of heat rejected to the hot water loop may however exceed the hot water load. In these cases, that heat gets transferred to the CW loop by bleeding CW into the HW loop. So:
 - i. Calculate excess hot water loop as the heat rejected from HRCs with condensers to the condenser water loop minus heating load from EnergyPlus. If this value is greater than zero, this heat shall be transferred to the CW loop.
13. Calculate the net heat added/removed from the condenser water loop without supplemental heat. This equals:
 - a. Heat gain from chillers with condensers indexed to the condenser water loop.
 - b. Plus excess heat from the hot water loop (see 12.a).

- c. Minus heat extracted by chillers with evaporators indexed to the condenser water loop.
 - d. Plus net gain/removal from WSHPs and the lobby WC/WS chiller (see 2.I).
14. If heat is added to the condenser water loop, determine whether that heat should be added to the TES tanks or rejected via cooling towers:
- a. If the tanks are not full, and the hourly heat load is less than the remaining available storage capacity in the tanks, assume all energy is rejected to the TES tanks.
 - b. If the tanks are not full, but the hourly head load exceeds the remaining available storage capacity in the tanks, the portion of the energy that can be rejected to the tanks shall be. The remainder shall be rejected through the cooling towers.
 - c. If the tanks are full, all energy is rejected through the cooling towers.
15. Determine whether the ASHPs operate during a given hour.
- a. If the net heat removal from the condenser water loop without supplemental heat exceeded 6 MBH during the previous hour, 4 MBH in each of the previous 2 consecutive hours, or 1.15 MBH in each of the previous 3 consecutive hours, run both ASHPs at full load.
 - b. Otherwise, the ASHPs shall be off.
16. Determine the ASHP Supply Temperature Setpoint
- a. If the CW storage tank is currently cycled through to 62 °F at the top/44 °F at the bottom, ASHP Supply Temperature Setpoint shall be 77 °F (minimum allowed by ASHP manufacturer).
 - b. If the CW storage tank is currently cycled through to 82 °F at the top/62 °F at the bottom, ASHP Supply Temperature Setpoint shall be 84 °F.
17. Calculate ASHP Capacity and Power
- a. ASHP capacity is primarily a function of outside air temperature and supply water temperature. Power is a function of the same variables and load. Since the model logic calls for running the ASHPs at full load, we can ignore load and just look at OAT and supply temperature.
 - b. Use a lookup table from the manufacturer with outside air temperature and supply water temperature as inputs, and capacity and power as outputs, to determine power draw and output for each hour when the ASHPs are enabled.
18. Calculate Net Heat Addition/Removal from Storage Tanks and Adjust ASHP Power
- a. Net heat added/removed to/from the storage tanks equals the net heat gain to the condenser water loop without any supplemental heat (per 12) less heat rejected through the cooling towers (per 14) plus heat added by ASHPs (per 17).

- b. If both ASHPs do not need to run the full hour to finish charging the tank, multiply the ASHP capacity output and power draw for that hour by the fraction of the hour that they need to run to finish charging the tank.

19. Calculate Primary CWP-4A/B Flow/Power

- a. If the CW storage tank is currently cycled through to 62 °F at the top/44 °F at the bottom:
 - i. Apply an 18 °F delta-T to condenser heat rejection load from chillers with condensers indexed to the CW loop to determine flowrate. However, if the ASHPs are enabled, flowrate shall be no less than 880 GPM.
- b. If the CW storage tank is currently cycled through to 82 °F at the top/62 °F at the bottom and cooling towers are not enabled during this hour:
 - i. Apply a 20 °F delta-T to condenser heat rejection load from chillers with condensers indexed to the CW loop to determine flowrate. However, if the ASHPs are enabled, flowrate shall be no less than 785 GPM.
- c. If the CW storage tank is currently cycled through to 82 °F at the top/62 °F at the bottom and cooling towers are enabled during this hour:
 - i. Each enabled chiller with its condenser indexed to the condenser loop shall operate at design condenser water flow.
 - ii. Additionally, add flow for any excess heat dumped from the HW loop to the CW loop (see 12.a). Assume this heat is dumped with a 48 °F delta-T for the purposes of calculating flow. (This is inherently conservative since delta-T will be even higher than HWST less design CWST (125 °F–77 °F) during most hours).
- d. Calculate power assuming head varies as $(\text{Flow})^{1.8}$, 80 percent pump efficiency, NEMA premium motor efficiency, 98 percent VFD efficiency.

20. Calculate Evaporator CWP-2A/B Flow/Power

- a. If the CW storage tank is currently cycled through to 62 °F at the top/44 °F at the bottom:
 - i. Apply an 18 °F delta-T to current evaporator load from chillers with evaporators indexed to the CW loop to determine flowrate.
- b. If the CW storage tank is currently cycled through to 82 °F at the top/62 °F at the bottom:
 - i. Apply a 20 °F delta-T to current evaporator load from chillers with evaporators indexed to the CW loop to determine flowrate.
- c. In neither scenario shall flowrate be less than 50 percent of the smallest heat recovery chiller's design evaporator flow.
- d. Calculate power assuming head varies as $(\text{Flow})^{1.4}$, 80 percent pump efficiency, NEMA premium motor efficiency, 98 percent VFD efficiency.

21. Calculate Tank CWP-3A/B Flow/Power

- a. If the CW storage tank is currently cycled through to 62 °F at the top/44 °F at the bottom:
 - i. Apply an 18 °F delta-T to the net heat removal/addition from the storage tanks to determine flowrate.
- b. If the CW storage tank is currently cycled through to 82 °F at the top/62 °F at the bottom:
 - i. Apply a 20 °F delta-T to the net heat removal/addition from the storage tanks to determine flowrate.
- c. Calculate power assuming head varies as $(\text{Flow})^{1.4}$, 75 percent pump efficiency, NEMA premium motor efficiency, 98 percent VFD efficiency.

22. Calculate Floor CWP Flow/Power

- a. Apply a 10 °F delta-T to condenser water load from each floor to determine flowrate.
- b. Calculate power assuming there is a fixed 5 psi DP setpoint, but the remainder of design head varies as $(\text{Flow})^{1.4}$, 72 percent pump efficiency, NEMA premium motor efficiency, and 98 percent VFD efficiency.

23. Calculate Cooling Tower CWP-1A/B Flow/Power

- a. Cooling tower pump flow equals Primary CWP Flow (see 19) when CWP-4A/B are enabled but shall be no less than 30 percent of design cooling tower flow.
- b. Calculate power assuming there is 15' of static head, but the remainder of design head varies as $(\text{Flow})^{1.4}$, 80 percent pump efficiency, NEMA premium motor efficiency, and 98 percent VFD efficiency.

24. Calculate Cooling Tower Temps and Power

- a. Cooling tower leaving temperature shall be calculated as:
 - i. When CWP-4A/B are on, CWRT setpoint (see 6.b), minus the delta-T resulting from the tower heat rejection load applied to the current CWP-4A/B flow, minus 2 °F.
 - ii. When CWP-4A/B are off but there is still tower heat rejection load due to floor auxiliary condenser water pumps, CWRT setpoint minus auxiliary load delta-T (10 °F), minus 2 °F.
 - iii. These strategies assume a fixed HX approach of 2 °F from the open CW loop to the closed CW loop, which is conservative. In practice, approach will decrease as flows decrease, but modeling those dynamics isn't justified.
- b. Cooling tower entering temperature shall be calculated as tower lower leaving temperature plus the delta-T resulting from the tower heat rejection load applied to the current CWP-1A/B flow.

- c. Using cooling tower flow from 23.a, tower entering and leaving temperatures, and ambient wet bulb, calculate cooling tower fan power using the CoolTools empirical model covered in Section 16.1.2.3 of the [EnergyPlus Engineering Reference](#) assuming both tower cells always run.

25. Calculate HWP Power

- a. Calculate power using HW flow from EnergyPlus. Assume head varies as $(\text{Flow})^{1.4}$, 78 percent pump efficiency, NEMA premium motor efficiency, and 98% VFD efficiency.

26. Calculate CHWP Power

- a. Calculate power using CHW flow from EnergyPlus, scaled linearly per the adjusted chilled water load from 3. Assume head varies as $(\text{Flow})^{1.4}$, 80 percent pump efficiency, NEMA premium motor efficiency, and 98 percent VFD efficiency.

27. Sum power from all end uses for the hour. Apply 2016 hourly TDV values to determine TDV from the TIER plant.

Limitations not elsewhere addressed

1. The above calculation method leaves the WSHPs and WS/WC lobby chiller in the EnergyPlus model. This means there is a disconnect between the condenser water loop temperatures that feed those devices in the model and the condenser water loop temperatures that they would see in practice per the TIER model. The implication of this omission is that these devices may be modeled as operating more or less efficient than they will in practice per the TIER model. Given the minor contribution of these loads, however, we believe this disconnect is acceptable.

Appendix I: Memo Discussing All-Electric Plant Options for a Large Office

The following narrative and sketches are reproduced from the bidding process for an actual project (the Oakland Site noted in Table 88 in Section 4.4.3.2). Three systems are described but the first one (All-Air All-Electric Plant) was not priced because it was expected that it would not comply with Title 24 for reasons discussed below. The intent of including this narrative is to illustrate the different hydronic all-electric design options available to large buildings. In addition, it is hoped that this narrative can further illustrate why heat recovery and thermal energy storage are such critical elements to all-electric designs in large buildings.

1. All-Air All-Electric Plant

For smaller buildings, an all-electric plant providing both heating and cooling can be provided using air-to-water, aka air-source, heat pump/chillers. They are available in two basic types:

- A 4-pipe version (commonly tagged ASHR) that can operate in 1) heating mode as an air-source heat pump, 2) cooling mode as an air-cooled chiller, and 3) simultaneous heating and cooling modes with partial or full heat recovery from the cooling system to the heating system. The ASHRs are piped separately to the hot water or chilled water distribution systems.
- A 2-pipe changeover version (commonly tagged ASHP) that can operate in either heating mode as an air-source heat pump, or cooling mode as an air-cooled chiller. These are piped with changeover piping to connect each ASHP to either the hot water or chilled water distribution systems.

The 4-pipe version is used when there are sufficient periods where both heating and cooling loads occur at the same time so energy can be recovered, but they cost 30 percent more than the 2-pipe version and are 10 to 15 percent less efficient when operating in either cooling mode or heating mode alone.

So a possibility for the Oakland Site would be to eliminate all of the chillers, cooling towers, and boilers and replace them with:

- Two (2) 4-pipe ASHRs, 120 tons and 1.1 MBH each. These units provide energy recovery when outdoor air temperature is between 60 °F and 75 °F and both mechanical cooling and heating occur simultaneously, and also assist with peak heating and peak cooling loads, and
- Six (6) 2-pipe changeover ASHPs, 160 tons and 1.4 MBH each. These provide the bulk of the heating and cooling loads.

This is likely the least expensive hydronic all-electric option. But it would be highly unlikely to comply with Title 24 Part 6 since the baseline in CBECC for large buildings is an all-variable speed water-cooled chiller plant (i.e., System 6 in the ACM Reference Manual), whereas this option would leverage air cooled chillers (when the ASHPs are in cooling mode). This all-air plant is not efficient enough to meet code for this building so it should not be budgeted. All-air source plants are an option for smaller low-rise buildings for which the baseline Title 24 HVAC system is a packaged air-cooled VAV system (i.e., System 5 in the ACM Reference Manual).

2. Hybrid All-Electric Plant

As noted above, to comply with Title 24 Part 6, the water-cooled variable speed chillers would need to be retained for at least most of the system cooling capacity. But it would be energy efficient to take advantage of the heat recovery from simultaneous heating and cooling that will occur during mild weather. So with this option, we have basically the same ASHP plant as Option 1 described above for heating but we retain the water-cooled plant. The difference is that the water-cooled plant can be reduced in size 20 percent due to the on-peak chilled water provided from the two heat recovery chillers.

Add:

- Two (2) 4-pipe Aermec NRP 1800 ASHRs, 120 tons and 1.1 MBH each.
- Six (6) 2-pipe Aermec NRB 2200HA heating-only ASHPs, ~1.4 MBH each.

Each ASHP and ASHR has internal primary pumps.

Revise the existing water-cooled plant design:

- Reduce chiller size from two at 600 tons to two at 480 tons. CHW pipe sizes remain the same.
- Reduce cooling tower from two at 1650 gpm to two at 1430 gpm. Tower pipe sizes remain the same.
- Reduce chiller CW pumps from two at 1100 gpm to two at 880 gpm. CW pipe sizes remain the same.

The heat recovery chillers are piped in series with the centrifugal chillers on the CHWR side so they can be base-loaded for heat recovery. Chilled water flow rate through the AHU coils and chillers and CHW pumps will stay the same as now shown.

The closed-loop condenser water (CCW) system for tenant and 1st floor WSHPs remains the same.

The roof plan and heat pump piping schematic are shown on the following pages.

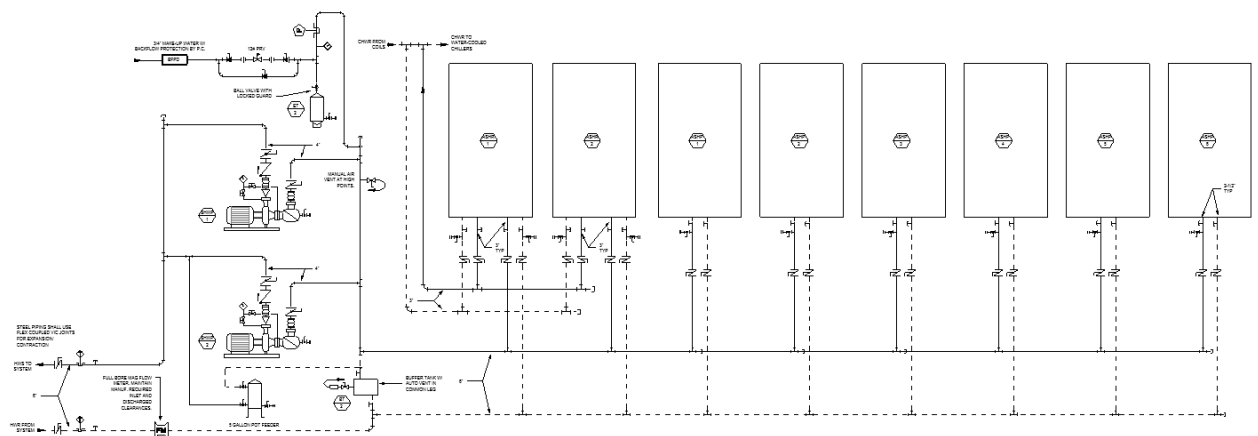
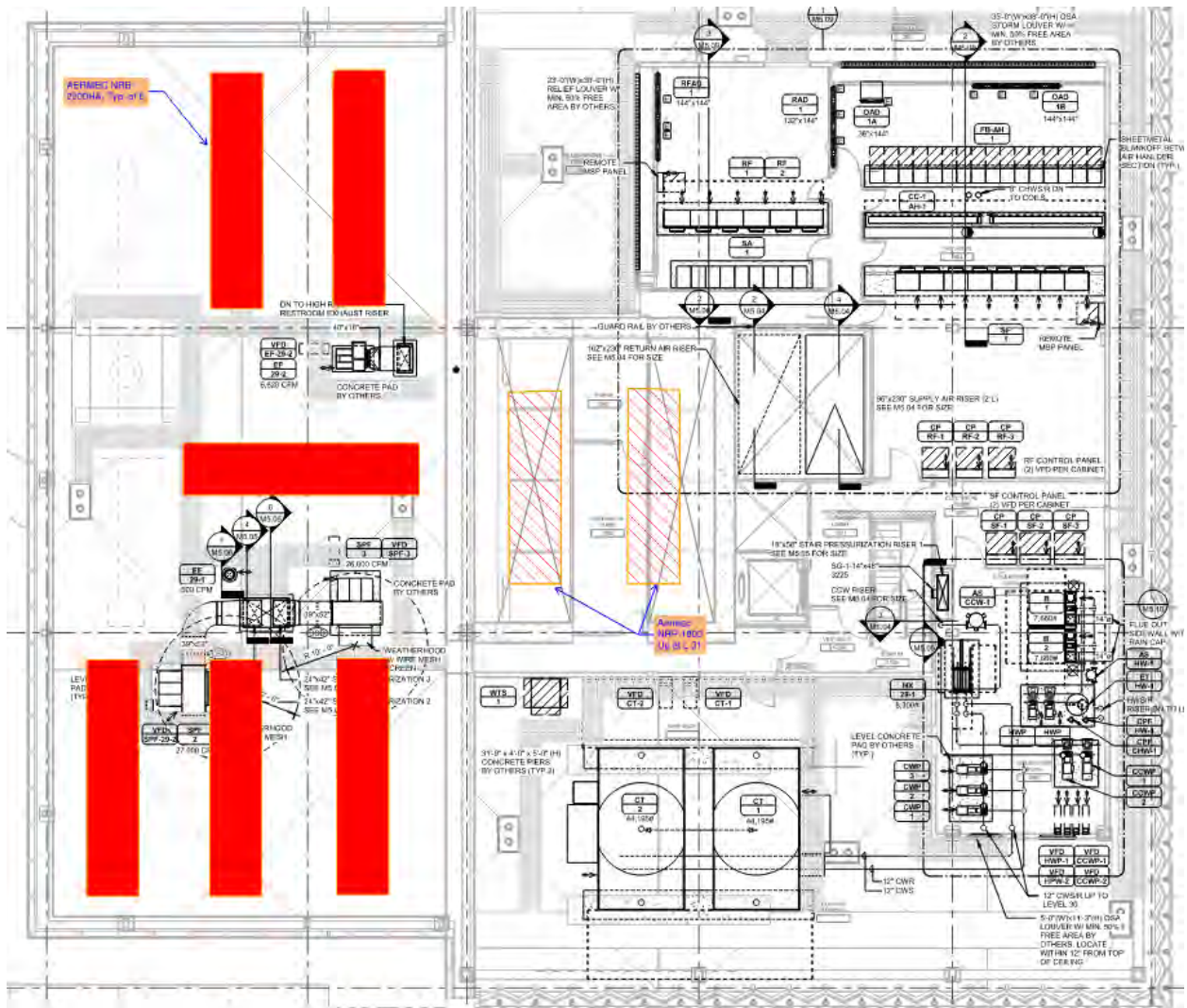

3. TIER Plant

The third option is the Time Independent Energy Recovery plant described in this paper: <https://taylorengeers.com/wp-content/uploads/2020/11/2020-12-29-TIER-Plant.pdf>.

The plant layout along with equipment sizes are described below.

The CCW riser that is currently 8" increases to 10" and requires 1" insulation. CCW taps on each floor for future WSHPs remain the same size but need 1" insulation due to possible cold CCW temperatures that may cause condensation. Future WSHPs will need head pressure control or other design elements to handle these low temperatures. After the tap to the 1st floor heat pump on L3, this riser reduces to 8" (now shown as 3") and pipes over to the current CCW riser location with taps for future retail WSHPs, then 8" CCW is piped to the TES tanks. See the plans and schematic on the following pages.

The L29 boiler room will include another pair of CW pumps and another plate heat exchanger in lieu of the boilers. The L30 chiller room will be crowded with two additional chillers and needs to be rearranged but should fit – see plans on the following pages. The two ASHPs will be located over the elevator room on L31.

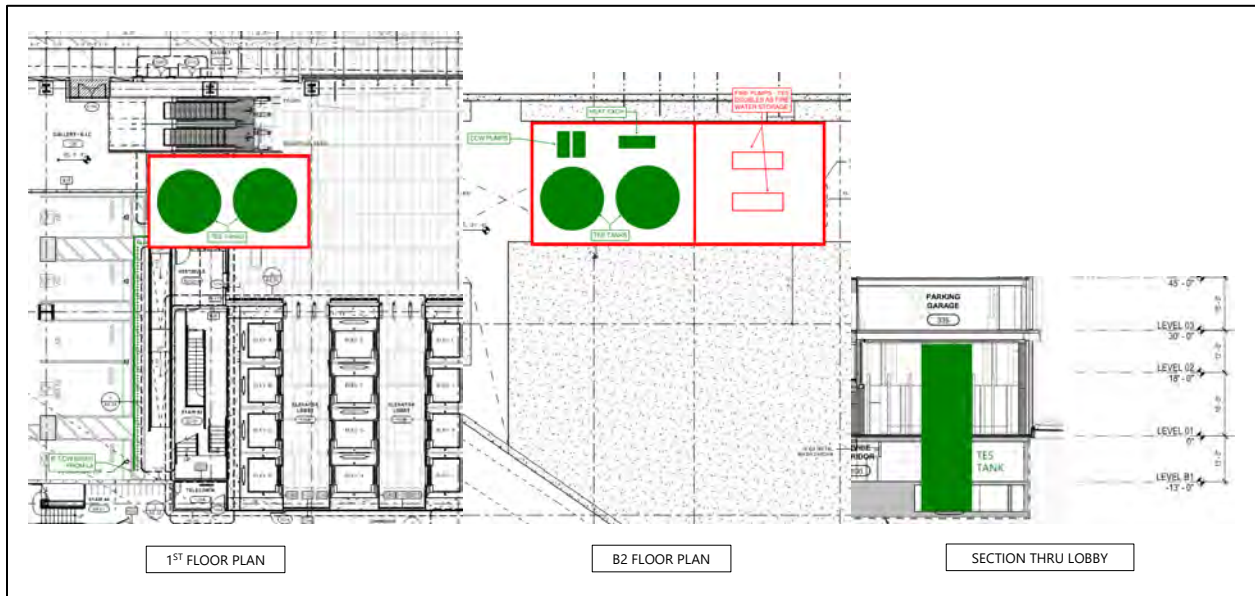

Appendix J: Updated Savings Tables for Mechanical Heat Recovery (October 2023)

This appendix presents updated savings values for the mechanical heat recovery measures that CEC decided to move forward with following the publication of the Final CASE Report. Due to CEC’s decision to shift its 2025 prescriptive baselines to all-electric HVAC system choices for large office and large school, this triggered the Statewide CASE Team to remodel the measures impacted by this change. The updated savings and cost-effectiveness results are presented throughout this appendix. Table 168 shows the “fate” of each modeling case after the final CASE report and the updated labeling scheme. The updated savings values are shown in Table 169 through Table 172. Table 173 through Table 178 show updated cost-effectiveness data. Table 179 shows updated statewide GHG emissions impacts.

Table 168: Lookup Table for Mechanical Heat Recovery Submeasures

Measure Name	Measure ID	Appendix J Status	Appendix J Label
Simultaneous Cooling and Heating (AWHP Baseline)	A	No change	A
Thermal Energy Storage (AWHP Baseline)	B	No change. CEC dropped so not shown.	-
Thermal Energy Storage (Gas Baseline)	C	No change. CEC dropped so not shown.	-
Heat Recovery for Service Water Heating	D	Replace fixed COP with curve	D ₁
Simultaneous Heat Recovery for Space Heating and Service Water Heating Scenario A	E	Replace fixed COP with curve, changed baseline to AWHP	E ₁
Simultaneous Heat Recovery for Space Heating and Service Water Heating Scenario B	F	Changes to “D” made that measure equivalent to this one, therefore, this measure is not shown.	-

Table 169: First Year Electricity Savings (kWh) Per Square Foot – Simultaneous Cooling and Heating (AWHP Baseline)

Measure ID	Prototype	CZ 1	CZ 2	CZ 3	CZ 4	CZ 5	CZ 6	CZ 7	CZ 8	CZ 9	CZ 10	CZ 11	CZ 12	CZ 13	CZ 14	CZ 15	CZ 16
A	Hospital	0.94	0.89	0.78	0.98	0.83	0.74	0.66	0.73	0.74	0.74	0.74	0.85	0.72	0.91	NA	1.10
D ₁	OfficeLarge	0.22	0.20	0.20	0.20	0.20	0.21	0.22	0.21	0.21	0.21	0.19	0.20	0.19	0.20	NA	0.18
D ₁	SchoolLarge	0.58	0.49	0.34	0.41	0.32	0.38	0.41	0.38	0.34	0.40	0.43	0.45	0.40	0.38	NA	0.36
E ₁	OfficeLarge	0.10	0.09	0.08	0.10	0.09	0.03	0.02	0.03	0.04	0.05	0.09	0.08	0.07	0.11	NA	0.18

Table 170: First Year Peak Demand Reduction (W) Per Square Foot

Measure ID	Prototype	CZ 1	CZ 2	CZ 3	CZ 4	CZ 5	CZ 6	CZ 7	CZ 8	CZ 9	CZ 10	CZ 11	CZ 12	CZ 13	CZ 14	CZ 15	CZ 16
A	Hospital	0.15	0.14	0.09	0.17	0.14	0.13	0.12	0.16	0.15	0.12	0.12	0.13	0.09	0.20	NA	0.17
D ₁	OfficeLarge	0.01	0.01	0.01	0.00	0.00	0.00	0.00	0.00	0.00	0.00	0.00	0.00	0.00	0.00	NA	0.00
D ₁	SchoolLarge	0.02	0.02	0.01	0.00	0.00	0.00	0.00	0.00	0.00	0.00	0.00	0.00	0.00	0.00	NA	0.00
E ₁	OfficeLarge	0.02	0.01	0.01	0.00	0.00	0.00	0.00	0.00	0.00	0.00	0.00	0.00	0.00	0.00	NA	0.00

Table 171: First Year Source Energy Savings (kBtu) Per Square Foot

Measure ID	Prototype	CZ 1	CZ 2	CZ 3	CZ 4	CZ 5	CZ 6	CZ 7	CZ 8	CZ 9	CZ 10	CZ 11	CZ 12	CZ 13	CZ 14	CZ 15	CZ 16
A	Hospital	2.15	2.17	1.66	2.34	1.89	1.68	1.47	1.62	1.63	1.67	1.85	1.96	1.63	2.57	NA	2.76
D ₁	OfficeLarge	0.23	0.20	0.19	0.19	0.19	0.21	0.21	0.21	0.20	0.21	0.19	0.20	0.19	0.23	NA	0.19
D ₁	SchoolLarge	0.70	0.60	0.27	0.45	0.24	0.35	0.41	0.35	0.29	0.47	0.51	0.55	0.51	0.46	NA	0.41
E ₁	OfficeLarge	0.24	0.24	0.20	0.26	0.22	0.08	0.07	0.10	0.13	0.14	0.27	0.22	0.20	0.33	NA	0.46

Table 172: First Year LSC Energy Savings (\$) Per Square Foot

Measure ID	Prototype	CZ 1	CZ 2	CZ 3	CZ 4	CZ 5	CZ 6	CZ 7	CZ 8	CZ 9	CZ 10	CZ 11	CZ 12	CZ 13	CZ 14	CZ 15	CZ 16
A	Hospital	5.96	5.77	4.69	5.97	5.28	4.62	3.93	4.56	4.54	4.52	4.56	5.09	4.25	5.91	NA	7.15
D ₁	OfficeLarge	1.05	0.92	0.90	0.92	0.91	1.00	1.04	1.01	0.99	1.00	0.90	0.93	0.92	1.01	NA	0.85
D ₁	SchoolLarge	2.94	2.49	1.50	1.98	1.45	1.77	1.91	1.76	1.57	1.94	2.09	2.19	2.00	1.87	NA	1.79
E ₁	OfficeLarge	0.64	0.62	0.53	0.63	0.55	0.18	0.15	0.22	0.28	0.32	0.60	0.50	0.45	0.73	NA	1.19

Table 173: 2026 PV LSC Savings Over 30-Year Period of Analysis – Per Square Foot – New Construction and Additions – Large Office (Heat Recovery for Service Water Heating)

Climate Zone	30-Year LSC Electricity Savings (2026 PV\$)	30-Year LSC Natural Gas Savings (2026 PV\$)	Total 30-Year LSC Savings (2026 PV\$)
1	NA	NA	NA
2	NA	NA	NA
3	0.90	0.00	0.90
4	0.92	0.00	0.92
5	NA	NA	NA
6	1.00	0.00	1.00
7	1.04	0.00	1.04
8	1.01	0.00	1.01
9	0.99	0.00	0.99
10	1.00	0.00	1.00
11	0.90	0.00	0.90
12	0.93	0.00	0.93
13	NA	NA	NA
14	1.01	0.00	1.01
15	NA	NA	NA
16	0.85	0.00	0.85

Table 174: 2026 PV LSC Savings Over 30-Year Period of Analysis – Per Square Foot – New Construction and Additions – Large Office (Simultaneous Heat Recovery for Space Heating and Service Water Heating Scenario A)

Climate Zone	30-Year LSC Electricity Savings (2026 PV\$)	30-Year LSC Natural Gas Savings (2026 PV\$)	Total 30-Year LSC Savings (2026 PV\$)
1	NA	NA	NA
2	NA	NA	NA
3	0.53	0.00	0.53
4	0.63	0.00	0.63
5	NA	NA	NA
6	0.18	0.00	0.18
7	0.15	0.00	0.15
8	0.22	0.00	0.22
9	0.28	0.00	0.28
10	0.32	0.00	0.32
11	0.60	0.00	0.60
12	0.50	0.00	0.50
13	NA	NA	NA
14	0.73	0.00	0.73
15	NA	NA	NA
16	1.19	0.00	1.19

Table 175: 30-Year Cost-Effectiveness Summary Per Square Foot – New Construction/Additions – Large Office (Heat Recovery for Service Water Heating)

Climate Zone	Benefits LSC Savings + Other PV Savings (2026 PV\$)	Costs Total Incremental PV Costs (2026 PV\$)	Benefit-to-Cost Ratio
1	-	-	-
2	-	-	-
3	0.90	0.23	3.98
4	0.92	0.25	3.66
5	-	-	-
6	1.00	0.23	4.38
7	1.04	0.23	4.56
8	1.01	0.23	4.42
9	0.99	0.23	4.35
10	1.00	0.23	4.41
11	0.90	0.24	3.80
12	0.93	0.23	4.06
13	-	-	-
14	1.01	0.23	4.43
15	NA	NA	NA
16	0.85	0.23	3.67
Total	0.97	0.23	4.20

Table 176: 30-Year Cost-Effectiveness Summary Per Square Foot – New Construction/Additions – Large Office (Simultaneous Heat Recovery for Space Heating and Service Water Heating Scenario A)

Climate Zone	Benefits LSC Savings + Other PV Savings (2026 PV\$)	Costs Total Incremental PV Costs (2026 PV\$)	Benefit-to-Cost Ratio
1	-	-	-
2	-	-	-
3	0.53	0.13	3.91
4	0.63	0.16	3.87
5	-	-	-
6	0.18	0.12	1.55
7	0.15	0.11	1.43
8	0.22	0.11	1.92
9	0.28	0.12	2.39
10	0.32	0.12	2.55
11	0.60	0.15	4.07
12	0.50	0.14	3.59
13	-	-	-
14	0.73	0.14	5.27
15	NA	NA	NA
16	0.20	0.12	1.65
Total	1.19	0.14	8.26

Table 177: Statewide Energy and Energy Cost Impacts – New Construction and Additions – Heat Recovery for Service Water Heating

Climate Zone	Statewide New Construction & Additions Impacted by Proposed Change in 2026	First-Year ^a Electricity Savings (GWh)	First-Year Peak Electrical Demand Reduction (MW)	First-Year Natural Gas Savings (Million Therms)	First-Year Source Energy Savings (Million kBtu)	30-Year Present Valued Energy Cost Savings (Million 2026 PV\$)
1	571	0.00	0.00	0.00	0.00	\$0.00
2	11,215	0.01	0.00	0.00	0.01	\$0.03
3	512,319	0.11	0.00	0.00	0.10	\$0.51
4	251,242	0.06	0.00	0.00	0.06	\$0.27
5	3,203	0.00	0.00	0.00	0.00	\$0.00
6	243,670	0.06	0.00	0.00	0.06	\$0.28
7	164,604	0.05	0.00	0.00	0.05	\$0.22
8	387,599	0.10	0.00	0.00	0.09	\$0.45
9	683,842	0.16	0.00	0.00	0.15	\$0.75
10	127,883	0.04	0.00	0.00	0.05	\$0.20
11	45,870	0.02	0.00	0.00	0.02	\$0.08
12	178,817	0.06	0.00	0.00	0.07	\$0.29
13	54,173	0.02	0.00	0.00	0.03	\$0.11
14	41,570	0.01	0.00	0.00	0.01	\$0.05
15	9,306	0.00	0.00	0.00	0.00	\$0.00
16	12,720	0.00	0.00	0.00	0.00	\$0.02
Total	2,728,605	0.69	0.00	0.00	0.70	\$3.27

a. First-year savings from all buildings completed statewide in 2026.

Table 178: Statewide Energy and Energy Cost Impacts – New Construction and Additions - Large Office – Simultaneous Heat Recovery for Space Heating and Service Water Heating Scenario A

Climate Zone	Statewide New Construction & Additions Impacted by Proposed Change in 2026	First-Year ^a Electricity Savings (GWh)	First-Year Peak Electrical Demand Reduction (MW)	First-Year Natural Gas Savings (Million Therms)	First-Year Source Energy Savings (Million kBtu)	30-Year Present Valued Energy Cost Savings (Million 2026 PV\$)
1	0	0.00	0.00	0.00	0.00	\$0.00
2	0	0.00	0.00	0.00	0.00	\$0.00
3	145,045	0.01	0.00	0.00	0.03	\$0.08
4	70,773	0.01	0.00	0.00	0.02	\$0.04
5	0	0.00	0.00	0.00	0.00	\$0.00
6	63,777	0.00	0.00	0.00	0.01	\$0.01
7	37,001	0.00	0.00	0.00	0.00	\$0.01
8	102,617	0.00	0.00	0.00	0.01	\$0.02
9	186,217	0.01	0.00	0.00	0.02	\$0.05
10	17,563	0.00	0.00	0.00	0.00	\$0.01
11	4,880	0.00	0.00	0.00	0.00	\$0.00
12	25,775	0.00	0.00	0.00	0.01	\$0.01
13	0	0.00	0.00	0.00	0.00	\$0.00
14	8,979	0.00	0.00	0.00	0.00	\$0.01
15	NA	NA	NA	NA	NA	NA
16	2,240	0.00	0.00	0.00	0.00	\$0.00
Total	665,452	0.04	0.00	0.00	0.10	\$0.24

a. First-year savings from all buildings completed statewide in 2026.

Table 179: First-Year Statewide GHG Emissions Impacts

Measure	Electricity Savings^a (GWh/y)	Reduced GHG Emissions from Electricity Savings^a (Metric Tons CO₂e)	Natural Gas Savings^a (Million Therms/yr)	Reduced GHG Emissions from Natural Gas Savings^a (Metric Tons CO₂e)	Total Reduced GHG Emissions^b (Metric Ton CO₂e)	Total Monetary Value of Reduced GHG Emissions^c (\$)
Simultaneous Cooling and Heating	1.34	162	0	0	162	19,930
Heat Recovery for Service Water Heating	0.69	37	0.00	0	37	4,543
Simultaneous Heat Recovery for Space Heating and Service Water Heating Scenario A	0.04	6	0.00	0	6	679
TOTAL	2.07	204	0	0	204	25,153

- a. First-year savings from all buildings completed statewide in 2026.
- b. GHG emissions savings were calculated using hourly GHG emissions factors are published alongside the in the LSC hourly factors and Source Energy factors by CEC here: <https://www.energy.ca.gov/files/2025-energy-code-hourly-factors>.
- c. The monetary value of avoided GHG emissions is based on a proxy for permit costs (not social costs) derived from the 2022 TDV Update Model published by CEC here: <https://www.energy.ca.gov/files/tdv-2022-update-model>.