

IMPERIAL IRRIGATION DISTRICT

INTEGRATED ENERGY POLICY REPORT DATA SUBMITTAL

DOCKET #09-IEP-1D TRANSMISSION PLANNING

Carrie Anne Downey
Law Offices of Carrie Anne Downey
1313 Ynez Place
Coronado, CA 92118
cadowney@cadowneylaw.com
(619) 522-2040

TABLE OF CONTENTS

I. INTRODUCTION 1

II. IID's TRANSMISSION EXPANSION PLAN 1

 A. Update on IID's Transmission Expansion Plan 2

 B. The Imperial Valley Study Group..... 2

 C. IID's Recently Approved Transmission Projects. 3

 D. Upgrades to Path 42 5

 E. Green Path North Projects 6

III. RESPONSES TO DATA REQUESTS..... 6

I. INTRODUCTION

Description of Imperial Irrigation District's Bulk Electric System

The Imperial Irrigation District ("IID") owns and operates electric generation, transmission and distribution facilities. Its generating facilities include fossil fuel-fired and hydroelectric plants. IID's generating facilities have a total net capability (summer season) of 670 MW.

In summer 2008, the IID experienced a peak demand of 979 MW and the projected peak demand for summer 2009 is expected to be 964 MW.

IID's transmission system consists of approximately 1,394 miles of 500-kV, 230-kV, 161-kV and 92-kV lines. The backbone of IID's transmission system is at 161kV (310 miles).

IID owns 16 transmission substations with a total capacity of 2,401,497 kVA, 83 distribution substations with a total capacity of 1,904,494 kVA, and power plant substations with a total capacity of 772,312 kVA.

The District's transmission system is interconnected to Western Area Power Administration's (WAPA) system at Blythe and Pilot Knob; to the Arizona Public Service's (APS) system at Yucca substation; to Southern California Edison's (SCE) system at the Mirage/Devers substation at the northwest corner of the IID's service area; and to San Diego Gas & Electric's (SDG&E) system at Imperial Valley substation.

The IID tie-lines are as follows:

<i>From</i>	<i>To</i>	<i>Metering Point</i>	<i>Voltage (KV)</i>	<i>Path Rating (MW)</i>	<i>Import/Export</i>	<i>Length (Mi)</i>
Niland	Blythe	Blythe	161	275	Import/Export	60.8
Pilot Knob	Knob	Knob	161			2.1
ECSS	IV Sub	IV Sub	230	215	Import/Export	18.1
Ramon	Mirage	Mirage	230	600 (E) 100 (I)	Export/Import	0.05
Coachella Valley	Devers	Devers	230			20.0
Yucca 161kV	Yucca 69kV	Yucca	69	74	Import/Export	0.0

II. IID's TRANSMISSION EXPANSION PLAN

For nearly two decades, IID has been at the forefront of promoting renewable energy in the Imperial Valley. Nearly twenty years ago, IID upgraded its transmission system by building a collector system to accommodate the interconnection of new geothermal generation and export this renewable energy to SCE. Today, IID wheels approximately 550 MW of geothermal energy

from Imperial Valley into the California Independent System Operator (CAISO) balancing authority area.

IID remains committed to the development and export of renewable energy from the Imperial Valley to other parts of California. IID recognizes the importance of renewable energy development to the Imperial Valley to assist California meeting its renewable energy goals. IID has been and will remain a strong proponent of renewable energy as a means of meeting California's energy needs and preserving our environment. It looks forward to working with its neighbors in California to enhance the transmission system in order to facilitate the export of renewable energy to the rest of California.

IID recognizes that promotion of renewable energy projects in the Imperial Valley boosts local economic development and brings much-needed, good-paying jobs to a region of California that desperately needs them. IID looks forward to continuing to work with the State of California and other stakeholders to promote renewable energy goals in the Imperial Valley.

A. Update on IID's Transmission Expansion Plan

IID has been at the forefront of promoting renewable energy transmission for many years. The Salton Sea geothermal resource area lies right in the heart of Imperial Valley. This is one of the largest geothermal resources in North America. Approximately fifteen years ago, IID upgraded its transmission system in order to interconnect new geothermal generation that was being developed in the Imperial Valley and export these renewable energy resources to SCE. At that time, IID upgraded its transmission system by constructing a double-circuit 230 kV "collector system" across the entire span of the IID service area – called the KN/KS lines – to interconnect new geothermal generation that was being developed in the Imperial Valley. The KN/KS lines were built in excess of the needed capacity since IID anticipated additional renewable generation development. Therefore, IID has excess capacity on its collector system today that can be used to wheel renewable generation. At present, IID wheels approximately 550 MW of geothermal generation into the CAISO Balancing Authority

B. The Imperial Valley Study Group

IID was a major participant in the regional transmission planning effort known as the Imperial Valley Study Group (IVSG). The IVSG was a voluntary planning collaborative made up of regional stakeholders that met to develop a phased plan for the development of the necessary transmission to export up to 2,200 MW of renewable generation from the Imperial Valley region. The IVSG identified various transmission reinforcements that needed to be made to IID's transmission system in order to facilitate the export of renewable energy out of the Imperial Valley. These reinforcements have been included in IID's transmission planning and incorporated into IID's Transmission Expansion Plan (TEP). IID developed its TEP to accommodate IID's expected load growth and to provide for transmission of Imperial Valley renewable generation to neighboring transmission systems. IID continues to facilitate the development and transmission of renewable energy in Imperial Valley. As of July 2008 there are approximately 2262 MW of generation from 23 proposed generation projects in the IID queue. Most of this is

from renewable generation projects (1871.1 MW). IID is currently processing these interconnection requests and will continue to be one of the nation's leaders in the transmission of renewable energy.

C. IID's Recently Approved Transmission Projects.

IID continues to demonstrate its commitment to the development and export of renewable energy in the Imperial Valley. IID is working closely with its neighboring balancing authorities to develop new transmission projects to enhance the export of renewable energy to other parts of Southern California and Arizona.

IID is moving forward with three transmission projects that have been approved by the IID Board of Directors. Those three projects are:

- a 230 kV transmission line from the Midway substation to a new Bannister substation;
- a 230 kV transmission line from the Imperial Valley (IV) substation to Dixieland substation; and
- A joint transmission project proposed by APS, Salt River Project (SRP), Wellton Mohawk Irrigation and Drainage District (Wellton Mohawk) and IID for a 500 kV transmission line from the Palo Verde (PV) Hub to the North Gila substation near Yuma, Arizona.

These three projects will significantly increase the capability of IID to export renewable energy to its neighbors in Southern California and Arizona.

In addition, IID is also a partner in the Green Path North transmission project which is a 500 kV transmission line interconnecting IID's system and Los Angeles Department of Water and Power's (LADWP) system. IID is also working with SCE to increase the rating of WECC Path 42 to provide an additional 200 MW of export capability from IID's system into SCE's system.

1. Midway to Bannister Transmission Project

On February 19, 2008, the IID Board of Directors approved the construction of the first phase of a 35-mile transmission project to connect IID's Midway substation to a new Bannister substation. The 230 kV Midway-Bannister line will run right through the heart of the Salton Sea geothermal resource area and provide easy access to IID's transmission system for renewable generation being developed in this area. The line will connect IID's KN/KS line that runs on the east side of the Salton Sea to IID's 161 kV L-line that runs on the west side of the Salton Sea. It will provide a low-cost, reliable 1200 MW transmission path for renewable energy to flow to the north into SCE or to the west into San Diego Gas and Electric (SDGE).

The IID Board of Directors has already approved the right-of-way acquisition on the 35-mile Midway to Bannister line. IID has already completed the environmental studies and met all CEQA requirements for this project.

The estimated cost of this project is \$74 million and it has an expected in-service date of second quarter 2011.

The following drawing depicts the Midway to Bannister transmission project.

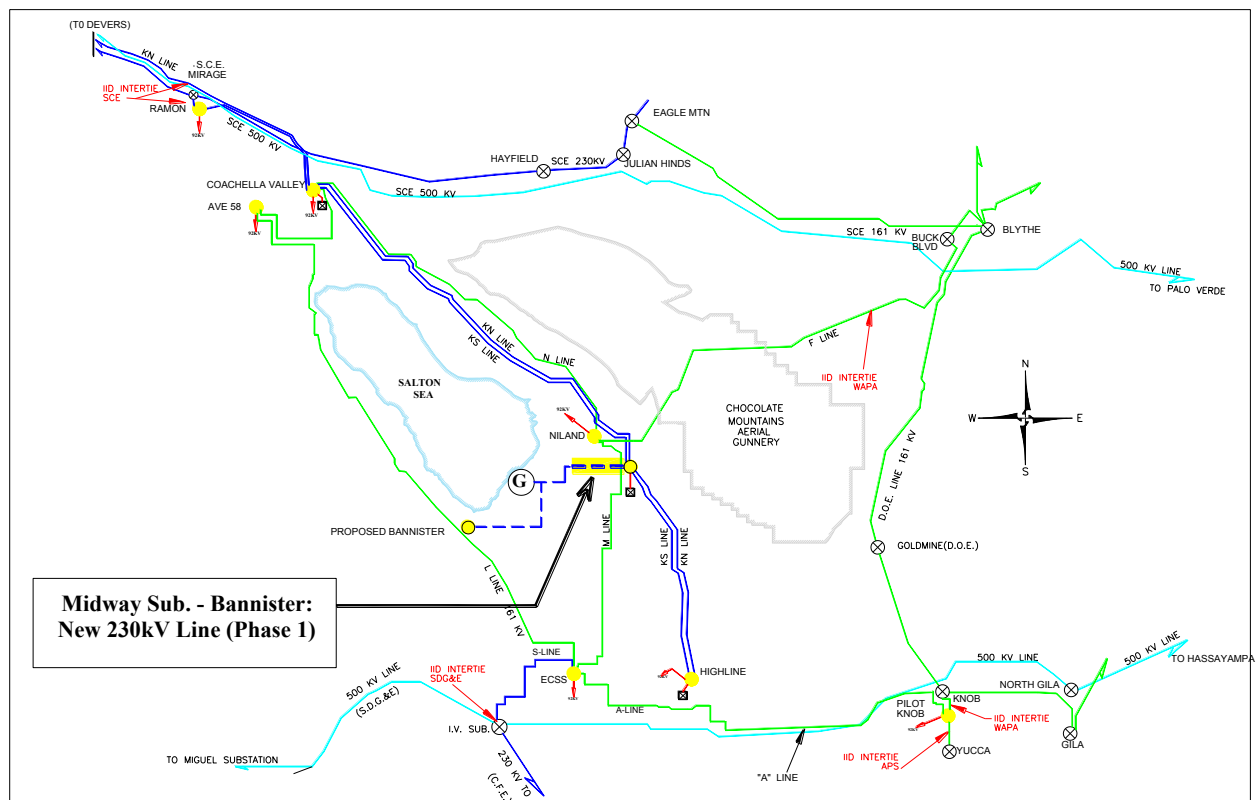

2. Dixieland-IV Transmission Project

The Dixieland-IV project was approved by the IID Board of Directors in November 2006. This is an eight-mile line that will connect the Dixieland substation to the IV substation. It will increase the export capability from IID to SDGE by approximately 400 MW. The Dixieland-IV transmission project is a prime example on how a low-cost alternative can bring substantial new transmission capacities for the export of renewable resources from the Imperial Valley. IID believes that entities such as SDGE can utilize these capabilities to export renewable energy to meet their needs.

The estimated cost of the project is \$20 million and the estimated completion date is December 2010. The following drawing depicts the IV-Dixieland interconnection project.

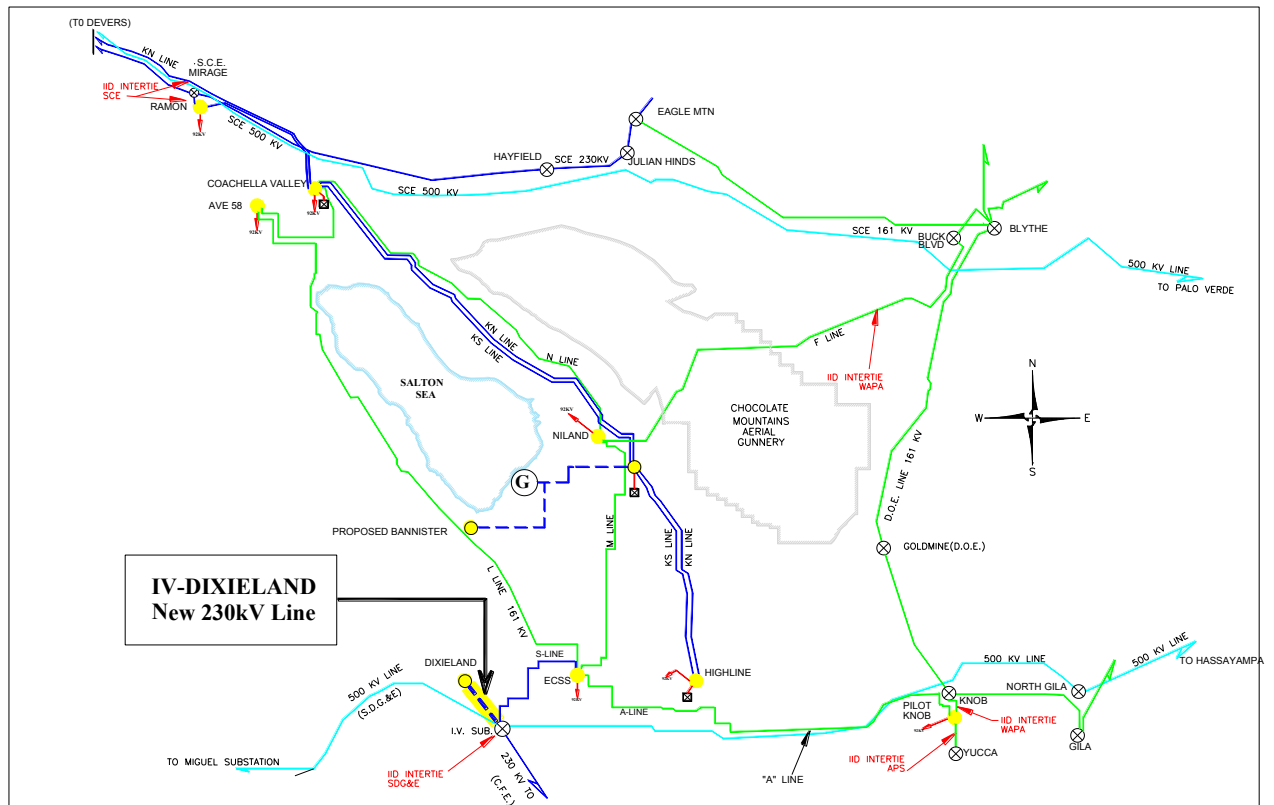

3. Palo Verde-North Gila Transmission Project

On January 14, 2008, the Arizona Corporation Commission (ACC) approved a new 500 kV transmission line from the PV Hub to the North Gila substation near Yuma, Arizona. This 117-mile transmission line is a joint project between IID, APS, SRP and Wellton Mohawk and will be capable of transporting up to 1200 MW of energy. This line will eventually be extended to IID's Highline substation. IID's estimated investment in this project will be \$70 million and it has an expected in-service date of 2014.

D. Upgrades to Path 42

WECC Path 42 includes two transmission lines from IID's Coachella Valley substation to SCE's Devers substation and IID's Ramon substation to SCE's Mirage substation. IID and SCE are in the process of re-rating Path 42. It is anticipated that the re-rating will increase the rating of Path 42 from 600 MW to approximately 800 MW. The Path 42 re-rating does not require transmission upgrades. The increased rating is based upon bringing the rating of Path 42 up to the thermal rating of the transmission lines. The current Path 42 rating is 600 MW but the transmission lines can accommodate a rating of up to 800 MW. IID and SCE are in the process of completing the re-rating studies and will submit it to WECC for approval. It is anticipated that the increase in Path 42 rating to 800 MW can be completed in the 2nd quarter 2009. This will provide an additional 200 MW of export capability from IID's system into SCE's system.

In addition, IID submits that with additional upgrades, the export capability of Path 42 could be increased by up to an additional 800 MW. The 20 miles of existing double circuit single-conductor 230 kV transmission line could be bundled into two conductors per phase. Thus, the total incremental increase in export capability on Path 42 could be approximately 1000 MW – from 600 MW to 1600 MW.

E. Green Path North Projects

1. Green Path North Project

The Green Path North (GPN) project is a proposed 500 kV transmission line that will carry between 1200-1600 MWs of energy between a new switching station in Hesperia near the SCE Lugo substation to a new switching station near Palm Springs and SCE's existing Devers substation. GPN will provide a transmission path for Imperial County renewable energy to reach the Los Angeles basin load centers. GPN has an estimated in-service date of October 2013

2. Coachella Valley-Devers II Project

IID is also planning to build a thirty-five mile transmission line that will connect the IID system in the Coachella Valley area to the LADWP and CAISO balancing authority areas near Palm Springs. The new line known as the Coachella Valley-Devers II project (CV-Devers II) will carry up to 1600 MWs of energy from IID's Coachella Valley substation to the proposed Devers II substation near SCE's existing Devers substation. The CV-Devers II project will be either a double-circuit 230 kV or single-circuit 500 kV line with an anticipated commercial operation date of 2013.

The federal right-of-way has been secured. The required federal environmental analysis has been completed.

III. RESPONSES TO DATA REQUESTS

Questions:

1. The electric transmission system owner's most recent transmission expansion plan. This plan should describe in detail all of the transmission facilities over 100 kV that the transmission owner needs to:
 - a. Meet applicable reliability and planning standards.
 - i. Ave 58 Substation:

Replace the existing 161/92 kV 125 MVA Auto-Transformer with a 230/161/92kV 300MVA Auto-Transformer.

Estimated Completion Date: December 2010

ii. El Centro Switching Station (ECSS) 230 kV Bank addition:

Install a new 230/92 kV 300MVA Auto-Transformer at El Centro Switching Station (ECSS)

Estimated Completion Date: June 2009

The project consists of installing a new 230/92kV transformer and related 230kV switchyard modifications at the existing ECSS.

The following is a simplified one line diagram showing the location of the proposed Transformer.

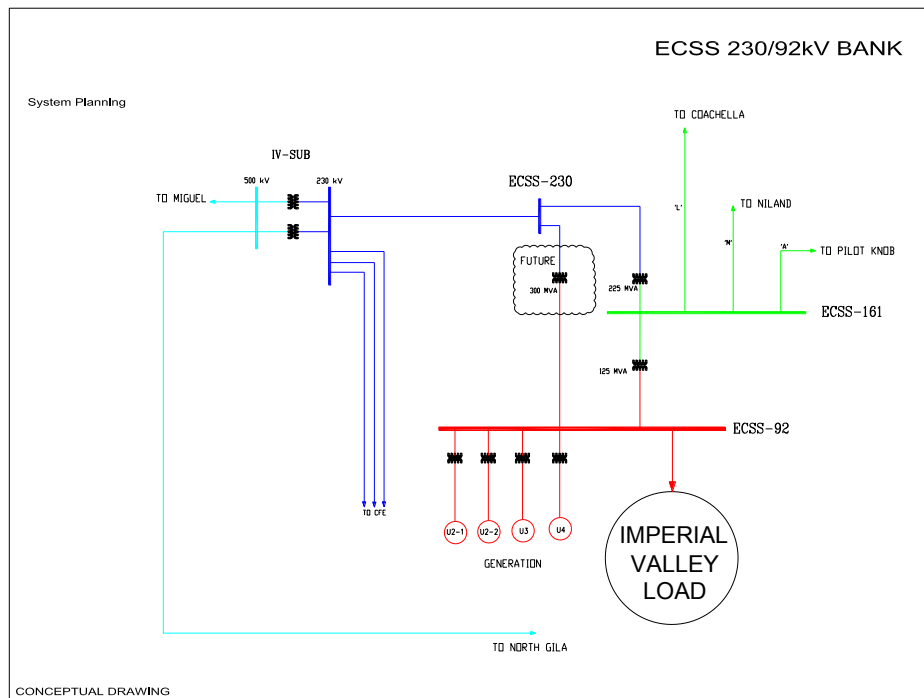

iii. Dixieland Substation to Imperial Valley Substation 230kV line project:

See Subsection II.C.2 above.

iv. Francis Way 230/ 92kV Switching Station:

Build a 230kV switching station to interconnect the existing 230kV KS line between Coachella Valley and Ramon substations. The project will include a 230/92kV transformer and a 92kV line extension to the existing Francis Way 92kV distribution station.

Estimated Completion Date: 2012

The following diagram depicts the layout of the proposed new Francis Way switching station.

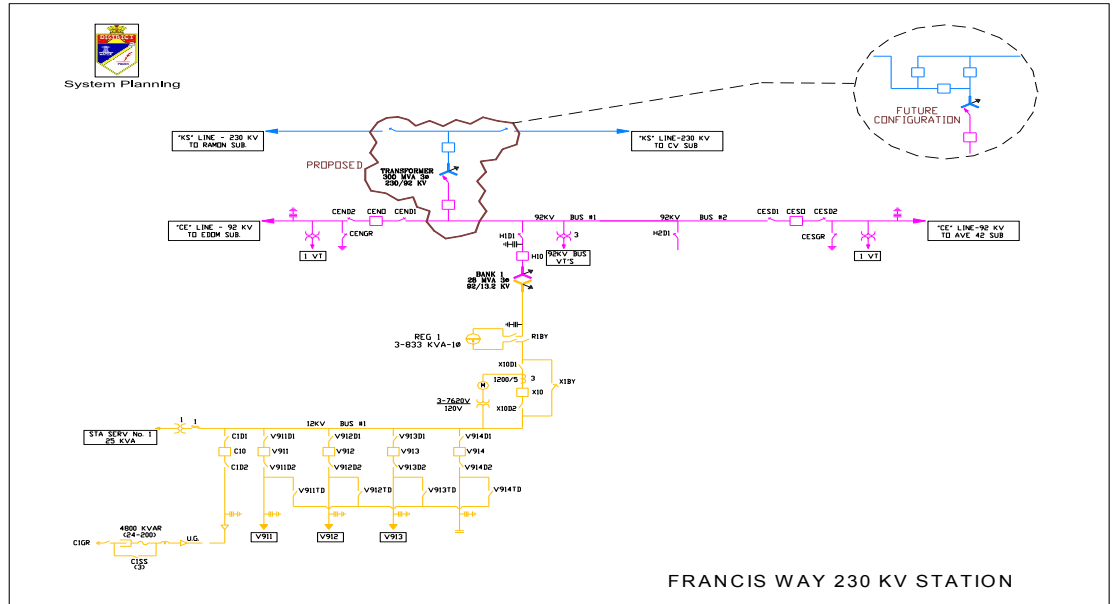

v. Coachella Valley Substation, Replace 230/161/92kV Transformers:

Replace the 230/92kV 150 MVA transformers with 230/92kV 225 MVA transformers.

Estimated Completion Date for Bank No. is 2014, and for Bank No.2 is 2015

The following is a one line diagram showing the location of the Coachella Valley switching station, where the proposed transformer change out will occur.

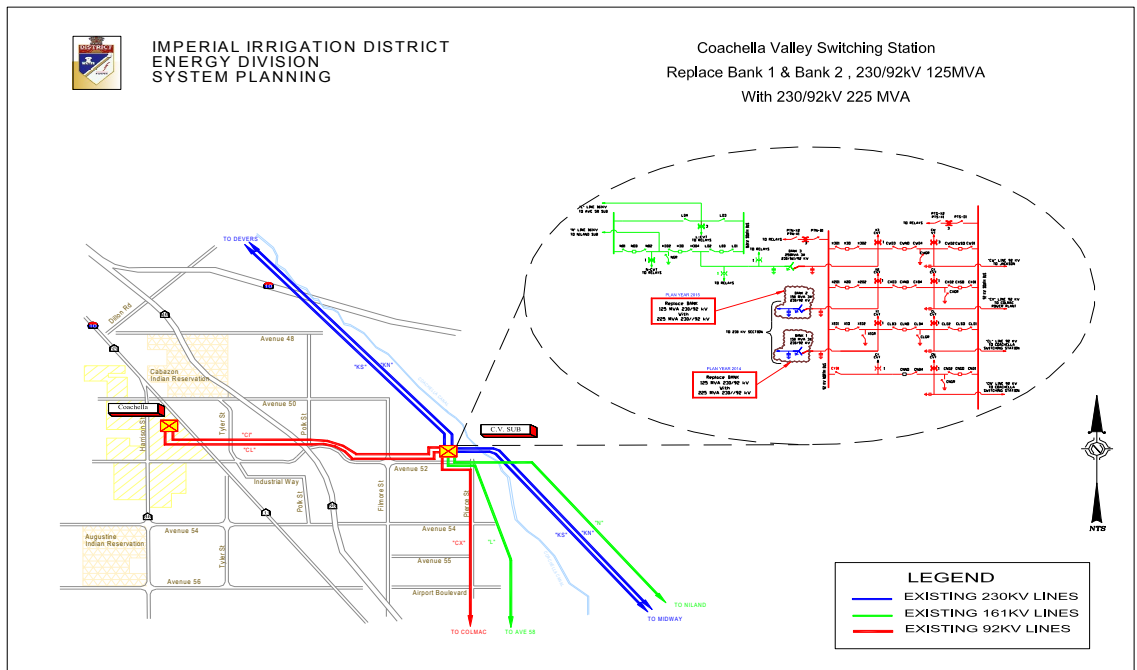

- b. Reduce congestion.
 - i. Coachella Valley Substation to Mirage Substation (Path 42) 230 kV line project:
See Subsection II.D above.
 - ii. El Centro Switching Station (ECSS) 230kV Bank addition:
See Subsection III.1.a.ii above.
 - iii. Dixieland Substation to Imperial Valley Substation 230kV line project:
See Subsection II.E.2 above.
 - iv. Coachella Valley to Devers II 230 kV line project:
See Subsection II.C.1 above.
- c. Meet state policy goals such as RPS or aging power plant retirement/once-through cooling goals.

See IID's transmission expansion plan in Section II above. IID's transmission system is situated in one of the key renewable resource areas in California. The focus of the IVSG was the export of renewables from the Imperial Valley. IID's transmission expansion plan was developed as a result of the IVSG report.

- 2. A description of the transfer capabilities for transmission lines or transmission paths delivering electric power into the electric transmission system owner's grid.
 - a. The description shall include the size (for example, megavolt ampere [MVA] or megawatt [MW]) length of the line or lines included in the path and the substations to which the line connects.

See Section I above.

- b. A description of any planned upgrades to the facilities that are used to import power into the electric transmission system owner's grid that are expected to be operational between January 2009 and December 2018, including:
 - i. Descriptions of the upgrades including costs, benefits, maps, and the MW impact of the upgrades on transfer capabilities.

Path 42 Upgrades – See Subsection II.D above.

ECSS 230 kV Bank addition – See Subsection III.1.a.ii above.

- ii. Descriptions of the alternatives considered in the developing the upgrades.

IID's transmission expansion plan is a systematic reinforcement of IID's existing transmission system that will create a robust network to facilitate the export of renewables from the Imperial Valley to more than one load center. The IID transmission expansion plan can be implemented in a phased approach that utilizes existing facilities and rights-of-way in a cost-effective manner with minimal environmental impacts.

- c. Any maintenance or construction that could impact transfer capabilities or the ability to move power over a path between January 2009 and December 2011.

If the Path 42 Upgrade project is undertaken, it will require curtailment of deliveries across Path 42 during the construction period.

- d. A description of any planned transmission facilities that would create a new transmission path or transmission line to import electric power into the electric transmission system owner's bulk electric network that are expected to be operational between January 2009 and December 2018, including:

- i. Descriptions of the facilities, including costs, benefits, maps, and the MW impact of the upgrade on transfer capabilities.

Coachella Valley to Devers II transmission project – See Subsection II.E.2 above.

Palo Verde to North Gila transmission project – See Subsection II.C.3 above.

Imperial Valley to Dixieland transmission project – See Subsection II.C.2 above.

- ii. Descriptions of the alternatives, including non-wires alternatives, considered in developing the upgrades.

IID's transmission expansion plan is a systematic reinforcement of IID's existing transmission system that will create a robust network to facilitate the export of renewables from the Imperial Valley to more than one load center. The IID transmission expansion plan can be implemented in a phased approach that utilizes existing facilities and rights-of-way in a cost-effective manner with minimal environmental impacts.

- e. A general description of any planned upgrades to the transmission network that imports electric power into the electric transmission system owner's bulk transmission grid that are expected to be operation after December 2018.

IID has not identified any additional transmission needed for imports post-2018. IID's transmission expansion plan is designed to facilitate the export of

renewables from the Imperial Valley. Much of the same transmission will be able to be utilized by IID for imports as well. In addition, in order to meet its RPS goals, IID will be more reliant upon Imperial Valley renewables to serve its load and will be less reliant upon imports of energy from outside its balancing authority area.

3. A description of the transfer capabilities for the bulk transmission lines or bulk transmission paths limiting the delivery of electric power within the electric transmission system owner's grid.
 - a. The description shall include the size (MVA, MW) and length of the line or lines included in the path and substations to which the line connects.

L line 161 kV line

The 161 kV L line interconnects IID's southern service area to the northern service area and consists of a single circuit wood pole structure interconnecting El Centro switching station (South) to Ave 58 substation and from Ave 58 substation (North) to Coachella Valley substation (North). This line has a thermal rating capacity of 165 MW and total line length is 99 miles.

- b. A description of any upgrades to the facilities that are used to import power into the electric transmission system owner's grid that are expected to be operational between January 2009 and December 2018, including:
 - i. Descriptions of the facility's or upgrade's costs, benefits, maps, and the megawatt impact of the upgrade on transfer capabilities.

ECSS 230 kV Bank addition – See Subsection III.1.a.ii above.

IID's import/export transfer capability from CAISO, IID/SDG&E Imperial Valley Substation 230 kV bus is currently limited to 215MW by ECSS 225 MVA, 230/161 kV transformer, the addition of the ECSS Bank No.4, 300 MVA will increase the import transfer capability to 370 MW.

The project's estimated cost is \$7,613,421.

- ii. Descriptions of the alternatives, such as non-wires alternatives, considered in developing the upgrades.

IID's transmission expansion plan is a systematic reinforcement of IID's existing transmission system that will create a robust network to facilitate the export of renewables from the Imperial Valley to more than one load center. The IID transmission expansion plan can be implemented in a phased approach that utilizes existing facilities and rights-of-way in a cost-effective manner with minimal environmental impacts.

- c. Any maintenance or construction that could impact transfer capabilities within the electric transmission system owner's bulk transmission grid between January 2009 and December 2011.

IID has a maintenance project scheduled for the KN-KS 230 kV line between Midway and Coachella Valley. The maintenance project will take place commence during the 4th Quarter of 2009 and is expected to continue through 4th Quarter of 2010. This may result in a reduction in transfer capability on the KN-KS line of 50 percent (800 MW). Since IID currently has over 1000 MW of excess capacity on the KN-KS line, IID's ability to wheel energy on this line is not expected to be affected.

- d. A description of any planned transmission facilities that would create a new means to transfer electric power within the electric transmission system owner's bulk transmission network that are expected to be operational between January 2009 and December 2018, including:
 - i. Descriptions of the facility's or upgrade's costs, benefits, maps, and the MW impact of the upgrade on transfer capabilities.

Midway to Bannister transmission project – See Subsection II.C.1 above.

A & B line transmission line upgrades

IID is planning to establish a 230 kV connection between the existing Highline substation and ECSS with the purpose to interconnect IID's radial collector system (KN-KS line) in the northern portion of its system to its 230 kV system in the southern portion of its system.

The project will consist of the following:

- (1) an upgrade to 18 miles of the existing "A" 161kV and "B" 92kV transmission lines between East Highline canal and ECSS;
- (2) a new one mile 230kV double circuit line to interconnect the "A" and "B" lines to the Highline substation; and
- (3) build a 161 kV and 92kV double circuit line to interconnect the east side portion of the "A" and "B" lines to Highline substation as well as the associated substation work at each end of the line.

The project is expected to establish approximately 800 MW of new transfer capability between Highline substation and ECSS.

<i>Transmission line</i>	<i>From</i>	<i>To</i>	<i>Circuits</i>	<i>Voltage (KV)</i>	<i>Total Transfer Capability (MW)</i>	<i>Length (Mi)</i>
A&B	Highline	ECSS	2	230	670	19

Dixieland – El Centro 230 kV transmission line

The Dixieland – El Centro 230 kV transmission project consists of construction of a single circuit 230 kV line between Dixieland substation and ECSS. The approximate length of the new 230 kV line will be 19 miles. The project is expected to establish approximately 600 MW of new transfer capability between Dixieland and ECSS. The estimated cost of the project is \$28.5 million.

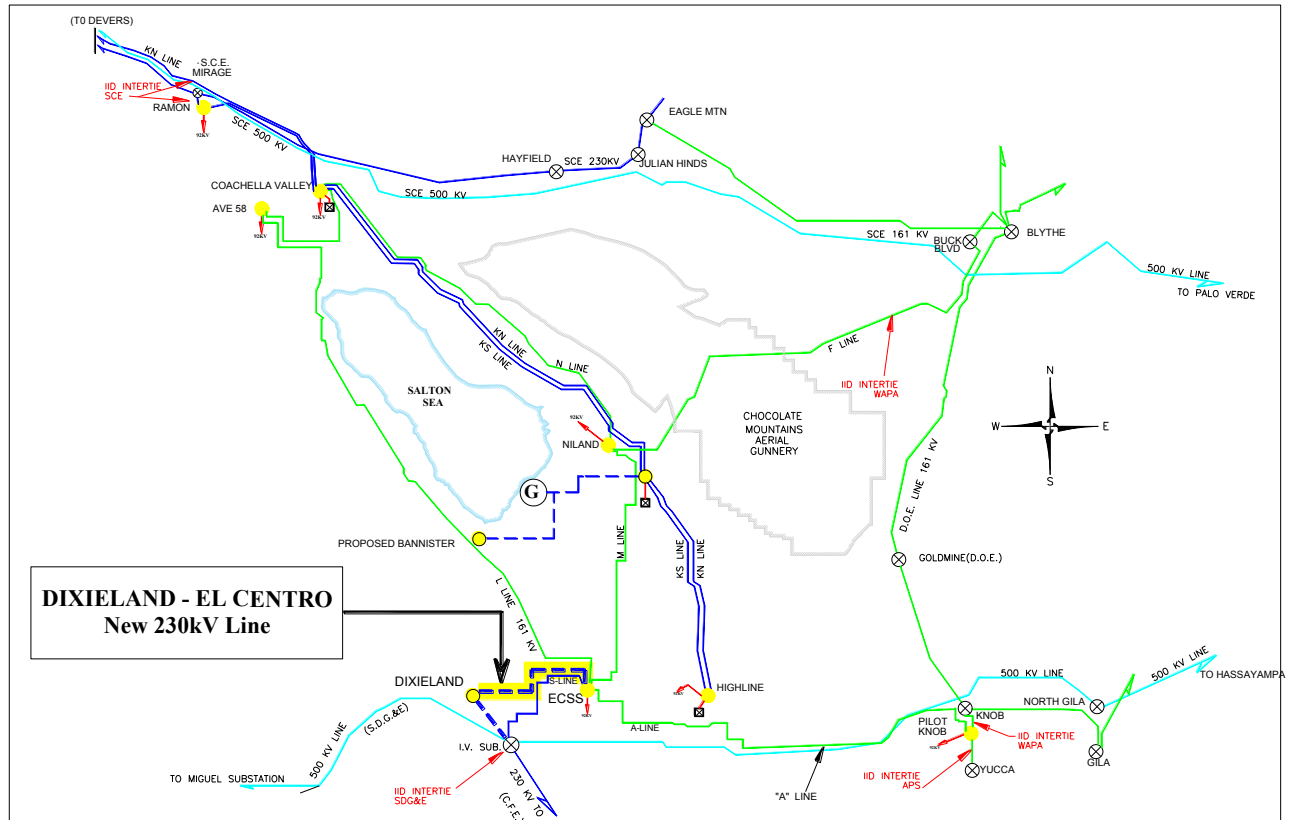

- ii. Descriptions of the alternatives, such as non-wires alternatives, considered in developing the upgrades.

IID's transmission expansion plan is a systematic reinforcement of IID's existing transmission system that will create a robust network to facilitate the export of renewables from the Imperial Valley to more than one load center. The IID transmission expansion plan can be implemented in a phased approach that utilizes existing facilities and rights-of-way in a cost-effective manner with minimal environmental impacts.

- e. A general description of any planned upgrades to the transmission network that transports electric power within the electric transmission system owner's bulk transmission network that are expected to be operational after December 2018.

L Line 161 kV Upgrade to 230 kV

The project will rebuild the single circuit "L" 161 kV line between the ECSS to the Ave 58 substation and from the Ave 58 substation to the Coachella Valley substation¹ to double circuit 230 kV. The project will be built in phases. The first phase will operate one of the circuits at 230 kV and the second circuit at 161 kV. The 230 kV circuit will establish an interconnection between ECSS to the proposed Bannister substation and from the Bannister substation to the Coachella Valley substation. The second circuit will be operated at 161 kV to maintain the interconnection between ECSS – Ave 58 substation – Coachella Valley substation. The ultimate plan for this line will be to cut over Ave 58 161 kV substation to 230 kV and operate the second circuit at 230 kV between ECSS – Ave 58 substation – Coachella Valley substation.

S line 230 kV Upgrade

This project will rebuild the single circuit "S" 230 kV line between ECSS and Imperial Valley substation to double circuit 230 kV line. This project will include the potential re-route of the planned 230 kV line between Imperial Valley substation and Dixieland substation into a potential IID switching station adjacent to Imperial Valley substation.

4. A description of the bulk transmission facilities needed for meeting state mandated electricity policy goals such as, renewable energy requirements, replacing aging power plants, complying with proposed State Water Resources Control Board policies for phasing out power plants that use once-through cooling or eliminating or reducing local capacity requirements.
 - a. The description shall include the size (MV& MW) and length of the lines or lines included in the path and the substations to which the line connects.

See IID's transmission expansion plan set forth in Section II above. IID's transmission system is situated in one of the key renewable resource areas in California. The focus of the IVSG was the export of renewables from the Imperial Valley. IID's transmission expansion plan was developed as a result of the IVSG report.

IID's transmission expansion plan is a systematic reinforcement of IID's existing transmission system that will create a robust network to facilitate the export of renewables from the Imperial Valley to more than one load center. The IID transmission expansion plan can be implemented in a phased approach that utilizes existing facilities and rights-of-way in a cost-effective manner with minimal environmental impacts.

- b. A description of any upgrades to the facilities in the electric transmission system owner's grid that are expected to be operating between January 2009 and December 2018, including:

¹ The portion of the line required to loop in and out Ave 58 Substation is configured as a double circuit structure, this line segment will be reinforced.

- i. Descriptions of the upgrades including costs, benefits, maps, and the MW impact of the upgrade on transfer capabilities.

See Subsections III.1.b; III.2.b.1; and III.2.d.i above.

- ii. Descriptions of the alternatives, such as non-wires alternatives considered in developing the upgrades.

IID's transmission expansion plan is a systematic reinforcement of IID's existing transmission system that will create a robust network to facilitate the export of renewables from the Imperial Valley to more than one load center. The IID transmission expansion plan can be implemented in a phased approach that utilizes existing facilities and rights-of-way in a cost-effective manner with minimal environmental impacts.

- c. A general description of any planned upgrades expected to begin operating after December 2018.

See Subsection III.3.e above.

5. For those point-to-point electric transfer needs identified in the sections (1-4) above, please discuss potential corridor needs in relation to the following:

- a. Opportunities to link with existing federally designated corridors or potential federal corridors identified under Section 368 of the Energy Policy Act of 2005.

Several of IID's proposed transmission projects and upgrades within its transmission expansion plan are within designated federal corridors. These include:

CV-Devers II project
PV-North Gila project
Path 42 Upgrade

- b. Opportunities to provide transmission capacity to develop the renewable generation resources needed to meet the state's Renewables Portfolio Standard (RPS) goals.

Since IID's transmission system is situated in one of the key renewable resource areas of California, IID's transmission expansion plan has been primarily driven by the need to export renewable energy from the Imperial Valley to other parts of California and into Arizona. The focus of the IVSG was the export of renewables from the Imperial Valley. The transmission plan of service set forth in IID's transmission expansion plan was developed as a result of the IVSG with the express intent of facilitating the export of renewable from the Imperial Valley. Therefore, IID's transmission upgrades are an integral element to accessing Imperial Valley renewables to help the state meet its RPS goals.

- c. Opportunities to import additional economical electricity from out of state.

Most of the point-to-point transfer needs identified in the sections (1-4) above are necessary for export of renewable energy from the Imperial Valley to other parts of California and into Arizona. IID's transmission expansion plan is designed to facilitate such exports. However, IID will be able to utilize much of the same transmission to import from the same interconnection points.

- d. Opportunities to export renewable-based generation outside of California.

It is expected that the Palo Verde to North Gila transmission project and the subsequent extension of that line to the Highline substation will be utilized to export Imperial Valley renewable into Arizona. IID will also be able to use this transmission path to import energy from Arizona as well.

- e. Opportunities to improve the reliability or reduce the congestion of the state's electricity system.

The proposed Path 42 upgrades will provide significant relief to a bottleneck between IID's system and SCE's system. In addition, IID's Coachella Valley to Devers II transmission project will alleviate congestion in this same region. Both of these upgrades will facilitate the export of renewable energy from the Imperial Valley to load centers in and around the Los Angeles basin.

- f. Opportunities to upgrade existing transmission lines.

At the core of IID's transmission expansion plan is the upgrade of existing IID transmission lines and the utilization of existing rights-of-way for new transmission. Between 2009 and 2018, IID is proposing upgrades to the following existing transmission lines:

Path 42 (up to 1000 MW)

In addition, IID is proposing the following upgrades to existing transmission lines post-2018:

L-Line (up to 1100 MW)

- g. Opportunities to meet future growth in load.

Most of the point-to-point transfer needs identified in the sections (1-4) above are necessary for export of renewable energy from the Imperial Valley to other parts of California and into Arizona. IID's transmission expansion plan is designed to facilitate such exports. However, much of the same transmission will be able to be utilized by IID for imports as well.

In addition, in order to meet its RPS goals, IID expects to rely upon renewables that are situated within its service territory. IID's transmission expansion plan is

designed to facilitate the interconnection of renewable generation in Imperial Valley.

- h. The potential to impact sensitive lands that may not be appropriate locations for energy corridors – including, but not limited to, state and national parks, state and national designated wilderness and wilderness study areas, state and national wildlife refuges and areas, critical inventoried roadless areas in national forests, habitat conservation plan areas, and special habitat mitigation areas.

IID's transmission expansion plan relies upon the upgrade of existing transmission lines and the utilization of existing rights-of-way for new transmission. None of IID's transmission expansion plan impacts state or federal parks or wilderness. As part of the required environmental studies for any of IID's transmission expansion plan projects, impacts to sensitive lands has been, and will be, considered.

- i. Consideration of the Garamendi Principles (See Appendix B) as identified in Senate Bill (SB) 2431 (Garamendi, Chapter 1457, Statutes of 1988) and as noted in SB 1059, Section 1 (Escutia and Morrow, Chapter 638, Statutes of 2006), in the case of existing corridors.

IID's transmission expansion plan was developed as a result of the IVSG Report. At the core of IID's transmission expansion plan is the upgrade of existing IID transmission lines and the utilization of existing rights-of-way for new transmission.

- j. Any work previously done with local agencies and any geographical areas of sensitivity that may have been identified.

IID, as a municipally-owned transmission provider, is the lead agency under CEQA. In developing transmission projects, IID must conduct the required environmental studies under CEQA and works with the federal government under NEPA.

- k. Any other known major issues that have the potential to impact a future corridor designation.

Future corridor designations should take into consideration the potential for stranded transmission investment of incumbent utilities. For instance, IID's renewable collector transmission system in the Salton Sea region currently has more than 1000 MW of excess capacity. A transmission corridor should not be designated that could result in the stranding of this excess capacity.

- 6. If you have no plans for proposing a transmission corridor, please identify the circumstances or planning timeframes where you would opt to obtain a transmission corridor designation

from the Energy Commission before applying for approval to build (or participate in) a transmission line project.

At this time, IID's transmission expansion plan does not require designation of a transmission corridor. IID's transmission expansion plan relies upon upgrades to existing transmission lines and utilization of existing rights-of-way. If in the future, IID identifies the need for a transmission line in a location where there is not existing transmission rights-of-way available or existing transmission corridors, IID would consider applying for a transmission corridor designation.

7. If you would not consider applying to the Energy Commission for a transmission corridor designation, please explain why not.

At this time, IID's transmission expansion plan does not require designation of a transmission corridor. IID's transmission expansion plan relies upon upgrades to existing transmission lines and utilization of existing rights-of-way.

LAW OFFICES OF CARRIE ANNE DOWNEY

1313 YNEZ PLACE
CORONADO, CA 92118
CADOWNEY@CADOWNEYLAW.COM

PHONE (619) 522-2040
FAX (619) 522-2043

DOCKET
09-IEP-1D

DATE	MAR 16 2009
RECD.	MAR 17 2009

March 16, 2009

California Energy Commission
Docket Unit
Attn: Docket 09-IEP-1D
1516 Ninth Street, MS-4
Sacramento, CA 95814-5512

RE: Docket #09-IEP-1D Imperial Irrigation District Integrated Policy Report Data Submittal

Enclosed, please find a hard copy and a CD of the Imperial Irrigation District Integrated Policy Report Data Submittal in docket #09-IEP-1D.

If there are any questions concerning the IID submittal, I can be reached at 619-522-2040 or cadowneylaw@cadowneylaw.com.

Sincerely,

Carrie A. Downey

Enc: (2)