

DOCKETED

Docket Number:	13-ATTCP-01
Project Title:	Acceptance and Training Certification
TN #:	211956-10
Document Title:	5.6 Appendix C UA_STAR_HVACR_STUDY_GUIDE_4_13_2015.pdf
Description:	N/A
Filer:	Rachel Shuman
Organization:	International Training Fund
Submitter Role:	Applicant
Submission Date:	6/23/2016 11:27:19 AM
Docketed Date:	6/23/2016



UA STAR HVACR STUDY GUIDE

UA Textbooks used as Reference in this Study Guide

This Study Guide is designed to help you be successful in taking the UA STAR exam. The exam is based upon a detailed job task analysis yielded 13 subject categories consisting of 90 different task description. The UA STAR exam is comprehensive and designed to test the knowledge of the experienced technician. The successful UA STAR test candidate is the technician who has completed UA training and has gained several years of field experience.

Revised April 2015 by Ferris State University for the International Training Fund – Revision content was developed by UA subject matter experts and Ferris State University HVACR faculty.

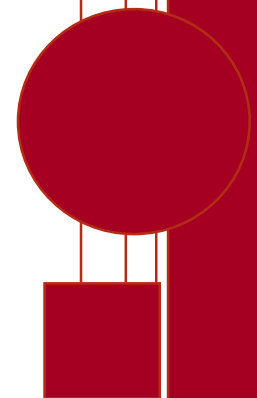

UA STAR HVACR STUDY GUIDE

This study guide was designed to help you be successful in taking the UA STAR exam. The exam is based upon a detailed job and task analysis performed by UA subject matter experts and administered by Ferris State University using the Turbo-DACUM© process. This analysis yielded 13 subject categories consisting of 90 different task descriptions. As the exam will assess your knowledge across each of these categories, you will find this guide very useful for structuring your preparations.

The UA STAR exam is comprehensive and designed to test the knowledge of the experienced technician. The successful UA STAR test candidate is the technician who has completed UA training and has gained several years of field experience. Many of the tasks and jobs identified by the Turbo-DACUM© are those that can only be learned by doing. This Study Guide is intended to serve as a valuable reference for these technicians in preparing for the exam. As the exam has been developed to assess knowledge developed in large part through experience, the inexperienced technician cannot expect to be adequately prepared to successfully complete the exam based knowledge attained solely from the Study Guide and other UA study materials.

Recognizing that even the best technician does not work in all areas of the service industry and that knowledge can diminish over time, it is highly recommended that you study each of the identified categories using multiple references. UA textbooks and references are listed following the table of contents and cited appropriately throughout the guide. The breadth of topics covered on the exam will likely necessitate consulting these and other resources in order to build your proficiency. Additionally, the UA textbooks and online resources provide many sample questions that can better prepare you for a successful exam experience.

UA STAR Certification Study Guide Contents

The Study Guide has been created to help provide an organized structure for preparing for the exam. The guide consists of:

- A concise list of study references.
- A table of contents to quickly locate topic areas.
- A comprehensive listing of the identified categories and tasks you can expect to encounter on the UA STAR exam. Each category and task is numbered, and each task is broken into a number of smaller jobs that a technician would be expected to perform in order to complete the task.
- Over 300 practice test questions. All questions are multiple choice, with four possible answers. The questions are designed to help you evaluate your knowledge of the material that you will need to know when taking the exam. The practice test questions will indicate to you where you need to concentrate study and take a deeper dive into additional references before taking the certification test.
- Practice question answer guide section with most questions followed-up by explanations for each of the correct and incorrect answers.

The UA STAR exam is a tough test, but fair and recognized by your industry. With some hard work, you can be successful in passing it. Good luck!

Contents

Category A: Mechanical Principles	8
Task 1. Troubleshoot/Repair/Replace Bearings and Bushings.....	8
Task 2. Troubleshoot/Repair/Replace Shafts	9
Task 3. Troubleshoot/Repair/Replace Seals and O-Rings	11
Task 4. Troubleshoot/Replace Belts, Sheaves/Pulley	12
Task 5. Perform Alignment and Balancing.....	14
Task 6. Maintain Couplings and System Operation	15
Category B: Electrical Principles	16
Task 7. Demonstrate Knowledge of Basic Electrical.....	16
Task 8. Service Electrical Power and Control Circuits.....	17
Task 9. Install/Repair/Replace Motors (AC)	19
Task 10. Troubleshoot/Replace/Install Circuit Boards	20
Task 11. Operate Electrical/Electronic Test Equipment.....	21
Task 12. Maintain Variable Frequency Drives (VFD)	23
Category C: Controls	24
Task 13. Install/Repair/Replace Starters.....	24
Task 14. Troubleshoot/Repair/Replace/Install Contactors	26
Task 15. Install/Maintain Relays	27
Task 16. Troubleshoot/Repair/Replace Actuators.....	28
Task 17. Troubleshoot/Repair/Replace Flow Switches or Sensors	29
Task 18. Troubleshoot/Repair/Replace Temperature Sensors.....	30
Task 19. Troubleshoot/Repair/Replace Pressure Sensors.....	32
Task 20. Troubleshoot/Repair/Replace Infrared Sensors	33
Task 21. Service/Maintain Operational and Safety Controls	34
Task 22. Install/Maintain Pneumatic Controls	35
Task 23. Install/Maintain Direct Digital Controls (DDC)	35
Task 24. Troubleshoot/Repair/Replace Liquid Level	36
Category D: Air Conditioning and Refrigeration	36

Task 25. Perform General Maintenance on Air Conditioning and Refrigeration Systems	36
Task 26. Maintain Air Conditioning/Refrigeration Systems	38
Task 27. Troubleshoot/Repair Leak	39
Task 28. Evacuate and Measure the Vacuum Level of Refrigeration Systems...	41
Task 29. Perform Refrigerant Recovery	42
Task 30. Charge Refrigeration Systems.....	44
Task 31. Perform General Maintenance on Compressors.....	45
Task 32. Maintain Reciprocating Compressors	47
Task 33. Maintain Scroll Compressors.....	48
Task 34. Maintain Helical Rotary Screw Compressors.....	50
Task 35. Maintain Centrifugal Compressors.....	51
Task 36. Troubleshoot/Install Refrigeration Valves.....	53
Task 37. Troubleshoot/Install Metering Devices	54
Task 38. Troubleshoot/Install Filters/Dryers	55
Task 39. Maintain Condenser/Evaporator System.....	56
Task 40. Maintain Cooling Towers/Evaporative Condensers	58
Task 41. Perform Refrigerant Conversion.....	59
Task 42. Perform Moisture Quality Test	60
Task 43. Maintain Variable Refrigerant Flow (VRF) systems.....	60
Category E: Heating	60
Task 44. Perform General Maintenance on Heating Systems.....	60
Task 45. Maintain Radiant Heating Systems	62
Task 46. Maintain Forced Air Heating Systems	63
Task 47. Maintain Boilers.....	64
Task 48. Maintain Oil/Gas Burner and Combustion Systems	66
Task 49. Troubleshoot/Install/Replace Gas Regulators	67
Task 50. Troubleshoot and Service Electric Heat.....	68
Task 51. Install, Vent, And Size Boilers	69
Category F: Hydronic Systems	70
Task 52. Install/Maintain Hydronic Heating and Cooling Systems.....	70
Task 53. Maintain Centrifugal Pumps	71
Task 54. Install/Maintain Solar Systems	72

Task 55. Install/Maintain Geothermal Systems	72
Task 56. Install/Maintain Water Source Heat Pumps	73
Task 57. Identify Installation Conditions That Impact Design for Hydronic Systems	73
Task 58. Calculate Flow Rates for Hydronic Systems.....	73
Category G: Steam System	74
Task 59. Maintain steam traps	74
Task 60. Maintain Steam Regulators.....	75
Task 61. Maintain Steam Coils.....	76
Task 62. Maintain Vacuum Breakers	77
Task 63. Maintain Steam Flash (Vent) Tanks.....	77
Task 64. Maintain Insulation Systems	78
Task 65. Maintain Vacuum Pumps.....	78
Task 66. Maintain Condensate Return System and Control Valves.....	79
Task 67. Identify Installation Conditions That Impact Design of Piping for Steam Systems.....	81
Category H: Ventilation.....	81
Task 68. Troubleshoot/Install Fans and Air Handling Equipment	81
Task 69. Maintain heat recovery systems	83
Task 70. Maintain Air Side Economizers.....	83
Task 71. Maintain Safety and Limits for Ventilation Equipment	84
Category I: Piping.....	84
Task 72. Perform Pipe Cutting, Joining and Bending	84
Task 73. Service/Install Piping and Tubing and Accessories.....	85
Task 74. Service/Install Refrigeration Piping/Trapping and Pitch.....	87
Task 75. Size Refrigeration Piping Lines.....	87
Category J: Lifting Equipment	87
Task 76. Install Rigging	87
Task 77. Operate Lifting and Moving Equipment.....	88
Category K: Safety, Regulatory and Environmental.....	89

Task 78. Demonstrate Knowledge of Common Mechanical Safety Principles ...	89
Task 79. Demonstrate Knowledge of Electrical Safety Including Lock Out and Tag.....	91
Task 80. Apply Environmental Protection Agency (EPA) Regulations	92
Task 81. Apply the Department of Transportation (DOT) Regulations.....	93
Task 82. Comply With CFC Venting Regulations	94
Task 83. Comply With Regulations Regarding Recovery/Recycle/Reclaiming...	94
Task 84. Comply with required evacuation levels and recovery unit requirements	94
Category L: Applied Math, Science and Blueprint Reading	94
Task 85. Perform Applied Math Operations	94
Task 86. Perform Applied Science Operations	95
Task 87. Interpret Blueprints.....	96
Category M: Customer Service	97
Task 88. Perform Recordkeeping	97
Task 89. Display Professionalism.....	98
Task 90. Communicate With Customers	99

UA Textbooks used as Reference in this Study Guide

- Air Conditioning Mechanical Equipment Service Manual
Copyright 2002
- Basic Electricity for United Association Journeyworkers & Apprentices
Copyright 2006
- Conservation and Safe Handling of Refrigerants
Copyright 2008
- Customer Service Skills
Copyright 2000
- Drawing Interpretation and Plan Reading
Copyright 2000
- Electric Controls For Mechanical Equipment Service
Copyright 1999
- Gas Installations for United Association Journeyworkers & Apprentices
Copyright 2001
- Green Awareness Systems
Copyright 2008
- HVACR Training Manual
Copyright 2006
Published by International Pipe Trades Joint Training Committee, Inc.
- HVACR Training Manual
Copyright 2006
Instructor's Guide
Published by International Pipe Trades Joint Training Committee, Inc.
- HVAC and Refrigeration Systems Training Manual
Copyright 2014
- OSHA Smart Mark
- Pneumatic Controls
Copyright 2006
- Pumps
Copyright 2000
- Refrigerant Controls
Copyright 2000

- Refrigeration Mechanical Equipment Service Manual Volume One
Copyright 2000
- Refrigeration Mechanical Equipment Service Manual Volume Two
Copyright 2000
- Solar Water Heating Systems
Copyright 2013
- Start, Test and Balance
Copyright 2003
- Steam Systems
Copyright 2003
- Soldering & Brazing Manual
Copyright 1999

Comprehensive internet reference materials are also available. For access to this information, please contact either:

Lester W. Guilfoyle III
UA Certified Instructor
UA Local 475
Email: lwgiii@uanj.org
Phone: 732-264-1174
Office Location: 7 Crown Plaza Hazlet, NJ 07730
Office Hours: Monday thru Friday 8:00 AM – 4:00 PM

George Schalk
UA Training Coordinator
UA Local 22
Email: geoschalk@hotmail.com
Phone: 716-662-5752

Category A: Mechanical Principles

Task 1. Troubleshoot/Repair/Replace Bearings and Bushings

- a. Visually inspect for:
 - seals, if present
 - cracks
 - missing elements
 - damage
 - fit/clearances/seating
 - lubrication
 - temperature
 - material type (bushings)
 - support structure/fasteners
 - cleanliness
- b. Verify vibration analysis as appropriate
- c. Check setscrews for appropriate tightness (proper torque)
- d. Check alignment
- e. Check for over lubrication and correct type of lubrication

Replace
- f. Replace with proper type
- g. Inspect shaft for straightness, wear, damage, dimensions
- h. Verify shaft and bearing surfaces are clean
- i. Pre-lubricate as appropriate
- j. Using proper tools, install bearing(s); heating, cooling, or pressing as required
- k. Establish proper clearances as appropriate
- l. Inspect oil and lubrication lines
- m. Verify proper alignment and tolerance
- n. Replace fasteners as needed

Tools and Equipment

- Common hand tools
- Press
- Puller
- Measurement equipment
- Installation tools
- Torch
- Induction heater
- Dry ice
- Shims
- Alignment tools
- Loctite
- Antiseize compound

Calculations

- Measure in thousandths
- Metric/English conversions

Communication

- Interpret written work order
- Verbal with co-workers
- Read technical manual
- Interpret schematic

- Verbal with vendors

Technology

- Bearing principles and types
 - pillow block
 - roller
 - ball
 - flange
 - linear
 - thrust
 - needle
 - cup and cone
 - sleeve
 - etc.
- Basic mechanical principles
- Lubrication/oil analysis
- Installation procedures

Safety

- Common safety practices
- PPE
- Cutting hazard
- Gloves
- Burn hazard
- Lifting hazard
- Lock out/tag out principles
- Pinch points
- Stored energy
- Confined space

Reference

HVAC and Refrigeration Systems Training Manual – Unit 13 page 230, 231

Task 2. Troubleshoot/Repair/Replace Shafts

- Visually inspect shafts:
 - wear
 - alignment
 - straightness/runout
 - keyways
 - contamination
 - shoulders
 - clearance
 - type of materials
 - mounting structure and fasteners
 - polish and surface condition
 - proper diameter
 - cracks; rust
- Send out for and/or repair shaft
- Replace shafts
 - inspect new shaft for physical condition
 - measure shaft clearance to match proper component clearance

- clean and polish shaft as needed
- install; change fasteners as needed
- check alignment as needed
- check rotation as appropriate

Tools and Equipment

- Common hand tools
- Press
- Puller
- Measurement equipment
- Installation tools
- Torch
- Induction heater
- Dry ice
- Shims
- Alignment tools
- Loctite
- Antiseize compound
- Wire brush
- Torque wrench

Calculations

- Measure in thousandths
- Metric/English conversions

Communication

- Interpret written work order
- Verbal with co workers
- Verbal with vendors
- Read technical manual
- Interpret schematic

Technology

- Shaft types
 - spline
 - taper
 - round stock
 - universal
 - hexagonal
 - eccentric
- Shaft material types
 - ground and polished
 - stainless
 - CRS
 - aluminum
 - brass/bronze
- Basic mechanical principles
- Installation procedures
- Lubrication principles

Safety

- Common safety practices
- PPE
- Cutting hazard
- Gloves
- Burn hazard
- Lifting hazard
- Lock out/tag out principles
- Pinch points
- Stored energy
- Confined space

Reference

HVAC and Refrigeration Systems Training Manual – Unit 13 Electric Motors and Solenoids, page 237

Task 3. Troubleshoot/Repair/Replace Seals and O-Rings

- a. Visually inspect for:
 - leaks
 - cracks
 - missing
 - damage
 - fit
 - lubrication
 - material type
 - seat
 - spring tension
- b. Adjust, repair, or replace as appropriate
- c. Prep as appropriate
- d. Check lubrication levels
- e. Check material type compatibility (application)

Tools and Equipment

- Common hand tools
- Press
- Puller
- Measurement equipment
- Installation tools
- Seal removal tools
- Scrapers

Calculations

- Measure in thousandths
- Metric/English conversions

Communications

- Interpret written work order
- Verbal with co workers
- Verbal with vendors
- Read technical manual
- Interpret schematic

Technology

- Seal principles & types
- Basic mechanical principles
- Lubrication
- Installation procedures

Safety

- Common safety practices
- PPE
- Cutting hazard
- Gloves
- Burn hazard
- Lifting hazard
- Lock out/tag out principles
- Pinch points
- Stored energy

Reference

HVAC and Refrigeration Systems Training Manual – Unit 13 Electric Motors and Solenoids, page 237

Task 4. Troubleshoot/Replace Belts, Sheaves/Pulley

- a. Perform visual inspection:
 - alignment
 - wear
 - belt condition
- b. Check run out on the face of the pulley
- c. Check balance of the pulley
- d. Check set screws
- e. Check belt tension
- f. Measure belt pulleys for wear
- g. Replace belt or unit as appropriate
- h. Inspect take-up equipment for function
- i. Check fit to shaft
- j. Clean pulley with wire brush and emery cloth
- k. Replace pulley

Tools and Equipment

- Common hand tools
- Micrometers
- Dial indicators
- Calipers
- Belt gage
- Straight edge
- Tension gage
- String line
- Puller
- Torch
- Reamer
- EZ-out

- Slide hammer
- Drill motor
- Taper lock
- Torque wrench

Calculations

- Measure in decimals (thousandths)
- Basic math
- Ratio
- Clearance (shaft to pulley)
- Rotational direction

Communication

- Interpret written work order
- Verbal with co workers
- Verbal with vendors
- Read technical manual
- Interpret schematic

Technology

- Types of pulleys:
 - v-belt
 - timing
 - cog
 - machine vs. pressed
 - balanced vs/ non-balanced
 - adjustable
 - flat
 - taper lock
 - Q-D
- Basic mechanical principles
- Measuring techniques
- Balancing concepts
- Alignment principles
- Speed and load capacity/limits
- Torque
- Belt tension

Safety

- Common safety practices
- PPE
- Pinch points
- Gloves
- Burn hazard
- Lifting hazard
- Lock out/tag out principles

Reference

HVAC and Refrigeration Systems Training Manual – Unit 13 Electric Motors and Solenoids, page 236, 237 & Unit 17 Forced-Air Furnace, page 301, 302

Task 5. Perform Alignment and Balancing

- a. Align belts and sheaves
- b. Align direct coupled shafts
- c. Align stationery equipment
- d. Correct soft foot

Tools and Equipment

- Common hand tools
- Dial indicators
- Straight edges
- Shim packs
- Laser alignment
- String lines
- Levels
- Feeler gages
- Taper gages
- Welding equipment
- Grinding equipment
- Drills
- Balancing equipment
- Scales
- Weights

Calculations

- Measure in thousandths
- Metric/English conversions
- Basic math
- Interpret analog scales
- Fractions
- Substitute numbers into a formula
- Measure displacement (mills)
- Create graphs
- Measure vectors

Communication

- Interpret written work order
- Verbal with co workers
- Input numeric data into computer
- Read technical manual
- Interpret schematic
- Verbal with vendors

Technology

- Alignment principles
- Alignments benefits
- Computer skills
- Balancing principles
- Mechanical skills

Safety

- Common safety practices
- PPE
- Cutting hazard

- Lifting hazard
- Pinch points
- Lock out/tag out
- Stored energy
- Confined space

Reference

HVAC and Refrigeration Systems Training Manual – Unit 13 Electric Motors and Solenoids, page 227

Task 6. Maintain Couplings and System Operation

- a. Perform visual inspection for:
 - wear
 - damage
 - lubrication
 - alignment
 - proper mounting on shafts
 - set screws
 - clearances
 - safety guards
 - coupling gap
- b. Lubricate coupling
- c. Replace grids, inserts, Lovejoy, spider, gear insert, etc.
- d. Replace chain couplings
- e. Align couplings

Tools and Equipment

- Common hand tools
- Measuring devices
- Grease gun
- Straight edge
- Alignment tools
- Appropriate grease for application

Calculations

- Measure in thousandths
- Basic math
- Interpret analog scales
- Fractions
- Substitute numbers into a formula
- English/Metric measurement

Communication

- Interpret written work order
- Verbal with co workers
- Verbal with vendors
- Read technical manual
- Interpret schematic
- Input numeric data into computer

Technology

- Basic mechanical
- Alignment principles
- Types of couplings:
 - spider
 - gear
 - grid
 - chain
 - tire
 - fixed/flexible
 - slip

Safety

- Common safety practices
- PPE
- Cutting hazard
- Lifting hazard
- Pinch points
- Lock out/tag out
- Stored energy

Reference

**HVAC and Refrigeration Systems Training Manual – Unit 46
Installing, Servicing, and Troubleshooting Air-Source Heat Pump
Systems, page 871**

Category B: Electrical Principles**Task 7. Demonstrate Knowledge of Basic Electrical**

- a. Apply principles of alternating and direct current
- b. Apply principles of series, parallel and compound circuits
- c. Recognize common single and three phase voltage systems
 - 230 v., 60 hz, single phase
 - 208v, 60 hz, three phase
 - 230 v., 60 hz, three phase
 - 460 v., 60 hz, three phase
 - 575 v, 60 hz, three phase (Canada)
- d. Apply principles of Ohm's Kirchhoff's and Watt's law
- e. Read and interpret voltage, ampere, Ohm, megohmmeter, and watt meters

Tools and Equipment

- Common hand tools
- Megohmmeter
- DVOM
- PPE
- Clamp-on ammeter
- Phase rotation device
- Temperature device
- Tachometer

Calculations

- Measure voltage
- Measure amps
- Measure resistance
- Decimals to tenths
- Read scale
- Basic math
- Substitute numbers into a formula
- Use a chart/table
- Measure rpm

Communication

- Verbal with supervisor
- Verbal with co-workers
- Read technical manuals
- Written documentation
- Red line documents
- Read vendor materials
- Verbal with mechanical

Technology

- NEC code
- Basic electrical principles
- Basic mechanical
- Electromagnetic principles

Safety

- OSHA regulations
- Common safety practices
- Electrocution hazard
- Short circuit protection
- Cutting hazards
- Safety equipment/PPE
- Lifting hazard
- Hoists/crane safety

Reference

**HVAC and Refrigeration Systems Training Manual – Unit 11
Electrical System Principles, page 191**

Task 8. Service Electrical Power and Control Circuits

- a. Verify operation
- b. Verify voltage and power supply
- c. Verify transformer operation and output
- d. Check control fuses
- e. Check all operational and safety controls
- f. Check voltage drop
- g. Diagnose distribution problems
 - phase and current imbalance
 - phase loss

- phase reversal
- phase shift
- power factor

Tools and Equipment

- Common hand tools
- Megohmmeter
- DVOM
- PPE
- Clamp-on ammeter
- Phase rotation device
- Temperature device
- Tachometer

Calculations

- Measure voltage
- Measure amps
- Measure resistance
- Decimals to tenths
- Read scale
- Basic math
- Substitute numbers into a formula
- Use a chart/table
- Measure rpm

Communication

- Verbal with supervisor
- Verbal with co-workers
- Read technical manuals
- Written documentation
- Red line documents
- Read vendor materials
- Verbal with mechanical

Technology

- NEC code
- Basic electrical principles
- Basic mechanical
- Electromagnetic principles

Safety

- OSHA regulations
- Common safety practices
- Electrocution hazard
- Short circuit protection
- Cutting hazards
- Safety equipment/PPE
- Lifting hazard
- Hoists/crane safety

Reference

**HVAC and Refrigeration Systems Training Manual – Unit 12
Electrical and Electronic Control Devices, page 207**

Task 9. Install/Repair/Replace Motors (AC)

Install

- a. Determine motor type and requirements (horsepower, voltage, type of wiring, etc.)
- b. Size the motor and frame, if required
- c. Mechanically prepare site (or request that it be done)
 - drill and tap holes
 - install mountings
- d. Bolt motor in position
- e. Attach motor to device
 - Attach coupling, pulleys
- f. Align motor to device(s)
- g. Attach wiring per appropriate schematic; verify integrity of wiring
- h. Power equipment and test operate
- i. Verify rotation

Repair/replace

- j. Inspect wiring and insulation with megohmmeter
- k. Inspect termination
- l. Check rotation
- m. Inspect coupling
- n. Inspect bearings
- o. Inspect shafts
- p. Check incoming power to unit
- q. Replace motor unit
- r. Replace bearings
- s. Replace rotors
- t. Replace wiring and re-terminate
- u. Clean components

Tools and Equipment

- Common hand tools
- Megohmmeter
- DVOM
- PPE
- Clamp-on ammeter
- Phase rotation device
- Temperature device
- Tachometer

Calculations

- Measure voltage
- Measure amps
- Measure resistance
- Decimals to tenths
- Read scale
- Basic math
- Substitute numbers into a formula
- Use a chart/table
- Measure rpm

Communication

- Verbal with supervisor
- Verbal with operations
- Read technical manuals
- Written documentation
- Red line documents
- Read vendor materials
- Verbal with mechanical

Technology

- NEC code
- Basic electrical principles
- Basic mechanical
- Electromagnetic principles
- Types of motors
 - inverter rated
 - DC drive
 - wash down rating
 - NEMA ratings
 - types of AC motors
(split phase, synchro, etc.)
 - induction
 - 3-phase, single phase
 - hertz

Safety

- OSHA regulations
- Common safety practices
- Electrocution hazard
- Short circuit protection
- Cutting hazards
- Safety equipment/PPE
- Lifting hazard
- Hoists/crane safety

Reference

**HVAC and Refrigeration Systems Training Manual – Unit 11
Electrical System Principles, page 191**

Task 10. Troubleshoot/Replace/Install Circuit Boards**Install/replace**

- a. Determine function of board or module
- b. Select appropriate board or module (vendor)
- c. Set jumpers or dip switches as required
- d. Follow vendor procedures to install board
- e. Calibrate board or module

Troubleshoot

- f. Perform visual inspection of board
- g. Check blown fuse
- h. Check inputs and outputs
- i. Verify calibration

- j. Program unit
- k. Verify configuration per vendor specifications
- l. Clean contacts
- m. Replace board as above
- n. Replace fuses

Tools and Equipment

- Common hand tools
- DVOM
- Simulators
- Calibrators
- Terminal computer
- Grounding device

Calculations

- Measure voltage
- Measure current
- Measure resistance
- Establish ranges
- Ratios
- Decimals
- Algebra

Communication

- Programming language
- Verbal with co-workers
- Verbal with vendors
- Interpret schematics
- Verbal with supervisor

Technology

- Computer literacy
- Advanced electronics
- Type of boards
 - A/D converters
 - D/A converters
 - I/O boards
- ESD practices
- Grounding device
- Shielding practices

Safety

- Common safety practices
- Electrical shock
- Electrocution hazard
- Confined space entry
- Vendor required safety

Reference

**HVAC and Refrigeration Systems Training Manual – Unit 12
Electrical and Electronic Control Devices, page 210**

Task 11. Operate Electrical/Electronic Test Equipment

- a. Operate DVOM
- b. Operate ammeter
- c. Operate megohmmeter
- d. Operate millivolt meter
- e. Operate computer terminal
- f. Operate sling psychrometer
- g. Operate power analyzer
- h. Operate phase rotation and sequencer indicator
- i. Operate electronic charging scale
- j. Operate micron gauge
- k. Operate electronic leak detector
- l. Operate milliamp generator
- m. Operate electronic thermometers
- n. Operate infrared thermometers
- o. Operate electronic manometer
- p. Operate electronic rotating vane velometers

Tools and Equipment

- DVOM
- Ammeter
- Oscilloscope
- Megohmmeter

Calculations

- Measure voltage
- Measure resistance
- Measure current
- Decimals
- Fractions
- Read scales (digital)

Communication

- Verbal with supervisor
- Read technical materials
- Verbal with vendors
- Verbal with co-workers

Technology

- Computer literacy
- Equipment knowledge
- Test equipment operation
- Basic electrical

Safety

- Common safety practices
- Electrical shock
- Electrocution hazard
- Confined space entry
- Vendor required safety

Reference

**HVAC and Refrigeration Systems Training Manual – Unit 5
Measurement Devices, page 88 - 108; Unit 53 Residential and Light
Commercial System Testing and Balancing, page 1016**

Task 12. Maintain Variable Frequency Drives (VFD)

- a. Install VFD's
- b. Configure/program VFD's
- c. Troubleshoot VFD operation
- d. Replace components (e.g., fuses, circuit boards, etc.)
- e. Identify mfg.'s of VFD's
- f. Test and verify proper operation
- g. Identify parameters of specific drive
- h. Install and commission VFD
- i. Troubleshoot VFD drives and interpret faults
 - trip on fault
 - external faults
 - relays
 - breakdown motor insulation
 - breakdown wiring insulation
 - over temp
- j. Perform PM
- k. Program drive; set minimums specific to each mfg. of drive
- l. Program in proper sequence and per specific manufacturer
- m. Verify operation of by-pass; confirm proper setting (automatic or by-pass)

Tools and Equipment

- Common hand tools
- DVOM
- PPE
- Tachometer
- PC
- Oscilloscope
- Frequency meters

Calculations

- Measure voltage
- Measure amps
- Measure resistance
- Decimals to tenths
- Read scale
- Basic math
- Substitute numbers into a formula
- Use a chart/table

Communication

- Verbal with engineering
- Read technical manuals
- Written documentation
- Red line documents
- Read vendor materials
- Verbal with maintenance

Technology

- Basic electrical principles
- Basic mechanical
- Electromagnetic principles
- Computer literacy
- Encoders
- Resolvers
- Closed and open loop systems
- VFD knowledge

Safety

- OSHA regulations
- Common safety practices
- Electrocution hazard
- Short circuit protection
- Cutting hazards
- Safety equipment/PPE
- Lifting hazard
- Hoists/crane safety

Reference

HVAC and Refrigeration Systems Training Manual – Unit 15 Motor Starters and Variable-Frequency Drives, page 276-278

Category C: Controls**Task 13. Install/Repair/Replace Starters**

- a. Determine appropriate size of the overload and breaker
- b. Secure appropriate starter required for the job and NEC regulations

Install

- c. Determine current and voltage requirements
- d. Size starter, breaker, overloads
- e. Obtain appropriate starter required for the job
- f. Drill and tap holes to mount starter
- g. Wire in the starter; terminate as appropriate
- h. Set overloads and short circuits adjustments for proper settings
- i. Install correct size if NEMA
- j. Initiate power and test system

Troubleshoot, Repair or replace

- k. Inspect for burned contacts
- l. Inspect for proper termination of wires; loose wires
- m. Inspect for burned wire
- n. Inspect overload units
- o. Inspect integrity of load wiring
- p. inspect condition of breaker
- q. Measure coil resistance using DVOM
- r. Replace coil
- s. Replace overload module on IEC

- t. Replace auxiliary contacts on IEC
- u. Replace contacts on NEMA
- v. Replace breaker on starter
- w. Replace overloads on NEMA
- x. Adjust settings on soft start, if required

Tools and Equipment

- Common hand tools
- Megohmmeter
- DVOM
- PPE
- Clamp-on ammeter
- Phase rotation device

Calculations

- Measure voltage
- Measure amps
- Measure resistance
- Decimals to tenths
- Read scale
- Basic math
- Substitute numbers into a formula
- Use a chart/table

Communication

- Verbal with supervisor
- Verbal with co-workers
- Read technical manuals
- Written documentation
- Red line documents
- Read vendor materials

Technology

- NEC code
- Basic electrical principles
- Basic mechanical
- Electromagnetic principles

Safety

- OSHA regulations
- Common safety practices
- Electrocutation hazard
- Short circuit protection
- Cutting hazards
- Safety equipment/PPE
- Lock out and tag

Reference

**HVAC and Refrigeration Systems Training Manual – Unit 12
Electrical and Electronic Control Devices, page 207; Unit 14 HVAC
and Refrigeration Control Systems, page 255; Unit 17 Forced-Air
Furnaces, page 295; Unit 54 Building Automation Principles, page**

**1040; Unit 55 Terminal Unit Heating and Cooling Control Methods,
page 1047**

Task 14. Troubleshoot/Repair/Replace/Install Contactors

Install

- a. Determine current and voltage requirements
- b. Size contactors
- c. Obtain appropriate contactor required for the job
- d. Drill and tap holes to mount contactor
- e. Install contactor
- f. Wire in the contactor; terminate as appropriate
- g. Initiate power and test system

Troubleshoot/repair/replace

- h. Measure coil resistance; contact resistance
- i. Check integrity of wires
- j. Check termination of wires
- k. Check appropriateness of contactor in system
- l. Replace coil or contacts

Tools and Equipment

- Common hand tools
- Megohmmeter
- DVOM
- PPE
- Clamp-on ammeter
- Torque wrench

Calculations

- Measure voltage
- Measure amps
- Measure resistance
- Decimals to tenths
- Read scale
- Basic math
- Use a chart/table

Communication

- Verbal with supervisor
- Verbal with co-workers
- Read technical manuals
- Written documentation
- Red line documents
- Read vendor materials

Technology

- NEC code
- Basic electrical principles
- Basic mechanical
- Electromagnetic principles

- Types of contactors
- Type of overload protections

Safety

- OSHA regulations
- Common safety practices
- Electrocution hazard
- Short circuit protection
- Cutting hazards
- Lock out and tag

Reference

HVAC and Refrigeration Systems Training Manual – Unit 14 HVAC and Refrigeration Control Systems, page 255

Task 15. Install/Maintain Relays

Install

- Determine type of relay to use for application (AC, DC, solid state)
- Determine number and type of contacts and mounting mechanism
- Determine current/voltage rating
- Mount and install and wire relay
- Determine type of surge suppression required
- Program controller
- Complete documentation
- Power up and test operate

Maintain

- Perform visual inspection of unit
- Clean or replace contacts
- Check wiring and termination
- Replace relay if faulty

Tools and Equipment

- Common hand tools
- DVOM
- PPE
- Tachometer
- PC
- Oscilloscope

Calculations

- Measure voltage
- Measure amps
- Measure resistance
- Decimals to tenths
- Read scale
- Basic math
- Substitute numbers into a formula
- Use a chart/table
- Measure rpm

Communication

- Verbal with supervisor
- Verbal with co-workers
- Read technical manuals
- Written documentation
- Red line documents
- Read vendor materials

Technology

- Basic electrical principles
- Basic mechanical
- Electromagnetic principles
- Computer literacy
- Encoders
- Resolvers
- Closed and open loop systems
- Basic servo systems
- Shaft positioning orientation

Safety

- OSHA regulations
- Common safety practices
- Electrocutation hazard
- Short circuit protection
- Cutting hazards
- Safety equipment/PPE
- Lifting hazard
- Hoists/crane safety

Reference

**HVAC and Refrigeration Systems Training Manual – Unit 12
Electrical and Electronic Control Devices, page 211; Unit 15 Motor
Starters and Variable-Frequency Drives, page 271, 272; Unit 54
Building Automation Principles, page 1039, 1040**

Task 16. Troubleshoot/Repair/Replace Actuators

- a. Replace limit or end switch
- b. Determine adjustment requirements using DVOM, visual, indicator displays
- c. Adjust lever position mechanically
- d. Inspect contacts for corrosion, high resistance, water, intermittent
- e. Inspect/replace rollers, lever arms and linkages
- f. Replace stop or cam
- g. Tighten mounting bolts or brackets
- h. Fabricate/design brackets to mount limit switches
- i. Set clearance on end switches

Tools and Equipment

- Common hand tools
- Drill and tapping equipment
- Drill motor
- Saws

- Grinders

Calculations

- Basic math
- Tolerances
- Calculate distance in mm
- Convert mm to ft.

Communication

- Verbal with supervisors
- Verbal with co-worker
- Verbal with mechanical tech
- Interpret technical manual/instruction sheet
- Verbal with supervisor
- Interpret schematics

Technology

- Basic electricity
- Limit switch operation
- Sensor principles
- Proximity switch operation
- Type of material
- Hall effect
- Inductive principles
- Capacitive principles

Safety

- Common safety practices
- PPE
- Shock hazard
- Pinch points
- Lock out/tag out
- Confining spaces

Reference

**HVAC and Refrigeration Systems Training Manual – Unit 12
Electrical and Electronic Control Devices, page 210**

Task 17. Troubleshoot/Repair/Replace Flow Switches or Sensors

- Set up switch or sensor
- Calibrate flow switches or sensors
- Install flow switches or sensors
- Interface flow sensor to microprocessor or control panel
- Repair/replace
- Unclog flow sensor
- Replace/repair circuit boards
- Replace paddle
- Replace transducer

Tools and Equipment

- Common hand tools
- Manometer

- Differential pressure gage
- DVOM
- Hand-held programmers
- Stop watch
- Weigh scale and bucket

Calculations

- Basic math
- Algebra

Communication

- Verbal with supervisors
- Verbal with co-worker
- Verbal with mechanical tech
- Interpret technical manual/
instruction sheet
- Verbal with supervisor
- Interpret schematics

Technology

- Types of flow sensors:
 - differential temperature
 - mass flow
 - flow indicating
 - volumetric
- Physics
- Sensor principles
- Densities

Safety

- Common safety practices
- PPE
- Shock hazard
- High pressure hazard
- Stored energy
- Burn hazard/steam
- Lock out/tag out
- Chemical hazard (MSDS)

Reference

HVAC and Refrigeration Systems Training Manual – Unit 34 High-Pressure-Side Accessories, page 587, 588; Unit 48 Installing, Servicing, and Troubleshooting Chiller Systems, page 923, 924; Unit 54 Building Automation Principles, page 1037

Task 18. Troubleshoot/Repair/Replace Temperature Sensors

- Check primary sensing element
- Calibrate temperature sensor
- Check and verify polarity
- Check connections for looseness
- Verify correct type of sensor

f. Verify controller parameters

Repair/replace

- g. Repair/replace primary sensor
- h. Repair/replace circuit boards
- i. Repair/replace extension wire
- j. Repair/replace well
- k. Clean the exhaust port (nozzle flapper)
- l. Replace the thermostat

Tools and Equipment

- Common hand tools
- DVOM
- Resistance substitution box
- Calibrate temperature source
- Thermometer
- Thermocouple calibrator
- Pneumatic calibrator
- Squeeze bulb

Calculations

- Algebra
- Measure temperature
- Convert temperature C to F
- RTD tables
- Thermocouple tables

Communication

- Verbal with supervisors
- Verbal with co-worker
- Verbal with mechanical tech
- Interpret technical manual/instruction sheet
- Verbal with supervisor
- Interpret schematics

Technology

- Types of temperature sensors
 - thermocouple
 - RTD
 - infrared
 - laser
 - capillary
 - bi-metal strip
- Thermocouple principles
- Peltier
- Temperature coefficients

Safety

- Common safety practices
- PPE
- Shock hazard
- High pressure hazard
- Stored energy
- Burn hazard/steam

- Lock out/tag out
- Chemical hazard (MSDS)

Reference

HVAC and Refrigeration Systems Training Manual – Unit 25 Air-Source Heat Pump Systems, page 425, 453; Unit 54 Building Automation Principles, page 1033

Task 19. Troubleshoot/Repair/Replace Pressure Sensors

- Set up pressure sensors
- Calibrate pressure sensors
- Replace pressure sensor
- Configure or program
- Tighten connections and tubing
- Inspect electrical connections

Repair/replace

- Repair/replace boards
- Repair/replace transmitters
- Repair/replace sensing unit
- Install and "pipe in" a pressure sensor

Tools and Equipment

- Common hand tools
- Tubing benders
- DVOM
- Hand-held programmer
- Calibrated pressure source
- Pipe threader

Calculations

- Algebra
- Measure pressure
- Conversions

Communication

- Verbal with supervisors
- Verbal with co-worker
- Verbal with mechanical tech
- Interpret technical manual/instruction sheet
- Interpret schematics

Technology

- Types of pressure sensors:
 - piezo electric
 - bourdon
 - capacitance
 - mechanical
 - pneumatic
- Types of pressures:
 - vacuum
 - absolute (psia)
 - differential (psi)

--atmospheric (psig)

Safety

- Common safety practices
- PPE
- Shock hazard
- High pressure hazard
- Stored energy
- Burn hazard/steam
- Lock out/tag out
- Chemical hazard (MSDS)

Reference

HVAC and Refrigeration Systems Training Manual – Unit 25 Air-Source Heat Pump Systems, page 452, 454

Task 20. Troubleshoot/Repair/Replace Infrared Sensors

- a. Clean lens
- b. Align infrared sensor
- c. Install and setup infrared sensor
- d. Inspect and check power supply and electrical connections
- e. Verify correct output
- f. Verify distance
- g. Repair/replace
- h. Replace unit
- i. Repair/replace circuit boards

Tools and Equipment

- Common hand tools
- DVOM

Calculations

- Algebra

Communication

- Verbal with supervisors
- Verbal with co-worker
- Verbal with mechanical tech
- Interpret technical manual/instruction sheet
- Interpret schematics

Technology

- Infrared technology
- Physics
- Basic electronics
- Optics and mirrors

Safety

- Common safety practices
- PPE
- Shock hazard
- Burn hazard/steam

- Lock out/tag out
- Pinch points
- Rotating equipment (top sealers)

Reference

**HVAC and Refrigeration Systems Training Manual – Unit 12
Electrical and Electronic Control Devices, page 224-226**

Task 21. Service/Maintain Operational and Safety Controls

- Service specialty safety controls including but not limited to
 - smoke detectors
 - refrigerant monitor
 - moisture
 - CO detector
 - spill alarm
 - high and low pressure
 - high and low temperature
 - pressure differential sensors
 - flame safeguard
 - motor protection controls
- Service specialty operational controls
 - temperature controls (proportional, etc.)
 - reset controller
 - pneumatic system controls

Tools and Equipment

- Common hand tools
- DVOM

Calculations

- Algebra

Communication

- Verbal with supervisors
- Verbal with co-worker
- Verbal with mechanical tech
- Interpret technical manual/instruction sheet
- Interpret schematics

Technology

- Infrared technology
- Physics
- Basic electronics
- Optics and mirrors

Safety

- Common safety practices
- PPE
- Shock hazard
- Burn hazard/steam
- Lock out/tag out
- Pinch points
- Rotating equipment (top sealers)

Reference

HVAC and Refrigeration Systems Training Manual – Unit 17 Forced-Air Furnace Components and Controls, page 313; Unit 35 Refrigeration Operating Controls, page 595-599; Unit 55 Terminal Unit Heating and Cooling Control Methods, page 1075, 1076

Task 22. Install/Maintain Pneumatic Controls

- a. Calibrate pneumatic controls
- b. Maintain compressor and compressed air tank
- c. Maintain air dryers
- d. Maintain filters and pressure regulators
- e. Calibrate controls
- f. Identify types of controls
 - reverse acting and direct acting
- g. Identify components
 - reversing valves
 - receivers
 - PE switches
 - EP switches
 - IP transducers
 - pneumatic sq. root extractors
 - spring range
 - pilot positioners
 - air source
 - air dryers
 - filters
 - restrictor
 - actuators
- h. Replace units as appropriate; replace with newer digital

Reference

HVAC and Refrigeration Systems Training Manual – Unit 5 Measurement Devices, page 75, 76

Task 23. Install/Maintain Direct Digital Controls (DDC)

- a. Maintain software; perform upgrades
- b. Identify and maintain network operation
- c. Maintain calibration of system
- d. Maintain microprocessor based controller with application specific routines (e.g., VAV, heat pump, etc.)
- e. Check interface with fire and/or security systems
- f. Install automatic temperature control
- g. Install sensors on air handling units
- h. Install terminal equipment controllers
- i. Install system controllers
- j. Install operator interface
- k. Manage multiple control loop such as proportional-integral-derivative (PID) control,

- energy management routines
- alarms
- 1. Install data transfer between DDC controllers and operator interface with various protocols
- control network

Reference

**HVAC and Refrigeration Systems Training Manual – Unit 5
Measurement Devices, page 75-76**

Task 24. Troubleshoot/Repair/Replace Liquid Level

- a. Install level sensors and controls
- b. Maintain liquid level
- c. Adjust level sensors and controls

Reference

HVAC and Refrigeration Systems Training Manual – Unit 34 High-Pressure Side Accessories, page 581

Category D: Air Conditioning and Refrigeration

Task 25. Perform General Maintenance on Air Conditioning and Refrigeration Systems

- a. Check and adjust belts
- b. Change oil
- c. Check operating conditions
 - pressure
 - temperature and temperature split
 - amperage and voltage
- d. Change filters
- e. Check condenser fan blades
- f. Lubricate
- g. Inspect and tighten all electrical connections and termination
- h. Perform visual inspection including inspecting for leaks
- i. Inspect covers and panels
- j. Check cleanliness and operation of blower, compressors, dampers
- k. Perform general housekeeping on unit
 - Clean coils
 - Clean drain lines and pans
- l. Check and calibrate thermostats

Tools and Equipment

- Common hand tools
- Refrigeration gauges
- Power washer
- DVOM
- Infrared guns
- Nitrogen

- Brushes
- Grease gun
- Amp probe
- Chemical sprayer

Calculations

- Measure temperature
- Calculate superheat
- Calculate sub cooling
- Calculate average temperatures
- Measure volume of grease
- Measure voltage and current imbalance
- Calculate percentage
- Measure liquid quantities
- Measure vacuum

Communication

- Verbal with customer
- Write service report
- Operate radio, cell phone, pagers
- Verbal with co-workers
- Follow written and oral directions
- Read technical manuals
- Interpret name plate on equipment

Technology

- Type of grease to use
- Type of oil to use
- Type of refrigerant
- Type of chemicals for cleaning
- Type of filter and filter sizes
- Basic refrigeration principles
- Basic mechanical principles
- Basic fan laws
- Input and analyze data from and in computer

Safety

- Personal protective equipment
- Common safety practices
- Lock out and tag
- Shock hazard
- Pinch points
- Chemical safety and burns
- Stored energy
- Rotating equipment safety
- Ladder safety
- Weather hazards
- Allergic reactions
- Hand and power tool safety

Reference

**HVAC and Refrigeration Systems Training Manual – Unit 6
Temperature, Pressure, and Thermodynamics, page 113**

Task 26. Maintain Air Conditioning/Refrigeration Systems

- a. Identify types of air conditioning systems
 - self-contained
 - split
 - built up systems
- b. Identify types of refrigeration systems
 - medium temperatures
 - low temperatures
 - multi-temperature systems
 - cascade
 - compound cascade
- c. Identify types of ice machines
 - large tonnage
 - small tonnage
- d. Identify types of condensing systems
 - air cooled
 - liquid cooled
 - evaporative condensers
 - liquid air cooled
- e. Identify types of evaporators
 - DX
 - flooded

Tools and Equipment

- Common hand tools
- Refrigeration gauges
- Power washer
- DVOM
- Infrared guns
- Nitrogen
- Brushes
- Grease gun
- Amp probe
- Chemical sprayer

Calculations

- Measure temperature
- Calculate superheat
- Calculate sub cooling
- Calculate average temperatures
- Measure volume of grease
- Measure voltage and current imbalance
- Calculate percentage
- Measure liquid quantities
- Measure vacuum

Communication

- Verbal with customer
- Verbal with service manager
- Verbal with dispatcher
- Write service report
- Operate radio, cell phone, pagers

- Verbal with co-workers
- Follow written and oral directions
- Read technical manuals
- Interpret name plate on equipment

Technology

- Type of grease to use
- Type of oil to use
- Type of refrigerant
- Type of chemicals for cleaning
- Type of filter and filter sizes
- Basic refrigeration principles
- Basic mechanical principles
- Basic fan laws
- Input and analyze data from and in computer

Safety

- Personal protective equipment
- Common safety practices
- Lock out and tag
- Shock hazard
- Pinch points
- Chemical safety and burns
- Stored energy
- Rotating equipment safety
- Ladder safety
- Weather hazards
- Allergic reactions
- Hand and power tool safety

Reference

HVAC and Refrigeration Systems Training Manual – Unit 30 Low-Pressure-Side Evaporators, page 523, 524, 527; Unit 33 High-Pressure-Side Condensers, page 568-579; Unit 40 Installing Residential Forced-Air Cooling Systems, page 701; Unit 50 HVAC Unit Selection, page 952

Task 27. Troubleshoot/Repair Leak

- a. Lock out and tag; isolate pressure sensitive components
- b. Check charge
- c. Perform visual/auditory inspection of the unit
 - oil residue
 - frost
 - wear on the copper tubing
 - damaged piping
 - listen for hissing sound
- d. Assess conditions for selecting method to perform test
 - weather conditions
 - size of leak
 - size of system
 - environmental conditions

- type of refrigerant
- e. Perform test using one of several methods
 - electronic
 - soap bubbles
 - ultraviolet
 - halide
 - ultrasonic
 - sulfur stick
 - standing vacuum
 - standing pressure (nitrogen)
- f. Isolate leak and relieve pressure, if appropriate
 - shut valve(s)
 - pump system down
 - cross refrigerant over
- g. Recover refrigerant
- h. Prepare surface for repair or replace leaking component
 - brazing or soldering
 - replace
 - weld ammonia system
- i. Pressure test repair using tracer gas and nitrogen

Tools and Equipment

- Common hand tools
- Nitrogen
- Leak detectors
- Nitrogen regulator
- Trace gases
- Recovery equipment
- Refrigeration manifolds
- Welding/brazing set
- Sand cloth
- Power cords
- Ground fault

Calculations

- Measure pressures
- Calculate weight of recovery refrigerant
- Measure distance in inches and/or feet
- Interpret numeric gauge data
- Interpret psi

Communication

- Verbal with customer
- Verbal with co-workers
- Verbal with supervisor
- Verbal with sales
- Read and interpret technical manuals
- Follow oral and written instructions
- Interpret technical data

Technology

- Atmospheric and gauge pressures
- Welding/brazing principles
- Recovery procedures, certification

- Type of refrigerant
- Basic mechanical principles
- Pressure/temperature relationships
- Stored energy

Safety

- Common safety practices
- PPE
- Ground fault
- Adequate ventilation
- Oxygen deprivation
- Fire safety
- Welding safety
- Burn hazard
- Pinch points
- Chemical hazard
- Explosion or burst hazard
- Ladder safety
- Lock out and tag

Reference

HVAC and Refrigeration Systems Training Manual – Unit 3 Electrical Safety, page 46, 47; Unit 5 Measurement Devices, page 107-112; Unit 37 Management of Refrigerants and Refrigerants and Refrigeration Systems, page 632, 633

Task 28. Evacuate and Measure the Vacuum Level of Refrigeration Systems

- a. Lock out and tag equipment
- b. Relieve pressure of nitrogen and tracer gases
- c. Verify operation of vacuum pump and insure clean oil in vacuum pump
 - conduct pull down test using indicating device on pump
- d. Verify removal of refrigerant
- e. Connect vacuum pump to access ports
- f. Confirm tightness of fittings
- g. Install vacuum measuring device
 - micron gauge
 - wet bulb indicator
 - mercury manometer
- h. Evacuate to proper level per mfg. specification verifying proper dehydration
- i. Monitor oil quality in vacuum pump as it is pulling
- j. Isolate vacuum pump
- k. Perform standing vacuum test per mfg. specifications
- l. Change oil as required

Tools and Equipment

- Common hand tools
- Micron gauge
- Wet bulb indicator

- Mercury manometer
- Vacuum pump
- Hoses
- Power cords
- Vacuum pump oil
- Compound gauge set

Calculations

- Convert mm to microns
- Interpret measuring devices
- Measure pressure
- Measure time
- Convert F to C
- Convert temperature to inches Hg

Communication

- Verbal with customer
- Verbal with co-workers
- Interpret mfg. literature
- Verbal with mfg.
- Follow written instructions

Technology

- Physics--boiling points of water
- Absolute pressures

Safety

- Common safety practices
- PPE
- Chemical safety (mercury and oil)
- Ground fault
- Ventilation
- Power cord safety
- Burn hazard
- Rotating equipment hazard
- Confined space
- Lock out and tag

Reference

HVAC and Refrigeration Systems Training Manual – Unit 5 Measurement Devices, page 110-112; Unit 36 Refrigerant Principles, page 603; Unit 37 Management of Refrigerants and Refrigeration Systems, page 617

Task 29. Perform Refrigerant Recovery

- a. Lock out and tag
- b. Identify refrigerant and type of recovery tanks required
 - high pressure
 - low pressure
- c. Weigh empty tanks; verify evacuation, certification, and cleanliness of tanks
- d. Determine vapor or liquid recovery

- e. Determine quantity of refrigerant to be recovered
- f. Use 'push and pull' method with liquid refrigerant
- g. Use 'vapor recovery' method for vapor
- h. Verify water flows to prevent freeze up on chilled water applications
- i. Recover to EPA guidelines
- j. Measure or weigh tanks with recovered refrigerant ; filled to maximum of 80%
- k. Label tanks with proper label
 - content of tank
 - gross weight of cylinder
 - location

Tools and Equipment

- Common hand tools
- Recovery devices/unit
- Scales
- Recovery cylinders
- Hoses or tubing
- Chain falls
- Labeling equipment
- Sight glass/moisture indicator
- Dryer
- Power cords
- Oil for recovery unit
- Rigging

Calculations

- Weights and measures
- Basic math
- Measure temperatures
- Measure pressures
- Calculate non-condensable in circuit
- Calculate cylinder capacity
- Net and gross weight of cylinders Communication

Communication

- Verbal with customer
- Verbal with co-workers
- Certification license
- Write legibly
- Interpret technical data

Technology

- Recovery principles
- Refrigerant principles
- Types of refrigerants
 - CFC
 - HCFC
 - HFC
- Current EPA regulations
- Temperature/pressure
- MSDS
- Current DOT regulations if transporting

Safety

- Common safety practices
- PPE
- Burn hazard/frost bite
- Chemical hazard
- Stored energy
- Lifting hazards
- Ladder safety
- GFI on recovery machine
- Power cord safety
- Lock out and tag
- Weather hazard

Reference

**HVAC and Refrigeration Systems Training Manual – Unit 37
Management of Refrigerants and Refrigeration Systems, page 633-638**

Task 30. Charge Refrigeration Systems

- a. Determine type of system (evaporator and condenser)
 - air medium
 - water medium
- b. Determine refrigerant level of system
- c. Insure adequate freeze prevention
 - establish water flows
 - vapor charge to above freezing (per specifications)
- d. Liquid charge once above freezing point of water
- e. Start machine and charge to proper level
 - Weigh in refrigerant
 - meter refrigerant until correct charge
 - subcooling and superheat
- f. Monitor system
 - refrigerant pressures and temperatures for proper temperature splits and operation
 - amperage for over or under charges
- g. Trim or adjust charge as required to designed conditions

Tools and Equipment

- Common hand tools
- Refrigerant
- Manifold gauge set
- Thermometer
- Ammeter
- DVOM
- Scales
- Ladder

Calculations

- Interpret visual charge charts
- Measure pressure
- Interpret pressure/temperature chart
- Basic math
- Calculate superheat

- Calculate sub cooling
- Calculate discharge superheat

Communication

- Interpret mfg. data
- Verbal with customer
- Verbal with co-workers
- Follow written and oral directions

Technology

- Interpret mfg. charging techniques
- Basic electrical principles
- Basic mechanical principles
- Refrigerant properties
- Thermodynamics
 - superheat principles
 - sub cooling principles
- Air flow principles
- Water flow principles
- Current EPA Regulations

Safety

- Common safety practices
- Chemical hazards
- PPE
- Burn hazard
- Lifting hazard
- Ladder safety
- Electrical safety
- EPA guidelines regarding refrigerants

Reference

**HVAC and Refrigeration Systems Training Manual – Unit 37
Management of Refrigerants and Refrigeration Systems, page 617**

Task 31. Perform General Maintenance on Compressors

- Identify types of compressors
 - reciprocating
 - scroll
 - helical rotary screw
 - centrifugal
 - rotary vane
- Identify style of compressor
 - open drive
 - semi hermetic
 - hermetic
- Check general operation of compressor
 - electrical connections; check amperage
 - mechanical operations
 - check oil levels
 - check refrigerant levels

- listen for abnormal sounds
- measure temperatures for overheating
- check pressures
- check crank case heater for proper operation
- check vibration

Tools and Equipment

- Common hand tool
- Torque wrench
- Pullers
- Precision measuring instruments
- Rigging equipment
- Cylinder hones
- Manifold gauges
- Impact wrench
- DVOM
- Amp probe
- Torch
- Welding equipment

Calculations

- Measure weights
- Pressure/temperature calculations
- Foot lbs. of torque
- Clearances (such as thrust, etc.)
- Tolerances
- Algebra
- Alignments
- Decimals
- Interpret gauge readings

Communication

- Verbal with customers
- Verbal with mfg. and vendors
- Verbal with co-worker
- Verbal with supervisor
- Interpret written materials
- Follow written and oral instructions

Technology

- Compressor principles
- Mechanical principles
- Electrical principles
- Rigging principles
- Weight
- Causes of failure on compressors
 - acid (electrical failures or moisture)
 - hydraulic problems
 - overheating
 - mechanical failure
 - improper operation/application
 - lubrication problems

Safety

- Common safety practices
- PPE
- Lifting hazards
- Pinch points
- Torch safety
- Shock hazard
- Fire hazard
- Chemical hazard
- Rotating equipment
- Stored energy
- Hearing protection
- GFI
- Ladder safety
- Power cords

Reference

HVAC and Refrigeration Systems Training Manual – Unit 29 Refrigeration Principles, page 550-560; Unit 32 High-Pressure-Side Compressors, page 549; Unit 35 Refrigeration Operating Controls, page 593

Task 32. Maintain Reciprocating Compressors

- a. Check internal suction/discharge valves to confirm operation of pump
- b. Check oil pressure and level
- c. Check crankcase temperature
- d. Check superheat
- e. Verify unloader operation
- f. Replace compressor unit on sealed hermetic compressor
- g. Overhaul of reciprocating compressor (semi-hermetic or open drive)
 - valves on semi hermetic or open drive compressor
 - replace oil pump on semi hermetic or open drive compressor
 - replace shaft seals
 - replace valve plates
 - replace pistons and rings

Tools and Equipment

- Common hand tool
- Torque wrench
- Pullers
- Precision measuring instruments
- Rigging equipment
- Cylinder hones
- Manifold gauges
- Impact wrench
- DVOM
- Amp probe
- Torch
- Welding equipment

Calculations

- Measure weights
- Pressure/temperature calculations
- Foot lbs. of torque
- Clearances (such as thrust, etc.)
- Tolerances
- Algebra
- Alignments
- Decimals
- Interpret gauge readings

Communication

- Verbal with customers
- Verbal with mfg. and vendors
- Verbal with co-worker
- Verbal with supervisor
- Interpret written materials
- Follow written and oral instructions

Technology

- Reciprocating compressor principles
- Mechanical principles
- Electrical principles
- Rigging principles
- Weight

Safety

- Common safety practices
- PPE
- Lifting hazards
- Pinch points
- Torch safety
- Shock hazard
- Fire hazard
- Chemical hazard
- Rotating equipment
- Stored energy
- Hearing protection
- GFI
- Ladder safety
- Power cords

Reference

**HVAC and Refrigeration Systems Training Manual – Unit 29
Refrigeration Principles, page 515; Unit 32 High-Pressure-Side
Compressors, page 549**

Task 33. Maintain Scroll Compressors

- a. Check for correct rotation
- b. Check for reverse rotation on shutdown
- c. Check discharge and suction superheat
- d. Replace unit

Tools and Equipment

- Common hand tool
- Torque wrench
- Pullers
- Precision measuring instruments
- Rigging equipment
- Cylinder hones
- Manifold gauges
- Impact wrench
- DVOM
- Amp probe
- Torch
- Welding equipment

Calculations

- Measure weights
- Pressure/temperature calculations
- Foot lbs. of torque
- Clearances (such as thrust, etc.)
- Tolerances
- Algebra
- Alignments
- Decimals
- Interpret gauge readings

Communication

- Verbal with customers
- Verbal with mfg. and vendors
- Verbal with co-worker
- Verbal with supervisor
- Interpret written materials
- Follow written and oral instructions

Technology

- Scroll compressor principles
- Mechanical principles
- Electrical principles
- Rigging principles
- Weight

Safety

- Common safety practices
- PPE
- Lifting hazards
- Pinch points
- Torch safety
- Shock hazard
- Fire hazard
- Chemical hazard
- Rotating equipment
- Stored energy
- Hearing protection
- GFI

- Ladder safety
- Power cords

Reference

**HVAC and Refrigeration Systems Training Manual – Unit 29
Refrigeration Principles, page 515; Unit 32 High-Pressure-Side
Compressors, page 559**

Task 34. Maintain Helical Rotary Screw Compressors

- Check oil differential pressure
- Check pressure drop across oil filters
- Check rotation
- Check discharge superheat
- Check load and unload capacities
- Replace unit
- Overhaul
 - replace bearings
 - rebuild slide valve
 - replace rotors
 - replace shaft seals

Tools and Equipment

- Common hand tool
- Torque wrench
- Pullers
- Precision measuring instruments
- Rigging equipment
- Cylinder hones
- Manifold gauges
- Impact wrench
- DVOM
- Amp probe
- Torch
- Welding equipment

Calculations

- Measure weights
- Pressure/temperature calculations
- Foot lbs. of torque
- Clearances (such as thrust, etc.)
- Tolerances
- Algebra
- Alignments
- Decimals
- Interpret gauge readings

Communication

- Verbal with customers
- Verbal with mfg. and vendors
- Verbal with co-worker
- Verbal with supervisor

- Interpret written materials
- Follow written and oral instructions

Technology

- Helical rotary screw compressor principles
- Mechanical principles
- Electrical principles
- Rigging principles
- Weight

Safety

- Common safety practices
- PPE
- Lifting hazards
- Pinch points
- Torch safety
- Shock hazard
- Fire hazard
- Chemical hazard
- Rotating equipment
- Stored energy
- Hearing protection
- GFI
- Ladder safety
- Power cords

Reference

HVAC and Refrigeration Systems Training Manual – Unit 32 High-Pressure-Side Compressors, page 560

Task 35. Maintain Centrifugal Compressors

- Check vibration
- Check capacity control
- Check rotation
- Replace unit
- Overhaul
 - replace bearings
 - replace impellers
 - replace gears
 - replace seals
 - replace motors
 - replace O-rings and gaskets
 - rebuild or replace vane assembly

Tools and Equipment

- Common hand tool
- Torque wrench
- Pullers
- Precision measuring instruments
- Rigging equipment
- Cylinder hones
- Manifold gauges

- Impact wrench
- DVOM
- Amp probe
- Torch
- Welding equipment

Calculations

- Measure weights
- Pressure/temperature calculations
- Foot lbs. of torque
- Clearances (such as thrust, etc.)
- Tolerances
- Algebra
- Alignments
- Decimals
- Interpret gauge readings

Communication

- Verbal with customers
- Verbal with mfg. and vendors
- Verbal with co-worker
- Verbal with supervisor
- Interpret written materials
- Follow written and oral instructions

Technology

- Centrifugal compressor principles
- Mechanical principles
- Electrical principles
- Rigging principles
- Weight

Safety

- Common safety practices
- PPE
- Lifting hazards
- Pinch points
- Torch safety
- Shock hazard
- Fire hazard
- Chemical hazard
- Rotating equipment
- Stored energy
- Hearing protection
- GFI
- Ladder safety

Reference

HVAC and Refrigeration Systems Training Manual – Unit 32 High-Pressure-Side Compressors, page 560

Task 36. Troubleshoot/Install Refrigeration Valves

- a. Identify types of valves
 - control (such as head pressure control, check valves, etc.)
 - safety relief valves
 - isolation valves (such as shut off valves, etc.)
 - solenoid valves
- b. Replace safety relief valves
- c. Rebuild valves, when appropriate
 - replace O-rings
 - replace coils
 - replace diaphragm
 - replace plunger
 - replace seat and stem
 - replace packing material
 - replace Teflon seat

Tools and Equipment

- Common hand tools
- Torch

Calculations

- Interpret gauge readings

Communication

- Verbal with customers
- Verbal with mfg. and vendors
- Verbal with co-worker
- Verbal with supervisor
- Interpret written materials
- Follow written and oral instructions

Technology

- Valve operation
- Types of valves
 - ball
 - butterfly
 - solenoid
 - relief
 - box
 - float
 - EPR and CPR
 - ORD
- Basic mechanical principles

Safety

- Common safety practices
- PPE
- Stored energy
- Burn hazard
- Pinch points
- Electrical safety
- Lifting hazard
- CPR and basic first aid
- Ladder safety

Reference

HVAC and Refrigeration Systems Training Manual – Unit 20 Hydronic Heating Boiler Components and Controls, page 359, 360; Unit 24 Steam Heating Distribution Systems, page 591, 592; Unit 34 High-Pressure Side Accessories, page 591, 592

Task 37. Troubleshoot/Install Metering Devices

- a. Identify types of metering devices
 - thermostatic expansion valve
 - electronic expansion valves
 - capillary tubes
 - fixed orifice
 - hand valve
 - automatic expansion valve
 - float valve (high side and low side)
 - variable orifice (such as poppet valve)
- b. Determine refrigerant flow
- c. Assess for proper operation
- d. Measure and adjust superheat; calibrate as required
- e. Rebuild or replace if system not functioning
 - replace power head
 - replace push pins
 - replace springs
 - clean strainer
 - replace seat
 - replace O-ring
 - replace float
 - clean orifice
 - replace capillary tubes if plugged or broken
 - replace strainer on capillary tube

Tools and Equipment

- Common hand tools
- Thermometers
- Pressure gauges
- Infrared thermometer
- Rags
- Torch set
- Specialty tools
- Measure device
 - scale or ruler
- Recovery unit
- Vacuum pump

Calculations

- Calculate super heat
- Basic math
- Pressure/temperature conversion

Communication

- Verbal with co-workers
- Verbal with customer
- Verbal with mfg. and vendors
- Verbal with supervisor
- Follow oral and written instructions
- Interpret technical materials

Technology

- Superheat principles
- Refrigerant principles
- Precision measurement
- Valve operation
- Types of metering devices

Safety

- Common safety practices
- Stored energy
- PPE
- Burn hazard/frostbite
- Fire safety
- Ladder safety
- Rigging and lifting hazard
- Proper ventilation
- Chemical hazard
- Oxygen deprivation

Reference

HVAC and Refrigeration Systems Training Manual – Unit 31 Low-Pressure-side Expansion Devices and Accessories, page 537-545

Task 38. Troubleshoot/Install Filters/Dryers

- a. Identify types of dryers
 - shell and core unit (such as liquid line and suction line, etc.)
 - sealed unit
- b. Identify sizing code
- c. Identify function of dryers
 - dehydrate and clean systems
 - filter and capture acids and moisture and particles
- d. Identify connection types
 - flare
 - solder and sweat
- e. Check pressure and temperature drop across dryer
- f. Replace sealed units when pressure drop exceeds specifications
- g. Replace core on the shell and core units
- h. Clean screen and shell with rag

Tools and Equipment

- Common hand tools
- Lint free rags
- Torch
- Recover unit

- Manifold gauges
- Thermometer (infrared)

Calculations

- Calculate pressure drop
- Calculate temperature difference

Communication

- Follow written instructions
- Verbal with co-workers
- Verbal with customers
- Customer relations skills
- Interpret technical material
- Verbal with vendor
- Complete documentation
- Input data into a computer

Technology

- Refrigeration principles
- Welding principles
- Mechanical principles
- Piping principles
- Types of dryers and filters

Safety

- Common hand tools
- PPE
- Burn hazard/frostbite
- Stored energy
- Chemical hazard
- Ventilation

Reference

HVAC and Refrigeration Systems Training Manual – Unit 34 High-Pressure Side Accessories, page 589, 590

Task 39. Maintain Condenser/Evaporator System

- Differentiate between high and low pressure side of system
- Identify operation of specific components; repair/replace
 - condenser fan
 - evaporator fan
 - condenser cooling water
 - cooling towers
 - expansion valves
 - compressor
 - heater
 - accumulator
 - high pressure cut out
 - receiver
 - sight glass
 - filter dryer
- Adjust the extended heating surface of the tube

- d. Charge the system
- e. Repair/replace piping system

Tools and Equipment

- Fin fork
- Common hand tools
- Swage tools
- Flaring tools
- Pipe cutter
- Leak detectors
- Evacuation system
- Dial-a-charge

Calculations

- Basic math

Communication

- Follow written instructions
- Verbal with co-workers
- Verbal with customers
- Customer relations skills
- Interpret technical material
- Verbal with vendor
- Complete documentation
- Input data into a computer

Technology

- Geo-thermal principles
- Heat pump principles
- Interpret schematics
- Types of refrigerants
- Soldering principles
- Basic HVAC
- Basic computer skills
- Basic mechanical
- Basic electrical
- Thermal dynamic theory
- Refrigerant recovery certification
- Federal/state regulations
- NEC and BOCA
- Computer literacy

Safety

- Common safety practices
- PPE
- Lifting hazard
- MSDS
- OSHA regulations
- Confined space entry
- Cutting hazard
- Biological factors
- Environmental concerns
- Hazardous material
- Burn hazard

- Soldering safety

Reference

HVAC and Refrigeration Systems Training Manual – Unit 30 Low-Pressure-Side Evaporators, page 521, Unit 31 Low-Pressure-Side Expansion Devices and Accessories, page 535; Unit 32 High-Pressure-Side Compressors, page 549; Unit 33 High-Pressure-Side Condensers, page 567; Unit 34 High-Pressure Side Accessories, page 581; Unit 35 Refrigeration Operating Controls, page 598; Unit 36 Refrigerant Principles, page 603; Unit 37 Management of Refrigerants and Refrigeration Systems, page 617; Unit 40 Installing Residential Forced-Air Colling Systems, page 701; Unit 41 Servicing and Troubleshooting Residential Forced-Air HVAC Systems, page 733; Unit 44 Installing Light Commercial HVAC Systems, page 813; Unit 45 Servicing and Troubleshooting Light Commercial HVAC Systems, page 853; Unit 48 Installing, Servicing, and Troubleshooting Chiller Systems, page 909

Task 40. Maintain Cooling Towers/Evaporative Condensers

- Clean sump, fill and intake screens and strainers
- Check chemistry of water
- Maintain float valve or fill valve
- Check and adjust fan alignment
- Clean and/or replace nozzles
- Test approach temperatures
- Check sump heater/heat tracing
- Verify bleed off operation
- Maintain gear boxes and belts
- Maintain oil level
- Check fan performance
- Balance water flow
- Inspect for water and refrigerant leaks; repair as appropriate
- Clean and descale tubing

Tools and Equipment

- Common hand tools
- DVOM
- Water test kit
- Sling psychomotor
- Rubber boots and gloves
- Shovel
- Pressure washer
- Grease gun
- Amprobe
- Chemicals
- Mask

Calculations

- Basic math
- Calculate temperature
- Calculate pH
- Calculate load
- Calculate water flows

- Calculate concentration

Communication

- Follow written instructions
- Verbal with co-workers
- Verbal with customers
- Customer relations skills
- Interpret technical material
- Verbal with vendor
- Complete documentation
- Input data into a computer

Technology

- Chiller operation
- Fan laws
- Evaporation principles
- Pressure and temperature
- Refrigeration principles
- Electrical principles
- Mechanical principles

Safety

- Common safety practices
- Rotating parts and equipment
- Pinch points
- Chemical hazards
- PPE
- Biological hazards
- Slip and fall hazards
- Lock out and tag
- Ladder safety
- Stored energy
- Confined space

Reference

HVAC and Refrigeration Systems Training Manual – Unit 29 Refrigeration Principles, page 513; Unit 30 Low-Pressure-side evaporators, page 521; Unit 48 Installing, Servicing, and Troubleshooting Chiller Systems, page 909

Task 41. Perform Refrigerant Conversion

- Flush system
- Modify necessary components
- Charge system with appropriate lubricant and refrigerant
- Perform PM on systems including cleaning condenser and evaporator
- Check defrost controls
- Replace drier(s) as required
- Monitor system for operational performance and correct operation
- Modify/replace controls as required including low ambient controls, pressure switches (low and high), safety relief valves

Reference

HVAC and Refrigeration Systems Training Manual – Unit 25 Air-Source Heat Pump systems; Unit 36 Refrigerant Principles, page 603; Unit 37 Management of Refrigerants and Refrigeration Systems, page 617

Task 42. Perform Moisture Quality Test

- a. Remove sample of refrigerant
- b. Interpret results from test
- c. Perform adjustments depending on test results
- d. Clean up system
- e. Retro commission system

Reference

HVAC and Refrigeration Systems Training Manual – Unit 37 Management of Refrigerants and Refrigeration Systems, page 617

Task 43. Maintain Variable Refrigerant Flow (VRF) systems

- a. Install VRF system and multiple components
 - compressor
 - evaporators
- b. Configure controls
- c. Identify characteristics of VRF systems--two or three pipe systems
- d. Design piping system for VRF systems
- e. Design operation of a VRF system (including advantages and disadvantages of VRF system)
- f. Maintain refrigerant farm installation
- g. Interpret piping diagram and refrigerant flow characteristics
- h. Charge system
- i. Perform pressure testing of VRF systems

Tools and Equipment

- Long stick matches
- Natural gas leak detector
- Soap bubbles

Reference

HVAC and Refrigeration Systems Training Manual – Unit 37 Management of Refrigerants and Refrigeration Systems, page 617

Category E: Heating**Task 44. Perform General Maintenance on Heating Systems**

- a. Identify types of heating systems
 - radiant
 - convection
 - conduction
- b. Identify energy sources
 - electric

- solar
- gas (oil, propane, fossil fuel, etc.)
- wood and corn
- c. Identify transfer mediums
 - water
 - steam
 - air
- d. Identify system types
 - heat pump
 - forced air (gas, electric, steam, fuel)
 - electric resistant
 - radiant (hot water or electric)
- e. Troubleshoot combustion controls
 - gas valves
 - gas trains
- f. Inspect heat exchanger
- g. Inspect air/fuel mixture; adjust
- h. Clean burners
- i. Check for temperature rise
- j. Check low water cut off
- k. Check blowers and belts
- l. Replace filters

Tools and Equipment

- Common hand tools
- Pressure gauges
- Meters
- Thermometers
- Manometers
- Brush
- Flue gas analyzer
- Inspection Mirror
- DVOM
- Flashlight
- Long stick matches
- Natural gas leak detector
- Soap bubbles

Calculations

- Check temperature rise
- Basic math

Communication

- Follow written instructions
- Verbal with co-workers
- Verbal with customers
- Customer relations skills
- Interpret technical material
- Verbal with vendor
- Complete documentation
- Input data into a computer

Technology

- Combustion principles

- Thermodynamics
- System operation
- Types of heat systems

Safety

- Common safety practices
- PPE
- Explosion hazard
- Lock out and tag
- Confined space
- Burn hazard
- Stored energy
- Electrical hazards

Reference

HVAC and Refrigeration Systems Training Manual – Unit 6 Temperature, Pressure, and Thermodynamics, page 117-121; Unit 9 Indoor Air Quality, page 177; Unit 16 Forced-Air Furnaces, page 285; Unit 17 Forced-Air Furnace Components and Controls, page 295; Unit 18 Forced-Air Heating Distribution Systems, page 319; Unit 19 Hydronic Heating System Boilers, page 349; Unit 20 Hydronic Heating Boiler Components and Controls, page 359; Unit 21 Hydronic Heating Distribution Systems, page 382, 383; Unit 22 Steam Heating-Boiler, page 387; Unit 23 Steam Heating Boiler Components and Controls, page 397; Unit 24 Steam Heating Distribution Systems, page 432; Unit 25 Air-Source Heat Pump Systems, page 439; Unit 26 Water-Source and Geothermal Heat Pump Systems, page 459; Unit 28 Miscellaneous Manufactured and Field Installed Systems, page 493; Unit 41 Servicing and Troubleshooting Residential Forced-Air HVAC Systems, page 776-777

Task 45. Maintain Radiant Heating Systems

- Repair/replace components
 - radiant panels
 - circulation pumps
 - heating element
 - infrared fire tube
- Clean surface

Tools and Equipment

- Common hand tools
- Pressure gauges
- Meters
- Thermometers
- Manometers
- Brush
- Flue gas analyzer
- Inspection Mirror
- DVOM
- Flashlight
- Long stick matches
- Natural gas leak detector

- Soap bubbles

Calculations

- Check temperature rise
- Basic math

Communication

- Follow written instructions
- Verbal with co-workers
- Verbal with customers
- Customer relations skills
- Interpret technical material
- Verbal with vendor
- Complete documentation
- Input data into a computer

Technology

- Combustion principles
- Thermodynamics
- System operation
- Radiant heating principles

Safety

- Common safety practices
- PPE
- Explosion hazard
- Lock out and tag
- Confined space
- Burn hazard
- Stored energy
- Electrical hazards

Reference

**HVAC and Refrigeration Systems Training Manual – Unit 28
Miscellaneous Manufactured and Field Installed Systems, page 493**

Task 46. Maintain Forced Air Heating Systems

- a. Repair/replace components
 - gas train
 - blower
 - heat exchanger
 - filters
 - belts
 - bearings
- b. Lubricate

Tools and Equipment

- Common hand tools
- Pressure gauges
- Meters
- Thermometers
- Manometers

- Brush
- Flue gas analyzer
- Inspection Mirror
- DVOM
- Flashlight

Calculations

- Check temperature rise
- Basic math

Communication

- Follow written instructions
- Verbal with co-workers
- Verbal with customers
- Customer relations skills
- Interpret technical material
- Verbal with vendor
- Complete documentation
- Input data into a computer

Technology

- Combustion principles
- Thermodynamics
- System operation
- Forced air heating

Safety

- Common safety practices
- PPE
- Explosion hazard
- Lock out and tag
- Confined space
- Burn hazard
- Stored energy
- Electrical hazards

Reference

HVAC and Refrigeration Systems Training Manual – Unit 16 Forced-Air Furnaces, page 285; Unit 17 Forced-Air Furnace Components and Controls, page 295; Unit 18 Forced-Air Heating Distribution Systems, page 319

Task 47. Maintain Boilers

- a. Identify types of boilers
 - water tube
 - fire tube
 - high and low pressure
 - hot water boilers
 - steam boilers
- b. Identify energy sources
 - electric

- solar
- gas (oil, propane, fossil fuel, etc.)
- wood and corn
- c. Identify safety devices on boilers
 - pressure relief valves
 - low water cut off
 - high temperature cut off
 - high and low gas pressure switch
- d. Replace components
 - tubes
 - burners
 - controls
 - fans
 - gas valves
 - pilot assemblies
 - gaskets
- e. Clean boilers
- f. Blow down safety

Tools and Equipment

- Common hand tools
- Tube cleaning tools
- Manometers
- Pressure gauges
- Meters
- Flue analyzers
- Welding equipment
- Cutting tools
- Collapsing tools
- Grinder

Calculations

- Measure btu
- Calculate temperatures
- Calculate temperature rise

Communication

- Follow written instructions
- Verbal with co-workers
- Verbal with customers
- Customer relations skills
- Interpret technical material
- Verbal with vendor
- Complete documentation
- Input data into a computer

Technology

- Boiler operation
- Principles of combustion
- Thermodynamics
- Sequence of boiler operation

Safety

- Common safety practices
- PPE
- Explosion hazard
- Lock out and tag
- Confined space
- Burn hazard
- Stored energy
- Electrical hazards

Reference

HVAC and Refrigeration Systems Training Manual – Unit 19 Hydronic Heating system Boilers, Page 349; Unit 20 Hydronic Heating Boiler Components and Controls, page 359

Task 48. Maintain Oil/Gas Burner and Combustion Systems

- a. Inspect for leaks
- b. Check supply and burner pressure for gas/oil
- c. Perform combustion analysis
- d. Inspect gear pump for proper operation
- e. Check/confirm appropriate oil levels in supply tank
- f. Inspect motor; replace as needed
- g. Inspect couplings for wear and alignment
- h. Maintain appropriate clearances between gears and housing
- i. Service specialty operational controls
 - ignition controls
 - flame rectification
 - infrared
 - ultraviolet
- j. Test limits and safeties
- k. Check rotation

Tools and Equipment

- Common hand tools
- Vibration analyzer
- Lubrication equipment
- Hoisting/lifting equipment
- Feeler gage
- Alignment equipment
- Basic measuring equipment
- Precision measuring equipment

Calculations

- Basic math
- Measure to thousandths
- Interpret analog scales

Communication

- Verbal with co workers
- Verbal with mfg.
- Verbal with co-worker

- Read technical manual
- Interpret schematics

Technology

- Gear pump operation
- Plumbing and piping principles
- Vibration analysis
- Alignment principles

Safety

- Common safety practices
- Lock out/tag out
- Pinch points
- Lifting hazards
- PPE
- Stored energy
- Burn hazard

Reference

HVAC and Refrigeration Systems Training Manual – Unit 27 Fuel Oil Heating Systems, page 483

Task 49. Troubleshoot/Install/Replace Gas Regulators

- Check and adjust gas regulator
- Check diaphragm vent
- Check for proper operation; adjust as required
- Conduct leak test

Tools and Equipment

- Manometers
- Pressure gauge
- Common hand tools
- Soap bubbles

Calculations

- Basic math
- Measure pressures in WC

Communication

- Follow written instructions
- Verbal with co-workers
- Verbal with customers
- Customer relations skills
- Interpret technical material
- Verbal with vendor
- Complete documentation
- Input data into a computer

Technology

- Interpret schematics
- Types of refrigerants
- Soldering principles

- Basic HVAC
- Basic computer skills
- Basic mechanical
- Basic electrical
- Thermal dynamic theory
- Refrigerant recovery certification
- Federal/state regulations
- NEC and BOCA
- Computer literacy

Safety

- Common safety practices
- PPE
- Lifting hazard
- MSDS
- OSHA regulations
- Confined space entry
- Cutting hazard

Reference

HVAC and Refrigeration Systems Training Manual – Unit 17 Forced-Air Furnace Components and Controls, page 295; Unit 23 Steam Heating Boiler Components and Controls, page 397; Unit 41 Servicing and Troubleshooting Residential Forced-Air HVAC Systems, page 733

Task 50. Troubleshoot and Service Electric Heat

- a. Check electrical connections
- b. Check elements
- c. Check high limit safety; adjust as required
- d. Check amperage
- e. Check air flow and safety
- f. Check input voltage
- g. Check temperature rise
- h. Check belt and motor for proper operation
- i. Replace components
 - heating elements
 - safety components
 - electrical components
 - blower motor

Tools and Equipment

- Common hand tools
- Ammeter
- DVOM
- Thermometer

Calculations

- Measure temperature rise
- Measure amperage
- Measure voltage
- Calculate kw

- Calculate cfm

Communication

- Follow written instructions
- Verbal with co-workers
- Verbal with customers
- Customer relations skills
- Interpret technical material
- Verbal with vendor
- Complete documentation
- Input data into a computer

Technology

- Interpret schematics
- Types of refrigerants
- Soldering principles
- Basic HVAC
- Basic computer skills
- Basic mechanical
- Basic electrical
- Thermal dynamic theory
- Refrigerant recovery certification
- Federal/state regulations
- NEC and BOCA
- Computer literacy

Safety

- Common safety practices
- PPE
- Lifting hazard
- MSDS
- OSHA regulations
- Confined space entry
- Cutting hazard

Reference

HVAC and Refrigeration Systems Training Manual – Unit 17 Forced-Air furnace Components and Controls, page 295; Unit 28 miscellaneous Manufactured and Field Installed Systems, page 493; Unit 41 Servicing and Troubleshooting Residential Forced-Air HVAC Systems, page 733

Task 51. Install, Vent, And Size Boilers

- Measure pressure in a vent stack
- Select appropriate vent material for condensing boilers

Reference

HVAC and Refrigeration Systems Training Manual – Unit 4 Tools and Equipment, page 49

Category F: Hydronic Systems

Task 52. Install/Maintain Hydronic Heating and Cooling Systems

- a. Diagnose system problems:
 - perform visual inspection; listen for abnormal sounds
 - check water supply and return temperatures
 - measure temperature with infrared gun
- b. Replace/repair circulating pumps in the hydronic system
- c. Repair, replace and vent hydronic circulating bleeder vents
- d. Replace/repair pressure regulating valves (PRV)
- e. Grease fittings
- f. Lubricate and pack expansion joints (slide type and loop type)
- g. Repack and reseal valves
- h. Conduct water analysis; adjust chemicals
- i. Check water cleanliness
- j. Calculate pressure and temperature differences in fill and compression tanks
- k. Set up fill and compression tanks
- l. Identify potential design flaws upon inspection of system

Tools and Equipment

- Infrared gun
- Stethoscope
- Common hand tools
- Thermometers
- Pressure gauges
- Grease guns
- Water test kit
- TDS meter
- Conductivity tester

Calculations

- Measure BTU
- Gallons per minute

Communication

- Follow written instructions
- Verbal with co-workers
- Verbal with customers
- Customer relations skills
- Interpret technical material
- Verbal with vendor
- Complete documentation
- Input data into a computer

Technology

- Geo-thermal principles
- Heat pump principles
- Interpret schematics
- Types of refrigerants
- Soldering principles
- Basic HVAC
- Basic computer skills

- Basic mechanical
- Basic electrical
- Thermal dynamic theory
- Chemistry

Safety

- Common safety practices
- PPE
- Lifting hazard
- MSDS
- OSHA regulations
- Confined space entry
- Cutting hazard
- Biological factors
- Environmental concerns
- Hazardous material
- Burn hazard

Reference

**HVAC and Refrigeration Systems Training Manual – Unit 42
Installing Residential Hydronic Systems, page 761**

Task 53. Maintain Centrifugal Pumps

- Check seals
- Check connections for leaks
- Inspect coupling
- Inspect motor
- Replace seals
- Inspect housing for cracks; repair or replace as required
- Inspect inlet strainers; clean if required
- Check alignment
- Check impeller; replace if required
- Check mounting flanges
- Check foundation for deterioration
- Check fasteners for looseness or corrosion
- Verify or perform vibration analysis on motor and pump bearings
- Grease motor and pump bearings
- Inspect flush lines for proper operation
- Inspect gages and record information

Tools and Equipment

- Common hand tools
- Vibration analyzer
- Lubrication equipment
- Hoisting/lifting equipment
- Feeler gage
- Alignment equipment
- Basic measuring equipment

Calculations

- Basic math

- Measure to thousandths
- Interpret analog scales

Communication

- Verbal with co workers
- Verbal with mfg.
- Verbal with co-worker
- Read technical manual
- Interpret schematics
- Log written data

Technology

- Pump principles
- Plumbing and piping principles
- Vibration analysis
- Alignment principles

Safety

- Common safety practices
- Lock out/tag out
- Pinch points
- Lifting hazards
- PPE
- Stored energy
- Burn hazard

Reference

HVAC and Refrigeration Systems Training Manual – Unit 21 Hydronic Heating Distribution Systems, page 373; Unit 42 installing Residential Hydronic Systems, page 761

Task 54. Install/Maintain Solar Systems

- Install solar panels and associated piping
- Properly charge and maintain chemical levels, as required
- Clean the system after startup
- Maintain pumps
- Verify freeze protection for low ambient conditions
- Identify panel orientation issues (vertical, horizontal, and inclination)
- Calculate efficiency and amount of heat being absorbed

Reference

HVAC and Refrigeration Systems Training Manual – Unit 28 Miscellaneous Manufactured and Field Installed Systems, 493

Task 55. Install/Maintain Geothermal Systems

- Install geothermal system
- Check for leaks
- Add heat controls, as needed
- Maintain the water source heat pumps
- Balance branch lines at the manifold as required

- f. Verify flow rate using a pump curve

Reference

HVAC and Refrigeration Systems Training Manual – Unit 26 Water-Source and Geothermal Heat Pump Systems, page 459

Task 56. Install/Maintain Water Source Heat Pumps

- a. Add heat controls and boilers
- b. Balance branch lines at the manifold as required
- c. Charge compression tanks
- d. Maintain heat pumps mechanically and electrically
- e. Maintain heat rejection controls for cooling tower
- f. Maintain cooling tower
- g. Perform PM on cooling tower; filter changes; inspect boilers
- h. Verify flow rate using a pump curve

Reference

HVAC and Refrigeration Systems Training Manual – Unit 22 Steam Heating-Boilers, page 387; Unit 23 Steam Heating Boiler Components and Controls, page 397; Unit 24 Steam Heating Distribution Systems, page 413; Unit 25 Air-Source Heat Pump Systems, page 439; Unit 26 Water-Source and Geothermal Heat Pump Systems, page 459

Task 57. Identify Installation Conditions That Impact Design for Hydronic Systems

- a. Trace the sequence of operation through a system
- b. Identify bottlenecks in the system that can cause problems
- c. Interpret consequences of flaws in the pipe design
- d. Troubleshoot to the component level
- e. Interpret how their installation actions impact design performance
- f. Identify primary and secondary piping systems
- g. Identify faulty site conditions that impact performance
- h. Measure flow rates with pressure differentials
- i. Communicate with designers

Reference

HVAC and Refrigeration Systems Training Manual – Unit 19 Hydronic Heating System Boiler, page 349; Unit 20 Hydronic Heating Boiler Components and Controls, page 359; Unit 21 Hydronic Heating Distribution Systems, page 373

Task 58. Calculate Flow Rates for Hydronic Systems

- a. Calculate pressure difference across pump
- b. Verify impeller diameter and flow rate using a pump curve
- c. Identify equipment minimum and maximum flow rates

Reference

HVAC and Refrigeration Systems Training Manual – Unit 19 Hydronic Heating System Boiler, page 349; Unit 20 Hydronic Heating Boiler Components and Controls, page 359; Unit 21 Hydronic Heating Distribution Systems, page 373

Category G: Steam System**Task 59. Maintain steam traps**

- a. Perform ultrasonic test for operation
- b. Check strainers; clean as required
- c. Inspect orifice size; replace, rebuild or clean as required
- d. Rebuild trap
- e. Replace inverted buckets
- f. Replace float, if appropriate
- g. Visually inspect for leaks

Tools and Equipment

- Common hand tools
- Pipe wrench
- Ultrasonic
- Tape measure
- Wire gage

Calculations

- Basic math
- Read tape

Communication

- Verbal with co workers
- Verbal with mfg.
- Read technical manual
- Interpret schematic

Technology

- Steam principles
- Plumbing and piping principles
- Ultrasonic principles
- Steam system standards

Safety

- Common safety practices
- Burn hazard
- PPE
- Lifting hazard
- Explosion hazard
- Lock out/tag out
- Gloves

Reference

HVAC and Refrigeration Systems Training Manual – Unit 24 Steam Heating Distribution Systems, page 413

Task 60. Maintain Steam Regulators

- a. Perform visual inspect for leaks
- b. Inspect for air leaks
- c. Measure pressure; adjust as required
- d. Inspect equalizer line for obstruction; clean as required

Tools and Equipment

- Common hand tools
- Pipe wrench
- Tape measure
- Wire gage
- Lifting and rigging equipment

Calculations

- Basic math
- Read tape

Communication

- Verbal with co workers
- Verbal with mfg.
- Read technical manual
- Interpret schematic

Technology

- Steam principles
- Plumbing and piping principles
- Steam system standards
- Regulator principles
- Mechanical principles

Safety

- Common safety practices
- Burn hazard
- PPE
- Lifting hazard
- Explosion hazard
- Lock out/tag out
- Gloves

Reference

HVAC and Refrigeration Systems Training Manual – Unit 23 Steam Heating boiler Components and Controls, page 397

Task 61. Maintain Steam Coils

- a. Inspect for leaks and cleanliness; weld or solder to repair
- b. Inspect for fin damage; comb the coils with fin comb
- c. Inspect for proper drainage
- d. Inspect temperature distribution over the coils; clear blockage or replace coils
- e. Inspect for air flow over the coils; clear blockage or replace coils
- f. Remove coils and send for repair; replace if required
- g. Check filters; replace as required
- h. Inspect strainers; clean or replace as required
- i. Inspect mounting hardware; repair as needed
- j. Verify adequacy of pressure; adjust as required

Tools and Equipment

- Common hand tools
- Pipe wrench
- Tape measure
- Welding equipment
- Lifting and rigging equipment
- Comb
- Wire brush
- Soldering equipment
- Forklift

Calculations

- Basic math
- Read tape

Communication

- Verbal with co workers
- Verbal with mfg.
- Read technical manual
- Interpret schematic

Technology

- Steam principles
- Plumbing and piping principles
- Steam system standards
- Coil design and operation
- Mechanical principles

Safety

- Common safety practices
- Burn hazard
- PPE
- Lifting hazard
- Lock out/tag out

Reference

HVAC and Refrigeration Systems Training Manual – Unit 24 Steam Heating Distribution Systems, page 413

Task 62. Maintain Vacuum Breakers

- a. Inspect for leaks and proper operation; repair
- b. Replace unit as required

Tools and Equipment

- Common hand tools
- Pipe wrench
- Pipe dope

Communication

- Verbal with co workers
- Verbal with mfg.
- Read technical manual

Technology

- Steam principles
- Plumbing and piping principles
- Steam system standards

Safety

- Common safety practices
- Burn hazard
- PPE
- Lock out/tag out

Reference

HVAC and Refrigeration Systems Training Manual – Unit 23 Steam Heating Boiler Components and Controls, page 397; Unit 24 Steam Heating Distribution Systems, page 413

Task 63. Maintain Steam Flash (Vent) Tanks

- a. Inspect for cracks; weld as required
- b. Inspect vents for proper operation
- c. Inspect water level controls; repair or replace as needed

Tools and Equipment

- Common hand tools
- Pipe wrench
- Pipe dope

Communication

- Verbal with co workers
- Verbal with mfg.
- Read technical manual

Technology

- Steam principles
- Plumbing and piping principles
- Steam system standards

Safety

- Common safety practices
- Burn hazard
- PPE
- Lock out/tag out

Reference

HVAC and Refrigeration Systems Training Manual – Unit 23 Steam Heating Boiler Components and Controls, page 397

Task 64. Maintain Insulation Systems

- a. Inspect for tears and damage; replace as required
- b. Check for water contamination/damage
- c. Verify appropriate seal

Tools and Equipment

- Common hand tools
- Safety knife
- Infrared gun

Communication

- Verbal with co workers
- Verbal with mfg.
- Read technical manual

Technology

- Sanitation principles
- Insulation principles

Safety

- Common safety practices
- Burn hazard
- PPE

Reference

HVAC and Refrigeration Systems Training Manual – Unit 1 HVAC and Refrigeration Systems, page 1; Unit 26 Water-Source and Geothermal Heat Pump Systems, page 459

Task 65. Maintain Vacuum Pumps

- a. Inspect strainers; clean or replace as required
- b. Check motor coupling; repair as required
- c. Inspect suction lines for leaks; repair/replace as required
- d. Check motor for proper operation
- e. Check pressure gages
- f. Check level control operation

Tools and Equipment

- Common hand tools
- Vibration analyzer

- Lubrication equipment
- Hoisting/lifting equipment
- Feeler gage
- Alignment equipment
- Basic measuring equipment

Calculations

- Basic math
- Measure to thousandths
- Interpret analog scales

Communication

- Verbal with co workers
- Verbal with mfg.
- Verbal with co-worker
- Read technical manual
- Interpret schematics
- Log written data

Technology

- Vacuum pump principles
- Plumbing and piping principles
- Vibration analysis
- Alignment principles

Safety

- Common safety practices
- Lock out/tag out
- Pinch points
- Lifting hazards
- PPE
- Stored energy
- Burn hazard

Reference

HVAC and Refrigeration Systems Training Manual – Unit 23 Steam Heating Boiler Components and Controls, page 397; Unit 24 Steam Heating Distribution Systems, page 413

Task 66. Maintain Condensate Return System and Control Valves

- Inspect vacuum pumps
- Inspect traps
- Monitor water returns and treat with protective chemicals
- Inspect for contaminate and leaks
- Inspect condensate tank receiver
- Maintain controllers; monitor
- Repair/replace water make-up valve
- Install gauge glass
- Check floats for proper operation
- Check piping

- k. Replace/repair steam traps (ball float, thermostatic expansion, impulse, inverted bucket, float)
- l. Adjust controls to verify proper steam flow

Tools and Equipment

- Common hand tools
- Specialist tools for traps
- Stethoscope

Calculations

- Measure voltage
- Interpret set point
- Maximum and min.
- Measure pressure

Communication

- Follow written instructions
- Verbal with co-workers
- Verbal with customers
- Customer relations skills
- Interpret technical material
- Verbal with vendor
- Complete documentation
- Input data into a computer

Technology

- Interpret schematics
- Types of refrigerants
- Soldering principles
- Basic HVAC
- Basic computer skills
- Basic mechanical
- Basic electrical
- Thermal dynamic theory
- Refrigerant recovery certification
- Federal/state regulations
- NEC and BOCA
- Computer literacy

Safety

- Common safety practices
- PPE
- Lifting hazard
- MSDS
- OSHA regulations
- Confined space entry
- Cutting hazard

Reference

HVAC and Refrigeration Systems Training Manual – Unit 23 Steam Heating Boiler Components and Controls, page 397; Unit 24 Steam Heating Distribution Systems, page 413

Task 67. Identify Installation Conditions That Impact Design of Piping for Steam Systems

- a. Steam supply connections orientation
- b. Identify limits on branch lines with pressure reducing valves
- c. Identify pitch of steam mains and condensate returns
- d. Troubleshoot piping issues that impact steam trap problems and selection
- e. Troubleshoot piping issues that impact condensate pumps
- f. Troubleshoot piping issues that impact steam vents
- g. Troubleshoot pressure reducing stations
- h. Troubleshoot boiler feed tanks and deaerators
- i. Maintain level controls in steam systems
- j. Trace the common operation of a steam system
- k. Maintain temperature and pressure controls

Reference

HVAC and Refrigeration Systems Training Manual – Unit 24 Steam Heating Distribution Systems, page 413

Category H: Ventilation

Task 68. Troubleshoot/Install Fans and Air Handling Equipment

- a. Visually check for balance
- b. Lubricate bearings
- c. Inspect drive systems
- d. Check for deterioration of outer housing and all components
- e. Tighten, clean and lubricate
- f. Align pulleys and shafts
- g. Check for proper rotation
- h. Check for bent shaft
- i. Inspect fan components for cracks, damage, etc.
- j. Replace filter and check exhaust ducts
- k. Check insulation
- l. Check for duct blockages
- m. Check operation and condition of safety guards
- n. Check for fan wheel to shaft fit
- o. Check for looseness
- p. Check set screw torque
- q. Check belt tension; replace belts if appropriate
- r. Replace a fan unit
- s. Regulate the humidity in the system
- t. Inspect indoor air quality using air sniffers
- u. Repair/replace modulating motors
- v. Repair/replace coils
- w. Repair/replace louvers and dampers
- x. Calibrate controls on the system
- y. Adjust variable air volume control devices (VAV)
- z. Monitor and clean air wash system, if appropriate
- aa. Locate and identify freeze and fire stat; check operation
- bb. Lock out and tag

- cc. Check system for capacity
- dd. Clean drain pans and flush condensate drain line
- ee. Confirm adequacy of ducting and fan systems; consequences of improper ducting

Tools and Equipment

- Common hand tools
- Lubrication tools
- Alignment tools
- Welding equipment
- Measuring equipment
- High pressure sprayer
- Soap and water
- Oil
- Smoke detectors
- Grease gun
- Oil can

Calculations

- Basic math
- Measure temperature

Communication

- Interpret written work order
- Verbal with co workers
- Verbal with co-worker
- Read technical manual
- Interpret schematic
- Verbal with vendors
- Input numeric data into computer

Technology

- Basic mechanical
- Alignment principles
- Types of fans
 - propeller
 - forward curve
 - reverse curve
 - air foil
 - van axial
- Principles of rotating equipment
- Fan theory
- Rotation principles
- Geo-thermal principles
- Heat pump principles
- Interpret schematics
- Types of refrigerants
- Soldering principles
- Basic HVAC
- Basic computer skills
- Basic electrical
- Thermal dynamic theory
- Refrigerant recovery certification
- Federal/state regulations

Safety

- Common safety practices
- PPE
- Cutting hazard
- Lifting hazard
- Pinch points
- Lock out/tag out
- Stored energy
- MSDS
- OSHA regulations
- Confined space entry
- Biological factors
- Environmental concerns
- Hazardous material
- Burn hazard
- Soldering safety

Reference

**HVAC and Refrigeration Systems Training Manual – Unit 39
Installing Residential Forced-Air Heating Systems, page 663; Unit 53
Residential and Light Commercial System Testing and Balancing,
page 1005; 54 Building Automation Principles, page 1025; Unit 55
Terminal Unit Heating and Cooling Control Methods, page 1047**

Task 69. Maintain heat recovery systems

- a. Maintain heat recovery wheel
- b. Clean the wheel; perform general maintenance on wheel
- c. Check air flows across the wheel
- d. Check heat exchanger surface across wheel
- e. Check for damage
- f. Check motor, belt and bearings
- g. Inspect seals for cross-contamination

Reference

**HVAC and Refrigeration Systems Training Manual – Unit 37
Management of Refrigerants and Refrigeration Systems, page 617**

Task 70. Maintain Air Side Economizers

- a. Set damper controls for proper air flow
- b. Identify role of CO₂ in economizers
- c. Maintain ventilation controls for economizers
- d. Maintain modulating economizing control system
- e. Diagnose operation of sensors
- f. Maintain outside air inlet filters
- g. Confirm operation of exhaust ventilation air system

Reference

**HVAC and Refrigeration Systems Training Manual – Unit 53
Residential and Light Commercial system Testing and Balancing,
page 1005; Unit 55 Terminal Unit Heating and Cooling Control
Methods, page 1047**

Task 71. Maintain Safety and Limits for Ventilation Equipment

- a. Check and adjust coil freezing protection
- b. Check and adjust static pressure
- c. Check and adjust discharge air temperature

Reference

**HVAC and Refrigeration Systems Training Manual – Unit 53
Residential and Light Commercial system Testing and Balancing,
page 1005; Unit 55 Terminal Unit Heating and Cooling Control
Methods, page 1047**

Category I: Piping**Task 72. Perform Pipe Cutting, Joining and Bending**

- a. Cut pipe:
 - torch
 - hack saw
 - tube cutter (hand and wheel type)
- b. Join pipe
 - soldering, brazing and welding
 - compression fittings
 - threading
 - flare and swage
 - glue
 - groove type (Victaulic)
- c. Bending:
 - manual bending tool
 - spring type tool
 - design fittings

Tools and Equipment

- Torch
- Hack saw
- Tube cutter
- Soldering equipment
- Welding equipment
- Compression fittings
- Threader
- Flaring equipment
- Glue
- Manual bending tool
- Spring type bending tool

- Design fittings
- Swaging tool

Calculations

- Measure length
- Measure adjustment
- Measure angles

Communication

- Verbal with co-workers
- Verbal with customers
- Follow written instructions
- Interpret technical material
- Interpret schematics
- Follow verbal instructions

Technology

- Basic plumbing
- Basic mechanical
- Computer literacy
- Health and plumbing codes
- Pipe sizing parameters

Safety

- Common safety practices
- PPE
- MSDS
- Burn hazard
- Lifting hazard
- Health hazards

Reference

HVAC and Refrigeration Systems Training Manual – Unit 4 Tools and Equipment, page 49

Task 73. Service/Install Piping and Tubing and Accessories

- Measure, cut and specify pipe and tubing
- Attach fittings (compression, swage, flare)
- Attach support pipe hangers; mounted to ceilings, floors, truss, rafters
- Solder ends
- Install, specify and maintain valves in the lines
 - gauge valves
 - globe valves
 - check valves
 - expansion valves
 - hot gas by-pass valve
 - solenoid valve
- Install insulation around piping and tubing
 - interior
 - exterior
- Repair/replace vents

- h. Service accessories
 - accumulators
 - oil separators
 - discharge mufflers
 - receiver
 - evaporator pressure regulator
 - crank case pressure regulator

Tools and Equipment

- Common hand tools
- Soldering equipment
- Pipe cutter
- Flaring tool
- Swage tool
- Refrigeration tools
- Refrigerant
- Micrometer
- Shears (left, right and straight)
- Shrinking tools

Calculations

- Measure in inches
- Basic shop math
- Angles and basic trig functions
- Measure pressure
- Measure ID and OD of pipe and tube
- Measure capacities

Communication

- Follow written instructions
- Verbal with co-workers
- Verbal with customers
- Customer relations skills
- Interpret technical material
- Verbal with vendor
- Complete documentation
- Input data into a computer

Technology

- Interpret schematics
- Types of refrigerants
- Soldering principles
- Basic HVAC
- Basic computer skills
- Basic mechanical
- Basic electrical
- Thermal dynamic theory
- Refrigerant recovery certification
- Federal/state regulations

Safety

- Common safety practices
- PPE
- Lifting hazard

- MSDS
- OSHA regulations
- Confined space entry
- Cutting hazard
- Biological factors
- Environmental concerns
- Hazardous material
- Burn hazard
- Soldering safety

Reference

HVAC and Refrigeration Systems Training Manual – Unit 4 Tools and Equipment, page 49

Task 74. Service/Install Refrigeration Piping/Trapping and Pitch

- a. Properly install a hot gas muffler
- b. Identify types of copper tubing
- c. Identify labeling of copper tubing
Braze copper tubing--safety issues

Reference

HVAC and Refrigeration Systems Training Manual – Unit 4 Tools and Equipment, page 49

Task 75. Size Refrigeration Piping Lines

- a. Size air conditioning piping per manufacturer's specifications
- b. Size suction risers for higher velocity and lower pressure drop
- c. Connect steam branch lines
- d. Correctly size branch lines to prevent pressure drops

Reference

HVAC and Refrigeration Systems Training Manual – Unit 4 Tools and Equipment, page 49

Category J: Lifting Equipment

Task 76. Install Rigging

- a. Determine weight of the load to be lifted
- b. Select appropriate slings
- c. Select appropriate lifting device
 - come along or tug it
 - chain hoist
 - cranes
 - T-frame or A-frame
- d. Determine appropriate anchor and lift points
 - alert to center of gravity
- e. Install rope as a tag line to guide load if required
- f. Verify clear area to move load

- g. Confirm equipment disconnected and bolts
- h. Activate lifting device to lift and relocate load
- i. Install skid rollers or use lift trucks to relocate load
- j. Clear area before lifting

Tools and Equipment

- Common hand tools
- Hoists
- Slings
- Lifting eye-bolt
- Shackles
- Clevises
- Rope

Calculations

- Calculate weight
- Estimate center of gravity

Communication

- Verbal with co workers
- Verbal with supervisor
- Hand signals

Technology

- Limits of each lifting device
- Rigging principles
- Safety practices
- Equipment operation

Safety

- Common safety practices
- PPE
- Lifting hazard
- Falling objects
- Stored energy
- Clear area

Reference

HVAC and Refrigeration Systems Training Manual – Unit 44
Installing Light Commercial HVAC Systems, page 818-820

Task 77. Operate Lifting and Moving Equipment

- a. Operate chain falls
- b. Operate jacks and porta power
- c. Operate pry bars
- d. Operate come alongs
- e. Direct operator of cranes and boom trucks
- f. Operate machine dolly's
- g. Use hand signals for crane and helicopter lifting
- h. Operate hydraulic lift

Tools and Equipment

- Chain falls
- Jacks
- Porta power system
- Pry bars
- Come alongs
- Forklift
- Cranes
- Hydraulic lift

Calculations

- Measure weight

Communication

- Verbal with co-workers
- Verbal with supervisor
- Interpret schematics
- Create schematics

Technology

- Lifting and hoisting principles
- Operation principles of each type of lifting equipment
- License for equipment when required

Safety

- PPE
- Common safety practices
- Lifting safety
- Hoisting safety
- Crushing hazards
- Pinch points
- Moving equipment hazards

Reference

HVAC and Refrigeration Systems Training Manual – Unit 2 HVAC and Refrigeration System Safety, page 15

Category K: Safety, Regulatory and Environmental**Task 78. Demonstrate Knowledge of Common Mechanical Safety Principles**

- a. Awareness of surroundings; utilize common safety practices
- b. Confined space hazards
- c. Rotating equipment hazards
- d. Location of exits
- e. Fire extinguishers
- f. CPR
- g. Appropriate lifesaving equipment
- h. Location of power source for emergency shutdown
- i. Ladders and lifts

- j. Hoist capacities
- k. Evacuation procedures
- l. Comply with National Fuel Gas regulations
- m. Personal Protective Equipment
 - safety glasses
 - hard hat
 - jewelry
 - shoes
 - gloves
 - hearing protection
 - body harness
 - clothing (long sleeves, non-flammable, 100% cotton, etc.)
- n. Compressed air safety
- o. MSDS
- p. PPE related to chemical safety
- q. Respirators

Tools and Equipment

- Fire extinguishers
- Lifesaving equipment
- Ladders
- Lifts

Calculations

- Measure weight
- Measure length and height

Communication

- Verbal with co-workers
- Verbal with supervisor

Technology

- Fire extinguisher use
- CPR
- Lifesaving equipment usage
- Knowledge of hoists
- Rotating equipment hazards

Safety

- Common safety practices
- Personal protective equipment
- Confined space procedures
- OSHA regulations
- Breathing apparatus
- Explosion hazard
- Gas hazard
- Flood hazard
- Cave in hazard
- Shock hazard
- CPR training
- Electrocution hazard

Reference

HVAC and Refrigeration Systems Training Manual – Unit 1 HVAC and Refrigeration Systems, page 1; Unit 2 HVAC and Refrigeration System Safety, page 15; Unit 3 Electrical Safety, page 37

Task 79. Demonstrate Knowledge of Electrical Safety Including Lock Out and Tag

- a. Go to equipment previously locked out by operations
- b. Place on work order and place individual lock/tag on equipment for each trade on job
- c. Determine sources of power and de-energize them related to the problem
 - mechanical
 - hydraulic
 - thermal
 - electrical/NFPA 70E regulations
- d. Open up power sources and test operation to confirm de-energized
- e. Make required repairs
- f. Complete documentation
- g. Verify removal of all locks

General Electrical Safety

- h. Shock hazards
- i. Confined space entry
- j. Hot work permits
- k. Scaffold safety
- l. Fire extinguishers (types and operation)
- m. HAZCOM
- n. Asbestos hazards
- o. PCB hazards
- p. Blood born pathogen
- q. Emergency response procedures
- r. Machine guarding
- s. Potential hazards (energy, chemical and engulfment)
- t. Burn safety
- u. Pressurized vessel systems

Tools and Equipment

- Common safety tools
- Locks and tags
- Chains
- Lock chains
- OSHA Forms

Calculations

- Basic math

Communication

- Complete documentation
- Verbal with co-workers
- Importance of documentation

Technology

- Safety practices
- CPR training

Safety

- OSHA regulations documentation requirement
- Common safety practices

Reference

HVAC and Refrigeration Systems Training Manual – Unit 3 Electrical Safety, page 37

Task 80. Apply Environmental Protection Agency (EPA) Regulations

- Demonstrate and apply venting regulations
- Demonstrate and apply recovery regulations
- Demonstrate and apply reclaiming regulations
- Demonstrate knowledge of recycling refrigerants
- Demonstrate and apply indoor air quality regulations
- Demonstrate and apply proper disposal of refrigerant oil and waste materials
- Demonstrate knowledge of storage of refrigerants
 - approved vessels
 - ventilated area
 - away from heat sources

Tools and Equipment

- Common safety tools
- Locks and tags
- Chains
- Lock chains
- OSHA Forms

Calculations

- Basic math

Communication

- Complete documentation
- Verbal with co-workers
- Importance of documentation

Technology

- Safety practices
- CPR training

Safety

- EPA regulations documentation requirement
- Common safety practices

Reference

HVAC and Refrigeration Systems Training Manual – Unit 2 HVAC and Refrigeration System Safety, page 15

Task 81. Apply the Department of Transportation (DOT) Regulations

- a. Demonstrate knowledge regarding transportation of hazardous materials
 - properly labeled
 - properly stored
 - appropriate quantities transported
- b. Demonstrate knowledge regarding handling of hazardous materials
- c. Maintain log book (Canadian) during transportation
- d. Operate motor vehicles
 - security of contents vehicle
 - proper licensure when appropriate
 - perform vehicle maintenance
 - adhere to company policies and procedures as appropriate

Tools and Equipment

- Common safety tools
- Locks and tags
- Chains
- Lock chains
- OSHA Forms

Calculations

- Basic math

Communication

- Complete documentation
- Verbal with co-workers
- Importance of documentation

Technology

- Safety practices
- CPR training

Safety

- DOT regulations documentation requirement
- Common safety practices

Reference

HVAC and Refrigeration Systems Training Manual – Unit 2 HVAC and Refrigeration System Safety, page 15

Task 82. Comply With CFC Venting Regulations

- a. Identify types of CFC refrigerants
- b. Define terms in the CFC regulations
- c. Section 608 Refrigerant Recycling regulations of the Clean Air Act of 1990
- d. Illegal to intentionally vent into the air CFC's and HCFC's

Reference

**HVAC and Refrigeration Systems Training Manual – Unit 36
Refrigeration Principles, page 603**

Task 83. Comply With Regulations Regarding Recovery/Recycle/Reclaiming

- a. Use appropriate PPE
- b. Treat liquid refrigerant as frostbite

Reference

**HVAC and Refrigeration Systems Training Manual – Unit 36
Refrigeration Principles, page 603**

Task 84. Comply with required evacuation levels and recovery unit requirements

- a. Identify types of cylinder recovery tank required for R410a
- b. EPA regulations regarding testing of refrigerant recovery and recycling equipment

Reference

HVAC and Refrigeration Systems Training Manual – Unit 9 Indoor Air Quality, page 161; Unit 36 Refrigeration Principles, page 603

Category L: Applied Math, Science and Blueprint Reading**Task 85. Perform Applied Math Operations**

- a. Interpret pump and fan curves and laws
- b. Calculate electrical formulas such as Ohm's law, etc.
- c. Use weights and measurements
- d. Interpret pressure and temperature relationships using charts
- e. Interpret charts and graphs
- f. Convert F to C
- g. Calculate volume and pressure relationships
- h. Interpret psychometric charts
- i. Interpret pressure enthalpy diagrams
- j. Perform hydronic calculations including psi/ft.
- k. Calculate basic load calculations

Tools and Equipment

- Common hand tools
- Calculator

Calculations

- Math and science principles
- Formulas
- Algebra
- Operate calculator

Communication

- Verbal with co-workers
- Verbal with supervisors

Technology

- Math and science principles

Safety

- PPE
- Common safety practices

Reference

**HVAC and Refrigeration Systems Training Manual – Unit 6
Temperature, Pressure, and Thermodynamics, page 113; Unit 7
Combustion and Fuels, page 131; Unit 8 Psychometrics, page 143**

Task 86. Perform Applied Science Operations

- a. Interpret psychometric charts
- b. Interpret pressure enthalpy diagrams
- c. BTU calculations
- d. Thermodynamics
- e. Phase of states (liquid, solid, vapor)
- f. Sensible and latent heat
- g. Static pressures
- h. Matter, energy and heat
- i. The refrigeration process

Tools and Equipment

- Common hand tools
- Calculator

Calculations

- Math and science principles
- Formulas
- Algebra
- Operate calculator

Communication

- Verbal with co-workers
- Verbal with supervisors

Technology

- Math and science principles

Safety

- PPE
- Common safety practices

Reference

**HVAC and Refrigeration Systems Training Manual – Unit 6
Temperature, Pressure, and Thermodynamics, page 113; Unit 7
Combustion and Fuels, page 131; Unit 8 Psychometrics, page 143**

Task 87. Interpret Blueprints

- Identify basic blueprint symbols
 - different dimension (height, thickness, length, etc.)
 - exploded views
 - plan and elevation views
 - isometric
- Identify basic mechanical symbols
 - valves
 - motors
 - switches
 - gear box
 - couplings
 - door ways
 - duct runs and supply and return
 - equipment
 - shafts
- Identify common piping and ductwork symbols
 - fittings (elbows, T's, transitions, etc.)
 - pipe sizes
- Identify common electrical symbols and wiring diagrams
 - motor
 - switches
 - relays
 - transformer
 - contacts
 - controls
 - breakers
 - fuses
 - terminals
- Identify pneumatic symbols
 - controls
 - thermostats
 - sensors
 - actuators
 - relays
 - valves

Tools and Equipment

- Blueprints to read
- Technical manuals

Calculations

- Measure length
- Measure angles
- Metric/English conversion

Communication

- Verbal with co-workers
- Verbal with supervisors
- Interpret schematics
- Create schematics

Technology

- Blueprint reading principles
- Knowledge of symbols:
 - welding
 - mechanical
 - construction
 - pneumatic/hydraulic
- Knowledge of scales

Safety

- PPE
- Common safety practices

Reference

HVAC and Refrigeration Systems Training Manual – Unit 10 HVAC and Refrigeration System Print reading, page 181

Category M: Customer Service**Task 88. Perform Recordkeeping**

- a. Calculate hourly/daily/weekly reports
- b. Create invoices
- c. Maintain inventory (supplies and materials)
- d. Log EPA and refrigerant use
- e. Calculate estimating costs
- f. Create written description of work performed
- g. Attend site and survey meetings
- h. Create maintenance logs
- i. Demonstrate computer literacy
 - database
 - spreadsheet
- j. Use mobile technology for recordkeeping

Tools and Equipment

- Common hand tools
- Calculator
- Computer

Calculations

- Bookkeeping principles
- Formulas
- Operate calculator

Communication

- Verbal with co-workers
- Verbal with supervisors
- Data input into computer

Technology

- Recordkeeping principles
- Tax information
- Company policies and procedures
- Invoices
- EPA Regulations
- Inventory principles

Safety

- Common safety practices

Reference

HVAC and Refrigeration Systems Training Manual – Unit 40 Installing Residential Forced-Air Cooling Systems, page 701; Unit 41 Servicing and Troubleshooting Residential Forced-Air HVAC Systems, page 733; Unit 42 Installing Residential Hydronic Systems, page 761; Unit 43 Servicing and Troubleshooting Residential Hydronic Systems, page 797; Unit 44 Installing Light Commercial HVAC Systems, page 813; Unit 45 Servicing and Troubleshooting Light Commercial HVAC Systems, page 853; Unit 46 Installing, Servicing, and Troubleshooting Air-Source Heat Pump Systems, page 871; Unit 47 Installing, Servicing, and Troubleshooting Water-Source and Geothermal Heat Pump Systems, page 887; Unit 48 Installing, Servicing, and Troubleshooting Chiller Systems, page 909

Task 89. Display Professionalism

- Read professional journals
- Maintain service truck
- Demonstrate professional appearance for profession
- Display punctuality
- Demonstrate leadership
- Demonstrate self-confidence and motivation
- Respond to customers who are upset

Tools and Equipment

- Professional journals

Calculations

- Basic math

Communication

- Verbal with supervisor
- Verbal with customer

Technology

- Professional literature
- Professional organizations

Safety

- Common safety practices

Reference

HVAC and Refrigeration Systems Training Manual – Unit 40 Installing Residential Forced-Air Cooling Systems, page 701; Unit 41 Servicing and Troubleshooting Residential Forced-Air HVAC Systems, page 733; Unit 42 Installing Residential Hydronic Systems, page 761; Unit 43 Servicing and Troubleshooting Residential Hydronic Systems, page 797; Unit 44 Installing Light Commercial HVAC Systems, page 813; Unit 45 Servicing and Troubleshooting Light Commercial HVAC Systems, page 853; Unit 46 Installing, Servicing, and Troubleshooting Air-Source Heat Pump Systems, page 871; Unit 47 Installing, Servicing, and Troubleshooting Water-Source and Geothermal Heat Pump Systems, page 887; Unit 48 Installing, Servicing, and Troubleshooting Chiller Systems, page 909

Task 90. Communicate With Customers

- Demonstrate proficiency of computer communication
 - e-mail
 - search internet for information
- Compose proposals and correspondence
- Display professional telephone etiquette
- Respond to pagers and cell phone
- Maintain communication with dispatcher and supervisor
- Convey technical information in easy to understand method to customers
- Comply with Standard for Excellence initiative

Tools and Equipment

- Computer
- Telephone
- Communication devices
 - pagers
 - radios

Calculations

- Basic math

Communication

- Verbal with customer
- Verbal with co-workers

Technology

- Communication principles

Safety

- Common safety practices

Reference

**HVAC and Refrigeration Systems Training Manual – Unit 40
Installing Residential Forced-Air Cooling Systems, page 701; Unit 41
Servicing and Troubleshooting Residential Forced-Air HVAC
Systems, page 733; Unit 42 Installing Residential Hydronic Systems,
page 761; Unit 43 Servicing and Troubleshooting Residential
Hydronic Systems, page 797; Unit 44 Installing Light Commercial
HVAC Systems, page 813; Unit 45 Servicing and Troubleshooting
Light Commercial HVAC Systems, page 853; Unit 46 Installing,
Servicing, and Troubleshooting Air-Source Heat Pump Systems, page
871; Unit 47 Installing, Servicing, and Troubleshooting Water-Source
and Geothermal Heat Pump Systems, page 887; Unit 48 Installing,
Servicing, and Troubleshooting Chiller Systems, page 909**

UA STAR HVACR PRACTICE QUESTIONS

Practice Questions

1. The evaporator in a refrigeration system:
 - A. Meters the refrigerant
 - B. Condenses the refrigerant
 - C. Is the component where refrigerant boils and absorbs heat
 - D. Compresses the vaporized refrigerant

2. The purpose of the compressor is to change _____.
 - A. Low-pressure, low-temperature liquid to a high-pressure, high-temperature liquid
 - B. High-pressure, high-temperature vapor to a low-pressure, low-temperature vapor
 - C. Low-pressure, low-temperature vapor to a high-pressure, high-temperature vapor
 - D. High-pressure, high-temperature liquid to a low-pressure, low-temperature liquid

3. A common refrigerant leak detection device is the:
 - A. Micron gage
 - B. Halide torch
 - C. U-tube manometer
 - D. All of the above

4. Copper-plating of compressor parts is:
 - A. Done at the factory to prevent rusting
 - B. Caused by contaminants in the system
 - C. Unlikely to happen unless the motor has a ground
 - D. Prevented by adding methanol to the system

5. If not properly installed, a hot-gas muffler might trap:
 - A. Hot gas
 - B. Superheated vapor
 - C. Suction gas
 - D. Oil

6. Unit ventilators are usually equipped with outside air dampers to:
 - A. Provide ventilation air during building occupancy
 - B. Comply with most local or state codes
 - C. Provide free cooling in winter months
 - D. Both A and B are correct

7. Face and bypass dampers should be adjusted to provide:
 - A. A mixture of heated or cooled air at all times
 - B. Tight shut off to reduce the possibility of overcooling or overheating
 - C. The proper air volume at all load conditions
 - D. A uniform air flow rate at low load conditions

8. With belt driven equipment, alignment of the motor and driven equipment pulleys
 - A. Is not critical, since the belts are flexible
 - B. Is accomplished using a string or straight edge
 - C. Is accomplished when the belts are parallel to one another
 - D. Is accomplished using a dial indicator

9. To assist consumers in making an informed choice when purchasing unitary air conditioning equipment, the efficiency of such units is expressed as Energy Efficiency Ratio (EER or SEER) the units of which are:
 - A. Btuh/ampere
 - B. Btuh/volt
 - C. Btuh/watt
 - D. Btuh/hp

10. Firestats located in the air stream of air handling units:
- A. Are required in both the supply and return air streams
 - B. Should be the manual reset type
 - C. Should be nonadjustable
 - D. All of the above
11. A sleeve bearing would typically be used in a motor that:
- A. Operates with a light load and where noise is a factor
 - B. Operates with a heavy load and where noise is not a factor
 - C. Operates with a heavy load in a dirty atmosphere
 - D. Operates with a heavy load in a moist atmosphere
12. A bearing used on the bottom of a motor where the shaft is positioned vertically is called a _____ bearing.
- A. Sleeve
 - B. Ball
 - C. Thrust
 - D. Bronze
13. To produce electromagnetism, relative motion is required between a magnetic field and a/an:
- A. Switch
 - B. Conductor
 - C. Element
 - D. Ground
 - E. Insulator

14. Materials which do not allow their electrons to spin out of orbit easily are called:
- A. Conductors
 - B. Grounds
 - C. Insulators
 - D. Elements
 - E. Magnets
15. A battery is an example of a/an _____ source.
- A. Alternating current
 - B. Series current
 - C. Magnetic
 - D. Parallel circuit
 - E. Direct current
16. *“Current flowing through a conductor in one direction for a split second, then in the opposite direction for a split second”* would be a good definition of:
- A. Alternating current
 - B. Direct current
 - C. Voltage
 - D. Resistance
 - E. Wattage
17. If a pressure gauge reads five psig at sea level elevation, the corresponding absolute pressure is _____ psia.
18. Solar _____ is the amount of solar thermal energy produced divided by the water heating energy demand of the building.
- A. fractional
 - B. Ratio
 - C. Cost
 - D. Efficiency

19. The portion of the electromagnetic spectrum to which solar collectors respond is _____ and near-infrared radiation.
- A. Gamma rays
 - B. Microwaves
 - C. Ultra violet light
 - D. Visible light
20. During winter, _____.
- A. Daylight is shorter and the Northern Hemisphere is angled away from the sun
 - B. Daylight is shorter and the Northern Hemisphere is angled toward from the sun
 - C. Daylight is longer and the Northern Hemisphere is angled away from the sun
 - D. Daylight is longer and the Northern Hemisphere is angled toward the sun
21. Unless equipped with OSHA or Canadian Standards Association (CSA) approved ground-fault circuit interrupters, portable electric lighting used in wet and-or other conductive locations as, for example, drums, tanks and vessels, shall be operated at _____ volts or less.
- A. 12
 - B. 24
 - C. 120
 - D. None of the above
22. Receivers are usually required in systems having:
- A. Cooling towers
 - B. Evaporative condensers
 - C. Shell-and-tube condensers
 - D. Pump-down control

23. An important feature of a refrigerant receiver, in the case where the liquid line to the evaporator comes out of the top of the receiver, is a:
- A. Gage glass
 - B. Drain valve
 - C. Liquid level test cock
 - D. Dip tube
24. A pressure regulator is constructed so that a rise in _____ steam pressure reduces off the inlet flow of supply steam.
- A. Barometric
 - B. Inlet
 - C. Downstream
 - D. Upstream
25. A vacuum breaker is used to avoid which of the following:
- A. Positive absolute pressure
 - B. Negative absolute pressure
 - C. Positive gauge pressure
 - D. negative gauge pressure
26. Lock-out relays are used in air conditioning systems to:
- A. provide automatic restart
 - B. prevent compressor short-cycling
 - C. lock-out the thermostat
 - D. lock-out the overloads
27. When measuring the winding resistance of a split-phase compressor motor, the smallest value will be measured between the:
- A. The run terminal and the common terminal
 - B. The common terminal and the metal frame of the compressor
 - C. The start terminal and the common terminal
 - D. The run and start windings

28. Cavitation in a pump pumping hot water:
- A. Makes a pump noisy
 - B. Is the result of water boiling into the steam
 - C. Is the result of insufficient NPSH
 - D. All of the above
29. The amount of heat removed to lower the temperature of 15 lbs. of water from 48 degrees F to 39 degrees F is:
- A. 0.0113
 - B. 135 Btu.
 - C. 970 Btu/lb.
 - D. 135 Btu/lb.
30. Atmospheric pressure at sea level is:
- A. 0 psi
 - B. 14.7 psi
 - C. 32 psi
 - D. 212 psi
31. A dual-element fuse has:
- A. Two normal one-time fuse links
 - B. A thermal cutout only
 - C. A thermal cutout and a normal fuse link
 - D. The ability to carry locked-rotor current of a motor but not to protect against short circuits.
32. A single-phase motor in which the run capacitor remains connected when the motor runs is called a:
- A. Capacitor-start induction-run motor
 - B. Permanent-split capacitor motor
 - C. Split-phase motor

- D. Capacitor-start capacitor-run motor
33. Refrigerant leaves the compressor through the _____ line.
- A. Suction
 - B. Expansion
 - C. Discharge
 - D. Liquid
34. The symbol below would be used to indicate a _____ switch.

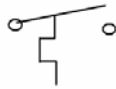

- A. Pressure-actuated
 - B. Temperature-actuated
 - C. Spring loaded
 - D. Flow
35. A refrigeration system has a hand-operated needle valve for the refrigerant expansion device. If refrigeration load and suction pressure remain constant, a decrease in condensing temperature will:
- A. Result in greater refrigerant flow
 - B. Result in reduced refrigerant flow unless the valve is opened
 - C. Increase available pressure difference
 - D. Be automatically compensated for
36. A full voltage starter has:
- A. One contactor
 - B. Two contactors
 - C. Two contactors and a time delay relay
 - D. Resistors in the starting circuit

37. The voltage rating of motor controller holding coils is:
- A. Always the same as the motor supply voltage
 - B. Always less than the motor supply voltage
 - C. Not necessarily the same as the motor supply voltage
 - D. Not important if the control circuit is isolated
38. A lock-out relay should drop out when:
- A. The thermostat is satisfied
 - B. The compressor contactor opens
 - C. The compressor short-cycles
 - D. An overload relay opens
39. In starting up a chilled water system, the first piece of equipment to start should be the:
- A. Compressor oil pump
 - B. Compressor if it has a built-in oil pump
 - C. Chilled water pump
 - D. Condenser water pump
40. In a gas-fired warm air furnace, the furnace fan should:
- A. Be controlled by the room thermostat
 - B. Be controlled by furnace bonnet temperature
 - C. Start at the same time that the burner comes on
 - D. Stop immediately if the high-limit safety control opens
41. A damper that must throttle air flow should have:
- A. Opposed blade operation
 - B. Parallel blade operation
 - C. Face and bypass damper action
 - D. Constant volume control

42. A pressure regulator is constructed so that a rise in _____ steam pressure reduces off the inlet flow of supply steam.
- A. Barometric
 - B. Inlet
 - C. Downstream
 - D. Upstream
43. A vacuum breaker is used to avoid which of the following:
- A. Positive absolute pressure
 - B. Negative absolute pressure
 - C. Positive gauge pressure
 - D. Negative gauge pressure
44. If the R value on a section of insulation is 8, what would the value be when saturated with water?
- A. 0
 - B. 4
 - C. 8
 - D. 12
45. In a RTD (resistance type device), as temperature increases, resistance will:
- A. Increase linearly
 - B. Decrease linearly
 - C. Increase exponentially
 - D. Decrease logarithmically
46. Why is a surge suppressor used on a contactor coil?
- A. To prevent damage to the control circuit
 - B. To smooth circuit wave forms
 - C. To prevent damage when contacts close
 - D. For a faster and smoother start

47. A minimum evacuation level for an air conditioning system is:
- A. 5,000 microns
 - B. 1,000 microns
 - C. 500 microns
 - D. 100 microns
48. One horsepower is the same as
- A. Watts
 - B. 3,143 watts
 - C. 746 watts
 - D. 1,000 watts
49. One watt is equivalent to
- A. 3.413 Btu
 - B. 3,413 Btu
 - C. 746 Btu
 - D. 1,000 Btu
50. One kilowatt is equivalent to
- A. 100.0 watts
 - B. 3,413 watts
 - C. 1000 watts
 - D. 746 watts
51. The purpose of the external equalizer line used with a thermostatic expansion valve is to compensate for:
- A. Air friction over the evaporator
 - B. Refrigerant pressure drop across the valve orifice
 - C. Refrigerant friction through the evaporator
 - D. Superheat

52. Cleaning refrigerants to ARI 700 standards is called:

- A. Recovery
- B. Reclaiming
- C. Recycling
- D. Reusing

53. The unit of measure for the specific volume of air is:

- A. Btu/lb.
- B. Lbs./btu
- C. Lbs./ft³
- D. Ft³/lb.

54. The amount of heat removed by evaporating one pound of water in an evaporative cooling tower is approximately:

- A. 1 btu
- B. 5 btu
- C. 100 btu
- D. 1000 btu

55. Which of the four lifting sling configurations shown below creates the greatest amount of load strain on the sling?

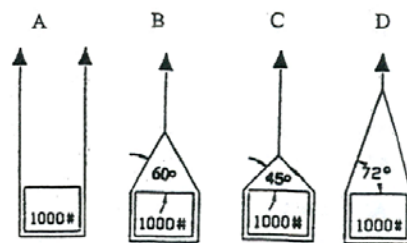

- A. A
- B. B
- C. C
- D. D

56. The components marked “B” would be called the

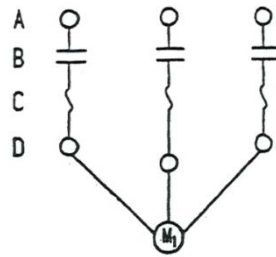

- A. Capacitors
 - B. N.O. push buttons
 - C. Motor contacts
 - D. Overload contacts
57. Which of the following plans are typically NOT supplied in a complete set of Building Plans?
- A. Architectural
 - B. Structural
 - C. Plumbing
 - D. Mechanical
 - E. As built
 - F. Electrical
58. Common Relay configurations are
- A. (SPST) Single Pole Single Throw
 - B. (DPDT) Double Pole Double Throw
 - C. A Only
 - D. Both A and B
59. The _____ is a device that allows the use of a low voltage power source to operate a high Current load powered device.
- A. Knife Disconnect switch
 - B. Contactor
 - C. SPDT Switch
 - D. Thermostat

60. When troubleshooting a contactor in a system. One should check the contact surfaces for:

- A. Shininess
- B. Pitting
- C. Wear due to Arcing
- D. Both B and C
- E. B only
- F. Both C and D

61. Terminals “A” would be labeled

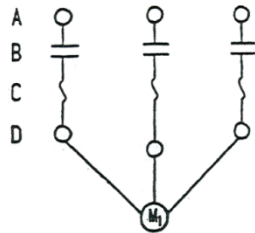

- A. T1, T2, T3
- B. L1, L2, L3
- C. H1, H2, H3
- D. X1, X2, X3

62. The terminals marked “D” would be labeled

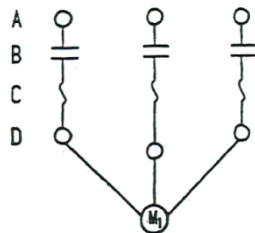

- A. T1, T2, T3
- B. L1, L2, L3
- C. H1, H2, H3
- D. X1, X2, X3

63. Pushing P1 down energizes

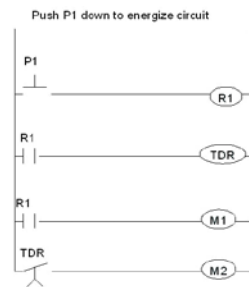

- A. M1 first
 - B. M2 first
 - C. Both at the same time
 - D. Only M1
64. A (VFD) Variable Frequency Drive controls all but?
- A. Direction
 - B. Speed
 - C. Torque
 - D. Motor life
 - E. Motor Protection
65. Three general categories of motor starter problems include all except:
- A. Installation and Selection
 - B. Sizing
 - C. Component Problems
 - D. Application and wiring
66. VFD's can be tested when _____ by means of _____ measurements for various sections.
- A. Energized, Voltage
 - B. De-energized, Current
 - C. Energized, Resistance
 - D. De-energized, Voltage

67. If the value of R1 is lowered, the current

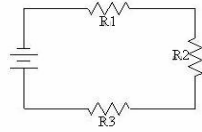

- A. Increases
- B. Decreases
- C. Remains the same
- D. Goes to zero

68. If resistor R2 burns open, the current

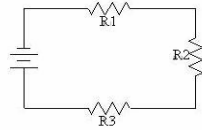

- A. Increases
- B. Decreases
- C. Remains the same
- D. Goes to zero

69. If the value of R3 is raised, the current

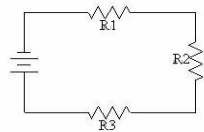

- A. Increases
- B. Decreases
- C. Remains the same
- D. Goes to zero

70. All Screw compressors consist of 2 Rotors:

- A. Both rotors are male
- B. Both rotors touch during operation
- C. One male and one female rotor

71. Capacity control for a helical screw compressor is done by?

- A. The slide valve
- B. Motor speed
- C. Refrigerant charge
- D. Both A & B
- E. Compressor housing

72. If resistor R3 is shorted out the current

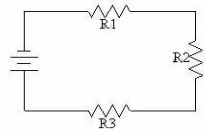

- A. Increases
- B. Decreases
- C. Remains the same
- D. Goes to zero

73. If the voltage goes up, the current

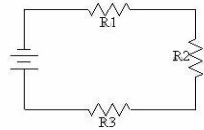

- A. Increases
- B. Decreases
- C. Remains the same
- D. Goes to zero

74. If you find yourself at odds with a confrontational customer, you should
- A. Tell the customer you're not being paid to be a whipping post, pack your tools and leave
 - B. Tell the customer that you're not going to take his abuse, but try finishing the job
 - C. Defend yourself by telling the customer that it's not your fault and try to finish the job
 - D. Keep your cool, learn as much as possible, but call your supervisor to report the incident
75. For applications where quiet operation and light axial load characteristics are found, the type of bearing normally used is the:
- A. Ball bearing
 - B. Thrust bearing
 - C. Sleeve bearing
 - D. Roller bearing
76. Sleeve bearings with the oil port lubrication system must be lubricated with the proper oil because
- A. Oil that is too thin will allow the shaft to run against the bearing surface
 - B. Oil that is too thick will not run into the clearance between the shaft and the bearing surface
 - C. The correct oil allows the motor shaft to float on a film of oil between the shaft and bearing surface
 - D. All of the above
77. Too much grease in grease lubricated ball bearing
- A. Is not a problem
 - B. Is not possible
 - C. Causes overheating
 - D. Reduces friction

78. A ladder must extend above the edge of a roof by at least _____.
- A. One foot
 - B. Two feet
 - C. Three feet
 - D. Four feet
79. The proper angle for a ladder is achieved when the distance of the ladder from the building at the base is about _____ the working length (height) of the ladder.
- A. One half
 - B. One third
 - C. One fourth
 - D. One fifth
80. Air handling systems that employ economizers which permit outside air “free cooling”
- A. Are most economical when controlled by an enthalpy controller
 - B. Increase building cooling loads during summer operation
 - C. Are required for proper building ventilation
 - D. Increase building heating load during summer operation
81. When face and bypass dampers are used on systems with direct expansion cooling coils:
- A. Compressor capacity control is required
 - B. An end switch on the damper operator should shut down the compressor when the face damper opens
 - C. The bypass damper should remain open at all times during cooling operation
 - D. The face damper should remain closed during cooling operation

82. The rate of flow of electrons in a circuit is termed:
- A. Voltage
 - B. Amperage
 - C. Resistance
 - D. Induction
 - E. Wattage
83. “Pressure” differential in an electrical resistance is the:
- A. Voltage
 - B. Amperage
 - C. Resistance
 - D. Wattage
 - E. Ohmage
84. The unit used to measure electrical resistance is the:
- A. Ampere
 - B. Watt
 - C. Volt
 - D. Ohm
 - E. Joule
85. The four essential parts of the vapor compression cycle compressor, condenser, evaporator and:
- A. Evaporator fan
 - B. Expansion device
 - C. Weatherproof casing
 - D. Suction line

86. How is an anticipator connected to a single contact cooling thermostat?
- A. In parallel with contacts
 - B. In series with contacts
 - C. Between the C and R terminals
 - D. In series parallel with contacts
87. The process of removing moisture from air is called:
- A. Freezing
 - B. Dehumidification
 - C. Saturation
 - D. Enthalpy
88. Basic types of air supply outlets are:
- A. Trough
 - B. Slot ceiling
 - C. Grilles
 - D. All of the above
89. With reference to copper tube, what is meant by the letters ACR?
- A. Average construction rating tube
 - B. Air conditioning and refrigeration tube
 - C. Air and condensate return tube
 - D. Acid and corrosion resistant tube
90. How is the heat anticipator wired in with heating contacts on a 24 volt space thermostat?
- A. Parallel
 - B. Series
 - C. Series parallel
 - D. None of the above

91. A piece of ice weighs 20 lbs. and its specific heat is 0.49. It will require _____ Btu to heat the piece of ice from 27 degrees to 31 degrees F.
92. Given a rate of air flow of 2250 cfm in a duct having a cross-section 18 inches by 18 inches, the duct velocity should be _____ fpm.
93. If a refrigerant sight glass shows bubbles, you know:
- A. There is air in the system
 - B. There is gas in the liquid
 - C. The system has too much refrigerant
 - D. A restriction must be causing flash gas
94. A liquid refrigerant receiver has two liquid level test cocks, one near the top of the receiver and one near the bottom. If the system contains enough refrigerant, when the lower cock is opened:
- A. Refrigerant vapor should come out of the test cock
 - B. The test cock should discharge liquid refrigerant
 - C. Water should drain out
 - D. The dip tube should become completely drained
95. Desiccants are used in:
- A. Strainers
 - B. Moisture indicators
 - C. Gage glasses if combined with indicators
 - D. Driers
96. Only _____% of the direct radiation at the edge of Earth's atmosphere reaches the Earth's surface.
- A. 11
 - B. 31
 - C. 51
 - D. 71

97. Collectors should face as close as possible to _____?
- A. Magnetic North
 - B. True North
 - C. Magnetic South
 - D. True South
98. _____ occurs in a Solar Thermal System when the heated transfer fluid within the absorber piping rises within the collector and is replaced by cooler fluid downstream.
- A. Conduction
 - B. Convection
 - C. Absorption
 - D. Reflection
99. A (n) _____ system uses a Heat Transfer Fluid and heat exchanger to transfer heat to the Domestic Hot Water without the use of mechanical means to circulate the HTF.
- A. Passive direct
 - B. Active direct
 - C. Passive indirect
 - D. Active indirect
100. Self-pumping Systems are _____ systems.
- A. Passive direct
 - B. Active direct
 - C. Active indirect
 - D. None of the above

101. The vacuum pump used in vacuum steam heating systems that creates a vacuum using high velocity water is the:
- A. Velocity pump
 - B. Jet type pump
 - C. Turbine pump
 - D. Lift pump
102. Vacuum pumps used in vacuum steam heating systems can be destroyed if they are made to pump:
- A. Air
 - B. Steam
 - C. Water
 - D. Both A and B from above
103. If a vacuum pump in a vacuum steam heating system burns out, a very common cause is:
- A. Incorrect voltage to the pump
 - B. Backward rotation
 - C. A failed vacuum breaker
 - D. A failed steam trap
104. Effective recovery of condensate reduces the following cost of making steam:
- A. Fuel/energy costs associated with producing steam
 - B. Boiler water make-up and sewage treatment
 - C. Boiler water chemical treatment
 - D. All of the above
105. A symptom of a failed steam trap is:
- A. A trap that is colder than the steam temperature
 - B. A trap that is colder than condensate temperature
 - C. A trap that is warmer than condensate temperature
 - D. A trap that is warmer than steam temperature

106. When entering a customer residential premises you should always
- A. Wipe your feet on their rug to make sure your shoes are clean
 - B. Remove your shoes at the door
 - C. Place a clean pair of disposable covers over your shoes
 - D. Let the customer know that you have checked your shoes and they are clean
107. If the technician is on a service call and notices another potential problem not related to the current work order, what should the technician do?
- A. Don't bother to mention it and go ahead and repair it if you can do it quickly and it won't cost anything
 - B. Generate a service ticket and replace the component
 - C. Ignore it and hope that it turns into another service call for your company
 - D. Discuss what you have with the customer and your supervisor so that the customer can decide whether to authorize the additional repair
108. Which of the following is required part of the work order?
- A. Wholesale cost of parts used
 - B. Form completed in legible hand writing
 - C. Complete list of materials used and amount of time spent on the job
 - D. Both B and C
109. Getting the customer to sign the work order should be
- A. The first thing you should do before starting the work
 - B. The last thing that you should do before leaving the job
 - C. Could be done at any time
 - D. Either A or B

110. Which of the following is a part of your responsibility relative to your work crew?
- A. Keeping to yourself and not bothering others
 - B. Worrying about what others have been assigned to do by the supervisor
 - C. Working safely on the worksite
 - D. Keeping to yourself and not bothering others
111. The maximum desirable operating temperature of a ball bearing is
- A. 180 degrees F
 - B. 212 degrees F
 - C. 150 degrees F
 - D. 350 degrees F
112. Shaft runout can be measured with
- A. A dial indicator
 - B. A runout gage
 - C. A micrometer
 - D. Both A and B
113. The seal in a compressor is necessary to prevent
- A. Refrigerant from leaking out the rotating shaft
 - B. Air from leaking out at the rotating shaft
 - C. Oil from leaking out at the rotating shaft
 - D. Both A and C from above
114. The mating seal surfaces on a sleeve type rotary bellows seal are:
- A. Two polished steel surfaces
 - B. Polished steel surfaces and neoprene
 - C. Polished steel surfaces and a carbon ring
 - D. Steel grooves and waxed cord

115. With belt driven equipment, alignment of the motor and driven equipment pulleys
- Is not critical, since the belts are flexible
 - Is accomplished using a string or straight edge
 - Is accomplished when the belts are parallel to one another
 - Is accomplished using a dial indicator

116. Draw a Northeast view of the piping shown in Figure 5-1 and a Southeast view of the piping shown in Figure 5-2.

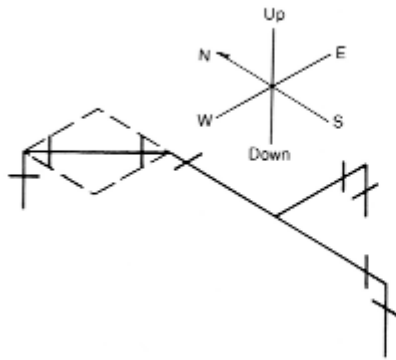

Fig. 5-1

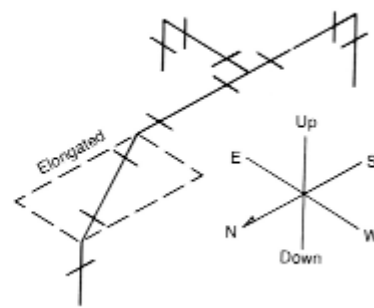

Fig. 5-2

117. A lock and tag may only be removed by the employee that applied it, unless the employee is absent from the workplace, then the lock or tag may be removed by a qualified person designated by the employer to perform this task provided that the employer ensures that _____.
- The employee who applied the lock or tag is employed by his company and under his jurisdiction
 - The employee who applied the lock or tag is not available at the workplace
 - The employee who applied the lock or tag is aware that it has been removed before he or she resumes work at that workplace
 - Both B and C from above
118. Section 608 of the Act prohibits you from knowingly venting ozone-depleting compounds used as refrigerants into the atmosphere while maintaining, servicing, repairing, or disposing of air-conditioning or refrigeration equipment (appliances). The prohibition went into effect on _____.
- July 13, 1993
 - November 14, 1994

- C. July 1, 1992
 - D. November 1995
119. When working on a HCFC-22 appliance, or isolated component of such appliance, normally containing 200 pounds or more of refrigerant and using recovery or recycling equipment manufactured or imported on or after November 15, 1993, you are required to evacuate to a level of
- A. 10 in. Hg
 - B. 4 in. Hg
 - C. 0 in. Hg
 - D. 25 in. Hg
120. If a compressor burn has occurred, the refrigerant must be _____.
- A. Recovered
 - B. Reclaimed
 - C. Recycled
 - D. Both A and B from above
121. An advantage of the inverted bucket trap is that:
- A. There are no moving parts to wear
 - B. It can be installed in any position
 - C. Its design prevents it being damaged due to freezing
 - D. It also vents air and carbon dioxide continuously at steam pressure
122. Flash steam is caused by:
- A. Pipe friction
 - B. Reduced pressure
 - C. A vertical rise in a condensate line
 - D. All of the above
123. The purpose of a drip leg in a steam line is to:
- A. Create a venturi to pull condensate out of a trap

- B. Let condensate escape by gravity from the fast-moving steam
 - C. Store condensate until it can be discharged through the steam trap
 - D. Both B and C from above
124. Inadequate trapping of steam mains often leads to:
- A. Water hammer and damaging slugs of condensate
 - B. Condensate flowing in one direction while steam flows in the opposite
 - C. Loss of steam energy by conduction through the walls of the pipe
 - D. Excessively low temperature condensate
125. Pressure in a vertical position condensate pipe will drop 1 psi for every _____ feet in elevation. This is an important factor, since boiling temperature drops as pressure drops. When elevating condensate, this drop in pressure can cause flash steam.
- A. 1.08
 - B. 2.31
 - C. 8.33
 - D. 10
126. When using a listening device to test a steam trap, what would the technician listen for that could indicate a problem.
- A. Continuous condensate discharge
 - B. Intermittent condensate discharge
 - C. High velocity sound
 - D. Gurgling and bubbling
127. If an inverted bucket steam trap is blowing live steam, what might the trouble be?
- A. The valve may have failed to seat because of wear or a piece of dirt or scale
 - B. The trap may have lost its prime
 - C. The bucket is stuck or has a hole in it
 - D. All of the above

128. The _____ drains the condensate from the steam header and returns it to the boiler below the water line while preventing the boiler water from flowing out of the boiler into the return line main.
- A. Equalizing line
 - B. Hartford Loop
 - C. Wet return
 - D. Steam header
129. The _____ is designed to protect boilers against the loss of water due to leaks in the return line.
- A. Equalizing line
 - B. Hartford Loop
 - C. Check valve
 - D. Steam header
130. The control valve in a sub-atmospheric steam heating system is limited to approximately _____ % change per minute.
- A. 12
 - B. 9
 - C. 6
 - D. 3
131. When the discharge of one compressor is piped into the suction of another compressor, it is called a:
- A. Single stage system
 - B. Two stage system
 - C. Cascade system
 - D. Air Cooled system

132. What is the most common cause of valve noise?
- A. Water pressure too high
 - B. Air pressure too low
 - C. Valve piped incorrectly
 - D. Wrong size operator on valve
133. If too much refrigerant is being fed to the evaporator _____.
- A. The superheat will be low
 - B. The superheat will be high
 - C. The superheat will not be affected
 - D. None of the above
134. The low pressure cap tube of an oil failure switch should be connected to the:
- A. Discharge port
 - B. Liquid line
 - C. Compressor crankcase
 - D. Oil pump connection
135. When copper tubing is being brazed, nitrogen gas can be purged through the system to prevent:
- A. Damaging temperature sensitive components
 - B. The tubing from overheating
 - C. Oxidation inside the tubing
 - D. Production of toxic fumes
136. In an economizer, an enthalpy control regulates the use of outdoor air on the basis of the air's:
- A. Humidity and temperature
 - B. Sensible heat
 - C. Latent heat
 - D. Return flow temperature

137. When removing the gauge port plug from a compressor discharge service valve, the valve should be:
- A. Front seated
 - B. Back seated
 - C. Cracked off the backseat
 - D. Closed
138. An acid test kit is used to test acidity of:
- A. Refrigerant
 - B. Oil
 - C. Condensate
 - D. Water
139. The TXV sensing bulb is mounted:
- A. On the liquid line between the condenser and the TXV
 - B. On the inlet to the condenser
 - C. On the suction line as it leaves the evaporator
 - D. On the compressor discharge line
140. In an air cooled system with capacity control, compressor unloading will cause the:
- A. Suction pressure to rise and the discharge pressure to fall
 - B. Suction pressure to fall and energy consumption to decrease
 - C. Suction pressure and discharge pressure to fall
 - D. Discharge pressure to rise and energy consumption to decrease
141. A lamp has a source voltage of 110 volts and a current of 0.9 amperes. What is the resistance of the lamp?

142. The amount of heat removed to lower the temperature of 15 lbs. of water from 48 degrees F to 39 degrees F is:
143. A belt-driven fan is to turn at 580 rpm. If the fan is driven by a 1740 rpm motor and the motor has a pulley with a three-inch pitch diameter, the fan pulley should have a pitch diameter of _____ in.
144. Using a rule-of-thumb figure, approximately how much heat, in Btu/hr., must be rejected by the condenser when the net refrigerating effect is 25 tons?
145. The heat transferred by circulating water can be expressed by the following equation:
$$\text{Btuh} = 500 \times \text{gpm} \times \Delta T$$
A particular heat exchanger is supplied with circulating chilled water flowing at a rate of 100 gpm. If heat is added to the water at a rate of 500,000 btuh when the initial (entering) water temperature is 40 degrees F, at what temperature does the water leave the heat exchanger?
146. What is the maximum safe amperage draw of the secondary winding of a 60 VA transformer output of 12 volts?
147. Theoretically, a pump can raise water by suction approximately _____ feet vertically.
148. The seal in a compressor is necessary to prevent
- A. Refrigerant from leaking out at the rotating shaft
 - B. Air from leaking out at the rotating shaft
 - C. Oil from leaking out at the rotating shaft
 - D. Both A and C from above
149. Some codes require a manual reset device on a safety limit
- A. So that the cause of the safety shutdown can be investigated prior to re-start
 - B. So that the equipment will not short-cycle
 - C. So that more technicians are needed, which helps the economy
 - D. Because automatic reset is more costly

150. A flame sensing relay strategy that takes advantage of the fact that hot gasses in a flame become ionized and conduct electricity is called a
- A. Cad cell
 - B. Thermocouple
 - C. Flame rod
 - D. Ion sensor
151. When charging a system, the refrigerant cylinder pressure may drop too low for further charging. Which of the following methods should *not* be used to increase the pressure?
- A. Heat the cylinder with a torch
 - B. Heat the cylinder with a heat lamp
 - C. Heat the cylinder by immersing it in a tub of warm water
 - D. Heat the cylinder by wrapping it in a specially built electric heater
152. In a thermostatic expansion valve, three forces act on the diaphragm in the power head, which is connected to the valve. Evaporator pressure acts to _____ the valve, spring pressure acts to _____ the valve and bulb pressure from the bulb attached to the evaporator outlet acts to _____ the valve.
- A. Open; open; close
 - B. Close; close; open
 - C. Close; open; open
 - D. Open; close; close
153. A stuffing box type of shaft seal on a centrifugal pump needs periodic maintenance. If the seal is found to be leaking excessively, the technician should
- A. Replace the carbon washer and/or tension the spring
 - B. Replace the entire seal as this is cheaper than repairing a leaking seal.
 - C. Tighten the packing gland and/or replace the packing
 - D. Replace the pump, as the seal is an integral part of the pump and not easily replaced or repaired

154. Cavitation can destroy a centrifugal pump, is noisy and is caused by
- A. Inlet pressure that is too high
 - B. Inlet pressure that is too low
 - C. Outlet pressure that is too low
 - D. Outlet pressure that is too high
155. Cavitation can destroy a centrifugal pump, is noisy and is caused by
- A. Inlet pressure that is too high
 - B. Inlet pressure that is too low
 - C. Outlet pressure that is too low
 - D. Outlet pressure that is too high
156. A vacuum breaker is installed between equipment and a steam trap to
- A. Allow a vacuum to be pulled on the system
 - B. Allow condensate to drain after the steam has been shut off
 - C. Prevent condensate from draining after the steam has been shut off
 - D. Trip on low pressure cutoff
157. Two types of thermal overload relays in common use today are
- A. The bimetal relay and the magnetic relay
 - B. The melting alloy relay and the Mercury bulb
 - C. The bimetal relay and the melting alloy relay
 - D. The bimetal relay and the trimetal relay
158. When soldering, solder is drawn into the joint by
- A. The heat of the torch
 - B. Capillary action
 - C. Gravity
 - D. Flux

159. The efficiency of an electric furnace is usually _____ percent.
- A. 10
 - B. 50
 - C. 80
 - D. 100
160. Defective rigging components and hardware should be
- A. Destroyed
 - B. Washed
 - C. Recycled
 - D. Repaired
161. In order to reduce pressure to an acetylene pressure regulator, the adjusting screw is turned
- A. Clockwise to its limit
 - B. Counter-clockwise until the tension is off
 - C. Clockwise one half turn
 - D. Clockwise one full turn
162. Suction gas temperature leaving evaporator minus saturated suction temperature equals
- A. Subcooling
 - B. Condensing temperature
 - C. Superheat
 - D. Evaporator operating temperature

163. Which of the following gases must never be used to pressurize or leak test a refrigeration system?
- A. Nitrogen
 - B. Oxygen
 - C. CO₂
 - D. Helium
164. For an electric heat furnace what size should the flue pipe be?
- A. 8"
 - B. 6"
 - C. No flue
 - D. 10"
165. Defrost systems can be terminated by
- A. Time
 - B. Pressure
 - C. Temperature
 - D. Any of the above
166. A refrigerant heat exchanger might cause:
- A. Too much subcooling for proper operation of the expansion valve
 - B. Flash vapor in the liquid line
 - C. The compressor to be overheated
 - D. The suction line to sweat
167. The purpose of a suction line accumulator is to:
- A. Trap and accumulate the noncondensables
 - B. Accumulate excess vapor
 - C. Trap oil
 - D. Trap liquid refrigerant

168. The proper location for an oil separator is near the:
- A. Compressor
 - B. Condenser
 - C. Receiver
 - D. Evaporator
169. The two planes of alignment that must be considered when aligning a flexible coupling are
- A. Axial and parallel
 - B. Parallel and perpendicular
 - C. Horizontal and vertical
 - D. Parallel and angular
170. How can you identify reverse operation with a scroll compressor?
- A. The compressor will not compress
 - B. The compressor will stop on motor overload
 - C. You can see it running backwards
 - D. Both A and B from above
171. When in doubt, what should be installed at the bottom of a suction line riser?
- A. A check valve
 - B. A p-trap
 - C. A service port
 - D. A balancing valve
172. Condenser saturation temperature on air cooled condenser should be higher than the ambient temperature by:
- A. 100 degrees F to 105 degrees F
 - B. 90 degrees F to 100 degrees F
 - C. 10 degrees F to 15 degrees F
 - D. 30 degrees F to 35 degrees F

173. The compression ratio in a system can be determined by:
- A. Multiplying discharge gage pressure by suction gage pressure
 - B. Dividing discharge pressure absolute by suction pressure absolute
 - C. Dividing suction pressure absolute by discharge pressure absolute
 - D. Subtract suction pressure absolute from discharge pressure absolute and divide by 12,000 btu/hr.
174. What is the “rule of thumb” in BTU’s per hour of heat rejection of a condenser?
- A. 10,000
 - B. 12,000
 - C. 15,000
 - D. 18,000
175. Typical suction superheat at the evaporator outlet of an air conditioning system is expected to be:
- A. 10 degrees F to 20 degrees F
 - B. 12 degrees F to 15 degrees F
 - C. 20 degrees F to 25 degrees F
 - D. 60 degrees F to 80 degrees F
176. The three pressures that operate the thermostatic expansion are bulb, spring and evaporator
- A. Bulb closes, spring closes, evaporator opens the valve
 - B. Bulb closes, spring opens, evaporator opens the valve
 - C. Bulb opens, spring closes, evaporator opens the valve
 - D. Bulb opens, spring closes, evaporator closes the valve
177. To add refrigerant to the system through the suction service valve, the valve stem must be:
- A. Back seated
 - B. Front seated
 - C. Mid seated
 - D. None of the above

178. How many Btu are there in 8 kW of electrical power?
- A. 26,286
 - B. 5,968
 - C. 27,304
 - D. 68,260
179. An enthalpy controlled economizer system uses _____ for change from mechanical cooling to economizer operation:
- A. Outside temperature sensor
 - B. Outside temperature and humidity sensor
 - C. Return air temperature
 - D. Space temperature and humidity
180. For a voltage measurement the meter is connected:
- A. In series with load
 - B. In parallel to with load
 - C. With load removed
 - D. With load bypassed
181. To measure motor current:
- A. Apply clamp-on amp meter around 2 or more wires
 - B. Apply clamp-on amp meter around wire
 - C. Connect amp meter in parallel to motor
 - D. Connect voltmeter across motor winding
182. Before you work on an electrical circuit (touching components)?
- A. Check amperage with a good meter
 - B. Check voltage with a good meter
 - C. Look to make sure switch is off
 - D. Turn power on

183. When measuring voltage, the meter test leads are connected in _____ with the component being tested.
- A. Series
 - B. Parallel
 - C. Series/parallel
 - D. Parallel/series
 - E. A "dead" circuit
184. If the voltage is kept constant at 240 volts, and the resistance measures 40 ohms, the current flowing through the conductor is:
- A. 6 amps
 - B. 60 amps
 - C. 24 volts
 - D. 240 volts
 - E. 6 volts
185. "VA" is the common term for:
- A. Amps
 - B. Ohms
 - C. Watts
 - D. Volts
 - E. Gigajoules
186. The device which operates similar to a fuse, but which can be reused, is a:
- A. Switch
 - B. Circuit breaker
 - C. Load
 - D. Source
 - E. Conductor

187. Fuses are sized by the _____ they can carry.
- A. Wattage
 - B. Ohms
 - C. Amperage
 - D. Current
 - E. Both C and D are correct
188. The 120V side of the transformer found on most heating system is referred to as the:
- A. Primary winding
 - B. Secondary winding
 - C. Hot winding
 - D. Initial winding
 - E. Number one winding
189. Relays are made up of a _____ and one or more _____.
- A. Switch, loads
 - B. Source, switches
 - C. Transformer, loads
 - D. Load, switches
 - E. Load, transformers
190. Terminal reheat systems:
- A. Permit any zone to have year round heating or cooling
 - B. Are the most economical temperature control systems to operate
 - C. Require a variable air quantity to each system
 - D. Cannot provide heating in the summer season

191. Variable volume systems:
- A. Supply each zone with a constant volume of air
 - B. Control space temperature by regulating the flow of air to each zone
 - C. Are less economical to operation than constant volume systems
 - D. Require no air balancing after installation
192. Volume limiting controls, also known as velocity controllers, used with variable air volume boxes:
- A. Reduce air volume to a zone when the duct pressure decreases
 - B. Maintain a stable discharge volume regardless of supply duct pressure
 - C. Regulate supply duct static pressure
 - D. Operate fan vortex dampers to maintain a constant velocity at the VAV box
193. Air handling units of the multizone type:
- A. Are able to supply each zone with heated or cooled air in all seasons
 - B. Are less economical to operate than VAV systems
 - C. Can have their hot deck temperature reset on coldest zone demand
 - D. All of the above
194. To improve their operating economy, multizone air handlers should:
- A. Maintain a hot deck temperature of at least 160 degrees F
 - B. Be used with a variable capacity squirrel cage fan
 - C. Have their hot deck temperature reset by outside air temperature or on coldest zone demand
 - D. Use parallel flow hot water coils

195. To improve their operating economy, multizone air handlers should:
- A. Maintain a hot deck temperature of at least 160 degrees F
 - B. Be used with a variable capacity squirrel cage fan
 - C. Have their hot deck temperature reset by outside air temperature or on coldest zone demand
 - D. Use parallel flow hot water coils
196. As compared to across-the-line starters, reduced voltage starters:
- A. Reduce starting torque required
 - B. Reduce inertia loads
 - C. Reduce starting current inrush
 - D. Reduce accelerating time
197. Closed transition starting means:
- A. The motor is never disconnected from the line during starting
 - B. The machine is started with the inlet vanes closed
 - C. The motor is only temporarily disconnected during start-up
 - D. The starter has timed-closed contacts
198. For maximum safety of equipment, overload relays should be:
- A. Manual reset type
 - B. Automatic reset type
 - C. Included in contactors
 - D. Not affected by motor current
199. For maximum safety of equipment, overload relays should be:
- A. Manual reset type
 - B. Automatic reset type
 - C. Included in contactors
 - D. Not affected by motor current

200. Outdoor reset of hot water temperature for heating gives:
- A. Hottest water during the coldest weather
 - B. Hottest water only in the morning
 - C. Hottest water during milder weather
 - D. Night setback
201. The heating capacity of an air-to-air heat pump:
- A. Is not affected by outside temperature
 - B. Increases as outdoor air gets colder
 - C. Decreases as outdoor air gets colder
 - D. Decreases as outside air gets warmer
202. The instrument used for finding humidity levels in the atmosphere is the:
- A. Sling psychrometer
 - B. Micron gage
 - C. Manometer
 - D. Infrared thermometer
203. Suction line filter-driers are usually equipped with gage connections so that pressure drops can be determined. Why?
- A. So that accurate superheat calculations can be made
 - B. To ensure that excessive load is not imposed on the compressor
 - C. To ensure that flash gas does not occur in the filter-drier
 - D. So that you can determine when to change the filter-drier
204. The average house line pressure for Natural Gas is
- A. 3.5 psi
 - B. 3.5" W.C.
 - C. 7 psi
 - D. 7" W.C.

205. What air distribution system includes both a warm air duct and a cool air duct, and utilizes mixing boxes near the zone to mix the cool air and warm air streams and achieve the desired temperature while delivering air at a near constant volume?
- A. Multizone
 - B. Dual duct
 - C. Mixing box system
 - D. Dual temperature system
206. Capacity control on a helical-rotary (screw) compressor is obtained using
- A. Inlet vanes
 - B. Hot gas bypass
 - C. Variable speed motors
 - D. A sliding valve
207. Which of the following reduced voltage starters uses a switching arrangement to connect the windings of three-phase motors in different configurations during startup and normal operation?
- A. Autotransformer starters
 - B. Start-run starters
 - C. Star-wye starters
 - D. Wye-delta starters
208. One type of pressure sensing device uses a flattened metal tube, which is bent into a part circle with one end fixed in place and connected to a system to be measured. The other end of the tube is closed and free to move. An increase in pressure tends to straighten the tube. The movement of the free end of the tube is connected to a dial that reads pressure. This type of gage is called a
- A. Whiskey tube
 - B. Bimetal tube
 - C. Bourdon tube
 - D. Flat-tube gage

209. With a change in temperature, a thermistor will change
- A. Resistance
 - B. Voltage
 - C. Current
 - D. Impedance
210. Electricity results from the movement of tiny negatively charged particles called
- A. Protons
 - B. Electrons
 - C. Neutrons
 - D. Ions
211. _____ is the capacity of a material to store thermal energy for extended periods.
- A. R-value
 - B. Thermal Mass
 - C. U-value
 - D. Absorbency
212. The expansion tank in a steamback system is _____ a normally sized expansion tank for a Solar Heating Water System.
- A. The same size as
 - B. Slightly smaller than
 - C. Significantly larger than
 - D. None of the above
213. Energy Efficient Ratio is a measure of the _____.
- A. Relative efficiency of a heating or cooling appliance
 - B. Electricity in Btu's
 - C. Cooling capacity measured in Btu's
 - D. None of the above

214. The ratio of the cooling output in Btu for the season, divided by the power consumption in watts per hour for the season.
- A. Seasonal energy efficiency ratio (SEER)
 - B. Heating seasonal performance factor (HSPF)
 - C. Coefficient of performance (COP)
 - D. All of the above
215. The heating Seasonal Performance Factor (HSPF):
- A. Does not measure the seasonal efficiency
 - B. Can only be used by contractors when purchasing equipment
 - C. Uses the total output of a system and the total electrical power used by a system over an entire heating season
 - D. None of the above
216. You are called to a job site to perform some maintenance work on a system and after you are finished the customer approaches you and offers to pay you cash directly to perform some additional work. In this situation it would be ok to?
- A. Accept the offer but tell him you will have to come back with your own truck and tools
 - B. Negotiate with the customer to see if you can get him to increase his offer
 - C. accept the offer, but tell the customer that this is the only time that you will be able to help him out
 - D. Refuse the offer politely and if it happens again notify your supervisor of the situation

217. What should the technician do in a situation where he is working on a refrigeration system that operates a case that holds perishable food items, the compressor has failed, it is 5:00 on a Monday evening, and will take a few additional hours to repair the rack?
- A. Leave the job site, go to dinner, and return after dinner to complete the job
 - B. Request authorization from the customer to leave the job to go to dinner telling him that you will return that evening to finish the job
 - C. Request authorization from the customer to stay on the job until it is finished that evening
 - D. Request authorization from the customer to leave the job telling him that you will return first thing in the morning to finish the job
218. The most important element(s) of non-verbal communication is (are)
- A. Spoken words
 - B. Voice inflection
 - C. Body language
 - D. All of the above
219. The quality of customer service can be enhanced if the technician takes the time to actively listen
- A. Explain in detail how the HVAC system works
 - B. Explain the billing process and when the bill is due
 - C. Use HVAC technical terms in explaining the work that has been completed
220. An HVAC technician should always attempt to convey a professional image by
- A. Clean and neat personal appearance
 - B. Clean and neat service vehicle (inside and outside)
 - C. Maintaining a clean and organized work site
 - D. All of the above

221. If a technician determines he cannot keep a scheduled customer appointment he should
- A. Travel as fast as possible to get there as soon as possible
 - B. Call the customer to keep them informed of your delay
 - C. Do nothing, the customer expects service people to be late
 - D. Call the customer and tell them you have been on a more important service call
222. Background checks are necessary to disclose employee history associated with
- A. Criminal records
 - B. Credit reports
 - C. Drug testing
 - D. All of the above
223. Which of the following would be a display of professionalism?
- A. Work uniform with company logo
 - B. Being punctual
 - C. Use of good people skills
 - D. All of the above
224. When completing a service call the last action taken is presenting the invoice to the customer and obtaining a signature. Why it is important that all work performed is accurately described on the invoice?
- A. To reference details at a later date
 - B. To identify warranty parts or service
 - C. To provide service details in written communication form
 - D. All of the above

225. Service technicians must be thorough in order to prevent a breakdown in communication that results in lost time (money). Which of the following is not part of the required invoice information?
- A. Date of repair
 - B. Actual labor
 - C. Total cost
 - D. Original supplier of equipment
226. What measures can service technicians take to ensure that work orders are complete?
- A. Write legibly
 - B. Do not rush
 - C. Explain the work order to the customer and ask if they have any questions
 - D. All of the above
227. To correct for soft foot:
- A. Replace soft material with a material of sufficient hardness
 - B. Shim under the high foot with shim stock equal to a reading on the indicator
 - C. Replace the resilient material in the coupling
 - D. Replace vibration isolators with isolators properly rated for the pump
228. The two planes of alignment that must be considered when aligning a flexible coupling are
- A. Axial and parallel
 - B. Parallel and perpendicular
 - C. Horizontal and vertical
 - D. Parallel and angular

229. On the spool sheet shown in Fig. 4-1 write in the missing dimensions and draw in the pressure relief valve and the manual air vent. This is the section of piping from the convertor to the air separator on drawing SB-10. Also find the E-E lengths of the pieces of pipe marked D-1, D-2, and D-3.

NOTE: Always allow $\frac{1}{8}$ " for weld gaps and $\frac{1}{16}$ " for gaskets.

MATERIAL LIST	
ITEM #	QTY.
A	1
B	2
C	1
D	11'
E	1
D-1	1
D-2	1
D-3	1
SK #2 SB-10 6"H.W. FROM CONVERTOR TO AIR SEPARATOR	

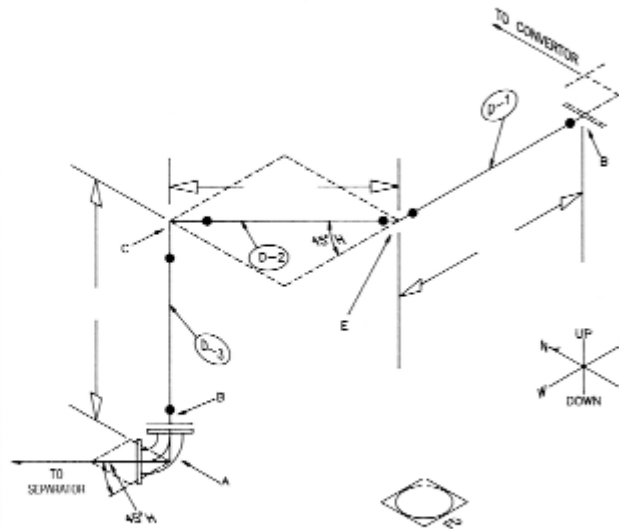

230. Draw a Northeast view of the piping shown in Figure 5-1 and a Southeast view of the piping shown in Figure 5-2.

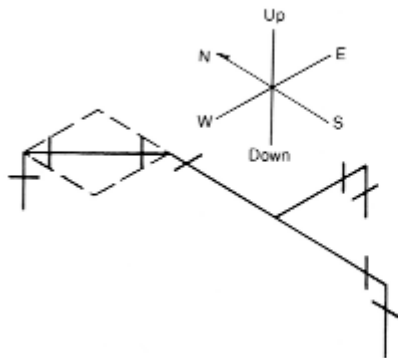

Fig. 5-1

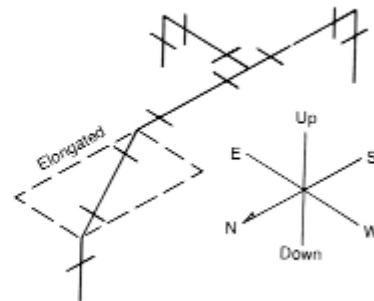

Fig. 5-2

231. On the spool sheet shown in Fig. 4-1 write in the missing dimensions and draw in the pressure relief valve and the manual air vent. This is the section of piping from the convertor to the air separator on drawing SB-10. Also find the E-E lengths of the pieces of pipe marked D-1, D-2, and D-3.

NOTE: Always allow $\frac{1}{8}$ " for weld gaps and $\frac{1}{16}$ " for gaskets.

MATERIAL LIST	
ITEM #	QTY.
A	1
B	2
C	1
D	11'
E	1
D-1	1
D-2	1
D-3	1
SK #2 SB-10 6"H.W. FROM CONVERTOR TO AIR SEPARATOR	

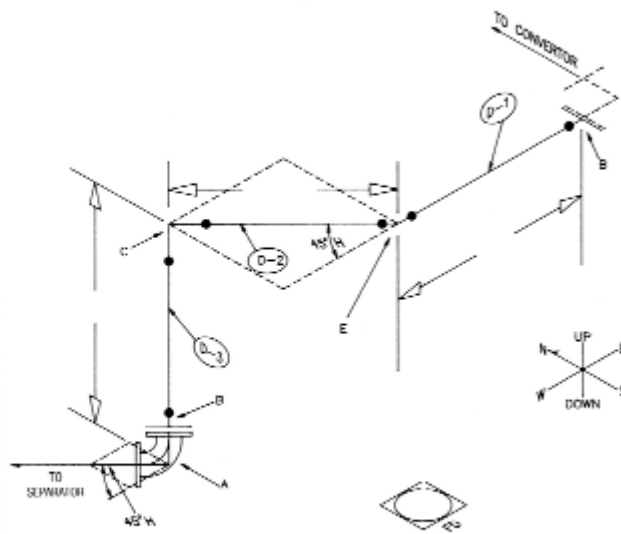

Figure 4-1

232. Fill the proper name of the symbols shown in Fig. 3-2.

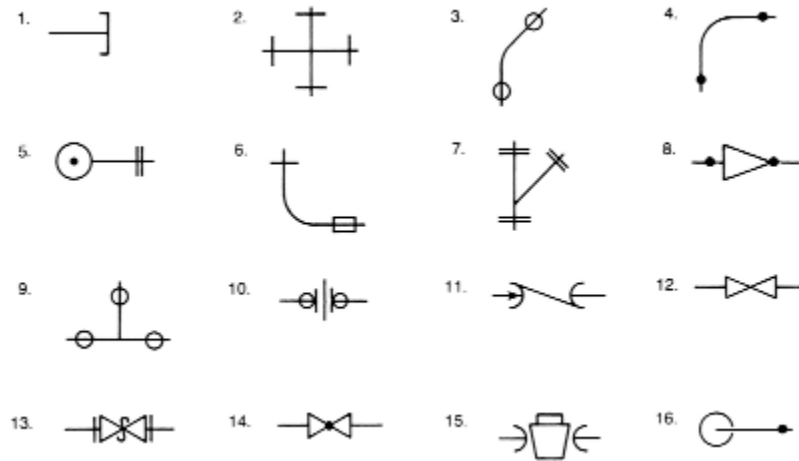

Figure 3-2

1 _____	2 _____	3 _____	4 _____
5 _____	6 _____	7 _____	8 _____
9 _____	10 _____	11 _____	12 _____
13 _____	14 _____	15 _____	16 _____

233. The first thing a service mechanic should do before performing service work on refrigeration equipment is to:

- A. Pull the disconnect switch
- B. Locate the disconnect switch
- C. Lock the disconnect switch in open position
- D. Stop the system with the motor controller

234. EER labels are used on window units, unitary equipment and _____.

- A. Refrigerators
- B. Garbage disposals
- C. Water heaters
- D. Heat pumps

235. EER labels are used on window units, unitary equipment and _____.
- A. Refrigerators
 - B. Garbage disposals
 - C. Water heaters
 - D. Heat pumps
236. The Seasonal Energy Efficiency Ratio is used to measure the efficiency of _____.
- A. Central air conditioning
 - B. Forced air furnaces
 - C. Window air conditioners
 - D. All of the above
237. AFUE stands for Annual Fuel _____ Efficiency.
- A. Use
 - B. Utilization
 - C. Usage
 - D. User
238. Which Government agency requires the display of the AFUE rating on equipment?
- A. Dept. of Energy
 - B. Dept. of Natural Resources
 - C. Federal Trade Commission
 - D. EPA
239. It is not uncommon for condensing residential furnaces to approach AFUE levels of _____%.
- A. 96
 - B. 97
 - C. 95
 - D. 98

240. _____ are used to control ventilation by monitoring the outdoor temperature and humidity.
- A. Humidifiers
 - B. Economizers
 - C. Ventilators
 - D. Humidistats
241. An air filter with a MERV-6 rating or higher will reduce levels of small particulates and improve indoor air quality. MERV stands for _____ value.
- A. Minimum energy rating
 - B. Maximum energy rating
 - C. Minimum efficiency reporting
 - D. Maximum efficiency reporting
242. A solar Chimney used natural rising of warm air through a structure to remove heat, this is true _____.
- A. Radiant cooling
 - B. Aggressive cooling
 - C. Progressive cooling
 - D. Passive cooling
243. There are two kinds of desiccant Solar Systems, they are _____ and _____.
- A. Solid, gas
 - B. Liquid, gas
 - C. Solid, liquid
 - D. Gas, vapor

244. To freeze one pound of water, _____Btu of latent heat must be removed.
- A. 145
 - B. 144
 - C. 143
 - D. 146
245. The type of refrigerant that must be used now must be _____.
- A. HCFC
 - B. HCF
 - C. HFC
 - D. HFCE
246. All fittings and connections where refrigerants may be present should be _____.
- A. Brazed
 - B. Flared
 - C. Soldered
 - D. Compression
247. The thermal storage system that uses small plastic balls for storage is called a _____.
- A. Ball
 - B. Tank
 - C. Cell
 - D. Combination
248. The refrigerant line that connects the condenser to the metering device is _____ line.
- A. Discharge
 - B. Expansion
 - C. Liquid
 - D. Suction

249. The four main components of a refrigeration system are
- A. Compendium tube, cooler, hot coil, & compressor
 - B. Compressor, condenser, evaporator, & metering device
 - C. Eliminator, pressure-enthalpy device, refrigerant, & oil separator
 - D. Receiver, sight glass, accumulator, and compressor
250. When an object is refrigerated:
- A. Some of its heat energy is destroyed
 - B. Heat is removed from it
 - C. More cooling is added
 - D. Its molecules move faster
251. A hand placed near a hot stove or fireplace is quickly heated by:
- A. Radiation
 - B. Convection
 - C. Conduction
 - D. Refrigeration
252. If you want to replace a defective capacitor but the only replacements you can find do not have enough capacitance, you can increase their capacitance by:
- A. Connecting two or more capacitors in series
 - B. Connecting two or more capacitors in parallel
 - C. Increasing the voltage with a potential relay
 - D. Reducing the motor current with a current relay
253. The rotation of a three-phase motor can be reversed by interchanging:
- A. The collector ring
 - B. Any two leads
 - C. The starting winding
 - D. The running winding

254. A lamp source has a voltage of 110 volts and a current of 0.9 amperes. What is the resistance of the lamp?
- A. 12.22
 - B. 122.2
 - C. 0.008
 - D. 0.08 ohms
255. The difference between a contactor and a motor starter is:
- A. Physical size
 - B. Overload protection
 - C. Wire size
 - D. Timing
256. When a three-phase motor single-phases, it:
- A. Draws power from the two remaining phases
 - B. Draws power from only one phase
 - C. Always short-cycles
 - D. Runs cooler
257. The approach temperature for the evaporator is:
- A. The difference in the suction and head pressure converted to temperature
 - B. The difference in the refrigerant boiling temperature and the suction-line temperature
 - C. The difference in the refrigerant boiling temperature and the inlet water temperature
 - D. The difference in the refrigerant boiling temperature and the leaving-water temperature

258. In a chiller, the refrigerant boils by _____.
- A. Absorbing heat from the air passing through it
 - B. Absorbing heat from the water passing through it
 - C. Rejecting heat to the air passing through it
 - D. Rejecting heat to the water passing through it
259. If refrigerant condenses at a temperature of 105 degrees F and the water leaves the condenser at a temperature of 95 degrees F, the _____.
- A. Condenser approach temperature will be 10 degrees
 - B. Condenser approach temperature will be 95 degrees
 - C. Evaporator (chiller) approach temperature will be 10 degrees
 - D. Evaporator (chiller) approach temperature will be 105 degrees
260. When water is introduced into the end of a chiller it is contained in:
- A. Water boxes
 - B. A combination filter receiver
 - C. A receiver
 - D. None of the above
261. When using a thermostatic expansion valve with a _____ charged element, hunting can be considerably reduced.
- A. Gas
 - B. Liquid
 - C. Cross
 - D. Parallel
262. A vacuum breaker is installed between equipment and a steam trap to:
- A. Allow a vacuum to be pulled on the system
 - B. Allow condensate to drain after the steam has been shut off
 - C. Prevent condensate from draining after the steam has been shut off
 - D. Trip on low pressure cutoff

263. The device which forms a water seal that prevents raw steam from entering and damaging pressure gauges, vaporstats, pressuretrols, etc. is a (n):
- A. Pigtail
 - B. ?Dip tube
 - C. Safety glass
 - D. Sight glass
264. The boiler return line is connected to the steam main by a (n):
- A. Drop connection
 - B. Hartford loop
 - C. Drip connection
 - D. Equalizing line
265. The device which prevents a vacuum from forming in a low-pressure gravity return steam heating system where automatic control is not used is a (n):
- A. Vacuum breaker
 - B. Atmospheric connection
 - C. Air vent
 - D. Safety relief valve
266. The device which prevents a vacuum from forming in a low-pressure gravity return steam heating system where automatic control is not used is a (n):
- A. Vacuum breaker
 - B. Atmospheric connection
 - C. Air vent
 - D. Safety relief valve

267. The length of the pipe (drip connection) that is needed to overcome the pressure drop in a one-pipe gravity return steam heating system and return condensate to the boiler is:
- A. 14 inches
 - B. 12 inches
 - C. 28 inches
 - D. 2 to 4 inches
268. In a one-pipe gravity return steam heating system, the main vent should be installed:
- A. In a tee at the end of the last steam carrying main
 - B. 15 to 18 inches back from the end of the last steam carrying main
 - C. 2 to 4 inches past the end of the last steam carrying main
 - D. A main vent is not necessary in a one-pipe gravity return steam heating system
269. A thermostatic steam trap that fails in the closed position would cause a heating unit to become:
- A. Waterlogged
 - B. Superheated
 - C. Subcooled
 - D. None of the above
270. If the float in a F&T trap failed and filled with water, the trap would:
- A. Discharge condensate continually
 - B. Discharge steam continually
 - C. No condensate would be discharged
 - D. No air would be discharged

271. If used to drip the end of a steam main, the type of steam trap that would require a cooling leg is a (n):
- A. Thermostatic
 - B. F&T
 - C. Inverted bucket
 - D. Thermodynamic
272. In a two-pipe gravity return steam system, the device that prevents raw steam from entering the piping is a:
- A. Hartford loop
 - B. Dry return
 - C. Steam trap
 - D. Filter drier
273. The pump motor on a condensate receiver is usually started by:
- A. Low water condition in the boiler
 - B. Low water condition in the receiver
 - C. High water condition in the boiler
 - D. High condition in the receiver
274. The device that could be used to regulate the discharge pressure of a condensate pump is a:
- A. Check valve
 - B. Gate valve
 - C. Plug cock
 - D. Flow control valve

275. The device used to actuate the vacuum pump in a vacuum steam heating system when there is a loss of vacuum in the system return piping is the:
- A. Pressuretrol
 - B. Aquastat
 - C. Vacuum switch
 - D. Thermostat
276. The device which can be used to elevate condensate in a vacuum steam heating system is a:
- A. Steam trap
 - B. Vacuum breaker
 - C. Lift fitting
 - D. Control line
277. The device that is incorporated into a vacuum steam heating system to protect the vacuum pump from creating too low (deep) a vacuum is a:
- A. Relief valve
 - B. Control line
 - C. Vacuum breaker
 - D. Vacuum switch
278. In a vapor steam heating system, condensate is returned to the boiler by means of a:
- A. Vacuum pump
 - B. Condensate receiver
 - C. Boiler feed pump
 - D. Boiler return trap (gravity)

279. Air is eliminated from a vapor system by a (n):
- A. Standard air vent
 - B. Boiler return trap
 - C. Air eliminator
 - D. Main vent
280. The device that is used to maintain a pressure differential between the supply and return piping in a sub-atmospheric steam heating system is a:
- A. Pressure controller
 - B. Vaporstat
 - C. Differential controller
 - D. Control valve
281. If the water flow to a water-cooled condenser is reduced, the temperature difference across the condenser will:
- A. Increase
 - B. Decrease
 - C. Remain the same
 - D. Cannot be determined
282. Basic types of heat pump, classified as to their heat source and the medium being heated are:
- A. Air-to-air
 - B. Water-to-air
 - C. Water-to-water
 - D. All of the above

283. The external equalizer line on an expansion valve performs the following function:
- A. Equalizes system pressures on the off cycle
 - B. Equalizes the internal and external pressures in the expansion valve
 - C. Compensates for any pressure drop in the evaporator coil
 - D. Collects any moisture that may be present at the expansion valve
284. When the suction pipe from a direct expansion coil must rise to a level above the coil outlet, what purpose is served by a trap placed in the line directly at the coil outlet?
- A. It assists the return of the oil to the compressor
 - B. It prevents migration of refrigerant to the evaporator
 - C. It stabilizes the superheat setting
 - D. It compensates for an overcharge of the system
285. If not properly installed, a hot-gas muffler might trap:
- A. Hot gas
 - B. Superheated vapor
 - C. Suction gas
 - D. Oil
286. Double suction riser are used in refrigeration system when
- A. Large fluctuations in system capacity will occur
 - B. Two or more compressors are installed on the system
 - C. There are multiple cases installed on one suction line
 - D. There is a cost savings with this practice
287. Suction risers are typically reduced by one size over that of the main suction run
- A. Reduce installation costs
 - B. To avoid using a suction riser trap
 - C. To decrease velocity and reduce pressure drop
 - D. To increase refrigerant velocity to aid in proper oil return

288. The liquid receiver is located between the?
- A. Compressor suction and the evaporator
 - B. Compressor discharge and the condenser
 - C. Condenser and the expansion device
 - D. Expansion device and the evaporator
289. Which device is used in a refrigeration system to protect the compressor from liquid slugs?
- A. Suction accumulator
 - B. Liquid receiver
 - C. TXV
 - D. None of the above
290. Which device is used to stop the flow of liquid or vapor in a refrigeration system?
- A. Suction accumulator
 - B. Liquid receiver
 - C. TXV
 - D. Solenoid valve
291. When soldering a copper pipe connection which of the following processes allow for alloy to be drawn into the space between copper pipe and the fitting connection?
- A. Conduction
 - B. Drawing effect
 - C. Capillary action
 - D. Convection

292. Before proceeding to make any braze connection in a refrigeration system all of the internal piping should be purged of atmosphere with
- A. CO₂
 - B. R-22
 - C. Nitrogen
 - D. A or C
293. The purpose of the crankcase pressure regulator is to:
- A. Maintain constant pressure in the crankcase
 - B. Maintain constant pressure in the evaporator
 - C. Prevent a compressor from going into a vacuum
 - D. Prevent a compressor overload condition.
294. The function of the evaporator pressure regulator is to:
- A. Maintain a constant evaporator pressure
 - B. Prevent a minimum pressure in the regulator
 - C. Maintain a constant evaporator temperature
 - D. Prevent a maximum pressure in the evaporator
295. Oxygen hoses are generally what color?
- A. Green
 - B. White
 - C. Blue
 - D. Red
296. A type of copper tube joint is:
- A. Soldered
 - B. Flared
 - C. Compression
 - D. All of the above

297. If you were on a job and ran out of 5/8" O.D. fittings while installing 5/8" ACR tube which of the following sizes of copper water tube fittings could be used?
- A. 3/4"
 - B. 5/8"
 - C. 1/2"
 - D. Water tube fittings cannot be used with ACR tube
298. When soldering copper tube, after the tube and fitting are cleaned and fluxed, they should be soldered:
- A. Within 24 hours
 - B. As soon as possible
 - C. Within 3 hours
 - D. Anytime
299. Condensate drain traps must be used on draw through evaporator coils in order to prevent:
- A. Water overflow
 - B. High air resistance
 - C. Low static pressure
 - D. Drainpipe freezing
300. An excess of acetylene in an oxy-acetylene flame will give a/an:
- A. Neutral flame
 - B. Carburizing flame
 - C. Oxidizing flame
 - D. Invisible flame
301. In order to reduce pressure to an acetylene pressure regulator, the adjusting screw is turned
- A. Clockwise to its limit
 - B. Counter-clockwise until the tension is off
 - C. Clockwise one half turn
 - D. Clockwise one full turn

302. The wall thickness of Type K copper tube is:
- A. Greater than that of Type L or Type M
 - B. Less than Type L but greater than Type M
 - C. Less than Type M but greater than Type L
 - D. Same as ACR hard tempered tube
303. Overheating a joint when brazing a wrought copper fitting causes
- A. The joint to swell
 - B. The flux to flame
 - C. The flux to change to a dry, chalky powder
 - D. Oxidation and distortion of the joint
304. Which action is incorrect when working with an oxy-acetylene?
- A. Never exceed 15 psi on the acetylene regulator
 - B. Use grease on the hose and regulator threading connections
 - C. Never open the acetylene cylinder valve more than 1/4 turns
 - D. Store oxygen cylinders away from combustibles
305. When in doubt, what should be installed at the bottom of a suction line riser?
- A. A check valve
 - B. A p-trap
 - C. A service port
 - D. Balancing valve
306. With reference to copper tube, what is meant by the letters ACR?
- A. Average construction rating tube
 - B. Air conditioning and refrigeration tube
 - C. Air and condensate return tube
 - D. Acid and corrosion resistant tube

307. Superheater tubes are protected from warping or burning out by:
- A. Circulating water around them
 - B. Circulating exhaust gas through them
 - C. Circulating steam through them
 - D. Circulating fresh air around them
308. To increase the life of furnace refractory, water-tube boilers are equipped with:
- A. Feedwater cooler
 - B. Waterwalls
 - C. Feedwater heaters
 - D. Desuperheaters
309. When steam is superheated its:
- A. Pressure and temperature are increased
 - B. Temperature is increased with no increase in pressure
 - C. Pressure is increased with no increase in temperature
 - D. Steam cannot be superheated
310. Air is eliminated from a sub-atmospheric system by a (n):
- A. Air vent
 - B. Vacuum pump
 - C. Air eliminator
 - D. Air scoop

311. The device that controls the steam pressure on the supply side of a sub-atmospheric steam heating system is a:
- A. Differential controller
 - B. Control valve
 - C. Control panel
 - D. Vacuum pump
312. In order to return condensate to a boiler, the height of the water column needed to overcome the pressure drop in a two-pipe gravity return system is:
- A. 28 inches
 - B. 2 to 4 inches
 - C. 15 to 18 inches
 - D. 28 inches for each pound of pressure the boiler is producing
313. The pump motor on a boiler feed pump is started when there is:
- A. A low water condition in the boiler
 - B. A high water condition in the boiler
 - C. Only removed from superheater tubes
 - D. Saved to make insulation
314. Soot should be:
- A. Removed from boiler tubes for better heat transfer
 - B. Left on the tubes to insulate them
 - C. Only removed from superheater tubes
 - D. Saved to make insulation

315. Thermostatic traps are opened and closed by a (n):
- A. Float
 - B. Inverted bucket
 - C. Electric sensor
 - D. Flexible bellows
316. In a float and thermostatic trap the float rises to discharge:
- A. Condensate
 - B. Air and steam
 - C. Air
 - D. Steam
317. Condensate in steam lines could result in:
- A. Water hammer
 - B. Priming
 - C. Foaming
 - D. Carryover
318. The type of traps normally used on steam radiators are:
- A. F&T traps
 - B. Disc traps
 - C. Inverted bucket traps
 - D. Thermostatic traps

319. Which of the following is the common cause of back pressure in a condensate return line?
- A. Faulty steam trap
 - B. Vacuum
 - C. Excessive steam pressure
 - D. Inadequate steam pressure
320. A vacuum breaker is used to avoid which of the following:
- A. Positive absolute pressure
 - B. Negative absolute pressure
 - C. Positive gauge pressure
 - D. Negative gauge pressure
321. System powered variable air volume systems:
- A. Require either electric or pneumatic volume damper actuators
 - B. Operate by the system duct air pressure
 - C. Are normally used in heating only applications
 - D. Regulate duct static pressure
322. The secondary water temperature of primary-secondary hydronic cooling system, supplied to induction coils or chilled beams is regulated to:
- A. Avoid over cooling of the controlled space
 - B. Promote moisture formation on cooling coils
 - C. Achieve maximum sensible cooling without latent cooling
 - D. Reduce chiller load
323. When used as terminal units, induction units with chilled water coils require:
- A. A small fan motor at each secondary water coil
 - B. A deeper than normal condensate pan under the chilled water coil
 - C. A source of dehumidified primary air
 - D. 6 row secondary chilled water coils

324. Fan coil units used with a two-pipe dual temperature system:
- A. Can provide both heating and cooling simultaneously
 - B. Require more water flow for heating than for cooling
 - C. Must be used with single speed fans
 - D. Require a changeover control to reverse the action of the fan coil thermostat
325. As a rule, the best general type of air diffuser to use in a variable air volume system is the:
- A. Side-wall grille
 - B. Ceiling diffuser
 - C. Slot diffuser
 - D. Air distribution ceiling
326. What is the maximum safe amperage draw of the secondary winding of a 40 VA transformer output of 24 volts?
- A. 0.60 amps
 - B. 1.67 amps
 - C. 960 amps
 - D. 0.84 amps
327. The purpose of a hot-gas bypass valve is too:
- A. Provide condenser reheat
 - B. Maintain condenser pressure
 - C. Maintain evaporator load
 - D. Defrost evaporator coil

328. If a refrigerant sight glass shows bubbles, you know:
- A. There is air in the system
 - B. There is gas in the liquid
 - C. The system has too much refrigerant
 - D. A restriction must be causing flash gas
329. A hermetic motor should never be energized or tested with a megohmmeter when in a deep vacuum because
- A. Electric arcs can contaminate refrigerant in the system
 - B. The motor could draw too much amperage
 - C. The vacuum pump could be damaged
 - D. The dielectric strength of the motor's insulation would be greatly reduced
330. In order to protect a load, safety limit devices are most often wired
- A. In parallel
 - B. In series
 - C. Upstream
 - D. Downstream
331. In a balanced three-phase system, the phase the voltage waveforms differ in phase by:
- A. 90 degrees
 - B. 120 degrees
 - C. Square root of 3
 - D. Zero degrees
332. Electrical pressure is measured in
- A. Amps
 - B. Ohms
 - C. Watts
 - D. Volts

333. A bellows is used:
- A. Only in pressure controllers
 - B. Only in temperature controllers
 - C. In both pressure and temperature controllers
 - D. Only with remote-bulb thermostats
334. Roller bearings are normally used with:
- A. Small light-duty motors
 - B. Small motors where there is a noise factor
 - C. Large motors operating with a heavy load
 - D. None of the above
335. The width of a drive belt is classified as:
- A. Large or small
 - B. Narrow or wide
 - C. A or B
 - D. 1 or 2
336. An instrument often used to check the alignment of two shafts is the:
- A. Micrometer
 - B. Dial indicator
 - C. Manometer
 - D. Sling psychrometer
337. A loose-fitting belt on a belt-driven device will cause:
- A. Bearing wear
 - B. Overheating motor
 - C. Pulley wobble
 - D. Worn pulley grooves

338. A flexible coupling between the drive and driven device:
- A. Corrects minor misalignment
 - B. Prevents liquid from entering the bearings
 - C. Reduces suction gas noise
 - D. Prevents airflow problems
339. If refrigerant is to be added to a system, the refrigerant cylinder is usually connected to the
- A. Center port of gauge manifold
 - B. Discharge service valve of the compressor
 - C. Left-handed port of the manifold gauge
 - D. Right-handed port of the manifold gauge
340. On centrifugal pumps, if it is ever necessary to reduce pump flow, do so by
- A. Throttling the discharge
 - B. Throttling the suction line
 - C. Both A and B
 - D. None of the above
341. Which of the following would happen if the vent port on a gas regulator is plugged?
- A. Outlet pressure will be reduced
 - B. Outlet pressure will increase
 - C. Inlet pressure will be reduced
 - D. Nothing, this is normal operation
342. Which of the following is NOT used to size gas regulators?
- A. Pipe size
 - B. Inlet pressure
 - C. Type of ignition system
 - D. Volume

343. Which of the following is the common cause of back pressure in a condensate return line?
- A. Faulty steam trap
 - B. Vacuum
 - C. Excessive steam pressure
 - D. Inadequate steam pressure
344. An evaporative cooling tower's bleed rate is adjusted to maintain
- A. The desired concentration of total dissolved solids
 - B. Return water temperature
 - C. The desired leaving water temperature
 - D. A water seal in the drain line trap
345. The run windings of a motor have _____ turns as compared to the start windings.
- A. Fewer
 - B. More
 - C. The same number
 - D. An infinite number of
346. On a typical split-phase electric motor the start winding circuit is de-energized as it reaches approximately _____ of its operating speed?
- A. 50%
 - B. 65%
 - C. 75%
 - D. 90%
347. What component wired in series with the start windings on a single-phase motor will create greater starting torque
- A. A capacitor
 - B. A transistor
 - C. A rectifier
 - D. A thermistor

348. A three-phase motor does not have
- A. Start windings
 - B. A start capacitor
 - C. A start relay
 - D. All of the above
349. A start component that is rated in microfarad would be a
- A. Capacitor
 - B. Thermistor
 - C. Transistor
 - D. Rectifier
350. What effect will a higher than rated supply voltage have on the current draw of an electric motor?
- A. It will be lower than it should be
 - B. It will remain the same
 - C. It will be higher than it should be
 - D. It will be erratic
351. With an electric motor running normally at full load the amperage reading would be called?
- A. Full-load amperage
 - B. Run-load amperage
 - C. Locked-rotor amperage
 - D. A or B
352. What device would be discharged using a 20,000-ohm, 5 watt resistor?
- A. Capacitor
 - B. Thermistor
 - C. Transistor
 - D. Rectifier

353. The run-load amperage on an electric motor is typically
- A. 1/2 that of the locked-rotor amperage
 - B. 1/6 that of the locked-rotor amperage
 - C. 1/5 that of a full-load amperage
 - D. 1/10 that of full-load amperage
354. What device is used to energize another load such as a contactor or motor starter which in turn would start or stop a motor?
- A. A switch
 - B. A circuit breaker
 - C. A line fuse
 - D. A pilot duty relay
355. A magnetic coil and electrical contacts are the primary components of this electrical device?
- A. A centrifugal switch
 - B. A circuit breaker
 - C. A thermal overload
 - D. A contactor
356. A magnetic coil, overload protector and electrical contactors are the primary components of this electrical device
- A. A circuit breaker
 - B. A thermal overload
 - C. A contactor or relay
 - D. A motor starter

357. An electric motor that has an internal overload would have a?
- A. Circuit breaker
 - B. A thermal device buried in the motor windings
 - C. Line fuse
 - D. None of the above
358. What device could be used as external protection for a motor?
- A. A line fuse
 - B. A circuit breaker
 - C. Magnetic overload
 - D. All of the above
359. If a technician uses an ohm meter to check the windings of an electric motor and records an infinite reading on the start windings this would indicate?
- A. The start winding is shorting to ground
 - B. The start winding is shorting to the run winding
 - C. The start winding is shorting to itself
 - D. The start winding has an open somewhere
360. What type of motor would a technician switch any two legs on to reverse the rotation of the motor?
- A. CSIR
 - B. CSCR
 - C. PSC
 - D. Three Phase
361. Induction motors obtain good starting and running torque from
- A. Start and run capacitors
 - B. Start windings
 - C. Shaded pole circuits
 - D. Three phase windings

362. Shaded-pole motors can most easily be identified by
- A. A small pole of thick copper wire
 - B. A start capacitor
 - C. A run capacitor
 - D. Both start and run capacitor
363. The primary application for shaded-pole motors would be
- A. When low start torque is required
 - B. When low run torque is required
 - C. When three phase power is not available
 - D. Both A and B
364. One of the most popular motors used in the HVAC industry with low starting torque but improved running is the _____ motor.
- A. Capacitor start capacitor run
 - B. Shaded pole
 - C. Capacitor-run
 - D. Three Phase

**UA STAR HVACR
PRACTICE QUESTIONS
ANSWERS
WITH EXPLANATIONS**

Practice Questions Answers with Explanations

1. The evaporator in a refrigeration system:

- A. Incorrect: Meters the refrigerant.
- B. Incorrect: Condenses the refrigerant.
- C. **Correct:** Is the component where refrigerant boils and absorbs heat.

The *evaporator* absorbs heat into the system. When the refrigerant is boiled at a lower temperature than that of the substance to be cooled, it absorbs heat from the substance.

HVACR Training Manual
Study Guide / Lab Manual
Unit 3 Refrigeration and Refrigerants
Review Test Question 4. Page 6.

HVACR Training Manual
Unit 3 Refrigeration and Refrigerants
3.7 The Evaporator. Page 31.

- D. Incorrect: Compresses the vaporized refrigerant.

PTS: 1

2. The purpose of the compressor is to change _____.

- A. Incorrect: Low-pressure, low-temperature liquid to a high-pressure, high temperature liquid
- B. Incorrect: High-pressure, high-temperature vapor to a low-pressure, low-temperature vapor
- C. **Correct:** Low-pressure, low-temperature vapor to a high-pressure, high-temperature vapor

The compressor can be considered a *vapor pump*. It reduces the pressure on the low-pressure side of the system, which includes the evaporator, and increases the pressure in the high-pressure side of the system. This creates refrigerant flow from the low-pressure side to the high-pressure side. All compressors in refrigeration systems perform this function by compressing the vapor refrigerant.

HVACR Training Manual
Instructor's Guide to Accompany the DVD Series Video #2
Refrigeration and Refrigerants **Post-Test**
Question 5. Page 10.

HVACR Training Manual
 Unit 3 Refrigeration and Refrigerants
 3.8 The Compressor. Page 32.

- D. **Incorrect:** High-pressure, high-temperature liquid to a low-pressure, low-temperature liquid

PTS: 1

3. A common refrigerant leak detection device is the:

- A. **Incorrect:** Micron gage.
 B. **Correct:** Halide torch.

Two refrigerant detection devices are commonly used: the halide torch and the electronic leak detector.

The halide torch cannot be calibrated, but it can be checked to make sure that it will detect leaks. It must be maintained to be reliable. It will detect a leak rate of about 7 oz. per year. The halide torch uses the primary airport to draw air into the burner through a flexible tube. If there is any chlorine-containing (CFC or HCFC) refrigerant in this air sample, it passes over a copper element, and the color of the flame changes from the typical blue of a gas flame to a green color. A large leak will extinguish the flame of the halide torch. The halide torch cannot be used with HFC refrigerants.

HVACR Training Manual
 Study Guide / Lab Manual
 Unit 11 Calibrating Instruments
 Review Test Question 11. Page 58.

HVACR Training Manual
 Unit 11 Calibrating Instruments
 11.6 Refrigerant Leak Detection Devices. Page 211.

- C. **Incorrect:** U-tube manometer.
 D. **Incorrect:** All of the above.

PTS: 1

4. Copper-plating of compressor parts is:

- A. **Incorrect:** Done at the factory to prevent rusting.
 B. **Correct:** Caused by contaminants in the system.

Copper Plating. Copper plating is the depositing of a layer of metallic copper on interior parts of a compressor, especially bearings, the plate on which the compressor valves are mounted, and other parts that may be subjected to high temperature. In severe cases of copper-plating, the copper deposit may build up to a thickness sufficient to interfere with proper operation of the compressor, and in extreme conditions may be a primary cause of compressor failure. There are two phases to the copper-plating process:

1. Copper is first dissolved into the refrigerant oil mixture.
2. Copper is then plated out on compressor parts.

Refrigeration Mechanical Equipment Service Manual Volume One
Chapter 5: Handling Refrigerants and Oil
Question 2. Page 53.

- C. Incorrect: Unlikely to happen unless the motor has a ground.
- D. Incorrect: Prevented by adding methanol to the system.

PTS: 1

5. If not properly installed, a hot-gas muffler might trap:

- A. Incorrect: Hot gas.
- B. Incorrect: Superheated vapor.
- C. Incorrect: Suction gas.
- D. Correct: Oil.

The muffler is installed in the discharge line as close as possible to the compressor. Due to their construction, mufflers usually form natural oil traps unless properly installed.

Refrigeration Mechanical Equipment Service Manual Volume One
Chapter 17: Refrigerant Piping Accessories
Question 9. Page 217.

PTS: 1

6. Unit ventilators are usually equipped with outside air dampers to:

- A. Partial Correct: Provide ventilation air during building occupancy
- B. Partial Correct: Comply with most local or state codes
- C. Incorrect: Provide free cooling in winter months
- D. **Correct:** Both A and B are correct

The unit ventilator has an outside air intake as well as a return air intake. One or more dampers in the outside air and return air passages are under automatic control to proportion the amount of each type of air admitted into the unit.

Although now available as a year-round air conditioner with cooling ability from mechanical refrigeration, the unit ventilator was originally intended to provide heating and ventilation. Its design is based on the principle that classrooms are rather densely populated areas and therefore:

1. Ventilation air is desirable at all times when the room is occupied and, in fact, may be required by state, local and provincial codes.

2. Heat generated by the occupants makes cooling desirable, even when outdoor temperature is fairly low, and at such times cooling can be accomplished by supplying an increased quantity of outdoor air.

Air Conditioning

Chapter 16: Air Conditioning Equipment Combinations

Review Exam I-72.

Question 16. Page 282.

PTS: 1

7. Face and bypass dampers should be adjusted to provide:

- A. Incorrect: A mixture of heated or cooled air at all times
- B. **Correct:** Tight shut off to reduce the possibility of overcooling or overheating

When installing face and bypass dampers, it is most important to assure they are properly adjusted so they will close tightly. Leakage of bypass dampers, when in closed position, can:

a. Seriously reduce the cooling capacity of the system.

b. Overheat the space if there is a heating coil in the bypass and it is in operation.

c. Cause overcooling, or a lack of heat during the heating season if the bypass contains a heating coil.

Air Conditioning

Chapter 16: Air Conditioning Equipment Combinations

Review Exam I-72.

Question 19. Page 293.

- C. Incorrect: The proper air volume at all load conditions
- D. Incorrect: A uniform air flow rate at low load conditions

PTS: 1

8. With belt driven equipment, alignment of the motor and driven equipment pulleys
- A. Incorrect: Is not critical, since the belts are flexible.
Misaligned pulleys will cause excessive wear on belts, pulleys and bearings.
 - B. **Correct:** Is accomplished using a string or straight edge.
A straight edge or string can be used to run from one pulley to the other. Alignment is complete when the string or straight edge touches both pulleys in two places at once.
 - C. Incorrect: Is accomplished when the belts are parallel to one another.
The belts will always be parallel to one another, even when the pulleys are not aligned.
 - D. Incorrect: Is accomplished using a dial indicator.
A dial indicator will not show misalignment between two pulleys.

PTS: 1

9. To assist consumers in making an informed choice when purchasing unitary air conditioning equipment, the efficiency of such units is expressed as Energy Efficiency Ratio (EER or SEER) the units of which are:
- A. Incorrect: Btuh/ampere
 - B. Incorrect: Btuh/volt
 - C. **Correct:** Btuh/watt

A way of expressing efficiency is by the *energy efficiency ratio*, (EER), which is defined as Btuh/watt or Btu/watt-hour, which is derived by dividing the cooling capacity in Btuh by the electric input in watts. Thus, a unit or unitary system having 78,000 Btuh cooling capacity and 11.3 kW input has an EER of 78,000 divided 11,300 or 6.9.

Air Conditioning

Chapter 16: Air Conditioning Equipment Combinations

Review Exam I-72.

Question 20. Page 295.

HVAC and Refrigeration Systems Training Manual
Unit 60. Page 1124

D. Incorrect: Btuh/hp

PTS: 1

10. Firestats located in the air stream of air handling units:

- A. Partially Correct: Are required in both the supply and return air streams
- B. Partially Correct: Should be the manual reset type
- C. Partially Correct: Should be nonadjustable
- D. **Correct:** All of the above

Central systems using return air are usually required to have a means for stopping the supply fan in the event of fire in the conditioned space.

This may be provided in small and medium-size systems by a safety high-limit thermostat, referred to as a firestat, which is placed in the return air duct. Upon sensing high temperature, it will trip and open an electrical circuit which stops the fan and thus avoids spreading the fire by way of the duct system. When tripped, the firestat requires manual reset.

Air Conditioning
Chapter 17: Automatic Controls
Review Exam I-73.
Question 1. Page 313.

PTS: 1

11. A sleeve bearing would typically be used in a motor that:

- A. **Correct:** Operates with a light load and where noise is a factor.

The sleeve bearing is used where the load is light and the noise must be low (e.g., a fan motor on a residential furnace).

HVACR Training Manual
Study Guide / Lab Manual
Unit 18 Application of Motors
Review Test Question 4. Page 109.

HVACR Training Manual
Unit 18 Application of Motors
18.5 Types of Bearings Page 351

- B. Incorrect: Operates with a heavy load and where noise is not a factor.

- C. Incorrect: Operates with a heavy load in a dirty atmosphere.
- D. Incorrect: Operates with a heavy load in a moist atmosphere.

PTS: 1

12. A bearing used on the bottom of a motor where the shaft is positioned vertically is called a _____ bearing.

- A. Incorrect: Sleeve
- B. Incorrect: Ball
- C. **Correct:** Thrust

The typical air-cooled condenser has a vertical motor shaft and is pushing the air out the top of the unit. This results in a downward thrust on the motor bearings. The vertical condenser fan is trying to fly downward into the unit to push air out the top. This puts a real load on the end of the bearing (*called the thrust surface*).

HVACR Training Manual
Study Guide / Lab Manual
Unit 18 Application of Motors
Review Test Question 5. Page 109.

HVACR Training Manual
Unit 18 Application of Motors
18.5 Types of Bearings Page 352.

- D. Incorrect: Bronze

PTS: 1

13. To produce electromagnetism, relative motion is required between a magnetic field and a/an:

- A. Incorrect: Switch
- B. **Correct:** Conductor

To produce electromagnetism, either the conductor moves through the field or the field is moved across the conductor. All that is really required is *relative motion* between a conductor and a magnetic field.

Gas Installations for United Association Journey workers & Apprentices
Chapter 6: Electrical Systems and Controls
Review Exam I-107.
Question 1. Page 188.

- C. Incorrect: Element

- D. Incorrect: Ground
- E. Incorrect: Insulator

PTS: 1

14. Materials which do not allow their electrons to spin out of orbit easily are called:

- A. Incorrect: Conductors
- B. Incorrect: Grounds
- C. **Correct:** Insulators

To produce electromagnetism, either the conductor moves through the field or the field is moved across the conductor. All that is really required is *relative motion* between a conductor and a magnetic field.

Gas Installations for United Association Journey workers & Apprentices
Chapter 6: Electrical Systems and Controls
Review Exam I-107.
Question 3. Page 189.

- D. Incorrect: Elements
- E. Incorrect: Magnets

PTS: 1

15. A battery is an example of a/an _____ source.

- A. Incorrect: Alternating current
- B. Incorrect: Series current
- C. Incorrect: Magnetic
- D. Incorrect: Parallel circuit
- E. **Correct:** Direct current

Direct current flows constantly in one direction. A battery is one source of direct current. It will always have two poles or terminals, one negative (-) and one positive (+). The electron flow is from positive to negative inside the battery. However, the external flow for the electrical circuits is always negative to positive. The electrons flow in only one direction. Direct current will continue to flow until the circuit is broken or the source of energy stops supplying electrons.

Gas Installations for United Association Journey workers & Apprentices
Chapter 6: Electrical Systems and Controls
Review Exam I-107.
Question 4. Page 190.

PTS: 1

16. “Current flowing through a conductor in one direction for a split second, then in the opposite direction for a split second” would be a good definition of:

A. **Correct:** Alternating current

Alternating current is defined as *current flowing through a conductor in one direction for a split second, then in the opposite direction for a split second.*

Gas Installations for United Association Journey workers & Apprentices
Chapter 6: Electrical Systems and Controls
Review Exam I-108.
Question 5. Page 192.

B. Incorrect: Direct current

C. Incorrect: Voltage

D. Incorrect: Resistance

E. Incorrect: Wattage

PTS: 1

17. If a pressure gauge reads five psig at sea level elevation, the corresponding absolute pressure is _____ psia.

ANS:

19.7

$5.0 \text{ psig} + 14.7 = 19.7 \text{ psia.}$

PTS: 1

18. Solar _____ is the amount of solar thermal energy produced divided by the water heating energy demand of the building.

A. **Correct:** Fractional

Solar Water Heating Systems
pg. 20

B. Incorrect: Ratio

C. Incorrect: Cost

D. Incorrect: Efficiency

PTS: 1

19. The portion of the electromagnetic spectrum to which solar collectors respond is _____ and near-infrared radiation.

- A. Incorrect: Gamma rays
- B. Incorrect: Microwaves
- C. Incorrect: Ultra violet light
- D. **Correct:** Visible light

Solar Water Heating Systems

Pg. 24

PTS: 1

20. During winter, _____.

- A. **Correct:** Daylight is shorter and the Northern Hemisphere is angled away from the sun
- B. Incorrect: Daylight is shorter and the Northern Hemisphere is angled toward from the sun
- C. Incorrect: Daylight is longer and the Northern Hemisphere is angled away from the sun
- D. Incorrect: Daylight is longer and the Northern Hemisphere is angled toward the sun

PTS: 1

21. Unless equipped with OSHA or Canadian Standards Association (CSA) approved ground-fault circuit interrupters, portable electric lighting used in wet and-or other conductive locations as, for example, drums, tanks and vessels, shall be operated at _____ volts or less.

- A. **Correct:** 12
- B. Incorrect: 24
24 volts is not acceptable.
- C. Incorrect: 120

Unless equipped with approved ground-fault circuit interrupters, 120 volt lighting is not acceptable.

D. Incorrect: None of the above

PTS: 1

22. Receivers are usually required in systems having:

A. Incorrect: Cooling towers

B. **Correct:** Evaporative condensers

Evaporative condensers and air-cooled condensers, being constructed with coiled tubing, contain very little storage space for refrigerant, and therefore systems with such condensers will generally require a receiver. (Water-cooled condensers of shell-and-tube type normally have enough volume to serve as receivers, and a separate or auxiliary receiver in this case is not needed unless the system is unusually extensive.)

Refrigeration Mechanical Equipment Service Manual Volume One
Chapter 17: Refrigerant Piping Accessories
Question 1. Page 218.

C. Incorrect: Shell-and-tube condensers

D. Incorrect: Pump-down control

PTS: 1

23. An important feature of a refrigerant receiver, in the case where the liquid line to the evaporator comes out of the top of the receiver, is a:

A. Incorrect: Gage glass

B. Incorrect: Drain valve

C. Incorrect: Liquid level test cock

D. **Correct:** Dip tube

Where liquid leaving the receiver flows vertically upward out of the receiver, an integral dip tube is an important feature of the receiver.

The dip tube, connected to the receiver outlet, extends to about one-half inch from the bottom of the receiver. Its purpose is to ensure that only liquid enters the line leaving the receiver, preventing any vapor from entering the liquid line. If replacing or re-installing a receiver, it is essential to determine which connection has the dip tube. A receiver may not contain an integral dip tube, and so it may have to be provided in the field. The bottom end of the dip tube should not be made with a square cut; it should be cut-off at an angle of approximately 45 degrees. For this purpose, a *receiver valve*, can be used.

The above considerations of the dip tube apply only to receivers where the liquid outlet is on the top of the receiver. If a receiver outlet is on the bottom of the receiver so that refrigerant can flow out by gravity, no special provision is needed to assure the liquid line being free of vapor; in such case, the dip tube must of course be omitted or only vapor would enter the liquid line.

Refrigeration Mechanical Equipment Service Manual Volume One
Chapter 17: Refrigerant Piping Accessories
Question 2. Pages 218 and 219.

PTS: 1

24. A pressure regulator is constructed so that a rise in _____ steam pressure reduces off the inlet flow of supply steam.
- A. Incorrect: Barometric
 - B. Incorrect: Inlet
 - C. **Correct:** Downstream

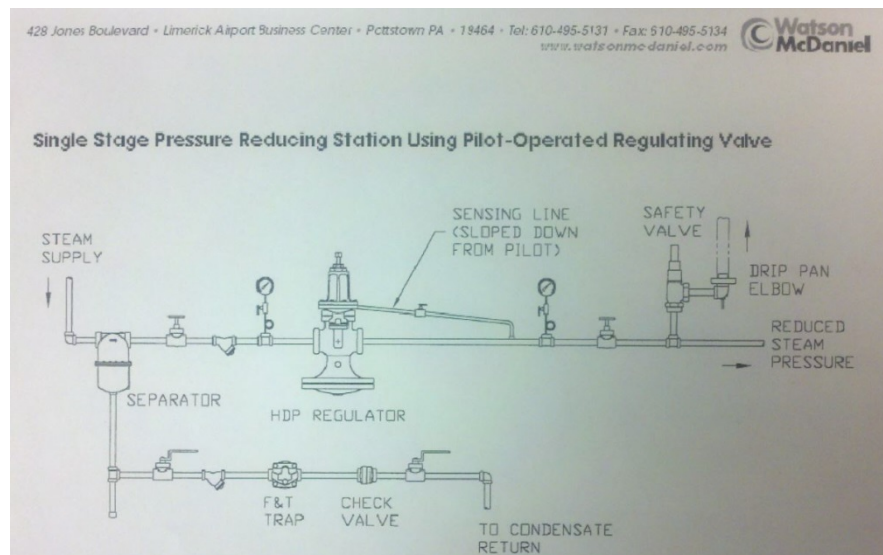

- D. Incorrect: Upstream

PTS: 1

25. A vacuum breaker is used to avoid which of the following:
- A. Incorrect: Positive absolute pressure
 - B. Incorrect: Negative absolute pressure
 - C. Incorrect: Positive gauge pressure
 - D. **Correct:** Negative gauge pressure

A vacuum breaker is designed to prevent the pressure in the condensate return from dropping too low. If system pressure drops below 15 in. Hg, the breaker opens and lets air into the system. Since the pump draws from a tank that is vented to the atmosphere (to allow air to escape), it will typically see atmospheric pressure at the inlet and will be unaffected by system pressure.

Steam Systems

Chapter 6: Vacuum Steam Heating Systems

Question 3. Page 67.

Steam Systems Review Exam Question 23. Page I-39.

PTS: 1

26. Lock-out relays are used in air conditioning systems to:

- A. Incorrect: Provide automatic restart
- B. **Correct:** Prevent compressor short-cycling

A lock-out relay is an electrically-operated control relay applied in such a way that it can “lockout” a circuit, or cause it to remain de-energized when once interrupted, as by some malfunction such as the tripping of a safety device.

Lock-out relays may be either of two types: the normally-open type having a coil and a set of normally-open contacts, or the normally-closed type having a coil and a set of normally-closed contacts.

Electric Controls for Mechanical Equipment Service

Chapter 11: Push-Buttons and Relay Applications/Control Action of Magnetic Starters

Question 3. Page 106.

- C. Incorrect: Lock-out the thermostat
- D. Incorrect: Lock-out the overloads

PTS: 1

27. When measuring the winding resistance of a split-phase compressor motor, the smallest value will be measured between the:

- A. **Correct:** The run terminal and the common terminal

A common type motor in fractional horsepower sizes is the *split-phase* induction motor, widely used in household refrigerators and small air conditioners.

This type of motor has two windings; the main or running winding, and an auxiliary or starting winding. **The running winding, located in the bottom of the stator slots, is made of many turns of relatively heavy wire; it therefore has little resistance but high inductance.** The starting winding located at the top of the stator slots, has fewer turns of smaller wire, and so has higher resistance but less inductance. Inductance of the windings causes their current to lag the voltage, and since the running winding has more inductance than the starting winding, its current and magnetic forces reach their peaks later in each AC cycle than do the current and magnetic forces of the starting winding.

Electric Controls for Mechanical Equipment Service
Chapter 10: Capacitors and Single-Phase Motors
Question 2. Pages 89 and 90.

HVAC and Refrigeration Systems
Unit 13. Pages 239-240.

- B. Incorrect: The common terminal and the metal frame of the compressor
- C. Incorrect: The start terminal and the common terminal
- D. Incorrect: The run and start windings

PTS: 1

28. Cavitation in a pump pumping hot water:

- A. Partial Correct: Makes a pump noisy
- B. Partial Correct: Is the result of water boiling into the steam
- C. Partial Correct: Is the result of insufficient NPSH
- D. **Correct:** All of the above

Cavitation is a result of the insufficient available net positive suction head (NPSH) that causes low pressures, such that some of the pumped liquid flashes into vapor and forms bubbles. These bubbles are carried with the liquid as it goes through the pump, until they reach a region of higher pressure within the pump. Within this region, the bubbles collapse with a severe shock on the adjacent surface. This is called *cavitation*, and is accompanied by **noises**; vibration may also occur. The result is mechanical destruction of the pump in the form of pitting and erosion.

Start, Test and Balance
Chapter 18: Centrifugal Pumps
Question 4. Page 215.

PTS: 1

29. The amount of heat removed to lower the temperature of 15 lbs. of water from 48 degrees F to 39 degrees F is:

- A. Incorrect: 0.0113
- B. **Correct:** 135 Btu.

$$\begin{aligned} \text{Heat} &= \text{Weight (lbs.)} \times \text{Specific Heat (Btu/lb. per degree F)} \times \text{Temperature} \\ &\text{(degrees F)} \\ &= 15 \times 1 \times (48-39) \text{ degrees F} \\ &= 15 \times 1 \times 9 \\ &= 135 \text{ Btu} \end{aligned}$$

Refrigeration Mechanical Equipment Service Manual Volume One
Chapter 1: Basic Physical Principles
Question 1. Pages 1 and 2.

HVAC and Refrigeration Systems
Unit 6. Page 119

- C. Incorrect: 970 Btu/lb.
- D. Incorrect: 135 Btu/lb.

PTS: 1

30. Atmospheric pressure at sea level is:

- A. Incorrect: 0 psi
- B. **Correct:** 14.7 psi

A column of this atmosphere one inch square and extending from sea level up to its maximum height (taken to be about 600 miles) weighs 14.7 pounds. Thus, the pressure at sea level is 14.7 psi.

Refrigeration Mechanical Equipment Service Manual Volume One
Chapter 1: Basic Physical Principles
Pages 6 and 7.

HVAC and Refrigeration Systems
Unit 6 Page 122

- C. Incorrect: 32 psi
- D. Incorrect: 212 psi

PTS: 1

31. A dual-element fuse has:

- A. Incorrect: Two normal one-time fuse links
- B. Incorrect: A thermal cutout only
- C. **Correct:** A thermal cutout and a normal fuse link

A dual-element fuse has a normal fuse link which will blow on a short circuit or very heavy overload.

The second element in a dual-element fuse is a thermal cutout containing a connection that is held in place by low melting point solder.

Electric Controls for Mechanical Equipment Service
Chapter 6: Electrical Diagrams, Fuses and Control Circuits
Question 1. Page 54.

- D. Incorrect: The ability to carry locked-rotor current of a motor but not to protect against short circuits.

PTS: 1

32. A single-phase motor in which the run capacitor remains connected when the motor runs is called a:

- A. Incorrect: Capacitor-start induction-run motor
- B. **Correct:** Permanent-split capacitor motor

Permanent-split capacitor motor. Some capacitor motors are constructed in the same manner as capacitor start motors except that they have no starting switch or relay; the capacitor and the starting winding are always connected.

Electric Controls for Mechanical Equipment Service
Chapter 10: Capacitors and Single-Phase Motors
Question 1. Page 91.

- C. Incorrect: Split-phase motor
- D. Incorrect: Capacitor-start capacitor-run motor

PTS: 1

33. Refrigerant leaves the compressor through the _____ line.

- A. Incorrect: Suction
- B. Incorrect: Expansion
- C. **Correct:** Discharge

Refer to the Basic Refrigeration System Cycle.

HVACR Training Manual
Instructor's Guide to Accompany the DVD Series Video #2
Refrigeration and Refrigerants **Post-Test**
Question 6. Page 10.

HVAC and Refrigeration Systems
Unit 32

D. Incorrect: Liquid

PTS: 1



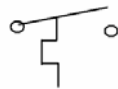





34. The symbol below would be used to indicate a _____ switch.

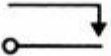

A. Incorrect: Pressure-actuated

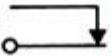
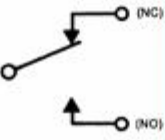
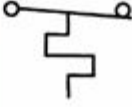
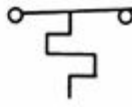
B. **Correct:** Temperature-actuated

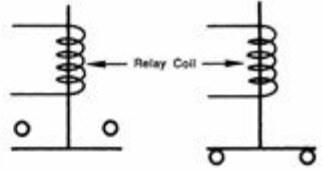
Table 1: Electrical Symbols (continued)

CONTACTS		PRESSURE ACTUATED	
GENERAL DESIGNATIONS:	Normally Open NO Normally Closed NC		
Normally Open (NO)	 or 		
		NO (Closes on Pressure Rise)	NC (Opens on Pressure Rise)
Normally Closed (NC)	 or 	TEMPERATURE ACTUATED	
SPDT Switching Action			
		NO (Closes on Temperature Rise)	NC (Opens on Temperature Rise)
TIME ACTUATED		RELAY CONTACTS	
Normally Open Timed Closed	 TC		
Normally Closed Timed Open	 TO	NO	NC

When Reading a Symbol off of a wiring diagram it is assumed that it is drawn in its de-energized state (no power applied). Temperature switches are drawn relative to a rise or fall in temperature. Switches above the points indicate a make or closure on temperature fall. Switches Below indicate a make or closure on a temperature rise.

HVAC and Refrigeration Systems Unit 11

- C. Incorrect: Spring loaded
- D. Incorrect: Flow

PTS: 1

35. A refrigeration system has a hand-operated needle valve for the refrigerant expansion device. If refrigeration load and suction pressure remain constant, a decrease in condensing temperature will:

- A. Incorrect: Result in greater refrigerant flow.
- B. **Correct:** Result in reduced refrigerant flow unless the valve is opened.

Hand Valve

A simple type of expansion device which can provide an orifice of variable size is a hand-operated valve. These were popular in ice plants that used ammonia. Their use was acceptable because of various reasons including the fact that there were always personnel available to adjust the valve, and plant efficiency was not very critical. **The disadvantage of manually operated valves is their inability to automatically adjust the flow rate of refrigerant to suit the load and other operating conditions.**

Refrigeration Mechanical Equipment Service Manual Volume One
Chapter 14: Refrigerant Expansion Devices
Question 1. Page 180.

- C. Incorrect: Increase available pressure difference.
- D. Incorrect: Be automatically compensated for.

PTS: 1

36. A full voltage starter has:

- A. **Correct:** One contactor.

Reduced Voltage Starting

An “across-the-line” starter also known as a “full-voltage” starter, means that when the contactor closes, the motor is immediately connected directly to the power supply lines, and full voltage is at once impressed on the motor. This is the least expensive way to start a three-phase motor. However, this means that the motor will draw locked-rotor current until it starts turning. Although this is not of any consequence with most motors, the starting inrush current of large horsepower motors may cause the power system voltage to dip, resulting in flickering of lights and other objectionable effects on other electrical devices such as computers or television apparatus.

Refrigeration Mechanical Equipment Service Manual Volume One
Chapter 24: Motor Controllers
Question 3. Page 315.

- B. Incorrect: Two contactors.
- C. Incorrect: Two contactors and a time delay relay.
- D. Incorrect: Resistors in the starting circuit.

PTS: 1

37. The voltage rating of motor controller holding coils is:

- A. Incorrect: Always the same as the motor supply voltage
- B. Incorrect: Always less than the motor supply voltage
- C. **Correct:** Not necessarily the same as the motor supply voltage

An example of this would be in a high-voltage system (460 volts or higher) where a lower control voltage would be desirable for safety reasons or because some required control devices (such as thermostats, etc.) may not be available in higher voltage ratings. Another example would be where automatic control system is of low-voltage type, such as 24 volts. In such cases, the holding coils are obtainable in the lower voltage ratings desired.

Electric Controls for Mechanical Equipment Service
Chapter 8: Application of Motor Controllers
Question 1. Page 69.

- D. Incorrect: Not important if the control circuit is isolated

PTS: 1

38. A lock-out relay should drop out when:

- A. Incorrect: The thermostat is satisfied
- B. Incorrect: The compressor contactor opens
- C. Incorrect: The compressor short-cycles
- D. **Correct:** An overload relay opens

A lock-out relay is an electrically-operated control relay applied in such a way that it can "lockout" a circuit, or cause it to remain de-energized when once interrupted, as by some malfunction such as the tripping of a safety device.

Electric Controls for Mechanical Equipment Service
Chapter 11: Push-Buttons and Relay Applications/Control Action of
Magnetic Starters
Question 4. Page 106.

PTS: 1

39. In starting up a chilled water system, the first piece of equipment to start should be the:

- A. Incorrect: Compressor oil pump
- B. Incorrect: Compressor if it has a built-in oil pump
- C. **Correct:** Chilled water pump

The chilled-water pump is manually started by pushing the start button. When the chilled-water pump is running, an auxiliary contact in its starter completes the circuit. If in the "continuous" position, the condenser-water pump will run whenever the chilled-water pump runs; if in the "automatic" position, the condenser-water pump will run on calls for cooling. The cooling-tower fan can be run at any time for test purposes by putting the control switch in "manual" position. For normal operation in "automatic" position, the cooling-tower fan can run on calls for cooling when the condenser pump is in operation. The interlock is accomplished through an auxiliary contact in the condenser-water pump starter which, upon closing, feeds control power to terminals in the machine control panel. The presence of control voltage at the terminals in the control panel also permits the lubricating oil pump to start, and when oil pressure has built up to normal, the compressor can start.

Electric Controls for Mechanical Equipment Service
Chapter 19: Control of Refrigeration Machinery and Water Piping Systems
Question 4. Pages 193 and 194.

- D. Incorrect: Condenser water pump

PTS: 1

40. In a gas-fired warm air furnace, the furnace fan should:

- A. Incorrect: Be controlled by the room thermostat
- B. **Correct:** Be controlled by furnace bonnet temperature

Bonnet temperature is sensed by the combination fan and limit control. As the bonnet warms up, the operating control switch will close, and start the fan. The main purpose of this control method is to keep the fan off until warm air is available, so that cold air will not be blown into the heated spaces.

Electric Controls for Mechanical Equipment Service
Chapter 17: Primary Source and Secondary Temperature Control
Question 5. Pages 176 and 177.

- C. Incorrect: Start at the same time that the burner comes on

D. Incorrect: Stop immediately if the high-limit safety control opens

PTS: 1

41. A damper that must throttle air flow should have:

A. **Correct:** Opposed blade operation

Where throttling is required, a damper having *opposed operation* should be used. In this type of damper, adjacent blades rotate in opposite directions, resulting in a series of slots that become increasingly narrow as the damper closes.

Electric Controls for Mechanical Equipment Service
Chapter 16: Valves and Dampers
Question 5. Page 162.

B. Incorrect: Parallel blade operation

C. Incorrect: Face and bypass damper action

D. Incorrect: Constant volume control

PTS: 1

42. A pressure regulator is constructed so that a rise in _____ steam pressure reduces off the inlet flow of supply steam.

A. Incorrect: Barometric

B. Incorrect: Inlet

C. **Correct:** Downstream

D. Incorrect: Upstream

PTS: 1

43. A vacuum breaker is used to avoid which of the following:

A. Incorrect: Positive absolute pressure

B. Incorrect: Negative absolute pressure

C. Incorrect: Positive gauge pressure

D. **Correct:** Negative gauge pressure

A vacuum breaker is designed to prevent the pressure in the condensate return from dropping too low. If system pressure drops below 15 in.Hg, the breaker opens and lets air into the system. Since the pump draws from a tank that is vented to the atmosphere (to allow air to escape), it will typically see atmospheric pressure at the inlet and will be unaffected by system pressure.

Steam Systems

Chapter 6: Vacuum Steam Heating Systems

Question 3. Page 67.

Steam Systems Review Exam Question 23. Page I-39.

PTS: 1

44. If the R value on a section of insulation is 8, what would the value be when saturated with water?

A. **Correct:** 0

The R value of the insulation when it is saturated with water has no insulation value.

Example: Steam or hot or cold insulated water line saturated with water.

B. Incorrect: 4

C. Incorrect: 8

D. Incorrect: 12

PTS: 1

45. In a RTD (resistance type device), as temperature increases, resistance will:

A. **Correct:** Increase linearly

The three main classifications of temperature sensors are: RTD (resistive temperature device), thermistor, and thermocouple.

- RTD's generally increase resistance linearly as temperatures rises (positive temperature coefficient).
- Thermistors devices generally decrease resistance as temperature increases and are less linear then RTD's.
- Thermocouples create a voltage proportional to temperature change. They are constructed using two conductors made from dissimilar metals that are connected at one end. This junction point forms the tip of the temperature probe. Thermocouples are highly versatile and can be adapted for use in many applications.

B. Incorrect: Decrease linearly

- C. Incorrect: Increase exponentially
- D. Incorrect: Decrease logarithmically

PTS: 1

46. Why is a surge suppressor used on a contactor coil?

- A. **Correct:** To prevent damage to the control circuit

What is a Surge Protector?

A device that shields computer and other electronic devices from surges in electrical power, or transient voltage that flow from the power supply. Standard American voltage for home and office buildings is 120 volts. Anything over this amount is considered transient and can damage electronic devices that are plugged into an outlet. Even though power surges are so brief that they are measured in nanoseconds, they can cause considerable damage to electronic equipment.

http://www.webopedia.com/TERM/S/surge_protector.html

HVAC and Refrigeration Systems
Unit 11. Pages 204-206.

- B. Incorrect: To smooth circuit wave forms
- C. Incorrect: To prevent damage when contacts close
- D. Incorrect: For a faster and smoother start

PTS: 1

47. A minimum evacuation level for an air conditioning system is:

- A. Incorrect: 5,000 microns.
- B. Incorrect: 1,000 microns.
- C. **Correct:** 500 microns.

A vacuum pump capable of removing the atmosphere down to a very low vacuum is necessary. The vacuum pumps usually used in the refrigeration field are manufactured with rotary compressors. The pumps that produce the lowest vacuums are two-stage rotary vacuum pumps. These vacuum pumps are capable of reducing the pressure in a leak-free vessel down to 0.1 micron. It is not practical to pull a vacuum this low in a field-installed system because the refrigerant oil in the system will boil slightly and create vapor. **The usual vacuum required by manufacturers is approximately 500 microns**, although some may require a vacuum as low as 250 microns.

Pulling a vacuum to a level of 500 microns will insure that all non-condensable have been removed from the system. This will insure that the system will not operate at a high head pressure or to be prone to acid formation.

HVACR Training Manual
Unit 8 System Evacuation
8.10 The Vacuum Pump
Page 144.

D. Incorrect: 100 microns.

PTS: 1

48. One horsepower is the same as

- A. Incorrect: Watts
- B. Incorrect: 3,143 watts
- C. **Correct: 746 watts**

Power and Energy

Power means a rate of doing work. A common unit of mechanical power is the horsepower. For example, a ten-horsepower motor can do mechanical work, be it hoisting an elevator or turning the shaft of a compressor, at a faster rate than can a one-horsepower motor. The unit of power in the electrical circuit is the *watt*. It is equal to the voltage multiplied by the current.

The formula is: Power = Voltage X Current or Watts = Volts X Amperes

A common unit of electrical power is the *kilowatt* which is 1000 watts.

Electrical power may be converted into mechanical power in an electric motor, or it may simply be turned into heat in a resistance. Equivalents are as follows:

One kilowatt (KW) = 1.34 horsepower

One watt = 3.413 Btu per hour

One horsepower is 746 watts

Energy is the amount of work done or explained. It is the product of the rate of doing work multiplied by a length of time during which work is done. The watt is the rate at which work is done electrically. The common unit of electrical energy is the watt-hour, this being a measure of the electrical energy consumed in one hour.

Refrigeration Mechanical Equipment Service Manual Volume One

Chapter 21: Electrical Fundamentals
Page 270.

D. Incorrect: 1,000 watts

PTS: 1

49. One watt is equivalent to

A. **Correct:** 3.413 Btu

Power and Energy

Power means a rate of doing work. A common unit of mechanical power is the horsepower. For example, a ten-horsepower motor can do mechanical work, be it hoisting an elevator or turning the shaft of a compressor, at a faster rate than can a one-horsepower motor. The unit of power in the electrical circuit is the *watt*. It is equal to the voltage multiplied by the current.

The formula is: Power = Voltage X Current or Watts = Volts X Amperes

A common unit of electrical power is the *kilowatt* which is 1000 watts.

Electrical power may be converted into mechanical power in an electric motor, or it may simply be turned into heat in a resistance. Equivalents are as follows:

One kilowatt (KW) = 1.34 horsepower

One watt = 3.413 Btu per hour

One horsepower is 746 watts

Energy is the amount of work done or explained. It is the product of the rate of doing work multiplied by a length of time during which work is done. The watt is the rate at which work is done electrically. The common unit of electrical energy is the watt-hour, this being a measure of the electrical energy consumed in one hour.

Refrigeration Mechanical Equipment Service Manual Volume One
Chapter 21: Electrical Fundamentals
Page 270.

B. Incorrect: 3,413 Btu

C. Incorrect: 746 Btu

D. Incorrect: 1,000 Btu

PTS: 1

50. One kilowatt is equivalent to

- A. Incorrect: 100.0 watts
- B. Incorrect: 3,413 watts
- C. **Correct:** 1,000 watts

Power and Energy

Power means a rate of doing work. A common unit of mechanical power is the horsepower. For example, a ten-horsepower motor can do mechanical work, be it hoisting an elevator or turning the shaft of a compressor, at a faster rate than can a one-horsepower motor. The unit of power in the electrical circuit is the *watt*. It is equal to the voltage multiplied by the current.

The formula is: Power = Voltage X Current or Watts = Volts X Amperes

A common unit of electrical power is the *kilowatt* which is 1000 watts.

Electrical power may be converted into mechanical power in an electric motor, or it may simply be turned into heat in a resistance. Equivalents are as follows:

One kilowatt (KW) = 1.34 horsepower

One watt = 3.413 Btu per hour

One horsepower is 746 watts

Energy is the amount of work done or explained. It is the product of the rate of doing work multiplied by a length of time during which work is done. The watt is the rate at which work is done electrically. The common unit of electrical energy is the watt-hour, this being a measure of the electrical energy consumed in one hour.

Refrigeration Mechanical Equipment Service Manual Volume One
Chapter 21: Electrical Fundamentals
Page 270.

- D. Incorrect: 746 watts

PTS: 1

51. The purpose of the external equalizer line used with a thermostatic expansion valve is to compensate for:

- A. Incorrect: Air friction over the evaporator
- B. Incorrect: Refrigerant pressure drop across the valve orifice

- C. **Correct:** Refrigerant friction through the evaporator

The External Equalizer

Superheat is abnormally high and serious loss of evaporator capacity results if the evaporator has any appreciable pressure drop. You might feel that you could compensate for the evaporator pressure by simply adjusting the valve, but this will not give the correct answer because the evaporator pressure drop varies. This pressure drop is due to friction developed when the refrigerant flows through the evaporator, just as friction is developed when a fluid flows through an ordinary pipe. Pressure drop at partial loads will be considerably less than at full load because of the smaller amount of refrigerant flowing at the lighter loads.

The variable evaporator pressure drop is corrected for by sensing evaporator pressure, not at the evaporator or valve inlet, but at the evaporator outlet. This is done with a connecting tube called an *external equalizer line*, and is connected to a suitable fitting on the expansion valve. Such a fitting on an expansion valve should never be capped or plugged. If the valve has an external equalizer connection, an external equalizer line must be installed. The line should be connected to the suction line as close as practical to the bulb; specially, there should be no elbows, or other fittings which increase flow friction, between the equalizer line connection and the bulb. The purpose of the external equalizer line is to be able to sense suction pressure at the point where the bulb is located. In this respect, you should consider that it is possible for some liquid refrigerant to flow from the valve, through the equalizer line into the suction line. Since any liquid will vaporize at that point, the resulting cooling effect could influence the temperature sensed by the bulb. To avoid this, the equalizer line should connect to the suction line at a point a little downstream from the bulb.

Refrigeration Mechanical Equipment Service Manual Volume One
Chapter 15: Application of the Thermostatic Expansion Valve
Question 3. Pages 195 and 196.

- D. **Incorrect:** Superheat

PTS: 1

52. Cleaning refrigerants to ARI 700 standards is called:

- A. **Incorrect:** Recovery
B. **Correct:** Reclaiming

Reclaim

The definition of **Reclaim** is to reprocess refrigerant to new product specifications by means which may include distillation. It will require chemical analysis of the refrigerant to determine that appropriate product specifications are met. This term usually implies the use of processes or procedures available only at a reprocessing or manufacturing facility.

Reclamation is required when the contamination of refrigerant is so severe that it does not meet industry standards. Offsite facilities can provide certification for reclaimed refrigerant and will meet the minimum standards required of ARI 700. The reclaim agent should provide information and cylinders to properly remove contaminated refrigerant from the system. They should also provide all pertinent information to ensure that the transfer and shipment of refrigerant meets all local, state and federal regulations. The EPA regulation prohibits the sale of CFCs and HCFCs that do not meet the minimum standards of ARI 700. Refrigerant transferred between owners must be reclaimed.

Conservation and Safe Handling of Refrigerants
Definitions of Recovery, Recycle and Reclaim
Page 17.

- C. Incorrect: Recycling
- D. Incorrect: Reusing

PTS: 1

53. The unit of measure for the specific volume of air is:

- A. Incorrect: BTU / LB
- B. Incorrect: LBS/BTU
- C. Incorrect: LBS/FT³
- D. **Correct:** FT³/LB

An important concern of air conditioning systems is the quantity of heat that a system can add or remove.

The quantity of heat transferred depends on three factors: the flow rate of the medium, its specific heat, and the temperature difference. Note that flow rate is based on lb. /hr., or the *weight* of air flowing in a given time. However, the design of duct and fan systems is based on volume (cfm) rather than weight, since ducts and fans must be of proper size to handle the necessary air volumes without objectionable results such as excessive pressure, velocity or noise.

Also, the systems and equipment should be tested for proper flow. It is more readily possible to measure air-flow rates by volume than by weight. However, the volume occupied by a given weight of air changes whenever there is a change in its temperature or pressure. In order to eliminate numerous calculations as well as avoid confusion which these variables could cause, it is desirable to have a fixed reference point for such things as duct-design data, and for ratings of equipment such as air diffusers, fans, coils, filters, and other air treating apparatus. **Such a reference point is standard air which is defined as dry air at pressure of 29.92 in.Hg (101.325 kPa) at exactly 68 degrees (20 degrees C) temperature. At these conditions, the density is 0.075 lb. /ft.3 (1.204 kg/m3). Based on this definition of standard air, the volume occupied by one pound of standard air is equal to 1 / 0.075, or 13.33 ft3.**

Air Conditioning Mechanical Equipment Service Manual
 Chapter 3: Properties of Air
 Chapters 1 Through 4
 Review Exam Question 15. I-58
 Page 33.

PTS: 1

54. The amount of heat removed by evaporating one pound of water in an evaporative cooling tower is approximately:
- A. Incorrect: 1 btu
 - B. Incorrect: 5 btu
 - C. Incorrect: 100 btu
 - D. **Correct:** 1000 btu

Performance and Water Usage

Once-through systems typically require a water flow rate of about 1.5 gpm per ton, whereas recirculated systems such as those with cooling towers require three gpm per ton.

In the once-through system, heat extraction depends entirely upon sensible heat gain of the water. Based on a 20-degree rise in water temperature there is a pick-up of 20 Btu per pound of water after which the water is disposed of.

In the recirculated system using evaporative cooling, it takes approximately 1000 Btu to evaporate a pound of water. For every pound of water evaporated, the removal will be 1000 Btu instead of only 20 Btu as in the once-through system. Therefore, one pound of water in a cooling tower system theoretically does as much work in removing heat as does 50 pounds of water in a once-through system. The cooling tower system uses only two percent of the water required for a once-through system. In actual practice, this amounts to about five percent due to evaporation, drift, and some intentional waste.

Refrigeration Mechanical Equipment Service Manual Volume One
Chapter 12: Water supply For Water-Cooled Condensers
Question 9. Pages 159 and 160.

PTS: 1

55. Which of the four lifting sling configurations shown below creates the greatest amount of load strain on the sling?

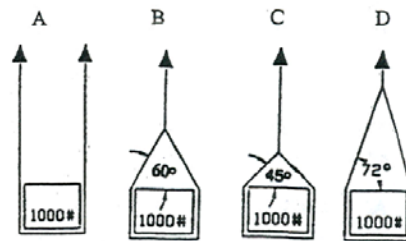

- A. Incorrect: A
B. Incorrect: B
C. **Correct: C**

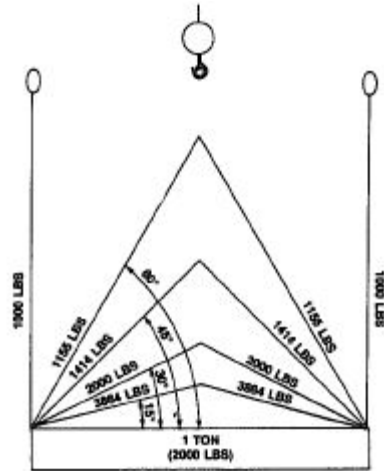

The sling angle determines the sling load

Fig. 2-22

When looking at the chart you will see that as the angle lessens the strain on the sling of the basket increase. The straighter the Basket the less strain.

D. Incorrect: D

PTS: 1

56. The components marked "B" would be called the

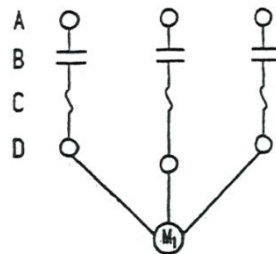

- A. Incorrect: Capacitors
- B. Incorrect: N.O. push buttons
- C. **Correct:** Motor contacts

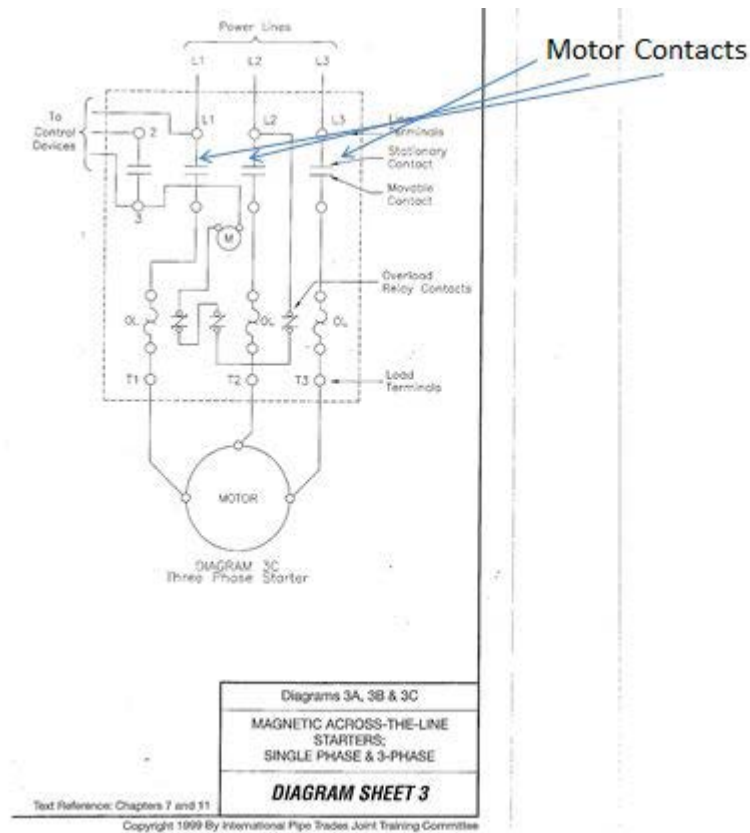

A typical across the line starter has a set of contacts rated for the load in which is going to be operated. These Contacts are represented by a moving set and a stationary set within the device.

D. Incorrect: Overload contacts

PTS: 1

57. Which of the following plans are typically NOT supplied in a complete set of Building Plans?

- A. Incorrect: Architectural
- B. Incorrect: Structural
- C. Incorrect: Plumbing
- D. Incorrect: Mechanical
- E. **Correct:** As built

And are usually submitted upon job completion once all construction is complete and the building is commissioned.

Drawing Interpretation and Plan Reading
Chapter 6 Interpretation of Building plans

F. Incorrect: Electrical

PTS: 1

58. Common Relay configurations are

- A. Incorrect: (SPST) Single Pole Single Throw
- B. Incorrect: (DPDT) Double Pole Double Throw
- C. Incorrect: A Only
- D. **Correct:** Both A and B

Relays typically used in the HVAC have the capability to do multi functions through the selection of NO or NC contacts. Multi configured relays can simultaneously operate devices in a system. Its usage depends on its current carrying capacity across the contacts.

HVAC and Refrigeration Systems Training Manual
Unit 15: Motor Starters and Variable-Frequency Drives
Page 271

PTS: 1

59. The _____ is a device that allows the use of a low voltage power source to operate a high Current load powered device.

- A. Incorrect: Knife Disconnect switch
- B. **Correct:** Contactor

A Contactor can use low voltage control power to operate the switching type relay to operate a High current capacity device. Typically Contacts on the contactor are rated much higher than a Common relay's internal contacts.

HVAC and Refrigeration Systems Training Manual
Unit 15: Motor Starters and Variable-Frequency Drives
Page 271

- C. Incorrect: SPDT Switch
- D. Incorrect: Thermostat

PTS: 1

60. When troubleshooting a contactor in a system. One should check the contact surfaces for:

- A. Incorrect: Shininess

- B. Incorrect: Pitting
- C. Incorrect: Wear due to Arcing
- D. **Correct:** Both B and C

When inspecting a contactor contacts for both the moving and stationary points needs to be checked regularly for wear due to High Current arcing which occurs overtime when device starts and stops. High current readings may result from poor contact closure. Typically excessive wear will require replacement of the contactor or contactor points. Depends on their serviceability and size.

HVAC and Refrigeration Systems Training Manual
 Unit 15: Motor Starters and Variable-Frequency Drives
 Page 271

- E. Incorrect: B only
- F. Incorrect: Both C and D

PTS: 1

61. Terminals "A" would be labeled

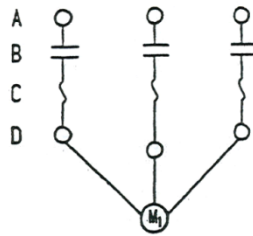

- A. Incorrect: T1, T2, T3
- B. **Correct:** L1, L2, L3

L1, L2, L3 Terminals

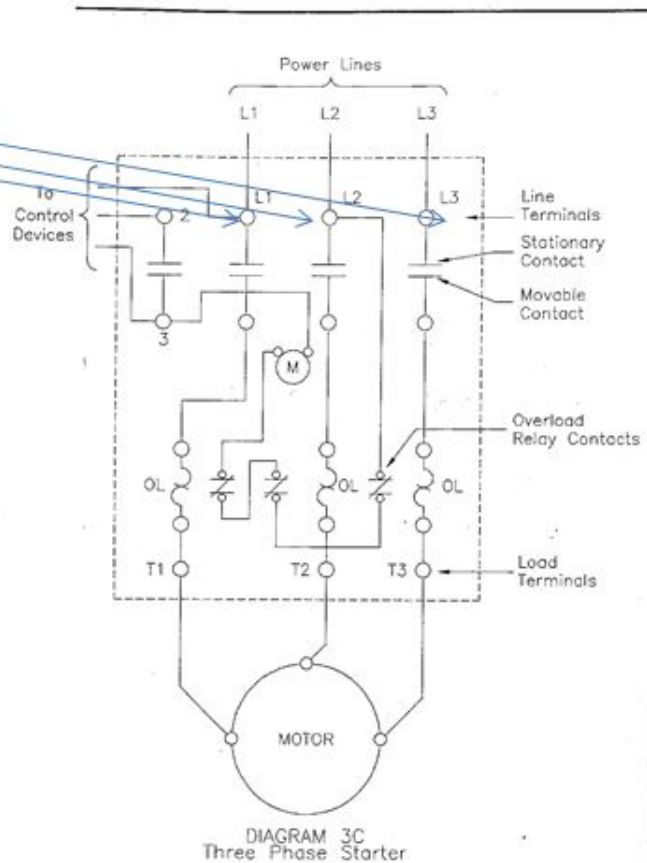

Diagrams 3A, 3B & 3C

MAGNETIC ACROSS-THE-LINE
STARTERS;
SINGLE PHASE & 3-PHASE

DIAGRAM SHEET 3

Text Reference: Chapters 7 and 11

Copyright 1999 By International Pipe Trades Joint Training Committee

When wiring the Starter the Line (Power supply) is landed on the “L” terminals of the starter typically labeled as L1, L2, L3. Most times located on the TOP portion of the device

- C. Incorrect: H1, H2, H3
- D. Incorrect: X1, X2, X3

PTS: 1

62. The terminals marked “D” would be labeled

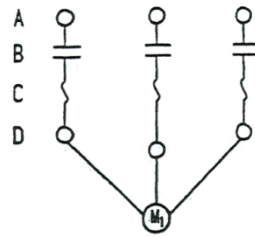

A. **Correct:** T1, T2, T3

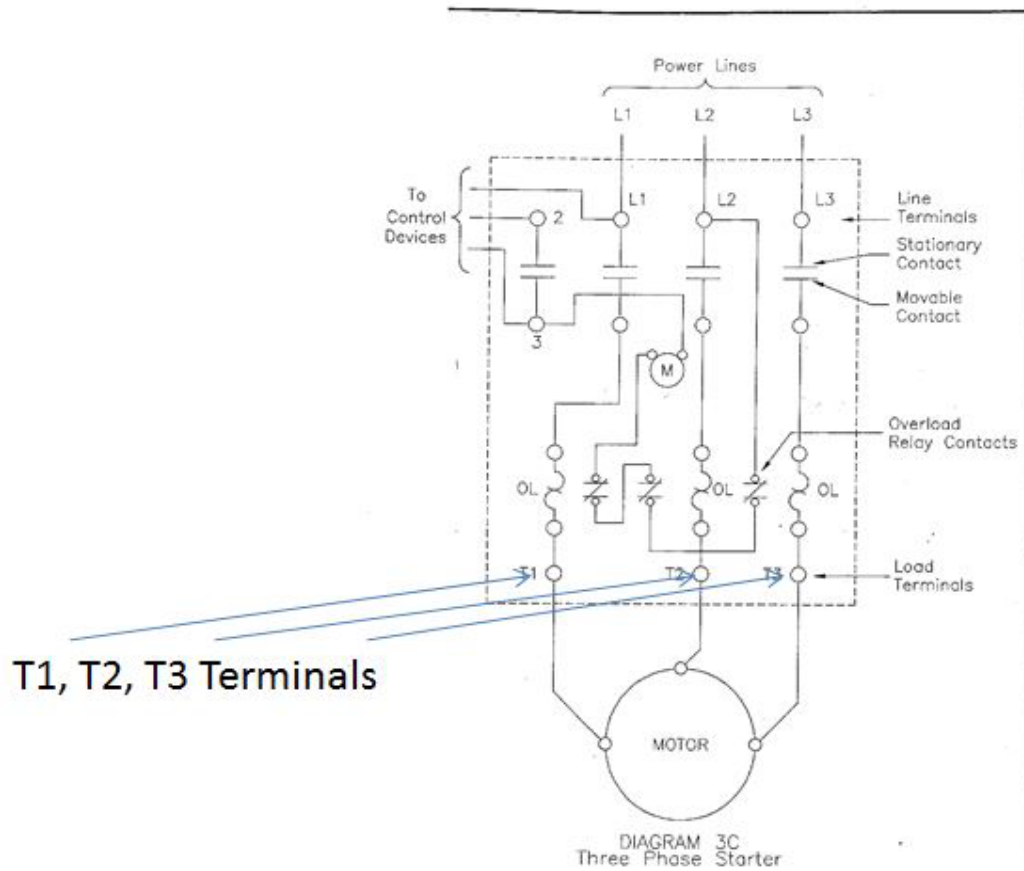

T1, T2, T3 Terminals

Diagrams 3A, 3B & 3C
MAGNETIC ACROSS-THE-LINE STARTERS; SINGLE PHASE & 3-PHASE
DIAGRAM SHEET 3

Text Reference: Chapters 7 and 11

Copyright 1999 By International Pipe Trades Joint Training Committee

Load being operated by the starter is connected to the “T” terminals of the device. These terminals are located downstream of the electrical overloads internal of the device. Typically on the bottom of the starter labeled T1, T2, T3.

- B. Incorrect: L1, L2, L3
- C. Incorrect: H1, H2, H3
- D. Incorrect: X1, X2, X3.

PTS: 1

63. Pushing P1 down energizes

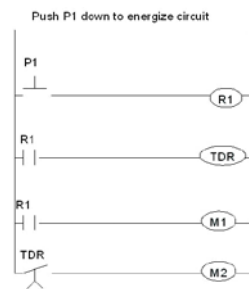

- A. **Correct:** M1 first

Pushing P1 down energizes R1 relay coil, closing R1 normally open contacts, energizing TDR relay coil and R1 normally open contacts energizing M1 coil first. After TDR (Time Delay Relay) times out M2 coil energizes second.

- B. Incorrect: M2 first
- C. Incorrect: Both at the same time
- D. Incorrect: Only M1

PTS: 1

64. A (VFD) Variable Frequency Drive controls all but?

- A. Incorrect: Direction
- B. Incorrect: Speed
- C. Incorrect: Torque
- D. **Correct:** Motor life

A Variable Frequency Drive is an electronic device that controls the direction, speed, torque, and other operating functions of an electronic motor in addition to providing motor protection and Monitoring functions. Incorrect VFD set-up may result in motor life reduction. It however does not specifically control motor life.

HVAC and Refrigeration Systems Training Manual
 Unit 15: Motor Starters and Variable-Frequency Drives
 Page 271

E. Incorrect: Motor Protection

PTS: 1

65. Three general categories of motor starter problems include all except:

A. Incorrect: Installation and Selection

B. **Correct:** Sizing

Though sizing could be a general problem when troubleshooting, reasons for problems could occur from improper application and selection. The location, for example, may be incorrect for operating conditions. Other reasons might include component, installation, or wiring issues.

HVAC and Refrigeration Systems Training Manual
 Unit 15: Motor Starters and Variable-Frequency Drives
 Page 271

C. Incorrect: Component Problems

D. Incorrect: Application and wiring

PTS: 1

66. VFD's can be tested when _____ by means of _____ Measurements for various sections.

A. **Correct:** Energized, Voltage

VFD's need to be checked for proper operation during them being energized and running by means of Voltage reading as typically required in the areas of the drive for proper parameters to be met for it's given application and use. Current cannot be detected in the de-energized state. Resistance reading should never be performed when any electrical system is energized and Voltage readings would not be possible when the VFD is not powered.

HVAC and Refrigeration Systems Training Manual
 Unit 15: Motor Starters and Variable-Frequency Drives
 Page 271

B. Incorrect: De-energized, Current

C. Incorrect: Energized, Resistance

D. Incorrect: De-energized, Voltage

PTS: 1

67. If the value of R1 is lowered, the current

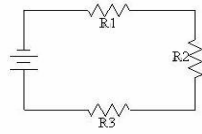
A. **Correct:** Increases

Ohms Law for DC and Resistive AC Circuits

The basic relationship of voltage (E), current (I) and resistance (R) is expressed by Ohms law. If any two of the three quantities are known, the third unknown quantity can be calculated using one of the equations below.

$$\text{Where: } E = I \times R \text{ or } I = \frac{E}{R} \text{ or } R = \frac{E}{I}$$

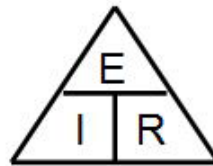

Figure 1

The triangle in Fig 1 is a handy way to remember Ohms Law. Simply place your finger on the value you wish to find and perform the multiplication or division process indicated.

When applying OHMS Law in an electrical circuit, substitute the values given in the formula to solve for the unknown. When asked what occurs when either one increases or decreases the values of the circuit reacts accordingly. Example use simple Numbers when calculating. *note the circuit needs to be a series circuit.

- B. Incorrect: Decreases
- C. Incorrect: Remains the same
- D. Incorrect: Goes to zero

PTS: 1

68. If resistor R2 burns open, the current

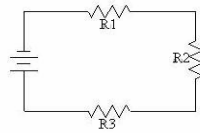

- A. Incorrect: Increases
- B. Incorrect: Decreases
- C. Incorrect: Remains the same
- D. **Correct:** Goes to zero

Ohms Law for DC and Resistive AC Circuits

The basic relationship of voltage (E), current (I) and resistance (R) is expressed by Ohms law. If any two of the three quantities are known, the third unknown quantity can be calculated using one of the equations below.

$$\text{Where: } E = I \times R \text{ or } I = \frac{E}{R} \text{ or } R = \frac{E}{I}$$

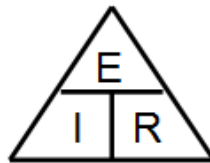

Figure 1

The triangle in Fig 1 is a handy way to remember Ohms Law. Simply place your finger on the value you wish to find and perform the multiplication or division process indicated.

When applying OHMS Law in an electrical circuit, substitute the values given in the formula to solve for the unknown. When asked what occurs when either one increases or decreases the values of the circuit reacts accordingly.

Example use simple Numbers when calculating. *note the circuit needs to be a series circuit.

PTS: 1

69. If the value of R3 is raised, the current

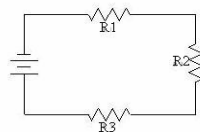

- A. Incorrect: Increases
- B. **Correct:** Decreases

Ohms Law for DC and Resistive AC Circuits

The basic relationship of voltage (E), current (I) and resistance (R) is expressed by Ohms law. If any two of the three quantities are known, the third unknown quantity can be calculated using one of the equations below.

$$\text{Where: } E = I \times R \text{ or } I = \frac{E}{R} \text{ or } R = \frac{E}{I}$$

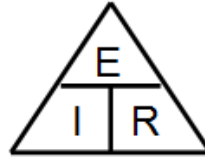

Figure 1

The triangle in Fig. 1 is a handy way to remember Ohms Law. Simply place your finger on the value you wish to find and perform the multiplication or division process indicated.

When applying OHMS Law in an electrical circuit, substitute the values given in the formula to solve for the unknown. When asked what occurs when either one increases or decreases the values of the circuit reacts accordingly. Example use simple Numbers when calculating. *note the circuit needs to be a series circuit.

- C. Incorrect: Remains the same
- D. Incorrect: Goes to zero

PTS: 1

70. All Screw compressors consist of 2 Rotors:

- A. Incorrect: Both rotors are male
- B. Incorrect: Both rotors touch during operation
- C. **Correct:** One male and one female rotor

Most all helical screw compressors consist of 1 male and 1 female rotor while operating. When operating rotor should never touch one another as this will cause damage and lost efficiency due to scorn rotor passages. In some case there may be a possible 3rd rotor from manufacturers for increased capacity and efficiency.

Refrigeration Mechanical Equipment Service Manual Volume One

PTS: 1

71. Capacity control for a helical screw compressor is done by?

- A. Incorrect: The slide valve
- B. Incorrect: Motor speed
- C. Incorrect: Refrigerant charge
- D. **Correct:** Both A & B

System capacity in a Helical Screw compressor is controlled by slide valve movement which adjusts the area in which refrigerant gas passes through the rotors during the operation. The more gas that is allowed to move through the rotors the more capacity is performed. By use of VFD motors it too is possible to adjust capacity by means of controlling the speed of the rotors which when lowered allows less refrigerant gas to pass reducing capacity.

Refrigeration Mechanical Equipment Service Manual Volume One

- E. Incorrect: Compressor housing

PTS: 1

72. If resistor R3 is shorted out the current

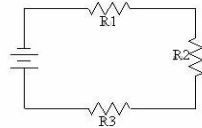

- A. **Correct:** Increases

Ohms Law for DC and Resistive AC Circuits

The basic relationship of voltage (E), current (I) and resistance (R) is expressed by Ohms law. If any two of the three quantities are known, the third unknown quantity can be calculated using one of the equations below.

$$\text{Where: } E = I \times R \text{ or } I = \frac{E}{R} \text{ or } R = \frac{E}{I}$$

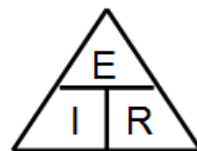

Figure 1

The triangle in Fig. 1 is a handy way to remember Ohms Law. Simply place your finger on the value you wish to find and perform the multiplication or division process indicated.

When applying OHMS Law in an electrical circuit, substitute the values given in the formula to solve for the unknown. When asked what occurs when either one increases or decreases the values of the circuit reacts accordingly. Example use simple Numbers when calculating. *note the circuit needs to be a series circuit.

- B. Incorrect: Decreases
- C. Incorrect: Remains the same
- D. Incorrect: Goes to zero

PTS: 1

73. If the voltage goes up, the current

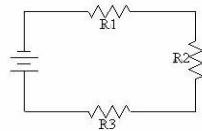

- A. **Correct:** Increases

Ohms Law for DC and Resistive AC Circuits

The basic relationship of voltage (E), current (I) and resistance (R) is expressed by Ohms law. If any two of the three quantities are known, the third unknown quantity can be calculated using one of the equations below.

$$\text{Where: } E = I \times R \text{ or } I = \frac{E}{R} \text{ or } R = \frac{E}{I}$$

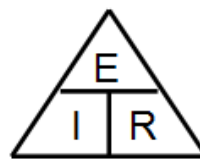

Figure 1

The triangle in Fig. 1 is a handy way to remember Ohms Law. Simply place your finger on the value you wish to find and perform the multiplication or division process indicated.

When applying OHMS Law in an electrical circuit, substitute the values given in the formula to solve for the unknown. When asked what occurs when either one increases or decreases the values of the circuit reacts accordingly. Example use simple Numbers when calculating. *note the circuit needs to be a series circuit.

- B. Incorrect: Decreases
- C. Incorrect: Remains the same

D. Incorrect: Goes to zero

PTS: 1

74. If you find yourself at odds with a confrontational customer, you should

A. Incorrect: Tell the customer you're not being paid to be a whipping post, pack your tools and leave

B. Incorrect: Tell the customer that you're not going to take his abuse, but try finishing the job

C. Incorrect: Defend yourself by telling the customer that it's not your fault and try to finish the job

D. **Correct:** Keep your cool, learn as much as possible, but call your supervisor to report the incident

When faced with a difficult customer your first objective is to not escalate the situation. In this case listen to customer and avoid getting into a verbal sparring match. If possible, try to finish the work that you have been called to perform. Let your supervisor know about the incident.

Customer Service Skills Pg. 40

PTS: 1

75. For applications where quiet operation and light axial load characteristics are found, the type of bearing normally used is the:

A. Incorrect: Ball bearing

Ball bearings are relatively noisy. Further, they can handle high loads and are generally considered to be too expensive to use in light load situations.

B. Incorrect: Thrust bearing

Thrust bearings are used in situations where the load is trying to push or pull the shaft.

C. **Correct:** Sleeve bearing

Sleeve bearings are reliable when used for small motors with light loads. Further, they offer quiet operation, which is important when used in applications close to the conditioned space.

D. Incorrect: Roller bearing

Roller bearings are used where large axial loads are present.

PTS: 1

76. Sleeve bearings with the oil port lubrication system must be lubricated with the proper oil because

- A. Partially Correct: Oil that is too thin will allow the shaft to run against the bearing surface.
- B. Partially Correct: Oil that is too thick will not run into the clearance between the shaft and the bearing surface.
- C. Partially Correct: The correct oil allows the motor shaft to float on a film of oil between the shaft and bearing surface.
- D. **Correct:** All of the above.

PTS: 1

77. Too much grease in grease lubricated ball bearing

- A. Incorrect: Is not a problem.
Too much grease does create a problem in a bearing, just as too little grease does.
- B. Incorrect: Is not possible.
It is possible, and a common problem, to over grease a ball bearing.
- C. **Correct:** Causes overheating.
In fact, the most common cause of overheating in a ball bearing is excess grease.
- D. Incorrect: Reduces friction.
Too much grease does not reduce friction, and should not be added to a properly greased bearing.

PTS: 1

78. A ladder must extend above the edge of a roof by at least _____ .

- A. Incorrect: One foot.
- B. Incorrect: Two feet.
- C. **Correct:** Three feet.
- D. Incorrect: Four feet.

PTS: 1

79. The proper angle for a ladder is achieved when the distance of the ladder from the building at the base is about _____ the working length (height) of the ladder.

A. Incorrect: One half.

The ladder would be too horizontal under this condition, and would be weakened.

B. Incorrect: One third.

The ladder would be too horizontal under this condition, and would be weakened.

C. **Correct:** One fourth.

D. Incorrect: One fifth.

The ladder would be too steep under this condition.

PTS: 1

80. Air handling systems that employ economizers which permit outside air “free cooling”

A. **Correct:** Are most economical when controlled by an enthalpy controller

Enthalpy controls may be thought of as combination controllers containing dry-bulb thermostats that are reset by a relative humidity element. At any given outside dry-bulb temperature, the air’s moisture content and its total heat content may vary significantly. In other words, 70 degree F dry air might be quite capable of cooling a building while 70 degree F saturated air would contribute to the same building’s cooling load.

Outside air enthalpy in the 21 btu/lb. to 24 btu/lb. range is normally considered adequate for comfort cooling of commercial buildings. Any combination of dry-bulb and wet-bulb temperatures providing enthalpy within that range will provide sufficient cooling.

Air Conditioning Mechanical Equipment Service Manual
Chapter 17: Automatic Controls
Review Exam I-73.
Question 2. Page 317.

B. Incorrect: Increase building cooling loads during summer operation

C. Incorrect: Are required for proper building ventilation

D. Incorrect: Increase building heating load during summer operation

PTS: 1

81. When face and bypass dampers are used on systems with direct expansion cooling coils:

- A. **Correct:** Compressor capacity control is required

Face and bypass dampers used with cooling or heating coils provide a method of regulating the amount of cooling or heating obtained from the coil without the need to control the flow of the medium, such as water or steam, being supplied to the coil. This is an advantage with chilled water cooling coils, as any appreciable reduction in water flow would raise the temperature of the coil surface and rapidly reduce or eliminate the ability of the coil to condense moisture from the air, a necessary step for dehumidification.

As the face damper decreases flow of air over the coil at reduced loads, it is necessary to keep suction pressure above freezing to keep ice from forming on the coil.

One possible method of avoiding freezing coil temperatures would be compressor cylinder unloading according to suction pressure.

Air Conditioning Mechanical Equipment Service Manual
Chapter 17: Automatic Controls
Review Exam I-73.
Question 3. Pages 317 through 319.

- B. Incorrect: An end switch on the damper operator should shut down the compressor when the face damper opens
- C. Incorrect: The bypass damper should remain open at all times during cooling operation
- D. Incorrect: The face damper should remain closed during cooling operation

PTS: 1

82. The rate of flow of electrons in a circuit is termed:

- A. Incorrect: Voltage
- B. **Correct:** Amperage

The ampere is the unit which represents the flow of electrons in an electrical circuit used to measure the flow of electrons in an electrical circuit.

Gas Installations for United Association Journey Workers & Apprentices
Chapter 6: Electrical Systems and Controls
Review Exam I-108.
Question 6. Page 194.

- C. Incorrect: Resistance
- D. Incorrect: Induction
- E. Incorrect: Wattage

PTS: 1

83. “Pressure” differential in an electrical resistance is the:

- A. **Correct:** Voltage

The pressure differential in an electrical circuit is called the *electromotive force (emf)*. This emf is measured in *volts*. The volt is the basic unit of potential difference.

Gas Installations for United Association Journey Workers & Apprentices
Chapter 6: Electrical Systems and Controls
Review Exam I-108.
Question 7. Page 196.

- B. Incorrect: Amperage
- C. Incorrect: Resistance
- D. Incorrect: Wattage
- E. Incorrect: Ohmage

PTS: 1

84. The unit used to measure electrical resistance is the:

- A. Incorrect: Ampere
- B. Incorrect: Watt
- C. Incorrect: Volt
- D. **Correct:** Ohm

The unit of resistance is the *ohm*, and the unit symbol is the Greek letter Omega. The letter symbol “*R*” is used to indicate resistance on schematic diagrams. All components in an electrical circuit contain some resistance to current flow.

Gas Installations for United Association Journey Workers & Apprentices
Chapter 6: Electrical Systems and Controls
Review Exam I-108.
Question 8. Page 196.

- E. Incorrect: Joule

PTS: 1

85. The four essential parts of the vapor compression cycle compressor, condenser, evaporator and:

- A. Incorrect: Evaporator fan
- B. **Correct:** Expansion device

Typical Refrigeration Systems

The basic vapor compression refrigeration cycle is applied in a number of ways. **This basic cycle requires the use of four essential components ——— the evaporator, the compressor, the condenser, and the expansion device.**

Refrigeration Mechanical Equipment Service Manual Volume One
Chapter 6: Application of the Vapor Compression Refrigeration Cycle
Question 4. Page 63.

- C. Incorrect: Weatherproof casing
- D. Incorrect: Suction line

PTS: 1

86. How is an anticipator connected to a single contact cooling thermostat?

- A. **Correct:** In parallel with contacts

The cooling anticipator is wired in parallel with the thermostat contacts so that it is energized during the cooling “off” periods.

The thermostat is calling for cooling by completing a circuit between terminals R and Y. Note that the cooling anticipator remains connected in the circuit but it has no effect because it is “shorted out” by the thermostat contacts. However, during the “off” periods, the heater is energized and falsely warms the thermostat, causing it to bring on cooling earlier than would occur without the anticipator.

The result of this method of “heat anticipation” is that smaller amounts of heat are added or removed at more frequent intervals than occurs with ordinary two-position control. This results in a smaller differential.

Electric Controls for Mechanical Equipment Service
Chapter 4: Types of Control Action
Question 4. Page 32.

- B. Incorrect: In series with contacts
- C. Incorrect: Between the C and R terminals

D. Incorrect: In series parallel with contacts

PTS: 1

87. The process of removing moisture from air is called:

A. Incorrect: Freezing

B. **Correct:** Dehumidification

Dehumidification is the process of removing moisture from the air, associated with the cooling or summer function of the system. Air can be dehumidified by bringing it into contact with a chemical that has an ability to absorb (or adsorb) water vapor, and this is sometimes done in industrial air conditioning where a high degree of dryness is needed. If necessary, however most dehumidification is done by cooling the air to a low enough temperature to cause some of the moisture to condense out as liquid water, just as dew is formed from the atmosphere.

Air Conditioning Mechanical Equipment Service Manual
Chapter 1: Fundamentals of Air Conditioning
Question 1. Page 2.

C. Incorrect: Saturation

D. Incorrect: Enthalpy

PTS: 1

88. Basic types of air supply outlets are:

A. Incorrect: Trough

B. Incorrect: Slot ceiling

C. **Correct:** Grilles

Three basic types of air supply outlets are:

1. **Grilles**
2. Slot diffuser outlets
3. Ceiling diffusers

The various types of outlets differ from one another in the amount of air entrainment and in the air distribution patterns produced. The type to be used depends partly on architectural design and on spaces available for duct. The type of outlet most desirable may also depend on the quantity of air to be supplied relative to the size of the room.

Start, Test and Balance
Chapter 5: Air Distribution System and Accessories
Question 3. Page 69.

D. Incorrect: All of the above

PTS: 1

89. With reference to copper tube, what is meant by the letters ACR?

- A. Incorrect: Average construction rating tube
- B. **Correct:** Air conditioning and refrigeration tube

**Air-Conditioning and Refrigeration Tube
(ACR)**

Type **ACR** copper tube is designated for **air-conditioning and refrigeration installations**. It is clean, moisture free and capped when it leaves the manufacturer, thus insuring the installer a non-contaminated tube. **ACR** copper tube differs from the other two classes of copper tube in two major respects: it is available in a greater number of sizes (especially the smaller sizes); and the sizes specified are actual outside diameters. Therefore, its designated size is always 1/8-inch larger than the designated size of copper water and DWV tube with the outside diameter. That is, 1/4-inch copper water tube has the same outside diameter as 3/8-inch **ACR** tube; 3/8-inch copper water tube has the same outside diameter as 1/2-inch **ACR** tube. Fittings used for **ACR** tube are the same as the fittings used for water tube. However, care should be exercised in ordering these fittings, because of the different method used in specifying the size of the tube. When ordering fittings of 7/8-inch **ACR** tube, it is necessary to order 3/4-inch nominal or 7/8-inch O.D., which is the same as required for 3/4-inch copper water tube. The wall thickness of hard temper copper **ACR** tube are the same as that of Type L water tube. The wall thickness of annealed **ACR** tube are close to, but not exactly the same as that of Type L water tube. **Air Conditioning and Refrigeration tube is made according to ASTM Standard B280.**

Soldering & Brazing

Chapter 3: Types and Uses of Copper Tube

Question 3. Pages 34 and 35.

- C. Incorrect: Air and condensate return tube
- D. Incorrect: Acid and corrosion resistant tube

PTS: 1

90. How is the heat anticipator wired in with heating contacts on a 24 volt space thermostat?

- A. Incorrect: Parallel
- B. **Correct:** Series

A heat anticipator is a small electrical resistance heater placed in a thermostat. By adding heat to the thermostat at certain times of the operating cycle, depending on whether the thermostat is to control heating or cooling, it reduces the effect of the time lag. On a fall in temperature, the mercury bulb will tilt to complete R to terminal W to turn on heating. Note that **the heating anticipator is in series with the thermostat contacts**, so that the heater is energized during the “on” periods but is de-energized during the “off” periods. When energized during the “on” portions of the cycle, the thermostat is warmed not only by the warmer air but also by the heating anticipator. The thermostat therefore becomes satisfied sooner in each “on” cycle than it would if the anticipator was not present. The effect is to prematurely shorten the “on” periods.

Electric Controls for Mechanical Equipment Service
Chapter 4: Types of Control Action
Question 4. Page 31.

- C. Incorrect: Series parallel
- D. Incorrect: None of the above

PTS: 1

91. A piece of ice weighs 20 LBS and its specific heat is 0.49. It will require _____ Btu to heat the piece of ice from 27 degrees to 31 degrees F.

ANS:

39.2 Solution: Use for Formula:
Heat (Btu) = Weight (pounds) x Specific Heat (Btu per LB per degree F) x
Temperature Difference (degrees F)
= 20 x 0.49 x (31-27) degrees F
= 20 x 0.49 x 4
= 39.2 Btu

PTS: 1

92. Given a rate of air flow of 2250 cfm in a duct having a cross-section 18 inches by 18 inches, the duct velocity should be _____ fpm.

ANS:

1000
 $V = 144 \times \text{cfm}$ divided by a
= 144×2250 (324,000) divided by 18×18 (324) = 1000 fpm

PTS: 1

93. If a refrigerant sight glass shows bubbles, you know:

- A. Incorrect: There is air in the system.
- B. **Correct:** There is gas in the liquid.

The sight glass in a refrigeration system permits a view of the refrigerant at the sight glass location. Installed in a liquid line, **the sight glass will show bubbling if there is any gas in the liquid refrigerant.** If only liquid, without gas, is present, the glass will show clear. It should be cautioned, however, that the glass will also clear if there is only gas or no refrigerant at all present.

Refrigeration Mechanical Equipment Service Manual Volume One
Chapter 17: Refrigerant Piping Accessories
Question 3. Page 225.

- C. Incorrect: The system has too much refrigerant.
- D. Incorrect: A restriction must be causing flash gas.

PTS: 1

94. A liquid refrigerant receiver has two liquid level test cocks, one near the top of the receiver and one near the bottom. If the system contains enough refrigerant, when the lower cock is opened:

- A. Incorrect: Refrigerant vapor should come out of the test cock.
- B. **Correct:** The test cock should discharge liquid refrigerant.

Where liquid leaving the receiver flows vertically upward out of the receiver, an integral dip tube is an important feature of the receiver. **The dip tube, connected to the receiver outlet, extends to about one-half inch from the bottom of the receiver. Its purpose is to ensure that only liquid enters the line leaving the receiver, preventing any vapor from entering the liquid line.** If replacing or re-installing a receiver, it is essential to determine which connection has the dip tube. A receiver may not contain an integral dip tube, and so it may have to be provided in the field. The bottom end of the dip tube should not be made with a square cut; it should be cut-off at an angle of approximately 45 degrees. For this purpose, a *receiver valve*, can be used. The above considerations of the dip tube apply only to receivers where the liquid outlet is on the top of the receiver. **If a receiver outlet is on the bottom of the receiver so that refrigerant can flow out by gravity, no special provision is needed to assure the liquid line being free of vapor; in such case, the dip tube must of course be omitted or only vapor would enter the liquid line.**

Refrigeration Mechanical Equipment Service Manual Volume One
Chapter 17: Refrigerant Piping Accessories
Question 4. Page 219.

- C. Incorrect: Water should drain out.
- D. Incorrect: The dip tube should become completely drained.

PTS: 1

95. Desiccants are used in:

- A. Incorrect: Strainers.
- B. Incorrect: Moisture indicators.
- C. Incorrect: Gage glasses if combined with indicators.
- D. **Correct:** Driers.

Driers used in refrigeration systems are based on the principle of bringing refrigerant in contact with a material which is capable of catching and retaining the moisture. Such materials are called desiccants, and those used in refrigerant driers usually are able to remove acid as well as plain water. In use, the desiccant sooner or later reaches a point where it can hold no more moisture and/or acid; it then is ineffective and should be replaced. Desiccants that have been used in refrigeration systems have retained oil and acid as well as water, and it is not acceptable to reactivate them (chemically dry them out) for re-use; they should be discarded when no longer effective.

Refrigeration Mechanical Equipment Service Manual Volume One
Chapter 17: Refrigerant Piping Accessories
Question 5. Page 223.

PTS: 1

96. Only _____% of the direct radiation at the edge of Earth's atmosphere reaches the Earth's surface.

- A. Incorrect: 11
- B. Incorrect: 31
- C. **Correct:** 51

Solar Water Heating Systems
Pg. 25

- D. Incorrect: 71

PTS: 1

97. Collectors should face as close as possible to _____?

- A. Incorrect: magnetic North

- B. Incorrect: true North
- C. Incorrect: magnetic South
- D. **Correct:** true South

Solar Water Heating Systems
Pg. 34

PTS: 1

98. _____ occurs in a Solar Thermal System when the heated transfer fluid within the absorber piping rises within the collector and is replaced by cooler fluid downstream.

- A. Incorrect: Conduction
- B. **Correct:** Convection

Solar Water Heating Systems
Pg. 38

- C. Incorrect: Absorption
- D. Incorrect: Reflection

PTS: 1

99. A (n) _____ system uses a Heat Transfer Fluid and heat exchanger to transfer heat to the Domestic Hot Water without the use of mechanical means to circulate the HTF.

- A. Incorrect: Passive direct
- B. Incorrect: Active direct
- C. **Correct:** Passive indirect

Solar Water Heating Systems
Pg. 109

- D. Incorrect: Active indirect

PTS: 1

100. Self-pumping Systems are _____ systems.

- A. **Correct:** Passive direct

Solar Water Heating Systems
Pg. 109

- B. Incorrect: Active direct
- C. Incorrect: Active indirect
- D. Incorrect: None of the above

PTS: 1

101. The vacuum pump used in vacuum steam heating systems that creates a vacuum using high velocity water is the:

- A. Incorrect: Velocity pump.
- B. **Correct:** Jet type pump.

The jet pump forces water through an injector that increases its velocity, creating a correspondingly low pressure around it, creating a suction that causes water to flow.

- C. Incorrect: Turbine pump.
- D. Incorrect: Lift pump

PTS: 1

102. Vacuum pumps used in vacuum steam heating systems can be destroyed if they are made to pump:

- A. Partially Correct: Air.

Partially correct. The pumps used are centrifugal pumps, which can be destroyed by cavitation.

- B. Partially Correct: Steam.

A common reason for pump failure is live steam entering the pump due to failed steam traps. The cause of the pump failure must be corrected at the same time the pump is repaired or replaced. If bad steam traps allowed the steam to reach the pump, the steam traps must be repaired or replaced or the new pump will soon fail again.

- C. Incorrect: Water.

The pump is designed to pump water through the pump's centrifugal impeller into an injector, where the high velocity discharges creates a low pressure that draws condensate into the tank.

- D. **Correct:** Both A and B from above.

Both air and steam can destroy a vacuum pump. However, through the design of vacuum steam heating vacuum pumps, air typically does not enter the pump. The intake of these pumps draw from a tank that is vented to the atmosphere. The vent is to allow air to escape. The pump intake is near the bottom of the tank, so only water is drawn into the pump. Further, pump cavitation is caused by low suction pressure. Since the intake of the pump is connected to a tank under atmospheric pressure, the pump does not see low suction pressures. Steam can reach the pump, however, if the steam traps allow live steam to blow by and enter the condensate lines.

PTS: 1

103. If a vacuum pump in a vacuum steam heating system burns out, a very common cause is:

A. Incorrect: Incorrect voltage to the pump.

While this will cause a pump motor to fail, it is not very common cause of failure. Further, the pump will likely fail very soon if supplied with improper voltage.

B. Incorrect: Backward rotation.

The centrifugal type pump used as a vacuum pump will pump even rotating when backwards. While this affects the ability of the pump to move water, it usually does not harm this type of pump.

C. Incorrect: A failed vacuum breaker.

A vacuum breaker is designed to prevent the pressure in the condensate return from dropping too low. If system pressure drops below 15 in. Hg, the breaker opens and lets air into the system. Since the pump draws from a tank that is vented to the atmosphere (to allow air to escape), it will typically see atmospheric pressure at the inlet and will be unaffected by system pressure.

D. **Correct:** A failed steam trap.

A failed steam trap will allow live steam to blow by. If the steam makes it to the vacuum pump, it can destroy the pump. In buildings with many steam traps and poor maintenance procedures, failed steam traps are a common cause of a vacuum pump failure.

PTS: 1

104. Effective recovery of condensate reduces the following cost of making steam:

A. Partially Correct: Fuel/energy costs associated with producing steam.

Other costs are also saved.

- B. Partially Correct: Boiler water make-up and sewage treatment.
Other costs are also saved.
- C. Partially Correct: Boiler water chemical treatment.
Other costs are also saved.
- D. **Correct:** All of the above.

PTS: 1

105. A symptom of a failed steam trap is:

- A. Incorrect: A trap that is colder than the steam temperature.
Actually, this is the condition that would you expect, as the trap is normally partially filled with condensate at a slightly lower temperature than the saturated steam.
- B. Incorrect: A trap that is colder than condensate temperature.
This would indicate a blockage further upstream of the trap. The only way a trap could be colder than the condensate is if no condensate or steam reached the trap.
- C. **Correct:** A trap that is warmer than condensate temperature.
A trap that is warmer than the condensate temperature indicates that steam is flowing freely through it, meaning that the trap is not trapping the steam as it is designed to do.
- D. Incorrect: A trap that is warmer than steam temperature.
It would not be possible for a trap to become warmer than the steam inside.

PTS: 1

106. When entering a customer residential premises you should always

- A. Incorrect: Wipe your feet on their rug to make sure your shoes are clean
- B. Incorrect: Remove your shoes at the door
- C. **Correct:** Place a clean pair of disposable covers over your shoes
When entering a customer's home you should always place shoe/boot covers on to protect floors from potential tracking of dirt, oil and grease.

Customer Service Skills Pg. 13

- D. Incorrect: Let the customer know that you have checked your shoes and they are clean

PTS: 1

107. If the technician is on a service call and notices another potential problem not related to the current work order, what should the technician do?

- A. Incorrect: Don't bother to mention it and go ahead and repair it if you can do it quickly and it won't cost anything
- B. Incorrect: Generate a service ticket and replace the component
- C. Incorrect: Ignore it and hope that it turns into another service call for your company
- D. **Correct:** Discuss what you have with the customer and your supervisor so that the customer can decide whether to authorize the additional repair

It is always best to clear any additional work through the customer before going ahead with the repairs.

Customer Service Skills Pg. 47-49

PTS: 1

108. Which of the following is required part of the work order?

- A. Incorrect: Wholesale cost of parts used
- B. Incorrect: Form completed in legible hand writing
- C. Incorrect: Complete list of materials used and amount of time spent on the job
- D. **Correct:** Both B and C

The wholesale cost of the parts used on a job would not be listed on the work order.

Customer Service Skills Pg. 47

PTS: 1

109. Getting the customer to sign the work order should be

- A. Incorrect: The first thing you should do before starting the work
- B. **Correct:** The last thing that you should do before leaving the job

After all work at the job has been completed and you have explained to the customer what repairs were performed you should request that the customer sign the work order acknowledging the work that was done.

Customer Service Skills Pg. 47

- C. Incorrect: Could be done at any time
- D. Incorrect: Either A or B

PTS: 1

110. Which of the following is a part of your responsibility relative to your work crew?

- A. Incorrect: Keeping to yourself and not bothering others
- B. Incorrect: Worrying about what others have been assigned to do by the supervisor
- C. **Correct:** Working safely on the worksite

As an integral part of a work crew you have a responsibility to interact with the other individuals in a positive, cooperative and safe manner.

HVACR Training Manual
Unit 4

- D. Incorrect: Keeping to yourself and not bothering others

PTS: 1

111. The maximum desirable operating temperature of a ball bearing is

- A. **Correct:** 180 degrees F.

A bearing hotter than 180 degrees F is an indication of possible trouble. Infrared thermometers can be used to quickly check for hot bearings.

- B. Incorrect: 212 degrees F.

This temperature is hotter than maximum desirable operating temperature.

- C. Incorrect: 150 degrees F.

This temperature is lower than the maximum desirable operating temperature. A bearing running at 150 degrees F is an indication of normal operation and is no cause for concern.

- D. Incorrect: 350 degrees F.

This is way too hot for a bearing under normal condition and is an indication that a problem has developed.

PTS: 1

112. Shaft runout can be measured with
- A. **Partially Correct:** A dial indicator.
A runout gage is also used for measuring runout.
 - B. **Partially Correct:** A runout gage.
A dial indicator is also used for measuring runout.
 - C. **Incorrect:** A micrometer.
A micrometer can be used for checking shaft alignment, but will not indicate runout.
 - D. **Correct:** Both A and B.

PTS: 1

113. The seal in a compressor is necessary to prevent
- A. **Partially Correct:** Refrigerant from leaking out the rotating shaft.
A function of a seal is to keep the refrigerant inside the system.
 - B. **Incorrect:** Air from leaking out at the rotating shaft.
It is the function of the seal to keep air from leaking in at the rotating shaft and contaminating the refrigerant.
 - C. **Partially Correct:** Oil from leaking out at the rotating shaft.
A function of a seal is to keep the refrigerant inside the system.
 - D. **Correct:** Both A and C from above.

PTS: 1

114. The mating seal surfaces on a sleeve type rotary bellows seal are:
- A. **Incorrect:** Two polished steel surfaces.
Steel on steel makes a poor seal.
 - B. **Incorrect:** Polished steel surfaces and neoprene.
While neoprene is used in the sleeve type rotary bellows seal, it is not the actual seal.
 - C. **Correct:** Polished steel surfaces and a carbon ring.

It is the mating surfaces of the steel and carbon ring that form the seal in this type of seal.

D. **Incorrect:** Steel grooves and waxed cord.

This type of seal is sometimes used as a low pressure oil seal in applications such as automotive engines, but not in the sleeve type rotary bellows seal.

PTS: 1

115. With belt driven equipment, alignment of the motor and driven equipment pulleys

A. **Incorrect:** Is not critical, since the belts are flexible.

Misaligned pulleys will cause excessive wear on belts, pulleys and bearings.

B. **Correct:** Is accomplished using a string or straight edge.

A straight edge or string can be used to run from one pulley to the other. Alignment is complete when the string or straight edge touches both pulleys in two places at once.

C. **Incorrect:** Is accomplished when the belts are parallel to one another.

The belts will always be parallel to one another, even when the pulleys are not aligned.

D. **Incorrect:** Is accomplished using a dial indicator.

A dial indicator will not show misalignment between two pulleys.

PTS: 1

116. Draw a Northeast view of the piping shown in Figure 5-1 and a Southeast view of the piping shown in Figure 5-2.

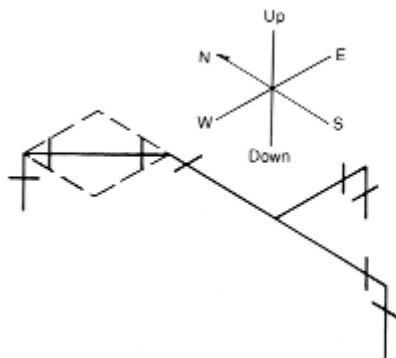

Fig. 5-1

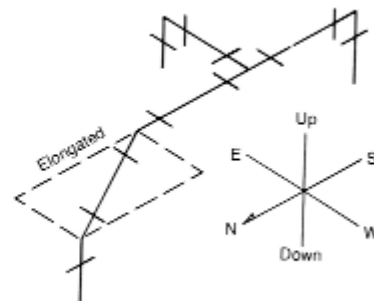
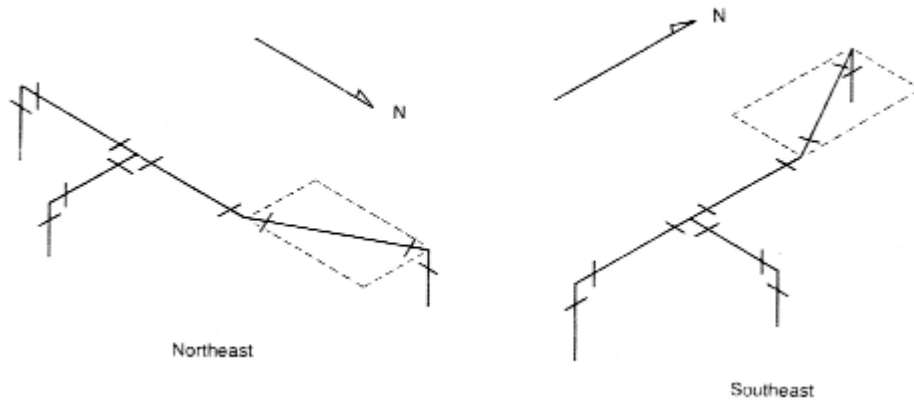

Fig. 5-2

ANS:



Chapter 5 Interpretation of Isometric Drawings

PTS: 1

117. A lock and tag may only be removed by the employee that applied it, unless the employee is absent from the workplace, then the lock or tag may be removed by a qualified person designated by the employer to perform this task provided that the employer ensures that _____.

- A. **Incorrect:** The employee who applied the lock or tag is employed by his company and under his jurisdiction.

An employer does not have the right to unilaterally decide to remove a lock or tag of an employee, since the employee could be in danger of injury if not aware that the circuit has been removed.

- B. **Partially Correct:** The employee who applied the lock or tag is not available at the workplace.

The employer must confirm that the employee is not at the workplace to ensure, among other things, that the employee is not in danger of injury when the circuit is energized.

- C. **Partially Correct:** The employee who applied the lock or tag is aware that it has been removed before he or she resumes work at that workplace.

The employer must ensure that the employee is aware that a circuit that he/she knew to be locked out is now energized.

- D. **Correct:** Both B and C from above.

PTS: 1

118. Section 608 of the Act prohibits you from knowingly venting ozone-depleting compounds used as refrigerants into the atmosphere while maintaining, servicing, repairing, or disposing of air-conditioning or refrigeration equipment (appliances). The prohibition went into effect on _____.

A. Incorrect: July 13, 1993

As of July 13, 1993, all systems in general that are opened to the atmosphere for any reason, including disposal, must have the refrigerant recovered and must be evacuated to the levels set forth by EPA.

B. Incorrect: November 14, 1994

Technician certification became a requirement on November 14, 1994, as did Sales Restrictions. Class I or Class II substances could only be sold to certified technicians after November 14, 1994.

C. **Correct:** July 1, 1992

D. Incorrect: November 1995

After this date, it was illegal to vent *substitutes* for CFC and HCFC refrigerants (unless EPA determines that it does not pose a threat to the environment).

PTS: 1

119. When working on a HCFC-22 appliance, or isolated component of such appliance, normally containing 200 pounds or more of refrigerant and using recovery or recycling equipment manufactured or imported on or after November 15, 1993, you are required to evacuate to a level of

A. **Correct:** 10 in. Hg.

B. Incorrect: 4 in. Hg.

4 in. Hg. is the required evacuation level when working on a HCFC-22 appliance, or isolated component of such appliance, normally containing 200 pounds or more of refrigerant and for recovery or recycling equipment manufactured before November 15, 1993.

C. Incorrect: 0 in. Hg.

0 in. Hg. is the required level of evacuation for HCFC appliances containing less than 200 pounds of refrigerant when using recovery or recycling equipment regardless of when it was manufactured.

D. Incorrect: 25 in. Hg.

25 in. Hg. is the required evacuation level for recovery or recycling equipment manufactured or imported before November 15, 1993 when used on a low-pressure appliance (CFC-11, HCFC-123).

PTS: 1

120. If a compressor burn has occurred, the refrigerant must be _____.
- A. Partially Correct: Recovered.
The refrigerant must be recovered from the system before the system can be repaired.
- B. Partially Correct: Reclaimed.
If a compressor burn has occurred, you should have the refrigerant reclaimed.
- C. Incorrect: Recycled.
After a compressor burn, the refrigerant should be cleaned to a higher standard than can be attained through recycling.
- D. **Correct:** Both A and B from above.

PTS: 1

121. An advantage of the inverted bucket trap is that:
- A. Incorrect: There are no moving parts to wear.
The bucket is constantly moving up and down and the valve is opening and closing. The bucket, the valve and other associated parts are all susceptible to wear.
- B. Incorrect: It can be installed in any position.
It must be installed with the bucket in the inverted position in order to operate.
- C. Incorrect: Its design prevents it being damaged due to freezing.
Its design prevents it being damaged due to freezing.
- D. **Correct:** It also vents air and carbon dioxide continuously at steam pressure.
During operation, steam, air, and CO₂ rise to top of the inverted bucket. The steam condenses, but the air and CO₂ remain a gas. When the valve at the top of the trap opens, the air and CO₂ are the first to leave the trap.

PTS: 1

122. Flash steam is caused by:
- A. Partially Correct: Pipe friction.

The friction of steam and condensate flowing along the pipe creates heat that re-flashes some of the condensate back to steam.

B. **Partially Correct:** Reduced pressure.

A drop in system pressure will lower the boiling point of the condensate and cause some of it to flash into steam.

C. **Partially Correct:** A vertical rise in a condensate line.

A vertical rise will lower the pressure of the condensate, thus lowering the boiling point, causing some of it to flash into steam.

D. **Correct:** All of the above.

PTS: 1

123. The purpose of a drip leg in a steam line is to:

A. **Incorrect:** Create a venturi to pull condensate out of a trap.

B. **Partially Correct:** Let condensate escape by gravity from the fast-moving steam.

There is another purpose.

C. **Partially Correct:** Store condensate until it can be discharged through the steam trap.

There is another purpose.

D. **Correct:** Both B and C from above.

PTS: 1

124. Inadequate trapping of steam mains often leads to:

A. **Correct:** Water hammer and damaging slugs of condensate.

Steam and condensate flowing in the same pipe can cause water hammer and in severe cases, actually destroy piping components leading to the discharge of live steam into the atmosphere.

B. **Incorrect:** Condensate flowing in one direction while steam flows in the opposite.

C. **Incorrect:** Loss of steam energy by conduction through the walls of the pipe.

The only way to prevent/minimize this loss is through pipe insulation.

D. Incorrect: Excessively low temperature condensate.

PTS: 1

125. Pressure in a vertical position condensate pipe will drop 1 psi for every _____ feet in elevation. This is an important factor, since boiling temperature drops as pressure drops. When elevating condensate, this drop in pressure can cause flash steam.

A. Incorrect: 1.08

B. **Correct:** 2.31

Feet of head is equal to 1 psi. This is the same factor used in pumping calculations.

C. Incorrect: 8.33

D. Incorrect: 10

PTS: 1

126. When using a listening device to test a steam trap, what would the technician listen for that could indicate a problem.

A. Incorrect: Continuous condensate discharge.

Some traps, such as the float and thermostatic (F&T) trap, operate with continuous discharge. Others, such as the inverted bucket (IB) and disc traps should have an intermittent discharge. Meanwhile, thermostatic traps can be either continuous or intermittent, depending on the load.

B. Incorrect: Intermittent condensate discharge.

Some traps, such as the float and thermostatic (F&T) trap, operate with continuous discharge. Others, such as the inverted bucket (IB) and disc traps should have an intermittent discharge. Meanwhile, thermostatic traps can be either continuous or intermittent, depending on the load.

C. **Correct:** High velocity sound.

Escaping steam will have a higher velocity sound than normal operation of the trap, be it continuous or intermittent. An electronic listening device can be used for this, although a simple screwdriver, with one end held against the trap and the other against your ear, works just as well. In either case, experience is required to distinguish between sounds of the trap and other sounds in the system.

D. Incorrect: Gurgling and bubbling.

Gurgling and bubbling are normal sounds in traps, as steam is constantly bubbling up through the condensate.

PTS: 1

127. If an inverted bucket steam trap is blowing live steam, what might the trouble be?

- A. **Partially Correct:** The valve may have failed to seat because of wear or a piece of dirt or scale.

A piece of dirt could be lodged between the valve and the valve seat, preventing the valve from closing and allowing steam to blow by.

- B. **Partially Correct:** The trap may have lost its prime.

A sudden or frequent drop in steam pressure is usually the cause of prime loss. The installation of a check valve upstream of the trap can prevent this problem.

- C. **Partially Correct:** The bucket is stuck or has a hole in it.

If the bucket is stuck in the down position for some reason, steam can fill it then blow by under the bottom of the bucket. If the bucket vent becomes oversized, steam can blow through the top of the bucket and blow out of the trap.

- D. **Correct:** All of the above.

PTS: 1

128. The _____ drains the condensate from the steam header and returns it to the boiler below the water line while preventing the boiler water from flowing out of the boiler into the return line main.

- A. **Correct:** Equalizing line

The water level in the equalizing line is the same as in the boiler, because the steam pressure on the top of both lines is the same. This prevents the boiler water from flowing out of the boiler into the return main.

- B. **Incorrect:** Hartford Loop

The function of the Hartford Loop is not to return condensate to the boiler.

- C. **Incorrect:** Wet return

The wet return does not return condensate to the boiler, but does not prevent water from flowing back out of the boiler.

- D. **Incorrect:** Steam header

The steam header connects outlet risers into a common pipe.

PTS: 1

129. The _____ is designed to protect boilers against the loss of water due to leaks in the return line.

A. Incorrect: Equalizing line

The equalizing line prevents the boiler water from flowing out of the boiler into the return main.

B. **Correct:** Hartford Loop

The Hartford Loop prevents water from dropping more than 2" to 4" below the normal operating water line (NOWL) through the condensate wet return line by breaking the siphoning effect once the water reaches that level.

C. Incorrect: Check valve

Check valves were found to be ineffective against loss of water due to a leak in the wet return line, since the check valves were by necessity installed at a low point in the system and were often stuck open with dirt from the system.

D. Incorrect: Steam header

The steam header connects outlet risers into a common pipe.

PTS: 1

130. The control valve in a sub-atmospheric steam heating system is limited to approximately _____ % change per minute.

A. Incorrect: 12

The control valve is designed with a small percentage of change so there are no radical changes in the pressure and steam temperature in the system piping.

B. Incorrect: 9

The control valve is designed with a small percentage of change so there are no radical changes in the pressure and steam temperature in the system piping.

C. Incorrect: 6

The control valve is designed with a small percentage of change so there are no radical changes in the pressure and steam temperature in the system piping.

D. Correct: 3

The control valve is designed with a small percentage of change so there are no radical changes in the pressure and steam temperature in the system piping.

PTS: 1

131. When the discharge of one compressor is piped into the suction of another compressor, it is called a:

- A. Incorrect: Single stage system
- B. **Correct:** Two stage system

Example of a Two-Stage Machine

There are several arrangements of the two impellers used in two-stage centrifugal compressors. **An impeller on each end of the motor shaft discharges gas from the first stage being conducted through a large pipe to the inlet of the second stage impeller.** This arrangement is suitable for hermetic type machines.

Refrigeration Mechanical Equipment Service Manual Volume Two
Chapter 26: Centrifugal Refrigeration Machines
Page 345.

- C. Incorrect: Cascade system
- D. Incorrect: Air Cooled system

PTS: 1

132. What is the most common cause of valve noise?

- A. Incorrect: Water pressure too high
- B. Incorrect: Air pressure too low
- C. **Correct:** Valve piped incorrectly

The valve installation is very important and must be used whenever a control valve is installed.

The valve installation law states that: The trim must always close against the flow.

When piping two-way control valves, always make certain that the trim, especially the plug, will close against the direction of flow of the process fluid. The process fluid should always be trying to force the valve *open*. **Control valves are stamped with a direction of flow arrow or the words *inlet* and *outlet* on the body. Failure to obey this law will result in objectionable water hammer and physical damage to the valve and piping system.**

Pneumatic Controls
Chapter 2: Control Valves
Question 7. Page 14.

D. Incorrect: Wrong size operator on valve

PTS: 1

133. If too much refrigerant is being fed to the evaporator _____.

A. **Correct:** The superheat will be low

If not enough refrigerant is being fed to the evaporator - the superheat will be high.

If too much refrigerant is being fed to the evaporator - the superheat will be low.

Too much refrigerant is being fed to the evaporator, perhaps so much that the liquid will reach the compressor. The cause may be due to the expansion valve not operating properly or it may be due to the compressor.

1. One of these systems may be attributed to improper expansion valve control.

Installation and engineering faults, incorrectly installed external equalizer, undersized compressor, poor refrigerant distribution, etc. are all problems associated with low superheat, as well as high superheat.

2. Dirt or foreign material, filings, etc. will restrict the flow of refrigerant when it collects at the valve port, which can also prevent the valve from tightly closing. The foreign material must be removed and a filter should be installed to provide effective filtration of the refrigerant.

3. Capacity of Direct Expansion Coils.

The capacity of a direct expansion coil depends upon the quantity of air passing through the coil, the dry and wet bulb temperatures of this air, and the temperature of the refrigerant. If the quantity of air is increased, the coil will have a greater capacity. Because of this increased capacity, the coil will be able to boil off or evaporate a greater quantity of refrigerant in a given time. On the other hand, **if the quantity of air, or the temperature difference between the air and the refrigerant, is reduced, (dirty evaporator coil) the rate of refrigerant evaporation will decrease and the coil capacity will correspondingly decreased.**

Any increase in the rate of evaporation will cause an increase in the quantity of refrigerant vapor created, and if the compressor is running at constant speed, the increased vapor flow will raise the suction pressure. Conversely, **any decrease in the rate of evaporation (dirty evaporator coil) will lower the suction pressure.**

Refrigerant Controls

Chapter 7: Servicing the Thermostatic Expansion Valve
Pages 45, 46, and 47.

Refrigeration Mechanical Equipment Service Manual Volume One
Chapter: 7 Evaporators
Page 81.

- B. Incorrect: The superheat will be high
- C. Incorrect: The superheat will not be affected
- D. Incorrect: None of the above

PTS: 1

134. The low pressure cap tube of an oil failure switch should be connected to the:
- A. Incorrect: Discharge port
 - B. Incorrect: Liquid line
 - C. **Correct:** Compressor crankcase

Oil Protection Control

High speed refrigeration compressors require the use of a pump to maintain uniform flow of oil and oil pressure in the lubrication systems of compressors. An ordinary pressurestat connected to the oil pump discharge line should not be relied upon to stop the compressor if oil pressure is too low. The oil pump draws oil from the compressor crankcase and pumps it into oil passages, and after the oil has lubricated the necessary parts of the compressor it drains back to the crankcase (except for the small portion which leaves the compressor with the refrigerant). **The oil system is subjected to compressor crankcase pressure which is also suction pressure**, and a pressure gage connected to the oil pump discharge would read the combination of suction pressure plus the pressure developed by the oil pump; but such but such a reading would be meaningless because suction pressure varies according to operating conditions. However, if the difference between oil pump discharge pressure and crankcase pressure was measured, you would have an indication of the actual pressure that is causing the oil to flow within the compressor. The pressure difference is referred to as the useful oil pressure. The oil protection control (which may also be called an oil pressure failure control, or an oil safety switch) measures this pressure difference by the use of two bellows opposed to each other.

Oil pump discharge pressure is exerted on one of the bellows, and suction pressure is exerted on the other bellows. The difference between these two pressures is the useful oil pressure. If this pressure is too low, the rod connecting the two bellows together will move so as to operate a switch to break an electric circuit and stop the compressor.

Refrigeration Mechanical Equipment Service Manual Volume One
Chapter 25: Related Electrical Equipment
Page 329.

- D. Incorrect: Oil pump connection
- PTS: 1
135. When copper tubing is being brazed, nitrogen gas can be purged through the system to prevent:
- A. Incorrect: Damaging temperature sensitive components
 - B. Incorrect: The tubing from overheating
 - C. **Correct:** Oxidation inside the tubing

Erection of Refrigerant Piping Systems Using Copper Tubing

When all fittings and sections of tubing are ready to be brazed, they should be assembled and securely blocked in position, firmly supported, and properly aligned so that tubing is concentric within fittings.

The next precaution to be observed is the prevention of forming copper oxide when the piping is heated. Even though every precaution may have been taken to avoid the presence of oxygen inside the piping, it must be assumed that some air, together with its oxygen, will have gotten into the piping by the time it is ready to be brazed. Silver brazing will require that the parts being brazed be heated to temperatures of 1100 degrees F to 1300 degrees F, and in the presence of oxygen, copper at such elevated temperatures will rapidly oxidize and form a scale. As previously discussed, this oxide scale is a contaminant which must be kept out of the system. **The recommended procedure is to prevent the formation of scale by purging the pipe to be brazed with dry nitrogen. This method will replace the air with a gas which is inert and so the copper on the inside of the pipe will not oxidize.** The nitrogen must be dry “oil-pumped” grade.

Refrigeration Mechanical Equipment Service Manual Volume One
Chapter 20: Refrigerant Piping Installation
Question 4. Page 260.

D. Incorrect: Production of toxic fumes

PTS: 1

136. In an economizer, an enthalpy control regulates the use of outdoor air on the basis of the air's:

A. **Correct:** Humidity and temperature

Enthalpy controls may be thought of as combination controllers containing dry-bulb thermostats that are reset by a relative humidity element. At any given outside dry-bulb temperature, the air's moisture content and its total heat content may vary significantly. In other words, 70 degree F dry air might be quite capable of cooling a building while 70 degree F saturated air would contribute to the same building's cooling load.

Outside air enthalpy in the 21 btu/lb. to 24 btu/lb. range is normally considered adequate for comfort cooling of commercial buildings. Any combination of dry-bulb and wet-bulb temperatures providing enthalpy within that range will provide sufficient cooling

Air Conditioning Mechanical Equipment Service Manual
Chapter 17: Automatic Controls
Question 1. Page 317.

B. Incorrect: Sensible heat

C. Incorrect: Latent heat

D. Incorrect: Return flow temperature

PTS: 1

137. When removing the gauge port plug from a compressor discharge service valve, the valve should be:

- A. Incorrect: Front seated
- B. **Correct:** Back seated

Using the Gage Manifold

For pressurized systems, a suggested procedure is:

Locate usable pressure taps. **Where compressors have service valves the valve gage ports would be used. In this case, the valve should be backseated to isolate the gage port from the system.** Next, the plug or cap should be slowly removed from the gage port, and any residual pressure be allowed to vent to atmosphere. Then an adapter having a male flare fitting to which the manifold hose can be connected.

Refrigeration Mechanical Equipment Service Manual Volume One
Chapter 31: Checking Refrigerant Temperature and Pressures
Question 1. Page 476.

- C. Incorrect: Cracked off the backseat
- D. Incorrect: Closed

PTS: 1

138. An acid test kit is used to test acidity of:

- A. Incorrect: Refrigerant
- B. **Correct:** Oil

Hermetic Compressor Motor Burnouts

If motor failure is evident, it should be determined whether a burnout has occurred. Test kits such as Carrier Total test should be used for this purpose.

The size and type of compressor will determine further procedures to confirm a burnout and to determine its extent. Burnouts are classed as *mild* or *severe*, depending upon the extent of clean-up recommended.

A sample of the compressor oil should be checked for color and odor. It should also be checked for acidity using an acid test kit.

Refrigeration Mechanical Equipment Service Manual Volume One
Chapter 34: Servicing Procedures

Question 6. Pages 527 and 528.

- C. Incorrect: Condensate
- D. Incorrect: Water

PTS: 1

139. The TXV sensing bulb is mounted:

- A. Incorrect: On the liquid line between the condenser and the TXV
- B. Incorrect: On the inlet to the condenser
- C. **Correct:** On the suction line as it leaves the evaporator

Valve Location and Installation

Unless instructed otherwise by the valve manufacturer, thermostatic expansion valves may be mounted in any position, although upright mounting with the power head on top is preferred. They should be installed as close as possible to the evaporator, and there should be no restrictions between the valve and the evaporator, other than a refrigerant distributor if used.

Proper location of the thermal bulb is very important. Requirements for correct bulb installation are:

The bulb should be close to the evaporator outlet. The bulb should always be installed in a horizontal line. If there is no way of avoiding installation on a vertical line, the bulb should be turned so that the capillary tube comes out at the top. The bulb should never be installed where liquid can trap. Liquid refrigerant or a mixture of liquid refrigerant and oil boiling out of the trap will give a false temperature rather than actual suction gas temperature. **The suction line where the bulb is to be mounted** should be cleaned, and the bulb should be securely attached with two clamps. Oil leaving the evaporator in an oil-refrigerant mixture generally flows along the lower portion of a horizontal suction line, and it is not good practice to place a bulb on the bottom of the line. It is preferable to locate the bulb on top of the line for lines 3/4 inch and smaller in size. On larger lines, it is generally recommended that the bulb be installed at a point midway down on the side of the line.

Refrigeration Mechanical Equipment Service Manual Volume One
Chapter 15: Application of the Thermostatic Expansion Valve
Pages 196 and 197.

- D. Incorrect: On the compressor discharge line

PTS: 1

140. In an air cooled system with capacity control, compressor unloading will cause the:

- A. **Correct:** Suction pressure to rise and the discharge pressure to fall

Multispeed Compressor Motors

Since the capacity of a compressor is proportional to the compressor speed, one way of regulating capacity is to vary the speed of the compressor.

One method of varying the speed of a compressor driven by an electric motor is to use a two-speed motor, two low-pressure switches, and a two-speed magnetic motor starter. **At high suction pressure, indicating a heavy load, the compressor is operated at high speed. As the load decreases and suction pressure falls, one of the low pressure switches opens and changes the speed from high to low.** Further decrease in load and suction pressure to a minimum causes the second low pressure switch to stop the compressor.

Multiple Compressors

One way to obtain capacity control is to use more than one compressor. For example, if a required capacity of 15 tons was split into three compressors each of five tons capacity, two compressors could run and have 67 percent capacity, or only one compressor and have 33 percent capacity; the one compressor could be cycled under on-off control for capacity below the 33 percent step.

This is desirable in some installations where complete shutdown due to failure of equipment would cause serious financial loss. An example of this is a cold storage refrigerator where the refrigerated meat, milk, etc., could spoil if left without refrigeration. The use of multiple compressors provides standby service, and under partial load conditions only the number of compressors would be operated as required by the load on the system. Since unneeded compressors are completely stopped, the horsepower requirements of a multiple compressor system are reduced proportionately as load decreases.

When multiple compressors are started in sequence, the draw of starting current is less than it would be to start one large compressor motor. This an advantage as it also allows the use of smaller electrical wiring. Another advantage is avoiding interruptions to electrical power systems which can occur when large motors are started.

However, there is a lubrication problem if more than one compressor is to be connected to a single evaporator piping system. Unless pressures in the crankcases of the several are equalized, the oil will leave the crankcase having the highest pressure. Methods of equalizing pressures and oil levels require careful planning.

Refrigeration Mechanical Equipment Service Manual Volume One
 Chapter 10: Capacity Control of Reciprocating Compressors
 Question 8. Pages 120 and 121.

- B. Incorrect: Suction pressure to fall and energy consumption to decrease
- C. Incorrect: Suction pressure and discharge pressure to fall
- D. Incorrect: Discharge pressure to rise and energy consumption to decrease

PTS: 1

141. A lamp has a source voltage of 110 volts and a current of 0.9 amperes. What is the resistance of the lamp?

ANS:

122.2 Solution: Ohms Law

$R = E \text{ divided by } I$

$110 \text{ divided by } 0.9 = 122.2 \text{ ohms}$

PTS: 1

142. The amount of heat removed to lower the temperature of 15 lbs. of water from 48 degrees F to 39 degrees F is:

ANS:

135 Solution:

Heat = Weight (lbs.) x Specific Heat (btu/lb. per degree) F x Temperature Change (degrees F)

$= 15 \times 1 (48-39) \text{ degrees f}$

$= 15 \times 1 \times 9$

$= 135 \text{ Btu}$

PTS: 1

143. A belt-driven fan is to turn at 580 rpm. If the fan is driven by a 1740 rpm motor and the motor has a pulley with a three-inch pitch diameter, the fan pulley should have a pitch diameter of _____ in.

ANS:

9 Solution: $RPM \times D = rpm \times d$

$580 \times D = 1740 \times 3 (5220)$

$D = 1740 \times 3 (5220) \text{ divided by } 580$

$= 9 \text{ in.}$

PTS: 1

144. Using a rule-of-thumb figure, approximately how much heat, in Btu/hr., must be rejected by the condenser when the net refrigerating effect is 25 tons?

ANS:

375,000 Solution:

“Rule-of-thumb” figure for condenser heat rejection is 15,000 Btu per ton of net refrigeration effect.

25 tons x 15,000 Btu per ton = 375,000 Btu per hour

PTS: 1

145. The heat transferred by calculating water can be expressed by the following equation:

$$\text{Btuh} = 500 \times \text{gpm} \times \text{delta T}$$

A particular heat exchanger is supplied with circulating chilled water flowing at a rate of 100 gpm. If heat is added to the water at a rate of 500,000 btuh when the initial (entering) water temperature is 40 degrees F, at what temperature does the water leave the heat exchanger?

ANS:

50 Solution: $\text{Btuh} = 500 \times \text{gpm} \times \text{delta T}$

$500,000 = 500 \times 100 \times \text{delta T}$

$\text{Delta T} = \frac{500,000}{500 \times 100}$

500×100

$\text{Delta T} = 10$

Leaving temperature = $40 + \text{delta t}$

Leaving temperature = $40 + 10$

Leaving temperature = 50 degree F

PTS: 1

146. What is the maximum safe amperage draw of the secondary winding of a 60 VA transformer output of 12 volts?

ANS:

5 Solution: Divide VA by volts

60 divided 12 = 5 amps.

PTS: 1

147. Theoretically, a pump can raise water by suction approximately _____ feet vertically.

ANS:

34 Solution: $\frac{\text{Atmospheric press. (14.7 psi)}}{\text{Weight of column of water 1' high}}$ = 33.95 (34) ft.

(.433 lb. per foot)

(.433 lb. per foot)

Theoretically, water can be pulled (raised) approximately 34' vertically. The positive atmospheric pressure forces the liquid up the suction pipe towards the lower pressure at the pump connection.

The partial vacuum in a pump is created by the piston in reciprocating pumps, by the cam or gear action in rotary pumps and in centrifugal pumps by the liquid being forced away from the center. The maximum practical suction lift on positive displacement pumps is 22' and on centrifugal pumps it is 15'.

PTS: 1

148. The seal in a compressor is necessary to prevent
- A. Partially Correct: Refrigerant from leaking out at the rotating shaft.
A function of a seal is to keep the refrigerant inside the system.
 - B. Incorrect: Air from leaking out at the rotating shaft.

It is the function of the seal to keep air from leaking in at the rotating shaft and contaminating the refrigerant.

- C. Partially Correct: Oil from leaking out at the rotating shaft.
A function of a seal is to keep the refrigerant inside the system.
- D. **Correct:** Both A and C from above.

PTS: 1

149. Some codes require a manual reset device on a safety limit
- A. **Correct:** So that the cause of the safety shutdown can be investigated prior to re-start.
A function of a seal is to keep the refrigerant inside the system.
 - B. Incorrect: So that the equipment will not short-cycle.
While it is true that a manual reset requires a person to reset the safety and would help to prevent short-cycle operation, the code is written so that the root cause of the safety shutdown can be identified.
 - C. Incorrect: So that more technicians are needed, which helps the economy.
Code officials do not consider the impact on the economy when writing code.
 - D. Incorrect: Because automatic reset is more costly.
Code officials are concerned with safety and not cost.

PTS: 1

150. A flame sensing relay strategy that takes advantage of the fact that hot gasses in a flame become ionized and conduct electricity is called a

A. Incorrect: Cad cell.

Cad cells “see” flame if it is colored yellow, as is fuel oil flame. Cad cells do not work for the blue flame of natural gas systems.

B. Incorrect: Thermocouple.

Thermocouples produce small voltage (about 30 millivolts DC) when heated in a flame. They use the principle that two dissimilar metals that are fused together at one end to form a “hot” junction, and open at the opposite end to form a “cold” junction, will generate electrical voltage when heating.

C. **Correct:** Flame rod.

Flame rods are designed so that current is conducted in the flame is much stronger in one direction (half cycle) than in the other, which produces a rectified signal.

D. Incorrect: Ion sensor.

PTS: 1

151. When charging a system, the refrigerant cylinder pressure may drop too low for further charging. Which of the following methods should *not* be used to increase the pressure?

A. **Correct:** Heat the cylinder with a torch.

You should never heat a cylinder with a torch, and should never raise the temperature above 125 degrees F.

B. Incorrect: Heat the cylinder with a heat lamp.

Using a heat lamp is an acceptable method for heating a cylinder. Care should be taken never to raise the temperature above 125 degrees F.

C. Incorrect: Heat the cylinder by immersing it in a tub of warm water.

Immersing a refrigerant cylinder in a tub of warm water (80 degrees F to 110 degrees F) is an acceptable method to use for heating a cylinder. Care should be taken to raise the temperature above 125 degrees F.

D. Incorrect: Heat the cylinder by wrapping it in a specially built electric heater.

Using a specially built electric heater is an acceptable method for heating a cylinder. Care should be taken never to raise the temperature above 125 degrees F.

PTS: 1

152. In a thermostatic expansion valve, three forces act on the diaphragm in the power head, which is connected to the valve. Evaporator pressure acts to _____ the valve, spring pressure acts to _____ the valve and bulb pressure from the bulb attached to the evaporator outlet acts to _____ the valve.

A. Incorrect: Open; open; close.

It is true that the force of the suction pressure from the bulb opposes the other two pressures, but not in the manner described by this choice.
close; close; open.

B. **Correct:** Close; close; open.

Both the evaporator pressure and the spring pressure act to close the valve, while the suction pressure from the bulb acts to open the valve.

C. Incorrect: Close; open; open.

The pressure from the evaporator and the spring act in the same direction and oppose the force of the suction pressure from the bulb.

D. Incorrect: Open; close; close.

The pressure from the evaporator and the spring act in the same direction and oppose the force of the suction pressure from the bulb.

PTS: 1

153. A stuffing box type of shaft seal on a centrifugal pump needs periodic maintenance. If the seal is found to be leaking excessively, the technician should

A. Incorrect: Replace the carbon washer and/or tension the spring.

The carbon washer and spring are components of the mechanical shaft seal.

B. Incorrect: Replace the entire seal as this is cheaper than repairing a leaking seal.

Periodic maintenance is expected with stuffing box seals and they're easy to maintain.

C. **Correct:** Tighten the packing gland and/or replace the packing.

In most cases, simply tightening the packing gland will minimize the leakage. Remember that this type of seal is designed to leak slightly, as water acts as a lubricant. If tightening the packing gland does not minimize the leak, the packing itself may be worn and need replacing.

- D. Incorrect: Replace the pump, as the seal is an integral part of the pump and not easily replaced or repaired.

The seal is an inexpensive part of an expensive pump. It is far more cost effective to tighten the seal than to replace the pump.

PTS: 1

154. Cavitation can destroy a centrifugal pump, is noisy and is caused by

- A. Incorrect: Inlet pressure that is too high.
 B. **Correct:** Inlet pressure that is too low.

Inlet pressure that falls below the manufacturer's recommended net positive suction head (NPSH) will cause water to boil due to the low pressure, causing bubbles and cavitation.

- C. Incorrect: Outlet pressure that is too low.
 D. Incorrect: Outlet pressure that is too high.

PTS: 1

155. Cavitation can destroy a centrifugal pump, is noisy and is caused by

- A. Incorrect: Inlet pressure that is too high.

While this will cause a pump motor to fail, it is not a very common cause of failure. Further, the pump will likely fail very soon if supplied with improper voltage.

- B. Incorrect: Inlet pressure that is too low.

The centrifugal type pump used as a vacuum pump will pump even when rotating backwards. While this affects the ability of the pump to move water, it usually does not harm this type of pump.

- C. Incorrect: Outlet pressure that is too low.

A vacuum breaker is designed to prevent the pressure in the condensate return from dropping too low. If system pressure drops below 15 in. Hg, the breaker opens and lets air into the system. Since the pump draws from a tank that is vented to the atmosphere (to allow air to escape), it will typically see atmospheric pressure at the inlet and will be unaffected by system pressure.

D. **Correct:** Outlet pressure that is too high.

A failed steam trap will allow live steam to blow by. If the steam makes it to the vacuum pump, it can destroy the pump. In buildings with many steam traps and poor maintenance procedures, failed steam traps are a common cause of vacuum pump failure.

PTS: 1

156. A vacuum breaker is installed between equipment and a steam trap to

A. Incorrect: Allow a vacuum to be pulled on the system.

B. **Correct:** Allow condensate to drain after the steam has been shut off.

Once the steam supply has been shut off, steam will condense and will be unable to drain because of the vacuum. The vacuum breaker provides a vent and allows the condensate to drain

C. Incorrect: Prevent condensate from draining after the steam has been shut off.

It is necessary to remove the condensate from certain parts of the system during off cycles to prevent freezing.

D. Incorrect: Trip on low pressure cutoff.

PTS: 1

157. Two types of thermal overload relays in common use today are

A. Incorrect: The bimetal relay and the magnetic relay.

The magnetic relay is another type of overload that uses the principle of magnetism instead of heat to protect the motor.

B. Incorrect: The melting alloy relay and the Mercury bulb.

Mercury bulbs are commonly used as switches in thermostats, but are not used for overload protection.

C. **Correct:** The bimetal relay and the melting alloy relay.

D. Incorrect: The bimetal relay and the trimetal relay.

There is no such thing as a trimetal relay.

PTS: 1

158. When soldering, solder is drawn into the joint by

- A. **Incorrect:** The heat of the torch.
The heat of the torch melts the solder but does not draw it into the joint.
- B. **Correct:** Capillary action.
Capillary action is the flow of a liquid when it is drawn into a small space between wetted surfaces. This is the same action that draws colored water into flowers during Biology experiences and allows trees to get water from the roots to the crown.
- C. **Incorrect:** Gravity.
Many times, solder must actually be drawn uphill.
- D. **Incorrect:** Flux.
Flux certainly does help the solder to flow, but does not draw it into the joint.
- PTS: 1
159. The efficiency of an electric furnace is usually _____ percent.
- A. **Incorrect:** 10
- B. **Incorrect:** 50
- C. **Incorrect:** 80
- D. **Correct:** 100
- PTS: 1
160. Defective rigging components and hardware should be
- A. **Correct:** Destroyed
Prior to each shift, a component person will inspect the sling and all fastenings and attachments for damage or defects. Inspections will continue as warranted during use. The *competent person* will immediately remove damaged or defective slings from service and keep documentation on the inspections.
- If any member of the crew sees a defect in rigging, he or she should not wait for the *competent person* to inspect it. The defective rigging should be immediately removed from service.
- OSHA SMART MARK
Materials Handling Subpart H Trainee Booklet
Pages 15. Question 4 Page 26.

- B. Incorrect: Washed
- C. Incorrect: Recycled
- D. Incorrect: Repaired

PTS: 1

161. In order to reduce pressure to an acetylene pressure regulator, the adjusting screw is turned

- A. Incorrect: Clockwise to its limit
- B. **Correct:** Counter-clockwise until the tension is off

Pressure adjusting screw. The regulator adjusting screw controls the flow of gas and delivery pressure to the hose and torch. As previously stated, the regulators function to reduce high supply pressures to a suitable working pressure range. When adjusting screw is turned clockwise, the regulator will allow gases to flow through the regulator to the hoses and to the torch. The threaded adjusting screw allows mechanical force to be applied to a spring which controls a flow valve in the regulator. If the adjusting screw is turned **counterclockwise**, tension on the spring is released and the regulator will not allow the gas to flow.

Soldering & Brazing
Chapter 6: Heating Equipment
Pages 90.
Question 8.

- C. Incorrect: Clockwise one half turn
- D. Incorrect: Clockwise one full turn

PTS: 1

162. Suction gas temperature leaving evaporator minus saturated suction temperature equals

- A. Incorrect: Subcooling
- B. Incorrect: Condensing temperature
- C. **Correct:** Superheat

Calculating superheat example using R-22.

NOTE: To arrive at the correct superheat reading, take the following steps.

- A. Note the suction pressure or evaporating pressure reading from the suction gage: 69 psig.
- B. Convert the suction pressure reading to suction or evaporating temperature using the pressure/temperature chart (PT chart) for R-22: 40 degrees F.

- C. Use a suitable thermometer to record the actual temperature of the suction line: 50 degrees F.
- D. Subtract the saturated suction line temperature from the actual suction line temperature: 50 degrees F - 40 degrees F = 10 degrees F of superheat.

HVACR Training Manual
 Unit 3 Refrigeration and Refrigerants
 3.11 Refrigeration System and Components. Page 39.

Definition of Superheat Glossary Page 1284.
 The temperature of vapor refrigerant above its saturation change-of-state temperature.

- D. Incorrect: Evaporator operating temperature

PTS: 1

163. Which of the following gases must never be used to pressurize or leak test a refrigeration system?

- A. Incorrect: Nitrogen
 B. **Correct:** Oxygen

Some precautions which must be taken when leak testing are:

1. Nitrogen must be oil-pumped dry nitrogen.
2. Although carbon dioxide (CO₂) could be used instead of nitrogen, **never** use oxygen or acetylene.
3. When using high-pressure gas such as nitrogen or carbon-dioxide in cylinders, always use a pressure regulator and a relief valve.

Refrigeration Mechanical Equipment Service Manual Volume Two
 Chapter 32: Leak Testing, Evacuating, and Charging
 Pages 481-482.
 Question 1.

- C. Incorrect: CO₂
 D. Incorrect: Helium

PTS: 1

164. For electric heat furnace what size should the flue pipe be?

- A. Incorrect: 8"
 B. Incorrect: 6"
 C. **Correct:** No flue

D. Incorrect: 10”

PTS: 1

165. Defrost systems can be terminated by

A. Partially Correct: Time

B. Partially Correct: Pressure

C. Partially Correct: Temperature

D. **Correct:** Any of the above

Defrost Timer. Defrost cycles are initiated at periodic intervals as, for example, every three hours.

The timer contains an electric clock which turns cams to operate one or more switches. Although it is standard practice to initiate defrost cycles according to time intervals, there are several ways by which the defrost cycle is terminated:

Time-terminated. The timer automatically returns the system to normal operation after a set number of minutes on defrost.

Temperature-termination. A remote-bulb thermostat senses the temperature of the evaporator coil surface. An accumulation of ice and frost will lower the coil surface temperature and upon being defrosted the temperature will rise to normal. The thermostat senses the temperature rise and terminates the defrost cycle, the timer will do so after a set elapse of time.

Pressure-terminated. When the evaporator has lost its capacity because of a coating of ice and frost, there will be a decrease in suction pressure. However, defrosting will restore ability of the evaporator to boil off refrigerant, so that suction pressure will rise. Suction pressure can be sensed by the defrost control and it will terminate the defrost cycle when suction pressure rises to normal. A possible difficulty is that if the suction line is exposed to a low ambient temperature or if it is cooled because of being installed near cold refrigerant lines, the suction pressure may remain low even though the evaporator is defrosted. Therefore, defrost controls usually include a fail-safe feature which automatically terminates the defrost cycle after a set elapse of time, even though suction pressure may not have risen enough to cause a pressure-termination of the cycle.

Refrigeration Mechanical Equipment Service Manual Volume Two
Chapter 29: Commercial Medium and Low Temperature Refrigeration
Pages 427-435.
Question 12.

PTS: 1

166. A refrigerant heat exchanger might cause:

- A. Incorrect: Too much subcooling for proper operation of the expansion valve.
- B. Incorrect: Flash vapor in the liquid line.
- C. **Correct:** The compressor to be overheated.

The term *heat exchanger* is a general one, applying to a device in any kind of mechanical system that transfers heat from one medium to another. However, as referred to specially refrigeration, a heat exchanger means a device to transfer heat from the liquid to the relatively cooler suction vapor.

Precautions.

1. Heat exchangers must be constructed and installed so as not to trap oil.
2. **The amount of superheating should be limited, as excessive superheating of suction gas will cause excessive discharge temperature and overheat the compressor.** This effect can be readily checked on Pressure-Enthalpy Charts. This precaution is especially important for hermetic motor-compressors, since the motors are cooled by the suction vapor.
3. HCFC-22 Systems: Heat exchangers ordinarily are *not* to be used in systems using HCFC-22. The usual condensing pressures are quite high with normal evaporator superheat, and further increase in superheat would raise discharge pressure and temperature so high as to overheat the compressor and damage the discharge valves. If an unusual low-temperature application should require a heat exchanger, it is considered good practice to provide a valve bypass line around the exchanger, to adjust flows so as to reduce any compressor overheating which may occur.
4. Heat exchangers should not be indiscriminately added to systems. Their use without proper investigation of system design and engineering can lead to compressor damage.

Refrigeration Mechanical Equipment Service Manual Volume One
Chapter 17: Refrigerant Piping Accessories
Question 6. Pages 220 and 221.

- D. Incorrect: The suction line to sweat.

PTS: 1

167. The purpose of a suction line accumulator is to:
- A. Incorrect: Trap and accumulate the noncondensables.
 - B. Incorrect: Accumulate excess vapor.
 - C. Incorrect: Trap oil.
 - D. **Correct:** Trap liquid refrigerant.

In some applications, such as heat pumps and hot-gas defrost systems, it is anticipated that in normal operation there will at times be liquid floodback from the evaporator. **The suction accumulator can be used to protect the compressor against entry of liquid in such cases where, although only occasional, the quantities of liquid are fairly large so that they could not be immediately evaporated in a heat exchanger.**

The suction accumulator is installed in the suction line between the evaporator and the compressor. It is basically a tank; a slug of liquid refrigerant and/or oil leaving the evaporator will be trapped in the accumulator.

Refrigeration Mechanical Equipment Service Manual Volume One
Chapter 17: Refrigerant Piping Accessories
Question 7. Page 221.

PTS: 1

168. The proper location for an oil separator is near the:

A. **Correct:** Compressor.

When reciprocating compressors are in normal operation, their pistons and piston rings ride on a film of lubricating oil. A small quantity of the oil is pushed through the cylinders and leaves the compressor along with the discharge gas. The oil must be returned to the compressor.

An oil separator is a tank-like device which removes oil from the refrigerant and automatically returns the oil to the compressor.

Refrigeration Mechanical Equipment Service Manual Volume One
Chapter 17: Refrigerant Piping Accessories
Question 8. Page 215.

B. Incorrect: Condenser.

C. Incorrect: Receiver.

D. Incorrect: Evaporator.

PTS: 1

169. The two planes of alignment that must be considered when aligning a flexible coupling are

A. Incorrect: Axial and parallel.

Axial and parallel mean the same thing in reference to a shaft. However, the shafts must be aligned parallel to one another, which is the same as saying that they must be aligned axially. This means that their centerlines must line up.

B. **Incorrect:** Parallel and perpendicular.

While it is true enough that the shafts must be aligned parallel to one another, they cannot be perpendicular to one another.

C. **Incorrect:** Horizontal and vertical.

D. **Correct:** Parallel and angular.

Shafts must be aligned so that the centerlines meet each other exactly in the center (parallel to one another, or axially), and they must be aligned so that they have no angular difference between them (also called radical alignment).

PTS: 1

170. How can you identify reverse operation with a scroll compressor?

A. **Partially Correct:** The compressor will not compress.

There are other symptoms.

B. **Partially Correct:** The compressor will stop on motor overload.

There are other symptoms.

C. **Incorrect:** you can see it running backwards.

The moving parts are sealed from view, so it is not possible to see operation.

D. **Correct:** Both A and B from above.

PTS: 1

171. When in doubt, what should be installed at the bottom of a suction line riser?

A. **Incorrect:** A check valve

B. **Correct:** A p-trap

Problems can occur in getting oil to flow upward in certain vertical piping, and a trap at the bottom of the riser can assist in getting the oil to begin the upward flow. Another purpose of a trap is to prevent oil in certain lines from draining back to the compressor during the off-cycle.

Refrigeration Mechanical Equipment Service Manual Volume One
Chapter 18: Refrigerant Piping ---- General Requirements and Pipe Sizing
Page 232.

C. **Incorrect:** A service port

D. Incorrect: A balancing valve

PTS: 1

172. Condenser saturation temperature on air cooled condenser should be higher than the ambient temperature by:

- A. Incorrect: 100 degrees F to 105 degrees F
- B. Incorrect: 90 degrees F to 100 degrees F
- C. Incorrect: 10 degrees F to 15 degrees F
- D. **Correct:** 30 degrees F to 35 degrees F

Air-cooled condensers have a relationship to the temperature of the air passing over them. The refrigerant inside the coil will normally condense at 30 degrees F higher than the air passing over it (also known as the ambient air). This statement is true for most standard-efficiency condensers that have been in service long enough to have a typical dirt deposit on the fins and tubing. The relationship can be improved by adding condenser surface area. With the outside air temperature of 95 degrees F, the condensing temperature will be about 125 degrees F.

HVACR Training Manual
Study Guide / Lab Manual
Unit 22 Condensers
Review Test Question 16. Page 134.

HVACR Training Manual
Unit 22 Condensers
22.5 Air-Cooled Condensers. Page 411.

PTS: 1

173. The compression ratio in a system can be determined by:

- A. Incorrect: Multiplying discharge gage pressure by suction gage pressure
- B. **Correct:** Dividing discharge pressure absolute by suction pressure absolute

The compression ratio of a compressor is the ratio of the absolute discharge pressure (psia) to the absolute suction pressure (psia):

$$\text{Compression Ratio} = \frac{\text{Discharge pressure, psia}}{\text{Suction pressure, psia}}$$

Note that compression ratio is always based on absolute pressures.

Refrigeration Mechanical Equipment Service Manual Volume One
 Chapter 9: Reciprocating Compressors
 Page 108.

- C. Incorrect: Dividing suction pressure absolute by discharge pressure absolute
- D. Incorrect: Subtract suction pressure absolute from discharge pressure absolute and divide by 12,000 btu/hr.

PTS: 1

174. What is the “rule of thumb” in BTU’s per hour of heat rejection of a condenser?

- A. Incorrect: 10,000
- B. Incorrect: 12,000
- C. **Correct:** 15,000

As a “rule of thumb,” it has long been considered that the heat rejection from an air conditioning system is about 15,000 Btu per hour for every 12,000 Btu per hour of cooling capacity, or 15,000 divided by 12,000 equals 1.25 times the net refrigeration effect.

Refrigeration Mechanical Equipment Service Manual Volume One
 Chapter 11: Condensers, General Principle Water-Cooled Condensers
 Page 136.

- D. Incorrect: 18,000

PTS: 1

175. Typical suction superheat at the evaporator outlet of an air conditioning system is expected to be:

- A. Incorrect: 10 degrees F to 20 degrees F
- B. **Correct:** 12 degrees F to 15 degrees F

Adjustment of a thermostatic expansion valve means adjusting the spring tension so that the valve controls at the desired value of superheat. The proper value of superheat is usually established by the manufacturers of the equipment, and their recommendations should be followed. As a general rule, the superheat setting for a relatively high temperature application, such as air conditioning, might be 10 to 15 degrees; for low temperature applications, the superheat probably should not exceed 10 degrees.

Refrigeration Mechanical Equipment Service Manual Volume One
 Chapter 15: Application of the Thermostatic Expansion Valve

Pages 197 and 198.

- C. Incorrect: 20 degrees F to 25 degrees F
- D. Incorrect: 60 degrees F to 80 degrees F

PTS: 1

176. The three pressures that operate the thermostatic expansion are bulb, spring and evaporator

- A. Incorrect: Bulb closes, spring closes, evaporator opens the valve
- B. Incorrect: Bulb closes, spring opens, evaporator opens the valve
- C. Incorrect: Bulb opens, spring closes, evaporator opens the valve
- D. **Correct:** Bulb opens, spring closes, evaporator closes the valve

The three fundamental pressures which affect the opening and closing of the thermostatic expansion valve are: 1) Bulb pressure, 2) Evaporator pressure, and 3) Spring pressure.

Bulb pressure works through the capillary tube on the top of valve diaphragm and it acts to **open** the expansion valve.

The **evaporator pressure** works under the diaphragm in the direction of **closing** the valve. This pressure is equal to the pressure which corresponds with the refrigerant saturation temperature.

Spring pressure also acts to **close** the expansion valve. This pressure is transmitted through the top of the pin carrier and the push rods to the underside of the diaphragm.

Refrigerant Controls
Chapter 2: Valve Operation
Pages 10 and 11.

PTS: 1

177. To add refrigerant to the system through the suction service valve, the valve stem must be:

- A. Incorrect: Back seated.
- B. Incorrect: Front seated.
- C. **Correct:** Mid seated

Refrigeration Mechanical Equipment Service Manual Volume One
Chapter 16: Miscellaneous Valves and Refrigerant Control Devices
Page 203.

In order to read the pressure at the gage port while the compressor is running, the valve should be back-seated, and then turned in one or two turns to slightly open the connection to the gage port.

The compressor is always open to either the line or the gage port, or both if the valve is neither front-seated nor back-seated.

HVACR Training Manual
Study Guide / Lab Manual
Unit 10 System Charging
Review Test Question 14, page 48.

D. Incorrect: none of the above.

PTS: 1

178. How many Btu are there in 8 kW of electrical power?

A. Incorrect: 26,286

B. Incorrect: 5,968

C. **Correct:** 27,304

The unit of measurement for electrical power is the *watt (W)*.

Converting electric heat rated in kilowatts (kW) to the equivalent gas or oil heat rated in Btu. Suppose that we know the capacity in Btu for a 20-kW electric heater

(a kilowatt is 1000 watts). $1 \text{ kW} = 3413 \text{ Btu}$.

$20 \text{ kW} \times 3413 \text{ Btu/kW} = 68,260 \text{ Btu of heat energy}$

Converting Btu to kW. Suppose that a gas or oil furnace has an output capacity of 100,000 Btu/h. Since $3413 \text{ Btu} = 1 \text{ kW}$, we have $100,000 \text{ Btu divided by } 3413 \text{ Btu/kW} = 29.3 \text{ kW}$

In other words, a 29.3 -kW electric heat system would be required to replace the 100,000-Btu/h furnace.

$3.413 \text{ Btu} = 1 \text{ W}$. 1 kW (1000 W) $3.413 \times 1000 = 3413 \text{ Btu}$.

$3413 \text{ Btu} \times 8 \text{ kW} = 27,304 \text{ Btu's}$

HVACR Training Manual
Study Guide / Lab Manual
Unit 2 Matter and Energy
Review Test Question 9. Page 4.

HVACR Training Manual
Unit 2 Matter and Energy
2.14 Electrical Power ----- The Watt Page 21.

- D. Incorrect: 68,260
- PTS: 1
179. An enthalpy controlled economizer system uses _____ for change from mechanical cooling to economizer operation:
- A. Incorrect: Outside temperature sensor.
An outside temperature control only reacts to sensible heat.
- B. **Correct:** Outside temperature and humidity sensor.
An enthalpy sensor reacts to the total heat content of air, both sensible and latent energy.
- C. Incorrect: Return air temperature.
Return air temperature only represent the sensible energy of the air.
- D. Incorrect: Space temperature and humidity
The decision to change over from mechanical cooling to economizer is based on outdoor air conditions not indoor air conditions. There are economizer controls that use enthalpy sensors for both return air and outside air.
- PTS: 1
180. For a voltage measurement the meter is connected:
- A. Incorrect: In series with load
- B. **Correct:** In parallel to with load
The voltmeter is designed much like the ammeter, but a resistor is added to the circuit to prevent a direct short and to allow electrons to flow in the meter. The voltmeter uses two leads that are connected to jacks which lead to internal wiring. In order to obtain a reading, the two leads must touch or be connected to the conductors supplying the load or to the circuit that transfers the emf to the meter.
- Basic Electricity for United Association Journey Workers & Apprentices
Chapter 17: Alternating Current Meters and Instruments
Question 4. Page 125.
- C. Incorrect: With load removed
- D. Incorrect: With load bypassed
- PTS: 1

181. To measure motor current:
- A. **Incorrect:** Apply clamp-on amp meter around 2 or more wires
Amperage is not measure using two or more wires.
 - B. **Correct:** Apply clamp-on amp meter around wire
Motor amperage is measure by clamping the jaws of the meter around one of the motor power wires.
 - C. **Incorrect:** Connect amp meter in parallel to motor
AC amperage is not measured in parallel.
 - D. **Incorrect:** Connect voltmeter across motor winding
A voltmeter is not used to measure amperage.

PTS: 1

182. Before you work on an electrical circuit (touching components)?

- A. **Incorrect:** Check amperage with a good meter
- B. **Correct:** Check voltage with a good meter

High voltages and currents are present that may cause serious injury or extensive equipment damage. Be certain that all power has been turned off, locked out, and tagged in any situation where you must actually come in contact with the circuit or equipment. Make sure that the circuit cannot be turned on by anyone but you.

Use only well designed and well maintained equipment to test, repair, and maintain electrical systems and equipment. Use appropriate safety equipment such as safety glasses, insulating gloves, flash suits, hard hats, insulating mats, etc. when working on electrical circuits. Make sure that multimeters used for working on power circuits contain adequate protection on all inputs, including fuse protection on **ALL** current measurements input jacks.

Refrigeration Mechanical Equipment Service Manual Volume Two
Chapter 33: Testing Electrical Components
Page 503.

- C. **Incorrect:** Look to make sure switch is off
- D. **Incorrect:** Turn power on

PTS: 1

183. When measuring voltage, the meter test leads are connected in _____ with the component being tested.

- A. Incorrect: Series
- B. **Correct:** Parallel

A voltmeter is used to measure voltage drop, or a potential difference, across any part of a circuit. A voltmeter is always connected across a device (in parallel). The voltmeter can be used to measure the voltage drop across any of several devices which make up the total load.

Gas Installations for United Association Journey Workers & Apprentices
Chapter 6: Electrical Systems and Controls
Review Exam I-108.
Question 9. Page 197.

- C. Incorrect: Series/parallel
- D. Incorrect: Parallel/series
- E. Incorrect: A "dead" circuit

PTS: 1

184. If the voltage is kept constant at 240 volts, and the resistance measures 40 ohms, the current flowing through the conductor is:

- A. **Correct:** 6 amps

When the source of EMF provides a constant potential difference in the circuit and the temperature is constant, current is inversely proportional to resistance; when resistance goes up, current goes down; when resistance goes down, current goes up.

The three forms of Ohm's Law follow:

$$1. R = \frac{E}{I}$$

$$2. E = I \times R$$

$$3. I = \frac{E}{R}$$

Gas Installations for United Association Journey Workers & Apprentices
Chapter 6: Electrical Systems and Controls
Review Exam I-109.
Question 10. Pages 197 and 198.

Where R is the resistance in ohms, E is the applied emf in volts, and I is the current in amperes.

Problem	Solution
E = 240 volts	$R = \frac{E}{I}$
R = 40 ohms	I = 240/40
I = Unknown	I = 6 amps

- B. Incorrect: 60 amps
- C. Incorrect: 24 volts
- D. Incorrect: 240 volts
- E. Incorrect: 6 volts

PTS: 1

185. "VA" is the common term for:

- A. Incorrect: Amps
- B. Incorrect: Ohms
- C. **Correct:** Watts

Electrical power relates to the time rate of doing work. The definition of electrical wattage is 1 watt of power is used to perform work when 1 volt causes 1 ampere of current flow for 1 second. The letter P is used to represent electrical power. Power is measured in units of the watt. The formula for electric power is:

$$P = E \times I$$

Transformers are rated in Volt - Amps

Transformer Rating = VA

VA = Voltage x Amperage

Example: VA = 24 Volts x 2 amps, VA = 48VA

Gas Installations for United Association Journey Workers & Apprentices

Chapter 6: Electrical Systems and Controls

Review Exam I-109.

Question 10. Pages 198 and 210.

- D. Incorrect: Volts
- E. Incorrect: Gigajoules

PTS: 1

186. The device which operates similar to a fuse, but which can be reused, is a:

- A. Incorrect: Switch

B. Correct: Circuit breaker

There are two major types of circuit protectors, *fuses* and *circuit breakers*.

A fuse is used in a circuit to protect the wiring against overloads. An overload occurs whenever there is too much current for the size of the wire. This could happen if too many loads are plugged into the same circuit.

The other type of circuit protector is the circuit breaker. Some circuit breakers look much like a switch. They usually have a lever with an ON and OFF position.

When in the ON position, current flows through a thermal device within the breaker. If excessive current passes through this device, it heats up. If the thermal element gets too hot, it trips the breaker. When the breaker is tripped, the lever is in the OFF position and the circuit is open. After the thermal element has cooled sufficiently, the breaker can be manually reset to close the circuit again.

Another type of circuit breaker looks like a regular strip fuse with a button protruding from the top. When this breaker trips, it can be manually reset by pressing the button.

Gas Installations for United Association Journey Workers & Apprentices
Chapter 6: Electrical Systems and Controls
Review Exam I-109.
Question 12. Page 206.

- C. Incorrect: Load
- D. Incorrect: Source
- E. Incorrect: Conductor

PTS: 1

187. Fuses are sized by the _____ they can carry.

- A. Incorrect: Wattage
- B. Incorrect: Ohms
- C. Partially Correct: Amperage
- D. Partially Correct: Current
- E. **Correct:** Both C and D are correct

The simplest fuse is a metal conductor with a low melting point. When excessive current flows through the circuit, the fuse begins to heat up. When the temperature reaches the melting point, the conductor melts (blows), breaking the circuit.

Fuses are sized according to the amount of amperage they will carry without breaking the circuit. A 15 amp fuse will conduct up to 15 amperes. If too much load is plugged into the circuit, or a short drawing more than 15 amps occurs, the fuse will blow. Fuses come in many different amperage ratings. *Never* use a larger fuse than the circuit is rated for. An oversized fuse does not protect a circuit.

Gas Installations for United Association Journey Workers & Apprentices
Chapter 6: Electrical Systems and Controls
Review Exam I-109.
Question 13. Page 206.

PTS: 1

188. The 120V side of the transformer found on most heating system is referred to as the:

A. **Correct:** Primary winding

Transformers are available in a variety of capacities for stepping-up or stepping down AC voltages.

The construction of a step-down transformer is simple. Windings of insulated wire and placed around one side of an iron core. This winding is connected to the power source and is called the primary winding. Another separate winding of insulated wire is placed opposite of the core. This is called the *secondary winding*.

There is no physical electrical connection between the primary and secondary of the transformer. Electrical energy is transferred from primary windings to secondary windings by the process of induction.

Gas Installations for United Association Journey Workers & Apprentices
Chapter 6: Electrical Systems and Controls
Review Exam I-110.
Question 14. Page 209.

B. Incorrect: Secondary winding

C. Incorrect: Hot winding

D. Incorrect: Initial winding

E. Incorrect: Number one winding

PTS: 1

189. Relays are made up of a _____ and one or more _____.

A. Incorrect: Switch, loads

- B. Incorrect: Source, switches
- C. Incorrect: Transformer, loads
- D. **Correct:** Load, switches

The relay is composed of two devices:

1. The coil portion, which is a *load* and performs work (the action of physically moving a switch).
2. A *switch* that controls the power source to another load.

Gas Installations for United Association Journey Workers & Apprentices
 Chapter 6: Electrical Systems and Controls
 Review Exam I-109.
 Question 14. Page 210.

- E. Incorrect: Load, transformers

PTS: 1

190. Terminal reheat systems:

- A. **Correct:** Permit any zone to have year round heating or cooling

Three principal advantages of reheat systems are:

1. They provide simultaneous sources of both cooling and heating, so that room or zone temperature can be controlled, no matter whether cooling or heating is needed to obtain the desired temperature.
2. They readily provide as many zones of control as may be desired, including control of each individual room, simply by providing the necessary number of coils and their heat source and controls.
3. They have the ability to maintain close control of humidity in the conditioned space, based on adequate control of the dew point of air supplied by the central apparatus.

Air Conditioning Mechanical Equipment Service Manual
 Chapter 18: Single Path All Air Systems
 Review Exam I-74.
 Question 7. Page 364.

- B. Incorrect: Are the most economical temperature control systems to operate
- C. Incorrect: Require a variable air quantity to each system
- D. Incorrect: Cannot provide heating in the summer season

PTS: 1

191. Variable volume systems:

- A. Incorrect: Supply each zone with a constant volume of air
- B. **Correct:** Control space temperature by regulating the flow of air to each zone

A variable air volume system has a terminal unit which contains an automatic damper by means of which the zone supply air quantity is varied. The automatic damper is under control of a thermostat which senses the temperature in the area or zone supplied by the terminal unit.

Air Conditioning Mechanical Equipment Service Manual
Chapter 18: Single Path All Air Systems
Review Exam I-75.
Question 9. Pages 365 and 366.

- C. Incorrect: are less economical to operation than constant volume systems
- D. Incorrect: require no air balancing after installation

PTS: 1

192. Volume limiting controls, also known as velocity controllers, used with variable air volume boxes:

- A. Incorrect: Reduce air volume to a zone when the duct pressure decreases
- B. **Correct:** Maintain a stable discharge volume regardless of supply duct pressure

Minimum and maximum limits can be readily obtained with volume regulators, by mechanical stops on mechanical volume regulators, or by setting of adjustment stops on pneumatic volume regulators.

Separate maximum volume limiters are also available for pneumatic systems such limiters sense velocity as indicated by a difference between total and static pressure of air in the terminal unit inlet, and act to limit the pneumatic air pressure supplied to the damper actuator.

A maximum volume limiter for electric control systems is wired into a control circuit and operates as follows: Excess velocity pressure closes a switch in the limiter which overrides the zone thermostat to drive the damper toward the closed position until velocity pressure and velocity drop to the predetermined value.

Air Conditioning Mechanical Equipment Service Manual

Chapter 18: Single Path All Air Systems
 Review Exam I-75.
 Question 10. Pages 382 and 383.

- C. Incorrect: regulate supply duct static pressure
- D. Incorrect: operate fan vortex dampers to maintain a constant velocity at the VAV box

PTS: 1

193. Air handling units of the multizone type:

- A. Partially Correct: Are able to supply each zone with heated or cooled air in all seasons
- B. Partially Correct: Are less economical to operate than VAV systems
- C. Partially Correct: Can have their hot deck temperature reset on coldest zone demand
- D. **Correct:** All of the above

Multiple-path systems have more than one path for the conditioned air supply, making it possible for the central apparatus to provide air at more than one temperature.

The multizone system uses a central air apparatus of the blow-through type. The supply fan discharges air through either the cooling coil or the heating coil, or air in varying proportions through each coil.

A disadvantage of multi-path systems is loss in operating economy compared to some other systems, the variable air volume system for instance.

A cold deck thermostat and hot deck thermostat each maintain their set point temperatures year-round. The cold deck temperature is set at a low enough temperature, typically about 55 degrees F, to provide cooling capacity equal to the design cooling load.

The hot deck temperature is set high enough typically about 120 degrees F, to satisfy the design heating load. Refrigeration and heating equipment is operated to satisfy the demands of the deck thermostats.

In practice, heating may be turned off in season of extreme cooling loads, and mechanical refrigeration turned off in extreme heating seasons. In intermediate seasons, all equipment should be operated so that the zone thermostats will be able to mix cold air and warm air to satisfy zone requirements.

This provides good temperature control, but the need for using energy to heat air for partially neutralizing air on which energy has been expended to cool it, or vice versa, it is not an economical process.

A method used for refining the control system is by adding outdoor reset control. Hot deck temperature is reduced as outdoor temperature rises.

Air Conditioning Mechanical Equipment Service Manual
Chapter 18: Multipath All Air Systems
Review Exam I-75.
Question 11. Pages 391 through 396.

PTS: 1

194. To improve their operating economy, multizone air handlers should:
- A. Incorrect: Maintain a hot deck temperature of at least 160 degrees F
 - B. Incorrect: Be used with a variable capacity squirrel cage fan
 - C. **Correct:** Have their hot deck temperature reset by outside air temperature or on coldest zone demand

A cold deck thermostat and hot deck thermostat each maintain their set point temperatures year-round. The cold deck temperature is set at a low enough temperature, typically about 55 degrees F, to provide cooling capacity equal to the design cooling load.

The hot deck temperature is set high enough typically about 120 degrees F, to satisfy the design heating load. Refrigeration and heating equipment is operated to satisfy the demands of the deck thermostats.

In practice, heating may be turned off in season of extreme cooling loads, and mechanical refrigeration turned off in extreme heating seasons. In intermediate seasons, all equipment should be operated so that the zone thermostats will be able to mix cold air and warm air to satisfy zone requirements.

This provides good temperature control, but the need for using energy to heat air for partially neutralizing air on which energy has been expended to cool it, or vice versa, it is not an economical process.

A method used for refining the control system is by adding outdoor reset control. Hot deck temperature is reduced as outdoor temperature rises.

Air Conditioning Mechanical Equipment Service Manual
Chapter 18: Multipath All Air Systems
Review Exam I-75.
Question 13. Page 396.

- D. Incorrect: Use parallel flow hot water coils
- PTS: 1
195. To improve their operating economy, multizone air handlers should:
- A. Incorrect: Maintain a hot deck temperature of at least 160 degrees F
- B. **Correct:** Be used with a variable capacity squirrel cage fan
- Morning warm-up.* If the building has been unoccupied at night or over a weekend during cold weather, the temperature in areas served by the variable air volume system may become uncomfortably cool. It may be necessary to supply warm air through the system for a short period of time until lights have been turned on and the building becomes occupied.
- Since the system is designed to supply less air in response to falling room temperature, the VAV dampers will have moved to their closed or minimum positions and depending on the controls used, the warm air may or may not be able to flow through the terminal units and into the space unless special provisions are made. If all terminals are constructed and adjusted to provide a minimum open position, warm-up may be obtained by simply supplying warm air for an adequate period prior to occupancy.
- Air Conditioning Mechanical Equipment Service Manual
Chapter 18: Single Path All Air Systems
Review Exam I-76.
Question 14. Page 384.
- C. Incorrect: have their hot deck temperature reset by outside air temperature or on coldest zone demand
- D. Incorrect: use parallel flow hot water coils
- PTS: 1
196. As compared to across-the-line starters, reduced voltage starters:
- A. Incorrect: Reduce starting torque required
- B. Incorrect: Reduce inertia loads
- C. **Correct:** Reduce starting current inrush

Because of the problems caused by large starting currents, it is often necessary to limit the amount of power that can be drawn in starting large motors. Another although less common reason for limiting starting power occurs in some applications where the mechanical shock resulting from full-power starts could cause damage to the driven equipment. Essentially, limiting the power at start-up means that locked-rotor current must be reduced, and several types of starters are used for this purpose. These usually employ some means of reducing the voltage that is impressed on the individual motor windings at start-up. Such starters are consequently referred to as *reduced voltage starters* (as opposed to full-voltage starters, a term often applied to across-the-line starters).

Electric Controls for Mechanical Equipment Service
Chapter 9: Starters for Large Motors
Question 1. Pages 78 and 79.

D. Incorrect: Reduce accelerating time

PTS: 1

197. Closed transition starting means:

A. **Correct:** The motor is never disconnected from the line during starting

Arranging the transfer so that the motor is never disconnected from the line during the starting period can eliminate this objection. The latter arrangement is called closed transition. Electric utility companies may demand closed transition starting when using such reduced voltage starters.

Closed transition is achieved by proper sequence operation of the contacts, so that the motor is never disconnected from the line.

Reference: Electric Controls for Mechanical Equipment Service Diagrams book.

Diagram 5 on Diagram Sheet 5

Electric Controls for Mechanical Equipment Service
Chapter 9: Starters for Large Motors
Question 4. Page 84.

B. Incorrect: The machine is started with the inlet vanes closed

C. Incorrect: The motor is only temporarily disconnected during start-up

D. Incorrect: The starter has timed-closed contacts

PTS: 1

198. For maximum safety of equipment, overload relays should be:

A. **Correct:** Manual reset type

Manual reset is preferred, however because it requires the operator to look for the cause of the overload.

Electric Controls for Mechanical Equipment Service
Chapter 7: Purpose and Construction of Motor Controllers
Question 5. Page 66.

B. Incorrect: Automatic reset type

C. Incorrect: Included in contactors

D. Incorrect: Not affected by motor current

PTS: 1

199. For maximum safety of equipment, overload relays should be:

A. **Correct:** Manual reset type

Another basic requirement of a motor controller is that it should provide motor protection. There are some exceptions to this, as will be discussed later, but the protection of the motor against over-current is a very common requirement of a motor controller. You have seen that the fuses (or circuit breakers) that are used to protect the feeders (branch circuits) are capable of carrying starting and running currents of the motor. Such branch-circuit protection will protect the motor from short-circuit currents, but will not adequately protect the motor against overheating due to currents that are less than short-circuit currents but which exceed the rated current of the motor.

Electric Controls for Mechanical Equipment Service
Chapter 7: Purpose and Construction of Motor Controllers
Question 2. Page 59.

B. Incorrect: Automatic reset type

C. Incorrect: Included in contactors

D. Incorrect: Not affected by motor current

PTS: 1

200. Outdoor reset of hot water temperature for heating gives:

A. **Correct:** Hottest water during the coldest weather

When the outside temperature is low, the hot water or warm air must be at a high temperature, but to avoid overheating, it is desirable that the water or air not be quite as hot during mild weather.

Electric Controls for Mechanical Equipment Service
Chapter 12: Application of Thermostats
Question 5. Page 112.

- B. Incorrect: Hottest water only in the morning
- C. Incorrect: Hottest water during milder weather
- D. Incorrect: Night setback

PTS: 1

201. The heating capacity of an air-to-air heat pump:

- A. Incorrect: Is not affected by outside temperature
- B. Incorrect: Increases as outdoor air gets colder
- C. **Correct:** Decreases as outdoor air gets colder

In air-to-air heat pumps, the outdoor coil, which is the condenser in the cooling cycle, becomes the evaporator when the heat pump is used for heating. In the latter operation, whenever the outdoor-coil temperature reaches 32 degrees or colder, ice can form on the coil and will accumulate until the coil is completely blocked. This will of course reduce heat transfer from the coil to the surrounding air, causing a loss in heating capacity of the heat pump.

Electric Controls for Mechanical Equipment Service
Chapter 20: Humidity, Electric Heating and Heat Pump Control
Question 5. Page 205.

- D. Incorrect: Decreases as outside air gets warmer

PTS: 1

202. The instrument used for finding humidity levels in the atmosphere is the:

- A. **Correct:** Sling Psychrometer

This instrument provides both wet bulb and dry bulb readings that can be used with the Psychrometric Chart to determine the properties of the air just sampled.

- B. Incorrect: Micron gage

This device is used to measure deep vacuums in refrigeration systems.

C. Incorrect: Manometer

This instrument is used for determining pressure.

D. Incorrect: Infrared thermometer

This instrument is used for determining temperature.

PTS: 1

203. Suction line filter-driers are usually equipped with gage connections so that pressure drops can be determined. Why?

A. Incorrect: So that accurate superheat calculations can be made.

While it is true that a pressure drop through a suction line filter-drier will affect superheat calculations, the difference is slight and of little consequence.

B. Incorrect: To ensure that excessive load is not imposed on the compressor.

Suction line filter-driers are designed with low pressure drops so as not to affect the system.

C. Incorrect: To ensure that flash gas does not occur in the filter-drier.

Suction line filter-driers are designed with low pressure drops so as not to affect the system.

D. **Correct:** So that you can determine when to change the filter-drier.

Manufacturers publish tables that specify permissible core pressure drops. When the drop exceeds recommendations the core should be replaced.

PTS: 1

204. The average house line pressure for Natural Gas is

A. Incorrect: 3.5 psi.

Residential gas pressure is less than 0.5 psi.

B. Incorrect: 3.5" W.C.

While manifold pressure may be adjusted to 3.5" W.C., line pressure is higher.

C. Incorrect: 7 psi.

Residential gas pressure is less than 0.5 psi.

D. **Correct:** 7" W.C.

PTS: 1

205. What air distribution system includes both a warm air duct and a cool air duct, and utilizes mixing boxes near the zone to mix the cool air and warm air streams and achieve the desired temperature while delivering air at a near constant volume?
- A. Incorrect: Multizone.
 - B. **Correct:** Dual duct.
 - C. Incorrect: Mixing box system.
 - D. Incorrect: Dual temperature system.

PTS: 1

206. Capacity control on a helical-rotary (screw) compressor is obtained using
- A. Incorrect: Inlet vanes.
Inlet vanes are used for capacity control on a centrifugal compressor.
 - B. Incorrect: Hot gas bypass.
Hot gas bypass is used for reciprocating compressors.
 - C. Incorrect: Variable speed motors.
Screw compressors are intended to operate at constant speed.
 - D. **Correct:** A sliding valve.

PTS: 1

207. Which of the following reduced voltage starters uses a switching arrangement to connect the windings of three-phase motors in different configurations during startup and normal operation?
- A. Incorrect: Autotransformer starters.
The autotransformer uses a transformer to reduce the voltage during startup. Once the motor has accelerated, the transformer is taken out of the circuit and the motor continues to run on full voltage.
 - B. Incorrect: Start-run starters.
There is no such thing as a start-run starter.
 - C. Incorrect: Star-wye starters.
Star and wye mean the same thing when referring to three-phase configurations.

D. **Correct:** Wye-delta starters.

Wye-delta starters connect the motor in a wye arrangement during startup. This limits starting current to about one third that of what it would be if the windings were connected in the delta configuration at startup. Once the motor has accelerated, the wiring configuration is switched to delta, and the motor continues to run under full voltage.

PTS: 1

208. One type of pressure sensing device uses a flattened metal tube, which is bent into a part circle with one end fixed in place and connected to a system to be measured. The other end of the tube is closed and free to move. An increase in pressure tends to straighten the tube. The movement of the free end of the tube is connected to a dial that reads pressure. This type of gage is called a

A. **Incorrect:** Whiskey tube.

The whiskey tube is not a pressure sensing device.

B. **Incorrect:** Bimetal tube.

Bimetal is used to sense temperature, not pressure.

C. **Correct:** Bourdon tube.

D. **Incorrect:** Flat-tube gage.

PTS: 1

209. With a change in temperature, a thermistor will change

A. **Correct:** Resistance.

B. **Incorrect:** Voltage.

Thermistors are variable resistors that change with temperature.

C. **Incorrect:** Current.

Thermistors are variable resistors that change with temperature.

D. **Incorrect:** Impedance.

Thermistors are variable resistors that change with temperature.

PTS: 1

210. Electricity results from the movement of tiny negatively charged particles called

A. **Incorrect:** Protons.

Protons, while part of the atom, are positively charged and exist in the nucleus but do not make electrical current.

B. **Correct:** Electrons.

C. **Incorrect:** Neutrons.

Neutrons, while part of the atom, carry a neutral charge and exist in the nucleus but not make electrical current.

D. **Incorrect:** Ions.

Ions are atoms that carry a charge, either negative or positive. When electron leaves an atom, that atom becomes a positively charged ion since it now has positively charged protons that outnumber the negatively charged electrons. It is the movement of the free electron that causes electricity.

PTS: 1

211. _____ is the capacity of a material to store thermal energy for extended periods.

A. **Incorrect:** R-value

B. **Correct:** Thermal Mass

Solar Water Heating Systems
Pg. 110

C. **Incorrect:** U-value

D. **Incorrect:** Absorbency

PTS: 1

212. The expansion tank in a steamback system is _____ a normally sized expansion tank for a Solar Heating Water System.

A. **Incorrect:** The same size as

B. **Incorrect:** Slightly smaller than

C. **Correct:** Significantly larger than

Solar Water Heating Systems
Pg. 118

D. **Incorrect:** None of the above

PTS: 1

213. Energy Efficient Ratio is a measure of the _____.
- A. **Correct:** Relative efficiency of a heating or cooling appliance
Green Awareness Systems
Pg. 16
 - B. Incorrect: Electricity in Btu's
 - C. Incorrect: Cooling capacity measured in Btu's
 - D. Incorrect: None of the above
- PTS: 1
214. The ratio of the cooling output in Btu for the season, divided by the power consumption in watts per hour for the season.
- A. **Correct:** Seasonal energy efficiency ratio (SEER)
Green Awareness Systems
Pg. 16
 - B. Incorrect: Heating seasonal performance factor (HSPF)
 - C. Incorrect: Coefficient of performance (COP)
 - D. Incorrect: All of the above
- PTS: 1
215. The heating Seasonal Performance Factor (HSPF):
- A. Incorrect: Does not measure the seasonal efficiency
 - B. Incorrect: Can only be used by contractors when purchasing equipment
 - C. **Correct:** Uses the total output of a system and the total electrical power used by a system over an entire heating season
Green Awareness Systems
Pg. 18
 - D. Incorrect: None of the above
- PTS: 1
216. You are called to a job site to perform some maintenance work on a system and after you are finished the customer approaches you and offers to pay you cash directly to perform some additional work. In this situation it would be ok to?

- A. Incorrect: Accept the offer but tell him you will have to come back with your own truck and tools
- B. Incorrect: Negotiate with the customer to see if you can get him to increase his offer
- C. Incorrect: Accept the offer, but tell the customer that this is the only time that you will be able to help him out
- D. **Correct:** Refuse the offer politely and if it happens again notify your supervisor of the situation

In this situation it is important to politely tell the customer “No you would not be interested”.

Customer Service Skills Pg. 38

PTS: 1

217. What should the technician do in a situation where he is working on a refrigeration system that operates a case that holds perishable food items, the compressor has failed, it is 5:00 on a Monday evening, and will take a few additional hours to repair the rack?
- A. Incorrect: Leave the job site, go to dinner, and return after dinner to complete the job
 - B. Incorrect: Request authorization from the customer to leave the job to go to dinner telling him that you will return that evening to finish the job
 - C. **Correct:** Request authorization from the customer to stay on the job until it is finished that evening

In a situation where there is a critical application where there could be potential for monetary losses it is important that the repairs be completed as quickly as possible. With that in mind a request should be made to continue working until the system is repaired and operational.

Customer Service Skills Pg. 35

- D. Incorrect: Request authorization from the customer to leave the job telling him that you will return first thing in the morning to finish the job

PTS: 1

218. The most important element(s) of non-verbal communication is (are)

- A. Incorrect: Spoken words

- B. Incorrect: Voice inflection
- C. **Correct:** Body language

Body language or motions and gestures during personal communication can speak volumes. Body language often communicates more than spoken words.

Customer Service Skills
Pg. 18

- D. Incorrect: All of the above

PTS: 1

219. The quality of customer service can be enhanced if the technician takes the time to

- A. **Correct:** Actively listen

What you say to the customer is very important but just as important is what the customer has to say to you. Listen to your customer and reiterate at the conclusion of your conversations to be certain all points are clear and understood.

Customer Service Skills
Pg. 27

- B. Incorrect: Explain in detail how the HVAC system works
- C. Incorrect: Explain the billing process and when the bill is due
- D. Incorrect: Use HVAC technical terms in explaining the work that has been completed

PTS: 1

220. An HVAC technician should always attempt to convey a professional image by

- A. Partially Correct: Clean and neat personal appearance
- B. Partially Correct: Clean and neat service vehicle (inside and outside)
- C. Partially Correct: Maintaining a clean and organized work site
- D. **Correct:** All of the above

An HVAC technician is a professional and should always present himself as professional. Part of the professional image includes; clean and neat personal appearance, clean and neat service vehicle, and maintaining an organized work space.

Customer Service Skills

Pg. 13

PTS: 1

221. If a technician determines he cannot keep a scheduled customer appointment he should

- A. Incorrect: Travel as fast as possible to get there as soon as possible
- B. **Correct:** Call the customer to keep them informed of your delay

Most customers recognize service companies/technicians are very busy people and that scheduled appointments sometimes get delayed. However, the customer is likely just as busy and may even have to take time off from work to meet you. Whenever you discover that you cannot meet for a scheduled customer appointment at least be courteous and professional and give the customer a phone call so they are not “left hanging”. They may not be happy that you have canceled or postponed but it is far better than not making contact at all.

- C. Incorrect: Do nothing, the customer expects service people to be late
- D. Incorrect: Call the customer and tell them you have been on a more important service call

PTS: 1

222. Background checks are necessary to disclose employee history associated with

- A. Partially Correct: Criminal records
- B. Partially Correct: Credit reports
- C. Partially Correct: Drug testing
- D. **Correct:** All of the above

Background checks can identify all of the above character faults. In today’s world background checks are part of life we all must get used to.

PTS: 1

223. Which of the following would be a display of professionalism?

- A. Partially Correct: Work uniform with company logo
- B. Partially Correct: Being punctual
- C. Partially Correct: Use of good people skills
- D. **Correct:** All of the above

Professionalism is boundless, all of the above are indicative of professionals.

PTS: 1

224. When completing a service call the last action taken is presenting the invoice to the customer and obtaining a signature. Why it is important that all work performed is accurately described on the invoice?

- A. Partially Correct: To reference details at a later date
- B. Partially Correct: To identify warranty parts or service
- C. Partially Correct: To provide service details in written communication form
- D. **Correct:** All of the above

For all parties concerned complete and accurate documentation should be completed on all invoices.

Customer Service Skills
Chapter 9 Tech to Tech

PTS: 1

225. Service technicians must be thorough in order to prevent a breakdown in communication that results in lost time (money). Which of the following is not part of the required invoice information?

- A. Incorrect: Date of repair
- B. Incorrect: Actual labor
- C. Incorrect: Total cost
- D. **Correct:** Original supplier of equipment

Date of repair, actual labor and the total cost are all very important to have listed on the invoice. The identification of the equipment supplier is not necessary.

PTS: 1

226. What measures can service technicians take to ensure that work orders are complete?

- A. Partially Correct: Write legibly
- B. Partially Correct: Do not rush

C. **Partially Correct:** Explain the work order to the customer and ask if they have any questions

D. **Correct:** All of the above

All of the above will help to assure completeness of invoices. Writing legibly helps yourself to double check your own documents as well as the customer will be able to understand what you have written and service you have performed. Further, a well written, clear, concise and legibly written invoice is a display of professionalism.

Customer Service Skills

Pg. 47

PTS: 1

227. To correct for soft foot:

A. **Incorrect:** Replace soft material with a material of sufficient hardness.

Soft foot is a condition in which one of the feet of a piece of machinery does not set flat on the base.

B. **Correct:** Shim under the high foot with shim stock equal to a reading on the indicator.

The indicator is set up to read any movement as a mounting bolt is loosened. If losing the bolt allows a foot to rise up, there is a soft foot condition, and shims must be added below the foot before the bolt is retightened.

C. **Incorrect:** Replace the resilient material in the coupling.

Soft foot is a condition in which one of the feet of a piece of machinery does not set flat on the base and does not apply to couplings.

D. **Incorrect:** Replace vibration isolators with isolators properly rated for the pump.

Soft foot is a condition in which one of the feet of a piece of machinery does not set flat on the base and distorts the equipment when bolted down.

There are no vibration isolators located between the equipment and the base.

PTS: 1

228. The two planes of alignment that must be considered when aligning a flexible coupling are

A. **Incorrect:** Axial and parallel.

Axial and parallel mean the same thing in reference to a shaft. However, the shafts must be aligned parallel to one another, which is the same as saying that they must be aligned axially. This means that their centerlines must line up.

B. Incorrect: Parallel and perpendicular.

While it is true enough that the shafts must be aligned parallel to one another, they cannot be perpendicular to one another.

C. Incorrect: Horizontal and vertical.

D. **Correct:** Parallel and angular.

Shafts must be aligned so that the centerlines meet each other exactly in the center (parallel to one another, or axially), and they must be aligned so that they have no angular difference between them (also called radical alignment).

PTS: 1

229. On the spool sheet shown in Fig. 4-1 write in the missing dimensions and draw in the pressure relief valve and the manual air vent. This is the section of piping from the convertor to the air separator on drawing SB-10. Also find the E-E lengths of the pieces of pipe marked D-1, D-2, and D-3.

NOTE: Always allow $\frac{1}{8}$ " for weld gaps and $\frac{1}{16}$ " for gaskets.

MATERIAL LIST		
ITEM #	QTY.	
A	1	6" 125# STD. 90° FLGD.ELL
B	2	6" 125# R.F. WELD NECK FLANGES
C	1	6" SCH. 40 STD. L.R. 90° WELD ELBOW
D	11'	6" SCH. 40 A-105 C.S. PIPE
E	1	6" SCH. 40 STD. L.R. 45° WELD ELBOW
D-1	1	
D-2	1	
D-3	1	
SK #2 SB-10 6" H.W. FROM CONVERTOR TO AIR SEPARATOR		

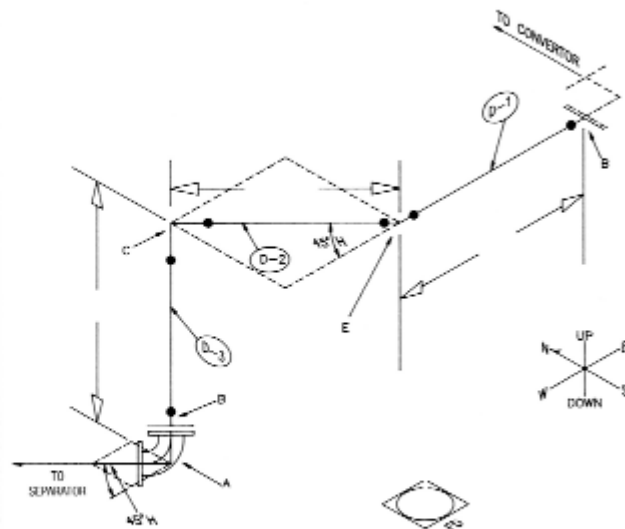

ANS:

MATERIAL LIST		
ITEM #	QTY.	
A	1	6" 125# STD. 90° FLGD.ELL
B	2	6" 125# R.F. WELD NECK FLANGES
C	1	6" SCH. 40 STD. L.R. 90° WELD ELBOW
D	11'	6" SCH. 40 A-105 C.S. PIPE
E	1	6" SCH. 40 STD. L.R. 45° WELD ELBOW
D-1	1	3-7 ¹ / ₂ "
D-2	1	3-6 ¹ / ₂ "
D-3	1	3-1 ¹ / ₂ "
SK #2 SB-10 6" H.W. FROM CONVERTOR TO AIR SEPARATOR		

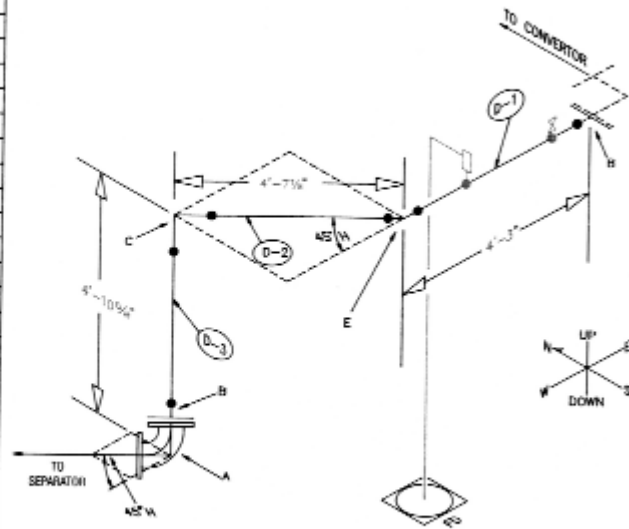

PTS: 1

230. Draw a Northeast view of the piping shown in Figure 5-1 and a Southeast view of the piping shown in Figure 5-2.

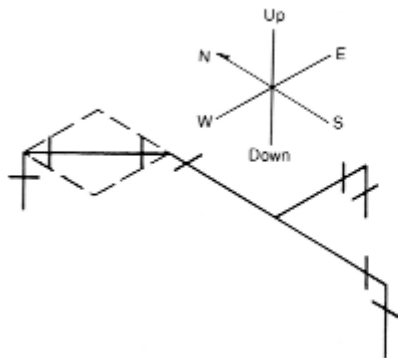

Fig. 5-1

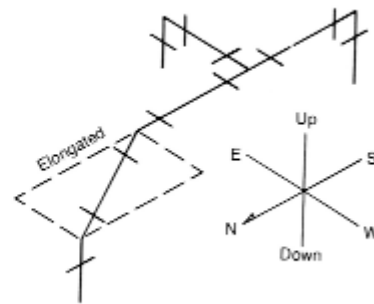
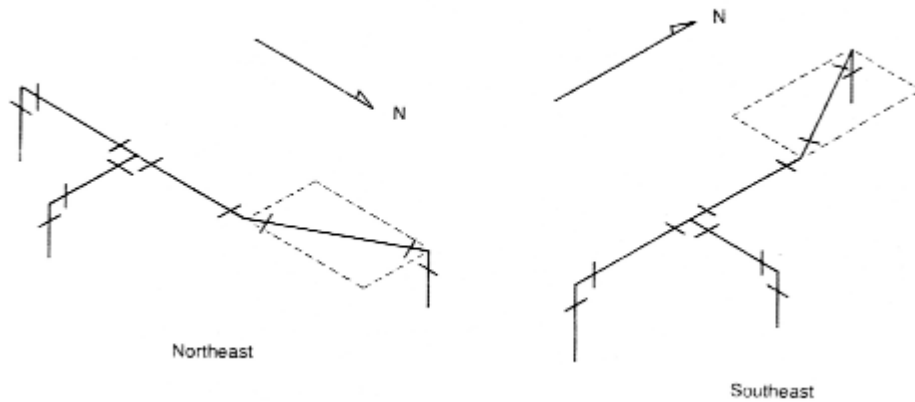

Fig. 5-2

ANS:



Drawing Interpretation and Plan Reading
 Chapter 5 Interpretation of Isometric Drawings

PTS: 1

231. On the spool sheet shown in Fig. 4-1 write in the missing dimensions and draw in the pressure relief valve and the manual air vent. This is the section of piping from the convertor to the air separator on drawing SB-10. Also find the E-E lengths of the pieces of pipe marked D-1, D-2, and D-3.

NOTE: Always allow $\frac{1}{8}$ " for weld gaps and $\frac{1}{16}$ " for gaskets.

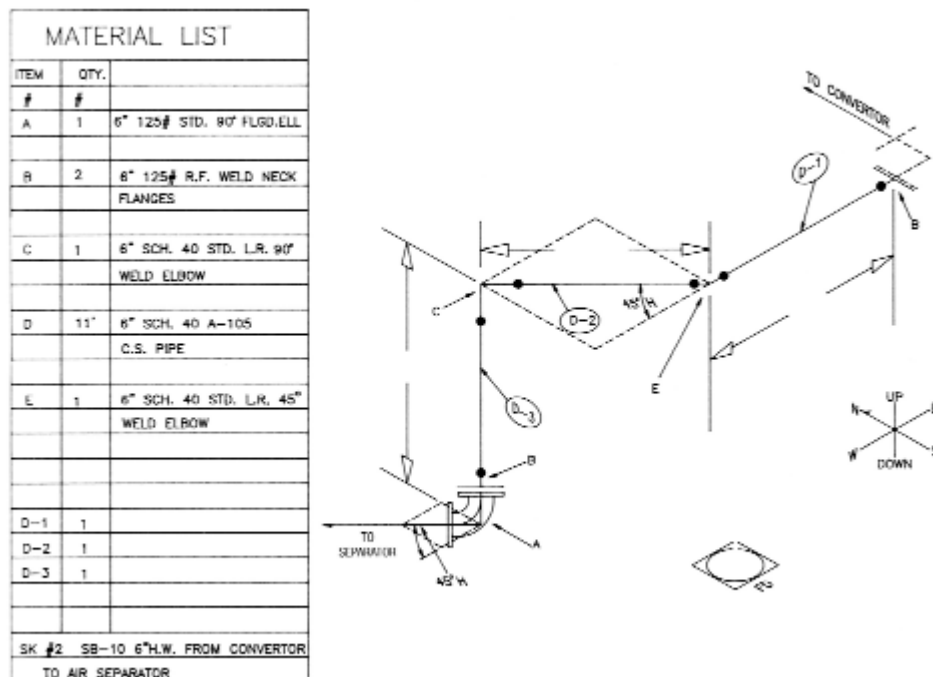
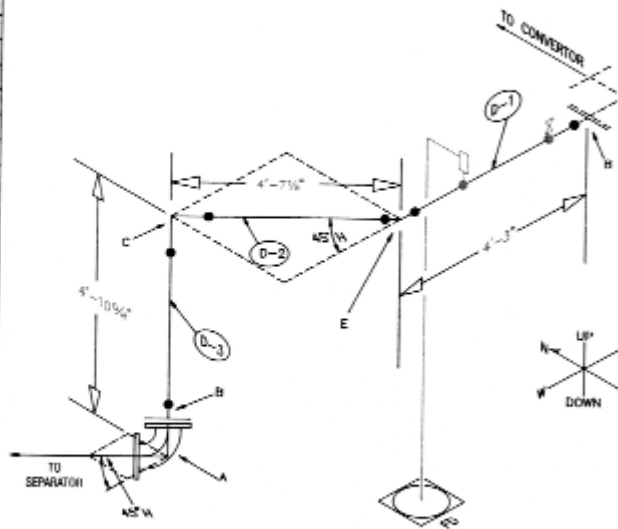

Figure 4-1

ANS:

MATERIAL LIST		
ITEM #	QTY.	
A	1	6" 125# STD. 90° FLG. ELL
B	2	6" 125# R.F. WELD NECK FLANGES
C	1	6" SCH. 40 STD. L.R. 90° WELD ELBOW
D	11"	6" SCH. 40 A-105 C.S. PIPE
E	1	6" SCH. 40 STD. L.R. 45° WELD ELBOW
D-1	1	3-7 1/2"
D-2	1	3-6 1/2"
D-3	1	3-5 1/2"
SK #2 SB-10. 6" H.W. FROM CONVERTOR TO AIR SEPARATOR		



Drawing Interpretation and Plan Reading

Chapter 4 Interpretation of Technical Diagrams and Piping Drawings

PTS: 1

232. Fill the proper name of the symbols shown in Fig. 3-2.

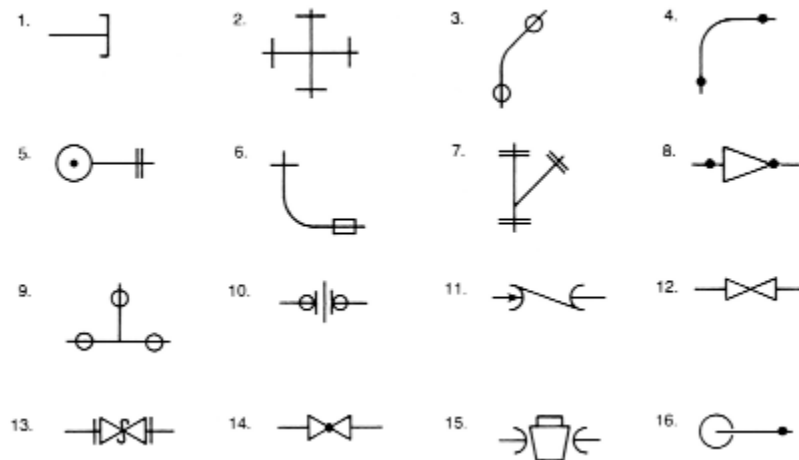

Figure 3-2

ANS:

Cap Screwed

45° Elbow -

90° Elbow —

1	(or Screwed Cap)	2	Cross-Screwed	3	Soldered	4	Welded
	90° Elbow –		90° Street Elbow		Lateral —		Concentric Reducer
5	Flanged	6	— Screwed	7	Flanged	8	— Welded
	Tee —		Union —		Check Valve —		Gate Valve —
9	Soldered	10	Soldered	11	Bell & Spigot	12	Screwed
	Safety Valve –		Globe Valve —		Cock — Bell &		90° Elbow –
13	Flanged	14	Screwed	15	Spigot	16	Welded

PTS: 1

233. The first thing a service mechanic should do before performing service work on refrigeration equipment is to:

- A. Incorrect: Pull the disconnect switch.
- B. **Correct:** Locate the disconnect switch.

One of the first things service mechanics should do when going on a job is to locate the disconnect switches. Then they must be certain to pull the appropriate switch if they are going to work on the equipment. However, the proper procedure is to first stop the equipment, if running, using such controls as will cause the motor controller to stop the motor, and then pull the disconnection. Likewise, equipment should be started by first determining that the motor controller is in the off position, then closing the disconnect switch, and finally starting the motor by means of its controller.

Refrigeration Mechanical Equipment Service Manual Volume One
Chapter 24: Motor Controllers
Question 2. Page 311.

- C. Incorrect: Lock the disconnect switch in open position.
- D. Incorrect: Stop the system with the motor controller.

PTS: 1

234. EER labels are used on window units, unitary equipment and _____.

- A. Incorrect: Refrigerators
- B. Incorrect: Garbage disposals
- C. Incorrect: Water heaters
- D. **Correct:** Heat pumps

Green Awareness Systems
Pg. 16

PTS: 1

235. EER labels are used on window units, unitary equipment and _____.

- A. Incorrect: Refrigerators
- B. **Correct:** Garbage disposals

Green Awareness Systems
Pg. 16

- C. Incorrect: Water heaters
- D. Incorrect: Heat pumps

PTS: 1

236. The Seasonal Energy Efficiency Ratio is used to measure the efficiency of _____.

- A. **Correct:** Central air conditioning

Green Awareness Systems
Pg. 16

- B. Incorrect: Forced air furnaces
- C. Incorrect: Window air conditioners
- D. Incorrect: All of the above

PTS: 1

237. AFUE stands for Annual Fuel _____ Efficiency.

- A. Incorrect: Use
- B. **Correct:** Utilization

Green Awareness Systems
Pg. 17

- C. Incorrect: Usage
- D. Incorrect: User

PTS: 1

238. Which Government agency requires the display of the AFUE rating on equipment?

- A. Incorrect: Dept. of Energy
 - B. Incorrect: Dept. of Natural Resources
 - C. **Correct:** Federal Trade Commission
Green Awareness Systems
Pg. 17
 - D. Incorrect: EPA
- PTS: 1
239. It is not uncommon for condensing residential furnaces to approach AFUE levels of _____%.
- A. **Correct:** 96
Green Awareness Systems
Pg. 17
 - B. Incorrect: 97
 - C. Incorrect: 95
 - D. Incorrect: 98
- PTS: 1
240. _____ are used to control ventilation by monitoring the outdoor temperature and humidity.
- A. Incorrect: Humidifiers
 - B. **Correct:** Economizers
Green Awareness Systems
Pg. 22
 - C. Incorrect: Ventilators
 - D. Incorrect: Humidistats
- PTS: 1
241. An air filter with a MERV-6 rating or higher will reduce levels of small particulates and improve indoor air quality. MERV stands for _____ value.
- A. Incorrect: Minimum energy rating
 - B. Incorrect: Maximum energy rating
 - C. **Correct:** Minimum efficiency reporting

Green Awareness Systems
Pg. 22

D. Incorrect: Maximum efficiency reporting

PTS: 1

242. A solar Chimney used natural rising of warm air through a structure to remove heat, this is true _____.

- A. Incorrect: Radiant cooling
- B. Incorrect: Aggressive cooling
- C. Incorrect: Progressive cooling
- D. **Correct:** Passive cooling

Green Awareness Systems
Pg. 28

PTS: 1

243. There are two kinds of desiccant Solar Systems, they are _____ and _____.

- A. Incorrect: Solid, gas
- B. Incorrect: Liquid, gas
- C. **Correct:** Solid, liquid

Green Awareness Systems
Pg. 33

D. Incorrect: Gas, vapor

PTS: 1

244. To freeze one pound of water, _____ Btu of latent heat must be removed.

- A. Incorrect: 145
- B. **Correct:** 144

Green Awareness Systems
Pg. 32

- C. Incorrect: 143
- D. Incorrect: 146

PTS: 1

245. The type of refrigerant that must be used now must be _____.
- A. Incorrect: HCFC
 - B. Incorrect: HCF
 - C. **Correct:** HFC
Green Awareness Systems
Pg. 33
 - D. Incorrect: HFCE
- PTS: 1
246. All fittings and connections where refrigerants may be present should be _____.
- A. **Correct:** Brazed
Green Awareness Systems
Pg. 35
 - B. Incorrect: Flared
 - C. Incorrect: Soldered
 - D. Incorrect: Compression
- PTS: 1
247. The thermal storage system that uses small plastic balls for storage is called a _____.
- A. Incorrect: Ball
 - B. Incorrect: Tank
 - C. **Correct:** Cell
Green Awareness Systems
Pg. 32
 - D. Incorrect: Combination
- PTS: 1
248. The refrigerant line that connects the condenser to the metering device is _____ line.

- A. Incorrect: Discharge
- B. Incorrect: Expansion
- HVACR Training Manual
Instructor's Guide to Accompany the DVD Series Video #2
Refrigeration and Refrigerants **Pre-Test**
Question 7. Page 8.
- Refer to the Basic Refrigeration System Cycle.
- C. **Correct:** Liquid
- D. Incorrect: Suction
- PTS: 1
249. The four main components of a refrigeration system are
- A. Incorrect: Compendium tube, cooler, hot coil, & compressor
- B. **Correct:** Compressor, condenser, evaporator, & metering device
- HVACR Training Manual
Instructor's Guide to Accompany the DVD Series Video #2
Refrigeration and Refrigerants **Pre-Test**
Question 1. (Similar) Page 8.
- Refer to the Basic Refrigeration System Cycle.
- C. Incorrect: Eliminator, pressure-enthalpy device, refrigerant, & oil separator
- D. Incorrect: Receiver, sight glass, accumulator, and compressor
- PTS: 1
250. When an object is refrigerated:
- A. Incorrect: Some of its heat energy is destroyed.
- B. **Correct:** Heat is removed from it.
- Refrigeration is the transfer of heat from one place to another by a change in state of a liquid.
Cold or coldness is an absence of heat, just as darkness is an absence of light or quietness is an absence of sound.
- Refrigeration Mechanical Equipment Service Manual Volume One
Chapter 1: Basic Physical Principles
Question 8. Page 1.

- C. Incorrect: More cooling is added.
- D. Incorrect: Its molecules move faster.

PTS: 1

251. A hand placed near a hot stove or fireplace is quickly heated by:

- A. **Correct:** Radiation

Radiation is the transfer of heat by waves, just as light is transmitted by waves. Heat from the sun can be considered a method of radiation. A hand placed near hot stove or fireplace is quickly heated by radiation. There is little heat flow due to radiation unless the radiating object has a high temperature.

Refrigeration Mechanical Equipment Service Manual Volume One
Chapter 1: Basic Physical Principles
Pages 3 and 4.

- B. Incorrect: Convection
- C. Incorrect: Conduction
- D. Incorrect: Refrigeration

PTS: 1

252. If you want to replace a defective capacitor but the only replacements you can find do not have enough capacitance, you can increase their capacitance by:

- A. Incorrect: Connecting two or more capacitors in series
- B. **Correct:** Connecting two or more capacitors in parallel

When selecting a capacitor for a specific application, a capacitor of the exact capacitance is not always available. However, correct capacitance can be obtained by using certain capacitors in series or parallel.

Two capacitors in parallel:

Total MFD = MFD, Capacitor 1 + MFD, Capacitor 2

Three capacitors in parallel:

Total MFD = MFD, Capacitor 1 + MFD, Capacitor 2 + MFD Capacitor 3

If more than three capacitors are used in parallel, the total MFD is the sum of the MFD ratings of all capacitors, just as in the above formulas.

Electric Controls for Mechanical Equipment Service
Chapter 10: Capacitors and Single-Phase Motors
Question 5. Pages 97 and 98.

- C. Incorrect: Increasing the voltage with a potential relay
- D. Incorrect: Reducing the motor current with a current relay

PTS: 1

253. The rotation of a three-phase motor can be reversed by interchanging:

- A. Incorrect: The collector ring
- B. **Correct:** Any two leads

The rotation of a three-phase motor can be reversed by interchanging any two leads because this changes the order of phase rotation and so changes the direction of the rotation of the field.

Basic Electricity for United Association Journey Workers & Apprentices
Chapter 15: Alternating Current Motors
Question 4. Page 107.

- C. Incorrect: The starting winding
- D. Incorrect: The running winding

PTS: 1

254. A lamp source has a voltage of 110 volts and a current of 0.9 amperes. What is the resistance of the lamp?

- A. Incorrect: 12.22
- B. **Correct:** 122.2

Ohms Law
 $R = E \text{ divided by } I$
 $110 \text{ divided by } 0.9 = 122.2 \text{ ohms}$

Basic Electricity for United Association Journey Workers & Apprentices
Chapter 6: Fundamentals of Electric Circuits
Question 2. Pages 33 and 34.

- C. Incorrect: 0.008
- D. Incorrect: 0.08 ohms

PTS: 1

255. The difference between a contactor and a motor starter is:

- A. Incorrect: Physical size

B. **Correct:** Overload protection

The starter is the same as the contactor, except for the addition of the overload relays and their wiring connections.

Electric Controls for Mechanical Equipment Service
Chapter 7: Purpose and Construction of Motor Controllers
Question 6. Page 63.

C. Incorrect: Wire size

D. Incorrect: Timing

PTS: 1

256. When a three-phase motor single-phases, it:

A. Incorrect: Draws power from the two remaining phases

B. **Correct:** Draws power from only one phase

Three-phase motors are subject to another cause of excessive current and heat, in the event that one phase fails. In this case the motor will be said to single-phase, meaning that its entire power supply is derived from one phase. You should note that in a three-phase system, failure of one phase does not leave two phases remaining, but leaves only one phase. When a motor single-phases, the current will increase theoretically 1.732 times. Actually, due to increased impedance drop, the current increase will be approximately 1 1/2 times the normal three-phase current. The assumption is that the motor is able to run on single-phase. If the motor is trying to start, or is running under a heavy load when the single-phase condition occurs, it could fail to start, or it could stop running and draw locked-rotor current.

Basic Electricity for United Association Journey Workers & Apprentices
Chapter 16: Motor Controls
Question 2. Page 113.

C. Incorrect: Always short-cycles

D. Incorrect: Runs cooler

PTS: 1

257. The approach temperature for the evaporator is:

A. Incorrect: The difference in the suction and head pressure converted to temperature

B. Incorrect: The difference in the refrigerant boiling temperature and the suction-line temperature

- C. Incorrect: The difference in the refrigerant boiling temperature and the inlet water temperature
- D. **Correct:** The difference in the refrigerant boiling temperature and the leaving-water temperature

The design water temperatures are typically 55 degrees F inlet water and 45 degrees outlet water for a two-pass chiller. The refrigerant is absorbing heat from the water so it is typically about 7 degrees colder than the leaving water. This is called approach temperature. **The approach temperature is very important to the technician for troubleshooting chiller performance.** The approach temperature is different for chillers with a different number of passes.

HVACR Training Manual
Unit 48 High-Pressure, Low-Pressure, and Absorption Chilled Water Systems
Question 9. Page 1198.

Unit 48 High-Pressure, Low-Pressure, and Absorption Chilled Water Systems
48.10 Flooded Evaporator Chillers. Page 1168.

PTS: 1

258. In a chiller, the refrigerant boils by _____.
- A. Incorrect: Absorbing heat from the air passing through it
- B. **Correct:** Absorbing heat from the water passing through it

A chiller refrigerates circulating water. As the water passes through the evaporator section of the machine, the temperature of the water is lowered. It is then circulated throughout the building where it picks up heat. The typical design temperature for circulating chilled water system are 45 degrees F water furnished to the building and 55 degree F water returned to the chiller from the building. The heat from the building adds 10 degrees F to the water that returns to the chiller. Here the heat is removed and the water is recirculated.

HVACR Training Manual
Instructor's Guide to Accompany the DVD Series Video #20
Chilled Water Systems, Cooling Towers, Pumps, and Maintenance **Pre-Test**
Question 5. Page 96.

HVACR Training Manual
Unit 48 High-Pressure, Low-Pressure, and Absorption Chilled water Systems

48.1 Chillers. Page 1160.

- C. Incorrect: Rejecting heat to the air passing through it
- D. Incorrect: Rejecting heat to the water passing through it

PTS: 1

259. If refrigerant condenses at a temperature of 105 degrees F and the water leaves the condenser at a temperature of 95 degrees F, the _____.

- A. **Correct:** Condenser approach temperature will be 10 degrees

The condenser, like the evaporator, has an approach relationship between the refrigerant condensing temperature and the leaving-water temperature. Most water-cooled condensers are two-pass condensers and are designed for 85 degree F entering and 95 degree F leaving water temperature with a condensing temperature of about 105 degrees F. This is an approach temperature of 10 degrees F and is important to the technician.

HVACR Training Manual

Instructor's Guide to Accompany the DVD Series Video #20

Chilled Water Systems, Cooling Towers, Pumps, and Maintenance **Post-**

Test

Question 8. Page 98.

HVACR Training Manual

Unit 48 High-Pressure, Low-Pressure, and Absorption Chilled Water Systems

48.13 Condenser Subcooling. Page1173.

- B. Incorrect: Condenser approach temperature will be 95 degrees
- C. Incorrect: Evaporator (chiller) approach temperature will be 10 degrees
- D. Incorrect: Evaporator (chiller) approach temperature will be 105 degrees

PTS: 1

260. When water is introduced into the end of a chiller it is contained in:

- A. **Correct:** Water boxes

Flooded chillers use much more refrigerant charge than direct expansion chillers so leak monitoring must be part of regular maintenance with high-pressure systems.

When the water is introduced into the end of the chiller, the water is contained in water boxes. When these water boxes have removable covers known as marine water boxes. When the piping is attached to the cover, the piping must be removed to remove the water box cover and these are known as standard covers. The water box also is used to direct the water for different applications.

HVACR Training Manual
Study Guide / Lab Manual
Unit 48 High-Pressure, Low-Pressure and Absorption Chilled Water Systems
Review Test Question 12. Page 447.

HVACR Training Manual
Unit 48 High-Pressure, Low-Pressure and Absorption Chilled Water Systems
48.10 Flooded Evaporator Chillers. Page 1168.

- B. Incorrect: A combination filter receiver
- C. Incorrect: A receiver
- D. Incorrect: None of the above

PTS: 1

261. When using a thermostatic expansion valve with a _____ charged element, hunting can be considerably reduced.

- A. Incorrect: Gas
- B. Incorrect: Liquid
- C. **Correct:** Cross

The operating characteristics of cross charge inherently reduce hunting. Cross-charged expansion valves are used on applications from +50 degrees F to -100 degrees F particularly where repetitive pull down cycles are encountered.

Refrigerant Controls
Chapter 3: Remote Bulb Charges
Question 9. Pages 18.

- D. Incorrect: Parallel

PTS: 1

262. A vacuum breaker is installed between equipment and a steam trap to:

- A. Incorrect: Allow a vacuum to be pulled on the system.

B. **Correct:** Allow condensate to drain after the steam has been shut off.

Once the steam supply has been shut off, steam will condense and will be unable to drain because of the vacuum. The vacuum breaker provides a vent and allows the condensate to drain.

C. **Incorrect:** Prevent condensate from draining after the steam has been shut off.

It is necessary to remove the condensate from certain parts of the system during off cycles to prevent freezing.

D. **Incorrect:** Trip on low pressure cutoff.

PTS: 1

263. The device which forms a water seal that prevents raw steam from entering and damaging pressure gauges, vaporstats, pressuretrols, etc. is a (n):

A. **Correct:** Pigtail

Pipe siphon (pigtail). A pipe siphon forms a water seal that prevents raw steam from entering a gage or control and damaging it. A gage cock or gate valve should be installed between a gage which is installed on a boiler and the pigtail so the gage or pipe siphon can be serviced.

Chapter 2: Basic Equipment in a One-Pipe Steam Heating System

Question 6. Page 11.

Steam Systems Review Exam Question 4. Page I-35.

B. **Incorrect:** Dip tube

C. **Incorrect:** Safety glass

D. **Incorrect:** Sight glass

PTS: 1

264. The boiler return line is connected to the steam main by a (n):

A. **Incorrect:** Drop connection

B. **Incorrect:** Hartford loop

C. **Incorrect:** Drip connection

D. **Correct:** Equalizing line

Equalizing Line (Balance Pipe). A pipe which connects the steam header to the boiler return connection. Drains the condensate from the steam header to the boiler return connection. Drains the condensate from the steam header and returns it to the boiler below the water line. Equalizes the supply pressure in the return line to the boiler. This prevents the boiler water from flowing out of the boiler into the return main.

Chapter 2: Basic Equipment in a One-Pipe Steam Heating System

Question 6. Page 11.

Steam Systems Review Exam Question 4. Page I-35.

PTS: 1

265. The device which prevents a vacuum from forming in a low-pressure gravity return steam heating system where automatic control is not used is a (n):

- A. Incorrect: Vacuum breaker
- B. Incorrect: Atmospheric connection
- C. **Correct:** Air vent

Air vent. The air vents that are used in steam systems are temperature-actuated devices which allow air to escape from the system piping while keeping steam in.

Steam Systems

Chapter 3: One-Pipe Steam Heating System

Question 8. Page 14.

Steam Systems Review Exam Question 5. Page I-35.

- D. Incorrect: Safety relief valve

PTS: 1

266. The device which prevents a vacuum from forming in a low-pressure gravity return steam heating system where automatic control is not used is a (n):

- A. Incorrect: Vacuum breaker
- B. Incorrect: Atmospheric connection
- C. **Correct:** Air vent

When installed in a one-pipe steam system radiator valves must be fully open or completely closed. If a radiator is overheating the only way to control steam flow is by regulating the rate at which air is eliminated.

The radiators closest to the boiler will heat up quickly, the units that are furthest away slowly. Air vents with the smallest air venting capacity should be installed on radiators that are closest to the boiler. This will slow down the steam flow into the radiator.

Naturally air vents with the largest air venting capacity should be installed on the radiators furthest away. By installing correctly sized air vents on each radiator, a one-pipe steam heating system can be balanced so that all radiators heat evenly and quickly.

Steam Systems

Chapter 3: One-Pipe Steam Heating System

Question 2. Page 21.

Steam Systems Review Exam Question 6. Page I-36.

D. Incorrect: Safety relief valve

PTS: 1

267. The length of the pipe (drip connection) that is needed to overcome the pressure drop in a one-pipe gravity return steam heating system and return condensate to the boiler is:

- A. Incorrect: 14 inches
- B. Incorrect: 12 inches
- C. **Correct:** 28 inches

There are no pumps in a gravity return steam system. At the end of the steam supply main a drip connection, which is often called the "A" dimension must be installed. A drip connection is just a piece of pipe which is installed vertically at the end of the last steam carrying main. The drip connection provides space for the condensate to collect. You should know, from the Basic Science, that the pressure at the bottom of a column of water is 2.31' (70.41 cm) or approximately **28"** (71.12 cm) high is 1 psig (6.90 kPa). When the condensate level stacks up high enough in the drip connection to overcome system pressure drop and the resistance in the wet return, the condensate will flow into the boiler.

It is standard practice for a system designed for 1/2 psig (3.45 kPa) pressure drop to make the minimum distance for dimension "A" not less than **28"** (71.12 cm) above the boiler water line.

Steam Systems

Chapter 3: One-Pipe Steam Heating System

Question 6. Page 22.

Steam Systems Review Exam Question 7. Page I-36.

D. Incorrect: 2 to 4 inches

PTS: 1

268. In a one-pipe gravity return steam heating system, the main vent should be installed:

A. **Correct:** In a tee at the end of the last steam carrying main.

The tee for the main vent(s) should be placed **15" to 18"** (38.1 cm to 45.72 cm) from the end of the last steam carrying main, and at the location a 6" to 10" (15.24 cm to 25.4 cm) long pipe nipple should be installed between the top of the tee and the main vent. By locating the main vent **15" to 18"** (38.1 cm to 45.72 cm) from the end of the line it will be protected from water hammer.

Steam Systems

Chapter 3: One-Pipe Steam Heating System

Question 5. Page 17.

Steam Systems Review Exam Question 11. Page I-36.

B. **Incorrect:** 15 to 18 inches back from the end of the last steam carrying main.

C. **Incorrect:** 2 to 4 inches past the end of the last steam carrying main.

D. **Incorrect:** A main vent is not necessary in a one-pipe gravity return steam heating system.

PTS: 1

269. A thermostatic steam trap that fails in the closed position would cause a heating unit to become:

A. **Correct:** Waterlogged

The disadvantages of a balanced pressure steam trap are:

1. Flexible bellows can be damaged by water hammer.

2. In order for the trap to open the condensate in the trap must cool below the boiling/condensing temperature at the given pressure inside the trap. This will likely result in condensate backing up into the equipment.

This is why thermostatic steam traps are *not* recommended when water logging of the steam space would create a problem. If a thermostatic steam trap is used for this purpose a cooling leg *at least 5' (1.52 m) long* should be installed before the trap. The condensate will back up and cool down in the cooling leg, not in the steam space of the equipment.

3. Most balanced pressure type thermostatic steam traps are *not* recommended for use on superheated steam systems.

Because of their size and cost, thermostatic steam traps are usually installed on steam radiators. They are often referred to as radiator traps.

Steam Systems

Chapter 4: Steam Traps

Question 4. Page 40.

Steam Systems Review Exam Question 13. Page I-37.

- B. Incorrect: Superheated
- C. Incorrect: Subcooled
- D. Incorrect: None of the above

PTS: 1

270. If the float in a F&T trap failed and filled with water, the trap would:

- A. Incorrect: Discharge condensate continually
- B. **Correct:** Discharge steam continually

The advantages of a float and thermostatic trap are:

1. Because of their thermostatic element, float and thermostatic traps offer excellent air venting capability.

2. Condensate is discharged on a continual basis.

3. It handles light or heavy condensate loads equally well.

4. Trap operation is *not* negatively affected by pressure fluctuations.

Steam Systems

Chapter 4: Steam Traps

Question 10. Page 44.

Steam Systems Review Exam Question 14. Page I-37.

- C. Incorrect: No condensate would be discharged
- D. Incorrect: No air would be discharged

PTS: 1

271. If used to drip the end of a steam main, the type of steam trap that would require a cooling leg is a (n):

A. **Correct:** Thermostatic

The disadvantages of a balanced pressure steam trap are:

1. Flexible bellows can be damaged by water hammer.
2. In order for the trap to open the condensate in the trap must cool below the boiling/condensing temperature at the given pressure inside the trap. This will likely result in condensate backing up into the equipment.

This is why thermostatic steam traps are *not* recommended when water logging of the steam space would create a problem. If a thermostatic steam trap is used for this purpose a cooling leg *at least 5' (1.52 m) long* should be installed before the trap. The condensate will back up and cool down in the cooling leg, not in the steam space of the equipment.

3. Most balanced pressure type thermostatic steam traps are *not* recommended for use on superheated steam systems.

Because of their size and cost, thermostatic steam traps are usually installed on steam radiators. They are often referred to as radiator traps.

Steam Systems

Chapter 4: Steam Traps

Question 4. Page 40.

Steam Systems Review Exam Question 15. Page I-37.

- B. Incorrect: F&T
 C. Incorrect: Inverted bucket
 D. Incorrect: Thermodynamic

PTS: 1

272. In a two-pipe gravity return steam system, the device that prevents raw steam from entering the piping is a:

- A. Incorrect: Hartford loop
 B. Incorrect: Dry return
 C. **Correct:** Steam trap

The major drawback of one-pipe steam systems is the ability to control the flow of steam into the heat transfer units.

The radiator valve *cannot* be throttled, it must be fully open or completely closed. **The development of the steam trap increased the popularity of two-pipe steam heating systems. When separate steam supply and condensate return lines are piped to each radiator, steam flow into the radiator can be controlled.**

Steam Systems

Chapter 5: Two-Pipe Steam Heating Systems

Question 4. Pages 53.

Steam Systems Review Exam Question 16. Page I-37.

D. Incorrect: Filter drier

PTS: 1

273. The pump motor on a condensate receiver is usually started by:

- A. Incorrect: Low water condition in the boiler
- B. Incorrect: Low water condition in the receiver
- C. Incorrect: High water condition in the boiler
- D. **Correct:** High condition in the receiver

If a condensate receiver is used to supply water to a boiler the pump will *not* react to a low water condition in the boiler. The boiler could be dangerously low on water and the condensate receiver pump(s) will *not* deliver water until **the water level in the receiver is high enough to close the electrical contacts and energize the pump(s).**

Steam Systems

Chapter 5: Two-Pipe Steam Heating Systems

Question 6. Pages 61 and 62.

Steam Systems Review Exam Question 17. Page I-37.

PTS: 1

274. The device that could be used to regulate the discharge pressure of a condensate pump is a:

- A. Incorrect: Check valve
- B. Incorrect: Gate valve
- C. **Correct:** Plug cock

A plug valve is needed to regulate the pumps discharge pressure.

Most two-pipe gravity return and mechanical return systems that employ boiler feed pumps and condensate receivers to return water to the boiler steam are designed to operate at 2 psig (13.79 kPa). If condensate is pumped into the boiler at 20 psig (137.92 kPa), the water will scream through the short run of pipe, create turbulence in the boiler and cause the check valve to chatter.

In this case the **plug valve** would be partially closed, so the pump(s) discharge pressure entering the boiler is 7 psig (48.27 kPa).

The operating pressure is 2 psig (13.79 kPa) and the additional pressure needed to overcome resistance in the piping would be 5 psig (34.48 kPa).

Steam Systems

Chapter 5: Two-Pipe Steam Heating Systems

Question 9. Page 56 and 58.

Steam Systems Review Exam Question 20. Page I-38.

D. Incorrect: Flow control valve

PTS: 1

275. The device used to actuate the vacuum pump in a vacuum steam heating system when there is a loss of vacuum in the system return piping is the:

- A. Incorrect: Pressuretrol
- B. Incorrect: Aquastat
- C. **Correct:** Vacuum switch

Vacuum switch. Actuates the pump; it senses the pressure at the end of the vacuum return main. Typically, it cycles the pump *on* at 3 and shuts it off when the vacuum is pulled down to 8" (20.32 cm) of mercury thus maintaining a pressure of about 5 1/2" (13.97 cm) of mercury in the return main.

Steam Systems

Chapter 6: Vacuum Steam Heating Systems

Question 1. Pages 65 and 66.

Steam Systems Review Exam Question 21. Page I-38.

D. Incorrect: Thermostat

PTS: 1

276. The device which can be used to elevate condensate in a vacuum steam heating system is a:

- A. Incorrect: Steam trap
- B. Incorrect: Vacuum breaker
- C. **Correct:** Lift fitting

Lift fittings. If it is necessary to elevate condensate in a vacuum system, a condensate receiver should be installed. In order to maintain a negative pressure the condensate receiver vent is tied into the vacuum return line. However, condensate receivers are expensive and in an effort to save money lift fittings were often incorporated into many system designs.

Steam Systems

Chapter 6: Vacuum Steam Heating Systems

Question 4. Pages 67.

Steam Systems Review Exam Question 22. Page I-38.

D. Incorrect: Control line

PTS: 1

277. The device that is incorporated into a vacuum steam heating system to protect the vacuum pump from creating too low (deep) a vacuum is a:

- A. Incorrect: Relief valve
- B. Incorrect: Control line
- C. **Correct:** Vacuum breaker

Vacuum breaker. Is incorporated into the system to protect the vacuum pump from creating too low a vacuum. The pump will be adversely affected if the induced vacuum the pump creates is too low. A vacuum breaker is incorporated into the pump to protect the vacuum pump from creating too low a vacuum. The vacuum breaker will open and let air into the system when the pressure inside the pump drops down to 15"of mercury.

Steam Systems

Chapter 6: Vacuum Steam Heating Systems

Question 3. Pages 67.

Steam Systems Review Exam Question 23. Page I-39.

D. Incorrect: Vacuum switch

PTS: 1

278. In a vapor steam heating system, condensate is returned to the boiler by means of a:

- A. Incorrect: Vacuum pump
- B. Incorrect: Condensate receiver
- C. Incorrect: Boiler feed pump

D. **Correct:** Boiler return trap (gravity)

How does a vapor steam heating system work?

Every heating unit is equipped with a thermostatic steam trap. If this system is installed in a multistory structure, the bottom of each riser must be trapped. **The discharge side of the steam traps is piped into the return piping.**

The boiler is fired, heat is added to the boiler water and steam is produced. The steam explodes out of the boiler pushing the air **and condensate** through the steam traps into the **return piping**. The radiators quickly fill with steam and the call for heat is satisfied. In this system the air flows back towards the boiler and is eliminated from the system by an air eliminator. *Some vapor systems utilize vacuum air vents to rid the system of air. Vacuum air vents permit air to leave the system but when the system cycles off air cannot reenter the system through the vacuum air vents.*

At this point in time air vents that were installed on a one-pipe system often spit out dirty water that would usually wind up on the drapery and carpets. One of the reasons the vapor system became so popular was, if some type of air eliminator was installed at the boiler no radiator vacuum air vents needed to be installed.

Steam Systems

Chapter 7: Vapor Steam Heating Systems

Question 1. Pages 71.

Steam Systems Review Exam Question 24. Page I-39.

PTS: 1

279. Air is eliminated from a vapor system by a (n):
- A. Incorrect: Standard air vent
 - B. Incorrect: Boiler return trap
 - C. **Correct:** Air eliminator

In a vapor system, preventing air from reentering the system can control radiator temperature. This can be accomplished by installing thermostatic steam traps or vacuum air vents or an **air elimination device**.

One of the reasons the vapor system became so popular was, if some type of air eliminator was installed at the boiler no radiator vacuum air vents needed to be installed.

The purpose of an **air eliminator** is to remove air from the system rapidly, and at as low a pressure as possible.

Steam Systems

Chapter 7: Vapor Steam Heating Systems

Question 4. Pages 71 and 72.

Steam Systems Review Exam Question 25. Page I-35.

D. Incorrect: Main vent

PTS: 1

280. The device that is used to maintain a pressure differential between the supply and return piping in a sub-atmospheric steam heating system is a:

A. Incorrect: Pressure controller

B. Incorrect: Vaporstat

C. **Correct:** Differential controller

Differential Controller. Ordinarily a pressure differential of 2" (5.08 cm) is required to assure proper steam circulation in any system. **The differential controller is the device that maintains the pressure differential between the supply and return piping in a sub-atmospheric steam heating system.** The controller is factory set to maintain this differential. The differential controller starts and stops the vacuum pump thus maintaining the system differential. For example, if the controller is set to maintain a 2" (5.08 cm) pressure differential and the vacuum in the steam supply piping is at 10" (25.4 cm), the pump will maintain 12" (30.48 cm) of vacuum in the return piping.

The preferred location for the differential controller is near the end of the steam main farthest from the control valve, it may, if necessary, be located nearer the vacuum pump.

Steam Systems

Chapter 8: Variable Vacuum (Sub-Atmospheric) Steam Heating Systems

Question 1. Pages 80.

Steam Systems Review Exam Question 27. Page I-39.

D. Incorrect: control valve

PTS: 1

281. If the water flow to a water-cooled condenser is reduced, the temperature difference across the condenser will:

A. Incorrect: Increase

B. **Correct:** Decrease

Effects of Water Quantity and Temperature on Performance of Water Cooled Condensers

The capacity of the condenser will increase whenever the average temperature difference between the refrigerant vapor and the water is increased. If the water quantity is not changed, the temperature difference can be increased by lowering the temperature of the entering water. If it is not possible to obtain colder condenser water, then capacity can be increased by increasing the water quantity. For a given condenser, if water quantity is increased it will increase the water velocity, and so increase the efficiency of heat transfer.

However, changes in water quantity have an even greater effect on capacity because of the resulting changes in average temperature difference. Assuming there are no changes in the refrigeration load or in the temperature at which water enters the condenser, if the water quantity is increased, the temperature of the leaving the condenser will be lower, so the average water temperature will be lower. This will result in an increase in temperature difference and a corresponding increase in capacity. On the other hand, **if water quantity is reduced, the leaving water will be warmer; the temperature difference will be smaller and the capacity will be reduced.**

Refrigeration Mechanical Equipment Service Manual Volume One
Chapter 11: Condensers, General Principles Water-Cooled Condensers
Page 141.

- C. Incorrect: Remain the same
- D. Incorrect: Cannot be determined

PTS: 1

282. Basic types of heat pump, classified as to their heat source and the medium being heated are:

- A. Partially Correct: Air-to-air
- B. Partially Correct: Water-to-air
- C. Partially Correct: Water-to-water
- D. **Correct:** All of the above

Heat pumps may use air or water as the heat source. As applied to air conditioning systems, the two commonly used types of heat pumps are the air to air and the water to air. They may either directly heat the air which is supplied to the space being heated, or they may heat water which then heats the supply air.

The four classifications of heat pumps are as follows:

Heat Source	- to -	Medium Being Heated
1. Air		Air

2. **Air** - to - **Water**
 3. **Water** - to - **Air**
 4. **Water** - to - **Water**

Air Conditioning Mechanical Equipment Service Manual
 Chapter 15: Heat Pumps
 Question 1. Page 246.

PTS: 1

283. The external equalizer line on an expansion valve performs the following function:
- A. Incorrect: Equalizes system pressures on the off cycle
 - B. Incorrect: Equalizes the internal and external pressures in the expansion valve
 - C. **Correct:** Compensates for any pressure drop in the evaporator coil

The External Equalizer

Superheat is abnormally high and serious loss of evaporator capacity results if the evaporator has any appreciable pressure drop. You might feel that you could compensate for the evaporator pressure by simply adjusting the valve, but this will not give the correct answer because the evaporator pressure drop varies. This pressure drop is due to friction developed when the refrigerant flows through the evaporator, just as friction is developed when a fluid flows through an ordinary pipe. Pressure drop at partial loads will be considerably less than at full load because of the smaller amount of refrigerant flowing at the lighter loads.

The variable evaporator pressure drop is corrected for by sensing evaporator pressure, not at the evaporator or valve inlet, but at the evaporator outlet. This is done with a connecting tube called an external equalizer line, and is connected to a suitable fitting on the expansion valve. Such a fitting on an expansion valve should never be capped or plugged. If the valve has an external equalizer connection, an external equalizer line must be installed. The line should be connected to the suction line as close as practical to the bulb; specially, there should be no elbows, or other fittings which increase flow friction, between the equalizer line connection and the bulb. The purpose of the external equalizer line is to be able to sense suction pressure at the point where the bulb is located. In this respect, you should consider that it is possible for some liquid refrigerant to flow from the valve, through the equalizer line into the suction line. Since any liquid will vaporize at that point, the resulting cooling effect could influence the temperature sensed by the bulb. To avoid this, the equalizer line should connect to the suction line at a point a little downstream from the bulb.

Refrigeration Mechanical Equipment Service Manual Volume One
 Chapter 15: Application of the Thermostatic Expansion Valve
 Question 3. Pages 195 and 196.

- D. **Incorrect:** Collects any moisture that may be present at the expansion valve

PTS: 1

284. When the suction pipe from a direct expansion coil must rise to a level above the coil outlet, what purpose is served by a trap placed in the line directly at the coil outlet?

- A. **Correct:** It assists the return of the oil to the compressor

How must the suction piping be installed?

The suction piping must be installed with proper regard for the return of oil to the compressor. If the suction piping rises from the coil outlet, it must be provided with proper oil traps, a trap for each coil section.

Traps assist in the return of oil by providing a location in which oil, draining from the evaporator coil, can collect and from which the refrigerant-suction gas can remove it by entrainment. The latter process requires the gas to have significant velocity, but the quantity of gas and its velocity will decrease at reduced loads, very markedly so if the one or more compressors in the system are arranged to provide capacity reduction.

Air Conditioning Mechanical Equipment Service Manual
 Chapter 13: Cooling and Heating Coils
 Question 8. Page181.

- B. **Incorrect:** It prevents migration of refrigerant to the evaporator
 C. **Incorrect:** It stabilizes the superheat setting
 D. **Incorrect:** It compensates for an overcharge of the system

PTS: 1

285. If not properly installed, a hot-gas muffler might trap:

- A. **Incorrect:** Hot gas.
 B. **Incorrect:** Superheated vapor.
 C. **Incorrect:** Suction gas.
 D. **Correct:** Oil.

The muffler is installed in the discharge line as close as possible to the compressor. **Due to their construction, mufflers usually form natural oil traps unless properly installed.**

Refrigeration Mechanical Equipment Service Manual Volume One
Chapter 17: Refrigerant Piping Accessories
Question 9. Page 217.

PTS: 1

286. Double suction riser are used in refrigeration system when

A. **Correct:** Large fluctuations in system capacity will occur

If a system has a large variation in capacity in order to keep the suction riser velocity high a double line may have to be installed. During low refrigerant mass flow rates one of the suction riser traps will fill with oil and the other pipe will maintain enough velocity to maintain oil return to the compressor.

Refrigeration Mechanical Equipment Service Manual Volume One
Chapter 19: Refrigerant Piping Design and Arrangement
Pages 245 -248

B. Incorrect: Two or more compressors are installed on the system

C. Incorrect: There are multiple cases installed on one suction line

D. Incorrect: There is a cost savings with this practice

PTS: 1

287. Suction risers are typically reduced by one size over that of the main suction run

A. Incorrect: Reduce installation costs

B. Incorrect: To avoid using a suction riser trap

C. Incorrect: To decrease velocity and reduce pressure drop

D. **Correct:** To increase refrigerant velocity to aid in proper oil return

As a general rule suction risers line sizes are reduced by one size so that refrigerant velocities can be maintained at acceptable levels to insure proper oil return.

Refrigeration Mechanical Equipment Service Manual Volume One
Chapter 17: Refrigerant Piping Accessories
Pages 245-248.

PTS: 1

288. The liquid receiver is located between the?

- A. Incorrect: Compressor suction and the evaporator
- B. Incorrect: Compressor discharge and the condenser
- C. **Correct:** Condenser and the expansion device

The receiver is located in the liquid line and is used to store the liquid refrigerant after it leaves the condenser.

The liquid receiver is always located after the condenser and before the expansion device.

HVACR Training Manual
Unit 25 Special Refrigeration System Components
25.32 Receivers.
Page 495.

- D. Incorrect: Expansion device and the evaporator

PTS: 1

289. Which device is used in a refrigeration system to protect the compressor from liquid slugs?

- A. **Correct:** Suction accumulator

The suction-line accumulator can be located in the suction line to prevent liquid refrigerant from passing into the compressor.

The suction accumulator is located between the evaporator and the compressor and is used to protect the compressor from liquids entering the compressor.

HVACR Training Manual
Unit 25 Special Refrigeration System Components
25.39 Suction-Line Accumulators
Page 500.

- B. Incorrect: Liquid receiver
- C. Incorrect: TXV
- D. Incorrect: None of the above

PTS: 1

290. Which device is used to stop the flow of liquid or vapor in a refrigeration system?

- A. Incorrect: Suction accumulator
- B. Incorrect: Liquid receiver
- C. Incorrect: TXV
- D. **Correct:** Solenoid valve

The solenoid valve is the most frequently used component to control fluid flow. This valve has a magnetic coil that when energized will lift a plunger into the coil. This valve can be either normally open (NO) or normally closed (NC). The NC valve is closed until energized; then it opens. The NO valve is normally open until energized; then it closes. The plunger is attached to the valve so that the plunger action moves the valve. Solenoid valves are snap-acting valves that open and close very fast with the electrical energy to the coil. **They can be used to control either liquid or vapor flow.**

The solenoid valve is the most frequently used component to control fluid flow in a refrigeration system. It can be designed as a NC or NO valve.

HVACR Training Manual
Unit 25 Special Refrigeration System Components
25.15 The Solenoid Valve.
Page 480

PTS: 1

291. When soldering a copper pipe connection which of the following processes allow for alloy to be drawn into the space between copper pipe and the fitting connection?
- A. Incorrect: Conduction
 - B. Incorrect: Drawing effect
 - C. **Correct:** Capillary action

Before you heat the joint, it is good practice to introduce nitrogen into the system to purge the air (containing oxygen) and reduce the possibility of oxidation to a minimum. A pressure of 1 to 2 psig is enough to purge the piping. Apply heat to the parts to be joined with an air-acetylene or oxyacetylene torch. Heat tube first, beginning about 1 in. from the edge of the fitting, sweeping the flame around the tube. It is very important to keep the flame in motion and to not overheat any one area. Then switch the flame to the fitting at the base of the cup. Heat uniformly, sweeping the flame from the fitting to the tube. Apply the filler rod or wire at a point where the tube enters the socket. **When the proper temperature is reached, the filler metal will flow readily by capillary attraction, into the space between the tube and the fitting.** As in soldering, do not heat the rod or wire itself. The temperature of the metal at the joint should be hot enough to melt the filler metal. When the joint is at the correct temperature, it will be cherry red in color. The procedures are the same as with soldering except for the materials used and the higher heat applied.

The flux used in the brazing process will cause oxidation. When brazing is done and cooled, wash these joints with soap and water.

Capillary action is the process by which the alloy is drawn into the gap between the pipe and the fitting. In order for this to occur there must be enough clearance between the two connections.

HVACR Training Manual
Unit 7 Tubing and Piping
7.10 Brazing Techniques
Pages 122-123.

D. Incorrect: Convection

PTS: 1

292. Before proceeding to make any braze connection in a refrigeration system all of the internal piping should be purged of atmosphere with

- A. Partially Correct: CO₂
- B. Incorrect: R-22
- C. Partially Correct: Nitrogen
- D. **Correct:** A or C

Before you heat the joint, it is good practice to introduce nitrogen into the system to purge the air (containing oxygen) and reduce the possibility of oxidation to a minimum. A pressure of 1 to 2 psig is enough to purge the piping.

By purging the atmosphere from the refrigerant piping the potential for copper oxides to be created during the brazing process is eliminated.

HVACR Training Manual
Unit 7 Tubing and Piping
7.10 Brazing Techniques
Page 122.

PTS: 1

293. The purpose of the crankcase pressure regulator is to:
- A. Incorrect: Maintain constant pressure in the crankcase
 - B. Incorrect: Maintain constant pressure in the evaporator
 - C. Incorrect: Prevent a compressor from going into a vacuum
 - D. **Correct:** Prevent a compressor overload condition.

The crankcase pressure (CPR valve) looks the same as the EPR valve, but it has a different function. The CPR valve is in the suction line also, but it is usually located close to the compressor rather than at the evaporator outlet. The CPR valve sensing bellows are on the true compressor suction side of the valve and would normally have a gage port on the evaporator side of the valve.

This valve is used to keep the low-temperature compressor from overloading on a hot pull down. A hot pull down would occur (1) when the compressor has been off for a long enough time and the foodstuff has a rise in temperature, (2) on start-up with a warm box, or (3) after a defrost period. In either case the temperature in the refrigerated box or the evaporator influences the suction pressure. When the temperature is high, the suction pressure is high. When the suction pressure goes up, the density of the suction gas goes up. The compressor is a constant-volume pump and does not know when the gas it is pumping is dense enough to create a motor overload.

HVACR Training Manual
Unit 25 Special Refrigeration System Components
25.7 Crankcase Pressure Regulator
Pages 476.

PTS: 1

294. The function of the evaporator pressure regulator is to:
- A. Incorrect: Maintain a constant evaporator pressure
 - B. **Correct:** Prevent a minimum pressure in the regulator

The evaporator pressure regulator valve (EPR valve) is a mechanical control that keeps the refrigerant pressure in the evaporator from going below a predetermined point. The EPR valve is installed in the suction line at the evaporator outlet. The bellows in the EPR valve senses evaporator pressure and throttles (modulates) the suction gas to the compressor. This will then allow the evaporator pressure to go as low as the pressure setting on the valve. When the EPR valve is used with the thermostatic expansion valve (TXV), the system now has the characteristics of maintaining a constant superheat and keeping the pressure from going too low.

HVACR Training Manual
Unit 25 Special Refrigeration System Components
25.4 Evaporator Pressure Control
Pages 473.

- C. Incorrect: Maintain a constant evaporator temperature
- D. Incorrect: Prevent a maximum pressure in the evaporator

PTS: 1

295. Oxygen hoses are generally what color?

- A. **Correct:** Green

Hose and Connections

The hoses used with oxyacetylene equipment are specially manufactured for this service. They must be of ample strength to resist internal pressure, sufficiently flexible to yield readily to the movements of the torch, and nonporous. **The oxygen hose is generally black or green in color,** and is fitted with special *right-hand* threaded connections and swivel nuts to attach to the oxygen regulator and oxygen connection to the torch. The color of the acetylene hose is *red* and is fitted with special left-hand threaded connections (with a groove around the outside) which can be attached to the acetylene regulator and the acetylene valve on the torch.

Soldering & Brazing
Chapter 6: Heating Equipment
Page 70.
Question 4.

- B. Incorrect: White
- C. Incorrect: Blue
- D. Incorrect: Red

PTS: 1

296. A type of copper tube joint is:
- A. Partially Correct: Soldered
 - B. Partially Correct: Flared
 - C. Partially Correct: Compression
 - D. **Correct:** All of the above

Introduction

Depending on the purpose for which it is to be used, copper tube may be joined by a number of methods. The most common method is by soldering with the use of a cup-joint fitting. **Solder joints** are used for domestic water, sanitary drain lines, hot water heating systems, and other lines where maximum temperatures do not exceed 250 degrees F. **Brazed joints**, with cup-joint fittings, are used where greater strength is required or where system operating temperatures are as high as 350 degrees F. Brazed joints have limited use for domestic water and drain lines but are sometimes used in steam, hot water heating, refrigeration and specialty applications such as medical gas piping systems. **Flared joints** are often used for connecting underground lines, for joints where the use of heat is impractical, and for joints that may have to be disconnected periodically. **Compression joints**, which are made by clamping the tube between threaded parts, are popular for small tube use.

Soldering & Brazing
 Chapter 2: The Soldering and Brazing Process
 Question 1. Page 25.

PTS: 1

297. If you were on a job and ran out of 5/8" O.D. fittings while installing 5/8" ACR tube which of the following sizes of copper water tube fittings could be used?
- A. Incorrect: 3/4"
 - B. Incorrect: 5/8"
 - C. **Correct:** 1/2"

**Air-Conditioning and Refrigeration Tube
 (ACR)**

Type ACR copper tube is designated for air-conditioning and refrigeration installations. It is clean, moisture free and capped when it leaves the manufacturer, thus insuring the installer a non-contaminated tube. ACR copper tube differs from the other two classes of copper tube in two major respects: it is available in a greater number of sizes (especially the smaller sizes); and the sizes specified are actual outside diameters. Therefore, its designated size is always 1/8-inch larger than the designated size of copper water and DWV tube with the outside diameter. **That is, 1/4-inch copper water tube has the same outside diameter as 3/8-inch ACR tube; 3/8-inch copper water tube has the same outside diameter as 1/2-inch ACR tube.** Fittings used for ACR tube are the same as the fittings used for water tube. However, care should be exercised in ordering these fittings, because of the different method used in specifying the size of the tube. When ordering fittings of 7/8-inch ACR tube, it is necessary to order 3/4-inch nominal or 7/8-inch O.D., which is the same as required for 3/4-inch copper water tube.

Example: 1/2-inch copper water tube has the same outside diameter as 5/8-inch ACR tube.

Soldering & Brazing

Chapter 3: Types and Uses of Copper Tube

Question 20. Pages 34 and 35.

- D. Incorrect: Water tube fittings cannot be used with ACR tube
- PTS: 1
298. When soldering copper tube, after the tube and fitting are cleaned and fluxed, they should be soldered:
- A. Incorrect: Within 24 hours
- B. **Correct:** As soon as possible

Assembly and Support

The assembly and support of soldered or brazed piping is an important part of the job. After both tube and fitting surfaces are properly fluxed, they should be assembled, making sure the tube seats against the base of the fitting socket. A slight twisting motion ensures even coverage by the flux. Remove excess flux with a cotton rag. Care must be taken to assure that the tube and fittings are properly supported with a uniform capillary space around the circumference of the joint. Uniformity of capillary space will ensure good filler metal penetration if the guidelines of successful joint making are followed. Excessive joint clearance can cause the filler metal to crack under stress or vibration.

The joint is now ready for soldering or for brazing, as the procedures to this point are the same for both processes. **Joints prepared and ready for soldering or brazing should be completed the same day and not left unfinished overnight.**

Soldering & Brazing
Chapter 5: Joint Preparation and Assembly
Question 5. Page 59.

- C. Incorrect: Within 3 hours
- D. Incorrect: Anytime

PTS: 1

299. Condensate drain traps must be used on draw through evaporator coils in order to prevent:

- A. **Correct:** Water overflow

Condensate Disposal for Cooling Coils. Cooling coils normally condense moisture from the air; the resulting water being collected in a pan from which it is carried away by drain piping.

The drain line should have a trap to provide an air seal. **Failure to do so can result in inadequate drainage of the pan or in undesirable sucking of air or gases into the conditioned air supply.** The trap should have a deep seal, related in depth to the static pressure of the fan, so that fan pressure will not break the water seal, and the trap and the drain line should have adequate cleanouts. The drain line should not be connected directly to a sewer, but may discharge to an indirect or open-sight waste or a storm sewer, as required by codes.

Drain connections should be on the downstream side of coils, and any baffle along the lower edge of the coils should have weep holes to permit passage, to the drain, of any water collecting on the upstream side of the coil and baffle. When two or more coil sections are stacked one above another, condensate is often carried out into the air stream as it drips from one coil section to the next lower one. In such cases, an intermediate drain pan or trough with drain line can be provided below each upper coil, to conduct condensate directly to the main drain pan.

Air Conditioning Mechanical Equipment Service Manual
Chapter 13: Cooling and Heating Coils
Page 179.

- B. Incorrect: High air resistance
- C. Incorrect: Low static pressure
- D. Incorrect: Drainpipe freezing

PTS: 1

300. An excess of acetylene in an oxy-acetylene flame will give a/an:
- A. Incorrect: Neutral flame
 - B. **Correct:** Carburizing flame

Oxyacetylene Flame.

The oxyacetylene flame has a peak temperature of about 6300 degrees F, and is known to be the highest temperature oxy-fuel gas flame produced. The highest temperature occurs just off the end of the inner cone of the flame.

Two volumes of acetylene combine with two volumes of hydrogen. This expression represents the burning of gases in the inner luminous cone. Just off the end of the cone a temperature of approximately 6300 degrees F is reached.

The gases burning in the outer envelope produce 956 Btu for each cubic foot of acetylene originally supplied to the torch. This consideration indicates that two thirds of the heat released by the flame is produced by the outer envelope and only one third of the heat comes from the inner cone. Thus it is seen that in any neutral flame there will be a temperature of approximately 6300 degrees F, but the total amount of heat produced will be dependent upon the size of the flame or, saying it otherwise, upon the number of cubic feet of acetylene burned per hour.

An excess of acetylene in the mixture will give a reducing or carburizing flame. This flame is readily recognizable by the secondary luminous envelope around the inner cone and inside the boundary of the outer envelope.

With a carburizing flame, the amount of acetylene is adjusted at the torch valve until the secondary luminous cone shrinks to the exact outline of the inner cone, forming the neutral flame.

If excess oxygen is added to the acetylene in the mixture, it will produce an oxidizing flame. When more oxygen is supplied to the neutral flame, the inner cone becomes darker and shorter and the whole flame is smaller and hotter. This flame is normally used for brazing certain nonferrous metals.

Never adjust an oxy-acetylene flame by reducing the amount of acetylene. This would underfeed the torch causing the flame to burn back into the tip causing overheating and backfire. Once the flame on an oxy-acetylene torch has been adjusted, *never* cut back on the acetylene after the initial adjustment.

Soldering & Brazing

Chapter 6: Heating
Question 7. Pages 65 and 66.

- C. Incorrect: Oxidizing flame
- D. Incorrect: Invisible flame

PTS: 1

301. In order to reduce pressure to an acetylene pressure regulator, the adjusting screw is turned

- A. Incorrect: Clockwise to its limit
- B. **Correct:** Counter-clockwise until the tension is off

Pressure adjusting screw. The regulator adjusting screw controls the flow of gas and delivery pressure to the hose and torch. As previously stated, the regulators function to reduce high supply pressures to a suitable working pressure range. When adjusting screw is turned clockwise, the regulator will allow gases to flow through the regulator to the hoses and to the torch. The threaded adjusting screw allows mechanical force to be applied to a spring which controls a flow valve in the regulator. If the adjusting screw is turned **counterclockwise**, tension on the spring is released and the regulator will not allow the gas to flow.

Soldering & Brazing
Chapter 6: Heating Equipment
Pages 69.
Question 8.

- C. Incorrect: Clockwise one half turn
- D. Incorrect: Clockwise one full turn

PTS: 1

302. The wall thickness of Type K copper tube is:

- A. **Correct:** Greater than that of Type L or Type M

Copper Water Tube

There are three types of copper water tube ----- K, L and M, each of which represents a series of sizes with different wall thickness.

Type K ---- Heavy Wall
Type L ---- Medium Wall
Type M --- Light Wall

Soldering & Brazing
 Chapter 3: Types and Uses of Copper Tube
 Question 21. Page 34.

- B. Incorrect: Less than Type L but greater than Type M
- C. Incorrect: Less than Type M but greater than Type L
- D. Incorrect: Same as ACR hard tempered tube

PTS: 1

303. Overheating a joint when brazing a wrought copper fitting causes

- A. Incorrect: The joint to swell
- B. Incorrect: The flux to flame
- C. Incorrect: The flux to change to a dry, chalky powder
- D. **Correct:** Oxidation and distortion of the joint

After the brazed joint has cooled, the flux residue should be removed with a clean cloth, brush or swab using warm water. Remove all flux residue to avoid the risk of the hardened flux temporarily retaining pressure and masking an imperfectly brazed joint. Wrought fittings may be cooled more readily than cast fittings, but all fittings should be allowed to cool naturally before wetting.

If the filler metal fails to flow or has a tendency to ball up, it indicates **oxidation** on the metal surfaces or insufficient heat on the parts to be joined. If tube or fitting start to oxide during heating there is too little flux. If the filler metal does not enter the joint and tends to flow over the outside of either member of the joint, it indicates that one member is overheated or the other is under heated. In either case, the filler metal will flow over the member which is overheated and away from the member that is not sufficiently heated.

HVACR Training Manual
 Chapter 9: Making a Brazed Joint
 Pages 102 and 103.
 Question 2.

PTS: 1

304. Which action is incorrect when working with an oxy-acetylene?

- A. Incorrect: Never exceed 15 psi on the acetylene regulator
- B. **Correct:** Use grease on the hose and regulator threading connections

Oil, grease and other easily oxidizable materials must be kept away from oxygen cylinders and valves, and also away from any other oxygen apparatus. A small drop of oil or grease inside an oxygen valve or oxygen regulator can cause an explosion.

Soldering & Brazing
Chapter 6: Heating Equipment
Pages 68.
Question 2.

- C. Incorrect: Never open the acetylene cylinder valve more than 1/4 turns
- D. Incorrect: Store oxygen cylinders away from combustibles

PTS: 1

305. When in doubt, what should be installed at the bottom of a suction line riser?

- A. Incorrect: A check valve
- B. **Correct:** A p-trap

Problems can occur in getting oil to flow upward in certain vertical piping, and a trap at the bottom of the riser can assist in getting the oil to begin the upward flow. Another purpose of a trap is to prevent oil in certain lines from draining back to the compressor during the off-cycle.

Refrigeration Mechanical Equipment Service Manual Volume One
Chapter 18: Refrigerant Piping --- General Requirements and Pipe Sizing
Page 232.

- C. Incorrect: A service port
- D. Incorrect: Balancing valve

PTS: 1

306. With reference to copper tube, what is meant by the letters ACR?

- A. Incorrect: Average construction rating tube
- B. **Correct:** Air conditioning and refrigeration tube

**Air-Conditioning and Refrigeration Tube
(ACR)**

Type **ACR** copper tube is designated for **air-conditioning and refrigeration installations**. It is clean, moisture free and capped when it leaves the manufacturer, thus insuring the installer a non-contaminated tube. **ACR** copper tube differs from the other two classes of copper tube in two major respects: it is available in a greater number of sizes (especially the smaller sizes); and the sizes specified are actual outside diameters. Therefore, its designated size is always 1/8-inch larger than the designated size of copper water and DWV tube with the outside diameter. That is, 1/4-inch copper water tube has the same outside diameter as 3/8-inch **ACR** tube; 3/8-inch copper water tube has the same outside diameter as 1/2-inch **ACR** tube. Fittings used for **ACR** tube are the same as the fittings used for water tube. However, care should be exercised in ordering these fittings, because of the different method used in specifying the size of the tube. When ordering fittings of 7/8-inch **ACR** tube, it is necessary to order 3/4-inch nominal or 7/8-inch O.D., which is the same as required for 3/4-inch copper water tube. The wall thickness of hard temper copper **ACR** tube are the same as that of Type L water tube. The wall thickness of annealed **ACR** tube are close to, but not exactly the same as that of Type L water tube. **Air Conditioning and Refrigeration tube is made according to ASTM Standard B280.**

Soldering & Brazing

Chapter 3: Types and Uses of Copper Tube

Question 3. Pages 34 and 35.

- C. Incorrect: Air and condensate return tube
- D. Incorrect: Acid and corrosion resistant tube

PTS: 1

307. Superheater tubes are protected from warping or burning out by:
- A. Incorrect: Circulating water around them
 - B. Incorrect: Circulating exhaust gas through them
 - C. **Correct:** Circulating steam through them

Many high-pressure installations require that the steam reach the equipment in a superheated condition. The tubes between the steam drum and the water or mud drum, called the boiler bank, have the largest amount of surface and are in the boiler proper.

They transfer most of their heat by convection as the hot gases pass between them. When it is desired to have a drier and higher temperature steam, the steam from the main steam drum is passed through tubes located in either the main furnace area or in the gas passage area and to the outlet header. These tubes are called the **superheaters** and transfer heat by both radiation and convection depending upon their location.

Steam Systems

Chapter 14: High-Pressure Steam Boilers

Question 5. Pages 140 and 141.

Steam Systems Review Exam Question 32. Page I-40.

D. Incorrect: Circulating fresh air around them

PTS: 1

308. To increase the life of furnace refractory, water-tube boilers are equipped with:

A. Incorrect: Feedwater cooler

B. **Correct:** Waterwalls

As boilers increased in size, the demand for more efficient heat transfer increased. **Waterwalls** in the furnace, that part of the boiler where combustion takes place, and other changes in design were introduced. The elimination of one or more boiler drums were also a major design change. Two-drum boilers, even boilers with one drum at the top and one or more large headers at the bottom, became common.

Five advantages of waterwall boiler design.

1. **Increased refractory life**
2. Increased steam production
3. Smaller furnace volume per unit of output
4. Increased firing rate per unit of furnace volume
5. Higher heat release in furnace area

Steam Systems

Chapter 14: High-Pressure Steam Boilers

Question 2. Pages 138 and 139.

Steam Systems Review Exam Question 33. Page I-40.

C. Incorrect: Feedwater heaters

D. Incorrect: Desuperheaters

PTS: 1

309. When steam is superheated its:

A. Incorrect: Pressure and temperature are increased

- B. **Correct:** Temperature is increased with no increase in pressure

Steam, at any given pressure, which is heated above the corresponding saturation temperature with no increase in pressure, is referred to as superheated steam. Only steam that is not in contact with water can be superheated.

Steam Systems

Chapter 1: Properties of Saturated Steam

Question 9. Page 3.

Chapter 14: High-Pressure Steam Boilers

Question 4. Page 140.

Steam Systems Review Exam Question 34. Page I-40.

- C. Incorrect: Pressure is increased with no increase in temperature

- D. Incorrect: Steam cannot be superheated

PTS: 1

310. Air is eliminated from a sub-atmospheric system by a (n):

- A. Incorrect: Air vent

- B. **Correct:** Vacuum pump

The **variable vacuum pump** discharges condensate to the boiler or boiler feed pump. When the vacuum pump is in operation and air is being exhausted from the heating system, a pressure differential is established. This in turn causes steam to flow from the steam supply main allowing air and condensate to be returned to the **vacuum pump**.

Steam Systems

Chapter 8: Variable Vacuum (Sub-Atmospheric) Steam Heating Systems

Question 2. Pages 77.

Steam Systems Review Exam Question 28. Page I-40.

- C. Incorrect: Air eliminator

- D. Incorrect: Air scoop

PTS: 1

311. The device that controls the steam pressure on the supply side of a sub-atmospheric steam heating system is a:

- A. Incorrect: Differential controller
- B. **Correct:** Control valve

Control valve. This valve controls the steam pressure on the steam supply side of a sub-atmospheric system. A control valve must be installed in a horizontal main and *never* in a vertical pipe. There should be at least 10' (3.05 m) of straight pipe beyond the control valve.

A compound gage with a pipe siphon should be installed about 10' (3.05 m) from the control valve. A pressure of 2 to 10 psig (13.79 to 68.96 kPa) (preferably) should be maintained ahead of the control valve at all times while the system is in operation. The valve is positioned and operated by either a low voltage electric motor, a pneumatic relay, or a combination pneumatic-electric relay according to the temperature readings at the window selector and room thermostat, as corrected by the heat balancer.

Steam Systems

Chapter 8: Variable Vacuum (Sub-Atmospheric) Steam Heating Systems

Question 4. Pages 80.

Steam Systems Review Exam Question 29. Page I-40.

- C. Incorrect: Control panel
- D. Incorrect: Vacuum pump

PTS: 1

312. In order to return condensate to a boiler, the height of the water column needed to overcome the pressure drop in a two-pipe gravity return system is:

- A. Incorrect: 28 inches
- B. Incorrect: 2 to 4 inches
- C. Incorrect: 15 to 18 inches
- D. **Correct:** 28 inches for each pound of pressure the boiler is producing

The major drawback of a two-pipe gravity return steam system is getting the returning condensate back to into the boiler.

In order to return water to the boiler in a one-pipe gravity return steam heating system a 28" (71.12 cm) "A" dimension is a drip leg located at the end of a steam supply or dry return mains. It provides space so condensate can accumulate and build up and create pressure. Along with the leftover pressure at the end of the main(s), about 1 1/2 psig (10.34 kPa), the pressure which is created in the drip leg will push the condensate back into the boiler.

All this changes with a two-pipe gravity return steam heating system. When the steam traps cycle closed, there is no left over steam pressure to help push the condensate back into the boiler. With no left over steam pressure, the length of the drip leg must be 30" (76.2 cm) long for each pound of pressure the boiler produces.

Remember, **the pressure at the bottom of a column of water 28" (71.12 cm) high is one psig.** The extra two inches are needed to overcome friction in the return piping. So, if the pressuretrol were set to shut the boiler off when the pressure reached 2 psig (913.79 kPa), the length of the drip leg would have to be 60" (152.4 cm) long. Quite often it is impossible to achieve the space needed to maintain the necessary distance required to return condensate back to a boiler.

Steam Systems

Chapter 5: Two-Pipe Steam Heating Systems

Question 2. Page 55 and 56.

Steam Systems Review Exam Question 18. Page I-38.

PTS: 1

313. The pump motor on a boiler feed pump is started when there is:

A. **Correct:** A low water condition in the boiler

The receiver must be supplied with make-up water to insure there is water in the receiver to supply water to the boiler. The make-up water to the receiver can be supplied using an electric solenoid or an electric motor-operated valve. **This valve is controlled by a float switch in the receiver to maintain the proper level of make-up water and condensate in the receiver.** Normally, the electric motor-operated valve or solenoid valve arrangement is used where large quantities of make-up water must be provided. If the receiver make-up water feeder is activated in order to supply water to the boiler, the likelihood of excess water and a flooded boiler or flooded receiver exist.

Steam Systems

Chapter 5: Two-Pipe Steam Heating Systems

Question 7. Pages 62.

Steam Systems Review Exam Question 19. Page I-38.

B. Incorrect: A high water condition in the boiler

C. Incorrect: Only removed from superheater tubes

D. Incorrect: Saved to make insulation

PTS: 1

314. Soot should be:

- A. **Correct:** Removed from boiler tubes for better heat transfer
Soot deposits reduce heat transfer rates on the heating surfaces and consequently reduce boiler efficiency, and increase metal surface deterioration.

Steam Systems

Chapter 14: High-Pressure Steam Boilers

Question 7. Pages 144.

Steam Systems Review Exam Question 36. Page I-41.

- B. Incorrect: Left on the tubes to insulate them
C. Incorrect: Only removed from superheater tubes
D. Incorrect: Saved to make insulation

PTS: 1

315. Thermostatic traps are opened and closed by a (n):

- A. Incorrect: Float
B. Incorrect: Inverted bucket
C. Incorrect: Electric sensor
D. **Correct:** Flexible bellows

Balanced pressure thermostatic steam trap. Located inside this trap is a corrugated metal bellows. Inside the bellows is an alcohol, distilled water or an alcohol/water mixture. All of the substances listed above boil at a lower temperature than water. When the system is *off* the trap is in the open position. When there is a call for steam, steam begins to circulate pushing the air in the piping through the steam traps.

After the air has been eliminated, cool condensate flows into the trap. As the condensate entering the trap becomes hotter the liquid inside the bellows boils, filling the bellows with vapor. When filled with vapor, the bellows expands forcing the valve onto the seat closing the trap. When the condensate inside the trap cools below the boiling/condensing temperature of the vapor inside of the bellows, the vapor condenses, the bellows contracts lifting the valve off the seat opening the trap.

Steam Systems

Chapter 4: Steam Traps

Question 2 Page 39.

PTS: 1

316. In a float and thermostatic trap the float rises to discharge:

A. **Correct:** Condensate

Float and thermostatic trap. When condensate enters the trap the water level rises lifting the float and opening the valve. Conversely, when the water level is lowered, the float falls closing the valve. Condensate is discharged from the trap almost as it enters, regardless of its temperature.

Steam Systems
Chapter 4: Steam Traps
Question 3. Page 43.

B. Incorrect: Air and steam

C. Incorrect: Air

D. Incorrect: Steam

PTS: 1

317. Condensate in steam lines could result in:

A. **Correct:** Water hammer

Condensate must be removed as quickly as possible from heat transfer units. If it is not removed quickly the units will fill with condensate and there will be no heat transfer. The steam coming in contact with the trapped condensate will create **water hammer**.

Steam Systems
Chapter 4: Steam Traps
Question 5. Page 34.

B. Incorrect: Priming

C. Incorrect: Foaming

D. Incorrect: Carryover

PTS: 1

318. The type of traps normally used on steam radiators are:

A. Incorrect: F&T traps

- B. Incorrect: Disc traps
- C. Incorrect: Inverted bucket traps
- D. **Correct:** Hermostatic traps

Because of their size and cost, thermostatic steam traps are usually installed on steam radiators. They are often referred to as radiator traps.

Steam Systems

Question 1. Chapter 5: Two-Pipe Steam Heating Systems

Answer page 40. Chapter 4: Steam Traps

PTS: 1

319. Which of the following is the common cause of back pressure in a condensate return line?

- A. **Correct:** Faulty steam trap

A steam trap is an automatic device which permits condensate, air and any non-condensable gases to flow out of heating units or steam piping into the condensate return piping without allowing live steam to escape. The basic functions of steam traps are to:

1. Prevent the loss of steam and maintain the pressure differential between the supply and return sides of a steam system.
2. Allow the passage of condensate, air, and other non-condensable gases from the steam supply to the condensate return portion of a steam system.

The flow of steam through steam supply piping is maintained by the pressure differential between the supply and return piping. Steam traps are the dividing point between steam supply and condensate return piping. If the pressure differential is not maintained no steam will circulate through the system piping.

Steam Systems

Chapter 4: Steam Traps

Pages 33-34.

Question 1.

- B. Incorrect: Vacuum
- C. Incorrect: Excessive steam pressure
- D. Incorrect: Inadequate steam pressure

PTS: 1

320. A vacuum breaker is used to avoid which of the following:

- A. Incorrect: Positive absolute pressure
- B. Incorrect: Negative absolute pressure
- C. Incorrect: Positive gauge pressure
- D. **Correct:** Negative gauge pressure

A vacuum breaker is designed to prevent the pressure in the condensate return from dropping too low. If system pressure drops below 15 in. Hg, the breaker opens and lets air into the system. Since the pump draws from a tank that is vented to the atmosphere (to allow air to escape), it will typically see atmospheric pressure at the inlet and will be unaffected by system pressure.

Steam Systems

Chapter 6: Vacuum Steam Heating Systems

Question 3. Page 67.

Steam Systems Review Exam Question 23. Page I-39.

PTS: 1

321. System powered variable air volume systems:

- A. Incorrect: Require either electric or pneumatic volume damper actuators
- B. **Correct:** Operate by the system duct air pressure

System powered controls. System powered controls use the duct pressure in the inlet of the terminal unit as the source of control power.

Air Conditioning Mechanical Equipment Service Manual

Chapter 18: Single Path All Air Systems

Review Exam I-76.

Question 15. Page 374.

- C. Incorrect: Are normally used in heating only applications
- D. Incorrect: Regulate duct static pressure

PTS: 1

322. The secondary water temperature of primary-secondary hydronic cooling system, supplied to induction coils or chilled beams is regulated to:

- A. Incorrect: Avoid over cooling of the controlled space
- B. Incorrect: Promote moisture formation on cooling coils
- C. **Correct:** Achieve maximum sensible cooling without latent cooling

The water system has two portions, indicated as *primary water circuit* and a *secondary water circuit*. Water in the primary circuit comes directly from the water chilling machines and is the coldest water in the system. Water in the secondary circuit is considerably warmer, consisting of a mixture of primary water, leaving the primary cooling coils and some water recirculated within the secondary circuit.

Since one of the features of the system is to perform all necessary dehumidification in the central air apparatus, the primary air must usually be cooled to approximately 50 degrees DB or less, and this requires very cold chilled water.

Air Conditioning Mechanical Equipment Service Manual
Chapter 20: Air-and-Air Water and All-Water Systems
Review Exam I-76.
Question 16. Page 411.

- D. Incorrect: Reduce chiller load

PTS: 1

323. When used as terminal units, induction units with chilled water coils require:

- A. Incorrect: A small fan motor at each secondary water coil
- B. Incorrect: A deeper than normal condensate pan under the chilled water coil
- C. **Correct:** A source of dehumidified primary air

The water system has two portions, indicated as *primary water circuit* and a *secondary water circuit*. Water in the primary circuit comes directly from the water chilling machines and is the coldest water in the system. Water in the secondary circuit is considerably warmer, consisting of a mixture of primary water, leaving the primary cooling coils and some water recirculated within the secondary circuit.

Since one of the features of the system is to perform all necessary dehumidification in the central air apparatus, the primary air must usually be cooled to approximately 50 degrees DB or less, and this requires very cold chilled water.

Air Conditioning Mechanical Equipment Service Manual
 Chapter 20: Air-and-Air Water and All-Water Systems
 Review Exam I-76.
 Question 17. Pages 409 through 412.

D. Incorrect: 6 row secondary chilled water coils

PTS: 1

324. Fan coil units used with a two-pipe dual temperature system:

- A. Incorrect: Can provide both heating and cooling simultaneously
- B. Incorrect: Require more water flow for heating than for cooling
- C. Incorrect: Must be used with single speed fans
- D. **Correct:** Require a changeover control to reverse the action of the fan coil thermostat

For year-round air conditioning the two-pipe system must be a dual-temperature system, supplying cold water for cooling and hot water for heating. **At some point, as governed by outdoor temperature, there must be a changeover so the system supplies cold water rather than hot-water, or vice versa.** The changeover is done at the central plant where the water is heated or chilled. If the units are equipped with automatic valves for thermostatic control of room temperature, the room thermostats must also be changed-over at the same time.

Air Conditioning Mechanical Equipment Service Manual
 Chapter 20: Air-and-Air Water and All-Water Systems
 Review Exam I-77.
 Question 19. Page 415.

PTS: 1

325. As a rule, the best general type of air diffuser to use in a variable air volume system is the:

- A. Incorrect: Side-wall grille
- B. Incorrect: Ceiling diffuser
- C. **Correct:** Slot diffuser

The success of VAV systems is the development of air diffusers which will perform satisfactorily with reduced air volumes so that air will not simply spill to the floor, but will continue to be evenly distributed about the room, without drafts.

The velocity of the air stream leaving an outlet must be high enough to provide the required throw. As air volume is reduced in the variable air volume system, outlet velocity is correspondingly decreased, and this can easily result in lack of throw, excessive drop and drafts.

Further, when an outlet discharges air along a flat surface such as a wall or a ceiling, the air stream tends to be held to the surface, this being referred to as a surface effect. Side wall grilles have comparatively little surface effect, ceiling diffusers have more, and slot diffusers have considerably more, especially when the diffuser is quite long as compared to the width of the slot.

Diffusers for variable air volume systems are of the slot or linear type, and because of the importance of diffuser selection, manufacturers of variable air volume control devices also offer suitable diffuser terminal units.

Air Conditioning Mechanical Equipment Service Manual
Chapter 18: Single Path All Air Systems
Question 6. I-49. Page 366.

D. Incorrect: Air distribution ceiling

PTS: 1

326. What is the maximum safe amperage draw of the secondary winding of a 40 VA transformer output of 24 volts?

A. Incorrect: 0.60 amps.

Divide VA by volts to obtain correct answer.

B. **Correct:** 1.67 amps.

C. Incorrect: 960 amps.

Divide VA by volts to obtain correct answer.

D. Incorrect: 0.84 amps.

Divide VA by volts to obtain correct answer.

PTS: 1

327. The purpose of a hot-gas bypass valve is too:

A. Incorrect: Provide condenser reheat.

Condenser reheat is not accomplished with a hot gas bypass valve.

B. Incorrect: Maintain condenser pressure.

A hot gas bypass valve is used to maintain evaporator pressure or load not condenser pressure.

- C. **Correct:** Maintain evaporator load.

A hot-gas bypass valve is adjusted to maintain a minimum evaporator pressure which prevent the evaporator from forming ice. The valve allows the compressor to operate when the evaporator load falls below the minimum capacity of the compressor.

- D. **Incorrect:** Defrost evaporator coil.

Hot gas is sometime used to defrost evaporator coils but the valve used to accomplish this is not referred to as a hot-gas bypass valve.

PTS: 1

328. If a refrigerant sight glass shows bubbles, you know:

- A. **Incorrect:** There is air in the system.
 B. **Correct:** There is gas in the liquid.

The sight glass in a refrigeration system permits a view of the refrigerant at the sight glass location. Installed in a liquid line, the sight glass will show bubbling if there is any gas in the liquid refrigerant. If only liquid, without gas, is present, the glass will show clear. It should be cautioned, however, that the glass will also clear if there is only gas or no refrigerant at all present.

Refrigeration Mechanical Equipment Service Manual Volume One
 Chapter 17: Refrigerant Piping Accessories
 Question 3. Page 225.

- C. **Incorrect:** The system has too much refrigerant.
 D. **Incorrect:** A restriction must be causing flash gas.

PTS: 1

329. A hermetic motor should never be energized or tested with a megohmmeter when in a deep vacuum because

- A. **Incorrect:** Electric arcs can contaminate refrigerant in the system.
 During a deep vacuum, the refrigerant is no longer in the system.
 B. **Incorrect:** The motor could draw too much amperage.
 Very little amperage would be drawn due to the lack of load on the motor.
 C. **Incorrect:** The vacuum pump could be damaged.

The system compressor would have no effect on the vacuum pump.

- D. **Correct:** The dielectric strength of the motor's insulation would be greatly reduced.

Deep vacuums have the effect of greatly reducing the dielectric strength of hermetic compressor motors insulation. Therefore, a hermetic compressor motor should never be energized, no matter how briefly, while it is in a deep vacuum. This would include performing a megohmmeter test of the motor's insulation while it is in a deep vacuum.

PTS: 1

330. In order to protect a load, safety limit devices are most often wired

- A. Incorrect: In parallel.

Parallel wiring would allow the load to be energized even if one safety tripped.

- B. **Correct:** In series.

Series wiring de-energizes the load when any one of several safeties trips.

- C. Incorrect: Upstream.

It doesn't matter if the safety limit is "upstream" or "downstream" of the load. What does matter is if it is in series or parallel.

- D. Incorrect: Downstream.

It doesn't matter if the safety limit is "upstream" or "downstream" of the load. What does matter is if it is in series or parallel.

PTS: 1

331. In a balanced three-phase system, the phase the voltage waveforms differ in phase by:

- A. Incorrect: 90 degrees

- B. **Correct:** 120 degrees

There are three electromotive forces differing in phase from each other by 120 degrees.

HVAC and Refrigeration Systems Training Manual
Unit 11: Electrical System Principles
Page 206

Basic Electricity for United Association Journey Workers & Apprentices
Chapter 13: Alternating Current Systems

Question 1. Page 89.

- C. Incorrect: Square root of 3
- D. Incorrect: Zero degrees

PTS: 1

332. Electrical pressure is measured in

- A. Incorrect: Amps
Amperage is measure of flow, not pressure.
- B. Incorrect: Ohms
Ohms are a measure of resistance, not pressure.
- C. Incorrect: Watts
Watts is a measure of power, not pressure.
- D. **Correct:** Volts

PTS: 1

333. A bellows is used:

- A. Incorrect: Only in pressure controllers
- B. Incorrect: Only in temperature controllers
- C. **Correct:** In both pressure and temperature controllers

A bellows will expand or contract as the pressure increases or decreases. It is a very popular pressure-sensing device, and is used in most pressure controllers.

A very common application of the Bourdon tube is in pressure gages.

Electric Controls for Mechanical Equipment Service
Chapter 2: Fundamentals of Measurement
Question 5. Pages 10 and 12.

- D. Incorrect: Only with remote-bulb thermostats

PTS: 1

334. Roller bearings are normally used with:

- A. Incorrect: Small light-duty motors

- B. Incorrect: Small motors where there is a noise factor.
- C. **Correct:** Large motors operating with a heavy load.

Large motors use a type of ball bearing called a *roller bearing*, which has cylindrically shaped rollers instead of balls.

HVACR Training Manual
Study Guide / Lab Manual
Unit 18 Application of Motors
Review Test Question 6. Page 109.

HVACR Training Manual
Unit 18 Application of Motors
18.5 Types of Bearings Page 353.

- D. Incorrect: None of the above.

PTS: 1

335. The width of a drive belt is classified as:

- A. Incorrect: Large or small.
- B. Incorrect: Narrow or wide.
- C. **Correct:** A or B.

Belt widths are denoted by “A” and “B”. An A width belt must not be used with a B width pulley nor vice versa.

HVACR Training Manual
Study Guide / Lab Manual
Unit 18 Application of Motors
Review Test Question 8. Page 110.

HVACR Training Manual
Unit 18 Application of Motors
18.7 Motor Drives Page 355.

- D. Incorrect: 1 or 2.

PTS: 1

336. An instrument often used to check the alignment of two shafts is the:

- A. Incorrect: Micrometer.
- B. **Correct:** Dial indicator.

A more complicated coupling is used between the motor and a larger pump or a compressor. This coupling and shaft must be in very close alignment, or vibration will occur. The alignment must be checked to see that the motor shaft is parallel with the compressor or pump shaft. Alignment is a very precise operation and is done by experienced technicians, using a dial indicator.

HVACR Training Manual
Study Guide / Lab Manual
Unit 18 Application of Motors
Review Test Question 9. Page 110.

HVACR Training Manual
Unit 18 Application of Motors
18.7 Motor Drives Page 357 and 358.

- C. Incorrect: Manometer.
- D. Incorrect: Sling psychrometer.

PTS: 1

337. A loose-fitting belt on a belt-driven device will cause:

- A. Incorrect: Bearing wear.
- B. Incorrect: Overheating motor.
- C. Incorrect: Pulley wobble.
- D. **Correct:** Worn pulley grooves.

Belts and pulleys wear like any moving or sliding surface. When a pulley begins to wear, the surface roughens and wears out the belts. Normal pulley wear is caused by use or running time. **Belt slippage** will cause premature wear. Pulleys must be inspected occasionally.

HVACR Training Manual
Study Guide / Lab Manual
Unit 18 Application of Motors
Review Test Question 15. Page 110.

HVACR Training Manual
Unit 18 Application of Motors
18.7 Motor Drives Page 357.

PTS: 1

338. A flexible coupling between the drive and driven device:

- A. **Correct:** Corrects minor misalignment.

Rigid-base-mount motors are similar to cradle-mount motors except that the base is fastened to the motor body. The sound isolation for this motor is in the belt, if one is used, that drives the prime mover. This motor is often used as a direct drive to turn a compressor or pump. A **flexible coupling** is used between the motor and prime mover in a direct-drive installation.

HVACR Training Manual
Study Guide / Lab Manual
Unit 18 Application of Motors
Review Test Question 16. Page 110.

HVACR Training Manual
Unit 18 Application of Motors
18.6 Motor Mounting Characteristics Page 354.

- B. Incorrect: Prevents liquid from entering the bearings.
- C. Incorrect: Reduces suction gas noise.
- D. Incorrect: Prevents airflow problems.

PTS: 1

339. If refrigerant is to be added to a system, the refrigerant cylinder is usually connected to the

- A. **Correct:** Center port of gauge manifold

The construction of a typical gage manifold has two shutoff valves and five external connections. The compound gage on the left-hand side is always open to the lower left-hand connection of the manifold, and will indicate suction pressure when connected to the gage port of the compressor suction service valve, or other suitable connection.

Similarly, the pressure gage on the right-hand side is always connected to the gage port of the compressor discharge service valve, or equivalent pressure connection.

When both manifold valves are closed (front-seated) the center or utility port is isolated, but the opening of either valve opens the center port to that side of the manifold and the refrigeration system. The hose connected to the center port can be attached to a container of refrigerant for charging the system. The center port can also be attached to a container of oil and the manifold used to control the addition of oil to the compressor, or it can be attached to a vacuum pump to evacuate the system.

Refrigeration Mechanical Equipment Service Manual Volume Two
Chapter 31: Checking Refrigerant Temperatures and Pressures
Pages 474-475.

Question 8.

- B. Incorrect: Discharge service valve of the compressor
- C. Incorrect: Left-handed port of the manifold gauge
- D. Incorrect: Right-handed port of the manifold gauge

PTS: 1

340. On centrifugal pumps, if it is ever necessary to reduce pump flow, do so by

- A. **Correct:** Throttling the discharge

The valve on the suction side of the pump should be fully open. Never throttle flow through the pump with the suction valve. It could cause cavitation. What is cavitation?

Cavitation is the flashing of a pumped liquid into vapor bubbles and the subsequent violent collapsing of those bubbles as the liquid moves from suction to discharge through the pump. It can be extremely damaging to the pump internally, as well as to the piping and pump mountings. It can cause the pump to vibrate and shake erratically. Cavitation can cause a sound like gravel passing through the pump.

Cavitation can be caused by suction pressure which is too low (insufficient static pressure in the system) or by excessive flow through the pump (**which can be corrected by throttling the discharge valve**) or by the fluid being too hot. If cavitation cannot be corrected quickly, the pump should be turned off to prevent damage.

Pumps

Chapter 3: Pump Installation

Pages 45.

Question 5.

- B. Incorrect: Throttling the suction line
- C. Incorrect: Both A and B
- D. Incorrect: None of the above

PTS: 1

341. Which of the following would happen if the vent port on a gas regulator is plugged?

- A. **Correct:** Outlet pressure will be reduced

The regulator vent is an essential part of regulator operation. What is the purpose of the regulator vent?

The regulator vent allows the air above the diaphragm to escape or enter as the diaphragm moves up or down. Blockage of the vent would cause the air above the diaphragm to become locked in, and prevent the free movement of the diaphragm. If the diaphragm should rupture allowing gas above the diaphragm, the vent allows this gas to escape into the atmosphere, rather than cause an unsafe operating condition. Most small regulators vent into the atmosphere but gas codes restrict the size of the vent opening. Larger regulators may pipe the vent opening to the combustion chamber beside a constant pilot flame or to the outdoors. Check state, local or provincial codes.

Gas Installations for United Association Journey Workers & Apprentices
Chapter 5: Valves and Regulators
Pages 168.

- B. Incorrect: Outlet pressure will increase
- C. Incorrect: Inlet pressure will be reduced
- D. Incorrect: Nothing, this is normal operation

PTS: 1

342. Which of the following is NOT used to size gas regulators?

- A. Incorrect: Pipe size
- B. Incorrect: Inlet pressure
- C. **Correct:** Type of ignition system

You must take into account certain factors relating to the piping system before you can select a regulator for a particular application. Which factors must be considered when selecting a regulator?

1. Rate of flow the regulator will be required to supply (usually in cubic feet per hour)
2. Type of gas (natural or propane)
3. Inlet gas pressure to the regulator (minimum and maximum)
4. Outlet gas pressure of the regulator
5. Size of gas pipe at the regulator

Gas Installations for United Association Journey Workers & Apprentices
Chapter 5: Valves and Regulators
Pages 166 and 167.
Question 8.

- D. Incorrect: Volume

PTS: 1

343. Which of the following is the common cause of back pressure in a condensate return line?

A. **Correct:** Faulty steam trap

A steam trap is an automatic device which permits condensate, air and any non-condensable gases to flow out of heating units or steam piping into the condensate return piping without allowing live steam to escape. The basic functions of steam traps are to:

1. Prevent the loss of steam and maintain the pressure differential between the supply and return sides of a steam system.
2. Allow the passage of condensate, air, and other non-condensable gases from the steam supply to the condensate return portion of a steam system.

The flow of steam through steam supply piping is maintained by the pressure differential between the supply and return piping. Steam traps are the dividing point between steam supply and condensate return piping. If the pressure differential is not maintained no steam will circulate through the system piping.

Steam Systems
Chapter 4: Steam Traps
Pages 33-34.
Question 1.

- B. Incorrect: Vacuum
- C. Incorrect: Excessive steam pressure
- D. Incorrect: Inadequate steam pressure

PTS: 1

344. An evaporative cooling tower's bleed rate is adjusted to maintain

A. **Correct:** The desired concentration of total dissolved solids

Cooling Tower drift is water lost from the tower due to drift, or carry-over of a water mist or water droplets due to being blown through the eliminators.

The proper location of a cooling tower bleed-off is: at the high point of the condenser water piping. This is important; otherwise the bleed-off line will act as a drain and cause an unnecessary waste of water when the system is off.

Refrigeration Mechanical Equipment Service Manual Volume One
Chapter 12: Water Supply for Water-Cooled Condensers

Pages 160 and 161.
Question 1, 3.

- B. Incorrect: Return water temperature
- C. Incorrect: The desired leaving water temperature
- D. Incorrect: A water seal in the drain line trap

PTS: 1

345. The run windings of a motor have _____ turns as compared to the start windings.

- A. **Correct:** Fewer

The run winding is wound with a large diameter wire than the start winding and have fewer turns.

HVACR Training Manual
Unit 17 Types of Electric Motors
17.5 Start Windings
Page 321.

- B. Incorrect: More
- C. Incorrect: The same number
- D. Incorrect: An infinite number of

PTS: 1

346. On a typical split-phase electric motor the start winding circuit is de-energized as it reaches approximately _____ of its operating speed?

- A. Incorrect: 50%
- B. Incorrect: 65%
- C. **Correct:** 75%

When the motor reaches approximately 75% of its normal speed the start winding is removed from the circuit.

HVACR Training Manual
Unit 17 Types of Electric Motors
17.5 Start Windings
Page 321.

HVAC and Refrigeration Systems Training Manual
Unit 13: Electric Motors and Solenoids
Page 239-242

D. Incorrect: 90%

PTS: 1

347. What component wired in series with the start windings on a single-phase motor will create greater starting torque

A. **Correct:** A capacitor

The start capacitor is wired in series with the start windings to give the motor more starting torque. The capacitor is chosen to make the phase angle such that is most efficient for starting the motor.

HVACR Training Manual
Unit 17 Types of Electric Motors
17.12 Capacitor-Start Motors
Page 326.

HVAC and Refrigeration Systems Training Manual
Unit 13: Electric Motors and Solenoids
Page 239-242

B. Incorrect: A transistor

C. Incorrect: A rectifier

D. Incorrect: A thermistor

PTS: 1

348. A three-phase motor does not have

A. Partially Correct: Start windings

B. Partially Correct: A start capacitor

C. Partially Correct: A start relay

D. **Correct:** All of the above

Three phase motors have no starting windings, capacitors, or relays. They can be thought of as having three separate single phase power supplies.

HVACR Training Manual
Unit 17 Types of Electric Motors
17.6 Three-phase Motors
Page 329.

HVAC and Refrigeration Systems Training Manual
Unit 13: Electric Motors and Solenoids
Page 242-244

PTS: 1

349. A start component that is rated in microfarad would be a

A. **Correct:** Capacitor

All capacitors are rated in microfarads.

HVACR Training Manual
Unit 17 Types of Electric Motors
17.13 Capacitor-Start, Capacitor-Run Motors
Page 326.

HVAC and Refrigeration Systems Training Manual
Unit 12: Electrical and Electronic Control Devices
Page 208

B. Incorrect: Thermistor

C. Incorrect: Transistor

D. Incorrect: Rectifier

PTS: 1

350. What effect will a higher than rated supply voltage have on the current draw of an electric motor?

A. **Correct:** It will be lower than it should be

The voltage of an installation is important because every motor operates within a specified voltage range, usually within + or- 10%. If the voltage is too low, the motor will draw a high current. For Example, if a motor is designed to operate on 230V but the supply voltage is really 200V, the motor's current draw will go up. The motor is trying to do its job, but it lacks the power, and it will overheat.

If the applied voltage is too high, the motor may develop local hot spots within its windings, but it will not experience high amperage. The high voltage will actually give the motor more power than it can use. A 1-hp motor with a voltage rating of 230V that is operating at 260V is running above its 10% maximum. The motor may be able to develop 1 1/4 hp at this higher-than-rated voltage, but the windings are not designed to operate at that level. The motor can overheat and eventually burn out if it continually runs overloaded. This can happen *without* drawing excessive current.

HVACR Training Manual
Unit 18 Application of Motors
18.2 Power Supply

Voltage
Page 346.

HVAC and Refrigeration Systems Training Manual
Unit 13: Electric Motors and Solenoids
Page 242-244

- B. Incorrect: It will remain the same
- C. Incorrect: It will be higher than it should be
- D. Incorrect: It will be erratic

PTS: 1

351. With an electric motor running normally at full load the amperage reading would be called?

- A. Incorrect: Full-load amperage
- B. **Correct:** Run-load amperage

Run load amperage is also referred to as the full load amperage and is the current drawn while the motor is running at full load.

HVACR Training Manual
Unit 19 Motor Controls
19.2 Motor Controls
Page 360.

HVAC and Refrigeration Systems Training Manual
Unit 13: Electric Motors and Solenoids
Page 229

- C. Incorrect: Locked-rotor amperage
- D. Incorrect: A or B

PTS: 1

352. What device would be discharged using a 20,000-ohm, 5 watt resistor?

- A. **Correct:** Capacitor

The safest way to discharge a capacitor is by using a 20,000-ohm, 5 watt resistor.

HVACR Training Manual
Unit 20 Troubleshooting Electric Motors
20.11 Checking Capacitors
Page 375.

- B. Incorrect: Thermistor
- C. Incorrect: Transistor
- D. Incorrect: Rectifier

PTS: 1

353. The run-load amperage on an electric motor is typically

- A. Incorrect: 1/2 that of the locked-rotor amperage
- B. Incorrect: 1/6 that of the locked-rotor amperage
- C. **Correct:** 1/5 that of a full-load amperage

Normally the Locked-Rotor-Amperage of a motor is about six times the Run-Load-Amperage.

HVACR Training Manual
Unit 18 Application of Motors
18.2 Power Supply
Current Capacity
Pages 346 and 347.

HVAC and Refrigeration Systems Training Manual
Unit 13: Electric Motors and Solenoids
Page 229

- D. Incorrect: 1/10 that of full-load amperage

PTS: 1

354. What device is used to energize another load such as a contactor or motor starter which in turn would start or stop a motor?

- A. Incorrect: A switch
- B. Incorrect: A circuit breaker
- C. Incorrect: A line fuse
- D. **Correct:** A pilot duty relay

Pilot duty relays can switch larger contactors or starter on or off.

HVACR Training Manual
Unit 19 Motor Controls
19.3 The Relay
Pages 360 and 361.

HVAC and Refrigeration Systems Training Manual
Unit 15: Motor Starters and Variable-Frequency Drives
Page 271-276

PTS: 1

355. A magnetic coil and electrical contacts are the primary components of this electrical device?

- A. Incorrect: A centrifugal switch
- B. Incorrect: A circuit breaker
- C. Incorrect: A thermal overload
- D. **Correct:** A contactor

A contactor is a larger version of a relay and can be rebuilt. The magnetic holding coil can be designed for various operating voltages.

HVACR Training Manual
Unit 19 Motor Controls
19.4 The Contactor
Page 362.

HVAC and Refrigeration Systems Training Manual
Unit 15: Motor Starters and Variable-Frequency Drives
Page 271-276

PTS: 1

356. A magnetic coil, overload protector and electrical contactors are the primary components of this electrical device

- A. Incorrect: A circuit breaker
- B. Incorrect: A thermal overload
- C. Incorrect: A contactor or relay
- D. **Correct:** A motor starter

A motor starter is similar to a contactor but also includes overload protections.

HVACR Training Manual
Unit 19 Motor Controls
19.5 Motor Starters
Pages 362 and 363.

HVAC and Refrigeration Systems Training Manual

Unit 15: Motor Starters and Variable-Frequency Drives
Page 271-276

PTS: 1

357. An electric motor that has an internal overload would have a?
- A. Incorrect: Circuit breaker
 - B. **Correct:** A thermal device buried in the motor windings

If a motor is designed with an internal overload the device will be buried in the motor windings and open if the temperature exceeds a predetermined limit.

HVACR Training Manual
Unit 19 Motor Controls
19.7 Inherent Motor Protection
Page 365.

HVAC and Refrigeration Systems Training Manual
Unit 15: Motor Starters and Variable-Frequency Drives
Page 271-276

- C. Incorrect: Line fuse
- D. Incorrect: None of the above

PTS: 1

358. What device could be used as external protection for a motor?
- A. Partially Correct: A line fuse
 - B. Partially Correct: A circuit breaker
 - C. Partially Correct: Magnetic overload
 - D. **Correct:** All of the above

Any of the items above could be used to protect a motor from over current, however the magnetic overload would also protect against over current independent of the ambient temperatures.

HVACR Training Manual
Unit 19 Motor Controls
19.6 Motor Protection
19.8 External Motor Protection
Pages 364, 365 and 366.

HVAC and Refrigeration Systems Training Manual

Unit 15: Motor Starters and Variable-Frequency Drives
Page 271-276

PTS: 1

359. If a technician uses an ohm meter to check the windings of an electric motor and records an infinite reading on the start windings this would indicate?
- A. Incorrect: The start winding is shorting to ground
 - B. Incorrect: The start winding is shorting to the run winding
 - C. Incorrect: The start winding is shorting to itself
 - D. **Correct:** The start winding has an open somewhere

On any circuit that is open an ohmmeter will have an infinite reading.

HVACR Training Manual
Unit 20 Troubleshooting Electric Motors
20.7 Open Windings
Page 372.

HVAC and Refrigeration Systems Training Manual
Unit 13: Electric Motors and Solenoids
Page 242-245

PTS: 1

360. What type of motor would a technician switch any two legs on to reverse the rotation of the motor?
- A. Incorrect: CSIR
 - B. Incorrect: CSCR
 - C. Incorrect: PSC
 - D. **Correct:** Three Phase

The direction of a three phase motor can be changed by reversing any two legs of the circuit. The direction of the other types of single phase motors cannot be changed externally.

HVACR Training Manual
Unit 17 Types of Electric Motors
17.6 Three-phase Motors
Page 329.

HVAC and Refrigeration Systems Training Manual
Unit 13: Electric Motors and Solenoids

Page 242-245

PTS: 1

361. Induction motors obtain good starting and running torque from

- A. Incorrect: Start and run capacitors
- B. **Correct:** Start windings

Since each of the induction motor's stator windings are 120° out of phase, it will generate both good start-up and run torques.

HVACR Training Manual
Unit 17 Types of Electric Motors
17.5 Start Windings
Page 321.

HVAC and Refrigeration Systems Training Manual
Unit 13: Electric Motors and Solenoids
Page 241-244

- C. Incorrect: Shaded pole circuits
- D. Incorrect: Three phase windings

PTS: 1

362. Shaded-pole motors can most easily be identified by

- A. **Correct:** A small pole of thick copper wire

Shaded pole motors can easily be identified by the heavy gauge copper band located around the stator of the motor.

HVACR Training Manual
Unit 17 Types of Electric Motors
17.15 Shaded-Pole Motors
Page 328.

HVAC and Refrigeration Systems Training Manual
Unit 13: Electric Motors and Solenoids
Page 238-239

- B. Incorrect: A start capacitor
- C. Incorrect: A run capacitor
- D. Incorrect: Both start and run capacitor

PTS: 1

363. The primary application for shaded-pole motors would be
- A. Partially Correct: When low start torque is required
 - B. Partially Correct: When low run torque is required
 - C. Incorrect: When three phase power is not available
 - D. **Correct:** Both A and B

Shaded pole motors are very common throughout the industry and are used in low torque applications.

HVACR Training Manual
Unit 17 Types of Electric Motors
17.15 Shaded-Pole Motors
Page 328.

HVAC and Refrigeration Systems Training Manual
Unit 13: Electric Motors and Solenoids
Page 238-239

PTS: 1

364. One of the most popular motors used in the HVAC industry with low starting torque but improved running is the _____ motor.
- A. Incorrect: Capacitor start capacitor run
 - B. Incorrect: Shaded pole
 - C. **Correct:** Capacitor-run

Capacitor-Run motors provide a moderate torque while maintaining good running efficiency. The capacitor start capacitor run motor is less efficient. The three phase motor is high torque.

HVACR Training Manual
Unit 17 Types of Electric Motors
17.13 Capacitor-Start, Capacitor- Run Motor
17.14 Permanent Split-Capacitor Motor
17.16 Three-Phase Motors
Pages 326, 328 and 329.

HVAC and Refrigeration Systems Training Manual
Unit 13: Electric Motors and Solenoids
Page 240-241

- D. Incorrect: Three Phase

PTS: 1