

# Electronic Displays

Codes and Standards Enhancement (CASE) Initiative  
For PY 2013: Title 20 Standards Development

Analysis of Standards Proposal for  
**Electronic Displays**

Docket Number: 12-AAER-2A; Consumer Electronics



July 29, 2013

Prepared for:



PACIFIC GAS & ELECTRIC  
COMPANY



SOUTHERN CALIFORNIA  
EDISON



SAN DIEGO GAS AND  
ELECTRIC



SOUTHERN CALIFORNIA  
GAS COMPANY

Prepared by:

Bijit Kundu, ENERGY SOLUTIONS

Clancy Donnelly, Katherine Dayem, Philip Walters, ECOVA

This report was prepared by the California Statewide Utility Codes and Standards Program and funded by the California utility customers under the auspices of the California Public Utilities Commission.

Copyright 2013 Pacific Gas and Electric Company, Southern California Edison, Southern California Gas, San Diego Gas & Electric.

All rights reserved, except that this document may be used, copied, and distributed without modification.

*Neither PG&E, SCE, SoCalGas, SDG&E, nor any of its employees makes any warranty, express of implied; or assumes any legal liability or responsibility for the accuracy, completeness or usefulness of any data, information, method, product, policy or process disclosed in this document; or represents that its use will not infringe any privately-owned rights including, but not limited to, patents, trademarks or copyrights.*

## Acknowledgements

The CASE Team would like to thank NRDC, in particular Pierre Delforge, for contributions in the development of this standards proposal.

# Table of Contents

<b>1</b>	<b>EXECUTIVE SUMMARY</b> .....	<b>1</b>
<b>2</b>	<b>PRODUCT DESCRIPTION</b> .....	<b>2</b>
<b>2.1</b>	Product Definitions .....	2
2.1.1	<i>Electronic Displays</i> .....	2
2.1.2	<i>Computer Monitors</i> .....	3
2.1.3	<i>Digital Picture Frames</i> .....	3
2.1.4	<i>Signage Displays</i> .....	4
2.1.5	<i>Digital Billboards</i> .....	5
2.1.6	<i>Televisions</i> .....	6
<b>2.2</b>	Scope .....	6
<b>2.3</b>	Applications .....	7
<b>2.4</b>	Power Mode Descriptions for Electronic Displays.....	7
2.4.1	<i>On Mode</i> .....	8
2.4.2	<i>Sleep Mode</i> .....	8
2.4.3	<i>Off Mode</i> .....	8
<b>2.5</b>	Product Design.....	8
2.5.1	<i>Liquid Crystal Display Panels</i> .....	8
2.5.2	<i>Plasma</i> .....	10
2.5.3	<i>Organic Light-Emitting Diode (OLED)</i> .....	11
2.5.4	<i>Digital Billboards</i> .....	11
<b>3</b>	<b>MANUFACTURING AND MARKET CHANNEL OVERVIEW</b> .....	<b>12</b>
<b>3.1</b>	Computer Monitor Lifecycle .....	12
<b>3.2</b>	Manufacturers .....	14
<b>3.3</b>	Market Channel .....	15
<b>3.4</b>	Market Segment .....	15
<b>3.5</b>	Market Trends .....	15
3.5.1	<i>Computer Monitors</i> .....	15
3.5.2	<i>Signage Displays</i> .....	17
3.5.3	<i>Size Groupings</i> .....	17
3.5.4	<i>Resolution</i> .....	20
3.5.5	<i>Other Attributes</i> .....	22
<b>4</b>	<b>ENERGY USAGE</b> .....	<b>23</b>
<b>4.1</b>	Test Methods .....	23
4.1.1	<i>Computer Monitors, Signage Displays, and Digital Picture Frames</i> .....	23
4.1.2	<i>Electronic Billboards</i> .....	24
<b>4.2</b>	Dataset .....	25
4.2.1	<i>Computer Monitors</i> .....	25
4.2.1	<i>Computer Monitor On Mode Dataset – LED Backlight</i> .....	31
4.2.2	<i>Signage Displays</i> .....	32
<b>4.3</b>	Duty Cycle.....	33
4.3.1	<i>Computer Monitors</i> .....	33
4.3.2	<i>Signage Displays</i> .....	34
<b>4.4</b>	Efficiency Measures .....	34
4.4.1	<i>General Efficiency Strategies</i> .....	34
4.4.2	<i>Backlight Sources</i> .....	35

4.4.3	<i>Optical Films</i> .....	35
4.4.4	<i>Brightness Control and Power Management</i> .....	35
4.4.5	<i>Power Supply</i> .....	36
4.4.6	<i>Energy Efficient Ethernet (EEE)</i> .....	37
4.5	<b>Computer Monitors</b> .....	37
4.5.1	<i>Energy Use per Unit for Non-qualifying Computer Monitors</i> .....	37
4.5.2	<i>Energy Use per Unit for Qualifying Computer Monitors</i> .....	37
4.6	<b>Signage Displays</b> .....	38
4.1	<b>Electronic Billboards</b> .....	39
<b>5</b>	<b>MARKET SATURATION &amp; SALES</b> .....	<b>39</b>
5.1	<b>Current Market Situation</b> .....	39
5.1.1	<i>Computer Monitors Shipments and Installed Base</i> .....	39
5.1.2	<i>Signage Displays Shipments</i> .....	40
5.1.3	<i>Computer Monitors: Market Share of High Efficiency Options</i> .....	41
5.1.4	<i>Signage Displays: Market Share of High Efficiency Options</i> .....	42
5.2	<b>Future Market Adoption of High Efficiency Options</b> .....	43
<b>6</b>	<b>SAVINGS POTENTIAL</b> .....	<b>44</b>
6.1	<b>Statewide California Energy Savings</b> .....	44
6.1.1	<i>Computer Monitors</i> .....	44
6.1.2	<i>Signage Displays</i> .....	45
6.2	<b>State or Local Government Costs and Savings</b> .....	47
<b>7</b>	<b>ECONOMIC ANALYSIS</b> .....	<b>47</b>
7.1	<b>Incremental Cost Methodology</b> .....	47
7.2	<b>Design Life</b> .....	53
7.3	<b>Lifecycle Cost / Net Benefit – Computer Monitors</b> .....	53
7.4	<b>Feasibility and Justification</b> .....	54
7.4.1	<i>LED improvements</i> .....	57
7.4.2	<i>Reflective polarizing film</i> .....	57
7.4.3	<i>Power supply improvements</i> .....	57
7.4.4	<i>Automatic Brightness Control (ABC)</i> .....	57
7.4.5	<i>Backlight Dimming To Video Content</i> .....	58
7.4.6	<i>Limit Screen Brightness (Calibration)</i> .....	61
7.4.7	<i>Emerging Technology Options</i> .....	61
<b>8</b>	<b>ACCEPTANCE ISSUES</b> .....	<b>63</b>
8.1	<b>Infrastructure issues</b> .....	63
8.2	<b>Existing Standards</b> .....	63
8.3	<b>Stakeholder Positions</b> .....	63
<b>9</b>	<b>ENVIRONMENTAL IMPACTS</b> .....	<b>64</b>
9.1	<b>Air Quality</b> .....	64
9.2	<b>Greenhouse Gases</b> .....	65
9.3	<b>Hazardous Materials</b> .....	66
<b>10</b>	<b>RECOMMENDATIONS</b> .....	<b>66</b>
10.1	<b>General Requirements</b> .....	66
10.1.1	<i>Rounding and Significant Digits</i> .....	66
10.1.2	<i>Power Management</i> .....	67

10.1.3	<i>Luminance Testing at Default Settings</i> .....	67
<b>10.2</b>	<b>Power Mode Requirements</b> .....	<b>67</b>
10.2.1	<i>Computer Monitors</i> .....	67
10.2.2	<i>Signage Displays – Power Mode Requirements</i> .....	70
<b>10.3</b>	<b>Test and List Requirements</b> .....	<b>72</b>
10.3.1	<i>USB-Powered Computer Monitors – Test and List</i> .....	72
10.3.2	<i>Digital Picture Frames – Test and List</i> .....	72
10.3.3	<i>Digital Billboards – Test and List</i> .....	73
<b>10.4</b>	<b>Reporting Requirements</b> .....	<b>73</b>
<b>10.1</b>	<b>Implementation Plan</b> .....	<b>73</b>
<b>11</b>	<b>REFERENCES</b> .....	<b>74</b>
<b>APPENDIX A: ELECTRONIC BILLBOARDS MARKETED AS TITLE 24-COMPLIANT</b> .....		<b>A-1</b>
<b>APPENDIX B: AS-ASSEMBLED TEST RESULTS</b> .....		<b>B-1</b>
<b>APPENDIX C: DATA SUBMITTAL REQUIREMENTS – ELECTRONIC BILLBOARDS</b> .....		<b>C-1</b>
<b>APPENDIX D: COST ANALYSIS ASSUMPTIONS</b> .....		<b>D-1</b>
<b>APPENDIX E: CRITERIA POLLUTANT EMISSIONS AND MONETIZATION</b> .....		<b>E-1</b>
E.1	Criteria Pollutant Emissions Calculation .....	E-1
E.2	Criteria Pollutant Emissions Monetization .....	E-1
<b>APPENDIX F: GREENHOUSE GAS VALUATION DISCUSSION</b> .....		<b>F-1</b>
F.1	Damage Cost Approach .....	F-1
F.1.1	<i>Interagency Working Group Estimates</i> .....	F-1
F.2	Abatement Cost Approach .....	F-2
F.3	Regulated Carbon Market Approach .....	F-3
F.3.1	<i>European Union Emissions Trading System</i> .....	F-3
F.3.2	<i>California Cap &amp; Trade</i> .....	F-3

# 1 Executive Summary

The Pacific Gas and Electric Company (PG&E), Southern California Edison (SCE), Southern California Gas (SCG), San Diego Gas & Electric (SDG&E) Codes and Standards Enhancement (CASE) Initiative Project seeks to address energy efficiency opportunities through development of new and updated Title 20 standards. Individual reports document information and data helpful to the California Energy Commission (CEC) and other stakeholders in the development of these new and updated standards. The objective of this project is to develop CASE Reports that provide comprehensive technical, economic, market, and infrastructure information on each of the potential appliance standards. This CASE Report covers standards options for electronic displays, including: computer monitors, signage displays, digital picture frames, and electronic billboards.

Computer monitors are ubiquitous in homes, offices, and other commercial settings. Based on various industry studies of existing stock, there are over 38 million computer monitors installed in the State of California (CA), which equates to one computer monitor per person. Monitors account for a significant portion of electricity consumed in computing use. Signage displays are a growing presence in commercial settings, such as retail and hospitality. Statewide, computer monitors and signage displays may consume approximately 3,200 gigawatt hours (GWh) of electricity per year and create a peak demand of almost 600 megawatts (MW).

Electricity consumption of computer monitors varies greatly, even within models of similar sizes and feature sets. Differences in some combination of the following components can account for the wide variation: backlighting, panel transmittance, optical films, and electronics (drive circuit, image circuit, and the power supply unit). Since 1992, the United States (U.S.) Environmental Protection Agency (EPA) has incentivized the development of efficient computer monitors as one of the first covered products under the ENERGY STAR<sup>®</sup> program. While ENERGY STAR has been successful in incentivizing the most efficient monitors in the marketplace, there remain a number of less efficient monitors that consume as much as six times more energy than a comparable-sized efficient model. To date, there are no federal or state regulations to incentivize the implementation of cost-effective, readily available technologies to improve the performance of these less efficient models.

Based on extensive testing, analysis, and review,<sup>1</sup> the CASE Team proposes maximum power limits for the different operating modes of a computer monitor based on screen area and screen resolution. Implementing proposed standards has the potential to almost halve the average energy use for a typical monitor, without sacrificing functionality or performance, using available, off-the-shelf technologies. The proposed standards would save over 400 gigawatt-hours (GWh) after stock turnover.

For signage displays, clarification of existing CEC efficiency regulations and expansion of scope to include models larger than 1,400 square inches could realize significant energy savings for Californians, saving an estimated 1,500 GWh after stock turnover.

With a total estimated savings of 1,900 GWh per year, electronic display standards if adopted would address some of the statewide policy objectives of Zero Net Energy California Long Term Energy Efficiency Strategic Plan and AB32 energy efficiency goals.

---

<sup>1</sup> As a follow-up document to this report, the CASE Team will be submitting a Technical Report with detailed results of our testing and analysis.

## 2 Product Description

### 2.1 Product Definitions

The Version 6.0 ENERGY STAR Displays Specification (referenced as “ENERGY STAR specification” throughout this report), developed by EPA, includes definitions for the following: Electronic Displays, Computer Monitors, Digital Picture Frames, and Signage Displays (EPA 2013a). The CASE Team recommends using these definitions and the product category nomenclature to align with ENERGY STAR. With the exception of digital billboards, these definitions have been thoroughly vetted by stakeholders through the ENERGY STAR specification development process.

The ENERGY STAR specification was finalized on September 4, 2012<sup>2</sup> and took EPA almost two years to complete with numerous stakeholders contributing to the development process, including: manufacturers, industry trade groups, non-governmental organizations, utility companies, government agencies, and other national and international stakeholders. The specification has been thoroughly scrutinized and accepted by this diverse group of stakeholders. Where possible, the CEC should consider aligning the framework and concepts provided in the existing ENERGY STAR specification.

There is some confusion on existing coverage of electronic displays under the current Title 20 standards for televisions (TVs). While some manufacturers believe that digital signage and billboards are covered under the existing television standards (Panasonic 2013), it is clear that not all manufacturers have been compliant with the existing standards for these products. With clearer, industry-accepted definitions, the expectation is that there will be greater compliance with existing standards.

Additionally, one manufacturer commented in their response to the Invitation to Participate (ITP) that there is no difference between a “television monitor” as currently defined in Section 1602(v) and a display. We agree with this comment. Additionally, based on a ruling by the Federal Communication Commission (FCC), as of March 1, 2007, new televisions must include a built-in digital tuner. Based on our understanding of the FCC ruling, TVs without tuners (what would fall under the CEC definition of a “television monitor”) are no longer able to be sold or marketed as a television in the U.S. Because of these reasons, this definition should be removed from Section 1602(v).

To help clarify this potential confusion, we are also recommending updating the current definition of “television” in Sec. 1602(v) to reflect industry-accepted definitions and terminology (see Section 2). Having industry-accepted definitions will be helpful to all of CEC’s stakeholders and should improve compliance to existing standards.

#### 2.1.1 Electronic Displays

Electronic displays are designed to display electronic images from a source. As defined by the ENERGY STAR specification, electronic displays are:

---

<sup>2</sup> EPA subsequently made additional clarifications to the specification and finalized the updated Version 6 specification on January 16, 2013 (EPA 2013b).

*A commercially-available product with a display screen and associated electronics, often encased in a single housing, that as its primary function displays visual information from (1) a computer, workstation or server via one or more inputs (e.g., VGA, DVI, HDMI, DisplayPort, IEEE 1394, USB), (2) external storage (e.g., USB flash drive, memory card), or (3) a network connection.*

### 2.1.2 Computer Monitors

The definition for “computer monitor” proposed below should replace the existing definition in Title 20 Sec. 1602(v):

*An electronic device, typically with a diagonal screen size greater than 12 inches and a pixel density greater than 5,000 pixels per square inch (pixels/in<sup>2</sup>), that displays a computer's user interface and open programs, allowing the user to interact with the computer, typically using a keyboard and mouse.*



**Figure 2.1 Computer Monitor**

Source: Google Images

A subcategory of computer monitors that the CEC should consider within the scope is Enhanced-Performance Displays (EPDs). ENERGY STAR provides a definition for EPDs as shown below. This definition was developed using international standards as a foundation and supplementing additional industry and stakeholder input and data analysis. The definition for “enhanced performance display” proposed below would be added to Title 20 Sec. 1602(v):

*A computer monitor that has all of the following features and functionalities:*

*A contrast ratio of at least 60:1 measured at a horizontal viewing angle of at least 85°, with or without a screen cover glass;*

*A native resolution greater than or equal to 2.3 megapixels (MP); and,*

*A color gamut size of at least sRGB as defined by IEC 61966 2-1. Shifts in color space are allowable as long as 99% or more of defined sRGB colors are supported.*

### 2.1.3 Digital Picture Frames

The definition for “digital picture frame” proposed below would be added to Title 20 Sec. 1602(v):



*An electronic device, typically with a diagonal screen size less than 12 inches, whose primary function is to display digital images. It may also feature a programmable timer, occupancy sensor, audio, video, or Bluetooth or wireless connectivity.*



**Figure 2.2 Digital Picture Frame**

Source: Google Images

#### 2.1.4 Signage Displays

The definition for “signage displays,” also called professional displays, proposed below would be added to Title 20 Sec. 1602(v):

*An electronic device typically with a diagonal screen size greater than 12 inches and a pixel density less than or equal to 5,000 pixels/in<sup>2</sup>. It is typically marketed as commercial signage for use in areas where it is intended to be viewed by multiple people in non-desk based environments, such as retail or department stores, restaurants, museums, hotels, outdoor venues, airports, conference rooms or classrooms.*



## Figure 2.3 Signage Display

Source: Google Images

### 2.1.5 Digital Billboards

Digital billboards, or electronic billboards, are a type of off-site sign utilizing digital message technology capable of electronically changing the static or animated message on the sign. A digital billboard may be internally or externally illuminated.

Digital billboard packages consist of three key pieces: player, extender(s), and display. The player is essentially a computer, equipped with software to generate the displayed content. Players are typically mounted behind the screen, and must be kept cool (via internal or accessory fan) and must be easily accessible for repairs or rebooting. These player/fan arrangements typically consume between 200 and 300 watts while running. Depending on the relative location of the player to the screen, there may be a need for a video extender, which is a cable that connects the player to the screen (Young 2010).



Figure 2.4 Digital Billboard

Source: Google Images

As with signage displays, there seems to be some confusion in the market as to whether or not billboards are already covered in the 2008 California Title 24 Building Energy Efficiency Standards under the Sign Lighting (Section 148) requirements or under the current Title 20 TV regulations. The Title 24 requirements (for internally illuminated signs) allow two separate pathways for compliance: (1) a performance-based pathway where the sign cannot exceed a maximum allowed power limit of 12 watts per square foot or (2) a prescriptive-approach to specify the type of light source used in the sign. Additionally in Title 24 there are mandatory requirements for lighting control devices (Section 119) with which the sign lighting must comply.

It is our understanding that electronic, or digital, billboards are not included in the scope of these Title 24 requirements. However, a couple manufacturers have marketed their electronic billboards

as Title 24-compliant (See Appendix A). Providing clarification to the existing definitions would help alleviate confusion in the marketplace.

#### 2.1.6 Televisions

The following definition for “television” is outlined in the Version 6.0 ENERGY STAR Televisions Specification and should be considered in an update to the existing definition in Title 20 Sec. 1602(v) (EPA 2012c):

*A product designed to be powered primarily by mains power having a diagonal screen size of 15 inches or larger that is manufactured with a TV tuner, and that is capable of displaying dynamic visual information from wired or wireless sources including but not limited to:*

- a) Broadcast and similar services for terrestrial, cable, satellite, and/or broadband transmission of analog and/or digital signals;*
- b) Display-specific data connections, such as Video Graphics Array (VGA), Digital Visual Interface (DVI), High-Definition Multimedia Interface (HDMI), DisplayPort;*
- c) Media storage devices such as a USB flash drive, a memory card, or a DVD; or*
- d) Network connections, usually using Internet Protocol, typically carried over Ethernet or WiFi.*

*A TV may contain, but is not limited to, one of the following display technologies: liquid crystal display (LCD), organic light-emitting diode (OLED), cathode-ray tube (CRT), or plasma display panel (PDP).*

Several national and international regulatory bodies and standards organizations have a proposed definition for televisions in test procedures that are currently in development. These organizations include the Consumer Electronics Association (CEA), International Electrotechnical Commission (IEC), and the U.S. Department of Energy (DOE). The CASE Team expects some of these draft documents will be finalized in the coming months. At that time, CEC should carefully consider the final definitions to ensure, where possible, there is industry-wide consistency so as to avoid confusion in the marketplace.

## 2.2 Scope

Similar to the scope outlined in the ENERGY STAR specification, products included in the scope of this report would meet the definitions listed below and are powered directly from AC mains using an external power supply or a bridging or network connection.<sup>3</sup>

For the purposes of this report, electronic displays exclude integrated displays, such as those built into laptop computers or all-in-one personal computers, as well as multimedia projectors. Other excluded products that should not be covered under the scope of an electronic displays regulation include:

- Products with an integrated television tuner;

---

<sup>3</sup> Displays powered with one or multiple DC universal serial bus (USB) cables would be excluded from the scope of the current standard proposal. However, as these DC-powered displays are increasing available and utilize very efficient technologies, a test-and-list requirement is recommended for these displays.

- Products that are marketed and sold as televisions, including products with a computer input port (e.g., VGA) that are marketed and sold primarily as televisions;
- Products that are component televisions. A component television is a product that is composed of two or more separate components (e.g., display device and tuner) that are marketed and sold as a television under a single model or system designation. A component television may have more than one power cord;
- Dual-function televisions/computer monitors that are marketed and sold as such;
- Mobile computing and communication devices (e.g., tablet computers, slates, electronic readers, smartphones); and
- Thin clients, ultra-thin clients, or zero clients.

### 2.3 Applications

Electronic displays are used in both residential and commercial applications. In the residential setting, computer monitors are found in home office settings. Digital picture frames are primarily used in residential settings throughout the home.

In commercial settings, electronic displays are used in a variety of applications. Computer monitors are used in a number of different office and specialty work environments. Signage displays are used in a various commercial applications:

- |                 |                      |
|-----------------|----------------------|
| • Retail        | • Transportation     |
| • Restaurants   | • Education          |
| • Hotels        | • Hospitals          |
| • Museums       | • Conference Centers |
| • Public Spaces |                      |

Digital billboards are used primarily in outdoor commercial applications for advertising.

### 2.4 Power Mode Descriptions for Electronic Displays

Electronic displays have three primary power modes: on, sleep, and off. On mode occurs when the display is on and displays an image. Sleep mode is a temporary low power state entered after a period of inactivity (e.g., for a monitor typically 15 minutes when power management is enabled). Off mode is the lowest power mode and is reached when the user powers down the display by manually switching it off. Power draws for display On Mode depend most strongly on display technology, screen size, and resolution. All three power modes are described in terms of watts (W). Below are the power mode definitions included in the ENERGY STAR specification (EPA 2013a).

As with the television definition, several national and international regulatory bodies and standards organizations, including CEA, IEC, and DOE, have proposed definitions for power modes that are currently in development. When these draft documents become final, CEC should carefully consider the final definitions to ensure, where possible, there is industry-wide consistency so as to avoid confusion in the marketplace.

### 2.4.1 On Mode

On Mode is the power mode in which the product is activated and is providing one or more of its principal functions. The common terms “active,” “in-use,” and “normal operation” also describe this mode. The power draw in this mode is typically greater than the draw in sleep and off modes.

### 2.4.2 Sleep Mode

Sleep Mode is the power mode the product enters into after a period of inactivity, in which a signal from a connected device or an internal stimulus (e.g., a timer or occupancy sensor) is received. The product may also enter this mode by virtue of a signal produced by user input.<sup>4</sup> The product must wake on receiving a signal from a connected device, a network, a remote control, and/or an internal stimulus. While the product is in this mode, it is not producing a visible picture, with the possible exception of user-oriented or protective functions such as product information or status displays, or sensor-based functions.

### 2.4.3 Off Mode

This is the power mode in which the product is connected to a power source but is not providing any On Mode or Sleep Mode functions. This mode may persist for an indefinite time. The product may only exit this mode by direct user actuation of a power switch or control. Some products may not have this mode.

## 2.5 Product Design

### 2.5.1 Liquid Crystal Display Panels

Liquid crystal display (LCD) panels make up a vast majority of the overall electronic display market today. A major transition from cathode ray tube (CRT) monitors to LCD took place in the early 2000s. No CRT monitor shipments have been reported since 2010. Other self-emissive flat panel display types available on the market, aside from LCDs, include plasma display panels and organic light emitting diodes (OLEDs).

LCD monitors use a backlight as a light source. The backlight source can vary from cold cathode fluorescent lamps (CCFLs) to more energy efficient light emitting diodes (LEDs). For LED-backlit monitors, the LEDs could be arranged behind the entire LCD panel (“full-array”) or arranged only along the edge of the LCD panel (“edge-lit”) and can illuminate the screen using light guides.

An LCD is made up of millions of pixels consisting of liquid crystals (LCs) that can alter their crystalline orientation when voltage is applied, resulting in different transparency levels. The light from the light source first passes through a polarization film, gets modulated by the LCs, and passes through a color filter that leaves it red, green, or blue. Each cluster of red green and blue makes up one pixel on the screen. By selectively illuminating the colors within each pixel, a wide range of hues can be produced on the larger display. Figure 2.5 and Figure 2.6 below show diagrams of a typical LCD screen and pixel.

---

<sup>4</sup> Note: A power control is not an example of user input.

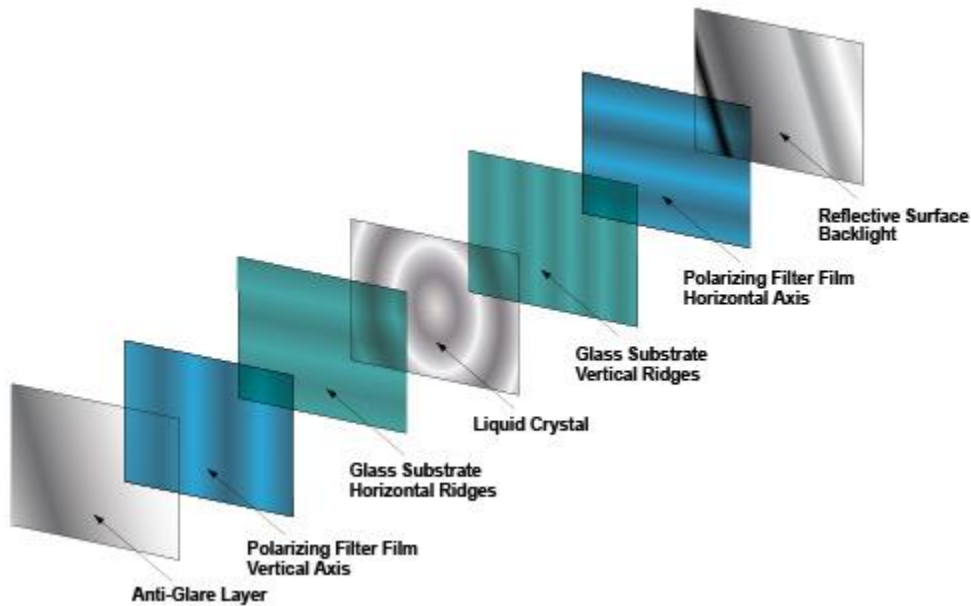

Figure 2.5 Typical Layers of an LCD Screen

Source: Google Images

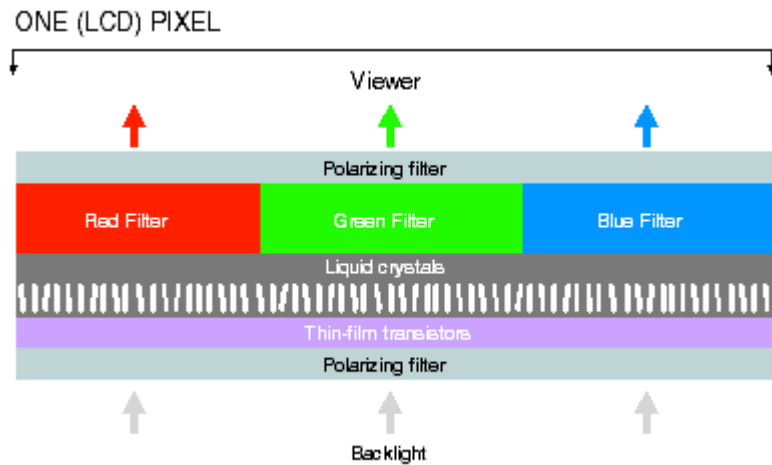

Figure 2.6 LCD Pixel Diagram

Source: Google Images

Several LCD technology choices exist. The three main panel technologies currently used in LCDs are: twisted nematic (TN), vertical alignment (VA), and in-plane switching (IPS).

#### 2.5.1.1 TN Panels

The main advantages of TN panels are their fast (usually 2 milliseconds [ms]) response time and low price. The major disadvantages are their narrow viewing angles, relatively low brightness, and inaccurate color reproduction. When no voltage is applied across a pixel on a TN panel, the pixel is open and light passes through it. To darken the pixel, a voltage is applied to close it. Thus TN panels use less power to display the mostly white images shown on monitors when displaying web content, word processing and other non-video content. TN has traditionally been the technology of choice because most content has been bright. Since monitors are now increasingly used for video, TN might not be the best choice.

#### 2.5.1.2 VA Panels

VA panels have improved viewing angles as compared to TNs. VAs also tend to have better color reproduction and typically have a much higher maximum brightness. In addition, they tend to have the lowest black levels of all four panel technologies. A VA panel's response time and input lag are not quite as fast as a TN panel, however.

#### 2.5.1.3 IPS Panels

IPS-based monitors are equivalent to the PLS in terms of best viewing angles and produce the most accurate colors. However, their black levels are not as deep as VA panels, but are better than TN panels. IPS monitors are the slowest of the panel types in both response time and input lag. Wider viewing angle and better contrast of IPS compared to TN make IPS popular for video content applications like gaming and watching TV (likely due to their larger screen sizes).

### 2.5.2 Plasma

Instead of using a backlight and a set of filters to illuminate pixels on the screen, images on a plasma screen are created by ionized gas that lights up when an electrical current is run through it (see Figure 2.7).

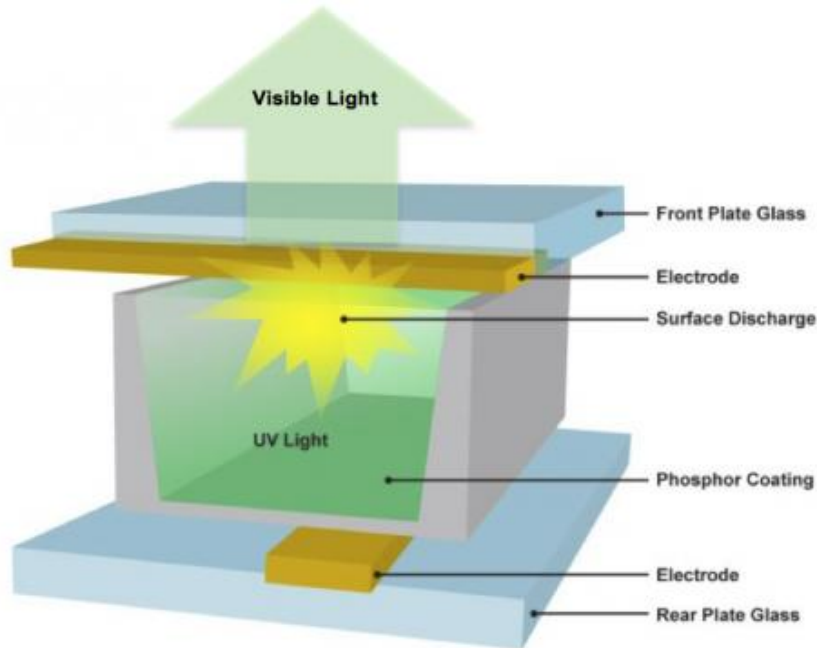

**Figure 2.7 Typical Plasma Screen Subpixel**

Source: Google Images

### 2.5.3 Organic Light-Emitting Diode (OLED)

OLEDs are also an emissive technology. OLEDs emit light through the application of voltage across organic thin films. If manufacturing challenges are met, this technology is expected to contend for market share due to its superior contrast ratio, viewing angle, color gamut, and color accuracy over LCD panels. Currently, OLEDs are found largely in the smart phone sector, as manufacturing smaller -sized panels has proven to be less of a challenge.

OLEDs have the potential to be less expensive and more efficient than LCDs since there are fewer components involved in creating an image.

### 2.5.4 Digital Billboards

Electronic billboards are typically comprised of a series of self-contained modules that house LED lamps, wiring, and electronics in an aluminum or steel enclosure. Each module, which can be square or rectangular (typically 2-3 feet on a side), weighs around 100-150 pounds, so a billboard comparable in size to a standard 14x48 foot roadside display will weigh several thousand pounds when installed.

Due to modular nature of today's LED billboard systems, standard-sized modules can be pre-built ahead of time, kept in inventory, and then stacked together in different shapes and configurations to meet the specific requirements of a particular billboard. This standardized approach translates to lower costs and faster delivery times, and makes it easy for customers to choose the exact shape and size of their billboard.



## 3 Manufacturing and Market Channel Overview

### 3.1 Computer Monitor Lifecycle

In 2001, the University of Tennessee's Center for Clean Products and Clean Technologies conducted a life-cycle assessment (LCA) of computer monitors for EPA (Socolof et. al. 2001). The comprehensive LCA report evaluated the environmental impacts from each of the following major life-cycle stages of a computer monitor: raw materials extraction/acquisition; materials processing; product manufacturing; product use, maintenance, and repair; and final disposition/end-of-life. The inputs (e.g., resources and energy) and outputs (e.g., products, emissions, and waste) within each life-cycle stage, as well as the interaction between each stage (e.g., transportation), were evaluated to determine their environmental impacts. Figure 3.1 below shows the various stages of an LCD monitor's lifecycle.

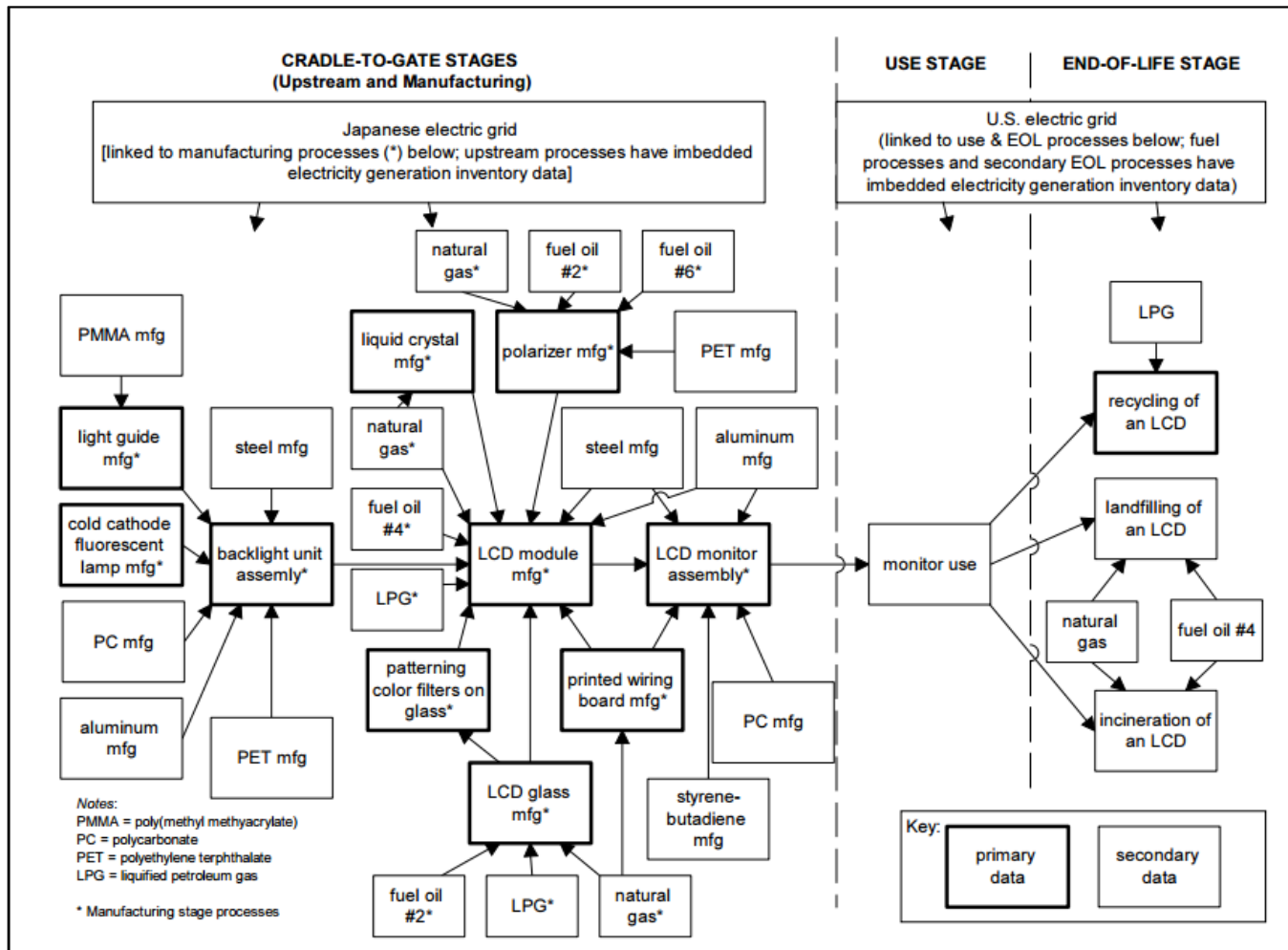

Figure 3.1 Life-cycle Assessment of an LCD Monitor

Source: Socolof et. al. 2001

Additionally, in the ENERGY STAR Partner Commitments section, material requirements, as defined in the restriction of hazardous substances (RoHS) regulations, were included to harmonize with worldwide RoHS regulations. The specification includes minimum toxicity and recyclability requirements for electronic displays. The CEC may wish to consider such requirements.

### 3.2 Manufacturers

The following information was obtained from a market report published by IHS iSuppli in 2012 entitled Worldwide Monitor Market Tracker (IHS iSuppli 2012a). This information includes shipments to North America by brand and manufacturer for only the first half of 2012. We do not expect that this market information will be significantly different in 2013, nor do we expect the market in California to be significantly different.

The list of computer monitor manufacturers worldwide includes: AmTran, Compal, Eizo, LG Electronics, Qisda, Quanta, Samsung, Tatung, TPV, Wistron, Innolux/CMI, and Jean/BOE. Less than one percent of the total shipments in the first half of 2012 were manufactured in the U.S. The vast majority of computer monitors, or 81 percent, are manufactured in China.

The following list includes all the major worldwide brands of computer monitors: Samsung, Dell, Hewlett-Packard, Lenovo, Acer, LG Electronics, AOC, Philips, ViewSonic, Asus, Apple, BenQ, Fujitsu, Iiyama, Hannspree, NEC Display Solutions, Eizo, IO-Data, Planar, Sharp, Epson, Belinea, Hitachi, and AG Neovo. Figure 3.2 shows the market share by brand in North America through the first half of 2012.

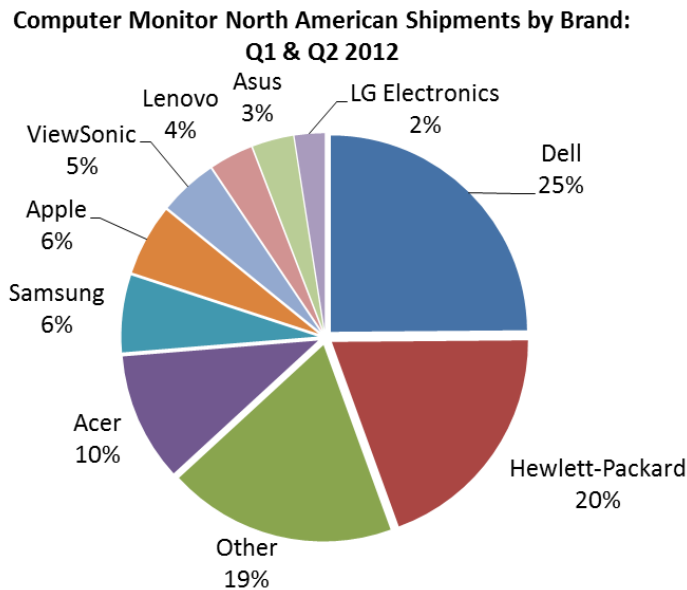

**Figure 3.2 Computer Monitor North American Shipments by Brand: First Half 2012**

Source: IHS iSuppli 2012a

### 3.3 Market Channel

This report only considers new products and does not account for re-sold or refurbished items. There are two primary market channels for computer monitors and digital signage:

- *Retail Outlets* – “Brick and Mortar” and internet outlets selling monitors directly to residential or commercial consumers at retail prices (no volume discount). Examples of this type of channel include Best Buy, Office Depot, Newegg, and Amazon.
- *Manufacturer-Direct* – Original equipment manufacturers (OEMs) and retail brands that can function as either retail or wholesale internet outlets. This channel includes major companies such as Dell, HP, Lenovo, Panasonic, and Acer.

Monitors for both business (commercial) and consumer (residential) can be purchased from either type of market channel. Based on anecdotal information, new models are typically introduced during the Fall (back-to-school) and spring seasons.

Digital picture frames are mainly sold through retail outlets, while digital billboards are mainly sold manufacturer-direct.

### 3.4 Market Segment

- *Consumer*: Captures monitors sold through consumer channels for personal use. Individual student purchases are included in this category.
- *Business*: Captures monitors sold to corporations, medium, and small businesses, as well as small offices and home offices. Also includes educational purchases at the institutional level as well as governmental purchases.

### 3.5 Market Trends

#### 3.5.1 Computer Monitors

Even though desktop computer shipments are projected to stabilize and eventually decrease slightly in the coming years due to the increase in more mobile forms of computing (e.g., laptops, tablets) (IDC iSuppli 2012), global computer monitor shipments are expected to experience continuous growth through 2016 largely driven by shipments in China, India, and Russia (IHS iSuppli 2012a). Generally, growth is also driven by monitor upgrades, increased adoption of larger screen sizes and higher resolutions, use with notebook computers, and dual or multiple monitor use (DisplaySearch2011a; Alexander 2010). However, due to a variety of economic factors in the U.S., computer monitor shipments in North America are expected to decline slightly. Pressure to reduce deficit spending in 2013 will likely reduce government and education spending, while private sector purchasing is expected to accelerate in 2013 (IHS iSuppli 2012a).

The following market information presented below was obtained from the IHS iSuppli market report entitled “Worldwide Monitor Market Tracker” (IHS iSuppli 2012a). This report provides shipment information for North America, which also includes Canada. U.S. shipments were estimated by assuming 90 percent of North American shipments were to the U.S. Finally, shipments to California were calculated by multiplying the U.S. shipments by 13 percent, the percentage of California’s share of the total U.S. gross domestic product (GDP).

Figure 3.3 shows computer monitor shipments in California from 2010 to 2016. Shipments in California to the business sector typically have been between 60 to 70 percent of overall shipments between 2011 and 2016 as shown in Figure 3.4.

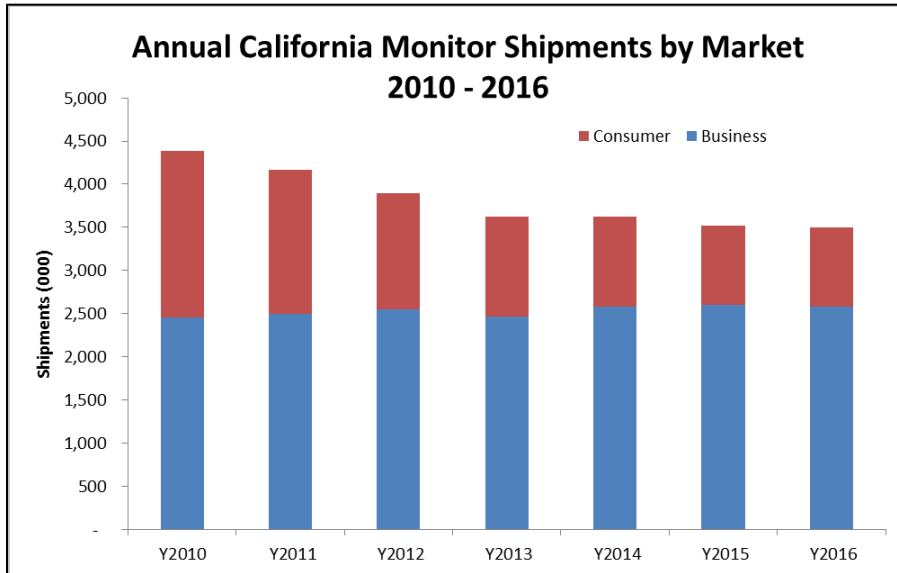

Figure 3.3 Annual California Monitor Shipments by Market

Source: IHS iSuppli 2012a

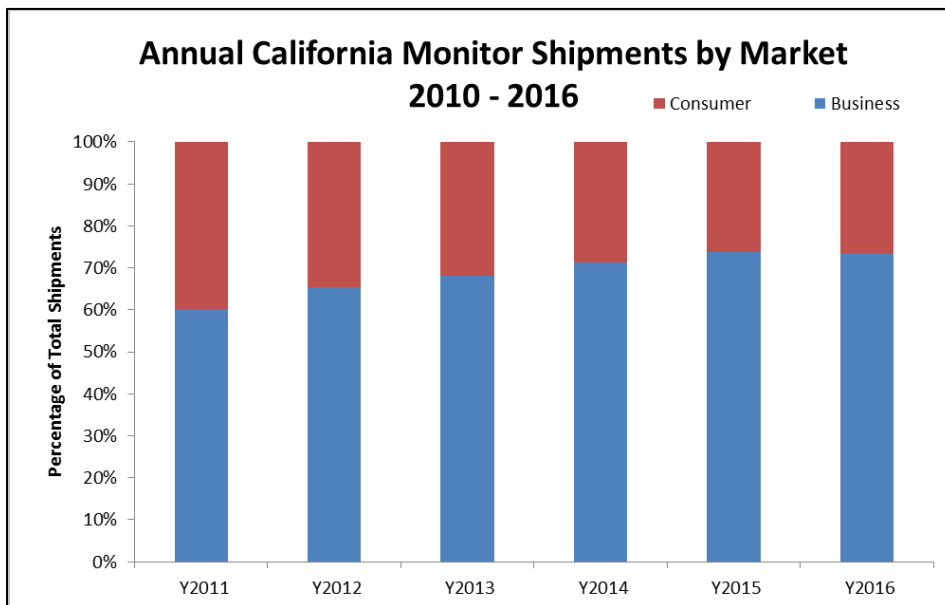

Figure 3.4 Annual California Monitor Shipments as a Percentage by Market

Source: IHS iSuppli 2012a

### 3.5.2 Signage Displays

Though the CASE Team did not have detailed shipment data for signage displays, we were able to provide high-level estimates on the annual shipments based on information based on the abstract of a market forecast (IHS iSuppli 2012ab), which shows continuous growth in this market from 2010 to 2016. Based on rough estimates, we expect annual sales of signage displays in California to grow from around 320,000 to over 400,000 between 2013 and 2015.

### 3.5.3 Size Groupings

A computer monitor size refers to the diagonal measurement of the screen in inches. Table 3.1 below outlines the computer monitor screen sizes under consideration and the size bins, based on the IHS iSuppli market data (IHS iSuppli 2012a).

**Table 3.1 Screen Size Categorizations for Some Market Analysis**

Size Bin	Included Diagonal Screen Sizes ( $d$ )
$\leq 15.x$ -inch	$d < 16$ -inch
16.x-17.x-inch	16-inch $\leq d < 18$ -inch
18.x-19.x-inch	18-inch $\leq d < 20$ -inch
20.x-inch	20-inch $\leq d < 21$ -inch
21.x-22.x-inch	21-inch $\leq d < 23$ -inch
23.x-24.x-inch	23-inch $\leq d < 25$ -inch
25.x-27.x-inch	25-inch $\leq d < 28$ -inch
28.x-30.x-inch	28-inch $\leq d < 31$ -inch

However, in order to align with the ENERGY STAR framework, this report proposes to use similar screen size bins as outlined in the ENERGY STAR specification (see Table 3.2 below). These screen size bins are broader than the bin sizes used in portions of our market analysis to group screen size categories based on likely purchasing decisions.

**Table 3.2 Computer Monitor Screen Size Categorizations for Proposal**

Size Bin	Included Diagonal Screen Sizes ( $d$ )
$d < 12$	$d < 12$ -inch
$12 \leq d < 17$	12-inch $\leq d < 17$ -inch
$17 \leq d < 23$	17-inch $\leq d < 23$ -inch
$23 \leq d < 25$	23-inch $\leq d < 25$ -inch
$25 \leq d \leq 61$	25-inch $\leq d \leq 61$ -inch

As signage displays are currently covered under existing California regulations, we use the existing size categorization as outlined in Title 20 Section 1605.3(v) and extend the scope to cover all units with a screen area of over 1400 in-sq. Rationale for this is provided in the following sections.

**Table 3.3 Signage Display Screen Size Categorizations for Proposal**

Screen Size (viewable screen area $A$ in inches-squared)
$A < 1400$
$A \geq 1400$

Typically, computer monitors are between 15- and 31-inches. Figure 3.5 and Figure 3.6 show the market share of each size bin in the business and consumer sectors in 2013.

**Computer Monitor California Shipments Y2013: Business Sector**

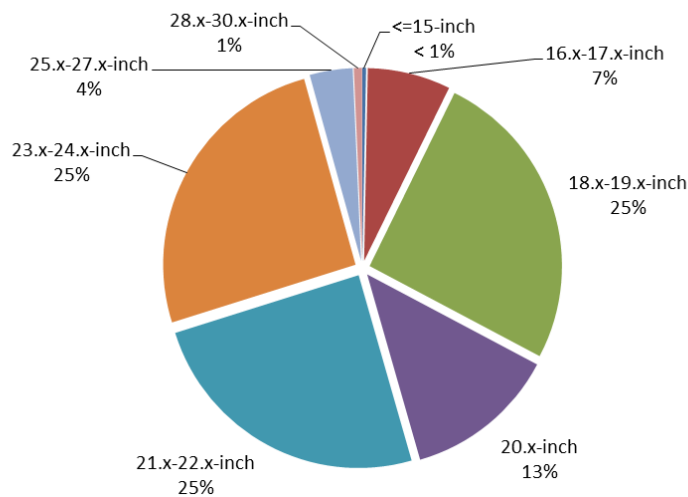

**Figure 3.5 Computer Monitor North American Shipments 2013: Business Sector**

Source: IHS iSuppli 2012a

### Computer Monitor California Shipments Y2013: Consumer Sector

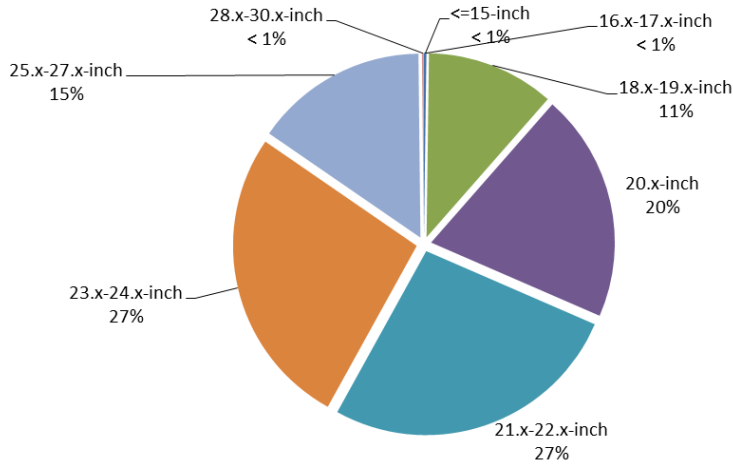

Figure 3.6 Computer Monitor California Shipments 2013: Consumer Sector

Source: IHS iSuppli 2012a

Figure 3.7 and Figure 3.8 show 2010-2016 California shipment trends for computer monitors for each sector by size bin.

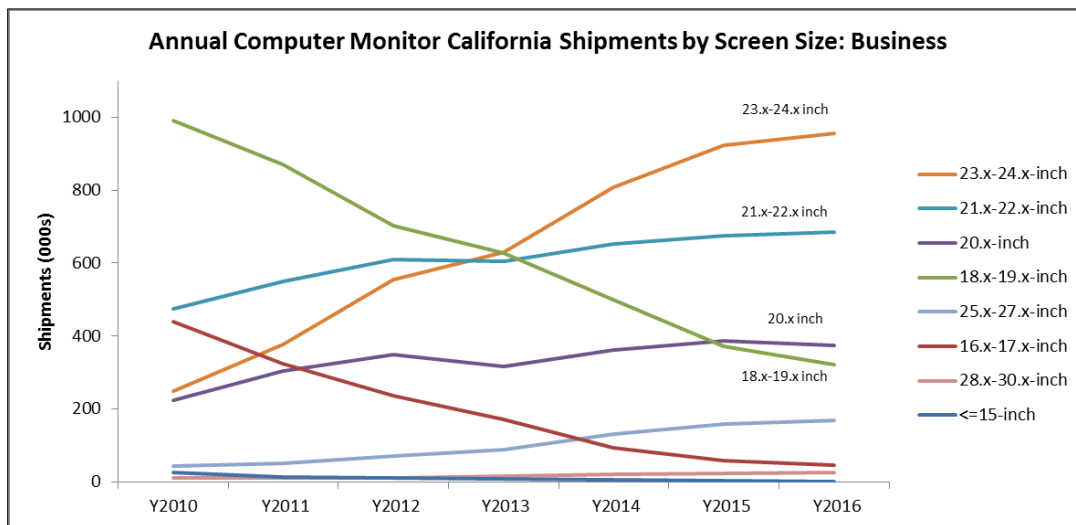

Figure 3.7 Annual Computer Monitor California Shipments by Screen Size: Business

Source: IHS iSuppli 2012a



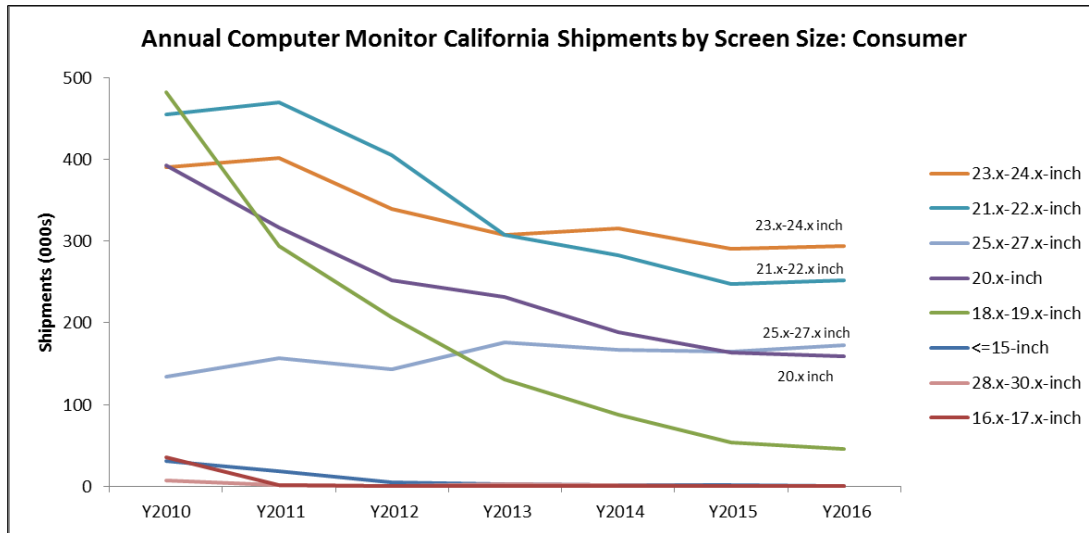

Figure 3.8 Annual Computer Monitor California Shipments by Screen Size: Consumer

Source: IHS iSuppli 2012a

Unlike the growing sizes of televisions, given the limited space on a desk (and therefore viewing distance), increases in the computer monitor screen sizes beyond 30-inches are not anticipated.

#### 3.5.4 Resolution

There are many different resolutions for computer monitors.

Table 3.4 below lists most of the resolution types for monitors considered in this report. Also listed in the table is the total native resolution in megapixels (MP). An approach was considered to propose on mode requirements based on only screen size (as is established in the Title 20 energy conservation standard for TVs). further analysis showed that resolution does not necessarily scale linearly with screen size. Given different applications for computer monitors of different screen resolutions, incorporating resolution into the requirement would ensure availability of models at most popular screen resolutions. For the purpose of this analysis, resolutions are binned in categories that align with market data.

**Table 3.4 Resolution Bins for Computer Monitor Dataset<sup>5</sup>**

Resolution Bin	Total Native Resolution (MP)
<=XGA	0 – 0.786
>=UXGA	1.920
>=WUXGA	2.07 and higher
SXGA	1.311
WSXGA	1.51 – 1.76
WXGA	1.024 – 1.049
WXGA+	1.296

Source: IHS iSuppli 2012a

Regarding resolution, there are increasing sales of higher resolution models (e.g., >=WUXGA). Typically, the higher resolution monitors consume more energy due to the increased brightness of the backlights.

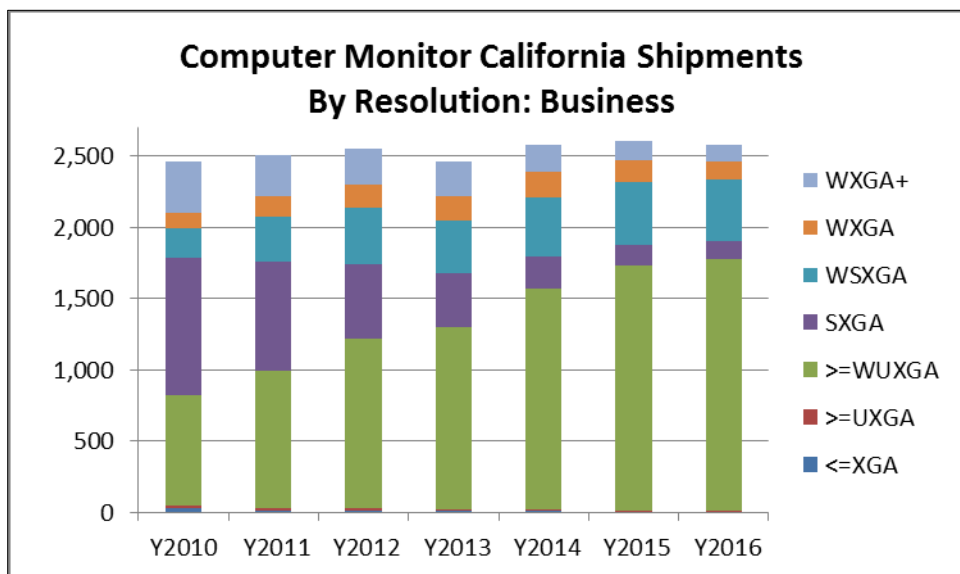

**Figure 3.9 Annual Computer Monitor California Shipments by Resolution: Business**

Source: IHS iSuppli 2012a

<sup>5</sup> NOTE: In our response to the Invitation to Participate (ITP), we incorrectly included 2.1 MP in the “>=UXGA” bin when it should have been included in the “>=WUXGA” bin.

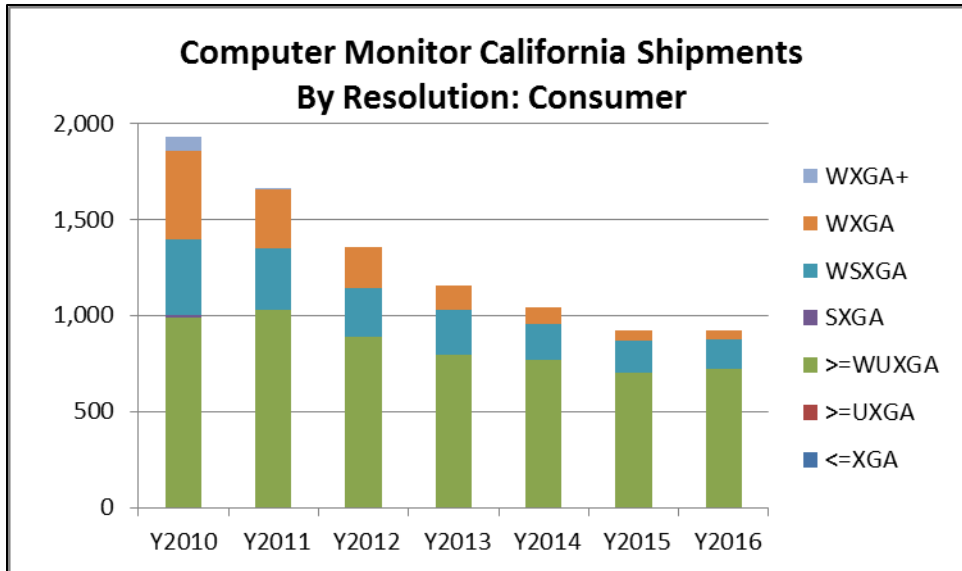

**Figure 3.10 Annual Computer Monitor California Shipments by Resolution: Consumer**

Source: IHS iSuppli 2012a

### 3.5.5 Other Attributes

The following features seen in some computer monitors could increase the monitor’s energy consumption. Some of these features were present on monitors the CASE Team purchased and tested (please see the associated Technical Report which we will be submitting to the CEC shortly):

- USB charging port (i.e., power draw when charging a device)
- Touch screen - enabled through a USB port
- Additional ports (e.g., HDMI, USB, DisplayPort)
- Camera/microphone – With increased remote working environments, it is possible that several monitors will include a built-in camera and microphone. This option is currently available at a comparable price to standard monitors (Amazon 2013)
- Integrated speakers
- 3-D
- Ambient backlighting (Engadget 2013)

## 4 Energy Usage

### 4.1 Test Methods

#### 4.1.1 Computer Monitors, Signage Displays, and Digital Picture Frames

In September 2012, EPA finalized the *ENERGY STAR Test Method for Determining Displays Energy Use Version 6.0*. As with the ENERGY STAR specification, this test procedure was developed with input from ENERGY STAR stakeholders and was thoroughly vetted through the ENERGY STAR specification development process. The CASE Team suggests that the following sections of the ENERGY STAR test procedure be used: test setup (Section 4), test conduct (Section 5), and test procedures (Section 6) with the exception of removing the screen luminance calibration requirement from Section 6.3 (see Section 4.1.1.1 below).

There are industry test procedures referenced in the ENERGY STAR method, notably:

- IEC 62301-2011: Household Electrical Appliances-Measurement of Standby Power;and
- IEC 62087, Ed 3.0: Methods of Measurement for the Power Consumption of Audio, Video and Related Equipment.

The IEC 62301-2011 test procedure is used to measure the power in sleep mode while IEC 62087 is used to measure on mode power. More detailed descriptions are included in the ENERGY STAR test method. Due to stakeholder input and acceptance of the ENERGY STAR test procedures listed above, this report proposes the same test procedures.

At this time, the recommendation is that one representative basic model, as defined in Title 20 Section 1602(a), should be tested for compliance.

##### 4.1.1.1 Non Calibration

Section 6.3 of the ENERGY STAR test procedure requires that display screen brightness be calibrated to 200 nits (candelas per square meter) for on mode testing. In our testing, the CASE Team found screen brightness values in default mode as-shipped to be significantly different from 200 nits. This in turn has a significant impact on the backlight unit (BLU) power (Table 4.1). Since most users likely do not adjust brightness settings from “out of the box” settings, this method is likely to be not representative of real world power usage. As shown in the table below, the efficient 18.5” monitor has a default luminance value of 255 nits and a corresponding on mode power of 14 W. Reducing the default brightness to 200 nits results in an on mode power of just under 12 W, a 17 percent reduction in power with zero incremental cost. Across all tested models, there was a 19 percent increase in reported power when luminance was tested its default setting as opposed to its calibrated setting.

**Table 4.1 Default and calibrated as-assembled power and luminance test results**

Display ID	Input Port	Test Description	Display Mode	Screen Luminance (cd/m <sup>2</sup> )	Power (W)
D19-1	VGA	Default	Standard	207.8	19.21

Display ID	Input Port	Test Description	Display Mode	Screen	
				Luminance (cd/m <sup>2</sup> )	Power (W)
Representative Model	VGA	ENERGY STAR: calibrated luminance	Standard	201.1	18.63
D19-2	VGA	Default	Standard	254.8	14.02
Efficient Model	VGA	ENERGY STAR: calibrated luminance	Standard	200.8	11.68
D22-1	DVI	Default	Standard	275.4	28.42
Representative Model	DVI	ENERGY STAR: calibrated luminance	Standard	202.5	22.46
D22-2	HDMI	Default	Standard	241.0	18.76
Efficient Model	HDMI	ENERGY STAR: calibrated luminance	Standard	201.0	16.82
D27-1	DP*	Default	Custom	400.8	38.56
Representative Model	DP	ENERGY STAR: calibrated luminance	Custom	199.2	22.99
D27-2	HDMI	Default	Standard	170.9	21.77
Efficient Model	HDMI	ENERGY STAR: calibrated luminance	Standard	200.1	25.23

Note: \*DP=DisplayPort  
Source: CASE Team analysis

For this reason, we recommend on mode testing for monitors without adjusting luminance settings from their default settings. By testing default settings, the state of California will be able to more accurately measure monitor energy usage that is more reflective of real-world conditions.

In order to prevent manufacturers setting the default picture setting to an unacceptably low level in order to achieve a lower on mode power measurement, the CASE Team suggests that the ratio of the default picture setting to the brightest picture setting be greater than or equal to 65 percent. This is a similar approach as outlined in the ENERGY STAR Television Specification, which also requires on mode testing to be conducted in the default setting. The CASE Team will continue to investigate alternative requirements to close any potential loopholes to the test procedure.

#### 4.1.1.2 Automatic brightness control (ABC) Testing

For products with automatic brightness control (ABC)-enabled by default, we recommend referencing the ENERGY STAR specification (Section 6.4). However, DOE plans to finalize a test procedure for measuring on mode power for TVs with ABC -enabled by default in the coming months. Once the test procedure has been finalized, modification of our ABC testing proposal (and the associated power allowance) may be necessary.

#### 4.1.2 Electronic Billboards

To date, the CASE Team is unaware of an industry-accepted test procedure to measure the power consumption of digital billboards. However, we are aware of Title 24 requirements for sign lighting that include, as one compliance pathway, a performance requirement of 12 watts per square foot. While we do not believe electronic billboards fall under the scope of these Title 24 regulations at this time, the power draw per area may be a feasible approach to regulate the power consumption

of electronic billboards in the absence of a test procedure. We are further investigating this approach as well as development of a test method to measure the power consumption of these products.

## 4.2 Dataset

### 4.2.1 Computer Monitors

The energy use information for computer monitors used in this report includes the following product datasets with the number of models in parenthesis:

- Non-ENERGY STAR qualified data that was provided by stakeholders during the development of the Version 6.0 specification (524).
- ENERGY STAR qualified data (posted on May 31, 2013) for those models that were qualified under the Version 5.1 specification (3,401).
- ENERGY STAR qualified data (posted on June 18, 2013) for those models that were qualified under the Version 6.0 specification (613) (EPA 2013a).

After combining the above datasets and removing duplicate entries and entries with incomplete data in necessary fields (e.g., missing resolution data), the resulting dataset included 4,010 computer monitor models from 35 different manufacturers.

The combined computer monitor dataset includes models between May 2006 and June 2013. During the Version 6 specification development process, stakeholders noted that the ENERGY STAR qualified product list, along with the non-qualified product submitted by manufacturers, was reflective of the entire computer monitor market.

Table 4.2 below describes the dataset by screen size bin and year the displays was first made available. The screen size bins are reflective of binning categorizations used in the IHS iSuppli market report.

**Table 4.2 Computer Monitor Dataset by Manufacture Year and Size Bin**

Diagonal Screen Size Bin (inches)	Year of Availability								Total Models
	2006	2008	2009	2010	2011	2012	2013	Unlisted	
<= 15.x			15	19	16	9	5		<b>64</b>
16.x-17.x				20	38	33	3	68	<b>162</b>
18.x-19.x	4	6	33	60	4	7	5	45	<b>164</b>
20.x	1	5	134	344	138	93	96	118	<b>929</b>
21.x-22.x		2	76	151	58	49	16	41	<b>393</b>
23.x-24.x		1	129	368	147	135	92	110	<b>982</b>
25.x-27.x		14	126	288	193	192	131	109	<b>1053</b>
28.x-30.x			15	28	54	63	55	22	<b>237</b>
> 30.x				2		5	8	11	<b>26</b>
<b>Grand Total</b>	<b>5</b>	<b>28</b>	<b>528</b>	<b>1280</b>	<b>648</b>	<b>586</b>	<b>411</b>	<b>524</b>	<b>4010</b>

Source: CASE Team analysis

There were 524 models in the dataset that did not include information on the date of availability. These are non-ENERGY STAR Version 5 qualified models that were submitted by manufacturers for the ENERGY STAR specification revision process. Of the 4,010 computer monitor models in the combined dataset, 24 models were listed as enhanced performance displays.

For this analysis, we used product data on models that were available since 2010. We assume that vast majority of models first made available prior to 2010 are no longer being manufactured nor are currently available for sale (561 models). We included the 524 non-ENERGY STAR Version 5 models that have no information on the date of availability to ensure we address stakeholder concerns that this product data are also included in the analysis. The resulting dataset of computer monitors includes 3,425 models.

#### 4.2.1.1 On Mode: Resolution Effects

Figure 4.1 shows the on mode power consumption of the computer monitor dataset between 0 and 350 inches-squared. Please note that some common diagonal screen sizes are indicated by grey vertical lines in the chart.

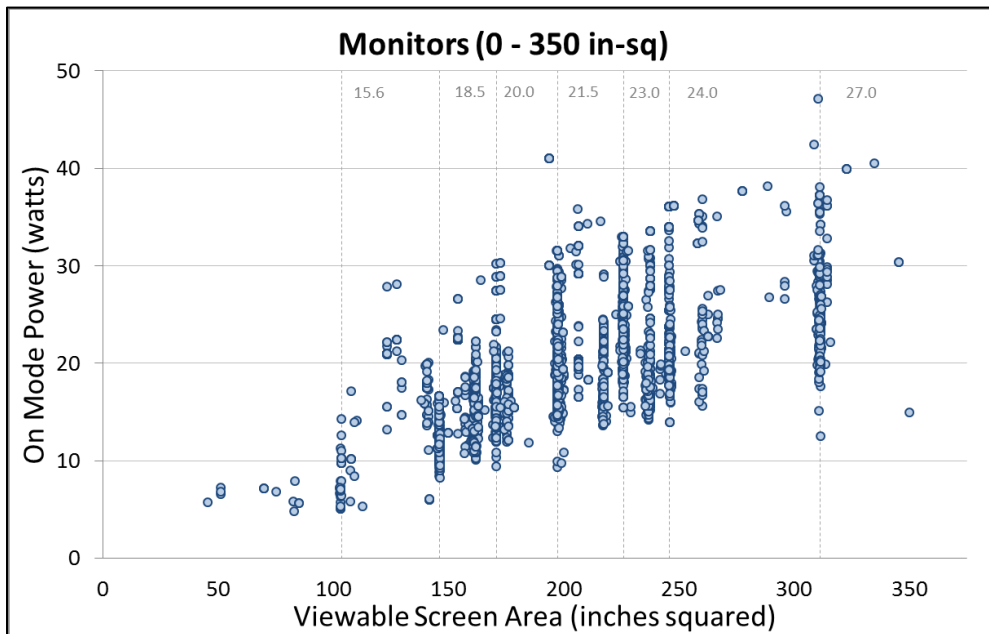

Figure 4.1 Computer Monitor On Mode Power Consumption: All Resolutions

Source: CASE Team analysis

Figure 4.1 shows wide variation in the on mode power consumption among screen sizes. To examine this spread in on mode across similar screen sizes, box plots were developed for the dataset and shown in Figure 4.2. The box plots display the maximum, third quartile, median, first quartile, and minimum on mode power consumption values for some popular screen size

categories. Table 4.3 lists the numeric values for these box plots as well as the mean and number of products for each screen size category. For each screen size, there are wide ranges in on mode power consumption for each size category. Energy conservation standards could potentially remove the lowest-performing products (in regards to power consumption) within a size category from the market, while still ensuring a large selection of models that perform the same utility.

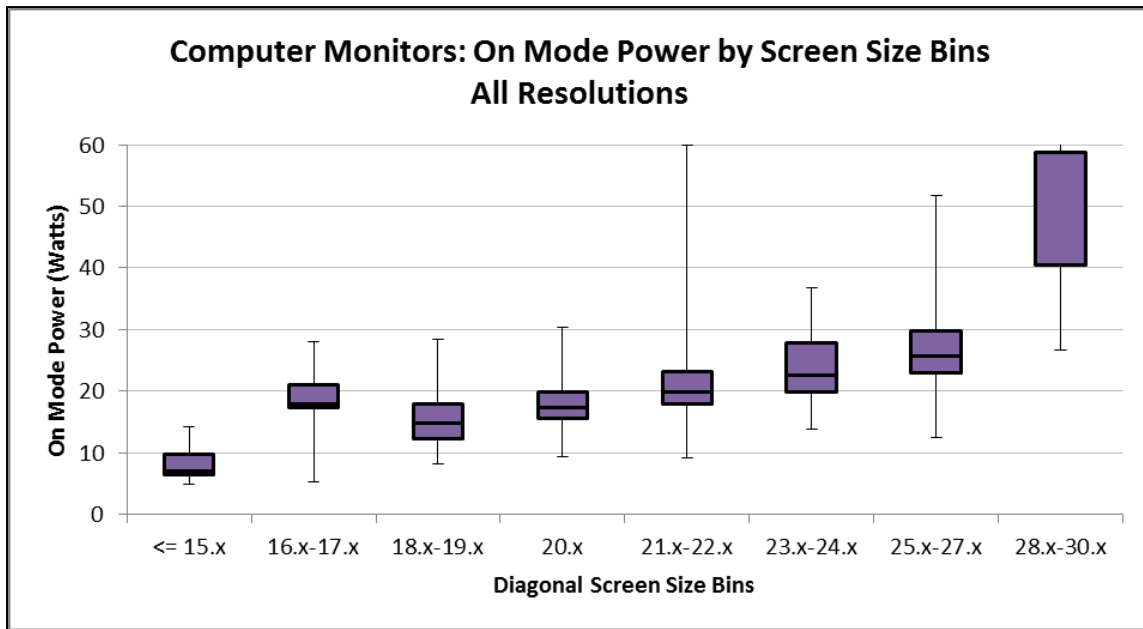

Figure 4.2 Computer Monitor On Mode Power Consumption Box Plot: All Resolutions

Source: CASE Team analysis

Table 4.3 Computer Monitor On Mode Power Consumption Box Plot: All Resolutions

	Screen Size Bin							
	<= 15.x	16.x-17.x	18.x-19.x	20.x	21.x-22.x	23.x-24.x	25.x-27.x	28.x-30.x
<b>Minimum</b>	4.8	5.3	8.2	9.4	9.3	13.9	12.5	26.6
<b>First Quartile</b>	6.4	17.4	12.4	15.5	17.8	19.8	23.1	40.5
<b>Median</b>	7.1	17.9	14.8	17.3	19.8	22.7	25.7	58.8
<b>Third Quartile</b>	9.7	21.0	17.9	19.8	23.1	27.8	29.8	58.8
<b>Maximum</b>	14.3	28.1	28.5	30.3	59.9	36.8	51.7	111.8
<b>Mean</b>	7.9	18.1	15.4	18.2	21.3	24.0	27.4	58.8
<b>Count</b>	49	121	788	315	852	902	215	21

Source: CASE Team analysis



The wide spread in on mode power is also seen when looking at single resolution categories as shown for the  $\geq$ WUXGA resolution in Figure 4.3.

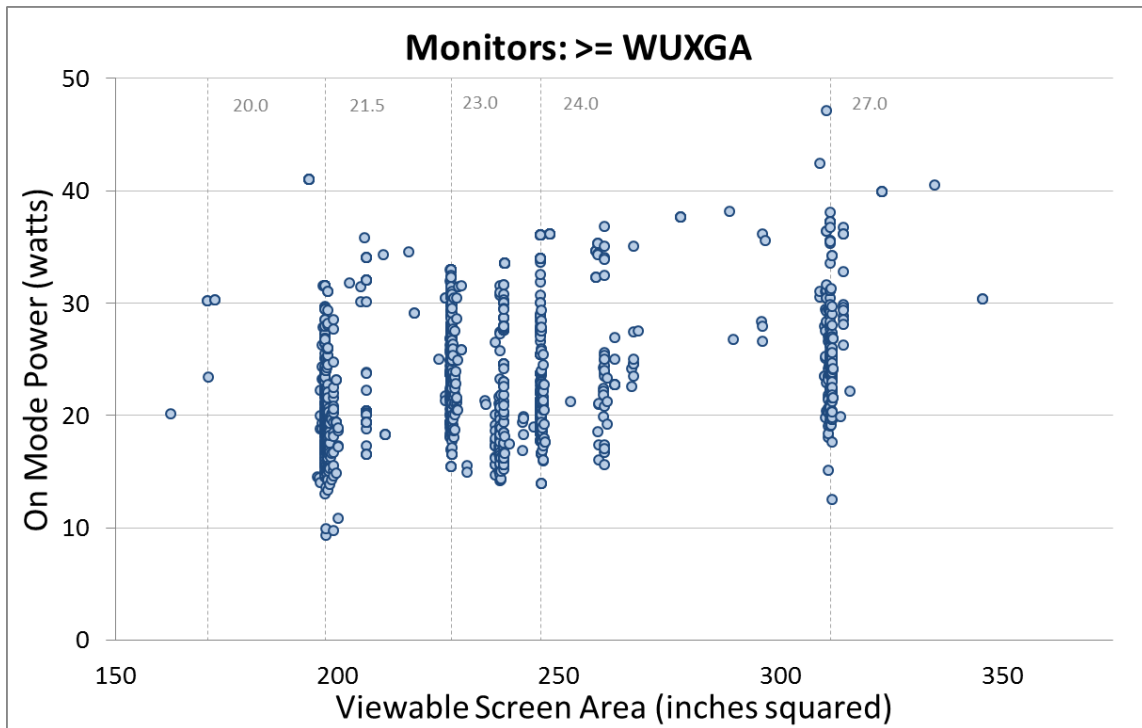

**Figure 4.3 Computer Monitor On Mode Power Consumption:  $\geq$ WUXGA Resolution**

Source: CASE Team analysis

Box plot charts were also developed to for models within the same resolution category to show the large spread in on mode across similar screen sizes. See Figure 4.4 and Table 4.4 below for on mode power of monitors in the most popular resolution category  $\geq$ WUXGA.

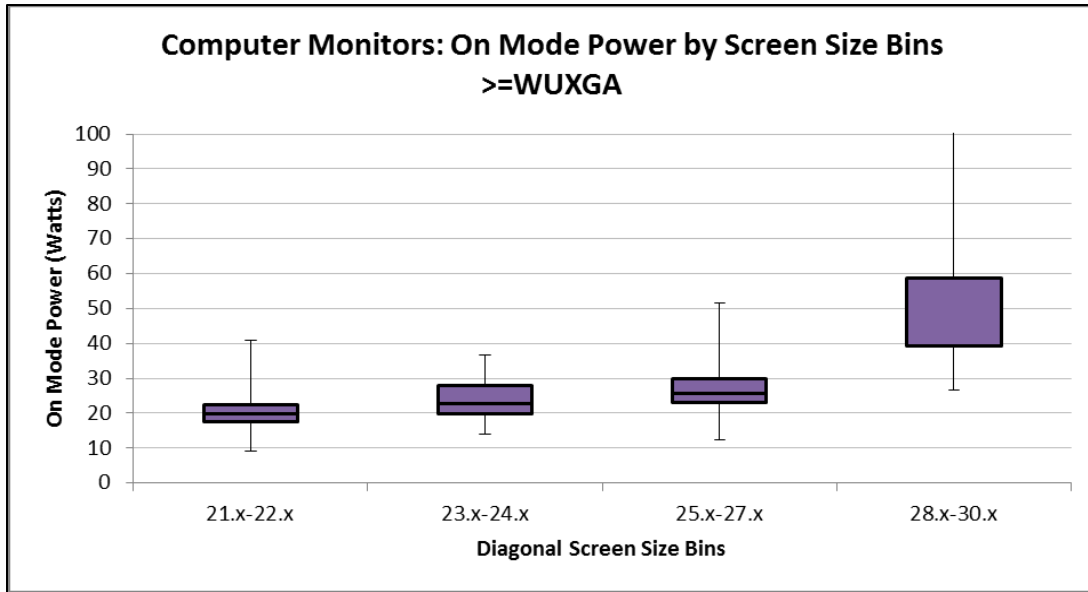

**Figure 4.4 Computer Monitor On Mode Power Consumption Box Plot: >=WUXGA Resolution**

Source: CASE Team analysis

**Table 4.4 Table to Computer Monitor On Mode Power Consumption Box Plot: >=WUXGA Resolution**

	Screen Size Bin			
	21.x-22.x	23.x-24.x	25.x-27.x	28.x-30.x
<b>Minimum</b>	9	14	13	27
<b>First Quartile</b>	18	20	23	39
<b>Median</b>	20	23	26	59
<b>Third Quartile</b>	22	28	30	59
<b>Maximum</b>	41	37	52	112
<b>Mean</b>	20.8	24.0	27.4	56.1
<b>Count</b>	621	897	215	20

Source: CASE Team analysis

Figure 4.5 shows the on mode power consumption of the models in our dataset by the next four popular resolution categories. Again, the wide spread in on mode power consumption within a screen size and resolution can be seen.

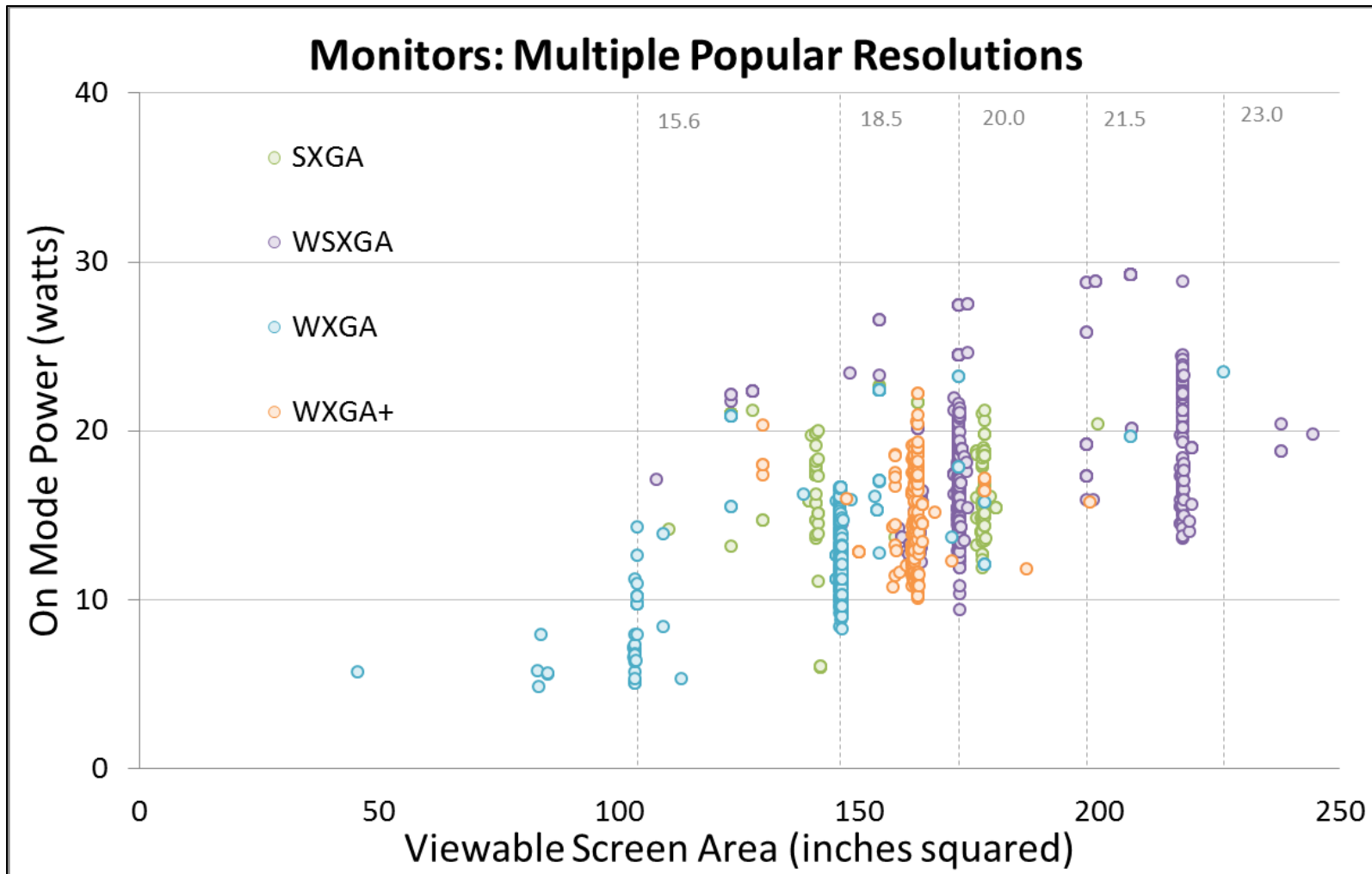

Figure 4.5 Computer Monitor On Mode Power by Resolution Category

Source: CASE Team analysis

#### 4.2.1.2 On Mode: Backlight Effects

Figure 4.6 shows the on mode power consumption of those models reported to use CCFL backlighting. The spread in on mode power does not seem to be as wide for this subset of monitors.

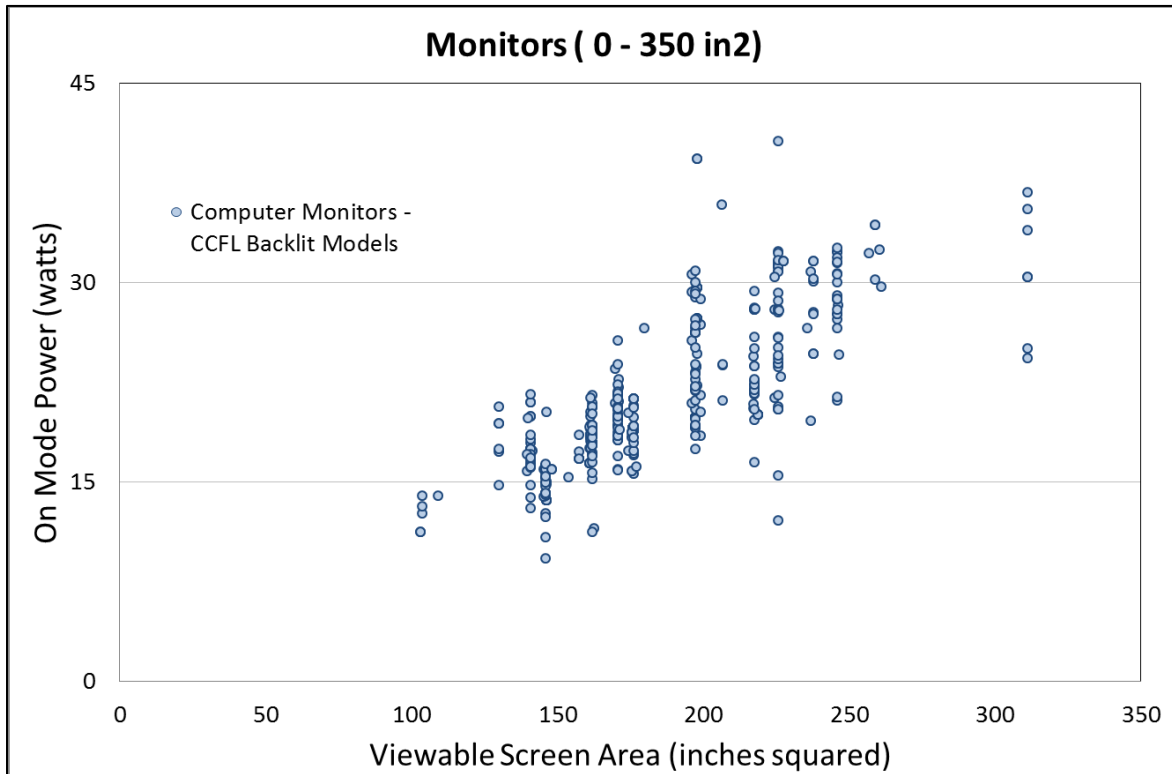
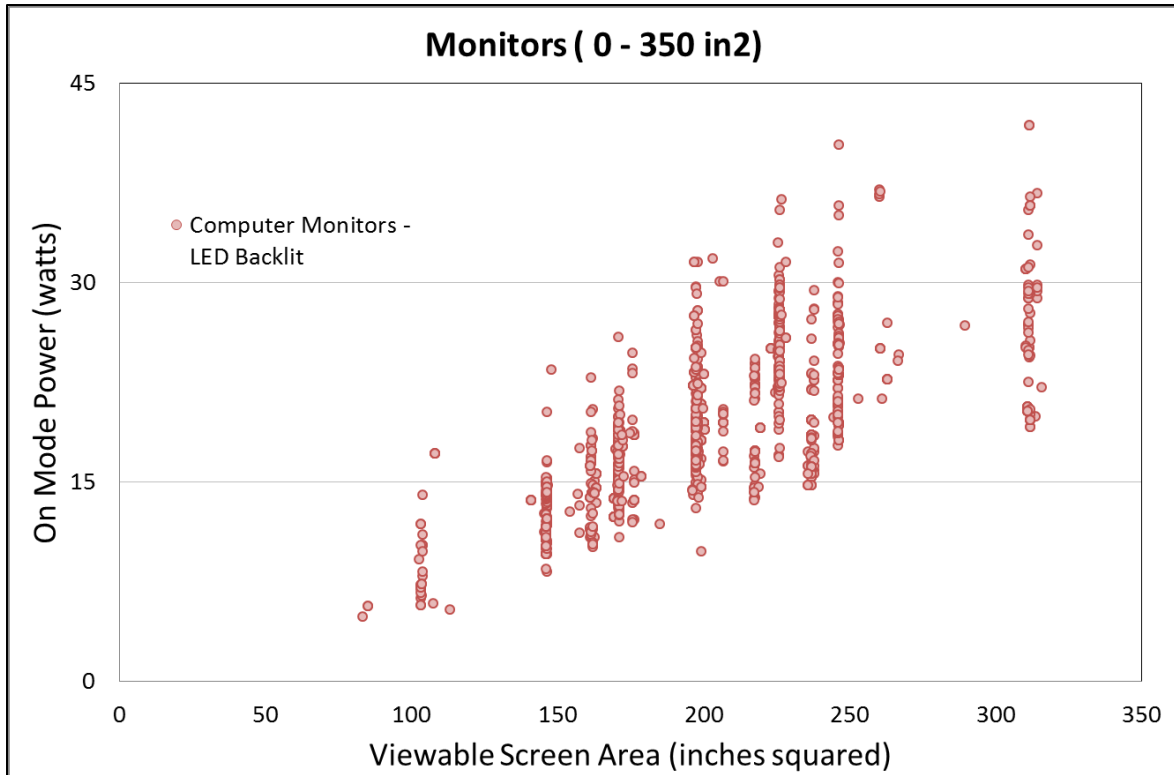

Figure 4.6 Computer Monitor On Mode Power Consumption: CCFL Backlighting

Source: CASE Team analysis

#### 4.2.1 Computer Monitor On Mode Dataset – LED Backlight

Figure 4.7 shows the on mode power consumption of those models reported to use LED backlighting. The spread in on mode power for LED units appears to be wider than CCFL monitors.



**Figure 4.7 Computer Monitor On Mode Power Consumption: LED Backlighting**

Source: CASE Team analysis

#### 4.2.2 Signage Displays

The energy use information for signage displays used in this report includes the following product datasets with the number of models in parenthesis:

- ENERGY STAR qualified data (posted on May 31, 2013) for those models that were qualified under the Version 5.1 specification (202).
- ENERGY STAR qualified data (posted on July 15, 2013) for those models that were qualified under the Version 6.0 specification (50).

After combining these datasets and removing duplicate entries, the resulting dataset included over 250 signage display entries as shown in Figure 4.8.

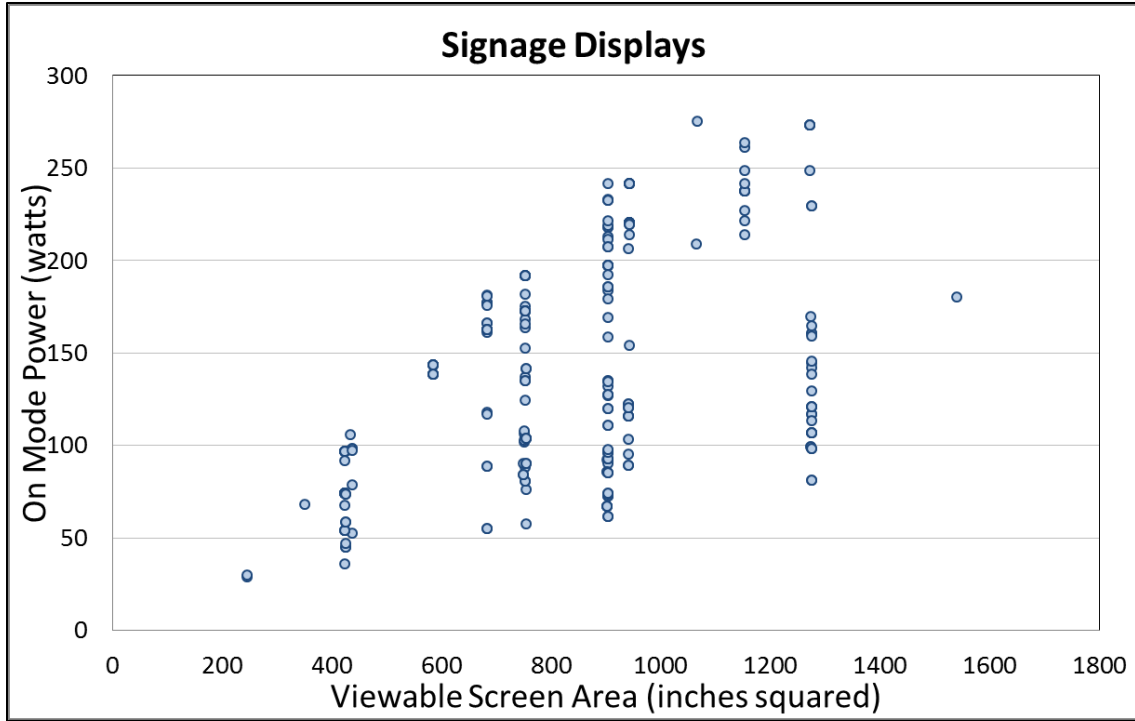

Figure 4.8 Signage Display On Mode Power Consumption

Source: CASE Team analysis

### 4.3 Duty Cycle

#### 4.3.1 Computer Monitors

Since these residential and commercial segments have very different operating hours, it is necessary to segregate their duty cycles. Both residential and commercial duty cycles are shown in

Table 4.5 below. The residential duty cycle is derived from an industry study (Fraunhofer 2011). The commercial duty cycle is derived from another study (Navigant 2009). There are a number of different studies that look at duty cycles for computer monitors, but the two noted here provide the most recent and robust results.

Table 4.5 Duty Cycle for Computer Monitors by Sector

Sector	On Mode (hrs/day)	Sleep Mode (hrs/day)	Off Mode (hrs/day)
<b>Residential</b>	6.9	9.7	7.4
<b>Commercial</b>	6.8	11.2	6.0

Source: Fraunhofer 2011; Navigant 2009

In order to calculate the operating hours per year for computer monitors in commercial setting, we needed to estimate the number of work days in the year. If we assume an average of five workdays a week and account for 20 day of paid time off (10 days of vacation/sick time and 10 holidays), the average worker is at work 240 days annually. We assume the computer monitor would be off for the 125 days a worker is not in the office. The average annual operating hours for computer monitors, by mode, in both residential and commercial settings are displayed below in Table 4.6. As usage patterns differ depending on the application, we determined a shipment-weighted average of total hours a year in each mode based on the 2013 shipments to California.

**Table 4.6 Annual Hours in Power Mode for Computer Monitors by Sector**

	On (hrs/yr)	Sleep (hrs/yr)	Off (hrs/yr)
<b>Residential</b>	2,519	3,541	2,701
<b>Commercial</b>	1,632	2,688	4,440
<b>Shipment-Weighted Averages</b>	<b>1,915</b>	<b>2,961</b>	<b>3,884</b>

Source: CASE Team analysis

#### 4.3.2 Signage Displays

Many signage displays promote themselves as being able to withstand “heavy” usage for commercial applications capable of a duty cycle of 24/7 operation. While some signage displays may run 24 hours a day in applications such as hospitals, hospitality, and transportation, other commercial applications may not require around the clock operation (e.g., retail, restaurants, and education settings). For signage displays, we estimated a general average of 18 hours per day in on mode and the remainder of the day (i.e., 6 hours) in sleep mode. We estimate that a majority of signage displays are used 365 days of the year.

### 4.4 Efficiency Measures

The wide range in on mode power consumption for electronic displays of the same size and resolution can be attributed to differences described in detail below. Most of this information was obtained from a recently published study by a group from Lawrence Berkeley National Laboratory (LBNL) entitled *Efficiency Improvement Opportunities for Personal Computer Monitors* (Park et al 2013).

#### 4.4.1 General Efficiency Strategies

The final luminance delivered out of the LCD is generally less than 10 percent of the initial luminance coming out of the backlight unit, because two crossed polarizers, a color filter, and thin-film transistor (TFT) arrays in the LCD panel absorb a significant amount of light from the backlight unit (Park et al 2013). Small improvements in panel transmittance and optical film efficiency can yield large improvements in terms of required luminance and a reduction in power draw (Park et al 2013). Aside from backlight source, optical films, and LCD panel transmittance, other factors that may affect the efficiency of a monitor include non-panel related components, such as the drive

circuit, the image circuit, and the power supply. Additionally, dimming and power management options can be considered to increase the efficiency of the display. Following is further discussion on these efficiency improvement options.

#### 4.4.2 Backlight Sources

The backlight source can vary from CCFLs to more energy efficient LED backlit monitors. LED backlit monitors are about 10-30% more efficient than CCFL backlit monitors (Park et al 2013). The vast majority of monitors available on the market today and projected in the future are LED backlit monitors as shown in Figure 4.9.

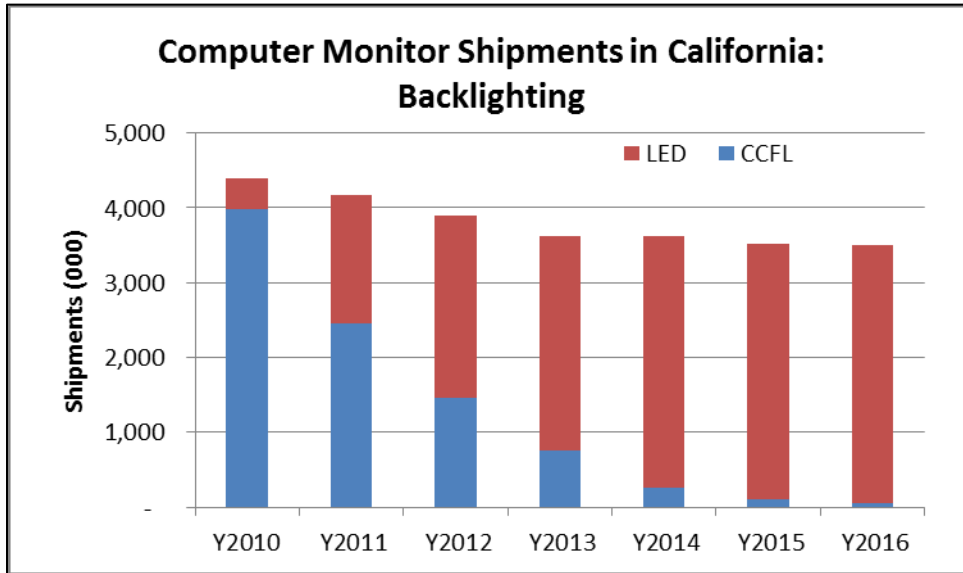

Figure 4.9 Computer Monitor CA Shipments by Backlight Source

Source: IHS iSuppli 2012a

The efficiency of LED backlight units is also expected to improve as a result of developments in advanced LED structure, phosphors, thermal management, and beam angles (Park et al 2013). The more efficient the LED lamps used, the fewer lamps would be required to put out the same luminance and, hence, the less the BLU will cost. This trend of increasing LED efficiency is reported by LBNL to go from 70-90 lumens per watt in 2011-2012 to go beyond 100 lm per watt in 2013.

#### 4.4.3 Optical Films

The use of optical films can increase the light that can pass from the BLU and therefore would reduce the amount of backlighting needed to achieve same luminance levels, resulting in a corresponding reduction of the electricity consumption of LCD monitors (Park et al 2013).

#### 4.4.4 Brightness Control and Power Management

Technology to dim the backlight lamps behind dark sections, where backlight is not needed, of an image can reduce the overall power draw of the BLU. This dimming can be done using various methods. Dimming the whole backlight by a universal amount varying by frame is called zero-



dimensional (0D), complete, or global dimming. Other options are to dim only the part of the backlight area depending on image via: 1) one-dimensional (1D), partial, or line dimming, and 2) two-dimensional (2D), or local dimming (Park et al 2013).

The LBNL paper qualifies that while dimming backlights according to dynamically changing pictures can be an effective way to reduce power consumption and enhance dynamic contrast ratio, dimming strategies are not widely employed with computer monitors because of the nature of the content displayed, typically static word processing or spreadsheet images. However, the CASE Team estimates that users increasingly use monitors for dynamic content such as gaming, movies and internet-based video content, given that larger monitors are becoming more prominent in the consumer sector (Figure 3.6 and Figure 3.8).

Backlight dimming due to user inactivity, or sleep mode, is another method to reduce energy use. Currently, all ENERGY STAR qualified models enter sleep mode after a certain period of user inactivity. Users can fit their preferences using the operating system settings, and the savings from this option depends on computer usage patterns. Some displays also incorporate presence sensors that allow the display to enter a reduced power mode if a user is not detected directly in front of the display.

ABC is a method for adjusting a display's brightness to increase in bright ambient conditions and decrease in more dimly lit conditions. Reducing screen brightness in darker conditions reduces eye strain and also reduces backlight unit (BLU) power. The CASE Team recognizes the potential energy savings of this feature for consumer models, rather than computer monitor models destined for office settings. Office settings are not likely to realize energy savings from ABC as typically recommended light levels for offices is between 300 and 500 lux, which would mean the display brightness would never dim (Park et al 2013).

Based on recent testing conducted by DOE in support of their televisions test procedure rulemaking, the ABC response on many TVs today does not follow the theoretical ABC response based on room illumination (DOE 2012). In other words, many of the tested TVs with the ABC feature did not show a gradual response of TV brightness (luminance) due to increasing room brightness (illumination). Therefore, it appears that ABC is not being properly implemented so as to save energy for consumers. Significant power savings can be achieved when the ABC response curve is gradual rather than a binary response. Additionally, DOE testing even showed evidence of the ABC test being "gamed" so as to achieve the greatest credit without regard to actual picture quality ENERGY STAR has addressed this in its most recent specification for displays, requiring that power measurements at 10 and 300 lux are significantly different in order to receive credit for implementing ABC in a display's default settings.

#### 4.4.5 Power Supply

Though there are current federal efficiency standards for external power supplies that have been in effect since July 2008 (and which DOE is currently updating – with a potential effective date September 2015), electronic displays can benefit from using power supplies that are more efficient than the federal baseline levels. Testing results described in Section 7.4 show a range of power supply efficiencies found in today's displays and demonstrate higher efficiency power supplies can cost-effectively save energy.

#### 4.4.6 Energy Efficient Ethernet (EEE)

Energy Efficient Ethernet can reduce the power draw when there is low data activity. To achieve any benefit of EEE, however, the devices on both ends of an Ethernet connection must have EEE enabled.

### 4.5 Computer Monitors

#### 4.5.1 Energy Use per Unit for Non-qualifying Computer Monitors

Based on performance of models in the dataset, the below table shows by mode and size bin the energy use of computer monitors that are considered the non-qualifying products that do not meet the proposed standard described in Section 10.2 of this report. Unit annual energy consumption was calculated for each size category based on determining the average power consumption in each mode and multiplying by the shipment-weighted average of annual hours in each mode in Table 4.7. Finally, shipment-weighted averages were calculated for each power mode based on 2013 shipments to California.

**Table 4.7 Average Energy Use for Non-qualifying Products**

Diagonal Screen Sizes, $d$ (inches)	On Mode Power Draw (W)	Sleep Mode Power Draw (W)	Off Mode Power Draw (W)	Unit Energy Consumption (kWh/yr)
$d < 12$	-	-	-	-
$12 \leq d < 17$	9.60	0.54	0.50	21.41
$17 \leq d < 23$	18.59	0.33	0.26	36.52
$23 \leq d < 25$	24.39	0.37	0.29	47.54
$25 \leq d \leq 61$	100.45	0.52	0.36	189.50
<b>Shipment-Weighted Average</b>	<b>26.31</b>	<b>0.36</b>	<b>0.28</b>	<b>51.04</b>

Source: CASE Team analysis

#### 4.5.2 Energy Use per Unit for Qualifying Computer Monitors

Qualifying products are products that meet the proposed standard described in Section 10.2 of this report. For qualifying products, unit annual energy consumption was calculated for each size category based on determining the average power consumption in each mode and multiplying by the shipment-weighted average of annual hours in each mode in Table 4.8. Finally, shipment-weighted averages were calculated for each power mode based on 2013 shipments to California.

**Table 4.8 Average Energy Use for Qualifying Products**

Diagonal Screen Sizes, $d$ (inches)	On Mode Power Draw (W)	Sleep Mode Power Draw (W)	Off Mode Power Draw (W)	Unit Energy Consumption (kWh/yr)
$d < 12$	6.55	0.40	0.41	14.97
$12 \leq d < 17$	6.38	0.35	0.29	14.02
$17 \leq d < 23$	11.44	0.29	0.22	22.99
$23 \leq d < 25$	15.45	0.31	0.23	30.52
$25 \leq d \leq 61$	21.24	0.29	0.25	41.29
<b>Shipment-Weighted Average</b>	<b>13.11</b>	<b>0.30</b>	<b>0.23</b>	<b>26.14</b>

Source: CASE Team analysis

#### 4.6 Signage Displays

Based on performance of models in the dataset, the below table shows by mode and size bin the energy use of computer monitors that are considered the non-qualifying products that do not meet the proposed standard described in Section 10.2 of this report. Unit annual energy consumption was calculated based on determining the average power consumption in each mode and multiplying by the assumed duty cycle for these products.

**Table 4.9 Average Energy Use for Non-qualifying Products – Signage Displays**

On Mode Power Draw (W)	Sleep Mode Power Draw (W)	Unit Energy Consumption (kWh/yr)
178	0.92	1174

Source: CASE Team analysis

**Table 4.10 Average Energy Use for Qualifying Products– Signage Displays**

On Mode Power Draw (W)	Sleep Mode Power Draw (W)	Unit Energy Consumption (kWh/yr)
92	0.35	608

Source: CASE Team analysis

## 4.1 Electronic Billboards

Though at this time we are not proposing power limits, there may be an opportunity for significant energy savings in California given the proliferation of electronic billboards, the large power draw required, and the 24-hour-a-day usage cycle. We are continuing to investigate potential requirements. One stakeholder in their response to the ITP provided energy use information regarding electronic billboards based on a study conducted by Scenic America (Young 2010). A chart from the Scenic America report is displayed below that highlights two electronic billboards of the same dimensions (14 foot by 48 foot) with a large variation in annual energy consumption. Based on this information, there is a potential for significant energy savings to be realized from standards.

**Approximate Annual Energy Usage for Billboards  
Static vs. LED**

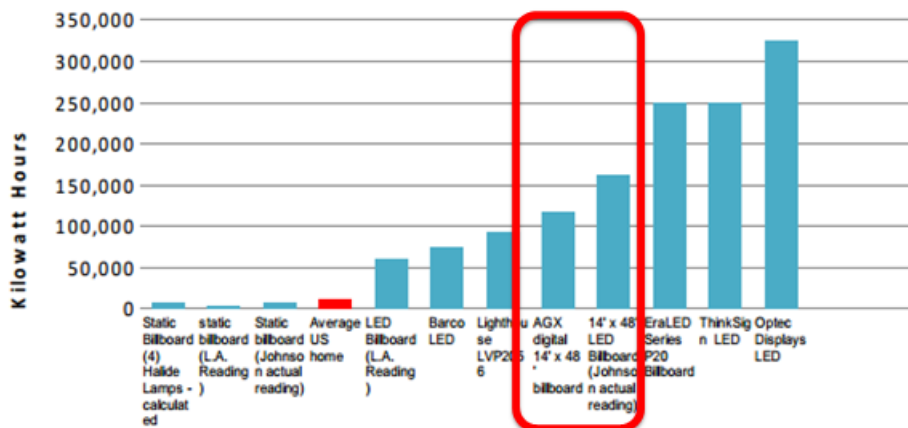

**Figure 4.10 Electronic Billboard Annual Energy Use**

Source: Young 2010

## 5 Market Saturation & Sales

### 5.1 Current Market Situation

#### 5.1.1 Computer Monitors Shipments and Installed Base

As noted previously, some growth in shipments of certain monitor types may be expected in specific sectors; however, due to the uncertainty of the current economic conditions, we assume a slight decline in overall shipments through 2016. Total shipments to California projected in 2013 to 2016 are shown in Figure 5.1. The current installed base of computer monitors in California is outlined in the following Table 5.1 for both residential and commercial applications based on two separate industry studies. Estimates of both shipments and installed base for California were

calculated using national numbers and assuming the share in California was 13 percent: the same percentage of California’s share of the total U.S. GDP.

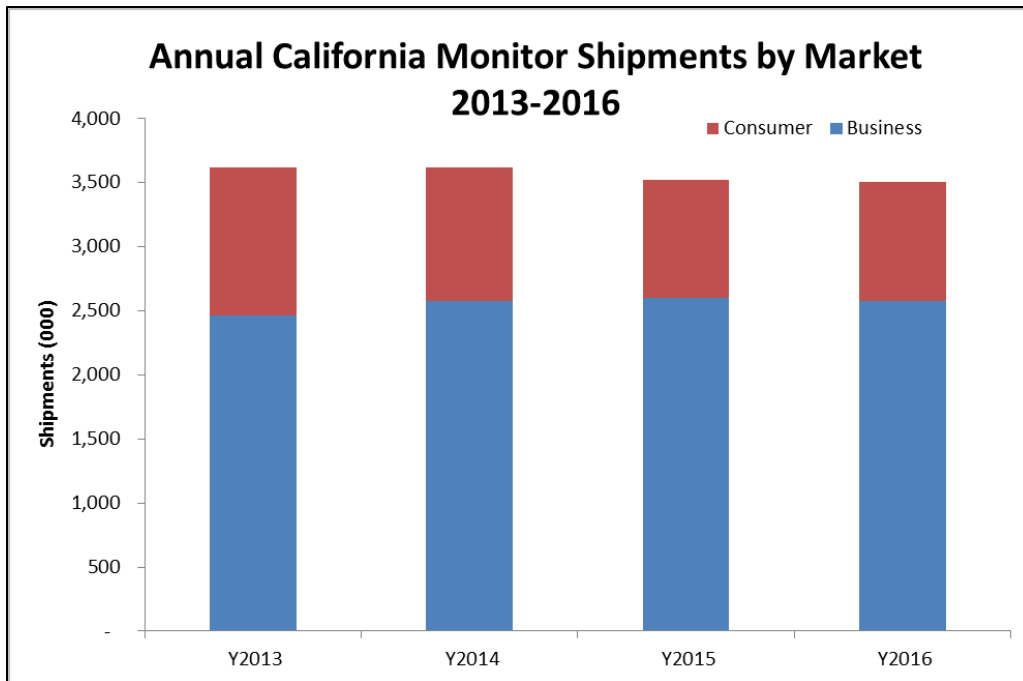

Figure 5.1 Annual Computer Monitor Shipments by Market Sector

Source: IHS iSuppli 2012a

Table 5.1 Installed Base in California by Sector – Computer Monitors

Sector	Installed Base (000)
Residential	17,135
Commercial	20,928
<b>Total</b>	<b>38,063</b>

Source: Fraunhofer 2011; TIAX 2010

Given an estimated 5 year design life (refer to Section 7.2) for computer monitors, based on the annual shipments, the *calculated* stock would be half the value of the stock estimates shown in Table 5.1. It is not known whether monitors are being used far beyond their design life. This report uses the shorter calculated stock value in order to conservatively estimate potential energy savings at this time.

### 5.1.2 Signage Displays Shipments

As noted previously, based on charts from market report abstracts, we estimated increasing shipments of signage displays to California through 2015 as shown in Figure 5.2.

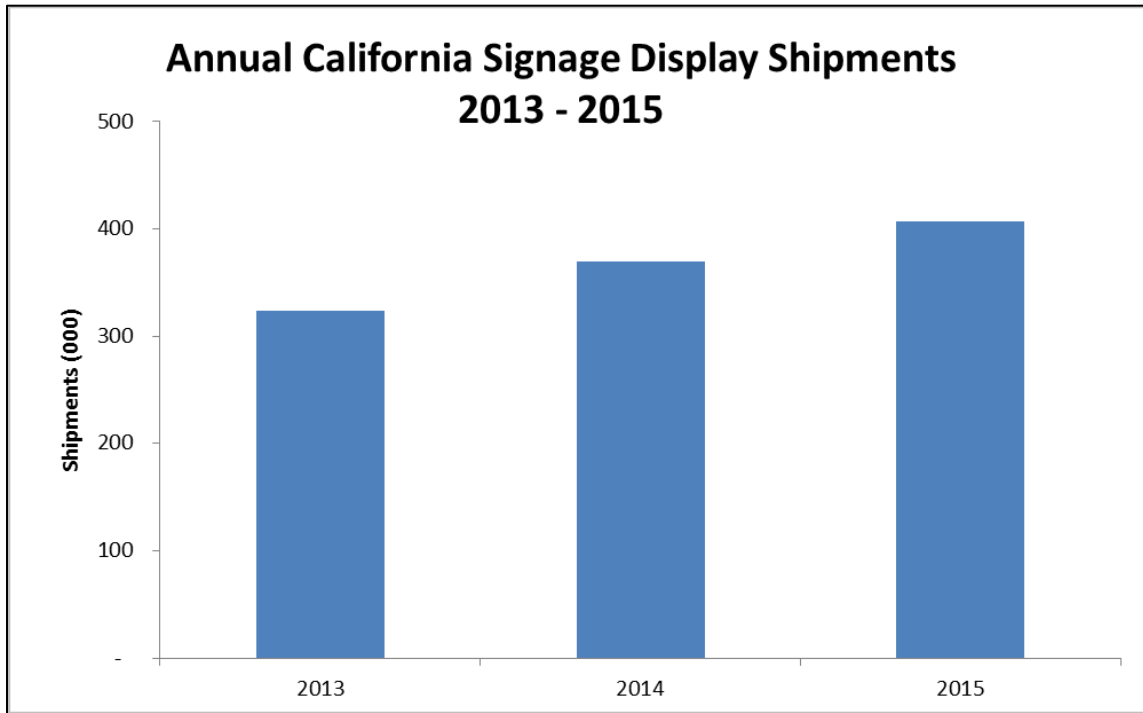
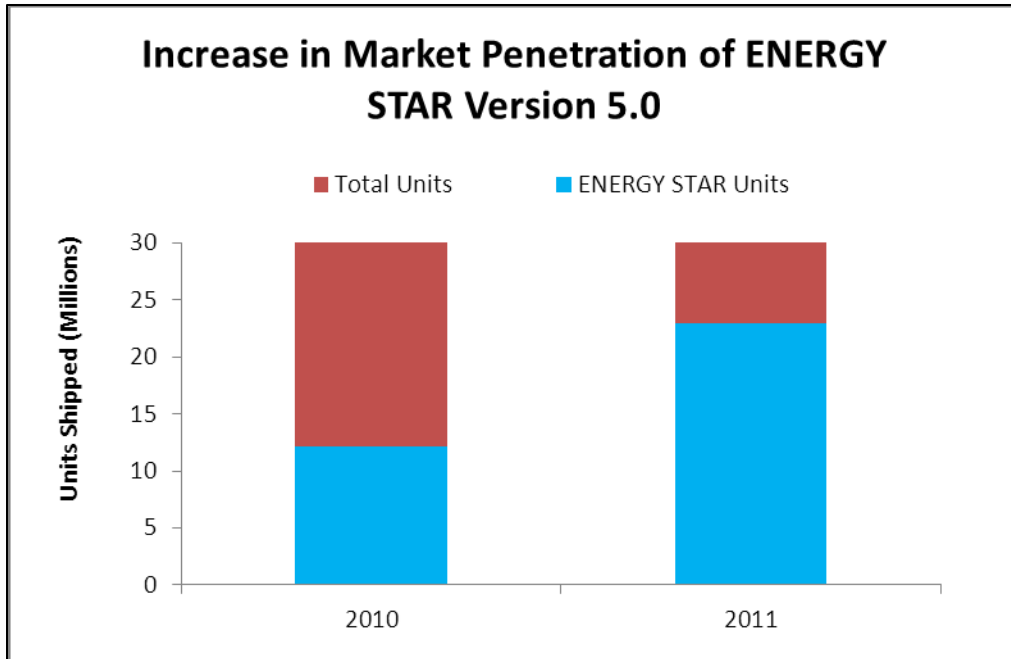

**Figure 5.2 Annual Signage Display Shipments by Market Sector**

Source: IHS iSuppli 2012b

### 5.1.3 Computer Monitors: Market Share of High Efficiency Options

Figure 5.3 shows that in 2010, the first full year of the ENERGY STAR Version 5.0 specification, the market penetration of models that met the Version 5 specification was 43 percent. In 2011, the second full year of the Version 5 specification, the market penetration jumped up to 85 percent. Given a historically rapid uptake of ENERGY STAR specification requirements, we could expect a similar trend with the Version 6 specification that took effect on June 1, 2013. In fact, an LBNL report expects the market compliance rate of the ENERGY STAR specification to be over 70 percent in 2013 as highly efficient LED monitors become dominant (LBNL 2013).



**Figure 5.3 Market Penetration of ENERGY STAR Version 5 Specification**

Source: EPA 2012b

#### 5.1.4 Signage Displays: Market Share of High Efficiency Options

When EPA was developing the Version 6 specification, it noted a low market share (less than 10 percent in 2010) of signage displays that met the Version 5 requirements which first took effect January 30, 2010. As explained in Section 10.2.2 below, in March 2010, CEC provided explicit guidance on a specific CEA inquiry confirming coverage of professional signage (e.g., signage displays) under the television regulations that first took effect in 2011. Considering the Title 20 Tier 1 TV regulations were more stringent than the ENERGY STAR Version 5 requirement (See Figure 5.4 below), we would assume that all signage display models shipped to California in 2011 would qualify as ENERGY STAR. However, 2011 annual shipment data provided to ENERGY STAR again confirmed very low (approximately 3 percent) market uptake of ENERGY STAR signage displays. Given the low market share, EPA did not modify the on mode requirements for signage displays in the Version 6 specification.

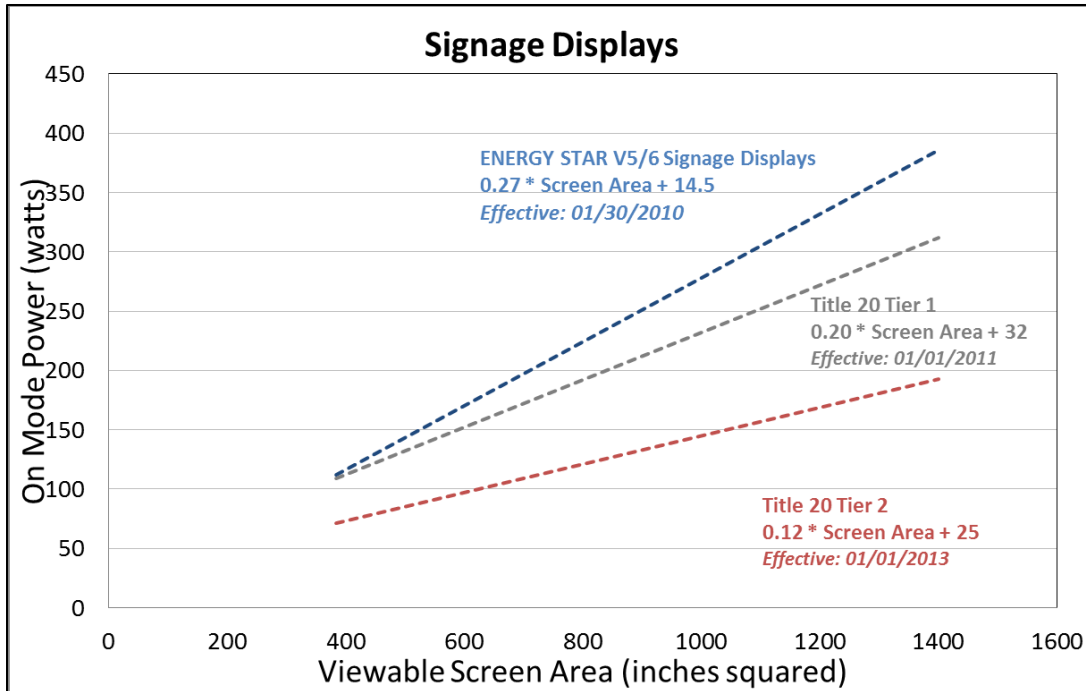

Figure 5.4 On Mode Requirements Signage Displays: ENERGY STAR and Title 20

Source: CASE Team analysis

There could be several explanations for low market share of ENERGY STAR signage displays, including: little customers demand for ENERGY STAR qualified signage displays, incomplete or inaccurate reporting of shipment data to ENERGY STAR a small market of signage displays designed only for the California market to comply with Title 20 regulations, or a lack of understanding that signage displays were required to meet the TV regulations.

Compliance with Title 20 regulations is based on date of manufacture. It is often difficult to discern compliance to existing standards as information on the date of manufacture is not often readily available. Given our preliminary survey of professional displays that did not comply with Title 20 regulations and were available for sale in California, we assume that there is a lack of compliance to current regulations due to lack of clarity with the current Title 20 regulations. We believe that updating the definitions as proposed in this report will increase compliance dramatically. Currently, however, we believe there is a limited market share of models that comply with the current Tier 2 TV regulations. We will continue to monitor the market to better under the compliance rate of signage displays to the existing Title 20 regulations.

## 5.2 Future Market Adoption of High Efficiency Options

Natural adoption of high efficiency options is occurring in some but not all segments of the electronic displays. For example, a small, but significant, portion of computer monitors still use CCFL backlighting even though more efficient LEDs are significantly more cost effective. A part of the electronic display market is driven primarily but purchase price minimization at the expense of lifecycle cost savings for the user.



The proposed standards will accelerate the adoption of cost-effective efficient designs compared to slower and more partial natural market adoption. They will guarantee that technology innovation is harnessed to reduce the energy use of electronic displays in California, and will provide safeguards against energy efficiency backsliding as performance increases and new features are introduced.

## 6 Savings Potential

### 6.1 Statewide California Energy Savings

#### 6.1.1 Computer Monitors

The following Table 6.1 outlines the computer monitor energy use calculations from the standards and absence of standards cases. It is important to note that as we only had shipment data through 2016, we estimated a stabilization of shipments at the 2016 levels through 2019.

**Table 6.1 California Statewide Non-Standards Case Energy Use & Peak Demand<sup>A</sup>**

Year	Sales		Stock	
	Energy Use (GWh/yr)	Peak Demand (MW)	Energy Use (GWh/yr)	Peak Demand (MW)
2013	181	28	905	141
2014	181	28	905	141
2015 (standard effective)	176	27	900	140
2016	175	27	894	139
2017	175	27	888	139
2018	175	27	882	138
2019 (stock turnover)	175	27	877	137

Source: CASE Team analysis

<sup>A</sup> Statewide demand (and demand reduction) is quantified as coincident peak load (and coincident peak load reduction), the simultaneous peak load for all end users, as defined by Koomey and Brown (2002).

The following Table 6.2 outlines the energy savings and peak demand reduction calculations from the establishing standards for computer monitors.

**Table 6.2 California Statewide Standards Case Energy Use & Peak Demand<sup>A</sup>**

Year	Sales		Stock	
	Energy Use (GWh/yr)	Peak Demand (MW)	Energy Use (GWh/yr)	Peak Demand (MW)
2013	181	28	905	141
2014	181	28	905	141
2015 (standard effective)	95	15	819	128
2016	94	15	732	114
2017	94	15	645	101
2018	94	15	558	87
2019 (stock turnover)	94	15	471	74

Source: CASE Team analysis

<sup>A</sup> Statewide demand (and demand reduction) is quantified as coincident peak load (and coincident peak load reduction), the simultaneous peak load for all end users, as defined by Koomey and Brown (2002).

The difference between the peak demand and energy consumption in the standard and no-standard cases is shown in Table 6.3.

**Table 6.3 Estimated California Statewide Energy Savings and Peak Demand Reduction with Standards Case<sup>A</sup>**

Year	Sales		Stock	
	Energy Use (GWh/yr)	Peak Demand (MW)	Energy Use (GWh/yr)	Peak Demand (MW)
2013	0	0	0	0
2014	0	0	0	0
2015 (standard effective)	81	13	81	13
2016	81	13	162	25
2017	81	13	243	38
2018	81	13	324	51
2019 (stock turnover)	81	13	405	63

Source: CASE Team analysis

<sup>A</sup> Statewide demand (and demand reduction) is quantified as coincident peak load (and coincident peak load reduction), the simultaneous peak load for all end users, as defined by Koomey and Brown (2002).

### 6.1.2 Signage Displays

All energy use numbers presented in this section apply to signage displays with a diagonal screen size of 61-inches or less. Product data on larger signage displays is not readily available at this time. Because these energy use values do not include units larger than 61-inches, which comprise a significant share of the market, these can be considered conservative estimates. As our shipment

estimates only went through 2015, we assumed a similar rate of increase through 2022, the year of stock turnover.

**Table 6.4 California Statewide Low Compliance Case Energy Use & Peak Demand**

Year	Sales		Stock	
	Energy Use (GWh/yr)	Peak Demand (MW)	Energy Use (GWh/yr)	Peak Demand (MW)
2013	306	64	2329	483
2014	350	73	2373	493
2015 (standard effective)	385	80	2452	509
2016	426	88	2571	534
2017	465	97	2730	567
2018	505	105	2928	608
2019	544	113	3166	657
2020	583	121	3565	740
2021	623	129	3881	806
2022 (stock turnover)	662	137	4193	870

Source: CASE Team analysis

**Table 6.5 California Statewide Full Compliance Case Energy Use & Peak Demand**

Year	Sales		Stock	
	Energy Use (GWh/yr)	Peak Demand (MW)	Energy Use (GWh/yr)	Peak Demand (MW)
2013	380	64	2886	483
2014	434	73	2940	493
2015 (standard effective)	247	51	2807	480
2016	273	57	2701	473
2017	299	62	2620	472
2018	324	67	2564	475
2019	349	72	2533	484
2020	374	78	2680	524
2021	400	83	2700	543
2022 (stock turnover)	425	88	2691	558

Source: CASE Team analysis

The difference between the peak demand and energy consumption in the low compliance and full compliance cases is shown in Table 6.6.

**Table 6.6 Estimated California Statewide Energy Savings and Peak Demand Reduction with Full Compliance Case**

Year	Sales		Stock	
	Energy Use (GWh/yr)	Peak Demand (MW)	Energy Use (GWh/yr)	Peak Demand (MW)
2013	0	0	0	0
2014	0	0	0	0
2015 (standard effective)	138	29	138	29
2016	153	32	291	60
2017	167	35	457	95
2018	181	38	638	132
2019	195	40	833	173
2020	209	43	1042	216
2021	223	46	1265	263
2022 (stock turnover)	237	49	1502	312

Source: CASE Team analysis

## 6.2 State or Local Government Costs and Savings

There are no known additional costs to state or local governments from the implementation of the standards proposal, given the CEC’s existing authority for establishing appliance standards and staffing to administer the process. Significant energy savings are expected for local and state governments and public institutions from the purchase of more efficient computer monitors and signage displays as a result of the proposed standards, with the savings amount dependent on the volume of products purchased.

## 7 Economic Analysis

### 7.1 Incremental Cost Methodology

To develop an initial cost-efficiency relationship for displays, we studied the performance of several pairs of models that we selected to represent the range of energy efficiency of displays currently on

the market. We will be submitting to the CEC a more detailed Technical Report (referenced as “Displays Technical Report”) of all our findings subsequent to the submission of this CASE Report.

To isolate differences in power due to energy efficient designs rather than functionality and other features, we selected three pairs of displays that had similar features but drew different amounts of power according to our dataset. The screen size pairs were 18.5-, 21.5-, and 27-inches viewable diagonal screen size to cover the range of popular screen sizes sold today. The representative models were chosen to represent a display of average energy efficiency; the efficient models represented one of the more efficient models that were available for purchase. Figure 7.1 shows the on mode power consumption of the models selected for testing. Table 7.1 shows the technical specifications of the models tested.

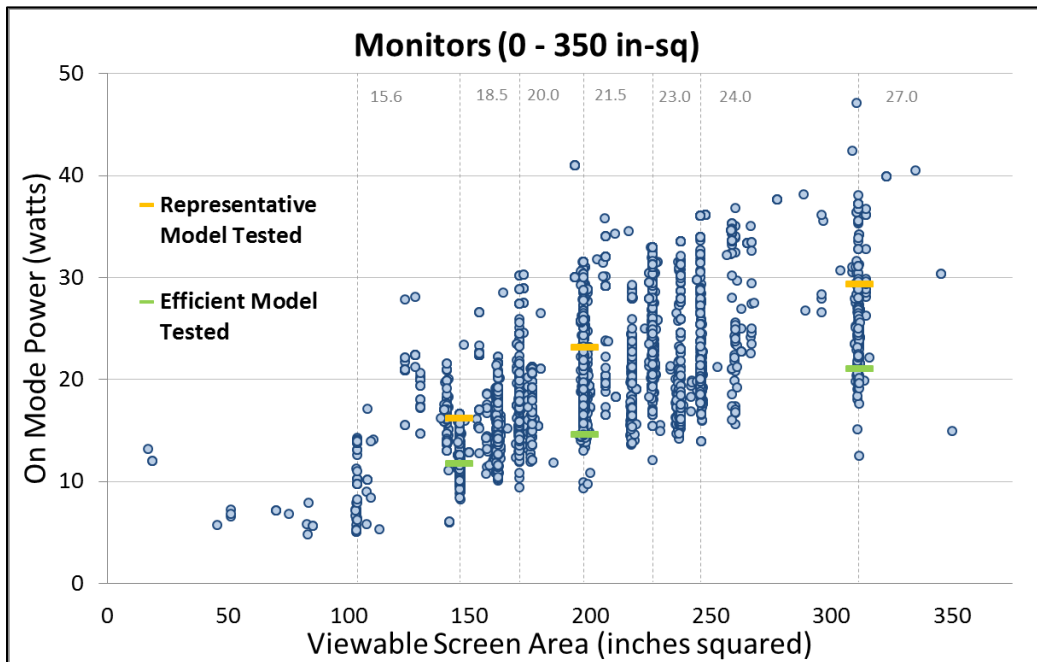

Figure 7.1 Measured On Mode Power of Tested Units

Source: CASE Team analysis

**Table 7.1 Features Sets of Tested Units**

Test Model Description Test Unit ID	Representative	Efficient	Representative	Efficient	Representative	Efficient
	D19-1	D19-2	D22-1	D22-2	D27-1	D27-2
Resolution (MP)	1.05	1.05	2.07	2.07	2.07	2.07
Screen Area (in-sq)	146	146	198	198	314	312
Diagonal Viewable Screen Size	18.5	18.5	21.5	21.5	27	27
Contrast Ratio	10,000:1	Not Listed	1000:1	1000:1	3,000:1	1000:1
Response Time (ms)	5	5	8	5	8	7
Power Supply	Internal	Internal	External	Internal	External	Internal
Panel Type	TN	TN	IPS	TN	TN	IPS
Weight (kg)	2.8	2	2.5	3.8	6.1	5.3
Video Ports	VGA	VGA	DVI, VGA	DVI, VGA, HDMI	DVI, VGA, DisplayPort	DVI, VGA, HDMI
Reported Brightness (cd/m <sup>2</sup> )	200	250	250	250	300	270
Horizontal Viewing Angle (deg)	90	170	178	170	170	178
Vertical Viewing Angle (deg)	50	160	178	160	160	178
Network Ports	None	None	None	None	None	None
Backlight	CCFL Edge (top and bottom)	LED Edge (bottom)	Edge (bottom)	Edge (side)	LED Edge (bottom)	Led Edge (side)
ABC	No	No	No	No	Yes	No
Power scaling mode	Yes	Yes	Yes	Yes	No	Yes

Source: CASE Team analysis

We performed as-assembled testing according to the ENERGY STAR test method for input power, luminance, illuminance, ambient temperature, relative humidity, power meter specifications and measurement accuracy (see Appendix B). We performed modal power testing according to the ENERGY STAR test method with the display in its as-shipped condition with all user-configurable options set to factory settings for default mode. Since ENERGY STAR requires test units to be calibrated to 200 candelas per square meter (nits), we also tested each display in its default luminance settings to get a more accurate measurement of real world power draw as most models are brighter than 200 nits “out of the box” and end users are not likely to calibrate to 200 nits. Finally, we also tested optional picture modes in default settings and other picture features enabled.

The purpose of the teardown analysis was to investigate power and optical systems to determine which components and designs produce more efficient displays, as well as to collect a bill of materials (BOM) for each display to be used in the incremental cost analysis. We targeted components that together draw the majority of power in a display and that have energy efficiency improvement potential. These components include the power supply, the light processing components and lamps used in BLUs and the panel drive electronics as shown in schematic in Figure 7.2.

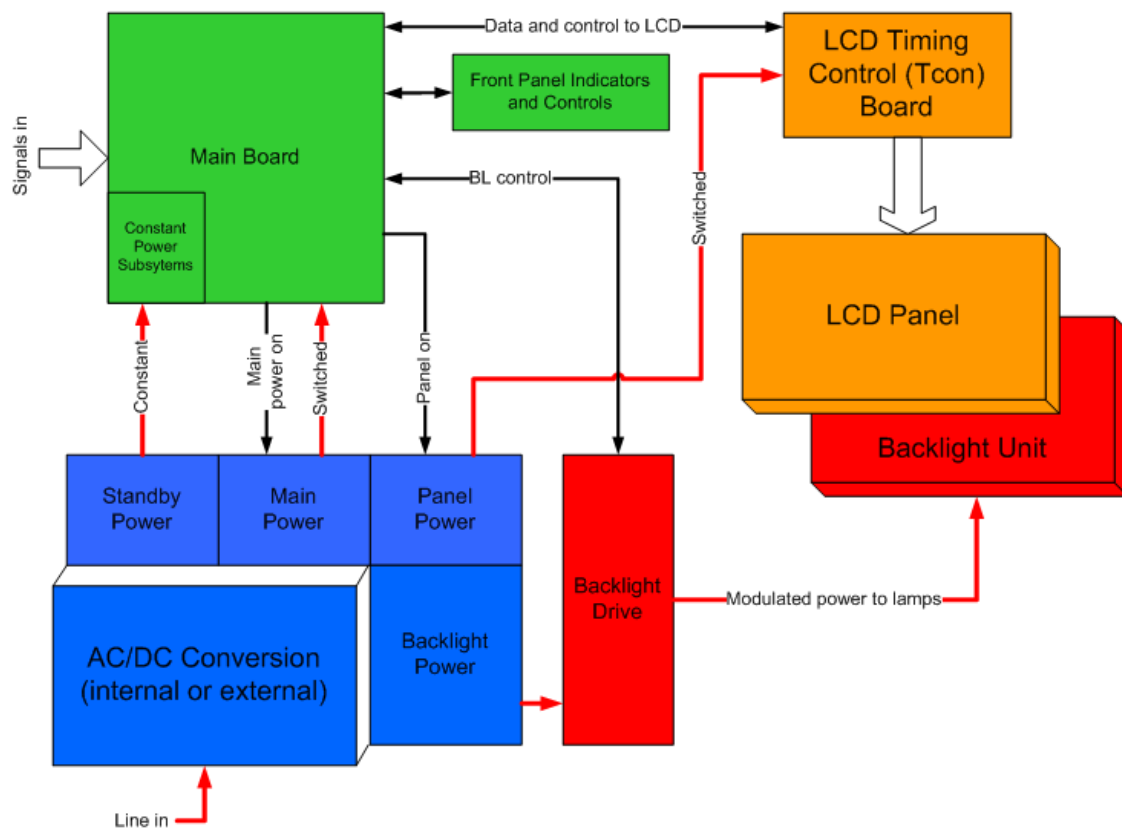

**Figure 7.2 Electronic block diagram of a typical LCD display**

Source: Ecova

We collected the following information from the tested models:<sup>6</sup>

- As-assembled and circuitry photographs: to document the display and its components.
- Detailed power budget: we used invasive techniques, including modifying circuit boards, for in-circuit power measurements such that the following loads could be measured separately:
  - BLU.
  - LCD panel and controller.
  - Main processor board and all other loads (e.g., sensors, keypads, audio).
  - AC plug load (total AC power draw of the display).
  - Power supply losses.
- Film characterization: we identified film types and the number of films in the stack.
- Optical film stack and LCD panel transmittance: we measured transmittance as the amount of light normal to the display that passes through each layer.
- Micrographs of optical films and LCD panel: we identified film and panel types using a 300X digital microscope to view internal structures.
- Lamp count: we recorded the number and size of the LEDs in the display.
- Lamp efficacy: we removed each display's LED strip to test lamp efficacy in an integrating sphere.

To develop cost-efficiency relationships, we first estimated bill of materials (BOM) costs for the representative and efficient test units. We obtained cost information from DisplaySearch, a research company that analyzes the electronic display market and interviews manufacturers to develop quarterly cost estimates of typical display models by technology and size. DisplaySearch currently forecasts these costs through 2017. Using results from the teardown analysis, we tailored these costs to each test unit to develop a specific BOM cost. We then applied a retail markup factor to determine retail costs.

Forecasts from DisplaySearch incorporate a logarithmic decline in display component and manufacturing costs over time following the initial date of mass production for any given model. This cost reduction has the effect of closing the incremental cost gap between market available displays and displays with maximum technology energy efficiency improvements.

Finally, we estimated cost and efficiency for several cost-effective scenarios to estimate the cost-efficiency relationship in the future display market. We used results from the teardown analysis to identify current technologies that may be used to improve energy efficiency, as well as market research to identify emerging technologies that may be available for future energy efficiency improvements.

An example (not actual) calculation is shown below for illustrative purposes in Table 7.2. Using DisplaySearch cost data, we first calculated the representative model price based on the components we found in the teardown of the unit. We then estimated the cost of an efficiency improvement, which in the example case was a scenario that involved replacing the backlight with improved LED lamps. This cost estimate may have come directly from DisplaySearch market data or industry expert opinion. The efficiency improvement itself comes from a reasonable estimate based on measured component level data. In the example below of improved LEDs, we use the

---

<sup>6</sup> Further details on the testing conducted and the information collected will be provided in the Technical Report.



measured LED efficacy of the unit, such as 100 lumens per watt, and calculated the power savings in the backlight unit associated with improving the LEDs to 110 lumens per watt. This energy savings is then applied to the measured backlight unit power and overall power draw of the unit is recalculated. The power savings was compared to the incremental cost to determine cost-effectiveness.

**Table 7.2 Example of Cost and Efficiency Calculation for an Individual Efficiency Measure**

Description	
Initial Model BOM Cost	\$75.00
Initial Model Price (with Retail Markup)	\$97.50
Incremental Cost of Efficiency Measure (e.g., higher efficacy LEDs)	\$2.00
New Model BOM Cost	\$77.00
New Model Price (with Retail Markup)	\$100.10
<b>Total Incremental Cost</b>	<b>\$2.60</b>
Measured Model-Level On Mode Power Draw	20 watts
Measured Backlight Unit Power Draw	9 watts
Backlight Unit Power Improvement (e.g., higher efficacy LEDs)	10%
Calculated Backlight Unit Power Draw	8.1 watts
Calculated Model-Level On Mode Power Draw	19.1 watts
<b>Total Power Savings</b>	<b>0.9 watts</b>

Source: CASE Team analysis

In Section 7.4, we discuss the results of combining individual efficiency improvements to create a multiple cost effective scenarios to achieve the proposed on mode requirements. Testing results and subsequent analysis show that the proposed on mode power levels in Section 10.2 are cost-effective using readily available, non-proprietary, off-the-shelf technology. Further efficiency improvements from maximum technology and emerging technology scenarios also have the potential to be combined for even **greater** improvements to a display's overall efficiency. The conclusion of the initial cost-efficiency analysis is that there are opportunities to improve the overall efficiency of displays at relatively low incremental cost.

## 7.2 Design Life

The design life of computer monitors varies by application. One LBNL study estimated the design life of a computer monitor to be 4 years based on an energy consumption study in the U.S. (LBNL 2011). A more recent LBNL study uses 6 years and cites a lifetime ranging from 3.5 to 7 years in the European region (LBNL 2013). ENERGY STAR uses 4 year equipment lifetime for commercial monitors and 5 years for residential monitors in the ENERGY STAR office equipment savings calculator (ENERGY STAR 2013d). In this analysis, we assume the average lifetime for computer monitors to be 5, which is a reasonable approximation of the average design life of computer monitors.

We estimate the design life for signage displays to be longer due to our initial review of marketing materials for signage displays. Typically, these electronic displays tend to be more durable as compared to computer monitors to accommodate the extended usage patterns of signage displays. Assuming the lifetime hours in on mode of signage displays is 50,000 hours and given the assumed duty cycle outlined in Section 4.3, we calculated a design life for signage displays of 7.6 years.

## 7.3 Lifecycle Cost / Net Benefit – Computer Monitors

The lifecycle costs and benefits represent the sum of the annual benefits and costs of the proposed standard over the entire design life of the product. The lifecycle costs and benefits of the proposed standards for computer monitors per unit are shown in Table 7.3. The overall lifecycle cost/benefit ratio and present value of all costs and benefits of the standard is shown in Table 7.4.

Lifecycle costs and benefits were not determined for signage displays larger than 61-inches, however, given similar energy saving technology costs to computer monitors (when scaled to size) and the heavy usage profiles of signage displays, we can assume a significantly higher benefit-cost ratio.

**Table 7.3 Lifecycle Costs and Benefits per Unit for Qualifying Products**

Year	Design Life (years)	Lifecycle Costs per Unit (Present Value \$)			Lifecycle Benefits per Unit (Present Value \$)		
		Incremental Costs per Unit	Additional Costs	<b>Total Costs<sup>a</sup></b>	Energy Savings per Unit <sup>c</sup>	Additional Benefits	<b>Total Benefits</b>
2015	5	\$10.26	n/a	<b>\$10.26</b>	\$19.89	n/a	<b>\$19.89</b>

<sup>a</sup> Cost calculations include 3% annual discounting from 2013 to account for production experience.

<sup>c</sup> Calculated using the CEC's average statewide present value statewide energy rates that assume a 3% discount rate (CEC 2012).

**Table 7.4 Lifecycle Cost Benefit Ratio for Qualifying Products and Net Present Values with Standards Case<sup>d</sup>**

Lifecycle Benefit / Cost Ratio <sup>a</sup>	Net Present Value <sup>b</sup>		
	Per Unit	First Year Sales (\$)	Stock Turnover (\$) <sup>c</sup>
2.01	\$9.64	\$ 30,564,000	167,240,000

<sup>a</sup> Total present value benefits per unit divided by total present value costs per unit for the period from the effective date of the tier through the earlier of 1) the stock turnover year (i.e., the NPV of “turning over” the whole stock of less efficient products that were in use at the effective date to more efficient products); or 2) the effective date of the next tier.

<sup>b</sup> Positive value indicates a reduced total cost of ownership over the life.

<sup>c</sup> Stock Turnover NPV is calculated by taking the sum of the NPVs for the products purchased each year following the standard’s effective date through the stock turnover year (see note a above) , plus any additional non-replacement units due to market growth, if applicable. For example, for a standard effective in 2015 applying to a product with a 6 year design life, the NPV of the products purchased in the 6<sup>th</sup> year (2020) includes lifecycle cost and benefits through 2025, and therefore, so does the Stock Turnover NPV.

<sup>d</sup> For price of electricity, average annual rates were used, starting in the effective year (see Appendix D: for more details). It should be noted that while the proposed standard is cost-effective, it may be more cost-effective if using alternative rate structures. For example, marginal utility rates may more accurately reflect what customers save on utility bills as result of the standard.

## 7.4 Feasibility and Justification

Using the methodology outlined in Section 7.1, we combined individual efficiency measures to generate four cost effective measures for each size analyzed (see Figure 7.3). All scenarios meet the proposed on mode power requirements, labeled as P<sub>ON\_MAX</sub>. To determine if a scenario was cost effective, we calculated the lifetime energy savings of the modeled more efficient display over the representative model and compared that to the incremental cost of the efficiency improvements.

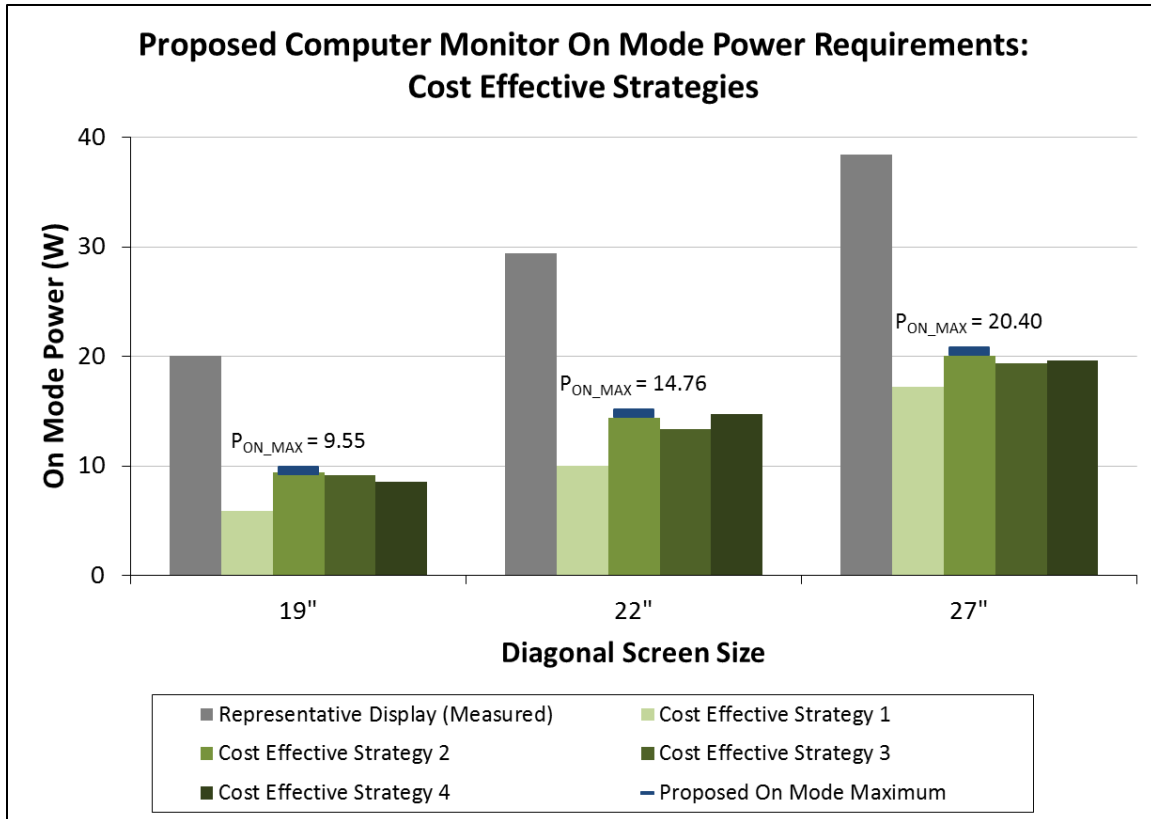

Note: Representative display power measured in display’s default luminance settings.

**Figure 7.3 Cost Effective Strategies to Meet On Mode Requirements– Computer Monitors**

Details regarding which efficiency measures we utilized for each scenario and the impact to on mode power draw are described in Table 7.5 below. Further background as well as incremental cost and efficiency information for the efficiency measures we considered is presented in the following Sections 7.4.1 through 7.4.7. More detailed information will be included in the Displays Technical Report.

Table 7.5 Description of Cost Effective Strategies to Meet On Mode Requirements – Computer Monitors

Diagonal Screen Size	Representative Display (Measured)	Cost Effective Strategy 1	Cost Effective Strategy 2	Cost Effective Strategy 3	Cost Effective Strategy 4
19"	On Mode: 20.01W PSU: 80% Reflective Polarizer: None Lamp Efficacy (CCFL): 47lm/W Screen Brightness: 255 nits Global Dimming: None ABC: None	On Mode: 5.9W PSU: 88% Reflective Polarizer: Yes Lamp Efficacy (LED): 110lm/W Screen Brightness: 200 nits Global Dimming: Yes ABC: Yes	On Mode: 9.44W PSU: 88% Reflective Polarizer: None Lamp Efficacy (LED): 110lm/W Screen Brightness: 255 nits Global Dimming: Yes ABC: None	On Mode: 9.16W PSU: 88% Reflective Polarizer: None Lamp Efficacy (LED): 110lm/W Screen Brightness: 200 nits Global Dimming: None ABC: None	On Mode: 8.55W PSU: 83% Reflective Polarizer: Yes Lamp Efficacy (LED): 125lm/W Screen Brightness: 255 nits Global Dimming: None ABC: None
22"	On Mode: 29.42W PSU: 87% Reflective Polarizer: None Lamp Efficacy (LED): 105lm/W Screen Brightness: 275 nits Global Dimming: Not enabled by default ABC: None	On Mode: 13.78W PSU: 88% Reflective Polarizer: Yes Lamp Efficacy (LED): 110lm/W Screen Brightness: 200 nits Global Dimming: Enabled by default ABC: Yes	On Mode: 14.34W PSU: 87% Reflective Polarizer: None Lamp Efficacy (LED): 110lm/W Screen Brightness: 241 nits Global Dimming: Enabled by default ABC: None	On Mode: 13.33W PSU: 87% Reflective Polarizer: Yes Lamp Efficacy (LED): 105lm/W Screen Brightness: 241 nits Global Dimming: Enabled by default ABC: None	On Mode: 14.73W PSU: 87% Reflective Polarizer: None Lamp Efficacy (LED): 125lm/W Screen Brightness: 241 nits Global Dimming: Not enabled by default ABC: None
27"	On Mode: 38.38W PSU: 88% Reflective Polarizer: Yes Lamp Efficacy (LED): 87lm/W Screen Brightness: 400 nits Global Dimming: None ABC: None	On Mode: 17.25W PSU: 88% Reflective Polarizer: Yes Lamp Efficacy (LED): 110lm/W Screen Brightness: 170 nits* Global Dimming: Yes ABC: None Improved TFT (low)	On Mode: 20.04W PSU: 88% Reflective Polarizer: Yes Lamp Efficacy (LED): 107lm/W Screen Brightness: 170 nits Global Dimming: None ABC: Yes	On Mode: 19.36W PSU: 88% Reflective Polarizer: Yes Lamp Efficacy (LED): 110lm/W Screen Brightness: 170 nits Global Dimming: Yes ABC: None	On Mode: 19.62W PSU: 88% Reflective Polarizer: Yes Lamp Efficacy (LED): 107lm/W Screen Brightness: 170 nits Global Dimming: Yes ABC: None

#### 7.4.1 LED improvements

We performed calculations for three scenarios representing improvements in LED lamp efficacy for each monitor pair: modeling increased lamp efficacy to 110 lumens per Watt (lm/W), 125 lm/W and 150 lm/W. Improving to 110lm/W is slightly better than current typical display lamp efficacy (95-100 lm/W according to discussions with industry experts). Increases in overall display efficiency of the efficient models ranged from 1 percent in the case of the 27" which already had efficient lamps (107lm/W) to 22 percent in the case of the 19" model. Costs for these lamps were estimated from discussions with industry experts based on DisplaySearch costs for slightly lower performance lamps. Further increasing lamp efficacy to 125lm/W and 150 lm/W increased total display efficiencies significantly (8% to 30%) while only moderately increasing costs. The reason for this favorable outcome stems from using more efficacious lamps to produce the same amount of backlight, which allows manufacturers to build displays with fewer lamps. Costs for the 125lm/W and 150lm/W lamps were conservatively estimated to be considerably higher (two times and eight times respectively) than the cost of typical lamps found in current displays.

#### 7.4.2 Reflective polarizing film

In the case of the 19" and 22" pairs, neither the representative nor the efficient test units contained a reflective polarizer which is a low cost means to recycle improperly polarized light rather than letting it be lost as absorbed heat. This improvement increases LCD transmissivity which enables the use of a less powerful BLU. When we theoretically added a reflective polarizer to the 19" and 22" efficient models, it increased overall efficiency by 10 percent and 15 percent respectively. This estimate is based on component manufacturer estimates for BLU improvements (HDTVExpert.com 2012, 3M 2013). Cost estimates are based on data supplied by DisplaySearch's BLU Cost Model. Both of the 27" models already contained a reflective polarizing film and therefore this efficiency improvement was not considered for the 27" pair analysis.

The market for reflective polarizing film has been dominated by 3M. Although 3M's patent has expired recently, other market players have yet to attain a significant market share<sup>7</sup>. For this reason, we have included the use of reflective polarizing as only one of several paths to our proposed efficiency levels. Our proposed limits do not require the use of reflective polarizing film.

#### 7.4.3 Power supply improvements

For the 22" pair, the efficient display included an internal power supply with a measured power supply efficiency of 80 percent. Recent improvements in power supply topologies have enabled more efficient power supplies to be developed and included in electronic devices. When we theoretically replaced the existing power supply with an 88 percent efficient power supply (the efficiency of the best power supply we tested) in the efficient model, it increased overall efficiency by nearly 8 percent at an estimated incremental cost of about \$3.00. The 19" efficient display showed a similar level of improvement while the 27" display demonstrated only a modest efficiency improvement (1%) since its power supply was already quite efficient (87%).

#### 7.4.4 Automatic Brightness Control (ABC)

ABC is a method for adjusting a display's brightness to increase in bright ambient conditions and decrease in more dimly lit conditions. Reducing screen brightness in darker conditions reduces eye

---

<sup>7</sup> Example of another manufacturer of reflective polarizing film:  
<http://www.nittousa.com/files/ProductDetails.aspx?PId=447>

strain and also reduces BLU power. In order to account for energy savings for ABC, an estimate for time spent in dim and bright conditions was made. For the purposes of this analysis, we estimated a split of 80 percent of on mode time in a bright room, such as an office, and 20 percent of the time spent in more dim conditions, such as a gaming or video viewing environment. Using ENERGY STAR's current power measurement points of 10 lux and 300 lux, we found a 9 percent savings in on mode power on the unit we tested equipped with ABC. Based on our testing, we are proposing to align with the ENERGY STAR approach of a 10 percent adder to the allowable on-mode power for monitors that meet its criteria for enabling ABC by default (ENERGY STAR 2013).

The cost associated with implementing ABC are based on three basic required components: (1) the ability of a display to dim its backlight, (2) an ambient light sensor that measures lighting levels, and (3) the software to interpret the light levels and translate them to a particular display brightness. All displays we tested had the ability to dim their backlight, so costs for this component were not considered. Conversations with sensor manufacturers have revealed that the sensors typically cost between 10 and 25 cents each. Finally, we estimated the cost of the software to communicate light levels to a display's backlight to be minimal when implemented in mass production, giving a total incremental cost of approximately 50 cents to implement ABC in a display.

#### 7.4.5 Backlight Dimming To Video Content

Similar to ABC, dimming (also referred to as global dimming) reduces the light output and therefore power of a display. However, the degree to which the backlight dims depends on the brightness of the video content instead of the brightness of the room. Two of the units tested incorporated dimming (22" representative model and 27" efficient model, see Figure 7.4 and Figure 7.5), however, they were not enabled by default. Power savings with dimming enabled using the IEC video clip were 35 percent and 40 percent for the 22" and 27" models respectively. For this analysis, a conservative power reduction of 30 percent was used and applied to all efficient units.

Through consultation with industry experts, we estimated costs for dimming to video content to be similar to those for ABC. The need to interpret signal picture levels and apply them to backlight output may require a slightly higher processing capability, so we used an incremental cost of \$1 for implementation of dimming strategies.

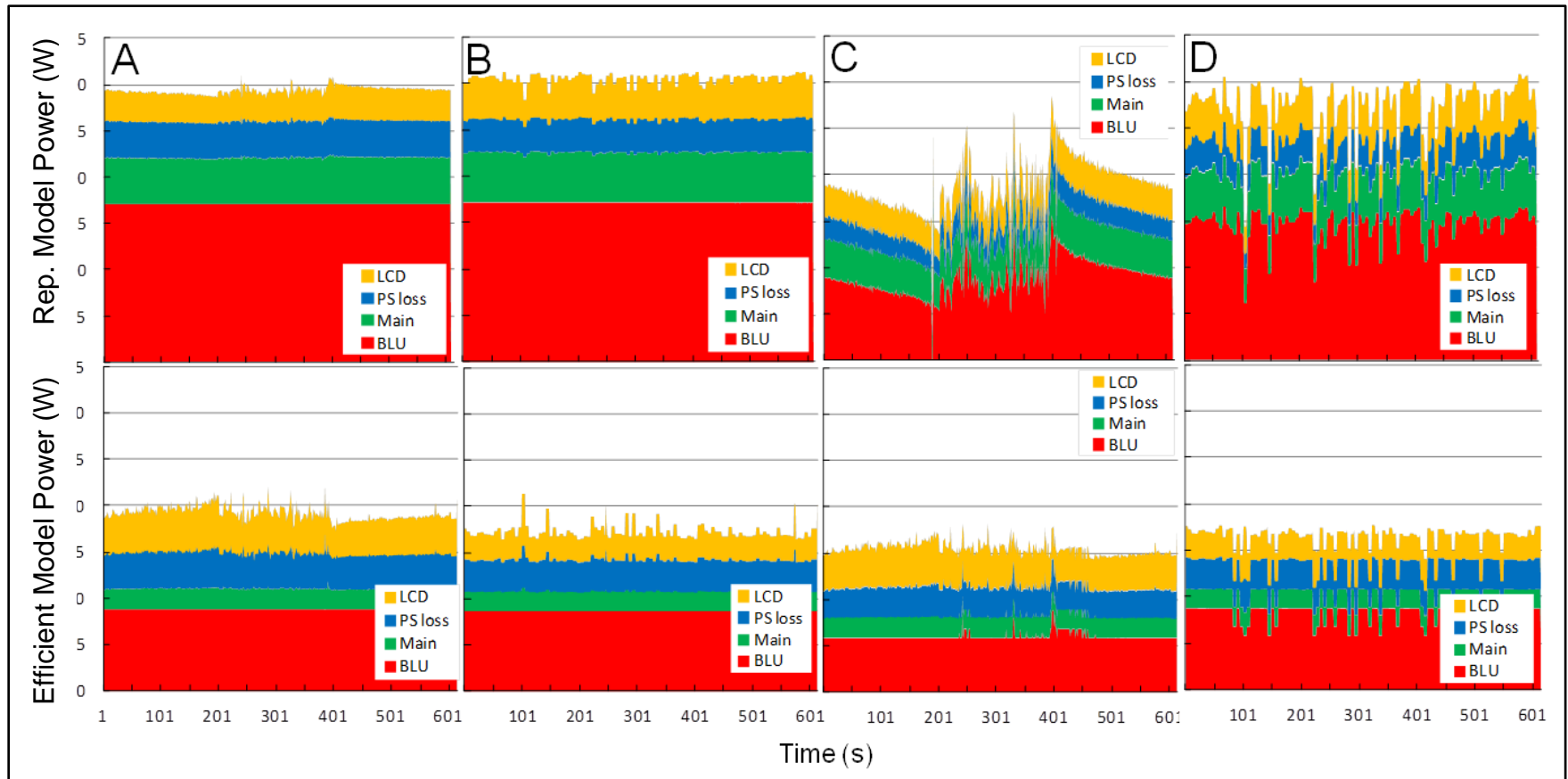
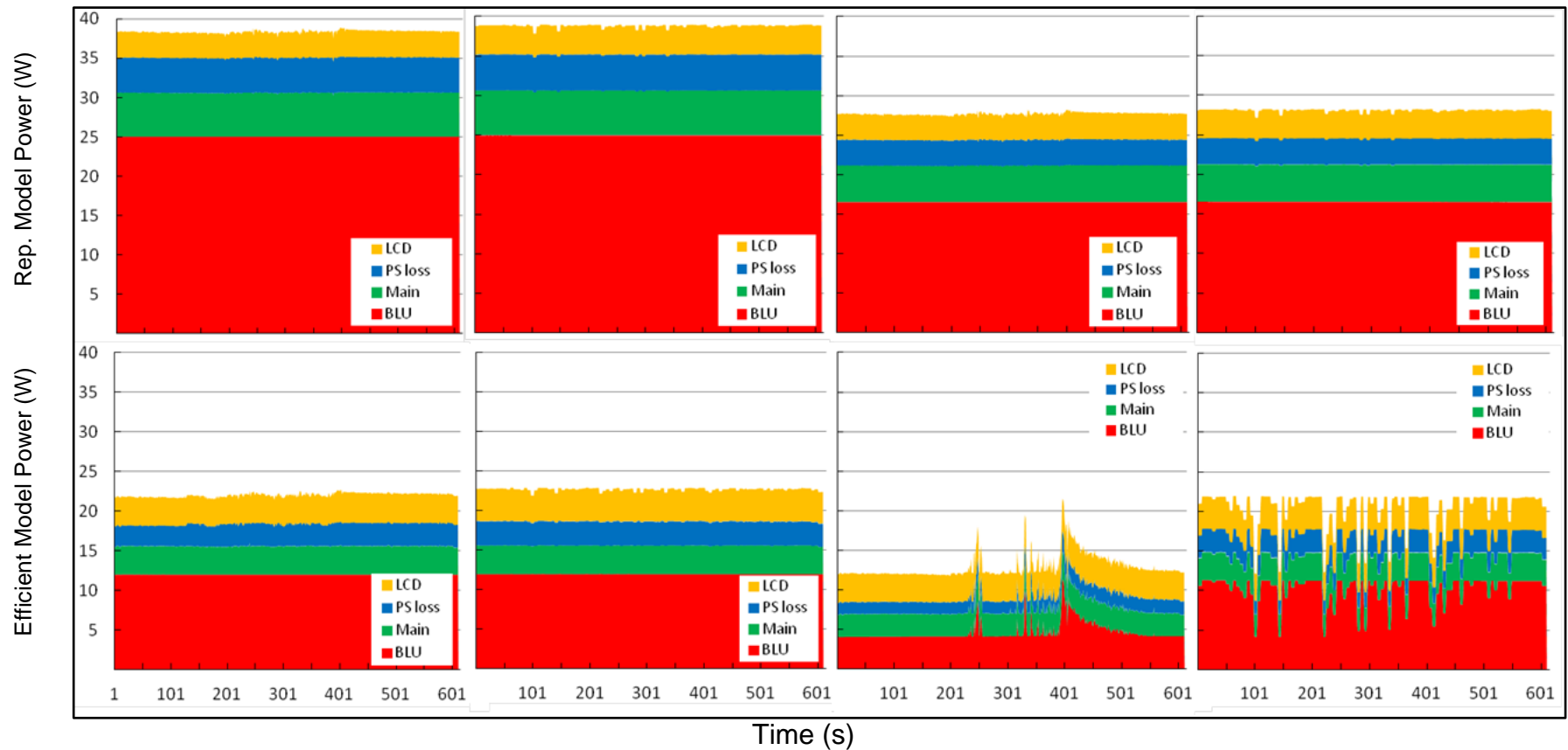

Figure 7.4 Instantaneous power over the 10-minute IEC test clip for the representative display (D22-1), top row, and efficient display (D22-2), bottom row. (A) IEC video test clip, default mode (B) IEC internet test clip, default mode (C) IEC video test clip, power scaling mode (D) IEC internet test clip, power scaling mode

Source: CASE Team analysis





**Figure 7.5** Instantaneous power over the 10-minute IEC test clip for the representative model (D27-1), top row, and efficient model (D27-2), bottom row. (A) IEC video test clip, default mode (B) IEC internet test clip, default mode (C) IEC video test clip, power scaling mode (D) IEC internet test clip, power scaling mode

Source: CASE Team analysis

#### 7.4.6 Limit Screen Brightness (Calibration)

In our testing, we found a wide range of screen brightness values in default mode which has a significant impact on BLU power (see Table 4.1). Although the ENERGY STAR test procedure requires calibration of units to 200 nits (candelas per square meter), our test data shows that this method is not representative of real world power usage. For example, the efficient 22" monitor had a default luminance value of 255 nits and a corresponding on mode power of 14 watts (Table 4.1). Reducing the default brightness to 200 nits results in an on mode power of just under 12 watts, a 15% reduction in power with zero incremental cost.

#### 7.4.7 Emerging Technology Options

It is important to note that for our cost effective analysis above we did not include scenarios including the following emerging technology options given the uncertainty in uptake of these technologies in the market. However, we did examine them given likely future development and cost reductions for these technologies that may lead to even greater future energy efficiency improvements in the coming years.

##### 7.4.7.1 Quantum Dots

Quantum dots are very tiny particles that can emit light at very specific wavelengths. Used in conjunction with an LCD panel's color filter, they can theoretically produce red, blue and green light more efficiently and with a greater color gamut than current displays (LEDs Magazine 2011). The increased efficiency comes in part from using current (blue light emitting) LEDs without a phosphor coating that creates white light. At least one manufacturer has begun implementing this technology and offered currently by multiple suppliers: QD Vision and 3M (CNET 2013a; QD Vision 2013; 3M 2013).

##### 7.4.7.2 Higher LCD Panel Transmissivity

Efficient approaches to reduce backlight demand include increasing pixel effective area by reducing the area of thin film transistors (TFTs) that block light (Figure 7.6). Sharp has introduced its indium gallium zinc oxide (IGZO) thin film transistor (TFT) technology which takes up less space than traditional amorphous silica TFTs (Reuters 2012). In addition, this technology reportedly saves energy through the reduction of screen refreshes required for still images when compared to amorphous silica TFT technology (CNET 2013b).

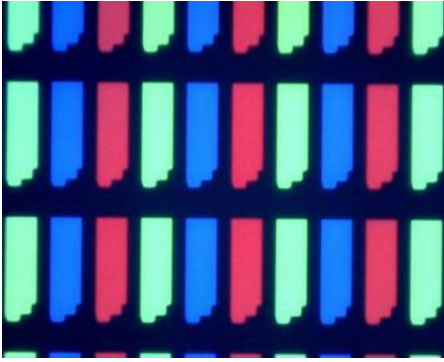

**Figure 7.6 Micrograph of a Twisted Nematic LCD Panel<sup>8</sup>**

Another potential method to reduce backlight demand includes adding additional sub-pixel colors beyond red, green and blue. In TVs, some manufacturers have implemented yellow or white sub-pixels to create a panel that reportedly transmits light more efficiently (Sharp 2010). We would expect this approach could be adapted for computer monitors as well.

Matching LCD technology to content and application is another way to increase panel transmissivity. IPS panels align liquid crystals to an open position when voltage is applied, while TN panels will remain open until a voltage is applied, blocking light from passing through. Using a test clip with more dark images than light images (such as the IEC video test clip) provides an advantage to the IPS technology. Additionally, TN panels have a narrower viewing angle which works well for an individual at a workstation, but is less optimal when a monitor is used as a television with multiple viewers. Therefore, matching IPS LCD technology to larger monitors intended for more television type usage (darker images, wider viewing angle) and TN technology to other monitors intended for more traditional computing type usage (white backgrounds, smaller viewing angle) makes sense from an energy standpoint.

#### 7.4.7.3 Organic light emitting diode (OLED)

Because they do not require a backlight or filters, OLED displays theoretically have the potential to use less energy than LCD displays. Our testing of an available 25" OLED monitor showed much higher average plug load power draw than the highly efficient 27" LED-LCD tested (58W vs. 22W). This was expected as the OLED display was an early generation model, not the product of a mature and efficient manufacturing process such as that of the 27" LED-LCD. In addition, the OLED display was designed for professional editing usage, incorporating fans and other heat protecting features to account for a duty cycle with greater time spent in active mode.

To account for these differences, we compared component level measurements between the two monitors and estimated the power draw of an OLED with more efficient processing and display controls that would be in line with a more mass produced product that is also designed for a more typical consumer duty cycle. This results in a modeled OLED display that uses 2 to 3 more watts than the LED-LCD display. With future improvements in the manufacturing process and OLED lighting efficiency, it is possible OLED displays will achieve the theoretical energy use advantage over LCDs.

---

<sup>8</sup> Each green, blue and red block is a subpixel that, when open, lets colored light out of the front of the display. Black areas are TFTs and structural material. The less space occupied by TFTs and structural material, the more light passes through the panel.

## 8 Acceptance Issues

### 8.1 Infrastructure issues

Aligning with many aspects of the ENERGY STAR framework minimizes most acceptance issues. The specification will have been effective since June 1, 2013. Since an estimated 70 percent of monitors are expected to meet Version 6.0 requirements in 2013, it is assumed that they will be able to meet the proposed standard levels by 2015 given the rapid rate of development in the consumer electronics industry.

The CA investor owned utilities (IOUs) have Consumer Electronics programs as a component of their energy efficiency program portfolios. These programs provide incentives for retailers and/or manufacturers to sell high-efficiency monitors and should thus help to prepare the market for the proposed Title 20 standard. As of November 1, 2009, PG&E and SMUD provide incentives for models that meet the proposed Title 20 standards. By 2014, this program should have helped move the market towards the proposed standard.

At this time, it is estimated that 10 percent of computer monitors being sold meet the new standard. By 2014, it is expected that most manufacturers will ramp up to meet ENERGY STAR, further increasing compliance with the proposed Title 20 standard.

One potential market barrier is retailer and manufacturer compliance to a California standard. While it is easier to enforce a standard on brick and mortar retailers, a standard may be difficult to enforce for online retailers shipping to California. Many monitors are purchased online, and many popular online retailers ship from out of state. Major OEMs such as Dell, HP, and Acer should be able to customize online purchasing options to California zip codes to ensure only products meeting this standard are sold in California. The CEC should work with all stakeholders in order to ensure that retailers are in compliance with the new standards.

### 8.2 Existing Standards

There are currently no federal or state standards for most electronic displays. However, as noted previously, signage displays up to 1,400 in-sq are covered under current California regulations. There are also state and federal voluntary programs that offer incentives for efficient displays meeting specific levels. Also note previously, there are current federal efficiency standards for external power supplies that have been in effect since July 2008 (and which DOE is currently updating – with a potential effective date September 2015).

The European Union (EU) is currently considering adopting minimum efficiency standards for electronic displays.

### 8.3 Stakeholder Positions

Refer to Invitation to Participate responses (CEC 2013) for stakeholder comments.

## 9 Environmental Impacts

### 9.1 Air Quality

The proposed measure for computer monitors is estimated to reduce total criteria pollutant emissions in California by 69,700 lbs/year in 2019, after stock turnover, as shown in Table 9.1 due to 405 GWh in reduced end user electricity consumption with an estimated value of \$3,338,600.

The proposed measure for signage displays is estimated to reduce total criteria pollutant emissions in California by 258,300 lbs/year in 2022, after stock turnover, as shown in Table 9.2 due to 1502 GWh in reduced end user electricity consumption with an estimated value of \$12,378,400.

Criteria pollutant emission factors for California electricity generation were calculated per MWh based on California Air Resources Board data of emission rates by power plant type and expected generation mix [CARB 2010]. The monetization of these criteria pollutant emission reductions is based on CARB power plant air pollution emission rate data times the dollar per ton value of these reductions based on Carl Moyer values where available, and San Joaquin Valley UAPCD “BACT” thresholds for sulfur oxides (SOx). These dollar per ton values vary significantly for fine particulates, as discussed in Appendix E: (CARB 2011a, CARB 2013a and San Joaquin Valley UAPCD).

**Table 9.1 Estimated California Criteria Pollutant Reduction Benefits (lbs/year) After Stock Turnover – Computer Monitors**

	lbs/year	Carl Moyer \$/ton (2013)	Monetization
ROG	11,160	\$17,460	\$97,428
NOx	38,064	\$17,460	\$332,295
SOx	4,001	\$18,300	\$36,606
PM2.5	16,450	\$349,200	\$2,872,223
<b>Total</b>			<b>\$3,338,600</b>

**Table 9.2 Estimated California Criteria Pollutant Reduction Benefits (lbs/year) After Stock Turnover – Signage Displays**

	lbs/year	Carl Moyer \$/ton (2013)	Monetization
ROG	41,379	\$17,460	\$361,236
NOx	141,129	\$17,460	\$1,232,058
SOx	14,833	\$18,300	\$135,726

	lbs/year	Carl Moyer \$/ton (2013)	Monetization
PM2.5	60,993	\$349,200	\$10,649,416
<b>Total</b>			<b>\$12,378,400</b>

## 9.2 Greenhouse Gases

Table 9.3 shows the annual and stock GHG savings for computer monitors by year and the range of the societal benefits as a result of the standard. By stock turnover in 2019, this standard would save 177,000 metric tons of CO<sub>2</sub>e, equal to between \$9,111,827 and \$27,118,533 of societal benefits.

Table 9.4 shows the annual and stock GHG savings for signage displays by year and the range of the societal benefits as a result of the standard. By stock turnover in 2022, this standard would save 657,000 metric tons of CO<sub>2</sub>e, equal to between \$36,211,537 and \$108,634,610 of societal benefits.

**Table 9.3 Estimated California Statewide Greenhouse Gas Savings and Cost Savings for Standards Case – Computer Monitors**

Year	Annual GHG Savings (MT of CO <sub>2</sub> e/yr)	Stock GHG Savings (MT of CO <sub>2</sub> e/yr)	Value of Stock GHG Savings - low (\$)	Value of Stock GHG Savings - high (\$)
2013	0	0	\$-	\$-
2014	0	0	\$-	\$-
2015	35,568	35,568	\$1,656,488	\$4,751,504
2016	35,362	70,929	\$3,390,305	\$9,823,192
2017	35,362	106,291	\$5,210,801	\$15,241,593
2018	35,362	141,653	\$7,117,975	\$21,006,707
2019	35,362	177,014	\$9,111,827	\$27,118,533

**Table 9.4 Estimated California Statewide Greenhouse Gas Savings and Cost Savings for Full Compliance Case – Signage Displays**

Year	Annual GHG Savings (MT of CO <sub>2</sub> e/yr)	Stock GHG Savings (MT of CO <sub>2</sub> e/yr)	Value of Stock GHG Savings - low (\$)	Value of Stock GHG Savings - high (\$)
2013	0	0	\$-	\$-
2014	0	0	\$-	\$-
2015	60,313	60,313	\$2,808,949	\$8,057,250

Year	Annual GHG Savings (MT of CO <sub>2</sub> e/yr)	Stock GHG Savings (MT of CO <sub>2</sub> e/yr)	Value of Stock GHG Savings - low (\$)	Value of Stock GHG Savings - high (\$)
2016	66,698	127,012	\$6,070,934	\$17,590,143
2017	72,859	199,871	\$9,798,437	\$28,660,429
2018	79,020	278,891	\$14,014,110	\$41,358,713
2019	85,181	364,072	\$18,740,604	\$55,775,606
2020	91,342	455,413	\$24,000,572	\$72,001,715
2021	97,502	552,916	\$29,816,665	\$89,449,996
2021	103,663	656,579	\$36,211,537	\$108,634,610

The total avoided CO<sub>2</sub>e is based on CARB’s estimate of 437 MT CO<sub>2</sub>e/GWh of energy savings from energy efficiency improvements, and includes additional electrical transmission and distribution losses estimated at 7.8% (CARB 2008a). The range of societal benefits per year is based on a range of annual \$ per metric ton of CO<sub>2</sub> (in 2013 dollars) sourced from the U.S. Government's Interagency Working Group on Social Cost of Carbon (SCC) (Interagency Working Group 2013). The low end uses the average SCC, while the high end incorporates SCC values which use climate sensitivity values in the 95th percentile, both with 3% discount rate. It is important to note that this range can be lower and higher, depending on the approach used, so policy judgments should consider this uncertainty. See Appendix F: for more details regarding this and other approaches.

### 9.3 Hazardous Materials

At this time, we are not aware of any known net negative hazardous materials impacts from incremental efficiency improvements as a result of the proposed standards.

## 10 Recommendations

### 10.1 General Requirements

#### 10.1.1 Rounding and Significant Digits

In regards to rounding and significant digits, we propose the requirements to align with requirements in Section 3.1 of the ENERGY STAR specification. That is, all calculations should be carried out with directly measured (unrounded) values; compliance with specification requirements shall be evaluated using directly measured or calculated values without any benefit from rounding; and directly measured or calculated values that are submitted for reporting shall be rounded to the nearest significant digit as expressed in the corresponding specification requirements.

### 10.1.2 Power Management

We propose the requirements to align with the following power management requirements outlined in Section 3.2.2 of the ENERGY STAR specification:

- Products shall offer at least one power management feature that is enabled by default, and that can be used to automatically transition from On Mode to Sleep Mode either by a connected host device or internally (e.g., support for VESA Display Power Management Signaling (DPMS), enabled by default).
- Products that generate content for display from one or more internal sources shall have a sensor or timer enabled by default to automatically engage Sleep or Off Mode.
- For products that have an internal default delay time after which the product transitions from On Mode to Sleep Mode or Off Mode, the delay time shall be reported.
- Computer monitors shall automatically enter Sleep Mode or Off Mode within 15 minutes of being disconnected from a host computer.

### 10.1.3 Luminance Testing at Default Settings

Measured luminance in the default picture setting ( $L_{\text{DEFAULT}}$ ) shall be greater than or equal to 65% of measured peak luminance in the brightest picture setting ( $L_{\text{BRIGHTEST}}$ ).

## 10.2 Power Mode Requirements

### 10.2.1 Computer Monitors

Modal power limits place a cap on the amount of power that computer monitors can draw in a given mode. Modal power limits save energy by reducing the amount of energy computer monitors use in any regulated operational mode.

The proposed standards establish on mode power maximum ( $P_{\text{ON\_MAX}}$ ) for computer monitors based on screen area and resolution and outlined in Table 10.1. This approach is similar to how ENERGY STAR establishes on mode power requirements and is accepted by stakeholders. While an approach was considered to propose on mode requirements based on only screen size (as is established in the Title 20 energy conservation standard for TVs), further analysis showed that resolution does not necessarily scale linearly with screen size. The CASE Team is continuing to investigate the appropriate power adder for resolution and may refine this proposal as additional information or test data are made available. Additional power maximum are proposed for standby mode ( $P_{\text{SLEEP\_MAX}}$ ) and off modes ( $P_{\text{OFF\_MAX}}$ ).



**Table 10.1 Maximum Power Requirements by Mode – Computer Monitors**

Diagonal Screen Size in Inches ( <i>d</i> )	On Mode in Watts ( $P_{ON\_MAX}$ )	Standby Mode in Watts ( $P_{SLEEP\_MAX}$ )	Off Mode in Watts ( $P_{OFF\_MAX}$ )
$d < 12''$	$(4.2 * r) + (0.04 * A) + 1.8$		
$12'' \leq d < 17''$	$(4.2 * r) + (0.01 * A) + 3.5$		
$17'' \leq d < 23''$	$(4.2 * r) + (0.02 * A) + 2.2$	1.0	0.5
$23'' \leq d < 25''$	$(4.2 * r) + (0.04 * A) - 2.4$		
$25'' \leq d < 61''$	$(4.2 * r) + (0.07 * A) - 10.2$		

*r* = Screen resolution (megapixels)

*A* = Viewable screen area (square inches)

### Automatic Brightness Control (ABC)

As stated previously, ABC has the potential to save energy by decreasing display brightness in darker room conditions. Though we are not aware of conclusive studies that show ABC as currently implemented in computer monitors save energy, we recognize the energy saving potential of this feature. Therefore, at this time, we are proposing to align with the approach outlined in the ENERGY STAR Specification. The following 10 percent power allowance ( $P_{ABC}$ ) for products with ABC enabled by default in Equation 10.1, shall be added to  $P_{ON\_MAX}$ , as calculated per Table 10.1. The power allowance, however, can only be applied to  $P_{ON\_MAX}$  if the On Mode power reduction ( $R_{ABC}$ ) between the power measured at 300 lux ( $P_{300}$ ) and 10 lux ( $P_{100}$ ) is greater than or equal to 20 percent (Equation 9.2).

#### Equation 10.1 Calculation of $P_{ABC}$

$$P_{ABC} = 0.10 * P_{ON\_MAX}$$

#### Equation 10.2 Calculation of $R_{ABC}$

$$R_{ABC} = 100 * [(P_{300} - P_{10}) / P_{300}]$$

### Enhanced Performance Displays (EPDs)

We understand from industry representatives that some of the enhanced capabilities of EPDs include: increased color range, better viewing angles, higher resolution, integrated accessories, and expansion potential. We also understand that there are specialized applications for EPDs for

engineering, medical, architecture, and graphic design. More detailed market information for EPDs can be obtained from IHS iSuppli (IHS iSuppli 2010).

Because of these enhanced capabilities, ENERGY STAR also established power adders to the calculated On Mode power limit in order to account for additional power consumption due to enhanced capabilities based on data submitted to ENERGY STAR. To date, there are already 19 product entries, representing numerous EPD models that meet the Version 6 requirements (EPA 2013c).

For products meeting the definition of an EPD, a power allowance ( $P_{EP}$ ), similar to the ENERGY STAR Specification, shall be added to the on mode power maximum ( $P_{ON\_MAX}$ ) as calculated in Table 10.1. In these cases, measured on mode power ( $P_{ON}$ ) shall be less than or equal to the sum of  $P_{EP}$  and  $P_{ON\_MAX}$ . The power allowance ( $P_{EP}$ ) shall be calculated using the following equations in Table 10.2 depending on the diagonal screen size of the EPD.

**Table 10.2 Calculation of On Mode Power Allowance for Enhanced Performance Displays**

Diagonal Screen Size in Inches ( $d$ )	On Mode Power Allowance in Watts ( $P_{EP}$ )
$d < 27''$	$0.30 * PON\_MAX$
$d \geq 27''$	$0.75 * PON\_MAX$

**Products with Pixel Density ( $Dp$ ) > 20,000 pixels per sq-in**

One area we are not at this time proposing alignment with the ENERGY STAR approach is regarding products with a pixel density greater than 20,000 pixels per square-inch. The ENERGY STAR specification includes separate on mode power requirements for these products. In our entire dataset of over 4,000 models, we have identified a total of five models that meet this criterion. Of those five models, the two 2013 models would meet the on mode power requirements listed in Table 10.1 (i.e., they would not need separate requirements). Until further information or test data are provided, we are not proposing separate requirements for these products.

**Sleep Mode Requirements**

Another area we our proposal diverges from the ENERGY STAR approach is regarding sleep mode. ENERGY STAR sets a base sleep mode of 0.5 watts with additional allowances for bridging or network capabilities that could exceed 1.0 watt. Based on our testing and the dataset, an allowance of 1.0 watt would be appropriate for a California regulation. The previous ENERGY STAR specification (Version 5) had a 1.0 watt requirement. As previously noted, the shipment data provided to ENERGY STAR by manufacturers showed that 85 percent of all models shipped in 2011 met the 1.0 watt Sleep Mode criteria. We would expect that percentage to include almost all models shipped by 2012. Unless additional data are provided, at this time we are recommending a 1.0 watt sleep mode power requirement. We are continuing to investigate this area and may refine this initial proposal as test data and information is made available.

### 10.2.2 Signage Displays – Power Mode Requirements

Based on guidance provided by the CEC to the Consumer Electronics Association (CEA) in a letter dated March 29, 2010, and referenced by a stakeholder in their response to the ITP request (Panasonic 2013), electronic displays that do not contain tuners are subject to the television regulations. In their response to the ITP, the stakeholder noted they understood that Professional Signage (i.e., Signage Displays) were already covered under the TV regulations (Docket No. 09-AAER-1C). The manufacturer stated that they were designing and registering applicable products to adhere to these existing regulations.

Therefore, we propose to update the definitions in Title 20 to provide clarity. Additionally, we suggest clearly outlining power mode requirements for signage displays as a separate category from TVs as these are distinct products. Table 10.3 below outlines the on mode and standby mode power requirements currently in effect under Title 20 for signage displays. The new requirements proposed in Table 10.3 are (1) an off mode requirement of 0.5 watts (in alignment with ENERGY STAR specification) and (2) an extension of modal power requirements to previously uncovered signage display products (i.e., products with a screen area greater than or equal to 1,400 in-sq). Figure 10.1 also depicts the current on mode power standard and newly proposed on mode requirements. At this time we are proposing these levels at a minimum.

**Table 10.3 Maximum Power Requirements by Mode – Signage Displays**

Screen Size (area <i>A</i> in inches squared)	On Mode (W)	Standby Mode (W)	Off Mode (W)
$A < 1400$	$(0.12 * A) + 25$	1	0.5
$A \geq 1400$	$(0.12 * A) + 25$	1	0.5

Where *A* = Viewable screen area (square inches).

Shaded requirements indicate current T20 regulations in effect since January 1, 2013.

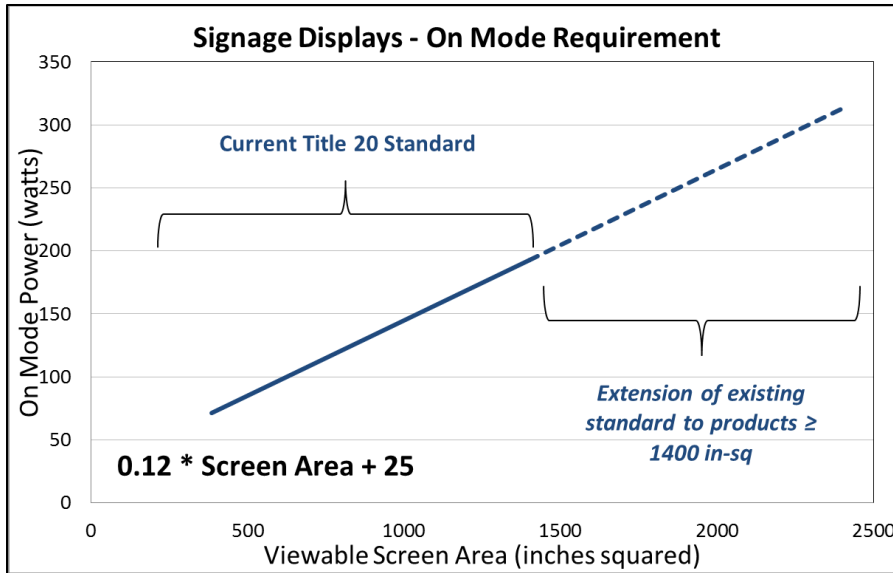
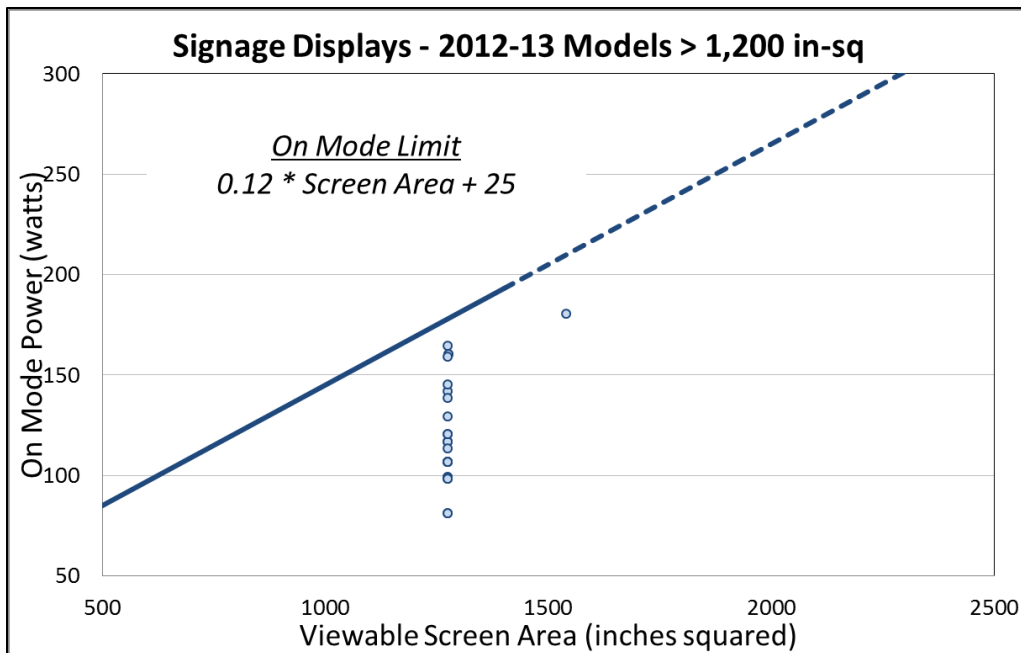

Figure 10.1 On Mode Power Requirements – Signage Displays

We are proposing extending the on mode requirements for signage displays over 1,400 in-sq (57 inches diagonal) because energy use data for recently-manufactured signage displays in a similar large size category (i.e., greater than 50-inches diagonal) shows that the current limit is achievable. Specifically, *all* 24 of the signage displays greater than 50 inches manufactured in 2012 and 2013 in the ENERGY STAR qualified product list (dated July 23, 2013) meet the Title 20 on mode requirements which are almost 50% more stringent than the ENERGY STAR requirement. As shown in Figure 10.2, these large signage displays models consume on average **32% less** than their calculated Title 20 on mode power limit. We believe implementation of the same technologies and approaches to limit the energy consumption in 1,200+ in-sq models is scalable to models larger than 1,400 in-sq as they are used in similar applications and, therefore, should be considered for inclusion under the existing regulations.

The extended usage profile for signage displays in commercial applications, as discussed in Section 4.3, requires these large signage displays to be in on mode for a much higher percentage of the time than computer monitors. Given their significant energy use in California and feasibility of meeting cost-effective, technically feasible efficiency standards, signage displays larger than 1,400 in-sq should be considered for inclusion under the existing regulations.



**Figure 10.2 On Mode Values for 2012-2013 Signage Displays > 1,200 in-sq**

Source: CASE Team Analysis

We are continuing to investigate the (1) current compliance rate to the Title 20 standard; (2) energy use characteristics of units not within the scope of existing standards; and (3) overall market characteristics for signage displays in an effort to analyze power requirements that would achieve even greater energy savings that are cost-effective and technically-feasible.

### 10.3 Test and List Requirements

#### 10.3.1 USB-Powered Computer Monitors – Test and List

As noted previously, the scope of this proposal only includes those products powered directly from AC mains. Therefore, monitors powered with one or multiple DC universal serial bus (USB) cables would be excluded from the scope of the proposed modal power requirements. However, as these DC-powered monitors are becoming more available and utilize very efficient technologies, a test-and-list requirement is recommended for these displays at this time. This would require manufacturers to test their products to a standard test procedure and report to the CEC the amount of power these monitors use in the different power modes. The test procedure to measure modal power use for these products should be the applicable test method section of the ENERGY STAR specification.

#### 10.3.2 Digital Picture Frames – Test and List

A test and list requirement is also suggested at this time for digital picture frames. A "test and list" requirement does not place a limit on power used by digital picture frames, just requires the reporting of power usage in the various modes. The test procedure to measure modal power use for these products should be the applicable test method section of the ENERGY STAR specification.

### 10.3.3 Digital Billboards – Test and List

To-date, we are unaware of an industry-accepted test procedure to measure the typical power consumption of digital billboards. As we investigate several options to develop a test procedure, a requirement to report characteristics and specifications of digital billboards sold or installed in California is suggested at this time and some initial fields are outlined in Appendix C. One characteristic the CASE Team would be especially interested in is a watts-per-square-foot value for a billboard project. Reporting requirements would compel manufacturers to submit relevant information on their products to the CEC.

## 10.4 Reporting Requirements

For computer monitors, signage displays, and digital picture frames, many of the same fields marked as “Required” in the Displays Template for ENERGY STAR qualification (EPA 2013e) could be included in the reporting requirements of a Title 20 regulation.

For digital billboards, an initial list of fields to be included in the reporting requirements for Title 20 regulations is outlined in Appendix C.

## 10.1 Implementation Plan

The expected implementation for this standards proposal is for the CEC to proceed with its appliance standards rulemaking authority, from pre-rulemaking and rulemaking through adoption, and for manufacturer compliance upon effective date.

## 11 References

- 3M. 2013. "Nanosys and 3M to Bring Amazing Color to Consumer Electronic Displays". <http://news.3m.com/press-release/company/nanosys-and-3m-bring-amazing-color-consumer-electronic-displays>.
- Ackerman, Frank and Elizabeth A. Stanton. 2012. Stockholm Environment Institute. *Climate Risks and Carbon Prices: Revising the Social Cost of Carbon*. <http://www.economics-ejournal.org/economics/journalarticles/2012-10>. Economics. April 4.
- [Amazon] Amazon.com. 2013. ViewSonic VX2255wmb 22" LCD Monitor with Integrated Webcam. <http://www.amazon.com/ViewSonic-VX2255wmb-Monitor-Integrated-Webcam/dp/B000OLG74I>. Accessed on May 8, 2013.
- Brown, Richard E. and Jonathan G. Koomey. 2002. "Electricity Use in California: Past Trends and Present Usage Patterns." *Energy Policy* (also LBNL-47992). vol. 31, no. 9. July. pp. 849-864.
- [CARB] California Air Resources Board. 2008a. AB 32 Technical Stakeholder Working Group Meeting. *Cost-Effectiveness*. [http://www.arb.ca.gov/cc/scopingplan/economics-sp/meetings/060308/ce\\_white\\_paper.pdf](http://www.arb.ca.gov/cc/scopingplan/economics-sp/meetings/060308/ce_white_paper.pdf). June 3.
- . 2008b. *Climate Change Scoping Plan Appendices Volume II: Analysis and Documentation*. [http://www.arb.ca.gov/cc/scopingplan/document/appendices\\_volume2.pdf](http://www.arb.ca.gov/cc/scopingplan/document/appendices_volume2.pdf). December.
- . 2010. Proposed Regulation for a California Renewable Electricity Standard Staff Report: Initial Statement of Reasons Appendix D. <http://www.arb.ca.gov/regact/2010/res2010/res10isor.pdf>. Accessed July 24, 2013.
- . 2011a. California Air Resources Board. *Appendix C: Cost Effectiveness Calculation Methodology*. [http://www.arb.ca.gov/msprog/moyer/guidelines/2011gl/appc\\_3\\_10\\_11.pdf](http://www.arb.ca.gov/msprog/moyer/guidelines/2011gl/appc_3_10_11.pdf). March 10.
- . 2011b. *Emission Reduction Offsets Transaction Cost Summary Report for 2011*. <http://www.arb.ca.gov/nsr/erco/erco.htm>.
- . 2012. *Emission Reduction Offsets Transaction Cost Summary Report for 2012*. <http://www.arb.ca.gov/nsr/erco/erco.htm>.
- . 2013a. *Mail-Out #MSC 13-09*. <http://www.arb.ca.gov/msprog/mailouts/msc1309/msc1309.pdf>. March 25.
- . 2013b. California Air Resources board Quarterly Auction 3, May 2013 – *Summary Results Report*. [www.arb.ca.gov/cc/capandtrade/auction/may-2013/results.pdf](http://www.arb.ca.gov/cc/capandtrade/auction/may-2013/results.pdf).
- [CEC] California Energy Commission. 2012. *Adopted California Energy Commission Demand Forecast Report 2012-2022*. Mid-Case Final Demand Forecast. Updated September 19, 2012.
- . 2013. Responses to the Invitation to Participate in the 2013 Appliance Efficiency Rulemaking. <http://www.energy.ca.gov/appliances/2013rulemaking/documents/responses/>.
- [CLASP] Collaborative Labeling and Appliance Standards Program. 2013. Global S&L Database Website. [http://clasponline.org/en/Tools/Tools/SL\\_Search](http://clasponline.org/en/Tools/Tools/SL_Search). Washington, D.C. Accessed on May 8, 2013.

- [CNET] CNET. 2013a. "What are Quantum Dots, and how could they help your next TV?" [http://reviews.cnet.com/8301-33199\\_7-57569549-221/what-are-quantum-dots-and-how-could-they-help-your-next-tv/](http://reviews.cnet.com/8301-33199_7-57569549-221/what-are-quantum-dots-and-how-could-they-help-your-next-tv/). Accessed on May 8, 2013.
- \_\_\_ . 2013b. "At CES, Sharp explains benefits of its IGZO display tech". [http://ces.cnet.com/8301-34435\\_1-57562862/at-ces-sharp-explains-benefits-of-its-igzo-display-tech/](http://ces.cnet.com/8301-34435_1-57562862/at-ces-sharp-explains-benefits-of-its-igzo-display-tech/). Accessed on May 8, 2013.
- [Daktronics] Daktronics. 2011. "Daktronics Receives UL Energy Efficiency Certification" <http://www.daktronics.com/Company/NewsReleases/Pages/UL-Energy-Efficiency-Certification.aspx>. Accessed on July 28, 2013.
- [DigiTimes] DigiTimes. 2013. "Do quantum dot displays pose challenges for OLED?" <http://www.digitimes.com/news/a20130320VL200.html>. Accessed on May 8, 2013.
- [DOE] United States Department of Energy. 2012. Analysis of Room Illuminance and Televisions with Automatic Brightness Control. Dated March 2012.
- \_\_\_ . 2013. *Energy Conservation Program: Energy Conservation Standards for Standby Mode and Off Mode for Microwave Ovens*. <http://www.regulations.gov/#!docketDetail;rpp=10;po=0;D=EERE-2011-BT-STD-0048>. June 17, 2013.
- [DOL] United States Department of Labor. 2012. Bureau of Labor Statistics, CPI Inflation Calculator. [http://www.bls.gov/data/inflation\\_calculator.htm](http://www.bls.gov/data/inflation_calculator.htm). Accessed June 13, 2013.
- [Engadget] Engadget. 2013. Insert Coin: Lightpack turns your computer display into an ambient backlight. <http://www.engadget.com/2013/04/25/insert-coin-lightpack/>. Accessed on May 8, 2013.
- [EPA 2011] United States Environmental Protection Agency. 2011. ENERGY STAR® Unit Shipment and Market Penetration Report Calendar Year 2010 Summary.
- \_\_\_ . 2012a. ENERGY STAR® Displays Dataset. Revised 2012.
- \_\_\_ . 2012b. ENERGY STAR® Unit Shipment and Market Penetration Report Calendar Year 2011 Summary.
- \_\_\_ . 2012c. ENERGY STAR® Program Requirements for Television. Revised September 2012.
- \_\_\_ . 2013a. ENERGY STAR® Program Requirements for Displays. Revised January 2013.
- \_\_\_ . 2013b. Clarification Memo to the Version 6.0 ENERGY STAR® Displays Specification. Dated January 13, 2013.
- \_\_\_ . 2013c. ENERGY STAR® Displays Product List. Dated May 8, 2013.
- \_\_\_ . 2013d. ENERGY STAR® Office Equipment Calculator. Accessed on July 28, 2013.
- \_\_\_ . 2013e. ENERGY STAR® Displays Template. Dated July 28, 2013.
- [FHWA] United States Federal Highway Administration. 2001. "Research Review Of Potential Safety Effects Of Electronic Billboards On Driver Attention And Distraction". [http://www.fhwa.dot.gov/real\\_estate/practitioners/oac/electronic\\_billboards/chap00.cfm](http://www.fhwa.dot.gov/real_estate/practitioners/oac/electronic_billboards/chap00.cfm). Dated September 11, 2001.



- [Fraunhofer] Fraunhofer Center for Sustainable Energy Systems. 2011. "Energy Consumptions of Consumer Electronics in U.S. Homes in 2010". Dated December 2011.
- Horii, Brian and Dr. Jim Williams, Energy and Environmental Economics. 2013. *CPUC Workshop on Societal Cost Test*. <http://www.cpuc.ca.gov/NR/rdonlyres/E7263960-03C4-4BB2-8FD2-2FBF7DAD3436/0/SCTWorkshop6102013.pdf>. June.
- [IDC] International Data Corporation. 2013. "Soft PC Shipments in Fourth Quarter Lead to Annual Decline as HP Holds Onto Top Spot". <http://www.idc.com/getdoc.jsp?containerId=prUS23903013>. Press Release Accessed on May 8, 2013.
- [IHS iSuppli] IHS iSuppli. 2010. Specialty Monitor Market Tracker. Market Report Abstract. 2010.
- \_\_. 2012a. Worldwide Monitor Market Tracker Q3 2012. Market Report. 2012.
- \_\_. 2012b. Worldwide Signage & Professional Displays Market Tracker. Market Report. 2012.
- [Interagency Working Group] Interagency Working Group on Social Cost of Carbon, United States Government. 2013. Technical Support Document: Technical Update of the Social Cost of Carbon for Regulatory Impact Analysis Under Executive Order 12866. [http://www.whitehouse.gov/sites/default/files/omb/inforeg/social\\_cost\\_of\\_carbon\\_for\\_ria\\_2013\\_update.pdf](http://www.whitehouse.gov/sites/default/files/omb/inforeg/social_cost_of_carbon_for_ria_2013_update.pdf).
- Johnson, Laurie T. and Chris Hope. 2012. Journal of Environmental Studies and Sciences, Journal no. 13412. *The social cost of carbon in U.S. regulatory impact analyses: an introduction and critique*. [http://www.eenews.net/assets/2012/09/17/document\\_gw\\_05.pdf](http://www.eenews.net/assets/2012/09/17/document_gw_05.pdf). September 12.
- [LBNL] Lawrence Berkeley National Laboratory. 2011. "Max Tech and Beyond Cumulative Technical Potential Estimates". Dated April 22, 2011.
- LEDs Magazine. "Quantum dots unleash high-color-gamut performance in LED-backlit displays". <http://ledsmagazine.com/features/8/10/14>. Accessed on May 8, 2013.
- [Navigant] Navigant Consulting, Inc. 2009. "Energy Savings Potential and RD&D Opportunities for Commercial Building Appliances". Final Report Dated December 21, 2009.
- [OAAA] Outdoor Advertising Association of America. 2013. <http://www.oaaa.org/>. Washington, D.C. Accessed on May 8, 2013.
- [Park et al] Won Young Park, Amol Phadke, Nihar Shah. 2013. "Efficiency improvement opportunities for personal computer monitors: implications for market transformation programs." Final Report Published January 23, 2013.
- [Panasonic] Panasonic Corporation. 2013. "Comments for Panasonic Corporation of North America 2013 Rulemaking on Appliance Efficiency Regulations Order Instituting Rulemaking Proceedings Phase 1: Consumer Electronics – Displays." Dated May 9, 2013.
- QD Vision. <http://www.qdvision.com/>. Accessed on May 8, 2013.
- San Joaquin Valley UAPCD. 2008. *Final Staff Report: Update to Rule 2201 Best Available Control Technology (BACT) Cost Effectiveness Thresholds*. <http://www.valleyair.org/busind/pto/bact/May%202008%20BACT%20cost%20effectiveness%20threshold%20update%20staff%20report.pdf>. May 14.

Sharp (Europe). 2010. "Dawn of the golden age: Sharp adds a fourth primary colour for consumer LCD TVs". <http://www.sharp.eu/cps/rde/xchg/eu/hs.xsl/-/html/dawn-of-the-golden-age-sharp-adds-a-fourth-primary-colour-for-consumer-lcd-tvs.htm>. Accessed on May 8, 2013.

[Socolof et al] Maria Leet Socolof, Jonathan G. Overly, Lori E. Kincaid, Jack R. Geibig. 2010. "Desktop Computer Displays: A life-cycle assessment". Final Report Dated on December 2001.

[TIAX] TIAX LLC. 2010. "Commercial Miscellaneous Electric Loads: Energy Consumption Characterization and Savings Potential in 2008 by Building Type". Final Report Dated on May 2010.

[Watchfire] Watchfire. 2011. "Watchfire Signs and Digital Billboards Receive UL-Greenleaf Certification" <http://www.watchfiredigitaloutdoor.com/press/watchfire-receives-ul-environment's-energy-efficiency-certification?c=1130>. Accessed on July 28, 2013.

Young, Gregory. 2010. Digital Signage and Philadelphia's Green Future. Scenic Philadelphia.

# Appendix A: Electronic Billboards Marketed as Title 24-Compliant

7/29/13

Watchfire Receives UL-Environment's Energy Efficiency Certification - Outdoor Digital Billboard Manufacturer



[Print](#)

## WATCHFIRE SIGNS AND DIGITAL BILLBOARDS RECEIVE UL-GREENLEAF CERTIFICATION

[Back to Press Releases](#)

May 11, 2011 - Danville, Ill.

LED signs and digital billboards manufactured by Watchfire are the first in the industry to receive Energy Efficiency Certification from Underwriters Laboratories' UL-Environment group. Through UL's Energy Efficiency Certification Program, manufacturers demonstrate that their products are helping lower energy demand. UL and UL Environment, working with the California Energy Commission (CEC) and sign industry representatives, developed the program to assist sign manufacturers with testing and certifying products for their compliance to a variety of energy efficiency requirements, including those within Title 24 of the California Energy Commission's Building Energy Efficiency Standards.

Watchfire products are the first in the digital sign and billboard industry to demonstrate compliance and carry the UL-E Green Leaf Mark. The UL Safety Mark and the UL-E Energy Verified Mark will always appear together on all Watchfire LED signs distributed in the United States. "Certification from UL and UL Environment indicates Watchfire's compliance to stringent energy efficiency requirements, and we are very happy to achieve this designation," said Jeff Koeblich, vice president of engineering at Watchfire Signs.

Certification standards include mandatory automatic control requirements for all illuminated signs. In addition, the standards set limits on installed lighting power for illuminated signs.

Watchfire is the only manufacturer that fully encapsulates its LED modules in a thick bed of silicone gel, enabling the modules to operate in the harshest weather conditions. Durability is further enhanced by Watchfire's streamlined engineering, which focuses on driving down parts counts and connections, improving projected reliability. All Watchfire boards feature lightweight extruded aluminum cabinetry that complies with IBC 2006/2009 windload standards and allows for low cost, fast installation and streamlined maintenance. Watchfire's warranty, lead times, customer support, and software are considered to be the best in the industry.

### About Watchfire Digital Outdoor

Watchfire Digital Outdoor is the digital billboard division of Watchfire Signs, which has been manufacturing outdoor electronic signs since 1932. Watchfire has manufactured LED signs since 1996 and digital billboards since 2006. Watchfire makes the best looking, most reliable, high performance digital billboards, with more than 45,000 outdoor LED signs and digital billboards in operation worldwide.

For more information, please call 800-219-0496.

[What is Digital Outdoor?](#) | [Why Watchfire?](#) | [Products](#) | [Media Gallery](#) | [Common Questions](#) | [Press](#) | [Request Literature](#) | [Blog](#)  
©2011 - 2013 | Looking for an greentech LED sign? visit [www.watchfireofgs.com](http://www.watchfireofgs.com)

[www.watchfire.digitaloutdoor.com/press/watchfire-receives-ul-environment-s-energy-efficiency-certification?c=1130](http://www.watchfire.digitaloutdoor.com/press/watchfire-receives-ul-environment-s-energy-efficiency-certification?c=1130)

1/2

Source: Watchfire 2011



PRODUCTS

MARKETS

SUPPORT & SERVICES

ABOUT US

Global Websites | Contact Us

News Releases

From  To

Keywords

Product Category

Application

Country

### Daktronics Receives UL Energy Efficiency Certification

New certification applies to its Galaxy®, GalaxyPro®, Vanguard® and Series 4100 digital billboard products

BROOKINGS, S.D. – Oct. 19, 2011 – Daktronics Inc. (NASDAQ:DAKT) announces its Energy Efficiency Certification from Underwriters Laboratories, Inc. (UL) for the Galaxy®, GalaxyPro®, Vanguard® and Series 4100 digital billboard products. These products, made for a wide variety of commercial and transportation applications, now carry the UL Green Leaf symbol as a result of their compliance with a variety of energy efficiency requirements.



"Daktronics has always been committed to reaching new milestones in energy efficiency," says Brad Wleemann, Daktronics vice president of commercial and transportation business. "More efficient light emitting diodes (LEDs) and Daktronics research, design and testing contribute to our ability to reduce overall display power consumption that means lower cost of ownership for our customers."

Products with Energy Efficiency Certification must be UL listed and also meet the stringent California Title 24 standard for energy consumption. The California Energy Commission that established Title 24 leads the country in encouraging responsible energy use and reduction of electricity and natural gas costs. Daktronics meets and exceeds the standards by working closely with suppliers to engineer the industry's leading products for digital displays.

Daktronics continuously works to improve energy efficiency. Through ground-breaking design efforts, Daktronics has consistently improved energy efficiency with each new product release.

For more information on UL Energy Certification, talk to your Daktronics representative or visit: [www.ulenvironment.com/ulenvironment/eng/pages/](http://www.ulenvironment.com/ulenvironment/eng/pages/)

#### About Daktronics

Daktronics has strong leadership positions in, and is the world's largest supplier of, computer-programmable displays, large screen video displays, digital billboards, electronic scoreboards and control systems. The company excels in the control of large display systems, including those that require integration of multiple complex displays showing real-time information, graphics, animation and video. Daktronics designs, manufactures, markets and services display systems for customers around the world, in sport, business and transportation applications.

For more information, visit the company's World Wide Web site at: <http://www.daktronics.com/commercial> or e-mail the company at [commercial@daktronics.com](mailto:commercial@daktronics.com), call (605) 692-0200 ext. 56219 or toll-free (800) 325-8766 in the United States or write to the company at 201 Daktronics Drive PO Box 5128 Brookings, S.D. 57006-5128.

Also find us at:   

For more information contact:  
MEDIA RELATIONS  
Teri Ronning  
Commercial Marketing  
tel (605) 691-3582  
e-mail [Teri.Ronning@daktronics.com](mailto:Teri.Ronning@daktronics.com)

Source: Daktronics 2011

## Appendix B: As-Assembled Test Results

### 19” Pair

Power and screen luminance test results for the two 19” test units are shown in Table B.1. The representative model (D19-1) had a default luminance of 208 cd/m<sup>2</sup> and corresponding power of 19.2 W. The efficient model (D19-2) had a default luminance of 255 cd/m<sup>2</sup> and power of 14.0 W. The ENERGY STAR test method requires that screen luminance is calibrated to 200 cd/m<sup>2</sup> and average power measured over the 10-minute IEC video test clip. In this state, the representative and efficient displays drew just slightly less power (0-3%), respectively, than in their as-shipped conditions.

Both displays had user-selectable features that resulted in significantly lower power draw when enabled. With its Eco mode selected, the representative model drew 25% less power than in its default standard mode. In its Text display mode, the efficient display reduced its power by 38% compared to its default mode power.

In sleep mode, the representative and efficient displays drew about 0.3 W and 0.2 W, respectively. The representative model measured full power when it was disconnected from its source. This is due to the backlight remaining on to display a message to the user that the source has been disconnected.

**Table B.1 As-assembled power and luminance test results for 19” displays**

Display ID	Input Port	Test Description	Display Mode	Screen Luminance (cd/m <sup>2</sup> )	Power (W)
D19-1 Representative	VGA	Default	Standard	207.8	19.21
	VGA	Default	Graphics	210.6	19.12
	VGA	Default	Movie	180.6	17.16
	VGA	Default	Eco	137.8	14.48
	VGA	Default	User	208.9	19.30
	VGA	Color temp: cool	Standard	177.5	19.26
	VGA	ENERGY STAR: calibrated luminance	Standard	201.1	18.63
	VGA	Max brightness	Standard	212.9	19.25
	VGA	Sleep (sleep signal source)	Standard		0.30
	VGA	Sleep (disconnect signal source)	Standard		19.08
	VGA	Off	Standard		0.20
D19-2 Efficient	VGA	Default	Standard	254.8	14.02
	VGA	Default	Text	125.6	8.73
	VGA	Default	Internet	164.5	10.30
	VGA	Default	Game	202.4	11.68
	VGA	Default	Movie	293.3	13.34
	VGA	Default	Sports	279.7	15.05

Display ID	Input Port	Test Description	Display Mode	Screen	Power (W)
				Luminance (cd/m <sup>2</sup> )	
	VGA	Color temp: Normal	Standard	252.3	14.04
	VGA	Color temp: Cool	Standard	219.8	14.06
	VGA	Color temp: sRGB	Standard	233.9	14.04
	VGA	ENERGY STAR: calibrated luminance	Standard	200.8	11.65
	VGA	Max brightness	Standard	275.6	14.96
	VGA	Sleep (sleep signal source)	Standard		0.20
	VGA	Sleep (disconnect signal source)	Standard		0.20
	VGA	Off	Standard		0.14

## 22" Pair

Power and screen luminance test results for the two 22" test units are shown in Table B.2. Both displays shipped with relatively high screen luminance (Default/Standard mode). The representative model (D22-1) had a default luminance of 275 cd/m<sup>2</sup> and corresponding power of 28.4 W. The efficient model (D22-2) had a default luminance of 241 cd/m<sup>2</sup> and power of 18.9 W. With luminance calibrated for the ENERGY STAR test procedure, the representative and efficient displays drew 21% and 11% less power, respectively, than in their as-shipped conditions.

Both displays had user-selectable features that resulted in significantly lower power draw when enabled. With its Dynamic Contrast feature enabled, the representative model drew 35% less power than in its default Dynamic Contrast off state. In its ECO mode, the efficient display reduced its power by 20% compared to its default mode power.

In standby mode, the representative and efficient displays drew about 0.3 W and 0.2 W, respectively. The representative model had an auto power-down mode in which it drew 0.2 W. The efficient display had an off mode and drew 0.1 W in it.

**Table B.2 As-assembled power and luminance test results for 22" displays**

Display ID	Input Port	Test Description	Display Mode	Screen	Power (W)
				Luminance (cd/m <sup>2</sup> )	
D22-1 Representative	DVI	Default	Standard	275.4	28.42
	DVI	Default	ECO Optimize	202.8	23.06
	DVI	Default	ECO Conserve	129.6	17.23
	DVI	Dynamic Contrast enabled	Standard	184.0	18.43
	DVI	ENERGY STAR: calibrated luminance	Standard	202.5	22.46
	DVI	Max brightness	Standard	284.8	28.69
	VGA	Default	Standard	270.3	28.25
	VGA	ENERGY STAR: calibrated luminance	Standard	202.3	22.27
	VGA	Max brightness	Standard	274.5	28.53
	DVI	Standby (sleep signal source)	Standard		0.28
DVI	Standby (disconnect signal source)	Standard		0.26	

Display ID	Input Port	Test Description	Display Mode	Screen	Power (W)
				Luminance (cd/m <sup>2</sup> )	
	DVI	Auto-Powerdown enabled	Standard		0.20
D22-2 Efficient	HDMI	Default	Standard	241.0	18.76
	HDMI	Default	Scenery	225.0	18.38
	HDMI	Default	Theater	220.0	18.34
	HDMI	Default	Game	233.0	18.29
	HDMI	Default	Night View	226.0	18.31
	HDMI	Default	sRGB Mode	173.0	15.57
	HDMI	ENERGY STAR: calibrated luminance	Standard	201.0	16.82
	HDMI	Max brightness	Standard	247.0	18.64
	HDMI	w/ Smartview enabled	Standard	245.0	18.30
	HDMI	w/ ASCR enabled	Scenery	241.0	19.03
	HDMI	w/ ECO Mode	Standard	167.0	15.08
	DVI	Default	Standard	246.0	18.71
	VGA	Default	Standard	246.0	18.50
	HDMI	Sleep (sleep signal source)	Standard		0.16
HDMI	Sleep (disconnect signal source)	Standard		0.16	
HDMI	Off	Standard		0.12	

## 27" Pair

Power and screen luminance test results for the two 27" test units are shown in Table B.3. The displays shipped very different screen luminance (Default/Standard mode). The representative model (D27-1) had a default luminance of 400 cd/m<sup>2</sup> and corresponding power of 38.6 W. The efficient model (D27-2) had a default luminance of 171 cd/m<sup>2</sup> and power of 21.8 W. With luminance calibrated for the ENERGY STAR test procedure (200 cd/m<sup>2</sup>), the representative display drew 40% less power than in its as-shipped condition while the efficient display drew 16% more power than in its as-shipped condition.

Both displays had user-selectable features that resulted in significantly lower power draw when enabled. With its Eco Saving feature enabled, the representative model drew 65% less power than in its default (as-shipped) state. In its energy smart feature enabled, the efficient model reduced its power by 48% compared to its default mode power.

In standby mode, the representative and efficient displays drew about 0.3 W and 0.2 W, respectively. The representative model had an auto power-down mode in which it drew 0.2 W. The efficient display had an off mode and drew 0.1 W in it.

**Table B.3 As-assembled power and luminance test results**

Display ID	Input Port	Test Description	Display Mode	Screen	Power (W)
				Luminance (cd/m <sup>2</sup> )	
D27-1	DP*	Default	Custom	400.8	38.56

Display ID	Input Port	Test Description	Display Mode	Screen	Power (W)
				Luminance (cd/m <sup>2</sup> )	
Representative	DP	Default	Standard	203.9	22.96
	DP	Default	Game	400.7	38.47
	DP	Default	Cinema	400.4	38.41
	DP	Default	Dyn. Contrast	400.3	34.69
	DP	Magic color: Full	Custom	400.7	38.39
	DP	Magic color: intelligent	Custom	401.0	38.37
	DP	Response time: normal	Custom	400.3	38.33
	DP	Response time: fastest	Custom	400.2	38.34
	DP	Eco Saving: 50%	Custom	142.1	18.23
	DP	Eco Saving: 75%	Custom	269.2	27.91
	DP	ENERGY STAR: calibrated luminance	Custom	199.2	22.99
	DP	Max brightness	Custom	402.3	38.47
	DVI	Default	Custom	397.6	38.41
	VGA	Default	Custom	379.6	38.43
	DP	Sleep (sleep signal source)	Custom		0.34
	DP	Sleep (disconnected signal source)	Custom		0.34
	DP	Off by timer (1 hour)	Custom		0.33
DP	Off	Custom		0.33	
D27-2 Efficient	HDMI	Default	Standard	170.9	21.77
	HDMI	Default	Multimedia	154.4	23.51
	HDMI	Default (dyn. contrast enabled)	Movie	168.9	25.93
	HDMI	Default	Game	166.6	23.48
	HDMI	Default	Text	128.5	17.48
	HDMI	Default	Warm	170.5	23.56
	HDMI	Default	Cool	163.3	23.28
	HDMI	ENERGY STAR: calibrated luminance	Standard	200.1	25.23
	HDMI	Max brightness	Standard	247.3	25.84
	HDMI	w/ Image enhance enabled	Standard	171.5	21.79
	HDMI	Dynamic contrast disabled	Movie	152.6	23.53
	HDMI	w/ energy smart enabled	Standard	89.3	12.88
	DVI	Default	Standard	202.4	21.64
	VGA	Default	Standard	186.5	21.17
	HDMI	Sleep (sleep signal source)	Standard		0.28
HDMI	Sleep (disconnect signal source)	Standard		0.29	
HDMI	Off	Standard		0.24	

\*DP=DisplayPort



Average power consumption increased approximately linearly with screen luminance as shown in Figure B.1. This suggests that the majority of power draw variability is related to producing light and generating an image on the screen. Signal processing and other functions draw relatively constant power when the display is showing a picture.

**Figure B.1 Screen luminance versus power for the representative and efficient test units**  
(Lines are linear fits to the data. Note that luminance and power are approximately linearly related)

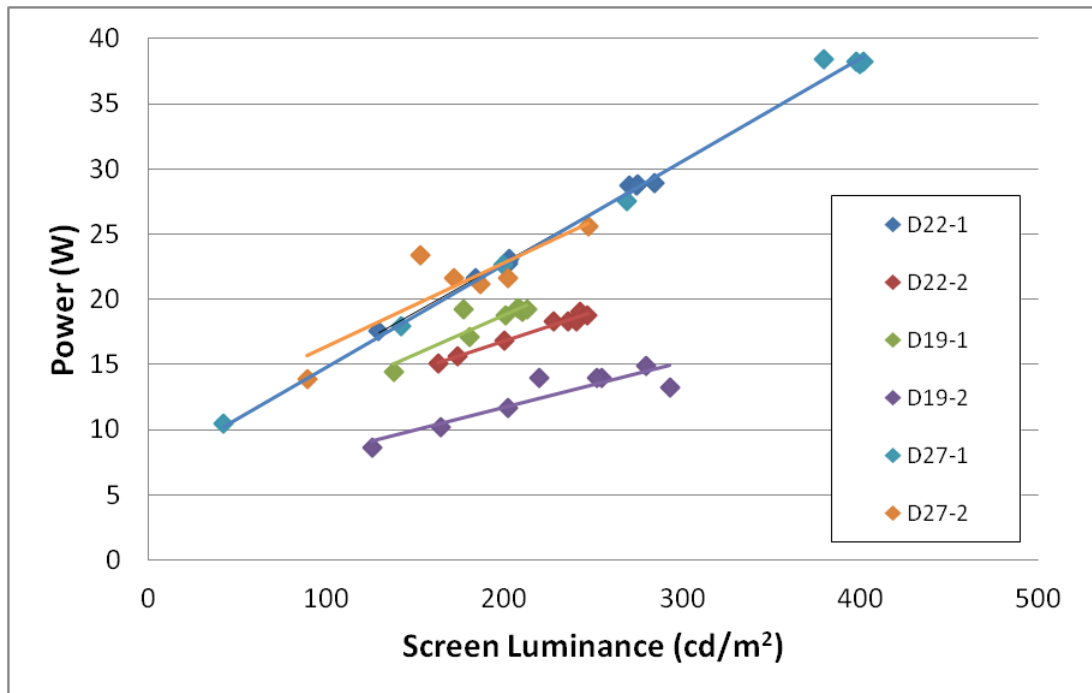

## Appendix C: Data Submittal Requirements – Electronic Billboards

---

### Required Information

---

Total Billboard Size – Length (ft)  
Total Billboard Size – Height (ft)  
Module Size – Length (ft)  
Module Size – Height (ft)  
Number of Modules for Project  
Lifetime (hours)  
Dual Sided?  
Pixel Pitch  
Installation Type  
Outdoors/Indoors Installation  
Cooling Unit?  
If Cooling Unit is Separate, Maximum Rated Power (watts)  
Electric Connection  
Connectivity  
Lighting Power (watts per foot-squared)  
Lighting Maximum Rated Power (watts per foot-squared)  
Light Source  
Daylight Control Dimming?  
Demand Response Control?  
Time Switch Control?  
Media Player Power – On Mode (watts)  
Video Extender

---

## Appendix D: Cost Analysis Assumptions

The electricity rates used in the analysis of this CASE Report were derived from projected future prices for residential, commercial and industrial sectors in the CEC’s “Mid-case” projection of the 2012 Demand Forecast (2012), which used a 3% discount rate and provide prices in 2010 dollars. The sales weighted average of the 5 largest utilities in California was converted to 2013 dollars using an inflation adjustment of 1.07 (DOL 2013). A sector weighted average electricity rate was then calculated using 70% commercial, 30% residential, 0% industrial for monitors and 100% commercial for signage displays (Hamm & Greene 2008). See the rates by year below in Table D.1 and Table D-2.

**Table D.1 Statewide Weighted Average Electricity Rates 2015 - 2040 (PG&E, SCE, SDG&E, LADWP and SMUD - 5 largest Utilities) in 2013 cents/kWh – Computer Monitors**

Year	Residential	Commercial	Industrial	Sector Weighted Average
2015	16.82	14.67	11.31	15.31
2016	17.02	14.84	11.43	15.49
2017	17.24	15.02	11.56	15.69
2018	17.47	15.22	11.70	15.90
2019	17.71	15.42	11.84	16.10
2020	18.00	15.67	12.01	16.37
2021	18.34	15.98	12.23	16.69
2022	18.70	16.29	12.45	17.01
2023	19.06	16.61	12.67	17.34
2024	19.43	16.93	12.90	17.68
2025	19.81	17.27	13.13	18.03
2026	20.19	17.60	13.37	18.38
2027	20.59	17.95	13.61	18.74
2028	20.98	18.30	13.86	19.11
2029	21.39	18.66	14.12	19.48
2030	21.81	19.03	14.38	19.86
2031	22.23	19.40	14.64	20.25
2032	22.66	19.78	14.92	20.65
2033	23.10	20.17	15.19	21.05
2034	23.55	20.57	15.48	21.46
2035	24.01	20.97	15.77	21.88
2036	24.48	21.38	16.06	22.31
2037	24.96	21.80	16.37	22.75
2038	25.44	22.23	16.68	23.20
2039	25.94	22.67	16.99	23.65

Year	Residential	Commercial	Industrial	Sector Weighted Average
2040	26.44	23.12	17.32	24.12

**Table D.2 Statewide Weighted Average Electricity Rates 2015 - 2040 (PG&E, SCE, SDG&E, LADWP and SMUD - 5 largest Utilities) in 2013 cents/kWh – Signage Displays**

Year	Residential	Commercial	Industrial	Sector Weighted Average
2015	16.82	14.67	11.31	14.67
2016	17.02	14.84	11.43	14.84
2017	17.24	15.02	11.56	15.02
2018	17.47	15.22	11.70	15.22
2019	17.71	15.42	11.84	15.42
2020	18.00	15.67	12.01	15.67
2021	18.34	15.98	12.23	15.98
2022	18.70	16.29	12.45	16.29
2023	19.06	16.61	12.67	16.61
2024	19.43	16.93	12.90	16.93
2025	19.81	17.27	13.13	17.27
2026	20.19	17.60	13.37	17.60
2027	20.59	17.95	13.61	17.95
2028	20.98	18.30	13.86	18.30
2029	21.39	18.66	14.12	18.66
2030	21.81	19.03	14.38	19.03
2031	22.23	19.40	14.64	19.40
2032	22.66	19.78	14.92	19.78
2033	23.10	20.17	15.19	20.17
2034	23.55	20.57	15.48	20.57
2035	24.01	20.97	15.77	20.97
2036	24.48	21.38	16.06	21.38
2037	24.96	21.80	16.37	21.80
2038	25.44	22.23	16.68	22.23
2039	25.94	22.67	16.99	22.67
2040	26.44	23.12	17.32	23.12

## Appendix E: Criteria Pollutant Emissions and Monetization

### E.1 Criteria Pollutant Emissions Calculation

To calculate the statewide emissions rate for California, the incremental emissions between CARB's high load and low load power generation forecasts for 2020 were divided by the incremental generation between CARB's high load and low load power generation forecast for 2020. Incremental emissions were calculated based on the delta between California emissions in the high and low generation forecasts divided by the delta of total electricity generated in those two scenarios. This emission rate per MWh is intended to provide a benchmark of emission reductions attributable to energy efficiency measures that could help achieve the low load scenario instead of the high load scenario. While emission rates may change somewhat over time, 2020 was considered a representative year for this measure.

### E.2 Criteria Pollutant Emissions Monetization

Avoided ambient ozone precursor and fine particulate air pollution benefits were monetized based on avoided control costs rather than damage costs due to the availability of emission control cost-effectiveness thresholds, as well as challenges in quantifying a specific value for damages per ton of pollutants.

Two sources of data for cost-effectiveness thresholds were evaluated. The first is Carl Moyer cost-effectiveness thresholds for ozone precursors and fine particulates (CARB 2011a, CARB 2013a and 2013b). The Carl Moyer program has provided incentives for voluntary reductions in criteria pollutant reductions from a variety of mobile combustion sources as well as stationary agricultural pumps that meet specified cost-effectiveness cut-offs.

The second is the San Joaquin Valley UAPCD Best-Available Control Technology ("BACT") cost-effectiveness thresholds study. Pollution reduction technologies that are not yet demonstrated in practice (in which case they are required without a cost-effectiveness evaluation) can be required at new power plants and other sources if technologically feasible and within cost-effectiveness thresholds. San Joaquin Valley UAPCD conducted a state-wide study as the basis for updating their BACT thresholds in 2008.

This CASE report relies primarily on the Carl Moyer thresholds due to their state-wide nature and applicability to combustion sources<sup>9</sup>. In addition, the Carl Moyer fine particulate values for fine particulate apply to combustion sources with specific health impacts, while BACT thresholds include both combustion sources and dust. The Carl Moyer values are somewhat more conservative for ozone precursors than San Joaquin Valley UAPCD BACT thresholds, and significantly higher for fine particulate<sup>10</sup>. The Carl Moyer program does not address sulfur oxides, however, thus the San Joaquin BACT thresholds were used for this pollutant.

Price reports for California Emission Reduction Credit (ERCs, i.e. air pollution credits purchased to offset regulated emission increases) for 2011 and 2012 were also compared to the values selected

---

<sup>9</sup> Further evaluation of the qualitative impacts of combustion fine particulate emissions from power generation and transportation sources may be beneficial.

<sup>10</sup> We note that both the Carl Moyer and San Joaquin Valley UAPCD BACT cost-effectiveness thresholds for fine particulates fall within the wide range of fine particulate ERC trading prices in California in 2011 and 2012.

in this CASE report. For each pollutant there is a wide range of ERC values per ton that are both higher and lower than the values per ton used in this CASE report [CARB 2011b and 2012]. Due to wide variability and low trading volumes, ERC values were evaluated for comparative purposes only.

## Appendix F: Greenhouse Gas Valuation Discussion

The climate impacts of pollution from fossil fuel combustion and other human activities, including the greenhouse gas effect, present a major risk to global economies, public health and the environment. While there are uncertainties of the exact magnitude given the interconnectedness of ecological systems, at least three methods exist for estimating the societal costs of greenhouse gases: 1) the Damage Cost Approach 2) the Abatement Cost Approach and 3) the Regulated Carbon Market Approach. See below for more details regarding each approach.

### F.1 Damage Cost Approach

In 2007, the U.S. Court of Appeals for the Ninth Circuit ruled that the National Highway Transportation Traffic Safety Administration (NHTSA) was required to assign a dollar value to benefits from abated carbon dioxide emissions. The court stated that while there are a wide range of estimates of monetary values, the price of carbon dioxide abatement is indisputably non-zero. In 2009, to meet the necessity of a consistent value for use by government agencies, the Obama Administration established the Interagency Working Group on the Social Cost of Carbon to establish official estimates (Johnson and Hope).

The Interagency Working Group primarily uses estimates of avoided damages from climate change which are valued at a price per ton of carbon dioxide, a method known as the damage cost approach.

#### F.1.1 Interagency Working Group Estimates

The Interagency Working Group SCC estimates, based on the damage cost approach, were calculated using three climate economic models called integrated assessment models which include the Dynamic Integrated Climate Economy (DICE), Policy Analysis of the Greenhouse Effect (PAGE), and Climate Framework for Uncertainty, Negotiation, and Distribution (FUND) models. These models incorporate projections of future emissions translated into atmospheric concentration levels which are then translated into temperature changes and human welfare and ecosystem impacts with inherent economic values. As part of the Federal rulemaking process, DOE publishes estimated monetary benefits using Interagency Working Group SCC values for each Trial Standard Level considered in their analyses, calculated as a net present value of benefits received by society from emission reductions and avoided damages over the lifetime of the product. The recent U.S. DOE Final Rulemaking for microwave ovens contains a Social Cost of Carbon section that presents the Interagency Working Group's most recent SCC values over a range of discount rates (DOE 2013) as shown in Table F.1. The two \$ metric ton of values used in this CASE report were taken from the two highlighted columns, and converted to 2013 dollars.

**Table F.1 Social Cost of CO<sub>2</sub> 2010 – 2050 (in 2007 dollars per metric ton of CO<sub>2</sub>)**

Discount Rate	5.0%	3.0%	2.5%	3.0%
Year	Avg	Avg	Avg	95th
2010	11	33	52	90

<b>Discount Rate</b>	<b>5.0%</b>	<b>3.0%</b>	<b>2.5%</b>	<b>3.0%</b>
Year	Avg	Avg	Avg	95th
2015	12	38	58	109
2020	12	43	65	129
2025	14	48	70	144
2030	16	52	76	159
2035	19	57	81	176
2040	21	62	87	192
2045	24	66	92	206
2050	27	71	98	221

Source: Interagency Working Group on Social Cost of Carbon, United States Government, 2013

The Interagency Working Group decision to implement a global estimate of the SCC rather than a domestic value reflects the reality of environmental damages which are expected to occur worldwide. Excluding global damages is inconsistent with U.S. regulatory policy aimed at incorporating international issues related to resource use, humanitarian interests, and national security. As such, a regional SCC value specific to the Western United States or California specifically should be at similarly inclusive of global damages. Various studies state that certain values may be understated due to the asymmetrical risk of catastrophic damage if climate change impacts are above median predictions, and some estimates indicate that the upper end of possible damage costs could be substantially higher than indicated by the IWG (Ackerman and Stanton 2012, Horii and Williams 2013).

## F.2 Abatement Cost Approach

Abating carbon dioxide emissions can impose costs associated with more efficient technologies and processes, and policy-makers could also compare strategies using a different by estimating the annualized costs of reducing one ton of carbon dioxide net of savings and co-benefits. The cost of abatement approach could reflect established greenhouse gas reduction policies and establish values for carbon dioxide reductions relative to electricity de-carbonization and other measures. (While recognizing the potential usefulness of this method, this report utilizes the IWG SCC approach and we note that the value lies within the range of abatement costs discussed further below.)

The cost abatement approach utilizes market information regarding emission abatement technologies and processes and presents a wide-range of values for the price per ton of carbon dioxide. The California Air Resources Board data of the cost-effectiveness of energy efficiency measures and emission regulations would provide one source of potential data for an analysis under this method. To meet the AB 32 target, ARB has established the “Cost of a Bundle of Strategies Approach” which includes a range of cost-effective strategies and regulations (CARB 2008b). The results of this approach within the framework of the Climate Action Team Macroeconomic Analysis are provided for California, Arizona, New Mexico, the United States, and a global total identified in that same report, as shown in Table F.2 below.



**Table F.2 Cost-effectiveness Range for the CAT Macroeconomic Analysis**

Exhibit 3: Cost-effectiveness Range for the CAT Macroeconomic Analysis, Selected States, United States, Global -

State	Cost-effectiveness Range \$/ ton CO <sub>2</sub> eq	Tons Reduced MMTCO <sub>2</sub> e/yr	Percent of BAU
California 2020 (CAT <sup>1</sup> , CEC <sup>2</sup> )	- 528 to 615	132	22
Arizona <sup>3</sup> 2020	- 90 to 65	69	47
New Mexico <sup>4</sup> 2020	- 120 to 105	35	34
United States (2030) <sup>5</sup>	-93 to 91	3,000	31
Global Total (2030)	-225 to 91	26,000	45

- Source: 1. Climate Action Team Updated Macroeconomic Analysis of Climate Strategies. Presented in the March 2006 Climate Action Team Report, September 2007.  
 2. California Energy Commission, *Emission Reduction Opportunities for Non-CO2 Greenhouse Gases in California*, July 2005. ICF (\$/MTCO<sub>2</sub>eq).  
 3. Arizona Climate Change Advisory Group, *Climate Change Action Plan*, August 2006. (\$/MTCO<sub>2</sub>eq).  
 4. New Mexico Climate Change Advisory Group, *Final Report*, December 2006.  
 5. McKinsey & Company, *Reducing U.S. Greenhouse Gas Emissions: How Much at What Cost?* December 2007.  
 6. The McKinsey Quarterly, McKinsey & Company, *A Cost Curve for Greenhouse Gas Reduction*, Fall 2007.

Source: CARB 2008b

Energy and Environmental Economics (E3) study defines the cost abatement approach more specifically as electricity de-carbonization and is based on annual emissions targets consistent with existing California climate policy. Long-term costs are determined by large-scale factors such as electricity grid stability, technological advancements, and alternative fuel prices. Near-term costs per ton of avoided carbon could be \$200/ton in the near-term (Horii and Williams 2013), thus as noted earlier the value used in this report may be conservative.

### F.3 Regulated Carbon Market Approach

Emissions allowance markets provide a third potential method for valuing carbon dioxide. Examples include the European Union Emissions Trading System and the California AB32 cap and trade system as described below. Allowances serve as permits authorizing emissions and are traded through the cap-and-trade market between actors whose economic demands dictate the sale or purchase of permits. In theory, allowance prices could serve as a proxy for the cost of abatement. However, this report does not rely on the prices of cap-and-trade allowances due to the vulnerability of the allowance market to external fluctuations, and the influence of regulatory decisions affecting scarcity or over-allocation unrelated to damages or abatement costs.

#### F.3.1 European Union Emissions Trading System

The European Union Emissions Trading System (EU ETS) covers more than 11,000 power stations, industrial plants, and airlines in 31 countries. However, the market is constantly affected by over-supply following the 2008 global recession and has seen prices drop to dramatic lows in early 2013, resulting in the practice of “back-loading” (delaying issuances of permits) by the European parliament. At the end of June 2013, prices of permits dropped to \$5.41/ton, a price which is well below damage cost estimates and sub-optimal for encouraging innovative carbon dioxide emission abatement strategies.

#### F.3.2 California Cap & Trade

In comparison, California cap-and-trade allowance prices were reported to be at least \$14/ton in May of 2013, with over 14.5 million total allowances sold for 2013 (CARB 2013b). However, cap-

and-trade markets are likely to cover only subsets of emitting sectors of the industry covered by AB 32. In addition, the market prices of allowances are determined only partly by costs incurred by society or industry actors and largely by the stringency of the cap determined by regulatory agencies and uncontrollable market forces, as seen by the failure of the EU ETS to set a consistent and effective signal to curb carbon dioxide emissions.