

**DOCKETED**

|                         |   |
|-------------------------|---|
| <b>Docket Number:</b>   | 01-AFC-24C  |
| <b>Project Title:</b>   | Palomar Energy Project Compliance                     |
| <b>TN #:</b>            | 242185  |
| <b>Document Title:</b>  | Petition to Amend - Palomar Hydrogen Project - update |
| <b>Description:</b>     | N/A   |
| <b>Filer:</b>           | Jason Dobbs   |
| <b>Organization:</b>    | San Diego Gas and Electric                            |
| <b>Submitter Role:</b>  | Applicant   |
| <b>Submission Date:</b> | 3/1/2022 10:51:43 AM                                  |
| <b>Docketed Date:</b>   | 3/1/2022  |

Petition to Amend:  
Palomar Hydrogen Project

Palomar Energy Center  
(01-AFC-24C)

Submitted by:  
San Diego Gas & Electric



Palomar Energy Center  
2300 Harveson Place  
Escondido, California 92029

Prepared by:  
Yorke Engineering, LLC  
31726 Rancho Viejo Road, Suite 218  
San Juan Capistrano, CA 92675



Submitted to:  
California Energy Commission

February 22, 2022

## Table of Contents

|            |   |           |
|------------|---|-----------|
| <b>1.0</b> | <b>INTRODUCTION .....</b>   | <b>1</b>  |
| 1.1        | Palomar Hydrogen Project Overview.....  | 1         |
| 1.2        | Change in Reheat Bowl Temperature Used for Startup Definition .....   | 2         |
| 1.3        | Information Requirements for Post-Certification Amendments .....  | 2         |
| <b>2.0</b> | <b>REQUIRED INFORMATION FOR POST-CERTIFICATION AMENDMENTS .....</b>   | <b>4</b>  |
| <b>A.</b>  | <b>Complete description of the proposed change, including new language for any conditions of certification that will be affected.....</b>   | <b>4</b>  |
| A.1        | Facility Permitting Background.....   | 4         |
| A.2        | Proposed Project Description.....   | 6         |
| A.2.1      | <i>Combined-Cycle Power Plant Hydrogen Consumption.....</i>   | <i>7</i>  |
| A.2.2      | <i>Hydrogen Production and Integration .....</i>  | <i>7</i>  |
| A.2.3      | <i>Hydrogen Fueling Station .....</i>   | <i>10</i> |
| A.2.4      | <i>Solar Photovoltaic System.....</i>   | <i>10</i> |
| A.2.5      | <i>Other Ancillary Site Improvements .....</i>  | <i>11</i> |
| A.2.6      | <i>Project Construction Schedule.....</i>   | <i>11</i> |
| A.3        | Proposed Changes to the Conditions of Certification.....  | 11        |
| <b>B.</b>  | <b>A discussion of the necessity for the proposed change and an explanation of why the change should be permitted. ....</b>   | <b>13</b> |
| <b>C.</b>  | <b>A description of any new information or change in circumstances that necessitated the change.....</b>  | <b>13</b> |
| <b>D.</b>  | <b>An analysis of the effects that the proposed change to the project may have on the environment and proposed measures to mitigate any significant environmental effects..</b>                       | <b>14</b> |
| <b>E.</b>  | <b>An analysis of how the proposed change would affect the project’s compliance with applicable laws, ordinances, regulations, and standards.....</b>   | <b>17</b> |
| <b>F.</b>  | <b>A discussion of how the proposed change would affect the public. ....</b>  | <b>17</b> |
| <b>G.</b>  | <b>A list of current assessor’s parcel numbers and owners’ names and addresses for all parcels within 500 feet of any affected project linears and 1,000 feet of the project site... </b>             | <b>18</b> |
| <b>H.</b>  | <b>A discussion of the potential effect of the proposed change on nearby property owners, residents, and the public.....</b>  | <b>18</b> |
| <b>I.</b>  | <b>A discussion of any exemptions from the California Environmental Quality Act, of the Public Resources Code, that the project owner believes may apply to approval of the proposed change. ....</b> | <b>18</b> |
| <b>3.0</b> | <b>SUMMARY AND CONCLUSIONS .....</b>  | <b>19</b> |
| <b>4.0</b> | <b>REFERENCES.....</b>  | <b>20</b> |

## List of Appendices

**APPENDIX A – AUTHORITY TO CONSTRUCT PERMIT FOR PEC ISSUED FEBRUARY 3, 2022**

**APPENDIX B – FACILITY PLOT PLAN AND SOLAR CANOPIES LOCATIONS**

**APPENDIX C – AIR QUALITY AND PUBLIC HEALTH, GHG EMISSIONS AND ENERGY USE, AND NOISE AND VIBRATION ANALYSES**

## List of Figures

|  |   |
|--|---|
| Figure 2-1: Aerial View of the Palomar Energy Center and Surrounding Area.....                   | 5 |
| Figure 2-2: Aerial View Showing the Existing Use of the Proposed Hydrogen Project Location ..... | 6 |
| Figure 2-3: Palomar Hydrogen Project Components Process Flow Diagram .....                       | 8 |

## List of Tables

|  |    |
|--|----|
| Table 2-1: Electrolyzer Specification .....            | 8  |
| Table 2-2: Hydrogen Compressor Design Criteria .....   | 8  |
| Table 2-3: Hydrogen Storage Design Criteria .....      | 9  |
| Table 2-4: Hydrogen Fueling Station Requirements ..... | 10 |
| Table 2-5: Environmental Impact Summary.....           | 14 |

## List of Acronyms and Abbreviations

|                   |   |
|-------------------|---|
| AAQS              | Ambient Air Quality Standard                          |
| AB                | Assembly Bill   |
| acf               | Actual Cubic Foot                                     |
| AFC               | Application for Certification                         |
| AQMD              | [South Coast] Air Quality Management District         |
| ARB               | [California] Air Resources Board                      |
| ATC               | Authority to Construct                                |
| BMP               | Best Management Practice                              |
| Btu               | British Thermal Unit                                  |
| CalARP            | California Accidental Release Prevention [Program]    |
| CalEEMod          | California Emissions Estimator Model <sup>®</sup>     |
| CalOES            | California Office of Emergency Services               |
| Cal/OSHA          | California Division of Occupational Safety and Health |
| CAP               | Climate Action Plan                                   |
| CAPCOA            | California Air Pollution Control Officers Association |
| CCR               | California Code of Regulations                        |
| CEC               | California Energy Commission                          |
| CEQA              | California Environmental Quality Act                  |
| CH <sub>4</sub>   | Methane   |
| City              | City of Escondido                                     |
| CNEL              | Community Noise Exposure Level                        |
| CO                | Carbon Monoxide                                       |
| CO <sub>2</sub>   | Carbon Dioxide  |
| CO <sub>2</sub> e | Carbon Dioxide Equivalent                             |
| COC               | Condition of Certification                            |
| County            | County of San Diego                                   |
| CPM               | Compliance Project Manager                            |
| CTG               | Combustion Turbine Generator                          |
| dBA               | A-Weighted Decibel                                    |
| DC                | Direct Current  |
| District          | San Diego County Air Pollution Control District       |
| DPM               | Diesel Particulate Matter                             |
| dscf              | Dry Standard Cubic Foot                               |
| DW                | Demineralized Water                                   |
| EPA               | [United States] Environmental Protection Agency       |
| ERTC              | Escondido Research and Technology Center              |
| °F                | Degrees Fahrenheit                                    |
| FCEV              | Fuel-Cell Electric Vehicle                            |
| FCS               | Fuel Cell Store                                       |

|                   |   |
|-------------------|---|
| ft                | Foot  |
| FSA               | Final Staff Assessment  |
| GHG               | Greenhouse Gas  |
| GPM               | Gallons per Minute  |
| GWP               | Global Warming Potential                                      |
| H <sub>2</sub>    | Hydrogen  |
| HARRF             | Hale Avenue Resource Recovery Facility                        |
| HHV               | Higher Heating Value  |
| HMBP              | Hazardous Materials Business Plan                             |
| hr                | Hour  |
| HRA               | Health Risk Assessment  |
| HRSG              | Heat Recovery Steam Generator                                 |
| in                | Inch  |
| IPCC              | Intergovernmental Panel on Climate Change                     |
| kW                | Kilowatt  |
| kWh               | Kilowatt Hour   |
| L                 | Liter   |
| lb(s)             | Pound(s)  |
| LHV               | Lower Heating Value   |
| LORS              | Laws, Ordinances, Regulations, and Standards                  |
| LTS               | Less Than Significant   |
| MGD               | Million Gallons per Day                                       |
| MT                | Metric Ton  |
| MW                | Megawatt  |
| MWh               | Megawatt-Hour   |
| N <sub>2</sub> O  | Nitrous Oxide   |
| NO <sub>x</sub>   | Oxides of Nitrogen  |
| Nm <sup>3</sup>   | Normal cubic meter  |
| OEHHA             | [California] Office of Environmental Health Hazard Assessment |
| OEM               | Original Equipment Manufacturer                               |
| PEC               | Palomar Energy Center   |
| PEM               | Polymer Electrolyte Membrane                                  |
| PM <sub>10</sub>  | Respirable Particulate Matter                                 |
| PM <sub>2.5</sub> | Fine Particulate Matter                                       |
| psia              | Pound per Square Inch Absolute                                |
| psig              | Pound per Square Inch Gauge                                   |
| PTA               | Petition to Amend   |
| PTO               | Permit to Operate   |
| PUC               | [California] Public Utilities Commission                      |
| PV                | Photovoltaic  |
| RMP               | Risk Management Plan  |

|                 |   |
|-----------------|---|
| S&W             | Soil and Water                                  |
| SANDAG          | San Diego Association of Governments            |
| SB              | Senate Bill                                     |
| SCADA           | Supervisory Control and Data Acquisition        |
| scf             | Standard Cubic Foot                             |
| SDAPCD          | San Diego County Air Pollution Control District |
| SDG&E           | San Diego Gas & Electric                        |
| SME             | Subject Matter Expert                           |
| SO <sub>x</sub> | Oxides of Sulfur                                |
| SR              | State Route                                     |
| STG             | Steam Turbine Generator                         |
| SWPPP           | Stormwater Pollution Prevention Plan            |
| TAC             | Toxic Air Contaminant                           |
| tpy             | Tons per Year                                   |
| TQ              | Threshold Quantity                              |
| VOC             | Volatile Organic Compound                       |
| yr              | Year  |

# Palomar Energy Center (01-AFC-24C) Petition to Amend: Palomar Hydrogen Project

## 1.0 INTRODUCTION

San Diego Gas & Electric (SDG&E or the Applicant) is submitting this **updated** Petition for a Post-Certification Amendment of its Palomar Energy Center (PEC), Docket 01-AFC-24C. SDG&E is proposing to implement a hydrogen generation and energy storage project at the PEC. This Petition to Amend (PTA) is filed to make the changes necessary to the project design as approved by the California Energy Commission (CEC) in accordance with California Code of Regulations (CCR) Title 20 Section 1769(a)(1).

A PTA was submitted by SDG&E to the CEC in August 2021 for the proposed Palomar Hydrogen Project (TN 239330). Subsequent to submittal of that petition, it was identified that changes to a few of the conditions in the Permit to Operate (PTO) issued by the San Diego Air Pollution Control District (SDAPCD) were needed to allow the use of a hydrogen blended fuel at PEC. SDG&E submitted a Change of Condition Application to the SDAPCD on December 16, 2021. In response to that application, SDAPCD issued an Authority to Construct (ATC) permit for the Palomar Hydrogen Project on February 3, 2022 (see Appendix A). This PTA has been updated from the version submitted to the CEC in August 2021 to reflect the ATC issued by SDAPCD. In addition to slightly revised figures, changes in this PTA version from the August 2021 version are highlighted in yellow.

### 1.1 Palomar Hydrogen Project Overview

SDG&E is planning to implement one of its initial clean energy projects at the PEC. Currently, the PEC is a combined-cycle power plant generating approximately 588-megawatt (MW)<sup>1</sup> in Escondido, California. The PEC includes operation of two natural gas-fired, combustion turbine generators (CTGs) and a steam turbine generator (STG). The Palomar Hydrogen Project is proposed to meet SDG&E's objective to move toward a 100% renewable and net zero carbon-free future (SDG&E 2021).

Pursuant to 20 CCR Section 1769(a)(1), as revised in September 2019, SDG&E, the Project Owner, is filing this PTA to include installation of the following new equipment and facilities at the PEC:

1. Hydrogen generation and storage with the use of an electrolyzer and hydrogen storage vessels;
2. 300 kilowatts (kW) of photovoltaic (PV) solar panels on canopies over existing parking areas; and
3. A hydrogen fueling station for SDG&E on-site maintenance vehicles and off-site fleet vehicles (cars and trucks).

---

<sup>1</sup> PEC was initially approved by the Energy Commission as an approximately 560 MW power plant in 2003. An Advanced Gas Path Turbine Upgrade was approved by the SDAPCD and Energy Commission in 2017 (Order No. 17-1213-1d), which increased the power output of the CTGs and duct burners to approximately 588 MW.



These facilities will be used to produce hydrogen, which will be injected into the natural gas stream used in the CTGs and used for fueling hydrogen fuel-cell electric vehicles (FCEVs). The hydrogen generated on-site will also be used for generator cooling, which is currently provided by purchasing hydrogen in compressed gas cylinders, which are stored on-site. Other than adding these components to the project description, **four** Conditions of Certification (COCs) require modification to allow for implementation of this project. The proposed modifications to the COCs include:

- AQ-2 to allow for the use of blended natural gas and hydrogen fuel in the CTGs;
- AQ-37 to monitor hydrogen gas flow rate to the turbine;
- AQ-44 to monitor the amount of hydrogen used; and
- HAZ-1 (Appendix C to the COC) revisions related to the increased amount of hydrogen storage allowed on-site.

Although hydrogen is not a regulated pollutant or toxic air contaminant (TAC), SDAPCD required a revision of the PTO as described above for the PEC associated with the Palomar Hydrogen Project. No other environmental permits related to water supply, biological resources, waste management, etc. are expected to be needed.

The proposed new Palomar Hydrogen Project components comply with all laws, ordinances, regulations, and standards (LORS) and do not have a significant environmental impact, as further described in this PTA. The proposed revisions to the COCs will not have significant impact on property owners, the public, or any other parties.

## **1.2 Change in Reheat Bowl Temperature Used for Startup Definition**

In addition to the Palomar Hydrogen Project changes, SDG&E also submitted an ATC application to the SDAPCD in November 2020 to revise the reheat bowl temperature that is used to determine whether a startup of the CTGs is considered to be a regular or an extended startup. This revision relates to COC AQ-28 to change the startup pivot temperature in the COC from 500°F to 750°F. This change is consistent with all LORS and does not lead to an increase in emissions. **The recently issued ATC permit includes this change to COC AQ-28 as well.**

## **1.3 Information Requirements for Post-Certification Amendments**

This Petition contains the information required under the CEC's Siting Regulations for post-certification project modifications [20 CCR Section 1769(a)(1)], including the following:

- A. A complete description of the proposed change, including new language for any conditions of certification that will be affected;
- B. A discussion of the necessity for the proposed change and an explanation of why the change should be permitted;
- C. A description of any new information or change in circumstances that necessitated the change;
- D. An analysis of the effects that the proposed change to the project may have on the environment and proposed measures to mitigate any significant environmental effects;
- E. An analysis of how the proposed change would affect the Project's compliance with applicable laws, ordinances, regulations, and standards;

- F. A discussion of how the proposed change would affect the public;
- G. A list of current assessor's parcel numbers and owners' names and addresses for all parcels within 500 feet of any affected project linears and 1,000 feet of the project site;
- H. A discussion of the potential effect of the proposed change on nearby property owners, residents, and the public; and
- I. A discussion of any exemptions from the California Environmental Quality Act (CEQA), of the Public Resources Code, that the project owner believes may apply to approval of the proposed change.

Each of these requirements is addressed in Section 2.

## **2.0 REQUIRED INFORMATION FOR POST-CERTIFICATION AMENDMENTS**

### **A. Complete description of the proposed change, including new language for any conditions of certification that will be affected.**

#### ***A.1 Facility Permitting Background***

The PEC, a combined-cycle, natural gas-fired power plant, was certified by the CEC with a Final Decision on August 6, 2003 and began commercial operation on April 1, 2006. The facility is located in the City of Escondido in San Diego County, California. An aerial view of the facility and its environs is shown in Figure 2-1. Some of the subsequent amendments made to the COCs in the Final Decision are described below.

In June 2005, SDG&E obtained approval to revise the amounts of hazardous chemicals stored on-site (as listed in Appendix C of COC HAZ-1), including hydrogen. Due to an issue with temporary loss of its reclaimed water supply, SDG&E requested and received approval of a revision to COC SOIL&WATER-5 in April 2006.

On February 22, 2013, the SDG&E filed a petition (TN 69634) with the CEC requesting to modify the Final Decision for the PEC. That PTA requested the CEC to: (1) modify certain air quality COCs to be consistent with the most recent SDAPCD PTO; and (2) upgrade the advanced gas path technology for two existing General Electric Frame 7-FA combined-cycle gas turbines. The changes to the SDAPCD PTO were made due to changes to the PEC's Title V Permit issued by the U.S. Environmental Protection Agency (EPA).

As docketed on September 20, 2013, SDG&E requested to split the PTA into two separate amendments (TN 200539). On March 5, 2015, CEC staff published an analysis of SDG&E's request to update certain air quality conditions of certification (TN 203772). On April 14, 2015, during the 30-day public review period, SDG&E submitted a response to the staff's analysis (TN 204166). In this response, SDG&E requested additional clarification regarding removal of obsolete conditions to ensure consistency with reporting requirements between the CEC and the SDAPCD and to make administrative changes. No other comments were received on the staff analysis.

On December 1, 2015, SDG&E submitted a second addendum (TN 206895) to their amendment request to delete COC AQ-38, which limits the annual combined fuel input into the duct burners.

As docketed on February 25, 2016, SDG&E filed a request to the CEC (TN 210531) to recombine the PTAs to (1) Upgrade the Advanced Gas Path Technology of the combustion turbine; and (2) Conform air quality conditions with the SDAPCD's PTO. On June 20, 2016, the SDAPCD granted the SDG&E PEC's Authority to Construct (ATC) (TNs 211984 and 211985) pursuant to Rule 20 of the Air Pollution Control District Rules and Regulations.

CEC staff reviewed these prior petitions, the requested changes, and the response to the staff's initial analysis and assessed the impacts of this proposal on environmental quality and public health and safety. It was the staff's opinion that, with the implementation of new and/or revised air quality COCs, the facility would remain in compliance with all applicable LORS and the proposed changes would not result in any significant, adverse, direct, indirect, or cumulative impacts to the environment. Based on the staff's recommendation, SDG&E's petition was approved at the Business Meeting of the California CEC on December 13, 2017.

Figure 2-1: Aerial View of the Palomar Energy Center and Surrounding Area



## A.2 Proposed Project Description

The proposed Project includes the following primary components:

- Hydrogen production system, including an electrolyzer system with integral hydrogen cooling and drying, a hydrogen compressor, and pressurized storage vessels, along with ancillary equipment;
- A hydrogen fueling station for vehicles, which will include one dispenser and necessary pressure regulators, compressors, and ancillary equipment;
- Elevated solar PV panels to provide supplemental electricity; and
- Electrical equipment that will tie-in with the hydrogen production system, including a transformer, utility interconnection, outgoing feeders, switchgears, motor control centers, and ancillary equipment.

These components are proposed to be installed on the eastern portion of the PEC site, within the existing facility footprint, in an area currently used as a storage and parking area. An enlargement of the aerial photograph showing the proposed area for the new facilities is provided in Figure 2-2, and a detailed facility plot plan is provided in Appendix B.

**Figure 2-2: Aerial View Showing the Existing Use of the Proposed Hydrogen Project Components Location**

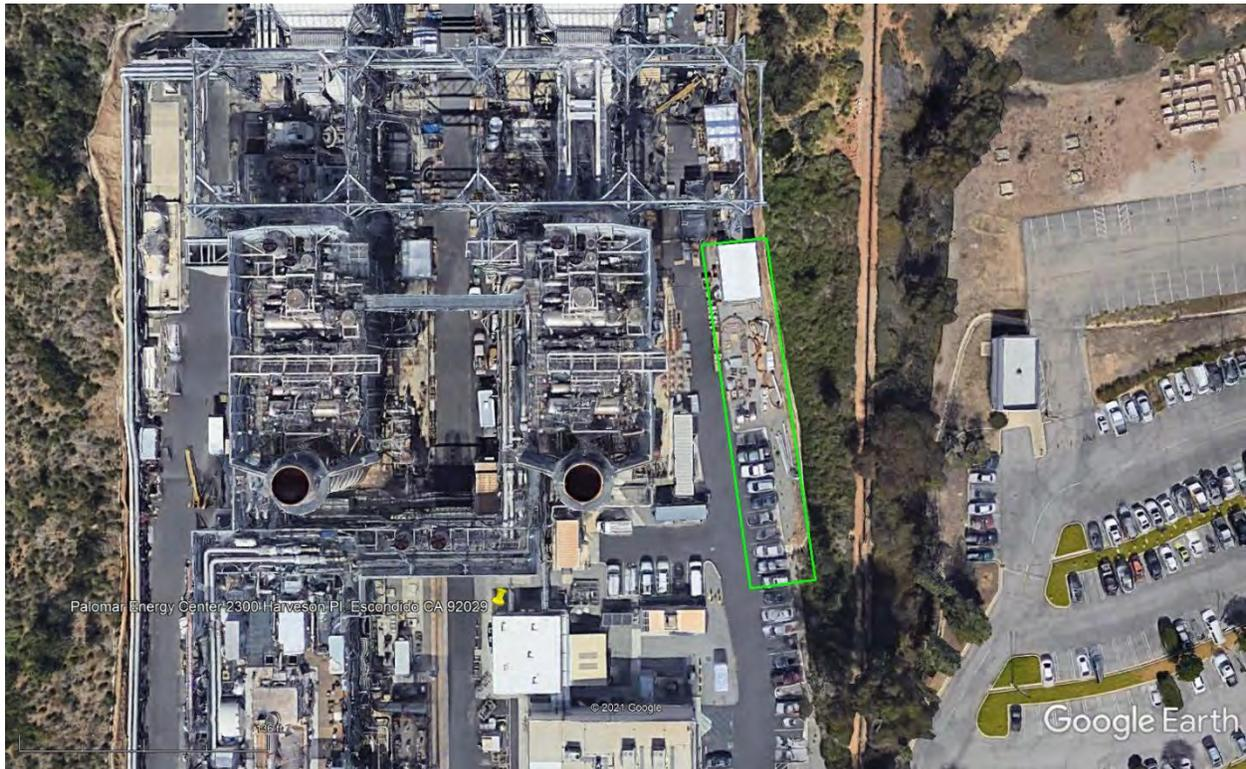

### ***A.2.1 Combined-Cycle Power Plant Hydrogen Consumption***

PEC is a 588-MW combined-cycle power plant with two generating units and a steam turbine. Hydrogen uses in the combined-cycle power plant are as follows:

- Hydrogen for generator cooling will be supplied to the Unit 1 and Unit 2 CTGs at 75 pounds per square inch gauge (psig) and regulated to 30 psig downstream of the existing pressure regulating valves. Hydrogen will be supplied to the STG at 125 psig and regulated to 45 psig downstream of the existing pressure regulating valves. The total hydrogen demand for CTG and STG cooling is 30 standard cubic feet (scf) per hour.
- Hydrogen blending in the fuel gas feed to the Units 1 and/or 2 CTGs is planned. A maximum blending of hydrogen of up to 2% of the fuel is currently anticipated, although the storage system has been sized based on an expected initial use of a 1% blend in one of the CTGs. The fuel gas supply is heated by the fuel gas heaters to 365°F at 500 psig. A fuel blending system will be provided to achieve uniform blending of hydrogen and natural gas.
- The hydrogen consumption for fuel gas blending is determined using the highest heat consumption case of 1,655 million British thermal units (MMBtu) per hour per CTG taken from the plant heat balances. As a basis for the natural gas supply to PEC, an annual average higher heating value (HHV) of 1,027 Btu per scf is calculated from SDG&E natural gas quality reports published for PEC's corresponding gas zone.

Based on the expected rate of 1% by volume blend of hydrogen in the fuel gas and using the typical lower heating values (LHV), it is estimated that a total of approximately 80,148 pounds per hour (lbs/hr) of blended gas is required to provide 1,655 MMBtu per hour to one CTG. This rate is equivalent to a demand of approximately 96 lbs/hr hydrogen from the storage cylinders.

### ***A.2.2 Hydrogen Production and Integration***

The proposed Project includes the integration of hydrogen into the fuel stream for on-site equipment and into the hydrogen fueling station through the electrolysis process. The electrolysis of water occurs through an electrochemical reaction that does not require external components or moving parts. It is very reliable and can produce ultra-pure hydrogen in a manner which does not produce greenhouse gas (GHG) emissions when the electrical source is renewable energy (FCS 2017). In times of excess electricity production from renewable sources, instead of curtailing the electricity as is commonly done, it is possible to use this excess electricity to produce hydrogen through electrolysis (USDOE 2020a). A Process Flow Diagram for the proposed Project is shown in Figure 2-3.

#### **Electrolyzer**

Electrolyzers can range in size from small, appliance-size equipment that is well-suited for small-scale distributed hydrogen production to large-scale, central production facilities. An electrolyzer consists of an anode and a cathode separated by an electrolyte. Different electrolyzers function in slightly different ways, mainly due to the different type of electrolyte material involved (USDOE 2020a). There are three primary types of

electrolyzers: proton exchange membrane (PEM); alkaline electrolyzers, and solid oxide electrolyzers. PEM electrolyzers typically use two membranes to achieve good efficiency.

**Figure 2-3: Palomar Hydrogen Project Components Process Flow Diagram**

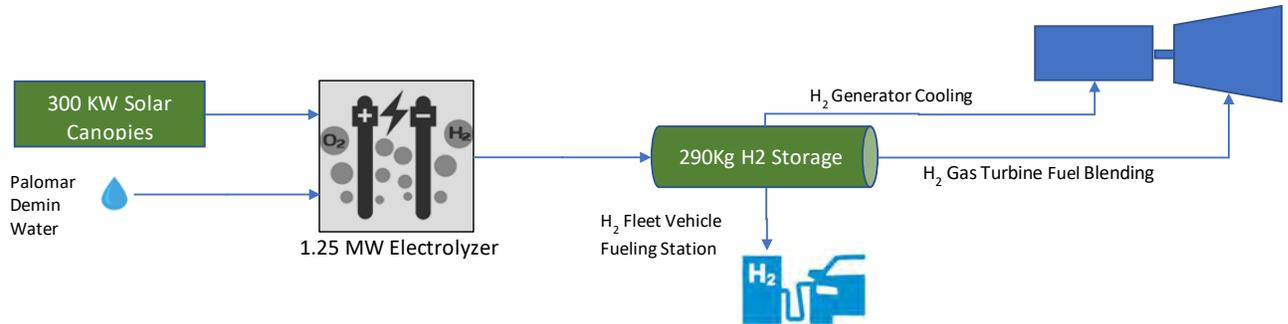

One electrolyzer will be used at PEC to create the hydrogen for the facility’s use. Hydrogen will be produced by a polymer electrolyte membrane (PEM) electrolyzer system. The electrolyzer specifications used as the basis of the conceptual design are included in Table 2-1.

**Table 1-2: Electrolyzer Specification**

|                                 |                       |  |   |
|---------------------------------|-----------------------|--|---|
| <b>Electrolyzer Type</b>        | PEM                   | <b>Rated Hydrogen Production</b>             | 49 lbs/hr [1,176 lbs/day]<br>(4.4 kilowatt-hours [kWh])/normal cubic meter [Nm <sup>3</sup> H <sub>2</sub> )                |
| <b>Rated Power</b>              | 1.25 MW               | <b>Rated Demineralized Water Requirement</b> | 0.9 Liters (L)/Nm <sup>3</sup> H <sub>2</sub><br>[0.00673 gallons/scf H <sub>2</sub><br>= 1.287 gallons/lb H <sub>2</sub> ] |
| <b>Output Hydrogen Pressure</b> | 435 psig<br>(30 barg) | <b>Output Hydrogen Purity</b>                | 99.9995%  |

### Hydrogen Compressors

Two intermediate-pressure compressors (A/B) are planned for the proposed Project. Each compressor will be an oil-free, motor-driven reciprocating or diaphragm compressor with a discharge pressure of 2,500 psig and discharge temperature suitable for storage and the downstream hydrogen users. The compressors will be designed to API 618 reciprocating compressor design criteria and either air cooling or closed circulating water systems will be used. Hydrogen compression requirements are provided in Table 2-2.

**Table 3-4: Hydrogen Compressor Design Criteria**

| Flow Rate | Suction Pressure/Temperature | Discharge Pressure |
|-----------|------------------------------|--------------------|
| 49 lbs/hr | 435 psig (30 barg)/105°F     | 2,500 psig         |

### Air Compressor

A single utility air compressor package located near the equipment requiring air will be supplied to meet the requirements of all new equipment. The compressor package will be modularized and packaged into skids that facilitate efficient shipping, installation, and maintenance.

### **Nitrogen Package**

The nitrogen package will provide gas to purge hydrogen from the electrolyzer, compressors, and other equipment requiring purge gas during continuous operation, shutdown, and maintenance. Nitrogen purge is not required for continuous operation, but it is recommended that a minimum of three standard 235-scf nitrogen gas cylinders be kept on-site for use during maintenance and complete shutdown. It is expected that nitrogen purge requirements can be met with a nitrogen gas cylinder storage system.

### **Blending Skid**

Hydrogen will pass through piping into the blending skid, which would combine hydrogen produced in the electrolyzer with natural gas. Given current pipeline operating conditions, a maximum blend ratio of 98% natural gas to 2% hydrogen could occur.

### **Storage Pressure Vessels**

Hydrogen that is not immediately needed to support the electrical generation equipment on-site or the hydrogen fueling station would be stored on-site in cylindrical storage pressure vessels.

Hydrogen storage will be nominally sized to maintain a minimum of 6 hours of hydrogen for the typical 1% by volume blending in the fuel gas into one CTG, which is equal to approximately 600 pounds or 114,759 scf.

Black & Veatch conducted a preliminary process optimization of the storage pressure, number of storage tanks, and sizing of the hydrogen compressors. The pressure for hydrogen storage was determined by balancing the required storage mass of hydrogen with the available footprint for storage and standard hydrogen storage offerings.

Given the available footprint at PEC and using 24-inch diameter, 40-foot-long cylindrical hydrogen storage vessels, it is estimated that the required mass of hydrogen could be stored in a rack arrangement 4 vessels high by 3 vessels wide (up to 12 total), in an approximately 11-foot by 40-foot footprint (440 square feet). This configuration would require the hydrogen to be compressed to 2,500 psig (2,515 psia) for storage. The hydrogen storage requirements are provided in Table 2-3.

**Table 5-6: Hydrogen Storage Design Criteria**

| <b>Storage Weight</b> | <b>Storage Volume</b>         | <b>Storage Vessels</b>                                      |
|-----------------------|-------------------------------|---|
| 600 lbs               | 114,759 scf (68°F, 14.7 psia) | 9 to 12 cylinders<br>(24 in. diameter x 40 ft. length each) |

### **Water Treatment and Cooling System**

PEC is required to use reclaimed water for all non-potable uses. Reclaimed water for PEC is obtained from the Hale Avenue Resource Recovery Facility (HARRF).

Reclaimed water to be used in the hydrogen process is demineralized and will be put into the existing demineralized water (DW) system at 85°F and 60 psig. The DW system at PEC consists of a 200,000-gallon Demin water storage tank and two Demin water pumps rated for 500 gallons per minute (GPM) at 90 feet total dynamic head. It is expected that



the existing demineralized water storage and transfer capabilities are sufficient in capacity and quality to meet the demands of the new hydrogen production system.

Hydrogen is needed for CTG cooling, CTG fuel blending, and the hydrogen fueling station. As shown in Table 2-1, in continuous operation, the electrolyzer could produce 1,176 pounds per day of hydrogen. Based on the water usage rate of 0.9 L/Nm<sup>3</sup> for the electrolyzer given in Table 2-1, it is estimated that the proposed Project will require on the order of 63 gallons per hour or 1,513 gallons per day [0.0015 million gallons per day (MGD)] of demineralized water to produce hydrogen at a rate of 49 lbs/hr in the electrolyzer.

Condensate from the compressor knockout drums and intermittent wastewater discharged from the electrolyzer will be gravity-drained to an underground sump and transferred to the existing heat recovery steam generator (HRSG) blowdown sump. While this wastewater is not suitable for reuse within the electrolyzer, it is expected to be high-quality, oil-free wastewater that is suitable for discharge to the cooling tower via the HRSG blowdown sump.

### ***A.2.3 Hydrogen Fueling Station***

The hydrogen fueling station requirements and specifications used as a basis for conceptual design are included in Table 2-4. It is expected the hydrogen fueling station will include integral compressors and a cooling system to achieve the required discharge pressure and temperature for fueling. Hydrogen for FCEV fueling will be stored at an intermediate pressure of 6,526 psig (450 barg) in a tank sized to support fueling five vehicles per day. The fueling station will take hydrogen from the lower ground storage pressure and compress the hydrogen to an intermediate pressure of 6,526 psig. The storage tank for vehicle fueling will be located with the other storage tanks. During FCEV fueling, the fueling station will take hydrogen from the 6,526-psig vehicle fueling storage tank and compress the hydrogen to 10,152 psig (700 barg). The compressed hydrogen will be cooled by the fueling station and delivered to the vehicle through the vehicle fueling dispenser. Vehicles will be refueled periodically on an as-needed basis, so the consumption will be intermittent.

**Table 7-8: Hydrogen Fueling Station Requirements**

|   |                                     |                                    |                           |
|---|-------------------------------------|------------------------------------|---------------------------|
| <b>Hydrogen Consumption per Vehicle</b> | 9-22 lbs<br>(4-10 kilograms)        | <b>Hydrogen Discharge Pressure</b> | 10,152 psig<br>(700 barg) |
| <b>Max Fueling Rate</b>                 | 8 lbs/minute<br>(60 gallons/second) | <b>Hydrogen Storage Pressure</b>   | 6,526 psig<br>(450 barg)  |

### ***A.2.4 Solar Photovoltaic System***

Solar PV systems convert sunlight into electrical energy. When the sun shines onto a solar panel, photons from the sunlight are absorbed by the cells in the panel, which creates an electric field across the layers and causes electricity to flow (USDOE 2020c). The proposed Project includes the placement of solar PV modules on canopies over the parking areas (see Appendix A). Up to 300 kW of total solar PV output that will provide power to the facility is being contemplated for the proposed Project.

### ***A.2.5 Other Ancillary Site Improvements***

The project includes the installation of other ancillary piping and equipment to support the operation of the compressor system and solar PV components. These components would be located within the fenced facility footprint.

In addition, a 20-foot-high fire wall will be installed on the northern and eastern sides of the hydrogen storage area (see plot plan in Appendix A). No changes to the existing security fencing or lighting are proposed.

### ***A.2.6 Project Construction Schedule***

SDG&E's currently planned construction schedule for the proposed Palomar Hydrogen Project includes completing the design, engineering, and procurement in 2021. The actual construction process would begin in late 2021. First, the solar PV arrays would be installed on canopies (see Appendix A). The civil/structural, electrical/instrumental, and mechanical components would be completed and hydrogen equipment installed. These construction activities are expected to take approximately six months. Once installed, the equipment will be tested prior to acceptance.

## ***A.3 Proposed Changes to the Conditions of Certification***

The following specific revisions to the COCs in the CEC's Final Commission Decision (or as subsequently revised as discussed in Section A.1) are proposed using **underline bold** for inserted text and **~~strikethrough bold~~** for deleted text. Only the COCs proposed for revision are included, with the ATC revisions issued by SDAPCD contained in Appendix A. In addition to the four COCs proposed for revision for the Palomar Hydrogen Project, AQ-28 is included for the change in the reheat bowl temperature used to define a regular or an extended startup (See Section 1.2).

**AQ-2** The unit shall be fired on Public Utility Commission (PUC) quality natural gas **blended with up to 2% hydrogen by volume** only. The project owner shall maintain quarterly records of sulfur content (grains/100 dscf) and higher and lower heating values (Btu/dscf) of the **natural gas blended fuel** and provide such records to the District personnel upon request.

**Verification:** The project owner shall certify compliance with this condition as part of the Quarterly Operational Report (AQ-SC7) and shall make the site and data available for inspection by representatives of the District, ARB or Energy Commission.

*Note: The change to AQ-28 is not related to the hydrogen project but is related to ongoing operations.*

**AQ-28** A startup period is the period of time that begins when fuel flows to the combustion turbine following a nonoperational period. For purposes of determining compliance with the emission limits of this permit, the duration of a startup period shall not exceed 120 consecutive minutes if the steam turbine reheat bowl temperature is above **750500**° F when the startup period begins and shall not exceed 360 consecutive minutes if the steam turbine reheat bowl temperature is less than or equal to **750500**° F when the startup period begins.

**Verification:** The project owner shall certify compliance with this condition as part of the Quarterly Operational Report (AQ-SC7) and shall make the site and data available for inspection by representatives of the District, ARB or Energy Commission.

The proposed changes to COC AQ-37 and AQ-44 will require monitoring and recordkeeping of the volume of hydrogen consumed in each CTG.

**AQ-37:** Continuous emission monitoring system (CEMS) shall be installed and properly maintained and calibrated to measure, calculate and record the following, in accordance with the District-approved CEMS protocol:

- A. Hourly average concentration of Oxides of Nitrogen (NOX) corrected to 15% oxygen, in parts per million (ppmvd);
- B. Concentration of Carbon Monoxide (CO) corrected to 15% oxygen, in parts per million (ppmvd);
- C. Percent oxygen (O<sub>2</sub>) in the exhaust gas (%) for each clock hour period;
- D. Average concentration of Oxides of Nitrogen (NOX) for each rolling 3-hour period, in parts per million (ppmv) corrected to 15% oxygen;
- E. Hourly and Monthly mass emissions of Oxides of Nitrogen (NOX), in pounds;
- F. Rolling 12-month mass emissions of Oxides of Nitrogen (NOX), in tons;
- G. Hourly and monthly mass emissions of Carbon Monoxide (CO), in pounds;
- H. Annual mass emissions of Carbon Monoxide (CO), in tons.
- I. Natural gas flow rate to combustion turbine in scf/hr.
- J. Natural gas flow rate to duct burner in scf/hr.
- K. Concentration of Volatile Organic Compounds (VOC) corrected to 15% oxygen, in parts per million (pmvd) for each rolling 3-hour period, based upon the approved VOC/CO surrogate relationship.
- L. Hourly and monthly mass emissions of VOC in pounds
- M. Rolling 12-month mass emissions of VOC in tons.
- N. Hydrogen gas flow rate to combustion turbine in scf/hr.**

The CEMS shall be in operation in accordance with the District approved CEMS monitoring protocol at all times when the combustion turbine is in operation. A copy of the District approved CEMS monitoring protocol shall be maintained on site and made available to District personnel upon request.

**Verification:** The project owner shall provide the information necessary for compliance with this condition in the permanent CEMS protocol required under Condition AQ-36.

**AQ-44** Operating logs or Data Acquisition System (DAS) records shall be maintained to record the beginning and end times and durations of all startups, shutdowns, low load operations, and tuning periods to the nearest minute; quantity of natural gasfuel used (in each clock hour, calendar month, and 12 calendar month period) in standard cubic feet; quantity of hydrogen used (in each clock hour, calendar month, and 12 calendar month period) in standard cubic feet, hours of daily operation; and total cumulative hours of operation during each calendar year.

**Verification:** The project owner shall certify compliance with this condition as part of the Quarterly Operational Report (AQ-SC7) and shall make the site and data available for inspection by representatives of the District, ARB or Energy Commission.

**HAZ-1** The project owner shall not use any hazardous materials not listed in Appendix C, appended to the end of these Conditions, below, or in greater quantities than those identified by chemical name in Appendix C, below, unless approved in advance by the CPM.

**Verification:** The project owner shall provide to the Compliance Project Manager (CPM), in the Annual Compliance Report, a list of hazardous materials contained at the facility in reportable quantities.

*Note: No changes are proposed to HAZ-1, only to the line for hydrogen in Appendix C.*

### APPENDIX C

#### Anticipated Hazardous Materials Use at the Palomar Energy Center Project

| Material | CAS No. or Chemical Makeup) | Location/ Application                                     | Hazardous Characteristics <sup>42</sup> | Maximum Quantity On Site   | Regulatory Thresholds (lb) |                          |                           |                          |
|----------|-----------------------------|---|---|--|----------------------------|--------------------------|---------------------------|--------------------------|
|          |                             |   |   |  | CalARP                     | Federal RQ <sup>43</sup> | Federal TPQ <sup>44</sup> | Federal TQ <sup>45</sup> |
| Hydrogen | 1333-74-0                   | Generator Cooling, <u>Fuel Blending, and FCEV Fueling</u> | <i>Health: toxic<br/>Physical: fire</i> | <del>80,000 scf</del><br><br><u>600 lbs or 114,759 scf (68°F, 14.7 psia)</u> | --                         | --                       | --                        | 10,000                   |

*Note: the amount of hydrogen and other materials were modified from the Final Decision on June 10, 2005.*

**B. A discussion of the necessity for the proposed change and an explanation of why the change should be permitted.**

Senate Bill (SB) 100 calls for the decarbonization of California’s electric grid by 2045. The Palomar Hydrogen Project is one of SDG&E’s initial efforts toward meeting that goal. The Project should be permitted as it will allow SDG&E to introduce up to 2% hydrogen blending with natural gas as a step in determining its feasibility. Installing a hydrogen fueling station also meets California goals of reducing GHG emissions from the transportation sector.

**C. A description of any new information or change in circumstances that necessitated the change.**

As part of efforts to support California’s GHG emissions reduction goals and its mission to become one of the cleanest, safest, and most innovative energy companies in America, SDG&E is focused on improving air quality in communities and decarbonizing its energy supply. SDG&E has established a pathway forward to reduce operational GHG emissions by introducing hydrogen to key electrical generation facilities as a first step in a long-term strategy to achieve these goals.

**D. An analysis of the effects that the proposed change to the project may have on the environment and proposed measures to mitigate any significant environmental effects.**

A summary of the expected impacts on each of the environmental resource areas is provided in Table 2-5 below. Additional analyses of the potential impacts on air quality and public health, GHG emissions and energy use, and noise and vibration are provided in Appendix C.

**Table 9-10: Environmental Impact Summary**

| Resource Area                | Significant Impact? |    | Analysis   |
|------------------------------|---------------------|----|--|
|                              | Yes                 | No |  |
| Air Quality                  |                     | X  | An air quality impact analysis is provided in Appendix B. As shown in this appendix, less than significant impacts to air quality are expected from construction or operation of the proposed Project. Construction emissions are expected to be minimal and temporary (approximately six months). Since hydrogen is not a regulated pollutant, no direct criteria pollutant emissions increases are expected from operation of the proposed new hydrogen generation system, due to fuel blending, or the hydrogen fueling station.  |
| Biological Resources         |                     | X  | The proposed Project components will be added within the existing facility footprint on an area currently used as a parking lot. The addition of these facilities in this previously disturbed area would not impact biological resources.   |
| Cultural Resources           |                     | X  | The proposed Project components will be added within the existing facility footprint on an area currently used as a parking lot. Although there will be some minor excavation needed related to the addition of new piping and electrical lines within the facility footprint, we note that the entire PEC site including this area underwent substantial grading and site preparation/leveling prior to the installation of the power plant, and hence the addition of the facilities including minor excavation would not impact cultural resources.                           |
| Efficiency and Reliability   |                     | X  | Allowing for use of an up to 2% blended hydrogen with the natural gas would not have an impact on efficiency and reliability of PEC.   |
| Geology, and Paleontology    |                     | X  | The area where the proposed Project components will be installed is already level and disturbed and hence no substantial changes to the Project footprint are proposed. Therefore, there would be no impact to geologic or paleontological resources. All new structures will be built to meet current codes related to potential seismic activity at the site.  |
| GHG Emissions and Energy Use |                     | X  | Analyses of the GHG emissions and energy usage for the Project are provided in Appendix B. Less than significant impacts related to these topics are expected from construction and operation of the proposed Project. GHG emissions from construction are very minor, and the GHG emissions associated with indirect electrical power generation needed for the electrolyzer would be less than significant. The proposed Project would be consistent with several strategies in the Escondido Climate Action Plan, including encouraging use of zero-emissions and alternative |

| Resource Area            | Significant Impact? |    | Analysis   |
|--------------------------|---------------------|----|--|
|                          | Yes                 | No |  |
|                          |                     |    | fueled vehicles, reduced use of fossil fuels, and increase in renewable and zero-carbon energy. The Project also meets California’s goals with the use of decarbonizing fuels to reduce GHG emissions.   |
| Hazardous Materials      |                     | X  | Hydrogen is already stored on-site, and the amount stored will increase (from approximately 418 lbs to 600 lbs) but will remain well below the Threshold Quantity (TQ) level of 10,000 pounds listed in the California Accidental Release Prevention (CalARP) Program.   |
| Land Use                 |                     | X  | The use of hydrogen for generator cooling is already allowed at PEC and the proposed changes will comply with requirements of the City of Escondido General Plan and Escondido Research and Technology Center (ERTC) Specific Plan, so no zoning changes will be needed. Therefore, impacts related to land use are not expected.  |
| Noises and Vibration     |                     | X  | An analysis of construction and operational noise and vibration is provided in Appendix B. Less than significant impacts are expected.   |
| Public Health            |                     | X  | Combustion or use of hydrogen will reduce the amount of fine and respirable particulate matter and GHG emissions from the CTGs. Therefore, the proposed Project will have a beneficial impact on public health in the nearby communities.  |
| Socioeconomic Resources  |                     | X  | The construction of the proposed Project will be temporary, and the proposed Project does not require any changes in operations workforce; hence, there will be no socioeconomic impact.   |
| Soil and Water Resources |                     | X  | <p>Impacts to Soils are not expected. The proposed Project will be constructed on a previously disturbed site and construction will occur on a previously graded and leveled area. If needed, the site’s Stormwater Pollution Prevention Plan (SWPPP) will be updated to ensure impacts to soils are minimized.</p> <p>Water use by the electrolyzers will have a less than significant impact on water resources/water quality. The project will utilize reclaimed water from the HARRF, and no potable water will be used. The reclaimed water will be processed in PEC’s DW system which currently has sufficient capacity for the proposed Project. Likewise, any process or wastewater discharge will be put into PEC’s existing system which has sufficient capacity to handle these flows.</p> <p>Soil and Water (S&amp;W) Resources Appendix A in the Final Staff Assessment (FSA) for PEC (CEC 2003) indicated that the HARRF would be able to produce up to 9 MGD of reclaimed water after planned improvements were made to add tertiary treatment to the HARRF. Of that amount, it was estimated in the FSA that PEC might use up to 3.6 MGD of reclaimed water. None of the S&amp;W COCs for PEC limit the amount of reclaimed water that can be used from the HARRF, and PEC was seen as substantial financial benefactor for the HARRF improvements by virtue of being a year-round user of the reclaimed</p> |

| Resource Area  | Significant Impact? |    | Analysis   |
|--|---------------------|----|--|
|  | Yes                 | No |  |
|  |                     |    | water. Based on the requirement of 0.9 L/Nm <sup>3</sup> of water for the production rate of 49 lbs/hr of hydrogen produced (See Table 2-1), it is estimated that the proposed Project could require approximately 0.0015 MGD of DW. Actual usage of reclaimed water by PEC in 2020 was an average of approximately 1.6 MGD. Therefore, the small usage of DW for the proposed Project would be well below that analyzed in the FSA for PEC and hence would have a less than significant impact on water supply.   |
| Traffic and Transportation                                 |                     | X  | The construction workforce will be minimal and construction worker parking and laydown areas can be accommodated on-site. The proposed Project does not require any changes in PEC workforce for plant operation; hence, there will be no traffic or transportation impact due to worker commute. The proposed changes will reduce the quantity of hazardous materials delivered to the Facility since hydrogen will now be produced on-site. The hydrogen fueling station may have up to 5 FCEVs per day travel to the site, but this amount of traffic would be minimal. Therefore, the proposed Project is expected to have a less than significant impact related to traffic and transportation. |
| Transmission Line Safety & Nuisance and System Engineering |                     | X  | The solar PV system will require interconnection on-site but no substantial changes to the offsite transmission system are anticipated due to the proposed Project. Therefore, impacts related to the transmission system are expected to be less than significant.  |
| Visual Resources   |                     | X  | An earthen berm currently runs along the eastern PEC property boundary to provide visual screening of the power plant from the adjacent properties, including the education center offices across from the proposed Project components. The tallest structures related to the proposed Project are the electrolyzer equipment at 20 feet and the solar PV canopies at 15 feet. The height of the berm near where the electrolyzer will be located is 25 feet, and hence provides sufficient screening of the view.   |
| Waste Management   |                     | X  | Construction waste will be minimized and recycled to the extent practicable. The proposed Project will not affect the level of solid waste production from the PEC; hence, there will be less than significant impact.   |
| Worker Safety and Fire Protection                          |                     | X  | All required plans such as the Hazardous Materials Business Plan (HMBP) will be updated if needed related to the production, increased storage, and use of hydrogen on-site. The incremental increase in hydrogen storage on-site is well below the TQ for hydrogen. As a result of the safety procedures in place and updated as needed, the proposed Project will have a less than significant impact on worker safety and fire protection.  |

**E. An analysis of how the proposed change would affect the project's compliance with applicable laws, ordinances, regulations, and standards.**

The Palomar Hydrogen Project is expected to continue compliance with all applicable LORS. The proposed Project only requires minor changes to COCs AQ-2, AQ-37, AQ-44, and HAZ-1, which do not change the facility's compliance with any additional LORS or cause any compliance constraints. The proposed Project involves adding hydrogen facilities to an existing power generation site, including an increase in the amount of hydrogen stored on-site, such that the power plant can continue to meet requirements with regulations and existing permits. For instance, the proposed Project will continue to comply with LORS as follows:

- Hydrogen is not a regulated air pollutant, so the proposed facilities do not require air permitting. Blending of up to 2% hydrogen in the natural gas fuel will not require any changes to the current SDAPCD PTO related to emissions limits.
- All hydrogen generation, storage, and fuel-related facilities will be built in compliance with applicable Building, Energy Efficiency, and Fire Codes.
- Hydrogen is already stored on-site, but the Hazardous Materials Business Plan (HMBP) and CalARP Risk Management Plan (RMP) will be reviewed and updated if needed.
- All architectural design and painting and landscaping will comply with the Escondido Research and Technology Center (ERTC) Specific Plan requirements.
- The main facility components will be constructed in a disturbed area currently used for storage and a parking lot. This area underwent substantial grading and ground disturbance during initial power plant construction, hence impacts related to biological, cultural, paleontological, geologic, soils, etc. are not expected. Should issues arise, SDG&E has biological and cultural subject matter experts (SMEs) who will be readily available to assist.
- As discussed in Appendix B, the proposed Project will comply with Escondido's General Plan and City Municipal Code related to noise and vibration impacts.
- The site's SWPPP will be updated if needed for construction of the new Project components.
- The project will utilize reclaimed water from the HARRF and no potable water will be used. The reclaimed water will be processed in PEC's DW system which currently has sufficient capacity for the project. Likewise, any process or wastewater discharge will be put into PEC's existing system which has sufficient capacity to handle these flows.

**F. A discussion of how the proposed change would affect the public.**

The proposed changes would have a positive effect on the public by allowing PEC to move toward implementation of SB 100 and California's goals of a carbon free energy future. The proposed Project would not have a substantial environmental impact on the public. The small increase in temporary criteria pollutant emissions related to construction would not cause or contribute to an exceedance of an ambient air quality standard (AAQS). The small increase in short-term TAC emissions during construction would not cause health risk impacts exceeding significance thresholds. The increase in risk from the increase in storage of hydrogen, which is a flammable hazardous material, from approximately 418 lbs to 600 lbs hydrogen storage on-site would be minimized by meeting applicable Building and Fire Codes, as well as updating the HMBP and



RMP if needed. The noise from the new air and hydrogen compressors would not be substantially different than the background noise from the power plant and would be within the requirements of the local ordinances and municipal codes. PEC uses reclaimed water from the HARRF and the small amount of reclaimed water used for the electrolyzer would not impact potable water supplies. Up to five FCEVs per day using the new hydrogen fueling station would not substantially increase traffic, and with the production of hydrogen on-site, there will no longer be a need to have deliveries of hydrogen cylinders. An existing earthen berm along the eastern property boundary would screen the new hydrogen facilities so that there would be no impact to the public's views.

**G. A list of current assessor's parcel numbers and owners' names and addresses for all parcels within 500 feet of any affected project linears and 1,000 feet of the project site.**

Nearby property owners, the public, and Parties to the Application Proceeding will not be affected by the proposed modification, since the proposed Project will be consistent with the current operation of the power plant, will have less than significant environmental effects, and will be in compliance with applicable LORS. Because there are no potentially affected property owners, a list of property owners is not included in this PTA. A list of property owners within 1,000 feet of the plant site has previously been provided to the CEC CPM for previous Post-Certification Amendments.

**H. A discussion of the potential effect of the proposed change on nearby property owners, residents, and the public.**

As seen in Figure 2-2, there is a large parking lot immediately east of the area where the proposed Project will be located, with the education center office building located more than 440 feet east of the closest Project components. There are light industrial buildings more than 460 feet to the northeast and a bakery more than 550 feet to the southeast. There is a hospital approximately 1,400 feet to the northwest and the closest residences to the proposed Project are more than 1,900 feet to the west (See Figure 2-1).

As discussed in Section F, significant effects are not expected on these nearby property owners or the public. The temporary (approximately 6 months) short-term emissions of criteria pollutants and diesel particulate matter during construction would have a negligible effect on nearby property owners, residents, and the public. Compliance with applicable California Building and Fire Codes and HMBP/RMP requirements will ensure that risks related to hazardous material (hydrogen) handling will be minimal. Noise from the hydrogen and air compressors and other equipment will meet the relevant NOISE COCs (e.g., NOISE-6 which limits noise in the residential areas west of the power plant site), as well as all Municipal Codes related to noise. The proposed Project will not use potable water and will not substantially increase use of reclaimed water by the power plant. The existing berm will block views of the proposed Project components from the adjacent parking lot and nearby buildings.

**I. A discussion of any exemptions from the California Environmental Quality Act, of the Public Resources Code, that the project owner believes may apply to approval of the proposed change.**

Exemptions to CEQA have not been identified.

### 3.0 SUMMARY AND CONCLUSIONS

The Palomar Hydrogen Project is proposed to support California's and SDG&E's goals to reduce GHG emissions and move toward a carbon free future.

Construction of the proposed new facilities are expected to take approximately a year, with the first six months for final engineering and design and equipment procurement, and approximately six months for the solar PV installation and construction and testing of the hydrogen components. The proposed Project will be constructed within the existing power plant footprint in an area currently used for storage and a parking lot. The area was extensively graded and disturbed during initial power plant construction, and no impacts to soils or to below ground level cultural or paleontological resources are expected. Minor air quality impacts during construction would be less than significant.

Operation of the proposed Project will entail hydrogen production using an electrolyzer and an increase in hydrogen storage in compressed gas cylinders from a maximum of 418 lbs to 600 lbs of hydrogen, which is still well below the TQ of 10,000 lbs where additional risk measures would need to be taken. Having an option to use a blended fuel will not affect power plant reliability or efficiency. No new off-site transmission system improvements or changes are needed. The proposed Project will include the installation of 300 kW PV solar which will reduce the amount of electricity needed from the grid for operation of the electrolyzer. Since the grid power is not yet 100% green, this energy use will cause indirect GHG emissions of approximately 2,724 metric tons (MT)/year related to the production of electricity, which is well below the San Diego County significance threshold of 10,000 MT per year.

Use of the blended fuel is not expected to impact SDG&E's ability to maintain compliance with the current SDAPCD PTO. No potable water will be used for hydrogen production and the additional reclaimed water used is small compared to other uses at PEC and well within the capacity of the HARRF. No changes to zoning or land use designation are needed, building design and painting as well as landscaping will remain consistent the ERTC Specific Plan, so there will be no land use impacts. There will be no change to the operational workforce needed and the up to five vehicles per day that would use the new hydrogen fueling station would not be a significant impact to traffic. The existing berm along the property boundary will sufficiently screen the new Project components from public view.

Implementation of the proposed Project does not introduce any new LORS for operation of the PEC since hydrogen is already used and stored on-site. Minor revisions to **four** of the COCs are proposed related to the proposed Project (AQ-2, **AQ-37, AQ-44**, and Appendix C of HAZ-1) and only one other COC (AQ-28) is proposed to reflect a change that the SDAPCD **also made** to the PEC PTO. Hydrogen is not a pollutant or TAC and no **other** new or revised environmental permits are needed. The nearby property owners, residents, or the public should not be significantly impacted by the project. Therefore, the proposed Project should be approved.

## 4.0 REFERENCES

- Baronas, Jean, Gerhard Achtehik, et al. 2020. Joint Agency Staff Report on Assembly Bill 8: 2020 Annual Assessment of Time and Cost Needed to Attain 100 Hydrogen Refueling Stations in California. California Energy Commission and California Air Resources Board. Publication Number: CEC-600-2020-008. Accessed online June 22, 2021: <https://www.energy.ca.gov/sites/default/files/2021-05/CEC-600-2020-008.pdf>
- California Air Pollution Control Officers Association (CAPCOA). 2008. CEQA & Climate Change: Evaluating and Addressing Greenhouse Gas Emissions from Projects Subject to the California Environmental Quality Act, January 2008. Accessed online June 24, 2021: (<http://www.capcoa.org/wp-content/uploads/downloads/2010/05/CAPCOA-White-Paper.pdf>).
- California Air Resources Board (ARB). 2017. California’s 2017 Climate Change Scoping Plan. Website (<https://ww3.arb.ca.gov/cc/scopingplan/scopingplan.htm>) accessed May 21, 2021.
- California Emissions Estimation Model® (CalEEMod). 2020. Version 2020.4. Website (<http://www.caleemod.com/>) accessed June 24, 2021.
- California Energy Commission. 2019. Building Energy Efficiency Program. Website (<https://www.energy.ca.gov/programs-and-topics/programs/building-energy-efficiency-standards>) accessed May 21, 2021.
- California Energy Commission. 2003. Final Staff Assessment Palomar Power Project. Application for Certification (01-AFC-24). January.
- California Governor’s Office of Emergency Services (CalOES). 2020. “California Accidental Release Prevention (CalARP) Program Guidance.” Website (<https://www.caloes.ca.gov/FireRescueSite/Documents/CalARP%20Guidance.pdf#search=hydrogen%20threshold%20quantity>) accessed June 22, 2021:
- California Independent System Operator (ISO). 2016. “Fast Facts: What the duck curve tells us about managing a green grid.” Accessed online June 22, 2021: [http://www.caiso.com/Documents/Flexibleresourceshelprenewables\\_FastFacts.pdf](http://www.caiso.com/Documents/Flexibleresourceshelprenewables_FastFacts.pdf)
- City of Escondido, Escondido Research and Technology Center (ER&TC) Specific Plan. Accessed online June 22, 2021: <https://www.escondido.org/Data/Sites/1/media/pdfs/Planning/ERTCSpecificPlan.pdf>
- County of San Diego (County). 2007. Guidelines for Determining Significance, Air Quality, March 2007. Accessed online June 24, 2021 (<https://www.sandiegocounty.gov/content/dam/sdc/pds/ProjectPlanning/docs/AQ-Guidelines.pdf>).
- County of San Diego (County). 2018. Guidelines for Determining Significance, Climate Change, February 2018. Accessed online June 24, 2021 (<https://www.sandiegocounty.gov/content/dam/sdc/pds/ProjectPlanning/docs/Final%20Climate%20Change%20Significance%20Guidelines%20Clean.pdf>).
- Fuel Cell Store (FCS). 2017. Introduction to Electrolyzers. Website ([www.fuelcellstore.com/blog-section/introduction-to-electrolyzers](http://www.fuelcellstore.com/blog-section/introduction-to-electrolyzers)) accessed June 24, 2021.

- GO-Biz (California Governor’s Office of Business and Economic Development). 2020. Hydrogen Station Permitting Guidebook. September. Accessed online June 22, 2021: [https://cdn.businessportal.ca.gov/wp-content/uploads/2020/09/GO-Biz\\_Hydrogen-Station-Permitting-Guidebook\\_Sept-2020.pdf](https://cdn.businessportal.ca.gov/wp-content/uploads/2020/09/GO-Biz_Hydrogen-Station-Permitting-Guidebook_Sept-2020.pdf)
- H2-international. 2017. Electrolyzer Manufacturers Stake Their Claims. Accessed online on June 22, 2021: <https://www.h2-international.com/2017/06/06/electrolyzer-manufacturers-stake-their-claims/>
- The Intergovernmental Panel on Climate Change (IPCC). 2014. *Climate Change 2014: Synthesis Report. Contribution of Working Groups I, II and III to the Fifth Assessment Report of the Intergovernmental Panel on Climate Change* [Core Writing Team, R.K. Pachauri and L.A. Meyer (eds.)]. IPCC, Geneva, Switzerland, 151 pp. Website (<https://www.ipcc.ch/reports/>) accessed June 24, 2021.
- Keating, Cecilia. 2020. “Green hydrogen could curb one-third of fossil fuel and industry emissions by 2050.” GreenBiz. April 7.
- Larson, Aaron. 2021. Power Podcasts: Hydrogen and the Energy Transition. Power Magazine. February 25. Accessed online June 22, 2021: <https://www.powermag.com/hydrogen-and-the-energy-transition/>
- San Diego Gas & Electric (SDG&E). 2021. Sustainability Strategy – Paving the Way to a Net Zero Future. Fact Sheet. Accessed online on June 22, 2021: <https://www.sdge.com/sites/default/files/5-6-21cleanenergyfactsheet.pdf>
- South Coast AQMD (South Coast Air Quality Management District). 2021. South Coast AQMD Advisor. January/February 2021. Volume 28. Issue 1. Accessed online June 22, 2021: <https://www.aqmd.gov/home/research/publications/jan-feb-2021/cec-hydrogen-fueling-stations>
- The Climate Registry (TCR). 2020. Default Emission Factors Document. Website (<https://www.theclimateregistry.org/wp-content/uploads/2020/04/The-Climate-Registry-2020-Default-Emission-Factor-Document.pdf>) accessed May 21, 2021.
- USDOE (US Department of Energy). 2017. Confronting the Duck Curve: How to Address Over-Generation of Solar Energy. October 12. Accessed online June 22, 2021: <https://www.energy.gov/eere/articles/confronting-duck-curve-how-address-over-generation-solar-energy>
- USDOE. 2020a. Hydrogen Production: Electrolysis. Department of Energy, Office of Energy Efficiency and Renewable Energy. Accessed online on June 22, 2021: <https://www.energy.gov/eere/fuelcells/hydrogen-production-electrolysis>
- USDOE. 2020b. Fuel Cells. Accessed Online January 27, 2020: Department of Energy, Office of Energy Efficiency and Renewable Energy: <https://www.energy.gov/eere/fuelcells/fuel-cells>
- USDOE. 2020c. Homeowner’s Guide to Going Solar. Accessed Online January 27, 2020: Department of Energy, Office of Energy Efficiency and Renewable Energy: <https://www.energy.gov/eere/solar/homeowner-s-guide-going-solar>

**APPENDIX A – AUTHORITY TO CONSTRUCT PERMIT FOR PEC ISSUED  
FEBRUARY 3, 2022**



**COUNTY OF SAN DIEGO AIR POLLUTION CONTROL DISTRICT**  
**10124 OLD GROVE ROAD, SAN DIEGO, CA 92131**  
**(858) 586-2600 FAX (858) 586-2601**  
**www.sdapcd.org**

**Application Record ID**

**APCD2021-APP-007099**



**Sectors: 2, D**

**Site Record ID: APCD2001-SITE-04276**

SDG&E Palomar Energy Center  
 Moses Peram  
 2300 Harveson Place  
 Escondido, CA 92029

**EQUIPMENT ADDRESS**

SDG&E Palomar Energy Center  
 Moses Peram  
 2300 Harveson Place  
 Escondido, CA 92029

**AUTHORITY TO CONSTRUCT**

**EXPIRES: February 3, 2023**

After examination of your Application for an Air Pollution Control District (**hereinafter referred to as** "the District") Authority to Construct and Permit to Operate for equipment located at the above location, the District has decided on the following actions:

Authority to Construct is granted pursuant to Rule 20 of the Air Pollution Control District Rules and Regulations for equipment to consist of:

Modification of equipment on PTO-000623 and PTO-000625 to add hydrogen as a supplemental fuel.

This Authority to Construct is issued with the following conditions:

1. This equipment shall be properly maintained and kept in good operating condition at all times. Rule 10, 20.3.
2. The unit shall be fired on Public Utility Commission (PUC) quality natural gas blended with up to 2% hydrogen by volume only. The permittee shall maintain quarterly records of sulfur content (grains/100 dscf) and higher and lower heating values (Btu/dscf) of the blended fuel and provide such records to the District personnel upon request. 40 CFR 60 subpart GG
3. The permittee shall comply with all the applicable provisions of 40 CFR 73, including requirements to offset, hold and retire SO2 allowances. 40 CFR 73.
4. For purposes of determining compliance based on source testing, the average of three subtests shall be used. For purposes of determining compliance with emission limits based on the CEMS, data collected in accordance with the CEMS protocol shall be used and averaging periods shall be as specified herein. 40 CFR 75.
5. When the unit is combusting fuel (operating), the concentration of oxides of Nitrogen (NOx), calculated as nitrogen dioxide (NO2) and measured in the exhaust stack, shall not exceed 2.0 parts per million by volume on a dry basis (ppmvd) corrected to 15% oxygen, except during periods of startup, shutdown, low load operation, or tuning. The following averaging periods shall apply to CEMS data:
  - A) During any clock hour when duct firing above 19.5 MMBTU/hr heat input is occurring (a "duct-fired hour"): 3-clock hour average, calculated as the average of the duct fired hour, the clock hour immediately prior to and the clock hour immediately following the duct-fired hour.
  - B) For any clock hour during which the change in gross electrical output produced by the combustion

turbine exceeds 50 MW per minute for one minute or longer (transient hour): 3-clock hour average, calculated as the average of the transient hour, the clock hour immediately prior to and the clock hour immediately following the transient hour.

C) All other hours: 1-clock-hour average.  
(NSR)

6. When the unit is operating, the concentration of CO measured in the exhaust stack shall not exceed 4.0 ppmvd corrected to 15% oxygen, except during periods of startup, shutdown, low load operation, or tuning. A 3-clock hour averaging period shall apply to CEMS data. (NSR)
7. When the unit is operating, the VOC concentration, calculated as methane and measured in the exhaust stack, shall not exceed 2.0 ppmvd corrected to 15% oxygen, except during periods of startup, shutdown, low load operation, or tuning. For purposes of determining compliance based on the CEMS, the District approved VOC/CO surrogate relationship, the CO CEMS data, and a 3-clock hour average shall be used in accordance with the CEMS protocol. The VOC/CO surrogate relationship shall be verified and/or modified, if necessary, based on source testing. (NSR)
8. When the unit is operating, the Ammonia concentration (Ammonia slip) measured in the exhaust stack, shall not exceed 5.0 ppmvd corrected to 15% oxygen, except during periods of startup, low load, or tuning. Rule 1200.
9. When the unit is operating, the concentration of Oxides of Nitrogen (NO<sub>x</sub>), calculated as nitrogen dioxide (NO<sub>2</sub>) and measured in the exhaust stack, shall not exceed 11.8 ppmvd corrected to 15% oxygen, averaged over each clock hour period, except for exempt periods of operation during startup, combined-cycle gas turbine extended startup, shutdowns, and low load operation, as defined in Rule 69.3.1. All CEMS calculations and averages shall be performed in accordance with the CEMS protocol approved by the District. [Rule 69.3.1(d)(1)]
10. When the unit is operating, the concentration of Oxides of Nitrogen (NO<sub>x</sub>), calculated as Nitrogen Dioxide (NO<sub>2</sub>) and measured in the exhaust stack, shall not exceed 42 ppmvd corrected to 15% oxygen, calculated over each clock hour period except for periods of Startup or Shutdown, as defined in Rule 69.3. All CEMS calculations, averages shall be performed in accordance with the CEMS protocol approved by the District. [Rule 69.3.]
11. The emissions of particulate matter less than 10 microns (PM-10) shall not exceed 14.0 lbs/hr for each unit with and without duct burner firing. Rule 20.3.
12. The discharge of particulate matter from the exhaust stack of the unit shall not exceed 0.10 grains per dry standard cubic foot (0.23 grams/dscm). The District may require periodic testing to verify compliance with this standard. (Rule 53)
13. Visible emissions from the lube oil vents and the exhaust stack of the unit shall not exceed 20% opacity for more than three (3) minutes in any period of 60 consecutive minutes. (Rule 50)
14. When operating with the duct burner at or below 19.5 MMBTU/hr heat input, mass emissions from each unit shall not exceed the following limits, except during periods of startup, shutdown, low load operation, or tuning. A 3 clock-hour averaging period for these limits shall apply to CEMS data except for NO<sub>x</sub> emissions during non-transient hours when a 1 clock-hour averaging period shall apply.  
Pollutant - Emission Limit, lbs/hr  
A) Oxides of Nitrogen, NO<sub>x</sub> (calculated as NO<sub>2</sub>) - 13.4  
B) Carbon Monoxide, CO - 16.3  
C) Volatile Organic Compounds, VOC - 4.0  
[Rule 20.3]
15. When operating with the duct burner firing above 19.5 MMBTU/hr heat input, mass emissions from each unit shall not exceed the following emission limits, except during periods of startup, shutdown, low load

operation, or tuning. A 3-clock-hour averaging period shall apply to CEMS data

Pollutant - Emission Limit, lbs/hr

A) Oxides of Nitrogen, NO<sub>x</sub> (calculated as NO<sub>2</sub>) - 14.9

B) Carbon Monoxide, CO - 18.1

C) Volatile Organic Compounds, VOC - 7.3

[Rule 20.3]

16. Total combined NO<sub>x</sub> emissions from both units shall not exceed 400 pounds per hour, calculated as Nitrogen Dioxide and measured over each 1-clock-hour period. These emission limits shall apply during all times during which one or both units are operating, including, but not limited to, emissions during periods of startup, shutdown, low load operation and tuning. In addition, Unit No. 1 shall not begin operating while Unit No. 2 is already operating in a startup period nor shall Unit No. 2 begin operating while Unit No. 1 is already operating in a startup period unless the unit already operating in a startup period meets all of the following in the clock-minute immediately preceding the clock-minute that the other unit begins operating:
  - A) Has been operating with a gross electrical output from the combustion turbine of 64 MW or more during the preceding 10 consecutive-clock-minute period;
  - B) The concentration of NO<sub>x</sub>, calculated as NO<sub>2</sub> and measured in the exhaust stack, does not exceed 2.0 ppmvd corrected to 15% oxygen; and
  - C) The concentration of CO measured in the exhaust stack does not exceed 4.0 ppmvd corrected to 15% oxygen.(Rule 20.3(d)(2)(i))
17. Total combined CO emissions from both units shall not exceed 2,000 pounds per hour measured over each 1-clock-hour period. This emission limit shall apply during all times that one or both units are operating, including, but not limited to emissions during periods of startup, shutdown, low load operation and tuning. (Rule 20.3(d) (2)(i))
18. Total aggregate emissions of oxides of nitrogen (NO<sub>x</sub>), calculated as nitrogen dioxide, from all stationary emission units at this stationary source, except emissions or emission units excluded from the calculation of aggregate potential to emit as specified in Rule 20.1 (d) (1), shall not exceed 104.3 tons in each rolling 12-calendar month period. The total aggregate emissions of NO<sub>x</sub> shall include emissions during all times that the equipment is operating, including but not limited to, emissions during periods of startup, shutdown, low load operation and tuning. [Rule 20.3]
19. Total aggregate emissions of Volatile Organic Compounds (VOC) from all stationary emission units at this stationary source, except emissions or emission units excluded from the calculation of aggregate potential to emit as specified in Rule 20.1 (d) (1), shall not exceed 50 tons in each rolling 12-calendar month period. The total aggregate emissions of VOC shall include emissions during all times that the equipment is operating, including but not limited to, emissions during periods of startup, shutdown, low load operation and tuning. [Rule 20.3]
20. The permittee shall maintain records, on at least a calendar quarterly basis, of total aggregate mass emissions of NO<sub>x</sub> and VOC in tons from all stationary emission units at this stationary source, except emissions or emission units excluded from the calculation of aggregate potential to emit as specified in Rule 20.1 (d) (1), for each rolling 12-calendar month period. These records shall be made available for inspection within 30 calendar days after the end of each calendar quarter. [Rule 20.3]
21. The emissions of any single Federal Hazardous Air Pollutant (HAP) shall not equal or exceed 10 tons, and the aggregate emissions of all Federal HAPs shall not equal or exceed 25 tons in any rolling 12-calendar month period. Compliance with these single and aggregate HAP limits shall be based on a methodology approved by the District for the purpose of calculating HAP emissions for this permit. If emissions exceed these limits, the permittee shall apply to amend permit to reflect applicable Federal Maximum Achievable Control Technology (MACT) standards and requirements in accordance with applicable provisions (including timing requirements) of 40 CFR Part 63.



22. The maximum total dissolved solids (TDS) concentration of the water used in the cooling towers shall not exceed 4,000 mg/l. This concentration shall be verified through quarterly testing of the water by a certified lab using EPA approved methods. [Rule 20.3, 1200]
23. When combusting fuel, Ammonia shall be injected at all times that the SCR outlet temperature is 510 degrees Fahrenheit or greater. [Rule 20.3]
24. The Ammonia injection flow rate shall be continuously measured, recorded and controlled. The Ammonia injection flow control equipment shall be installed, calibrated and maintained in accordance with a District approved protocol. [Rule 20.3]
25. Except during periods when the Ammonia injection system is being tuned or one or more Ammonia injection systems is in manual control (for compliance with applicable permits), the automatic Ammonia injection system serving the SCR shall be in operation in accordance with manufacturer's specifications at all times when Ammonia is being injected into the SCR. Manufacturer specifications shall be maintained on site and made available to District personnel upon request. [Rule 20.3]
26. The concentration of Ammonia solution used in the Ammonia injection system shall be less than 20% ammonia by weight. Records of Ammonia solution concentration shall be maintained on site and made available to District personnel upon request. [40 CFR 68, Rule 1200]
27. For purposes of determining compliance with the emission limits of this permit, a shutdown period is the period of time that begins with the lowering of the gross electrical output of the combustion turbine below 64 MW and that ends five minutes after fuel flow to the combustion turbine ceases, not to exceed 65 consecutive minutes. [Rule 20.3 69.3.1]
28. A startup period is the period of time that begins when fuel flows to the combustion turbine following a non-operational period. For purposes of determining compliance with the emission limits of this permit, the duration of a startup period shall not exceed 120 consecutive minutes if the steam turbine reheat bowl temperature is above 750° F when the startup period begins and shall not exceed 360 consecutive minutes if the steam turbine reheat bowl temperature is less than or equal to 750° F when the startup period begins. [Rule 20.3, 69.3.1]
29. Low load operation is a period of time that begins when the gross electrical output (load) of the combustion turbine is reduced below 64 MW from a higher load and that ends 10 consecutive minutes after the combustion turbine load next exceeds 64 MW provided that fuel is continuously combusted during the entire period and one or more clock hour concentration emission limits specified in this permit are exceeded as a result of the low-load operation. Periods of operation at low load shall not exceed 130 minutes in any calendar day nor an aggregate of 780 minutes in any calendar year, and no period of operation at low load shall begin during a startup period. [Rule 20.3, 69.3.1]
30. Tuning is defined as adjustments to the combustion system that involves operating the unit in a manner such that the emissions control equipment may not be fully effective or operational. Only one combustion turbine will be tuned at any given time. Tuning events shall not exceed 480 minutes in a calendar day nor exceed 40 hours in a calendar year. The District compliance division shall be notified at least 24 hours in advance of any tuning event. [Rule 20.3, 69.3.1]
31. A CEMS Protocol is a document approved in writing by the APCD M&TS division that describes the Quality Assurance and Quality Control procedures for monitoring, calculating and recording stack emissions from the unit. [40 CFR 75]
32. This unit shall be source tested to demonstrate compliance with the NO<sub>x</sub>, CO, VOC, PM-10, and Ammonia emission standards of this permit, using District approved methods. The source test and the NO<sub>x</sub> and CO Relative Accuracy Test Audit (RATA) tests shall be conducted in accordance with the applicable RATA frequency requirements of 40 CFR 75, appendix B, sections 2.3.1 and 2.3.3. [Rule 20.3, 1200]

33. A Relative Accuracy Test Audit (RATA) and all other required certification tests shall be performed and completed on the CEMS in accordance with applicable provisions of 40 CFR part 75 Appendix A and B performance specifications. At least 30 days prior to the test date, the permittee shall submit a test protocol to the District for approval. Additionally, the District shall be notified a minimum of 21 days prior to the test so that observers may be present. [40 CFR 75]
34. If source testing will be performed by an independent contractor and witnessed by the District, a source test protocol shall be submitted to the District for written approval at least 30 days prior to source testing. The source test protocol shall comply with the following requirements:
- A) Measurements of NOX, CO, and O2 emissions shall be conducted in accordance with U.S. Environmental Protection Agency (EPA) methods 7E, 10, and 3A, respectively, and District Source Test, method 100, or alternative methods approved by the District and EPA.
  - B) Measurement of VOC emissions shall be conducted in accordance with EPA Methods 25A and/or 18, or alternative methods approved by the District and EPA.
  - C) Measurements of ammonia emissions shall be conducted in accordance with Bay Area Air Quality Management District ST-1B or an alternative method approved by the District and EPA.
  - D) Measurements of PM-10 emissions shall be conducted in accordance with EPA Methods 201A and 202 or alternative methods approved by the district and EPA.
  - E) Source testing shall be performed with both the combustion turbine and the duct burner in operation. Each duct burner shall operate with a minimum heat input of 97 MMBTU/hr.
  - F) Source testing shall be performed at the most frequently used load level, as specified in 40 CFR Part 75 Appendix A Section 6.5.2.1.d, provided it is not less than 80% of the unit's rated load unless it is demonstrated to the satisfaction of the district that the unit cannot operate under these conditions. If the demonstration is accepted, then emissions source testing shall be performed at the highest achievable continuous level power level.
  - G) Measurements of particulate matter emissions shall be conducted in accordance with SDAPCD Method 5 or an alternative method approved by the District and EPA.
  - H) Measurements of opacity shall be conducted in accordance with EPA Method 9 or an alternative method approved by the District and EPA.
  - I) Measurement of fuel flow shall be conducted in accordance with an approved test protocol.
- [Rule 20.3, 69.3.1, 40 CFR 60 subpart GG]
35. Within 45 days after completion of the renewal source test or RATA, a final test report shall be submitted to the District for review and approval. [Rule 20.3, 69.3.1, 40 CFR 60 subpart GG]
36. The Oxides of Nitrogen (NOx) and Oxygen (O2) CEMs shall be certified and maintained in accordance with applicable federal regulations including the requirements of Sections 75.10 and 75.12 of Title 40, Code of Federal Regulations Part 75 (40 CFR75), the performance specifications of Appendix A of 40 CFR 75, the quality assurance procedures of Appendix B of 40 CFR 75 and the CEMs protocol approved by the District. The Carbon Monoxide (CO) CEMs shall be certified and maintained in accordance with 40 CFR 60, Appendices B and F, unless otherwise specified in this permit.  
[40 CFR 60, 40 CFR 75]
37. Continuous emission monitoring system (CEMS) shall be installed and properly maintained and calibrated to measure, calculate and record the following, in accordance with the District approved CEMS protocol:
- A) Hourly average concentration of Oxides of Nitrogen (NOX) corrected to 15% oxygen, in parts per million (ppmvd);
  - B) Concentration of Carbon Monoxide (CO) corrected to 15% oxygen, in parts per million (ppmvd);
  - C) Percent oxygen (O2) in the exhaust gas (%) for each clock hour period;
  - D) Average concentration of Oxides of Nitrogen (NOX) for each rolling 3-hour period, in parts per million (ppmv) corrected to 15% oxygen;
  - E) Hourly and Monthly mass emissions of Oxides of Nitrogen (NOX), in pounds;
  - F) Rolling 12 month mass emissions of Oxides of Nitrogen (NOX), in tons;
  - G) Hourly and monthly mass emissions of Carbon Monoxide (CO), in pounds;

- H) Annual mass emissions of Carbon Monoxide (CO), in tons.
- I) Natural gas flow rate to combustion turbine in scf/hr.
- J) Natural gas flow rate to duct burner in scf/hr.
- K) Concentration of Volatile Organic Compounds (VOC) corrected to 15% oxygen, in parts per million (pmvd) for each rolling 3-hour period, based upon the approved VOC/CO surrogate relationship.
- L) Hourly and monthly mass emissions of VOC in pounds
- M) Rolling 12-month mass emissions of VOC in tons.
- N) Hydrogen gas flow rate to combustion turbine in scf/hr.

The CEMS shall be in operation in accordance with the District approved CEMS monitoring protocol at all times when the combustion turbine is in operation. A copy of the District approved CEMS monitoring protocol shall be maintained on site and made available to District personnel upon request.

[Rule 20.3, 40 CFR 75]

- 38. When the CEMs is not recording data and the unit is operating, hourly NOx emissions annual calculations shall be determined in accordance with 40 CFR 75 Appendix C. Additionally, hourly CO emissions for the annual emission calculations shall be determined using the hourly emission rate recorded by the CEMs during the most recent hours in which the unit operated 3 continuous hours at no less than 80% of full power rating. Alternate CO emission factors shall be determined from compliance source test emissions data. The alternate hourly CO emission rate shall be reviewed and approved by the District, in writing. [Rule 20.3]
- 39. Any violation of any emission standard as indicated by the CEMs shall be reported to the District's Compliance Division within 96 hours after such occurrence. [Rule 20.3]
- 40. The CEMs shall be maintained and operated, and reports submitted, in accordance with the requirements of Rule 19.2 sections (d), (e), (f)(2),(f)(3), (f)(4) and (f)(5) and CEMs protocol approved by the District. [Rule 19.2]
- 41. The District shall be notified at least two weeks prior to any changes made in CEMS software that affect the measurement, calculation or correction of data displayed and/or recorded by the CEMS. [40 CFR 75]
- 42. Fuel flowmeters with an accuracy of +/- 2% shall be maintained to measure the volumetric flow rate corrected for temperature and pressure. Correction factors and constants shall be maintained on site and made available to the District upon request. The fuel flowmeters shall meet the applicable quality assurance requirements of 40 CFR Part 75, Appendix D, and Section 2.1.6. [Rule 20.3, 40 CFR 75]
- 43. The unit shall be equipped with continuous monitors to measure, calculate and record the following operational characteristics:
  - A) Ammonia injection rate in lb/hr of solution.
  - B) Outlet temperature of SCR in degrees Fahrenheit.
  - C) Combustion turbine power output (MW).
  - D) Steam turbine reheat bowl temperature in degrees Fahrenheit.
 The monitors shall be installed, calibrated, and maintained in accordance with a protocol approved by the District, which shall include any relevant calculation methodologies. The monitors shall be in full operation at all times when the combustion turbine is in operation. Calibration records for the continuous monitors shall be maintained on site and made available to the District upon request. [Rule 69.3.1]
- 44. Operating logs or Data Acquisition System (DAS) records shall be maintained to record the beginning and end times and durations of all startups, shutdowns, low load operations, and tuning periods to the nearest minute; quantity of natural gas used (in each clock hour, calendar month, and 12 calendar month period) in standard cubic feet; quantity of hydrogen used (in each clock hour, calendar month, and 12 calendar month period) in standard cubic feet; hours of daily operation; and total cumulative hours of operation during each calendar year. [Rule 20.3, 69.3.1]
- 45. All records required by this written permit shall be maintained on site for a minimum of five years and

made available to the District upon request. (Title V - Rule 1421)

46. Access, facilities, utilities and any necessary safety equipment for source testing and inspection shall be provided upon request of the Air Pollution Control District.
47. The District may require one or more of the following compounds, or additional compounds to be quantified through source testing periodically to ensure compliance with rule 1200:
  - A) Acetaldehyde
  - B) Acrolein
  - C) Benzene
  - D) Formaldehyde
  - E) Toluene
  - F) Xylenes

If the District requires the permittee to perform this source testing, the District shall request the testing in writing a reasonable period of time prior to the testing date, and the permittee shall submit a source test protocol to the District for written approval at least 30 days prior to the testing date.

48. This Air Pollution Control District Permit does not relieve the holder from obtaining permits or authorizations required by other governmental agencies.
49. The permittee shall, upon determination of applicability and written notification by the District, comply with all applicable requirements of the Air Toxics "Hot Spots" Information and Assessment Act (California Health and Safety Code Section 44300 et seq.)

This Authority to Construct does not authorize operation of the above-specified equipment until written notification has been provided to the District indicating that construction (or modification) has been completed in accordance with this Authority to Construct. Upon submission of this notification, temporary Permit to Operate shall take effect and will remain in effect, unless withdrawn or modified by the District, until the equipment is inspected by the District and a revised temporary permit (Startup Authorization) is issued or a Permit to Operate is granted or denied.

This Authority to Construct shall be posted on or within 25 feet of the above described equipment or maintained readily available at all times on the operating premises.

Upon completion of construction (or modification) in accordance with this Authority to Construct, and prior to commencing operation, the applicant must complete and mail, deliver or email to [APCDPermits@sdcounty.ca.gov](mailto:APCDPermits@sdcounty.ca.gov) the enclosed Construction Completion Notice to the District. After mailing, delivering or emailing the notice, the applicant may commence operation of the equipment. Operation must be in compliance with all the conditions of this Authority to Construct and applicable District Rules.

This Authority to Construct does not relieve the holder from obtaining permits or authorizations, which may be required by other governmental agencies. This Authority to Construct is not authority to exceed any applicable emission standard established by this District or any other governmental agency. This authorization is subject to cancellation if any emission standard or condition is violated.

Within 30 days after receipt of this Authority to Construct, the applicant may petition the Hearing Board for a hearing on any conditions imposed herein in accordance with Rule 25.

This Authority to Construct will expire on 02/03/2023 unless an extension is granted in writing.

This is not a Permit to Operate. Please be advised that installation or operation of this process or equipment without written authorization may be a misdemeanor subject to fines and penalties.

If you have any questions regarding this action, please contact me at 858-692-7281 or via email at [Maria.Galvez@sdapcd.org](mailto:Maria.Galvez@sdapcd.org).

Maria Galvez  
Asst APC Engineer

CC: Compliance Division

**APPENDIX B – FACILITY PLOT PLAN AND SOLAR CANOPIES LOCATIONS**

1 2 3 4 5 6 7 8 9 10

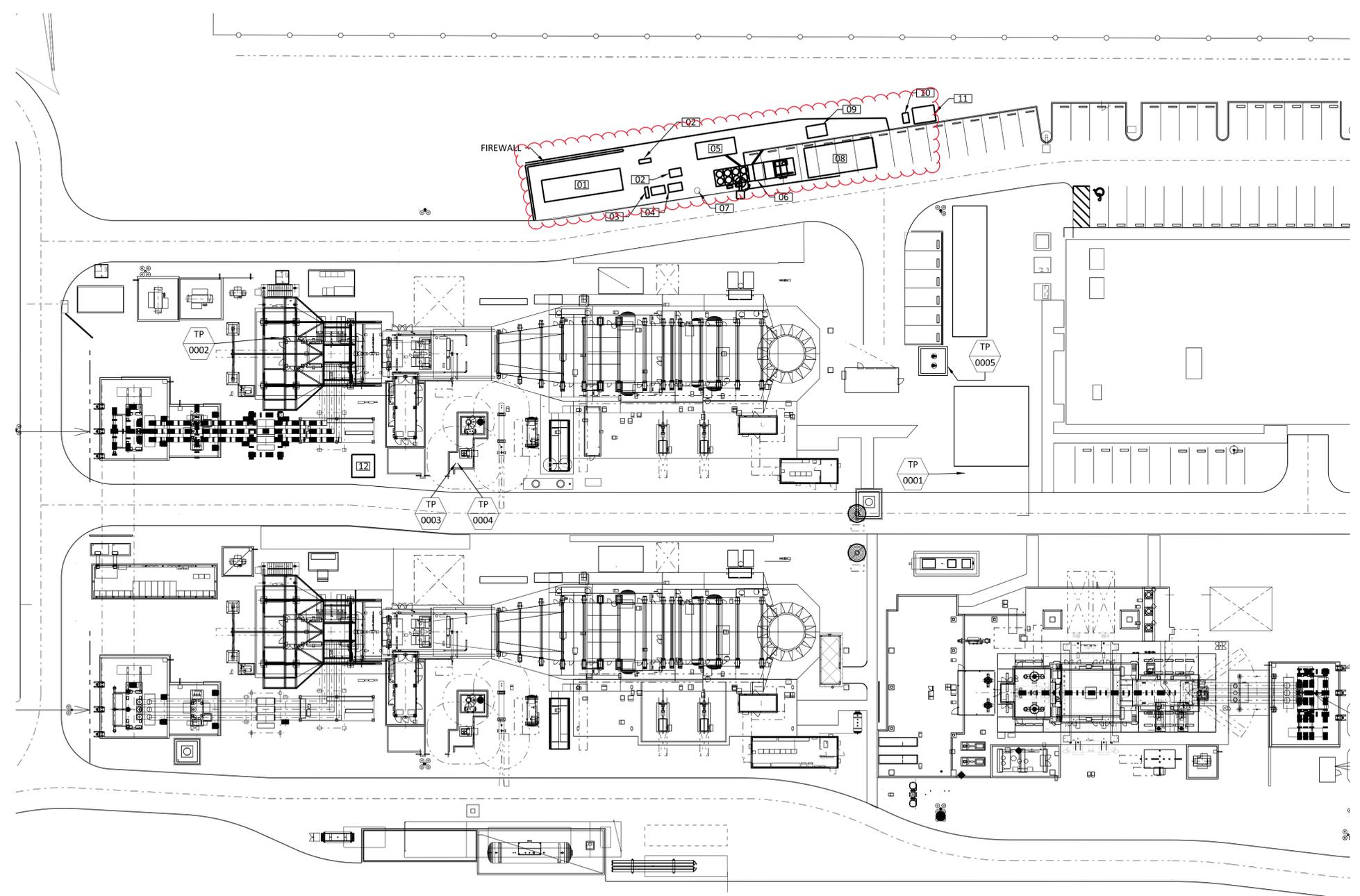
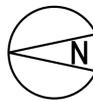

| EQUIPMENT IDENTIFICATION |                                  |
|--------------------------|----------------------------------|
| DWG REF                  | DESCRIPTION                      |
| 01                       | HYDROGEN STORAGE                 |
| 02                       | AIR COOLED HX PUMPS AND TANK     |
| 03                       | NITROGEN RACK                    |
| 04                       | COMPRESSORS                      |
| 05                       | RECTIFIER                        |
| 06                       | ELECTROLYZER                     |
| 07                       | WASTEWATER SUMP                  |
| 08                       | ELECTRICAL ENCLOSURE             |
| 09                       | AUXILIARY TRANSFORMER            |
| 10                       | VEHICLE FUELING DISPENSER        |
| 11                       | VEHICLE HYDROGEN FUELING STATION |
| 12                       | U2 FG BLENDING SKID              |
|                          |                                  |
|                          |                                  |

| TERMINAL POINT IDENTIFICATION |                                 |
|-------------------------------|---------------------------------|
| TP REF                        | DESCRIPTION                     |
| 0001                          | DEMIN WATER TO ELECTROLYZER     |
| 0002                          | H2 TO U1/U2 CTG AND STG COOLING |
| 0003                          | U2 FG TO U2 BLENDING SKID       |
| 0004                          | U2 FG BLENDING TO U2 FG HEATER  |
| 0005                          | WASTEWATER SUMP TO HRSG BD SUMP |
|                               |                                 |
|                               |                                 |
|                               |                                 |

- NOTES:
- THIS ARRANGEMENT IS CONCEPTUAL ONLY. CONTRACTOR TO CONFIRM ARRANGEMENT FOR EQUIPMENT AND PROCESS BEING PROPOSED.
  - ALL FINISHED GRADE SHALL HAVE AGGREGATE.



**NOT TO BE USED FOR CONSTRUCTION**  
 THE DISTRIBUTION AND USE OF THE NATIVE FORMAT CAD FILE OF THIS DRAWING IS UNCONTROLLED. THE USER SHALL VERIFY TRACEABILITY OF THIS DRAWING TO THE LATEST CONTROLLED VERSION.

she98467  
 ANO.D 34622  
 12/09/2020 03:45 PM  
 MicroStation v8.11.9.578  
 1 = 1" Full Size

| NO | DATE       | REVISIONS AND RECORD OF ISSUE | DRN | DES | CHK | PDE | APP |
|----|------------|-------------------------------|-----|-----|-----|-----|-----|
| C  | 02/16/2021 | REVISED PER CLIENT'S REQUEST  | HFS | VMM | JEB |     |     |
| B  | 12/7/2020  | ISSUE FOR RFP                 | NNR | VMM | JEB |     |     |
| A  | 11/12/2020 | ISSUED FOR CLIENT REVIEW      | NNR | VMM | JEB |     |     |

**BLACK & VEATCH**

|          |       |
|----------|-------|
| DESIGNER | DRAWN |
| CHECKED  | DATE  |

**PALOMAR ENERGY CENTER**  
 HYDROGEN PROJECT  
 GENERAL ARRANGEMENT

|                   |                |     |
|-------------------|----------------|-----|
| PROJECT           | DRAWING NUMBER | REV |
| 406498-1UUU-M2001 |                | C   |
| CODE              |                |     |
| AREA              |                |     |





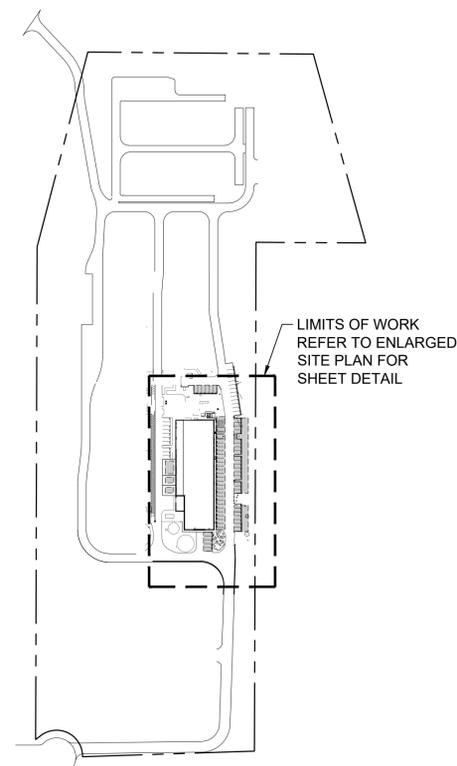
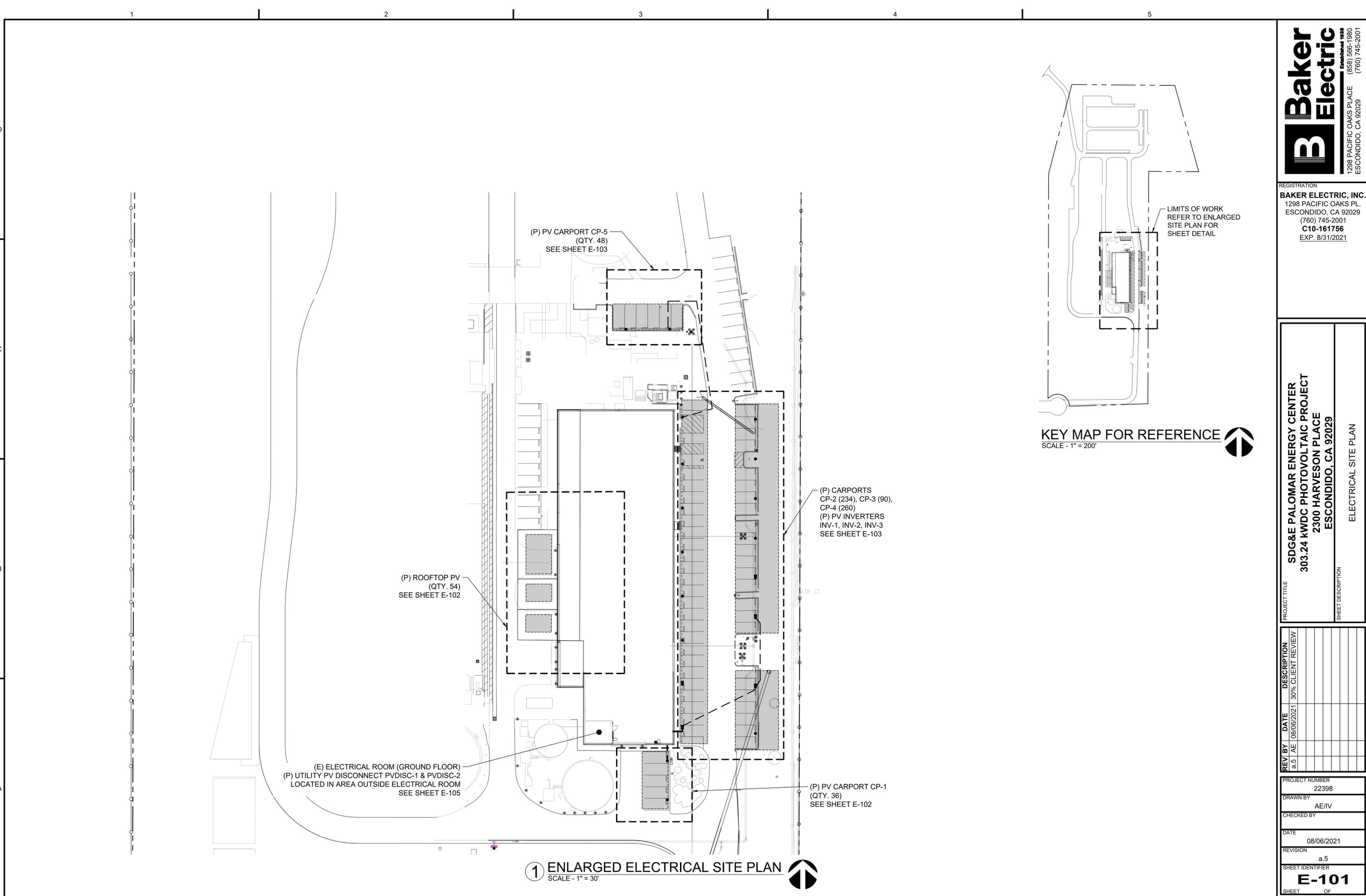

**KEY MAP FOR REFERENCE**  
SCALE - 1" = 200'

**1 ENLARGED ELECTRICAL SITE PLAN**  
SCALE - 1" = 30'

|                   |   |
|-------------------|---|
| PROJECT TITLE     | SDG&E PALOMAR ENERGY CENTER<br>303.24 KWDC PHOTOVOLTAIC PROJECT<br>2300 HARVESON PLACE<br>ESCONDIDO, CA 92029 |
| SHEET DESCRIPTION | ELECTRICAL SITE PLAN  |

| REV BY   | DATE       | DESCRIPTION       |
|----------|------------|-------------------|
| a.5 / AE | 08/06/2021 | 30% CLIENT REVIEW |
|          |            |                   |
|          |            |                   |
|          |            |                   |

|                  |              |
|------------------|--------------|
| PROJECT NUMBER   | 22398        |
| DRAWN BY         | AE/IV        |
| CHECKED BY       |              |
| DATE             | 08/06/2021   |
| REVISION         | a.5          |
| SHEET IDENTIFIER | <b>E-101</b> |
| SHEET            | OF           |

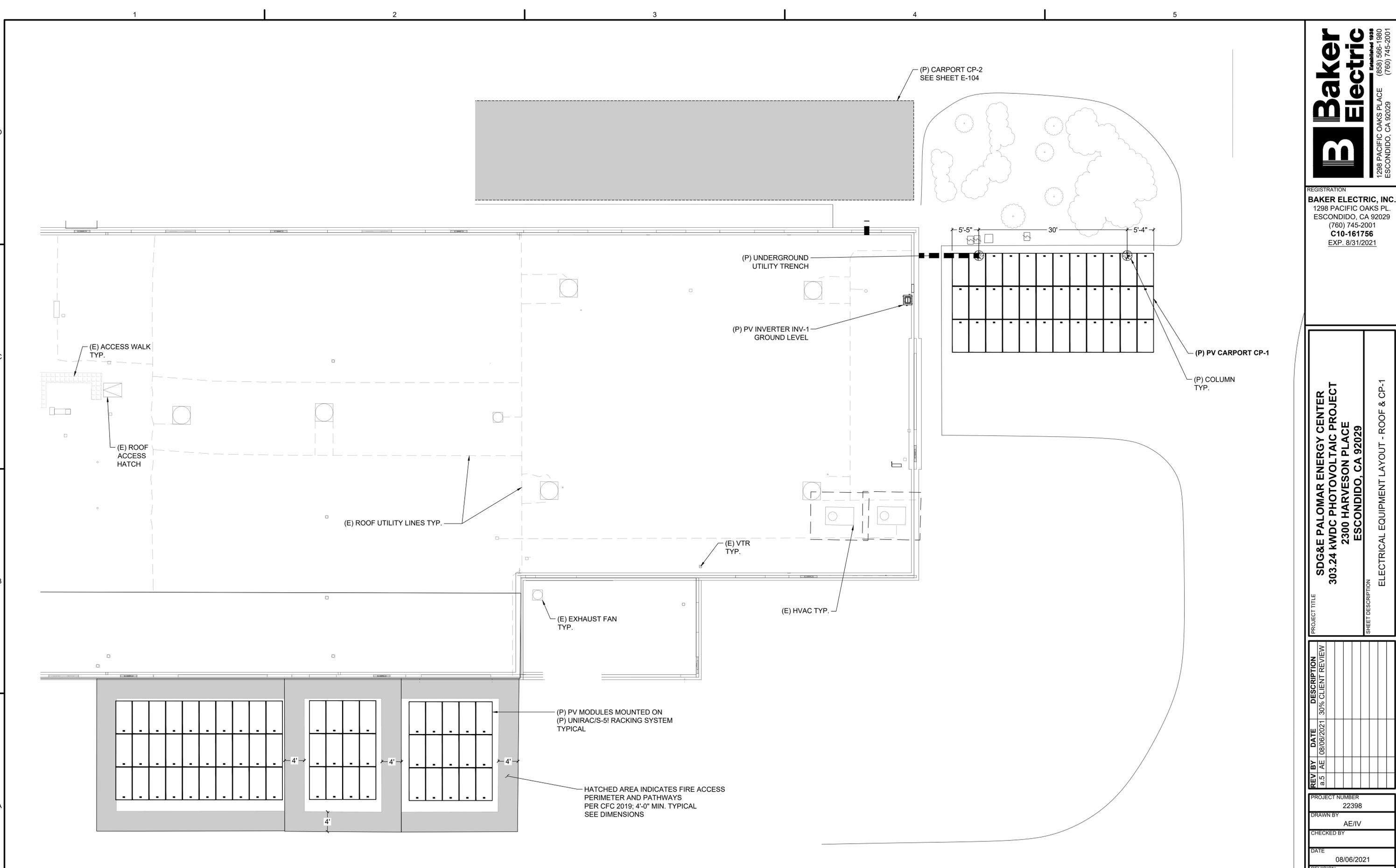

(P) CARPORT CP-2  
SEE SHEET E-104

(P) UNDERGROUND  
UTILITY TRENCH

(P) PV INVERTER INV-1  
GROUND LEVEL

5'-5" 30' 5'-4"

(P) PV CARPORT CP-1

(P) COLUMN  
TYP.

(E) ACCESS WALK  
TYP.

(E) ROOF  
ACCESS  
HATCH

(E) ROOF UTILITY LINES TYP.

(E) VTR  
TYP.

(E) EXHAUST FAN  
TYP.

(E) HVAC TYP.

(P) PV MODULES MOUNTED ON  
(P) UNIRAC/S-51 RACKING SYSTEM  
TYPICAL

HATCHED AREA INDICATES FIRE ACCESS  
PERIMETER AND PATHWAYS  
PER CFC 2019; 4'-0" MIN. TYPICAL  
SEE DIMENSIONS

**1** ELECTRICAL EQUIPMENT LAYOUT - ROOF & CP-1  
SCALE - 3/32" = 1'-0"



**Baker Electric**  
Established 1938  
1298 PACIFIC OAKS PLACE  
ESCONDIDO, CA 92029  
(760) 745-2001

REGISTRATION  
**BAKER ELECTRIC, INC.**  
1298 PACIFIC OAKS PL.  
ESCONDIDO, CA 92029  
(760) 745-2001  
**C10-161756**  
EXP. 8/31/2021

|                   |   |
|-------------------|---|
| PROJECT TITLE     | <b>SDG&amp;E PALOMAR ENERGY CENTER<br/>303.24 KWDC PHOTOVOLTAIC PROJECT<br/>2300 HARVESON PLACE<br/>ESCONDIDO, CA 92029</b> |
| SHEET DESCRIPTION | <b>ELECTRICAL EQUIPMENT LAYOUT - ROOF &amp; CP-1</b>  |

| REV | BY | DATE       | DESCRIPTION       |
|-----|----|------------|-------------------|
| a.5 | AE | 08/06/2021 | 30% CLIENT REVIEW |
|     |    |            |                   |
|     |    |            |                   |
|     |    |            |                   |

|                  |              |
|------------------|--------------|
| PROJECT NUMBER   | 22398        |
| DRAWN BY         | AE/IV        |
| CHECKED BY       |              |
| DATE             | 08/06/2021   |
| REVISION         | a.5          |
| SHEET IDENTIFIER | <b>E-102</b> |
| SHEET            | OF           |

| REV | BY | DATE       | DESCRIPTION       |
|-----|----|------------|-------------------|
| a.5 | AE | 08/06/2021 | 30% CLIENT REVIEW |
|     |    |            |                   |
|     |    |            |                   |
|     |    |            |                   |
|     |    |            |                   |

|                  |              |
|------------------|--------------|
| PROJECT NUMBER   | 22398        |
| DRAWN BY         | AE/IV        |
| CHECKED BY       |              |
| DATE             | 08/06/2021   |
| REVISION         | a.5          |
| SHEET IDENTIFIER | <b>E-103</b> |
| SHEET            | OF           |

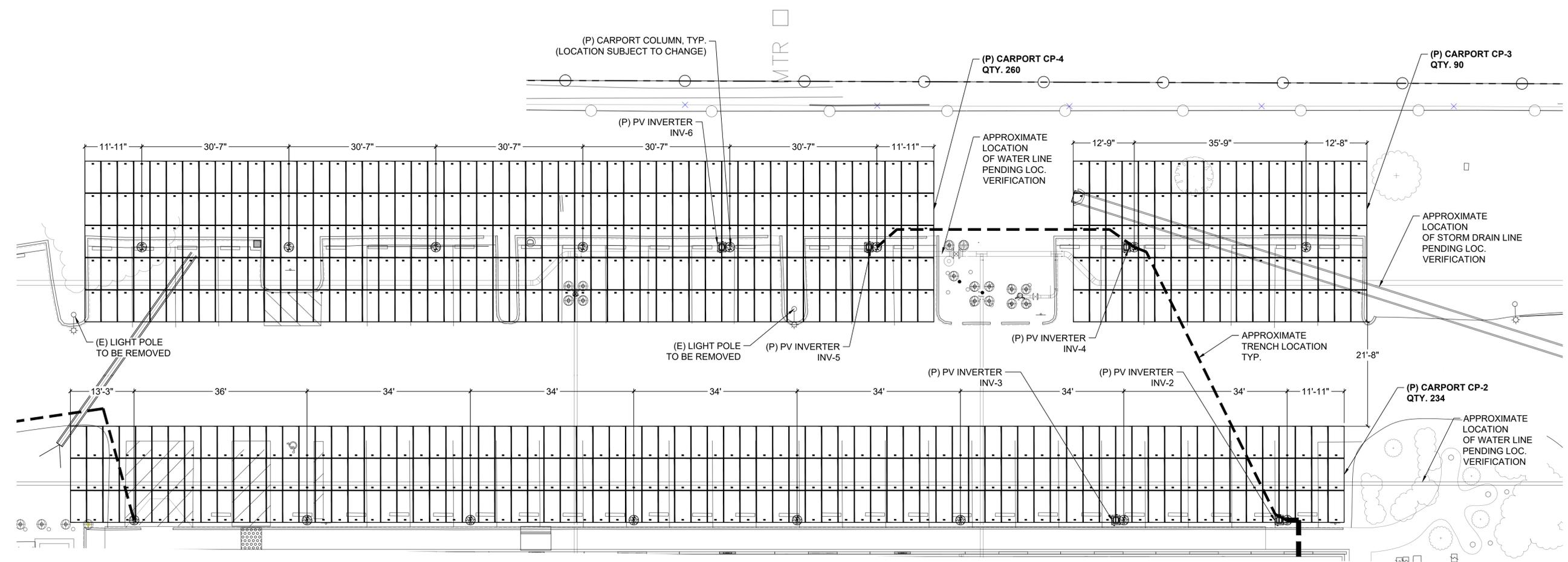

**1 ELECTRICAL EQUIPMENT LAYOUT - CARPORTS CP-2, CP-3, CP-4**  
 SCALE - 3/32" = 1'-0"

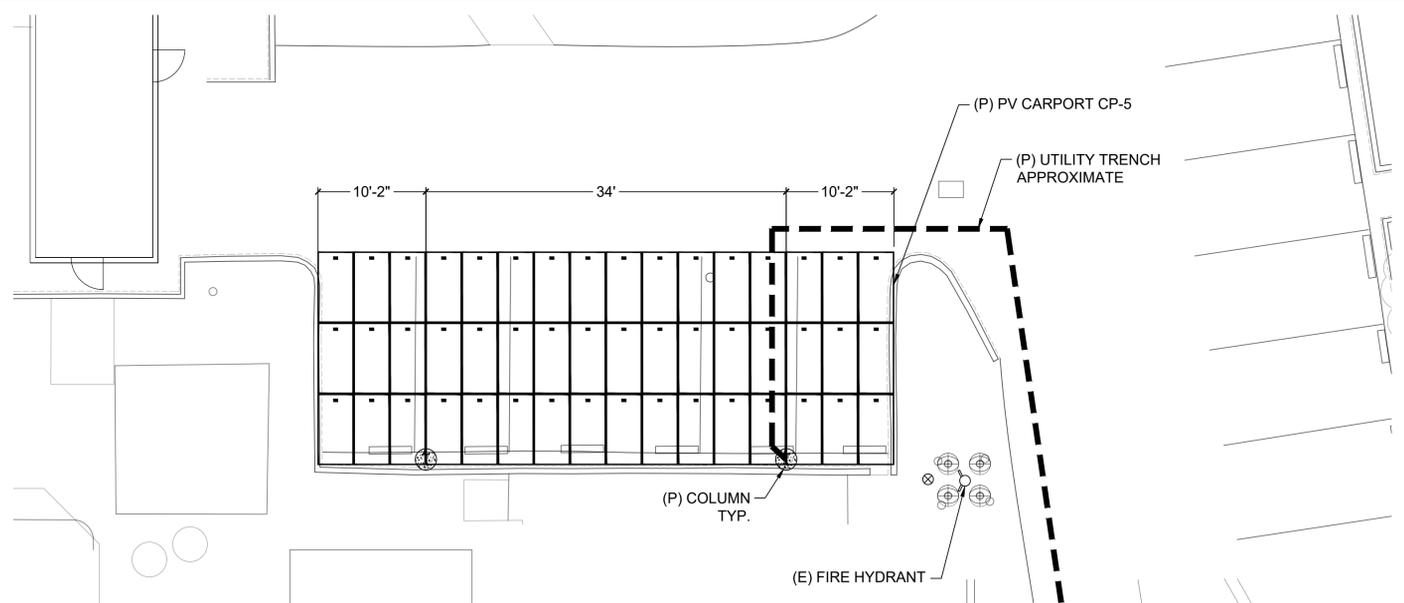

**2 ELECTRICAL EQUIPMENT LAYOUT - CARPORT CP-5**  
 SCALE - 1/8" = 1'-0"

| REV | BY | DATE       | DESCRIPTION       |
|-----|----|------------|-------------------|
| a.5 | AE | 08/06/2021 | 30% CLIENT REVIEW |
|     |    |            |                   |
|     |    |            |                   |
|     |    |            |                   |
|     |    |            |                   |

|                  |              |
|------------------|--------------|
| PROJECT NUMBER   | 22398        |
| DRAWN BY         | AE/IV        |
| CHECKED BY       |              |
| DATE             | 08/06/2021   |
| REVISION         | a.5          |
| SHEET IDENTIFIER | <b>E-104</b> |
| SHEET            | OF           |

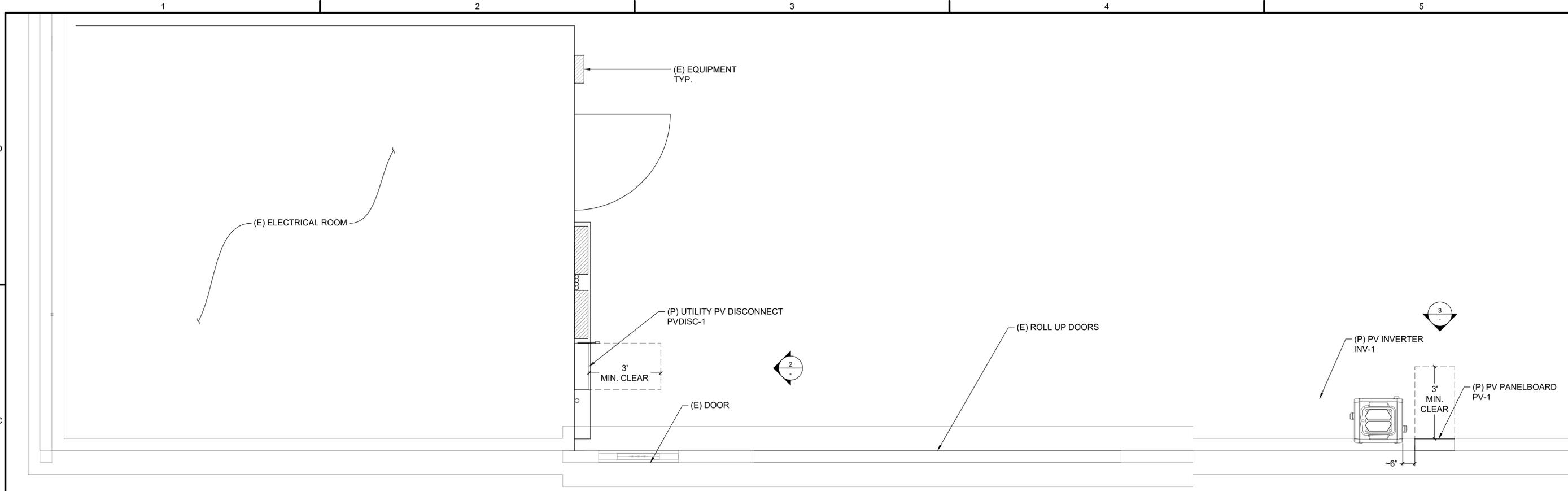

**1 ELECTRICAL EQUIPMENT PLAN VIEW - GROUND FLOOR**  
 SCALE - 1/2" = 10"

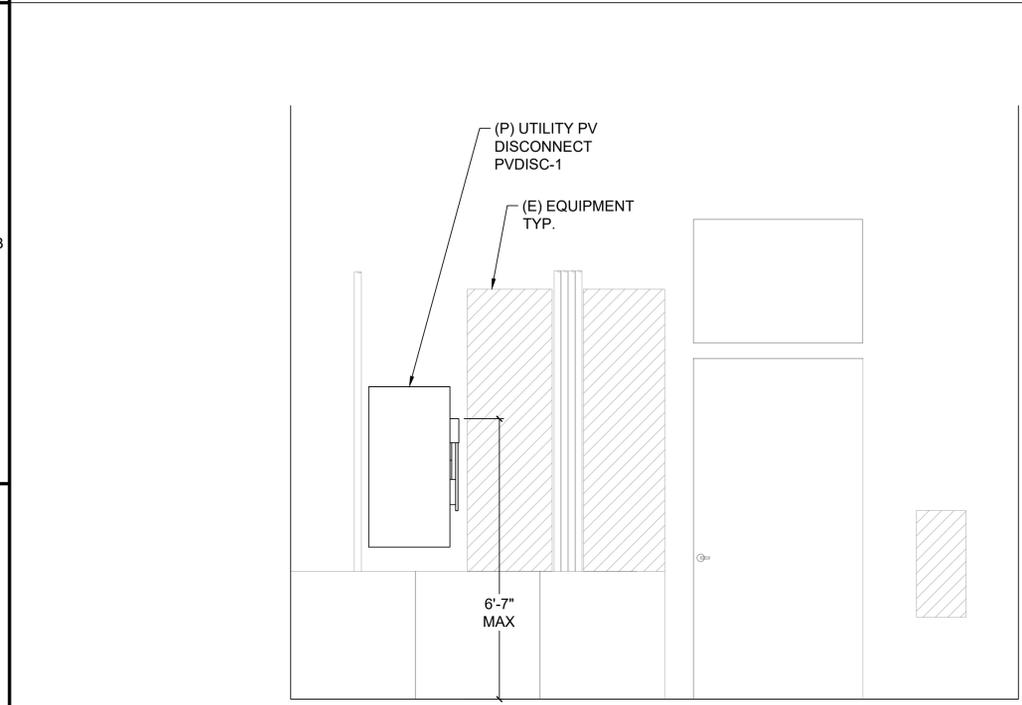

**2 PVDISC-1 ELEVATION - GROUND FLOOR**  
 SCALE - 1/2" = 10"

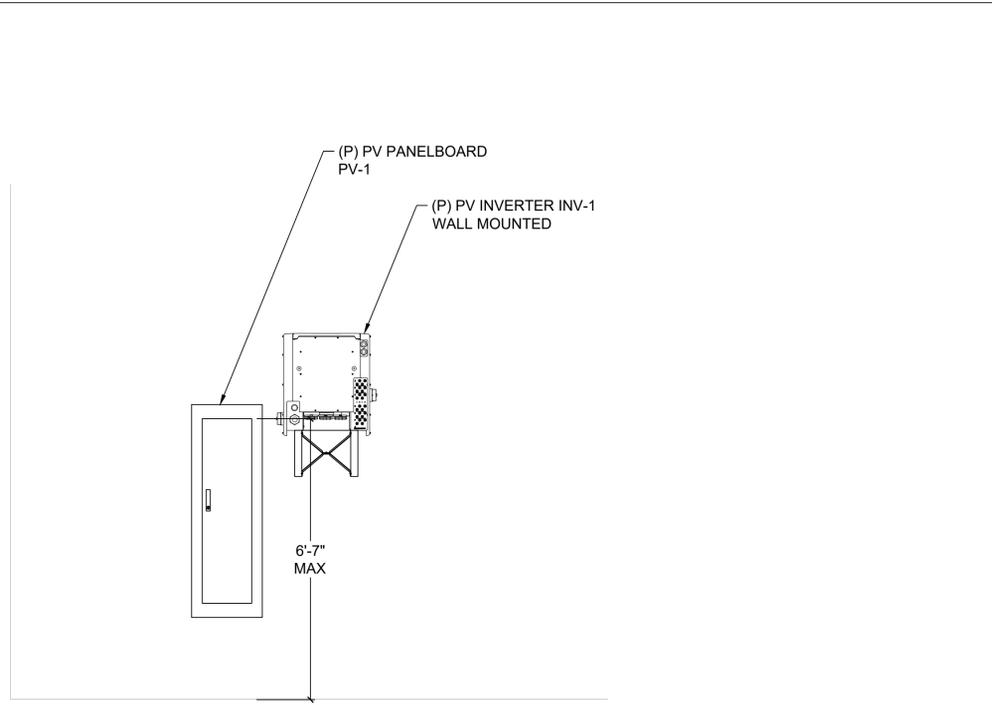

**3 PVDISC -2 ELEVATION - GROUND FLOOR**  
 SCALE - 1/2" = 10"

# LG NeON<sup>2</sup>

LG420N2W-V5

420W

The LG NeON<sup>2</sup> is LG's best selling solar module, and is one of the most powerful and versatile modules on the market today. Featuring LG's Cello Technology, the LG NeON<sup>2</sup> increases power output. New updates include an extended performance warranty from 86% to 90.08% to give customers higher performance and reliability.

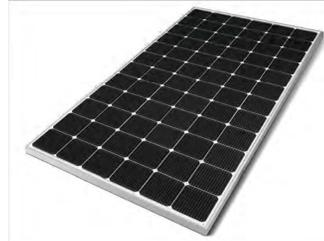

## Features

- Enhanced Performance Warranty**  
LG NeON<sup>2</sup> has an enhanced performance warranty. After 25 years, LG NeON<sup>2</sup> is guaranteed at least 90.08% of initial performance.
- Enhanced Product Warranty**  
LG has extended the warranty of the NeON<sup>2</sup> to 25 years including labor, which is top level in the industry.
- Better Performance on a Sunny Day**  
LG NeON<sup>2</sup> now performs better on sunny days, thanks to its improved temperature coefficient.
- BOS (Balance Of System) Saving**  
LG NeON<sup>2</sup> can reduce the total number of strings due to its high module efficiency resulting in a more cost effective and efficient solar power system.

When you go solar, ask for the brand you can trust: LG Solar

## About LG Electronics

LG Electronics is a global leader in electronic products in the clean energy market by offering solar PV panels and energy storage systems. The company first embarked on a solar energy source research program in 1985, supported by LG Group's vast experience in the semi-conductor, LCD, chemistry and materials industries. In 2015, LG Solar successfully received the first NeON<sup>2</sup> order in the market, which is now available in 32 countries. The NeON<sup>2</sup> (previous NeON<sup>2</sup> Neo2), NeON<sup>2</sup> Neo2P, NeON<sup>2</sup> Neo2P+ marked the "Transformer Award" in 2015, 2016 and 2017, which demonstrates LG's leadership and innovation in the solar industry.



# SUNNY TRIPOWER CORE1 33-US / 50-US / 62-US



- Fully integrated**
  - Innovative design requires no additional racking for rooftop installation
  - Integrated DC and AC disconnects and overvoltage protection
  - 12 direct string inputs for reduced labor and material costs
- Increased power, flexibility**
  - Multiple power ratings for small to large scale commercial PV installations
  - 5x MPPT trackers for flexible stringing and maximum power production
  - ShadeFix, SMA's proprietary shade management solution, optimizes of the string level
- Enhanced safety, reliability**
  - Integrated SunSpec PLC signal for module-level rapid shutdown compliance to 2017 NEC
  - Newgen DC AC/DC arch fault protection certified to new Standard UL 1699B Ed. 1
- Smart monitoring, control, service**
  - Advanced smart inverter grid support capabilities
  - Increased ROI with SMA annexOS cross sector energy management platform
  - SMA Smart Connected proactive O&M solution reduces time spent diagnosing and servicing in the field

## SUNNY TRIPOWER CORE1 33-US / 50-US / 62-US

It stands on its own

The Sunny Tripower CORE1 is the world's first free-standing PV inverter for commercial rooftops, carports, ground mount and repowering legacy solar projects. From distribution to construction to operation, the Sunny Tripower CORE1 enables logistical, material, labor and service cost reductions, and is the most versatile, cost-effective commercial solution available. Integrated SunSpec PLC for rapid shutdown and enhanced DC AFCI arc-fault protection ensure compliance to the latest safety codes and standards. With Sunny Tripower CORE1 and SMA's annexOS cross sector energy management platform, system integrators can deliver comprehensive commercial energy solutions for increased ROI.

www.SMA-America.com

# S-5!

## The Right Way!

The right way to attach almost anything to metal roofs!

### RibBracket™

RibBracket™ can be used to mount almost anything onto the most common exposed-fastened, trapezoidal roof profiles marketed in North America today. No messy sealants to apply! No chance for leaks! The RibBracket comes with a factory-applied EPDM rubber gasket seal already on the base, and the S-5! patented reservoir conceals the EPDM from UV exposure, preventing drying and cracks.

Installation is simple! The RibBracket is mounted directly onto the crown of the panel, straddling the profile. No surface preparation is necessary; simply wipe away excess oil and debris, align, and apply. Secure through the pre-punched holes using the appropriate fasteners or Bulb-tite rivets for the supporting roof material.

RibBracket is the perfect match for our S-5-PV Kit, or any other ancillary application, without worrying about cold bridging! RibBracket is extremely economical and facilitates quick and easy installation.

The slotted top hole, which accommodates standard MS nuts and bolts, simplifies alignment and maximizes flexibility in attaching ancillaries.

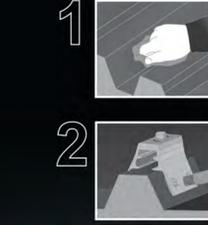

S-5!® RibBracket™ is the right way to attach almost anything to select exposed-fastened, trapezoidal roof profiles, including PV through DirectAttached™ or rail methods.

888-825-3432 | www.S-5.com

# IRONRIDGE

# XR Rail Family

## Solar Is Not Always Sunny

Over their lifetime, solar panels experience countless extreme weather events. Not just the worst storms in years, but the worst storms in 40 years. High winds capable of ripping panels from a roof, and snowfalls weighing enough to buckle a panel frame.

XR Rails are the structural backbone preventing these results. They resist uplift, protect against buckling and safely and efficiently transfer loads into the building structure. Their superior spanning capability requires fewer roof attachments, reducing the number of roof penetrations and the amount of installation time.

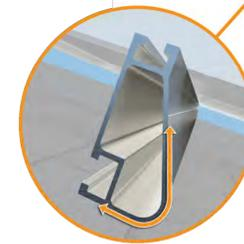

**Force-Stabilizing Curve**  
Sloped roofs generate both vertical and lateral forces on mounting rails which can cause them to bend and twist. The curved shape of XR Rails is specially designed to increase strength in both directions while resisting the twisting. This unique feature ensures greater security during extreme weather and a longer system lifetime.

**Compatible with Flat & Pitched Roofs**  
XR Rails are compatible with FlashFoot and other flat roof attachments.



**Corrosion-Resistant Materials**  
IronRidge offers a range of fill leg options for flat roof mounting applications. All XR Rails are made of 6000-series aluminum alloy, then protected with an anodized finish. Anodizing prevents surface and structural corrosion, while also providing a more attractive appearance.



# LG NeON<sup>2</sup>

LG420N2W-V5

| General Data                     |                                |
|----------------------------------|--------------------------------|
| Cell Properties (Material/Type)  | Monocrystalline/Type           |
| Cell Material                    | LG                             |
| Cell Configuration               | 72 Cells (6 x 12)              |
| Number of Busbars                | 12 GA                          |
| Module Dimensions (L x W x H)    | 2,025mm x 1,026mm x 40mm       |
| Weight                           | 20.3 kg                        |
| Glass (Thickness/Material)       | Tempered Glass with AR Coating |
| Backsheet (Color)                | White                          |
| Frame (Material)                 | Anodized Aluminum              |
| Junction Box (Protection Degree) | IP68                           |
| Cables (Length)                  | 1,200mm x 2 EA                 |
| Connector (Type/Maker)           | MCA Compatible                 |

| Electrical Properties (STC)*  |             |
|---|-------------|
| Model   | LG420N2W-V5 |
| Maximum Power (Pmax)** [W]  | 420         |
| MPPT Voltage (Vmpq) [V]   | 42.1        |
| MPPT Current (Impq) [A]   | 9.98        |
| Open Circuit Voltage (Voc) [V]  | 45.7        |
| Short Circuit Current (Isc) [A]   | 10.63       |
| Module Efficiency [%]   | 20.3        |
| Power Tolerance [%]   | ±0.3        |
| *STC (Standard Test Conditions) Irradiance 1000 W/m², cell temperature 25°C, AM 1.5 |             |
| **Measure tolerance of Pmax: ±1.3%  |             |

| Operating Conditions  |                       |
|---|-----------------------|
| Operating Temperature [°C]  | -40 ~ +90             |
| Maximum System Voltage [V]  | 1,000 (IEC/UL504 (2)) |
| Maximum Series Fuse Rating [A]  | 30                    |
| Mechanical Test Load (Front) [Pa/m²]  | 5,400/113             |
| Mechanical Test Load (Rear) [Pa/m²]   | 3,000/63              |
| *IEC (International Electrotechnical Commission) based on IEC 61715-2:2016 (Dist. Load - Design Load Safety Factor 1.5) |                       |

| Packaging Configuration                      |                       |
|--|-----------------------|
| Number of Modules per Pallet [EA]            | 25                    |
| Number of Modules per 40ft HQ Container [EA] | 200                   |
| Module Size Performance Type [L3, T303]      |                       |
| Packaging Box Dimensions (L x W x H) [mm]    | 2,080 x 1,120 x 1,235 |
| Packaging Box Gross Weight [kg]              | 351                   |

| Dimensions (mm/Inch) |                     |
|----------------------|---------------------|
| Module Length        | 2,025 mm (79.72 in) |
| Module Width         | 1,026 mm (40.35 in) |
| Module Height        | 40 mm (1.57 in)     |
| Module Weight        | 20.3 kg (44.75 lb)  |

| Temperature Characteristics  |        |
|--|--------|
| IMPT** [°C]  | 42 ± 3 |
| Pmax [°C]  | -0.36  |
| Voc [°C]   | -0.26  |
| Isc [°C]   | 0.02   |
| **IMPT: Nominal Module Operating Temperature; Irradiance 800 W/m², Ambient temperature 20°C, Wind speed 1 m/s, Spectrum AM 1.5 |        |

| Electrical Properties (NI02)    |             |
|---------------------------------|-------------|
| Model                           | LG420N2W-V5 |
| Maximum Power (Pmax) [W]        | 315         |
| MPPT Voltage (Vmpq) [V]         | 39.6        |
| MPPT Current (Impq) [A]         | 7.95        |
| Open Circuit Voltage (Voc) [V]  | 46.9        |
| Short Circuit Current (Isc) [A] | 8.55        |

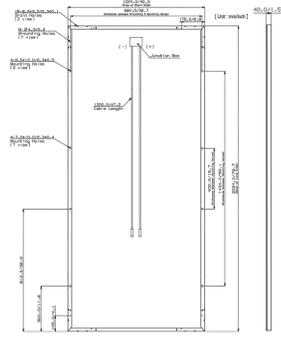
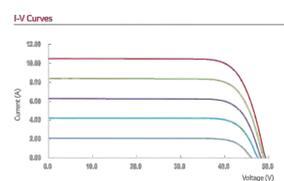

Product specifications are subject to change without notice. LG420N2W-V5.pdf © 2020 LG Electronics, Inc. All rights reserved.

| Technical data  | Sunny Tripower CORE1 33-US   | Sunny Tripower CORE1 50-US   | Sunny Tripower CORE1 62-US   |
|---|--|--|--|
| <b>Input (DC)</b>   |  |  |  |
| Maximum array power   | 50000 Wp STC   | 75000 Wp STC   | 97350 Wp STC   |
| Maximum system voltage  | 1000 V   | 1000 V   | 1000 V   |
| Rated MPPT voltage range  | 330 V ~ 800 V  | 500 V ~ 800 V  | 550 V ~ 800 V  |
| MPPT operating voltage range                                    | 150 V ~ 1000 V   | 150 V ~ 1000 V   | 150 V ~ 1000 V   |
| Minimum DC voltage / start voltage                              | 130 V / 188 V  | 130 V / 188 V  | 130 V / 188 V  |
| MPPT tracking / strings per MPPT input                          | 5 / 2  | 5 / 2  | 5 / 2  |
| Maximum operating input current / per MPPT tracker              | 120 A / 20 A   | 120 A / 20 A   | 120 A / 20 A   |
| Maximum short circuit current per MPPT / per string input       | 30 A / 30 A  | 30 A / 30 A  | 30 A / 30 A  |
| <b>Output (AC)</b>  |  |  |  |
| AC nominal power  | 33300 VA   | 50000 VA   | 62500 VA   |
| Maximum apparent power  | 33300 VA   | 50000 VA   | 62500 VA   |
| Output phases / line connections                                | 3 / 3 N/PE   | 3 / 3 N/PE   | 3 / 3 N/PE   |
| Nominal AC voltage  | 480 V / 277 V WYE  | 244 V ~ 305 V  | 244 V ~ 305 V  |
| AC voltage range  | 244 V ~ 305 V  | 244 V ~ 305 V  | 244 V ~ 305 V  |
| Maximum output current  | 40 A   | 64 A   | 80 A   |
| Rated grid frequency  | 60 Hz  | 60 Hz  | 60 Hz  |
| Grid frequency / range  | 50 Hz, 60 Hz / ± 6 Hz ~ ± 6 Hz   | 50 Hz, 60 Hz / ± 6 Hz ~ ± 6 Hz   | 50 Hz, 60 Hz / ± 6 Hz ~ ± 6 Hz   |
| Power factor (rated power) / adjustable displacement            | 1 / 0.9 leading ~ 0.9 lagging  | 1 / 0.9 leading ~ 0.9 lagging  | 1 / 0.9 leading ~ 0.9 lagging  |
| Harmonics THD   | < 3%   | < 3%   | < 3%   |
| <b>Efficiency</b>   |  |  |  |
| CEC efficiency  | 97.5%  | 97.5%  | 97.5%  |
| <b>Protection and safety features</b>                           |  |  |  |
| Load rated DC disconnect  | ●  | ●  | ●  |
| Load rated AC disconnect  | ●  | ●  | ●  |
| Ground fault monitoring: Rise / Differential current            | ●  | ●  | ●  |
| DC AC/DC arc-fault protection                                   | ●  | ●  | ●  |
| SunSpec PLC signal for rapid shutdown                           | ●  | ●  | ●  |
| DC reverse polarity protection                                  | ●  | ●  | ●  |
| AC short circuit protection                                     | ●  | ●  | ●  |
| DC surge protection: Type 2 / Type 1+2                          | 0 / 0  | 0 / 0  | 0 / 0  |
| AC surge protection: Type 2 / Type 1+2                          | 0 / 0  | 0 / 0  | 0 / 0  |
| Protection class / overvoltage category (as per UL 840)         | 1 / 1  | 1 / 1  | 1 / 1  |
| <b>General data</b>   |  |  |  |
| Device dimensions (W / H / D)                                   | 621 mm / 733 mm / 569 mm (24.4 in x 28.8 in x 22.4 in)                                     | 621 mm / 733 mm / 569 mm (24.4 in x 28.8 in x 22.4 in)                                     | 621 mm / 733 mm / 569 mm (24.4 in x 28.8 in x 22.4 in)                                     |
| Device weight   | 84 kg (185 lb)   | 84 kg (185 lb)   | 84 kg (185 lb)   |
| Operating temperature range                                     | 23 °C ~ +60 °C (113 °F ~ +140 °F)  | 23 °C ~ +60 °C (113 °F ~ +140 °F)  | 23 °C ~ +60 °C (113 °F ~ +140 °F)  |
| Storage temperature range                                       | -40 °C ~ +70 °C (-40 °F ~ +158 °F)   | -40 °C ~ +70 °C (-40 °F ~ +158 °F)   | -40 °C ~ +70 °C (-40 °F ~ +158 °F)   |
| audible noise emissions (full power @ 1m and 25 °C)             | 55 dB(A)   | 55 dB(A)   | 55 dB(A)   |
| Internal consumption of night                                   | 5 W  | 5 W  | 5 W  |
| Topology  | Transformerless  | Transformerless  | Transformerless  |
| Cooling concept   | OptiCool (forced convection, variable speed fans)  | OptiCool (forced convection, variable speed fans)  | OptiCool (forced convection, variable speed fans)  |
| Enclosure protection rating                                     | Type 4X, 35X (as per UL 50E)   | Type 4X, 35X (as per UL 50E)   | Type 4X, 35X (as per UL 50E)   |
| Maximum permissible relative humidity (non-condensing)          | 100%   | 100%   | 100%   |
| <b>Additional information</b>                                   |  |  |  |
| Mounting  | Free-standing with included mounting feet  | Free-standing with included mounting feet  | Free-standing with included mounting feet  |
| DC connection   | Anphelux LXTX PV connectors  | Anphelux LXTX PV connectors  | Anphelux LXTX PV connectors  |
| AC connection   | Some terminals - A / W / N in A / D / AWG / CU / AL  | Some terminals - A / W / N in A / D / AWG / CU / AL  | Some terminals - A / W / N in A / D / AWG / CU / AL  |
| LED indicators (Status / Fault / Communication)                 | ●  | ●  | ●  |
| Network interfaces: Ethernet / WLAN / RS485                     | ●  | ●  | ●  |
| Data protocols: SMA Modbus / SunSpec Modbus / Webconnect        | ●  | ●  | ●  |
| Multifunction relay   | ●  | ●  | ●  |
| ShadeFix technology for string level optimization               | ●  | ●  | ●  |
| Integrated Flood Control / 0.2m Demand 24/7                     | ●  | ●  | ●  |
| OR-Grid capable / SMA Fail-Save Controller compatible           | ●  | ●  | ●  |
| SMA Smart Connected (proactive monitoring and service support)  | ●  | ●  | ●  |
| <b>Certifications and approvals</b>                             |  |  |  |
| FCC compliance  | UL 1741, UL 1699B Ed. 1, UL 1998, CSA 22.2 1071, PV Rapid Shutdown System Equipment        | UL 1741, UL 1699B Ed. 1, UL 1998, CSA 22.2 1071, PV Rapid Shutdown System Equipment        | UL 1741, UL 1699B Ed. 1, UL 1998, CSA 22.2 1071, PV Rapid Shutdown System Equipment        |
| Grid interconnection standards                                  | IEEE 1547, UL 1741 SA, CA Rule 21, HECCO Rule 1491   | IEEE 1547, UL 1741 SA, CA Rule 21, HECCO Rule 1491   | IEEE 1547, UL 1741 SA, CA Rule 21, HECCO Rule 1491   |
| Advanced grid support capabilities                              | L/HVRT, L/HVMT, Volt-MV, Volt-Watt, Frequency-Watt, Ramp-Rate Control, Power Factor Factor | L/HVRT, L/HVMT, Volt-MV, Volt-Watt, Frequency-Watt, Ramp-Rate Control, Power Factor Factor | L/HVRT, L/HVMT, Volt-MV, Volt-Watt, Frequency-Watt, Ramp-Rate Control, Power Factor Factor |
| <b>Warranty</b>   |  |  |  |
| Standard  | 10 years   | 10 years   | 10 years   |
| Optional extensions   | 15 / 20 years  | 15 / 20 years  | 15 / 20 years  |
| Type designation  | STP 33-US-41   | STP 50-US-41   | STP 62-US-41   |
| <b>Accessories</b>  |  |  |  |
| SMA Data Manager M1 (DM15US-10)                                 | ●  | ●  | ●  |
| SMA Smart Module MD 50NUS-40                                    | ●  | ●  | ●  |
| General Mounting System SWS_XF 10                               | ●  | ●  | ●  |
| AC Surge Protection Module Kit AC_SPS_M11 10, AC_SPS_M12, T112  | ●  | ●  | ●  |
| DC Surge Protection Module Kit DC_SPS_M17A 10, DC_SPS_M15, T112 | ●  | ●  | ●  |

Toll Free +1 888 4 SMA USA  
www.SMA-America.com  
SMA America, LLC

# S-5!

## The Right Way!

RibBracket™ is the perfect attachment solution for specific North American trapezoidal, exposed-fastened metal roofs! It can be used for almost any attachment need. No messy sealants to apply. The factory-applied EPDM rubber gasket weather-proofs and makes installation easy!

Each RibBracket™ comes with a factory-applied EPDM rubber gasket on the base. A structural aluminum attachment bracket, RibBracket is compatible with most common metal roofing materials and many North American trapezoidal profiles. For design assistance, ask your distributor, or visit [www.S-5.com](http://www.S-5.com) for the independent lab test data that can be used for load-critical designs and applications. Also, please visit our website for more information including metallurgical compatibilities and specifications. S-5!® holding strength is unmatched in the industry.

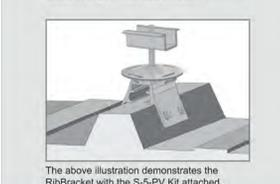
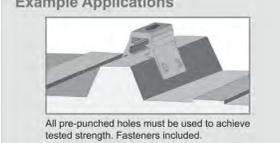

The above illustration demonstrates the RibBracket with the S-5-PV Kit attached.

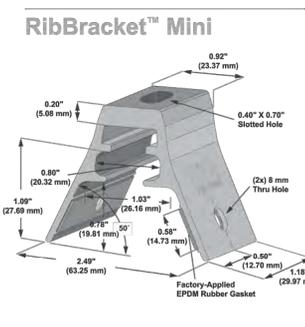
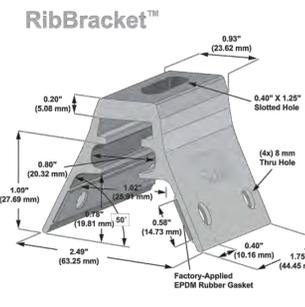

S-5!® Warning! Please use this product responsibly!  
Products are protected by multiple U.S. and foreign patents. For published data regarding holding strength, fastener torque, stresses and trademarks, visit the S-5! website at [www.S-5.com](http://www.S-5.com).  
Copyright 2015 MetalRoofInnovations, Ltd.  
S-5! is a registered trademark of MetalRoofInnovations, Ltd.

| Load | Rail Span |       |    |       |        |     |
|------|-----------|-------|----|-------|--------|-----|
|      | 4'        | 5'-4" | 6' | 8'    | 10'    | 12' |
| None | 90        |       |    |       |        |     |
|      | 120       |       |    |       |        |     |
|      | 140       | XR10  |    | XR100 |        |     |
|      | 160       |       |    |       | XR1000 |     |
| 20   | 90        |       |    |       |        |     |
|      | 120       |       |    |       |        |     |
|      | 140       |       |    |       |        |     |
|      | 160       |       |    |       |        |     |
| 30   | 90        |       |    |       |        |     |
|      | 160       |       |    |       |        |     |
|      | 90        |       |    |       |        |     |
|      | 160       |       |    |       |        |     |
| 40   | 90        |       |    |       |        |     |
|      | 160       |       |    |       |        |     |
|      | 80        |       |    |       |        |     |
|      | 160       |       |    |       |        |     |
| 120  | 160       |       |    |       |        |     |

\*Table is meant to be a simplified span chart for conveying general rail capabilities. Use approved certification letters for actual design guidance.  
© 2020 IronRidge, Inc. All rights reserved. Visit [www.ironridge.com](http://www.ironridge.com) or call 1-800-227-9022 for more information. Version 1.00

**Baker Electric**  
Established 1938  
1298 PACIFIC OAKS PLACE  
ESCONDIDO, CA 92029  
(760) 745-2001  
(858) 566-1980

REGISTRATION  
**BAKER ELECTRIC, INC.**  
1298 PACIFIC OAKS PL.  
ESCONDIDO, CA 92029  
(760) 745-2001  
**C10-161756**  
EXP. 8/31/2021

PROJECT TITLE  
**SDG&E PALOMAR ENERGY CENTER**  
**303.24 KWDC PHOTOVOLTAIC PROJECT**  
2300 HARVESON PLACE  
ESCONDIDO, CA 92029

SHEET DESCRIPTION  
DATA SHEETS

| REV | BY | DATE       | DESCRIPTION       |
|-----|----|------------|-------------------|
| a.5 | AE | 08/06/2021 | 30% CLIENT REVIEW |

PROJECT NUMBER  
22398

DRAWN BY  
AE/IV

CHECKED BY

DATE  
08/06/2021

REVISION  
a.5

SHEET IDENTIFIER  
**E-801**

SHEET OF



Raising the bar in innovative DC MLPE solar power systems

## RSD-S-PLC

- Meets NEC2017&2020 (690.12) requirements
- Executes rapid shutdown of system when Transmitter-PLC signal is absent
- Meets SunSpec requirements

### RSD-S-PLC Technical Data

| Model                                 | RSD-S-PLC  |
|---------------------------------------|--|
| <b>Input Data (DC)</b>                |  |
| Input Operating Voltage Range         | 8-80V  |
| Maximum Cont. Input Current (Imax)    | 15A  |
| <b>Output Data (DC)</b>               |  |
| Output Operating Voltage Range        | 8-80V  |
| Maximum System Voltage                | 1000V/1500V  |
| <b>Mechanical Data</b>                |  |
| Operating Ambient Temperature Range   | -40 °F to +185 °F (-40 °C to + 85 °C)  |
| Dimensions (without cable&connectors) | 5" x 1.2" x 0.6"(129 mm x 30 mm x 16 mm)                                     |
| Cable Length                          | Input 250mm/Output 1200mm  |
| Connector                             | MC4 or Customize   |
| Enclosure Rating                      | Type 6P / IP68   |
| Over Temperature Protection           | Yes  |
| <b>Features &amp; Compliance</b>      |  |
| Communication                         | PLC  |
| Safety Compliance                     | NEC2017&2020 (690.12); UL1741; CSA C22.2 No. 330-17; IEC/EN62109-1; 2PFG2305 |
| EMC Compliance                        | FCC Part15; ICES-003; IEC/EN61000-6-1/-2/-3/-4                               |

© All Rights Reserved

REV 2.0 2020-11-26



The RSD-S-PLC meets SunSpec requirements, maintaining normal function by continually receiving a heartbeat signal from the APsmart Transmitter. The RSD executes rapid system shutdown when the Transmitter signal is absent. Users can manually execute rapid shutdown using Transmitter breaker switch.

### RSD-S-PLC Wiring Diagram

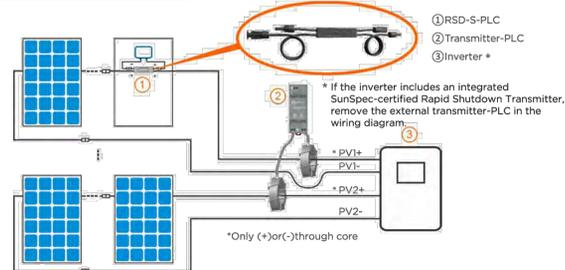

### Working Schematic Diagram

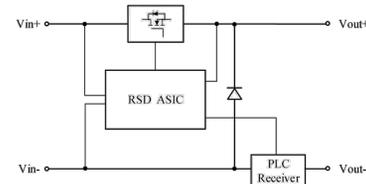

APsmart  
19925 Stevens Creek Blvd, Suite 100, Cupertino, CA 95014  
+1 737-218-8486 | info@APsmartGlobal.com | APsmartGlobal.com

REV 2.0 2020-11-26



Established 1938  
1298 PACIFIC OAKS PLACE  
ESCONDIDO, CA 92029  
(858) 566-1980  
(760) 745-2001

REGISTRATION  
**BAKER ELECTRIC, INC.**  
1298 PACIFIC OAKS PL.  
ESCONDIDO, CA 92029  
(760) 745-2001  
**C10-161756**  
EXP. 8/31/2021

PROJECT TITLE  
**SDG&E PALOMAR ENERGY CENTER  
303.24 KWDC PHOTOVOLTAIC PROJECT  
2300 HARVESON PLACE  
ESCONDIDO, CA 92029**

SHEET DESCRIPTION  
DATA SHEETS

| REV | BY | DATE       | DESCRIPTION       |
|-----|----|------------|-------------------|
| a.5 | AE | 08/06/2021 | 30% CLIENT REVIEW |

PROJECT NUMBER  
22398

DRAWN BY  
AE/IV

CHECKED BY

DATE  
08/06/2021

REVISION  
a.5

SHEET IDENTIFIER  
**E-802**

SHEET OF

© 2021 BAKER ELECTRIC, INC.

**APPENDIX C – AIR QUALITY AND PUBLIC HEALTH, GHG EMISSIONS AND ENERGY USE, AND NOISE AND VIBRATION ANALYSES**

# **Appendix B – Air Quality and Public Health, GHG Emissions and Energy Use, and Noise and Vibration Analyses**

Prepared for:

**San Diego Gas & Electric  
Palomar Energy Center  
2300 Harveson Place  
Escondido, California 92029**

August 2021



## Table of Contents

|            |   |           |
|------------|---|-----------|
| <b>1.0</b> | <b>INTRODUCTION .....</b>   | <b>1</b>  |
| <b>2.0</b> | <b>AIR QUALITY AND PUBLIC HEALTH.....</b>                           | <b>1</b>  |
| 2.1        | Construction Emissions.....   | 1         |
| 2.2        | Operational Emissions.....  | 3         |
| <b>3.0</b> | <b>GREENHOUSE GAS EMISSIONS AND ENERGY USE.....</b>                 | <b>3</b>  |
| 3.1        | Greenhouse Gas and Energy Significance Criteria.....                | 4         |
| 3.1.1      | <i>County Climate Change Guidelines .....</i>                       | <i>4</i>  |
| 3.1.2      | <i>City of Escondido General Plan and Climate Action Plan .....</i> | <i>4</i>  |
| 3.1.3      | <i>State Energy Standards .....</i>                                 | <i>5</i>  |
| 3.2        | GHG Emissions and Energy Use for Project Construction.....          | 6         |
| 3.3        | GHG Emissions and Energy Use for Project Operation .....            | 7         |
| <b>4.0</b> | <b>NOISE AND VIBRATION .....</b>                                    | <b>8</b>  |
| 4.1        | Noise Significance Criteria .....                                   | 8         |
| 4.1.1      | <i>City of Escondido General Plan.....</i>                          | <i>8</i>  |
| 4.1.2      | <i>City of Escondido Municipal Code .....</i>                       | <i>9</i>  |
| 4.2        | Noise and Vibration Impacts During Construction .....               | 9         |
| 4.3        | Noise and Vibration Impacts During Operation .....                  | 10        |
| <b>5.0</b> | <b>REFERENCES.....</b>  | <b>10</b> |

## Table of Attachments

### ATTACHMENT 1 – CALEEMOD ATTACHMENTS

### List of Tables

|            |  |   |
|------------|--|---|
| Table B-1: | Daily and Annual Construction Emissions and Significance Evaluation..... | 2 |
| Table B-2: | Construction Greenhouse Gas Emissions Summary .....                      | 6 |
| Table B-3: | Estimated Construction Fuel Consumption – CalEEMod Basis .....           | 6 |
| Table B-4: | Estimated Operation Electric Power Usage – Maxima .....                  | 7 |
| Table B-5: | Operational Indirect Greenhouse Gas Emissions – SDG&E Power Mix.....     | 7 |

# Appendix B – Air Quality and Public Health, GHG Emissions and Energy Use, and Noise and Vibration Analyses

## 1.0 INTRODUCTION

This appendix contains evaluations of several of the topics, specifically air quality, public health, greenhouse gas (GHG) emissions, energy, and noise and vibration, that required more detailed quantitative analyses.

## 2.0 AIR QUALITY AND PUBLIC HEALTH

### 2.1 Air Quality and Public Health Significance Criteria

The potential for impacts to air quality and public health from construction and operation of the proposed Project are discussed in this section. The San Diego County *Guidelines for Determining Significance, Air Quality* (County 2007) was used as a basis for determining the significance of the impact to air quality. Guidelines for health risk assessments (HRAs) published by the California Office of Environmental Health Hazard Assessment (OEHHA 1990) were used to assess impacts to public health.

### 2.2 Construction Emissions

The construction emissions analysis was performed using the California Emissions Estimator Model<sup>®</sup> (CalEEMod) version 2020.4.0, the official statewide land use computer model designed to provide a uniform platform for estimating potential criteria pollutant and GHG emissions associated with construction of land use projects under the California Environmental Quality Act (CEQA). The model quantifies direct emissions from construction, including off-road equipment and on-road vehicle use. The mobile source emission factors used in the model include the Assembly Bill (AB) 1493 standards of 2002 and Low Carbon Fuel Standards. The 2020 version allows an analysis to be conducted which relies upon either the original EMFAC2017 emission factors or the California Air Resources Board's (ARB's) EMFAC2017 off-model adjustment factors for certain gasoline-fueled light duty and medium duty vehicles to account for the SAFE Vehicle Rule – Part One. The model also identifies regulatory measures and mitigation measures to reduce criteria pollutant and GHG emissions and calculates the benefits achieved from the selected measures. CalEEMod was developed by the California Air Pollution Control Officers Association (CAPCOA) in collaboration with the San Diego County Air Pollution Control District (SDAPCD) and other California air districts. Default land use data (e.g., emission factors, trip lengths, meteorology, source inventory, etc.) were provided by the various California air districts to account for local requirements and conditions.

The following information and assumptions were used in developing the emissions estimates for the Project using CalEEMod:

- Some project parameters (i.e., planned construction schedule and site layout) were defined by San Diego Gas and Electric (SDG&E), while others (i.e., overall site area) were determined using Google Earth measurement tools or site plan drawings;

- Default construction equipment horsepower ratings and load factors contained in CalEEMod were applied to all phases of the Project; and
- The default equipment performance parameters from CalEEMod for each construction phase are representative of actual construction equipment used during construction.

For this project, CalEEMod was run in default mode for the land use category “General Light Industry” for the entire 7,000-square-foot project area to estimate maximum potential impacts. The analysis assumed maximum demolition debris of approximately 76 tons of old asphalt and concrete to clear the project area, or eight truckloads. No site preparation or grading will be necessary or performed. For fugitive dust control from exposed soil on the small, previously graded construction site, twice daily water application was assumed as a mitigation measure in CalEEMod. Peak daily and annual criteria pollutant emissions are summarized in Table B-1 and compared to the San Diego County daily and annual screening-level significance thresholds (County 2007).

The use of diesel-powered construction equipment emits ozone precursors oxides of nitrogen (NO<sub>x</sub>) and volatile organic compounds (VOCs), as well as diesel particulate matter (DPM), which is a composite of toxic air contaminants (TACs) containing a variety of hazardous substances. DPM has been identified as a carcinogen by OEHHA (1990). Large construction projects using multiple large earthmoving equipment are often evaluated to determine if on-site activities may exceed the daily threshold for NO<sub>x</sub> emissions or temporarily expose area residents to hazardous levels of DPM. However, because the proposed Project construction will not involve large earthmoving equipment and is of small size (7,000 square feet) and short duration (less than 6 months), cumulative risks from DPM emissions would be avoided. Per guidance from OEHHA, it is generally not required to perform a health risk assessment (HRA) for construction lasting less than six months and the impacts to public health can be considered to be less than significant (LTS).

As shown in Table B-1, mass emissions of criteria pollutants from construction are below applicable County daily and annual significance thresholds, and hence the impact would be LTS. The CalEEMod output is provided in Attachment 1.

**Table B-1: Daily and Annual Construction Emissions and Significance Evaluation**

| Criteria Pollutants     | Daily Emissions (lbs/day) | Threshold (lbs/day) | Annual Emissions (tpy) | Threshold (tpy) | Significance |
|-------------------------|---------------------------|---------------------|------------------------|-----------------|--------------|
| VOC                     | 16.43                     | 75                  | 0.1                    | 13.7            | LTS          |
| NO <sub>x</sub>         | 7.09                      | 250                 | 0.4                    | 40              | LTS          |
| CO                      | 7.76                      | 550                 | 0.4                    | 100             | LTS          |
| SO <sub>x</sub>         | 0.01                      | 250                 | 0.0                    | 40              | LTS          |
| Total PM <sub>10</sub>  | 0.51                      | 100                 | 0.02                   | 15              | LTS          |
| Total PM <sub>2.5</sub> | 0.36                      | 55                  | 0.02                   | 10              | LTS          |

Sources: County 2007, CalEEMod version 2020.4.0.

Notes:

lbs/day are winter or summer maxima for planned land use.

Total PM<sub>10</sub> / PM<sub>2.5</sub> comprises fugitive dust plus engine exhaust and account for application of fugitive dust control mitigation.

### 2.3 Operational Emissions

There would be no direct operational emissions of pollutants from the generation of hydrogen in the electrically powered electrolyzer system. The principal byproduct gas from electrolysis is oxygen (O<sub>2</sub>). There could be some indirect pollutant emissions due to power generation requirements of the new electrolyzer equipment that are over the amount of power produced by the new on-site solar photovoltaic (PV) system.

The normal operating condition will be a 1% blend of hydrogen in the natural gas fuel in one of the PEC combustion turbine generators (CTGs), but the maximum design blend will be 2% per CTG. A blend of up to 2% hydrogen with the natural gas in the two PEC CTGs is not expected to affect the ability of PEC to comply with its existing Permit to Operate (PTO) or air quality Conditions of Certification (COCs). According to recent articles, the major original equipment manufacturers (OEMs) have advanced-class gas turbines that are available and can operate with a blend of up to 30% hydrogen, and research is underway to develop technology to burn up to 100% hydrogen. According to these sources, NO<sub>x</sub> emissions can be controlled to approximately the same levels as natural gas combustion with a blend of up to 30% hydrogen in the fuel. Controlling NO<sub>x</sub> above 30% blend becomes more difficult, requiring more sophisticated burners, fine tuning of the combustion process, a selective catalytic reduction system, or some combination of these solutions.

Likewise, the current oxidation catalysts in use on the two CTGs at PEC are expected to continue to meet permit limits related to carbon monoxide (CO), VOC, and TACs when burning up to 2% (or more) hydrogen in the fuel. The blended hydrogen fuel would also have less sulfur and produce less oxides of sulfur (SO<sub>x</sub>) and fine and respirable particulate matter (PM<sub>10</sub>/PM<sub>2.5</sub>) than 100% pipeline quality natural gas.

At the proposed up to 2% blend level, SDG&E expects that no changes to its current SDAPCD PTO emissions limits will be needed.

Since the new system would be operated by current power plant staff, no additional worker vehicle trips would occur; thus, no quantifiable increase in operational mobile source emissions would be attributable to the proposed Project. Any additional vendor trips associated with the new system would be essentially de minimis compared to existing vendor trips serving the existing PEC facility. The existing delivery of hydrogen cylinders used for generator cooling would no longer be needed because the hydrogen would be produced on-site.

Thus, there would be no direct impacts attributable to criteria pollutant or TAC emissions from Project operation, and the air quality and public health impacts due to the proposed Project will be less than significant.

### 3.0 GREENHOUSE GAS EMISSIONS AND ENERGY USE

GHGs – primarily carbon dioxide (CO<sub>2</sub>), methane (CH<sub>4</sub>), and nitrous oxide (N<sub>2</sub>O), collectively reported as carbon dioxide equivalents (CO<sub>2</sub>e) – are directly emitted from stationary source combustion of natural gas in equipment such as water heaters, boilers, process heaters, and furnaces. GHGs are also emitted from mobile sources such as on-road vehicles and off-road construction equipment burning fuels such as gasoline, diesel, biodiesel, propane, or natural gas (compressed or liquefied). Indirect GHG emissions result from electric power generated elsewhere (i.e., power plants) used to operate process equipment, lighting, and utilities at a facility. Also

included in GHG quantification is electric power used to pump the water supply (e.g., aqueducts, wells, pipelines) and disposal and decomposition of municipal waste in landfills (ARB 2017).

### **3.1 Greenhouse Gas and Energy Significance Criteria**

SDAPCD does not publish CEQA significance criteria related to GHG emissions. The criteria published by San Diego County and the City of Escondido are discussed below.

#### ***3.1.1 County Climate Change Guidelines***

Because the SDAPCD has not adopted numerical GHG thresholds, the District relies on the February 2018 San Diego County *Guidelines for Determining Significance, Climate Change* and the January 2008 CAPCOA publication *CEQA & Climate Change: Evaluating and Addressing Greenhouse Gas Emissions from Projects Subject to the California Environmental Quality Act*.

Per the County Guidelines, a proposed project would have a less than significant cumulatively considerable contribution to climate change impacts if it is found to be consistent with the County's Climate Action Plan (CAP) and would normally have a cumulatively considerable contribution to climate change impacts if it is found to be inconsistent with the CAP (County 2018).

Consistency with the CAP is determined through the CAP Consistency Review Checklist for discretionary development projects (County 2018). Examples of discretionary projects include growth-inducing residential and commercial developments. However, the proposed project is an industrial activity at an existing, permitted industrial facility (i.e., electric power generation), entirely within land presently zoned industrial, and would not contribute to growth because the hydrogen system would be operated by current employees, i.e., no increase in employment at the site. Thus, the project falls outside the scope of the CAP Consistency Review because it is not a land use development project and would not be growth-inducing.

For industrial projects (stationary sources), the CAPCOA-recommended numeric GHG threshold is 10,000 metric tons (MT) CO<sub>2e</sub> per year (CAPCOA 2008). This threshold has been adopted by other California air districts, such as the South Coast Air Quality Management District (SCAQMD) and Bay Area Air Quality Management District (BAAQMD). Projects with incremental increases below this threshold would not be considered cumulatively considerable. Since the project would have GHG impacts below this threshold (Tables B-2 and B-5), impacts would not be cumulatively considerable.

#### ***3.1.2 City of Escondido General Plan and Climate Action Plan***

The City of Escondido General Plan Resource Conservation Element (Chapter VII) Air and Climate Element (Subchapter I) refers to the CAP, as discussed below.

The City of Escondido's 2021 CAP is an update to the GHG inventories, emission projections, and GHG reduction measures identified in the 2013 CAP. The 2021 CAP was developed in partnership with the San Diego Association of Governments (SANDAG) with the goal of achieving GHG reductions and addressing climate change at the local level. The 2021 CAP sets GHG reduction targets and proposes achievable, locally based strategies to reduce GHG emissions from both municipal and community activities (City 2021).

Acting on climate change means both reducing GHG emissions from activities within the City and helping the community adapt to climate change and improve its resilience over the long term. Three essential steps to the CAP process include (City 2021):

1. Develop and maintain a CAP, which includes preparing baseline emissions estimates and projections and developing reduction targets and strategies;
2. Implement the CAP through local measures; and
3. Monitor and report progress on CAP implementation and identify improvements or adjustments that can be made to the plan in the future.

To meet the City’s 2030 and 2035 GHG reduction targets under AB 32 and SB 32, the 2021 CAP defines nine GHG reduction strategies and 31 specific measures across five source categories: transportation, energy (electricity and natural gas consumption), water and wastewater, solid waste, and carbon sequestration. The City’s nine strategies in the 2021 CAP are:

1. Increase the Use of Zero-Emission or Alternative Fuel Vehicles;
2. Reduce Fossil Fuel Use;
3. Reduce Vehicle Miles Traveled;
4. Increase Building Energy Efficiency;
5. Increase Renewable and Zero-Carbon Energy;
6. Increase Water Efficiency;
7. Diversify Local Water Supply;
8. Reduce and Recycle Solid Waste; and
9. Carbon Sequestration and Land Conservation.

The nine strategies and 31 source-specific measures are consistent with SANDAG’s Regional Climate Action Planning Framework.

The proposed Project is consistent with and directly supports CAP strategies 1, 2, and 5 above. The hydrogen system, supplemented with on-site photovoltaic renewable power generation and a hydrogen vehicle fueling station, will enable the use of zero-emission and alternative fuel vehicles, reduce fossil fuel use, and promote zero-carbon energy. Therefore, the proposed Project would not conflict with an applicable plan, policy, or regulation adopted for the purpose of reducing GHG emissions. Also, because the proposed Project would provide an alternative to fossil fuel use in electric power generation and vehicles, it would not generate GHG emissions, either directly or indirectly, that may have a significant impact on the environment.

### **3.1.3 State Energy Standards**

California’s Energy Code is designed to reduce wasteful and unnecessary energy consumption in new construction and refurbishment projects. The California Energy Commission updates the Building Energy Efficiency Standards (Title 24, Parts 6 and 11) every 3 years. The 2019 standards improved on the 2016 standards and went into effect on January 1, 2020. In new construction, standards require designed-in energy

conservation features such as high-efficiency lighting and high-efficiency electric motors (CEC 2019).

The proposed Project would utilize all-new equipment that meets current energy efficiency standards, such as high-efficiency electric motors and LED lighting. The proposed Project would also offset approximately 10% of its energy requirements with on-site PV renewable power generation. The proposed Project would be in compliance with applicable energy efficiency standards.

### 3.2 GHG Emissions and Energy Use for Project Construction

Using CalEEMod, direct on-site and off-site GHG emissions were estimated for Project construction. Table B-2 compares total annual construction GHG emissions to the CAPCOA industrial significance threshold of 10,000 MT/year of CO<sub>2</sub>e emissions. CalEEMod default off-site traffic emissions (i.e., worker commuting, truck transport) are included in these emissions estimates. As shown, GHG emissions due to proposed Project construction would be below the 10,000 MT per year significance threshold for industrial sources (CAPCOA 2008) and hence the impacts would be LTS.

**Table B-2: Construction Greenhouse Gas Emissions Summary**

| Greenhouse Gases  | GHG Emissions (MT/yr) | Threshold (MT/yr) | Significance |
|-------------------|-----------------------|-------------------|--------------|
| CO <sub>2</sub>   | 59.2                  | –                 | –            |
| CH <sub>4</sub>   | 0.02                  | –                 | –            |
| N <sub>2</sub> O  | 0.00                  | –                 | –            |
| CO <sub>2</sub> e | 60                    | 10,000            | LTS          |

Sources: CAPCOA 2008, CalEEMod version 2020.4.0

Notes:

Based on peak annual construction emissions

Table B-3 breaks down construction emissions and corresponding fuel usage by mobile source type/group: off-road equipment (Tiers 1-4), on-road heavy-heavy duty diesel trucks (HHDT), on-road medium-heavy and heavy-heavy duty diesel trucks (MHDT, HHDT), and light-duty automobiles and trucks (LDA, LDT1, LDT2).

**Table B-3: Estimated Construction Fuel Consumption – CalEEMod Basis**

| Mobile Sources | Types           | Fuels    | MT CO <sub>2</sub> | CO <sub>2</sub> Emission Factor (kg/gal) | Fuel Consumption (gallons) |
|----------------|-----------------|----------|--------------------|--|----------------------------|
| Off-Road       | Tiers 1-4       | Diesel   | 56.6               | 10.21                                    | 5,540                      |
| Hauling        | HHDT            | Diesel   | 0.3                | 10.21                                    | 20                         |
| Vendor         | MHDT, HHDT      | Diesel   | 1.0                | 10.21                                    | 100                        |
| Worker         | LDA, LDT1, LDT2 | Gasoline | 1.3                | 8.78                                     | 150                        |
| <b>Totals</b>  |                 |          | <b>60</b>          | –  | <b>5,810</b>               |

Sources: CalEEMod version 2020.4.0, TCR 2020, 40 CFR 98 Subpart C.

As shown in Table B-3, Project construction would consume approximately 5,800 gallons of liquid fuels, diesel and gasoline combined.

### 3.3 GHG Emissions and Energy Use for Project Operation

As configured, the new hydrogen system will consist of five main groups of electrically powered components: the electrolyzer, two storage cylinder compressors (A/B), the utility air compressor, the paired hydrogen fueling station compressors, ancillary equipment such as supervisory control and data acquisition (SCADA), and nighttime lighting. With all equipment operating, aggregated load would total about 1,480 kilowatts (kW).

A 300-kW solar PV array would provide some offsetting renewable power that would decrease the amount of SDG&E grid power used by the system in aggregate. Since the PV array would supply about 9% of system power needs overall (annual basis), the other 91% would be provided by the SDG&E grid. As shown in Table B-4, after the photovoltaic offset, grid power used by the new system could total approximately 11,000 megawatt-hours (MWh) annually (net load).

**Table B-4: Estimated Operation Electric Power Usage – Maxima**

| Device                  | Type                         | Input Power (kW) | Operation (hrs/yr) | Consumption (MWh/yr) |
|-------------------------|------------------------------|------------------|--------------------|----------------------|
| Electrolyzer            | High Voltage DC Power Supply | 1,250            | 8,760              | 10,950               |
| Storage Compressors A/B | 3-Phase Motors               | 125              | 8,760              | 1,095                |
| Utility Air Compressor  | Single-Phase Motor           | 2                | 8,760              | 17.5                 |
| Dispenser Compressors   | 3-Phase Motors               | 100              | 400                | 40.0                 |
| SCADA & Lighting        | Misc. Devices                | 3                | 8,760              | 26.3                 |
| <b>Total Load</b>       | –                            | <b>1,480</b>     | –                  | <b>12,129</b>        |
| Load Offset             | Solar PV Array               | 300              | 3,500              | (1,050)              |
| <b>Net Load</b>         | –                            | –                | –                  | <b>11,079</b>        |

Source: SDG&E 2021

Per current Intergovernmental Panel on Climate Change (IPCC) Fifth Assessment Report (AR5) Global Warming Potentials (GWPs), the SDG&E power mix comprises a GHG content of approximately 542 pounds CO<sub>2</sub>e per MWh (IPCC 2014, CalEEMod 2020). As shown in Table B-5, when computed against the total net load of 11,079 MWh provided in Table B-4, indirect GHG emissions would total approximately 2,724 MT CO<sub>2</sub>e annually, which is below the 10,000 MT per year significance threshold for industrial sources (CAPCOA 2008) and hence the impact from GHG emissions during operation would be LTS.

**Table B-5: Operational Indirect Greenhouse Gas Emissions – SDG&E Power Mix**

| Greenhouse Gases        | GHG Intensity Factors (lbs/MWh) | Consumption (MWh/yr) | Indirect GHG (MT/yr) | Threshold (MT/yr) | Significance |
|-------------------------|---------------------------------|----------------------|----------------------|-------------------|--------------|
| CO <sub>2</sub>         | 539.98                          | –                    | –                    | –                 | –            |
| CH <sub>4</sub>         | 0.033                           | –                    | –                    | –                 | –            |
| N <sub>2</sub> O        | 0.004                           | –                    | –                    | –                 | –            |
| CO <sub>2</sub> e (AR5) | 541.96                          | 11,079               | 2,724                | 10,000            | LTS          |

Sources: IPCC October 2014, CAPCOA 2008, CalEEMod version 2020.4.0



## 4.0 NOISE AND VIBRATION

The Project site is in the City of Escondido, San Diego County, in a characteristically urban and densely populated area subject to noise from local traffic on public streets (e.g., Auto Park Way and Citracado Parkway), traffic on highways (I-15 and SR-78), aircraft flyovers, trains, construction, and small power equipment (e.g., pressure washers, utility generators, etc.). The Project site is part of an existing industrial land use, where power plant operational noise has existed since the facility began commercial operation on April 1, 2006. No residences are within 0.25 mile (1,320 feet) of the Project site, which is sufficient attenuation distance from the facility and construction zone to mitigate normal noise effects emanating from the proposed Project site during construction or operation of the new equipment.

### 4.1 Noise Significance Criteria

#### 4.1.1 City of Escondido General Plan

California's State General Plan Guidelines direct agencies to incorporate a number of elements into their General Plans, including Safety. Escondido's Community Protection Element (Chapter VI) includes a Noise Element (Subchapter G), which is a required component for General Plans (City 2012).

##### 4.1.1.1 Noise-Sensitive Land Uses

Land uses are located throughout the City in areas where the impacts of noise could affect operations or activities. Noise-sensitive land uses (receptors) include:

- Residential developments and care facilities;
- Schools, churches, and transient lodging;
- Hospitals and health care facilities;
- Libraries, museums, and cultural facilities; and
- Golf courses and passive recreational sites.

Noise exposure levels for a variety of land uses are identified in the Noise element, including commercial and industrial land uses, as described below.

##### 4.1.1.2 Commercial and Industrial Land Uses

Escondido's development pattern generally distributes commercial and industrial land uses in a north-south and east-west alignment along major transportation corridors in the urban core. Residential areas generally surround these commercial and industrial areas, which can cause noise conflicts depending on several factors. These factors include the type of commercial/industrial activity, hours of operation, building orientation, and the commercial/industrial site location relative to other land uses. The Noise element defines the following acceptance criteria for land use development (City 2012):

- Normally Acceptable – Specified land use is satisfactory, based upon the assumption that buildings involved are of normal conventional construction without any special noise insulation requirements;
- Conditionally Acceptable – New construction or development should be undertaken only after a detailed analysis of the noise reduction requirements is

made and needed noise insulation features included in the design; conventional construction, but with closed windows and fresh air supply systems or air conditioning, will usually suffice;

- Normally Unacceptable – New construction or development should generally be discouraged; if new construction or development does proceed, a detailed analysis of the noise reduction requirements must be made with noise insulation features included in the design; and
- Clearly Unacceptable – New construction or development should generally not be undertaken.

For industrial, manufacturing, utility, and agricultural land uses, the Noise element defines the following limits in terms of Community Noise Exposure Level [Ldn or CNEL, in A-weighted decibels (dBA)]:

- Normally Acceptable: up to 75 dBA;
- Conditionally Acceptable: 70 to 80 dBA;<sup>1</sup>
- Normally Unacceptable: over 80 dBA; and
- Clearly Unacceptable: Not defined for commercial and industrial land uses.

#### ***4.1.2 City of Escondido Municipal Code***

Consistent with the Noise element, the City of Escondido Municipal Code, Chapter 17, Article 12, Section 17-229 defines a 1-hour Light Industrial noise limit of 70 dBA and a 1-hour General Industrial noise limit of 75 dBA, both applying at any time day or night. As applicable, the sound level limit at a location on a boundary between two land use classifications is the limit applicable to the receiving land use, and fixed-location public utility distribution or transmission facilities located on or adjacent to a property line shall be subject to the noise level limits measured at or beyond 6 feet (1.83 meters) from the boundary of the easement upon which the equipment is located (City 2017).

## **4.2 Noise and Vibration Impacts During Construction**

The Project site (construction area) is approximately 50 feet (15 meters) from one of two combined cycle generating units. When operating, these generating units are on-site sources of continuous background noise. The facility complies with California Division of Occupational Safety and Health (Cal/OSHA) requirements for on-site worker noise protection.

Construction of the proposed Project would require the use of engine-powered equipment. During each phase, there would be a different mix of equipment operating, and cumulative noise levels would vary based on the amount of equipment in operation and the location of each activity at the Project site. In general, use of off-road equipment, on-road vehicles, and portable equipment would generate noise due to engine mechanicals, engine exhaust, driveline mechanicals, shaft-driven devices and accessories, hydraulics operation, and ground friction. No intense percussive actions (e.g., hard rock breaking, large pile-driving) are planned to occur during the site work, and

---

<sup>1</sup> Overlaps 5 dBA with Normally Acceptable.

no strong ground-borne vibrations are expected to be generated that could affect nearby structures or be noticeable to persons.

Construction noise is expected to blend with existing industrial operational background noise at the Project site. All construction activities would be short-term and temporary (less than six months). All construction work is planned to be conducted during daylight hours; no nighttime work is planned to be performed. Upon completion of construction, construction-generated noise would permanently cease.

### **4.3 Noise and Vibration Impacts During Operation**

The new hydrogen system will include electric motor-driven compressors for the hydrogen storage vessels and the fueling station. These compressors, the primary operational noise sources of the new system, will meet Cal/OSHA worker protection noise limits for industrial equipment, e.g., 85 dBA for 8 hours, or 83 dBA for 12 hours. At 16.5 feet, the storage compressor will emit approximately 74 dBA, and the fueling station compressor will emit approximately 70 dBA, which are below Cal/OSHA limits in common use. Operational noise will also be below the General Plan Normally Unacceptable limit (80 dBA) and the Municipal Code General Industrial limit (75 dBA).

Since the facility is an industrial land use and existing workers will operate the new system, no significant additional long-term worker traffic is expected. Since the compression equipment will meet workplace and community standards and will operate in close proximity against existing power plant background noise, with sensitive receptors (e.g., residences and hospital) over 1,000 feet from the site, no significant additional Project-related noise impact is expected over the long term.

## **5.0 REFERENCES**

- California Office of Environmental Health Hazard Assessment (OEHHA). 1990. Diesel Exhaust Particulate. Website (<https://oehha.ca.gov/chemicals/diesel-exhaust-particulate>) accessed June 30, 2021.
- City of Escondido (City). 2021. Climate Action Plan. Website (<https://www.escondido.org/climate-action-plan-documents.aspx>) accessed June 30, 2021.
- City of Escondido (City). 2017. Municipal Code. Chapter 17, Article 12, Section 17-229 – Sound Level Limits Table 17-229. Website (<https://www.escondido.org/escondido-municipal-code>) accessed June 30, 2021.
- City of Escondido (City). 2012. General Plan, and as amended. Chapter VI – Community Protection, Subchapter G – Noise. Website (<https://www.escondido.org/Data/Sites/1/media/PDFs/Planning/GPUupdate/GeneralPlanChapterVI.pdf>) accessed June 30, 2021.

**ATTACHMENT 1 – CALEEMOD ATTACHMENTS**

Palomar Hydrogen Project - San Diego County, Winter

**EMFAC Off-Model Adjustment Factors for Gasoline Light Duty Vehicle to Account for the SAFE Vehicle Rule Not Applied**

**Palomar Hydrogen Project  
San Diego County, Winter**

**1.0 Project Characteristics**

**1.1 Land Usage**

| Land Uses              | Size | Metric   | Lot Acreage | Floor Surface Area | Population |
|------------------------|------|----------|-------------|--------------------|------------|
| General Light Industry | 7.00 | 1000sqft | 0.16        | 7,000.00           | 0          |

**1.2 Other Project Characteristics**

|                                |                          |                                |       |                                  |       |
|--------------------------------|--------------------------|--------------------------------|-------|----------------------------------|-------|
| <b>Urbanization</b>            | Urban                    | <b>Wind Speed (m/s)</b>        | 2.6   | <b>Precipitation Freq (Days)</b> | 40    |
| <b>Climate Zone</b>            | 13                       |                                |       | <b>Operational Year</b>          | 2023  |
| <b>Utility Company</b>         | San Diego Gas & Electric |                                |       |                                  |       |
| <b>CO2 Intensity (lb/MWhr)</b> | 539.98                   | <b>CH4 Intensity (lb/MWhr)</b> | 0.033 | <b>N2O Intensity (lb/MWhr)</b>   | 0.004 |

**1.3 User Entered Comments & Non-Default Data**

- Project Characteristics - Construction only
- Land Use -
- Construction Phase - 2 weeks for painting
- Demolition -
- Vehicle Trips - Construction only
- Consumer Products - Construction only
- Area Coating - Construction only
- Landscape Equipment - Construction only
- Energy Use - Construction only
- Water And Wastewater - Construction only
- Solid Waste - Construction only
- Construction Off-road Equipment Mitigation -

## Palomar Hydrogen Project - San Diego County, Winter

**EMFAC Off-Model Adjustment Factors for Gasoline Light Duty Vehicle to Account for the SAFE Vehicle Rule Not Applied**

| Table Name            | Column Name                  | Default Value | New Value |
|-----------------------|------------------------------|---------------|-----------|
| tblAreaCoating        | Area_Nonresidential_Exterior | 3500          | 0         |
| tblAreaCoating        | Area_Nonresidential_Interior | 10500         | 0         |
| tblConstructionPhase  | NumDays                      | 5.00          | 10.00     |
| tblConstructionPhase  | PhaseEndDate                 | 6/22/2022     | 6/17/2022 |
| tblConstructionPhase  | PhaseEndDate                 | 6/8/2022      | 6/3/2022  |
| tblConstructionPhase  | PhaseStartDate               | 6/16/2022     | 6/6/2022  |
| tblConstructionPhase  | PhaseStartDate               | 1/20/2022     | 1/17/2022 |
| tblConsumerProducts   | ROG_EF                       | 2.14E-05      | 1E-07     |
| tblConsumerProducts   | ROG_EF_Degreaser             | 3.542E-07     | 1E-10     |
| tblConsumerProducts   | ROG_EF_PesticidesFertilizers | 5.152E-08     | 1E-11     |
| tblEnergyUse          | LightingElect                | 2.83          | 0.00      |
| tblEnergyUse          | NT24E                        | 4.27          | 0.00      |
| tblEnergyUse          | NT24NG                       | 7.25          | 0.00      |
| tblEnergyUse          | T24E                         | 1.08          | 0.00      |
| tblEnergyUse          | T24NG                        | 4.27          | 0.00      |
| tblLandscapeEquipment | NumberSummerDays             | 180           | 1         |
| tblSolidWaste         | SolidWasteGenerationRate     | 8.68          | 0.00      |
| tblVehicleTrips       | ST_TR                        | 1.99          | 0.00      |
| tblVehicleTrips       | SU_TR                        | 5.00          | 0.00      |
| tblVehicleTrips       | WD_TR                        | 4.96          | 0.00      |
| tblWater              | IndoorWaterUseRate           | 1,618,750.00  | 0.00      |

**2.0 Emissions Summary**



Palomar Hydrogen Project - San Diego County, Winter

**EMFAC Off-Model Adjustment Factors for Gasoline Light Duty Vehicle to Account for the SAFE Vehicle Rule Not Applied**

**2.2 Overall Operational**

**Unmitigated Operational**

|              | ROG                | NOx                | CO                 | SO2           | Fugitive PM10 | Exhaust PM10  | PM10 Total    | Fugitive PM2.5 | Exhaust PM2.5 | PM2.5 Total   | Bio- CO2 | NBio- CO2          | Total CO2          | CH4           | N2O           | CO2e               |
|--------------|--------------------|--------------------|--------------------|---------------|---------------|---------------|---------------|----------------|---------------|---------------|----------|--------------------|--------------------|---------------|---------------|--------------------|
| Category     | lb/day             |                    |                    |               |               |               |               |                |               |               | lb/day   |                    |                    |               |               |                    |
| Area         | 7.7000e-004        | 1.0000e-005        | 7.1000e-004        | 0.0000        |               | 0.0000        | 0.0000        |                | 0.0000        | 0.0000        |          | 1.5300e-003        | 1.5300e-003        | 0.0000        |               | 1.6300e-003        |
| Energy       | 0.0000             | 0.0000             | 0.0000             | 0.0000        |               | 0.0000        | 0.0000        |                | 0.0000        | 0.0000        |          | 0.0000             | 0.0000             | 0.0000        | 0.0000        | 0.0000             |
| Mobile       | 0.0000             | 0.0000             | 0.0000             | 0.0000        | 0.0000        | 0.0000        | 0.0000        | 0.0000         | 0.0000        | 0.0000        |          | 0.0000             | 0.0000             | 0.0000        | 0.0000        | 0.0000             |
| <b>Total</b> | <b>7.7000e-004</b> | <b>1.0000e-005</b> | <b>7.1000e-004</b> | <b>0.0000</b> | <b>0.0000</b> | <b>0.0000</b> | <b>0.0000</b> | <b>0.0000</b>  | <b>0.0000</b> | <b>0.0000</b> |          | <b>1.5300e-003</b> | <b>1.5300e-003</b> | <b>0.0000</b> | <b>0.0000</b> | <b>1.6300e-003</b> |

**Mitigated Operational**

|              | ROG                | NOx                | CO                 | SO2           | Fugitive PM10 | Exhaust PM10  | PM10 Total    | Fugitive PM2.5 | Exhaust PM2.5 | PM2.5 Total   | Bio- CO2 | NBio- CO2          | Total CO2          | CH4           | N2O           | CO2e               |
|--------------|--------------------|--------------------|--------------------|---------------|---------------|---------------|---------------|----------------|---------------|---------------|----------|--------------------|--------------------|---------------|---------------|--------------------|
| Category     | lb/day             |                    |                    |               |               |               |               |                |               |               | lb/day   |                    |                    |               |               |                    |
| Area         | 7.7000e-004        | 1.0000e-005        | 7.1000e-004        | 0.0000        |               | 0.0000        | 0.0000        |                | 0.0000        | 0.0000        |          | 1.5300e-003        | 1.5300e-003        | 0.0000        |               | 1.6300e-003        |
| Energy       | 0.0000             | 0.0000             | 0.0000             | 0.0000        |               | 0.0000        | 0.0000        |                | 0.0000        | 0.0000        |          | 0.0000             | 0.0000             | 0.0000        | 0.0000        | 0.0000             |
| Mobile       | 0.0000             | 0.0000             | 0.0000             | 0.0000        | 0.0000        | 0.0000        | 0.0000        | 0.0000         | 0.0000        | 0.0000        |          | 0.0000             | 0.0000             | 0.0000        | 0.0000        | 0.0000             |
| <b>Total</b> | <b>7.7000e-004</b> | <b>1.0000e-005</b> | <b>7.1000e-004</b> | <b>0.0000</b> | <b>0.0000</b> | <b>0.0000</b> | <b>0.0000</b> | <b>0.0000</b>  | <b>0.0000</b> | <b>0.0000</b> |          | <b>1.5300e-003</b> | <b>1.5300e-003</b> | <b>0.0000</b> | <b>0.0000</b> | <b>1.6300e-003</b> |



Palomar Hydrogen Project - San Diego County, Winter

**EMFAC Off-Model Adjustment Factors for Gasoline Light Duty Vehicle to Account for the SAFE Vehicle Rule Not Applied**

|                   | ROG  | NOx  | CO   | SO2  | Fugitive PM10 | Exhaust PM10 | PM10 Total | Fugitive PM2.5 | Exhaust PM2.5 | PM2.5 Total | Bio- CO2 | NBio-CO2 | Total CO2 | CH4  | N2O  | CO2e |
|-------------------|------|------|------|------|---------------|--------------|------------|----------------|---------------|-------------|----------|----------|-----------|------|------|------|
| Percent Reduction | 0.00 | 0.00 | 0.00 | 0.00 | 0.00          | 0.00         | 0.00       | 0.00           | 0.00          | 0.00        | 0.00     | 0.00     | 0.00      | 0.00 | 0.00 | 0.00 |

**3.0 Construction Detail**

**Construction Phase**

| Phase Number | Phase Name            | Phase Type            | Start Date | End Date  | Num Days Week | Num Days | Phase Description |
|--------------|-----------------------|-----------------------|------------|-----------|---------------|----------|-------------------|
| 1            | Demolition            | Demolition            | 1/3/2022   | 1/14/2022 | 5             | 10       |                   |
| 2            | Building Construction | Building Construction | 1/17/2022  | 6/3/2022  | 5             | 100      |                   |
| 3            | Architectural Coating | Architectural Coating | 6/6/2022   | 6/17/2022 | 5             | 10       |                   |

**Acres of Grading (Site Preparation Phase): 0**

**Acres of Grading (Grading Phase): 0**

**Acres of Paving: 0**

**Residential Indoor: 0; Residential Outdoor: 0; Non-Residential Indoor: 10,500; Non-Residential Outdoor: 3,500; Striped Parking Area: 0 (Architectural Coating – sqft)**

**OffRoad Equipment**

| Phase Name            | Offroad Equipment Type    | Amount | Usage Hours | Horse Power | Load Factor |
|-----------------------|---------------------------|--------|-------------|-------------|-------------|
| Architectural Coating | Air Compressors           | 1      | 6.00        | 78          | 0.48        |
| Demolition            | Concrete/Industrial Saws  | 1      | 8.00        | 81          | 0.73        |
| Building Construction | Cranes                    | 1      | 4.00        | 231         | 0.29        |
| Building Construction | Forklifts                 | 2      | 6.00        | 89          | 0.20        |
| Demolition            | Rubber Tired Dozers       | 1      | 1.00        | 247         | 0.40        |
| Building Construction | Tractors/Loaders/Backhoes | 2      | 8.00        | 97          | 0.37        |
| Demolition            | Tractors/Loaders/Backhoes | 2      | 6.00        | 97          | 0.37        |

**Trips and VMT**

Palomar Hydrogen Project - San Diego County, Winter

**EMFAC Off-Model Adjustment Factors for Gasoline Light Duty Vehicle to Account for the SAFE Vehicle Rule Not Applied**

| Phase Name            | Offroad Equipment Count | Worker Trip Number | Vendor Trip Number | Hauling Trip Number | Worker Trip Length | Vendor Trip Length | Hauling Trip Length | Worker Vehicle Class | Vendor Vehicle Class | Hauling Vehicle Class |
|-----------------------|-------------------------|--------------------|--------------------|---------------------|--------------------|--------------------|---------------------|----------------------|----------------------|-----------------------|
| Demolition            | 4                       | 10.00              | 0.00               | 8.00                | 10.80              | 7.30               | 20.00               | LD_Mix               | HDT_Mix              | HHDT                  |
| Building Construction | 5                       | 3.00               | 1.00               | 0.00                | 10.80              | 7.30               | 20.00               | LD_Mix               | HDT_Mix              | HHDT                  |
| Architectural Coating | 1                       | 1.00               | 0.00               | 0.00                | 10.80              | 7.30               | 20.00               | LD_Mix               | HDT_Mix              | HHDT                  |

**3.1 Mitigation Measures Construction**

Water Exposed Area

**3.2 Demolition - 2022**

**Unmitigated Construction On-Site**

|               | ROG           | NOx           | CO            | SO2           | Fugitive PM10 | Exhaust PM10  | PM10 Total    | Fugitive PM2.5 | Exhaust PM2.5 | PM2.5 Total   | Bio- CO2 | NBio- CO2         | Total CO2         | CH4           | N2O | CO2e              |
|---------------|---------------|---------------|---------------|---------------|---------------|---------------|---------------|----------------|---------------|---------------|----------|-------------------|-------------------|---------------|-----|-------------------|
| Category      | lb/day        |               |               |               |               |               |               |                |               |               | lb/day   |                   |                   |               |     |                   |
| Fugitive Dust |               |               |               |               | 0.1647        | 0.0000        | 0.1647        | 0.0249         | 0.0000        | 0.0249        |          |                   | 0.0000            |               |     | 0.0000            |
| Off-Road      | 0.7094        | 6.4138        | 7.4693        | 0.0120        |               | 0.3375        | 0.3375        |                | 0.3225        | 0.3225        |          | 1,147.9025        | 1,147.9025        | 0.2119        |     | 1,153.2001        |
| <b>Total</b>  | <b>0.7094</b> | <b>6.4138</b> | <b>7.4693</b> | <b>0.0120</b> | <b>0.1647</b> | <b>0.3375</b> | <b>0.5022</b> | <b>0.0249</b>  | <b>0.3225</b> | <b>0.3475</b> |          | <b>1,147.9025</b> | <b>1,147.9025</b> | <b>0.2119</b> |     | <b>1,153.2001</b> |

Palomar Hydrogen Project - San Diego County, Winter

**EMFAC Off-Model Adjustment Factors for Gasoline Light Duty Vehicle to Account for the SAFE Vehicle Rule Not Applied**

**3.2 Demolition - 2022**

**Unmitigated Construction Off-Site**

|              | ROG           | NOx           | CO            | SO2                | Fugitive PM10 | Exhaust PM10       | PM10 Total    | Fugitive PM2.5 | Exhaust PM2.5      | PM2.5 Total   | Bio- CO2 | NBio- CO2       | Total CO2       | CH4                | N2O           | CO2e            |
|--------------|---------------|---------------|---------------|--------------------|---------------|--------------------|---------------|----------------|--------------------|---------------|----------|-----------------|-----------------|--------------------|---------------|-----------------|
| Category     | lb/day        |               |               |                    |               |                    |               |                |                    |               | lb/day   |                 |                 |                    |               |                 |
| Hauling      | 3.4900e-003   | 0.1348        | 0.0321        | 5.0000e-004        | 0.0140        | 1.2500e-003        | 0.0153        | 3.8400e-003    | 1.2000e-003        | 5.0300e-003   |          | 55.2890         | 55.2890         | 2.6500e-003        | 8.7800e-003   | 57.9727         |
| Vendor       | 0.0000        | 0.0000        | 0.0000        | 0.0000             | 0.0000        | 0.0000             | 0.0000        | 0.0000         | 0.0000             | 0.0000        |          | 0.0000          | 0.0000          | 0.0000             | 0.0000        | 0.0000          |
| Worker       | 0.0316        | 0.0214        | 0.2455        | 7.1000e-004        | 0.0822        | 4.6000e-004        | 0.0826        | 0.0218         | 4.3000e-004        | 0.0222        |          | 71.5946         | 71.5946         | 2.3300e-003        | 2.1300e-003   | 72.2866         |
| <b>Total</b> | <b>0.0351</b> | <b>0.1562</b> | <b>0.2776</b> | <b>1.2100e-003</b> | <b>0.0961</b> | <b>1.7100e-003</b> | <b>0.0979</b> | <b>0.0256</b>  | <b>1.6300e-003</b> | <b>0.0273</b> |          | <b>126.8836</b> | <b>126.8836</b> | <b>4.9800e-003</b> | <b>0.0109</b> | <b>130.2593</b> |

**Mitigated Construction On-Site**

|               | ROG           | NOx           | CO            | SO2           | Fugitive PM10 | Exhaust PM10  | PM10 Total    | Fugitive PM2.5 | Exhaust PM2.5 | PM2.5 Total   | Bio- CO2      | NBio- CO2         | Total CO2         | CH4           | N2O | CO2e              |
|---------------|---------------|---------------|---------------|---------------|---------------|---------------|---------------|----------------|---------------|---------------|---------------|-------------------|-------------------|---------------|-----|-------------------|
| Category      | lb/day        |               |               |               |               |               |               |                |               |               | lb/day        |                   |                   |               |     |                   |
| Fugitive Dust |               |               |               |               | 0.0741        | 0.0000        | 0.0741        | 0.0112         | 0.0000        | 0.0112        |               |                   | 0.0000            |               |     | 0.0000            |
| Off-Road      | 0.7094        | 6.4138        | 7.4693        | 0.0120        |               | 0.3375        | 0.3375        |                | 0.3225        | 0.3225        | 0.0000        | 1,147.9025        | 1,147.9025        | 0.2119        |     | 1,153.2001        |
| <b>Total</b>  | <b>0.7094</b> | <b>6.4138</b> | <b>7.4693</b> | <b>0.0120</b> | <b>0.0741</b> | <b>0.3375</b> | <b>0.4116</b> | <b>0.0112</b>  | <b>0.3225</b> | <b>0.3338</b> | <b>0.0000</b> | <b>1,147.9025</b> | <b>1,147.9025</b> | <b>0.2119</b> |     | <b>1,153.2001</b> |

Palomar Hydrogen Project - San Diego County, Winter

**EMFAC Off-Model Adjustment Factors for Gasoline Light Duty Vehicle to Account for the SAFE Vehicle Rule Not Applied**

**3.2 Demolition - 2022**

**Mitigated Construction Off-Site**

|              | ROG           | NOx           | CO            | SO2                | Fugitive PM10 | Exhaust PM10       | PM10 Total    | Fugitive PM2.5 | Exhaust PM2.5      | PM2.5 Total   | Bio- CO2 | NBio- CO2       | Total CO2       | CH4                | N2O           | CO2e            |
|--------------|---------------|---------------|---------------|--------------------|---------------|--------------------|---------------|----------------|--------------------|---------------|----------|-----------------|-----------------|--------------------|---------------|-----------------|
| Category     | lb/day        |               |               |                    |               |                    |               |                |                    |               | lb/day   |                 |                 |                    |               |                 |
| Hauling      | 3.4900e-003   | 0.1348        | 0.0321        | 5.0000e-004        | 0.0140        | 1.2500e-003        | 0.0153        | 3.8400e-003    | 1.2000e-003        | 5.0300e-003   |          | 55.2890         | 55.2890         | 2.6500e-003        | 8.7800e-003   | 57.9727         |
| Vendor       | 0.0000        | 0.0000        | 0.0000        | 0.0000             | 0.0000        | 0.0000             | 0.0000        | 0.0000         | 0.0000             | 0.0000        |          | 0.0000          | 0.0000          | 0.0000             | 0.0000        | 0.0000          |
| Worker       | 0.0316        | 0.0214        | 0.2455        | 7.1000e-004        | 0.0822        | 4.6000e-004        | 0.0826        | 0.0218         | 4.3000e-004        | 0.0222        |          | 71.5946         | 71.5946         | 2.3300e-003        | 2.1300e-003   | 72.2866         |
| <b>Total</b> | <b>0.0351</b> | <b>0.1562</b> | <b>0.2776</b> | <b>1.2100e-003</b> | <b>0.0961</b> | <b>1.7100e-003</b> | <b>0.0979</b> | <b>0.0256</b>  | <b>1.6300e-003</b> | <b>0.0273</b> |          | <b>126.8836</b> | <b>126.8836</b> | <b>4.9800e-003</b> | <b>0.0109</b> | <b>130.2593</b> |

**3.3 Building Construction - 2022**

**Unmitigated Construction On-Site**

|              | ROG           | NOx           | CO            | SO2           | Fugitive PM10 | Exhaust PM10  | PM10 Total    | Fugitive PM2.5 | Exhaust PM2.5 | PM2.5 Total   | Bio- CO2 | NBio- CO2         | Total CO2         | CH4           | N2O | CO2e              |
|--------------|---------------|---------------|---------------|---------------|---------------|---------------|---------------|----------------|---------------|---------------|----------|-------------------|-------------------|---------------|-----|-------------------|
| Category     | lb/day        |               |               |               |               |               |               |                |               |               | lb/day   |                   |                   |               |     |                   |
| Off-Road     | 0.6863        | 7.0258        | 7.1527        | 0.0114        |               | 0.3719        | 0.3719        |                | 0.3422        | 0.3422        |          | 1,103.9393        | 1,103.9393        | 0.3570        |     | 1,112.8652        |
| <b>Total</b> | <b>0.6863</b> | <b>7.0258</b> | <b>7.1527</b> | <b>0.0114</b> |               | <b>0.3719</b> | <b>0.3719</b> |                | <b>0.3422</b> | <b>0.3422</b> |          | <b>1,103.9393</b> | <b>1,103.9393</b> | <b>0.3570</b> |     | <b>1,112.8652</b> |

Palomar Hydrogen Project - San Diego County, Winter

**EMFAC Off-Model Adjustment Factors for Gasoline Light Duty Vehicle to Account for the SAFE Vehicle Rule Not Applied**

**3.3 Building Construction - 2022**

**Unmitigated Construction Off-Site**

|              | ROG           | NOx           | CO            | SO2                | Fugitive PM10 | Exhaust PM10       | PM10 Total    | Fugitive PM2.5     | Exhaust PM2.5      | PM2.5 Total        | Bio- CO2 | NBio- CO2      | Total CO2      | CH4                | N2O                | CO2e           |
|--------------|---------------|---------------|---------------|--------------------|---------------|--------------------|---------------|--------------------|--------------------|--------------------|----------|----------------|----------------|--------------------|--------------------|----------------|
| Category     | lb/day        |               |               |                    |               |                    |               |                    |                    |                    | lb/day   |                |                |                    |                    |                |
| Hauling      | 0.0000        | 0.0000        | 0.0000        | 0.0000             | 0.0000        | 0.0000             | 0.0000        | 0.0000             | 0.0000             | 0.0000             |          | 0.0000         | 0.0000         | 0.0000             | 0.0000             | 0.0000         |
| Vendor       | 2.2100e-003   | 0.0552        | 0.0183        | 2.1000e-004        | 6.7700e-003   | 5.8000e-004        | 7.3500e-003   | 1.9500e-003        | 5.5000e-004        | 2.5000e-003        |          | 22.9944        | 22.9944        | 7.0000e-004        | 3.3400e-003        | 24.0073        |
| Worker       | 9.4700e-003   | 6.4100e-003   | 0.0737        | 2.1000e-004        | 0.0246        | 1.4000e-004        | 0.0248        | 6.5400e-003        | 1.3000e-004        | 6.6700e-003        |          | 21.4784        | 21.4784        | 7.0000e-004        | 6.4000e-004        | 21.6860        |
| <b>Total</b> | <b>0.0117</b> | <b>0.0616</b> | <b>0.0920</b> | <b>4.2000e-004</b> | <b>0.0314</b> | <b>7.2000e-004</b> | <b>0.0321</b> | <b>8.4900e-003</b> | <b>6.8000e-004</b> | <b>9.1700e-003</b> |          | <b>44.4728</b> | <b>44.4728</b> | <b>1.4000e-003</b> | <b>3.9800e-003</b> | <b>45.6933</b> |

**Mitigated Construction On-Site**

|              | ROG           | NOx           | CO            | SO2           | Fugitive PM10 | Exhaust PM10  | PM10 Total    | Fugitive PM2.5 | Exhaust PM2.5 | PM2.5 Total   | Bio- CO2      | NBio- CO2         | Total CO2         | CH4           | N2O | CO2e              |
|--------------|---------------|---------------|---------------|---------------|---------------|---------------|---------------|----------------|---------------|---------------|---------------|-------------------|-------------------|---------------|-----|-------------------|
| Category     | lb/day        |               |               |               |               |               |               |                |               |               | lb/day        |                   |                   |               |     |                   |
| Off-Road     | 0.6863        | 7.0258        | 7.1527        | 0.0114        |               | 0.3719        | 0.3719        |                | 0.3422        | 0.3422        | 0.0000        | 1,103.9393        | 1,103.9393        | 0.3570        |     | 1,112.8652        |
| <b>Total</b> | <b>0.6863</b> | <b>7.0258</b> | <b>7.1527</b> | <b>0.0114</b> |               | <b>0.3719</b> | <b>0.3719</b> |                | <b>0.3422</b> | <b>0.3422</b> | <b>0.0000</b> | <b>1,103.9393</b> | <b>1,103.9393</b> | <b>0.3570</b> |     | <b>1,112.8652</b> |

Palomar Hydrogen Project - San Diego County, Winter

**EMFAC Off-Model Adjustment Factors for Gasoline Light Duty Vehicle to Account for the SAFE Vehicle Rule Not Applied**

**3.3 Building Construction - 2022**

Mitigated Construction Off-Site

|              | ROG           | NOx           | CO            | SO2                | Fugitive PM10 | Exhaust PM10       | PM10 Total    | Fugitive PM2.5     | Exhaust PM2.5      | PM2.5 Total        | Bio- CO2 | NBio- CO2      | Total CO2      | CH4                | N2O                | CO2e           |
|--------------|---------------|---------------|---------------|--------------------|---------------|--------------------|---------------|--------------------|--------------------|--------------------|----------|----------------|----------------|--------------------|--------------------|----------------|
| Category     | lb/day        |               |               |                    |               |                    |               |                    |                    |                    | lb/day   |                |                |                    |                    |                |
| Hauling      | 0.0000        | 0.0000        | 0.0000        | 0.0000             | 0.0000        | 0.0000             | 0.0000        | 0.0000             | 0.0000             | 0.0000             |          | 0.0000         | 0.0000         | 0.0000             | 0.0000             | 0.0000         |
| Vendor       | 2.2100e-003   | 0.0552        | 0.0183        | 2.1000e-004        | 6.7700e-003   | 5.8000e-004        | 7.3500e-003   | 1.9500e-003        | 5.5000e-004        | 2.5000e-003        |          | 22.9944        | 22.9944        | 7.0000e-004        | 3.3400e-003        | 24.0073        |
| Worker       | 9.4700e-003   | 6.4100e-003   | 0.0737        | 2.1000e-004        | 0.0246        | 1.4000e-004        | 0.0248        | 6.5400e-003        | 1.3000e-004        | 6.6700e-003        |          | 21.4784        | 21.4784        | 7.0000e-004        | 6.4000e-004        | 21.6860        |
| <b>Total</b> | <b>0.0117</b> | <b>0.0616</b> | <b>0.0920</b> | <b>4.2000e-004</b> | <b>0.0314</b> | <b>7.2000e-004</b> | <b>0.0321</b> | <b>8.4900e-003</b> | <b>6.8000e-004</b> | <b>9.1700e-003</b> |          | <b>44.4728</b> | <b>44.4728</b> | <b>1.4000e-003</b> | <b>3.9800e-003</b> | <b>45.6933</b> |

**3.4 Architectural Coating - 2022**

Unmitigated Construction On-Site

|                 | ROG            | NOx           | CO            | SO2                | Fugitive PM10 | Exhaust PM10  | PM10 Total    | Fugitive PM2.5 | Exhaust PM2.5 | PM2.5 Total   | Bio- CO2 | NBio- CO2       | Total CO2       | CH4           | N2O | CO2e            |
|-----------------|----------------|---------------|---------------|--------------------|---------------|---------------|---------------|----------------|---------------|---------------|----------|-----------------|-----------------|---------------|-----|-----------------|
| Category        | lb/day         |               |               |                    |               |               |               |                |               |               | lb/day   |                 |                 |               |     |                 |
| Archit. Coating | 16.2225        |               |               |                    |               | 0.0000        | 0.0000        |                | 0.0000        | 0.0000        |          |                 | 0.0000          |               |     | 0.0000          |
| Off-Road        | 0.2045         | 1.4085        | 1.8136        | 2.9700e-003        |               | 0.0817        | 0.0817        |                | 0.0817        | 0.0817        |          | 281.4481        | 281.4481        | 0.0183        |     | 281.9062        |
| <b>Total</b>    | <b>16.4270</b> | <b>1.4085</b> | <b>1.8136</b> | <b>2.9700e-003</b> |               | <b>0.0817</b> | <b>0.0817</b> |                | <b>0.0817</b> | <b>0.0817</b> |          | <b>281.4481</b> | <b>281.4481</b> | <b>0.0183</b> |     | <b>281.9062</b> |

Palomar Hydrogen Project - San Diego County, Winter

**EMFAC Off-Model Adjustment Factors for Gasoline Light Duty Vehicle to Account for the SAFE Vehicle Rule Not Applied**

**3.4 Architectural Coating - 2022**

**Unmitigated Construction Off-Site**

|              | ROG                | NOx                | CO            | SO2                | Fugitive PM10      | Exhaust PM10       | PM10 Total         | Fugitive PM2.5     | Exhaust PM2.5      | PM2.5 Total        | Bio- CO2 | NBio- CO2     | Total CO2     | CH4                | N2O                | CO2e          |
|--------------|--------------------|--------------------|---------------|--------------------|--------------------|--------------------|--------------------|--------------------|--------------------|--------------------|----------|---------------|---------------|--------------------|--------------------|---------------|
| Category     | lb/day             |                    |               |                    |                    |                    |                    |                    |                    |                    | lb/day   |               |               |                    |                    |               |
| Hauling      | 0.0000             | 0.0000             | 0.0000        | 0.0000             | 0.0000             | 0.0000             | 0.0000             | 0.0000             | 0.0000             | 0.0000             |          | 0.0000        | 0.0000        | 0.0000             | 0.0000             | 0.0000        |
| Vendor       | 0.0000             | 0.0000             | 0.0000        | 0.0000             | 0.0000             | 0.0000             | 0.0000             | 0.0000             | 0.0000             | 0.0000             |          | 0.0000        | 0.0000        | 0.0000             | 0.0000             | 0.0000        |
| Worker       | 3.1600e-003        | 2.1400e-003        | 0.0246        | 7.0000e-005        | 8.2100e-003        | 5.0000e-005        | 8.2600e-003        | 2.1800e-003        | 4.0000e-005        | 2.2200e-003        |          | 7.1595        | 7.1595        | 2.3000e-004        | 2.1000e-004        | 7.2287        |
| <b>Total</b> | <b>3.1600e-003</b> | <b>2.1400e-003</b> | <b>0.0246</b> | <b>7.0000e-005</b> | <b>8.2100e-003</b> | <b>5.0000e-005</b> | <b>8.2600e-003</b> | <b>2.1800e-003</b> | <b>4.0000e-005</b> | <b>2.2200e-003</b> |          | <b>7.1595</b> | <b>7.1595</b> | <b>2.3000e-004</b> | <b>2.1000e-004</b> | <b>7.2287</b> |

**Mitigated Construction On-Site**

|                 | ROG            | NOx           | CO            | SO2                | Fugitive PM10 | Exhaust PM10  | PM10 Total    | Fugitive PM2.5 | Exhaust PM2.5 | PM2.5 Total   | Bio- CO2      | NBio- CO2       | Total CO2       | CH4           | N2O | CO2e            |
|-----------------|----------------|---------------|---------------|--------------------|---------------|---------------|---------------|----------------|---------------|---------------|---------------|-----------------|-----------------|---------------|-----|-----------------|
| Category        | lb/day         |               |               |                    |               |               |               |                |               |               | lb/day        |                 |                 |               |     |                 |
| Archit. Coating | 16.2225        |               |               |                    |               | 0.0000        | 0.0000        |                | 0.0000        | 0.0000        |               |                 | 0.0000          |               |     | 0.0000          |
| Off-Road        | 0.2045         | 1.4085        | 1.8136        | 2.9700e-003        |               | 0.0817        | 0.0817        |                | 0.0817        | 0.0817        | 0.0000        | 281.4481        | 281.4481        | 0.0183        |     | 281.9062        |
| <b>Total</b>    | <b>16.4270</b> | <b>1.4085</b> | <b>1.8136</b> | <b>2.9700e-003</b> |               | <b>0.0817</b> | <b>0.0817</b> |                | <b>0.0817</b> | <b>0.0817</b> | <b>0.0000</b> | <b>281.4481</b> | <b>281.4481</b> | <b>0.0183</b> |     | <b>281.9062</b> |

Palomar Hydrogen Project - San Diego County, Winter

**EMFAC Off-Model Adjustment Factors for Gasoline Light Duty Vehicle to Account for the SAFE Vehicle Rule Not Applied**

**3.4 Architectural Coating - 2022**

**Mitigated Construction Off-Site**

|              | ROG                | NOx                | CO            | SO2                | Fugitive PM10      | Exhaust PM10       | PM10 Total         | Fugitive PM2.5     | Exhaust PM2.5      | PM2.5 Total        | Bio- CO2 | NBio- CO2     | Total CO2     | CH4                | N2O                | CO2e          |
|--------------|--------------------|--------------------|---------------|--------------------|--------------------|--------------------|--------------------|--------------------|--------------------|--------------------|----------|---------------|---------------|--------------------|--------------------|---------------|
| Category     | lb/day             |                    |               |                    |                    |                    |                    |                    |                    |                    | lb/day   |               |               |                    |                    |               |
| Hauling      | 0.0000             | 0.0000             | 0.0000        | 0.0000             | 0.0000             | 0.0000             | 0.0000             | 0.0000             | 0.0000             | 0.0000             |          | 0.0000        | 0.0000        | 0.0000             | 0.0000             | 0.0000        |
| Vendor       | 0.0000             | 0.0000             | 0.0000        | 0.0000             | 0.0000             | 0.0000             | 0.0000             | 0.0000             | 0.0000             | 0.0000             |          | 0.0000        | 0.0000        | 0.0000             | 0.0000             | 0.0000        |
| Worker       | 3.1600e-003        | 2.1400e-003        | 0.0246        | 7.0000e-005        | 8.2100e-003        | 5.0000e-005        | 8.2600e-003        | 2.1800e-003        | 4.0000e-005        | 2.2200e-003        |          | 7.1595        | 7.1595        | 2.3000e-004        | 2.1000e-004        | 7.2287        |
| <b>Total</b> | <b>3.1600e-003</b> | <b>2.1400e-003</b> | <b>0.0246</b> | <b>7.0000e-005</b> | <b>8.2100e-003</b> | <b>5.0000e-005</b> | <b>8.2600e-003</b> | <b>2.1800e-003</b> | <b>4.0000e-005</b> | <b>2.2200e-003</b> |          | <b>7.1595</b> | <b>7.1595</b> | <b>2.3000e-004</b> | <b>2.1000e-004</b> | <b>7.2287</b> |



Palomar Hydrogen Project - San Diego County, Winter

**EMFAC Off-Model Adjustment Factors for Gasoline Light Duty Vehicle to Account for the SAFE Vehicle Rule Not Applied**

**4.0 Operational Detail - Mobile**

**4.1 Mitigation Measures Mobile**

|             | ROG    | NOx    | CO     | SO2    | Fugitive PM10 | Exhaust PM10 | PM10 Total | Fugitive PM2.5 | Exhaust PM2.5 | PM2.5 Total | Bio- CO2 | NBio- CO2 | Total CO2 | CH4    | N2O    | CO2e   |
|-------------|--------|--------|--------|--------|---------------|--------------|------------|----------------|---------------|-------------|----------|-----------|-----------|--------|--------|--------|
| Category    | lb/day |        |        |        |               |              |            |                |               |             | lb/day   |           |           |        |        |        |
| Mitigated   | 0.0000 | 0.0000 | 0.0000 | 0.0000 | 0.0000        | 0.0000       | 0.0000     | 0.0000         | 0.0000        | 0.0000      |          | 0.0000    | 0.0000    | 0.0000 | 0.0000 | 0.0000 |
| Unmitigated | 0.0000 | 0.0000 | 0.0000 | 0.0000 | 0.0000        | 0.0000       | 0.0000     | 0.0000         | 0.0000        | 0.0000      |          | 0.0000    | 0.0000    | 0.0000 | 0.0000 | 0.0000 |

**4.2 Trip Summary Information**

| Land Use               | Average Daily Trip Rate |          |        | Unmitigated | Mitigated  |
|------------------------|-------------------------|----------|--------|-------------|------------|
|                        | Weekday                 | Saturday | Sunday | Annual VMT  | Annual VMT |
| General Light Industry | 0.00                    | 0.00     | 0.00   |             |            |
| Total                  | 0.00                    | 0.00     | 0.00   |             |            |

**4.3 Trip Type Information**

| Land Use               | Miles      |            |             | Trip %     |            |             | Trip Purpose % |          |         |
|------------------------|------------|------------|-------------|------------|------------|-------------|----------------|----------|---------|
|                        | H-W or C-W | H-S or C-C | H-O or C-NW | H-W or C-W | H-S or C-C | H-O or C-NW | Primary        | Diverted | Pass-by |
| General Light Industry | 9.50       | 7.30       | 7.30        | 59.00      | 28.00      | 13.00       | 92             | 5        | 3       |

**4.4 Fleet Mix**

| Land Use               | LDA      | LDT1     | LDT2     | MDV      | LHD1     | LHD2     | MHD      | HHD      | OBUS     | UBUS     | MCY      | SBUS     | MH       |
|------------------------|----------|----------|----------|----------|----------|----------|----------|----------|----------|----------|----------|----------|----------|
| General Light Industry | 0.553514 | 0.062792 | 0.181046 | 0.120736 | 0.024419 | 0.006214 | 0.008493 | 0.006184 | 0.000715 | 0.000556 | 0.029185 | 0.000982 | 0.005164 |

Palomar Hydrogen Project - San Diego County, Winter

**EMFAC Off-Model Adjustment Factors for Gasoline Light Duty Vehicle to Account for the SAFE Vehicle Rule Not Applied**

**5.0 Energy Detail**

Historical Energy Use: N

**5.1 Mitigation Measures Energy**

|                        | ROG    | NOx    | CO     | SO2    | Fugitive PM10 | Exhaust PM10 | PM10 Total | Fugitive PM2.5 | Exhaust PM2.5 | PM2.5 Total | Bio- CO2 | NBio- CO2 | Total CO2 | CH4    | N2O    | CO2e   |
|------------------------|--------|--------|--------|--------|---------------|--------------|------------|----------------|---------------|-------------|----------|-----------|-----------|--------|--------|--------|
| Category               | lb/day |        |        |        |               |              |            |                |               |             | lb/day   |           |           |        |        |        |
| NaturalGas Mitigated   | 0.0000 | 0.0000 | 0.0000 | 0.0000 |               | 0.0000       | 0.0000     |                | 0.0000        | 0.0000      |          | 0.0000    | 0.0000    | 0.0000 | 0.0000 | 0.0000 |
| NaturalGas Unmitigated | 0.0000 | 0.0000 | 0.0000 | 0.0000 |               | 0.0000       | 0.0000     |                | 0.0000        | 0.0000      |          | 0.0000    | 0.0000    | 0.0000 | 0.0000 | 0.0000 |

**5.2 Energy by Land Use - NaturalGas**

**Unmitigated**

|                        | NaturalGas Use | ROG           | NOx           | CO            | SO2           | Fugitive PM10 | Exhaust PM10  | PM10 Total    | Fugitive PM2.5 | Exhaust PM2.5 | PM2.5 Total   | Bio- CO2 | NBio- CO2     | Total CO2     | CH4           | N2O           | CO2e          |
|------------------------|----------------|---------------|---------------|---------------|---------------|---------------|---------------|---------------|----------------|---------------|---------------|----------|---------------|---------------|---------------|---------------|---------------|
| Land Use               | kBTU/yr        | lb/day        |               |               |               |               |               |               |                |               |               | lb/day   |               |               |               |               |               |
| General Light Industry | 0              | 0.0000        | 0.0000        | 0.0000        | 0.0000        |               | 0.0000        | 0.0000        |                | 0.0000        | 0.0000        |          | 0.0000        | 0.0000        | 0.0000        | 0.0000        | 0.0000        |
| <b>Total</b>           |                | <b>0.0000</b> | <b>0.0000</b> | <b>0.0000</b> | <b>0.0000</b> |               | <b>0.0000</b> | <b>0.0000</b> |                | <b>0.0000</b> | <b>0.0000</b> |          | <b>0.0000</b> | <b>0.0000</b> | <b>0.0000</b> | <b>0.0000</b> | <b>0.0000</b> |

Palomar Hydrogen Project - San Diego County, Winter

**EMFAC Off-Model Adjustment Factors for Gasoline Light Duty Vehicle to Account for the SAFE Vehicle Rule Not Applied**

**5.2 Energy by Land Use - NaturalGas**

Mitigated

|                        | NaturalGas Use | ROG           | NOx           | CO            | SO2           | Fugitive PM10 | Exhaust PM10  | PM10 Total    | Fugitive PM2.5 | Exhaust PM2.5 | PM2.5 Total   | Bio- CO2 | NBio- CO2     | Total CO2     | CH4           | N2O           | CO2e          |
|------------------------|----------------|---------------|---------------|---------------|---------------|---------------|---------------|---------------|----------------|---------------|---------------|----------|---------------|---------------|---------------|---------------|---------------|
| Land Use               | kBTU/yr        | lb/day        |               |               |               |               |               |               |                |               |               | lb/day   |               |               |               |               |               |
| General Light Industry | 0              | 0.0000        | 0.0000        | 0.0000        | 0.0000        |               | 0.0000        | 0.0000        |                | 0.0000        | 0.0000        |          | 0.0000        | 0.0000        | 0.0000        | 0.0000        | 0.0000        |
| <b>Total</b>           |                | <b>0.0000</b> | <b>0.0000</b> | <b>0.0000</b> | <b>0.0000</b> |               | <b>0.0000</b> | <b>0.0000</b> |                | <b>0.0000</b> | <b>0.0000</b> |          | <b>0.0000</b> | <b>0.0000</b> | <b>0.0000</b> | <b>0.0000</b> | <b>0.0000</b> |

**6.0 Area Detail**

**6.1 Mitigation Measures Area**

|             | ROG         | NOx         | CO          | SO2    | Fugitive PM10 | Exhaust PM10 | PM10 Total | Fugitive PM2.5 | Exhaust PM2.5 | PM2.5 Total | Bio- CO2 | NBio- CO2   | Total CO2   | CH4    | N2O | CO2e        |
|-------------|-------------|-------------|-------------|--------|---------------|--------------|------------|----------------|---------------|-------------|----------|-------------|-------------|--------|-----|-------------|
| Category    | lb/day      |             |             |        |               |              |            |                |               |             | lb/day   |             |             |        |     |             |
| Mitigated   | 7.7000e-004 | 1.0000e-005 | 7.1000e-004 | 0.0000 |               | 0.0000       | 0.0000     |                | 0.0000        | 0.0000      |          | 1.5300e-003 | 1.5300e-003 | 0.0000 |     | 1.6300e-003 |
| Unmitigated | 7.7000e-004 | 1.0000e-005 | 7.1000e-004 | 0.0000 |               | 0.0000       | 0.0000     |                | 0.0000        | 0.0000      |          | 1.5300e-003 | 1.5300e-003 | 0.0000 |     | 1.6300e-003 |

Palomar Hydrogen Project - San Diego County, Winter

**EMFAC Off-Model Adjustment Factors for Gasoline Light Duty Vehicle to Account for the SAFE Vehicle Rule Not Applied**

**6.2 Area by SubCategory**

**Unmitigated**

|                       | ROG                | NOx                | CO                 | SO2           | Fugitive PM10 | Exhaust PM10  | PM10 Total    | Fugitive PM2.5 | Exhaust PM2.5 | PM2.5 Total   | Bio- CO2 | NBio- CO2          | Total CO2          | CH4           | N2O | CO2e               |
|-----------------------|--------------------|--------------------|--------------------|---------------|---------------|---------------|---------------|----------------|---------------|---------------|----------|--------------------|--------------------|---------------|-----|--------------------|
| SubCategory           | lb/day             |                    |                    |               |               |               |               |                |               |               | lb/day   |                    |                    |               |     |                    |
| Architectural Coating | 0.0000             |                    |                    |               |               | 0.0000        | 0.0000        |                | 0.0000        | 0.0000        |          |                    | 0.0000             |               |     | 0.0000             |
| Consumer Products     | 7.0000e-004        |                    |                    |               |               | 0.0000        | 0.0000        |                | 0.0000        | 0.0000        |          |                    | 0.0000             |               |     | 0.0000             |
| Landscaping           | 7.0000e-005        | 1.0000e-005        | 7.1000e-004        | 0.0000        |               | 0.0000        | 0.0000        |                | 0.0000        | 0.0000        |          | 1.5300e-003        | 1.5300e-003        | 0.0000        |     | 1.6300e-003        |
| <b>Total</b>          | <b>7.7000e-004</b> | <b>1.0000e-005</b> | <b>7.1000e-004</b> | <b>0.0000</b> |               | <b>0.0000</b> | <b>0.0000</b> |                | <b>0.0000</b> | <b>0.0000</b> |          | <b>1.5300e-003</b> | <b>1.5300e-003</b> | <b>0.0000</b> |     | <b>1.6300e-003</b> |

Palomar Hydrogen Project - San Diego County, Winter

**EMFAC Off-Model Adjustment Factors for Gasoline Light Duty Vehicle to Account for the SAFE Vehicle Rule Not Applied**

**6.2 Area by SubCategory**

Mitigated

|                       | ROG                | NOx                | CO                 | SO2           | Fugitive PM10 | Exhaust PM10  | PM10 Total    | Fugitive PM2.5 | Exhaust PM2.5 | PM2.5 Total   | Bio- CO2 | NBio- CO2          | Total CO2          | CH4           | N2O | CO2e               |
|-----------------------|--------------------|--------------------|--------------------|---------------|---------------|---------------|---------------|----------------|---------------|---------------|----------|--------------------|--------------------|---------------|-----|--------------------|
| SubCategory           | lb/day             |                    |                    |               |               |               |               |                |               |               | lb/day   |                    |                    |               |     |                    |
| Architectural Coating | 0.0000             |                    |                    |               |               | 0.0000        | 0.0000        |                | 0.0000        | 0.0000        |          |                    | 0.0000             |               |     | 0.0000             |
| Consumer Products     | 7.0000e-004        |                    |                    |               |               | 0.0000        | 0.0000        |                | 0.0000        | 0.0000        |          |                    | 0.0000             |               |     | 0.0000             |
| Landscaping           | 7.0000e-005        | 1.0000e-005        | 7.1000e-004        | 0.0000        |               | 0.0000        | 0.0000        |                | 0.0000        | 0.0000        |          | 1.5300e-003        | 1.5300e-003        | 0.0000        |     | 1.6300e-003        |
| <b>Total</b>          | <b>7.7000e-004</b> | <b>1.0000e-005</b> | <b>7.1000e-004</b> | <b>0.0000</b> |               | <b>0.0000</b> | <b>0.0000</b> |                | <b>0.0000</b> | <b>0.0000</b> |          | <b>1.5300e-003</b> | <b>1.5300e-003</b> | <b>0.0000</b> |     | <b>1.6300e-003</b> |

**7.0 Water Detail**

---

**7.1 Mitigation Measures Water**

Palomar Hydrogen Project - San Diego County, Winter

**EMFAC Off-Model Adjustment Factors for Gasoline Light Duty Vehicle to Account for the SAFE Vehicle Rule Not Applied**

**8.0 Waste Detail**

---

**8.1 Mitigation Measures Waste**

**9.0 Operational Offroad**

---

| Equipment Type | Number | Hours/Day | Days/Year | Horse Power | Load Factor | Fuel Type |
|----------------|--------|-----------|-----------|-------------|-------------|-----------|
|----------------|--------|-----------|-----------|-------------|-------------|-----------|

**10.0 Stationary Equipment**

---

**Fire Pumps and Emergency Generators**

| Equipment Type | Number | Hours/Day | Hours/Year | Horse Power | Load Factor | Fuel Type |
|----------------|--------|-----------|------------|-------------|-------------|-----------|
|----------------|--------|-----------|------------|-------------|-------------|-----------|

**Boilers**

| Equipment Type | Number | Heat Input/Day | Heat Input/Year | Boiler Rating | Fuel Type |
|----------------|--------|----------------|-----------------|---------------|-----------|
|----------------|--------|----------------|-----------------|---------------|-----------|

**User Defined Equipment**

| Equipment Type | Number |
|----------------|--------|
|----------------|--------|

**11.0 Vegetation**

---

Palomar Hydrogen Project - San Diego County, Summer

**EMFAC Off-Model Adjustment Factors for Gasoline Light Duty Vehicle to Account for the SAFE Vehicle Rule Not Applied**

**Palomar Hydrogen Project  
San Diego County, Summer**

**1.0 Project Characteristics**

**1.1 Land Usage**

| Land Uses              | Size | Metric   | Lot Acreage | Floor Surface Area | Population |
|------------------------|------|----------|-------------|--------------------|------------|
| General Light Industry | 7.00 | 1000sqft | 0.16        | 7,000.00           | 0          |

**1.2 Other Project Characteristics**

|                                |                          |                                |       |                                  |       |
|--------------------------------|--------------------------|--------------------------------|-------|----------------------------------|-------|
| <b>Urbanization</b>            | Urban                    | <b>Wind Speed (m/s)</b>        | 2.6   | <b>Precipitation Freq (Days)</b> | 40    |
| <b>Climate Zone</b>            | 13                       |                                |       | <b>Operational Year</b>          | 2023  |
| <b>Utility Company</b>         | San Diego Gas & Electric |                                |       |                                  |       |
| <b>CO2 Intensity (lb/MWhr)</b> | 539.98                   | <b>CH4 Intensity (lb/MWhr)</b> | 0.033 | <b>N2O Intensity (lb/MWhr)</b>   | 0.004 |

**1.3 User Entered Comments & Non-Default Data**

- Project Characteristics - Construction only
- Land Use -
- Construction Phase - 2 weeks for painting
- Demolition -
- Vehicle Trips - Construction only
- Consumer Products - Construction only
- Area Coating - Construction only
- Landscape Equipment - Construction only
- Energy Use - Construction only
- Water And Wastewater - Construction only
- Solid Waste - Construction only
- Construction Off-road Equipment Mitigation -

## Palomar Hydrogen Project - San Diego County, Summer

**EMFAC Off-Model Adjustment Factors for Gasoline Light Duty Vehicle to Account for the SAFE Vehicle Rule Not Applied**

| Table Name            | Column Name                  | Default Value | New Value |
|-----------------------|------------------------------|---------------|-----------|
| tblAreaCoating        | Area_Nonresidential_Exterior | 3500          | 0         |
| tblAreaCoating        | Area_Nonresidential_Interior | 10500         | 0         |
| tblConstructionPhase  | NumDays                      | 5.00          | 10.00     |
| tblConstructionPhase  | PhaseEndDate                 | 6/22/2022     | 6/17/2022 |
| tblConstructionPhase  | PhaseEndDate                 | 6/8/2022      | 6/3/2022  |
| tblConstructionPhase  | PhaseStartDate               | 6/16/2022     | 6/6/2022  |
| tblConstructionPhase  | PhaseStartDate               | 1/20/2022     | 1/17/2022 |
| tblConsumerProducts   | ROG_EF                       | 2.14E-05      | 1E-07     |
| tblConsumerProducts   | ROG_EF_Degreaser             | 3.542E-07     | 1E-10     |
| tblConsumerProducts   | ROG_EF_PesticidesFertilizers | 5.152E-08     | 1E-11     |
| tblEnergyUse          | LightingElect                | 2.83          | 0.00      |
| tblEnergyUse          | NT24E                        | 4.27          | 0.00      |
| tblEnergyUse          | NT24NG                       | 7.25          | 0.00      |
| tblEnergyUse          | T24E                         | 1.08          | 0.00      |
| tblEnergyUse          | T24NG                        | 4.27          | 0.00      |
| tblLandscapeEquipment | NumberSummerDays             | 180           | 1         |
| tblSolidWaste         | SolidWasteGenerationRate     | 8.68          | 0.00      |
| tblVehicleTrips       | ST_TR                        | 1.99          | 0.00      |
| tblVehicleTrips       | SU_TR                        | 5.00          | 0.00      |
| tblVehicleTrips       | WD_TR                        | 4.96          | 0.00      |
| tblWater              | IndoorWaterUseRate           | 1,618,750.00  | 0.00      |

**2.0 Emissions Summary**





Palomar Hydrogen Project - San Diego County, Summer

**EMFAC Off-Model Adjustment Factors for Gasoline Light Duty Vehicle to Account for the SAFE Vehicle Rule Not Applied**

**2.2 Overall Operational**

**Unmitigated Operational**

|              | ROG                | NOx                | CO                 | SO2           | Fugitive PM10 | Exhaust PM10  | PM10 Total    | Fugitive PM2.5 | Exhaust PM2.5 | PM2.5 Total   | Bio- CO2 | NBio- CO2          | Total CO2          | CH4           | N2O           | CO2e               |
|--------------|--------------------|--------------------|--------------------|---------------|---------------|---------------|---------------|----------------|---------------|---------------|----------|--------------------|--------------------|---------------|---------------|--------------------|
| Category     | lb/day             |                    |                    |               |               |               |               |                |               |               | lb/day   |                    |                    |               |               |                    |
| Area         | 7.7000e-004        | 1.0000e-005        | 7.1000e-004        | 0.0000        |               | 0.0000        | 0.0000        |                | 0.0000        | 0.0000        |          | 1.5300e-003        | 1.5300e-003        | 0.0000        |               | 1.6300e-003        |
| Energy       | 0.0000             | 0.0000             | 0.0000             | 0.0000        |               | 0.0000        | 0.0000        |                | 0.0000        | 0.0000        |          | 0.0000             | 0.0000             | 0.0000        | 0.0000        | 0.0000             |
| Mobile       | 0.0000             | 0.0000             | 0.0000             | 0.0000        | 0.0000        | 0.0000        | 0.0000        | 0.0000         | 0.0000        | 0.0000        |          | 0.0000             | 0.0000             | 0.0000        | 0.0000        | 0.0000             |
| <b>Total</b> | <b>7.7000e-004</b> | <b>1.0000e-005</b> | <b>7.1000e-004</b> | <b>0.0000</b> | <b>0.0000</b> | <b>0.0000</b> | <b>0.0000</b> | <b>0.0000</b>  | <b>0.0000</b> | <b>0.0000</b> |          | <b>1.5300e-003</b> | <b>1.5300e-003</b> | <b>0.0000</b> | <b>0.0000</b> | <b>1.6300e-003</b> |

**Mitigated Operational**

|              | ROG                | NOx                | CO                 | SO2           | Fugitive PM10 | Exhaust PM10  | PM10 Total    | Fugitive PM2.5 | Exhaust PM2.5 | PM2.5 Total   | Bio- CO2 | NBio- CO2          | Total CO2          | CH4           | N2O           | CO2e               |
|--------------|--------------------|--------------------|--------------------|---------------|---------------|---------------|---------------|----------------|---------------|---------------|----------|--------------------|--------------------|---------------|---------------|--------------------|
| Category     | lb/day             |                    |                    |               |               |               |               |                |               |               | lb/day   |                    |                    |               |               |                    |
| Area         | 7.7000e-004        | 1.0000e-005        | 7.1000e-004        | 0.0000        |               | 0.0000        | 0.0000        |                | 0.0000        | 0.0000        |          | 1.5300e-003        | 1.5300e-003        | 0.0000        |               | 1.6300e-003        |
| Energy       | 0.0000             | 0.0000             | 0.0000             | 0.0000        |               | 0.0000        | 0.0000        |                | 0.0000        | 0.0000        |          | 0.0000             | 0.0000             | 0.0000        | 0.0000        | 0.0000             |
| Mobile       | 0.0000             | 0.0000             | 0.0000             | 0.0000        | 0.0000        | 0.0000        | 0.0000        | 0.0000         | 0.0000        | 0.0000        |          | 0.0000             | 0.0000             | 0.0000        | 0.0000        | 0.0000             |
| <b>Total</b> | <b>7.7000e-004</b> | <b>1.0000e-005</b> | <b>7.1000e-004</b> | <b>0.0000</b> | <b>0.0000</b> | <b>0.0000</b> | <b>0.0000</b> | <b>0.0000</b>  | <b>0.0000</b> | <b>0.0000</b> |          | <b>1.5300e-003</b> | <b>1.5300e-003</b> | <b>0.0000</b> | <b>0.0000</b> | <b>1.6300e-003</b> |

Palomar Hydrogen Project - San Diego County, Summer

**EMFAC Off-Model Adjustment Factors for Gasoline Light Duty Vehicle to Account for the SAFE Vehicle Rule Not Applied**

|                   | ROG  | NOx  | CO   | SO2  | Fugitive PM10 | Exhaust PM10 | PM10 Total | Fugitive PM2.5 | Exhaust PM2.5 | PM2.5 Total | Bio- CO2 | NBio-CO2 | Total CO2 | CH4  | N2O  | CO2e |
|-------------------|------|------|------|------|---------------|--------------|------------|----------------|---------------|-------------|----------|----------|-----------|------|------|------|
| Percent Reduction | 0.00 | 0.00 | 0.00 | 0.00 | 0.00          | 0.00         | 0.00       | 0.00           | 0.00          | 0.00        | 0.00     | 0.00     | 0.00      | 0.00 | 0.00 | 0.00 |

**3.0 Construction Detail**

**Construction Phase**

| Phase Number | Phase Name            | Phase Type            | Start Date | End Date  | Num Days Week | Num Days | Phase Description |
|--------------|-----------------------|-----------------------|------------|-----------|---------------|----------|-------------------|
| 1            | Demolition            | Demolition            | 1/3/2022   | 1/14/2022 | 5             | 10       |                   |
| 2            | Building Construction | Building Construction | 1/17/2022  | 6/3/2022  | 5             | 100      |                   |
| 3            | Architectural Coating | Architectural Coating | 6/6/2022   | 6/17/2022 | 5             | 10       |                   |

**Acres of Grading (Site Preparation Phase): 0**

**Acres of Grading (Grading Phase): 0**

**Acres of Paving: 0**

**Residential Indoor: 0; Residential Outdoor: 0; Non-Residential Indoor: 10,500; Non-Residential Outdoor: 3,500; Striped Parking Area: 0 (Architectural Coating – sqft)**

**OffRoad Equipment**

| Phase Name            | Offroad Equipment Type    | Amount | Usage Hours | Horse Power | Load Factor |
|-----------------------|---------------------------|--------|-------------|-------------|-------------|
| Architectural Coating | Air Compressors           | 1      | 6.00        | 78          | 0.48        |
| Demolition            | Concrete/Industrial Saws  | 1      | 8.00        | 81          | 0.73        |
| Building Construction | Cranes                    | 1      | 4.00        | 231         | 0.29        |
| Building Construction | Forklifts                 | 2      | 6.00        | 89          | 0.20        |
| Demolition            | Rubber Tired Dozers       | 1      | 1.00        | 247         | 0.40        |
| Building Construction | Tractors/Loaders/Backhoes | 2      | 8.00        | 97          | 0.37        |
| Demolition            | Tractors/Loaders/Backhoes | 2      | 6.00        | 97          | 0.37        |

**Trips and VMT**

Palomar Hydrogen Project - San Diego County, Summer

**EMFAC Off-Model Adjustment Factors for Gasoline Light Duty Vehicle to Account for the SAFE Vehicle Rule Not Applied**

| Phase Name            | Offroad Equipment Count | Worker Trip Number | Vendor Trip Number | Hauling Trip Number | Worker Trip Length | Vendor Trip Length | Hauling Trip Length | Worker Vehicle Class | Vendor Vehicle Class | Hauling Vehicle Class |
|-----------------------|-------------------------|--------------------|--------------------|---------------------|--------------------|--------------------|---------------------|----------------------|----------------------|-----------------------|
| Demolition            | 4                       | 10.00              | 0.00               | 8.00                | 10.80              | 7.30               | 20.00               | LD_Mix               | HDT_Mix              | HHDT                  |
| Building Construction | 5                       | 3.00               | 1.00               | 0.00                | 10.80              | 7.30               | 20.00               | LD_Mix               | HDT_Mix              | HHDT                  |
| Architectural Coating | 1                       | 1.00               | 0.00               | 0.00                | 10.80              | 7.30               | 20.00               | LD_Mix               | HDT_Mix              | HHDT                  |

**3.1 Mitigation Measures Construction**

Water Exposed Area

**3.2 Demolition - 2022**

**Unmitigated Construction On-Site**

|               | ROG           | NOx           | CO            | SO2           | Fugitive PM10 | Exhaust PM10  | PM10 Total    | Fugitive PM2.5 | Exhaust PM2.5 | PM2.5 Total   | Bio- CO2 | NBio- CO2         | Total CO2         | CH4           | N2O | CO2e              |
|---------------|---------------|---------------|---------------|---------------|---------------|---------------|---------------|----------------|---------------|---------------|----------|-------------------|-------------------|---------------|-----|-------------------|
| Category      | lb/day        |               |               |               |               |               |               |                |               |               | lb/day   |                   |                   |               |     |                   |
| Fugitive Dust |               |               |               |               | 0.1647        | 0.0000        | 0.1647        | 0.0249         | 0.0000        | 0.0249        |          |                   | 0.0000            |               |     | 0.0000            |
| Off-Road      | 0.7094        | 6.4138        | 7.4693        | 0.0120        |               | 0.3375        | 0.3375        |                | 0.3225        | 0.3225        |          | 1,147.9025        | 1,147.9025        | 0.2119        |     | 1,153.2001        |
| <b>Total</b>  | <b>0.7094</b> | <b>6.4138</b> | <b>7.4693</b> | <b>0.0120</b> | <b>0.1647</b> | <b>0.3375</b> | <b>0.5022</b> | <b>0.0249</b>  | <b>0.3225</b> | <b>0.3475</b> |          | <b>1,147.9025</b> | <b>1,147.9025</b> | <b>0.2119</b> |     | <b>1,153.2001</b> |

Palomar Hydrogen Project - San Diego County, Summer

**EMFAC Off-Model Adjustment Factors for Gasoline Light Duty Vehicle to Account for the SAFE Vehicle Rule Not Applied**

**3.2 Demolition - 2022**

**Unmitigated Construction Off-Site**

|              | ROG           | NOx           | CO            | SO2                | Fugitive PM10 | Exhaust PM10       | PM10 Total    | Fugitive PM2.5 | Exhaust PM2.5      | PM2.5 Total   | Bio- CO2 | NBio- CO2       | Total CO2       | CH4                | N2O           | CO2e            |
|--------------|---------------|---------------|---------------|--------------------|---------------|--------------------|---------------|----------------|--------------------|---------------|----------|-----------------|-----------------|--------------------|---------------|-----------------|
| Category     | lb/day        |               |               |                    |               |                    |               |                |                    |               | lb/day   |                 |                 |                    |               |                 |
| Hauling      | 3.5900e-003   | 0.1299        | 0.0316        | 5.0000e-004        | 0.0140        | 1.2500e-003        | 0.0152        | 3.8400e-003    | 1.2000e-003        | 5.0300e-003   |          | 55.2656         | 55.2656         | 2.6600e-003        | 8.7800e-003   | 57.9482         |
| Vendor       | 0.0000        | 0.0000        | 0.0000        | 0.0000             | 0.0000        | 0.0000             | 0.0000        | 0.0000         | 0.0000             | 0.0000        |          | 0.0000          | 0.0000          | 0.0000             | 0.0000        | 0.0000          |
| Worker       | 0.0292        | 0.0190        | 0.2589        | 7.5000e-004        | 0.0822        | 4.6000e-004        | 0.0826        | 0.0218         | 4.3000e-004        | 0.0222        |          | 75.7708         | 75.7708         | 2.1900e-003        | 1.9700e-003   | 76.4114         |
| <b>Total</b> | <b>0.0328</b> | <b>0.1489</b> | <b>0.2905</b> | <b>1.2500e-003</b> | <b>0.0961</b> | <b>1.7100e-003</b> | <b>0.0979</b> | <b>0.0256</b>  | <b>1.6300e-003</b> | <b>0.0273</b> |          | <b>131.0364</b> | <b>131.0364</b> | <b>4.8500e-003</b> | <b>0.0108</b> | <b>134.3596</b> |

**Mitigated Construction On-Site**

|               | ROG           | NOx           | CO            | SO2           | Fugitive PM10 | Exhaust PM10  | PM10 Total    | Fugitive PM2.5 | Exhaust PM2.5 | PM2.5 Total   | Bio- CO2      | NBio- CO2         | Total CO2         | CH4           | N2O | CO2e              |
|---------------|---------------|---------------|---------------|---------------|---------------|---------------|---------------|----------------|---------------|---------------|---------------|-------------------|-------------------|---------------|-----|-------------------|
| Category      | lb/day        |               |               |               |               |               |               |                |               |               | lb/day        |                   |                   |               |     |                   |
| Fugitive Dust |               |               |               |               | 0.0741        | 0.0000        | 0.0741        | 0.0112         | 0.0000        | 0.0112        |               |                   | 0.0000            |               |     | 0.0000            |
| Off-Road      | 0.7094        | 6.4138        | 7.4693        | 0.0120        |               | 0.3375        | 0.3375        |                | 0.3225        | 0.3225        | 0.0000        | 1,147.9025        | 1,147.9025        | 0.2119        |     | 1,153.2001        |
| <b>Total</b>  | <b>0.7094</b> | <b>6.4138</b> | <b>7.4693</b> | <b>0.0120</b> | <b>0.0741</b> | <b>0.3375</b> | <b>0.4116</b> | <b>0.0112</b>  | <b>0.3225</b> | <b>0.3338</b> | <b>0.0000</b> | <b>1,147.9025</b> | <b>1,147.9025</b> | <b>0.2119</b> |     | <b>1,153.2001</b> |

Palomar Hydrogen Project - San Diego County, Summer

**EMFAC Off-Model Adjustment Factors for Gasoline Light Duty Vehicle to Account for the SAFE Vehicle Rule Not Applied**

**3.2 Demolition - 2022**

**Mitigated Construction Off-Site**

|              | ROG           | NOx           | CO            | SO2                | Fugitive PM10 | Exhaust PM10       | PM10 Total    | Fugitive PM2.5 | Exhaust PM2.5      | PM2.5 Total   | Bio- CO2 | NBio- CO2       | Total CO2       | CH4                | N2O           | CO2e            |
|--------------|---------------|---------------|---------------|--------------------|---------------|--------------------|---------------|----------------|--------------------|---------------|----------|-----------------|-----------------|--------------------|---------------|-----------------|
| Category     | lb/day        |               |               |                    |               |                    |               |                |                    |               | lb/day   |                 |                 |                    |               |                 |
| Hauling      | 3.5900e-003   | 0.1299        | 0.0316        | 5.0000e-004        | 0.0140        | 1.2500e-003        | 0.0152        | 3.8400e-003    | 1.2000e-003        | 5.0300e-003   |          | 55.2656         | 55.2656         | 2.6600e-003        | 8.7800e-003   | 57.9482         |
| Vendor       | 0.0000        | 0.0000        | 0.0000        | 0.0000             | 0.0000        | 0.0000             | 0.0000        | 0.0000         | 0.0000             | 0.0000        |          | 0.0000          | 0.0000          | 0.0000             | 0.0000        | 0.0000          |
| Worker       | 0.0292        | 0.0190        | 0.2589        | 7.5000e-004        | 0.0822        | 4.6000e-004        | 0.0826        | 0.0218         | 4.3000e-004        | 0.0222        |          | 75.7708         | 75.7708         | 2.1900e-003        | 1.9700e-003   | 76.4114         |
| <b>Total</b> | <b>0.0328</b> | <b>0.1489</b> | <b>0.2905</b> | <b>1.2500e-003</b> | <b>0.0961</b> | <b>1.7100e-003</b> | <b>0.0979</b> | <b>0.0256</b>  | <b>1.6300e-003</b> | <b>0.0273</b> |          | <b>131.0364</b> | <b>131.0364</b> | <b>4.8500e-003</b> | <b>0.0108</b> | <b>134.3596</b> |

**3.3 Building Construction - 2022**

**Unmitigated Construction On-Site**

|              | ROG           | NOx           | CO            | SO2           | Fugitive PM10 | Exhaust PM10  | PM10 Total    | Fugitive PM2.5 | Exhaust PM2.5 | PM2.5 Total   | Bio- CO2 | NBio- CO2         | Total CO2         | CH4           | N2O | CO2e              |
|--------------|---------------|---------------|---------------|---------------|---------------|---------------|---------------|----------------|---------------|---------------|----------|-------------------|-------------------|---------------|-----|-------------------|
| Category     | lb/day        |               |               |               |               |               |               |                |               |               | lb/day   |                   |                   |               |     |                   |
| Off-Road     | 0.6863        | 7.0258        | 7.1527        | 0.0114        |               | 0.3719        | 0.3719        |                | 0.3422        | 0.3422        |          | 1,103.9393        | 1,103.9393        | 0.3570        |     | 1,112.8652        |
| <b>Total</b> | <b>0.6863</b> | <b>7.0258</b> | <b>7.1527</b> | <b>0.0114</b> |               | <b>0.3719</b> | <b>0.3719</b> |                | <b>0.3422</b> | <b>0.3422</b> |          | <b>1,103.9393</b> | <b>1,103.9393</b> | <b>0.3570</b> |     | <b>1,112.8652</b> |

Palomar Hydrogen Project - San Diego County, Summer

**EMFAC Off-Model Adjustment Factors for Gasoline Light Duty Vehicle to Account for the SAFE Vehicle Rule Not Applied**

**3.3 Building Construction - 2022**

**Unmitigated Construction Off-Site**

|              | ROG           | NOx           | CO            | SO2                | Fugitive PM10 | Exhaust PM10       | PM10 Total    | Fugitive PM2.5     | Exhaust PM2.5      | PM2.5 Total        | Bio- CO2 | NBio- CO2      | Total CO2      | CH4                | N2O                | CO2e           |
|--------------|---------------|---------------|---------------|--------------------|---------------|--------------------|---------------|--------------------|--------------------|--------------------|----------|----------------|----------------|--------------------|--------------------|----------------|
| Category     | lb/day        |               |               |                    |               |                    |               |                    |                    |                    | lb/day   |                |                |                    |                    |                |
| Hauling      | 0.0000        | 0.0000        | 0.0000        | 0.0000             | 0.0000        | 0.0000             | 0.0000        | 0.0000             | 0.0000             | 0.0000             |          | 0.0000         | 0.0000         | 0.0000             | 0.0000             | 0.0000         |
| Vendor       | 2.2300e-003   | 0.0532        | 0.0178        | 2.1000e-004        | 6.7700e-003   | 5.8000e-004        | 7.3500e-003   | 1.9500e-003        | 5.5000e-004        | 2.5000e-003        |          | 22.9826        | 22.9826        | 7.0000e-004        | 3.3400e-003        | 23.9941        |
| Worker       | 8.7600e-003   | 5.7000e-003   | 0.0777        | 2.2000e-004        | 0.0246        | 1.4000e-004        | 0.0248        | 6.5400e-003        | 1.3000e-004        | 6.6700e-003        |          | 22.7312        | 22.7312        | 6.6000e-004        | 5.9000e-004        | 22.9234        |
| <b>Total</b> | <b>0.0110</b> | <b>0.0589</b> | <b>0.0955</b> | <b>4.3000e-004</b> | <b>0.0314</b> | <b>7.2000e-004</b> | <b>0.0321</b> | <b>8.4900e-003</b> | <b>6.8000e-004</b> | <b>9.1700e-003</b> |          | <b>45.7138</b> | <b>45.7138</b> | <b>1.3600e-003</b> | <b>3.9300e-003</b> | <b>46.9176</b> |

**Mitigated Construction On-Site**

|              | ROG           | NOx           | CO            | SO2           | Fugitive PM10 | Exhaust PM10  | PM10 Total    | Fugitive PM2.5 | Exhaust PM2.5 | PM2.5 Total   | Bio- CO2      | NBio- CO2         | Total CO2         | CH4           | N2O | CO2e              |
|--------------|---------------|---------------|---------------|---------------|---------------|---------------|---------------|----------------|---------------|---------------|---------------|-------------------|-------------------|---------------|-----|-------------------|
| Category     | lb/day        |               |               |               |               |               |               |                |               |               | lb/day        |                   |                   |               |     |                   |
| Off-Road     | 0.6863        | 7.0258        | 7.1527        | 0.0114        |               | 0.3719        | 0.3719        |                | 0.3422        | 0.3422        | 0.0000        | 1,103.9393        | 1,103.9393        | 0.3570        |     | 1,112.8652        |
| <b>Total</b> | <b>0.6863</b> | <b>7.0258</b> | <b>7.1527</b> | <b>0.0114</b> |               | <b>0.3719</b> | <b>0.3719</b> |                | <b>0.3422</b> | <b>0.3422</b> | <b>0.0000</b> | <b>1,103.9393</b> | <b>1,103.9393</b> | <b>0.3570</b> |     | <b>1,112.8652</b> |

Palomar Hydrogen Project - San Diego County, Summer

**EMFAC Off-Model Adjustment Factors for Gasoline Light Duty Vehicle to Account for the SAFE Vehicle Rule Not Applied**

**3.3 Building Construction - 2022**

**Mitigated Construction Off-Site**

|              | ROG           | NOx           | CO            | SO2                | Fugitive PM10 | Exhaust PM10       | PM10 Total    | Fugitive PM2.5     | Exhaust PM2.5      | PM2.5 Total        | Bio- CO2 | NBio- CO2      | Total CO2      | CH4                | N2O                | CO2e           |
|--------------|---------------|---------------|---------------|--------------------|---------------|--------------------|---------------|--------------------|--------------------|--------------------|----------|----------------|----------------|--------------------|--------------------|----------------|
| Category     | lb/day        |               |               |                    |               |                    |               |                    |                    |                    | lb/day   |                |                |                    |                    |                |
| Hauling      | 0.0000        | 0.0000        | 0.0000        | 0.0000             | 0.0000        | 0.0000             | 0.0000        | 0.0000             | 0.0000             | 0.0000             |          | 0.0000         | 0.0000         | 0.0000             | 0.0000             | 0.0000         |
| Vendor       | 2.2300e-003   | 0.0532        | 0.0178        | 2.1000e-004        | 6.7700e-003   | 5.8000e-004        | 7.3500e-003   | 1.9500e-003        | 5.5000e-004        | 2.5000e-003        |          | 22.9826        | 22.9826        | 7.0000e-004        | 3.3400e-003        | 23.9941        |
| Worker       | 8.7600e-003   | 5.7000e-003   | 0.0777        | 2.2000e-004        | 0.0246        | 1.4000e-004        | 0.0248        | 6.5400e-003        | 1.3000e-004        | 6.6700e-003        |          | 22.7312        | 22.7312        | 6.6000e-004        | 5.9000e-004        | 22.9234        |
| <b>Total</b> | <b>0.0110</b> | <b>0.0589</b> | <b>0.0955</b> | <b>4.3000e-004</b> | <b>0.0314</b> | <b>7.2000e-004</b> | <b>0.0321</b> | <b>8.4900e-003</b> | <b>6.8000e-004</b> | <b>9.1700e-003</b> |          | <b>45.7138</b> | <b>45.7138</b> | <b>1.3600e-003</b> | <b>3.9300e-003</b> | <b>46.9176</b> |

**3.4 Architectural Coating - 2022**

**Unmitigated Construction On-Site**

|                 | ROG            | NOx           | CO            | SO2                | Fugitive PM10 | Exhaust PM10  | PM10 Total    | Fugitive PM2.5 | Exhaust PM2.5 | PM2.5 Total   | Bio- CO2 | NBio- CO2       | Total CO2       | CH4           | N2O | CO2e            |
|-----------------|----------------|---------------|---------------|--------------------|---------------|---------------|---------------|----------------|---------------|---------------|----------|-----------------|-----------------|---------------|-----|-----------------|
| Category        | lb/day         |               |               |                    |               |               |               |                |               |               | lb/day   |                 |                 |               |     |                 |
| Archit. Coating | 16.2225        |               |               |                    |               | 0.0000        | 0.0000        |                | 0.0000        | 0.0000        |          |                 | 0.0000          |               |     | 0.0000          |
| Off-Road        | 0.2045         | 1.4085        | 1.8136        | 2.9700e-003        |               | 0.0817        | 0.0817        |                | 0.0817        | 0.0817        |          | 281.4481        | 281.4481        | 0.0183        |     | 281.9062        |
| <b>Total</b>    | <b>16.4270</b> | <b>1.4085</b> | <b>1.8136</b> | <b>2.9700e-003</b> |               | <b>0.0817</b> | <b>0.0817</b> |                | <b>0.0817</b> | <b>0.0817</b> |          | <b>281.4481</b> | <b>281.4481</b> | <b>0.0183</b> |     | <b>281.9062</b> |



Palomar Hydrogen Project - San Diego County, Summer

**EMFAC Off-Model Adjustment Factors for Gasoline Light Duty Vehicle to Account for the SAFE Vehicle Rule Not Applied**

**3.4 Architectural Coating - 2022**

**Unmitigated Construction Off-Site**

|              | ROG                | NOx                | CO            | SO2                | Fugitive PM10      | Exhaust PM10       | PM10 Total         | Fugitive PM2.5     | Exhaust PM2.5      | PM2.5 Total        | Bio- CO2 | NBio- CO2     | Total CO2     | CH4                | N2O                | CO2e          |
|--------------|--------------------|--------------------|---------------|--------------------|--------------------|--------------------|--------------------|--------------------|--------------------|--------------------|----------|---------------|---------------|--------------------|--------------------|---------------|
| Category     | lb/day             |                    |               |                    |                    |                    |                    |                    |                    |                    | lb/day   |               |               |                    |                    |               |
| Hauling      | 0.0000             | 0.0000             | 0.0000        | 0.0000             | 0.0000             | 0.0000             | 0.0000             | 0.0000             | 0.0000             | 0.0000             |          | 0.0000        | 0.0000        | 0.0000             | 0.0000             | 0.0000        |
| Vendor       | 0.0000             | 0.0000             | 0.0000        | 0.0000             | 0.0000             | 0.0000             | 0.0000             | 0.0000             | 0.0000             | 0.0000             |          | 0.0000        | 0.0000        | 0.0000             | 0.0000             | 0.0000        |
| Worker       | 2.9200e-003        | 1.9000e-003        | 0.0259        | 7.0000e-005        | 8.2100e-003        | 5.0000e-005        | 8.2600e-003        | 2.1800e-003        | 4.0000e-005        | 2.2200e-003        |          | 7.5771        | 7.5771        | 2.2000e-004        | 2.0000e-004        | 7.6411        |
| <b>Total</b> | <b>2.9200e-003</b> | <b>1.9000e-003</b> | <b>0.0259</b> | <b>7.0000e-005</b> | <b>8.2100e-003</b> | <b>5.0000e-005</b> | <b>8.2600e-003</b> | <b>2.1800e-003</b> | <b>4.0000e-005</b> | <b>2.2200e-003</b> |          | <b>7.5771</b> | <b>7.5771</b> | <b>2.2000e-004</b> | <b>2.0000e-004</b> | <b>7.6411</b> |

**Mitigated Construction On-Site**

|                 | ROG            | NOx           | CO            | SO2                | Fugitive PM10 | Exhaust PM10  | PM10 Total    | Fugitive PM2.5 | Exhaust PM2.5 | PM2.5 Total   | Bio- CO2      | NBio- CO2       | Total CO2       | CH4           | N2O | CO2e            |
|-----------------|----------------|---------------|---------------|--------------------|---------------|---------------|---------------|----------------|---------------|---------------|---------------|-----------------|-----------------|---------------|-----|-----------------|
| Category        | lb/day         |               |               |                    |               |               |               |                |               |               | lb/day        |                 |                 |               |     |                 |
| Archit. Coating | 16.2225        |               |               |                    |               | 0.0000        | 0.0000        |                | 0.0000        | 0.0000        |               |                 | 0.0000          |               |     | 0.0000          |
| Off-Road        | 0.2045         | 1.4085        | 1.8136        | 2.9700e-003        |               | 0.0817        | 0.0817        |                | 0.0817        | 0.0817        | 0.0000        | 281.4481        | 281.4481        | 0.0183        |     | 281.9062        |
| <b>Total</b>    | <b>16.4270</b> | <b>1.4085</b> | <b>1.8136</b> | <b>2.9700e-003</b> |               | <b>0.0817</b> | <b>0.0817</b> |                | <b>0.0817</b> | <b>0.0817</b> | <b>0.0000</b> | <b>281.4481</b> | <b>281.4481</b> | <b>0.0183</b> |     | <b>281.9062</b> |

Palomar Hydrogen Project - San Diego County, Summer

**EMFAC Off-Model Adjustment Factors for Gasoline Light Duty Vehicle to Account for the SAFE Vehicle Rule Not Applied**

**3.4 Architectural Coating - 2022**

**Mitigated Construction Off-Site**

|              | ROG                | NOx                | CO            | SO2                | Fugitive PM10      | Exhaust PM10       | PM10 Total         | Fugitive PM2.5     | Exhaust PM2.5      | PM2.5 Total        | Bio- CO2 | NBio- CO2     | Total CO2     | CH4                | N2O                | CO2e          |
|--------------|--------------------|--------------------|---------------|--------------------|--------------------|--------------------|--------------------|--------------------|--------------------|--------------------|----------|---------------|---------------|--------------------|--------------------|---------------|
| Category     | lb/day             |                    |               |                    |                    |                    |                    |                    |                    |                    | lb/day   |               |               |                    |                    |               |
| Hauling      | 0.0000             | 0.0000             | 0.0000        | 0.0000             | 0.0000             | 0.0000             | 0.0000             | 0.0000             | 0.0000             | 0.0000             |          | 0.0000        | 0.0000        | 0.0000             | 0.0000             | 0.0000        |
| Vendor       | 0.0000             | 0.0000             | 0.0000        | 0.0000             | 0.0000             | 0.0000             | 0.0000             | 0.0000             | 0.0000             | 0.0000             |          | 0.0000        | 0.0000        | 0.0000             | 0.0000             | 0.0000        |
| Worker       | 2.9200e-003        | 1.9000e-003        | 0.0259        | 7.0000e-005        | 8.2100e-003        | 5.0000e-005        | 8.2600e-003        | 2.1800e-003        | 4.0000e-005        | 2.2200e-003        |          | 7.5771        | 7.5771        | 2.2000e-004        | 2.0000e-004        | 7.6411        |
| <b>Total</b> | <b>2.9200e-003</b> | <b>1.9000e-003</b> | <b>0.0259</b> | <b>7.0000e-005</b> | <b>8.2100e-003</b> | <b>5.0000e-005</b> | <b>8.2600e-003</b> | <b>2.1800e-003</b> | <b>4.0000e-005</b> | <b>2.2200e-003</b> |          | <b>7.5771</b> | <b>7.5771</b> | <b>2.2000e-004</b> | <b>2.0000e-004</b> | <b>7.6411</b> |

Palomar Hydrogen Project - San Diego County, Summer

**EMFAC Off-Model Adjustment Factors for Gasoline Light Duty Vehicle to Account for the SAFE Vehicle Rule Not Applied**

**4.0 Operational Detail - Mobile**

**4.1 Mitigation Measures Mobile**

|             | ROG    | NOx    | CO     | SO2    | Fugitive PM10 | Exhaust PM10 | PM10 Total | Fugitive PM2.5 | Exhaust PM2.5 | PM2.5 Total | Bio- CO2 | NBio- CO2 | Total CO2 | CH4    | N2O    | CO2e   |
|-------------|--------|--------|--------|--------|---------------|--------------|------------|----------------|---------------|-------------|----------|-----------|-----------|--------|--------|--------|
| Category    | lb/day |        |        |        |               |              |            |                |               |             | lb/day   |           |           |        |        |        |
| Mitigated   | 0.0000 | 0.0000 | 0.0000 | 0.0000 | 0.0000        | 0.0000       | 0.0000     | 0.0000         | 0.0000        | 0.0000      |          | 0.0000    | 0.0000    | 0.0000 | 0.0000 | 0.0000 |
| Unmitigated | 0.0000 | 0.0000 | 0.0000 | 0.0000 | 0.0000        | 0.0000       | 0.0000     | 0.0000         | 0.0000        | 0.0000      |          | 0.0000    | 0.0000    | 0.0000 | 0.0000 | 0.0000 |

**4.2 Trip Summary Information**

| Land Use               | Average Daily Trip Rate |          |        | Unmitigated | Mitigated  |
|------------------------|-------------------------|----------|--------|-------------|------------|
|                        | Weekday                 | Saturday | Sunday | Annual VMT  | Annual VMT |
| General Light Industry | 0.00                    | 0.00     | 0.00   |             |            |
| Total                  | 0.00                    | 0.00     | 0.00   |             |            |

**4.3 Trip Type Information**

| Land Use               | Miles      |            |             | Trip %     |            |             | Trip Purpose % |          |         |
|------------------------|------------|------------|-------------|------------|------------|-------------|----------------|----------|---------|
|                        | H-W or C-W | H-S or C-C | H-O or C-NW | H-W or C-W | H-S or C-C | H-O or C-NW | Primary        | Diverted | Pass-by |
| General Light Industry | 9.50       | 7.30       | 7.30        | 59.00      | 28.00      | 13.00       | 92             | 5        | 3       |

**4.4 Fleet Mix**

| Land Use               | LDA      | LDT1     | LDT2     | MDV      | LHD1     | LHD2     | MHD      | HHD      | OBUS     | UBUS     | MCY      | SBUS     | MH       |
|------------------------|----------|----------|----------|----------|----------|----------|----------|----------|----------|----------|----------|----------|----------|
| General Light Industry | 0.553514 | 0.062792 | 0.181046 | 0.120736 | 0.024419 | 0.006214 | 0.008493 | 0.006184 | 0.000715 | 0.000556 | 0.029185 | 0.000982 | 0.005164 |

Palomar Hydrogen Project - San Diego County, Summer

**EMFAC Off-Model Adjustment Factors for Gasoline Light Duty Vehicle to Account for the SAFE Vehicle Rule Not Applied**

**5.0 Energy Detail**

Historical Energy Use: N

**5.1 Mitigation Measures Energy**

|                        | ROG    | NOx    | CO     | SO2    | Fugitive PM10 | Exhaust PM10 | PM10 Total | Fugitive PM2.5 | Exhaust PM2.5 | PM2.5 Total | Bio- CO2 | NBio- CO2 | Total CO2 | CH4    | N2O    | CO2e   |
|------------------------|--------|--------|--------|--------|---------------|--------------|------------|----------------|---------------|-------------|----------|-----------|-----------|--------|--------|--------|
| Category               | lb/day |        |        |        |               |              |            |                |               |             | lb/day   |           |           |        |        |        |
| NaturalGas Mitigated   | 0.0000 | 0.0000 | 0.0000 | 0.0000 |               | 0.0000       | 0.0000     |                | 0.0000        | 0.0000      |          | 0.0000    | 0.0000    | 0.0000 | 0.0000 | 0.0000 |
| NaturalGas Unmitigated | 0.0000 | 0.0000 | 0.0000 | 0.0000 |               | 0.0000       | 0.0000     |                | 0.0000        | 0.0000      |          | 0.0000    | 0.0000    | 0.0000 | 0.0000 | 0.0000 |

**5.2 Energy by Land Use - NaturalGas**

**Unmitigated**

|                        | NaturalGas Use | ROG           | NOx           | CO            | SO2           | Fugitive PM10 | Exhaust PM10  | PM10 Total    | Fugitive PM2.5 | Exhaust PM2.5 | PM2.5 Total   | Bio- CO2 | NBio- CO2     | Total CO2     | CH4           | N2O           | CO2e          |
|------------------------|----------------|---------------|---------------|---------------|---------------|---------------|---------------|---------------|----------------|---------------|---------------|----------|---------------|---------------|---------------|---------------|---------------|
| Land Use               | kBTU/yr        | lb/day        |               |               |               |               |               |               |                |               |               | lb/day   |               |               |               |               |               |
| General Light Industry | 0              | 0.0000        | 0.0000        | 0.0000        | 0.0000        |               | 0.0000        | 0.0000        |                | 0.0000        | 0.0000        |          | 0.0000        | 0.0000        | 0.0000        | 0.0000        | 0.0000        |
| <b>Total</b>           |                | <b>0.0000</b> | <b>0.0000</b> | <b>0.0000</b> | <b>0.0000</b> |               | <b>0.0000</b> | <b>0.0000</b> |                | <b>0.0000</b> | <b>0.0000</b> |          | <b>0.0000</b> | <b>0.0000</b> | <b>0.0000</b> | <b>0.0000</b> | <b>0.0000</b> |

Palomar Hydrogen Project - San Diego County, Summer

**EMFAC Off-Model Adjustment Factors for Gasoline Light Duty Vehicle to Account for the SAFE Vehicle Rule Not Applied**

**5.2 Energy by Land Use - Natural Gas**

Mitigated

|                        | Natural Gas Use | ROG           | NOx           | CO            | SO2           | Fugitive PM10 | Exhaust PM10  | PM10 Total    | Fugitive PM2.5 | Exhaust PM2.5 | PM2.5 Total   | Bio- CO2 | NBio- CO2     | Total CO2     | CH4           | N2O           | CO2e          |
|------------------------|-----------------|---------------|---------------|---------------|---------------|---------------|---------------|---------------|----------------|---------------|---------------|----------|---------------|---------------|---------------|---------------|---------------|
| Land Use               | kBTU/yr         | lb/day        |               |               |               |               |               |               |                |               |               | lb/day   |               |               |               |               |               |
| General Light Industry | 0               | 0.0000        | 0.0000        | 0.0000        | 0.0000        |               | 0.0000        | 0.0000        |                | 0.0000        | 0.0000        |          | 0.0000        | 0.0000        | 0.0000        | 0.0000        | 0.0000        |
| <b>Total</b>           |                 | <b>0.0000</b> | <b>0.0000</b> | <b>0.0000</b> | <b>0.0000</b> |               | <b>0.0000</b> | <b>0.0000</b> |                | <b>0.0000</b> | <b>0.0000</b> |          | <b>0.0000</b> | <b>0.0000</b> | <b>0.0000</b> | <b>0.0000</b> | <b>0.0000</b> |

**6.0 Area Detail**

**6.1 Mitigation Measures Area**

|             | ROG         | NOx         | CO          | SO2    | Fugitive PM10 | Exhaust PM10 | PM10 Total | Fugitive PM2.5 | Exhaust PM2.5 | PM2.5 Total | Bio- CO2 | NBio- CO2   | Total CO2   | CH4    | N2O | CO2e        |
|-------------|-------------|-------------|-------------|--------|---------------|--------------|------------|----------------|---------------|-------------|----------|-------------|-------------|--------|-----|-------------|
| Category    | lb/day      |             |             |        |               |              |            |                |               |             | lb/day   |             |             |        |     |             |
| Mitigated   | 7.7000e-004 | 1.0000e-005 | 7.1000e-004 | 0.0000 |               | 0.0000       | 0.0000     |                | 0.0000        | 0.0000      |          | 1.5300e-003 | 1.5300e-003 | 0.0000 |     | 1.6300e-003 |
| Unmitigated | 7.7000e-004 | 1.0000e-005 | 7.1000e-004 | 0.0000 |               | 0.0000       | 0.0000     |                | 0.0000        | 0.0000      |          | 1.5300e-003 | 1.5300e-003 | 0.0000 |     | 1.6300e-003 |

Palomar Hydrogen Project - San Diego County, Summer

**EMFAC Off-Model Adjustment Factors for Gasoline Light Duty Vehicle to Account for the SAFE Vehicle Rule Not Applied**

**6.2 Area by SubCategory**

**Unmitigated**

|                       | ROG                | NOx                | CO                 | SO2           | Fugitive PM10 | Exhaust PM10  | PM10 Total    | Fugitive PM2.5 | Exhaust PM2.5 | PM2.5 Total   | Bio- CO2 | NBio- CO2          | Total CO2          | CH4           | N2O | CO2e               |
|-----------------------|--------------------|--------------------|--------------------|---------------|---------------|---------------|---------------|----------------|---------------|---------------|----------|--------------------|--------------------|---------------|-----|--------------------|
| SubCategory           | lb/day             |                    |                    |               |               |               |               |                |               |               | lb/day   |                    |                    |               |     |                    |
| Architectural Coating | 0.0000             |                    |                    |               |               | 0.0000        | 0.0000        |                | 0.0000        | 0.0000        |          |                    | 0.0000             |               |     | 0.0000             |
| Consumer Products     | 7.0000e-004        |                    |                    |               |               | 0.0000        | 0.0000        |                | 0.0000        | 0.0000        |          |                    | 0.0000             |               |     | 0.0000             |
| Landscaping           | 7.0000e-005        | 1.0000e-005        | 7.1000e-004        | 0.0000        |               | 0.0000        | 0.0000        |                | 0.0000        | 0.0000        |          | 1.5300e-003        | 1.5300e-003        | 0.0000        |     | 1.6300e-003        |
| <b>Total</b>          | <b>7.7000e-004</b> | <b>1.0000e-005</b> | <b>7.1000e-004</b> | <b>0.0000</b> |               | <b>0.0000</b> | <b>0.0000</b> |                | <b>0.0000</b> | <b>0.0000</b> |          | <b>1.5300e-003</b> | <b>1.5300e-003</b> | <b>0.0000</b> |     | <b>1.6300e-003</b> |

Palomar Hydrogen Project - San Diego County, Summer

**EMFAC Off-Model Adjustment Factors for Gasoline Light Duty Vehicle to Account for the SAFE Vehicle Rule Not Applied**

**6.2 Area by SubCategory**

Mitigated

|                       | ROG                | NOx                | CO                 | SO2           | Fugitive PM10 | Exhaust PM10  | PM10 Total    | Fugitive PM2.5 | Exhaust PM2.5 | PM2.5 Total   | Bio- CO2 | NBio- CO2          | Total CO2          | CH4           | N2O | CO2e               |
|-----------------------|--------------------|--------------------|--------------------|---------------|---------------|---------------|---------------|----------------|---------------|---------------|----------|--------------------|--------------------|---------------|-----|--------------------|
| SubCategory           | lb/day             |                    |                    |               |               |               |               |                |               |               | lb/day   |                    |                    |               |     |                    |
| Architectural Coating | 0.0000             |                    |                    |               |               | 0.0000        | 0.0000        |                | 0.0000        | 0.0000        |          |                    | 0.0000             |               |     | 0.0000             |
| Consumer Products     | 7.0000e-004        |                    |                    |               |               | 0.0000        | 0.0000        |                | 0.0000        | 0.0000        |          |                    | 0.0000             |               |     | 0.0000             |
| Landscaping           | 7.0000e-005        | 1.0000e-005        | 7.1000e-004        | 0.0000        |               | 0.0000        | 0.0000        |                | 0.0000        | 0.0000        |          | 1.5300e-003        | 1.5300e-003        | 0.0000        |     | 1.6300e-003        |
| <b>Total</b>          | <b>7.7000e-004</b> | <b>1.0000e-005</b> | <b>7.1000e-004</b> | <b>0.0000</b> |               | <b>0.0000</b> | <b>0.0000</b> |                | <b>0.0000</b> | <b>0.0000</b> |          | <b>1.5300e-003</b> | <b>1.5300e-003</b> | <b>0.0000</b> |     | <b>1.6300e-003</b> |

**7.0 Water Detail**

---

**7.1 Mitigation Measures Water**

Palomar Hydrogen Project - San Diego County, Summer

**EMFAC Off-Model Adjustment Factors for Gasoline Light Duty Vehicle to Account for the SAFE Vehicle Rule Not Applied**

**8.0 Waste Detail**

---

**8.1 Mitigation Measures Waste**

**9.0 Operational Offroad**

---

| Equipment Type | Number | Hours/Day | Days/Year | Horse Power | Load Factor | Fuel Type |
|----------------|--------|-----------|-----------|-------------|-------------|-----------|
|----------------|--------|-----------|-----------|-------------|-------------|-----------|

**10.0 Stationary Equipment**

---

**Fire Pumps and Emergency Generators**

| Equipment Type | Number | Hours/Day | Hours/Year | Horse Power | Load Factor | Fuel Type |
|----------------|--------|-----------|------------|-------------|-------------|-----------|
|----------------|--------|-----------|------------|-------------|-------------|-----------|

**Boilers**

| Equipment Type | Number | Heat Input/Day | Heat Input/Year | Boiler Rating | Fuel Type |
|----------------|--------|----------------|-----------------|---------------|-----------|
|----------------|--------|----------------|-----------------|---------------|-----------|

**User Defined Equipment**

| Equipment Type | Number |
|----------------|--------|
|----------------|--------|

**11.0 Vegetation**

---



Palomar Hydrogen Project - San Diego County, Annual

**EMFAC Off-Model Adjustment Factors for Gasoline Light Duty Vehicle to Account for the SAFE Vehicle Rule Not Applied**

**Palomar Hydrogen Project**

**San Diego County, Annual**

**1.0 Project Characteristics**

**1.1 Land Usage**

| Land Uses              | Size | Metric   | Lot Acreage | Floor Surface Area | Population |
|------------------------|------|----------|-------------|--------------------|------------|
| General Light Industry | 7.00 | 1000sqft | 0.16        | 7,000.00           | 0          |

**1.2 Other Project Characteristics**

|                                |                          |                                |       |                                  |       |
|--------------------------------|--------------------------|--------------------------------|-------|----------------------------------|-------|
| <b>Urbanization</b>            | Urban                    | <b>Wind Speed (m/s)</b>        | 2.6   | <b>Precipitation Freq (Days)</b> | 40    |
| <b>Climate Zone</b>            | 13                       |                                |       | <b>Operational Year</b>          | 2023  |
| <b>Utility Company</b>         | San Diego Gas & Electric |                                |       |                                  |       |
| <b>CO2 Intensity (lb/MWhr)</b> | 539.98                   | <b>CH4 Intensity (lb/MWhr)</b> | 0.033 | <b>N2O Intensity (lb/MWhr)</b>   | 0.004 |

**1.3 User Entered Comments & Non-Default Data**

- Project Characteristics - Construction only
- Land Use -
- Construction Phase - 2 weeks for painting
- Demolition -
- Vehicle Trips - Construction only
- Consumer Products - Construction only
- Area Coating - Construction only
- Landscape Equipment - Construction only
- Energy Use - Construction only
- Water And Wastewater - Construction only
- Solid Waste - Construction only
- Construction Off-road Equipment Mitigation -

## Palomar Hydrogen Project - San Diego County, Annual

**EMFAC Off-Model Adjustment Factors for Gasoline Light Duty Vehicle to Account for the SAFE Vehicle Rule Not Applied**

| Table Name            | Column Name                  | Default Value | New Value |
|-----------------------|------------------------------|---------------|-----------|
| tblAreaCoating        | Area_Nonresidential_Exterior | 3500          | 0         |
| tblAreaCoating        | Area_Nonresidential_Interior | 10500         | 0         |
| tblConstructionPhase  | NumDays                      | 5.00          | 10.00     |
| tblConstructionPhase  | PhaseEndDate                 | 6/22/2022     | 6/17/2022 |
| tblConstructionPhase  | PhaseEndDate                 | 6/8/2022      | 6/3/2022  |
| tblConstructionPhase  | PhaseStartDate               | 6/16/2022     | 6/6/2022  |
| tblConstructionPhase  | PhaseStartDate               | 1/20/2022     | 1/17/2022 |
| tblConsumerProducts   | ROG_EF                       | 2.14E-05      | 1E-07     |
| tblConsumerProducts   | ROG_EF_Degreaser             | 3.542E-07     | 1E-10     |
| tblConsumerProducts   | ROG_EF_PesticidesFertilizers | 5.152E-08     | 1E-11     |
| tblEnergyUse          | LightingElect                | 2.83          | 0.00      |
| tblEnergyUse          | NT24E                        | 4.27          | 0.00      |
| tblEnergyUse          | NT24NG                       | 7.25          | 0.00      |
| tblEnergyUse          | T24E                         | 1.08          | 0.00      |
| tblEnergyUse          | T24NG                        | 4.27          | 0.00      |
| tblLandscapeEquipment | NumberSummerDays             | 180           | 1         |
| tblSolidWaste         | SolidWasteGenerationRate     | 8.68          | 0.00      |
| tblVehicleTrips       | ST_TR                        | 1.99          | 0.00      |
| tblVehicleTrips       | SU_TR                        | 5.00          | 0.00      |
| tblVehicleTrips       | WD_TR                        | 4.96          | 0.00      |
| tblWater              | IndoorWaterUseRate           | 1,618,750.00  | 0.00      |

**2.0 Emissions Summary**





Palomar Hydrogen Project - San Diego County, Annual

**EMFAC Off-Model Adjustment Factors for Gasoline Light Duty Vehicle to Account for the SAFE Vehicle Rule Not Applied**

**2.2 Overall Operational**

**Mitigated Operational**

|              | ROG                | NOx           | CO            | SO2           | Fugitive PM10 | Exhaust PM10  | PM10 Total    | Fugitive PM2.5 | Exhaust PM2.5 | PM2.5 Total   | Bio- CO2      | NBio- CO2     | Total CO2     | CH4           | N2O           | CO2e          |
|--------------|--------------------|---------------|---------------|---------------|---------------|---------------|---------------|----------------|---------------|---------------|---------------|---------------|---------------|---------------|---------------|---------------|
| Category     | tons/yr            |               |               |               |               |               |               |                |               |               | MT/yr         |               |               |               |               |               |
| Area         | 1.3000e-004        | 0.0000        | 0.0000        | 0.0000        |               | 0.0000        | 0.0000        |                | 0.0000        | 0.0000        | 0.0000        | 0.0000        | 0.0000        | 0.0000        | 0.0000        | 0.0000        |
| Energy       | 0.0000             | 0.0000        | 0.0000        | 0.0000        |               | 0.0000        | 0.0000        |                | 0.0000        | 0.0000        | 0.0000        | 0.0000        | 0.0000        | 0.0000        | 0.0000        | 0.0000        |
| Mobile       | 0.0000             | 0.0000        | 0.0000        | 0.0000        | 0.0000        | 0.0000        | 0.0000        | 0.0000         | 0.0000        | 0.0000        | 0.0000        | 0.0000        | 0.0000        | 0.0000        | 0.0000        | 0.0000        |
| Waste        |                    |               |               |               |               | 0.0000        | 0.0000        |                | 0.0000        | 0.0000        | 0.0000        | 0.0000        | 0.0000        | 0.0000        | 0.0000        | 0.0000        |
| Water        |                    |               |               |               |               | 0.0000        | 0.0000        |                | 0.0000        | 0.0000        | 0.0000        | 0.0000        | 0.0000        | 0.0000        | 0.0000        | 0.0000        |
| <b>Total</b> | <b>1.3000e-004</b> | <b>0.0000</b> | <b>0.0000</b> | <b>0.0000</b> | <b>0.0000</b> | <b>0.0000</b> | <b>0.0000</b> | <b>0.0000</b>  | <b>0.0000</b> | <b>0.0000</b> | <b>0.0000</b> | <b>0.0000</b> | <b>0.0000</b> | <b>0.0000</b> | <b>0.0000</b> | <b>0.0000</b> |

|                          | ROG         | NOx         | CO          | SO2         | Fugitive PM10 | Exhaust PM10 | PM10 Total  | Fugitive PM2.5 | Exhaust PM2.5 | PM2.5 Total | Bio- CO2    | NBio- CO2   | Total CO2   | CH4         | N2O         | CO2e        |
|--------------------------|-------------|-------------|-------------|-------------|---------------|--------------|-------------|----------------|---------------|-------------|-------------|-------------|-------------|-------------|-------------|-------------|
| <b>Percent Reduction</b> | <b>0.00</b> | <b>0.00</b> | <b>0.00</b> | <b>0.00</b> | <b>0.00</b>   | <b>0.00</b>  | <b>0.00</b> | <b>0.00</b>    | <b>0.00</b>   | <b>0.00</b> | <b>0.00</b> | <b>0.00</b> | <b>0.00</b> | <b>0.00</b> | <b>0.00</b> | <b>0.00</b> |

**3.0 Construction Detail**

**Construction Phase**

| Phase Number | Phase Name            | Phase Type            | Start Date | End Date  | Num Days Week | Num Days | Phase Description |
|--------------|-----------------------|-----------------------|------------|-----------|---------------|----------|-------------------|
| 1            | Demolition            | Demolition            | 1/3/2022   | 1/14/2022 | 5             | 10       |                   |
| 2            | Building Construction | Building Construction | 1/17/2022  | 6/3/2022  | 5             | 100      |                   |
| 3            | Architectural Coating | Architectural Coating | 6/6/2022   | 6/17/2022 | 5             | 10       |                   |

Palomar Hydrogen Project - San Diego County, Annual

**EMFAC Off-Model Adjustment Factors for Gasoline Light Duty Vehicle to Account for the SAFE Vehicle Rule Not Applied**

**Acres of Grading (Site Preparation Phase): 0**

**Acres of Grading (Grading Phase): 0**

**Acres of Paving: 0**

**Residential Indoor: 0; Residential Outdoor: 0; Non-Residential Indoor: 10,500; Non-Residential Outdoor: 3,500; Striped Parking Area: 0 (Architectural Coating – sqft)**

**OffRoad Equipment**

| Phase Name            | Offroad Equipment Type    | Amount | Usage Hours | Horse Power | Load Factor |
|-----------------------|---------------------------|--------|-------------|-------------|-------------|
| Architectural Coating | Air Compressors           | 1      | 6.00        | 78          | 0.48        |
| Demolition            | Concrete/Industrial Saws  | 1      | 8.00        | 81          | 0.73        |
| Building Construction | Cranes                    | 1      | 4.00        | 231         | 0.29        |
| Building Construction | Forklifts                 | 2      | 6.00        | 89          | 0.20        |
| Demolition            | Rubber Tired Dozers       | 1      | 1.00        | 247         | 0.40        |
| Building Construction | Tractors/Loaders/Backhoes | 2      | 8.00        | 97          | 0.37        |
| Demolition            | Tractors/Loaders/Backhoes | 2      | 6.00        | 97          | 0.37        |

**Trips and VMT**

| Phase Name            | Offroad Equipment Count | Worker Trip Number | Vendor Trip Number | Hauling Trip Number | Worker Trip Length | Vendor Trip Length | Hauling Trip Length | Worker Vehicle Class | Vendor Vehicle Class | Hauling Vehicle Class |
|-----------------------|-------------------------|--------------------|--------------------|---------------------|--------------------|--------------------|---------------------|----------------------|----------------------|-----------------------|
| Demolition            | 4                       | 10.00              | 0.00               | 8.00                | 10.80              | 7.30               | 20.00               | LD_Mix               | HDT_Mix              | HHDT                  |
| Building Construction | 5                       | 3.00               | 1.00               | 0.00                | 10.80              | 7.30               | 20.00               | LD_Mix               | HDT_Mix              | HHDT                  |
| Architectural Coating | 1                       | 1.00               | 0.00               | 0.00                | 10.80              | 7.30               | 20.00               | LD_Mix               | HDT_Mix              | HHDT                  |

**3.1 Mitigation Measures Construction**

Water Exposed Area

Palomar Hydrogen Project - San Diego County, Annual

**EMFAC Off-Model Adjustment Factors for Gasoline Light Duty Vehicle to Account for the SAFE Vehicle Rule Not Applied**

**3.2 Demolition - 2022**

**Unmitigated Construction On-Site**

|               | ROG                | NOx           | CO            | SO2                | Fugitive PM10      | Exhaust PM10       | PM10 Total         | Fugitive PM2.5     | Exhaust PM2.5      | PM2.5 Total        | Bio- CO2      | NBio- CO2     | Total CO2     | CH4                | N2O           | CO2e          |
|---------------|--------------------|---------------|---------------|--------------------|--------------------|--------------------|--------------------|--------------------|--------------------|--------------------|---------------|---------------|---------------|--------------------|---------------|---------------|
| Category      | tons/yr            |               |               |                    |                    |                    |                    |                    |                    |                    | MT/yr         |               |               |                    |               |               |
| Fugitive Dust |                    |               |               |                    | 8.2000e-004        | 0.0000             | 8.2000e-004        | 1.2000e-004        | 0.0000             | 1.2000e-004        | 0.0000        | 0.0000        | 0.0000        | 0.0000             | 0.0000        | 0.0000        |
| Off-Road      | 3.5500e-003        | 0.0321        | 0.0374        | 6.0000e-005        |                    | 1.6900e-003        | 1.6900e-003        |                    | 1.6100e-003        | 1.6100e-003        | 0.0000        | 5.2068        | 5.2068        | 9.6000e-004        | 0.0000        | 5.2308        |
| <b>Total</b>  | <b>3.5500e-003</b> | <b>0.0321</b> | <b>0.0374</b> | <b>6.0000e-005</b> | <b>8.2000e-004</b> | <b>1.6900e-003</b> | <b>2.5100e-003</b> | <b>1.2000e-004</b> | <b>1.6100e-003</b> | <b>1.7300e-003</b> | <b>0.0000</b> | <b>5.2068</b> | <b>5.2068</b> | <b>9.6000e-004</b> | <b>0.0000</b> | <b>5.2308</b> |

**Unmitigated Construction Off-Site**

|              | ROG                | NOx                | CO                 | SO2           | Fugitive PM10      | Exhaust PM10       | PM10 Total         | Fugitive PM2.5     | Exhaust PM2.5      | PM2.5 Total        | Bio- CO2      | NBio- CO2     | Total CO2     | CH4                | N2O                | CO2e          |
|--------------|--------------------|--------------------|--------------------|---------------|--------------------|--------------------|--------------------|--------------------|--------------------|--------------------|---------------|---------------|---------------|--------------------|--------------------|---------------|
| Category     | tons/yr            |                    |                    |               |                    |                    |                    |                    |                    |                    | MT/yr         |               |               |                    |                    |               |
| Hauling      | 2.0000e-005        | 6.7000e-004        | 1.6000e-004        | 0.0000        | 7.0000e-005        | 1.0000e-005        | 7.0000e-005        | 2.0000e-005        | 1.0000e-005        | 2.0000e-005        | 0.0000        | 0.2507        | 0.2507        | 1.0000e-005        | 4.0000e-005        | 0.2629        |
| Vendor       | 0.0000             | 0.0000             | 0.0000             | 0.0000        | 0.0000             | 0.0000             | 0.0000             | 0.0000             | 0.0000             | 0.0000             | 0.0000        | 0.0000        | 0.0000        | 0.0000             | 0.0000             | 0.0000        |
| Worker       | 1.4000e-004        | 1.0000e-004        | 1.2300e-003        | 0.0000        | 4.0000e-004        | 0.0000             | 4.0000e-004        | 1.1000e-004        | 0.0000             | 1.1000e-004        | 0.0000        | 0.3276        | 0.3276        | 1.0000e-005        | 1.0000e-005        | 0.3307        |
| <b>Total</b> | <b>1.6000e-004</b> | <b>7.7000e-004</b> | <b>1.3900e-003</b> | <b>0.0000</b> | <b>4.7000e-004</b> | <b>1.0000e-005</b> | <b>4.7000e-004</b> | <b>1.3000e-004</b> | <b>1.0000e-005</b> | <b>1.3000e-004</b> | <b>0.0000</b> | <b>0.5784</b> | <b>0.5784</b> | <b>2.0000e-005</b> | <b>5.0000e-005</b> | <b>0.5936</b> |

Palomar Hydrogen Project - San Diego County, Annual

**EMFAC Off-Model Adjustment Factors for Gasoline Light Duty Vehicle to Account for the SAFE Vehicle Rule Not Applied**

**3.2 Demolition - 2022**

**Mitigated Construction On-Site**

|               | ROG                | NOx           | CO            | SO2                | Fugitive PM10      | Exhaust PM10       | PM10 Total         | Fugitive PM2.5     | Exhaust PM2.5      | PM2.5 Total        | Bio- CO2      | NBio- CO2     | Total CO2     | CH4                | N2O           | CO2e          |
|---------------|--------------------|---------------|---------------|--------------------|--------------------|--------------------|--------------------|--------------------|--------------------|--------------------|---------------|---------------|---------------|--------------------|---------------|---------------|
| Category      | tons/yr            |               |               |                    |                    |                    |                    |                    |                    |                    | MT/yr         |               |               |                    |               |               |
| Fugitive Dust |                    |               |               |                    | 3.7000e-004        | 0.0000             | 3.7000e-004        | 6.0000e-005        | 0.0000             | 6.0000e-005        | 0.0000        | 0.0000        | 0.0000        | 0.0000             | 0.0000        | 0.0000        |
| Off-Road      | 3.5500e-003        | 0.0321        | 0.0374        | 6.0000e-005        |                    | 1.6900e-003        | 1.6900e-003        |                    | 1.6100e-003        | 1.6100e-003        | 0.0000        | 5.2068        | 5.2068        | 9.6000e-004        | 0.0000        | 5.2308        |
| <b>Total</b>  | <b>3.5500e-003</b> | <b>0.0321</b> | <b>0.0374</b> | <b>6.0000e-005</b> | <b>3.7000e-004</b> | <b>1.6900e-003</b> | <b>2.0600e-003</b> | <b>6.0000e-005</b> | <b>1.6100e-003</b> | <b>1.6700e-003</b> | <b>0.0000</b> | <b>5.2068</b> | <b>5.2068</b> | <b>9.6000e-004</b> | <b>0.0000</b> | <b>5.2308</b> |

**Mitigated Construction Off-Site**

|              | ROG                | NOx                | CO                 | SO2           | Fugitive PM10      | Exhaust PM10       | PM10 Total         | Fugitive PM2.5     | Exhaust PM2.5      | PM2.5 Total        | Bio- CO2      | NBio- CO2     | Total CO2     | CH4                | N2O                | CO2e          |
|--------------|--------------------|--------------------|--------------------|---------------|--------------------|--------------------|--------------------|--------------------|--------------------|--------------------|---------------|---------------|---------------|--------------------|--------------------|---------------|
| Category     | tons/yr            |                    |                    |               |                    |                    |                    |                    |                    |                    | MT/yr         |               |               |                    |                    |               |
| Hauling      | 2.0000e-005        | 6.7000e-004        | 1.6000e-004        | 0.0000        | 7.0000e-005        | 1.0000e-005        | 7.0000e-005        | 2.0000e-005        | 1.0000e-005        | 2.0000e-005        | 0.0000        | 0.2507        | 0.2507        | 1.0000e-005        | 4.0000e-005        | 0.2629        |
| Vendor       | 0.0000             | 0.0000             | 0.0000             | 0.0000        | 0.0000             | 0.0000             | 0.0000             | 0.0000             | 0.0000             | 0.0000             | 0.0000        | 0.0000        | 0.0000        | 0.0000             | 0.0000             | 0.0000        |
| Worker       | 1.4000e-004        | 1.0000e-004        | 1.2300e-003        | 0.0000        | 4.0000e-004        | 0.0000             | 4.0000e-004        | 1.1000e-004        | 0.0000             | 1.1000e-004        | 0.0000        | 0.3276        | 0.3276        | 1.0000e-005        | 1.0000e-005        | 0.3307        |
| <b>Total</b> | <b>1.6000e-004</b> | <b>7.7000e-004</b> | <b>1.3900e-003</b> | <b>0.0000</b> | <b>4.7000e-004</b> | <b>1.0000e-005</b> | <b>4.7000e-004</b> | <b>1.3000e-004</b> | <b>1.0000e-005</b> | <b>1.3000e-004</b> | <b>0.0000</b> | <b>0.5784</b> | <b>0.5784</b> | <b>2.0000e-005</b> | <b>5.0000e-005</b> | <b>0.5936</b> |



Palomar Hydrogen Project - San Diego County, Annual

**EMFAC Off-Model Adjustment Factors for Gasoline Light Duty Vehicle to Account for the SAFE Vehicle Rule Not Applied**

**3.3 Building Construction - 2022**

**Unmitigated Construction On-Site**

|              | ROG           | NOx           | CO            | SO2                | Fugitive PM10 | Exhaust PM10  | PM10 Total    | Fugitive PM2.5 | Exhaust PM2.5 | PM2.5 Total   | Bio- CO2      | NBio- CO2      | Total CO2      | CH4           | N2O           | CO2e           |
|--------------|---------------|---------------|---------------|--------------------|---------------|---------------|---------------|----------------|---------------|---------------|---------------|----------------|----------------|---------------|---------------|----------------|
| Category     | tons/yr       |               |               |                    |               |               |               |                |               |               | MT/yr         |                |                |               |               |                |
| Off-Road     | 0.0343        | 0.3513        | 0.3576        | 5.7000e-004        |               | 0.0186        | 0.0186        |                | 0.0171        | 0.0171        | 0.0000        | 50.0739        | 50.0739        | 0.0162        | 0.0000        | 50.4787        |
| <b>Total</b> | <b>0.0343</b> | <b>0.3513</b> | <b>0.3576</b> | <b>5.7000e-004</b> |               | <b>0.0186</b> | <b>0.0186</b> |                | <b>0.0171</b> | <b>0.0171</b> | <b>0.0000</b> | <b>50.0739</b> | <b>50.0739</b> | <b>0.0162</b> | <b>0.0000</b> | <b>50.4787</b> |

**Unmitigated Construction Off-Site**

|              | ROG                | NOx                | CO                 | SO2                | Fugitive PM10      | Exhaust PM10       | PM10 Total         | Fugitive PM2.5     | Exhaust PM2.5      | PM2.5 Total        | Bio- CO2      | NBio- CO2     | Total CO2     | CH4                | N2O                | CO2e          |
|--------------|--------------------|--------------------|--------------------|--------------------|--------------------|--------------------|--------------------|--------------------|--------------------|--------------------|---------------|---------------|---------------|--------------------|--------------------|---------------|
| Category     | tons/yr            |                    |                    |                    |                    |                    |                    |                    |                    |                    | MT/yr         |               |               |                    |                    |               |
| Hauling      | 0.0000             | 0.0000             | 0.0000             | 0.0000             | 0.0000             | 0.0000             | 0.0000             | 0.0000             | 0.0000             | 0.0000             | 0.0000        | 0.0000        | 0.0000        | 0.0000             | 0.0000             | 0.0000        |
| Vendor       | 1.1000e-004        | 2.7500e-003        | 9.0000e-004        | 1.0000e-005        | 3.3000e-004        | 3.0000e-005        | 3.6000e-004        | 1.0000e-004        | 3.0000e-005        | 1.2000e-004        | 0.0000        | 1.0427        | 1.0427        | 3.0000e-005        | 1.5000e-004        | 1.0886        |
| Worker       | 4.3000e-004        | 3.1000e-004        | 3.6800e-003        | 1.0000e-005        | 1.2000e-003        | 1.0000e-005        | 1.2100e-003        | 3.2000e-004        | 1.0000e-005        | 3.3000e-004        | 0.0000        | 0.9829        | 0.9829        | 3.0000e-005        | 3.0000e-005        | 0.9922        |
| <b>Total</b> | <b>5.4000e-004</b> | <b>3.0600e-003</b> | <b>4.5800e-003</b> | <b>2.0000e-005</b> | <b>1.5300e-003</b> | <b>4.0000e-005</b> | <b>1.5700e-003</b> | <b>4.2000e-004</b> | <b>4.0000e-005</b> | <b>4.5000e-004</b> | <b>0.0000</b> | <b>2.0256</b> | <b>2.0256</b> | <b>6.0000e-005</b> | <b>1.8000e-004</b> | <b>2.0808</b> |

Palomar Hydrogen Project - San Diego County, Annual

**EMFAC Off-Model Adjustment Factors for Gasoline Light Duty Vehicle to Account for the SAFE Vehicle Rule Not Applied**

**3.3 Building Construction - 2022**

**Mitigated Construction On-Site**

|              | ROG           | NOx           | CO            | SO2                | Fugitive PM10 | Exhaust PM10  | PM10 Total    | Fugitive PM2.5 | Exhaust PM2.5 | PM2.5 Total   | Bio- CO2      | NBio- CO2      | Total CO2      | CH4           | N2O           | CO2e           |
|--------------|---------------|---------------|---------------|--------------------|---------------|---------------|---------------|----------------|---------------|---------------|---------------|----------------|----------------|---------------|---------------|----------------|
| Category     | tons/yr       |               |               |                    |               |               |               |                |               |               | MT/yr         |                |                |               |               |                |
| Off-Road     | 0.0343        | 0.3513        | 0.3576        | 5.7000e-004        |               | 0.0186        | 0.0186        |                | 0.0171        | 0.0171        | 0.0000        | 50.0738        | 50.0738        | 0.0162        | 0.0000        | 50.4787        |
| <b>Total</b> | <b>0.0343</b> | <b>0.3513</b> | <b>0.3576</b> | <b>5.7000e-004</b> |               | <b>0.0186</b> | <b>0.0186</b> |                | <b>0.0171</b> | <b>0.0171</b> | <b>0.0000</b> | <b>50.0738</b> | <b>50.0738</b> | <b>0.0162</b> | <b>0.0000</b> | <b>50.4787</b> |

**Mitigated Construction Off-Site**

|              | ROG                | NOx                | CO                 | SO2                | Fugitive PM10      | Exhaust PM10       | PM10 Total         | Fugitive PM2.5     | Exhaust PM2.5      | PM2.5 Total        | Bio- CO2      | NBio- CO2     | Total CO2     | CH4                | N2O                | CO2e          |
|--------------|--------------------|--------------------|--------------------|--------------------|--------------------|--------------------|--------------------|--------------------|--------------------|--------------------|---------------|---------------|---------------|--------------------|--------------------|---------------|
| Category     | tons/yr            |                    |                    |                    |                    |                    |                    |                    |                    |                    | MT/yr         |               |               |                    |                    |               |
| Hauling      | 0.0000             | 0.0000             | 0.0000             | 0.0000             | 0.0000             | 0.0000             | 0.0000             | 0.0000             | 0.0000             | 0.0000             | 0.0000        | 0.0000        | 0.0000        | 0.0000             | 0.0000             | 0.0000        |
| Vendor       | 1.1000e-004        | 2.7500e-003        | 9.0000e-004        | 1.0000e-005        | 3.3000e-004        | 3.0000e-005        | 3.6000e-004        | 1.0000e-004        | 3.0000e-005        | 1.2000e-004        | 0.0000        | 1.0427        | 1.0427        | 3.0000e-005        | 1.5000e-004        | 1.0886        |
| Worker       | 4.3000e-004        | 3.1000e-004        | 3.6800e-003        | 1.0000e-005        | 1.2000e-003        | 1.0000e-005        | 1.2100e-003        | 3.2000e-004        | 1.0000e-005        | 3.3000e-004        | 0.0000        | 0.9829        | 0.9829        | 3.0000e-005        | 3.0000e-005        | 0.9922        |
| <b>Total</b> | <b>5.4000e-004</b> | <b>3.0600e-003</b> | <b>4.5800e-003</b> | <b>2.0000e-005</b> | <b>1.5300e-003</b> | <b>4.0000e-005</b> | <b>1.5700e-003</b> | <b>4.2000e-004</b> | <b>4.0000e-005</b> | <b>4.5000e-004</b> | <b>0.0000</b> | <b>2.0256</b> | <b>2.0256</b> | <b>6.0000e-005</b> | <b>1.8000e-004</b> | <b>2.0808</b> |

Palomar Hydrogen Project - San Diego County, Annual

**EMFAC Off-Model Adjustment Factors for Gasoline Light Duty Vehicle to Account for the SAFE Vehicle Rule Not Applied**

**3.4 Architectural Coating - 2022**

**Unmitigated Construction On-Site**

|                 | ROG           | NOx                | CO                 | SO2                | Fugitive PM10 | Exhaust PM10       | PM10 Total         | Fugitive PM2.5 | Exhaust PM2.5      | PM2.5 Total        | Bio- CO2      | NBio- CO2     | Total CO2     | CH4                | N2O           | CO2e          |
|-----------------|---------------|--------------------|--------------------|--------------------|---------------|--------------------|--------------------|----------------|--------------------|--------------------|---------------|---------------|---------------|--------------------|---------------|---------------|
| Category        | tons/yr       |                    |                    |                    |               |                    |                    |                |                    |                    | MT/yr         |               |               |                    |               |               |
| Archit. Coating | 0.0811        |                    |                    |                    |               | 0.0000             | 0.0000             |                | 0.0000             | 0.0000             | 0.0000        | 0.0000        | 0.0000        | 0.0000             | 0.0000        | 0.0000        |
| Off-Road        | 1.0200e-003   | 7.0400e-003        | 9.0700e-003        | 1.0000e-005        |               | 4.1000e-004        | 4.1000e-004        |                | 4.1000e-004        | 4.1000e-004        | 0.0000        | 1.2766        | 1.2766        | 8.0000e-005        | 0.0000        | 1.2787        |
| <b>Total</b>    | <b>0.0821</b> | <b>7.0400e-003</b> | <b>9.0700e-003</b> | <b>1.0000e-005</b> |               | <b>4.1000e-004</b> | <b>4.1000e-004</b> |                | <b>4.1000e-004</b> | <b>4.1000e-004</b> | <b>0.0000</b> | <b>1.2766</b> | <b>1.2766</b> | <b>8.0000e-005</b> | <b>0.0000</b> | <b>1.2787</b> |

**Unmitigated Construction Off-Site**

|              | ROG                | NOx                | CO                 | SO2           | Fugitive PM10      | Exhaust PM10  | PM10 Total         | Fugitive PM2.5     | Exhaust PM2.5 | PM2.5 Total        | Bio- CO2      | NBio- CO2     | Total CO2     | CH4           | N2O           | CO2e          |
|--------------|--------------------|--------------------|--------------------|---------------|--------------------|---------------|--------------------|--------------------|---------------|--------------------|---------------|---------------|---------------|---------------|---------------|---------------|
| Category     | tons/yr            |                    |                    |               |                    |               |                    |                    |               |                    | MT/yr         |               |               |               |               |               |
| Hauling      | 0.0000             | 0.0000             | 0.0000             | 0.0000        | 0.0000             | 0.0000        | 0.0000             | 0.0000             | 0.0000        | 0.0000             | 0.0000        | 0.0000        | 0.0000        | 0.0000        | 0.0000        | 0.0000        |
| Vendor       | 0.0000             | 0.0000             | 0.0000             | 0.0000        | 0.0000             | 0.0000        | 0.0000             | 0.0000             | 0.0000        | 0.0000             | 0.0000        | 0.0000        | 0.0000        | 0.0000        | 0.0000        | 0.0000        |
| Worker       | 1.0000e-005        | 1.0000e-005        | 1.2000e-004        | 0.0000        | 4.0000e-005        | 0.0000        | 4.0000e-005        | 1.0000e-005        | 0.0000        | 1.0000e-005        | 0.0000        | 0.0328        | 0.0328        | 0.0000        | 0.0000        | 0.0331        |
| <b>Total</b> | <b>1.0000e-005</b> | <b>1.0000e-005</b> | <b>1.2000e-004</b> | <b>0.0000</b> | <b>4.0000e-005</b> | <b>0.0000</b> | <b>4.0000e-005</b> | <b>1.0000e-005</b> | <b>0.0000</b> | <b>1.0000e-005</b> | <b>0.0000</b> | <b>0.0328</b> | <b>0.0328</b> | <b>0.0000</b> | <b>0.0000</b> | <b>0.0331</b> |

Palomar Hydrogen Project - San Diego County, Annual

**EMFAC Off-Model Adjustment Factors for Gasoline Light Duty Vehicle to Account for the SAFE Vehicle Rule Not Applied**

**3.4 Architectural Coating - 2022**

**Mitigated Construction On-Site**

|                 | ROG           | NOx                | CO                 | SO2                | Fugitive PM10 | Exhaust PM10       | PM10 Total         | Fugitive PM2.5 | Exhaust PM2.5      | PM2.5 Total        | Bio- CO2      | NBio- CO2     | Total CO2     | CH4                | N2O           | CO2e          |
|-----------------|---------------|--------------------|--------------------|--------------------|---------------|--------------------|--------------------|----------------|--------------------|--------------------|---------------|---------------|---------------|--------------------|---------------|---------------|
| Category        | tons/yr       |                    |                    |                    |               |                    |                    |                |                    |                    | MT/yr         |               |               |                    |               |               |
| Archit. Coating | 0.0811        |                    |                    |                    |               | 0.0000             | 0.0000             |                | 0.0000             | 0.0000             | 0.0000        | 0.0000        | 0.0000        | 0.0000             | 0.0000        | 0.0000        |
| Off-Road        | 1.0200e-003   | 7.0400e-003        | 9.0700e-003        | 1.0000e-005        |               | 4.1000e-004        | 4.1000e-004        |                | 4.1000e-004        | 4.1000e-004        | 0.0000        | 1.2766        | 1.2766        | 8.0000e-005        | 0.0000        | 1.2787        |
| <b>Total</b>    | <b>0.0821</b> | <b>7.0400e-003</b> | <b>9.0700e-003</b> | <b>1.0000e-005</b> |               | <b>4.1000e-004</b> | <b>4.1000e-004</b> |                | <b>4.1000e-004</b> | <b>4.1000e-004</b> | <b>0.0000</b> | <b>1.2766</b> | <b>1.2766</b> | <b>8.0000e-005</b> | <b>0.0000</b> | <b>1.2787</b> |

**Mitigated Construction Off-Site**

|              | ROG                | NOx                | CO                 | SO2           | Fugitive PM10      | Exhaust PM10  | PM10 Total         | Fugitive PM2.5     | Exhaust PM2.5 | PM2.5 Total        | Bio- CO2      | NBio- CO2     | Total CO2     | CH4           | N2O           | CO2e          |
|--------------|--------------------|--------------------|--------------------|---------------|--------------------|---------------|--------------------|--------------------|---------------|--------------------|---------------|---------------|---------------|---------------|---------------|---------------|
| Category     | tons/yr            |                    |                    |               |                    |               |                    |                    |               |                    | MT/yr         |               |               |               |               |               |
| Hauling      | 0.0000             | 0.0000             | 0.0000             | 0.0000        | 0.0000             | 0.0000        | 0.0000             | 0.0000             | 0.0000        | 0.0000             | 0.0000        | 0.0000        | 0.0000        | 0.0000        | 0.0000        | 0.0000        |
| Vendor       | 0.0000             | 0.0000             | 0.0000             | 0.0000        | 0.0000             | 0.0000        | 0.0000             | 0.0000             | 0.0000        | 0.0000             | 0.0000        | 0.0000        | 0.0000        | 0.0000        | 0.0000        | 0.0000        |
| Worker       | 1.0000e-005        | 1.0000e-005        | 1.2000e-004        | 0.0000        | 4.0000e-005        | 0.0000        | 4.0000e-005        | 1.0000e-005        | 0.0000        | 1.0000e-005        | 0.0000        | 0.0328        | 0.0328        | 0.0000        | 0.0000        | 0.0331        |
| <b>Total</b> | <b>1.0000e-005</b> | <b>1.0000e-005</b> | <b>1.2000e-004</b> | <b>0.0000</b> | <b>4.0000e-005</b> | <b>0.0000</b> | <b>4.0000e-005</b> | <b>1.0000e-005</b> | <b>0.0000</b> | <b>1.0000e-005</b> | <b>0.0000</b> | <b>0.0328</b> | <b>0.0328</b> | <b>0.0000</b> | <b>0.0000</b> | <b>0.0331</b> |

Palomar Hydrogen Project - San Diego County, Annual

EMFAC Off-Model Adjustment Factors for Gasoline Light Duty Vehicle to Account for the SAFE Vehicle Rule Not Applied

4.0 Operational Detail - Mobile

4.1 Mitigation Measures Mobile

|             | ROG     | NOx    | CO     | SO2    | Fugitive PM10 | Exhaust PM10 | PM10 Total | Fugitive PM2.5 | Exhaust PM2.5 | PM2.5 Total | Bio- CO2 | NBio- CO2 | Total CO2 | CH4    | N2O    | CO2e   |
|-------------|---------|--------|--------|--------|---------------|--------------|------------|----------------|---------------|-------------|----------|-----------|-----------|--------|--------|--------|
| Category    | tons/yr |        |        |        |               |              |            |                |               |             | MT/yr    |           |           |        |        |        |
| Mitigated   | 0.0000  | 0.0000 | 0.0000 | 0.0000 | 0.0000        | 0.0000       | 0.0000     | 0.0000         | 0.0000        | 0.0000      | 0.0000   | 0.0000    | 0.0000    | 0.0000 | 0.0000 | 0.0000 |
| Unmitigated | 0.0000  | 0.0000 | 0.0000 | 0.0000 | 0.0000        | 0.0000       | 0.0000     | 0.0000         | 0.0000        | 0.0000      | 0.0000   | 0.0000    | 0.0000    | 0.0000 | 0.0000 | 0.0000 |

4.2 Trip Summary Information

| Land Use               | Average Daily Trip Rate |          |        | Unmitigated | Mitigated  |
|------------------------|-------------------------|----------|--------|-------------|------------|
|                        | Weekday                 | Saturday | Sunday | Annual VMT  | Annual VMT |
| General Light Industry | 0.00                    | 0.00     | 0.00   |             |            |
| Total                  | 0.00                    | 0.00     | 0.00   |             |            |

4.3 Trip Type Information

| Land Use               | Miles      |            |             | Trip %     |            |             | Trip Purpose % |          |         |
|------------------------|------------|------------|-------------|------------|------------|-------------|----------------|----------|---------|
|                        | H-W or C-W | H-S or C-C | H-O or C-NW | H-W or C-W | H-S or C-C | H-O or C-NW | Primary        | Diverted | Pass-by |
| General Light Industry | 9.50       | 7.30       | 7.30        | 59.00      | 28.00      | 13.00       | 92             | 5        | 3       |

4.4 Fleet Mix

| Land Use               | LDA      | LDT1     | LDT2     | MDV      | LHD1     | LHD2     | MHD      | HHD      | OBUS     | UBUS     | MCY      | SBUS     | MH       |
|------------------------|----------|----------|----------|----------|----------|----------|----------|----------|----------|----------|----------|----------|----------|
| General Light Industry | 0.553514 | 0.062792 | 0.181046 | 0.120736 | 0.024419 | 0.006214 | 0.008493 | 0.006184 | 0.000715 | 0.000556 | 0.029185 | 0.000982 | 0.005164 |





Palomar Hydrogen Project - San Diego County, Annual

**EMFAC Off-Model Adjustment Factors for Gasoline Light Duty Vehicle to Account for the SAFE Vehicle Rule Not Applied**

**5.3 Energy by Land Use - Electricity**

Unmitigated

|                        | Electricity Use | Total CO2     | CH4           | N2O           | CO2e          |
|------------------------|-----------------|---------------|---------------|---------------|---------------|
| Land Use               | kWh/yr          | MT/yr         |               |               |               |
| General Light Industry | 0               | 0.0000        | 0.0000        | 0.0000        | 0.0000        |
| <b>Total</b>           |                 | <b>0.0000</b> | <b>0.0000</b> | <b>0.0000</b> | <b>0.0000</b> |

Mitigated

|                        | Electricity Use | Total CO2     | CH4           | N2O           | CO2e          |
|------------------------|-----------------|---------------|---------------|---------------|---------------|
| Land Use               | kWh/yr          | MT/yr         |               |               |               |
| General Light Industry | 0               | 0.0000        | 0.0000        | 0.0000        | 0.0000        |
| <b>Total</b>           |                 | <b>0.0000</b> | <b>0.0000</b> | <b>0.0000</b> | <b>0.0000</b> |

**6.0 Area Detail**

**6.1 Mitigation Measures Area**





Palomar Hydrogen Project - San Diego County, Annual

**EMFAC Off-Model Adjustment Factors for Gasoline Light Duty Vehicle to Account for the SAFE Vehicle Rule Not Applied**

**6.2 Area by SubCategory**

Mitigated

|                       | ROG                | NOx           | CO            | SO2           | Fugitive PM10 | Exhaust PM10  | PM10 Total    | Fugitive PM2.5 | Exhaust PM2.5 | PM2.5 Total   | Bio- CO2      | NBio- CO2     | Total CO2     | CH4           | N2O           | CO2e          |
|-----------------------|--------------------|---------------|---------------|---------------|---------------|---------------|---------------|----------------|---------------|---------------|---------------|---------------|---------------|---------------|---------------|---------------|
| SubCategory           | tons/yr            |               |               |               |               |               |               |                |               |               | MT/yr         |               |               |               |               |               |
| Architectural Coating | 0.0000             |               |               |               |               | 0.0000        | 0.0000        |                | 0.0000        | 0.0000        | 0.0000        | 0.0000        | 0.0000        | 0.0000        | 0.0000        | 0.0000        |
| Consumer Products     | 1.3000e-004        |               |               |               |               | 0.0000        | 0.0000        |                | 0.0000        | 0.0000        | 0.0000        | 0.0000        | 0.0000        | 0.0000        | 0.0000        | 0.0000        |
| Landscaping           | 0.0000             | 0.0000        | 0.0000        | 0.0000        |               | 0.0000        | 0.0000        |                | 0.0000        | 0.0000        | 0.0000        | 0.0000        | 0.0000        | 0.0000        | 0.0000        | 0.0000        |
| <b>Total</b>          | <b>1.3000e-004</b> | <b>0.0000</b> | <b>0.0000</b> | <b>0.0000</b> |               | <b>0.0000</b> | <b>0.0000</b> |                | <b>0.0000</b> | <b>0.0000</b> | <b>0.0000</b> | <b>0.0000</b> | <b>0.0000</b> | <b>0.0000</b> | <b>0.0000</b> | <b>0.0000</b> |

**7.0 Water Detail**

---

**7.1 Mitigation Measures Water**

Palomar Hydrogen Project - San Diego County, Annual

**EMFAC Off-Model Adjustment Factors for Gasoline Light Duty Vehicle to Account for the SAFE Vehicle Rule Not Applied**

|             | Total CO2 | CH4    | N2O    | CO2e   |
|-------------|-----------|--------|--------|--------|
| Category    | MT/yr     |        |        |        |
| Mitigated   | 0.0000    | 0.0000 | 0.0000 | 0.0000 |
| Unmitigated | 0.0000    | 0.0000 | 0.0000 | 0.0000 |

**7.2 Water by Land Use**

**Unmitigated**

|                        | Indoor/Outdoor Use | Total CO2     | CH4           | N2O           | CO2e          |
|------------------------|--------------------|---------------|---------------|---------------|---------------|
| Land Use               | Mgal               | MT/yr         |               |               |               |
| General Light Industry | 0 / 0              | 0.0000        | 0.0000        | 0.0000        | 0.0000        |
| <b>Total</b>           |                    | <b>0.0000</b> | <b>0.0000</b> | <b>0.0000</b> | <b>0.0000</b> |

Palomar Hydrogen Project - San Diego County, Annual

**EMFAC Off-Model Adjustment Factors for Gasoline Light Duty Vehicle to Account for the SAFE Vehicle Rule Not Applied**

**7.2 Water by Land Use**

Mitigated

|                        | Indoor/Outdoor Use | Total CO2     | CH4           | N2O           | CO2e          |
|------------------------|--------------------|---------------|---------------|---------------|---------------|
| Land Use               | Mgal               | MT/yr         |               |               |               |
| General Light Industry | 0 / 0              | 0.0000        | 0.0000        | 0.0000        | 0.0000        |
| <b>Total</b>           |                    | <b>0.0000</b> | <b>0.0000</b> | <b>0.0000</b> | <b>0.0000</b> |

**8.0 Waste Detail**

---

**8.1 Mitigation Measures Waste**

Category/Year

|             | Total CO2 | CH4    | N2O    | CO2e   |
|-------------|-----------|--------|--------|--------|
|             | MT/yr     |        |        |        |
| Mitigated   | 0.0000    | 0.0000 | 0.0000 | 0.0000 |
| Unmitigated | 0.0000    | 0.0000 | 0.0000 | 0.0000 |

Palomar Hydrogen Project - San Diego County, Annual

**EMFAC Off-Model Adjustment Factors for Gasoline Light Duty Vehicle to Account for the SAFE Vehicle Rule Not Applied**

**8.2 Waste by Land Use**

**Unmitigated**

|                        | Waste Disposed | Total CO2     | CH4           | N2O           | CO2e          |
|------------------------|----------------|---------------|---------------|---------------|---------------|
| Land Use               | tons           | MT/yr         |               |               |               |
| General Light Industry | 0              | 0.0000        | 0.0000        | 0.0000        | 0.0000        |
| <b>Total</b>           |                | <b>0.0000</b> | <b>0.0000</b> | <b>0.0000</b> | <b>0.0000</b> |

**Mitigated**

|                        | Waste Disposed | Total CO2     | CH4           | N2O           | CO2e          |
|------------------------|----------------|---------------|---------------|---------------|---------------|
| Land Use               | tons           | MT/yr         |               |               |               |
| General Light Industry | 0              | 0.0000        | 0.0000        | 0.0000        | 0.0000        |
| <b>Total</b>           |                | <b>0.0000</b> | <b>0.0000</b> | <b>0.0000</b> | <b>0.0000</b> |

**9.0 Operational Offroad**

| Equipment Type | Number | Hours/Day | Days/Year | Horse Power | Load Factor | Fuel Type |
|----------------|--------|-----------|-----------|-------------|-------------|-----------|
|----------------|--------|-----------|-----------|-------------|-------------|-----------|

Palomar Hydrogen Project - San Diego County, Annual

**EMFAC Off-Model Adjustment Factors for Gasoline Light Duty Vehicle to Account for the SAFE Vehicle Rule Not Applied**

**10.0 Stationary Equipment**

---

**Fire Pumps and Emergency Generators**

| Equipment Type | Number | Hours/Day | Hours/Year | Horse Power | Load Factor | Fuel Type |
|----------------|--------|-----------|------------|-------------|-------------|-----------|
|----------------|--------|-----------|------------|-------------|-------------|-----------|

**Boilers**

| Equipment Type | Number | Heat Input/Day | Heat Input/Year | Boiler Rating | Fuel Type |
|----------------|--------|----------------|-----------------|---------------|-----------|
|----------------|--------|----------------|-----------------|---------------|-----------|

**User Defined Equipment**

| Equipment Type | Number |
|----------------|--------|
|----------------|--------|

**11.0 Vegetation**

---