

DOCKETED

Docket Number:	21-ESR-01
Project Title:	Energy System Reliability
TN #:	240249
Document Title:	Steve Uhler Comments - ESR-21-01 The LOLE approach
Description:	N/A
Filer:	System
Organization:	Steve Uhler
Submitter Role:	Other Interested Person
Submission Date:	11/4/2021 9:02:28 AM
Docketed Date:	11/4/2021

*Comment Received From: Steve Uhler
Submitted On: 11/4/2021
Docket Number: 21-ESR-01*

ESR-21-01 The LOLE approach

ESR-21-01 The LOLE approach

Dear Commissioner Gunda,

The commission's misinterpreted use LOLE where the commission states "The typical standard is for the analysis to predict a loss-of-load event no more than once every 10 years." is misleading.

Based on the attached NERC document, the commission has misinterpreted LOLE as a frequency index.

TN239881 (<https://efiling.energy.ca.gov/GetDocument.aspx?tn=239881>) describes the LOLE approach as:

"The LOLE approach considers the probability of a wide range of distributions of key variables and relies on thousands of simulations drawing randomly from different combinations of demand, solar, and wind profiles as well as unexpected plant outages to arrive at the LOLE metrics."

and

"The LOLE approach considers the probability for a wide range of distributions of key variables, including demand, solar, wind, and forced outages (or unplanned outages). These probability distributions are randomly sampled thousands of times for each scenario. Each sample is then run to produce results for each sample. These results are then compiled into a collection for each scenario. This compilation of results is analyzed to arrive at the LOLE metrics."

and

"Reliability Analysis and Considerations

Reliability analysis is an essential component of electric sector planning. For the purposes of long-term planning and procurement, reliability need is typically assessed through loss of load expectation (LOLE) studies, which are stochastic analyses. They draw on a distribution of future demand profiles, historic wind and solar profiles, and randomized forced outages to determine a probability for a supply shortfall, for a given mix of resources expected to be connected to the grid. The typical standard of reliability for this analysis is to meet a loss of load event of no more than one day of unserved energy every 10 years. A day with unserved energy means a single day with any length of outage."

Basic Probability and Reliability Concepts

1. Develop an expression for the reliability of the following system. Calculate the system reliability if all the components have a reliability of 0.8.

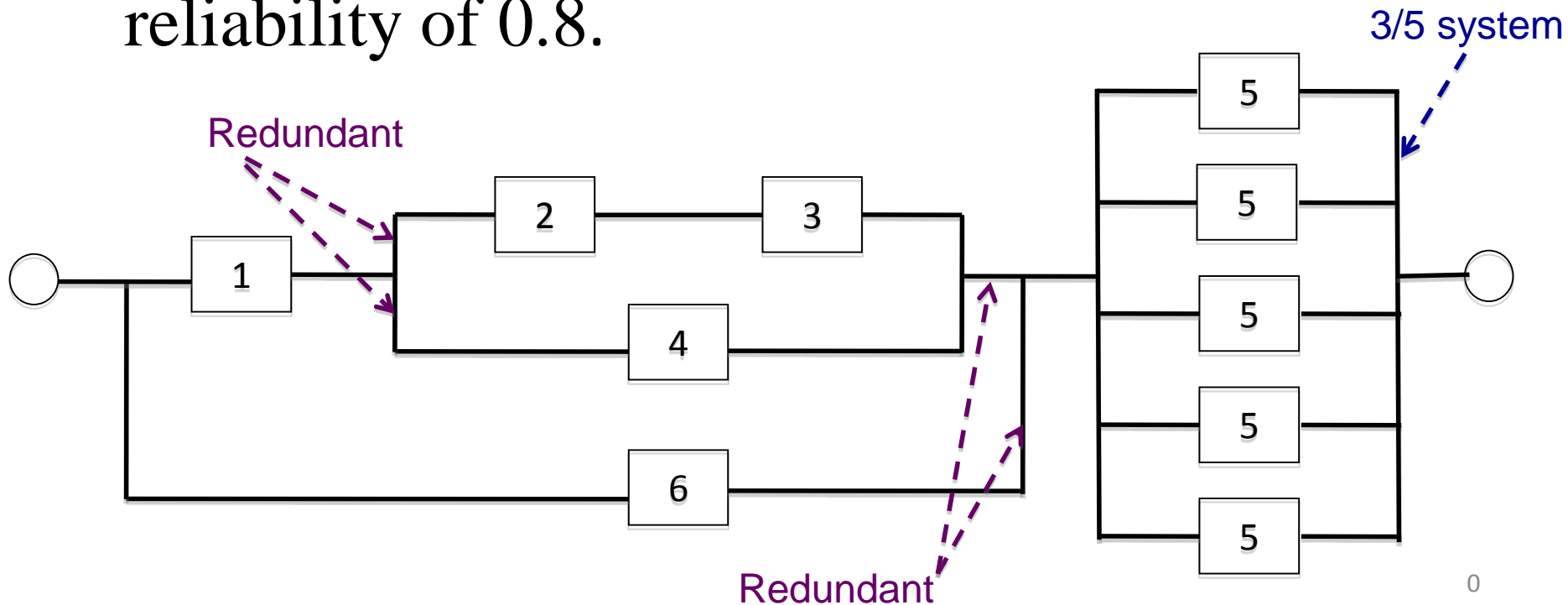

Basic Probability and Reliability Concepts

$$R_S = [R_1(R_2R_3 + R_4 - R_2R_3R_4) + R_6 - R_1R_6(R_2R_3 + R_4 - R_2R_3R_4)] \\ \times [R_5^5 + 5R_5^4Q_5 + 10R_5^3Q_5^2]$$

$$R = 0.8$$

$$R_S = [0.8(0.928) + 0.8 - 0.64(0.928)][0.942080] \\ = [0.948480][0.94208] = \underline{0.893544}$$

Basic Probability and Reliability Concepts

2. (a) Calculate the availability of the following system if each component has a failure rate of 5 f/yr and an average repair time of 92.21 hours.

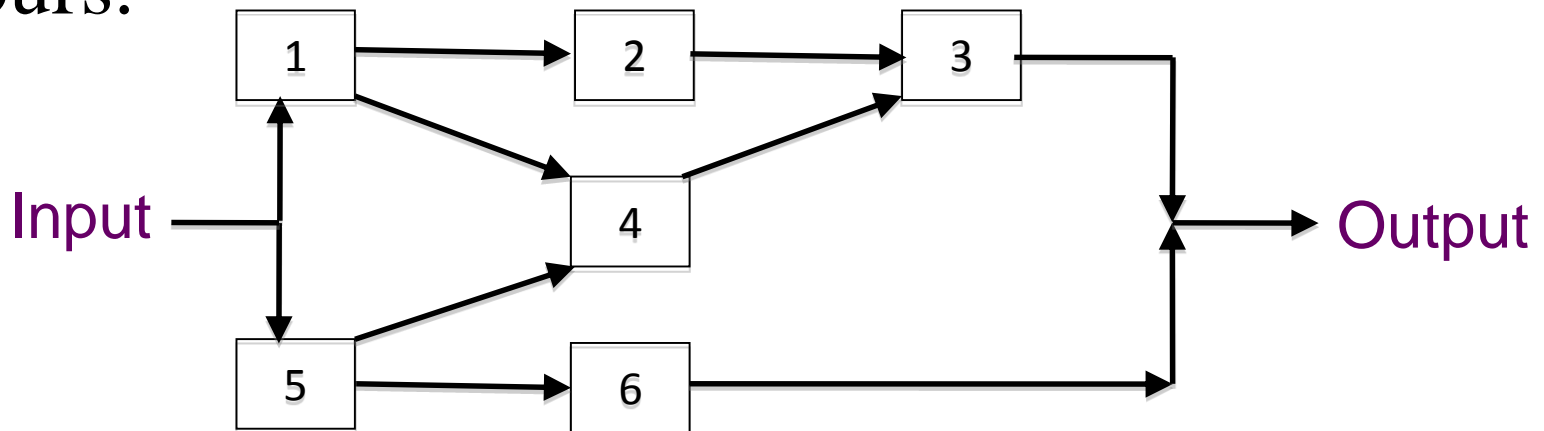

(b) Estimate the system availability using minimal cut sets.

Basic Probability and Reliability Concepts

$$R_s = R_s(4 \text{ is good})R_4 + R_s(4 \text{ is bad})Q_4$$

Given **4 is good**

$$\begin{aligned} R_s &= R_s(3 \text{ is good})R_3 + R_s(3 \text{ is bad})Q_3 \\ &= (R_1 + R_5 - R_1R_5) R_3 + (R_5R_6) Q_3 \end{aligned}$$

Given **4 is bad**

$$R_s = R_1R_2R_3 + R_5R_6 - R_1R_2R_3R_5R_6$$

Substituting

$$\begin{aligned} R_s &= R_4[(R_1 + R_5 - R_1R_5) R_3 + (R_5R_6) Q_3] \\ &\quad + Q_4[R_1R_2R_3 + R_5R_6 - R_1R_2R_3R_5R_6] \end{aligned}$$

Basic Probability and Reliability Concepts

$$\text{Component Unavailability} = Q = \frac{\lambda}{\lambda + \mu} = \frac{5}{5 + 95} = 0.05$$

$$\begin{aligned} \text{System availability} &= (0.95)[0.99275] + (0.05)[0.986094] \\ &= \underline{0.992417} \end{aligned}$$

$$\text{System Unavailability} = \underline{0.007583}$$

Basic Probability and Reliability Concepts

Min Cuts	Probability
1, 5	0.0025
3, 5	0.0025
3, 6	0.0025
2, 4, 5	0.000125
2, 4, 6	0.000125
1, 4, 6	0.000125
System Unavailability	≤ 0.007875
System Availability	≥ 0.992125

Basic Probability and Reliability Concepts

1. Develop an expression for the reliability of the following system. Calculate the system reliability if all the components have a reliability of 0.8.

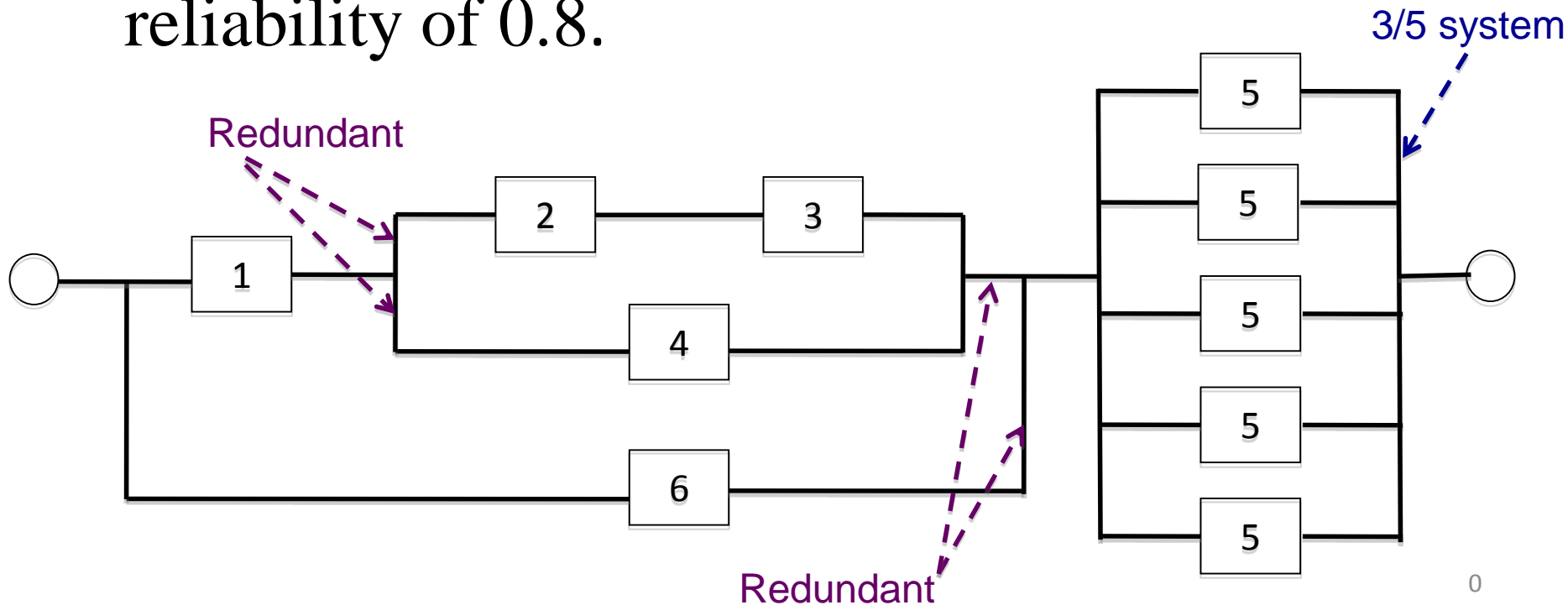

Basic Probability and Reliability Concepts

2. (a) Calculate the availability of the following system if each component has a failure rate of 5 f/yr and an average repair time of 92.21 hours.

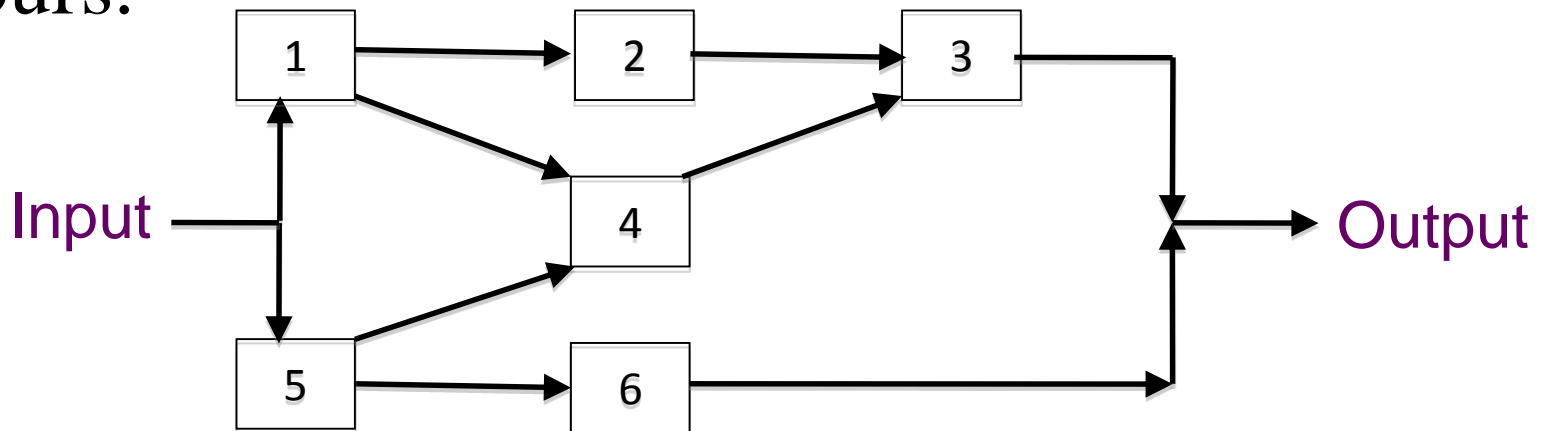

(b) Estimate the system availability using minimal cut sets.

Generating Capacity Reliability Evaluation

1. A generating system contains three 25 MW generating units each with a 4% FOR and one 30 MW unit with a 5% FOR. If the peak load for a 100 day period is 75 MW, what is the LOLE and LOEE for this period. Assume that the appropriate load characteristic is a straight line from the 100% to the 60% point.

Generating Capacity Reliability Evaluation

3 - 25 MW units

$U = 0.04$

Cap Out	Probability
---------	-------------

0	0.884736
---	----------

25	0.110592
----	----------

50	0.004608
----	----------

75	<u>0.000064</u>
----	-----------------

	<u>1.000000</u>
--	-----------------

1 - 30 MW units

$U = 0.05$

Cap Out	Probability
---------	-------------

0	0.95
---	------

30	0.05
----	------

	<u>1.000000</u>
--	-----------------

Generating Capacity Reliability Evaluation

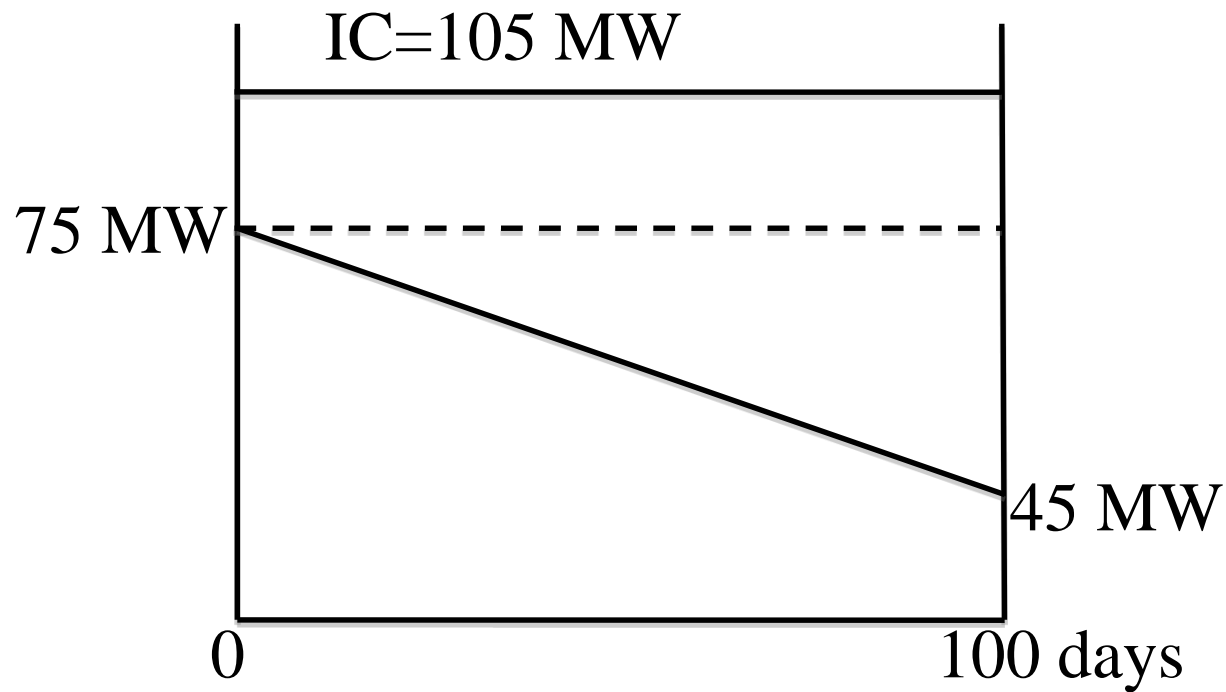

Generating Capacity Reliability Evaluation

Total Capacity

Cap Out	Probability	Time (hrs)	Energy (MWh)
0	0.840499	--	
25	0.105062	--	
30	0.044237	--	
50	0.004378	1600	16,000
55	0.005530	2000	25,000
75	0.000061	2400	72,000
80	0.000230	2400	84,000
105	0.000003	2400	144,000
	1.0		

Generating Capacity Reliability Evaluation

$$LOLE = \sum_{k=1}^n p_k t_k = \mathbf{18.77 \text{ hrs/100d period}}$$

$$LOEE = \sum_{k=1}^n p_k E_k = \mathbf{232.44 \text{ MWh / 100 day period}}$$

Generating Capacity Reliability Evaluation

- Loss of Load Expectation, LOLE = 18.77 hrs/100 d period
- Loss of Energy Expectation, LOEE = 232.44 MWh/100 d period
- Energy Index Reliability EIR = $1 - \frac{232.44}{144,000} = \underline{0.998386}$
- Energy Index of Unavailability EIU = 0.001614
- Units per Million UPM = 1614
- System Minutes SM = $\frac{232.44}{75} \times 60 = \underline{185.95}$

Generating Capacity Reliability Evaluation

2. Two power systems are interconnected by a 20 MW tie line. System A has three 20 MW generating units with forced outage rate of 10%. System B has two 30 MW units with forced outage rates of 20%. Calculate the LOLE in System A for a one-day period, given that the peak load in both System A and System B is 30 MW.

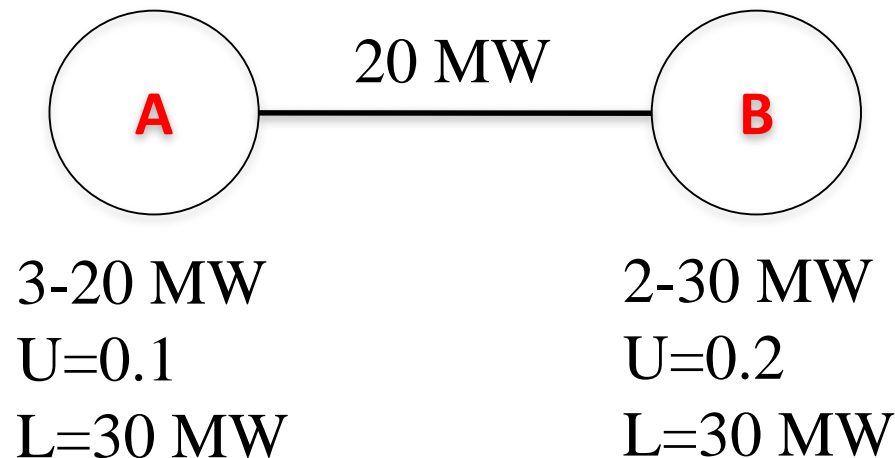

Generating Capacity Reliability Evaluation

System A

Cap Out	Probability
---------	-------------

0	0.729
---	-------

20	0.243
----	-------

40	0.027
----	-------

60	<u>0.001</u>
----	--------------

System B

Cap Out	Probability
---------	-------------

0	0.64
---	------

30	0.32
----	------

60	0.04
----	------

	<u>1.00</u>
--	-------------

Generating Capacity Reliability Evaluation

Capacity Array Approach

System B

		0	30	60
<u>System A</u>	0	0.46656	0.23328	0.02916
	20	0.15552	0.07776	0.00972
	40	0.01728	0.00864	0.00108
	60	0.00064	0.00032	0.00004

$\text{LOLE(A)[Single System]} = 0.028 \text{ days/day}$

$\text{LOLE(A)[Interconnected System]} = 0.01072 \text{ days/day}$

Generating Capacity Reliability Evaluation

Equivalent Unit Approach

20 MW Assisting Unit

Modified System A IC = 80 MW

Cap Out	Probability	Cap Out	Probability	Cum. Probability
0	0.64	0	0.46656	1
20	0.36	20	0.41796	0.53344
		40	0.10476	0.11548
		60	0.01036	0.01072
		80	0.00036	0.00036
			1.000000	

LOLE(A)[Interconnected System] = 0.01072 days/day

Generating Capacity Reliability Evaluation

1. A generating system contains three 25 MW generating units each with a 4% FOR and one 30 MW unit with a 5% FOR. If the peak load for a 100 day period is 75 MW, what is the LOLE and LOEE for this period. Assume that the appropriate load characteristic is a straight line from the 100% to the 60% point.

Generating Capacity Reliability Evaluation

2. Two power systems are interconnected by a 20 MW tie line. System A has three 20 MW generating units with forced outage rate of 10%. System B has two 30 MW units with forced outage rates of 20%. Calculate the LOLE in System A for a one-day period, given that the peak load in both System A and System B is 30 MW.

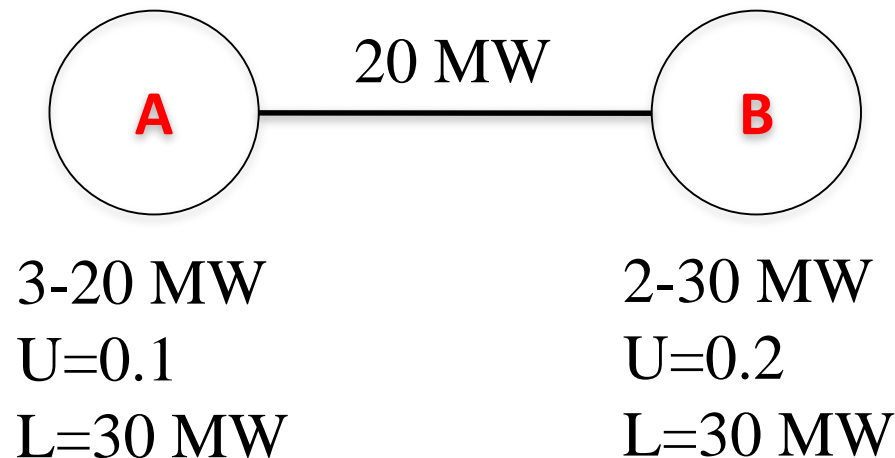

Transmission System Reliability Evaluation

1. Consider the following system

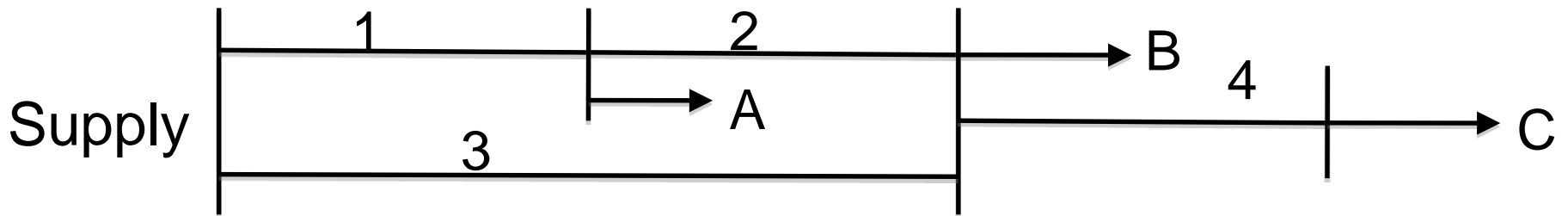

The supply is assumed to have a failure rate of 0.5 f/yr with an average repair time of 2 hours. The line data are as follows.

Transmission System Reliability Evaluation

<u>Line</u>	<u>Failure Rate</u>	<u>Average Repair Time</u>
1	4.0 f/yr	8 hrs
2	2.0	6
3	6.0	8
4	2.0	12

Use the minimal cut set approach to calculate a suitable set of indices at each load point.

Transmission System Reliability Evaluation

Load Point A

Min Cut	λ (f/yr)	r (hrs)	U (hrs/yr)
Supply	0.5	2.0	1.0
1, 3	0.043836	4.0	0.175344
1, 2	0.012785	3.4286	0.043835
	<hr/>		
	0.556621	2.19	1.219179

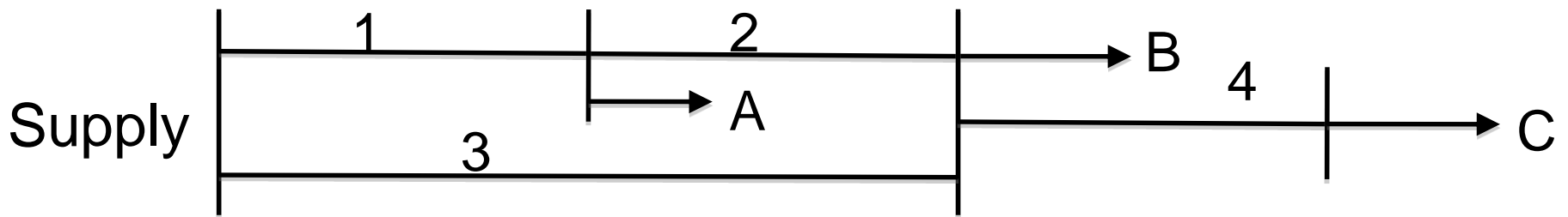

Transmission System Reliability Evaluation

Load Point B

Min Cut	λ (f/yr)	r (hrs)	U(hrs/yr)
Supply	0.5	2.0	1.0
1, 3	0.043836	4.0	0.175344
2, 3	0.019178	3.4285	0.065753
	0.563014	2.2044	1.241097

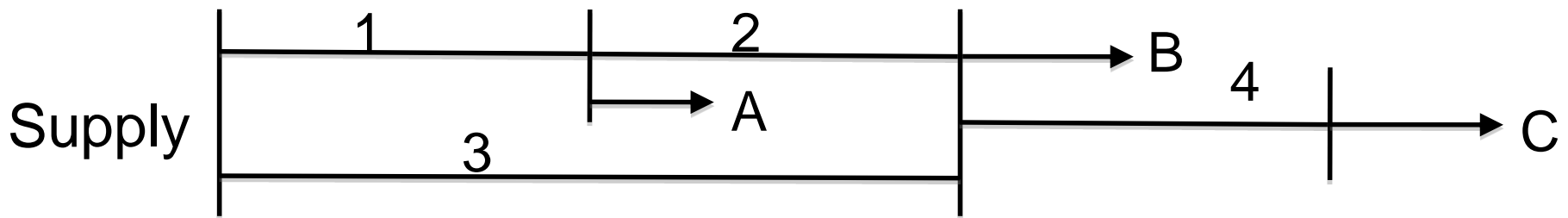

Transmission System Reliability Evaluation

Load Point C

Min Cut	λ (f/yr)	r (hrs)	U(hrs/yr)
At B	0.563014	2.2044	1.241097
4	2.0	12	24
	2.563014	9.848	25.241097

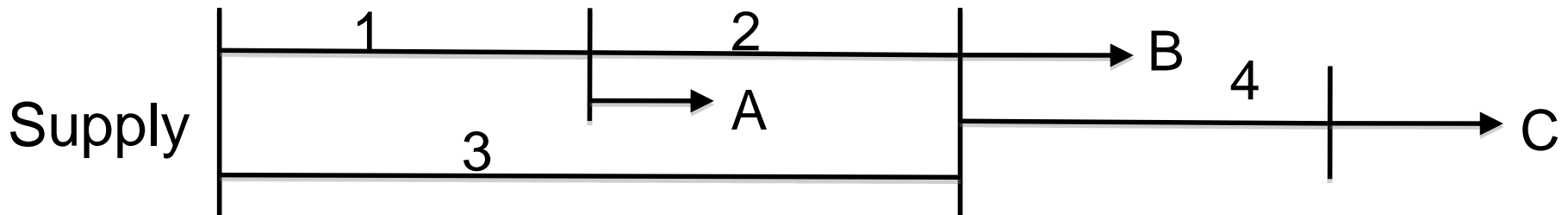

Transmission System Reliability Evaluation

Summary

Min Cut	λ (f/yr)	r (hrs)	U (hrs/yr)
A	0.5566	2.19	1.219
B	0.5630	2.20	1.241
C	2.5630	9.85	25.241

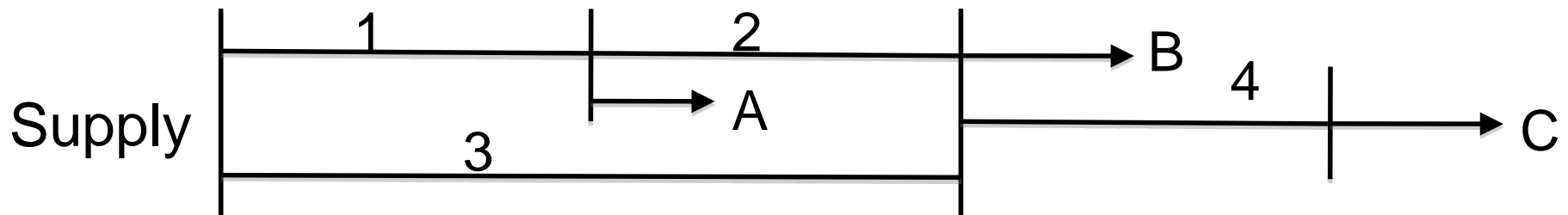

Composite System Reliability Evaluation

2. A four unit hydro plant serves a remote load through two transmission lines. The four units are connected to a single step-up transformer which is then connected to two transmission lines. The remote load has a daily peak load variation curve which is a straight line from the 100% to the 60% point. Calculate the annual loss of load expectation for a forecast peak of 70 MW using the following data.

Hydro Units – 25 MW

FOR = 2%

Transformer – 110 MVA

U = 0.2%

Transmission lines – Carrying capability 50 MW per line

– Failure rate = 2 f/yr

– Average repair time = 24 hrs

Composite System Reliability Evaluation

Calculate the LOLE in three stages using the following configurations.

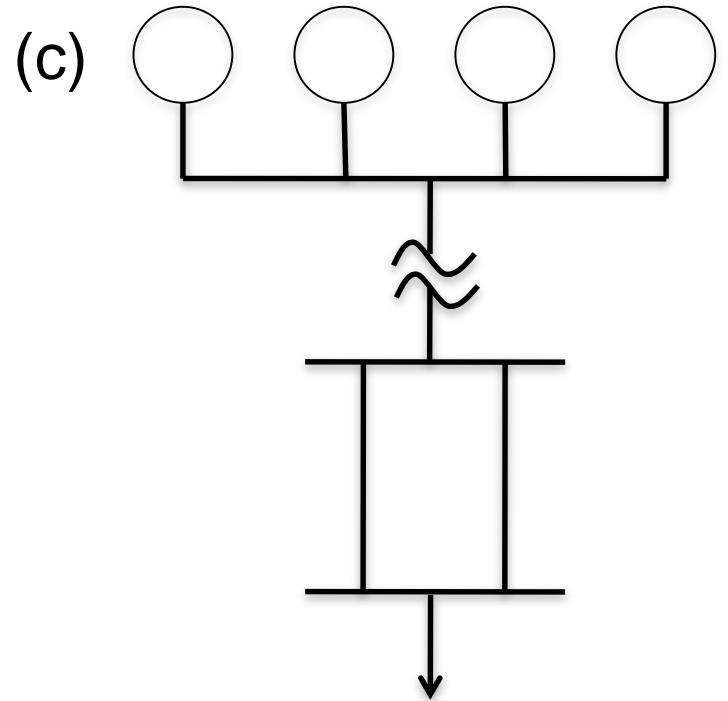
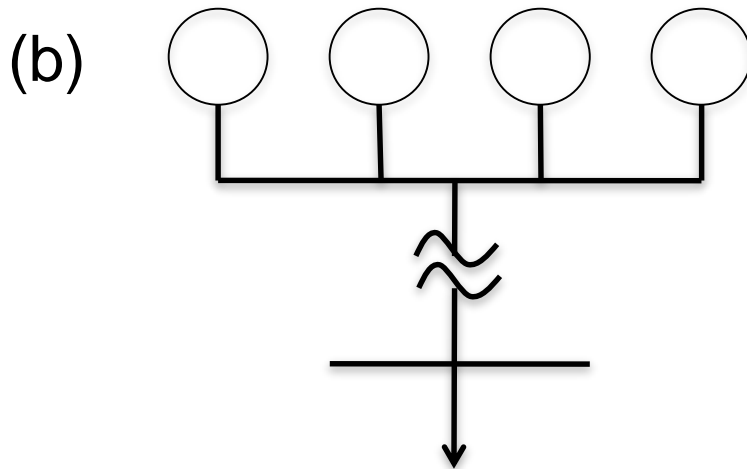
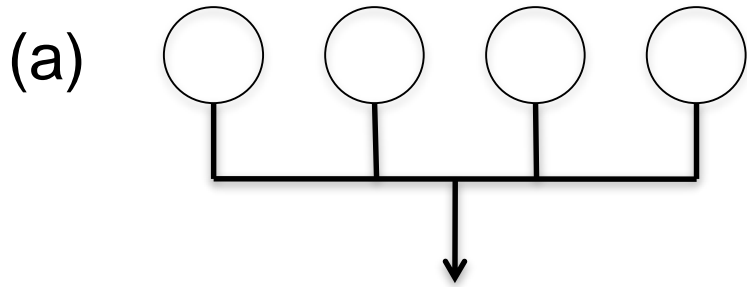

- (d) Calculate the LOLE for Configuration (b), if the single step-up transformer is removed and replaced by individual unit step-up transformers with a FOR of 0.2%.**
- (e) Calculate the LOLE for the conditions in (d) with each transmission line rated at 50 MW.**
- (f) Calculate the LOLE for the conditions in (d) with each transmission line rated at 75 MW.**
- (g) Calculate the LOLE for the conditions in (d) with each transmission line rated at 100 MW.**
- (h) Calculate the LOLE for the conditions in (f) with Model 1 common mode TL failure. [$\lambda_c = 0.2$ f/yr]**
- (i) Calculate the LOLE for the conditions in (f) with Model 3 common mode TL failure. [$\lambda_c = 0.2$ f/yr, $r_c = 36$ hr]**

Composite System Reliability Evaluation

Configuration (a)

Capacity Out	Probability	Time	Expectation
0 MW	0.922368	0.0	
25	0.075295	0.0	
50	0.002305	260.71	0.600937
75	0.000032	365.0	0.011680
100	-	365.0	-
	<u>1.000000</u>		<u>0.612617</u>

LOLE = 0.613 days/yr

Composite System Reliability Evaluation

Configuration (b)

Capacity Out	Probability	Time	Expectation
0 MW	0.920524	0.0	
25	0.075144	0.0	
50	0.002300	260.71	0.599633
75	0.000032	365.0	0.011680
100	0.002000	365.0	0.730000
	<u>1.000000</u>		<u>1.341313</u>

LOLE = 1.341 days/yr

Composite System Reliability Evaluation

Configuration (c)

Transmission lines $\lambda = 2 \quad f / yr$

$$\mu = \frac{1}{r} = \frac{8760}{24} = 365 \quad r / yr$$

$$Unavailability = \frac{\lambda}{\lambda + \mu} = \frac{2}{2 + 365} = 0.005450$$

<i>Availability</i> = 0.994550	<u>Cap. Out</u>	<u>Probability</u>
	0 MW	0.989130
	50	0.010840
	100	<u>0.000030</u>
		<u>1.000000</u>

Composite System Reliability Evaluation

		Generation – In (MW)				
		100	75	50	25	0
Transmission-In (MW)	100	100	75	50	25	0
	50	50	50	50	25	0
	0	0	0	0	0	0

System Capacity States

Composite System Reliability Evaluation

Configuration (c)

<u>Capacity</u>		<u>Probability</u>	<u>Time</u>	<u>Expectation</u>
<u>In</u>	<u>Out</u>			
100	0	0.910518	0.0	
75	25	0.074327	0.0	
50	50	0.013093	260.71	3.413476
25	75	0.000032	365.0	0.011680
0	100	<u>0.002030</u>	365.0	<u>0.740950</u>
		<u>1.000000</u>		<u>4.166106</u>

LOLE = 4.166 days/yr

Composite System Reliability Evaluation

Configuration (d)

Calculate the LOLE for Configuration (b), if the single step-up transformer is removed and replaced by individual unit step-up transformers with a FOR of 0.2%.

$$\text{Generating unit FOR} = 0.02 + 0.002 - (0.02)(0.002)$$

$$U = 0.021960$$

$$A = 0.978040$$

Composite System Reliability Evaluation

Configuration (d)

<u>Capacity</u>		<u>Probability</u>	<u>Time</u>	<u>Expectation</u>
<u>In</u>	<u>Out</u>			
100	0	0.915012	0.0	
75	25	0.082179	0.0	
50	50	0.002768	260.71	0.721645
25	75	0.000041	365.0	0.014965
0	100	-	365.0	-
		<u>1.000000</u>		<u>0,733661</u>

LOLE = 0.734 days/yr

(e) Calculate the LOLE for the conditions in (d) with each transmission line rated at 50 MW.

<u>Capacity</u>		<u>Probability</u>	<u>Time</u>	<u>Expectation</u>
<u>In</u>	<u>Out</u>			
100	0	0.905066	0.0	
75	25	0.081286	0.0	
50	50	0.013577	260.71	3.539660
25	75	0.000041	365.0	0.014965
0	100	<u>0.000030</u>	365.0	<u>0.010950</u>
		<u>1.000000</u>		<u>3.565575</u>

LOLE = 3.566 days/yr

(f) Calculate the LOLE for the conditions in (d) with each transmission line rated at 75 MW.

<u>Capacity</u>		<u>Probability</u>	<u>Time</u>	<u>Expectation</u>
<u>In</u>	<u>Out</u>			
100	0	0.905066	0.0	
75	25	0.092095	0.0	
50	50	0.002768	260.71	0.721645
25	75	0.000041	365.0	0.014965
0	100	<u>0.000030</u>	365.0	<u>0.010950</u>
		<u>1.000000</u>		<u>0.747550</u>

LOLE = 0.748 days/yr

(g) Calculate the LOLE for the conditions in (d) with each transmission line rated at 100 MW.

<u>Capacity</u>		<u>Probability</u>	<u>Time</u>	<u>Expectation</u>
<u>In</u>	<u>Out</u>			
100	0	0.914985	0.0	
75	25	0.082177	0.0	
50	50	0.002768	260.71	0.721645
25	75	0.000041	365.0	0.014965
0	100	<u>0.000030</u>	365.0	<u>0.010950</u>
		<u>1.000000</u>		<u>0.747550</u>

LOLE = 0.748 days/yr

(h) Calculate the LOLE for the conditions in (f) with Model 1 common mode TL failure.

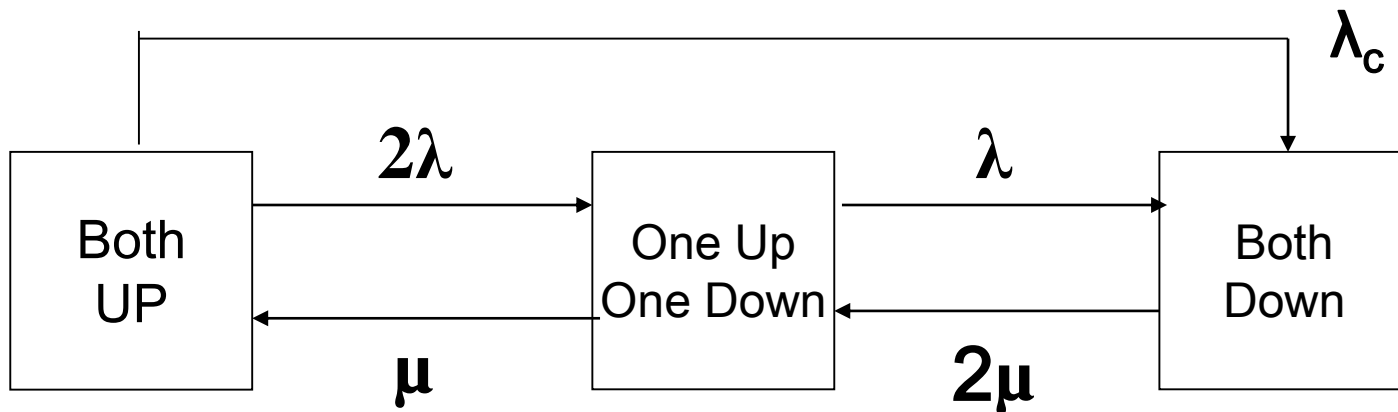

P(Both Up)	= 0.988326
P(One Up and One Down)	= 0.011372
P(Both Down)	= 0.000302

Markov analysis of Model 1

$$P_4 = [\lambda_1 \lambda_2 (\lambda_1 + \lambda_2 + \mu_1 + \mu_2) + \lambda_c (\lambda_1 + \mu_2)(\lambda_2 + \mu_1)] / D$$

$$D = (\lambda_1 + \mu_1)(\lambda_2 + \mu_2)(\lambda_1 + \lambda_2 + \mu_1 + \mu_2) + \lambda_c [(\lambda_1 + \mu_1)(\lambda_2 + \mu_1 + \mu_2) + \mu_2 (\lambda_2 + \mu_2)]$$

If the two components are identical

$$P_4 = [2\lambda^2 + \lambda_c (\lambda + \mu)] / [2(\lambda + \mu)^2 + \lambda_c (\lambda + 3\mu)]$$

$$= P(\text{Both Down}) = 0.000302$$

The basic reliability indices for Model 1 can be estimated using an approximate method [1].

System failure rate = $\lambda_s = \lambda_1 \lambda_2 (r_1 + r_2) + \lambda_c$

Average system outage time = $r_s = (r_1 r_2) / (r_1 + r_2)$

System unavailability = $U_s = \lambda_s r_s$

P(Both Down) = 0.000304

Approximate calculation for:

$$\begin{aligned} P(\text{One line Up \& One line Down}) &= 2 A_L \cdot U_L \\ &= 2 \cdot (2/367) \cdot (365/367) \\ &= \underline{0.010840} \end{aligned}$$

$$\begin{aligned} P(\text{Both lines Up}) &= 1.0 - 0.010840 - 0.000304 \\ &= \underline{0.988856} \end{aligned}$$

Combine the generation and transmission states.

$$\mathbf{LOLE = 0.847310 \text{ days/year}}$$

Approximate method applied to Model 3

In this case:

$$\lambda_s = \lambda_1 \lambda_2 (r_1 + r_2) + \lambda_c$$

$$U_s = \lambda_1 \lambda_2 r_1 r_2 + \lambda_c r_c$$

$$r_s = U_s / \lambda_s$$

$$P(\text{Both Down}) = 0.000852$$

Approximate calculation for:

$$\begin{aligned} P(\text{One line Up \& One line Down}) &= 2 A_L \cdot U_L \\ &= 2 \cdot (2/367) \cdot (365/367) \\ &= \underline{0.010840} \end{aligned}$$

$$\begin{aligned} P(\text{Both lines Up}) &= 1.0 - 0.010840 - 0.000852 \\ &= \underline{0.988308} \end{aligned}$$

Combine the generation and transmission states.

$$\mathbf{LOLE = 1.47069 \text{ days/year}}$$

Composite System Reliability Evaluation

<u>Conditions</u>	<u>LOLE d/y</u>
(a) Generation (G) only	0.613
(b) (G) with single transformer (T)	1.341
(c) G, T and two 50 MW transmission lines	4.166
(d) (G) with unit transformers	0.734
(e) Generation only	0.613
(f) Condition (d) with two 50 MW transmission lines	3.566
(g) Condition (d) with two 75 MW transmission lines	0.748
(h) Condition (d) with two 100 MW transmission lines	0.748
(i) Condition (f) with Model 1 common mode TL failure	0.847
(j) Condition (f) with Model 3 common mode TL failure	1.471

Composite System Reliability Evaluation

2. Consider the following system

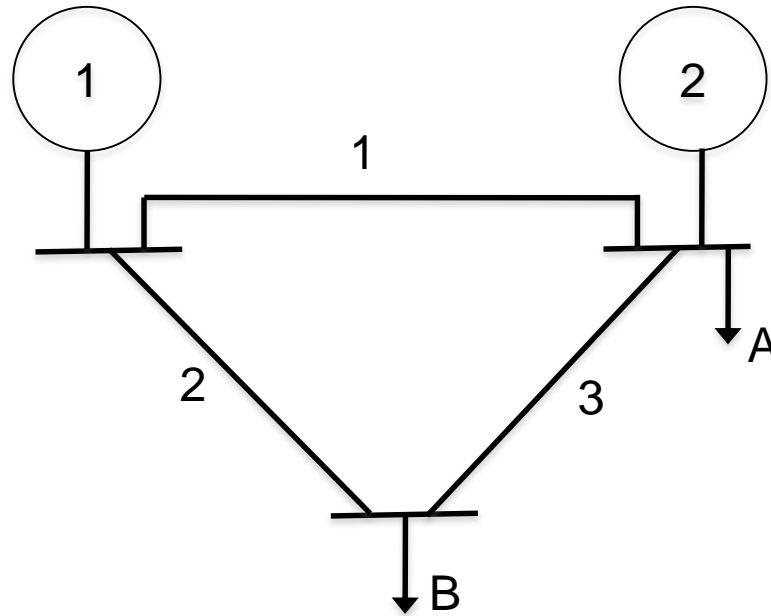

1. Calculate the probability of load curtailment at load points A and B
2. Calculate the EENS at load points A and B

Composite System Reliability Evaluation

- System Data

Generating Stations

1. 4*25 MW units $\lambda = 2.0$ f / yr $\mu = 98.0r / yr$
2. 2*40 MW units $\lambda = 3.0$ f / yr $\mu = 57.0r / yr$

Loads

A 80 MW

B 60 MW

Transmission Lines

- 1 $\lambda = 4 f / yr,$ $r = 8hrs,$ $LCC = 80MW$
- 2 $\lambda = 5 f / yr,$ $r = 8hrs,$ $LCC = 60MW$
- 3 $\lambda = 3 f / yr,$ $r = 12hrs,$ $LCC = 50MW$

Composite System Reliability Evaluation

- Conditions
 - Assume that the loads are constant
 - Assume that the transmission loss is zero
 - Consider up to two simultaneous outages
 - Assume that all load deficiencies are shared equally where possible.

Composite System Reliability Evaluation

- Element Probabilities

<u>Element</u>	<u>λ</u>	<u>μ/r</u>	<u>A</u>	<u>U</u>
25 MW unit	2.0 f/yr	98.0 r/yr	0.98	0.02
40 MW unit	3.0	57.0	0.95	0.05
L1	4.0	8 hrs	0.99636033	0.00363967
L2	5.0	8	0.99545455	0.00454545
L3	3.0	12	0.99590723	0.00409277

Composite System Reliability Evaluation

- Plant Probabilities

<u>Conditions</u>	<u>P(Plant 1)</u>	<u>P(Plant 2)</u>
All Units In	0.92236816	0.90250
1 Unit Out	0.07529536	0.09500
2 Unit Out	0.00230496	0.00250
All Lines In	0.98777209	

Basic Structure:

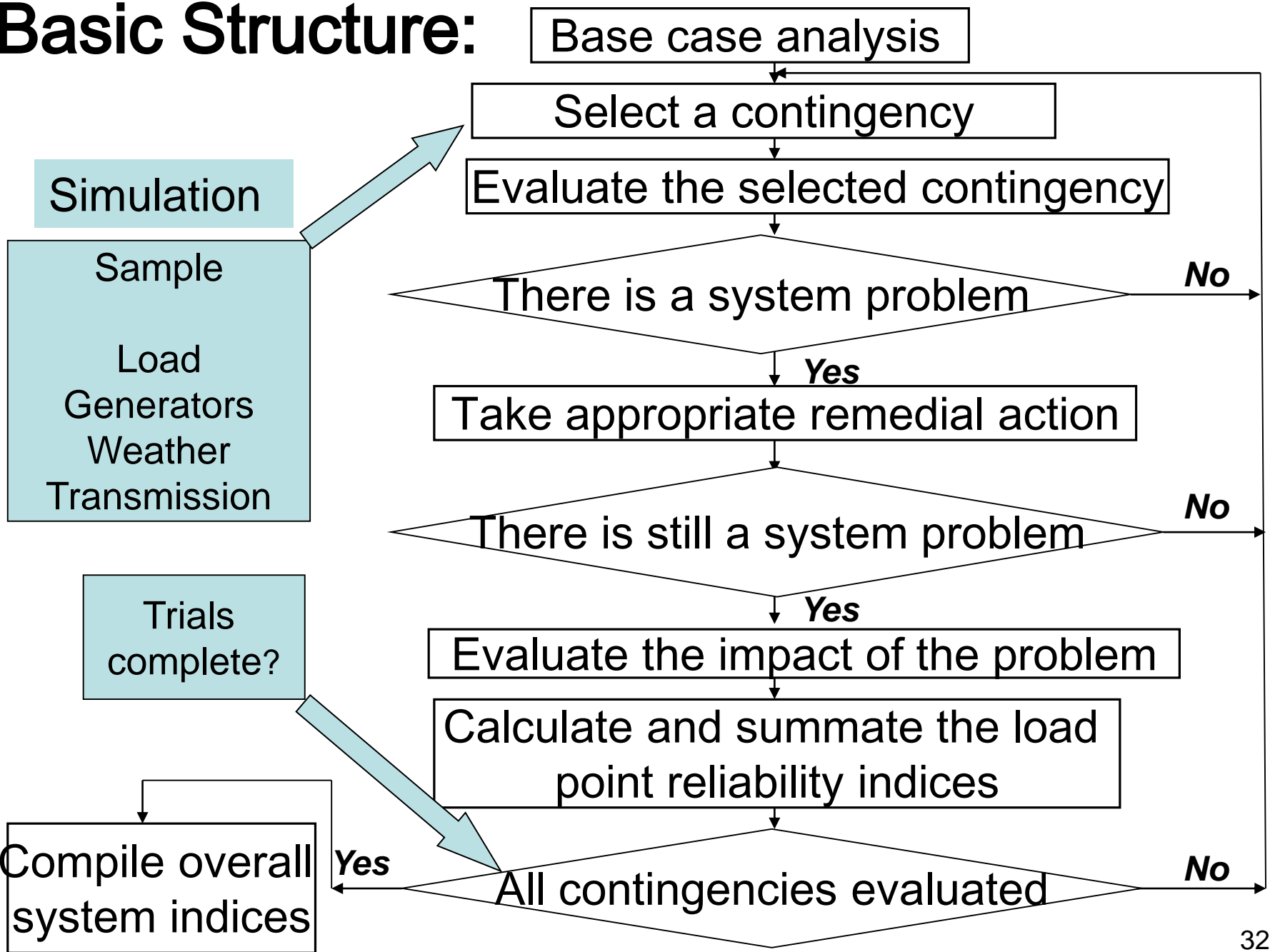

Composite System Reliability Evaluation

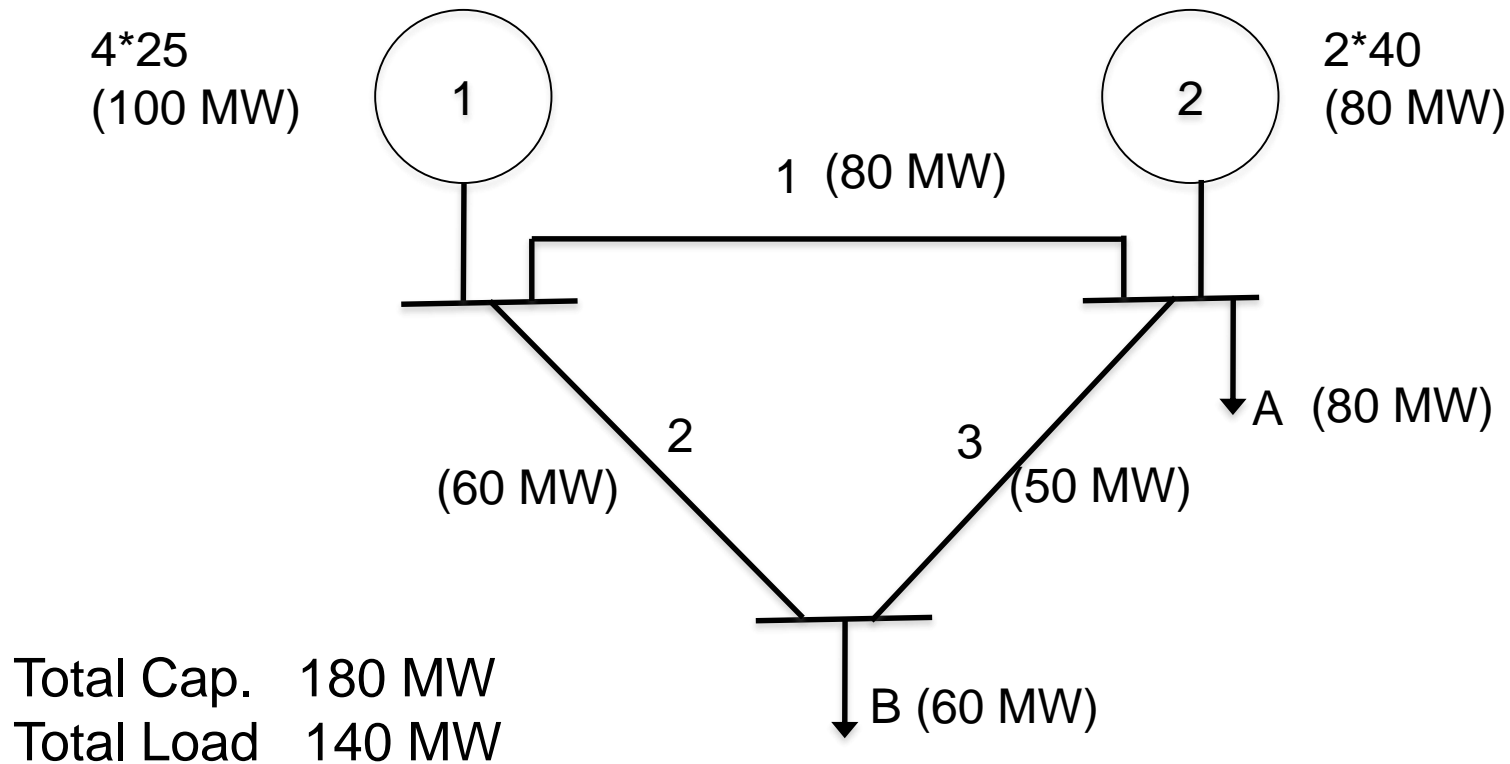

Composite System Reliability Evaluation

<u>State</u>	<u>Condition</u>	<u>A</u>	<u>B</u>	<u>State</u>	<u>Condition</u>	<u>A</u>	<u>B</u>
1	No Outages	--	--	10	1 G2, L1	×	×
2	1 G1	--	--	11	1 G2, L2	×	×
3	1 G1, 1 G1	×	×	12	1 G2, L3	--	--
4	1 G1, 1 G2	×	×	13	L1,	--	--
5	1 G1, L1	--	--	14	L1, L2	×	×
6	1 G1, L2	--	×	15	L1, L3	--	--
7	1 G1, L3	--	--	16	L2	--	×
8	1 G2,	--	--	17	L2, L3	--	×
9	1 G2, 1 G2	×	×	18	L3,	--	--

Composite System Reliability Evaluation

<u>State</u>	<u>Condition</u>	<u>Probability</u>	<u>LC</u>	<u>EENS</u>
3	G1, G1	0.002055	5 MW	90.01 MWh/yr
4	G1, G2	0.007066	12.5	773.73
9	G2, G2	0.002278	20	399.11
10	G2, L1	0.000316	20	55.36
11	G2, L2	0.000395	10	34.60
14	L1, L2	<u>0.000014</u>	30	<u>3.68</u>
		<u>0.012124</u>		<u>1356.49</u>

$$U(A) = 0.012124$$

$$EENS(A) = 1356.49 \text{ MWh/yr}$$

Composite System Reliability Evaluation

<u>State</u>	<u>Condition</u>	<u>Probability</u>	<u>LC</u>	<u>EENS</u>
3	G1, G1	0.002055	5 MW	90.01 MWh/yr
4	G1, G2	0.007066	12.5	773.73
6	G1, L2	0.000307	10	26.89
9	G2, G2	0.002278	20	399.11
10	G2, L1	0.000316	20	55.36
11	G2, L2	0.000395	10	34.60
14	L1, L2	0.000014	30	3.68
16	L2	0.003755	10	328.94
17	L2, L3	<u>0.000015</u>	60	<u>7.88</u>
		<u>0.016201</u>		<u>1720.20</u>

$$U(B) = 0.016201$$

$$EENS(B) = 1720.20 \text{ MWh/yr}$$

Transmission System Reliability Evaluation

1. Consider the following system

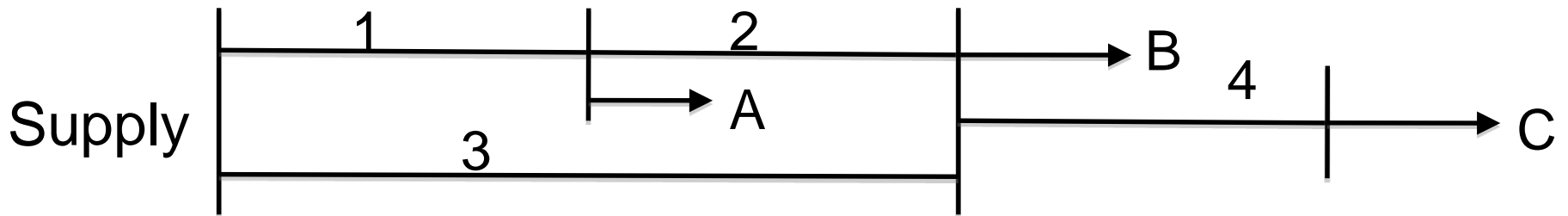

The supply is assumed to have a failure rate of 0.5 f/yr with an average repair time of 2 hours. The line data are as follows.

Transmission System Reliability Evaluation

<u>Line</u>	<u>Failure Rate</u>	<u>Average Repair Time</u>
1	4.0 f/yr	8 hrs
2	2.0	6
3	6.0	8
4	2.0	12

Use the minimal cut set approach to calculate a suitable set of indices at each load point.

Composite System Reliability Evaluation

2. A four unit hydro plant serves a remote load through two transmission lines. The four units are connected to a single step-up transformer which is then connected to two transmission lines. The remote load has a daily peak load variation curve which is a straight line from the 100% to the 60% point. Calculate the annual loss of load expectation for a forecast peak of 70 MW using the following data.

Hydro Units – 25 MW

FOR = 2%

Transformer – 110 MVA

U = 0.2%

Transmission lines – Carrying capability 50 MW per line

– Failure rate = 2 f/yr

– Average repair time = 24 hrs

Composite System Reliability Evaluation

Calculate the LOLE in three stages using the following configurations.

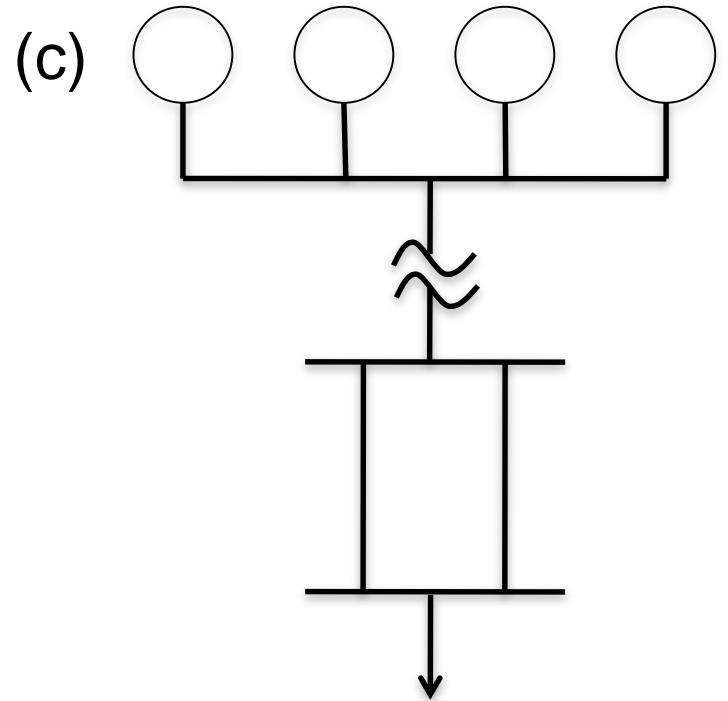
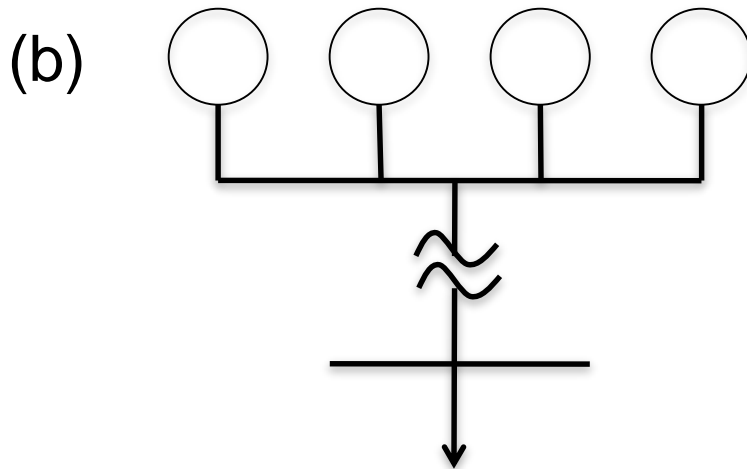
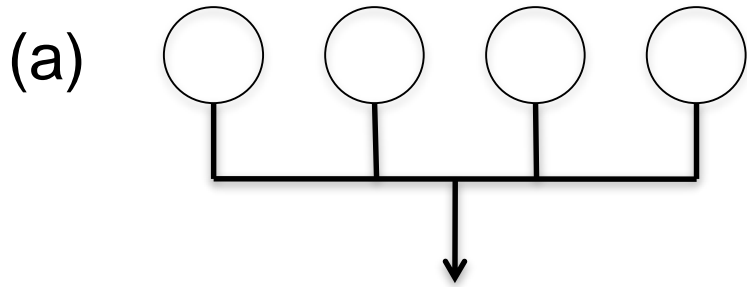

- (d) Calculate the LOLE for Configuration (b), if the single step-up transformer is removed and replaced by individual unit step-up transformers with a FOR of 0.2%.**
- (e) Calculate the LOLE for the conditions in (d) with each transmission line rated at 50 MW.**
- (f) Calculate the LOLE for the conditions in (d) with each transmission line rated at 75 MW.**
- (g) Calculate the LOLE for the conditions in (d) with each transmission line rated at 100 MW.**
- (h) Calculate the LOLE for the conditions in (f) with Model 1 common mode TL failure. [$\lambda_c = 0.2$ f/yr]**
- (i) Calculate the LOLE for the conditions in (f) with Model 3 common mode TL failure. [$\lambda_c = 0.2$ f/yr, $r_c = 36$ hr]**

Composite System Reliability Evaluation

2. Consider the following system

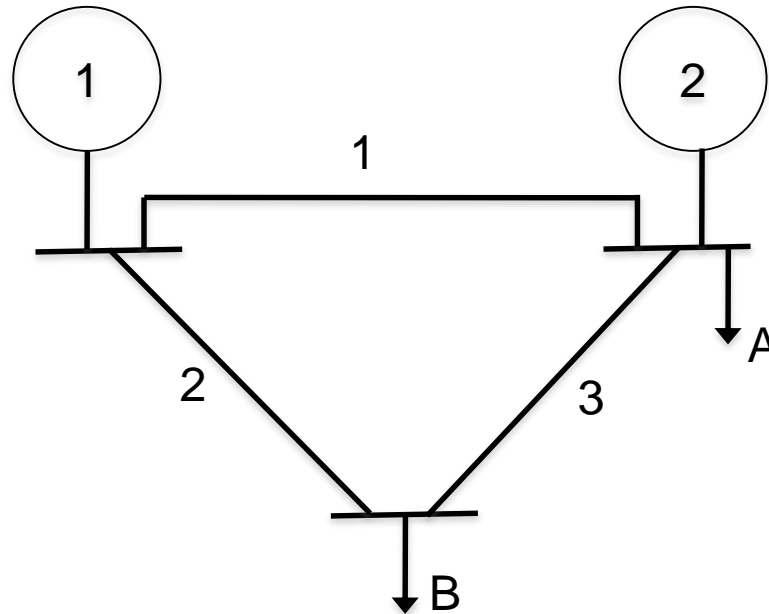

1. Calculate the probability of load curtailment at load points A and B
2. Calculate the EENS at load points A and B

Composite System Reliability Evaluation

- System Data

Generating Stations

1. 4*25 MW units $\lambda = 2.0$ f / yr $\mu = 98.0r / yr$
2. 2*40 MW units $\lambda = 3.0$ f / yr $\mu = 57.0r / yr$

Loads

A 80 MW

B 60 MW

Transmission Lines

- 1 $\lambda = 4 f / yr,$ $r = 8hrs,$ $LCC = 80MW$
- 2 $\lambda = 5 f / yr,$ $r = 8hrs,$ $LCC = 60MW$
- 3 $\lambda = 3 f / yr,$ $r = 12hrs,$ $LCC = 50MW$

Composite System Reliability Evaluation

- Conditions
 - Assume that the loads are constant
 - Assume that the transmission loss is zero
 - Consider up to two simultaneous outages
 - Assume that all load deficiencies are shared equally where possible.

Probability Fundamentals and Models in Generation and Bulk System Reliability Evaluation

Roy Billinton

Power System Research Group

University of Saskatchewan

CANADA



Mission Reliability

Reliability is the **probability** of a device or system performing its **purpose adequately** for the **period of time intended** under the **operating conditions encountered**.

C.R. Knight, E.R. Jervis, G.R. Herd, "Terms of Interest in the Study of Reliability", IRE Transactions on Reliability and Quality Control. Vol. PGRQC-5, April 1955, pp. 34-56.

Reliability

**A measure of the ability of the system
to perform its intended function**

Reliability Assessment

Deterministic

Probabilistic

Deterministic

- adjective

To determine:

- to fix
- to resolve
- to settle
- to regulate
- to limit
- to define

- % Reserve
- (N-1)
- Worst case condition

Probabilistic - adjective

Probability – likelihood of an event, the expected relative frequency of occurrence of a specified event in a very large collection of possible outcomes.

- Probability
- a quantitative measure of the likelihood of an event.
 - a quantitative measure of the uncertainty associated with the event occurring.
 - a quantitative indicator of **uncertainty**.

Probability concepts provide the ability to **quantitatively** incorporate **uncertainty** in power system planning applications.

This cannot be done using deterministic methods and criteria.

Power system reliability assessment is usually divided into the two areas of Adequacy and Security evaluation

- Adequacy is generally considered to be the existence of sufficient facilities within the system to satisfy the consumer demand.**
- Security is considered to relate to the ability of the system to respond to disturbances arising within that system.**

Incremental Reliability

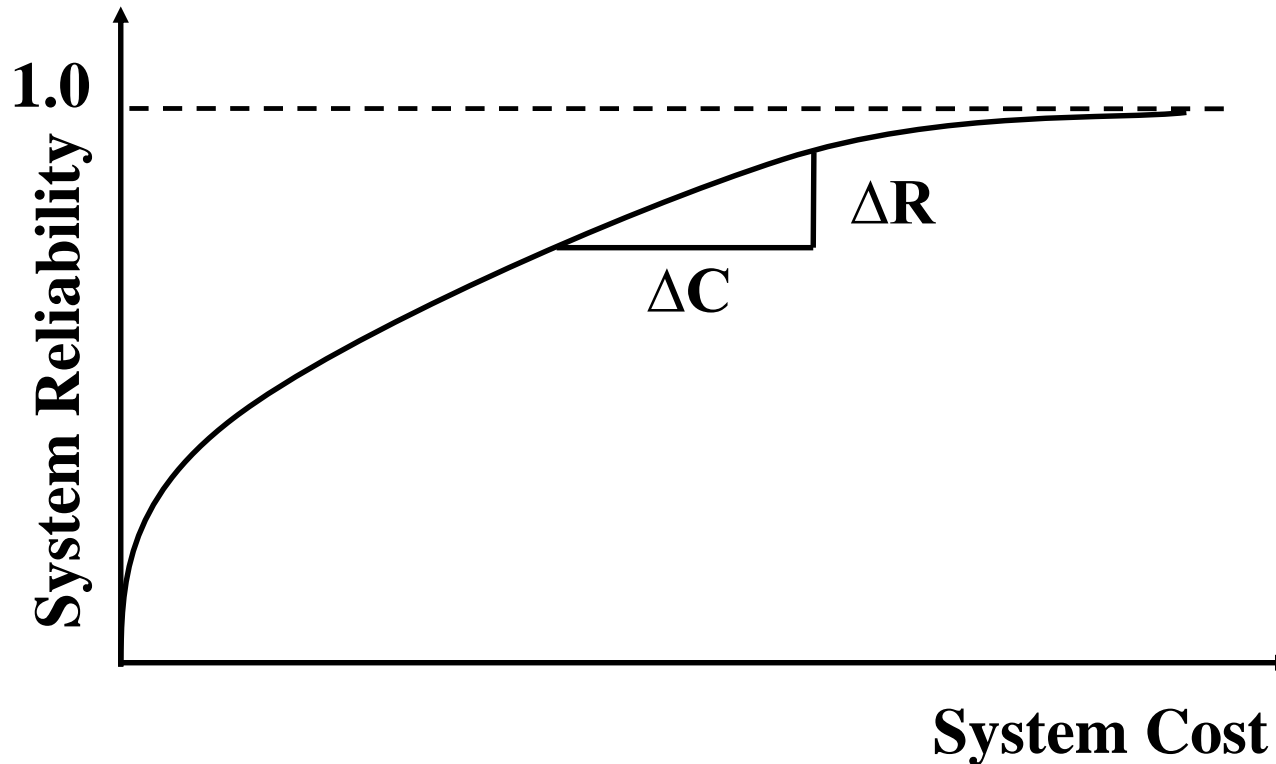

What is the system reliability benefit for the next dollar invested?

This requires a quantitative evaluation of system reliability.

Value Based Reliability Assessment (VBRA) is a useful extension to conventional reliability evaluation and provides valuable input to the decision making process.

Reliability Cost/Worth

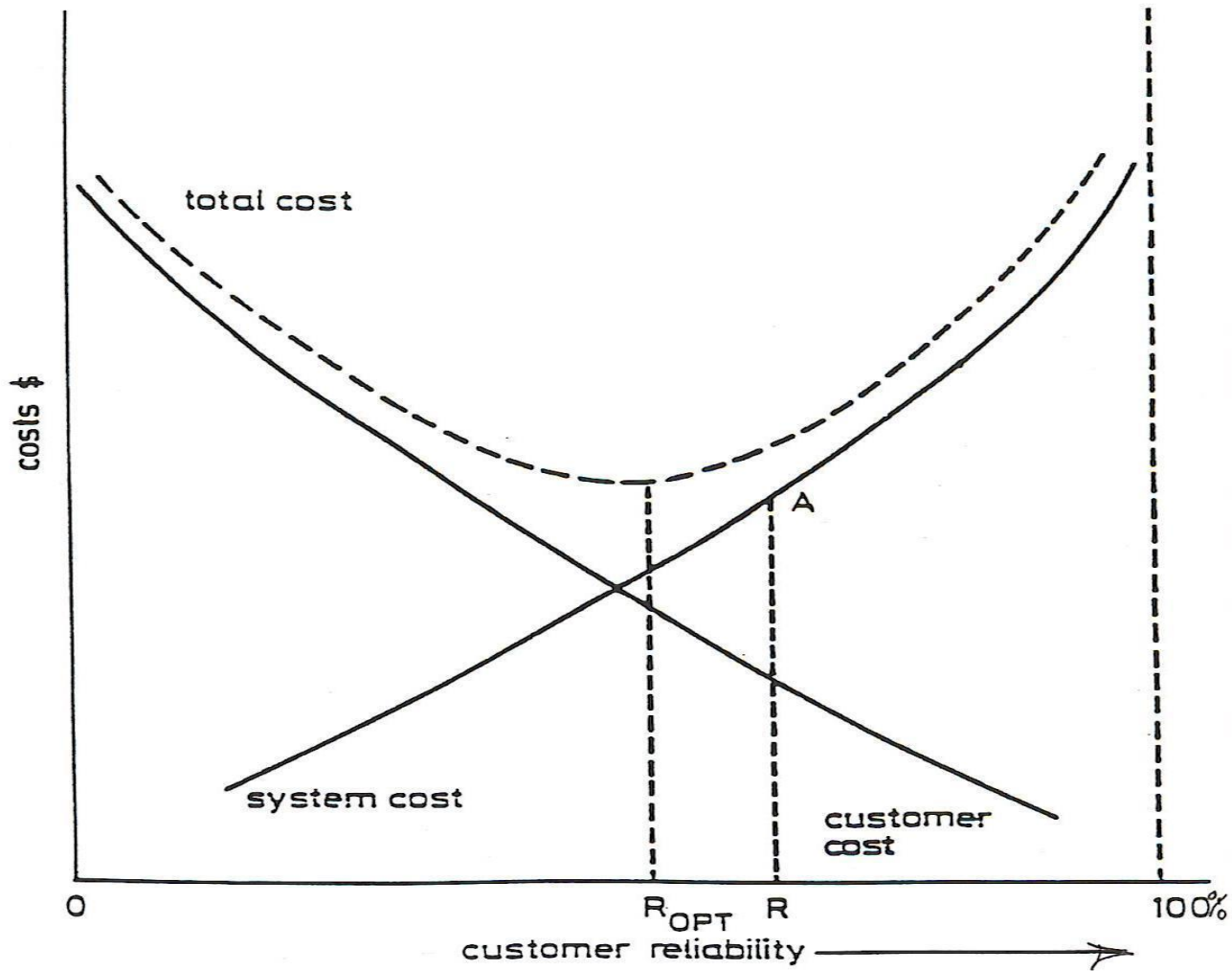

Ontario Energy Board stated that Ontario Hydro had too high a level of generation system reliability.

Ontario Hydro conducted a series of studies in 1976 – 1979 to determine the customer costs associated with electric power supply failures and produced:

“The SEPR Study: System Expansion Program Reassessment Study” Final Report 1979

Functional Zones and Hierarchical Levels

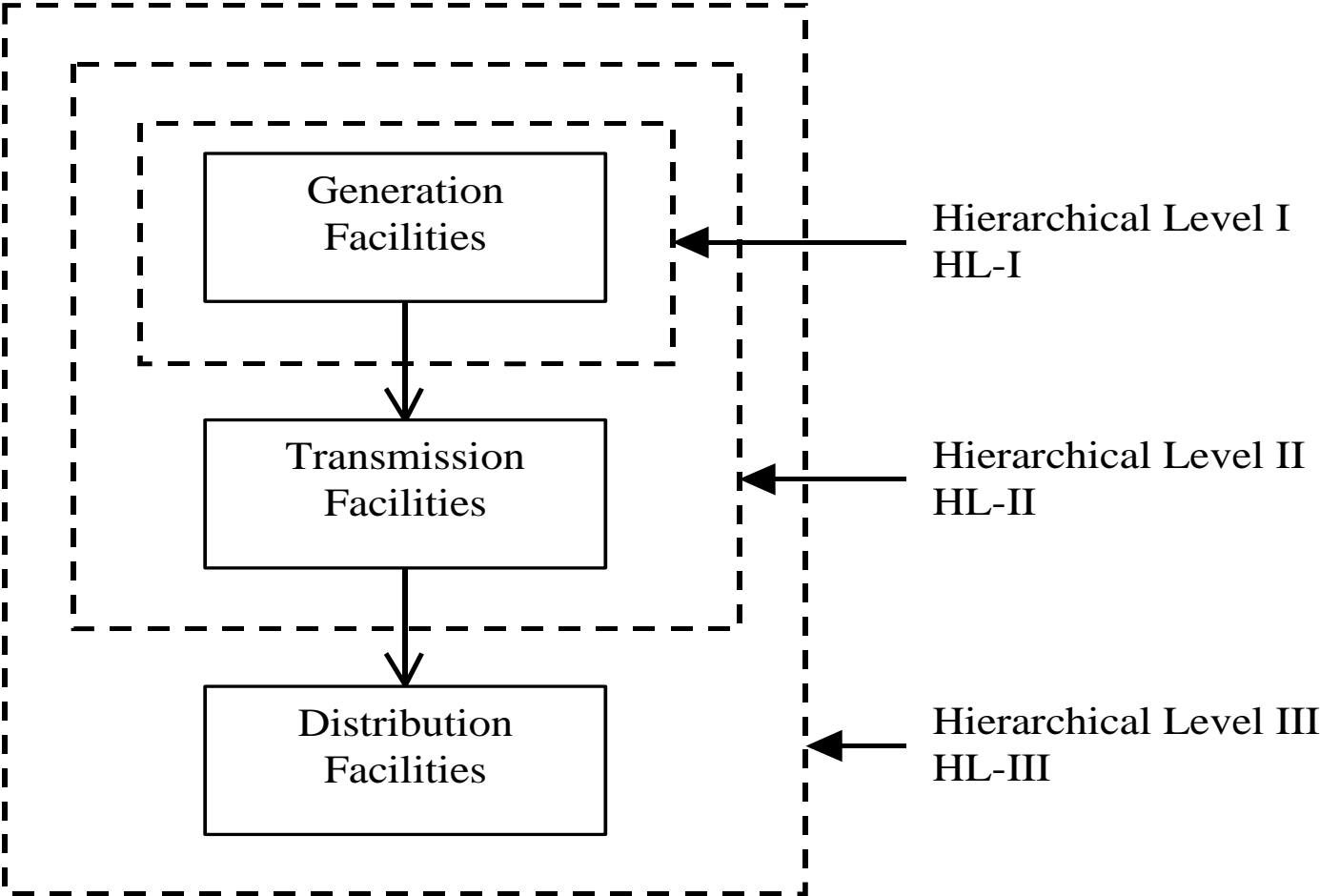

Basic Probability and Reliability Concepts

Roy Billinton

Power System Research Group

University of Saskatchewan

CANADA



Basic Probability

Probability

- **measure of chance**
- **quantitative statement about the likelihood of an event or events**

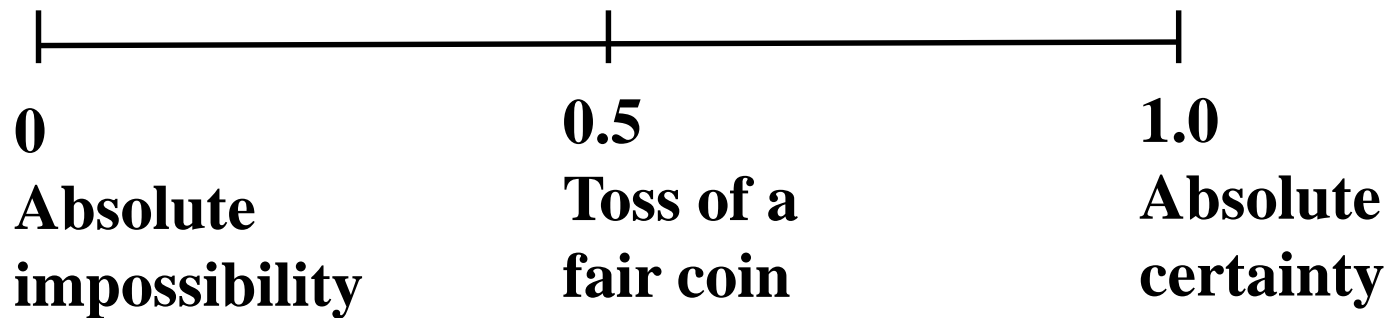

Basic Probability

Apriori Probability

$$P[\text{success}] = \frac{\text{Number of Successes}}{\text{Number of Possible Outcomes}}$$

$$P[\text{Failure}] = \frac{\text{Number of Failures}}{\text{Number of Possible Outcomes}}$$

$$\text{Coin - } P[\text{Head}] = \frac{1}{2}$$

$$\text{Die - } P[\text{Six}] = \frac{1}{6}$$

Basic Probability

Consider two dice – what is the probability of getting a total of 6 in a single roll?

Possible outcomes = $6 \times 6 = 36$ ways

**Successful outcomes = (1+5) (2+4) (3+3) (4+2) (5+1)
= 5 ways**

P [Six] = 5/36

Total	2	3	4	5	6	7	8	9	10	11	12
Prob. in 36ths											

Basic Probability

Relative frequency interpretation of probability

$$P[\text{of a particular event occurring}] = \lim_{n \rightarrow \infty} \frac{f}{n}$$

n = number of times an experiment is repeated

f = number of occurrences of a particular outcome.

Consider tossing a coin, rolling a die.

Estimate the unavailability or probability of finding a piece of equipment on outage at some distant time in the future.

$$\text{Unavailability} = \frac{\sum (\text{Outage Time})}{\sum (\text{Outage Time}) + \sum (\text{Operating Time})}$$

Basic Probability

Basic Rules

- 1. Independent events:** Two events are said to be independent if the occurrence of one event does not affect the probability of occurrence of the other event.
- 2. Mutually exclusive events:** Two events are said to be mutually exclusive or disjoint if they cannot both happen at the same time.
- 3. Complimentary events:** Two outcomes of an event are said to be complimentary if, when one outcome occurs, the other cannot occur.

Basic Probability

4. Conditional events: Conditional events are events which occur conditionally on the occurrence of another event or events.

Consider two events A and B and consider the probability of event A occurring under the condition that B has occurred. This probability is $P(A|B)$.

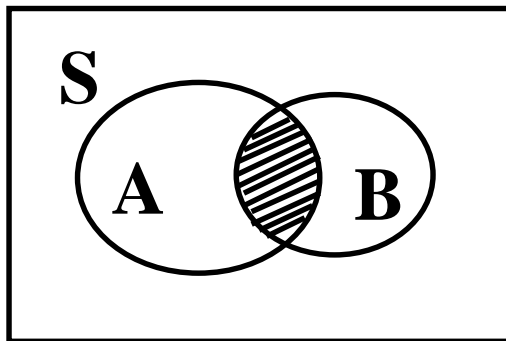

$$P(A | B) = \frac{\text{Number of ways A and B can occur}}{\text{Number of ways B can occur}}$$

$$P(A \cap B) = \frac{A \cap B}{S}$$

$$P(B) = \frac{B}{S}$$

$$P(A | B) = \frac{S \cdot P(A \cap B)}{S \cdot P(B)} = \frac{P(A \cap B)}{P(B)}$$

Basic Probability

Independent events

$$P(A | B) = P(A)$$

$$\begin{aligned} P(A \cap B) &= P(A | B) \cdot P(B) \\ &= P(A) \cdot P(B) \end{aligned}$$

$$P(A_1 \cap A_2 \cap A_3 \dots \dots n) = \prod_{i=1}^n P(A_i)$$

Basic Probability

The occurrence of at least one of two events **A** and **B** is the occurrence of **A OR B OR BOTH**.

$$P(A \cup B) = P(A) + P(B) - P(A \cap B)$$

$$= P(A) + P(B) - P(A | B) \cdot P(B)$$

$$= P(A) + P(B) - P(A) \cdot P(B)$$

if **A** and **B** are independent events

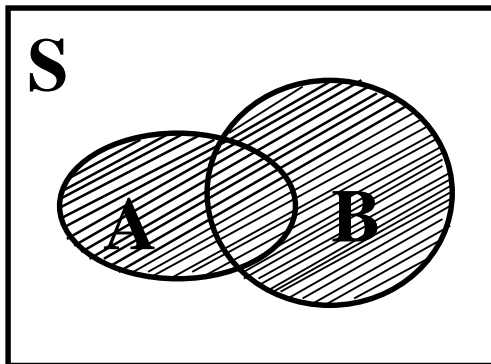

Basic Probability

$$P(\mathbf{A} \cap \mathbf{B}) = P(\mathbf{A} | \mathbf{B}) \cdot P(\mathbf{B})$$

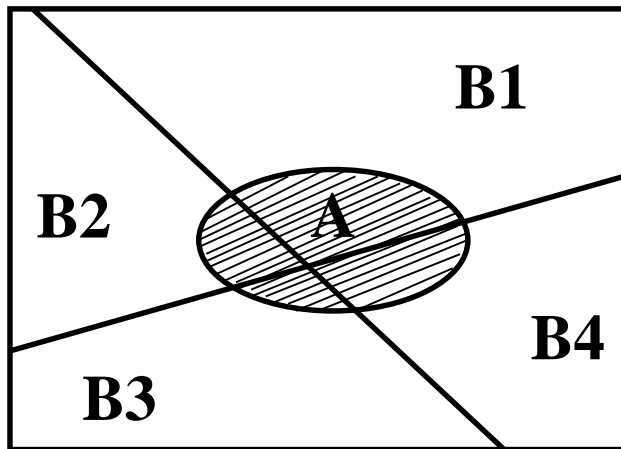

\mathbf{B}_i = mutually exclusive events

$$P(\mathbf{A} \cap \mathbf{B}_1) = P(\mathbf{A} | \mathbf{B}_1) \cdot P(\mathbf{B}_1)$$

$$P(\mathbf{A} \cap \mathbf{B}_2) = P(\mathbf{A} | \mathbf{B}_2) \cdot P(\mathbf{B}_2)$$

$$P(\mathbf{A} \cap \mathbf{B}_3) = P(\mathbf{A} | \mathbf{B}_3) \cdot P(\mathbf{B}_3)$$

$$P(\mathbf{A} \cap \mathbf{B}_4) = P(\mathbf{A} | \mathbf{B}_4) \cdot P(\mathbf{B}_4)$$

$$\sum_{i=1}^4 P(\mathbf{A} \cap \mathbf{B}_i) = \sum_{i=1}^4 P(\mathbf{A} | \mathbf{B}_i) \cdot P(\mathbf{B}_i)$$

$$P(\mathbf{A}) = \sum_{i=1}^n P(\mathbf{A} | \mathbf{B}_i) \cdot P(\mathbf{B}_i)$$

Expectation

Discrete distribution

$$\mathbf{E} = \sum_{i=1}^n \mathbf{x}_i \mathbf{p}_i$$

Continuous distribution

$$\mathbf{E} = \int_0^{\infty} \mathbf{x} \cdot \mathbf{f}(\mathbf{x}) d\mathbf{x}$$

Example:

$$\mathbf{Prize} = \$10.00$$

$$\mathbf{P}(\mathbf{Winning}) = \frac{1}{5}$$

$$\mathbf{Expectation} = \frac{1}{5} \times 10 + \frac{4}{5} \times 0 = \$2.00$$

Example

Probability that a 30 year old man will survive a fixed time period is 0.995. Insurance company offers a \$2000 policy for \$20. What is the company's expected gain?

<u>Probability</u>	<u>Gain</u>
0.995	20
0.005	-1980

$$\begin{aligned} E(\text{Gain}) &= 0.995 \cdot (20) + 0.005 \cdot (-1980) \\ &= \underline{\$10.00} \end{aligned}$$

Expectation Example

The distribution (discrete) of the power output from a 100 MW wind farm is given in the table below.

What is the expected power output?

i	Capacity (x_i MW)	Probability (p_i)	$x_i \cdot p_i$ (MW)
1	100	0.03	3.00
2	75	0.08	5.25
3	50	0.15	7.50
4	25	0.35	8.75
5	0	0.39	0.00
Expected Power Output (MW) = 25.25			

Expectation

$$\mathbf{E} = \sum_{i=1}^n \mathbf{x}_i \mathbf{p}_i$$

$$\mathbf{E} = \int_{-\infty}^{\infty} \mathbf{x} \cdot \mathbf{f}(\mathbf{x}) d\mathbf{x}$$

Mean Time to Failure

$$E(t) = \int_0^{\infty} t \cdot f(t) dt$$

$$MTTF = \int_0^{\infty} t \cdot f(t) dt$$

$$= \int_0^{\infty} t \cdot \lambda e^{-\lambda t} dt = \frac{1}{\lambda}$$

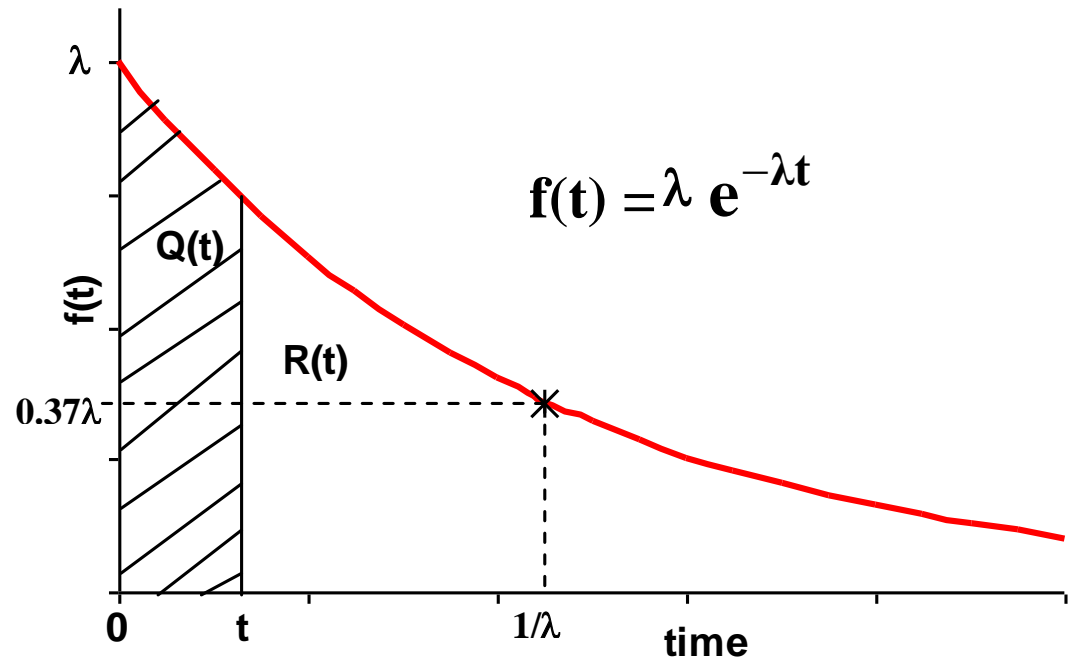

Expectation Indices

- Expected Frequency of Failure
- Expected Duration of Failure
- Expected Annual Outage Time
- Expected Energy Not Supplied
- Expected Annual Outage Cost

Binomial Distribution

$$(p+q)^2 = p^2 + 2pq + q^2$$

$$(p+q)^3 = p^3 + 3p^2q + 3pq^2 + q^3$$

General Expression for Binomial Distribution:

$$(p + q)^n = p^n + n p^{n-1} q + \dots + \frac{n(n-1)\dots[n-(r-1)]}{r!} p^{n-r} q^r + \dots + q^n$$

n = number of components or trials

p = probability of success

q = probability of failure



$$\frac{n!}{r!(n-r)!} = {}_n C_r$$

Probability of exactly r failures (and $n-r$ successes),

$$P_r = {}_n C_r p^{(n-r)} q^r$$

AIEE Committee Report, Tables of Binomial Probability Distribution to Six Decimal Places, AIEE Transactions (August 1952), pp. 597-620.

Binomial Distribution

$$P_r = {}_n C_r p^r q^{n-r} = \frac{n!}{r!(n-r)!} p^r q^{n-r}$$

Consider a 3*5 MW unit plant. Each unit has a F.O.R of 3%.

$$(R + Q)^3 = R^3 + 3R^2Q + 3RQ^2 + Q^3$$

Units Out	Capacity Out (MW)	Capacity Available (MW)	Probability
0	0	15	0.912673
1	5	10	0.084681
2	10	5	0.002619
3	15	0	0.000027
			1.000000

Boiler Circulating Pumps

3 pumps – each pump rated at 90% F.L.R

pump unavailability = 0.01

Pumps Out	Unit Capacity Out	Probability	Expectation
0	-	0.97029890	-
1	-	0.02940299	-
2	10%	0.00029700	0.00297
3	100%	0.00000100	<u>0.00010</u>
			<u>0.00307</u>

3 Pump Systems

Pump Rating	Expected % Capacity Loss
100	0.00010
90	0.00307
80	0.00604
70	0.00901
60	0.01198
50	0.01495
40	0.60598

Basic Reliability

Let $R=P$ [Success]

$Q=P$ [Failure]

$$R+Q=1$$

Series Systems

$$\begin{aligned} Q_s &= 1 - R_s \\ &= 1 - R_1 \cdot R_2 \\ &= 1 - (1 - Q_1)(1 - Q_2) \\ &= Q_1 + Q_2 - Q_1 \cdot Q_2 \end{aligned}$$

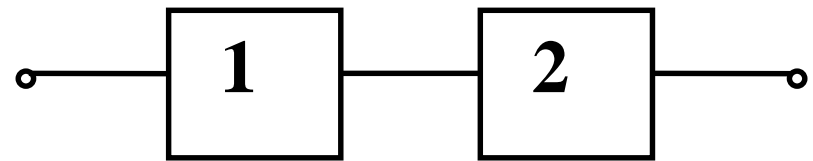

$$\begin{aligned} R_s &= R_1 \cdot R_2 \\ &= \prod_{i=1}^n R_i \end{aligned}$$

Series System

If each component has a reliability of 0.9.

Number of Components	Reliability
1	0.9
2	0.81
3	0.729
4	0.6561
5	0.59049
10	0.348678
20	0.121577
50	0.005154

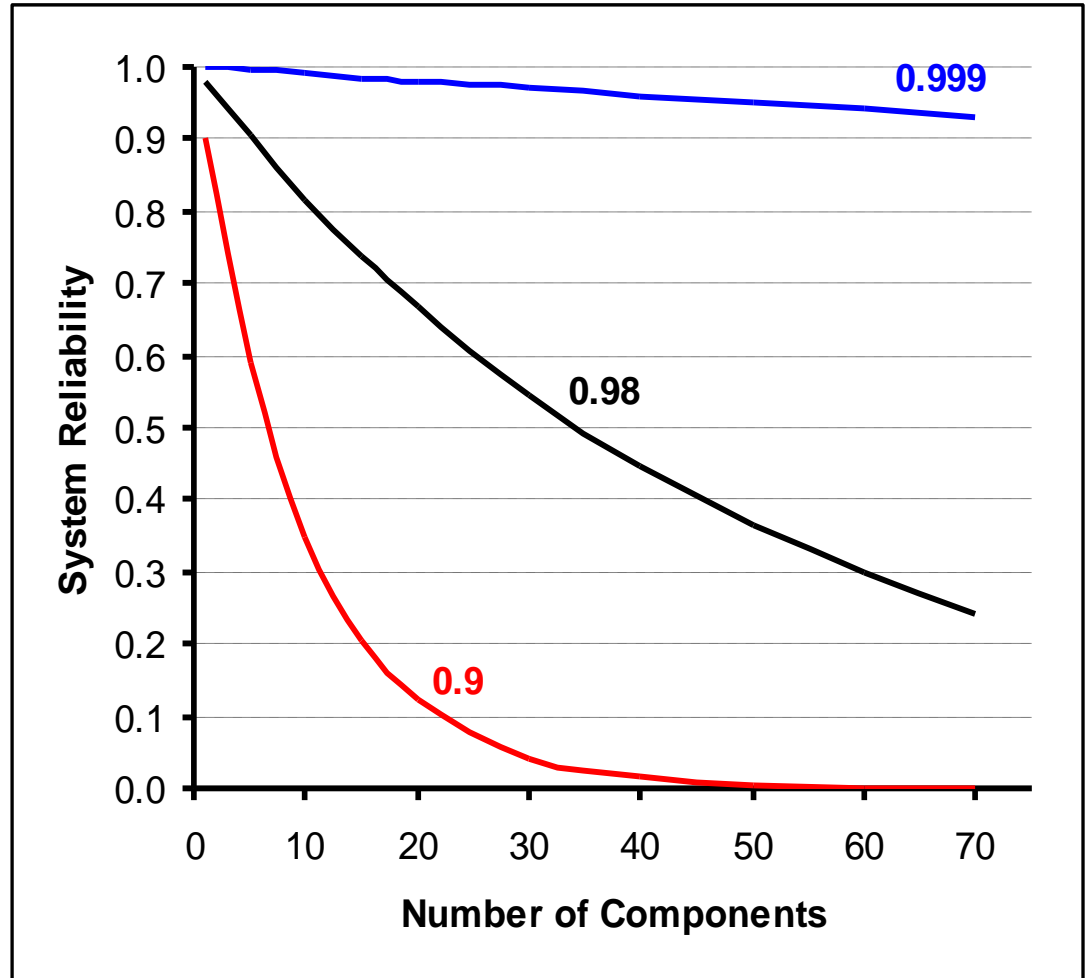

System Reliability decreases as the number of components increases in a Series System. The number on the curve is the reliability of each component.

Basic Reliability

Parallel Redundant Systems

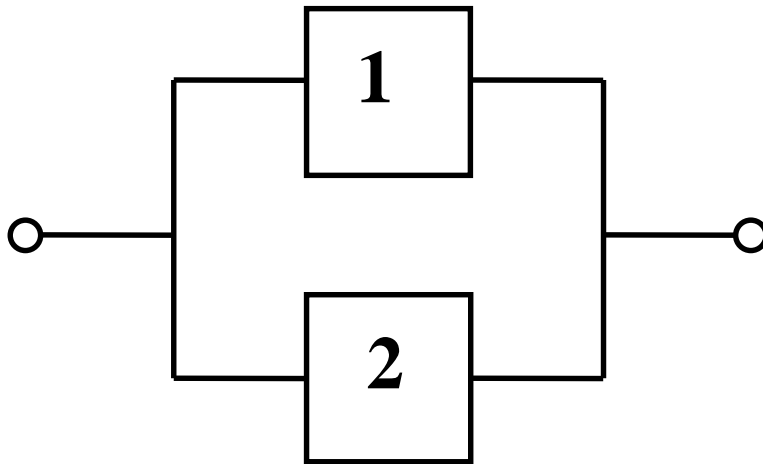

$$Q_s = Q_1 \cdot Q_2$$

$$R_s = 1 - Q_s$$

$$= 1 - Q_1 \cdot Q_2$$

$$= 1 - (1 - R_1)(1 - R_2)$$

$$= R_1 + R_2 - R_1 \cdot R_2$$

Parallel System

Number of Components	Reliability
1	0.9
2	0.99
3	0.999
4	0.9999
5	0.99999

Basic Reliability

Series/Parallel Systems

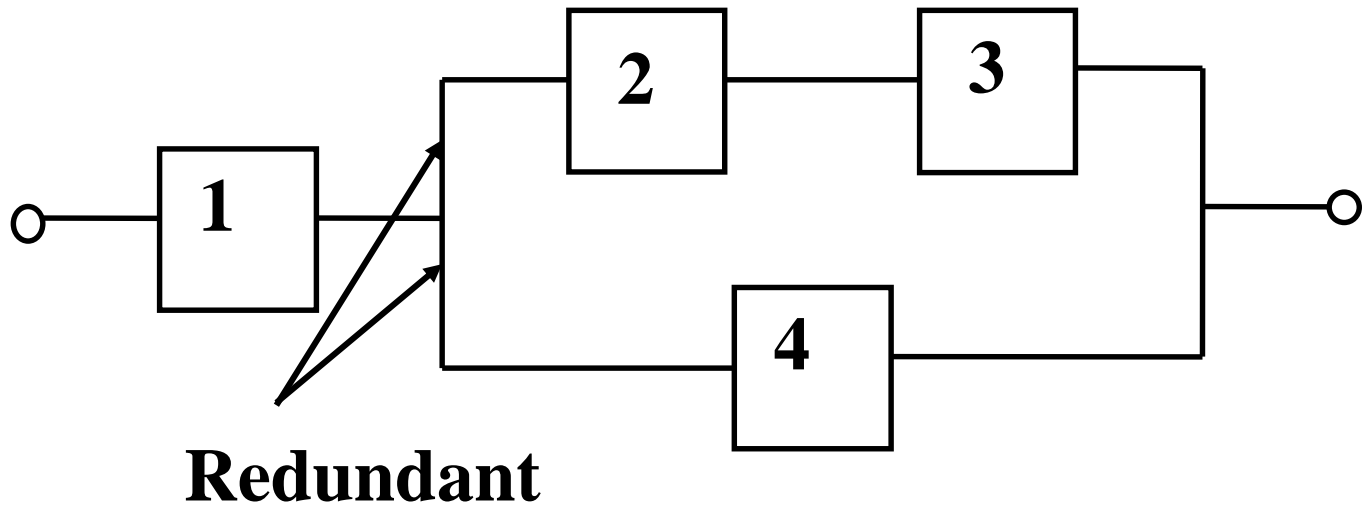

$$R_s = R_1 [R_2 R_3 + R_4 - R_2 R_3 R_4]$$

Binomial Systems

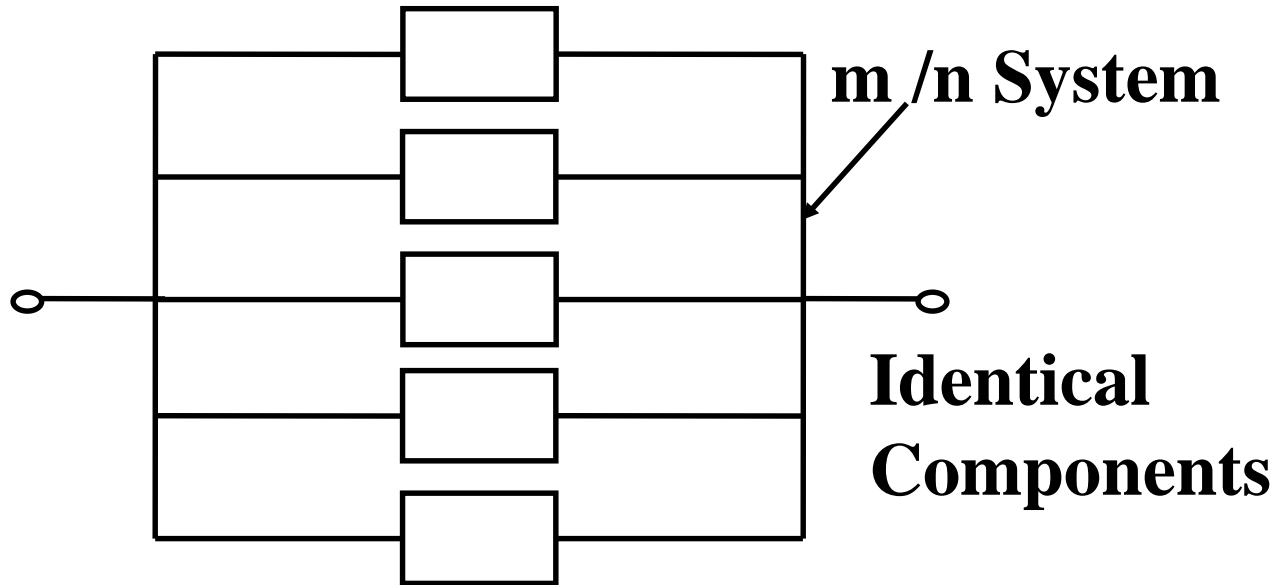

$$(R + Q)^5 = \underbrace{R^5 + 5R^4Q + 10R^3Q^2}_{R_s} + \underbrace{10R^2Q^3 + 5RQ^4 + Q^5}_{Q_s}$$

System Criterion = 3/5

Conditional Probability Approach

If the occurrence of an event A is dependent upon a number of events B_j which are mutually exclusive.

$$P(A) = \sum_{i=1}^j P(A | B_i) \cdot P(B_i)$$

If A is defined as system success

$$P(\text{SystemSuccess}) = P(SS | B_x) \cdot P(B_x) + P(SS | B_y) \cdot P(B_y)$$

If A is defined as system failure

$$P(\text{SystemFailure}) = P(SF | B_x) \cdot P(B_x) + P(SF | B_y) \cdot P(B_y)$$

Series System

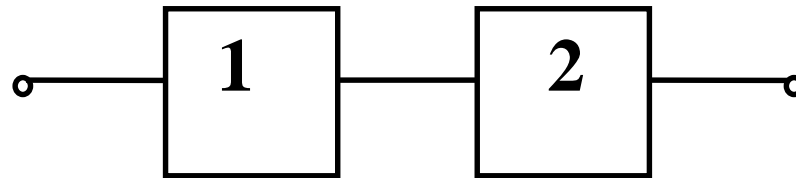

$$\begin{aligned} P(SS) &= P(SS | 1 \text{ is good}) \cdot R_1 + P(SS | 1 \text{ is bad}) \cdot Q_1 \\ &= R_1 R_2 + 0 \cdot Q_1 \\ &= R_1 R_2 \end{aligned}$$

Parallel System

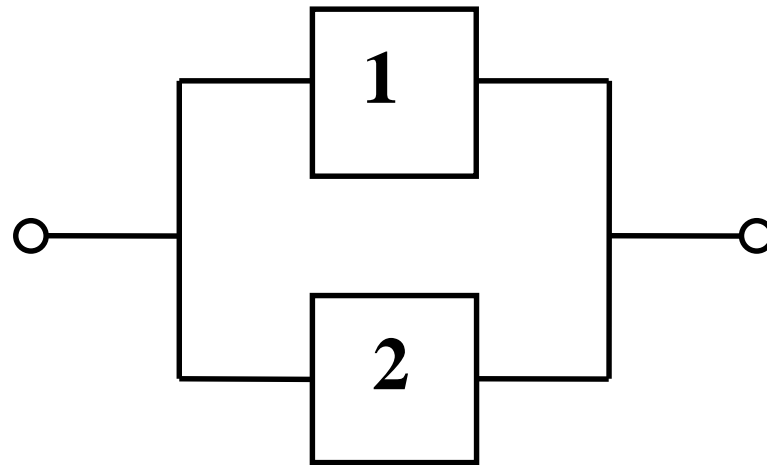

$$\begin{aligned} P(SS) &= P(SS | 1 \text{ is good}) \cdot R_1 + P(SS | 1 \text{ is bad}) \cdot Q_1 \\ &= 1 \cdot R_1 + R_2 \cdot Q_1 \\ &= R_1 + R_2 - R_1 R_2 \end{aligned}$$

Non Series/Parallel Systems

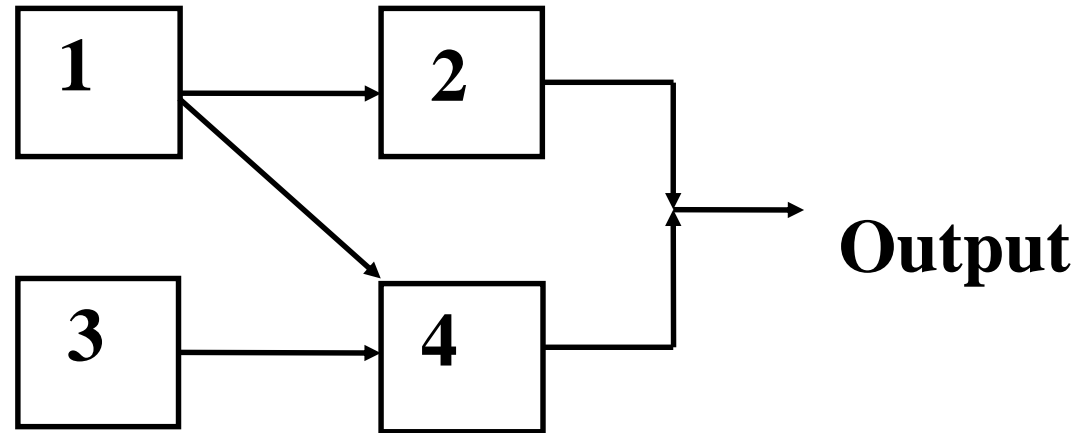

$$\begin{aligned} P(SS) &= P(SS | 1 \text{ is good}) \cdot R_1 + P(SS | 1 \text{ is bad}) \cdot Q_1 \\ &= [R_2 + R_4 - R_2 \cdot R_4] \cdot R_1 + R_3 \cdot R_4 \cdot Q_1 \end{aligned}$$

Minimal Cut Set Method

Cut Set – A set of components which if removed from the network separate the input from the output.
i.e. cause the network to fail.

Minimal Cut Set – Any cut set which does not contain any other cut sets as subsets.

$$\begin{aligned} P\{\text{SystemFailure}\} &= P\{\text{Union of All Cut Sets}\} \\ &= P\{\text{Union of All Minimal Cut Sets}\} \\ &\leq \sum P\{\text{Min Cut Sets}\} \end{aligned}$$

This is a good approximation for highly reliable components.

$$\begin{aligned}
\mathbf{P\{SystemFailure\}} &= \mathbf{P\{Union\ of\ All\ Minimal\ Cut\ Sets\}} \\
&= \mathbf{P\{C_1 \cup C_2 \cup C_3 \dots \cup C_n\}} \\
&\leq \sum_{i=1}^n \mathbf{P(C_i)}
\end{aligned}$$

Consider

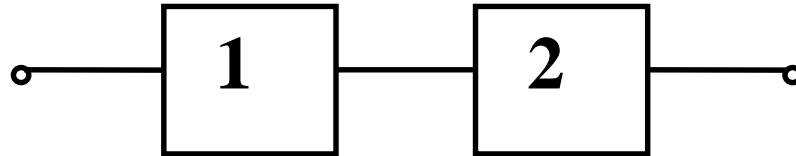

$$\begin{aligned}
\mathbf{Q_s} &= \mathbf{P\{C_1 \cup C_2\}} \\
&= \mathbf{P(C_1) + P(C_2) - P(C_1 \cap C_2)} \\
&= \mathbf{Q_1 + Q_2 - Q_1 \cdot Q_2} \\
&\leq \mathbf{Q_1 + Q_2}
\end{aligned}$$

Basic Reliability

Consider:

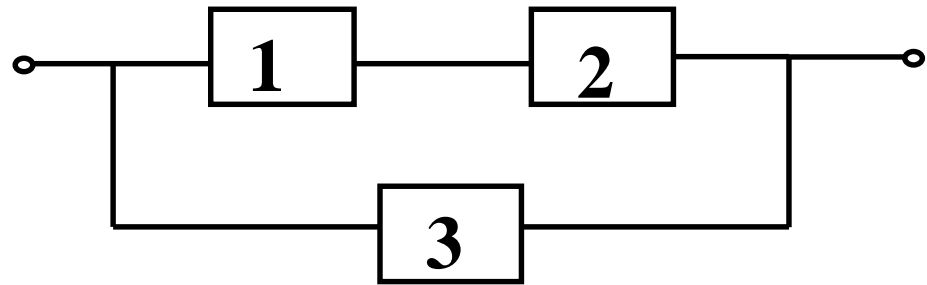

<u>Cuts</u>	<u>Min Cuts</u>	<u>Probability</u>
1,3	1,3	Q_1Q_3
2,3	2,3	Q_2Q_3
1,2,3	---	-
		$Q_s < Q_1Q_3 + Q_2Q_3$

Complete Equation:

$$\begin{aligned}
 Q_s &= Q_3[Q_1 + Q_2 - Q_1Q_2] \\
 &= Q_1Q_3 + Q_2Q_3 - Q_1Q_2Q_3
 \end{aligned}$$

Mission Orientated Systems

Reliability is the probability of a device or system performing its purpose adequately for the period of time intended under the operating conditions encountered.

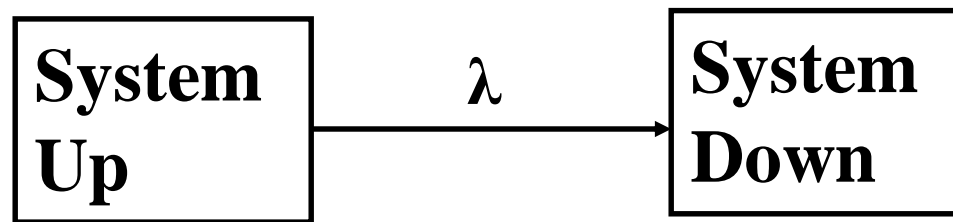

$$R(t) = e^{-\lambda t}$$

Where λ = component failure rate

Mission Reliability

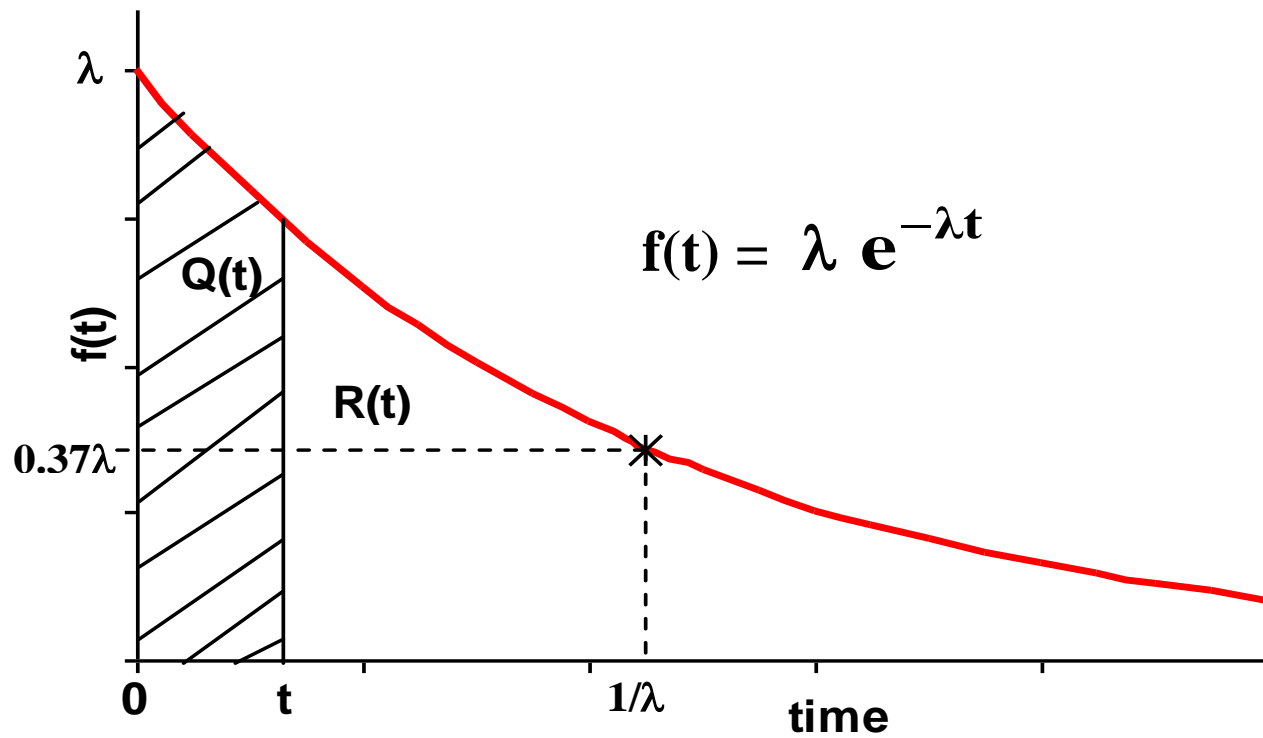

Conventional Bathtub Curve

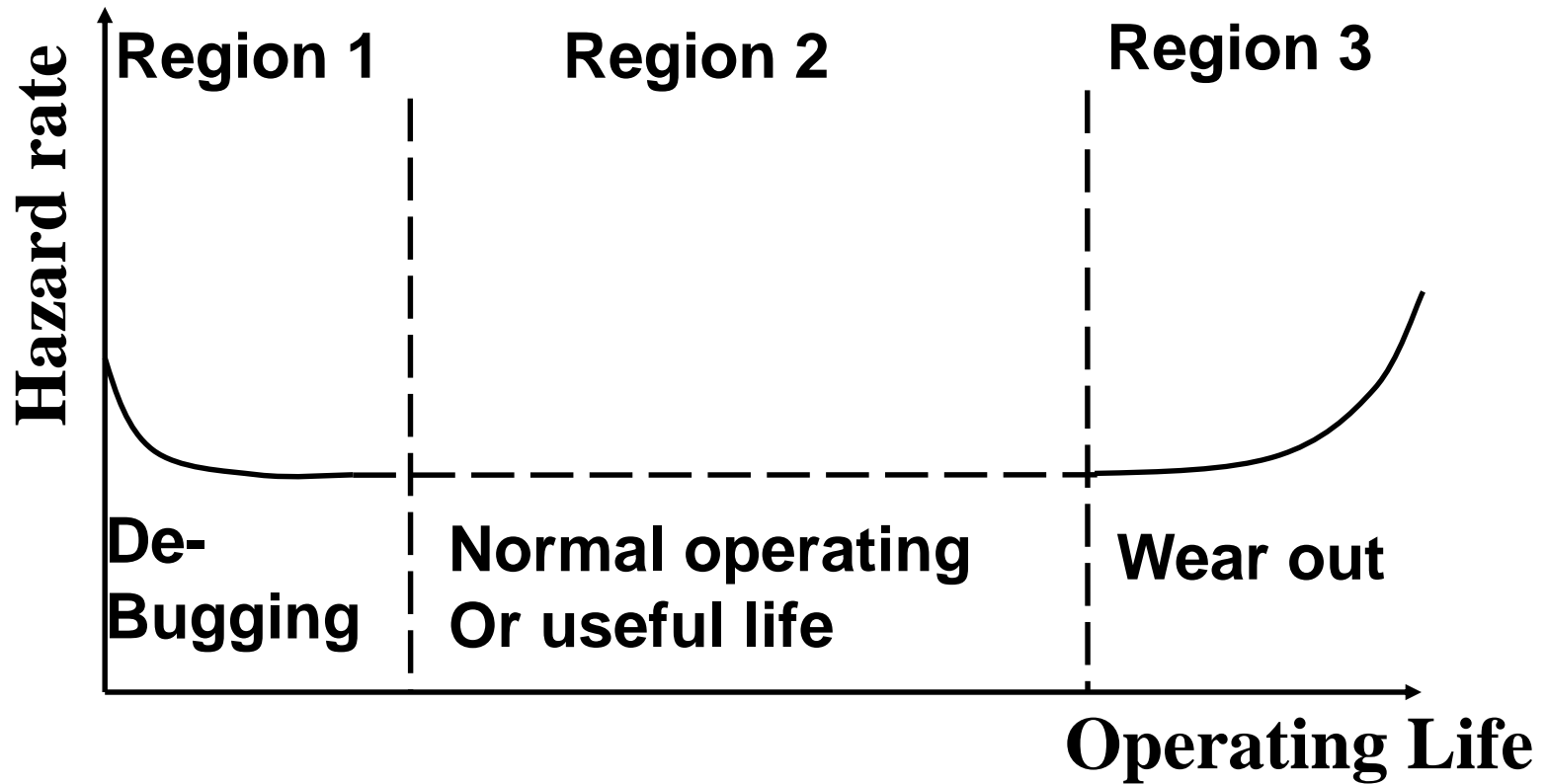

Typical Electric Component Hazard Rate as a Function of Age

Network Models and Mission Reliability

Series Systems

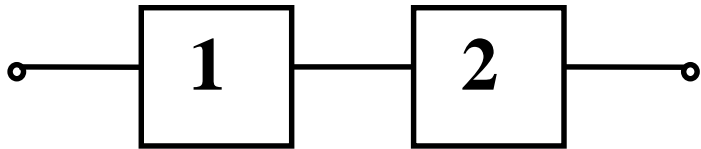

product rule of reliability

$$\begin{aligned} \mathbf{R}_s &= \mathbf{R}_1 \mathbf{R}_2 \\ &= e^{-\lambda_1 t} \cdot e^{-\lambda_2 t} \\ &= e^{-(\lambda_1 + \lambda_2) t} \\ &= e^{-\sum \lambda_i t} \end{aligned}$$

Parallel Systems

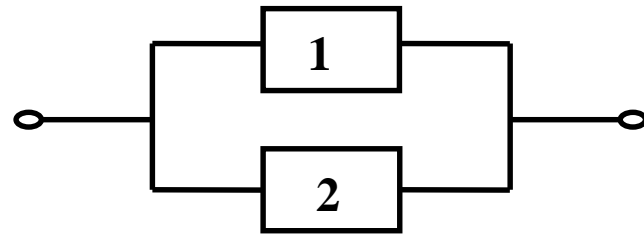

product rule of unreliability

$$\begin{aligned} \mathbf{Q}_s &= \mathbf{Q}_1 \cdot \mathbf{Q}_2 \\ \mathbf{R}_s &= \mathbf{R}_1 + \mathbf{R}_2 - \mathbf{R}_1 \mathbf{R}_2 \\ \mathbf{R}_s &= e^{-\lambda_1 t} + e^{-\lambda_2 t} - e^{-(\lambda_1 + \lambda_2) t} \end{aligned}$$

Basic Reliability

Mission systems

***Develop the basic equations**

***Substitute**

$$\mathbf{R(t) = e^{-\lambda t}}$$

$$\mathbf{Q(t) = 1 - e^{-\lambda t}}$$

System Reliability and Availability

Reliability –

probability of a system staying in the operating state without failure

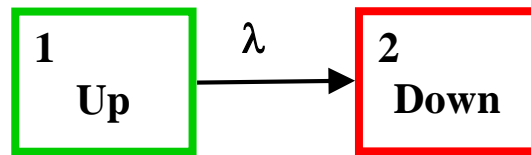

$$R(t) = e^{-\lambda t}$$

Availability –

probability of finding a system in the operating state at some time into the future

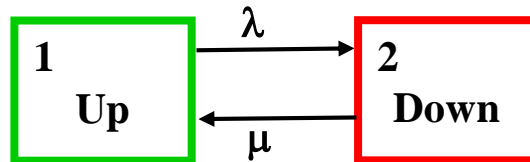

$$A(t) = \frac{\mu}{\lambda + \mu} + \frac{\lambda}{\lambda + \mu} e^{-(\lambda + \mu)t}$$

System Reliability and Availability

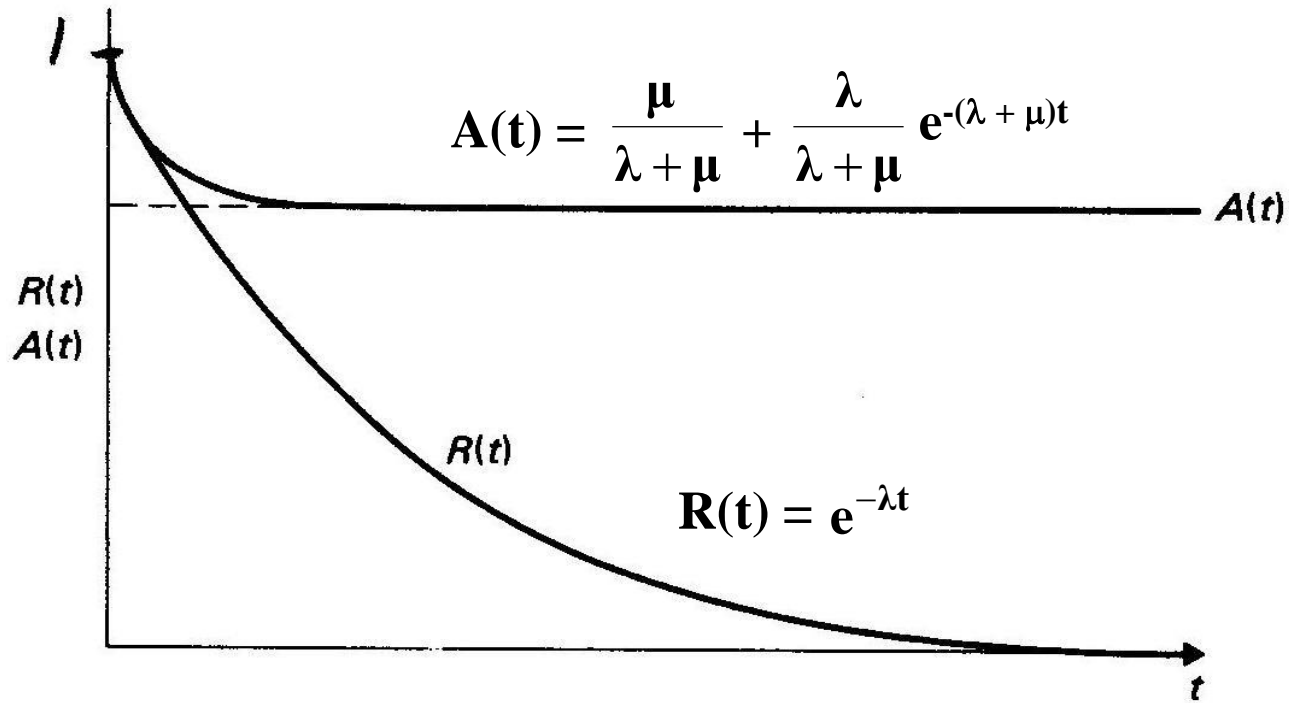

In the limiting state:

$$A = \frac{\mu}{\lambda + \mu}$$

$$U = \frac{\lambda}{\lambda + \mu}$$

Markov Analysis

Application:

Random behaviour of systems that vary discretely or continuously with respect to time and space.

Reliability Evaluation:

Space: Normally discrete and identifiable states.

Time: Discrete (Markov Chain)

Continuous (Markov Process)

Markov Analysis

Applicability

Systems characterized by a lack of memory. Future states are independent of all past states except the immediately preceding one.

System process must be stationary. Probability of making a transition from one state to another is the same (stationary) at all times. The state probability distribution is characterized by a constant transition rate.

Markov Analysis

State Space / State Transition Diagram

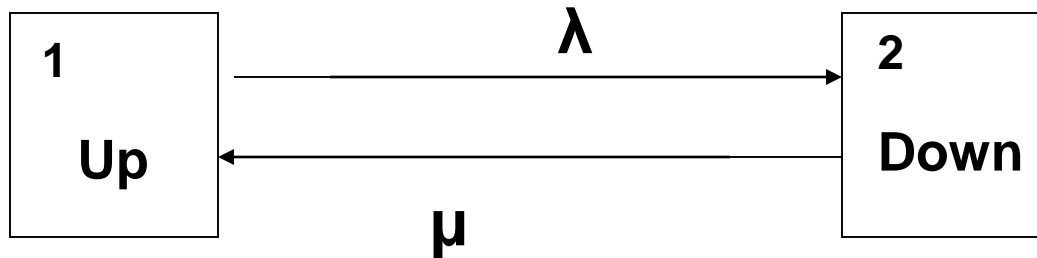

Stochastic transitional probability matrix P

$$P = \begin{array}{c|cc} & 1 & 2 \\ \hline 1 & 1 - \lambda\Delta t & \lambda\Delta t \\ \hline 2 & \mu\Delta t & 1 - \mu\Delta t \\ \hline \end{array}$$

State probabilities after n increments = P^n

Markov Analysis

Limiting state probability vector = [P₁ P₂]

$$[P_1 \ P_2] P = [P_1 \ P_2]$$

$$[P_1 \ P_2] \begin{vmatrix} 1 - \lambda\Delta t & \lambda\Delta t \\ \mu\Delta t & 1 - \mu\Delta t \end{vmatrix} = [P_1 \ P_2]$$

$$-\lambda P_1 + \mu P_2 = 0$$

$$\lambda P_1 - \mu P_2 = 0$$

$$P_1 + P_2 = 1.0$$

$$P_1 = \frac{\mu}{\lambda + \mu}$$

$$P_2 = \frac{\lambda}{\lambda + \mu}$$

System Availability

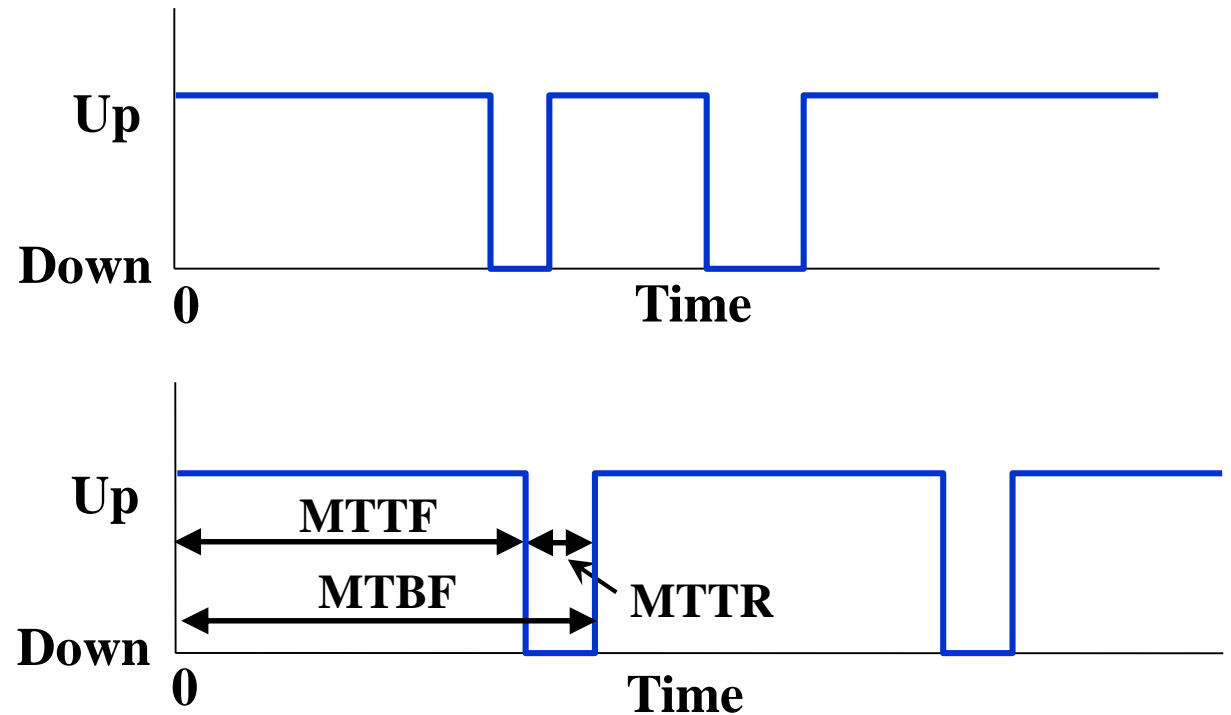
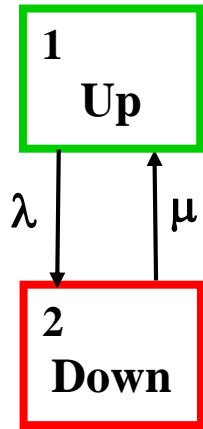

$$\text{MTTF} = \frac{\text{total up time}}{\# \text{ of failures}} = \frac{1}{\lambda}$$

$$\text{MTBF} = 1/F$$

$$\text{MTTR} = \text{average repair time} = r = \frac{\text{total down time}}{\# \text{ of failures}} = \frac{1}{\mu}$$

System Availability Example

Example: If the failure rate of a system is 1.5 failures/year and the average repair time is 10 hours, what is the system unavailability?

$$\begin{aligned}\lambda &= 1.5 \text{ f/yr} & r &= 10 \text{ hr} = 10/8760 \text{ yr} \\ \mu &= 1/r = 8760/10 = 876 \text{ repairs/yr}\end{aligned}$$

Unavailability

$$\begin{aligned}U &= \lambda/(\lambda+\mu) = 1.5/(1.5+876) = 0.00171 \\ &= 0.00171 \times 8760 = \mathbf{14.97 \text{ hr/yr}}\end{aligned}$$

Availability Example – Series System

A generator supplies power through a transmission line. The failure rate and the average repair time of the generator are 4 failures/year and 60 hours respectively, and that of the line are 2 failures/year and 10 hours respectively. What is the unavailability of power supply?

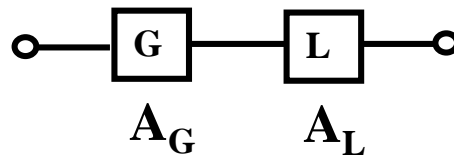

Generator:

$$\lambda_G = 4 \text{ f/yr}$$

$$\mu_G = 1/r_G = 8760/60 = 146 \text{ rep/yr}$$

$$A_G = \mu_1/(\lambda_G + \mu_G) = 146/(4 + 146) \\ = 0.973333$$

Transmission Line:

$$\lambda_L = 2 \text{ f/yr}$$

$$\mu_L = 1/r_L = 8760/10 = 876 \text{ rep/yr}$$

$$A_L = \mu_L/(\lambda_L + \mu_L) = 876/(2 + 876) \\ = 0.997722$$

$$\text{Availability of the series system, } A_{\text{sys}} = A_G \times A_L \\ = 0.973333 \times 0.997722 = 0.971116$$

$$\text{System Unavailability, } U_{\text{sys}} = 1 - A_{\text{sys}} = 1 - 0.971116 = 0.028884 \\ = 0.028884 \times 8760 = 253.0 \text{ hr/yr}$$

Frequency and Duration Evaluation

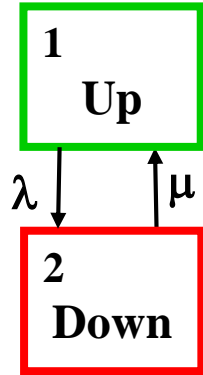

Frequency of encountering State i

= P (being in State i) x (rate of departure from State i)

= P (not being in State i) x (rate of entry into State i)

$$P_1 \cdot \lambda = P_2 \cdot \mu \quad \text{..} \quad \text{Eq. 1}$$

$$P_1 + P_2 = 1 \quad \text{..} \quad \text{Eq. 2}$$

Solving Equations 1 and 2, $P_1 = \frac{\mu}{\lambda + \mu} = A$ and $P_2 = \frac{\lambda}{\lambda + \mu} = U$

Frequency of encountering the Down State,

$$F_{\text{Down}} = P_2 \times (\text{rate of departure from State 2}) = \frac{\lambda}{\lambda + \mu} \mu$$

Mean Duration in the Down State = $U / F_{\text{Down}} = 1/\mu$

Frequency and Duration Evaluation

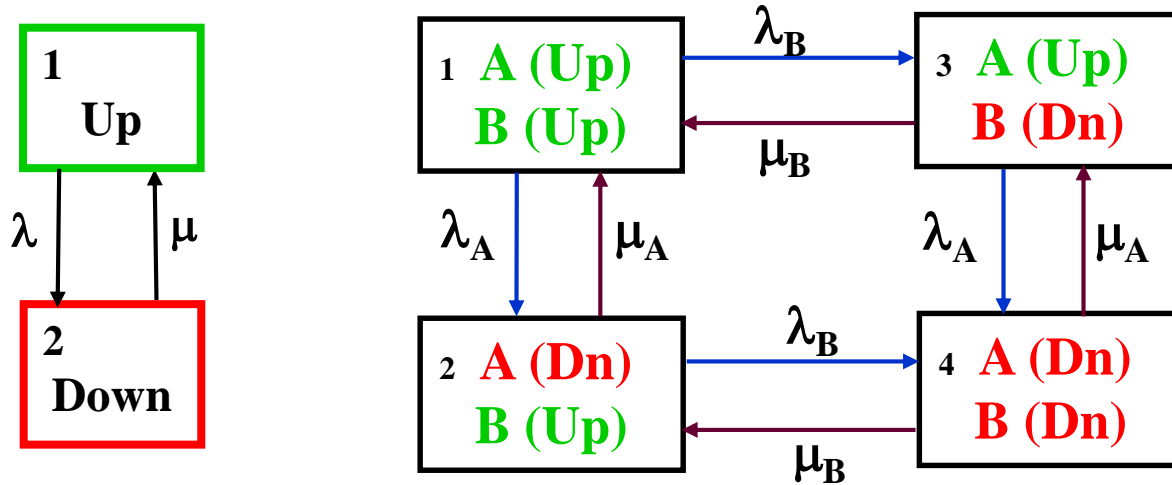

Probability of being in State $i \rightarrow$ Availability, Unavailability

Frequency of encountering State i

= P(being in State i) x (rate of departure from State i)

$$\text{Mean Duration in State } i = \frac{\text{Probability of being in State } i}{\text{Frequency of encountering State } i}$$

Parallel System Evaluation

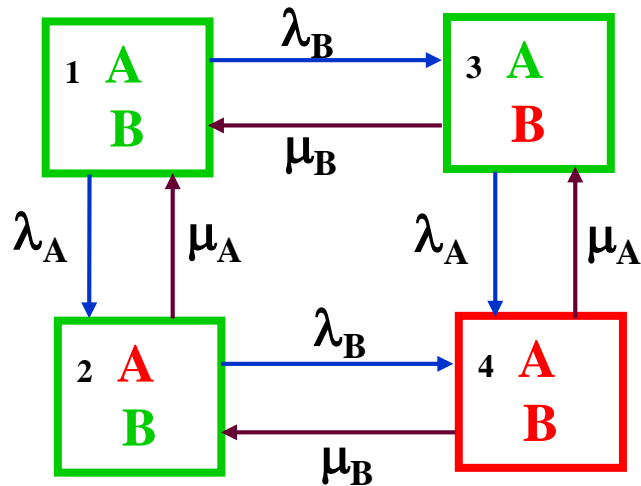

$$P_1 = \left(\frac{\mu_A}{\lambda_A + \mu_A} \right) \left(\frac{\mu_B}{\lambda_B + \mu_B} \right)$$

$$P_2 = \left(\frac{\lambda_A}{\lambda_A + \mu_A} \right) \left(\frac{\mu_B}{\lambda_B + \mu_B} \right)$$

$$P_3 = \left(\frac{\mu_A}{\lambda_A + \mu_A} \right) \left(\frac{\lambda_B}{\lambda_B + \mu_B} \right)$$

$$P_4 = \left(\frac{\lambda_A}{\lambda_A + \mu_A} \right) \left(\frac{\lambda_B}{\lambda_B + \mu_B} \right)$$

System Unavailability, $U = P_4 = \left(\frac{\lambda_A}{\lambda_A + \mu_A} \right) \left(\frac{\lambda_B}{\lambda_B + \mu_B} \right)$

Frequency of Failure

$$= (P_4) \cdot (\text{rate of departure from State 4}) = U \cdot (\mu_A + \mu_B)$$

Mean Duration of Failure = $U / F_{\text{failure}} = 1 / (\mu_A + \mu_B)$

Parallel System Example

A customer is supplied by a distribution system that consists of an underground cable in parallel with an overhead line. The failure rate and the average repair time of the cable are 1 failure/year and 100 hours respectively, and that of the overhead line are 2 failure/year and 10 hours respectively. Evaluate the unavailability, frequency and the mean duration of failure of the distribution system.

Underground Cable:

$$\lambda_A = 1 \text{ f/yr}$$

$$\mu_A = 1/r_1 = 8760/100 = 87.6 \text{ rep/yr}$$

Overhead Line:

$$\lambda_B = 2 \text{ f/yr}$$

$$\mu_B = 1/r_2 = 8760/10 = 876 \text{ rep/yr}$$

$$\begin{aligned} \text{System Unavailability, } U = P_4 &= \left(\frac{\lambda_A}{\lambda_A + \mu_A} \right) \left(\frac{\lambda_B}{\lambda_B + \mu_B} \right) \\ &= [1/(1+87.6)] \cdot [2/(2+876)] = \mathbf{0.000026} \\ &= \mathbf{0.000026 \times 8760 = 0.2252 \text{ hr/yr}} \end{aligned}$$

$$\text{Frequency of Failure} = U \cdot (\mu_A + \mu_B) = 0.000026 \times (87.6 + 876) = \mathbf{0.0251 \text{ f/yr}}$$

$$\text{Mean Duration of Failure} = 1/(\mu_A + \mu_B) = 1/(87.6 + 876) = 0.001 \text{ yr} = \mathbf{9.09 \text{ hr}}$$

Series System Evaluation

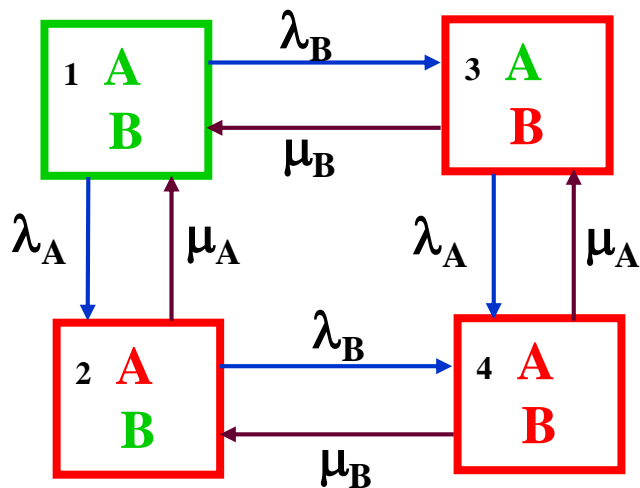

Component A: $\lambda_A = 1$ f/yr, $\mu_A = 87.6$ r/yr

Component B: $\lambda_B = 2$ f/yr, $\mu_B = 876$ r/yr

$$P_1 = 0.986461$$

$$P_2 = 0.011261$$

$$P_3 = 0.002252$$

$$P_4 = 0.000026$$

System Unavailability, $U = P_2 + P_3 + P_4 = 0.013539$
 $= 0.013539 \times 8760 = 118.60$ hr/yr

Frequency of Failure, $F_{\text{failure}} = P_2 \cdot \mu_A + P_3 \cdot \mu_B$
 $= 0.011261 \times 87.6 + 0.002252 \times 876 = 2.96$ f/yr

Mean Duration of Failure $= U / F_{\text{failure}} = 0.013539 / 2.96 = 0.004575$ yr
 $= 0.004575 \times 8760 = 40.08$ hr

Modeling Failure, Repair, Installation

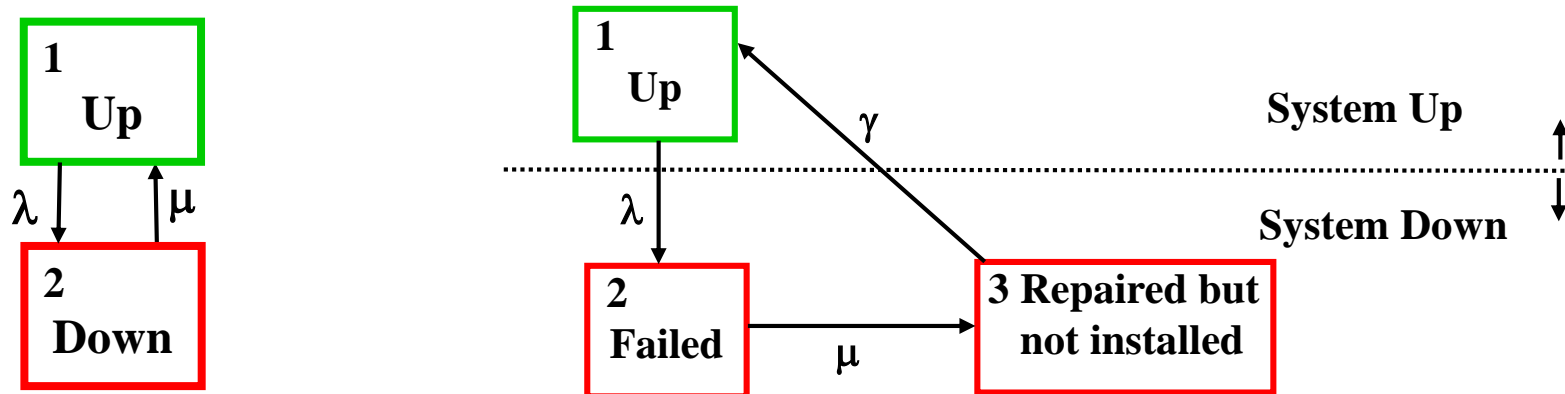

$$\begin{aligned}P_1 \cdot \lambda &= P_3 \cdot \gamma \\P_2 \cdot \mu &= P_1 \cdot \lambda \\P_1 + P_2 + P_3 &= 1\end{aligned}$$

Unavailability, $U = P_2 + P_3$

Frequency of encountering the Down State, $F_{\text{Down}} = P_3 \cdot \gamma$

Mean Duration in the Down State = U / F_{Down}

Modeling Spares and Installation Process

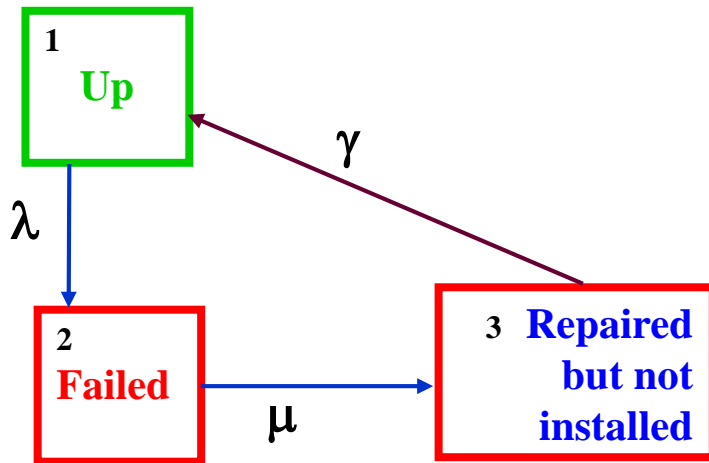

$$P_1 = \frac{\mu\gamma}{\lambda\mu + \lambda\gamma + \mu\gamma}$$

$$P_2 = \frac{\lambda\gamma}{\lambda\mu + \lambda\gamma + \mu\gamma}$$

$$P_3 = \frac{\lambda\mu}{\lambda\mu + \lambda\gamma + \mu\gamma}$$

System Unavailability, $U = P_2 + P_3$

Frequency of Failure, $F_{\text{failure}} = P_3 \cdot \gamma = \frac{\lambda\mu\gamma}{\lambda\mu + \lambda\gamma + \mu\gamma}$

Mean Duration of Failure = $U / F_{\text{failure}} = (1/\mu) + (1/\gamma)$

Modeling Failure, Repair, Installation

Example: A 138 kV, 40 MVA transformer has a failure rate of 0.1625 f/yr, and average repair and installation times of 171.4 hours and 48 hours respectively.

$$\lambda = 0.1625 \text{ f/yr}$$

$$\mu = 1/r = 8760/171.4 = 51.1 \text{ r/yr}$$

$$\gamma = 8760/48 = 182.5$$

$$P_1 = \frac{\mu\gamma}{\lambda\mu + \lambda\gamma + \mu\gamma} = 0.995946$$

$$P_2 = \frac{\lambda\gamma}{\lambda\mu + \lambda\gamma + \mu\gamma} = 0.003167$$

$$P_3 = \frac{\lambda\mu}{\lambda\mu + \lambda\gamma + \mu\gamma} = 0.000887$$

$$\text{Unavailability, } U = P_2 + P_3 = 0.004053 = 35.50 \text{ h/yr}$$

$$\text{Frequency of encountering the Down State, } F_{\text{Down}} = P_3 \cdot \gamma = 0.1619 \text{ f/yr}$$

$$\text{Mean Duration in the Down State} = U / F_{\text{Down}} = 219.3 \text{ h}$$

Spare Component Assessment

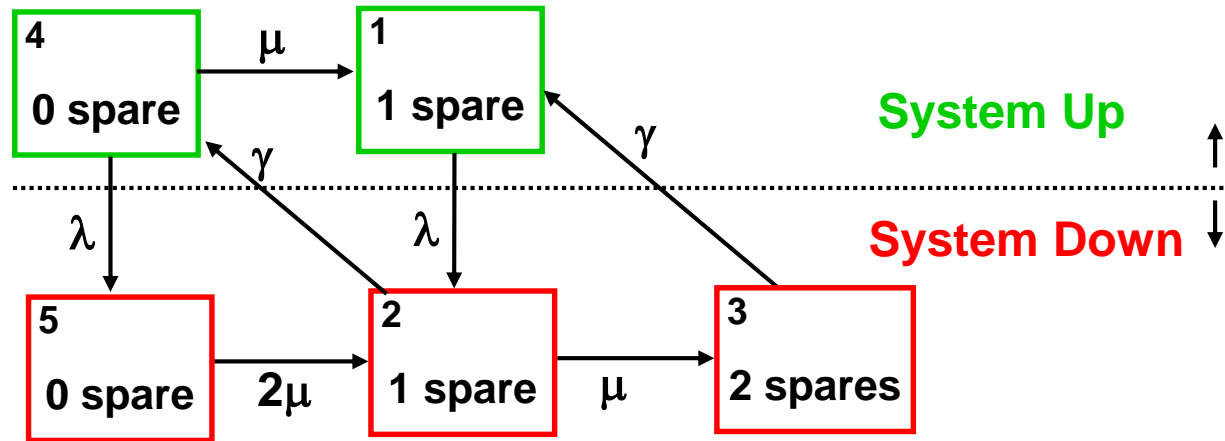

Unavailability, $U = P_2 + P_3 + P_5 = 1 - (P_1 + P_4)$

Frequency of encountering the Down State, $F_{\text{Down}} = (P_2 + P_3) \cdot \gamma = (P_1 + P_4) \cdot \lambda$

Mean Duration in the Down State = U / F_{Down}

Spare Assessment Example

Example: A 138 kV, 40 MVA transformer has a failure rate of 0.1625 f/yr, and average repair and installation times of 171.4 hours and 48 hours respectively. An identical spare is available.

$$\lambda = 0.1625 \text{ f/yr}$$

$$\mu = 1/r = 8760/171.4 = 51.1 \text{ r/yr}$$

$$\gamma = 8760/48 = 182.5$$

$$P_1 = 0.9966326$$

$$P_4 = 0.0024738$$

$$\text{Unavailability, } U = 1 - (P_1 + P_4) = 0.0008936 = 7.828 \text{ h/yr}$$

$$\text{Frequency of encountering the Down State, } F_{\text{Down}} = (P_1 + P_4) \cdot \lambda = 0.1623 \text{ f/yr}$$

$$\text{Mean Duration in the Down State} = U / F_{\text{Down}} = 48.23 \text{ h}$$

F & D Using Approximate Equations

$$U = F_{\text{failure}} \cdot r$$

$$\approx \lambda \cdot r \quad \text{for} \quad \text{MTTF} (1/\lambda) \approx \text{MTBF} (1/ F_{\text{failure}})$$

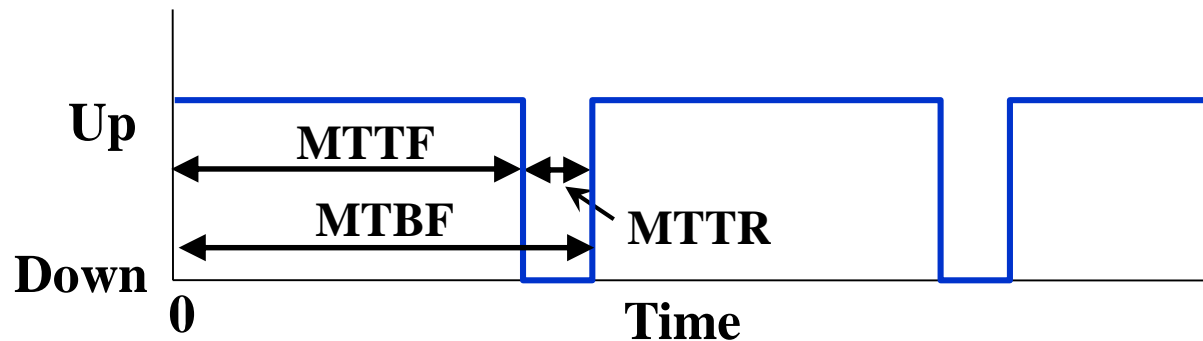

Practical Adequacy Indices

- **Failure rate (or frequency)**
 $\lambda = \text{failures/operating time}$
 $f = \text{failures/time}$
- **Average outage time**
 $r = \text{time/failure}$
- **Average annual outage time**
 $U = f.r \approx \lambda.r$

Series Systems

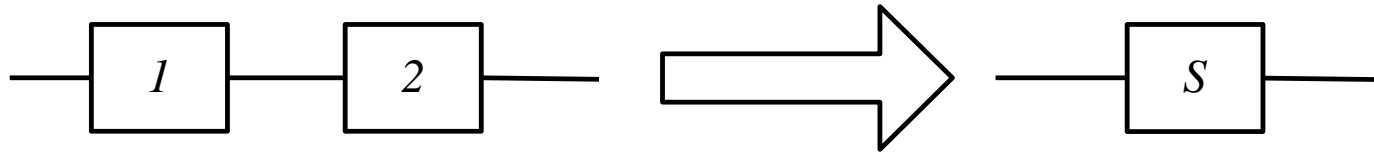

$$\lambda_s = \lambda_1 + \lambda_2 = \sum \lambda_i$$

$$r_s = \frac{\lambda_1 r_1 + \lambda_2 r_2 + \lambda_1 \lambda_2 r_1 r_2}{\lambda_1 + \lambda_2}$$

$$\approx \frac{\lambda_1 r_1 + \lambda_2 r_2}{\lambda_1 + \lambda_2} = \frac{\sum \lambda_i r_i}{\sum \lambda_i}$$

$$U_s \approx \lambda_s r_s$$

Parallel Systems

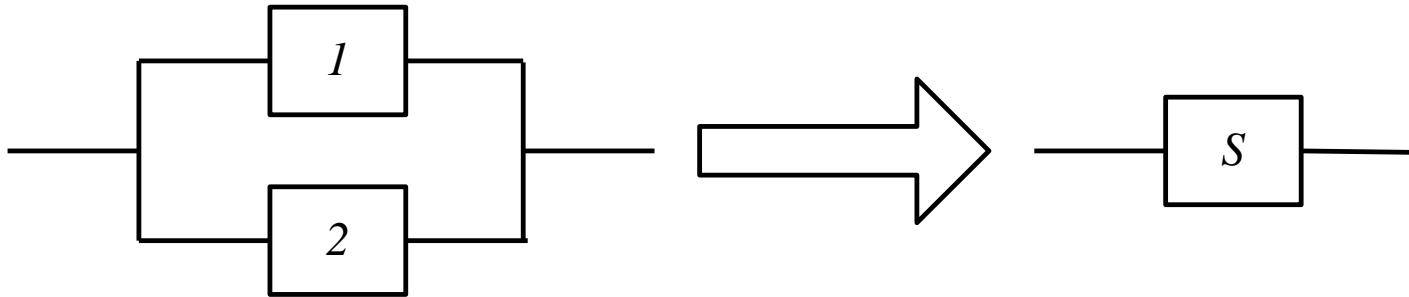

$$\lambda_s = \frac{\lambda_1 \lambda_2 (r_1 + r_2)}{1 + \lambda_1 r_1 + \lambda_2 r_2}$$

$$\approx \lambda_1 \lambda_2 (r_1 + r_2)$$

$$r_s = \frac{r_1 r_2}{r_1 + r_2}$$

$$U_s \approx \lambda_s r_s$$

Availability, F & D – Series System

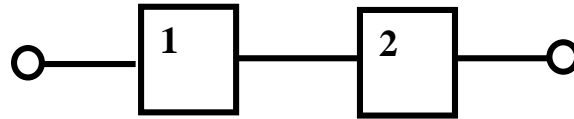

Component 1:

$$\lambda_1 = 1 \text{ f/yr}$$

$$r_1 = 100 \text{ hr}$$

Component 2:

$$\lambda_2 = 2 \text{ f/yr}$$

$$r_2 = 10 \text{ hr}$$

System failure rate,

$$\lambda_s = \sum \lambda_i = \lambda_1 + \lambda_2 = 1 + 2 = 3 \text{ f/yr}$$

System unavailability,

$$U_s = \sum \lambda_i r_i = 1 \times 100 + 2 \times 10 = 120 \text{ hr/yr}$$

System average down time, $r_s = U_s / \lambda_s = 120/3 = 40 \text{ hr}$

Availability, F & D – Parallel System

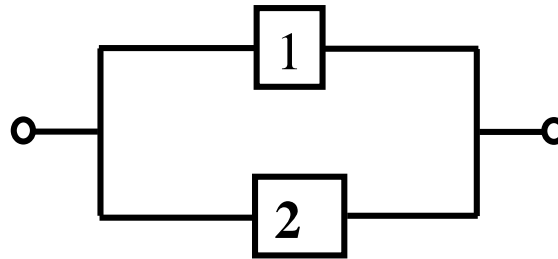

Component 1:

$$\lambda_1 = 1 \text{ f/yr}$$

$$r_1 = 100 \text{ hr}$$

Component 2:

$$\lambda_2 = 2 \text{ f/yr}$$

$$r_2 = 10 \text{ hr}$$

System failure rate,

$$\lambda_s = \lambda_1 \cdot \lambda_2 (r_1 + r_2)$$

$$= 1 \times 2 \times (100 + 10) / 8760 = \mathbf{0.0251 \text{ f/yr}}$$

System average down time, $r_s = r_1 \cdot r_2 / (r_1 + r_2)$

$$= 100 \times 10 / (100 + 10) = \mathbf{9.09 \text{ hr}}$$

System unavailability,

$$U_s = \lambda_s r_s = 0.025 \times 9.09 = \mathbf{0.228 \text{ hr/yr}}$$

Approximate Equations for Parallel Systems

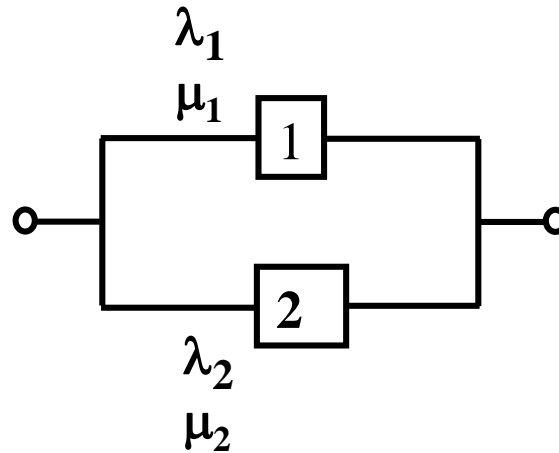

For a 2-component parallel system,

$$\lambda_s \approx \lambda_1 \cdot \lambda_2 (r_1 + r_2) \quad \text{for } \lambda_i \cdot r_i \ll 1 \quad \rightarrow \quad \lambda_s = \lambda_1(\lambda_2 r_1) + \lambda_2(\lambda_1 r_2)$$

$$r_s = r_1 \cdot r_2 / (r_1 + r_2) \quad \rightarrow \quad \mu_s = \Sigma \mu_i$$

$$U_s = \lambda_s \cdot r_s$$

Similar equations can be used to incorporate:

- **Forced outages overlapping maintenance outages**
- **Temporary outages**
- **Common mode outages**
- **Failure bunching due to adverse weather.**

Forced outages overlapping maintenance outages

$$\lambda_{pm} = \lambda_1''(\lambda_2 r_1'') + \lambda_2''(\lambda_1 r_2'')$$

$$U_{pm} = \lambda_1''(\lambda_2 r_1'')(r_1'' r_2)/(r_1'' + r_2) + \lambda_2''(\lambda_1 r_2'')(r_1 r_2'')/(r_1 + r_2'')$$

$$r_{pm} = U_{pm} / \lambda_{pm}$$

where: λ'' = maintenance outage rate

r'' = maintenance time

Basic Network Analysis Techniques

- **Series / Parallel Reduction**
- **Minimal Cut Set Analysis**

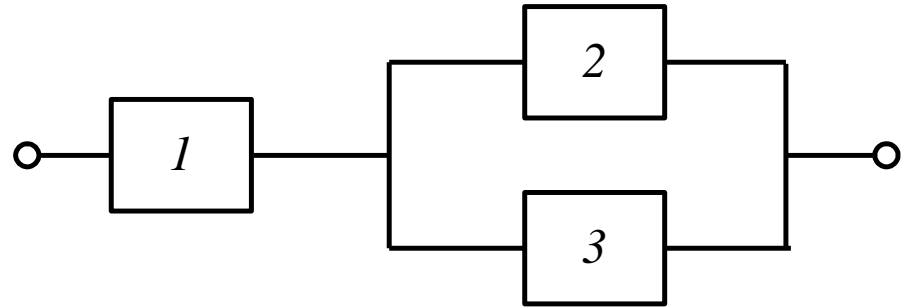

Minimal Cut Set Analysis

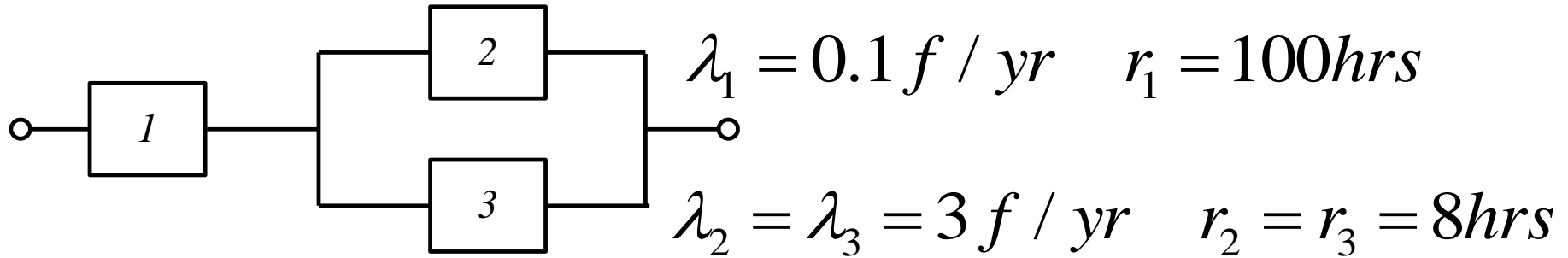

Min Cuts	λ	r	U
1	0.1	100	10.0000
2,3	0.0164	4	0.0656
Total	0.1164	86.47	10.0656

$$\lambda_s = 0.1164 f / yr$$

$$r_s = 86.47hrs$$

$$U_s = 10.0656hrs / yr$$

Monte Carlo Simulation

Reliability Evaluation Techniques:

Analytical Technique

represent the system by a mathematical model (usually simplified for practical systems)

direct mathematical solution

Simulation Technique

simulate the actual process (using random numbers) over the period of interest

repeat simulation for a large number of times until convergence criteria is met

Advantages:

short solution time

same results for the same problem (greater but perhaps unrealistic confidence to user)

can incorporate complex systems

(analytical approach simplification can be unrealistic)

wide range of output parameters including probability distributions

(analytical approach usually limited to expected values)

MCS Methods

Random Simulation

Basic (time) intervals chosen randomly

Can be applied when events in one basic interval do not affect the other basic intervals

Sequential Simulation

Basic (time) intervals in chronological order

Required when one basic interval has a significant effect on the next interval

Can also provide frequency and duration indices

Random Simulation

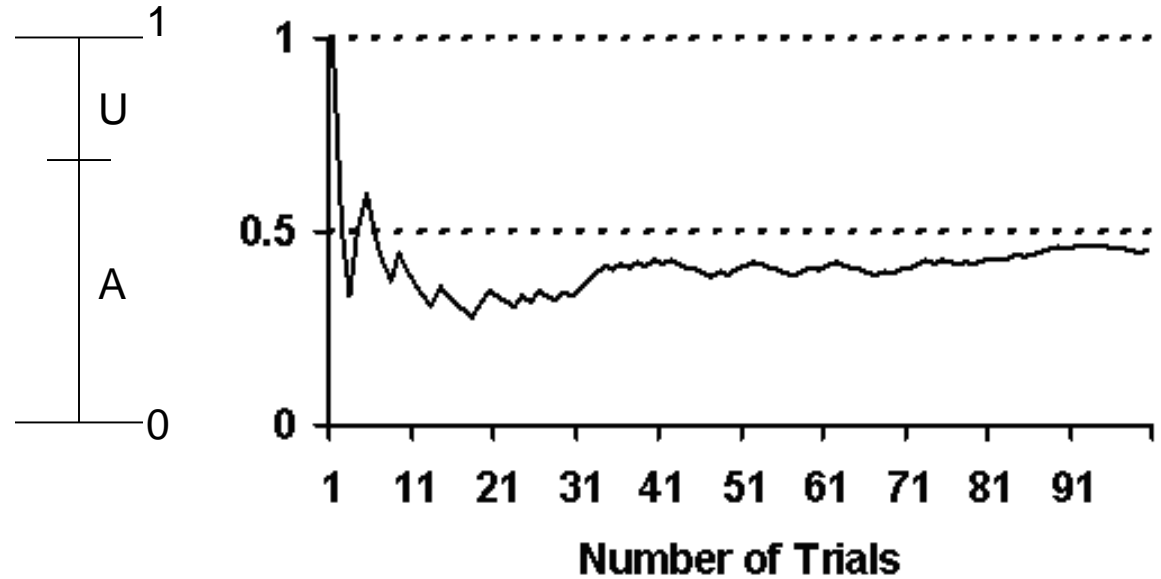
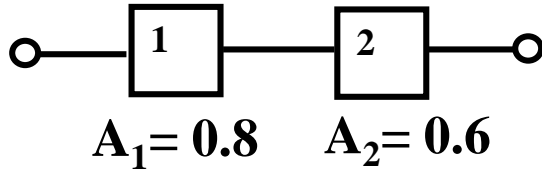

$U = \text{Random \# (0 - 1)}$
Simulation Convergence

Trial #	Component 1 simulation		Component 2 simulation		System State	System Availability
	Rand #	State	Rand #	State		
1	0.12	Up	0.35	Up	Up	1/1 = 1.00
2	0.87	Down	0.21	Up	Down	1/2 = 0.50
3	0.95	Down	0.62	Down	Down	1/3 = 0.33
4	0.59	Up	0.18	Up	Up	2/4 = 0.50
5						

Inverse Transform Method

An exponential variate T has the density function:

$$f_T(t) = \lambda e^{-\lambda t}$$

Using the inverse transform method:

U is a uniform random number in the range of (0, 1).

$$U = F_T(T) = 1 - e^{-\lambda t}$$

$$T = \frac{-1}{\lambda} \ln(1 - U)$$

$$\lambda$$

$$= \frac{-1}{\lambda} \ln U$$

$$\lambda$$

Sequential Simulation

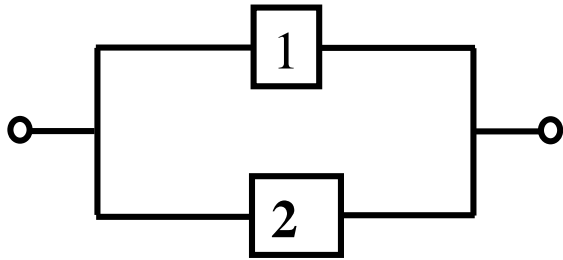

Component 1:
 $\lambda_1 = 1$ f/yr

Component 2:
 $\lambda_2 = 5$ f/yr

Evaluate the system reliability for an operating time of 20 hours.

$$\text{Up time} = -\frac{1}{\lambda} \ln U$$

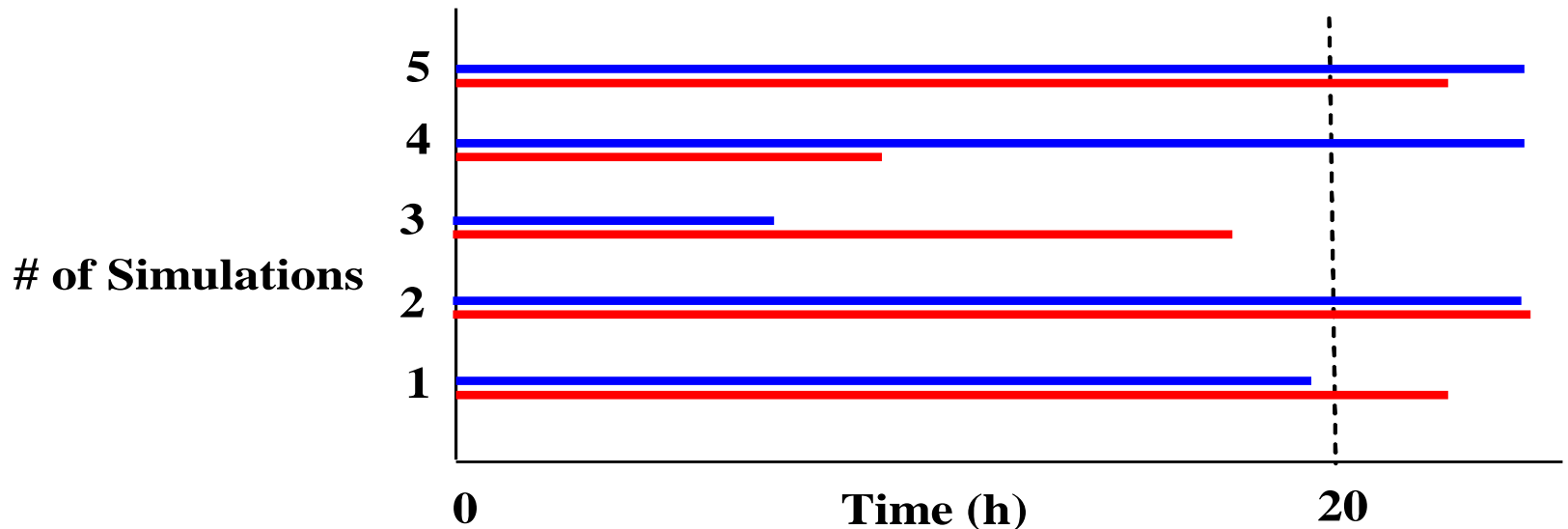

Sequential Simulation

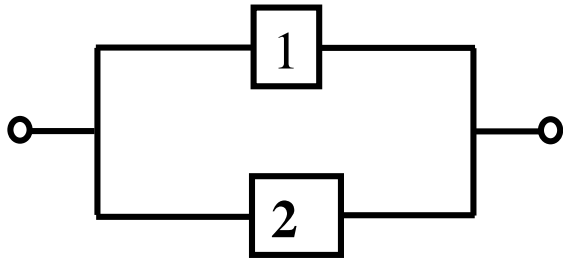

Component 1:

$$\lambda_1 = 1 \text{ f/yr}$$

$$r_1 = 100 \text{ hr}$$

Component 2:

$$\lambda_2 = 5 \text{ f/yr}$$

$$r_2 = 444 \text{ hr}$$

$$U_{\text{sys}} = U_1 \times U_2 = 0.00228 = 20 \text{ hr/yr}$$

$$\text{Up time} = -\frac{1}{\lambda} \ln X$$

$$\text{Down time} = -\frac{1}{\mu} \ln X$$

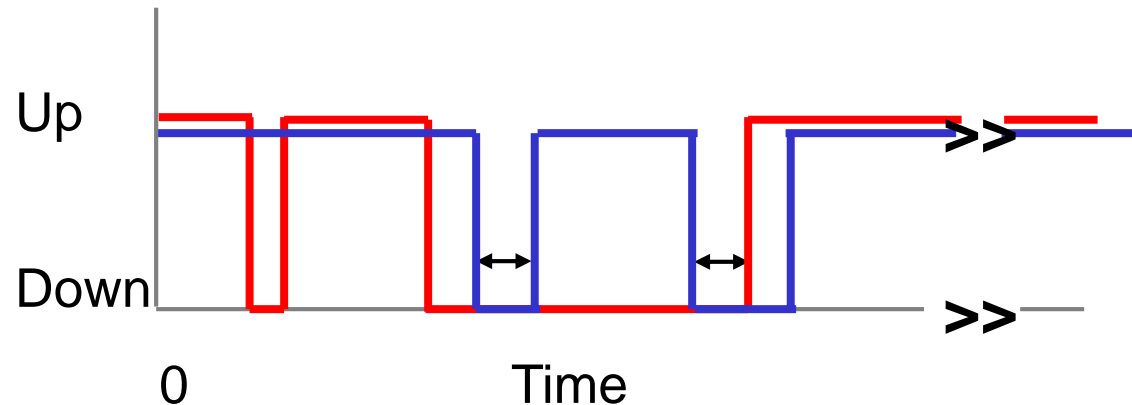

$$U = \frac{\text{total outage time}}{\text{total simulation time}}$$

$$\text{Frequency of Failure} = \frac{\text{total \# of failures}}{\text{total simulation time}}$$

$$\text{Duration of Failure} = \frac{\text{total outage time}}{\text{total \# of failures}}$$

Monte Carlo / Analytical Methods

- **Monte Carlo simulation is a very powerful approach and can be used to solve a wide range of problems.**
- **In many cases, a suitable solution can be obtained by using a direct analytical technique.**
- **Use the most appropriate method for the given problem**

- **“Reliability Evaluation of Engineering Systems, Second Edition”**, R. Billinton and R.N. Allan, Plenum Press, 1992., pp. 453.

Generating Capacity Reliability Evaluation

Roy Billinton
Power System Research Group
University of Saskatchewan
CANADA



Functional Zones and Hierarchical Levels

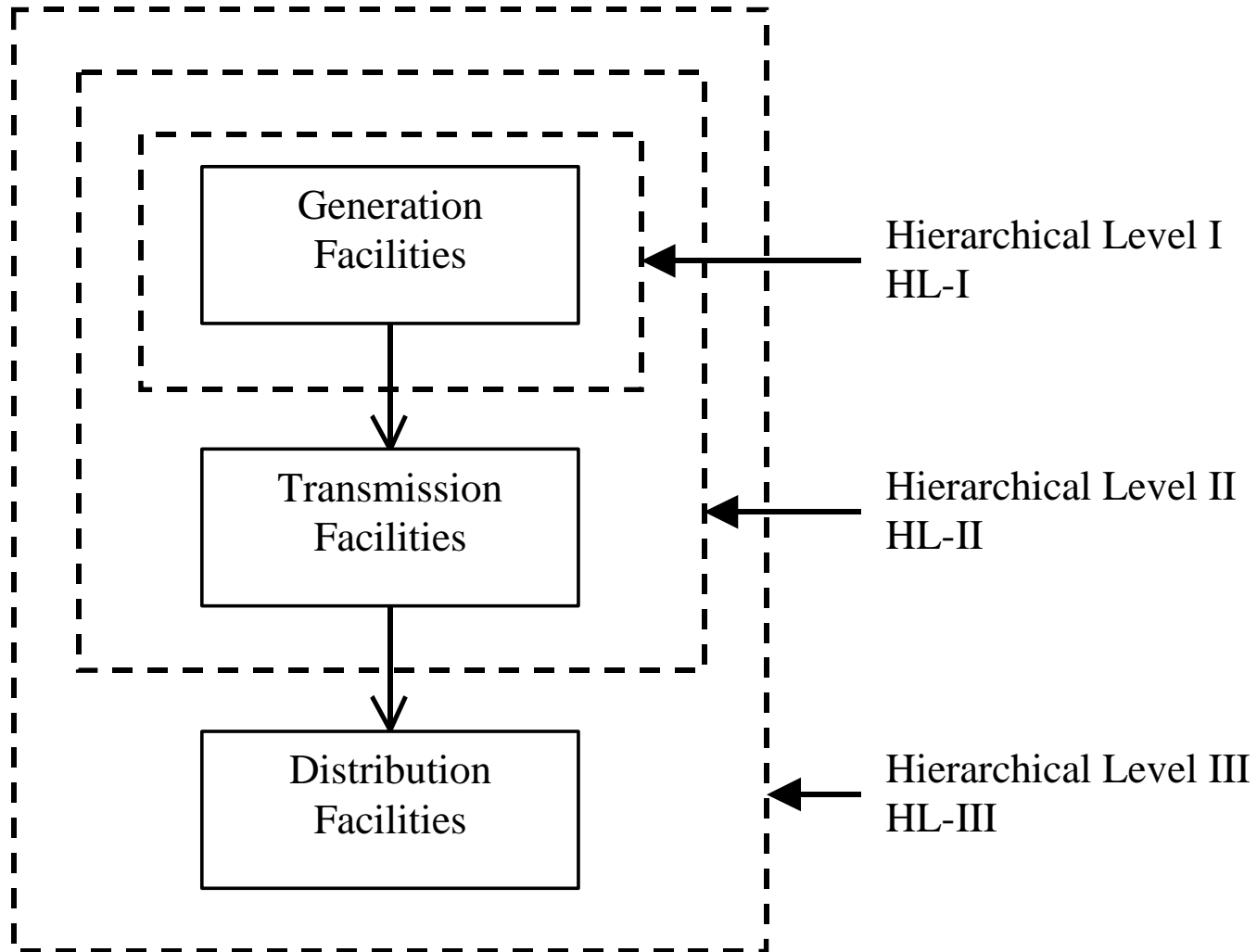

Hierarchical Level I – HL-I

Classical generating capacity planning

Task – plan a generating system to meet the system load requirement as economically as possible with an acceptable level of reliability.

System Model

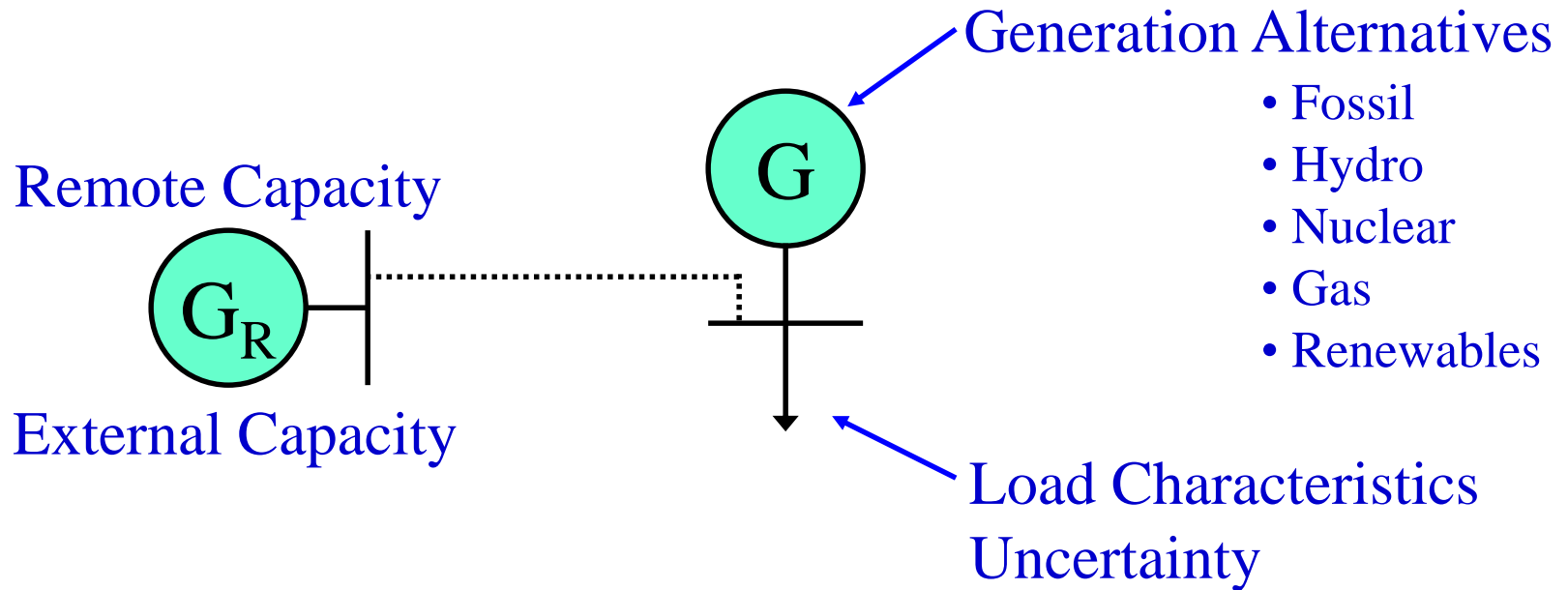

Conceptual Tasks in Reliability Evaluation at HLI

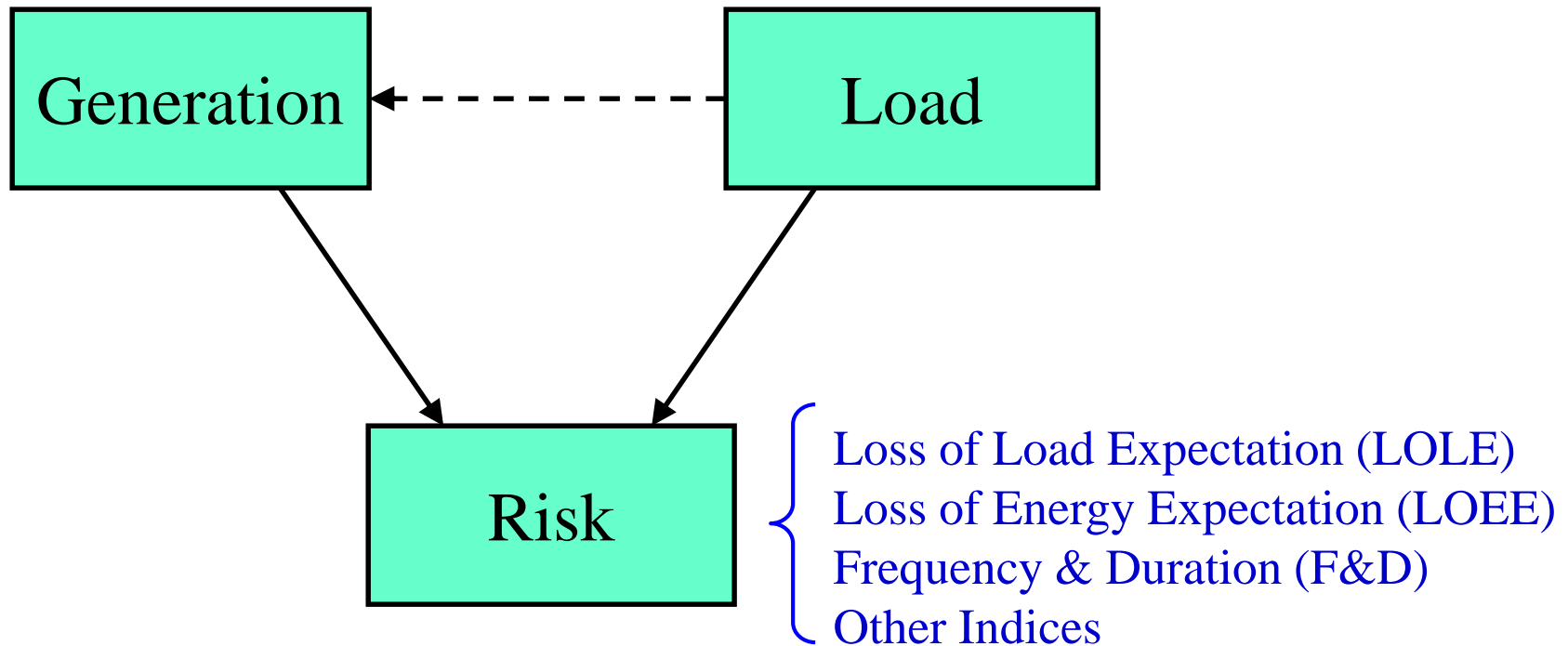

Loss of Load Expectation (LOLE) is the expected number of hours or days in a given period of time that the load exceeds the available generation.

Loss of Energy Expectation (LOEE) is the expected energy not supplied in a given period of time due to the load exceeding the available generation.

The **LOLE** and **LOEE** are long run average values and are important indicators of HLI adequacy.

The basic component model used in most power system reliability studies is the two state representation shown in Fig. 2.

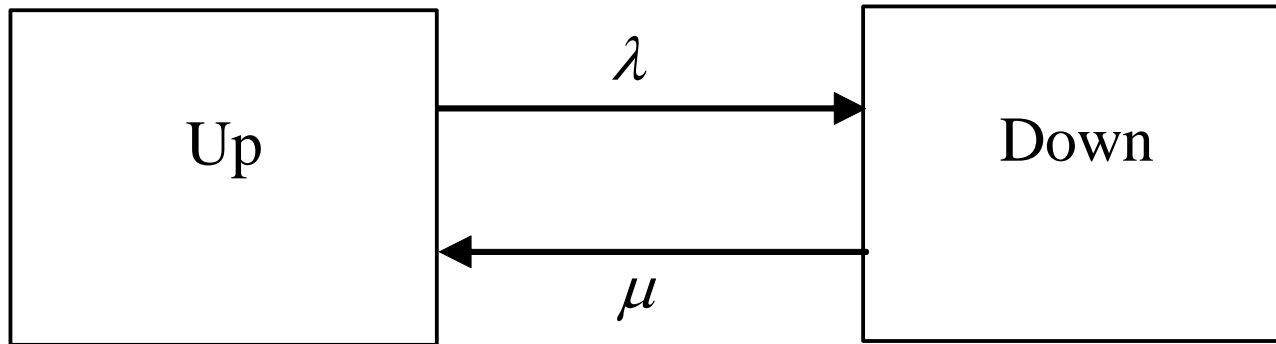

Fig. 2. Two state component model

The model shown in Fig. 2 is a simple but reasonably robust representation. The component availability (A) and unavailability (U) (Forced Outage Rate) are given by Equation (1).

$$A = \frac{\mu}{\lambda + \mu} \tag{1}$$

$$U = \frac{\lambda}{\lambda + \mu} = \frac{\sum (\text{Down Time})}{\sum (\text{Up Time}) + \sum (\text{Down Time})}$$

There are many variations and expansions of the model shown in Fig. 2, particularly in research related studies and developments. Some of these are:

- The inclusion of derated states in generating units.**
- The four state model used to recognize the conditional probability of failure associated with peaking units.**
- The three state model used to consider active and passive failures of circuit breakers.**
- The recognition of non-exponential state residence time distributions and variable failure and repair rates due to component aging, repair and maintenance practices.**

Derated State Model

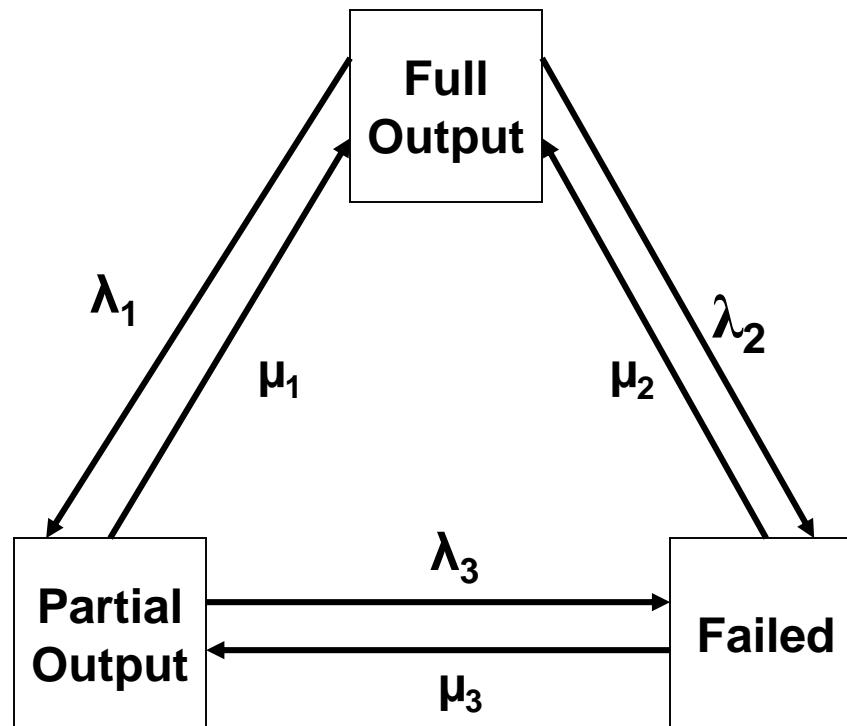

Two-State Models

The unit derated state model can be reduced to a two-state representation. The derated adjusted forced outage rate (DAFOR) is used by the Canadian Electricity Association (CEA) to represent the probability of a multi-state unit being in the forced outage state. and is obtained by apportioning the time spent in the derated states to the full up and down states. This is known as the equivalent forced outage rate (EFOR) in the NERC-GADS

The two state representation in which the unit is available or unavailable for service is a valid representation for base load units but does not adequately represent intermittent operating units used to meet peak load conditions. Peaking units are started when they are needed and normally operate for relatively short periods. The operation of peaking units can be described by the frequency and duration of their service and shutdown states and the transitions between these states.

Four-State Model

The IEEE Subcommittee on the Application of Probability Methods proposed a four-state model for peaking units.

This model includes reserve shutdown and forced out but not needed states.

Four-State Model

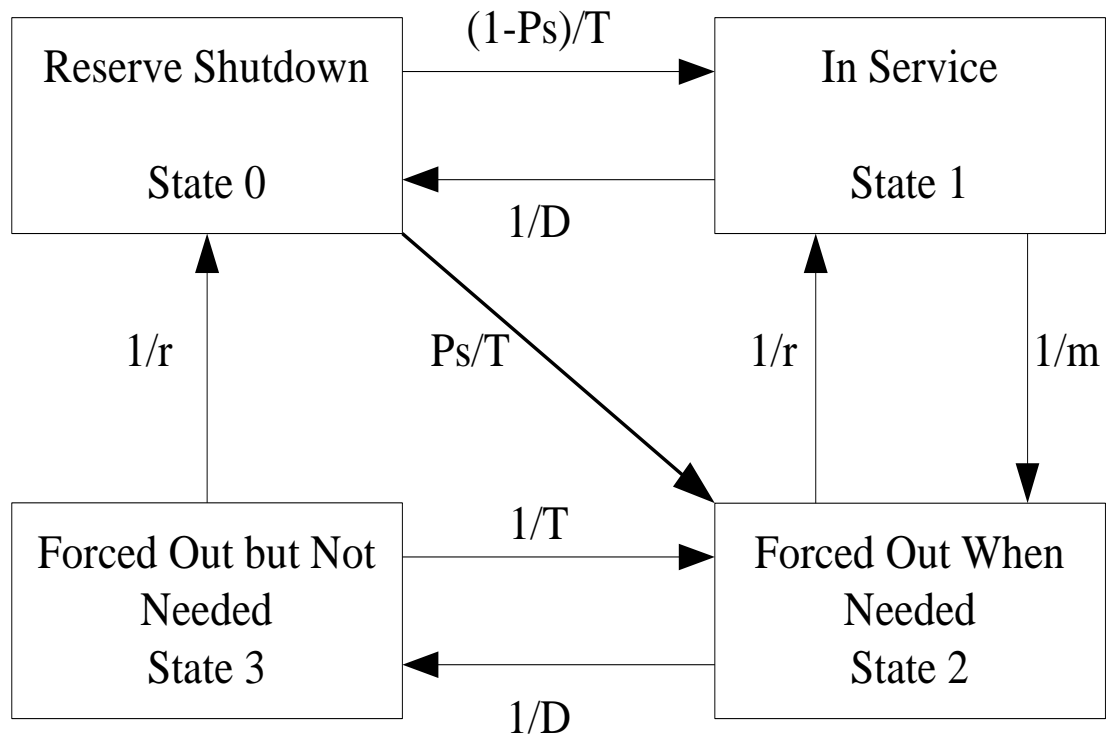

T = Average reserve shutdown time between periods of need.

D = Average in service time per occasion of demand.

Ps = Probability of starting failure.

m and r are the same as in the two-state model.

The UFOP and The Demand Factor

- **The Utilization Forced Outage Probability (UFOP) is the probability of a generating unit not being available when needed.**

$$UFOP = \frac{P_2}{P_1 + P_2}$$

- **The demand factor f of a peaking unit is calculated as follows.**

$$f = \frac{P_2}{P_2 + P_3} = \frac{(1/r + 1/T)}{1/D + 1/r + 1/T}$$

- **P_i represents the probability of State i .**

The UFOP and The Demand Factor

The conventional forced outage rate is:

$$\text{FOR} = (\text{FOH}) / (\text{SH} + (\text{FOH}))$$

The conditional forced outage rate is:

$$\text{UFOP} = f(\text{FOH}) / (\text{SH} + f(\text{FOH}))$$

Canadian Electricity Association Equipment Reliability Information System Components

- **Generation Equipment Status Reporting System**
- **Transmission Equipment Outage Reporting System**
- **Distribution Equipment Outage Reporting System**

In Table 1:

FOR = Forced Outage Rate,

DAFOR = Derated Adjusted Forced Outage Rate; This is known as EFOR in the NERC-GADS

DAUFOP = Derated Adjusted Utilization Forced Outage Probability; This is known as EFORd in the NERC-GADS and is the conditional probability of finding the unit in the modified down state given that the system needs the unit.

Table 1
Generating Unit Unavailability Statistics

Unit Type	FOR %	DAFOR %	DAUFOP %
Hydraulic	1.97	2.03	1.74
Fossil	7.32	10.74	9.16
Nuclear	7.64	9.16	9.12
CTU	29.78	-----	8.13

where: CTU = Combustion Turbine Unit

Table 2

FOR, DAFOR and DAUFOP for Hydraulic Units by Unit Size

MCR (MW)	FOR (%)	DAFOR (%)	DAUFOP (%)
5 – 23	3.67	3.71	3.17
24 – 99	1.48	1.56	1.38
100 – 199	1.08	1.13	0.95
200 – 299	2.30	2.36	1.94
300 – 399	0.93	0.93	0.82
400 – 499	1.26	1.29	1.10
500 – over	0.64	0.64	0.59

Canadian Electricity Association “*Generation Equipment Status*”, 2002-2006

Table 3
FOR, DAFOR and DAUFOP for Fossil Units-Coal
by Years of Service

Years of Service	FOR (%)	DAFOR (%)	DAUFOP (%)
6th – 10th	2.00	2.75	2.73
11th – 15th	2.06	2.89	3.25
16th – 20th	3.76	4.67	4.64
21st – 25th	4.26	6.22	6.10
26th – 30th	6.61	11.26	10.58
31st – 35th	9.26	13.57	12.82
36th – 40th	12.90	18.89	15.73
41st – 45th	12.69	17.15	13.99
46th – 50th	4.18	12.45	12.06

The unavailability statistics shown in Tables 1-3 are normally associated with adequacy assessment and used in planning studies. The most important parameters in an operating or short-term sense is the generating unit failure rate (λ). The probability of a unit failing in the next few hours, $Q(t)$, is given by Equation (4).

$$Q(t) = 1 - e^{-\lambda t} \approx \lambda.t \quad (4)$$

The assumption in this case is that the time period t is sufficiently short that repair is not a factor.

The $\lambda.t$ term has been designated as the Outage Replacement Rate (ORR) and is used as the basic generating unit statistic in spinning or operating reserve studies. Table 4 shows representative failure rates for the general unit classes in Table 1.

Table 4
Generating Unit Failure Rates

Unit Type	Failure Rate (f/a)
Hydraulic	2.30
Fossil	10.70
Nuclear	2.24
CTU	10.82

Risk evaluation method and equations

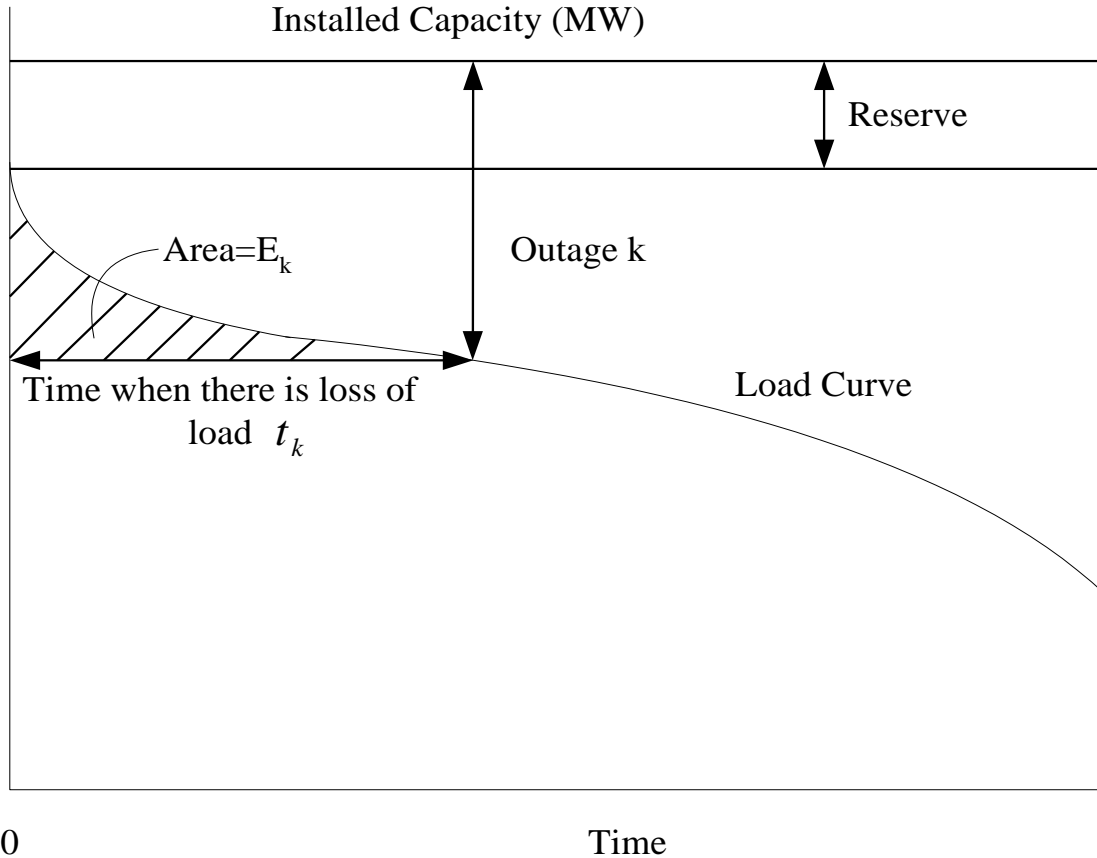

$$LOLE = \sum_{k=1}^n p_k t_k$$

$$LOEE = \sum_{k=1}^n p_k E_k$$

where

n is the total number of capacity outage states.

p_k is the individual probability of the capacity outage state k .

t_k is the number of time units when there is a loss of load.

E_k represents the energy that cannot be supplied in a capacity outage state k .

Monte Carlo Simulation

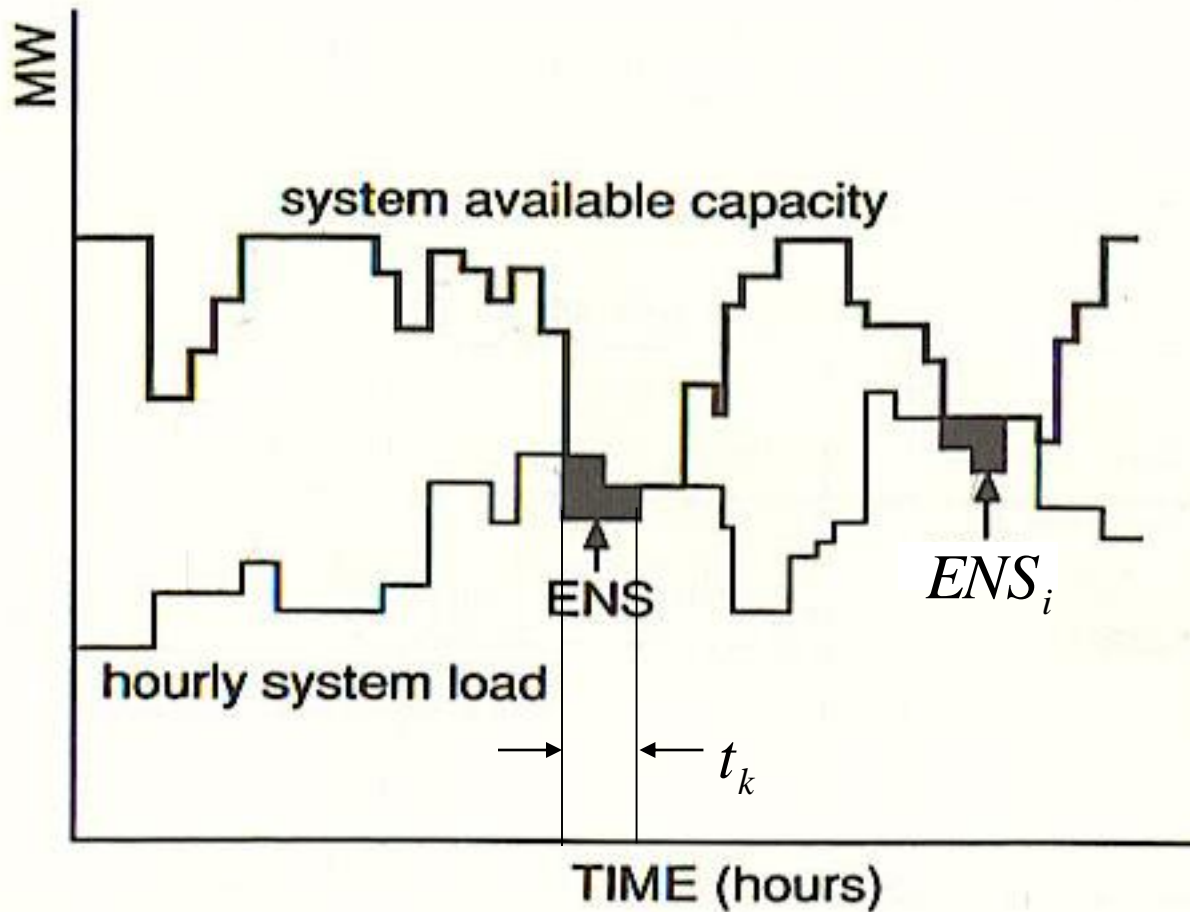

$$LOLE = \frac{\sum_{k=1}^M t_k}{N}$$

$$LOEE = \frac{\sum_{i=1}^M ENS_i}{N} \quad MWh/yr$$

N: Sampling years

M: Number of the occurrence of Loss of Load in N years.

Generation Model

- **Example: A 100 MW generating system consists of five 20 MW units. Each unit has an FOR of 0.03.**
- **Binomial Distribution**

Units Out	Capacity Out (MW)	Capacity In (MW)	Individual Probability	Cumulative Probability
0	0	100	0.858734	1
1	20	80	0.132794	0.141266
2	40	60	0.008214	0.008472
3	60	40	0.000254	0.000258
4	80	20	0.000004	0.000004
5	100	0	0.000000	0.000000

Load Model

- A load with a peak of 60 MW and a load factor of 75%.

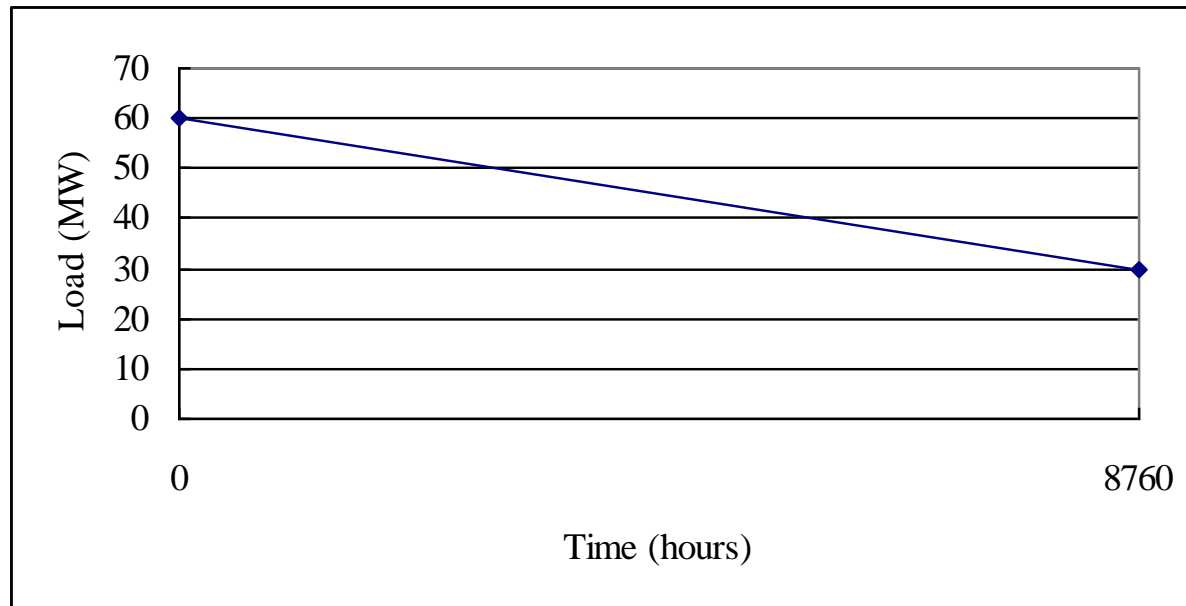

Risk Evaluation

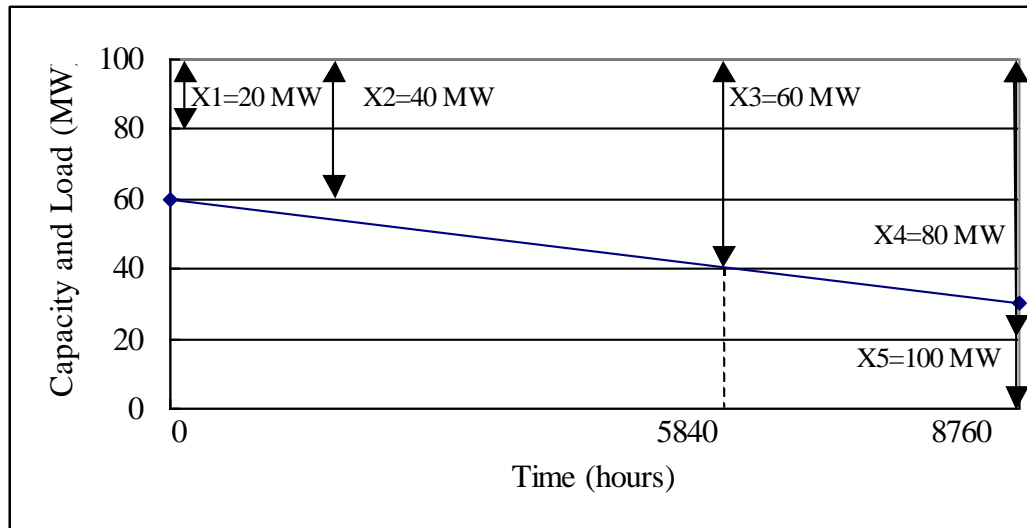

Cap. Out (MW)	Cap. In (MW)	Individual Probability	Outage Time (hours)	LOL (hours/year) =C3*C4	LOE (MWh/year)
0	100	0.858734	0	0	0
20	80	0.132794	0	0	0
40	60	0.008214	0	0	0
60	40	0.000254	5840	1.483360	14.8336
80	20	0.000004	8760	0.034427	0.8607
100	0	0.000000	8760	0.000213	0.0096
				LOLE=1.5180	LOEE=15.7039

LOLE versus Peak Load

- **5*20 MW Generating System**

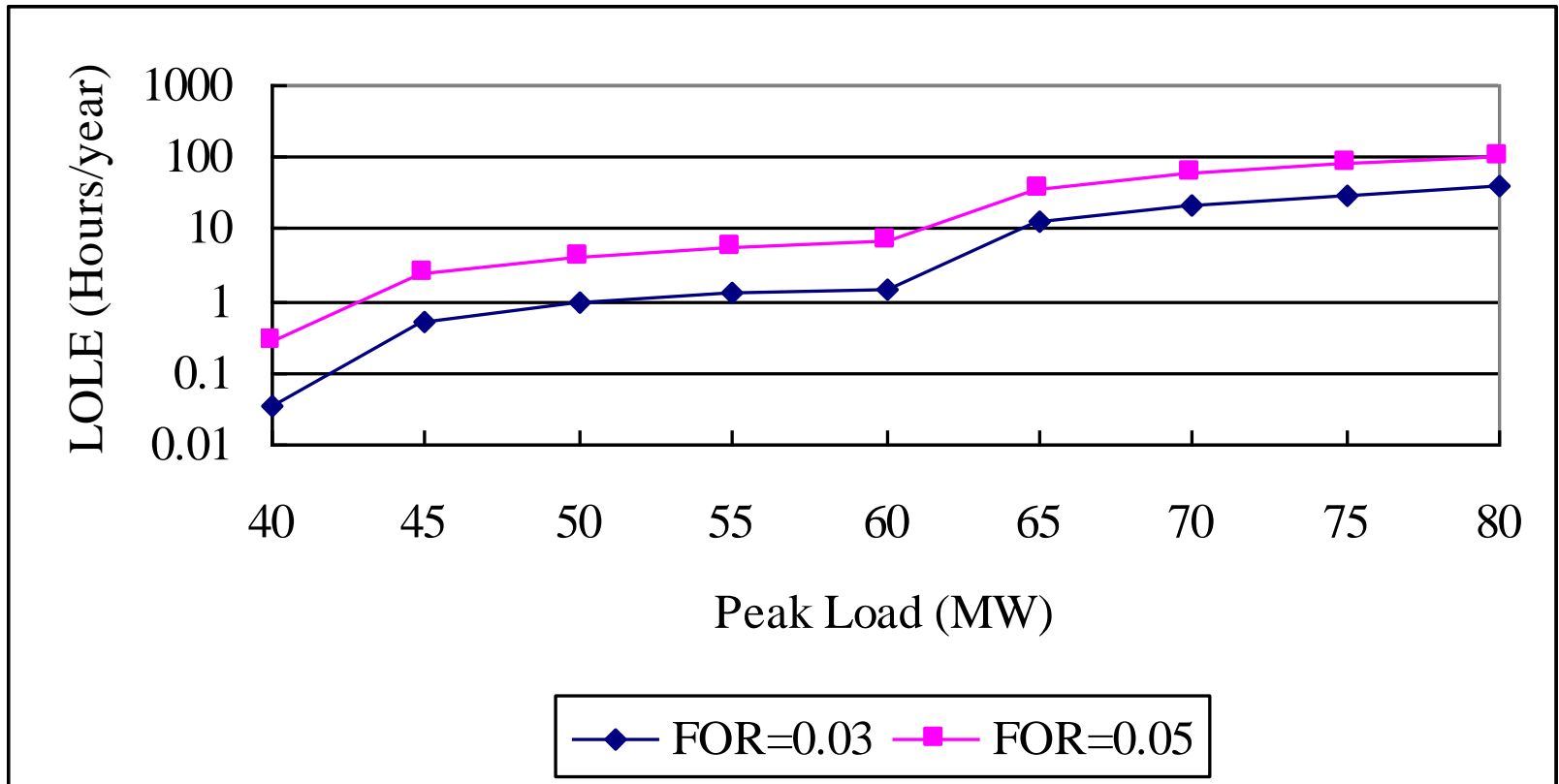

Add a 50 MW Unit, FOR=0.05

- Create a new COPT using the conditional probability method

$$P(A) = \sum_{j=1}^2 P(A | B_j) P(B_j)$$

5*20 MW + 1*50 MW

5*20 MW FOR=0.03

Cap. Out (MW)	Cap. In (MW)	Individual Probability
0	100	0.858734
20	80	0.132794
40	60	0.008214
60	40	0.000254
80	20	0.000004
100	0	0.000000

1*50 MW FOR=0.05

Cap. Out (MW)	Cap. In (MW)	Individual Probability
0	50	0.95
50	0	0.05

Cap. Out (MW)	Cap. In (MW)	Individual Probability
0	150	0.8157973
20	130	0.1261542
40	110	0.0078034
50	100	0.0429367
60	90	0.0002413
70	80	0.0066397
80	70	0.0000037
90	60	0.0004107
100	50	0.0000000
110	40	0.0000127
130	20	0.0000002
150	0	0.0000000

LOLE versus Peak Load

- 5*20 MW(FOR=0.03) Plus 1*50 MW(FOR=0.05)

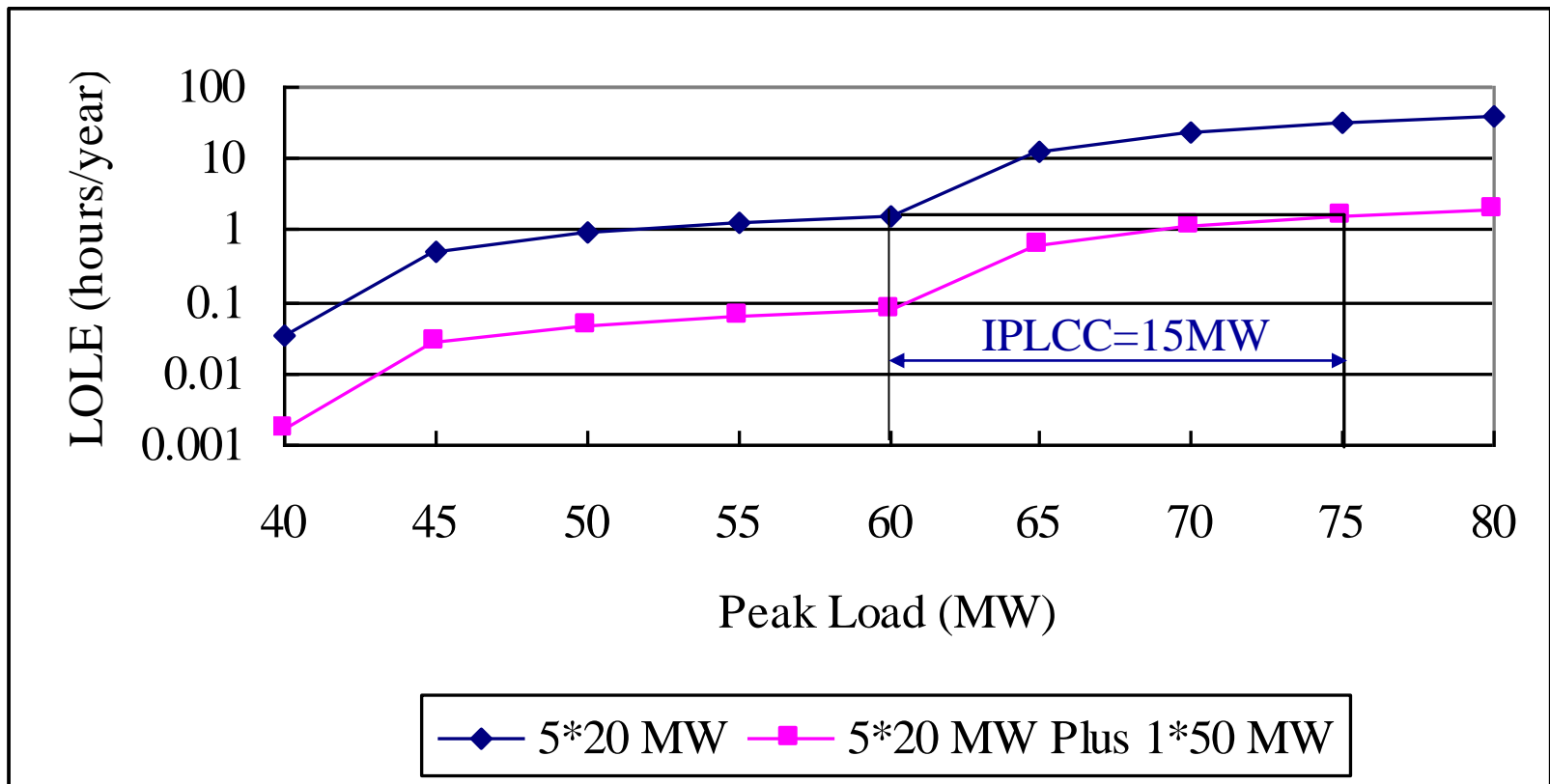

Generation Models

Hydro and SCGT Units – 2 state models
 Base load units – FOR, DAFOR
 As needed unit - UFOP

CCGT Units – multi-state models for combined units

State #	Units Unavailable	Available Capacity	Probability
1	none	$2C_{GT} + C_{ST}$	$(1-FOR_{ST}) \times (1-FOR_{GT})^2$
2	ST	$2C_{GT}$	$FOR_{ST} \times (1-FOR_{GT})^2$
3	1 GT	$C_{GT} + 0.5C_{ST}$	$2 \times (1-FOR_{ST}) \times (1-FOR_{GT}) \times FOR_{GT}$
4	1 GT + ST	C_{GT}	$2 \times FOR_{ST} \times (1-FOR_{GT}) \times FOR_{GT}$
5	2 GT	0	FOR_{GT}^2

Wind Power Modeling and Data

The power produced by a wind turbine generator (WTG) at a particular site is highly dependent on the wind regime at that location. Appropriate wind speed data are therefore essential elements in the creation of a suitable WTG model. The actual data for a site or a statistical representation created from the actual data can be used in the model.

This is illustrated using data for a site located at Swift Current in Saskatchewan, Canada.

The mean and standard deviation of the wind speed at the Swift Current site are 19.46 km/h and 9.7km/h respectively. The hourly mean and standard deviation of wind speeds from a 20-year database (1 Jan.1984 to 31 Dec. 2003) for the Swift Current location were obtained from Environment Canada. These data were used to build an Auto-Regressive Moving Average Model (ARMA) time series model.

The ARMA (4,3) model is the optimal time series model for the Swift Current site and the parameters are shown in Equation (1):

Swift Current: ARMA (4, 3):

$$\begin{aligned} y_t = & 1.1772y_{t-1} + 0.1001y_{t-2} - 0.3572y_{t-3} + 0.0379y_{t-4} \\ & + \alpha_t - 0.5030\alpha_{t-1} - 0.2924\alpha_{t-2} + 0.1317\alpha_{t-3} \end{aligned} \quad (1)$$
$$\alpha_t \in NID(0, 0.524760^2)$$

The simulated wind speed SW_t can be calculated from Equation (2) using the wind speed time series model.

$$SW_t = \mu_t + \sigma_t \times y_t \quad (2)$$

where μ_t is the mean observed wind speed at hour t , σ_t is the standard deviation of the observed wind speed at hour t , $\{\alpha_t\}$ is a normal white noise process with zero mean and the variance 0.524760^2 .

The hourly wind data produced by the ARMA model can be used in a sequential Monte Carlo simulation of the total system generation or to create a multi-state model of the WTG that can be used in an analytical technique or a non-sequential Monte Carlo approach to generating capacity assessment. A capacity outage probability table (COPT) of a WTG unit can be created by applying the hourly wind speed to the power curve.

The power output characteristics of a WTG are quite different from those of a conventional generating unit and depend strongly on the wind regime as well as on the performance characteristics of the generator.

The parameters commonly used are the cut-in wind speed (at which the WTG starts to generate power), the rated wind speed (at which the WTG generates its rated power) and the cut-out wind speed (at which the WTG is shut down for safety reasons) .

Wind Turbine Generating Unit Power Curve

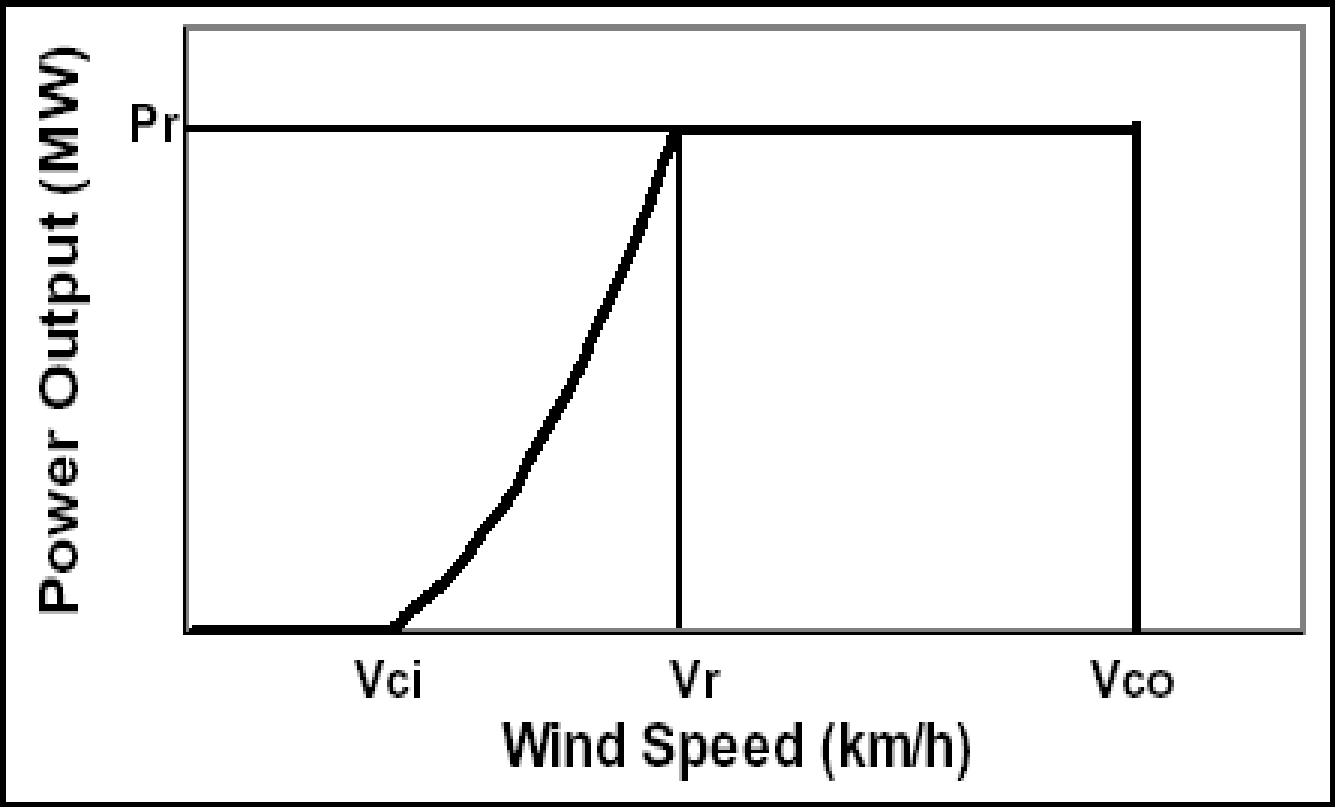

Renewable energy sources, such as wind and solar power, behave quite differently than conventional generation facilities.

Wind speeds & power outputs from two consecutively simulated years (the first week of January)

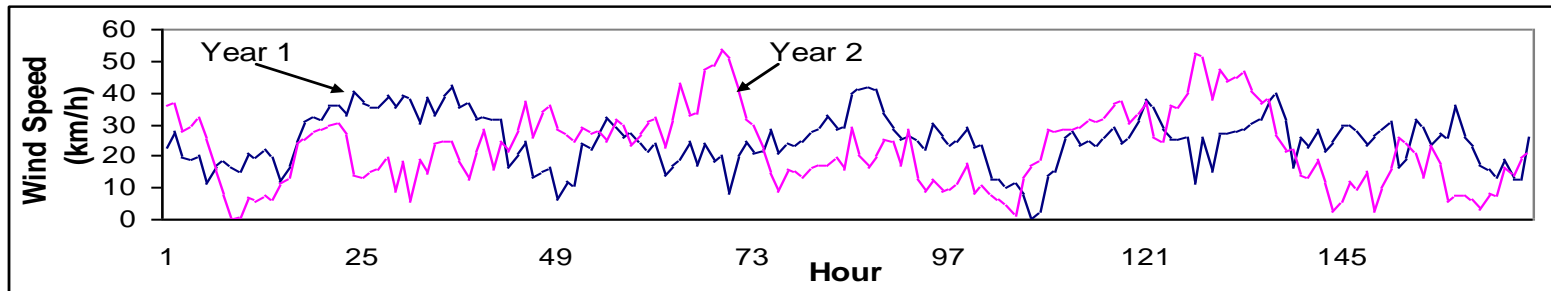

Power Curve Parameters:

Cut-in speed (V_{ci}) = 14.4 km/h

Rated speed (V_r) = 36.0 km/h

Cut-out speed (V_{co}) = 80.0 km/h

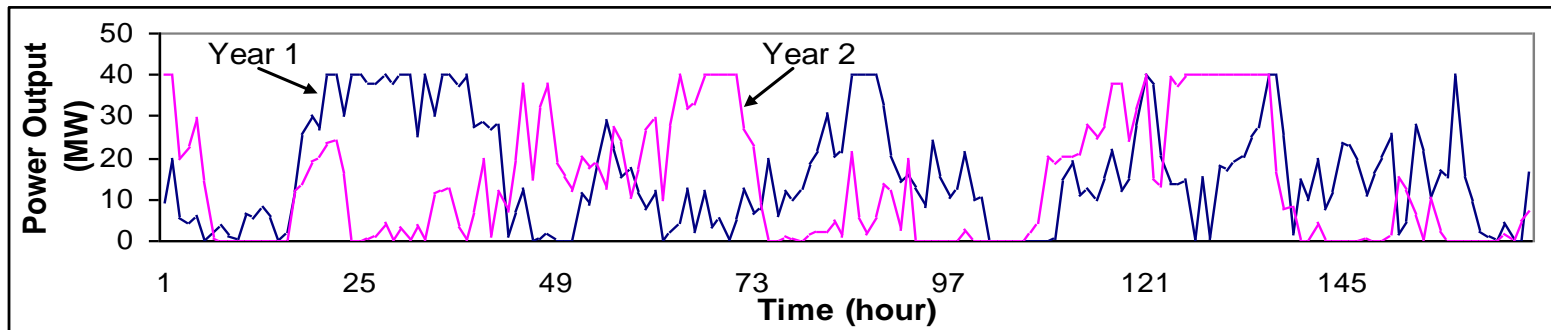
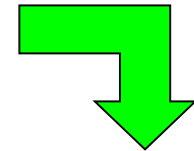
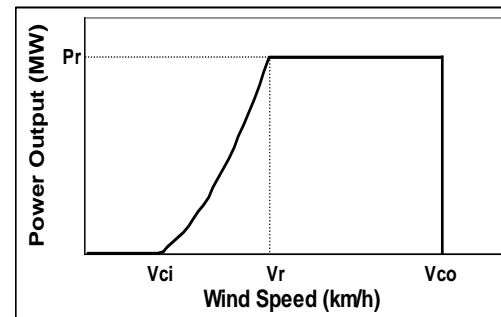
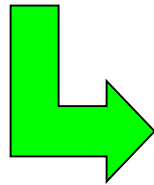

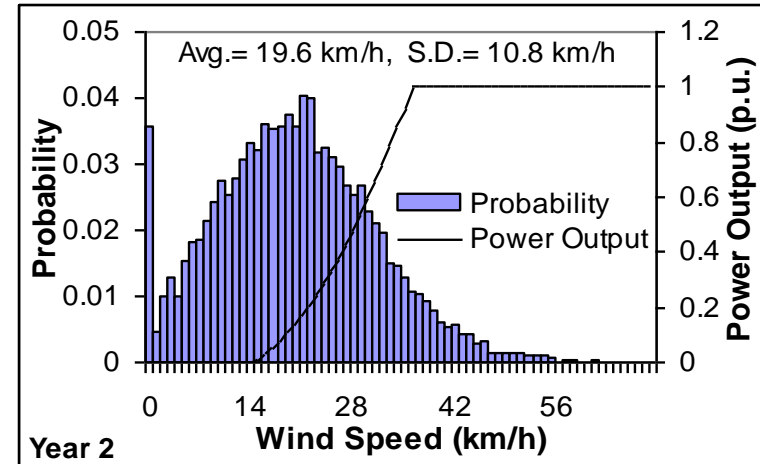
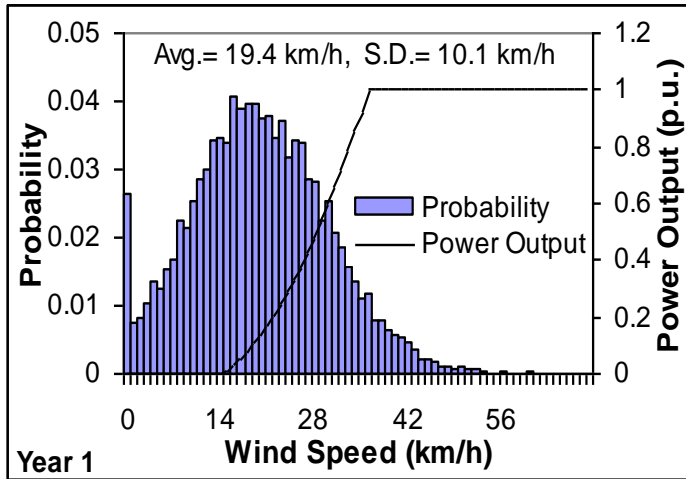

Probability distributions of *annual wind speeds* for two simulated years

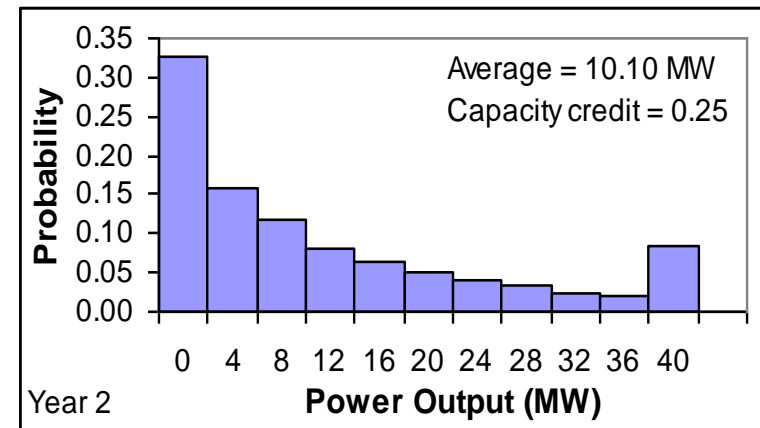
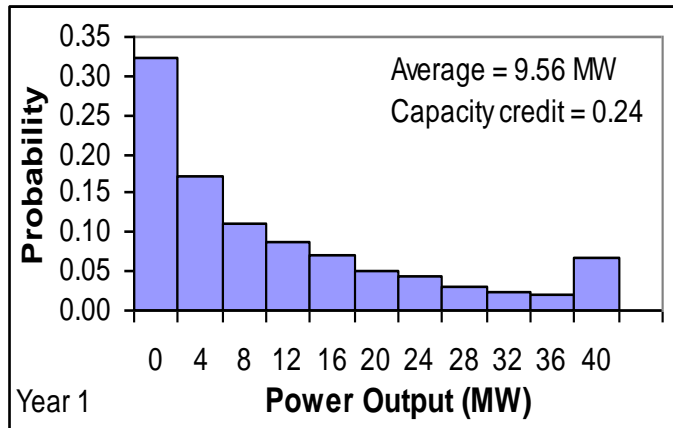
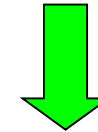

Probability distributions of *annual power outputs* for two simulated years

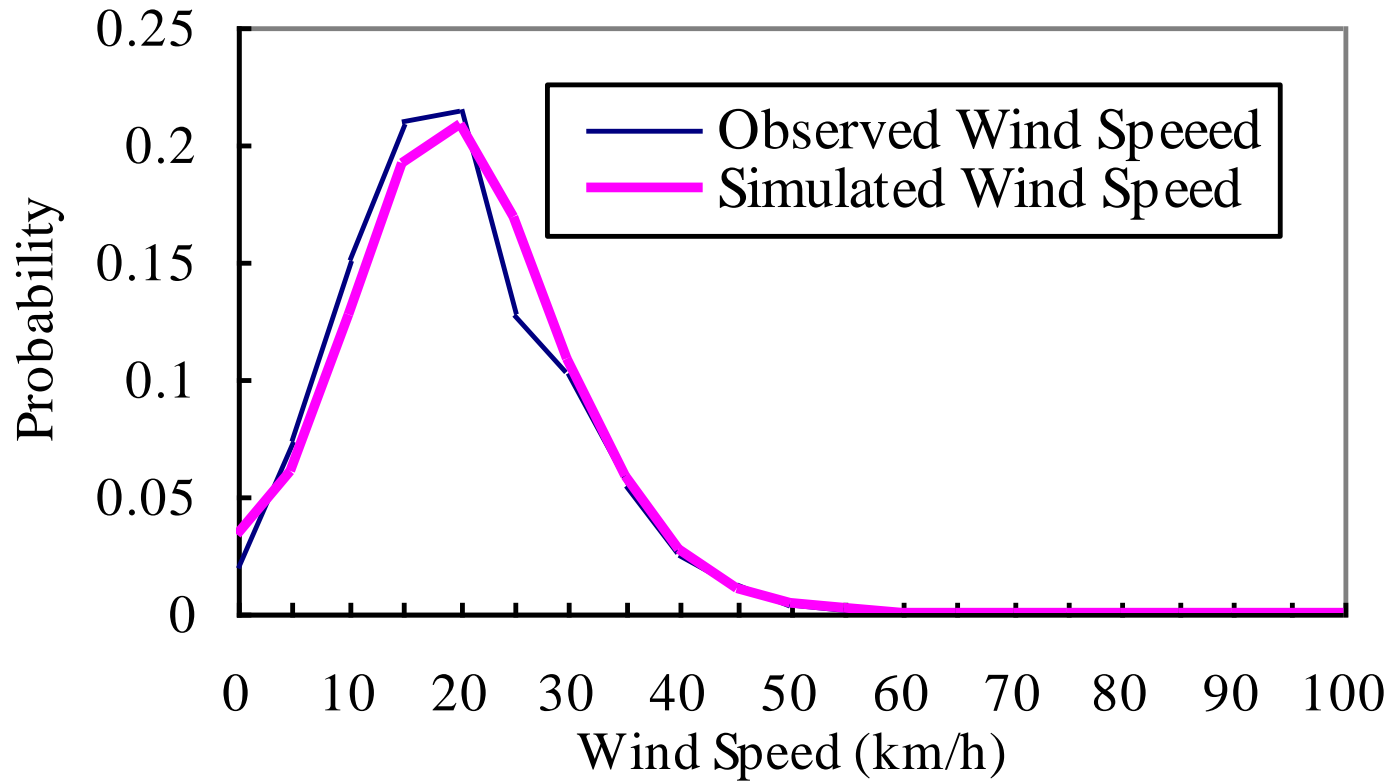

Fig. 1. Observed and simulated wind speed distributions for the Swift Current site

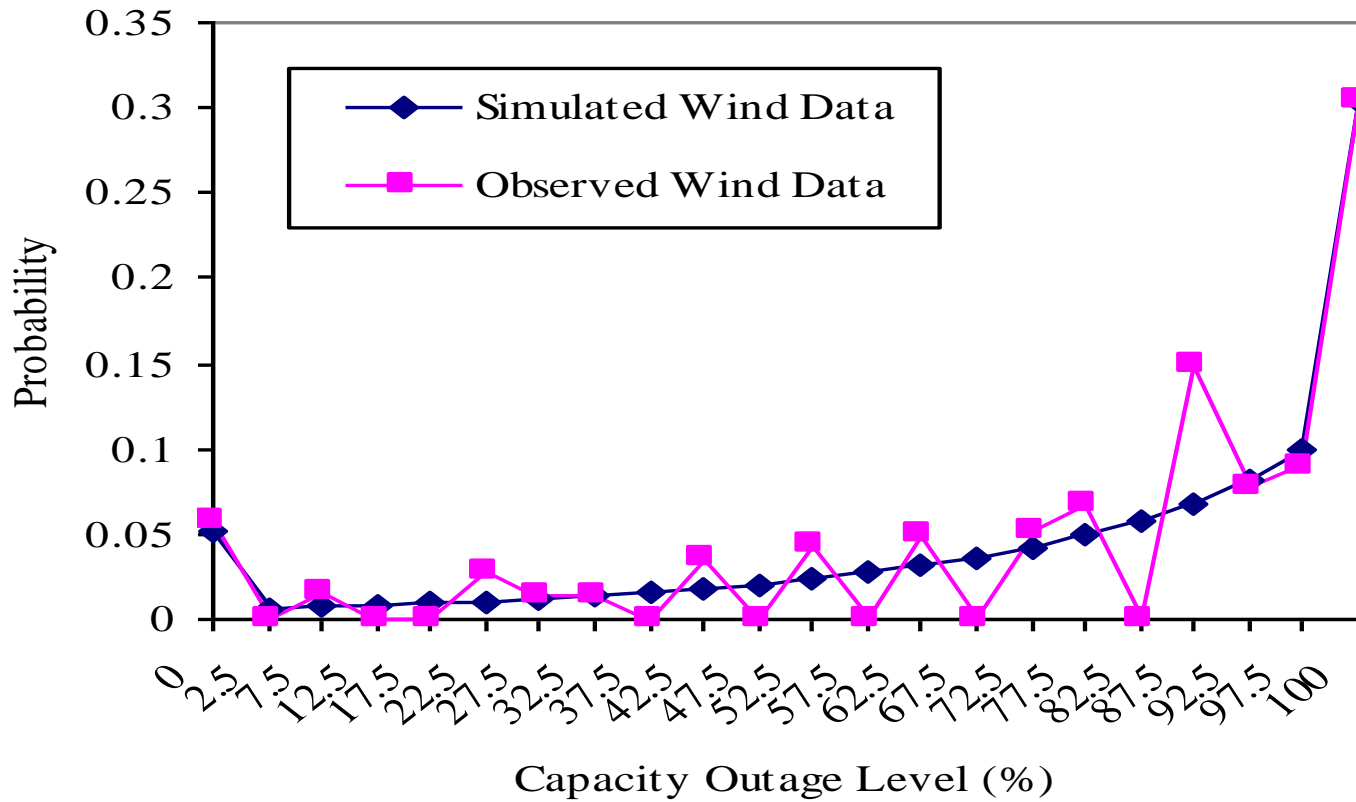

Fig. 2. Capacity outage probability profile for the WTG unit

Five State Capacity Outage Probability Table for a 20 MW WECS

Capacity Outage (MW)	Probability	
	FOR = 0%	FOR = 4%
0	0.07021	0.05908
5	0.05944	0.06335
10	0.11688	0.11475
15	0.24450	0.24408
20	0.50897	0.51875
DAFORW	0.76564	0.77501

LOLE Versus Peak Load

- **5*20 MW (FOR = 0.03) Plus 20 MW wind**

20MW Wind

Multi-state wind model

Cap. Out (MW)	Individual Probability
0	0.07021
5	0.05944
10	0.11688
15	0.24450
20	0.50897

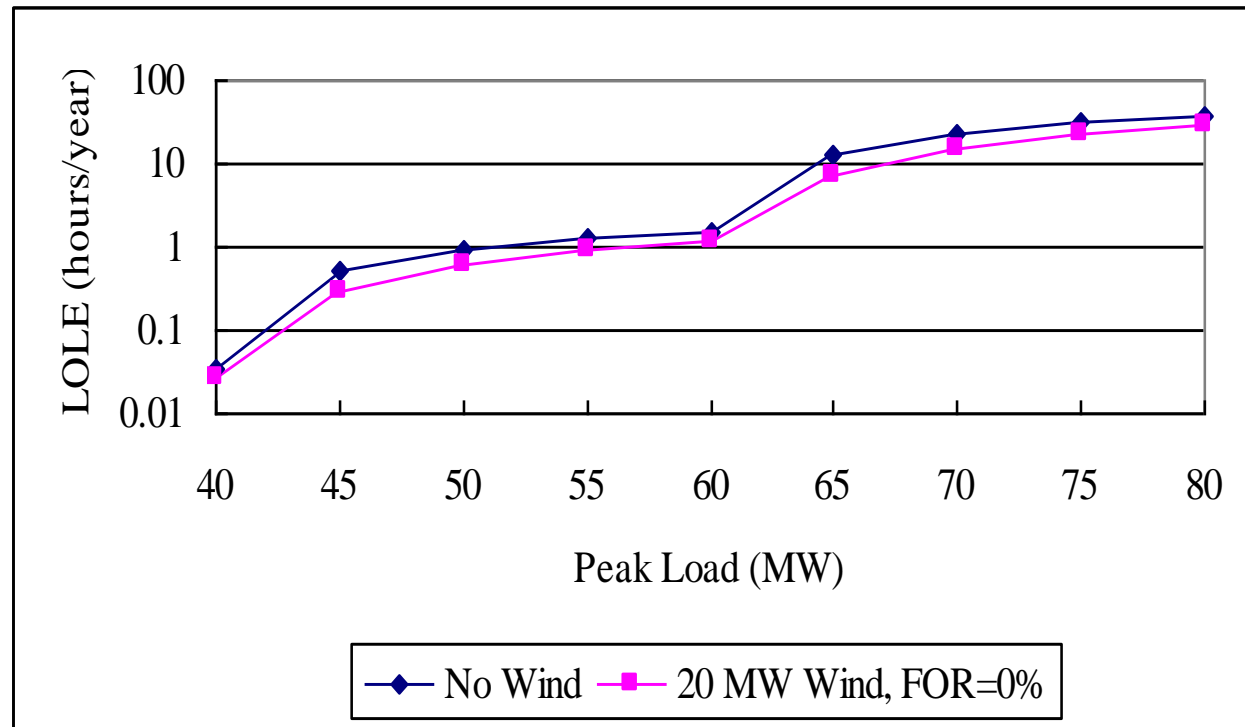

Aleatory and Epistemic Uncertainty

There are two fundamentally different forms of uncertainty in power system reliability assessment

The component failure and repair processes are random and create variability known as *aleatory uncertainty*.

There are also limitations in assessing the actual parameters of the key elements in a reliability assessment. This is known as *epistemic uncertainty*. It is knowledge based and therefore can be reduced by better information.

It is important to recognize the difference in *aleatory* and *epistemic* uncertainty.

Representation of Load Forecast Uncertainty

It is difficult to obtain sufficient historical data to determine the distribution type and the most common practice is to describe the epistemic uncertainty by a normal distribution with a given standard deviation. The distribution mean is the forecast peak load. The load uncertainty represented by a normal distribution can be approximated using the discrete interval method, or simulated using the tabulating technique of sampling.

Risk Evaluation with Load Forecast Uncertainty (LFU)

Assume the load forecast uncertainty is represented as in the figure.

$$LOLE = \sum_{i=1}^3 P_i * LOLE_i$$

P_i is the probability of each load level

$LOLE_i$ is the LOLE for each load level

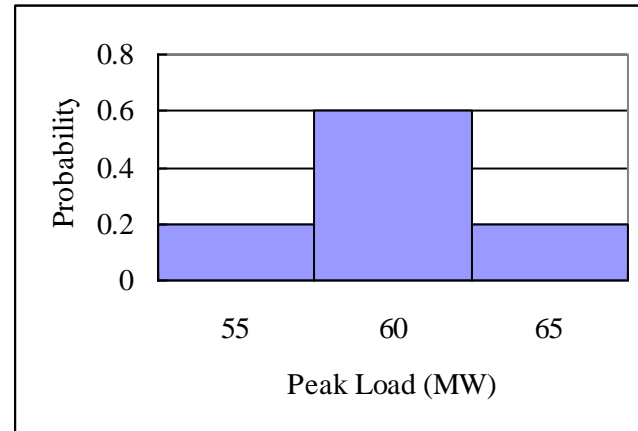

Peak Load (MW)	$LOLE_i$ (hrs/year)	Probability	C2*C3
55	1.248490	0.2	0.249698
60	1.518238	0.6	0.910943
65	12.816507	0.2	2.563301
		1.0	LOLE = 3.723942

Study System-RBTS Data

- **Installed Capacity = 240 MW**

Unit (MW)	Type	No. of Units	MTTF (hr)	Failure Rate (occ/yr)	MTTR (hr)	Repair Rate (/yr)	FOR
5	Hydro	2	4380	2.0	45	198	0.010
10	Lignite	1	2190	4.0	45	196	0.020
20	Hydro	4	3650	2.4	55	157	0.015
20	Lignite	1	1752	5.0	45	195	0.025
40	Hydro	1	2920	3.0	60	147	0.020
40	Lignite	2	1460	6.0	45	194	0.030

- **Peak Load=185MW**
- **The load duration curve is taken from the IEEE-RTS**

RBTS Analysis at HLI

- **Basic System- LOLE versus Peak Load**

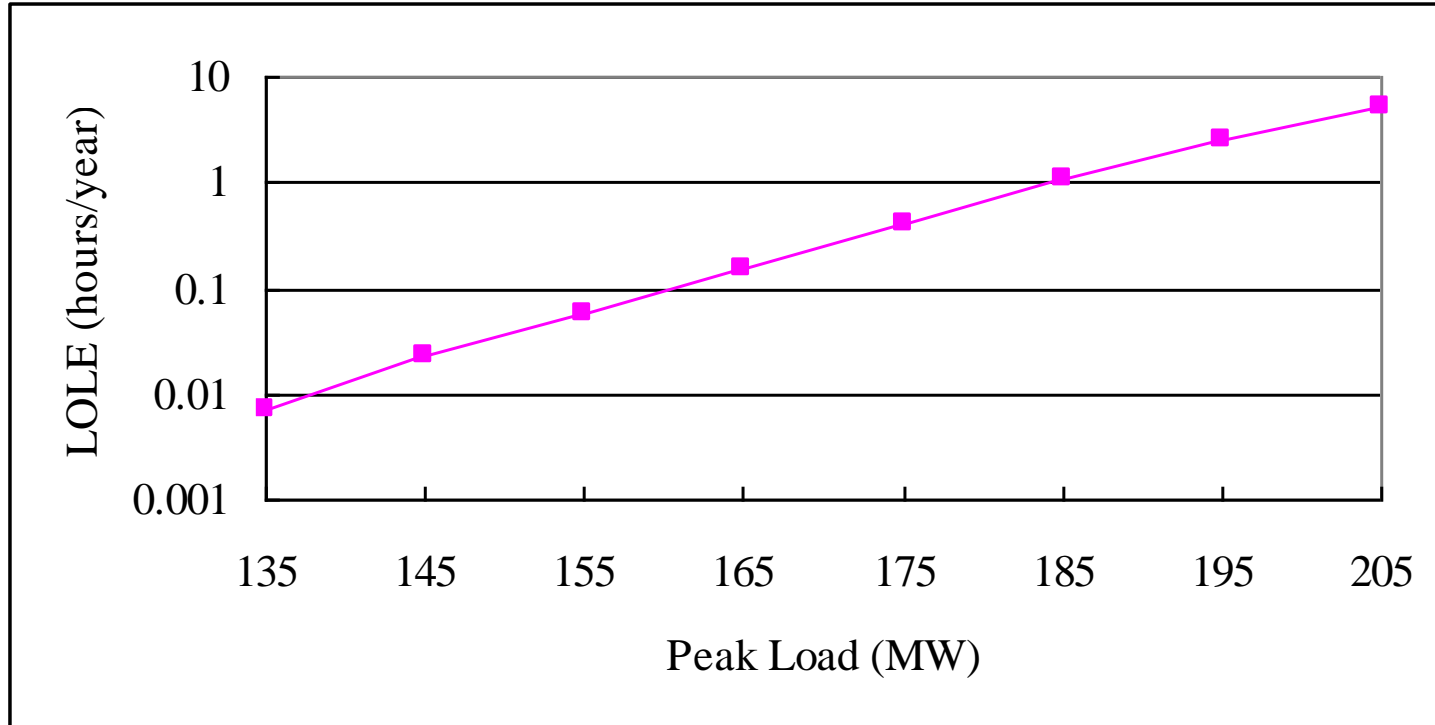

RBTS Analysis at HLI

- LOLE versus WTG total capacity
- Installed Capacity=240 MW, Peak Load =185MW

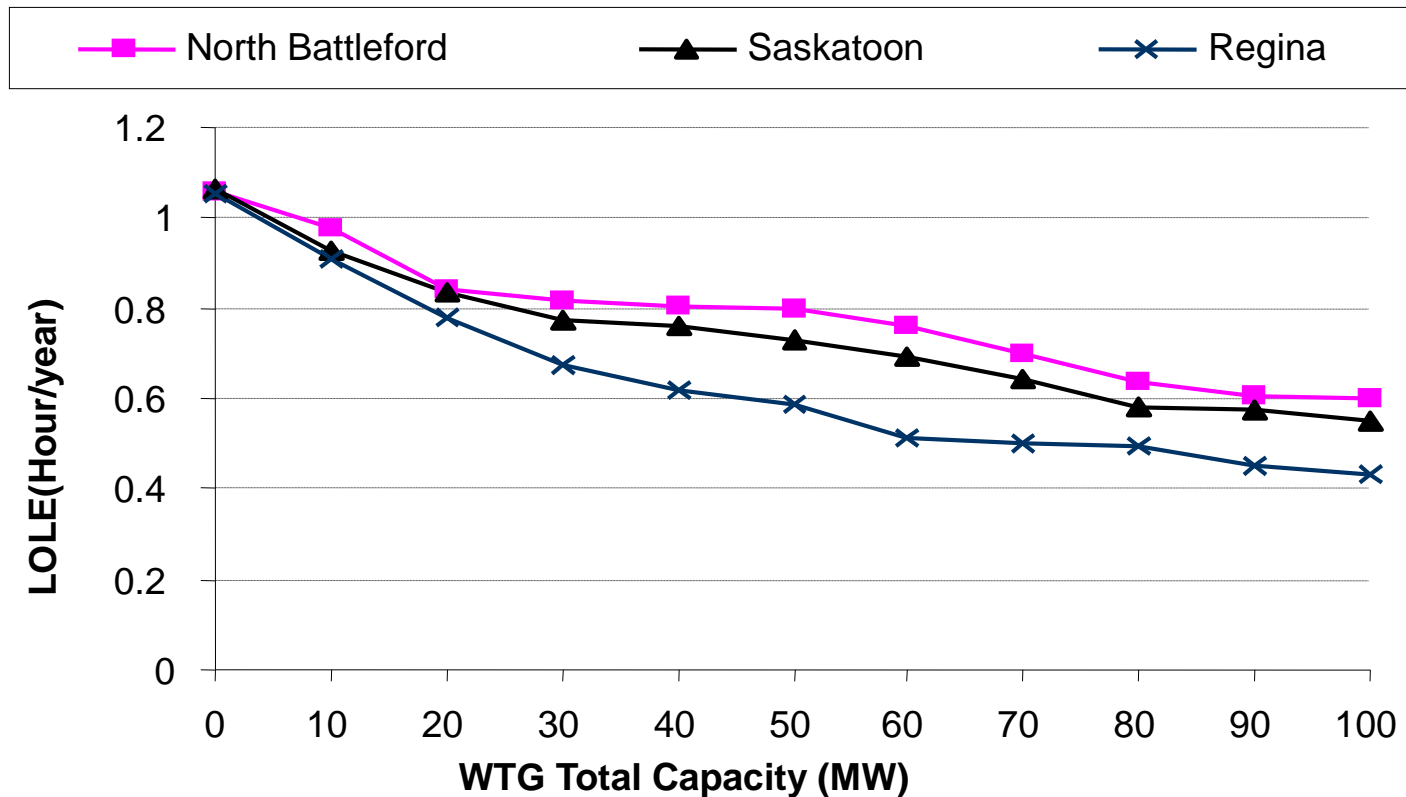

RBTS Analysis at HLI

Add 20 MW wind power to the RBTS

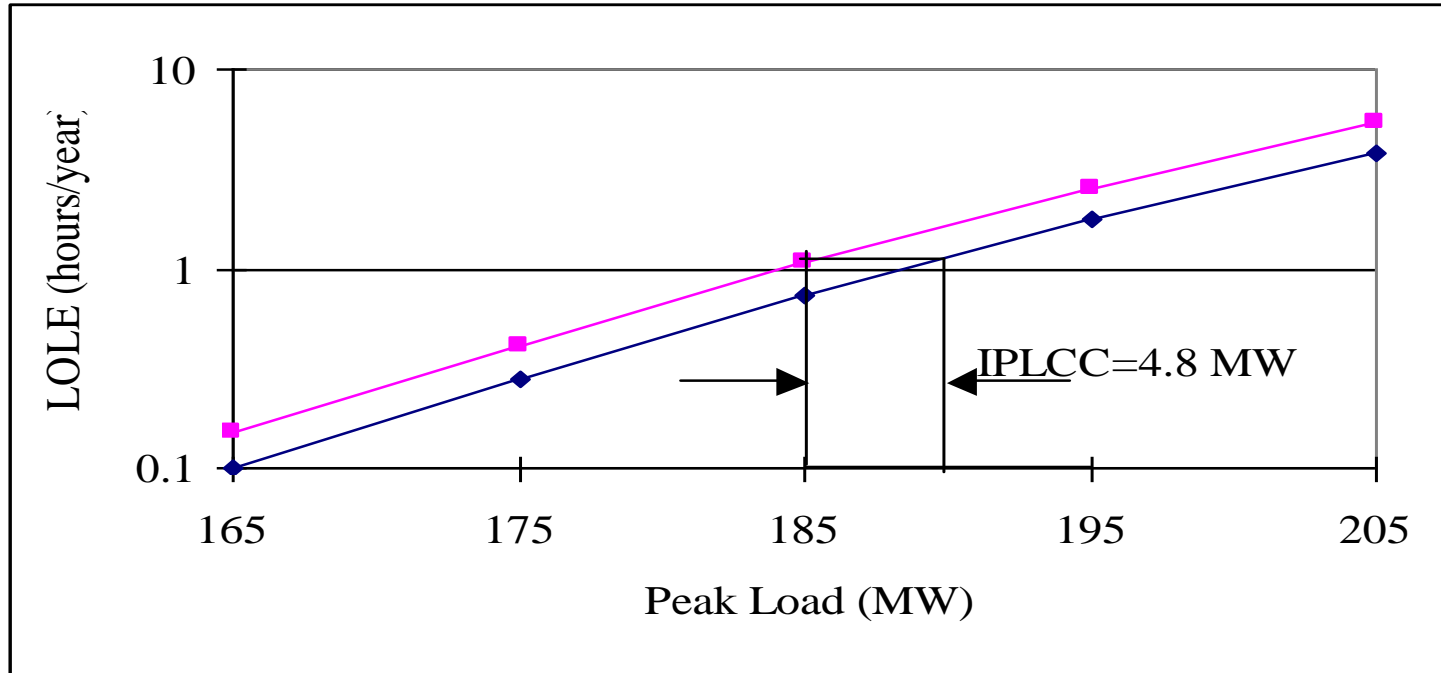

$$\begin{aligned}\text{Capacity Credit (CC)} &= \text{IPLCC} / \text{Wind Capacity} \\ &= 4.8 / 20.0 = 0.24 = 24\%\end{aligned}$$

An important consideration in adequacy evaluation of power systems containing wind energy is the reliability contribution that WTG units make compared with that of conventional generating units.

In order to investigate this, different units in the reliability test system were removed, and the number of WTG units required to maintain the criterion reliability was determined.

System Studies

- **Two published reliability test systems with different capacities, the RBTS and the IEEE Reliability Test System (IEEE-RTS) were used in these studies.**
- **The RBTS consists of 11 conventional generating units with a total capacity of 240 MW. The total capacity of the IEEE-RTS is 3405 MW. The annual peak load for the RBTS is 185 MW. The annual peak load is 2850 MW for the IEEE-RTS.**

A 5 MW conventional generating unit was first removed from the RBTS and replaced by WTG units. A Regina location wind regime was assumed. The risk criterion is the RBTS original LOLE of 1.05 hours/year. The LOLE increases from 1.05 hours/year to 1.68 hours/year after the 5 MW unit is removed from the RBTS. The LOLE is restored to 1.05 hours/year when 45 MW of WTG is added.

This indicates that 45 MW of WTG is able to replace a 5 MW conventional generating unit under this particular condition. The wind capacity replacement ratio in this situation is 9.0.

R BTS Analysis at HLI

- Replacement ratio versus mean wind speed multiplication factor

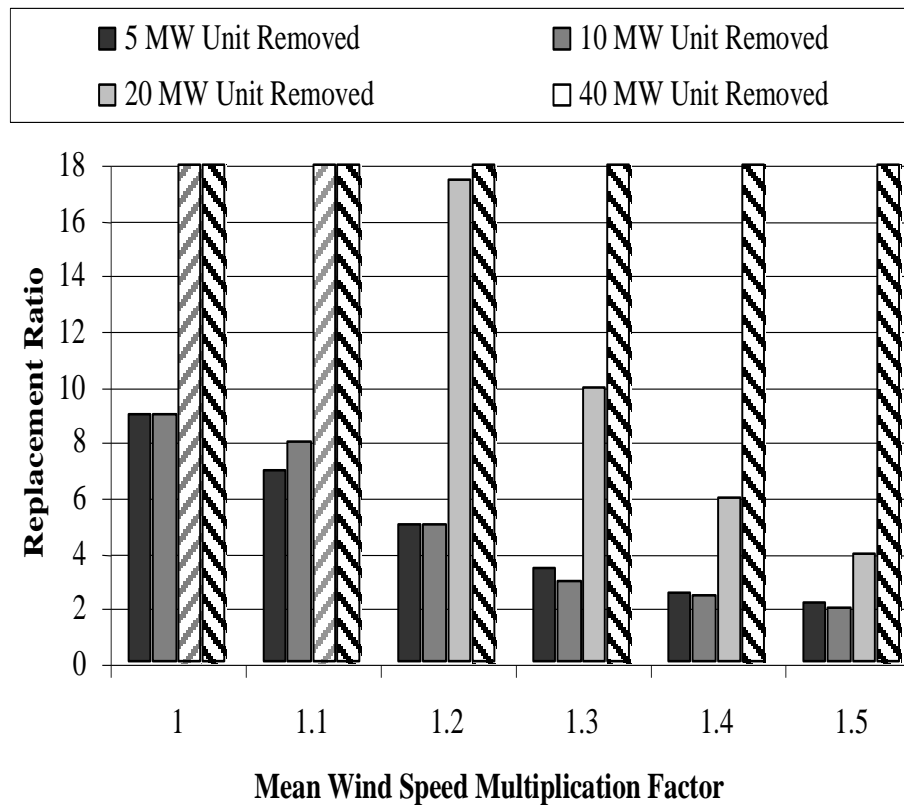

Replacement ratio versus mean wind speed multiplication factor (IEEE-RTS)

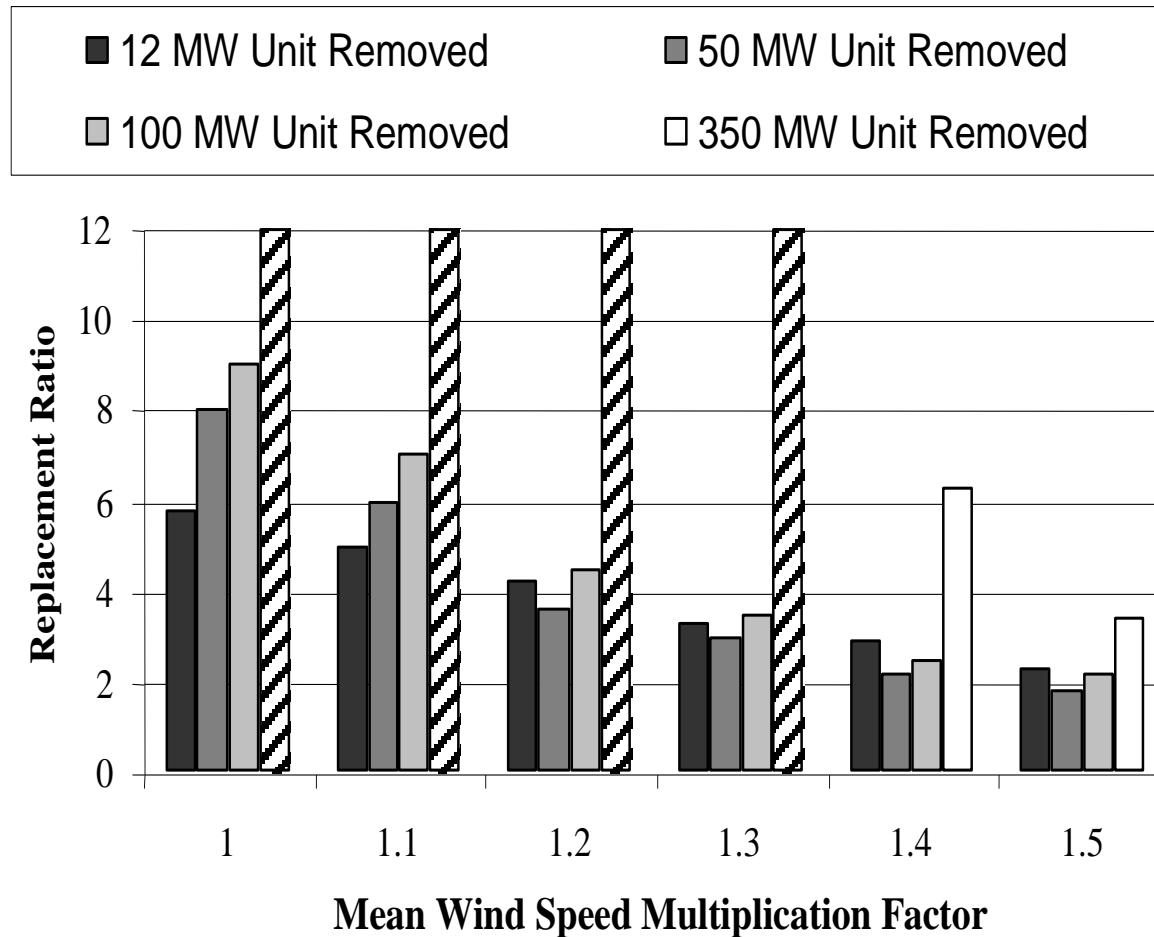

Independent Wind Energy Sources

A WTG produces no power in the absence of sufficient wind and there is a definable probability that there will be insufficient wind at a given site.

The probability, however, of there being no wind simultaneously at two widely separated independent wind sites is much less, and locating WTG at independent wind sites can provide considerable benefits.

Replacement ratio versus the capacity removed from the RBTS (single, two and three wind farms)

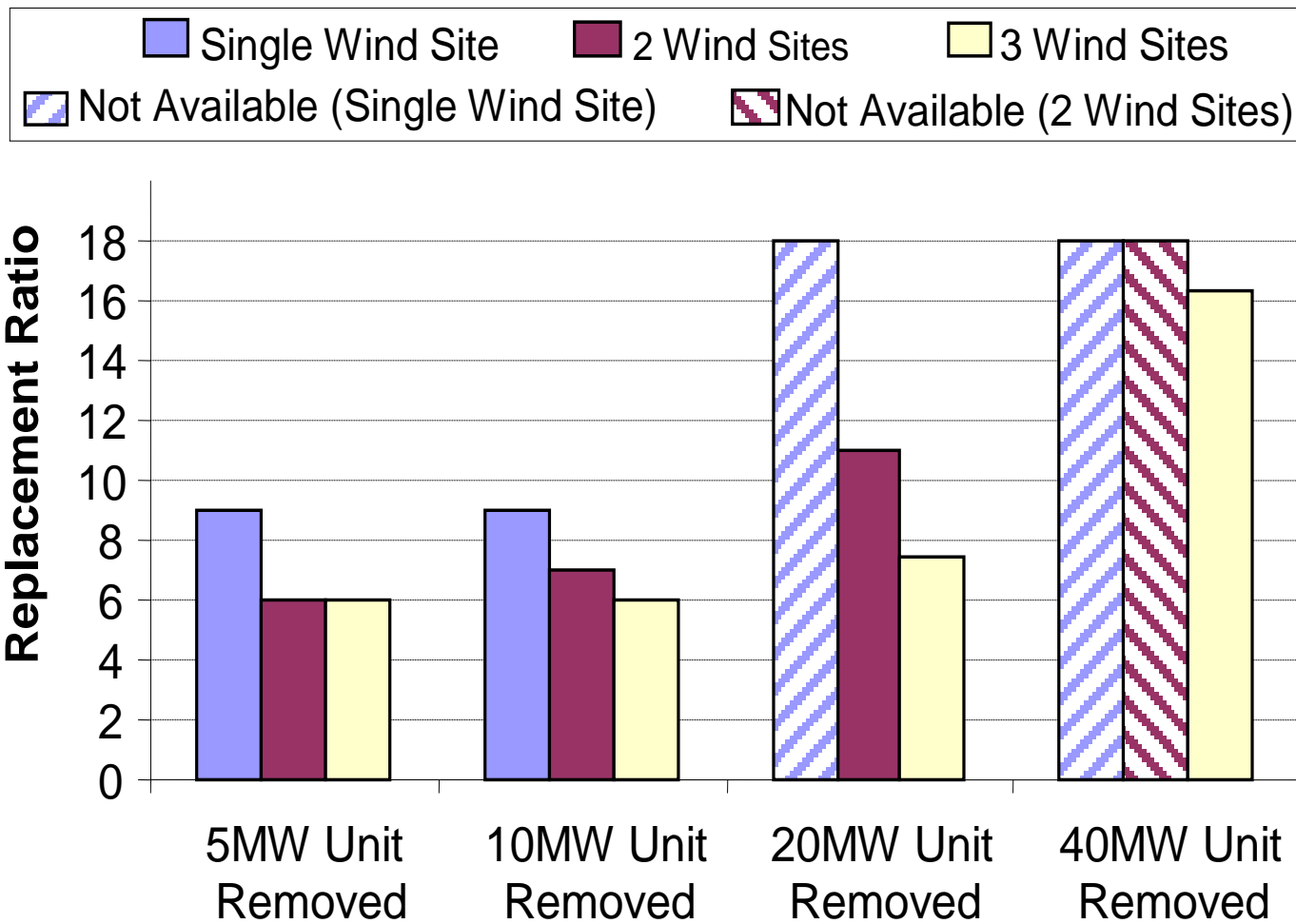

Replacement ratio versus the capacity removed from the IEEE-RTS (single, two and three wind farms)

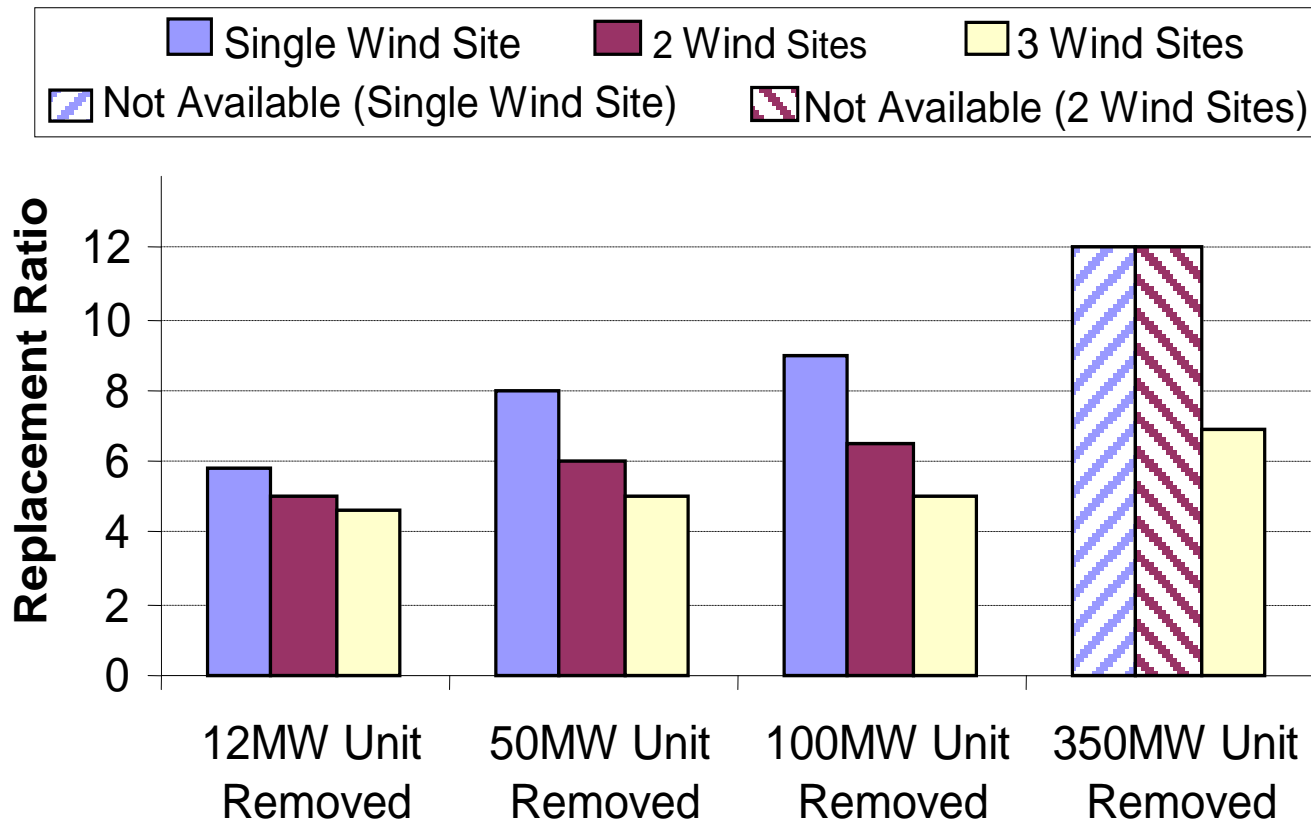

Planning Capacity Credit Evaluation

A sequential Monte Carlo simulation program developed for generating capacity adequacy evaluation was used to study the IEEE-RTS at a peak load of 2850 MW. Five 100 MW WECS were added sequentially to the IEEE-RTS using the Regina wind regime data. The sampling size for the IEEE-RTS is 20,000 years.

Effects on the System Reliability Indices of Adding Wind Power

The added wind capacity is considered to be either completely dependent or fully independent. These conditions may not exist in an actual system and there will be some degree of cross-correlation between the site wind regimes. The dependent and independent conditions provide boundary values that clearly indicate the effects of site wind speed correlation.

Increase in Peak Load Carrying Capability with Added Wind Power

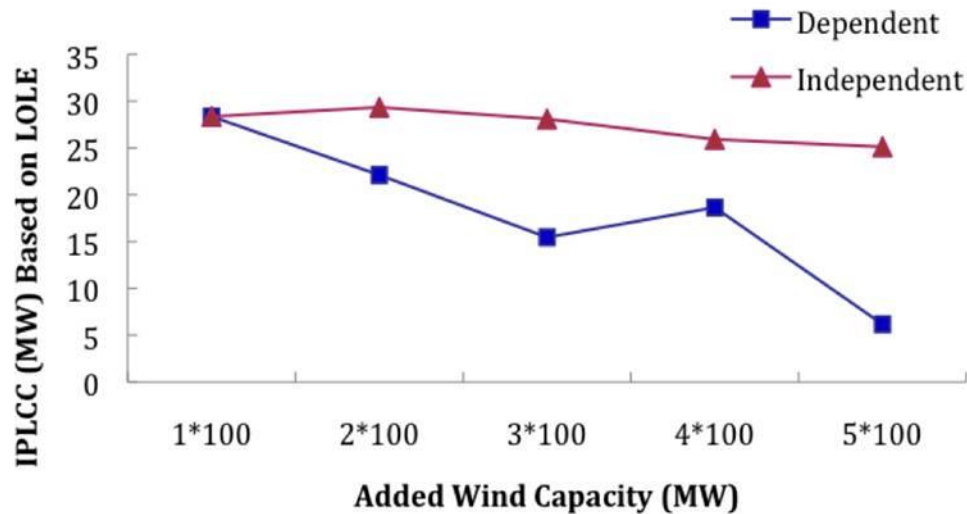

The IEEE-RTS IPLCC as a function of the added wind capacity

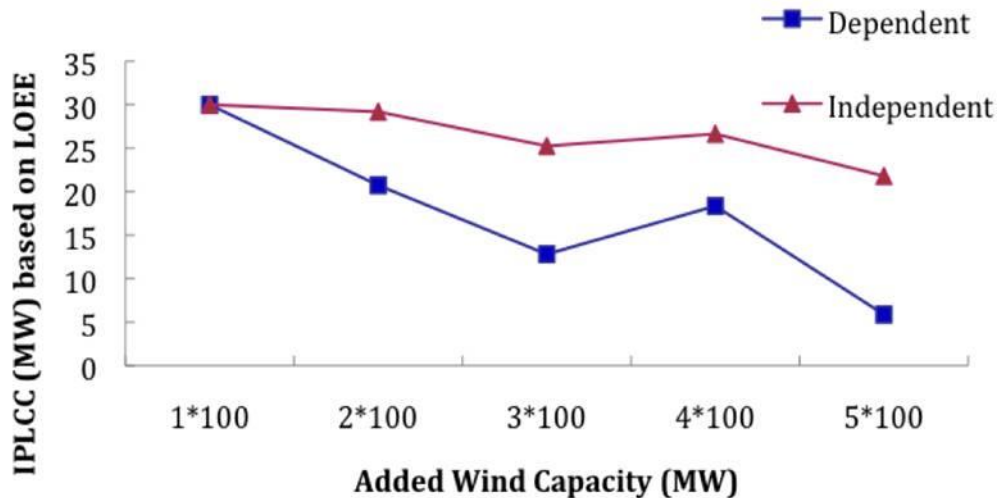

The IEEE-RTS Wind Planning Capacity Credit (PCC) with Sequential Wind Power Additions Based on LOLE

Indv. Wind Capacity (MW)	Wind Regimes		Agg. Wind Capacity (MW)	Wind Regimes	
	<i>Dep.</i>	<i>Indep.</i>		<i>Dep.</i>	<i>Indep.</i>
	<i>PCC(%)</i>	<i>PCC(%)</i>		<i>PCC(%)</i>	<i>PCC(%)</i>
1*100	28.57	28.57	100	28.57	28.57
2*100	22.32	29.55	200	25.44	29.06
3*100	15.66	28.30	300	22.18	28.81
4*100	18.85	26.13	400	21.35	28.14
5*100	6.37	25.32	500	18.35	27.57

The IEEE-RTS Wind Planning Capacity Credit (PCC) with Sequential Wind Power Additions Based on LOEE

Indv. Wind Capacity (MW)	Wind Regimes		Agg. Wind Capacity (MW)	Wind Regimes	
	<i>Dep.</i>	<i>Indep.</i>		<i>Dep.</i>	<i>Indep.</i>
	<i>PCC(%)</i>	<i>PCC(%)</i>		<i>PCC(%)</i>	<i>PCC(%)</i>
1*100	30.19	30.19	100	30.19	30.19
2*100	20.94	29.39	200	25.56	29.79
3*100	13.01	25.45	300	21.38	28.34
4*100	18.55	26.84	400	20.67	27.97
5*100	6.09	22.00	500	17.76	26.77

The IEEE-RTS IPLCC as a function of the added conventional generating capacity based on the LOLE and LOEE

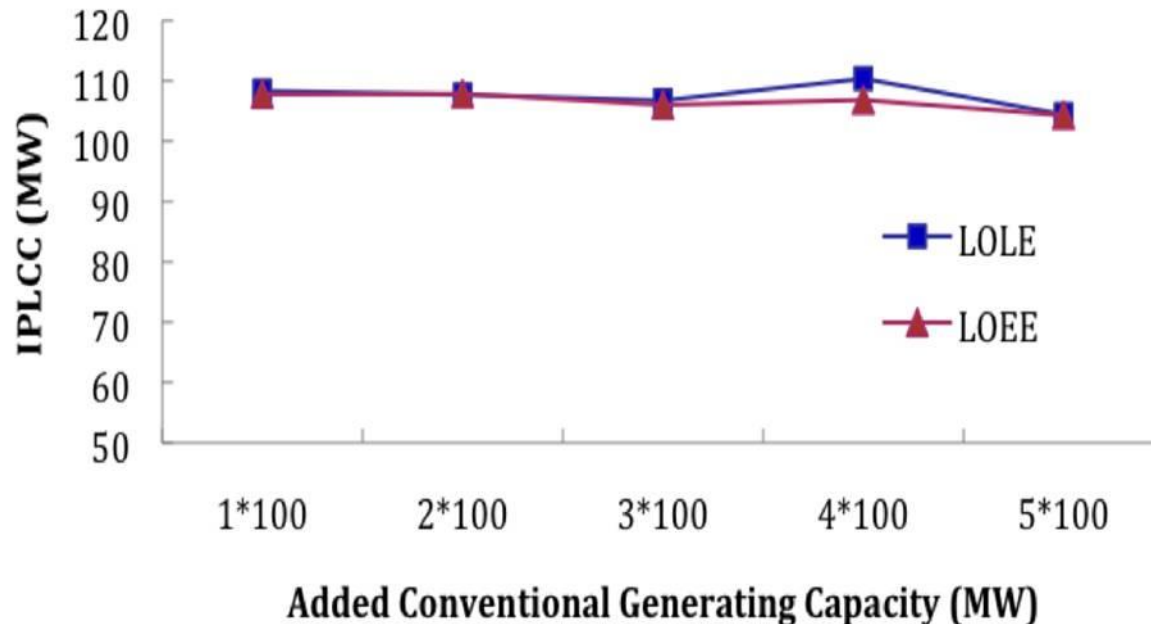

Security Based Adequacy Evaluation Using the System Well-Being Approach

The system well-being approach provides a combined framework that incorporates both deterministic and probabilistic criteria. The combination of deterministic and probabilistic concepts occurs through the definition of the system operating states.

Security Based Adequacy Evaluation Using the System Well-Being Approach

Success

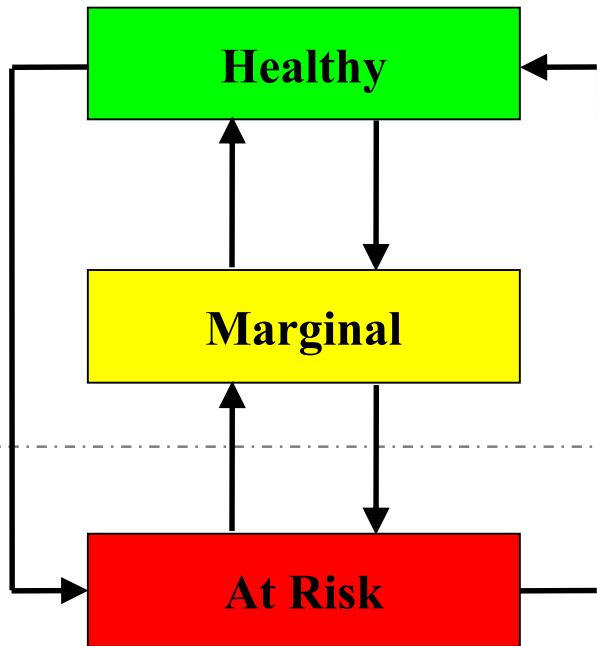

System Well-Being Framework

Healthy state – all equipment and operating constraints are within limits and there is sufficient margin to serve the total load demand even with the loss of any element (i.e. the N-1 deterministic criterion is satisfied.).

Marginal state – the system is still operating within limits, but there is no longer sufficient margin to satisfy the acceptable deterministic criterion.

At risk state – equipment or system constraints are violated and load may be curtailed.

Security Based Adequacy Evaluation Using the System Well-Being Approach

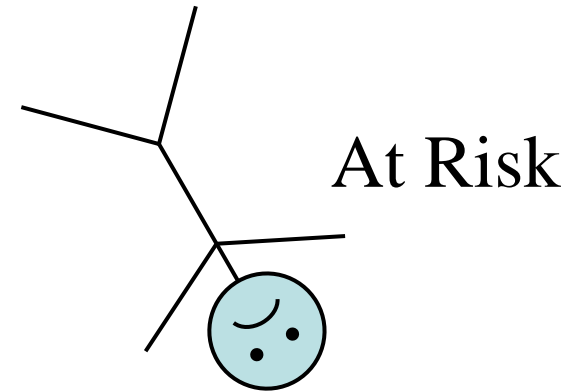
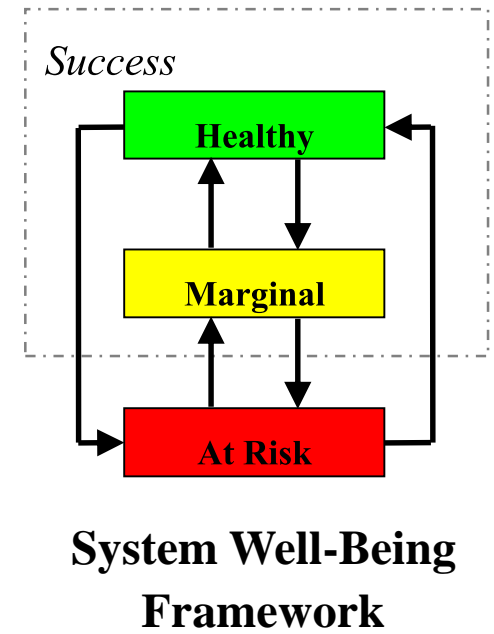
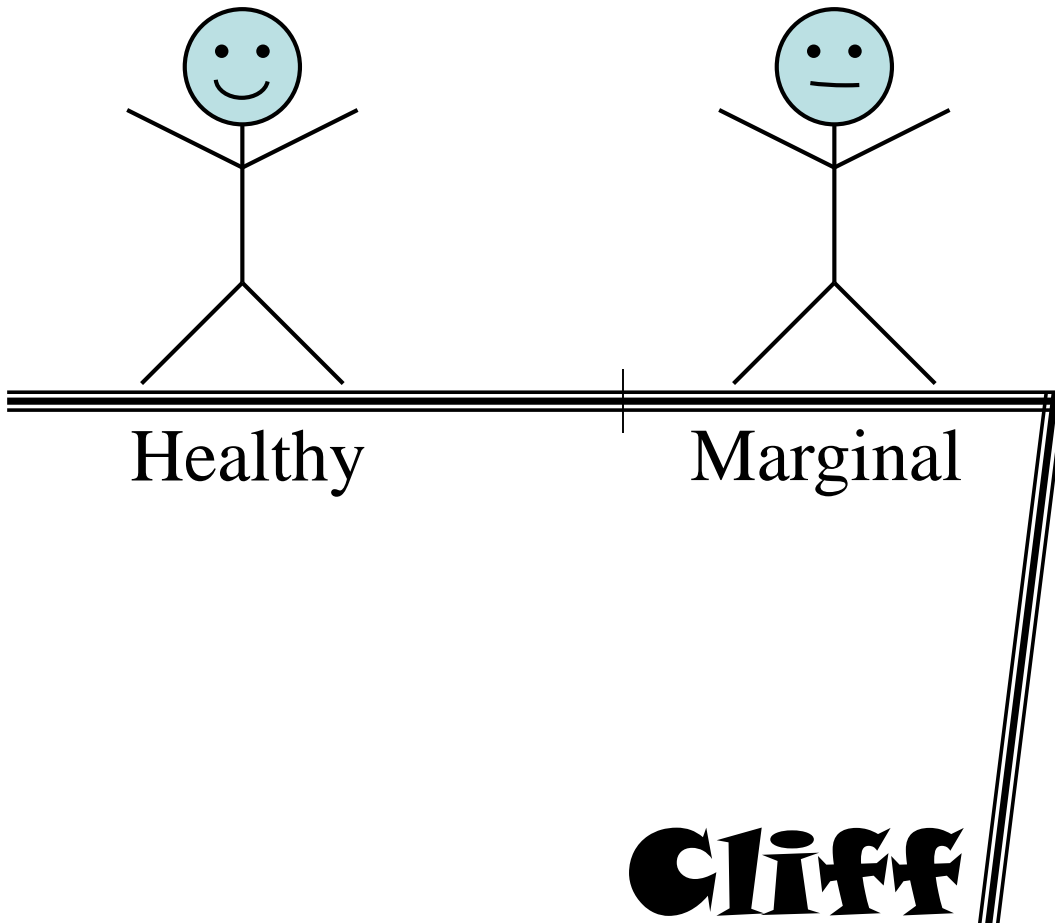

Security Based Adequacy Evaluation Using the System Well-Being Approach

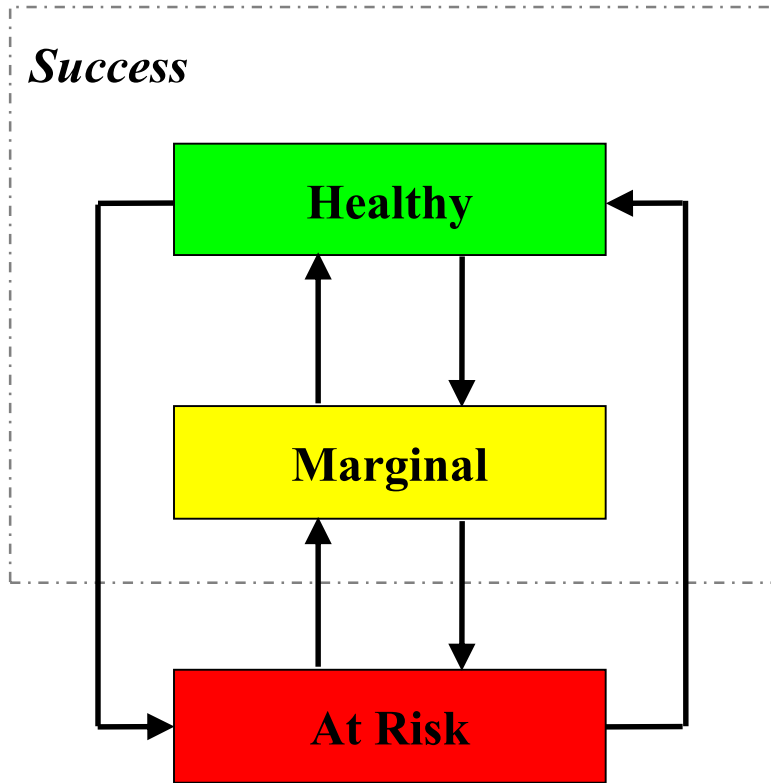

System Well-Being Framework

System Well-Being Indices:

Prob{H}

Freq{H}

Prob{M}

Freq{M}

Prob{R}

Freq{R}

Security Based Adequacy Evaluation Using the System Well-Being Approach

Base Case – RBTS with no wind generation.

Case A – RBTS with a 10 MW unit replaced by 2 – 18 MW wind farms at W1 and W2.

Case B – RBTS with a 10 MW unit replaced by 3- 9 MW wind farms at W1, W2 and W3.

The system P(R) is 0.00043 in all three cases.

Wind Farm	W1	W2	W3
Mean Wind Speed (m/s)	9.10	8.38	10.03
Standard Deviation (m/s)	5.50	4.48	5.20
Correlation w.r.t W1	1.00	0.85	0.05

Security Based Adequacy Evaluation Using the System Well-Being Approach

Index	Base Case	Case A	Case B
P(H)	0.98456	0.98130	0.97834
P(M)	0,01501	0.01827	0.02122
P(R)	0.00043	0.00043	0.00043
F(H) occ./ yr	25.1	33.9	36.3
F(M) occ./ yr	25.8	34.9	37.1
F(R) occ./ yr	0.8	1.0	0.9
D(H) hrs./ occ.	403.2	283.7	263.3
D(M) hrs./ occ.	5.1	4.6	5.01
D(R) hrs./ occ.	4.6	3.6	3.8

Epistemic Uncertainty

Load growth and load forecast uncertainty are affected by social, political, environmental and economic factors.

Load forecast uncertainty also depends on the required length of time in the future of the forecast. Different types of generating capacity have different lead times that involve regulatory and environmental approvals.

Nuclear - 8 to 10 years,

Fossil - 5 to 6 years,

Wind -1 to 2 years.

Hydro - 6 to 8 years,

Gas turbines - 2 to 3 years,

RBTS Analysis at HLI

- Considering Load Forecast Uncertainty

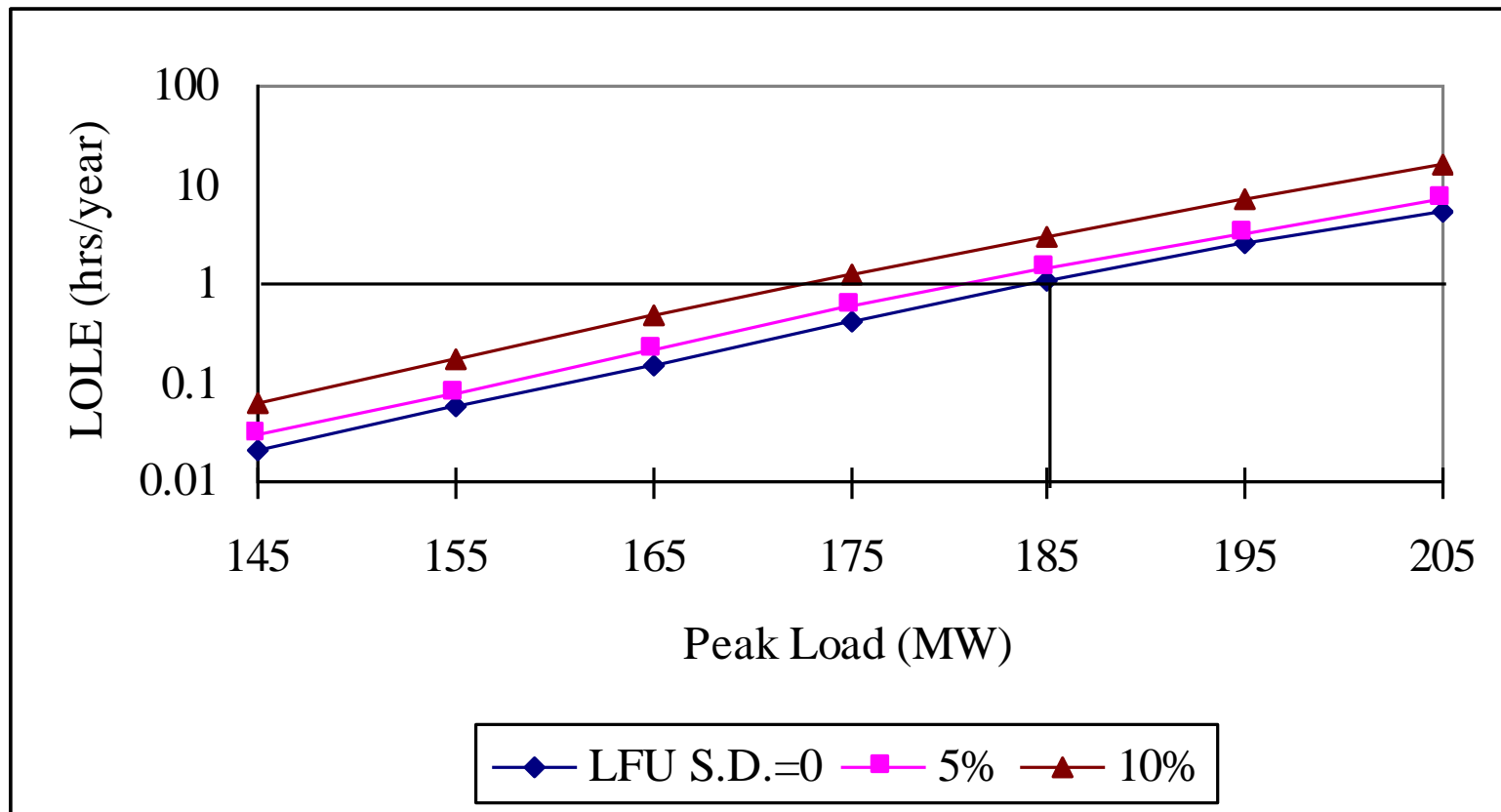

Aleatory Uncertainty

The Loss of Load (LOL) in a given period is a random variable and is dependent on the failure and repair processes of the system components.

The LOLE is the mean value of the LOL distribution.

RBTS Analysis at HLI

- LOL Distribution**

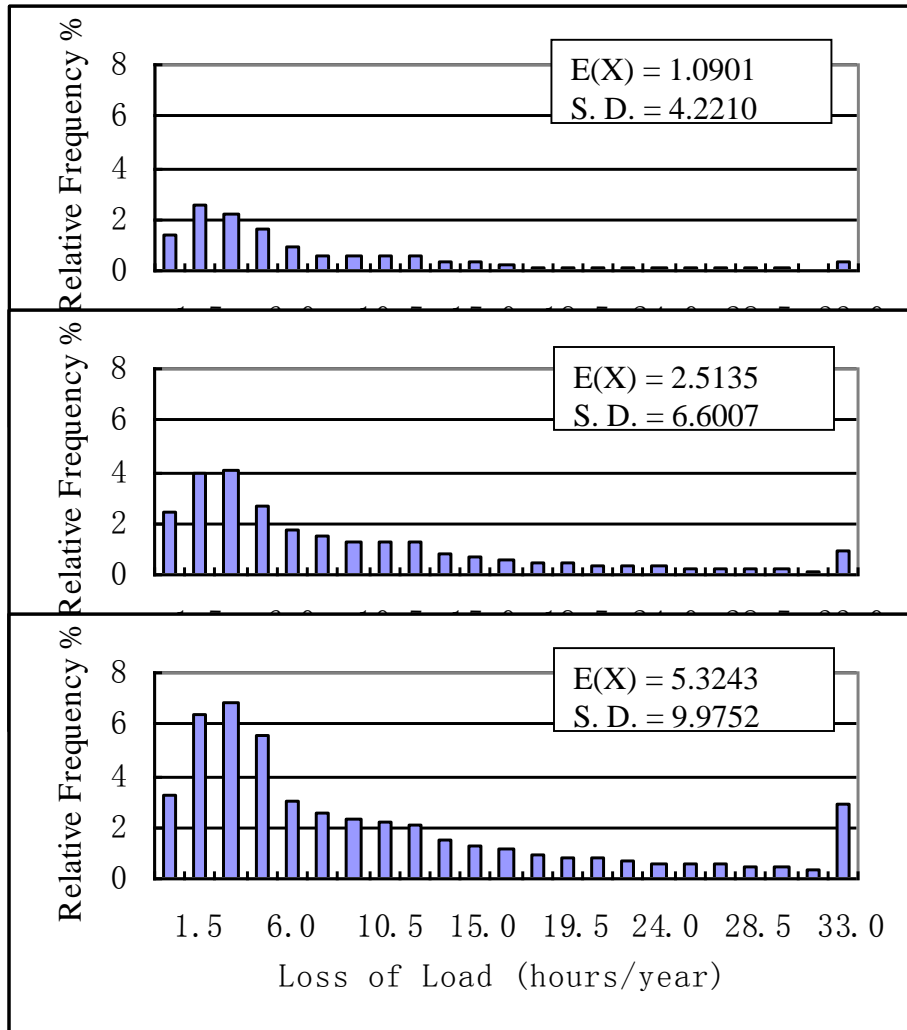

Peak Load (MW)	Zero LOL Probability
----------------	----------------------

185	86.49%
-----	--------

195	73.70%
-----	--------

205	52.59%
-----	--------

Example Reliability Criterion – NERC Region XXX

“Sufficient megawatt generating capacity shall be installed to ensure that in each year for the XXX system the probability of occurrence of load exceeding the available generating capacity shall not be greater, on the average, than *one day in ten years*. Among the factors to be considered in the calculation of the probability are *the characteristics of the loads, the probability of error in load forecast, the scheduled maintenance requirements for generating units, the forced outage rates of generating units, limited energy capacity, the effects of connections to the pools, and network transfer capabilities* within the XXX systems.”

Scheduled Maintenance

Period Evaluation Method

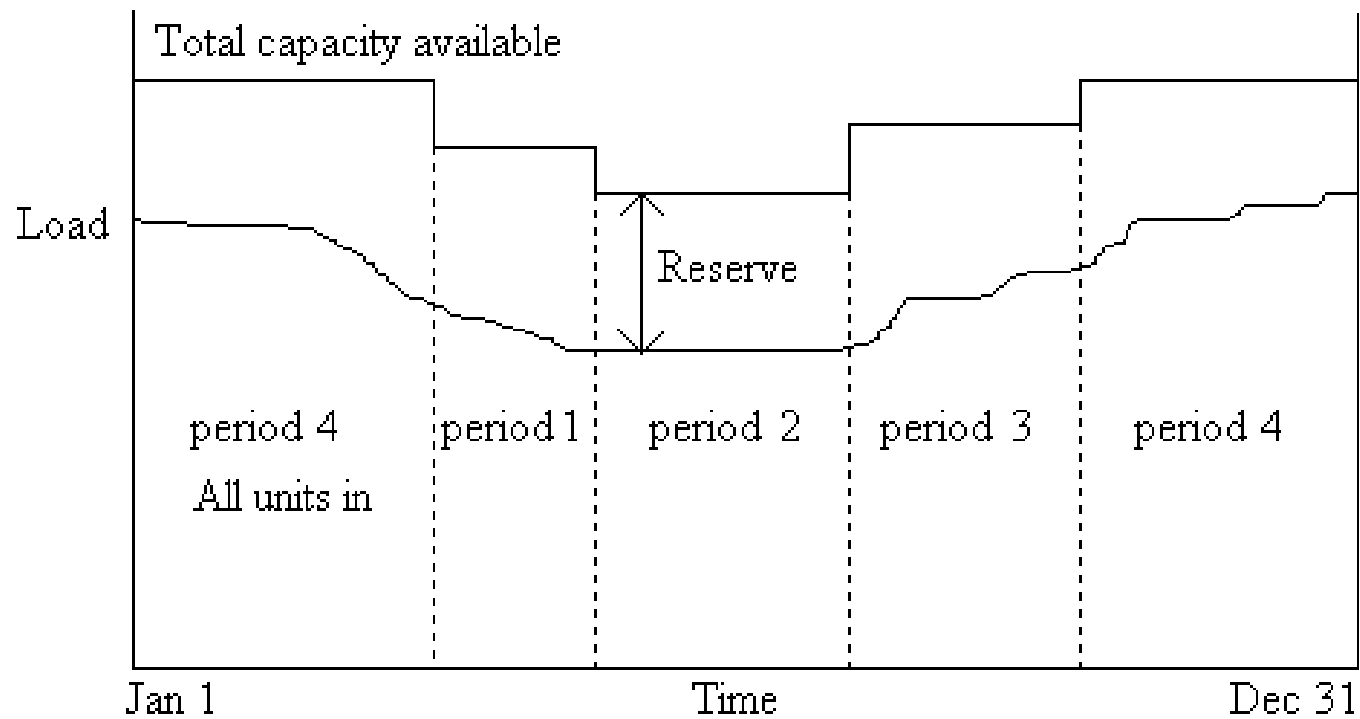

Period Analysis

$$\text{LOLE} = \sum_{p=1}^n \text{LOLE}_p$$

$$\text{LOEE} = \sum_{p=1}^n \text{LOEE}_p \quad \text{and} \quad \text{UPM} = \frac{\text{LOEE}}{\text{Annual Energy Demand}} \times 10^6$$

where, n = number of sub-periods within the total period

LOLE_p = LOLE for sub-period p

LOEE_p = LOEE for sub-period p .

$n = 12$ in monthly analysis
 $= 4$ in seasonal analysis

- **Different reliability indices are obtained using different load models.**
- **The LOLE index in hours is obtained using hourly load values.**
- **The LOLE index in days is evaluated using daily peak load values.**
- **It is not valid to obtain the LOLE in hours by multiplying the days/year value by 24. The commonly used index of 0.1 days/year, which is often expressed as one day in ten years, cannot be simply converted to an equivalent index of 2.4 hours/year. This is because the hourly load profile is normally different from that of the daily peak load.**

Load Models

Daily peak load variation curve (DPLVC) – LOLE in days/year

Load duration curve (LDC) – LOLE in hours/year & energy based indices, UPM

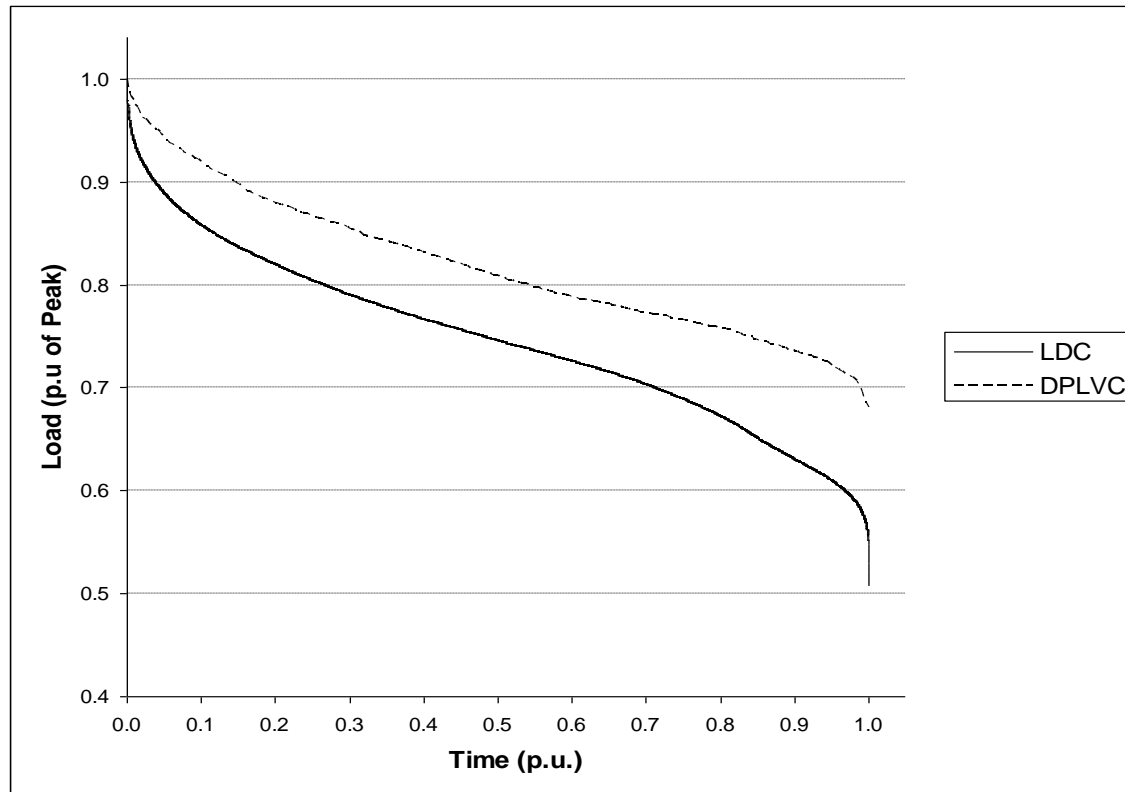

Basic RBTS HLI Analysis

The following studies were done using two general generating capacity adequacy evaluation programs.

Reliability Index	Analytical Program			Simulation Program		
	Constant Load	Daily Peak Loads	Hourly Loads	Constant Load	Daily Peak Loads	Hourly Loads
LOLE (days/year)	3.0447	0.1469	-	3.0258	0.1496	-
LOLE (hours/year)	73.0728	-	1.0919	72.6183	-	1.0901
LOEE (MWh/year)	823.2555	-	9.8613	816.8147	-	9.9268
LOLF (occ/year)	-	-	-	2.8309	0.2171	0.2290

Ratio of the LOLE (hours/year) over the LOLE (days/year) for the RBTS

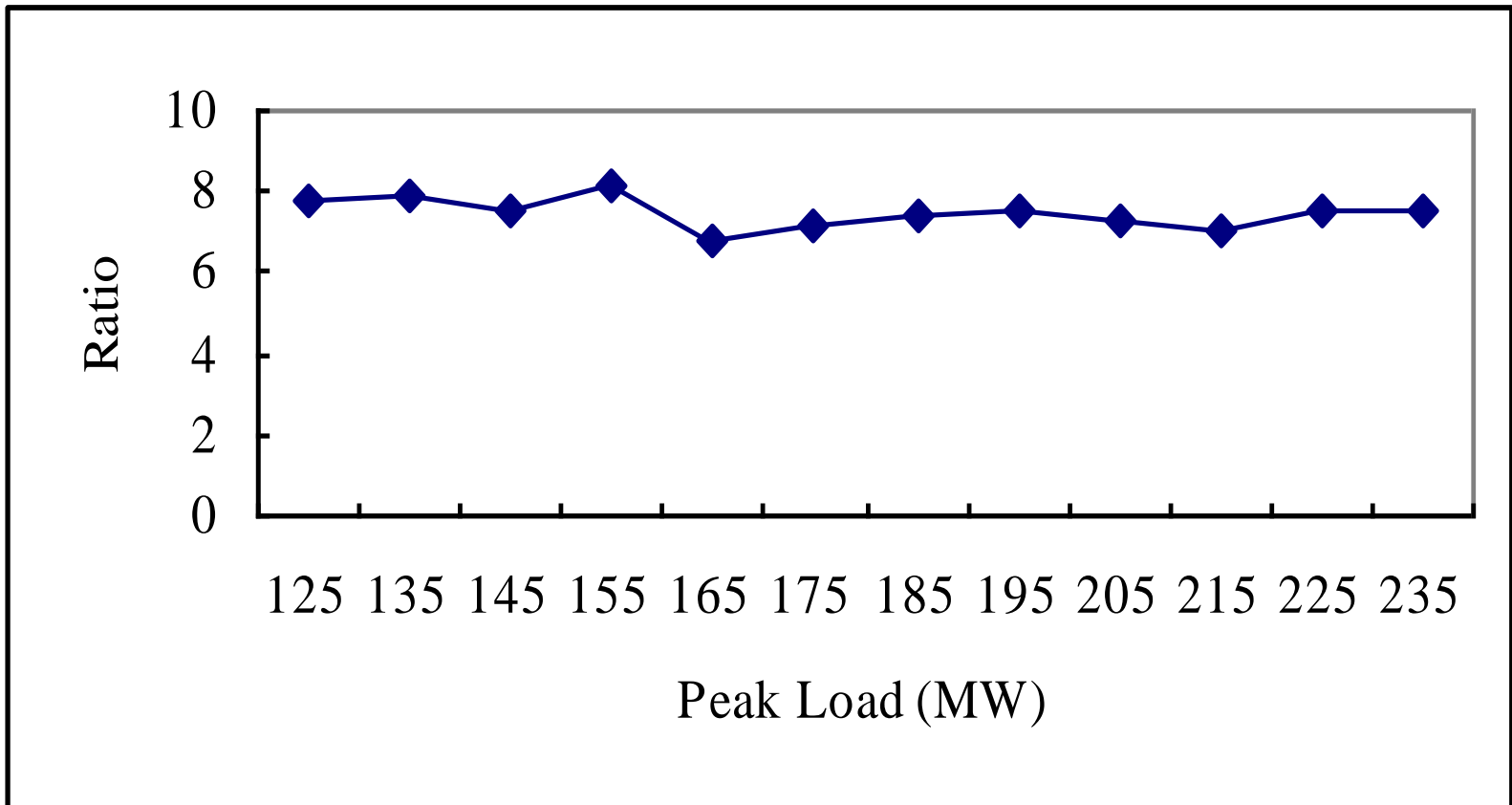

Ratio of the LOLE (hours/year) over the LOLE (days/year) for the IEEE-RTS

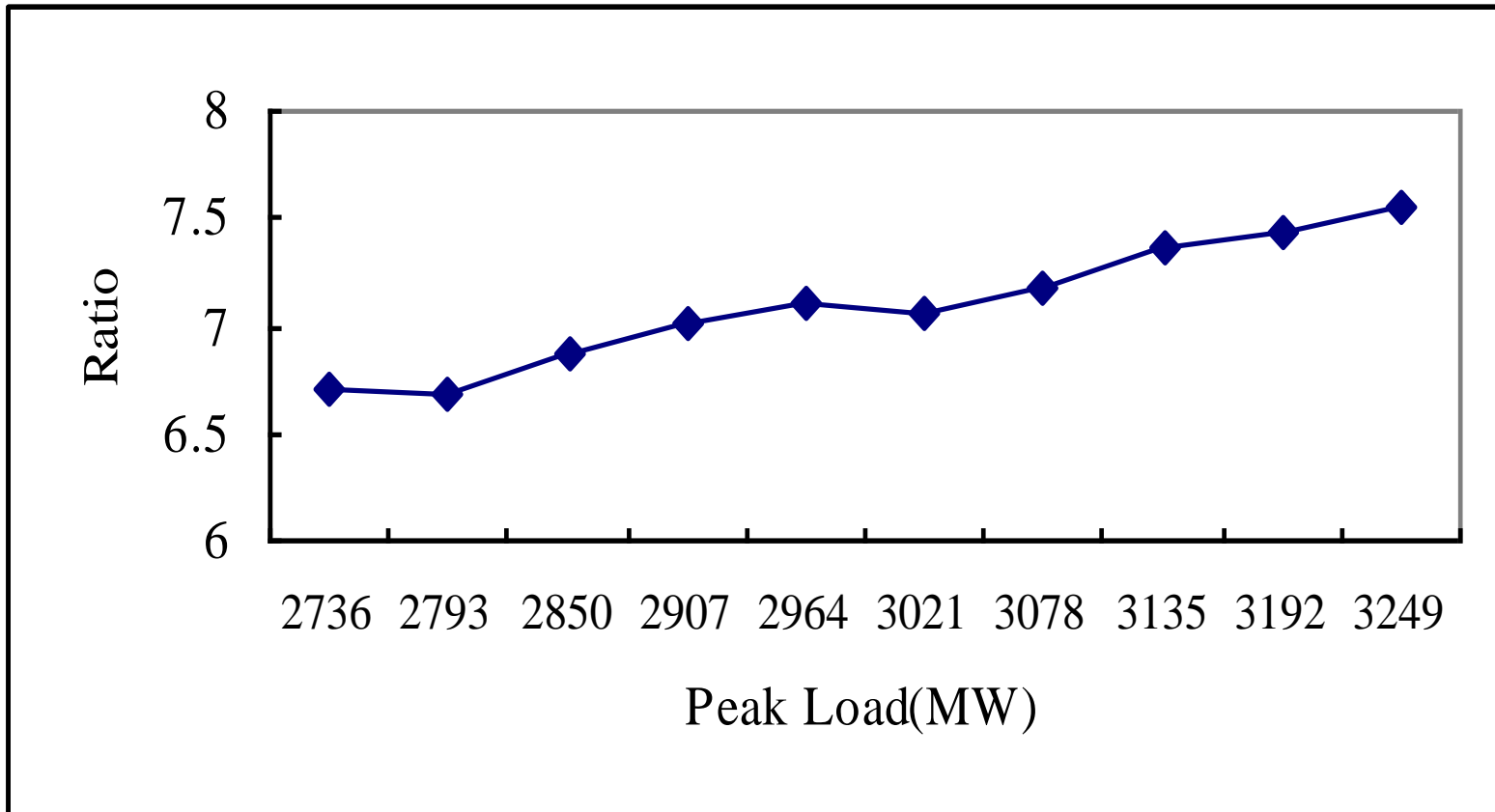

LOLE(hours/year) and LOLE (days/year)

The LOLE in days/year provides a more pessimistic appraisal than that given by the LOLE in hours/year. The two test systems have the same normalized chronological hourly load model and therefore the same daily and annual load duration curves. The system load factor is 61.44%. The ratio difference in the two test systems is therefore due to the different generation compositions.

The reciprocal of the LOLE in years per day is often misinterpreted as a frequency index. As an example, the commonly used LOLE index of 0.1 days/year is often expressed as one day in ten years and extended to mean “once in ten years”. This is not a valid extension and has a frequency of load loss connotation that is not present in the LOLE index. In order to illustrate this, a comparison of the LOLE (days/year) and LOLF (occ/year) indices was conducted using the two test systems.

Ratio of the Reciprocal of the LOLE (days/year) over the Reciprocal of the LOLF (occ/year) for the RBTS.

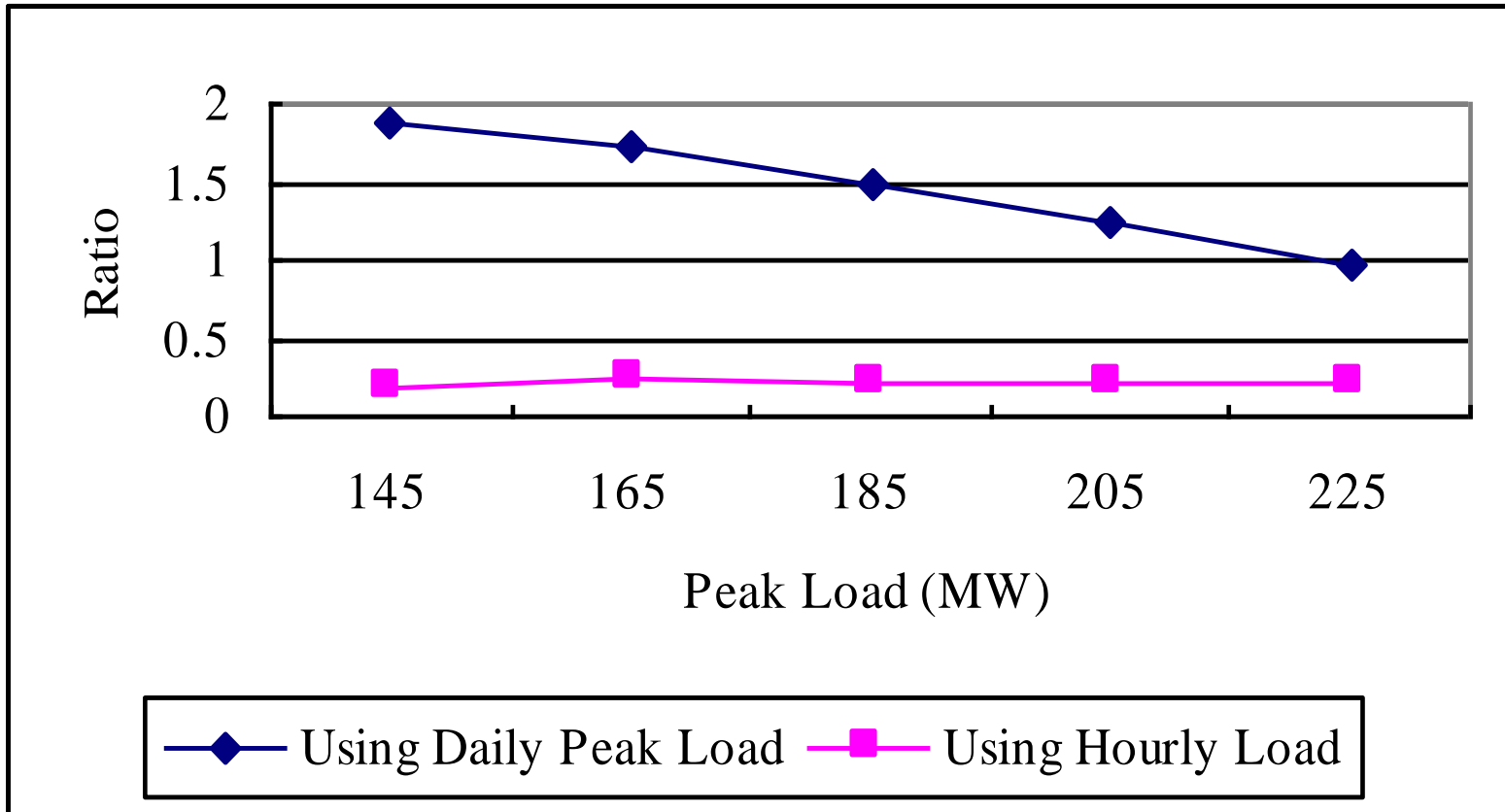

Ratio of the Reciprocal of the LOLE (days/year) over the Reciprocal of the LOLF (occ/year) for the IEEE-RTS.

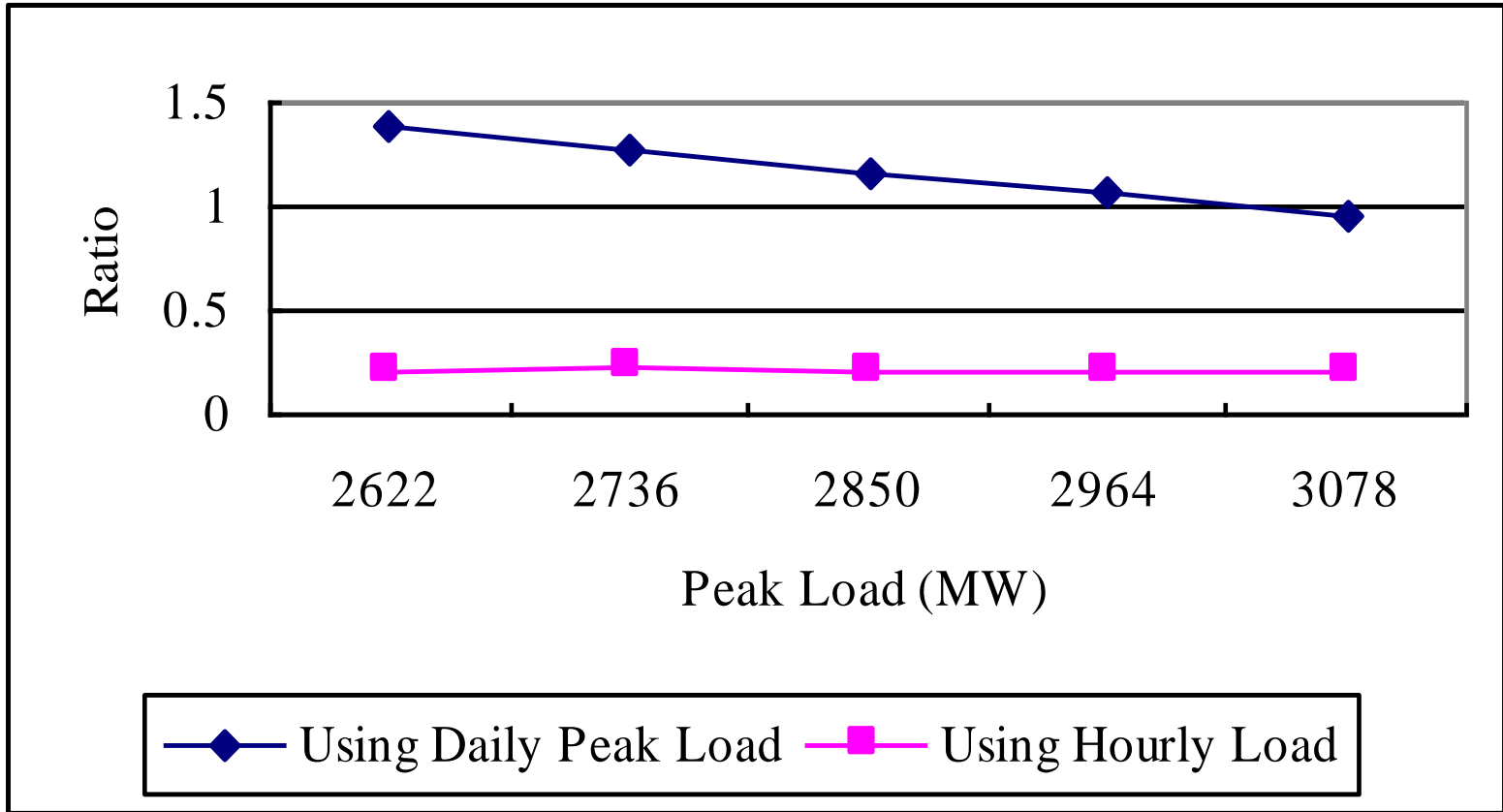

Reliability Index Probability Distributions

The simulation program was applied to the IEEE-RTS to create the reliability index probability distributions.

The load is represented by the hourly values.

The sampling size for the IEEE-RTS is 20,000 sampling years, which provides a coefficient of variation less than 1%.

LOLE and Probability of Zero LOL for the IEEE-RTS.

Peak Load (MW)	LOLE (hours/year)	LOL Standard Deviation	Probability of no LOL
2850	9.39	16.49	43.35%
2964	19.36	24.99	21.12%
3078	36.33	35.66	7.04%

LOEE, LOLF and the Standard Deviations for the IEEE-RTS.

Peak Load (MW)	LOEE (MWh/year)	LOE Standard Deviation	LOLF (occ/year)	LOLF Standard Deviation
2850	1192.51	3061.14	2.00	2.79
2964	2621.69	4891.98	3.98	4.06
3078	5214.57	7407.87	7.21	5.59

The Distribution of the LOL for the IEEE-RTS.

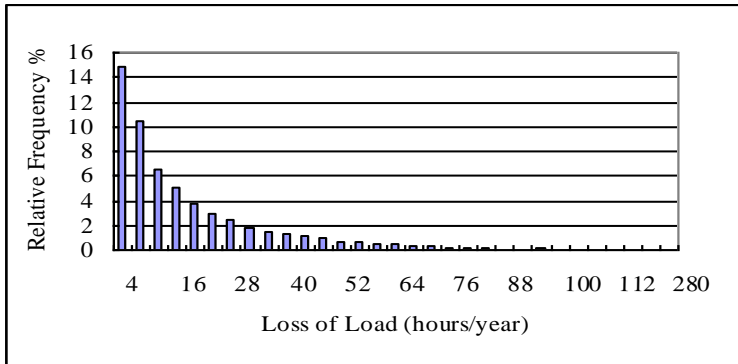

Peak Load = 2850 MW

P (zero LOL) = 43.35%

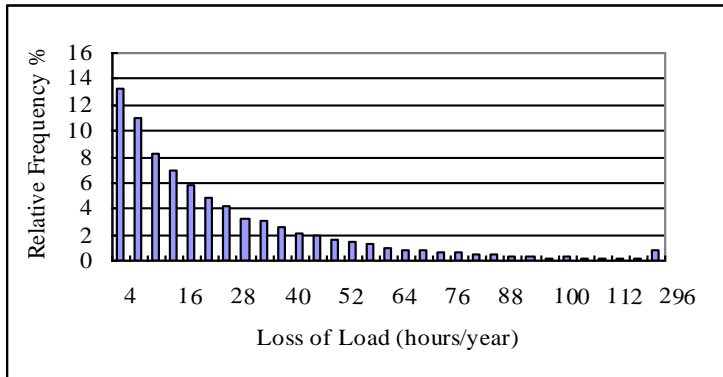

Peak Load = 2964 MW

P (zero LOL) = 21.12%

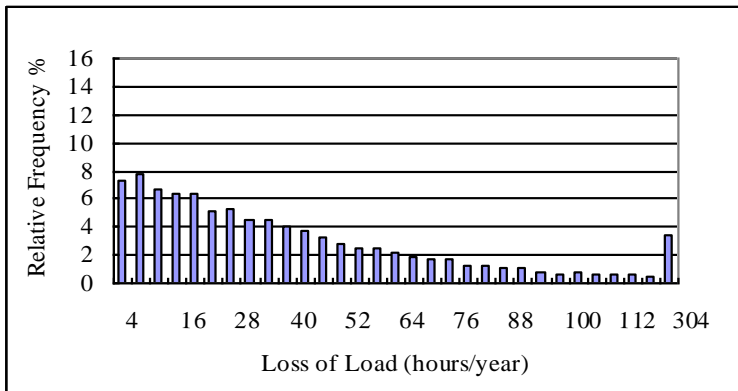

Peak Load = 3078 MW

P (zero LOL) = 7.04%

The Distribution of the LOE for the IEEE-RTS.

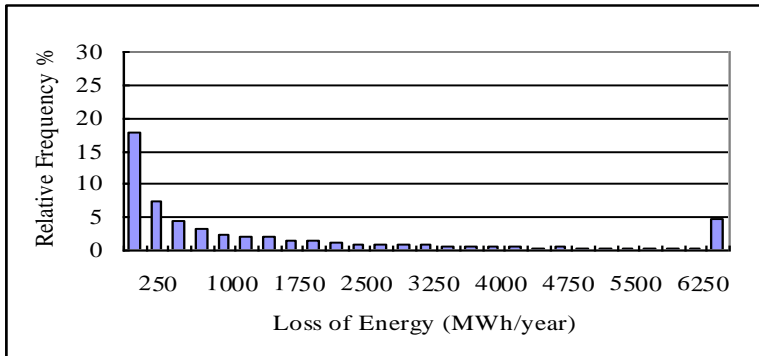

Peak Load = 2850 MW

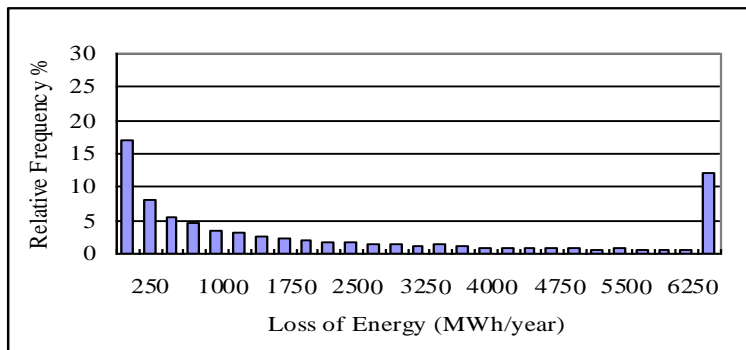

Peak Load = 2964 MW

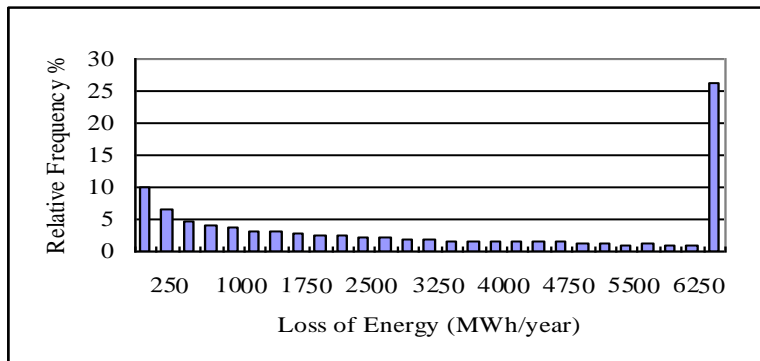

Peak Load = 3078 MW

As noted earlier, the LOLE index is the most commonly used adequacy index in generating capacity planning. The LOLE does not contain any information on the magnitude of load loss due to insufficient generation. It simply indicates the expected number of hours of load loss in a given year. The LOEE is a more complex index and is a composite of the frequency, duration and magnitude of load loss.

The LOEE can be combined with an index known as the Interrupted Energy Assessment Rate (IEAR) to give the expected customer economic loss due to capacity deficiencies. Assuming an IEAR of 15.00/kWh of unserved energy, the expected customer interruption costs (ECOST) are as follows:

Peak Load (MW)	ECOST(\$)
2850	17,887,608
2964	39,325,287
3078	78,218,605

These values were obtained by taking the product of the IEAR and the respective LOEE.

Additional information on the likelihood of encountering a particular level of monetary loss can be obtained using the distribution in the previous figure. As an example, the relative frequencies of encountering a monetary loss exceeding 900 million dollars are as follows.

Peak Load (MW)	Relative Frequencies(%)
2850	5.38
2964	13.28
3078	28.03

The distributions provide considerable additional information that can be used in electricity utility risk assessment and management.

The Distribution of the LOLF for the IEEE-RTS

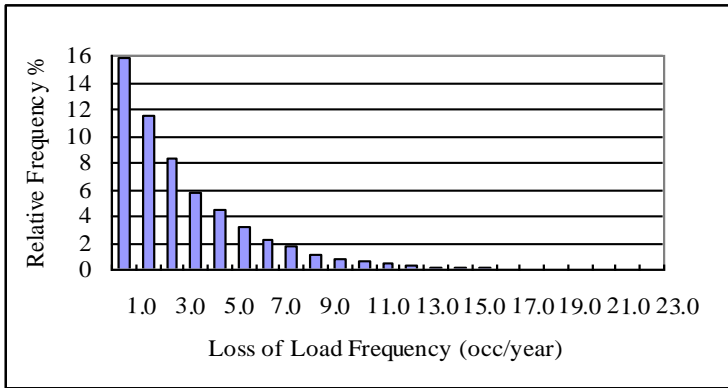

Peak Load = 2850 MW

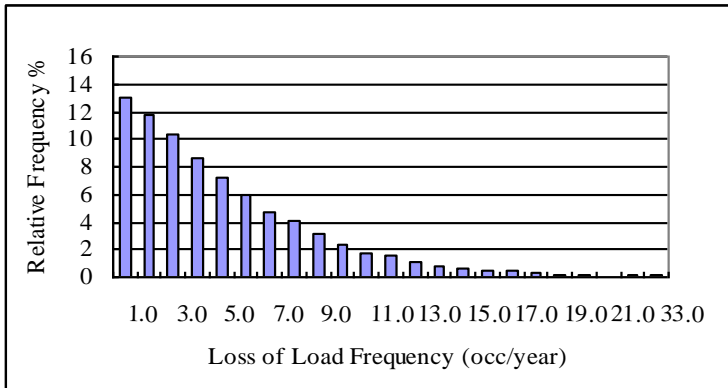

Peak Load = 2964 MW

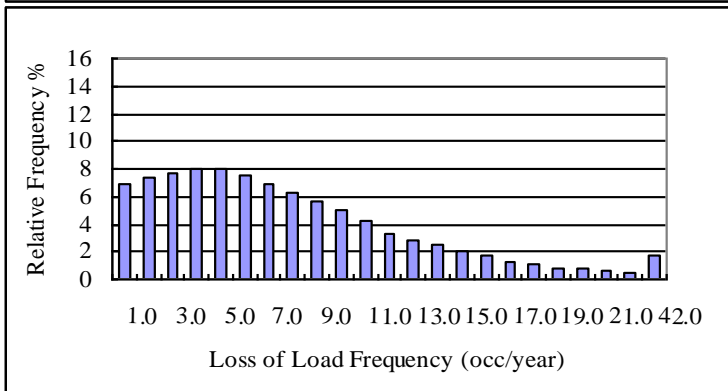

Peak Load = 3078 MW

The basic generating capacity adequacy indices can be determined using analytical techniques or simulation methods.

Simulation can be used to provide a wide range of indices, to incorporate complex operational constraints, and create reliability index probability distributions.

1. **“Reliability Evaluation of Power Systems, Second Edition”**, R. Billinton and R.N. Allan, Plenum Press, 1996, pp. 514.
2. **“Reliability Assessment of Electric Power Systems Using Monte Carlo Methods”**, R. Billinton and W. Li, Plenum Press, 1994, pp. 351.

Transmission and Bulk System Reliability Evaluation

**Roy Billinton
Power System Research Group
University of Saskatchewan
CANADA**



Hierarchical Level II -- HL-II

Task– plan a bulk electric system (BES) to serve the load requirements at the BES delivery points as economically as possible with an acceptable level of reliability.

The system analysis is considerably more complicated at HL-II.

HL-II Reliability Assessment Methods

Analytical methods:

State enumeration

Monte Carlo techniques:

State sampling (non-sequential)

State duration sampling (sequential)

Basic Concepts of Contingency Enumeration

The fundamental procedure for contingency enumeration at HL-II is comprised of three basic steps:

- 1. Systematic selection and evaluation of contingencies.**
- 2. Contingency classification according to predetermined failure criteria.**
- 3. Compilation of appropriate predetermined adequacy indices.**

Basic Adequacy Indices

BES Load Point Indices:

Probability of Load Curtailment (PLC)

Frequency of Load Curtailment (FLC)

Expected Energy Not Supplied (EENS)

Expected Customer Interruption Cost (ECOST)

BES System Indices:

Probability of load curtailment (SPLC)

Frequency of Load Curtailment (SFLC)

Expected Energy Not Supplied (SEENS)

Expected Customer Interruption Cost (SECOST)

Severity Index (SI)

System Average Interruption Frequency Index
(SAIFI)

System Average Interruption Duration Index (SAIDI)

Basic Structure:

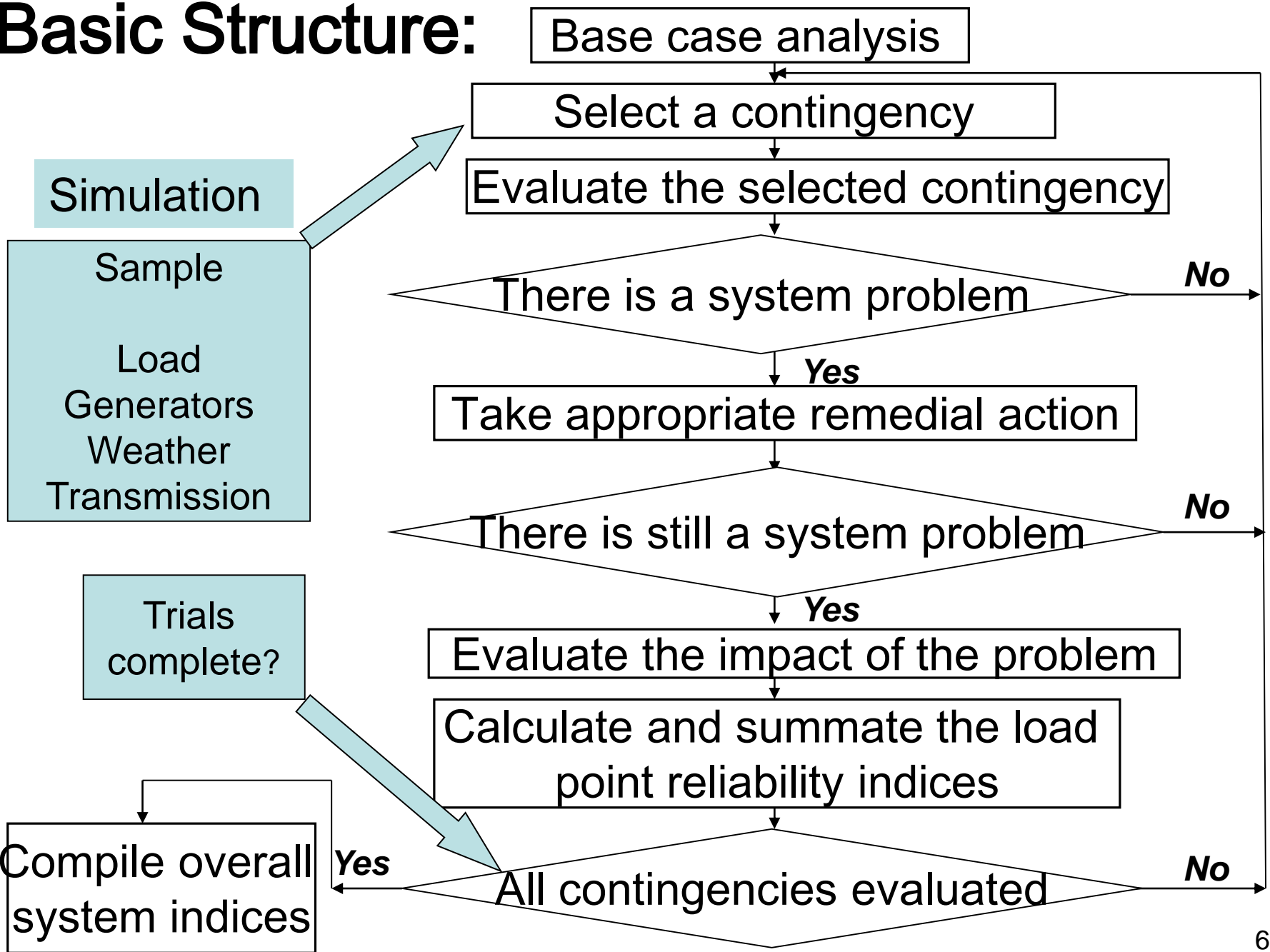

HL-II Network Analysis Techniques

The adequacy assessment of a bulk power system generally involves the solution of the network configuration under selected outage situations.

Network flow methods

DC load flow methods

AC load flow methods

Recommended Failure Criteria for Different Solution Techniques

- | | |
|----------------------------|---|
| Network Flow Method | <ol style="list-style-type: none">1. Load curtailments at bus(es) due to capacity deficiency in the system .2. Load curtailment, if necessary, at isolated bus(es). |
| DC Load Flow Method | <ol style="list-style-type: none">3. Load curtailment , if necessary, at bus(es) in the network islands formed due to line outages.4. Load curtailment at bus(es) due to line/transformer overloads. |
| AC Load Flow Method | <ol style="list-style-type: none">5. Voltage collapse at system bus(es).6. Generating unit Mvar limits violations.7. Ill-conditioned network situations. |

Analytical Method (State enumeration)

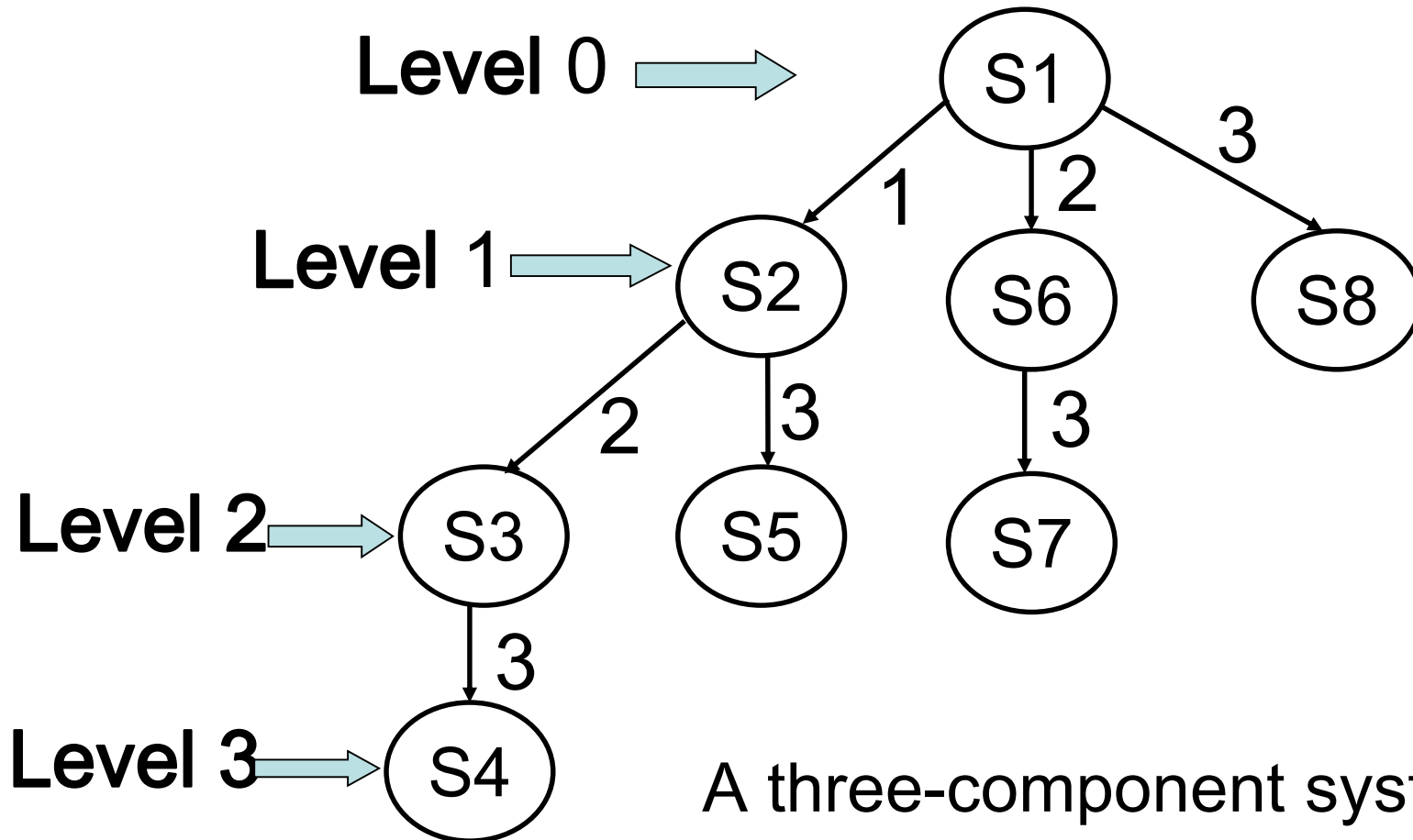

A three-component system
outage state enumeration

CEA Transmission Equipment Reporting System

This system deals with nine major components of transmission equipment:

lines

cables

circuit breakers

transformers

shunt reactor banks

shunt capacitor banks

series capacitor banks,

synchronous and static compensators.

The database contains design information for all components as well as details on all forced outages that occurred for each participating utility.

Transmission Equipment Data

The basic two state model is used to represent a wide array of transmission and distribution equipment. This equipment does not generally operate in a derated capacity state and transit directly from/to the up and down states shown in the two state modal. Transmission and distribution equipment also operate, in most cases, in a continuous sense as compared to generating equipment that is placed in service and removed from service to accommodate fluctuating load levels.

The following data are taken from the CEA-ERIS. This system compiles data on all equipment with an operating voltage of 60 kV and above and includes those elements associated with transmission systems such as synchronous and static compensators and also shunt reactors and capacitors on the tertiaries of transformers of 60 kV and above. A Major Component includes all the associated auxiliaries that make it a functional entity.

A Sustained Forced Outage of a transmission line relates to those events with a duration of one minute or more and therefore does not include automatic reclosure events.

A Transient Forced Outage has a duration of less than one minute.

The following abbreviations are used in the table headings in Tables 1 – 4.

VC – Voltage classification in kV

KY – Kilometer years in km.a

CY – Component years

TY – Terminal years (a)

NO – Number of outages

TT – Total time in hours

FK – Frequency in 100 km.a

FO – Frequency in occurrences/year

MD – Mean duration in hours

U – Unavailability in %

Transmission Line Performance

The transmission line performance statistics are given on a per 100 kilometer-year basis for line-related outages and on a per terminal-year basis for terminal-related outages. Tables 1, 2 and 3 summarize the more detailed listings in [1] for line-related and terminal-related forced outages.

[1] Canadian Electricity Association “*Forced Outage Performance of Transmission Equipment*”, 2010-2014

Table 1.
Summary of Transmission Line Statistics for
Line Related Sustained Forced Outages

VC	KY	NO	TT	FK	MD	U
Up to 109	55,992	1,551	43,958	2.7701	28.3	0.896
110 - 149	195,880	1,812	32,041	0.9251	17.7	0.187
150 - 199	9,063	96	4,597	1.0593	47.9	0.579
200 - 299	163,144	721	24,921	0.4419	34.6	0.174
300 - 399	34,271	99	28,769	0.2889	290.6	0.958
500 - 599	51,716	109	3,046	0.2108	27.9	0.067
600 – 799	24,846	67	10,470	0.2697	156.3	0.481

Table 2.
Summary of Transmission Line Statistics for
Line-Related Transient Forced Outages

VC	KY	NO	FK
Up to 109	55,992	1,392	2.4861
110 - 149	195,880	1,761	0.8990
150 - 199	9,063	9	0.0993
200 - 299	163,144	776	0.4757
300 - 399	34,271	16	0.0467
500 - 599	51,716	589	1.1389
600 - 799	24,846	4	0.0161

Table 3.
Summary of Transmission Line Statistics for
Terminal-Related Forced Outages

VC	TY	NO	TT	FK	MD	U
Up to 109	3,160.5	622	49,704	0.1968	79.9	0.180
110 - 149	9,273.5	1,381	80,385	0.1489	58.2	0.099
150 - 199	368.0	68	32,754	0.1848	481.7	1.016
200 - 299	5,079.5	662	57,428	0.1303	86.7	0.129
300 - 399	798.0	135	69,879	0.1692	517.6	1.000
500 - 599	763.5	138	3,138	0.1807	22.7	0.047
600 - 799	433.0	147	66,462	0.3395	452.1	1.752

Transformer Bank Performance

Transformer Bank performance statistics are shown by voltage classification and three-phase rating. The voltage classification refers to the system operating voltage at the high-voltage-side of the transformer. The three-phase rating is the MVA rating with all cooling equipment in operation. Table 4 summarizes the more detailed listings in [1].

[1] Canadian Electricity Association “*Forced Outage Performance of Transmission Equipment – 2010-2014*”

Table 4.

Summary of Transformer Bank Statistics by Voltage Classification for Forced Outages Involving Integral Subcomponents and Terminal Equipment

VC	CY	NO	TT	F (Per a)	MD	U
Up to 109	7,862	445	177,341	0.0566	398.5	0.257
110 - 149	8,475	1,581	482,789	0.1866	305.4	0.650
150 - 199	553	112	40,257	0.2027	359.4	0.832
200 - 299	5,075	771	205,354	0.1519	266.3	0.462
300 - 399	1,456	372	200,216	0.2556	538.2	1.570
500 - 599	433	109	38,685	0.2517	354.9	1.020
600 - 799	1,383	184	104,730	0.1331	569.2	0.865

Single Line Diagram of the RBTS

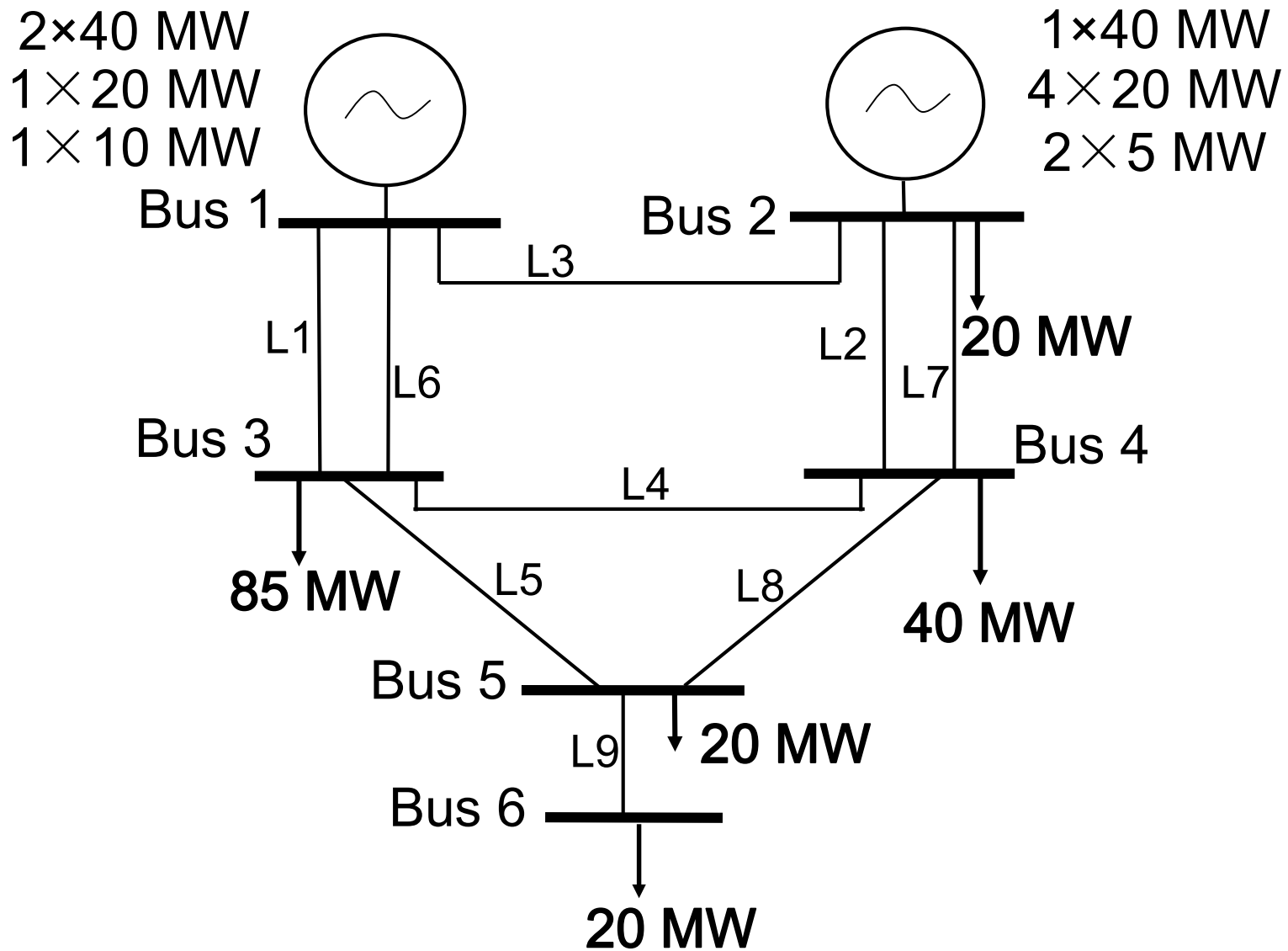

IEAR and Priority Order for Load Points in the RBTS

Bus No.	IEAR (\$/kWh)	Priority Order
2	7.41	1
3	2.69	5
4	6.78	2
5	4.82	3
6	3.63	4

$$\text{IEAR}_i = \frac{\text{ECOST}_i}{\text{EENS}_i} \quad (i = \text{load point } i)$$

Basic RBTS Load Point Indices

Bus No.	PLC	ENLC (1/yr)	EENS (MWh/yr)
2	0.0000	0.0000	0.000
3	0.0002	0.0787	12.561
4	0.0000	0.0011	0.029
5	0.0000	0.0055	0.291
6	0.0012	1.1822	137.942

Obtained using the MECORE (Monte Carlo composite generation and transmission system reliability evaluation) state sampling software.

Basic RBTS System Indices

- **SPLC = 0.0014**
- **SEFLC = 1.26 (1/year)**
- **SEENS = 150.82 (MWh/year)**
- **SI = 48.92 (system minutes/ year)**

Obtained using the MECORE (Monte Carlo composite generation and transmission system reliability evaluation) state sampling software.

Load Point EENS Versus Peak Load

Bus 3 EENS

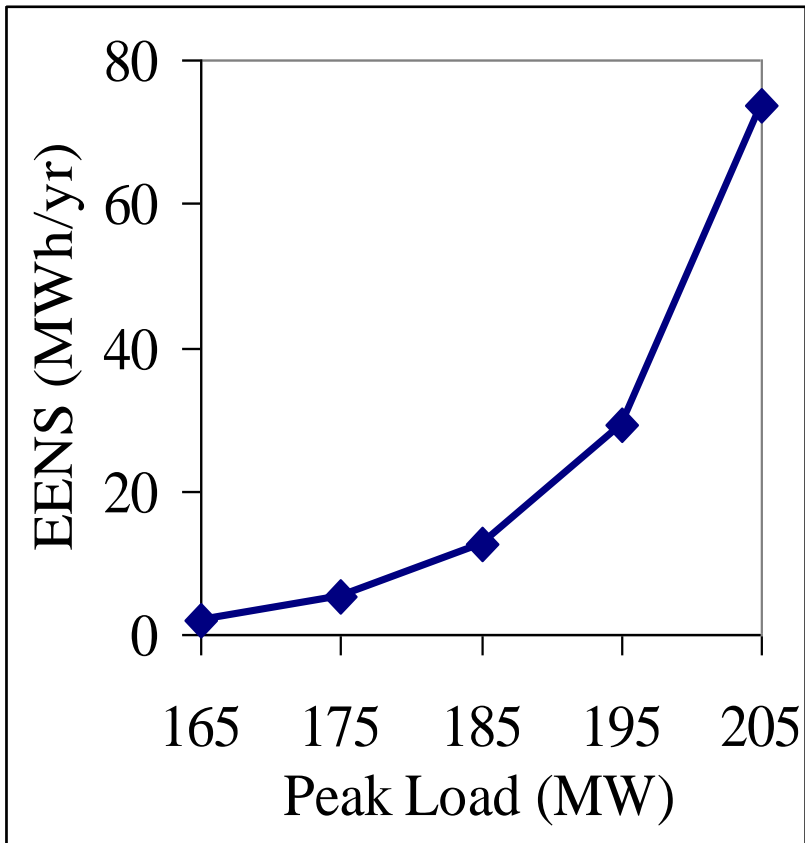

Bus 6 EENS

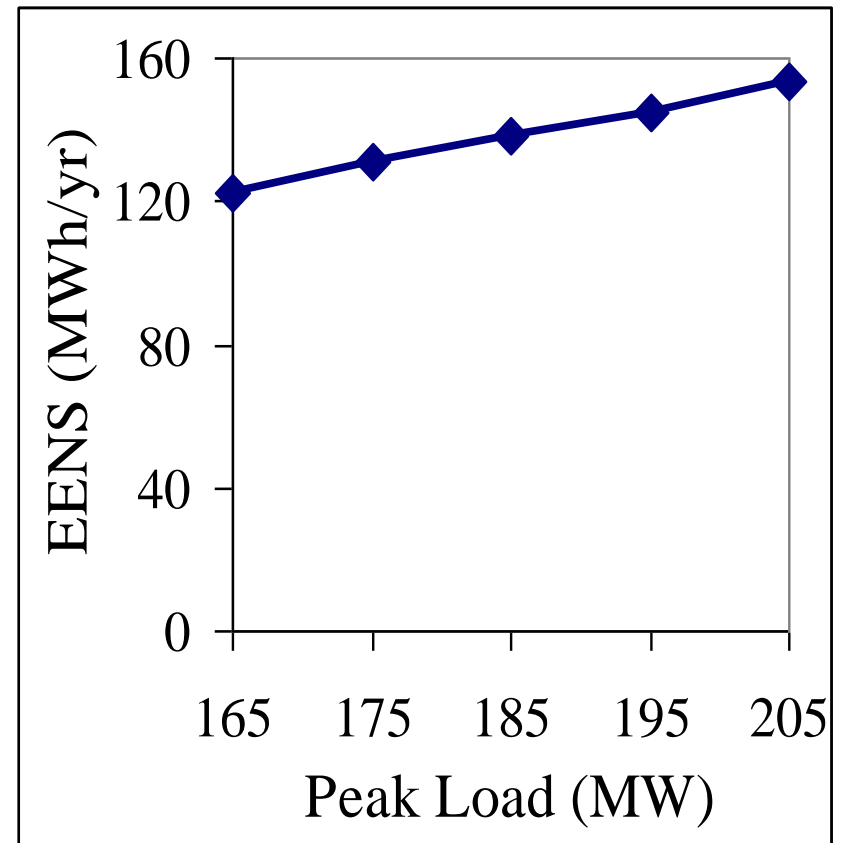

System EENS Versus Peak Load

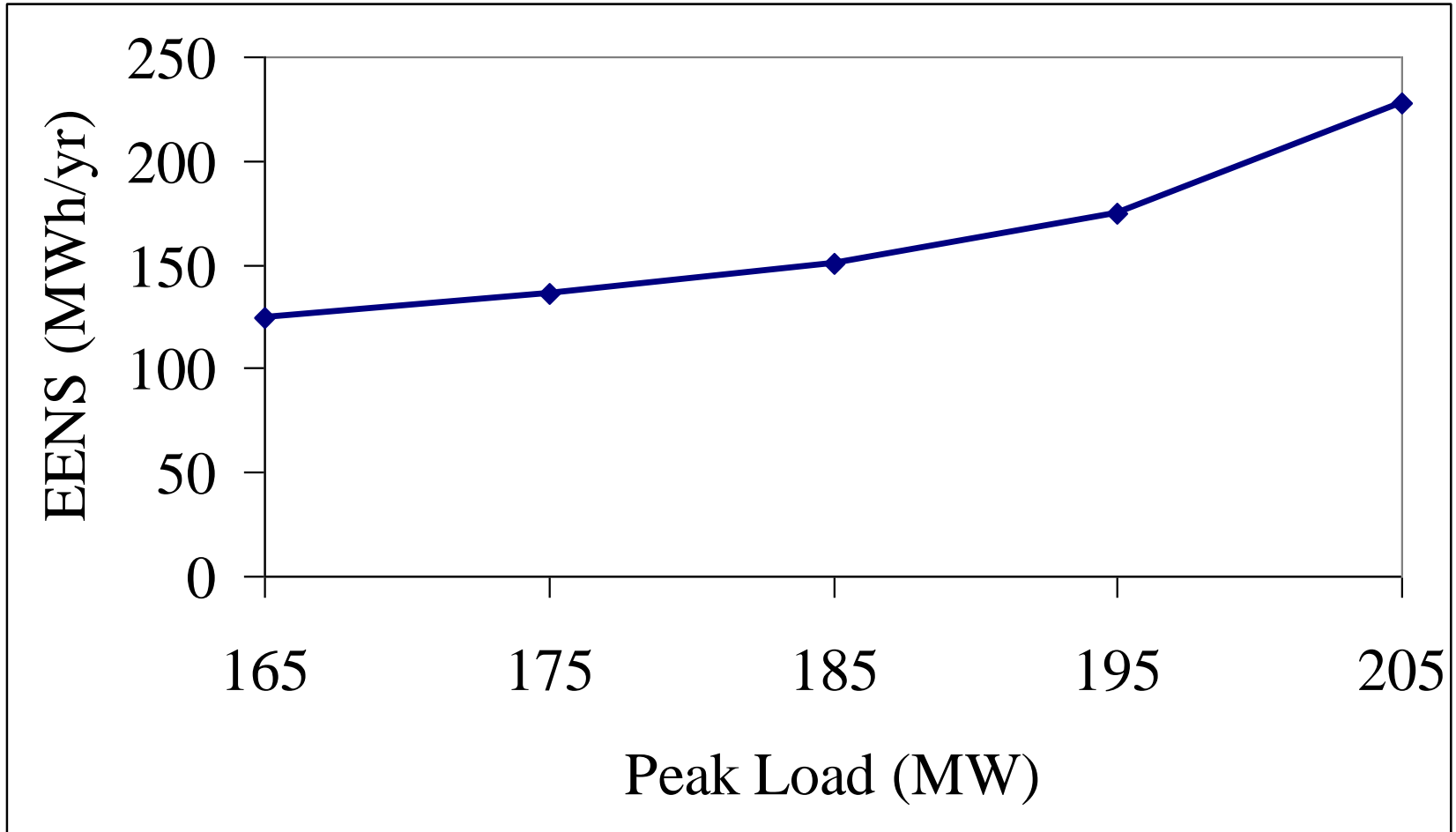

Load Curtailment Policies

- **Priority Order Policy**

This philosophy is based on ranking all the bulk delivery point using a reliability index such as the interrupted energy assessment rate (IEAR) in \$/KWh.

- **Pass-1 Policy**

In this load shedding policy, loads are curtailed at the delivery

points that are closest to (or one line away from) the element(s) on outage.

- **Pass-2 policy**

This load shedding policy extends the concept of the pass-1 policy. Loads are curtailed at the delivery points that surround the outaged element.

Load Point and System EENS (MWh/yr) for the RBTS using Three Load Curtailment Policies

Bus No.	Priority Order Policy	Pass-1 Policy	Pass-2 Policy
2	0.31	1.64	1.64
3	44.63	29.61	29.61
4	1.92	17.57	17.57
5	1.23	1.40	1.40
6	104.88	102.74	102.74
Sys.	152.97	152.96	152.96

Obtained using the RapHL-II (Reliability analysis program for HL-II) sequential simulation software.

Load Forecast Uncertainty

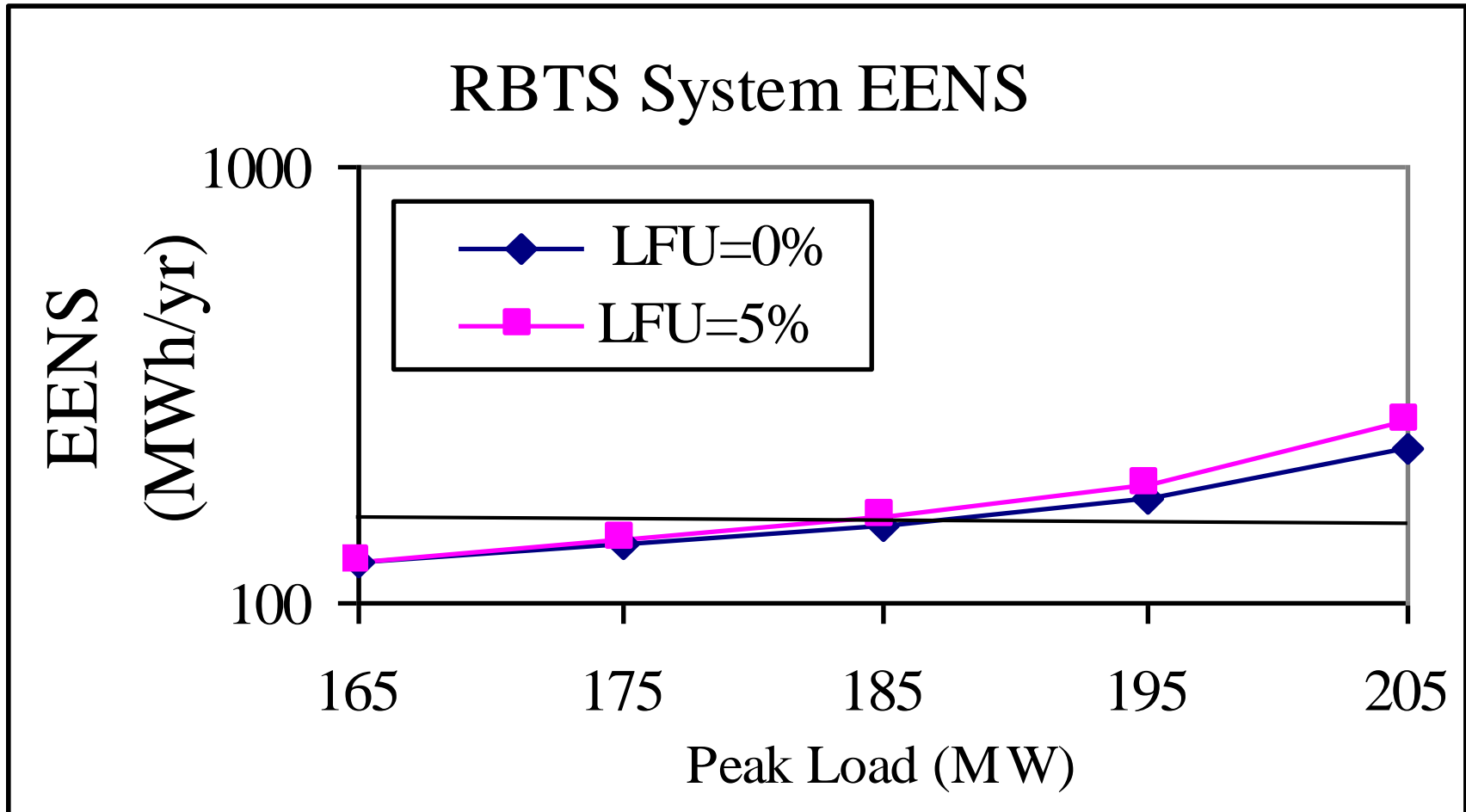

Load Forecast Uncertainty

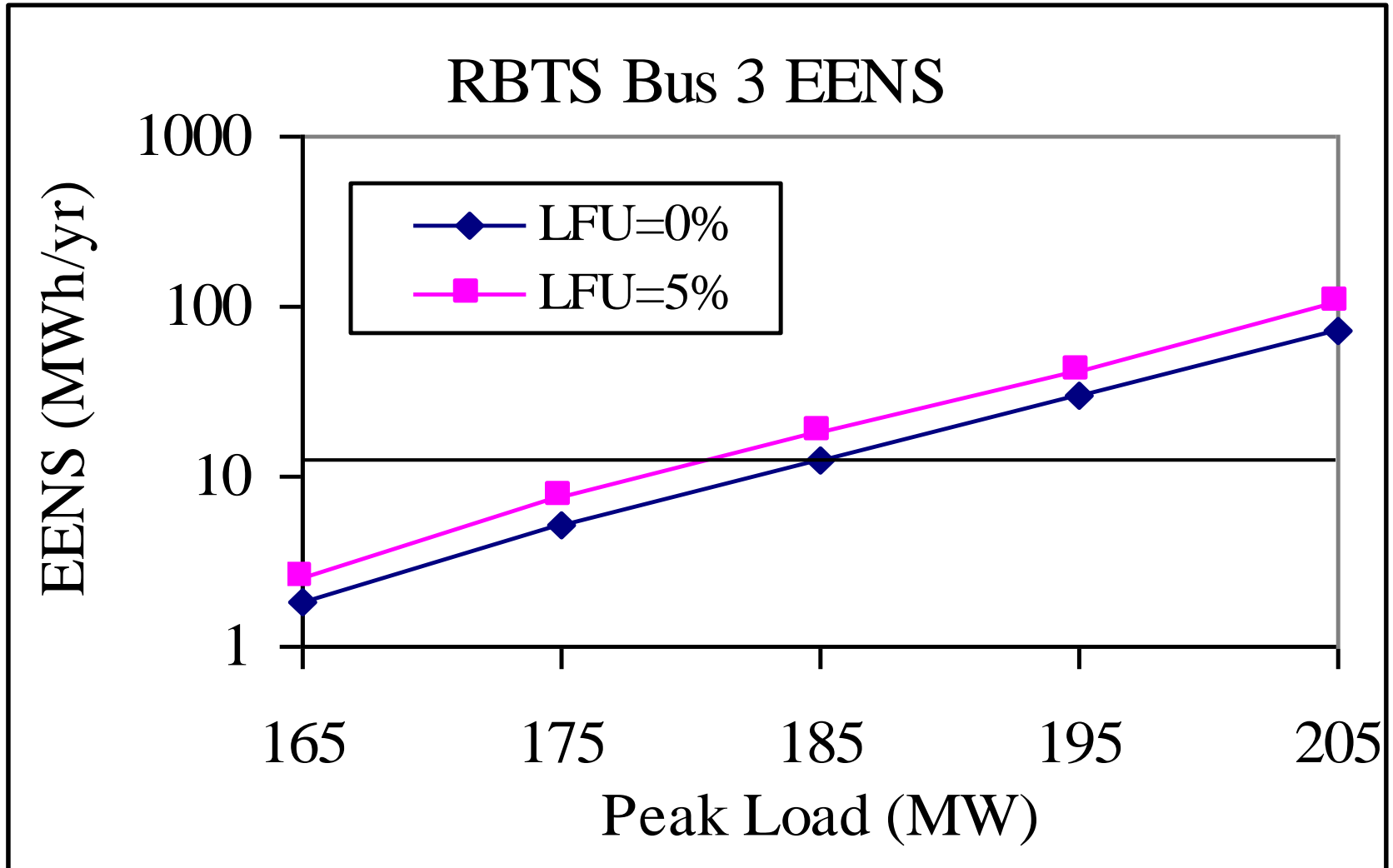

Load Forecast Uncertainty

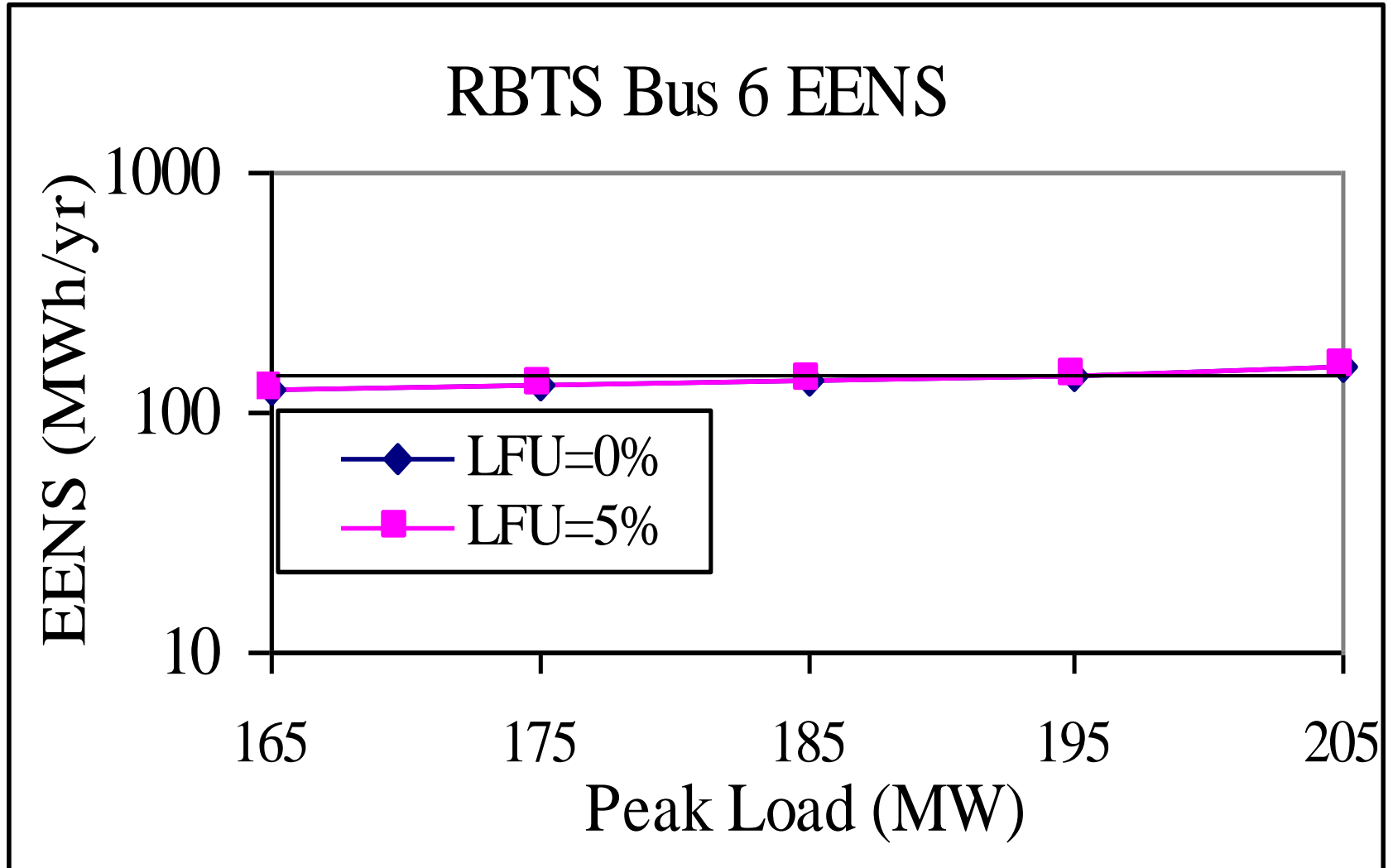

The RBTS EENS for WECS Installed Capacity at Bus 3

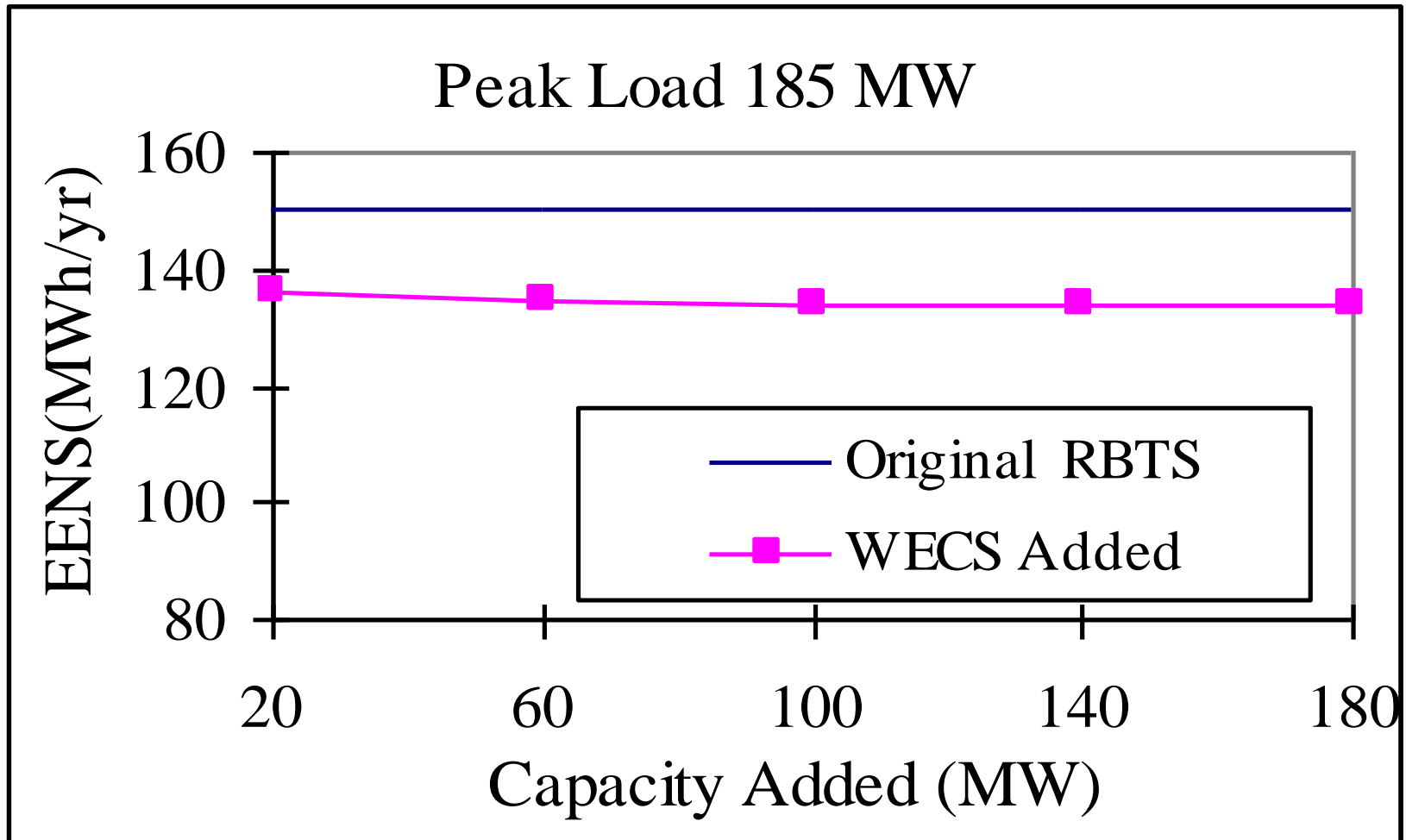

Load Point EENS for WECS Installed Capacity at Bus 3

Bus 3

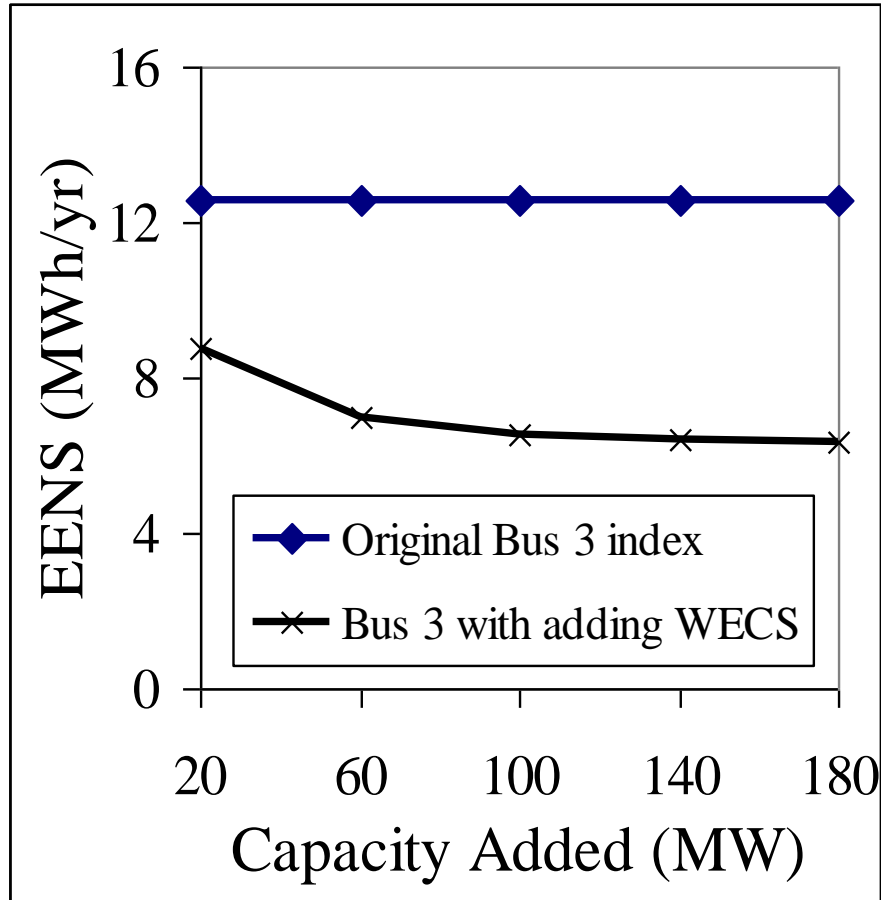

Bus 6

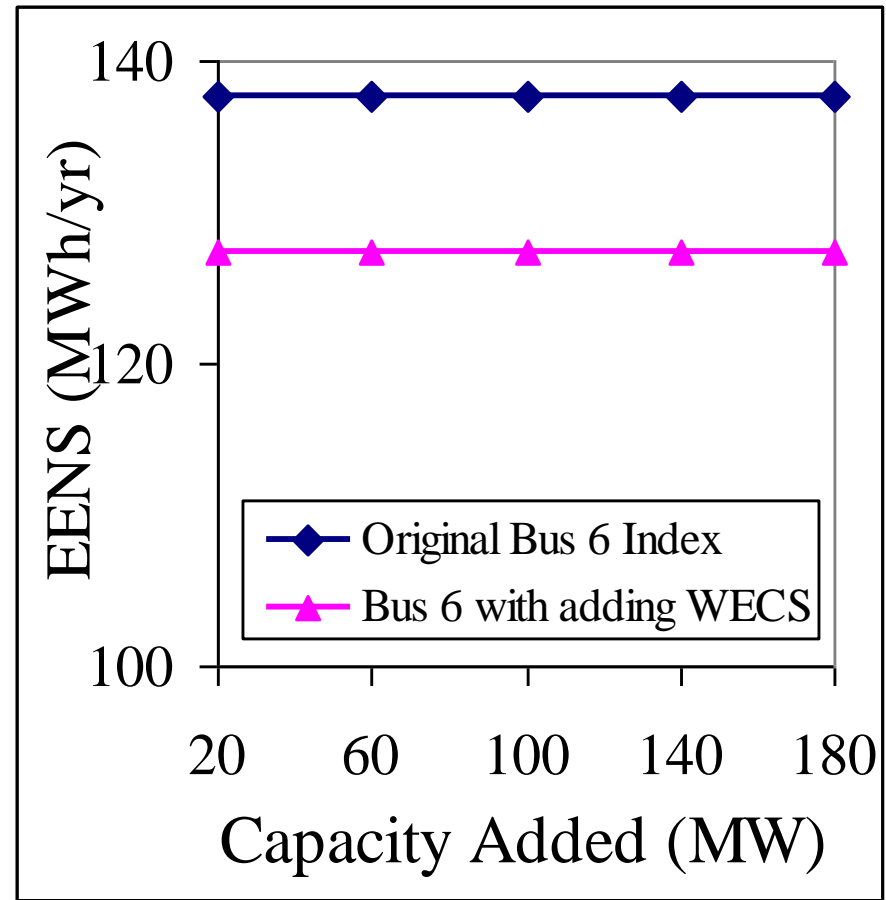

Bulk Electric System Adequacy Evaluation Incorporating WECS

The RTS has 32 generating units, 33 transmission lines and transformers. It is considered to have a relatively strong transmission system and to be generation deficient.

The modified RTS(MRTS) was created by increasing the generation and load while leaving the transmission unchanged.

Bulk Electric System Adequacy Evaluation

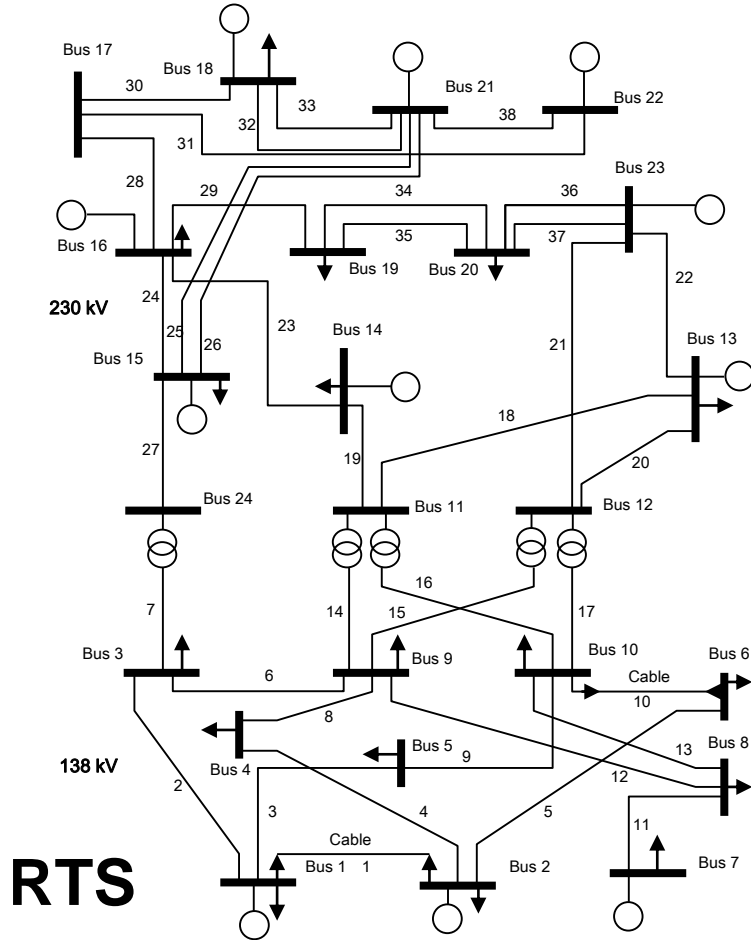

Sequential Monte Carlo simulation

Overall System EDLC (hrs/yr)	Location to Connect the WECS			
	at Bus 1	at Bus 8	at Bus 13	at Bus 18
RTS-120 MW WP	29.00	28.83	32.02	28.98
RTS-480 MW WP	24.59	24.53	19.86	20.25
MRTS-120 MW WP	11.54	11.80	13.25	13.13
MRTS-480 MW WP	11.53	9.02	10.07	15.11

The EDLC for the RTS and the MRTS respectively with no WECS are 35.26 and 13.55 hrs/yr

Bulk Electric System Adequacy Evaluation

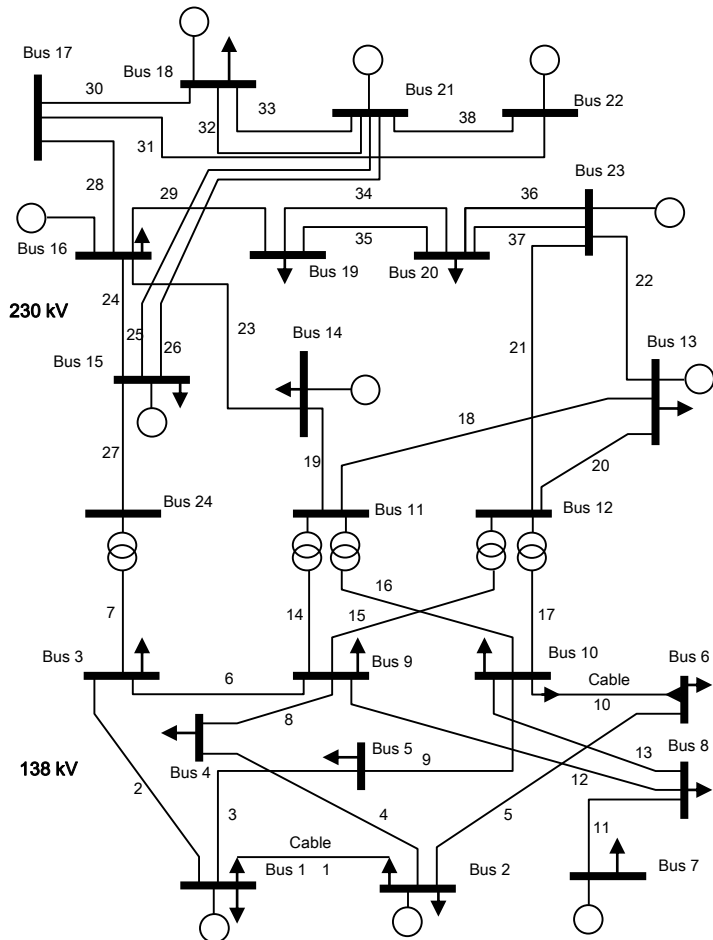

State sampling Monte Carlo simulation (MECORE program)

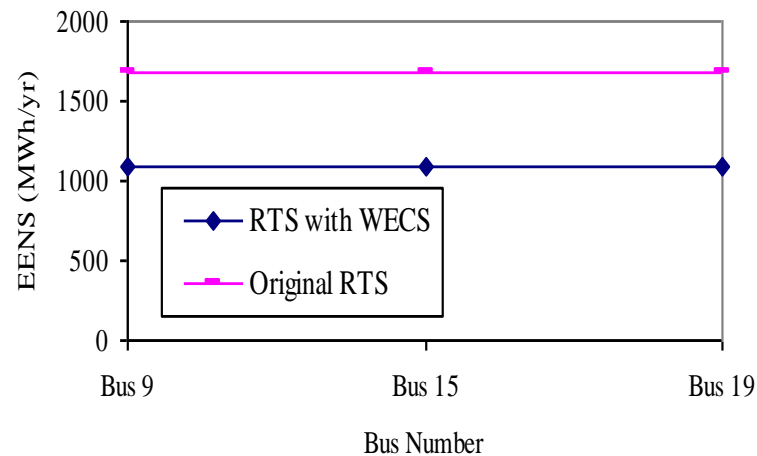

System EENS with a 400 MW WECS added to the RTS

RTS EENS (MWh/yr) with the addition of WECS at different locations

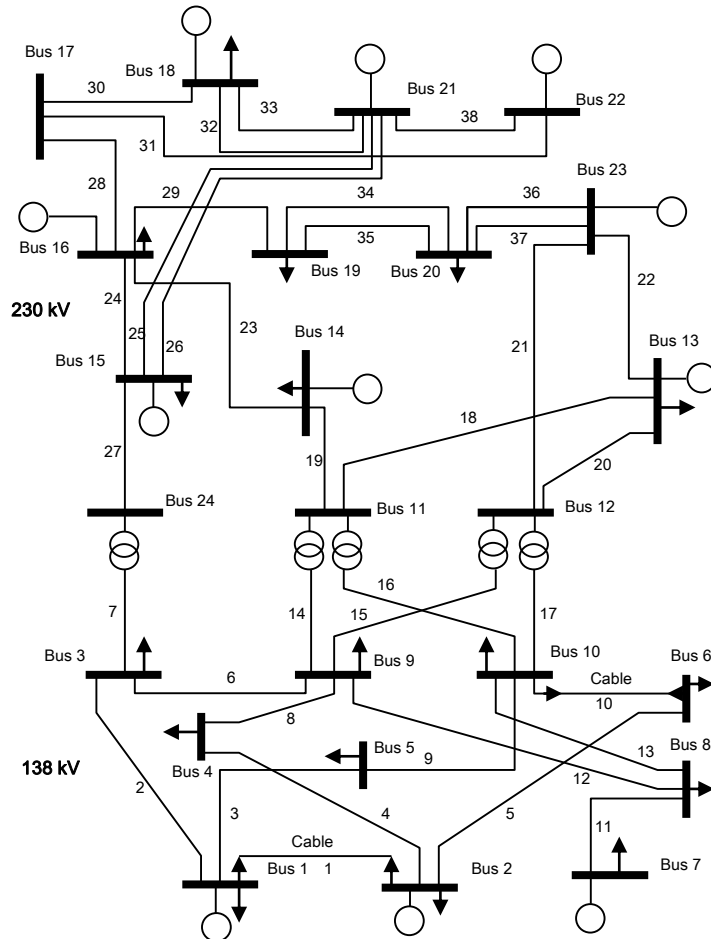

Case 1: WECS additions at Bus 1 and Bus 3
 Case 2: WECS additions at Bus 1 and Bus 4
 Case 3: WECS additions at Bus 1 and Bus 6

EENS

600 MW WECS				
	Base case	Case 1	Case 2	Case 3
$R_{xy}=0$	1674.799	807.828	808.400	807.913
$R_{xy}=0.2$		845.162	845.722	845.251
$R_{xy}=0.5$		896.342	896.965	896.468
$R_{xy}=0.8$		953.109	953.718	953.234
1400 MW WECS				
	Base case	Case 1	Case 2	Case 3
$R_{xy}=0$	1674.799	569.087	578.826	576.520
$R_{xy}=0.2$		631.899	639.780	637.480
$R_{xy}=0.5$		718.404	724.783	722.585
$R_{xy}=0.8$		815.928	819.587	817.615

CEA BES Reliability Performance Indices

- **Transmission System Average Interruption Frequency Index- Sustained Interruptions (T-SAIFI-SI)**

A measure of the average number of sustained interruptions that DP experience during a given period, usually one year.

$$\text{T - SAIFI - SI} = \frac{\text{Total No. of Sustained Interruptions}}{\text{Total No. of Delivery Points Monitored}}$$

CEA BES Reliability Performance Indices

- **Transmission System Average Interruption Duration Index (T-SAIDI)**

A measure of the average interruptions duration that DP experience during a given period, usually one year.

$$T - SAIDI = \frac{\text{Total Duration of all Interruptions}}{\text{Total No. of Delivery Points Monitored}}$$

CEA BES Reliability Performance Indices

- **Delivery Point Unreliability Index (DPUI)**
A measure of overall BES performance in terms of a composite index of unreliability expressed as System-Minutes.

$$\text{DPUI} = \frac{\text{Total Unsupplied Energy (MW - Minutes)}}{\text{System Peak Load (MW)}}$$

Electric Power System Reliability Assessment (EPSRA) Bulk Electricity System (BES)

- **Delivery Point Indices – 2016**

T-SAIFI-SI

Single Circuit	1.08 occ/yr
Multi Circuit	0.28 occ/yr
All	0.75 occ/yr

T-SAIDI-SI

Single Circuit	151.74 min/yr
Multi Circuit	66.38 min/yr
All	115.92 min/yr

BES DPUI 22.33 SM

CEA BES Delivery Point Performance

Annual SAIFI-SI for the 1998-2003 period

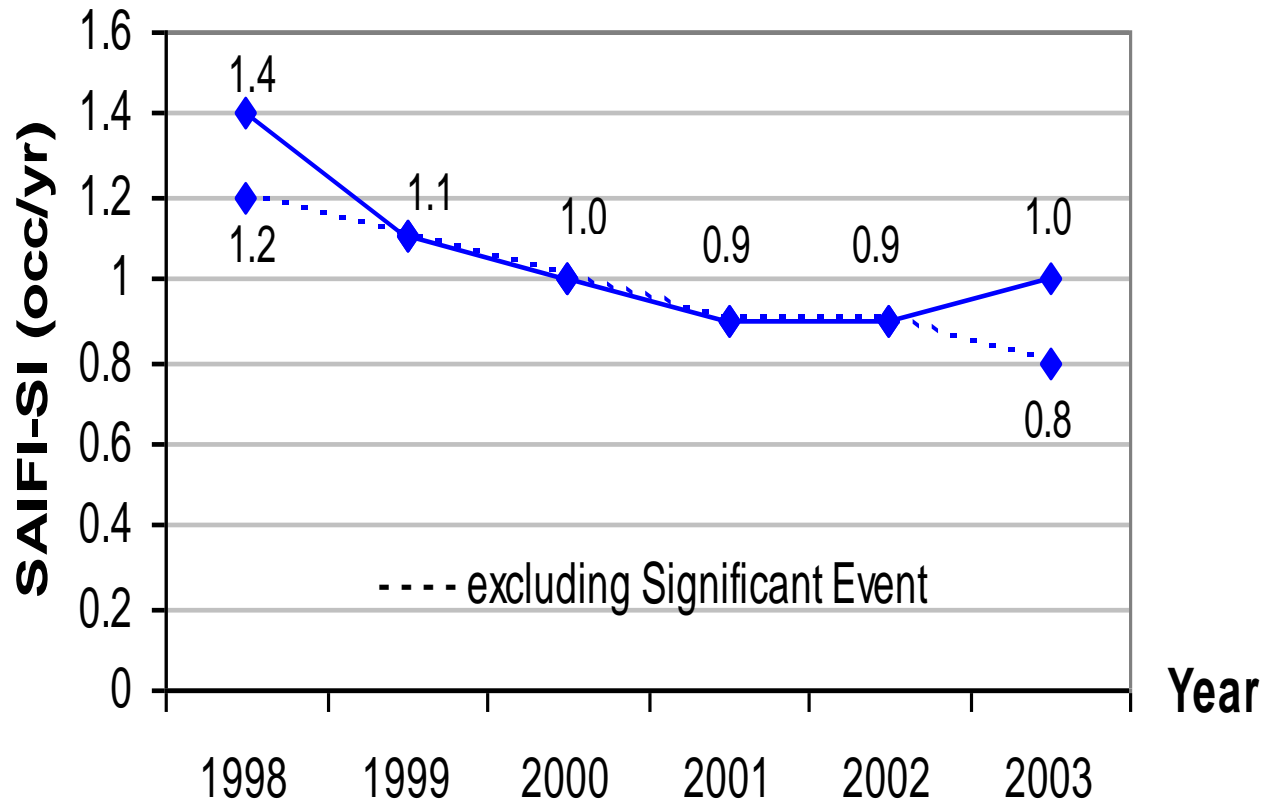

CEA BES Delivery Point Performance Annual SAIDI for the 1998-2003 period

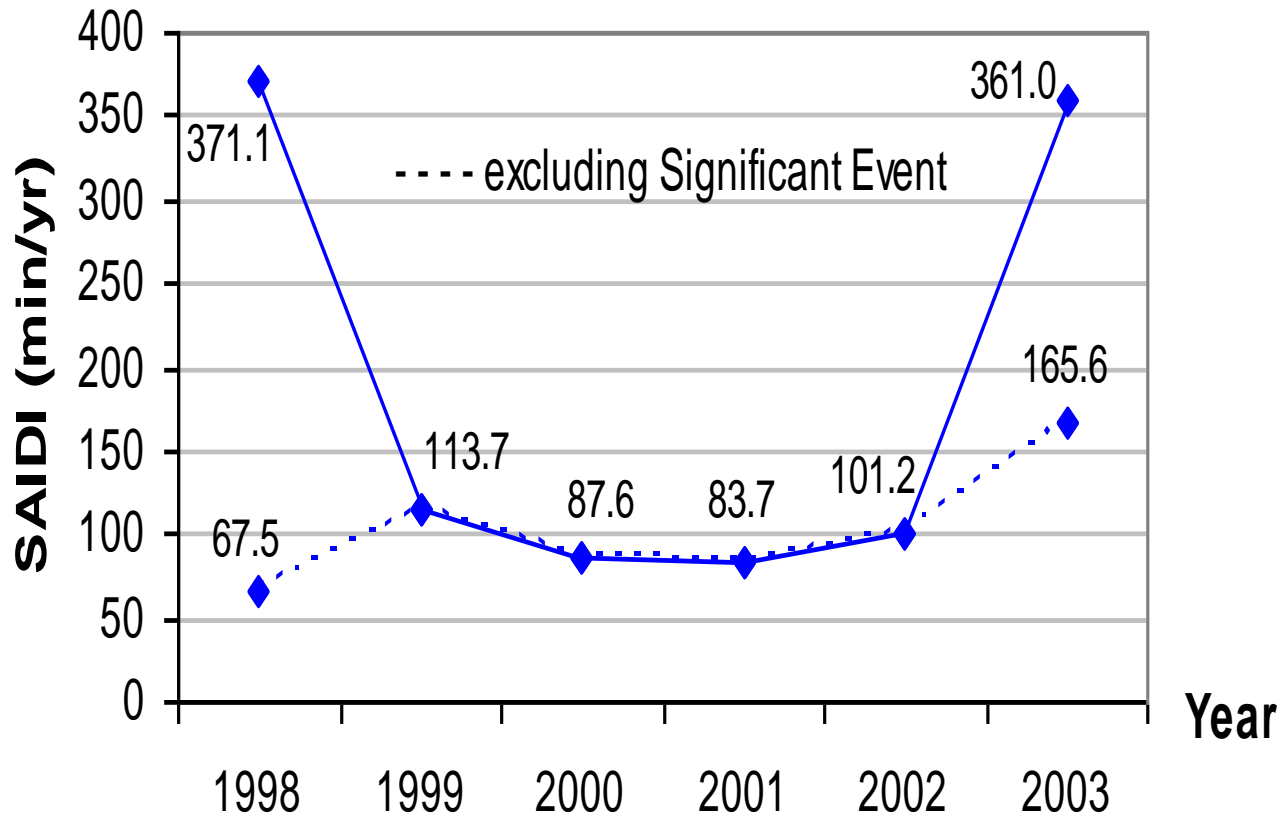

CEA BES Delivery Point Performance

Annual DPUI for the 1998-2003 period

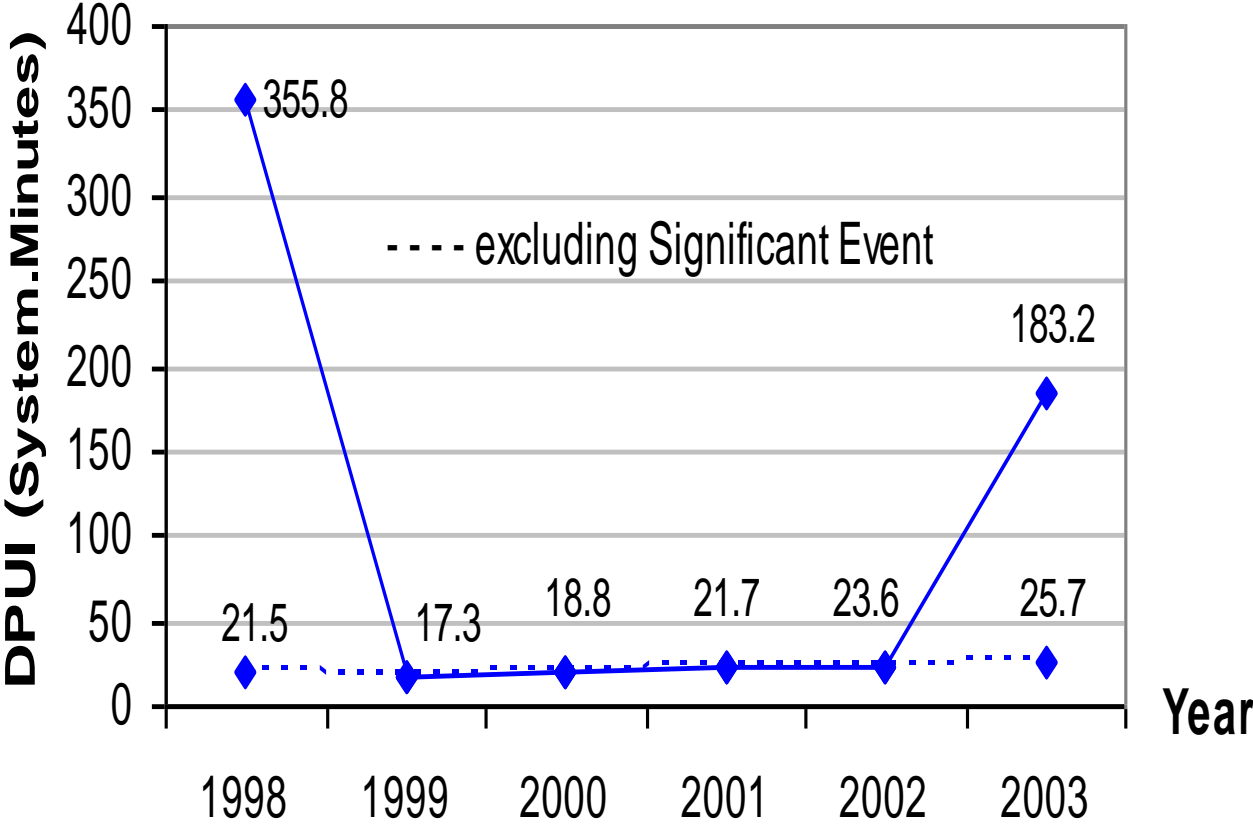

BES Reliability:

- **can be measured at the individual load points and for the system.**
- **can be predicted for the individual load points and for the system.**

SAIFI (occ./yr) for the RBTS using the Three Load Curtailment Policies

Priority Order Policy	Pass-1 Policy	Pass-2 Policy
0.47	0.52	0.52

SAIDI (hrs/yr) for the RBTS using the Three Load Curtailment Policies

Priority Order Policy	Pass-1 Policy	Pass-2 Policy
2.99	3.27	3.27

Aleatory uncertainty associated with an annual BES index

Probability distributions of SAIFI and SAIDI for the IEEE-RTS

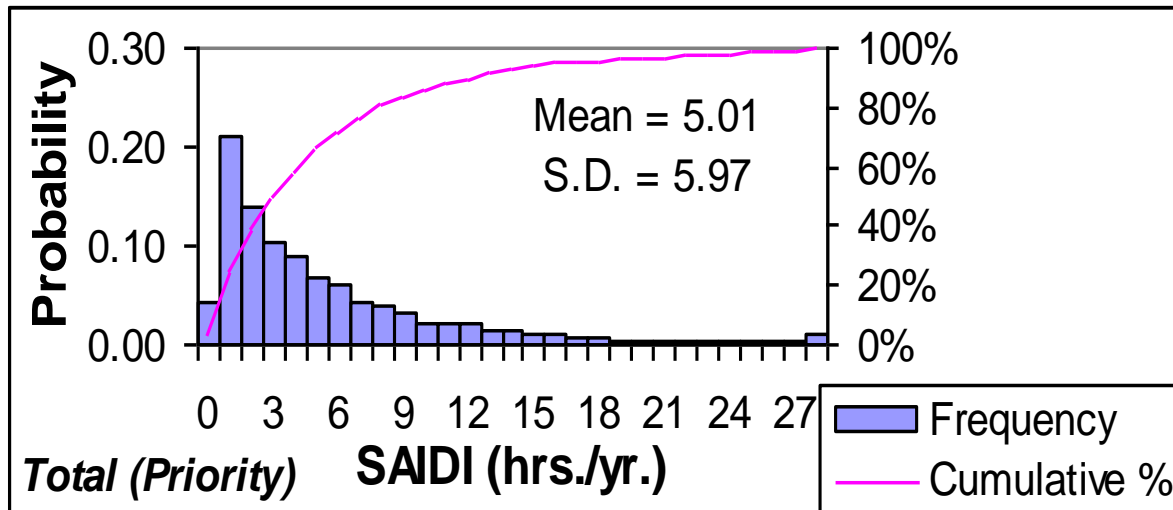
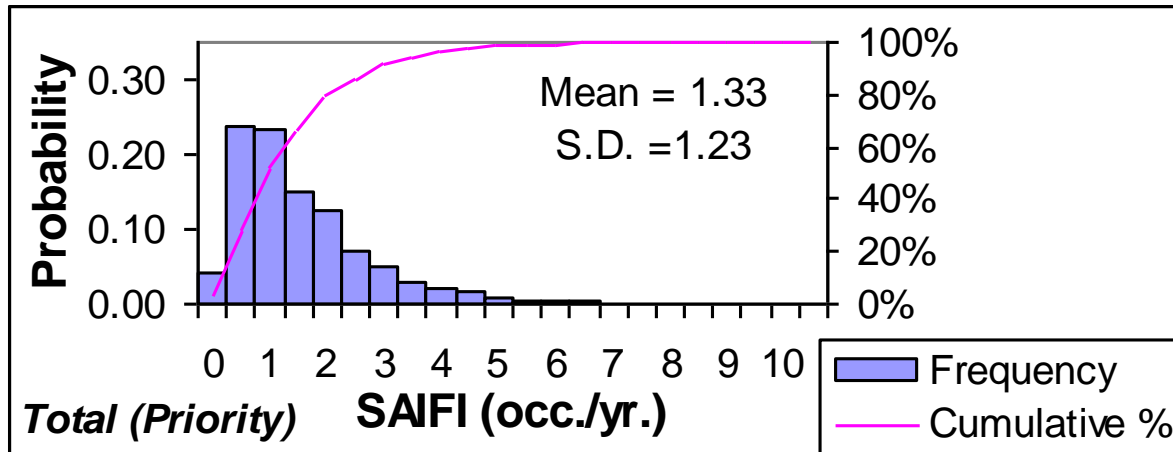

Performance Based Regulation (PBR)

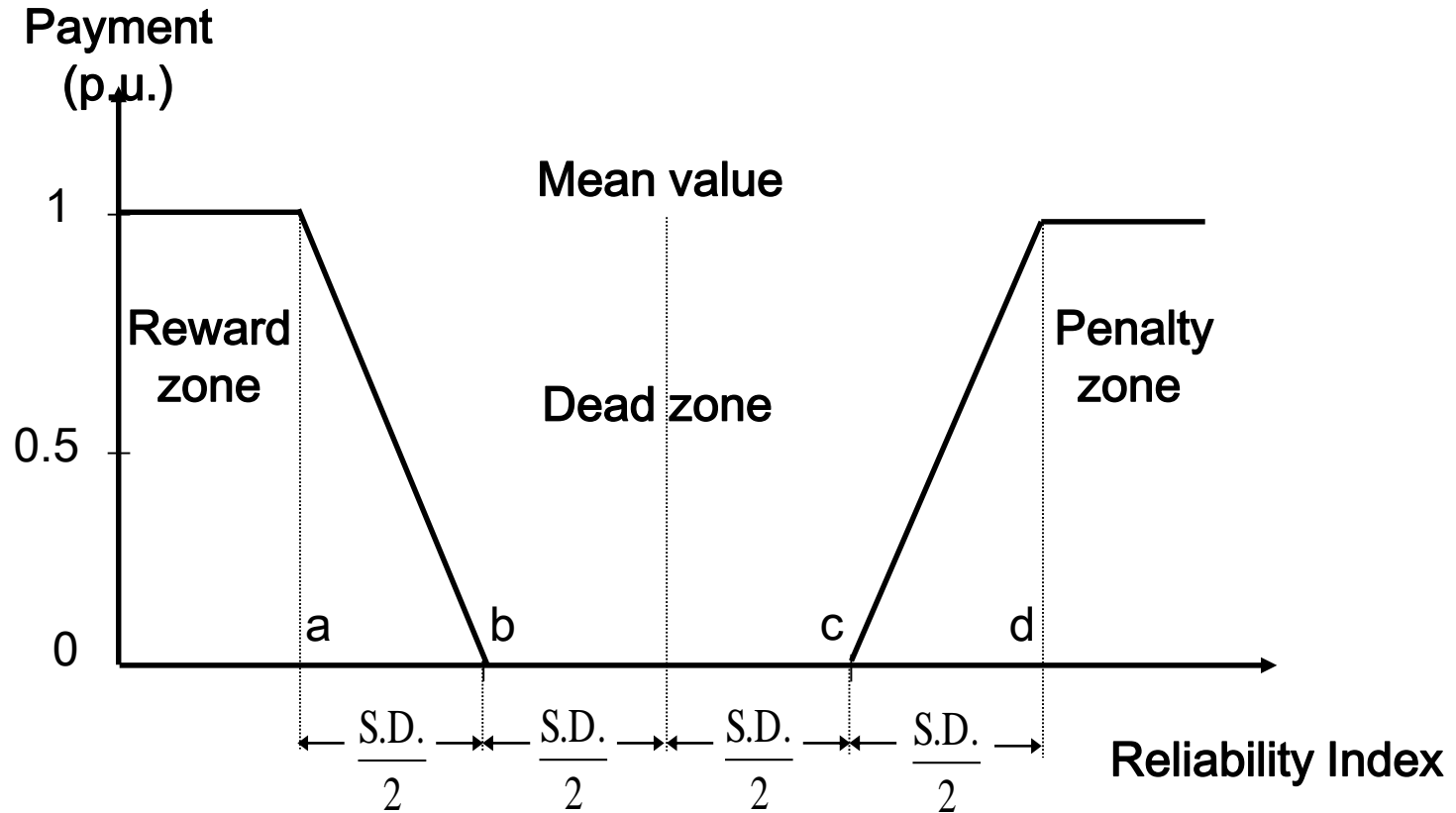

Performance Based Regulation (PBR)

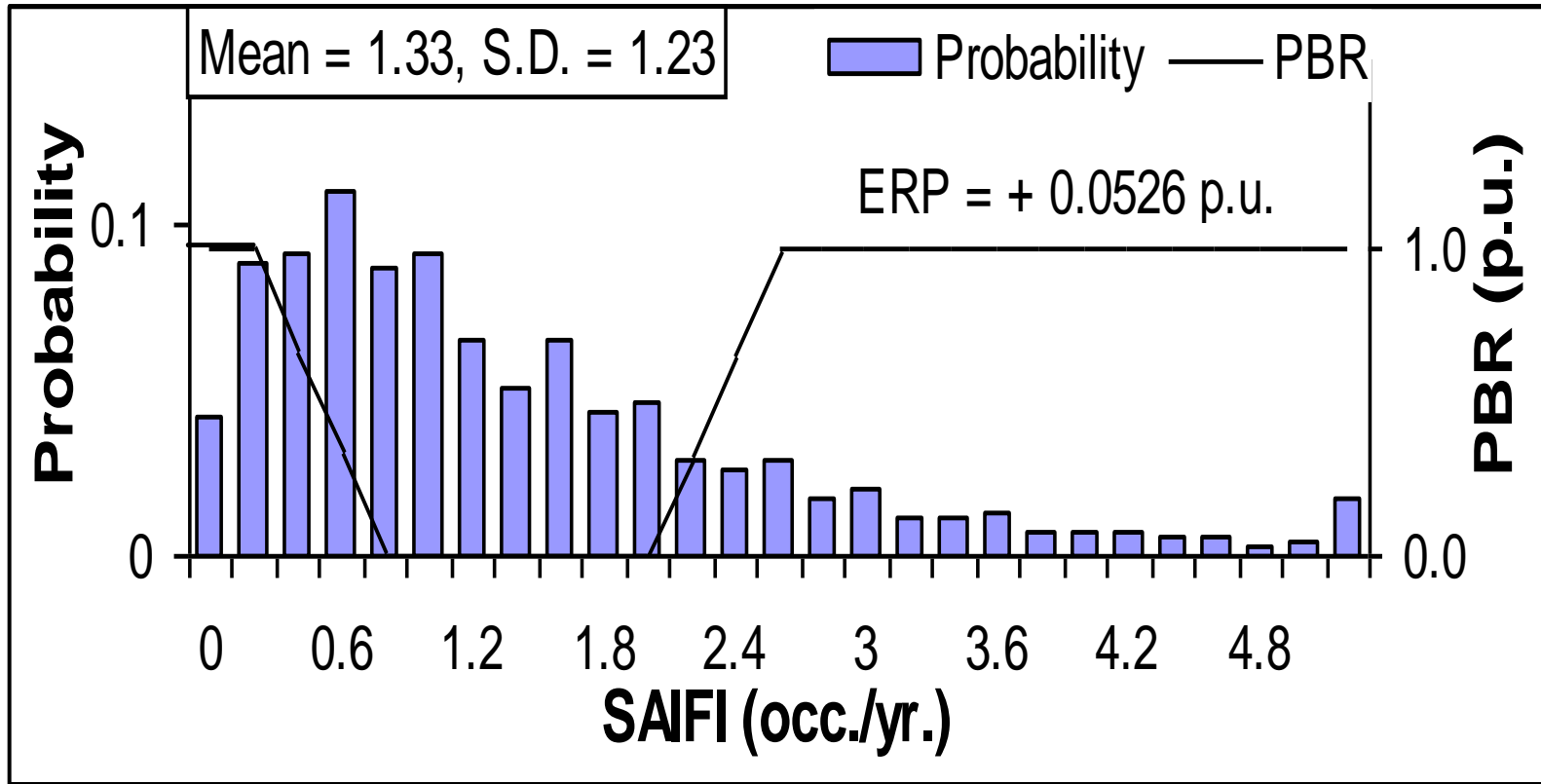

SAIFI distribution for the IEEE-RTS implemented in a PBR framework

Common Mode Failures

The primary assumption in most reliability studies is that component failures are independent events and that system state probabilities can be determined by simple multiplication of the relevant probabilities.

This assumption simplifies the calculation process but is inherently optimistic and can in certain cases be quite misleading.

Common Mode Failures

The IEEE Subcommittee on the Application of Probability Methods initiated an investigation of this problem through a Task Force on Common Mode Outages of Bulk Power Supply Facilities and published a paper in 1976. This paper emphasized the importance of recognizing the existence of common mode outages and recommended a format for reporting the data.

Common Mode Failures

The APM Subcommittee defined a common mode failure:

“as an event having a single external cause with multiple failure effects where the effects are not consequences of each other”.

Task Force of the IEEE Application of Probability Methods Subcommittee.
"Common Mode Forced Outages Of Overhead Transmission Lines",
IEEE Transactions, PAS-95, No. 3, May/June 1976, pp. 859-863.

Common Mode Failures

Fig. 1. Two different arrangements for two transmission circuits

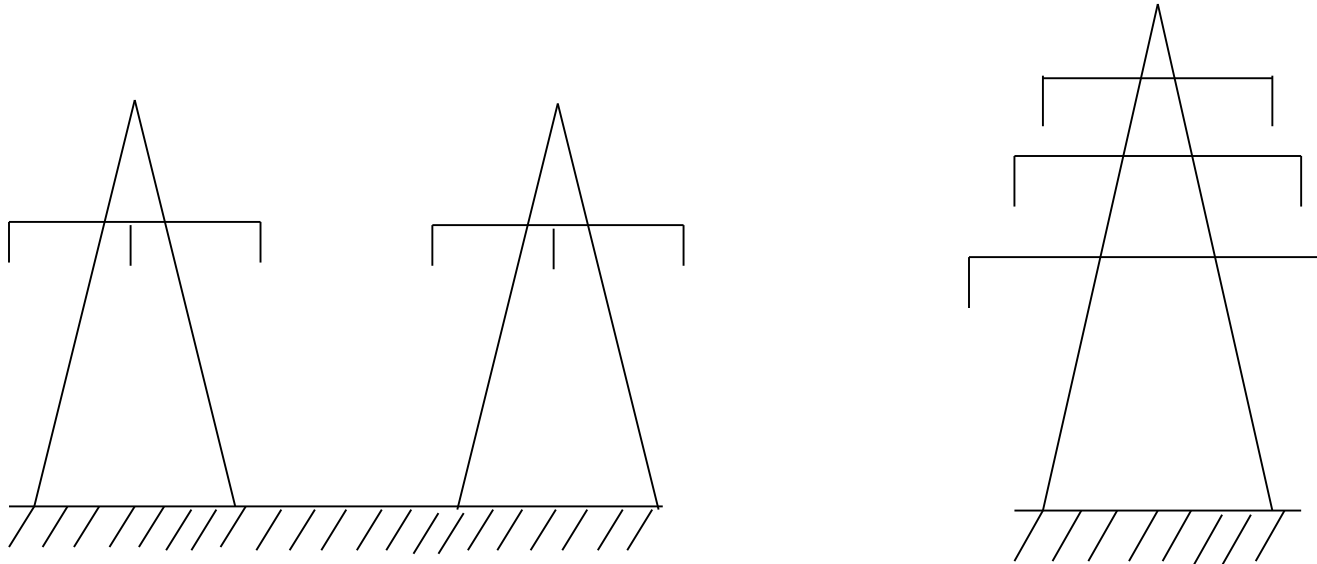

BASIC MODELS

The basic component model in power system reliability / availability analysis is the two state representation in which a component is either in an operable or inoperable condition. In this model, λ is the failure rate in failures per year and μ is the repair rate in repairs per year. The average repair time r is the reciprocal of the repair rate.

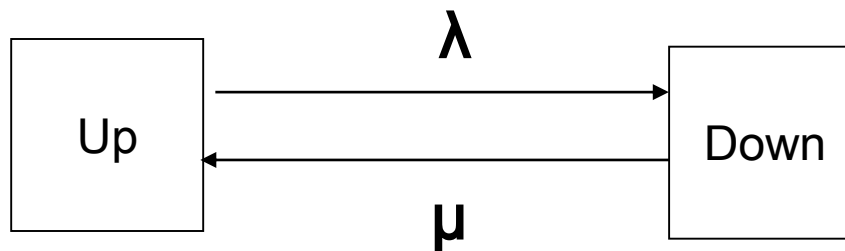

Two non-identical independent component model

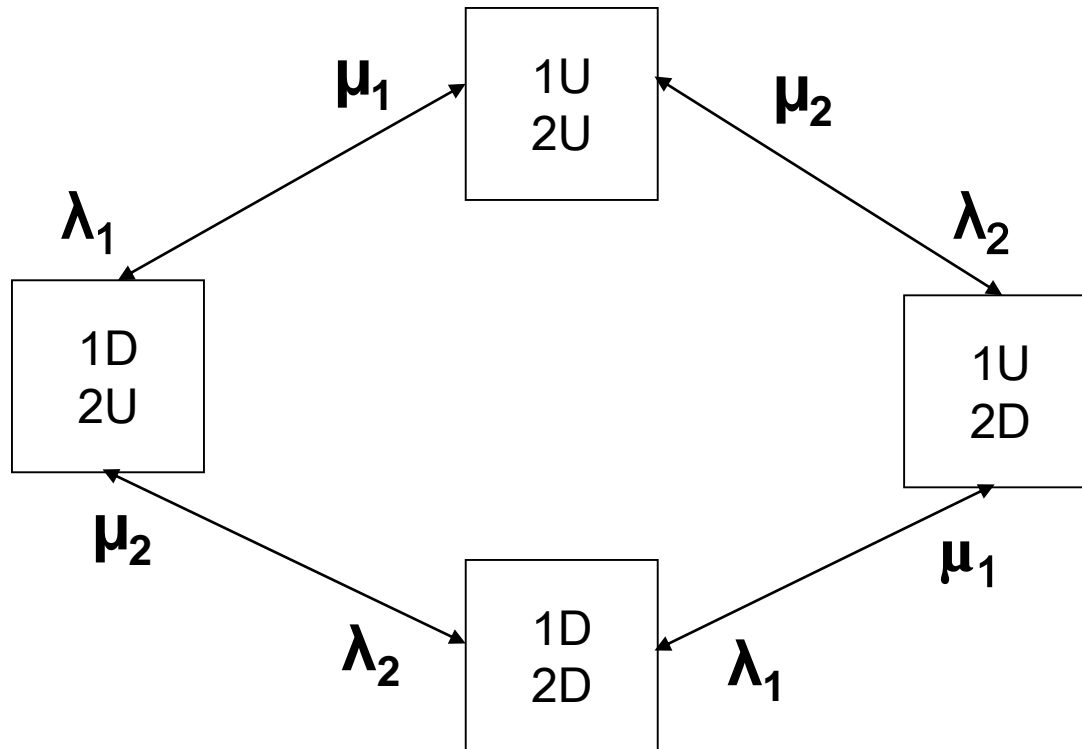

Two identical independent component model

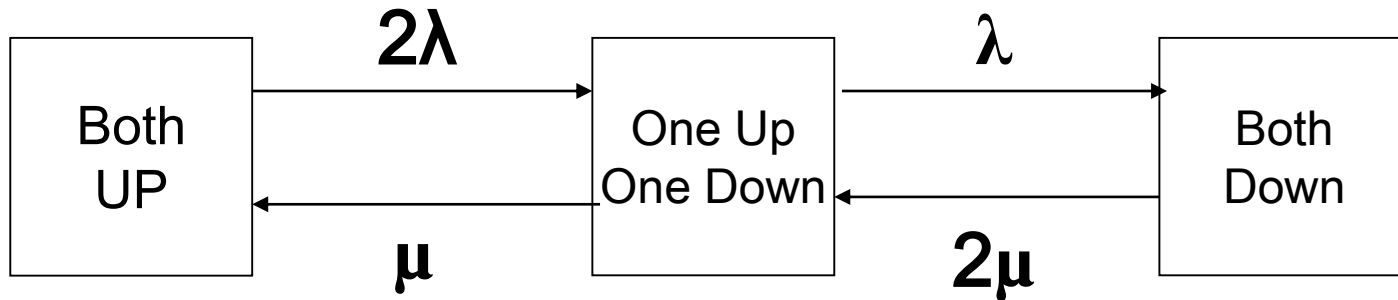

The APM Subcommittee proposed a two component system model incorporating common mode failure.

Model 1

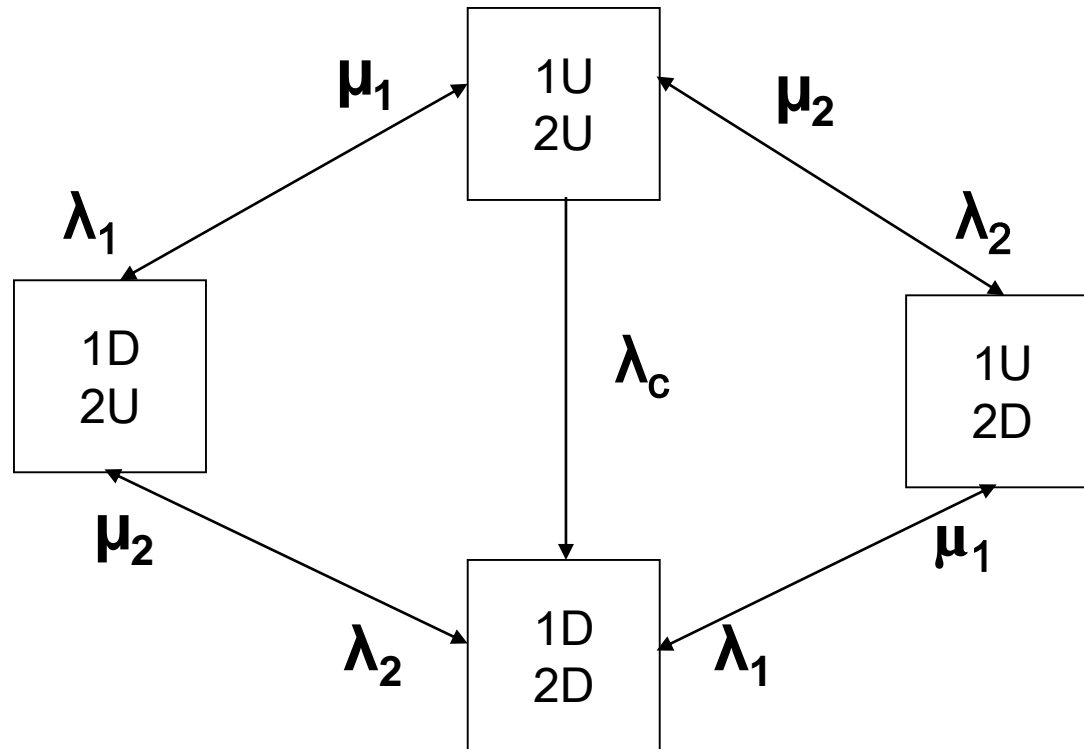

Two identical component model with common mode failure

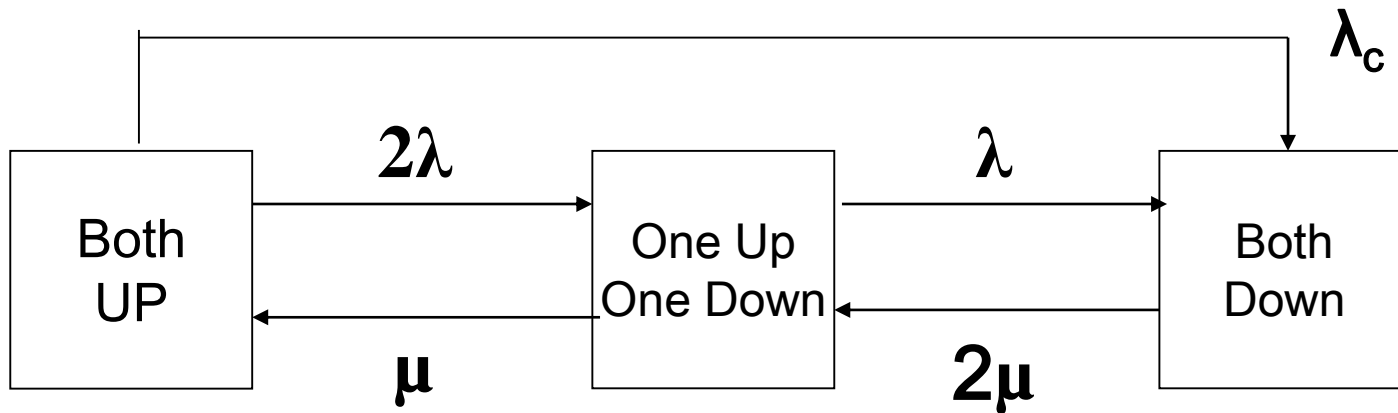

Modified common mode model for two non-identical components

Model 2

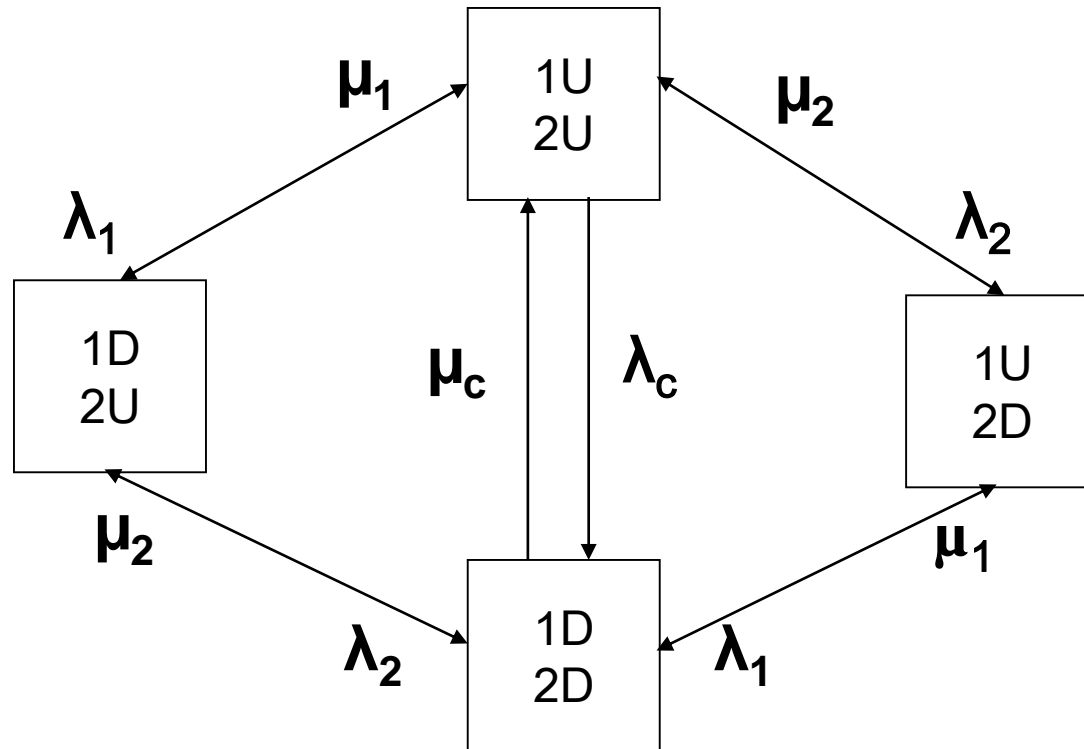

Separate repair process common mode model for two non-identical components.

Model 3

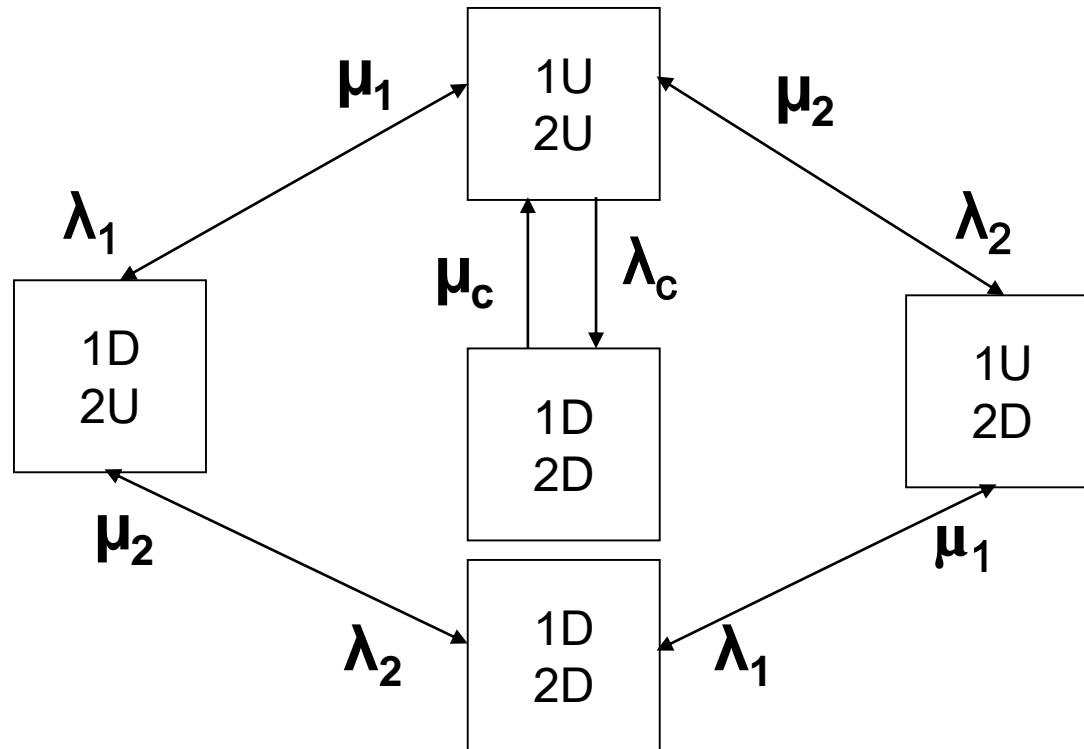

Markov analysis of Model 1

$$P_4 = [\lambda_1 \lambda_2 (\lambda_1 + \lambda_2 + \mu_1 + \mu_2) + \lambda_c (\lambda_1 + \mu_2)(\lambda_2 + \mu_1)] / D$$

$$D = (\lambda_1 + \mu_1)(\lambda_2 + \mu_2)(\lambda_1 + \lambda_2 + \mu_1 + \mu_2) + \lambda_c [(\lambda_1 + \mu_1)(\lambda_2 + \mu_1 + \mu_2) + \mu_2 (\lambda_2 + \mu_2)]$$

If the two components are identical

$$P_4 = [2\lambda^2 + \lambda_c (\lambda + \mu)] / [2(\lambda + \mu)^2 + \lambda_c (\lambda + 3\mu)]$$

Consider a transmission line with $\lambda = 1.00$ f/yr and $r = 7.5$ hours ($\mu = 1168$ r/yr).

The line unavailability (U) is $\frac{\lambda}{\lambda + \mu} = 0.000855$

If $\lambda_c = 0$ in Model 1, the probability of both lines out of service (U_s) is 0.00000073.

**If $\lambda_c = 0.01$ (1% of λ), $U_s = 0.000005$
 $= 0.043800$ hrs/yr**

**If $\lambda_c = 0.10$ (10% of λ), $U_s = 0.00004350$
 $= 0.38106$ hrs/yr**

The basic reliability indices for Model 1 (Fig. 3) can be estimated using an approximate method [1].

$$\text{System failure rate} = \lambda_s = \lambda_1 \lambda_2 (r_1 + r_2) + \lambda_c$$

$$\text{Average system outage time} = r_s = (r_1 r_2) / (r_1 + r_2)$$

$$\text{System unavailability} = U_s = \lambda_s r_s$$

Model 1

Reliability indices for a range of λ_c values

λ_c/λ %	λ_s f/yr	r_s hrs	U_s	U_s hrs/yr
0	0.001712	3.75	0.00000073	0.006
1.0	0.011712	3.75	0.00000501	0.044
2.5	0.026712	3.75	0.00001144	0.100
5.0	0.051712	3.75	0.00002214	0.194
7.5	0.076712	3.75	0.00003284	0.288
10.0	0.101712	3.75	0.00004354	0.381
15.0	0.151712	3.75	0.00006495	0.569

The approximate method approach can also be applied to Model 2

In this case:

$$\lambda_s = \lambda_1 \lambda_2 (r_1 + r_2) + \lambda_c$$

$$r_s = (r_1 r_2 r_c) / (r_1 r_2 + r_2 r_c + r_c r_1)$$

$$U_s = \lambda_s r_s$$

If: $\lambda_c = 0.1$ (10% of λ) and $r_c = 15$ hrs

$$\lambda_s = 0.101712 \text{ f/yr}$$

$$U_s = 0.00003483 = 0.305 \text{ hrs/yr}$$

Approximate method applied to Model 3

In this case:

$$\lambda_s = \lambda_1 \lambda_2 (r_1 + r_2) + \lambda_c$$

$$U_s = \lambda_1 \lambda_2 r_1 r_2 + \lambda_c r_c$$

$$r_s = U_s / \lambda_s$$

If: $\lambda_c = 0.1$ f/yr and $r_c = 15$ hrs

$$\lambda_s = 0.101712 \text{ f/yr}$$

$$U_s = 0.00017197 = 1.506 \text{ hrs/yr}$$

$$r_s = 14.81 \text{ hrs}$$

Reliability index comparison for the three models

Reliability Index	Model 1 Figure 3	Model 2 Figure 5	Model 3 Figure 6
λ_s f/yr	0.101712	0.101712	0.101712
r_s hrs	3.75	3.00	14.81
U_s hrs/yr	0.381	0.305	1.506

Dependent Outage Events

A dependent outage is an event which is dependent on the occurrence of one or more other outages or events.

Extreme weather conditions can create significant increases in transmission element stress levels leading to sharp increases in component failure rates. The probability of a transmission line failure is therefore dependent on the intensity of the adverse weather stress to which the line is subjected. The phenomenon of increased transmission line failures during bad weather is generally referred to as “failure bunching**”.**

Dependent Outage Events

This condition is not a common mode failure event and should be recognized as overlapping independent failure events due to enhanced transmission element failure rates in a common adverse environment.

Independent failure events with a two state weather model

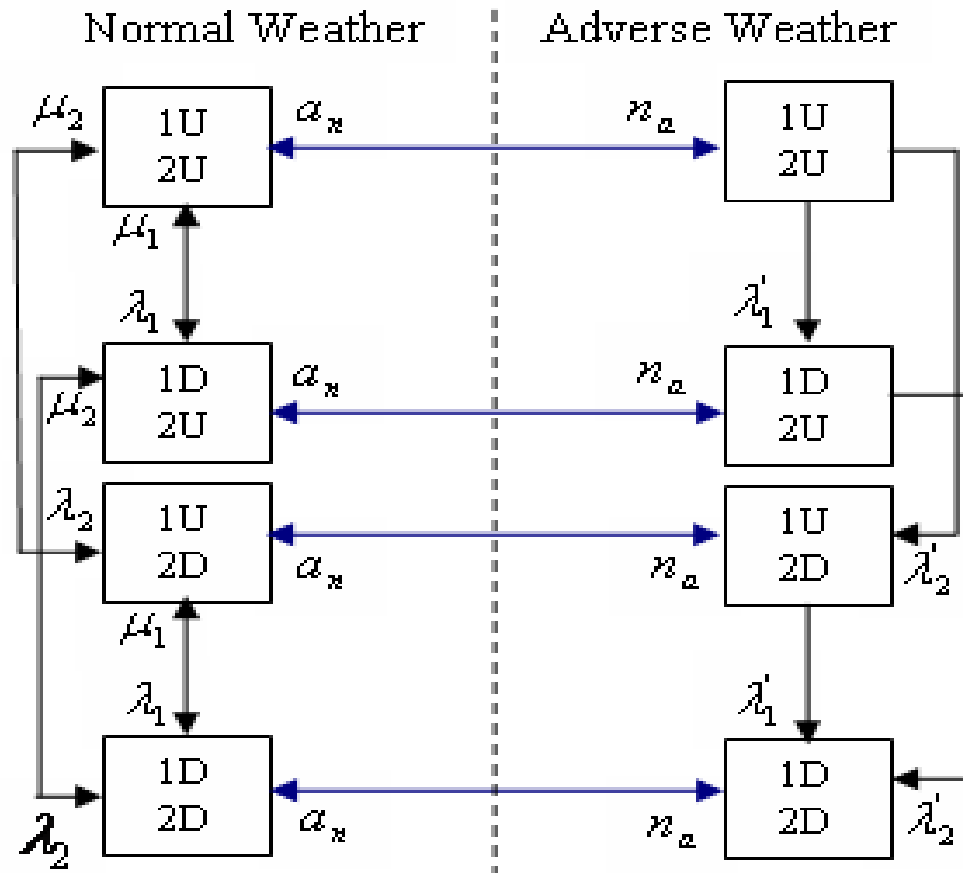

Basic data

Average failure rate of each component, $\lambda_{av} = 1.0$ f/yr

Average repair rate for each component, $\mu = 1168$ rep/yr,
($r = 7.5$ hrs)

Average duration of normal weather, $N = 200$ hrs

Average duration of adverse weather, $S = 2$ hrs

Average duration of major adverse weather, $MA = 1$ hr.

Assume that 50% of the failures occur in adverse weather.

$$\lambda_{av} = \frac{N}{N+S} \lambda + \frac{S}{N+S} \lambda' \quad (1.0 = 0.5 + 0.5)$$

$$\lambda = 0.505 \text{ f/yr (nw)}$$

$$\lambda' = 50.5 \text{ f/yr (aw)}$$

Independent failure events with a two state weather model.

% of line failures occurring in adverse weather)	System failure rate (f/yr)	System unavailability (hrs/yr)
0	0.0017	0.01
10	0.0022	0.01
20	0.0035	0.02
30	0.0058	0.03
40	0.0089	0.05
50	0.0128	0.07
60	0.0176	0.10
70	0.0232	0.13
80	0.0295	0.17
90	0.0367	0.21
100	0.0446	0.26

State space model for independent and common mode failure events with a two state weather model

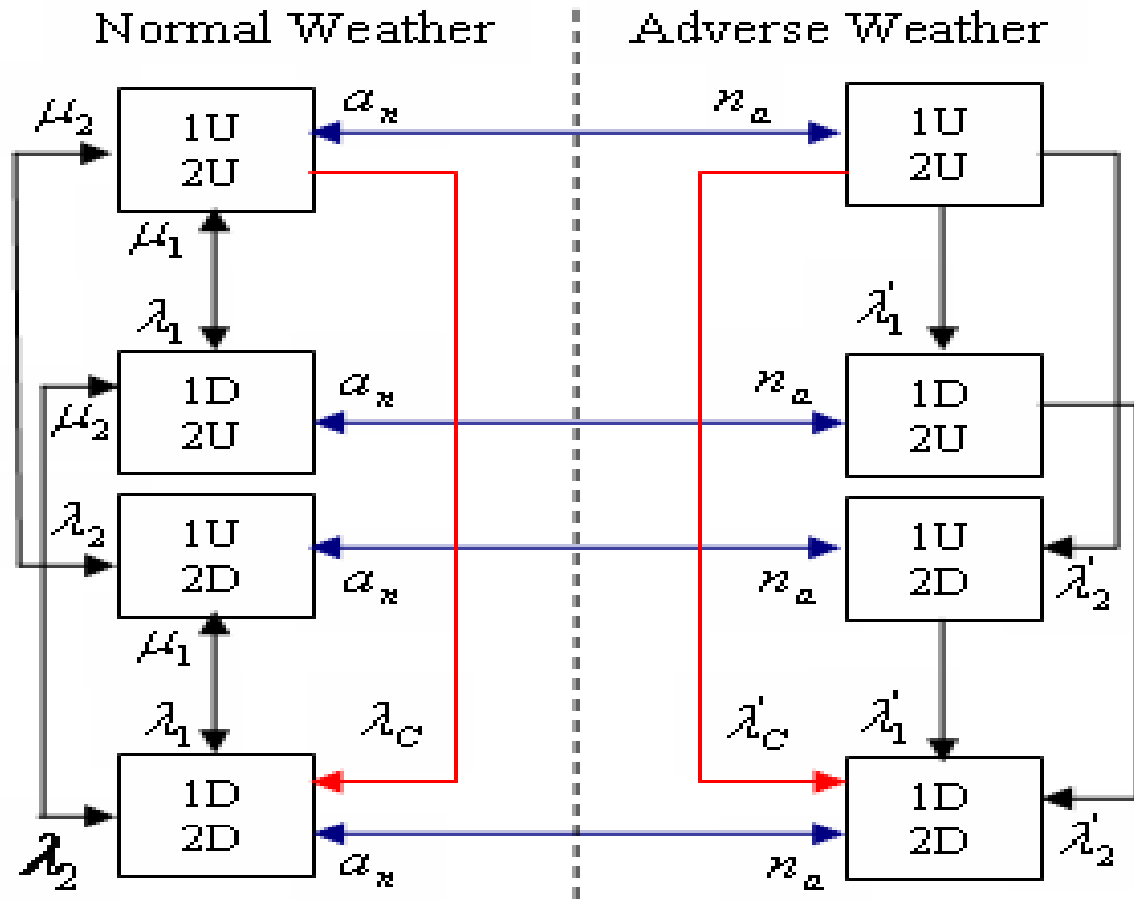

Independent and common mode failure events with a two state weather model. CM=1%

% of line failures occurring in adverse weather	System failure rate (failures/year)	System unavailability (hours/year)
0	0.0117	0.04
10	0.0122	0.05
20	0.0135	0.06
30	0.0157	0.07
40	0.0188	0.09
50	0.0227	0.12
60	0.0274	0.15
70	0.0329	0.18
80	0.0392	0.22
90	0.0463	0.27
100	0.0541	0.31

Independent and common mode failure events with a two state weather model. CM=10%

% of line failures occurring in adverse weather (F)	System failure rate (failure/year)	System unavailability (hours/year)
0	0.1016	0.38
10	0.1020	0.41
20	0.1032	0.43
30	0.1052	0.47
40	0.1079	0.50
50	0.1114	0.54
60	0.1157	0.59
70	0.1207	0.64
80	0.1263	0.69
90	0.1327	0.75
100	0.1397	0.81

Effect of independent failure, common mode failure and adverse weather on the system failure rate with a two-state weather model

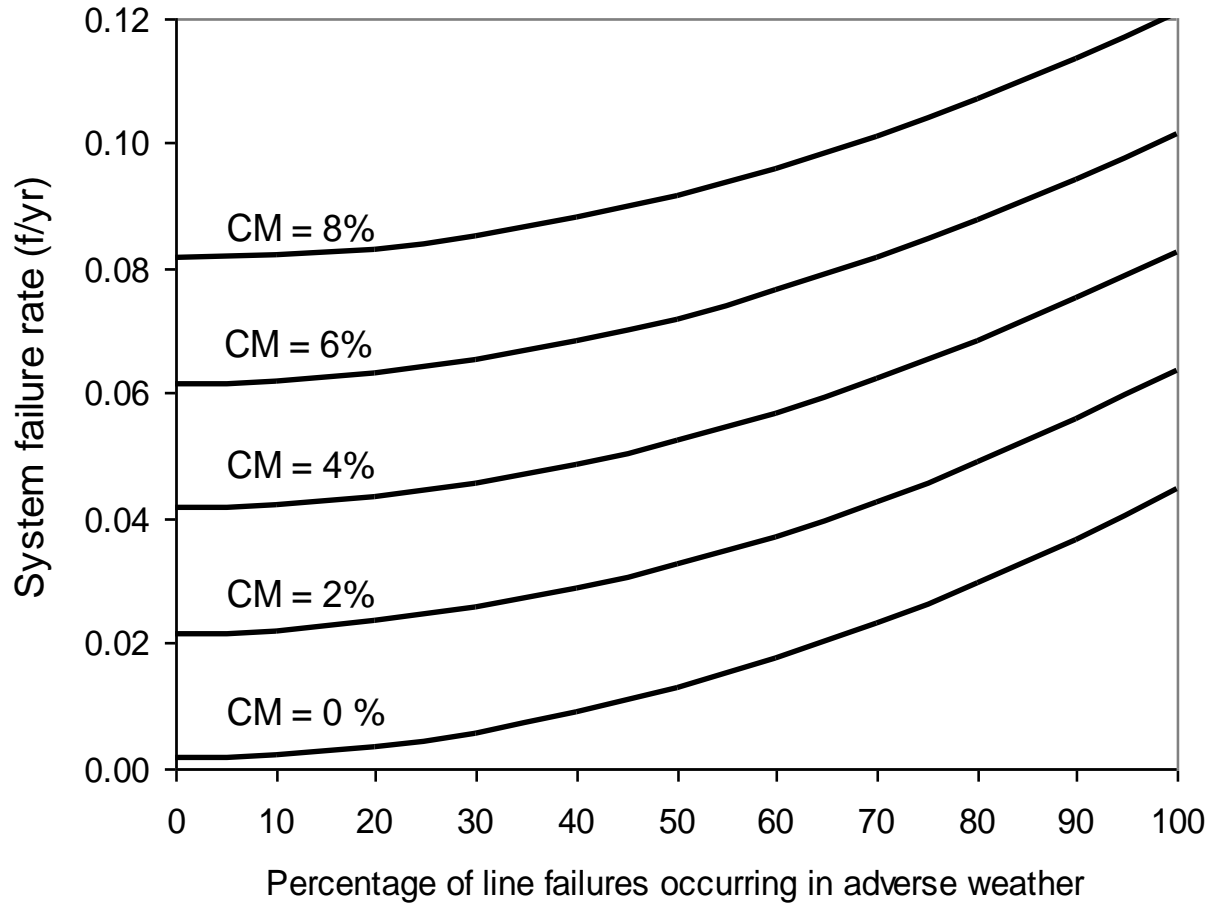

State space model for independent failures with a three-state weather model

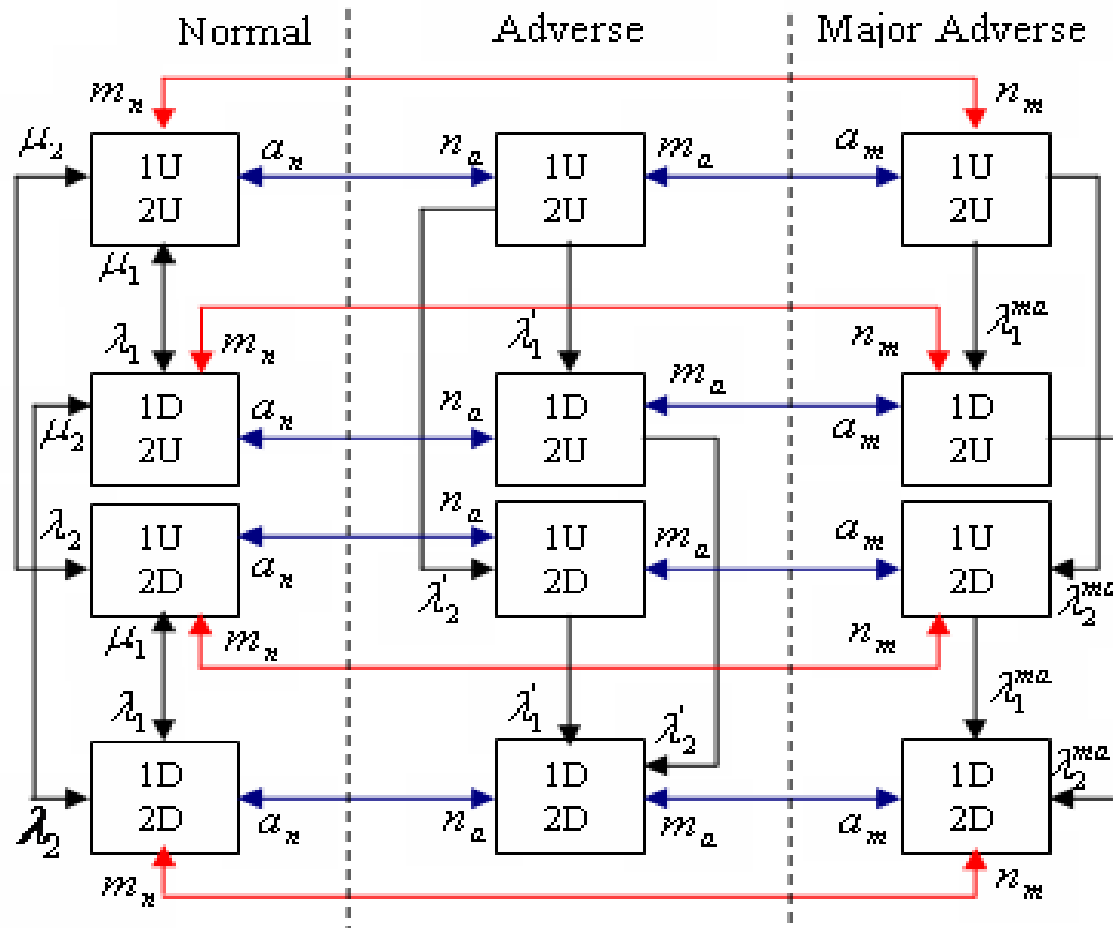

Effect of independent failures and bad weather on the system failure rate with a three-state weather model

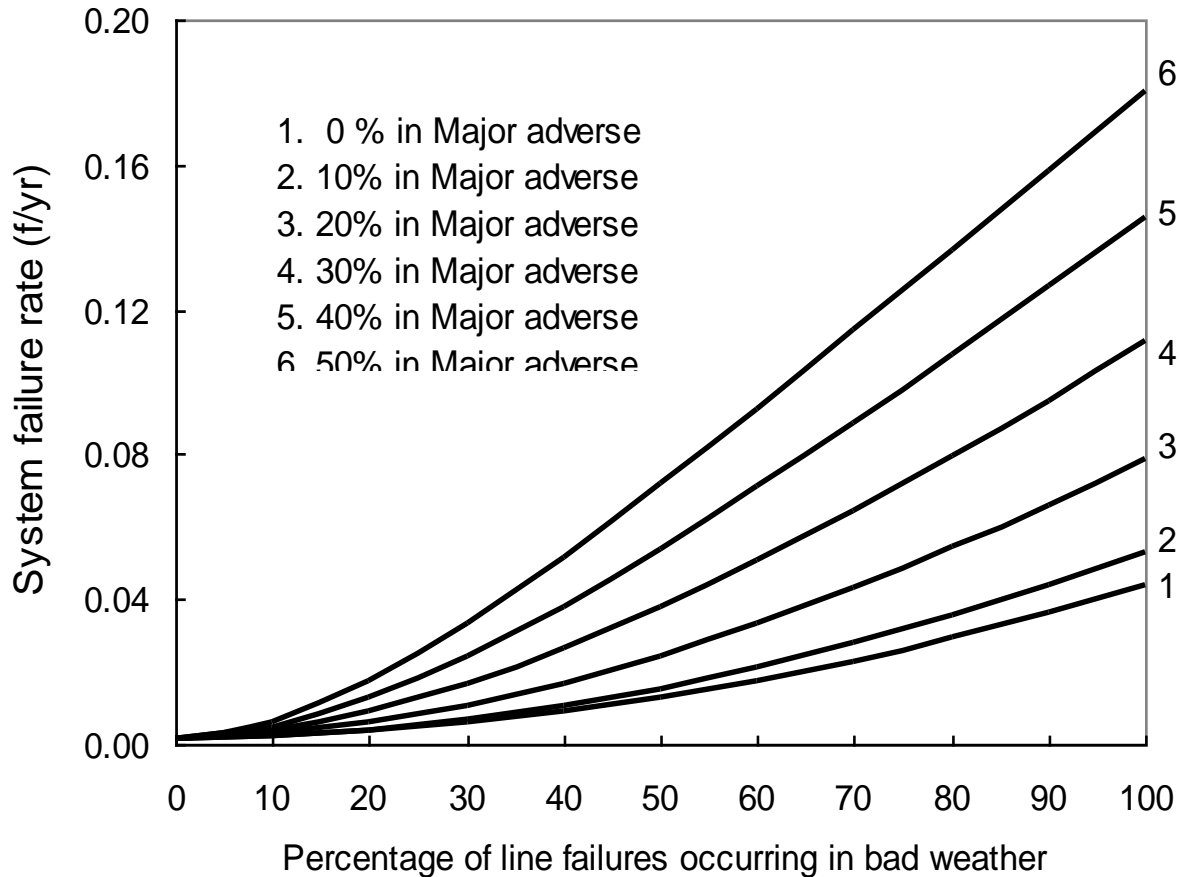

State space model for independent and common mode failures with a three-state weather model

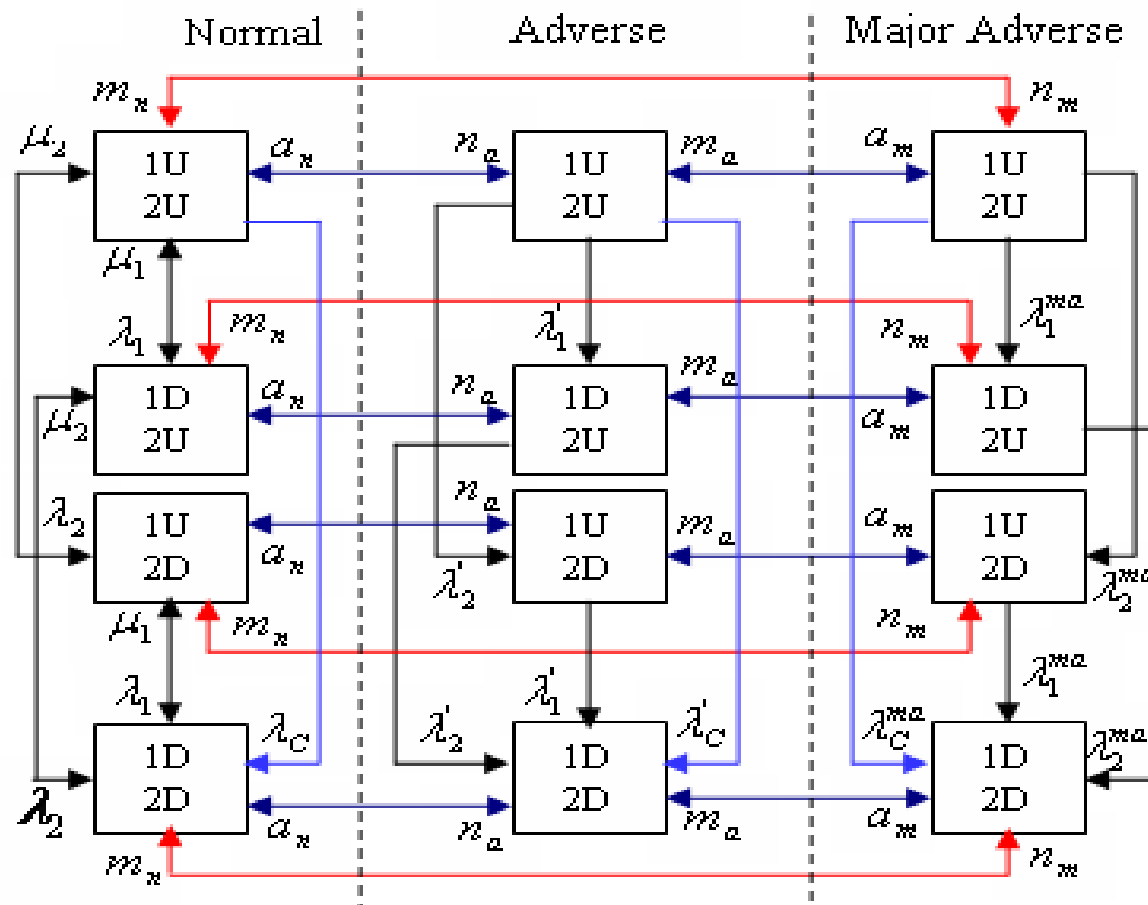

Independent failures, common mode failures and bad weather using a three-state weather model with 10% of the bad weather failures in major adverse weather

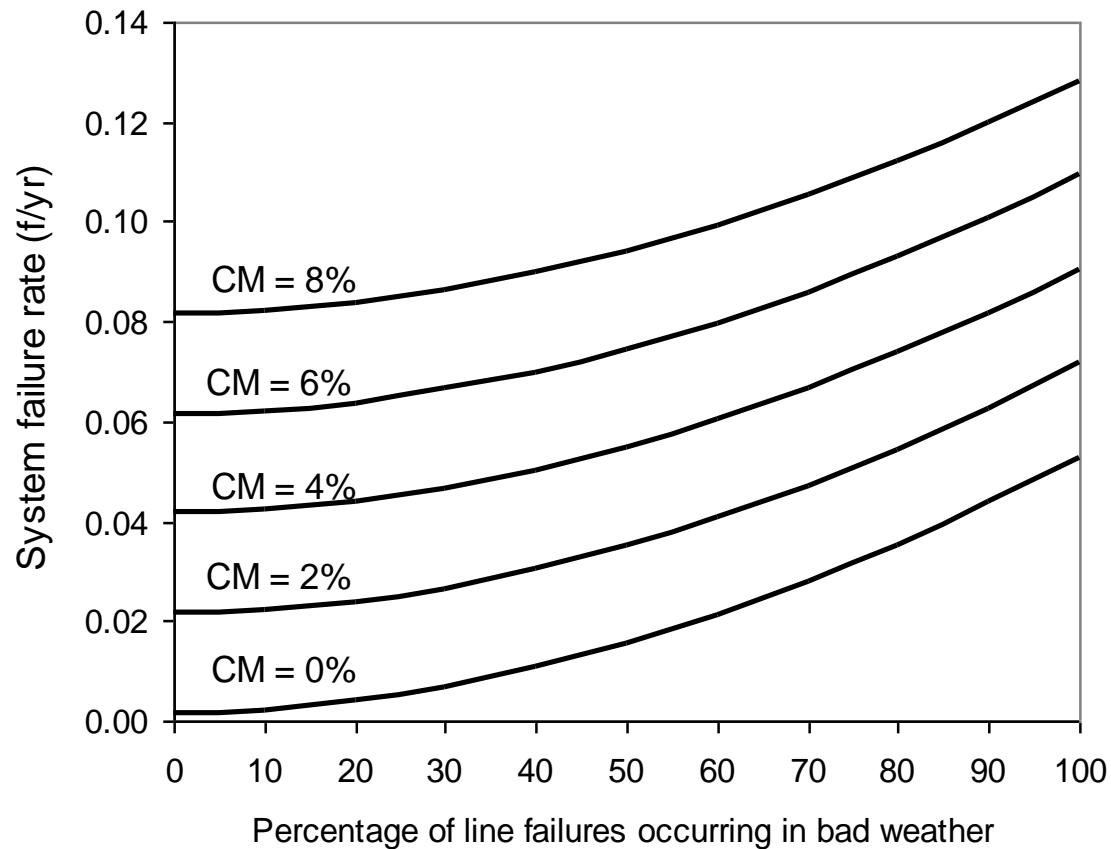

Independent failures, common mode failures and bad weather using a three-state weather model with 50% of the bad weather failures in major adverse weather

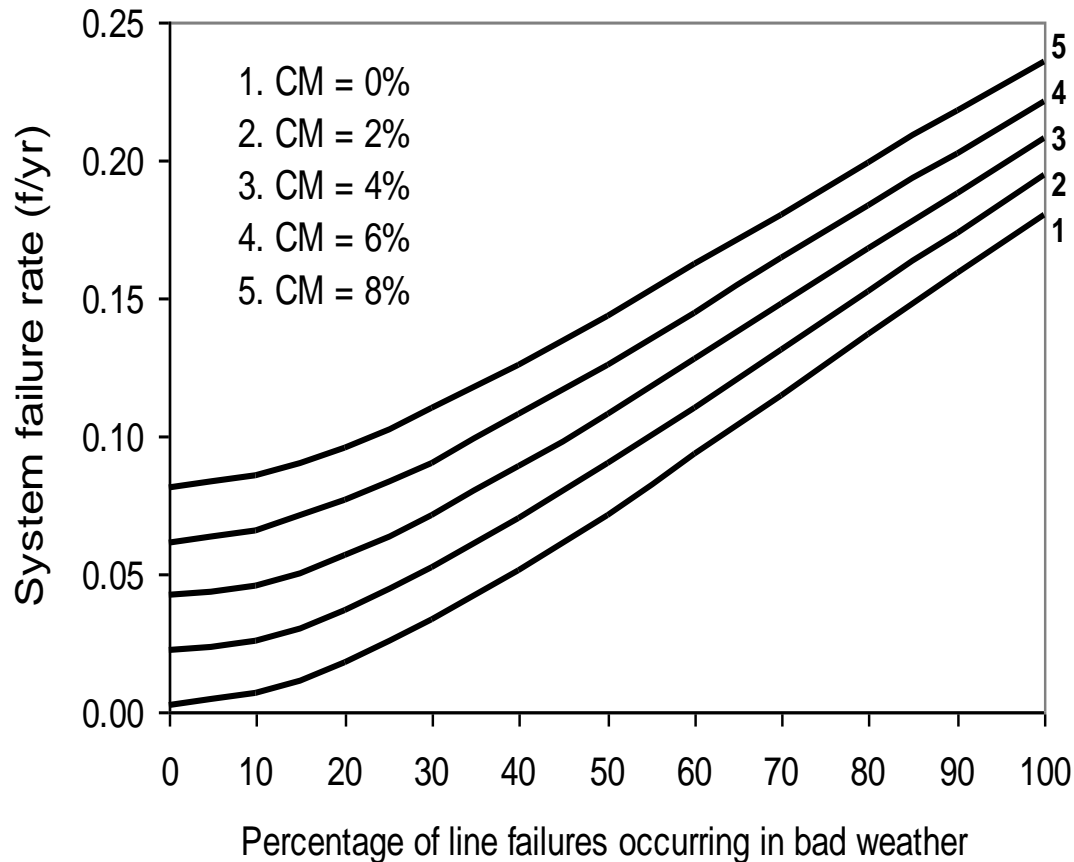

Dependent Outages

A dependent outage is an event which is dependent on the occurrence of one or more other outages or events.

Independent failure of one of the circuits in Fig. 1 causes the second circuit to be overloaded and removed from service. It should be noted that while the second circuit is on outage or out of service, it has not failed and cannot be restored by repair action on the line. The outage duration is related to system conditions and operator action.

A similar situation exists when a circuit breaker in a ring bus fails to ground (active failure) and is isolated by the two adjacent circuit breakers. The actively failed component is isolated and the protection breakers restored. Assuming that the two system elements adjacent to the faulted circuit breaker are transmission lines, they would be removed from service by breakers tripping at the other ends of the lines. The lines are on outage but have not physically failed. This is not a common mode failure.

Active and Passive Failure Model

Passive event: a component failure mode that does not cause operation of protection breakers and therefore does not impact the remaining healthy components.

Active event: a component failure mode that causes the operation of the primary protection zone around the failed component and can therefore cause the removal of other healthy components and branches from service.

Active and Passive Failure Model

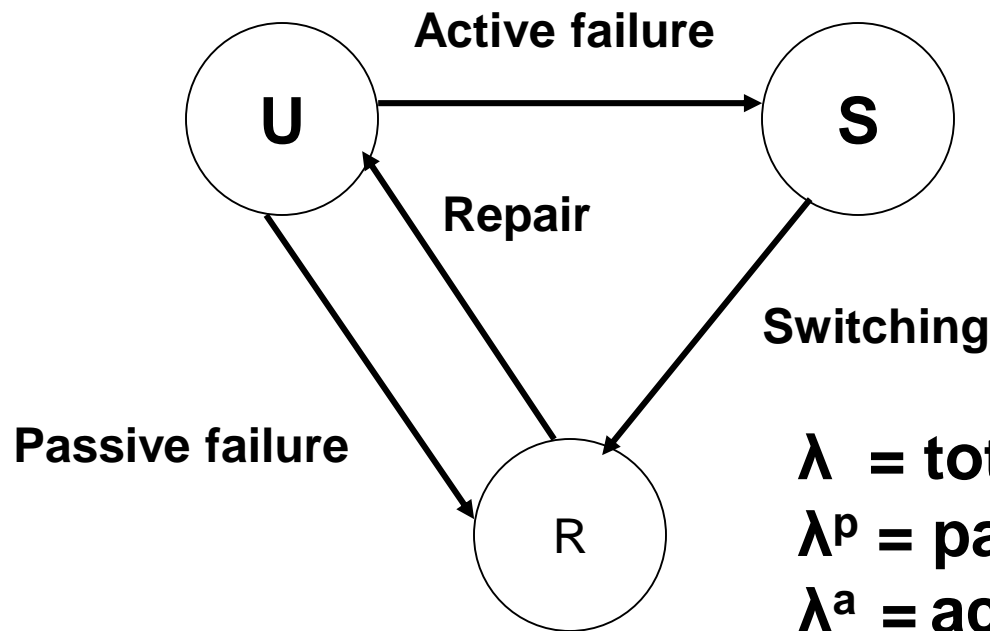

λ = total failure rate

λ^p = passive failure rate

λ^a = active failure rate

r = repair time

S = switching or isolation time

STATION RELATED FORCED AND MAINTENANCE OUTAGES IN BULK SYSTEM RELIABILITY ANALYSIS

Substations and switching stations (stations) are important elements and are energy transfer points between power sources, transmission lines and customers.

The major station components are circuit breakers, bus bars and isolators. Station related outages include forced outages (random events) and maintenance outages (scheduled events).

Evaluation method

The minimal cut set method is used to incorporate station related forced and maintenance outages in composite system reliability evaluation. This method is illustrated using a simple ring bus station.

1. Determine the minimal cut sets related to station component outages that cause failure of the terminals.
 - Independent minimal cut sets - cause failure of only one terminal
 - Common terminal minimal cut sets - cause failure of two or more terminals

Table 1. Independent minimal cut sets for Terminal 1

Minimal cut set types	Without maintenance	Maintenance outages
Independent minimal cut sets	Bus 1	-
	CB1(T)+CB2(T)	CB2(M)+CB1(T)
	Bus 2+CB1(T)	CB1(M)+CB2(T)
	Bus 2+CB4(A)	CB1(M)+Bus 2
	Bus 4+CB2(T)	CB2(M)+Bus 4
	Bus 4+CB3(A)	

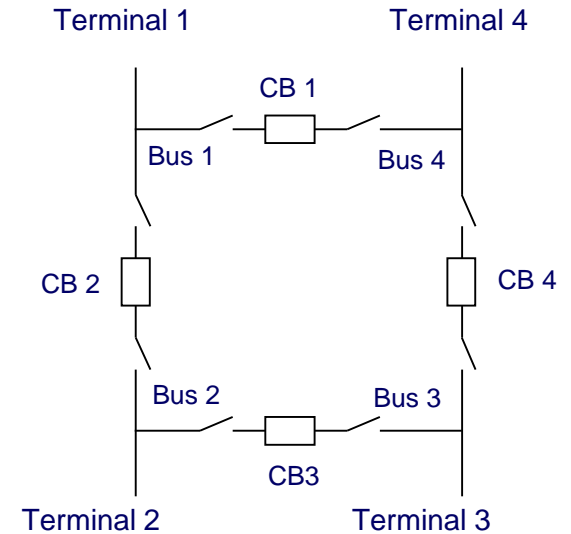

Fig. 1. Single line diagram of a ring bus station

Table 2. Common minimal cut sets for the four terminals

Terminal 1	Terminal 2	Terminal 3	Terminal 4
CB1 (A) ₁	CB2 (A) ₂	CB3 (A) ₃	CB1 (A) ₁
CB2 (A) ₂	CB3 (A) ₃	CB4 (A) ₄	CB4 (A) ₄
Bus2 + Bus4 ₆	Bus1 + Bus3 ₅	Bus2 + Bus4 ₆	Bus1 + Bus3 ₅

Evaluation method

- 2. Calculate the reliability indices of the independent and common terminal minimal cut sets (failure rate, average outage time and unavailability).**
- 3. Modify the basic reliability data of the composite system by including the independent and common terminal data.**
- 4. Evaluate the composite system reliability incorporating station related outages using a computer program – MECORE.**

System application

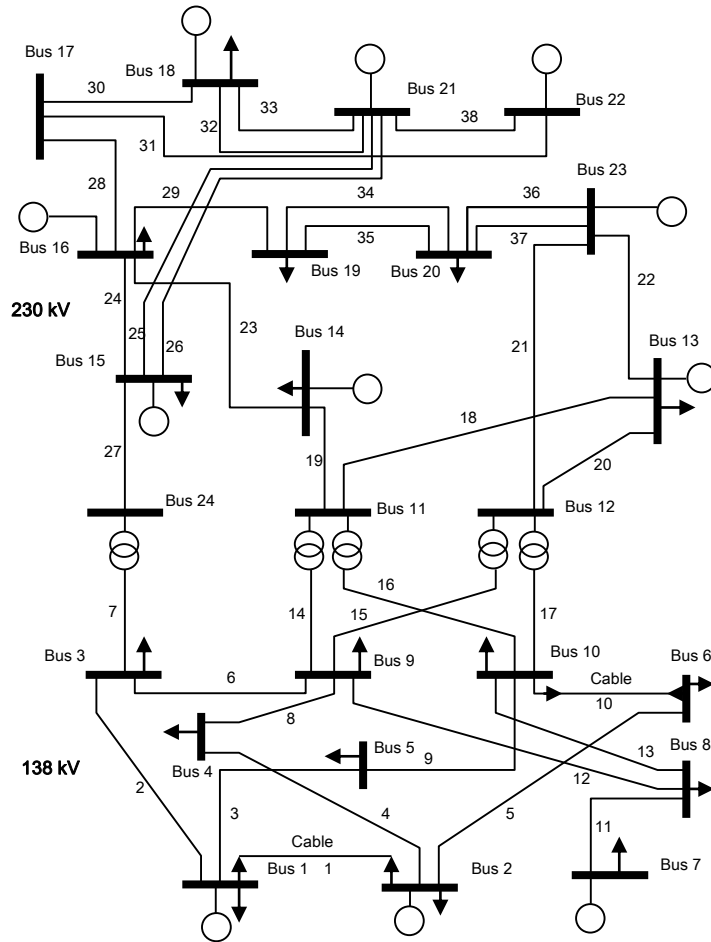

- IEEE-RTS contains:**
- 32 generators**
- 38 transmission lines**
- 24 buses**
- 10 load buses**
- Total generating capacity: 3405 MW**
- Total load: 2850 MW**

Fig. 2: Single line diagram of the IEEE-Reliability Test System.

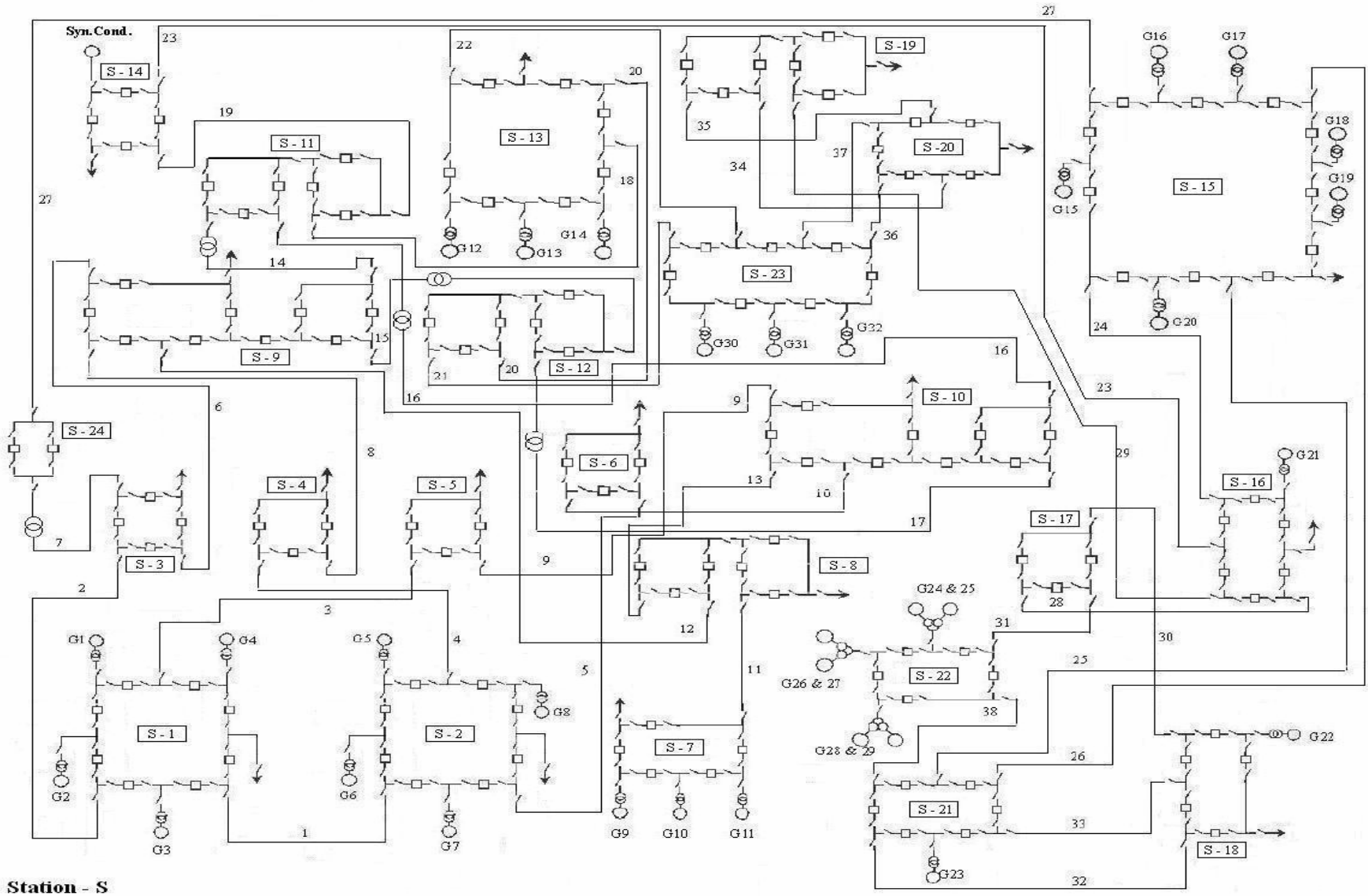

Single line diagram of the IEEE-RTS with ring bus configurations

Selected load point and system EENS without and with station related forced outages for the IEEE-RTS with ring bus schemes.

Station No.	EENS(MWh/yr) (without stations)	EENS(MWh/yr) (ring bus station)	Increase (MWh/yr)
3	0.223	66.718	66.50
8	0.004	72.822	72.82
10	2.388	98.168	95.78
13	0.041	115.839	115.80
15	484.203	588.760	104.56
18	21.298	131.837	110.54
System	2384.230	3501.206	1116.98

Selected load point and system EENS without and with station maintenance outages for the IEEE-RTS

Station No.	EENS(MWh/yr) (without maint.)	EENS(MWh/yr) (including maint.)	Increase rate (%)
3	66.718	70.816	6.14
8	72.822	76.655	5.26
10	98.168	109.460	11.50
13	115.839	124.765	7.71
15	588.760	639.453	8.61
18	131.837	145.437	10.32
System	3501.206	3752.043	7.16

Station modifications

Generating stations 13, 15 and 18 and transmission stations 3, 8 and 10 were selected for modification to one and one half breaker configurations in order to improve the system reliability performance.

Example: Station 15

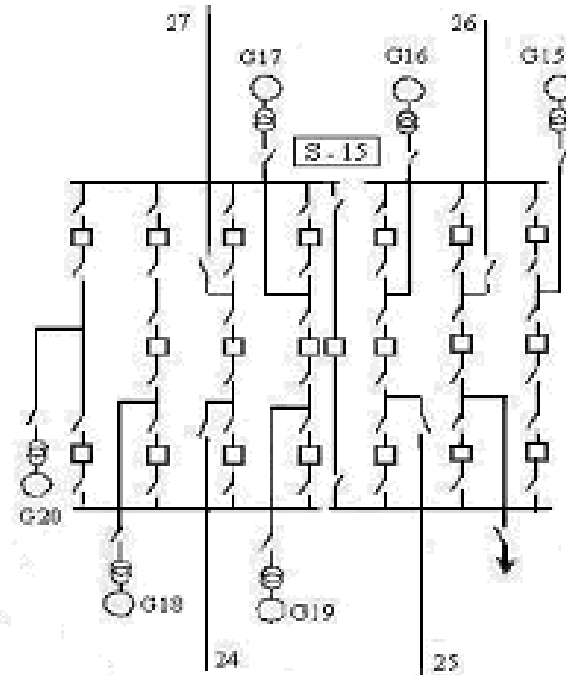
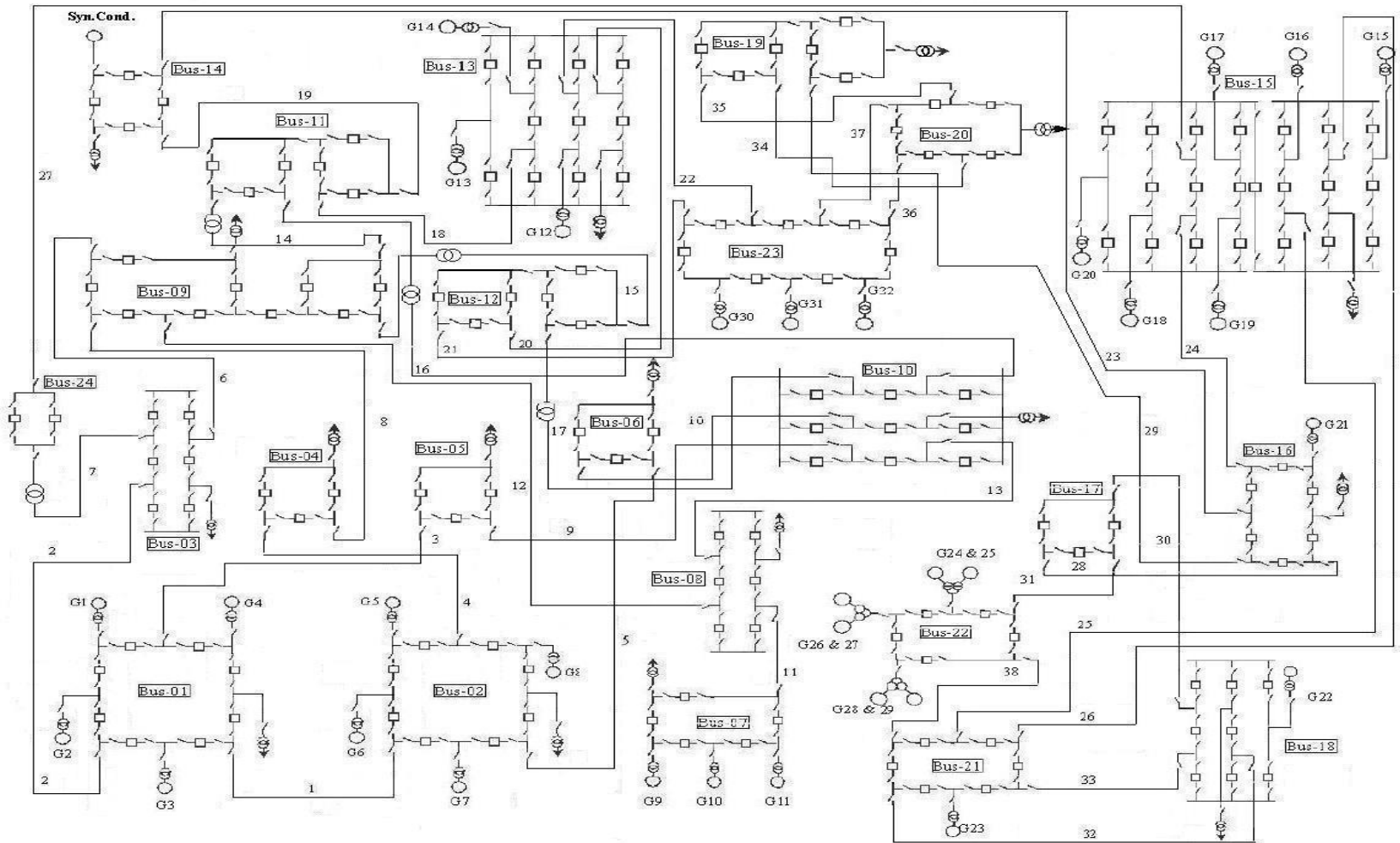

Fig. 4: One and one half breaker configurations used at Station 15.

IEEE-RTS with mixed ring bus and one and one half breaker configurations



Selected load point and system EENS comparison for the IEEE-RTS with ring bus schemes and with mixed station schemes

Station No.	EENS(MWh/yr) (Ring)	EENS(MWh/yr) (Mixed)	Decrease rate (%)
3	70.816	18.373	74.06
8	76.655	21.082	72.50
10	109.460	41.754	61.85
13	124.765	44.584	64.27
15	639.453	568.037	11.17
18	145.437	93.348	35.82
System	3752.043	3365.459	10.30

Station originated events require individual station analysis and are directly related to the station topology and design. The outcome of such an analysis is the recognition of a group of possible multi-element outages (removals from service) due to single element failures in the station

The durations of the multi-element outages are usually dictated by the station topology and possible switching actions not by repair of the failed element.

Value Based Reliability Planning

Two classical approaches exist for relating the socio-economic costs to the risk index.

These are the implicit cost and the explicit cost methods.

With respect to the implicit cost, it can be argued that the value of the risk indices adopted by utilities in response to public needs as shaped by economic and/or regulatory forces, should reflect the optimum trade-off between the cost of achieving the value and the benefits derived by society.

Interruption Costs As “Reliability Worth”

COST

to society of
providing quality
and continuity
of electric supply

Should be
related
to

WORTH or BENEFIT

to society of
having quality
and continuity
of electric supply

Value Based Reliability Planning

VBRP explicitly incorporates the cost of customer losses in the decision making process.

VBRP involves the ability to perform quantitative reliability assessment of the system or subsystem and to estimate the customer outage costs associated with possible planning alternatives.

Data Concepts and Requirements for Value-Based Transmission and Distribution Reliability Planning

- **Basic data sets**
 1. **Relevant component outage data**
 2. **Customer interruption cost data**
- **Quantitative reliability evaluation techniques**

Impacts of Interruptions

Direct Costs

- Economic**
- Lost production
 - Product spoilage
 - Paid staff unable to work

- Social**
- Transportation unavailable
 - Risk of injury, death
 - Uncomfortable building temperature
 - Loss of leisure time
 - Fear of crime

Impacts of Interruptions

- **Indirect**

- Economic - Changes in business plans & schedules**

- Social &**

- Relational - Looting**

- Rioting**

- Legal & Insurance costs**

- Changes in business patterns**

Approaches Used In Assessing Interruption Costs

- **Analytical Methods**
- **Failure Impact Studies**
- **Surveys**

Various Analytical Methods

- **Electric Rates**
(Customer's price of supply)
- **Past Implicit Reliability Evaluation**
(Rule-of-thumb)
- **Gross Economic Indices**
(eg: global GNP/kWh)
- **Price Elasticity**
(Market value)
- **Customer Subscription**
(Priority service, insurance schemes)
- **Cost of Backup Supply**

Customer Survey Methodologies

- **Random sampling of entire population (statistically meaningful sample sizes by group and subgroup)**
- **Focus study groups (especially for questionnaire development)**
- **Telephone, postal or in-person surveys**

Interruption Cost Evaluation Methods

- **Direct loss evaluation**
 - **use of categories**

Rate change approach

- **willingness to pay**
- **willingness to accept**

Indirect evaluation

- **Hypothetical insurance premium for assured supply or compensation for loss**
- **Preparatory action**

Cost Analysis and Reporting

- **Average reported costs**
- **Consumption or demand-normalized costs**
- **Weighted costs (within sectors and among sectors)**
- **Variations with duration and frequency of outage**
- **Variation with time of day, week, and season**
- **Worst case costs**

Customer Damage Function (CDF)

- variation of interruption cost with outage duration.**

Costs are normalized with regard to:

- total annual consumption (\$/kWh)**
- annual peak demand (\$/kW)**
- energy not supplied (\$/kWh)**

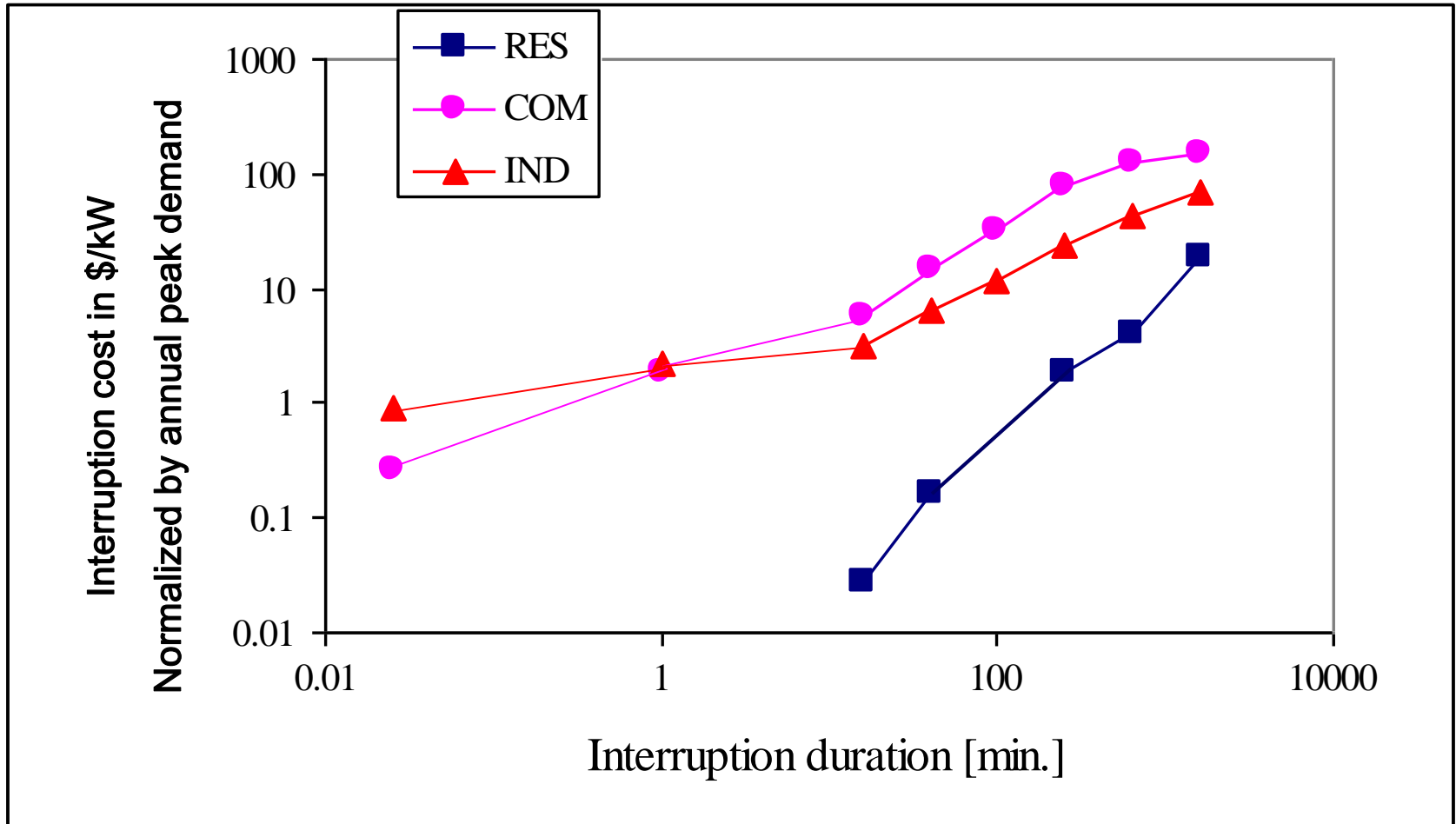

1991 sector customer damage functions in Canadian dollars

Summary of the surveys presented in CIGRE TF 38.06.01

Survey	Customer Sectors	Duration of outage	Normalization	Year of Survey
Australia	A,C, I, L, R	2 sec – 48 h	Annual energy	1996-1997
Canada	A,C,I,O,R	2 sec – 24 h	Annual energy ; Peak demand	1985-1995
Denmark	A,C,I,O,R	1 sec – 8 h	Peak demand	1993-1994
Great Britain	C,I,L,R	Momentary – 24 h	Annual energy ; Peak demand	1993
Greece	C,I	Momentary – 24 h	Peak demand	1997-1998
Iran	C,I,R	2 sec – 2 h	Peak demand	1995
Nepal	C,I,R	1 min – 48 h	Annual energy ; Peak demand	1996
New Zealand	C,I,R	< 2 h		1987
Norway	A,C,I, R	1 min – 8 h	Peak demand	1989-1991
Portugal	C,I,R	1 min – 6 h	Annual energy	1997-1998
Saudi Arabia	C,I,R	20 min – 8 h	Annual energy ; Peak demand	1988-1991
Sweden	A,C,I, R	2 min – 8 h	Peak demand	1994
USA	A,C,I, R	Momentary – 4 h	Unserved energy	1986-1993

- **More recent studies have been done in**
- **Italy**
- **Norway**
- **United Kingdom**
- **U.S.A**

Composite Customer Damage Function

A CCDF is an arithmetic combination of Cost Functions and the Composition Weights of the constituent user groups.

Composition Weight – the fraction of the total utilization of electrical supply.

Based on:

- annual consumption
- annual peak demand
- energy not supplied

Creation of Composite Customer Damage Functions (CCDF)

Consider a load point with the following sector load distribution.

Sector	Energy and Peak
Industrial	25%
Commercial	35%
Residential	40%
	100%

Weight by Energy- produce a CCDF for the load point

Sector interruption cost estimates (CDF)
expressed in kW of annual peak demand (\$/kW)

User Sector	Interruption Duration				
	1 min	20 min	1 hr	4 hr	8 hr
Industrial	1.625	3.868	9.085	25.163	55.808
Commercial	0.381	2.969	8.552	31.317	83.008
Residential	0.001	0.093	0.482	4.914	15.690
	Composite Customer Damage Functions				
CCDF \$/kW	0.54	2.04	5.46	19.22	49.28
CCDF \$/kWh	32.40	6.13	5.46	4.80	6.16

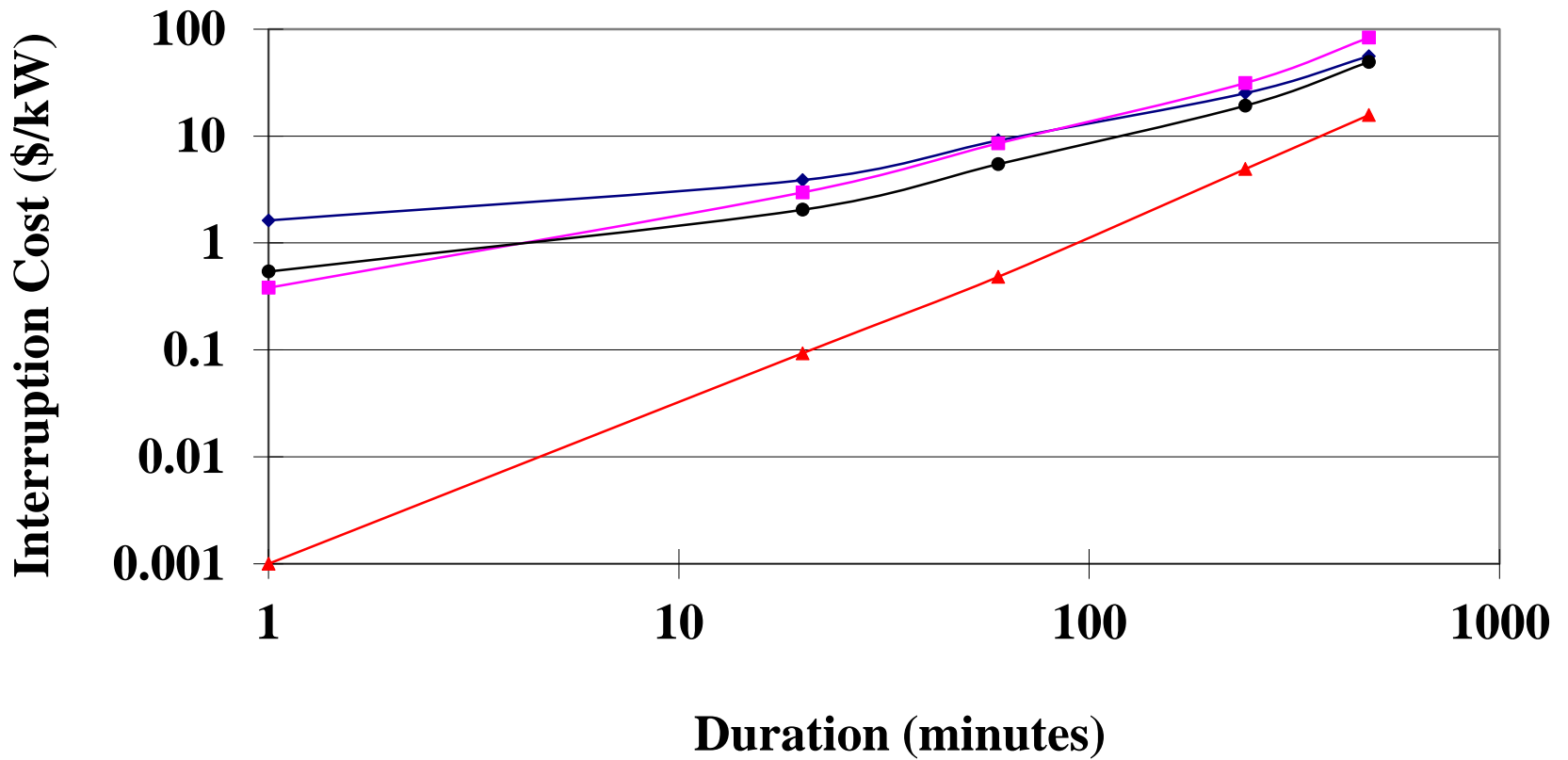

◆ Industrial
 ■ Commercial
 ▲ Residential
 ● CCDF \$/kW

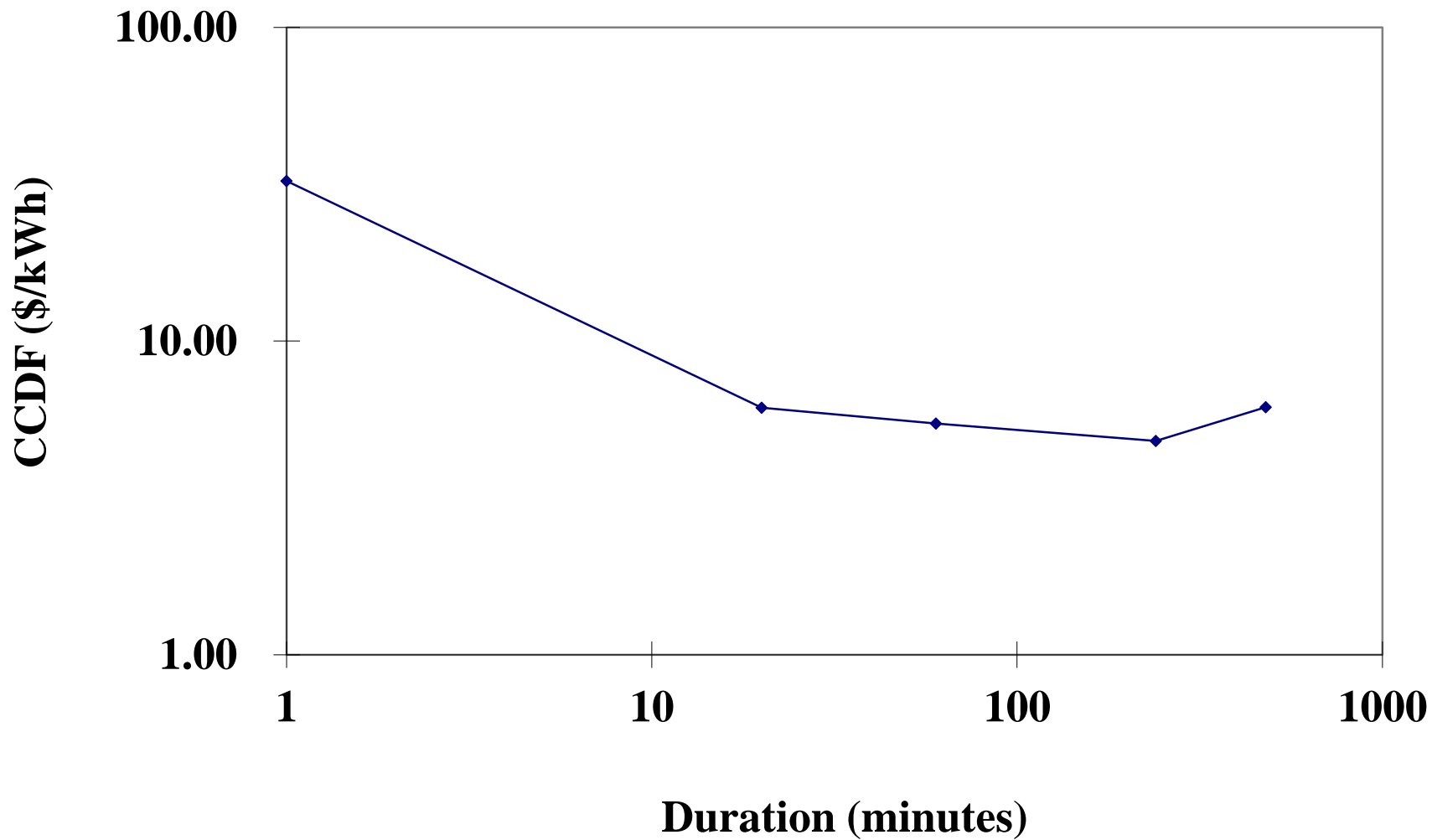

Quantitative Reliability Evaluation

Basic Techniques

Analytical Methods

- State enumeration
- Contingency enumeration

Monte Carlo Simulation

- State sampling
- Sequential sampling

*“Reliability Evaluation of Electric Power Systems
Second Edition”*, R.Billinton, R.N. Allan, Plenum Press,
1996

ECOST Evaluation

Contingency Enumeration

$$ECOST = \sum_{i=1}^n f_i L_i C(d_i)$$

f_i = Frequency of interruption i in occ/yr

L_i = Average load interrupted in kW

$C(d_i)$ = Cost of interruption of average duration d_i in \$/kW

ECOST Evaluation

Sequential Monte Carlo Simulation

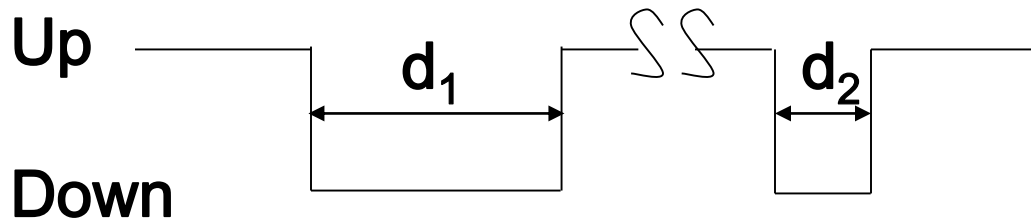

$$ECOST = \frac{\sum_{i=1}^n L_i C(d_i)}{n} \quad \text{in \$ /yr}$$

$C(d_i)$ = Cost of an interruption of duration d_i in \$/kW

L_i = Load interrupted during d_i in kW

n = Number of simulation years

Interrupted Energy Assessment Rate - IEAR

$$IEAR = \frac{ECOST}{EENS} = \frac{\sum_{i=1}^n f_i L_i C(d_i)}{\sum_{i=1}^n f_i L_i d_i}$$

ECOST -- Expected cost of interruptions

EENS -- Expected energy not supplied

IEAR -- Average interrupted energy
assessment rate

$$ECOST = [EENS][IEAR]$$

Customer Interruption Cost Assessment

Transformer Example

138 kV transformer, 40 MVA supplying a 35MW load.

Straight line load duration curve, LF = 75%

Failure Frequency = 0.1625 f/yr, Average repair time= 171.4 hours. **U=0.003180, A = 0.996820**

IEAR = 15 \$ /kWh = 15,000 \$ /MWh

Cap Out	Probability	ENS(MWh)	EENS(MWh)	ECOST(\$)
0	0.996820	0	0	
40	0.003180	229,950	731.241	10,968,615

<u>Condition</u>	<u>ECOST(\$)</u>
1-40 MVA transformer	10,968,615
Mobile spare, replacement in 48 hours	3,069,833
2-40 MVA transformers	34,875
2-20 MVA transformers	5,390,175
3-20 MVA transformers	25,655

Customer Interruption Cost Assessment Composite System Example

RBTS

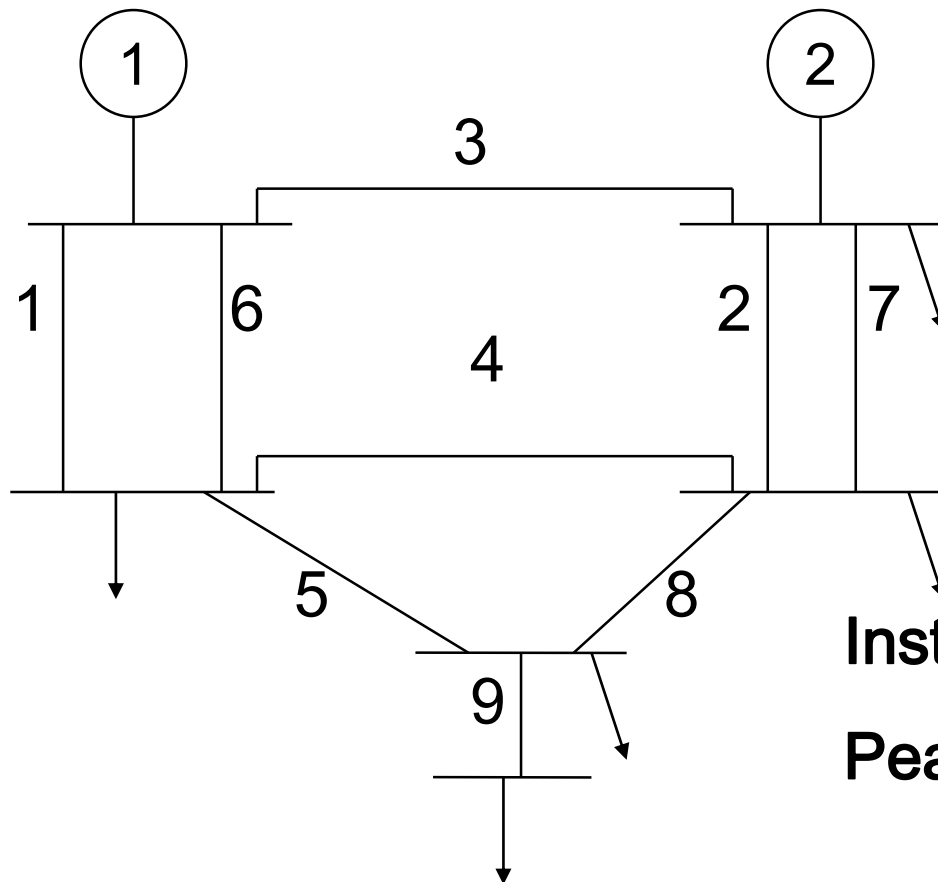

Installed Capacity = 240 MW

Peak Load = 179.3 MW

Customer Interruption Cost Assessment

Basic Indices

Bus No.	Priority Order Policy				Pass-1 Policy				Pass-2 Policy			
	EDLC hrs/yr	EFLC occ/yr	EENS MWh/yr	ECOST k\$/yr	EDLC hrs/yr	EFLC occ/yr	EENS MWh/yr	ECOST k\$/yr	EDLC hrs/yr	EFLC occ/yr	EENS MWh/yr	ECOST k\$/yr
2	0.10	0.07	0.31	2.38	0.56	0.21	1.64	12.93	0.56	0.21	1.64	12.93
3	3.83	0.88	44.63	120.71	3.27	0.76	29.61	79.62	3.27	0.76	29.61	79.62
4	0.29	0.11	1.92	12.10	2.54	0.58	17.57	110.40	2.54	0.58	17.57	110.40
5	0.24	0.09	1.23	9.09	0.27	0.10	1.40	10.41	0.27	0.10	1.40	10.41
6	10.49	1.19	104.88	404.33	9.70	0.92	102.74	395.44	9.70	0.92	102.74	395.44
Sys.	13.32	1.72	152.97	548.61	13.32	1.72	152.96	608.80	13.32	1.72	152.96	608.80

EDLC – Expected Duration of Load Curtailment (hours/yr)

EFLC – Expected Frequency of Load Curtailment (occurrences/year)

EENS – Expected Energy Not Supplied (MWh/year)

ECOST – Expected Customer Interruption Cost (\$/year)

Customer Interruption Cost Assessment Composite System Example

IEEE-RTS

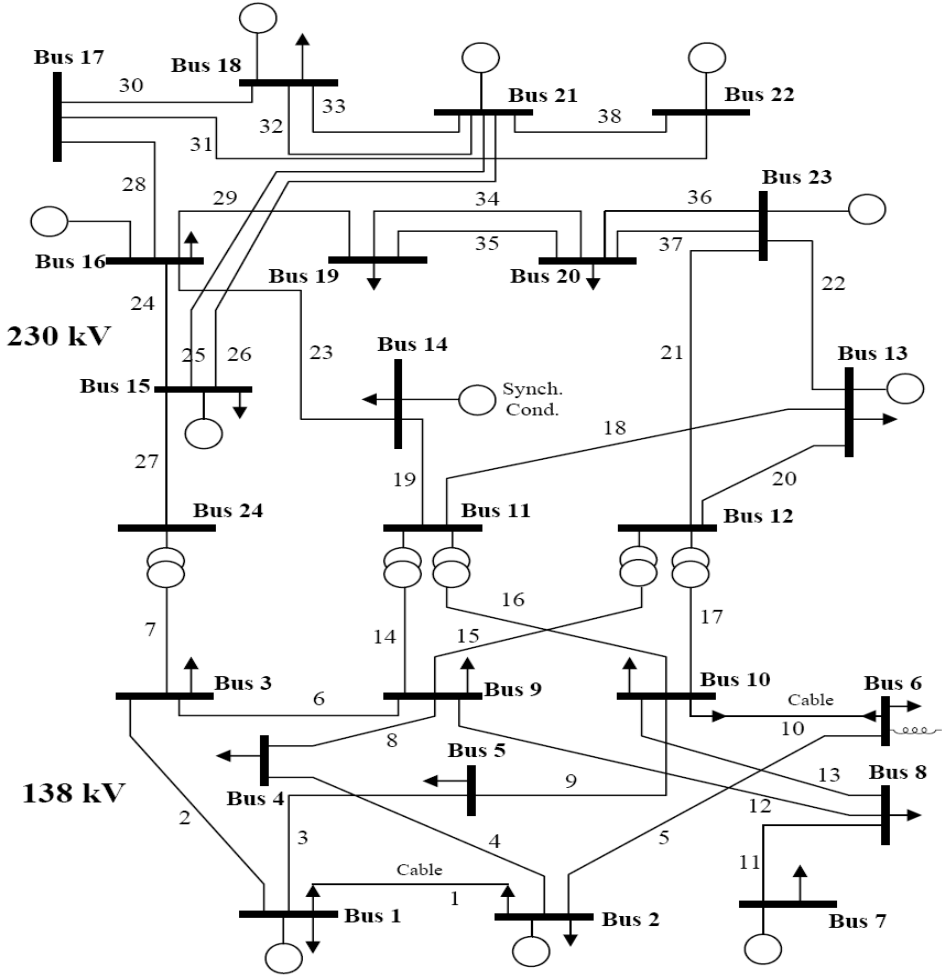

Customer Interruption Cost Assessment IEAR

Values for each load bus in the IEEE-RTS

“Economic Costs of Power Interruptions: A Consistent Model and Methodology”. R.F. Ghajar and R. Billinton, *Electrical Power and Energy Systems*, Vol. 28, No. 1, January 2006

Bus	IEAR (\$/kWh)	Bus	IEAR (\$/kWh)	Bus	IEAR (\$/kWh)
1	6.20	7	5.41	15	3.01
2	4.89	8	5.40	16	3.54
3	5.30	9	2.30	18	3.75
4	5.62	10	4.14	19	2.29
5	6.11	13	5.39	20	3.64
6	5.5	14	3.41		

Based on: Sector CCDF, Customer composition and load at each bus, contingency enumeration. ECOST = 6.59 M\$/yr based on load curtailment using an economic priority order

IEEE-RTS Wind Study

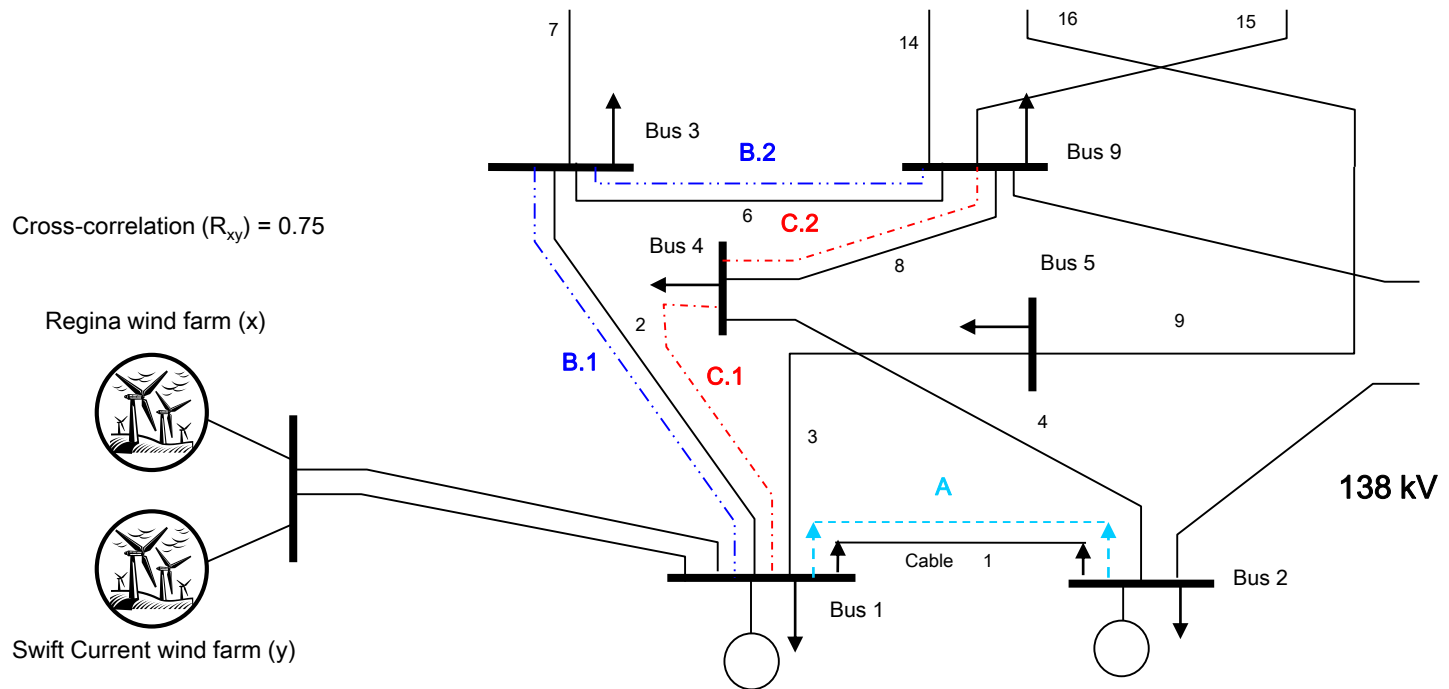

IEEE-RTS Wind Study

Consider a situation in which a 480 MW wind farm is to be added to the IEEE-RTS.

Alternative 1: Constructing Line A

Alternative 2: Constructing Line B.1

Alternative 3: Constructing Line C.1

Alternative 4: Constructing Lines B.1 and B.2

Alternative 5: Constructing Lines C.1 and C.2

Reliability-Based Transmission Reinforcement Planning Associated with Large-Scale Wind Farms". R. Billinton, W. Wangdee. IEEE Trans. on Power Systems, Vol. 22, No. 1, February 2007, pp. 34-41.

IEEE-RTS Wind Study

Obtained using the RapHL-II (Reliability Analysis program for HL-II) sequential simulation software

Overall System Reliability Indices	Alt.1	Alt.2	Alt.3	Alt.4	Alt.5
EFLC (occ/yr)	2.77	4.01	3.05	3.53	2.88
EDLC (hrs/yr)	8.18	9.45	8.45	8.47	7.75
ECOST (M\$/yr)	5.12	4.73	5.74	4.34	4.61
DPUI (syst.min)	24.27	21.59	26.50	19.86	21.19

IEEE-RTS Wind Study

ACP-Annual Capital Payment

ECOST-Expected Outage Cost

TOC-Total Cost

Reinforcement Alternative	ACP (M\$/yr)	ECOST (M\$/yr)	TOC (M\$/yr)
1	1.057	5.123	6.180
2	3.099	4.729	7.828
3	1.268	5.740	7.008
4	4.861	4.339	9.200
5	2.818	4.609	7.427

Value Based Reliability Assessment (VBRA) is a useful extension to conventional reliability evaluation and provides valuable input to the decision making process.

Component and System Data

Probabilistic evaluation requires the consistent collection of relevant system and component data. These data should be collected using comprehensive and consistent definitions thoroughly understood by the participating entities.

The data collected on system and component performance are valuable elements in the prediction of future performance.

- 1. “Reliability Evaluation of Engineering Systems, Second Edition”,** R. Billinton and R.N. Allan, Plenum Press, 1992., pp. 453.
- 2. “Reliability Evaluation of Power Systems, Second Edition”,** R. Billinton and R.N. Allan, Plenum Press, 1996, pp. 514.
- 3. “Reliability Assessment of Electric Power Systems Using Monte Carlo Methods”,** R. Billinton and W. Li, Plenum Press, 1994, pp. 351.