

DOCKETED

| | |
|-------------------------|---|
| Docket Number: | 20-LITHIUM-01 |
| Project Title: | Lithium Valley Commission |
| TN #: | 239214 |
| Document Title: | Presentation - Lithium Valley Commission 7-29-21 Updated V2 |
| Description: | July 29, 2021 Lithium Valley Commission Presentation |
| Filer: | Elisabeth de Jong |
| Organization: | California Energy Commission |
| Submitter Role: | Commission Staff |
| Submission Date: | 8/9/2021 1:26:25 PM |
| Docketed Date: | 8/9/2021 |



Lithium Valley Commission Meeting

July 29, 2021





Steps to Select English Channel

1) Click “Interpretation” icon.

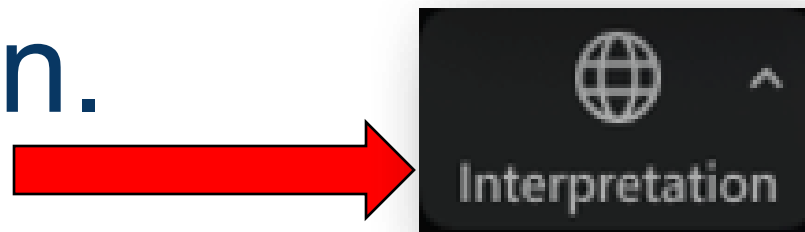

2) Click “EN English” option

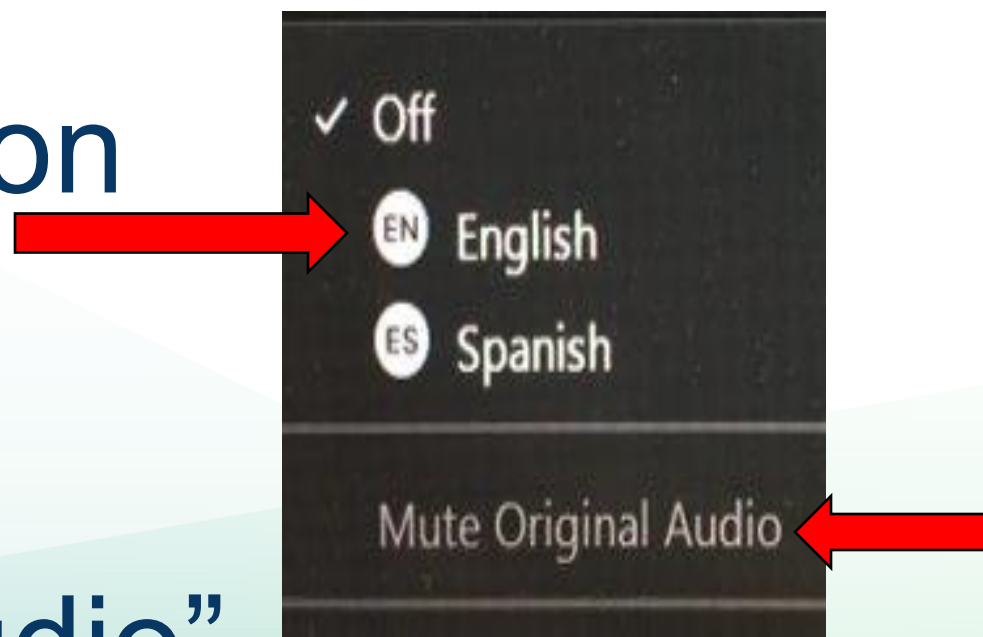

3) Click “Mute Original Audio”



Interpretation / Interpretación

1) Click globe “Interpretation” icon.

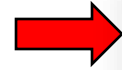

2) Click “ES Spanish” option

3) Click “Mute Original Audio”

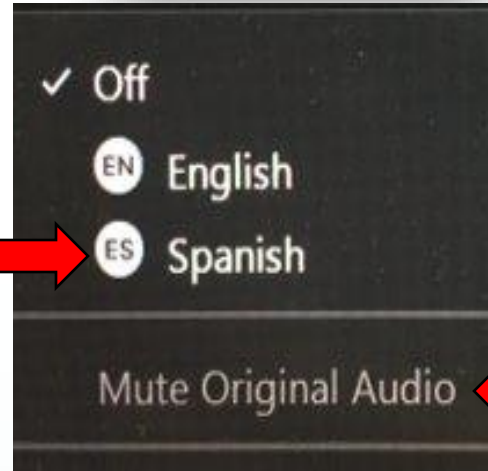

1) Haga clic en el icono del globo de interpretación

2) Haga clic donde dice “ES Spanish”

3) Haga clic en “Mute Original Audio”

NOTE: To use interpretation feature, download Zoom application on your device. Interpreter will relate everything from English to Spanish during meeting and will inform you when to make public comment. Speak in Spanish and interpreter will relate comments to English.

NOTA: Para utilizar la función de interpretación, descargue la aplicación Zoom en su aparato. El intérprete relacionará todo lo dicho en inglés al español durante la junta y le informará cuándo podrá hacer un comentario público. Hable en español y el intérprete relatará sus comentarios en inglés.



Interpreting on Tablet/Smartphone

Interpretación usando tableta o teléfono inteligente

To listen in Spanish, use controls to:

- 1) Tap for more options
- 2) Tap interpretation
- 3) Tap preferred language
- 4) Tap "Mute Original Audio"

Note: To use interpretation feature, download Zoom application on your device.

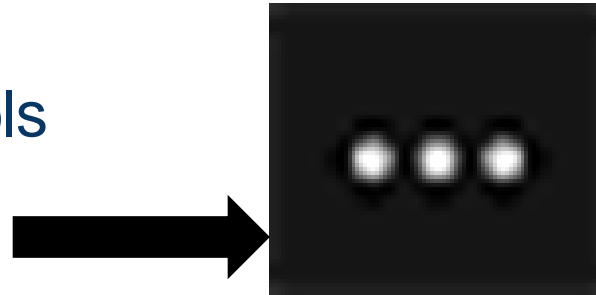

Para escuchar en español, use los controles para:

- 1) Tener más opciones
- 2) Hacer clic en interpretación
- 3) Escoger el idioma preferido
- 4) Hacer clic en "Mute Original Audio"

Nota: Para usar la opción de interpretación, descargue la aplicación Zoom en su aparato.



Welcome – Administrative Items

- Meeting conducted remotely via Zoom
 - Recorded and transcribed by court reporter
- To participate in public comment...
 - By computer: use the “raise hand” feature in Zoom
 - Over the telephone: dial *9 to “raise hand” and *6 to mute/unmute your phone line
- Written comments
 - Submit through the e-commenting system at:
 - <https://efiling.energy.ca.gov/Ecomment/Ecomment.aspx?docketnumber=20-LITHIUM-01>



Welcome and Roll Call



Agenda

- Welcome and Roll Call
- Administrative Items
 - Approval of June 24, 2021 Action Minutes
- Information Items
 - Media and Legislation Updates
 - Lithium Valley Commissioner Updates
- Lithium Extraction Methods
 - Overview
 - Lithium Extraction Methods Presentation
 - Lithium Resource Panel
- Determination of Agenda Topics, Speakers, and Presentation for Future Meetings
- Public Comment
- Adjourn



Administrative Items

- **Approval of Past Meeting Action Minutes**



Public Comment

Comment Instructions:

Limited to 3 minutes per comment

By computer: use the “raise hand” feature in Zoom

By telephone: dial *9 to “raise hand” and *6 to mute/unmute your phone line





Media and Legislation Updates



Lithium Valley Commissioner Updates



Lithium Extraction Methods Workshop



California
Energy Commission

RD&D on Lithium Recovery from Geothermal

Energy Research and Development Division

Rizaldo Aldas

Energy Generation Research Office





Geothermal RD&D: Improving Production and Flexibility of Existing Geothermal and Advancing Economics through Mineral Recovery

- Develop Advanced Technologies and Strategies to Improve the Cost-Effectiveness of Geothermal Energy Production
 - Subsurface Imaging
 - Distributed Generation Geothermal
 - Managing silica
- Investigate Flexible Generation Capabilities
 - Computer Modeling
 - Field Testing
- **Enabling cost-effective Mineral Recovery**
 - Improving technology and processes for lithium recovery
 - Deployment and demonstration of lithium recovery systems



Past Mineral Recovery R&D Projects - Public Interest Energy Research (PIER) Program

Examples of Completed Mineral Recovery R&D Projects:

- Co-Production of Silica from Geothermal Fluids (LLNL, 2002-2005)
- Pilot-Scale Geothermal Silica Recovery at Mammoth Lakes (LLNL, 2005-2008)
- Proof-of-Concept of Co-Production of Electrical Power and Lithium from Geothermal Fluids (Paula Moon & Associates, 2010-2011)
- Technologies for extracting valuable metals and compounds from geothermal fluids (Simbol, Inc. 2011-2014)

Simbol Mineral Recovery Project

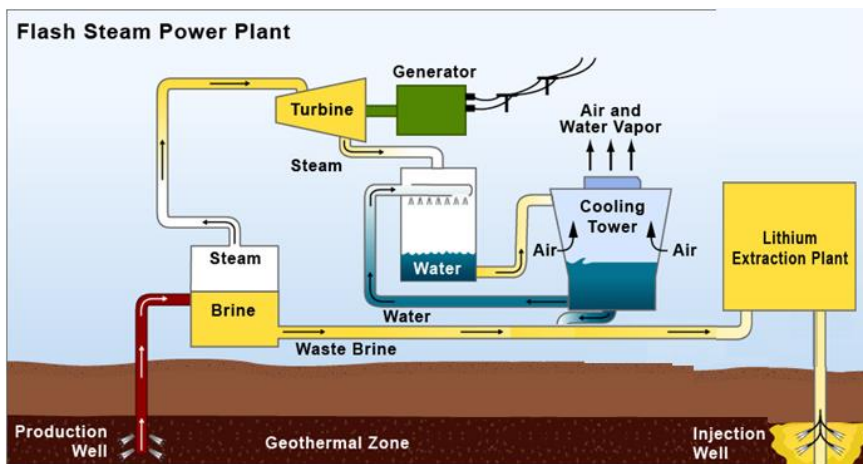

- Demonstrated the key steps to produce lithium
- Planned commercial plant with a lithium production of 15,000 metric tons per year
- Critical lessons learned from the technology and business aspects

Concept of mineral extraction plant utilizing post-power production, pre-injection geothermal brine

Well to Wheels Lithium Design (EnergySource Minerals, LLC)



ES Minerals Pilot Unit

- Developed a robust engineering package for a facility that will extract lithium and mineral co-products from geothermal brines
 - Using processes and equipment from the water treatment, metal processing and chemical processing industries.
 - Accurately estimated installed project costs

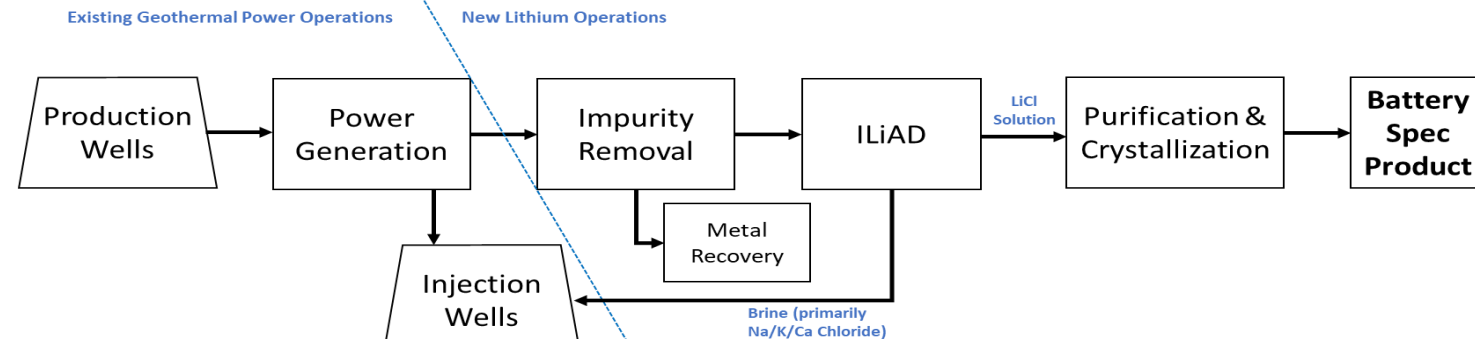

Simplified Process Flow Diagram



RD&D on Lithium Recovery from Geothermal – EPIC Program

A. Improving Process and Technology for Lithium Recovery

- Systems or subsystems enabling recovery of lithium from geothermal brine on a pilot scale.
 - Achieve an estimated production cost of less than \$5,000/metric ton of lithium carbonate equivalent.
 - Demonstrate the potential for a payback period of less than 5 years.

B. Deployment and Demonstration of Lithium Recovery from Geothermal Brines

- Demonstrate entire systems enabling recovery of lithium from geothermal brine on a large scale.
 - Field demonstration, scaled up to at least one-tenth of commercial scale.
 - Achieve an estimated production cost of less than \$4,000/metric ton of lithium carbonate equivalent.
 - Demonstrate the potential for a payback period of less than 5 years.

Improving Process and Technology for Lithium Recovery

Hell's Kitchen Geothermal Lithium Extraction Pilot (Hell's Kitchen Geothermal)

- Integrate multiple brine pretreatment processes to demonstrate a system for completely preparing geothermal brine for lithium extraction
 - Management and precipitation of lead, silver, zinc, iron, manganese, and silica.
 - Demonstrate on flowing geothermal brine at 5 gal/min

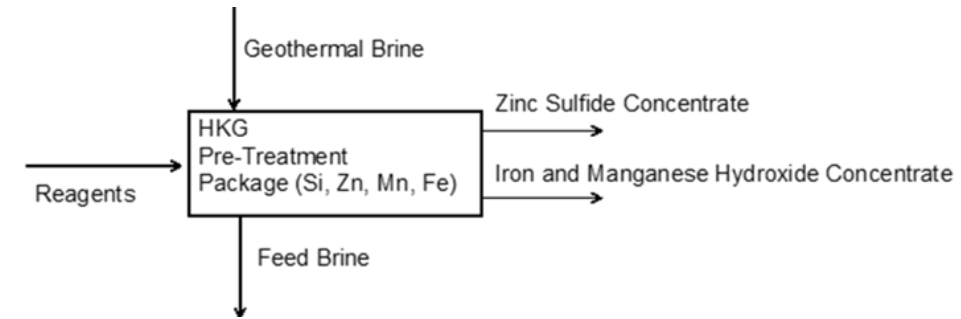
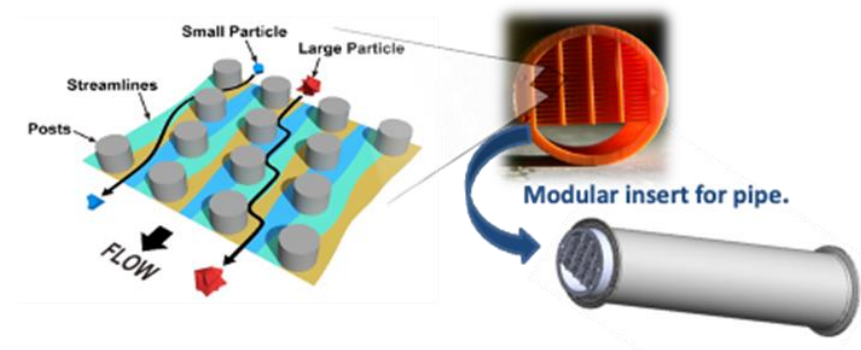

Diagram of integrated pretreatment process

Improved Silica Removal for Enhanced Geothermal Plant Performance (Hell's Kitchen Geothermal)

- Develop and demonstrate a fundamentally new and innovative method for managing silica in geothermal operations
 - Carefully positioned staggered/offset posts of Geothermal Micropillar Enabled Separators



Improving Process and Technology for Lithium Recovery

Pilot Scale Recovery of Lithium from Geothermal Brines (Materials Research)

- Demonstrate a pilot scale integrated process for the recovery of lithium from geothermal brines
 - High-capacity selective solid sorbent developed by SRI International

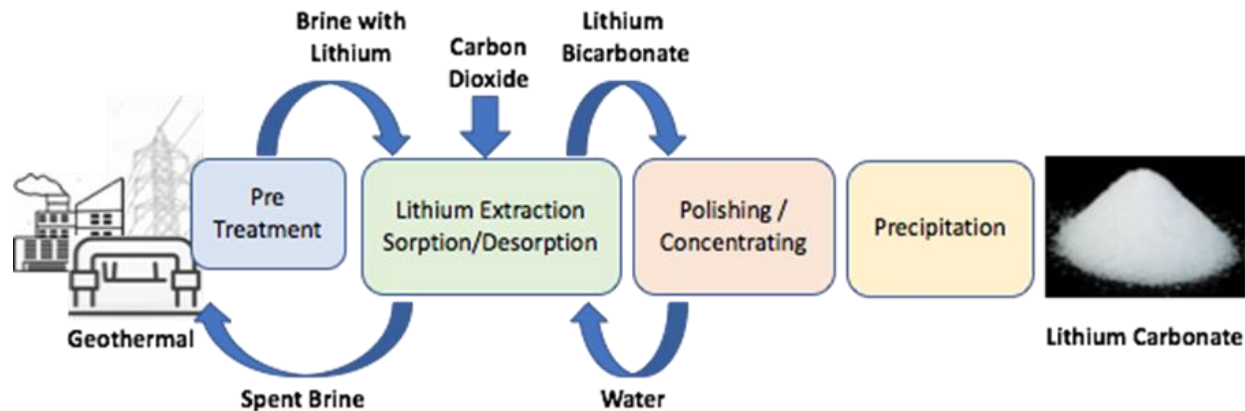

Lithium recovery process schematic

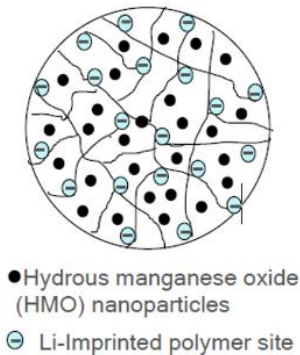

Recovery of Lithium from Geothermal Brines (SRI International)

- New high-capacity selective composite sorbent comprised of inorganic lithium-ion sieves and lithium-ion-imprinted polymers
- New eco-friendly sorbent regeneration process



Deployment and Demonstration of Lithium Recovery from Geothermal Brines

Salton Sea Geothermal Lithium Recovery Demonstration Project (BHER Minerals)

- An integrated geothermal brine pre-treatment and lithium recovery system at an existing geothermal power facility
 - Brine processing rate of at least 100 gallons per minute
 - Estimated production cost of less than \$4,000/metric ton of lithium carbonate equivalent;
 - Minimize environmental impacts; freshwater usage below 50,000 gallons per tonne of lithium carbonate
 - Lithium recovery of >85% from raw brine to high-purity lithium carbonate

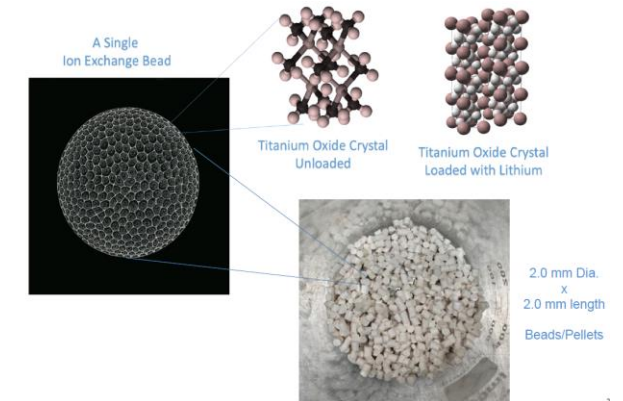

Ion Exchange Media



The demonstration system at a geothermal power plant in Calipatria, California



Lithium Recovery RD&D Initiatives for EPIC 4

Draft Initiative RD&D Areas

- **Advancing mineral recovery technology and processes**
 - Lithium extraction methods with improved performance and longevity and lower costs
 - Technologies and methods for the recovery of other valuable co-products
 - Decrease waste products and improve the overall value proposition
- **Large-scale demonstrations of mineral recovery systems**
 - Prove increased performance and lower costs in real-world applications



Lithium Recovery RD&D Initiatives for EPIC 4

- **Electric Program Investment Charge 2021-2025 Investment Plan Scoping – Draft Initiatives for EPIC 4**

Date: August 4, 2021

Time: 9:00 AM

Additional details: <https://www.energy.ca.gov/event/workshop/2021-08/electric-program-investment-charge-2021-2025-investment-plan-scoping-draft>

To stay involved in EPIC 4, visit www.energy.ca.gov/epic4

Please use CEC's e-commenting system to submit written comments:

<https://efiling.energy.ca.gov/Ecomment/Ecomment.aspx?docketnumber=20-EPIC-01>

See notice for e-mail and U.S. Mail commenting instructions:

<https://efiling.energy.ca.gov/getdocument.aspx?tn=238093>

Direct Lithium Extraction Technology Development: The Global Perspective

Alex Grant

Principal, Jade Cove Partners

✉ ag@jadecove.com

🌐 www.jadecove.com/research

🐦 [alexjadecove](https://twitter.com/alexjadecove)

Lithium Valley Commission

29 July 2021

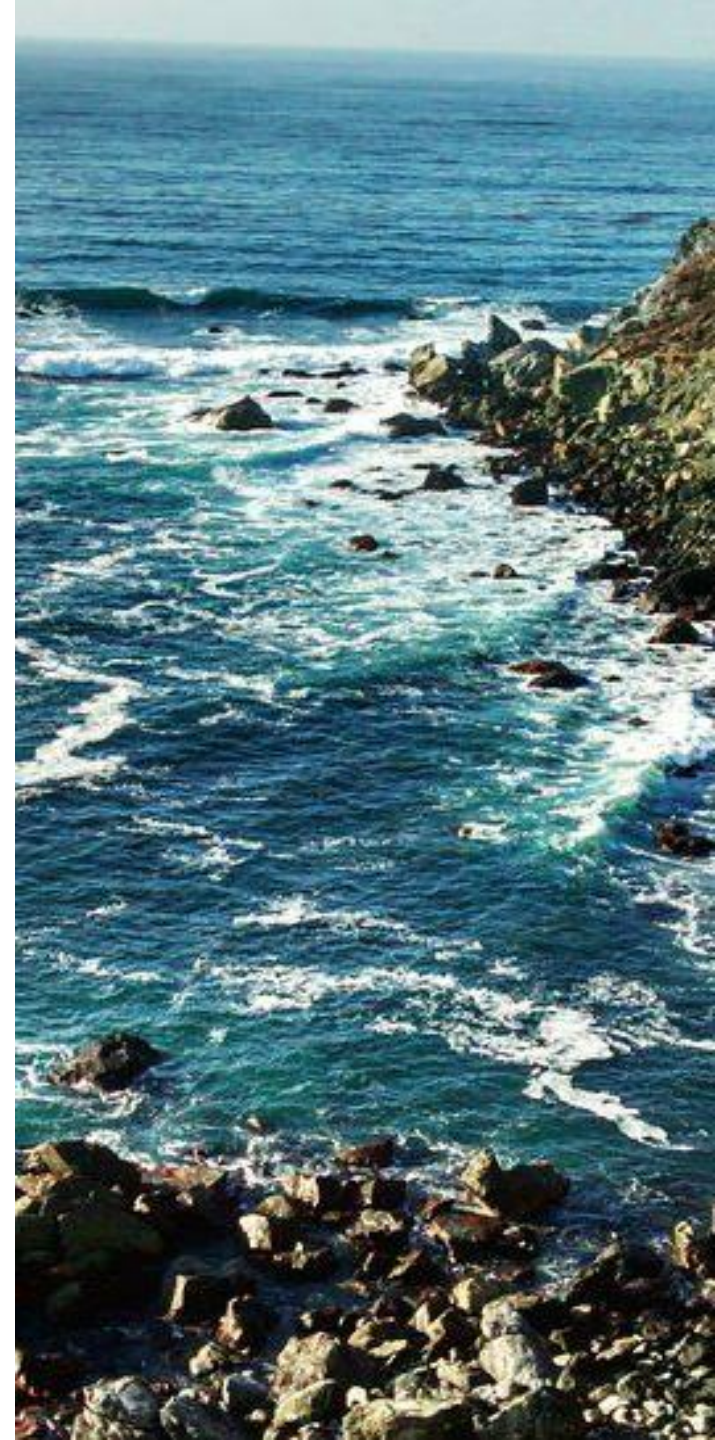

My Background



1992



2010



2015



2016



2019

What I Do Now

Jade Cove's mission is to cultivate transparency and new ideas in mineral and chemical industries which support improvement of environmental performance of battery material supply chains.

Worked with 15 brine projects on 4 continents, 5 sedimentary clay projects, 5 tech companies, and 10 investment groups. Built 15 life cycle assessments of lithium resource projects in development around the world.

You can find some of my research public at:
www.jadecove.com/research

Articles, Essays, and Op-Eds

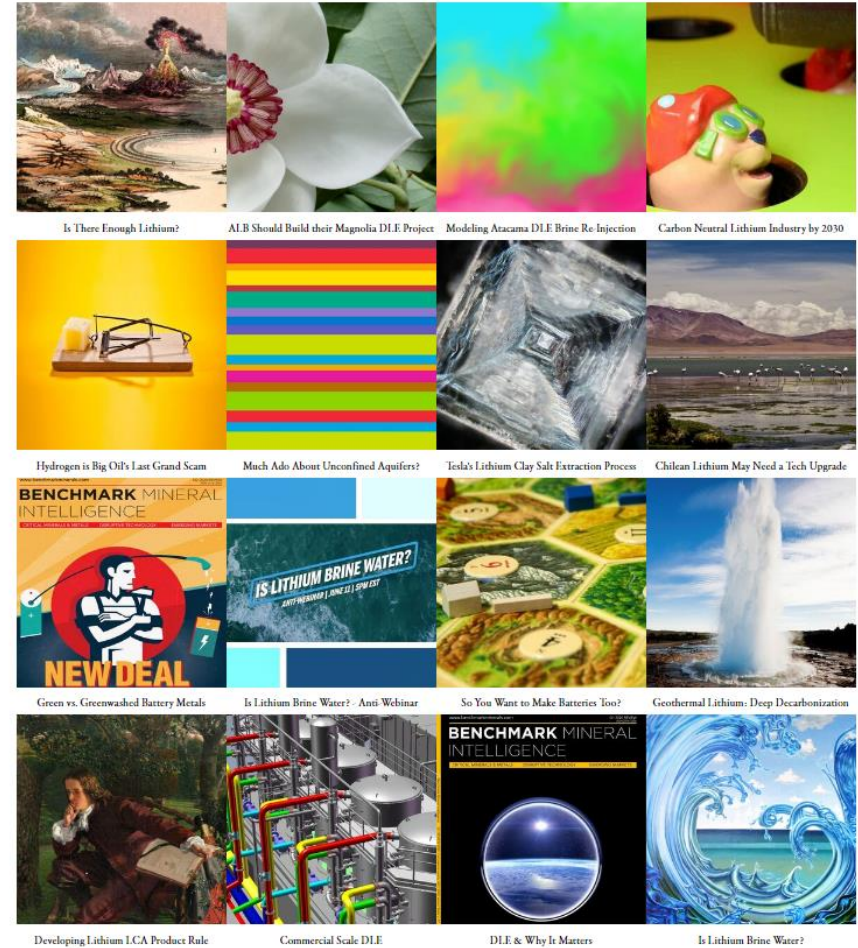

Lithium Demand

80% of 2030's lithium supply **does not exist yet.**

Is There Enough Lithium to Make All the Batteries?

Yes! The ocean contains 1 trillion tonnes of lithium carbonate equivalent (LCE).

So the right question is not “is there enough?” It’s “**how should/will we produce it?**” and the following more detailed questions:

1. How much lithium will we produce?
2. From what type of resources?
3. In what jurisdictions?
4. Using what extraction and process tech?
5. With what operating/capital costs?
6. Incurring what environmental impacts?
7. To make what type of lithium chemicals?

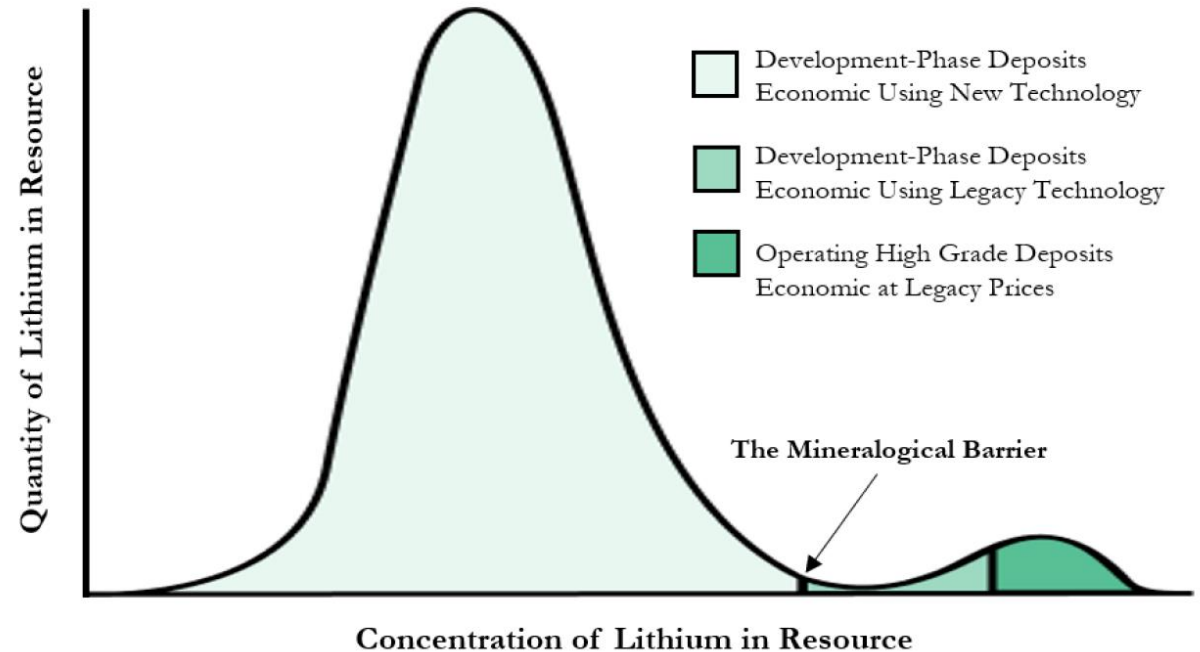

The domain that asks these questions is called process mineralogy.

The Mineralogical Barrier (Skinner, 1976)



Types of Lithium Natural Resources

Families of Lithium Natural Resources

| Brine | Pegmatite | Sedimentary & Others |
|--|---|--|
| Salar Oilfield Geothermal Ocean Waste Streams | Spodumene Petalite Amblygonite Eucryptite Lepidolite Zinnwaldite | Smectites Illites Jadarite Zabuyelite Zeolites Volcanic Tuffs & Glasses |
|  |  |  |

How Each Are Processed Into Lithium Chemicals

Generalized Process Pathways for Different Lithium Natural Resources

| Resource Type | Pumping | Evaporation | Mining | Crushing and Upgrading | Roasting and Calcination | Chemical Leach from Mineral | Chemical Refining to Product |
|----------------------|--------------------|--------------------|--------------------|------------------------|--------------------------|-----------------------------|------------------------------|
| Evaporative Brine | Always of Frequent | Always of Frequent | Never or Rarely | Never or Rarely | Never or Rarely | Never or Rarely | Always of Frequent |
| DLE Brine | Always of Frequent | Sometimes | Never or Rarely | Never or Rarely | Never or Rarely | Never or Rarely | Always of Frequent |
| Sedimentary Minerals | Never or Rarely | Never or Rarely | Always of Frequent | Sometimes | Sometimes | Always of Frequent | Always of Frequent |
| Pegmatite Minerals | Never or Rarely | Never or Rarely | Always of Frequent | Always of Frequent | Sometimes | Always of Frequent | Always of Frequent |

 Always of Frequent
  Sometimes
  Never or Rarely

CO₂ Intensity of Making Battery Chemicals is Increasing

Due to a rapid shift in production of battery metals and chemicals in the last decade:

1. To lower grade, less pure resources
2. To relying on Chinese processing with heavy fossil fuel use

The CO₂ emissions of making lithium chemicals, graphite, nickel, and other components have shot through the roof.

These emissions need to be reduced in order to **maximize the CO₂ emission mitigation opportunity of the EV transition.**

CO₂ Intensity of Manufacturing Different LiOH·H₂O Products

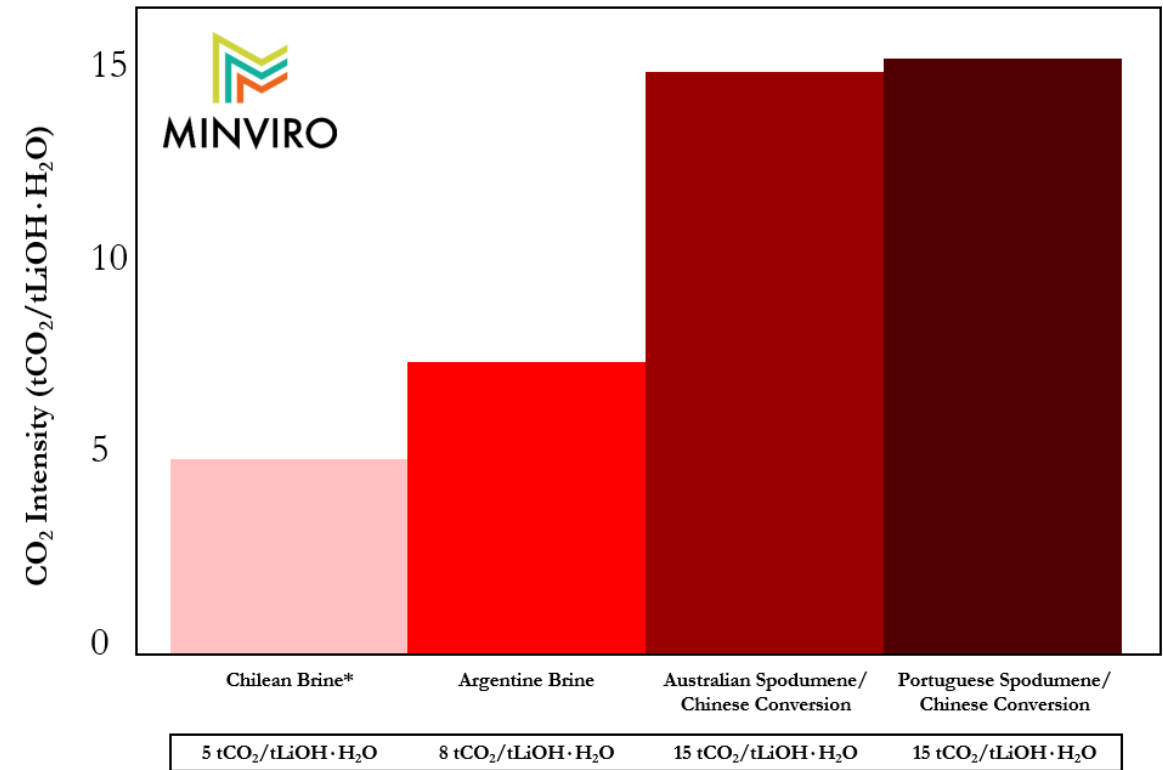

* Technical grade, not battery-quality

“Conventional” Lithium Processing is a Myth

The Atacama and Cauchari-Olaroz Basins from Space



Enter DLE

Direct lithium extraction (DLE) is the use of a **selective site on an engineered material** to remove lithium from a brine without the need to remove water from the brine or the majority of other impurities.

DLE has been used in Argentina by American company Livent for 20 years, and has recently been scaled up in Qinghai, China at ~5 different brine projects, where lithium is now produced from magnesium sulfate brines.

DLE is not new but has recently been creatively re-invented and upgraded by a number of different companies around the world.

Schematic of a Generalized DLE Process

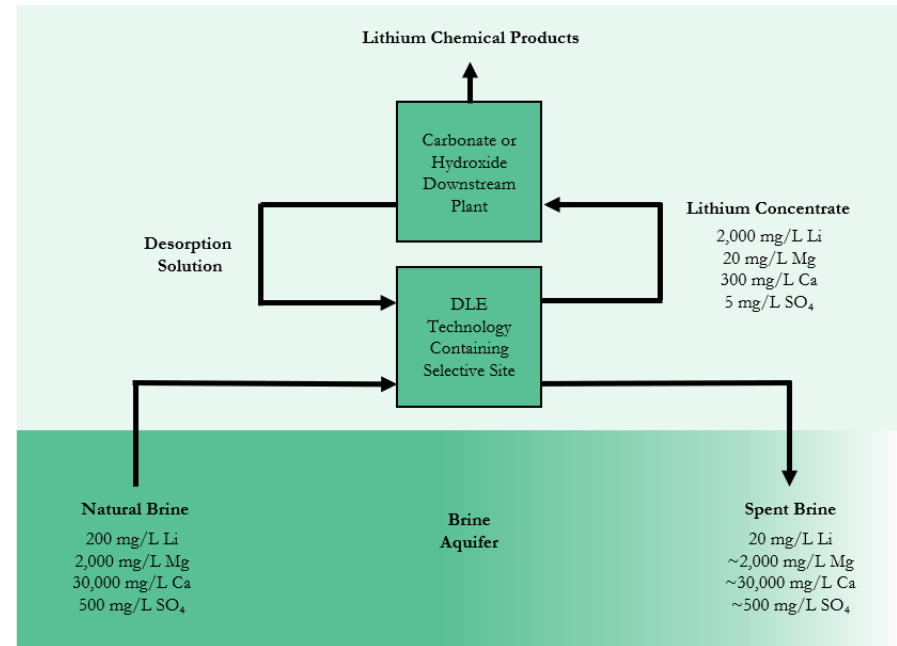

Livent is the only lithium producer in the world with a successful, multi-decade track record of using a DLE technology process on a commercial scale.

No solvents or hazardous chemicals are introduced to the environment as part of Livent's process.

Source: Livent Sustainability Report (2019)

Extraction Process

GRI 306-1, GRI 306-5, UNSDG: 12, 14

To extract lithium from brine, we use a proprietary DLE process, known as Selective Adsorption (SA), which takes in freshwater and uses it to separate lithium from brine. Water is a key raw ingredient in our DLE process and our SA technology speeds up the concentration process and reduces the need for large pre-concentration evaporation ponds commonly used by conventional brine-based lithium producers. By not relying on large pre-concentration ponds, we do not add to the natural rate of evaporative loss in the Salar by exposing huge volumes of underground brine to the elements over 18–24 months. Through Livent's process, we are also able to return most of the used brine/water volume to the surrounding Salar habitat, without introducing solvents or hazardous chemicals into the environment and without altering the pH of the used brine.

Conventional pond strings for lithium extraction require a large land footprint and may increase the evaporative loss of water from the local ecosystem. Livent's physical footprint is significantly lower than that of conventional brine-based lithium producers. Over the next few years, we intend to reduce our overall land use by decommissioning our relatively small number of remaining evaporation ponds.

Water Use

GRI 303-1, GRI 303-3, GRI 303-2, GRI 303-4, GRI 303-5, SASB:TC-ES-140a.1, SASB:EM-MM-140a.1, UNSDG: 14

Our current production in Argentina utilizes water from the Trapiche aquifer. We utilize a comprehensive approach to manage and record parameters such as water flows, chemical transport and salinity to use water resources sustainably. In addition to our in-house expertise, Livent has a long-term working relationship with a geology firm to conduct modeling of both the freshwater aquifer and the Salar. The modeling helps us draw brine and water at sustainable rates that should not interfere with the natural equilibrium of the Salar.

Our processes return a significant portion of the brine we use back to the Salar, free from any contaminants or solvents, and without altering the pH of the brine. Our processes also do not add to the natural rate of evaporation in the Salar basin, minimizing our overall impact on the local ecosystem. We have worked closely with the government of Argentina for over 20 years and have Salar / hydrogeological models to provide for sustainable water use and minimize our environmental impact. We have not contributed to a decrease in brine or water over the 20 years we have operated at the Salar. Even though there is very little direct precipitation at the Salar, 210 million cubic meters of water flows into the "closed" Salar basin every year, largely through inflows from higher elevations in the Andes Mountains. Livent intercepts less than 2% of that very large annual water flow. The total watershed area for the Salar (3,900 cubic km) is larger than the US state of Rhode Island.



Pre-concentration pond, Salar del Hombre Muerto, Argentina.



Academic research teams leading the lithium water study. Photo taken prior to global pandemic declaration. University of Alaska Anchorage and University of Massachusetts Amherst®.

We will continue to work closely with our third-party geology firm as we expand our operations in Argentina to minimize future impacts. We plan to use a secondary water source, the Los Patos River, for our expansion. This would reduce our reliance on the Trapiche aquifer. We have already installed monitoring wells on both of these water sources to track water levels, recharge rate and water chemistry to help us use water in a sustainable manner. The government of Catamarca has also conducted extensive environmental reviews of our current water use and expansion plan with the help of independent third parties.

Lithium Water Study Collaboration

Livent is participating in a geohydrological water study on the impact of lithium mining on local water resources and the surrounding ecosystems, led by the University of Alaska Anchorage and the University of Massachusetts Amherst. The study is sponsored by The BMW Group and BASF. The aim is to improve a scientific understanding of the relationship between fresh water and lithium brine aquifers, evaluate different technologies and processes and provide greater insights into sustainable lithium mining.



Three Main Families of DLE

Three Main Families of DLE Technologies

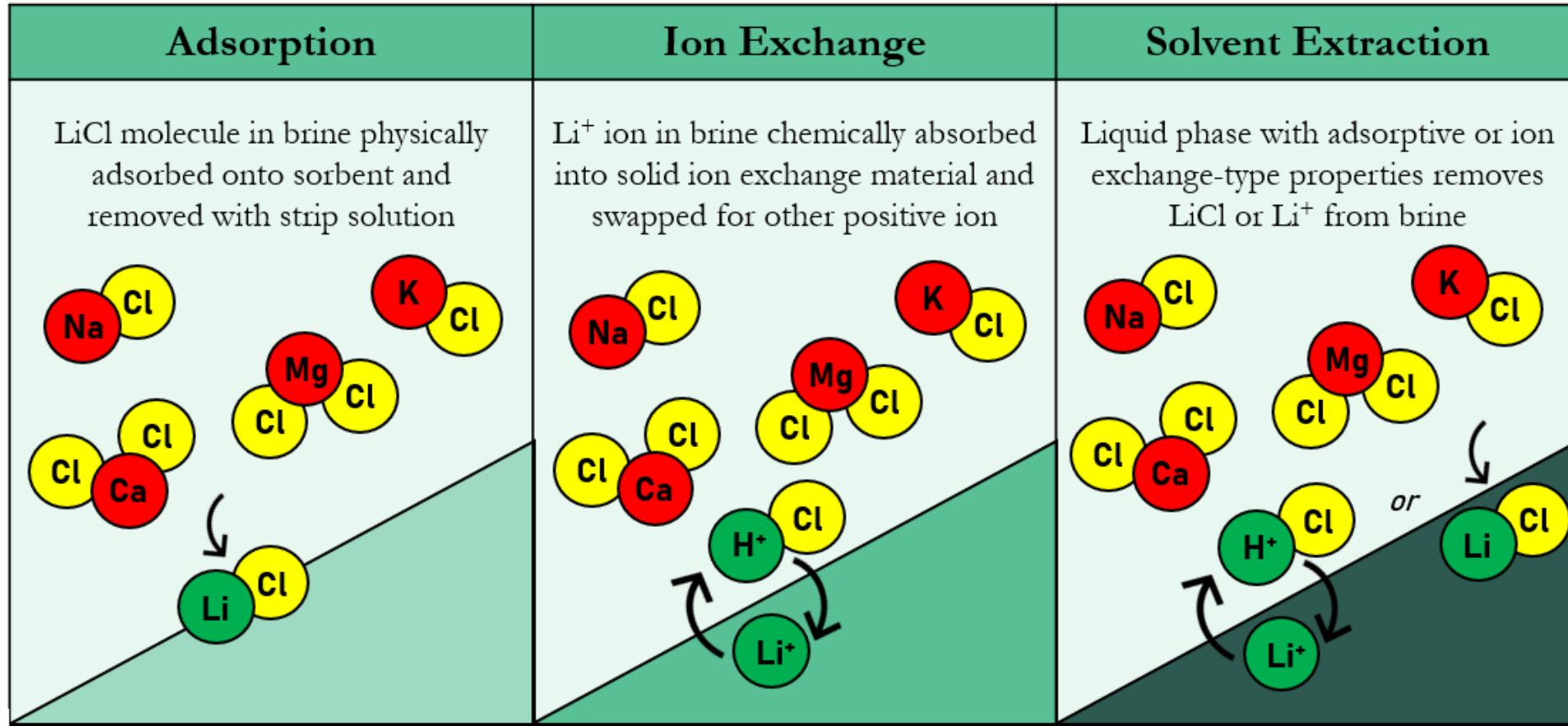

“Brine” Can Mean Many Things

Geochemistry & Thermodynamic Trends for Different Types of Brines

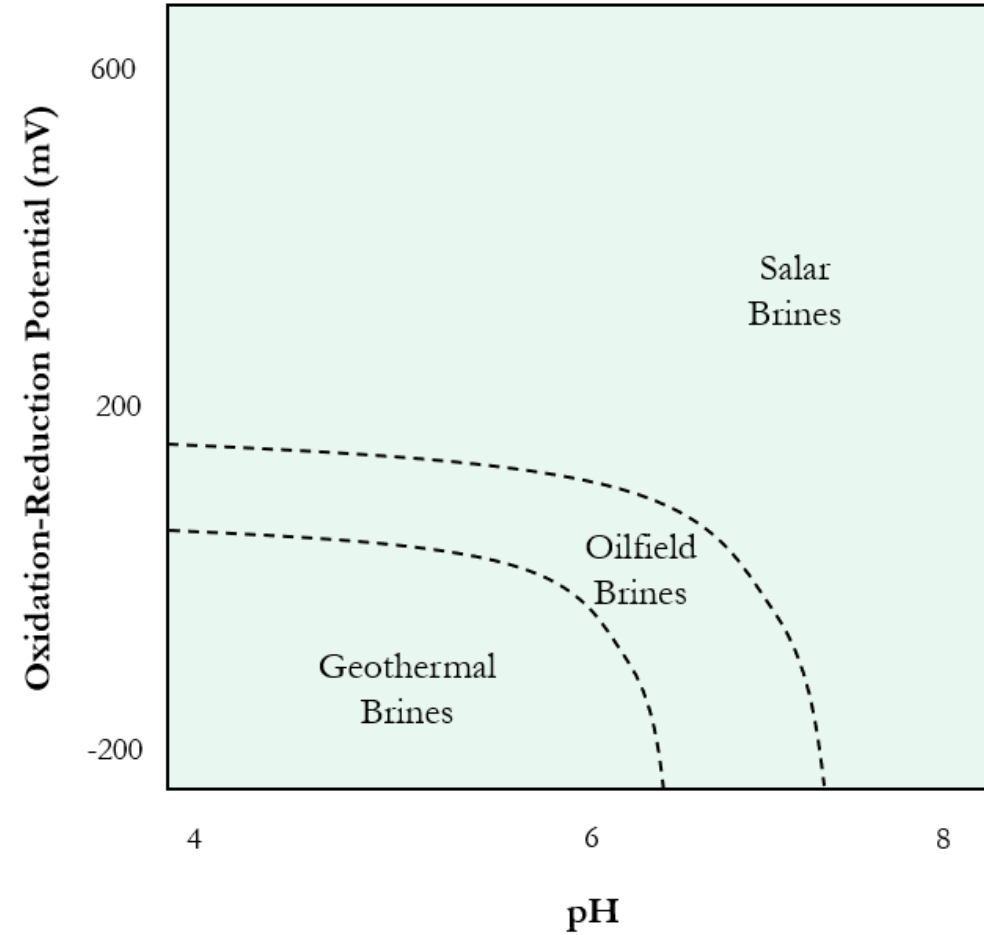
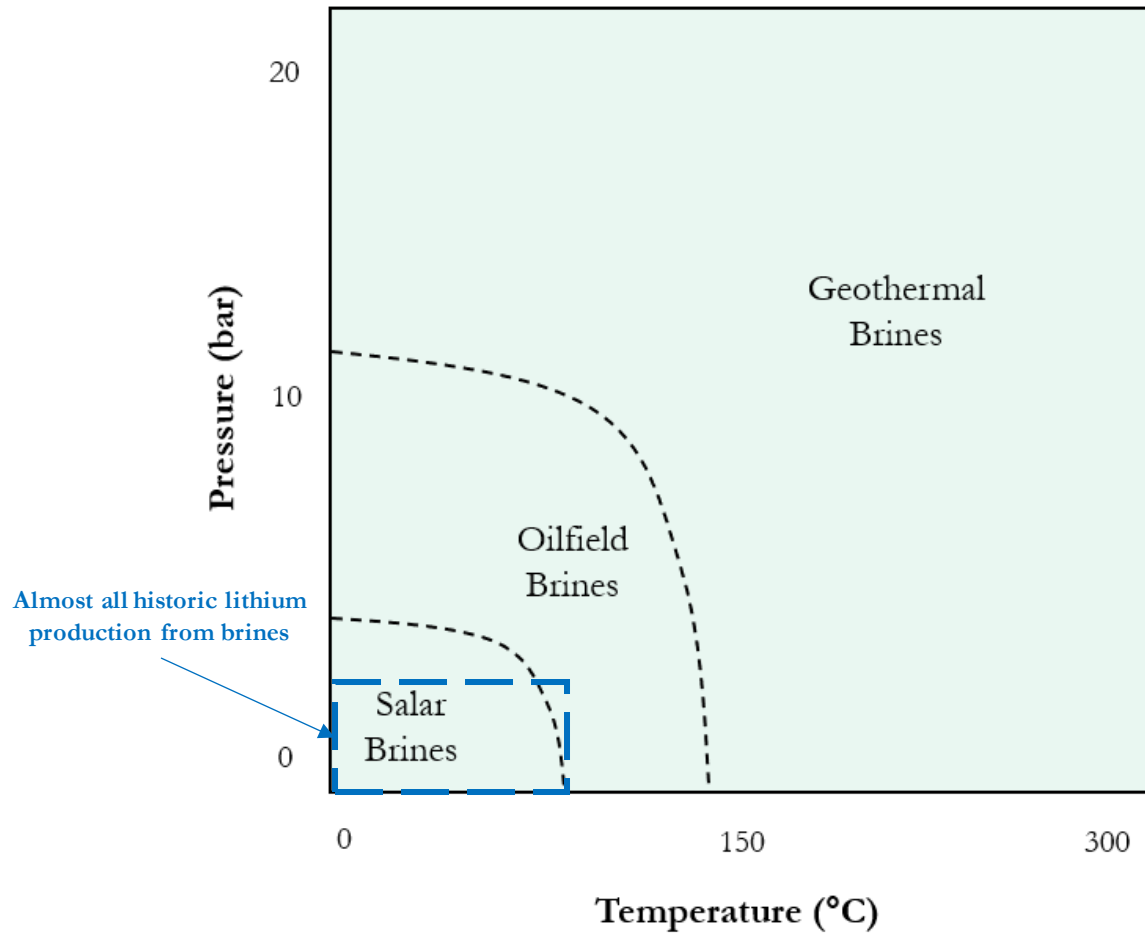

Please reach out if you have any questions!

Alex Grant

Principal, Jade Cove Partners

✉ ag@jadecove.com

🌐 www.jadecove.com/research

🐦 [alexjadecove](https://twitter.com/alexjadecove)

Lithium Valley Commission

29 July 2021

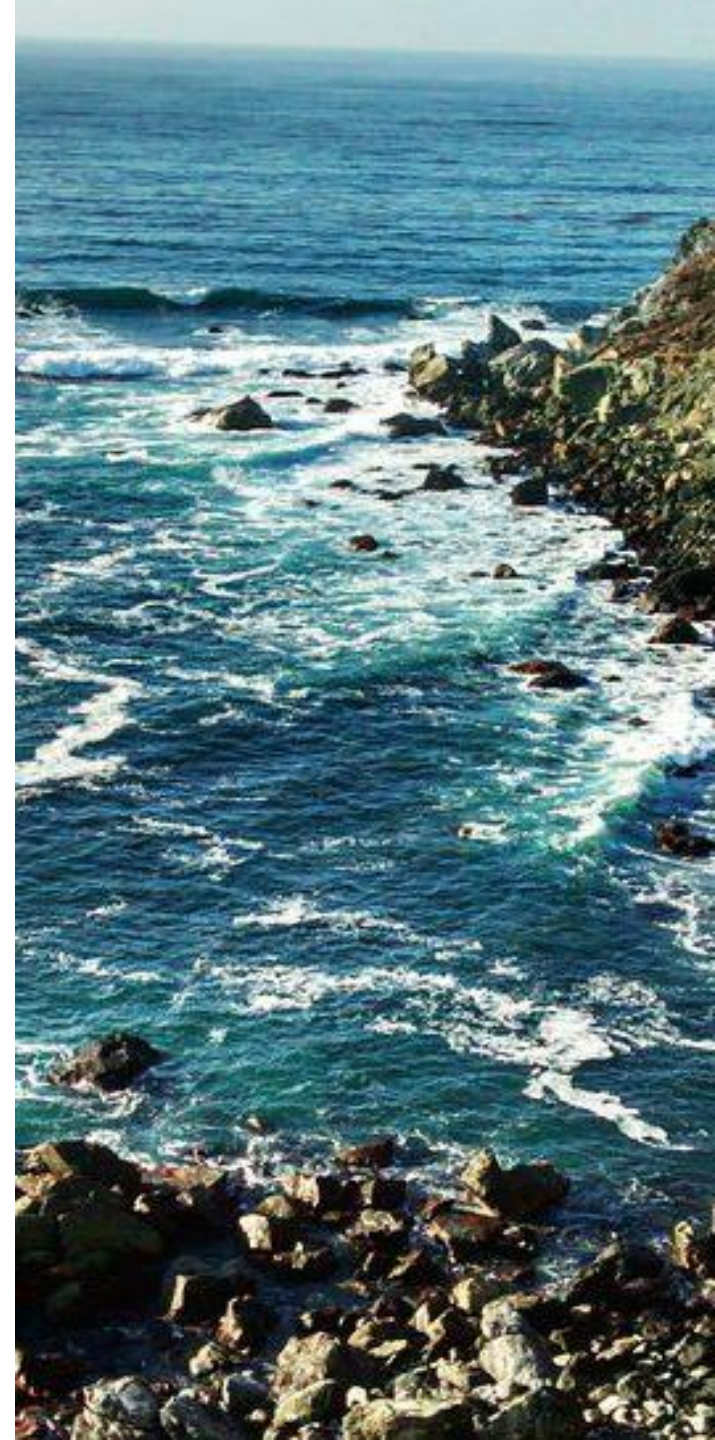



Lithium Extraction from Geothermal Brines

Ian Warren, Senior Geoscientist, NREL
Lithium Valley Commission meeting
July 2021

Lithium in Geothermal Brines

- Highest geothermal lithium concentrations occur at Salton Sea, CA (up to 400 mg/kg)

Salton Sea Resource

- Estimated 15 million metric tons Li (Chao, 2020)
- Potential production estimated at 600,000 mt LCE/yr
- Salton Sea powerplants had 2019 throughput containing ~127,750 mt LCE

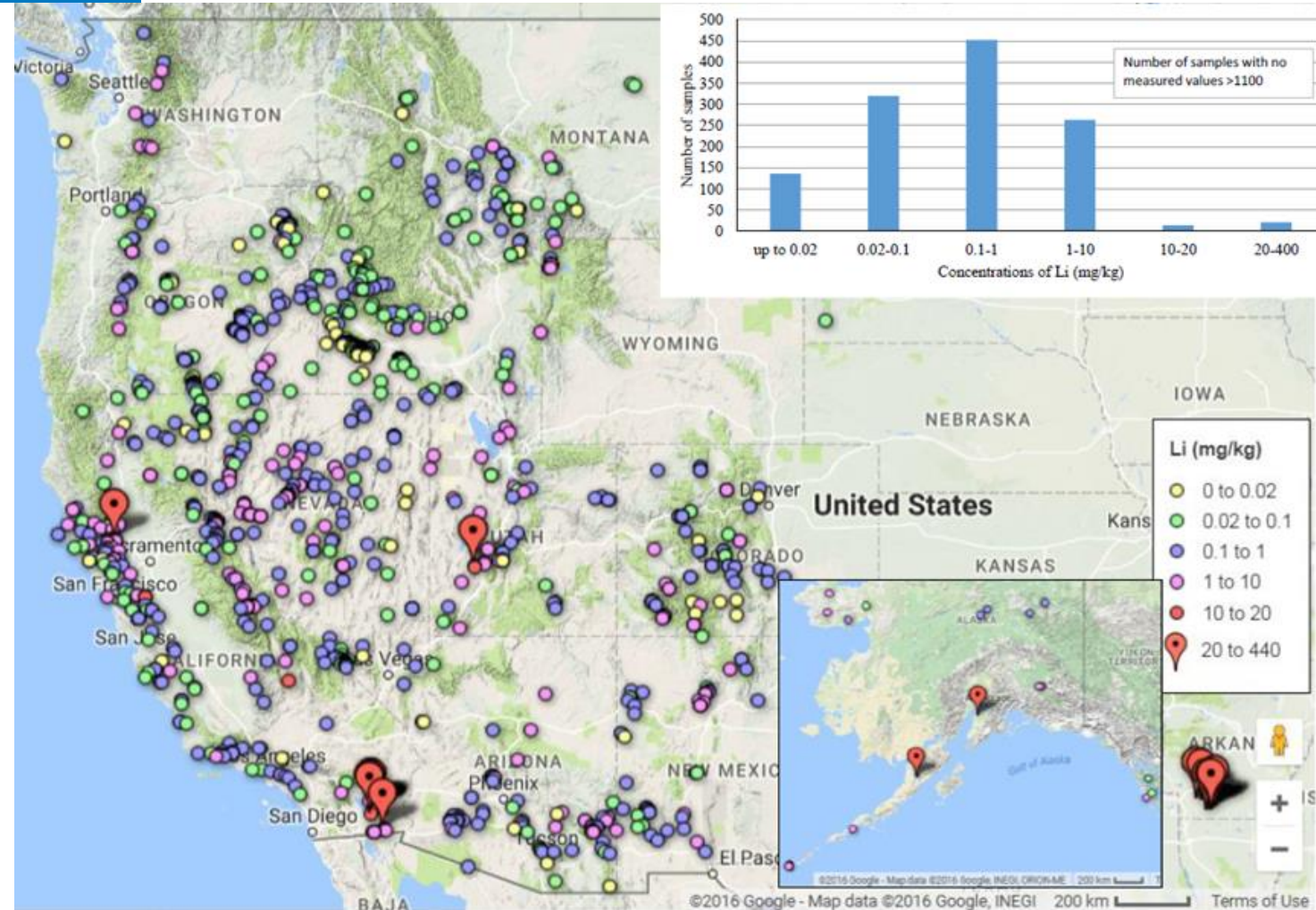

Neupane and Wendt (2017)

Past and Present

- **Waireki, NZ 1961:** Kennedy proposed concentration via electrolysis and evaporation
- **Salton Sea 1970:** Werner proposed sorption of metal ammines onto activated charcoal and sequential precipitation in evaporative ponds
- **Salton Sea 1970s and 80s:** U.S. Bureau of Mines studied metal concentrations in brines and processes to extract precious and base metals
- **Salton Sea 1980s and 90s:** Dow Chemical Company begins developing ion exchange resins for extracting lithium from brine, evolving to ion exchange pellets containing microcrystalline Li-Al salts
- **Salton Sea 1990s and 2000s:** Continued development largely focused on refining Li ion exchange materials and adsorption processes with Simbol project demonstrating technical and economic feasibility of Li extraction.
- **Salton Sea 2010s:** EnergySource, Controlled Thermal Resources, and others focusing on project development
- **Salton Sea today:** CEC-funded demonstration projects

DOE Support

Simbol pilot at CalEnergy and EnergySource power plants (2009-2014)

- Advances in silica management, lithium extraction, purification, concentration, and conversion into lithium hydroxide and lithium carbonate products.
- 95% of lithium extracted as LiCl with sorbents utilizing lithium-aluminum double hydroxide chloride.
- Concentrated LiCl solution could be converted to Li_2CO_3 and $\text{LiOH}\cdot\text{H}_2\text{O}$ end products with 90% yield (Harrison 2014).

Additional DOE R&D funding awarded in 2014

- Development of novel ion exchange resins and processes (Ventura et al. 2016). Continued refinement funded by CEC (Ventura et al. 2018, 2020).
- Thermoelectric generation, membrane distillation, Mn-oxide exchange resins (Renew & Hansen 2017).

Lithium Extraction Techniques

- Researchers are investigating a range of techniques with focus on (see Stringfellow and Dobson, 2021):
 - Sorbent selectivity
 - Tolerance for interfering ions
 - Purity of extracted lithium
- Companies are proposing adsorption, ion exchange, and solvent extraction processes for Li extraction from brines

Direct Lithium Extraction Techniques

Precipitation

Organic sorbents

Organic ion-exchange resins

Ion-imprinted polymers and other organic sorbents

Inorganic sorbents

Aluminum hydroxides

Manganese oxides

Titanium oxides

Other inorganic sorbents (various metal oxides)

Organic solvents

Crown ethers

Multicomponent

Extractant, co-extractant, diluent

Alternative diluents — ionic liquids, supercritical CO₂

Supported liquid membranes

Membranes

Reverse osmosis

Nanofiltration

Electrochemical separation

Electrodialysis

Combination with membrane and ion-exchange processes

Estimated Costs

(Publicly reported DLE projects)

Warren (2021) <https://www.nrel.gov/docs/fy21osti/79178.pdf>

| Project | Salton Sea | Upper Rhine Valley | Lanxess Smackover | Clearwater | Paradox Stage 3 | Clayton Valley | Kachi |
|-----------------------------|---------------------------------|-----------------------|---------------------------------|-----------------------|---------------------------------|-----------------------|---------------------------------|
| Location | California, USA | SW Germany | Arkansas, USA | Alberta, CAN | Utah, USA | Nevada, USA | Argentina |
| Brine type | geothermal | geothermal | evaporite (Br tail brine) | oilfield | evaporite | evaporite | salar |
| Resource (1000kg LCE) | NA | 15850000 | 3140000 | 2200000 | 192000 | 217700 | 1010000 |
| Li concentration (mg/L) | 400 | 181 | 168 | 74.6 | 100-500 | 65-221 | 289 |
| Production (mt/yr) | 20000 | 40000 | 20900 | 20000 | 15000 | 11500 | 25500 |
| Production cost (\$/mt LCE) | 3845 | 3656 | 4319 | 4155 | 4545 | 3217 | 4178 |
| Technology | ion exchange | adsorption | ion exchange | ion exchange | ion exchange | solvent extraction | ion exchange |
| Lithium recovery | 90% | 90% | 90% | >90% | 75% | 90% | 83.20% |
| Product | Li ₂ CO ₃ | LiOH·H ₂ O | Li ₂ CO ₃ | LiOH·H ₂ O | Li ₂ CO ₃ | LiOH·H ₂ O | Li ₂ CO ₃ |

- Estimates reported from a CEC/DOE-funded project and from public companies following stock exchange requirements
- Estimated costs from a range of brine types range from \$3217 to \$4319/mt LCE
- Cost estimates scaled from models, bench tests, and mini pilot tests



Salton Sea Geothermal Power

In 2020: >120 million metric tons of production; >2.9 GWh

Integrate Li extraction with power generation

- Power for processing
- Heat rejection (extraction techniques not designed for high temperature)
- Fluids handling for power production provide a “head start” for Li extraction

Or stand alone, Li-only (?)

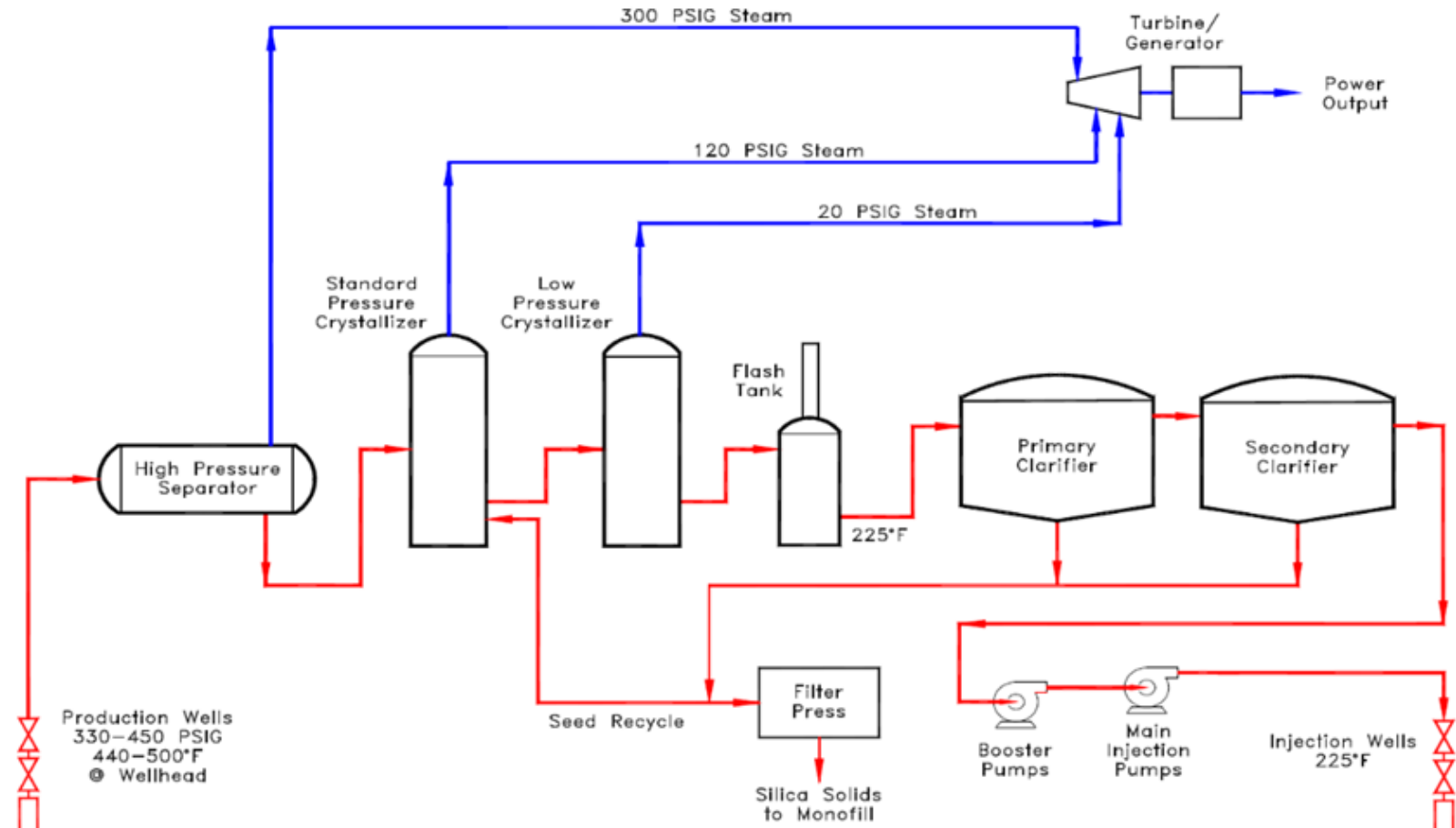

Example power production cycle at Salton Sea

Salton Sea Lithium Extraction (an example)

- Power plant injectate processed to remove additional silica, iron, zinc, manganese
- Concentrated LiCl stream with >90% of lithium from raw brine and >99.5% of impurities removed (details next slide)
- Polishing to remove calcium and magnesium
- Reverse osmosis Li concentration
- Evaporator water removal, additional Li concentration
- Precipitate lithium carbonate, remove water, redissolve, final impurity removal
- Recrystallize high purity lithium carbonate

Power generation

DLE and impurity removal

Lithium concentrating and impurity removal

Refining to make final lithium carbonate

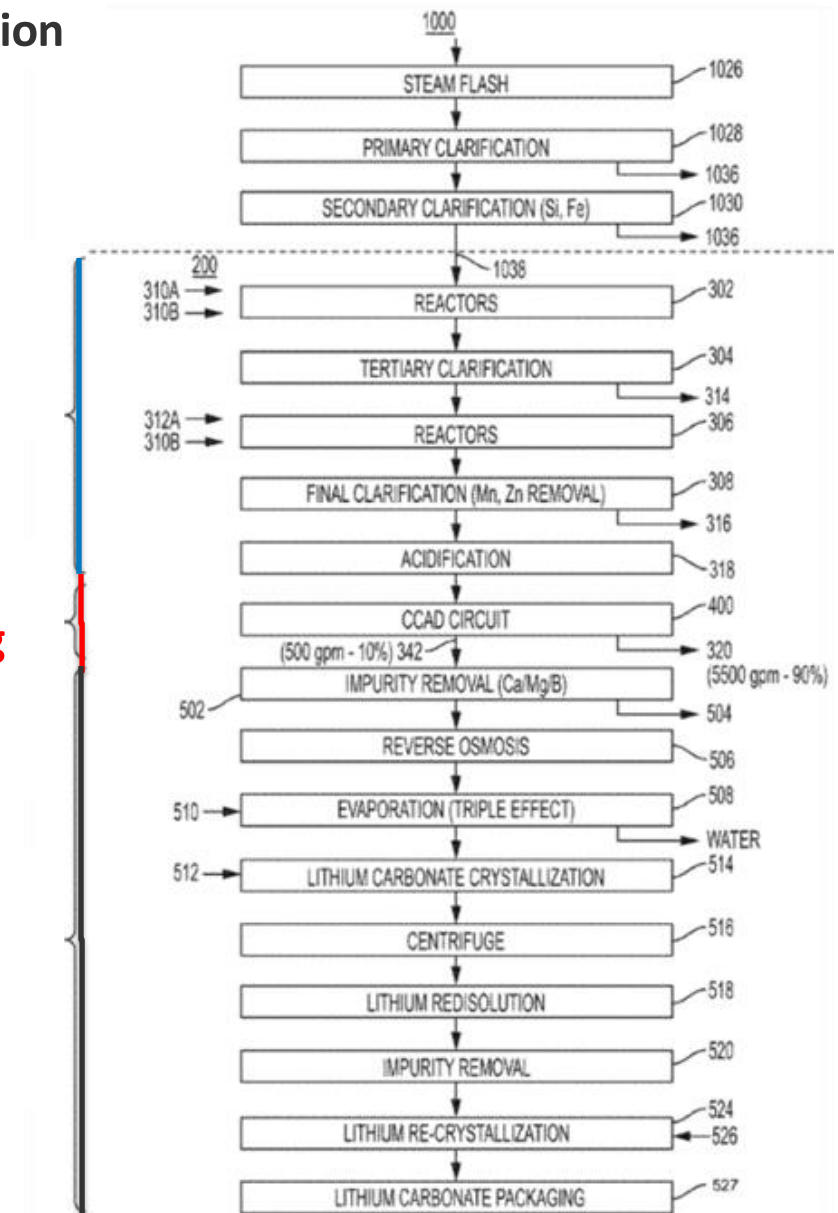

Salton Sea DLE (an example)

- Li-selective adsorption beds cycle continuously
- Polished LiCl brine pumped into adsorption loading zone
- Depleted brine removed
- Stripping solution (eluant) removes Li from adsorbent
- LiCl stream with 10-20x concentration and 99.9% of impurities removed

Continuous Countercurrent Adsorption and Desorption (CCAD)

A. adsorption displacement B. adsorption loading C. entrainment rejection D. elution

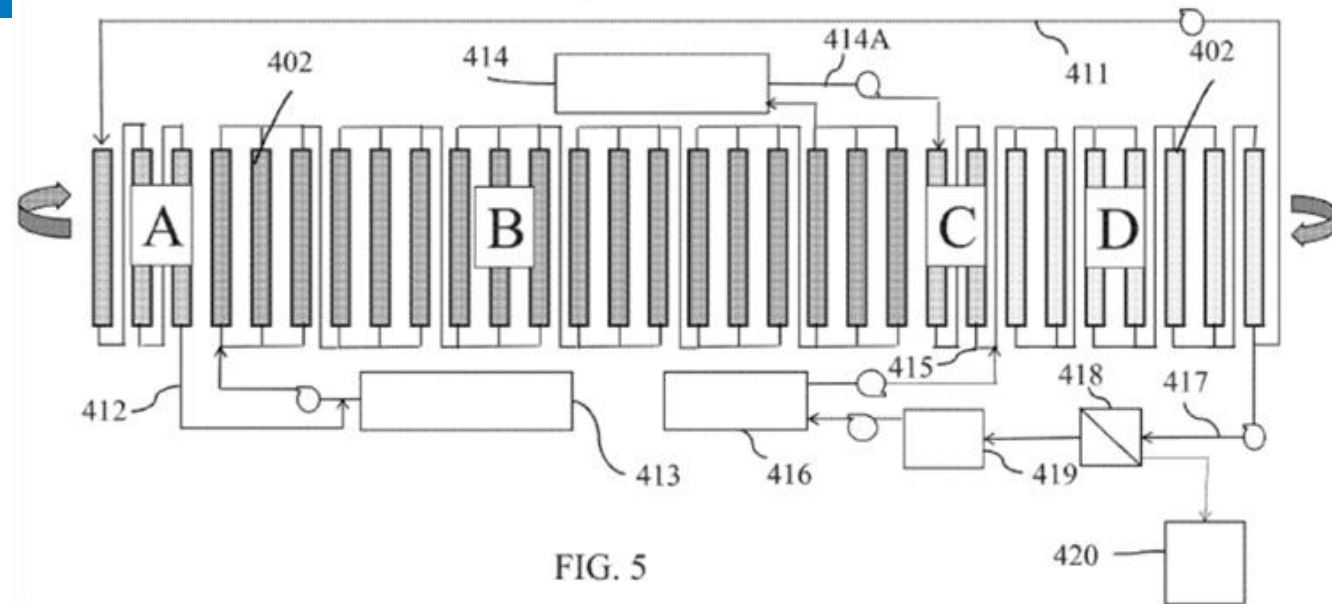

- 402: lithium selective adsorption beds cycle continuously through ABCD process zones
- 411: remove residual brine and salts from elution zone with portion of LiCl product stream
- 412: elution volume of feed brine removed
- 413: polished feedstock brine pumped into adsorption loading zone (B)
- 414: depleted brine to raffinate
- 414A: raffinate pumped to entrainment rejection (C) to displace latent eluate solution
- 415: latent eluate solution entrained in transition from entrainment rejection (C) to elution (D)
- 416: eluant (stripping solution) pumped countercurrent to adsorption advance in elution zone (D)
- 417: LiCl product stream with 10-20x Li concentration of eluant and 99.9% of impurities removed
- 418: optional reverse osmosis or nanofiltration membrane to further concentrate Li
- 419: recycled to make up eluant (416)
- 420: further Li-concentrated product stream

Conclusions

- Salton Sea brines are a significant potential lithium resource (15 million metric tons)
- A variety of processes can be adapted to extract lithium from geothermal brine
- Any given process likely will be unique to a lithium extraction operation, including different projects located in the Salton Sea KGRA, based on fluid physical and chemical properties and on technology availability and cost.
- Public information from multiple lithium brine projects (geothermal, oilfield, evaporite) suggest operating costs of \$4000/mt LCE are achievable.
- Performance and cost data from demonstrations are crucial to understand the opportunity and potential of lithium production at scale at Salton Sea.

Thank you!

www.nrel.gov

Techno-Economic Analysis of Lithium Extraction from Geothermal Brines
<https://www.nrel.gov/docs/fy21osti/79178.pdf>

This work was authored by the National Renewable Energy Laboratory, operated by Alliance for Sustainable Energy, LLC, for the U.S. Department of Energy (DOE) under Contract No. DE-AC36-08GO28308. Funding provided by U.S. Department of Energy, Office of Energy Efficiency and Renewable Energy, Geothermal Technologies Office. The views expressed in the article do not necessarily represent the views of the DOE or the U.S. Government. The U.S. Government retains and the publisher, by accepting the article for publication, acknowledges that the U.S. Government retains a nonexclusive, paid-up, irrevocable, worldwide license to publish or reproduce the published form of this work, or allow others to do so, for U.S. Government purposes.





Lithium Resource Panel

- Moderator:
 - Michael Whittaker, Lawrence Berkeley National Laboratory
- Panelists:
 - Eric Smith, BHE Renewables
 - Derek Benson, EnergySource Minerals
 - Jim Turner, Controlled Thermal Resources

Lithium Resource Research and Innovation Center

Lawrence Berkeley National Laboratory



Powering the resource-to-recharge revolution

Lithium Resource Research and Innovation Center
LiRRIC (/ˈlɪrɪk/) – sounds like ‘lyric’

Motivation

- **Urgency:** Exponential EV demand growth will require unprecedented quantities of lithium. Grid-scale storage will require orders of magnitude more. The US produces almost none of its own lithium.
- **Opportunity:** Unconventional domestic resources have sufficient lithium to satisfy demand for a century. Unlocking them will make domestic lithium highly cost competitive with the right understanding of 1) the resources 2) extraction technology

Mission

- **Discovery:** Technology breakthroughs catalyzed by deep understanding of natural and produced resources
- **Leadership:** Environmentally responsible empirical analysis and industrial partnership across the lithium resource spectrum
- **Action:** Getting solutions from bench to battery quickly through hands-on training, active collaboration, technology incubation, and IP transfer

LBNL: lithium research, workforce, and tech

Diverse Research



fundamental geoscience



clean water hub



battery research and technology

Hands-on Training

user facilities:



Technology Transfer

entrepreneurship:

cyclotronroad

business development:



Industrial Partnerships



LithiumAmericas

ioneer



Liveint

...and many more

LiRRIC - Geothermal lithium experts

Technology for Lithium Extraction in the Context of Hybrid Geothermal Power

William T. Stringfellow and Patrick F. Dobson

Lawrence Berkeley National Laboratory, Energy Geosciences Division, Berkeley, CA 94720

wstringfellow@lbl.gov, pfdobson@lbl.gov

Retrospective on Recent DOE-Funded Studies Concerning the Extraction of Rare Earth Elements & Lithium from Geothermal Brines LBNL-2001359 (Final Report)

*William T. Stringfellow & Patrick F. Dobson
Lawrence Berkeley National Laboratory
Energy Geosciences Division*

September 23, 2020

Funded by CEC and DOE for technoeconomic analysis of full and pilot scale plants
Funded by LBL for LiRRIC and UC Davis collaboration
Partnering with Mike McKibben's team at UC Riverside on resource quantification

more information at www.lirric.lbl.gov/publications/

LiRRIC and LVC – maximizing impact

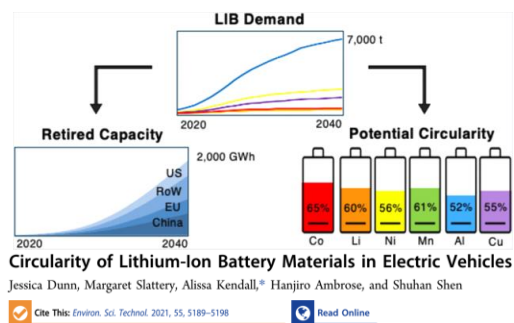

- Partnered with Alissa Kendall’s team at UC Davis
 - Experience with lithium battery recycling analysis
 - Supporting AB2832 implementation for 100% battery reuse or recycling
 - Similar process to AB1657 (LVC)

New LiRRIC-sponsored research with Berkeley Lab and UC Davis teams on geothermal lithium in the Salton Sea region

- Goal: use themes raised by LVC stakeholders to guide life cycle assessment – underway now!

LVC transcript analysis

9. So it's going to be important that we
10. have those conversations. Does a community want
11. jobs, benefits, so on? Yeah, I think we all
12. want that; right? But we've got to make sure
13. that we, again, are recalibrating and addressing
14. through this great opportunity, because a lot of
15. times we don't have that opportunity.

16. And I think it's going to be important to
17. talk about the waste streams. Is enough being
18. done? I've always publicly and, you know, very

Community engagement
Waste stream

emerging themes

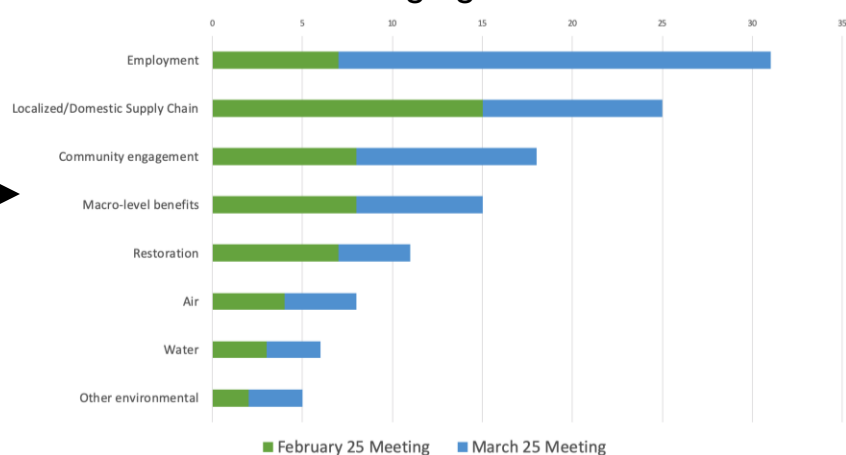

do you have a stake in Lithium Valley?
we want to hear from you!

www.lirric.lbl.gov/LVC



Happening Now: Panel discussion

AB 1657: (5) Safe environmental methods and standards for lithium extraction from geothermal brines and how this compares to other methods for deriving lithium

(10 minutes) each Panelists: BHE, EnergySource, CTR

Questions to cover during presentations

- what's your **technology**
- what are your **waste streams** (of lithium extraction)
- what's the **status of your development**

(20 minutes) Moderated Discussion

(20 minutes) Lithium Valley Commission Q&A

Reminder: This is the first of 8 subtopics

- our goal is to establish a a common understanding of the core technologies and developments
- there will be ample time in future meetings to address other subtopic issues



Lithium Valley Commission

July 29, 2021 Meeting

BHE Renewables, LLC Update

Eric Smith

**Vice President, Lithium Development
BHE Renewables, LLC**

Presentation Topics



- Technology
- Waste Streams
- Status of Development

Imperial Valley, California





**BERKSHIRE HATHAWAY
ENERGY**

Sustainable Lithium. Delivered.

Lowest environmental footprint
Resilient US-based supply
Executing on-time, at quality



PROJECT ATLiS DELIVERS

Most resilient and sustainable source of battery-spec lithium in the USA, available **starting 2024**.

Nameplate capacity:

- **20k tpa LiOH.H₂O**, with
- Mn and Zn co-products

Advanced, de-risked stage of execution. Pilot facility **product meet quality specs**. Feasibility Study compete.

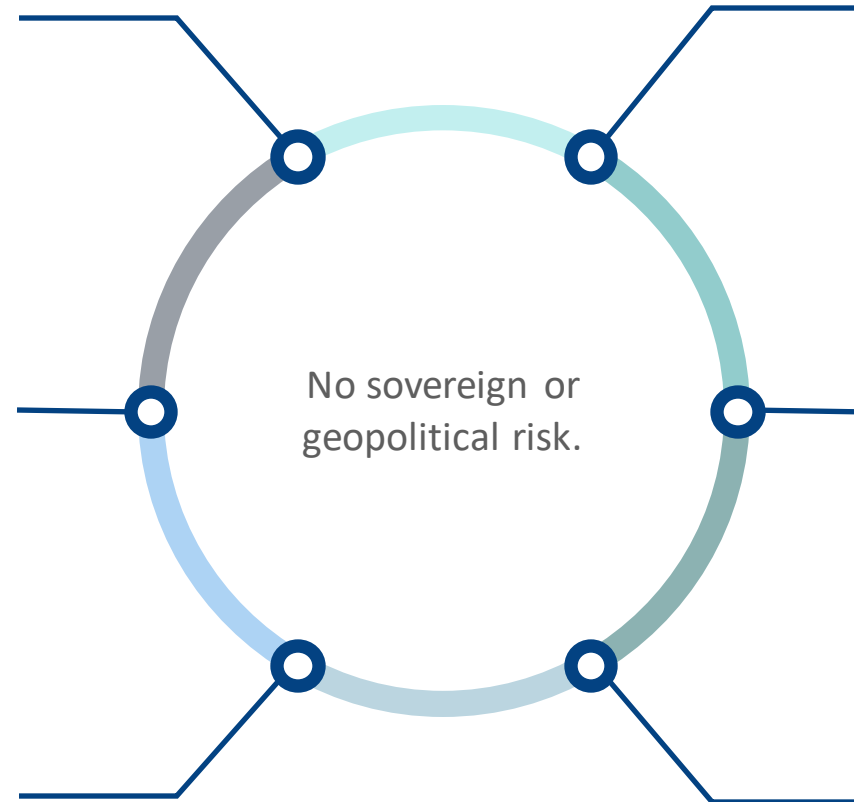

Execution team includes industry veterans, local expertise, and world-class vendor-partners.

Hosted by existing industrial facility in Southern California, a commercial **55 MW geothermal plant** circulating brine since 2012.

Option to source low-footprint, low-risk **Mn and Zn co-products**.

PROJECT DE-RISKED



LESSONS LEARNED

Analyze past successes and failures in the lithium industry and advance the project on lessons learned.



EXISTING OPERATIONS

Integrates with existing 55 MW geothermal plant circulating Li-bearing brine at 7,000 gpm / 1,574 m³/hr.



VENDOR SELECTION

Selecting partners remedies the process, technology, and product quality risk.



EARLY ENGAGEMENT

Engaging customers early ensures the product is a fit before commercial supply commences.

DEVELOPMENT TIMELINE

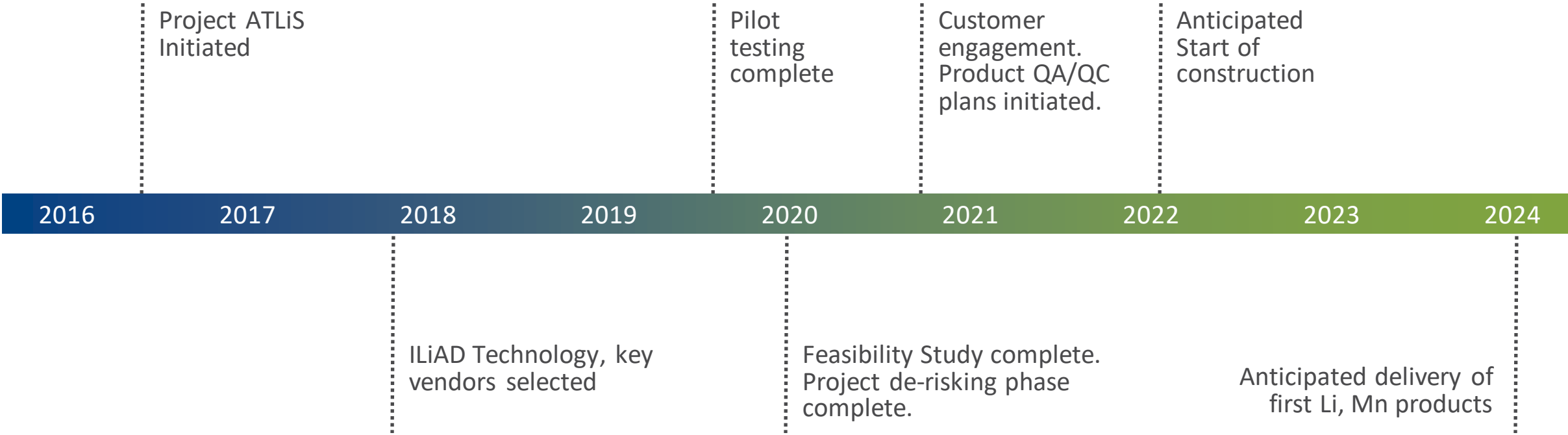

Project ATLiS is among the most advanced lithium projects:

- 5 years of development and piloting on real brines
- Will integrate with existing geothermal production
- Awaiting final permits

COMMERCIALLY READY TECHNOLOGY

The ILiAD™ Platform

At TRL 8...

ILiAD is a technology platform capable of unlocking most major brine resources.

ILiAD transforms the production process of battery spec lithium carbonate or hydroxide and can be integrated into conventional downstream crystallization processes.

ILiAD delivers best in class lithium recovery, lowest capital and operating costs for separation, and the smallest environmental footprint.

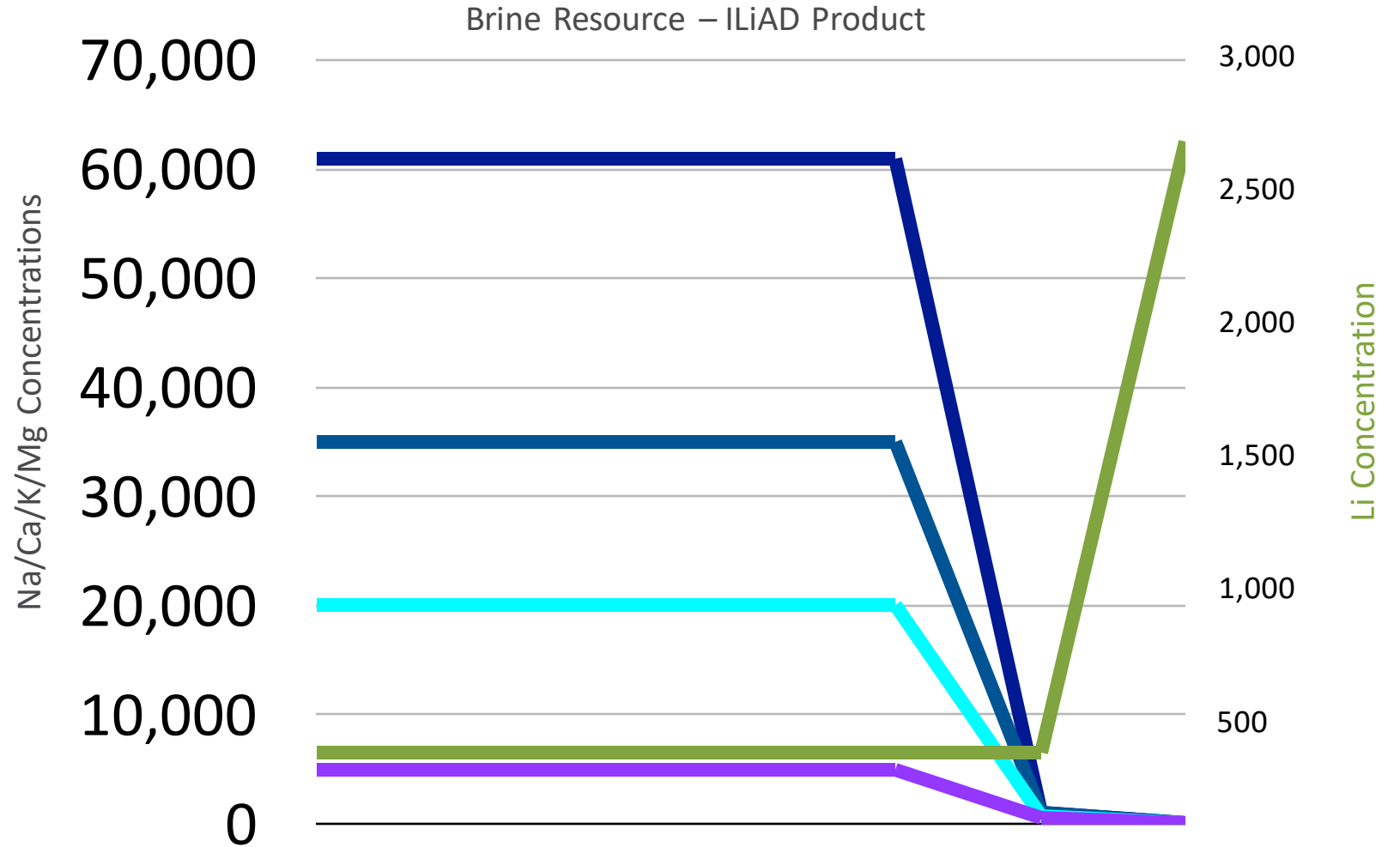

COMMERCIALY READY TECHNOLOGY

The ILiAD™ Platform

Market acceptance with TRL 8...

ILiAD technology platform is being deployed currently on multiple North American resources, two South American resources, with more two follow.

ILiAD scalability offers great flexibility for wide range of applications and deployments;

- 1 gpm and 5 gpm pilots operational
- 100 gpm commercial demonstration in construction
- 1,500 gpm commercial design (5x1 configuration) at Project ATLiS.



ILiAD TECHNOLOGY

The ILiAD advantage:

- ✓ No reagents, no deleterious waste products
- ✓ Lowest water use
- ✓ Lowest resin inventory of any DLE approach
- ✓ Durable sorbent: 1000's of cycles without degradation, at high temperature
- ✓ Qualified blue-chip vendors
- ✓ Scalable deployment in modular phases
- ✓ Lowest cost, lowest footprint, commercially-deployable today
- ✓ Patented + trade secret

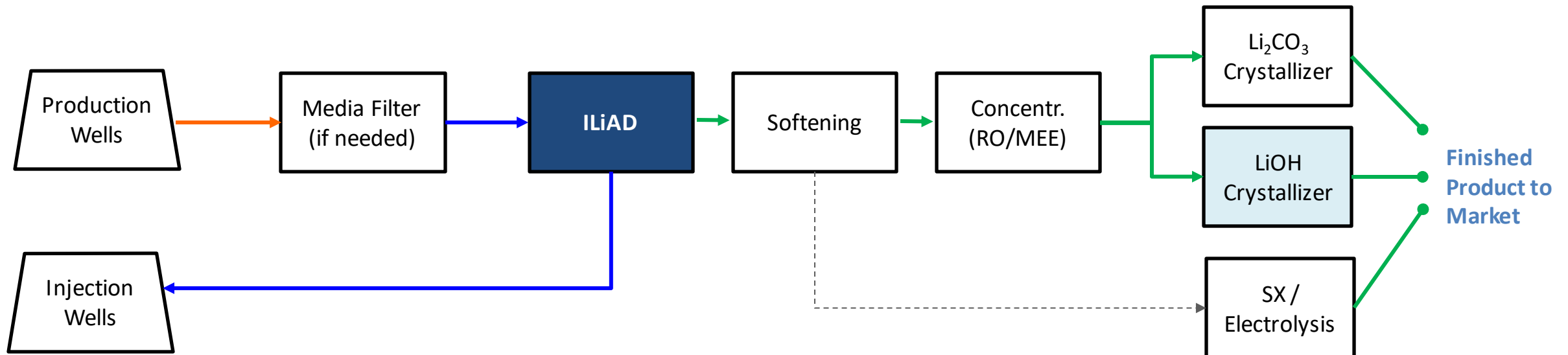

LITHIUM DELIVERED

BATTERY-SPEC LITHIUM PRODUCED

Sample battery-spec lithium carbonate and lithium hydroxide material produced in 2019.

Feasibility study completed in 2019 and backed by vendor-partners.

Confirmed that costs remain low on the industry cost curve.

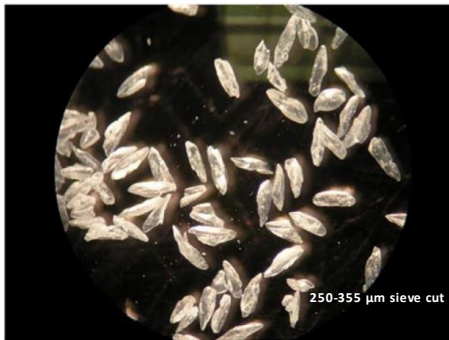

| ELEMENT | SPECIFICATION | UNITS | RESULTS | ANALYSIS |
|--------------------|---------------|------------|---------|-----------|
| LiOH | 56.5 | wt% | 56.5 | OH |
| CO2 | 3000 | mg/kg, max | 656 | TIC |
| Cl | 15 | mg/kg, max | <10 | titration |
| Na | 20 | mg/kg, max | <10 | AA |
| K | 10 | mg/kg, max | <10 | AA |
| Ca | 10 | mg/kg, max | <1 | ICP |
| Mg | 10 | mg/kg, max | <10 | AA |
| Fe | 20 | mg/kg, max | <1 | ICP |
| Mn | 5 | mg/kg, max | <1 | ICP |
| Cu | 5 | mg/kg, max | <1 | ICP |
| Ni | 10 | mg/kg, max | <1 | ICP |
| Zn | 10 | mg/kg, max | <1 | ICP |
| SO4 | 50 | mg/kg, max | <50 | ICP |
| B | | mg/kg, max | <1 | ICP |
| Si | 30 | mg/kg, max | 9 | ICP |
| Al | 10 | mg/kg, max | <1 | ICP |
| Cr | 5 | mg/kg, max | <1 | ICP |
| Heavy Metals as Pb | 10 | mg/kg, max | <1 | Pb(ICP) |

PROJECT ATLiS



The most sustainable source of lithium, operating at a fraction of the carbon, water and land footprints of today's production facilities.

PROJECT ATLiS

Lowest CO₂ Emissions

Tons CO₂ eq.
per ton
LiOH•H₂O

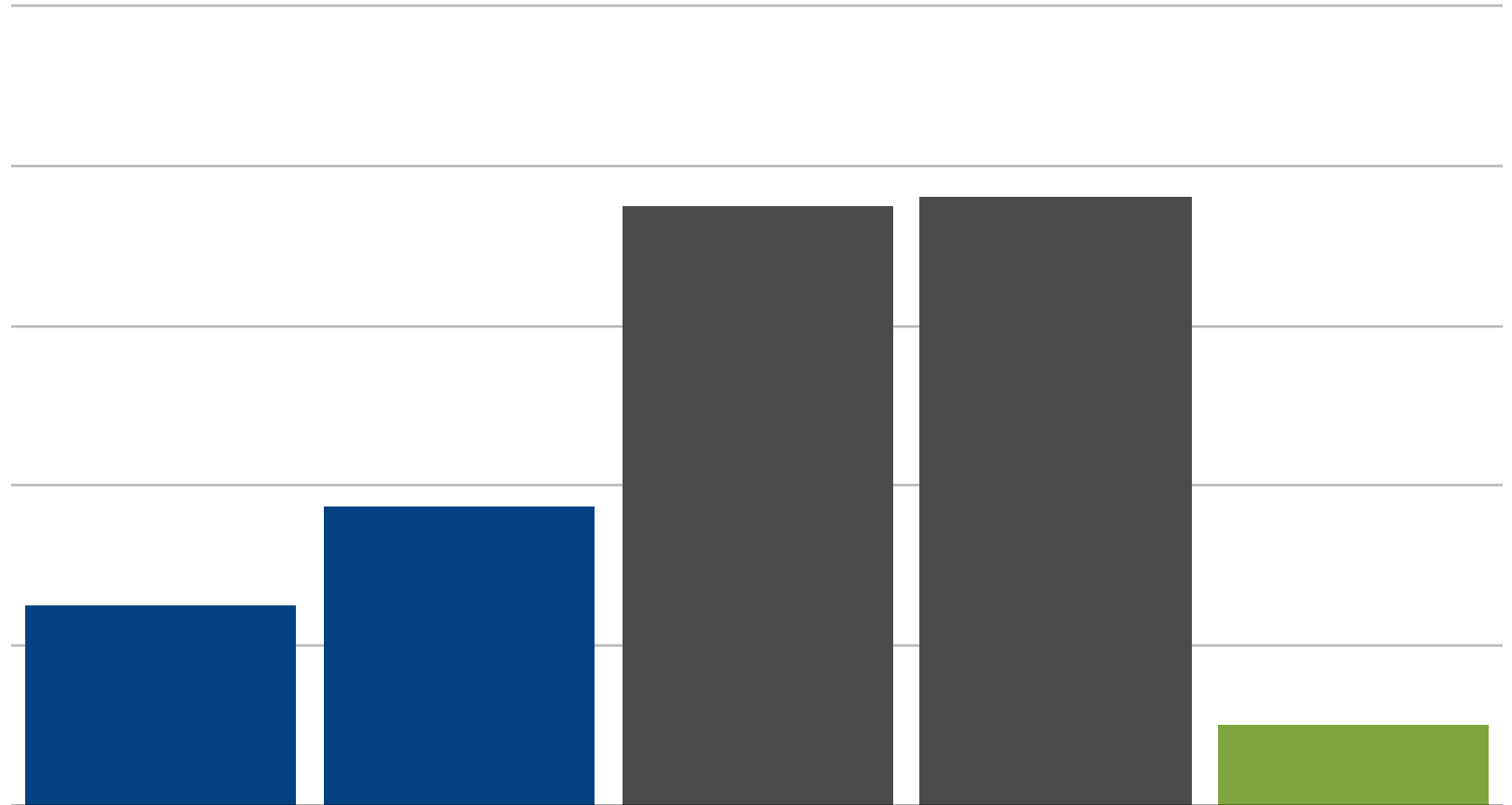

South
American
Brine #1

South
American
Brine #2

W.
Australian
Hard Rock

Eurasian
Hard Rock

Project Atlas

PROJECT ATLiS

Lowest Water Demand

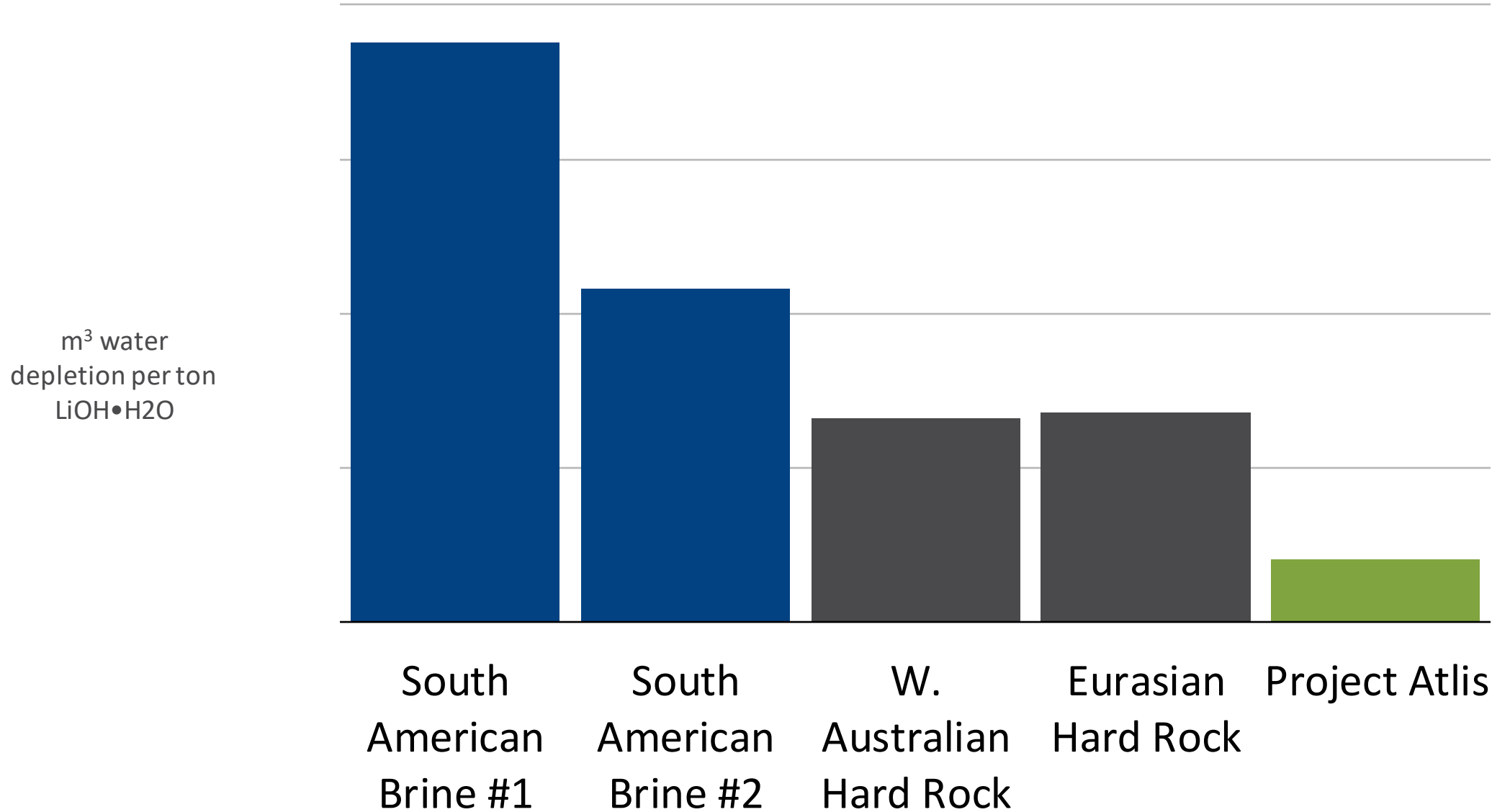

PROJECT ATLiS

Smallest Land Use

Land Use
(m² per ton
LiOH•H₂O)

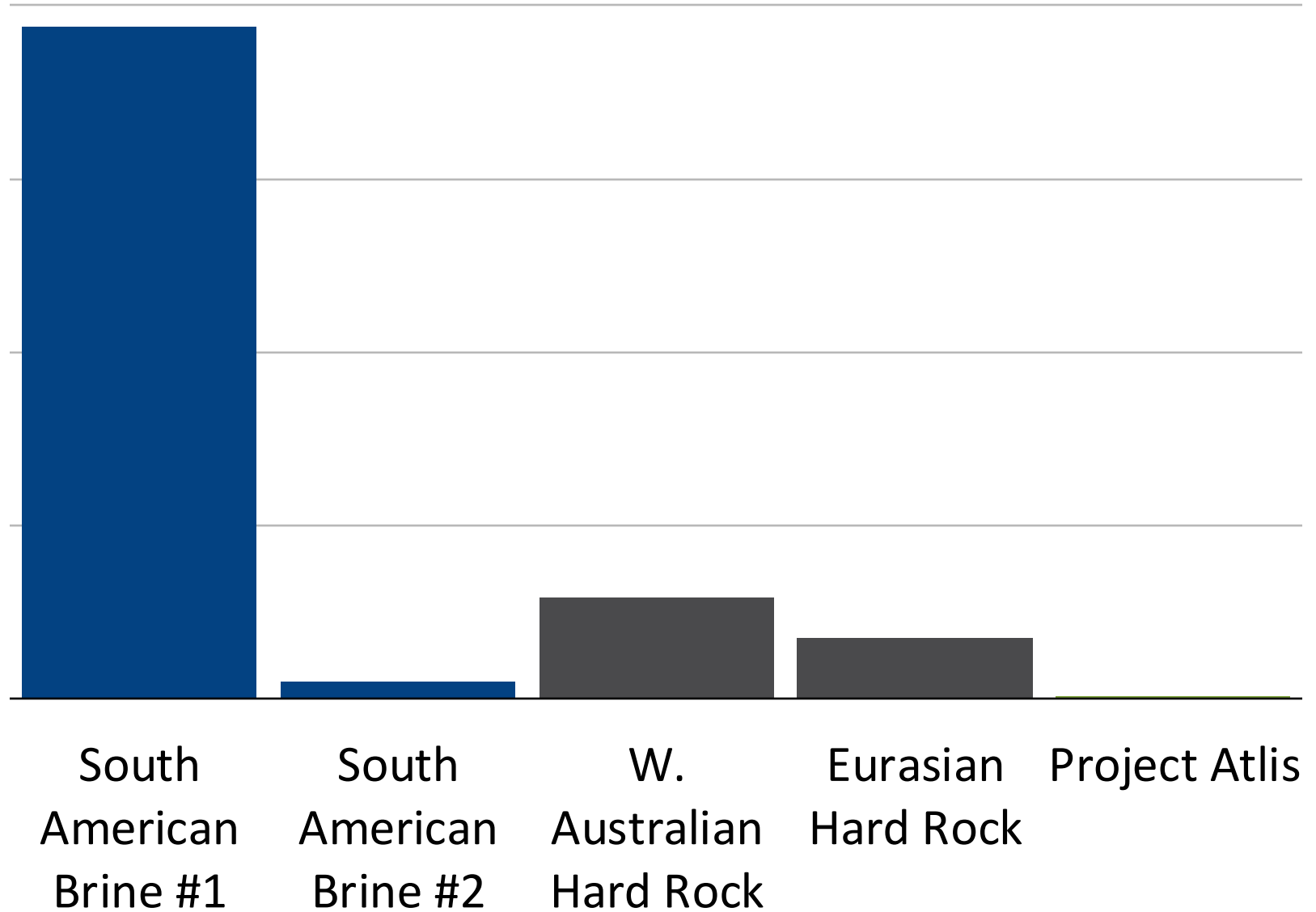

COMPETITIVE ON ALL FRONTS



Environment



Cost



Location



Execution

Thank You

Derek Benson
Chief Operating Officer

dbenson@energysource.us.com

www.esminerals.com

The **POWER** of California's



CONTROLLED
THERMAL
RESOURCES

Lithium Valley



4,000+
Jobs



Reliable
Clean Energy



New Lithium
Economy

Salton Sea
Repair

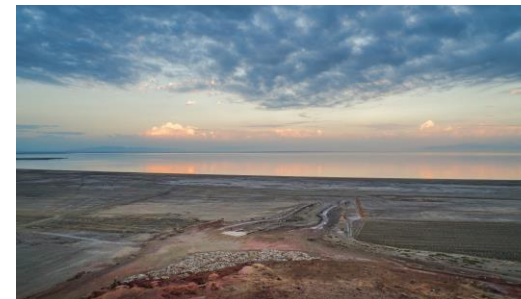

Jim Turner – Chief Operating Officer

- 25+ years' experience at the Salton Sea
- 20 years with Dow Chemical
- Loaned to Magma Power in 1993 – CalEnergy – Mid American – Berkshire Hathaway
- ProSonic Drilling
- EnergySource
- Controlled Thermal Resources



Hell's Kitchen Lithium + Power

The background of the slide is a photograph of an industrial facility. It features several large, vertical, cylindrical stainless steel tanks. A complex network of metal scaffolding and walkways is visible, with some walkways having orange safety railings. The lighting is bright, suggesting an outdoor or well-lit indoor environment.

Growth in our understanding of this robust resource

Salton Sea Geothermal Field Resource Estimate
~600,000 tonnes per annum LCE

Hell's Kitchen Total Lithium capacity:
~300,000 tonnes per annum LCE

Hell's Kitchen Total Power capacity:
~1,100 megawatts

Additional resources include potassium, zinc, manganese, iron and rubidium

Fully integrated design for power and lithium

- No evaporation ponds
- No production tailings
- No open pit mines

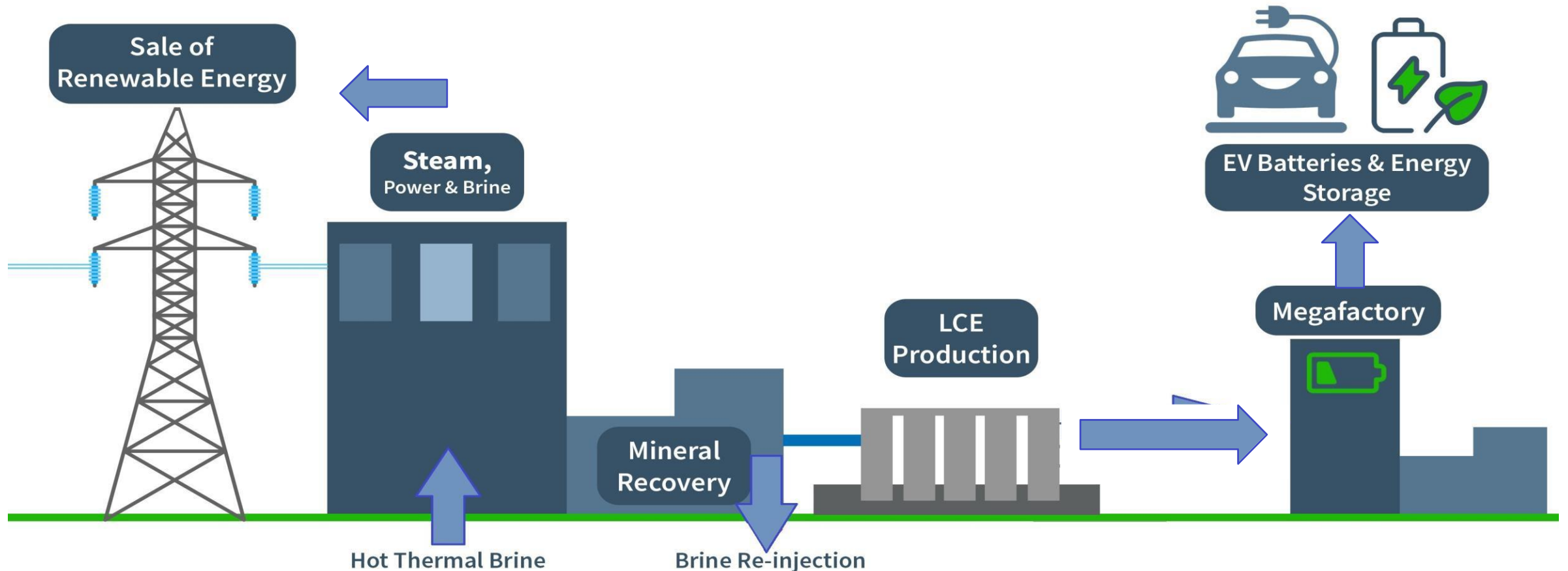

Reduce toxic dust and air pollutants with master-planned solutions



Key benefits and Goals

- Create new project, construction and ancillary jobs
- Strengthen community infrastructure programs
- Support U.S. clean power and critical minerals supply
- Assist in dust abatement in an area designated as an Imperial County State of Emergency
- Develop long-term economic, educational and positive community growth

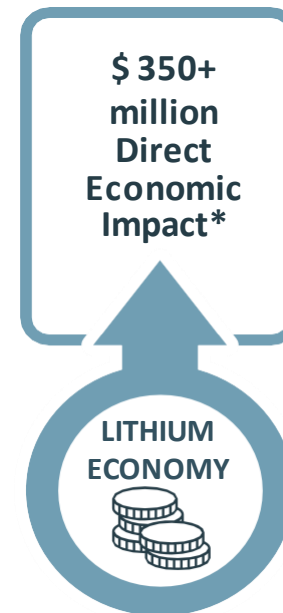
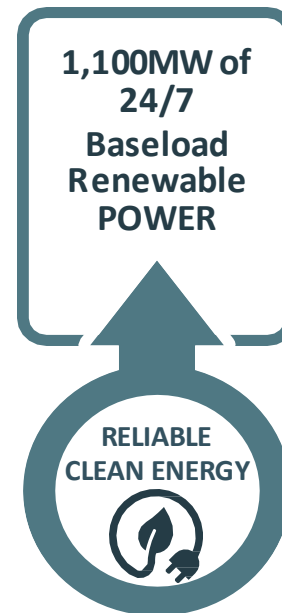
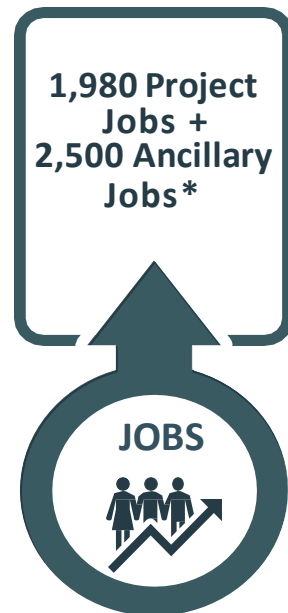

*Source: Imperial Valley Economic Development Corporation – Hell’s Kitchen Lithium and Power Project: Economic Impact Analysis (Total Capacity)



CONTROLLED THERMAL RESOURCES

CTR is committed to creating a thriving, safe and sustainable future for generations to come.

447 West Aten Road, Suite G
Imperial, California USA 92251
www.cthermal.com
info@cthermal.com

Disclaimer: This presentation was prepared by Controlled Thermal Resources (US) Inc. and affiliates (the "Company") in order to provide preliminary information. This presentation is not a prospectus for a public offering, an offering memorandum or a solicitation to enter into any kind of transaction, including to sell the securities of any entity. Neither the Company nor any of its representatives make any representation or warranty, express or implied, as to the accuracy or completeness of this presentation or the information contained herein. This presentation may include certain statements, estimates and projections provided by the Company with respect to the future performance of the Company. Such statements, estimates and projections reflect assumptions made by the Company concerning anticipated results and are subject to business, economic and competitive risks, uncertainties and contingencies, many of which are beyond the control of the Company. Accordingly, there can be no assurance that such statements, estimates and projections will be realized, and actual results may differ materially from those

suggested or implied by such statements, estimates and projections.



CONTROLLED
THERMAL
RESOURCES



Moderated Discussion

- Moderator:
 - Michael Whittaker, Lawrence Berkeley National Laboratory
- Panelists:
 - Eric Smith, BHE Renewables
 - Derek Benson, EnergySource Minerals
 - Jim Turner, Controlled Thermal Resources



Lithium Valley Commission Q&A

- Moderator:
 - Michael Whittaker, Lawrence Berkeley National Laboratory
- Panelists:
 - Eric Smith, BHE Renewables
 - Derek Benson, EnergySource Minerals
 - Jim Turner, Controlled Thermal Resources



Public Comment

Comment Instructions:

Limited to 3 minutes per comment

By computer: use the “raise hand” feature in Zoom

By telephone: dial *9 to “raise hand” and *6 to mute/unmute your phone line





Future Meeting Discussion

- Determination of Agenda Topics, Speakers, Presentations
 - August – Furthering Geothermal Development
 - September – Market Opportunities for Lithium
 - October – Economic and Environmental Impacts
 - Suggested December - Incentives



Public Comment

Comment Instructions:

Limited to 3 minutes per comment

By computer: use the “raise hand” feature in Zoom

By telephone: dial *9 to “raise hand” and *6 to mute/unmute your phone line





Public Comment

Comment Instructions:

Limited to 3 minutes per comment

By computer: use the “raise hand” feature in Zoom

By telephone: dial *9 to “raise hand” and *6 to mute/unmute your phone line





Adjourn



Webpage: <https://www.energy.ca.gov/data-reports/california-power-generation-and-power-sources/geothermal-energy/lithium-valley>

List Serv: Lithium Valley Commission

Thank you!

LithiumValleyCommission@energy.ca.gov



Break

LithiumValleyCommission@energy.ca.gov