

DOCKETED	
Docket Number:	21-BSTD-01
Project Title:	2022 Energy Code Update Rulemaking
TN #:	237707
Document Title:	Nonresidential Computer Room Efficiency CASE Report
Description:	Document Relied Upon. CASE Report #2022-NR-HVAC1-F. Authors: Hillary Weitze, Neil Bulger, and Jeff Stein. March 2021.
Filer:	Adrian Ownby
Organization:	California Energy Commission
Submitter Role:	Commission Staff
Submission Date:	5/6/2021 10:54:21 AM
Docketed Date:	5/6/2021

Nonresidential Computer Room Efficiency

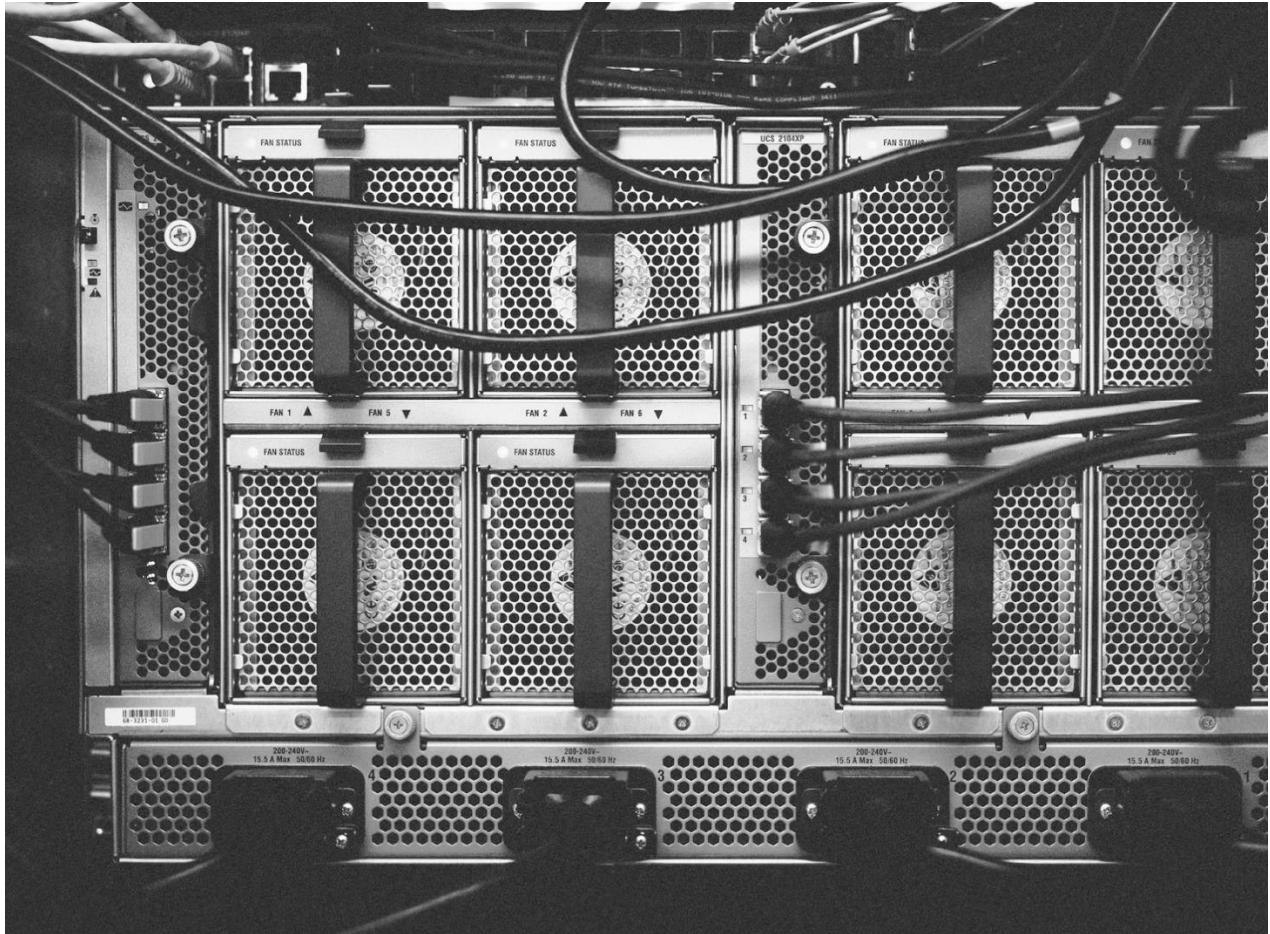

2022-NR-HVAC1-F | Nonresidential HVAC | March 2021

UPDATED FINAL CASE REPORT

Prepared by Red Car Analytics

Please submit comments to info@title24stakeholders.com.



This report was prepared by the California Statewide Codes and Standards Enhancement (CASE) Program that is funded, in part, by California utility customers under the auspices of the California Public Utilities Commission.

Copyright 2020 Pacific Gas and Electric Company, Southern California Edison, San Diego Gas & Electric Company, Los Angeles Department of Water and Power, and Sacramento Municipal Utility District. All rights reserved, except that this document may be used, copied, and distributed without modification.

Neither Pacific Gas and Electric Company, Southern California Edison, San Diego Gas & Electric Company, Los Angeles Department of Water and Power, Sacramento Municipal Utility District or any of its employees makes any warranty, express or implied; or assumes any legal liability or responsibility for the accuracy, completeness or usefulness of any data, information, method, product, policy or process disclosed in this document; or represents that its use will not infringe any privately-owned rights including, but not limited to, patents, trademarks or copyrights.



Document Information

Category:	Codes and Standards
Keywords:	Statewide Codes and Standards Enhancement (CASE) Initiative; California Statewide Utility Codes and Standards Team; Codes and Standards Enhancements; 2022 California Energy Code; 2022 Title 24, Part 6; efficiency; computer room; data center; economizer; uninterruptible power supply; power usage effectiveness; air containment.
Authors:	Hillary Weitze, Neil Bulger (Red Car Analytics), Jeff Stein (Taylor Engineering)
Acknowledgements:	Tim Minezaki (Energy Solutions), Tasha Harvey, Paul Langer, Elizabeth Joyce (Arup)
Prime Contractor:	Energy Solutions
Project Management:	California Statewide Utility Codes and Standards Team: Pacific Gas and Electric Company, Southern California Edison, San Diego Gas & Electric Company, Los Angeles Department of Water and Power, Sacramento Municipal Utility District.

Table of Contents

- 1. Introduction** **7**
 - 1.1 Introduction to Statewide CASE Team 7
 - 1.2 Document Structure..... 8
 - 1.3 Context Relevant to all Submeasures 10
 - 1.4 Market Analysis Relevant to All Submeasures 16
- 2. Increased Temperature Threshold** **28**
 - 2.1 Measure Description..... 28
 - 2.2 Market Analysis 32
 - 2.3 Energy Savings 38
 - 2.4 Cost and Cost Effectiveness..... 56
 - 2.5 First-Year Statewide Impacts..... 73
- 3. Computer Room Heat Recovery** **79**
 - 3.1 Measure Description..... 79
 - 3.2 Market Analysis 82
 - 3.3 Energy Savings 85
 - 3.4 Cost and Cost Effectiveness..... 92
 - 3.5 First-Year Statewide Impacts..... 96
- 4. Uninterruptible Power Supply (UPS) Efficiency** **99**
 - 4.1 Measure Description..... 99
 - 4.2 Market Analysis 101
 - 4.3 Energy Savings 103
 - 4.4 Cost and Cost Effectiveness..... 113
 - 4.5 First-Year Statewide Impacts..... 120
- 5. Power Usage Effectiveness (PUE) Monitoring** **122**
 - 5.1 Measure Description..... 122
 - 5.2 Market Analysis 124
 - 5.3 Energy Savings 126
 - 5.4 Cost and Cost Effectiveness..... 133
 - 5.5 First-Year Statewide Impacts..... 138
- 6. Proposed Revisions to Code Language** **141**
 - 6.1 Summary of Proposed Changes to Code Documents 141
 - 6.2 Guide to Markup Language 145
 - 6.3 Standards 145
 - 6.4 Reference Appendices 152
 - 6.5 ACM Reference Manual 153

6.6 Compliance Manuals	156
6.7 Compliance Documents	156
7. Bibliography	158
Appendix A : Statewide Savings Methodology	165
Appendix B : Embedded Electricity in Water Methodology	167
Appendix C : Environmental Impacts Methodology	170
Appendix D : California Building Energy Code Compliance (CBECC) Software Specification	172
Appendix E : Impacts of Compliance Process on Market Actors	184
Appendix F : Summary of Stakeholder Engagement	189
Appendix G : New Buildings Increased Economizer Temperature Threshold Exception	192
Appendix H : Heat Recovery Chiller Cost Estimate Details	196
Appendix I : Air-Cooled Chiller with Evaporative Cooling Tower Water Economizer System Cost Estimate Details	199
Appendix J : Air Containment Cost-Effectiveness Analysis	201
Appendix K : Nominal TDV Results Tables	206

List of Tables

Table 1: Scope of Code Change Proposal	2
Table 2: Summary of Per-Unit Energy Savings Results by Submeasure	1
Table 3: Benefit-to-Cost Ratio Results Summary	2
Table 4: First-Year Statewide Energy Impacts	3
Table 5: First-Year Statewide GHG Emissions Impacts	4
Table 6: First-Year Water and Embedded Electricity Impacts, per kW of ITE Design Load	4
Table 7: Where Proposed Computer Room Requirements Apply	11
Table 8: California Construction Industry, Establishments, Employment, and Payroll ..	18
Table 9: Specific Subsectors of the California Commercial Building Industry Impacted by Proposed Change to Code/Standard	19
Table 10: California Building Designer and Energy Consultant Sectors	20
Table 11: Employment in California State and Government Agencies with Building Inspectors	22

Table 12: Estimated Impact that Adoption of the Proposed Measure would have on the California Commercial Construction Sector.....	23
Table 13: Estimated Impact that Adoption of the Proposed Measure would have on the California Building Designers and Energy Consultants Sectors	23
Table 14: Estimated Impact that Adoption of the Proposed Measure Would Have on California Building Inspectors.....	24
Table 15: Net Domestic Private Investment and Corporate Profits, U.S.	25
Table 16: Estimated Computer Room Cooling System Types in California.....	34
Table 17: Energy Analysis Assumptions: Increased Temperature Threshold for Economizers, Case 1 (DX CRAC Cooling with Air Economizing)	40
Table 18: Energy Analysis Assumptions: Increased Temperature Threshold for Economizers, Case 2 (Chilled Water CRAH Cooling with Air Economizing).....	42
Table 19: Energy Analysis Assumptions: Increased Temperature Threshold for Economizers, Case 2b (Chilled Water CRAH Cooling with Water Economizing and Evaporative Cooling Tower).....	44
Table 20: Energy Analysis Assumptions: Increased Temperature Threshold for Economizers, Case 2c (Chilled Water CRAH Cooling with Water Economizing: Dry Cooler vs. Evaporative Cooling Tower).....	46
Table 21: Modifications Made to Standard Design in Each Simulation Case to Simulate Proposed Code Change: Increased Temperature Threshold for Economizers Submeasure.....	49
Table 22: First-Year Energy Impacts Per IT Equipment Load kW – Increased Temperature Threshold for Economizers Submeasure, DX CRAC Air Economizing Case.....	52
Table 23: First-Year Energy Impacts Per IT Equipment Load kW – Increased Temperature Threshold for Economizers Submeasure, Chilled Water CRAH Air Economizing Case	53
Table 24: First-Year Energy Impacts Per IT Equipment Load kW – Increased Temperature Threshold for Economizers Submeasure, Water Economizing with Evaporative Cooling Tower Case	54
Table 25: First-Year Energy Impacts Per IT Equipment Load kW – Increased Temperature Threshold for Economizers Submeasure, Dry Cooler vs. Evaporative Cooling Tower Case.....	55

Table 26: 2023 PV TDV Energy Cost Savings Over 15-Year Period of Analysis – Per IT Equipment Load kW – New Construction, Increased Temperature Threshold for Economizers Submeasure (DX CRAC Air Economizing Case).....	57
Table 27: 2023 PV TDV Energy Cost Savings Over 15-Year Period of Analysis – Per IT Equipment Load kW – New Construction, Increased Temperature Threshold for Economizers Submeasure (Chilled Water CRAH Air Economizing Case)	58
Table 28: 2023 PV TDV Energy Cost Savings Over 15-Year Period of Analysis – Per IT Equipment Load kW – New Construction, Increased Temperature Threshold for Economizers Submeasure (Water Economizing with Evaporative Cooling Tower Case).....	59
Table 29: 2023 PV TDV Energy Cost Savings Over 15-Year Period of Analysis – Per IT Equipment Load kW – New Construction, Increased Temperature Threshold for Economizers Submeasure (Dry Cooler vs. Evaporative Cooling Tower Case)	60
Table 30: Incremental First Cost Assumptions: Increased Temperature Threshold for Economizers Submeasure, Air Economizing – Case 1: DX CRAC Air Economizer	63
Table 31: Incremental First Cost Assumptions: Increased Temperature Threshold for Economizers Submeasure, Air Economizing – Case 2: CHW CRAH Air Economizer	64
Table 32: Water Economizer Heat Exchanger Sizing Parameters	65
Table 33: Incremental First Cost Assumptions: Increased Temperature Threshold for Economizers Submeasure, Water Economizing – Case 2b: CHW CRAH Water Economizer with Evaporative Cooling Tower	65
Table 34: Cooling Tower Sizing Parameters	66
Table 35: Chiller Sizing Parameters	66
Table 36: Cooling Tower Pump Sizing Parameters.....	67
Table 37: Incremental First Cost Assumptions: Increased Temperature Threshold for Economizers Submeasure – Case 2c: Air-Cooled Chillers with Dry Cooler vs. Air-Cooled Chillers with Evaporative Cooling Tower.....	67
Table 38: 15-Year Cost-Effectiveness Summary Per IT Equipment Load kW – New Construction, Increased Temperature Threshold for Economizers Submeasure, Case 1: DX CRAC with Air Economizer	70
Table 39: 15-Year Cost-Effectiveness Summary Per IT Equipment Load kW – New Construction, Increased Temperature Threshold for Economizers Submeasure, Case 2: CHW CRAH with Air Economizer.....	71

Table 40: 15-Year Cost-Effectiveness Summary Per IT Equipment Load kW – New Construction, Increased Temperature Threshold for Economizers Submeasure, Case 2b: CHW CRAH with Water Economizer with Evaporative Cooling Tower	72
Table 41: 15-Year Cost-Effectiveness Summary Per IT Equipment Load kW – New Construction, Increased Temperature Threshold for Economizers Submeasure, Case 2c: CHW CRAH with Water Economizer Dry Cooler vs. Evaporative Cooling Tower	73
Table 42: Statewide Savings Economizer Type Mapping	74
Table 43: Statewide Energy and Energy Cost Impacts, Increased Temperature Threshold for Economizers – New Construction, Alterations, and Additions.....	75
Table 44: First-Year Statewide GHG Emissions Impacts – Increased Temperature Threshold for Economizers	76
Table 45: Impacts on Water Use and Embedded Electricity in Water	77
Table 46: First-Year Statewide Impacts on Material Use: Increased Temperature Threshold for Economizers	78
Table 47: Energy Analysis Assumptions: Computer Room Heat Recovery	87
Table 48: Prototype Buildings Used for Energy, Demand, Cost, and Environmental Impacts Analysis	88
Table 49: Modifications Made to Standard Design in Each Simulation Case to Simulate Proposed Code Change: Heat Recovery Submeasure	89
Table 50: First-Year Energy Impacts Per IT Equipment Load kW – Heat Recovery Submeasure	91
Table 51: 2023 PV TDV Energy Cost Savings Over 15-Year Period of Analysis – Per IT Equipment Load kW – New Construction, Computer Room Heat Recovery Submeasure	93
Table 52: Incremental First Cost Assumptions: Heat Recovery Submeasure	94
Table 53: 15-Year Cost-Effectiveness Summary Per IT Equipment Load kW – New Construction, Computer Room Heat Recovery Submeasure	96
Table 54: Statewide Energy and Energy Cost Impacts, Heat Recovery – New Construction, Alterations, and Additions.....	97
Table 55: First-Year Statewide GHG Emissions Impacts – Heat Recovery	98
Table 56: First-Year Statewide Impacts on Material Use: Computer Room Heat Recovery	98
Table 57: ENERGY STAR UPS Product Survey	102

Table 58: Energy Analysis Assumptions: UPS Efficiency, Case 1 (DX CRAC Cooling)	104
Table 59: Energy Analysis Assumptions: UPS Efficiency, Case 2 (Chilled Water CRAH Cooling).....	106
Table 60: Modifications Made to Standard Design in Each Simulation Case to Simulate Proposed Code Change: UPS Efficiency Submeasure	109
Table 61: First-Year Energy Impacts Per IT Equipment Load kW – DX CRAC Case, UPS Efficiency Submeasure	111
Table 62: First-Year Energy Impacts Per IT Equipment Load kW – Chilled Water CRAH Case, UPS Efficiency Submeasure	112
Table 63: 2023 PV TDV Energy Cost Savings Over 15-Year Period of Analysis – Per IT Equipment Load kW – New Construction, UPS Efficiency Submeasure (Average Savings for both Simulation Cases)	114
Table 64: Incremental First Cost Assumptions: UPS Efficiency Submeasure – Case 1: DX CRAC	115
Table 65: Incremental First Cost Assumptions: UPS Efficiency Submeasure – Case 2: CHW CRAH	116
Table 66: 15-Year Cost-Effectiveness Summary Per IT Equipment Load kW – New Construction and Additions/Alterations, UPS Efficiency Submeasure, Case 1: DX CRAC	118
Table 67: 15-Year Cost-Effectiveness Summary Per IT Equipment Load kW – New Construction and Additions/Alterations, UPS Efficiency Submeasure, Case 2: CHW CRAH	119
Table 68: Statewide Energy and Energy Cost Impacts, UPS Efficiency – New Construction, Alterations, and Additions.....	120
Table 69: First-Year Statewide GHG Emissions Impacts – UPS Efficiency	121
Table 70: First-Year Statewide Impacts on Material Use: UPS Efficiency.....	121
Table 71: Energy Analysis Assumptions: PUE Monitoring, Case 1 (Chilled Water CRAH)	129
Table 72: Prototype Buildings Used for Energy, Demand, Cost, and Environmental Impacts Analysis	130
Table 73: Modifications Made to Standard Design in Each Prototype Simulation Case to Simulate Proposed Code Change: PUE Monitoring Submeasure.....	131

Table 74: First-Year Energy Impacts Per IT Equipment Load kW – Chilled Water CRAH Case, PUE Monitoring Submeasure.....	133
Table 75: 2023 PV TDV Energy Cost Savings Over 15-Year Period of Analysis – Per IT Equipment Load kW – New Construction, PUE Monitoring Submeasure.....	134
Table 76: Incremental First Cost Assumptions: PUE Monitoring Submeasure.....	136
Table 77: 15-Year Cost-Effectiveness Summary Per IT Equipment Load kW – New Construction and Additions/Alterations, PUE Monitoring Submeasure, Case 1: CHW CRAH	138
Table 78: Statewide Energy and Energy Cost Impacts, PUE Monitoring – New Construction, Alterations, and Additions.....	139
Table 79: First-Year Statewide GHG Emissions Impacts – PUE Monitoring	140
Table 80: First-Year Statewide Impacts on Material Use: PUE Monitoring	140
Table 81: Estimated Existing Statewide Computer Room Energy Parameters	165
Table 82: Estimated New Construction Statewide Computer Room Energy Parameters	166
Table 83: Embedded Electricity in Water by California Department of Water Resources Hydrologic Region (kWh Per Acre Foot (AF))	168
Table 84: Statewide Population-Weighted Average Embedded Electricity in Water ...	169
Table 85: Roles of Market Actors in the Proposed Compliance Process	186
Table 86: Key Energy Simulation Inputs for Economizer Performance Tradeoff Evaluation	193
Table 87: Energy Simulation Results Comparison	195
Table 88: Heat Recovery Chiller System Design Costs	198
Table 89: Energy Analysis Assumptions: Air Containment.....	202
Table 90: First-Year Energy Impacts Per IT Equipment Load kW – Air Containment .	203
Table 91: Incremental First Cost Assumptions: Air Containment	204
Table 92: 15-Year Cost-Effectiveness Summary Per IT Equipment Load kW – Air Containment.....	205
Table 93: Nominal TDV Energy Cost Savings Over 15-Year Period of Analysis – Per IT Equipment Load kW – New Construction, Increased Temperature Threshold for Economizers Submeasure (DX CRAC Air Economizing Case).....	206

Table 94: Nominal TDV Energy Cost Savings Over 15-Year Period of Analysis – Per IT Equipment Load kW – New Construction, Increased Temperature Threshold for Economizers Submeasure (Chilled Water CRAH Air Economizing Case)	207
Table 95: Nominal TDV Energy Cost Savings Over 15-Year Period of Analysis – Per IT Equipment Load kW – New Construction, Increased Temperature Threshold for Economizers Submeasure (Water Economizing with Evaporative Cooling Tower Case).....	208
Table 96: Nominal TDV Energy Cost Savings Over 15-Year Period of Analysis – Per IT Equipment Load kW – New Construction, Increased Temperature Threshold for Economizers Submeasure (Dry Cooler vs. Evaporative Cooling Tower Case)	209
Table 97: Nominal TDV Energy Cost Savings Over 15-Year Period of Analysis – Per IT Equipment Load kW – New Construction, Computer Room Heat Recovery Submeasure	210
Table 98: Nominal TDV Energy Cost Savings Over 15-Year Period of Analysis – Per IT Equipment Load kW – New Construction, UPS Efficiency Submeasure (Average Savings for both Simulation Cases)	211
Table 99: Nominal TDV Energy Cost Savings Over 15-Year Period of Analysis – Per IT Equipment Load kW – New Construction, PUE Monitoring Submeasure.....	212

List of Figures

Figure 1. Hot aisle/cold aisle server arrangement schematic.	17
Figure 2. Example design temperatures: air economizer (left) and water economizer (right).....	36
Figure 3. Comparison of 2019 Title 24 and proposed 2022 Title 24 dry-bulb economizing hours.	51
Figure 4. Comparison of 2019 Title 24 and proposed 2022 Title 24 wet-bulb economizing hours.	51
Figure 5. Example return air chimney and enclosed server rack product.....	62
Figure 6. Computer room heat recovery example mechanical diagram: DFDD.	83
Figure 7. Computer room heat recovery example mechanical plan: fan powered boxes.	84
Figure 8. Proposed CBEECC-Com Air System Data Input Additions	176
Figure 9. Proposed CBEECC-Com Space Data Input Additions	178
Figure 10. Proposed Space Function Options.....	179

Executive Summary

This document presents recommended code changes that the California Energy Commission will be considering for adoption in 2021. This is an updated version of the report that was initially shared in September 2020. If you have comments or suggestions prior to the adoption, please email info@title24stakeholders.com. Comments will not be released for public review or will be anonymized if shared.

Introduction

The Codes and Standards Enhancement (CASE) Initiative presents recommendations to support the California Energy Commission's (Energy Commission) efforts to update the California Energy Code (Title 24, Part 6) to include new requirements or to upgrade existing requirements for various technologies. Three California Investor Owned Utilities (IOUs) – Pacific Gas and Electric Company, San Diego Gas and Electric, and Southern California Edison – and two Publicly Owned Utilities – Los Angeles Department of Water and Power and Sacramento Municipal Utility District (herein referred to as the Statewide CASE Team when including the CASE Author) – sponsored this effort. The program goal is to prepare and submit proposals that will result in cost-effective enhancements to improve energy efficiency and energy performance in California buildings. This report and the code change proposal presented herein are a part of the effort to develop technical and cost-effectiveness information for proposed requirements on building energy-efficient design practices and technologies.

The Statewide CASE Team submits code change proposals to the Energy Commission, the state agency that has authority to adopt revisions to Title 24, Part 6. The Energy Commission will evaluate proposals submitted by the Statewide CASE Team and other stakeholders. The Energy Commission may revise or reject proposals. See the Energy Commission's 2022 Title 24 website for information about the rulemaking schedule and how to participate in the process: <https://www.energy.ca.gov/programs-and-topics/programs/building-energy-efficiency-standards/2022-building-energy-efficiency>.

The overall goal of this CASE Report is to present a code change proposal for computer room efficiency. The report contains pertinent information supporting the code change.

The Statewide CASE Team is also recommending removing the healthcare exemption from computer room prescriptive requirements based on input from California's Office of Statewide Health Planning and Development (OSHPD) and various healthcare stakeholders.

Measure Description

Background Information

Prescriptive requirements for computer rooms¹ were added to Title 24, Part 6 for the 2013 code cycle. This code change proposal includes updates to existing prescriptive requirements, as well as adding new prescriptive and mandatory requirements. The goal of the proposed changes is to better align computer room efficiency requirements in California with industry design best practices and other industry standards and guidelines where applicable.

This code change proposal includes the following four submeasures. Background information is summarized for each submeasure below.

1. Increased Temperature Threshold for Economizers

This submeasure proposes changes to the temperature thresholds for economizers for computer rooms in new buildings. The proposed changes only apply to new buildings and include simplifying the Title 24, Part 6, 140.9(a) prescriptive economizing requirements to a single outdoor air temperature condition for all economizer types, increasing the minimum outdoor temperatures for 100 percent economizing to 65°F dry-bulb or 50°F wet-bulb for all economizer types, and decreasing the computer room equipment load threshold for when air containment is required to 10 kW per room.² To provide more design flexibility options, an exception has been included to allow projects to meet the economizer temperature requirements as long as they also implement higher efficiency fan systems, air containment, and cooling equipment.

Requirements for existing computer rooms would remain largely unchanged, except for minor modifications to Exception 4, and would move to Title 24, Part 6, 141.1(b). The addition of code language in 141.1(b) would not introduce new requirements for computer rooms but would serve to add clarity to which requirements apply to computer rooms in new buildings and which requirements apply to computer rooms in additions and alterations.

Title 24, Part 6, Section 140.9(a) currently requires computer room cooling systems to provide full air economizing at 55°F dry-bulb and 50°F wet-bulb and below or full

¹ According to Title 24, Part 6, a Computer Room is a room whose primary function is to house electronic equipment and that has a design equipment power density exceeding 20 watts/ft² (215 watts/m²) of conditioned floor area.

² A typical computer room server rack is designed for 5-10 kW equipment load per rack, with smaller computer rooms typically designed for closer to 5 kW per rack. Therefore, 10 kW represents two racks designed for 5 kW each.

water economizing at 40°F dry-bulb and 35°F wet-bulb and below. These temperature thresholds are relatively low, indicative of fairly cold supply air temperatures (around 55°F). Title 24, Part 6, Section 140.9(a) also requires air containment for large computer rooms. However, air containment has become more common practice for computer rooms of all sizes since the 2013 code cycle, and computer rooms are commonly being designed at higher air temperatures as a result of containment and in accordance with American Society of Heating, Refrigerating, and Air-Conditioning (ASHRAE) Guidelines for Data Processing Environments (ASHRAE 2015). Increasing the outdoor temperature threshold for all economizers and requiring containment for smaller computer rooms to accommodate a supply air temperature of 70°F or higher would provide significant energy savings and align with ASHRAE guidelines and industry best practices.

2. Computer Room Heat Recovery

Computer rooms produce constant heat (24 hours a day, seven days a week). When a computer room is located in a facility that also has a heating load, recovered heat from the computer room can provide heating for the other facility heating loads while also reducing the cooling load on the computer room cooling system. While not yet industry standard practice, computer room heat recovery provides significant heating savings opportunities for buildings where computer rooms are collocated with spaces with significant heating loads. The Statewide CASE Team is defining computer room heat recovery as a mechanical system that transfers heat from computer room return air to provide desired heating to other zones in the building. Examples of heat recovery systems include: computer room return air transferred directly to air systems providing heating, heat recovery chillers, air-source or water-source heat pumps providing simultaneous heating and cooling, and variable refrigerant flow systems with heat recovery.

This submeasure proposes adding prescriptive requirements for computer rooms in new buildings to include heat recovery if the building has a total computer room cooling ITE design load and a design heating load exceeding certain thresholds based on climate zone and a minimum annual number hours with a heating load.

3. Uninterruptible Power Supply (UPS) Efficiency

This submeasure proposes adding minimum UPS prescriptive efficiency requirements and testing requirements, based on ENERGY STAR® Version 2.0 for AC-output UPS units used in computer rooms. The minimum average UPS efficiency takes into account UPS efficiency at 100%, 75%, 50%, and 25% load factors.

Nearly every computer room uses a UPS to provide constant backup power and/or power quality management to information technology (IT) equipment. As

unregulated equipment, UPSs vary in efficiency, depending on UPS model, operating mode, and load factor. ENERGY STAR provides elective efficiency and test standards for UPSs and serves as a model for California to achieve significant statewide energy savings due to the large volume of UPSs installed.

4. Power Usage Effectiveness (PUE) Monitoring

PUE is a common metric to evaluate energy efficiency for data centers. Measuring PUE provides data center operators feedback on how efficiently their computer room is performing and indicates its energy savings potential. Measuring PUE over time can also indicate degradations to data center efficiency compared to original operation. The goal of making PUE monitoring mandatory is to give data center operators information they can act on to maintain high energy performance in the data center after construction. This submeasure proposes adding mandatory PUE monitoring requirements for large computer rooms.

Proposed Code Changes

This proposed code change applies to new construction computer rooms, which include a design information technology (IT) equipment power density greater than 20 W/ft² as defined in Title 24, Part 6.

1. Increased Temperature Threshold for Economizers:

This proposed change would update requirements in Section 140.9(a) with the following changes:

- For computer rooms in new buildings, increase minimum outdoor temperatures for full economizing to 65°F dry-bulb or 50°F wet-bulb for any type of economizer; currently the thresholds are 55°F dry-bulb and 50°F wet-bulb for air economizers and 40°F dry-bulb and 35°F wet-bulb for water economizers. An exception is included to allow new buildings to meet existing economizer temperature requirements as long as they also implement higher efficiency fan systems, air containment, and cooling equipment. The current economizer temperature requirements would remain unchanged for computer rooms in existing buildings.
- Decrease the computer room minimum size threshold for requiring air containment from 175 kW per room to 10 kW per room ITE design load.

This proposed change would add a new subsection as Section 141.1(b) for economizing requirements in existing computer rooms. This would not introduce new requirements for computer rooms but would serve to add clarity to which requirements apply to computer rooms in new buildings and which requirements apply to computer rooms in additions/alterations. The 141.1(b) requirements would match 2019 Title 24, Part 6, Section 140.9(a) computer room outdoor air economizer temperature thresholds (55°F dry-bulb/50°F wet-bulb for air economizers and 40°F

dry-bulb/35°F wet-bulb for water economizers) and with the same exceptions as 2019 Title 24, Part 6, Section 140.9(a) for certain computer rooms in existing buildings.

- 2. Computer Room Heat Recovery.** This proposed change would add a prescriptive requirement in Section 140.9(a) to require heat recovery for computer rooms in new buildings meeting with a total ITE design load and heating design load exceeding the combination of values listed below and with an annual heating load of at least 1,400 hours per year.
 - For Climate Zones 1, 2, 3, 4, 5, 11, 12, 13, 14, and 16: total ITE design load exceeding 200 kW and design heating load greater than 4,000,000 Btu/hr; or total ITE design load exceeding 500 kW and design heating load greater than 2,500,000 Btu/hr.
 - For Climate Zones 6, 7, 8, 9, 10, or 15: total ITE design load exceeding 300 kW and design heating load greater than 5,000,000 Btu/hr.
- 3. UPS Efficiency.** This proposed change would add a prescriptive requirement in Section 140.9(a) for UPSs serving computer rooms to have a minimum efficiency matching ENERGY STAR Version 2.0 efficiency and testing requirements.
- 4. Power Usage Effectiveness (PUE) Monitoring.** This proposed change would add a prescriptive requirement in Section 140.9(a) for computer rooms exceeding 2,000 kW ITE design load to have power usage effectiveness (PUE) monitoring.

Scope of Code Change Proposal

summarizes the scope of the proposed changes and which sections of standards, Reference Appendices, Alternative Calculation Method (ACM) Reference Manual, and compliance documents that would be modified as a result of the proposed change(s).

Table 1 summarizes the scope of the proposed changes and which sections of standards, Reference Appendices, Alternative Calculation Method (ACM) Reference Manual, and compliance documents that would be modified as a result of the proposed change(s).

Table 1: Scope of Code Change Proposal

Measure Name	Type of Requirement	Modified Section(s) of Title 24, Part 6	Modified Title 24, Part 6 Appendices	Would Compliance Software Be Modified	Modified Compliance Document(s)
Increased Temperature Threshold for Economizers	Prescriptive	140.9(a), 141.1(b) (new)	No	Yes; ACM 5.7.2.3 Supply Air Temperature Control, Cooling Supply Air Temperature table	NRCC-PRC-E (Table M, column 2: Economizer Compliance Method)
Computer Room Heat Recovery	Prescriptive	140.9(a)	No	Yes; ACM 5.7.6.6 Computer Room Heat Recovery Coil Option 1 (new), 5.7.6.7 Computer Room Heat Recovery Coil Option 2 (new)	NRCC-PRC-E (Update to Table C applicable Computer Room standards sections; addition to Table M)
UPS Efficiency	Prescriptive	140.9(a)	No	Yes; ACM 5.4.6 Receptacle Loads, Receptacle Power table Standard Design, Appendix 5.4A for Computer Room-UPS	NRCC-PRC-E (Update to Table C applicable Computer Room standards sections; addition to Table M)
PUE Monitoring	Mandatory	120.6(i)	NA7.19.1 (new)	No	NRCC-PRC-E (Update to Table C applicable Computer Room standards sections; addition to Table M); NRCA-PRC-17-F (new)

Market Analysis and Regulatory Assessment

This proposal updates existing Title 24, Part 6 prescriptive requirements for computer room economizers and air containment to improve alignment with ASHRAE thermal guidelines for computer rooms, align with design best practices, and save energy. This proposal adds new requirements to Title 24, Part 6 for UPS efficiency to match ENERGY STAR Program Requirements for UPSs - Eligibility Criteria Version 2.0 (E. P. Agency 2019), for efficiency and testing requirements, and for computer room heat recovery and PUE Monitoring to align with design best practices and save energy.

This proposal requires the use of building mechanical and electrical system technologies that are widely available on the market and offered by a number of manufacturers. Implementing these requirements requires care by the mechanical and electrical engineering design teams to select and lay out equipment that meets the proposed efficiency requirements using approaches that are already common in design.

Cost Effectiveness

A summary of energy savings and peak demand reductions per unit are presented in Table 2 for new construction.

Table 2: Summary of Per-Unit Energy Savings Results by Submeasure

Submeasure	Annual Electricity Energy Savings (kWh/yr per IT Equipment Load kW)	Annual Natural Gas Energy Savings (therm/yr per IT Equipment Load kW)	Peak Demand Reduction (kW per IT Equipment Load kW)
Increased Temperature Threshold for Economizers	161-955	0	0.0
Computer Room Heat Recovery	(224)-(124)	28-51	0.0
UPS Efficiency	53-69	0	0.0
PUE Monitoring	8-12	0	0.0

The proposed code change was found to be cost effective for all climate zones where it is proposed to be required. The benefit-to-cost (B/C) ratio compares the benefits or cost savings to the costs over the 15-year period of analysis. Proposed code changes that have a B/C ratio of 1.0 or greater are cost-effective. The larger the B/C ratio, the faster the measure pays for itself from energy cost savings.

Table 3: Benefit-to-Cost Ratio Results Summary

Measure Name	B/C Ratio Range	Notes
Increased Temperature Threshold for Economizers	1.5 - infinite	B/C ratio depends on cooling system type and climate zone.
Computer Room Heat Recovery	1.0 - 1.5	B/C ratio depends on cooling system type and climate zone.
UPS Efficiency	1.2 - 1.8	B/C ratio depends on cooling system type and climate zone.
PUE Monitoring	1.0 - 1.6	B/C ratio depends on cooling system type and climate zone.

See Sections 2.4, 3.4, 4.4, and 5.4 for the methodology, assumptions, and results of the cost-effectiveness analysis.

Statewide Energy Impacts: Energy, Water, and Greenhouse Gas (GHG) Emissions Impacts

Table 4 presents the estimated energy and demand impacts of the proposed code change that would be realized statewide during the first 12 months that the 2022 Title 24, Part 6 requirements are in effect. First-year statewide energy impacts are represented by the following metrics: electricity savings in gigawatt-hours per year (GWh/yr), peak electrical demand reduction in megawatts (MW), natural gas savings in million therms per year (MMTherms/yr), and time dependent valuation (TDV) energy savings in kilo British thermal units per year (TDV kBtu/yr). One kBtu equals 1 thousand British thermal units (Btu). See Sections 2.5, 3.5, 4.5, and 5.5 for more details on the first-year statewide impacts calculated by the Statewide CASE Team. Refer to Appendix A for more detail on the statewide energy savings assumptions.

Table 4: First-Year Statewide Energy Impacts

Measure	Electricity Savings (GWh/yr)	Peak Electrical Demand Reduction (MW)	Natural Gas Savings (MMTherm s/yr)	TDV Energy Savings (million TDV kBtu/yr)
Increased Temperature Threshold for Economizers (Total)	6.3	0.8	0	169
New Construction	6.3	0.8	0	169
Additions and Alterations	0	0	0	0
Computer Room Heat Recovery (Total)	(0.8)	0	0.2	24
New Construction	(0.8)	0	0.2	24
Additions and Alterations	0	0	0	0
UPS Efficiency (Total)	2.2	0.1	0	59
New Construction	0.7	0.0	0	19
Additions and Alterations	1.5	0.0	0	41
PUE Monitoring (Total)	0.3	0.1	0	8
New Construction	0.1	0.0	0	3
Additions and Alterations	0.2	0.0	0	5

Table 5 presents the estimated avoided GHG emissions associated with the proposed code change for the first year that the standards are in effect. Avoided GHG emissions are measured in metric tons of carbon dioxide equivalent (metric tons CO₂e). Assumptions used in developing the GHG savings are provided in Sections 2.5.2, 3.5.2, 4.5.2, 5.5.2 and Appendix C of this report. The monetary value of avoided GHG emissions is included in TDV cost factors and is thus included in the cost-effectiveness analysis.

Table 5: First-Year Statewide GHG Emissions Impacts

Measure	Avoided GHG Emissions (Metric Tons CO2e/yr)	Monetary Value of Avoided GHG Emissions (\$2023)
Increased Temperature Threshold for Economizers	1,513	\$160,704
Computer Room Heat Recovery	832	\$88,306
UPS Efficiency	518	\$55,025
PUE Monitoring	69	\$7,362
Total	2,932	\$311,397

Water and Water Quality Impacts

Water savings that the proposed code changes would have during the first year that they are in effect are presented in Table 6 along with the associated embedded electricity savings. See Sections 2.5.3, 3.5.3, 4.5.3, and 5.5.3 of this report for water quality impacts and the methodology used to derive water savings and water quality impacts. The methodology used to calculate embedded electricity in water is presented in Appendix B.

Table 6: First-Year Water and Embedded Electricity Impacts, per kW of ITE Design Load

Submeasure	On-Site Indoor Water Savings (gallons/yr)	On-Site Outdoor Water Savings (gallons/yr)^a	Embedded Electricity Savings (kWh/yr)
Increased Temperature Threshold for Economizers	0	(310)	(1.1)
Computer Room Heat Recovery	0	0	0
UPS Efficiency	0	0	0
PUE Monitoring	0	0	0

- a. For the increased temperature threshold for economizers submeasure, the HVAC system type determines the impact on water use. Comparing the proposed code changes' impact on a water-cooled chiller plant using air economizing, water savings ranges from 100 – 900 gallons per kW of ITE design load depending on climate zone. Comparing the proposed code changes' impact on an air-cooled cooling plant using an evaporative cooling tower water economizer compared to a baseline dry cooler, water use increases by 1,000 – 2,500 gallons per kW of ITE design load depending on climate zone. The results presented in the table represent an estimated average for all economizer system types.

Compliance and Enforcement

Overview of Compliance Process

The Statewide CASE Team worked with stakeholders to develop a recommended compliance and enforcement process and to identify the impacts this process would have on various market actors. The compliance process is described in Sections 2.1.3, 3.1.3, 4.1.3, and 5.1.3. Impacts that the proposed measure would have on market actors is described in Appendix E. The key issues related to compliance and enforcement are summarized below:

- The increased temperature threshold for the increased economizer temperatures submeasure modifies temperature requirements for economizers and computer room design supply air temperatures in new buildings, which does not change the current compliance process. This submeasure also reduces the computer ITE design capacity threshold for when air containment is required, which applies to new construction. As this is a proposed modification to an existing requirement, mechanical contractors already have to determine if the computer room size triggers the air containment requirement and if the mechanical design meets the economizer temperature requirements, and this effort is unchanged (though the trigger value itself has changed). The two changes in the compliance process for this submeasure are mechanical designers must include air containment on permit drawings and specifications for smaller computer rooms and mechanical designers must determine which economizer temperature requirements apply to their project.
- The computer room heat recovery submeasure requires mechanical designers to determine if the project meets the triggers for requiring that heat recovery be installed and, if required, to include the heat recovery system in the permit design drawings and specifications. Mechanical designers must show the computer room heat recovery system coefficient of performance (COP) meets the code requirement in the mechanical schedules by showing: total input power of computer room heat recovery system and amount of heat transferred under design conditions. The mechanical contractor and controls contractor must install the system to meet the design specifications.
- The UPS efficiency submeasure requires electrical engineers to specify a UPS that meets Title 24, Part 6 minimum efficiency requirements and include required information on permit compliance documents. Including UPS information on electrical equipment schedule is standard practice. Specifying minimum efficiency requirements is not uniformly standard practice, but efficiency information is readily available from manufacturers. Some additional

effort is required for electrical contractors to select and install a UPS that meets the design specification.

- The PUE monitoring submeasure requires the electrical contractor to include the electrical submetering system and dashboard in the permit drawings and specification. If PUE monitoring is otherwise planned for the project, the additional effort for code compliance is limited to the electrical design engineer and electrical contractor filling out compliance documents. The electrical contractor must also complete compliance verification form NRCA-PRC-17-F.

Field Verification and Acceptance Testing

A new acceptance test (NRCA-PRC-17-F) would be required to verify the PUE Monitoring system. PUE Monitoring requires contractor field verification that the electrical meters are installed in the correct locations, are configured correctly, and are communicating with the dashboard; the acceptance test also includes verification that the dashboard is configured properly. Refer to Sections 2.1.3, 3.1.3, 4.1.3, and 5.1.3 for additional information.

The Statewide CASE Team is also recommending clarifying code language be added to Sections 120.6, and 120.8 that makes it clearer that computer room mechanical systems are subject to acceptance tests required for mechanical systems in other nonresidential space types. This is not being proposed as a new requirement but as a clarification to existing requirements, as described in the 2013 Data Center code change proposal (Engineering 2011).

1. Introduction

This document presents recommended code changes that the California Energy Commission will be considering for adoption in 2021. If you have comments or suggestions prior to the adoption, please email info@title24stakeholders.com. Comments will not be released for public review or will be anonymized if shared.

1.1 Introduction to Statewide CASE Team

The Codes and Standards Enhancement (CASE) initiative presents recommendations to support the California Energy Commission's (Energy Commission) efforts to update the California Energy Code (Title 24, Part 6) to include new requirements or to upgrade existing requirements for various technologies. Three California Investor Owned Utilities (IOUs) – Pacific Gas and Electric Company, San Diego Gas and Electric, and Southern California Edison – and two Publicly Owned Utilities – Los Angeles Department of Water and Power and Sacramento Municipal Utility District (herein referred to as the Statewide CASE Team when including the CASE Author) – sponsored this effort. The program goal is to prepare and submit proposals that will result in cost-effective enhancements to improve energy efficiency and energy performance in California buildings. This report and the code change proposal presented herein are a part of the effort to develop technical and cost-effectiveness information for proposed requirements on building energy-efficient design practices and technologies.

The Statewide CASE Team submits code change proposals to the Energy Commission, the state agency that has authority to adopt revisions to Title 24, Part 6. The Energy Commission will evaluate proposals submitted by the Statewide CASE Team and other stakeholders. The Energy Commission may revise or reject proposals. See the Energy Commission's 2022 Title 24 website for information about the rulemaking schedule and how to participate in the process: <https://www.energy.ca.gov/programs-and-topics/programs/building-energy-efficiency-standards/2022-building-energy-efficiency>.

The overall goal of this CASE Report is to present a code change proposal for computer room efficiency. The report contains pertinent information supporting the code change.

When developing the code change proposal and associated technical information presented in this report, the Statewide CASE Team worked with a number of industry stakeholders including manufacturers, builders, design engineers, and data center developers and operators, Title 24 energy analysts, equipment vendors, and others involved in the code compliance process. The proposal incorporates feedback received during a public stakeholder workshops that the Statewide CASE Team held on October 15, 2019 (Team, Nonresidential HVAC Part 1: Data Centers, Boilers, Controls Utility-Sponsored Stakeholder Meeting Notes 2019), and March 12, 2020 (Team,

Nonresidential and Single Family HVAC Part 1: Data Centers, Boilers, Air Distribution, Variable Capacity 2020).

1.2 Document Structure

This Final CASE Report presents four unique code change proposal for computer room efficiency. The specific recommendations for each submeasure are presented in Section 2 through 5 of this report. The overall document structure and content is structured as follows:

- Section 1 - Introduction provides context that is relevant to all four submeasures including measure history and regulator context. The regulatory context details whether the proposed measure overlaps or conflicts with other portions of the building standards, such as fire, seismic, and other safety standards, and whether technical, compliance, or enforceability challenges exist.
- Section 2 – Increased Temperature Threshold submeasure detailed code change recommendations and justifications.
- Section 3 – Computer Room Heat Recovery submeasure detailed code change recommendations and justifications.
- Section 4 – Uninterruptible Power Supply (UPS) Efficiency submeasure detailed code change recommendations and justifications.
- Section 5 – Power Usage Effectiveness (PUE) Monitoring submeasure detailed code change recommendations and justifications.
- Section 6 – Proposed Revisions to Code Language concludes the report with specific recommendations with ~~strikeout~~ (deletions) and underlined (additions) language for the standards, Reference Appendices, Alternative Calculation Method (ACM) Reference Manual, compliance manual, and compliance documents.
- Section 7 – Bibliography presents the resources that the Statewide CASE Team used when developing this report.
- Appendix A: Statewide Savings Methodology presents the methodology and assumptions used to calculate statewide energy impacts.
- Appendix B: Embedded Electricity in Water Methodology presents the methodology and assumptions used to calculate the electricity embedded in water use (e.g., electricity used to draw, move, or treat water) and the energy savings resulting from reduced water use.
- Appendix C: Environmental Impacts Methodology presents the methodologies and assumptions used to calculate impacts on GHG emissions and water use and quality.
- Appendix D: California Building Energy Code Compliance (CBECC) Software

Specification presents relevant proposed changes to the compliance software (if any).

- Appendix E: Impacts of Compliance Process on Market Actors presents how the recommended compliance process could impact identified market actors.
- Appendix F : Summary of Stakeholder Engagement documents the efforts made to engage and collaborate with market actors and experts.
- Appendix G: New Buildings Increased Economizer Temperature Threshold Exception describes the energy analysis used to develop the proposed exception to 140.9(a)1.
- Appendix H: Heat Recovery Chiller Cost Estimate Details provides details on the estimated incremental implementation costs for meeting the proposed prescriptive computer room heat recovery requirement using a heat recovery chiller.
- Appendix I: Air-Cooled Chiller with Evaporative Cooling Tower Water Economizer System Cost Estimate Details provides details on the estimated incremental implementation costs for using an evaporative cooling tower and heat exchanger with an air-cooled chiller for meeting the proposed increased economizer temperature thresholds.
- Appendix J: Air Containment Cost-Effectiveness Analysis shows the cost-effectiveness analysis results for lowering the computer room size threshold for air containment without changes to economizer temperatures.
- Appendix K: Nominal TDV Results Tables contains nominal TDV energy cost savings for each submeasure.

The following is a brief summary of the contents of subsections within Sections 2 through 5 of the report:

- Measure Description provides a description of the measure and its background. This section also presents a detailed description of how this code change is accomplished in the various sections and documents that make up the Title 24, Part 6 Standards.
- In addition to the Market Analysis, this section includes a review of the current market structure. This section describes the feasibility issues associated with the code change.
- Energy Savings presents the per-unit energy, demand reduction, and energy cost savings associated with the proposed code change. This section also describes the methodology that the Statewide CASE Team used to estimate per-unit energy, demand reduction, and energy cost savings.
- Cost and Cost Effectiveness presents the materials and labor required to implement the measure and a quantification of the incremental cost. It also

includes estimates of incremental maintenance costs, i.e., equipment lifetime and various periodic costs associated with replacement and maintenance during the period of analysis.

- First-Year Statewide Impacts presents the statewide energy savings and environmental impacts of the proposed code change for the first year after the 2022 code takes effect. This includes the amount of energy that would be saved by California building owners and tenants and impacts (increases or reductions) on material with emphasis placed on any materials that are considered toxic by the state of California. Statewide water consumption impacts are also reported in this section.

1.3 Context Relevant to all Submeasures

1.3.1 Measure Overview

The proposed code changes apply to computer rooms that have a design information technology equipment (ITE)³ load over 20 Watts per square foot (W/ft²) as defined by Title 24, Part 6⁴ and impacts both new construction, additions, and alterations unless otherwise noted below. The proposed prescriptive submeasures would appear in Section 140.9(a) and new subsection 141.1(b), and the proposed mandatory PUE monitoring requirement would appear in a new subsection in Section 120.6. All of the prescriptive requirements would have associated updates to the compliance software. No update to the compliance software is required for the proposed new mandatory requirement.

These proposed code changes include adding definitions to Section 100.1(b) to include UPS, computer room heat recovery, and computer room equipment load term definitions. A new section would be added as Nonresidential Appendix NA7.19 for Computer Room Acceptance Tests and would include an acceptance test for PUE monitoring.

Table 7 presents a summary of threshold triggers and exceptions for each submeasure.

³ ITE is a term adopted from ASHRAE 90.4 *Energy Standard for Data Centers*. ITE includes computers, data storage, servers, and network/communication equipment. This term would be added to Section 100.1(b).

⁴ According to Title 24, Part 6, a Computer Room is defined as a room whose primary function is to house electronic equipment and that has a design equipment power density exceeding 20 watts/ft² (215 watts/m²) of conditioned floor area.

Table 7: Where Proposed Computer Room Requirements Apply

Submeasure	Where Requirements Apply	Exceptions
Increased Temperature Threshold for Economizers	Computer rooms in new buildings with ITE design load over 20 W/ft ²	<ol style="list-style-type: none"> 1. Computer rooms in existing buildings 2. Buildings where the local water authority does not allow cooling towers 3. Computer rooms with design cooling loads less than 20 tons served by two systems (see 140.9(a) for more detail) 4. Computer rooms with design fan power no greater than 0.35 W/cfm, air containment, and 25°F supply and return air temperature differential, and cooling equipment that is 20 percent or more efficient than minimum code efficiency.
Computer Room Heat Recovery	For new buildings in Climate Zones 1, 2, 3, 4, 5, 11, 12, 13, 14, or 16 with a total ITE design load exceeding 200 kW and with a design heating load greater than 4,000,000 Btu/hr; or buildings in Climate Zones 1, 2, 3, 4, 5, 11, 12, 13, 14, or 16 with a total ITE design load exceeding 500 kW and with a design heating load greater than 2,500,000 Btu/hr; or buildings in Climate Zones 6, 7, 8, 9, 10, or 15 with a total ITE design load exceeding 300 kW and with a design heating load greater than 5,000,000 Btu/hr	<ol style="list-style-type: none"> 1. Heating system has coefficient of performance (COP) of at least 4.0 at design conditions 2. Computer rooms in existing buildings
UPS Efficiency	Computer rooms with ITE design load over 20 W/sf with AC-output UPSs	UPSs utilizing NEMA 1-15P or 5-15P input plugs
PUE Monitoring	<ol style="list-style-type: none"> 1. At least 2,000 kW computer room ITE design load; and 2. At least 80 percent of building cooling capacity serves computer rooms; and 3. Computer room uses UPS 	N/A

The Statewide CASE Team is also recommending removing the healthcare exemption from computer room prescriptive requirements in Section 140.9(a), based on input from California's Office of Statewide Health Planning and Development (OSHPD) and various healthcare stakeholders.

During the second stakeholder presentation on March 12, 2020, a few stakeholders requested that the definitions for “computer room” and “data center” be updated in Title 24, Part 6, to match ASHRAE 90.4 definitions, which delineate the definition of “computer room” and “data center” by defining computer rooms as having an ITE load less than or equal to 10 kW and by defining data centers as having an ITE load greater than 10 kW. The reason for having this 10-kW delineation is because ASHRAE 90.1 covers computer rooms up to 10 kW and ASHRAE 90.4 covers computer rooms greater than 10 kW. However, Title 24 covers computer rooms of all sizes and follows the ASHRAE 90.1 definition of computer room, which is “a room whose primary function is to house equipment for the processing and storage of electronic data and that has a design electronic data equipment power density exceeding 20 W/ft² of conditioned floor area”. Furthermore, ASHRAE 90.4 defines a “data center” as a space type or a building that houses computer rooms with an ITE load greater than 10 kW, whereas Title 24 defines “data center” as a building type only.

The Statewide CASE Team is not proposing to change the definitions of “data center” or “computer room” to match ASHRAE 90.4 because changes these definitions is not necessary for any of the proposed submeasures. Updating these definitions may cause unnecessary confusion by stakeholders trying to comply with and enforce Title 24. Additionally, changing the definition of “data center” to include a space type has potential implications for how Title 24 compliance software is defined, which would cause unnecessary complication to update the software.

See Section 6.3 of this report for the proposed code language.

1.3.2 Measure History

Prescriptive requirements for computer rooms were added to Title 24, Part 6 for the 2013 code cycle. Title 24, Part 6 requirements for computer rooms have not been substantially updated since that time.

Since 2013, common computer room cooling efficiency strategies have progressed beyond the minimum requirements in Title 24, Part 6. Efficient computer room products have become less expensive as they have become more widely adopted, and other industry guidelines have surpassed Title 24, Part 6 Standards. Performance monitoring of computer rooms has become more common practice, such as server utilization monitoring and power monitoring.

While computer room electrical infrastructure efficiency is a source of significant energy savings potential, particularly for uninterruptible power supplies (UPS), Title 24, Part 6 currently does not address computer room electrical equipment efficiency and treats all computer room electrical equipment as an unregulated load. A California Energy Commission Public Interest Energy Research (PIER) Program, which identified a potential of 0.11-0.42 terawatt-hours per year energy savings potential by establishing minimum UPS efficiencies (E. P. Lawrence Berkeley National Laboratory (LBNL) 2008). Utility energy efficiency programs such as PG&E's Savings by Design and Customized Retrofit have also set minimum UPS efficiency standards to encourage efficient UPS installations (Taylor Engineering 2016).

The goal of the proposed code changes is to better align computer room efficiency requirements in California with industry design best practices and other industry standards and guidelines where applicable.

1.3.3 Regulatory Context for all Submeasures

1.3.3.1 Existing Requirements in the California Energy Code

Title 24, Part 6 first began regulating computer rooms in 2013. These standards focused on cooling system efficiency, particularly fan energy and cooling compressor energy.

Title 24, Part 6, 2019 includes the following relevant requirements:

- Section 140.9(a)1 requires full computer room economizing at outdoor temperatures of 55°F dry-bulb and 50°F wet-bulb and below for air economizers or at outdoor temperatures of 40°F dry-bulb and 35°F wet-bulb and below for water economizers, for computer rooms pursuing prescriptive compliance.
- Section 140.9(a)6 requires air containment for computer rooms exceeding 175 kW per room ITE design load and pursuing prescriptive compliance.
- Section 130.5(a) has mandatory electrical metering requirements for electrical loads of various size thresholds.
- Section 120.6(b)4A has a mandatory requirement that refrigerated warehouses with cooling loads greater than 150,000 Btu/hr have heat recovery, which demonstrates precedent to require heat recovery for a covered process.
- Section 120.1 states that computer room (not printing) spaces have an Air Class 1 designation per Table 120.1-A – Minimum Ventilation Rates, and therefore computer room air may be transferred to any space type per 120.1(g)1.

There are no relevant existing requirements in Title 24, Part 6 for UPS efficiency.

1.3.3.2 Relationship to Requirements in Other Parts of the California Building Code

Appendix E: Sustainable Practices of the 2019 California Mechanical Code includes provisions that address energy performance of computer rooms. This appendix is provided for reference, but provisions in Appendix E are not mandatory throughout California or in any local jurisdiction. Section E 503.5 includes prescriptive requirements for economizers. Exceptions (11) and (12) specify when economizer requirements apply to computer rooms. The mechanical code requires less stringent prescriptive economizer requirements for computer rooms than the 2019 Title 24, Part 6 requirements and the proposed code changes by allowing more exceptions to when economizers are required. Section E 503.8 presents an alternative compliance path that gives credit to computer rooms with modeled PUE values meeting certain thresholds as defined by ASHRAE 90.1. It is not anticipated that introducing a PUE monitoring requirement under Title 24, Part 6 would impact Appendix E requirements, since Appendix E is not a requirement anywhere in California and Appendix E would only apply to design and not building operation.

The 2019 California Electrical Code includes installation requirements for UPSs in section 645.11 but no requirements for UPS efficiency. The 2019 Appliance Efficiency Standards (Title 20) section 1605.3(w)(4) includes requirements for battery backup systems to consume no more than $0.8 + 0.0021 \times E_b$ watts in maintenance mode where E_b is the battery capacity in watt-hours.

The 2019 California Electrical Code includes installation requirements for electric meters, which would be applicable to PUE monitoring devices, in sections 230.82, 230.94 Exception 5, 250.142(B), 250.174, 250.176, 501.105, and 501.150.

There are no relevant requirements in other parts of the California Building Code for computer room heat recovery.

1.3.3.3 Relationship to Local, State, or Federal Laws

There are no relevant local, state, or federal laws for an increased temperature threshold for economizers or computer room heat recovery.

UPS Efficiency. On January 10, 2020, the United States (U.S.) Department of Energy (DOE) passed a Final Rule establishing minimum efficiency standards for AC-output UPSs using NEMA 1-15P or 5-15P input plugs by Federal Regulation Code Title 10, Part 430 (Office of Energy Efficiency and Renewable Energy n.d.). The cited Final Rule document describes the full technical, market, and cost-effectiveness analysis. The new federal requirements apply to UPSs manufactured on and after January 10, 2022. The federal requirements cover UPS products that use a 120 V plug and are aimed at UPSs used in residential and small commercial appliances that are smaller than those typically used in computer rooms. The federal requirements include minimum UPS

efficiencies for UPSs in three size categories: less than 300 W, greater than 700 W, and between 300 W and 700 W. As noted in the Final Rule, NEMA 1-15P and 5-15P plugs are capable of handling up to 15 A and 125 V, which gives them an upper power limit of 1,875 W. This means an 1,875 W UPS is effectively the largest UPS capacity subject to the federal UPS requirement. UPSs used in computer rooms are typically larger, centralized systems serving many servers and use 480 V or 208 V. To explicitly avoid overlap with the federal UPS standard, the Statewide CASE Team is recommending an exception from the proposed Title 24 minimum UPS efficiency requirement for UPSs that use NEMA 1-15P or 5-15P input plugs.

PUE Monitoring. Data centers are required to report annual energy use data to the Energy Commission’s Building Energy Benchmarking Program (CEC 2019), under California Assembly Bill 802. However, the Benchmarking Program only reports annual energy use per square foot for all buildings. PUE is a more meaningful energy efficiency metric for computer rooms/data centers since their energy use is so strongly dependent on the installed IT equipment load, rather than floor area. Requiring data centers to have the monitoring infrastructure under Title 24, Part 6, could enable data centers to more easily report PUE to the Building Energy Benchmarking Program if the program were to decide to incorporate PUE.

1.3.3.4 Relationship to Industry Standards

ASHRAE Standard 90.1 defines “computer room” as “a room whose primary function is to house equipment for the processing and storage of electronic data and that has a design electronic data equipment power density exceeding 20 W/ft of conditioned floor area” (ASHRAE, Standard 90.1 Energy Standard for Buildings Except Low-Rise Residential Buildings 2019). Title 24, Part 6 follows this definition.

ASHRAE 90.1 2019 section 6.5.1.2.1 includes exceptions for computer room cooling and defines outdoor economizing temperature requirements by climate zones. These temperature requirements are less stringent than 2019 Title 24 economizer requirements.

ASHRAE 90.1 2019 section 6.5.1.11 provides an exception for computer room economizing where the local water authority does not allow cooling towers. The Statewide CASE Team is proposing to include this exception for the new economizer temperature threshold requirements.

The proposed UPS efficiency submeasure matches ENERGY STAR Program Requirements for UPSs - Eligibility Criteria Version 2.0, for efficiency and testing requirements. ASHRAE Standard 90.4 “Energy Standard for Data Centers” (ASHRAE, Energy Standard for Data Centers 2016) includes UPS efficiency requirements. Washington State recently adopted ASHRAE 90.4 2016, Chapter 8, which will go into effect for data centers in July 2020.

The International Electrotechnical Commission is working on developing a UPS test standard under IEC 62040-3. This standard is anticipated to be released by the end of 2020.

There are no relevant industry standards for computer room heat recovery or PUE monitoring.

The 2019 California Building Code section 1224.5.2.1 defines a *healthcare technology equipment center* as a “space that is not used for any purpose other than electronic data storage, processing, and networking.” This is very similar to a *computer room* as defined in Title 24, Part 6.

1.4 Market Analysis Relevant to All Submeasures

1.4.1 Market Structure

The Statewide CASE Team performed a market analysis with the goals of identifying current technology availability, current product availability, and market trends. It then considered how the proposed standard may impact the market in general as well as individual market actors. Information was gathered about the incremental cost of complying with the proposed measure. Estimates of market size and measure applicability were identified through research and outreach with stakeholders including utility program staff, Energy Commission staff, and a wide range of industry actors. In addition to conducting personalized outreach to stakeholders, the Statewide CASE Team discussed the current market structure and potential market barriers during public stakeholder meetings that the Statewide CASE Team held on October 15, 2019 (Team, Nonresidential HVAC Part 1: Data Centers, Boilers, Controls Utility-Sponsored Stakeholder Meeting Notes 2019) and March 12, 2020 (Team, Nonresidential and Single Family HVAC Part 1: Data Centers, Boilers, Air Distribution, Variable Capacity 2020)).

1.4.2 Technical Feasibility, Market Availability, and Current Practices

Title 24, Part 6, defines a computer room as a room within a building whose primary function is to house electronic equipment and that has a design equipment power density exceeding 20 watts/ft² of conditioned floor area. Due to the high receptacle loads from IT equipment, cooling energy from fans and compressors are two of the largest opportunities for saving energy of Title 24-regulated loads in computer rooms.

To reduce fan energy, IT racks can be arranged in “hot aisles” and “cold aisles”, such that servers are installed to all face the same direction in a row of racks. The “cold aisle” is the air space between server racks where the cool supply air enters the front of servers, and the “hot aisle” is the air space between server racks where the warm return

air exits the back of the servers. Figure 1 below shows an elevation view of IT racks arranged in a hot and cold aisle configuration.

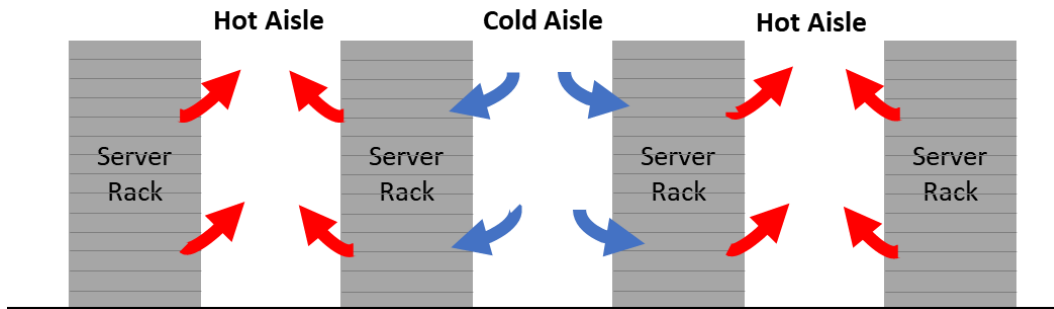

Figure 1. Hot aisle/cold aisle server arrangement schematic.

Source: Red Car Analytics, 2020.

1.4.3 Market Impacts and Economic Assessments

1.4.3.1 Impact on Builders

Builders of residential and commercial structures are directly impacted by many of the proposed code changes for the 2022 code cycle. It is within the normal practices of these businesses to adjust their building practices to changes in building codes. When necessary, builders engage in continuing education and training in order to remain compliant with changes to design practices and building codes.

California's construction industry is comprised of about 80,000 business establishments and 860,000 employees (see Table 8).⁵ In 2018, total payroll was \$80 billion. Nearly 60,000 of these business establishments and 420,000 employees are engaged in the residential building sector, while another 17,000 establishments and 344,000 employees focus on the commercial sector. The remainder of establishments and employees work in industrial, utilities, infrastructure, and other heavy construction (industrial sector).

⁵ Average total monthly employment in California in 2018 was 18.6 million; the construction industry represented 4.5 percent of 2018 employment.

Table 8: California Construction Industry, Establishments, Employment, and Payroll

Construction Sectors	Establishments	Employment	Annual Payroll (billions \$)
Commercial	17,273	343,513	\$27.8
Commercial Building Construction	4,508	75,558	\$6.9
Foundation, Structure, & Building Exterior	2,153	53,531	\$3.7
Building Equipment Contractors	6,015	128,812	\$10.9
Building Finishing Contractors	4,597	85,612	\$6.2
Industrial, Utilities, Infrastructure, & Other	4,103	96,550	\$9.2
Industrial Building Construction	299	5,864	\$0.5
Utility System Construction	1,643	47,619	\$4.3
Land Subdivision	952	7,584	\$0.9
Highway, Street, and Bridge Construction	770	25,477	\$2.4
Other Heavy Construction	439	10,006	\$1.0

Source: (State of California, Employment Development Department n.d.)

The proposed changes to computer rooms would likely affect commercial builders but would not impact firms that focus on construction and retrofit of industrial buildings, utility systems, public infrastructure, or other heavy construction. The effects on the residential and commercial building industry would not be felt by all firms and workers, but rather would be concentrated in specific industry subsectors. Table 9 shows the commercial building subsectors the Statewide CASE Team expects to be impacted by the changes proposed in this report. The increased temperature threshold for economizers and heat recovery submeasures primarily impact HVAC contractors but are expected to also impact electrical and HVAC controls contractors. The UPS efficiency and PUE monitoring submeasures primarily impact electrical contractors, with the PUE monitoring submeasure also impacting controls contractors. The Statewide CASE Team’s estimates of the magnitude of these impacts are shown in Section 3.4 Economic Impacts.

Table 9: Specific Subsectors of the California Commercial Building Industry Impacted by Proposed Change to Code/Standard

Construction Subsector	Establishments	Employment	Annual Payroll (billions \$)
Commercial Building Construction	4,508	75,558	\$6.9
Nonresidential Electrical Contractors	3,115	66,951	\$5.6
Nonresidential plumbing and HVAC contractors	2,394	52,977	\$4.5
Other Nonresidential equipment contractors	506	8,884	\$0.9
All other Nonresidential trade contractors	988	17,960	\$1.4

Source: (State of California, Employment Development Department n.d.)

1.4.3.2 Impact on Building Designers and Energy Consultants

Adjusting design practices to comply with changing building codes practices is within the normal practices of building designers. Building codes (including Title 24, Part 6) are typically updated on a three-year revision cycle and building designers and energy consultants engage in continuing education and training in order to remain compliant with changes to design practices and building codes.

Businesses that focus on residential, commercial, institutional, and industrial building design are contained within the Architectural Services sector (North American Industry Classification System 541310). Table 10: California Building Designer and Energy Consultant Sectors shows the number of establishments, employment, and total annual payroll for Building Architectural Services. The proposed code changes would potentially impact all firms within the Architectural Services sector. The Statewide CASE Team anticipates the impacts for computer room efficiency to affect firms that focus on nonresidential construction.

There is not a North American Industry Classification System (NAICS)⁶ code specific for energy consultants. Instead, businesses that focus on consulting related to building

⁶ NAICS is the standard used by Federal statistical agencies in classifying business establishments for the purpose of collecting, analyzing, and publishing statistical data related to the U.S. business economy. NAICS was developed jointly by the U.S. Economic Classification Policy Committee (EPC), Statistics Canada, and Mexico's Instituto Nacional de Estadística y Geografía, to allow for a high level of comparability in business statistics among the North American countries. NAICS replaced the Standard Industrial Classification (SIC) system in 1997.

energy efficiency are contained in the Building Inspection Services sector (NAICS 541350), which is comprised of firms primarily engaged in the physical inspection of residential and nonresidential buildings.⁷ It is not possible to determine which business establishments within the Building Inspection Services sector are focused on energy efficiency consulting. The information shown in Table 10 provides an upper bound indication of the size of this sector in California.

Table 10: California Building Designer and Energy Consultant Sectors

Sector	Establishments	Employment	Annual Payroll (billions \$)
Architectural Services ^a	3,704	29,611	\$2.9
Building Inspection Services ^b	824	3,145	\$0.2

Source: (State of California, Employment Development Department n.d.)

- a. Architectural Services (NAICS 541310) comprises private-sector establishments primarily engaged in planning and designing residential, institutional, leisure, commercial, and industrial buildings and structures;
- b. Building Inspection Services (NAICS 541350) comprises private-sector establishments primarily engaged in providing building (residential & nonresidential) inspection services encompassing all aspects of the building structure and component systems, including energy efficiency inspection services.

1.4.3.3 Impact on Occupational Safety and Health

The proposed code change does not alter any existing federal, state, or local regulations pertaining to safety and health, including rules enforced by the California Division of Occupational Safety and Health (Cal/OSHA). All existing health and safety rules would remain in place. Complying with the proposed code change is not anticipated to have adverse impacts on the safety or health of occupants or those involved with the construction, commissioning, and maintenance of the building.

1.4.3.4 Impact on Building Owners and Occupants in Commercial Buildings

The commercial building sector includes a wide array of building types, including offices, restaurants and lodging, retail, and mixed-use establishments, and warehouses (including refrigerated) (Kenny, Bird and Rosales 2019). Energy use by occupants of

⁷ Establishments in this sector include businesses primarily engaged in evaluating a building's structure and component systems and includes energy efficiency inspection services and home inspection services. This sector does not include establishments primarily engaged in providing inspections for pests, hazardous wastes or other environmental contaminants, nor does it include state and local government entities that focus on building or energy code compliance/enforcement of building codes and regulations.

commercial buildings also varies considerably with electricity used primarily for lighting, space cooling and conditioning, and refrigeration. Natural gas consumed primarily for heating water and for space heating. According to information published in the 2019 California Energy Efficiency Action Plan, there is more than 7.5 billion square feet of commercial floor space in California and consumes 19 percent of California's total annual energy use (Kenny, Bird and Rosales 2019). The diversity of building and business types within this sector creates a challenge for disseminating information on energy and water efficiency solutions, as does the variability in sophistication of building owners and the relationships between building owners and occupants.

Building owners and occupants would benefit from lower energy bills. As discussed in Section 1.4.4.1, when building occupants save on energy bills, they tend to spend it elsewhere in the economy thereby creating jobs and economic growth for the California economy. The Statewide CASE Team does not expect the proposed code change for the 2022 code cycle to impact building owners or occupants adversely.

1.4.3.5 Impact on Building Component Retailers (Including Manufacturers and Distributors)

The proposed increased temperature threshold for economizers sets more aggressive energy performance requirements that not all products available in today's market may be able to meet prescriptively. The UPS efficiency submeasure would require manufacturers to perform efficiency testing per ENERGY STAR requirements to demonstrate the UPS meets the proposed prescriptive Title 24 requirement.

1.4.3.6 Impact on Building Inspectors

Table 11 shows employment and payroll information for state and local government agencies in which many inspectors of residential and commercial buildings are employed. Building inspectors participate in continuing training to stay current on all aspects of building regulations, including energy efficiency. The Statewide CASE Team therefore anticipates the proposed change would have minimal impact on employment of building inspectors or the scope of their role conducting energy efficiency inspections.

Table 11: Employment in California State and Government Agencies with Building Inspectors

Sector	Govt.	Establishments	Employment	Annual Payroll (millions \$)
Administration of Housing Programs ^a	State	17	283	\$29.0
	Local	36	2,882	\$205.7
Urban and Rural Development Admin ^b	State	35	552	\$48.2
	Local	52	2,446	\$186.6

Source: (State of California, Employment Development Department n.d.)

- a. Administration of Housing Programs (NAICS 925110) comprises government establishments primarily engaged in the administration and planning of housing programs, including building codes and standards, housing authorities, and housing programs, planning, and development.
- b. Urban and Rural Development Administration (NAICS 925120) comprises government establishments primarily engaged in the administration and planning of the development of urban and rural areas. Included in this industry are government zoning boards and commissions.

1.4.3.7 Impact on Statewide Employment

As described in Sections 3.3.1 through 3.3.6, the Statewide CASE Team does not anticipate significant employment or financial impacts to any particular sector of the California economy. This is not to say that the proposed change would not have modest impacts on employment in California. In Section 3.4, the Statewide CASE Team estimated the proposed changes in computer room efficiency would affect statewide employment and economic output directly and indirectly through its impact on builders, designers and energy consultants, and building inspectors. In addition, the Statewide CASE Team estimated how energy savings associated with the proposed changes in computer room efficiency would lead to modest ongoing financial savings for California residents, which would then be available for other economic activities.

1.4.4 Economic Impacts

Adoption of this code change proposal would result in relatively modest economic impacts through the additional direct spending by those in the commercial building industry, architects, energy consultants, and building inspectors. The Statewide CASE Team does not anticipate that money saved by commercial building owners or other organizations affected by the proposed 2022 code cycle regulations would result in additional spending by those businesses.

Table 12: Estimated Impact that Adoption of the Proposed Measure would have on the California Commercial Construction Sector

Type of Economic Impact	Employment (jobs)	Labor Income (millions \$)	Total Value Added (millions \$)	Output (millions \$)
Direct Effects (Additional spending by Commercial Builders)	100	\$10	\$13	\$21
Indirect Effect (Additional spending by firms supporting Commercial Builders)	0	\$2	\$4	\$7
Induced Effect (Spending by employees of firms experiencing “direct” or “indirect” effects)	100	\$4	\$6	\$11
Total Economic Impacts	200	\$16	\$23	\$39

Source: Analysis by Evergreen Economics of data from the IMPLAN V3.1 modeling software.

Table 13: Estimated Impact that Adoption of the Proposed Measure would have on the California Building Designers and Energy Consultants Sectors

Type of Economic Impact	Employment (jobs)	Labor Income (millions \$)	Total Value Added (millions \$)	Output (millions \$)
Direct Effects (Additional spending by Building Designers & Energy Consultants)	0.1	\$0.01	\$0.01	\$0.01
Indirect Effect (Additional spending by firms supporting Bldg. Designers & Energy Consult.)	0	\$0.00	\$0.00	\$0.01
Induced Effect (Spending by employees of firms experiencing “direct” or “indirect” effects)	0	\$0.00	\$0.00	\$0.01
Total Economic Impacts	0.1	\$0.01	\$0.01	\$0.03

Source: Analysis by Evergreen Economics of data from the IMPLAN V3.1 modeling software.

Table 14: Estimated Impact that Adoption of the Proposed Measure Would Have on California Building Inspectors

Type of Economic Impact	Employment (jobs)	Labor Income (millions \$)	Total Value Added (millions \$)	Outputs (millions \$)
Direct Effects (Additional spending by Building Inspectors)	0	\$0.00	\$0.00	\$0.00
Indirect Effect (Additional spending by firms supporting Building Inspectors)	0	\$0.00	\$0.00	\$0.00
Induced Effect (Spending by employees of Building Inspection Bureaus and Departments)	0	\$0.00	\$0.00	\$0.00
Total Economic Impacts	0	\$0.00	\$0.00	\$0.00

Source: Analysis by Evergreen Economics of data from the IMPLAN V3.1 modeling software.

1.4.4.1 Creation or Elimination of Jobs

The Statewide CASE Team does not anticipate that the measures proposed for the 2022 code cycle regulation would lead to the creation of new *types* of jobs or the elimination of *existing* types of jobs. In other words, the Statewide CASE Team’s proposed change would not result in economic disruption to any sector of the California economy. Rather, the estimates of economic impacts discussed in Section 3.4 would lead to modest changes in employment of existing jobs.

1.4.4.2 Creation or Elimination of Businesses in California

As stated in Section 3.4.1, the Statewide CASE Team’s proposed change would not result in economic disruption to any sector of the California economy. Therefore, the Statewide CASE Team does not foresee any new businesses being created, nor does the Statewide CASE Team think any existing businesses would be eliminated due to the proposed code changes.

1.4.4.3 Competitive Advantages or Disadvantages for Businesses in California

The proposed code changes would apply to all businesses operating in California, regardless of whether the business is incorporated inside or outside of the state.⁸ Therefore, the Statewide CASE Team does not anticipate that these measures proposed for the 2022 code cycle regulation would have an adverse effect on the competitiveness of California businesses. Likewise, the Statewide CASE Team does not anticipate businesses located outside of California would be advantaged or disadvantaged.

1.4.4.4 Increase or Decrease of Investments in the State of California

The Statewide CASE Team analyzed national data on corporate profits and capital investment by businesses that expand a firm's capital stock (referred to as net private domestic investment, or NPDI).⁹ As Table 15 shows between 2015 and 2019, NPDI as a percentage of corporate profits ranged from 26 to 35 percent, with an average of 31 percent. While only an approximation of the proportion of business income used for net capital investment, the Statewide CASE Team believes it provides a reasonable estimate of the proportion of proprietor income that would be reinvested by business owners into expanding their capital stock.

Table 15: Net Domestic Private Investment and Corporate Profits, U.S.

Year	Net Domestic Private Investment by Businesses, Billions of Dollars	Corporate Profits After Taxes, Billions of Dollars	Ratio of Net Private Investment to Corporate Profits
2015	609.3	1,740.4	35%
2016	456.0	1,739.8	26%
2017	509.3	1,813.6	28%
2018	618.3	1,843.7	34%
2019	580.9	1,827.0	32%
5-Year Average			31%

Source: (Federal Reserve Economic Data n.d.)

The Statewide CASE Team anticipates about a \$0.6 million net increase in private investment from the proposed measure.

⁸ Gov. Code, §§ 11346.3(c)(1)(C), 11346.3(a)(2); 1 CCR § 2003(a)(3) Competitive advantages or disadvantages for California businesses currently doing business in the state.

⁹ Net private domestic investment is the total amount of investment in capital by the business sector that is used to expand the capital stock, rather than maintain or replace due to depreciation. Corporate profit is the money left after a corporation pays its expenses.

1.4.4.5 Effects on the State General Fund, State Special Funds, and Local Governments

The Statewide CASE Team does not expect the proposed code changes would have a measurable impact on California's General Fund, any state special funds, or local government funds.

1.4.4.6 Cost of Enforcement

Cost to the State

State government already has budgeted for code development, education, and compliance enforcement. While state government would be allocating resources to update the Title 24, Part 6 Standards, including updating education and compliance materials and responding to questions about the revised requirements, these activities are already covered by existing state budgets. The costs to state government are small when compared to the overall costs savings and policy benefits associated with the code change proposals. The proposed code changes are expected to have a minimal impact on state buildings by only impacting computer room space types, with most impacts being for new construction buildings. Each submeasure has been found to be cost effective.

Cost to Local Governments

All proposed code changes to Title 24, Part 6 would result in changes to compliance determinations. Local governments would need to train building department staff on the revised Title 24, Part 6 Standards. While this re-training is an expense to local governments, it is not a new cost associated with the 2022 code change cycle. The building code is updated on a triennial basis, and local governments plan and budget for retraining every time the code is updated. There are numerous resources available to local governments to support compliance training that can help mitigate the cost of retraining, including tools, training and resources provided by the IOU Codes and Standards program (such as Energy Code Ace). As noted in Section 2.5 and Appendix C, the Statewide CASE Team considered how the proposed code change might impact various market actors involved in the compliance and enforcement process and aimed to minimize negative impacts on local governments.

1.4.4.7 Impacts on Specific Persons

While the objective of any of the Statewide CASE Team's proposal is to promote energy efficiency, the Statewide CASE Team recognizes that there is the potential that a proposed code change may result in unintended consequences. This proposal is not expected to result in impacts on specific persons different from the general population. Impacts of the proposed submeasures on individual persons is anticipated to be very

minimal, as the proposed code changes impact building systems serving covered process spaces, not accessible to typical building occupants.

2. Increased Temperature Threshold

2.1 Measure Description

2.1.1 Measure Overview

This submeasure proposal includes the following modifications to Section 140.9(a) prescriptive requirements for computer rooms.

- Establish a single set of outdoor temperatures for all economizer types, instead of having separate requirements for air and water economizers.
- Increase minimum outdoor temperatures for full economizing to 65°F dry-bulb or 50°F wet-bulb for any type of economizer. Currently the thresholds are 55°F dry-bulb and 50°F wet-bulb for air economizers, and 40°F dry-bulb and 35°F wet-bulb for water economizers. An exception is included to allow projects to meet the 2019 Section 140.9(a)1 economizer temperature requirements as long as they also implement higher efficiency fan systems, air containment, and cooling equipment.
- Decrease the computer room minimum size threshold for requiring air containment from 175 kW per room to 10 kW per room ITE design load.
- Modify 140.09(a)1 Exception 4 to allow for the computer room to be served by the maximum spare cooling capacity from the economizing fan system rather than requiring the economizing fan system to serve the full design cooling load of the computer room, as long as at least five tons of economizer cooling is provided. This exception would apply to all computer rooms.

This submeasure proposal includes the following modifications in Section 141.1(b) prescriptive requirements for computer rooms in existing buildings.

- Addition of economizer requirements for computer rooms in existing buildings. This involves moving 2019 Title 24, Part 6, 140.9(a)1 requirements to this new subsection. This would not introduce new requirements for computer rooms in additions/ alterations but would clarify which requirements apply to computer rooms in new buildings and which requirements apply to computer rooms in additions/alterations.

Finally, this submeasure proposal includes recommendations to update the compliance software to allow designers who use the performance approach to model the impacts of computer room economizers. California Building Energy Code Compliance software for commercial buildings (CBECC-Com) is not currently capable of modeling dry cooler or refrigerant economizers. Both of these economizer types are commonly used in California and offered by a number of major manufacturers. The Statewide CASE Team

recommends that CBECC-Com be updated so dry cooler and refrigerant economizers can be modeled and projects using these technologies may pursue the performance compliance path.

CBECC-Com currently has limitations on the air temperatures that can be modeled for computer rooms. Based on reviews of dozens of computer room designs, stakeholder consultations, and best practice guideline references such as ASHRAE (ASHRAE, Thermal Guidelines for Data Processing Environments, Fourth Edition 2015), it is evident that a variety of supply and return air temperatures are commonly used in computer room designs, which have a large impact on compressor energy based on economizing hours and on fan energy. The Statewide CASE Team recommends that CBECC-Com be updated so exact design supply and return air temperatures can be modeled and the economizing system incorporates these temperatures.

See Appendix D for additional information about proposed changes to the compliance software.

2.1.2 Measure History

Since 2013, Title 24, Part 6 has included prescriptive requirements for computer rooms with ITE design loads greater than 20 W/ft². One of these requirements is to utilize full economizing at 55°F dry-bulb and 50°F wet-bulb outdoor temperature and below for air economizers or to utilize full economizing at 40°F dry-bulb and 35°F wet-bulb outdoor temperature and below for water economizers (Section 140.9(a)1). These requirements assume a 60°F computer room supply air temperature, which is included in compliance modeling software. A 60°F supply air temperature is below the recommended range for computer rooms per ASHRAE Thermal Guidelines for Data Processing Environments (ASHRAE 2015), which includes a recommended server inlet dry-bulb temperature between 64.4°F and 80.6°F. Another requirement is to install air containment for rooms exceeding 175 kW/room (Section 140.9(a)6). While these were important first steps in establishing statewide energy savings for computer rooms, these requirements are relatively conservative compared to computer room design best practices and when considering pricing of air containment products available on the market. This submeasure seeks to improve Title 24, Part 6 alignment with ASHRAE Thermal Guidelines for Data Processing Environments (ASHRAE 2015), by increasing the minimum outdoor temperature requirement for full economizing with any type of economizer to 65°F dry-bulb or 50°F wet-bulb temperature. These values are based on

an assumed 70°F computer room supply air dry-bulb temperature setpoint,¹⁰ which falls in the lower range of ASHRAE's recommended server inlet dry-bulb temperature. Increasing the outdoor temperature for full economizing would save significant energy for all climate zones in California by increasing the annual hours of economizing.

Some significant barriers were identified for implementing these increased economizing temperature thresholds for computer rooms in existing buildings, both new computer rooms in existing buildings and expansions of existing computer rooms. These barriers include difficulty in accessing outside air for direct air economizing for computer rooms located in core zones, cooling coils sized for colder supply air temperatures (e.g., 60°F) not being able to meet cooling loads if operated at warmer temperatures, and cooling towers or dry coolers sized for colder temperatures and not having adequate approach temperatures to meet the proposed elevated outdoor temperature requirements. Due to these barriers, the proposed increased temperature thresholds for economizers are proposed for new construction computer rooms only.

To supply air at 70°F dry-bulb temperature and maintain server inlet temperature below 80.6°F, air containment can be used to reduce mixing of hot return air with cool supply air before the cool air reaches the server inlets. Air containment has become increasingly prevalent in computer rooms, with many available products, including blanking panels, strip curtains, solid doors/panels, and return air chimneys, providing cost-effective containment options for computer rooms of varying sizes.

By reducing mixing of supply and return air, installing air containment reduces the amount of airflow needed to provide cooling, which results in reduced cooling fan power demand and annual energy savings. There are not significant differences in the implementation of installing air containment in new computer rooms compared to existing computer rooms. Therefore, the air containment component of this submeasure is being proposed for both new construction and alterations to match the current air containment application.

While computer room economizer requirements have been included in Title 24, Part 6 since 2013, compliance software provides limited options in which economizer system types and operating conditions that can be modeled. For example, dry cooler and refrigerant economizers cannot be modeled in the software. Also, the software does not allow for deviation from standard supply and return air temperatures (60°F and 80°F) to be modeled, such that computer rooms designed for elevated temperatures cannot take

¹⁰ Air economizer: 100% outside air can be provided for up to 65°F outdoor dry-bulb and up to 5°F temperature increase due to fan heat to meet the supply air temperature setpoint. Water economizer: 100% of the computer room cooling load can be provided by cooling towers with a 10°F wet-bulb approach temperature, 3°F heat exchanger approach temperature, and 7°F chilled water coil approach temperature plus fan heat temperature increase.

full credit for the increased economizer hours their design provides. The lack of air temperature flexibility also does not allow for designs to take credit for larger supply and return air differentials, when computer rooms are often designed for 25°F or 30°F, which can use significantly less fan energy than computer rooms designed for a 20°F supply and return air differential.

2.1.3 Compliance and Enforcement

When developing this proposal, the Statewide CASE Team considered methods to streamline the compliance and enforcement process and how negative impacts on market actors who are involved in the process could be mitigated or reduced. This section describes how to comply with the proposed code change. It also describes the compliance verification process. Appendix E presents how the proposed changes could impact various market actors.

The activities that need to occur during each phase of the project are described below.

- **Design Phase:** The mechanical design engineer determines which economizer requirements are triggered based on the computer room ITE design load, building type (new or existing), and if the computer room ITE design load triggers the requirement for air containment. The mechanical design engineer performs this load calculation as current standard practice. Mechanical design engineers show cooling coil temperatures and economizers are sized to meet economizing requirements and air containment on permit design drawings, and specifications as needed. Coordination with the architect is required for all mechanical design elements and in particular, for air economizing systems which require access to outside air for the computer room. Mechanical design engineers or energy consultants complete Nonresidential Certificate of Compliance (NRCC) forms with the permit package. These activities are the same as current requirements; however, the mechanical design engineer would need to follow the new requirements.
- **Permit Application Phase:** The plans examiner reviews mechanical permit drawings and specifications to confirm if air containment is required and, if so, that it is shown on the permit documents. The plans examiner also reviews equipment schedules to confirm economizer type and design temperatures. If the heat recovery exception is being used, then the mechanical drawings must show CBECC-Com simulation results that show at least 80 percent of the annual computer room cooling load is used to provide heating to other building heating loads.
- **Construction Phase:** The mechanical contractor reviews mechanical design documents to confirm air containment and economizer requirements, and then selects and installs air containment (if required) and an economizer that meets

the design specification. The controls contractor installs controls to allow the economizer system to operate per the design specification.

- **Inspection Phase:** The mechanical contractor completes Nonresidential Certificate of Installation (NRCI) forms.

2.2 Market Analysis

2.2.1 Market Structure

2.2.1.1 Market Overview

Market surveys by the Uptime Institute, a leading computer room industry research group, indicated 80 percent of survey respondents use air containment in their computer rooms, 63 percent of respondents use elevated temperatures, and 61 percent use air or water economizing (Institute 2014). Though responses were from global participants, these numbers are thought to reflect common practices in California computer rooms. These numbers indicate wide adoption of these technologies in computer rooms in 2014 when these technologies became required for computer rooms in Title 24, Part 6. Since that time, economizing in computer rooms and air containment have become even more common practice in California, as building operators have come to realize the significant energy savings associated with these strategies and more cost-effective products are available in the market.

The air temperatures at which a computer room operates are dependent on several factors, including server arrangement, installed air containment products, supply air (or return air) temperature setpoint, supply fan speed control method and setpoint, and cooling coil design condition selection. The operating temperatures impact how many annual hours the computer room can operate in economizing mode. Many of the design features are determined by the mechanical design engineer (e.g., temperature and fan speed control sequences of operation, selected coil conditions), who typically works with the owner to determine acceptable design temperature and humidity conditions for computer room operation. The design engineer also coordinates with other engineering trades such as architects, electrical engineers, and structural engineers) to select location and orientation for server racks and IT equipment, while considering requirements for airflow, and mechanical, electrical, and structural infrastructure. Lastly, products are specified to meet the design requirements. Air containment products are sold directly from manufacturers or sales representatives, and mechanical economizer equipment is sold by third party sales representatives. Containment and economizer products may consist of customized components or pre-packaged systems. In either case, there are many manufacturers that make and sell these products in California.

Computer rooms vary in size and can range from a few kilowatts of ITE design load up to tens of megawatts of ITE design load. Smaller computer rooms are typically located in buildings that are designed primarily for other uses (e.g., offices, schools) and are owned and/or operated by the same entity owning/operating the rest of the building. Very small computer rooms (approximately 10 kW of ITE design load and lower) are typically served by larger building air handling systems with economizers with a dedicated variable air volume terminal unit serving the computer room. On the other hand, very large computer rooms (or “data centers”) are typically located in buildings that were designed and constructed to be primarily computer room space, and space layouts and building infrastructure are designed and constructed to be optimized for computer room equipment. These large data centers can be developed and operated by companies who specialize in building and operating data centers for tenants.

A couple of data center developers expressed concern about the proposed increase to temperature thresholds for economizing because their standard designs include air-cooled chillers with integrated dry cooler economizers, and they do not include evaporative cooling (e.g., water-cooled chillers and evaporative cooling towers). Their stated reasons for this design include water use concerns, demand from tenants and market competition to build faster than what water-cooled chiller plants allow, and ability to build out cooling equipment modularly to be able to segregate cooling equipment by tenant in the case of multiple tenants and to be able to build out cooling equipment capacity by construction phase. To address the speed to market concern, it is noted that the proposed energy code change would apply to all new computer rooms, so all owners would have equal requirements.

The Statewide CASE Team worked with prominent national manufacturers to obtain market data of the relative numbers of different types of economizers used in computer rooms in California, in addition to U.S. DOE national data (U.S. Department of Energy 2011) and CBECS chiller data (U.S. Department of Energy 2012). This information was used to estimate the market share of prominent economizer types in California computer rooms. The results are shown in the table below.

Table 16: Estimated Computer Room Cooling System Types in California

Cooling System Type	Portion of California Computer Rooms
CRACs without fluid/refrigerant economizer	54%
CRACs with fluid/refrigerant economizer	13%
CRAHs served by water-cooled chillers	23%
CRAHs served by air-cooled chillers	10%
Total	100%

The DOE data includes national CRAC sales data and indicates 19 percent of CRACs have economizers and 81 percent of CRACs are not sold with economizers; this ratio stays constant from 2018 through at least 2023. Manufacturer data indicated that California’s market matches the national CRAC market in terms of the portion of CRACs sold with and without economizers.

Manufacturers provided information that helped estimate the market portion using CRACs and CRAHs. Data on other cooling system types such as DX package units or in-row chilled water fan coils was not obtained. To determine the breakdown of water-cooled chillers and air-cooled chillers serving CRAHs, CBECS data for the Pacific Region was used for all buildings with chillers. It is assumed this distribution applies to computer rooms in the same ratios as all buildings included in the CBECS survey.

Data was not broken out by new construction and additions/alterations. For the purposes of this report, it is assumed there is no significant difference in market share by computer room cooling system type between new construction computer rooms and computer rooms in existing buildings.

2.2.1.2 Design

This submeasure largely relies on the mechanical design engineer to design the mechanical system to properly comply with the code requirement. This starts with identifying which code requirements are triggered based on the ITE design load in the computer room. The mechanical design engineer must select and size mechanical cooling technologies to provide sufficient cooling capacity through the economizer at the required outdoor temperatures; this includes sizing the cooling coil for temperatures that allow the code requirement to be met, including air containment on drawings, coordinating space requirements with the architect and other trades especially when using air economizers, and developing a mechanical controls sequence of operation that achieves code requirements.

Coordination between the mechanical and electrical designers is required to lay out server rack orientation for the air containment system. Air containment systems are

often packaged products sold from vendors, so the mechanical engineer may develop a design specification geared toward a specific vendor product.

All of these activities must be performed for computer rooms under Title 24, Part 6, 2019, and have been required since 2013. This code change proposal requires designing for higher temperatures.

2.2.1.3 Installation and Commissioning

After procuring materials from equipment vendors, the mechanical contractor installs the mechanical and air containment systems. The cooling system is commissioned by the mechanical contractor and a third-party commissioning agent. These are activities that have been required under Title 24, Part 6 since 2013 and would remain in place under this proposal. Because computer rooms are typically considered critical loads, typical practice includes commissioning to confirm mechanical and electrical systems are installed properly.

2.2.2 Technical Feasibility, Market Availability, and Current Practices

The proposed code change assumes a cooling coil supply air temperature (supply air temperature) of 70°F. Designing for the proposed supply air temperature of 70°F is easily achievable using market-available computer room air handling equipment (cooling coils, fans, etc.), provided by predominant HVAC manufacturers in the California market, such as Liebert, Schneider Electric, DataAir, Stulz, etc., and air containment product suppliers. A supply air temperature of 70°F is achievable using common mechanical equipment. Selecting equipment for these design temperatures is half of the technical effort required to implement this submeasure. The other half requires air containment to avoid mixing of cool supply air with hot return air before the supply air enters the servers or other IT equipment, to prevent air that is too hot from entering the servers/IT equipment. See ASHRAE's *Thermal Guidelines for Data Processing Environments* (ASHRAE 2015) for recommended and allowable IT equipment inlet temperatures. Containment technologies are available from many manufacturers and range from rigid aisle enclosures, to strip curtains, to server rack return air chimneys, to blanking panels, and more. With sufficient containment to provide air barriers such that there is no significant air path for warm computer equipment return air to recirculate back to computer inlets without passing through a cooling system (i.e., containment as defined in Title 24, Part 6, 2019), a 20°F temperature differential or greater between supply and return air at the cooling coils is achievable.

Exceptions for computer rooms less than 20 tons ITE design load served by non-dedicated cooling systems and computer rooms less than 5 tons ITE design load in buildings without economizers would remain. Computer rooms less than 10 kilowatts ITE design load utilizing the first exception are commonly served by the building's main

air handling system and use VAV terminal units to provide cool air to the computer room.

Water Economizers Using Evaporative Cooling Tower and Air Economizers

Air and water economizers sized to meet the proposed economizing requirements are also widely available as built-up units or pre-packaged products, from many manufacturers. The proposed economizing temperatures allow for as low as a 70°F supply air temperature with full air economizing at outdoor dry-bulb temperatures of 65°F and below, as shown in an example system schematic in Figure 2 below. The proposed economizing temperatures allow for a 70°F supply air temperature with full water economizing at outdoor wet-bulb temperatures of 50°F and below, assuming a 10°F cooling tower wet-bulb approach temperature, 3°F heat exchanger approach temperature, and 7°F cooling coil approach temperature plus temperature increase due to fan waste heat, as shown in an example system schematic in Figure 2 below. All of these are common design approach temperatures and are offered by numerous product manufacturers. It is important to recognize that all redundant equipment (e.g., cooling towers, CRAHs) should be running in economizer mode and that the load on the cooling towers would be below design load (e.g., no chiller heat to reject) in full economizer mode. This makes it easier to achieve full economizing at 50°F wet-bulb.

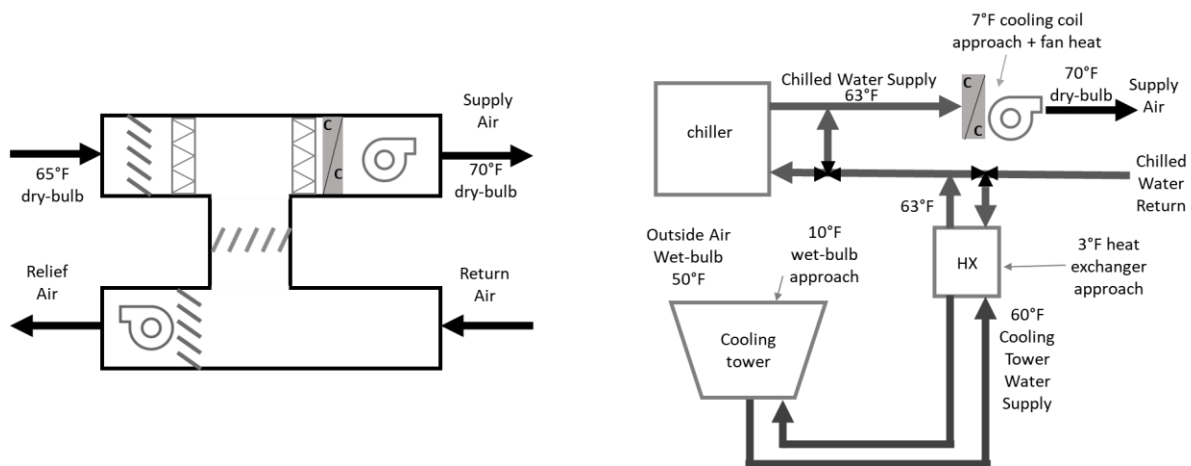

Figure 2. Example design temperatures: air economizer (left) and water economizer (right).

Source: Red Car Analytics, 2020.

Air-Cooled Chillers with Dry Cooler Economizers

Some stakeholders expressed that they typically use air-cooled chillers with integrated dry cooler economizers to meet current Title 24 economizer temperature requirements. Most dry coolers would have difficulty meeting the new prescriptive 65°F outdoor dry-bulb temperature economizer requirement. In cases where owners use air-cooled

chillers and dry coolers to achieve economizing as their typical practice, this proposed code change may require evaporative cooling towers to be added to the design to meet the new economizer prescriptive requirements, or the project may elect to pursue the performance code compliance path. The Statewide CASE Team is also proposing an exception to the proposed increased economizer temperatures, which would allow new computer rooms to adhere to 2019 Title 24 economizer temperature requirements if the project also implements a higher efficiency fan system, enhanced air containment, and more efficient cooling equipment. Refer to Appendix G for details on the energy savings tradeoff for this proposed exception. Because this is being proposed as an exception to a code requirement, a cost-effectiveness analysis was not performed.

Refrigerant Economizers

A review of refrigerant economizers on the market indicate that some can meet the proposed prescriptive economizing temperature thresholds. For example, one unit can provide full economizing at 65°F outdoor dry-bulb temperature while providing a supply air temperature of 75°F (Munters 2020). While this is higher than the proposed value of 70°F supply air temperature, it is still within ASHRAE's Recommended range (ASHRAE, Thermal Guidelines for Data Processing Environments, Fourth Edition 2015). Other products' literature indicates meeting the proposed prescriptive economizing temperature thresholds may or may not be feasible, depending on a number of factors including return air temperature and system load factor.

Potential Market Barriers

While this submeasure is feasible from a technological perspective, the Statewide CASE Team has identified elevated temperatures in aisles as a potential barrier to implementation through their work in computer rooms and conversations with computer room operators. Elevated temperatures result in warmer hot aisles, in cases where server racks are arranged in a hot aisle / cold aisle configuration. While computer rooms are not regularly populated, IT personnel may enter the space for maintenance. This means workers at times may experience environments of 90°F or above in the computer room hot aisle. To address this concern, hot aisle containment may be used so the majority of the computer room space is the cold aisle and operates at a more comfortable temperature of around 70°F. Computer room operators also indicated training and education for workers on the thermal conditions of their work environment and what to expect as an effective strategy to mitigate this concern, similar to other process load facilities such as manufacturing. Containing the hot aisle also avoids concerns about needing to insulate walls of a hot room computer room that shares a wall with an adjacent space with a lower zone temperature.

A couple of data center developers expressed concern about the proposed increase to temperature thresholds for economizing because their standard designs include air-

cooled chillers with integrated dry cooler economizers, and they do not include evaporative cooling (e.g., water-cooled chillers and evaporative cooling towers). Their stated reasons for this design include water use and reliability concerns and ability to build out cooling equipment modularly to be able to segregate cooling equipment by tenant in the case of multiple tenants and to be able to build out cooling equipment capacity by construction phase.

To address water use concerns, the Statewide CASE Team has included water use in the cost-effectiveness analysis. Energy codes are a good way to address public perception and concerns regarding site water use, providing equal requirements to all owners. While not included in the scope of the cost-effectiveness analysis of the CASE Report, saving site energy saves water energy at fossil fuel utility plants. To address water reliability concerns, recycled water can be used for cooling towers. Recycled water is available from many water utilities throughout the state. To address the cooling equipment segregation by customer concern, water energy meters could be used to measure each tenant's portion of the central cooling plant load to achieve energy cost submetering for each tenant. This is commonly done for district heating and cooling systems on campuses and cities throughout California and the U.S. Because tenant water submetering is not a Title 24 requirement, water meters are not included in the cost effectiveness analysis for chilled water systems, but given their relatively low cost and the high cost effectiveness under this submeasure, the inclusion of water meters is not expected to bring the benefit-to-cost ratio below 1.0. See section 5 of this report for more details on the cost effectiveness analysis. A central water-cooled chiller plant serving multiple tenants can be held to the same reliability and maintenance standards as segregated smaller plants. To address the modular build out concern, water-cooled chiller plants can also be built out over time similar to air-cooled chiller plants.

2.3 Energy Savings

2.3.1 Key Assumptions for Energy Savings Analysis

The energy and cost analysis presented in this report used the TDV factors that are consistent with the TDV factors presented during the Energy Commission's March 27, 2020 workshop on compliance metrics (California Energy Commission 2020). The electricity TDV factors include the 15 percent retail adder and the natural gas TDV factors include the impact of methane leakage on the building site. The electricity TDV factors used in the energy savings analyses were obtained from Energy and Environmental Economics, Inc. (E3), the contractor that is developing the 2022 TDV factors for the Energy Commission, in a spreadsheet titled "Electric TDVs 2022 - 15 pct Retail Adj Scaled by Avoided Costs.xlsx". The natural gas TDV factors used in the energy savings analyses were obtained via email from E3 in a spreadsheet titled "2022_TDV_Policy_Compliant_CH4Leak_FlatRtlAdd_20191210.xlsx". The electricity

demand factors used in the energy savings analysis were obtained from E3 in a spreadsheet titled “2022 TDV Demand Factors.xlsx”. The Energy Commission notified the Statewide CASE Team on April 21, 2020 that they were investigating further refinements to TDV factors using 20-year global warming potential (GWP) values instead of the 100-year GWP values that were used to derive the current TDV factors. It is anticipated that the 20-year GWP values will increase the TDV factors slightly. As a result, the TDV energy savings presented in this report are lower than the values that are expected if the final TDV use 20-year GWP values, and the proposed code changes will be more cost effective using the revised TDV. Energy savings presented in kWh and therms are not affected by TDV or demand factors.

Because this submeasure impacts cooling system energy use, the energy savings vary depending on cooling system type and efficiency and climate zone. Therefore, an energy analysis was performed to demonstrate cost effectiveness for both computer room cooling system types: direct-expansion (DX) computer room air conditioners (CRACs) and chilled water computer room air handlers (CRAHs). Based on feedback following the March 12, 2020, public stakeholder meeting, the Statewide CASE Team also included a cost-effectiveness analysis for two additional cases: water economizing using water-cooled chillers and evaporative cooling towers and water economizing using air-cooled chillers (dry cooler baseline compared to evaporative cooling tower proposed case).

2.3.1.1 Case 1: DX CRAC Cooling with Air Economizing

- System Overview: 2019 Title 24, Part 6 Standard design air-cooled DX CRAC cooling system type and efficiency are used in both the baseline and proposed cases. The proposed system operates at warmer air temperatures as proposed by the submeasure. Table 17 describes the key modeling assumptions for the energy savings analysis.
- An ITE load of 50 kW was selected as representative of computer rooms below the existing 175 kW ITE load threshold for requiring air containment.
- Modeling Software Approach: annual hourly spreadsheet simulation. See section 4.2.1 Energy Savings Methodology for more information.
- Description of Energy Savings: This measure saves energy in three ways:
 1. Higher supply air and return air temperatures increase the number of annual economizer hours, which reduces the cooling load on the compressor.
 2. A higher return air temperature impacts CRAC efficiency.
 3. Requiring containment for smaller computer rooms than 175 kW increases the temperature differential between supply air and return air, which decreases fan energy.

Table 17: Energy Analysis Assumptions: Increased Temperature Threshold for Economizers, Case 1 (DX CRAC Cooling with Air Economizing)

Input Parameter	Baseline	Proposed	Notes
IT Equipment Load (kW)	50	50	N/A
IT Equipment Load Schedule	DataReceptacle	DataReceptacle	ACM, Appendix 3-4B. Load cycles each month among 25%, 50%, 75%, and 100% load factor.
Supply Air Dry-bulb Temperature (°F)	60	70	Baseline: ACM (resulting from 20°F supply and return air temperature differential per Supply Fan Design Airflow table, 5.7.3.2). Proposed: Proposed code change.
Return Air Dry-bulb Temperature (°F)	75	90	Baseline: Assumed value for non-contained computer room. This value may result in a slightly conservative (higher) supply and return air temperature differential than typical (Group 2013). Proposed: Proposed code change.
Supply and Return Air Dry-bulb Temperature Differential (°F)	15	20	= (Return air temperature – supply air temperature)
Supply Fan Efficiency (W/cfm)	0.58	0.58	140.9(a)4: 27 W/kBtu/hr, and 20F delta-T (per Supply Fan Design Airflow table, 5.7.3.2).
Supply Fan Speed Control	Variable-flow, VSD	Variable-flow, VSD	Table 10, ACM page 5-124.
Minimum Airflow	50 percent	50 percent	Table 10, ACM page 5-124, assumed to apply to CRACs as conservative estimate; ACM only specifies CRAH minimum airflow.
Cooling System Type	CRAC (air-source DX, two-speed)	CRAC (air-source DX, two-speed)	Matches ACM.
Cooling System Sizing Safety Factor	15%	15%	Matches ACM for sizing equipment in standard design (2.5.2).
Cooling System Capacity (Btu/hr)	196,190	196,190	= IT equipment Load * (1+sizing safety factor)

Input Parameter	Baseline	Proposed	Notes
Cooling System Capacity (tons)	16.3	16.3	Conversion to tons.
Cooling System Full Load Efficiency (kW/ton)	1.09	1.09	Title 24 2019, Part 6, Table 110.2-A, air-cooled, ≥ 135 kBtu/hr and < 240 kBtu/hr.
Cooling System Part-Load Efficiency Curves	ACM Appendix 5.7	ACM Appendix 5.7	DXEIR_fPLFCrvRef, Air-Source DX (Other), DXEIR_fTempCrvRef, Air-Source DX (Other), Cap_fFlowCrvRef, Air-Source DX (Two speed), Cap_fTempCrvRef, Air-Source DX (Other)
Economizer Type	Air	Air	Matches ACM.
Maximum Outdoor Dry-bulb Temperature for Full Economizing (°F)	55	65	Baseline: ACM. Proposed: Proposed code change.
Maximum Outdoor Dry-bulb Temperature for Partial Economizing (°F)	75	85	Baseline: ACM. Proposed: Proposed code change.
Minimum Ventilation Rate to Space (cfm/sf)	0	0	Removed for simplicity. Does not affect submeasure savings.
Energy Commission Climate Zones	All	All	N/A

2.3.1.2 Case 2: Chilled Water CRAH Cooling with Air Economizing

- System Overview: 2019 Title 24, Part 6 standard design chilled water CRAH cooling system type and efficiency are used in both the baseline and proposed cases. The proposed system operates at warmer air temperatures as proposed by the submeasure. Table 18 describes the key modeling assumptions for the energy savings analysis.
- An ITE load of 1,000 kW was selected as representative of computer rooms above the 3,000,000 Btu/hr cooling load threshold for requiring chilled water CRAHs under the Standard Design.
- Modeling Software Approach: annual hourly spreadsheet simulation. See section 4.2.1 Energy Savings Methodology for more information.
- Description of Energy Savings: This measure saves energy because higher supply air and return air temperatures increase the number of annual economizer hours, which reduces the cooling load on the compressor.

Table 18: Energy Analysis Assumptions: Increased Temperature Threshold for Economizers, Case 2 (Chilled Water CRAH Cooling with Air Economizing)

Input Parameter	Baseline	Proposed	Notes
IT Equipment Load (kW)	1,000	1,000	N/A
IT Equipment Load Schedule	DataReceptacle	DataReceptacle	ACM, Appendix 3-4B. Load cycles each month among 25%, 50%, 75%, and 100% load factor.
Supply Air Dry-bulb Temperature (°F)	60	70	Baseline: ACM (resulting from 20°F supply and return air temperature differential per Supply Fan Design Airflow table, 5.7.3.2). Proposed: Proposed code change.
Return Air Dry-bulb Temperature (°F)	80	90	Baseline: CBECC-Com default. Proposed: Proposed code change.
Supply and Return Air Dry-bulb Temperature Differential (°F)	20	20	= (Return air temperature – supply air temperature)
Supply Fan Efficiency (W/cfm)	0.58	0.58	140.9(a)4: 27 W/kBtu/hr, and 20F delta-T (per Supply Fan Design Airflow table, 5.7.3.2).
Supply Fan Speed Control	Variable-flow, VSD	Variable-flow, VSD	Table 10, ACM page 5-124.
Minimum Airflow	50%	50%	Table 10, ACM page 5-124.
Cooling System Type	CRAH (2 water-cooled screw chillers, equally sized)	CRAH (2 water-cooled screw chillers, equally sized)	Per ACM page 5-190.
Cooling System Sizing Safety Factor	15%	15%	Matches ACM for sizing equipment in standard design (2.5.2).
Cooling System Capacity (Btu/hr)	3,923,800	3,923,800	= IT equipment Load * (1+sizing safety factor)
Cooling System Capacity (tons)	327	327	Conversion to tons.
Chiller Full Load Efficiency (kW/ton)	0.625	0.625	Title 24 2019, Part 6, Table 110.2.D, path A, positive displacement chiller. CHW pump, CW pump, and cooling tower energy is not modeled for simplicity; including these

Input Parameter	Baseline	Proposed	Notes
			components would show additional energy savings and improve measure cost-effectiveness.
Chiller Part-Load Efficiency Curves	ACM Appendix 5.7	ACM Appendix 5.7	Water-Cooled Pos Displacement, Path A, All Capacities: Cap_fTempCrvRef, EIR_fTempCrvRef, EIR_fPLRCrvRef
Economizer Type	Air	Air	Matches ACM.
Maximum Outdoor Dry-bulb Temperature for Full Economizing (°F)	55	65	Baseline: CBECC-Com default. Proposed: Proposed code change.
Maximum Outdoor Dry-bulb Temperature for Partial Economizing (°F)	75	85	Baseline: CBECC-Com default. Proposed: Proposed code change.
Minimum Ventilation Rate to Space (cfm/sf)	0	0	Removed for simplicity. Does not affect submeasure savings.
Energy Commission Climate Zones	All	All	N/A

2.3.1.3 Case 2b: Chilled Water CRAH Cooling with Water-Cooled Chiller and Evaporative Cooling Tower Economizer

- System Overview: 2019 Title 24, Part 6 standard design chilled water CRAH cooling system type and efficiency are used in both the baseline and proposed cases. The proposed system operates at warmer air temperatures as proposed by the submeasure. Table 19 describes the key modeling assumptions for the energy savings analysis.
- An ITE load of 1,000 kW was selected as representative of computer rooms above the 3,000,000 Btu/hr cooling load threshold for requiring chilled water CRAHs under the Standard Design.
- Modeling Software Approach: annual hourly spreadsheet simulation. See section 4.2.1 Energy Savings Methodology for more information.
- Description of Energy Savings: This measure saves energy because higher supply air and return air temperatures increase the number of annual economizer hours, which reduces the cooling load on the compressor.

Table 19: Energy Analysis Assumptions: Increased Temperature Threshold for Economizers, Case 2b (Chilled Water CRAH Cooling with Water Economizing and Evaporative Cooling Tower)

Input Parameter	Baseline	Proposed	Notes
IT Equipment Load (kW)	1,000	1,000	N/A
IT Equipment Load Schedule	DataReceptacle	DataReceptacle	ACM, Appendix 3-4B. Load cycles each month among 25%, 50%, 75%, and 100% load factor.
Supply Air Dry-bulb Temperature (°F)	60	70	Baseline: ACM (resulting from 20°F supply and return air temperature differential per Supply Fan Design Airflow table, 5.7.3.2). Proposed: Proposed code change.
Return Air Dry-bulb Temperature (°F)	80	90	Baseline: CBECC-Com default. Proposed: Proposed code change.
Supply and Return Air Dry-bulb Temperature Differential (°F)	20	20	= (Return air temperature – supply air temperature)
Supply Fan Efficiency (W/cfm)	0.58	0.58	140.9(a)4: 27 W/kBtu/hr, and 20F delta-T (per Supply Fan Design Airflow table, 5.7.3.2).
Supply Fan Speed Control	Variable-flow, VSD	Variable-flow, VSD	Table 10, ACM page 5-124.
Minimum Airflow	50%	50%	Table 10, ACM page 5-124.
Cooling System Type	CRAH (2 water-cooled screw chillers, equally sized)	CRAH (2 water-cooled screw chillers, equally sized)	Per ACM page 5-190.
Cooling System Sizing Safety Factor	15%	15%	Matches ACM for sizing equipment in standard design (2.5.2).
Cooling System Capacity (Btu/hr)	3,923,800	3,923,800	= IT equipment Load * (1+sizing safety factor)
Cooling System Capacity (tons)	327	327	Conversion to tons.
Chiller Full Load Efficiency (kW/ton)	0.625	0.625	Title 24 2019, Part 6, Table 110.2.D, path B, positive displacement chiller.

Input Parameter	Baseline	Proposed	Notes
Chiller Part-Load Efficiency Curves	ACM Appendix 5.7	ACM Appendix 5.7	Water-Cooled Pos Displacement, Path A, All Capacities: Cap_fTempCrvRef, EIR_fTempCrvRef, EIR_fPLRCrvRef
Cooling Tower Efficiency Design (gpm/hp)	42.1	42.1	Title 24 2019, Part 6, Table 110.2-G, axial open circuit tower
Economizer Type	Water with Evaporative Cooling Tower	Water with Evaporative Cooling Tower	Simulation case
Maximum Outdoor Wet-bulb Temperature for Full Economizing (°F)	35	50	Baseline: 140.9(a)1B. Proposed: Proposed code change.
Maximum Outdoor Wet-bulb Temperature for Partial Economizing (°F)	45	60	10F CHW Delta-T
Minimum Ventilation Rate to Space (cfm/sf)	0	0	Removed for simplicity. Does not affect submeasure savings.
Energy Commission Climate Zones	All	All	N/A

2.3.1.4 Case 2c: Chilled Water CRAH Cooling with Air-Cooled Chiller: Dry Cooler vs. Evaporative Cooling Tower Economizer

- System Overview: 2019 Title 24, Part 6 standard design chilled water CRAH cooling system type and efficiency are used in both the baseline and proposed cases. The proposed system operates at warmer air temperatures as proposed by the submeasure. Table 20 describes the key modeling assumptions for the energy savings analysis.
- An ITE load of 10,000 kW was selected as representative of computer typically implementing air-cooled chillers with integrated economizers based on stakeholder feedback.
- Modeling Software Approach: annual hourly spreadsheet simulation. See section 4.2.1 Energy Savings Methodology for more information.
- Description of Energy Savings: This measure saves energy because higher supply air and return air temperatures increase the number of annual economizer hours, which reduces the cooling load on the compressor.

Table 20: Energy Analysis Assumptions: Increased Temperature Threshold for Economizers, Case 2c (Chilled Water CRAH Cooling with Water Economizing: Dry Cooler vs. Evaporative Cooling Tower)

Input Parameter	Baseline	Proposed	Notes
IT Equipment Load (kW)	10,000	10,000	Typical value for this system type based on stakeholder feedback.
IT Equipment Load Schedule	DataReceptacle	DataReceptacle	ACM, Appendix 3-4B. Load cycles each month among 25%, 50%, 75%, and 100% load factor.
Supply Air Dry-bulb Temperature (°F)	60	70	Baseline: ACM (resulting from 20°F supply and return air temperature differential per Supply Fan Design Airflow table, 5.7.3.2). Proposed: Proposed code change.
Return Air Dry-bulb Temperature (°F)	80	90	Baseline: CBECC-Com default. Proposed: Proposed code change.
Supply and Return Air Dry-bulb Temperature Differential (°F)	20	20	= (Return air temperature – supply air temperature)
Supply Fan Efficiency (W/cfm)	0.58	0.58	140.9(a)4: 27 W/kBtu/hr, and 20F delta-T (per Supply Fan Design Airflow table, 5.7.3.2).
Supply Fan Speed Control	Variable-flow, VSD	Variable-flow, VSD	Table 10, ACM page 5-124.
Minimum Airflow	50%	50%	Table 10, ACM page 5-124.
Cooling System Type	CRAH (air-cooled screw chillers with integrated dry coolers, equally sized)	CRAH (air-cooled screw chillers, equally sized and evaporative cooling tower and heat exchanger)	N/A
Cooling System Sizing Safety Factor	15%	15%	Matches ACM for sizing equipment in standard design (2.5.2).
Cooling System Capacity (Btu/hr)	39,238,000	39,238,000	= IT equipment Load * (1+sizing safety factor)

Input Parameter	Baseline	Proposed	Notes
Cooling System Capacity (tons)	3,270	3,270	Conversion to tons.
Chiller Full Load Efficiency (kW/ton)	1.25	1.085	Manufacturer data, air-cooled chiller with (Baseline) and without (Proposed) integrated economizer
Chiller Part-Load Efficiency Curves	Manufacturer data	DOE2.2	N/A
Cooling Tower Efficiency Design (gpm/hp)	N/A	42.1 (CZ1, CZ16) 60 (CZ2 – CZ15)	2019 Title 24, Part 6, Table 110.2-G, axial open circuit tower
Cooling Tower Pump Efficiency	N/A	19 W/gpm	ASHRAE 90.1-2019, variable speed
Economizer Type	Water with Dry Cooler	Water with Evaporative Cooling Tower	Simulation case
Maximum Outdoor Temperature for Full Economizing (°F)	40 Dry-Bulb	50 Wet-bulb	Baseline: 140.9(a)1B. Proposed: Proposed code change.
Maximum Outdoor Temperature for Partial Economizing (°F)	45 Dry-Bulb	60 Wet-bulb	10F CHW Delta-T
Minimum Ventilation Rate to Space (cfm/sf)	0	0	Removed for simplicity. Does not affect submeasure savings.
Energy Commission Climate Zones	All	All	N/A

2.3.2 Energy Savings Methodology

2.3.2.1 Energy Savings Methodology per Prototypical Building/Simulation Case

Although the Energy Commission indicated a preference for simulating energy impacts using CBECC-Com, a spreadsheet was used to calculate energy impacts of the increased temperature threshold for economizers submeasure instead of simulating in CBECC-Com because alterations to the Standard Design air temperatures were needed to correctly model the measures impact. CBECC-Com does not currently support the requirements for modeling the increased air temperatures; instead CBECC-Com models a Standard Design supply air temperature of 60°F and return air

temperature of 80°F for all computer rooms regardless of whether they have air containment or not. This results in an underestimate of Standard Design fan energy and unrealistically high return air temperatures for non-contained computer rooms. Therefore, an annual hourly spreadsheet analysis was used to calculate the fan and cooling energy savings of this submeasure. The spreadsheet analysis followed the 2019 Nonresidential ACM Reference Manual for key inputs affecting energy use, as described in Table 21.

The Standard Design represents the geometry of the design that the builder would like to build and inserts a defined set of features that result in an energy budget that is minimally compliant with 2019 Title 24, Part 6 code requirements. Features used in the Standard Design are described in the 2019 Nonresidential ACM Reference Manual. Minimal 2019 Title 24, Part 6 compliance includes a computer room with mechanical systems and efficiencies meeting 140.9(a) prescriptive requirements, which include: full air economizing at outdoor temperatures of 55°F dry-bulb and below, variable speed fan control with a fan system design power demand of 27 W/kBtu-h of net sensible cooling capacity (this equates to 0.58 W/cfm with a 20°F supply and return air temperature difference, which is more efficient than the ACM listed value of 0.81 W/cfm for CRACs/CRAHs), supply air temperature of 60°F, and return air temperature of 80°F.

The Standard Design models were modified to increase the temperature thresholds for economizers. Standard Design return air temperature was decreased from 80°F to 75°F for computer rooms less than 175 kW, which do not have containment, to more accurately model non-contained computer room air conditions.

The Proposed Design represents the same geometry as the Standard Design, but it assumes the energy features that the software user describes with user inputs. The Proposed Design was identical to the Standard Design in all ways except for the revisions that represent the proposed changes to the code. Table 21 presents a summary of key parameters that were modified and what values were used in the Standard Design and Proposed Design.

To develop savings estimates for the proposed code changes, the Statewide CASE Team created a Standard Design and Proposed Design for each design case. Comparing the energy impacts of the Standard Design to the Proposed Design reveals the impacts of the proposed code change relative to a building that is minimally compliant with the 2019 Title 24, Part 6 requirements.

Table 21: Modifications Made to Standard Design in Each Simulation Case to Simulate Proposed Code Change: Increased Temperature Threshold for Economizers Submeasure

Simulation Case/ Prototype ID	Climate Zone	Parameter Name	Standard Design Parameter Value	Proposed Design Parameter Value
Case 1: DX CRAC	All	Supply Air Temperature	60°F	70°F
Case 1: DX CRAC	All	Return Air Temperature	75°F	90°F
Case 2: CHW CRAH	All	Supply Air Temperature	60°F	70°F
Case 2: CHW CRAH	All	Return Air Temperature	80°F	90°F

The Statewide CASE Team calculated energy consumption for every hour of the year measured in kilowatt-hours per year (kWh/yr) and therms per year (therms/yr), then applied the 2022 time dependent valuation (TDV) factors to calculate annual energy use in kilo British thermal units per year (TDV kBtu/yr) and annual peak electricity demand reductions measured in kilowatts (kW). TDV energy cost savings were also calculated in 2023 present value dollars (2023 PV\$) and nominal dollars.

The energy impacts of the proposed code change vary by climate zone. The Statewide CASE Team calculated the energy impacts in every climate zone and applied the climate-zone specific TDV factors when calculating energy and energy cost impacts.

Per-unit energy impacts for nonresidential buildings are presented in savings per kilowatt of IT equipment load. Annual energy and peak demand impacts were translated into impacts per kW IT equipment load by dividing by the kW of IT equipment load for each simulated case. This step allows for an easier comparison of savings across different building types and enables a calculation of statewide savings using the construction forecast that is published in terms of floor area by building type

2.3.2.2 Statewide Energy Savings Methodology

As described above, the per unit energy impacts are presented in savings per design ITE load. Savings do not vary significantly by building type, but rather by ITE load. Although the per unit savings were calculated using prototypical buildings, the per unit savings apply to any building type.

The per-unit energy impacts were extrapolated to statewide impacts using the Statewide Construction Forecasts that the Energy Commission provided (California Energy Commission Building Standards Office n.d.). The Statewide Construction Forecasts estimate new construction that will occur in 2023, the first year that the 2022 Title 24, Part 6 requirements are in effect. It also estimates the size of the total existing building stock in 2023 that the Statewide CASE Team used to approximate savings

from building alterations. The construction forecast is provided in square footage of new and existing floorspace.

Because ITE load, not total building floor area, is the driver for computer room energy use, the Statewide CASE Team correlated ITE load to building floor area by assuming a watts per square foot of ITE design load density. The ITE design load density varies by measure type and is described in Appendix A.

Appendix A presents additional information about the methodology and assumptions used to calculate statewide energy impacts.

2.3.3 Per Unit Energy Impacts Results

The per-unit energy savings do not account for naturally occurring market adoption or compliance rates. Table 22 through Table 25 show the first year per-unit energy savings and demand reduction ranges, which vary by climate zone and system type. There is a positive net energy savings in all climate zones.

Because there are multiply types of computer room cooling systems and economizer types, the energy savings varies by mechanical system type and climate zone. For example, climate zones with the most hours where outdoor dry-bulb temperatures are between 55°F and 65°F, show the greatest air economizing energy savings. Climate zones with the most hours where outdoor wet-bulb temperatures are between 35°F and 50°F, show the greatest water economizing energy savings. Figure 3 and Figure 4 show a comparison of the number of annual economizing hours with 2019 Title 24 and proposed 2022 Title 24 computer room economizing temperature thresholds. Proposed changes in dry-bulb economizing hours and wet-bulb economizing hours both provide a significant increase in economizer hours for all climate zones.

This submeasure would not have a significant impact on demand response/flexibility, peak power demand, or load shifting.

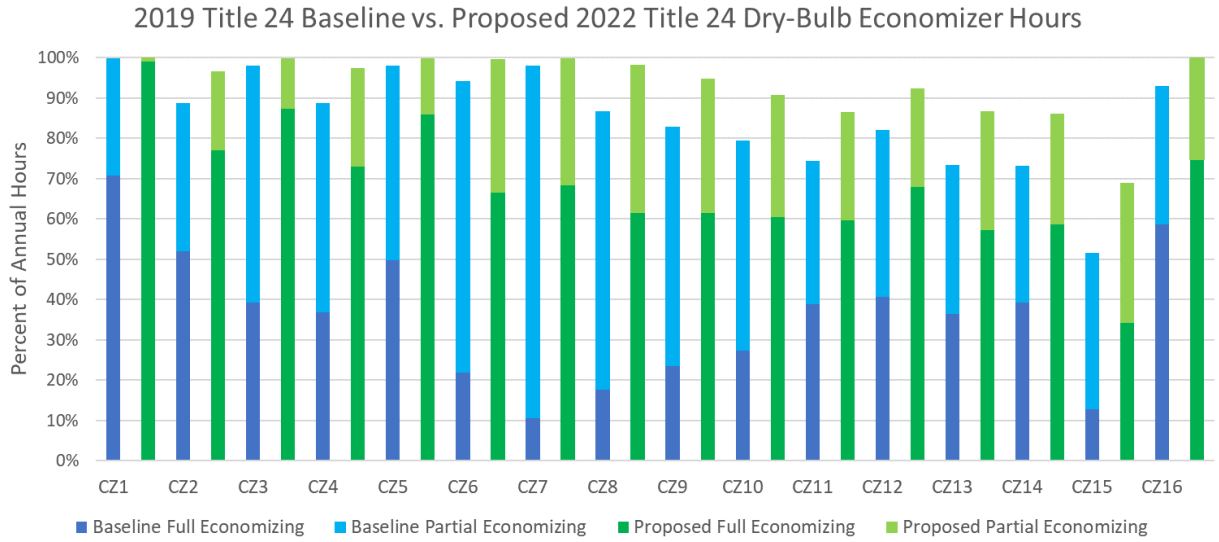

Figure 3. Comparison of 2019 Title 24 and proposed 2022 Title 24 dry-bulb economizing hours.

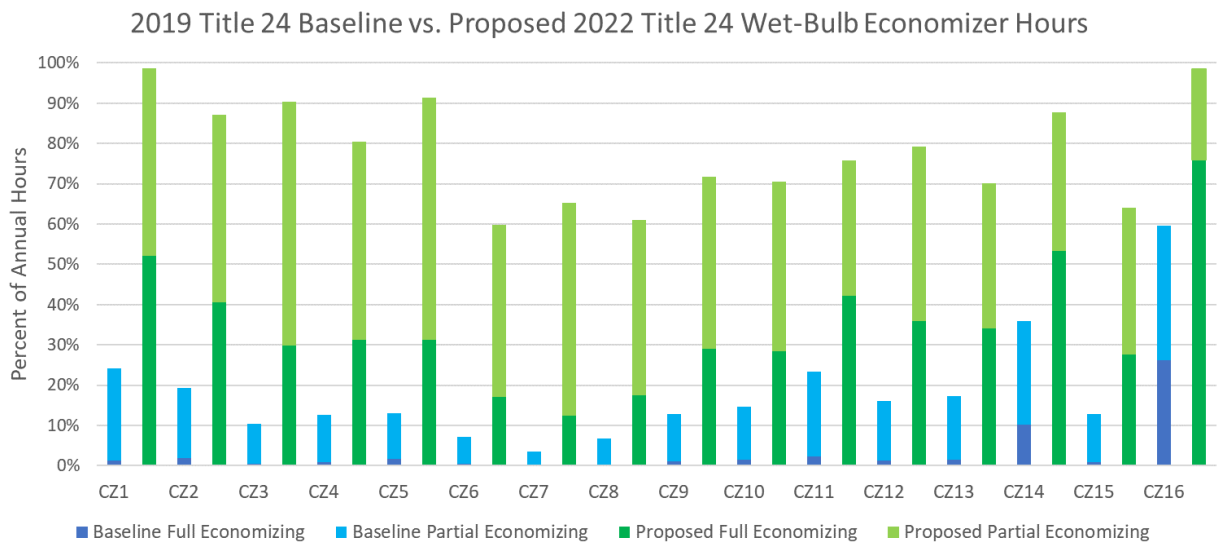

Figure 4. Comparison of 2019 Title 24 and proposed 2022 Title 24 wet-bulb economizing hours.

Table 22: First-Year Energy Impacts Per IT Equipment Load kW – Increased Temperature Threshold for Economizers Submeasure, DX CRAC Air Economizing Case

Climate Zone	Electricity Savings (kWh/yr)	Peak Electricity Demand Reduction (kW)	Natural Gas Savings (therms/yr)	TDV Energy Savings (TDV kBtu/yr)
1	331	0.0	0	8,753
2	452	0.0	0	11,776
3	596	0.0	0	18,060
4	574	0.0	0	15,469
5	534	0.0	0	14,211
6	788	0.0	0	22,148
7	955	0.0	0	26,937
8	758	0.0	0	20,066
9	644	0.0	0	16,830
10	577	0.0	0	14,942
11	439	0.1	0	11,931
12	493	0.0	0	12,597
13	446	0.0	0	11,357
14	420	0.0	0	10,591
15	464	0.1	0	11,918
16	440	0.0	0	11,616
TOTAL	8,911	0.4	0	239,203

Table 23: First-Year Energy Impacts Per IT Equipment Load kW – Increased Temperature Threshold for Economizers Submeasure, Chilled Water CRAH Air Economizing Case

Climate Zone	Electricity Savings (kWh/yr)	Peak Electricity Demand Reduction (kW)	Natural Gas Savings (therms/yr)	TDV Energy Savings (TDV kBtu/yr)
1	181	0.0	0	4,499
2	200	0.0	0	4,989
3	331	0.0	0	9,271
4	281	0.0	0	7,592
5	260	0.0	0	7,360
6	361	0.0	0	9,701
7	440	0.0	0	11,858
8	361	0.0	0	9,472
9	315	0.0	0	8,209
10	275	0.0	0	7,056
11	186	0.0	0	4,728
12	222	0.0	0	5,663
13	189	0.0	0	4,637
14	175	0.0	0	4,374
15	202	0.0	0	5,202
16	161	0.0	0	4,159
TOTAL	4,140	0.2	0	108,770

Table 24: First-Year Energy Impacts Per IT Equipment Load kW – Increased Temperature Threshold for Economizers Submeasure, Water Economizing with Evaporative Cooling Tower Case

Climate Zone	Electricity Savings (kWh/yr)	Peak Electricity Demand Reduction (kW)	Natural Gas Savings (therms/yr)	TDV Energy Savings (TDV kBtu/yr)
1	748	0.0	0	21,632
2	585	0.0	0	15,399
3	521	0.0	0	13,844
4	476	0.0	0	12,656
5	510	0.0	0	14,281
6	284	0.0	0	7,969
7	258	0.0	0	7,093
8	308	0.0	0	8,560
9	429	0.0	0	11,458
10	405	0.0	0	10,897
11	542	0.0	0	14,160
12	506	0.0	0	13,441
13	469	0.0	0	12,440
14	548	0.0	0	13,723
15	412	0.0	0	11,097
16	565	0.0	0	14,593
TOTAL	7,566	-0.1	0	203,241

Table 25: First-Year Energy Impacts Per IT Equipment Load kW – Increased Temperature Threshold for Economizers Submeasure, Dry Cooler vs. Evaporative Cooling Tower Case

Climate Zone	Electricity Savings (kWh/yr)	Peak Electricity Demand Reduction (kW)	Natural Gas Savings (therms/yr)	TDV Energy Savings (TDV kBtu/yr)
1	607	0.2	0	17,168
2	573	0.3	0	15,264
3	539	0.2	0	14,309
4	505	0.2	0	13,476
5	524	0.2	0	14,391
6	385	0.2	0	10,502
7	412	0.2	0	11,181
8	424	0.2	0	11,501
9	525	0.3	0	13,849
10	503	0.3	0	13,331
11	582	0.3	0	15,472
12	534	0.3	0	14,280
13	512	0.3	0	13,614
14	667	0.3	0	17,388
15	602	0.3	0	16,022
16	683	0.3	0	18,499
TOTAL	8,578	4.1	0	230,247

2.4 Cost and Cost Effectiveness

2.4.1 Energy Cost Savings Methodology

Energy cost savings were calculated by applying the TDV energy cost factors to the energy savings estimates that were derived using the methodology described in Section 2.3.3 TDV is a normalized metric to calculate energy cost savings that accounts for the variable cost of electricity and natural gas for each hour of the year, along with how costs are expected to change over the period of analysis (30 years for residential measures and nonresidential envelope measures and 15 years for all other nonresidential measures). In this case, the period of analysis used is 15 years. The TDV cost impacts are presented in nominal dollars and in 2023 present value dollars and represent the energy cost savings realized over 15 years.

2.4.2 Energy Cost Savings Results

Per-unit energy cost savings for newly constructed buildings and alterations that are realized over the 15-year period of analysis are presented in 2023 dollars in Table 26 through Table 29. Energy savings for new construction and alterations are expected to be the same.

The TDV methodology allows peak electricity savings to be valued more than electricity savings during non-peak periods. Because internal equipment loads drive the energy use in computer rooms and that equipment load is typically relatively flat throughout the day, submeasures that reduce equipment load (e.g., UPS efficiency) provide a relatively constant demand reduction. The increased air economizing temperatures component of the Increased Temperature Threshold for Economizers submeasure does not save peak demand in afternoons when outdoor temperatures are hottest, but the air containment component of the submeasure provides a constant load reduction by reducing fan power at all times.

This submeasure save energy cost in all climate zones.

Table 26: 2023 PV TDV Energy Cost Savings Over 15-Year Period of Analysis – Per IT Equipment Load kW – New Construction, Increased Temperature Threshold for Economizers Submeasure (DX CRAC Air Economizing Case)

Climate Zone	15-Year TDV Electricity Cost Savings (2023 PV\$)	15-Year TDV Natural Gas Cost Savings (2023 PV\$)	Total 15-Year TDV Energy Cost Savings (2023 PV\$)
1	\$779	\$0	\$779
2	\$1,048	\$0	\$1,048
3	\$1,607	\$0	\$1,607
4	\$1,377	\$0	\$1,377
5	\$1,265	\$0	\$1,265
6	\$1,971	\$0	\$1,971
7	\$2,397	\$0	\$2,397
8	\$1,786	\$0	\$1,786
9	\$1,498	\$0	\$1,498
10	\$1,330	\$0	\$1,330
11	\$1,062	\$0	\$1,062
12	\$1,121	\$0	\$1,121
13	\$1,011	\$0	\$1,011
14	\$943	\$0	\$943
15	\$1,061	\$0	\$1,061
16	\$1,034	\$0	\$1,034
TOTAL	\$21,289	\$0	\$21,289

Table 27: 2023 PV TDV Energy Cost Savings Over 15-Year Period of Analysis – Per IT Equipment Load kW – New Construction, Increased Temperature Threshold for Economizers Submeasure (Chilled Water CRAH Air Economizing Case)

Climate Zone	15-Year TDV Electricity Cost Savings (2023 PV\$)	15-Year TDV Natural Gas Cost Savings (2023 PV\$)	Total 15-Year TDV Energy Cost Savings (2023 PV\$)
1	\$400	\$0	\$400
2	\$444	\$0	\$444
3	\$825	\$0	\$825
4	\$676	\$0	\$676
5	\$655	\$0	\$655
6	\$863	\$0	\$863
7	\$1,055	\$0	\$1,055
8	\$843	\$0	\$843
9	\$731	\$0	\$731
10	\$628	\$0	\$628
11	\$421	\$0	\$421
12	\$504	\$0	\$504
13	\$413	\$0	\$413
14	\$389	\$0	\$389
15	\$463	\$0	\$463
16	\$370	\$0	\$370
TOTAL	\$9,681	\$0	\$9,681

Table 28: 2023 PV TDV Energy Cost Savings Over 15-Year Period of Analysis – Per IT Equipment Load kW – New Construction, Increased Temperature Threshold for Economizers Submeasure (Water Economizing with Evaporative Cooling Tower Case)

Climate Zone	15-Year TDV Electricity Cost Savings (2023 PV\$)	15-Year TDV Natural Gas Cost Savings (2023 PV\$)	Total 15-Year TDV Energy Cost Savings (2023 PV\$)
1	\$1,925	\$0	\$1,925
2	\$1,371	\$0	\$1,371
3	\$1,232	\$0	\$1,232
4	\$1,126	\$0	\$1,126
5	\$1,271	\$0	\$1,271
6	\$709	\$0	\$709
7	\$631	\$0	\$631
8	\$762	\$0	\$762
9	\$1,020	\$0	\$1,020
10	\$970	\$0	\$970
11	\$1,260	\$0	\$1,260
12	\$1,196	\$0	\$1,196
13	\$1,107	\$0	\$1,107
14	\$1,221	\$0	\$1,221
15	\$988	\$0	\$988
16	\$1,299	\$0	\$1,299
TOTAL	\$18,088	\$0	\$18,088

Table 29: 2023 PV TDV Energy Cost Savings Over 15-Year Period of Analysis – Per IT Equipment Load kW – New Construction, Increased Temperature Threshold for Economizers Submeasure (Dry Cooler vs. Evaporative Cooling Tower Case)

Climate Zone	15-Year TDV Electricity Cost Savings (2023 PV\$)	15-Year TDV Natural Gas Cost Savings (2023 PV\$)	Total 15-Year TDV Energy Cost Savings (2023 PV\$)
1	\$1,528	\$0	\$1,528
2	\$1,358	\$0	\$1,358
3	\$1,273	\$0	\$1,273
4	\$1,199	\$0	\$1,199
5	\$1,281	\$0	\$1,281
6	\$935	\$0	\$935
7	\$995	\$0	\$995
8	\$1,024	\$0	\$1,024
9	\$1,233	\$0	\$1,233
10	\$1,186	\$0	\$1,186
11	\$1,377	\$0	\$1,377
12	\$1,271	\$0	\$1,271
13	\$1,212	\$0	\$1,212
14	\$1,548	\$0	\$1,548
15	\$1,426	\$0	\$1,426
16	\$1,646	\$0	\$1,646
TOTAL	\$20,492	\$0	\$20,492

2.4.3 Incremental First Cost

Incremental first cost is the initial cost to adopt more efficient equipment or building practices when compared to the cost of an equivalent baseline project. Therefore, it was important that the Statewide CASE Team consider first costs in evaluating overall measure cost effectiveness. Incremental first costs are based on data available today and can change over time as markets evolve and professionals become familiar with new technology and building practices.

Table 30, Table 31, Table 33, and Table 37 describe the incremental first costs for case.

2.4.3.1 Case 1: DX CRAC with Air Economizer Case

Costs for this submeasure were obtained from air containment vendors and construction projects with which Statewide CASE Team members were involved. While there are many types of aisle containment products available on the market, such as strip curtains or aisle enclosures, the Statewide CASE Team used costs for a return air chimney style containment product, which can be installed on a per-server-rack basis and is therefore scalable for both small and large computer rooms. See Figure 5 for an example of this product. This type of containment strategy is also more expensive than other containment options such as strip curtains, so the cost-effectiveness results presented in this report are thought to be conservative. Incremental costs for this submeasure include the following items:

- Server rack with solid rear door versus server rack with perforated rear door.
- Return air chimney ducted from each server rack to a return air plenum
- Combined costs of the above two items ranges from about \$500 per rack to \$2,200 per rack, with the average cost being \$1,400 per rack
- Labor time to install the return air chimney: assumed two hours per server rack at a rate of \$175 per hour
- No incremental costs were assumed for selecting and operating the CRAC at warmer air economizer temperatures.

Costs were calculated on a “per kW of IT equipment load” basis by taking the total cost per rack and dividing by an assumed 5 kW per rack.

Costs are anticipated to be the same for new construction and additions/alterations for this submeasure; note that only the air containment component of this measure applies to additions/alterations.

Costs are not anticipated to change over time for this measure.



Figure 5. Example return air chimney and enclosed server rack product.

Source: Eaton 2020.

Computer rooms less than 10 kW, which would not require air containment, typically utilize an exception to 140.9(a)1 because they are served by larger building air handler systems to meet the economizer requirements. Therefore, a separate cost effectiveness analysis was not performed for computer rooms less than 10 kW meeting the new computer room economizer proposal.

Table 30: Incremental First Cost Assumptions: Increased Temperature Threshold for Economizers Submeasure, Air Economizing – Case 1: DX CRAC Air Economizer

Cost Item	Incremental First Cost (\$ per ITE design load kW)	Cost Source
Return air rack chimneys with ducted return air	\$280	Cost data from 2 projects in California and input from 2 vendors.
Labor	\$70	Estimate based on Bay Area mechanical contractor rate.
Controls	\$0	No additional controls hardware or programming beyond 2019 Title 24, Part 6.
Commissioning	\$0	No additional commissioning labor beyond 2019 Title 24, Part 6.
Total	\$350	

2.4.3.2 Case 2: CHW CRAH with Air Economizer Case

Incremental costs for this scenario are currently assumed to be \$0, since containment is already required by 140.9(a) for computer rooms greater than 175 kW ITE design load, and no additional increase in system costs are expected for selecting and operating the CRAH at warmer air economizer temperatures.

Table 31: Incremental First Cost Assumptions: Increased Temperature Threshold for Economizers Submeasure, Air Economizing – Case 2: CHW CRAH Air Economizer

Cost Item	Incremental First Cost (\$ per ITE design load kW)	Cost Source
Air containment equipment	\$0	The equipment required to meet computer room economizing is already required 2019 Title 24, Part 6. Therefore, there are no equipment or installation costs associated with meeting the computer room economizing requirements.
Air containment labor	\$0	The equipment required to meet computer room economizing is already required 2019 Title 24, Part 6. Therefore, there are no equipment or installation costs associated with meeting the computer room economizing requirements. Required in Standard Design and Proposed Design.
Controls	\$0	No additional controls hardware or programming beyond 2019 Title 24, Part 6.
Commissioning	\$0	No additional commissioning labor beyond 2019 Title 24, Part 6.
Total	\$0	

2.4.3.3 Case 2b: CHW CRAH Water Economizing with Evaporative Cooling Tower

Costs for this scenario were obtained from two Bay Area mechanical equipment sales representatives and include a larger heat exchanger required for achieving the proposed increased outdoor temperature thresholds. The sales representatives indicated the proposed heat exchanger would be about twice as large as the standard design heat exchanger. Costs were obtained for two ITE design load scenarios (1 MW and 10 MW); the 1 MW case is presented in this Final CASE Report. The maximum cost provided by the two sources is used in the cost-effectiveness analysis; thus, the results indicate conservative cost-effectiveness results. The following system design parameters were provided to the equipment sales representatives for pricing.

Table 32: Water Economizer Heat Exchanger Sizing Parameters

Option	1MW Baseline	1MW Proposed	10MW Baseline	10MW Proposed
HX CHW EWT	73	73	73	73
HX CHW LWT	63	63	63	63
HX CHW GPM	785	785	7850	7850
HX CW EWT	48	60	48	60
HX CW LWT	58	70	58	70
HX CW GPM	785	785	7850	7850
HX approach	15	3	15	3
Maximum water pressure drop	5 psi	5 psi	5 psi	5 psi

An additional 40 hours of labor at \$175 per hour was estimated for installing the larger heat exchanger.

Cooling tower equipment selections were performed using 2019 Title 24, 140.9(a) water economizer outdoor wet-bulb temperatures and the proposed water economizer outdoor wet-bulb temperature, and no difference in cooling tower size was shown; therefore there is no incremental cost for the cooling tower for this submeasure.

Table 33: Incremental First Cost Assumptions: Increased Temperature Threshold for Economizers Submeasure, Water Economizing – Case 2b: CHW CRAH Water Economizer with Evaporative Cooling Tower

Cost Item	Incremental First Cost (\$ per ITE design load kW)	Cost Source
Heat exchanger	\$23.38	Cost data from 2 mechanical equipment sales representatives in Bay Area.
Labor	\$7.00	Estimated based on Bay Area mechanical contractor rate.
Total	\$30.38	

2.4.3.4 Case 2c: CHW CRAH Water Economizing: Dry Cooler vs. Evaporative Cooling Tower

This scenario compares an air-cooled chiller with built-in dry cooler economizer in the baseline case to a 2019 Title 24-minimally compliant non-economizing air-cooled chiller with an evaporative cooling tower and heat exchanger economizer. Costs for the baseline chillers and proposed chillers, cooling towers, condenser water pumps, and heat exchanger were obtained from two Bay Area mechanical equipment sales representatives. A Bay Area mechanical contractor provided estimates for the proposed

cooling tower piping with accessories, water treatment system, controls, and annual maintenance. Costs for this scenario include the following items:

- Baseline air-cooled chillers with built-in dry cooler economizer
- Proposed air-cooled chillers (no economizer)
- Proposed evaporative cooling towers
- Proposed heat exchanger (same as Case 2b, 10 MW ITE load)
- Proposed cooling tower pumps
- Proposed additional piping, water treatment, and maintenance for evaporative cooling system. The value used in the cost-effectiveness analysis is more than double the actual cost for this equipment based on estimates from a Bay Area mechanical contractor.

The following proposed system design parameters were provided to the equipment sales representatives for pricing for a 10 MW ITE design load. The same heat exchanger in Case 2b was used.

Table 34: Cooling Tower Sizing Parameters

design capacity	3,7543,000 Btu/hr
design flow	7,500 gpm
design OAWB	50 °F
design CT approach	10 °F
design CT range	10 °F
design CWST/CWRT	60 °F / 70 °F

Table 35: Chiller Sizing Parameters

design capacity per chiller	450 tons
design CHWST/CHWRT	60 °F / 70 °F
design outdoor dry-bulb temperature	95 °F
chiller efficiency	T24 2019
chiller type	air-cooled screw

Table 36: Cooling Tower Pump Sizing Parameters

design head (8.4 psi for cooling tower, 5 psi for heat exchanger, 15 ft miscellaneous)	46 ft
pump quantity	2
design flow per pumps	3,750 gpm

Table 37: Incremental First Cost Assumptions: Increased Temperature Threshold for Economizers Submeasure – Case 2c: Air-Cooled Chillers with Dry Cooler vs. Air-Cooled Chillers with Evaporative Cooling Tower

Cost Item	Baseline First Cost (\$ per ITE design load kW)	Proposed First Cost (\$ per ITE design load kW)	Incremental First Cost (\$ per ITE design load kW)	Cost Source
Air-cooled chiller	\$225	\$139	-\$86	Average cost from 2 mechanical equipment sales representatives in Bay Area.
Cooling tower	\$0	\$37	\$37	Cost from Bay Area mechanical sales representative.
Heat exchanger	\$0	\$39	\$39	Average cost from 2 mechanical equipment sales representatives in Bay Area.
Cooling tower water pump	\$0	\$4	\$4	Cost from Bay Area mechanical sales representative.
Miscellaneous equipment (CW piping, water treatment, etc.)	\$0	\$503	\$503	A Bay Area mechanical contractor estimates that this budget is more than double the actual cost.
Total	\$225	\$722	\$497	

2.4.4 Incremental Maintenance and Replacement Costs

Incremental maintenance cost is the incremental cost of replacing the equipment or parts of the equipment, as well as periodic maintenance required to keep the equipment operating relative to current practices over the 15-year period of analysis. The present value of equipment maintenance costs (savings) was calculated using a 3 percent discount rate (d), which is consistent with the discount rate used when developing the 2022 TDV. The present value of maintenance costs that occurs in the n^{th} year is calculated as follows:

$$\text{Present Value of Maintenance Cost} = \text{Maintenance Cost} \times \left[\frac{1}{1 + d} \right]^n$$

The HVAC system type determines whether the proposed changes to economizing temperature requirements is expected to result in an incremental maintenance cost compared to current Title 24, Part 6 (baseline) requirements.

- Using an air economizer is estimated to have no incremental maintenance cost compared to a baseline air economizer.
- Using an evaporative cooling tower and heat exchanger for a water economizer is estimated to have no incremental maintenance cost compared to a baseline evaporative cooling tower and heat exchanger water economizer.
- Using air-cooled chillers with evaporative cooling towers and heat exchanger for water economizing for a 10 MW ITE design load has an estimated \$10,000 per year of annual maintenance costs for the cooling towers, pumps and heat exchanger, compared to a baseline air-cooled chiller with dry cooler water economizer. See Appendix I for more details on the system design assumptions.

Adding a requirement to install air containment for smaller server rooms has a useful life over 15 years, based on the DEER economic useful life database that indicates a 18-20-year economic useful life for duct equipment (C. P. Commission 2014), indicating no incremental maintenance cost for air containment.

2.4.5 Cost Effectiveness

This measure proposes a prescriptive requirement. As such, a cost analysis is required to demonstrate that the measure is cost effective over the 15-year period of analysis.

The Energy Commission establishes the procedures for calculating cost effectiveness. The Statewide CASE Team collaborated with Energy Commission staff to confirm that the methodology in this report is consistent with their guidelines, including which costs were included in the analysis. The incremental first cost and incremental maintenance costs over the 15-year period of analysis were included. The TDV energy cost savings from electricity and natural gas savings were also included in the evaluation. In cases where the proposed submeasure increases water use, such as the air-cooled chiller with dry cooler economizer versus air-cooled chiller with evaporative cooling tower economizer, the estimated 15-year water use cost was also included in the cost-effectiveness analysis.

Design costs were not included nor were the incremental costs of code compliance verification.

According to the Energy Commission's definitions, a measure is cost effective if the benefit-to-cost (B/C) ratio is greater than 1.0. The B/C ratio is calculated by dividing the

cost benefits realized over 15 years by the total incremental costs, which includes maintenance costs for 15 years. The B/C ratio was calculated using 2023 PV costs and cost savings.

Results of the per-unit cost-effectiveness analyses are presented in Table 38 through Table 41 for new construction and alterations.

The proposed submeasure saves money over the 15-year period of analysis relative to existing requirements. The proposed change is cost effective in every climate zone for the simulation case. The results are the same for new construction and additions/alterations.

The proposed submeasure saves money over the 15-year period of analysis relative to existing requirements. The proposed change is cost effective in every climate zone for all simulation cases:

- Air economizing with DX CRAC cooling
- Air economizing with CHW CRAH cooling and water-cooled chillers
- Water economizing with CHW CRAH cooling and water-cooled chillers
- Water economizing with CHW CRAH cooling, air-cooled chillers, and evaporative cooling tower for economizing versus air-cooled chillers with dry cooler economizer. This scenario's cost-effectiveness analysis includes 15-year water use from an evaporative cooling tower at a water cost rate of \$0.0072/gallon (average based on sampling of California commercial water cost rates).

The results apply to new construction.

An analysis was performed for reducing the air containment ITE design load threshold without changing economizing temperatures. The results show this component of the increased temperature threshold for economizers submeasure is cost effective by itself. The results apply to new construction and additions/alterations. See Appendix J for results.

Table 38: 15-Year Cost-Effectiveness Summary Per IT Equipment Load kW – New Construction, Increased Temperature Threshold for Economizers Submeasure, Case 1: DX CRAC with Air Economizer

Climate Zone	Benefits TDV Energy Cost Savings + Other PV Savings^a (2023 PV\$)	Costs Total Incremental PV Costs^b (2023 PV\$)	Benefit-to- Cost Ratio
1	\$779	\$350	2.2
2	\$1,048	\$350	3.0
3	\$1,607	\$350	4.6
4	\$1,377	\$350	3.9
5	\$1,265	\$350	3.6
6	\$1,971	\$350	5.6
7	\$2,397	\$350	6.9
8	\$1,786	\$350	5.1
9	\$1,498	\$350	4.3
10	\$1,330	\$350	3.8
11	\$1,062	\$350	3.0
12	\$1,121	\$350	3.2
13	\$1,011	\$350	2.9
14	\$943	\$350	2.7
15	\$1,061	\$350	3.0
16	\$1,034	\$350	3.0

- a. **Benefits: TDV Energy Cost Savings + Other PV Savings:** Benefits include TDV energy cost savings over the period of analysis (Energy + Environmental Economics 2020). Other savings are discounted at a real (nominal – inflation) three percent rate. Other PV savings include incremental first-cost savings if proposed first cost is less than current first cost. Includes PV maintenance cost savings if PV of proposed maintenance costs is less than PV of current maintenance costs.
- b. **Costs: Total Incremental Present Valued Costs:** Costs include incremental equipment, replacement, and maintenance costs over the period of analysis. Costs are discounted at a real (inflation-adjusted) three percent rate and if PV of proposed maintenance costs is greater than PV of current maintenance costs. If incremental maintenance cost is negative, it is treated as a positive benefit. If there are no total incremental PV costs, the B/C ratio is infinite.

Table 39: 15-Year Cost-Effectiveness Summary Per IT Equipment Load kW – New Construction, Increased Temperature Threshold for Economizers Submeasure, Case 2: CHW CRAH with Air Economizer

Climate Zone	Benefits TDV Energy Cost Savings + Other PV Savings^a (2023 PV\$)	Costs Total Incremental PV Costs^b (2023 PV\$)	Benefit-to- Cost Ratio^c
1	\$400	\$0	infinite
2	\$444	\$0	infinite
3	\$825	\$0	infinite
4	\$676	\$0	infinite
5	\$655	\$0	infinite
6	\$863	\$0	infinite
7	\$1,055	\$0	infinite
8	\$843	\$0	infinite
9	\$731	\$0	infinite
10	\$628	\$0	infinite
11	\$421	\$0	infinite
12	\$504	\$0	infinite
13	\$413	\$0	infinite
14	\$389	\$0	infinite
15	\$463	\$0	infinite
16	\$370	\$0	infinite

- a. **Benefits: TDV Energy Cost Savings + Other PV Savings:** Benefits include TDV energy cost savings over the period of analysis (Energy + Environmental Economics 2020). Other savings are discounted at a real (nominal – inflation) three percent rate. Other PV savings include incremental first-cost savings if proposed first cost is less than current first cost. Includes PV maintenance cost savings if PV of proposed maintenance costs is less than PV of current maintenance costs.
- b. **Costs: Total Incremental Present Valued Costs:** Costs include incremental equipment, replacement, and maintenance costs over the period of analysis. Costs are discounted at a real (inflation-adjusted) three percent rate and if PV of proposed maintenance costs is greater than PV of current maintenance costs. If incremental maintenance cost is negative, it is treated as a positive benefit. If there are no total incremental PV costs, the B/C ratio is infinite.
- c. Refer to Table 31 for details on the cost assumptions.

Table 40: 15-Year Cost-Effectiveness Summary Per IT Equipment Load kW – New Construction, Increased Temperature Threshold for Economizers Submeasure, Case 2b: CHW CRAH with Water Economizer with Evaporative Cooling Tower

Climate Zone	Benefits TDV Energy Cost Savings + Other PV Savings^a (2023 PV\$)	Costs Total Incremental PV Costs^b (2023 PV\$)	Benefit-to- Cost Ratio
1	\$1,925	\$30	63
2	\$1,371	\$30	45
3	\$1,232	\$30	41
4	\$1,126	\$30	37
5	\$1,271	\$30	42
6	\$709	\$30	23
7	\$631	\$30	21
8	\$762	\$30	25
9	\$1,020	\$30	34
10	\$970	\$30	32
11	\$1,260	\$30	41
12	\$1,196	\$30	39
13	\$1,107	\$30	36
14	\$1,221	\$30	40
15	\$988	\$30	33
16	\$1,299	\$30	43

- a. **Benefits: TDV Energy Cost Savings + Other PV Savings:** Benefits include TDV energy cost savings over the period of analysis (Energy + Environmental Economics 2020). Other savings are discounted at a real (nominal – inflation) three percent rate. Other PV savings include incremental first-cost savings if proposed first cost is less than current first cost. Includes PV maintenance cost savings if PV of proposed maintenance costs is less than PV of current maintenance costs.
- b. **Costs: Total Incremental Present Valued Costs:** Costs include incremental equipment, replacement, and maintenance costs over the period of analysis. Costs are discounted at a real (inflation-adjusted) three percent rate and if PV of proposed maintenance costs is greater than PV of current maintenance costs. If incremental maintenance cost is negative, it is treated as a positive benefit. If there are no total incremental PV costs, the B/C ratio is infinite.

Table 41: 15-Year Cost-Effectiveness Summary Per IT Equipment Load kW – New Construction, Increased Temperature Threshold for Economizers Submeasure, Case 2c: CHW CRAH with Water Economizer Dry Cooler vs. Evaporative Cooling Tower

Climate Zone	Benefits TDV Energy Cost Savings + Other PV Savings^a (2023 PV\$)	Costs Total Incremental PV Costs^b (2023 PV\$)	Benefit-to- Cost Ratio
1	\$1,278	\$540	2.4
2	\$1,153	\$540	2.1
3	\$1,084	\$540	2.0
4	\$1,029	\$540	1.9
5	\$1,088	\$540	2.0
6	\$823	\$540	1.5
7	\$886	\$540	1.6
8	\$906	\$540	1.7
9	\$1,080	\$540	2.0
10	\$1,037	\$540	1.9
11	\$1,192	\$540	2.2
12	\$1,093	\$540	2.0
13	\$1,049	\$540	1.9
14	\$1,333	\$540	2.5
15	\$1,283	\$540	2.4
16	\$1,376	\$540	2.5

- a. **Benefits: TDV Energy Cost Savings + Other PV Savings:** Benefits include TDV energy cost savings over the period of analysis (Energy + Environmental Economics 2020). Other savings are discounted at a real (nominal – inflation) three percent rate. Other PV savings include incremental first-cost savings if proposed first cost is less than current first cost. Includes PV maintenance cost savings if PV of proposed maintenance costs is less than PV of current maintenance costs.
- b. **Costs: Total Incremental Present Valued Costs:** Costs include incremental equipment, replacement, and maintenance costs over the period of analysis. Costs are discounted at a real (inflation-adjusted) three percent rate and if PV of proposed maintenance costs is greater than PV of current maintenance costs. If incremental maintenance cost is negative, it is treated as a positive benefit. If there are no total incremental PV costs, the B/C ratio is infinite.

2.5 First-Year Statewide Impacts

2.5.1 Statewide Energy and Energy Cost Savings

The Statewide CASE Team calculated the first-year statewide savings for new construction by multiplying the per-unit savings, which are presented in Section 2.3.3, by assumptions about the percentage of newly constructed buildings that would be impacted by the proposed code. The statewide new construction forecast for 2023 is

presented in Appendix A as are the Statewide CASE Team’s assumptions about the percentage of new construction and additions and alterations that would be impacted by the proposal. A summary of estimated statewide energy impacts for new construction and additions/alterations are presented in Table 43.

The first-year energy impacts represent the first-year annual savings from all buildings that were completed in 2023. The 15-year energy cost savings represent the energy cost savings over the entire 15-year analysis period. The statewide savings estimates do not take naturally occurring market adoption or compliance rates into account.

For the increased temperature threshold for economizers submeasure, the estimated statewide new construction savings estimates utilize the data in Table 16. The cooling system types were translated to the cost-effectiveness scenarios analyzed for this code change proposal as per Table 42.

Table 42: Statewide Savings Economizer Type Mapping

Cooling System Type	Portion of California Computer Rooms	Economizer Type for Statewide Analysis
CRACs without fluid/refrigerant economizer	54%	Case 1: CRAC with Air Economizer
CRACs with fluid/refrigerant economizer	13%	Case 2c: CRAH with Air-Cooled Chiller
CRAHs served by water-cooled chillers	23%	50% Case 2: CRAH with Air Economizer (11.5% of total); 50% Case 2b: CRAH with Water Economizer (11.5% of total)
CRAHs served by air-cooled chillers	10%	Case 2c: CRAH with Air-Cooled Chiller
Total	100%	

Table 43: Statewide Energy and Energy Cost Impacts, Increased Temperature Threshold for Economizers – New Construction, Alterations, and Additions

Construction Type	First-Year Electricity Savings (GWh)	First-Year Peak Electrical Demand Reduction (MW)	First -Year Natural Gas Savings (MMTherms)	15-Year Present Valued Energy Cost Savings (PV\$ million in 2023)
New Construction	6.3	0.8	0	\$15
Additions and Alterations ^a	0	0	0	0
TOTAL	6.3	0.8	0	\$15

a. Includes energy savings from lowering the size threshold for computer rooms requiring air containment only.

2.5.2 Statewide Greenhouse Gas (GHG) Emissions Reductions

The Statewide CASE Team calculated avoided GHG emissions assuming the emissions factors specified in the United States Environmental Protection Agency (U.S. EPA) Emissions & Generation Resource Integrated Database (eGRID) for the Western Electricity Coordination Council California (WECC CAMX) subregion. Avoided GHG emissions from natural gas savings attributable to sources other than utility-scale electrical power generation are calculated using emissions factors specified in U.S. EPA’s Compilation of Air Pollutant Emissions Factors (AP-42). See Appendix C for additional details on the methodology used to calculate GHG emissions. In short, this analysis assumes an average electricity emission factor of 240.4 metric ton CO₂e per GWh based on the average emission factors for the CACX EGRID subregion.

Table 44 presents the estimated first-year avoided GHG emissions of the proposed code change. During the first year, GHG emissions of 51,623 metric tons of carbon dioxide equivalents (metric tons CO₂e) would be avoided.

Table 44: First-Year Statewide GHG Emissions Impacts – Increased Temperature Threshold for Economizers

Measure	Electricity Savings^a (GWh/yr)	Reduced GHG Emissions from Electricity Savings^a (Metric Ton CO₂e)	Natural Gas Savings^a (MMTherms /yr)	Reduced GHG Emissions from Natural Gas Savings^a (Metric Ton CO₂e)	Total Reduced CO₂e Emissions^{a, b} (Metric Ton CO₂e)
Increased Temperature Threshold for Economizers	6.3	1,513	0	0	1,513

a. First-year savings from all buildings completed statewide in 2023.

b. Assumes the following emission factors: 240.4 MTCO₂e/GWh and 5,454.4 MTCO₂e/MMTherms.

2.5.3 Statewide Water Use Impacts

For the increased temperature threshold for economizers submeasure, the HVAC system type determines the impact on water use. For computer rooms using air economizers and an evaporatively-cooled chiller plant, the proposed code change reduces water use by decreasing the cooling load on evaporative cooling towers; savings range from 100 – 900 gallons per kW of ITE design load depending on climate zone. For computer rooms that previously would have used air-cooled cooling equipment that elect to use an evaporative cooling tower for water economizing under the proposed economizing temperatures, the proposed code change increases water use by using evaporative cooling towers to serve the economizer load; increased water use ranges from 1,000 – 2,500 gallons per kW of ITE design load depending on climate zone.

Impacts on water use are presented in Table 45. It was assumed that all water savings occurred outdoors, and the embedded electricity value was 3,565 (outdoor water use) kWh/million gallons of water. The embedded electricity estimate was derived from a 2015 CPUC study that quantified the embedded electricity savings from IOU programs that save both water and energy (CPUC 2015). See in Appendix B additional information on the embedded electricity savings estimates.

Table 45: Impacts on Water Use and Embedded Electricity in Water

Submeasure	Impact	On-site Outdoor Water Savings (gallons/yr)	Embedded Electricity Savings ^a (kWh/yr)
Increased temperature threshold for economizers	Per kW of ITE Load Impact	(310)	(1.1)

a. Assumes embedded energy factor of 3,565 kWh per million gallons of water for outdoor water use (CPUC 2015). For the increased temperature threshold for economizers submeasure, the HVAC system type determines the impact on water use. The results presented in the table represent an estimated average for all economizer system types.

2.5.4 Statewide Material Impacts

The increased temperature threshold for economizers submeasure requires additional plastic materials for air containment to be installed for computer rooms 10 kW to 175 kW of ITE design load. If the project is greater than 175 kW ITE design load and uses air economizing, no impact on materials is expected. When comparing the impact of the proposed requirements on an evaporative cooling tower water economizer system, the proposed requirements increase the heat exchanger size. In cases where owners use air-cooled chillers and dry coolers to achieve economizing as their typical practice, this proposed code change may require additional evaporative cooling towers, piping, and heat exchangers to be added to the design to meet the new economizer prescriptive requirements if the project is pursuing prescriptive compliance and is not exercising the performance tradeoff exception.

Table 46: First-Year Statewide Impacts on Material Use: Increased Temperature Threshold for Economizers

Material	Impact (I, D, or NC) ^a	Impact on Material Use (per year)	
		Per-Unit Impacts (lbs/kW of ITE load) ^b	First-Year Statewide Impacts (lbs/yr) ^c
Mercury	NC	N/A	N/A
Lead	NC	N/A	N/A
Steel	I	4.0	11,000
Plastic	I	5.0	32,000

- a. Material Increase (I), Decrease (D), or No Change (NC) compared to base case (lbs/yr).
- b. Per-Unit Impact represents value if applicable to project. Not all scenarios include an increase in materials as described above.
- c. First-year savings from all buildings completed statewide in 2023.

2.5.5 Other Non-Energy Impacts

There are no anticipated other non-energy impacts.

3. Computer Room Heat Recovery

3.1 Measure Description

3.1.1 Measure Overview

This submeasure proposal includes adding prescriptive requirements for computer rooms to Section 140.9 to require new buildings with both a computer room and sizable heating loads to recover heat from the computer room to serve other spaces. Computer room heat recovery is being defined as a mechanical system that transfers heat from computer rooms to provide heating to other zones in the building that require heating. This submeasure only applies to computer rooms in new buildings. There are two scenarios when computer room heat recovery would apply. If a building met the triggers for both scenarios, it would only be required to comply with one scenario.

For new buildings meeting the thresholds described below, a heat recovery system capable of providing at least 50 percent of the total computer room design cooling load or 50 percent of the total building design heating load would be required. These combinations of heating and cooling loads were determined to be cost effective for each climate zone. See Section 5 for more details on the cost-effectiveness analysis. This requirement would apply to the following buildings with an annual heating load of at least 1,400 hours per year:

- Climate Zones 1–5, 11–14, or 16: new buildings with a total cooling ITE design load exceeding 200 kW and with a total design heating load greater than 4,000,000 Btu/hr.
- Climate Zones 1–5, 11–14, or 16: new buildings with a total cooling ITE design load exceeding 500 kW and with a total design heating load greater than 2,500,000 Btu/hr.
- Climate Zones 6–10, or 15: new buildings with a total cooling ITE design load exceeding 300 kW and with a total design heating load greater than 5,000,000 Btu/hr.

This proposal includes recommendations to update the compliance software to allow designers who use the performance approach to model the impacts of computer room heat recovery. Commonly used heat recovery systems such as water-cooled chillers or transfer air are not able to be modeled, which limits the ability to properly capture the energy use of a computer room heat recovery system. The Statewide CASE Team recommends that CBECC-Com be updated to include commonly used heat recovery systems such as heat recovery chillers and transfer air systems. See Appendix D for additional information about proposed changes to the compliance software.

3.1.2 Measure History

Computer rooms produce constant heat from IT equipment. When a computer room is located in a facility that also has heating loads, either for comfort or process heating, recovered heat from the computer room can provide heating for the other facility heating loads, while also reducing the cooling load on the computer room cooling system. While not yet standard practice in the U.S., computer room heat recovery is increasing in the market, and provides significant cooling and heating energy savings during times when the facility requires heating simultaneously with computer room cooling. In some parts of Europe, like Stockholm, data center heat recovery is mandatory, and many large data centers reject heat to district heating systems in Europe.

There are many forms of computer room heat recovery. One of the most efficient and economical forms of heat recovery is direct or indirect air transfer. Computer room hot aisle temperatures are typically 90-110°F. This air can be ducted directly to occupied spaces; there is no need to boost the temperature higher. Another highly efficient form of heat recovery is direct water transfer from water-cooled servers. Most computer servers are air-cooled, but for a 10-15 percent upcharge most servers can be converted to, or replaced with, water-cooled servers. The conversion consists of placing small water-cooled heat exchangers on the server central processing unit and other server components and allows over 80 percent of the server heat to be removed by water. This conversion allows the server fans to be downsized or removed, saving about 20 percent of the total server energy. Water-cooled servers can operate with 130°F entering water temperature and 140°F leaving water temperature. This 140°F water can be used directly by most mechanical systems (e.g., variable air volume with reheat, radiant, etc.) without any need to boost the temperature higher. If the computer room load exceeds the demand for heat then the excess heat can be rejected with a simple dry-cooler or evaporative cooling tower. No compressor cooling is needed in any typical California climate.

Another common form of heat recovery is water-to-water heat pumps or heat recovery chillers. For example, a building may have a chiller plant that serves office air handlers and computer room air handlers (CRAHs) and a boiler plant that serves heating air handlers, variable air volume (VAV) reheat terminal units, radiant heat, or fan coils, etc. Typical CRAH operating conditions are 60°F entering water temperature and 70°F leaving water temperature. VAV reheat and other heating systems typically need hot water supplied in the 120-160°F range. In this scenario, a heat pump or boiler is required to boost the heat rejected by the CRAH units from 70°F to roughly 140°F for use by the heating system.

For the proposed code requirement, a computer room heat recovery system is any mechanical system that transfers heat from computer room return air to provide heating to other zones in the building demanding heating. Examples of heat recovery systems

include: computer room return air transferred directly to air systems providing heating, heat recovery chillers, air-source or water-source heat pumps providing simultaneous heating and cooling, and variable refrigerant flow systems with heat recovery.

Commonly used heat recovery systems such as water-cooled chillers or transfer air are not able to be modeled in the compliance software, which limits the ability to properly capture the energy use of a computer room heat recovery system. The Statewide CASE Team recommends that CBECC-Com be updated to include commonly used heat recovery systems such as heat recovery chillers and transfer air systems.

3.1.3 Compliance and Enforcement

When developing this proposal, the Statewide CASE Team considered methods to streamline the compliance and enforcement process and how negative impacts on market actors who are involved in the process could be mitigated or reduced. This section describes how to comply with the proposed code change. It also describes the compliance verification process. Appendix E presents how the proposed changes could impact various market actors.

The activities that need to occur during each phase of the project are described below.

- **Design Phase:** Mechanical design engineers determine if the computer room ITE design load along with the building design heating load trigger the heat recovery requirement. The mechanical design engineer performs these load calculations as current standard practice. If the heat recovery requirement is triggered, mechanical design engineers must include the heat recovery system on the mechanical permit plans and show the system efficiency (coefficient of performance) on the mechanical schedules. To provide sufficient information for the permit plans examiner to verify the coefficient of performance, the permit plans must show the computer room heat recovery system's total input power and amount of heat transferred at design conditions. Mechanical design engineers complete NRCC forms with the permit package.
- **Permit Application Phase:** The mechanical design engineer documents the computer room design cooling loads, building total and zone heating loads, and heat recovery system power at design conditions, which are used to calculate heat recovery system COP. This information is developed as part of the design process and is not a new requirement. The plans examiner reviews mechanical permit drawings and specifications to confirm if heat recovery is required and, if so, that it is shown on the permit documents. The plans examiner reviews the computer room heat recovery system COP and, if an exception is utilized, the heating system COP.
- **Construction Phase:** The mechanical contractor reviews mechanical design

documents to confirm heat recovery requirements, and then selects and installs a heat recovery system that meets the design specification. The controls contractor installs controls to allow the heat recovery system to operate per the design specification.

- **Inspection Phase:** The mechanical contractor completes NRCI forms.

3.2 Market Analysis

3.2.1 Market Structure

3.2.1.1 Market Overview

Heat recovery is a common energy efficiency strategy in commercial buildings; however, heat recovery in computer rooms is typically only found in the highest performance computer rooms, such as National Renewable Energy Laboratory's (NREL) Energy Systems Integration Facility in Golden, Colorado, which transfers computer room waste heat to hydronically heat nearby offices and laboratories (Laboratory n.d.). Successful implementation of heat recovery requires planning by the mechanical engineer, as well as coordination with the architect for locating spaces with heating demands near the computer room. Heat recovery systems are designed and specified by the mechanical engineer using off-the-shelf products. A heat recovery system may consist of multiple mechanical system components specified together or packaged products such as heat recovery chillers. In either case, there are many manufacturers that make and sell these products in California.

3.2.1.2 Design

This submeasure largely relies on the mechanical design engineer to properly design the mechanical system to comply with the code requirement. This starts with identifying which code requirements are triggered based on the ITE design load in the computer room. The mechanical design engineer must size mechanical systems to provide sufficient heat recovery capacity to meet the code requirement, as well as develop a mechanical controls sequence of operation that achieves code requirements. If the heat recovery system is used to provide heating to a process heating system, then coordination with the plumbing engineer or other entity designing the process heating system is required to coordinate the heating and cooling loads and size the heat recovery system appropriately for the application and to meet code requirements.

There are many options for computer room heat recovery, such as computer room return air transferred directly to air systems providing heating, heat recovery chillers, air-source or water-source heat pumps providing simultaneous heating and cooling, or variable refrigerant flow systems with heat recovery. One of the most common is directly transferring hot air from the "hot aisle" of a computer room to the hot deck of a dual fan

dual duct (DFDD) system serving occupied spaces in proximity to the computer room. Figure 6 is a schematic illustrating this approach. In this case, the computer room does not have an air economizer. Thus, a cooling only VAV box from the DFDD cold deck provides makeup air for the heat recovery air transferred out of the computer room and also provides some free air economizer savings to the computer room.

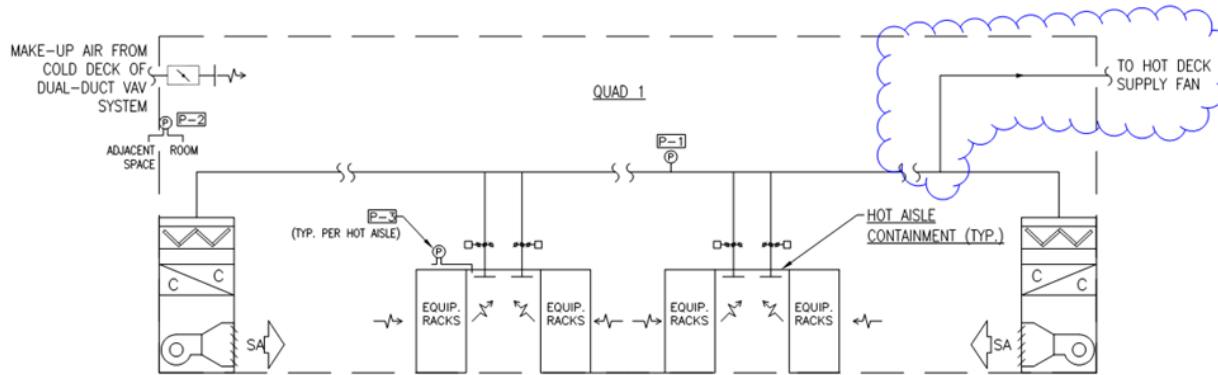

Figure 6. Computer room heat recovery example mechanical diagram: DFDD.

Source: Taylor Engineering, 2020.

Figure 7 shows a similar approach in an actual computer room directly transferring hot aisle air to parallel fan powered boxes in a VAV reheat system serving an office.

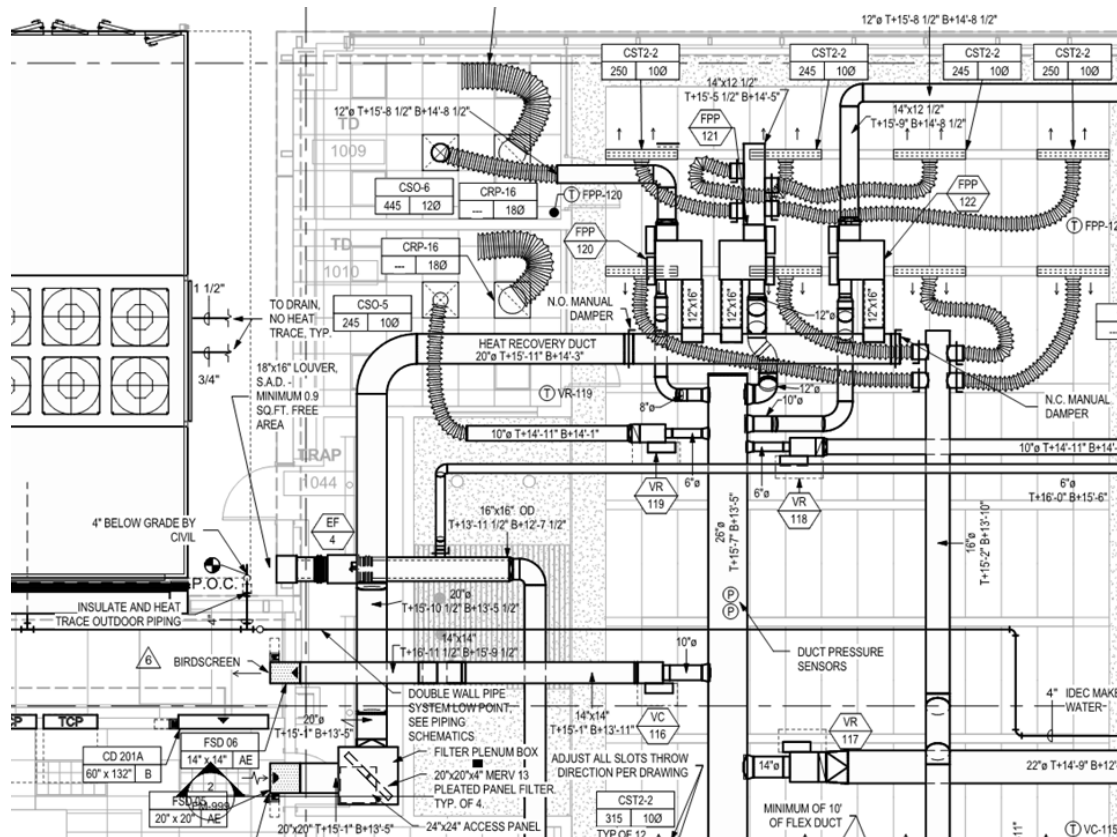

Figure 7. Computer room heat recovery example mechanical plan: fan powered boxes.

Source: Taylor Engineering, 2020.

Another common approach is to include computer rooms in buildings with systems that are already recovering heat between zones. Examples include VRF systems and WSHP systems. A multiple zone VRF or WSHP system allows a zone in heating to recover heat from a zone in cooling. It is common to put a VRF fan coil or WSHP unit in a computer room to effectively allow the computer room to heat other zones in the building.

Another common approach is locating the heating heat pump condenser in the computer room hot aisle to absorb and transfer heat from the computer room to a heating building load. This can be done for comfort heating or heat pump water heaters for domestic hot water.

A third approach, common in all-electric buildings, is water-to-water heat recovery chillers. A building that uses chilled water cooling and hydronic heating (e.g., VAV reheat, radiant floors, hot water fan coils, etc.) can use a heat recovery chiller to transfer heat from the chilled water loads (e.g., chilled water computer room air handlers) to the hot water loads (e.g., hot water reheat boxes, radiant panels, etc.). One advantage of

this approach is that the computer room(s) can be located far from the heating zones in the building.

3.2.1.3 Installation and Commissioning

The mechanical contractor installs the heat recovery system. The system is commissioned by the mechanical contractor and a third-party commissioning agent. Because computer rooms are typically considered critical loads, typical practice includes commissioning to confirm mechanical and electrical systems are installed properly.

3.2.2 Technical Feasibility, Market Availability, and Current Practices

There are several technically feasible and widely available current practices for computer room heat recovery. The most significant barrier may be a mindset adjustment that architects and engineers need to make in order to consider computer room heat recovery early in the design process.

Heat recovery requires coordination between the design of the computer room system and the design of the associated heating system. If the computer room can be located in close proximity to spaces that can use the recovered heat then more system options are available, like direct air transfer to a DFDD hot deck. The designer of the associated heating system needs to design it to accept the recovered heat, e.g., by selecting a DFDD system over other options. If computer room heat recovery is treated as an afterthought, then the system options decrease and the cost can increase.

Computer room spaces have an Air Class 1 designation per Table 120.1-A – Minimum Ventilation Rates, and therefore computer room air may be transferred to any space type per 120.1(g)1.

3.3 Energy Savings

3.3.1 Key Assumptions for Energy Savings Analysis

The energy and cost analysis presented in this report used the TDV factors that are consistent with the TDV factors presented during the Energy Commission’s March 27, 2020 workshop on compliance metrics (California Energy Commission 2020). The electricity TDV factors include the 15 percent retail adder and the natural gas TDV factors include the impact of methane leakage on the building site. The electricity TDV factors used in the energy savings analyses were obtained from Energy and Environmental Economics, Inc. (E3), the contractor that is developing the 2022 TDV factors for the Energy Commission, in a spreadsheet titled “Electric TDVs 2022 - 15 pct Retail Adj Scaled by Avoided Costs.xlsx”. The natural gas TDV factors used in the energy savings analyses were obtained via email from E3 in a spreadsheet titled

“2022_TDV_Policy_Compliant_CH4Leak_FlatRtlAdd_20191210.xlsx”. The electricity demand factors used in the energy savings analysis were obtained from E3 in a spreadsheet titled “2022 TDV Demand Factors.xlsx”. The Energy Commission notified the Statewide CASE Team on April 21, 2020 that they were investigating further refinements to TDV factors using 20-year global warming potential (GWP) values instead of the 100-year GWP values that were used to derive the current TDV factors. It is anticipated that the 20-year GWP values will increase the TDV factors slightly. As a result, the TDV energy savings presented in this report are lower than the values that are expected if the final TDV use 20-year GWP values, and the proposed code changes will be more cost effective using the revised TDV. Energy savings presented in kWh and therms are not affected by TDV or demand factors.

Large Computer Room(s) in Building with Large Heating Load

- **System Overview:** 2019 Title 24, Part 6 standard design large office was modeled. The computer room heat output is transferred to the office heating zones via a heat recovery chiller when the zones demand heating. Table 47 describes the key modeling assumptions for the energy savings analysis.
- **Modeling Software Approach:** The CBECC-Com 2019 large office prototype model was simulated for each climate zone to output annual hourly heating and cooling loads. The results were then post-processed in a spreadsheet due to the limitations of the compliance software to simulate heat recovery. Hourly computer room ITE load was simulated in a spreadsheet using the CBECC-com DataReceptacle schedule and design ITE load. Energy savings from the heat recovery system was analyzed in a spreadsheet by determining the smaller of: the computer room ITE load and total office heating load and calculating that value as the amount of heat recovered (a reduction of load on the heating system). Multiple load scenarios were simulated to determine load size thresholds for the measure to be cost effective.
- **Description of Energy Savings:** This measure saves heating energy by reducing the heating load on the mechanical heating system.

Table 47: Energy Analysis Assumptions: Computer Room Heat Recovery

Input Parameter	Baseline	Proposed	Notes
ITE Design Load (kW)	200, 300, 500	200, 300, 500	Multiple load scenarios were simulated to determine load size threshold for measure to be cost effective.
IT Equipment Load Schedule	DataReceptacle	DataReceptacle	ACM, Appendix 3-4B. Load cycles each month among 25%, 50%, 75%, and 100% load factor.
Office Hourly Thermal Load Profile	Large Office Prototype	Large Office Prototype	Loads were scaled to determine load size thresholds for measure to be cost effective.
Office Heating System Type	Non-condensing natural gas hot water boiler	heat recovery chiller with non-condensing natural gas hot water boiler booster	Baseline: ACM, Table 4 Proposed: Proposed by submeasure. Natural gas boiler is used only to boost recovered hot water from 140°F to 160°F)
Design Boiler Efficiency	80%	80%	ACM.
Average Boiler Efficiency	65%	65%	Estimate from DOE 2-2 curves.
Heat Recovery Chiller Efficiency (COP)	N/A	3.52	manufacturer data
Heat Recovery Chiller Part-Load Efficiency	N/A	manufacturer data	Chiller plant efficiency
Design Hot Water Supply Temperature	180°F	180°F	ACM Hot Water Supply Temperature, page 5-188
Chilled Water Supply Temperature in Heat Recovery Mode	N/A	55°F	Proposed: Assumed to be in reset when offices are in heating mode.
Energy Commission Climate Zones	All	All	N/A

3.3.2 Energy Savings Methodology

3.3.2.1 Energy Savings Methodology per Prototypical Building/Simulation Case

The Energy Commission directed the Statewide CASE Team to model the energy impacts using specific prototypical building models that represent typical building geometries for different types of buildings (California Energy Commission n.d.). The large office prototype model was used to assess the heat recovery submeasure. See details in Table 48. This prototype model is available at the following link:

<http://bees.archenergy.com/software2022.html>.

Table 48: Prototype Buildings Used for Energy, Demand, Cost, and Environmental Impacts Analysis

Submeasure	Prototype Name	Number of Stories	Floor Area (square feet)	Description
Heat Recovery	Office Large	12	498,589	12 story + 1 basement office building with 5 zones and a ceiling plenum on each floor. WWR-0.40

Although the Energy Commission indicated a preference for simulating energy impacts using CBECC-Com, a spreadsheet was used to calculate energy impacts of the computer room heat recovery submeasure. Multiple mechanical systems were modeled to evaluate heat recovery, including some such as dual fan dual duct and heat recovery chillers which are not currently available in CBECC-Com; also, CBECC-Com does not provide the ability to model heat recovery between computer rooms and other building spaces, so a spreadsheet was used.

Since CBECC-Com does not allow heat to be recovered from a computer room and be used to heat another space and also does not heat recovery chillers, an annual hourly spreadsheet analysis was used to simulate heat recovery between computer rooms and commercial spaces with a heating demand. The spreadsheet analysis followed the ACM for key inputs affecting energy use, as described in Table 49.

The Standard Design represents the geometry of the design that the builder would like to build and inserts a defined set of features that result in an energy budget that is minimally compliant with 2019 Title 24, Part 6 code requirements. Features used in the Standard Design are described in the 2019 Nonresidential ACM Reference Manual. There is an existing Title 24, Part 6 requirement that covers the building system in question and applies to both new construction and alterations, so the Standard Design is minimally compliant with the 2019 Title 24, Part 6 requirements. Minimal 2019 Title 24, Part 6 compliance includes a computer room with mechanical systems and efficiencies meeting 140.9(a) prescriptive requirements, which include: full air

economizing at outdoor temperatures of 55°F dry-bulb and below, variable speed fan control with a fan system design power demand of 27 W/kBtu-h of net sensible cooling capacity (this equates to 0.58 W/cfm with a 20°F supply and return air temperature difference, which is more efficient than the ACM listed value of 0.81 W/cfm for CRACs/CRAHs), supply air temperature of 60°F, and return air temperature of 80°F.

The Proposed Design represents the same geometry as the Standard Design, but it assumes the energy features that the software user describes with user inputs. To develop savings estimates for the proposed code changes, the Statewide CASE Team created a Standard Design and Proposed Design for each prototypical building.

The Proposed Design was identical to the Standard Design in all ways except for the revisions that represent the proposed changes to the code. Table 49 presents a summary of key parameters that were modified and what values were used in the Standard Design and Proposed Design. Comparing the energy impacts of the Standard Design to the Proposed Design reveals the impacts of the proposed code change relative to a building that is minimally compliant with the 2019 Title 24, Part 6 requirements.

Table 49: Modifications Made to Standard Design in Each Simulation Case to Simulate Proposed Code Change: Heat Recovery Submeasure

Simulation Case/ Prototype ID	Climate Zone	Parameter Name	Standard Design Parameter Value	Proposed Design Parameter Value
Large Office	All	Heat Recovery Chiller Efficiency	N/A	3.52 COP

The Statewide CASE Team calculated energy consumption for every hour of the year measured in kWh/yr and therms/yr, then applied the 2022 TDV factors to calculate annual energy use in TDV kBtu/yr and annual peak electricity demand reductions measured in kW. TDV energy cost savings were also calculated in 2023 PV\$ and nominal dollars.

The energy impacts of the proposed code change vary by climate zone. The Statewide CASE Team simulated the energy impacts in every climate zone and applied the climate-zone specific TDV factors when calculating energy and energy cost impacts. Aside from weather data, modeling inputs did not vary by climate zone.

Per-unit energy impacts for nonresidential buildings are presented in savings per kilowatt of IT equipment load. Annual energy and peak demand impacts were translated into impacts per kW IT equipment load by dividing by the kW of IT equipment load for each simulated case. This step allows for an easier comparison of savings across

different building types and enables a calculation of statewide savings using the construction forecast that is published in terms of floor area by building type.

3.3.2.2 Statewide Energy Savings Methodology

As described above, the per unit energy impacts are presented in savings per design ITE load. Savings do not vary significantly by building type, but rather by ITE load. Although the per unit savings were calculated using prototypical buildings, the per unit savings apply to any building type.

The per-unit energy impacts were extrapolated to statewide impacts using the Statewide Construction Forecasts that the Energy Commission provided (California Energy Commission Building Standards Office n.d.). The Statewide Construction Forecasts estimate new construction that will occur in 2023, the first year that the 2022 Title 24, Part 6 requirements are in effect. It also estimates the size of the total existing building stock in 2023 that the Statewide CASE Team used to approximate savings from building alterations. The construction forecast is provided in square footage of new and existing floorspace.

Because ITE load, not total building floor area, is the driver for computer room energy use, the Statewide CASE Team correlated ITE load to building floor area by assuming a watts per square foot of ITE design load density. The ITE design load density varies by measure type and is described in Appendix A.

Appendix A presents additional information about the methodology and assumptions used to calculate statewide energy impacts.

3.3.3 Per Unit Energy Impacts Results

The per-unit energy savings do not account for naturally occurring market adoption or compliance rates. Table 50 show the first year per-unit energy savings and demand reduction ranges, which vary by climate zone and system type. There is a positive net energy savings in all climate zones.

Computer room heat recovery provides the most energy savings in colder climates that have more heating load such as offices and schools. Milder climates zones (6 through 10, and 15) show less energy savings than colder climate zones (1 through 5, 11 through 14, and 16). Electricity savings are negative because the analysis uses an electric heat recovery chiller in the proposed case compared to all heating being done with natural gas boilers in the baseline case. Multiple load scenarios were simulated to determine load size thresholds for the measure to be cost effective. The energy savings impacts for Climate Zones 1 through 5, 11 through 14, and 16 assume an ITE design cooling load of 500 kW and 2.5 million Btu/hr building design heating load; and for climate zones 300 kW ITE design cooling load and 5 million Btu/hr building design heating load for Climate Zones 6 through 10 and 15.

This submeasure would not have a significant impact on demand response/flexibility, peak power demand, or load shifting in buildings that use natural gas heating sources, which is the Standard Design system used in this analysis. For buildings that use electric heating sources, which are expected to increase in number, this submeasure will have electric energy and peak demand savings.

Table 50: First-Year Energy Impacts Per IT Equipment Load kW – Heat Recovery Submeasure

Climate Zone	Electricity Savings (kWh/yr)	Peak Electricity Demand Reduction (kW)	Natural Gas Savings (therms/yr)	TDV Energy Savings (TDV kBtu/yr)
1	(224)	0.0	51	5,031
2	(139)	0.0	32	4,175
3	(139)	0.0	32	4,175
4	(124)	0.0	28	3,464
5	(124)	0.0	28	3,464
6	(165)	0.0	39	5,034
7	(165)	0.0	39	5,034
8	(165)	0.0	39	5,034
9	(165)	0.0	39	5,034
10	(165)	0.0	39	5,034
11	(133)	0.0	30	3,823
12	(133)	0.0	30	3,823
13	(133)	0.0	30	3,823
14	(124)	0.0	28	3,464
15	(165)	0.0	39	5,034
16	(224)	0.0	51	5,031
TOTAL	(2,490)	0.0	571	70,475

3.4 Cost and Cost Effectiveness

3.4.1 Energy Cost Savings Methodology

Energy cost savings were calculated by applying the TDV energy cost factors to the energy savings estimates that were derived using the methodology described in Section 3.3.3 TDV is a normalized metric to calculate energy cost savings that accounts for the variable cost of electricity and natural gas for each hour of the year, along with how costs are expected to change over the period of analysis (30 years for residential measures and nonresidential envelope measures and 15 years for all other nonresidential measures). In this case, the period of analysis used is 15 years. The TDV cost impacts are presented in nominal dollars and in 2023 present value dollars and represent the energy cost savings realized over 15 years.

3.4.2 Energy Cost Savings Results

Per-unit energy cost savings for newly constructed buildings and alterations that are realized over the 15-year period of analysis are presented in 2023 dollars in Table 51. The heat recovery submeasure only applies to new construction.

The TDV methodology allows peak electricity savings to be valued more than electricity savings during non-peak periods. Because internal equipment loads drive the energy use in computer rooms and that equipment load is typically relatively flat throughout the day, submeasures that reduce equipment load (e.g., UPS efficiency) provide a relatively constant demand reduction. The heat recovery submeasure is a heating energy savings measure; depending on the heating fuel source, this submeasure either savings natural gas energy (default assumption) or can save electricity demand if the heating source is electric. The majority of the heating savings is expected to occur during cooler months and during occupied hours, but may vary by building depending on building heating load sources and occupancy schedules.

This submeasure save energy cost in all climate zones.

Table 51: 2023 PV TDV Energy Cost Savings Over 15-Year Period of Analysis – Per IT Equipment Load kW – New Construction, Computer Room Heat Recovery Submeasure

Climate Zone	15-Year TDV Electricity Cost Savings (2023 PV\$)	15-Year TDV Natural Gas Cost Savings (2023 PV\$)	Total 15-Year TDV Energy Cost Savings (2023 PV\$)
1	\$0	\$448	\$448
2	\$0	\$372	\$372
3	\$0	\$372	\$372
4	\$0	\$308	\$308
5	\$0	\$308	\$308
6	\$0	\$448	\$448
7	\$0	\$448	\$448
8	\$0	\$448	\$448
9	\$0	\$448	\$448
10	\$0	\$448	\$448
11	\$0	\$340	\$340
12	\$0	\$340	\$340
13	\$0	\$340	\$340
14	\$0	\$308	\$308
15	\$0	\$448	\$448
16	\$0	\$448	\$448
TOTAL	\$0	\$6,272	\$6,272

3.4.3 Incremental First Cost

Incremental first cost is the initial cost to adopt more efficient equipment or building practices when compared to the cost of an equivalent baseline project. Therefore, it was important that the Statewide CASE Team consider first costs in evaluating overall measure cost effectiveness. Incremental first costs are based on data available today and can change over time as markets evolve and professionals become familiar with new technology and building practices.

Table 52 describes the incremental first costs for this submeasure.

For the large computer room in building with large heating room case, costs were obtained for two heat recovery chiller sizes: 40 tons and 150 tons. Costs for each climate zone were linearly interpolated based on chiller size for each simulation case. Refer to Appendix H for a more detailed cost information.

Table 52: Incremental First Cost Assumptions: Heat Recovery Submeasure

Cost Item	Incremental First Cost (\$ total)	Cost Source
Heat recovery chiller (installation materials)	\$35,800 - \$66,900	average of 3 heat recovery chiller vendors in CA
Installation Labor	\$25,700-\$39,700	Bay Area mechanical contractor (for 40 and 150 ton chillers)
Controls	\$33,975-\$38,975	Bay Area mechanical contractor (for 40 and 150 ton chillers)
Commissioning, Miscellaneous	\$19,000	Bay Area mechanical contractor (for 40 and 150 ton chillers)
Total	\$114,475-\$164,575	

3.4.4 Incremental Maintenance and Replacement Costs

Incremental maintenance cost is the incremental cost of replacing the equipment or parts of the equipment, as well as periodic maintenance required to keep the equipment operating relative to current practices over the 15-year period of analysis. The present value of equipment maintenance costs (savings) was calculated using a 3 percent discount rate (d), which is consistent with the discount rate used when developing the 2022 TDV. The present value of maintenance costs that occurs in the nth year is calculated as follows:

$$\text{Present Value of Maintenance Cost} = \text{Maintenance Cost} \times \left[\frac{1}{1 + d} \right]^n$$

Annual maintenance costs are estimated to be \$2,100 per year for a heat recovery chiller, ranging from 40 tons to 150 tons in capacity; this cost estimate was obtained from a Bay Area mechanical contractor.

3.4.5 Cost Effectiveness

This measure proposes a prescriptive requirement. As such, a cost analysis is required to demonstrate that the measure is cost effective over the 15-year period of analysis.

The Energy Commission establishes the procedures for calculating cost effectiveness. The Statewide CASE Team collaborated with Energy Commission staff to confirm that the methodology in this report is consistent with their guidelines, including which costs were included in the analysis. The incremental first cost and incremental maintenance costs over the 15-year period of analysis were included. The TDV energy cost savings from electricity and natural gas savings were also included in the evaluation. In cases where the proposed submeasure increases water use, such as the air-cooled chiller

with dry cooler economizer versus air-cooled chiller with evaporative cooling tower economizer, the estimated 15-year water use cost was also included in the cost-effectiveness analysis.

Design costs were not included nor were the incremental costs of code compliance verification.

According to the Energy Commission's definitions, a measure is cost effective if the benefit-to-cost (B/C) ratio is greater than 1.0. The B/C ratio is calculated by dividing the cost benefits realized over 15 years by the total incremental costs, which includes maintenance costs for 15 years. The B/C ratio was calculated using 2023 PV costs and cost savings.

Results of the per-unit cost-effectiveness analyses are presented in Table 53 for new construction. This submeasure does not apply to alterations.

The proposed submeasure saves money over the 15-year period of analysis relative to existing requirements. The proposed change is cost effective in every climate zone for the simulation case. The results are the same for new construction and additions/alterations.

The proposed submeasure saves money over the 15-year period of analysis relative to existing requirements. The proposed change is cost effective in every climate zone. The results apply only to new construction.

Table 53: 15-Year Cost-Effectiveness Summary Per IT Equipment Load kW – New Construction, Computer Room Heat Recovery Submeasure

Climate Zone	Benefits TDV Energy Cost Savings + Other PV Savings^a (2023 PV\$)	Costs Total Incremental PV Costs^b (2023 PV\$)	Benefit-to- Cost Ratio
1	\$448	\$296	1.5
2	\$372	\$296	1.3
3	\$372	\$296	1.3
4	\$308	\$296	1.0
5	\$308	\$296	1.0
6	\$448	\$424	1.1
7	\$448	\$424	1.1
8	\$448	\$424	1.1
9	\$448	\$424	1.1
10	\$448	\$424	1.1
11	\$340	\$296	1.1
12	\$340	\$296	1.1
13	\$340	\$296	1.1
14	\$308	\$296	1.0
15	\$448	\$296	1.1
16	\$448	\$296	1.5

- a. **Benefits: TDV Energy Cost Savings + Other PV Savings:** Benefits include TDV energy cost savings over the period of analysis (Energy + Environmental Economics 2020). Other savings are discounted at a real (nominal – inflation) three percent rate. Other PV savings include incremental first-cost savings if proposed first cost is less than current first cost. Includes PV maintenance cost savings if PV of proposed maintenance costs is less than PV of current maintenance costs.
- b. **Costs: Total Incremental Present Valued Costs:** Costs include incremental equipment, replacement, and maintenance costs over the period of analysis. Costs are discounted at a real (inflation-adjusted) three percent rate and if PV of proposed maintenance costs is greater than PV of current maintenance costs. If incremental maintenance cost is negative, it is treated as a positive benefit. If there are no total incremental PV costs, the B/C ratio is infinite.

3.5 First-Year Statewide Impacts

3.5.1 Statewide Energy and Energy Cost Savings

The Statewide CASE Team calculated the first-year statewide savings for new construction by multiplying the per-unit savings, which are presented in Section 3.3.3, by assumptions about the percentage of newly constructed buildings that would be impacted by the proposed code. The statewide new construction forecast for 2023 is

presented in Appendix A as are the Statewide CASE Team’s assumptions about the percentage of new construction and additions and alterations that would be impacted by the proposal. A summary of estimated statewide energy impacts for new construction and additions/alterations are presented in Table 54. The first-year energy impacts represent the first-year annual savings from all buildings that were completed in 2023. The 15-year energy cost savings represent the energy cost savings over the entire 15-year analysis period. The statewide savings estimates do not take naturally occurring market adoption or compliance rates into account.

Table 54: Statewide Energy and Energy Cost Impacts, Heat Recovery – New Construction, Alterations, and Additions

Construction Type	First-Year Electricity Savings (GWh)	First-Year Peak Electrical Demand Reduction (MW)	First -Year Natural Gas Savings (MMTherms)	15-Year Present Valued Energy Cost Savings (PV\$ million in 2023)
New Construction	(0.8)	0	0.2	\$2
Additions and Alterations	0	0	0	0
TOTAL	(0.8)	0	0.2	\$2

3.5.2 Statewide Greenhouse Gas (GHG) Emissions Reductions

The Statewide CASE Team calculated avoided GHG emissions assuming the emissions factors specified in the United States Environmental Protection Agency (U.S. EPA) Emissions & Generation Resource Integrated Database (eGRID) for the Western Electricity Coordination Council California (WECC CAMX) subregion. Avoided GHG emissions from natural gas savings attributable to sources other than utility-scale electrical power generation are calculated using emissions factors specified in U.S. EPA’s Compilation of Air Pollutant Emissions Factors (AP-42). See Appendix C for additional details on the methodology used to calculate GHG emissions. In short, this analysis assumes an average electricity emission factor of 240.4 metric ton CO₂e per GWh based on the average emission factors for the CACX EGRID subregion.

Table 55 presents the estimated first-year avoided GHG emissions of the proposed code change. During the first year, GHG emissions of 28,373 metric tons CO₂e would be avoided.

Table 55: First-Year Statewide GHG Emissions Impacts – Heat Recovery

Measure	Electricity Savings ^a (GWh/yr)	Reduced GHG Emissions from Electricity Savings ^a (Metric Ton CO ₂ e)	Natural Gas Savings ^a (MMTherms/yr)	Reduced GHG Emissions from Natural Gas Savings ^a (Metric Ton CO ₂ e)	Total Reduced CO ₂ e Emissions ^{a, b} (Metric Ton CO ₂ e)
Heat Recovery	(0.8)	(195)	0.2	1,027	832

a. First-year savings from all buildings completed statewide in 2023.

b. Assumes the following emission factors: 240.4 MTCO₂e/GWh and 5,454.4 MTCO₂e/MMTherms.

3.5.3 Statewide Water Use Impacts

The heat recovery submeasure does not have an impact on site water use.

3.5.4 Statewide Material Impacts

The heat recovery submeasure does not have an impact on materials use.

Table 56: First-Year Statewide Impacts on Material Use: Computer Room Heat Recovery

Material	Impact (I, D, or NC) ^a
Mercury	NC
Lead	NC
Copper	NC
Steel	NC
Plastic	NC

3.5.5 Other Non-Energy Impacts

There are no anticipated other non-energy impacts.

4. Uninterruptible Power Supply (UPS) Efficiency

4.1 Measure Description

4.1.1 Measure Overview

This submeasure proposal includes adding a prescriptive requirement for all alternating current (AC)-output UPSs serving computer rooms, except for UPSs that use NEMA 1-15P or 5-15P input plugs, to match ENERGY STAR® Version 2.0 minimum efficiency and testing requirements. UPS unit efficiency is not currently regulated by Title 24, Part 6.

This submeasure proposal includes recommendations to update the compliance software to allow designers who use the performance approach to model the impacts of UPS efficiency. Because UPSs are currently an unregulated load, they are not included in CBECC-Com. Almost every computer room uses a UPS. The Statewide CASE Team recommends that CBECC-Com be updated to include UPS efficiency. UPS efficiency should be modeled with at least a four-point part-load efficiency curve for 25 percent, 50 percent, 75 percent and 100 percent load factors. Users should then have the option to determine the percentage of computer room IT load is served by the UPS (typically this will be 100 percent), which will be used to calculate the operating UPS load factor and UPS efficiency for each hour of the year. The UPS waste heat and IT load are cooling loads on the cooling system. See Appendix D for additional information about proposed changes to the compliance software.

4.1.2 Measure History

Nearly every computer room uses a UPS¹¹ to provide constant backup power and/or power quality management to IT equipment. UPSs vary in efficiency, depending on UPS model and load factor; typically, UPS efficiency can vary from 70 to 99 percent efficiency. Increasing UPS efficiency reduces twenty-four hours a day, seven days a week computer room electrical support system power demand and energy use.

Minimum UPS efficiency requirements have been encouraged by California IOU energy efficiency incentive programs for over a decade (Engineers 2007), and ENERGY STAR has provided a UPS efficiency certification since 2012. The current version of the

¹¹ Federal statutes include the following definition, “*Uninterruptible power supply or UPS* means a battery charger consisting of a combination of convertors, switches, and energy storage devices (such as batteries), constituting a power system for maintaining continuity of load power in case of input power failure,” (10 CFR Appendix Y to Subpart B of Part 430 – Uniform Test Method for Measuring the Energy Consumption of Battery Chargers).

ENERGY STAR UPS efficiency standard (version 2.0) sets minimum UPS efficiencies between 94 to 97 percent (weighted average of part-load efficiencies), depending on UPS type and size ((EPA) n.d.).

In 2019, Washington State adopted ASHRAE 90.4, 2016 Chapter 8, which includes minimum UPS efficiency requirements ranging from 80 to 88 percent, depending on load factor and electrical system redundancy configuration; these requirements will go into effect in July 2020 ((WSEC) 2019).

Effective March 10, 2020, the U.S. Department of Energy (DOE) adopted minimum efficiency requirements for AC-output UPSs that utilize NEMA 1-15P or 5-15P input plugs (U. D. Energy 2020). This legislation is aimed at smaller UPSs (typically less than 1,000 kW) than what are typically installed in computer rooms.

The Statewide CASE Team is pursuing this measure because of its potential to save significant energy and to align with minimum ENERGY STAR efficiency requirements.

Currently UPSs are an unregulated load and included in the plug load input of compliance software. Introducing UPS efficiency as a prescriptive requirement introduces the need for compliance modelers to be able model the efficiency of the design's UPS, so that the compliance simulation captures the UPS efficiency and waste heat on the cooling system. Including a four-point UPS part-load performance efficiency curve for the design's UPS as an input, as described in Section 4.1, can achieve this modeling need.

4.1.3 Compliance and Enforcement

When developing this proposal, the Statewide CASE Team considered methods to streamline the compliance and enforcement process and how negative impacts on market actors who are involved in the process could be mitigated or reduced. This section describes how to comply with the proposed code change. It also describes the compliance verification process. Appendix E presents how the proposed changes could impact various market actors.

- **Design Phase:** If a UPS is planned for the computer room, the electrical design engineer selects a UPS that meets the required minimum efficiency requirement. The electrical engineer includes the UPS capacity, type (voltage independent, voltage and frequency dependent, or voltage and frequency independent), and minimum efficiency in the electrical permit schedule or specifications. As current standard practice, UPS capacity is typically included in the electrical equipment schedule, and UPS efficiency may be included in the electrical specification. The electrical design engineer completes NRCC forms with the permit package.
- **Permit Application Phase:** The plans examiner reviews electrical permit

drawings and specifications to confirm if a UPS is included and, if so, that it meets minimum efficiency requirements. The plans examiner may confirm the UPS meets the efficiency requirements by checking the UPS is on ENERGYSTAR's certification list or the Energy Commission could maintain their own list of acceptable UPSs, similar to the approach that is used for Occupant Controlled Smart Thermostats.

- **Construction Phase:** The electrical contractor reviews electrical design documents to confirm UPS efficiency requirements, and then selects and installs a UPS that meets the design specification.
- **Inspection Phase:** The electrical contractor completes NRCI forms.

4.2 Market Analysis

4.2.1 Market Structure

4.2.1.1 Market Overview

UPS units are products specified by electrical engineers and sold by equipment representatives. There are more than ten major manufacturers that sell UPSs with capacities commonly found in computer rooms in California (i.e., greater than 100 kilowatts).

4.2.1.2 Design

This submeasure relies on the electrical design engineer to select UPS equipment that meets code-required minimum efficiency. The electrical design engineer works with a UPS vendor to confirm product efficiency and includes that information in the design drawings. Many UPSs include output power metering capabilities which meet part of the mandatory PUE monitoring requirement; the electrical design engineer may wish to confirm that functionality with the vendor and include that functionality in their design specification for the selected UPS in order to meet the PUE monitoring requirement more cost effectively.

4.2.1.3 Installation and Commissioning

The electrical contractor installs the UPS system which is commissioned by the electrical contractor and a third-party commissioning agent. The UPS vendor is usually present for UPS startup. Because computer rooms are typically considered critical loads, typical practice includes commissioning to confirm mechanical and electrical systems are installed properly.

4.2.2 Technical Feasibility, Market Availability, and Current Practices

ENERGY STAR has certified UPSs ranging in size from less than 350 W to over 1 MW and includes UPSs serving a variety of product types including residential and commercial appliances and computer rooms. Computer rooms vary in size, but computer rooms typically utilize UPSs on the larger end of ENERGY STAR’s offering, approximately 20 kW and greater. Federal UPS standards regulate UPSs ranging from less than 300 W to greater than 700 W, whereas most UPSs serving computer rooms are much larger than UPSs covered by federal requirements.

As of January 2020, the ENERGY STAR product finder website shows the following ENERGY STAR Certified UPSs ((EPA), Energy Star Certified Uninterruptible Power Supplies n.d.).

Table 57: ENERGY STAR UPS Product Survey

UPS Capacity Range	Number of ENERGY STAR Certified Products	Number of Unique Vendors Offering Certified UPSs
20 – 100 kW	39	7
100 – 500 kW	23	6
> 500 kW	2	2

There are more UPSs available in smaller sizes for smaller computer rooms. This indicates that there are multiple products available by multiple manufacturers in the California market that comply with this proposed submeasure. Electrical design engineers must specify a UPS from the EnergyStar Certified list or a UPS that demonstrates equivalent or better efficiency to provide a design that meets this submeasure’s requirements.

While multiple manufacturer product options are available between 100 kW and 500 kW, there are only two ENERGY STAR certified UPS greater than 500 kW. Given the relatively limited quantity of known UPSs that can meet the proposed efficiency requirement in this size range, this submeasure is being proposed as a prescriptive requirement to provide owners flexibility in the UPS they select.

Through discussions, additional major UPS manufacturers and vendors indicated that they offer UPSs that likely can meet ENERGY STAR efficiency criteria even though these UPSs are not currently certified and that they would pursue certification if California adopts the ENERGY STAR efficiency requirements. Therefore, Statewide CASE Team anticipates additional ENERGY STAR UPSs greater than 100 kW would become available on the market by the time this submeasure would take effect. Another option for owners is to install multiple smaller UPS (less than 500 kW each) together to meet larger capacity requirements. This typically is a slightly more expensive option, as

smaller UPSs tend to have a higher first cost per kW of capacity and there is more electrical infrastructure required for multiple UPSs.

4.3 Energy Savings

4.3.1 Key Assumptions for Energy Savings Analysis

The energy and cost analysis presented in this report used the TDV factors that are consistent with the TDV factors presented during the Energy Commission’s March 27, 2020 workshop on compliance metrics (California Energy Commission 2020). The electricity TDV factors include the 15 percent retail adder and the natural gas TDV factors include the impact of methane leakage on the building site. The electricity TDV factors used in the energy savings analyses were obtained from Energy and Environmental Economics, Inc. (E3), the contractor that is developing the 2022 TDV factors for the Energy Commission, in a spreadsheet titled “Electric TDVs 2022 - 15 pct Retail Adj Scaled by Avoided Costs.xlsx”. The natural gas TDV factors used in the energy savings analyses were obtained via email from E3 in a spreadsheet titled “2022_TDV_Policy_Compliant_CH4Leak_FlatRtlAdd_20191210.xlsx”. The electricity demand factors used in the energy savings analysis were obtained from E3 in a spreadsheet titled “2022 TDV Demand Factors.xlsx”. The Energy Commission notified the Statewide CASE Team on April 21, 2020 that they were investigating further refinements to TDV factors using 20-year global warming potential (GWP) values instead of the 100-year GWP values that were used to derive the current TDV factors. It is anticipated that the 20-year GWP values will increase the TDV factors slightly. As a result, the TDV energy savings presented in this report are lower than the values that are expected if the final TDV use 20-year GWP values, and the proposed code changes will be more cost effective using the revised TDV. Energy savings presented in kWh and therms are not affected by TDV or demand factors.

Because this submeasure impacts cooling system energy use, an energy analysis was performed to demonstrate cost effectiveness for both computer room cooling system types: DX CRACs and chilled water CRAHs.

Case 1: DX CRAC Cooling

- **System Overview:** The UPS is modeled in a standalone room without air economizing. The 2019 Title 24, Part 6 standard design air-cooled DX CRAC cooling system type and efficiency is used in both the baseline and proposed cases. A more efficient UPS is used in the proposed case. Table 58 describes the key modeling assumptions for the energy savings analysis.
- **Modeling Software Approach:** annual hourly spreadsheet simulation. See section 4.2.1 Energy Savings Methodology for more information.

- Description of Energy Savings: This measure saves energy in two ways:
 1. More efficient UPS uses less electricity.
 2. Reduction in UPS waste heat reduces cooling load on the CRAC.

Table 58: Energy Analysis Assumptions: UPS Efficiency, Case 1 (DX CRAC Cooling)

Input Parameter	Baseline	Proposed	Notes
IT Equipment Load (kW)	200	200	N/A
UPS Capacity (kW)	200	200	No sizing safety factor or redundancy assumed.
IT Equipment Load Schedule	DataRec eptacle	DataRece ptacle	ACM, Appendix 3-4B. Load cycles each month among 25%, 50%, 75%, and 100% load factor such that the UPS spends a total of 3 months at each load factor.
UPS Efficiency, 25% Load Factor	91.2%	93.9%	<ul style="list-style-type: none"> • Baseline: Average part-load efficiencies for EnergyStar v1.0 database UPSs greater than 100 kW capacity that are lower than EnergyStar 2.0 baseline efficiency (weighted average efficiency = 93.4%)¹². • Proposed: EnergyStar v2.0-certified UPS greater than 100 kW with the lowest weighted average efficiency (94.9%) per ENERGY STAR weighting factors (E. P. Agency 2019).
UPS Efficiency, 50% Load Factor	94.0%	95.3%	See UPS Efficiency, 25% Load Factor note.
UPS Efficiency, 75% Load Factor	94.6%	95.2%	See UPS Efficiency, 25% Load Factor note.

¹² The Statewide CASE Team received stakeholder feedback recommending that sales volume by efficiency be used to determine baseline UPS efficiency, since industry standard practice may not be the average of the market survey of available manufacturer products. The Statewide CASE Team agreed with this feedback and sought this information from ENERGY STAR, multiple UPS manufacturers/distributors, and online market research. However, this data was not available from any of the sources researched, so the method described in Table 58 was used instead.

Input Parameter	Baseline	Proposed	Notes
UPS Efficiency, 100% Load Factor	94.6%	94.7%	See UPS Efficiency, 25% Load Factor note.
Cooling System Type	CRAC (air-source DX, two-speed)	CRAC (air-source DX, two-speed)	Matches ACM.
Cooling System Sizing Safety Factor	15%	15%	Matches ACM for sizing equipment in standard design (2.5.2).
UPS Cooling System Capacity (Btu/hr)	44,391	42,174	= UPS waste heat * (1+sizing safety factor). UPS waste heat = UPS input power – UPS output power.
UPS Cooling System Capacity (tons)	3.7	3.5	Conversion to tons.
Cooling System Full Load Efficiency (kW/ton)	1.07	1.07	Title 24 2019, Part 6, Table 110.2-A, air-cooled, ≥ 65 kBtu/hr and < 135 kBtu/hr.
Cooling System Part-Load Efficiency Curves	ACM Appendix 5.7	ACM Appendix 5.7	DXEIR_fPLFCrvRef, Air-Source DX (Other), DXEIR_fTempCrvRef, Air-Source DX (Other), Cap_fFlowCrvRef, Air-Source DX (Two speed), Cap_fTempCrvRef, Air-Source DX (Other)
Economizer?	No	No	Proposed UPS waste heat < 54,000 Btu/hr, so economizer is not required per 2019 Title 24, Part 6, 140.4(e)1 requirements, based on ITE design load UPS waste heat load. Match baseline economizer requirement to proposed.
Return Air Dry-bulb Temperature (°F)	80	80	CBECC-Com default.
Supply and Return Air Dry-bulb Temperature Differential (°F)	20	20	ACM (Supply Fan Design Airflow table, 5.7.3.2).
Supply Fan Efficiency (W/cfm)	0.58	0.58	140.9(a)4: 27 W/kBtu/hr, and 20F delta-T (per Supply Fan Design Airflow table, 5.7.3.2).
Minimum Ventilation Rate to Space (cfm/sf)	0	0	Removed for simplicity. Does not affect submeasure savings.
Energy Commission	All	All	N/A

Input Parameter	Baseline	Proposed	Notes
Climate Zones			

Case 2: Chilled Water CRAH Cooling

- **System Overview:** The UPS is modeled in a standalone room with air economizing. The 2019 Title 24, Part 6 standard design chilled water CRAH cooling system type and efficiency is used in both the baseline and proposed cases. A more efficient UPS is used in the proposed case. Table 60 describes the key modeling assumptions for the energy savings analysis.
- **Modeling Software Approach:** annual hourly spreadsheet simulation. See section 4.2.1 Energy Savings Methodology for more information.
- **Description of Energy Savings:** This measure saves energy in two ways:
 1. A more efficient UPS reduces UPS waste heat.
 2. A reduction in UPS waste heat reduces cooling load on the CRAH.

Table 59: Energy Analysis Assumptions: UPS Efficiency, Case 2 (Chilled Water CRAH Cooling)

Input Parameter	Baseline	Proposed	Notes
IT Equipment Load (kW)	1,000	1,000	N/A
UPS Capacity (kW)	1,000	1,000	No sizing safety factor or redundancy assumed.
IT Equipment Load Schedule	DataReceptacle	DataReceptacle	ACM, Appendix 3-4B. Load cycles each month among 25%, 50%, 75%, and 100% load factor such that the UPS spends a total of 3 months at each load factor.
UPS Efficiency, 25% Load Factor	91.2%	93.9%	Baseline: Average part-load efficiencies for EnergyStar v1.0 database UPSs greater than 100 kW capacity that are lower than EnergyStar 2.0 baseline efficiency (weighted average efficiency = 93.4%). Proposed: EnergyStar v2.0-certified UPS greater than 100 kW with the lowest weighted average efficiency (94.9%) per ENERGY STAR weighting factors (E. P. Agency 2019).
UPS Efficiency, 50% Load Factor	94.0%	95.3%	See UPS Efficiency, 25% Load Factor note.

Input Parameter	Baseline	Proposed	Notes
UPS Efficiency, 75% Load Factor	94.6%	95.2%	See UPS Efficiency, 25% Load Factor note.
UPS Efficiency, 100% Load Factor	94.6%	94.7%	See UPS Efficiency, 25% Load Factor note.
Cooling System Type	CRAH (2 water-cooled screw chillers, equally sized)	CRAH (2 water-cooled screw chillers, equally sized)	Per ACM page 5-190, matches computer room system type.
Cooling System Sizing Safety Factor	15%	15%	Matches ACM for sizing equipment in standard design (2.5.2).
UPS Cooling System Capacity (Btu/hr)	221,957	210,868	= UPS waste heat * (1+sizing safety factor). UPS waste heat = UPS input power – UPS output power.
UPS Cooling System Capacity (tons)	18.5	17.6	Conversion to tons.
Cooling System Full-Load Efficiency (kW/ton)	0.625	0.625	Title 24 2019, Part 6, Table 110.2.D, path B, positive displacement chiller. CHW pump, CW pump, and cooling tower energy is not modeled for simplicity; including these components would show additional energy savings and improve measure cost-effectiveness.
Cooling System Part-Load Efficiency Curves	ACM Appendix 5.7	ACM Appendix 5.7	Water-Cooled Pos Displacement, Path A, All Capacities: Cap_fTempCrvRef, EIR_fTempCrvRef, EIR_fPLRCrvRef
Economizer?	Air	Air	Per Title 24 2019, Part 6, 140.4(e)1 requirements, based on ITE design load UPS waste heat load. Match baseline economizer requirement to proposed.
Return Air Dry-bulb Temperature (°F)	80	80	CBECC-Com default.
Supply and Return Air Dry-bulb Temperature Differential (°F)	20	20	ACM (Supply Fan Design Airflow table, 5.7.3.2).
Supply Fan Efficiency (W/cfm)	0.58	0.58	140.9(a)4: 27 W/kBtu/hr, and 20F delta-T (per Supply Fan Design Airflow table, 5.7.3.2).

Input Parameter	Baseline	Proposed	Notes
Minimum Ventilation Rate to Space (cfm/sf)	0	0	Removed for simplicity. Does not affect submeasure savings.
Energy Commission Climate Zones	All	All	N/A

4.3.2 Energy Savings Methodology

4.3.2.1 Energy Savings Methodology per Prototypical Building/Simulation Case

Although the Energy Commission indicated a preference for simulating energy impacts using CBECC-Com, a spreadsheet was used to calculate energy impacts of the UPS efficiency submeasure. UPS efficiency involves adding a new system to CBECC-Com; it is not possible to model part-load UPS efficiency in the current software, so a spreadsheet was used. Since CBECC-Com does not have the capability to model UPS units, including full and part-load efficiency, UPS capacity, and cooling system serving the UPS room, an annual hourly spreadsheet analysis was used to simulate UPS efficiency, waste heat, and cooling energy. The spreadsheet analysis followed the ACM for key inputs affecting energy use, as described in Table 60.

The Standard Design represents the geometry of the design that the builder would like to build and inserts a defined set of features that result in an energy budget that is minimally compliant with 2019 Title 24, Part 6 code requirements. Features used in the Standard Design are described in the 2019 Nonresidential ACM Reference Manual.

For the UPS efficiency submeasure, there are no existing requirements in 2019 Title 24, Part 6 that cover the building system in question. The Statewide CASE Team created a spreadsheet analysis to calculate UPS efficiency so that it calculated energy impacts of the most common industry standard practice, and modeled cooling energy based on a Standard Design according to the 2019 ACM. Standard Design UPS efficiency was estimated by taking the average part-load efficiencies from the ENERGY STAR v1.0 UPS database for UPSs greater than 100 kW and that are lower than ENERGY STAR v2.0 weighted average baseline efficiency for UPSs greater than 100 kW. Proposed UPS efficiency was simulated as the ENERGY STAR v2.0-certified UPS greater than 100 kW with the lowest weighted average efficiency (94.9 percent), using ENERGY STAR weighting factors. UPS units are modeled to be in a standalone room served by the same cooling system type as the computer room. The UPS room cooling system is subject to the efficiency requirements of 110.2 and air economizing requirements of 140.4(e)1.

The Proposed Design represents the same geometry as the Standard Design, but it assumes the energy features that the software user describes with user inputs. To develop savings estimates for the proposed code changes, the Statewide CASE Team created a Standard Design and Proposed Design for each prototypical building.

The Proposed Design was identical to the Standard Design in all ways except for the revisions that represent the proposed changes to the code. Table 60 presents a summary of key parameters that were modified and what values were used in the Standard Design and Proposed Design.

Comparing the energy impacts of the Standard Design to the Proposed Design reveals the impacts of the proposed code change relative to industry typical practices.

Table 60: Modifications Made to Standard Design in Each Simulation Case to Simulate Proposed Code Change: UPS Efficiency Submeasure

Simulation Case/ Prototype ID	Climate Zone	Parameter Name	Standard Design Parameter Value	Proposed Design Parameter Value
Case 1: DX CRAC	All	UPS efficiency at 25% load factor	91.2%	93.9%
Case 1: DX CRAC	All	UPS efficiency at 50% load factor	94.0%	95.3%
Case 1: DX CRAC	All	UPS efficiency at 75% load factor	94.6%	94.7%
Case 1: DX CRAC	All	UPS efficiency at 100% load factor	94.6%	94.9%
Case 2: CHW CRAH	All	UPS efficiency at 25% load factor	91.2%	93.9%
Case 2: CHW CRAH	All	UPS efficiency at 50% load factor	94.0%	95.3%
Case 2: CHW CRAH	All	UPS efficiency at 75% load factor	94.6%	94.7%
Case 2: CHW CRAH	All	UPS efficiency at 100% load factor	94.6%	94.9%

The Statewide CASE Team calculated energy consumption for every hour of the year measured in kWh/yr and therms/yr, then applied the 2022 TDV factors to calculate annual energy use in TDV kBtu/yr and annual peak electricity demand reductions measured in kW. TDV energy cost savings were also calculated in 2023 PV\$ and nominal dollars.

The energy impacts of the proposed code change vary by climate zone. The Statewide CASE Team simulated the energy impacts in every climate zone and applied the climate-zone specific TDV factors when calculating energy and energy cost impacts. Aside from weather data, modeling inputs did not vary by climate zone.

Per-unit energy impacts for nonresidential buildings are presented in savings per kilowatt of IT equipment load. Annual energy and peak demand impacts were translated into impacts per kW IT equipment load by dividing by the kW of IT equipment load for each simulated case. This step allows for an easier comparison of savings across different building types and enables a calculation of statewide savings using the construction forecast that is published in terms of floor area by building type.

4.3.2.2 Statewide Energy Savings Methodology

As described above, the per unit energy impacts are presented in savings per design ITE load. Savings do not vary significantly by building type, but rather by ITE load. Although the per unit savings were calculated using prototypical buildings, the per unit savings apply to any building type.

The per-unit energy impacts were extrapolated to statewide impacts using the Statewide Construction Forecasts that the Energy Commission provided (California Energy Commission Building Standards Office n.d.). The Statewide Construction Forecasts estimate new construction that will occur in 2023, the first year that the 2022 Title 24, Part 6 requirements are in effect. It also estimates the size of the total existing building stock in 2023 that the Statewide CASE Team used to approximate savings from building alterations. The construction forecast is provided in square footage of new and existing floorspace.

Because ITE load, not total building floor area, is the driver for computer room energy use, the Statewide CASE Team correlated ITE load to building floor area by assuming a watts per square foot of ITE design load density. The ITE design load density varies by measure type and is described in Appendix A.

Appendix A presents additional information about the methodology and assumptions used to calculate statewide energy impacts.

4.3.3 Per Unit Energy Impacts Results

The per-unit energy savings do not account for naturally occurring market adoption or compliance rates. Table 61 and Table 62 show the first year per-unit energy savings and demand reduction ranges, which vary by climate zone and system type. There is a positive net energy savings in all climate zones.

The primary energy savings from this submeasure does not vary by climate zone, but because this measure reduces equipment load which is a load on the cooling system, energy savings vary minimally by climate zone.

This submeasure would not have a significant impact on demand response/flexibility, peak power demand, or load shifting.

Table 61: First-Year Energy Impacts Per IT Equipment Load kW – DX CRAC Case, UPS Efficiency Submeasure

Climate Zone	Electricity Savings (kWh/yr)	Peak Electricity Demand Reduction (kW)	Natural Gas Savings (therms/yr)	TDV Energy Savings (TDV kBtu/yr)
1	54.4	0.0	0	1,533
2	54.6	0.0	0	1,538
3	54.7	0.0	0	1,542
4	54.8	0.0	0	1,532
5	54.6	0.0	0	1,560
6	54.8	0.0	0	1,574
7	54.9	0.0	0	1,552
8	54.9	0.0	0	1,577
9	54.9	0.0	0	1,591
10	54.9	0.0	0	1,573
11	54.9	0.0	0	1,538
12	54.8	0.0	0	1,539
13	54.9	0.0	0	1,554
14	54.9	0.0	0	1,524
15	55.3	0.0	0	1,557
16	54.5	0.0	0	1,591
TOTAL	877	0.0	0	24,875

Table 62: First-Year Energy Impacts Per IT Equipment Load kW – Chilled Water CRAH Case, UPS Efficiency Submeasure

Climate Zone	Electricity Savings (kWh/yr)	Peak Electricity Demand Reduction (kW)	Natural Gas Savings (therms/yr)	TDV Energy Savings (TDV kBtu/yr)
1	52.9	0.0	0	1,436
2	55.0	0.0	0	1,459
3	61.9	0.0	0	1,671
4	59.8	0.0	0	1,630
5	57.9	0.0	0	1,581
6	64.5	0.0	0	1,746
7	68.8	0.0	0	1,857
8	64.7	0.0	0	1,754
9	62.2	0.0	0	1,683
10	60.0	0.0	0	1,625
11	55.1	0.0	0	1,392
12	56.7	0.0	0	1,427
13	55.4	0.0	0	1,402
14	54.6	0.0	0	1,395
15	57.4	0.0	0	1,498
16	52.7	0.0	0	1,410
TOTAL	940	0.1	0	24,967

4.4 Cost and Cost Effectiveness

4.4.1 Energy Cost Savings Methodology

Energy cost savings were calculated by applying the TDV energy cost factors to the energy savings estimates that were derived using the methodology described in Section 4.3.3 TDV is a normalized metric to calculate energy cost savings that accounts for the variable cost of electricity and natural gas for each hour of the year, along with how costs are expected to change over the period of analysis (30 years for residential measures and nonresidential envelope measures and 15 years for all other nonresidential measures). In this case, the period of analysis used is 15 years. The TDV cost impacts are presented in nominal dollars and in 2023 present value dollars and represent the energy cost savings realized over 15 years.

4.4.2 Energy Cost Savings Results

Per-unit energy cost savings for newly constructed buildings and alterations that are realized over the 15-year period of analysis are presented in 2023 dollars in Table 63. Energy savings for new construction and alterations are expected to be the same.

The TDV methodology allows peak electricity savings to be valued more than electricity savings during non-peak periods. Because internal equipment loads drive the energy use in computer rooms and that equipment load is typically relatively flat throughout the day, submeasures that reduce equipment load (e.g., UPS efficiency) provide a relatively constant demand reduction.

This submeasure save energy cost in all climate zones.

Table 63: 2023 PV TDV Energy Cost Savings Over 15-Year Period of Analysis – Per IT Equipment Load kW – New Construction, UPS Efficiency Submeasure (Average Savings for both Simulation Cases)

Climate Zone	15-Year TDV Electricity Cost Savings (2023 PV\$)	15-Year TDV Natural Gas Cost Savings (2023 PV\$)	Total 15-Year TDV Energy Cost Savings (2023 PV\$)
1	\$132	\$0	\$132
2	\$133	\$0	\$133
3	\$143	\$0	\$143
4	\$141	\$0	\$141
5	\$140	\$0	\$140
6	\$148	\$0	\$148
7	\$152	\$0	\$152
8	\$148	\$0	\$148
9	\$146	\$0	\$146
10	\$142	\$0	\$142
11	\$130	\$0	\$130
12	\$132	\$0	\$132
13	\$132	\$0	\$132
14	\$130	\$0	\$130
15	\$136	\$0	\$136
16	\$134	\$0	\$134
TOTAL	\$2,218	\$0	\$2,218

4.4.3 Incremental First Cost

Incremental first cost is the initial cost to adopt more efficient equipment or building practices when compared to the cost of an equivalent baseline project. Therefore, it was important that the Statewide CASE Team consider first costs in evaluating overall measure cost effectiveness. Incremental first costs are based on data available today and can change over time as markets evolve and professionals become familiar with new technology and building practices.

4.4.3.1 Table 64 and Table 65 describe the incremental first costs for Case 1: DX CRAC Case and Case 2: CHW CRAH.

Costs for this submeasure were obtained from UPS vendors, manufacturers, and construction projects with which CASE Team members were involved. The CASE Team spoke with three UPS vendors/manufacturers and received cost data from three vendors. There is no incremental contractor installation labor for this measure, so labor cost is excluded. Incremental costs for this submeasure include the incremental cost of

a more expensive UPS unit. Costs for redundant equipment are not included. Costs assume the UPS is sized to match the ITE load, as opposed to using multiple smaller UPS to reach the required capacity, which may incur additional infrastructure costs for additional units.

Costs are anticipated to be the same for new construction and additions/alterations for this submeasure.

Costs are not anticipated to change over time for this submeasure.

The expected useful life of a UPS is estimated to be 10 years, so the incremental cost of one replacement in the 15-year cost-effectiveness analysis timeframe is included in the cost table below; this replacement cost is currently shown as a first cost.

Table 64: Incremental First Cost Assumptions: UPS Efficiency Submeasure – Case 1: DX CRAC

Cost Item	Incremental First Cost (\$ per ITE design load kW)	Cost Source
High efficiency UPS (equipment)	\$112	Cost data from 3 vendors, includes startup cost.
Labor	\$0	N/A
Controls	\$0	No additional controls hardware or programming beyond industry standard UPS.
Commissioning	\$0	No additional commissioning labor beyond industry standard UPS.
Total	\$112	

Table 65: Incremental First Cost Assumptions: UPS Efficiency Submeasure – Case 2: CHW CRAH

Cost Item	Incremental First Cost (\$ per ITE design load kW)	Cost Source
High efficiency UPS (equipment)	\$91	Cost data from 3 vendors. No incremental labor cost.
Labor	\$0	N/A
Controls	\$0	No additional controls hardware or programming beyond industry standard UPS.
Commissioning	\$0	No additional commissioning labor beyond industry standard UPS.
Total	\$91	

4.4.4 Incremental Maintenance and Replacement Costs

Incremental maintenance cost is the incremental cost of replacing the equipment or parts of the equipment, as well as periodic maintenance required to keep the equipment operating relative to current practices over the 15-year period of analysis. The present value of equipment maintenance costs (savings) was calculated using a 3 percent discount rate (d), which is consistent with the discount rate used when developing the 2022 TDV. The present value of maintenance costs that occurs in the nth year is calculated as follows:

$$\text{Present Value of Maintenance Cost} = \text{Maintenance Cost} \times \left[\frac{1}{1 + d} \right]^n$$

There is no expected incremental maintenance cost for this measure except for equipment replacement compared to baseline.

4.4.5 Cost Effectiveness

This measure proposes a prescriptive requirement. As such, a cost analysis is required to demonstrate that the measure is cost effective over the 15-year period of analysis.

The Energy Commission establishes the procedures for calculating cost effectiveness. The Statewide CASE Team collaborated with Energy Commission staff to confirm that the methodology in this report is consistent with their guidelines, including which costs were included in the analysis. The incremental first cost and incremental maintenance costs over the 15-year period of analysis were included. The TDV energy cost savings from electricity and natural gas savings were also included in the evaluation. In cases where the proposed submeasure increases water use, such as the air-cooled chiller

with dry cooler economizer versus air-cooled chiller with evaporative cooling tower economizer, the estimated 15-year water use cost was also included in the cost-effectiveness analysis.

Design costs were not included nor were the incremental costs of code compliance verification.

According to the Energy Commission's definitions, a measure is cost effective if the benefit-to-cost (B/C) ratio is greater than 1.0. The B/C ratio is calculated by dividing the cost benefits realized over 15 years by the total incremental costs, which includes maintenance costs for 15 years. The B/C ratio was calculated using 2023 PV costs and cost savings.

Results of the per-unit cost-effectiveness analyses are presented in Table 66 and Table 67 for new construction and alterations.

The proposed submeasure saves money over the 15-year period of analysis relative to existing requirements. The proposed change is cost effective in every climate zone for the simulation case. The results are the same for new construction and additions/alterations.

The proposed submeasure saves money over the 15-year period of analysis relative to existing requirements. The proposed change is cost effective in every climate zone for both simulations cases (DX CRAC cooling and CHW CRAH cooling). The results are the same for new construction and additions/alterations.

Table 66: 15-Year Cost-Effectiveness Summary Per IT Equipment Load kW – New Construction and Additions/Alterations, UPS Efficiency Submeasure, Case 1: DX CRAC

Climate Zone	Benefits TDV Energy Cost Savings + Other PV Savings^a (2023 PV\$)	Costs Total Incremental PV Costs^b (2023 PV\$)	Benefit-to- Cost Ratio
1	\$136	\$112	1.2
2	\$137	\$112	1.2
3	\$137	\$112	1.2
4	\$136	\$112	1.2
5	\$139	\$112	1.2
6	\$140	\$112	1.3
7	\$138	\$112	1.2
8	\$140	\$112	1.3
9	\$142	\$112	1.3
10	\$140	\$112	1.3
11	\$137	\$112	1.2
12	\$137	\$112	1.2
13	\$138	\$112	1.2
14	\$136	\$112	1.2
15	\$139	\$112	1.2
16	\$142	\$112	1.3

- a. **Benefits: TDV Energy Cost Savings + Other PV Savings:** Benefits include TDV energy cost savings over the period of analysis (Energy + Environmental Economics 2020). Other savings are discounted at a real (nominal – inflation) three percent rate. Other PV savings include incremental first-cost savings if proposed first cost is less than current first cost. Includes PV maintenance cost savings if PV of proposed maintenance costs is less than PV of current maintenance costs.
- b. **Costs: Total Incremental Present Valued Costs:** Costs include incremental equipment, replacement, and maintenance costs over the period of analysis. Costs are discounted at a real (inflation-adjusted) three percent rate and if PV of proposed maintenance costs is greater than PV of current maintenance costs. If incremental maintenance cost is negative, it is treated as a positive benefit. If there are no total incremental PV costs, the B/C ratio is infinite.

Table 67: 15-Year Cost-Effectiveness Summary Per IT Equipment Load kW – New Construction and Additions/Alterations, UPS Efficiency Submeasure, Case 2: CHW CRAH

Climate Zone	Benefits TDV Energy Cost Savings + Other PV Savings^a (2023 PV\$)	Costs Total Incremental PV Costs^b (2023 PV\$)	Benefit-to- Cost Ratio^c
1	\$128	\$91	1.4
2	\$130	\$91	1.4
3	\$149	\$91	1.6
4	\$145	\$91	1.6
5	\$141	\$91	1.5
6	\$155	\$91	1.7
7	\$165	\$91	1.8
8	\$156	\$91	1.7
9	\$150	\$91	1.6
10	\$145	\$91	1.6
11	\$124	\$91	1.4
12	\$127	\$91	1.4
13	\$125	\$91	1.4
14	\$124	\$91	1.4
15	\$133	\$91	1.5
16	\$126	\$91	1.4

- a. **Benefits: TDV Energy Cost Savings + Other PV Savings:** Benefits include TDV energy cost savings over the period of analysis (Energy + Environmental Economics 2020). Other savings are discounted at a real (nominal – inflation) three percent rate. Other PV savings include incremental first-cost savings if proposed first cost is less than current first cost. Includes PV maintenance cost savings if PV of proposed maintenance costs is less than PV of current maintenance costs.
- b. **Costs: Total Incremental Present Valued Costs:** Costs include incremental equipment, replacement, and maintenance costs over the period of analysis. Costs are discounted at a real (inflation-adjusted) three percent rate and if PV of proposed maintenance costs is greater than PV of current maintenance costs. If incremental maintenance cost is negative, it is treated as a positive benefit. If there are no total incremental PV costs, the B/C ratio is infinite.
- c. If multiple 100 kW UPSs are used, the B/C ratio ranges from 1.1 to 1.5 based on the increased cost of the UPS equipment. No additional infrastructure costs due to using a larger quantity of equipment is included in this estimate.

4.5 First-Year Statewide Impacts

4.5.1 Statewide Energy and Energy Cost Savings

The Statewide CASE Team calculated the first-year statewide savings for new construction by multiplying the per-unit savings, which are presented in Section 4.3.3, by assumptions about the percentage of newly constructed buildings that would be impacted by the proposed code. The statewide new construction forecast for 2023 is presented in Appendix A as are the Statewide CASE Team’s assumptions about the percentage of new construction and additions and alterations that would be impacted by the proposal. A summary of estimated statewide energy impacts for new construction and additions/alterations are presented in Table 68. The first-year energy impacts represent the first-year annual savings from all buildings that were completed in 2023. The 15-year energy cost savings represent the energy cost savings over the entire 15-year analysis period. The statewide savings estimates do not take naturally occurring market adoption or compliance rates into account.

Table 68: Statewide Energy and Energy Cost Impacts, UPS Efficiency – New Construction, Alterations, and Additions

Construction Type	First-Year Electricity Savings (GWh)	First-Year Peak Electrical Demand Reduction (MW)	First -Year Natural Gas Savings (MMTherms)	15-Year Present Valued Energy Cost Savings (PV\$ million in 2023)
New Construction	0.7	0.0	0	\$2
Additions and Alterations	1.5	0.1	0	\$4
TOTAL	2.2	0.1	0	\$6

4.5.2 Statewide Greenhouse Gas (GHG) Emissions Reductions

The Statewide CASE Team calculated avoided GHG emissions assuming the emissions factors specified in the United States Environmental Protection Agency (U.S. EPA) Emissions & Generation Resource Integrated Database (eGRID) for the Western Electricity Coordination Council California (WECC CAMX) subregion. Avoided GHG emissions from natural gas savings attributable to sources other than utility-scale electrical power generation are calculated using emissions factors specified in U.S. EPA’s Compilation of Air Pollutant Emissions Factors (AP-42). See Appendix C for additional details on the methodology used to calculate GHG emissions. In short, this analysis assumes an average electricity emission factor of 240.4 metric ton CO₂e per GWh based on the average emission factors for the CACX EGRID subregion.

Table 69 presents the estimated first-year avoided GHG emissions of the proposed code change. During the first year, GHG emissions of 32,871 metric tons CO₂e would be avoided.

Table 69: First-Year Statewide GHG Emissions Impacts – UPS Efficiency

Measure	Electricity Savings ^a (GWh/yr)	Reduced GHG Emissions from Electricity Savings ^a (Metric Ton CO ₂ e)	Natural Gas Savings ^a (MMTherms /yr)	Reduced GHG Emissions from Natural Gas Savings ^a (Metric Ton CO ₂ e)	Total Reduced CO ₂ e Emissions ^{a,b} (Metric Ton CO ₂ e)
UPS Efficiency	2.2	518	0.0	0	518

a. First-year savings from all buildings completed statewide in 2023.

b. Assumes the following emission factors: 240.4 MTCO₂e/GWh and 5,454.4 MTCO₂e/MMTherms.

4.5.3 Statewide Water Use Impacts

The UPS efficiency submeasure has a slight decrease in site water use for water-cooled cooling equipment due to the decrease in cooling load from the more efficient UPS. Because these changes are minimal, they are not quantified in the Final CASE Report.

4.5.4 Statewide Material Impacts

The UPS efficiency submeasure does not have an impact on materials use.

Table 70: First-Year Statewide Impacts on Material Use: UPS Efficiency

Material	Impact (I, D, or NC) ^a
Mercury	NC
Lead	NC
Copper	NC
Steel	NC
Plastic	NC

a. Material Increase (I), Decrease (D), or No Change (NC) compared to base case (lbs/yr).

4.5.5 Other Non-Energy Impacts

There are no anticipated other non-energy impacts.

5. Power Usage Effectiveness (PUE) Monitoring

5.1 Measure Description

5.1.1 Measure Overview

This submeasure proposal includes adding a mandatory requirement to install PUE monitoring in buildings whose primary function is to house computer rooms (defined as “data centers” in Title 24, Part 6). The major criteria triggering this requirement are a total computer room ITE design load over 2,000 kW and where at least 80 percent of the total cooling capacity serves computer rooms or associated electrical rooms.

Since this submeasure is being proposed as a mandatory requirement, it has no proposed software changes.

5.1.2 Measure History

Power usage effectiveness (PUE) is the most common metric used to assess energy efficiency of data centers (buildings whose primary function is to house computer rooms); it is analogous to energy use intensity (EUI), measured in kBtu/ft²-yr, which is often used to compare building energy use among commercial buildings. PUE is a unitless metric and is equal to total computer room energy use divided by IT equipment energy use. A lower PUE indicates higher computer room energy efficiency, with the lowest theoretical PUE being 1.0.

While there are many variables that affect EUI, such as occupancy levels, hours of operation, and IT equipment loads, PUE is a more robust metric because it only applies to one space type (computer rooms), which operate constantly and have a single driver of thermal loads (IT equipment heat). PUE is still valid if the data center is mostly empty or fully loaded.

Monitoring PUE requires that electricity use be measured using two parameters: total data center electricity and total IT equipment electricity. Those measurements are then divided to calculate PUE through a monitoring system or dashboard. Total data center electricity can be measured by an electrical submeter or utility meter if the building is primarily data center space. Based on the data center size trigger for PUE monitoring, the building would be required to have an electrical meter per Table 130.5-A Minimum Requirements for Metering of Electrical Load which would meet the total computer room energy use measurement requirement for PUE monitoring. Commonly, IT equipment load is measured at the output of each UPS. If there are multiple UPSs installed, then calculating total IT equipment load requires summing the electrical load measured at each UPS output. Most UPSs serving large computer rooms have an integral output power meter that can be connected through a remote monitoring digital dashboard

through common communication protocols such as BACnet or Modbus. The monitoring digital dashboard can be configured to receive live trends, calculate PUE, store trend data, and provide visual performance feedback to the facility operator. For buildings that are fully or primarily computer room space (i.e., data centers), total data center electricity use is close to equaling total building electricity use and the whole building meter can be used for the numerator of the PUE calculation.

In August 2016, the U.S. federal government required PUE measurements for all government data centers through the Data Center Optimization Initiative (Scott 2016), which built upon Executive Order 13693, “Planning for Federal Sustainability in the Next Decade” (U. S. Agency 2015), which required federal agencies to install and monitor advanced energy meters in data centers by September 30, 2018.

PUE measurements have become increasingly common in data centers over the last ten years (Institute 2014). Establishing PUE as a more common metric would give data center operators real time data on how efficiently their data center is operating. This information can also be used to assess how much energy savings opportunity there is in the data center and prompt operators to act on this information if they observe a low PUE in their data center.

5.1.3 Compliance and Enforcement

When developing this proposal, the Statewide CASE Team considered methods to streamline the compliance and enforcement process and how negative impacts on market actors who are involved in the process could be mitigated or reduced. This section describes how to comply with the proposed code change. It also describes the compliance verification process. Appendix E presents how the proposed changes could impact various market actors.

The activities that need to occur during each phase of the project are described below.

- **Design Phase:** Electrical design engineers determine if the computer room ITE design load triggers the requirement for PUE monitoring. The ITE design load is typically calculated by the mechanical engineer, but the electrical engineer needs to know this information for sizing the electrical system. The electrical design engineer includes a PUE utilization monitoring system that meets code requirements in the electrical permit drawings and specifications. The project’s building automation system can be used to monitor and trend PUE, and therefore this system may be included in the mechanical or controls specifications. The electrical design engineer completes NRCC forms with the permit package.
- **Permit Application Phase:** The plans examiner reviews electrical permit drawings and specifications to confirm if PUE monitoring is required and, if so, that it is shown on the permit documents.

- **Construction Phase:** The electrical contractor reviews electrical design documents to confirm PUE monitoring requirements, and then selects and installs a PUE monitoring system that meets the design specification. The controls contractor assists with integration of the electric submeters and dashboard.
- **Inspection Phase:** The electrical contractor completes NRCI and NRCA forms.

Because the increased temperature submeasure involves only modifying equipment design temperature values and trigger values and size threshold for air containment, it does not change the existing compliance process. While the other three submeasures add steps to the compliance process, the additional requirements and documentation are relatively simple and include many activities that are part of a typical design process.

There is some additional effort on the design and construction teams to include additional elements in the project that may not otherwise be included for the heat recovery and PUE monitoring submeasures. To address this additional complexity, the Statewide CASE Team supports developing case studies for similar applications and providing training such as a “Decoding Talk” and has proposed code language that is easy to understand and aligns with other code triggers.

There is also some additional effort by the contractor teams to complete NRCI and NRCA forms. New compliance documents would be developed, including:

- New NRCA-PRC-17-A form for Computer Rooms

The Statewide CASE Team has mitigated any potential compliance and enforcement challenges by clarifying Acceptance Test requirements, providing recommended changes to compliance manuals and compliance documents, and committing to work with industry stakeholders to help them prepare for the code change before it takes effect.

By adding new requirements and Title 24-regulated scope in the computer room heat recovery, UPS efficiency, and PUE monitoring submeasures, enforcement would add burden to plans examiners. However, there is no expected additional building site inspection work to building officials.

5.2 Market Analysis

5.2.1 Market Structure

5.2.1.1 Market Overview

This submeasure involves utilizing equipment already installed in a data center: the whole building meter and the output power monitoring point provided from the UPS. The

submeasure then requires effort from the electrical or mechanical design engineer to specify a dashboard monitoring system to integrate the data. Most large data centers are already going through this effort, and it is something with which electrical engineers involved in data center designs and the controls contractors implementing the dashboard are familiar. The project's building automation system can be used to monitor, calculate, and trend PUE, so no additional software infrastructure or subscription is required, though some data center operators may elect to use a dedicated PUE monitoring system.

5.2.1.2 Design

This submeasure only applies to large computer rooms that have UPS systems serving the IT equipment with an ITE design load over 2,000 kW. Data centers of this size are required to have a whole building power meter under Section 130.5(a). The whole building power meter and UPSs output power internal meter provide the monitoring data required to calculate PUE. All such data centers have data collection systems through their building automation system, so there is zero or minimal additional hardware required to meet this part of the requirement. All that is required is the software and coordination to ensure the data is correctly captured, stored and reported. The electrical design engineer works with the UPS (or power meter) vendor to confirm metering functionality and include that information in the design drawings. The mechanical or electrical design engineer includes the PUE monitoring and dashboard requirements in the design specification, usually with input from the owner.

5.2.1.3 Installation and Commissioning

The electrical contractor installs the meters and supports the controls contractor in their work to configure the metering dashboard. The system is commissioned by the electrical contractor, controls contractor, and a third-party commissioning agent. Because computer rooms are typically considered critical loads, typical practice includes commissioning to confirm mechanical and electrical systems are installed properly.

5.2.2 Technical Feasibility, Market Availability, and Current Practices

The Office of Energy Efficiency & Renewable Energy (EERE) defines “benchmarking” as “the practice of comparing the measured performance of a device, process, facility, or organization to itself, its peers, or established norms, with the goal of informing and motivating performance improvement. When applied to building energy use, benchmarking serves as a mechanism to measure energy performance of a single building over time...” (Office of Energy Efficiency & Renewable Energy n.d.). EERE goes on to state that “Commercial building energy performance benchmarking is a foundational element of an organization's energy management strategy because you

can't manage what you don't measure" (Office of Energy Efficiency & Renewable Energy n.d.). Monitoring PUE is an effective way to achieve the values of benchmarking to facilitate ongoing operational energy efficiency in data centers.

PUE monitoring is straightforward to implement through the building's whole-building electrical meter and UPS output power monitoring points, both of which are included in the building's design to trigger this submeasure requirement. When speaking with market actors and through direct experience on construction projects, the Statewide CASE Team identified power meter trend data quality can be an issue if the meters are not properly installed and configured with the dashboard. To address this issue, the Statewide CASE Team proposes to add acceptance testing requirements to help verify meter installation and data integrity. The building's building automation system can be used to record meter trend data, calculate PUE, and store data; no additional software is required to meet the proposed requirements.

5.3 Energy Savings

5.3.1 Key Assumptions for Energy Savings Analysis

The energy and cost analysis presented in this report used the TDV factors that are consistent with the TDV factors presented during the Energy Commission's March 27, 2020 workshop on compliance metrics (California Energy Commission 2020). The electricity TDV factors include the 15 percent retail adder and the natural gas TDV factors include the impact of methane leakage on the building site. The electricity TDV factors used in the energy savings analyses were obtained from Energy and Environmental Economics, Inc. (E3), the contractor that is developing the 2022 TDV factors for the Energy Commission, in a spreadsheet titled "Electric TDVs 2022 - 15 pct Retail Adj Scaled by Avoided Costs.xlsx". The natural gas TDV factors used in the energy savings analyses were obtained via email from E3 in a spreadsheet titled "2022_TDV_Policy_Compliant_CH4Leak_FlatRtlAdd_20191210.xlsx". The electricity demand factors used in the energy savings analysis were obtained from E3 in a spreadsheet titled "2022 TDV Demand Factors.xlsx". The Energy Commission notified the Statewide CASE Team on April 21, 2020 that they were investigating further refinements to TDV factors using 20-year global warming potential (GWP) values instead of the 100-year GWP values that were used to derive the current TDV factors. It is anticipated that the 20-year GWP values will increase the TDV factors slightly. As a result, the TDV energy savings presented in this report are lower than the values that are expected if the final TDV use 20-year GWP values, and the proposed code changes will be more cost effective using the revised TDV. Energy savings presented in kWh and therms are not affected by TDV or demand factors.

This submeasure only applies to computer rooms with greater than 2,000 kW of IT equipment load, so just one mechanical system type is applicable: chilled water CRAHs.

Case 1: Chilled Water CRAH Cooling

- **System Overview:** 2019 Title 24, Part 6 standard design chilled water CRAH cooling system type and efficiency are used in both the baseline and proposed cases. Table 71 describes the key modeling assumptions for the energy savings analysis.
- **Modeling Software Approach:** The CBEC-Com 2019 large office prototype model for climate zone 12 was modified to convert the core zone on each floor into a computer room space type thermal zone. The output EnergyPlus file was modified so that mechanical equipment would auto-size when the models were simulated in EnergyPlus. Then JEPlus v2.0.0 was used to batch simulate models in EnergyPlus 9.0 for all 16 climate zones. For each climate zone, one baseline model was simulated. Output files for baseline cases were combined in a spreadsheet where computer room cooling energy was calculated based on calculating the computer room IT equipment load as a fraction of total building equipment and lighting load and multiplying that fraction by total building fans, pumps, and cooling energy, for each climate zone. Then 1 percent savings was applied to the computer room cooling energy to calculate hourly energy and TDV savings.
- **Description of Energy Savings:** This measure facilitates energy savings by providing computer room operators with real-time and historical energy performance feedback. The intent of this submeasure is that this data would empower computer room operators to make operational changes to improve the energy performance of their computer room if they have a high PUE or if the PUE increases over time. A conservative 1 percent decrease in proposed design annual HVAC energy is assumed here to demonstrate cost-effectiveness. Some examples of energy savings sources include improved air containment (e.g., fixing air leaks, adjusting blanking panels, rearranging underfloor supply air diffuser locations) to decrease required cooling airflow and fan energy or a revision to controls logic for supply air temperature reset to increase economizer hours. This 1 percent impact on HVAC energy use is based on studies demonstrating the energy savings from building energy benchmarking¹³, which include weather-normalized energy savings estimates ranging from 1.6 percent

¹³ As previously described, “benchmarking” is the practice of comparing the measured performance of a device, process, facility, or organization to itself, its peers, or established norms, with the goal of informing and motivating performance improvement (Office of Energy Efficiency & Renewable Energy n.d.).

to 14 percent (E. M. Lawrence Berkeley National Laboratory (LBNL) 2017) (NMR Group 2012) ((EPA), Energy Star Portfolio Manager 2012). The ENERGY STAR study stated that “slow and steady improvements over time are typical of buildings that consistently track and benchmark energy consumption” ((EPA), Energy Star Portfolio Manager 2012).

Table 71: Energy Analysis Assumptions: PUE Monitoring, Case 1 (Chilled Water CRAH)

Input Parameter	Baseline	Proposed	Notes
IT Equipment Load (kW)	1,000	1,000	N/A
IT Equipment Load Schedule	DataReceptacle	DataReceptacle	ACM, Appendix 3-4B. Load cycles each month among 25%, 50%, 75%, and 100% load factor.
Supply Air Dry-bulb Temperature (°F)	60	60	ACM (resulting from 20°F supply and return air temperature differential per Supply Fan Design Airflow table, 5.7.3.2).
Return Air Dry-bulb Temperature (°F)	80	80	CBECC-Com default.
Supply Fan Efficiency (W/cfm)	0.58	0.58	140.9(a)4: 27 W/kBtu/hr, and 20F delta-T (per Supply Fan Design Airflow table, 5.7.3.2).
Supply Fan Speed Control	Variable-flow, VSD	Variable-flow, VSD	Table 10, ACM page 5-124.
Cooling System Type	CRAH (2 water-cooled screw chillers, equally sized)	CRAH (2 water-cooled screw chillers, equally sized)	Per ACM page 5-190.
Cooling System Full Load Efficiency (kW/ton)	0.625	0.625	Title 24 2019, Part 6, Table 110.2.D, path B, positive displacement chiller.
Total Occupants	0	0	Assumed. Does not impact measure savings.
Ventilation Function	Misc – Computer (not printing)	Misc – Computer (not printing)	Assumed. Does not impact measure savings.
Energy Commission Climate Zones	All	All	N/A

5.3.2 Energy Savings Methodology

5.3.2.1 Energy Savings Methodology per Prototypical Building/Simulation Case

The Energy Commission directed the Statewide CASE Team to model the energy impacts using specific prototypical building models that represent typical building

geometries for different types of buildings (California Energy Commission n.d.). The large office with computer room prototype model was used to assess the PUE monitoring submeasure. See Table 72 for details. This prototype model is available online at the following link: <http://bees.archenergy.com/software2022.html>.

Table 72: Prototype Buildings Used for Energy, Demand, Cost, and Environmental Impacts Analysis

Submeasure	Prototype Name	Number of Stories	Floor Area (square feet)	Description
PUE Monitoring	Office Large-Data	12	498,589	12 story + 1 basement office building with 5 zones and a ceiling plenum on each floor. WWR-0.40; core office thermal zones converted to computer room zones

The Statewide CASE Team estimated energy and demand impacts by simulating the proposed code change using the 2022 Research Version of CBECC-Com, available at <http://bees.archenergy.com/software2022.html>.

CBECC-Com generates two models based on user inputs: the Standard Design and the Proposed Design. The Standard Design represents the geometry of the design that the builder would like to build and inserts a defined set of features that result in an energy budget that is minimally compliant with 2019 Title 24, Part 6 code requirements. Features used in the Standard Design are described in the 2019 Nonresidential ACM Reference Manual. Minimal 2019 Title 24, Part 6 compliance includes a computer room with mechanical systems and efficiencies meeting 140.9(a) prescriptive requirements, which include: full air economizing at outdoor temperatures of 55°F dry-bulb and below, variable speed fan control with a fan system design power demand of 27 W/kBtu-h of net sensible cooling capacity (this equates to 0.58 W/cfm with a 20°F supply and return air temperature difference, which is more efficient than the ACM listed value of 0.81 W/cfm for CRACs/CRAHs), supply air temperature of 60°F, and return air temperature of 80°F.

The Proposed Design represents the same geometry as the Standard Design, but it assumes the energy features that the software user describes with user inputs. To develop savings estimates for the proposed code changes, the Statewide CASE Team created a Standard Design and Proposed Design for each prototypical building.

The Proposed Design was identical to the Standard Design in all ways except for the revisions that represent the proposed changes to the code. Table 73 presents a

summary of key parameters that were modified and what values were used in the Standard Design and Proposed Design.

Comparing the energy impacts of the Standard Design to the Proposed Design reveals the impacts of the proposed code change relative to a building that is minimally compliant with the 2019 Title 24, Part 6 requirements relative to industry typical practices.

Table 73: Modifications Made to Standard Design in Each Prototype Simulation Case to Simulate Proposed Code Change: PUE Monitoring Submeasure

Simulation Case/ Prototype ID	Climate Zone	Parameter Name	Standard Design Parameter Value	Proposed Design Parameter Value
Case 1: CHW CRAH	All	Annual computer room HVAC energy (post-processed)	N/A	1% decrease from Standard Design

CBEECC-Com calculates whole-building energy consumption for every hour of the year measured in kWh/yr and therms/yr, then applies the 2022 TDV factors to calculate annual energy use in TDV kBtu/yr and annual peak electricity demand reductions measured in kW. TDV energy cost savings were also calculated in 2023 PV\$ and nominal dollars.

The energy impacts of the proposed code change vary by climate zone. The Statewide CASE Team simulated the energy impacts in every climate zone and applied the climate-zone specific TDV factors when calculating energy and energy cost impacts. Aside from weather data, modeling inputs did not vary by climate zone.

Per-unit energy impacts for nonresidential buildings are presented in savings per kilowatt of IT equipment load. Annual energy and peak demand impacts for each submeasure were translated into impacts per kW IT equipment load by dividing by the kW of IT equipment load for each simulated case. This step allows for an easier comparison of savings across different building types and enables a calculation of statewide savings using the construction forecast that is published in terms of floor area by building type.

5.3.2.2 Statewide Energy Savings Methodology

As described above, the per unit energy impacts are presented in savings per design ITE load. Savings do not vary significantly by building type, but rather by ITE load. Although the per unit savings were calculated using prototypical buildings, the per unit savings apply to any building type.

The per-unit energy impacts were extrapolated to statewide impacts using the Statewide Construction Forecasts that the Energy Commission provided (California Energy Commission Building Standards Office n.d.). The Statewide Construction Forecasts estimate new construction that will occur in 2023, the first year that the 2022 Title 24, Part 6 requirements are in effect. It also estimates the size of the total existing building stock in 2023 that the Statewide CASE Team used to approximate savings from building alterations. The construction forecast is provided in square footage of new and existing floorspace.

Because ITE load, not total building floor area, is the driver for computer room energy use, the Statewide CASE Team correlated ITE load to building floor area by assuming a watts per square foot of ITE design load density. The ITE design load density varies by measure type and is described in Appendix A.

Appendix A presents additional information about the methodology and assumptions used to calculate statewide energy impacts.

5.3.3 Per Unit Energy Impacts Results

The per-unit energy savings do not account for naturally occurring market adoption or compliance rates. Table 74 shows the first year per-unit energy savings and demand reduction ranges, which vary by climate zone and system type. There is a positive net energy savings in all climate zones.

Because this submeasure reduces mechanical system energy, which varies by climate zone, this submeasure's energy savings vary with climate zone. The hotter the climate zone, the more energy savings this measure provides by resulting in a more efficient mechanical cooling and fan system.

This submeasure would not have a significant impact on demand response/flexibility, peak power demand, or load shifting.

Table 74: First-Year Energy Impacts Per IT Equipment Load kW – Chilled Water CRAH Case, PUE Monitoring Submeasure

Climate Zone	Electricity Savings (kWh/yr)	Peak Electricity Demand Reduction (kW)	Natural Gas Savings (therms/yr)	TDV Energy Savings (TDV kBtu/yr)
1	8	0.0	0	215
2	9	0.0	0	254
3	9	0.0	0	251
4	9	0.0	0	251
5	9	0.0	0	239
6	11	0.0	0	301
7	10	0.0	0	297
8	11	0.0	0	305
9	10	0.0	0	294
10	11	0.0	0	300
11	10	0.0	0	294
12	10	0.0	0	277
13	11	0.0	0	303
14	10	0.0	0	294
15	12	0.0	0	345
16	9	0.0	0	255
TOTAL	158	0.1	0	4,475

5.4 Cost and Cost Effectiveness

5.4.1 Energy Cost Savings Methodology

Energy cost savings were calculated by applying the TDV energy cost factors to the energy savings estimates that were derived using the methodology described in Section 5.3.3. TDV is a normalized metric to calculate energy cost savings that accounts for the variable cost of electricity and natural gas for each hour of the year, along with how costs are expected to change over the period of analysis (30 years for residential measures and nonresidential envelope measures and 15 years for all other nonresidential measures). In this case, the period of analysis used is 15 years. The TDV cost impacts are presented in nominal dollars and in 2023 present value dollars and represent the energy cost savings realized over 15 years.

5.4.2 Energy Cost Savings Results

Per-unit energy cost savings for newly constructed buildings and alterations that are realized over the 15-year period of analysis are presented in 2023 dollars in Table 75. Energy savings for new construction and alterations are expected to be the same.

The TDV methodology allows peak electricity savings to be valued more than electricity savings during non-peak periods. Because internal equipment loads drive the energy use in computer rooms and that equipment load is typically relatively flat throughout the day, submeasures that reduce equipment load (e.g., UPS efficiency) provide a relatively constant demand reduction.

This submeasure saves energy cost in all climate zones.

Table 75: 2023 PV TDV Energy Cost Savings Over 15-Year Period of Analysis – Per IT Equipment Load kW – New Construction, PUE Monitoring Submeasure

Climate Zone	15-Year TDV Electricity Cost Savings (2023 PV\$)	15-Year TDV Natural Gas Cost Savings (2023 PV\$)	Total 15-Year TDV Energy Cost Savings (2023 PV\$)
1	\$19	\$0	\$19
2	\$23	\$0	\$23
3	\$22	\$0	\$22
4	\$22	\$0	\$22
5	\$21	\$0	\$21
6	\$27	\$0	\$27
7	\$26	\$0	\$26
8	\$27	\$0	\$27
9	\$26	\$0	\$26
10	\$27	\$0	\$27
11	\$26	\$0	\$26
12	\$25	\$0	\$25
13	\$27	\$0	\$27
14	\$26	\$0	\$26
15	\$31	\$0	\$31
16	\$23	\$0	\$23
TOTAL	\$398	\$0	\$398

5.4.3 Incremental First Cost

Incremental first cost is the initial cost to adopt more efficient equipment or building practices when compared to the cost of an equivalent baseline project. Therefore, it was

important that the Statewide CASE Team consider first costs in evaluating overall measure cost effectiveness. Incremental first costs are based on data available today and can change over time as markets evolve and professionals become familiar with new technology and building practices.

Table 76 presents the incremental first costs, which were obtained from online pricing research by the Statewide CASE Team, interviews with electrical engineers, controls contractors, commissioning agents, and construction projects with which Statewide CASE Team members were involved. Overall, costs for nine metering products, average labor costs from two Bay Area electrical and controls contractors, and average labor costs for two Bay Area commissioning agents were used in the analysis.

Incremental costs for this submeasure include the following items:

- Whole building electrical meter equipment, capable of remote communication (BACnet, Modbus, etc.). Note that including this cost is a conservative estimate. Title 24, Part 6, Section 130.5(a) requires a meter for loads greater than 1000 kVA, which would apply to all buildings subject to the PUE monitoring requirement. The CASE Team has included this cost in case the electrical meter used to comply with 130.5(a) for some reason is not accessible for PUE monitoring.
- Labor time to install the whole building electrical meter
- Labor time to connect the electrical meters the building automation system and configure the meter data to calculate PUE
- Combined costs of the above two items ranged are assumed to be 40 hours at a rate of \$215 per hour
- Labor time to commission the meters and perform the Acceptance Test, assumed to be 8 hours at a rate of \$140 per hour
- In-house labor time to review PUE monitoring data, assumed to be 20 hours per year for each year of the 15-year life of the system at an in-house labor rate of \$50 per hour

To trigger the PUE monitoring requirement, a UPS must be installed in the computer room. It is assumed the UPS has an internal meter for output power, a very common feature for UPSs of the size being used in computer rooms triggering this requirement, and that internal meter is used for the denominator component of the PUE calculation.

Costs are anticipated to be the same for new construction and additions/alterations for this submeasure.

Costs are not anticipated to change over time for this measure.

The costs presented in the following table assume a computer room with a 2,000 kW ITE design load, with three 1,000 kW UPSs (N+1 redundancy) and one whole building electric meter.

Table 76: Incremental First Cost Assumptions: PUE Monitoring Submeasure

Cost Item	Incremental First Cost (\$ per ITE design load kW)	Cost Source
Electric submeter for whole building load	\$6.52	Average cost of 9 power meter products.
Installation Labor	\$4.30	Estimate based on data from electrical and controls contractors
Controls	\$0	N/A
Commissioning	\$0.56	Estimate based on input from commissioning agents
In-house maintenance	\$7.50	Estimate of \$100,000/yr salary, does not include taxes and benefits
Total	\$18.88	

The incremental first costs for this submeasure include the installation and labor to install the PUE monitoring system and do not include additional costs to implement additional energy efficiency measures identified through PUE monitoring. The one percent energy savings estimate for this submeasure assumes energy savings are achieved through operational improvements that can be implemented through routine system maintenance such as improved air containment (e.g., fixing air leaks, adjusting blanking panels, rearranging underfloor supply air diffuser locations) or controls logic revisions (e.g., air temperature reset or pressure reset).

5.4.4 Incremental Maintenance and Replacement Costs

Incremental maintenance cost is the incremental cost of replacing the equipment or parts of the equipment, as well as periodic maintenance required to keep the equipment operating relative to current practices over the 15-year period of analysis. The present value of equipment maintenance costs (savings) was calculated using a 3 percent discount rate (d), which is consistent with the discount rate used when developing the 2022 TDV. The present value of maintenance costs that occurs in the nth year is calculated as follows:

$$\text{Present Value of Maintenance Cost} = \text{Maintenance Cost} \times \left[\frac{1}{1 + d} \right]^n$$

As noted in the previous section, there is estimated to be 20 hours per year for each year of the 15-year life of the system at an in-house labor rate of \$50 per hour to review PUE data and inform maintenance activities to maintain system performance. Both an annual 3 percent discount rate and 3 percent labor escalation are assumed, so the maintenance cost is included in the first cost table with other implementation costs for this submeasure.

5.4.5 Cost Effectiveness

This measure proposes a mandatory requirement. As such, a cost analysis is required to demonstrate that the measure is cost effective over the 15-year period of analysis.

The Energy Commission establishes the procedures for calculating cost effectiveness. The Statewide CASE Team collaborated with Energy Commission staff to confirm that the methodology in this report is consistent with their guidelines, including which costs were included in the analysis. The incremental first cost and incremental maintenance costs over the 15-year period of analysis were included. The TDV energy cost savings from electricity and natural gas savings were also included in the evaluation. In cases where the proposed submeasure increases water use, such as the air-cooled chiller with dry cooler economizer versus air-cooled chiller with evaporative cooling tower economizer, the estimated 15-year water use cost was also included in the cost-effectiveness analysis.

Design costs were not included nor were the incremental costs of code compliance verification.

According to the Energy Commission's definitions, a measure is cost effective if the benefit-to-cost (B/C) ratio is greater than 1.0. The B/C ratio is calculated by dividing the cost benefits realized over 15 years by the total incremental costs, which includes maintenance costs for 15 years. The B/C ratio was calculated using 2023 PV costs and cost savings.

Results of the per-unit cost-effectiveness analyses are presented in Table 77 for new construction and alterations.

The proposed submeasure saves money over the 15-year period of analysis relative to existing requirements. The proposed change is cost effective in every climate zone for the simulation case. The results are the same for new construction and additions/alterations.

Table 77: 15-Year Cost-Effectiveness Summary Per IT Equipment Load kW – New Construction and Additions/Alterations, PUE Monitoring Submeasure, Case 1: CHW CRAH

Climate Zone	Benefits TDV Energy Cost Savings + Other PV Savings^a (2023 PV\$)	Costs Total Incremental PV Costs^b (2023 PV\$)	Benefit-to- Cost Ratio
1	\$19	\$19	1.0
2	\$23	\$19	1.2
3	\$22	\$19	1.2
4	\$22	\$19	1.2
5	\$21	\$19	1.1
6	\$27	\$19	1.4
7	\$26	\$19	1.4
8	\$27	\$19	1.4
9	\$26	\$19	1.4
10	\$27	\$19	1.4
11	\$26	\$19	1.4
12	\$25	\$19	1.3
13	\$27	\$19	1.4
14	\$26	\$19	1.4
15	\$31	\$19	1.6
16	\$23	\$19	1.2

- a. **Benefits: TDV Energy Cost Savings + Other PV Savings:** Benefits include TDV energy cost savings over the period of analysis (Energy + Environmental Economics 2020). Other savings are discounted at a real (nominal – inflation) three percent rate. Other PV savings include incremental first-cost savings if proposed first cost is less than current first cost. Includes PV maintenance cost savings if PV of proposed maintenance costs is less than PV of current maintenance costs.
- b. **Costs: Total Incremental Present Valued Costs:** Costs include incremental equipment, replacement, and maintenance costs over the period of analysis. Costs are discounted at a real (inflation-adjusted) three percent rate and if PV of proposed maintenance costs is greater than PV of current maintenance costs. If incremental maintenance cost is negative, it is treated as a positive benefit. If there are no total incremental PV costs, the B/C ratio is infinite.

5.5 First-Year Statewide Impacts

5.5.1 Statewide Energy and Energy Cost Savings

The Statewide CASE Team calculated the first-year statewide savings for new construction by multiplying the per-unit savings, which are presented in Section 5.3.3, by assumptions about the percentage of newly constructed buildings that would be impacted by the proposed code. The statewide new construction forecast for 2023 is

presented in Appendix A as are the Statewide CASE Team’s assumptions about the percentage of new construction and additions and alterations that would be impacted by the proposal. A summary of estimated statewide energy impacts for new construction and additions/alterations are presented in Table 78. The first-year energy impacts represent the first-year annual savings from all buildings that were completed in 2023. The 15-year energy cost savings represent the energy cost savings over the entire 15-year analysis period. The statewide savings estimates do not take naturally occurring market adoption or compliance rates into account.

Table 78: Statewide Energy and Energy Cost Impacts, PUE Monitoring – New Construction, Alterations, and Additions

Construction Type	First-Year Electricity Savings (GWh)	First-Year Peak Electrical Demand Reduction (MW)	First -Year Natural Gas Savings (MMTherms)	15-Year Present Valued Energy Cost Savings (PV\$ million in 2023)
New Construction	0.1	0.0	0	\$0
Additions and Alterations	0.2	0.1	0	\$1
TOTAL	0.3	0.1	0	\$1

5.5.2 Statewide Greenhouse Gas (GHG) Emissions Reductions

The Statewide CASE Team calculated avoided GHG emissions assuming the emissions factors specified in the United States Environmental Protection Agency (U.S. EPA) Emissions & Generation Resource Integrated Database (eGRID) for the Western Electricity Coordination Council California (WECC CAMX) subregion. Avoided GHG emissions from natural gas savings attributable to sources other than utility-scale electrical power generation are calculated using emissions factors specified in U.S. EPA’s Compilation of Air Pollutant Emissions Factors (AP-42). See Appendix C for additional details on the methodology used to calculate GHG emissions. In short, this analysis assumes an average electricity emission factor of 240.4 metric ton CO₂e per GWh based on the average emission factors for the CACX EGRID subregion.

Table 79 presents the estimated first-year avoided GHG emissions of the proposed code change. During the first year, GHG emissions of 1,906 metric tons of carbon dioxide equivalents (metric tons CO₂e) would be avoided.

Table 79: First-Year Statewide GHG Emissions Impacts – PUE Monitoring

Measure	Electricity Savings ^a (GWh/yr)	Reduced GHG Emissions from Electricity Savings ^a (Metric Ton CO ₂ e)	Natural Gas Savings ^a (MMTherms/yr)	Reduced GHG Emissions from Natural Gas Savings ^a (Metric Ton CO ₂ e)	Total Reduced CO ₂ e Emissions ^{a,b} (Metric Ton CO ₂ e)
PUE Monitoring	0.3	69	0	0	69

a. First-year savings from all buildings completed statewide in 2023.

b. Assumes the following emission factors: 240.4 MTCO₂e/GWh and 5,454.4 MTCO₂e/MMTherms.

5.5.3 Statewide Water Use Impacts

The PUE monitoring submeasure also has a slight decrease in site water use for water-cooled cooling equipment due to the decrease in cooling energy. Because these changes are minimal, they are not quantified in the Final CASE Report.

5.5.4 Statewide Material Impacts

The PUE monitoring submeasure requires additional network infrastructure to connect whole building and UPS power meters to a network energy dashboard.

Table 80: First-Year Statewide Impacts on Material Use: PUE Monitoring

Material	Impact (I, D, or NC) ^a
Mercury	NC
Lead	NC
Copper	NC
Steel	NC
Plastic	NC

a. Material Increase (I), Decrease (D), or No Change (NC) compared to base case (lbs/yr).

5.5.5 Other Non-Energy Impacts

There are no anticipated other non-energy impacts.

6. Proposed Revisions to Code Language

6.1 Summary of Proposed Changes to Code Documents

The sections below summarize how the standards, Reference Appendices, Alternative Calculation Method (ACM) Reference Manuals, and compliance documents would be modified by the proposed change. See Section 6 of this report for detailed proposed revisions to code language.

6.1.1 Summary of Changes to the Standards

This proposal would modify the following sections of the California Energy Code as shown below. See Section 6.3 of this report for marked-up code language.

SECTION 100.1 – DEFINITIONS AND RULES OF CONSTRUCTION

Section 100.1(b) – Definitions.

The purpose of the changes is to define terms added to Sections 120.8(i), 140.9(a), and 141.1(b). The proposed requirements add new definitions for the following terms:

- “alternating current-output uninterruptible power supply” – adds definition matching ENERGY STAR Program Requirements for Uninterruptible Power Supplies (UPS) - Eligibility Criteria Version 2.0 definition.
- “ANSI/NEMA WD 6” – adds definition for NEMA specifications
- “computer room heat recovery coefficient of performance” – adds definition for system efficiency
- “computer room heat recovery” – adds definition of system
- “cumulative power usage effectiveness (PUE)” – adds definition of PUE
- “information technology equipment (ITE)” – adds definition matching ASHRAE 90.4
- “ITE design load” – adds definition of design parameter matching ASHRAE 90.4

SECTION 120.6 – MANDATORY REQUIREMENTS FOR COVERED PROCESSES

Section 120.6(i) – Mandatory Requirements for Computer Rooms:

This is a new Section (120.6(i)) for computer rooms mandatory requirements, for which previously there were none. The purpose of the change is to create mandatory requirements for computer rooms. The Reheat, Humidification, and Fan Control requirements, Sections 140.9(a)2, 140.9(a)3, and 140.9(a)5, respectively, have been

prescriptive requirements for computer rooms since the 2013 code cycle and have since become standard practice for computer rooms. The PUE monitoring requirement is included to encourage energy savings persistence for all large computer rooms. The computer room system acceptance section is added to include a PUE monitoring acceptance test and clarify that mechanical and lighting systems in Sections 120.5 and 130.4 that serve computer rooms must meet Sections 120.5 and 130.4 requirements. The PUE monitoring acceptance test is added to check proper implementation of the new PUE monitoring requirement in 120.6(i).

SECTION 140.9 – PRESCRIPTIVE REQUIREMENTS FOR COVERED PROCESSES

Section 140.9(a) – Prescriptive Requirements for Computer Rooms:

The purpose of the changes is to increase economizer temperature thresholds to increase energy savings and align with computer room efficiency best practices as well as clarify grammar; these requirements apply to new construction computer rooms only because of the recognized implementation challenges with computer rooms in existing buildings. Heat recovery is added as a requirement for large computer rooms in buildings with large heating loads so that the computer rooms 24/7 heating load is utilized for space heating when needed. The Reheat, Humidification, and Fan Control requirements have been prescriptive requirements for computer rooms since the 2013 code cycle and have since become standard practice for computer rooms. Language establishing a minimum efficiency standard for UPSs is added based on ENERGY STAR Version 2.0 requirements. Specific changes include:

- Increased temperature threshold for economizers modifies existing language (Section 140.9(a)1) with updated economizer temperature requirements and air containment requirements, as well as modifies exceptions to 140.9(a)1.
- Computer room heat recovery adds new subsection for computer room heat recovery requirement.
- Removes Sections 140.9(a)2, 140.9(a)3, and 140.9(a)5, which would become mandatory requirements.
- UPS efficiency adds a new subsection for minimum UPS efficiency requirements.
- Removal of healthcare exception to 140.9(a) requirements.

SECTION 141.1 – REQUIREMENTS FOR COVERED PROCESSES IN ADDITIONS, ALTERATIONS, TO EXISTING NONRESIDENTIAL, HIGH-RISE RESIDENTIAL, AND HOTEL/MOTEL BUILDINGS

Section 141.1(b) – Requirements for Computer Rooms:

The purpose of these changes is to move existing requirements from the new construction Section 140.9(a) for computer rooms to the alterations and additions Section 141.1(b) for clarity. Language for refrigerant economizers is added based on

the Energy Commission's decision to allow refrigerant economizers per computer rooms in Docket 15-MISC-03, TN#206117.

6.1.2 Summary of Changes to the Reference Appendices

This proposal would modify the sections of the Reference Appendices identified below. See Section 6.4 of this report for the detailed proposed revisions to the text of the reference appendices.

NONRESIDENTIAL APPENDICES

NA7.19 – Computer Room Acceptance Tests: A new section for a PUE Monitoring Acceptance Test would be added as NA7.7.19.1.

6.1.3 Summary of Changes to the Nonresidential ACM Reference Manual

This proposal would modify the following sections of the Nonresidential ACM Reference Manual as shown below. See Section 6.5 of this report for the detailed proposed revisions to the text of the ACM Reference Manual.

5.4.6 RECEPTACLE LOADS

Receptacle Power table: If the proposed design includes a UPS, then the Standard Design includes a UPS. The Standard Design UPS waste heat receptacle load is calculated based on the Standard Design UPS efficiency and does not necessarily match the proposed design UPS waste heat receptacle load. The Standard Design uses a UPS efficiency of 91.2 percent at 25 percent load factor, 94.0 percent at 50 percent load factor, 94.6 percent at 75 percent load factor, and 94.6 percent at 100 percent load factor. The proposed Design requires user inputs for UPS efficiency at 25 percent, 50 percent, 75 percent, and 100 percent load factors. If the proposed UPS is in a separate room with a separate cooling system from the computer room, the Standard Design UPS is also modeled in a separate room with a dedicated cooling system. The Standard Design cooling system type is matched to the computer room cooling system type (CRAC or CRAH). The Standard Design includes air economizing per 140.4(e)1 requirements.

5.7 HVAC SECONDARY SYSTEMS

5.7.2.3 Supply Air Temperature Control, Cooling Supply Air Temperature table:

The Standard Design supply air temperature would be changed from 60°F to 70°F, and baseline return (zone) air temperature would be changed from 80°F to 90°F for all computer rooms greater than 10 kW, which require air containment. For computer rooms less than 10 kW, which do not require air containment, the Standard Design supply air temperature would also change to 70°F, and the return (zone) air temperature would be changed from 80°F to 85°F, such that the supply and return air temperature differential is 15°F; a 10°F supply and return air temperature differential is a more

realistic value for non-contained computer rooms (Group 2013) than the current 20°F value for all system types. Proposed designs that do not install containment would not be able to claim a design supply and return air temperature differential greater than 15°F or a design supply air temperature greater than 65°F. Small computer rooms less than 10 kW are commonly served by house air systems with economizers, which allows them to meet economizing requirements by utilizing 2019 Title 24, Part 6, 140.9(a)1 Exception 4.

The Standard Design would include full air economizing with differential dry-bulb temperature high limit control based on the computer room supply and return air temperatures.

5.7.3.2 Supply Fans: Supply Fan Power Index table:

The Standard Design CRAC and CRAH system fan power index would be modified from 0.81 W/cfm to 0.58 W/cfm, which matches the Section 140.9(a) fan power requirement of 27 W/kBtu-h of sensible cooling capacity at a 20°F temperature differential between supply and return air temperature since the Standard Design assumes a 20°F temperature differential per ACM section 5.7.2.3. The current Supply an Power Index table assumes 400 cfm/ton which corresponds to a 27.8°F temperature differential which does not match the Standard Design for computer rooms.

5.7.6.6 Computer Room Heat Recovery Coil Option 1 tables: Tables would be added to define computer room heat recovery systems for buildings using packaged single zone (SZAC), packaged variable air volume (PVAV), and packaged single-zone variable air volume unit (SZVAV) heating systems.

5.7.6.6 Computer Room Heat Recovery Coil Option 2 tables: Tables would be added to define computer room heat recovery systems for buildings using four-pipe fan coil (FPFC) and built-up variable air volume (VAVS) heating systems.

6.1.4 Summary of Changes to the Nonresidential Compliance Manual

The proposed code change would modify the following sections of the Nonresidential Compliance Manual:

- Appendix A – Compliance Documents
- Chapter 10 – Covered Processes
- Chapter 13 – Acceptance Requirements

See Section 6.6 of this report for the detailed proposed revisions to the text of the compliance manuals.

6.1.5 Summary of Changes to Compliance Documents

The proposed code change would modify the compliance documents listed below.

- NRCC-PRC-E
 - Update section C. Compliance Results to reference correct sections of Title 24, Part 6: 120.6(i), 140.9(a), and 141.1(b).
 - Update economizer thresholds in Table M, column 2.
 - Add columns to Table M for computer room heat recovery, UPS efficiency, and PUE monitoring.
 - Add NRCA-PRC-17-F Computer Room acceptance test for PUE monitoring as a form option in section Q. Declaration of Required Certificates of Acceptance.
- NRCA-PRC-17-F Computer Rooms: create a new document.
 - Add new acceptance test section for computer room PUE monitoring system configuration.

6.2 Guide to Markup Language

The proposed changes to the standards, Reference Appendices, and the ACM Reference Manuals are provided below. Changes to the 2019 documents are marked with red underlining (new language) and ~~strikethroughs~~ (deletions).

Language that the Statewide CASE Team recommends moving from prescriptive to mandatory are highlighted in blue text.

6.3 Standards

SECTION 100.1 – DEFINITIONS AND RULES OF CONSTRUCTION

- b) **Definitions.** Terms, phrases, words and their derivatives in Part 6 shall be defined as specified in Section 100.1. Terms, phrases, words and their derivatives not found in Section 100.1 shall be defined as specified in the “Definitions” chapters of Title 24, Parts 1 through 5 of the California Code of Regulations. Where terms, phrases, words and their derivatives are not defined in any of the references above, they shall be defined as specified in *Webster's Third New International Dictionary of the English Language, Unabridged* (1961 edition, through the 2002 addenda), unless the context requires otherwise.

ALTERNATING CURRENT-OUTPUT UNINTERRUPTIBLE POWER SUPPLY (AC-output UPS) is a combination of convertors, switches, and energy storage devices (such as batteries) constituting a power system for maintaining continuity of load power in case of input power failure. Input power failure occurs when voltage and frequency are outside rated steady-state and transient tolerance bands or when distortion or interruptions are outside the limits specified for the UPS. An AC-output UPS is a UPS that supplies power with a continuous flow of electric charge that periodically reverses direction.

ANSI/NEMA WD 6 is the National Electrical Manufacturers Association Document titled, “Wiring Devices—Dimensional Specifications,” 2016 (ANSI/NEMA WD 6-2016).

COEFFICIENT OF PERFORMANCE (COP), COMPUTER ROOM HEAT RECOVERY is the ratio of heat transferred from the computer room to the rate of energy input of the computer room heat recovery system, calculated under design conditions and expressed in consistent units.

COMPUTER ROOM is a room within a building whose primary function is to house electronic equipment and that has a design *information technology equipment (ITE)* power density exceeding 20 watts/ft² (215 watts/m²) of conditioned floor area.

COMPUTER ROOM HEAT RECOVERY is a mechanical system that transfers heat from computer room ITE to provide heating to other zones in the building with heating loads.

CUMULATIVE POWER USAGE EFFECTIVENESS (PUE) is equal to total building cumulative electricity use (measured in kilowatt hours) in the time period divided by total cumulative ITE electricity use (measured in kilowatt hours) in that time period. Total building cumulative electricity use includes electricity produced on site (e.g., by photovoltaics) that is consumed on site.

DATA CENTER is a building whose primary function is to house computer room(s).

INFORMATION TECHNOLOGY EQUIPMENT (ITE) includes computers, data storage, servers, and network/communication equipment located in a computer room.

ITE DESIGN LOAD is the combined power of all the ITE loads for which the ITE cooling system is designed.

SECTION 120.6 – MANDATORY REQUIREMENTS FOR COVERED PROCESSES

(i) **Mandatory Requirements for Computer Rooms.** Space conditioning systems serving a computer room shall conform to the following requirements:

1. **Reheat.** Each computer room zone shall have controls that prevent reheating, recooling and simultaneous provisions of heating and cooling to the same zone, such as mixing or simultaneous supply of air that has been previously mechanically heated and air that has been previously cooled, either by cooling equipment or by economizer systems.
2. **Humidification.** Any humidification shall be adiabatic ~~Nonadiabatic humidification (e.g. steam, infrared) is prohibited. Only adiabatic humidification (e.g., direct evaporative, ultrasonic) is permitted.~~
3. **Fan Control.** Each unitary air conditioner with mechanical cooling capacity exceeding 60,000 Btu/hr and each chilled water fan system shall be designed to vary the airflow rate

as a function of actual load and shall have controls and/or devices (such as two-speed or variable speed control) that will result in fan motor demand of no more than 50 percent of design wattage at 66 percent of design fan speed.

4. **Power Usage Effectiveness (PUE) Monitoring.** Buildings with at least 2,000 kW of computer room *ITE design load* and where at least 80 percent of the total building cooling capacity serves computer rooms or associated electrical rooms and where IT equipment loads are served by an *AC-output UPS* shall include a power usage effectiveness monitoring system with the following minimum requirements:
 - A. True root mean square (RMS) power measurements of total computer room *ITE* power demand and total building power demand. *ITE* power shall be measured immediately downstream of any UPS, such that UPS losses are not included in *ITE* energy.
 - B. Data transfer on a server capable of trending and storing data for a minimum of 18 months, with data collected at 15-minute intervals or less.
 - C. Time series plots of hourly, daily, and monthly *cumulative PUE* are displayed on a visual dashboard visible to the building operator. If electricity produced and consumed on site is not included in the whole building electricity meter then it shall be metered and included in the total building electricity use.

5. **Computer Room System Acceptance.** Before an occupancy permit is granted for a new computer room, or before a new computer room is operated for normal use, the following equipment and systems shall be certified as meeting the Acceptance Requirements for Code Compliance, as specified in the Reference Nonresidential Appendix NA7. A Certificate of Acceptance shall be submitted to the enforcement agency that certifies that the equipment and systems meet the acceptance requirements:
 - A. PUE Monitoring equipment shall be tested in accordance with NA7.19.1.
 - B. Mechanical and lighting systems in Sections 120.5 and 130.4 that serve computer rooms.

SECTION 120.8 – NONRESIDENTIAL BUILDING COMMISSIONING

- (g) **Functional performance testing.** Functional performance tests shall demonstrate the correct installation and operation of each component, system and system-to-system interface in accordance with the acceptance test requirements in Sections 120.5, 120.6, 130.4 and 140.9. Functional performance testing reports shall contain information addressing each of the building components tested, the testing methods utilized, and include any readings and adjustments made.

SECTION 140.9 – PRESCRIPTIVE REQUIREMENTS FOR COVERED PROCESSES

(a) **Prescriptive Requirements for Computer Rooms.** ~~Space conditioning systems serving a~~ Computer rooms with a power density greater than 20 W/ft² shall comply with this section ~~by being designed with and having constructed and installed a cooling system that meets the requirements of Subsections 1 through 6.~~

1. **Economizers.** Each individual cooling system primarily serving computer rooms shall include ~~either:~~

~~A. An integrated air economizer capable of providing 100 percent of the expected system cooling load as calculated in accordance with a method approved by the Commission, at 64.4°F to 80.6°F supply air temperature at outside air temperatures of 65.5°F dry-bulb/ and below or 50°F wet-bulb and below, and be equipped with a fault detection and diagnostic system that complies with as specified by Section 120.2(i); or~~

~~B. An integrated water economizer capable of providing 100 percent of the expected system cooling load as calculated in accordance with a method approved by the Commission, at outside air temperatures of 40°F dry bulb/35°F wet bulb and below.~~

EXCEPTION 1 to Section 140.9(a)1: Individual computer rooms with an ITE design load under 5 tons (18 kW) in a building that does not have any economizers.

~~**EXCEPTION 2 to Section 140.9(a)1:** New cooling systems serving an existing computer room in an existing building up to a total of 50 tons of new cooling equipment per building.~~

~~**EXCEPTION 3 to Section 140.9(a)1:** New cooling systems serving a new computer room in an existing building up to a total of 20 tons of new cooling equipment per building.~~

EXCEPTION 42 to Section 140.9(a)1: A computer room with an ITE design load less than 20 tons (70 kW) may be served by a fan system without an economizer if it is also served by a second fan system with an economizer that also serves other spaces within the building provided that all of the following are met:

- ~~i. The economizer system is sized to meet the design cooling load of the computer room when the other spaces within the building are at 50 percent of their design load; and~~
- ii. The economizer system has the ability to serve only the computer rooms connected to it, e.g., shut off flow to other spaces within the building when unoccupied; and

- ii. The economizer system has the ability to deliver either the computer room *ITE design load* or the maximum of 5 tons and at least 25 percent of the economizer system capacity at design conditions.
- iii. ~~The noneconomizer system does not operate when the outside air drybulb temperatures is below 60.5°F and, the cooling load of other spaces within the building served by the economizer system is less than 50 percent of design load.~~

EXCEPTION 3 to Section 140.9(a)1: If the local water authority does not allow cooling towers the cooling system shall include either:

- A. An integrated air economizer capable of providing 100 percent of the expected system cooling load up to 80°F room supply air temperature at outside air temperatures of 55°F dry-bulb/50°F wet-bulb and below, and be equipped with a fault detection and diagnostic system that complies with Section 120.2(i); or
- B. An integrated water economizer capable of providing 100 percent of the expected system cooling load up to 80°F room supply air temperature at outside air temperatures of 40°F dry-bulb/35°F wet-bulb and below.
- C. In Climate Zones 1-9, 11-14, 16, an integrated refrigerant economizer capable of providing 100 percent of the expected system cooling load up to 80°F room supply air temperature at outside air temperatures of 40°F dry-bulb/35°F wet-bulb and below.

EXCEPTION 4 to Section 140.9(a)1: If the total fan power at design conditions of each fan system serving a computer room does not exceed (0.35 W/cfm) and if the supply air dry-bulb temperature and return air dry-bulb temperature differential at the cooling coil at design conditions is at least 25°F and if the cooling system efficiency is at least 20 percent better than the values listed in Table 110.2-A through Table 110.2-K or Title 20, Table C-7 Standards for Computer Room Air Conditioners, whichever is applicable to the design, the cooling system shall include either:

- A. An integrated air economizer capable of providing 100 percent of the expected system cooling load up to 80°F room supply air temperature at outside air temperatures of 55°F dry-bulb/50°F wet-bulb and below, and be equipped with a fault detection and diagnostic system that complies with Section 120.2(i); or
- B. An integrated water economizer capable of providing 100 percent of the expected system cooling load up to 80°F room supply air temperature at outside air temperatures of 40°F dry-bulb/35°F wet-bulb and below.
- C. In Climate Zones 1-9, 11-14, 16, an integrated refrigerant economizer capable of providing 100 percent of the expected system cooling load up to 80°F room supply air temperature at outside air temperatures of 40°F dry-bulb/35°F wet-bulb and below.

~~2. **Reheat.** Each computer room zone shall have controls that prevent reheating, recooling and simultaneous provisions of heating and cooling to the same zone, such as mixing or simultaneous supply of air that has been previously mechanically heated and air that has been previously cooled, either by cooling equipment or by economizer systems.~~

~~3. **Humidification.** Nonadiabatic humidification (e.g. steam, infrared) is prohibited. Only adiabatic humidification (e.g. direct evaporative, ultrasonic) is permitted.~~

2.4. Power Consumption of Fans. The total fan power at design conditions of each fan system shall not exceed 27 W/kBtu·h of net sensible cooling capacity.

~~5. **Fan Control.** Each unitary air conditioner with mechanical cooling capacity exceeding 60,000 Btu/hr and each chilled water fan system shall be designed to vary the airflow rate as a function of actual load and shall have controls and/or devices (such as two-speed or variable speed control) that will result in fan motor demand of no more than 50 percent of design wattage at 66 percent of design fan speed.~~

3.6. Air Containment. Computer rooms with air-cooled computers in racks and with a *ITE design load* exceeding 10.75 kW (2.8 tons) per /room shall include air barriers such that there is no significant air path for computer discharge air to recirculate back to computer inlets without passing through a cooling system.

EXCEPTION 1 to Section 140.9(a)36: Expansions of existing computer rooms.

EXCEPTION 2 to Section 140.9(a)36: Computer racks with a design load less than 1 kW (0.28 tons) per /rack.

EXCEPTION 3 to Section 140.9(a)36: Equivalent energy performance based on computational fluid dynamics or other analysis.

4. Heat Recovery. New buildings with a total building cooling ITE design load and total building heating design load exceeding the values in Table 140.9-A and an annual heating load for at least 1,400 hours, computer room heat recovery is required. The heat recovery system must have a computer room heat recovery COP of at least 3.0 at design conditions. The computer room heat recovery system shall be capable of transferring at least 50 percent of the total building ITE design load or at least 50 percent of the total building design heating load from the computer room(s) to conditioned space(s) requiring heating.

TABLE 140.9-A: COMPUTER ROOM HEAT RECOVERY

<u>Climate Zone</u>	<u>Total Building Cooling ITE Design Load</u>	<u>Total Building Heating Design Load ^a</u>
<u>1-5, 11-14, 16</u>	<u>> 200 kW (57 tons)</u>	<u>> 4 million Btu/hr</u>
<u>1-5, 11-14, 16</u>	<u>> 500 kW (141 tons)</u>	<u>> 2.5 million Btu/hr</u>
<u>6-10, 15</u>	<u>> 300 kW (85 tons)</u>	<u>> 5 million Btu/hr</u>

a. Includes heating load for comfort and process loads.

EXCEPTION 1 to Section 140.9(a)4: Buildings that use electric heating equipment with a building-wide average heating COP of 4.0 or greater.

5. Uninterruptible Power Supplies (UPS). Alternating Current-output UPS systems serving a computer room shall meet or exceed ENERGY STAR Program Requirements for Uninterruptible Power Supplies (UPSs) - Eligibility Criteria Version 2.0 efficiency and testing requirements.

EXCEPTION to 140.9(a)5: UPS that utilizes standardized NEMA 1-15P or NEMA 5-15P input plug, as specified in ANSI/NEMA WD-6-2016.

~~EXCEPTION to Section 140.9(a): Computer rooms located in healthcare facilities.~~

SECTION 141.1 – REQUIREMENTS FOR COVERED PROCESSES IN ADDITIONS, ALTERATIONS TO EXISTING NONRESIDENTIAL, HIGH-RISE RESIDENTIAL, AND HOTEL/MOTEL BUILDINGS

Covered processes in additions or alterations to existing buildings that will be nonresidential, high-rise residential, and hotel/motel occupancies shall comply with the applicable subsections of section 120.6 and 140.9.

(a) Lab and Process Facility Exhaust Systems. All newly installed fan systems for a laboratory or process facility exhaust system greater than 10,000 CFM shall meet the requirements of Section 140.9(c).

NOTE: For alterations that change the occupancy classification of the building, the requirements of Section 141.1 apply to the occupancy that will exist after the alterations.

NOTE: Authority: Sections 25213, 25218, 25218.5, 25402 and 25402.1, Public Resources Code. Reference: Sections 25007, 25008, 25218.5, 25310, 25402, 25402.1, 25402.4, 25402.8, and 25943, Public Resources Code.

(b) Computer Rooms. All newly installed computer room cooling systems and uninterruptible power supply systems in additions/alterations shall meet the requirements of Sections 120.6(i), 140.9(a)2, and 140.9(a)5 and comply with the following Subsections.

1. Economizers. Each individual cooling system primarily serving computer rooms in an existing building shall include either:

- A. An integrated air economizer capable of providing 100 percent of the expected system cooling load up to 80°F room supply air temperature at outside air temperatures of 55°F dry-bulb/50°F wet-bulb and below, and be equipped with a fault detection and diagnostic system that complies with Section 120.2(i); or
- B. An integrated water economizer capable of providing 100 percent of the expected system cooling load up to 80°F room supply air temperature at outside air temperatures of 40°F dry-bulb/35°F wet-bulb and below.

C. In Climate Zones 1-9, 11-14, 16, an integrated refrigerant economizer capable of providing 100 percent of the expected system cooling load up to 80°F room supply air temperature at outside air temperatures of 40°F dry-bulb/35°F wet-bulb and below.

EXCEPTION 1 to Section 141.1(b)1: Individual computer rooms with an *ITE design load* under 5 tons (18 kW) in a building that does not have any economizers.

EXCEPTION 2 to Section 141.1(b)1: New cooling systems serving an existing computer room in an existing building with an *ITE design load* up to a total of 50 tons (176 kW).

EXCEPTION 3 to Section 141.1(b)1: New cooling systems serving a new computer room in an existing building with an *ITE design load* up to a total of 20 tons (70 kW).

EXCEPTION 4 to Section 141.1(b)1: A computer room with an *ITE design load* less than 20 tons (70 kW) may be served by a fan system without an economizer if it is also served by a fan system with an economizer that also serves other spaces within the building provided that all of the following are met:

- i. The economizer system has the ability to serve only the computer room; and
- ii. The economizer system has the ability to deliver either the computer room *ITE design load* or the maximum of 5 tons and at least 25 percent of the economizer system capacity at design conditions.

6.4 Reference Appendices

NA7.19 Computer Room Acceptance Tests

NA7.19.1 Power Usage Effectiveness (PUE) Monitoring

NA7.19.1.1 Construction Inspection

Verify and document the following prior to functional testing:

- (a) Prior to installation, assess the loads and confirm the current transducers (CTs) are adequately sized based on manufacturer specifications for amperage range and accuracy. Record each CT's amperage range and accuracy.
- (b) Verify a meter capable of recording "true root mean square (RMS) power" has been installed to capture the total computer room ITE power demand. Record make, model, and serial # of meter.
- (c) Verify the location of the computer room ITE power meter and ensure that it is installed downstream of any UPS, such that the losses are not included in the ITE energy.
- (d) Verify a meter capable of recording "true root mean square (RMS) power" has been installed to capture the total building power demand. Record make, model, and serial number of meter.

- (e) Verify that meter for the total building power demand includes all electricity consumed and produced on-site. If electricity produced onsite is not included then it shall be metered and included in the total building electricity use. Record make, model, and serial number of onsite production meter if applicable.
- (f) Verify that CTs and voltage leads are fully clamped and properly oriented.
- (g) Verify that the meters have been configured for the correct CT type and size.
- (h) Verify the remote data acquisition system has been configured correctly and is communicating with meter.

NA7.19.1.2 Functional Testing

For each meter installed to calculate PUE, confirm the following:

- (a) Confirm the meter measured real time values are within manufacturer stated accuracy for a known, non-zero load.
- (b) Check the power factor of each phase. For three-phase loads, the power factors on each phase should be approximately balanced (within 15%).
- (c) Verify that the recorded per phase electricity values are positive. NOTE: it is possible in some applications that this is a negative value; however, in most applications this should be positive, and a negative value may be an indication that the CT is installed backwards.
- (d) For each load, use an independent, portable meter to confirm the voltage, amperage, and power reading on the installed meter.
- (e) Compare data from meter and data acquisition system with spot measurements from the portable meter. All three sources should agree (within 1-2%). From all three sources, record the following measurements:
 - a. Amperage
 - b. Kilowatts
 - c. Voltage
- (f) Confirm data acquisition system is set up to store data for a minimum of 18 months with data collected at 15-minute intervals (or less).
- (g) Confirm cumulative PUE is being calculated properly. Cumulative PUE is equal to total building, including onsite electricity production, cumulative electricity use (measured in kilowatt-hours) in the time period divided by total ITE electricity use (measured in kilowatt-hours).
- (h) Confirm time series plots for hourly, daily, and monthly PUE are displayed on a visual dashboard accessible to building operator and archiving to the server for storage.

6.5 ACM Reference Manual

5.4.6 Receptacle Loads

Receptacle loads contribute to heat gains in spaces and directly use energy.

Receptacle Power	
<i>Applicability</i>	All building projects

<i>Definition</i>	Receptacle power is power for typical general service loads in the building. Receptacle power includes equipment loads normally served through electrical receptacles, such as office equipment and printers, but does not include either task lighting or equipment used for HVAC purposes. Receptacle power values are slightly higher than the largest hourly receptacle load that is actually modeled because the receptacle power values are modified by the receptacle schedule, which approaches but does not exceed 1.0.												
<i>Units</i>	<p>Total power (W) or the space power density (W/ft²)</p> <p>Compliance software shall also use the following prescribed values to specify the latent heat gain fraction and the radiative/convective heat gain split.</p> <p>For software that specifies the fraction of the heat gain that is lost from the space, this fraction shall be prescribed at 0.</p> <p>Heat Gain Fractions:</p> <table border="1"> <thead> <tr> <th></th> <th>Radiative</th> <th>Latent</th> <th>Convective</th> </tr> </thead> <tbody> <tr> <td>Receptacle Power</td> <td>0.20</td> <td>0.00</td> <td>0.80</td> </tr> <tr> <td>Gas Equipment Power</td> <td>0.15</td> <td>0.00</td> <td>0.00</td> </tr> </tbody> </table>		Radiative	Latent	Convective	Receptacle Power	0.20	0.00	0.80	Gas Equipment Power	0.15	0.00	0.00
	Radiative	Latent	Convective										
Receptacle Power	0.20	0.00	0.80										
Gas Equipment Power	0.15	0.00	0.00										
<i>Input Restrictions</i>	Prescribed to values from Appendix 5.4A												
<i>Standard Design</i>	Same as proposed (<u>except for computer room uninterruptible power supply equipment</u>)												
<i>Standard Design: Existing Buildings</i>	Same as for new construction												

5.7.2.3 Supply Air Temperature Control

Cooling Supply Air Temperature	
<i>Applicability</i>	Applicable to all systems
<i>Definition</i>	The supply air temperature setpoint at design cooling conditions
<i>Units</i>	Degrees Fahrenheit (°F)
<i>Input Restrictions</i>	As designed
<i>Standard Design</i>	For healthcare facilities, same as the Proposed Design. For all others, 15°F below the space temperature setpoint for interior zones that are served by multiple zone systems <u>and for computer rooms without air containment (where space temperature equals return air temperature)</u> ; for all other zones, 20°F below the space temperature setpoint

<i>Standard Design: Existing Buildings</i>	
--	--

5.7.3.2 Supply Fans

Supply Fan Power Index	
<i>Applicability</i>	Fan systems that use the power-per-unit-flow method
<i>Definition</i>	The supply fan power (at the motor) per unit of flow
<i>Units</i>	W/cfm
<i>Input Restrictions</i>	As designed or specified in the manufacturers' literature
<i>Standard Design</i>	For healthcare facilities, same as the Proposed Design. For all others, For FPFC systems, 0.35 W/cfm for heating and ventilation only systems, 0.53 W/cfm ; For CRAC and CRAH systems, <u>0.580-84</u> W/cfm (approximate value for 27 W/kBtu-h of sensible cooling capacity assuming <u>20°F differential between supply air temperature and return air temperature</u> 400-cfm/ton). For other systems, not applicable.
<i>Standard Design: Existing Buildings</i>	

5.7.6.6 Computer Room Heat Recovery Coil Option 1

<u>Recovery Type</u>	
<i><u>Applicability</u></i>	<u>SZAC, PVAV, SZVAV</u>
<i><u>Definition</u></i>	<u>The type of heat recovery system</u>
<i><u>Units</u></i>	
<i><u>Input Restrictions</u></i>	<u>Computer room supply air temperature</u> <u>As designed heat recovery coil capacity</u>
<i><u>Standard Design</u></i>	
<i><u>Standard Design: Existing Buildings</u></i>	

5.7.6.7 Computer Room Heat Recovery Coil Option 2

<u>Recovery Type</u>	
<i><u>Applicability</u></i>	<u>FPFC, VAVS</u>
<i><u>Definition</u></i>	<u>The type of heat recovery system</u>
<i><u>Units</u></i>	

<u><i>Input Restrictions</i></u>	<u><i>Computer room supply air temperature</i></u> <u><i>As designed heat recovery coil capacity</i></u>
<u><i>Standard Design</i></u>	
<u><i>Standard Design:</i></u> <u><i>Existing Buildings</i></u>	

6.6 Compliance Manuals

Chapter 10, 13, and Appendix A of the Nonresidential Compliance Manual would need to be revised.

Chapter 10 would require updates to sections 10.4.1 Overview, 10.4.2 Mandatory Measures, 10.4.3 Prescriptive Measures, and 10.4.4 Healthcare Facilities. Section 10.4.1 should be updated to state that Title 24, Part 6 Sections 120.6, 140.9(a), and 141.1(b) provide minimum requirements to computer rooms, and those sections are not limited to providing conditioning requirements. Section 10.4.2 should be updated to add new computer room mandatory measures included in Title 24, Part 6 120.6(i)1 through 120.6(i)5. Section 10.4.3 should be updated to remove prescriptive measures that became mandatory (reheat, humidification, and fan control); add new prescriptive measures (UPS efficiency and heat recovery); and modify economizer and containment requirements. Section 10.4.4 text should be updated to indicate healthcare facilities are not required to meet Section 140.9(a), 141.1(b), or 120.6(i).

Chapter 13 would require adding NRCA-PRC-17-F Computer Rooms for a PUE Monitoring acceptance test to Table 13-1: Acceptance Documents and to Section 13.4.4 Covered Process Systems and Equipment.

Appendix A would require adding NRCA-PRC-17-F Computer Rooms to the Certificate of Acceptance table.

6.7 Compliance Documents

Compliance document NRCC-PRC-E would need to be revised, and new document NRCA-PRC-17-F would need to be created.

NRCC-PRC-E would be revised as follows:

- Update section C. Compliance Results to reference correct sections of Title 24, Part 6: 120.6(i), 140.9(a), and 141.1(b).
- Update economizer thresholds in Table M, column 2.
- Add columns to Table M for computer room heat recovery, UPS efficiency, and PUE monitoring.

- Add NRCA-PRC-17-F Computer Room acceptance test for PUE monitoring as a form option in section Q. Declaration of Required Certificates of Acceptance.

NRCA-PRC-17-F Computer Rooms would be created. The computer room PUE monitoring system acceptance test contained within is described Section 7.3. The acceptance test is intended to address common electricity meter and dashboard integration issues to provide accurate electricity readings and power usage effectiveness calculations on the monitoring dashboard for the owner.

7. Bibliography

- (EPA), Environmental Protection Agency. n.d. *Energy Star Certified Uninterruptible Power Supplies*. Accessed January 2020.
<https://www.energystar.gov/productfinder/product/certified-uninterruptible-power-supplies>.
- . 2012. "Energy Star Portfolio Manager." *Data Trends: Benchmarking and Energy Savings*. October. Accessed January 2020.
https://www.energystar.gov/sites/default/files/buildings/tools/DataTrends_Savings_20121002.pdf.
- (WSEC), Washington State Energy Code. 2019. "Chapter 51-11C WAC State Building Code Adoption and Amendment of the 2018 Edition of the International Energy Conservation Code, Commercial." *Washington State Energy Code (WSEC)*. Accessed 2020.
<https://wseccompliancedocuments.com/pdf/2018%20WSEC%20-%20Commercial%20Final%20Rulemaking.10.2019.pdf>.
- n.d. http://bees.archenergy.com/Documents/Software/CBECC-Com_2016.3.0_SP1_Prototypes.zip.
- Agency, Environmental Protection. 2019. *ENERGY STAR Uninterruptible Power Supplies Version 2.0 Program Requirements*. Energy Star.
- Agency, United States Environmental Protection. 2015. "Executive Order 13693, Planning for Federal Sustainability in the Next Decade." *Greening EPA*. March 19. Accessed March 17, 2020. <https://www.epa.gov/greeningepa/executive-order-13693-planning-federal-sustainability-next-decade>.
- ASHRAE. 2019. *Energy Standard for Data Centers*.
- . 2016. *Energy Standard for Data Centers*.
- . 2019. *Standard 90.1 Energy Standard for Buildings Except Low-Rise Residential Buildings*. ASHRAE.
- . 2015. *Thermal Guidelines for Data Processing Environments, Fourth Edition*.
- BW Research Partnership. 2016. *Advanced Energy Jobs in California: Results of the 2016 California Advanced Energy*. Advanced Energy Economy Institute.
- California Air Resources Board. 2019. "Global Warming Potentials."
<https://www.arb.ca.gov/cc/inventory/background/gwp.htm#transition>.
- California Department of Water Resources. 2016. "California Counties by Hydrologic Regions." Accessed April 3, 2016.
<http://www.water.ca.gov/landwateruse/images/maps/California-County.pdf>.

- California Energy Commission. 2015. *2016 Building Energy Efficiency Standards: Frequently Asked Questions*.
http://www.energy.ca.gov/title24/2016standards/rulemaking/documents/2016_Building_Energy_Efficiency_Standards_FAQ.pdf.
- California Energy Commission Building Standards Office. n.d. "Nonresidential Construction Forecasts." <https://www.energy.ca.gov/title24/participation.html>.
- California Energy Commission. n.d. *CBECC-Com Nonresidential Compliance Software*.
<http://bees.archenergy.com/software2022.html>, California Energy Commission Building Standards Office.
- . 2022. "Energy Code Data for Measure Proposals." *energy.ca.gov*.
https://www.energy.ca.gov/title24/documents/2022_Energy_Code_Data_for_Measure_Proposals.xlsx.
- . 2019. "Housing and Commercial Construction Data - Excel." https://ww2.energy.ca.gov/title24/documents/2022_Energy_Code_Data_for_Measure_Proposals.xlsx.
- . 2018. "Impact Analysis: 2019 Update to the California Energy Efficiency Standards for Residential and Non-Residential Buildings." *energy.ca.gov*. June 29.
https://www.energy.ca.gov/title24/2019standards/post_adoption/documents/2019_Impact_Analysis_Final_Report_2018-06-29.pdf.
- California Public Utilities Commission (CPUC). 2015b. "Water/Energy Cost-Effectiveness Analysis: Revised Final Report." Prepared by Navigant Consulting, Inc. <http://www.cpuc.ca.gov/WorkArea/DownloadAsset.aspx?id=5360>.
- California Public Utilities Commission. 2015a. "Water/Energy Cost-Effectiveness Analysis: Errata to the Revised Final Report." Prepared by Navigant Consulting, Inc. . <http://www.cpuc.ca.gov/WorkArea/DownloadAsset.aspx?id=5350>.
- n.d. *CBECC-Com Nonresidential Compliance Software*.
<http://bees.archenergy.com/software2022.html>.
- CEC, California Energy Commission. 2019. *Building Energy Benchmarking Program*. Accessed 12 19, 2019. <https://www.energy.ca.gov/programs-and-topics/programs/building-energy-benchmarking-program>.
- Commission, California Energy. 2019. *2018 Total System Electric Generation*. Accessed 2020. <https://www.energy.ca.gov/data-reports/energy-almanac/california-electricity-data/2019-total-system-electric-generation/2018#:~:text=The%20Year%20in%20Review&text=In%202018%2C%20total%20generation%20for,to%2056%20percent%20in%202017>.

- Commission, California Public Utility. 2014. *DEER Resources*.
[hwww.deeresources.com/files/DEER2013codeUpdate/download/DEER2014-EUL-table-update_2014-02-05.xlsx&usg=AOvVaw1rR5tI92u](http://www.deeresources.com/files/DEER2013codeUpdate/download/DEER2014-EUL-table-update_2014-02-05.xlsx&usg=AOvVaw1rR5tI92u).
- Davis, UC. 2014. "UC Davis Campus Design Guide." July. Accessed June 2020.
<https://dcm.ucdavis.edu/sites/g/files/dgvnsk1011/files/cdg/documents/2014/iii-construction-divisions/div-27-communications-14.pdf>.
- Eaton. 2020. *Eaton Heat Containment System*. Accessed March 12, 2020.
<http://powerquality.eaton.in/products-services/airflow-management/heat-containment-system.asp?cx=36>.
- Energy + Environmental Economics. 2016. "Time Dependent Valuation of Energy for Developing Building Efficiency Standards: 2019 Time Dependent Valuation (TDV) Data Sources and Inputs." Prepared for the California Energy Commission. July. http://docketpublic.energy.ca.gov/PublicDocuments/16-BSTD-06/TN212524_20160801T120224_2019_TDV_Methodology_Report_7222016.pdf.
- Energy + Environmental Economics. 2020. "Time Dependent Valuation of Energy for Developing Building Efficiency Standards: 2022 Time Dependent Valuation (TDV) and Source Energy Metric Data Sources and Inputs."
- Energy, Department of. n.d. *2020-01-10 Energy Conservation Program: Energy Conservation Standards for Uninterruptible Power Supplies; Final rule*. Accessed 2020 3, 2020. <https://www.regulations.gov/document?D=EERE-2016-BT-STD-0022-0035>.
- Energy, U.S. Department of. 2020. "2020-01-10 Energy Conservation Program: Energy Conservation Standards for Uninterruptible Power Supplies; Final rule." *Regulations.gov*. Accessed March 3, 2020.
<https://www.regulations.gov/document?D=EERE-2016-BT-STD-0022-0035>.
- Engineering, Taylor. 2011. "2013 Data Center Final CASE Report." *Title24Stakeholders.com*. May 31. Accessed August 2020.
<https://title24stakeholders.com/wp-content/uploads/2020/08/2013-Data-Center-Final-CASE-Report-1.pdf>.
- Engineers, Rumsey. 2007. *PG&E High Tech Energy Efficiency Baselines: Datacenters*. Pacific Gas, & Electric (PG&E).
- Ettenson, Lara , and Christa Heavey. 2015. *California's Golden Energy Efficiency Opportunity: Ramping Up Success to Save Billions and Meet Climate Goals*. Natural Resources Defense Council & Environmental Entrepreneurs (E2).
- Federal Reserve Economic Data. n.d. <https://fred.stlouisfed.org> .

- Goldman, Charles, Merrian C. Fuller, Elizabeth Stuart, Jane S Peters, Marjorie McRay, Nathaniel Albers, Susan Lutzenhiser, and Mersiha Spahic. 2010. *Energy Efficiency Services Sector: Workforce Size and Expectations for Growth*. Lawrence Berkeley National Laboratory.
- Group, Integral. 2013. "Energy Efficiency Baselines for Data Centers." *Statewide Customized New Construction and Customized Retrofit Incentive Programs*. March 1. Accessed 2020.
https://www.pge.com/includes/docs/pdfs/mybusiness/energysavingsrebates/incentivesbyindustry/hightech/data_center_baseline.pdf.
- Institute, Uptime. 2014. "2014 Data Center Industry Survey."
- Institute, Uptime. 2019. "2019 Annual Data Center Survey Results."
- Kenny, Michael, Heather Bird, and Heriberto Rosales. 2019. *2019 California Energy Efficiency Action Plan*. Publication Number: CEC-400-2019-010-CMF, California Energy Commission.
- Koomey, Jonathan. 2011. *Growth in Data center electricity use 2005 to 2010*. Oakland: Analytics Press. <http://www.analyticspress.com/datacenters.html>.
- Koomey, Jonathan, and Jon Taylor. 2017. ".Zombie/Comatose Servers Redux."
- Koomey, Jonathan, and Jon Taylor. 2015. "New data supports finding that 30 percent of servers are 'Comatose', indicating that nearly a third of capital in enterprise data centers is wasted."
- Laboratory, National Renewable Energy. n.d. *High-Performance Computing Data Center Waste Heat Reuse*. Accessed January 21, 2020.
<https://www.nrel.gov/computational-science/waste-heat-energy-reuse.html>.
- Lawrence Berkeley National Laboratory (LBNL), Electric Markets and Policy Group. 2017. "Evaluation of U.S. Building Energy Benchmarking and Transparency Programs: Attributes, Impacts, and Best Practices." April 28. Accessed January 2020.
https://emp.lbl.gov/sites/default/files/lbnl_benchmarking_final_050417_0.pdf.
- Lawrence Berkeley National Laboratory (LBNL), Electric Power Research Institute (EPRI). 2008. "Uninterruptible Power Supplies: A Data Center Efficiency Opportunity ." *California Energy Commission's Public Interest Energy Research Program* . September. Accessed 2020.
<https://ww2.energy.ca.gov/2008publications/CEC-500-2008-065/CEC-500-2008-065-FS.PDF>.

- Munters. 2020. "SyCool Split." *Munters.com*. February. Accessed March 2020.
<https://www.munters.com/globalassets/inriver/resources/pg0100-01-sycool-split.pdf>.
- National Energy Assistance Directors' Association. 2011. *2011 National Energy Assistance Survey Final Report*.
<http://www.appriseinc.org/reports/Final%20NEADA%202011%20Report.pdf>.
- NMR Group, Inc., Optimal Energy, Inc. 2012. "Statewide Benchmarking Process Evaluation." *CALifornia Measurement Advisory Council (CALMAC)*. April. Accessed January 2020.
http://www.calmac.org/publications/Statewide_Benchmarking_Process_Evaluation_Report_CPU0055.pdf.
- Office of Energy Efficiency & Renewable Energy. n.d. "Building Energy Use Benchmarking." *State and Local Solution Center*. Accessed March 17, 2020.
<https://www.energy.gov/eere/slsc/building-energy-use-benchmarking>.
- Office of Energy Efficiency and Renewable Energy, Department of Energy. n.d. "Energy Conservation Program: Energy Conservation Standards for Uninterruptible Power Supplies ." Accessed February 2020.
https://www.energy.gov/sites/prod/files/2016/12/f34/UPS_ECS_Final_Rule.pdf.
- Scott, Tony. 2016. "Data Center Optimization Initiative (DCOI)." August 1. Accessed March 17, 2020. https://datacenters.cio.gov/assets/files/m_16_19.pdf.
- State of California, Employment Development Department. n.d.
<https://www.labormarketinfo.edd.ca.gov/cgi/dataanalysis/areaselection.asp?table name=industry> .
- Stone, Nehemiah, Jerry Nickelsburg, and William Yu. 2015. *Codes and Standards White Paper: Report - New Home Cost v. Price Study*. Pacific Gas and Electric Company. Accessed February 2, 2017.
<http://docketpublic.energy.ca.gov/PublicDocuments/Migration-12-22-2015/Non-Regulatory/15-BSTD-01/TN%2075594%20April%202015%20Codes%20and%20Standards%20White%20Paper%20-%20Report%20-%20New%20Home%20Cost%20v%20Price%20Study.pdf>.
- Taylor Engineering, Pacific Gas and Electric. 2016. "2016 PG&E Data Center Baseline and Measurement and Verification (M&V) Guidelines ." February. Accessed 2020.
www.calmac.org/publications/2016_PG%26E_Data_Center_Baseline_and_M%26V_Guidelines.pdf.

- Team, Statewide Utility Codes and Standards. 2020. *Nonresidential and Single Family HVAC Part 1: Data Centers, Boilers, Air Distribution, Variable Capacity*. <https://title24stakeholders.com/wp-content/uploads/2020/01/2022-T24-Stakeholder-Meeting-Notes-20220412.pdf>.
- . 2019. *Nonresidential HVAC Part 1: Data Centers, Boilers, Controls Utility-Sponsored Stakeholder Meeting Notes*. <https://title24stakeholders.com/wp-content/uploads/2019/07/T24-2022-Stakeholder-Meeting-Notes-Nonresidential-HVAC.pdf>.
- Technology, Duke Office of Information. 2016. "Communication Facilities Construction Design Standards." February. Accessed June 2020. https://oit.duke.edu/sites/default/files/atoms/files/Design_2016.pdf.
- Thornberg, Christopher, Hoyu Chong, and Adam Fowler. 2016. *California Green Innovation Index - 8th Edition*. Next 10.
- U.S. Census Bureau, Population Division. 2014. "Annual Estimates of the Resident Population: April 1, 2010 to July 1, 2014." <http://factfinder2.census.gov/bkmk/table/1.0/en/PEP/2014/PEPANNRES/0400000US06.05000>.
- U.S. Department of Energy. 2012. *Commercial Buildings Energy Consumption Survey (CBECS)*. Washington, DC: U.S. Energy Information Administration.
- U.S. Department of Energy. 2011. *Technical Support Document: Energy Efficiency Program for Commercial and Industrial Equipment: Efficiency Standards for Commercial Heating, Air-Conditioning, and Water-Heating Equipment, EERE-2011-BT-STD-0029-005*. Washington, DC: Office of Energy Efficiency and Renewable Energy.
- U.S. EPA (United States Environmental Protection Agency). 2011. "Emission Factors for Greenhouse Gas Inventories." Accessed December 2, 2013. <http://www.epa.gov/climateleadership/documents/emission-factors.pdf>.
- United States Environmental Protection Agency. 1995. "AP 42, Fifth Edition Compilation of Air Pollutant Emissions Factors, Volume 1: Stationary Point and Area Sources." <https://www.epa.gov/air-emissions-factors-and-quantification/ap-42-compilation-air-emissions-factors#5thed>.
- United States Environmental Protection Agency. 2018. "Emissions & Generation Resource Integrated Database (eGRID) 2016." <https://www.epa.gov/energy/emissions-generation-resource-integrated-database-egrid>.
- University, Iowa State. n.d. "Telecommunication Closet Standards." Accessed June 2020.

https://www.fpm.iastate.edu/fdm/FDM/P2/D27sup/Telecom_Closet_Standards.pdf.

Zabin, Carol, and Karen Chapple. 2011. *California Workforce Education & Training Needs Assessment: For Energy Efficiency, Distributed Generation, and Demand Reponse*. University of California, Berkeley Donald Vial Center on Employment in the Green Economy. Accessed February 3, 2017.
http://laborcenter.berkeley.edu/pdf/2011/WET_Appendices_ALL.pdf.

Appendix A: Statewide Savings Methodology

To calculate first-year statewide savings, the Statewide CASE Team reviewed available estimates of statewide computer room energy. Computer room floor area and energy estimates are not available from standard nonresidential construction forecasts provided by the Energy Commission Building Standards Office on the Energy Commission’s website: <https://www.energy.ca.gov/title24/participation.html>.

Both new construction and existing statewide computer room IT loads were estimated using the methodology and parameters in the tables below.

Table 81: Estimated Existing Statewide Computer Room Energy Parameters

Parameter Letter	Parameter Name	Parameter Value	Source
A	Total CA statewide building electricity consumption 2018	285,488 GWh/yr	(C. E. Commission 2019)
B	Total computer room energy (IT + support systems) as a percent of existing building energy	1.56%	(J. Koomey 2011)
C	Existing statewide computer room total (IT + support systems energy consumption	4,462 GWh/yr	A * B
D	Computer room PUE	2.0	Estimate. ¹⁴
E	Existing statewide computer room IT energy consumption	2,231 GWh/yr	C ÷ D
F	Existing average statewide IT load	254,656 kW	$E \times 10^6 \div 8760$ hr/yr

¹⁴ Note that an estimate of 2.0 PUE results in a lower estimate of IT load for computer rooms operating more efficiently than a PUE of 2.0. It is anticipated that many recently-constructed computer rooms operate with a PUE lower than 2.0. Therefore the resulting statewide savings estimates for all submeasures, which are based on statewide IT load, are thought to be conservative.

Table 82: Estimated New Construction Statewide Computer Room Energy Parameters

Parameter Letter	Parameter Name	Parameter Value	Source
G	Annual percent increase in computer room energy	4.6%	(J. Koomey 2011)
H	New statewide computer room total (IT + support systems) energy consumption	206 GWh/yr	$C * G$
I	New statewide computer room IT energy consumption	103 GWh/yr	$H \div D$
J	New average statewide IT load	11,753 kW	$I \times 10^6 \div 8760 \text{ hr/yr}$

Estimated Percent of Statewide Existing Buildings Impacted

- Increased temperature threshold for economizers: 0%
- Computer room heat recovery: 0%
- UPS Efficiency: 10% (UPS lifespan = 10 years; 10% of UPSs are replaced each year)
- PUE Monitoring: 7% (lifespan = 15 years; 7% of computer rooms are triggered each year)

Estimated Percent of Statewide New Construction Buildings Impacted by Each Submeasure

- All submeasures are assumed to impact 100% of new construction computer room IT load.

Appendix B: Embedded Electricity in Water Methodology

The Statewide CASE Team assumed the following embedded electricity in water values: 4,848 kWh/million gallons of water for indoor water use and 3,565 kWh/million gallons for outdoor water use. Embedded electricity use for indoor water use includes electricity used for water extraction, conveyance, treatment to potable quality, water distribution, wastewater collection, and wastewater treatment. Embedded electricity for outdoor water use includes all energy uses upstream of the customer; it does not include wastewater collection or wastewater treatment. The embedded electricity values do not include on-site energy uses for water, such as water heating and on-site pumping. On-site energy impacts are accounted for in the energy savings estimates presented in Section 2.5, 3.5, 4.5, and 5.5 of this report.

These embedded electricity values were derived from research conducted for CPUC Rulemaking 13-12-011. The CPUC study aimed to quantify the embedded electricity savings associated with IOU incentive programs that result in water savings, and the findings represent the most up-to-date research by the CPUC on embedded energy in water throughout California (California Public Utilities Commission 2015a, California Public Utilities Commission (CPUC) 2015b). The CPUC analysis was limited to evaluating the embedded electricity in water and does not include embedded natural gas in water. For this reason, this CASE Report does not include estimates of embedded natural gas savings associated with water reductions, though the embedded electricity values can be assumed to have the same associated emissions factors as grid-demanded electricity in general.

The specific CPUC embedded electricity values used in the CASE analysis are shown in Table 83. These values represent the average energy intensity by hydrologic region, which are based on the historical supply mix for each region regardless of who supplied the electricity (IOU-supplied and non-IOU-supplied electricity). The CPUC calculated the energy intensity of marginal supply but recommended using the average IOU and non-IOU energy intensity to estimate total statewide average embedded electricity of water use in California.

Table 83: Embedded Electricity in Water by California Department of Water Resources Hydrologic Region (kWh Per Acre Foot (AF))

Region	Extraction, Conveyance, and Treatment	Distribution	Wastewater Collection + Treatment	Outdoor (Upstream of Customer)	Indoor (All Components)
NC	235	163	418	398	816
SF	375	318	418	693	1,111
CC	513	163	418	677	1,095
SC	1,774	163	418	1,937	2,355
SR	238	18	418	255	674
SJ	279	18	418	297	715
TL	381	18	418	399	817
NL	285	18	418	303	721
SL	837	163	418	1,000	1,418
CR	278	18	418	296	714

Hydrologic Region Abbreviations:

NC = North Coast, SF = San Francisco Bay, CC = Central Coast, SC = South Coast, SR = Sacramento River, SJ = San Joaquin River, TL = Tulare Lake, NL = North Lahontan, SL = South Lahontan, CR = Colorado River

Source: Navigant team analysis

Source: (California Public Utilities Commission (CPUC) 2015b).

The Statewide CASE Team used CPUC’s indoor and outdoor embedded electricity estimates by hydrologic region (presented in Table 83) and population data by hydrologic region from the U.S. Census Bureau (U.S. Census Bureau, Population Division 2014) to calculate the statewide population-weighted average indoor and outdoor embedded electricity values that were used in the CASE analysis (see Table 84). The energy intensity values presented in Table 83 were converted from kWh per acre foot to kWh per million gallons to harmonize with the units used in the CASE analysis. There are 3.07 acre feet per million gallons.

Table 84: Statewide Population-Weighted Average Embedded Electricity in Water

Hydrologic Region	Indoor Water Use (kWh/million gallons)	Outdoor Water Use (kWh/million gallons)	Percent of California Population
North Coast	2,504	1,221	2.1%
San Francisco	3,410	2,127	18.2%
Central Coast	3,360	2,078	3.8%
South Coast	7,227	5,944	44.8%
Sacramento River	2,068	783	8.1%
San Joaquin River	2,194	911	4.7%
Tulare Lake	2,507	1,224	6.3%
North Lahontan	2,213	930	0.1%
South Lahontan	4,352	3,069	5.5%
Colorado River	2,191	908	6.5%
Statewide Population-Weighted Average	4,848	3,565	N/A

Sources: (U.S. Census Bureau, Population Division 2014) and (California Department of Water Resources 2016).

Appendix C: Environmental Impacts Methodology

Greenhouse Gas (GHG) Emissions Factors

As directed by Energy Commission staff, GHG emissions were calculated making use of the average emissions factors specified in the United States Environmental Protection Agency (U.S. EPA) Emissions & Generation Resource Integrated Database (eGRID) for the Western Electricity Coordination Council California (WECC CAMX) subregion (United States Environmental Protection Agency 2018). This ensures consistency between state and federal estimations of potential environmental impacts. The electricity emissions factor calculated from the eGRID data is 240.4 metric tons CO₂e per GWh. The Summary Table from eGRID 2016 reports an average emission rate of 529.9 pounds CO₂e/MWh for the WECC CAMX subregion. This value was converted to metric tons per GWh.

Avoided GHG emissions from natural gas savings attributable to sources other than utility-scale electrical power generation are calculated using emissions factors specified in Chapter 1.4 of the U.S. EPA's Compilation of Air Pollutant Emissions Factors (AP-42) (United States Environmental Protection Agency 1995). The U.S. EPA's estimates of GHG pollutants that are emitted during combustion of one million standard cubic feet of natural gas are: 120,000 pounds of CO₂ (Carbon Dioxide), 0.64 pounds of N₂O (Nitrous Oxide) and 2.3 pounds of CH₄ (Methane). The emission value for N₂O assumed that low NO_x burners are used in accordance with California air pollution control requirements. The carbon equivalent values of N₂O and CH₄ were calculated by multiplying by the global warming potentials (GWP) that the California Air Resources Board used for the 2000-2016 GHG emission inventory, which are consistent with the 100-year GWPs that the Intergovernmental Panel on Climate Change used in the fourth assessment report (AR4). The GWP for N₂O and CH₄ are 298 and 25, respectively. Using a nominal value of 1,000 Btu per standard cubic foot of natural gas, the carbon equivalent emission factor for natural gas consumption is 5,454.4 metric tons per MMTherms.

GHG Emissions Monetization Methodology

The 2022 TDV energy cost factors used in the lifecycle cost-effectiveness analysis include the monetary value of avoided GHG emissions based on a proxy for permit costs (not social costs). To demonstrate the cost savings of avoided GHG emissions, the Statewide CASE Team disaggregated the value of avoided GHG emissions from the other economic impacts. The authors used the same monetary values that are used in the TDV factors – \$106.20 per metric ton CO₂e.

Water Use and Water Quality Impacts Methodology

The proposed code changes have no impacts to water quality.

Appendix D: California Building Energy Code Compliance (CBECC) Software Specification

Introduction

The purpose of this appendix is to present proposed revisions to CBECC for commercial buildings (CBECC-Com) along with the supporting documentation that the Energy Commission staff and the technical support contractors would need to approve and implement the software revisions.

Technical Basis for Software Change

Increased Temperature Threshold for Economizers

While computer room economizer requirements have been included in Title 24, Part 6 since 2013, compliance software provides limited options in which economizer system types and operating conditions that can be modeled. For example, dry cooler and refrigerant economizers cannot be modeled in the software. Also, the software does not allow for deviation from standard supply and return air temperatures (60°F and 80°F) to be modeled, such that computer rooms designed for elevated temperatures cannot take full credit for the increased economizer hours their design provides. The lack of air temperature flexibility also does not allow for designs to take credit for larger supply and return air temperature differentials, when computer rooms are often designed for 25°F or 30°F temperature differentials, which can use significantly less fan energy than computer rooms designed for a 20°F supply and return air differential.

Computer Room Heat Recovery

There are multiple HVAC system types that can be used to meet the proposed computer room heat recovery requirement, but compliance software currently provides the ability to simulate very few of these systems (e.g., VRF). Commonly used heat recovery systems such as water-cooled chillers or transfer air are not able to be modeled, which limits the ability to properly capture the energy use of a computer room heat recovery system.

UPS Efficiency

Currently UPSs are an unregulated load and included in the plug load input of compliance software. Introducing UPS efficiency as a prescriptive requirement introduces the need for compliance modelers to be able model the efficiency of the design's UPS, so that the compliance simulation captures the UPS efficiency and waste heat on the cooling system. Including a four-point UPS part-load performance efficiency

curve for the design's UPS as an input, as described in Section 4.1, can achieve this modeling need.

PUE Monitoring

Since this submeasure is being proposed as a mandatory requirement, it has no proposed software changes.

Description of Software Change

Background Information for Software Change

Computer rooms may be located in all nonresidential building types in all California climate zones. The CBECC-Com features proposed in this appendix would be available for use in all nonresidential building types and climate zones.

Increased Temperature Threshold for Economizers

CBECC-Com is not currently capable of modeling dry cooler or refrigerant economizers. Both of these economizer types are commonly used in California and offered by a number of major manufacturers. The Statewide CASE Team recommends that CBECC-Com be updated so dry cooler and refrigerant economizers can be modeled and projects using these technologies may pursue the performance compliance path.

CBECC-Com currently has limitations on the air temperatures that can be modeled for computer rooms. Based on reviews of dozens of computer room designs, stakeholder consultations, and best practice guideline references such as ASHRAE (ASHRAE, Thermal Guidelines for Data Processing Environments, Fourth Edition 2015), it is evident that a variety of supply and return air temperatures are commonly used in computer room designs, which have a large impact on compressor energy based on economizing hours and on fan energy. The Statewide CASE Team recommends that CBECC-Com be updated so exact design supply and return air temperatures can be modeled and the economizing system incorporates these temperatures.

Computer Room Heat Recovery

Commonly used heat recovery systems such as water-cooled chillers or transfer air are not able to be modeled, which limits the ability to properly capture the energy use of a computer room heat recovery system. The Statewide CASE Team recommends that CBECC-Com be updated to include commonly used heat recovery systems such as heat recovery chillers and transfer air systems.

UPS Efficiency

Because UPSs are currently an unregulated load, they are not included in CBECC-com. Almost every computer room uses a UPS. The Statewide CASE Team recommends

that CBECC-Com be updated to include UPS efficiency. UPS efficiency should be modeled with at least a four-point part-load efficiency curve for 25%, 50%, 75%, and 100% load factors. Users should then have the option to determine the percentage of computer room IT load is served by the UPS (typically this will be 100%), which will be used to calculate the operating UPS load factor and UPS efficiency for each hour of the year. The UPS waste heat and IT load are cooling loads on the cooling system.

Existing CBECC-Com Modeling Capabilities

Increased Temperature Threshold for Economizers

CBECC-Com can model air economizers and water economizers using evaporative cooling towers.

CBECC-Com forces a room (return) air temperature of 80°F, resulting in a fan energy penalty for computer rooms designed for a supply air temperature greater than 60°F and in a prohibition from taking advantage of some partial economizer hours for systems designed for greater than 80°F return air temperature.

CBECC-Com allows supply air temperatures of 50°F-80°F to be input by users.

CBECC-Com limits air economizer upper dry-bulb temperature limit to 85°F.

Computer Room Heat Recovery

CBECC-Com does not allow for heat from computer rooms to be recovered and used for other spaces.

UPS Efficiency

UPS energy is included as part of the electrical plug load input.

Summary of Proposed Revisions to CBECC-Com

Increased Temperature Threshold for Economizers

- Add dry cooler and refrigerant economizer modeling capabilities.
- Allow users to input supply and return air temperatures per design and use those temperatures in the annual simulation to calculate fan energy and economizing.
 - Supply air temperature should not exceed the upper limit for ASHRAE's Allowable range for server inlet temperature (ASHRAE, Thermal Guidelines for Data Processing Environments, Fourth Edition 2015).
 - Return air temperature should not exceed 25°F above supply air temperature.
- For computer rooms greater than 10 kW of design ITE load, the baseline supply

and return air temperature are 70°F and 90°F, respectively.

- For computer rooms less than 10 kW of design ITE load, the baseline supply and return air temperature are 70°F and 85°F, respectively.
- Air economizers are capable of economizing at outdoor dry-bulb temperatures equal to the return air temperature.

Computer Room Heat Recovery

- Add heat recovery simulation capabilities for heat recovery chillers.
- Add heat recovery simulation capabilities for transfer air for nearby zones.
- Add method to determine location of zones and which are subject to heat recovery requirements. Calculate recovered heat to reduce heating load in those zones.
- Add calculation of percentage of annual computer room internal cooling load that is recovered and provides heating to other spaces.

UPS Efficiency

- Add capability to input UPS efficiency at 25 percent, 50 percent, 75 percent, and 100 percent part load factors.
- Add capability to calculate UPS waste heat based on UPS efficiency. UPS waste heat is a thermal load on the computer room cooling system.
- Baseline UPS efficiency is set to baseline UPS efficiency curve based on 25 percent, 50 percent, 75 percent, and 100 percent part load factors. Baseline UPS efficiency should be calculated based on average ENERGY STAR UPS efficiency as described in Section 41.3.
- Add UPS input power as a Process load in the energy summary table, below the Compliance Total line.

User Inputs to CBECC-Com

Increased Temperature Threshold for Economizers

The Statewide CASE Team recommends adding a new user field to the Air System Data inputs tab based on the Sub Type selection of CRAC or CRAH for Air Containment (user selected dropdown “Yes/No”)

The image below provides an example markup in red text of where these input fields could be located.

Air System Data		Ducts	Acceptance Certificates	Pressure Drop Adjustments	Sizing
Currently Active Air System: CoreZnPSZ AirSys					<input type="checkbox"/> Acceptance Test Required?
Name:	CoreZnPSZ AirSys			Availability Sch:	- none -
Type:	SZVAVAC	Status:	New	Fan Control:	Continuous
Sub Type:	CRAC	Count:	1	Night Cycling:	CycleOnCallPrimaryZone
Control Zone:	Core_ZN Thermal Zone	Design OA Flow:	825 cfm	<input type="checkbox"/> 100% OA System	
Description:		Control Type:	Other	<input type="checkbox"/> Optimum Start	
		Air Containment:	[Yes/No]	<input type="checkbox"/> Complex Mechanical System? (per Section 10-102)	
Cooling		Heating		Supply Flow	
Design Supply Air Temp:	60.0 °F			--- Sizing Parameters ---	
Net Capacity*:	660,247 Btu/h		0 Btu/h	Design Flow/Area:	4.000 cfm/ft2
*Reflects capacity of a single system if Count is >1. Heating capacity includes terminal units.				Design Flow/Ton:	400.0 cfm/ton
Fan Position:	DrawThrough				
Supply Temp Control:	Fixed				
Cooling		Heating			
Fixed Supply Temp:	60.0 °F				
Setpoint Temp Sch.:	- none -				
Reset Supply High:		@ Outdoor Temp:			
Reset Supply Low:		@ Outdoor Temp:			

OK

Figure 8. Proposed CBECC-Com Air System Data Input Additions

Computer Room Heat Recovery

The software shall be capable of simulating two types of heat recovery from a data center room to the buildings space heating system:

1. hydronic heat recovery through a data center CRAH being served by a heat recovery chiller.
2. air based heat recovery by transferring data center hot air to other building locations.

If this is to be implemented the methodology would utilize the available components in EnergyPlus and a series of checks and balances to ensure heat can be recovered and the quality of heat makes sense and stays within the boundaries of physics.

Hydronic Heat Recovery

A data center space served by a CRAH unit with a cooling coil and heating coil on a primary CHW and HW loop with a heat recovery chiller object should work within the boundaries of the heat recovery chiller object to directly recover heat from the space to thermal loop. This object should be able to account for ensuring heat is only recovered if the temperature of the data center exceeds the chilled water temperature. This would

effectively manage itself for temperature quality. With a data center space type at 90°F default air temperature this measure recommends an assumed 6°F coil approach temperature to the CRAH chilled water return water temperature (84°F). With the assumed delta-T for a chilled water loop being 12°F, this would only be feasible for data centers with chilled water supply temperatures of 72°F or lower.

A model validation check is recommended during the compiling phase where if the computer room thermostat must be 18°F greater than the specified chilled water temperature setpoint and any chilled water maximum reset setpoint.

Air Based Heat Recovery

There is no direct way to simulate the air based heat recovery system. For smaller buildings utilizing air to air heat recovery or transfer air to move heat from a data center to nonresidential spaces in energy modeling software will depend on the buildings HVAC system configuration to determine how to apply this heating credit effectively.

- A portion of the data center heat would need to be specified as the design heat transfer capacity, either as a percentage or as a defined number, kW of heat output.
- The data center room would need to be at a temperature above the space heating thermostat for the rest of the building, 70°F is a common nonresidential room thermostat setpoint. Assuming the default computer room is 90°F and options are added for higher temperatures.

This configuration would require the software to check:

- That the user has specified ‘the data center includes air to air heat recovery’
- The user specifies the % of IT load or the design kW of heat to be transferred.
- A user would also need to create a hydronic hot water loop and series of heating coils to represent the heat transfer. The methods and user inputs are included in the next section of this CASE report.

UPS Efficiency

The Statewide CASE Team recommends adding two additional inputs to the Process Loads inputs tab in CBECC-Com if Envelope/Space Data/Space Function = Computer Room:

- Under Process and Other Electric Use, UPS Installed (user selected dropdown “Yes/No”)
 - Users should select “Yes” if a UPS that fall under 140.9(a)5 regulations is installed.
- If “Yes” is selected for the UPS Installed input, then four inputs for UPS efficiency at 25 percent, 50 percent, 75 percent, and 100 percent load factor

should be made available. This input data is available from the ENERGY STAR published test data for the UPS.

The image below provides an example markup in red text of where these input fields could be located.

The screenshot shows the 'Building Model Data' window with the 'Process Loads' tab selected. The 'Currently Active Space' is set to 'Core_ZN'. Below the tab navigation, there is a note: '-- Some fields on this page are defaulted based on Function Defaults selection on main Space Data tab --'. The main content area is divided into two sections: 'Process and Other Electric Use' and 'Natural Gas Use'. In the 'Process and Other Electric Use' section, the following fields are visible: 'Process Electric' (0.00 W/ft2), 'Refrigeration' (0.00 W/ft2), 'Elevator Count' (empty), 'Escalator Count' (empty), and 'UPS Installed' ([Yes/No]). To the right of these fields are columns for 'Radiant Frac.', 'Latent Frac.', and 'Lost Frac.', and a 'Schedule Name*' dropdown menu. In the 'Natural Gas Use' section, there are fields for 'Gas Equipment' (0.00 Btu/h-ft2) and 'Process Gas' (0.00 Btu/h-ft2), also with 'Radiant Frac.', 'Latent Frac.', 'Lost Frac.', and 'Schedule Name*' fields. Red text is used to highlight the 'UPS Efficiency, 25% Load Factor: __%', 'UPS Efficiency, 50% Load Factor: __%', 'UPS Efficiency, 75% Load Factor: __%', and 'UPS Efficiency, 100% Load Factor: __%' fields, as well as the 'UPS Installed' field.

Figure 9. Proposed CBECC-Com Space Data Input Additions

Simulation Engine Inputs

Increased Temperature Threshold for Economizers

EnergyPlus/California Simulation Engine Inputs

Currently room (return) air temperature for computer rooms is fixed at 80°F. This should be allowed to increase and be set equal to one of the following values: 75°F, 80°F, 85°F, 90°F, or 95°F based on the Space Data/Space Function type selected by the user. Instead of having only “Computer Room” as an option, there should be five computer room space type options, one for each of the design room (return) air temperature options.

The image below provides an example markup in red text of where these input fields could be located.

Building Model Data

Space Data | Ventilation and Exhaust | Daylighting | Mandatory Lighting Controls | Dwelling Unit Data | Process Loads

Currently Active Space: Core_ZN Daylightable Area: Total: 0 ft2 (0%)

Space Name: Core_ZN Multiplier: 1 Space Status: New

Conditioning Type: DirectlyConditioned Fir-to-Clg Ht: 10.0 ft Envelope: New

Thermal Zone Ref: Core_ZN Thermal Zone Space Area: 1,610.9 ft2 Lighting: New

Supply Plenum Space: - none - Space Perim: 171.6 ft HVAC: New

Return Plenum Space: - none - Volume: 16,120 ft3 Overall: New

Occupancy Class: Nonresidential Space Geometry

Function Defaults: Data Defaults

Space Function: Computer Room Fixed Seating: Atrium > 55 ft tall: Healthcare Space:

Vent. Function: Misc - Computer (not printing) Schedule Group: Data

Occupancy: 3.00 people/1,000 fx Fraction 0.50 = 1.50 people/1,000 ft2 Total Occupants: 2.4 people Schedule Name**: Office Occupancy

SHW FluidSeg: SHWSupply1 Res DHW Sys: - none - Hot Water Temp: 135 °F Office ServiceHotWater

Electric Use

Ltg. Specification: AreaCategoryMethod

Regulated Lighting: 0.50 W/ft2 Fraction to Space: 1.00 Radiant Fraction: 0.58 Schedule Name**: Office Lights

NonReg. Lighting: W/ft2 - none -

Plug Loads: 20.00 W/ft2 ** Schedules will be defaulted for compliance analysis Office Receptacle

OK

Figure 10. Proposed Space Function Options

Currently the maximum dry-bulb temperature for air economizing is 85°F. The maximum economizer dry-bulb temperature should be able to go as high as room (return) air temperature, if Envelope/Space Data/Space Function = Computer Room.

Calculated Values, Fixed Values, and Limitations

A calculated value for design *Computer Room Air Delta-T*(°F), equal to supply air and return air temperature differential (delta-T) should be added. This value should be used to generate runtime errors for the following:

- If “No” is selected in the Air Containment user input and the Computer Room Air Delta-T(°F) is greater than 15°F.
- If “Yes” is selected in the Air Containment user input and the Computer Room Air Delta-T(°F) is greater than 25°F.

While stakeholders reported designing computer rooms for delta-Ts as high as 30°F, most computer rooms are designed for a delta-T of 20-25°F. Limiting the input to 25°F will avoid designs from claiming excessive fan energy savings without designing for adequate air containment and controls strategies.

Computer Room Heat Recovery

EnergyPlus/California Simulation Engine Inputs

Air heat transfer method

- A hot water hydronic loop and district heating object would need to be created with a maximum capacity not to exceed the defined heat transfer value of the data center noted by the user for heat recovery. This would require a hot water hydronic loop to have a sub type or some input field for validation purposes in CBECC-Com only to note that whole hot water loop is for heat recovery purposes only and not a true system in the building.
- A heating coil or multiple heating coils could then be added to this hot water hydronic loop such that the sum capacity of all those coils did not exceed the capacity of the specified heat transfer capacity of the data center.

Calculated Values, Fixed Values, and Limitations

- A default setpoint for supply air temperature would be needed after each of the heating coils to only heat the air stream to the computer room setpoint minus an assumed loss of 4 deg F. This setpoint controller is recommended to be auto created by CBECC-Com on run time to minimize user input errors. A data center free-heating hot water coil object would only be allowed to heat an air stream to the data center computer room thermostat (80F) minus this offset (80-4 = 76F). This would be required to ensure the quality of heat is not incorrect.

This configuration would require the software to check:

1. That the user has specified 'the data center includes air to air heat recovery'
2. The user specifies the % of IT load or the design kW of heat to be transferred.
3. A heating hydronic loop to represent the free heat is allowed to be created.
4. The heating district heat object is fixed to a capacity no more than the design kW.
5. The sum of any heating coils on this loop does not exceed the defined capacity.
6. Node supply air temperature setpoints are created by the software based on a formula of the computer room space type thermostat minus an offset and this control object is added to each of the heating coils for any system utilizing the heat recovered.
7. The heating hot water loop utilized to reflect the heat transfer uses a pump which does not consume power and is created only for modeling purposes.

UPS Efficiency

EnergyPlus/California Simulation Engine Inputs

If Envelope/Space Data/Space Function = Computer Room and if the UPS Installed = Yes, then the following should be included in the simulation:

- Baseline UPS efficiency calculated from the baseline UPS efficiency curve at 25 percent, 50 percent, 75 percent, and 100 percent part load factors. Baseline UPS efficiency should be calculated based on ENERGY STAR UPS efficiency using the methodology as described in Section 4.1.3.
- Proposed UPS efficiency calculated from user inputs for UPS efficiency.
- UPS waste heat is a thermal load on the computer room cooling system.

Calculated Values, Fixed Values, and Limitations

- In baseline and proposed simulation cases, UPS waste heat is calculated according to the following formulas:

$$\text{UPS input power (kW)} = \text{UPS output power (kW)} / \text{UPS efficiency (\%)}$$

$$\text{UPS waste heat (kW)} = \text{UPS input power (kW)} - \text{UPS output power (kW)}$$

- Allowable UPS efficiency range is 1%-100%.
- UPS input power (kW) must be greater than UPS output power (kW).

Simulation Engine Output Variables

CBECC-Com generates hourly EnergyPlus simulation results to CSV files during analysis. These hourly simulation results can be used by the analyst to debug a building energy model. Variables of particular interest in this case would include the following.

Increased Temperature Threshold for Economizers

The Statewide CASE Team is not recommending additional output variables to be added.

Computer Room Heat Recovery

- Sensible heat recovered by zone – heating rate [W]
- Sensible heat recovered by zone – cooling rate [W]
- Computer room heat recovery system COP (as defined in Section 7.2 of this report)
- Percentage of recovered computer room cooling load used for heating [%]

UPS Efficiency

- UPS input power [W]
- UPS output power [W]
- UPS waste heat [W]
- UPS efficiency [%]

Compliance Report

Increased Temperature Threshold for Economizers

The Statewide CASE Team is not recommending changes for this submeasure.

Computer Room Heat Recovery

The Statewide CASE Team is not recommending changes for this submeasure.

UPS Efficiency

CBECC-Com generates a Title 24 Compliance Report that presents the results of the building's compliance analysis. The UPS efficiency submeasure would require a new compliance analysis table for UPS efficiency. The table should show annual UPS input energy as compared to the Standard Design annual UPS input energy.

Compliance Verification

Increased Temperature Threshold for Economizers

Permit reviewers should confirm the following:

- Cooling coils shown on mechanical schedules are sized for supply air dry-bulb and return air dry-bulb temperatures that match the CBECC-Com user inputs for Design Supply Air Temp and Design Return Air Temperature.
- If "Yes " for the Air Containment user input is selected, mechanical drawing Details sheets should show air containment.

Computer Room Heat Recovery

The plans examiner confirms the computer room heat recovery system COP simulated matches the mechanical schedules on the permit drawings.

UPS Efficiency

Permit reviewers should confirm the proposed UPS is listed on ENERGY STAR's UPS Product Finder website as a certified UPS:

<https://www.energystar.gov/productfinder/product/certified-uninterruptible-power-supplies/results>

Testing and Confirming CBECC-Com Modeling

Testing and confirmation checks defined in previous sections of this appendix.

Description of Changes to ACM Reference Manual

Refer to section 7.4 ACM Reference Manual in this report for a description of proposed changes to the ACM Reference Manual.

Appendix E: Impacts of Compliance Process on Market Actors

This appendix discusses how the recommended compliance process, which is described in Sections 2.1.3, 3.1.3, 4.1.3, and 5.1.3 could impact various market actors. Table 85 identifies the market actors who would play a role in complying with the proposed change, the tasks for which they would be responsible, their objectives in completing the tasks, how the proposed code change could impact their existing work flow, and ways negative impacts could be mitigated. The information contained in Table 85 is a summary of key feedback the Statewide CASE Team received when speaking to market actors about the compliance implications of the proposed code changes. Appendix F summarizes the stakeholder engagement that the Statewide CASE Team conducted when developing and refining the code change proposal, including gathering information on the compliance process.

Below is a summary of proposed changes to the current compliance and enforcement process for the computer room efficiency submeasures. With the exception of the Increased Temperature Threshold for Economizers submeasure which modifies existing requirements, all of the proposed computer room efficiency submeasures are new code requirements.

- The following items involve new design and code compliance documentation to appear in design drawings and specifications:
 - Computer room heat recovery requires new information to be specified in mechanical permit drawings and specifications. If installed, heat recovery equipment is typically included in mechanical design drawings and specifications, so including it in the permit documentation package is only additional effort where otherwise heat recovery equipment would not have been installed. Some additional effort is required for mechanical designers to fill out required compliance document.
 - PUE monitoring and UPS efficiency submeasures require new information to be specified in electrical permit drawings and specifications. While not currently required to be included in permit documents, UPS units are typically included in electrical design equipment schedules and specifications, so including them in permit drawings is not additional effort. If installed, PUE Monitoring equipment is typically included in electrical design drawings and specifications, so including it in the permit documentation package is only additional effort where otherwise PUE equipment would not have been installed. Some additional effort is required for electrical designers to fill out required compliance documents.

- The following items involve new tasks during the construction process.
 - PUE monitoring requires an additional acceptance test.
 - For PUE monitoring, UPS efficiency, and computer room heat recovery submeasures, some additional effort is required for electrical and mechanical contractors to fill out required compliance documents.

Table 85: Roles of Market Actors in the Proposed Compliance Process

Market Actor	Task(s) In Compliance Process	Objective(s) in Completing Compliance Tasks	How Proposed Code Change Could Impact Workflow	Opportunities to Minimize Negative Impacts of Compliance Requirement
Electrical/ Low Voltage Engineer	<ul style="list-style-type: none"> • UPS: N.A. (no previous requirement) • PUE: N.A. (no previous requirement) 	<ul style="list-style-type: none"> • UPS: Quickly and easily determine efficiency requirements. • PUE: Quickly and easily determine monitoring capability requirements. 	<ul style="list-style-type: none"> • UPS: Specify a UPS that has the equivalent efficiency requirements of ENERGY STAR. • PUE: Include meters in drawings and software/ dashboard in specs. 	<ul style="list-style-type: none"> • UPS: Outreach for electrical engineers to ensure they are aware of the requirement and what needs to be included on the drawings. • PUE: Outreach for electrical engineers to ensure they are aware of the requirement and what needs to be included on the drawings.
Electrical Contractor	<ul style="list-style-type: none"> • UPS: N.A. (no previous requirement) • PUE: N.A. (no previous requirement) 	<ul style="list-style-type: none"> • UPS: Quickly verify installed equipment matches NRCCs. and quickly and easily completed NRCCs • PUE: Quickly verify installed equipment matches NRCCs and quickly and easily complete NRCCs. 	<ul style="list-style-type: none"> • UPS: See ENERGY STAR-equivalent requirement in spec. and install that equipment. • PUE: Install meters as indicated in NRCCs and complete NRCCs and NRCA. 	<ul style="list-style-type: none"> • UPS: Clearly identify specs on NRCC and improve NRCCs to match dynamic NRCCs. • PUE: Clearly identify specs on NRCCs and improve NRCCs to match dynamic NRCCs.

Market Actor	Task(s) In Compliance Process	Objective(s) in Completing Compliance Tasks	How Proposed Code Change Could Impact Workflow	Opportunities to Minimize Negative Impacts of Compliance Requirement
HVAC Designer	<ul style="list-style-type: none"> Heat Recovery: N.A. (no previous requirement) Increased Temperature Threshold for Economizers: Show air containment and economizer design temperatures on drawings. 	<ul style="list-style-type: none"> Heat Recovery: Quickly and easily determine the requirements and when they trigger. Increased Temperature Threshold for Economizers: Quickly and easily determine the requirements and when they trigger. 	<ul style="list-style-type: none"> Heat Recovery: Include equipment load calculation on plans to show trigger. Include heat recovery system efficiency (COP) and capacity of heat recovery equipment on mechanical equipment drawings/schedule. Increased Temperature Threshold for Economizers: Be aware of new trigger and requirement thresholds. 	<ul style="list-style-type: none"> Heat Recovery: Provide Case Studies for similar applications. Provide training such as a “Decoding Talk”. Create code language that is easy to understand and aligns with other triggers. Increased Temperature Threshold for Economizers: Provide outreach and training on new triggers and requirement thresholds.
HVAC Contractor	<ul style="list-style-type: none"> Heat recovery: N.A. (no previous requirements) Increased Temperature Threshold for Economizers: Identify equipment on NRCCs and install. 	<ul style="list-style-type: none"> Heat Recovery: Quickly verify installed system matches NRCCs and quickly and easily complete NRCI. Increased Temperature Threshold for Economizers: Quickly verify installed system matches NRCCs and quickly and easily complete NRCI. 	<ul style="list-style-type: none"> Heat Recovery: Install equipment as indicated on NRCC and complete NRIs and NRCA. Increased Temperature Threshold for Economizers: N.A. 	<ul style="list-style-type: none"> Heat Recovery: Clearly identify specs on NRCCs, improve NRIs to match dynamic NRCCs. Increased Temperature Threshold for Economizers: N.A.

Market Actor	Task(s) In Compliance Process	Objective(s) in Completing Compliance Tasks	How Proposed Code Change Could Impact Workflow	Opportunities to Minimize Negative Impacts of Compliance Requirement
Controls Contractor	<ul style="list-style-type: none"> • PUE: N.A. (no previous requirements) • Heat recovery: N.A (no previous requirements). • Increased Temperature Threshold for Economizers: Identify equipment on NRCCs and install. 	<ul style="list-style-type: none"> • PUE: Easily identify equipment specs on NRCC. • Heat Recovery: Quickly identify controls on NRCC. • Increased Temperature Threshold for Economizers: Quickly identify controls on NRCC. 	<ul style="list-style-type: none"> • PUE: Integrate meters into building automation system as indicated on NRCC. • Heat Recovery: Install controls as indicated on NRCC. • Increased Temperature Threshold for Economizers: Install controls for system to operate as indicated on NRCC. 	<ul style="list-style-type: none"> • PUE: Controls infrastructure specified on drawings for clarity. • Heat Recovery: Clearly identify specs on NRCC. • Increased Temperature Threshold for Economizers: Clearly identify specs on NRCC .
Plans Examiner	<ul style="list-style-type: none"> • UPS: N.A. (no previous requirements) • PUE: N.A. (no previous requirements) • Increased Temperature Threshold for Economizers: Confirm that design documents match what has been indicated on the NRCCs. • Heat Recovery: N.A. (no previous requirements) 	<ul style="list-style-type: none"> • UPS: Quickly and easily determine if data in design documents meets requirements. • PUE: Quickly and easily determine if data in design documents meets requirements. • Increased Temperature Threshold for Economizers: Quickly and easily determine if data in design documents meets requirements. • Heat Recovery: Quickly and easily determine if data in design documents meets requirements. 	<ul style="list-style-type: none"> • UPS: Confirm ENER STAR-equivalent requirement is in the construction documents (specifications). • PUE: Confirm monitoring equipment is included on drawings/specs. • Increased Temperature Threshold for Economizers: Confirm containment shown on mechanical drawings/specs and economizer design temperatures. • Heat recovery: Confirm heat recovery system shown on drawings. 	<ul style="list-style-type: none"> • UPS: Automate calculation in dynamic form including inputs. • PUE: Add mandatory measure note blocks to the dynamic forms for verification. • Increased Temperature Threshold for Economizers: Indicate in dynamic forms. • Heat Recovery: Dynamic forms should clearly indicate if system includes heat recovery and its effectiveness (percent).

Appendix F: Summary of Stakeholder Engagement

Collaborating with stakeholders that might be impacted by proposed changes is a critical aspect of the Statewide CASE Team's efforts. The Statewide CASE Team aims to work with interested parties to identify and address issues associated with the proposed code changes so that the proposals presented to the Energy Commission in this CASE Report are generally supported. Public stakeholders provide valuable feedback on draft analyses and help identify and address challenges to adoption including: cost-effectiveness, market barriers, technical barriers, compliance and enforcement challenges, or potential impacts on human health or the environment. Some stakeholders also provide data that the Statewide CASE Team uses to support analyses.

This appendix summarizes the stakeholder engagement that the Statewide CASE Team conducted when developing and refining the recommendations presented in this report.

Utility-Sponsored Stakeholder Meetings

Utility-sponsored stakeholder meetings provide an opportunity to learn about the Statewide CASE Team's role in the advocacy effort and to hear about specific code change proposals that the Statewide CASE Team is pursuing for the 2022 code cycle. The goal of stakeholder meetings is to solicit input on proposals from stakeholders early enough to ensure the proposals and the supporting analyses are vetted and have as few outstanding issues as possible. To provide transparency in what the Statewide CASE Team is considering for code change proposals, during these meetings the Statewide CASE Team asks for feedback on:

- Proposed code changes
- Draft code language
- Draft assumptions and results for analyses
- Data to support assumptions
- Compliance and enforcement, and
- Technical and market feasibility

The Statewide CASE Team hosted two stakeholder meetings for computer room efficiency via webinar. Please see below for dates and links to event pages on [Title24Stakeholders.com](https://www.title24stakeholders.com). Materials from each meeting, such as slide presentations, proposal summaries with code language, and meeting notes, are included in the bibliography section of this report.

Meeting Name	Meeting Date	Event Page from Title24stakeholders.com
First Round of Nonresidential HVAC Utility-Sponsored Stakeholder Meeting	Tuesday, October 15, 2019	https://title24stakeholders.com/event/nonresidential-hvac-utility-sponsored-stakeholder-meeting/
Second Round of Nonresidential HVAC Utility-Sponsored Stakeholder Meeting	Thursday, March 12, 2020	https://title24stakeholders.com/event/nonresidential-and-single-family-hvac-part-1-data-centers-boilers-air-distribution-variable-capacity/

The first round of utility-sponsored stakeholder meetings occurred from September to November 2019 and were important for providing transparency and an early forum for stakeholders to offer feedback on measures being pursued by the Statewide CASE Team. The objectives of the first round of utility-stakeholder meetings were to solicit input on the scope of the 2022 code cycle proposals; request data and feedback on the specific approaches, assumptions, and methodologies for the energy impacts and cost-effectiveness analyses; and understand potential technical and market barriers. The Statewide CASE Team also presented initial draft code language for stakeholders to review.

The second round of utility-sponsored stakeholder meetings occurred from March to May 2020 and provided updated details on proposed code changes. The second round of meetings introduced early results of energy, cost-effectiveness, and incremental cost analyses, and solicited feedback on refined draft code language.

Utility-sponsored stakeholder meetings were open to the public. For each stakeholder meeting, two promotional emails were distributed from info@title24stakeholders.com. One email was sent to the entire Title 24 Stakeholders listserv, totaling over 1,900 individuals, and a second email was sent to a targeted list of individuals on the listserv depending on their subscription preferences. The Title 24 Stakeholders' website listserv is an opt-in service and includes individuals from a wide variety of industries and trades, including manufacturers, advocacy groups, local government, and building and energy professionals. Each meeting was posted on the Title 24 Stakeholders' LinkedIn page¹⁵ (and cross-promoted on the Energy Commission LinkedIn page) two weeks before each meeting to reach out to individuals and larger organizations and channels outside of the listserv. The Statewide CASE Team conducted extensive personal outreach to stakeholders identified in initial work plans who had not yet opted into the listserv. Exported webinar meeting data captured attendance numbers and individual comments,

¹⁵ Title 24 Stakeholders' LinkedIn page can be found here: <https://www.linkedin.com/showcase/title-24-stakeholders/>.

and recorded outcomes of live attendee polls to evaluate stakeholder participation and support.

Statewide CASE Team Communications

The Statewide CASE Team held personal communications over email and phone with numerous stakeholders when developing this report. Some of the stakeholders engaged are listed below; this list is not exhaustive of all stakeholders engaged.

- United States Environmental Protection Agency
- National Resources Defense Council
- Jacobs Engineering
- 2020 Engineering
- RagingWire Data Centers
- CyrusOne
- Mitsubishi
- Liebert/Vertiv
- Air-Conditioning, Heating, and Refrigeration Institute (AHRI)
- Office of Statewide Health Planning and Development (OSHPD)

Appendix G: New Buildings Increased Economizer Temperature Threshold Exception

This appendix describes proposed Exception 4 to 140.9(a). The following combination of computer room cooling system design features were determined to provide equivalent energy savings as the proposed increased temperature requirements for economizing in computer rooms in new buildings. This exception is intended to address concerns from stakeholders that use air-cooled chillers with dry cooler economizers to meet the existing (2019) prescriptive requirements for computer room economizers in Section 140.9(a)1B.

Key energy simulation input parameters to determine simulation case B has an equivalent energy performance to simulation case C are shown in Table 86.

Table 86: Key Energy Simulation Inputs for Economizer Performance Tradeoff Evaluation

Simulation Case	A	B	C
Modeled Parameter	Baseline: 2019 Title 24, Part 6, Section 140.9(a)1B	Proposed: 2022 Title 24, Part 6, Section 140.9(a)2	Proposed Tradeoff Exception: 2022 Title 24, Part 6, Section 140.9(a)2 Exception 2
ITE Design Load (kW)	1,000	1,000	1,000
Supply Air Temperature (°F)	60	70	60
Return Air Temperature (°F)	80	90	85
Fan Efficiency at Design Conditions (W/cfm)	0.58	0.58	0.35
Maximum Outdoor Temperature for 100% Economizing	40°F dry-bulb	50°F wet-bulb	40°F dry-bulb
Economizer Type	Dry Cooler	Evaporative Cooling Tower + Heat Exchanger	Dry Cooler
Cooling System Type	Air-cooled screw chiller	Air-cooled screw chiller	Air-cooled screw chiller
Chiller Efficiency	2019 Title 24, Table 110.2-D	2019 Title 24, Table 110.2-D	20% better than 2019 Title 24, Table 110.2-D
CEC Climate Zones	1-16	1-16	1-16

As shown in Table 87, the energy simulations show that the combination of reduced design fan power (0.35 W/cfm), increased differential between supply and return air temperature (25°F), and improved chiller efficiency (20 percent improvement) provide equivalent energy savings as the proposed increased temperature thresholds for economizers using an air-cooled chiller and evaporative cooling tower for water economizing.

The reduced design fan power value of 0.35 W/cfm can be achieved by using computer room cooling technologies such as in-row fan coils (available using chilled water or refrigerant) or direct liquid-cooled servers. The 25°F supply and return air temperature differential can be achieved through cooling coils designed for at least 25°F delta-T and comprehensive air containment features including fully enclosed hot or cold aisles, including air barriers at tops of racks and end of aisles and server racks arranged in

hot/cold aisles. A 20 percent efficiency improvement compared to Title 24 Table 110.2-D is achievable through many chiller products available on today's market. All of these improved design features can be shown on permit plans and specifications.

Table 87: Energy Simulation Results Comparison

		CZ1	CZ2	CZ3	CZ4	CZ5	CZ6	CZ7	CZ8		
Annual Energy Savings (kWh/yr)	B (Proposed)	749,996	638,644	693,181	562,523	636,877	400,052	446,479	453,290		
	C (Exception Tradeoff)	479,887	497,854	518,657	512,307	504,909	529,893	540,431	537,382		
	(C) Exception Tradeoff Savings Percent of (B) Proposed Savings	64%	78%	75%	91%	79%	132%	121%	119%		
TDV Energy Savings (kTDV/yr)	B (Proposed)	20,787,117	16,511,179	17,947,069	14,481,194	17,547,778	10,840,633	11,937,321	12,096,974		
	C (Exception Tradeoff)	13,204,122	13,918,709	14,468,919	14,411,672	13,940,433	14,587,206	15,006,153	14,846,928		
	(C) Exception Tradeoff Savings Percent of (B) Proposed Savings	64%	84%	81%	100%	79%	135%	126%	123%		
		CZ9	CZ10	CZ11	CZ12	CZ13	CZ14	CZ15	CZ16	Average	
Annual Energy Savings (kWh/yr)	B (Proposed)	580,213	532,503	593,823	574,438	521,851	656,967	585,786	642,034	92%	
	C (Exception Tradeoff)	534,911	529,889	513,197	511,513	519,148	499,949	564,327	433,294		
	(C) Exception Tradeoff Savings Percent of (B) Proposed Savings	92%	100%	86%	89%	99%	76%	96%	67%		
TDV Energy Savings (kTDV/yr)	B (Proposed)	15,116,260	13,845,614	15,154,228	14,775,837	13,333,306	16,288,636	15,351,373	16,877,674	97%	
	C (Exception Tradeoff)	14,736,762	14,630,565	14,462,774	14,282,358	14,482,117	13,969,316	15,734,170	11,813,391		
	(C) Exception Tradeoff Savings Percent of (B) Proposed Savings	97%	106%	95%	97%	109%	86%	102%	70%		

Appendix H: Heat Recovery Chiller Cost Estimate Details

This section describes the theoretical system design that was used as the basis of the cost-effectiveness analysis for using a heat recovery chiller to meet the proposed computer room heat recovery requirement.

Design Description

A typical actual office building was used to determine first cost. The building (which was constructed in 2010) has a chiller plant and boiler plant but does not have a heat recovery chiller. A heat recovery chiller was added to the drawings, including all required piping, valves, etc. Piping was sized for both the 40 ton chiller and the 150 ton chiller.

In addition to the mechanical design, a controls design was also developed.

- Controls Points List:
 - CHWS/R temps
 - HWS/R temps
 - CHW Delta-P
 - HW Delta-P
 - CHW valve output (AO)
 - HW valve output (AO)
 - Boiler bypass valve (AO)
 - Outputs to chiller (hardwired)
 - Enable
 - CHWST setpoint
 - HWST setpoint
 - Inputs from chiller (network)
 - Status
 - Alarm
 - CHW/HW temps

Controls Sequence of Operation Description

- Enable HR chiller when there is simultaneous heating and cooling. For example, if HW load > XX Btu/hr and CHW load > YY Btu/hr (if CRAHs have air economizers rather than water economizer then use CRAH fan speed and airside Delta-T to estimate additional CHW load). Disable HR chiller otherwise.
- When HR chiller is enabled:
 - Modulate the CHW and HW valves to maintain HR chiller Delta-P at 120 percent of design (since HR chiller is probably not sized for the plant design CHW or HW flow).
 - HR chiller internal controls try to achieve the CHWST and HWST setpoints.
 - If HR chiller is able to achieve CHWST setpoint at chiller inlet or HWST setpoint at boiler inlet then disable chiller/boiler and open chiller/boiler bypass. Enable chiller/boiler if HR chiller loses setpoint.

Heat Recovery Equipment Cost Summary

Heat recovery chiller data was provided by Bay Area representatives of three different heat recovery chiller vendors. Aggregated pricing, including shipping, factory start-up, and warranty is as follows:

- Nominal 40 ton chiller: \$23,500
- Nominal 150 ton chiller: \$49,400

The estimating department for a large Bay Area mechanical contractor reviewed the mechanical and controls design and provided the following first cost data for the two chiller sizes.

Table 88: Heat Recovery Chiller System Design Costs

Chiller Size (tons)	40	150
HR Chiller (including startup, shipping, etc.)	\$23,500	\$49,400
Chiller Install (labor)	\$6,500	\$6,500
CHW piping (materials)	\$2,000	\$5,000
CHW Piping (labor)	\$8,000	\$15,000
HHW Piping (materials)	\$3,000	\$5,000
HHW Piping (labor)	\$8,000	\$15,000
Startup (labor - NI factory)	\$3,200	\$3,200
Insulation	\$7,300	\$7,500
Rigging	\$1,000	\$ 1,000
Electrical	\$15,000	\$ 20,000
Controls	\$19,000	\$19,000
Total First Cost	\$114,475	\$ 164,575

The mechanical contractor also estimated annual maintenance at \$2,100 per year for both sizes.

For the proposed submeasure cost-effectiveness analysis, first costs for systems between 40 and 150 tons were linearly interpolated based on the cost data for these two sizes.

Appendix I: Air-Cooled Chiller with Evaporative Cooling Tower Water Economizer System Cost Estimate Details

This section describes the theoretical system design that was used as the basis of the cost-effectiveness analysis comparing a baseline case of using air-cooled chillers with integrated dry coolers for economizing at 2019 Title 24, Part 6 Section 140.9(a)1 temperature conditions and a proposed case of using air-cooled chillers and evaporative cooling towers to meet the proposed economizing temperature conditions.

Baseline Design Description

Rooftop air-cooled chillers, nominal 450-tons each, with integrated dry cooler coils for free cooling. Because of the 50% ethylene glycol required for the dry cooler economizer, capacity at full load and 95°F outdoor dry-bulb temperature is 397 tons. The data center is served by a single 18-inch chilled water supply and return piping from the chiller plant.

Proposed Design Description

Rooftop air-cooled chillers, nominal 450-tons each, with rooftop cooling towers and a plate and frame heat exchanger for economizing.

The data center is served by a single 18-inch chilled water supply and return piping from the chiller plant. The chilled water return from the building has a heat exchanger piped in a side stream configuration, with a two-way valve in the chilled water return line between the supply and return from the heat exchanger. When the two-way valve is closed, the heat exchanger operates in series with, and upstream of, the chillers.

Proposed System Incremental Costs

In addition to the net incremental equipment costs of the chillers, cooling towers, heat exchanger, and cooling tower pumps, the following system components are included in the proposed system incremental cost used in the cost-effectiveness analysis.

First Costs

1. Roof curbs and piping fit out for the following pumps, cooling towers, and heat exchanger
 - a. Three-cell evaporative cooling tower (3,125 tons, 7,500 gpm)
 - b. one plate and frame heat exchanger for waterside economizing
 - c. two 60 hp condenser water (cooling tower) pumps
 - d. Note: does not include rigging costs

2. 40 feet of chilled water supply and 40 feet of chilled water return piping and supports from chilled water return to heat exchanger (18-inch, steel, insulated pipe)
3. 40 feet of condenser water supply and 40 feet of condenser water return piping and supports from tower to heat exchanger (18-inch, galvanized, uninsulated pipe)
4. 200 feet of 3-inch makeup water from ground level to roof (copper or PVC)
5. 50 feet of drain piping
6. Condenser water treatment system
7. Variable frequency drives for cooling tower cells and condenser water pumps
8. Controls for cooling towers, pumps, and heat exchanger, including:
 - a. 18-inch heat exchanger diverting valve
 - b. 18-inch chiller bypass valve
 - c. Three cooling tower inlet control valves (no control valves at cooling tower outlets)
 - d. Temperature sensors
 - e. Makeup water and drain flow meters. No condenser water or chilled water flow meters

Annual Maintenance Costs

1. Water treatment
2. Cooling towers, condenser water pumps, and heat exchanger

Appendix J: Air Containment Cost-Effectiveness Analysis

The increased temperature threshold for economizers submeasure consists of two components: increasing the outdoor temperature threshold where full economizing is required for computer rooms in new buildings and reducing the computer room size threshold for where air containment is required. The energy savings and cost-effectiveness results presented previously in the body of this report assume both components are implemented.

A cost-effectiveness analysis was performed for reducing the computer room size threshold to 10 kW of design ITE load, without including increased economizer hours due to elevated computer room supply and return air temperatures. This analysis shows the fan energy savings by itself due to an increased supply and return air temperature differential enabled by air containment is sufficient for the air containment component of the increased temperature threshold for economizers submeasure to be cost effective in all California climate zones.

Key Assumptions of Energy Analysis

Table 89 shows the energy analysis inputs. The energy analysis was performed using an annual hourly spreadsheet model.

Table 89: Energy Analysis Assumptions: Air Containment

Input Parameter	Baseline	Proposed	Notes
IT Equipment Load (kW)	10	10	Minimum load proposed by submeasure.
IT Equipment Load Schedule	DataReceptacle	DataReceptacle	Matches ACM. Load cycles each month among 25%, 50%, 75%, and 100% load factor.
Supply Air Dry-bulb Temperature (°F)	60	70	Baseline: ACM. Proposed: Proposed code change.
Return Air Dry-bulb Temperature (°F)	75	90	Baseline: Assumed value for non-contained computer room. Proposed: Proposed code change.
Supply and Return Air Dry-bulb Temperature Differential (°F)	15	20	= (Return air temperature – supply air temperature)
Supply Fan Efficiency (W/cfm)	0.58	0.58	140.9(a)4: 27 W/kBtu/hr and 20F delta-T
Supply Fan Speed Control	Variable-flow, VSD	Variable-flow, VSD	Table 10, ACM page 5-124.
Minimum Airflow	50 percent	50 percent	Table 10, ACM page 5-124.
Cooling System Type	N/A	N/A	Not included in analysis.
Economizer Type	N/A	N/A	Not included in analysis.
Minimum Ventilation Rate to Space (cfm/sf)	0	0	Removed for simplicity. Does not affect submeasure savings.
Energy Commission Climate Zones	All	All	N/A

Per-Unit Energy Impact Results

Table 90 shows the energy savings for all climate zones on a “per IT equipment load kW” basis.

Table 90: First-Year Energy Impacts Per IT Equipment Load kW – Air Containment

Climate Zone	Electricity Savings (kWh/yr)	Peak Electricity Demand Reduction (kW)	Natural Gas Savings (therms/yr)	TDV Energy Savings (TDV kBtu/yr)
1	185	0.0	0	5,164
2	185	0.0	0	5,075
3	185	0.0	0	5,119
4	185	0.0	0	5,169
5	185	0.0	0	5,109
6	185	0.0	0	5,049
7	185	0.0	0	5,102
8	185	0.0	0	5,102
9	185	0.0	0	5,044
10	185	0.0	0	5,066
11	185	0.0	0	5,132
12	185	0.0	0	5,093
13	185	0.0	0	5,068
14	185	0.0	0	5,109
15	185	0.0	0	5,067
16	185	0.0	0	5,147

Incremental Cost

This analysis assumes the same air containment costs as the increased temperature threshold for economizers, Case 1: DX CRAC with Air Economizer Case, repeated below:

- Server rack with solid rear door versus server rack with perforated rear door
- Return air chimney ducted from each server rack to a return air plenum
- Combined costs of the above two items ranged from about \$500 per rack to \$2,200 per rack, with the average cost being \$1,400 per rack
- Labor time to install the return air chimney: assumed two hours per server rack at a rate of \$175 per hour

Costs were calculated on a “per kW of IT equipment load” basis by taking the total cost per rack and dividing by an assumed 5 kW per rack.

Costs are anticipated to be the same for new construction and additions/alterations.

No incremental maintenance/replacement costs were included.

Table 91: Incremental First Cost Assumptions: Air Containment

Cost Item	Incremental First Cost (\$ per ITE design load kW)	Cost Source
Return air rack chimneys with ducted return air	\$280	Cost data from 2 projects in California and input from 2 vendors.
Labor	\$70	Estimate based on Bay Area mechanical contractor rate.
Controls	\$0	No additional controls hardware or programming beyond 2019 Title 24, Part 6.
Commissioning	\$0	No additional commissioning labor beyond 2019 Title 24, Part 6.
Total	\$350	

Cost Effectiveness-Results

Table 92 shows the 15-year benefit-to-cost ratio for air containment. As shown in the table, reducing the ITE design load threshold to 10 kW for requiring air containment is cost effective in all climate zones.

Table 92: 15-Year Cost-Effectiveness Summary Per IT Equipment Load kW – Air Containment

Climate Zone	Benefits TDV Energy Cost Savings + Other PV Savings^a (2023 PV\$)	Costs Total Incremental PV Costs^b (2023 PV\$)	Benefit-to- Cost Ratio
1	\$460	\$350	1.3
2	\$452	\$350	1.3
3	\$456	\$350	1.3
4	\$460	\$350	1.3
5	\$455	\$350	1.3
6	\$449	\$350	1.3
7	\$454	\$350	1.3
8	\$454	\$350	1.3
9	\$449	\$350	1.3
10	\$451	\$350	1.3
11	\$457	\$350	1.3
12	\$453	\$350	1.3
13	\$451	\$350	1.3
14	\$455	\$350	1.3
15	\$451	\$350	1.3
16	\$458	\$350	1.3

Appendix K: Nominal TDV Results Tables

In Section 5, the energy cost savings of the proposed code changes over the 15- and 30-year period of analysis are presented in 2023 present value dollars.

This appendix presents energy cost savings in nominal dollars. Energy costs are escalating as in the TDV analysis but the time value of money is not included so the results are not discounted.

Table 93: Nominal TDV Energy Cost Savings Over 15-Year Period of Analysis – Per IT Equipment Load kW – New Construction, Increased Temperature Threshold for Economizers Submeasure (DX CRAC Air Economizing Case)

Climate Zone	15-Year TDV Electricity Cost Savings (Nominal \$)	15-Year TDV Natural Gas Cost Savings (Nominal \$)	Total 15-Year TDV Energy Cost Savings (Nominal \$)
1	\$1,098	\$0	\$1,098
2	\$1,478	\$0	\$1,478
3	\$2,266	\$0	\$2,266
4	\$1,941	\$0	\$1,941
5	\$1,783	\$0	\$1,783
6	\$2,779	\$0	\$2,779
7	\$3,380	\$0	\$3,380
8	\$2,518	\$0	\$2,518
9	\$2,112	\$0	\$2,112
10	\$1,875	\$0	\$1,875
11	\$1,497	\$0	\$1,497
12	\$1,581	\$0	\$1,581
13	\$1,425	\$0	\$1,425
14	\$1,329	\$0	\$1,329
15	\$1,496	\$0	\$1,496
16	\$1,458	\$0	\$1,458
TOTAL	\$30,018	\$0	\$30,018

Table 94: Nominal TDV Energy Cost Savings Over 15-Year Period of Analysis – Per IT Equipment Load kW – New Construction, Increased Temperature Threshold for Economizers Submeasure (Chilled Water CRAH Air Economizing Case)

Climate Zone	15-Year TDV Electricity Cost Savings (Nominal \$)	15-Year TDV Natural Gas Cost Savings (Nominal \$)	Total 15-Year TDV Energy Cost Savings (Nominal \$)
1	\$565	\$0	\$565
2	\$626	\$0	\$626
3	\$1,163	\$0	\$1,163
4	\$953	\$0	\$953
5	\$924	\$0	\$924
6	\$1,217	\$0	\$1,217
7	\$1,488	\$0	\$1,488
8	\$1,189	\$0	\$1,189
9	\$1,030	\$0	\$1,030
10	\$885	\$0	\$885
11	\$593	\$0	\$593
12	\$711	\$0	\$711
13	\$582	\$0	\$582
14	\$549	\$0	\$549
15	\$653	\$0	\$653
16	\$522	\$0	\$522
TOTAL	\$13,650	\$0	\$13,650

Table 95: Nominal TDV Energy Cost Savings Over 15-Year Period of Analysis – Per IT Equipment Load kW – New Construction, Increased Temperature Threshold for Economizers Submeasure (Water Economizing with Evaporative Cooling Tower Case)

Climate Zone	15-Year TDV Electricity Cost Savings (Nominal \$)	15-Year TDV Natural Gas Cost Savings (Nominal \$)	Total 15-Year TDV Energy Cost Savings (Nominal \$)
1	\$2,715	\$0	\$2,715
2	\$1,932	\$0	\$1,932
3	\$1,737	\$0	\$1,737
4	\$1,588	\$0	\$1,588
5	\$1,792	\$0	\$1,792
6	\$1,000	\$0	\$1,000
7	\$890	\$0	\$890
8	\$1,074	\$0	\$1,074
9	\$1,438	\$0	\$1,438
10	\$1,367	\$0	\$1,367
11	\$1,777	\$0	\$1,777
12	\$1,687	\$0	\$1,687
13	\$1,561	\$0	\$1,561
14	\$1,722	\$0	\$1,722
15	\$1,393	\$0	\$1,393
16	\$1,831	\$0	\$1,831
TOTAL	\$25,505	\$0	\$25,505

Table 96: Nominal TDV Energy Cost Savings Over 15-Year Period of Analysis – Per IT Equipment Load kW – New Construction, Increased Temperature Threshold for Economizers Submeasure (Dry Cooler vs. Evaporative Cooling Tower Case)

Climate Zone	15-Year TDV Electricity Cost Savings (Nominal \$)	15-Year TDV Natural Gas Cost Savings (Nominal \$)	Total 15-Year TDV Energy Cost Savings (Nominal \$)
1	\$2,154	\$0	\$2,154
2	\$1,915	\$0	\$1,915
3	\$1,796	\$0	\$1,796
4	\$1,691	\$0	\$1,691
5	\$1,806	\$0	\$1,806
6	\$1,318	\$0	\$1,318
7	\$1,403	\$0	\$1,403
8	\$1,443	\$0	\$1,443
9	\$1,738	\$0	\$1,738
10	\$1,673	\$0	\$1,673
11	\$1,942	\$0	\$1,942
12	\$1,792	\$0	\$1,792
13	\$1,708	\$0	\$1,708
14	\$2,182	\$0	\$2,182
15	\$2,011	\$0	\$2,011
16	\$2,321	\$0	\$2,321
TOTAL	\$28,894	\$0	\$28,894

Table 97: Nominal TDV Energy Cost Savings Over 15-Year Period of Analysis – Per IT Equipment Load kW – New Construction, Computer Room Heat Recovery Submeasure

Climate Zone	15-Year TDV Electricity Cost Savings (Nominal \$)	15-Year TDV Natural Gas Cost Savings (Nominal \$)	Total 15-Year TDV Energy Cost Savings (Nominal \$)
1	\$0	\$636	\$636
2	\$0	\$528	\$528
3	\$0	\$528	\$528
4	\$0	\$438	\$438
5	\$0	\$438	\$438
6	\$0	\$636	\$636
7	\$0	\$636	\$636
8	\$0	\$636	\$636
9	\$0	\$636	\$636
10	\$0	\$636	\$636
11	\$0	\$483	\$483
12	\$0	\$483	\$483
13	\$0	\$483	\$483
14	\$0	\$438	\$438
15	\$0	\$636	\$636
16	\$0	\$636	\$636
TOTAL	\$0	\$8,907	\$8,907

Table 98: Nominal TDV Energy Cost Savings Over 15-Year Period of Analysis – Per IT Equipment Load kW – New Construction, UPS Efficiency Submeasure (Average Savings for both Simulation Cases)

Climate Zone	15-Year TDV Electricity Cost Savings (Nominal \$)	15-Year TDV Natural Gas Cost Savings (Nominal \$)	Total 15-Year TDV Energy Cost Savings (Nominal \$)
1	\$186	\$0	\$186
2	\$188	\$0	\$188
3	\$202	\$0	\$202
4	\$198	\$0	\$198
5	\$197	\$0	\$197
6	\$208	\$0	\$208
7	\$214	\$0	\$214
8	\$209	\$0	\$209
9	\$205	\$0	\$205
10	\$201	\$0	\$201
11	\$184	\$0	\$184
12	\$186	\$0	\$186
13	\$185	\$0	\$185
14	\$183	\$0	\$183
15	\$192	\$0	\$192
16	\$188	\$0	\$188
TOTAL	\$3,127	\$0	\$3,127

Table 99: Nominal TDV Energy Cost Savings Over 15-Year Period of Analysis – Per IT Equipment Load kW – New Construction, PUE Monitoring Submeasure

Climate Zone	15-Year TDV Electricity Cost Savings (Nominal \$)	15-Year TDV Natural Gas Cost Savings (Nominal \$)	Total 15-Year TDV Energy Cost Savings (Nominal \$)
1	\$27	\$0	\$27
2	\$32	\$0	\$32
3	\$31	\$0	\$31
4	\$31	\$0	\$31
5	\$30	\$0	\$30
6	\$38	\$0	\$38
7	\$37	\$0	\$37
8	\$38	\$0	\$38
9	\$37	\$0	\$37
10	\$38	\$0	\$38
11	\$37	\$0	\$37
12	\$35	\$0	\$35
13	\$38	\$0	\$38
14	\$37	\$0	\$37
15	\$43	\$0	\$43
16	\$32	\$0	\$32
TOTAL	\$562	\$0	\$562