

DOCKETED

Docket Number:	21-BSTD-01
Project Title:	2022 Energy Code Update Rulemaking
TN #:	237692
Document Title:	All-Electric Multifamily CASE Report
Description:	Document Relied Upon. CASE Report #2022-MF-AEP-F. Authors: Abhijeet Pande, Jingjuan (Dove) Feng, Julianna Yun Wei, and Mia Nakajima. April 2021.
Filer:	Adrian Ownby
Organization:	California Energy Commission
Submitter Role:	Energy Commission
Submission Date:	5/6/2021 9:23:26 AM
Docketed Date:	5/6/2021

All-Electric Multifamily Compliance Pathway



2022-MF-AEP-F | Multifamily | April 2021

FINAL CASE REPORT (Updated)

Prepared by TRC

Please submit comments to info@title24stakeholders.com.



This report was prepared by the California Statewide Codes and Standards Enhancement (CASE) Program that is funded, in part, by California utility customers under the auspices of the California Public Utilities Commission.

Copyright 2020 Pacific Gas and Electric Company, Southern California Edison, San Diego Gas & Electric Company, Los Angeles Department of Water and Power, and Sacramento Municipal Utility District. All rights reserved, except that this document may be used, copied, and distributed without modification.

Neither Pacific Gas and Electric Company, Southern California Edison, San Diego Gas & Electric Company, Los Angeles Department of Water and Power, Sacramento Municipal Utility District or any of its employees makes any warranty, express or implied; or assumes any legal liability or responsibility for the accuracy, completeness or usefulness of any data, information, method, product, policy or process disclosed in this document; or represents that its use will not infringe any privately-owned rights including, but not limited to, patents, trademarks or copyrights.



Document Information

Category:	Codes and Standards
Keywords:	Statewide Codes and Standards Enhancement (CASE) Initiative; California Statewide Utility Codes and Standards Team; Codes and Standards Enhancements; 2022 California Energy Code; 2022 Title 24, Part 6; efficiency; air conditioner; water heater.
Authors:	Abhijeet Pande, Jingjuan (Dove) Feng, Julianna Yun Wei, Mia Nakajima (TRC)
Project Management:	California Statewide Utility Codes and Standards Team: Pacific Gas and Electric Company, Southern California Edison, San Diego Gas & Electric Company, Sacramento Municipal Utility District, and Los Angeles Department of Water and Power.

1 Table of Contents

1 Introduction	28
2 Measure Description	31
2.1 Measure Overview	31
2.2 Measure History	34
2.3 Summary of Proposed Changes to Code Documents	40
2.4 Regulatory Context	45
2.5 Compliance and Enforcement	50
3 Market Analysis	53
3.1 Electric HVAC Systems	55
3.2 Electric DHW Systems	71
3.3 Electric Appliances and Miscellaneous Load	98
3.4 Energy Efficiency Measures	99
4 Energy Savings	100
4.1 Key Assumptions for Energy Savings Analysis	100
4.2 Energy Savings Methodology	100
4.3 Per-Unit Energy Impacts Results	113
5 Cost and Cost Effectiveness	122
5.1 Energy Cost Savings Methodology	122
5.2 Energy Cost Savings Results	122
5.3 Incremental First Cost	133
5.4 Incremental Maintenance and Replacement Costs	143
5.5 Cost Effectiveness	144
6 First-Year Statewide Impacts	157
6.1 Statewide Energy and Energy Cost Savings	157
6.2 Statewide Greenhouse Gas (GHG) Emissions Reductions	159
6.3 Statewide Water Use Impacts	160
6.4 Statewide Material Impacts	160
6.5 Other Non-Energy Impacts	164
7 Proposed Revisions to Code Language	166
7.1 Guide to Markup Language	166
7.2 Standards	166
7.3 Reference Appendices	170
7.4 ACM Reference Manual	173
7.5 Compliance Manuals	185
7.6 Compliance Documents	188

List of Tables

Table 1: Scope of Code Change Proposal	20
Table 2: First-Year Statewide Energy and Impacts – New Construction	26
Table 3: First-Year Statewide GHG Emissions Impacts	26
Table 4: Background Analysis done in 2018 Showing Heat Pump Heating and Total TDV Penalties Compared to 2019 Title 24, Part 6 Gas Baseline TDV using 2019 TDV values.....	36
Table 5: Federal Minimum Efficiency Requirements for Residential Water Heaters (Partial).....	47
Table 6: Federal Minimum Efficiency Requirements for HVAC Systems	48
Table 7: California Construction Industry, Establishments, Employment, and Payroll ..	64
Table 8: Size of the California Residential Building Industry by Subsector	64
Table 9: California Building Designer and Energy Consultant Sectors.....	65
Table 10: California Housing Characteristics	66
Table 11: Distribution of California Housing by Vintage	67
Table 12: Owner- and Renter-Occupied Housing Units in California by Income	68
Table 13: Employment in California State and Government Agencies with Building Inspectors.....	69
Table 14: Net Domestic Private Investment and Corporate Profits, U.S.	70
Table 15: Examples of Multifamily Properties with Operational Central HPWH Systems	76
Table 16: Environmental Impacts Potential by Refrigerant Type.....	81
Table 17: Comparison of Single-Pass and Multi-Pass HPWH	85
Table 18: Estimated Impact that Adoption of the Proposed Measure would have on the California Residential Construction Sector	98
Table 19: Prototype Buildings Used for Energy, Demand, Cost, and Environmental Impacts Analysis	101
Table 20: HVAC Modifications Made to Standard Design in Each Prototype to Simulate Proposed Code Change.....	103
Table 21: Modifications Made to Standard Design in Each Prototype to Simulate Measure Package for Climate Zone 16	104

Table 22. Percentage of Dwelling Units with Each Window Type	104
Table 23: Basis of Design for Baseline Mixed-Fuel HVAC System in Dwelling Units..	105
Table 24: Basis of Design for Ducted Split Heat Pump System in Dwelling Units	106
Table 25: Basis of Design for Ductless Mini-Split Heat Pump System in Dwelling Units	107
Table 26: VRF System Design	108
Table 27: Modifications Made to Standard Design in Each Prototype to Simulate Proposed Code Change.....	110
Table 28: Multifamily Building Types and Associated Prototype Weighting	111
Table 29: New Construction Impacts by Fuel Type for Electric HVAC Measure	112
Table 30: New Construction Impacts by Fuel Type for Central HPWH Measure	112
Table 31: First-Year Energy Impacts Per Dwelling Unit – 2-Story Garden Style – SZHP with efficiency measures	114
Table 32: First-Year Energy Impacts Per Dwelling Unit – 3-Story Loaded Corridor – SZHP with efficiency measures.....	114
Table 33: First-Year Energy Impacts Per Dwelling Unit – 5-Story Mixed-Use Building – SZHP (CZ16 only with added efficiency measures and gas supplemental heat) ..	115
Table 34: First-Year Energy Impacts Per Dwelling Unit – 5-Story Mixed-Use Building – CZ16 SZHP with efficiency measures by Window Type.....	116
Table 35: First-Year Energy Impacts Per Dwelling Unit – 10-Story Mixed-Use Building – SZHP (CZ16 only with efficiency measures and gas supplemental heat)	116
Table 36: First-Year Energy Impacts Per Dwelling Unit – 5-Story Mixed-Use Building – CZ16 SZHP with efficiency measures by Window Type.....	116
Table 37: First-Year Energy Impacts Per Dwelling Unit – 5-Story Mixed-Use Building – Mini-Split	117
Table 38: First-Year Energy Impacts Per Dwelling Unit – 10-Story Mixed-Use Building – Mini-Split	117
Table 39: First-Year Energy Impacts Per Dwelling Unit – 5-Story Mixed-Use Building – VRF System	118
Table 40: First-Year Energy Impacts Per Dwelling Unit – 10-Story Mixed-Use Building – VRF	119
Table 41: First-Year Energy Impacts Per Dwelling Unit– 2-Story Garden Style Prototype Building	120

Table 42: First-Year Energy Impacts Per Dwelling Unit– 3-Story Loaded Corridor Prototype Building	120
Table 43: First-Year Energy Impacts Per Dwelling Unit– 5-Story Mixed Use Prototype Building	121
Table 44: First-Year Energy Impacts Per Dwelling Unit– 10-Story Mixed Use Prototype Building	121
Table 45: 2023 TDV Energy Cost Savings Over 30-Year Period of Analysis – Per Dwelling Unit – 2-Story Garden Style New Construction – SZHP with efficiency measures	123
Table 46: 2023 TDV Energy Cost Savings Over 30-Year Period of Analysis – Per Dwelling Unit – 3-Story Loaded Corridor New Construction – SZHP with efficiency measures	124
Table 47: 2023 TDV Energy Cost Savings Over 30-Year Period of Analysis – Per Dwelling Unit – 5-Story Mixed-Use New Construction – SZHP (CZ16 only with efficiency measures and gas supplemental heat)	125
Table 48: 2023 TDV Energy Cost Savings Over 30-Year Period of Analysis – Per Dwelling Unit – 10-Story Mixed-Use New Construction – SZHP (CZ16 with efficiency measures)	126
Table 49: 2023 TDV Energy Cost Savings Over 30-Year Period of Analysis – Per Dwelling Unit – 5-Story Mixed-Use New Construction – Mini-Split.....	127
Table 50: 2023 TDV Energy Cost Savings Over 30-Year Period of Analysis – Per Dwelling Unit – 10-Story Mixed-Use New Construction – Mini-Split.....	128
Table 51: 2023 TDV Energy Cost Savings Over 30-Year Period of Analysis – Per Dwelling Unit – 5-Story Mixed-Use New Construction – VRF System.....	129
Table 52: 2023 TDV Energy Cost Savings Over 30-Year Period of Analysis – Per Dwelling Unit – 10-Story Mixed-Use New Construction – VRF System.....	130
Table 53: 2023 PV TDV Energy Cost Savings Over 30-Year Period of Analysis – Per Dwelling Unit– New Construction – Low-Rise Garden	131
Table 54: 2023 PV TDV Energy Cost Savings Over 30-Year Period of Analysis – Per Dwelling Unit– New Construction – Low-Rise Loaded Corridor	131
Table 55: 2023 PV TDV Energy Cost Savings Over 30-Year Period of Analysis – Per Dwelling Unit– New Construction – 5-Story Mixed-Use.....	132
Table 56: 2023 PV TDV Energy Cost Savings Over 30-Year Period of Analysis – Per Dwelling Unit– New Construction – 10-Story Mixed-Use.....	133

Table 57: Average Per Dwelling Unit Costs for HVAC Systems: SZHP Compared to Gas-Fired Furnace + Split DX – 2- and 3-Story Prototypes.....	136
Table 58: Average Per Dwelling Unit Costs for HVAC Systems: SZHP Compared to Gas-Fired Furnace + Split DX – 5- and 10-Story Prototypes.....	136
Table 59: Average Per Dwelling Unit Incremental Costs for HVAC Systems: SZHP + Furnace Compared to Gas-Fired Furnace + Split DX – Climate Zone 16	137
Table 60: Average Per Dwelling Unit Costs for HVAC Systems: Ductless Mini-Split Heat Pump Compared to Gas-Fired Furnace + Split DX	138
Table 61: Average Per Dwelling Unit Costs for HVAC Systems: VRF Compared to Gas-Fired Furnace + Split DX	138
Table 62: Installed Cost for Baseline and Proposed Central DWH Designs for Each Prototype.....	139
Table 63: Installed Cost for Solar Thermal System	140
Table 64: Installed Cost Breakdown for Baseline and Proposed Central DWH Designs for Low-Rise Garden Style and Low-Rise Loaded Corridor.....	140
Table 65: Installed Cost Breakdown for Baseline and Proposed Central DWH Designs for 5-Story Mixed-Use and 10-Story Mixed-Use	140
Table 66. Fenestration Costs	142
Table 67: Cost of Base Case: Discrete Supply In-line Fan.....	142
Table 68: Cost of Proposed Case: ERV	143
Table 69: Replacement and Maintenance Nominal Cost for Baseline and Proposed Single-Pass Central DWH Designs for Each Prototype.....	144
Table 70: 30-Year Cost-Effectiveness Summary Per Dwelling Unit – 2-Story Garden New Construction – SZHP with efficiency measures.....	146
Table 71: 30-Year Cost-Effectiveness Summary Per Dwelling Unit – 3-Story Loaded Corridor New Construction – SZHP with efficiency measures.....	147
Table 72: 30-Year Cost-Effectiveness Summary Per Dwelling Unit – 5-Story Mixed-Use New Construction – SZHP (Climate Zone 16 with efficiency measures)	148
Table 73: 30-Year Cost-Effectiveness Summary Per Dwelling Unit – 10-Story Mixed-Use New Construction – SZHP (Climate Zone 16 with efficiency measures).....	149
Table 74: 30-Year Cost-Effectiveness Summary Per Dwelling Unit – SZHP – Midrise and Highrise Combined for Climate Zone 16	150
Table 75: 30-Year Cost-Effectiveness Summary Per Dwelling Unit – 5-Story Mixed-Use New Construction – Mini-Split	151

Table 76: 30-Year Cost-Effectiveness Summary Per Dwelling Unit – 10-Story Mixed-Use New Construction – Mini-Split	152
Table 77: 30-Year Cost-Effectiveness Summary Per Dwelling Unit – 5-Story Mixed-Use New Construction – VRF	153
Table 78: 30-Year Cost-Effectiveness Summary Per Dwelling Unit – 10-Story Mixed-Use New Construction – VRF	154
Table 79: 30-Year Cost-Effectiveness Summary Per Dwelling Unit – Central HPWH – 5-Story Mixed-Use New Construction.....	155
Table 80: 30-Year Cost-Effectiveness Summary Per Dwelling Unit – Central HPWH – 10-Story Mixed-Use New Construction	156
Table 81: Statewide Energy and Energy Cost Impacts – SZHP – New Construction ^a	158
Table 82: Statewide Energy and Energy Cost Impacts – Central HPWH – New Construction ^a	159
Table 83: First-Year Statewide GHG Emissions Impacts	160
Table 84: First-Year Statewide Impacts on Material Use - SZHP.....	161
Table 85: Materials in Thermal Collectors by Area.....	162
Table 86: Baseline Model Materials by Prototype	162
Table 87: Central Heat Pump Water Heater Materials by Prototype	163
Table 88: First-Year Statewide Impacts on Material Use - CHPWH.....	164
Table 89: Standard Design Heating System	183
Table 90: Multifamily Building Types and Associated Prototype Weighting	197
Table 91. New Construction HVAC Fuel Type	198
Table 92: Estimated New Construction and Existing Building Stock for Multifamily Buildings by Climate Zone Impacted by SZHP Measure.....	198
Table 93: Classification of Project Data into CASE Prototypes by Number of Stories	199
Table 94: Central versus Individual Water Heating by Prototype	199
Table 95. New Construction Impacts by Fuel Type for Central HPWH Measure	200
Table 96: Estimated New Construction and Existing Building Stock for Multifamily Buildings by Climate Zone Impacted by Central HPWH Measure	200
Table 97: Roles of Market Actors in the Proposed Compliance Process	208
Table 98: Stakeholder Meetings Hosted for Multifamily All-Electric CASE Topic	211
Table 99: Stakeholder List.....	212

Table 100: Statewide CASE Team Internal Subject Matter Experts.....	213
Table 101: Capacity Requirements for Fossil Gas Boiler System	216
Table 102: Solar Thermal Energy Offset for San Francisco	217
Table 103: Solar Thermal Energy Offset for Sacramento.....	217
Table 104: Gas Boiler.....	218
Table 105: Primary Hot Water Storage Tank	218
Table 106: Solar Thermal Pre-Heat Water Storage Tank.....	218
Table 107: Additional Appurtenances.....	219
Table 108: Capacity Requirements for Single-Pass Heat Pump System	221
Table 109: Primary Heat Pump	222
Table 110: Primary Hot Water Storage Tank	222
Table 111: Primary Electric Resistance Back-Up.....	222
Table 112: Temperature Maintenance Heat Pump	222
Table 113: Temperature Maintenance Electric Resistance Back-Up	223
Table 114: Additional Appurtenances.....	223
Table 115: Capacity Requirements for Multi-Pass Heat Pump System.....	225
Table 116: Primary Heat Pump	226
Table 117: Primary Hot Water Storage Tank	226
Table 118: Primary Electric Resistance Back-Up.....	226
Table 119: Temperature Maintenance Heat Pump	227
Table 120: Temperature Maintenance Electric Resistance Back-Up	227
Table 121: Additional Appurtenances.....	227
Table 122: High-rise Multifamily Electric HVAC Compliance Penalty in Climate Zone 12	253
Table 123: Heating and Total TDV Penalties Compared To The Gas Baseline TDV For Mid And High-Rise Multifamily For The Five Climate Zones And Three Efficiency Options Analyzed	255
Table 124: Heat Pump Clothes Dryer Product Availability	256
Table 125: Combined Energy Factors for Heat Pump Dryers Compared to Federal Standards.....	257

Table 126: Nominal TDV Cost Savings Over 30-Year Period of Analysis – Per Dwelling Unit – 2-Story Garden Style New Construction – SZHP with efficiency measures	261
Table 127: Nominal TDV Cost Savings Over 30-Year Period of Analysis – Per Dwelling Unit – 3-Story Loaded Corridor New Construction – SZHP with efficiency measures	262
Table 128: Nominal TDV Cost Savings Over 30-Year Period of Analysis – Per Dwelling Unit – 5-Story Mixed-Use New Construction – SZHP (CZ16 with efficiency measures)	263
Table 129: Nominal TDV Cost Savings Over 30-Year Period of Analysis – Per Dwelling Unit – 10-Story Mixed-Use New Construction – SZHP (CZ16 with efficiency measures)	264
Table 130: Nominal TDV Cost Savings Over 30-Year Period of Analysis – Per Dwelling Unit – 5-Story Mixed-Use New Construction – Mini-split	265
Table 131: Nominal TDV Cost Savings Over 30-Year Period of Analysis – Per Dwelling Unit – 10-Story Mixed-Use New Construction – Mini-split	265
Table 132: Nominal TDV Cost Savings Over 30-Year Period of Analysis – Per Dwelling Unit – 5-Story Mixed-Use New Construction – VRF System	266
Table 133: Nominal TDV Cost Savings Over 30-Year Period of Analysis – Per Dwelling Unit – 10-Story Mixed-Use New Construction – VRF System	267
Table 134: Nominal TDV Energy Cost Savings Over 30-Year Period of Analysis – Per Dwelling Unit– New Construction – 2-Story Garden	268
Table 135: Nominal TDV Energy Cost Savings Over 30-Year Period of Analysis – Per Dwelling Unit– New Construction – 3-Story Loaded Corridor	268
Table 136: Nominal TDV Energy Cost Savings Over 30-Year Period of Analysis – Per Dwelling Unit– New Construction – 5-Story Mixed-Use	269
Table 137: Nominal TDV Energy Cost Savings Over 30-Year Period of Analysis – Per Dwelling Unit– New Construction – 10-Story Mixed-Use	269
Table 138: Nominal TDV Energy Cost Savings Over 30-Year Period of Analysis – Per Dwelling Unit – 5-Story Mixed-Use New Construction – SZHP & Mini-Split + CHPWH	270
Table 139: Nominal TDV Energy Cost Savings Over 30-Year Period of Analysis – Per Dwelling Unit – 10-Story Mixed-Use New Construction – SZHP & Mini-Split + CHPWH	271
Table 140: Nominal TDV Energy Cost Savings Over 30-Year Period of Analysis – Per Dwelling Unit – 5-Story Mixed-Use New Construction – VRF + CHPWH	272

Table 141: Nominal TDV Energy Cost Savings Over 30-Year Period of Analysis – Per Dwelling Unit – 10-Story Mixed-Use New Construction – VRF + CHPWH	272
Table 142: First-Year Energy Impacts Per Dwelling Unit– 5-Story Mixed Use Prototype Building – SZHP/Mini-Split + Central HPWH Combined	274
Table 143: First-Year Energy Impacts Per Dwelling Unit– 10-Story Mixed Use Prototype Building - SZHP/Mini-Split + Central HPWH Combined	275
Table 144: First-Year Energy Impacts Per Dwelling Unit– 5-Story Mixed Use Prototype Building – VRF + Central HPWH Combined.....	276
Table 145: First-Year Energy Impacts Per Dwelling Unit– 10-Story Mixed Use Prototype Building - VRF + Central HPWH Combined	276
Table 146: 2023 TDV Energy Cost Savings Over 30-Year Period of Analysis – Per Dwelling Unit – 5-Story Mixed-Use New Construction – SZHP & Mini-Split + CHPWH.....	278
Table 147: 2023 TDV Energy Cost Savings Over 30-Year Period of Analysis – Per Dwelling Unit – 10-Story Mixed-Use New Construction – SZHP & Mini-Split + CHPWH.....	279
Table 148: 2023 TDV Energy Cost Savings Over 30-Year Period of Analysis – Per Dwelling Unit – 5-Story Mixed-Use New Construction – VRF + CHPWH	279
Table 149: 2023 TDV Energy Cost Savings Over 30-Year Period of Analysis – Per Dwelling Unit – 10-Story Mixed-Use New Construction – VRF + CHPWH	280
Table 150: 30-Year Cost-Effectiveness Summary Per Dwelling Unit – 5-Story Mixed-Use New Construction – SZHP + Central HPWH.....	281
Table 151: 30-Year Cost-Effectiveness Summary Per Dwelling Unit – 10-Story Mixed-Use New Construction – SZHP + Central HPWH.....	282
Table 152: Statewide Energy and Energy Cost Impacts – Package A: Combined SZHP + Central HPWH – New Construction ^a	283
Table 153: First-Year Statewide GHG Emissions Impacts	283
Table 154: PG&E ATS Laboratory Air Handler Evaluation Results.....	285
Table 155: CVRH Reference HP Air Handler Fan Efficacy	286

List of Figures

Figure 1: Electric HVAC system type by number of stories.	22
Figure 2: DHW distribution types of heat pump water heater systems.	23
Figure 3: Heat pump water heater configuration types and capacity range.....	24

Figure 4: Central HPWH design schematic that complies with 2019 Title 24, Part 6 by executive director.	46
Figure 5: (Left) Histogram of system types by conditioned floor area; (Right) Histogram of system types by number of stories.	54
Figure 6: Electric HVAC system type by number of stories.	57
Figure 7: SEER of heat pump systems by Title 24, Part 6 code cycle.	58
Figure 8: HSPF of electric heating systems by Title 24, Part 6 code cycle.	59
Figure 9: Fan Efficacy of Exhaust Fans and In-line Fans from Home Ventilating Institute Database (Source: Home Ventilating Institute Database)	62
Figure 10: DHW distribution types of heat pump water heater systems.	79
Figure 11: Schematic depiction of single-pass HPWH system.	83
Figure 12: Schematic depiction of multi-pass HPWH system.	84
Figure 13: Heat pump water heater configuration types and capacity range.	88
Figure 14: Air source HPWH with current near-term availability in California, by capacity.	91
Figure 15: Available air source HPWH models (n=41, two NA's).	92
Figure 16: Available air source HPWH: refrigerant type.	93
Figure 17: Available air source HPWH: COP.	94
Figure 18: Operating OAT range per manufacturer model.	95
Figure 19: Example of central single-pass heat pump water heater system schematic.	187
Figure 20: Example of central multi-pass heat pump water heater system schematic.	187
Figure 21: HPWH Configurations in CBECC-Res (2022.0.2 RV 1136).	205
Figure 22: Gas boiler system.	216
Figure 23: Single-pass heat pump system (2-story garden style and 3-story loaded corridor).	220
Figure 24: Single-pass heat pump system (mid-rise mixed-use and high-rise).	221
Figure 25: Multi-pass heat pump system (2-story garden and 3-story loaded corridor).	224
Figure 26: Multi-pass heat pump system (mid-rise mixed-use and high-rise).	225
Figure 27: SEER of split heat pumps in MAEDbS.	229

Figure 28: HSPF of split heat pumps in MAEDbS.	229
Figure 29: Histogram of EER of PTHPs in MAEDbS.	230
Figure 30: EER vs. cooling capacity of PTHPs in MAEDbS.	231
Figure 31: Histogram of COP of PTHPs in MAEDbS.	231
Figure 32: COP vs. cooling output of PTHPs in MAEDbS.	232
Figure 33: (Left) VRF heat pump EER histogram $\geq 65,000$ Btu/h, $< 135,000$ Btu/h; (Right) VRF heat pump COP histogram $\geq 65,000$ Btu/h, $< 135,000$ Btu/h.	233
Figure 34: (Left) VRF heat pump EER histogram $\geq 135,000$ Btu/h, $< 240,000$ Btu/h; (Right) VRF heat pump COP histogram $\geq 135,000$ Btu/h, $< 240,000$ Btu/h.	233
Figure 35: (Left) VRF heat pump EER histogram $\geq 240,000$ Btu/h; (Right) VRF heat pump COP histogram $\geq 240,000$ Btu/h.	234
Figure 36: (Left) VRF with heat recovery EER histogram $\geq 65,000$ Btu/h, $< 135,000$ Btu/h; (Right) VRF with heat recovery COP histogram $\geq 65,000$ Btu/h, $< 135,000$ Btu/h.	234
Figure 37: (Left) VRF with heat recovery EER histogram $\geq 135,000$ Btu/h, $< 240,000$ Btu/h; (Right) VRF with heat recovery COP histogram $\geq 135,000$ Btu/h, $< 240,000$ Btu/h.	235
Figure 38: (Left) VRF with heat recovery EER histogram $\geq 240,000$ Btu/h; VRF with heat recovery COP histogram $\geq 240,000$ Btu/h.	235
Figure 39: Simplified HPWH plant schematic-Batick apartment.	238
Figure 40: HPWH plant schematic – Elizabeth James house.	243
Figure 41: SEER histogram of product availability for three-phase commercial air-cooled split system heat pumps $< 65,000$ Btu/H.	254

Executive Summary

This document presents recommended code changes that the California Energy Commission will be considering for adoption in 2021. This report has been updated to include an electric space heating baseline for multifamily buildings three stories and fewer since the Final CASE Report was posted in November 2020. If you have comments or suggestions prior to the adoption, please email info@title24stakeholders.com. Comments will not be released for public review or will be anonymized if shared.

Introduction

The Codes and Standards Enhancement (CASE) Initiative presents recommendations to support the California Energy Commission's (Energy Commission) efforts to update the California Energy Code (Title 24, Part 6) to include new requirements or to upgrade existing requirements for various technologies. Three California Investor Owned Utilities (IOUs) – Pacific Gas and Electric Company (PG&E), San Diego Gas and Electric, Southern California Edison – and two Publicly Owned Utilities – Los Angeles Department of Water and Power, and Sacramento Municipal Utility District (herein referred to as the Statewide CASE Team when including the CASE Author) – sponsored this effort. The program goal is to prepare and submit proposals that would result in cost-effective enhancements to improve energy efficiency and energy performance in California buildings. This report and the code change proposals presented herein are a part of the effort to develop technical and cost-effectiveness information for proposed requirements on building energy-efficient design practices and technologies.

The Statewide CASE Team submits code change proposals to the Energy Commission, the state agency that has authority to adopt revisions to Title 24, Part 6. The Energy Commission will evaluate proposals submitted by the Statewide CASE Team and other stakeholders. The Energy Commission may revise or reject proposals. See the Energy Commission's 2022 Title 24 website for information about the rulemaking schedule and how to participate in the process: <https://www.energy.ca.gov/programs-and-topics/programs/building-energy-efficiency-standards/2022-building-energy-efficiency>.

The overall goal of this CASE Report is to present a code change proposal for an all-electric compliance pathway for multifamily buildings. The report contains pertinent information supporting the code change.

Measure Description

Background Information

This CASE Report proposes prescriptive and performance compliance pathways for all-electric multifamily buildings that use high efficiency electric appliances for all regulated and non-regulated end uses. This topic builds on the 2019 Title 24, Part 6 prescriptive requirements for residential buildings, including multifamily buildings three stories and fewer, that allow individual heat pump water heating and heat pump space heating in both the prescriptive approach as well as standard systems in the performance approach. The limitation of 2019 Title 24, Part 6 is that the electric systems are part of a dual baseline approach where the baseline system mirrors the fuel of choice for the proposed design. Thus, a building with a proposed electric space and water heating system would be compared to a standard building with electric space and water heating, but if the proposed building uses natural gas, the Standard Design will use natural gas-based systems as well. Another limitation of the current requirement is that electric water heating as a baseline is only available for multifamily buildings with individual water heaters, while the dual baseline option for heating ventilation and air conditioning (HVAC) is available only for multifamily buildings three stories and fewer. 2019 Title 24, Part 6 Standards do not address central water heating. 2019 Title 24, Part 6 also does not address electric HVAC and non-regulated end uses such as appliances and plug loads for multifamily buildings four stories and greater.

Local jurisdictions and efficiency advocates, including building decarbonization advocates, are increasingly proposing all-electric multifamily buildings in California. As of April 2021, approximately 40 local jurisdictions have adopted or proposed local ordinances that exceed the 2019 Title 24, Part 6 Standards with a specific goal of promoting decarbonization through building electrification (Building Decarbonization Coalition 2020). These ordinances are reacting to the need to align energy policies and building construction practices with the fact that the state's electricity generation, distribution, and consumption results in lower greenhouse gas and carbon emissions than those from mixed-fuel buildings that use natural gas for space heating, water heating, and other end uses.

Decarbonization is now the stated policy goal for the state as enshrined in Assembly Bill 32 (AB-3232 Zero-emissions buildings and sources of heat energy 2018), Senate Bill 350 (Clean Energy and Pollution Reduction Act - SB 350 2019), and the 2019 Integrated Energy Policy Report (IEPR) (CEC 2019). Whereas the previous iterations of IEPR primarily supported Zero Net Energy (ZNE) goals for buildings to meet the state's energy targets, the recent IEPR makes a direct connection to building decarbonization as the means to meet the state's overall climate change mitigation goals.

Several local, regional, national, and international organizations, including the Natural Resources Defense Council (NRDC), have embraced decarbonization strategies and through their grassroots and policy advocacy work have supported building electrification efforts across the state. Designers and engineers are increasingly adopting and supporting building electrification in multifamily buildings as the Statewide CASE Team outlines further in this report's market assessment section.

During the open comment period for the Draft CASE Report, many stakeholders submitted letters to support adoption of an all-electric code in the 2022 Title 24, Part 6 code. Appendix F includes a list of stakeholders.

A 2018 study completed by TRC for PG&E – Multifamily Market Analysis – showed that heat pumps are already the system of choice for space heating in multifamily new construction (TRC 2018).

Proposed Code Change

This CASE Report proposes prescriptive and performance compliance pathway(s) for all-electric multifamily buildings that use electric appliances for regulated and non-regulated end uses. This topic builds on the 2019 Title 24, Part 6 Standards that allow a dual baseline strategy wherein electrically space- and water-heated buildings are compared to a code minimum electrically space- and water-heated building whereas a building with natural gas-based systems for space heating and water heating is compared to a code minimum natural gas-based systems. The limitation to 2019 Title 24, Part 6 is that this dual baseline is only available for buildings with individual heat pump water heaters and only available to multifamily buildings three stories and fewer. The 2019 Title 24, Part 6 Standards do not address central water heating. 2019 Title 24, Part 6 also does not address electric HVAC and non-regulated end uses such as appliances and plug loads for multifamily buildings four stories and greater.

The Statewide CASE Team investigated suitable strategies for achieving all-electric, including electric heat pump HVAC systems, heat pump water heating (HPWH) systems, building envelope improvements, appliances, and miscellaneous load, as well as on-site renewables.

For space heating, the Statewide CASE Team investigated electric heat pump HVAC systems to be the prescriptive requirement and the baseline (Standard Design) system for the performance approach for all multifamily buildings.

- For multifamily buildings four stories and greater, the Statewide CASE Team chose a single zone ducted split heat pumps system (SZHP) as the proposed baseline system choice with efficiency levels required by and constrained by federal appliance standards for residential heat pump systems. For the limited new multifamily construction expected in Climate

Zone 16, a cost-effective all-electric solution for space heating was not identified. The Statewide CASE Team analyzed a combined measure package which includes natural gas. Builders in this region may opt to comply via the performance approach to avoid the additional costs of natural gas infrastructure. The measures included in this package are: The use of a gas-fired furnace as supplemental heating for the electric heat pump, and fenestration U-factor and solar heat gain coefficient (SHGC) requirements. The fenestration requirements are presented in a separate CASE Report (Multifamily Restructuring CASE Report 2020), and incorporated into this CASE Report for completeness of the all-electric proposal. Summary values for proposed fenestration requirements are presented in Table 21.

- For multifamily buildings three stories and fewer, the Statewide CASE Team chose SZHP as the proposed baseline system choice with efficiency levels limited by federal appliance standards for residential heat pump systems for Climate Zone 1-15. For Climate Zone 16, the Statewide CASE Team analyzed the dual-fuel heat pump combined with efficiency measures but did not identify a cost-effective package to establish heat pump as the baseline. Therefore, the baseline system would remain a single zone air conditioner (SZAC) with gas-fired furnace for Climate Zone 16. For Climate Zone 4 to 10, 14 and 15, the heat pump measure alone cannot achieve equivalent TDV as the SZAC with gas-fired furnace design, and the Statewide CASE Team analyzed the heat pump system with efficiency measures. For Climate Zone 4 to 10, the Standard Design would be a SZHP system along with balanced ventilation systems without heat or energy recovery that have fan efficacy of 0.4W/cfm. For prototypes in Climate Zone 14 and 15, the Statewide CASE Team analyzed the SZHP system combined with balanced ventilation with energy recovery ventilation (ERV) or heat recovery ventilation (HRV). The ERV/HRV measure is presented in a separate CASE Report (Multifamily IAQ CASE Report 2020) as new prescriptive requirements to be included in the 2022 code cycle.

For water heating, the Statewide CASE Team reviewed options for establishing a baseline for central water heating systems utilizing heat pump water heaters. For unregulated loads, the Statewide CASE Team reviewed options for establishing appropriate modeling of electric end uses for cooking, clothes washing, clothes drying and other internal loads.

Based on the analysis of these measures and packages, the Statewide CASE Team proposes the following code changes:

- Prescriptive Requirements

- Space heating for multifamily buildings four stories and greater: Require electric space heating. The prescriptive requirement would be a SZHP. For Climate Zone 16, allow the use of gas-fired furnace for supplemental heating.
- Space heating for multifamily buildings three stories and fewer: Require electric space heating in Climate Zone 1-15. The prescriptive requirement would be a SZHP. Additionally, for Climate Zone 4 to 10, the prescriptive requirements include a balanced ventilation system without heat or energy recovery that have fan efficacy of 0.4W/cfm. In Climate Zone 16, prescriptive requirement is a SZAC with gas-fired furnace for space conditioning.
- Central water heating: Provide an alternate: Alternate pathway for central HPWH systems. The current 2019 Title 24, Part 6 prescriptive alternate pathway for individual HPWH will be retained.
- Individual domestic hot water (DHW) systems: Retain the current 2019 Title 24, Part 6 requirements.
- Performance Requirements
 - HVAC System for multifamily buildings four stories and greater: Regardless of the proposed system fuel type, the Standard Design shall be SZHP for multifamily buildings four stories and greater. The electric SZHP would have minimum efficiency levels meeting applicable state and federal appliance standards. For Climate Zone 16, the SZHP shall allow a gas-fired furnace for supplemental heating.
 - HVAC System for multifamily buildings three stories and fewer: Independent of the proposed system fuel type, the Standard Design shall be SZHP in Climate Zone 1-15. The electric SZHP would have minimum efficiency levels meeting applicable state and federal appliance standards. In addition, for Climate Zone 4-10, the Standard Design shall include balanced ventilation system have a fan efficiency of 0.4W/cfm. For Climate Zone 16, the Standard Design would be an air conditioner with gas-fired furnace. For Climate Zone 15, the Standard Design SZHP fan efficiency shall be 0.45 W/cfm.
 - Central DHW system: Allow a Standard system fuel type matching the proposed design. The Standard Design shall be a central HPWH system if the proposed design uses central electric water heating and a gas central water heater if the proposed design uses natural gas.
 - Individual DHW systems: Retain the current 2019 Title 24, Part 6

requirements. The standard DHW system shall be an individual HPWH system if proposed design uses individual HPWH in multifamily building and an individual gas water heater if the proposed design uses natural gas.

- Appliances and miscellaneous electric load (MEL): Modeling rulesets for multifamily dwelling units in buildings four stories and greater shall be modified to match existing requirements for low-rise residential buildings in 2019 Title 24, Part 6 rulesets in CBECC-Res.

The proposed measure does not apply to alterations or additions.

The proposed code change would modify the following compliance documents:

- For the DHW prescriptive compliance approach, the proposed code change would add a table to an existing or create a new Worksheet (CR1R-PLB).
- For the prescriptive HVAC change, update the NRCC-MCH-E to remove the gas space heating option for multifamily buildings four stories and greater. Minor updates may be needed in CF1R-NCB-01-E accordingly.
- For the prescriptive HVAC change, update CF1R-NCB-01-E to remove the gas space heating option for multifamily buildings three stories and fewer in Climate Zone 1-15. Add data field for ventilation system fan efficacy.
- Add field verification of installed heat pump EER. Minor updates may be needed in CF1R-NCB-01-E accordingly.

The proposed changes would also require updates to the following compliance forms:

- CF2R-PLB-01a-NonHERS-MultifamilyCentralHotWaterSystemDistribution
- CF2R-PLB-21a-HERS-MultifamilyCentralHotWaterSystemDistribution
- CF3R-PLB-21a-HERS-MultifamilyCentralHotWaterSystemDistribution
- NRCI-PLB-02-HighRiseResHotelMotel-MultifamilyCentral-HWSystemDistribution
- NRCI-PLB-21-HERS-HighRiseResHotelMotel-MultifamilyCentral-HWSystemDistribution
- NRCV-PLB-21-HERS-HighRiseResHotelMotel-MultifamilyCentral-HWSystemDistribution

Minor updates may be needed in CF1R-PRF-E and NRCC-PRF-E accordingly.

The proposed code change would add descriptions and data fields for the field testing and visual inspection of central HPWH systems.

Examples of the revised document are presented in Section 7.6.

Scope of Code Change Proposal

Table 1 summarizes the scope of the proposed changes and which sections of the Standards, Reference Appendices, Alternative Calculation Method (ACM) Reference Manuals, and compliance documents that would be modified as a result of the proposed change(s).

Table 1: Scope of Code Change Proposal

Measure Name	Type of Requirement	Modified Section(s) of Title 24, Part 6	Modified Title 24, Part 6 Appendices	Would Compliance Software Be Modified	Modified Compliance Document(s)
Central HPWH for all multifamily buildings	Prescriptive Alternate Path Performance Path Baseline System	Section 150.1(c) 8 Residential ACM Reference Manual Section 2.9.3 Multiple Dwelling Units	New JA 14 RA 3.6.x	Yes	CF1R-PLB Worksheet, CF1R-NCB-01-E, CF1R-PRF-01-E, CF2R-PLB-01a, CF2R-PLB-21a, CF3R-PLB-01a, NRCC-PRF-01-E, NRCC-PLB-E, NRCI-PLB-02, NRCI-PLB-21, NRCV-PLB-21
Electric Space Heating for multifamily buildings four stories and greater	Performance Path Baseline System Prescriptive Requirement	Nonresidential ACM Reference Manual Section 5.1.2 Section 140.4, New Section 140.10 and Table 140.3 - C	New NA 2.4	Yes	CF1R-NCB-01-E, NRCC-ENV-E, NRCC-MCH-E, CF2R-ENV-01 CF2R-ENV-02
Electric Space Heating for Multifamily Buildings Three Stories and Fewer	Performance Path Baseline System Prescriptive Requirement	Residential ACM Reference Manual Section 2.4.1 Section 150.1 (c) 6, and Table 1150.1-B	N/A	Yes	CF2R-MCH-01-a, CF1R-NCB-01-E,
Appliances and Plug Loads for Multifamily Buildings Four Stories and Greater	Nonresidential ACM Reference Manual Change	Nonresidential ACM Reference Manual	N/A	Yes	NRCC-PRF-01-E

Market Analysis and Regulatory Assessment

For multifamily buildings four stories and greater, the performance pathway under 2019 Title 24, Part 6 code uses a mixed fueled HVAC system as the baseline (CEC 2019). The California Energy Commission has proposed changes to the current 2019 Title 24,

Part 6 code Nonresidential ACM Reference Manual. The changes include a single zone constant volume direct expansion air conditioner (Split Dx) with gas-fired furnace per multifamily dwelling unit in buildings four stories and greater.

For multifamily buildings three stories and fewer, 2019 Title 24, Part 6 code uses electric heat pumps when the proposed system is an electric water heating system serving individual dwelling units, or when the electric heat pump water heater serves up to eight dwelling units with no recirculating loops or pumps.

The Statewide CASE Team uses this proposed baseline systems as the basis of this CASE analysis.

On Dec 19, 2019, the Energy Commission provided an Executive Directive that allows central HPHW systems that meet specified installation criteria in addition to solar thermal or PV installation requirements to show compliance to 2019 Title 24, Part 6 (California Energy Commission 2019).

As of November 2020, almost 40 local jurisdictions have adopted local ordinances (Building Decarbonization Coalition 2020) that encourage or require the use of electric space heating and water heating in residential and/or nonresidential applications.

The U.S. Department of Energy (U.S. D.O.E.) has federal minimum efficiency requirements for DHW and HVAC equipment specified in the Code of Federal Regulations at 10 CFR 430.32(d) (Code of Federal Regulations 2020). Efficiency varies with the equipment class and the equipment capacity.

Minimum efficiency for heat pump water heaters with rated storage volume less than 120 gallons are specified in the Code of Federal Regulations at 10 CFR 430.32(d), see Table 5. While some of the heat pump water heaters falling into the regulated category (less than 120 gallons) can be used for central water heater design, the proposed measure does not require HPWHs that fall into this category, thus the proposal does not trigger preemption.

There is no federal efficiency standard for commercial size HPWHs, as defined by 10 CFR 431.102.

The Statewide CASE Team reviewed 103 buildings that installed an electric HVAC system from data provided by stakeholders. Most of the buildings (49) had individual SZHP systems in the residential units. Other HVAC systems included ductless heat pump systems, water source heat pumps, packaged terminal heat pumps (PTHP), electric baseboard heating, electric resistance heating, and variable refrigerant flow (VRF) systems. Figure 1 shows the HVAC systems as a function of the number of stories in a building. Ducted air source heat pump systems are most common for most of the number of stories. The electric resistance heating was installed only in affordable housing projects where cooling was not installed.

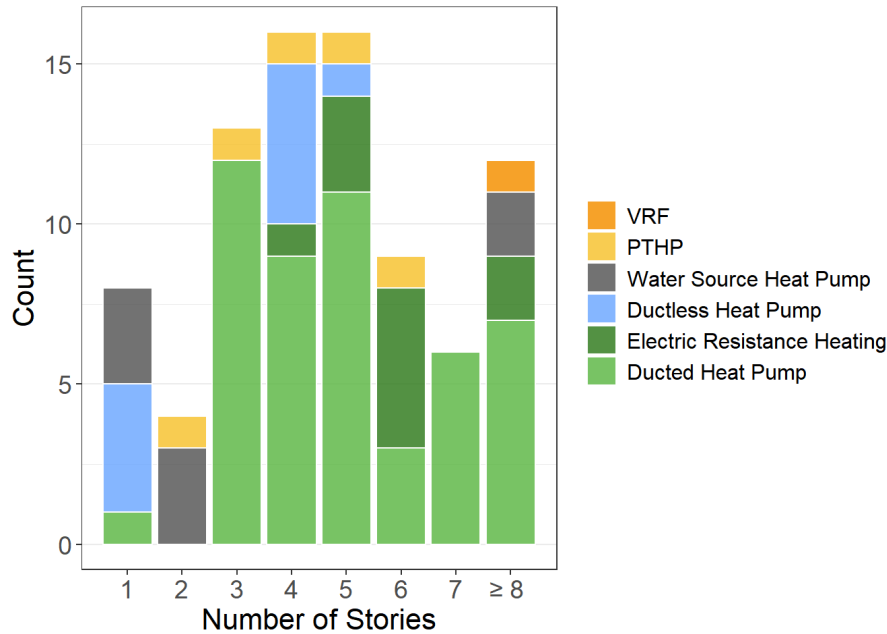

Figure 1: Electric HVAC system type by number of stories.

Source: Project Based Data.

The Statewide CASE Team reviewed the product availability of split heat pumps, PTHPs, and VRF systems relative to federal and state required minimum efficiency levels. To review product availability of split heat pumps and packaged terminal heat pumps, the Statewide CASE Team used the Modernized Appliance Efficiency Database System (MAEDbS), which shows appliances compliant under Title 20. Since VRF systems were not listed in the MAEDbS, the Statewide CASE Team collected VRF system information from manufacturer websites. About 95 percent of split heat pumps and PTHPs and about 80 percent of VRF systems were at or above federal minimum efficiency levels, indicating considerable market availability of higher efficiency products if desired. Detailed product availability analysis is provided in Appendix H.

To review current practices of electric DHW systems, the Statewide CASE Team analyzed buildings with electric DHW systems from the Project Based Data provided by stakeholders.¹ There were eighty-six buildings with electric DHW systems. Buildings

¹ Project information was collected using a combination of the following approaches: interview, survey, design drawing review and Title 24 compliance document review. Data sources include projects from Association for Energy Affordability (AEA), Frontier Energy, Redwood Energy, EHDD, Gabel Energy, Build it Green (now Franklin Energy), Mithun, California Multi-Family New Homes (CMFNH) program. Although the CASE team aimed for statewide data, note that there may be a self-selection bias in the dataset as the information volunteered was from organizations that had most projects in Northern California.

either used a heat pump or electric storage DHW system with the majority (80) of systems using a heat pump. Since an electric resistance storage DHW system is less energy efficient, the market analysis focused on heat pump water heating systems. Figure 2 shows distribution types of the heat pump water heater systems installed in these projects.

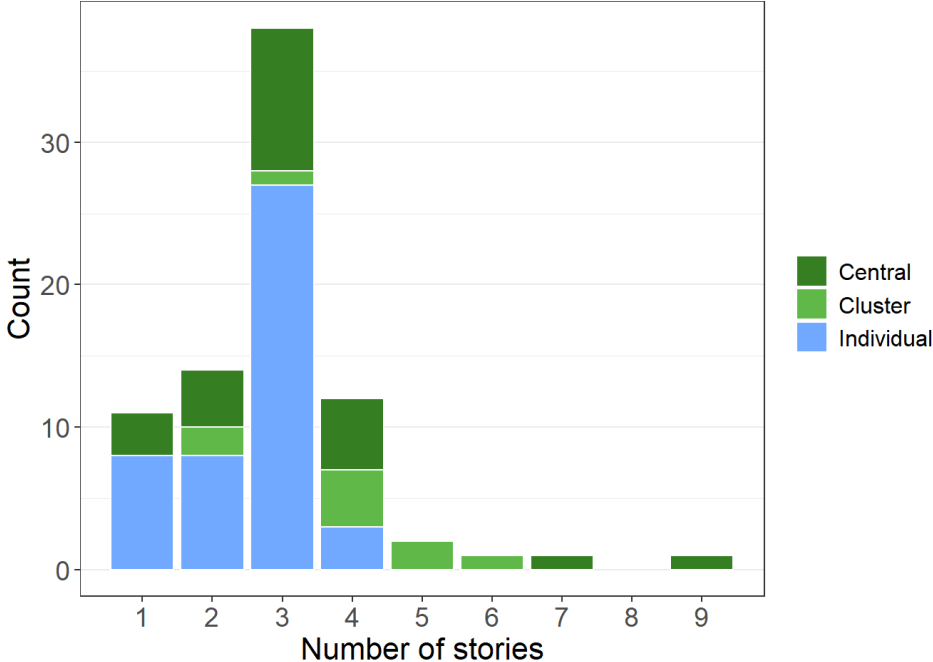

Figure 2: DHW distribution types of heat pump water heater systems.

Source: Project Based Data.

Based on review of product literature, interviews with industry practitioners and manufacturers, and individual central HPHW project experience, the Statewide CASE Team segmented HPWH equipment into three categories: integrated HP + Tank, split HP – water loop, and standalone HP. Figure 13 shows the number of models available for each of the categories at various HPWH capacity ranges. The analysis includes HPWH products that are currently available in the California market and products that are currently available internationally but with confirmation from manufacturers that they will be available in California in the near future.

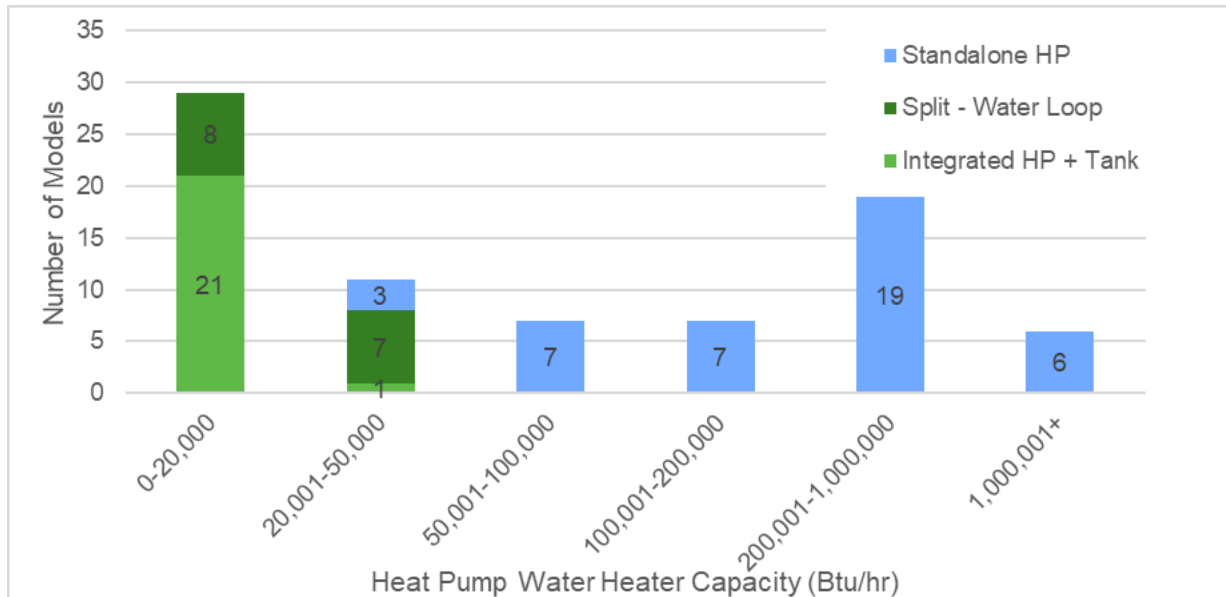

Figure 3: Heat pump water heater configuration types and capacity range.

Source: Project Based Data.

As part of the CASE research, the Statewide CASE Team evaluated whether the plug load calculations needed to be further modified to account for the emergence of new appliance technologies. Currently, neither the residential nor nonresidential modeling methodologies account for the impact of choosing emerging appliance technologies like induction ranges and heat pump dryers. Details of the analysis are presented in Section 3 and in Appendix I. The Statewide CASE Team recommends no change to the Residential ACM Reference Manual but recommends that the Nonresidential ACM Reference Manual be updated to match the Residential ACM Reference Manual for multifamily dwelling unit appliances and plug loads.

Cost Effectiveness

The Statewide CASE Team determined the proposed code change to be cost effective for all climate zones where it is proposed to be required. The benefit-to-cost (B/C) ratio compares the benefits or cost savings to the costs over the 30-year period of analysis common for residential measures. Proposed code changes that have a B/C ratio of 1.0 or greater are cost effective. The larger the B/C ratio, the faster the measure pays for itself from energy cost savings. The B/C ratio for this measure ranged between 1.1 and infinite depending on climate zone.

The B/C ratio is calculated by dividing the cost benefits realized over 30 years by the total incremental costs, which includes maintenance costs for 30 years. The B/C ratio was calculated using 2023 Present Value (PV) projected costs and cost savings.

See Section 5 for the methodology, assumptions, and results of the cost-effectiveness analysis.

Statewide Energy Impacts: Energy, Water, and Greenhouse Gas (GHG) Emissions Impacts

The Statewide CASE Team calculated the first-year statewide savings for new construction by multiplying the per-unit savings, which are presented in Section 4.3, by assumptions about the percentage of newly constructed buildings that would be impacted by the proposed code. The statewide new construction forecast for 2023 is presented in Appendix A, as are the Statewide CASE Team's assumptions about the percentage of new construction that would be impacted by the proposal (by climate zone and building type).

The first-year energy impacts represent the first-year annual savings from all buildings that were completed in 2023. The 30-year energy cost savings represent the energy cost savings over the entire 30-year analysis period. The statewide savings estimates do not take naturally occurring market adoption or compliance rates into account.

The SZHP measure results in an increase in first year electricity consumption and electric TDV energy use, which is more than offset by decrease in first year natural gas usage and natural gas TDV energy use. The net result is a decrease in the 30-year present valued energy costs in all climate zones.

The central HPWH measure results in an increase in first year electricity consumption and electric TDV energy use, which is more than offset by decrease in first year natural gas usage and natural gas TDV energy use. The net result is a decrease in the 30-year present valued energy costs in all climate zones.

Table 2 presents the estimated energy and demand impacts of the proposed code change that would be realized statewide during the first 12 months that the 2022 Title 24, Part 6 requirements are in effect. First-year statewide energy impacts are represented by the following metrics: electricity use increases in gigawatt-hours per year (GWh/yr), peak electrical demand increase in megawatts (MW), natural gas savings in million therms per year (MMTherms/yr), and time dependent valuation (TDV) energy savings in kilo British thermal units per year (TDV kBtu/yr).

Table 2: First-Year Statewide Energy and Impacts – New Construction

Measure	Electricity Increase (GWh/yr)	Peak Electrical Demand Increase (MW)	Natural Gas Savings (MMTherms/yr)	TDV Energy Savings (TDV kBtu/yr)
SZHP (2-Story Garden, 3-Story Loaded Corridor, 5-Story Mixed Use, 10-Story Mixed Use over 30 years)	5.99	0.00	0.64	41,638,205
Central HPWH (2-Story Garden, 3-Story Loaded Corridor, 5-Story Mixed Use, 10-Story Mixed Use over 30 years)	6.37	4.96	0.80	81,732,392

Table 3 presents the estimated avoided GHG emissions associated with the proposed code change for the first year the standards are in effect. Avoided GHG emissions are measured in metric tons of carbon dioxide equivalent (Metric Tons CO₂e).

Table 3: First-Year Statewide GHG Emissions Impacts

Measure	Avoided GHG Emissions (Metric Tons CO₂e/yr)	Monetary Value of Avoided GHG Emissions (\$2023)
SZHP (2-Story Garden, 3-Story Loaded Corridor, 5-Story Mixed Use, 10-Story Mixed Use over 30 years)	2,029	\$215,474
Central HPWH (2-Story Garden, 3-Story Loaded Corridor, 5-Story Mixed Use, 10-Story Mixed Use over 30 years)	2,810	\$298,422

Assumptions used in developing the GHG savings are provided in Section 6.2 and Appendix C of this report. The monetary value of avoided GHG emissions is included in TDV cost factors and is thus included in the cost-effectiveness analysis.

Water and Water Quality Impacts

The proposed measure is not expected to have any impacts on water use or water quality, excluding impacts that occur at power plants.

Compliance and Enforcement

Overview of Compliance Process

The Statewide CASE Team worked with stakeholders to develop a recommended compliance and enforcement process and to identify the impacts this process would have on various market actors. Section 2.5 describes the compliance process. Section 3.1.3 and Appendix E describe impacts that the proposed measure would have on market actors. The key issues related to compliance and enforcement are:

- Specification of space heating systems to meet or exceed the energy efficiency of ducted heat pump systems meeting federal appliance standard mandated energy efficiency
- Specification of central water heating systems to meet or exceed the energy efficiency of central heat pump water heating (central HPWH) baseline system when the proposed system uses electricity
- Field verification of central HPWH system

Field Verification and Diagnostic Testing

The central HPWH measure would require field verification and diagnostic testing. Please refer to Section 2.5 for additional information.

1 Introduction

This document presents recommended code changes that the California Energy Commission will be considering for adoption in 2021. This report has been updated to include an electric space heating baseline for multifamily buildings three stories and fewer since the Final CASE Report was posted in November 2020. If you have comments or suggestions prior to the adoption, please email info@title24stakeholders.com. Comments will not be released for public review or will be anonymized if shared.

The Codes and Standards Enhancement (CASE) initiative presents recommendations to support the California Energy Commission's (Energy Commission) efforts to update California Energy Code (Title 24, Part 6) to include new requirements or to upgrade existing requirements for various technologies. The three California Investor Owned Utilities (IOUs) – Pacific Gas and Electric Company (PG&E), San Diego Gas and Electric, Southern California Edison – and two Publicly Owned Utilities – Los Angeles Department of Water and Power, and Sacramento Municipal Utility District (herein referred to as the Statewide CASE Team when including the CASE Author) – sponsored this effort. The program goal is to prepare and submit proposals that would result in cost-effective enhancements to improve energy efficiency and energy performance in California buildings. This report and the code change proposal presented herein are a part of the effort to develop technical and cost-effectiveness information for proposed requirements on building energy-efficient design practices and technologies.

The Statewide CASE Team submits code change proposals to the Energy Commission, the state agency that has authority to adopt revisions to Title 24, Part 6. The Energy Commission will evaluate proposals submitted by the Statewide CASE Team and other stakeholders. The Energy Commission may revise or reject proposals. See the Energy Commission's 2022 Title 24 website for information about the rulemaking schedule and how to participate in the process: <https://www.energy.ca.gov/programs-and-topics/programs/building-energy-efficiency-standards/2022-building-energy-efficiency>.

The overall goal of this CASE Report is to present a code change proposal for an all-electric compliance pathway for multifamily buildings. The report contains pertinent information supporting the code change.

When developing the code change proposal and associated technical information presented in this report, the Statewide CASE Team worked with a number of industry stakeholders including manufacturers, designers, Title 24 energy analysts, and others involved in the code compliance process. The proposal incorporates feedback received during a public stakeholder workshop that the Statewide CASE Team held on September 10, 2019, and March 17, 2020.

The following is a summary of the contents of this report:

- Section 2 – Measure Description of this CASE Report provides a description of the measure and its background. This section also presents a detailed description of how this code change is accomplished in the various sections and documents that make up the Title 24, Part 6 Standards.
- Section 3 – In addition to the Market Analysis section, this section includes a review of the current market structure. Section 3.1.2 describes the feasibility issues associated with the code change, including whether the proposed measure overlaps or conflicts with other portions of the building standards, such as fire, seismic, and other safety standards, and whether technical, compliance, or enforceability challenges exist.
- Section 4 – Energy Savings presents the per-unit energy, demand reduction, and energy cost savings associated with the proposed code change. This section also describes the methodology that the Statewide CASE Team used to estimate per-unit energy, demand reduction, and energy cost savings.
- Section 5 – This section includes a discussion and presents analysis of the materials and labor required to implement the measure and a quantification of the incremental cost. It also includes estimates of incremental maintenance costs, i.e., equipment lifetime and various periodic costs associated with replacement and maintenance during the period of analysis.
- Section 6 presents the statewide energy savings and environmental impacts of the proposed code change for the first year after the 2022 code takes effect. This includes the amount of energy that would be saved by California building owners and tenants and impacts (increases or reductions) on material with emphasis placed on any materials that are considered toxic by the state of California. Statewide water consumption impacts are also reported in this section.
- Section 7 – Proposed Revisions to Code Language concludes the report with specific recommendations with ~~strikeout~~ (deletions) and underlined (additions) language for the Standards, Reference Appendices, ACM Reference Manuals, Compliance Manual, and compliance documents.
- Section 8 – Bibliography presents the resources that the Statewide CASE Team used when developing this report.
- Appendix A: Statewide Savings Methodology presents the methodology and assumptions used to calculate statewide energy impacts.
- Appendix B: Embedded Electricity in Water Methodology presents the methodology and assumptions used to calculate the electricity embedded in water use (e.g., electricity used to draw, move, or treat water) and the energy

savings resulting from reduced water use.

- Appendix C: Environmental Impacts Methodology presents the methodologies and assumptions used to calculate impacts on GHG emissions and water use and quality.
- Appendix D: California Building Energy Code Compliance (CBECC) Software Specification presents relevant proposed changes to the compliance software (if any).
- Appendix E: Impacts of Compliance Process on Market Actors presents how the recommended compliance process could impact identified market actors.
- Appendix F: Summary of Stakeholder Engagement documents the efforts made to engage and collaborate with market actors and experts.
- Appendix G: Basis of Design for the Cost-Effectiveness Analysis provides details on the system design options used to develop energy savings and installation and maintenance costs.
- Appendix H: Heat pump product availability analysis provides analysis of heat pump products available in the market and how they relate to federal and California appliance standards.
- Appendix I: Central Heat Pump Water Heater Case Studies provides design strategies, field measured performance data and lessons learned from two recent projects to use central heat pump water heating (central HPWH) systems.
- Appendix J: Manufacturer Code Requirement Review Interview Questions provides survey questions used to solicit inputs from heat pump water heater manufacturers.
- Appendix K: NRDC Memo to Energy Commission on multifamily all-electric baseline in 2019 ACM summarizes work done by the statewide CASE Team in coordination with NRDC and several stakeholders to outline issues and potential solutions for all-electric multifamily compliance with 2019 Title 24, Part 6 with an eye towards addressing those issues in 2022 Title 24 CASE updates.
- Appendix L: Review and Appliances and Miscellaneous Loads in Multifamily Buildings provides results from a literature review and data collection for appliances and plug loads relevant to electrification strategies.
- Appendix M: Nominal Savings Tables presents the energy cost savings in nominal dollars by building type and climate zone.
- Appendix N: Savings and Cost-effectiveness Analysis for Heat Pump Space Heating and Central Heat Pump Water Heating Combined

2 Measure Description

2.1 Measure Overview

This CASE Report proposes prescriptive and performance compliance pathway(s) for all-electric multifamily buildings that use electric appliances for regulated and non-regulated end uses. This topic builds on the 2019 Title 24, Part 6 Standards that allow a dual baseline strategy wherein electrically heated and water-heated buildings are compared to a code minimum electrically heated and water-heated building, whereas natural gas-based systems for heating and water heating are compared to code minimum natural gas-based systems. The limitation is that the dual baseline option for water heating is only available for multifamily buildings with individual water heaters, and the dual baseline option for heating ventilation and air conditioning (HVAC) is available only for multifamily buildings three stories and fewer. The 2019 Title 24, Part 6 Standards did not address central water heating. It also did not address HVAC and non-regulated end uses, such as appliances and plug loads for multifamily buildings four stories and greater.

The Statewide CASE Team investigated suitable strategies for achieving all-electric, including electric heat pump HVAC systems, heat pump water heating (HPWH) systems, building envelope improvements, appliances, and miscellaneous loads, as well as on-site renewables. For space heating, the Statewide CASE Team investigated electric heat pump HVAC systems to be the prescriptive requirement and the baseline (Standard Design) system for the performance approach for all multifamily buildings.

- For multifamily buildings four stories and greater, the Statewide CASE Team chose SZHP as the proposed baseline system choice with efficiency levels required by and constrained by federal appliance standards for residential heat pump systems. For Climate Zone 16 only, the Statewide CASE Team analyzed a combined measure package that includes the limited use of natural gas. The measure included in the Climate Zone 16 package include the use of gas-fired furnace as supplemental heating for the electric heat pump and fenestration U-factor and solar heat gain coefficient (SHGC) requirements. The fenestration requirements are presented in a separate CASE Report (Multifamily Restructuring CASE Report 2020), and incorporated into this CASE Report for completeness of the all-electric proposal. Summary values for proposed fenestration requirements are presented in Table 21. For the limited anticipated multifamily new construction in Climate Zone 16 during the 2022 code cycle, the Statewide CASE Team did not identify a cost-effective all electric space heating option. It is expected, however, that most builders will opt for the performance approach for projects in this region.

For multifamily buildings three stories and fewer, the Statewide CASE Team chose SZHPs as the proposed baseline system choice with efficiency levels required by and constrained by federal appliance standards for residential heat pump systems for Climate Zone 1-15. For Climate Zone 16, the Statewide CASE Team analyzed the dual-fuel heat pump combined with efficiency measures but did not identify a cost-effective package to establish heat pump as the baseline. Therefore, the baseline system remains as single zone air conditioner (SZAC) with gas-fired furnace for Climate Zone 16. For Climate Zone 4 to 10, 14 and 15, the heat pump measure alone cannot achieve equivalent TDV as the SZAC with gas-fired furnace design, and the Statewide CASE Team analyzed the heat pump system with efficiency measures. For Climate Zone 4 to 10, the Standard Design would be a SZHP system along with balanced ventilation systems without heat or energy recovery that have fan efficacy of 0.4W/cfm. For prototypes in Climate Zone 14 and 15, the Statewide CASE Team analyzed the SZHP system combined with balanced ventilation with ERV or HRV. The ERV/HRV measure is presented in a separate CASE report (Multifamily IAQ CASE Report 2020) as new prescriptive requirements to be included in the 2022 code cycle.

- For water heating, the Statewide CASE Team reviewed options for establishing a baseline for central water heating systems utilizing heat pump water heaters. For unregulated loads, the Statewide CASE Team reviewed options for establishing appropriate modeling of electric end uses for cooking, clothes washing, clothes drying and other internal loads.

Based on the analysis of these measures and packages, the Statewide CASE Team proposes the following code changes:

- Prescriptive Requirements
 - Space heating for multifamily buildings four stories and greater: Require electric space heating. The prescriptive requirement would be a SZHP. For Climate Zone 16, allow the use of gas-fired furnace for supplemental heating.
 - Space heating for multifamily buildings three stories and fewer: Require electric space heating in Climate Zone 1-15. The prescriptive requirement would be a SZHP. Additionally, for Climate Zone 4 to 10, the prescriptive requirements include a balanced ventilation system without heat or energy recovery that have fan efficacy of 0.4W/cfm. For Climate Zone 16, prescriptively requires a SZAC with a gas-fired furnace for space conditioning.
 - Central Water Heating: Prescriptive alternate pathway for central HPWH. The current 2019 Title 24, Part 6 prescriptive alternate pathway for

individual HPWH will be retained.

- Individual DHW systems: Retain the current 2019 Title 24, Part 6 requirements.
- Performance Requirements
 - HVAC System for multifamily buildings four stories and greater: Regardless of the proposed system fuel type, the Standard Design shall be SZHP. The electric SZHP would have minimum efficiency levels meeting applicable state and federal appliance standards. For Climate Zone 16, the SZHP shall have a gas-fired furnace for supplemental heating.
 - HVAC System for multifamily buildings three stories and fewer: Regardless of the proposed system fuel type, the Standard Design shall be SZHP in Climate Zone 1-15. The electric SZHP would have minimum efficiency levels meeting applicable state and federal appliance standards. In addition, the Standard Design shall include balanced ventilation system have a fan efficiency of 0.4W/cfm. For Climate Zone 16, the Standard Design would be a SZAC with gas-fired furnace. For Climate Zone 15, the Standard Design SZHP fan efficiency shall be 0.45 W/cfm.
 - Central DHW system: Standard system fuel type is the same as the proposed design. The Standard Design shall be a central HPWH system if proposed design uses central electric water heating.
 - Individual DHW systems: Retain the current 2019 Title 24, Part 6 requirements. The standard DHW system be an individual HPWH system if proposed design uses individual HPWH in multifamily buildings.
 - Appliances and miscellaneous electric load (MEL) modeling rulesets for multifamily dwelling units in buildings four stories and greater shall be modified to match existing requirements for low-rise residential buildings in 2019 Title 24, Part 6 rulesets in CBECC-Res.

The proposed measure does not apply to alterations or additions.

The proposed code change would modify the following compliance documents.

- For the DHW prescriptive compliance approach, the proposed code change would add a table to an existing or create a new Worksheet (CR1R-PLB).
- For prescriptive HVAC change, update the NRCC-MCH-E to remove gas space heating option for multifamily buildings four stories and greater. Minor updates may be needed in CF1R-NCB-01-E accordingly.
- For prescriptive HVAC change, update CF1R-NCB-01-E to remove gas space

heating option for multifamily buildings three stories and fewer in Climate Zone 1-15. Add data field for ventilation system fan efficacy.

- Add field verification of installed heat pump EER. Minor updates may be needed in CF1R-NCB-01-E accordingly.

The proposed changes would also require updates to the following compliance forms:

- CF2R-PLB-01a-NonHERS-MultifamilyCentralHotWaterSystemDistribution
- CF2R-PLB-21a-HERS-MultifamilyCentralHotWaterSystemDistribution
- CF3R-PLB-21a-HERS-MultifamilyCentralHotWaterSystemDistribution
- NRCI-PLB-02-HighRiseResHotelMotel-MultifamilyCentral-HWSystemDistribution
- NRCI-PLB-21-HERS-HighRiseResHotelMotel-MultifamilyCentral-HWSystemDistribution
- NRCV-PLB-21-HERS-HighRiseResHotelMotel-MultifamilyCentral-HWSystemDistribution

Minor updates may be needed in CF1R-PRF-E and NRCC-PRF-E accordingly.

The proposed code change would add descriptions and data fields for the field testing and visual inspection of central HPWH systems. Examples of the revised document are presented in Section 7.6.

The nonresidential grid integration CASE Report expands the HPWH demand flexibility compliance credit that is available for residential buildings that use the performance approach to comply with code so that a similar credit would also be available for nonresidential buildings including multifamily buildings with individual and central HPWH systems (Statewide CASE Team 2020). Specific revisions include updating Joint Appendix 13 – Qualification Requirements for Heat Pump Water Heating Demand Management Systems (JA13) to make the language more inclusive of HPWH systems installed in nonresidential buildings. The updated language in JA13 would align with the eligibility requirements for the Self-Generation Incentive Program (SGIP), which added HPWH as an eligible measure in January 2020. For this compliance option to become available for use, the compliance software would need to be updated to add a feature that would simulate the energy impacts of operating HPWHs with demand management capabilities enabled, which could include optimizing for utility time-of-use or critical peak pricing rates.

2.2 Measure History

Local jurisdictions and efficiency advocates, including building decarbonizations groups, are increasingly proposing all-electric multifamily buildings in California. As of March

2020, 29 local jurisdictions have adopted or proposed local ‘reach’ codes that exceed the 2019 Title 24, Part 6 Standards with a specific goal of promoting decarbonization through building electrification (Building Decarbonization Coalition 2020). These reach codes address the need to adjust energy policies and building construction practices with the state’s desire to lower greenhouse gas and carbon emissions from buildings. Decarbonization is now the stated policy goal for the state as enshrined in Assembly Bill 32 (AB-3232 Zero-emissions buildings and sources of heat energy 2018), Senate Bill 350 (Clean Energy and Pollution Reduction Act - SB 350 2019) and the 2019 Integrated Energy Policy Report (IEPR) (CEC 2019). Whereas the previous iterations of IEPR primarily supported Zero Net Energy (ZNE) goals for buildings to meet the state’s energy targets, the recent IEPR makes a direct connection to building decarbonization as the means to meet the state’s overall climate change mitigation goals. Several local, regional, national, and international organizations, including the Natural Resources Defense Council, have embraced decarbonization strategies and through their grassroots and policy advocacy work have supported building electrification efforts across the state. Designers and engineers are increasingly adopting and supporting building electrification in multifamily buildings, as the Statewide CASE Team outlines further in this report’s market assessment section. TRC’s 2018 Multifamily Market Analysis completed for PG&E showed that heat pumps are increasingly the system of choice for space heating and water heating in multifamily new construction (TRC 2018).

For the 2019 Title 24, Part 6 code cycle, the Energy Commission made significant progress toward achieving the decarbonization goal by increasing energy efficiency requirements, leveling the playing field for all-electric single family and multifamily buildings three stories and fewer that use individual water heating systems.

There are still hurdles remaining for multifamily buildings four stories and greater or buildings with central heat pump water heaters. The main barriers are in the lack of a prescriptive pathway for central heat pump water heaters, additional system modeling options through the compliance software, and the 2019 ACM Reference Manuals, which are critical components of the implementation of the standards. The 2019 ACM Reference Manuals align with the ASHRAE 90.1-2016 baseline system mapping for DHW and HVAC, which uses natural gas systems. The use of the 2019 TDV metric with this baseline makes it difficult for efficient buildings with efficient electric systems to comply with the 2019 Standards. Presentations made by Energy Commission staff and their consultants during the 2019 Title 24, Part 6 pre-rulemaking and rulemaking events show that all-electric buildings would generate less overall carbon than mixed-fuel buildings. However, the all-electric buildings use more TDV energy than mixed fuel because of the way TDV values electricity use higher than natural gas/propane during peak periods. Thus, the goals of cost effectiveness (using TDV) and overall carbon reductions are currently in conflict even with the improvements in the 2019 Title 24, Part 6. The Energy Commission has proposed alternatives and improvements to the 2022

code compliance metrics to address these issues. The Statewide CASE Team has leveraged these efforts to re-evaluate the relative cost effectiveness and carbon reductions from all-electric multifamily buildings. The California Energy Commission released a new set of TDV values for the 2022 Title 24, Part 6 code cycle, which make all-electric buildings more feasible than under the 2019 TDV metric.

In the following sub-sections, the Statewide CASE Team presents the measure history and background for each of the three submeasures in this CASE Report – electric HVAC, electric DHW, and electric appliances and miscellaneous loads.

2.2.1 Electric HVAC Systems

2019 Title 24, Part 6 provided an alternative pathway for all-electric HVAC system for multifamily buildings three stories and fewer in both the prescriptive and performance pathways. The Energy Commission changed the HVAC baselines such that the baseline system fuel type is the same as the proposed system fuel type. For buildings with electric space heating, the baseline is a minimum efficiency heat pump system.

The 2019 Title 24, Part 6 performance baseline is a central gas-fired furnace with split direct expansion (split DX) for multifamily buildings four to seven floors and a four-pipe fan coil (FPFC) system for buildings eight floors and greater, regardless of the fuel used for the proposed building. As part of the 2019 Title 24, Part 6 post-adoption process, the Energy Commission is working with decarbonization advocates to minimize the impact of this baseline on all-electric buildings. A study coordinated by NRDC and supported by several designers, engineers and consultants including members of the Statewide CASE Team showed that the four-pipe fan coil system is the primary challenge for all-electric multifamily buildings. As seen in

Table 4, using any heat pump system – even those that are the most efficient in the market – results in significant TDV penalties since they are compared to a baseline of a FPFC system in multifamily buildings eight stories and greater. For multifamily buildings four to seven stories, using a heat pump also results in a compliance penalty when compared to a natural gas-fired furnace and split DX but this penalty is much smaller than that for multifamily buildings eight stories and greater.

Table 4: Background Analysis done in 2018 Showing Heat Pump Heating and Total TDV Penalties Compared to 2019 Title 24, Part 6 Gas Baseline TDV using 2019 TDV values

		TDV Difference from Standard Design Compliance TDV % using 2019 Title 24 TDV values				
		CZ 3	CZ 6	CZ 9	CZ 12	CZ 16
	Heating	-2%	-5%	0%	-1%	-7%

4- to 7-Story Multifamily	Total	-1%	-4%	-2%	-1%	-7%
8+ Story Multifamily (14 SEER)	Heating	-11%	-9%	-3%	-9%	-20%
	Total	-16%	-14%	-9%	-20%	-31%
8+ Story Multifamily (14.5 SEER)	Heating	-11%	-9%	-3%	-9%	-20%
	Total	-15%	-13%	-8%	-19%	-29%
8+ Story Multifamily (16 SEER)	Heating	-11%	-9%	-3%	-9%	-20%
	Total	-12%	-10%	-4%	-15%	-26%

The Energy Commission has proposed to change the multifamily HVAC baseline for eight floors and above to be the same as that for four to seven floors – split DX for cooling and gas-fired furnace for heating. This CASE Report builds on this proposed realignment of the baseline and the analysis presented in later sections of this document assumes this proposed change to the system baseline for multifamily buildings four stories and greater.

During the 2019 Title 24, Part 6 Standards development process, the fan efficacy requirements for residential HVAC equipment were reviewed to determine appropriate adjustments in response to new federal fan standards. The new federal requirements were designed to drive adoption of higher efficiency motor technologies in residential gas-fired furnaces. It was determined through analysis of the federal standards and supported through laboratory testing of representative gas-fired furnaces, that the Title 24, Part 6 fan efficacy requirement for residential air conditioners should be modified from 0.58 W/cfm to 0.45 W/cfm in the 2019 standards. This change was applied only to gas-fired furnaces, with the requirement for heat pump air handlers remaining at 0.58 W/cfm. The requirement is only applicable to multifamily buildings three stories and fewer.

The lower fan efficiency requirement for heat pump creates a challenge for a heat pump system to achieve equivalent TDV as a gas-fired furnace system, as demonstrated in Section 4.3.1. To establish all-electric HVAC as the single baseline, the Statewide CASE Team combined the heat pump measure with additional efficiency measures to achieve equivalent TDV as a gas-fired furnace system.

The Statewide CASE Team reviewed residential heat pump fan efficiency testing results from PG&E ATS laboratory in San Ramon, CA. The results show that residential heat pumps with nominal capacity less than or equal to 50,000 BTU/h can meet a requirement of 0.45 W/cfm to match the requirement for air conditioners. See Appendix O for details. The Statewide CASE Team is not recommending a change in fan

efficiency requirement for heat pump but recommend a review of this requirement for a future code cycle.

2.2.2 Central HPWH Systems

Central HPWH systems use electricity to produce hot water by transferring heat energy from one source, typically air, to potable water. This process can be two to three times more energy efficient than a fossil-gas or electric-resistance water heating system. HPWH is also a key technology to decarbonize domestic water heating as the system uses electricity instead of natural gas.

Central HPWH systems are DHW systems with recirculation loop designed to deliver hot water produced by HPWH equipment from a centralized location to multiple end users. Several successful central HPWH designs have been implemented and are operational in California and Washington. However, energy performance of the systems is highly dependent on design and not guaranteed. Example design considerations reported from several field studies include:

- Heat pump water heaters require low entering water temperature and warm incoming air temperature to operate at high efficiencies.
- Design variables critical to system performance include energy loss in the distribution system, hot water usage by occupants, and hot water draw schedules throughout a multifamily building.
- Stratification strategies such as tank sizing and piping configuration keep HPWHs operating at desirable conditions.
- Multiple modules of a water heater can operate in parallel to increase overall capacity, and each heat pump water heater model has different performance characteristics.

In the 2019 Title 24, Part 6, the residential DHW baseline is an electric HPWH when the proposed system is a heat pump or electric resistance system serving individual dwelling unit or serving multiple dwelling units with no recirculating loops. The prescriptive pathway allows either heat pump water heaters meeting federally regulated efficiency levels along with supporting measures such as compact hot water distribution, drain water heat recovery or a Northwest Energy Efficiency Alliance (NEEA) Tier-III rated heat pump water heater. NEEA Tier-III rated equipment represent the most efficient heat pump water heaters available in the market that are rated to perform at outdoor conditions found in cold climate locations. The performance approach uses the federal minimum efficiency heat pump water heater along with the associated measures.

Under 2019 Title 24, Part 6 code, the DHW baseline follows the same rules for all multifamily buildings. The 2016 Title 24, Part 6 baseline DHW was gas water heater regardless of the proposed system fuel type.

2019 Title 24, Part 6 provides an alternative performance approach for HPWHs that serve more than one and up to eight units without the use of recirculation loops or pumps. This option is often called a ‘clustered’ design or approach. Under 2019 Title 24, Part 6, the clustered approach is considered analogous to the individual heat pump water heater approach and does not incur any compliance penalties.

Under the 2019 Title 24, Part 6 as well as previous code iterations, there is no prescriptive pathway for central HPWH with recirculation.

On Dec 19, 2019, the Energy Commission provided an Executive Director Determination Pursuant to Section 150.1 (c)8C that allows central HPHW systems that meet specified design and installation criteria, in addition to solar thermal or photovoltaic (PV) system requirements, to show compliance with 2019 Title 24, Part 6 under the prescriptive path (California Energy Commission 2019). The specified design allowed under this exception is a single-pass system with a specific configuration of heat pump water heaters, storage tanks, valves, and other controls.

Prior to February 2020, central HPWH with recirculation could not be modeled in the official compliance software. These limitations effectively eliminated a designer’s ability to replace a conventional central gas-fired water heater including recirculation with a central heat pump water heater. In the CBECC-Res 2019 version 1.2 released in February 2020, modeling of central heat pump water heating was added as a new feature with limited capabilities. CBECC-Res 2019 version 1.3 released in September 2020 added more configurations, large compressor types, loop tank options and tank locations. Even so, the capabilities for modeling the different configurations of central HPWH systems is limited as is the ability to accurately compare between various design choices and their impact on compliance. This is because there is limited performance data from the field to validate the software assumptions.

This measure is not required nor adequately modeled by other codes, such as the International Energy Conservation Code (IECC) and the American Society of Heating, Refrigerating and Air-Conditioning Engineers (ASHRAE) Standard 90.1, or voluntary rating systems, such as Leadership in Energy and Environmental Design (LEED) and ENERGY STAR®.

2.2.3 Electric Appliances and Miscellaneous Load

The Residential ACM Reference Manual applies to multifamily buildings three stories and fewer and contains a methodology for calculating appliances and miscellaneous loads that accounts for the specific appliances included in the dwelling units as well as the size of the dwelling unit and number of bedrooms. This appliance and

miscellaneous load are used both to calculate internal loads for space conditioning as well as total energy consumption for the whole building energy use using the Energy Design Rating (EDR) compliance approach. However, the Nonresidential ACM Reference Manual applicable to multifamily buildings four stories and greater contains a fixed plug load density of 0.50 W/ft² with no accounting for the specific appliances in the dwelling units or the size of the dwelling unit, or number of bedrooms. The Statewide CASE Team proposes that dwelling units in multifamily buildings four stories and greater use values and calculation methods from the Residential ACM Reference Manual.

2.2.4 Energy Efficiency Measures

The fenestration and wall u-factor requirements and related measure history is presented in a separate CASE Report (Multifamily Restructuring CASE Report 2020). Summary values are presented in Section 7.2.

2.3 Summary of Proposed Changes to Code Documents

The sections below summarize how the proposed change would modify the standards, Reference Appendices, ACM Reference Manuals, and compliance documents. See Section 7 of this report for detailed proposed revisions to code language.

The Energy Commission is considering consolidation of multifamily requirements under a new multifamily section(s) in 2022 Title 24, Part 6. Restructuring the standards for multifamily building may also result in revisions to Reference Appendices, ACM Reference Manuals, compliance manuals, and compliance documents. Location and section numbering of the 2022 Standards and supporting documents for multifamily buildings depend on the Energy Commission's approach to and acceptance of a unified multifamily section(s). For clarity, this CASE Report demonstrates the proposed changes in terms of the 2019 structure and language.

2.3.1 Summary of Changes to the Standards

This proposal would modify the following sections of Title 24, Part 6 as shown below. See Section 7.2 of this report for marked-up code language.

SECTION 150.1 PERFORMANCE AND PRESCRIPTIVE COMPLIANCE APPROACHES FOR LOW-RISE RESIDENTIAL BUILDINGS

(c) Prescriptive Standards/Components Package

8. Domestic Water-Heating Systems.

B. For system serving multiple dwelling units

- The proposed code change would add an alternative prescriptive pathway for heat pump water heater system serving multiple dwelling units and exempt the

solar water heating system requirement when a central HPWH system is installed.

SECTION 150.1 PERFORMANCE AND PRESCRIPTIVE COMPLIANCE APPROACHES FOR LOW-RISE RESIDENTIAL BUILDINGS

6. Heating System Type and Table 150.1-B

- Modify Section 150.1 (c) 6. Heating System Type to establish SZHP as baseline for multifamily buildings three stories and fewer.
- Modify Table 150.1-B to be consistent with modified Section 150.1 (c) 6

Section 140.4 PRESCRIPTIVE REQUIREMENTS FOR SPACE CONDITIONING SYSTEMS

- The proposed code change would prescriptively require space conditioning system to be electric SZHP system for all multifamily buildings four stories and greater. For Climate Zone 16, gas supplemental heating is required.

Section 140.3 PRESCRIPTIVE REQUIREMENTS FOR BUILDING ENVELOPES Table 140.3-C

- The proposal consolidates and aligns fenestration requirements in Climate Zone 16. The fenestration requirements are presented in a separate CASE Report (Multifamily Restructuring CASE Report 2020).

2.3.2 Summary of Changes to the Reference Appendices

This proposal would modify the following sections of the Reference Appendices for the measures associated with Electric HVAC for multifamily buildings four stories and greater and Central HPWH. No change would be needed of the Reference Appendices for measures associated with Electric HVAC for multifamily buildings three stories and fewer. See Section 7.3 of this report for the detailed proposed revisions to the text of the reference appendices.

- **New NA 2.4 Field Verification of Installed Heat Pump System in Highrise Residential Dwelling Units:** The purpose of these procedures is to verify that residential space cooling systems and heat pumps have the required components to achieve the energy efficiency claimed in the compliance documents. The procedures apply when an HSPF, SEER, or EER higher than the default is claimed.
- **JA14 Qualification Requirements for Central Heat Pump Water Heater System:** The proposed code change would add a new Joint Appendix to include testing and design documentation requirements for central HPWH systems in multifamily and nonresidential buildings.

- **Table RA2-1 Summary of Measures Requiring Field Verification and Diagnostic Testing:** The proposed new Central HPWH verification requirement would add an entry to the summary table under the Multifamily DHW Heating Measures heading.
- **New RA 3.6.x Field-Verified Central Heat Pump Water Systems Serving Multiple Dwelling Units:** The proposed code change would add a new section to the Reference Appendix to include field visual verification for central HPWH systems. The verification procedure would include verification of equipment specifications, minimum system capabilities, plumbing configuration, and installation requirements.

2.3.3 Summary of Changes to the Residential/Nonresidential ACM Reference Manuals

This proposal would modify the following sections of the Residential and Nonresidential ACM Reference Manuals as shown below. See Section 7.4 of this report for the detailed proposed revisions to the text of the ACM Reference Manuals.

NONRESIDENTIAL ACM REFERENCE MANUAL

SECTION 5 BUILDING DESCRIPTORS REFERENCE

- **5.1.2 HVAC System Map:** The proposal would update the Standard Design for residential buildings with seven or fewer floors as well as eight or more floors above grade to an electric heating system regardless of the proposed design fuel type. The Standard Design would be a SZHP system, and for Climate Zone 16 the Standard Design would be a SZHP with gas-fired furnace for supplemental heating. Table 5 would be updated to reflect the new standard system types.
- **5.7.5.2 Direct Expansion:** For ducted heat pump in dwelling units and common areas of multifamily buildings four stories and greater, the Standard Design Energy Efficiency Ratio (EER) would be 11.7.
- **5.7.6.4 Electric Heat Pump Supplemental Heat Source:** For dwelling units in multifamily buildings four stories and greater in Climate Zone 16, the Standard Design would be gas-fired furnace. In Climate Zones 1-15, the Standard Design would have electric resistance supplemental heat.
- **5.3.3 Receptacle Load:** The proposal suggests a change for dwelling units in multifamily buildings four stories and greater to use values from Appendix E – Plug Loads and Lighting Modeling from the 2019 Residential Alternative Calculation Method Reference Manual.

RESIDENTIAL ACM REFERENCE MANUAL SECTION

2.4 Building Mechanical System

- **2.4.1 Heating Subsystems:** The proposed code change would modify the section describing the Standard Design for space heating system to include

SZHP as baseline for Climate Zone 1-15. Additionally, for Climate Zone 4 to 10, the Standard Design would include a balanced ventilation system without heat or energy recovery that has a fan efficacy of 0.4W/cfm. For Climate Zone 16, the Standard Design would be a SZAC with gas-fired furnace for space conditioning. For Climate Zone 15, the Standard Design SZHP fan efficiency shall be 0.45 W/cfm.

2.9 DOMESTIC HOT WATER (DHW)

- **2.9.3 Multiple Dwelling Units:** The proposed code change would add a section describing the Standard Design for a central HPWH system with recirculation loop. It would also clarify Standard Design for individual heat pump water heaters serving multiple dwelling units without recirculation loop.

2.3.4 Summary of Changes to the Residential/Nonresidential Compliance Manual

The proposed code change would modify the Nonresidential Compliance Manual to include prescriptive requirement for electric heat pump for multifamily buildings four stories and greater.

The proposed code change would modify the following section of the Residential Compliance Manual:

- **4.2.2 Prescriptive Requirements for Heating Equipment** - update to explain the prescriptive requirement for the Standard Design to include SZHP as baseline for Climate Zone 1-15. Additionally, for Climate Zone 4 to 10, the Standard Design would include a balanced ventilation system without heat or energy recovery that have fan efficacy of 0.4W/cfm. For Climate Zone 16, prescriptively requires a SZAC with gas-fired furnace for space conditioning.
- **Section 5.1 Overview** – add overview of new requirements around Central HPWH
- **Section 5.2 Residential Water Heating Equipment** - Add descriptions on the central HPWH equipment, design, plumbing configurations, and installation requirements.
- **Section 5.4 Prescriptive Requirements for Water Heating** - Add the Code of Federal Regulation (CFR) reference for the 12-kW threshold for the “residential electric storage” water heater designation and clarify the definition of “central HPWH” for code requirement perspective.
- **Section 5.4.2 Prescriptive Requirements for Water Heating for Multiple Dwelling Units** - The proposed change would add a new section to explain intent and reasonings for the central HPWH prescriptive alternative and describe best practices for designing and sizing central HPWH systems.
- **Section 5.5.3 Performance Approach Compliance for Water Heating Systems Serving Multiple Dwelling Units.**

The proposed code change would modify the following section of the Nonresidential Compliance Manual:

- **Section 4.8.3 Prescriptive Requirements Applicable to High-rise Residential**
- **Section 13 Acceptance Test Requirements**

See Section 7.5 of this report for the detailed proposed revisions to the text of the Compliance Manuals.

2.3.5 Summary of Changes to Compliance Documents

The proposed code change would modify the following compliance documents. Examples of the revised document are presented in Section 7.6.

For Electric HVAC measure, for the prescriptive compliance approach the proposed code change would add a table to an existing Certificate of Compliance or create a new Certificate of Compliance (CF1R-PLB and NRCC-PLB-E).

- Update the NRCC-MCH-E forms to remove gas space heating as a standard system for multifamily buildings four stories and greater.
- Update the NRCI-MCH-E to add verification of installed HVAC system efficiency.
- Update CF1R-NCB-01-E to remove gas space heating option for multifamily buildings three stories and fewer in Climate Zone 1-15. Add data field for ventilation system fan efficacy.

For the CHPWH prescriptive compliance approach the proposed code change would add a table to an existing Certificate of Compliance or create a new Certificate of Compliance (CF1R-PLB and NRCC-PLB-E)

For the CHPWH performance compliance approach the proposed changes would require updates to the following compliance forms:

- CF2R-PLB-01a-NonHERS-MultifamilyCentralHotWaterSystemDistribution
- CF2R-PLB-21a-HERS-MultifamilyCentralHotWaterSystemDistribution
- CF3R-PLB-21a-HERS-MultifamilyCentralHotWaterSystemDistribution
- NRCI-PLB-02-HighRiseResHotelMotel-MultifamilyCentral-HWSystemDistribution
- NRCI-PLB-21-HERS-HighRiseResHotelMotel-MultifamilyCentral-HWSystemDistribution
- NRCV-PLB-21-HERS-HighRiseResHotelMotel-MultifamilyCentral-HWSystemDistribution

The proposed code change would add descriptions and data fields for the field testing and visual inspection of central HPWH systems.

2.4 Regulatory Context

2.4.1 Existing Requirements in the California Energy Code

This topic builds on the 2019 Title 24, Part 6 Standards that allow a dual baseline strategy wherein electrically space- and water-heated buildings are compared to a code minimum electrically space- and water-heated building, whereas natural gas-based systems for heating and water heating are compared to code minimum natural gas-based systems. The limitation is that the dual baseline option for water heating is only available for multifamily buildings with individual water heaters, and the dual baseline option for HVAC is available only for multifamily buildings three stories and fewer. The 2019 Title 24, Part 6 Standards did not address central water heating. It also did not address HVAC and non-regulated end uses, such as appliances and plug loads for multifamily buildings four stories and greater.

Under the 2019 Title 24, Part 6 requirements, all multifamily buildings follow the same rules for the DHW baseline. 2019 Title 24, Part 6 provides an alternative performance approach for HPWHs that serve more than one and up to eight units without the use of recirculation loops or pumps. This option is often called a 'clustered' design or approach. Under 2019 Title 24, Part 6, the clustered approach is considered analogous to the individual heat pump water heater approach and does not incur any compliance penalties.

For multifamily buildings four stories and greater, the performance pathway under 2019 Title 24, Part 6 code uses mixed fueled HVAC system as the baseline (CEC 2019). The California Energy Commission has proposed changes to the current 2019 Title 24, Part 6 code Nonresidential ACM Reference Manual to use the following equipment as baseline HVAC systems. The new baseline system is single zone constant volume direct expansion air conditioner (Split Dx) with gas-fired furnace. The Statewide CASE Team uses these proposed baseline systems as the basis of this CASE Report analysis for multifamily buildings four stories and greater.

The 2019 Title 24, Part 6 Residential ACM Reference Manual specifies a Seasonal Energy Efficiency Ratio (SEER) of 14.0 and Energy Efficiency Ratio (EER) of 11.7 for space cooling systems. The Statewide CASE Team uses this existing requirement as the basis to compare heat pump technologies versus split system air conditioners with gas-fired furnaces for dwelling units in multifamily buildings four stories and greater.

On December 19, 2019, the Energy Commission provided an Executive Directive that allows central HPHW systems that meet specified installation criteria in addition to solar thermal or PV installation requirements to show compliance to 2019 Title 24, Part 6 (California Energy Commission 2019). Figure 4 is a schematic of the system.

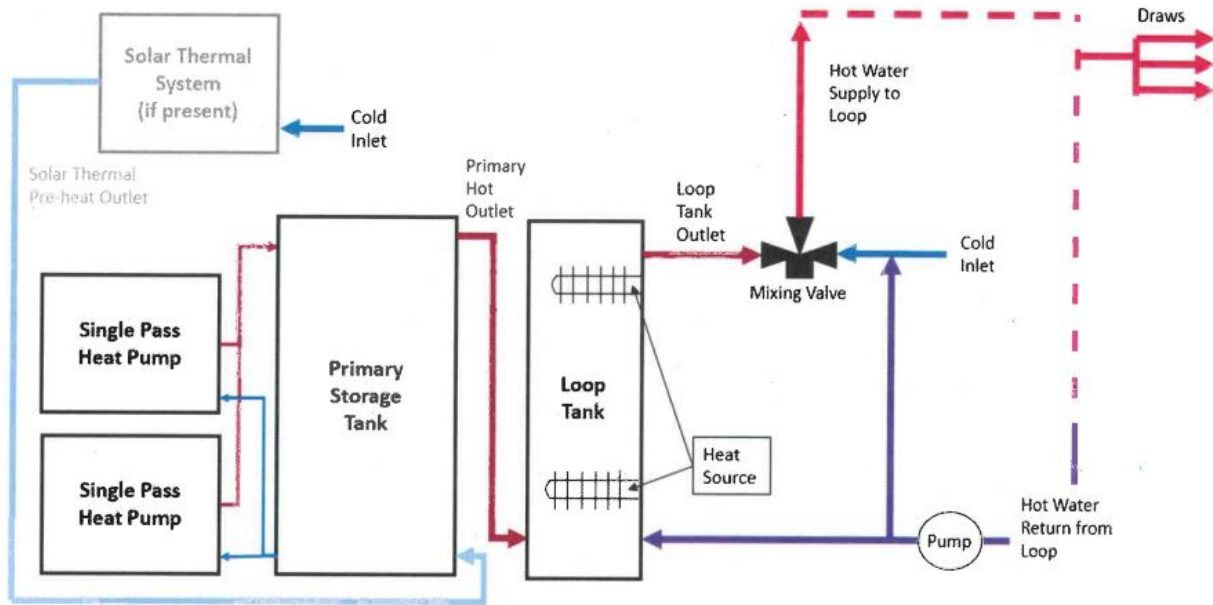

Figure 4: Central HPWH design schematic that complies with 2019 Title 24, Part 6 by executive director.

Source: (CEC 2019).

2.4.2 Relationship to Requirements in Other Parts of the California Building Code

There are no relevant requirements in other parts of the California Building Code.

2.4.3 Relationship to Local, State, or Federal Laws

U.S. D.O.E. has federal minimum efficiency requirements for DHW and HVAC equipment specified in the Code of Federal Regulations at 10 CFR 430.32(d) (Code of Federal Regulations 2020). Efficiency varies with the equipment class and the equipment capacity. Table 5 and Table 6 give a summary of the federal efficiency requirements.

U.S. D.O.E. has a federal efficiency standard for HPWHs with rated storage volume less than 120 gallons specified in the Code of Federal Regulations at [10 CFR 430.32\(d\)](#) (Code of Federal Regulations 2020). There is no federal efficiency standard for HPWHs with larger storage volume. While many of the heat pump water heaters in the regulated category (less than 120 gallons) can be used for central water heater design, the proposed measure does not require efficiency above the federal standards and thus, does not trigger preemption.

There is no federal efficiency standard for commercial size HPWHs, as defined by 10 CFR 431.102.

As of November 2020, approximately 4390 local jurisdictions have adopted local ordinances (Building Decarbonization Coalition 2020) that encourage or require the use

of electric water heating in residential and/or nonresidential applications. Some of these ordinances, such as Berkeley, Morgan Hill, and Cupertino, have language similar to the following:

“Exception: Natural Gas Infrastructure may be permitted in a Newly Constructed Building if the Applicant establishes that it is not physically feasible to construct the building without Natural Gas Infrastructure. For purposes of this exception, “physically feasible” to construct the building means either an all-electric prescriptive compliance approach is available for the building under the Energy Code or the building is able to achieve the performance compliance standards under the Energy Code using commercially available technology and an approved calculation method (City of Berkeley 2019).

Discussion with city staff and associated consultants indicate that the language was specifically written with central HPWH with recirculation in mind. These local ordinances intend to encourage the electrification code proposal despite broader implementation challenges. Under the original 2019 Title 24, Part 6, there is no prescriptive path or a performance modeling approach for central HPWH with recirculation. While it is possible for central water heaters distributed throughout the building, each serving up to eight dwelling units with a trunk and branch system, to currently comply with Title 24, Part 6 performance method, the clustered design is a departure from current industry practice for multifamily buildings.

Table 5: Federal Minimum Efficiency Requirements for Residential Water Heaters (Partial)

Product class	Rated storage volume and input rating (if applicable)	Draw pattern	Uniform energy factor
Electric Storage Water Heaters	≥20 gallons and ≤55 gallons	Very Small	$0.8808 - (0.0008 \times V_r)$
		Low	$0.9254 - (0.0003 \times V_r)$
		Medium	$0.9307 - (0.0002 \times V_r)$
		High	$0.9349 - (0.0001 \times V_r)$
	>55 gallons and ≤120 gallons	Very Small	$1.9236 - (0.0011 \times V_r)$
		Low	$2.0440 - (0.0011 \times V_r)$
		Medium	$2.1171 - (0.0011 \times V_r)$
		High	$2.2418 - (0.0011 \times V_r)$

* V_r is the Rated Storage Volume (in gallons), as determined pursuant to 10 CFR 429.17.

Table 6 summarizes the federal minimum efficiency requirement for HVAC systems. The federal requirements that go into effect January 1, 2023 will apply during the 2022 Title 24, Part 6 code cycle, which will also go into effect January 1, 2023. The proposed measure does not require HVAC systems having efficiency above the federal standards, thus does not trigger preemption.

Table 6: Federal Minimum Efficiency Requirements for HVAC Systems

Product	Sub-category	Heating Type	Ducts	Capacity	Efficiency	Date
Central air conditioner	Split		Ducted	<45,000 Btu/h	14 SEER; 12.2 EER	January 1, 2015 to January 1, 2023
Central heat pump	Split		Ducted	<65,000 Btu/h	14 SEER; 8.2 HSPF	January 1, 2015 to January 1, 2023
Central air conditioner	Split		Ductless	<45,000 Btu/h	14 SEER; 12.2 EER	January 1, 2015 to January 1, 2023
Central heat pump	Split		Ductless	<65,000 Btu/h	14 SEER; 8.2 HSPF	January 1, 2015 to January 1, 2023
Central air conditioner	Packaged			<65,000 Btu/h	14 SEER; 11.0 EER	January 1, 2015 to January 1, 2023
Central heat pump	Packaged			<65,000 Btu/h	14 SEER; 8.0 HSPF	January 1, 2015 to January 1, 2023
Central air conditioner	Split		Ducted	>=45,000 Btu/h; <65,000 Btu/h	14 SEER; 11.7 EER	January 1, 2015 to January 1, 2023
Central air conditioner	Split		Ductless	>=45,000 Btu/h; <65,000 Btu/h	14 SEER; 11.7 EER	January 1, 2015 to January 1, 2023
Central air conditioner	Split		Ducted	<45,000 Btu/h	14.3 SEER2; 11.7 EER2 (if SEER2 < 15.2); 9.8 EER2 (if SEER2 >= 15.2)	January 1, 2023 onwards
Central heat pump	Split		Ducted	<65,000 Btu/h	14.3 SEER2; 7.5 HSPF2	January 1, 2023 onwards
Central air conditioner	Split		Ductless	<45,000 Btu/h	14.3 SEER2; 11.7 EER2 (if SEER2 < 15.2); 9.8 EER2 (if SEER2 >= 15.2)	January 1, 2023 onwards
Central heat pump	Split		Ductless	<65,000 Btu/h	14.3 SEER2; 7.5 HSPF2	January 1, 2023 onwards
Central air conditioner	Packaged			<65,000 Btu/h	13.4 SEER2; 10.6 EER2	January 1, 2023 onwards
Central heat pump	Packaged			<65,000 Btu/h	13.4 SEER2; 6.7 HSPF2	January 1, 2023 onwards
Central air conditioner	Split		Ducted	>=45,000 Btu/h; <65,000 Btu/h	13.8 SEER2; 11.2 EER2 (if SEER2 < 15.2); 9.8 EER2 (if SEER2 >= 15.2)	January 1, 2023 onwards

Product	Sub-category	Heating Type	Ducts	Capacity	Efficiency	Date
Central air conditioner	Split		Ductless	>=45,000 Btu/h; <65,000 Btu/h	13.8 SEER2; 11.2 EER2 (if SEER2 < 15.2); 9.8 EER2 (if SEER2 >= 15.2)	January 1, 2023 onwards
VRF Multi-Split Air Conditioner (Air-Cooled)		All Heating Types		<65,000 Btu/h	13.0 SEER	June 16, 2008 onwards
VRF Multi-Split Heat Pump (Air-Cooled)		All Heating Types		<65,000 Btu/h	13.0 SEER, 7.7 HSPF	June 16, 2008 onwards
VRF Multi-Split Heat Pump (Air-Cooled)		No Heating or Electric Resistance Heating		>=65,000 Btu/h; <135,000 Btu/h	11.0 EER, 3.3 COP	January 1, 2010 onwards
VRF Multi-Split Heat Pump (Air-Cooled)		All Other Types of Heating		>=65,000 Btu/h; <135,000 Btu/h	10.8 EER, 3.3 COP	January 1, 2010 onwards
VRF Multi-Split Heat Pump (Air-Cooled)		No Heating or Electric Resistance Heating		>=135,000 Btu/h; <240,000 Btu/h	10.6 EER; 3.2 COP	January 1, 2010 onwards
VRF Multi-Split Heat Pump (Air-Cooled)		All Other Types of Heating		>=135,000 Btu/h; <240,000 Btu/h	10.4 EER; 3.2 COP	January 1, 2010 onwards
VRF Multi-Split Air Conditioner (Air-Cooled)		No Heating or Electric Resistance Heating		>=65,000 Btu/h; <135,000 Btu/h	11.2 EER	January 1, 2010 onwards
VRF Multi-Split Air Conditioner (Air-Cooled)		All Other Types of Heating		>=65,000 Btu/h; <135,000 Btu/h	11.0 EER	January 1, 2010 onwards
VRF Multi-Split Air Conditioner (Air-Cooled)		No Heating or Electric Resistance Heating		>=135,000 Btu/h; <240,000 Btu/h	11.0 EER	January 1, 2010 onwards
VRF Multi-Split Air Conditioner (Air-Cooled)		All Other Types of Heating		>=135,000 Btu/h; <240,000 Btu/h	10.8 EER	January 1, 2010 onwards

2.4.4 Relationship to Industry Standards

ASHRAE 90.1 Energy Cost Budget Method Figure 11.5.2 defines the HVAC system baseline based on proposed heating system fuel type. Title 24, Part 6 and 90.1 map system and fuel types differently.

There are no relevant requirements for Central HPWH in national model codes, such as IECC, ASHRAE 90.1, and ASHRAE 189.1. There are several industry standards for HPWH testing procedure:

- Residential water heaters, with a nameplate input rating of 12 kW or less, and containing more than one gallon of water per 4,000 Btu per hour of input, can be rated according to Code of Federal Regulation Title 10 Appendix E to Subpart B of Part 430—Uniform Test Method for Measuring the Energy Consumption of Water Heaters.
- Commercial HPWHs, having a rated electric power input greater than 12 KW (10 CFR §431.102 2020), can be rated according to Code of Federal Regulation Title 10 Appendix E to Subpart G of Part 431 - Uniform Test Method for the Measurement of Energy Efficiency of Commercial Heat Pump Water Heaters (CFR 10 431 Subpart G 2020).
- Commercial HPWHs can also be rated according to ANSI/AHRI Standard 1301 Performance Rating of Commercial Heat Pump Water Heaters.

However, most of the HPWH manufacturers interviewed by the Statewide CASE Team suggested that there is no clear Code of Federal Regulation (CFR) classification for the HPWH products most relevant to this proposal, and most manufacturers test their product using in-house procedure that is not publicly available.

The Statewide CASE Team proposed to establish a standardized testing procedure, as presented in the new Joint Appendix 14. The new testing method references 10 CFR Appendix E to Subpart G of Part 431 for test setup and calculation approach and requires testing conditions that are included in the PG&E ATS lab testing currently being conducted and future tests planned by the California Statewide IOUs described in Section 2.2.2.

The performance curves developed for individual heat pump waters through research conducted by NEEA, may be applicable to some central system products. The PG&E ATS lab testing and algorithm development would provide performance curves for more central HPWH product.

2.5 Compliance and Enforcement

When developing this proposal, the Statewide CASE Team considered methods to streamline the compliance and enforcement process and how to mitigate or reduce

negative impacts on market actors who are involved in the process. This section describes how to comply with the proposed code change. It also describes the compliance verification process. Appendix E presents how the proposed changes could impact various market actors.

Compliance and Enforcement would remain the same for all-electric HVAC designs even though the choice of Standard Design will change to a SZHP system.

Compliance activities associated with central HPWH measure include:

- **Design Phase:** Design engineers (generally plumbing engineers) specify heat pump water heater equipment and recirculation system design according to best practices guide and manufacturer guidelines. Designers would specify space footprint and clearance and structural support for large storage tanks; this practice is similar to current practice for conventional gas-fired water heater systems. The design drawings show additional design features and details for ventilation requirements and condensate pipe. Design engineers provide modeling inputs for the central HPWH system in the compliance software and information on system designs and features on the Certificate of Compliance Documents. Activities designers would perform are as follows:
 - Estimate recirculation loop loss to assist sizing of recirculation loop tank heating capacity. Although plumbing engineers should have performed similar analyses when sizing for a gas-fired DHW system, this step is not critical for gas-fired systems and therefore is often overlooked.
 - Size and specify storage tanks. The larger HPWH equipment most suitable for central systems is configured as standalone heat pumps. Therefore, the storage tank must be separately sized. This contrasts with gas-fired systems where many large water heaters (with sufficient storage capacity) are readily available, which are easily specified and designed with minimal custom engineering work.
 - Increase electrical panels to support additional loads.
 - Communicate with compliance modeling consultant to provide design inputs.
- **Permit Application Phase:** Design engineers and energy consultant work together to model the central HPWH system via compliance software. Building officials would perform plan check reviews as usual on equipment location, recirculation system design, and verify that the building adheres to the performance budget or is designed according to prescriptive standards.
- **Construction Phase:** Plumbing contractors would install the central HPWH system including the heat pump, storage tanks, plumbing components, and specialties including mixing valves and control sensors – as designed and per

manufacturer instructions. After installation, either a design engineering team member or a contracted third party would perform necessary commissioning testing to ensure the system and controls are installed and function as designed.

- **Inspection Phase:** Plumbing contractors would populate CF2R-PLB-XX or NRCI form and schedule on-site verifications. HERS Raters or ATTs would perform on-site verification to ensure that the equipment, system design, piping configurations, and controls are in alignment with submitted plans and code requirements. HERS Raters or ATTs would submit CF3R/NRCA/NRCV forms accordingly.

The compliance process for central HPWH systems requires a higher degree of design engineer and energy consultant coordination during design phase, closer contractor adherence to the design details during installation, and continued oversight from design engineers throughout and after installation, compared to a similar gas-fired system.

Incorporating the proposed code changes for central HPWH systems would provide the minimum requirements to ensure safety, reliability, and performance of heat pump water heating systems. The Statewide CASE Team developed the requirements based on the latest available body of knowledge gained from project experience and insights gleaned from expert designers.

3 Market Analysis

The Statewide CASE Team has reached out to stakeholders to collect information on the state and challenges of current all-electric designs in multifamily buildings in California. Appendix F summarizes stakeholder engagement efforts. Stakeholder interviews revealed that the main drivers for a project to use an all-electric design include:

- Environmental reasons. In many cases, the project owner came into the design process with the intent of going all-electric to reduce GHG emissions or achieve zero-net energy.
- Reduced overall construction cost achieved through elimination of gas infrastructure on site, reduction of design and construction coordination needs without gas system,
- Benefits of lower operation and maintenance costs, in some cases, and better indoor air quality.
- Resiliency of all-electric buildings, especially with the potential for battery storage.

All-electric buildings are increasing rapidly and as more local jurisdictions support decarbonization initiatives, there will be significant increase in all-electric buildings in the state. The Statewide CASE Team collected all-electric project information using interviews, surveys, design drawing review, and Title 24, Part 6 compliance document review. Data sources included Association for Energy Affordability (AEA), Frontier Energy, Redwood Energy, EHDD, Gabel Energy, Build it Green (now Franklin Energy), Mithun, and the CMFNH program, collectively referred as “Project Based Data” in this document.

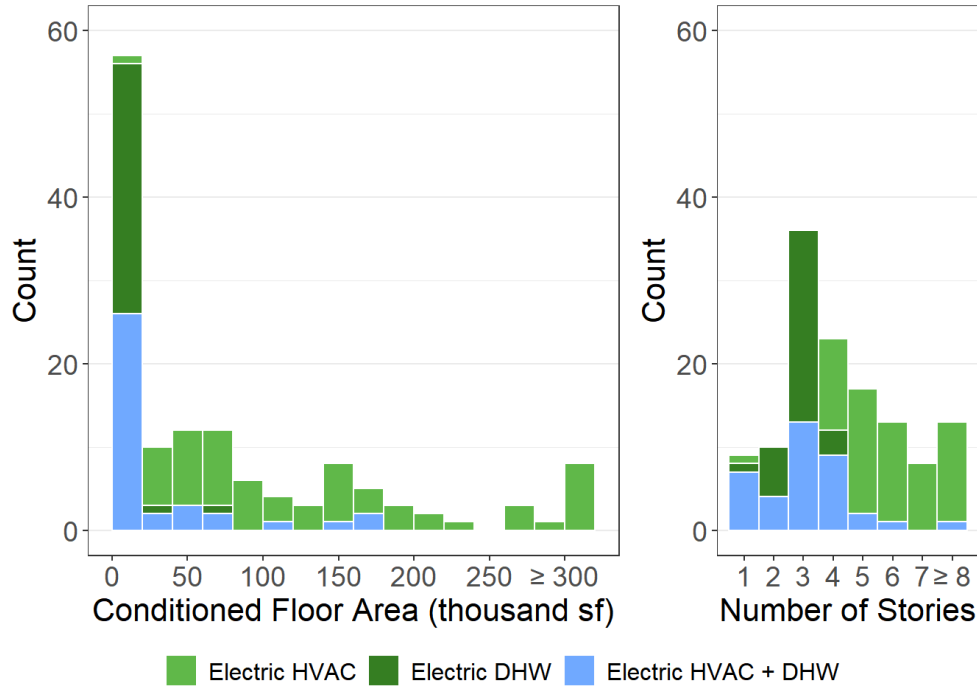

Figure 5: (Left) Histogram of system types by conditioned floor area; (Right) Histogram of system types by number of stories.

Source: Project Based Data.

Note that this dataset has a self-selection bias since the Statewide CASE Team received data from those stakeholders willing to share data. As a result, most projects are in Northern California. This does not mean that other areas of the state are not seeing similar trends.

As seen in Figure 5, projects may have either an electric HVAC or DHW system, but not necessarily both. The Statewide CASE Team reviewed buildings with electric HVAC and DHW systems from data provided by stakeholders to study current market practices. Out of 136 buildings with an electric HVAC or DHW system, 37 projects had both an electric HVAC and DHW system, 66 had only an electric HVAC system, and 33 had only an electric DHW system. The 37 projects that had both an electric HVAC and DHW system are in cities that cover a wide range of climate conditions including Climate Zones 2, 3, 4, and 12.

Figure 5 compares characteristics of buildings with an electric HVAC system only, an electric DHW system only and both an electric HVAC and DHW system. Although electric HVAC systems exist in both small and large buildings, buildings with an electric DHW system, and buildings with both electric HVAC and DHW systems are often less than three-stories and 20,000 ft², with 10 to 20 dwelling units.

3.1 Electric HVAC Systems

3.1.1 Market Structure

The Statewide CASE Team performed a market analysis to identify current technology availability, current product availability, and market trends and to determine how the proposed standard may impact the market in general as well as individual market actors. The Statewide CASE Team also gathered information about the incremental cost of complying with the proposed measure. The Statewide CASE Team estimated market size and measure applicability through research and outreach with stakeholders including utility program staff, Energy Commission staff, and a wide range of industry actors. In addition to conducting personalized outreach, the Statewide CASE Team discussed the current market structure and potential market barriers during a public stakeholder meeting that the Statewide CASE Team September 10, 2019, and March 17, 2020.

The all-electric space heating technology market actors include building owners/developers, design consultant team, contractors, equipment manufacturers, and energy consultants. Description of each type of market actor below.

- **Architects** – Architects are part of the project design consultant team that include architects, mechanical, plumbing, structural, and electrical consultants. Architects design the buildings and plan for the spaces where mechanical and plumbing equipment are installed. Decisions made by architects on the size and location of mechanical/plumbing areas, as well as other aspects of building layout, can significantly impact the feasibility of split heat pump system and variable refrigerant flow (VRF) systems. For example, there are strict length limitations on refrigerant piping for VRF and split heat pump systems such that the outdoor unit of a heat pump system cannot be too far away from its indoor unit which is installed in the space it is serving. Architects need to provide space to accommodate the outdoor units for the heat pump systems.
- **Building owners/developers** – Owners and developers are the decision-makers on the type of systems that go into their buildings. The project owner came into the design process with the intent of going all-electric or was interested in zero-net energy from the onset in many of the projects reviewed by the CASE Team that use both all-electric HVAC and DHW systems.
- **Mechanical engineers** - Mechanical engineers are responsible for designing HVAC systems. They are responsible for determining HVAC system type to be used in the building and ensuring the design satisfy all installation requirements of each equipment such that the HVAC system can function properly. This involves coordination with architect/structural/plumbing/electrical to ensure space requirement, structural support, etc. Stakeholder interviews revealed that the

project consultant team can have a strong influence on building owner/developer in decision of the type of HVAC and plumbing system that go into a building, Design consultant team need to have the knowledge of the all-electric HVAC technology and ability to communicate value proposition to the building owner and developers. In addition, as of March 2020, 29 local jurisdictions have adopted local ordinances (Building Decarbonization Coalition 2020) that encourage or require the use of electric space heating. These professionals need to follow reach code requirements when deciding whether a mixed-fuel or all-electric system to use.

- **Manufacturers** – Equipment manufacturers develop, market, and sell HVAC equipment. Manufacturers support design engineers by providing equipment selection software and suggesting equipment layout concept. They also support equipment installation, start-up testing by providing training to contractors and builders. Manufacturer’s reps provide local design, installation, and commissioning assistance for equipment manufactures not located in California. Details on manufacturers and product availability is in section 3.1.2.2.
- **Contractors** - The mechanical contractor usually installs the HVAC equipment, with some coordination by a general contractor. There are many contractors with extensive experience in installing heat pump systems, including VRF systems.
- **Energy consultants** – Energy consultants both complete energy code-compliance modeling and advise design teams on improved design approaches. These professionals would need to learn how the design and modeling of an all-electric HVAC system is different from gas-based HVAC systems so that they can appropriately advise design teams and accurately model the systems for code-compliance.

3.1.2 Technical Feasibility, Market Availability, and Current Practices

3.1.2.1 Technical Feasibility

The Statewide CASE Team reviewed 103 buildings with electric HVAC systems installed. Most of the buildings (49) had individual SZHP systems in the dwelling units. Other HVAC systems used include ductless heat pump systems, water source heat pumps, PTHP, electric baseboard heating, electric resistance heating, and VRF systems.

Figure 6 shows the HVAC systems used as a function of the number of stories in the building. SZHP systems are most common. Electric resistance heating was found only in affordable housing projects where cooling was not installed because of the building’s location in mild climates. For taller buildings, even though VRF systems are not as common as SZHPs in existing projects, the majority of the stakeholders the Statewide

CASE Team interviewed mentioned VRF system being the system of choice for high rise multifamily buildings.

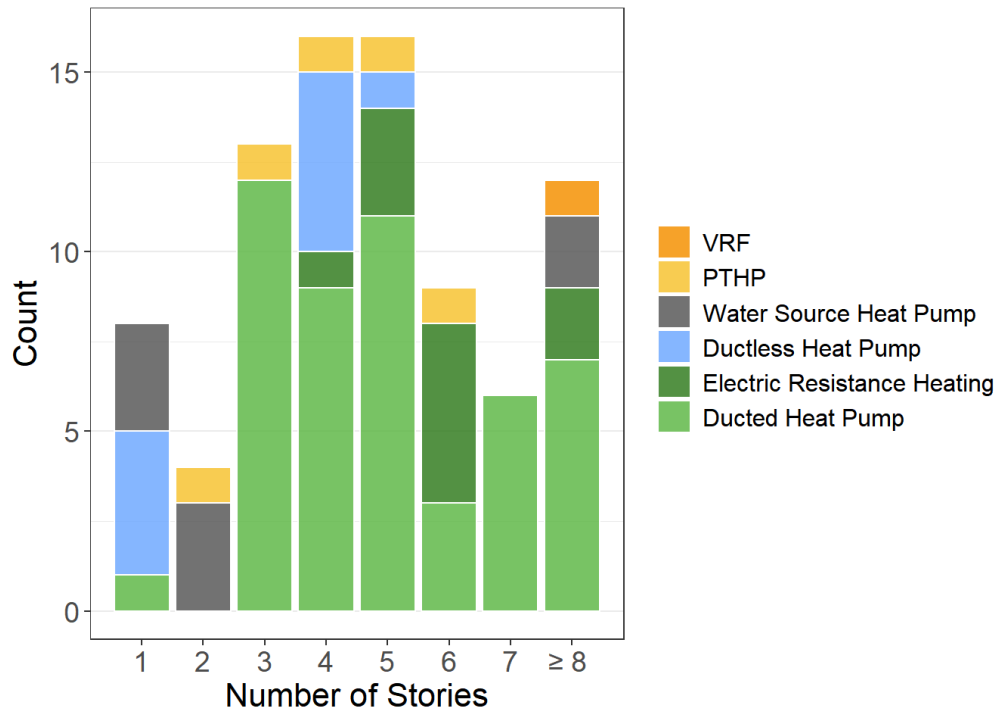

Figure 6: Electric HVAC system type by number of stories.

Source: Project Based Data.

The Statewide CASE Team also reviewed system efficiencies used in the projects. Figure 7 and Figure 8 show efficiencies by system type split by the code cycle of Title 24, Part 6 for which the project pulled a permit. A Seasonal Energy Efficiency Ratio (SEER) of 13 was required for the 2008 and part of the 2013 code cycle (until 2015). The SEER requirement increased to 14 in 2015. For the 2013 and 2016 code cycles, most of the air source heat pumps used in projects had SEER values exactly at the Title 24, Part 6 minimum requirement (SEER 14). An increasing number of projects used heat pumps with a higher SEER rating than required over the years. However, a higher SEER compared to the Title 24, Part 6-required SEER did not necessarily result in a higher space cooling compliance margin, suggesting the higher efficiency equipment was used to make up for high energy usage elsewhere in the building envelope or systems.

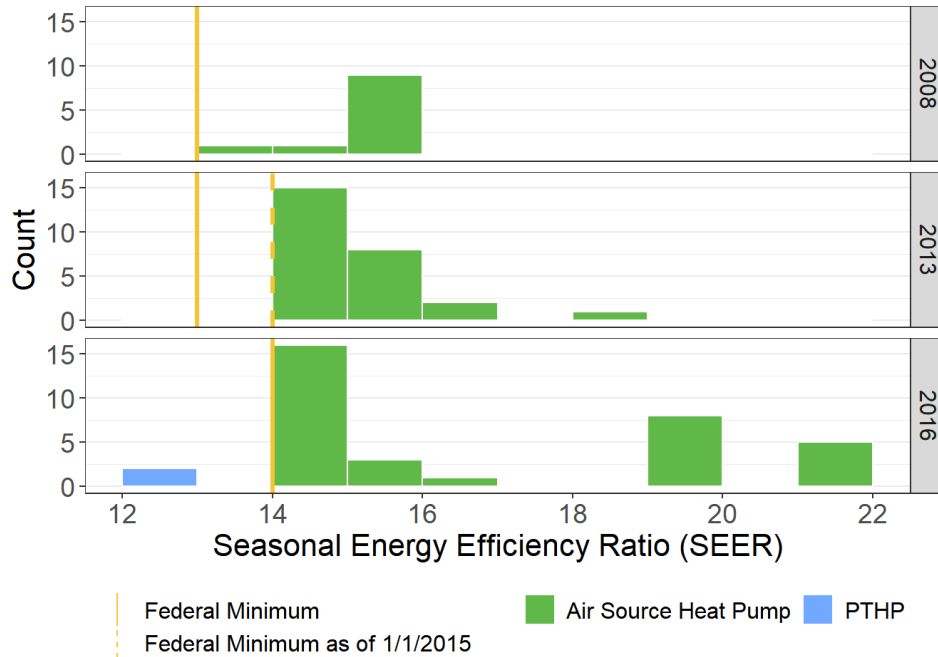

Figure 7: SEER of heat pump systems by Title 24, Part 6 code cycle.

Source: Project Based Data.

The Heating Seasonal Performance Factor (HSPF) requirement of air source heat pumps for Title 24, Part 6 was 7.7 during the 2008 code cycle and part of the 2013 code cycle (until 2015). After 2015, for the 2013 and 2016 code cycles, the HSPF requirement for Title 24, Part 6 was 8.0 for packaged and 8.2 for split systems. Similar to the heat pump SEER values, most projects during the 2013 and 2016 cycles were exactly at the Title 24, Part 6 code minimum HSPF requirement for split systems. Higher HSPF values than required did not necessarily result in a higher space heating compliance margin.

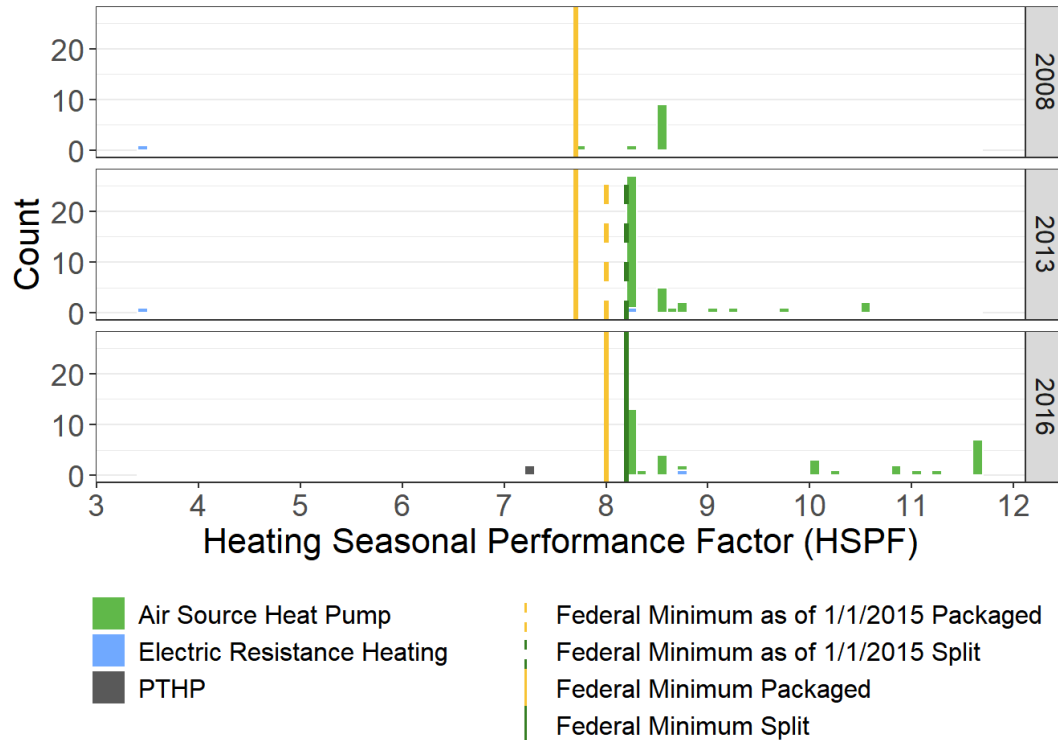

Figure 8: HSPF of electric heating systems by Title 24, Part 6 code cycle.

Source: Project Based Data.

Cold Climate Performance

Heat pumps face a challenge in colder climates where their capacity for providing heat and the efficiency of the equipment reduces as the outdoor temperature drops. This is especially true for the type of minimal efficiency heat pumps that are the basis for the federal appliance standards for heat pumps. In California, there is currently limited application of heat pumps in cold climates. The data presented in this section mostly represents heat pump installations in areas of the state that do not see significant heating loads or temperatures below freezing.

Across the nation, there have been several initiatives to develop cold climate heat pump specifications. The Northwest Energy Efficiency Partnership (NEEP) has developed and continues to update Cold Climate Air Source Heat Pump Specifications. The latest specification (version 3) was released in June 2020 (NEEP 2020). This specification requires that air source heat pumps have variable capacity compressors with at least three of more distinct operating speeds, indoor and outdoor units must be part of an AHRI matched system and have higher efficiencies than the federal standards (HSPF ≥ 9 for Ducted systems and COP $5^{\circ}\text{F} > 1.75$ (at maximum capacity operation) for all ducted systems and SEER ≥ 15).

While these heat pumps perform better in colder climates like Climate Zone 16 in California, their use to set code requirements is limited by federal appliance standards that pre-empt these higher efficiency systems.

As an alternative, the Statewide CASE Team reviewed recommendations from NEEA and other entities on options to use standard or minimal efficiency heat pump systems. These are primarily focused on retrofit applications or applications where the standard heat pumps will have performance issues.

One example is the work done by the New York State Energy Research and Development Authority (NYSERDA) to develop an analysis of heat pump potential and economics (NYSERDA 2019). This report identified a need to maintain conventional heating systems to serve peak heating loads. Here is an excerpt from that report:

“ASHPs were assumed to be sized to serve full cooling demand in both retrofit and new construction situations; however, for existing buildings it was assumed that the conventional heating system (oil, gas, or electric resistance heating) would remain in place to serve peak heating loads in the winter that would exceed the capacity of the heat pump. Accordingly, such ASHP systems were assumed to be installed at a somewhat smaller system capacity of 3 tons for single-family and 5 tons for small multifamily (compared to the reference site size of 4 tons and 6 tons, respectively) to reflect their sizing to meet summer cooling load rather than the higher winter peak load. By contrast, ASHP installations in single-family and small multifamily new construction settings were assumed to be sized somewhat bigger than the reference size (at 5 tons for single family and 8 tons for small multifamily) to enable such ASHP systems to meet the peak heating demand despite their expected lower performance levels during the coldest hours of the years.”

The Statewide CASE Team therefore considered the option of using gas supplemental heat in colder climates in California where the standard efficiency heat pump systems would struggle to meet heating loads.

3.1.2.2 Market Availability

The Statewide CASE Team reviewed the product availability of split heat pumps, PTHPs, and VRF systems relative to federal and state required minimum efficiency levels. To review product availability of split heat pumps and packaged terminal heat pumps, the Statewide CASE Team used the Modernized Appliance Efficiency Database System (MAEDbS), which shows appliances compliant under Title 20. Since VRF systems were not listed in the MAEDbS, the Statewide CASE Team collected VRF system information from manufacturer websites. About 95 percent of split heat pumps and PTHP and about 80 percent of VRF systems were at or above federal minimum

efficiency levels indicating considerable market availability of higher efficiency products if desired.

Detailed product availability analysis is provided in Appendix G. In summary:

- **Air source split heat pump:** The Statewide CASE Team reviewed split heat pumps that were added to the MAEDbS on or after January 1st, 2015 (the last update to the federal minimum efficiency for split heat pump systems). There were 18 manufacturers with a total of 268 models in the California market. The five manufacturers that had the most models listed were: Carrier Corporation, Nortec Global HVAC, Midea Group, Johnson Controls International PLC, and Rheem Manufacturing Company. All split heat pumps had a cooling capacity of less than 65,000 Btu/h, which has a federal minimum efficiency requirement of SEER at 14.0 and HSPF at 8.2. Nineteen percent of the models available were just meeting federal minimum efficiency, and 23 percent of the models have SEER 16.2 and HSPF 8.5 or better.
- **PTHP:** The Statewide CASE Team reviewed PTHPs added to the MAEDbS on or after October 8th, 2012 (the latest updated to the federal minimum efficiency for PTHPs). There were 10 manufacturers of this subset of PTHPs. The five manufacturers that had the most models available were: Gree Comfort, Midea Group, GE Appliances, Sharp Electronics and Chigo Electrical Appliances. Five percent of the models available were just meeting federal minimum efficiency, and less than one percent of the models had both EER and COP 15 percent higher than federal minimum efficiency requirement.
- **VRF:** The Statewide CASE Team reviewed VRF systems with heating provided by either heat recovery or heat pump. The Statewide CASE Team looked at five manufacturers – Carrier Corporation, Daikin North America LLC, Mitsubishi Electric Trane HVAC US LLC, Johnson Controls International plc, and Lenox International Incorporated. Eight percent of heat pump models and two percent of heat recovery models available were just meeting federal minimum efficiency, and six percent of both heat pump and heat recovery models had both EER and COP 15 percent higher than federal minimum efficiency requirement.

Balanced Ventilation Fan Efficacy

Balanced systems use an exhaust fan and a supply fan to move approximately the same volume of air into and out of the dwelling. To be considered a balanced ventilation system, the total supply airflow and the total exhaust airflow must be within 20 percent of each other. The 2019 Title 24, Part 6 Standards require that all new construction multifamily units provide either balanced ventilation or demonstrate “compartmentalization” through a blower door test that confirms the leakage of the dwelling unit envelope area does not exceed a certain value.

For 2-story garden style and 3-story loaded corridor prototypes in Climate Zone 4 to 10, the Statewide CASE Team analyzed a combined measure package with a SZHP system along with balanced ventilation systems without heat or energy recovery that have fan efficacy of 0.4W/cfm. As shown in see Figure 9, the Statewide CASE Team analyzed fan efficacy of exhaust fans and in-line supply fans listed in the Home Ventilating Institute Database. Only fans with rated CFM lower than 200 CFM were included. Those products are the most relevant for multifamily applications. The median fan efficacy is 0.20W/CFM. This indicates the total fan efficacy of a balanced ventilation system which consists of two fans can achieve a total of about 0.4 W/CFM.

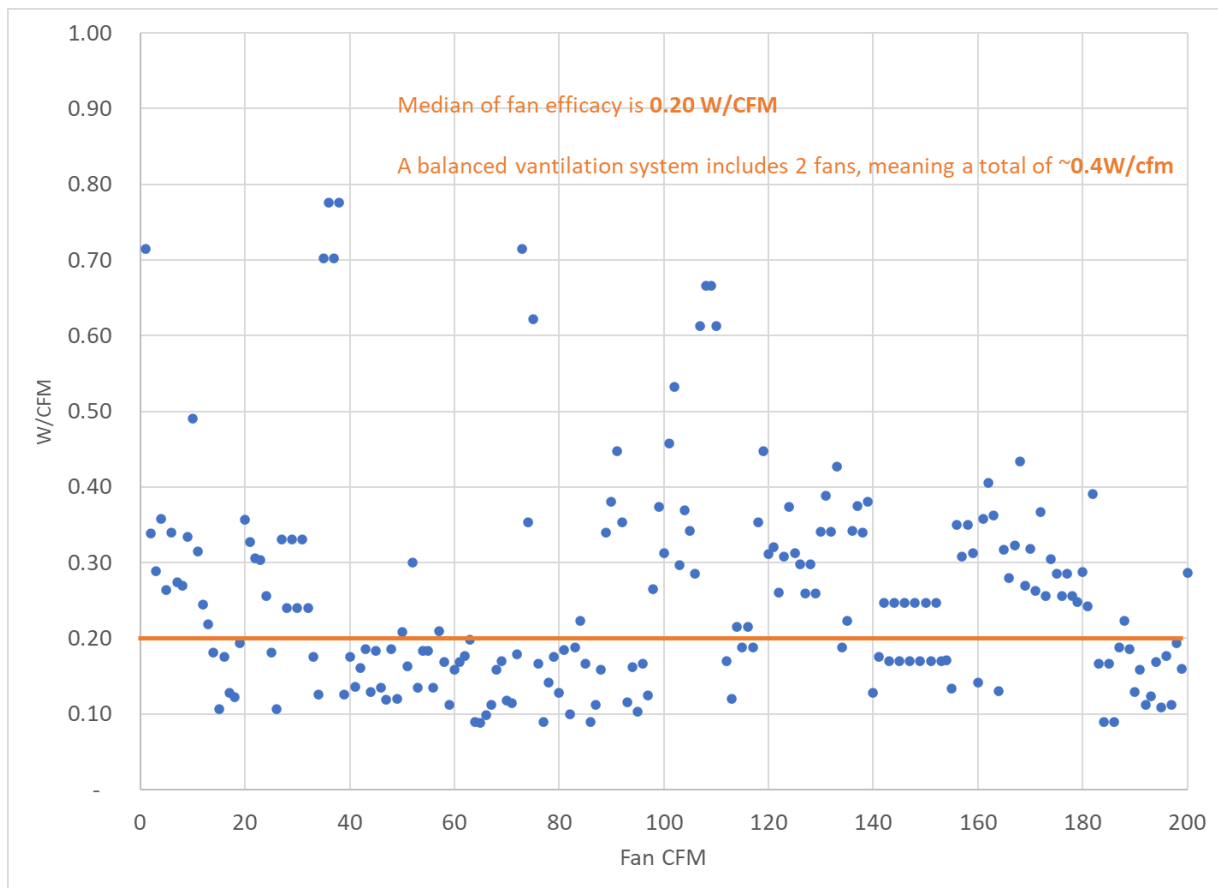

Figure 9: Fan Efficacy of Exhaust Fans and In-line Fans from Home Ventilating Institute Database (Source: Home Ventilating Institute Database)

3.1.3 Market Impacts and Economic Assessments

For the 2022 code cycle, the Statewide CASE Team used the IMPLAN model software, along with economic information from published sources, and professional judgement to develop estimates of the economic impacts associated with each proposed code

changes.² While this is the first code cycle in which the Statewide CASE Team developed estimates of economic impacts using IMPLAN, it is important to note that the economic impacts developed for this report are only estimates and are based on limited and to some extent speculative information. In addition, the IMPLAN model provides a relatively simple representation of the California economy and, though the Statewide CASE Team is confident that the direction and approximate magnitude of the estimated economic impacts are reasonable, it is important to understand that the IMPLAN model is a simplification of extremely complex actions and interactions of individual, businesses, and other organizations as they respond to changes in energy efficiency codes. In all aspect of this economic analysis, the CASE Authors rely on conservative assumptions regarding the likely economic benefits associated with the proposed code change. By following this approach, the Statewide CASE Team believes the economic impacts presented below represent lower bound estimates of the actual impacts associated with this proposed code change.

Adoption of this code change proposal would result in relatively modest economic impacts through the additional direct spending by those in the residential building and remodeling industry, as well as indirectly as residents spend all or some of the money saved through lower utility bills on other economic activities. There may also be some nonresidential customers that are impacted by this proposed code change; however, the Statewide CASE Team does not anticipate such impacts to be materially important to the building owner and would have measurable economic impacts.

3.1.3.1 Impact on Builders

Builders of residential and commercial structures are directly impacted by many of the measures proposed by the Statewide CASE Team for the 2022 code cycle. It is within the normal practices of these businesses to adjust their building practices to changes in building codes. When necessary, builders engage in continuing education and training to remain compliant with changes to design practices and building codes.

California's construction industry is comprised of about 80,000 business establishments and 860,000 employees (see Table 7).³ In 2018, total payroll was \$80 billion. Nearly 60,000 of these business establishments and 420,000 employees are engaged in the residential building sector.

² IMPLAN (Impact Analysis for Planning) software is an input-output model used to estimate the economic effects of proposed policies and projects. IMPLAN is the most used economic impact model due to its ease of use and extensive detailed information on output, employment, and wage information.

³ Average total monthly employment in California in 2018 was 18.6 million; the construction industry represented 4.5 percent of 2018 employment.

Table 7: California Construction Industry, Establishments, Employment, and Payroll

Construction Sectors	Establishments	Employment	Annual Payroll (billions \$)
Residential	59,287	420,216	\$23.3
Residential Building Construction Contractors	22,676	115,777	\$7.4
Foundation, Structure, & Building Exterior	6,623	75,220	\$3.6
Building Equipment Contractors	14,444	105,441	\$6.0
Building Finishing Contractors	15,544	123,778	\$6.2

Source: (State of California, Employment Development Department n.d.)

The proposed change to electric HVAC systems would likely affect residential builders but would not impact firms that focus on construction and retrofit of industrial buildings, utility systems, public infrastructure, or other heavy construction. The effects on the residential building industry would not be felt by all firms and workers, but rather would be concentrated in specific industry subsectors. Table 8 shows the residential building subsectors the Statewide CASE Team expects to be impacted by the changes proposed in this report. The Statewide CASE Team’s estimates of the magnitude of these impacts are shown in Section 3.1.4 Economic Impacts.

Table 8: Size of the California Residential Building Industry by Subsector

Residential Building Subsector	Establishments	Employment	Annual Payroll (billions \$)
New multifamily general contractors	406	5,333	\$0.5
Residential Electrical Contractors	6,095	37,933	\$2.1
Residential plumbing and HVAC contractors	8,086	66,177	\$3.8
Other Residential Equipment Contractors	263	1,331	\$0.1

Source: (State of California, Employment Development Department n.d.)

3.1.3.2 Impact on Building Designers and Energy Consultants

Adjusting design practices to comply with changing building codes is within the normal course of business for building designers. Building codes (including Title 24, Part 6) are typically updated on a three-year revision cycle and building designers and energy consultants engage in continuing education and training to remain compliant with changes to design practices and building codes.

Businesses that focus on residential, commercial, institutional, and industrial building design are contained within the Architectural Services sector (North American Industry

Classification System 541310). Table 9: California Building Designer and Energy Consultant Sectors shows the number of establishments, employment, and total annual payroll for Building Architectural Services. The proposed code changes would potentially impact all firms within the Architectural Services sector. The Statewide CASE Team anticipates the impacts for electric HVAC systems to affect firms that focus on multifamily construction.

There is not a North American Industry Classification System (NAICS)⁴ code specific for energy consultants. Instead, businesses that focus on consulting related to building energy efficiency are contained in the Building Inspection Services sector (NAICS 541350), which is comprised of firms primarily engaged in the physical inspection of residential and nonresidential buildings.⁵ It is not possible to determine which business establishments within the Building Inspection Services sector are focused on energy efficiency consulting. The information shown in Table 9 provides an upper bound indication of the size of this sector in California.

Table 9: California Building Designer and Energy Consultant Sectors

Sector	Establishments	Employment	Annual Payroll (billions \$)
Architectural Services ^a	3,704	29,611	\$2.91
Building Inspection Services ^b	824	3,145	\$0.22

Source: (State of California, Employment Development Department n.d.)

- a. Architectural Services (NAICS 541310) comprises private-sector establishments primarily engaged in planning and designing residential, institutional, leisure, commercial, and industrial buildings and structures.
- b. Building Inspection Services (NAICS 541350) comprises private-sector establishments primarily engaged in providing building (residential & nonresidential) inspection services encompassing all aspects of the building structure and component systems, including energy efficiency inspection services.

⁴ NAICS is the standard used by Federal statistical agencies in classifying business establishments for the purpose of collecting, analyzing, and publishing statistical data related to the U.S. business economy. NAICS was developed jointly by the U.S. Economic Classification Policy Committee (ECPC), Statistics Canada, and Mexico's Instituto Nacional de Estadística y Geografía, to allow for a high level of comparability in business statistics among the North American countries. NAICS replaced the Standard Industrial Classification (SIC) system in 1997.

⁵ Establishments in this sector include businesses primarily engaged in evaluating a building's structure and component systems and includes energy efficiency inspection services and home inspection services. This sector does not include establishments primarily engaged in providing inspections for pests, hazardous wastes or other environmental contaminants, nor does it include state and local government entities that focus on building or energy code compliance/enforcement of building codes and regulations.

3.1.3.3 Impact on Occupational Safety and Health

The proposed code change does not alter any existing federal, state, or local regulations pertaining to safety and health, including rules enforced by the California Division of Occupational Safety and Health (Cal/OSHA). All existing health and safety rules would remain in place. Complying with the proposed code change is not anticipated to have adverse impacts on the safety or health of occupants or those involved with the construction, commissioning, and maintenance of the building.

3.1.3.4 Impact on Building Owners and Occupants (Including Homeowners and Potential First-Time Homeowners)

According to data from the U.S. Census, American Community Survey (ACS), there were nearly 14.3 million housing units in California in 2018 and nearly 13.1 million were occupied (see Table 10). Most housing units (nearly 9.2 million) were single-family homes (either detached or attached), while about 2 million homes were in building containing two to nine units and 2.5 million were in multi-family building containing 10 or more units. The U.S. Census reported that 59,200 single-family and 50,700 multifamily homes were constructed in 2019.

Table 10: California Housing Characteristics

Housing Measure	Estimate
Total housing units	14,277,867
Occupied housing units	13,072,122
Vacant housing units	1,205,745
Homeowner vacancy rate	1.2%
Rental vacancy rate	4.0%
Units in Structure	Estimate
1-unit, detached	8,177,141
1-unit, attached	1,014,941
2 units	358,619
3 or 4 units	783,963
5 to 9 units	874,649
10 to 19 units	742,139
20 or more units	1,787,812
Mobile home, RV, etc.	538,603

Source: (2018 American Community Survey n.d.)

Table 11 shows the distribution of California homes by vintage. About 15 percent of California homes were built in 2000 or later and another 11 percent built between 1990 and 1999. The majority of California’s existing housing stock (8.5 million homes – 59 percent of the total) were built between 1950 and 1989, a period of rapid population and

economic growth in California. Finally, about 2.1 million homes in California were built before 1950. According to Kenney et al, 2019, more than half of California’s existing multifamily buildings (those with five or more units) were constructed before 1978 when there no building energy efficiency standards (Kenney 2019).

Table 11: Distribution of California Housing by Vintage

Home Vintage	Units	Percent	Cumulative Percent
Built 2014 or later	343,448	2.4%	2.4%
Built 2010 to 2013	248,659	1.7%	4.1%
Built 2000 to 2009	1,553,769	10.9%	15.0%
Built 1990 to 1999	1,561,579	10.9%	26.0%
Built 1980 to 1989	2,118,545	14.8%	40.8%
Built 1970 to 1979	2,512,178	17.6%	58.4%
Built 1960 to 1969	1,925,945	13.5%	71.9%
Built 1950 to 1959	1,896,629	13.3%	85.2%
Built 1940 to 1949	817,270	5.7%	90.9%
Built 1939 or earlier	1,299,845	9.1%	100.0%
Total housing units	14,277,867	100%	

Source: (2018 American Community Survey n.d.)

Table 12 shows the distribution of owner- and renter-occupied housing by household income. Overall, about 55 percent of California housing is owner-occupied and the rate of owner-occupancy generally increases with household income. The owner-occupancy rate for households with income below \$50,000 is only 37 percent, whereas the owner occupancy rate is 72 percent for households earning \$100,000 or more.

Table 12: Owner- and Renter-Occupied Housing Units in California by Income

Household Income	Total	Owner Occupied	Renter Occupied
Less than \$5,000	391,235	129,078	262,157
\$5,000 to \$9,999	279,442	86,334	193,108
\$10,000 to \$14,999	515,804	143,001	372,803
\$15,000 to \$19,999	456,076	156,790	299,286
\$20,000 to \$24,999	520,133	187,578	332,555
\$25,000 to \$34,999	943,783	370,939	572,844
\$35,000 to \$49,999	1,362,459	590,325	772,134
\$50,000 to \$74,999	2,044,663	1,018,107	1,026,556
\$75,000 to \$99,999	1,601,641	922,609	679,032
\$100,000 to \$149,999	2,176,125	1,429,227	746,898
\$150,000 or more	2,780,761	2,131,676	649,085
Total Housing Units	13,072,122	7,165,664	5,906,458
Median household income	\$75,277	\$99,245	\$52,348

Source: (2018 American Community Survey n.d.)

Understanding the distribution of California residents by home type, home vintage, and household income is critical for developing meaningful estimates of the economic impacts associated with proposed code changes affecting residents. Many proposed code changes specifically target single-family or multifamily residences and so the counts of housing units by building type shown in Table 10 provides the information necessary to quantify the magnitude of potential impacts. Likewise, impacts may differ for owners and renters, by home vintage, and by household income, information provided in Table 11 and Table 12.

3.1.3.5 Impact on Building Component Retailers (Including Manufacturers and Distributors)

The Statewide CASE Team anticipates the proposed change would have no material impact on California component retailers.

3.1.3.6 Impact on Building Inspectors

Table 13 shows employment and payroll information for state and local government agencies in which many inspectors of multifamily buildings are employed. Building inspectors participate in continuing training to stay current on all aspects of building regulations, including energy efficiency. The Statewide CASE Team, therefore, anticipates the proposed change would have no impact on employment of building inspectors or the scope of their role conducting energy efficiency inspections.

Table 13: Employment in California State and Government Agencies with Building Inspectors

Sector	Govt.	Establishments	Employment	Annual Payroll (millions \$)
Administration of Housing Programs ^a	State	17	283	\$29.0
	Local	36	2,882	\$205.7
Urban and Rural Development Admin ^b	State	35	552	\$48.2
	Local	52	2,446	\$186.6

Source: (State of California, Employment Development Department n.d.)

- a. Administration of Housing Programs (NAICS 925110) comprises government establishments primarily engaged in the administration and planning of housing programs, including building codes and standards, housing authorities, and housing programs, planning, and development.
- b. Urban and Rural Development Administration (NAICS 925120) comprises government establishments primarily engaged in the administration and planning of the development of urban and rural areas. Included in this industry are government zoning boards and commissions.

3.1.3.7 Impact on Statewide Employment

As described in Sections 3.1.3.1 through 3.1.3.6, the Statewide CASE Team does not anticipate significant employment or financial impacts to any particular sector of the California economy. This is not to say that the proposed change would not have modest impacts on employment in California. In Section 3.1.4, the Statewide CASE Team estimated the proposed change in electric HVAC systems would affect statewide employment and economic output directly and indirectly through its impact on builders, designers, and energy consultants, and building inspectors. In addition, the Statewide CASE Team estimated how energy savings associated with the proposed change in electric HVAC systems would lead to modest ongoing financial savings for California residents, which would then be available for other economic activities.

3.1.4 Economic Impacts

3.1.4.1 Creation or Elimination of Jobs

The Statewide CASE Team does not anticipate that the measures proposed for the 2022 code cycle regulation would lead to the creation of new *types* of jobs or the elimination of *existing* types of jobs. In other words, the Statewide CASE Team’s proposed change would not result in economic disruption to any sector of the California economy. Rather, the estimates of economic impacts discussed in Section 3.1.4 would lead to modest changes in employment of existing jobs.

3.1.4.2 Creation or Elimination of Businesses in California

As stated in Section 3.1.4.1, the Statewide CASE Team’s proposed change would not result in economic disruption to any sector of the California economy. The proposed change represents a modest change to HVAC systems, which would not excessively

burden or competitively disadvantage California businesses – nor would it necessarily lead to a competitive advantage for California businesses. Therefore, the Statewide CASE Team does not foresee any new businesses being created, nor does the Statewide CASE Team think any existing businesses would be eliminated due to the proposed code changes.

3.1.4.3 Competitive Advantages or Disadvantages for Businesses in California

The proposed code changes would apply to all businesses incorporated in California, regardless of whether the business is located inside or outside of the state.⁶ Therefore, the Statewide CASE Team does not anticipate that these measures proposed for the 2022 code cycle regulation would have an adverse effect on the competitiveness of California businesses. Likewise, the Statewide CASE Team does not anticipate businesses located outside of California would be advantaged or disadvantaged.

3.1.4.4 Increase or Decrease of Investments in the State of California

The Statewide CASE Team analyzed national data on corporate profits and capital investment by businesses that expand a firm’s capital stock (referred to as net private domestic investment, or NPDI).⁷ As Table 14 shows, between 2015 and 2019, NPDI as a percentage of corporate profits ranged from 26 to 35 percent, with an average of 31 percent. While only an approximation of the proportion of business income used for net capital investment, the Statewide CASE Team believes it provides a reasonable estimate of the proportion of proprietor income that would be reinvested by business owners into expanding their capital stock.

Table 14: Net Domestic Private Investment and Corporate Profits, U.S.

Year	Net Domestic Private Investment by Businesses, Billions of Dollars	Corporate Profits After Taxes, Billions of Dollars	Ratio of Net Private Investment to Corporate Profits
2015	609.3	1,740.4	35%
2016	456.0	1,739.8	26%
2017	509.3	1,813.6	28%
2018	618.3	1,843.7	34%
2019	580.9	1,827.0	32%
		5-Year Average	31%

⁶ Gov. Code, §§ 11346.3(c)(1)(C), 11346.3(a)(2); 1 CCR § 2003(a)(3) Competitive advantages or disadvantages for California businesses currently doing business in the state.

⁷ Net private domestic investment is the total amount of investment in capital by the business sector that is used to expand the capital stock, rather than maintain or replace due to depreciation. Corporate profit is the money left after a corporation pays its expenses.

Source: (Federal Reserve Economic Data n.d.)

The Statewide CASE Team does not anticipate that the economic impacts associated with the proposed measure would lead to significant change (increase or decrease) in investment in any directly or indirectly affected sectors of California's economy.

3.1.4.5 Effects on the State General Fund, State Special Funds, and Local Governments

The Statewide CASE Team does not expect the proposed code changes would have a measurable impact on the California's General Fund, any state special funds, or local government funds.

3.1.4.6 Impacts on Specific Persons

While the objective of any of the Statewide CASE Team's proposal is to promote energy efficiency, the Statewide CASE Team recognizes that there is the potential that a proposed code change may result in unintended consequences.

3.2 Electric DHW Systems

3.2.1 Market Structure

The Statewide CASE Team performed a market analysis that covers both residential size HPWH products that can be used for clustered design and commercial size HPWH units for central system design. The heat pump water heating market in California is currently in a state of rapid growth and development. The main market actors include architects, building owners/developers, contractors, equipment manufacturers, design engineers, and energy consultants.

- **Architects** – Architects design the buildings and plan for the spaces where central HPWH systems are installed. Decisions made by architects on the size and location of mechanical/plumbing areas, as well as other aspects of building layout, can significantly impact the feasibility of central HPWH systems. For example, insufficient space for central HPWH storage tanks would mean the system would need more heat pumps, increasing system cost. Locating the hot water system on the roof versus on the ground floor may require increased structural requirements to support large storage tanks.
- **Building owners/developers** – Owners and developers are the ultimate decision-makers on the type of systems that go into their buildings. For an emerging technology like central HPWH system to become widely adopted, owners and developers must become acquainted with it and feel confident that the systems will perform to make the investment.

- **Design engineers:** Design engineers (generally plumbing engineers) are responsible for designing plumbing systems, including central HPWH. As of December 2019, 24 local jurisdictions have adopted local ordinances that encourage or require the use of electric water heating in residential and/or nonresidential applications. These professionals need to follow reach code requirements and would need to learn how energy-efficient and cost-effective design of central HPWH systems differs from that of traditional gas-fired DHW systems.
- **Manufacturers** – Equipment manufacturers develop, market, and sell central HPWH equipment. For central HPWH to be widely adopted, these companies would need to increase production, California distribution, and support for central HPWH equipment.
- **Manufacturer’s reps** – Manufacturer’s reps provide local design, installation, and commissioning assistance for equipment manufacturers not located in California. These companies would need to increase their familiarity with the considerations of central HPWH systems to support wider adoption of these systems.
- **Contractors** – Central HPWH equipment is usually installed by the plumbing contractor, with some coordination by a general contractor. After installation, depending on the type of work, maintenance and repairs of central HPWH equipment may need to be performed by an HVAC contractor, or other professional licensed to work with refrigerant-containing components.
- **Energy consultants** – Energy consultants both complete energy code-compliance modeling and advise design teams on improved design approaches. These professionals would need to learn how the design and modeling of central HPWH systems is different from gas-based DHW systems so that they can appropriately advise design teams and accurately model the systems for code-compliance. Note that there are current local reach codes that already require all-electric construction and so energy consultants are likely to be aware of the compliance options for electric systems.

In addition to traditional market actors, because central HPWH is a growing market, state and local government bodies and agencies with regulatory and program activities play an important role in the direction, pace, and rules around central HPWH’s adoption. These market actors and their activities are listed below.

- **Investor-owned utilities:** The Statewide Utility Codes and Standards Team is funding the lab-testing of central HPWH equipment to help the Energy Commission develop performance curves and algorithms to accurately model the performance of central HPWH equipment. IOUs also provide educational classes

at venues such as the PG&E Pacific Energy Center in San Francisco, and the SCE Energy Education Center in Irwindale. These education centers, along with online educational resources, would be critical to ensuring all market actors have access to training on best practices and approaches to central HPWH systems.

- **Program implementers: Community choice aggregators (CCAs) and municipal utilities (Munis)** have been some of the earliest actors to create incentives and programs to assist developers in design and installation of central HPWH systems. Examples of these organizations that have created programs to assist with central HPWH are East Bay Community Energy (EBCE) and the Sacramento Municipal Utility District (SMUD). IOUs and Regional Energy Networks (RENs), can offer ratepayer-funded incentives for central HPWH retrofit projects that involve fuel substitution, subject to the California Public Utility Commission's (CPUC's) Fuel Substitution Test. Other entities, such as the Bay Area Air Quality Management District (BAAQMD) and South Coast Air Quality Management District (SCAQMD) are creating programs offering non-ratepayer-funded incentives for replacing gas equipment with heat pump technology, including central HPWH, to reduce local air pollution.
- **Researchers:** Research groups are studying the design and performance aspects of central HPWH systems and are helping to inform new industry standards and best practices for design and operation of these systems. Examples of such groups are the Northwest Energy Efficiency Alliance (NEEA) and some Energy Commission-funded Electric Program Investment Charge (EPIC) research program, such as that under Grant Funding Opportunity (GFO) 15-308, led by Build It Green (Franklin Energy), studying design and implementation of central HPWH systems in affordable multifamily buildings.
- **State regulatory agencies:** State regulatory agencies like the Energy Commission and CPUC create and maintain the rules that govern the installation and incentives for central HPWH systems. New and updated policies from these agencies, such as the CPUC's revision of the three-Prong Test to the Fuel Substitution Test, have the potential to help move the market in the direction of energy efficient low-carbon systems like central HPWH.
- **Local governments:** Local governments in jurisdictions such as San Jose, Berkeley, San Luis Obispo, and Carlsbad have passed electric-favoring reach codes and/or gas bans for new construction that would accelerate the adoption of central HPWH systems. Some local governments are also putting on public awareness and industry education campaigns to make people in their community more aware of and comfortable with central HPWH and other all-electric technologies.

3.2.2 Technical Feasibility, Market Availability, and Current Practices

3.2.2.1 Current Practice

A Central HPWH Symposium held at Sacramento Municipal Utility District (SMUD) in December 2018 developed group consensus on the following:

- Central HPWH design is not simple, and there is insufficient design guidance on the market. Energy savings are possible when compared to gas DHW system, but not guaranteed.
- Several field installations and monitoring studies are underway by Ecotope, Bright Power, Build it Green (Franklin Energy), and Association for Energy Affordability (AEA). Best practices are currently being identified but are dependent on further testing.
- At the time of the symposium, there was no compliance pathway for central HPWH with a recirculation loop other than the exceptional calculation method for Energy Commission Executive Director approval. Spreadsheet calculations are often used to demonstrate savings, or simply modeling Central HPWH equal to the Prescriptive/Standard Design, so that there is no penalty or credit in the performance compliance per Energy Commission software support staff guidance.

Central HPWH is a relatively new design approach with fewer than 100 installations in the state,⁸ and no standardized design guidelines exist to ensure appropriate design. The Statewide CASE Team gathered the following information from various on-going research efforts, described in more detail later in this section:

- HPWH model selection and sizing in different climates.
- Tank sizing and piping configurations that lead to beneficial stratification.
- Control methods to maintain supply water temperature, minimize electric resistance usage when present, reduce cycling, and optimize defrosting.
- Location within the building and distribution piping, including impact on space heating and cooling loads.

Multiple, ongoing efforts are underway to support the incorporation of a prescriptive central HPWH pathway in Title 24, Part 6. The Statewide CASE Team leveraged and integrated the latest findings and results from these efforts into this report:

- **Recirculation loop modeling:** In January 2019, a research version of CBEECC-Res was released that included modeling of central HPWH systems. However, these systems were only allowed to be modeled without a recirculation loop or

⁸ Statewide CASE Team's professional judgement based on available data.

pumps (i.e., supply pipe only). While this is a step forward for integrating central heat pump water heaters, it does not address a large part of the multifamily market that installs central DHW with recirculation pumps. In March 2020, the Energy Commission Software Development Team, with inputs and contributions from the Statewide Investor-owned Utility (IOU) Codes and Standards (C&S) program, released a CBECC-Res version that has incorporated recirculation loops. This release has the capability to model one HPWH model for central DHW system, and able to incorporate primary storage tank and recirculation loop tank.

- **Performance testing of central HPWH components:** The Statewide IOU C&S program is conducting lab testing of central HPWH at PG&E’s Applied Technology Services (ATS) test facility. The Statewide CASE Team worked with the PG&E ATS laboratory to ensure that lab test plans consider criteria necessary for code integration, including a variety of climatic conditions, different multifamily building sizes and draw profiles, and documentation of hourly energy impacts to be translated into TDV or time dependent metrics. Test results will not be released in time for incorporation in this report.
- **Best practices design guides:** In a parallel effort to the performance testing, the Statewide IOU C&S program is developing a best practices design guide for central HPWH. This remains a living document, and it is dependent on the outcomes of the performance testing. A best practice design guide is crucial for central HPWH because an improper design can reduce heat pump efficiency and increase energy consumption unnecessarily.

The Statewide CASE Team collected data on design, configuration, and savings from existing projects in California and Washington State with central heat pump water heating. Northwest Energy Efficiency Alliance (NEEA) has rated several models of heat pump water heaters and developed tiered specifications (e.g., Tier 3) representing the relative performance of these water heaters. The Statewide CASE Team has used this body of knowledge and methods to inform code development for central HPWH systems.

In December 2019, discussions between the Energy Commission and policy advocates led the Energy Commission to provide a critical “bridge solution” available on January 1, 2020 (California Energy Commission 2019). This solution allows for an Energy Commission Executive Director determination for specific central HPWH designs to comply prescriptively, meaning there is no credit for higher performance, but there is a compliance pathway as of January 1, 2020. This bridge solution removes a critical design impediment and enables easier implementation for local jurisdictions implementing all-electric reach codes. For the longer term, this CASE Report provides a clear compliance pathway for central HPWH with recirculation and enables plumbing

designers to exercise design choices according to actual equipment and locational constraints rather than modelling constraints.

In the last five years, several new construction projects have utilized central HPWH systems that serve as useful case studies. In addition to new construction installations, there have been HPWH system installations in multifamily retrofit projects under the Low Income Weatherization Program for Large Multifamily Buildings, administered by California Community Services Division. These projects have demonstrated the viability of central HPWH, even in challenging retrofit circumstances.

The Statewide CASE Team is aware of 13 properties with installed and operational central HPWH systems, as of January 2020 as shown in Table 15, with many more in various stages of design and construction to be completed in 2020 and 2021. Data sources include projects from AEA, Frontier Energy, Redwood Energy, EHDD, Gabel Energy, Build it Green (Franklin Energy), and Mithun.

Table 15: Examples of Multifamily Properties with Operational Central HPWH Systems

Property Location	Dwelling Units	New Construction/ Retrofit	System Type	# Central HPWH Plants	HPWH Manufacturer
Davis	108	New Construction	unknown	9	unknown
Davis	591	New Construction	unknown	5	unknown
Davis	90	New Construction	unknown	6	unknown
Fresno	93	Retrofit	Single-Pass	12	Sanden
Napa	50	New Construction	Multi-Pass	1	Colmac
Oakley	24	Retrofit	Single-Pass	1	Colmac
Richmond	324	Retrofit	Single-Pass	26	Sanden
Rodeo	50	Retrofit	Single-Pass	1	Colmac
Sunnyvale	66	New Construction	Single-Pass	1	Sanden
Sacramento	36	Retrofit	Single-Pass	1	Sanden
San Francisco	333	New Construction	Multi-Pass	1	Nyle
San Francisco	41	Retrofit	Single-Pass	1	Sanden
Walnut Creek	46	New Construction	Single-Pass	2	Sanden

Central HPWH is still relatively uncommon in California, though adoption is accelerating rapidly. Several factors contributed to the limited historical adoption of central HPWH in California. These include:

- **Title 24 Code Compliance Pathways:** Until 2020, there was no prescriptive compliance pathway for central HPWH. Since the Energy Commission transitioned Title 24, Part 6 code compliance software from the DOE2 engine to

CBECC-Res and CBECC-Com in 2016, it has not been possible to model central HPWH systems for performance compliance. Lack of modeling capability prevented central HPWH from inclusion in performance-based above-code incentive programs and meant that any project wishing to pursue central HPWH would need to use an alternative compliance methodology as allowed by the local jurisdiction.

- **Product Availability and Awareness:** There has historically been poor availability and awareness of central HPWH equipment in California. Multiple interviewed central HPWH practitioners expressed a desire for more robust design assistance and/or plug-and-play configurations with heat pump and tank to reduce engineering burden and potential installation issues.
- **CPUC Three-Prong Test:** Since the 1990s, the CPUC has required that any ratepayer-funded project that involved switching from one regulated fuel to another (such as gas to electricity, or vice versa) pass the Three-Prong Test. While the Three-Prong Test made sense at the time it was put in place, it has severely limited fuel substitution projects funded through the state's energy efficiency programs over the last two decades, even with rapid improvements in the efficiency of heat pump technology and the state's transition to carbon reduction goals.

In August of 2019, the CPUC voted unanimously to replace the Three-Prong Test (discussed in Section 3.2.1.4) with the Fuel Substitution Test. This new test effectively opens up California's one billion dollars in ratepayer-funded efficiency programs to fuel substitution measures. While the specifics of implementation are still being worked out, it is extremely likely that 2020 will see the first retrofit installations of central HPWH systems to replace gas-fired water heating under ratepayer-funded efficiency programs.

- **Low Cost of Natural Gas:** Gas has been widely available to owners and developers across most regions of California and is the default choice for water heating in many areas of the state. While on a per-energy content basis gas is cheaper than electricity almost everywhere in the state, heat pumps can achieve significantly higher efficiency than that of central gas-fired water heating, particularly when renewable systems are included.
- **General Resistance to Change:** Even with available equipment, compliance pathways, knowledge of environmental benefits, and improving market awareness of design strategies, there is still general resistance to change within the building development, design, and construction industry. The Statewide CASE Team and the practitioners they interviewed, have had many discussions with reluctant design and construction teams who, when asked why they have not used central

heat pump water heating, replied that it was simply not standard practice.

Despite central HPWH being a new approach in California, the technologies involved are not new. Heat pumps have been installed for space heating and cooling for decades, and hot water tanks and pumps are not significantly different for central HPWH. From an installer's perspective, there should be no new installation techniques required for central HPWH that are not already required for other systems, such as gas water heating, or HVAC heat pumps, though for proper system performance, designers and installers must follow manufacturers' guidance.

There has been an increasing movement in the building design and construction industry toward decarbonization, or the direct targeting of GHG emissions reductions from buildings, rather than the traditional focus just on energy efficiency. As a result, 2019 saw many jurisdictions in California begin to pass building electrification policies. Policies like these are sending a strong market signal that all-electric new construction is a priority for California cities. This clear policy direction should in turn give equipment manufacturers confidence that there will be sufficient demand for central HPWH products in California to justify investing the time and resources required to bring new products to the California market.

3.2.2.2 Technical Feasibility

To review current practices of electric DHW systems, the Statewide CASE Team reviewed buildings with electric DHW systems from the Project Based Data provided by stakeholders⁹.

There were eighty-six buildings with an electric DHW system. Buildings either used a heat pump or electric storage DHW system with the majority (80) of systems using a heat pump. Since electric storage DHW system is less energy efficient, the market analysis focused on heat pump water heater systems. Figure 10 shows distribution types of the heat pump water heater systems installed in these projects.

⁹ Project information was collected using a combination of the following approaches: interview, survey, design drawing review and Title 24 compliance document review. Data sources include projects from Association for Energy Affordability (AEA), Frontier Energy, Redwood Energy, EHDD, Gabel Energy, Build it Green (now Franklin Energy), Mithun, CMFNH program. Note that this is a biased dataset as most projects are in Northern California.

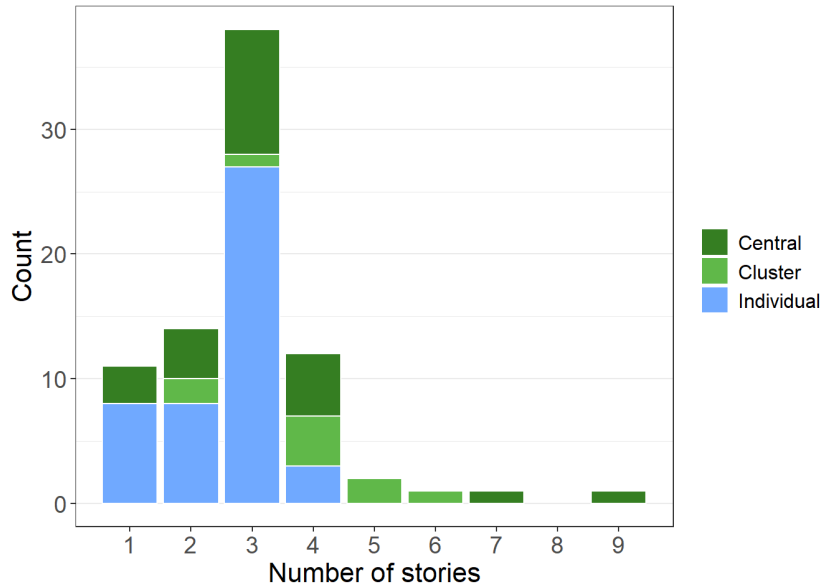

Figure 10: DHW distribution types of heat pump water heater systems.

Source: Project Based Data.

Stakeholder interviews suggested that project budget, space availability for DHW storage, building size, technical feasibility, and operation and maintenance cost are the main determining factors of DHW system types.

Individual HPWH systems are most common in multifamily buildings three or fewer stories. Compared to central and clustered design approaches, the market is more mature for this type of design in terms of familiarity by the industry, and code readiness. There is a prescriptive pathway in 2019 Title 24, Part 6 for such designs to show compliance. However, individual HPWH systems, like individual gas hot water systems, are not common for larger size buildings due to increased installation, operation and maintenance costs associated with individual systems. Clustered design includes four-eight water heaters serving multiple units without using recirculation loop.

Central system design is the preferred approach as the number of dwelling units served by the DHW system increased. The following sections describe technical considerations and best practices associated with the design and installation of central HPWH systems.

3.2.2.2.1 Design and Sizing of Central HPWH Systems

Central HPWH system designers and consultants interviewed by the Statewide CASE Team report that sizing a hot water system is an inexact exercise. Most designers rely on sizing guidelines from the American Society of Plumbing Engineers (ASPE) or American Society of Heating, Refrigeration, and Air Conditioning Engineers (ASHRAE), which are based on hot water usage data collected in the 1990s. Further research and

field surveys of hot water usage patterns could greatly benefit the industry and help designers avoid oversizing, improving the cost effectiveness of hot water systems broadly.

Larger capacity HPWHs are nearly all split type, with the tank separate from the heat pump. With few exceptions, the larger HPWH equipment most suitable for applications in central HPWH systems is configured as standalone heat pumps, with a separate tank sized and specified by the design engineer. Most central HPWH manufacturers (or their reps) can assist a design team in specifying a storage tank, but there are few turnkey solutions for central HPWH. This is in contrast to gas-fired DHW systems where many commercial and multifamily sized water heaters are readily available, and equipment and systems can be easily specified and designed with minimal custom engineering work.

One fundamental difference between optimally designed electric heat pump water heating systems and gas-fired water heating systems is that a heat pump system will have a much larger ratio of storage capacity (gallons) to recovery capacity (Btu/hr). Heat pump water heating systems benefit from having larger storage capacity for several reasons:

- A central HPWH system with a large storage volume and smaller heat pumps will usually have a lower first cost, because tanks are less expensive than heat pumps. Smaller heat pump capacity also reduces electrical service and infrastructure requirements for a building, further reducing first-cost impacts.
- Slightly larger tanks and heat pumps could enable load shifting by providing sufficient storage to disable the heat pumps during periods of peak electric pricing. The slightly larger heat pumps could recharge the tanks more quickly during off-peak periods.
- The optimal storage-to-recovery ratio for a central HPWH system will vary from project to project and is still a topic of discussion among early-adopters. Thus, the Statewide CASE Team is not offering a specific recommendation.
- Buildings that use central HPWH instead of gas-fired water heaters will sometimes require a larger electrical service to the building, including panels, subpanels, and transformers. This impact can be mitigated by designing a system with larger storage volumes and smaller and/or fewer heat pumps.

To improve storage volume more effectively, most central HPWH systems have storage tanks set to 140°F or higher and require a mixing valve to mix the hot water down to 120°F before distribution to the building.

Since there is no combustion in electric heat pump water heating systems, projects will have no combustion safety testing requirements for water heating equipment.

Depending on local fire inspector requirements, eliminating combustion equipment from a building may also eliminate other requirements under California Fire Code.

3.2.2.2 Refrigerants

Central HPWH equipment utilizes a range of refrigerant types, each with different properties, advantages, and disadvantages. Central HPWH refrigerant type determines the equipment’s operation, such as incoming cold-water temperature. One of the metrics used to differentiate refrigerants is global warming potential (GWP) that, measures the environmental destructiveness of the pollutant, as refrigerants are climate pollutants. California Air Resources Board (CARB) defines GWP as “the total contribution to global warming resulting from the emission of one unit of that gas relative to one unit of the reference gas, CO₂, which is assigned a value of 1” (California Air Resources Board 2019). Refrigerants with very high greenhouse gas (GHG) emitters are getting phased out and will not be allowed to be used in new products. Depending on how quickly this shift happens in relation to technological development of systems with low GWP refrigerant, this could impact central HPWH product availability.

Refrigerants have different thermodynamic properties, which impact their operation pressure, their efficiency to move heat, and other chemical properties. The refrigerant can dictate whether electric resistance backup, integrated or otherwise, is needed. A given refrigerant can achieve a certain heat transfer rate at an achievable pressure. If the heat transfer rate is insufficient under low outdoor temperatures or during certain draw periods (e.g., high total hot water usage), then electric resistance backup heating becomes necessary. The refrigerant likewise may be able to operate more efficiently at a higher pressure, negating the need for back up electric resistance; however, that pressure may not be achievable in the equipment’s system. Therefore, the properties of the refrigerant play a big part in system design and capability. Figure 17 displays common refrigerant types for HPWH equipment, their respective GWP, and key characteristics.

Refrigerant R744 (CO₂) is both the benchmark of the GWP scale and the lowest GWP refrigerant used in HPWHs. Due to R744’s high operating pressure, heat pump units utilizing R744 generally have all refrigerant-containing components factory-installed inside the heat pump, whereas units with refrigerants with lower operating pressures may have a refrigerant loop between the heat pump and the tank.

Table 16: Environmental Impacts Potential by Refrigerant Type

Refrigerant	Other Name(s)	Global Warming Potential (GWP)	Key Characteristics
R32	Difluoromethane	675	Similar properties to R410A – likely successor in many applications

R134a	Tetrafluoroethane	1,430	
R407C	N/A	1,774	Blend of multiple refrigerants; replacement for phased-out R22
R410A	Puron	2,090	Widely used in HVAC equipment
R417A	N/A	2,346	Replacement for phased-out R22
R744	CO ₂	1	High operating pressures; high COP (4+); low minimum OAT (-15°F); high minimum water temperature lift (~30°F)

Source: (California Air Resources Board 2019)

3.2.2.2.3 Single-Pass vs. Multi-Pass

A key design feature of a central HPWH system is whether it is piped to be single-pass or multi-pass.

In a single-pass HPWH system, the cold water passes through the heat pump(s) one time and is heated to the intended storage temperature. In this type of system, the heat pump draws cold water from the bottom of the storage tank and delivers hot water to the top of the storage tank, resulting in a highly stratified tank. HPWH equipment that uses R744 must be configured as single-pass, since R744 requires a large (20°F+) water temperature increase through the heat pump. Some R134 and R410A systems can also be configured as single-pass.

In a single-pass system, recirculation return water (which will be warm) is usually returned to the middle or bottom of the storage tank, where the adjacent water is likely to be closest to the same temperature. Some designers choose to separate the recirculation water entirely from the primary heating loop, returning recirculation water to a separate tank that is heated with either a separate heat pump (configured for multi-pass operation) or an electric resistance coil. Separating the recirculation water from the main plant avoids warm incoming water to the main heat pumps, improving their efficiency, particularly for R744 systems. This approach has less impact with R410A and R134a heat pumps. Figure 11 shows the basic piping configuration of a single-pass HPWH system. For simplicity, the multiple possible recirculation return configurations are omitted.

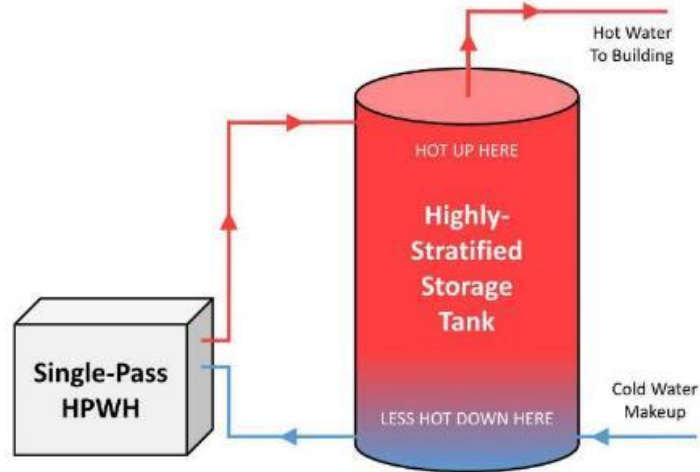

Figure 11: Schematic depiction of single-pass HPWH system.

Source: ECOTOPE

In a multi-pass HPWH system, the cold water passes through the heat pump(s) multiple times, each time gaining a 7-10°F temperature increase, until the tank reaches the intended storage temperature. In a multi-pass system, the heat pumps draw cold water from the bottom third of the storage tank and deliver hot water to just above where it is drawn. This piping configuration can still produce a stratified tank, but less so than in a single-pass configuration. HPWH equipment that uses R410A, R134a, and refrigerants other than R744 can be configured as multi-pass, since they can handle a small water temperature lift through the heat pump. Some R134a and R410A systems can be configured as either single-pass or multi-pass.

In a multi-pass system, it is not necessary to separate the recirculation water from the main tank since the heat pumps will frequently receive warm incoming water during normal operation. Figure 12 shows the basic piping configuration of a multi-pass HPWH system. For simplicity, the multiple possible recirculation return configurations are omitted.

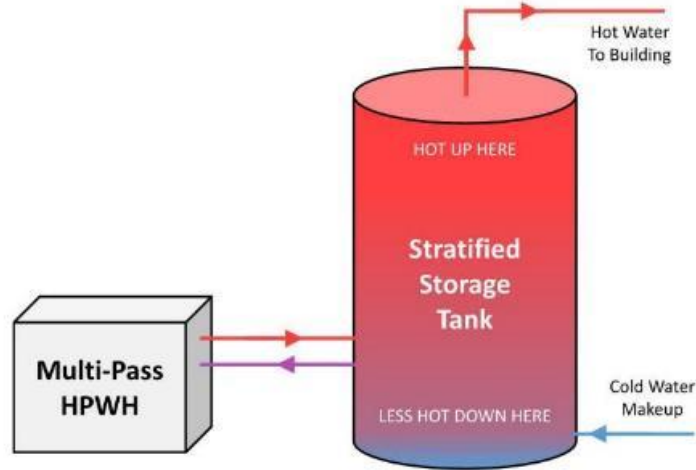

Figure 12: Schematic depiction of multi-pass HPWH system.

Source: ECOTOPE

Table 17 compares performance and design configurations of single-pass and multi-pass HPWH systems. With current HPWH product features, availability, and price points, single-pass models have higher reported COP values though integrating single-pass HPWH with the recirculation system is a more complex and costly endeavor due to HPWH sensitivity to inlet water temperature. In contrast, multi-pass models integrated with the recirculation system better resembles standard practice of gas-fired water heaters, which makes multi-pass models a more familiar and economic choice albeit with a lower COP values.

Table 17: Comparison of Single-Pass and Multi-Pass HPWH

	Single-Pass	Multi-Pass
Applicable refrigerants	Any	All but R744
Temperature lift through heat pump	Large (20+°F)	Small (7-12°F)
Location of cold water (to HPWH) on storage tank	Bottom	Bottom Third
Location of hot water (from HPWH) on storage tank	Top	Bottom Third (above HP supply)
Tank stratification	High	Moderate
Recirculation return location	Mid-to-low on tank, or separate tank	Mid-to-low on tank
Advantages	Higher maximum rated COP than multi-pass	Simpler and lower-cost system than single-pass w/ separate recirculation heater; Piping configuration significantly resembles standard gas boilers; Less complicity in commissioning and system start -up
Disadvantages	More complex and expensive system than multi-pass; Separate recirculation heater piping configuration different from gas boiler systems	Lower maximum rated COP than single-pass

3.2.2.2.4 Equipment Location

Heat pumps need access to outdoor air or to a high volume of ventilation air. Many existing gas-fired boilers are located in small rooms in tight corners of building and vented as necessary to meet code. Tight locations without adequate outdoor air and airflow may not be sufficient for central HPWH equipment. There are three typical locations for central HPWH equipment:

- Outside:** The most straightforward location for central HPWH equipment is outside, either on the roof or on the ground. All standalone HPWH units are rated for outdoor use. For ground-level installation, designers need to ensure the discharge air from the heat pump (which would be noticeably cold), is not directed at locations where people are likely to spend significant time, particularly in the winter. Equipment located outside or on a roof may present noise and/or vibration control concerns. As such, designers would need to consult manufacturer sound decibel ratings and implement appropriate noise/vibration control measures, particularly if equipment is located adjacent to living spaces.

- **Parking garage:** Ground floor or underground garages are another common location for central HPWH equipment. A covered, naturally ventilated garage is an ideal location for a HPWH, since it is effectively outside with respect to air circulation but protected from sun and rain. Central HPWH can also be located in fan-exhausted garages, and some designers have connected the heat pumps to the garage exhaust systems or used the heat pumps as the exhaust system. In colder climates, locating a HPWH in a garage, which will generally be slightly warmer than the outside air in the winter, can help raise the average air temperature seen by the heat pump and improve system efficiency (Ecotope 2009).
- **Inside with ducting:** In some circumstances, central HPWH equipment may need to be located inside, or in areas with insufficient natural air circulation. In these cases, the units need to be ducted. Manufacturers typically recommend ducting the (cold) exhaust air from the heat pumps out of the space and allowing makeup air into the room via passive louvers, though both air streams can generally be ducted if necessary. Designers must ensure louvers are large enough, and that the ducting is designed to not exceed the static pressure limits of the heat pump fans.

3.2.2.2.5 Electric Resistance “Backup”

Many existing integrated heat pump plus tank units include both a heat pump and electric resistance backup. Additionally, many early designs for central HPWH utilized electric resistance backup heat to ensure the units could meet hot water demand on the coldest winter days. Based on these factors, one might conclude that central HPWH systems need electric resistance backup.

However, there have been recent advances in low-temperature operation of R410A and R134a HPWH units allowing operation down to 15-20°F and R744 central HPWH equipment that can operate well below 0°F. Properly sized and selected heat pumps should be able to eliminate the need for electric resistance backup in nearly all central HPWH applications in California climates. Avoiding electric resistance backup would bring down the electrical service size for projects, while reducing operation energy usage and utility bills. On the other hand, the system first cost maybe lower if using electric resistance backup to trim the HPWH size. Designers should carefully consider the trade-off of installation and operation cost when sizing HPWH and determining whether electric resistance back is needed.

3.2.2.2.6 Pairing with Solar PV versus Solar Thermal

The Statewide CASE Team investigated the opportunities for pairing central heat pump water heaters with either a solar photovoltaic (PV) system or a solar thermal system.

The Statewide CASE Team proposes to exempt the solar thermal requirement whenever a central HPWH systems is used for the reasons given below.

While it is technically possible to connect a solar thermal system to a central HPWH plant, there are several considerations raised by HPWH manufacturers and experienced practitioners regarding pairing central HPWH systems with a solar thermal heating system.

- **System efficiency:** HPWHs operate at a lower COP with warmer incoming water temperature. This is particularly true for single-pass systems, especially those that use R744. A central HPWH plant paired with solar thermal can meet the HPWH manufacturer's requirements using less overall energy than one with no solar preheat, but it would be operating more often in the less inefficient portion of its operating temperature range.
- **System simplicity:** Most buildings would likely have some PV that can accommodate a heat pump water heating system. A PV system requires regular maintenance and monitoring and has no moving parts and generally simpler maintenance procedures than solar thermal.
- **Design independence:** A solar thermal system design must be closely coordinated with, and physically coupled to the DHW plant. Effective design requires careful coordination between the plumbing design engineer, solar thermal designer, as well as the plumbing contractor and solar thermal contractor, all of whom are often separate parties. On the other hand, a PV system requires no physical connection to the hot water system, and while the PV should be sized to offset as much of the building loads as possible, there is less need for specific coordination between plumbing engineer and contractor and the PV system designer.
- **Operational cost:** A solar thermal system can be practically sized to offset at most 70 percent of a building's DHW usage. Thus, a building with solar thermal would still have at least 30 percent of the DHW energy supplied by electricity. PV, on the other hand, can be sized to offset 100 percent of the hot water system energy usage. This enables a project to have a no energy cost for water heating (or with enough PV potentially the entire building).

3.2.2.3 Market Availability

There has historically been limited availability and awareness of central HPWH equipment in California. Some central HPWH products, such as those from the smaller American manufacturers Colmac and Nyle, have been available in the U.S. for many years, but did not have local California representation (manufacturer's reps) until a few years ago. Manufacturers interviewed by the Statewide CASE Team stated that they

had not historically seen much indication of demand for central HPWH in California, and thus had not devoted resources to expand their market and presence accordingly.

As of 2019, both smaller American central HPWH manufacturers Colmac and Nyle, have local manufacturer’s reps in California. Furthermore, there is increasing engagement in the central HPWH market from larger manufacturers. For example, AO Smith introduced a new central HPWH product targeting small commercial applications in 2019, and multiple other companies that sell central HPWH equipment in other markets (such as Asia, Europe, and Australia) have indicated to the Statewide CASE Team that they will be bringing those products to the California market in the next two years, as well as working to develop additional products.

Based on review of product literature, interviews with industry practitioners and manufacturers, and individual central HPHW project experience, the Statewide CASE Team has segmented HPWH equipment into three categories: integrated HP + Tank, split HP – water loop, and standalone HP. Figure 13 shows the number of models available for each of the categories at various HPWH capacity ranges. The analysis includes HPWH products that are currently available in the California market and products that are currently available internationally but with confirmation from manufacturers that they will be available in California in the near future.

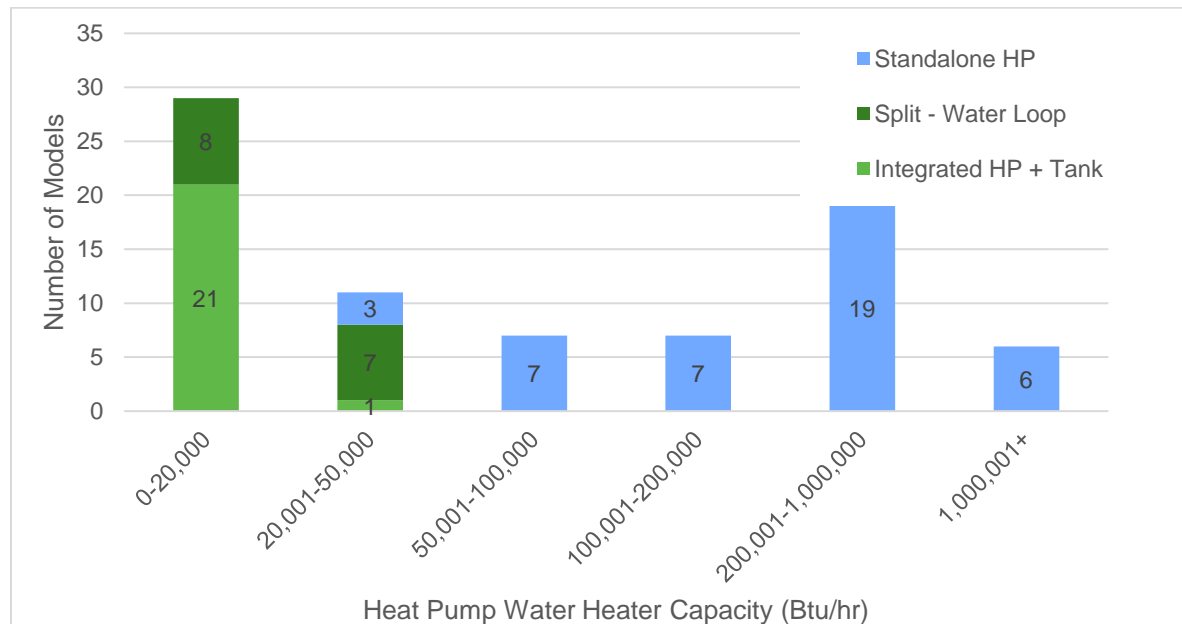

Figure 13: Heat pump water heater configuration types and capacity range.

Source: Project Based Data

3.2.2.3.1 Product and Cost Data Collection

The Statewide CASE Team performed extensive data collection in the following two areas:

1. Central HPWH Product Availability and Specification, and
2. Central HPWH Product and System Costs

The Statewide CASE Team identified major HPWH manufacturers and compiled product specification information via the AHRI online product directory and from respective manufacturers' websites for North America and international markets. The Statewide CASE Team gained access to additional product technical documentations from involved and knowledgeable industry affiliates directly. The Statewide CASE Team contacted central HPWH manufacturers with a survey questionnaire via a combination of phone calls and email correspondence. The survey questionnaire contained questions regarding quantitative information on HPWH product offerings and costs as well as qualitative feedback on market trends and barriers. Cost data collection was supplemented with accessing product price data readily available via retail websites. Through these efforts, the Statewide CASE Team identified manufacturers and models of central HPWH products and organized pertinent product information into a database format to enable product characterization by relevant categories. Pertinent data includes heating capacity, storage capacity, equipment configuration, refrigerant, manufacturer listed COP, and operating ambient temperature range.

3.2.2.3.2 Manufacturers and Available Central HPWH Products

The Statewide CASE Team's product research resulted in a list of over 150 air source HPWH products from 17 manufacturers. To prioritize our data collection efforts, the Statewide CASE Team sorted products into three categories based on availability in California:

1. **Currently Available** – These products are currently available for purchase in California.
2. **Potentially Available Soon** – These products are available internationally from companies that currently sell other products in California and could enter the California market in the near future. The Statewide CASE Team received informal acknowledgement of manufacturer plans to bring the products to California by 2023 for some products under this category.
3. **Availability Uncertain** – These are products not yet available in California from companies that do not appear to currently sell other products in California. These products are likely to take longer to enter the California market due to lack of current presence.

Using this prioritization strategy, the Statewide CASE Team filtered out category 3 products (with uncertain availability), to create a list of 74 products from 13 manufacturers. The Statewide CASE Team further focused on HPWH products with capacity larger than 20 kBTU/hr as products below this threshold are mostly sized and suitable for single dwelling units. This size threshold was applied with one exception – Sanden equipment. This was done with knowledge that Sanden actively positions their equipment for central HPWH applications, and multiple systems as such have been deployed in California. Applying the 20 kBTU/hr threshold except for Sanden units results in a database of 41 air source HPWH suitable for central HPWH application with current and near-term availability in California.

The following figures present the resulting product availability by the following characteristics: size category (capacity), single-pass vs. multi-pass vs. both, refrigerant types, coefficient of performance (COP), and outdoor air temperature range for operations.

Figure 14 shows the number of products from each manufacturer in current or near-term availability HPWH products, by BTU/hr capacity. The size ranges are product capacities commonly used in central system designs for small-to-medium sized multifamily buildings, with the largest bin (1,000+ kBTU/hr) representing systems appropriate for large buildings. This is with exception of Sanden units that are marketed to individual DHW installation with known instances of central HPWH deployments. Aermec, AO Smith, Colmac, Nyle, and Sanden units are currently available in California, and Mitsubishi, Mayekawa, and Rheem are the three manufacturers with near-term availability.

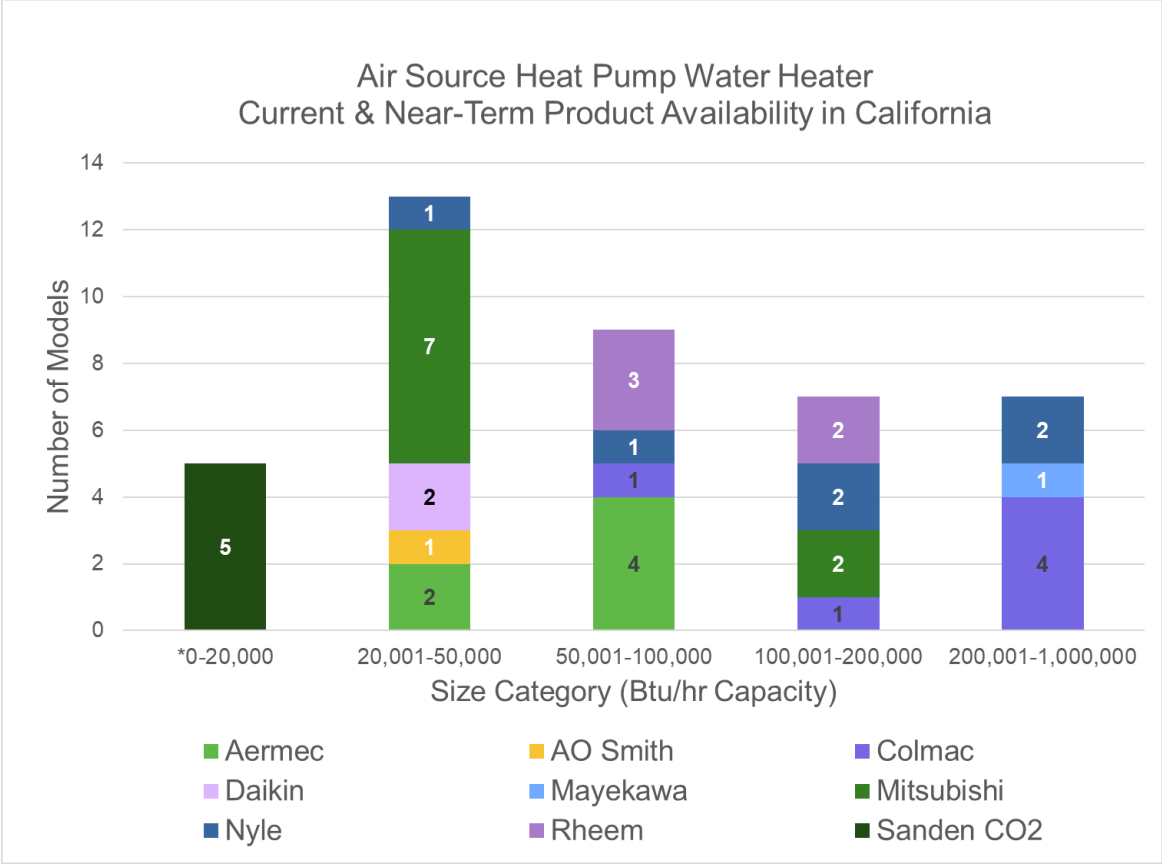

Figure 14: Air source HPWH with current near-term availability in California, by capacity.

Source: Statewide CASE Team

Figure 15 shows the split between HPWH units that are single-pass, multi-pass, as well as models that may be configured as either. 11 of the 41 models, or just over 25 percent, are multi-pass while 16 models are single-pass, 12 models have both single-pass and multi-pass capabilities, and the other two models are unclassified.

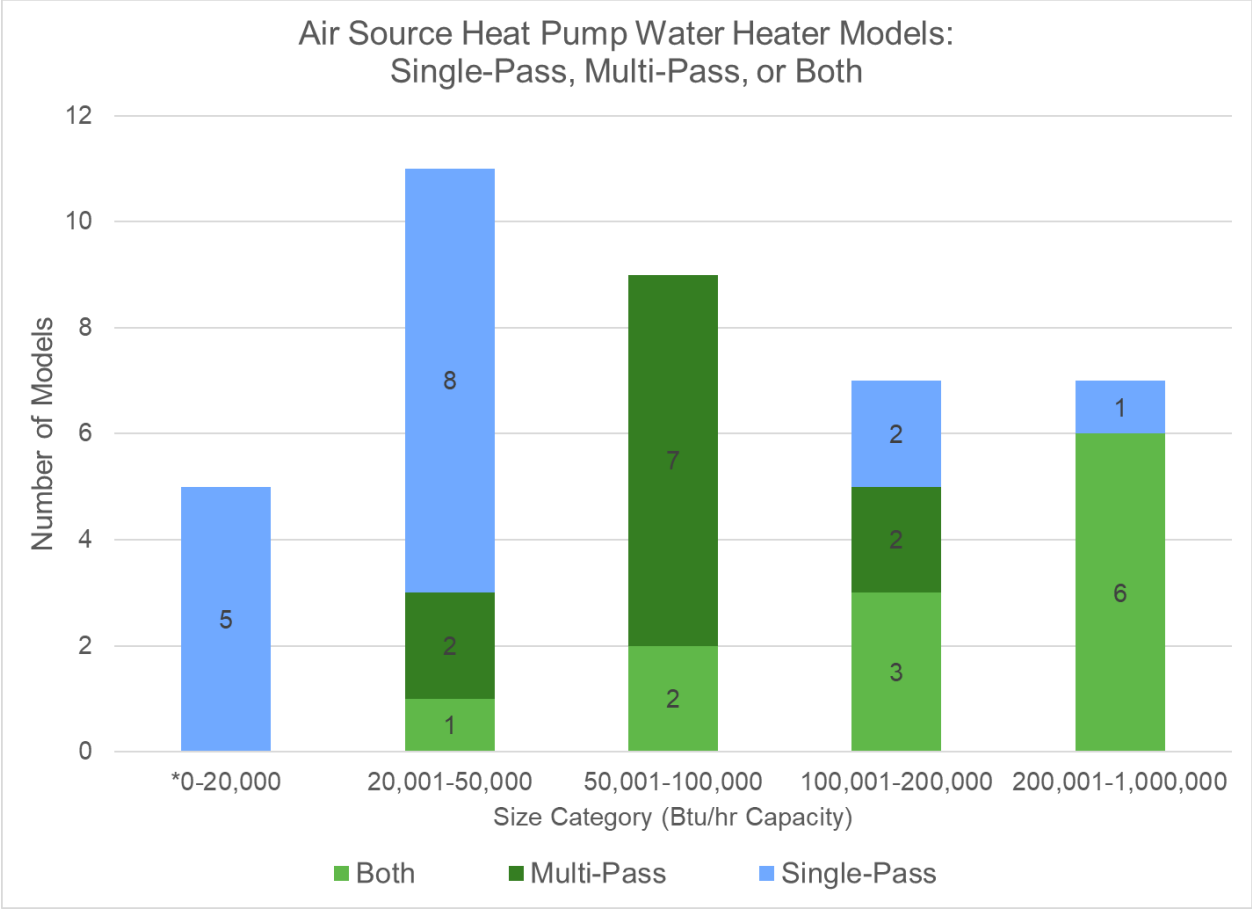

Figure 15: Available air source HPWH models (n=41, two NA's).

Source: Statewide CASE Team

Figure 16 shows the HPWH models by refrigerant type. Seventeen, or 41 percent of the models use R134a refrigerant, followed by 14 models that use R410A, eight models that use R744 or CO₂, and two models that use R32.

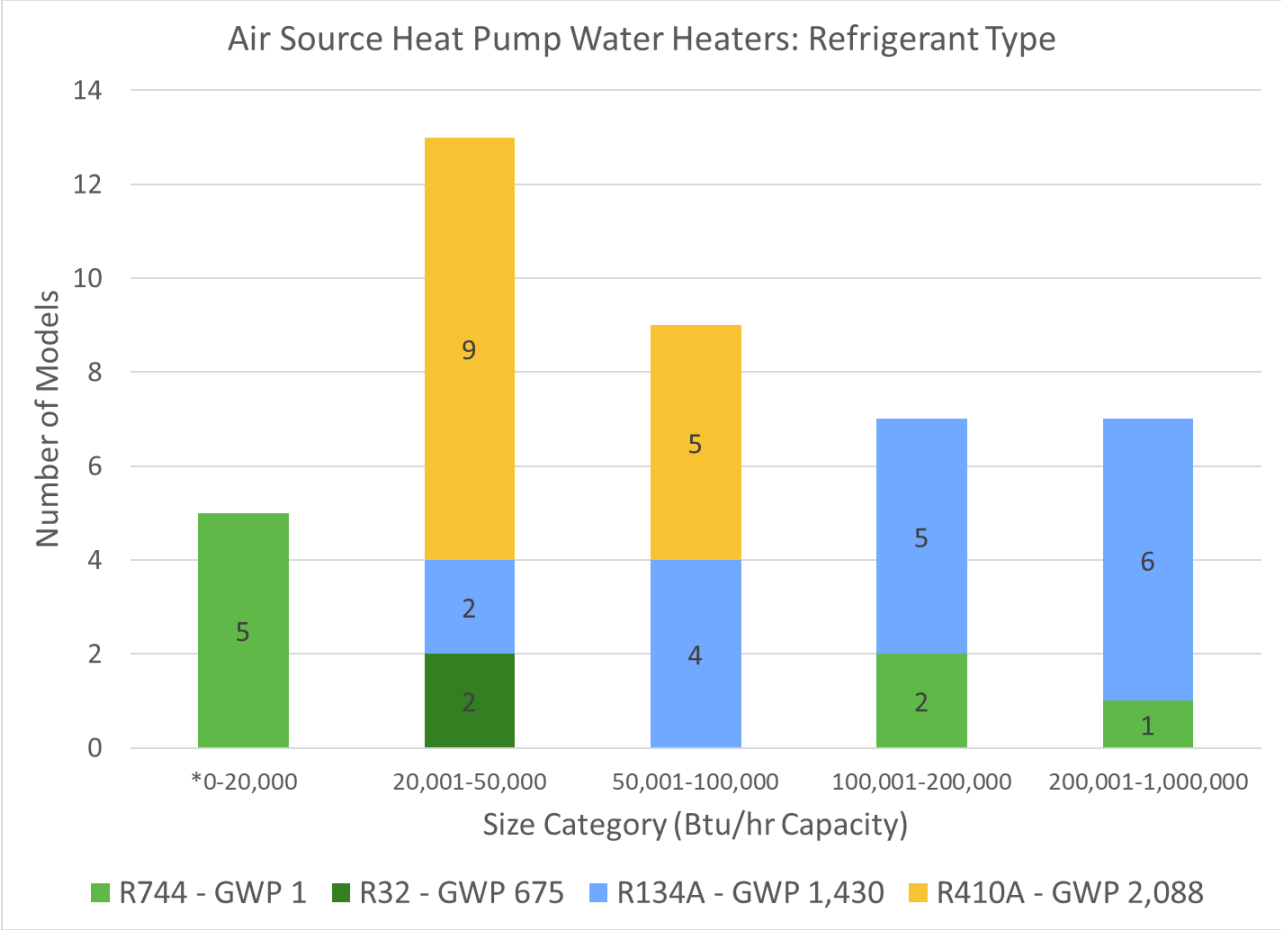

Figure 16: Available air source HPWH: refrigerant type.

Source: Statewide CASE Team

Figure 17 displays the average COP values for each size category as provided by manufacturers via their website, brochures, and publicly available sources. Since there are currently no standardized test procedures for HPWH models, the model COP values used to calculate the average are inevitably derived using different test configurations and conditions deemed suitable by each manufacturer.

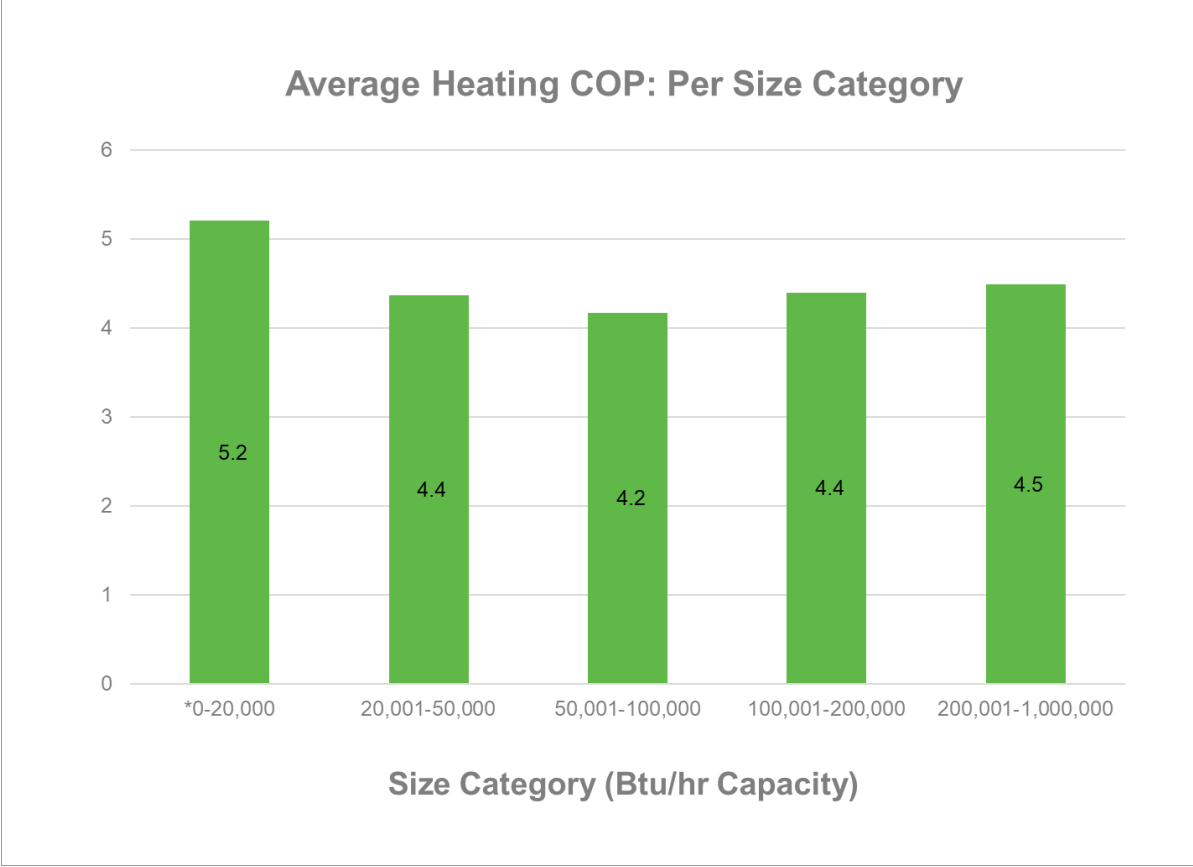

Figure 17: Available air source HPWH: COP.

Source: Statewide CASE Team

Since heat pumps are more sensitive to low outdoor air temperatures (OAT) than gas-fired water heating systems, it is important to ensure that a selected HPWH product would operate at or below the winter design temperature for the building location. Generally, R744 systems have the best low-temperature performance (in some cases down to -15°F) due to the innate properties of the refrigerant. Many HPWH systems with R134a, and other traditional refrigerants often operate natively only down to approximately 40°F, with operation at colder temperatures dependent on either hot-gas bypass functionality (which only some units currently offer) or, in other cases, electric resistance backup/frost protection. Figure 18 below shows the average operating OAT by manufacturer.

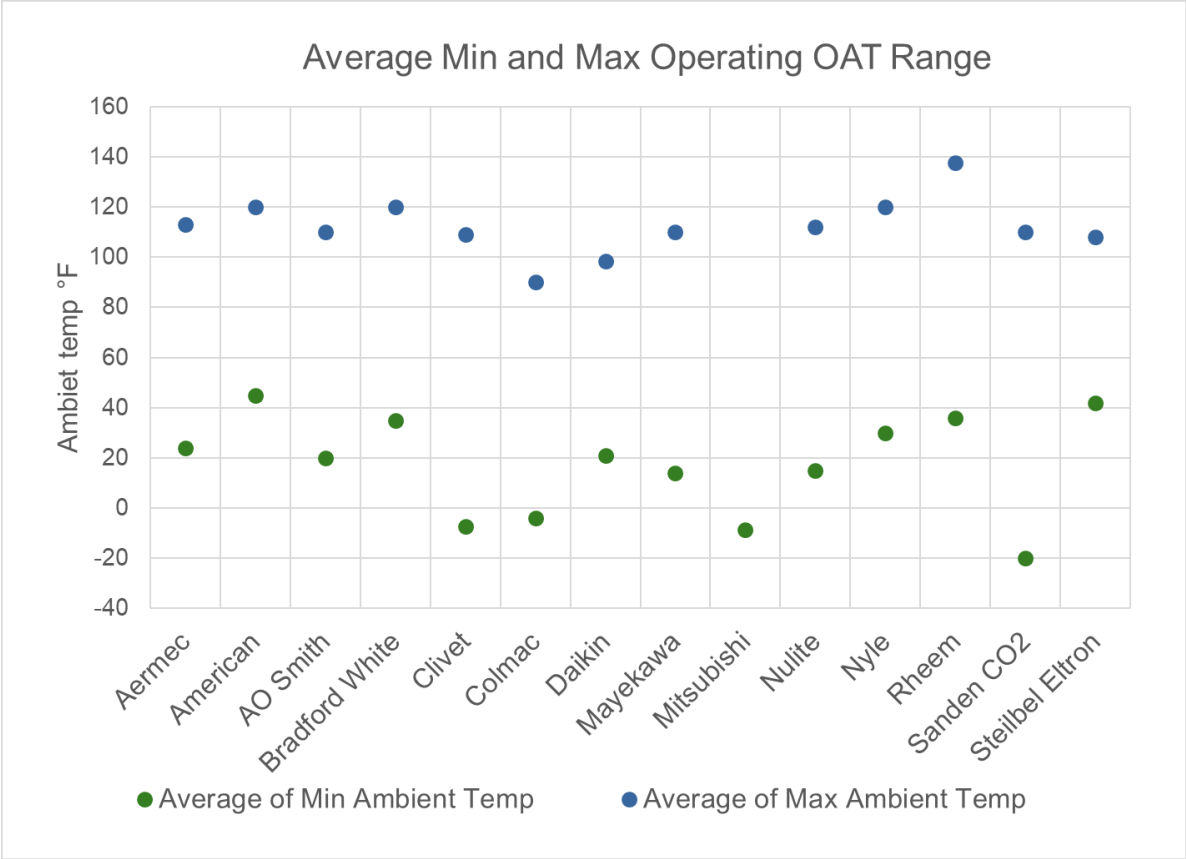

Figure 18: Operating OAT range per manufacturer model.

Source: Statewide CASE Team

3.2.2.3.3 Central HPWH Equipment Configurations

To understand the different types of central HPWH equipment being used in California, it is important to understand the basic types of equipment configurations. Based on review of product literature, interviews with industry practitioners, and individual central HPWH project experience, the Statewide CASE Team segmented equipment into the following categories:

- Integrated Heat Pump + Tank (not commonly used for central HPWH design)
- Split Heat Pump + Tank
- Standalone Heat Pump

Integrated Heat Pump + Tank

The simplest and most readily available type of HPWH is an integrated HP + tank. These units are a single package, and physically resemble the size and form factor of a traditional residential tank-type gas water heater. Manufacturers of this type include American, A.O. Smith, Bradford White, Rheem, and Reliance.

A HPWH of this type generally consists of a 50 to 120-gallon storage tank, with an attached heat pump unit that extracts heat from the surrounding air and exhausts cool air. Inlet and outlet air for many of these units can be ducted, although the units can also be located inside a dwelling unit with no outdoor air source, extracting heat from the indoor air and slightly cooling the surrounding space.

Most integrated HP + tank units are sized for single-unit or light commercial applications. Smaller units can be clustered to create simple multifamily central systems without recirculation system (clustered design) with minimal engineering.

HPWH in this category is regulated by federal minimum efficiency requirement. Most products, except for two models offered by American, available in the California market have an energy factor higher than 3.0.

Split Heat Pump + Tank

A second type of smaller HPWH is the split HP + Tank. The most common example of this type of water heater is the Sanden SANCO2. This residential-sized unit has a heat pump unit that uses R-744 (CO₂) as the refrigerant, with a water loop between the heat pump and the 50- to 120-gallon tank. The total footprint of a unit like this is larger than the integrated HP + tank type, but there is more flexibility because the tank and the heat pump can be located as far as 50 feet apart from each other.

There are additional residential sized split HP + tank products from manufacturers other than Sanden (such as Daikin, Fujitsu, Mitsubishi, and Sanyo) with either R744 or more traditional refrigerants such as R410 or R134, that are available in other markets, but the Sanden SANCO2 is the only unit of this type currently available in California. There is some indication that additional products of this type from manufacturers other than Sanden will be made available in California in the coming years.

Due to its high operating pressure, R744 units generally have all refrigerant-containing components factory-installed inside the heat pump, whereas units with more traditional refrigerants at lower pressures may have a refrigerant loop between the heat pump and the tank. This impacts field installation procedures.

HPWH in this category is regulated by federal minimum efficiency requirement. Products currently available in California are offered by Sanden have energy factors range from 2.85 to 3.34 and COP of 5.20. Mitsubishi has confirmed availability in near future and their product have a COP range from 4.18 to 4.5.

Standalone Heat Pump

The largest-capacity equipment configuration for central HPHW is a standalone heat pump that the design engineer pairs with a separate storage tank or tanks. Manufacturers of this type include Nyle, Colmac, Mitsubishi, Mayekawa, Aermec.

Currently, only Nyle, Colmac and Aermec have product available in the California Market. Mitsubishi and Mayekawa have products available internationally and have confirmed with the Statewide CASE Team about their plans to make those products available in California soon.

These units have all refrigerant-containing components and heat exchangers contained within the unit, and a potable water loop between the heat pump and the tank. Standalone heat pump units range in size from 15,000 Btu/hr to modular units that can be combined for capacities of over 2,000,000 Btu/hr. These units use a range of refrigerants, from traditional R410A and R134a, to lower global warming potential (GWP) R32 and R744. Many units in this category are available in either air source or water source versions, but this report will focus on air-source units, as they have the broadest application for standalone DHW use in California.

Since these HPWH systems do not come packaged with a storage tank, the design engineer must size the heat pump and storage tank combination to meet the hot water demand calculations for the building.

Standalone HPWHs are commercial size HPWHs and do not have federal minimum efficiency requirement. Products currently available in California offered by Aermec, Nyle and Colmac have a COP range from 3.02 to 5.33.

3.2.3 Market Impacts and Economic Assessments

Please refer to sections 3.1.3 and 3.1.4 for general information about market and economic impacts. For economic impacts regarding the electric DHW systems measure that differ from the electric HVAC systems measure, refer to Section 3.2.4 below.

3.2.4 Economic Impacts

3.2.4.1 Increase or Decrease of Investments in the State of California

Based on the incremental measure cost of electric DHW systems over the period of analysis of 30 years, the Statewide CASE Team anticipates economic impacts according to Table 27 below.

Table 18: Estimated Impact that Adoption of the Proposed Measure would have on the California Residential Construction Sector

Type of Economic Impact	Employment (jobs)	Labor Income (millions \$)	Total Value Added (millions \$)	Output (millions \$)
Direct Effects (Additional spending by Residential Builders)	131	\$8.4	\$14.2	\$23.0
Indirect Effect (Additional spending by firms supporting Residential Builders)	50	\$3.2	\$5.1	\$9.0
Induced Effect (Spending by employees of firms experiencing “direct” or “indirect” effects)	62	\$3.5	\$6.2	\$10.1
Total Economic Impacts	243	\$15.0	\$25.4	\$42.1

Source: Analysis by Evergreen Economics of data from the IMPLAN V3.1 modeling software.

3.3 Electric Appliances and Miscellaneous Load

3.3.1 Market Structure

The 2019 Title 24, Part 6 Residential ACM Reference Manual includes detailed information for modeling appliances, plug loads and miscellaneous loads for residential buildings which currently applies to multifamily buildings three stories and fewer as well. This includes estimates of market penetration of various devices for cooking, refrigeration, clothes washing and drying, entertainment devices, lighting and other plug loads. For multifamily buildings, decisions on which appliances get installed are determined by the multifamily developer when the multifamily units are meant to be leased to tenants. For multifamily buildings that are purchased by individuals rather than rented, the decision on which appliances to use is a combination of options provided by the developer as well as the preferences of the buyers.

3.3.2 Technical Feasibility, Market Availability, and Current Practices

Recent developments in technology and focus on decarbonization has resulted in increased interest in induction cooking equipment, heat pump dryers and other higher efficiency options. However, these newer products are still not popular among homeowners and require additional education and marketing efforts to get further traction in the market. SMUD is taking aggressive steps to promote these technologies through their ‘Go Electric’ campaign that combines rebates, education and training and market awareness activities.

The Statewide CASE Team evaluated whether the current plug load calculations in 2019 Title 24, Part 6 need to be modified to account for the emergence of these new appliance technologies. Currently, neither the Residential nor the Nonresidential ACM

Reference Manuals account for the impact of choosing induction ranges and heat pump dryers. The team examined existing literature on these technologies to assess whether there was a basis for adjusting the plug load calculation methodology in the Nonresidential and/or Residential ACM Reference Manuals.

The Statewide CASE Team did not find currently available information to be sufficient to modify the existing requirements in the Residential ACM Reference Manual. Details are provided in Appendix I.

The Statewide CASE Team did however find that the 2019 Title 24, Part 6 Nonresidential ACM Reference Manual calculation for plug loads and appliances is not aligned with the data used for the Residential ACM Reference Manual and likely results in over-predicting energy use of these appliances and plug loads.

3.3.3 Market Impacts and Economic Assessments

The proposal would update Nonresidential ACM Reference Manual calculation for plug loads and appliances and does not require any efficiency improvements to the proposed design. There is no market and economic impact for this submeasure.

3.3.4 Economic Impacts

There is no economic impact for this submeasure.

3.4 Energy Efficiency Measures

The Statewide CASE Team presented the market analysis results for the fenestration and wall u-factor measures in the multifamily restructuring CASE Report. The multifamily IAQ CASE report includes market analysis for HRV and ERV measure.

4 Energy Savings

4.1 Key Assumptions for Energy Savings Analysis

The Statewide CASE Team conducted energy savings and cost-effectiveness analysis separately for HVAC and central DHW systems as well as when combined in an all-electric package. The Statewide CASE Team assumed all DHW and HVAC equipment covered by federal regulations would meet appropriate minimum efficiency requirements.

The Statewide CASE Team conducted energy savings analysis using energy models for prototype buildings modeled in research versions of Title 24, Part 6 compliance software for both the baseline and proposed cases. The baseline models use DHW and HVAC systems that utilize gas for heating, whereas in the proposed models, the DHW and HVAC systems utilize electric heat pumps for heating. The function that the systems provide is the same between the baseline and the proposed cases (i.e., the HVAC systems provide the same amount of ventilation and maintain space temperatures at the same setpoints in the baseline and the proposed). All other inputs between the baseline and the proposed energy models are the same.

4.2 Energy Savings Methodology

4.2.1 Prototypical Buildings

The Energy Commission directed the Statewide CASE Team to model the energy impacts using specific prototypical building models that represent typical building geometries for different types of buildings (California Energy Commission 2019). The prototype buildings that the Statewide CASE Team used in the analysis are presented in Table 19. Details on these prototypes are available in a report prepared by TRC for the Statewide Utility Codes and Standards Team based on review of hundreds of multifamily buildings constructed over the last decade across California (TRC 2019).

Note that there are four prototypes identified in Table 19 and all four were modeled for central HPWH measure and for the electric SZHP HVAC measure. Only the 5-story and 10-story prototypes were modeled for Mini-split and VRF HVAC measure.

Table 19: Prototype Buildings Used for Energy, Demand, Cost, and Environmental Impacts Analysis

Prototype Name	Number of Stories	Floor Area (square feet)	Description
2-Story Garden	2	7,680	8-unit residential building with slab on-grade foundation, wood framed wall construction and a sloped roof. Individual space conditioning serving each unit. Window to Wall Ratio 0.15. The building has a central gas DHW system. ^a
3-Story Loaded Corridor	3	40,000	36-unit residential building with slab on-grade foundation, wood framed wall construction, and a flat roof. Window to Wall Ratio 0.25. Dwelling units flank and central corridor and common area spaces included on bottom floor. Individual space conditioning systems and shared DHW system.
5-Story Mixed Use	5	113,100	88-unit building with four-story residential plus one-story commercial. Concrete podium construction with underground parking, wood framed wall construction, and flat roof. Window to Wall Ratio-0.10 (ground floor) 0.25 (residential floors). Individual space conditioning systems and a central DHW system.
10-Story Mixed Use	10	125,400	117-unit building with nine-story residential + one-story commercial. Concrete podium construction with underground parking, steel framed wall construction, and a flat roof. Window to wall ratio-0.10 (ground floor) 0.40 (residential floors). Central space conditioning and DHW systems.

- a. The 2-story garden prototype assumes individual DHW systems. This was changed to a central system to analyze energy savings and cost effectiveness of this measure for multifamily buildings of similar size, but with central systems.

The Statewide CASE Team estimated energy and demand impacts by simulating the proposed code change using the 2022 Research Versions of the California Building Energy Code Compliance (CBECC) software for residential buildings (CBECC-Res) (CalCERTS, Inc. 2019). The 2-story garden and 3-story loaded corridor prototypes were analyzed using CBECC-Res whereas the 5-story mixed use and 10-story mixed use were analyzed using CBECC-Com (California Energy Commission 2020a).

CBECC-Com/Res generates two models based on user inputs: the Standard Design and the Proposed Design.¹⁰ The Standard Design represents the geometry of the

¹⁰ CBECC-Res creates a third model, the Reference Design, that represents a building similar to the Proposed Design, but with construction and equipment parameters that are minimally compliant with the

design that the builder would like to build and inserts a defined set of features that result in an energy budget that is minimally compliant with 2019 Title 24, Part 6 code requirements. Features used in the Standard Design are described in the 2019 Residential/Nonresidential ACM Reference Manuals. The Proposed Design represents the same geometry as the Standard Design, but it assumes the energy features that the software user describes with user inputs. To develop savings estimates for the proposed code changes, the Statewide CASE Team created a Standard Design and Proposed Design for each prototypical building. There is an existing Title 24, Part 6 requirement that covers the baseline HVAC and DHW systems that applies to new construction multifamily buildings. The Statewide CASE Team used assumptions for HVAC Standard Design based on the 2019 Title 24, Part 6 Residential ACM Reference Manual which uses a HVAC system with a Seasonal Energy Efficiency Ratio (SEER) of 14.0 and an Energy Efficiency Ratio (EER) of 11.7.

The Proposed Design was identical to the Standard Design in all ways except for the revisions that represent the proposed changes to the code. Table 20 presents parameters modified and values used in the Standard Design and Proposed Designs. While the measure description does not change by climate zone, the impacts of the proposed measure are climate-specific due to the impact of outdoor weather conditions on building heating and cooling and water heating needs.

Comparing the energy impacts of the Standard Design to the Proposed Design reveals the impacts of the proposed code change relative to a building that is minimally compliant with the 2019 Title 24, Part 6 requirements.

2006 International Energy Conservation Code (IECC). The Statewide CASE Team did not use the Reference Design for energy impacts evaluations.

Table 20: HVAC Modifications Made to Standard Design in Each Prototype to Simulate Proposed Code Change

Prototype ID	Climate Zone	Standard Design Description	Proposed Design Description
2-Story Garden, 3-Story Loaded Corridor,	CZ 1-3, 11-13	SZAC with gas-fired furnace	SZHP
2-Story Garden, 3-Story Loaded Corridor,	CZ 4-10	SZAC with gas-fired furnace	SZHP + Balanced ventilation system with fan efficacy of 0.4W/cfm
2-Story Garden, 3-Story Loaded Corridor,	CZ 14,15	SZAC with gas-fired furnace	SZHP + balanced ventilation with ERV or HRV
2-Story Garden, 3-Story Loaded Corridor,	CZ 16	SZAC with gas-fired furnace	SZHP with gas supplemental heating
5-Story Mixed Use, 10-Story Mixed Use	CZ 1-15	SZAC with gas-fired furnace	SZHP
5-Story Mixed Use, 10-Story Mixed Use	CZ 16	SZAC with gas-fired furnace	SZHP with gas supplemental heating + fenestration measure (see Table 21)
5-Story Mixed Use, 10-Story Mixed Use	All	SZAC with gas-fired furnace	Ductless mini-split heat pump
5-Story Mixed Use, 10-Story Mixed Use	All	SZAC with gas-fired furnace	Variable Refrigerant Flow (VRF)

For Climate Zone 16, the Statewide CASE Team analyzed a combined measure package with a SZHP system along with:

- For all four prototypes, the use of gas-fired furnace as supplemental heating
- For the 5- and 10-story prototypes, fenestration u-factor and solar heat gain coefficient (SHGC). The fenestration and wall u-factor requirements are presented in a separate CASE Report (Multifamily Restructuring CASE Report 2020), and incorporated into this CASE Report for completeness of the all-electric proposal.

For 2-story garden style and 3-story loaded corridor prototypes in Climate Zone 4 to 10, the Statewide CASE Team analyzed a combined measure package with a SZHP system along with balanced ventilation systems without heat or energy recovery that have fan efficacy of 0.4W/cfm. For prototypes in Climate Zone 14 and 15, the Statewide CASE Team analyzed the SZHP system combined with balanced ventilation with ERV or HRV. The ERV/HRV requirements are presented in a separate CASE report (Multifamily IAQ CASE Report 2020), and incorporated into this report to complete a total combined all-electric proposal.

Table 21 presents precisely which parameters were modified and what values were used in the Standard Design and Proposed Design for Climate Zone 16 measure package. Table 22 shows the percentages of dwelling units with each window type modeled.

Table 21: Modifications Made to Standard Design in Each Prototype to Simulate Measure Package for Climate Zone 16

Prototype ID	Climate Zone	Parameter Name	Standard Design Description	Proposed Design Description
2-Story Garden, 3-Story Loaded Corridor, 5-Story Mixed Use, 10-Story Mixed Use	CZ16	HVAC system type	SZAC with gas-fired furnace	SZHP With gas-fired furnace for supplemental heating
		Window U-factor and SHGC (Only for 5-Story Mixed Use, 10-Story Mixed Use)	Curtain Wall/Storefront -U-factor: 0.41 -SHGC: 0.26 All Other Window: -U-factor: 0.4 -SHGC: 0.24 Class AW Window: -U-factor: 0.4 -SHGC: 0.24	Curtain Wall/Storefront -U-factor: 0.38 -SHGC: 0.25 All Other: -U-factor: 0.30 -SHGC: 0.23 Class AW Window: -U-factor: 0.38 -SHGC: 0.24

Table 22. Percentage of Dwelling Units with Each Window Type

Window Type	Midrise (89% of all buildings four stories and greater)	Highrise (11% of all buildings four stories and greater)
Curtain Wall/Storefront	7%	70%
Class AW Window	16%	28%
All Other Window	77%	2%

For Climate Zone 16, the Statewide CASE Team developed a weighted average for energy savings and cost effectiveness results for the 5- and 10-story prototypes.

4.2.2 Electric HVAC Basis of Design

For electric HVAC systems, the Statewide CASE Team analyzed three separate system types – Ducted Heat Pumps (SZHP), Ductless Mini-Split Heat Pumps (mini-split) and VRF systems. These were chosen based on the market data presented in Section 3.1.

The Statewide CASE Team developed a basis of design for each of the three electric HVAC system type as well as the baseline mixed-fuel system (Split Dx for cooling and gas-fired furnace for heating) as detailed in Table 23 through Table 25. The Statewide CASE Team contracted with a professional mechanical engineering firm to develop the basis of design which was also used (as explained in Section 5.3) to estimate incremental measure costs for the electric HVAC systems when compared with the mixed-fuel baseline.

Table 23: Basis of Design for Baseline Mixed-Fuel HVAC System in Dwelling Units

Unit locations: Condensing unit on roof. Furnace with evaporator coil in closet in dwelling unit.				
		Type 1	Type 2	Type 3
Air Conditioner	Total Cooling Capacity (Btu/h)	7,161	18,649	30,137
	Efficiency (SEER)	14	14	14
	Airflow (cfm)	268	699	1,129
Furnace	Heating capacity (Btu/h)	8,000	15,500	23,000
	Efficiency (AFUE)	80	80	80
	Flue	Vent at exterior wall	Vent at exterior wall	Vent at exterior wall
Ductwork	N/A	Designed per type of Dwelling unit (Studio, 1-Bed, 2-Bed, 3-Bed)		
Supply grilles	Type	2-way wall/ceiling register		

Table 24: Basis of Design for Ducted Split Heat Pump System in Dwelling Units

Unit locations: Outdoor unit on roof. Coil in closet in dwelling unit				
		Type 1	Type 2	Type 3
Heat pump	Total Cooling Capacity (Btu/h)	7,161	18,649	30,137
	Efficiency (SEER)	14	14	14
	Airflow (cfm)	268	699	1,129
	Heat pump heating capacity (Btu/h)	7,519	19,582	31,644
	Efficiency (HSPF)	8.2	8.2	8.2
	Electric Resistance Capacity (Btu/h)	5,871	15,290	24,708
	Airflow (cfm)	268	699	1,129
Ductwork	N/A	Designed per type of Dwelling unit (Studio, 1-Bed, 2-Bed, 3-Bed)		
Supply grilles	Type	2-way wall/ceiling register		

Table 25: Basis of Design for Ductless Mini-Split Heat Pump System in Dwelling Units

Unit locations: Outdoor unit on roof. One indoor unit per room									
		System 1 (Studio)	System 2 (Studio)	System 3 (1-bed)	System 4 (1-bed)	System 5 (2-bed)	System 6 (2-bed)	System 7 (3-bed)	System 8 (3-bed)
Outdoor Unit – Cooling	Total Capacity (Btu/h)	7,161	14,892	9,548	15,695	14,321	22,236	18,697	30,137
	Efficiency - SEER	14	14	14	14	14	14	14	14
	Efficiency - EER	12.2	12.2	12.2	12.2	12.2	12.2	12.2	12.2
Outdoor Unit – Heating	Heat pump capacity (Btu/h)	7,519	15,637	10,025	16,479	10,025	23,348	19,632	31,644
	Efficiency - HSPF	8.2	8.2	8.2	8.2	8.2	8.2	8.2	8.2
	Electric Resistance Capacity (Btu/h)	5,871	12,210	7,828	12,868	7,828	18,230	15,329	24,708
Indoor unit 1	Total Cooling Capacity (Btu/h)	7,161	14,892	4,774	7,847	4,774	7,412	4,674	7,534
	Total Heating Capacity (Btu/h)	13,390	15,637	5,013	8,240	3,342	7,783	4,908	7,911
	Airflow (cfm)	268	461	179	294	119	278	175	282
Indoor unit 2	Total Cooling Capacity (Btu/h)	N/A	N/A	4,774	7,847	4,774	7,412	4,674	7,534
	Total Heating Capacity (Btu/h)	N/A	N/A	5,013	8,240	3,342	7,783	4,908	7,911
	Airflow (cfm)	N/A	N/A	179	294	119	278	175	282
Indoor unit 3	Total Cooling Capacity (Btu/h)	N/A	N/A	N/A	N/A	4,774	7,412	4,674	7,534
	Total Heating Capacity (Btu/h)	N/A	N/A	N/A	N/A	3,342	7,783	4,908	7,911
	Airflow (cfm)	N/A	N/A	N/A	N/A	119	278	175	282
Indoor unit 4	Total Cooling Capacity (Btu/h)	N/A	N/A	N/A	N/A	N/A	N/A	4,674	7,534
	Total Heating Capacity (Btu/h)	N/A	N/A	N/A	N/A	N/A	N/A	4,908	7,911
	Airflow (cfm)	N/A	N/A	N/A	N/A	N/A	N/A	175	282
Refrigerant piping	Horizontal runs	Per floor plans	Per floor plans	Per floor plans	Per floor plans	Per floor plans	Per floor plans	Per floor plans	Per floor plans
	Vertical runs								

For the VRF system, the Statewide CASE Team provided space heating and cooling loads by dwelling unit and by prototype building, as well as the design outside air conditions to a mechanical contractor for system designs to be used for energy analysis and cost-benefit analysis. The system that the mechanical contractor designed for the 5-story prototype is shown in Table 26. The main components of the VRF system are the condensing unit (CU), the branch selector box (BSB), and the fan coil unit (FCU). The CUs and BSBs are located on the roof, with the FCUs in the closets of the dwelling units. Each CU and BSB serve half of a floor. The FCUs are ducted, with the same ducted air distribution system as the other HVAC systems.

Table 26: VRF System Design

Prototype	Condensing Units (#)	BSB (#)	# FCU per CU/BSB
5-Story Mixed Use	8	8	12
10-Story Mixed Use	9	9	13

Balanced ventilation systems provide the outdoor ventilation air required for indoor air quality to each dwelling unit and common areas in both the baseline and proposed designs.

4.2.3 Central HPWH Basis of Design

For DHW systems, the Statewide CASE Team worked with an experienced HPWH design consultant firm to develop the basis of design for both the central gas water heater and the central HPWH for the four multifamily prototype buildings. Key assumptions are summarized here, and Appendix G provides detailed system sizing criteria, equipment selection, and plumbing configurations.

The base case central gas-fired system design is based on the 2019 Title 24, Part 6 Residential Compliance Manual and includes:

- A gas storage water heating system with thermal efficiency of 0.8, and
- A solar thermal hot water system with solar saving fraction that meets 2019 Title 24, Part 6 code minimum requirement. It is assumed that the thermal collectors are flat plate design and glazed.

The proposed central HPWH systems design represents current best practice in the industry, and assumes:

- A single-pass system, due to limitations in software modeling capabilities;
- No rooftop solar thermal system.

The Statewide CASE Team estimated energy and demand impacts by simulating the proposed code change using the 2022 Research Version of the CBECC software. The publicly available research version for either CBECC-Res or CBECC-Com are not adept to model central HPWHs. An internal subversion of CBECC-Res 2022.0.2 RV developed by the CBECC-Res software team is used to perform central HPWH simulations. However, it is limited to one single-pass heat pump water heater model and multifamily buildings up to three stories only. The 5- and 10-story mixed-use prototypes are modeled in 2022 research version of CBECC-Com 2022.0.2 RV for Standard Design baseline and California Simulation Engine (CSE) version 0.868.0 for the proposed HPWH design.¹¹ The CSE input file generated from baseline 5- and 10-story mixed use simulations in CBECC-Com 2022.0.2 RV is modified to create CSE input file for proposed design. The CSE engine version 0.868.0 is commonly used for all the simulations for central HPWH modeling.

There are no existing requirements in Title 24, Part 6 that cover the central HPWH system. The Statewide CASE Team modified the Standard Design to calculate energy impacts of the most common current design practice or industry standard practice. The Standard Design for new construction assumes a gas-fired boiler system with storage tank of federal minimum efficiency. The Proposed Design was identical to the Standard Design in all ways except for the revisions that represent the proposed changes to the

¹¹ See CBECC-Com 2022.0.1 RV software at <http://bees.archenergy.com/software2022.html>

code. Table 27 presents precisely which parameters were modified and what values were used in the Standard Design and Proposed Design. Specifically, the proposed conditions assume a central HPWH with storage tanks per the sizing requirements in Appendix G. The code change requirements do not vary by climate zone but the energy saving impacts would vary, hence the measure is modeled in all climate zones.

Comparing the energy impacts of the Standard Design to the Proposed Design provides the impacts of the proposed code change relative to a building that follows industry typical practices.

Table 27: Modifications Made to Standard Design in Each Prototype to Simulate Proposed Code Change

Prototype ID	Climate Zone	Standard Design: Central Gas storage water heater at 0.8 thermal efficiency	Proposed Design: Central HPWH system
2-Story Garden	Total heating capacity (kBtu/hr)	75	31
	Primary storage tank (gallon)	120	135
	Solar thermal fraction	CZ 01-09: 0.2 CZ 10-16: 0.35	N/A
3-Story Loaded Corridor	Total heating capacity (kBtu/hr)	200	61.6
	Primary storage tank (gallon)	238	525
	Solar thermal fraction	CZ 01-09: 0.2 CZ 10-16: 0.35	N/A
5-Story Mixed Use	Total heating capacity (kBtu/hr)	480	275
	Primary storage tank (gallon)	600	1500
	Solar thermal fraction	CZ 01-09: 0.2 CZ 10-16: 0.35	N/A
10-Story Mixed Use	Total heating capacity (kBtu/hr)	560	407
	Primary storage tank (gallon)	800	1500
	Solar thermal fraction	CZ 01-09: 0.2 CZ 10-16: 0.35	N/A

Research subversion of CBECC-Res 2022 and CBECC-Com 2022 provided whole-building and DHW energy consumption for every hour of the year measured in kilowatt-hours per year (kWh/yr) and therms per year (therms/yr). The Statewide CASE Team then applied the 2022 time dependent valuation (TDV) multipliers to calculate annual

energy use in TDVkBtu/yr and annual peak electricity demand reductions measured in kilowatts (kW). The Statewide CASE Team used the 2022 residential TDV factors for zero percent avoided costs and no leakage for all the four prototypes.

The energy impacts of the proposed code change vary by climate zone. The Statewide CASE Team simulated the energy impacts in every climate zone and applied the climate-zone specific TDV factors when calculating energy and energy cost impacts.

The Statewide CASE Team calculated annual energy and peak demand impacts per dwelling unit by dividing the results for each prototype building by the number of dwelling units in the prototype building.

4.2.4 Statewide Energy Savings Methodology

The statewide CASE Team extrapolated statewide impacts by multiplying the per-unit savings by the total number of dwelling units affected based on the construction forecast provided by the Energy Commission in terms of number of multifamily dwelling units by climate zone. The Statewide Construction Forecasts estimate new construction that will occur in 2023, the first year that the 2022 Title 24, Part 6 requirements are in effect. It also estimates the size of the total existing building stock in 2023 that the Statewide CASE Team used to approximate savings from building alterations. The construction forecast provides construction (new construction and existing building stock) by building type and climate zone. The building types used in the construction forecast, Building Type ID, are not identical to the prototypical building types available in CBECC-Com/Res, so the Energy Commission provided guidance on which prototypical buildings to use for each Building Type ID when calculating statewide energy impacts. Table 28 presents the prototypical buildings and weighting factors that the Energy Commission requested the Statewide CASE Team use for each Building Type ID in the Statewide Construction Forecast.

Appendix A presents additional information about the methodology and assumptions used to calculate statewide energy impacts.

Table 28: Multifamily Building Types and Associated Prototype Weighting

Building Type ID from Statewide Construction Forecast	Building Prototype for Energy Modeling	Weighting Factors for Statewide Impacts Analysis (percent of total annual new construction of multifamily dwelling units)
Multifamily	2-Story Garden	4%
	3-Story Loaded Corridor	33%
	5-Story Mixed Use	58%
	10-Story Mixed Use	5%

For this CASE topic, the Statewide CASE Team further estimated a portion of the annual new construction by prototype relevant to the proposed code change. This is to

account for the fact that all-electric construction practices represent a growing but small proportion of the overall new construction market. The Statewide CASE Team developed this estimate based on the percentage of existing high-performance multifamily buildings that are using either electric HVAC systems or central DHW systems plus the growing movement statewide through local ordinances and reach codes to promote all-electric multifamily buildings starting in 2020. The statewide CASE Team anticipates a more rapid adoption of electric HVAC and central HPWH designs by 2023 as new Energy Commission and CPUC policies supporting building decarbonization are implemented.

The Statewide CASE Team estimated the percentage of new construction affected by the proposed code changes independently for Electric HVAC and Central HPWH since the type of multifamily buildings impacted varies.

For the 2- and 3-story prototypes, the proposed all-electric HVAC requirement would impact the buildings that use mixed-fuel HVAC because the 2019 Title 24, Part 6 has already included all-electric HVAC as an alternative baseline if the proposed designs use an all-electric HVAC system.

For 5- and 10-story prototypes, the proposed prescriptive requirements would impact 100 percent of the new construction buildings.

For the statewide savings analysis for multifamily buildings three stories and fewer, the weighting factors from Table 28 are multiplied by the percentage of buildings with mixed fuel HVAC in Table 29 and central HPWH systems in Table 30. The methodology for how the values in Table 29 and Table 30 are described in detail in Appendix A. Impacts to multifamily buildings three stories and fewer in Climate Zone 16 are excluded because the proposed baseline is still SZAC with gas-fired furnace.

Table 29: New Construction Impacts by Fuel Type for Electric HVAC Measure

Building Prototype for Energy Modeling	Percent of Buildings All-Electric	Percent of Buildings Mixed Fuel
2-Story Garden	27%	73%
3-Story Loaded Corridor	25%	75%

Table 30: New Construction Impacts by Fuel Type for Central HPWH Measure

Building Prototype for Energy Modeling	Percent of Buildings with Central DHW system	Percent of Buildings with Central HPWH system
2-Story Garden	37%	9%
3-Story Loaded Corridor	49%	12%
5-Story Mixed Use	97%	24%
10-Story Mixed Use	100%	25%

4.3 Per-Unit Energy Impacts Results

4.3.1 Electric HVAC Systems

This section presents results for three separate electric HVAC technologies - Ducted Heat Pumps (SZHP), Ductless Mini-Split Heat Pumps (Mini-Split) and VRF systems. For SZHPs only, the Statewide CASE Team added efficiency measures (furnace supplemental heating and higher efficiency windows) described in Section 4.2.1 to Climate Zone 16 to achieve positive TDV Energy savings.

Mini-split systems are modeled as a minimally code compliant SZHP system in the compliance software; the results for Climate Zones 1 through 15 are therefore the same as the SZHP system. VRF systems are modeled with a different efficiency level and their results are presented separately. The Statewide CASE Team calculated TDV energy savings using 30-year residential values.

4.3.1.1 SZHP & Mini-Split Systems

Energy savings and peak demand reductions per unit for SZHP systems are presented in Table 33 and Table 35. The per-unit energy savings figures do not account for naturally occurring market adoption or current compliance rates. As expected, the per-unit electricity usage for the first year increases and natural gas usage decreases. There are positive TDV energy savings for all climate zones.

For the 2-story garden style building type, per-unit first year electricity increases between 33 and 1,040 kWh except for in climate zones 6 through 8, where there are electricity savings. The per-unit first year natural gas usage reduces by 1 to 98 therms.

For the 3-story loaded corridor building type, per-unit first year electricity increases between 4 and 688 kWh except for in climate zones 6 through 8, where there are electricity savings. The per-unit first year natural gas usage reduces by 0 to 58 therms.

The energy impacts per dwelling unit in Table 33 and Table 35 for Climate Zone 16 show a weighted average of energy impacts by the percentage of dwelling units with each window type shown in Table 22. Table 34 and Table 36 show the energy impacts by window type used to calculate the average.

For the 5-story mixed-use prototype, per-unit first year electricity usage increases between 23 to 443 kWh/yr compared to baseline mixed-fuel system, per-unit first year natural gas usage reduces by 3 to 51 therms/yr.

For the 10-Story mixed-use building type, per-unit first year electricity usage increases between 18 to 434 kWh/yr, per-unit first year natural gas usage decreased between 2 to 50 therms/yr.

Table 31: First-Year Energy Impacts Per Dwelling Unit – 2-Story Garden Style – SZHP with efficiency measures

Climate Zone	Electricity Savings (kWh/yr)	Peak Electricity Demand Reductions (kW)	Natural Gas Savings (therms/yr)	TDV Energy Savings (TDV kBtu/yr)
1	(1,040)	0	98	3,931
2	(598)	0	50	1,243
3	(278)	0	24	677
4	(193)	0	22	213
5	(208)	0	21	1,205
6	10	0	4	1,385
7	48	0	2	1,695
8	17	0	2	460
9	(33)	0	6	530
10	(132)	0	13	(164)
11	(572)	0	44	(1,094)
12	(498)	0	41	(674)
13	(443)	0	32	(1,828)
14	(317)	0	41	6,011
15	(39)	0	1	893
16	(366)	0	34	2,733

Table 32: First-Year Energy Impacts Per Dwelling Unit – 3-Story Loaded Corridor – SZHP with efficiency measures

Climate Zone	Electricity Savings (kWh/yr)	Peak Electricity Demand Reductions (kW)	Natural Gas Savings (therms/yr)	TDV Energy Savings (TDV kBtu/yr)
1	(688)	0	58	(65)
2	(427)	0	32	(661)
3	(173)	0	12	(702)
4	(110)	0	13	(106)
5	(97)	0	10	503
6	35	0	1	826
7	57	0	0	1,249
8	28	0	1	313
9	(4)	0	3	189
10	(84)	0	8	(505)
11	(442)	0	30	(2,254)
12	(380)	0	28	(2,203)
13	(342)	0	22	(2,819)

14	(210)	0	27	3,967
15	(53)	0	0	379
16	(240)	0	18	347

Energy savings and peak demand reductions per unit for mini-split systems are presented in Table 36: First-Year Energy Impacts Per Dwelling Unit – 5-Story Mixed-Use Building – CZ16 SZHP with efficiency measures by Window Type

Window Type	Electricity Savings (kWh/yr)	Peak Electricity Demand Reductions (kW)	Natural Gas Savings (therms/yr)	TDV Energy Savings (TDV kBtu/yr)
All Other	(99)	(0.01)	29	8,302
Curtainwall	(131)	0	21	4,292
Class AW	(128)	0	20	3,914

Table 37

and Table 38. Climate Zone 16 has negative TDV energy savings, showing just a SZHP or mini-split system alone is not enough to achieve positive TDV energy savings.

Table 33: First-Year Energy Impacts Per Dwelling Unit – 5-Story Mixed-Use Building – SZHP (CZ16 only with added efficiency measures and gas supplemental heat)

Climate Zone	Electricity Savings (kWh/yr)	Peak Electricity Demand Reductions (kW)	Natural Gas Savings (therms/yr)	TDV Energy Savings (TDV kBtu/yr)
1	(443)	0	51	3,798
2	(292)	0	30	2,411
3	(159)	0	20	2,335
4	(135)	0	15	1,332
5	(165)	0	18	1,095
6	(39)	0	5	620
7	(26)	0	4	533
8	(36)	0	5	579
9	(60)	0	7	881
10	(104)	0	11	902
11	(303)	0	33	3,190
12	(275)	0	29	2,215
13	(232)	0	25	2,041
14	(270)	0	26	1,278
15	(23)	0	3	377
16	(121)	0	24	5,922

Table 34: First-Year Energy Impacts Per Dwelling Unit – 5-Story Mixed-Use Building – CZ16 SZHP with efficiency measures by Window Type

Window Type	Electricity Savings (kWh/yr)	Peak Electricity Demand Reductions (kW)	Natural Gas Savings (therms/yr)	TDV Energy Savings (TDV kBtu/yr)
All Other	(117)	0	26	6,713
Curtainwall	(112)	0	17	3,465
Class AW	(142)	0	19	3,186

Table 35: First-Year Energy Impacts Per Dwelling Unit – 10-Story Mixed-Use Building – SZHP (CZ16 only with efficiency measures and gas supplemental heat)

Climate Zone	Electricity Savings (kWh/yr)	Peak Electricity Demand Reductions (kW)	Natural Gas Savings (therms/yr)	TDV Energy Savings (TDV kBtu/yr)
1	(434)	0	50	4,250
2	(272)	0	28	2,336
3	(138)	0	17	2,049
4	(117)	0	13	1,125
5	(134)	0	15	992
6	(27)	0	4	450
7	(22)	0	3	476
8	(27)	0	4	431
9	(50)	0	6	729
10	(91)	0	10	807
11	(329)	0	36	3,529
12	(265)	0	28	2,250
13	(223)	0	24	1,931
14	(277)	0	27	1,356
15	(18)	0	2	278
16	(130)	0	21	4,266

Table 36: First-Year Energy Impacts Per Dwelling Unit – 5-Story Mixed-Use Building – CZ16 SZHP with efficiency measures by Window Type

Window Type	Electricity Savings (kWh/yr)	Peak Electricity Demand Reductions (kW)	Natural Gas Savings (therms/yr)	TDV Energy Savings (TDV kBtu/yr)
All Other	(99)	(0.01)	29	8,302
Curtainwall	(131)	0	21	4,292
Class AW	(128)	0	20	3,914

Table 37: First-Year Energy Impacts Per Dwelling Unit – 5-Story Mixed-Use Building – Mini-Split

Climate Zone	Electricity Savings (kWh/yr)	Peak Electricity Demand Reductions (kW)	Natural Gas Savings (therms/yr)	TDV Energy Savings (TDV kBtu/yr)
1	(443)	0	51	3,798
2	(292)	0	30	2,411
3	(159)	0	20	2,335
4	(135)	0	15	1,332
5	(165)	0	18	1,095
6	(39)	0	5	620
7	(26)	0	4	533
8	(36)	0	5	579
9	(60)	0	7	881
10	(104)	0	11	902
11	(303)	0	33	3,190
12	(275)	0	29	2,215
13	(232)	0	25	2,041
14	(270)	0	26	1,278
15	(23)	0	3	377
16	(860)	0	73	(5,071)

Table 38: First-Year Energy Impacts Per Dwelling Unit – 10-Story Mixed-Use Building – Mini-Split

Climate Zone	Electricity Savings (kWh/yr)	Peak Electricity Demand Reductions (kW)	Natural Gas Savings (therms/yr)	TDV Energy Savings (TDV kBtu/yr)
1	(434)	0	50	4,250
2	(272)	0	28	2,336
3	(138)	0	17	2,049
4	(117)	0	13	1,125
5	(134)	0	15	992
6	(27)	0	4	450
7	(22)	0	3	476
8	(27)	0	4	431
9	(50)	0	6	729
10	(91)	0	10	807
11	(329)	0	36	3,529
12	(265)	0	28	2,250
13	(223)	0	24	1,931
14	(277)	0	27	1,356
15	(18)	0	2	278
16	(982)	0	82	(5,041)

4.3.1.2 VRF System

Energy savings and peak demand reductions per unit for VRF systems are presented in Table 39 and Table 40. The per-unit energy savings figures do not account for naturally occurring market adoption or compliance rates. As with SZHP and Mini-Split systems, the per-unit electricity usage for the first year is expected to increase and natural gas usage is expected to decrease. There are TDV Savings for only Climate Zone 1. For the 10-story prototype, there are positive TDV savings for Climate Zones 1 through 3, and 11. VRF systems have a lower efficiency standard than SZHP or Mini-Split systems and as such the energy use of minimally code compliance VRF systems is higher.

For the 5-story mixed-use building type, per-unit first year electricity usage increases between 216 to 1,047 kWh/yr, per-unit natural gas usage decreases between 3 to 73 therms/yr, and per-unit electricity demand increases by 0.01 to 0.06 kW.

For 10-story mixed-use building type, per-unit first year electricity usage increases between 166 to 1,135 kWh/yr, per-unit natural gas usage decreases between 2 to 82 therms/yr, and per-unit electricity demand increases by 0.01 to 0.04 kW.

Table 39: First-Year Energy Impacts Per Dwelling Unit – 5-Story Mixed-Use Building – VRF System

Climate Zone	Electricity Savings (kWh/yr)	Peak Electricity Demand Reductions (kW)	Natural Gas Savings (therms/yr)	TDV Energy Savings (TDV kBtu/yr)
1	(422)	(0.02)	51	4,531
2	(399)	(0.04)	30	(353)
3	(231)	(0.03)	20	(103)
4	(289)	(0.05)	15	(2,743)
5	(252)	(0.03)	18	(1,230)
6	(235)	(0.06)	5	(4,816)
7	(216)	(0.06)	4	(5,050)
8	(252)	(0.05)	5	(4,740)
9	(261)	(0.05)	8	(3,865)
10	(302)	(0.05)	11	(4,154)
11	(461)	(0.03)	33	(427)
12	(424)	(0.05)	29	(1,704)
13	(445)	(0.03)	25	(3,846)
14	(396)	(0.03)	26	(986)
15	(278)	(0.01)	3	(5,713)
16	(1,047)	(0.04)	73	(10,304)

Table 40: First-Year Energy Impacts Per Dwelling Unit – 10-Story Mixed-Use Building – VRF

Climate Zone	Electricity Savings (kWh/yr)	Peak Electricity Demand Reductions (kW)	Natural Gas Savings (therms/yr)	TDV Energy Savings (TDV kBtu/yr)
1	(396)	(0.01)	50	5,521
2	(336)	(0.03)	28	1,076
3	(203)	(0.03)	17	169
4	(229)	(0.03)	13	(1,914)
5	(213)	(0.03)	15	(1,127)
6	(166)	(0.04)	4	(3,139)
7	(159)	(0.04)	3	(3,506)
8	(159)	(0.03)	4	(2,605)
9	(169)	(0.02)	6	(1,827)
10	(202)	(0.02)	10	(1,785)
11	(458)	(0.02)	36	556
12	(402)	(0.04)	28	(1,301)
13	(415)	(0.02)	24	(3,583)
14	(390)	(0.02)	27	(718)
15	(216)	(0.00)	2	(4,519)
16	(1,135)	(0.04)	82	(9,460)

4.3.2 Central HPWH System

Energy savings and peak demand reductions per unit for new construction are presented in Table 41 to Table 44. The per-unit energy savings figures do not account for naturally occurring market adoption or compliance rates. For all prototypes evaluated, as expected electricity usage increases and gas usage decreases, resulting in positive TDV impacts for all climate zones and all prototypes.

For 2-story garden style building type, per-unit first year electricity usage increases between 674 to 923 kWh/yr, per-unit natural gas usage decreases between 87 to 143 therms/yr, and per-unit electricity demand increases between 4 to 5 kW.

For 3-story loaded corridor style building type, per-unit first year electricity usage increases between 548 to 809 kWh/yr, per-unit natural gas usage decreases between 40 to 100 therms/yr, and per-unit electricity demand increases between 0.4 to 0.8 kW.

For 5-story mixed-use building type, per-unit first year electricity usage increases between 522 to 759 kWh/yr, per-unit natural gas usage decreases between 57 to 101 therms/yr, and per-unit electricity demand increases between 0.3 to 0.5 kW.

For 10-story mixed-use building type, per-unit first year electricity usage increases between 417 to 653 kWh/yr, per-unit natural gas usage decreases between 50 to 90 therms/yr, and per-unit electricity demand increases between 0.3 to 0.4 kW.

Table 41: First-Year Energy Impacts Per Dwelling Unit– 2-Story Garden Style Prototype Building

Climate Zone	Electricity Savings (kWh/yr)	Peak Electricity Demand Reductions (kW)	Natural Gas Savings (therms/yr)	TDV Energy Savings (TDV kBtu/yr)
1	(858.70)	(3.90)	142.77	28,633
2	(825.00)	(4.17)	131.53	26,412
3	(814.45)	(3.75)	131.62	25,936
4	(781.43)	(3.97)	124.87	24,197
5	(812.92)	(4.04)	131.78	25,589
6	(752.29)	(3.74)	121.07	24,325
7	(750.52)	(3.73)	121.04	24,027
8	(739.59)	(3.64)	117.58	23,778
9	(747.24)	(4.61)	118.58	24,335
10	(746.98)	(4.58)	101.77	17,761
11	(775.93)	(4.31)	103.59	16,981
12	(787.79)	(4.13)	106.54	17,786
13	(757.27)	(4.15)	100.53	16,834
14	(780.13)	(4.82)	104.36	18,277
15	(674.31)	(3.66)	86.75	14,683
16	(923.03)	(5.52)	119.91	18,212

Table 42: First-Year Energy Impacts Per Dwelling Unit– 3-Story Loaded Corridor Prototype Building

Climate Zone	Electricity Savings (kWh/yr)	Peak Electricity Demand Reductions (kW)	Natural Gas Savings (therms/yr)	TDV Energy Savings (TDV kBtu/yr)
1	(777.91)	(0.73)	100.08	14,225
2	(700.05)	(0.71)	77.01	9,728
3	(694.38)	(0.67)	75.79	9,488
4	(659.36)	(0.67)	67.36	6,762
5	(692.96)	(0.65)	70.88	6,889
6	(634.73)	(0.59)	59.85	5,223
7	(633.13)	(0.58)	63.02	6,453
8	(619.39)	(0.53)	57.55	4,331
9	(625.94)	(0.60)	56.64	4,053
10	(627.89)	(0.66)	56.22	4,105
11	(655.62)	(0.72)	66.27	6,601
12	(667.99)	(0.71)	68.89	7,282
13	(637.53)	(0.65)	61.66	5,457
14	(658.44)	(0.70)	55.46	2,820
15	(547.81)	(0.38)	39.49	797
16	(809.40)	(0.78)	83.94	6,279

Table 43: First-Year Energy Impacts Per Dwelling Unit– 5-Story Mixed Use Prototype Building

Climate Zone	Electricity Savings (kWh/yr)	Peak Electricity Demand Reductions (kW)	Natural Gas Savings (therms/yr)	TDV Energy Savings (TDV kBtu/yr)
1	(735.33)	(0.35)	100.61	17,197
2	(670.27)	(0.38)	91.80	16,030
3	(660.40)	(0.34)	91.86	15,482
4	(629.21)	(0.36)	86.58	15,227
5	(658.52)	(0.37)	92.00	15,433
6	(601.97)	(0.34)	83.63	14,785
7	(599.35)	(0.34)	83.55	14,634
8	(589.34)	(0.33)	80.90	14,473
9	(596.41)	(0.36)	81.67	14,459
10	(596.95)	(0.42)	68.84	10,074
11	(622.91)	(0.39)	70.24	9,847
12	(635.41)	(0.37)	72.57	9,968
13	(605.41)	(0.38)	67.96	9,725
14	(627.76)	(0.44)	70.86	10,327
15	(522.15)	(0.33)	57.07	7,983
16	(758.97)	(0.50)	82.93	9,286

Table 44: First-Year Energy Impacts Per Dwelling Unit– 10-Story Mixed Use Prototype Building

Climate Zone	Electricity Savings (kWh/yr)	Peak Electricity Demand Reductions (kW)	Natural Gas Savings (therms/yr)	TDV Energy Savings (TDV kBtu/yr)
1	(629.32)	(0.33)	90.47	13,919
2	(565.91)	(0.34)	82.10	13,595
3	(557.54)	(0.33)	82.15	13,476
4	(525.98)	(0.30)	77.14	13,539
5	(554.56)	(0.35)	82.28	13,130
6	(499.08)	(0.29)	74.32	12,986
7	(497.43)	(0.32)	74.24	12,752
8	(485.52)	(0.27)	71.73	13,259
9	(493.06)	(0.28)	72.47	13,430
10	(492.53)	(0.32)	60.52	8,938
11	(518.74)	(0.32)	61.99	8,339
12	(531.06)	(0.33)	64.12	8,641
13	(502.29)	(0.32)	59.83	8,163
14	(520.95)	(0.39)	62.44	9,363
15	(417.47)	(0.33)	49.44	7,388
16	(653.20)	(0.42)	73.88	6,933

5 Cost and Cost Effectiveness

The code change proposal would not modify the stringency of the existing Title 24, Part 6, so the Energy Commission does not need a complete cost-effectiveness analysis to approve the proposed change. The Statewide CASE Team still presents a detailed cost-effectiveness analysis in this section to provide appropriate context for the proposed code language presented in Section 7.

5.1 Energy Cost Savings Methodology

Energy cost savings were calculated by applying the TDV energy cost factors to the energy savings estimates using the methodology described in Section 4.2. TDV is a normalized metric to calculate energy cost savings that accounts for the variable cost of electricity and natural gas for each hour of the year, along with how costs are expected to change over the period of analysis. In this case, the period of analysis used is 30 years. In each case, the finalized 2022 Residential TDV (2022 TDV CH4_Leak_20yr_15RA) values are used to develop the cost-effectiveness and energy cost savings analysis. The TDV cost impacts are presented in nominal dollars and in 2023 present value dollars and represent the energy cost savings realized over 30 years.

5.2 Energy Cost Savings Results

5.2.1 Electric HVAC Systems

The Statewide CASE Team presents per-unit energy cost savings realized over a 30-Year Period of Analysis in 2023 present-value dollars in Table 45 through Table 52. Energy cost savings in nominal dollars are presented in Appendix M.

Table 45: 2023 TDV Energy Cost Savings Over 30-Year Period of Analysis – Per Dwelling Unit – 2-Story Garden Style New Construction – SZHP with efficiency measures

Climate Zone	30-Year TDV Electricity Cost Savings (2023 PV\$)	30-Year TDV Natural Gas Cost Savings (2023 PV\$)	Total 30-Year TDV Energy Cost Savings (2023 PV\$)
1	(\$5,728)	\$6,408	\$680
2	(\$3,167)	\$3,382	\$215
3	(\$1,528)	\$1,645	\$117
4	(\$1,443)	\$1,479	\$37
5	(\$1,210)	\$1,418	\$208
6	(\$67)	\$307	\$240
7	\$173	\$120	\$293
8	(\$53)	\$132	\$80
9	(\$326)	\$418	\$92
10	(\$890)	\$861	(\$28)
11	(\$3,182)	\$2,992	(\$189)
12	(\$2,892)	\$2,776	(\$117)
13	(\$2,530)	\$2,214	(\$316)
14	(\$1,769)	\$2,809	\$1,040
15	\$118	\$37	\$155
16	(\$1,740)	\$2,213	\$473

For the 2-story garden style building type with a SZHP system, per-unit first year electricity costs are expected to increase up to \$5,728 or decrease up to \$173 in 2023 present-value dollars depending on climate zone, per-unit natural gas costs decrease between \$37 and \$6,408 in 2023 present-value dollars with the total 30-year TDV energy costs ranging between a saving of \$1,040 and a cost increase of \$316 in 2023 present-value dollars. All climate zones have positive TDV cost savings.

Table 46: 2023 TDV Energy Cost Savings Over 30-Year Period of Analysis – Per Dwelling Unit – 3-Story Loaded Corridor New Construction – SZHP with efficiency measures

Climate Zone	30-Year TDV Electricity Cost Savings (2023 PV\$)	30-Year TDV Natural Gas Cost Savings (2023 PV\$)	Total 30-Year TDV Energy Cost Savings (2023 PV\$)
1	(\$3,694)	\$3,683	(\$11)
2	(\$2,222)	\$2,108	(\$114)
3	(\$943)	\$822	(\$121)
4	(\$857)	\$838	(\$18)
5	(\$596)	\$684	\$87
6	\$51	\$92	\$143
7	\$192	\$24	\$216
8	\$8	\$46	\$54
9	(\$163)	\$196	\$33
10	(\$605)	\$518	(\$87)
11	(\$2,402)	\$2,012	(\$390)
12	(\$2,211)	\$1,830	(\$381)
13	(\$1,912)	\$1,424	(\$488)
14	(\$1,116)	\$1,802	\$686
15	\$61	\$4	\$66
16	(\$1,104)	\$1,164	\$60

For the 3-story loaded corridor style building type with a SZHP system, per-unit first year electricity costs are expected to increase up to \$3,694 or decrease up to \$192 in 2023 present-value dollars depending on climate zone, per-unit natural gas costs decrease between \$4 and \$3,683 in 2023 present-value dollars with the total 30-year TDV energy costs ranging between a saving of \$686 and a cost increase of \$488 in 2023 present-value dollars. All climate zones have positive TDV cost savings.

For the 5-and 10-story prototypes in Climate Zone 16, the measure package included use of gas-fired furnace as supplemental heating and fenestration u-factor and solar heat gain coefficient (SHGC) requirement dependent on window type. The weighted average savings are shown in the tables below.

Table 47: 2023 TDV Energy Cost Savings Over 30-Year Period of Analysis – Per Dwelling Unit – 5-Story Mixed-Use New Construction – SZHP (CZ16 only with efficiency measures and gas supplemental heat)

Climate Zone	30-Year TDV Electricity Cost Savings (2023 PV\$)	30-Year TDV Natural Gas Cost Savings (2023 PV\$)	Total 30-Year TDV Energy Cost Savings (2023 PV\$)
1	(\$2,550)	\$3,207	\$657
2	(\$1,535)	\$1,952	\$417
3	(\$866)	\$1,270	\$404
4	(\$754)	\$984	\$230
5	(\$949)	\$1,139	\$189
6	(\$226)	\$333	\$107
7	(\$146)	\$238	\$92
8	(\$213)	\$313	\$100
9	(\$335)	\$488	\$152
10	(\$572)	\$728	\$156
11	(\$1,569)	\$2,121	\$552
12	(\$1,508)	\$1,891	\$383
13	(\$1,265)	\$1,619	\$353
14	(\$1,480)	\$1,701	\$221
15	(\$134)	\$199	\$65
16	(\$514)	\$1,539	\$1,025

For the 5-story mixed-use building type with a SZHP system, per-unit first year electricity costs increase between \$134 to \$2,550 in 2023 present-value dollars, per-unit natural gas costs decrease between \$199 and \$3,207 in 2023 present-value dollars with the total 30-year TDV energy costs ranging between a saving of \$65 and \$1,025 in 2023 present-value dollars. All climate zones have positive TDV cost savings.

Table 48: 2023 TDV Energy Cost Savings Over 30-Year Period of Analysis – Per Dwelling Unit – 10-Story Mixed-Use New Construction – SZHP (CZ16 with efficiency measures)

Climate Zone	30-Year TDV Electricity Cost Savings (2023 PV\$)	30-Year TDV Natural Gas Cost Savings (2023 PV\$)	Total 30-Year TDV Energy Cost Savings (2023 PV\$)
1	(\$2,431)	\$3,166	\$735
2	(\$1,433)	\$1,837	\$404
3	(\$753)	\$1,107	\$355
4	(\$658)	\$852	\$195
5	(\$764)	\$935	\$172
6	(\$155)	\$233	\$78
7	(\$113)	\$196	\$82
8	(\$159)	\$233	\$75
9	(\$280)	\$407	\$126
10	(\$499)	\$639	\$140
11	(\$1,700)	\$2,310	\$611
12	(\$1,449)	\$1,838	\$389
13	(\$1,225)	\$1,559	\$334
14	(\$1,521)	\$1,756	\$235
15	(\$105)	\$153	\$48
16	(\$556)	\$1,294	\$738

For the 10-story mixed-use building type with a SZHP system, per-unit first year electricity costs increase between \$105 to \$2,431 in 2023 present-value dollars, per-unit natural gas costs decrease between \$153 to \$3,166 in 2023 present-value dollars with the total 30-year TDV energy costs ranging between a saving of \$48 to \$738 in 2023 present-value dollars. All climate zones have TDV Energy Cost Savings.

Table 49: 2023 TDV Energy Cost Savings Over 30-Year Period of Analysis – Per Dwelling Unit – 5-Story Mixed-Use New Construction – Mini-Split

Climate Zone	30-Year TDV Electricity Cost Savings (2023 PV\$)	30-Year TDV Natural Gas Cost Savings (2023 PV\$)	Total 30-Year TDV Energy Cost Savings (2023 PV\$)
1	(\$2,550)	\$3,207	\$657
2	(\$1,535)	\$1,952	\$417
3	(\$866)	\$1,270	\$404
4	(\$754)	\$984	\$230
5	(\$949)	\$1,139	\$189
6	(\$226)	\$333	\$107
7	(\$146)	\$238	\$92
8	(\$213)	\$313	\$100
9	(\$335)	\$488	\$152
10	(\$572)	\$728	\$156
11	(\$1,569)	\$2,121	\$552
12	(\$1,508)	\$1,891	\$383
13	(\$1,265)	\$1,619	\$353
14	(\$1,480)	\$1,701	\$221
15	(\$134)	\$199	\$65
16	(\$5,522)	\$4,645	(\$877)

For the 5-story mixed-use building type with a Mini-split system, per-unit first year electricity costs increase between \$134 to \$5,522 in 2023 present-value dollars, per-unit natural gas costs decrease between \$199 and \$4,645 in 2023 present-value dollars with the total 30-year TDV energy costs ranging between a saving of \$65 and increase of \$877 in 2023 present-value dollars. All climate zones have positive TDV cost savings except for Climate Zone 16.

Table 50: 2023 TDV Energy Cost Savings Over 30-Year Period of Analysis – Per Dwelling Unit – 10-Story Mixed-Use New Construction – Mini-Split

Climate Zone	30-Year TDV Electricity Cost Savings (2023 PV\$)	30-Year TDV Natural Gas Cost Savings (2023 PV\$)	Total 30-Year TDV Energy Cost Savings (2023 PV\$)
1	(\$2,431)	\$3,166	\$735
2	(\$1,433)	\$1,837	\$404
3	(\$753)	\$1,107	\$355
4	(\$658)	\$852	\$195
5	(\$764)	\$935	\$172
6	(\$155)	\$233	\$78
7	(\$113)	\$196	\$82
8	(\$159)	\$233	\$75
9	(\$280)	\$407	\$126
10	(\$499)	\$639	\$140
11	(\$1,700)	\$2,310	\$611
12	(\$1,449)	\$1,838	\$389
13	(\$1,225)	\$1,559	\$334
14	(\$1,521)	\$1,756	\$235
15	(\$105)	\$153	\$48
16	(\$6,123)	\$5,251	(\$872)

For the 10-story mixed-use building type with a SZHP system, per-unit first year electricity costs increase between \$105 to \$6,123 in 2023 present-value dollars, per-unit natural gas costs decrease between \$153 to \$5,251 in 2023 present-value dollars with the total 30-year TDV energy costs ranging between a saving of \$48 to an increase of \$872 in 2023 present-value dollars. All climate zones have TDV Energy Cost Savings except for Climate Zone 16.

Table 51: 2023 TDV Energy Cost Savings Over 30-Year Period of Analysis – Per Dwelling Unit – 5-Story Mixed-Use New Construction – VRF System

Climate Zone	30-Year TDV Electricity Cost Savings (2023 PV\$)	30-Year TDV Natural Gas Cost Savings (2023 PV\$)	Total 30-Year TDV Energy Cost Savings (2023 PV\$)
1	(\$2,423)	\$3,206	\$784
2	(\$2,014)	\$1,953	(\$61)
3	(\$1,288)	\$1,271	(\$18)
4	(\$1,460)	\$986	(\$475)
5	(\$1,352)	\$1,140	(\$213)
6	(\$1,168)	\$334	(\$833)
7	(\$1,112)	\$239	(\$874)
8	(\$1,134)	\$314	(\$820)
9	(\$1,157)	\$489	(\$669)
10	(\$1,447)	\$729	(\$719)
11	(\$2,196)	\$2,122	(\$74)
12	(\$2,188)	\$1,893	(\$295)
13	(\$2,285)	\$1,619	(\$665)
14	(\$1,873)	\$1,702	(\$171)
15	(\$1,187)	\$199	(\$988)
16	(\$6,430)	\$4,647	(\$1,783)

For the 5-story mixed-use building type with VRF systems, per-unit first year electricity costs increase between \$1,112 to \$6,430 in 2023 present-value dollars, per-unit natural gas costs decrease between \$199 to \$4,647 in 2023 present-value dollars. The total TDV energy cost savings range from a savings of \$784 to an increase of \$1,783 in 2023 present-value dollars. There is positive TDV energy cost savings for only climate zone – Climate Zone 1.

Table 52: 2023 TDV Energy Cost Savings Over 30-Year Period of Analysis – Per Dwelling Unit – 10-Story Mixed-Use New Construction – VRF System

Climate Zone	30-Year TDV Electricity Cost Savings (2023 PV\$)	30-Year TDV Natural Gas Cost Savings (2023 PV\$)	Total 30-Year TDV Energy Cost Savings (2023 PV\$)
1	(\$2,211)	\$3,166	\$955
2	(\$1,652)	\$1,838	\$186
3	(\$1,078)	\$1,108	\$29
4	(\$1,184)	\$853	(\$331)
5	(\$1,131)	\$936	(\$195)
6	(\$776)	\$233	(\$543)
7	(\$802)	\$196	(\$606)
8	(\$684)	\$233	(\$451)
9	(\$723)	\$407	(\$316)
10	(\$948)	\$639	(\$309)
11	(\$2,215)	\$2,311	\$96
12	(\$2,063)	\$1,838	(\$225)
13	(\$2,179)	\$1,559	(\$620)
14	(\$1,881)	\$1,756	(\$124)
15	(\$935)	\$153	(\$782)
16	(\$6,887)	\$5,251	(\$1,636)

For the 10-story mixed-use prototype with VRF systems, per-unit first year electricity costs increase between \$684 to \$6,887 in 2023 present-value dollars, per-unit natural gas costs decrease between \$153 to \$5,251 in 2023 present-value dollars. TDV energy costs range from a savings of \$955 to an increase of \$1,636 in 2023 present-value dollars.

5.2.2 Electric Central HPWH Systems

The Statewide CASE Team presents per-unit energy cost savings for newly constructed buildings over a 30-year period of analysis in 2023 present-value dollars in Table 53 through Table 56.

For 2-story garden style building type, per-unit first year electricity costs increase between \$6,267 to \$9,391 in nominal dollars or \$3,057 to \$4,581 in 2023 present-value dollars, per-unit natural gas costs decrease between \$5,597 to \$9,130 in nominal dollars or \$5,069 to \$12,700 in 2023 present-value dollars with the total 30-year Residential TDV energy costs savings between \$5,151 to \$10,063 in nominal dollars \$2,540 to \$4,954 in 2023 present-value dollars.

For 3-story loaded corridor building type, per-unit first year electricity costs increase between \$4,812 to \$8,574 in nominal dollars or \$2,347 to \$4,182 in 2023 present-value dollars, per-unit natural gas costs decrease between \$5,069 to \$12,700 in nominal dollars or \$2,485 to \$6,225 in present-value dollars with the total 30-year TDV energy costs ranging between increase of \$138 to savings of \$6,225 in present-value dollars.

Table 53: 2023 PV TDV Energy Cost Savings Over 30-Year Period of Analysis – Per Dwelling Unit– New Construction – Low-Rise Garden

Climate Zone	30-Year TDV Electricity Cost Savings (2023 PV\$)	30-Year TDV Natural Gas Cost Savings (2023 PV\$)	Total 30-Year TDV Energy Cost Savings (2023 PV\$)
1	(\$4,176)	\$9,130	\$4,954
2	(\$3,858)	\$8,427	\$4,569
3	(\$3,930)	\$8,417	\$4,487
4	(\$3,815)	\$8,001	\$4,186
5	(\$3,991)	\$8,418	\$4,427
6	(\$3,542)	\$7,751	\$4,208
7	(\$3,606)	\$7,762	\$4,157
8	(\$3,419)	\$7,533	\$4,114
9	(\$3,390)	\$7,600	\$4,210
10	(\$3,470)	\$6,542	\$3,073
11	(\$3,754)	\$6,692	\$2,938
12	(\$3,788)	\$6,865	\$3,077
13	(\$3,579)	\$6,491	\$2,912
14	(\$3,567)	\$6,729	\$3,162
15	(\$3,057)	\$5,597	\$2,540
16	(\$4,581)	\$7,731	\$3,151

Table 54: 2023 PV TDV Energy Cost Savings Over 30-Year Period of Analysis – Per Dwelling Unit– New Construction – Low-Rise Loaded Corridor

Climate Zone	30-Year TDV Electricity Cost Savings (2023 PV\$)	30-Year TDV Natural Gas Cost Savings (2023 PV\$)	Total 30-Year TDV Energy Cost Savings (2023 PV\$)
1	(\$3,765)	\$6,225	\$2,461
2	(\$3,136)	\$4,819	\$1,683
3	(\$3,081)	\$4,723	\$1,641
4	(\$3,046)	\$4,216	\$1,170
5	(\$3,210)	\$4,402	\$1,192
6	(\$2,823)	\$3,727	\$904
7	(\$2,807)	\$3,923	\$1,116
8	(\$2,838)	\$3,588	\$749
9	(\$2,831)	\$3,533	\$701
10	(\$2,806)	\$3,517	\$710

Climate Zone	30-Year TDV Electricity Cost Savings (2023 PV\$)	30-Year TDV Natural Gas Cost Savings (2023 PV\$)	Total 30-Year TDV Energy Cost Savings (2023 PV\$)
11	(\$3,040)	\$4,182	\$1,142
12	(\$3,074)	\$4,333	\$1,260
13	(\$2,946)	\$3,890	\$944
14	(\$2,997)	\$3,485	\$488
15	(\$2,347)	\$2,485	\$138
16	(\$4,182)	\$5,269	\$1,086

For the 5-story mixed-use building type, per-unit first year electricity costs increase between \$4,451 to \$7,182 in nominal dollars or \$2,137 to \$4,182 in 2023 present-value dollars, per-unit natural gas costs decrease between \$2,485 to \$5,269 in nominal dollars or \$3,516 to \$6,137 in present-value dollars with the total 30-year Residential TDV energy costs ranging between increase of \$1,381 to savings of \$2,975 in 2023 present-value dollars.

For the 10-story mixed-use building type, per-unit first year electricity costs increase between \$3,602 to \$6,870 in nominal dollars or \$1,772 to \$3,351 in 2023 present-value dollars, per-unit natural gas costs decrease between \$6,222 to \$11,259 nominal dollars or \$3,050 to \$5,519 in 2023 present-value dollars with the total 30-year TDV energy costs ranging between increase of \$1,199 to savings of \$2,408 in 2023 present-value dollars.

Table 55: 2023 PV TDV Energy Cost Savings Over 30-Year Period of Analysis – Per Dwelling Unit– New Construction – 5-Story Mixed-Use

Climate Zone	30-Year TDV Electricity Cost Savings (2023 PV\$)	30-Year TDV Natural Gas Cost Savings (2023 PV\$)	Total 30-Year TDV Energy Cost Savings (2023 PV\$)
1	(\$3,162)	\$6,137	\$2,975
2	(\$2,839)	\$5,612	\$2,773
3	(\$2,925)	\$5,604	\$2,678
4	(\$2,660)	\$5,294	\$2,634
5	(\$2,935)	\$5,605	\$2,670
6	(\$2,550)	\$5,108	\$2,558
7	(\$2,580)	\$5,111	\$2,532
8	(\$2,441)	\$4,945	\$2,504
9	(\$2,493)	\$4,994	\$2,501
10	(\$2,482)	\$4,225	\$1,743
11	(\$2,632)	\$4,336	\$1,703
12	(\$2,742)	\$4,467	\$1,724

13	(\$2,510)	\$4,193	\$1,682
14	(\$2,577)	\$4,364	\$1,787
15	(\$2,137)	\$3,518	\$1,381
16	(\$3,499)	\$5,106	\$1,607

Table 56: 2023 PV TDV Energy Cost Savings Over 30-Year Period of Analysis – Per Dwelling Unit– New Construction – 10-Story Mixed-Use

Climate Zone	30-Year TDV Electricity Cost Savings (2023 PV\$)	30-Year TDV Natural Gas Cost Savings (2023 PV\$)	Total 30-Year TDV Energy Cost Savings (2023 PV\$)
1	(\$3,111)	\$5,519	\$2,408
2	(\$2,668)	\$5,020	\$2,352
3	(\$2,681)	\$5,012	\$2,331
4	(\$2,376)	\$4,718	\$2,342
5	(\$2,742)	\$5,014	\$2,272
6	(\$2,293)	\$4,540	\$2,247
7	(\$2,336)	\$4,542	\$2,206
8	(\$2,092)	\$4,385	\$2,294
9	(\$2,109)	\$4,432	\$2,323
10	(\$2,169)	\$3,715	\$1,546
11	(\$2,386)	\$3,829	\$1,443
12	(\$2,454)	\$3,949	\$1,495
13	(\$2,281)	\$3,694	\$1,412
14	(\$2,227)	\$3,847	\$1,620
15	(\$1,772)	\$3,050	\$1,278
16	(\$3,351)	\$4,551	\$1,199

5.3 Incremental First Cost

Incremental first cost is the initial cost to adopt more efficient equipment or building practices when compared to the cost of an equivalent baseline project. Therefore, it was important that the Statewide CASE Team consider first costs in evaluating overall measure cost effectiveness. Incremental first costs are based on data available today and can change over time as markets evolve and professionals become familiar with new technology and building practices.

Note that the CASE Team has not included any cost savings from eliminating natural gas infrastructure to the building in the analysis presented in this report. Any natural gas infrastructure savings shown in this report are for gas pipelines from the building main meter to individual space heating systems serving individual dwelling units.

For both the baseline and proposed systems, the Statewide CASE Team gathered costs for the entire HVAC and DHW systems. The difference between the baseline and proposed systems costs is the incremental costs.

The Statewide CASE Team developed a basis of design for all prototypes described in section 4.2 and worked with a mechanical contractor to get cost estimates. The mechanical contractor provided material and labor cost estimates for the entire HVAC and DHW systems, disaggregated by the HVAC and DHW equipment itself; refrigerant piping; structural; electrical supply; gas supply; controls; commissioning and startup; general conditions and overhead; design and engineering; permit, testing, and inspection; and a contractor profit or market factor.

For the dwelling unit HVAC systems, the Statewide CASE Team determined design heating and cooling loads and capacities by climate zone and by dwelling unit from the energy models. The Statewide CASE Team requested costs for the smallest capacity unit required (a studio in Climate Zone 1), the largest capacity unit required (a three-bedroom unit in Climate Zone 12), and a capacity in the middle. The Statewide CASE Team specified the unit efficiencies to be the federal minimum efficiencies. The Statewide CASE Team also located the units, specified venting, and specified air distribution based on typical design practices. The mechanical contractor provided costs for each of the three system capacities, based on which the Statewide CASE Team developed a relationship between HVAC system capacity and cost. Using this relationship, the Statewide CASE Team calculated the cost for each dwelling unit in each climate zone. The Statewide CASE Team adjusted material and labor costs for each climate zone based on weighting factors from RS Means provided in the statewide savings calculator for the Statewide CASE Team.

The Statewide CASE Team also gathered costs from actual new construction and retrofit projects. Installers and consultants provided data on projects that they have completed in California. This provided a range of costs, representing a range of real-building considerations. The cost data did not have many details, and in most cases, it was not clear whether items such as labor, controls, commissioning, gas connections, and electrical wiring were included in the costs or not. Therefore, because the Statewide CASE Team cannot compare costs directly to each other, it is not possible for the Statewide CASE Team to determine incremental costs from this data. Additionally, building-specific costs that exist due to unique circumstances of the building are not possible for the Statewide CASE Team to separate out. Lastly, these costs would be difficult to match up with the energy savings calculations, which are based on the prototype buildings.

The Statewide CASE Team used the real project costs to determine the expected range of costs for each HVAC and DHW system. The Statewide CASE Team compared the costs received from the mechanical contractor to the range of real project costs to vet

them. The Statewide CASE Team used the costs from the mechanical contractor in the analysis. While these costs are slightly limited in that they are from a single contractor and they are not from a real building and therefore may be idealized, these costs do not have the same limitations as the real project costs.

5.3.1 HVAC First Costs – Baseline and Proposed

Table 57 through Table 61 show the resulting HVAC incremental first costs. The ducted and ductless heat pump systems and VRF systems are less expensive to install than the baseline system of gas-fired furnace and split DX combination.

Table 57: Average Per Dwelling Unit Costs for HVAC Systems: SZHP Compared to Gas-Fired Furnace + Split DX – 2- and 3-Story Prototypes

Items		2-Story Garden		3-Story Loaded Corridor	
		Gas-fired furnace + Split SZAC	SZHP	Gas-fired furnace + Split SZAC	SZHP
Equipment	Dwelling Unit HVAC	\$5,603	\$4,106	\$5,651	\$4,141
	Common Area Ventilation	\$0	\$0	\$0	\$0
	Refrigerant piping	\$352	\$352	\$563	\$563
	Gas piping	\$177	\$0	\$92	\$0
	Electrical circuits	\$0	\$150	\$0	\$150
Labor		\$10,143	\$6,387	\$11,353	\$8,007
Overhead/Markup/Design/Permit		\$4,475	\$3,023	\$4,856	\$3,537
Total		\$20,750	\$14,018	\$22,516	\$16,398
Incremental Cost per Dwelling Unit			-\$6,732		-\$6,118

Table 58: Average Per Dwelling Unit Costs for HVAC Systems: SZHP Compared to Gas-Fired Furnace + Split DX – 5- and 10-Story Prototypes

Items		5-Story Mixed-Use		10-Story Mixed-Use	
		Gas-fired furnace + Split SZAC	SZHP	Gas-fired furnace + Split SZAC	SZHP
Equipment	Dwelling Unit HVAC	\$5,619	\$4,121	\$5,567	\$4,092
	Common Area Ventilation	\$307	\$376	\$351	\$373
	Refrigerant piping	\$423	\$423	\$442	\$442
	Gas piping	\$227	\$0	\$237	\$0
	Electrical circuits	\$0	\$150	\$0	\$150
Labor		\$10,996	\$6,985	\$11,000	\$6,946
Overhead/Markup/Design/Permit		\$4,833	\$3,315	\$4,839	\$3,301
Total		\$22,405	\$15,371	\$22,435	\$15,304
Incremental Cost per Dwelling Unit			-\$7,034		-\$7,131

The Statewide CASE Team has not included any cost savings from eliminating natural gas infrastructure to the building in the analysis. The gas piping costs and savings shown in this section are for gas pipelines from the building main meter to individual space heating systems serving individual dwelling units.

Table 59: Average Per Dwelling Unit Incremental Costs for HVAC Systems: SZHP + Furnace Compared to Gas-Fired Furnace + Split DX – Climate Zone 16

Items		5-Story Mixed-Use/ 10-Story Mixed-Use	
		Gas-fired furnace + Split SZAC	Gas-fired furnace + Split SZHP
Equipment	Dwelling Unit HVAC	\$5,619	\$6,109
	Common Area Ventilation	\$307	\$307
	Refrigerant piping	\$423	\$423
	Gas piping	\$227	\$227
	Electrical circuits	\$0	\$0
Labor		\$10,996	\$6,985
Overhead/Markup/Design/Permit		\$4,833	\$3,315
Total		\$22,405	\$22,895
Incremental Cost per Dwelling Unit			\$490

As seen in Table 57, the SZHP systems are less expensive to install than the baseline mixed-fuel system both due to lower equipment cost as well as lower labor costs. This is because the baseline system includes two separate devices – a gas-fired furnace and a split DX cooling system – whereas the proposed system is a single system that provides both cooling and heating. Further, unlike single family residential buildings and smaller multifamily buildings, there are limitations to where a gas-fired furnace can be placed in larger multifamily buildings due to constraints on open combustion devices and the need for venting. Therefore, the installation costs for a gas-fired furnace and air conditioner are both higher in these multifamily buildings than in single family. The gas-fired furnace per unit installation cost includes gas-fired furnace installation (\$500), flue to exterior wall (\$2,700), gas piping and connection to unit (\$1,850), miscellaneous supplies (\$500), and adder (\$1,500). The baseline system costs account for gas piping to the gas-fired furnace whereas the SZHP system costs account for additional electrical capacity. SZHP systems likewise cost more to install in a multifamily building than in a single family building but are overall cheaper to install than the baseline systems due to the reasons explained above.

Note that the Statewide CASE Team has not included any cost savings from eliminating natural gas infrastructure to the building in the analysis. The gas piping costs and savings shown in this section are for gas pipelines from the building main meter to individual space heating systems serving individual dwelling units.

In Climate Zone 16, when a gas-fired furnace is used as supplemental heating, the only incremental cost is from the equipment cost difference between a SZAC vs. SZHP. For smaller capacity unit (2.0 ton and lower), the incremental cost is about \$200-300. For

units 2.5 ton or larger, the incremental cost ranges from \$600 to \$750. For cost effectiveness analysis, the Statewide CASE Team used an average of \$490 per unit.

Table 60: Average Per Dwelling Unit Costs for HVAC Systems: Ductless Mini-Split Heat Pump Compared to Gas-Fired Furnace + Split DX

Items		5-Story Mixed-Use		10-Story Mixed-Use	
		Gas-fired furnace + Split Dx	Ductless Mini-split HP	Gas-fired furnace + Split Dx	Ductless Mini-split HP
Equipment	Dwelling Unit HVAC	\$5,619	\$4,760	\$5,567	\$4,486
	Common Area Ventilation	\$307	\$376	\$351	\$373
	Refrigerant piping	\$423	\$672	\$442	\$679
	Gas piping	\$227	\$0	\$237	\$0
	Electrical circuits	\$0	\$150	\$0	\$150
Labor		\$10,996	\$9,573	\$11,000	\$9,294
Overhead/Markup/Design/Permit		\$4,833	\$4,271	\$4,839	\$4,120
Total		\$22,405	\$19,802	\$22,435	\$19,102
Incremental Cost per Dwelling Unit			-\$2,604		-\$3,332

As seen in Table 60 Mini-Split systems are also less expensive than the mixed-fuel system baseline for similar reasons as SZHP systems. Mini-Split systems are more expensive to install than SZHP systems.

Table 61: Average Per Dwelling Unit Costs for HVAC Systems: VRF Compared to Gas-Fired Furnace + Split DX

Items		5-Story Mixed-Use		10-Story Mixed-Use	
		Gas-fired furnace + Split Dx	VRF	Gas-fired furnace + Split Dx	VRF
Equipment	Dwelling Unit HVAC	\$5,619	\$2,974	\$5,567	\$2,814
	Common Area Ventilation	\$307	\$342	\$351	\$279
	Refrigerant piping	\$423	\$3,014	\$442	\$3,024
	Gas piping	\$227	\$0	\$237	\$0
	Electrical circuits	\$0	\$150	\$0	\$150
Labor		\$10,996	\$7,373	\$11,000	\$7,103
Overhead/Markup/Design/Permit		\$4,833	\$3,753	\$4,839	\$3,638
Total		\$22,405	\$17,606	\$22,435	\$17,008
Incremental Cost per Dwelling Unit			-\$4,800		-\$5,427

As seen in Table 61, VRF systems are more expensive than SZHP systems but less expensive than Mini-Split systems. VRF systems are still less expensive to install than the baseline mixed-fuel systems.

5.3.2 Central HPWH First Costs – Baseline and Proposed

The Statewide CASE Team developed a basis of design for all prototypes described in Table 62 and worked with a mechanical contractor on cost estimates. Basis of design is presented in Appendix G. The mechanical contractor provided material and labor cost estimates for the entire DHW systems. Incremental costs for each prototype include material and installation cost for the following items:

- Equipment, including heaters, tanks, solar thermal system (for baseline system only), etc.
- Material, including piping, insulation
- Plumbing, including pumps, valves, and fittings
- Structural, such as roof load bearing capacity
- Electrical, including panels, circuits, and utility service
- Gas supply, assuming the main building has gas service, i.e., cost does not include gas lateral
- Controls, including sensors and controllers
- Commissioning and start-up
- Markups for overhead and profit

Costs for the baseline and proposed designs are presented in Table 62. Table 63 presents detailed costs for solar thermal system installed in the baseline. Table 64 presents detailed costs for the prototypes to illustrate the cost components.

Table 62: Installed Cost for Baseline and Proposed Central DWH Designs for Each Prototype

Prototype	Central Gas System	Central HPWH System Single-pass
2-Story Garden	CZ 01 – 09: \$99,989	\$104,780
	CZ 10 – 16: \$100,965	
3-Story Loaded Corridor	CZ 01 – 09: \$173,772	\$211,531
	CZ 10 – 16: \$182,810	
5-Story Mixed Use	CZ 01 – 09: \$279,163	\$439,218
	CZ 10 – 16: \$300,883	
10-Story Mixed Use	CZ 01 – 09: \$319,920	\$564,851

Table 63: Installed Cost for Solar Thermal System

Cost Items	3-Story Loaded Corridor		5-Story Mixed-Use	
	0.2 SSF	0.35 SSF	0.2 SSF	0.35 SSF
Solar Collectors + Pump/tank/piping	\$17,250	\$24,250	\$33,975	\$48,975
Labor	\$24,800	\$24,888	\$47,740	\$49,776
Overhead/Markup/Design/Permit	27.50%	27.50%	27.50%	27.50%
Total	\$53,614	\$62,651	\$104,187	\$125,908
Cost per unit	\$1,489	\$1,740	\$1,184	\$1,431

Table 64: Installed Cost Breakdown for Baseline and Proposed Central DWH Designs for Low-Rise Garden Style and Low-Rise Loaded Corridor

Items		2-Story Garden Style		3-Story Loaded Corridor	
		Gas	HPWH	Gas	HPWH
Equipment	Water Heaters	\$4,150	\$4,000	\$8,300	\$8,000
	Primary HW Storage Tank	\$2,250	\$4,500	\$4,500	\$9,600
	Solar Thermal System (0.35 SSF)	\$9,160	N/A	\$24,250	N/A
	Primary ER backup	N/A	N/A	N/A	N/A
	Temp Maintenance HP	N/A	N/A	N/A	N/A
	TM ER backup	N/A	\$2,500	N/A	\$24,215
	Other (Piping/valve/pump)	\$29,500	\$25,000	\$39,500	\$45,000
Labor		\$26,764	\$28,516	\$99,012	\$55,340
Control		\$2,600	\$2,664	\$2,600	\$2,600
Gas or electrical connection		\$4,764	\$15,000	\$9,065	\$8,890
27.50%27.50%Overhead/Markup/Design/Permit		27.50%	27.50%	27.50%	27.50%
Total		\$100,965	\$104,780	\$182,810	\$211,531
Incremental Cost per Dwelling Unit		-	\$477	-	\$798

Table 65: Installed Cost Breakdown for Baseline and Proposed Central DWH Designs for 5-Story Mixed-Use and 10-Story Mixed-Use

Items		5-Story Mixed-Use		10-Story Mixed-Use	
		Gas	HPWH	Gas	HPWH
Equipment	Water Heaters	\$12,660	\$120,000	\$13,050	\$170,000
	Primary HW Storage Tank	\$16,650	\$27,180	\$12,900	\$27,180
	Solar Thermal System (0.35 SSF)	\$48,975	N/A	\$57,450	N/A

Items	5-Story Mixed-Use		10-Story Mixed-Use	
	Gas	HPWH	Gas	HPWH
Primary ER backup	N/A	\$4,665	N/A	\$4,665
Temp Maintenance HP	N/A	\$27,500	N/A	\$27,500
TM ER backup	N/A	\$20,600	N/A	\$60,000
Other (Piping/valve/pump)	\$54,000	\$56,000	\$57,000	\$56,000
Labor	\$99,012	\$60,876	\$117,372	\$70,011
Control	\$2,600	\$2,664	\$2,600	\$2,664
Gas or electrical connection	\$9,065	\$25,000	\$9,590	\$25,000
Overhead/Markup/Design/Permit	27.50%	27.50%	27.50%	27.50%
Total	\$300,883	\$439,218	\$344,202	\$564,851
Incremental Cost per Dwelling Unit	N/A	\$1,572	N/A	\$2,507

In addition to the Basis of Design, the Statewide CASE Team collected real-world project costs to establish a knowledge base for multifamily developments using heat pump water heaters, including purchase costs, a range of final installed costs, the methodology used by contractors to determine costs, and the design and installation best practices necessary to minimize costs in a variety of applications. Projects include both buildings that have central gas and central HPWH systems. This research confirms that the central HPWH market is relatively small now and there is a wide cost range due to differences in design approaches, building specifics, regional labor pricing and mark-up. Because the Statewide CASE Team cannot compare costs directly to each other, it is not possible for the Statewide CASE Team to determine incremental costs from this data. Additionally, building-specific costs that exist due to unique circumstances of the building are not possible for the Statewide CASE Team to separate out. Lastly, these costs would be difficult to match up with the energy savings calculations, which are based on the prototype buildings.

The five new construction central HPWH project costs range from \$2800 to \$4020 per dwelling unit, and the four gas DHW project costs range from \$850 to \$1770, not including gas lateral gas cost to building. Note that the cost data did not have many details, and in most cases, it was not clear whether items such as controls, commissioning, gas connections, and electrical wiring were included or not.

Compared to the real-world cost data the Statewide CASE Team collected, the costs presented in Table 62 to Table 64, for both gas and HPWH systems are on the high end. The central HPWH Basis of Design represents current best industry practice that includes:

- Latest HPWH product models with accessories to ensure good performance. Stakeholders reported reliability issues in some early HPWH models, and

manufacturers have made improvement to their product and included new features in the latest models.

- The BOD includes a recirculation loop tank with temperature maintenance heater. This design approach is critical to maintain efficient operation of the single pass primary heat pump water heaters and it also allows the primary water heaters to stay mostly off during off-peak hours and still able to keep up with morning peak demand. Since this approach is relatively new, adds first cost and demands additional space, it is not widely implemented in real projects.
- The BOD includes optional electrical resistance back-up heaters for the primary heat pumps and the recirculation loop temperature maintenance heat pumps.

5.3.3 Fenestration Costs

Multifamily Restructuring CASE Report presents the cost associated with the fenestration requirements for the baseline and proposed cases. Table 66 below shows the incremental costs used this analysis.

Table 66. Fenestration Costs

Window Type	Incremental Cost (\$/ft ² of window)	Midrise Total Incremental Cost (\$)	Highrise Total Incremental Cost (\$)
All Other	\$0.36	\$3,352	\$6,820
Curtainwall Window	\$1.00	\$9,310	\$18,945
Class AW Window	\$1.09	\$10,148	\$20,650

5.3.4 HRV/ERV Cost

Multifamily IAQ CASE Report presents the cost associated with the HRV/ERV requirements for the baseline and proposed cases. The base case and proposed case costs using statewide average costs are provided in Table 67 and Table 68

Table 67: Cost of Base Case: Discrete Supply In-line Fan

Product Description	Quantity	Material Cost	Labor Cost	Labor Hours	Cost per Residential Unit
Supply Fan	1	\$200	\$130	1.5	\$330
Supply Air Filter (MERV13)	1	\$41	\$0	0	\$41
Exhaust Fan	1.4	\$209	\$111	2.03	\$319

Total Cost	\$690
------------	-------

Table 68: Cost of Proposed Case: ERV

Product Description	Quantity	Material Cost	Labor Cost	Labor Hours	Cost per Residential Unit
ERV	1	\$900	\$130	1.5	\$1,030
ERV Filter (MERV 13	1	\$40	\$0	0	\$40
Total Cost					\$1,070

As shown, the base case is \$690 and proposed cost is \$1,070, for an incremental first cost of \$380 per dwelling unit. Incremental Maintenance and Replacement Costs

Incremental maintenance cost is the incremental cost of replacing the equipment or parts of the equipment, as well as periodic maintenance required to keep the equipment operating relative to current practices over the 30-Year Period of Analysis for HVAC and the 30-year period of analysis for DHW.

The Statewide CASE Team assumed that the expected useful life (EUL) of the HVAC and DHW measures is 15 years, and that after this time, the HVAC and DHW equipment would have to be replaced. The Statewide CASE Team assumed that the supporting infrastructure would not need to be replaced.

The Statewide CASE Team assumed that maintenance costs are the same between system types, and therefore did not account for any incremental maintenance costs.

For HVAC systems, the Statewide CASE Team assumed equipment would have to be replaced after 15 years.

The Statewide CASE Team assumed regular maintenance costs between the central gas and HPWH systems are the same. Equipment, including water heaters and storage tanks, need to be replaced every 15 years. For the 5- and 10-story mixed use prototype HPWH systems, the Statewide CASE Team assumed that replacement cost did not include the electric resistance backup heater to the primary and temperature maintenance heat pumps. For the 2-story and 3-story prototypes, electric resistance heaters are used for temperature maintenance purpose and need to be replaced at year 15. Solar thermal collectors can have a life expectancy of more than 20 years or even 30 years if well maintained. To be conservative, solar thermal collectors are replaced at year 20.

Table 69 summarizes the replacement and maintenance cost during the 30-year period of analysis.

Table 69: Replacement and Maintenance Nominal Cost for Baseline and Proposed Single-Pass Central DWH Designs for Each Prototype

Incremental Cost	Year	2-Story Garden		3-Story Loaded Corridor	
		Gas	HPWH	Gas	HPWH
Water heaters, Primary storage tanks, Solar thermal tank	15	\$18,727	\$26,469	\$31,419	\$68,961
Solar thermal collector	20	SSF 0.2: \$10,940 SSF 0.35: \$14,178	N/A	SSF 0.2: \$29,172 SSF 0.35: \$42,534	N/A
Glycol Replacement	9,18,27	\$1,300	N/A	\$1,300	N/A

Incremental Cost	Year	5-Story Mixed Use		10-Story Mixed Use	
		Gas	HPWH	Gas	HPWH
Water heaters, Primary storage tanks, Solar thermal tank	15	\$52,742	\$238,439	\$58,762	\$344,673
Solar thermal collector	20	SSF 0.2: \$69,284 SSF 0.35: \$96,410	N/A	SSF 0.2: \$83,870 SSF 0.35: \$116,260	N/A
Glycol Replacement	9,18,27	\$1,300	N/A	\$1,300	N/A

5.4 Cost Effectiveness

This measure proposes alternate pathways to existing prescriptive requirements for electric equipment rather than mandatory or prescriptive requirements for all multifamily buildings. Cost analysis is not required because the measure does not change baseline level of stringency. The Statewide CASE Team has provided information about the cost effectiveness of the measure even though the Energy Commission does not require a cost-effectiveness analysis for the measure to be adopted.

According to the Energy Commission’s definitions, a measure is cost effective if the benefit-to-cost (B/C) ratio is greater than 1.0. The B/C ratio is calculated by dividing the cost benefits realized over 30 years by the total incremental costs, which includes maintenance costs for 30 years. The B/C ratio was calculated using 2023 PV costs and cost savings. HVAC and CHPWH savings are both calculated over 30 years.

Results of the per-unit cost-effectiveness analyses are presented for new HVAC and Central HPWH by climate zone in the following sub-sections.

5.4.1 Electric HVAC System Cost Effectiveness

The Statewide CASE Team presents cost-effectiveness analysis for the three electric HVAC system analyzed – SZHP, Mini-Split and VRF. Note that this section typically presents TDV energy cost savings, incremental measure costs and overall benefit-to-cost ratio. However, for Electric HVAC systems, there are TDV cost increases, incremental cost savings and benefit-to-cost ratio.

SZHP Systems

For the 2-story and 3-story prototypes, the measure is cost effective in all climate zones except for Climate Zone 16 as shown in Table 70 and Table 71. The TDV energy costs range from a savings of \$1,040 to an increase of \$488 in 2023 present-value dollars across the two prototypes. There are significant incremental cost savings for all climate zones except for Climate Zone 16 because electric equipment is less expensive to install than the mixed fuel system. For climate zones with TDV energy cost savings, the benefit-to-cost ratios are all greater than one except for climate zone 16 because there are both TDV energy cost and measure cost savings. For climate zones with a TDV energy cost increase, all climate zones have a TDV energy cost increase less than the incremental measure cost savings and have benefit-to-cost ratios greater than one. For Climate Zone 16, there is significant incremental cost with adding gas supplemental heating to the heat pump, and the Statewide CASE Team did not find the measure to be cost effective.

For the 5- and 10-story prototypes, replacing the mixed-fuel baseline system with SZHP results in a decrease in TDV energy costs for all climate zones as shown in Table 72 and Table 73. Additionally, there are significant incremental cost savings across both prototypes since the electric equipment is less expensive to install than the mixed-fuel system for all climate zones except for Climate Zone 16. Since there are both incremental cost savings and TDV energy cost savings, the benefit-to-cost ratios for Climate Zones 1 through 15 are all greater than 1. The efficiency measures added for Climate Zone 16 make the proposed system more expensive to install than the baseline mixed-fuel system, making this measure not cost effective for some window types in Climate Zone 16. However, the Statewide CASE Team found the prototype-weighted average benefit-to-cost ratio for Climate Zone 16 is 1.06. Therefore, for the combined mid-rise and high-rise prototypes, the measure is cost effective in all climate zones. Table 74 shows the specific costs for each window type and prototype used to calculate the weighted averages.

The costs and benefit-to-cost ratios in Table 72 and Table 73 for climate zone 16 show a weighted average of the costs and benefit-to-cost ratios by the percentage of dwelling units with each window type.

Table 70: 30-Year Cost-Effectiveness Summary Per Dwelling Unit – 2-Story Garden New Construction – SZHP with efficiency measures

Climate Zone	Benefits TDV Energy Cost Savings + Other PV Savings ^a (2023 PV\$)	Benefits Total Incremental PV Cost Savings ^b (2023 PV\$)	Benefit-to-Cost Ratio
1	\$680	\$9,436	Infinite
2	\$215	\$12,055	Infinite
3	\$117	\$11,524	Infinite
4	\$37	\$11,564	Infinite
5	\$208	\$9,463	Infinite
6	\$240	\$9,452	Infinite
7	\$293	\$9,486	Infinite
8	\$80	\$9,559	Infinite
9	\$92	\$9,459	Infinite
10	(\$28)	\$9,718	342
11	(\$189)	\$9,848	52
12	(\$117)	\$9,618	82
13	(\$316)	\$9,683	31
14	\$1,040	\$9,037	Infinite
15	\$155	\$9,047	Infinite
16	\$473	(\$867)	0.55

- a. **Cost: TDV Energy Cost Savings + Other PV Savings:** Benefits include TDV energy cost savings/increase over the period of analysis (Energy + Environmental Economics 2016, 51-53). Note: This source to be updated when 2022 TDV methodology report is released by the Energy Commission. Other savings are discounted at a real (nominal – inflation) three percent rate. Other PV savings include incremental first-cost savings if proposed first cost is less than current first cost. Includes PV maintenance cost savings if PV of proposed maintenance costs is less than PV of current maintenance costs.
- b. **Benefit: Total Incremental Present Valued Cost Savings:** Costs include incremental equipment, replacement, and maintenance costs over the period of analysis. Costs are discounted at a real (inflation-adjusted) three percent rate and if PV of proposed maintenance costs is greater than PV of current maintenance costs. If incremental maintenance cost is negative, it is treated as a positive benefit. If there are no total incremental PV costs, the B/C ratio is infinite.

Table 71: 30-Year Cost-Effectiveness Summary Per Dwelling Unit – 3-Story Loaded Corridor New Construction – SZHP with efficiency measures

Climate Zone	Benefits TDV Energy Cost Savings + Other PV Savings ^a (2023 PV\$)	Benefits Total Incremental PV Cost Savings ^b (2023 PV\$)	Benefit-to-Cost Ratio
1	(\$11)	\$8,892	793
2	(\$114)	\$11,313	99
3	(\$121)	\$10,830	89
4	(\$18)	\$10,865	592
5	\$87	\$8,915	Infinite
6	\$143	\$8,904	Infinite
7	\$216	\$8,942	Infinite
8	\$54	\$9,009	Infinite
9	\$33	\$8,911	Infinite
10	(\$87)	\$9,115	104
11	(\$390)	\$9,195	24
12	(\$381)	\$9,105	24
13	(\$488)	\$9,083	19
14	\$686	\$8,395	Infinite
15	\$66	\$8,397	Infinite
16	\$60	(\$867)	0.07

- a. **Cost: TDV Energy Cost Savings + Other PV Savings:** Benefits include TDV energy cost savings/increase over the period of analysis (Energy + Environmental Economics 2016, 51-53). Note: This source to be updated when 2022 TDV methodology report is released by the Energy Commission. Other savings are discounted at a real (nominal – inflation) three percent rate. Other PV savings include incremental first-cost savings if proposed first cost is less than current first cost. Includes PV maintenance cost savings if PV of proposed maintenance costs is less than PV of current maintenance costs.
- b. **Benefit: Total Incremental Present Valued Cost Savings:** Costs include incremental equipment, replacement, and maintenance costs over the period of analysis. Costs are discounted at a real (inflation-adjusted) three percent rate and if PV of proposed maintenance costs is greater than PV of current maintenance costs. If incremental maintenance cost is negative, it is treated as a positive benefit. If there are no total incremental PV costs, the B/C ratio is infinite.

Table 72: 30-Year Cost-Effectiveness Summary Per Dwelling Unit – 5-Story Mixed-Use New Construction – SZHP (Climate Zone 16 with efficiency measures)

Climate Zone	Benefits TDV Energy Cost Savings + Other PV Savings ^a (2023 PV\$)	Benefits Total Incremental PV Cost Savings ^b (2023 PV\$)	Benefit-to-Cost Ratio
1	\$657	\$9,719	Infinite
2	\$417	\$12,472	Infinite
3	\$404	\$11,904	Infinite
4	\$230	\$11,950	Infinite
5	\$189	\$9,760	Infinite
6	\$107	\$9,749	Infinite
7	\$92	\$9,781	Infinite
8	\$100	\$9,857	Infinite
9	\$152	\$9,760	Infinite
10	\$156	\$10,001	Infinite
11	\$552	\$10,087	Infinite
12	\$383	\$9,954	Infinite
13	\$353	\$9,967	Infinite
14	\$221	\$9,897	Infinite
15	\$65	\$10,016	Infinite
16	\$1,025	(\$923)	1.11

- c. **Cost: TDV Energy Cost Savings + Other PV Savings:** Benefits include TDV energy cost savings/increase over the period of analysis (Energy + Environmental Economics 2016, 51-53). Note: This source to be updated when 2022 TDV methodology report is released by the Energy Commission. Other savings are discounted at a real (nominal – inflation) three percent rate. Other PV savings include incremental first-cost savings if proposed first cost is less than current first cost. Includes PV maintenance cost savings if PV of proposed maintenance costs is less than PV of current maintenance costs.
- d. **Benefit: Total Incremental Present Valued Cost Savings:** Costs include incremental equipment, replacement, and maintenance costs over the period of analysis. Costs are discounted at a real (inflation-adjusted) three percent rate and if PV of proposed maintenance costs is greater than PV of current maintenance costs. If incremental maintenance cost is negative, it is treated as a positive benefit. If there are no total incremental PV costs, the B/C ratio is infinite.

Table 73: 30-Year Cost-Effectiveness Summary Per Dwelling Unit – 10-Story Mixed-Use New Construction – SZHP (Climate Zone 16 with efficiency measures)

Climate Zone	Benefits TDV Energy Cost Savings + Other PV Savings ^a (2023 PV\$)	Benefits Total Incremental PV Cost Savings ^b (2023 PV\$)	Benefit-to-Cost Ratio
1	\$735	\$9,766	Infinite
2	\$404	\$12,567	Infinite
3	\$355	\$11,979	Infinite
4	\$195	\$12,034	Infinite
5	\$172	\$9,834	Infinite
6	\$78	\$9,823	Infinite
7	\$82	\$9,860	Infinite
8	\$75	\$9,932	Infinite
9	\$126	\$9,842	Infinite
10	\$140	\$10,079	Infinite
11	\$611	\$10,170	Infinite
12	\$389	\$10,054	Infinite
13	\$334	\$10,052	Infinite
14	\$235	\$9,979	Infinite
15	\$48	\$10,122	Infinite
16	\$738	(\$1,031)	0.72

- a. **Benefits: TDV Energy Cost Savings + Other PV Savings:** Benefits include TDV energy cost savings over the period of analysis (Energy + Environmental Economics 2016, 51-53). This source to be updated when 2022 TDV methodology report is released by the Energy Commission. Other savings are discounted at a real (nominal – inflation) three percent rate. Other PV savings include incremental first-cost savings if proposed first cost is less than current first cost. Includes PV maintenance cost savings if PV of proposed maintenance costs is less than PV of current maintenance costs.
- b. **Costs: Total Incremental Present Valued Cost Savings:** Costs include incremental equipment, replacement, and maintenance costs over the period of analysis. Costs are discounted at a real (inflation-adjusted) three percent rate and if PV of proposed maintenance costs is greater than PV of current maintenance costs. If incremental maintenance cost is negative, it is treated as a positive benefit. If there are no total incremental PV costs, the B/C ratio is infinite.

Table 74: 30-Year Cost-Effectiveness Summary Per Dwelling Unit – SZHP – Midrise and Highrise Combined for Climate Zone 16

Window Type	Benefits TDV Energy Cost Savings + Other PV Savings ^a (2023 PV\$)		Costs Total Incremental PV Cost Savings ^b (2023 PV\$)		Benefit-to-Cost Ratio		Percentage Impact ^c	
	Midrise	Highrise	Midrise	Highrise	Midrise	Highrise	Midrise	Highrise
All Other	\$1,161	\$1,436	\$906	\$926	1.28	1.55	69%	0.2%
Curtain wall	\$599	\$743	\$973	\$1,029	0.62	0.72	6%	8%
Class AW	\$554	\$677	\$983	\$1,044	0.56	0.65	14%	3%
Combined	\$993		\$935		1.06			

- a. **Benefits: TDV Energy Cost Savings + Other PV Savings:** Benefits include TDV energy cost savings over the period of analysis (Energy + Environmental Economics 2016, 51-53). This source to be updated when 2022 TDV methodology report is released by the Energy Commission. Other savings are discounted at a real (nominal – inflation) three percent rate. Other PV savings include incremental first-cost savings if proposed first cost is less than current first cost. Includes PV maintenance cost savings if PV of proposed maintenance costs is less than PV of current maintenance costs.
- b. **Costs: Total Incremental Present Valued Cost Savings:** Costs include incremental equipment, replacement, and maintenance costs over the period of analysis. Costs are discounted at a real (inflation-adjusted) three percent rate and if PV of proposed maintenance costs is greater than PV of current maintenance costs. If incremental maintenance cost is negative, it is treated as a positive benefit. If there are no total incremental PV costs, the B/C ratio is infinite.
- c. **Percentage Impact:** Calculated by multiplying the percentage of dwelling units with each window type shown in Table 22 by the relative percentages of mid-rise (89%) and high-rise (11%) buildings that make up all midrise and high-rise buildings combined.

Mini-Split Systems

Replacing the baseline mixed-fuel system with Mini-Split system similarly results in a decrease in TDV energy costs for all climate zones except for Climate Zone 16 as seen in Table 75 and Table 76. There are significant incremental cost savings across both prototypes since the electric equipment is less expensive to install than the mixed-fuel system. Therefore, the benefit cost ratio is above one, and the measure is cost effective.

Table 75: 30-Year Cost-Effectiveness Summary Per Dwelling Unit – 5-Story Mixed-Use New Construction – Mini-Split

Climate Zone	Benefits TDV Energy Cost Savings + Other PV Savings ^a (2023 PV\$)	Benefits Total Incremental PV Costs ^b (2023 PV\$)	Benefit-to-Cost Ratio
1	\$657	\$1,453	Infinite
2	\$417	\$1,156	Infinite
3	\$404	\$1,625	Infinite
4	\$230	\$1,223	Infinite
5	\$189	\$1,136	Infinite
6	\$107	\$1,146	Infinite
7	\$92	\$1,265	Infinite
8	\$100	\$1,270	Infinite
9	\$152	\$1,180	Infinite
10	\$156	\$1,523	Infinite
11	\$552	\$1,721	Infinite
12	\$383	\$1,358	Infinite
13	\$353	\$1,507	Infinite
14	\$221	\$1,616	Infinite
15	\$65	\$1,619	Infinite
16	(\$877)	\$1,223	1.4

- a. Benefits: TDV Energy Cost Savings + Other PV Savings:** Benefits include TDV energy cost savings over the period of analysis (Energy + Environmental Economics 2016, 51-53). Note: This source to be updated when 2022 TDV methodology report is released by the Energy Commission. Other savings are discounted at a real (nominal – inflation) three percent rate. Other PV savings include incremental first-cost savings if proposed first cost is less than current first cost. Includes PV maintenance cost savings if PV of proposed maintenance costs is less than PV of current maintenance costs.
- b. Costs: Total Incremental Present Valued Costs:** Costs include incremental equipment, replacement, and maintenance costs over the period of analysis. Costs are discounted at a real (inflation-adjusted) three percent rate and if PV of proposed maintenance costs is greater than PV of current maintenance costs. If incremental maintenance cost is negative, it is treated as a positive benefit. If there are no total incremental PV costs, the B/C ratio is infinite.

Table 76: 30-Year Cost-Effectiveness Summary Per Dwelling Unit – 10-Story Mixed-Use New Construction – Mini-Split

Climate Zone	Benefits TDV Energy Cost Savings + Other PV Savings ^a (2023 PV\$)	Benefits Total Incremental PV Cost Savings ^b (2023 PV\$)	Benefit-to-Cost Ratio
1	\$735	\$2,004	Infinite
2	\$404	\$2,330	Infinite
3	\$355	\$2,220	Infinite
4	\$195	\$2,331	Infinite
5	\$172	\$2,135	Infinite
6	\$78	\$2,148	Infinite
7	\$82	\$2,246	Infinite
8	\$75	\$2,254	Infinite
9	\$126	\$2,188	Infinite
10	\$140	\$2,511	Infinite
11	\$611	\$2,715	Infinite
12	\$389	\$2,377	Infinite
13	\$334	\$2,498	Infinite
14	\$235	\$2,624	Infinite
15	\$48	\$2,659	Infinite
16	(\$872)	\$2,651	3

- a. **Benefits: TDV Energy Cost Savings + Other PV Savings:** Benefits include TDV energy cost savings over the period of analysis (Energy + Environmental Economics 2016, 51-53). This source to be updated when 2022 TDV methodology report is released by the Energy Commission. Other savings are discounted at a real (nominal – inflation) three percent rate. Other PV savings include incremental first-cost savings if proposed first cost is less than current first cost. Includes PV maintenance cost savings if PV of proposed maintenance costs is less than PV of current maintenance costs.
- b. **Costs: Total Incremental Present Valued Costs:** Costs include incremental equipment, replacement, and maintenance costs over the period of analysis. Costs are discounted at a real (inflation-adjusted) three percent rate and if PV of proposed maintenance costs is greater than PV of current maintenance costs. If incremental maintenance cost is negative, it is treated as a positive benefit. If there are no total incremental PV costs, the B/C ratio is infinite.

VRF Systems

Replacing baseline mixed-fuel system with VRF system results in reduced TDV energy costs for all climate zones except Climate Zones 1 for the midrise and Climate Zones 1 through 3, and 11 for the high-rise prototype as seen in Table 77 and Table 78. However, there are significant incremental cost savings as well since the electric equipment is less expensive to install than the mixed-fuel system. Therefore, the benefit cost ratio is above one, and the measure is cost effective.

Table 77: 30-Year Cost-Effectiveness Summary Per Dwelling Unit – 5-Story Mixed-Use New Construction – VRF

Climate Zone	Benefits TDV Energy Cost Savings + Other PV Savings ^a (2023 PV\$)	Benefits Total Incremental PV Cost Savings ^b (2023 PV\$)	Benefit-to-Cost Ratio
1	\$784	\$5,029	Infinite
2	(\$61)	\$12,477	204
3	(\$18)	\$11,044	620
4	(\$475)	\$11,245	24
5	(\$213)	\$5,233	25
6	(\$833)	\$5,202	6
7	(\$874)	\$5,506	6
8	(\$820)	\$5,591	7
9	(\$669)	\$5,157	8
10	(\$719)	\$5,843	8
11	(\$74)	\$5,970	81
12	(\$295)	\$5,775	20
13	(\$665)	\$5,746	9
14	(\$171)	\$5,285	31
15	(\$988)	\$5,608	6
16	(\$1,783)	\$5,555	3

- a. Benefits: TDV Energy Cost Savings + Other PV Savings:** Benefits include TDV energy cost savings over the period of analysis (Energy + Environmental Economics 2016, 51-53). Note: This source to be updated when 2022 TDV methodology report is released by the Energy Commission. Other savings are discounted at a real (nominal – inflation) three percent rate. Other PV savings include incremental first-cost savings if proposed first cost is less than current first cost. Includes PV maintenance cost savings if PV of proposed maintenance costs is less than PV of current maintenance costs.
- b. Costs: Total Incremental Present Valued Cost Savings:** Costs include incremental equipment, replacement, and maintenance costs over the period of analysis. Costs are discounted at a real (inflation-adjusted) three percent rate and if PV of proposed maintenance costs is greater than PV of current maintenance costs. If incremental maintenance cost is negative, it is treated as a positive benefit. If there are no total incremental PV costs, the B/C ratio is infinite.

Table 78: 30-Year Cost-Effectiveness Summary Per Dwelling Unit – 10-Story Mixed-Use New Construction – VRF

Climate Zone	Benefits TDV Energy Cost Savings + Other PV Savings ^a (2023 PV\$)	Benefits Total Incremental PV Cost Savings ^b (2023 PV\$)	Benefit-to-Cost Ratio
1	\$955	\$5,708	Infinite
2	\$186	\$13,225	Infinite
3	\$29	\$11,738	Infinite
4	(\$331)	\$11,972	36
5	(\$195)	\$6,022	31
6	(\$543)	\$5,993	11
7	(\$606)	\$6,314	10
8	(\$451)	\$6,409	14
9	(\$316)	\$6,006	19
10	(\$309)	\$6,665	22
11	\$96	\$6,803	Infinite
12	(\$225)	\$6,637	29
13	(\$620)	\$6,599	11
14	(\$124)	\$6,119	49
15	(\$782)	\$6,535	8
16	(\$1,636)	\$6,267	4

- a. **Benefits: TDV Energy Cost Savings + Other PV Savings:** Benefits include TDV energy cost savings over the period of analysis (Energy + Environmental Economics 2016, 51-53). This source to be updated when 2022 TDV methodology report is released by the Energy Commission. Other savings are discounted at a real (nominal – inflation) three percent rate. Other PV savings include incremental first-cost savings if proposed first cost is less than current first cost. Includes PV maintenance cost savings if PV of proposed maintenance costs is less than PV of current maintenance costs.
- b. **Costs: Total Incremental Present Valued Cost Savings:** Costs include incremental equipment, replacement, and maintenance costs over the period of analysis. Costs are discounted at a real (inflation-adjusted) three percent rate and if PV of proposed maintenance costs is greater than PV of current maintenance costs. If incremental maintenance cost is negative, it is treated as a positive benefit. If there are no total incremental PV costs, the B/C ratio is infinite.

5.4.2 Electric Central HPWH System Cost Effectiveness

The Statewide CASE Team presents cost effectiveness for Central HPWH systems accounting for TDV energy cost savings and incremental measure costs using 2023 present value dollars.

For the 5-story mixed-use building prototype, TDV energy cost savings/increase in 2023 present value dollars range from an increase of \$58.72 to savings of \$944.30. These are only partially offset by total incremental measure costs ranging from \$2,711 to \$2,293. As a result, the measure is not cost effective in any climate zone.

Table 79: 30-Year Cost-Effectiveness Summary Per Dwelling Unit – Central HPWH – 5-Story Mixed-Use New Construction

Climate Zone	Benefits TDV Energy Cost Savings + Other PV Savings ^a (2023 PV\$)	Costs Total Incremental PV Costs ^b (2023 PV\$)	Benefit-to-Cost Ratio
1	\$2,975.01	\$2,710.7	1.10
2	\$2,773.27	\$2,710.7	1.02
3	\$2,678.40	\$2,710.7	0.99
4	\$2,634.21	\$2,710.7	0.97
5	\$2,669.88	\$2,710.7	0.98
6	\$2,557.84	\$2,710.7	0.94
7	\$2,531.63	\$2,710.7	0.93
8	\$2,503.81	\$2,710.7	0.92
9	\$2,501.36	\$2,710.7	0.92
10	\$1,742.86	\$2,293.2	0.76
11	\$1,703.46	\$2,293.2	0.74
12	\$1,724.46	\$2,293.2	0.75
13	\$1,682.48	\$2,293.2	0.73
14	\$1,786.51	\$2,293.2	0.78
15	\$1,381.00	\$2,293.2	0.60
16	\$1,606.54	\$2,293.2	0.70

- a. **Benefits: TDV Energy Cost Savings + Other PV Savings:** Benefits include TDV energy cost savings over the period of analysis (Energy + Environmental Economics 2016, 51-53). This source to be updated when 2022 TDV methodology report is released by the Energy Commission. Other savings are discounted at a real (nominal – inflation) three percent rate. Other PV savings include incremental first-cost savings if proposed first cost is less than current first cost. Includes PV maintenance cost savings if PV of proposed maintenance costs is less than PV of current maintenance costs.
- b. **Costs: Total Incremental Present Valued Costs:** Costs include incremental equipment, replacement, and maintenance costs over the period of analysis. Costs are discounted at a real (inflation-adjusted) three percent rate and if PV of proposed maintenance costs is greater than PV of current maintenance costs. If incremental maintenance cost is negative, it is treated as a positive benefit. If there are no total incremental PV costs, the B/C ratio is infinite.

For the 10-story mixed-use building prototype, TDV energy cost savings/increase in 2023 present value dollars range from an increase of \$274.89 to savings of \$835.86. These are only partially offset by total incremental measure costs ranging from \$2,844 to \$3,245. As a result, the measure is not cost effective in any climate zone.

**Table 80: 30-Year Cost-Effectiveness Summary Per Dwelling Unit – Central HPWH
– 10-Story Mixed-Use New Construction**

Climate Zone	Benefits TDV Energy Cost Savings + Other PV Savings^a (2023 PV\$)	Costs Total Incremental PV Costs^b (2023 PV\$)	Benefit-to-Cost Ratio
1	\$2,408.04	\$3,245.0	0.74
2	\$2,351.92	\$3,245.0	0.72
3	\$2,331.33	\$3,245.0	0.72
4	\$2,342.26	\$3,245.0	0.72
5	\$2,271.52	\$3,245.0	0.70
6	\$2,246.51	\$3,245.0	0.69
7	\$2,206.10	\$3,245.0	0.68
8	\$2,293.74	\$3,245.0	0.71
9	\$2,323.41	\$3,245.0	0.72
10	\$1,546.33	\$2,884.2	0.54
11	\$1,442.63	\$2,884.2	0.50
12	\$1,494.85	\$2,884.2	0.52
13	\$1,412.18	\$2,884.2	0.49
14	\$1,619.73	\$2,884.2	0.56
15	\$1,278.20	\$2,884.2	0.44
16	\$1,199.34	\$2,884.2	0.42

6 First-Year Statewide Impacts

The code change proposal would not modify the stringency of the existing Title 24, Part 6, so the savings associated with this proposed change are minimal. Typically, the Statewide CASE Team presents a detailed analysis of statewide energy and cost savings associated with the proposed change in Section 6 of the CASE Report. As discussed in Section 4, although the TDV energy savings are limited, the measure would promote building decarbonization and results in significant source energy and greenhouse gas emissions savings.

6.1 Statewide Energy and Energy Cost Savings

The Statewide CASE Team calculated the first-year statewide savings for new construction by multiplying the per-unit savings, which are presented in Section 4.3, by assumptions about the percentage of newly constructed buildings that would be impacted by the proposed code. The statewide new construction forecast for 2023 is presented in Appendix A as are the Statewide CASE Team's assumptions about the percentage of new construction that would be impacted by the proposal (by climate zone and building type).

The first-year energy impacts represent the first-year annual savings from all buildings that were completed in 2023. The 30-year energy cost savings represent the energy cost savings over the entire 30-year analysis period. The statewide savings estimates do not take naturally occurring market adoption or compliance rates into account.

Table 81 presents the first-year statewide energy and energy cost savings from newly constructed buildings by climate zone for the electric space heating (SZHP) measure. The increase in first year electricity consumption and the resultant increase in electric TDV energy use is partially offset by decrease in first year natural gas usage and the resultant decrease in natural gas TDV energy use. The net result is a slight increase in the 15-year present valued energy costs in most climate zones.

Table 82 presents the first-year statewide energy and energy cost savings from newly constructed buildings by climate zone for the central electric water heating (Central HPWH) measure. The increase in first year electricity consumption and the resultant increase in electric TDV energy use is more than offset by decrease in first year natural gas usage and the resultant decrease in natural gas TDV energy use. The net result is a decrease in the 30-year present valued energy costs in all climate zones.

Appendix N presents a combined result of the two measures for multifamily buildings four stories and greater – SZHP and Central HPWH – and shows that there is an overall increase in electricity energy use, but it is more than offset by the decrease in natural gas energy use. The net result in an overall decrease in present value energy cost savings across all climate zones except Climate Zone 15 and 16.

**Table 81: Statewide Energy and Energy Cost Impacts – SZHP –
New Construction^a**

Climate Zone	Statewide New Construction Impacted by Proposed Change in 2023 (dwelling units)	First-Year^b Electricity Savings (GWh)	First-Year Peak Electrical Demand Reduction (MW)	First-Year Natural Gas Savings (MMTherms)	30-Year Present Valued Energy Cost Savings (PV\$ million in 2023)
1	240	(0.09)	0.00	0.01	0.08
2	1,426	(0.48)	0.00	0.04	0.38
3	6,918	(1.15)	0.00	0.12	1.72
4	3,604	(0.46)	0.00	0.05	0.56
5	640	(0.09)	0.00	0.01	0.10
6	3,056	(0.05)	0.00	0.01	0.37
7	3,285	(0.00)	0.00	0.01	0.43
8	4,296	(0.07)	0.00	0.02	0.37
9	10,086	(0.44)	0.00	0.06	1.17
10	3,563	(0.35)	0.00	0.04	0.29
11	1,017	(0.36)	0.00	0.03	0.28
12	5,744	(1.78)	0.00	0.17	0.91
13	1,676	(0.45)	0.00	0.04	0.17
14	762	(0.19)	0.00	0.02	0.29
15	496	(0.02)	0.00	0.00	0.03
16	52	(0.01)	0.00	0.00	0.05
TOTAL	46,862	(5.99)	0.00	0.64	7.20

- a. Savings represent 30 year present value savings for 5-Story Mixed Use, 10-Story Mixed Use prototypes
- b. First-year savings from all buildings completed statewide in 2023.

Table 82: Statewide Energy and Energy Cost Impacts – Central HPWH – New Construction^a

Climate Zone	Statewide New Construction Impacted by Proposed Change in 2023 (dwelling units)	First-Year ^b Electricity Savings (GWh)	First-Year Peak Electrical Demand Reduction (MW)	First-Year Natural Gas Savings (MMTherms)	30-Year Present Valued Energy Cost Savings (PV\$ million in 2023)
1	52	(0.04)	(0.03)	0.01	\$0.15
2	310	(0.21)	(0.16)	0.03	\$0.79
3	1,505	(1.00)	(0.71)	0.13	\$3.73
4	784	(0.50)	(0.38)	0.06	\$1.84
5	139	(0.09)	(0.07)	0.01	\$0.33
6	665	(0.40)	(0.30)	0.05	\$1.48
7	715	(0.43)	(0.32)	0.06	\$1.61
8	935	(0.55)	(0.40)	0.07	\$2.02
9	2,194	(1.31)	(1.06)	0.17	\$4.73
10	775	(0.46)	(0.42)	0.05	\$1.20
11	221	(0.14)	(0.12)	0.02	\$0.35
12	1,250	(0.80)	(0.64)	0.09	\$2.05
13	365	(0.22)	(0.18)	0.02	\$0.56
14	166	(0.10)	(0.09)	0.01	\$0.25
15	108	(0.06)	(0.04)	0.01	\$0.12
16	67	(0.05)	(0.04)	0.01	\$0.10
TOTAL	10,252	(6.37)	(4.96)	0.80	\$21.32

- a. Savings represent 30 year present value savings for 2-Story Garden, 3-Story Loaded Corridor, 5-Story Mixed Use, 10-Story Mixed Use prototypes
- b. First-year savings from all buildings completed statewide in 2023.

6.2 Statewide Greenhouse Gas (GHG) Emissions Reductions

The Statewide CASE Team calculated avoided GHG emissions assuming the emissions factors specified in the United States Environmental Protection Agency (U.S. EPA) Emissions & Generation Resource Integrated Database (eGRID) for the Western Electricity Coordination Council California (WECC CAMX) subregion. Avoided GHG emissions from natural gas savings attributable to sources other than utility-scale electrical power generation are calculated using emissions factors specified in U.S. EPA’s Compilation of Air Pollutant Emissions Factors (AP-42). See Appendix C for additional details on the methodology used to calculate GHG emissions. In short, this analysis assumes an average electricity emission factor of 240.4 metric tons CO₂e per GWh based on the average emission factors for the CACX EGRID subregion.

Table 83: First-Year Statewide GHG Emissions Impacts

Measure	Electricity Increase ^a (GWh/yr)	Increased GHG Emissions from Electricity Increase ^a (Metric Tons CO ₂ e)	Natural Gas Savings ^a (MMTherms /yr)	Reduced GHG Emissions from Natural Gas Savings ^a (Metric Tons CO ₂ e)	Total Reduced CO ₂ e Emissions ^{a,b} (Metric Tons CO ₂ e)
SZHP (2-Story Garden, 3-Story Loaded Corridor, 5-Story Mixed Use, 10-Story Mixed Use over 30 years)	5.99	1,440	0.64	3,469	2,029
Central HPWH (2-Story Garden, 3-Story Loaded Corridor, 5-Story Mixed Use, 10-Story Mixed Use over 30 years)	6.37	1,531	0.80	4,341	2,810

a. First-year savings from all affected buildings completed statewide in 2023.

b. Assumes the following emission factors: 240.4 MTCO₂e/GWh and 5,454.4 MTCO₂e/ MMTherms.

Table 83 presents the estimated first-year avoided GHG emissions of the proposed code change. During the first year, a total of GHG emissions of 2,810 metric tons of carbon dioxide equivalents (metric tons CO₂e) would be avoided for Central HPWH measure alone as it applies to four multifamily prototypes. For the SZHP measure, a total of GHG emissions of 2,029 metric tons of carbon dioxide equivalents (metric tons CO₂e) would be avoided.

6.3 Statewide Water Use Impacts

The proposed code change would not result in water savings.

6.4 Statewide Material Impacts

6.4.1 Electric HVAC Material Impacts

To estimate the statewide material impacts for a SZHP system, the Statewide CASE Team looked at the difference in materials used in the indoor units, as well as the additional gas-fired furnace, gas piping and flue used in the baseline system. There is negligible difference in outdoor units between the proposed and baseline and were

excluded from the analysis. The Statewide CASE Team reviewed manufacturer websites for estimates of materials used in their products. Relative to weight,

- Furnaces (40 kBtu/h) were estimated to be 95 percent steel
- Indoor units (1.5 ton) were estimated to be 95 percent steel excluding weight from the aluminum coils. The proposed case included a blower in the indoor unit.

Weight of aluminum coils and refrigerant were the same for both baseline and proposed cases.

The Statewide CASE Team also calculated the length of gas piping required for the baseline system and estimated using 10 feet of piping for each dwelling unit for the flue. Gas piping was assumed to be all steel and piping for the flue was all Polyvinyl Chloride (PVC). The final statewide material impacts are shown in Table 84.

Table 84: First-Year Statewide Impacts on Material Use - SZHP

Material	Impact (I, D, or NC) ^a	Impact on Material Use (pounds/year)	
		Per-Unit Impacts	First-Year ^b Statewide Impacts
Steel	D	37	1,734,638
PCV	D	7	318,309
Aluminum	NC	N/A	N/A
Refrigerant (R410a)	NC	N/A	N/A

a. Material Increase (I), Decrease (D), or No Change (NC) compared to base case (lbs/yr).

b. First-year savings from all buildings completed statewide in 2023.

6.4.2 Central Heat Pump Water Heater Material Impacts

To estimate the statewide material impacts for the Central Heat Pump Water Heater measure, the Statewide CASE Team reviewed materials used in products in the Basis of Design. Table 86 and Table 87 below show the materials used according to the Basis of Design for the baseline and proposed cases. The Statewide CASE Team checked manufacturer websites and asked manufacturers for estimates of materials used in their products. Relative to weight,

- Boilers were estimated to be 70 percent steel and 30 percent iron
- Storage tanks were estimated to be 95 percent steel and 5 percent insulation
- Heat Pumps were estimated to be 90 percent steel, or 75 percent steel, 10 percent copper and 15 percent aluminum depending on manufacturer
- Electric resistance back-ups were estimated to be 95 percent steel and 5 percent insulation.

For the baseline case, the Statewide CASE Team separately calculated material impacts of the thermal collectors according to the collector area. Table 85 shows assumed pounds of copper, plastic, glass, and aluminum per thermal collector area.

Table 85: Materials in Thermal Collectors by Area

	Copper (lb)	Insulation (lb)	Glass (lb)	Aluminum (lb)
Per SF collector area	0.725	0.259	1.95	0.526

Source: California Utilities Statewide Codes and Standards Team 2011.

Table 86: Baseline Model Materials by Prototype

	Model	Weight per Model (lb)	Count	Total Weight (lb)	Steel (lb)	Iron (lb)	Insulation (lb)
2-Story Garden Style	54 kBtu/hr Gas Boiler	228	1	228	160	68	0
	119 gallon Storage Tank	225	1	225	214	0	11
	80 gallon Storage Tank	100	1	100	95	0	5
	Total				468	68	16
3-Story Loaded Corridor	76 kBtu/hr Gas Boiler	287	2	574	402	172	0
	119 gallon Storage Tank	225	3	675	641	0	34
	Total				1,043	172	34
5-Story Mixed-Use	113 kBtu/hr Gas Boiler	487	3	1461	1023	438	0
	200 gallon Storage Tank	435	3	1305	1240	0	65
	280 gallon Storage Tank	483	1	483	459	0	24
	Total				2,721	438	89
10-Story Mixed-Use	134 kBtu/hr Gas Boiler	487	3	1461	1023	438	0
	200 gallon Storage Tank	435	4	1740	1653	0	87
	400 gallon Storage Tank	435	2	870	827	0	44
	Total				3,502	438	131

Table 87: Central Heat Pump Water Heater Materials by Prototype

	Model	Weight per Model (lb)	Count	Total Weight (lb)	Steel (lb)	Copper (lb)	Aluminum (lb)	Insulation (lb)	R744 (lb)	R134a (lb)	R410a (lb)
2-Story Garden Style	15.4 kBtu/hr Heat Pump	106	2	212	159	21	32	N/A	3		
	45 gallon Storage Tank	88	3	264	251	N/A	N/A	13			
	80 gallon Electric Resistance Back-up	200	1	200	190	N/A	N/A	10			
	Total				600	21	32	23	3		
3-Story Loaded Corridor	15.4 kBtu/hr Heat Pump	106	4	424	318	42	64	N/A	6		
	175 gallon Storage Tank	340	3	1,020	N/A	N/A	N/A	N/A			
	250 gallon Electric Resistance Back-up	1,165	1	1,165	1,107	N/A	N/A	58			
	Total				1,425	42	64	58	6		
5-Story Mixed-Use	137.5 kBtu/hr Heat Pump	860	2	1,720	1,548	N/A	N/A	N/A		18	
	500 gallon Storage Tank	1038	3	3,114	2,958	N/A	N/A	156			
	50 gallon Electric Resistance Back-up	270	1	270	257	N/A	N/A	14			
	42 kBtu/hr Heat Pump	615	1	615	554	N/A	N/A	N/A			4
	250 gallon Electric Resistance Back-up	1,145	1	1,145	N/A	N/A	N/A	N/A			
	Total				5,316				169		18
10-Story Mixed-Use	203.7 kBtu/hr Heat Pump	875	2	1,750	1,575	N/A	N/A	N/A		22	
	500 gallon Storage Tank	1038	3	3,114	2,958	N/A	N/A	156			
	50 gallon Electric Resistance Back-up	270	1	270	257			14			
	137.5 kBtu/hr Heat Pump	860	1	860	774					9	
	500 gallon Electric Resistance Back-up	1,700	1	1,700	1,615			85			
	Total				7,179				254		31

Table 88 below shows statewide impacts for the Central Heat Pump Water Heater measure. Results show an increase in steel and refrigerant and a decrease in copper, insulation, glass, and aluminum.

Table 88: First-Year Statewide Impacts on Material Use - CHPWH

Material	Impact (I, D, or NC) ^a	Impact on Material Use (pounds/year)	
		Per-Unit Impacts	First-Year ^b Statewide Impacts
Steel	I	25	261,378
Iron	D	5	50,530
Copper	D	5	51,154
Insulation	I	0	81
Glass	D	14	145,613
Aluminum	D	3	34,803
Refrigerant (R744)	I	0.04	405
Refrigerant (R134a)	I	0.2	1,667
Refrigerant (R410a)	I	0.03	332

a. Material Increase (I), Decrease (D), or No Change (NC) compared to base case (lbs/yr).

b. First-year savings from all buildings completed statewide in 2023.

6.5 Other Non-Energy Impacts

Electric heat pump water and space heating systems save on-site and system-wide emissions as captured in Section 6.2. Additionally, use of the heat pump technologies provides improved indoor air quality due to the lack of any combustion devices in these systems and they replace natural gas or propane systems that produce harmful pollutants in the space. These air quality improvements in turn provide health benefits to occupants, especially those with respiratory illnesses such as asthma.

6.5.1 Improved Safety

Buildings with heat pump space heating and DHW systems have fewer pieces of combustion equipment and less gas piping. All-electric designs eliminate gas piping and combustion from the property, and with them the associated risk of fire and explosion (particularly during/after an earthquake). Eliminating combustion from a building via all-electric design also significantly reduces sources of carbon monoxide (CO) poisoning for occupants.

Since there is no combustion in electric heat pump water heating systems, projects would have no combustion safety testing requirements for water heating equipment. Depending on local fire inspector requirements, eliminating combustion equipment from a building may also eliminate some other requirements under California Fire Code.

6.5.2 Improved Air Quality and Resiliency

Heat pump HVAC and DHW systems improve air quality at the building, as well as locally and regionally by eliminating a source NOx emission. While recent years have seen California residents subject to more frequent, and longer-duration electricity outages than in previous years, electric HPWH systems are likely to be more resilient than gas water heating systems for a number of reasons.

- All modern gas equipment requires electricity to operate. Since modern gas equipment has done away with standing pilot lights in favor of electronic ignition, power outages would take both gas and electric equipment offline.
- Central HPWH systems have large storage tanks compared to modern gas water heating which may have small or in many cases zero storage (tankless). An optimally designed central HPWH plant that is fully charged when the power goes out should be able to meet the hot water demands of the building for many hours, or potentially an entire day.
- Studies show that after a natural disaster, such as an earthquake, electricity is restored more quickly than gas service.

6.5.3 Increase in Refrigerant Amount

Increase adoption of heat pump HCAC and HVAC would increase the amount of refrigerant usage. Refrigerants are very potent greenhouse gas emitters when released into the environment and regulatory bodies are working to encourage use of less potent refrigerants to curb this environmental issue. Due to their destructive properties, refrigerants with very high GWP are getting phased out and will not be allowed to be used in new products including a halt of production and import. Section 6.4 estimates the refrigerant increase of the proposed measures on. However, the estimation was based on existing product information. Most manufacturers are actively developing products with low GWP refrigerants, and the impact is likely less significant as lower GWP products become available.

7 Proposed Revisions to Code Language

7.1 Guide to Markup Language

The proposed changes to the standards, Reference Appendices, and the ACM Reference Manuals are provided below. Changes to the 2019 documents are marked with red underlining (new language) and ~~strikethroughs~~ (deletions).

7.2 Standards

The Energy Commission plans to create a multifamily chapter for inclusion in 2022 Title 24, Part 6. The multifamily chapter would draw from the appropriate sections of the 2019 residential and nonresidential standards. The Statewide CASE Team uses the language and section numbering from residential and nonresidential standards and Reference Appendices to show the proposed changes below. Changes to the 2019 documents are marked with red underlining (new language) and ~~strikethroughs~~ (deletions). These changes are specific to multifamily buildings and not indicative of changes that apply to residential or nonresidential buildings.

Electric HVAC systems

Modify Section 150.1 (c) 6. Heating System Type to establish SZHP as baseline for multifamily buildings three stories and fewer.

2019 Title 24, Part 6 SECTION 150.1 PERFORMANCE AND PRESCRIPTIVE COMPLIANCE APPROACHES FOR LOW-RISE RESIDENTIAL BUILDINGS

[Item (c)6]

- 6. Heating System Type.** Heating system types shall be installed as required in TABLE 150.1-A or B. For climate zones 1 through 15, the space conditioning system shall be a heat pump. For climate zones 16, the space conditioning system shall be a SZAC with furnace. Additionally, for climate zones 4-10, balanced ventilation systems without heat or energy recovery shall have fan efficacy of 0.4 W/cfm or less.

EXCEPTION to Section 150.1(c)6: A supplemental heating unit may be installed in a space served directly or indirectly by a primary heating system, provided that the unit thermal capacity does not exceed 2 kW or 7,000 Btu/hr and is controlled by a time-limiting device not exceeding 30 minutes.

[Item (c)Table 150.1-B]

TABLE 150.1-B COMPONENT PACKAGE – Multifamily Standard Building Design

			Climate Zone																
			1	2	3	4	5	6	7	8	9	10	11	12	13	14	15	16	
HVAC SYSTEM	Space Heating ⁸	Electric-Resistance Allowed	No	No	No	No	No	No	No	No	No	No	No	No	No	No	No	No	
		If gas, AFUE	MIN N/A	MIN N/A	MIN N/A	MIN N/A	MIN N/A	MIN N/A	MIN N/A	MIN N/A	MIN N/A	MIN N/A	MIN N/A	MIN N/A	MIN N/A	MIN N/A	MIN N/A	MIN N/A	MIN
		If Heat Pump, HSPF ⁷	MIN	MIN	MIN	MIN	MIN	MIN	MIN	MIN	MIN	MIN	MIN	MIN	MIN	MIN	MIN	MIN	MIN
	Balanced Ventilation	Fan Efficiency when without HRV/ERV	NR	NR	NR	0.4	0.4	0.4	0.4	0.4	0.4	0.4	NR	NR	NR	NR	NR	NR	NR
	Space cooling	SEER	MIN	MIN	MIN	MIN	MIN	MIN	MIN	MIN	MIN	MIN	MIN	MIN	MIN	MIN	MIN	MIN	MIN
		Refrigerant Charge Verification or Fault Indicator Display	NR	REQ	NR	NR	NR	NR	NR	REQ	REQ	REQ	REQ	REQ	REQ	REQ	REQ	REQ	NR
	Central System Air Handlers	Central Fan Integrated Ventilation System Fan Efficacy	REQ	REQ	REQ	REQ	REQ	REQ	REQ	REQ	REQ	REQ	REQ	REQ	REQ	REQ	REQ	REQ	REQ
	Ducts ⁹	Roof/Ceiling Option B	Duct Insulation	R-8	R-8	R-6	R-8	R-6	R-6	R-6	R-8	R-8	R-8	R-8	R-8	R-8	R-8	R-8	R-8
			§150.1(c)9A	NA	NA	NA	NA	NA	NA	NA	NA	NA	NA	NA	NA	NA	NA	NA	NA
		Roof/Ceiling Option C	Duct Insulation	R-6	R-6	R-6	R-6	R-6	R-6	R-6	R-6	R-6	R-6	R-6	R-6	R-6	R-6	R-6	R-6
§150.1(c)9B			REQ	REQ	REQ	REQ	REQ	REQ	REQ	REQ	REQ	REQ	REQ	REQ	REQ	REQ	REQ	REQ	REQ
Water Heating	All Buildings	System Shall meet Section 150.1(c)8																	

For multifamily buildings four stories and greater, add new sections in **2019 Title 24, Part 6 SUBCHAPTER 5 NONRESIDENTIAL, HIGH-RISE RESIDENTIAL, AND HOTEL/MOTEL OCCUPANCIES—PERFORMANCE AND PRESCRIPTIVE COMPLIANCE APPROACHES FOR ACHIEVING ENERGY EFFICIENCY**

SECTION 140.4 PRESCRIPTIVE REQUIREMENTS FOR SPACE CONDITIONING SYSTEMS

- (p) High-Rise Residential Occupancies. Space conditioning systems shall be electric ducted heat pump meeting efficiency requirements in Section 110.2. In Climate Zone 16, a gas supplemental heating unit may be installed.**

Central HPWH Systems

2019 Title 24, Part 6 SECTION 150.1 PERFORMANCE AND PRESCRIPTIVE COMPLIANCE APPROACHES FOR LOW-RISE RESIDENTIAL BUILDINGS

[Item (c)8]

8. Domestic Water-Heating Systems. **Water-heating** systems shall meet the requirements of either A B, ~~or~~ C, or D. For recirculation distribution systems serving individual dwelling unit, only Demand Recirculation Systems with manual on/off control as specified in the Reference Appendix RA4.4.9 shall be used. Recirculation system serving multiple dwelling units shall meet the requirements of Sections 110.3(c)2 and 110.3(c)5, includes two or more separate recirculation loops serving separate dwelling units, and is capable of automatically controlling the recirculation pump operation based on measurement of hot water demand and hot water return temperature.
- A. For systems serving individual dwelling units, the water heating system shall meet the requirement of either i, ii, iii, iv, or v:
- i. One or more gas or propane instantaneous water heater with an input of 200,000 Btu per hour or less and no storage tank.
 - ii. A single gas or propane storage type water heater with an input of 75,000 Btu per hour or less, rated volume less than or equal to 55 gallons and that meets the requirements of Sections 110.1 and 110.3. The dwelling unit shall have installed fenestration products with a weighted average U-factor no greater than 0.24, and in addition one of the following shall be installed:
 - a. A compact hot water distribution system that is field verified as specified in the Reference Appendix RA4.4.16; or
 - b. A drain water heat recovery system that is field verified as specified in the Reference Appendix RA3.6.9.
 - iii. A single gas or propane storage type water heater with an input of 75,000 Btu per hour or less, rated volume of more than 55 gallons.
 - iv. A single heat pump water heater. The storage tank shall be located in the garage or conditioned space. In addition, one of the following:

- a. A compact hot water distribution system as specified in the Reference Appendix RA4.4.6 and a drain water heat recovery system that is field verified as specified in the Reference Appendix RA3.6.9; or
- b. For Climate Zones 2 through 15, a photovoltaic system capacity of 0.3 kWdc larger than the requirement specified in Section 150.1(c)14; or
- c. For Climate Zones 1 and 16, a photovoltaic system capacity of 1.1 kWdc larger than the requirement specified in Section 150.1(c)14.
- v. A single heat pump water heater that meets the requirements of NEEA Advanced Water Heater Specification Tier 3 or higher. The storage tank shall be located in the garage or conditioned space. In addition, for Climate Zones 1 and 16, a photovoltaic system capacity of 0.3 kWdc larger than the requirement specified in Section 150.1(c)14 or a compact hot water distribution system as specified in the Reference Appendix RA4.4.6.

B. For heat pump water-heating systems serving multiple dwelling units, the water heating system shall meet requirements in Joint Appendix JA14, be field verified as specified in the Reference Appendix RA3.6.x, and meet the following additional requirements:

- i. The hot water return from the recirculation loop shall connect to a recirculation loop tank and shall not directly connect to the primary heat pump water heater inlet or the primary storage tanks.
- ii. The fuel source for the recirculation loop tank shall be electricity if auxiliary heating is needed. The recirculation loop heater shall be capable of multi-pass water heating operation
- iii. For systems with single pass primary heat pump water heater, the primary storage tanks shall be piped in series if multiple tanks are used. For systems with multi-pass primary heat pump water heater, the primary storage tanks shall be piped in parallel if multiple tanks are used.
- iv. The primary heat pump water heater (s) shall draw cold water from the bottom of the primary storage and return hot water to the top of the primary storage. For a series storage tank configuration, the cold water shall be drawn from the bottom of the first tank and return the hot water to top of last tank.
- v. The primary storage tank temperature setpoint shall be at least 140°F.
- vi. The recirculation loop tank temperature setpoint shall be at least 20°F lower than the primary storage tank temperature setpoint such that hot water from the recirculation loop tank is used for the temperature maintenance load before engaging the recirculation loop tank heater.
- vii. The minimum heat pump water heater compressor cut-off temperature shall be equal to or lower than 40°F ambient air temperature.
- viii. A recirculation system.

EXCEPTION to Section 150.1(c)8Bviii: Buildings with eight or fewer dwelling units

BC. For systems serving multiple dwelling units, a central water-heating system that includes the following components shall be installed:

- i. Gas or propane water heating system; and
- ii. A recirculation system ~~that meets the requirements of Sections 110.3(e)2 and 110.3(e)5, includes two or more separate recirculation loops serving separate dwelling units, and is capable of automatically controlling the recirculation pump operation based on measurement of hot water demand and hot water return temperature;~~ and

EXCEPTION to Section 150.1(c)8BCii: Buildings with eight or fewer dwelling units ~~may use a single recirculation loop.~~

- iii. A solar water-heating system meeting the installation criteria specified in Reference Residential Appendix RA4 and with a minimum solar savings fraction of either a or b below:
 - a. A minimum solar savings fraction of 0.20 in Climate Zones 1 through 9 or a minimum solar savings fraction of 0.35 in Climate Zones 10 through 16; or
 - b. A minimum solar savings fraction of 0.15 in Climate Zones 1 through 9 or a minimum solar savings fraction of 0.30 in Climate Zones 10 through 16. In addition, a drain water heat recovery system that is field verified as specified in the Reference Appendix RA3.6.9.

CD. A water-heating system serving multiple dwelling units determined by the Executive Director to use no more energy than the one specified in subsection B above.

7.3 Reference Appendices

Electric HVAC Systems

NA 2.4 – Field-Verified Energy Efficiency Ratio for Heat Pumps in Highrise Residential Dwelling Units and Common Areas

The purpose of these procedures is to verify that residential space cooling systems and heat pumps have the required components to achieve the energy efficiency claimed in the compliance documents. The procedures apply when an HSPF, SEER, or EER higher than the default is claimed. For dwelling units with multiple systems, the procedures shall be applied to each system separately.

Central HPWH Systems

The proposed code language proposes to add a new Joint Appendix 14 to include testing, configuration, installation, and control requirements for central HPWH systems. The proposed code change also includes a new Reference Appendix RA Section 3.6.x to include field verification for central HPWH systems. This additional section would be referenced in Table RA2-1 under section RA2.2 summarizing all the measures requiring HERS or ATT verification.

JA14 Qualification Requirements for Central Heat Pump Water Heater System

JA14.1 Purpose and Scope

Joint Appendix JA14 provides the qualification requirements to meet the standards for Central Heat Pump Water Heater Systems set forth in Title 24, Part 6, Section 170.2(d)2 and in performance standards set forth in Section 150.1(b) and 140.1.

JA14.2 Central Heat Pump Water Heater Requirements

Central heat pump water heater products shall be certified to the Energy Commission to meet the following requirements:

- (a) Submit heat pump water heater test data in accordance with JA14.3 to the Energy Commission.
- (b) Document defrost strategy, including the method of detecting frosting conditions (onset conditions), algorithm used for defrosting, and the defrost cycle length and process.

JA14.3 Test Procedure and Reporting

The test setup, installation, calculation procedure and instruments required for the test are as described in Title 10 CFR Appendix E to Subpart G of Part 431. The central HPWH shall be tested for the following performance specifications:

- Water heater input power
- Water heater output capacity
- Water heater COP

The central HPWH shall be tested at the following conditions

- Inlet ambient air temperature: Maximum, minimum, and two midpoint temperatures of the manufacturer specified operating range. Minimum shall be equal to or lower than 40 °F.
- Inlet water temperature: Maximum, minimum, and two midpoint temperatures of the manufacturer specified operating range.

- Outlet water temperature: Maximum, midpoint, and minimum of outlet water (setpoint) temperatures of the manufacturer specified operating range. Maximum shall be equal to or greater than 140 °F.

JA14.4 Design Condition Documentation Requirements

The central heat pump water heater system shall be capable of supplying hot water at design outlet water temperature under specified operating ranges for:

- Minimum and maximum ambient air temperature
- Minimum and maximum cold-water temperature
- Minimum and maximum building demand at design draw and recovery conditions and duration.
- Recirculation loop heat loss

Design documentation shall specify the operating conditions at which the primary heat pump water heater can supply hot water at design outlet water temperature without engaging auxiliary heating mechanism.

RA2.2 Measures that Require Field Verification and Diagnostic Testing

Table RA2-1 describes the measures that require installer certification and independent field verification and diagnostic testing and identifies the protocol or test procedure in the Reference Residential Appendices that shall be used for completing installer and field verification and diagnostic testing.

Table RA2-1 – Summary of Measures Requiring Field Verification and Diagnostic Testing

Multi Family Domestic Hot Water Heating Measures		
Multiple Recirculation Loop Design for DHW Systems Serving Multiple Dwelling Units	Inspection that a central DHW system serving a building with more than eight dwelling units has at least two recirculation loops, each serving roughly the same number of dwelling units. These recirculation loops may <u>serve</u> the same water heating equipment or be connected to <u>individual</u> pendent water heating equipment.	RA3.6.8
Verified Drain Water Heat Recovery System (DWHR-H)	Inspection to verify that the DWHR unit(s) and installation configuration match the compliance document and the DWHR(s) is certified to the Commission to have met the requirements.	RA3.6.9
<u>Central Heat Pump Water Heating Systems Serving Multiple Dwelling Units</u>	<u>Visual inspection to verify a central HPWH system serving multiple dwelling units meets the minimum equipment specifications and installation requirements.</u>	<u>RA3.6.x</u>

RA3.6.X – Field-Verified Central HPWH Systems Serving Multiple Dwelling Units

The visual inspection shall verify that the central HPWH system is installed per requirements in JA14. Unless otherwise dictated by JA14, central heat pump water heater systems shall be installed according to manufacturer design and installation guidelines.

Visual inspection shall verify that the installed HPWH ambient air and cold water temperature ranges match those specified on design drawings.

Additionally, for projects taking the prescriptive compliance approach, visual inspection shall verify the central HPWH system is installed per requirements in Section 150.1(c)8B:

- (a) HPWH equipment's minimum compressor operation temperature is lower than 40°F based on manufacturer equipment specifications.
- (b) Multiple storage tanks are piped in series for a single-pass system.
- (c) multiple storage tanks are piped in parallel for a multi-pass system.
- (d) Verify that recirculation loop return water is connected to a recirculation loop tank or heater, and no recirculation return water is plumbed directly back to the primary storage tank or primary water heater.
- (e) The recirculation loop tank uses electricity as the fuel source. These may be electric resistance element or a dedicated multi-pass HPWH.

7.4 ACM Reference Manuals

Electric HVAC Systems

7.4.1 Nonresidential Alternative Calculation Method Reference Manual

5.1.2 HVAC System Map

The HVAC system in the Standard Design depends on the primary building activity, the size of the building, and the number of floors. Details about these systems are provided in subsequent sections.

Many of the building descriptors have a one-to-one relationship between the proposed design and the Standard Design; for example, every wall in the proposed design has a corresponding wall in the Standard Design. For HVAC systems, however, this one-to-one relationship generally does not hold. The HVAC system serving the proposed design and the Standard Design may be completely different, each with different components.

The HVAC system in the Standard Design shall be selected from Table 2: HVAC System Map, and be based on building type, number of floors, conditioned floor area, and heating source. Moreover, the selected system shall conform to the descriptions in Table 5: System Descriptions.

For systems 1, 2, 3, 7, 10, and 11, each thermal zone shall be modeled with a respective HVAC system. For systems 5, 6, and 9, each floor shall be modeled with a separate HVAC system. Floors with identical thermal zones and occupancies can be grouped for modeling. The Standard Design heating source is natural gas.

TABLE 2: HVAC System MAP

Building Type	Standard Design
Residential or hotel/motel guestrooms in a building with seven or fewer floors above grade	<u>System 1—SZAC</u> <u>Climate Zones 1-15: System 4 SZHP</u> <u>Climate Zone 16: System 14 SHZP</u> <u>with Gas Supplemental Heat</u>
Residential or hotel/motel guestrooms in a building with eight or more floors above grade	<u>System 2—FPFC</u> <u>Climate Zones 1-15: System 4 SZHP</u> <u>Climate Zone 16: System 14 SHZP</u> <u>with Gas Supplemental Heat</u>
Retail building two floors or fewer	System 7 - SZVAV*
Warehouse and light manufacturing space types (per the Appendix 5.4A Schedule column) that do not include cooling in the proposed design	System 9 - HEATVENT
Covered process	See Table 4: System Map for Covered Processes
Healthcare Facilities	Same as the Proposed Design
All other space types	See Table 3: Nonresidential Spaces (Not Including Covered Processes)

TABLE 5: System Descriptions

System Type	Description	Detail
System 1 – SZAC	Residential Air Conditioner	Single zone system with constant volume fan, no economizer, DX cooling and furnace
System 2 – FPFC	Four-Pipe Fan Coil	Central plant with terminal units with hot

		water and chilled water coils, with separate ventilation source
System 3 – SZAC	Packaged Single Zone	Single-zone constant volume DX unit with gas heating
System 4 – RESERVED-SZHP	<u>Split Single Zone Ducted Heat pump</u>	<u>Single zone central ducted split heat pump system with constant volume fan, no economizer</u>
System 5 – PVAV	Packaged VAV Unit	VAV reheat system; packaged variable volume DX unit with gas heating and with hot water reheat terminal units
System 6 – VAVS	Built-up VAV Unit	Variable volume system with chilled water and hot water coils, water-cooled chiller, tower, and central boiler
System 7 – SZVAV	Packaged Single-Zone VAV Unit	Single-zone variable volume DX unit with variable-speed drive and gas heating
System 8 – RESERVED		
System 9 – HEATVENT	Heating and Ventilation Only	Gas heating and ventilation
System 10 – CRAH	Computer Room Air Handler	Built-up variable volume unit with chilled water, no heating
System 11 – CRAC	Computer Room Air Conditioner	Packaged variable volume DX unit with no heating
System 12 – LAB	Laboratory HVAC System	<p>Laboratory spaces in a building having a total laboratory design maximum exhaust rate of 15,000 cfm or less use Table 3, Nonresidential System Map.</p> <p>Laboratory spaces in a building with building floor area < 150,000 ft²: System 5 – PVAV</p> <p>Laboratory spaces in a building with building floor Area ≥ 150,000 ft²: System 6 – VAVS</p>
System 13 – KITCH	Kitchen HVAC System	Dedicated single-zone makeup air unit (MAU) with dedicated exhaust fan. If the building is VAVS per Table 3, the cooling source is chilled

		water and the heating source is hot water. Otherwise, cooling source is DX and heating source is a gas-fired furnace.
<u>System 14 SHZP with Gas Supplemental Heat</u>	<u>Split Single Zone Ducted Heat pump with Gas Supplemental Heat</u>	<u>Single zone ducted split heat pump system with constant volume fan, no economizer with supplemental heat provided by gas- or oil-fired central furnaces, propane furnaces, or heating equipment considered equivalent to a gas-fired central furnace, such as wood stoves that qualify for the wood heat exceptional method. Gas fan-type central furnaces have a minimum AFUE=80%. Distribution can be gravity flow or use any of the ducted systems.</u>

Verified Energy Efficiency Ratio (EER) for Highrise Residential Dwelling Units and Common Areas

PROPOSED DESIGN

Software shall allow the user the option to enter an EER rating for central cooling equipment. For equipment that is rated only with an EER (room air conditioners), the user will enter the EER. The Appliance Efficiency Regulations require a minimum SEER and EER for central cooling equipment. Only if a value higher than a default minimum EER is used is it reported as a HERS-verified measure.

STANDARD DESIGN

The Standard Design for central air-conditioning equipment is 11.7 EER.

VERIFICATION AND REPORTING

EER verification is required only if higher than 11.7 EER with 14 SEER is modeled or higher than the standard EER. The EER rating is verified using rating data from AHRI Directory of Certified Product Performance website or another directory of certified product performance ratings approved by the Energy Commission for determining compliance. Verified EER is reported in the required verification listings on the NRCC-MCH-E and NRCI-MCH-E.

Verified Seasonal Energy Efficiency Ratio (SEER) for Highrise Residential Dwelling Units and Common Areas

PROPOSED DESIGN

The software allows the user to specify the SEER value.

STANDARD DESIGN

The Standard Design is based on the default minimum efficiency SEER for the type of cooling equipment modeled in the proposed design, based on the applicable Appliance Efficiency Regulations. For central-cooling equipment, the minimum efficiency is 14 SEER and 11.7 EER.

VERIFICATION AND REPORTING

If a SEER higher than the default minimum efficiency is modeled in software, the SEER requires field verification. The higher than minimum SEER rating is verified using rating data from AHRI Directory of Certified Product Performance website or another directory of certified product performance ratings approved by the Commission for determining compliance. Verified SEER is reported in the required verification listings on the NRCC-MCH-E and NRCI-MCH-E.

5.7.6.2 Electric Heat Pump

Electric Heat Pump Supplemental Heating Source	
<i>Applicability</i>	All heat pumps
<i>Definition</i>	The auxiliary heating source for a heat pump heating system The common control sequence is to lock out the heat pump compressor when the supplemental heat is activated. Other building descriptors may be needed if this is not the case. Choices for supplemental heat include: <ul style="list-style-type: none"> • Electric resistance • Gas-fired furnace • Oil furnace • Hot water • Other
<i>Units</i>	List (see above)
<i>Input Restrictions</i>	As designed
<i>Standard Design</i>	For healthcare facilities, same as the Proposed Design. <u>For dwelling units and common areas in multifamily buildings four stories and greater located in Climate Zone 16, gas-fired furnace.</u> For all others, electric resistance

Appliances and Plug Loads

Add language to the Nonresidential Alternative Calculation Method Reference Manual to modify the procedures for calculating plug load and MEL energy use for standard and proposed designs. Language to be copied from 2019 Title 24, Part 6 Residential

Alternative Calculation Method Reference Manual Appendix E – Plug loads and lighting modeling.

Table x: User Inputs Affecting Estimated Plug Load and Lighting Energy Use

<u>End Use</u>	<u>User Inputs that Determine Estimated Energy Use</u>	<u>Notes</u>
<u>Primary Refrigerator/ Freezer</u>	<ul style="list-style-type: none"> - <u>BRperUnit</u> - <u>Optional: rated annual kWh usage from the Energy Guide label of the installed device</u> 	<ul style="list-style-type: none"> - <u>Default kWh can be overridden with the rated annual kWh usage input on the Energy Guide label; however, there is a maximum allowable kWh credit dependent on BRperUnit.</u> - <u>Energy use adjusted on an hourly basis depending on the indoor temperature in the kitchen simulated in the software.</u>
<u>Non-Primary Refrigerators and Separate Freezers</u>	<ul style="list-style-type: none"> - <u>BRperUnit</u> - <u>Single-family or multi-family housing</u> 	<ul style="list-style-type: none"> - <u>Assumed to be installed in the garage in new, single-family homes.</u> - <u>Assumed to be absent in multi-family dwelling units.</u>
<u>Dishwasher</u>	<ul style="list-style-type: none"> - <u>BRperUnit</u> - <u>Presence of device</u> - <u>Single-family or multi-family</u> 	<ul style="list-style-type: none"> - <u>Ruleset estimates machine energy use only.</u> - <u>Energy use is only included if user indicates the device will be present.</u> - <u>Assumed different usage patterns in single family and multi-family when developing algorithms.</u>
<u>Clothes Washer</u>	<ul style="list-style-type: none"> - <u>BRperUnit</u> - <u>Presence of device</u> - <u>Single-family or multi-family</u> - <u>Optional: whether installed device will comply with the 2015 federal efficiency standards (credit for installing new or nearly-new device)</u> 	<ul style="list-style-type: none"> - <u>Ruleset estimates machine energy use only.</u> - <u>Energy use is only included if user indicates the device will be present.</u> - <u>Assumed different usage patterns in single family and multi-family when developing algorithms.</u> - <u>Default energy use can be reduced if the user specifies the device will meet the 2015 federal standard, which can be determined by looking up the model on the California Appliance Efficiency Database.</u>

<u>End Use</u>	<u>User Inputs that Determine Estimated Energy Use</u>	<u>Notes</u>
<u>Clothes Dryer</u>	<ul style="list-style-type: none"> - <u>BRperUnit</u> - <u>Presence of device</u> - <u>Fuel type (natural gas, propane, or electric)</u> - <u>Single-family or multi-family</u> - <u>Optional: percent remaining moisture content (RMC) of the clothes washer</u> 	<ul style="list-style-type: none"> - <u>Energy use is only included if user indicates the device will be present.</u> - <u>User can select fuel type. If user indicates natural gas is available at the site (see Section 2.2.10 of Residential ACM Reference Manual) then the default fuel type is natural gas. If user indicates that natural gas is not available at the site, then the default fuel type is electric. User cannot select natural gas as the fuel type if natural gas is not available at the site.</u> - <u>Default energy use can be reduced if the user specifies that the installed clothes washer has a rated RMC of less than 50 percent.</u>
<u>Oven</u>	<ul style="list-style-type: none"> - <u>BRperUnit</u> - <u>Presence of device</u> - <u>Fuel type (natural gas, propane, or electric)</u> 	<ul style="list-style-type: none"> - <u>Energy use is only included if user indicates the device will be present.</u> - <u>User can select fuel type, but default assumption is natural gas if user indicates that natural gas is available on-site and electric if user indicates natural gas is not available on-site</u>
<u>Cooktop</u>		
<u>Televisions</u>	<ul style="list-style-type: none"> - <u>BRperUnit</u> 	
<u>Set-Top Boxes</u>		
<u>Computers and Monitors</u>		
<u>Residual MELs</u>		
<u>Interior Lighting</u>	<ul style="list-style-type: none"> - <u>CFAperUnit</u> 	
<u>Exterior Lighting</u>		
<u>Garage Lighting</u>	<ul style="list-style-type: none"> - <u>CFAperUnit</u> - <u>Presence of garage</u> 	<ul style="list-style-type: none"> - <u>Energy use is only included if user indicates there is a garage present.</u> - <u>Garage lighting is assigned to multi-family buildings if there is at least once garage present.</u> - <u>Carport lighting is covered under the exterior lighting ruleset.</u>

Table x: Algorithms for Plug Load and Lighting Annual Energy Use

<u>End Use</u>	<u>Standard Design Fuel Type</u>	<u>kWh or therms</u>	<u>Intercept</u>	<u>Slope</u>	<u>Per-Unit BR or CFA</u>
<u>Primary Refrigerator/Freezer</u>	<u>Electricity</u>	<u>kWh</u>	<u>454</u>	<u>37.0</u>	<u>BR</u>
<u>Non-Primary Refrigerators and Separate Freezers (Single-Family only)</u>	<u>Electricity</u>	<u>kWh</u>	<u>0</u>	<u>71.0</u>	<u>BR</u>
<u>Oven</u>	<u>Electricity</u>	<u>kWh</u>	<u>138</u>	<u>16</u>	<u>BR</u>
<u>Oven</u>	<u>Gas</u>	<u>therms</u>	<u>6.0</u>	<u>0.95</u>	<u>BR</u>
<u>Oven</u>	<u>Gas</u>	<u>kWh</u>	<u>41</u>	<u>4.79</u>	<u>BR</u>
<u>Cooktop</u>	<u>Electricity</u>	<u>kWh</u>	<u>84</u>	<u>5.68</u>	<u>BR</u>
<u>Cooktop</u>	<u>Gas</u>	<u>therms</u>	<u>5.0</u>	<u>0.30</u>	<u>BR</u>
<u>Cooktop</u>	<u>Gas</u>	<u>kWh</u>	<u>0</u>	<u>0</u>	<u>BR</u>
<u>Televisions</u>	<u>Electricity</u>	<u>kWh</u>	<u>265</u>	<u>31.8</u>	<u>BR</u>
<u>Set-Top Boxes</u>	<u>Electricity</u>	<u>kWh</u>	<u>76</u>	<u>59.4</u>	<u>BR</u>
<u>Computers and Monitors</u>	<u>Electricity</u>	<u>kWh</u>	<u>79</u>	<u>55.4</u>	<u>BR</u>
<u>Residual MELs</u>	<u>Electricity</u>	<u>kWh</u>	<u>672</u>	<u>235</u>	<u>BR</u>
<u>Interior Lighting</u>	<u>Electricity</u>	<u>kWh</u>	<u>100</u>	<u>0.1775</u>	<u>CFA</u>
<u>Exterior Lighting</u>	<u>Electricity</u>	<u>kWh</u>	<u>8.0</u>	<u>0.0532</u>	<u>CFA</u>
<u>Garage Lighting</u>	<u>Electricity</u>	<u>kWh</u>	<u>20</u>	<u>0.0063</u>	<u>CFA</u>

Table x: Multi-Family Dwelling Unit Algorithms for Dishwasher, Clothes Washer, and Clothes Dryer Annual Energy Use

<u>BRperUnit</u>	<u>Dishwashers (kWh/yr)</u>	<u>Clothes Washers (kWh/yr)</u>	<u>Electric Clothes Dryer (kWh/yr)</u>	<u>Gas Clothes Dryers</u>	
				<u>Natural Gas Usage (therms/yr)</u>	<u>Electricity Usage (kWh/yr)</u>
<u>0</u>	<u>56</u>	<u>66</u>	<u>496</u>	<u>17</u>	<u>25</u>
<u>1</u>	<u>68</u>	<u>70</u>	<u>527</u>	<u>19</u>	<u>26</u>
<u>2</u>	<u>96</u>	<u>99</u>	<u>745</u>	<u>26</u>	<u>37</u>
<u>3</u>	<u>94</u>	<u>97</u>	<u>733</u>	<u>26</u>	<u>37</u>
<u>4</u>	<u>121</u>	<u>118</u>	<u>885</u>	<u>31</u>	<u>44</u>
<u>5+</u>	<u>114</u>	<u>107</u>	<u>805</u>	<u>28</u>	<u>40</u>

Central HPWH Systems

7.4.2 Residential Alternative Calculation Method Reference Manual

SECTION 2.4.1 Heating Subsystems

The heating subsystem describes the equipment that supplies heat to a space-conditioning system. ~~Heating subsystems are categorized according to the types shown in Error! Reference source not found..~~

Proposed Design

The user selects the type and supplies required inputs for the heating subsystem including the appropriate rated heating efficiency. Except for heat pumps, the rated heating capacity is not used as a compliance variable by the compliance software.

When the proposed space-conditioning system is a heat pump, the user either allows the system capacity to be set automatically by the software or elects to specify rated heating capacity at 47°F and 17°F for the heat pump compressor. The capacity is used to determine the effect of backup electric resistance heat in the simulation. Either the user-entered or software-specified capacities are listed on the CF1R for verification by a HERS rater.

Standard Design

~~For Climate Zone 1 through 15, When electricity is used for ducted heating,~~ the heating equipment for the Standard Design is an electric split-system heat pump with default ducts in the attic and a heating seasonal performance factor (HSPF) meeting the current *Appliance Efficiency Regulations* minimum efficiency for split-systems. The Standard Design heat pump compressor size is determined by the software as the larger of the compressor size calculated for air-conditioning load, or the compressor with a 47°F rating that is 75 percent of the heating load (at the heating design temperature). Additionally, for Climate Zone 4 through 10, the Standard Design shall include unitary balanced ventilation systems without heat or energy recovery. The balanced ventilation system fan efficacy shall be 0.4 W/cfm or less. For other Climate Zones, if a balanced ventilation system is used to meet dwelling unit ventilation requirement, the Standard Design may include heat or energy recovery as required by the Standard.

~~When electricity is used for a proposed ductless heating system, the Standard Design is a ductless system with the minimum HSPF from the *Appliance Efficiency Regulations*.~~

~~For Climate Zone 16, When proposed heating equipment is a ducted gas system,~~ the equipment used in the Standard Design building is a gas-fired furnace (or propane if natural gas is not available) with default ducts in the attic and an annual fuel utilization efficiency (AFUE) meeting the *Appliance Efficiency Regulations* minimum efficiency for central systems. When a proposed design uses both electric and non-electric heat, the Standard Design is a gas-fired furnace.

~~See Table 89 for complete details on heating systems noted above and other possible proposed systems.~~

~~Table 89: Standard Design Heating System~~

Proposed Design	Standard Design
Central furnace, ducted	80 percent AFUE central furnace, default duct
Central heat pump, ducted	8.2 HSPF central heat pump, auto-size capacity, default duct
Wall furnace, gravity	59 percent AFUE gravity wall furnace
Wall furnace, fan type	72 percent AFUE fan-type wall furnace
Ducted minisplit, multisplit, and variable refrigerant charge heat pump, ducted	8.2 HSPF central heat pump, auto-size capacity, default duct
Ductless minisplit, multisplit, and variable refrigerant charge heat pump, ductless	8.2 HSPF central heat pump, auto-size capacity, default duct
Room heater, ductless	

~~Source: California Energy Commission~~

7.4.2.1.1 Verification and Reporting

The proposed heating system type and rated efficiency are reported in the compliance documentation on the CF1R. For heat pumps, which are supplemented by electric resistance backup heating, the HERS-verified capacity is listed, and the rated heating capacity of each proposed heat pump is reported on the CF1R. Installed capacities must be equal or larger than the capacities reported for modeled at 47° and 17° (RA 3.4.4.2).

SECTION 2.9.3 Multiple Dwelling Units

When the proposed design is a central water heating system, the Standard Design consists of the water heating devices, a recirculation system, and solar systems as follows:

Water-heating device. The Standard Design consists of the same number of water-heating devices as the proposed design using the efficiencies required in the appliance efficiency standards. The Standard Design is natural gas when the proposed device is natural gas. The Standard Design is propane if the proposed device is propane. Each water-heating device in the proposed system is examined separately. If the proposed water-heating device is gas or propane, the Standard Design is set to the same type and characteristics as the proposed design.

If the proposed water-heating device is electric resistance or heat pump with no recirculating loops (fewer than eight dwelling units), then the Standard Design is a heat pump water heater with 2.0 UEF with no recirculation loops. If the proposed central water-heating device is electric resistance or heat pump with recirculating loops, the Standard Design is ~~natural gas or propane~~ central heat pump water heater system with recirculating loop.

The appropriate efficiencies and standby losses for each standard water-heating device are then assigned to match the minimum federal requirements. The standards for consumer water heaters, as defined by 42 U.S.C 6291(16), are specified in 10 CFR 430.32(d); the standards for commercial water heaters, as defined by 42 U.S.C 6291(16), are specified in 10 CFR 431.110.

Recirculating system. The Standard Design includes a recirculation system with controls that regulate pump operation based on measurement of hot water demand and hot water return temperature, and capable of turning off the system as described in Appendix B4 Hourly Recirculation Distribution Loss for Central Water Heating Systems. The Standard Design has one recirculation loop.

Central HPWH system. The standard central HPWH system uses a heat pump water heater meeting requirement specified in Section 150.1(c) 8 B. and JA 14.

Solar thermal water-heating system. The Standard Design has a solar water heating system meeting the installation criteria specified in Residential Reference Appendix RA4 and with a minimum solar savings fraction of 0.20 in Climate Zones 1-9, or 0.35 in Climate Zones 10-16.

VERIFICATION AND REPORTING

All modeled features and the number of devices modeled for the water heating system are reported on the CF1R. Electric resistance and heat pump water heaters indicate the location of the water heater. NEEA-rated heat pumps are identified by the brand and model, which must be verified by the building inspector. Where water heating system features or distribution systems specify or require HERS or ATT verification, those features are listed in the HERS or ATT required verification listings on the CF1R.

7.5 Compliance Manuals

Electric HVAC Systems

The Nonresidential Compliance Manual would be updated to include a new section 4.6.2.10 High-rise residential occupancy requirement to prescriptively require electric ducted heat pump systems for multifamily buildings four stories and greater. It would include the gas supplemental heating requirement for Climate Zone 16.

The Residential Compliance Manual Section 4.2.2 Prescriptive Requirements for Heating Equipment would be updated to explain the prescriptive requirement for the Standard Design to include SZHP as baseline for Climate Zone 1-15. Additionally, for Climate Zone 4 to 10, the Standard Design would include a balanced ventilation system without heat or energy recovery that has a fan efficacy of 0.4W/cfm. For Climate Zone 16, prescriptively require a SZAC with gas-fired furnace for space conditioning.

Central HPWH Systems

Chapter 5.1 of the Residential Compliance Manual would be updated to add a summary of the new requirements around central HPWH systems. Chapter 5.2.2.2 would add a sentence to explain what central HPWH systems refer to in the context of HPWH equipment. Chapter 5.4.2 of the Residential Compliance Manual would be updated to explain prescriptive requirements around central heat pump water heating. Chapter 5.5.3 of the Residential Compliance Manual would be updated to explain the performance method requirements around central heat pump water heating.

Chapter 4.7.3 and 4.8 of the Nonresidential Compliance Manual would be updated to explain the requirements around central heat pump water heating. Chapter 5 of the Residential Compliance Manual would need to be revised.

5.2.2.2 Heat Pump Water Heater (HPWH)

Central HPWH systems are DHW systems with recirculation loop designed to deliver hot water produced by HPWH equipment from a centralized location to multiple end users.

5.4.2 Multiple Dwelling Units: Multifamily, Motel/Hotels, and High-Rise Residential

There are ~~two~~ three options for using the prescriptive approach to compliance for multifamily buildings:

1. A water heater must be installed in each unit that meets the requirements for a single family building.
2. A central heat pump water heater system meeting JA 14 and field verified as specified in the Reference Appendix RA3.6.x

3. A central gas or propane-fired water heater or boiler. The water heater must have an efficiency that meets the requirements in §110.1 and §110.3 (as listed in Table 5-5).

5.4.2.3 Central HPWH Systems

Central HPWH systems are DHW systems with recirculation loop designed to deliver hot water produced by HPWH equipment from a centralized location to multiple end users.

A key design feature of a central HPWH system is whether the primary HPWH is single-pass or multi-pass. In a single-pass HPWH system, the cold water passes through the heat pump(s) one time and is heated to the intended storage temperature. In a multi-pass HPWH system, the cold water passes through the heat pump(s) multiple times, each time gaining a 7-10°F temperature increase, until the tank reaches the intended storage temperature

This section would include:

- Equipment and system sizing best practice recommendation
 - o Primary HPWH capacity
 - o Primary storage capacity
 - o Recirculation loop tank capacity
- Plumbing configuration recommendations for both single-pass and multi-pass HPWH systems
 - o Describe the concept of using recirculation loop tank to improve HPWH efficiency
 - o Plumbing configurations for primary storage tanks
 - o Include Figure 19 as an example of a single-pass central heat pump water heater system schematic and Figure 20 for an example of a multi-pass central heat pump water heater system schematic.
- Control best practice and the concept of using recirculation loop tank as a “swing tank”

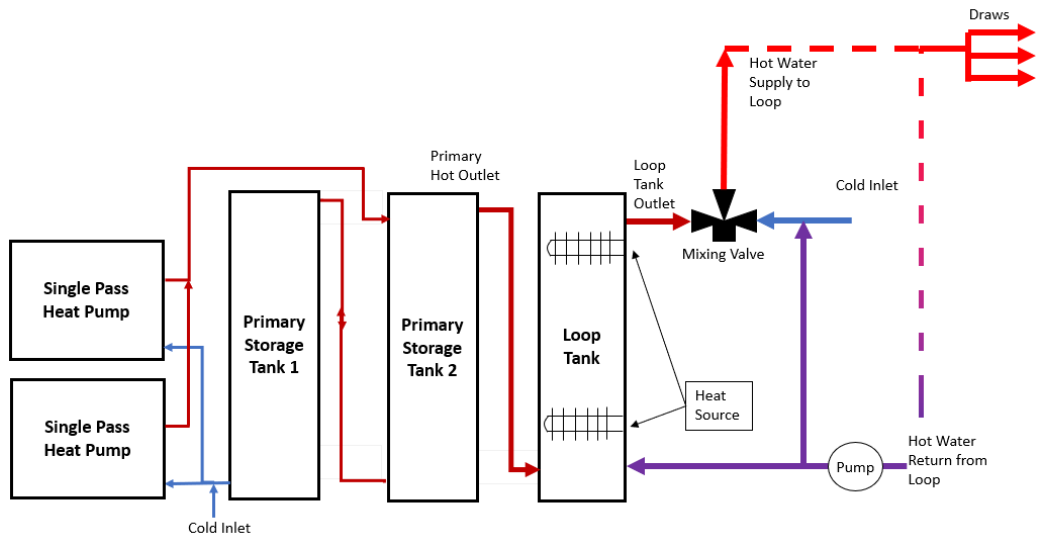

Figure 19: Example of central single-pass heat pump water heater system schematic.

Source: Statewide CASE Team

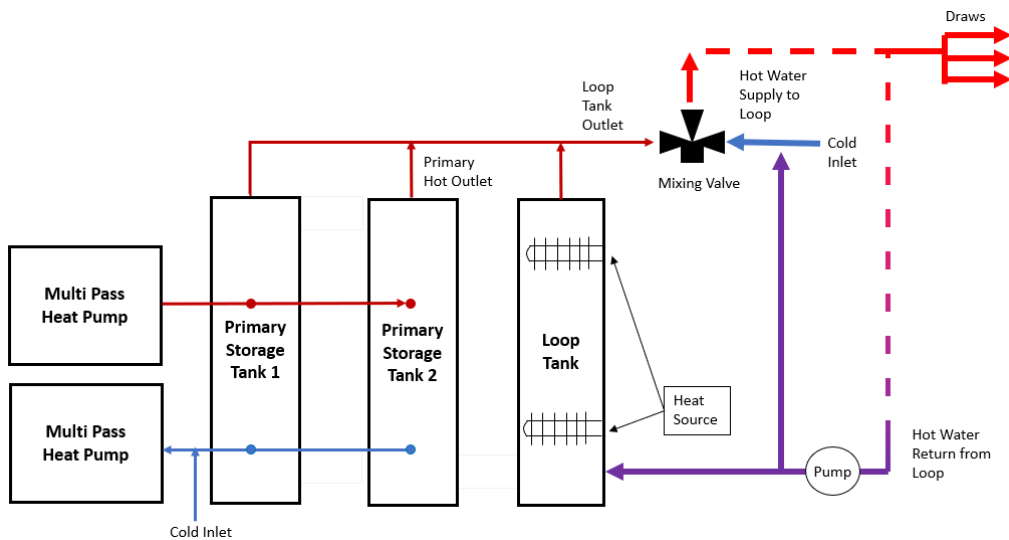

Figure 20: Example of central multi-pass heat pump water heater system schematic.

Source: Statewide CASE Team

7.6 Compliance Documents

Electric HVAC Systems

For multifamily buildings four stories and greater, compliance document NRCC-MCH-E would be updated to remove gas space heating for multifamily buildings four stories and greater, except allowing gas supplemental heating in Climate Zone 16.

The Multifamily Restructuring CASE Report includes changes associated with fenestration and wall u-factor requirements.

Update CF1R-NCB-01-E to remove gas space heating option for multifamily buildings three stories and fewer in Climate Zone 1-15. Add data field for ventilation system fan efficacy.

Central HPWH Systems

Compliance document CF1R-PLB and NRCC-PLB-E would need revision to add requirements specific to central HPWH systems.

For Prescriptive Compliance Approach

For the prescriptive compliance approach only the proposed code change would add a table to an existing worksheet or create a new worksheet (CF1R-PLB). Minor updates in CF1R-NCB-01-E may be needed accordingly.

Additional data fields needed for the CF1R-PLB worksheet include:

Design and sizing

- Specify design operating conditions, including minimum and maximum ambient air temperature (°F), minimum and maximum cold water temperature (°F), minimum and maximum building hot water demand at design draw (gallons/min), design recovery conditions and duration (hr)
 - Compliance form to auto-check that system is capable of supplying hot water meeting at conditions specified by designers
- Specify operating conditions during which the primary HPWH can meet load without engaging the auxiliary heating, including ambient air temperature range (°F) and cold water temperature range (°F).
- Specify design recirculation loop heat loss
 - Compliance form to auto-check that heat capacity from recirculation loop tank/heater is larger than design heat losses from recirculation loop

System and configurations

- Specify location of HPWH
- Drop down menu for specifying whether single-pass vs. multi-pass HPWH are used as primary water heaters
- Checkbox for verifying that the hot water return from the recirculation loop is connected to a recirculation loop tank and is not directly connected to the primary HPWH inlet
- Checkbox for verifying primary storage tank configuration is in series with the loop recirculation tank
- Checkbox for verifying primary storage tank configuration is in series or “in parallel” with other storage tank(s)
 - Auto-populate the checkbox to display “in series” if single-pass; “in parallel” if multiple-pass
- Drop down menu for specifying a temperature maintenance approach.
 - Options may include a passive recirculation loop tank; a recirculation loop tank with an electric resistance element; a dedicated multi-pass HPWH; or others: specify.
- Checkbox for verifying the primary heat pump water heater(s) draw cold water from the bottom of the primary storage and return hot water to the top of the primary storage. For a series storage tank configuration, the cold water shall be drawn from the bottom of the first tank and return the hot water to top of last tank.

Equipment and controls

- Checkbox for verifying the primary storage tank temperature setpoint is at or higher than 140°F.
- Checkbox for verifying recirculation loop tank heater setpoint is at least 20°F lower than primary storage tank temperature setpoint.
- Checkbox for verifying minimum compressor operation temperature is at or lower than 40°F

For Both Prescriptive and Performance Compliance Approaches

For both prescriptive and performance compliance approach the proposed changes would require updates to the following compliance forms:

- CF2R-PLB-01a-NonHERS-MultifamilyCentralHotWaterSystemDistribution
- CF2R-PLB-21a-HERS-MultifamilyCentralHotWaterSystemDistribution
- CF3R-PLB-21a-HERS-MultifamilyCentralHotWaterSystemDistribution

- NRCI-PLB-02-HighRiseResHotelMotel-MultifamilyCentral-HWSystemDistribution
- NRCI-PLB-21-HERS-HighRiseResHotelMotel-MultifamilyCentral-HWSystemDistribution
- NRCV-PLB-21-HERS-HighRiseResHotelMotel-MultifamilyCentral-HWSystemDistribution

Additionally, updates to CF1R-NCB-01-E and CF1R-PRF-E are needed accordingly.

The proposed code change would add descriptions and items for visual inspection of central HPWH systems. Additional data fields needed include:

For Prescriptive compliance approach

- The installed HPWH ambient air and cold water temperature ranges match those specified on design drawings.
- The installed HPWH minimum compressor operation temperature is at or lower than 40°F based on equipment specification on design drawings.
- For a single-pass system, multiple storage tanks are piped in series
- For a multi-pass system, multiple storage tanks are piped in parallel.
- Recirculation return water is not plumbed directly back to the primary HPWH inlet or primary storage tank,
- Recirculation temperature maintenance loop tank uses electricity as the fuel source, and recirculation loop heater is capable of multi-pass water heating operation.
- A Verification Status field (Pass/Fail/All N/A) and a Correction Notes field.

For Performance compliance approach

- The installed HPWH ambient air and cold water temperature ranges match those specified on design drawings.
- A Verification Status field (Pass/Fail/All N/A) and a Correction Notes field.

8 Bibliography

- n.d. http://bees.archenergy.com/Documents/Software/CBECC-Com_2016.3.0_SP1_Prototypes.zip.
- 10 CFR §431.102. 2020. *10 CFR § 431.102 - Definitions concerning commercial water heaters, hot water supply boilers, unfired hot water storage tanks, and commercial heat pump water heaters*. <https://www.govinfo.gov/app/details/CFR-2010-title10-vol3/CFR-2010-title10-vol3-sec431-102>.
- 2018 American Community Survey. n.d. *1-Year Estimates*. <https://data.census.gov/cedsci/>.
- AB-3232 Zero-emissions buildings and sources of heat energy*. 2018. Assembly Bill No. 3232 (California State Assembly, September 14). https://leginfo.legislature.ca.gov/faces/billTextClient.xhtml?bill_id=201720180AB3232.
- Association, National Energy Assistance Directors. 2011. "2011 National Energy Assistance Survey Final Report." Accessed February 2, 2017. <http://www.appriseinc.org/reports/Final%20NEADA%202011%20Report.pdf>.
- Building Decarbonization Coalition. 2020. "Decarbonization Code Comparison Matrix as of 10/28/2020." <https://www.buildingdecarb.org/active-code-efforts.html>.
- BW Research Partnership. 2016. *Advanced Energy Jobs in California: Results of the 2016 California Advanced Energy*. Advanced Energy Economy Institute.
- CalCERTS, Inc. 2019. *CBECC-Res 2019*. <https://www.calcerts.com/cbecc-res-2019/>.
- California Air Resources Board. 2019. "Global Warming Potentials." <https://www.arb.ca.gov/cc/inventory/background/gwp.htm#transition>.
- California Air Resources Board. 2019. "High-GWP Refrigerants." *Refrigerant Management Program*. <https://ww2.arb.ca.gov/resources/documents/high-gwp-refrigerants>.
- California Department of Water Resources. 2016. "California Counties by Hydrologic Regions." Accessed April 3, 2016. <http://www.water.ca.gov/landwateruse/images/maps/California-County.pdf>.
- California Energy Commission. 2015. *2016 Building Energy Efficiency Standards: Frequently Asked Questions*. http://www.energy.ca.gov/title24/2016standards/rulemaking/documents/2016_Building_Energy_Efficiency_Standards_FAQ.pdf.
- . 2020. *2020 Workshops and Meetings*. <https://ww2.energy.ca.gov/title24/2022standards/prerulemaking/documents/>.

- . 2020a. *CBECC-Com Nonresidential Compliance Software 2022*.
<http://bees.archenergy.com/software2022.html>.
 - . 2019. *CBECC-Com Nonresidential Compliance Software Resources*.
<http://bees.archenergy.com/resources.html>.
 - . 2022. "Energy Code Data for Measure Proposals." *energy.ca.gov*.
https://www.energy.ca.gov/title24/documents/2022_Energy_Code_Data_for_Measure_Proposals.xlsx.
- California Energy Commission. 2019. "Executive Director Determination Pursuant for Section 150.1 (c)SC."
<https://efiling.energy.ca.gov/GetDocument.aspx?tn=231318&DocumentContentId=63067> .
- . 2019. "Executive Director Determination Pursuant to Section 150.1 (c)SC." December. <http://efiling.energy.ca.gov/GetDocument.aspx?tn=231318>.
 - . 2019. "Housing and Commercial Construction Data - Excel."
https://ww2.energy.ca.gov/title24/documents/2022_Energy_Code_Data_for_Measure_Proposals.xlsx.
 - . 2018. "Impact Analysis: 2019 Update to the California Energy Efficiency Standards for Residential and Non-Residential Buildings." *energy.ca.gov*. June 29.
https://www.energy.ca.gov/title24/2019standards/post_adoption/documents/2019_Impact_Analysis_Final_Report_2018-06-29.pdf.
- California Public Utilities Commission (CPUC). 2015b. "Water/Energy Cost-Effectiveness Analysis: Revised Final Report." Prepared by Navigant Consulting, Inc. <http://www.cpuc.ca.gov/WorkArea/DownloadAsset.aspx?id=5360>.
- California Public Utilities Commission. 2015a. "Water/Energy Cost-Effectiveness Analysis: Errata to the Revised Final Report." Prepared by Navigant Consulting, Inc. . <http://www.cpuc.ca.gov/WorkArea/DownloadAsset.aspx?id=5350>.
- California Utilities Statewide Codes and Standards Team. 2011. "Multifamily Central DHW and Solar Water Heating." October.
- CEC. 2019. "2019 Integrated Energy Policy Report."
https://ww2.energy.ca.gov/2019_energypolicy/.
- CEC. 2019. "Nonresidential ACM Reference Manual." 52.
<https://ww2.energy.ca.gov/2019publications/CEC-400-2019-006/CEC-400-2019-006-CMF.pdf>.
- CFR 10 431 Subpart G. 2020. "Code of Federal Regulations Title 10." *Appendix E to Subpart G of Part 431—Uniform Test Method for the Measurement of Energy Efficiency of Commercial Heat Pump Water Heaters*. <https://www.ecfr.gov/cgi->

bin/text-
idx?SID=b98f928f0434c0366cf933bff0ef6bd3&mc=true&node=sp10.3.431.g&rgn
=div6#ap10.3.431_1110.e.

City of Berkeley . 2019. "Local Ordinance #xxxx." December.

Clean Energy and Pollution Reduction Act - SB 350. 2019. SB 350 (California Senate).
<https://www.energy.ca.gov/rules-and-regulations/energy-suppliers-reporting/clean-energy-and-pollution-reduction-act-sb-350>.

Code of Federal Regulations. 2020. "Electronic Code of Federal Regulations." *Code of Federal Regulations Title 10 CFR 430.32(d)*. https://www.ecfr.gov/cgi-bin/text-idx?SID=80dfa785ea350ebee184bb0ae03e7f0&mc=true&node=se10.3.430_132&rgn=div8.

Denkenberger, Dave, Chris Calwell, Apurva Pawashe, David Thomsen, Brian Spak, and Ecova Gary Fernstrom. 2014. *The Time is Ripe for Paying Attention to Clothes Drying Technology and Policy in Relation to Efficiency and Drying Time* . ACEEE.
<https://pdfs.semanticscholar.org/872d/2105fe2e547095780b094483be53e0dba604.pdf>.

Denkenberger, David, Serena Mau, Chris Calwell, and Eric Wanless . 2011. *Residential Clothes Dryers: A Closer Look at Energy Efficiency Test Procedures and Savings Opportunities*. Natural Resources Defense Council.
https://www.nrdc.org/sites/default/files/ene_14060901a.pdf.

Dymond, Christopher. 2018. *Heat Pump Clothes Dryers in the Pacific Northwest -- Abridged Field & Lab Study Report*. NEEA.
<https://neea.org/img/documents/Heat-Pump-Clothes-Dryers-in-the-Pacific-Northwest.pdf>.

E3 Rooftop Solar PV System Report. n.d.
<https://efiling.energy.ca.gov/getdocument.aspx?tn=221366>.

Ecotope. 2009. "Multifamily Billing Analysis: New Mid-Rise Buildings in Seattle." *Prepared for: City of Seattle Department of Planning & Development*. Ecotope.

Energy + Environmental Economics. 2016. "Time Dependent Valuation of Energy for Developing Building Efficiency Standards: 2019 Time Dependent Valuation (TDV) Data Sources and Inputs." Prepared for the California Energy Commission. July. http://docketpublic.energy.ca.gov/PublicDocuments/16-BSTD-06/TN212524_20160801T120224_2019_TDV_Methodology_Report_7222016.pdf.

Energy Star. n.d. "Clothes Dryers Key Product Criteria." Accessed September 22, 2019. https://www.energystar.gov/products/appliances/clothes_dryers/key_product_criteria.

Ettenson, Lara , and Christa Heavey. 2015. *California's Golden Energy Efficiency Opportunity: Ramping Up Success to Save Billions and Meet Climate Goals*. Natural Resources Defense Council & Environmental Entrepreneurs (E2).

Federal Reserve Economic Data. n.d. <https://fred.stlouisfed.org> .

Goldman, Charles, Merrian C. Fuller, Elizabeth Stuart, Jane S Peters, Marjorie McRay, Nathaniel Albers, Susan Lutzenhiser, and Mersiha Spahic. 2010. *Energy Efficiency Services Sector: Workforce Size and Expectations for Growth*. Lawrence Berkeley National Laboratory.

Kenney, Michael, Heather Bird, and Heriberto Rosales. 2019. *2019 California Energy Efficiency Action Plan*. Publication Number: CEC- 400-2019-010-CMF , California Energy Commission. Kenney, Michael, Heather Bird, and Heriberto Rosales. 2019. 2019 California Energy Efficiency Action Plan. California Energy Commission. Publication Number: CEC- 400-2019-010-CMF .

Livchak , Denis, Russell Hedrick , and Richard Young . 2019. *Residential Cooktop Performance and Energy Comparison Study*. Frontier Energy. <https://cao-94612.s3.amazonaws.com/documents/Induction-Range-Final-Report-July-2019.pdf>.

Multifamily DHW CASE Report . 2020. "Multifamily DHW CASE Report ."

Multifamily IAQ CASE Report. 2020. "Multifamily IAQ CASE Report." https://title24stakeholders.com/wp-content/uploads/2020/10/MF-IAQ_Final-CASE-Report_Statewide-CASE-Team_Final.pdf.

Multifamily Restructuring CASE Report. 2020. "Multifamily Restructuring CASE Report." <https://title24stakeholders.com/measures/cycle-2022/multifamily-chapter-restructuring/>.

National Energy Assistance Directors' Association. 2011. *2011 National Energy Assistance Survey Final Report*. <http://www.appriseinc.org/reports/Final%20NEADA%202011%20Report.pdf>.

National Renewable Energy Laboratory (NREL). Q1 2016. <https://www.nrel.gov/docs/fy16osti/66532.pdf>.

National Research Center Inc. 2002. *A National Study of Water & Energy Consumption in Multifamily Housing: In-Apartment Washers vs. Common Area Laundry Rooms*. National Research Center Inc. [2022 Title 24, Part 6 Final CASE Report – 2022-MF-DHW-F | 194](https://www.mla-online.com/pdf/NRC-</p></div><div data-bbox=)

- 2002-A-National-Study-of-Water-and-Energy-Consumption-in-Mutli-Family-Housing.pdf.
- NEEP. 2020. *Cold Climate Air Source Heat Pump Specification- Version 3.0*. NEEP. Accessed November 16, 2020. <https://neep.org/sites/default/files/ColdClimateAirSourceHeatPumpSpecification-Version3.0FINALMEMO.pdf>.
- Nieman, Bob. 2015. *Taking a New Route*. Planet Laundry. <https://planetlaundry.com/taking-a-new-route/>.
- NYSERDA. 2019. *New Efficiency: New York Analysis of Residential Heat Pump Potential and Economics*. NYSERDA. <https://www.nyserda.ny.gov/-/media/Files/Publications/PPSER/NYSERDA/18-44-HeatPump.pdf>.
- Pande, Abhijeet, and Dove Feng. 2019. "Multifamily All Electric Compliance Pathway." Sponsored Stakeholder Meeting Presentation.
- State of California, Employment Development Department. n.d. <https://www.labormarketinfo.edd.ca.gov/cgi/dataanalysis/areaselection.asp?tablename=industry> .
- Statewide CASE Team. 2020. "Nonresidential Grid Integration CASE Report." https://title24stakeholders.com/wp-content/uploads/2020/08/NR-Grid-Integration_Final-CASE-Report_Statewide-CASE-Team.pdf.
- Stone, Nehemiah, Jerry Nickelsburg, and William Yu. 2015. *Codes and Standards White Paper: Report - New Home Cost v. Price Study*. Pacific Gas and Electric Company. Accessed February 2, 2017. <http://docketpublic.energy.ca.gov/PublicDocuments/Migration-12-22-2015/Non-Regulatory/15-BSTD-01/TN%2075594%20April%202015%20Codes%20and%20Standards%20White%20Paper%20-%20Report%20-%20New%20Home%20Cost%20v%20Price%20Study.pdf>.
- Sweeney, Micah, Jeff Dols, Brian Fortenbery, and Frank Sharp. 2014. *Induction Cooking Technology Design and Assessment*. Electric Power Research Institute. <https://www.aceee.org/files/proceedings/2014/data/papers/9-702.pdf>.
- Team, Statewide Codes and Standards. 2020. "Domestic Hot Water CASE Report."
- Thornberg, Christopher, Hoyu Chong, and Adam Fowler. 2016. *California Green Innovation Index - 8th Edition*. Next 10.
- TRC. 2018. "Multifamily Market Analysis." http://title24stakeholders.com/wp-content/uploads/2018/09/PGE_MultifamilyMarketAnalysis_TRC_FinalReport_2018-05-18.pdf.

TRC. 2019. "Multifamily Prototypes."

U.S. Census Bureau, Population Division. 2014. "Annual Estimates of the Resident Population: April 1, 2010 to July 1, 2014."

<http://factfinder2.census.gov/bkmk/table/1.0/en/PEP/2014/PEPANNRES/0400000US06.05000>.

U.S. EPA (United States Environmental Protection Agency). 2011. "Emission Factors for Greenhouse Gas Inventories." Accessed December 2, 2013.

<http://www.epa.gov/climateleadership/documents/emission-factors.pdf>.

United States Environmental Protection Agency. 1995. "AP 42, Fifth Edition Compilation of Air Pollutant Emissions Factors, Volume 1: Stationary Point and Area Sources." <https://www.epa.gov/air-emissions-factors-and-quantification/ap-42-compilation-air-emissions-factors#5thed>.

United States Environmental Protection Agency. 2018. "Emissions & Generation Resource Integrated Database (eGRID) 2016."

<https://www.epa.gov/energy/emissions-generation-resource-integrated-database-egrid>.

Zabin, Carol, and Karen Chapple. 2011. *California Workforce Education & Training Needs Assessment: For Energy Efficiency, Distributed Generation, and Demand Reponse*. University of California, Berkeley Donald Vial Center on Employment in the Green Economy. Accessed February 3, 2017.

http://laborcenter.berkeley.edu/pdf/2011/WET_Appendices_ALL.pdf.

Appendix A. Statewide Savings Methodology

The Statewide CASE Team estimated statewide impacts for the first year by multiplying per-unit savings estimates by statewide construction forecasts that the Energy Commission provided (California Energy Commission 2019). The Statewide CASE Team made assumptions about the percentage of buildings in each climate zone that would be impacted by the proposed code change. Table 92 presents the number of dwelling units, both newly constructed and existing, that the Statewide CASE Team assumed would be impacted by the proposed code change during the first year the 2022 code is in effect.

Table 90 presents the prototypical buildings and weighting factors that the Energy Commission requested the Statewide CASE Team use for each Building Type ID in the Statewide Construction Forecast.

Table 90: Multifamily Building Types and Associated Prototype Weighting

Building Type ID from Statewide Construction Forecast	Building Prototype for Energy Modeling	Weighting Factors for Statewide Impacts Analysis (percent of total annual new construction of multifamily dwelling units)
Multifamily	2-Story Garden	4%
	3-Story Loaded Corridor	33%
	5-Story Mixed Use	58%
	10-Story Mixed Use	5%

For this CASE topic, the Statewide CASE Team further estimated a portion of the annual new construction by prototype that are relevant to the proposed code change. This includes multifamily buildings that would have used a mixed-fuel HVAC in absence of the proposed code change. 2019 Title 24, Part 6 already includes all-electric HVAC as the baseline if the proposed design is electric.

The Statewide CASE Team developed this estimate based on the percentage of existing high-performance multifamily buildings that are all-electric plus the growing movement statewide through local ordinances and reach codes to promote all-electric multifamily buildings starting in 2020. The Statewide CASE Team anticipates a more rapid adoption of all-electric buildings by 2023 as new Energy Commission and CPUC policies supporting building decarbonization take hold.

For the 5-story and 10-story prototypes, the proposed prescriptive requirements would impact 100 percent of the new buildings.

Table 91. New Construction HVAC Fuel Type

Building Prototype for Energy Modeling	Percent of Buildings All-Electric	Percent of Buildings Mixed Fuel
2-Story Garden	27%	73%
3-Story Loaded Corridor	25%	75%

For the statewide all-electric HVAC savings analysis, the weighting factors from Table 90 are multiplied by the percentage of buildings that are deemed mixed fuel in Table 91. Results are presented in Table 92.

Table 92: Estimated New Construction and Existing Building Stock for Multifamily Buildings by Climate Zone Impacted by SZHP Measure

Building Climate Zone	New Construction in 2023 (dwelling units)			Existing Building Stock in 2023 (dwelling units)		
	Total Dwelling Units Completed in 2023 [A]	Percent of New Dwelling Units Impacted by Proposal [B]	Dwelling Units Impacted by Proposal in 2023 C = A x B	Total Existing Dwelling Units in 2023 [D]	Percent of New Dwelling Units Impacted by Proposal [E]	Dwelling Units Impacted by Proposal in 2023 F = D x E
1	265	91%	240	17,126	0%	0
2	1,573	91%	1,426	101,721	0%	0
3	7,630	91%	6,918	530,089	0%	0
4	3,975	91%	3,604	278,535	0%	0
5	706	91%	640	44,816	0%	0
6	3,370	91%	3,056	315,784	0%	0
7	3,623	91%	3,285	291,804	0%	0
8	4,738	91%	4,296	489,337	0%	0
9	11,124	91%	10,086	1,086,699	0%	0
10	3,930	91%	3,563	316,384	0%	0
11	1,122	91%	1,017	81,820	0%	0
12	6,335	91%	5,744	455,265	0%	0
13	1,849	91%	1,676	154,048	0%	0
14	840	91%	762	79,142	0%	0
15	547	91%	496	40,033	0%	0
16	339	15%	52	27,505	0%	0
TOTAL	51,966		46,862	4,310,108		0

The Statewide CASE Team used project data from energy consultants and from the HERS registry to determine the fraction of dwelling units served by central water heating for each prototype. The project data showed individual buildings, number of stories, number of dwelling units, and DHW configuration (central or individual). The Statewide CASE Team associated each building in the dataset with prototypes based on the

number of stories. Table 93 shows the number of stories associated with each prototype, as well as the number of buildings and dwelling units represented in the data for each prototype.

Table 93: Classification of Project Data into CASE Prototypes by Number of Stories

Prototype	Number of Stories	Number of Buildings Represented	Number of Dwelling Units Represented
2-Story Garden Style	1-2	474	4,720
3-Story Loaded Corridor	3	404	7,882
5-Story Mixed Use	4-6	56	4,296
10-Story Mixed Use	7+	20	3,125

The Statewide CASE Team totaled the number of dwelling units with central water heating and individual water heating from both the energy consultant data and the HERS Registry data. The Statewide CASE Team used the resulting fraction of the dwelling units with central water heating as the fraction of all newly constructed multifamily dwelling units with central water heating in each climate zone. Table 94 shows the results of this analysis.

Table 94: Central versus Individual Water Heating by Prototype

Prototype	Individual Water Heating	Central Water Heating
2-Story Garden Style	63%	37%
3-Story Loaded Corridor	51%	49%
5-Story Mixed Use	3%	97%
10-Story Mixed Use	0%	100%

The Statewide CASE Team further estimated that 25 percent of the central water heating system would use electricity as heating source. The Statewide CASE Team acknowledged that all-electric central DHW represents a growing but small proportion of the overall new construction market. Accounting for the growing movement statewide through local ordinances and reach codes to promote all-electric DHW design for multifamily buildings starting in 2020, the Statewide CASE Team anticipates a more rapid adoption of central HPWH design by 2023 as new Energy Commission and CPUC policies supporting building decarbonization are implemented. The Statewide CASE Team used these assumptions to estimate the percent of buildings with central HPWH systems as shown in Table 95.

Table 95. New Construction Impacts by Fuel Type for Central HPWH Measure

Building Prototype for Energy Modeling	Percent of Buildings with Central HPWH System	Percent of Buildings Mixed Fuel or Individual HPWH System
2-Story Garden Style	9%	91%
3-Story Loaded Corridor	12%	88%
5-Story Mixed Use	24%	76%
10-Story Mixed Use	25%	75%

For the statewide central HPWH savings analysis, the weighting factors from Table 90 are multiplied by the percentage of buildings that are deemed Central HPWH in Table 95. Results are presented in Table 96.

Table 96: Estimated New Construction and Existing Building Stock for Multifamily Buildings by Climate Zone Impacted by Central HPWH Measure

Building Climate Zone	New Construction in 2023 (dwelling units)			Existing Building Stock in 2023 (dwelling units)		
	Total Dwelling Units Completed in 2023 [A]	Percent of New Dwelling Units Impacted by Proposal [B]	Dwelling Units Impacted by Proposal in 2023 $C = A \times B$	Total Existing Dwelling Units in 2023 [D]	Percent of New Dwelling Units Impacted by Proposal [E]	Dwelling Units Impacted by Proposal in 2023 $F = D \times E$
1	265	20%	52	17,126	0%	0
2	1,573	20%	310	101,721	0%	0
3	7,630	20%	1505	530,089	0%	0
4	3,975	20%	784	278,535	0%	0
5	706	20%	139	44,816	0%	0
6	3,370	20%	665	315,784	0%	0
7	3,623	20%	715	291,804	0%	0
8	4,738	20%	935	489,337	0%	0
9	11,124	20%	2194	1,086,699	0%	0
10	3,930	20%	775	316,384	0%	0
11	1,122	20%	221	81,820	0%	0
12	6,335	20%	1250	455,265	0%	0
13	1,849	20%	365	154,048	0%	0
14	840	20%	166	79,142	0%	0
15	547	20%	108	40,033	0%	0
16	339	20%	67	27,505	0%	0
TOTAL	51,966	20%	10,252	4,310,108	0%	0

Appendix B. Embedded Electricity in Water Methodology

There are no on-site water savings associated with the proposed code change.

Appendix C. Environmental Impacts Methodology

Greenhouse Gas (GHG) Emissions Factors

As directed by Energy Commission staff, GHG emissions were calculated making use of the average emissions factors specified in the United States Environmental Protection Agency (U.S. EPA) Emissions & Generation Resource Integrated Database (eGRID) for the Western Electricity Coordination Council California (WECC CAMX) subregion (United States Environmental Protection Agency 2018). This ensures consistency between state and federal estimations of potential environmental impacts. The electricity emissions factor calculated from the eGRID data is 240.4 metric tons CO₂e per GWh. The Summary Table from eGrid 2016 reports an average emission rate of 529.9 pounds CO₂e/MWh for the WECC CAMX subregion. When the eGRID value is converted to units of metric tons/GWh this results in an electricity emissions factor of 240.4 metric tons CO₂e per GWh.

Avoided GHG emissions from natural gas savings attributable to sources other than utility-scale electrical power generation are calculated using emissions factors specified in Chapter 1.4 of the U.S. EPA's Compilation of Air Pollutant Emissions Factors (AP-42) (United States Environmental Protection Agency 1995). The U.S. EPA's estimates of GHG pollutants that are emitted during combustion of one million standard cubic feet of natural gas are: 120,000 pounds of CO₂ (Carbon Dioxide), 0.64 pounds of N₂O (Nitrous Oxide) and 2.3 pounds of CH₄ (Methane). The emission value for N₂O assumed that low NO_x burners are used in accordance with California air pollution control requirements. The carbon equivalent values of N₂O and CH₄ were calculated by multiplying by the global warming potentials (GWP) that the California Air Resources Board used for the 2000-2016 GHG emission inventory, which are consistent with the 100-year GWPs that the Intergovernmental Panel on Climate Change used in the fourth assessment report (AR4). The GWP for N₂O and CH₄ are 298 and 25, respectively. Using a nominal value of 1,000 Btu per standard cubic foot of natural gas, the carbon equivalent emission factor for natural gas consumption is 5,454.4 metric tons per MMTherms.

GHG Emissions Monetization Methodology

The 2022 TDV energy cost factors used in the lifecycle cost-effectiveness analysis include the monetary value of avoided GHG emissions based on a proxy for permit costs (not social costs). To demonstrate the cost savings of avoided GHG emissions, the Statewide CASE Team disaggregated the value of avoided GHG emissions from the other economic impacts. The authors used the same monetary values that are used in the TDV factors – \$106/MTCO₂e.

Water Use and Water Quality Impacts Methodology

There are no impacts to water quality or water use.

Appendix D. California Building Energy Code Compliance (CBECC) Software Specification

The purpose of this appendix is to present proposed revisions to CBECC for residential/commercial buildings (CBECC-Res/Com) along with the supporting documentation that the Energy Commission staff, and the technical support contractors would need to approve and implement the software revisions.

Technical Basis for Software Change

Central HPWH systems, a DHW system utilizing HPWH with a recirculation distribution system is critical to the electrification of multifamily buildings. Laboratory tests to map HPWH performance and energy impacts coupled with various recirculation system configurations are ongoing. The new prescriptive criteria for central HPWH systems established in this Final CASE Report and the newly available laboratory test results provide the basis for which central HPWH should be designed, and outline the key variables needed to simulate the performance of these systems in energy modeling software.

Description of Software Change

Background Information for Software Change

The proposed central HPWH software changes would apply to the DHW module used for multifamily buildings with central DHW systems across all climate zones.

Existing CBECC-Res Modeling Capabilities

CBECC-Res can currently model select HPWH models and a recirculation system independently; it has no capabilities to couple HPWH with a DHW recirculation system. Figure 21 shows the schematics of the system that can be modeled in CBECC-Res 2022.0.2RV (1136).

The compliance software already has the following features:

- HPWH model: Sanden SANCO₂
- Ability to let user specify the number of HPWH compressor
- Recirculation system: A recirculation loop tank that decouple the recirculation system from the primary HPWH loop
- Ability to let user specify loop tank and primary tank volume

The current software is inadequate because functionality and system performance are highly dependent on performance of the HPWH product, HPWH configurations and

controls, distribution design variables, and storage tank stratification strategies and pipe plumbing configurations.

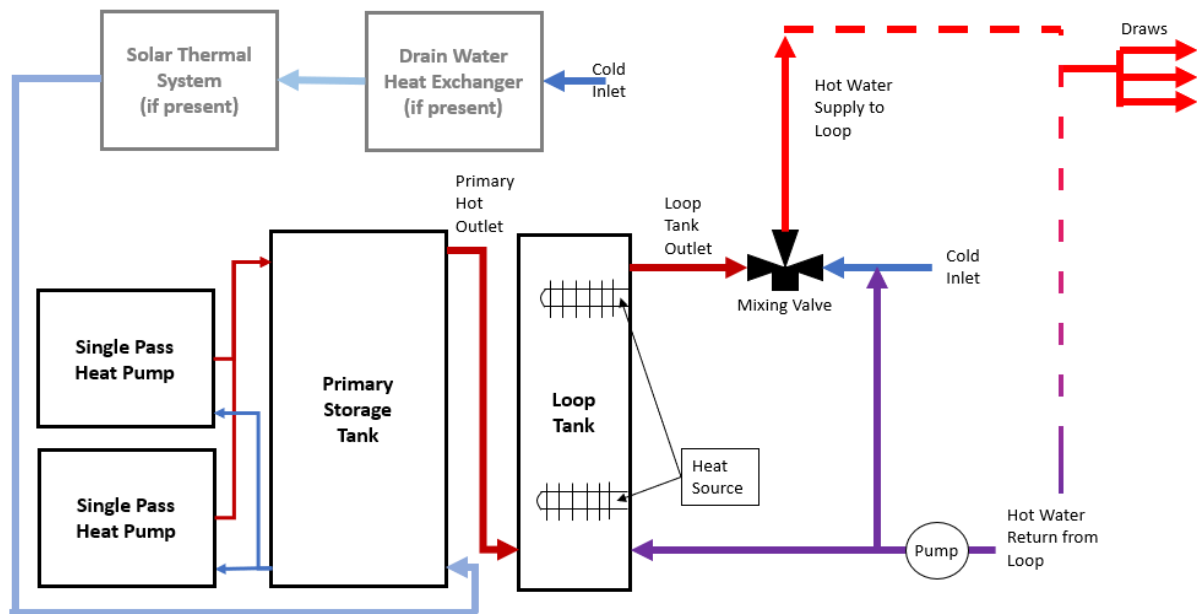

Figure 21: HPWH Configurations in CBECC-Res (2022.0.2 RV 1136).

Source: CBECC-Res Development Team.

Summary of Proposed Revisions to CBECC-Res

Modeling features to be added to CBECC-Res include:

- Capability to model different HPWH models: single-pass and multi-pass models
- Compressor capacity
- Capability to model auxiliary heating mechanism
- Primary storage tank features
 - Storage volume
 - Plumbing configuration if there are multiple tanks: in parallel and in series
 - Insulation of storage tank and pad
- Recirculation loop tank features
 - Performance difference with and without recirculation loop tank
 - Type: passive (no heating mechanism), electric resistance, multi-pass heat pump and gas heater
 - Recirculation tank piped in series and in parallel with primary tanks

- Storage volume and heating capacity
- Insulation of storage tank and pad
- Recirculation loss: designer input, can be used for recirculation loop tank sizing
- Controls
 - Primary storage tank setpoint
 - Recirculation loop tank setpoint
 - Defrost capability:
 - Different types of defrost hot gas bypass, electric resistance, etc.
 - Manufacturer's specified compressor cutoff temperature

This report describes central HPWH systems features to be implemented in CBECC-Res. Since CBECC-Com uses CBECC-Res to simulate residential DHW system, the changes to CBECC-Res would directly be applied to CBECC-Com.

Appendix E. Impacts of Compliance Process on Market Actors

This appendix discusses how the recommended compliance process, which is described in Section 2.5, could impact various market actors. Table 97 identifies the market actors who would play a role in complying with the proposed change, the tasks for which they would be responsible, their objectives in completing the tasks, how the proposed code change could impact their existing workflow, and ways negative impacts could be mitigated. The information contained in Table 97 is a summary of key feedback the Statewide CASE Team received when speaking to market actors about the compliance implications of the proposed code changes. Appendix F summarizes the stakeholder engagement that the Statewide CASE Team conducted when developing and refining the code change proposal, including gathering information on the compliance process.

Compliance process for all-electric HVAC and central HPWH systems general fits within the current workflow of market actors involved with elevated efforts in a number of ways. The proposed compliance, particularly the HPWH system process, requires a higher degree of design engineer and energy consultant coordination during design phase, closer contractor adherence to the design details during installation, and continued oversight from design engineers throughout and after installation.

Particularly for the design engineers, designing and sizing for the central HPWH and associated recirculation plumbing configuration is not yet common practice. The prescriptive compliance path requires design engineers to document design conditions and provide calculations beyond what current compliance process would for a gas-fired water heating system. Both design engineers and energy consultants would climb the learning curve in terms of modeling the systems in the compliance software.

The required field verification require new knowledge and skill sets for HER Rater/ATT personnel.

The compliance process would require updates to the existing sets of certificates of installation and verifications. The most departure from existing compliance document comes from adding to an existing Certificate of Compliance for design engineers to record system parameters and calculations in greater detail than before.

Table 97: Roles of Market Actors in the Proposed Compliance Process

Market Actor	Task(s) In Compliance Process	Objective(s) in Completing Compliance Tasks	How Proposed Code Change Could Impact Workflow	Opportunities to Minimize Negative Impacts of Compliance Requirement
Plumbing Designer	<ul style="list-style-type: none"> • Performs equipment sizing and system design to confirm compliance • Coordinates design with other team members, including energy consultant • Completes compliance document for permit application 	<ul style="list-style-type: none"> • Ensures equipment and system design meets hot water loads • Streamlined coordination with team members • Demonstrates compliance with system characteristics and calculations • Quickly completes compliance documents 	<ul style="list-style-type: none"> • Would need to document calculations in further detail • Would need elevated coordination with team members • Would need to manage and submit compliance form for prescriptive path 	<ul style="list-style-type: none"> • Revise compliance forms to automate data field QC/check for compliance with standards • Modeling software would queue applicable compliance forms to simplify process for performance path • Software model training may help with team collaboration
Energy Consultant	<ul style="list-style-type: none"> • Performs compliance modeling and coordinates with team members, including designers • Completes compliance document for permit application 	<ul style="list-style-type: none"> • Streamlined coordination with team members • Quickly completes compliance documents 	<ul style="list-style-type: none"> • Would work with designer to iterate on system designs for compliance purposes • Would need to manage and submit compliance forms for performance path 	<ul style="list-style-type: none"> • Revise compliance forms to automate data field QC/check for compliance with standards • Modeling software would queue applicable compliance forms to simplify process for performance path • Software model training helps accurate use of features and accelerate learning curve
Energy Commission	NA	NA	NA	<ul style="list-style-type: none"> • Incorporate and update HERS verification scope and procedure in compliance forms. • Determine and support HERS or ATT infrastructure needs for compliance data hosting and maintenance
Plans Examiner	<ul style="list-style-type: none"> • Identifies relevant requirements • Confirms plans/specifications 	<ul style="list-style-type: none"> • Quickly determines requirements based on project scope 	<ul style="list-style-type: none"> • Would need to verify new data fields and calculations are compliant 	<ul style="list-style-type: none"> • Revise compliance forms to automate data field QC/check for compliance with standards

Market Actor	Task(s) In Compliance Process	Objective(s) in Completing Compliance Tasks	How Proposed Code Change Could Impact Workflow	Opportunities to Minimize Negative Impacts of Compliance Requirement
	match data on documents <ul style="list-style-type: none"> • Confirms data on documents are compliant • Provides correction comments if necessary 	<ul style="list-style-type: none"> • Easily locates and checks plans against submitted documents • Provides comments that will resolve issues 	<ul style="list-style-type: none"> • Would need to verify calculations match plans 	<ul style="list-style-type: none"> • Modeling software would queue applicable compliance forms to simplify process
Contractor/ Installer	<ul style="list-style-type: none"> • Performs installation as design drawings dictate for both HPWH and recirculation plumbing • Populates and signs the Certificate of Installations 	<ul style="list-style-type: none"> • Quickly install the system as designed • Smooth completion and satisfactory submission of compliance forms 	Would need to self-certify system installations meet design plans and code requirements	Technology training to increase understanding and familiarity and enhance compliance performance
HERS Rater/ ATT	<ul style="list-style-type: none"> • Performs field verification • Populates and signs the Certificate of Verification 	<ul style="list-style-type: none"> • Accurately and efficiently perform visual verification • Smooth completion and submission of compliance forms 	NA	HERS Rater/ATT training to increase understanding and familiarity with verification protocols

Appendix F. Summary of Stakeholder Engagement

Collaborating with stakeholders that might be impacted by proposed changes is a critical aspect of the Statewide CASE Team's efforts. The Statewide CASE Team aims to work with interested parties to identify and address issues associated with the proposed code changes so that the proposals presented to the Energy Commission in this Final CASE Report are generally supported. Public stakeholders provide valuable feedback on draft analyses and help identify and address challenges to adoption including cost effectiveness; market barriers; technical barriers; compliance and enforcement challenges; or potential impacts on human health or the environment. Some stakeholders also provide data that the Statewide CASE Team uses to support analyses.

This appendix summarizes the stakeholder engagement that the Statewide CASE Team conducted when developing and refining the recommendations presented in this report.

Utility-Sponsored Stakeholder Meetings

Utility-sponsored stakeholder meetings provide an opportunity to learn about the Statewide CASE Team's role in the advocacy effort and to hear about specific code change proposals that the Statewide CASE Team is pursuing for the 2022 Title 24, Part 6 code cycle. The goal of stakeholder meetings is to solicit input on proposals from stakeholders early enough to ensure the proposals and the supporting analyses are vetted and have as few outstanding issues as possible. To provide transparency in what the Statewide CASE Team is considering for code change proposals, during these meetings the Statewide CASE Team asks for feedback on:

- Proposed code changes
- Draft code language
- Draft assumptions and results for analyses
- Data to support assumptions
- Compliance and enforcement, and
- Technical and market feasibility

The Statewide CASE Team hosted two stakeholder meetings for this CASE topic via webinar. Please see below for dates and links to event pages on [Title24Stakeholders.com](https://www.title24stakeholders.com). Materials from each meeting. Such as slide presentations, proposal summaries with code language, and meeting notes, are included in the bibliography section of this report.

Table 98: Stakeholder Meetings Hosted for Multifamily All-Electric CASE Topic

Meeting Name	Meeting Date	Event Page from Title24stakeholders.com
Grid Integration Utility-Sponsored Stakeholder Meeting	Tuesday, September 10, 2019	https://title24stakeholders.com/event/grid-integration-utility-sponsored-stakeholder-meeting/
Water Heating and Multifamily All Electric Package Utility-Sponsored Stakeholder Meeting	Tuesday, March 17, 2020	https://title24stakeholders.com/event/water-heating-and-multifamily-all-electric-package/

The first round of utility-sponsored stakeholder meetings occurred from September to November 2019 and were important for providing transparency and an early forum for stakeholders to offer feedback on measures being pursued by the Statewide CASE Team. The objectives of the first round of stakeholder meetings were to solicit input on the scope of the 2022 code cycle proposals; request data and feedback on the specific approaches, assumptions, and methodologies for the energy impacts and cost-effectiveness analyses; and understand potential technical and market barriers. The Statewide CASE Team also presented initial draft code language for stakeholders to review.

The second round of utility-sponsored stakeholder meetings occurred from March to May 2020 and provided updated details on proposed code changes. The second round of meetings introduced early results of energy, cost effectiveness, and incremental cost analyses, and solicited feedback on refined draft code language.

Utility-sponsored stakeholder meetings were open to the public. For each stakeholder meeting, two promotional emails were distributed from info@title24stakeholders.com. One email was sent to the entire Title 24 Stakeholders listserv, totaling over 1,900 individuals, and a second email was sent to a targeted list of individuals on the listserv depending on their subscription preferences. The Title 24 Stakeholders' website listserv is an opt-in service and includes individuals from a wide variety of industries and trades, including manufacturers, advocacy groups, local government, and building and energy professionals. Each meeting was posted on the Title 24 Stakeholders' LinkedIn page¹² (and cross-promoted on the Energy Commission LinkedIn page) two weeks before each meeting to reach out to individuals and larger organizations and channels outside of the listserv. The Statewide CASE Team conducted extensive personal outreach to stakeholders identified in initial work plans who had not yet opted into the listserv. Exported webinar meeting data captured attendance numbers and individual comments, and recorded outcomes of live attendee polls to evaluate stakeholder participation and support.

¹² Title 24 Stakeholders' LinkedIn page can be found here: <https://www.linkedin.com/showcase/title-24-stakeholders/>.

Statewide CASE Team Communications

The Statewide CASE Team held personal communications over email and phone with numerous stakeholders shown in Table 99 when developing this report.

Table 99: Stakeholder List

Organization	Person	Role
A.O. Smith Water Heaters	Bill Hosken	Manufacturer
Alter Consulting Engineers	Stefan Gracik	Engineer/Designer
Beyond Efficiency	Dan Johnson	Engineer/Designer
Build It Green (now Franklin Energy)	Amy Dryden	Consultant
Building Decarbonization Coalition	Panama Bartholomy	Efficiency Advocate
California Energy Commission	Payam Bozorgchami	Regulatory Agency
City of Berkeley	Billi Romain	Efficiency Advocate
City of Berkeley	Sarah Moore	Efficiency Advocate
City of San Jose	Ken Davies	Efficiency Advocate
Colmac	Evan Green	Manufacturer
EHDD Architecture	Scott Shell	Architect
Gabel Energy	Jim Hurley	Consultant
Gabel Energy	Marina Chavez-Blanco	Consultant
Gabel Energy	Gina Rodda	Consultant
Gary Klein and Associates	Gary Klein	Consultant
Guttman & Blaevoet Consulting Engineers	Steve Guttman	Engineer/Designer
Guttman & Blaevoet Consulting Engineers	Jeff Blaevoet	Engineer/Designer
Guttman Blaevoet	Ted Tiffany	Engineer/Designer
Hot Water Research	Jim Lutz	Consultant
Innovation Network for Communities	Jenna Tatum	Efficiency Advocate
Interface Engineering	Inna Dolottseva	Engineer/Designer
Interface Engineering, Inc	Hormoz Janssens	Engineer/Designer
Interface Engineering, Inc	Steve Gross	Engineer/Designer
Mithun	Hilary Noll	Engineer/Designer
Mithun	Sandy Mendler	Engineer/Designer
Mitsubishi Electric	Bruce Severance	Manufacturer
Mitsubishi Electric	Cain White	Manufacturer
Mitsubishi Electric	Sam Beeson	Manufacturer
Natural Resource Defense Council	Meg Waltner	Efficiency Advocate
Natural Resource Defense Council	Pierre Delforge	Efficiency Advocate
Nyle	Ryan Hamilton	Manufacturer
Nyle	Jacob Bucklin	Manufacturer
PG&E	Mary Anderson	Participating C&S Utility
Rocky Mountain Institute	Michael Gartman	Researcher
SAC Software Solutions	Scott Criswell	Engineer/Designer

Organization	Person	Role
San Francisco Department of Environment	Barry Hooper	Efficiency Advocate
Sanden	John Miles	Manufacturer
Smith Group	Stet Sanborn	Engineer/Designer

Many stakeholders have actively contributed to this CASE report and are part of the Statewide CASE Team.

Table 100: Statewide CASE Team Internal Subject Matter Experts

Organization	Person	Role
AEA	Nick Young	Engineer/Designer
Bruce Wilcox	Bruce Wilcox	Consultant
ECOTOPE	Shawn Oram	Engineer/Designer
ECOTOPE	Colin Grist	Engineer/Designer
Larson Energy Research	Ben Larson	Consultant
Redwood Energy	Sean Armstrong	Engineer/Designer

All-Electric Design Strategy Interviews and Projects Data Collection

The Statewide CASE Team conducted interviews with eight multifamily designers to garner feedback on 1) common all-electric solutions for multifamily new-construction buildings, 2) drivers and decision-making process for all-electric projects, 3) design challenges and lessons learned. Lessons learned from the interview are summarized in Section 3 Market Analysis

The stakeholder outreach involving design team professionals resulted in promising signs for the state of all-electric multifamily design and construction in California. Industry professionals shared project information to support all-electric market assessment. Project data sources included Association for Energy Affordability (AEA), Frontier Energy, Redwood Energy, EHDD, Gabel Energy, Build it Green (Franklin Energy), Mithun.

HPWH Manufacturer Market Outlook and Barrier Survey

HPWH Manufacturers who provided verbal and written responses to the survey on market outlook and barriers include representatives from A.O Smith, Aermec, Rheem, Sanden, Colmac, Nyle, Mayekawa, State and Mitsubishi.

Central HPWH Real-world Cost Data Information

The Statewide CASE Team contacted experienced general contractors for central HPWH project installation cost. The goal was to establish a knowledge base for multifamily developments using heat pump water heaters, including purchase costs, a range of final installed costs, the methodology used by contractors to determine costs, and the design

and installation best practices necessary to minimize costs in a variety of applications. This research confirms that the central HPWH market is relatively small now and there is a wide cost range due to differences in buildings, regional labor pricing and mark-up.

HPWH Manufacturer Code Proposal Feedback

The Statewide CASE Team interviewed manufacturers to review proposed code requirements and implications for product development, understand current HPWH market and manufacturer's plan to meet market demand, understand manufacturer's role in design practice. Manufacturers interviewed include representatives from Sanden, Colmac, Nyle and Mitsubishi. Interview questions are included in Appendix J.

Stakeholder Review of Basis of Design and Cost Assumptions

The Statewide CASE Team held a meeting with industry experts to review Basis of Design (BOD) used in the CASE analysis and discuss cost assumptions presented in Section 5.3.2. Stakeholders agreed with the BOD and cost assumptions.

Stakeholder Docketed Comments Supporting All-Electric Code

Stakeholders have submitted comments to support adoption of an all-electric code in the 2022 Title 24, Part 6 code, including:

- 350 Bay Area
- A.O. Smith
- Alter Consulting Engineers
- American Institute of Architects
- Ashley McClure (Individual, primary care physician and medical community climate organizer)
- Bay Area Air Quality Management District
- City of Menlo Park
- City of Hayward
- City of Santa Barbara
- NRDC
- Rocky Mountain Institute
- San Francisco Electrical Contractors Association (SFECA)
- SERA Architects
- Sierra Club – 35 California elected officials
- Sierra Club – 81 Environmental organizations
- Southern California Edison
- Stephanie Ellis (individual)
- Sunrun
- Tom Kabat (Individual)
- Undersigned Organizations Env and Climate Justice

Appendix G. Central HPWH Basis of Design for the Cost-Effectiveness Analysis

This appendix describes the basis of design for the central gas DHW system and the proposed central HPWH system for the four prototype buildings.

- a. The *Low-Rise Garden Style* is a two-story, 8-unit building with 2 one-bedroom and 2 two-bedroom dwelling units. The total conditioned floor area of the building is 7,320 square feet.
- b. The *Low-Rise Loaded Corridor* is a three-story, 36-unit building with dwelling unit entry off an interior corridor, common laundry, gym, and business center. The prototype has 6 studio, 12 one-bedroom, 12 two-bedroom, and 6 three-bedroom dwelling units. The total conditioned floor area of the building is 39,372 square feet.
- c. The *Mid-Rise Mixed-Use* is a five-story, 88-unit building with one story of retail and common spaces under four stories of residential space. The prototype has 8 studios, 40 one-bedroom, 32 two-bedroom, and 8 three-bedroom dwelling units. The total conditioned floor area of the building is 113,700 square feet.
- d. The *High-Rise Mixed-Use* is a 10-story, 117-unit building with one story of retail and common space under nine stories of residential space. The prototype has 18 studios, 54 one-bedroom, and 45 two-bedroom dwelling units. The total conditioned floor area of the building is 125,400 square feet.

Sizing Criteria

The basis of design uses the following assumptions:

1. On average, the studio units have 1 occupant, the one-bedroom units have 1.5 occupants, the two-bedroom units have 2.5 occupants, and the three-bedroom units have 3.5 occupants.
2. The gas water heating plant is sized per the federal minimum efficiency and performance requirement in ASHRAE Standard 90.1 (Table 6.8.1 - Minimum Efficiency Requirement Listed Equipment - Standard Rating and Operating Conditions 2019).
3. The gas boiler central heat plant also includes an auxiliary rooftop solar thermal water preheating system as required in the Residential Compliance Manual (California Energy Commission 2016). The thermal collectors are flat plate design and glazed.
4. The heat pump central heat plants do not include a rooftop solar thermal system.
5. The average maximum hot water demand is 22 gallons per person per day delivered at 120°F at the fixtures. This hot water demand assumption is based on practical experience and is between the low and medium guidelines in the ASHRAE HVAC

Applications Handbook, Chapter 50 Service Water Heating (Table 7 - Hot Water Demand and Use Guidelines for Apartment Buildings 2019).

Standard Design Gas Boiler System Sizing and Equipment Selection

The gas boiler system with its associated solar thermal water heating system is shown in Figure 22.

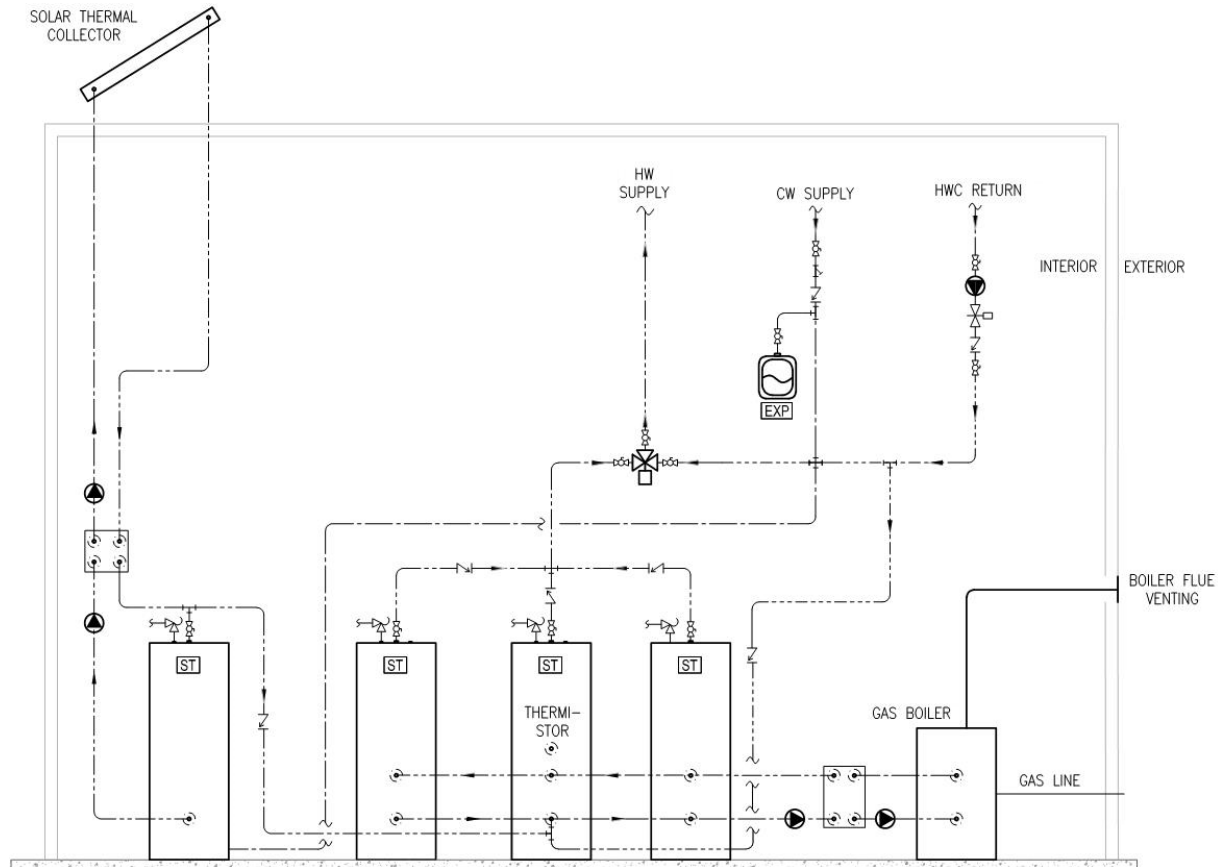

Figure 22: Gas boiler system.

Source: Statewide CASE Team

The capacity requirements for gas boiler system are shown in Table 101.

Table 101: Capacity Requirements for Fossil Gas Boiler System

Building	System Power Requirement (kBtu/hr)	Hot Water Storage Requirement (Gallon)
Low-Rise Garden Style	41.8	92
Low-Rise Loaded Corridor	130.7	246
Mid-Rise Mixed-Use	306.8	578
High-Rise Mixed-Use	369.5	697

The solar thermal water preheating system is used to offset a fraction of the total heat plant capacity, known as the Solar Savings Fraction (SSF). The SSF offset is only applied to the heat plant itself.

Solar thermal collector data was gathered from the list of glazed flat plate collectors in the ICC-SRCC’s OG-100 Certified Solar Thermal Collector Directory (Solar Rating & Certification Corporation 2019). A median panel size of 27.02 ft² and median solar radiation potential of 1.03 kBtu/ft²/day was calculated from the list of 219 certified products.

To find the solar radiation potential specific to San Francisco (CZ3) representing CZ01-09 and Sacramento (CZ12) representing CZ 10-16, the Statewide CASE Team used NREL’s PVWatts tool (National Renewable Energy Laboratory 2019). The Statewide CASE Team normalized the annual energy output of a nominal one kW solar photovoltaic system and converted it to an equivalent energy output of a solar thermal water heating system in the same location.

The number of solar thermal collector plates required to offset 20 percent (for San Francisco) and 35 percent (for Sacramento) of the total heat plant energy production is shown in Table 102 and Table 103 for sites in San Francisco and Sacramento, respectively.

Table 102: Solar Thermal Energy Offset for San Francisco

Building	Heat Plant Total Energy Solar Thermal Production (kWh/Yr)	SSF	Energy Offset (kWh/yr)	Solar thermal collectors
Low-Rise Garden Style	32,838	0.20	6,568	3
Low-Rise Loaded Corridor	102,620	0.20	20,524	8
Mid-Rise Mixed-Use	240,815	0.20	48,163	19
High-Rise Mixed-Use	289,388	0.20	57,878	23

Table 103: Solar Thermal Energy Offset for Sacramento

Building	Heat Plant Total Energy Solar Thermal Production (kWh/Yr)	SSF	Energy Offset (kWh/yr)	Solar thermal collectors
Low-Rise Garden Style	32,838	0.35	11,493	5
Low-Rise Loaded Corridor	102,620	0.35	35,917	15
Mid-Rise Mixed-Use	240,815	0.35	84,285	34
High-Rise Mixed-Use	289,388	0.35	101,286	41

The equipment selected for use in the gas boiler system are show in Table 104 through Table 107.

Table 104: Gas Boiler

Building	Product	Qty	Input Power (kBtu/hr)	Net IBR (kBtu/hr)	AFUE
Low-Rise Garden Style	Bosch Buderus GC144/3	1	74.0	54.0	85%
Low-Rise Loaded Corridor	Bosch Buderus GC144/4	2	103.0	76.0	85%
Mid-Rise Mixed-Use	Bosch Buderus G234X/38	3	160.0	113.0	84.3%
High-Rise Mixed-Use	Bosch Buderus G234X/45	3	187.0	134.0	84.3%

Table 105: Primary Hot Water Storage Tank

Building Capacity	Product	Qty	Capacity (gallons)	Total (gallons)
Low-Rise Garden Style	Niles S-24-062-TC	1	119	119
Low-Rise Loaded Corridor	Niles S-24-062-TC	2	119	238
Mid-Rise Mixed-Use	Niles S-28-079-TC	3	200	600
High-Rise Mixed-Use	Niles S-28-079-TC	4	200	800

Table 106: Solar Thermal Pre-Heat Water Storage Tank

Building Capacity	Product	Qty	Capacity (gallons)	Total (gallons)
Low-Rise Loaded Corridor	Niles S-24-062-TC	1	119	119
Mid-Rise Mixed-Use	Niles S-30-099-TC	1	280	280
High-Rise Mixed-Use	Niles S-28-079-TC	2	200	400

Table 107: Additional Appurtenances

Category	Equipment
Utility Connection	Gas piping from utility point of connection to building meter, gas meter, pressure relief valve, earthquake valve, utility hookup fees, electrical circuit for boiler controls
Heat Exchanger	Double wall heat exchanger between boiler and potable water
Pumps	Cast iron and stainless steel for potable water (qty 2)
Controls	Staging controller and backup heat controller on boiler; Boiler equipment protection controls (e.g., condensation prevention when incoming water is greater than 140°F); Differential controller for electronic mixing valve on solar thermal system
Piping	Piping for boiler flue is double wall type B vent construction, ensure 1-inch clearance to combustibles (for exhaust only); Piping between storage tank and heat exchanger and heat exchanger to solar collector is copper, insulation thickness equivalent to pipe diameter, R-16 jacket with R-10 pad, earthquake strapping, outdoor piping in colder climates has freeze protection with propylene glycol
Valves	Electronic mixing valve with tight control for primary hot water storage and solar thermal system; Automatic air venting valve that vents to high point of solar thermal system; Miscellaneous check valves, service valves, air-eliminator valves
Tanks	Expansion tank for hot water storage
Meters	Make-up water meter to understand if a leak has occurred

Proposed Design Single-Pass Heat Pump System Sizing and Equipment Selection

The single-pass heat pump plant design for the Low-Rise Garden Style and Low-Rise Loaded Corridor buildings is shown in Figure 23. This design corresponds to test profile A10 being performed concurrently by the PG&E ATS laboratory.

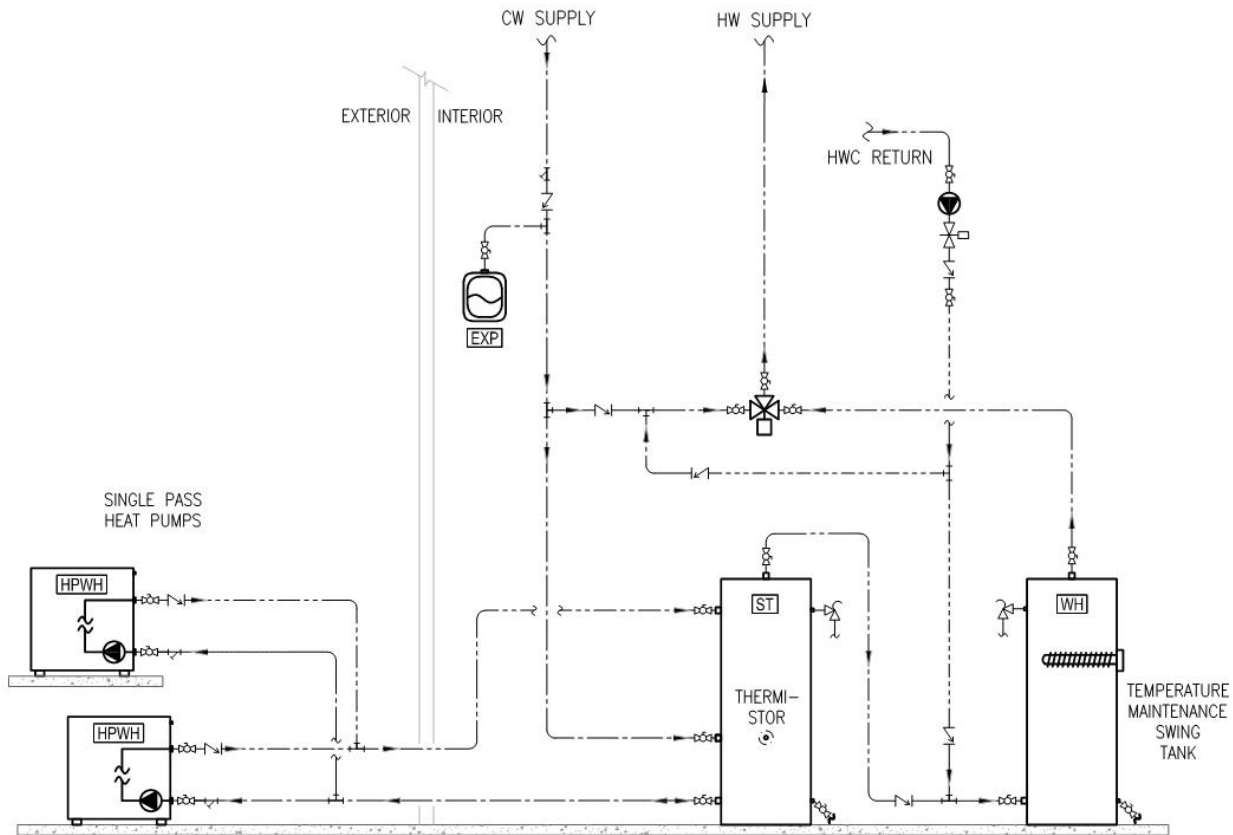

Figure 23: Single-pass heat pump system (2-story garden style and 3-story loaded corridor).

Source: Statewide CASE Team

The single-pass heat pump plant design for the mid-rise mixed-use and high-rise buildings is shown in Figure 24. This design corresponds to test profile A11 being performed concurrently by the PG&E ATS laboratory.

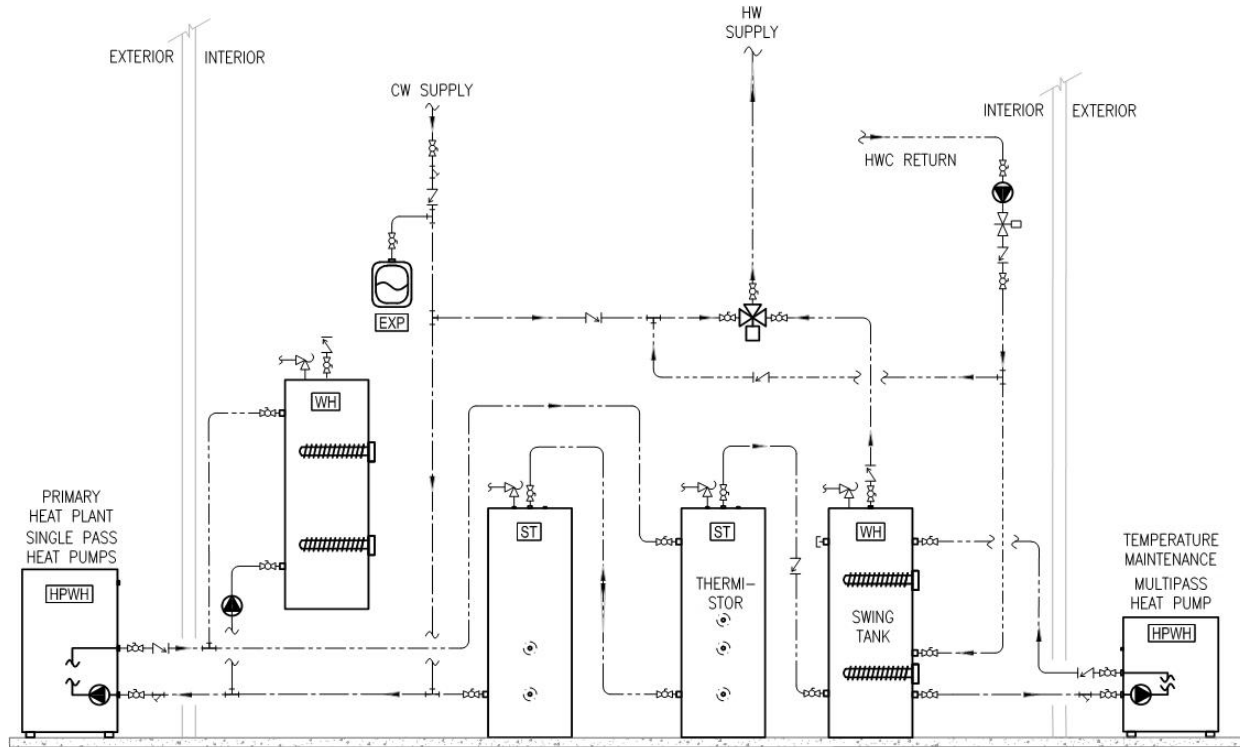

Figure 24: Single-pass heat pump system (mid-rise mixed-use and high-rise).

Source: Statewide CASE Team

The capacity requirements for single-pass heat pump system are shown in Table 108.

Table 108: Capacity Requirements for Single-Pass Heat Pump System

Building	System Power Requirement (kBtu/hr)	System Power Requirement (Tons)	Hot Water Storage Requirement (Gallons)	Additional Transformer Capacity (kVA)
Low-Rise Garden Style	21.6	1.8	150	11
Low-Rise Loaded Corridor	58.8	4.9	500	24
Mid-Rise Mixed-Use	135.6	11.3	1,300	61
High-Rise Mixed-Use	184.8	15.4	1,500	99

The selected equipment for the single-pass heat pump system is shown in Table 109 and Table 113. Note that input power listed in the tables are rated power of the water heater. Since most heat pump water heaters' actual capacity decrease significantly at lower ambient air temperature, equipment selection should be based on project's design conditions.

Table 109: Primary Heat Pump

Building Power	Product	Qty	Input Power (kBtu/hr)	Electrical Consumption (kVA)
Low-Rise Garden Style	Sanden	2	15.4	6.0
Low-Rise Loaded Corridor	Sanden	4	15.4	12.0
Mid-Rise Mixed-Use	Colmac CxA-10	2	137.5	17.8
High-Rise Mixed-Use	Colmac CxA-15	2	203.7	43.8

Table 110: Primary Hot Water Storage Tank

Building	Product	Qty	Capacity (gallons)	Total Capacity (gallons)
Low-Rise Garden Style	Sanden SAN-45SSAQA	3	45	135
Low-Rise Loaded Corridor	Niles S-30-063-TC	3	175	525
Mid-Rise Mixed-Use	Niles S-48-073-TC	3	500	1,500
High-Rise Mixed-Use	Niles S-48-073-TC	3	500	1,500

Table 111: Primary Electric Resistance Back-Up

Building	Product	Qty	Capacity (gallons)	Electrical Power Consumption (kVA)
Low-Rise Garden Style	<i>(Not Required)</i>	N/A	N/A	N/A
Low-Rise Loaded Corridor	<i>(Not Required)</i>	N/A	N/A	N/A
Mid-Rise Mixed-Use	Bradford White CEHD50	1	50	27.0
High-Rise Mixed-Use	Bradford White CEHD50	1	50	27.0

Table 112: Temperature Maintenance Heat Pump

Building	Product	Qty	Input Power (kBtu/hr)	Electrical Power Consumption (kVA)
Low-Rise Garden Style	<i>(Not Required)</i>	N/A	N/A	N/A
Low-Rise Loaded Corridor	<i>(Not Required)</i>	N/A	N/A	N/A
Mid-Rise Mixed-Use	Colmac CxV	1	42.0	7.0
High-Rise Mixed-Use	Colmac CxA-10	1	137.5	15.8

Table 113: Temperature Maintenance Electric Resistance Back-Up

Building	Product	Qty	Capacity (gallons)	Electrical Power Consumption (kVA)
Low-Rise Garden Style	Lochinvar ETP080KD ¹³	1	80	4.5
Low-Rise Loaded Corridor	Rheem EVRO250 ⁶	1	250	12.0
Mid-Rise Mixed-Use	Durawatt PVI 45 L 250A-VE	1	250	9.0
High-Rise Mixed-Use	Rheem EVRO500	1	500	11.6

Table 114: Additional Appurtenances

Category	Equipment
Utility Connection	Additional utility transformer capacity; additional sub-panel and wiring connections on 240V/1PH, 208V/3PH, and 408V/3PH systems
Controls	Staging controller, backup heat controller
Piping	Copper, insulation thickness equivalent to pipe diameter, R-16 jacket with R-10 pad, earthquake strapping with optional R-11 aftermarket jacketing, outdoor piping in colder climates has heat trace for freeze protection that requires electrical service
Valves	Electronic mixing valve with tight control for primary hot water storage; miscellaneous check valves, service valves, air-eliminator valves
Tanks	Expansion tank for hot water storage

Multi-Pass Heat Pump System Sizing and Equipment Selection

Single- and multi-pass heat pumps differ in the number of times the water cycles between the heat pump and the hot water storage tank. A single-pass system heats water to a usable temperature in one cycle. A multi-pass system only raises the temperature of the water by 10°F to 15°F each cycle.

The multi-pass heat plant design for the Low-Rise Garden Style and Low-Rise Loaded Corridor buildings is shown in Figure 25. This design does not directly correspond to test profile being performed concurrently by the PG&E laboratory but is most similar to the temperature maintenance subsystem in test profile A13.

¹³ In the Low-Rise designs, the temperature maintenance electric resistance back-up tank also provides temperature maintenance functionality under normal operation.

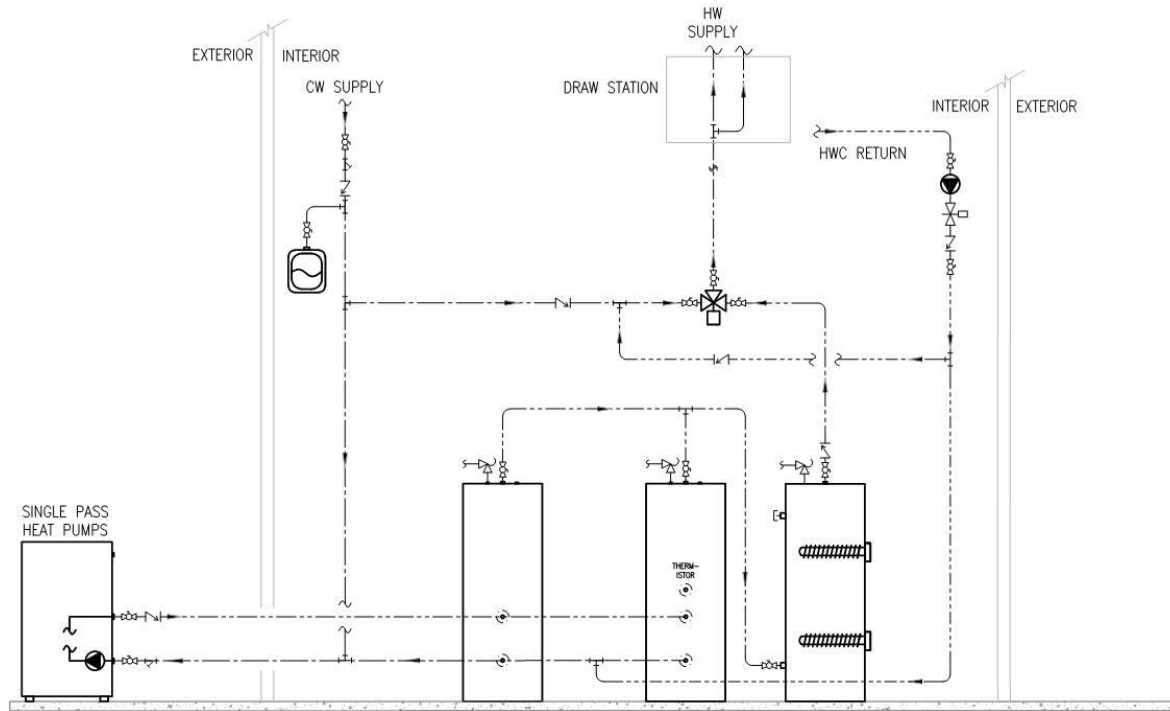

Figure 25: Multi-pass heat pump system (2-story garden and 3-story loaded corridor).

Source: Statewide CASE Team

The multi-pass heat plant design for the mid-rise mixed-use and high-rise buildings is shown in Figure 26. This design corresponds to test profile A13 being performed concurrently by the PG&E ATS laboratory.

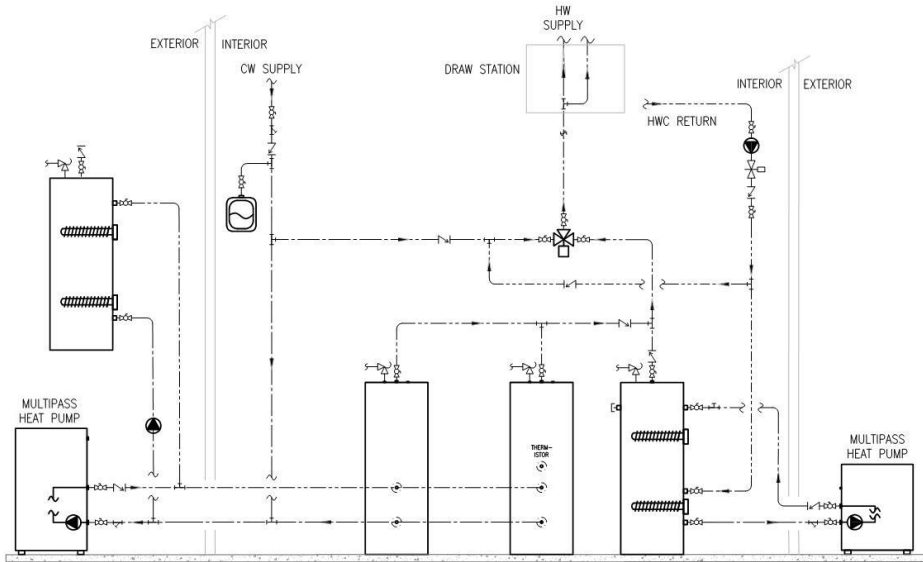

Figure 26: Multi-pass heat pump system (mid-rise mixed-use and high-rise).

Source: Statewide CASE Team

The capacity requirements for multi-pass heat pump system are shown in Table 115.

Table 115: Capacity Requirements for Multi-Pass Heat Pump System

Building	System Power Requirement (kBtu/hr)	System Power Requirement (Tons)	Hot Water Storage Requirement (Gallons)	Additional Transformer Capacity (kVA)
Low-Rise Garden Style	26.4	2.2	150	13
Low-Rise Loaded Corridor	84.0	7.0	600	25
Mid-Rise Mixed-Use	133.2	11.1	1,500	61
High-Rise Mixed-Use	188.4	15.7	1,700	99

The selected equipment for the multi-pass heat pump system is shown in Table 116 and Table 121.

Table 116: Primary Heat Pump

Building	Product	Qty	Input Power (kBtu/hr)	Electrical Power Consumption (kVA)
Low-Rise Garden Style	Versati II+ Outdoor Unit	1	52.9	6.7
	Versati II+ Indoor Unit	1	N/A	6.2
Low-Rise Loaded Corridor	Colmac CxV	1	42.0	7.0
Mid-Rise Mixed-Use	Colmac CxA-10	2	137.5	17.8
High-Rise Mixed-Use	Colmac CxA-15	2	203.7	43.8

Table 117: Primary Hot Water Storage Tank

Building	Product	Qty	Capacity (gallons)	Total Capacity (gallons)
Low-Rise Garden Style	Niles S-24-062-TC	2	119	238
Low-Rise Loaded Corridor	Niles S-28-079-TC	3	200	600
Mid-Rise Mixed-Use	Niles S-48-073-TC	3	500	1,500
High-Rise Mixed-Use	Niles S-48-073-TC	3	600	1,800

Table 118: Primary Electric Resistance Back-Up

Building	Product	Qty	Capacity (gallons)	Electrical Power Consumption (kVA)
Low-Rise Garden Style	<i>(Not Required)</i> ³	N/A	N/A	N/A
Low-Rise Loaded Corridor	Rheem EVRO250 ⁴	1	250	18.0
Mid-Rise Mixed-Use	Bradford White CEHD50	1	50	27.0
High-Rise Mixed-Use	Bradford White CEHD50	1	50	27.0

³ In the low-rise design, the primary heat pump has an integral electric resistance back-up element within the unit.

⁴ In the Low-Rise Loaded Corridor design, the electric resistance back-up tank also functions as a trim tank to ensure output water temperature reaches the specified design temperature.

Table 119: Temperature Maintenance Heat Pump

Building	Product	Qty	Input Power (kBtu/hr)	Electrical Power Consumption (kVA)
Low-Rise Garden Style	<i>(Not Required)</i>	N/A	N/A	N/A
Low-Rise Loaded Corridor	<i>(Not Required)</i>	N/A	N/A	N/A
Mid-Rise Mixed-Use	Colmac CxV	1	42.0	7.0
High-Rise Mixed-Use	Colmac CxA-10	1	137.5	15.8

Table 120: Temperature Maintenance Electric Resistance Back-Up

Building	Product	Qty	Capacity (gallons)	Electrical Power Consumption (kVA)
Low-Rise Garden Style	(Not Required)	N/A	N/A	N/A
Low-Rise Loaded Corridor	(Not Required)	N/A	N/A	N/A
Mid-Rise Mixed-Use	Durawatt PVI 45 L 250A-VE	1	250	9.0
High-Rise Mixed-Use	Rheem EVRO500	1	500	11.6

Table 121: Additional Appurtenances

Category	Equipment
Utility Connection	Additional utility transformer capacity; additional sub-panel and wiring connections on 240V/1PH, 208V/3PH, and 408V/3PH systems
Heat Exchanger	Double wall heat exchangers for all Versati heat pumps
Pumps	Cast iron and stainless steel for potable water (qty 2)
Controls	Staging controller, backup heat controller
Piping	Copper, insulation thickness equivalent to pipe diameter, R-16 jacket with R-10 pad, earthquake strapping with optional R-11 aftermarket jacketing, outdoor piping in colder climates has heat trace for freeze protection that requires electrical service
Valves	Electronic mixing valve with tight control for primary hot water storage; miscellaneous check valves, service valves, air-eliminator valves
Tanks	Expansion tank for hot water storage

Appendix H. Heat Pump Product Availability Analysis

The Statewide CASE Team reviewed the availability of split heat pump, PTHP, and VRF systems. To review product availability of split heat pumps and packaged terminal heat pumps, the Statewide CASE Team used the Modernized Appliance Efficiency Database System (MAEDbS), which shows appliances compliant under Title 20. Since VRF systems were not listed in the MAEDbS, the Statewide CASE Team collected VRF system information from manufacturer websites.

Split Heat Pump

The Statewide CASE Team considered split heat pumps that were added to the MAEDbS on or after January 1st, 2015 (the last update to the federal minimum efficiency for split heat pump systems)¹⁴. In this subset of heat pumps in the MAEDbS, there were 20 manufacturers with a total of 268 models offering in the California market. The five manufacturers that have the most models available are: Carrier Corporation, Nortec Global HVAC, Midea Group, Johnson Controls International plc, and Rheem Manufacturing Company.

To compare split heat pump efficiencies of the market to the federal minimum efficiency, the Statewide CASE Team considered split heat pumps that were added to the MAEDbS on or after January 1st, 2015 (the last update to the federal minimum efficiency for split heat pump systems). In the following figures, the red dashed line indicates the federal minimum efficiency. All split heat pumps had a cooling capacity of less than 65,000 Btu/h, which has a federal minimum efficiency requirement of SEER at 14.0 and HSPF at 8.2. Nineteen percent of the models available are just meeting federal minimum efficiency.

¹⁴ The following AHRI heat pump types are included: 1) HRCU-A-C: heat pump with remote outdoor unit, no indoor fan, air source; 2) HRCU-A-CB: split system: heat pump with remote outdoor unit, air source; 3) HRCU-A-CB-O: split system: heat pump with remote outdoor unit, air source, free delivery.

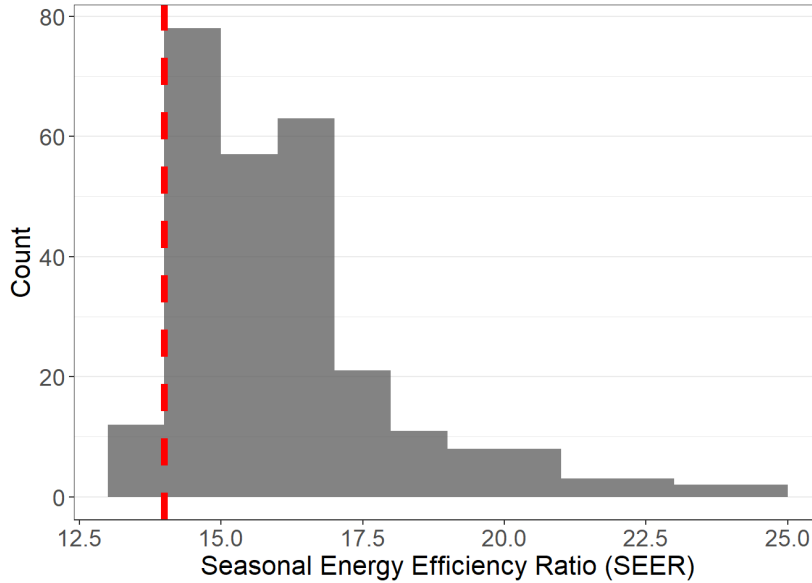

Figure 27: SEER of split heat pumps in MAEDbS.

Source: Statewide CASE Team

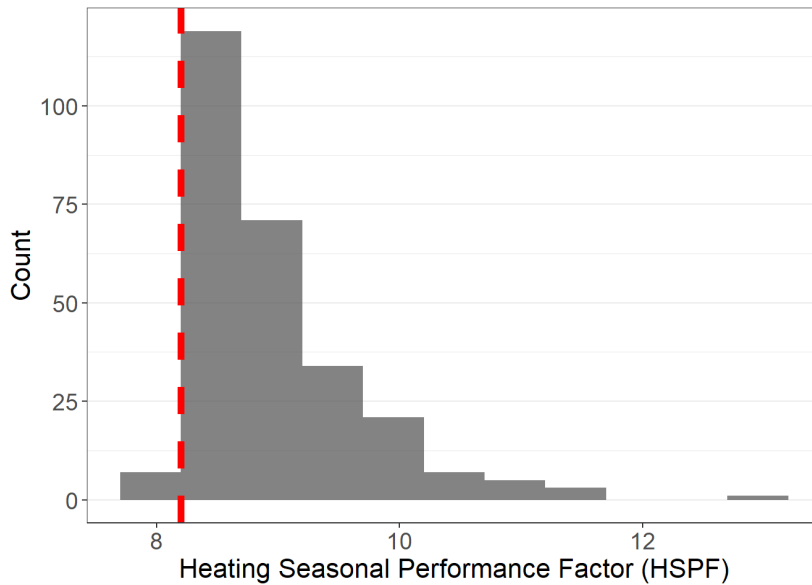

Figure 28: HSPF of split heat pumps in MAEDbS.

Source: Statewide CASE Team

Packaged Terminal Heat Pump

The Statewide CASE Team reviewed PTHPs added to the MAEDbS on or after October 8th, 2012 (the latest updated to the federal minimum efficiency for PTHPs). There were nine manufacturers of this subset of PTHPs.

Figure 29 and Figure 31 show histograms of the energy efficiency ratio (EER) and coefficient of performance (COP) of the PTHPs in the MAEDbS. Since PTHP EER and COP is dependent on cooling capacity, to compare the EER and COP to that of the federal minimum efficiency, Figure 30 and

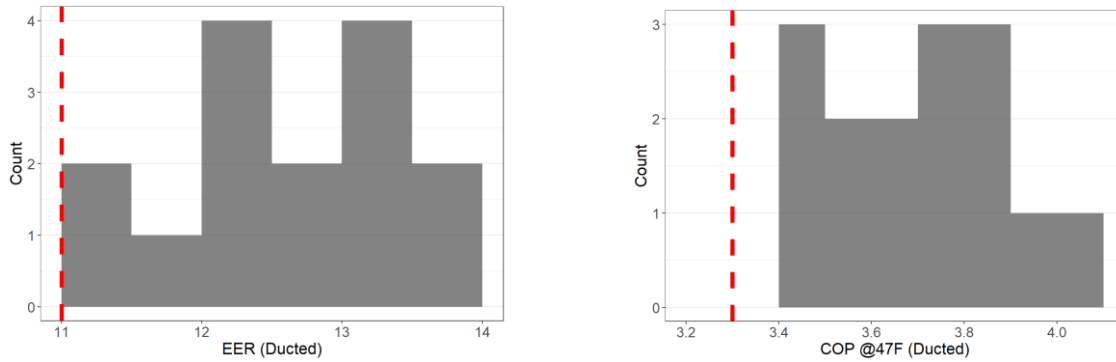

Figure 33

show scatter plots of the EER and COP relative to the cooling capacity. The federal minimum efficiency is indicated by the red dashed line.

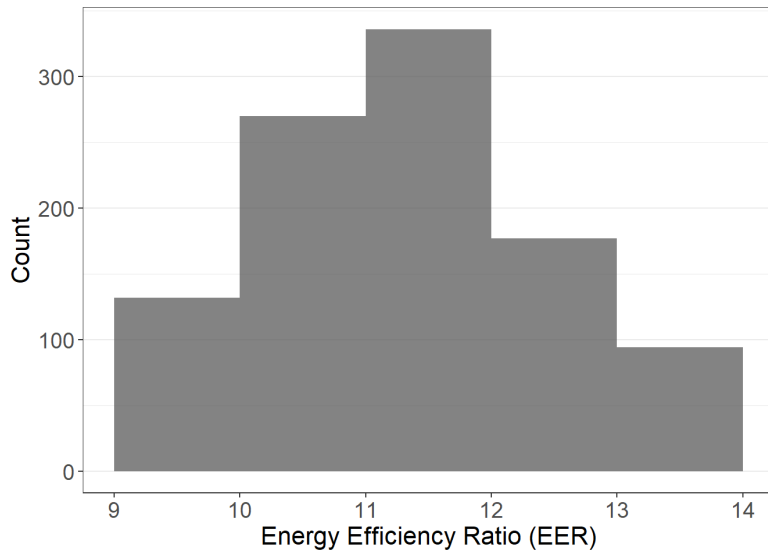

Figure 29: Histogram of EER of PTHPs in MAEDbS.

Source: Statewide CASE Team

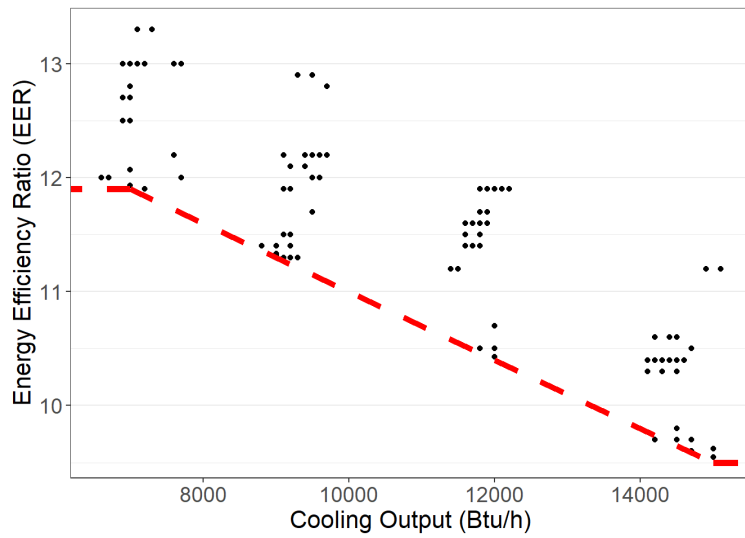

Figure 30: EER vs. cooling capacity of PTHPs in MAEDbS.

Source: Statewide CASE Team

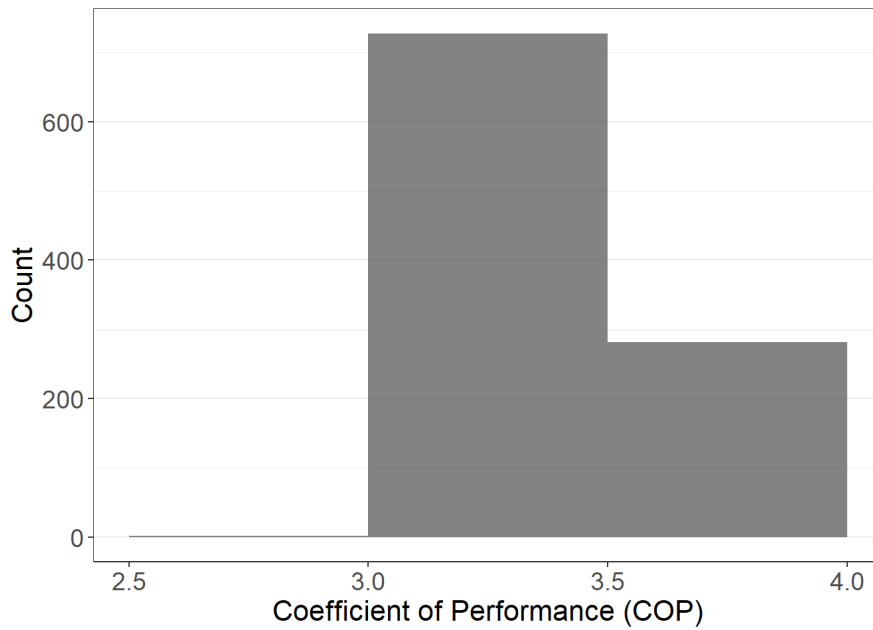

Figure 31: Histogram of COP of PTHPs in MAEDbS.

Source: Statewide CASE Team

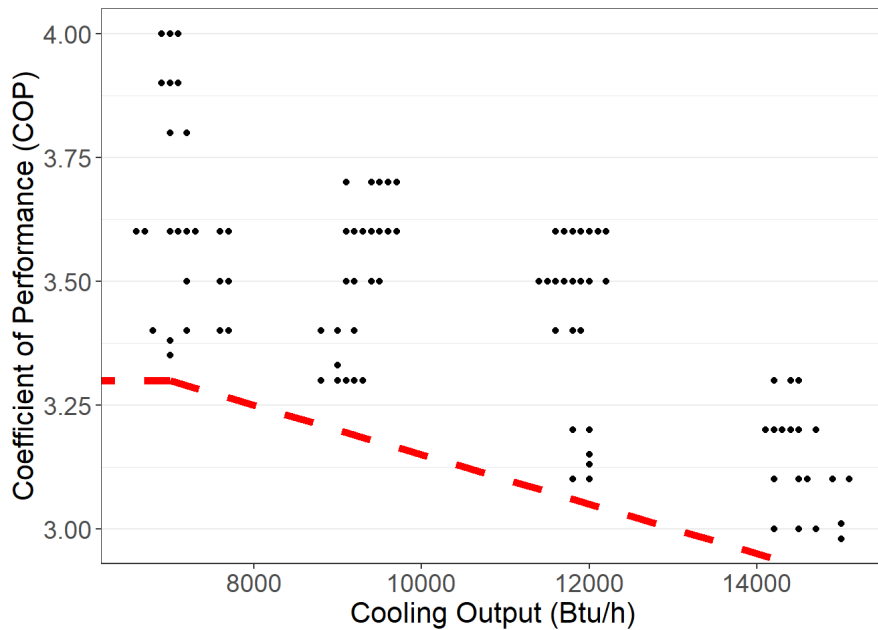

Figure 32: COP vs. cooling output of PTHPs in MAEDbS.

Source: Statewide CASE Team

Variable Refrigerant Flow System

The Statewide CASE Team reviewed VRF systems with heating provided by either heat recovery or heat pump. Since the MAEDbS did not include VRF systems, the Statewide CASE Team reviewed VRF system efficiencies by collecting information from manufacturer websites. The Statewide CASE Team looked at 5 manufacturers – Carrier Corporation, Daikin North America LLC, Mitsubishi Electric Trane HVAC US LLC, Johnson Controls International plc, Lenox International Incorporated. The following figures show EER and COP of the collected VRF products as compared to the federal minimum efficiencies (dependent on cooling capacity) shown by the red dashed line.

VRF with Heat Pump Heating

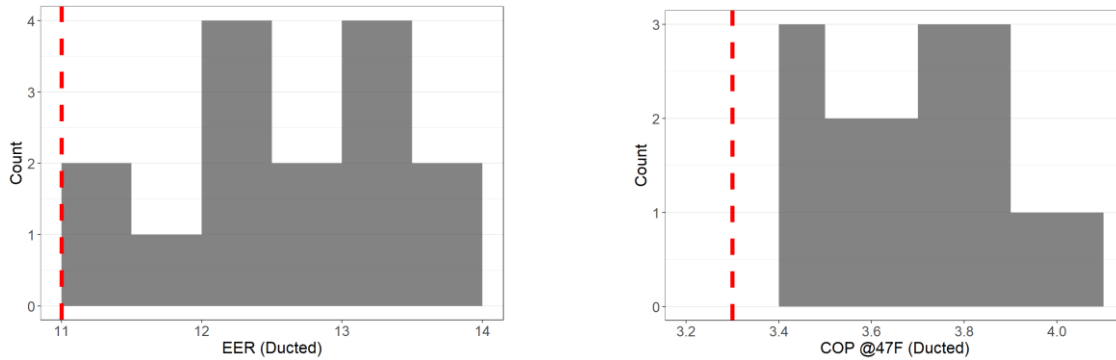

Figure 33: (Left) VRF heat pump EER histogram $\geq 65,000$ Btu/h, $< 135,000$ Btu/h; (Right) VRF heat pump COP histogram $\geq 65,000$ Btu/h, $< 135,000$ Btu/h.

Source: Statewide CASE Team

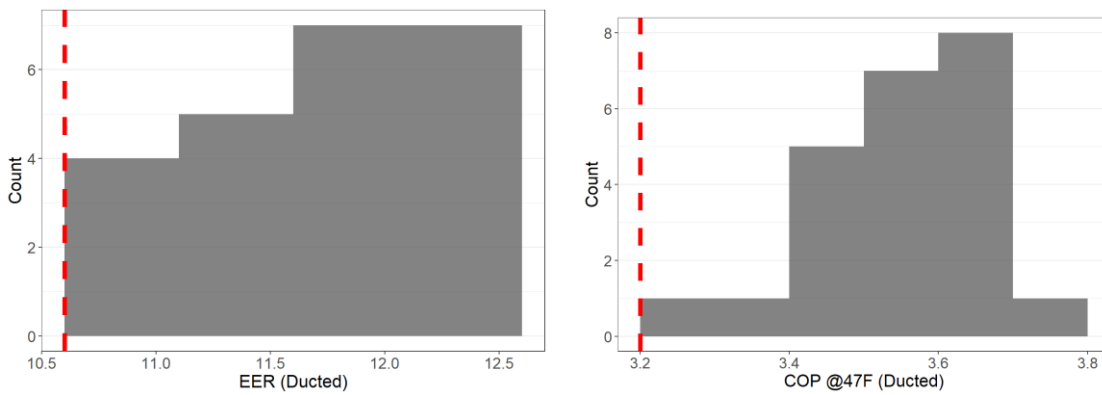

Figure 34: (Left) VRF heat pump EER histogram $\geq 135,000$ Btu/h, $< 240,000$ Btu/h; (Right) VRF heat pump COP histogram $\geq 135,000$ Btu/h, $< 240,000$ Btu/h.

Source: Statewide CASE Team

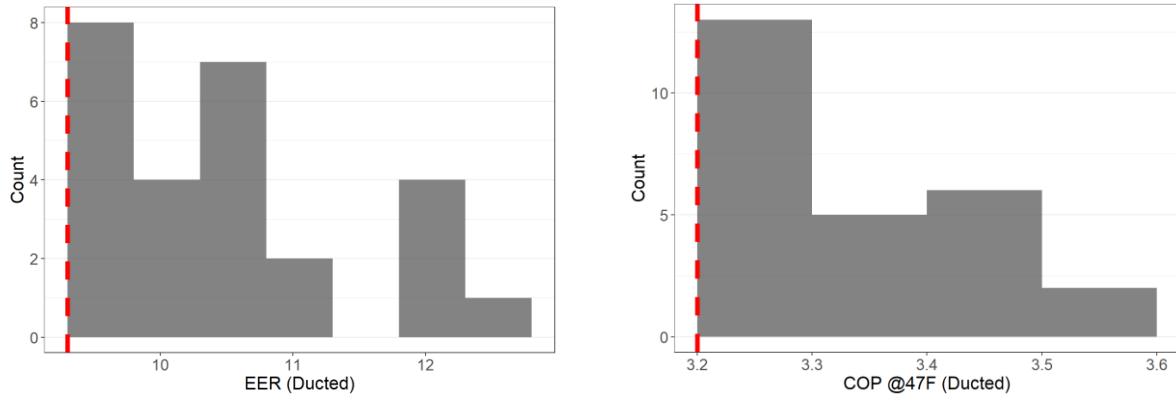

Figure 35: (Left) VRF heat pump EER histogram $\geq 240,000$ Btu/h; (Right) VRF heat pump COP histogram $\geq 240,000$ Btu/h.

Source: Statewide CASE Team

VRF with Heat Recovery

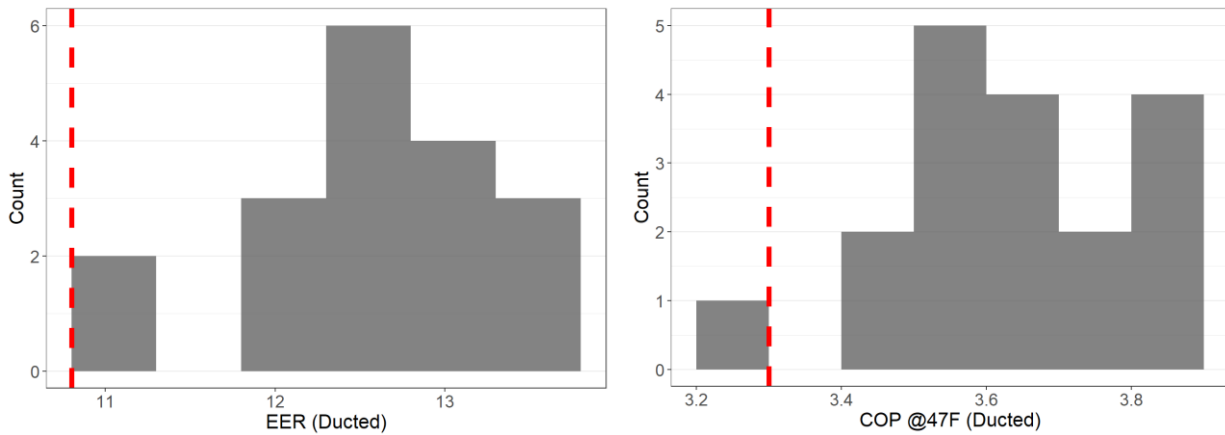

Figure 36: (Left) VRF with heat recovery EER histogram $\geq 65,000$ Btu/h, $< 135,000$ Btu/h; (Right) VRF with heat recovery COP histogram $\geq 65,000$ Btu/h, $< 135,000$ Btu/h.

Source: Statewide CASE Team

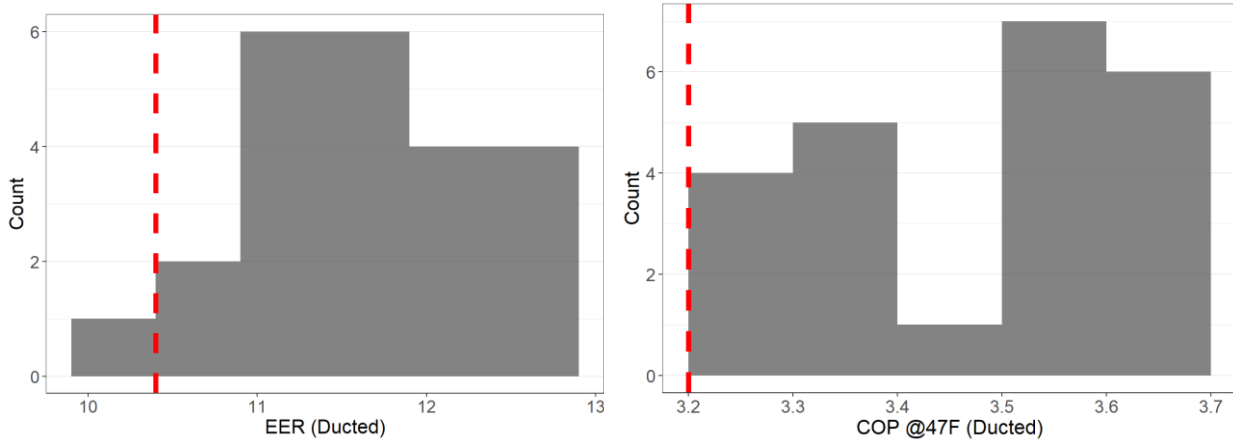

Figure 37: (Left) VRF with heat recovery EER histogram $\geq 135,000$ Btu/h, $< 240,000$ Btu/h; (Right) VRF with heat recovery COP histogram $\geq 135,000$ Btu/h, $< 240,000$ Btu/h.

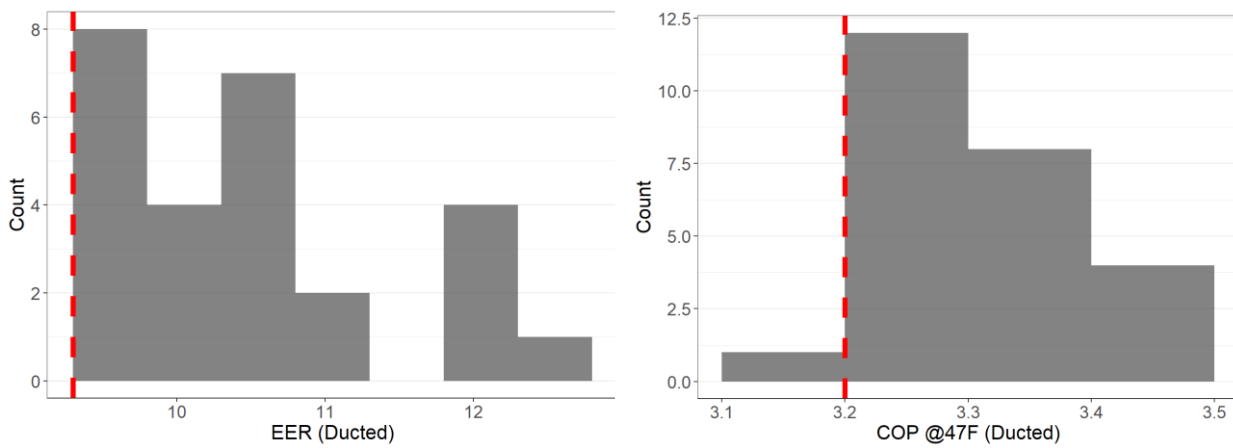

Figure 38: (Left) VRF with heat recovery EER histogram $\geq 240,000$ Btu/h; VRF with heat recovery COP histogram $\geq 240,000$ Btu/h.

Appendix I. Central Heat Pump Water Heater Case Studies

This appendix documents the design strategies, field measured performance data and lessons learned from two projects:

- Elizabeth James House: four-story, 60-unit low-income senior apartment building located in Seattle, Washington
- Batik Apartment: eight-story, 195-unit mixed used building in Seattle, Washington

Batik Apartment

This is a case study on the use of heat pumps in a central plant configuration to produce DHW in multi-unit residential buildings (MURBS). The Batik apartments is a seven story, 195-unit mixed use building located within the publicly owned Yesler Terrace housing community in downtown Seattle, Washington. Batik is a “nearly all-electric” solar PV-ready building, the lone exception being a gas-powered fireplace in the entrance lobby. The 226,000 ft² building was completed in early 2018 and is currently fully occupied.

For this building, the Statewide CASE Team provided a central plant using a Colmac HPWH, 2,500 gallons of primary hot water storage, and a recirculation loop with a dedicated HPWH to deliver a high COP without using any gas for DHW production. The HPWHs used in this case study contain R-134 a refrigerant which does not function well at very low supply air temperatures. A key innovation implemented for this system was to locate the HPWHs in the below-grade parking garage. The underground parking levels provide thermal buffering effects that allow year-round use of R-134 a heat pump technology to produce DHW in the Pacific Northwest climate. The Statewide CASE Team found that when placed outside in ambient conditions where air temperatures drop below 45°F wetbulb, the HPWHs operate at a reduced capacity and may not be capable of providing 100 percent of the DHW load.

HPWH technology is moving toward becoming more of a “plug and play” technology whereby designers would be able to provide input information such as number of apartments, expected peak occupancy, or occupancy type, and a manufacturer could provide a recommended package of components with recommended installation instructions such that much of the need for specialized knowledge and custom design is eliminated (along with much of the risk associated with a new technology). The technology positioned in this way would have the potential to reduce energy use for multifamily water heating by approximately a factor of three.

HPWH Plant

The following narrative explains the critical features to central HPWH DHW plant design. Refer to Figure 39 below for a simplified visual representation of the plant.

- *Single-Pass*: The design is based around a “Single-Pass” heat exchange strategy as opposed to the typical “Multi Pass” strategy employed in most hydronic space heating applications. This means that the flow of water through the heat pump is regulated by a control valve to maintain a target output temperature of 130-140°F. This results in a variable flow rate and variable temperature rise across the heat pump as opposed to the typical fixed flow rate and fixed 10- 20°F temperature rise on the water. The heat pump can therefore output 140°F water with incoming water temperatures ranging from 45-110°F.¹⁵ The advantage of the single-pass arrangement is that a usable water temperature is always delivered to the top of the storage reservoir.
- *Multiple Storage Tanks*: This design is based around the use of multiple storage tanks plumbed in series. The series plumbing arrangement enables a high degree of temperature stratification throughout the system with the hottest water at the end of the storage system where water is then delivered to the apartments. It also allows for the use of smaller tanks that are less expensive and easier to install.
- *Storage Temperature*: The water is produced at a relatively high temperature (≈140°F) to effectively increase the stored heating capacity of the plant and to control possible legionella bacteria. To prevent scalding, it is tempered with recirculation water and/or incoming city water down to 120°F before delivery to the apartments.
- *Backup Electric*: This design incorporates a backup electric water heater, in parallel with the primary heat pumps, which would come on if the primary hot water storage is depleted in the event of a failure of one of the heat pumps.
- *Temperature Maintenance*: A tank with a dedicated HPWH unit is included in the circuit immediately upstream of the thermostatic mixing valve. This tank and HPWH, together with the recirculation ring main loop, comprise the temperature maintenance system. Cooler recirculation water is returned to the tank and is mixed in with the high-temperature water from the HPWH to reheat it. The tank is set to maintain 122-125°F water. When the water in the temperature maintenance tank drops below setpoint due to the distribution losses in the system, this dedicated HPWH would provide the additional heat whenever possible. The temperature maintenance tank is also equipped with an electric element to deliver backup heating capacity.

¹⁵ If the incoming water to the heat pump is much hotter than about 110°F, the flow is not adequate to remove all the heat generated by the refrigeration cycle and the refrigerant pressure will rise and shut the system down on a high-limit control.

- Controls:** Aquastats are temperature sensing devices used in water systems, synonymous to thermostats in non-hydronic systems. They have high- and low-temperature settings and control the ON/OFF status of the heating equipment (HPWHs in this case) as well as the circulator pump. The primary HPWHs are set to switch on when an aquastat in the middle storage tank drops below approximately 115°F, and to stay on until an aquastat in the first storage tank rises to approximately 100°F.

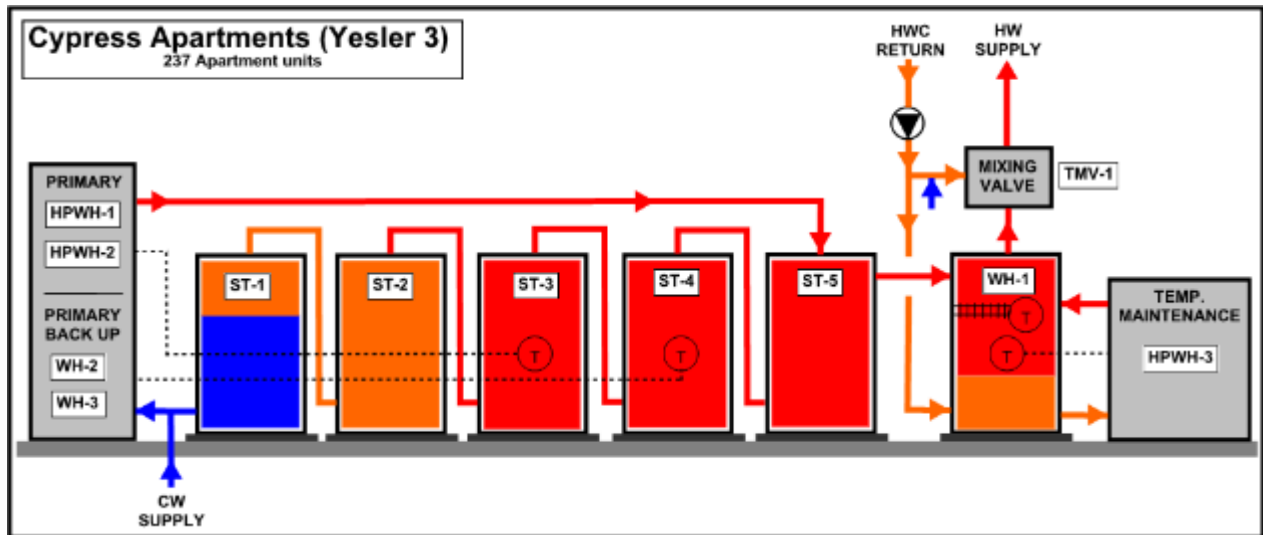

Figure 39: Simplified HPWH plant schematic-Batick apartment.

Source: Statewide CASE Team

Recirculation Analysis

The system at Batik has a separate HPWH specifically for handling recirculation loop temperature maintenance. This HPWH was configured as a multi-pass device to handle hotter incoming water without alarming on high head pressure. This allows the primary HPWHs to process only relatively cold water at higher efficiencies. A tank with backup electric elements serves as the final storage location for the water before it is supplied to the building through a mixing valve. That storage tank receives water, already at set point temperature, from both the main HPWHs and the HPWH that reheats the circulation loop water. Finally, a single bank of storage tanks (as opposed to parallel banks) now serves both main HPWHs and can be operated from a single point of control. The HPWHs were configured to operate in tandem, which produces more hot water at once and allows more time between each cycle. This process also reduces cycling losses and increases temperature stratification in the storage tanks.

If a central HPWH system is compared to a central electric boiler or central gas water heating system, the Statewide CASE Team can use the equipment efficiency as the comparison since the distribution losses should be approximately the same—regardless

of the water heating plant used. In this case a HPWH system would use 36 to 42 percent of the water heating energy used by an electric boiler system, and 29 to 33 percent of the water heating energy used by a gas boiler with 80 percent combustion efficiency. This represents about a 15 percent reduction in the energy use of the entire building, based on typical mid-rise multifamily construction in the Seattle area (Ecotope 2009).

However, since some of the distribution losses go to offset space heating energy, the overall effect on the building's total energy use is more complicated. If the Statewide CASE Team installs a HPWH system in an electrically heated building, then the savings are increased by the amount of space heating offset that occurs. This interactive effect is difficult to estimate. But if the Statewide CASE Team assume that one third of the distribution losses go to offset electric space heating, then the distribution losses from the HPWH system are neutral in terms of total building energy use. In this case, the HPWH represents about an 18 percent reduction in the building's total energy use, compared to an electric resistance or gas boiler water heating system.

Measurement and Verification (M&V)

This section highlights the importance of measurement and verification (M&V) equipment on new technology installations. M&V allows for early diagnosis of problems potentially before expensive equipment replacement is needed. Analysis of M&V data also leads to learning that can be used to improve system performance or make changes in future designs. Additionally, long-term monitoring can be valuable for informing persistence studies.

At the time of this report, M&V data have been collected for over 22 months. As indicated above, events during the early commissioning period resulted in the system not operating as designed for several months, but since June 2018 the operation has been largely stable. Longer-term data collection provided the opportunity for annual estimates of delivered hot water and system performance. And the period from August 1, 2018, to July 31, 2019, is used to calculate annual equipment performance and water usage summaries for this report.

For the period included in this report, the delivered hot water was approximately 23 gallons per unit per day. Assuming 1.3 occupants per apartment unit, the Statewide CASE Team estimates an average of 18 gallons per occupant per day. The average performance of the main water heating equipment (including the backup electric water heater to the main HPWHs) was 2.75 and the temperature maintenance HPWH (excluding backup operation) had an annual average COP of 2.3.

It is also worth noting that the building was increasing its occupancy over the analysis period (and is near full occupancy as of the time of this report). Anecdotally, the average gallons per unit per day for the period August 1, 2019, through October 31, 2019, was

approximately 25 percent higher than the same period in 2018. This is due to increased building occupancy. As a result, future delivered water summaries for this building may be slightly higher.

Elizabeth James House

This is a case study on the use of Sanden CO₂ heat pump water heaters (HPWH) in a central plant configuration to produce DHW for a multi-unit apartment building. The Elizabeth James House is an existing 4-story, 60-unit, low-income senior apartment building located in Seattle, Washington. It is an “all-electric” building with an existing electric resistance water heating system. The primary focus of this case study is the retrofit of the existing electric resistance DHW system to a HPWH DHW system. For the Elizabeth James House, the Statewide CASE Team designed a central plant using four 15,000BtuH Sanden heat pump water heaters, the three existing storage tanks, a new 175-gallon storage tank, the three existing instantaneous electric water heaters and pump, and a building hot water circulation pump. This system utilized the existing equipment to reduce upfront costs and to provide emergency backup.

HPWH Plant

The Sanden HPWHs used contain R-744 refrigerant commonly referred to as CO₂. This refrigeration cycle does not function well at warm incoming water temperatures (above 113°F). Building hot water circulation pumps typically return water at 115°F to the storage tanks. In DHW systems based around fossil gas or electric resistance, this warm water can go directly back to the primary storage tanks or primary heaters. However, the HPWHs would not respond or perform well to this warm incoming water temperature. A critical design feature of HPWH systems with hot water circulation systems is to separate these two distinct building DHW loads. In doing so the DHW system designer can prioritize sending cool water to the HPWHs while maintaining thermal stratification in the primary tanks. This results in optimal equipment efficiency, less cycling of the heating equipment, and better reliability of the system. However, a dedicated system to reheat the warm circulation is required.

A key innovation implemented for the Elizabeth James House retrofit project was a “recirculation loop tank” (temperature maintenance tank) design to reheat the warm return water from the building’s hot water circulation loop. The existing instantaneous electric water heaters were arranged to provide backup heating capacity to the entire system. An aquastat in the fourth storage tank controls the existing tank circulation pump ON or OFF based on the tank temperature. This water is pumped through the three existing instantaneous electric water heaters and returned to the top of the fourth tank. This results in a robust backup system for both the primary heating system (HPWHs) and the temperature maintenance heating system (“recirculation loop tank”).

The HPWHs produce hot water at temperatures near 150°F, therefore, a thermostatic mixing valve was added to prevent scalding and conserve energy.

Refer to the schematic diagram (Figure 40) for a simplified visual representation of the plant. The narrative that follows explains the critical features central to the Elizabeth James HPWH DHW plant design.

- *Single Pass*: The design is based around a “Single Pass” heat exchange strategy as opposed to the typical “Multi Pass” strategy employed in most hydronic space heating applications. This means that the flow of water through the heat pump is regulated by a control valve to maintain a target output temperature of 149°F. This results in a variable flow rate and variable temperature rise across the heat pump, as opposed to the typical fixed flow rate and fixed 10- 20°F temperature rise on the water. The heat pump can therefore output 149°F water with incoming water temperatures ranging from 45-113°F.³ The advantage of the Single Pass arrangement is that a usable water temperature is always delivered to the top of the storage reservoir.
- *Multiple Storage Tanks*: This design is based around the use of multiple storage tanks plumbed in series. The series plumbing arrangement enables a high degree of temperature stratification throughout the system, with the hottest water at the end of the primary storage system (ST-3). It also allows for the use of smaller tanks that are less expensive and easier to install (and able to fit through the mechanical room door). At Elizabeth James House, the three existing tanks were reused for the primary storage tanks. A fourth tank was added to act as a dedicated temperature maintenance tank (“recirculation loop tank”). This fourth tank is in series with the three primary tanks as shown in Figure 10.
- *Storage Temperature*: The water is heated to a relatively high temperature (149°F) to effectively increase the stored heating capacity of the plant, to control possible legionella bacteria, and to increase the effectiveness of the recirculation loop tank (ST-4). To avoid scalding, outgoing water is tempered with recirculation water and/or incoming city water down to 125°F before delivery to the apartments.
- *Backup Electric Water Heaters*: This design utilizes the three existing instantaneous electric water heaters as backup. They are configured in parallel and operate in unison to deliver 135°F water to ST-4. The backup instantaneous electric water heaters operate any time the final storage tank drops below 120°F either due to inadequate capacity coming from the HPWHs or due to extended periods of time with no hot water draws and continuous cooling from the recirculation system.
- *Temperature Maintenance Recirculation Loop Tank*: This tank is designed to

swing in temperature between 125°F and 149°F. During periods with hot water use, over-heated 149°F water moves from the primary storage tank to the recirculation loop tank. These periodic draws keep the recirculation loop tank primed above 125°F. If the recirculation loop tank drops below 125°F during an extended period of 6+ hours without water draw, the backup electric water heaters are initiated to maintain the recirculation loop tank above 125°F.

- Serial Primary and Temperature Maintenance Tank Arrangement:** The series configuration enables a “recirculation loop tank” concept, which is defined as providing over-heated water from the primary tanks to be mixed with cooler recirculation water in the recirculation loop tank. If there is enough over-heated water from the primary tanks, the mixed temperature in the recirculation loop tank would be greater than or equal to the needed use temperature. This strategy has the potential to work effectively with heat pump cycles designed to impart a large temperature lift to the water, like CO₂-refrigerant heat pumps. If there is enough hot water use to balance out the circulation loop losses, no additional heat is needed in the recirculation loop tank. If additional heat is needed, it can be supplied by resistance heat or a heat pump. At Elizabeth James House, the existing instantaneous electric resistance water heaters were reused to provide backup.
- Controls:** There is no central DHW plant controller for the Elizabeth James House HPWH system, so each of the Sanden HPWHs operates in parallel with its own stand-alone controls. Each of the Sanden HPWHs has built-in control logic to cycle the units ON or OFF based on a thermocouple reading. The middle primary tank (ST-2) contains four thermocouples that are connected to the HPWHs. The HPWHs are turned ON when the thermocouple readings drop below 113°F. Heating continues until the water entering the HPWHs exceeds the setpoint temperature. Heating continues until the water entering the HPWHs exceeds the setpoint temperature.

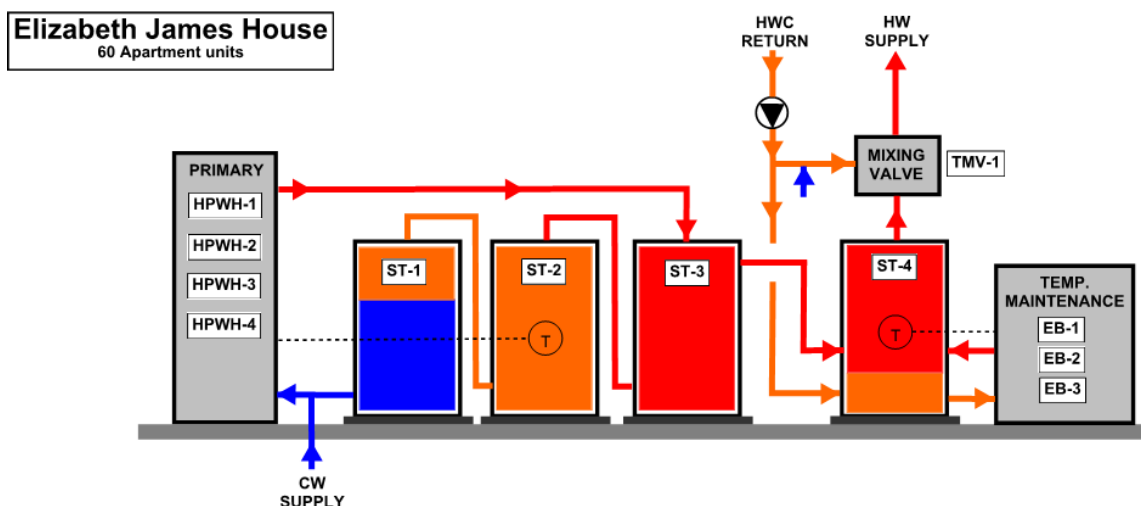

Figure 40: HPWH plant schematic – Elizabeth James house.

Source: Statewide CASE Team

Measurement and Verification (M&V)

M&V data from March 20, 2018 through Dec 7, 2019 were used in this analysis. The end of November and beginning of December provided approximately a week of cooler outside air temperatures, which gives a basis for cold weather estimates. Outside air temperatures for the as-yet unmonitored December 2019 through March 2020 period and for additional previous data gaps were estimated using 5-year daily averages from nearby NOAA weather station data. With average daily temperatures for these unmonitored periods, regression analyses were used to predict the daily coefficient of performance and gallons per unit metrics, which were then included in annual estimates.

For the period included in this report, delivered hot water was approximately 20 gallons per unit per day. The exact occupancy of the building is unknown, but the water usage is a little higher than measured in previous multifamily studies which reported 15 GPD per person (irrespective of household size).^{5,6} This may be due to the building's senior demographic, with the occupants spending more time at home compared to multifamily buildings with working occupants. The average performance of the heat pump water heaters was a COP of 3.3- a three-fold improvement over the original electric resistance water heating system. This site will continue M&V monitoring through at least March 2020, at which time a full year of M&V observations will be collected.

Lessons Learned

The key lessons learned at the Batik Apartments relate to proper management of these simple fundamentals:

- HPWHs function best with cold incoming water temperatures. If the incoming water temperature is too high, efficiency drops and the refrigerant pressures get too high, and the heat pump cannot function. This requires careful design and management of the building hot water circulation system and an effective strategy for stratifying water storage to feed cold water to heat pumps while still delivering usable hot water.
- HPWHs function best with warm incoming air temperature. If the air temperature gets too cold, the capacity and performance drop dramatically. This requires the heat pumps to be installed in an area that will stay within their refrigerant's reasonable operating range throughout the winter.
- Heat pumps must be able to manage frost buildup on the air coils. When the

source air is cool and moist, ice will develop on the coils and impede airflow and heat transfer. If the ice is not removed effectively, the heat pump cannot function properly and may sustain damage if it continues to run. Effective frost management requires controls to sense or predict when ice is forming and manage the heat pump cycles and defrost times.

- Hot water recirculation systems will typically use a very large amount of energy in multifamily buildings with central hot water systems (about a third of the total thermal energy). Depending on how recirculation systems are designed, they can disrupt temperature stratification in the storage and feed hot water back to the heat pumps. The temperature maintenance system design is critical to overall hot water energy use and heat pump water heater system performance.
- Water quality is important to consider when specifying HPWHs for a new or existing building. At Elizabeth James House, debris in the existing piping system caused multiple alarm events at the HPWHs. This was due to excessive piping debris getting caught in the strainer and clogging it to a point at which the HPWH's internal controller prevented operation due to a low flowrate through the heat exchanger. All these instances were discovered by the Statewide Team upon review of the M&V data stream. Maintenance personnel were trained to clean the strainers and instructed to do so on a regular basis. During these events, the backup electric resistance system kicked ON to maintain hot water delivery temperatures to the building.
- Alerts to the building maintenance personnel are critical for optimal system performance. As mentioned above, building maintenance personnel were not aware the HPWHs were in alarm and not providing heat to the system when the strainers were clogged. Hot water delivery to the apartments was uninterrupted due to the backup electric resistance system. A central plant control system is necessary to prevent excessive cycling of the backup system (when a backup system is present). The central plant control system should be capable of receiving error notifications for the HPWH equipment and sending an alarm to the building maintenance personnel. This error notification could be required to be sent out to a utility when utility incentive programs are present. Doing so would create more confidence that incentive programs were achieving the anticipated energy savings.

Some of the key design principles that emerged out of the HPWH design at the Batik Apartments are as follows:

- Sizing: storage and HPWHs should be sized per ASHRAE 2015 "Low water usage" methodology.
- Source air temperature: in cool climates, HPWHs must be installed in buffered space and discharge cold air to outside to maintain appropriate source air

temperatures.

- Source water temperature: storage and controls must be configured to allow a large volume of cold water to be stored before turning on heat pumps. Doing so allows for a longer cycle length without having water that is too hot enter the heat pump, which could result in low efficiency and possible high head pressure shutdowns.
- Manage defrost cycles to prevent frost buildup on coils. An effective strategy to defrost condenser coils is essential to the reliability of HPWH systems. Ideally, manufacturers would make frost detection available on their HPWH products.
- When a building hot water recirculation system is present, temperature maintenance is a significant part of the system's energy usage, and so using electric resistance would result in a major decrease in efficiency. However, a large volume of warm water returning to the HPWHs from the recirculation loop also results in lower performance. An effective strategy has been to separate the temperature maintenance load from the primary load allowing the primary HPWH system to run at peak efficiency and treat recirculation loop with a separate multi-pass HPWH, which can be configured to accept higher incoming water temperatures.
- The recirculation loop tank design philosophy is a proven concept and works to keep the electric resistance temperature maintenance of the recirculation loop to a minimum.
- Aquastat location is important. Locate aquastat far enough away from incoming water to avoid triggering aquastat every time any water is used. Locating the aquastat in a second serial storage tank accomplishes this goal. Time delay built into HPWH operation can also help with this.
- Typical non-electric tempering valves do not function well with varying inlet water temperatures. Consider use of electronic tempering valves.
- Balancing the hot water circulation loop is critical to a properly functioning system. Too low of a flow rate leads to cool water temperatures and complaints from the tenants about long waits for hot water. Too fast of a flow rate flushes through the storage tanks and breaks up temperature stratification.
- Heat lost from the circulation loop and distribution piping can account for 30 to 45 percent of the heat produced by the HPWH system. Pay close attention to the insulation of the circulation and distribution piping. Eliminate all areas of thermal bridging. Note that in a building heated with electric resistance space heaters, the losses from the distribution and circulation piping are at least partially offset by

reduction in electric resistance space heating.

- Selection of equipment is important for system efficiency. Pay attention to selection and proper sizing of fans and pumps. These auxiliary items can have a big impact on overall system COP. Use no more than 150 Watts/ton of heat pump capacity for auxiliary pumping and fans.
- Include robust measurement, verification, monitoring, and alarm functions with any emerging technology design to assist in diagnosing issues and improving future designs.

Conclusions

HPWHs can yield significant energy savings for multifamily buildings in the Pacific Northwest climate. The Batik Apartments demonstrated an overall hot water energy use reduction of between 55 to 70 percent and an overall total building energy use reduction of 15 to 18 percent by unitizing HPWH technologies. For the Elizabeth James project, it is estimated the HPWH system would use 29 to 31 percent of the water heating energy used by an electric boiler system, and 24 to 26 percent of the water heating energy used by a gas boiler with 80 percent combustion efficiency. This represents about a 17 percent reduction in the energy use of the entire building based on typical mid-rise multifamily construction in the Seattle area.

Entering water temperature has a significant impact on the efficiency of HPWHs. Efficiency drops dramatically as inlet water temperature increases. The hot water recirculation coming back to the storage system raises the water temperature supplied to the heat pumps with a consequent efficiency penalty. Managing this recirculated water is a critical design issue to solve in future HPWH designs. There are various ways to reduce this impact:

- The most important one is to reduce the heat loss of the distribution and recirculation piping by optimizing the piping design and insulating the piping.
- The recirculation loop should also be treated separately by returning water to a recirculation loop tank instead of directly to the primary HPWH or the primary storage tanks. This involves using over-heated storage water in a recirculation loop tank, which is then tempered for building occupant use. The recirculation loop tank concept was proven to be a successful and efficient way to treat the building hot water circulation loop heat losses. If active heating is needed for recirculation loop temperature maintenance load, use small multi-pass heat pump so that the recirculation does not interact with the primary HPWH storage system.

The specification of the equipment itself is important to the performance of the overall system. Sizing and efficiency of the fans and pumps associated with the system can have a significant impact on the overall system performance.

While the M&V metering equipment installed was primarily conceived to evaluate the performance of the equipment, it also served the purpose of diagnosing and solving operational problems that were negatively impacting the performance. Without the M&V equipment it would not have been possible to determine what was happening with the system and how to improve operations. Some level of M&V equipment for the purpose of troubleshooting should be included in all emerging technology installations.

Appendix J. Manufacturer Code Requirement Review Interview Questions

1. What is your title, and experience with central HPWH technology?
2. Are there any US manufacturing facilities?
3. What is the distribution channel in CA?
4. Can you estimate the number of central HPWH projects in CA in the past year?
5. Explicit market plans and outlook for California for multifamily HPWH.
6. Please describe manufacturer's role in designing a central HPWH project. What information do you provide to designers to best design around your product? For example, do you provide recommendation for storage tank requirement, recirculation piping configuration?
7. Do you have common or "standard" configurations that can be applied to many project types, or is each job custom-engineered?
8. (For Nyle and Colmac) Your product can be configured to either operate in multi-pass or single-pass configuration. Do you provide recommendation to designers to determine which configuration to use? If so, how do you determine which configuration to recommend?
9. Do you have a design strategy for maintaining lower water heater inlet water temperatures?
10. In addition to code requirements that ensure system performance and efficiency – of the floor requirements – what are some design dos and don'ts to ensure systems are designed, installed, operated to achieve performance and efficiency?
11. What is manufacturer's role after installation? Does manufacturer provide field testing and support commissioning?
12. Do your HPWH systems come packaged with other components, or are they separately purchased, including: Storage tanks/Recirculation pumps
13. Our understanding is that most central HPWH systems sold require custom engineering for controller and controls programming. The plumbing contractors are responsible for ensuring the performance of and effectively commissioning the systems now. Could you confirm this is the case or help paint a picture on the state of ready-to-go system offerings? For example: What else besides controls should be included in the Commissioning scope? (existing plumbing system) Do you have plans to, or are you aware of plans to partner with/provide companion stand-alone controllers, or even integrate necessary controls capabilities soon?
14. Product U.S. D.O.E. category and testing protocol: Commercial HPWH should be

rated by COP and tested in according to Appendix E to subpart G of Part 431. There is no minimum efficiency requirement by CFR. And, commercial HPWHs has a rated electric power input greater than 12 kW. *Residential electric water heater ([defined as has a nameplate input rating of 12 KW or less](#)) and residential duty commercial water heaters should be rated by UEF and a bunch of other parameters (first hour rating, etc.) in according to [Appendix E to Subpart B of Part 430](#).*

- Do your products fall under commercial water heater, residential electric water heater or residential duty commercial water heater?
- Do you test the product according to [Appendix E to subpart G of Part 431](#)? Or [Appendix E to Subpart B of Part 430](#).

The Statewide CASE Team reviewed proposed code requirement with each interviewee and collected feedback. Proposed code requirement under consideration are as follows:

HPWH equipment specifications design parameters

- All central HPWH shall be certified to the Energy Commission by the manufacturers, including provide performance data required to support compliance software modeling
- Capable of providing hot water temperature greater than 150°F with ambient air temperature between 5 – 100°F; Capable of operating with a minimum ambient temperature of -20°F
- Defrost control capability
- All hot water storage tanks shall be insulated to a minimum of R-22 and be set on a minimum R-10 pad

Plumbing configurations

- System types: single pass system or multi-pass system
- Multiple HPWH compressors shall be installed to operate in parallel with each other
- Storage tank configuration
 - For a single-pass system: multiple storage tanks shall be piped in series; no recirculation water piped directly into HPWH
 - For a multi-pass system, multiple storage tanks shall be piped in parallel
- Plant serving more than xx dwelling units, design shall have a separate temperature maintenance (“recirculation loop tank”) mechanism from primary hot water load system; this could be either be a recirculation loop tank or dedicated multi-pass system

- Incorporate a mixing valve capable of supplying hot water to building, at the user set temperature, consistent with the requirement of the California Plumbing Code. Mixing valve shall be capable of supply hot water at the user set temperature at the minimum and maximum building demand flow rates.
- Recirculation loop tank piping connection requirement (*ED*):
 - The primary storage hot outlet shall be piped to the bottom of the recirculation loop tank.
 - The return from hot water circulation loop shall be piped to the bottom of the recirculation loop tank.
 - Hot water delivered to the mixing valve (described below) shall be piped from the top of the recirculation loop tank.

Equipment Sizing

- Size/capacity in kBTU/hr: meets or exceeds reference industry design guidelines
- Minimum storage tank to heat pump capacity ratio exceeds Y gallon per kBTU/hr

Control capabilities

- Tank temperature sensor shall be located in the primary storage volume at 30-50 percent of the effective volume from the bottom of the tank. For tanks in series, the effective volume is defined as the sum of all tank volumes. The bottom height corresponds to the bottom of the first tank and the top height corresponds to the top of the last tank. (*ED*)
- Temperature set point of primary storage shall be at least 150°F (*ED*)
- If system has a recirculation loop tank, loop tank temperature setpoint shall be at least 20°F below the primary storage tank temperature (*ED*)
- Allow staging by individual heat pumps if multiple units are installed
- Automatic alarming capability for system failure, indicated by equipment fault, low storage tank temperature, and low hot water supply temperature

Installations

- Adequate access to ventilation per manufacturer requirements
- Follow manufacturers requirements on total allowed pipe length between HPWHs and storage tanks, total allowed vertical separation, and appropriate tank connections.

Functional testing and acceptance testing after installation

- Load shifting per code reference

- Maintenance requirement

Heat Pump Maintenance

Based on manufacturer literature, the maintenance for central HPWH system maintenance is heat pump-related, and tank-related. Common maintenance procedures for each are:

- Filters (if present)
- Removing debris from and cleaning the heat exchanger coil – can usually be rinsed clean with water
- Flushing or de-scaling the heat exchanger and connected components (such as check valves) may be necessary for some equipment or in locations with harder water.
- Inspecting heat pump for damage and repairing any broken/damaged components.
- Storage Tank Maintenance
 - Cleaning / flushing the tank per tank manufacturer’s recommendations
 - Replacing tank sacrificial anode rods to limit scale
 - Inspecting storage tank for damage and repairing any broken/damaged components

Appendix K. NRDC Memo to Energy Commission on Multifamily All-Electric Baseline in 2019 ACM

Note: Below is a copy of the memo submitted by NRDC on behalf of various stakeholders including TRC as part of this CASE effort.

To: California Energy Commission

From: Pierre Delforge, NRDC

Date: 8/9/19

Re: High-rise multifamily all-electric baseline in 2019 ACM

This memo summarizes preliminary findings of the informal working group convened by NRDC to discuss and develop solutions to the HVAC baseline issues that many stakeholders raised during the 2019 ACM process. The purpose of this memo is to provide preliminary results and to seek feedback to inform the development of the group's final proposal for high-rise multifamily buildings.

The working group collectively modeled all-electric HVAC systems in six buildings using the Energy Commission prototypes for retail, restaurant, school, and office buildings and the Noresco 2022 prototypes for mid- and high-rise multifamily buildings. For most building types, a minimum efficiency split system heat pump was modeled, except for the office building where a VRF system was modeled. Minimum efficiency equipment was modeled both because of preemption, since any alternate baseline would need to be set based on federal minimums, and because the group determined that it is representative of the systems currently being installed in the field, as discussed in more detail below.

The group found a significant penalty for the high-rise multifamily building, a moderate penalty for the mid-rise multifamily building, and no to minor penalties in all other building types. In Climate Zone 12, the total compliance penalty was found to be 20 percent for the high-rise multifamily prototype, with the penalty defined as the ratio of the negative compliance margin of the electric HVAC model compared to the standard compliance TDV budget. The total compliance margin results for CZ 12 for three efficiency options analyzed to date are shown in Table 1. Full results for the five climate zones analyzed, including the breakdown between heating and total penalty, are shown in Table 2.

Table 122: High-rise Multifamily Electric HVAC Compliance Penalty in Climate Zone 12

Split HP Efficiency	Current TDV Penalty Compared to Gas Baseline	Relative Cost / Availability¹⁶	TDV Penalty if HP is Used to Set All-Electric Baseline
SEER 14/ 8.2 HSPF	20%	Low	0%
SEER 14.5/ 8.2 HSPF	19%	Medium	1%
SEER 16/ 8.2 HSPF	15%	High	5%

The high penalty for high-rise multifamily stems from the use of the four-pipe fan coil (FPFC) as the baseline system. This system type creates both a heating penalty and a cooling penalty for a split system heat pump compared to the central boiler and chiller baseline, as shown in Table 2. Based on the experience of the group and TRC’s survey of multifamily building system types, the FPFC is not commonly seen in practice in multifamily buildings. While there is no single common system type in high-rise multifamily buildings, the following system types were discussed for the all-electric high-rise multifamily baseline system type: packaged/vertical terminal heat pumps (PTACs/VTACs), split system heat pumps, VRF, water source heat pumps (WSHPs) served by a heat pump fed central water loop, and heat recovery chillers. Of these, a split system heat pump was chosen for the all-electric baseline based on its higher efficiency compared to P/VTACs, established modeling compared to VRF, and ability to be modeled in CBECC-Com compared to WSHPs or heat recovery chillers.

As can be seen in Table 121 and Table 123, the split system HP has a significant heating and cooling penalty compared to the FPFC baseline. The group also modeled two higher SEER options to understand what the envelope tradeoff might if a minimum efficiency heat pump were used as the baseline system (i.e., could higher efficiency equipment be traded for a less efficient envelope). These results are also shown in Table 1. Based on discussion with the group, SEER 14 equipment is the most common and there is a large cost premium for higher efficiency equipment. This group discussion is corroborated by the 2015 U.S. D.O.E. Final Rule for ASHRAE products, which showed limited product availability above 14 SEER, as shown in Figure 1. The SEER 14.5 equipment reduces the compliance penalty by one percent compared to the minimum efficiency heat pump and the SEER 16 equipment reduces the compliance penalty by about five percent compared to the minimum efficiency heat pump (i.e., in Climate Zone 12, the total penalty decreases from 20 to 15 percent).

¹⁶ Based on discussions in ACM working group of available products and cost for above minimum efficiency.

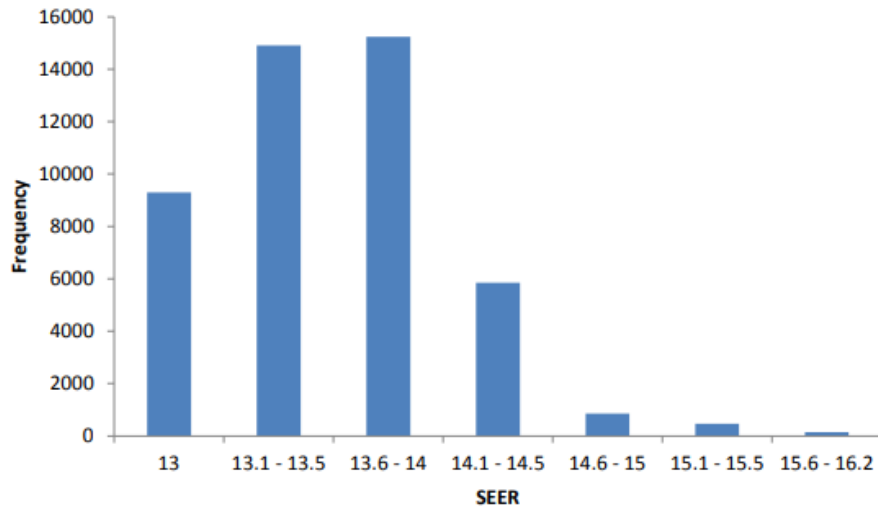

Figure 41: SEER histogram of product availability for three-phase commercial air-cooled split system heat pumps <65,000 Btu/H.

Source: Statewide CASE Team

The group would like to propose an alternative compliance package for all-electric HVAC systems that would use a split system heat pump as the baseline system type. As shown in Table 1, an alternative baseline using a minimum efficiency of SEER 14 would result in no penalty for electric systems. Alternatively, an alternative compliance package could be developed using a minimum efficiency split system HP plus complementary measures. For this alternative package, the TDV energy use of either the 14.5 or 16 SEER options could be used as a target compliance budget. That is to say that complementary measures could be set so that the TDV energy use of minimum efficiency equipment plus complementary measures would equal the energy use of using SEER 14.5 or 16 equipment on its own, or roughly a one or five percent penalty compared to the gas baseline (in Climate Zone 12). This would result in a TDV score for the alternate electric baseline that is 15-19 percent higher than the current gas baseline created by the FPFC system (in Climate Zone 12 for SEER 16).

The Statewide CASE Team thinks that an alternative all electric baseline is warranted as there is currently a significant penalty for all-electric HVAC equipment in high-rise multifamily buildings and eliminating this difference in TDV entirely would negate the point of setting an alternate electric baseline. Setting the target TDV using SEER 14.5 or 16 as a benchmark would eliminate potential envelope tradeoffs through specification of higher efficiency equipment, but still somewhat penalize electric construction.

The Statewide CASE Team is looking for feedback from the Energy Commission on whether to move forward with this approach and analyze complementary measures to pair with a minimum efficiency split heat pump to establish an alternate electric baseline, and whether to target SEER 14, 14.5, or 16.

Table 123: Heating and Total TDV Penalties Compared to The Gas Baseline TDV For Mid and High-Rise Multifamily for The Five Climate Zones and Three Efficiency Options Analyzed

		TDV Difference from Standard Design Compliance TDV % (Positive = Penalty)				
		CZ 3	CZ 6	CZ 9	CZ 12	CZ 16
Mid-rise Multifamily	Heating	2%	5%	0%	1%	7%
	Total	1%	4%	2%	1%	7%
High-rise Multifamily (14 SEER)	Heating	11%	9%	3%	9%	20%
	Total	16%	14%	9%	20%	31%
High-rise Multifamily (14.5 SEER)	Heating	11%	9%	3%	9%	20%
	Total	15%	13%	8%	19%	29%
High-rise Multifamily (16 SEER)	Heating	11%	9%	3%	9%	20%
	Total	12%	10%	4%	15%	26%

Appendix L. Review of Appliances and Miscellaneous Loads in Multifamily Buildings

Heat Pump Dyers

A heat pump dryer utilizes a heat pump to generate heat instead of an electric resistance coil or gas. The heat pump allows the dryer to be ventless. Heat pump dryers have only recently entered the American market in a significant sense but have a longer market history internationally. Model availability is still limited and the CEF of models varies substantially for compact and full-sized models (see table below).

Table 124: Heat Pump Clothes Dryer Product Availability

Model	CEF	ENERGY STAR® Annual Energy Use (kWh/yr)	Size
Whirlpool - WHD862CH	5.20	460	Full
Whirlpool - WHD560CH	5.20	460	Full
Whirlpool - WED7990FW	4.50	531	Full
Whirlpool - WED99HED	4.50	531	Full
LG - DLHX4372	4.30	556	Full
LG - DLHX4072	4.30	556	Full
Kenmore - 8159#####	4.30	556	Full
Miele - PDR908 HP	9.75	87	Compact
Miele - TWB120 WP	6.37	133	Compact
Miele - TWF160 WP	6.37	133	Compact
Miele - TWF180 WP	6.37	133	Compact
Samsung - DV22N685*H*	5.85	145	Compact
Samsung - DV22N680*H*	5.70	145	Compact
Blomberg - DHP24412W	5.70	149	Compact
Beko - HPD24400W	5.70	149	Compact
Blomberg - DHP24400W	5.70	149	Compact
Beko - HPD24412W	5.70	149	Compact
Asko - T208H.W.U	4.50	189	Compact

Heat pump appliances have the potential to provide significant energy savings over electric resistance and gas dryers. Dryer efficiency is rated by Combined Energy Factor. “Combined Energy Factor (CEF) is the quotient of the test load size, 8.45 lbs for standard dryers and 3 lbs for compact dryers, C, divided by the sum of the machine electric energy use during standby and operational cycles” (Energy Star n.d.) Heat pump dryers are capable of achieving very high CEFs compared to the rest of the market (see table below).

Table 125: Combined Energy Factors for Heat Pump Dryers Compared to Federal Standards

	CEF	Annual Energy (kWh)
Federal Requirements	3.73	
ENERGY STAR® Minimum*	3.93	608
Full-Sized Heat Pump Dryer*	4.3-5.2	460-556
Compact Heat Pump Dryer *	4.5-9.75	87-189
*From EnergyStar product directory		

There are not many studies that have examined the efficiency of heat pump dryers. The other is that many of the models now available in the American market are early generation designs, which may be impacting performance (Denkenberger, et al. 2011).

The literature review resulted in some key findings:

- The existing studies consistently found savings compared to electric resistance and gas dryers; however, the magnitude of the savings was inconsistent and uncertain (Denkenberger, et al. 2014). The uncertainty was because the studies frequently studied the energy impact of a heat pump dryer together with a high efficiency washer, so it was unclear how much of the savings were due to the dryer, and how much were due to the impact of greater water extraction by the clothes washer.
- Efficiency ratings and estimated annual performance are very different for full-sized versus compact HP dryers. Annual energy consumption between full-sized and compact models varies significantly, even with similar CEF ratings. This is pertinent since some energy savings claims are based on compact models.
- Relying only on the U.S. D.O.E. testing methodology (76 FR 22454) may overestimate the actual energy performance of heat pump dryers (Denkenberger, et al. 2011). This is due largely to the testing cloths required by the U.S. D.O.E. methodology.
- In one study, the savings from first generation US market heat pump dryers was 20-25 percent (although these savings include the savings from high efficiency washers) compared to the 30 percent savings that were anticipated based purely on the CEF (Dymond 2018). However, savings for the second generation of dryers were more than 30 percent.
- In one study, heat pump dryers set to automatic stop did not always fully dry the clothes (Denkenberger, et al. 2014). This resulted in users “re-drying” clothes or turning off the “eco” mode which resulted in more energy consumption. This may be connected to the first vs second generation issue.

- There can be an impact on space conditioning. However, the impact may be less than might be anticipated (Denkenberger, et al. 2011). Although the ventless operation saves energy compared to traditional vented dryers that exhaust conditioned air, all the heat generated by the dryer is ejected into the space. This would be advantageous to heating load dominated buildings, but disadvantageous to cooling load dominated buildings. None of the studies in the literature quantified this impact, for California or any other market.

Heat Pump dryer technology provides the potential for significant energy savings. However, until the real-world savings can be established through more robust performance study, there is not a justification for changing the Title 24, Part 6 ACM Reference Manuals to accommodate the use of this technology. This would be a good topic for future CASE studies.

Central Laundry

The Residential ACM Reference Manual includes an input for in-unit laundry, but no input for central laundry. Efficiency advocates have long claimed that multifamily buildings with common area laundries consume less energy than those with in-unit laundry because common area laundries encourage users to run fewer, fuller laundry loads. In-unit equipment encourages tenants to do smaller, more convenient loads of laundry.

The literature review resulted in some key findings:

- The Statewide CASE Team found only one study that examined the energy difference between common area and in-unit laundries (National Research Center Inc. 2002). The study found that energy use averaged five times higher in multifamily buildings with in-unit versus common area laundries.
- The distribution of common area versus in-unit laundry varied significantly from one market to another (Nieman 2015). The occurrence of common area laundries varied from 39-88 percent. In-unit laundries ranged from 11-42 percent. Those with none varied from 7-21 percent.

Induction Ranges

An induction range utilizes a magnetic field to induce heat in ferrous cooking vessels instead of a resistance coil or gas flame. This allows for faster heat-up times and therefore reduced cooking times in certain cooking tasks. Since only the cooking vessel itself heats up and not the hob (the “burner” in a traditional range), there is the potential for less heat to be contributed to the space. This would have an impact on space conditioning energy use through reducing cooling loads and increasing heating loads; therefore, the impact would vary based on climate zone.

Induction ranges have the potential to provide energy savings over conventional electric resistance and gas burner ranges. Unlike heat pump dryers, ranges do not have a federal testing methodology. This means that there is not an established method for assessing energy savings of ranges (although it also means that these appliances could be directly regulated in California).

The literature review resulted in some key findings:

- A benefit of induction ranges is that they effectively turn the heating vessel into the heating element. This eliminates the energy wasted from the mismatch between heating elements or gas burners and cooking vessels. This can mean that "90 percent of the energy consumed is transferred to the food, compared to about 74 percent for traditional electric systems and 40 percent for gas" (Sweeney, et al. 2014).
- The efficiency gains of induction ranges vary substantially based on cooking task (Livchak , Hedrick and Young 2019). In real-world cooking tests, the efficiency gains were greater for shorter cooking tasks where heat-up energy represents a larger portion of the total energy for the cooking task (Table 1 from the study). For longer cooking tasks, the efficiency gains were less (Table 4 from the study).
- Estimating savings is also complicated by the selection of baseline. As can be seen in the tables above, energy savings are more when compared to resistance coil ranges versus resistance ceramic changes. For some cooking tasks, the study did not find any notable savings above a resistance ceramic range even when there were savings above a resistance coil.
- Estimating the actual energy savings impact is complicated by the lack of a standard for cooking patterns. Since the savings vary significantly depending on cooking task, total energy savings would vary significantly depending on the combination of cooking tasks that are assumed over the course of a day, week, and year. For example, the only study that estimated annual energy use resulted in an annual energy use much greater than the annual energy use assumed by the Residential ACM Reference Manual.
- One of the bigger opportunities for an impact on total building energy consumption is the impact on space conditioning. Since induction ranges deliver more of the energy to the cooking vessel and less to the surrounding air, there is an impact on space conditioning. This would potentially lower cooling energy use but increase heating energy use. However, none of the studies in the literature review examined the impact on space conditioning.
- The high cost of induction ranges has a significant impact on the potential cost effectiveness. According to one study, the payback could be as high as 44 years (Sweeney, et al. 2014).

Induction ranges have the potential to deliver energy savings. However, the lack of reliable energy savings estimates means that more research needs to be done before that can happen. This would be an appropriate topic for future CASE studies. Any future study would need to include research into reasonable cooking profiles for California households.

Appendix M. Nominal Savings Tables

In Section 5.3, the energy cost savings of the proposed code changes over the 15 and 30-year period of analysis are presented in 2023 present value dollars.

This appendix presents energy cost savings in nominal dollars. Energy costs are escalating as in the TDV analysis, but the time value of money is not included so the results are not discounted.

Electric HVAC Systems

Table 126: Nominal TDV Cost Savings Over 30-Year Period of Analysis – Per Dwelling Unit – 2-Story Garden Style New Construction – SZHP with efficiency measures

Climate Zone	30-Year TDV Electricity Cost Savings (Nominal \$)	30-Year TDV Natural Gas Cost Savings (Nominal \$)	Total 30-Year TDV Energy Cost Savings (Nominal \$)
1	(\$11,743)	\$13,073	\$1,330
2	(\$6,493)	\$6,900	\$407
3	(\$3,132)	\$3,356	\$224
4	(\$2,957)	\$3,018	\$61
5	(\$2,481)	\$2,894	\$413
6	(\$138)	\$626	\$488
7	\$355	\$245	\$600
8	(\$108)	\$270	\$162
9	(\$669)	\$853	\$184
10	(\$1,824)	\$1,757	(\$67)
11	(\$6,522)	\$6,104	(\$418)
12	(\$5,929)	\$5,662	(\$267)
13	(\$5,187)	\$4,517	(\$670)
14	(\$3,627)	\$5,730	\$2,104
15	\$241	\$75	\$316
16	(\$3,567)	\$4,514	\$947

Table 127: Nominal TDV Cost Savings Over 30-Year Period of Analysis – Per Dwelling Unit – 3-Story Loaded Corridor New Construction – SZHP with efficiency measures

Climate Zone	30-Year TDV Electricity Cost Savings (Nominal \$)	30-Year TDV Natural Gas Cost Savings (Nominal \$)	Total 30-Year TDV Energy Cost Savings (Nominal \$)
1	(\$7,572)	\$7,513	(\$60)
2	(\$4,555)	\$4,300	(\$255)
3	(\$1,934)	\$1,677	(\$257)
4	(\$1,756)	\$1,710	(\$46)
5	(\$1,223)	\$1,394	\$172
6	\$105	\$187	\$292
7	\$393	\$49	\$443
8	\$17	\$94	\$110
9	(\$334)	\$399	\$65
10	(\$1,240)	\$1,056	(\$184)
11	(\$4,924)	\$4,105	(\$820)
12	(\$4,533)	\$3,733	(\$800)
13	(\$3,919)	\$2,905	(\$1,014)
14	(\$2,287)	\$3,676	\$1,389
15	\$125	\$9	\$134
16	(\$2,264)	\$2,375	\$111

Table 128: Nominal TDV Cost Savings Over 30-Year Period of Analysis – Per Dwelling Unit – 5-Story Mixed-Use New Construction – SZHP (CZ16 with efficiency measures)

Climate Zone	30-Year TDV Electricity Cost Savings (Nominal \$)	30-Year TDV Natural Gas Cost Savings (Nominal \$)	Total 30-Year TDV Energy Cost Savings (Nominal \$)
1	(\$5,227)	\$6,542	\$1,315
2	(\$3,147)	\$3,982	\$835
3	(\$1,775)	\$2,590	\$815
4	(\$1,545)	\$2,008	\$463
5	(\$1,946)	\$2,323	\$377
6	(\$464)	\$680	\$217
7	(\$299)	\$485	\$187
8	(\$437)	\$639	\$202
9	(\$687)	\$995	\$307
10	(\$1,172)	\$1,485	\$313
11	(\$3,216)	\$4,326	\$1,110
12	(\$3,091)	\$3,858	\$766
13	(\$2,594)	\$3,302	\$708
14	(\$3,034)	\$3,470	\$436
15	(\$274)	\$406	\$132
16	(\$1,054)	\$3,140	\$2,086

Table 129: Nominal TDV Cost Savings Over 30-Year Period of Analysis – Per Dwelling Unit – 10-Story Mixed-Use New Construction – SZHP (CZ16 with efficiency measures)

Climate Zone	30-Year TDV Electricity Cost Savings (Nominal \$)	30-Year TDV Natural Gas Cost Savings (Nominal \$)	Total 30-Year TDV Energy Cost Savings (Nominal \$)
1	(\$4,983)	\$6,459	\$1,476
2	(\$2,938)	\$3,748	\$810
3	(\$1,543)	\$2,259	\$716
4	(\$1,348)	\$1,739	\$390
5	(\$1,565)	\$1,908	\$342
6	(\$317)	\$475	\$157
7	(\$232)	\$399	\$167
8	(\$325)	\$476	\$151
9	(\$575)	\$830	\$255
10	(\$1,023)	\$1,303	\$280
11	(\$3,485)	\$4,713	\$1,229
12	(\$2,970)	\$3,750	\$780
13	(\$2,511)	\$3,180	\$669
14	(\$3,119)	\$3,582	\$463
15	(\$215)	\$312	\$97
16	(\$1,140)	\$2,640	\$1,500

Table 130: Nominal TDV Cost Savings Over 30-Year Period of Analysis – Per Dwelling Unit – 5-Story Mixed-Use New Construction – Mini-split

Climate Zone	30-Year TDV Electricity Cost Savings (Nominal \$)	30-Year TDV Natural Gas Cost Savings (Nominal \$)	Total 30-Year TDV Energy Cost Savings (Nominal \$)
1	(\$5,227)	\$6,542	\$1,315
2	(\$3,147)	\$3,982	\$835
3	(\$1,775)	\$2,590	\$815
4	(\$1,545)	\$2,008	\$463
5	(\$1,946)	\$2,323	\$377
6	(\$464)	\$680	\$217
7	(\$299)	\$485	\$187
8	(\$437)	\$639	\$202
9	(\$687)	\$995	\$307
10	(\$1,172)	\$1,485	\$313
11	(\$3,216)	\$4,326	\$1,110
12	(\$3,091)	\$3,858	\$766
13	(\$2,594)	\$3,302	\$708
14	(\$3,034)	\$3,470	\$436
15	(\$274)	\$406	\$132
16	(\$11,321)	\$9,476	(\$1,845)

Table 131: Nominal TDV Cost Savings Over 30-Year Period of Analysis – Per Dwelling Unit – 10-Story Mixed-Use New Construction – Mini-split

Climate Zone	30-Year TDV Electricity Cost Savings (Nominal \$)	30-Year TDV Natural Gas Cost Savings (Nominal \$)	Total 30-Year TDV Energy Cost Savings (Nominal \$)
1	(\$4,983)	\$6,459	\$1,476
2	(\$2,938)	\$3,748	\$810
3	(\$1,543)	\$2,259	\$716
4	(\$1,348)	\$1,739	\$390
5	(\$1,565)	\$1,908	\$342
6	(\$317)	\$475	\$157
7	(\$232)	\$399	\$167
8	(\$325)	\$476	\$151
9	(\$575)	\$830	\$255
10	(\$1,023)	\$1,303	\$280
11	(\$3,485)	\$4,713	\$1,229
12	(\$2,970)	\$3,750	\$780
13	(\$2,511)	\$3,180	\$669
14	(\$3,119)	\$3,582	\$463
15	(\$215)	\$312	\$97
16	(\$12,552)	\$10,712	(\$1,840)

Table 132: Nominal TDV Cost Savings Over 30-Year Period of Analysis – Per Dwelling Unit – 5-Story Mixed-Use New Construction – VRF System

Climate Zone	30-Year TDV Electricity Cost Savings (Nominal \$)	30-Year TDV Natural Gas Cost Savings (Nominal \$)	Total 30-Year TDV Energy Cost Savings (Nominal \$)
1	(\$4,966)	\$6,541	\$1,575
2	(\$4,129)	\$3,984	(\$145)
3	(\$2,641)	\$2,592	(\$49)
4	(\$2,993)	\$2,011	(\$983)
5	(\$2,773)	\$2,325	(\$447)
6	(\$2,394)	\$682	(\$1,711)
7	(\$2,280)	\$487	(\$1,793)
8	(\$2,324)	\$640	(\$1,684)
9	(\$2,372)	\$997	(\$1,376)
10	(\$2,967)	\$1,486	(\$1,480)
11	(\$4,501)	\$4,329	(\$173)
12	(\$4,484)	\$3,861	(\$623)
13	(\$4,684)	\$3,304	(\$1,380)
14	(\$3,839)	\$3,473	(\$367)
15	(\$2,433)	\$405	(\$2,028)
16	(\$13,181)	\$9,480	(\$3,701)

Table 133: Nominal TDV Cost Savings Over 30-Year Period of Analysis – Per Dwelling Unit – 10-Story Mixed-Use New Construction – VRF System

Climate Zone	30-Year TDV Electricity Cost Savings (Nominal \$)	30-Year TDV Natural Gas Cost Savings (Nominal \$)	Total 30-Year TDV Energy Cost Savings (Nominal \$)
1	(\$4,532)	\$6,459	\$1,926
2	(\$3,386)	\$3,749	\$363
3	(\$2,210)	\$2,259	\$49
4	(\$2,427)	\$1,740	(\$687)
5	(\$2,318)	\$1,909	(\$409)
6	(\$1,591)	\$475	(\$1,116)
7	(\$1,644)	\$399	(\$1,245)
8	(\$1,402)	\$476	(\$926)
9	(\$1,482)	\$830	(\$652)
10	(\$1,943)	\$1,304	(\$639)
11	(\$4,540)	\$4,714	\$174
12	(\$4,230)	\$3,750	(\$480)
13	(\$4,467)	\$3,180	(\$1,286)
14	(\$3,856)	\$3,583	(\$272)
15	(\$1,917)	\$313	(\$1,604)
16	(\$14,119)	\$10,712	(\$3,407)

Electric Central HPWH Systems

Table 134: Nominal TDV Energy Cost Savings Over 30-Year Period of Analysis – Per Dwelling Unit– New Construction – 2-Story Garden

Climate Zone	30-Year TDV Electricity Cost Savings (Nominal \$)	30-Year TDV Natural Gas Cost Savings (Nominal \$)	Total 30-Year TDV Energy Cost Savings (Nominal \$)
1	(\$8,561)	\$18,624	\$10,063
2	(\$7,909)	\$17,192	\$9,283
3	(\$8,056)	\$17,170	\$9,114
4	(\$7,820)	\$16,322	\$8,502
5	(\$8,181)	\$17,172	\$8,991
6	(\$7,262)	\$15,811	\$8,550
7	(\$7,392)	\$15,835	\$8,444
8	(\$7,010)	\$15,367	\$8,358
9	(\$6,949)	\$15,504	\$8,554
10	(\$7,113)	\$13,346	\$6,234
11	(\$7,696)	\$13,651	\$5,955
12	(\$7,766)	\$14,005	\$6,239
13	(\$7,337)	\$13,242	\$5,905
14	(\$7,312)	\$13,727	\$6,415
15	(\$6,267)	\$11,418	\$5,151
16	(\$9,391)	\$15,772	\$6,381

Table 135: Nominal TDV Energy Cost Savings Over 30-Year Period of Analysis – Per Dwelling Unit– New Construction – 3-Story Loaded Corridor

Climate Zone	30-Year TDV Electricity Cost Savings (Nominal \$)	30-Year TDV Natural Gas Cost Savings (Nominal \$)	Total 30-Year TDV Energy Cost Savings (Nominal \$)
1	(\$7,717)	\$12,700	\$4,983
2	(\$6,429)	\$9,831	\$3,402
3	(\$6,316)	\$9,634	\$3,318
4	(\$6,245)	\$8,601	\$2,356
5	(\$6,580)	\$8,980	\$2,399
6	(\$5,787)	\$7,602	\$1,815
7	(\$5,754)	\$8,003	\$2,249
8	(\$5,818)	\$7,319	\$1,500
9	(\$5,804)	\$7,206	\$1,402
10	(\$5,753)	\$7,174	\$1,421
11	(\$6,233)	\$8,532	\$2,299
12	(\$6,301)	\$8,840	\$2,539
13	(\$6,039)	\$7,935	\$1,897
14	(\$6,143)	\$7,109	\$965
15	(\$4,812)	\$5,069	\$258
16	(\$8,574)	\$10,748	\$2,174

Table 136: Nominal TDV Energy Cost Savings Over 30-Year Period of Analysis – Per Dwelling Unit– New Construction – 5-Story Mixed-Use

Climate Zone	30-Year TDV Electricity Cost Savings (Nominal \$)	30-Year TDV Natural Gas Cost Savings (Nominal \$)	Total 30-Year TDV Energy Cost Savings (Nominal \$)
1	(\$6,482)	\$12,520	\$6,037
2	(\$5,819)	\$11,448	\$5,629
3	(\$5,997)	\$11,432	\$5,435
4	(\$5,452)	\$10,799	\$5,347
5	(\$6,017)	\$11,435	\$5,417
6	(\$5,227)	\$10,419	\$5,192
7	(\$5,288)	\$10,427	\$5,139
8	(\$5,004)	\$10,088	\$5,083
9	(\$5,110)	\$10,188	\$5,078
10	(\$5,088)	\$8,618	\$3,531
11	(\$5,396)	\$8,845	\$3,449
12	(\$5,622)	\$9,112	\$3,490
13	(\$5,146)	\$8,553	\$3,407
14	(\$5,283)	\$8,902	\$3,619
15	(\$4,381)	\$7,177	\$2,796
16	(\$7,174)	\$10,416	\$3,242

Table 137: Nominal TDV Energy Cost Savings Over 30-Year Period of Analysis – Per Dwelling Unit– New Construction – 10-Story Mixed-Use

Climate Zone	30-Year TDV Electricity Cost Savings (Nominal \$)	30-Year TDV Natural Gas Cost Savings (Nominal \$)	Total 30-Year TDV Energy Cost Savings (Nominal \$)
1	(\$6,378)	\$11,259	\$4,881
2	(\$5,470)	\$10,241	\$4,771
3	(\$5,496)	\$10,225	\$4,729
4	(\$4,870)	\$9,624	\$4,754
5	(\$5,622)	\$10,228	\$4,606
6	(\$4,701)	\$9,261	\$4,560
7	(\$4,789)	\$9,266	\$4,477
8	(\$4,288)	\$8,946	\$4,658
9	(\$4,323)	\$9,042	\$4,719
10	(\$4,446)	\$7,579	\$3,133
11	(\$4,892)	\$7,811	\$2,919
12	(\$5,031)	\$8,056	\$3,025
13	(\$4,677)	\$7,535	\$2,858
14	(\$4,566)	\$7,848	\$3,282
15	(\$3,632)	\$6,222	\$2,590
16	(\$6,870)	\$9,283	\$2,413

Package A: Combined Electric HVAC and Central HPWH Systems

Table 138: Nominal TDV Energy Cost Savings Over 30-Year Period of Analysis – Per Dwelling Unit – 5-Story Mixed-Use New Construction – SZHP & Mini-Split + CHPWH

Climate Zone	30-Year TDV Electricity Cost Savings (Nominal \$)	30-Year TDV Natural Gas Cost Savings (Nominal \$)	Total 30-Year TDV Energy Cost Savings (Nominal \$)
1	(\$11,710)	\$19,062	\$7,352
2	(\$8,966)	\$15,431	\$6,464
3	(\$7,772)	\$14,022	\$6,250
4	(\$6,997)	\$12,807	\$5,810
5	(\$7,963)	\$13,757	\$5,794
6	(\$5,690)	\$11,100	\$5,409
7	(\$5,587)	\$10,912	\$5,325
8	(\$5,441)	\$10,727	\$5,285
9	(\$5,798)	\$11,183	\$5,385
10	(\$6,260)	\$10,103	\$3,843
11	(\$8,611)	\$13,170	\$4,559
12	(\$8,713)	\$12,970	\$4,257
13	(\$7,740)	\$11,855	\$4,115
14	(\$8,317)	\$12,372	\$4,055
15	(\$4,656)	\$7,583	\$2,927
16	(\$18,494)	\$19,892	\$1,398

Table 139: Nominal TDV Energy Cost Savings Over 30-Year Period of Analysis – Per Dwelling Unit – 10-Story Mixed-Use New Construction – SZHP & Mini-Split + CHPWH

Climate Zone	30-Year TDV Electricity Cost Savings (Nominal \$)	30-Year TDV Natural Gas Cost Savings (Nominal \$)	Total 30-Year TDV Energy Cost Savings (Nominal \$)
1	(\$11,361)	\$17,718	\$6,357
2	(\$8,408)	\$13,989	\$5,581
3	(\$7,039)	\$12,484	\$5,445
4	(\$6,218)	\$11,363	\$5,145
5	(\$7,187)	\$12,136	\$4,949
6	(\$5,018)	\$9,736	\$4,717
7	(\$5,021)	\$9,665	\$4,644
8	(\$4,613)	\$9,422	\$4,809
9	(\$4,898)	\$9,871	\$4,973
10	(\$5,470)	\$8,882	\$3,413
11	(\$8,377)	\$12,524	\$4,148
12	(\$8,000)	\$11,805	\$3,805
13	(\$7,187)	\$10,715	\$3,527
14	(\$7,685)	\$11,430	\$3,745
15	(\$3,847)	\$6,534	\$2,687
16	(\$19,423)	\$19,995	\$573

VRF Systems Combined with Central HPWH System

Table 140: Nominal TDV Energy Cost Savings Over 30-Year Period of Analysis – Per Dwelling Unit – 5-Story Mixed-Use New Construction – VRF + CHPWH

Climate Zone	30-Year TDV Electricity Cost Savings (Nominal \$)	30-Year TDV Natural Gas Cost Savings (Nominal \$)	Total 30-Year TDV Energy Cost Savings (Nominal \$)
1	(\$11,449)	\$19,061	\$7,612
2	(\$9,948)	\$15,432	\$5,484
3	(\$8,638)	\$14,024	\$5,385
4	(\$8,445)	\$12,810	\$4,364
5	(\$8,790)	\$13,760	\$4,970
6	(\$7,621)	\$11,102	\$3,481
7	(\$7,568)	\$10,914	\$3,345
8	(\$7,328)	\$10,727	\$3,399
9	(\$7,483)	\$11,185	\$3,702
10	(\$8,055)	\$10,105	\$2,050
11	(\$9,897)	\$13,173	\$3,276
12	(\$10,106)	\$12,973	\$2,867
13	(\$9,829)	\$11,857	\$2,027
14	(\$9,122)	\$12,374	\$3,252
15	(\$6,814)	\$7,582	\$768
16	(\$20,354)	\$19,896	(\$459)

Table 141: Nominal TDV Energy Cost Savings Over 30-Year Period of Analysis – Per Dwelling Unit – 10-Story Mixed-Use New Construction – VRF + CHPWH

Climate Zone	30-Year TDV Electricity Cost Savings (Nominal \$)	30-Year TDV Natural Gas Cost Savings (Nominal \$)	Total 30-Year TDV Energy Cost Savings (Nominal \$)
1	(\$10,910)	\$17,718	\$6,808
2	(\$8,856)	\$13,990	\$5,135
3	(\$7,706)	\$12,485	\$4,778
4	(\$7,297)	\$11,364	\$4,067
5	(\$7,939)	\$12,137	\$4,197
6	(\$6,292)	\$9,736	\$3,444
7	(\$6,434)	\$9,665	\$3,232
8	(\$5,690)	\$9,422	\$3,732
9	(\$5,805)	\$9,871	\$4,067
10	(\$6,389)	\$8,883	\$2,493
11	(\$9,432)	\$12,525	\$3,093
12	(\$9,261)	\$11,806	\$2,545
13	(\$9,143)	\$10,715	\$1,572
14	(\$8,421)	\$11,431	\$3,010
15	(\$5,549)	\$6,535	\$985
16	(\$20,990)	\$19,995	(\$994)

Appendix N. Savings and Cost-effectiveness Analysis for Heat Pump Space Heating and Central Heat Pump Water Heating Combined

The Statewide CASE Team analyzed energy savings and cost effectiveness of the combined all-electric HVAC plus Central HPWH measure for multifamily buildings four stories and greater.

Energy Savings

This section presents results for an all-electric building where the designer chooses both an electric HVAC system (SZHP, Mini-Split or VRF) and a Central HPWH system. Results for SZHP + Central HPWH and Mini-Split + Central HPWH are the same since SZHP and Mini-Split per-unit savings are the same as explained in Section 4.3.1.. Per-unit savings for electric HVAC systems presented in Section 4.3.1 are based on 30-year TDV analysis while per-unit savings for Central HPWH presented in Section 4.3.2 are based on 30-year TDV analysis. For the combined package of HVAC and Central HPWH, this sub-section uses values for 30-year TDV for both electric HVAC and Central HPWH.

SZHP or Mini-Split HVAC System Combined with Central HPWH

Energy savings and peak demand reductions per unit for combined SZHP or Mini-Split system with a Central HPWH are presented in Table 142 and Table 143.

The per-unit energy savings figures do not account for naturally occurring market adoption or compliance rates. For all climate zones, the per-unit electricity usage for the first year increases and natural gas usage decreases, resulting in positive TDV energy savings for Climate Zones 1 to 15, but not Climate Zone 16 for both the 5- and 10-story prototypes.

Table 142: First-Year Energy Impacts Per Dwelling Unit– 5-Story Mixed Use Prototype Building – SZHP/Mini-Split + Central HPWH Combined

Climate Zone	Electricity Savings (kWh/yr)	Peak Electricity Demand Reductions (kW)	Natural Gas Savings (therms/yr)	TDV Energy Savings (TDV kBtu/yr)
1	(1,178)	(0.4)	152	20,995
2	(962)	(0.4)	122	18,441
3	(819)	(0.3)	112	17,817
4	(764)	(0.4)	102	16,559
5	(824)	(0.4)	110	16,528
6	(641)	(0.3)	89	15,405

7	(625)	(0.3)	88	15,167
8	(625)	(0.3)	86	15,052
9	(656)	(0.4)	89	15,340
10	(701)	(0.4)	80	10,976
11	(926)	(0.4)	103	13,037
12	(910)	(0.4)	102	12,183
13	(837)	(0.4)	93	11,766
14	(898)	(0.4)	97	11,605
15	(545)	(0.3)	60	8,360
16	(1,619)	(0.5)	156	4,215

For the 5-story prototype, per-unit first year electricity usage increases between 618 to 2,087 kWh/yr, per-unit natural gas usage decreases between 73 to 198 therms/yr, and per-unit electricity demand increases between 0.3 to 0.5 kW.

For the 10-story prototype, per-unit first year electricity usage increases between 498 to 2,173 kWh/yr, per-unit natural gas usage decreases between 62 to 209 therms/yr, and per-unit electricity demand increases between 0.3 to 0.4 kW.

Table 143: First-Year Energy Impacts Per Dwelling Unit– 10-Story Mixed Use Prototype Building - SZHP/Mini-Split + Central HPWH Combined

Climate Zone	Electricity Savings (kWh/yr)	Peak Electricity Demand Reductions (kW)	Natural Gas Savings (therms/yr)	TDV Energy Savings (TDV kBtu/yr)
1	(1,063)	(0.33)	140	18,169
2	(838)	(0.34)	110	15,931
3	(696)	(0.33)	99	15,525
4	(643)	(0.30)	90	14,664
5	(689)	(0.35)	97	14,122
6	(526)	(0.29)	78	13,436
7	(519)	(0.32)	77	13,228
8	(513)	(0.27)	76	13,690
9	(543)	(0.28)	78	14,159
10	(584)	(0.32)	71	9,745
11	(848)	(0.32)	98	11,868
12	(796)	(0.33)	92	10,891
13	(725)	(0.32)	84	10,094
14	(798)	(0.39)	89	10,719
15	(435)	(0.33)	51	7,666
16	(1,635)	(0.42)	156	1,892

VRF HVAC System Combined with Central HPWH System

Energy savings and peak demand reductions per unit for combined VRF with Central HPWH system are presented in Table 144 and Table 145. The per-unit energy savings figures do not account for naturally occurring market adoption or compliance rates. For all climate zones, the per-unit electricity usage for the first year increases and natural gas usage decreases. There are positive TDV savings for all climate zones except for Climate Zone 15 and 16 for the 5- and 10-story prototypes.

For the 5-story mixed-use prototype, per-unit first year electricity usage increases between 875 to 2,173 kWh/yr, per-unit natural gas usage decreases between 69 to 198 therms/yr, and per-unit electricity demand increases between 0.3 to 0.5 kW.

For the 10-story mixed-use prototype, per-unit first year electricity usage increases between 706 to 2,183 kWh/yr, per-unit natural gas usage decreases between 62 to 209 therms/yr, and per-unit electricity demand increases between 0.3 to 0.4 kW.

Table 144: First-Year Energy Impacts Per Dwelling Unit– 5-Story Mixed Use Prototype Building – VRF + Central HPWH Combined

Climate Zone	Electricity Savings (kWh/yr)	Peak Electricity Demand Reductions (kW)	Natural Gas Savings (therms/yr)	TDV Energy Savings (TDV kBtu/yr)
1	(1,157)	(0.37)	151	21,727
2	(1,070)	(0.42)	122	15,678
3	(891)	(0.37)	112	15,379
4	(918)	(0.41)	102	12,483
5	(910)	(0.40)	110	14,203
6	(837)	(0.40)	89	9,969
7	(815)	(0.40)	87	9,584
8	(842)	(0.38)	86	9,733
9	(858)	(0.41)	89	10,594
10	(899)	(0.46)	80	5,921
11	(1,084)	(0.42)	103	9,419
12	(1,060)	(0.42)	102	8,264
13	(1,050)	(0.40)	93	5,880
14	(1,024)	(0.46)	97	9,341
15	(801)	(0.35)	60	2,270
16	(1,806)	(0.54)	156	(1,018)

Table 145: First-Year Energy Impacts Per Dwelling Unit– 10-Story Mixed Use Prototype Building - VRF + Central HPWH Combined

Climate Zone	Electricity Savings (kWh/yr)	Peak Electricity Demand Reductions (kW)	Natural Gas Savings (therms/yr)	TDV Energy Savings (TDV kBtu/yr)
1	(1,026)	(0.34)	140	19,440

2	(902)	(0.36)	110	14,671
3	(760)	(0.36)	99	13,645
4	(755)	(0.33)	90	11,625
5	(767)	(0.38)	97	12,003
6	(665)	(0.33)	78	9,847
7	(657)	(0.36)	77	9,246
8	(645)	(0.30)	75	10,654
9	(662)	(0.30)	79	11,603
10	(694)	(0.34)	70	7,153
11	(976)	(0.34)	98	8,895
12	(933)	(0.37)	92	7,340
13	(917)	(0.34)	84	4,580
14	(911)	(0.41)	89	8,644
15	(634)	(0.34)	52	2,869
16	(1,788)	(0.46)	156	(2,527)

Energy Cost Savings

This section presents results for an all-electric building where the designer chooses both an electric HVAC system (SZHP, Mini-Split or VRF) and a Central HPWH system for a multifamily building four stories and greater. Results for SZHP + Central HPWH and Mini-Split + Central HPWH are the same since SZHP and Mini-Split per-unit savings are the same as explained in Section 4.3.1.. Per-unit savings for electric HVAC systems presented in Section 5.2.1 are based on 15-year TDV analysis while per-unit savings for Central HPWH presented in Section 5.2.2 are based on 30-year TDV analysis. For the combined package of HVAC and Central HPWH, this sub-section uses values for 30-year TDV for both electric HVAC and Central HPWH.

SZHP or Mini-Split Systems Combined with Central HPWH System

For the 5-story prototype, per-unit first year electricity costs increase between \$5,518 to \$25,760 in nominal dollars or \$2,692 to \$12,566 in 2023 present-value dollars, per-unit natural gas costs decrease between \$7,727 to \$23,843 in nominal dollars or \$3,788 to \$11,631 in 2023 present-value dollars with the total 30-year TDV energy costs ranging between increase of \$2,784 to savings of \$5,634 in nominal dollars or an increase of \$1,308 to savings of \$2,871 in 2023 present-value dollars.

For the 10-story mixed-use prototype, per-unit first year electricity costs increase between \$4,577 to \$25,569 in nominal dollars or \$2,233 to \$12,473 in 2023 present-value dollars, per-unit natural gas costs decrease between \$6,541 to \$22,255 in nominal dollars or \$3,207 to \$10,909 in 2023 present-value dollars with the total 30-year TDV energy costs ranging between an increase of \$3,314 to savings of \$4,846 in nominal dollars or an increase of \$1,563 to savings of \$2,399 in 2023 present-value dollars.

Table 146: 2023 TDV Energy Cost Savings Over 30-Year Period of Analysis – Per Dwelling Unit – 5-Story Mixed-Use New Construction – SZHP & Mini-Split + CHPWH

Climate Zone	30-Year TDV Electricity Cost Savings (2023 PV\$)	30-Year TDV Natural Gas Cost Savings (2023 PV\$)	Total 30-Year TDV Energy Cost Savings (2023 PV\$)
1	(\$5,712)	\$9,344	\$3,632
2	(\$4,374)	\$7,564	\$3,190
3	(\$3,791)	\$6,874	\$3,082
4	(\$3,414)	\$6,278	\$2,864
5	(\$3,884)	\$6,744	\$2,859
6	(\$2,776)	\$5,441	\$2,665
7	(\$2,726)	\$5,349	\$2,624
8	(\$2,654)	\$5,258	\$2,604
9	(\$2,828)	\$5,482	\$2,653
10	(\$3,054)	\$4,953	\$1,899
11	(\$4,201)	\$6,457	\$2,255
12	(\$4,250)	\$6,358	\$2,107
13	(\$3,775)	\$5,812	\$2,035
14	(\$4,057)	\$6,065	\$2,008
15	(\$2,271)	\$3,717	\$1,446
16	(\$9,022)	\$9,751	\$729

Table 147: 2023 TDV Energy Cost Savings Over 30-Year Period of Analysis – Per Dwelling Unit – 10-Story Mixed-Use New Construction – SZHP & Mini-Split + CHPWH

Climate Zone	30-Year TDV Electricity Cost Savings (2023 PV\$)	30-Year TDV Natural Gas Cost Savings (2023 PV\$)	Total 30-Year TDV Energy Cost Savings (2023 PV\$)
1	(\$4,544)	\$7,356	\$2,812
2	(\$3,421)	\$6,127	\$2,707
3	(\$3,339)	\$5,864	\$2,526
4	(\$3,140)	\$5,653	\$2,514
5	(\$2,897)	\$5,247	\$2,350
6	(\$2,406)	\$4,736	\$2,329
7	(\$2,495)	\$4,775	\$2,281
8	(\$2,372)	\$4,792	\$2,420
9	(\$2,608)	\$5,071	\$2,463
10	(\$3,869)	\$6,025	\$2,157
11	(\$3,835)	\$5,667	\$1,832
12	(\$3,679)	\$5,508	\$1,829
13	(\$3,802)	\$5,450	\$1,647
14	(\$2,332)	\$4,000	\$1,668
15	(\$2,328)	\$4,344	\$2,016
16	(\$9,474)	\$9,802	\$327

VRF Systems Combined with Central HPWH System

For the 5-story mixed-use prototype, per-unit first year electricity costs increase between \$7,845 to \$24,497 in nominal dollars or \$3,827 to \$11,950 in 2023 present-value dollars, per-unit natural gas costs decrease between \$7,218 to \$21,927 in nominal dollars or \$3,538 to \$10,749 in 2023 present-value dollars with the total 30-year TDV energy costs ranging between an increase of \$4,438 to savings of \$7,003 in nominal dollars, or an increase of \$1,627 to savings of \$3,469 in 2023 present-value dollars.

Table 148: 2023 TDV Energy Cost Savings Over 30-Year Period of Analysis – Per Dwelling Unit – 5-Story Mixed-Use New Construction – VRF + CHPWH

Climate Zone	30-Year TDV Electricity Cost Savings (2023 PV\$)	30-Year TDV Natural Gas Cost Savings (2023 PV\$)	Total 30-Year TDV Energy Cost Savings (2023 PV\$)
1	(\$5,585)	\$9,343	\$3,759
2	(\$4,853)	\$7,565	\$2,712
3	(\$4,214)	\$6,874	\$2,661
4	(\$4,120)	\$6,279	\$2,160
5	(\$4,288)	\$6,745	\$2,457

Climate Zone	30-Year TDV Electricity Cost Savings (2023 PV\$)	30-Year TDV Natural Gas Cost Savings (2023 PV\$)	Total 30-Year TDV Energy Cost Savings (2023 PV\$)
6	(\$3,717)	\$5,442	\$1,725
7	(\$3,692)	\$5,350	\$1,658
8	(\$3,575)	\$5,259	\$1,684
9	(\$3,650)	\$5,483	\$1,833
10	(\$3,929)	\$4,953	\$1,024
11	(\$4,828)	\$6,457	\$1,630
12	(\$4,930)	\$6,359	\$1,430
13	(\$4,795)	\$5,812	\$1,017
14	(\$4,450)	\$6,066	\$1,616
15	(\$3,324)	\$3,717	\$393
16	(\$9,929)	\$9,753	(\$176)

For the 10-story mixed-use building type, per-unit first year electricity costs increase between \$6,573 to \$25,540 in nominal dollars or \$3,206 to \$12,458 in 2023 present-value dollars, per-unit natural gas costs decrease between \$6,541 to \$22,255 in nominal dollars or \$3,207 to \$10,909 in 2023 present-value dollars with the total 30-year TDV energy costs ranging between an increase of \$3,284 to savings of \$7,119 in nominal dollars or an increase of \$1,549 to savings of \$3,525 in 2023 present-value dollars.

Table 149: 2023 TDV Energy Cost Savings Over 30-Year Period of Analysis – Per Dwelling Unit – 10-Story Mixed-Use New Construction – VRF + CHPWH

Climate Zone	30-Year TDV Electricity Cost Savings (2023 PV\$)	30-Year TDV Natural Gas Cost Savings (2023 PV\$)	Total 30-Year TDV Energy Cost Savings (2023 PV\$)
1	(\$5,322)	\$8,685	\$3,363
2	(\$4,320)	\$6,858	\$2,538
3	(\$3,759)	\$6,120	\$2,361
4	(\$3,559)	\$5,571	\$2,011
5	(\$3,873)	\$5,949	\$2,077
6	(\$3,069)	\$4,773	\$1,703
7	(\$3,138)	\$4,738	\$1,600
8	(\$2,776)	\$4,619	\$1,843
9	(\$2,832)	\$4,839	\$2,007
10	(\$3,117)	\$4,354	\$1,238
11	(\$4,601)	\$6,140	\$1,539
12	(\$4,517)	\$5,787	\$1,270
13	(\$4,460)	\$5,253	\$792
14	(\$4,108)	\$5,603	\$1,495
15	(\$2,707)	\$3,203	\$496
16	(\$10,239)	\$9,802	(\$437)

Cost Effectiveness

The Statewide CASE Team presents cost-effectiveness results for combination of electric HVAC and central HPWH systems in this section using a 30-year analysis period and 2023 present value dollars.

SZHP systems have lower TDV energy costs and lower incremental costs compared with mixed-fuel baseline HVAC systems as seen in Section 5.4.1, whereas Central HPWH systems have lower TDV energy costs and higher incremental costs compared with a gas-fired water heater. Combining these two measures results in lower TDV energy costs in all climate zones and reduction in incremental costs and therefore the combined measure is infinitely cost effective, since there are no upfront or TDV energy cost increases.

For the 5-story and 10-story mixed-use prototypes (Table 150 and Table 151), there are both incremental cost savings and TDV energy cost savings in all climate zones.

Table 150: 30-Year Cost-Effectiveness Summary Per Dwelling Unit – 5-Story Mixed-Use New Construction – SZHP + Central HPWH

Climate Zone	Benefits TDV Energy Cost Savings + Other PV Savings ^a (2023 PV\$)	Benefits Total Incremental PV Cost Savings ^b (2023 PV\$)	Benefit-to- Cost Ratio
1	\$3,632	\$7,008	Infinite
2	\$3,190	\$9,761	Infinite
3	\$3,082	\$9,193	Infinite
4	\$2,865	\$9,240	Infinite
5	\$2,859	\$7,049	Infinite
6	\$2,665	\$7,038	Infinite
7	\$2,624	\$7,071	Infinite
8	\$2,604	\$7,146	Infinite
9	\$2,654	\$7,049	Infinite
10	\$1,899	\$7,708	Infinite
11	\$2,255	\$7,794	Infinite
12	\$2,108	\$7,661	Infinite
13	\$2,036	\$7,674	Infinite
14	\$2,008	\$7,604	Infinite
15	\$1,446	\$7,722	Infinite
16	\$729	\$7,703	Infinite

- a. **Benefits: TDV Energy Cost Savings + Other PV Savings:** Benefits include TDV energy cost savings over the period of analysis (Energy + Environmental Economics 2016, 51-53). Note: This source to be updated when 2022 TDV methodology report is released by the Energy Commission. Other savings are discounted at a real (nominal – inflation) three percent rate. Other PV savings include incremental first-cost savings if proposed first cost is less than current first cost. Includes PV

maintenance cost savings if PV of proposed maintenance costs is less than PV of current maintenance costs.

- b. Costs: Total Incremental Present Valued Costs:** Costs include incremental equipment, replacement, and maintenance costs over the period of analysis. Costs are discounted at a real (inflation-adjusted) three percent rate and if PV of proposed maintenance costs is greater than PV of current maintenance costs. If incremental maintenance cost is negative, it is treated as a positive benefit. If there are no total incremental PV costs, the B/C ratio is infinite.

Table 151: 30-Year Cost-Effectiveness Summary Per Dwelling Unit – 10-Story Mixed-Use New Construction – SZHP + Central HPWH

Climate Zone	Benefits TDV Energy Cost Savings + Other PV Savings^a (2023 PV\$)	Benefits Total Incremental PV Costs^b (2023 PV\$)	Benefit-to-Cost Ratio
1	\$3,143	\$6,521	Infinite
2	\$2,756	\$9,322	Infinite
3	\$2,686	\$8,734	Infinite
4	\$2,537	\$8,789	Infinite
5	\$2,443	\$6,589	Infinite
6	\$2,324	\$6,578	Infinite
7	\$2,288	\$6,615	Infinite
8	\$2,368	\$6,687	Infinite
9	\$2,450	\$6,597	Infinite
10	\$1,686	\$7,194	Infinite
11	\$2,053	\$7,286	Infinite
12	\$1,884	\$7,170	Infinite
13	\$1,746	\$7,168	Infinite
14	\$1,854	\$7,094	Infinite
15	\$1,326	\$7,237	Infinite
16	\$327	\$7,147	Infinite

- a. Benefits: TDV Energy Cost Savings + Other PV Savings:** Benefits include TDV energy cost savings over the period of analysis (Energy + Environmental Economics 2016, 51-53). This source to be updated when 2022 TDV methodology report is released by the Energy Commission. Other savings are discounted at a real (nominal – inflation) three percent rate. Other PV savings include incremental first-cost savings if proposed first cost is less than current first cost. Includes PV maintenance cost savings if PV of proposed maintenance costs is less than PV of current maintenance costs.

- b. Costs: Total Incremental Present Valued Costs:** Costs include incremental equipment, replacement, and maintenance costs over the period of analysis. Costs are discounted at a real (inflation-adjusted) three percent rate and if PV of proposed maintenance costs is greater than PV of current maintenance costs. If incremental maintenance cost is negative, it is treated as a positive benefit. If there are no total incremental PV costs, the B/C ratio is infinite.

First Year Statewide Impacts

Table 152: Statewide Energy and Energy Cost Impacts – Package A: Combined SZHP + Central HPWH – New Construction^a

Climate Zone	Statewide New Construction Impacted by Proposed Change in 2023 (dwelling units)	First-Year ^b Electricity Savings (GWh)	First-Year Peak Electrical Demand Reduction (MW)	First-Year Natural Gas Savings (MMTherms)	30-Year Present Valued Energy Cost Savings (PV\$ million in 2023)
1	41	(0.05)	(0.01)	0.01	\$0.13
2	241	(0.23)	(0.09)	0.03	\$0.71
3	1,169	(0.95)	(0.40)	0.13	\$3.34
4	609	(0.46)	(0.22)	0.06	\$1.66
5	108	(0.09)	(0.04)	0.01	\$0.30
6	516	(0.33)	(0.17)	0.05	\$1.33
7	555	(0.34)	(0.19)	0.05	\$1.42
8	726	(0.45)	(0.24)	0.06	\$1.84
9	1,704	(1.10)	(0.60)	0.15	\$4.37
10	602	(0.42)	(0.25)	0.05	\$1.09
11	172	(0.16)	(0.07)	0.02	\$0.34
12	970	(0.87)	(0.36)	0.10	\$1.85
13	283	(0.23)	(0.11)	0.03	\$0.52
14	129	(0.11)	(0.06)	0.01	\$0.24
15	84	(0.04)	(0.03)	0.00	\$0.12
16	52	(0.08)	(0.03)	0.01	\$0.04
TOTAL	7,959	(5.91)	(2.84)	0.76	\$19.29

a. Savings represent 30-year present value savings for 5-Story Mixed Use, 10-Story Mixed Use prototypes

b. First-year savings from all buildings completed statewide in 2023.

Table 153: First-Year Statewide GHG Emissions Impacts

Measure	Electricity Increase ^a (GWh/yr)	Increased GHG Emissions from Electricity Increase ^a (Metric Tons CO ₂ e)	Natural Gas Savings ^a (MMTherms /yr)	Reduced GHG Emissions from Natural Gas Savings ^a (Metric Tons CO ₂ e)	Total Reduced CO ₂ e Emissions ^{a,b} (Metric Tons CO ₂ e)
Package A: Combined SZHP + Central HPWH ^c (5-Story Mixed Use,	5.9	1,421	0.76	4,132	2,711

10-Story Mixed Use over 30 years)					
--------------------------------------	--	--	--	--	--

- a. First-year savings from all affected buildings completed statewide in 2023.
- b. Assumes the following emission factors: 240.4 MTCO₂e/GWh and 5,454.4 MTCO₂e/ MMTherms.

Appendix O. Fan Efficacy for Heat Pump Air Handlers

(Source: CEC Abram Conant, Proctor Engineering Group, Ltd.)

Background

During the 2019 Title 24, Part 6 Standards development process, the fan efficacy requirements for residential HVAC equipment were reviewed to determine appropriate adjustments in response to new federal fan standards. The new federal requirements were designed to drive adoption of higher efficiency motor technologies in residential gas-fired furnaces. It was determined through analysis of the federal standards, and supported through laboratory testing of representative furnaces, that the Title 24, Part 6 fan efficacy requirement for residential air conditioners should be modified from 0.58 W/cfm to 0.45 W/cfm in the 2019 standards. This change was applied only to gas-fired furnaces, with the requirement for heat pump air handlers remaining at 0.58 W/cfm.

Heat Pump Air Handler Evaluation

Seven residential heat pump air handlers ranging in size from 2 to 5 tons nominal capacity were tested at the PG&E ATS laboratory in San Ramon, CA during November and December 2017. The tests measured airflow and input power to the air handler at external static pressure ranging from 0 to 1.0 inches water column in 0.1 IWC increments. Tests were repeated for each available speed setting on each air handler. The resulting data were analyzed to determine if fan efficacy requirements for heat pump air handlers should be set equal to the air conditioner requirement of 0.45 W/cfm.

Results are tabulated in Table 1. Air handlers were determined to be capable of meeting the proposed fan efficacy standard if the laboratory results demonstrated the ability to provide at least 350 cfm/ton of airflow at less than 0.45 W/cfm when tested at 0.5 IWC external static pressure.

Table 154: PG&E ATS Laboratory Air Handler Evaluation Results

Unit #	Nominal Capacity (tons)	Capable of meeting proposed standard	Comments
1	4	Yes	
2	2	Yes	
3	3	Yes	

4	2	Yes	
5	5	No	This unit was able to meet the proposed fan efficacy requirement but was only able to provide 348 cfm/ton at the highest fan speed setting.
6	3	Yes	
7	5	No	0.47 W/cfm at 353 cfm/ton

These results suggest that heat pump air handlers can meet a requirement of 0.45 W/cfm at sizes smaller than 5 tons. The 5-ton nominal capacity units that were tested did not demonstrate ability to deliver 350 cfm/ton airflow at less than 0.45 W/cfm. In one instance the laboratory measured airflow was lower than indicated in the manufacturer’s published performance data, resulting in laboratory measured airflow 2 cfm/ton lower than required in Title 24, Part 6. In the other case, fan efficacy exceeded the proposed 0.45 W/cfm requirement by 0.02 W/cfm.

Measured airflow and air handler watt draw from minimum efficiency single speed heat pumps that have been monitored at the Central Valley Research Homes (CVRH) in Stockton, CA were reviewed and found to be supportive of the conclusion that small to mid-size heat pump air handlers can meet the proposed requirement. Results are tabulated in Table 2. The measured airflow for all units exceeded 350 W/cfm, and fan efficacy was below 0.45 W/cfm for all units.

Table 155: CVRH Reference HP Air Handler Fan Efficacy

Unit	Nominal Capacity (tons)	Fan Efficacy (W/cfm)
C	2.5	0.4
G	1.5	0.29
M	2	0.34

Recommendations

Residential heat pumps with nominal capacity less than or equal to 50,000 BTU/h:

It is recommended that the fan efficacy requirement be set at 0.45 W/cfm to match the requirement for air conditioners. This includes nominal capacities up to 4 tons.

Residential heat pumps with nominal capacity greater than 50,000 BTU/h: It is recommended that the fan efficacy requirement remain at 0.58 W/cfm. This includes 5-ton nominal capacity units.