

DOCKETED

Docket Number:	19-BSTD-03
Project Title:	2022 Energy Code Pre-Rulemaking
TN #:	235021
Document Title:	Jim Marsh, Munters Data Centers Comments - Support Increased Temperature Threshold for Economizers and Recommend Add Integrated Refrigerant Economizer to Prescriptive
Description:	N/A
Filer:	System
Organization:	Jim Marsh, Munters Data Centers
Submitter Role:	Public
Submission Date:	10/5/2020 2:22:48 PM
Docketed Date:	10/5/2020

Comment Received From: Jim Marsh, Munters Data Centers
Submitted On: 10/5/2020
Docket Number: 19-BSTD-03

**Support Increased Temperature Threshold for Economizers and
Recommend Add Integrated Refrigerant Economizer to Prescriptive**

Additional submitted attachment is included below.



10/05/20

In Regards To -

Docket Number: 19-BSTD-03

Project Title: 2022 Energy Code Pre-Rulemaking

TN #: 234664

Document Title: *CASE Report Nonresidential Computer Room Efficiency*

Submission Date: 9/11/20

And –

Staff Pre-Rulemaking Workshop, 9/23/20: *Nonresidential Computer Room Efficiency Proposals for 2022*

To: Haile Bucaneg, California Energy Commission

From: Jim Marsh, Munters Data Centers

Statement in Support of *CASE Report Nonresidential Computer Room Efficiency Code Change Recommendations, Specific to 1. Increased Temperature Threshold for Economizers*

Munters has invented and developed a number of highly efficient cooling, pressure and humidity control solutions for computer rooms for over two decades. With a continuous focus on sustainability, Munters Data Centers supports the recommended increase in temperature threshold for 100 percent economizing to 65°F dry-bulb or 50°F wet-bulb and below for all economizer types in new construction and concur that current computer room designs include supply air temperatures of 70°F or higher and achieve 20°F temperature differential, a.k.a. Delta T, between supply and return air through the prevalent use of containment.

According to highly referenced The Green Grid maps showing available hours of air and water economizing, California overall is clearly well aligned with air economizing and much less so for water economizing. Through the use of evaporative cooling, both economizer types can be greatly enhanced in effectiveness and operating hours to better align with the goals of Title 24 2022.

Recommend Addition of *Integrated Refrigerant Economizer* in Prescriptive Economizer Types to Air and Water Economizers

To provide additional context in support of the CASE Report section on Refrigerant Economizers, to address a concern expressed during the workshop on 9/23/20 that only proprietary equipment is able to meet prescriptive performance, and to differentiate integrated refrigerant thermosyphon economizer from integrated pumped refrigerant economizer, we present the following information to support recommendation to add *Integrated Refrigerant Economizer* to prescriptive economizer types:

Refrigerant Thermosyphon is a time proven technology for energy recovery and heat rejection:

Munters Corporation

225 S. Magnolia Avenue, Buena Vista, VA 24416 USA Phone: +1 540 291 1111. FAX +1 540 291 2222
datacenters@munters.com www.munters.us/datacenters

<https://en.wikipedia.org/wiki/Thermosiphon>

Thermosiphon (or **thermosyphon**) is a method of passive [heat exchange](#), based on natural [convection](#), which circulates a [fluid](#) without the necessity of a mechanical pump.

Thermosyphon has been manufactured and deployed in HVAC applications in general and computer rooms specifically:

- <https://www.heatpipe.com/products/hrm-v-split-passive-heat-pipes-series/>
- <https://www.johnsoncontrols.com/hybrid-cooling-systems>
- <https://www.quantacool.com/>
- <https://datacenters.lbl.gov/resources/thermosyphon-cooler-hybrid-system-1>
- <https://www.munters.com/en/munters/products/coolers--humidifiers/sycool-split/>

Munters has developed a waterless or “dry” thermosyphon product specific to data centers, branded SyCool, to provide the greatest number of economizer hours without the use of evaporative cooling, thus reducing electric and water utility consumption.

Evaporative assist is available as a “wet” option to increase economizer effectiveness and reduce peak power thus potentially reducing electrical service component sizing, e.g. generators and switchgear.

The following are selections for three sites in California:

- San Jose
- Sacramento
- Burbank

These were selected to provide climate variation while remaining applicable to larger data center deployments historical in the associated regions.

The baseline for all sites is 75°F SAT / 95°F RAT, 20°F Delta T as the current industry standard give or take 5°F on both SAT & Delta T. Common for all: 100% critical IT load @ 2MW, 0.25” ESP, 0.5” filter @ critical:

Baseline - 75°F SAT / 95°F RAT, Dry	San Jose	Sacramento	Burbank
Elevation, feet above sea level	50	15	775
N = 5, N+1 redundancy	6 units	7 units	7 units
Net system critical capacity (kW)	400	333	333
Net normal operation capacity (kW)	333	286	286
Summer design ambient (°F DB)	104.7	111.1	110.9
Full economization threshold (°F)	64.0	66.2	66.0
Peak critical mechanical pPUE	1.422	1.453	1.459
Est. annual normal operation pPUE	1.098	1.109	1.129
Predicted annual ton-hours DX	14.5%	18.6%	23.3%
Predicted annual ton-hours Econ	85.5%	81.4%	76.7%

Adding evaporative assist option:

Evap Assist - 75°F SAT / 95°F RAT	San Jose	Sacramento	Burbank
N = 5, N+1 redundancy	6 units	6 units	6 units
Net system critical capacity (kW)	400	400	400
Net normal operation capacity (kW)	333	333	333
Summer design ambient (°F DB/WB)	104.7/78.8	111.1/82.2	110.9/82.9
Est. full eco. threshold (°F DB / MCWB)	73.0/60.6	75.0/60.6	71.0/60.6
Peak critical mechanical pPUE	1.351	1.360	1.367
Est. annual normal operation pPUE	1.074	1.085	1.105
Predicted annual ton-hours DX	4.2%	8.8%	13.1%
Predicted annual ton-hours Econ	95.8%	91.2%	86.9%
Predicted annual water used (1K gal)*	1,380	2,227	2,621
Total max water usage rate (1K GPH)*	1.68	1.76	1.68

*evaporation & bleed @ 5 cycles of concentration

San Jose with variables in SAT / RAT design criteria, dry and wet:

San Jose - SAT / RAT, No Evap Assist	70°F / 90°F	75°F / 100°F
N = 6, N+1 redundancy	7 units	6 units
Net system critical capacity (kW)	333	400
Net normal operation capacity (kW)	286	333
Summer design ambient (°F)	105	105
Full economization threshold (°F)	61.3	65.4
Peak critical mechanical pPUE	1.452	1.397
Est. annual normal operation pPUE	1.113	1.074
Predicted annual ton-hours DX	19.7%	10.6%
Predicted annual ton-hours Econ	80.3%	89.4%

San Jose - SAT / RAT, With Evap Ass't	70°F / 90°F	75°F / 100°F
N = 5, N+1 redundancy	6 units	6 units
Net system critical capacity (kW)	400	400
Net normal operation capacity (kW)	333	333
Summer design ambient (°F)	105	105
Est. full eco. threshold (°F DB / MCWB)	65.0/56.7	77.0/62.3
Peak critical mechanical pPUE	1.422	1.314
Est. annual normal operation pPUE	1.098	1.052
Predicted annual ton-hours DX	14.5%	2.1%
Predicted annual ton-hours Econ	85.5%	97.9%
Predicted annual water used (1K gal)*	1,807	1,157
Total max water usage rate (1K GPH)*	1.53	1.61

*Includes evaporation and bleed @ 5 cycles of concentration

Reference Graph

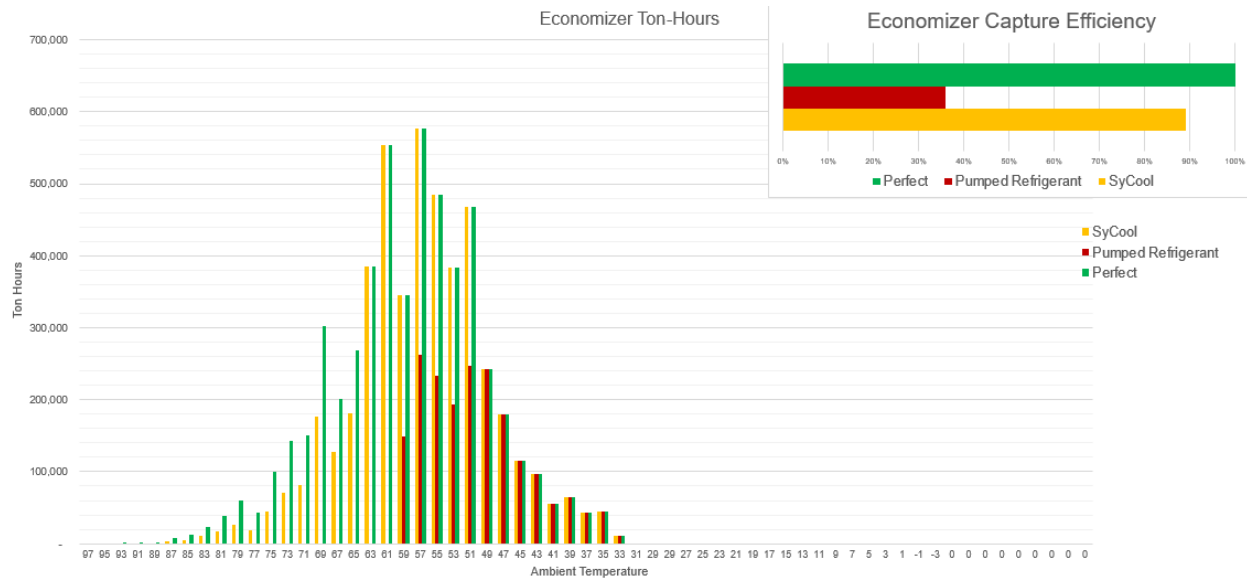

Ton-hours per bin temperature graph: Munters SyCool thermosyphon refrigerant economizer capture efficiency (yellow) compared with perfect – 100% economization/year (green) and integrated pumped refrigerant economizer (red), based on San Jose, 75°F SAT / 95°F RAT, 80% load, no evaporative assist. Pumped refrigerant data: <https://www.vertiv.com/en-us/support/tools-applications/free-cooling-economizer-calculator/>, Model DA 150

Additional Comments

Economizer Definitions

The current 140.9(a) differentiates and provides separate and different full economizing thresholds for “air economizing”, 55°F dry-bulb and 50°F wet-bulb and below, and “water economizing”, 40°F dry-bulb and 35°F wet-bulb and below.

We recommend describing the several variations of each overall categories of *air economizing*, *water economizing*, and *refrigerant economizing* to include:

Air Economizer

An air economizer is the use of ambient outdoor air to provide or assist computer room cooling, either directly through introduction of ambient outdoor air to the computer room or indirectly through an air-to-air heat exchange, when conditions allow to maintain process design conditions at lowest operating cost.

Water Economizer

A water economizer is the use of ambient outdoor air to provide or assist computer room cooling, indirectly through an air-to-water heat exchange, when conditions allow to maintain process design conditions at lowest operating cost.

Refrigerant Economizer

A refrigerant economizer is the use of ambient outdoor air to provide or assist computer room cooling, indirectly through an air-to-refrigerant heat exchange driving refrigerant phase change, passively without electro-mechanical compression, due to relatively warm air passing over an evaporator and relatively cool air passing over an associated connected condenser, when conditions allow to maintain process design conditions at lowest operating cost.

Evaporative Cooling

Evaporative, a.k.a adiabatic, cooling uses water evaporation applied to both air and water economizers to reduce or eliminate electro-mechanical cooling, i.e. compressorized refrigeration via a direct expansion (DX) circuit internal to the system or indirectly from a chilled water plant.

Economizer Strategy

Economizer strategy is determined by many factors including building size, use, form factor, location, ambient design conditions, process design conditions, electrical utility cost, water utility cost, water availability, waste water rejection availability, routine maintenance and emergency service availability, etc.

As seen below, there are many variations and combinations of air, water, and evaporative economizers applied to air handlers and chillers.

Air Economizer

- Direct Economizer – This type of air economizer brings cooling outdoor air directly into the computer room without the use of a heat exchanger and requires relief air from the space served to avoid over pressurization. Direct economizers do not have temperature losses related to heat exchange but must provide for treatment of undesirable ambient conditions including humidity level, particular and gaseous contaminants. It can be applied to both packaged and split air handling:
 - Direct Air Economizer (see 9/11 Final CASE Report Figure 2., left diagram) – This type of direct economizer allows the introduction of cooling outdoor air to the computer room

typically requiring additional full load electro-mechanical cooling for extreme summer ambient design conditions*.

- Direct Evaporative Economizer– This type of direct economizer uses water for adiabatic cooling of the outdoor airstream in order to reduce or eliminate the need for additional electro-mechanical cooling.
- Indirect Economizer – This type of economizer applies intermediate air-to-air heat exchange to separate the heat rejection cooling outdoor air, a.k.a. scavenger air, from the process cooling air recirculated through the computer room and cooling equipment. Indirect economizers have temperature losses related to heat exchange expressed as ambient temperature approach delta to supply air temperature:
 - Packaged Indirect Economizer – This type of indirect economizer includes all components required for the management of recirculating process cooling air heat exchange with scavenger air in a single housed air handling and heat rejection unit. Typical application locations are rooftop or perimeter mount:
 - Packaged Indirect Air Economizer – This type of packaged indirect air economizer typically utilizes a dry aluminum plate heat exchanger and additional full load electro-mechanical cooling for extreme summer ambient design conditions*.
 - Packaged Indirect Evaporative Economizer – This type of packaged indirect air economizer typically utilizes water distributed over to a polymer tube or metallic heat exchanger for adiabatic cooling of the scavenger air in order to reduce or eliminate the need for additional electro-mechanical cooling.

Refrigerant Economizer

- Split Refrigerant Economizer - This type of refrigerant economizer has separate system sections for the management of recirculating process cooling air and the scavenger air. The heat exchange sections are decoupled and connected via fluid piping. The medium for the piped heat exchange is typically a refrigerant that changes phase from a liquid to a gas, i.e. evaporation, and back to a liquid, i.e. condensation, through the application of moving air streams with different temperatures, a.k.a. Delta T, and typically requires additional full load electro-mechanical cooling*:
 - Integrated Thermosiphon Refrigerant Economizer – This type of split refrigerant economizer uses the liquid-gas phase change of the refrigerant itself to move the fluid through a passive circuit akin to a circuited heat pipe, with the evaporator below the condenser, without the use of pumping or bypass control valves. Additional electro-mechanical cooling is applied either in parallel or in series to the passive thermosiphon circuit and has discrete fluid piping.

- Integrated Pumped Refrigerant Economizer – This type of split refrigerant economizer combines the functionality, refrigerant, and piping of a traditional split system indoor full load electro-mechanical DX Computer Room Air Conditioner (CRAC) and matched outdoor condenser with the economization of non-DX refrigerant phase change. Control valves are used to bypass the compressors and refrigerant pumping is applied to move the fluid through the common piping system.
- Packaged Refrigerant Economizer – This type of refrigerant economizer includes all components required for the management of recirculating process cooling air heat exchange with scavenger air in a single housed air handling and heat rejection unit. Typical application locations are rooftop or perimeter mount.

Water Economizer

A water economizer passes ambient outdoor air across an air-to-water heat exchanger, a.k.a. fluid cooler, and pumps that cooled water back to a water-to-air heat exchanger, a.k.a. chilled water coil. A glycol solution may be required for freeze protection. Typically requires additional full load electro-mechanical cooling for extreme summer ambient design conditions*:

- Water Cooled DX Computer Room Air Conditioner (CRAC) Economizer – This type of water economizer diverts DX heat rejection water from an internal refrigerant-to-water heat exchange condenser to an integral economizer chilled water coil.
- Air Cooled Chiller with Remote Evaporative Tower (see 9/11 Final CASE Report Figure 2., right diagram) – This type of water economizer diverts warm return chilled water to a water-to-water heat exchanger, which couples to a remote evaporative cooling tower.
- Free Cooling Air-Cooled Chillers – This type of water economizer diverts DX heat rejection water from internal refrigerant-to-water heat exchange condenser to an economizer fluid cooler, either direct or remote mounted, when ambient outdoor air conditions at the fluid cooler allows for economization.
 - Adiabatic Assist – applies an evaporative media to the air inlet side of the fluid cooler to increase the economizer effectiveness

*Note: Electro-mechanical cooling can be reduced or eliminated through elevated process cooling design supply/return temperatures, Delta T, and/or adiabatic assist processes.

Water Cooled Chiller

Water cooled chillers utilize remote evaporative cooling towers to cool refrigerant process condenser water. The base process does not provide economization. Economizer strategies for water cooled chillers are equivalent to air cooled chillers, e.g. the evaporative cooling tower can be used as an economizer with bypass and heat exchange.

The list of economizer strategies presented above does not necessarily represent all variations of economization in computer rooms but is an attempt to clarify the differences between the most recognized forms of computer room economization.

Part Load Operation

Computer room cooling equipment is selected for two operational states:

- N = number of systems required to cover 100% critical IT load
- Normal operation = $N+X$ where X is the number of systems required in addition to N to provide specified redundancy

Market feedback tells us that data centers rarely if ever have 100% critical IT load actually installed and operating. The industry has recently standardized on tracking part load operational levels of 75%, 50%, and 25% critical IT load metrics. These variations can have profound effects on full economization threshold and economization effectiveness.

There is an equivalency to normal operation compared with operating at full critical load at N with all units running at part load, e.g. a system designed $N = 1$ with $N+1$ redundancy, 100% IT load will require all systems during normal operation at 50% of capacity, $N = 2$ with $N+1$ redundancy system operation at 66% capacity, etc.

Combining normal operation with IT part load results in cascaded capacity reduction, e.g. $N = 4$ with $N+1$ redundancy and 75% IT load will require all systems during normal operation at 60% capacity.

We recommend clarification of baseline definition for critical IT load and redundancy used in rating economizer performance and to include part load economization performance metrics in line with ANSI/ASHRAE Standard 90.4 – 2019, 6.5 *Maximum Annualized Mechanical Load Component (MLC)* for comparison of economizer strategies.

DATA CENTER COOLING

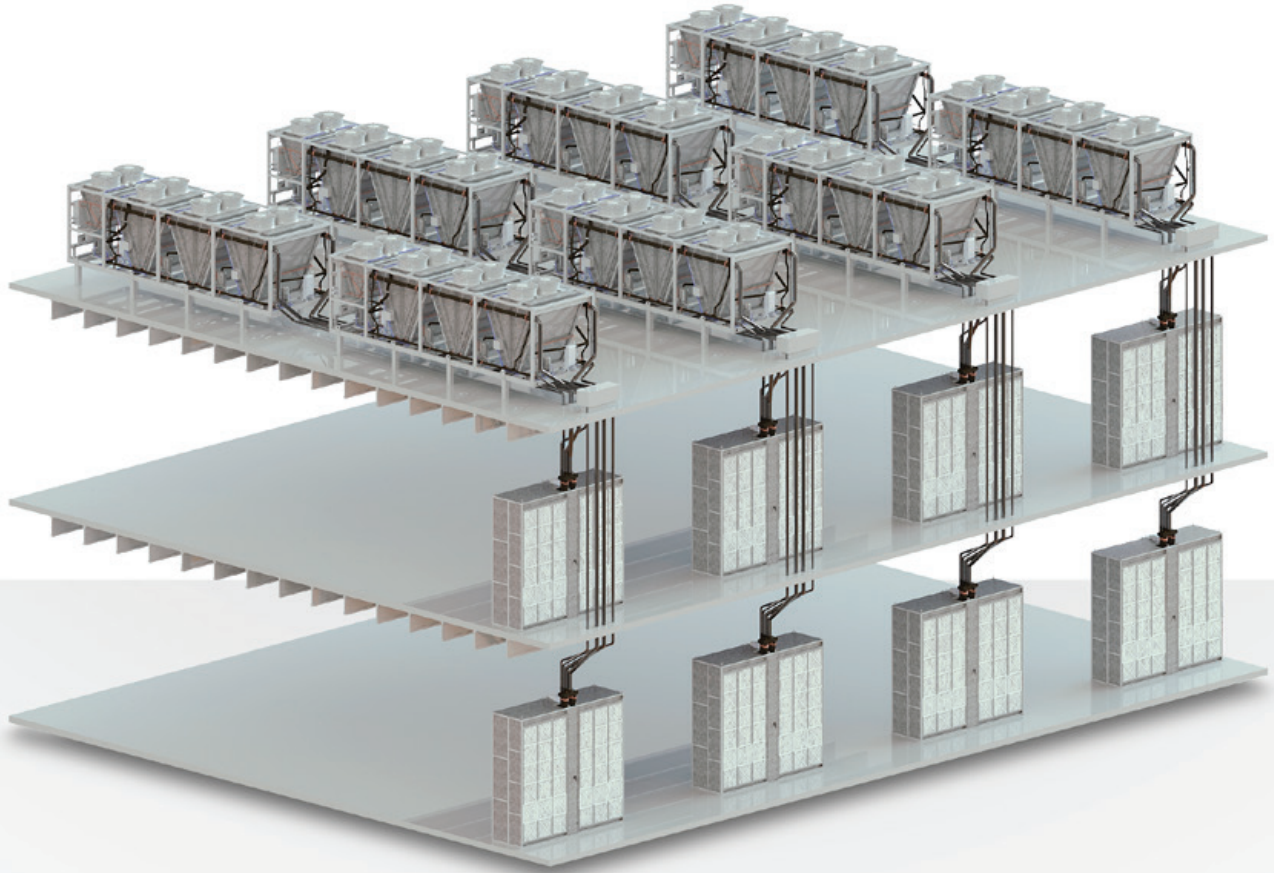

SyCool[®] Split

Indirect Air Side Economizer — 400 kW

SyCool Split is an energy efficient, thermosyphon based dry cooling solution for data centers.

Thermosyphon heat exchangers move heat from the data center to ambient through the evaporation of liquid refrigerant in the SyCool Evaporator,

and condensing of the same refrigerant in the SyCool Condenser. The evaporator is connected to the condenser with refrigerant piping allowing up to 500' of separation. SyCool seamlessly transitions from economizer mode to full DX mode by

staging compressors as required. SyCool is very efficient, providing a tight approach to ambient conditions, and the ability to economize during all ambient conditions where the ambient temperature is cooler than the hot air leaving the servers in the data center.

SyCool Evaporator

- Estimated unit weight: 6,200 lbs.
- Minimum 60" clearance required on air inlet and air outlet sides
- No clearance required between units
- Ships in two sections

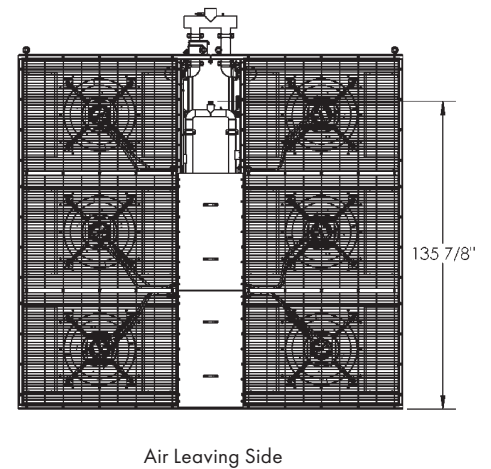
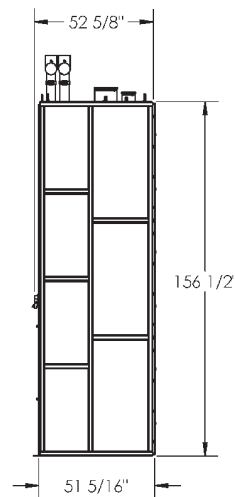
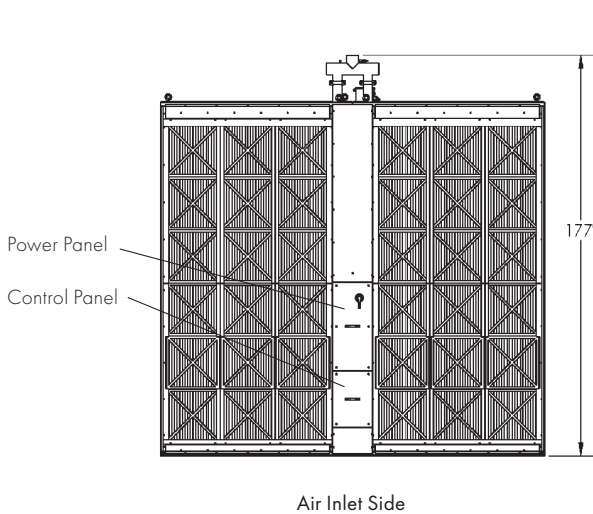
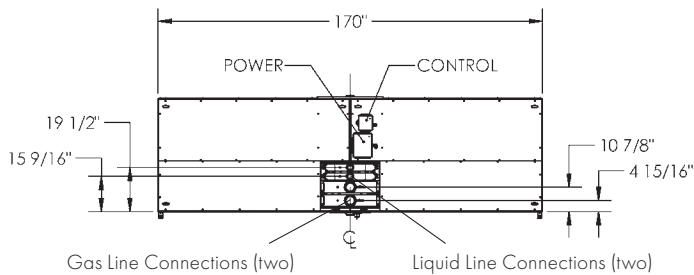

Supply air to the data hall

Partition between the return and supply of the evaporator

Hot aisle containment return plenum

*Hot aisle containment system not shown

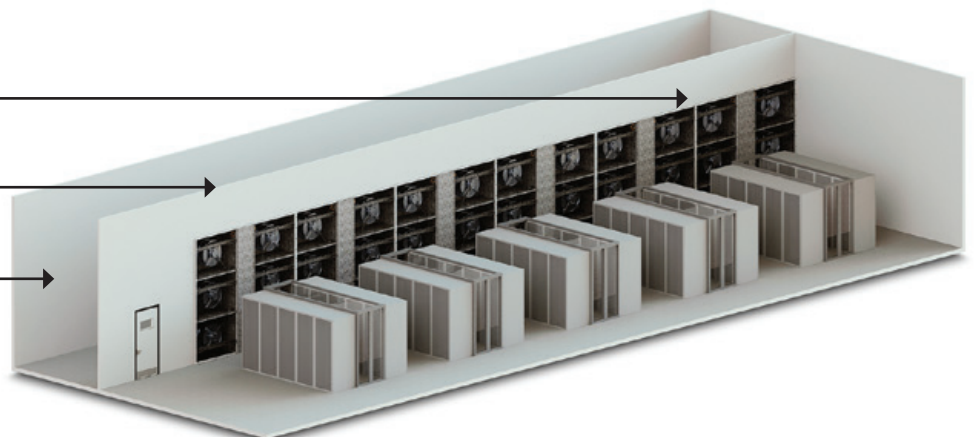

SyCool Condenser

- Estimated unit weight: 11,000 lbs.
- Minimum 96" between units side to side*
- Minimum 60" between unit end to end*

* Contact Munters for pairing condensers or options for reduced clearance

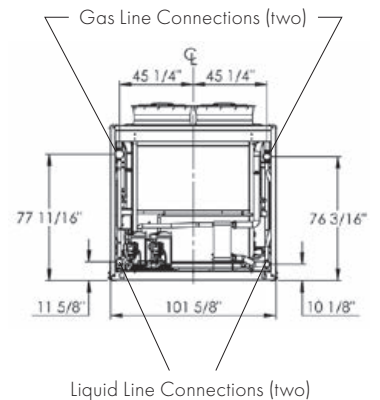
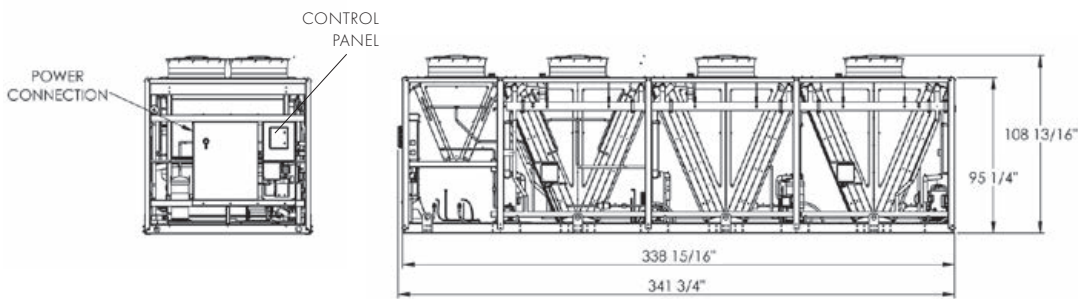

Installation Notes:

1. Two 4" gas lines and two 2" liquid lines are required per 400 kW system.
2. Refrigerant grade clean type "L" ACR copper pipe (cleaned and capped) between SyCool 400 kW Condenser and Evaporator.
3. Copper lines may be connected using Victaulic type fittings, or they may be brazed with nitrogen purge.
4. Connecting copper lines not to exceed 500 equivalent feet per run (see installation manual for specific fitting losses).
5. All connecting lines require contractor install of minimum 1/2" insulation or equivalent heat gain/loss prevention using insulated chases.
6. All connecting lines shall be leak tested at 250 PSIG, and vacuum tested to below 500 microns prior to charging process.
7. Contractor to evacuate and charge each 400 kW system.
8. Each 400 kW system contains two thermosyphon circuits. Each circuit typically requires 300-420 lbs. R-134A refrigerant. (Refrigerant by contractor. Munters to verify exact charge based on vertical and horizontal piping distance. Long piping runs exceeding 200ft require more refrigerant.)
9. Do not add oil to the refrigerant charge. Thermosyphon circuits do not require lubrication.
10. Thermosyphon piping does not require any traps.

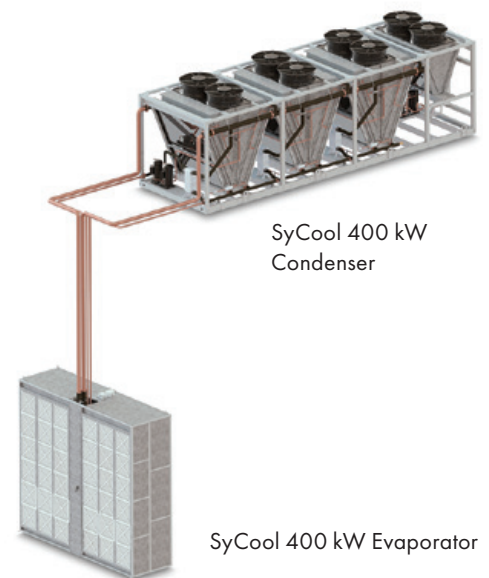

SyCool Performance

			Supply T. - 20 Deg. Delta T			Supply T. - 25 Deg. Delta T		
			70	75	80	70	75	80
Ambient Temperature (Deg. F)	105	Cooling Capacity (kW)	370	400	400	375	400	430
		Peak Power (kW) - Note 1 and 2	164	169	164	158	160	164
		Peak PUE	1.442	1.422	1.409	1.419	1.398	1.380
		Full Ambient Economizer (Deg. F) - Note 3	62	67	71	63	67	71
	100	Cooling Capacity (kW)	382	400	400	388	420	445
		Peak Power (kW) - Note 1 and 2	159	160	158	152	157	159
		Peak PUE	1.415	1.399	1.393	1.392	1.372	1.357
		Full Ambient Economizer (Deg. F) - Note 3	62	67	71	63	67	71
	95	Cooling Capacity (kW)	395	400	400	400	435	460
		Peak Power (kW) - Note 1 and 2	155	152	144	148	153	156
		Peak PUE	1.391	1.379	1.359	1.368	1.350	1.337
		Full Ambient Economizer (Deg. F) - Note 3	61	67	71	62	66	70

- Notes:
1. Data is based on 100% cooling (Peak) capacity at sea level. Consult Munters for different elevations.
 2. Peak data based on 0.25" WG external static pressure and partially loaded MERV 8 filters.
 3. Full Ambient Economizer (Deg. F) based on 75% Cooling Capacity.

SyCool provides annualized pPUE values less than 1.1 for many USA cities.

Note: 75°F supply, 20°F delta T, operating with 75% of maximum load per system

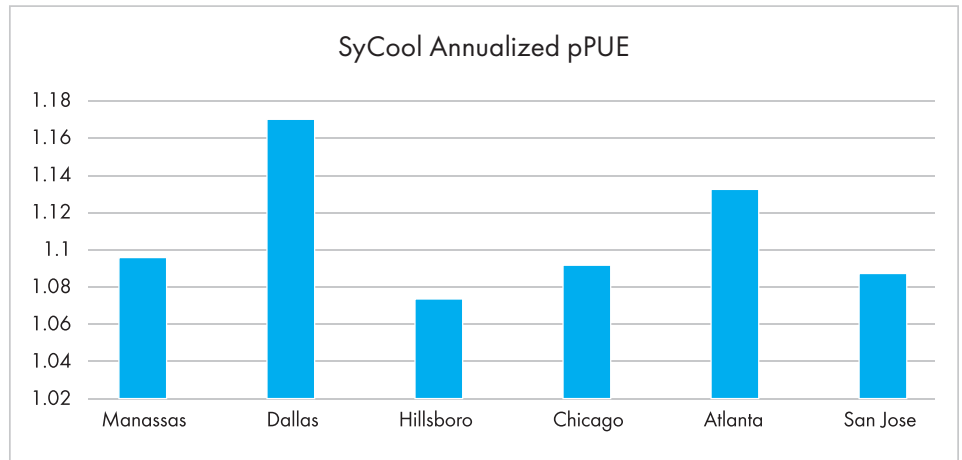

Return = 95°F
Supply = 75°F

Effectiveness
Econ T

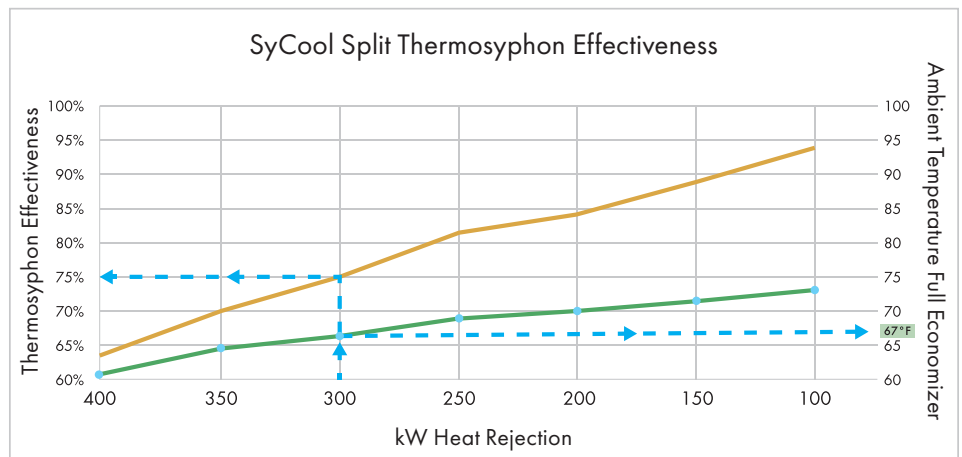

SyCool Piping

Full Economizer Mode

Refrigerant gas is condensed by drawing ambient air, 67°F or cooler over the passive condensers (based on operating conditions shown). The condenser fans ramp up to a maximum speed at the point ambient temperature can no longer support the full economizer mode. At this speed, the condenser and supply fans consume *48 kW of energy.

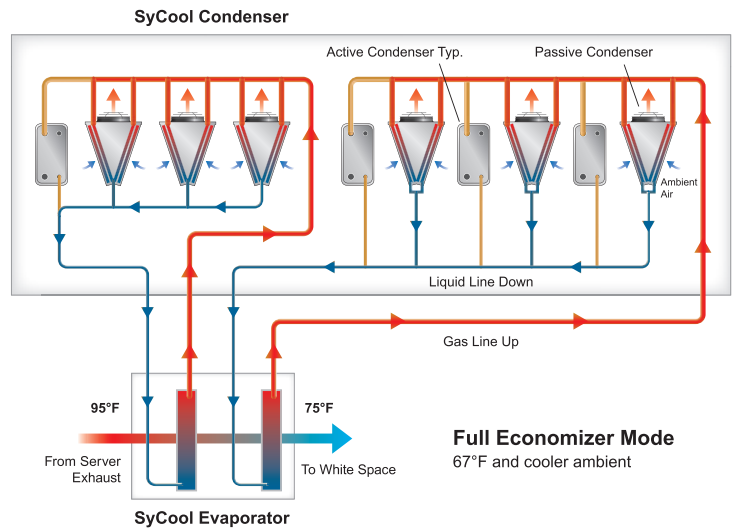

Transition Mode

Between 67 and 95°F ambient, refrigerant gas is condensed by drawing ambient air over the passive condensers and by active condensers contained within the thermosyphon refrigerant circuits. The active condensers reject heat to an integrated compressor based DX system. Power consumed by condenser fans, supply fans, and compressors at the upper end of this transition is approximately *128 kW.

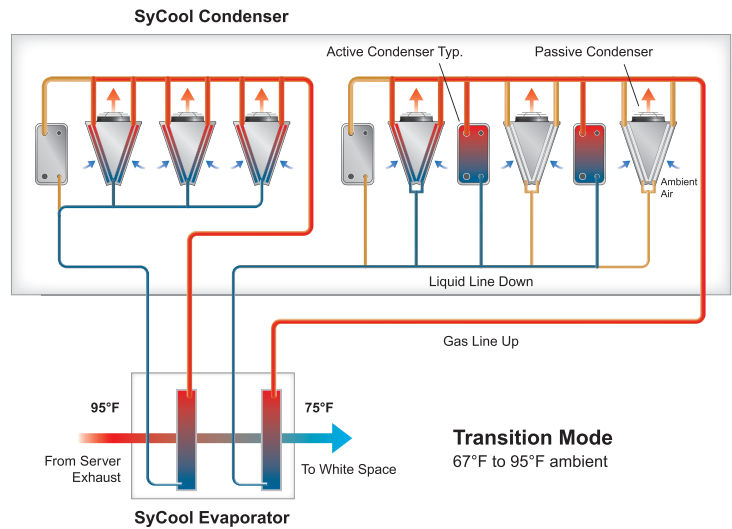

Full DX Mode

Above 95°F ambient, refrigerant gas is condensed by active condensers. Maximum energy for all fans and compressors is approximately *170 kW.

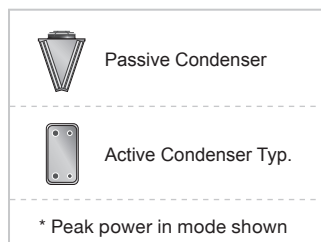
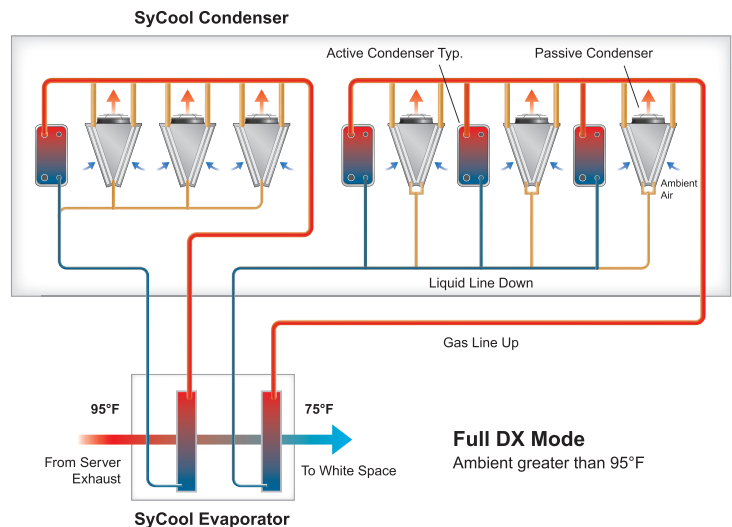

Economizer Capture Efficiency

Economizer Capture Efficiency demonstrates economizer cooling achieved relative to maximum available, providing a means to compare the annual economizing potential of various cooling systems. As shown in the chart on right, SyCool technology captures close to 90% of the available free cooling for the cities shown. Maximizing free cooling helps to minimize the mechanical PUE of the cooling system. This characteristic combined with low fan energy, results in SyCool consuming about 50% of the annual cooling energy of the primary competing waterless technology.

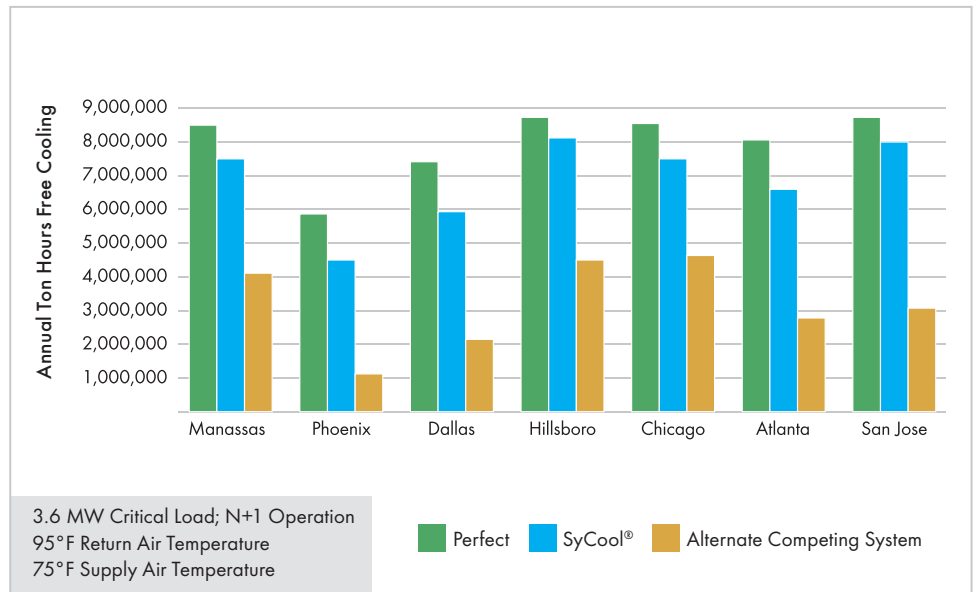

Other SyCool Benefits

No Water

SyCool is a completely dry heat exchanger process that works against ambient temperature. Additionally, the piping system and heat exchange process works exclusively with refrigerant avoiding water in or around the white space completely. No worries with water leaks, corrosion, or freezing.

Multi-Story Compatible

SyCool Split is designed for up to 500' of equivalent straight pipe length between the Evaporator and Condenser, solving the design challenge of achieving high efficiency cooling with multiple-story data centers.

Scalable Blocks of Capacity

SyCool 400 kW Condensers coupled with 400 kW Evaporators offers "plug and play" building blocks and ease of redundancy.

Complete Factory Controls

SyCool systems are provided with microprocessor controls for all operational and monitoring functions including BMS communication and optional multi-unit data hall control

High Density Applications

SyCool Evaporator systems installed side-by-side along both sides of the white space perimeter can achieve over

56 kW of cooling capacity per lineal foot of wall. This cooling capacity can accommodate densities of over 400 watts per square foot, depending on operating parameters. SyCool Evaporator units flood the room with low exit velocity air, helping ensure all servers receive the cooling required.

Reliable

The SyCool active DX elements are close-coupled and factory piped and charged, increasing system reliability. The thermosyphon system is very simple requiring no valves or pumps to operate.

Australia Phone +61 2 8843 1588, dh.info@munters.com.au Austria Phone +43 1 6164298-0, luftentfeuchtung@munters.at Belgium Phone +32 1528 5611, info@muntersbelgium.be Brazil Phone +55 41 3317 5050, munters@munters.com.br Canada Phone +1 905 858 5894, dhinfo@munters.com China Phone +86 10 8041 8000, info@munters.com.cn Czech Republic Phone +420 544 211 434, info@munters-odvlhcovani.cz Denmark Phone +45 4495 3355, info@munters.dk Finland Phone +358 20 776 8230, laitemyynti@munters.fi France Phone +33 1 3411 5757, dh@munters.fr Germany Phone +49 4087 96900, mgd@munters.de India Phone +91 20 668 18 900, info@munters.in Italy Phone +39 0183 52 11, marketing@munters.it Japan Phone +81 3 5970 0021, mkk@munters.co.jp Korea Phone +82 2761 8701, munters@munters.co.kr Mexico Phone +52 722 270 40 49, munters@munters.com.mx Netherlands Phone +31 172 433231, vochtbeheersing@munters.nl Poland Phone +48 58305 3517, dh@munters.pl Singapore Phone +65 6744 6828, info@munters.com.sg South Africa Phone +27 11 997 2000, info@munters.co.za Spain Phone +34 91 640 09 02, marketing@munters.es Sweden Phone +46 8 626 63 00, avfukning@munters.se Switzerland Phone +41 52 343 8886, info.dh@munters.ch Thailand Phone +66 2642 2670, info@munters.com.th Turkey Phone +90 216 548 1444, info@muntersform.com UAE +971 4887 6462, middle.east@munters.com United Kingdom Phone +44 1480 432243, info@munters.co.uk USA Phone +1 978 241 1100, dhinfo@munters.com Vietnam Phone +84 8 8256 838, vietnam@muntersasia.com



Munters Corporation
Tel: (800) 843-5360 E-mail: dhinfo@munters.com
www.munters.com

DATA CENTERS



Energy Efficient Climate Control



Munters History of Innovation

Munters has been an industry leading innovator of climate control products since 1955. Desiccant dehumidification, direct and indirect evaporative cooling, and air-to-air heat exchangers are a few technology areas where Munters is recognized as a leader. Our history combining areas of core competency within packaged systems to meet customer needs is without equal in the industry. Driven by customer demand to reduce energy consumption, Munters has extensively applied its deep knowledge of direct/indirect evaporative cooling and air-to-air heat exchangers to provide products that efficiently reject heat from data centers.

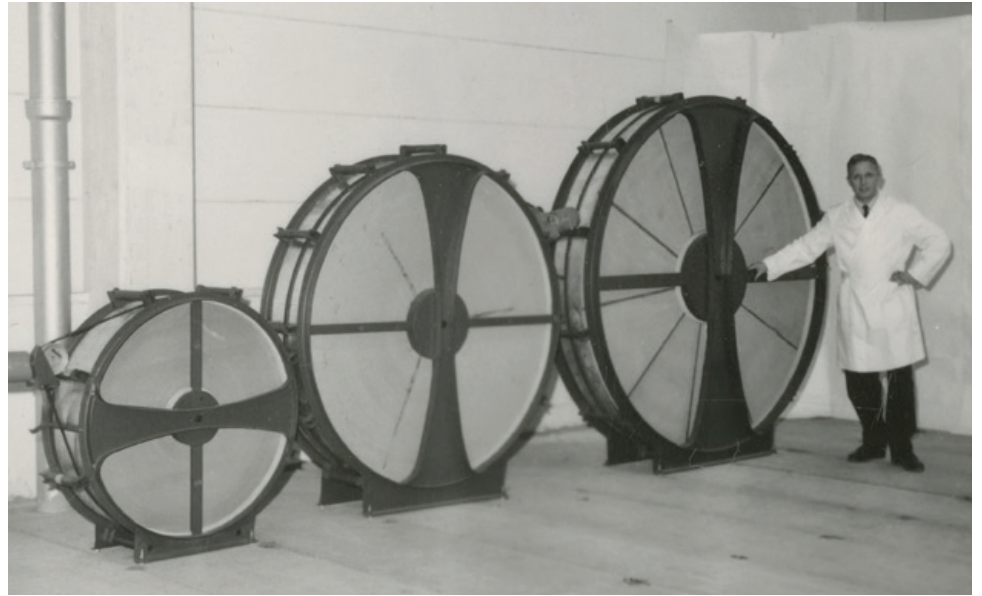

Data Center Cooling Technology

When choosing a Munters cooling solution there are a variety of considerations, including past experience, ambient design conditions, space operating envelope, water availability, and a balance between efficiency, cost and reliability. Some large hyperscalers utilize direct air-side economizers, usually

with direct evaporative cooling active during warm ambient periods. These data centers operate with an expanded temperature and humidity envelope. Other customers require more precise space control and are more sensitive to ambient pollution and humidity extremes, requiring a closed loop cooling solution.

Closed loop cooling may also incorporate the benefit of air-side economization using an air-to-air heat exchanger. Ambient air (scavenger air) is drawn through one side of the heat exchanger while the hot return air from the data hall (process air) passes over the opposite side of the heat exchanger.

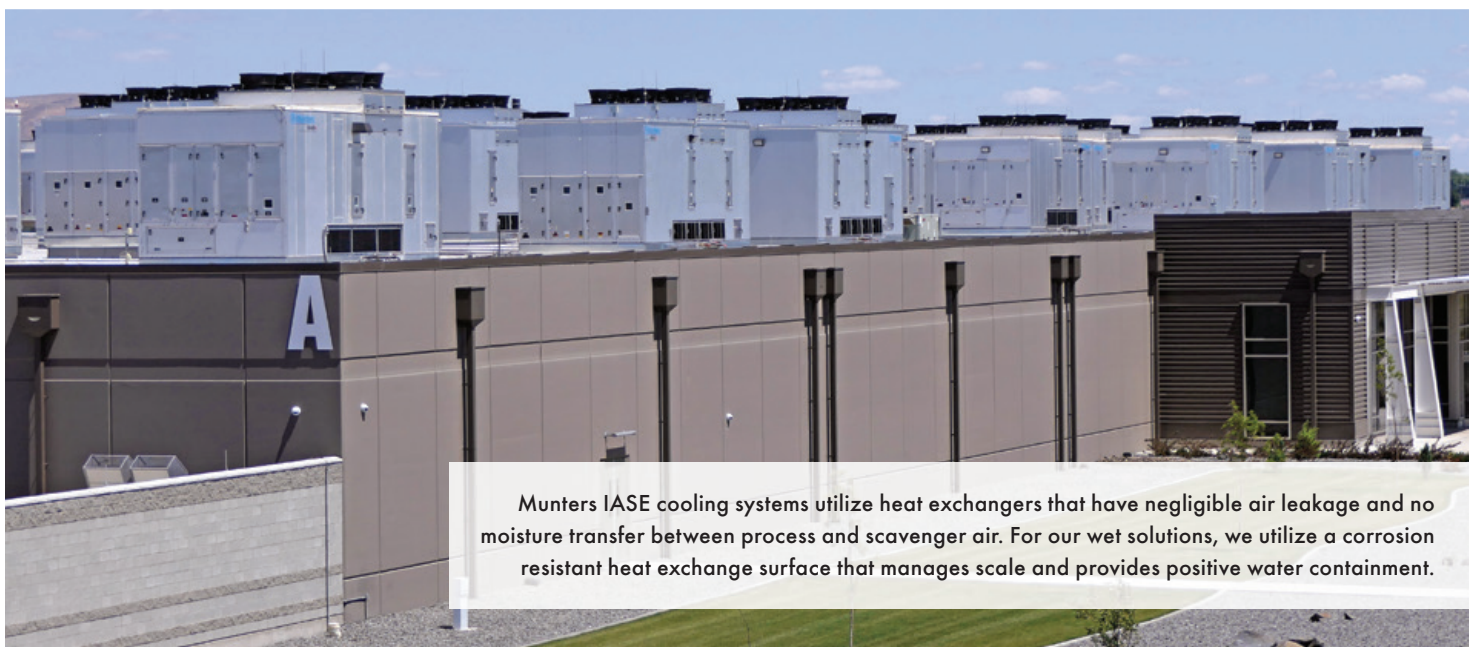

Munters IASE cooling systems utilize heat exchangers that have negligible air leakage and no moisture transfer between process and scavenger air. For our wet solutions, we utilize a corrosion resistant heat exchange surface that manages scale and provides positive water containment.

Cooler scavenger air extracts heat from the process air, but the two air streams are completely separate.

Munters provides solutions for both direct and indirect economizer options. For indirect economizers, we utilize a variety of heat exchange technologies that work either exclusively dry or with a combination of dry (during cooler ambient conditions) and wet (evaporatively, during warmer ambient

conditions) to reject data center heat to ambient air without the introduction of outdoor air into the data hall.

Dry solutions cool the process air toward ambient dry-bulb (DB) temperature while the wet (indirect evaporative cooling) solutions cool the process air towards ambient wet-bulb (WB) temperature. The approach of process air to ambient conditions is a measure of exchanger effectiveness. Munters typically

achieves up to 70% or better heat transfer effectiveness either dry (approach to DB) or wet (approach to WB).

With our indirect solutions, we can often satisfy data center cooling demands with no mechanical refrigeration deployed for most annual operating hours. In some cases, usually in dry and cooler climates, our wet heat exchanger solutions can eliminate the need for DX cooling completely.

Indirect Air-Side Economizer

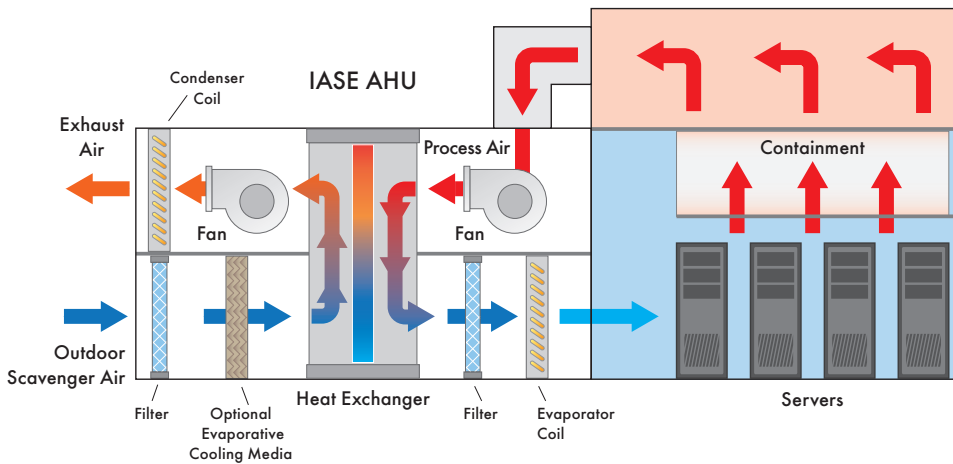

The concept of IASE was used in the mid 70's with heat exchangers used to cool large DC motors operating in dirty coal mines. In the 90's, IASE's were used to cool remote mounted electrical enclosures for telecom. By 2007, data center cooling was considered as process air cooling, making the IASE concept a simple and viable energy efficient solution.

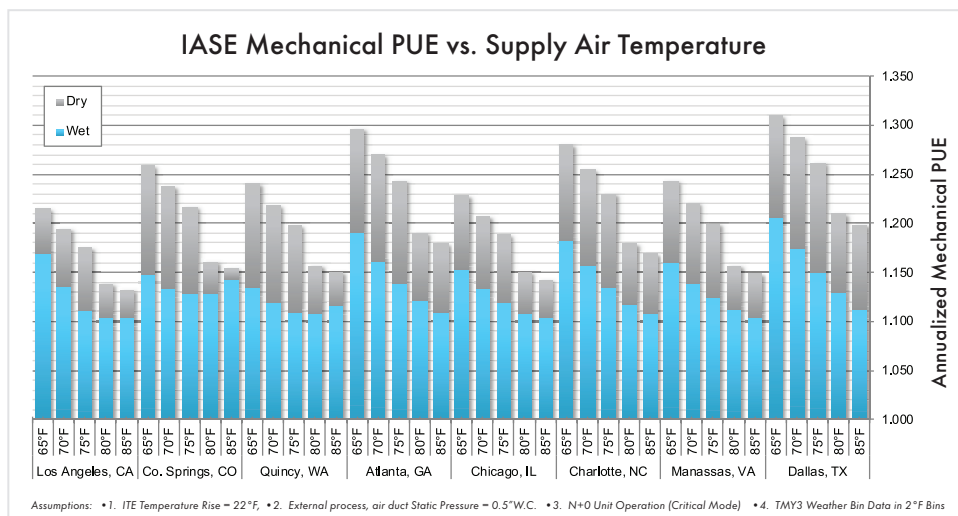

Both dry and wet IASE cooling approaches offer excellent performance with annualized pPUE's in the 1.1-1.3 range depending on location and operating temperatures.

Wet or Dry Packaged Solutions - 100 to 600 kW Capacity

Wet: Polymer Tube Heat Exchanger with Indirect Evaporative Cooling (Oasis®)



BENEFITS

- 70-80% approach to ambient wet bulb for maximum “economizer cooling”
- Reduce or eliminate mechanical cooling - peak PUE typically 1.25 or lower
- Positively contains water to the scavenger side of heat exchanger
- Polymer tubes flex during operation, shedding scale that forms during the evaporative process
- Polymer and stainless steel heat exchanger construction minimizes corrosion and helps manage scale formation
- Typically operates dry below 50°F reducing annual water consumption and eliminating freeze issues

Dry: Aluminum Plate or Heat Pipe Heat Exchanger with Sensible only Heat Transfer



BENEFITS

- Waterless technology
- 50-70% approach to ambient dry bulb for maximum “economizer cooling”
- No moving parts for maximum reliability and minimum maintenance
- Minimum filtration required for scavenger air (large HX plate spacing allows small particles to pass through)
- Economizer savings available when ambient temperature is less than data center hot air return

Mounting Configurations

PERIMETER MOUNT CONFIGURATIONS

Include supply and return air ducts on the same end. Typically, either a bottom plenum (shown) or top plenum routes air to or from the data center. Units can be grouped side by side to optimize layout.

ROOF MOUNT CONFIGURATIONS

Units can be installed on steel dunnage or roof curbs. Curb mounted versions can include a base-frame that is designed to self flash over the roof curb for ease of installation. Utilities can be routed from below or above the roof line through factory provided chases and penetrations. Munters' standard all welded stainless steel floor includes an upturn flange around all openings and unit perimeter to minimize the risk of water intrusion.

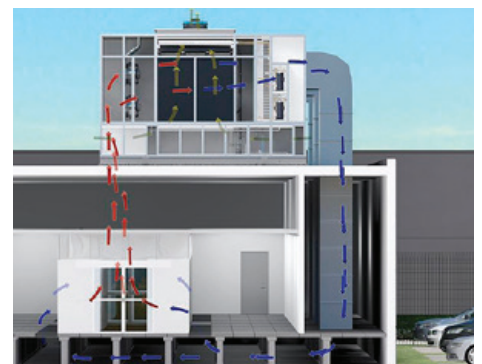
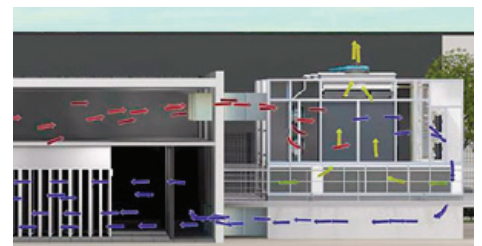

Dry Split Solution - 400 kW Capacity

Thermosyphon Heat Exchanger (SyCool™ Split)

Thermosyphon heat exchangers move heat from the data center to ambient through the evaporation of liquid refrigerant in the SyCool CRAH, and condensing of the same refrigerant in the SyCool condenser. The CRAH is connected to the condenser with refrigerant piping allowing up to 175' of low pressure thermosyphon refrigerant piping. Heat is exchanged passively for "free cooling" of the data center when ambient conditions are favorable.

A simplified version of the system is schematically shown below right.

BENEFITS

- Split system eliminates duct penetrations through the building envelope
- No water consumption
- Typical operation with up to 70% approach to ambient temperature for best in class free cooling
- Transitions to full DX only as ambient temperature approaches the hot air temperature from the servers
- Low peak power
- Thermosyphon piping is low pressure allowing time saving mechanical pipe joining systems such as Victaulic to be used
- CRAH units can be installed side-by-side allowing maximum air flow required by higher density installations

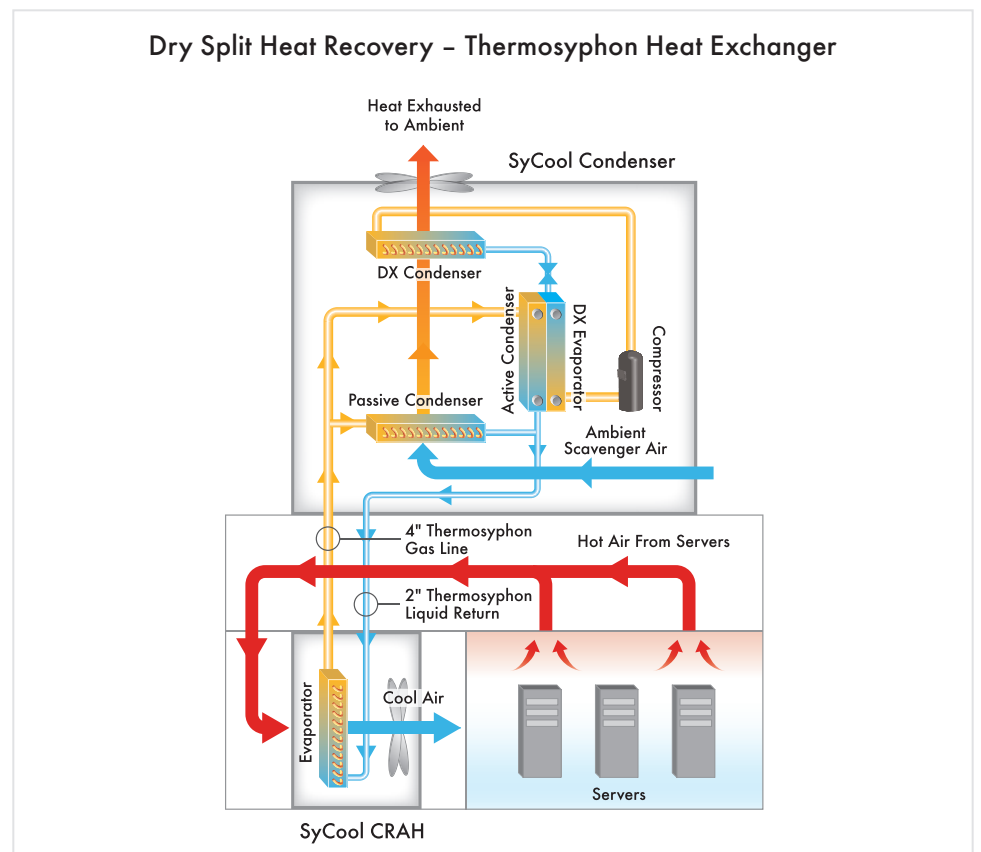
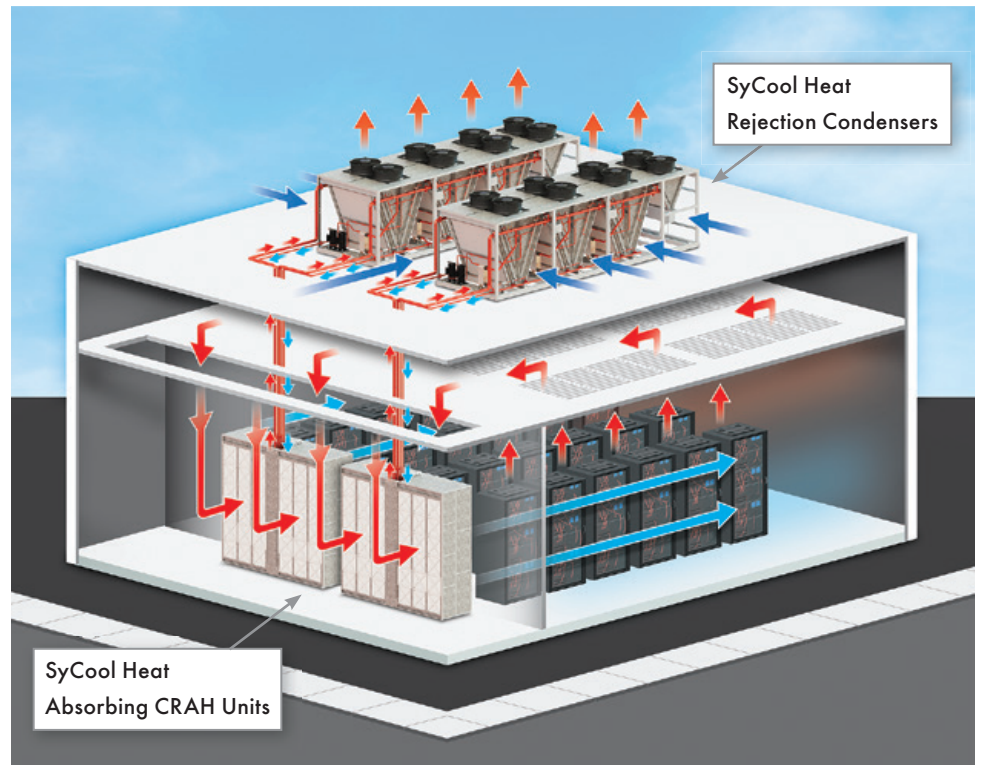

Make-up Air Systems



Munters manufactures make-up air systems that include variable airflow, efficient filtration, humidification, and dehumidification capabilities, either stand-alone or integrated with cooling units.

Direct Evaporative Air-Handling System



Munters DASE (Direct Air-Side Economizer)

Munters manufactures complete direct air-side economizing air-handling systems that utilize direct evaporative media for cooling data centers. These systems are usually installed in dry or mild climates with clean ambient air. During cooler ambient conditions, outdoor air is mixed with warm return air to achieve the desired supply condition. During such conditions, it is possible to use the evaporative media to provide the required humidification. During warm ambient conditions, these systems deliver 100% outdoor air to the data hall, cooled by the evaporative media, and all hot air from the servers is exhausted.

Cooling and Humidification Products



Munters **FA6™** Evaporative Humidifier/Cooler is available in a wide variety of sizes and is designed to provide easier maintenance.



Munters patented **MRM™** was invented to conserve water. Mineral Removal Media (MRM) is a disposable evaporative pad, installed upstream of the primary evaporative process. Bleed water is piped to the MRM where it evaporates into the airstream, providing beneficial cooling. Systems using MRM have nearly zero waste water sent to sewer.



Munters **Humimax™** is a series of stand-alone humidifiers. Units are available in (2) two different sizes for space or plenum mounting.

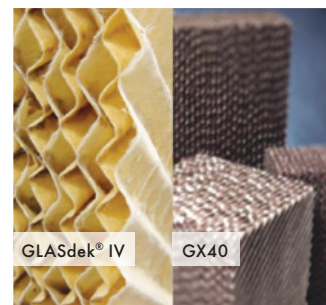

Munters Evaporative Media

GLASdek IV: Fire Rated (UL900), optional 1/2" TUFedg coating, available 4", 6", 8", 12", 18" deep, GREENGUARD Gold Certified

GX40: More resistant to high and low pH levels, excellent fire resistance, available media depth 8" only, suitable for higher face velocity requirements up to 800 ft/m.

Project Management & Service



“Munters takes a *project based* approach to managing data center accounts. A customer-focused project team, consisting of a Project Manager, Application Engineers, and Service Specialists, oversees each project. All members of the project team are experts with Munters equipment in data center applications and are committed to project success from conception to completion. Our team is focused on understanding our customer’s perspective in order to provide the highest quality support while adhering to Munters’ core values.”

– Michael Gantert, President - Data Centers



Project Management

A dedicated Project Manager (PM) is assigned to every data center project and serves as a single point of contact responsible for project delivery to our customer.

- Provides project specific schedule for customers to track manufacturing progress and plan factory visits, testing, and equipment delivery.
- Acts as customer liaison to Munters Engineering, Production, Quality, and Service to ensure project success.
- Creates project specific documentation including Factory Acceptance Test (FAT) scripts, rigging and installation instructions, IOM’s, Start-up checklists, and training plans (if necessary).
- Oversees the implementation of project field activities including equipment delivery and installation, levels 3/4/5 testing, training, and warranty work.



Service

The Munters Service Team consists of 75+ personnel, including a dedicated team of technical support, parts specialists, service sales, and field technicians to support data center projects.

- Project field support options include delivery/installation supervision, level 3 Start-up (required), level 4 commissioning support, level 5 Integrated Systems Testing (IST) support, and on-site training.
- Preventative maintenance options include extended warranties, routine maintenance and inspections, technical support with remote monitoring, retrofits, and critical spare parts packages.
- 24/7/365 technical support helpline available.

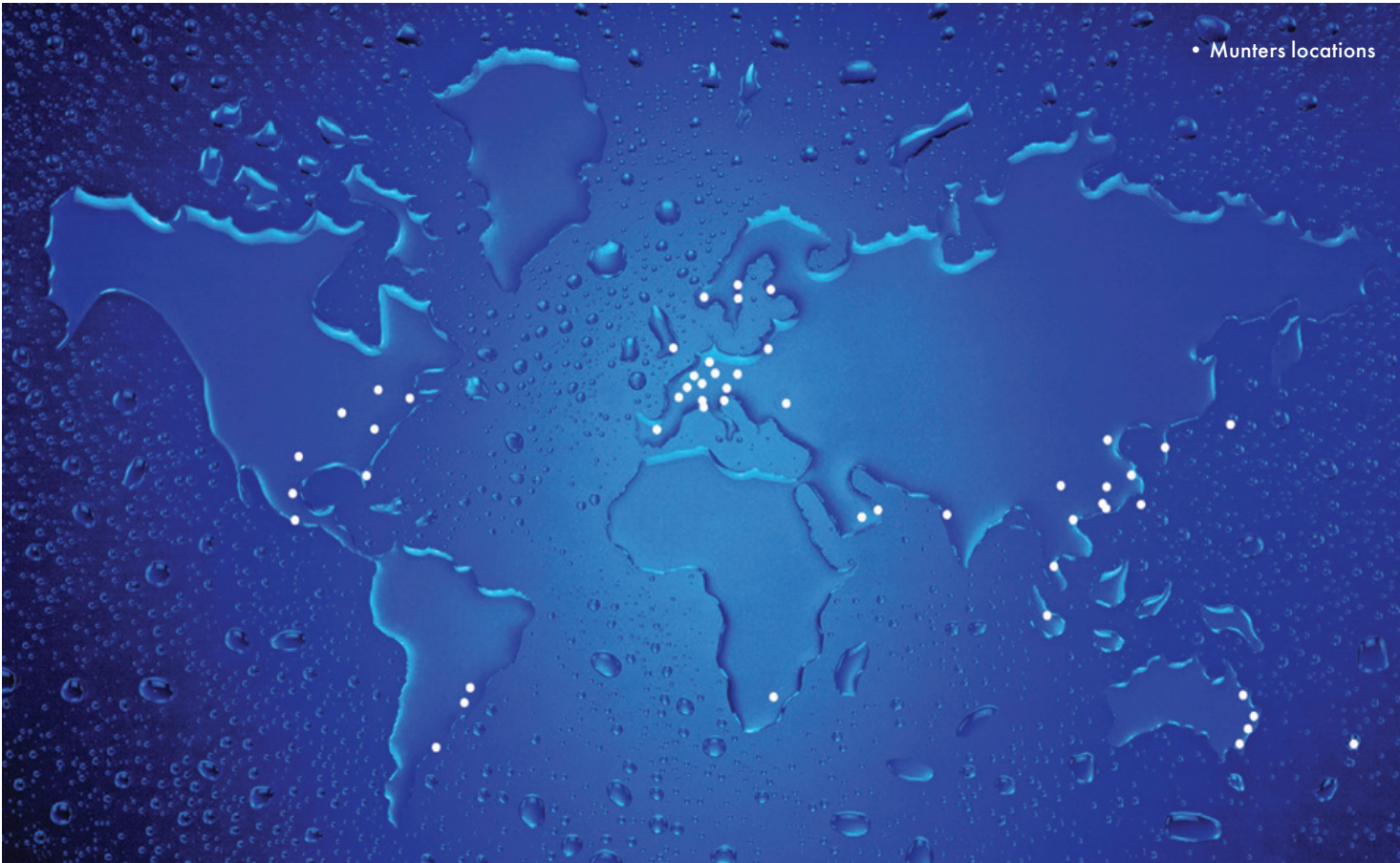

Munters manufacturing facility in Buena Vista, VA

Munters is a global leader in energy efficient and sustainable air treatment solutions.

Using innovative technologies, Munters creates the perfect climate for demanding industrial applications and has been defining the future of air treatment since 1955. Today, around 3,600 employees carry out manufacturing and sales in more than 30 countries. Munters has annual net sales of above SEK 7,2 billion and is listed on Nasdaq Stockholm.

For more information, please visit www.munters.com.

www.linkedin.com/company/munters

Australia Phone +61 2 8843 1588, dh.info@munters.com.au **Austria** Phone +43 1 6164298-0, luftentfeuchtung@munters.at **Belgium** Phone +32 1528 5611, info@muntersbelgium.be **Brazil** Phone +55 41 3317 5050, munters@munters.com.br **Canada** Phone +1 905 858 5894, dhinfo@munters.com **China** Phone +86 10 8041 8000, info@munters.com.cn **Czech Republic** Phone +420 544 211 434, info@munters-odvlhcovani.cz **Denmark** Phone +45 4495 3355, info@munters.dk **Finland** Phone +358 20 776 8230, laitemyynti@munters.fi **France** Phone +33 1 3411 5757, dh@munters.fr **Germany** Phone +49 4087 96900, mgd@munters.de **India** Phone +91 20 668 18 900, info@munters.in **Italy** Phone +39 0183 52 11, marketing@munters.it **Japan** Phone +81 3 5970 0021, mkk@munters.co.jp **Korea** Phone +82 2761 8701, munters@munters.co.kr **Mexico** Phone +52 722 270 40 49, munters@munters.com.mx **Netherlands** Phone +31 172 433231, vochtbeheersing@munters.nl **Poland** Phone +48 58305 3517, dh@munters.pl **Singapore** Phone +65 6744 6828, info@munters.com.sg **South Africa** Phone +27 11 997 2000, info@munters.co.za **Spain** Phone +34 91 640 09 02, marketing@munters.es **Sweden** Phone +46 8 626 63 00, avfuktning@munters.se **Switzerland** Phone +41 52 343 8886, info.dh@munters.ch **Thailand** Phone +66 2642 2670, info@munters.co.th **Turkey** Phone +90 216 548 1444, info@muntersform.com **UAE** +971 4887 6462, middle.east@munters.com **United Kingdom** Phone +44 1480 432243, info@munters.co.uk **USA** Phone +1 978 241 1100, dhinfo@munters.com **Vietnam** Phone +84 8 8256 838, vietnam@muntersasia.com



Munters Corporation
Tel: (800) 843-5360 E-mail: datacenters@munters.com
www.munters.com/datacenters