

DOCKETED	
Docket Number:	20-IEPR-02
Project Title:	Transportation
TN #:	233877
Document Title:	IEA - Fuel Economy
Description:	N/A
Filer:	Christina Cordero
Organization:	California Energy Commission
Submitter Role:	Commission Staff
Submission Date:	7/15/2020 11:35:47 AM
Docketed Date:	7/15/2020



FUEL ECONOMY IN MAJOR CAR MARKETS: TECHNOLOGY AND POLICY DRIVERS 2005-2017

Working Paper 19





*This work is available under the Creative Commons Attribution-NonCommercial-NoDerivatives 3.0 IGO licence (**CC BY-NC-ND 3.0 IGO**) <https://creativecommons.org/licenses/by-nc-nd/3.0/igo/>. You are free to copy and redistribute the material, provided the use is for non-commercial purposes, under the following conditions:*

Attribution - *Please cite the work as follows: International Energy Agency (IEA), 2019, (Fuel Economy in Major Car Markets: Technology and Policy Drivers 2005-2017). Licence: Creative Commons Attribution CC BY-NC-ND 3.0 IGO for all parts of the work except chapters 4 and Annex B, and International Energy Agency (IEA)/International Council on Clean Transportation (ICCT), 2019, (Fuel Economy in Major Car Markets: Technology and Policy Drivers 2005-2017). Licence: Creative Commons Attribution CC BY-NC-ND 3.0 IGO for chapters 4 and Annex B of the work.*

Third-party content—*the OECD/IEA and ICCT do not necessarily own each component of the content contained within the work. Therefore, neither the OECD, the IEA, nor ICCT warrant that the use of any third-party owned individual component or part contained in the work will not infringe on the rights of those third parties. The risk of claims resulting from such infringement rests solely with you. If you wish to re-use a component of the work, it is your responsibility to determine whether permission is needed for that re-use and to obtain permission from the copyright owner. Examples of components can include, but are not limited to, tables, figures, or images*

Acknowledgements

This publication was prepared by the Energy Technology Policy Division of the Directorate of Sustainability, Technology and Outlooks of the International Energy Agency (IEA), under the direction of Mechthild Wörsdörfer and the guidance of Timur Gül. Pierpaolo Cazzola co-ordinated the project. The report was prepared in collaboration with the International Council on Clean Transportation (ICCT), who developed the sections on compliance and enforcement under the co-ordination of Zifei Yang.

The structure of this report, the methodological choices, the selection of indicators and their analysis were jointly developed by Pierpaolo Cazzola, Sacha Scheffer, Leonardo Paoli, Matteo Craglia, Uwe Tietge and Zifei Yang. Leonardo Paoli and Matteo Craglia led the development of the IEA database update underlying this analysis. Uwe Tietge and Zifei Yang led the drafting of the compliance and enforcement section. Renske Schuitmaker, Hugo Signollet and Jacopo Tattini provided valuable support, most notably for the country reports. Bertrand Sadin assisted with the graphic design.

Representatives of the Global Fuel Economy Initiative (GFEI) partner organisations reviewed the manuscript, including: Zifei Yang of ICCT, Stephen Perkins of the International Transport Forum, Sheila Watson and Richard Clarke of the FIA Foundation, Bert Fabian of the United Nations Environment Program and Lew Fulton of the Institute for Transportation Studies at University of California, Davis.

Peer reviewers provided essential feedback to improve the quality of the report. They include: Marine Gerner, Jacob Teter, Jacopo Tattini, Christophe Barret and Apostolos Petropoulos of the IEA; Christina Victoriano (Ministry of Energy Chile); Andrew Giallonardo (Environment and Climate Change Canada); Ichiro Gonda (NGK NTK); Christine Rousselle (University of Orleans); Kaoru Horie and Yuichiro Tanabe (Honda); Lina J. Kindermann (Volkswagen); Paul Miles (Sandia National Laboratory); Philip Lenart (ExxonMobil); Samsun Remzi Can (Jülich Research Centre); Sara Arab (Natural Resources Canada); Sonja Munnix (Netherlands Enterprise Agency - RVO); Thierry Spiess (Natural Resources Canada); Yasuhiro Horikawa (Ministry of Economics, Trade and Industry Japan); Julio Vassallo (Secretariat of Energy and Mines Argentina) and Yali Zheng (Society of Automotive Engineers China).

Debra Justus was the primary editor of this report. The authors would also like to thank the IEA Communications and Digital Office, in particular Astrid Dumond and Therese Walsh, for their assistance in production and editing.

The FIA Foundation provided funding for this work.

Table of Contents

Key findings	4
Market status of new light-duty vehicles	4
Drivers of recent fuel economy trends.....	5
Links between vehicle efficiency and other attributes to prices.....	7
The role of policy	7
Focus on electrification.....	8
Real-world fuel economy gap.....	9
Looking ahead: Policy recommendations.....	10
Introduction	11
Scope	12
1. Status of light-duty vehicle fuel economy	13
Global light-duty vehicle market	13
<i>Status in 2017</i>	13
<i>Developments since 2005</i>	14
LDV fuel consumption.....	15
<i>Status in 2017</i>	15
<i>Fuel economy developments since 2005</i>	17
<i>Prospects for fuel economy developments to 2030</i>	22
2. Drivers of LDV fuel economy	25
Vehicle size segments	27
Vehicle powertrain technology.....	30
Vehicle power	33
Engine displacement.....	35
Vehicle weight	37
Vehicle footprint.....	39
Fuel saving technology deployment: Lessons learned	41
Relationship between fuel economy and vehicle purchase price	43
3. Focus on powertrain electrification	50
Market structure and key attributes of electrified vehicles	51
<i>Market structure</i>	51
<i>Power rating</i>	52
<i>Weight distribution</i>	53
Effect of EV attributes on fuel economy.....	54
Contribution of electrified vehicles to fuel economy improvements.....	55
4. Gap between tested values and real driving fuel economy	57
Real driving fuel economy for conventional vehicles.....	57
<i>Tested versus real driving fuel economy</i>	57
<i>What is widening the gap?</i>	58

Policy response	60
<i>Compliance and enforcement</i>	61
Real driving fuel economy for electric vehicles	64
References	67
Annex A. Methodology: LDV fuel economy analysis.....	74
Data sources	74
Scope	75
Annex B. Fuel economy standards: real driving versus tested fuel economy gaps, compliance and enforcement in major vehicle markets.....	76
Real driving versus tested fuel economy gaps.....	76
<i>China</i>	76
<i>European Union</i>	77
<i>Japan</i>	78
<i>United States</i>	80
Compliance requirements for fuel economy standards.....	81
<i>China</i>	81
<i>European Union</i>	82
<i>Japan</i>	82
<i>United States</i>	83
Enforcement of fuel economy standards	84
<i>China</i>	84
<i>European Union</i>	84
<i>Japan</i>	85
<i>United States</i>	85
Annex C. Statistical tables	86
Table C.1 • New light-duty vehicle registrations (thousands).....	86
Table C.2 • Average CO ₂ emissions/kilometre (g CO ₂ /km, WLTP).....	87
Table C.3 • Average fuel consumption (Lge/100 km, WLTP).....	88
Table C.4 • Average power (kW)	89
Table C.5 • Average displacement (cm ³)	90
Table C.6 • Average kerb weight (kg)	91
Table C.7 • Average footprint (m ²)	92
Table C.8 • Average vehicle price (thousand USD 2017).....	93
Annex D. Definitions	94

Key findings

Market status of new light-duty vehicles

Page | 4

The global average fuel consumption of newly registered¹ light-duty vehicles (LDVs) reached 7.2 litres of gasoline-equivalent per 100 kilometres (Lge/100 km) in 2017 within an LDV market where sales have grown by around 10% between 2015 and 2017 (Figure KF1). The average fuel consumption between countries differs substantially among countries, ranging between 5.2 Lge/100 km and 8.9 Lge/100 km.

Countries can be clustered in three main groups:

- Advanced economies with a gasoline price below USD 1/L – Australia, Canada and the United States, where average fuel consumption is in the 7.9 to 9 Lge/100 km range.
- Advanced economies with gasoline prices above USD 1/L – European Union,² Turkey, Japan and Korea, where fuel use per kilometre ranges between 5.2 and 6.5 Lge/100 km.
- Emerging economies, with average fuel consumption in the 6.5 to 8.5 Lge/100 km range, with India – which has a fuel consumption of 5.6 Lge/100 km – as an outlier.

Figure KF1 • Average new LDV fuel economy by country or region (2005-17) and new registrations (2017)

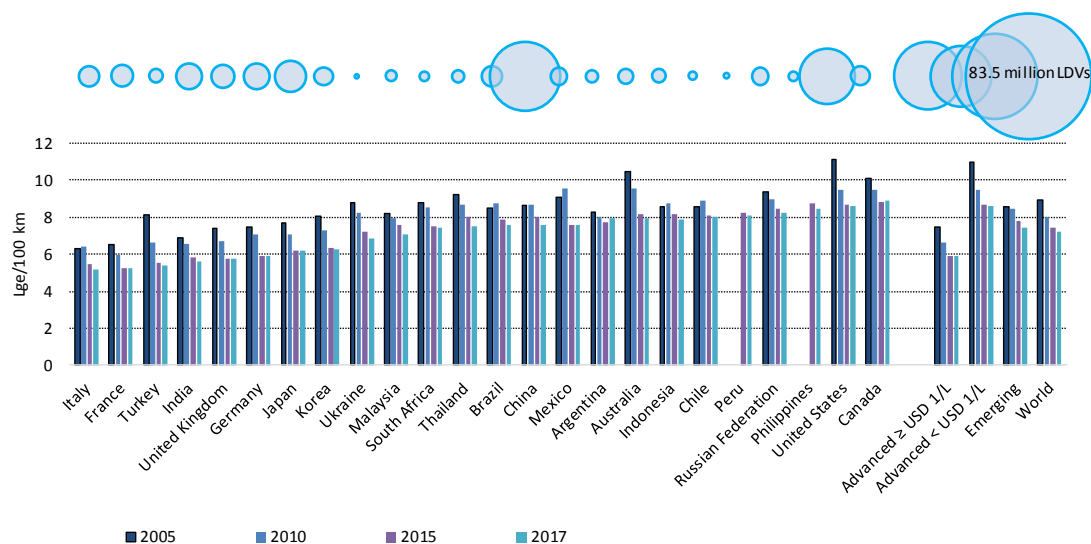

Key point: Average LDV fuel economy improved in all regions between 2005 and 2017, though there is a wide divergence of absolute levels and trends between countries and regions.

Note: Fuel consumption measured in Lge/100 km, WLTP.

Sources: IEA elaboration and enhancement for broader coverage of IHS Markit database (IHS Markit, 2018).

The average fuel economy improvement rate between 2015 and 2017 slowed down to 1.4% per year, which is the lowest since the GFEI benchmarking started (Table KF1). This is one-third of the

¹ Note that the IHS database used as a basis for the LDV market volumes tracked in this publication aims to cover the first registration of new vehicles in each market. These data may be subject to some degree of inaccuracy due to data collection challenges (e.g. for second hand imports of vehicles by private individuals moving into the country). Despite this, these data have been interpreted here as representative of new vehicle sales, and referred to as 'new sales' or 'new vehicle registrations'.

² Including the other countries in the European Economic Area (Iceland, Norway and Switzerland), depending on the data availability per parameter per year (see Annex C).

required improvement rate (3.7% per year) to meet the 2030 GFEI target, owing to the lower improvement between 2005 and 2017.

The reduction of the average fuel consumption per kilometre slowed down in advanced economies to only 0.2% per year, on average, between 2015 and 2017, with more than 20 countries experiencing a reversal in the evolution of their fuel economy. In contrast, the improvement of fuel use per kilometre in emerging economies accelerated to 2.3%.

Table KF1 • Progress in average fuel economy improvement in different regions and GFEI target for 2030

		2005	2010	2015	2017	2030
Advanced (Gasoline price ≥ USD 1/L)	average fuel economy (Lge/100km)	7.4	6.5	5.8	5.8	4.4
	annual improvement rate (% per year)	-2.4%		-2.5%	-0.1%	
		-2.0%				
Advanced (Gasoline price < USD 1/L)	average fuel economy (Lge/100km)	11.0	9.5	8.6	8.6	
	annual improvement rate (% per year)	-2.9%		-1.9%	-0.4%	
		-2.0%				
Emerging	average fuel economy (Lge/100km)	8.6	8.5	7.8	7.5	
	annual improvement rate (% per year)	-0.2%		-1.6%	-2.3%	
		-1.2%				
Global average	average fuel economy (Lge/100km)	8.8	8.0	7.4	7.2	
	annual improvement rate (% per year)	-2.0%		-1.5%	-1.4%	
		-1.7%				
GFEI target	Required annual improvement rate (% per year)	2005 base year	-2.8%			
		2017 base year	-3.7%			

Note: To remain consistent with previous GFEI benchmarking publications, this table includes all countries in the European Union. This leads to a minor difference for the average fuel consumption of *Advanced ≥ USD 1/L* and the *Global average* in other analyses that only include the weighted average of the countries that are presented in the graph. Further details on the updated methodology and data used for this evaluation are available in Annex A.

Sources: IEA elaboration and enhancement for broader coverage of IHS Markit database (IHS Markit, 2018).

Key point: Annual improvement is slowing in advanced economies and accelerating in emerging economies. Both rates are below those needed to achieve the GFEI target.

Drivers of recent fuel economy trends

Key drivers of the recent developments of the average fuel consumption include the rapid decline of diesel sales in several major vehicle markets, most notably in Europe, the advanced economy with the greatest reliance on this powertrain technology (Figure KF2). Since 2015, diesel shares have fallen by 5-15 percentage points in the largest EU markets, a change that was not sufficiently counterbalanced by the 1-3 percentage point growth of electrified LDVs to maintain efficiency improvements over gasoline vehicles.

Figure KF2 • Diesellisation rate and average fuel consumption trends in selected countries, 2014-17

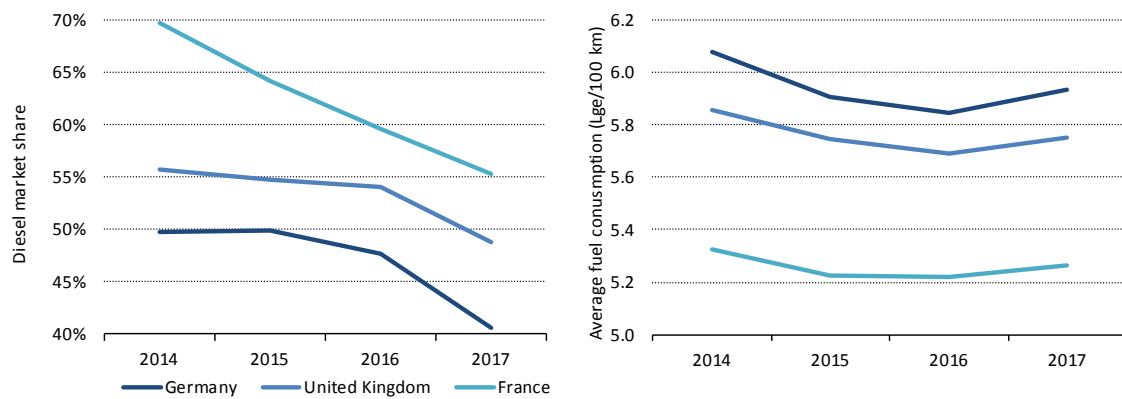

Sources: IEA elaboration and enhancement for broader coverage of IHS Markit database (IHS Markit, 2018).

Key point: Countries with decreasing shares of diesel powertrains saw a worsening trend in average fuel consumption in 2016-17.

The growing consumer demand for larger vehicles – a characteristic that has been common to all vehicle markets despite ongoing efficiency improvements per vehicle segment – is also a major determinant of recent developments in the average fuel economy of LDVs (Figure KF2). The market share of sport-utility vehicles (SUVs) and pick-ups has grown by 11 percentage points since 2014 and, in 2017, represented nearly 40% of the global LDV market. North America and Australia have had a particularly high market share of SUVs/pick-ups, closing in on 60% in 2017. Most of the growth has taken place in the small SUV/pick-up segment, which includes many cross-over versions of popular passenger cars.

Figure KF3 • Global average market share per vehicle segment and average fuel consumption per segment, 2014-17

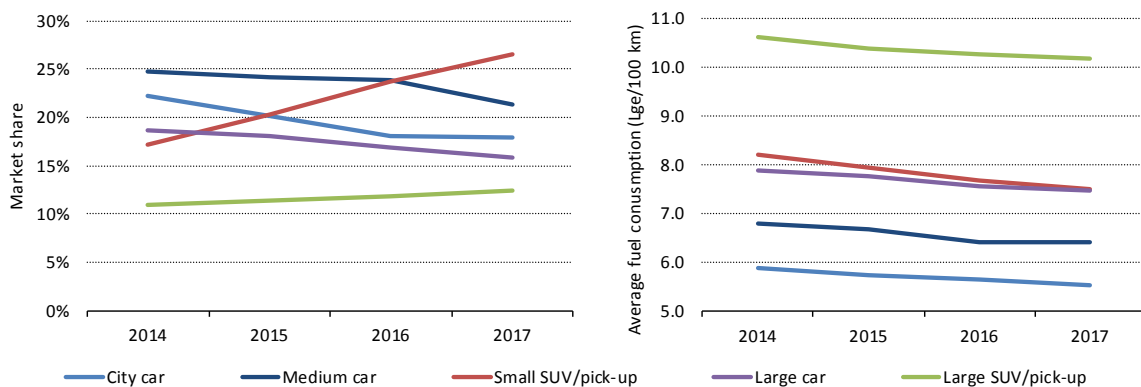

Sources: IEA elaboration and enhancement for broader coverage of IHS Markit database (IHS Markit, 2018).

Key point: Even if the average fuel consumption of each vehicle segment continues to improve, the overall average fuel consumption is affected by the growing market share of more energy-intensive SUVs and pick-ups, taking place at the expense of more fuel-efficient passenger car segments.

A third important, determining factor in recent global fuel economy developments is the shift in market structures of advanced economies. There has been a decline in the market share of North America (which has larger and, therefore, less efficient vehicles), and a subsequent growth of the relevance of markets characterised by the smaller and more efficient vehicles sold in Europe, Japan and Korea. This has been accompanied by a contextual increase, for emerging economies, of the relevance of the People’s Republic of China (“China”) – where fuel economy is subject to

regulations requiring significant fuel economy improvements – and India, a market that has traditionally been characterised by large shares of small and fuel-efficient cars.

Links between vehicle efficiency and other attributes to prices

Analysing vehicle prices against other attributes indicates that consumers are prepared to pay a significant price premium for vehicles belonging to large market segments (with higher mass and footprint) and for those having a high power rating. Changes in vehicle attributes such as power, weight or footprint can mitigate the risk of price increases that could be induced by the increased adoption of fuel-efficient technologies.

Diesels, hybrids and electric vehicles cost more than gasoline vehicles having similar attributes. In particular, battery-electric vehicles (BEVs) and plug-in hybrid electric vehicles (PHEVs) offer very large improvements in fuel consumption, but this was coupled with a significant price premium in 2017. However, vehicle prices need to be analysed in rather narrow groups of attributes such as power, market segment, and size in order to see the impact of changes in powertrain technologies. This suggests that the impact of powertrain choices on vehicle prices is lower than is the impact of changes in other vehicle attributes.

When looking at vehicles in the same market segment, with similar power and size, and with the same powertrain type, fuel efficiency is not coupled with higher vehicle prices. The 25% most efficient vehicles cost 5-7% less than the average equivalent vehicle, and the average fuel economy improvements they deliver are between 0.6 and 0.8 Lge/100 km.

The analysis of vehicle prices also shows that small vehicles are cheaper in emerging economies than in advanced countries, and that this is not the case for large segments.

The role of policy

A growing amount of evidence highlights the importance of policies to improve average fuel consumption (Figure KF4). Countries with regulations and/or efficiency-based purchase incentives in place improved on average 60% faster than countries without such policies. The higher improvement rate is also reflected by the higher market share of electrified LDVs (hybrids, PHEVs, BEVs and fuel cell electric vehicles).

Even if none of the countries with policies in place experienced fuel economy improvements fast enough to keep up with the 2030 GFEI target of halving the average fuel use per kilometre by 2030 (against a 2005 benchmark), several markets require improvement rates that are in line with it.

The scope of existing fuel economy regulations is limited to the next few years in nearly all cases. Standards in North America range between 2018 and 2025, whereas no Asian country has a standard beyond 2022. Europe is the only region that defined fuel economy improvements reaching to the year 2030.

Figure KF4 • Average annual fuel economy improvement rates for selected countries with and without fuel economy regulations between 2012 and 2017

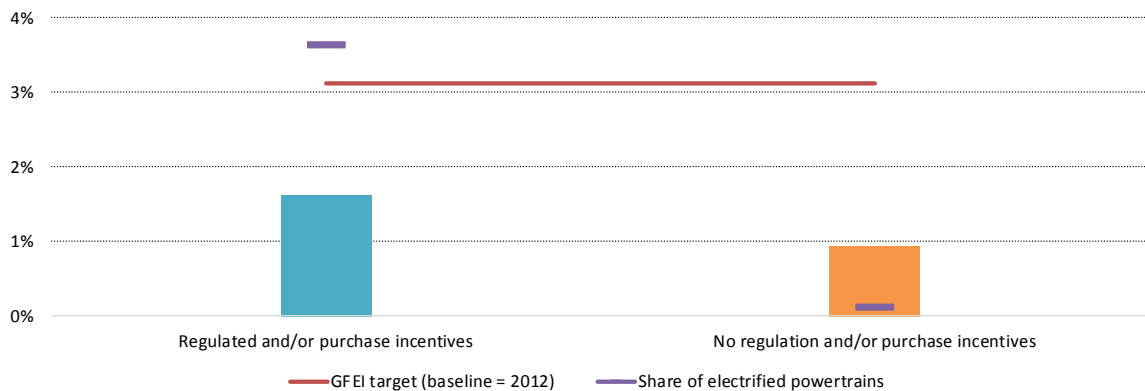

Notes: Regulated countries are Canada, China, European Union, India, Japan, Mexico, Korea and the United States. Countries without regulations but with incentives are Australia, Brazil, Chile, Malaysia, South Africa, Thailand and Turkey. Countries without incentives and regulations are Argentina, Egypt, Indonesia, Peru, Philippines, Russian Federation and Ukraine. Values are weighted based on vehicle sales in 2017. Incentives are efficiency-based taxes or subsidies for vehicle purchase on a national level. Alternative powertrains are hybrids, PHEVs and BEVs.

Sources: IEA elaboration and enhancement for broader coverage of IHS Markit database (IHS Markit, 2018); (Transportpolicy.net, 2018a); (IEA, 2018b); (ICCT, 2018c).

Key point: Yearly improvement rates for fuel consumption are higher in countries with regulations or incentives. Nearly no countries or regions are on track to meet the 2030 GFEI target.

Focus on electrification

The electrification of LDVs is going to be crucial to ensure that fuel economy can be effectively improved, especially if diesel shares keep falling (Figure KF5). Electrified vehicles are already contributing positively to improve the country-weighted average fuel consumption by up to 3.5%. Japan experienced the largest gains due having to the largest market share globally for hybrids, followed by the United States with a mix of electrified vehicle types (HEV, BEV and PHEV). Electrification in China was also very relevant to improve the average fuel economy, thanks to a fast-growing market share for BEVs and PHEVs. Countries that currently have high average fuel consumption values (which typically go hand-in-hand with high shares of large and heavy vehicles) can benefit the most from electrification since electrified vehicle efficiency is less dependent on size and weight.

Figure KF5 • Contribution to the fuel consumption savings from electrified vehicles, 2017

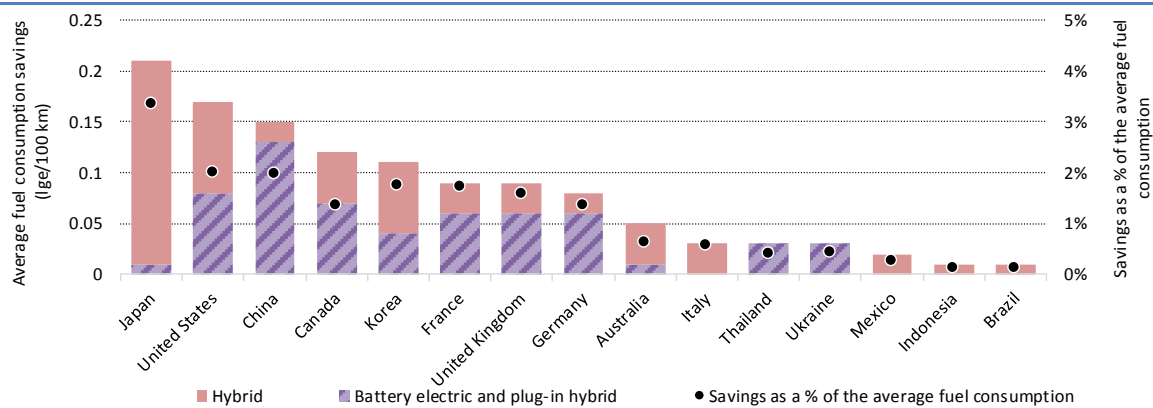

Note: Savings are calculated by substituting electrified vehicles, in each market segment and power class, by vehicles characterised by the average fuel use of the market segment and power class.

Source: IEA elaboration and enhancement for broader coverage of IHS Markit database (IHS Markit, 2018).

Key point: The largest fuel economy benefits from electrification in 2017 were experienced by Japan, the United States and China.

Real-world fuel economy gap

The gap between fuel consumption measured according to test values and in real-driving conditions grew over the past decade in most vehicle markets to reach values in 2017 that in some cases were almost 50% higher than the tested fuel consumption per kilometre (Figure KF6).

Figure KF6 • Divergence between official and real-world CO₂ emission values for selected countries, 2001-14

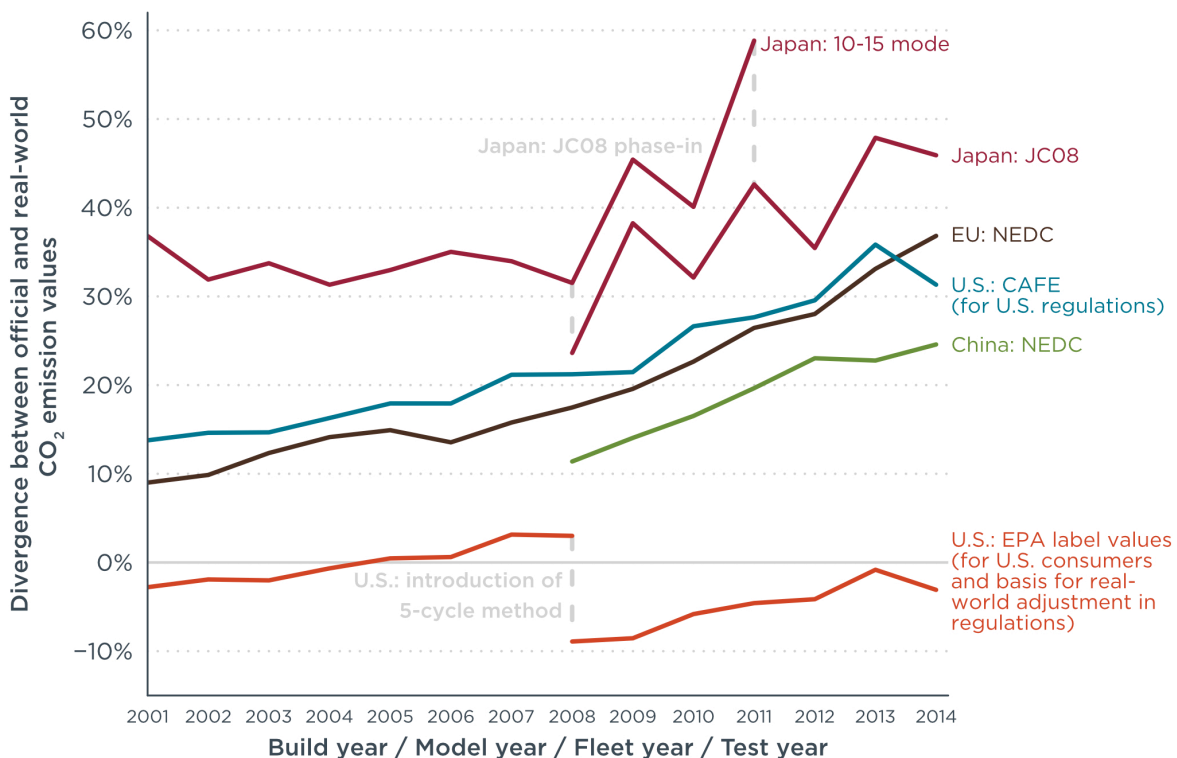

Source: Tietge et al. (2017).

Key point: All key vehicle markets except for the United States show a gap of more than 10% between laboratory tested and real-world fuel consumption, which diverged to as high as 50% by 2014.

Compliance and enforcement policies help achieve a more realistic representation of fuel economy in real-world conditions. Most major vehicle markets have started to take action to develop these measures and currently have varying types of compliance policies in place, whereas enforcement policies are less abundant. The United States has the most comprehensive policy framework to ensure well-functioning compliance and enforcement.

Looking ahead: Policy recommendations

Meeting the 2030 GFEI target at the global level requires a widespread adoption of regulatory policies setting requirements for the improvement of fuel economies over time, combined with fiscal instruments to stimulate consumer demand for the vehicle technologies that offer the best performance. Long-term commitments are important to ensure that the investments necessary to deploy electrification technologies, which are crucial to meeting the GFEI targets in a phase where consumers are losing confidence in diesel, can take place. Tightening the rules governing the measurement of fuel consumption during tests, combined with measures capable of safeguarding on-road compliance, are essential to ensure that all stakeholders take effective action to meet the policy goals.

Introduction

This report builds on a series of Global Fuel Economy Initiative (GFEI)³ working papers investigating the fuel economy of newly registered⁴ light-duty vehicles (LDVs) across the world from 2005 to 2017.⁵ The results are tracked relative to established GFEI targets, which are an intermediate target of 30% improvement of new LDV fuel economy, weighted globally, by 2020, and 50% by 2030.

The analysis builds on methodological improvements introduced in the previous GFEI report (GFEI and IEA, 2017; GFEI and IEA, 2014; GFEI and IEA, 2012), and it maintains the broad country coverage that has characterised these analyses. Only Norway and Switzerland did not have additional data for 2016 and 2017. This report presents all the fuel consumption results calibrated to the Worldwide Harmonised Light-Duty Test Procedure (WLTP) (ICCT, 2014).⁶

Key elements of this report include:

- An assessment of LDV fuel economy progress from 2005 to 2017. It describes the main indicators in 2017 and evaluates progress in the previous two years as well as the twelve-year trend.
- Analysis of key developments of major drivers that influence fuel economy, outlining the status per country in 2017 and the twelve-year evolution of these variables for key regional groupings. These results are also considered in terms of expected progress towards the 2030 GFEI goals.
- A focus on LDV prices which aims to provide better insight into the costs of energy efficiency in the LDV market.
- A section investigating the main drivers of tested fuel economy in electrified vehicles.
- A special focus looking at the divergence between real driving fuel consumption and tested fuel economy of LDVs, and the corresponding compliance and enforcement aspects related to testing. It takes account of the evidence emerging from recent assessments (e.g. Tietge et al., 2017) that show that the revision of test procedures, and, in particular, the introduction of the WLTP, enable only limited progress to match real driving fuel consumption values. This section discusses measures that can help narrow the gap.

In addition, this report is accompanied by a set of 18 country-specific assessments containing information on key socio-economic indicators, brief outlines of the policy framework influencing vehicle fuel economy and graphs showing key vehicle characteristics over time. These country assessments are available online at: www.iea.org/topics/transport/gfei.

³ The GFEI is a partnership of the International Energy Agency (IEA), United Nations Environment Program (UNEP), International Transport Forum of the OECD (ITF), International Council on Clean Transportation (ICCT), Institute for Transportation Studies at University of California Davis, and the FIA Foundation.

⁴ Note that the IHS database used as a basis for the LDV market volumes tracked in this publication aims to cover the first registration of new vehicles in each market. These data may be subject to some degree of inaccuracy due to data collection challenges (e.g. for second-hand imports of vehicles by private individuals moving into the country). Despite this, these data have been interpreted here as representative of new vehicle sales, and referred to as “new sales” or “new vehicle registrations”.

⁵ The report updates the information published in GFEI Working Paper 15 (GFEI and IEA, 2017).

⁶ Three test cycles are applied worldwide to measure specific fuel consumption (litres of gasoline equivalent per 100 kilometres) or fuel economy (miles per gallon or kilometres per litres of gasoline equivalent): the European New European Driving Cycle (NEDC), the US Corporate Average Fuel Economy (CAFE) and the Japan Cycle '08 (JC08). The WLTP and its related test cycle (WLTC) have been developed (and are being refined) to replace region-specific approaches with a harmonised testing scheme (UNECE, 2014). The conversion of the results (published according to region-specific test results) was performed using conversion equations developed by the ICCT (2014).

The methodology adopted to develop the IEA-GFEI database underpinning the analysis is outlined in Annex A. Annex B gives details on the growing evidence of increasing gaps between on-road and tested fuel economy performance, and highlights compliance and enforcement frameworks in the major vehicle markets. Annex C includes statistical tables with data on new vehicle registrations, average grammes of carbon dioxide emissions per kilometre, fuel consumption, power, displacement, weight, footprint and price.

Scope

This study includes the new registrations of light-duty vehicles, a category defined as passenger cars, passenger light trucks and light-commercial vehicles below 3.5 tonnes. The countries included in this analysis are Argentina, Australia, Brazil, Canada, Chile, People's Republic of China, Egypt, most European countries (all countries in the European Union, the other countries in the European Economic Area [including Iceland, Norway and Switzerland], Former Yugoslav Republic of Macedonia, Turkey and Ukraine), India, Indonesia, Japan, Malaysia, Mexico, Peru, Philippines, Russian Federation, South Africa, Korea, Thailand and United States. Germany, France, Italy and United Kingdom are presented separately from the European Union, with more detailed information in several analyses. Due to data availability, not each country could be represented for all years in this analysis (coverage is available in Annex C).

1. Status of light-duty vehicle fuel economy

Global light-duty vehicle market

Status in 2017

Worldwide sales of new vehicles totalled nearly 97 million in 2017, of which 26 million commercial vehicles⁷ and 71 million passenger cars (OICA, 2018). Passenger cars sales went up 4 million from 2015 and 25 million more than in 2005. The IEA-GFEI database for 2017 covers 45 million passenger cars and 38 million passenger light trucks or light-commercial vehicles. Emerging and advanced economies had similar numbers of new light-duty vehicle (LDV) registrations⁸ with 47% and 53% of the market respectively (Figure 1). The largest single market is China with 25.5 million sales in 2017, followed by the European Union with 16.7 million, United States with 16.3 million and Japan with 5.1 million in LDV sales. The countries analysed in this report represent more than 90% of estimated global new LDV sales (OICA, 2018).

Figure 1 • New LDV registrations, 2017

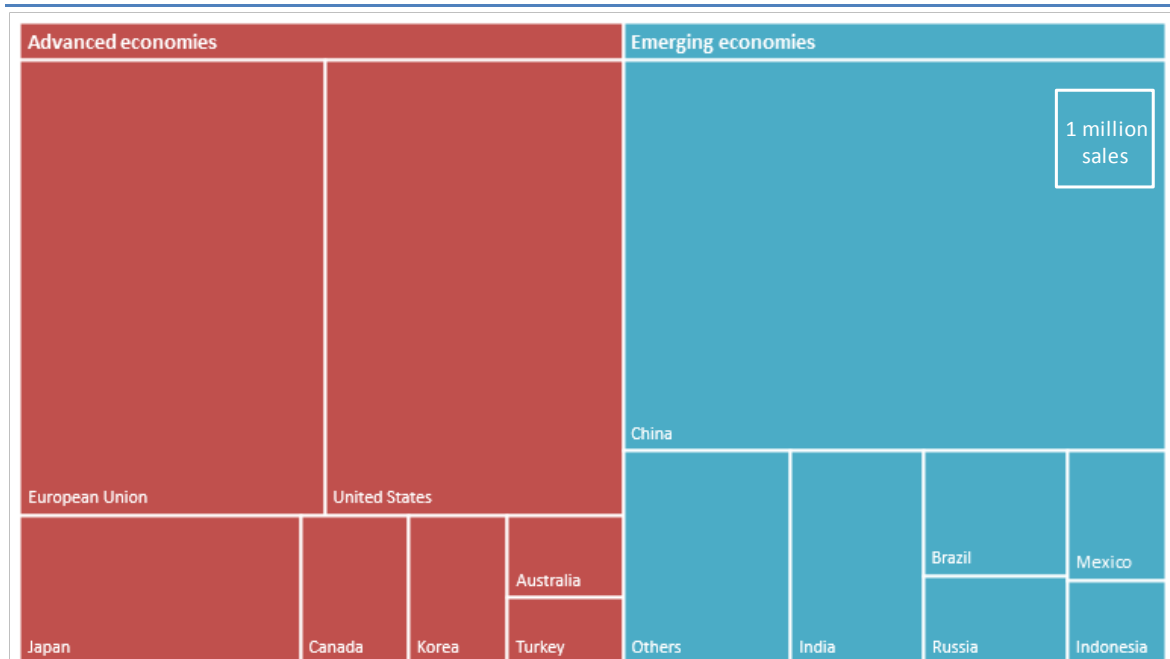

Note: *Others* (emerging economies) includes Argentina, Chile, Egypt, Malaysia, Peru, Philippines, South Africa, Thailand and Ukraine.

Sources: IEA analysis based on IHS Markit database (IHS Markit, 2018).

Key point: Sales in advanced economies are 11% higher than in emerging economies. Together China, European Union and United States accounted for 59 million LDV sales.

⁷ Commercial vehicles includes both LDVs and heavy-duty vehicles (HDVs), making it challenging to estimate the total LDV sales.

⁸ Note that the IHS database used as a basis for the LDV market volumes tracked in this publication aims to cover the first registration of new vehicles in each market. These data may be subject to some degree of inaccuracy due to data collection challenges (e.g. for second-hand imports of vehicles by private individuals moving into the country). Despite this, these data have been interpreted here as representative of new vehicle sales, and referred to as “new sales” or “new vehicle registrations”.

Developments since 2005

The increasing share of LDVs sold in emerging economies accounted for most of the additions to the world's vehicle stock in 2017 (Figure 1). The starkest example is the People's Republic of China ("China") where new registrations increased 17% per year in the period 2005 to 2017.⁹ Other countries with rapidly increasing vehicle sale rates are India at 9% and Indonesia at 7%. Consequently, LDV sales in emerging economies have tripled since 2005 with the biggest volume rise in China, where sales were seven-times higher in 2017 than in 2005.

LDV sales in advanced economies are characterised by stagnation and, in some cases, slight decreases. Annual growth rates in advanced economies have been below 1%, resulting in a sale volume increase of 5.5% over the 12-year period. The European Union market increased by 12%, with the largest markets (France, Germany and United Kingdom) increasing between 1.5% and 4.5%. Italy and Japan are the two largest advanced markets that saw lower LDV sale volumes (-13% and -9% respectively) over the 12-year period. LDV sales also stagnated in the United States, with 2017 sales only being 1% higher than those in 2005.

Given the growth dynamics of emerging economies and a development phase that, historically, has been characterised by strong increases in LDV ownership, it is likely that these economies will continue to account for most of the increase of global vehicle sales in the years ahead. Conversely, most advanced economies are considered saturated due to high vehicle ownership levels; sales volumes are therefore expected to remain relatively steady in these markets in the years ahead (IEA, 2018a).

Figure 2 • LDV sales in selected advanced and emerging economies, 2005-17

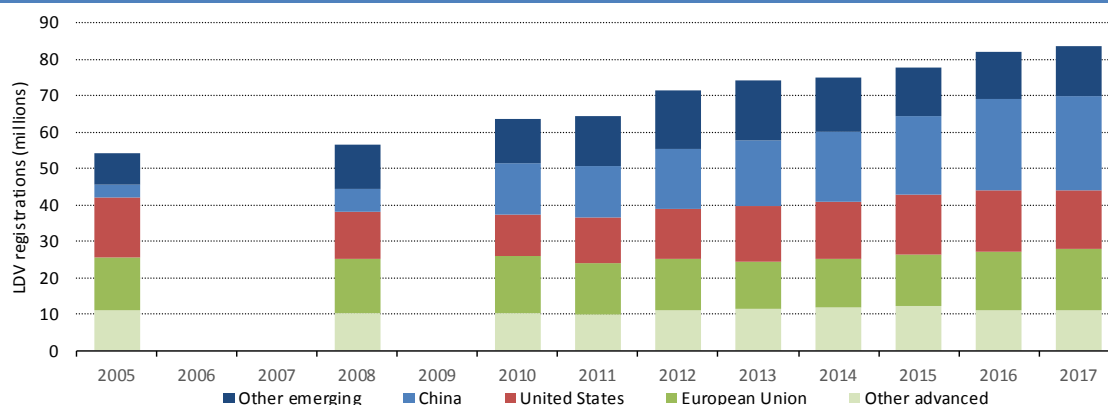

Note: *Other emerging* economies includes Argentina, Brazil, Chile, Egypt, India, Indonesia, Malaysia, Mexico, Peru, Philippines, Russian Federation, South Africa, Thailand and Ukraine. *Other advanced* economies includes Australia, Canada, Japan, Korea and Turkey. Source: IEA analysis based on IHS Markit database (IHS Markit, 2018).

Key point: Sales volume in emerging economies increased more than three-fold between 2005 and 2017, while sales in advanced economies were relatively flat.

⁹ The most recent sales statistics indicate that 2018 will be the first year with a decrease in LDV sales in China since the early 1990s (Reuters, 2019).

LDV fuel consumption

Status in 2017

There were large differences in the average sales-weighted specific fuel consumption litres of gasoline equivalent per kilometre [Lge/km] of new vehicles in countries around the world in 2017 (Table 1).¹⁰

Italy, France, Turkey and India have the lowest average specific fuel consumption (hereafter, “fuel consumption”) of all major car markets examined in this report, with values equal to 5.4 Lge/100 km or lower. Other large countries in the European Union, Japan and Korea have fuel economies in the range of 5.8 to 6.3 Lge/100 km. Most emerging economies have fuel economies between 7.0 and 8.4 Lge/100 km, with the exception of India (5.6 Lge/100 km) and Ukraine (6.8 Lge/100 km). On a global basis, Canada (8.9 Lge/100 km) and United States (8.6 Lge/100 km) have the highest average fuel consumption per kilometre.

Table 1 • Tested fuel consumption of new LDVs in selected markets, 2017

Country	Lge/100 km	Country	Lge/100 km	Country	Lge/100 km
Argentina	7.9	Germany	5.9	Peru	8.1
Australia	7.9	India	5.6	Philippines	8.4
Brazil	7.6	Indonesia	7.9	Russian Federation	8.2
Canada	8.9	Italy	5.2	South Africa	7.4
Chile	8	Japan	6.2	Thailand	7.5
China	7.6	Korea	6.3	Turkey	5.4
Egypt	8	Malaysia	7.1	Ukraine	6.8
France	5.3	Mexico	7.6	United Kingdom	5.8
				United States	8.6

Note: Lge = litres of gasoline equivalent per kilometre.

Source: IEA analysis based on IHS Markit database (IHS Markit, 2018).

Key point: Average fuel consumption ranges between 5.2 and 8.9 Lge/100 km.

Figure 3 illustrates the sales-weighted average fuel consumption in select countries relative to gross domestic product (GDP) per capita and gasoline price in US dollars (USD) at annual average market exchange rates in 2017.

¹⁰ All fuel consumption values in this report are expressed as litres of gasoline-equivalent per 100 kilometres. Values are converted from national drive cycles to the Worldwide Harmonised Light-Duty Test Procedure (WLTP) cycle.

Figure 3 • Fuel consumption relative to GDP and gasoline price (2016) for selected countries, 2017

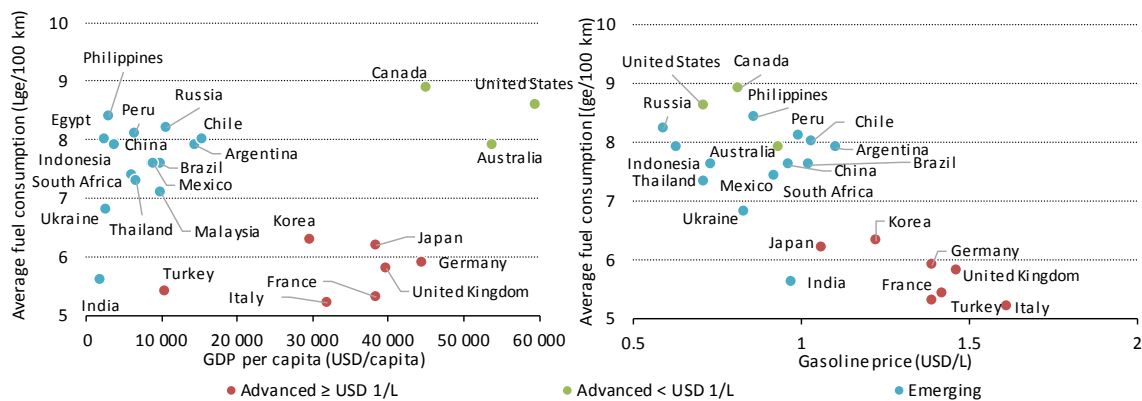

Notes: GDP values refer to USD with annual average exchange rates in 2017. Gasoline prices are for 2016. Advanced <math><</math> USD 1/L = advanced economies with gasoline prices below USD 1 per litre; Advanced \geq USD 1/L = advanced economies with gasoline prices above USD 1 per litre.

Sources: IEA analysis based on IHS Markit database (IHS Markit, 2018); World Bank (2018) for GDP per capita and GIZ (2017) for gasoline prices.

Key point: Countries can be grouped based on their average fuel consumption, income level and fuel price, and fuel economy is better in country groups subject to higher-than-average fuel prices.

Figure 3 suggests that countries can be broadly classified into three clusters with similar LDV market characteristics. These categories are used throughout this report to discuss global developments.

- **Advanced economies with 2016 gasoline prices below USD 1 per litre at market exchange rates (MER)** (Australia, Canada and United States).¹¹

Australia, Canada and United States accounted for around 23% of total LDV sales in 2017. The group is characterised by high-income levels, fuel taxes that are on the low end of the global range and high fuel consumption per kilometre. These countries are characterised by relatively low population density and a high vehicle mileage compared to the global average (IEA, 2018a).

- **Advanced economies with 2016 gasoline prices above USD 1 per litre (MER)** (European Union,¹² Japan, Korea and Turkey).

The European Union, Japan, Korea and Turkey accounted for approximately 30% of global LDV sales of in 2017. The cluster is characterised by medium- to high-income levels, high fuel taxes and relatively low fuel consumption per kilometre.¹³ These countries have a higher population density and lower average vehicle mileage than those in the other advanced economy category (IEA, 2018a).

- **Emerging economies**¹⁴

This category includes a variety of countries from across the globe and accounts for 47% of total LDV sales of in 2017. It is characterised by countries with low- to medium-income levels, generally lower fuel taxes than countries in the second advanced economy category and have fairly high fuel consumption per kilometre (IEA, 2018a). The population density is more

¹¹ Gasoline was chosen as the benchmark as it fuels the majority of LDVs worldwide. In most cases, countries with a gasoline price below USD 1/L also have diesel price in that price range.

¹² Including the other countries in the European Economic Area (Iceland, Norway and Switzerland), depending on the data availability per parameter per year (see Annex C).

¹³ Turkey is an exception due to lower income levels. It is included in this category due to the proximity of its car market to the European Union.

¹⁴ Argentina, Brazil, Chile, China, Egypt, India, Indonesia, Malaysia, Mexico, Peru, Philippines, Russian Federation, South Africa, Thailand and Ukraine.

variable than advanced economies, as well as the vehicle mileage, which is generally lower than advanced economies due to less developed infrastructure.

India is included in this cluster because of its income level, despite having lower fuel consumption than the category average.

Fuel economy developments since 2005

The expanding volume of LDVs sales in emerging economies since 2005 has had a substantial impact on average fuel economy on a worldwide basis (Figure 4). In 2005, global average fuel consumption reflected the level in advanced economies since they comprised almost 80% of the global car market. In the period since 2005, emerging markets have accounted for rising shares of LDV sales and fuel economy improvements in advanced economies have had a weaker influence on the measure of global average fuel consumption (and, vice versa, the influence of emerging economies gained strength).

Figure 4 • LDV sales and average fuel consumption in advanced and emerging economies, 2005-17

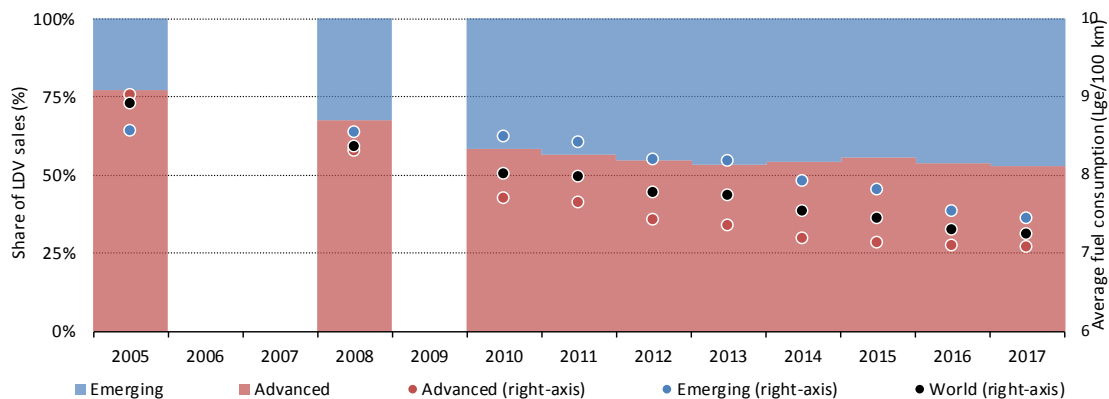

Note: Advanced < USD 1/L = advanced economies with gasoline prices below USD 1 per litre; Advanced ≥ USD 1/L = advanced economies with gasoline prices above USD 1 per litre.

Source: IEA analysis based on IHS Markit database (IHS Markit, 2018).

Key point: Global average fuel consumption is increasingly influenced by trends in emerging economies.

Between 2005 and 2011, average fuel consumption in advanced economies improved at a rate of 2.7% per year compared with 0.3% per year in emerging economies. Conversely, in the period between 2011 and 2017, emerging economies improved at a faster rate (2.0%) than advanced economies (1.3%).

Shifting sales and changes in the rates of fuel efficiency improvements in both advanced and emerging economies have led to a convergence of the impact on the global average fuel consumption. Both advanced economies and emerging economies varied less than 3% from the global average fuel consumption in 2017, whereas this variance was almost 6% in 2013.

The bigger impact of emerging economies on global average fuel consumption in the period 2005-17 is evident in a variety of trends within and between countries (Figure 5). Among the emerging economies, China had the largest increment in the number of new LDV registrations at 22 million and its market share expanded by nearly 600%. In 2005, 3.7 million LDV sales in China represented only 30% of all such sales in emerging economies, whereas China's LDV sales of 25.5 million in 2017 accounted for nearly two-thirds of the LDV market in emerging economies. Second after China, India's LDV sales have tripled since 2005 and the year-on-year sales growth rate increased from 5.5% in 2015 to 9.7% in 2017, which is almost three-times the overall sales growth rate in emerging economies. In other emerging economies, year-on-year LDV sales did not show distinct growth patterns over the past five years. For example, LDV sales in Brazil increased by 9.5%

between 2016 and 2017 after four years of decline ranging between -1.6% and -25.6%. Mexico declined by 4.5% in 2017 from the previous year after two years of nearly 20% annual growth.

Average fuel economy accelerated in emerging economies from 1.5% per year in 2010-15 to 2.4% in 2015-17. This boost reflects strong efficiency gains in China and other emerging Asian economies (excluding India), which improved by nearly 3% per year. The pace of fuel economy improvements in Latin America, India and other emerging economies slowed to 0.3-1.8% in the 2015-17 period. The increased improvement rate for emerging economies was strengthened by a shift in market size towards China and other Asia of 9%. Recent trends in emerging economies vehicle markets have been volatile; China improved by 3.9% in 2015-16, while only at 1.6% in 2016-17.

Figure 5 • Share of LDV sales and average fuel consumption in emerging economies, 2005-17

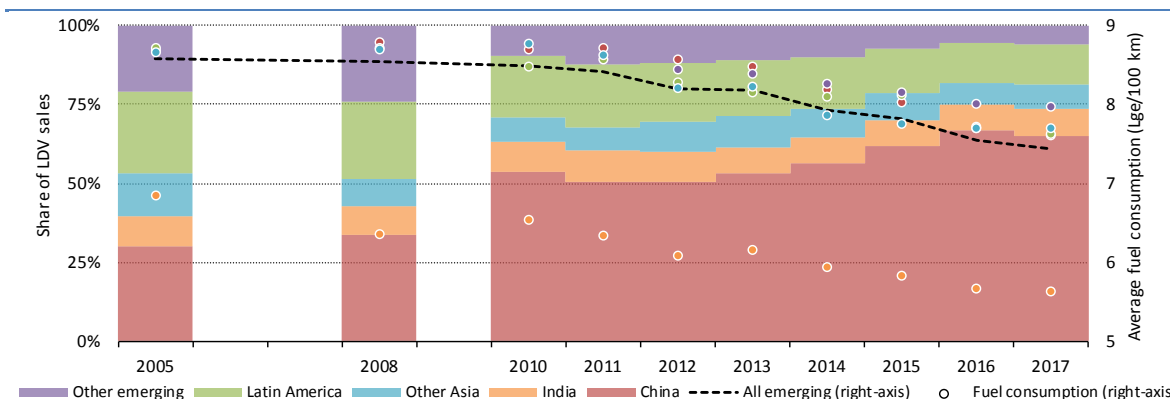

Notes: *Other Asia* includes Indonesia, Malaysia, Philippines and Thailand. *Latin America* includes Argentina, Brazil, Chile, Mexico and Peru. *Other emerging* economies include Egypt, Russian Federation, South Africa and Ukraine.

Source: IEA analysis based on IHS Markit database (IHS Markit, 2018).

Key point: China’s LDV market grew the most among emerging economies in both absolute terms and market share. Most emerging economies boosted fuel economy after 2011, though with a slowdown in 2015-17.

In 2017, the average fuel consumption of emerging economies was rather close to the average of all advanced economies and the global average. The main exception is India, with average fuel consumption that consistently has been around 25% lower than the average of all emerging economies since 2005. Excluding India, the average fuel consumption in emerging economies would have been 0.2 Lge/100 km higher in 2017.

LDV sales and average fuel consumption in advanced economies show mixed trends in the period since 2005 (Figure 6). Japan did not experience major changes in its market size. The European Union experienced a decline in LDV sales after the 2008 economic crisis until 2014. The market size increased in Korea and rebounded significantly in North America after the 2008 economic crisis, starting in 2011. This led to a shift towards markets that have higher fuel use per kilometre in the cluster of advanced economies, and came with a reduction in the fuel efficiency rate of improvement in advanced economies in the 2010-14 period, compared with earlier years. Since 2014, the situation reversed, with European Union sales growing faster than North America. This largely explains why the fuel economy across all advanced economies continued to improve in recent years, despite stagnating or worsening average fuel consumption in around half of the countries in the advanced economy categories.

Figure 6 • Market distribution and average fuel consumption in advanced economies, 2005-17

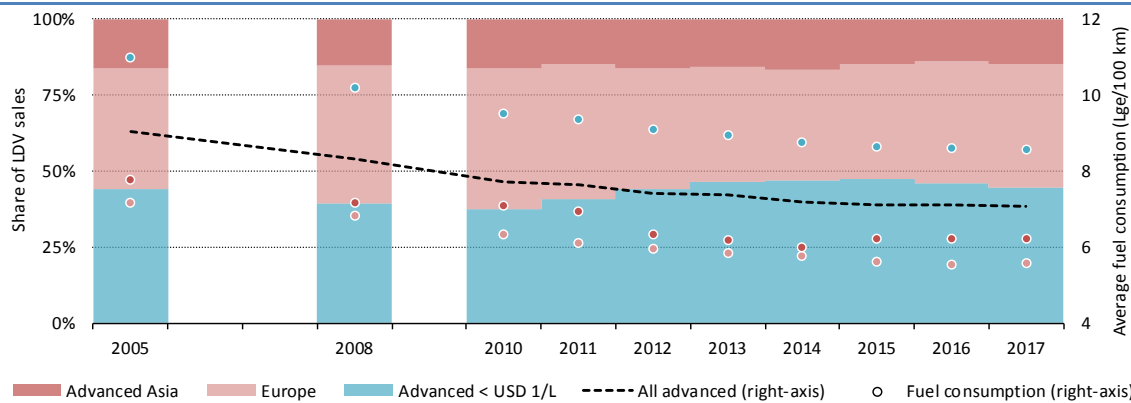

Notes: *Advanced Asia* includes Japan and Korea. *Europe* includes the European Union, Iceland, Norway, Switzerland and Turkey. *Advanced < USD 1/L* includes Australia, Canada and United States.

Source: IEA analysis based on IHS Markit database (IHS Markit, 2018).

Key point: The increase in the market share of Canada and the United States, combined with a reduction in fuel economy improvements in recent years in Europe and Japan, led to a deceleration of fuel economy improvements in advanced economies after 2010.

The impact of the introduction of mandatory fuel economy standards or efficiency-based incentives for vehicle purchase is visible in the market. The average fuel economy improvement rate of countries after implementing fuel consumption standards or efficiency-based purchase incentives after 2005 was nearly 60% higher than countries without standards and incentives (Figure 7). Nevertheless, the improvement rate of countries with fuel efficiency measures falls short by about half of the rate required to reach the GFEI 2030 target. For countries without regulations and incentives, improvements have been less than a third of what is required to meet the GFEI 2030 target.

Figure 7 • Average annual fuel economy improvement rates for countries with and without fuel economy regulations/incentives, 2012-17

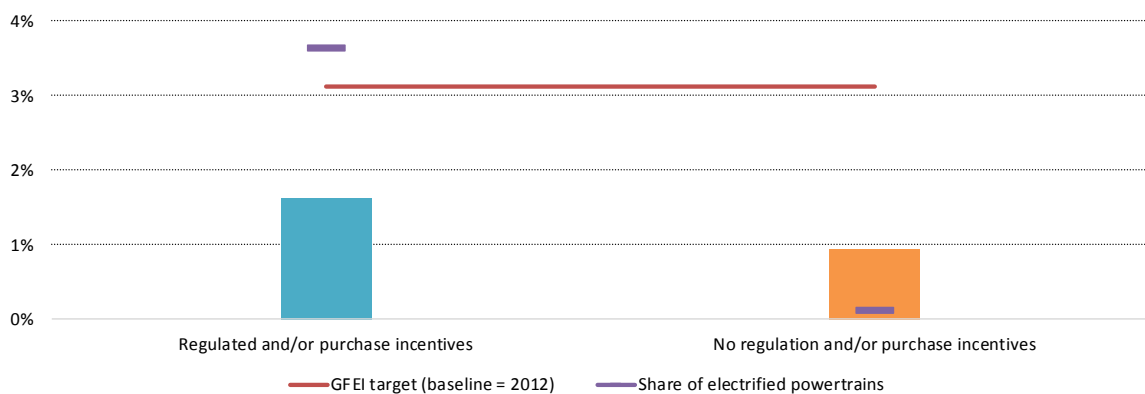

Notes: Countries that have fuel economy regulations are Canada, China, European Union (including European Economic Area), India, Japan, Mexico, Korea and United States. Countries without regulations, but with incentives are Australia, Brazil, Chile, Malaysia, South Africa, Thailand and Turkey. Countries without regulations or incentives are Argentina, Egypt, Indonesia, Peru, Philippines, Russian Federation and Ukraine. Values are weighted based on vehicle sales in 2017. Incentives are efficiency-based taxes or subsidies for vehicle purchase. Electrified powertrains are hybrids, plug-in hybrids, fuel-cell electric vehicles and battery-electric vehicles.

Sources: IEA analysis based on IHS Markit database (IHS Markit, 2018); Transportpolicy.net (2018a); IEA (2018b); ICCT (2018a).

Key point: Annual fuel economy improvement rates are higher in countries with regulations and/or incentives, yet no country group is on track to meet the GFEI 2030 target.

Korea, China and the European Union have achieved the fastest rates of improvement since their fuel economy regulations came into force with annual improvement rates of 1.7-2.3%. The average improvement rate prior to the regulations was 1.1% per year, a rate similar to countries

today that do not have fuel economy regulations. This highlights the potential of fuel efficiency gains when regulations are implemented.

Countries that do not have fuel economy standards or incentive may have more year-on-year swings in fuel efficiency. For example, average fuel economy worsened in at least four years in Argentina and Indonesia since 2005, whereas this slippage occurred only once in the European Union (2017) and not at all in the United States in the period since 2005.

The uptake of fuel saving electric powertrain technologies (hybrid, plug-in hybrid and battery electric) is higher in countries with regulations and incentives than those without. For countries with regulations and/or incentives, electric LDVs represented 3.6% of new sales in 2017, while for countries without regulations or incentives electric LDV sales were only 0.1%.

The structure of the efficiency-based incentives is also relevant, as one of the biggest barriers to consumers is the upfront price gap between an electric vehicle and an internal combustion engine alternative (IEA, 2018c). For example, the electric powertrain share in France was 4.3% in 2017 and its “bonus-malus” incentive scheme covered up to EUR 10 000 (USD 11 300) per car, which can represent up to 30% of the vehicle price (Ademe, 2017). The market share in 2017 for electric powertrains only reached 1.1% in Australia where there are no federal fuel economy regulations, though several states provide incentives up to 4% of the vehicle price (Queensland Government, 2018; NSW Government, 2018).

Focus on the 2015-17 period

Fuel economy improvements slowed significantly between 2015 and 2017 in advanced economies, and accelerated in developing economies (Table 2).

Table 2 • Fuel economy improvements by category, 2005-17 and GFEI 2030 target

		2005	2010	2015	2017	2030
Advanced (Gasoline price ≥ USD 1/L)	average fuel economy (Lge/100km)	7.4	6.5	5.8	5.8	4.4
	annual improvement rate (% per year)	-2.4%		-2.5%	-0.1%	
		-2.0%				
Advanced (Gasoline price < USD 1/L)	average fuel economy (Lge/100km)	11.0	9.5	8.6	8.6	
	annual improvement rate (% per year)	-2.9%		-1.9%	-0.4%	
		-2.0%				
Emerging	average fuel economy (Lge/100km)	8.6	8.5	7.8	7.5	
	annual improvement rate (% per year)	-0.2%		-1.6%	-2.3%	
		-1.2%				
Global average	average fuel economy (Lge/100km)	8.8	8.0	7.4	7.2	
	annual improvement rate (% per year)	-2.0%		-1.5%	-1.4%	
		-1.7%				
GFEI target	Required annual improvement rate (% per year)	2005 base year	-2.8%			
		2017 base year	-3.7%			

Note: To remain consistent with previous GFEI benchmarking publications, this table includes all countries in the European Union, which leads to a minor difference for the average fuel consumption of Advanced ≥ USD 1/L and the Global average in other analyses that only include the weighted average of the countries that are presented in each graph. Further details on the updated methodology and data used for this evaluation are available in Annex A.

Source: IEA analysis based on IHS Markit database (IHS Markit, 2018).

Key point: Annual fuel efficiency gains are slowing in advanced economies and accelerating in emerging economies. Both rates are below those needed to achieve the GFEI 2030 target.

The slowdown in both advanced economy categories is underpinned by a trend of worsening average fuel economy in at least 17 countries since 2015. This was most significant in several European countries, i.e. Germany, France and United Kingdom, as well as in Canada. Japan, where the average fuel economy level was stable between 2015 and 2017, also contributed to the trend

for the advanced economies. Fuel economy in the United States continued to improve, though at less than a quarter of the rate of the two-year period before 2015.

A key reason for the decline in fuel economy in the European Union was a shift in consumer preference away from diesel LDVs, which are more fuel-efficient than similarly sized gasoline engines.¹⁵ The sales share of new diesel vehicles dropped by around 5% in the United Kingdom and France, and by 7% in Germany between 2016 and 2017 (Figure 8). This trend was even more notable in specific vehicle segments. In the small SUV/pick-up truck segment, the share of new diesel vehicles dropped by 11%, 8% and 13% respectively between 2016 and 2017. The share of new sales for gasoline engine vehicles expanded, which increased the average fuel consumption.

Figure 8 • Dieselisation rate and average fuel consumption trends in selected countries, 2014-17

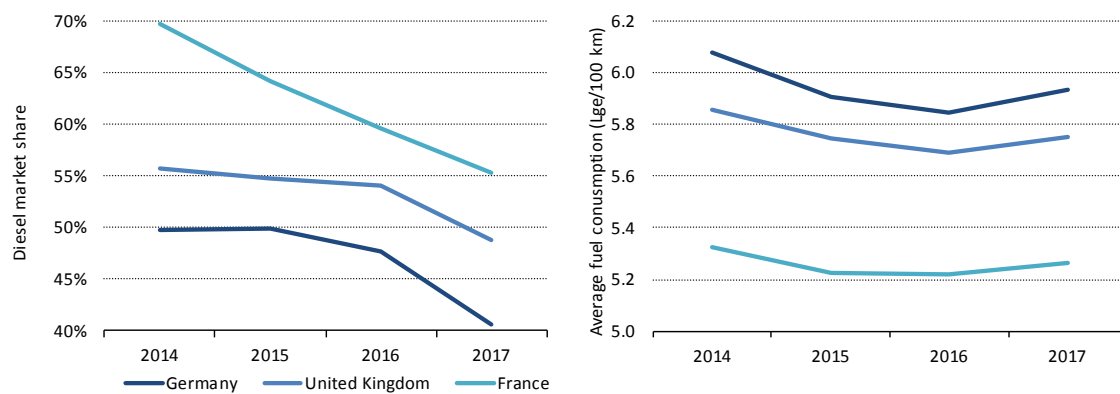

Source: IEA analysis based on IHS Markit database (IHS Markit, 2018).

Key point: Countries with falling shares of diesel powertrain vehicles reduced average fuel consumption.

Another reason for the slowdown in fuel economy gains in advanced economies was the rising share of large vehicles, which, in most cases, are less efficient (Figure 9). Globally, the market share of sports utility vehicles (SUVs) and pick-ups has grown by 11 percentage points since 2014 and represented nearly 40% of the global LDV market in 2017. This explains the decline of fuel economy trends in Canada, where more than 60% of new LDVs were sport-utility vehicles (SUVs) or pick-up trucks in 2017. The slowdown in the United States occurred while shares of SUV/pick-up trucks in new vehicle sales were growing rapidly, from 49% in 2015 to 57% in 2017 (IEA, 2018d). Beyond North America, all vehicle markets have been similarly affected to a certain extent. The direction of the change in consumer preferences towards larger vehicles occurring between 2015 and 2016 is consistent with the decline in gasoline and diesel prices that took place after the oil price peaked at the end of 2014. (Gasoline prices fell 21-33% between 2014 and 2016 in the United States, China, India, Japan, Germany and the United Kingdom [IEA, 2018c].) This trend continued also in 2017, despite a 5% to 10% rebound in oil prices between 2016 and 2017.

¹⁵ The decline in diesel sales followed the issue of a notice of violation by the US Environmental Protection Agency to the Volkswagen group in September 2015 (US EPA, 2015). This notification involved the use of defeat devices to comply with pollutant emission limits and was the first case in what was later called “diesel-gate” scandal, including the subsequent investigation of other vehicle manufacturers.

Figure 9 • Global average market share per vehicle size segment and fuel consumption, 2014-17

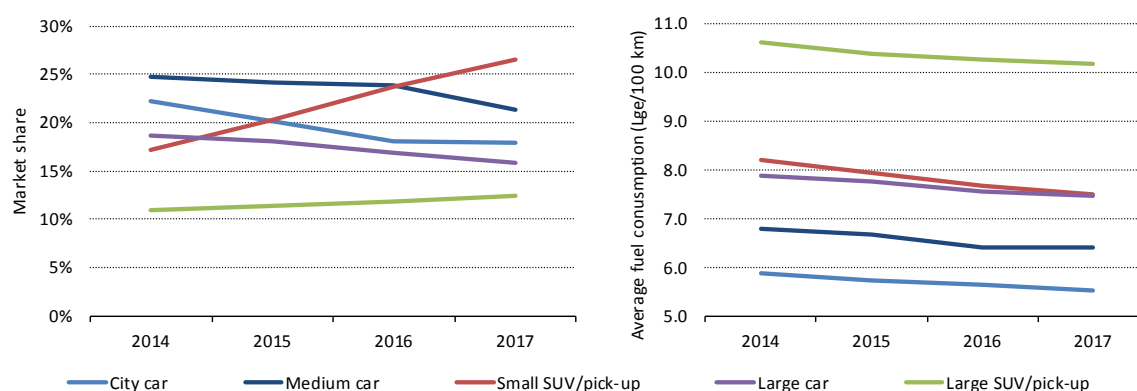

Source: IEA analysis based on IHS Markit database (IHS Markit, 2018).

Key point: Average fuel economy in each vehicle size category improved, but the overall average fell due to increasing market shares of larger and less fuel-efficient vehicles.

The upward pressure on fuel consumption per kilometre induced by the decline in diesel LDVs and rising consumer preference for larger vehicles was not offset by an uptake in fuel saving technologies. In the European Union, hybrids, plug-in hybrids, battery electric and fuel cell electric LDVs were less than 4% of new LDV sales in 2017, even though such models had tripled their market share from 2015. In Australia, Canada and the United States, the market share of these options were around 1-3% of sales in 2017. Japan and Korea were the largest markets for hybrids. Korea was the only advanced country that witnessed a sizeable increase in the share of hybrid vehicle sales, from 2% in 2014 to 6% in 2017. In Japan, hybrids accounted for 14% of all LDV sales in 2017,¹⁶ declining from a 17% share in 2015 and the peak of 21% in 2014.¹⁷

Prospects for fuel economy developments to 2030

Both in emerging and advanced economy categories, the rate of fuel efficiency gains falls significantly short of what is needed to meet the GFEI 2030 target of halving fuel consumption to 4.4 Lge/100 km from the 2005 average (Table 2). Meeting this target requires more significant efficiency gains (3.7% per year) than have been achieved in the 12-year period. Encouraging signs emerge, however, from a number of countries that are continuing efforts to improve fuel economy and increasing commitments to electrification of vehicle fleets, which is expected to spur fuel economy improvements.

While the global average fuel economy improvement induced by policies to date is not aligned with the ambition needed to meet the GFEI 2030 target, several countries and regions (accounting for 80% of the car market) now have fuel economy standards in place that are consistent with the ambition of this target (Figure 9).¹⁸

¹⁶ Japan is the country with the highest share of hybrids in vehicle sales in 2017. Note that the registrations and the market share of hybrids in Japan might be underestimated for the period 2014-17 (METI, 2019). According to the Japanese Automobile Manufacturers Association (JAMA), the market share of hybrids in Japan was 31.6% in 2017 (JAMA, 2018).

¹⁷ The decline in the share of hybrid sales occurred in the context that the average fuel consumption per kilometre in Japan in 2011 had already exceeded the 2015 target of the standard, and by 2013, it had achieved the 2020 target level, while the efficiency of all vehicle types continued to improve (Yang, 2017).

¹⁸ Besides the countries included in Figure 9, Japan is considering further updates to its fuel economy standards. Canada, China, Japan, and the United States already have heavy-duty vehicle (HDV) fuel efficiency targets in place (not covered in this report) (IEA, 2018d). India introduced a new fuel economy standard for commercial HDVs (including trucks and buses) in 2017 (Garg and Sharpe, 2017). The European Union has submitted a proposal for CO₂ emissions performance standards for new HDVs (EC, 2018).

A key caveat is that currently only the European Union has an agreed proposal, included in the third clean mobility package, which extends to 2030 (European Parliament, 2018). A second caveat is that some of the existing fuel economy standards are being reconsidered. This is the case in the United States, in particular, where in August 2018 the US Environmental Protection Agency (EPA) proposed to freeze fuel economy standards at the 2020 level for 2021-26 instead of requiring continuous improvements, though no final decision has been taken as of January 2019 (US EPA, 2018a).¹⁹ More than 7 000 comments from various institutions and citizens both praising and rejecting the proposal had been received by the end of October 2018 that will help to further assess the feasibility of the proposed rules in 2019 (Regulations.gov, 2018).

Meeting the GFEI 2030 target requires that fuel economy standards continue after their specified term, and be strengthened in many countries (Figure 10).

Figure 10 • Annual implied fuel economy improvements of existing or draft standards relative to the GFEI 2030 target

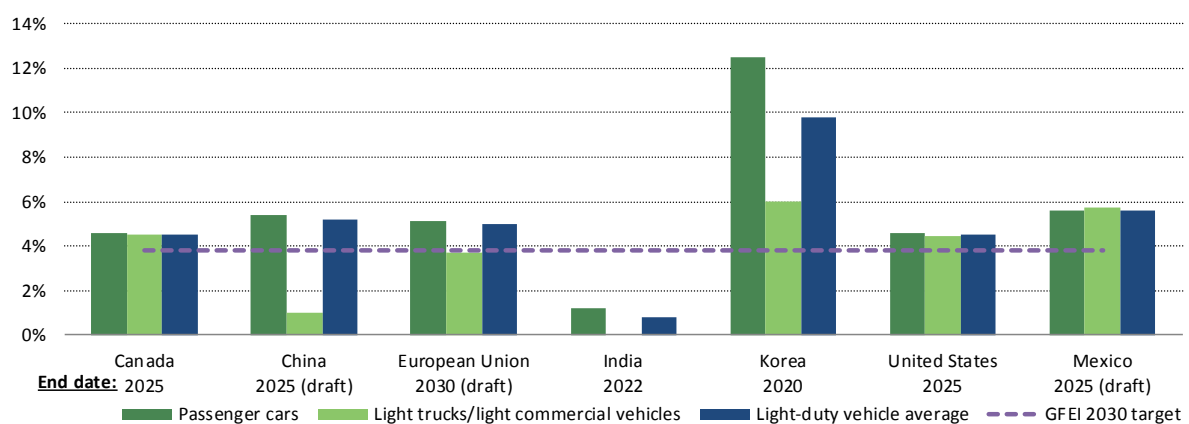

Notes: Standards and the GFEI target for 2030 in this graph are set relative to a 2017 baseline. The European Union and Chinese passenger light truck fuel economy standards are assumed to only apply to light-commercial vehicles. The light truck standards in Canada and United States are allocated based on the vehicles subject to the Gas Guzzler Tax (US DoE, 2018). Light truck standards in Korea are based on the small SUV/pick-up truck, large SUV/pick-up truck and van/light-commercial vehicle segments. The share of passenger cars relative to SUV/pick-up trucks and Van/LCVs to calculate the light-duty vehicle average are based on 2017 registrations. The final rule of the European Union 2030 standard is still pending and is based on the latest agreement. The 2025 Chinese standard is a draft (open for comments since 24 January 2019) and so far only applies to passenger cars (Van/LCV assumed flat until 2025). The United States 2025 standard is under review by the US EPA. The Mexican standard is currently a draft awaiting updates and approval after consultation in the fall of 2018.

Sources: ICCT (2018a); United States (US EPA and NHTSA, 2012); Korea (Transportpolicy.net, 2018b); Mexico (SEGOB, 2013; SEGOB, 2018); India (Government of India, 2014 and 2015); Canada (Government of Canada, 2014); China (ICCT, 2018b; MIIT, 2017; MIIT, 2019); European Union (European Parliament, 2018).

Key point: Various fuel economy regulations help to achieve the GFEI 2030 target if stringency levels continue to improve at similar rates until 2030.

Role of electrification

The GFEI target was set in 2010 and built on analytical assessments that showed that it could be met cost effectively using technologies that do not require the full electrification of the

¹⁹ The state of California, which was granted a waiver by the EPA to implement a state-level greenhouse gas emissions standard in 2009, which was adopted by ten other states, aims to maintain its stricter standard (State of California, 2018).

powertrain, recent policy,²⁰ technology²¹ and commercial²² developments point to an increasing likelihood of a substantial increase in sales of electric vehicles. In the *World Energy Outlook 2018*, the New Policies Scenario, which takes into account existing and announced policies, the number of electric LDVs on the road reaches around 120 million by 2030 (IEA, 2018e). Should the policy ambition continue to rise to meet climate goals and other sustainability targets, the IEA's EV30@30 Scenario suggests that the number of electric LDVs on the road could be as high as 228 million in 2030 (IEA, 2018b). The rise in market share of battery-electric and plug-in hybrid vehicles has already started to affect country-level fuel consumption, since the typical energy consumption of electric vehicles (EVs) is one-third of equivalent internal combustion engine (ICE) vehicles.²³ A specific focus on the effect of powertrain electrification, included in this report, provides further insights.

²⁰ In 2017, China, the European Union and India, which together account for roughly 60% of the global LDV market, proposed or implemented significant policy changes that are likely to accelerate the phase-in of electric vehicles and shape their deployment on a global scale (IEA, 2018b). Other countries that have set EV targets or objectives are Canada, India, Japan, Mexico, New Zealand, Korea and United States (IEA, 2018b).

²¹ Estimates of battery costs show a range that varies between 360 USD per kilowatt-hour (kWh) for small batteries produced in small volumes to USD 155/kWh for large batteries produced in large volumes. Cost reductions for batteries over the period to 2030 are likely to stem from three main drivers: battery capacities will increase to serve large all-electric driving range; battery manufacturing will take place in plants with large production capacities that provide economies of scale; and battery chemistries are expected to evolve to options with higher energy density and lower reliance on cobalt. The result of these combined effects has the capacity to lower battery costs in the range of USD 100/kWh to USD 122/kWh (IEA, 2018b).

²² The auto industry is responding swiftly and nearly all of the major manufacturers have announced ambitious scales of production and development of new EV models or targets for EV sales (IEA, 2018b).

²³ The energy consumption of EVs, often expressed in kilowatt-hour per kilometre (kWh/km) can be converted to litres of gasoline equivalent and compared to vehicles powered by internal combustion engines. The conversion is based on a constant conversion factor representing the energy content of 1 litre (L) of gasoline (33.5 megajoules per litre, or 9.3 kWh/L). The energy consumption of EVs does not include energy losses associated with the generation, transport and distribution of the electricity (well-to-tank). Similarly, the energy consumption of ICE vehicles excludes losses occurring the fuel production, transport and distribution phases.

2. Drivers of LDV fuel economy

The countries analysed in this report are ranked by average fuel economy or specific fuel consumption (hereafter, “fuel consumption”) value in 2017 in Table 3. The values are coupled with relevant characteristics such as power, engine displacement, weight, footprint and share of vehicle types.

Table 3 • LDV fuel economy and vehicle characteristics by country, 2017

Country	Fuel economy (Lge/100 km, WLTP)	Power (kW)	Empty weight (kg)	Footprint (m ²)	Share of SUV/pick-up trucks	Share of diesel and electrified powertrains
Canada	8.9	180	1 717	4.7	61%	3%
United States	8.6	176	1 733	4.6	57%	4%
Russian Federation	8.2	100	1 436	4.0	41%	10%
Chile	8.0	98	1 447	4.1	48%	28%
Egypt	8.0	90	1 478	4.1	34%	
Argentina	7.9	89	1 308	4.0	29%	18%
Australia	7.9	135	1 663	4.3	57%	34%
Indonesia	7.9	78	1 186	3.8	22%	11%
Brazil	7.6	86	1 243	3.8	29%	8%
China	7.6	108	1 439	4.2	40%	4%
Mexico	7.6	103	1 316	3.9	34%	1%
Thailand	7.5	93	1 553	4.2	58%	
South Africa	7.4	97	1 476	4.1	46%	34%
Malaysia	7.1	90	1 219	4.0	22%	
Ukraine	6.8	107	1 504	4.2	50%	42%
Korea	6.3	135	1 480	4.3	30%	43%
Japan	6.2	78	1 230	3.7	11%	16%
Germany	5.9	111	1 462	4.1	25%	44%
United Kingdom	5.8	104	1 448	4.1	30%	53%
India	5.6	62	1 143	3.6	27%	47%
Turkey	5.4	84	1 375	4.2	16%	70%
France	5.3	86	1 334	4.1	28%	60%
Italy	5.2	80	1 308	3.9	29%	62%
<i>Advanced economies with gasoline prices ≥ USD 1/L</i>	5.8	94	1 367	4	23%	49%
<i>Advanced economies with gasoline prices < USD 1/L</i>	8.6	174	1 727	4.6	57%	5%
<i>Emerging economies</i>	7.5	100	1 390	4.1	38%	11%
Average of listed countries	7.3	118	1 466	4.2	39%	17%

Notes: Lge/100 km = litres of gasoline equivalent per 100 kilometres; WLTP = Worldwide Harmonised Light-Duty Test Procedure (WLTP). Electric powertrains include hybrid, plug-in hybrid, battery-electric and hydrogen fuel cell vehicles. Diesel and electric powertrains are combined as both technologies lead to better fuel consumption for a similar vehicle. The colour scheme indicates the contribution to per vehicle attribute. The darker blue the cell, the higher the value of the attribute relative to other countries, whereas red is the opposite.

Source: IEA analysis based on IHS Markit database (IHS Markit, 2018).

Key point: Average LDV fuel consumption levels in major economies in the European Union, Japan and Korea are lower than the global average. Australia, Canada and United States consume more than the global average reflecting bigger vehicles and fewer diesel LDVs. Fuel economy levels in emerging economies fall between these two groups.

Table 3 shows Footprint(m²) that average LDV fuel consumption tends to be lower in countries where engine power, displacement, vehicle weight and footprint are smaller, as these attributes negatively correlate with fuel consumption (Figure 11). Large and heavy vehicles tend to consume more fuel because of the additional energy needed for acceleration. High-powered vehicles have larger engines and generally consume more fuel per kilometre.

Figure 11 • Effects of vehicle footprint, weight, power and engine displacement on fuel consumption for various LDV models

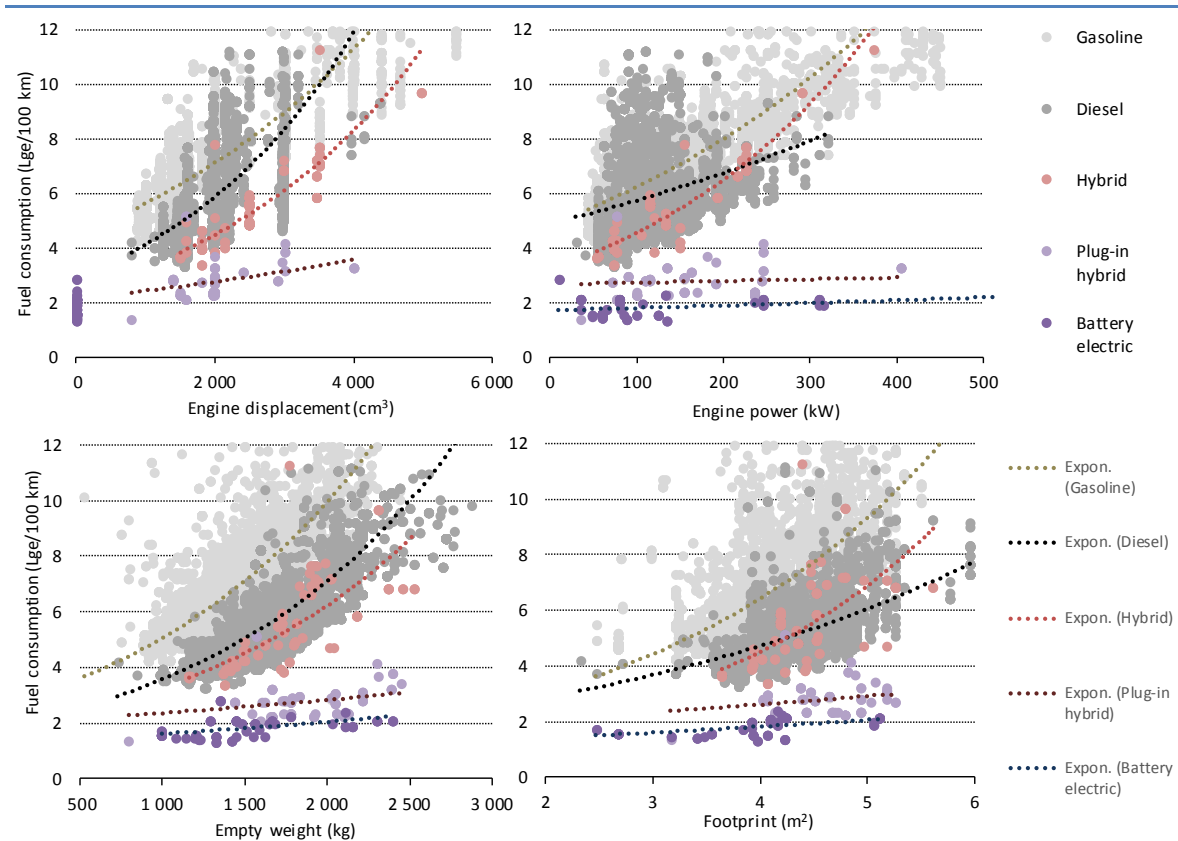

Notes: Expon = exponential correlation curve; cm³ = cubic metre; m² = square metre; kW = kilowatt; kg = kilogramme. Each dot represents one vehicle model. Source: IEA analysis based on IHS Markit database (IHS Markit, 2018).

Key point: Bigger, heavier and more powerful vehicles consume more fuel than lighter versions. Gasoline powertrains consume more fuel than diesels, while hybrids, PHEVs and EVs are more efficient.

Figure 11 illustrates the large differences in fuel consumption between powertrains. Diesel vehicles tend to have lower fuel consumption than the equivalent gasoline vehicle due to higher thermal efficiency (coupled with higher compression ratios). Hybrid vehicles improve fuel consumption by running the engine for more time at the peak operating efficiency. Battery-electric (BEV) and plug-in hybrid (PHEV) vehicles consume less fuel due to the high efficiency of electric motors.²⁴

Countries with a significant share of diesel powertrains tend to have lower average fuel consumption than those with high shares of gasoline powertrains (Table 3). And, those with better average fuel consumption tend to have a higher share of hybrid, BEV and PHEV

²⁴ The CO₂ emission benefits of electric vehicles relative to other powertrains depend on the carbon intensity of the electricity used to power the EV (as well as life-cycle cost). This report focusses on final energy consumption (the energy purchased by the consumer to refill/recharge a vehicle); however, the importance of the carbon intensity of electricity should be taken into consideration, as should the emissions associated with the vehicle manufacturing process.

powertrains. Yet hybrid and electric vehicles represent only a small share of most vehicle fleets and so currently only have limited impact on national level average fuel consumption indicators. (See Section 3 on powertrain electrification.)

Vehicle size segments

In order to assess trends, we have defined categories based on LDV vehicle size to designate market segments.²⁵ Table 4 lists the six categories used in this report and gives samples of the vehicle models included. While the categories, to some extent, are based on subjective classification, the consistent application of the segmentation across all markets and years is sufficient to overcome limitations related to classification of specific vehicle models. Coupling this approach with other vehicle attributes (e.g. power, weight, footprint, engine displacement, powertrain technology and fuel economy) provides a basis to examine the key implications of evolving consumer choices for the various attributes.

Table 4 • Market segment by vehicle size

Market segment	Selected examples of vehicle models
City car	Volkswagen Polo, Renault Clio, Chevrolet Onix, Kia Rio
Medium car	Volkswagen Golf, Honda Civic, Toyota Corolla, Volkswagen Laida
Small SUV/pick-up truck	Toyota RAV4, Honda CR-V, Great Wall Haval H6, Nissan Rogue
Large car	Toyota Camry, Honda Accord, Audi A4, Hyundai Elantra
Large SUV/pick-up truck	Ford F-150, Toyota Hilux, BMW X5, Isuzu D-Max, Audi Q7
Van/light-commercial vehicle	Ford Transit, Renault Master, Fiat Doblo, Tata Ace, Isuzu Elf

Notes: SUV = sport-utility vehicles. Details of the allocation of vehicles to various market segments are in Annex A.

Source: IEA analysis based on IHS Markit database (IHS Markit, 2018).

Key point: Vehicles are categorised by segment to gain useful insights into the evolving structure of vehicle markets.

Vehicle size is a key factor for consumers making a LDV purchasing decision. Often consumers prefer a larger vehicle or at least a similar size for the purchase (GFEI, 2018). Shares of the LDV categories in a particular country reflect a variety of geographical, socio-economic and cultural factors. Advanced countries with relatively low population density and low fuel prices have larger shares of SUV/pick-up trucks than other advanced economies. This is the case especially for Australia, Canada and the United States where about 30% of LDV sales were large SUV/pick-up trucks in 2017 (Figure 13). In the same year, small SUV/pick-up trucks accounted for 31% of new LDV sales in Canada, 29% in Australia and 27% in the United States. Whereas the European Union, Japan and Korea, with much higher population densities and higher fuel prices, have smaller vehicles. In Japan, large SUV/pick-up trucks had only 2% market share and small SUV/pick-up trucks were just 9% of LDV sales in 2017. Large SUV/pick-up trucks accounted for less than 5% of the LDV market in Germany, France, Korea and United Kingdom.

There are large differences in the market share by vehicle size among emerging economies. India had the highest share of small vehicles in the world with over 60% of new sales in 2017 in the city car segment. Conversely, Thailand had the highest global share of large SUV/pick-up trucks at 51%. China had a higher share of small SUV/pick-up trucks than Germany and the United Kingdom at 34% in 2017.

²⁵ There is no accepted standard definition of vehicle size categories and various classification methods are used in the literature (GFEI, 2018).

Figure 12 • New LDV market share by vehicle size segment and fuel consumption, 2017

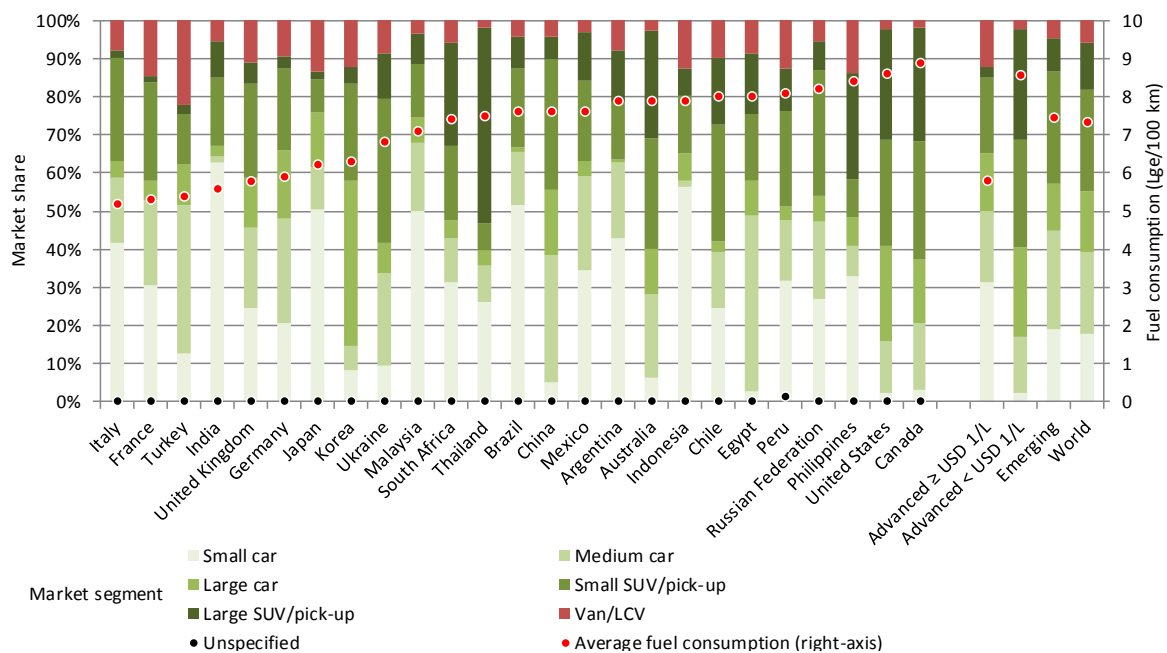

Notes: The country-groups and world only include the country listed in the graph. LCV = light-commercial vehicle. Advanced < USD 1/L = advanced economies with gasoline prices below USD 1 per litre; Advanced ≥ USD 1/L = advanced economies with gasoline prices above USD 1 per litre. Unspecified is the share of vehicles where there is no data on the size segment and the values are not included in the denominator to calculate market shares.

Source: IEA analysis based on IHS Markit database (IHS Markit, 2018).

Key point: Vehicle size differs significantly across countries. Australia, Canada and United States have large shares of SUV/pick-ups and so does Thailand. India has the highest share of small vehicles, followed by Japan, Malaysia and European Union countries.

A key development in the past decade is the increasing share worldwide of the small SUV/pick-up truck segment (Figure 14). This expansion occurred at varying degrees across different geographic and socio-economic areas, and it is accelerating. Between 2005 and 2010, the small SUV/pick-up truck segment gained market share at a rate of 0.6 percentage per year globally. Between 2010 and 2015, the annual rate increased to 2 percentage points, and between 2015 and 2017, it further accelerated to 3%. Small SUV/pick-up trucks primarily replaced city cars, medium and large cars. They had limited effects on the market shares of large SUV/pick-up trucks.

Figure 13 • Evolution of LDV market share by size segment 2005-17

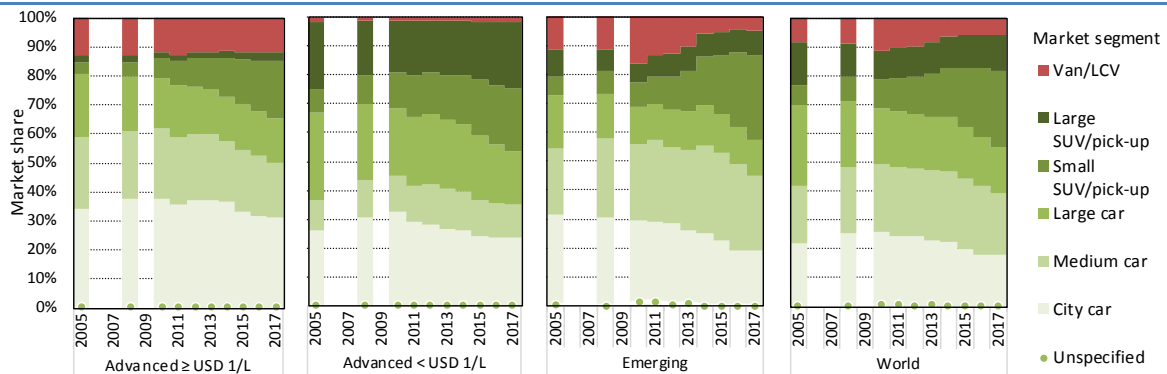

Notes: LCV = light-commercial vehicle. Advanced < USD 1/L = advanced economies with gasoline prices below USD 1 per litre; Advanced ≥ USD 1/L = advanced economies with gasoline prices above USD 1 per litre. Unspecified is the share of vehicles where there is no data on the size segment and the values are not included in the denominator to calculate market shares.

Source: IEA analysis based on IHS Markit database (IHS Markit, 2018).

Key point: Small SUV/pick-up truck segment has have been gaining LDV market share over the last decade in all the advanced and emerging economies.

An overview of fuel economy by segment shows higher average fuel consumption in the largest size categories (large SUV/pick-up and van/LCVs) and lower than average fuel use per kilometre in the small car group (Figure 15). Vehicles within in the same size segment can have substantially different fuel economy among the country economic clusters largely reflecting the shares of options such as powertrains and turbocharging. For example, city cars in the Europe Union are 15% more efficient than comparable ones in Australia, Canada and United States, and small SUV/pick-ups are almost 25% more efficient. This is due to the much higher share of diesel vehicles in Europe and the uptake of other fuel saving technologies (e.g. turbocharging).

Figure 14 • Relationship between vehicle size category and fuel economy, 2017

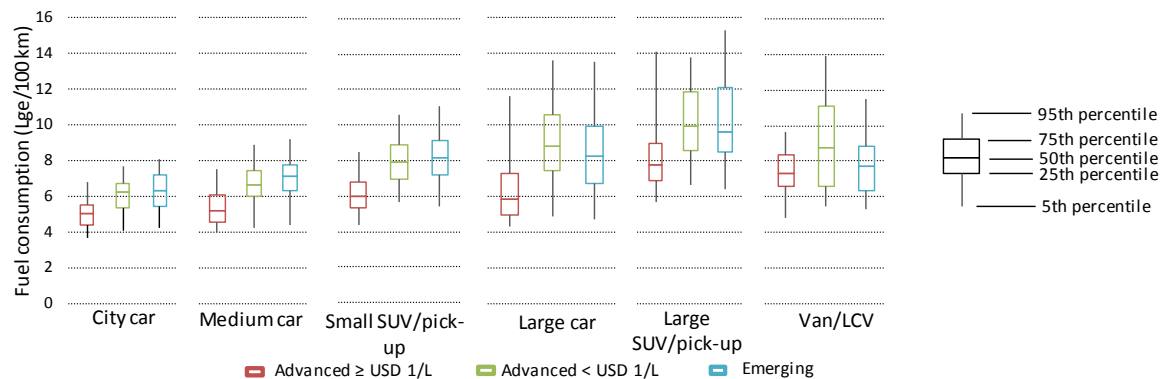

Notes: LCV = light-commercial vehicle. Advanced < USD 1/L = advanced economies with gasoline prices below USD 1 per litre; Advanced > USD 1/L = advanced economies with gasoline prices above USD 1 per litre.

Source: IEA analysis based on IHS Markit database (IHS Markit, 2018).

Key point: Larger car segments have on average a higher fuel consumption per kilometre than smaller car segments, as well as a wider variation of fuel consumption per segment.

Consumer preference for large vehicles has offset the impacts of technical improvements on average fuel consumption in the 2005-17 period (Figure 16). In advanced economies with gasoline prices above USD 1/L (European Union, Japan and Korea), the average fuel consumption of new LDVs in 2005 was similar to that of the medium car size segment. Over the period, an increasing share of larger LDVs means that the average fuel consumption increased such that in 2017 it was similar to the small SUV/pick-up truck level and well above the medium car size segment. Similar trends are evidenced in emerging economies, where the average fuel consumption of size segments decreased considerably from 2011 onwards, but the average for the emerging economies group did not keep pace as larger vehicles gained market shares.

Figure 15 • Average fuel economy by vehicle size segment, 2005-17

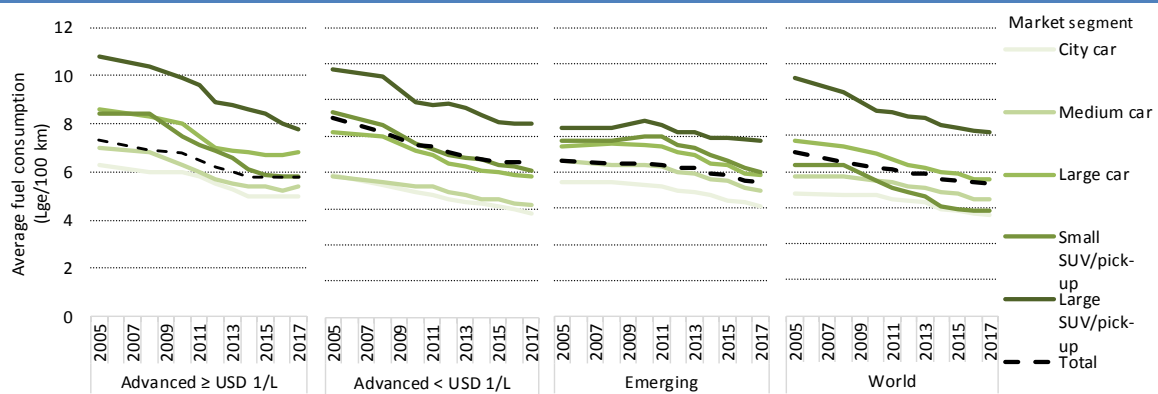

Notes: Advanced < USD 1/L = advanced economies with gasoline prices below USD 1 per litre; Advanced ≥ USD 1/L = advanced economies with gasoline prices above USD 1 per litre.

Source: IEA analysis based on IHS Markit database (IHS Markit, 2018).

Key point: Average fuel consumption in advanced economies with fuel prices above USD 1/L is more efficient than in similar vehicle size market segments in economic groups with fuel prices below USD 1/L. Consumer preferences for the large vehicle categories have lifted overall fuel consumption averages.

Between 2010 and 2017, the overall average fuel consumption in advanced economies with gasoline prices above USD 1/L improved by 15% and in emerging economies it improved by 13%. Advanced economies with gasoline prices below USD 1/L improved by 9.5%. If the size segmentation of the market had remained at 2010 levels, the overall average fuel consumption in 2017 would have been an additional 1.9²⁶, 3.7 and 3.1 percentage points better within these country clusters.

Vehicle powertrain technology

Diesel and gasoline internal combustion engines (ICEs), by far, are the most common type of powertrain for LDVs in almost all countries, though their market shares differ between countries (Figure 17). In the European Union, India and Korea the share of diesels exceeded 35% in 2017. Conversely, Canada, China, Japan, Mexico and United States have few diesel LDVs. Worldwide, 76% of new LDVs sold in 2017 were gasoline ICEs and just under 17% were diesel.

Flex-fuel powertrains, which burn ethanol-based fuels, represent around 4% of LDV sales in 2017 and are most prominent in Brazil, where they currently have a market share of nearly 80%. The United States and Canada have around one-tenth of the flex-fuel market share of Brazil, whereas Argentina and Chile are the only other countries in this study with a market share above 1%.

Liquefied petroleum gas (LPG) vehicles represented a significant share of the new LDV market in 2017 only in Korea, Italy and Ukraine, each with shares less than 10%. Compressed natural gas (CNG) powertrains were most common in Italy, with a market share of 1.6% in 2017.

Hybrids accounted for 14%²⁷ of all LDV sales in 2017 in Japan and 5% in Korea, whereas hybrids represented less than 3% elsewhere. Electric vehicles have market shares up to 2% of all LDV sales in 2017 and are most common in China, France, Germany and the United Kingdom. (Iceland,

²⁶ Only including data from IHS Markit (2018) which does not include other European countries from the European Environment Agency dataset (EEA, 2018).

²⁷ Note that the registrations and the market share of hybrids in Japan might be underestimated for the period 2014-17 (METI, 2019). According to the Japanese Automobile Manufacturers Association (JAMA), the market share of hybrids in Japan was 31.6% in 2017 (JAMA, 2018).

Netherlands, Norway and Sweden have higher shares of EVs, but they are not included in the selected countries shown in Figure 17 (IEA, 2018b; IEA, 2018a) (IEA, 2018b; IEA, 2018a)).

Figure 16 • New LDV market share by vehicle powertrain technology and fuel consumption, 2017

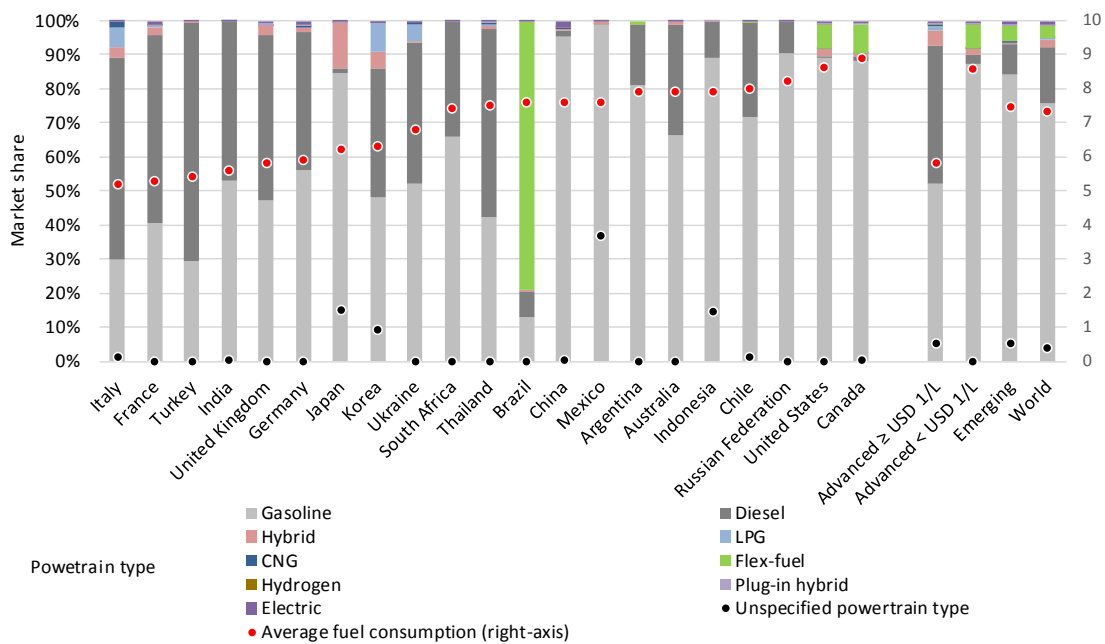

Notes: The country-groups and world only include the country listed in the graph. Advanced < USD 1/L = advanced economies with gasoline prices below USD 1 per litre; Advanced ≥ USD 1/L = advanced economies with gasoline prices above USD 1 per litre. Unspecified is the share of vehicles where there is no data on the powertrain of the LDV and is not included in the denominator to calculate market shares. The registrations and the market share of hybrids in Japan might be underestimated for the period 2014-17 (METI, 2019). According to the Japanese Automobile Manufacturers Association (JAMA), the market share of hybrids in Japan was 31.6% in 2017 (JAMA, 2018).

Source: IEA analysis based on IHS Markit database (IHS Markit, 2018).

Key point: Countries with high shares of diesel powertrains tend to have lower national average fuel economy than those with higher shares of gasoline engines.

Powertrain technologies can be a strong determinant of average fuel economy viewed at a national level. Countries with high shares of diesels or hybrids, which have better fuel economy than gasoline ICEs, all else being equal, have better average fuel consumption than those with a high proportion of gasoline or flex-fuel cars. Among the ten economies with the best average fuel consumption analysed in this report, nine (six countries in the European Union, India, Korea and Thailand) had diesel shares above 35% in 2017, and Japan had hybrid shares above 10%.

Figure 17 • Evolution of LDV market share by powertrain technology, 2005-17

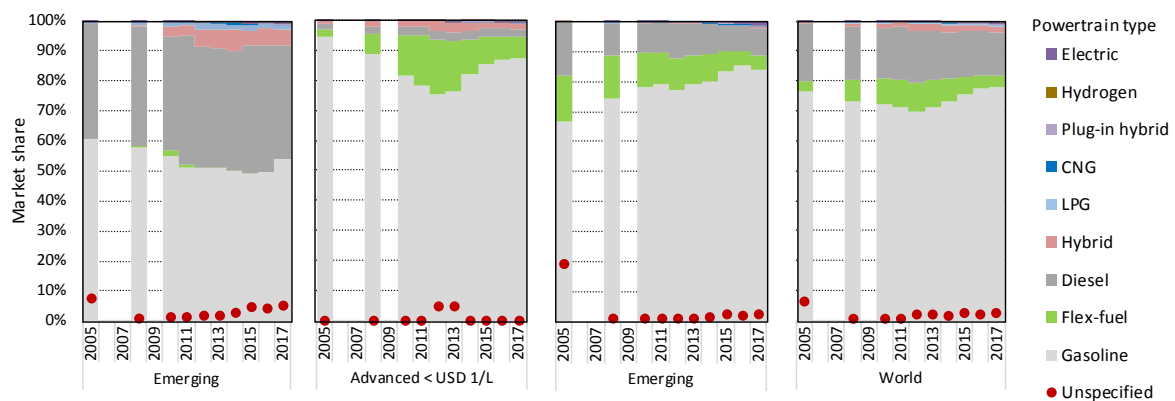

Notes: Advanced < USD 1/L = advanced economies with gasoline prices below USD 1 per litre; Advanced ≥ USD 1/L = advanced economies with gasoline prices above USD 1 per litre. Unspecified is the share of vehicles where there is no data on the powertrain of the LDV and is not included in the denominator to calculate market shares.

Source: IEA analysis based on IHS Markit database (IHS Markit, 2018).

Key point: Gasoline ICEs increased their global market share from 2011. In the Europe Union, diesel vehicle shares have declined since 2015. Flex-fuel LDVs lost market share reflecting declining shares in the United States and that Brazil accounted for diminishing shares of total LDVs among the emerging economies.

In the period since 2012, gasoline ICE LDVs have increased substantially in emerging economies, both in absolute values and in market share (Figure 18). Much of this reflects growth in gasoline LDVs in China.

Flex-fuel vehicles show varying trends since 2005. Flex-fuel vehicles were taken up in Canada and the United States in response to incentive measures for manufacturers in the framework of fuel economy regulations in 2012. After a peak in 2012, flex fuel vehicles have gradually lost market share. Market shares of flex-fuel vehicles declined after regulatory changes in 2016 (US DoE, 2018; US EPA, 2018b; Transportpolicy.net, 2018c; Government of Canada, 2018; US EPA, 2018c). In North America, the availability of ethanol-based fuels above E15 (more than 15% ethanol in the blend) is limited. Brazil’s flex-fuel market share remains high, though the size of the Brazilian LDV market relative to the global LDV market decreased. Even though the global share of flex-fuel powertrains has decreased in recent years, it still represents around 4% in 2017.

In the European Union, the shares of diesel vehicles have dropped significantly since 2015.²⁸ This led to a reversal of fuel economy trends in France, Germany and the United Kingdom (among the European Union countries included here). Italy was the only European Union country considered here where diesel sales did not fall in 2017.

²⁸ This turning point was likely due to the diesel-gate" scandal revealed in 2015 in which several auto manufacturers illegally manipulated fuel economy test procedures to comply with pollutant emission limits (US EPA, 2015).

Figure 18 • Average fuel economy by powertrain technology, 2005-17

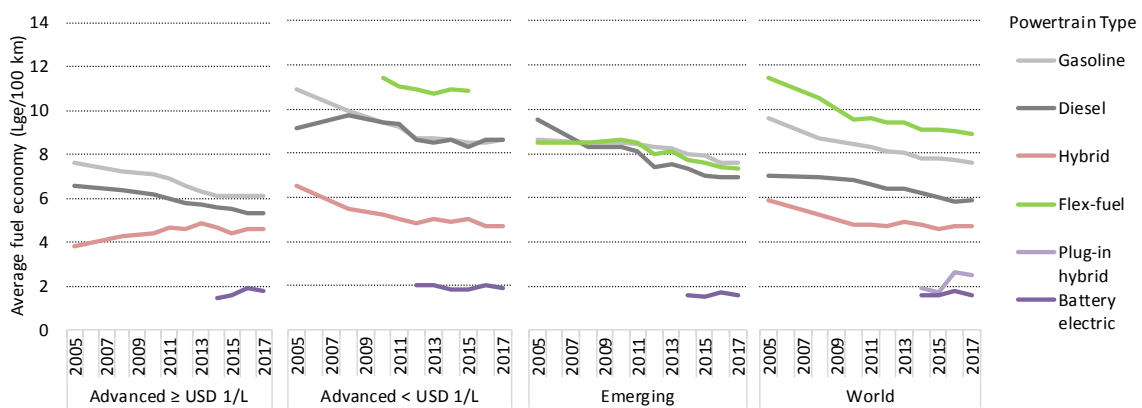

Notes: Advanced < USD 1/L = advanced economies with gasoline prices below USD 1 per litre; Advanced ≥ USD 1/L = advanced economies with gasoline prices above USD 1 per litre.

Source: IEA analysis based on IHS Markit database (IHS Markit, 2018).

Key point: The fuel consumption of hybrid and electric LDVs is better than gasoline ICE vehicles in all markets. Diesel LDVs are larger in size in North America (where they have small market shares), and this leading to higher average fuel consumption.

The market segments in which various powertrain types are used influence the average fuel consumption of each powertrain type. In Australia, Canada and United States, and most emerging economies (except India), diesel LDVs have a low market share and are generally only used in very large vehicles. This means that the fuel consumption of an average diesel LDV in these countries is comparable to that of the average gasoline LDV (Figure 19). In countries where diesel LDVs have large market shares, gasoline and diesel LDVs have similar sizes. This results in a more visible difference in fuel economy for the average diesel and gasoline LDV.

Hybrid LDVs consume less fuel per kilometre than ICE models. Yet, this variance in fuel economy has changed over time due to rising shares of hybrid powertrains across vehicle size segments. In the European Union, hybrids have been increasingly popular in the small SUV/pick-up truck segment, which in 2017 exceeded the share of the medium car segment (e.g. Toyota Prius), which had dominated the hybrid market. The average fuel consumption of hybrid vehicles in Australia, Canada and the United States has been improving due to steadily rising market shares in the medium and large car segments.

Vehicle power

Vehicle power is correlated with fuel consumption and relates to the coupling of power rating with vehicle mass and volume (and therefore the stronger inertial forces and increased drag).²⁹ Power ratings are also higher in the large vehicle size market segments (Figure 20, right).

In Canada and the United States, more than 40% of new LDVs sold in 2017 had over 200 kilowatts (kW) of engine power, and more than 90% of new LDVs had more than 100 kW (Figure 21). This reflects consumer preference for large vehicles (see Figure 13) and that the power ratings are higher in each vehicle size market segment (Figure 21). At the other end of the spectrum for new LDV sales in 2017, France, India, Indonesia, Italy, Japan and Turkey all had average power ratings below 90 kW.

²⁹ In on-road driving, this is exacerbated by the strong acceleration that high power vehicles can deliver, inducing engines to run outside of their optimum efficiency window (Sovran, 2003). Some of these effects can be mitigated by powertrain technologies, such as cylinder deactivation, turbocharging and a high number of gears, which can maximise the time an engine runs at optimum efficiency.

Figure 19 • Relationship between vehicle fuel consumption, power and size segment, 2017

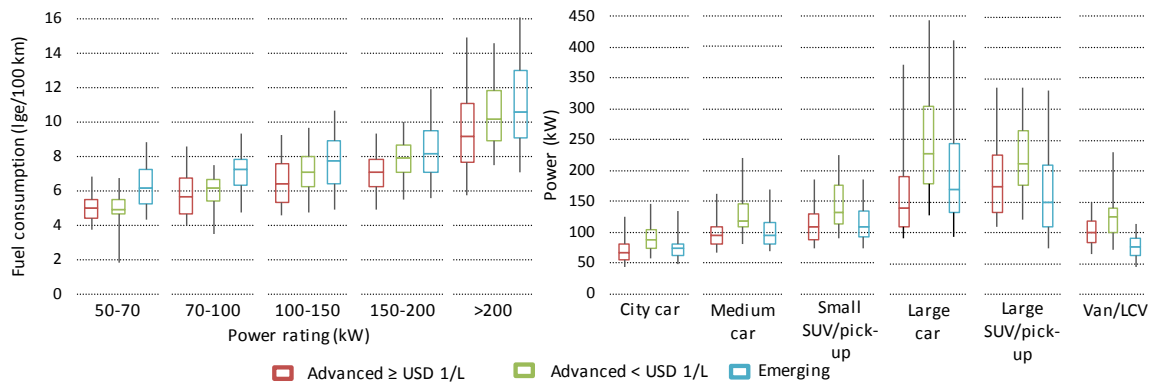

Notes: kW = kilowatt. Advanced < USD 1/L = advanced economies with gasoline prices below USD 1 per litre; Advanced ≥ USD 1/L = advanced economies with gasoline prices above USD 1 per litre. The box plots represent model averages, not sales-weighted averages. Source: IEA analysis based on IHS Markit database (IHS Markit, 2018).

Key point: Higher power is coupled with increased fuel consumption. Power is also higher for vehicles in large-size market segments. The advanced economies with gasoline prices above USD 1/L have better fuel consumption in all power classes.

Comparing countries with similar average fuel economy but different power ratings, such as Germany and India, or Australia and Russian Federation (“Russia”), suggests that the deployment of fuel-efficient technologies (enabling lower fuel use per kilometre at a given power rating, and including different powertrain types) is stronger in advanced economies (Figure 20).

Figure 20 • New LDV market share by vehicle power and fuel consumption, 2017

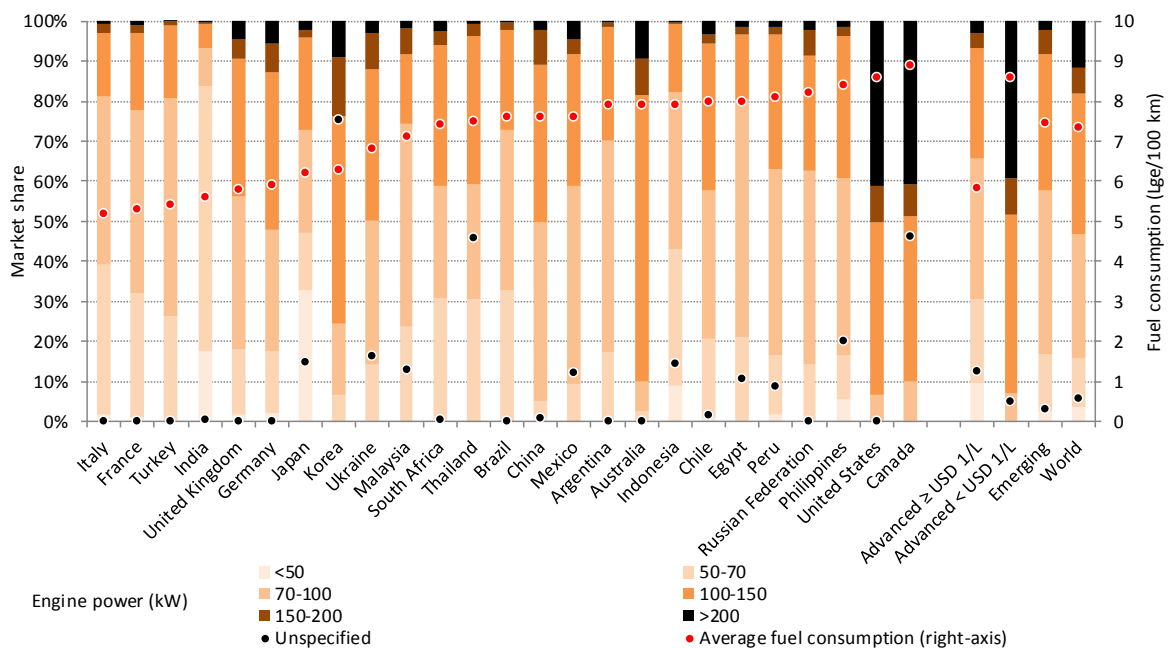

Notes: The country-groups and world only include the country listed in the graph. Advanced < USD 1/L = advanced economies with gasoline prices below USD 1 per litre; Advanced ≥ USD 1/L = advanced economies with gasoline prices above USD 1 per litre. Unspecified is the share of vehicles where there is no data on engine power and is not included in the denominator to calculate market shares. Source: IEA analysis based on IHS Markit database (IHS Markit, 2018).

Key point: Average fuel consumption is elevated in countries where high-powered vehicles have a large market share.

In the period since 2005, LDVs have become more powerful across all regions (Figure 22). In the advanced economies with low gasoline prices – Australia, Canada and United States – the share

of vehicles above 200 kW almost doubled over the period while the share of LDVs below 150 kW has remained relatively constant since 2011. In emerging economies, the share of vehicles over 150 kW expanded rapidly and is currently comparable to advanced economies with gasoline prices above USD 1/L – Europe, Japan and Korea. Vehicles with power ratings of 100-150 kW broadened their market share in emerging economies, mostly to accommodate the increasing appeal for vehicles in the large-size market segments in China.

Figure 21 • Evolution of LDV market share by power rating, 2005-17

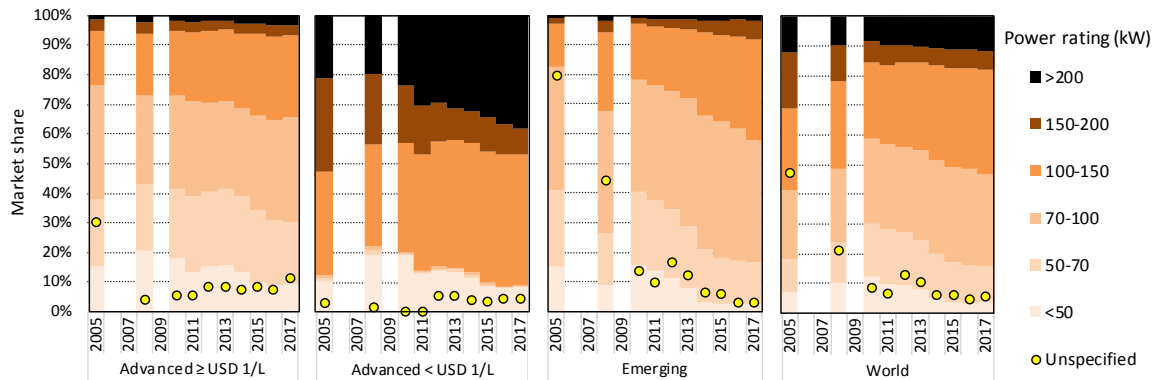

Notes: Advanced < USD 1/L = advanced economies with gasoline prices below USD 1 per litre; Advanced \geq USD 1/L = advanced economies with gasoline prices above USD 1 per litre. Unspecified is the share of vehicles where there is no data on engine power and is not included in the denominator to calculate market shares.

Source: IEA analysis based on IHS Markit database (IHS Markit, 2018).

Key point: New LDVs have become increasingly powerful since 2005. Advanced countries with low fuel prices have higher-powered vehicles, while LDVs in emerging economies have similar power characteristics as advanced countries with higher fuel prices.

Engine displacement

Countries with the best average fuel economy tend to have a lower average internal combustion engine displacement³⁰ compared with countries with high fuel consumption per kilometre.³¹ In 2017, Italy, France and Turkey, the three markets with the best average fuel economy among the countries analysed here, more than 75% of vehicles have ICEs smaller than 1 600 cubic centimetres (cm³). At the opposite end of the spectrum, in Canada and the United States more than 85% of new vehicles exceed 1 600 cm³ of engine displacement and around 40% exceed 3 200 cm³.

Japan is unique in that one-third of new LDVs in 2017 had engine displacement of less than 800 cubic centimetres (cc). This reflects government policies that provided tax incentives for the purchase of small engine vehicles (Rutherford, 2014). This effect combined with higher shares of hybrid powertrains put Japanese LDVs in a similar range of average fuel economy to European Union vehicles without a significant proportion of diesel powertrains.

Comparing engine displacement with powertrain, engine power and fuel economy suggests that there are significant differences in vehicle technology deployment across countries. For example, India and Germany have comparably high shares of diesel powertrains (see Figure 17) and similar average fuel economy, but have large differences in power ratings (see Figure 21) and engine

³⁰ Engine displacement represents the combined volume of pistons within the cylinders of an engine that allows that engine to produce mechanical energy while being fueled by a combustible fuel.

³¹ The main exception to this relates to engines using the Atkinson cycle, i.e. a cycle where the expansion phase is longer than the compression one, and therefore associated with larger engine displacements, despite the better efficiency. The same thermodynamic cycle is also enabled by variable valve timing when engines are at part-load. If the use of the Atkinson cycle is limited to part-load uses, it does not have an impact on displacement.

displacement (Figure 23). This means that cars in Germany consume the same amount of fuel, on average, as cars in India, but deliver higher power per unit of fuel, and do so using larger engines equipped with advanced fuel saving technologies. Similarly, Mexico and Russia have average fuel economy in the same range as Canada and the United States, but have significantly smaller engines and lower power ratings. This suggests that LDVs sold in Canada and the United States deliver higher power per unit of fuel and do so using larger engines, than those available in Mexico and Russia.

Figure 22 • New LDV market share by engine displacement and fuel consumption, 2017

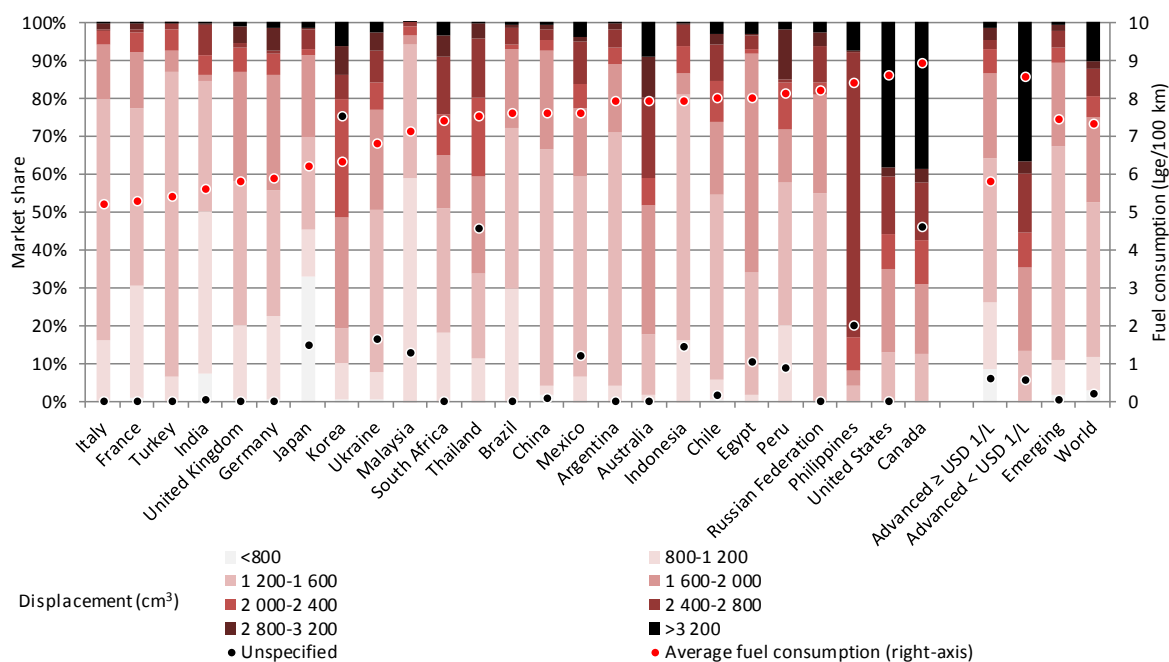

Note: The country-groups and world only include the country listed in the graph. Advanced < USD 1/L = advanced economies with gasoline prices below USD 1 per litre; Advanced ≥ USD 1/L = advanced economies with gasoline prices above USD 1 per litre. Unspecified is the share of vehicles where there is no data on engine displacement and is not included in the denominator to calculate market shares.

Source: IEA analysis based on IHS Markit database (IHS Markit, 2018).

Key point: Countries with significant market shares of large engine displacement tend to have higher average fuel consumption.

Unlike vehicle power and size, engine displacement has tended to decline over the past decade. This reflects the effect of engine downsizing, driven by improvements in the power and torque output per unit of engine displacement that was enabled by fuel saving technologies such as turbocharging and direct fuel injection.

The strongest declines in engine displacement were on those bigger than 1 600 cm³ and had a faster pace in advanced economies (Figure 24). Globally, gasoline powered large SUV/pick-up trucks dropped from an average engine displacement of 4 300 cm³ in 2008 to less than 3 700 cm³ in 2017. Similarly, the small gasoline SUV/pick-up category dropped engine displacements from 2 700 cm³ to 1 850 cm³, and the share of vehicles with engines below 1 600 cm³ increased from 29% to 53% between 2005 and 2017. The decreases in engine displacement within each size segment were partly mitigated by a progressive shift to larger vehicle segments. This resulted in slower overall decrease in displacement. The rapid market shift to large vehicles in emerging economies also induced a slower decrease in average engine displacement than in advanced economies.

Figure 23 • Evolution of LDV market share by engine displacement, 2005-17

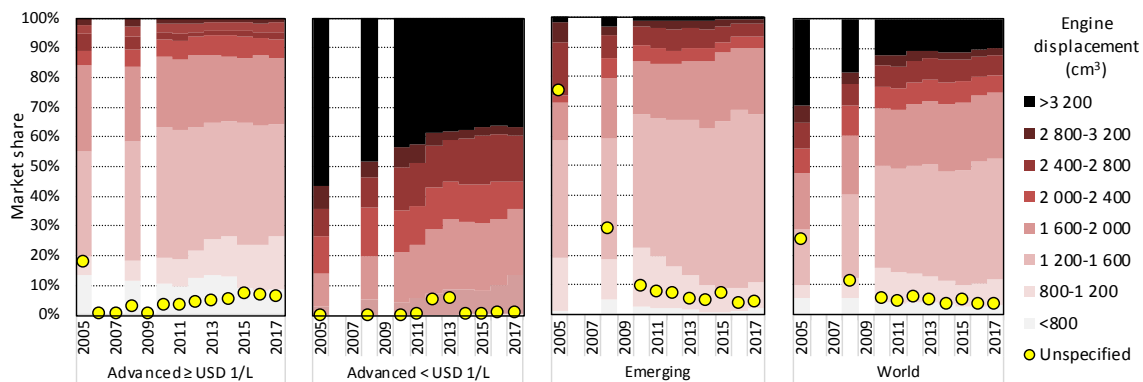

Note: Advanced < USD 1/L = advanced economies with gasoline prices below USD 1 per litre; Advanced ≥ USD 1/L = advanced economies with gasoline prices above USD 1 per litre. Unspecified is the share of vehicles where there is no data on engine displacement and is not included in the denominator to calculate market shares.

Source: IEA analysis based on IHS Markit database (IHS Markit, 2018).

Key point: Engine displacement has decreased in most market segments. Shifts in sales to larger vehicles have reduced this effect on average.

Vehicle weight

Vehicle weight is closely correlated with fuel use due to the relevance of inertial forces (directly proportional to the vehicle mass) for vehicle acceleration, leading to higher energy requirements to move heavier vehicles.³² Fuel consumption across different weight classes is illustrated in Figure 25 (left).

Figure 24 • Relationship between vehicle weight and fuel consumption, 2017

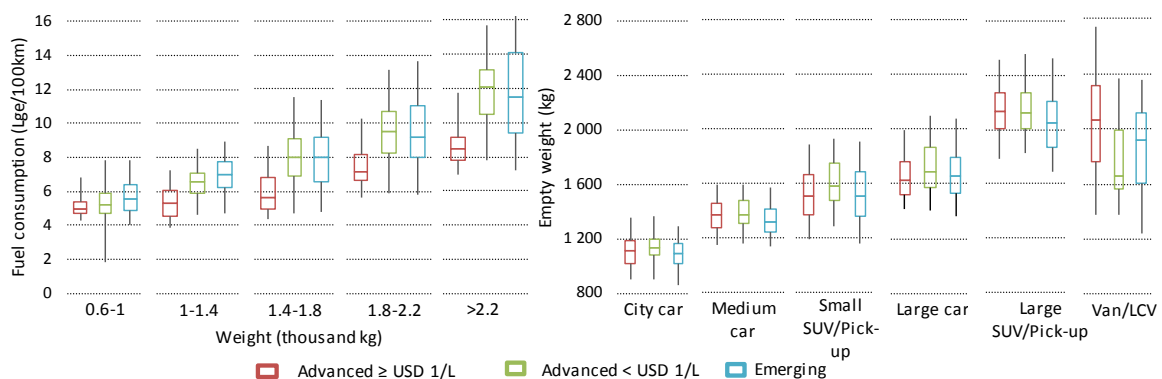

Note: Advanced < USD 1/L = advanced economies with gasoline prices below USD 1 per litre; Advanced ≥ USD 1/L = advanced economies with gasoline prices above USD 1 per litre.

Source: IEA analysis based on IHS Markit database (IHS Markit, 2018).

Key point: Vehicles in large-size segments are heavier and consume more fuel than the small size LDVs.

Weight characteristics by size segment are not very different across the advanced and emerging economies (Figure 25, right). As a result, the distribution of vehicles across different weight classes is heavily affected by the market segmentation. Over 70% of new LDVs sold in 2017 in Canada and the United States weighed more than 1 400 kilogrammes (kg), ranking them the world's highest

³² Hybrid or electric vehicles can recover some of this energy while braking, but these vehicles only represent a small percentage of the global vehicle fleet.

average vehicle weight markets. In contrast, around 70% of new LDVs in France and Italy weighed less than 1 400 kg, ranking them the most fuel-efficient among the countries assessed (Figure 26).

Figure 25 • New LDV market share by vehicle weight and fuel consumption, 2017

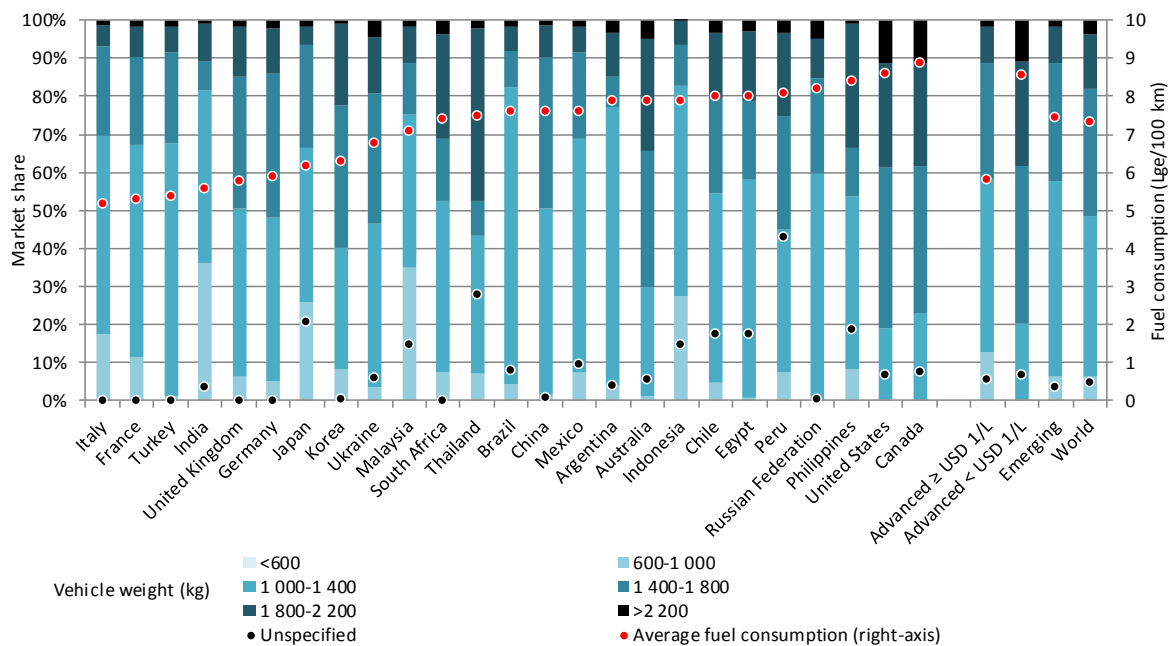

Note: The country-groups and world only include the country listed in the graph. Advanced < USD 1/L = advanced economies with gasoline prices below USD 1 per litre; Advanced ≥ USD 1/L = advanced economies with gasoline prices above USD 1 per litre. Unspecified is the share of vehicles where there is no data on vehicle weight and is not included in the denominator to calculate market shares.

Source: IEA analysis based on IHS Markit database (IHS Markit, 2018).

Key point: Countries with lighter weight vehicles tend to have better average fuel economy than those with heavier LDVs. This effect is less pronounced in countries with a high market share of diesel LDVs.

Over the 2005-17 period, the average weight of LDVs remained relatively stable at the global level (Figure 27). This reflects two counteracting trends. First, an increase in vehicle weight that accompanied the trend to large LDVs gaining market share. Second, the increasing volume of vehicles sold in emerging economies and their lighter average weight compared with the advanced countries, which tempered the global average downward.

In emerging economies, the share of vehicles below 1 000 kg dropped from 28% in 2005 to 6% in 2017, reflecting shifts in consumer preference that translated into purchases of larger vehicles. The heavier weight observed in emerging economies was also due to increases in weight within the size segments; by 5% for city cars, 10% for medium cars and 13% for large cars in the 2005-17 period. In the emerging economies and European Union countries, the share of vehicles heavier than 1 400 kg increased over the period, largely due to the rapidly growing share of small SUV/pick-up trucks and a general tendency to move towards larger vehicles. In Australia, Canada and United States, the weight of vehicles within size segments remained relatively constant between 2005 and 2017³³, and shifts towards larger LDVs increased average weight.

³³ The only size category to drop in weight was the small SUV/pick-up truck segment (from an average of 1 700 kg in 2005 to 1 600 kg in 2017). This happened in parallel with the proliferation of "cross-over" type SUVs, which are increasingly defining this market segment.

Figure 26 • Evolution of LDV market share by weight, 2005-17

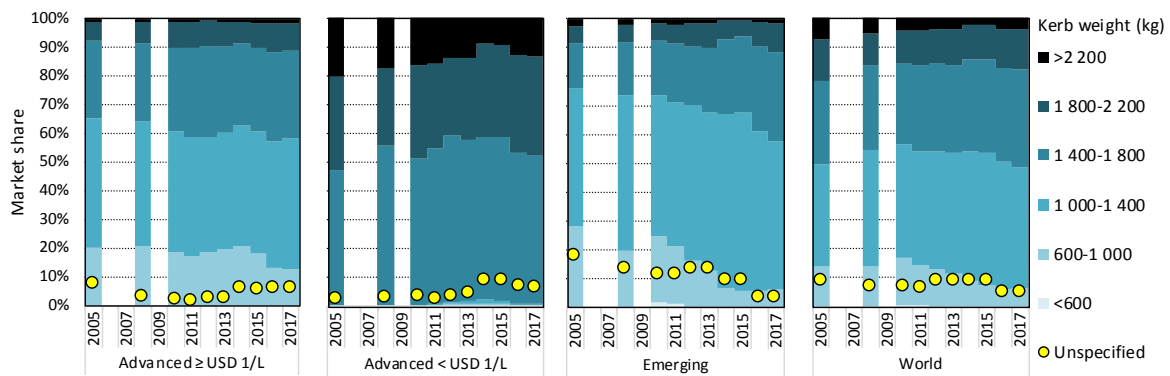

Note: Advanced < USD 1/L = advanced economies with gasoline prices below USD 1 per litre; Advanced \geq USD 1/L = advanced economies with gasoline prices above USD 1 per litre. Unspecified is the share of vehicles where there is no data on vehicle weight and is not included in the denominator to calculate market shares.

Source: IEA analysis based on IHS Markit database (IHS Markit, 2018).

Key point: Bigger market shares of heavier large LDVs in all economy groups were offset by bigger volumes of LDV sales in emerging economies that have lighter vehicles.

Vehicle footprint

Vehicle footprint denotes the area formed by the wheelbase and axle width. Footprint is generally used as an indicator of vehicle size (Figure 28). A bigger vehicle footprint often implies a larger frontal area, which in turn negatively affects fuel economy due to more aerodynamic drag. Unless they have light-weighting and material substitution technologies, vehicles with a large footprint also weigh more, again negatively affecting fuel economy.

Figure 27 • Vehicle footprint

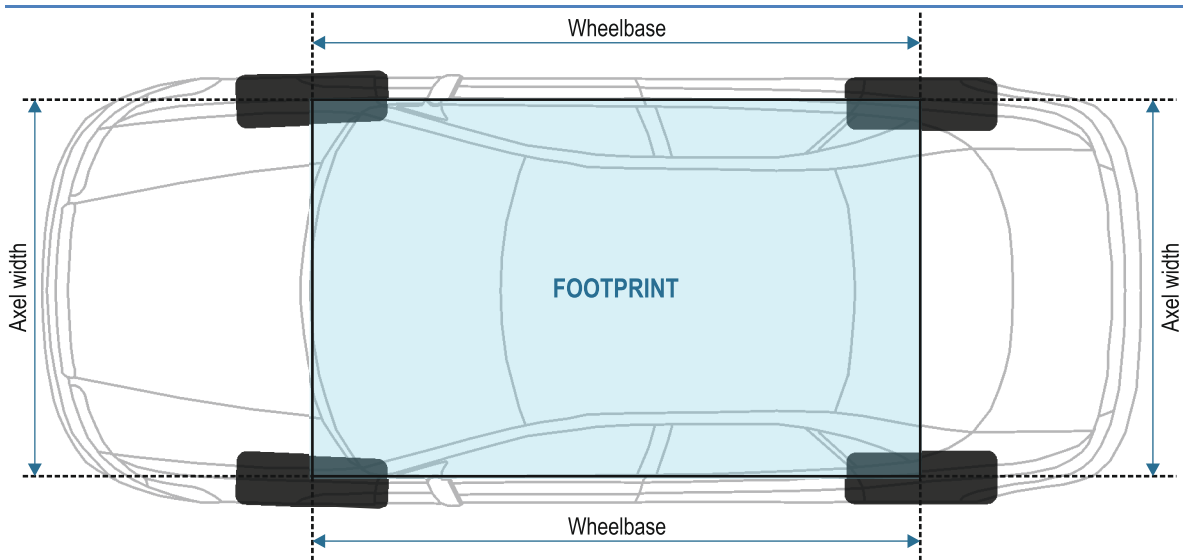

Source: NHTSA (2010).

Key point: Vehicle footprint denotes the area formed by the wheelbase and axle width.

In general, vehicles in a large LDV segment have a bigger footprint and worse average fuel consumption (Figure 29). Those segments – large cars, large SUV/pick-up trucks and van/LCVs – cover a wider spectrum of footprints than the small size vehicle segments. This effect is also evident in the variability of fuel economy, which is worse for vehicles above 4.5 square metres (m^2) compared with smaller footprint vehicles.

Figure 28 • Relationship between fuel consumption, vehicle footprint and size segment, 2017

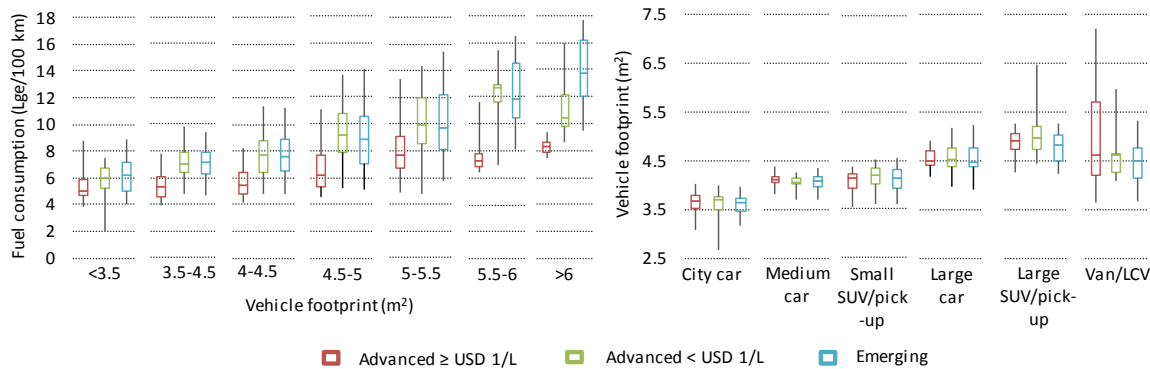

Note: Advanced < USD 1/L = advanced economies with gasoline prices below USD 1 per litre; Advanced ≥ USD 1/L = advanced economies with gasoline prices above USD 1 per litre.

Source: IEA analysis based on IHS Markit database (IHS Markit, 2018).

Key point: Vehicle footprint increases with size segment and is similar across the economy groupings. The footprint of medium cars and small SUV/pick-ups is similar, though the weight differs.

In 2017, Brazil, India, Indonesia and Japan had the largest share of vehicles with a footprint below 4 m² (Figure 30). Conversely, over 20% of new vehicles sold in Canada and United States had a footprint above 5 m². This is consistent with a high share of vehicles in the large car (most relevant in Korea) and large SUV/pick-up truck segments (most relevant in Canada, Thailand and United States). Vehicles in the European Union are also characterised by smaller footprint than those in Canada and the United States. For vehicles with large footprints, the Europe Union has larger shares of lighter vehicles. This is due to the higher share of SUVs/pick-up trucks in Canada and the United States, which weigh more than sedans having similar axle width and wheelbases.

Figure 29 • New LDV market share by vehicle footprint and fuel consumption, 2017

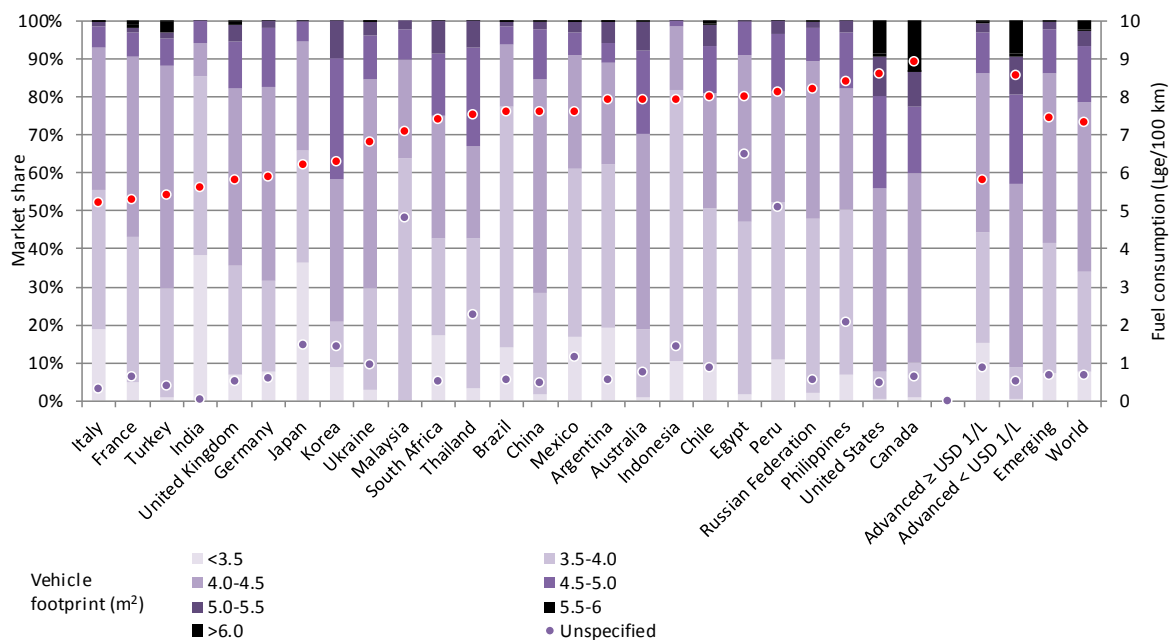

Note: The country-groups and world only include the country listed in the graph. Advanced < USD 1/L = advanced economies with gasoline prices below USD 1 per litre; Advanced ≥ USD 1/L = advanced economies with gasoline prices above USD 1 per litre. Unspecified is the share of vehicles where there is no data on vehicle footprint and is not included in the denominator to calculate market shares.

Source: IEA analysis based on IHS Markit database (IHS Markit, 2018).

Key point: Countries with bigger vehicle footprints tend to have higher average fuel consumption.

Vehicle footprint trends over the 2005-17 period have closely followed those observed for vehicle size segments (Figure 31). In particular, the notable shift away from small city cars to the small SUV/pick-up truck segment that took place in emerging economies and in the European Union led to a rapid increase in the share of vehicles with footprint sizes between 4.5-5.0 m².

Figure 30 • Evolution of LDV market share by vehicle footprint, 2005-17

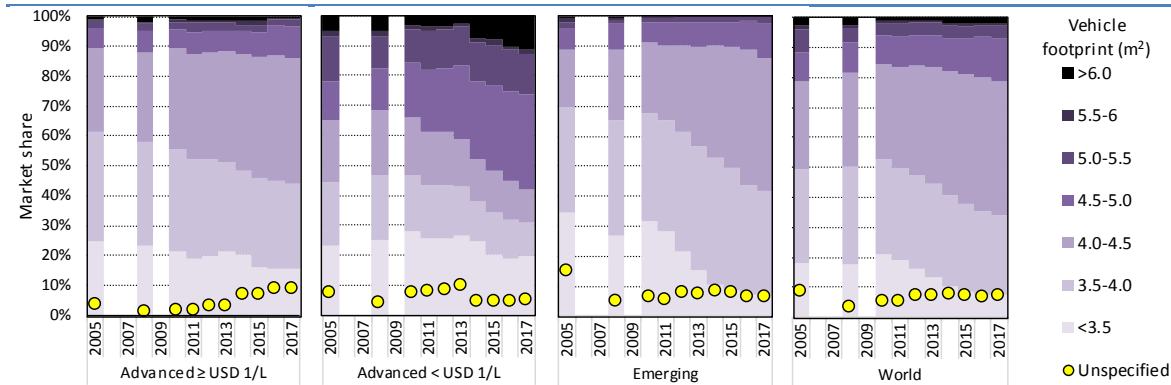

Note: Advanced < USD 1/L = advanced economies with gasoline prices below USD 1 per litre; Advanced ≥ USD 1/L = advanced economies with gasoline prices above USD 1 per litre. Unspecified is the share of vehicles where there is no data on vehicle footprint and is not included in the denominator to calculate market shares.

Source: IEA analysis based on IHS Markit database (IHS Markit, 2018).

Key point: Vehicle footprint has been increasing in all economy groups, with the fastest growth in emerging economies.

Fuel saving technology deployment: Lessons learned

Varieties of technologies have important impacts on fuel economy. This section considers three technologies: turbochargers, drivetrain and number of gears (technologies with a sufficient coverage in the IEA-GFEI database).

- Turbochargers enable the recovery of energy from exhaust gases and allow the engine to operate closer to its optimum efficiency throughout the drive cycle. In addition, they allow vehicles with the same power rating to be produced with smaller engine displacement and lower engine weight, further reducing fuel use per kilometre (Figure 32, left).
- Two-wheel drivetrains help to limit fuel consumption due to lower weight and lower transmission energy losses than four-wheel drivetrains (Figure 32, right).
- A higher number of gears helps to minimise fuel consumption by allowing engines to run more frequently in their peak efficiency operating window.

Figure 31 • Relationship between fuel consumption and turbocharging and type of drivetrain, 2017

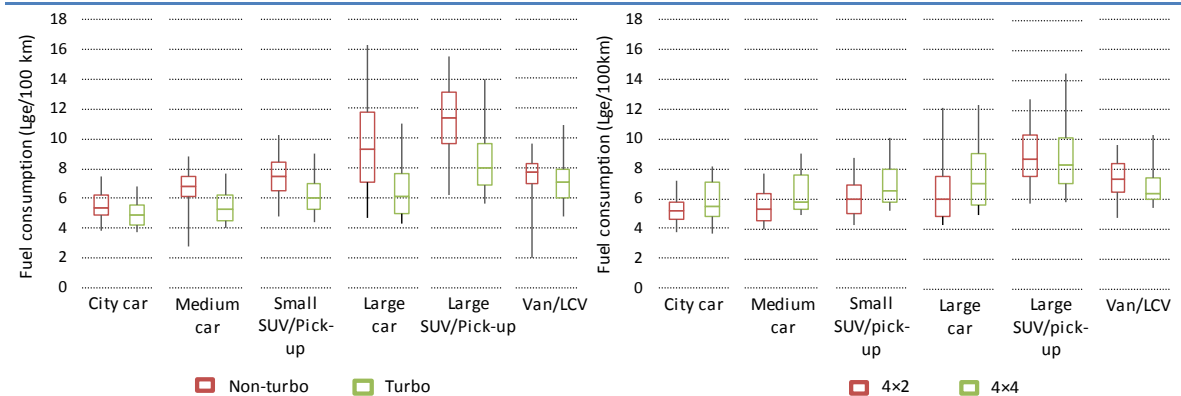

Source: IEA analysis based on IHS Markit database (IHS Markit, 2018).

Key point: Vehicles with turbochargers are more efficient than those without. Vehicles with four-wheel drive are less efficient than two-wheel drivetrains due to heavier weight and more transmission energy losses.

There are large differences in the penetration of these technologies across various markets, with mixed effects on fuel consumption (Figures 33 and 34).

- Shares of vehicles using turbochargers increased across all economy groupings between 2010 and 2017, and they are particularly high for countries with a large share of diesel powertrains.
- Increasing volumes of LDVs with four-wheel drivetrains are in the vehicle fleets in both advanced economies categories. This has been placing upward pressure on average fuel consumption.
- The share of vehicles with more than five gears has increased in almost all countries since 2010. Nevertheless, large differences across markets show that potential remains for improvements, particularly in emerging economies.

Figure 32 • Penetration of turbochargers by powertrain type, 2005-17

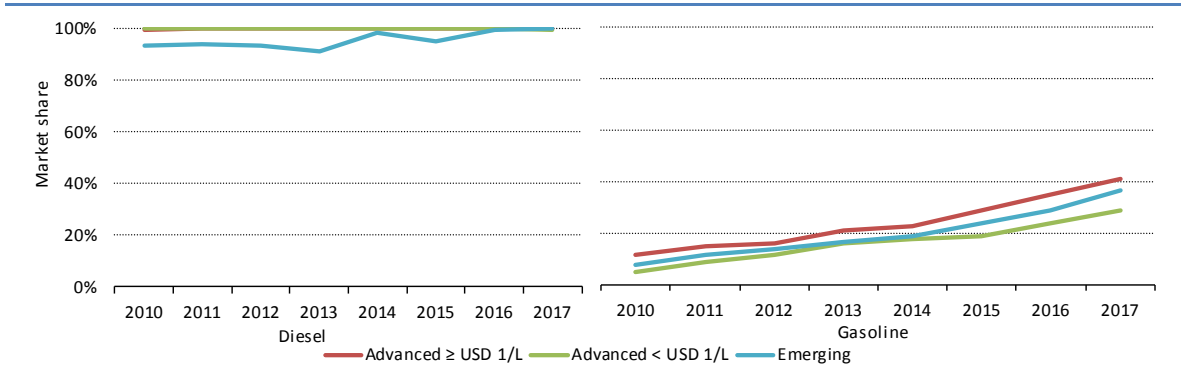

Note: Advanced < USD 1/L = advanced economies with gasoline prices below USD 1 per litre; Advanced ≥ USD 1/L = advanced economies with gasoline prices above USD 1 per litre.

Source: IEA analysis based on IHS Markit database (IHS Markit, 2018).

Key point: The penetration of turbochargers in diesel LDVs in emerging economies has reached the levels in the advanced economies. The share of turbochargers in gasoline vehicles has increased in all economy grouping. Australia, Canada and United States have a lower share than Europe Union, Japan and Korea.

Figure 33 • Penetration of four-wheel drivetrains and transmissions with more than five gears, 2017

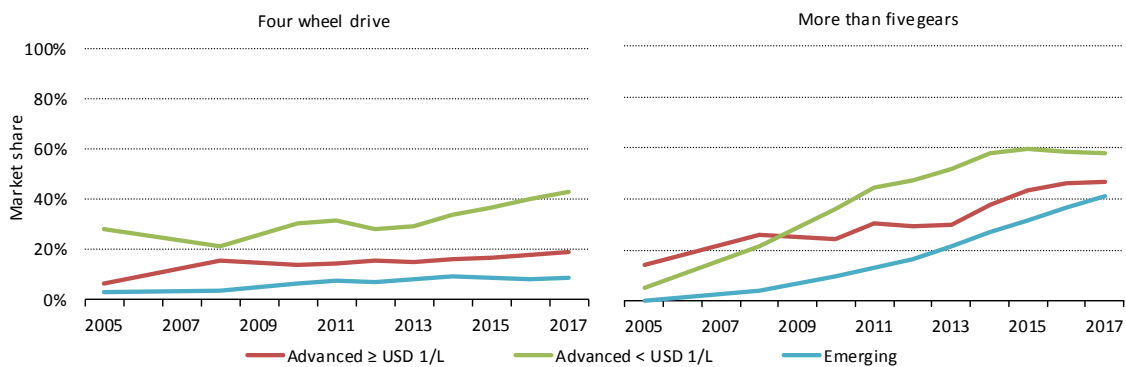

Note: Advanced $<$ USD 1/L = advanced economies with gasoline prices below USD 1 per litre; Advanced \geq USD 1/L = advanced economies with gasoline prices above USD 1 per litre.

Source: IEA analysis based on IHS Markit database (IHS Markit, 2018).

Key point: Consumers in advanced economies have increasingly bought four-wheel drive vehicles. The share of vehicles with more than five gears has been growing in advanced and emerging economies.

All diesel engines in advanced economies have been turbocharged for a decade. By 2016, emerging economies fully caught up on this technology application. Figure 34 shows that the situation is significantly different for gasoline vehicles. In the advanced economy group that includes the European Union, Japan and Korea, the share of turbocharged gasoline LDVs was more than 40% for the first time in 2016-17.

The diffusion of turbochargers in gasoline engines is lower in Australia, Canada and United States, where engine displacement remains far larger than elsewhere, and in emerging economies. Interestingly, turbocharged gasoline vehicles are more frequently available in emerging economies than in Australia, Canada and United States. This could be due to the similarities between the attributes of vehicles and powertrains available in the European Union, Korea and Japan (typically smaller than those used in Australia, Canada and United States, and having lower power ratings) and those demanded in emerging economies. The lower share of turbocharged gasoline vehicles in Australia, Canada and United States and emerging economies may also be partly due to lower fuel octane values.³⁴

Relationship between fuel economy and vehicle purchase price

The first observation to highlight is that a higher price for a new LDV is generally associated with higher fuel consumption. This is true both for advanced and emerging economies (Figure 35). In the European Union, the high share of diesel vehicles means the effect of vehicle price on fuel consumption is less important than in other regions. In the European Union, a premium vehicle with a price close to USD 40 000 consumes only slightly more fuel than a less expensive vehicle (which is more likely to be gasoline powered). Conversely, in Australia, Canada and United States, where almost all vehicles are gasoline, premium vehicles have significantly higher fuel consumption than LDVs with lower price tags.

³⁴ Lower octane numbers denote lower fuel quality and increase the risk of auto-ignition of the fuel. Increasing the octane number of fuel may allow for a larger penetration of turbocharging (Speth et al., 2014).

Figure 34 • Relationship between fuel consumption and vehicle retail price, 2017

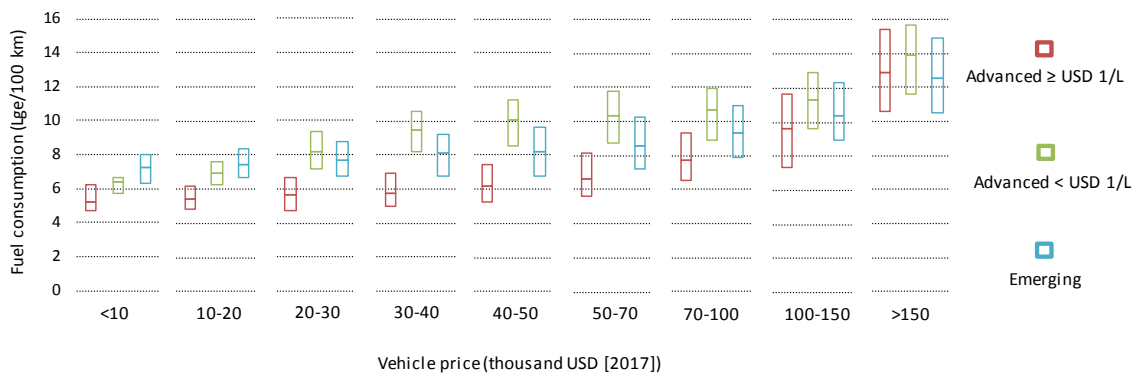

Note: Advanced < USD 1/L = advanced economies with gasoline prices below USD 1 per litre; Advanced \geq USD 1/L = advanced economies with gasoline prices above USD 1 per litre. The prices are in 2017 USD.

Source: IEA analysis based on IHS Markit database (IHS Markit, 2018).

Key point: Vehicles that are more expensive tend to have higher average fuel consumption. In the European Union, the high share of diesel vehicles reduces this effect.

Effect of main vehicle attributes on vehicle price

Some consumers are prepared to pay a premium for a number of vehicle attributes that positively correlate with high fuel consumption per kilometre (Figure 36). Prices are higher for vehicles belonging to the large-size segments (with more mass and bigger footprint) and those with a high power rating.

Comparing the price of various vehicle size segments in advanced and emerging economies (Figure 36, top left) shows that LDVs in Australia, Canada and United States cost less than comparable vehicles in the European Union, Korea and Japan. The comparison also shows that the market structure in emerging economies is characterised by a combination of two groups of vehicles with very different characteristics.

- Small- and medium-size vehicles in emerging economies have prices that are lower than in advanced economies. This reflects lower average incomes in emerging economies, likely paired with a lower willingness to pay, and indicates that price constraints have a significant role in determining vehicle purchases.
- Large-size vehicles in emerging economies have prices that are similar to or more expensive than vehicles in Australia, Canada and United States. This suggests that large vehicles sold in emerging economies are similar to those sold in premium markets, and indicates that price constraints have a lower relevance for the determination of vehicle purchase decisions for large LDVs.

Figure 35 • Relationship between price and other vehicle attributes, 2017

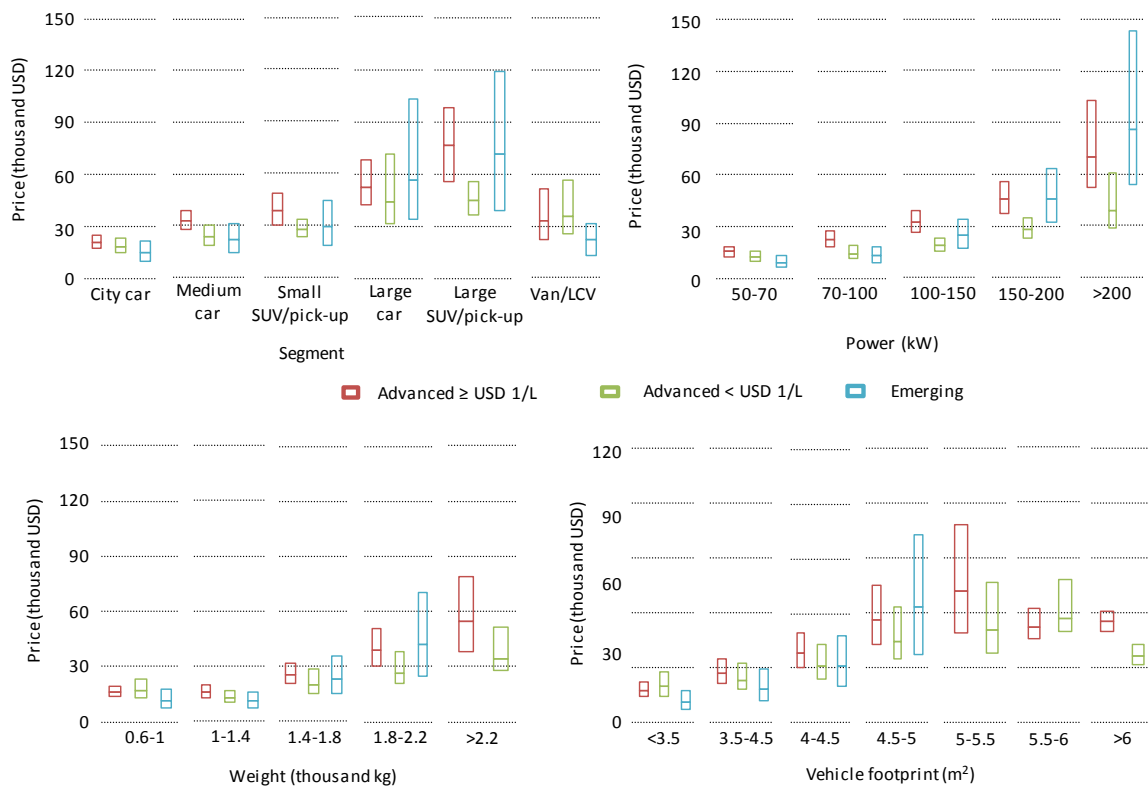

Note: Advanced $<$ USD 1/L = advanced economies with gasoline prices below USD 1 per litre; Advanced \geq USD 1/L = advanced economies with gasoline prices above USD 1 per litre. The prices are in 2017 USD.

Source: IEA analysis based on IHS Markit database (IHS Markit, 2018).

Key point: Retail price increases with vehicle size, power, weight and footprint. In emerging economies, small vehicles are less expensive than in advanced economies. This is not the case for large vehicles. Vehicles in Australia, Canada and United States are relatively less expensive than in other advanced economies.

Implications for vehicle fuel economy

There are significant opportunities to limit the fuel consumption of vehicles by changing attributes such as power and size, and further opportunities from marketing strategies that increase the consumer appeal of vehicles with improved fuel economy. The relationship between vehicle attributes and price imply that improving vehicle fuel economy by convincing consumers to drive smaller vehicles with less power would be cost-effective, as it would come with net savings (Figure 36). Despite the challenges posed by consumer preferences that are tending to larger size vehicles, the opportunities offered by changes in attributes such as power and size give automakers rather powerful means to manage cost increases. In particular, changing such vehicle attributes can act as a backstop solution against the risk of price increases that could be induced by fuel economy policies.

Effect of fuel-efficient powertrain technologies on vehicle price

The choice of vehicle powertrain significantly affects fuel consumption (see Figure 17). LDVs with gasoline engines are typically the cheapest option to purchase, but offer low fuel economy. LDVs with diesel engines, hybrids and EVs offer improvements in fuel economy, but these vehicle powertrain models typically come with a price premium.

Vehicle attributes such as power, market segment and size have a large impact on vehicle price. To assess the impact of changes in powertrain technologies on vehicle price, we compare fuel

economy and vehicle price by the size segment and power “bins” of 10 kW in both advanced and emerging economy markets. Results on fuel economy improvements for hybrid and diesel LDVs relative to a gasoline vehicle benchmark are shown in Table 5. In addition to the percentage of average fuel consumption, it includes information on the price increment observed for the same technologies and market segments.

Key insights from this comparison are:

- Better fuel economy associated with diesel engines comes with a slight price premium.
- Hybrid vehicles are not always more expensive than diesel counterparts, and hybrids deliver better fuel economy performance.
- In the European Union, which has a high share of diesel vehicles, the average premium to buy a diesel vehicle compared to a similar gasoline one is between 9% and 21%, and the diesel model delivers a 27-37% fuel economy improvement (1.5-3.2 Lge/100 km).
- Diesel powertrains are less common in the advanced economies with low gasoline prices (Australia, Canada and United States). For this reason, diesel LDVs have a much higher price premium compared with the advanced economies with higher gasoline prices (European Union, Japan and Korea).
- For emerging economies, higher price premiums apply to both diesel and hybrid vehicle powertrains. This is due to both the low market shares that these technologies have in comparison with advanced economies, as well as a lower gasoline vehicle price benchmark.

Table 5 • Average fuel economy improvement and price premiums of hybrids and diesels relative to a similar gasoline vehicle, 2017

	City car	Medium car	Small SUV/pick-up truck	Large car	Large SUV/pick-up truck
Fuel economy improvements relative to a gasoline vehicle benchmark (Lge/100 km)					
Advanced economies with gasoline price ≥ USD 1/L					
Hybrid	2.3	2.4	1.9	2.9	3.8
Diesel	1.5	1.8	1.5	2.2	3.2
Advanced economies with gasoline price < USD 1/L					
Hybrid	N/A	3.8	0.8	2.4	3.7
Diesel	2.0	1.2	0.9	1.2	1.9
Emerging economies					
Hybrid	2.2	3.3		2.8	3.1
Diesel	1.9	2.2	1.9	1.3	2.4
Fuel economy improvement relative to a gasoline vehicle benchmark (% increment)					
Advanced economies with gasoline price ≥ USD 1/L					
Hybrid	37%	35%	27%	35%	33%
Diesel	24%	25%	20%	27%	25%
Advanced economies with gasoline price < USD 1/L					
Hybrid	N/A	48%	11%	28%	31%
Diesel	29%	17%	10%	14%	16%
Emerging economies					
Hybrid	33%	42%		30%	28%
Diesel	28%	27%	23%	15%	18%
Price premium relative to a gasoline vehicle benchmark (% increment)					
Advanced economies with gasoline price ≥ USD 1/L					
Hybrid	14%	30%	29%	4%	6%
Diesel	19%	12%	21%	9%	11%
Advanced economies with gasoline price < USD 1/L					
Hybrid	N/A	7%	40%	20%	26%
Diesel	68%	42%	29%	60%	63%
Emerging economies					
Hybrid	105%	104%		42%	25%
Diesel	87%	134%	67%	92%	58%

Notes: The price premium for a hybrid or diesel vehicle is assessed comparing the hybrid or diesel price with a gasoline alternative in each of the categories. The premiums are then sales-weighted for each economy grouping and market segment, and expressed as a percentage of the average price of vehicles in the same category. Fuel economy improvements are expressed in terms of absolute savings, in Lge/100 km, compared with a gasoline vehicle benchmark. N/A = not available.

Source: IEA analysis based on IHS Markit database (IHS Markit, 2018).

Key point: Diesel and hybrid vehicles offer fuel economy gains compared with a similar gasoline vehicle, but at a price premium that is related to the level of penetration of these options in a given market. In the Europe Union, where both diesel and hybrid vehicles are common, the price premium is relatively small and hybrids are often cheaper than diesel LDVs.

Fuel consumption relative to type of powertrain and vehicle price for the two best-selling cars in the most popular market segment (medium-size cars) in six countries is shown in Figure 37. It underscores that gasoline LDVs tend to have the highest fuel consumption and the lowest purchase price, while diesel and hybrid models offer notable gains in fuel economy but have a price premium at purchase. BEV and PHEV offer significant improvements in fuel consumption, but came with a significant purchase price premium in 2017.

Figure 36 • Fuel economy and purchase price of the two best-selling vehicles in the medium car segment in selected countries, 2017

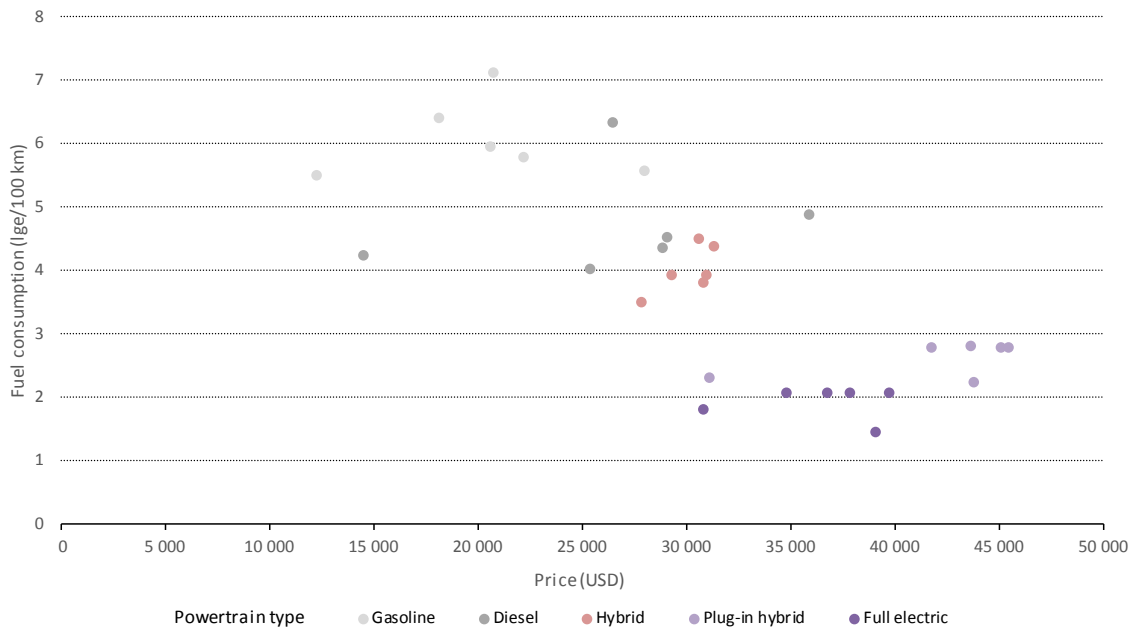

Notes: The countries in this figure are France, Germany, Italy, Japan, United Kingdom and United States. The purchase price and fuel economy reflect the weighted-average of the two most popular vehicle models in terms of sales. For example, the United Kingdom has the highest diesel sales in the medium car segment for the USD 28 000 Ford Focus and the USD 29 000 Volkswagen Golf, giving an average of USD 28 500. The same is applied to fuel consumption.

Source: IEA analysis based on IHS Markit database (IHS Markit, 2018).

Key point: Gasoline powertrains are the cheapest and least efficient. Other powertrain options offer improved fuel consumption, but come with a purchase price premium.

Other relationships between fuel economy and vehicle price

As discussed in the previous sections, the main vehicle attributes and powertrain technologies are important elements in relation to the retail purchase price of a LDV. Here we look at other fuel-efficient technologies and the relationship with purchase price by considering vehicles with very similar characteristics and the same powertrain. Each “group” includes vehicles in the same size segment, with the same powertrain and similar power ratings.³⁵ It compares the purchase price of the LDVs that have a lower than average fuel consumption in each group (starting with the best performance LDVs and ending with the maximum 25% of all sales to identify the average benchmark of the top performers) to the average price in each group.³⁶ For example, the price of the average small SUV/pick-up truck segment with a diesel powertrain between 90 and 100 kW in each country is compared with the average price of the top 25% most efficient vehicles in the same group.

The results, expressed as the percentage premium required to buy an efficient vehicle in the advanced and emerging economies groupings, are shown in Table 6. These results, which are robust as to the choice of size segment and power, indicate that the most efficient LDVs generally cost 5-7% less at retail purchase than the average vehicle in that group and provide fuel economy improvements of 0.6- 0.8 lge/100 km. The most efficient LDVs would also deliver net savings over their lifetime due to better fuel economy.

³⁵ Vehicles are grouped by detailed size segment (city car, medium car, large car, small SUV/pick-up truck, large SUV/pick-up truck and van/LCV), power (in groupings of 10 kW) and fuel type (gasoline, diesel, ethanol, LPG and CNG).

³⁶ Prices in the top 25% portion of models and across the whole category are averaged country-by-country and weighted accounting for the number of new vehicle registrations.

This is an encouraging message for energy efficiency in LDVs, since it shows that there is considerable potential to improve fuel economy without an increase in the purchase price of vehicles, or a need to compromise on other important vehicle attributes.

Table 6 • Purchase price premium for LDVs in the top 25% of fuel economy size segment, powertrain and power relative to an average vehicle in the same category

Category	Price premium (% of average vehicle)	Fuel economy improvement (Lge/100 km)
Advanced economies with gasoline price \geq USD 1/L	-5.3	0.6
Advanced economies with gasoline price < USD 1/L	-5.3	0.8
Emerging economies	-6.6	0.7

Source: IEA analysis based on IHS Markit database (IHS Markit, 2018).

Key point: Among LDVs of similar size, power and powertrain, efficient vehicles cost less than average-performing LDV in this group.

3. Focus on powertrain electrification

The electrification of various powertrain technologies can deliver significant gains in fuel economy or specific fuel consumption (hereafter, “fuel consumption”) and reduce polluting emissions that are particularly of concern in urban areas. Combined with low-carbon power generation, electrified vehicles can also deliver benefits in terms of lower well-to-wheel and life-cycle greenhouse gas emissions. Electrification technologies include:

- Hybrid electric vehicles (hereafter, “hybrids”) (HEVs), which use a single external energy source (typically gasoline or diesel) and are equipped with a powertrain containing at least one electric motor (or electric motor-generator) and one internal combustion engine (ICE) as propulsion energy converter. They can be subdivided in the following subtypes:
 - Mild hybrids are conventional LDVs equipped with larger batteries and regenerative braking systems that enable the recovery some kinetic energy to power auxiliaries and support the ICE drivetrain, for example the Honda Insight.
 - Full hybrids have both an ICE and an electrical powertrain. The flexibility of the two powertrains enables the ICE to be designed for maximum efficiency and to extend operation in its most efficient operating window. The most common full hybrid is the Toyota Prius.

Figure 37 • Fuel consumption range by type of powertrain and vehicle size, 2017

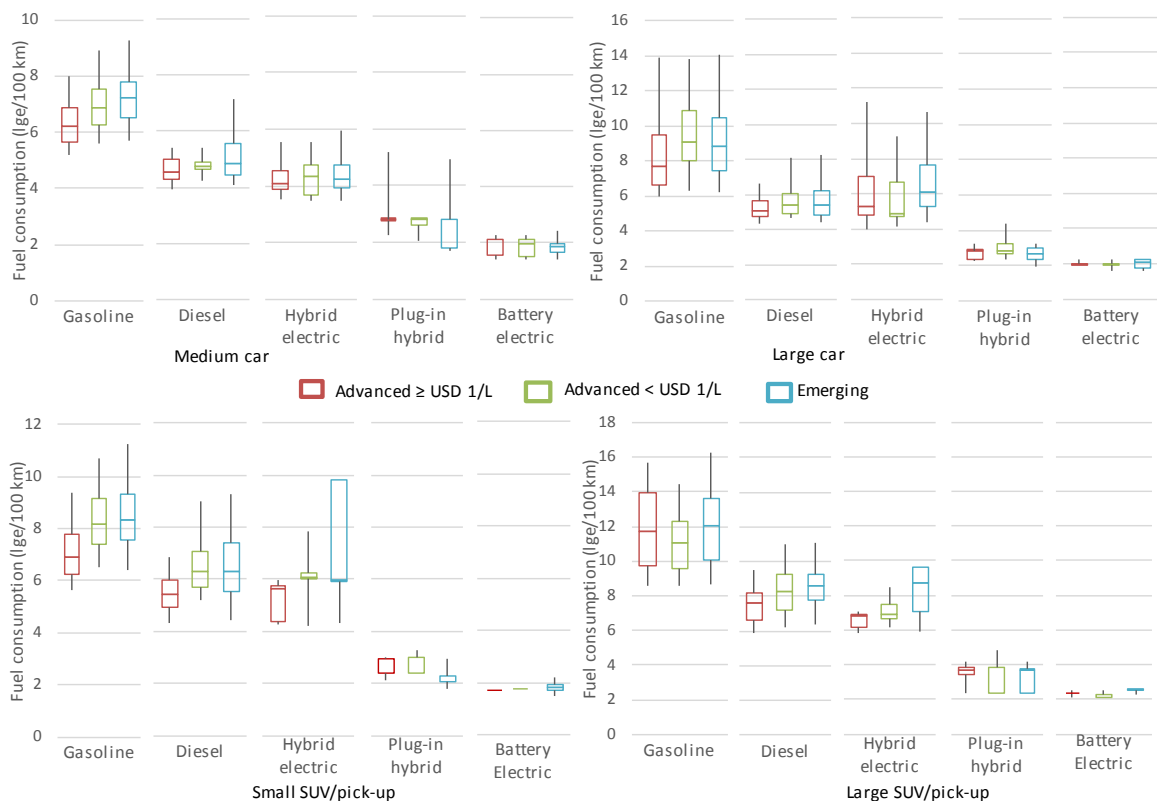

Note: Advanced < USD 1/L = advanced economies with gasoline prices below USD 1 per litre; Advanced ≥ USD 1/L = advanced economies with gasoline prices above USD 1 per litre.

Source: IEA analysis based on IHS Markit database (IHS Markit, 2018).

Key point: Electrical powertrains have lower fuel consumptions than gasoline LDVs, with the difference amplified in the larger vehicle segments.

- Plug-in electric hybrids (PHEVs), which are also equipped with a powertrain containing at least one electric motor (or electric motor-generator) and one ICE and have the capacity to rely on more than one external energy source (typically gasoline and electricity, or diesel and

electricity). PHEVs have a battery with sufficient capacity to power the vehicle for most of its use over short distances (PHEV test procedures are detailed in Box 2).

- Battery-electric vehicles (BEVs) rely solely on the electrical powertrain and electricity supply.
- Fuel cell electric vehicles (FCEVs) rely solely on the electrical powertrain using hydrogen as the energy source.

Analysing the fuel economy of LDVs using these technologies shows clearly that a higher degree of electrification enables lower energy consumption. Examining this in the various vehicle size segments shows that the difference in fuel consumption between ICE powertrains and electrical powertrains is more pronounced in the larger vehicle size segments (Figure 38).

Box 2 • Test procedures for fuel consumption in PHEVs

PHEVs can be used in two modes of operation: charge depleting (CD) and charge sustaining (CS). In CD mode, the PHEV is mostly behaving like a BEV, i.e. only using electricity from its battery as a mean of traction. In CS mode, the vehicle relies on the ICE to provide the power necessary to move the vehicle, effectively behaving like a hybrid vehicle. Since these two modes of operations have very different fuel consumption values, the determination of an overall consumption value is dependent on the testing protocol employed and the weight given to the two modes of operation (ICCT, 2017).

In the New European Driving Cycle (NEDC), the consumption of PHEVs is calculated assuming that the vehicle drives on average 25 kilometres in CS mode, combining this with the maximum range it can drive in CD mode after a full charge (the so-called “maximum all-electric range”). Since most PHEVs currently have an NEDC range of about 50 kilometres, this approach results in roughly two-thirds of the distance driven as a BEV and one-third as a hybrid vehicle.

The Worldwide Harmonized Light-Duty Test Procedure (WLTP) improves the way PHEV consumption is measured and communicated to consumers in two ways. First, the more demanding WLTP cycle will result in more realistic consumption figures for both the CS and CD modes, and therefore in a more realistic determination of the maximum all-electric range. Second, the distance driven in each mode will be a function of the electric range: vehicles with a higher all-electric range should be driven more often in CD mode than those with a shorter range. This can be quantified using a utility factor, representing the share of distance driven with the electrical powertrain.

The United States Corporate Average Fuel Economy (CAFE) procedure has some differences in the testing details compared with the WLTP procedure. The utility factors used to weigh the CD and CS mode differ from those in WLTP, reflecting the driving conditions for the average US fleet.

In this report, the fuel consumption conversion among test cycles for EVs follows the same method as conventional vehicles. However, this conversion method may not entirely reflect the impact of different utility factors applied for PHEVs. Thus, these values may vary from the official test value under WLTP, especially for PHEVs.

Market structure and key attributes of electrified vehicles

Market structure

Market penetration varies among the various types of electrified vehicles. Hybrids (mostly full hybrids) are most common in Japan. PHEVs and BEVs have shown strong growth in recent years yet account for a limited share of new LDV sales (see Figures 17 and 18). The distribution of LDV sales, EVs and ICEs, in 2017 for the six vehicle size categories and stratified for the three economic groupings and worldwide are shown in Figure 38. Key insights include:

- In 2017, the market segmentation of HEVs was the closest to conventional ICE LDVs, especially in the advanced economies with high gasoline prices grouping (European Union, Japan and Korea). In other markets, hybrids are sold predominantly in the medium and large vehicle segments. In the city car segment, there were no hybrid models available in emerging

economies and only a few models were available in the advanced economies with low gasoline prices grouping (Australia, Canada and United States).

- Most of the PHEV sales in 2017 were concentrated in the large car and large SUV/pick-up truck segments: there are no PHEV models in the city car segment. In China, nearly 60% of PHEVs sales are in the small and large SUV/pick-up truck segments, while in Canada and the United States they are mostly large and medium cars. The shares of PHEVs by market segment in the European Union, Japan and Korea fall in between those two levels.
- Worldwide, the 2017 sales of BEVs in the city car segment had a higher share than conventional ICE city cars. The biggest share was in China where over 70% of all BEV sales were in the city car segment. The smallest share was in Canada and the United States where the new BEVs sold were large cars and large SUVs/pick-up trucks. The 2017 sales of BEVs in the European Union, Japan and Korea were mostly in the city and medium car segments.

Technical reasons that influence these trends include:

- Hybrid powertrains take up volume, and increase the weight and price of a vehicle. Therefore, they are more likely to be used on large-size vehicles. Big vehicles tend to be heavier and have a large footprint and generally a price premium, making them less sensitive to these factors.
- The high cost of batteries on a per kilowatt-hour basis increases the pressure on manufacturers to limit the size of battery packs, but they also need to maximise the driving range to gain consumer acceptance. This makes BEV powertrains more suitable for LDVs that have limited energy requirements, and therefore more appealing for the smaller city car segment. A niche LDV segment for BEV powertrains are vehicles with high daily usage rates and access to rapid or overnight charging, such as taxi services, which often use medium to large cars.

Figure 38 • New LDV market share by vehicle size and powertrain type, 2017

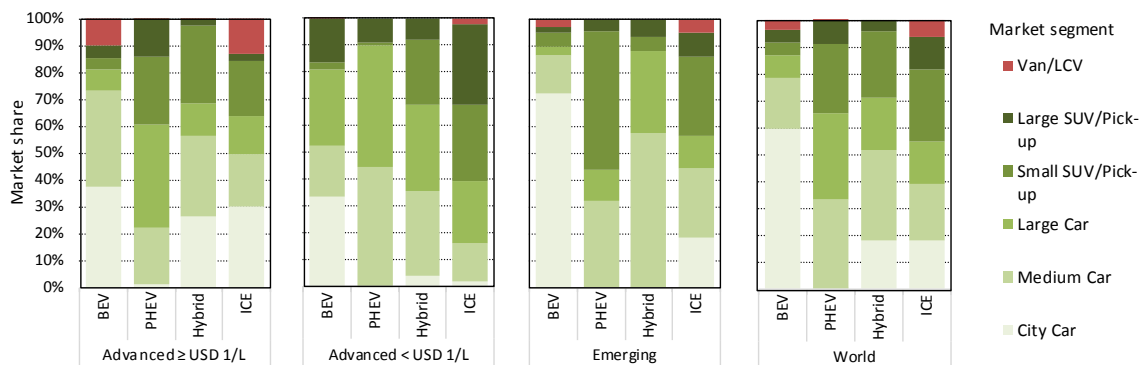

Notes: ICE = internal combustion engine. Advanced < USD 1/L = advanced economies with gasoline prices below USD 1 per litre; Advanced ≥ USD 1/L = advanced economies with gasoline prices above USD 1 per litre.

Source: IEA analysis based on IHS Markit database (IHS Markit, 2018).

Key point: Market penetration of new electrified vehicles varied by type and vehicle size across advanced and emerging economies.

Power rating

An overview of the distribution of electrical powertrain technologies by power ratings and those of ICEs is shown in Figure 40. Key points include:

- The distribution of hybrid-vehicle power ratings is most similar to conventional ICE vehicles in all markets, despite the absence of hybrid city car segments in advanced economies (also therefore hybrids with low power ratings). It reflects the proportion of vehicles with power ratings of 70-100 kW. (This is the segment that represents some of the most popular hybrid models, such as the Toyota Prius and Honda Insight).

- In the European Union, Canada and the United States, the average power of PHEVs and BEVs is higher than the average power of ICE LDVs. For PHEVs, this is due to their higher share of sales in the large car and SUV/pick-up truck segments (typically characterised by higher power ratings). For BEVs, this is consistent with lower marginal costs associated with power increases in electric motors (compared with ICEs) and consumer willingness to pay a premium for LDVs with high power ratings.
- The same trend is not observed in China, where BEVs have power ratings well below conventional ICE LDVs, most likely because of the need to compete with cars having a lower average price than in Australia, European Union, Japan, Korea and United States. Chinese PHEVs have higher power ratings than conventional ICE vehicles.

Figure 39 • New LDV market share by power rating and powertrain type, 2017

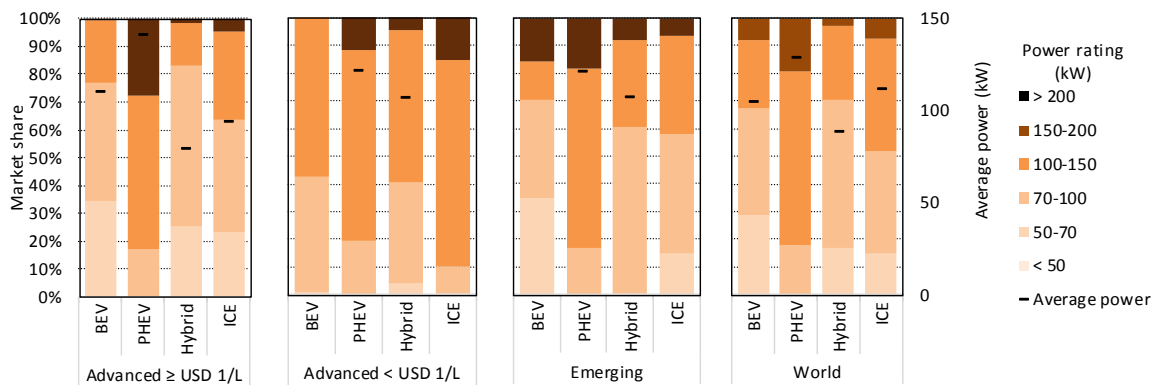

Notes: ICE = internal combustion engine. Advanced < USD 1/L = advanced economies with gasoline prices below USD 1 per litre; Advanced \geq USD 1/L = advanced economies with gasoline prices above USD 1 per litre.

Source: IEA analysis based on IHS Markit database (IHS Markit, 2018).

Key point: Electrified vehicles have a varied engine power distribution.

Weight distribution

The technology associated with electrical powertrains (dual powertrain or batteries) suggests that for a given vehicle type, electrified vehicles would be heavier than ICE models. All else being equal, hybrid vehicles are heavier because they have both the ICE powertrain and an electric motor.

Figure 40 • New LDV market share by weight and powertrain type, 2017

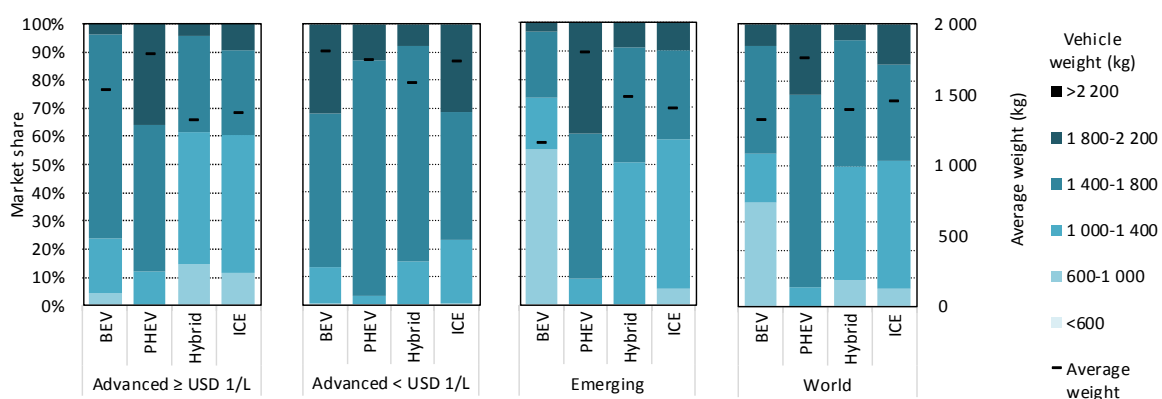

Notes: Weight = empty weight. ICE = internal combustion engine. Advanced < USD 1/L = advanced economies with gasoline prices below USD 1 per litre; Advanced \geq USD 1/L = advanced economies with gasoline prices above USD 1 per litre.

Source: IEA analysis based on IHS Markit database (IHS Markit, 2018).

Key point: The distribution by weight of different powertrains is relatively uniform worldwide. Hybrids have an average weight similar to ICE LDVs. PHEVs are always heavier than the average of the segment. BEVs are heavier in the advanced economies but lighter in emerging economies.

PHEVs because of the combined effect of the dual powertrain and larger batteries, PHEVs tend to have an even higher weight than an equivalent ICE LDV. As an example, the standard VW Golf SE weighs 1 216 kg, the PHEV Golf GTE weighs 1 510 kg and the BEV e-Golf weighs 1 615 kg. BEVs generally weigh more within their specific size segment because of the substantial weight added by the battery (GFEI, 2018).

The distribution by weight of the various powertrains in 2017 shows that hybrids did not have a substantial weight difference than conventional vehicles, reflecting the fact that they are the electrified vehicle with the closest configuration to ICE LDVs (Figure 40). PHEVs were heavier than the ICE vehicles worldwide. For BEVs, the average weight of the different powertrains was actually lower than for ICEs, hybrids and PHEVs. This is because the sales distribution of electrical powertrains is not uniform across the economy groupings and market size segments, as illustrated in the previous section, and in particular because BEVs were primarily in the city car segment in emerging economies (mostly in China). For all other groupings, the average BEV is heavier than ICE vehicles.

Effect of EV attributes on fuel economy

Sensitivity of energy use to weight for ICE and EVs

Vehicle weight has a strong positive correlation with fuel consumption in ICE vehicles. Vehicles with large mass require more energy to accelerate than smaller vehicles, and the inertia gained through acceleration is lost as heat in ICE vehicles.

The correlation between weight and fuel consumption is not the same in electrified vehicles because of regenerative braking – a crucial technology that recovers most of the energy used to accelerate the vehicle. For BEVs, the use of regenerative braking results in a much lower impact of mass on fuel consumption than ICE vehicles. The same is true for PHEVs and, to a lesser extent, for hybrid cars (Figure 42).³⁷ This characteristic explains the trend observed of increased fuel economy benefit for electrification in the larger vehicle segments (see Figure 38).

Figure 41 • Vehicle fuel consumption as a function of weight for various powertrains, 2017

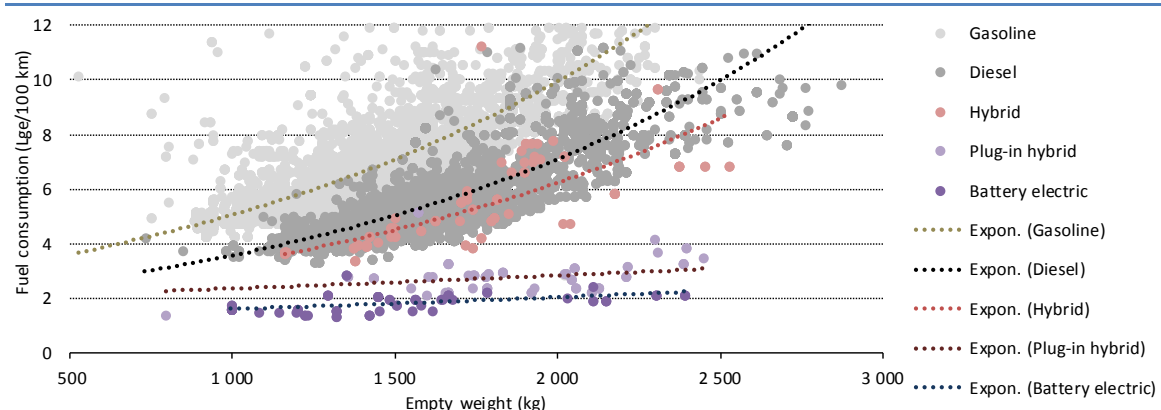

Notes: Expon = exponential correlation curve. The gradient of the lines shows that the dependency of fuel consumption on vehicle mass is much lower for electrified vehicles. The flatter the line, the lower this dependency. PHEVs follow the same trend as BEVs when driven in charge depleting mode, while when in charge sustaining mode they follow the trend of hybrid vehicles.

Source: IEA analysis based on IHS Markit database (IHS Markit, 2018).

Key point: Vehicle weight has much less influence on the fuel consumption of EVs than conventional LDVs.

³⁷ In hybrid cars, the amount of recoverable energy is limited by the small size of the battery.

Contribution of electrified vehicles to fuel economy improvements

Electrified vehicles contributed to improved fuel economy despite limited market penetration in 2017 (Figure 43).³⁸ Japan reaped the most benefits among the countries analysed. Its average fuel would have been 0.2 Lge/100 km (3.4%) higher in 2017 absent the benefits from hybrids, which have a significant market share, and fully electric vehicles. In China, PHEVs and BEVs gave the biggest boost to average fuel consumption savings. Annual fuel consumption in China would have been 0.13 Lge/100 km (2.0%) higher without EVs. (This analysis did not include Norway, Iceland and Sweden, which had higher EV market shares than in China in 2017.³⁹)

Figure 42 • Electrified vehicles contribution to average fuel consumption, 2017

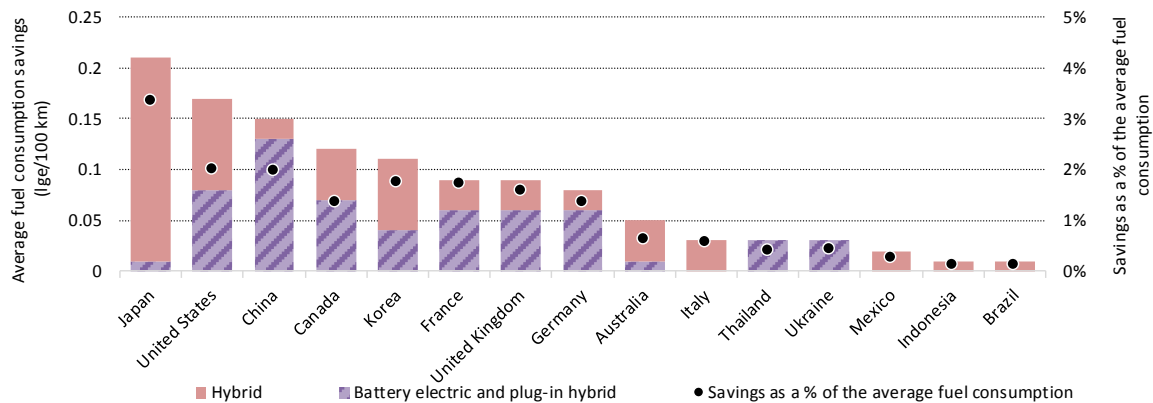

Note: The savings are calculated by substituting electrified vehicles in each market size segment and power class for vehicles with the average fuel use for the same size and power. The registrations and the market share of hybrids in Japan might be underestimated for the period 2014-17 (METI, 2019). According to the Japanese Automobile Manufacturers Association (JAMA), the market share of hybrids in Japan was 31.6% in 2017 (JAMA, 2018).

Source: IEA analysis based on IHS Markit database (IHS Markit, 2018).

Key point: The biggest fuel economy benefits from electrified vehicles were in Japan, the United States and China.

Assuming a worldwide 10% market share of BEVs across all market segments, the global average fuel economy would improve by 6%. The improvement would be larger (7%) in Australia, Canada and the United States, since large-size vehicles are a substantial share of the LDV market. More modest savings would be expected with a worldwide 10% market penetration of PHEVs and hybrids vehicles (Figure 44).

³⁸ It is important to highlight that this analysis is based on tank-to-wheel energy consumption. The fact that EVs have a much higher level of well-to-tank energy consumption is not accounted for here. Moreover, this does not take into account the differences in life-cycle environmental impacts that characterise various powertrains.

³⁹ See IEA (2018b) and IEA (2018d).

Figure 43 • Average fuel consumption attributed to electrified vehicles for varying market penetration levels

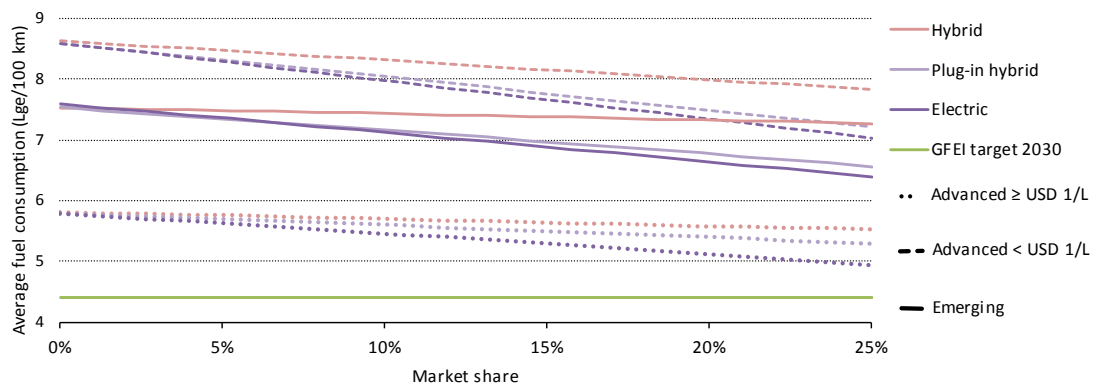

Notes: GFEI = Global Fuel Economy Initiative. Advanced < USD 1/L = advanced economies with gasoline prices below USD 1 per litre; Advanced \geq USD 1/L = advanced economies with gasoline prices above USD 1 per litre. The savings are calculated by substituting electrified vehicles in each market size segment and power class for vehicles with the average fuel use for the same size and power. Source: IEA analysis based on IHS Markit database (IHS Markit, 2018).

Key point: Increasing the share of electrified vehicles reduces average fuel consumption for the LDV stock in all markets.

4. Gap between tested values and real driving fuel economy

Real driving fuel economy for conventional vehicles⁴⁰

In 2017, nearly 80% of new light-duty vehicles (LDVs) sold were subject to fuel efficiency or carbon dioxide (CO₂) emissions standards, and nearly 60% of the world's LDV fleet was covered by fuel economy standards (IEA, 2018c). While the broad coverage of the market with fuel economy standards or related policies is notable, there is evidence of growing divergence between tested fuel economy values and real driving fuel consumption values in a number of markets, implying that laboratory test measurements are increasingly underestimating the fuel consumption.

Tested versus real driving fuel economy

Official fuel economy or specific fuel consumption (hereafter, "fuel consumption") or CO₂ emissions per kilometre⁴¹ used to determine compliance with fuel economy standards is measured in laboratories. Depending on the regulatory requirement of each country, such testing can be conducted by the government agency, certified independent laboratories, or manufacturers themselves, with or without supervision from government. During the testing, vehicles are placed on dynamometers that allow the vehicle to remain stationary while the wheels spin. Detailed testing procedures are established. While testing procedures vary among countries, there are certain elements that a testing procedure should follow. These include:

- Before the testing begins, the vehicle is conditioned to the required ambient temperature.
- The vehicle is driven on a chassis dynamometer following a strictly defined driving cycle.⁴²
- The resistance placed on the rollers of the chassis dynamometer is defined by an electronic controller that simulates the inertia effects due to the weight of the vehicle, aerodynamic drag and rolling resistance forces acting on a vehicle during on-road operation. These two effects are commonly referred to as the road-load.⁴³
- The vehicle follows precise instructions on use of auxiliary electric devices, such as air conditioning or entertainment systems.

The official fuel consumption value usually consists of a weighted-average fuel economy value from more than one laboratory test following different test cycles or procedures (e.g. city cycle and highway cycle) to reflect average fuel economy under different driving conditions.

Despite the efforts of regulators to ensure that the tested fuel consumption measured in laboratories reflects the fuel consumption that car owners experience in real driving, a growing body of evidence⁴⁴ highlights not only a difference between real driving fuel consumption and

⁴⁰ This section summarises from Tiegge et al. (2017); Tietge (2016); and Yang (2018).

⁴¹ Fuel consumption can be converted to CO₂ emissions per kilometre based on the carbon content of the fuel if one litre is used for combustion.

⁴² This consists of a prescribed sequence of different speeds over time.

⁴³ Road-load is measured during coast down testing, where vehicles are accelerated to a certain speed and then coast in neutral. The time it takes for the vehicle to decelerate is used to estimate the road-load force acting upon the vehicle. Some test procedures allow manufacturers to refer to predetermined values based on vehicle specifications to estimate road-loads.

⁴⁴ Evidence of the divergence between real driving and tested fuel consumption and CO₂ emission values was found in 2012 in Europe (Mock et al., 2012) and later in most countries and regions with fuel economy standards, including China, European Union, Japan and the United States (Tiegge et al., 2017).

laboratory test values,⁴⁵ but also a tendency for the gap to increase over time (Figure 45). The term “real driving” (or, similarly, “on-road”) refers to the actual experience of vehicle operation. Every driver has a distinct way of driving and on-road driving may have a variety of conditions, e.g. urban traffic versus highway trips, hilly versus flat terrain, and hence a technically clear definition of real driving is elusive. Nevertheless, by aggregating a large amount of driving data, clear trends can be observed and analysed. This growing gap of real driving versus tested results limits the impact of fuel economy standards and dilutes their intended benefits, which include mitigating climate change, curbing oil imports and reducing consumer fuel expenses. (Further details on the real driving and tested results gap and its development over time are in Annex 2.)

Figure 44 • Gap between real driving and tested CO₂ emissions values for select countries, 2001-14

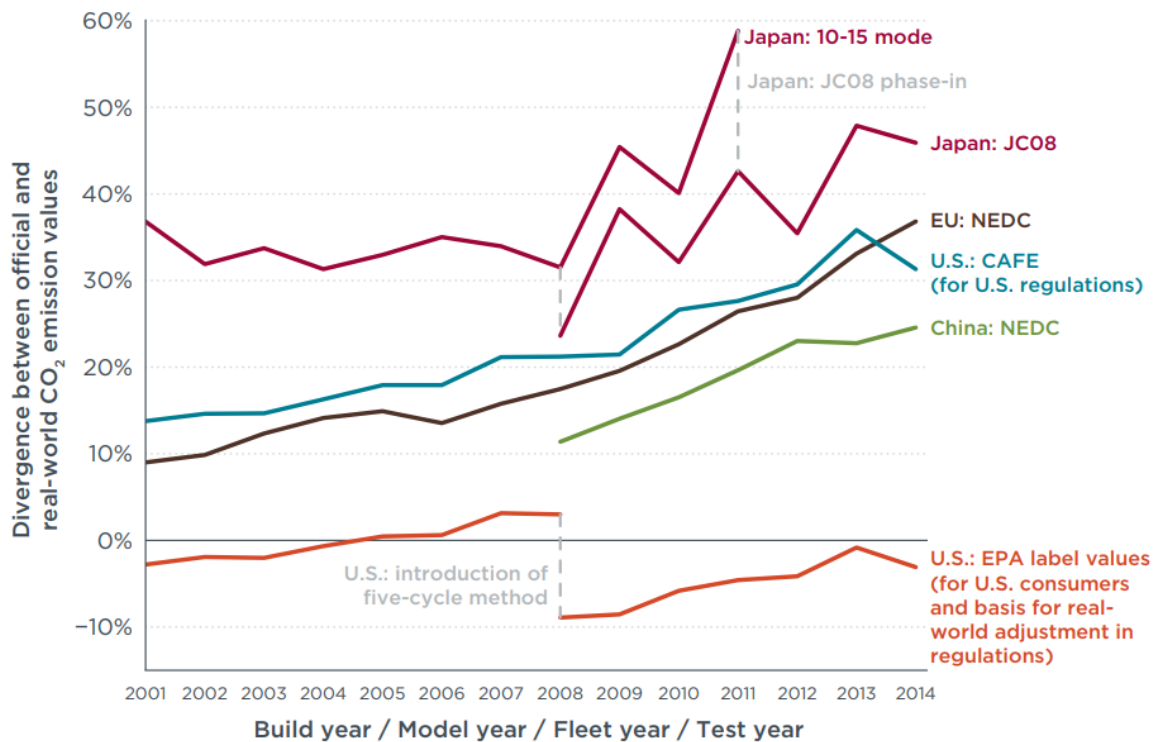

Note: JC08 = Japanese Cycle 2008; EU = European Union; NEDC = New European Driving Cycle; EPA = US Environmental Protection Agency; CAFE = Corporate Average Fuel Economy.

Source: Tietge et al. (2017).

Key point: Key vehicle markets except for the United States show an increasing gap between real driving and tested results of more than 10%, diverging to as high as 50%.

What is widening the gap?

Several factors are driving the widening gap between real driving and tested fuel economy in major vehicle markets. Two main contributing factors are:

- Increasing exploitation by manufacturers of tolerances and flexibilities in vehicle test procedures was identified as the most important factor for the widening divergence (Stewart, 2015). This includes testing conditions (e.g. high ambient temperature) and a number of other

⁴⁵ This difference, defined here as real driving versus tested fuel economy gap, can be expressed as a percentage of the official tested fuel consumption value. For example, a 30% gap implies that real driving fuel consumption is 30% higher than the fuel consumption measured in the laboratory test.

factors (e.g. allowable tolerances for laboratory instruments, testing of so-called “golden vehicles” and special test driving techniques).⁴⁶

- Recent developments in vehicle technologies that have been shown typically to provide disproportionate benefits during laboratory testing relative to real driving conditions. This includes technologies such as stop/start systems and hybrid electrical powertrains (Qin, 2016; Stewart, 2015). Auxiliary equipment, such as air-conditioning and entertainment systems, are turned off during testing procedures but consume power during real driving operations.

In addition, widening gaps are also attributable to the decreasing official average fuel consumption values heading towards the Global Fuel Economy Initiative target, as the decreasing denominator that may make any gap appear proportionally larger, is a minor factor that accounts for 10-20% of the increase in the gap in China, European Union and United States (Tietge et al., 2017). For example, a fuel consumption gap of 1 Lge/100 km for a country with an average fuel consumption of 5 litres of gasoline-equivalent per 100 kilometres (Lge/100 km) gives a larger gap (20%) than if the average fuel consumption was 6 Lge/100 km (17%).

- Driver behaviour is unlikely to account for the increase in the gap between real driving and tested fuel economy values over time, as the share of different driving styles remained fairly constant. In two cases, one in the European Union and one in the United States, real driving fuel economy data showed that all types of driver behaviour experienced an increase in the real driving versus tested gap over time (Tietge et al., 2015; Tietge et al., 2016).

Building on previous work and discussions with experts from the automotive and vehicle testing sector, Stewart (2015) estimated the gap between real driving and tested type-approval fuel consumption in the European Union on a bottom-up basis by contributing parameters (Figure 46). Looking forward, the gap in the European Union may continue to expand in the absence of effective regulatory changes, and could reach almost 50% by 2020.

⁴⁶ The coast down procedure used to estimate road-loads for the New European Driving Cycle testing also includes technical tolerances and imprecise definitions, which allows for pre-treatment of tyres by baking or shaving them, optimising aerodynamics, opening brake callipers or carefully selecting test tracks with smooth and hard road surfaces, among others (Kadijk, 2012; Kühlwein, 2016). The application of test flexibilities in the European Union is estimated to account for around 11 percentage points of the on-paper reduction in fuel consumption achieved between 2002 and 2010 for passenger cars (Kadijk, 2012).

Figure 45 • Estimate of the gap between real driving and tested type-approval CO₂ emissions in the European Union, differentiated by contributing parameters

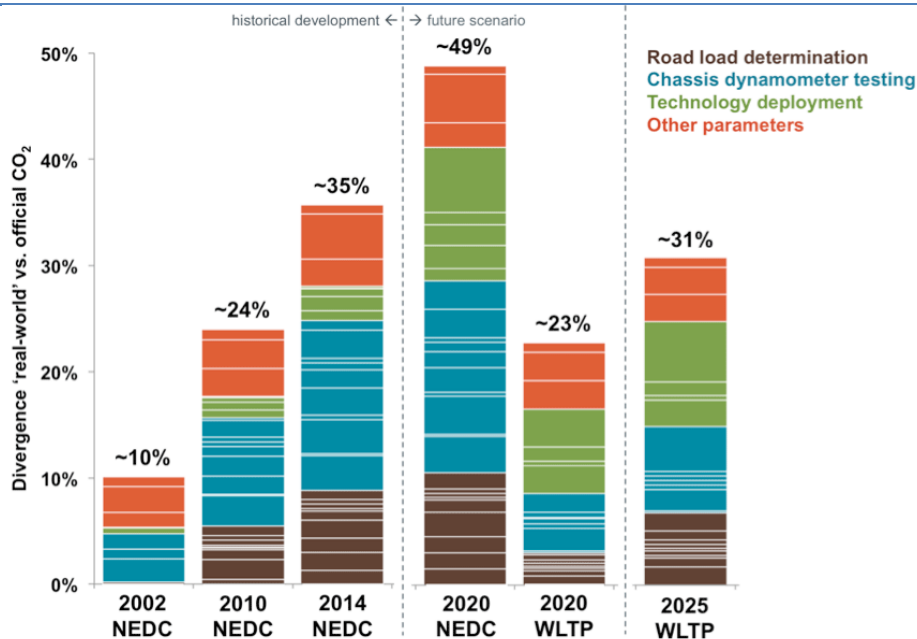

Note: NEDC = New European Driving Cycle testing; WLTP = Worldwide Harmonised Light-Duty Test Procedure.

Source: Stewart (2015).

Key point: The rising gap between real driving and tested fuel consumption or CO₂ emissions per kilometre is mostly driven by increased discrepancy in road-load determination and chassis dynamometer testing, while the new WLTP brings the gap back to the 2010 NEDC level.

Policy response⁴⁷

Measures are needed to try to close the gap between real driving fuel consumption and tested fuel economy values. In the European Union, the approach is to switch to a new test procedure, from the New European Driving Cycle (NEDC), last updated in 1997, to the Worldwide Harmonised Light-Duty Test Procedure (WLTP). This will close some loopholes in testing and help to bring the gap down from an estimated 49% to about 23% by 2020 (Figure 45), but by itself will not entirely close the gap (Stewart, 2015). This indicates that further measures are needed to decrease the gap, which holds not only for the European Union, but also in other LDV markets.

As well, the WLTP may bring loopholes that are not yet identifiable. Problems such as out-of-date or new test procedures could be compounded by insufficient oversight of testing done by manufacturers. Thus, countries need additional measures to strengthened test procedures (Mock, 2015).

To achieve actual on-road fuel economy benefits, countries need to pay attention to compliance and enforcement of fuel economy policies in order to better translate official fuel consumption values tested in laboratories into real driving fuel efficiency. Unless regulators handle the growing gap appropriately, the divergence between tested fuel economy values and real driving fuel consumption will continue to dilute fuel efficiency policies.

⁴⁷ This section summarises work from Yang (2017).

Compliance and enforcement

Compliance and enforcement of fuel economy standards are integral to a vehicle fuel economy regulatory framework.⁴⁸ Compliance and enforcement practices vary significantly in 14 major vehicle markets,⁴⁹ partly because of regulatory structures and partly because of the implementation of enforcement measures (Yang et al., 2017).

Legislative and regulatory frameworks

Legislation and regulations are core for a compliance and enforcement system. They specify the requirements for vehicle fuel economy performance and establish government oversight to hold manufacturers legally accountable for vehicle performance. Five key authorities that regulatory agencies need to form robust vehicle compliance and enforcement programmes were summarised by Yang et al. (2017). This work identified their authorised functions by major vehicle markets. Table 7 lists the legislation that empowers the regulatory agencies in nine vehicle markets to carry out compliance and enforcement of vehicle fuel economy standards. A notable inconsistency across these regimes is in their authority to mandate recalls or other civil penalties to bring non-compliant vehicles into compliance and impose punitive fines on non-compliant manufacturers.

⁴⁸ Compliance and enforcement refers to a system of laws, regulations, authorities and practices intended to ensure that vehicle performance meets the standards in force, and delivers real and ongoing fuel consumption savings. This broad definition distinguishes itself from the narrow legal definition that equates “compliance” with strict interpretation of certification or type-approval fuel consumption limits (Yang, 2017).

⁴⁹ Brazil, California, Canada, Chile, China, European Union, France, Germany, India, Japan, Korea, Mexico, United Kingdom and United States.

Table 7 • Regulatory authority for vehicle fuel efficiency in major markets

Country	Legislation	Authorised function*				
		Establish standards	Establish compliance method	Issue, suspend or withdraw type-approval	Recall mandate	Impose fines
Brazil	Law No. 8723/1993; Law 140/2011	✓	✓	✓		
	Decree 4059/2001	✓	✓			
Canada	Canadian Environmental Protection Act (1999)	✓	✓	✓**		
	Environmental Violations Administrative Monetary Penalties Act (2009)					✓ (Draft)
China	Energy Law (1997)	✓	✓	✓		
European Union	Framework for the type-approval of vehicles (2007/46/EC)	✓	✓		✓ (Sep 1 2020)	✓ (Sep 1 2020)
	Directive 98/69/EC		✓			
India	Central Motor Vehicle Act (1988)	✓	✓			
	Central Motor Vehicle Rules (1989)	✓	✓	✓		
Japan	Road Vehicle Act (1972)	✓	✓	✓	✓	✓
	Act on the Rational Use of Energy (1979)	✓				
Korea	Clean Air Conservation Law (1990)	✓	✓	✓	✓	✓
	Low-Carbon Green Growth Law (2011)	✓	✓			
Mexico	Federal Ministry of Environment & Natural Resources Internal Rule	✓	✓ (new vehicle)	✓		
United States	Clean Air Act (1970)	✓	✓	✓	✓	✓
	Energy Security and Independence Act (2007)	✓	✓			

Notes: * Legislation either specifies the details of the function or authorises agencies to establish relevant regulations.

** Canada does not issue certificates but rather accepts US EPA certificates to reduce administrative burden on companies. In the case of vehicles that are not US EPA certified, Canadian regulations require companies to submit evidence of conformity for review prior to introducing the vehicles into market.

Source: Yang et al., (2017).

Key point: Nearly all large vehicle markets have a regulatory structure to set standards and compliance methods, whereas enforcement capabilities are less wide spread.

In addition to a legislative framework, an effective regulatory framework is needed for compliance and enforcement. While the legislation empowers agencies to carry out compliance and enforcement of fuel economy standards, the regulatory framework determines the detailed provisions that equip an agency to carry out compliance activities. For example, a comprehensive regulatory framework would include a method to select representative vehicles to determine compliance with fuel economy targets, design proper procedures to determine road-loads and weights for vehicle testing, and require manufacturers to report the coast down test results and road-load factor used for type-approval testing. These would help streamline the compliance and enforcement procedures for both regulatory agencies and manufacturers. To date, only a few countries, e.g. Korea and United States, have elaborated such a comprehensive framework for implementing fuel economy standards.

Compliance monitoring for fuel economy standards

Monitoring activities are necessary to ensure compliance with vehicle regulatory requirements, deter non-compliance and to identify cases of non-compliance. The three main ones are:

Pre-production compliance requires a vehicle model to demonstrate conformity with applicable fuel economy standards. Based on evidence submitted by a manufacturer and, sometimes, a regulatory agency's investigation, the authorised agency issues a type-approval certification (or similar) that allows the vehicle model to enter the market.

In-production compliance, typically called conformity of production, ensures that vehicles in a production line or for sale at an auto retailer are in accordance with the approved specifications in the pre-production application. The required testing of in-production vehicles is typically the same as in the type-approval test. A regulatory agency may conduct additional coast down testing to verify vehicle road-load factor used for testing.

Post-production compliance ensures that vehicles meet applicable standards after they enter the market and are used in real driving. (Some countries use the terms "in-use compliance or in-service compliance".) Post-production compliance can identify issues that pre-production and in-production testing cannot. For example, it can verify the durability of key efficiency technologies, and identify vehicles with abnormal high fuel consumption due to poor design and defects that are may be the fault of the manufacturer.

A review of the application of such compliance activities in the major vehicle markets (China, European Union, Japan and United States) highlights that there is significant scope for improvement in current practices. This is particularly the case in China and the European Union. It suggests that compliance and enforcement practices are the most robust in the United States. (See Annex B for country-specific details.)

Enforcement of fuel economy standards

Enforcement activities are essential to achieve widespread compliance with fuel economy standards. They are necessary when vehicles or fleets are found to be non-compliant and intervention is needed to hold responsible parties accountable and to correct the situation. They include restrictions to the type-approval of vehicle models, financial penalties and recalls (Yang et al., 2017). Type-approval restrictions are possible in China. Financial penalties for failure to meet fleet-average CO₂ emissions requirements are possible in the European Union. Recalls are possible in the United States in the context of its strong regulatory framework. Starting in September 2020, recalls will be possible in the European Union in combination with fines per non-compliant vehicle. Financial penalties per non-compliant vehicle are authorised in Japan. (Details on the instruments available for the enforcement of fuel economy standards in major markets are included in Annex B.)

Real driving fuel economy for electric vehicles

Compliance and enforcement of fuel economy standards as they apply to electric vehicles is a new challenge for regulators. In most countries, the fuel consumption or CO₂ emissions of the electric component of electric vehicles (EVs) is counted as zero during type-approval testing. Thus, rather than fuel consumption, the issue at question for EVs is the manufacturer's stated all-electric driving range. The all-electric driving range, which is related to energy consumption, is taken especially seriously by consumers because it determines the how far a vehicle can be driven before needing to be charged.

Page | 64

There are a number of reasons of why the actual on-road performance of EVs is important in the context of this report. They include:

- Considering the need to accurately portray EV capabilities to consumers, gaps of driving ranges between real driving and testing values can reduce consumer confidence in test results, damaging the credibility of the type-approval systems.
- Some fuel economy regulations give credits to EVs, usually in form of multipliers, based on their electric range for fleet-average fuel economy calculations. Thus, overestimating electric driving range may lead to a significant over allocation of credits, which would significantly reduce environmental benefits of fuel economy regulations (Lutsey, 2017).
- Although most countries have not yet taken account of upstream energy consumption of electricity consumed by EVs, the well-to-wheel fuel consumption of EVs is already accounted for in the US fuel economy standard for LDVs, and is under consideration in China and the European Union (US EPA and NHTSA, 2012; EC, 2014; MIT, 2014). As electric range directly translates into energy consumption (in kWh/km), underestimating real driving range means more charging, more electricity generation and eventually higher fuel consumption.

The difference between laboratory conditions and real driving conditions has a larger impact on the driving range for electric vehicle than on fuel consumption of conventional LDVs. According to the United States Department of Energy (US DoE), these values can be affected by driver habits, driving conditions (e.g. speed changes, road gradient) and ambient temperature (Energy.gov, 2018). Small changes in auxiliary load (i.e. heat/cool the vehicle interior), road gradient or speed can have a large impact on the electric range of vehicles (Wager, 2016; Liu, 2017).

Vehicle fuel consumption in city and highway driving conditions

Regenerative braking is a crucial technology that enables battery-electric vehicles (BEVs) and other EVs to have much narrower fuel economy gaps between urban and highway operation than internal combustion engine (ICE) vehicles (Figure 47). The reason is that vehicles tend to have higher fuel consumption in urban driving conditions due to more frequent acceleration, braking and idling, and that the absence of regenerative braking on conventional LDVs excludes the possibility to recover the energy available from the vehicle inertia. For lightweight BEVs, fuel consumption in city driving test cycles is even lower than in the highway cycle, given the limited role played by aerodynamic forces and the large portion of energy from inertial forces that can be recovered.

Figure 46 • Ratio of vehicle fuel consumption in city and highway test cycles by weight class, 2017

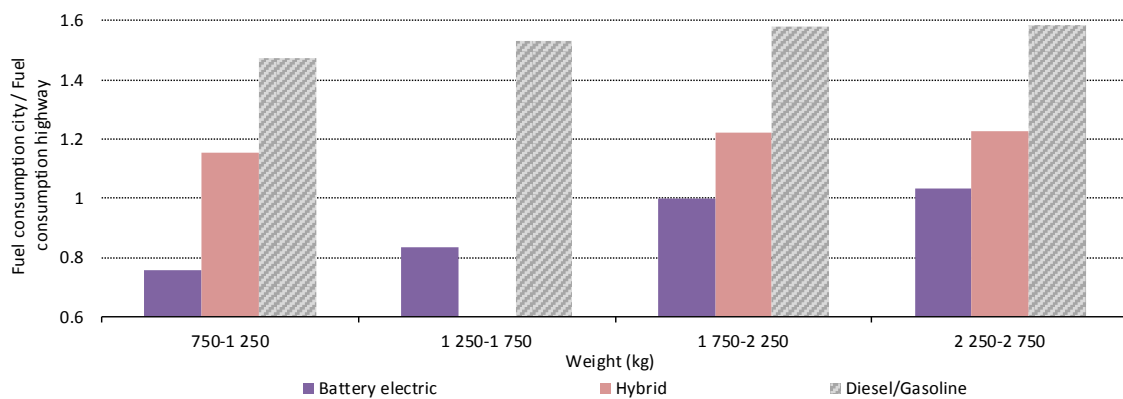

Notes: Data refer to vehicles tested in the United States for both the city highway cycles. BEVs used for the tests were Mitsubishi i-Miev, Nissan Leaf, Tesla Model S and Tesla Model X. Hybrids used for the tests were the Toyota Prius C, Toyota Prius, Audi Q5 and Volvo XC90. Diesel/gasoline models used for the tests were Toyota Yaris, Ford Focus, Jaguar F-Pace and Chevrolet Silverado 1500. A value of higher than 1 means that the city cycle is more energy consuming than the highway cycle.

Source: US EPA (2018a).

Key point: Lightweight BEVs have lower energy consumption in the city test cycle, while heavier ones have similar consumption in city and highway test cycles. Conventional LDVs consume more in the city test cycle.

As for highway driving, the higher speed profile has significant impact fuel consumption of BEVs. An analysis of the Nissan Leaf model found that the range of all-electric driving reduced 21-26% when the travelling speeds increased from 50 km/hour to 80 km/hour (Wager, 2016). As the WLTP is a more dynamic testing procedure and has a higher maximum speed for the highway test cycle, the all-electric driving range under WLTP is expected to be reduced by approximately 25% with respect to the NEDC-based range (Riemersma, 2017).

Impacts of auxiliary loads on fuel economy

Since EVs require roughly three-times less energy to drive the same distance as conventional vehicles, the impact of auxiliary loads is much larger in EVs as a percentage of total energy consumption. The percent gap in fuel use per kilometre due to air conditioning loads can increase energy consumption in EVs by up to 30% (Yuksel, 2015), thus reducing the driving range by the same share. Similar issues may arise with highly automated driving technologies such as LIDAR systems, where on-board equipment and sensors can draw up to 2 kW, negatively impacting fuel economy and driving range (Clean Technica, 2017; ICCT, 2018a; The Verge, 2017).

Heating loads are a slightly different issue. ICE vehicles can heat the interior cabin with the waste thermal energy of the engine so there is no additional auxiliary load. On the other hand, EVs experience high auxiliary loads with cold outside temperature conditions as the cabin is heated with energy from the battery through a heat pump.

For EVs, auxiliary loads are particularly important because they affect the driving range by increasing the energy consumption. Typically, auxiliary loads can decrease the standard range by 5-25% with the highest reduction experienced in areas that have either very high or very low median temperatures. Depending on how much the internal combustion part of the powertrain is used, plug-in hybrid vehicles (PHEVs) in real driving are subject to a lesser extent than BEVs.

Compared to BEVs that only use electricity as the power source, PHEVs provide a specific challenge to the type-approval testing process. PHEVs use two different energy sources, fuel and electricity, and the relative shares between these two depend on factors such as how the vehicle is driven and recharged. Therefore, PHEV owners may find that the fuel consumption values are better or worse than advertised and the advertised electric range is higher than what they experience in actual driving.

Procedures to determine fuel consumption for PHEVs vary under the NEDC, WLTP and the US CAFE testing protocols:

- A comprehensive study on real driving PHEV use (Ligterink, 2015) found that company car drivers in the Netherlands on average only covered about 30% of the type-approval electric mileage with electric drive in real driving and observed a decreasing trend in the electric drive share. The fuel consumption ratio between actual on-road performance and type-approval value from the PHEVs tracked during the study increased from 169% to 176% from 2013 to 2015. Similar real driving gaps were observed in the United Kingdom where the average fuel consumption of PHEVs used in corporate fleets was 225% higher per kilometre than the test values suggest (BBC, 2018).⁵⁰ In addition to the type-approval testing procedure, the United States corrects the fuel consumption and electric driving range values on fuel economy labels, visible to consumers on window stickers at auto retailers, to better reflect the actual on-road performance. For most PHEVs and BEVs, the corrected fuel economy and driving range values in the United States are 30% worse than the type-approval values.
- As the WLTP uses a utility factor to determine the range instead of a fixed value as in the NEDC, WLTP is likely to be more reflective of actual driving conditions, meaning a smaller fuel consumption gap for PHEVs is likely with the shift from NEDC to WLTP around 2020.

Various test procedures lead to differences in electric driving range and fuel consumption/CO₂ emissions values of EVs. A direct comparison of PHEVs in the European Union and the United States is difficult, because technical characteristics of the same vehicle model may vary in those markets. With this caveat, Table 8 provides a rough comparison for two PHEV models:

Table 8 • Comparison of PHEV electric driving range and energy consumption under different test procedures

Model	Specification	NEDC	WLTP	US CAFE	US label
2016 Porsche Cayenne 3 L PHEV	Driving range	38 km	/	32 km	22.5 km
	CO ₂ emissions	79 g/km	/	/	160 g/km
2018 BMW i3 94ah	Driving range	290-300 km	235-255 km	261 km	183 km

Sources: Porsche (2018); BMW (2018).

Key point: The average range of a PHEV can be more than 30% lower in real driving conditions relative to test results.

⁵⁰ On the other hand, consumers using PHEVs for private use seem to drive more in electric mode. In Sweden, PHEV users on average drive more than 70% on electric mode (Teknikens Värld, 2018).

References

- Ademe. (2017). *Consommations Conventionnelles de Carburant et Emissions de CO₂* (Consumption of conventional fuels and CO₂ emissions). Paris: Ademe.
- BBC. (2018). Government-subsidised plug-in cars may never have been charged. www.bbc.com/news/business-46152853
- BMW. (2018, December 6). Autonomie, recharge et efficience avec la nouvelle BMW i3 et la nouvelle BMW i3s (Autonomy, recharging and efficiency with the new BMW i3 and the new BMW i3s). www.bmw.fr/fr/tous-les-modeles/bmw-i/i3/2017/autonomie-recharge-efficience.html
- Clean Technica. (2017, October 13). Autonomous Cars Have Shorter Range Due To High Power Consumption By Computers. <https://cleantechnica.com/2017/10/13/autonomous-cars-shorter-range-due-high-power-consumption-computers/>
- Cui, H. (2018, January 11). China's New Energy Vehicle mandate policy (final rule). www.theicct.org/publications/china-nev-mandate-final-policy-update-20180111
- Ding, D., Dror, M.B., Kang, L., An, F. (2015, August 10). Real-world and certified fuel consumption gap analysis. www.efchina.org/Attachments/Report/report-ctp-20150810/real-world-and-certified-fuel-consumption-gap-analysis
- Dornoff, J., Miller, J., Mock, P., Tietge, U. (2018, January 9). The European Commission regulatory proposal for post-2020 CO₂ targets for cars and vans. www.theicct.org/publications/ec-proposal-post-2020-co2-targets-briefing-20180109
- EC. (2009, June 5). REGULATION (EC) No 443/2009 OF THE EUROPEAN PARLIAMENT AND OF THE COUNCIL of 23 April 2009 setting emission performance standards for new passenger cars as part of the Community's integrated approach to reduce CO₂ emissions from light-duty vehicles. <https://eur-lex.europa.eu/legal-content/EN/TXT/PDF/?uri=CELEX:32009R0443&from=EN>
- EC. (2011, May 31). REGULATION (EU) No 510/2011 OF THE EUROPEAN PARLIAMENT AND OF THE COUNCIL of 11 May 2011 setting emission performance standards for new light commercial vehicles as part of the Union's integrated approach to reduce CO₂ emissions from light-duty vehicles. <https://eur-lex.europa.eu/legal-content/EN/TXT/PDF/?uri=CELEX:32011R0510&from=EN>
- EC. (2014, April 5). REGULATION (EU) No 333/2014 OF THE EUROPEAN PARLIAMENT AND OF THE COUNCIL of 11 March 2014 amending Regulation (EC) No 443/2009 to define the modalities for reaching the 2020 target to reduce CO₂ emissions from new passenger cars. <https://eur-lex.europa.eu/legal-content/EN/TXT/PDF/?uri=CELEX:32014R0333&from=EN>
- EC. (2018). Proposal for a REGULATION OF THE EUROPEAN PARLIAMENT AND OF THE COUNCIL setting CO₂ emission performance standards for new heavy-duty vehicles. Brussels: European Commission. <https://eur-lex.europa.eu/legal-content/EN/TXT/?uri=COM:2018:284:FIN>
- EC. (2018a, May 17). Proposal for a REGULATION OF THE EUROPEAN PARLIAMENT AND OF THE COUNCIL setting CO₂ emission performance standards for new heavy-duty vehicles. <https://eur-lex.europa.eu/>: <https://eur-lex.europa.eu/legal-content/EN/TXT/?uri=COM:2018:284:FIN>
- EC. (2018b, November 23). Proposal for post-2020 CO₂ targets for cars and vans. https://ec.europa.eu/clima/policies/transport/vehicles/proposal_en
- EEA. (2018). Motor vehicle registrations in the EU. www.eea.europa.eu/: www.eea.europa.eu/data-and-maps/data/external/motor-vehicle-registrations-in-the-eu

- Energy.gov. (2018, September 21). Maximizing electric cars' range in extreme temperatures: <https://energy.gov/eere/electricvehicles/maximizing-electric-cars-range-extreme-temperatures>
- Energy.gov. (2018). Maximizing electric cars' range in extreme temperatures. Retrieved from www.energy.gov: www.energy.gov/eere/electricvehicles/maximizing-electric-cars-range-extreme-temperatures
- European Parliament. (2018, December 18). Emission performance standards for new passenger cars and for new light commercial vehicles. <http://www.europarl.europa.eu/news/en/press-room/20181218IPR22101/curbing-co2-emissions-from-cars-agreement-with-council>
- Garg, M. and Sharpe, B. (2017). Fuel consumption standards for heavy-duty vehicles in India. Washington DC: International Council on Clean Transportation. www.theicct.org/sites/default/files/publications/ICCT_India-HDV-fuel-consumption_policy-update_20171207.pdf
- GFEI. (2018). GFEI Working Paper 17 – Wider, Taller, Heavier: Evolution of Light Duty Vehicle Size over Generations. London: Global Fuel Economy Initiative.
- GFEI and IEA. (2012). GFEI Working Paper 8: International comparison of light-duty vehicle fuel economy. London/Paris: GFEI/IEA.
- GFEI and IEA. (2014). GFEI Working Paper 11: International comparison of light-duty vehicle fuel economy: Evolution over 8 years from 2005 to 2013. London/Paris: GFEI/IEA.
- GFEI and IEA. (2017). GFEI Working Paper 15: International comparison of light-duty vehicle fuel economy 2005-2015: Ten years of fuel economy benchmarking. London/Paris: Global Fuel Economy Initiative/IEA.
- GIZ. (2017, March 1). Non-Alternative Facts on International Fuel Prices in 2016. www.giz.de/expertise/downloads/giz2017-en-ifp2016-2017.pdf
- GIZ. (2018, September 11). International Fuel Prices. Retrieved from Energypedia: https://energypedia.info/wiki/International_Fuel_Prices
- Government of Canada. (2014, October 8). Regulations Amending the Passenger Automobile and Light Truck Greenhouse Gas Emission Regulations P.C. 2014-935. www.gazette.gc.ca/rp-pr/p2/2014/2014-10-08/html/sor-dors207-eng.html
- Government of Canada. (2018). Greenhouse gas emissions performance for 2011 to 2016 light-duty vehicles. www.canada.ca/en/environment-climate-change/services/canadian-environmental-protection-act-registry/greenhouse-gas-emissions-performance-2011-2016.html
- Government of India. (2014, January 30). Gazette of India REGD. NO. D. L.-33004/99, 2014. www.egazette.nic.in/WriteReadData/2014/158019.pdf
- Government of India. (2015, April 23). Gazette of India REGD. NO. D. L.-33004/99, 2015. www.egazette.nic.in/WriteReadData/2015/163817.pdf
- Government of Japan. (2018, November 26). About the automobile-related tax system (eco car tax reduction, greening special exception etc.). www.mlit.go.jp/jidosha/jidosha_fr1_000028.html
- Greene, D.L., Khattak, A., Liu, J., Hopson, J.L., Wang, X., Goeltz, R. (2015). How do motorists' own fuel economy estimates compare with official government ratings? A statistical analysis. http://bakercenter.utk.edu/wp-content/uploads/2015/09/BR_Greene_4-15.pdf

- He, H., Jin, L. (2017, April). A historical review of the U.S. vehicle emission compliance program and emission recall cases. www.theicct.org/sites/default/files/publications/EPA-Compliance-and-Recall_ICCT_White-Paper_12042017_vF.pdf
- Huo, H., Yao, Z., He, K., Yu, X. (2011). Fuel consumption rates of passenger cars in China: Labels versus real-world. *Energy Policy*, 7130-7135.
- ICCT. (2014). Development of test cycle conversion factors among worldwide light-duty vehicle CO2 emission standards. Washington DC: International Council on Clean Transportation.
- ICCT. (2017, July 28). Too low to be true? How to measure fuel consumption and CO2 emissions of plug-in hybrid vehicles, today and in the future. www.theicct.org/sites/default/files/publications/EU-PHEV_ICCT-Briefing-Paper_280717_vF.pdf
- ICCT. (2018a, November 26). Passenger vehicle fuel economy - Data tables. www.theicct.org/chart-library-passenger-vehicle-fuel-economy
- ICCT. (2018a, January 16). The future of transportation: autonomous and...internal combustion? www.theicct.org/blog/staff/future-transportation-autonomous-internal-combustion
- ICCT. (2018b, May 25). China's new energy vehicle mandate policy (final rule). www.theicct.org/sites/default/files/publications/China_NEV_mandate_PolicyUpdate%20_20180525.pdf
- ICCT. (2018c, November 26). Passenger vehicle fuel economy – Data tables. www.theicct.org/chart-library-passenger-vehicle-fuel-economy
- ICCT. (2018c, January 16). The future of transportation: autonomous and...internal combustion? www.theicct.org/blog/staff/future-transportation-autonomous-internal-combustion
- ICCT. (2018d, November 27). Official fuel efficiency and CO₂ emission data sources. www.theicct.org/node/1440
- IEA. (2018a). Mobility Model (database). Paris: OECD/IEA. www.iea.org/etp/etpmodel/transport/
- IEA. (2018b). Global EV Outlook 2018. Paris: OECD/IEA. <https://webstore.iea.org/global-ev-outlook-2018>
- IEA. (2018c). Energy Efficiency 2018: Analysis and Outlooks to 2040. Paris: OECD/IEA.
- IEA. (2018c). Nordic EV Outlook 2018. Paris: OECD/IEA. <https://webstore.iea.org/nordic-ev-outlook-2018>
- IEA. (2018d). Energy Efficiency 2018: Analysis and Outlooks to 2040. Paris: OECD/IEA.
- IEA. (2018e). World Energy Outlook 2018. <https://webstore.iea.org/world-energy-outlook-2018>
- IEA-HEV TCP. (2017). Hybrid and Electric Vehicles. IEA HEV.
- IEA-HEV. (2018, September 11). Turkey – Policies and Legislation. IEA-HEV TCP: www.ieahev.org/by-country/turkey-policy-and-legislation/
- IHS Markit. (2018, June 1). Vehicle Registrations and Other Characteristics at Model Level (database). <https://ihsmarkit.com/btp/polik.html>
- JAMA. (2018). The Motor Industry of Japan 2018. www.jama.org/wp-content/uploads/2018/07/mij2018.pdf
- Japantimes. (2017, January 27). Mitsubishi Motors faces ¥480 million fine over false fuel economy claims. www.japantimes.co.jp/news/2017/01/27/business/mitsubishi-motors-faces-¥480-million-fine-false-fuel-economy-claims/#.W6u9DBNKjbc

- Smokers, R., Kadijk, G.V., Dekker, H. (2012). Supporting Analysis regarding Test Procedure Flexibilities and Technology Deployment for Review of the Light Duty Vehicle CO2 Regulations. https://ec.europa.eu/clima/sites/clima/files/transport/vehicles/cars/docs/note_2012_en.pdf
- Kudoh, Y. (2012, November 14). Understanding Fuel Consumption/Economy of Passenger Vehicles in the Real World. www.intechopen.com/books/internal-combustion-engines/understanding-fuel-consumption-economy-of-passenger-vehicles-in-the-real-world
- Kühlwein, J. (2016, May 9). Official vs. real-world road-load parameters in EU vehicle efficiency testing. www.theicct.org/publications/official-vs-real-world-road-load-parameters-eu-vehicle-efficiency-testing
- Ligterink, N., Eijk, A.R.A. (2014). Update analysis of real-world fuel consumption of business passenger cars based on Travelcard Nederland fuelpass data. <https://www.tno.nl/nl/aandachtsgebieden/mobiliteit-logistiek/roadmaps/mobility-logistics-digitalisation/duurzame-mobiliteit/verbeteren-luchtkwaliteit-door-monitoring-werkelijke-uitstoot/overzicht-rapporten-praktijkverbruik-personenauto-s/>
- Ligterink, N.E., Smokers, R.T.M. (2015, January 11). Monitoring van plug-in hybride voertuigen (PHEVs) april 2012 t/m maart 2015. <http://repository.tudelft.nl/view/tno/uuid%3A72869589-afaf-41a9-9e1a-2dd0d0f05061/>
- Liu, K., Yamamoto, T., Morikawa, T. (2017). Impact of road gradient on energy consumption of electric vehicles. *Transportation Research Part D* 54, 74-81.
- Lutsey, N. (2017, June 22). Integrating electric vehicles within U.S. and EU efficiency regulations. www.theicct.org/integrating-EVs-vehicle-CO2-regs
- Maxwell, R., He, H. (2012, March 9). In-use Testing for CO2 and Fuel Economy in the United States. www.theicct.org/publications/use-testing-co2-and-fuel-economy-united-states
- Mellios, G., Hausberger, S., Keller, M., Samaras, C., Ntziachristos, L. (2011). Parametrization of fuel consumption and CO2 emissions of passenger cars and light commercial vehicles for modelling purposes. http://publications.jrc.ec.europa.eu/repository/bitstream/111111111/22474/1/co2_report_jrc_format_final2.pdf
- MIIT. (2014, December 22). Fuel consumption evaluation methods and targets for passenger cars. GB 27999-2014. www.miiit.gov.cn/n1146295/n1652858/n1653018/c3780606/part/3780613.pdf
- MIIT. (2017, September 27). Parallel Management regulation for corporate average fuel consumption and new energy vehicle credits for passenger cars. Retrieved from www.miiit.gov.cn/: www.miiit.gov.cn/n1146295/n1146557/n1146624/c5824932/content.html
- MIIT. (2019, January 24). Publicly solicited opinions on the mandatory national standards “Living Vehicle Fuel Consumption Limits” and “Pedestrian Vehicle Fuel Consumption Evaluation Methods and Indicators” (Draft for Comment). www.miiit.gov.cn/n1146295/n1652858/n1653100/n3767755/c6616494/content.html
- MIIT. (2017, September 29). Parallel management regulation for corporate average fuel consumption and new energy vehicle credits for passenger cars. www.miiit.gov.cn/n1146295/n1146557/n1146624/c5824932/content.html
- Mock, P., German, J. (2015, November 23). The future of vehicle emissions testing and compliance. www.theicct.org/publications/future-vehicle-emissions-testing-and-compliance
- Mock, P. (2015, September 9). Vehicle emissions testing in the EU: Why we are still struggling with the dead hand of the past- and what the future is likely to bring. www.theicct.org/blogs/staff/vehicle-co2-testing-eu-still-struggling

- Mock, P. (2018, May 29). Changes to the motor vehicle type-approval system in the European Union. www.theicct.org/publications/changes-to-EU-motor-vehicle-type-approval-system
- Mock, P. (2012). Discrepancies between type-approval and "real-world" fuel consumption and CO₂ values. Washington DC: International Council on Clean Transportation.
- Mock, P. et al. (2012, April 4). Discrepancies between type-approval and real-world fuel consumption and CO₂ values in 2001-2011 European passenger cars. www.theicct.org/publications/discrepancies-between-type-approval-and-real-world-fuel-consumption-and-co2-values-2001
- NHTSA. (2010, January 10). Corporate Average Fuel Economy (CAFE) - Enforcement Programs for Footprint Calculations and Credit Tracking and Allocation. www.nhtsa.gov/sites/nhtsa.dot.gov/files/hicks_sae2010.pdf
- NHTSA. (2017, July 12). 49 CFR Part 578 [Docket No. NHTSA-2017-0059]. www.gpo.gov/fdsys/pkg/FR-2017-07-12/pdf/2017-14525.pdf
- NSW Government. (2018, November 21). Registration costs and concessions. www.rms.nsw.gov.au/roads/registration/fees/
- Ntziachristos, L. et al. (2014). In-use vs. type-approval fuel consumption of current passenger cars in Europe. *Energy Policy*, 67, 403–411.
- OICA. (2018, October 31). 2005-2017 Sales Statistics. www.oica.net/category/sales-statistics/
- Porsche. (2018, December 6). Cayenne E-Hybrid. www.porsche.com/france/models/cayenne/cayenne-e-hybrid-models/cayenne-e-hybrid/
- Qin, L. et al. (2016, September). Real-world and certified fuel consumption gap analysis. www.icet.org.cn/admin/upload/2016092336232621.pdf
- Queensland Government. (2018, November 21). About vehicle registration duty. www.qld.gov.au/transport/registration/fees/duty/about
- Regulations.gov. (2018, October 26). Rulemaking to Revise Light-Duty Vehicle Greenhouse Gas Emission Standards and Corporate Average Fuel Economy Standards. www.regulations.gov/docket?D=EPA-HQ-OAR-2018-0283
- Reuters. (2019). China car sales hit reverse for first time since 1990s. www.reuters.com/article/us-china-autos-idUSKCN1P805Z
- Riemersma, I., Mock, P. (2017, July 28). Too low to be true? How to measure fuel consumption and CO₂ emissions of plug-in hybrid vehicles, today and in the future. www.theicct.org/publications/too-low-be-true-how-measure-fuel-consumption-and-co2-emissions-plug-hybrid-vehicles
- Rutherford, D. (2014, April 4). Hybrids break through in the Japan auto market. www.theicct.org/blog/staff/hybrids-break-through-japan-auto-market
- SEGOB. (2013). NOM-163-SEMARNAT-ENER-SCFI-2013. http://dof.gob.mx/nota_detalle.php?codigo=5303391&fecha=21/06/2013
- SEGOB. (2018). Modification to NOM-163-SEMARNAT-ENER-SCFI-201. https://dof.gob.mx/nota_detalle.php?codigo=5539494&fecha=28/09/2018
- Serrenho, A.C., Norman, J.B., Allwood, J. (2017). The impact of reducing car weight on global emissions: The future fleet in Great Britain. *Philos Trans A Math Phys Eng Sci*.
- Sovran, G., Blaser D. (2003). A contribution to understanding automotive fuel economy and its limits. SAE Government/Industry Meeting. Washington D.C.: SAE International.

- State of California. (2018). Governor Brown takes action to increase zero-emission vehicles, fund new climate investments. www.gov.ca.gov/2018/01/26/governor-brown-takes-action-to-increase-zero-emission-vehicles-fund-new-climate-investments/
- Stewart, A. (2015, September 7). Impact of real-world driving on emissions from United Kingdom cars and vans. [www.theccc.org.uk: www.theccc.org.uk/publication/impact-of-real-world-driving-emissions/](http://www.theccc.org.uk/publication/impact-of-real-world-driving-emissions/)
- Teknikens Värld. (2018). Svenska laddhybrider laddas ofta (Swedish PHEVs charge often). <https://teknikensvarld.se/svenska-laddhybrider-laddas-ofta/>
- The Verge. (2017, December 12). Not all of our self-driving cars will be electrically powered — Here's why. www.theverge.com/2017/12/12/16748024/self-driving-electric-hybrid-ev-av-gm-ford
- Tiege, U. et al. (2017). From laboratory to road – A comparison of official and real-world fuel consumption and CO2 values for passenger cars in Europe, the United States, China and Japan. Washington DC: International Council on Clean Transportation.
- Tietge et al. (2017, May 11). From laboratory to road – A 2017 update. www.theicct.org/publications/laboratory-road-2017-update
- Tietge, U., Diaz, S., Mock, P., German, J., Bandivadekar, A. (2016, May 16). From laboratory to road – A 2016 update. www.theicct.org/laboratory-road-2016-update
- Tietge, U., Diaz, S., Yang, Z., Mock, P. (2017, May 11). From laboratory to road international: A comparison of official and real-world fuel consumption and CO2 values for passenger cars in Europe, the United States, China, and Japan. www.theicct.org/publications/laboratory-road-intl
- Tietge, U., Diaz, S., Mock, P., Bandivadekar, A., Dornoff, J., Ligterink, N. (2019). From laboratory to road –A 2018 update. www.theicct.org/publications/laboratory-road-2018-update
- Tietge, U., Zacharof, N., Mock, P., Franco, V., German, J., Bandivadekar, A., Ligterink, N., Lambrecht, U. (2015, September 24). From laboratory to road – A 2015 update. <http://theicct.org/laboratory-road-2015-update>
- Transportpolicy.net. (2018a, November). Regions. www.transportpolicy.net/
- Transportpolicy.net. (2018b, November 23). South Korea: Light-duty: Fuel Economy and GHG. www.transportpolicy.net/standard/south-korea-light-duty-fuel-economy-and-ghg/
- Transportpolicy.net. (2018c, November 6). US: Fuels: Renewable fuel standard. www.transportpolicy.net/standard/us-fuels-renewable-fuel-standard/
- Transportpolicy.net. (2018d, November 26). Japan: Light-duty: Fuel economy. Retrieved from www.transportpolicy.net/: www.transportpolicy.net/standard/japan-light-duty-fuel-economy/
- Transportpolicy.net. (2018d, November 26). Japan: Light-duty: Fuel economy. www.transportpolicy.net/standard/japan-light-duty-fuel-economy/
- U.S. EPA. (2006). Fuel economy labelling of motor vehicle: Revisions to improve calculation of fuel economy estimates. www.epa.gov/carlabel/documents/420r06017.pdf
- UNECE. (2014, May 12). Global Technical Regulations (GTRs) No. 15. www.unece.org/fileadmin/DAM/trans/main/wp29/wp29r-1998agr-rules/ECE-TRANS-180a15e.pdf
- US DoE. (2018, 11 June). Biodiesel Production and Blending Tax Credit. www.afdc.energy.gov/laws/5831

- US DoE. (2018, November 11). Download Fuel Economy Data.
<https://fueleconomy.gov/feg/download.shtml>
- US DoE and US EPA. (2018, November 7). Find and Compare Cars.
www.fueleconomy.gov/feg/findacar.shtml
- US DoE and US EPA. (2018, November 7). Find and Compare Cars.
www.fueleconomy.gov/feg/findacar.shtml
- US EPA. (2015, September 18). Notice of Violation. www.epa.gov/sites/production/files/2015-10/documents/vw-nov-cao-09-18-15.pdf
- US EPA. (2018a). "U.S. EPA and DOT propose fuel economy standards for MY 2021-2026 vehicles. Washington, DC: United States Environmental Protection Agency.
www.epa.gov/newsreleases/us-epa-and-dot-propose-fuel-economy-standards-my-2021-2026-vehicles
- US EPA. (2018b). Renewable Fuel Standard Program. www.epa.gov/renewable-fuel-standard-program
- US EPA. (2018c). Greenhouse Gas (GHG) Emission Standards for Light-Duty Vehicles: Manufacturer Performance Report. www.epa.gov/regulations-emissions-vehicles-and-engines/greenhouse-gas-ghg-emission-standards-light-duty-vehicles
- US EPA. (2018d). Fuel Economy. www.epa.gov/fueleconomy
- US EPA and NHTSA. (2012, October 15). 2017 and Later Model Year Light-Duty Vehicle Greenhouse Gas Emissions and Corporate Average Fuel Economy Standards: Final Rule. www.gpo.gov/fdsys/pkg/FR-2012-10-15/pdf/2012-21972.pdf
- Wager, G., Whale, J. (2016). Driving electric vehicles at highway speeds: The effect of higher driving speeds on energy consumption and driving range for electric vehicles in Australia. *Renewable and Sustainable Energy Reviews* 63, 158-165.
- World Bank. (2018, October 31). GDP per capita (current USD).
<https://data.worldbank.org/indicator/NY.GDP.PCAP.CD?locations=AU-BR-CA-CL-CN-FR-DE-IN-ID-IT-JP-MX-RU-ZA-TH-TR-GB-US>
- XiaoXiongYouHao. (2018, November 7). Car fuel consumption ranking.
www.xiaoxiongyouhao.com/page_rank_chexi.php
- Yang, Z., Yang, L. (2018, June 21). Evaluation of real-world fuel consumption of light-duty vehicles in China. www.theicct.org/publications/real_world_fuel_consumption_ldv_China
- Yang, Z., Muncrief, R., Bandivadekar, A. (2017, November 14). Global baseline assessment of compliance and enforcement programs for vehicle emissions and energy efficiency.
www.theicct.org/publications/compliance-and-enforcement-global-baseline
- Yang, Z., Zhu, L., Bandivadekar, A. (2016, January 27). Review and evaluation of vehicle fuel efficiency labeling and consumer information programs. Asia-Pacific Economic Cooperation.
https://www.theicct.org/sites/default/files/publications/VFEL%20paper%20ICCT_%20for%20APEC%20-%202012%20Nov%202015%20FINAL.pdf
- Yuksel, T., Michalek, J.J. (2015). Effects of Regional Temperature on Electric Vehicle Efficiency, Range, and Emissions in the United States. *Environ. Sci. Technol.*, 3974-3980.
- Zhang, S., Wu, Y., Liu, H., Huang, R., Un, P., Zhou, Y., Fu, L., Hao, J. (2014). Real-world fuel consumption and CO₂ (carbon dioxide) emissions by driving conditions for light-duty passenger vehicles in China. *Energy*, 247-257.

Annex A. Methodology: LDV fuel economy analysis

Data sources

The International Energy Agency – Global Fuel Economy Initiative (IEA-GFEI) database used for this report is a multi-year dataset. It has been developed based on information from the IHS Markit databases (releases in 2005, 2008 and every two years since 2010) and additional information extracted from numerous technical sources, such as those listed in Table A.1.

The IHS Markit databases contain information on the number of vehicles registered at the model level, as well as characteristics such as drivetrain, engine volume and power, valves per cylinder, fuel and transmission type, turbocharging, empty weight, fuel economy and carbon dioxide emissions per kilometre. Building from this, the complementary technical sources facilitated the integration of additional inputs into the IEA-GFEI database. These inputs were integrated hierarchically at the model level or at lower disaggregation levels (depending on the details available), starting with the models with the broadest market coverage and reaching to cover at least 80% of all markets, and all parameters discussed in this report.

Results presented here benefited significantly from the database enhancements developed for previous assessments (GFEI and IEA, 2017; GFEI and IEA, 2014; GFEI and IEA, 2012). This report incorporates the methodological changes introduced in the previous update of this work (GFEI and IEA, 2017). These cover passenger cars, passenger light trucks (comprising SUVs, pick-up trucks and large cars), as well as light-commercial vehicles (LCVs) and adopt normalisation of all fuel economy estimates to the Worldwide Harmonised Light-Duty Test Procedure (WLTP).¹

All fuel economy values for the years 2014-15 have been revised due to the availability of more technical databases. This revision has primarily affected Canada, India, Korea, Mexico and the United States. In addition, the fuel economy trend has been revised for the period between 2005 and 2015 for the United States and Canada. Indian data were revised for the period between 2012 and 2015. This means that there are some differences in average fuel economy values compared to the previous iteration of the report.

¹ Three test cycles are applied worldwide to measure specific fuel consumption (litres of gasoline equivalent per 100 kilometres) or fuel economy (miles per gallon or per kilometre/ litres of gasoline equivalent): the European Union New European Driving Cycle (NEDC), the US Corporate Average Fuel Economy (CAFE) and the Japan Cycle '08 (JC08). The Worldwide Harmonised Light-Duty Test Procedure (WLTP) and its related test cycle (WLTC) have been advanced (and are being refined) to replace region-specific approaches with a harmonised testing scheme (UNECE, 2014). The conversion of the results (published according to region-specific test results) was performed using conversion equations advanced by the ICCT (2014).

Table A.1 • Fuel economy and CO₂ emission data sources

Country	Data source
Australia	www.greenvehicleguide.gov.au/
Austria	www.autoverbrauch.at/ireds-133453.html
Brazil	http://pbeveicular.petrobras.com.br/TabelaConsumo.aspx www.inmetro.gov.br/consumidor/tabelas_pbe_veicular.asp
Canada	http://oe.nrcan.gc.ca/fcr-rcf/public/index-e.cfm http://oe.nrcan.gc.ca/fcr-rcf/public/index-e.cfm www.canada.ca/en/environment-climate-change/services/canadian-environmental-protection-act-registry/greenhouse-gas-emissions-performance-2011-16.html
Chile	www.consumovehicular.cl/
China	http://chinaafc.miit.gov.cn/n2257/n2280/index.html
European Union	www.eea.europa.eu/data-and-maps/data/co2-cars-emission-14
France	www.ademe.fr/consommations-carburant-emissions-co2-vehicules-particuliers-neufs-vendus-france
Germany	www.pkw-label.de/autokauf/tool-neufahrzeuge-finden.html#/suche
India	www.siamindia.com/uploads/filemanager/256th-4 W-FE-Data-Declaration.pdf
Japan	www.mlit.go.jp/jidosha/jidosha_mn10_000002.html
Korea	http://bpms.kemco.or.kr/transport_2012/main/main.aspx
Mexico	www.ecovehiculos.gob.mx/
New Zealand	www.energywise.govt.nz/tools/fuel-economy/
South Africa	www.naamsa.co.za/Emissions
Switzerland	http://katalog.automobilrevue.ch/
United Kingdom	http://carfueldata.direct.gov.uk/
United States	www.fueleconomy.gov/feg/download.shtml

Sources: GFEI and IEA (2017); ICCT (2018d).

Scope

The markets covered in this analysis represent more than 80% of worldwide light-duty vehicle (LDV) sales in 2017, and close to 90% when all monitored European Union member countries are included. The IEA-GFEI database holds more than 1.5 million records.

The allocation of models to the various size segments has been revised for this report in order to better understand recent trends in market segmentation, in particular the shift towards the large-size vehicle market segments. The underlying segmentation is the same as previous editions and is based on classes and vehicle body type information provided by IHS Markit data, aggregated into six categories: city car, medium car, large car, small SUV/pick-up truck, large SUV/pick-up truck and van/LCV. The allocation of models to each segment is not based on direct numerical indicators and, to some extent, is based on subjective interpretations. However, the segmentation has been applied across all countries and all years, and therefore gives useful insights into the evolving market shares of the various segments, as well as their average parameters.

Annex B. Fuel economy standards: real driving versus tested fuel economy gaps, compliance and enforcement in major vehicle markets

Real driving versus tested fuel economy gaps

This section summarises real driving versus tested fuel economy findings in the People's Republic of China ("China"), Europe, Japan and the United States. Standards set by the European Union and the United States also affect fuel economy standards in other markets, since their regulations and test procedures are used elsewhere.¹ Therefore, the findings in the European Union and the United States have relevance beyond their borders.

The estimation of the gap in each market compares large samples of real driving fuel consumption measurements. Findings are presented in terms of the divergence between official tested (or type approval) fuel economy and real driving fuel consumption values.

China

In China, there is growing evidence of gaps between laboratory test values for type-approval and real driving fuel consumption (Tiege et al., 2017). Huo (2011) found that real driving fuel consumption of new cars sold in China in 2009, based on data for 153 vehicle models, was about 16% higher than the type-approval value. Zhang (2014) measured real driving fuel consumption from 60 passenger cars in 2013 in three cities using PEMS equipment and found that real driving fuel consumption normalised to the European Union New European Driving Cycle (NEDC) test were 30% higher than type-approval figures. Ding (2015) and Qin (2016) analysed sample data collected from consumers and found increasing gaps between real driving and type-approval fuel consumption from 2008 to 2015.

Yang and Yang (2018) analysed recent consumer experience data collected by XiaoXiongYouHao, which is a mobile application that allows drivers to track and compare their fuel consumption (XiaoXiongYouHao, 2018). The analysis summarised 902 000 individual vehicles representing more than 7 000 vehicle model types with model years ranging from 2007 to 2017.

Based on consumer reported consumption data and type-approval fuel economy values, the average gap between real driving and type-approval values widened by around 21 percentage points between model year (MY) 2007 and MY 2017, reaching 34% in MY 2017 (Figure B.1). The increase in the gap has accelerated in recent years. The gap increased for both automatic and manual transmission LDVs, although those with automatic transmissions consistently exhibited a higher divergence.

¹ Brazil, Canada, Mexico and South Korea use United States test cycles, while India and China employ test procedures similar to European Union test cycles.

Figure B.1 • Gap between consumer reported fuel consumption and tested fuel economy values by transmission type in China, 2007-17

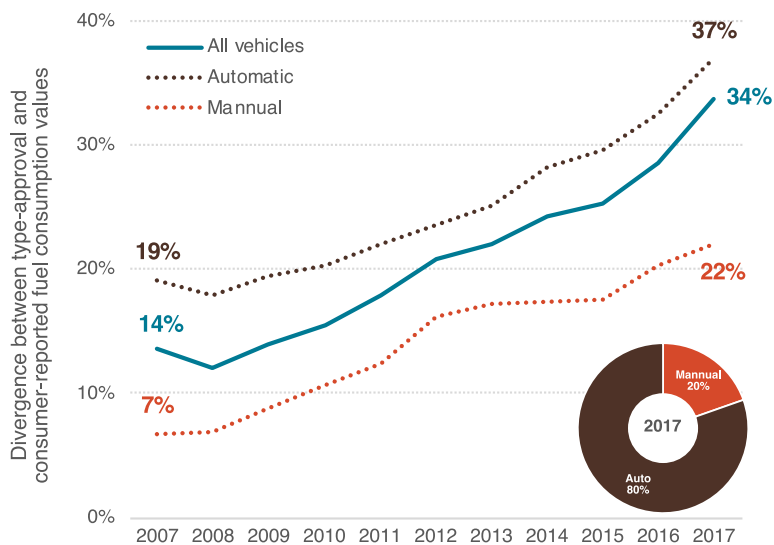

Sources: Yang and Yang (2018).

Key point: Real driving fuel consumption versus tested fuel economy gap more than doubled in ten years, most prevalent in manual transmission vehicles.

Aligning with increasing consumer preference for large vehicles and SUVs in China, there are changes in sample composition by segment. However, changes in market structure do not explain the increase in the average fuel consumption divergence over time as the fuel consumption gap increased across all segments (Yang and Yang, 2018).

Most fuel volume and odometer entries in the XiaoXiongYouHao application are assumed to be actual data that users input to track fuel consumption. There is no incentive for users to enter false data. The whole sample appears to provide a reasonable reflection of fuel economy in China’s new vehicle market with a potential bias of over representation of city driving because the use of smartphone apps for fuel expense recording may be more prevalent in urban areas. Nevertheless, the consistent data collection methods of the analysis enable the results to reflect the trend of the increasing divergence between real driving and type-approval fuel consumption over the decade.

European Union

A number of studies have observed an increasing gap between real driving and type-approval fuel consumption values of vehicles in the European Union fleet. Ligterink (2014) analysed real driving fuel consumption data from company cars in the Netherlands and found that the average divergence between real driving and type-approval fuel consumption values increased from approximately 10% in 2004 to 50% in 2013. Stewart et al. (2015) added a bottom-up analysis of the factors causing the gap and found that the divergence increased from around 10% in 2002 to about 35% in 2014. Mellios (2011) and Ntziachristos (2014) advanced a model to predict real driving fuel consumption of a given vehicle model based on vehicle specifications and found that actual fuel consumption of passenger cars tested between 2009 and 2011 on average was 11% and 16% higher than the type-approval fuel consumption values.

Tietge et al. (2017; 2019) provide a comprehensive estimate of the divergence between real driving and type-approval fuel consumption values in the European Union market using 15 data sources from 8 countries. A central estimate for the European Union, which combines analyses on approximately 1.3 million vehicles, indicates that the gap between real driving fuel consumption and tested fuel economy values of new passenger cars increased from approximately 9% in 2001

to 39% in 2017 (Figure B.2).² This central estimate involved calculating the annual average divergence from all private car data sources and company car (i.e. company purchased vehicles for either company or private use) data sets, and combing private and company estimates with equal weight under the assumption that the EU new car market consists of private and company cars in equal parts.

Figure B.2 • Gap between real driving and type-approval fuel consumption values in European Union member countries, 2001-17

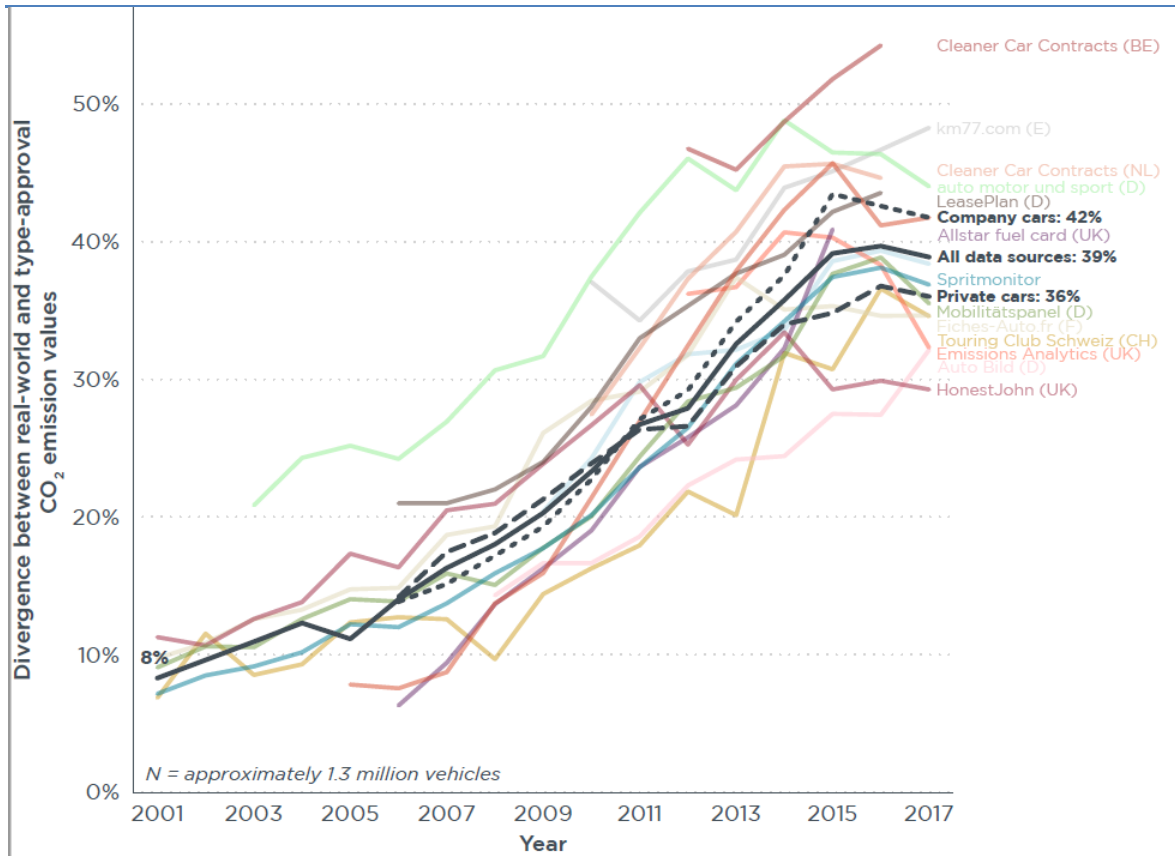

Note: The names in the graph refer to the original source of the data that was used to estimate the gap. More detailed information can be found in the cited source.

Sources: Tietge et al. (2019).

Key point: Divergence between real driving fuel consumption and tested fuel economy values in the EU LDV markets widened by up to 35 percentage points over 16 years.

These findings are robust given the considerable sample size, regional coverage and the heterogeneity of the data collected from consumers, company fleets and vehicle tests. Although the precise level of the gap varies from sample to sample, all data sources regardless of country, data collection methodology or vehicle ownership show a clear upward trend in the gap over time.

Japan

Tietge et al. (2017) estimated the gap between real driving and type-approval fuel consumption values using data from e-nenpi.com, a web service that allows users to monitor their fuel consumption by entering fuel quantity and odometer readings. Among a of handful studies on

² For the first time in years, in 2017 the average gap between real driving and type-approval test fuel consumption values for new LDVs in the European Union did not increase and was unchanged at 39%.

real driving fuel consumption in Japan, Kudoh (2012) observed a real driving fuel consumption shortfall of 32% in e-nenpi.com data from fiscal years 2001 to 2004.

Japan used a test cycle called “10-15 mode” from 1993 to 2004. A test procedure called the Japan Cycle '08 (JC08) was introduced in 2005 and fully phased in by October 2011 (Transportpolicy.net, 2018d). Compared to the 10-15 mode testing, JC08 is longer, has higher average and maximum speeds, and requires more acceleration that is aggressive. According to the Japanese government, the JC08 produces 10% higher fuel consumption values compared with 10-15 mode. The estimation of the real driving fuel consumption gap reflects this change in the test cycle (Tietge et al. 2017).

Tiege et al. (2017) analysed 47 000 cars from 2001 to 2014. The gap between the 10-15 mode values and real driving fuel consumption data is more or less constant for model years 2001 through 2007, after which there is a noticeable gap increase for both test cycles (Figure B.3). This development followed the introduction of the fuel economy targets for 2015 (agreed in 2007) and subsidies for vehicles exceeding the 2010 fuel economy standard by 15% or more, introduced in 2009 (Transportpolicy.net, 2018d; Government of Japan, 2018). The difference is even more pronounced when taking account of hybrid vehicles. Since the transition to the JC08 has made compliance with standards more difficult, the gap between real driving and test-approval fuel consumption values is lower under JC08 than the 10-15 mode. Nevertheless, the gap under JC08 increased from 24% in 2008 to 46% in 2014.

Figure B.3 • Gap between consumer reported fuel consumption and tested fuel economy values for model years 2001-15 in Japan

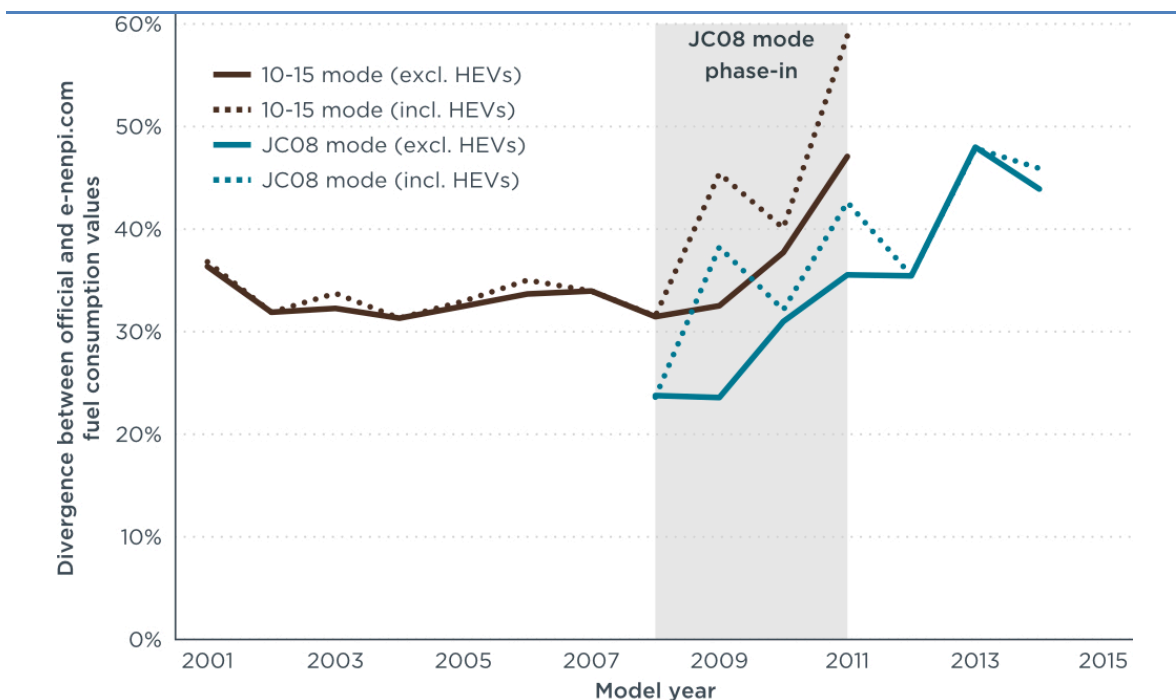

Notes: HEVs = hybrid electric vehicles. Two testing procedures, 10-15 mode and JC08, are shown. Consumer reported data are from e-nenpi.com.

Sources: Tietge et al. (2017).

Key point: The gap was about 35% between 2001 and 2007, after which it expanded with both testing procedures.

As for the representativeness of the e-nenpi.com sample, the data are skewed towards mid-sized cars, whereas Japan’s unique mini segment, mainly Kei cars, is significantly under represented. In addition, the size of the sample is relatively small, which further undermines the statistical significance of the analysis. Nevertheless, this estimate is among the first to tackle

the divergence between real driving and test-approval fuel consumption values in Japan's vehicle market and serves as a basis for subsequent research.

United States

An increasing divergence between real driving and test-approval fuel consumption values was concluded by Greene et al. (2015) and Tietge et al. (2017) based on data from *MyMPG*.

The US Department of Energy and the US Environmental Protection Agency (EPA) established and maintain *FuelEconomy.gov*, an online source for fuel economy information (US DoE and US EPA, 2018). The site aims to help consumers make informed fuel economy choices when purchasing vehicles and advises them on how to drive more efficiently. The site has an imbedded tool, *MyMPG*, which collects real driving fuel use and allows consumers to track their fuel consumption, and to compare it with fuel economy label values and input from other drivers. Tietge et al. (2017) estimated the gap between real driving and type-approval fuel consumption values in the US market using real driving records from *MyMPG* and the corresponding official information provided by the EPA. The study analysed 43 000 vehicles after eliminating invalid or incomplete records.

Two types of tested fuel economy values are available for LDVs in the United States. One is the CAFE values that are used for fuel economy standards, which are based on laboratory measurements of exhaust emissions during two driving cycles, the city cycle (FTP-75) and the US EPA Highway Fuel Economy Test Cycle (HWFET). The second is the fuel economy label values ("US EPA label values") that are provided at the point of purchase. EPA label values are meant to be representative of fuel consumption during actual driving. Before MY 2007, the label value was based on adjusting the FTP-75 fuel economy value down by 10% and the HWFET value down by 22% (US EPA, 2006). Since MY 2008, the label value has been based on a revised procedure, called the five-cycle method. This includes additional laboratory fuel consumption tests based on three cycles and a real driving adjustment factor.

Figure B.4 shows the trend in the gap between real driving and test-approval fuel consumption values of LDVs based on CAFE and EPA label values: the gap increased from around 16% in MY 2001 to 34% in MY 2015 for all LDVs. EPA label values more accurately reflect real driving fuel consumption data, but the gap between EPA and real driving fuel use also increased over time. Before MY 2008, the EPA label gap was consistently about 17 percentage points below the CAFE value gap, increasing from roughly 1% in MY 2001 to 4% in MY 2007. The new methodology, applied since MY 2008, produces the most realistic fuel consumption values, with estimates ranging from about 8% gap in MY 2008 to almost no gap in MY 2015.

Figure B.4 • Gap between consumer reported fuel consumption and tested fuel economy values of LDVs for model years 2001-15

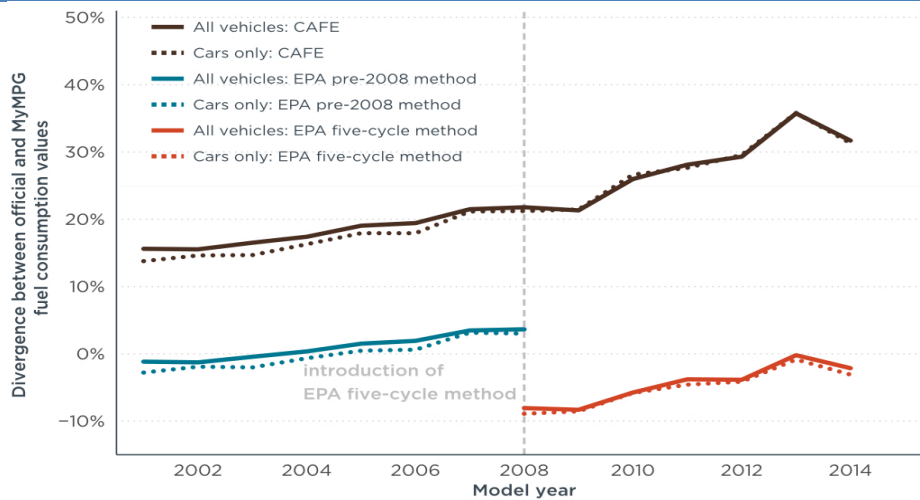

Note: Consumer reported data are from MyMPG.

Sources: Tietge et al. (2017).

Key point: The real driving performance gap has tripled under the CAFE test, whereas the EPA five-cycle method estimated higher fuel consumption than real driving since its introduction in 2008.

Similar to data representativeness in China, the consumer reported fuel consumption data may risk a self-selection bias, as the online service may attract consumers who are particularly concerned about fuel economy. However, the bias should be fairly consistent over time, so trends should be reasonably accurate. Greene et al. (2015) noted that the magnitude and direction of the gap was taken into account by the EPA.

Compliance requirements for fuel economy standards

China

In China, the Ministry of Industry, Information and Technology (MIIT) is responsible for implementing vehicle fuel economy standards.

Table B.1 • Compliance requirements for fuel economy standards in China

Pre-production

Manufacturers are required to conduct type-approval testing for LDVs at an authorised independent laboratory. Manufacturers pay laboratories directly to conduct tests and submit the data along with the claimed fuel consumption values in their application for type-approval. MIIT uses the approved fuel economy values to determine manufacturer compliance with the fleet-average fuel economy targets by the end of the year.

In-production

Manufacturers are required to ensure coefficient of performance (COP) of produced vehicles. Produced vehicles are allowed to consume up to 4% more than their certified fuel economy value. However, manufacturers are not required to prove that vehicles meet COP requirements.

Post-production

In-use surveillance testing requirements are not required to verify that vehicles meet the certified values throughout their useful life.

Source: ICCT analysis.

Key point: China has compliance requirements for pre-production and in-production, but none for post-production verifications.

MIIT has the authority to require sample vehicles or select produced vehicle from the production line to verify fuel economy values of in-production or new vehicles. However, there is no available evidence that such tests are carried out on a regular basis, or that any non-compliance has been discovered or published. Compared with increasing regulatory actions to verify compliance of vehicle emissions standards, compliance for fuel economy standards is falling behind (Yang et al., 2017).

European Union

For the European Union member states, the European Commission establishes the basic principles of compliance and empowers the member states to specify compliance methods, and to implement and enforce the regulations (EC, 2009; EC, 2011).

Table B.2 • Compliance requirements for fuel economy standards in the European Union

Pre-production

Type-approval CO₂ emissions testing in the European Union can be conducted or witnessed by the technical services certified by any member state. The authorised agency in each state issues a type-approval certificate based on test results from its certified technical services and recognises certificates from other type-approval authorities across the European Union. The test procedure switched from the New European Driving Cycle (NEDC) to the Worldwide Harmonised Light-Duty Test Procedure (WLTP) in 2017 to better align CO₂ emission values with real driving performance. However, the real driving emissions test procedure mandated for type-approval testing of nitrogen oxides and particulates since September 2017, is not required for CO₂ emissions testing (Mock, 2018).

In-production

The EU regulation requires manufacturers to demonstrate that each vehicle is manufactured to the approved specifications, which typically can be proven by using quality management systems (Mock and German, 2015). Manufacturers must also retest randomly chosen vehicles from the assembly line, and CO₂ emissions may not deviate from the type-approval value by more than 8%.

Post-production

In-service vehicle compliance checks are not required for CO₂ emissions.

Sources: ICCT analysis and the cited sources.

Key point: EU requirements provide the option to test vehicles in pre-production and in-production across the region, though there are no requirements in place for post-production compliance testing.

The existing EU compliance framework has systemic flaws. Similar to China, manufacturers pay a technical service provider to conduct laboratory tests, which could provide an incentive to produce favourable test results to attract business from manufacturers. In addition, important test parameters, such as road-load coefficients, are not independently verified or publicly available (Kühlwein, 2016). Both may cause lower compliance reliability for fuel economy standards.

The new type-approval scheme will come into effect 1 September 2020 and expects to improve the compliance requirements in several ways. The European Commission will have the power to carry out its own verification testing in this framework. In addition, EU member states will be required to perform tests on vehicles already on the market, in order to verify compliance of vehicles with their respective type-approval fuel consumption and emission values (Mock, 2018).

Japan

The Ministry of Economy, Trade and Industry (METI) and Ministry of Land, Infrastructure, Transport and Tourism (MLIT) jointly issue and enforce fuel economy standards.

Table B.3 • Compliance requirements for fuel economy standards in Japan

Pre-production

All manufacturers must test their vehicles at a national laboratory owned and operated by government, the National Traffic Safety and Environment Laboratory (NTSEL), or conduct testing with a witness from the NTSEL. Road-load in type-approval testing is determined by coast down tests conducted by manufacturers.

In-production

MLIT requires manufacturers to test regularly for fuel economy values of vehicles on the assembly line. MLIT investigates production lines to evaluate their capacity to produce qualified vehicles. After Mitsubishi was caught cheating in the coast down tests, MLIT announced plans to conduct confirmation road-load tests on produced vehicles or witness manufacturers' coast down tests (Tietge et al., 2017).

Post-production

In-use vehicle compliance checks are not required for fuel economy values.

Source: ICCT analysis.

Key point: Similar to China and the European Union, Japan can check for compliance during pre-production and in-production, while there are no requirements for post-production verification.

In Japan, the type-approval testing is conducted in a national laboratory or witnessed by representatives of that laboratory without any direct interest conflict. While MLIT has realised the importance to conduct confirmation tests to verify reported coast down, there is no confirmation coast down testing by the government agency to check compliance of produced vehicles. MLIT selects some models to conduct in-use tests each year, but only to confirm compliance with conventional pollutant emissions standards rather than fuel economy standards.

United States

The United States has five decades of experience in developing and refining its fuel economy standards, and its compliance and enforcement requirements, which is the oldest and most advanced in the world (Yang, Muncrief and Bandivadekar, 2017). Compliance with fuel economy regulations is carried out by the US EPA.

Table B.4 • Compliance requirements for fuel economy standards in the United States

Pre-production

Manufacturers do their own testing and report fuel economy values to the EPA. There is extensive guidance on all aspects of vehicle testing, including defining how to determine the vehicle weight, accessories installed, selection of representative tyres (and associated road-load), mileage accumulation adjustments, and how to test vehicles with driver-selectable devices. The EPA does confirmation testing of about 15% of the vehicles tested by manufacturers (Yang, Muncrief and Bandivadekar, 2017). If there is an ongoing issue between the two test results, EPA will increase the confirmation testing rate until the manufacturer fixes the problem. The road-load used for type-approval testing is publicly accessible online.

In-production

The EPA does not require manufacturers to test in-production new vehicles to verify compliance. However, EPA reserves the right to audit vehicles off the assembly line to ensure conformity of production (COP). Failed audits may trigger manufacturers to conduct extensive tests themselves (Mock and German, 2015). To avoid failing, manufacturers voluntarily test thousands of new cars each year to find potential problems before the EPA conducts its testing (He, 2017). There is no tolerance margin between fuel economy of produced vehicles and type-approval values, thus manufacturers usually leave some margin in the reported type-approval values.

Post-production

The EPA has conducted confirmation coast down testing on 10–20 vehicles per year since 2010 to verify the road-load coefficient used in the chassis dynamometer for emissions and fuel economy testing (Yang, Muncrief and Bandivadekar, 2017). The compliance programme for emissions standards requires manufacturers to conduct chassis dynamometer tests on at least one in-use vehicle for each test group at low mileage (10 000 miles or 16 000 km) and high mileage (50 000 miles or 80 000 km), and may require more tests if excess emissions were found in the testing. The EPA established the in-use CO₂ standard to be a level 10 % above the value used for each model when the initial corporate fleet-average CO₂ was computed for the purposes of determining compliance with the fleet-average standard (Maxwell and He, 2012). The EPA also randomly selects in-use vehicle for testing.

Sources: ICCT analysis and specific sources cited in the table.

Key point: The United States has the most extensive and robust compliance system in the world, covering options to check for compliance during all phases of the vehicle production and use.

In general, the EPA compliance regime covers vehicles throughout their useful life and has mechanisms in place to ensure independent testing of vehicles and testing of representative vehicles. The data transparency also enables third-party monitoring in addition to actions carried out by the EPA.

US consumers can report fuel consumption of their vehicles in real driving conditions online at fuelconomy.gov (Yang, Muncrief and Bandivadekar, 2017). Opening a portal for consumer reporting supports the collection of real driving fuel consumption data, as well as potentially helping to monitor fuel-economy standards compliance.

Enforcement of fuel economy standards

China

The Ministry of Industry, Information and Technology (MIIT), the regulatory agency, can influence type-approval applications for new vehicles, but does not have clear authority to recall vehicles for fuel economy standards compliance.

China enforces its fuel economy standards with administrative, rather than financial penalties. MIIT will “name and shame” manufacturers that fail to report individual and fleet-average fuel consumption information, or those that report incorrect fuel consumption and vehicle sales data (MIIT, 2017). Since April 2018, if a manufacturer fails to meet its corporate average fuel economy target after adopting all possible compliance pathways, including proposing adjusted plans to make up the deficit, MIIT will deny type-approval for new models that cannot meet specific fuel economy standards until the deficits are fully offset (Cui, 2018). The compliance provisions enable MIIT to apply some penalties for non-compliance.

European Union

Vehicles certified by any EU type-approval authority may be sold in all European Union member states. Only the issuing authority can mandate a recall of the vehicle. There is potential for conflict of interest in this system, especially if a manufacturer has some government ownership while also overseeing compliance with fuel economy standards.

A new type-approval system that will come into effect 1 September 2020 will provide a strong role for the European Commission in enforcement. This includes initiating and monitoring vehicle recalls, imposing fines on manufacturers of up to EUR 30 000 per non-compliant vehicle, but only in cases where a penalty has not been previously issued by a member state (Mock, 2018). The new system also allows member states to restrict or prohibit the use of affected vehicles or

require actions by the manufacturer. If there are no objections from other member states within one month, all member states must apply the same measures. In case of objections, the European Commission will take the decision.

If a manufacturer fails to meet its fleet CO₂ reduction requirement, financial penalties will be imposed for each newly registered vehicle. The penalty level is EUR 5 for the first gramme of CO₂ per kilometre (g CO₂/km) that exceeds the standard and ranges up to EUR 95 per g CO₂/km for emissions exceeding the standard by 3 g CO₂/km. Failure to meet the 2020/21 standards stipulates a uniform penalty of EUR 95 per g CO₂/km that exceeds the standard for each newly registered vehicle (Dornoff, 2018).

Japan

It is unclear whether the main regulatory agencies, MLIT and METI, will penalise manufacturers that manipulate vehicle testing (Yang, Muncrief and Bandivadekar, 2017). There is one public case where fines were imposed. In 2017, The Consumer Affairs Agency announced fines on Mitsubishi related to mislabelled cars that contained false claims on fuel consumption values (Japantimes, 2017).

United States

Enforcement of fuel economy and CO₂ emissions standards is the responsibility of the EPA and National Highway Traffic Safety Administration (NHTSA). Non-compliance discovered by confirmation testing, coast down testing and in-use testing may result in recall liability, under the Clean Air Act, only in cases where the problem is repairable, such as issues related to components, systems, software and calibration (Maxwell and He, 2012). If there are no defective parts and hence no obvious repairs which rules out a recall, EPA can assess compliance penalties of up to USD 37 500 per vehicle. The amount of a penalty considers a variety of factors, such as the gravity of the violation, its economic impact, the violator's history of compliance and other factors.

The United States is a good example of imposing serious penalties to increase non-compliance costs for manufacturers in cases where confirmation testing discovers non-compliance. In one of the highest profile civil cases related to vehicle fuel economy label value accuracy, automakers Hyundai and Kia agreed to pay USD 100 million in civil penalties for not properly following vehicle coast down procedures, which resulted in an inflated fuel economy estimate on nearly a million cars sold in the United States in 2012-13 (Yang et al., 2016).

If a manufacturer does not comply with the CAFE standards, which are set by regulation for the MY 2017-25, the Energy Policy and Conservation Act specifies a precise formula for determining the amount of civil penalty (NHTSA, 2017). The penalty is USD 5.50 for each 10th of a mile per gallon that the manufacturer's average fuel economy falls short of the standard for a given model year multiplied by the total volume of those vehicles in the affected fleet manufactured for that model year, and the amount is adjusted for inflation. With stringent enforcement, manufacturers are more likely to adhere to the regulations.

Annex C. Statistical tables

Data for many of the key indicators used in this analysis are presented in this annex. Data for average parameters are only shown in these tables when information is available for at least 50% of total vehicle registrations. In most cases, the coverage exceeds 80% of the total.

Table C.1 • New light-duty vehicle registrations⁵⁴ (thousands)

	2005	2006	2007	2008	2009	2010	2011	2012	2013	2014	2015	2016	2017
Argentina	355			569		637	812	796	895	645	616	689	856
Australia	952			975		1 007	980	1 080	1 104	1 050	1 092	1 142	1 149
Austria										335	342	364	392
Belgium										538	563	606	624
Brazil	1 618			2 707		3 359	3 514	3 626	3 569	3 318	2 469	1 979	2 167
Bulgaria												30	35
Canada	1 514			1 659		1 540	1 557	1 664	1 745	1 773	1 835	1 862	1 957
Chile	183			233		289	341	343	378	326	281	303	370
China	3 738			6 223		14 092	14 090	16 354	18 297	19 319	21 344	25 377	25 565
Croatia												52	53
Cyprus												13	14
Czech Republic												225	235
Denmark										217	240	256	254
Egypt	114			233				187	182	275	264	189	131
Estonia												27	30
Finland										117	120	128	129
France	2 487			2 508		2 627	2 592	2 241	2 121	2 125	2 249	2 407	2 528
Germany	3 517			3 313		3 113	3 407	3 302	3 165	3 167	3 335	3 482	3 567
Greece										76	81	84	94
Hungary												115	123
Iceland												18	21
India	1 159			1 656		2 597	2 768	3 078	2 872	2 717	2 867	3 121	3 423
Indonesia	469			519		660	770	897	1 196	1 150	920	975	1 005
Ireland										113	148	174	153
Italy	2 454			2 390		2 140	1 896	1 498	1 376	1 472	1 702	2 010	2 141
Japan	5 610			4 901		4 819	4 067	5 195	5 191	5 349	4 867	4 808	5 089
Korea	1 124			1 172		1 506	1 528	1 488	1 498	1 611	1 779	1 782	1 797
Latvia												17	17
Lithuania												23	28
Luxembourg										53	50	53	56
Macedonia								10	9				
Malaysia	533			529		588	582	611	633	621	661	576	588
Malta												8	8
Mexico	1 102			997		808	895	977	1 054	1 125	1 345	1 603	1 530
Netherlands										439	508	440	475
Norway										174	184		
Peru								175	174	163	144	151	164
Philippines								337	399	489	624	334	450
Poland												465	473
Portugal										168	208	240	260
Romania												105	118
Russian Federation	1 633			3 106		1 910	2 652	2 892	2 739	2 490	1 599	1 388	1 562
Slovakia												96	104
Slovenia												60	69
South Africa	538			454		446	520	604	619	610	584	515	526
Spain										966	1 184	1 294	1 407
Sweden										345	389	400	425
Switzerland										332	357		
Thailand	677			597		776	768	1 222	1 277	877	763	762	868
Turkey	622			560		749	852	762	840	751	941	967	940
Ukraine	294			662		175	236	232	218	97	46	68	86
United Kingdom	2 763			2 421		2 254	2 201	2 284	2 536	2 790	2 995	3 056	2 888
United States	16 105			12 918		11 235	12 344	13 892	14 890	15 611	16 453	16 686	16 341

⁵⁴ Note that the IHS database used as a basis for the LDV market volumes tracked in this publication aims to cover the first registration of new vehicles in each market. These data may be subject to some degree of inaccuracy due to data collection challenges (e.g. for second-hand imports of vehicles by private individuals moving into the country). Despite this, these data have been interpreted here as representative of new vehicle sales, and referred to as “new sales” or “new vehicle registrations”.

Table C.2 • Average CO₂ emissions/kilometre (g CO₂/km, WLTP)

	2005	2006	2007	2008	2009	2010	2011	2012	2013	2014	2015	2016	2017
Argentina	196			195		188	189	185	186	182	181	185	187
Australia	244			231		225	220	214		195	193	189	188
Austria										143	138	135	136
Belgium										137	134	132	133
Brazil	197			198		203	199	189	191	186	184	179	179
Bulgaria												142	140
Canada	235			228		221	217	210	205	203	204	206	206
Chile	201			195		209	205	201	196	189	191	188	189
China	201			204		202	202	199	197	190	186	178	175
Croatia												126	126
Cyprus												136	134
Czech Republic												136	140
Denmark										128	124	123	124
Egypt	191			191				193	194	185	188	184	187
Estonia												152	150
Finland										145	141	137	135
France	158			147		145	142	137	132	129	126	125	126
Germany	178			174		169	162	156	150	145	141	139	140
Greece										122	119	119	122
Hungary												145	143
Iceland												134	129
India	159			150		154	150	146	147	142	139	136	135
Indonesia	202			204		205	207	197	193	185	190	186	184
Ireland										133	131	128	127
Italy	153			152		153	143	140	135	131	128	125	124
Japan	179			163		163	159	147	143	136	143	144	144
Korea	190			181		169		148	148	151	150	146	147
Latvia												144	143
Lithuania												143	143
Luxembourg										143	141	139	140
Macedonia								155	151				
Malaysia	190			195		185	186	182	181	181	176	164	164
Malta												126	124
Mexico	211			218		221	217	203		177	174	176	175
Netherlands										128	122	127	127
Norway										129	121		
Peru								192	191	190	191	186	187
Philippines								210	211	205	203	193	196
Poland												143	143
Portugal										122	119	118	119
Romania												138	135
Russian Federation	219			210		209	205	201	200	198	197	194	192
Slovakia												142	142
Slovenia												136	136
South Africa	205			202		201	193	186	182	180	178	175	176
Spain										133	129	127	130
Sweden										148	143	136	139
Switzerland										159	152		
Thailand	225			218		208	208	194	189	196	193	185	180
Turkey	189			172		160	155	147	141	136	135	131	131
Ukraine	204			193		191	186	185	184	176	171	164	162
United Kingdom	176			167		161	155	149	145	141	138	136	137
United States	258			238		221	217	211	208	203	200	199	198

Table C.3 • Average fuel consumption (Lge/100 km, WLTP)

	2005	2006	2007	2008	2009	2010	2011	2012	2013	2014	2015	2016	2017
Argentina	8.3			8.3		8	8	7.9	7.9	7.8	7.7	7.9	7.9
Australia	10.5			9.8		9.5	9.3	9		8.2	8.1	8	7.9
Austria										6	5.7	5.6	5.7
Belgium										5.7	5.6	5.5	5.6
Brazil	8.5			8.5		8.7	8.6	8.1	8.2	7.9	7.9	7.6	7.6
Bulgaria												5.9	5.9
Canada	10.1			9.8		9.5	9.4	9.1	8.8	8.8	8.8	8.9	8.9
Chile	8.5			8.3		8.9	8.7	8.5	8.3	8	8.1	8	8
China	8.7			8.8		8.7	8.7	8.6	8.5	8.2	8	7.7	7.6
Croatia												5.2	5.2
Cyprus												5.7	5.6
Czech Republic												5.7	5.9
Denmark										5.4	5.3	5.2	5.2
Egypt	8.1			8.1				8.2	8.2	7.9	8	7.9	8
Estonia												6.4	6.4
Finland										6.1	5.9	5.8	5.8
France	6.5			6		6	5.8	5.6	5.4	5.3	5.2	5.2	5.3
Germany	7.4			7.3		7.1	6.8	6.5	6.3	6.1	5.9	5.8	5.9
Greece										5.1	4.9	4.9	5.1
Hungary												6.1	6.1
Iceland												5.7	5.6
India	6.8			6.3		6.5	6.3	6.1	6.2	5.9	5.8	5.7	5.6
Indonesia	8.6			8.7		8.7	8.9	8.5	8.3	7.9	8.2	8	7.9
Ireland										5.4	5.4	5.3	5.2
Italy	6.3			6.4		6.4	6	5.9	5.7	5.6	5.4	5.2	5.2
Japan	7.7			7		7	6.8	6.4	6.1	5.8	6.2	6.2	6.2
Korea	8.1			7.8		7.3		6.3	6.3	6.4	6.3	6.2	6.3
Latvia												6	6
Lithuania												6	6
Luxembourg										5.9	5.8	5.8	5.8
Macedonia								6.4	6.2				
Malaysia	8.2			8.3		7.9	8	7.8	7.7	7.8	7.6	7.1	7.1
Malta												5.3	5.2
Mexico	9.1			9.4		9.5	9.4	8.7		7.7	7.5	7.6	7.6
Netherlands										5.4	5.2	5.5	5.4
Norway										5.9	5.8		
Peru								8.3	8.2	8.2	8.2	8	8.1
Philippines								9.1	9.1	8.8	8.7	8.3	8.4
Poland												6.1	6
Portugal										5	4.9	4.9	4.9
Romania												5.7	5.6
Russian Federation	9.3			9		9	8.8	8.6	8.6	8.5	8.4	8.3	8.2
Slovakia												5.9	6
Slovenia												5.7	5.7
South Africa	8.8			8.6		8.6	8.2	7.9	7.7	7.6	7.5	7.4	7.4
Spain										5.5	5.3	5.3	5.4
Sweden										6.2	6	5.7	5.9
Switzerland										6.7	6.4		
Thailand	9.2			9		8.7	8.7	8.1	7.9	8.1	8	7.8	7.5
Turkey	8.2			7.2		6.6	6.4	6	5.8	5.6	5.6	5.4	5.4
Ukraine	8.8			8.3		8.2	8	7.9	7.8	7.5	7.2	7	6.8
United Kingdom	7.4			7		6.7	6.5	6.2	6	5.9	5.7	5.7	5.8
United States	11.1			10.2		9.5	9.4	9.1	9	8.8	8.6	8.6	8.6

Table C.4 • Average power (kW)

	2005	2006	2007	2008	2009	2010	2011	2012	2013	2014	2015	2016	2017
Argentina				76						91	84	86	89
Australia	129			131		129	127	128	128	130	132	134	135
Austria										89	91	94	95
Belgium										85	88	92	94
Brazil	46			70		71	75	77	80	82	84	86	86
Bulgaria												94	97
Canada	143			145		160	164	129	129	159	169	174	180
Chile	81			85		91	91	94	94	96	97	97	98
China				91		84	88	90	94	100	102	104	108
Croatia												82	83
Cyprus												91	92
Czech Republic												92	96
Denmark										77	82	84	86
Egypt	62			63				62	62	84	84	90	90
Estonia												103	102
Finland										97	92	98	100
France	75			75		74	78	80	80	80	83	85	86
Germany	90			96		95	99	100	100	102	105	108	111
Greece										71	72	77	77
Hungary												95	97
Iceland												94	96
India	0			41		54	55	56	57	61	61	61	62
Indonesia	76			77		85	79	0	78	77	77	77	78
Ireland										81	82	84	86
Italy	72			75		74	78	77	76	76	77	79	80
Japan	93			80		79	78	74	73	73	77	79	78
Korea	94			103		115	120	120	120	122	124	128	135
Latvia												97	100
Lithuania												94	93
Luxembourg										110	114	116	118
Macedonia								79	79				
Malaysia	72			74		78	80			93	99	89	90
Malta												74	74
Mexico	88			116		95	93	95	95	106	105	105	103
Netherlands										84	87	87	87
Norway										98	102		
Peru										92	92	94	94
Philippines										99	96	94	94
Poland												97	147
Portugal										80	80	81	82
Romania												88	88
Russian Federation	92			100		86	88	92	94	98	98	100	100
Slovakia												95	97
Slovenia												90	92
South Africa	89			96		97	95	95	96	96	96	98	97
Spain										83	84	86	86
Sweden										104	108	110	113
Switzerland										115	118		
Thailand	84			94		93	91	0	88	95	97	96	93
Turkey	94			80		74	76	78	79	80	82	84	84
Ukraine										101	103	107	107
United Kingdom	85			89		89	92	92	92	94	97	101	104
United States	161			162		166	169	168	169	169	171	174	176

Table C.5 • Average displacement (cm³)

	2005	2006	2007	2008	2009	2010	2011	2012	2013	2014	2015	2016	2017
Argentina	1 945			1 779		2 191	2 157	1 682	1 689	1 692	1 690	1 685	1 696
Australia	2 725			2 600		2 490	2 417	2 370	2 342	2 331	2 321	2 348	2 347
Austria										1 673	1 661	1 648	1 613
Belgium										1 624	1 618	1 608	1 589
Brazil	1 172			1 518		1 376	1 493	1 490	1 508	1 521	1 535	1 539	1 519
Bulgaria												1 680	1 669
Canada	3 055			2 986		3 095	3 018	2 290	2 235	2 844	2 860	2 886	2 909
Chile	1 933			1 876		1 935	1 873	1 873	1 843	1 865	1 881	1 851	1 852
China	0			1 703		1 651	1 696	1 694	1 709	1 741	1 709	1 661	1 655
Croatia												1 560	1 535
Cyprus												1 616	1 603
Czech Republic												1 578	1 592
Denmark										1 440	1 445	1 472	1 474
Egypt	2 495			2 490				1 642	1 639	1 620	1 646	1 643	1 667
Estonia												1 721	1 697
Finland										1 666	1 631	1 597	1 593
France	1 731			1 657		1 592	1 613	1 631	1 592	1 559	1 532	1 525	1 507
Germany	1 868			1 863		1 785	1 789	1 776	1 754	1 730	1 725	1 726	1 703
Greece										1 413	1 418	1 422	1 413
Hungary												1 682	1 646
Iceland												1 639	1 647
India	0			1 221		1 301	1 324	1 358	1 355	1 370	1 355	1 370	1 378
Indonesia	1 781			1 748		1 644	1 619	1	1 568	1 487	1 481	1 495	1 514
Ireland										1 636	1 633	1 636	1 602
Italy	1 623			1 584		1 530	1 558	1 536	1 507	1 478	1 475	1 498	1 497
Japan	1 177			1 439		1 404	1 375	1 342	1 311	1 301	1 385	1 403	1 358
Korea	2 089			1 954		1 956	1 958	1 919	1 936	1 976	1 979	1 969	2 004
Latvia												1 659	1 681
Lithuania												1 709	1 672
Luxembourg										1 869	1 873	1 839	1 803
Macedonia								1 621	1 606				
Malaysia	1 475			1 504		1 568	1 593	1 624	1 606	1 604	1 879	1 193	1 171
Malta												1 437	1 416
Mexico	1 881			2 407		1 848	1 798	1 817	1 796	1 951	1 892	1 856	1 827
Netherlands										1 491	1 502	1 438	1 390
Norway										1 786	1 796		
Peru								0	0	1 578	1 656	1 644	1 670
Philippines								0	0	2 513	2 547	2 586	2 572
Poland												1 635	1 627
Portugal										1 544	1 519	1 504	1 486
Romania												1 590	1 564
Russian Federation	1 895			1 942		1 782	1 784	1 849	1 865	1 910	1 922	1 932	1 907
Slovakia												1 642	1 625
Slovenia												1 584	1 566
South Africa	1 791			1 837		1 860	1 795	1 902	1 899	1 887	1 856	1 859	1 853
Spain										1 596	1 582	1 564	1 542
Sweden										1 798	1 816	1 763	1 762
Switzerland										1 844	1 824		
Thailand	2 404			2 243		2 165	2 089	2 040	2 004	2 060	2 061	1 990	1 959
Turkey	2 039			1 710		1 588	1 584	1 560	1 546	1 550	1 548	1 550	1 555
Ukraine	0			0		0	0	1 800	1 796	1 849	1 859	1 861	1 857
United Kingdom	1 804			1 782		1 726	1 735	1 706	1 683	1 675	1 675	1 684	1 676
United States	3 496			3 247		3 181	3 117	2 990	2 953	2 905	2 879	2 861	2 853

Table C.6 • Average kerb weight (kg)

	2005	2006	2007	2008	2009	2010	2011	2012	2013	2014	2015	2016	2017
Argentina	1 211			1 222		1 255	1 256	1 278	1 285	1 272	1 263	1 304	1 308
Australia	1 551			1 550		1 564	1 560	1 580	1 570	1 567	1 561	1 645	1 663
Austria										1 448	1 455	1 424	1 410
Belgium										1 404	1 409	1 409	1 418
Brazil	1 146			1 151		1 152	1 171	1 161	1 168	1 166	1 168	1 235	1 243
Bulgaria												1 398	1 399
Canada	1 603			1 635		1 697	1 691	1 600	1 601	1 678	1 690	1 709	1 717
Chile	1 342			1 330		1 383	1 375	1 415	1 402	1 440	1 428	1 445	1 447
China	1 204			1 282		1 264	1 306	1 317	1 341	1 384	1 388	1 413	1 439
Croatia												1 326	1 309
Cyprus												1 380	1 362
Czech Republic												1 330	1 364
Denmark										1 273	1 294	1 295	1 307
Egypt	1 306			1 297				1 334	1 353	1 358	1 359	1 463	1 478
Estonia												1 450	1 447
Finland										1 465	1 453	1 422	1 450
France	1 321			1 331		1 305	1 332	1 370	1 352	1 312	1 317	1 330	1 334
Germany	1 386			1 410		1 448	1 469	1 461	1 453	1 438	1 448	1 461	1 462
Greece										1 232	1 230	1 226	1 225
Hungary												1 405	1 390
Iceland												1 415	1 444
India	1 001			1 061		1 067	1 092	1 100	1 105	1 107	1 101	1 130	1 143
Indonesia	1 205			1 223		1 220	1 201	1 181	1 237	1 204	1 180	1 195	1 186
Ireland										1 422	1 427	1 417	1 418
Italy	1 230			1 249		1 256	1 286	1 285	1 281	1 266	1 266	1 308	1 308
Japan	1 185			1 186		1 199	1 183	1 179	1 167	1 127	1 170	1 246	1 230
Korea	1 595			1 529		1 533	1 517	1 492	1 517	1 421	1 441	1 477	1 480
Latvia												1 403	1 432
Lithuania												1 420	1 402
Luxembourg										1 493	1 504	1 451	1 457
Macedonia								1 372	1 340				
Malaysia	1 099			1 123		1 159	1 177	1 205	1 228	1 278	1 332	1 209	1 219
Malta												1 196	1 181
Mexico	1 327			1 394		1 380	1 365	1 397	1 388	1 328	1 310	1 317	1 316
Netherlands										1 327	1 357	1 318	1 304
Norway										1 532	1 561		
Peru								1 423	1 416	1 508	1 539	1 495	1 476
Philippines								1 505	1 527	1 478	1 465	1 415	1 439
Poland												1 386	1 271
Portugal										1 327	1 330	1 320	1 329
Romania												1 341	1 341
Russian Federation	1 293			1 356		1 369	1 378	1 362	1 384	1 407	1 391	1 436	1 436
Slovakia												1 386	1 388
Slovenia												1 369	1 385
South Africa	1 386			1 434		1 506	1 484	1 476	1 491	1 437	1 444	1 472	1 476
Spain										1 371	1 371	1 336	1 334
Sweden										1 551	1 566	1 493	1 533
Switzerland										1 506	1 514		
Thailand	1 642			1 559		1 506	1 476	1 563	1 529	1 491	1 491	1 563	1 553
Turkey	1 358			1 396		1 356	1 372	1 373	1 356	1 359	1 371	1 371	1 375
Ukraine	1 173			1 290		1 354	1 349	1 412	1 411	1 423	1 456	1 504	1 504
United Kingdom	1 345			1 367		1 384	1 408	1 406	1 401	1 398	1 413	1 434	1 448
United States	1 801			1 721		1 750	1 743	1 730	1 735	1 689	1 694	1 723	1 733

Table C.7 • Average footprint (m²)

	2005	2006	2007	2008	2009	2010	2011	2012	2013	2014	2015	2016	2017
Argentina	3.8			3.8		3.8	3.8	3.8	3.9	3.9	3.9	3.9	4
Australia	4.2			4.2		4.2	4.2	4.2	4.2	4.3	4.3	4.3	4.3
Austria										4.2	4.2	4.1	4.1
Belgium										4.2	4.2	4.1	4.2
Brazil	3.6			3.6		3.7	3.7	3.7	3.8	3.8	3.8	3.8	3.8
Bulgaria												4.1	4.2
Canada	4.3			4.3		4.4	4.4	4.3	4.3	4.6	4.6	4.6	4.7
Chile	3.8			3.9		4	4	4	4	4	4.1	4.1	4.1
China	3.8			3.9		3.8	3.9	3.9	4	4.1	4.1	4.1	4.2
Croatia												4	4
Cyprus												4.1	4.1
Czech Republic												4.1	4.1
Denmark										4	4	4	4
Egypt	3.9			3.9				4	4.1	4	4	4	4.1
Estonia												4.2	4.2
Finland										4.2	4.2	4.1	4.2
France	4			4.1		4	4.1	4.1	4.1	4.1	4.1	4.1	4.1
Germany	4			4.1		4.1	4.2	4.2	4.2	4.2	4.2	4.1	4.1
Greece										3.9	3.9	3.8	3.9
Hungary												4.1	4.1
Iceland												4	4.1
India	3.1			3.2		3.3	3.3	3.4	3.5	3.5	3.6	3.6	3.6
Indonesia	3.8			3.8		3.8	3.7	3.8	3.8	3.8	3.8	3.8	3.8
Ireland										4.2	4.2	4.1	4.2
Italy	3.8			3.8		3.8	3.9	3.9	3.9	3.9	3.9	3.9	3.9
Japan	3.6			3.5		3.6	3.6	3.6	3.5	3.6	3.6	3.7	3.7
Korea	4.2			4.2		4.1	4.2	4.2	4.2	4.3	4.3	4.3	4.3
Latvia												4.1	4.2
Lithuania												4	4
Luxembourg										4.2	4.3	4.1	4.2
Macedonia								4	4				
Malaysia	3.6			3.7		3.8	3.8	4	3.9	4	4	4	4
Malta												3.8	3.8
Mexico	4			4.1		4.1	4	4	4	3.9	3.9	3.9	3.9
Netherlands										4	4.1	4	4
Norway										4.2	4.3		
Peru								4	4	4	4.1	4.1	4
Philippines								4.1	4.1	4	4	4	4.1
Poland												4.1	3.4
Portugal										4	4	4	4
Romania												4.1	4.1
Russian Federation	3.9			4		3.9	4	3.9	4	4	4	4	4
Slovakia												4.1	4.1
Slovenia												4.1	4.1
South Africa	4.1			4.1		4.1	4.1	4	4.1	4.1	4.1	4.1	4.1
Spain										4.1	4.1	4	4
Sweden										4.3	4.3	4.2	4.3
Switzerland										4.2	4.2		
Thailand	4.4			4.3		4.2	4.2	4.2	4.3	4.2	4.2	4.2	4.2
Turkey	4			4.2		4.1	4.1	4.1	4.1	4.2	4.2	4.2	4.2
Ukraine	3.9			3.9		4	4	4	4	4.1	4.2	4.2	4.2
United Kingdom	4			4.1		4.1	4.1	4.1	4.1	4.1	4.1	4.1	4.1
United States	4.6			4.5		4.5	4.5	4.5	4.5	4.5	4.5	4.6	4.6

Table C.8 • Average vehicle price (thousand USD 2017)

	2005	2006	2007	2008	2009	2010	2011	2012	2013	2014	2015	2016	2017
Argentina				22						20	17	22	24
Australia				33		34	38	36	33	35	30	31	32
Austria										32	33	32	32
Belgium										30	31	30	32
Brazil						28	30	26	25	16	15	21	22
Bulgaria												27	29
Canada	27			25		31	32	29	28	28	25	26	28
Chile											27	30	30
China				26		23	27	28	29	34	27	25	27
Croatia												25	26
Cyprus												31	32
Czech Republic												28	30
Denmark										44	38	25	27
Egypt										33	30	25	27
Estonia												32	32
Finland										37	36	32	34
France	32			35		31	34	33	33	33	28	29	30
Germany	36			45		39	42	39	40	39	34	35	36
Greece										24	24	24	24
Hungary												28	29
Iceland												32	35
India						13	14	16	14	14	11	12	12
Indonesia				0					0	21	18	18	19
Ireland										29	33	30	29
Italy	29			34		29	32	29	30	30	25	26	27
Japan				21		26	29	28	22	22	19	21	22
Korea												31	33
Latvia												32	32
Lithuania										36	38	37	38
Luxembourg													
Macedonia				23						29	29	21	21
Malaysia												23	24
Malta				25		20	20	20	20	17	15	15	15
Mexico										29	32	28	28
Netherlands										59	47		
Norway										20	15	27	28
Peru										37	30	28	28
Philippines												29	25
Poland										31	31	26	27
Portugal												26	27
Romania						26	29	24	26	19	17	23	24
Russian Federation												29	31
Slovakia												27	29
Slovenia						45	43	37	34	24	21	27	27
South Africa										46	38	36	37
Spain										27	28	28	30
Sweden										42	36	37	39
Switzerland										45	43		
Thailand				22					29	32	29	31	32
Turkey				45				27	32		33	25	28
Ukraine										15		33	34
United Kingdom	37			37		34	37	36	37	41	35	32	35
United States	33			29		32	32	31	31	38	32	33	34

Annex D. Definitions

General

Advanced economies < USD 1/L: A group of economies in the middle- to high-income segment with 2016 gasoline prices below USD 1 per litre at market exchange rates (MER) (Australia, Canada and United States).

Advanced economies ≥ USD 1/L: A group of economies in the middle- to high-income segment with 2016 gasoline prices above USD 1 per litre (MER) (European Union,⁵⁵ Japan, Korea and Turkey).

Emerging economies: A group of economies in the middle- to low-income segment (Argentina, Brazil, Chile, China, Egypt, India, Indonesia, Malaysia, Mexico, Peru, Philippines, Russian Federation, South Africa, Thailand and Ukraine).

Global Fuel Economy Initiative (GFEI): The Global Fuel Economy Initiative is a partnership of six organisations: International Energy Agency (IEA); United Nations Environment Program (UNEP); International Transport Forum (ITF) of the Organisation for Economic Co-ordination and Development (OECD); International Council on Clean Transportation (ICCT); Institute for Transportation Studies at University of California Davis; and the FIA Foundation. The GFEI works to secure real improvements in fuel economy and the maximum deployment of existing fuel economy technologies in vehicles across the world. The initiative promotes these objectives through shared analysis, advocacy and the Cleaner, More Efficient Vehicles Tool for in-country policy support. (For more information, see: www.iea.org/topics/transport/gfei/.)

Market segment: This report uses six categories based on light-duty vehicle size to designate market segments. The categories are: city car; medium car; small sport-utility vehicle/pick-up truck (SUV/pick-up); large car; large SUV/pick-up; light-commercial vehicle (LCV)/van.

New registrations or sales: Represents new vehicles entering a country's vehicle fleet in a given year that have not previously been in use.

Vehicle stock: Number of vehicles registered on a given date in a country and licensed to use roads open to public traffic. The vehicle stock changes each year based on new registrations, second-hand imports and exports, and vehicle scrapping.

Policy

Compliance and enforcement: Refers to a system of laws, regulations, authorities and practices intended to ensure that vehicle performance meets the standards in force and that action can be taken if standards are not met. This broad definition distinguishes itself from the narrow legal definition that equates "compliance" with strict interpretation of certification or type-approval fuel consumption limits.

Fuel economy standard: A regulation that determines minimum requirements for the specific fuel consumption (litres of gasoline equivalent per vehicle-kilometre) for a vehicle or group of vehicles within a given jurisdiction.

⁵⁵ Including the other countries in the European Economic Area (Iceland, Norway and Switzerland), depending on the data availability per parameter per year (see Annex C).

Official or tested fuel economy: The emissions or fuel consumption for a given vehicle or group of vehicles determined by a defined test procedure and used to determine compliance with a fuel economy standard.

Real driving fuel consumption or carbon dioxide emissions: The fuel consumption or CO₂ emissions for a given vehicle that results from actual on-road driving behaviour.

Type-approval: Indication whether a product meets the minimum requirements set by a regulation.

Vehicle type

Heavy-duty vehicle (HDV): Road vehicle with a kerb weight above 3.5 tonnes. This broadly covers the UN categories M₂, M₃, N₂ and N₃ (UNECE, 2017).

Light-commercial vehicle (LCV): Light-duty vehicle that weighs less than 3.5 tonnes that is used for commercial transport services and falls within the GFEI segment of LCV/van. This broadly covers the UN category N₁ (UNECE, 2017).

Light-duty vehicle (LDV): A light-duty vehicle is a road vehicle with at least four wheels and with a kerb weight below 3.5 tonnes. This broadly covers the UN categories of M₁ and N₁ (UNECE, 2017).

Passenger car: Light-duty vehicle with a kerb weight below 3.5 tonnes that is used for passenger transport and falls within the size segment of city car, medium car or large car.

Passenger light-truck: Light-duty vehicle with a kerb weight below 3.5 tonnes that is used for passenger transport and falls within the size segment of small SUV/pick-up truck or large SUV/pick-up truck.

Passenger light-duty vehicle (PLDV): Light-duty vehicle with a kerb weight below 3.5 tonnes that is used for passenger transport. This covers the UN category M₁ (UNECE, 2017).

Vehicle technology

Auxiliary device: Devices that consume, convert, store or supply power within a vehicle that are not mainly used for vehicle propulsion and not considered a part of the powertrain.

Battery electric vehicle (BEV): Road vehicle uses only an electric powertrain powered by a battery that can be recharged via an external plug.

Electrified vehicle: A road vehicle that has a powertrain equipped with at least one electrical power source to propel the vehicle (UNECE, 2015).

Electric vehicle (EV): Road vehicle that has an electric powertrain with a battery that is capable of recharging from an external power supply.

Engine displacement: Engine displacement represents the combined volume of pistons within the cylinders of an engine that allows that engine to produce mechanical energy while being fuelled by a combustible fuel.

Flex-fuel vehicle: Vehicle with one fuel storage system for a mixture of fuels and an internal combustion engine that operates on a mixture on either of those fuels (UNECE, 2015).

Fuel-cell electric vehicle (FCEV): Road vehicle that uses a powertrain containing at least one fuel cell storage system and an electrical engine for propulsion (UNECE, 2015).

Hybrid electric vehicle (HEV): A road vehicle that use a single external energy source (typically gasoline or diesel) and are equipped with a powertrain containing at least one electric motor (or electric motor-generator) and one internal combustion engine (ICE) as propulsion energy converter.

Hybrid electric vehicle HEV – mild: A road vehicle that uses two propulsion methods, an internal combustion engine and an electric motor at a low voltage (60 Volts) level. The electric motor uses regenerative braking to capture energy and store it in the on board batteries, which is used to provide power to the electric motor.

Hybrid electric vehicle HEV – full: A road vehicle that uses two propulsion methods, an internal combustion engine and an electric motor that is more than 60 Volts, uses regenerative braking and does not have the option to plug into an external power source.

Internal combustion engine (ICE): Powertrain containing exclusively ICE(s) as propulsion energy converter(s), such as gasoline, diesel, biofuels, compressed natural gas and liquid petrol gas.

Kerb weight: The combined mass of a vehicle including its standard equipment and liquids required for operation. This is excluding any passengers or cargo.

Plug-in electric hybrids (PHEVs): A hybrid vehicle containing at least one electric motor (or electric motor-generator) and one ICE and have the capacity to rely on more than one external energy source (typically gasoline and electricity, or diesel and electricity).

Powertrain: The combination of the propulsion storage system, propulsion energy converter and drivetrain that provide the mechanical energy to deliver propulsion of the vehicle, including auxiliaries (UNECE, 2015).

Turbocharging: A device that increases the efficiency of a vehicle by using electrical energy to force air into the combustion chamber of an engine.

Vehicle power: Determination of the maximum strength output of an engine.

Well-to-wheel (WTW) greenhouse gas (GHG) emissions: Total emissions generated throughout the entire life cycle of a fuel, covering production, transformation, distribution and final use in a vehicle to power movement and other operations. These emissions are usually calculated as two components: well-to-tank (WTT) emissions and tank-to-wheel (TTW) emissions.

Abbreviations and acronyms

ASEAN	Association of Southeast Asian Nations
BEV	battery electric vehicle
CAFE	Corporate Average Fuel Economy (US)
CNG	compressed natural gas
CO ₂	carbon dioxide
EU	European Union
EUR	euro
EV	electric vehicle
FCEV	fuel-cell electric vehicle
g CO ₂	grammes of carbon dioxide
g CO ₂ /km	grammes of carbon dioxide per kilometre
GDP	gross domestic product
GFEI	Global Fuel Efficiency Initiative
GHG	greenhouse gas
HDV	heavy-duty vehicle

ICE	internal combustion engine
IEA	International Energy Agency
kg	kilogramme
kW	kilowatt
LCV	light-commercial vehicle
Lge	litre of gasoline equivalent
LPG	liquefied petroleum gas
MER	market exchange rate
NEDC	New European Driving Cycle
OECD	Organisation for Economic Co-operation and Development
PHEV	plug-in hybrid electric vehicle
PLDV	passenger light-duty vehicle
SUV	sport-utility vehicle
US	United States
USD	United States dollar
WLTC	test cycle of the WLTP
WLTP	Worldwide Harmonised Light-Duty Test Procedure

What is the Global Fuel Economy Initiative?

The Global Fuel Economy Initiative believes that large gains could be made in fuel economy which would help every country to address the pressing issues of climate change, energy security and sustainable mobility. We will continue to raise awareness, present evidence, and offer support to enable countries to adopt effective fuel economy standards and policies that work in their circumstances and with their vehicle fleet.



Secretariat

Global Fuel Economy Initiative
60 Trafalgar Square
London
WC2N 5DS
United Kingdom
+44 (0)207 930 3882 (t)
+44 (0)207 930 3883 (f)

Contact us

Email: info@globalfueleconomy.org
Web: www.globalfueleconomy.org



@GlobalFuelEcon | #GFEINetwork



www.youtube.com/GlobalFuelEcon



www.flickr.com/50by50campaign



With the support of

