

DOCKETED

Docket Number:	19-SB-100
Project Title:	SB 100 Joint Agency Report: Charting a path to a 100% Clean Energy Future
TN #:	229727
Document Title:	Clutch Company Comments SB 100 Joint Agency Report - Charting a path to a 100% Clean Energy Future
Description:	N/A
Filer:	System
Organization:	Clutch Company. Inc.
Submitter Role:	Public
Submission Date:	9/13/2019 7:58:08 AM
Docketed Date:	9/13/2019

*Comment Received From: Southport Equipment
Submitted On: 9/13/2019
Docket Number: 19-SB-100*

SB 100 Joint Agency Report - Charting a path to a 100% Clean Energy Future

Additional submitted attachment is included below.

Understanding the Reactive Power Problem and a Mechanical Solution Using Peaking or Retired Generators

ASME 2014 Power Conference
July 28–31, 2014

Randall M. Attix, Member ASME
Manager Application Engineering – SSS Clutch Co., Inc.

Donald M. Chamberlin, P.E.
Consultant

July 29, 2014



Clutch Company, Inc.

ASMEPOWER

ASME 2014 Power Conference

Understanding the Reactive Power Problem and a Mechanical Solution Using Peaking or Retired Generators



Transmission System

Peaking Gas Turbine



Understanding the Reactive Power Problem and a Mechanical Solution Using Peaking or Retired Generators

Reactive Power (Vars) - An Unwanted but Unavoidable part of AC electric power delivery systems



Vars – Some have drawn the analogy to the foam on the top of a beer.

- Reactive power is an essential part of an electrical system but it does no useful work
- The foam on the top of a beer is an essential part of the beer but you can't use it nor can you drink it.



Understanding the Reactive Power Problem and a Mechanical Solution Using Peaking or Retired Generators

Why A.C.?

Allows use of transformers, necessary for high voltage transmission lines

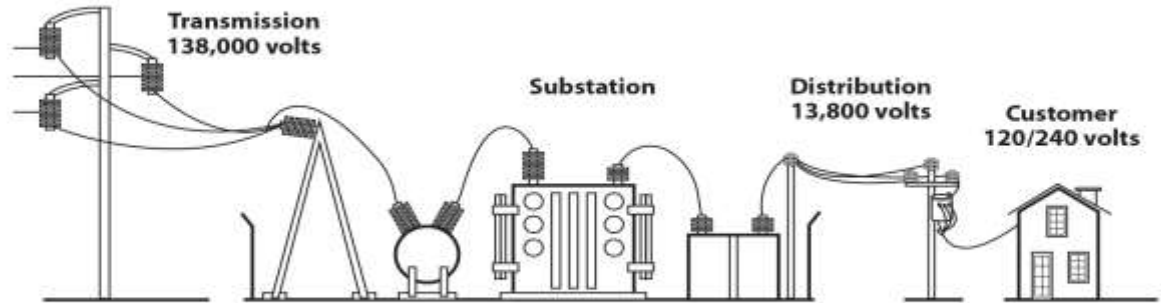
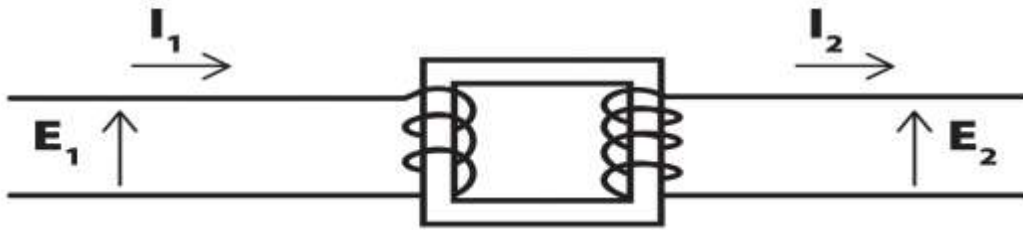

Understanding the Reactive Power Problem and a Mechanical Solution Using Peaking or Retired Generators

Why A.C.?

- Requires a polyphase system (usually three-phase) for a smooth delivery of power.

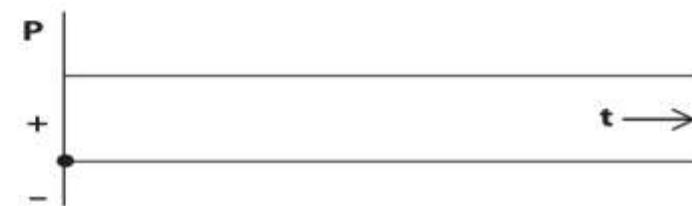
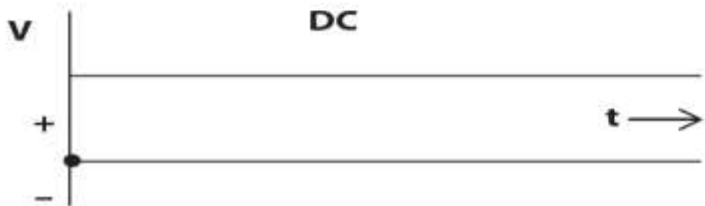
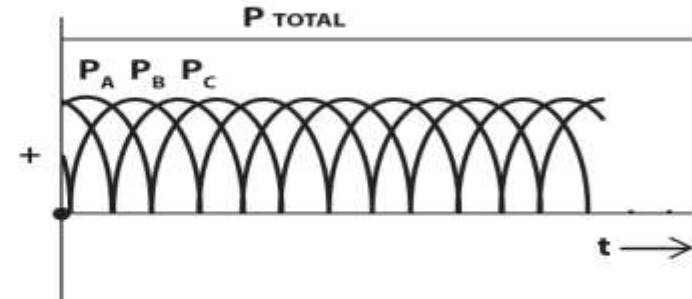
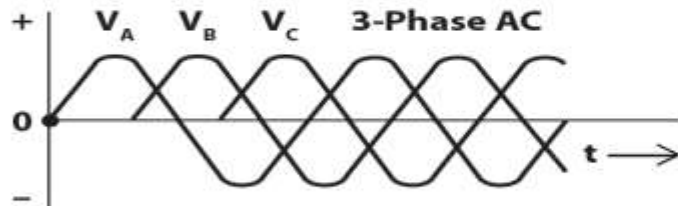
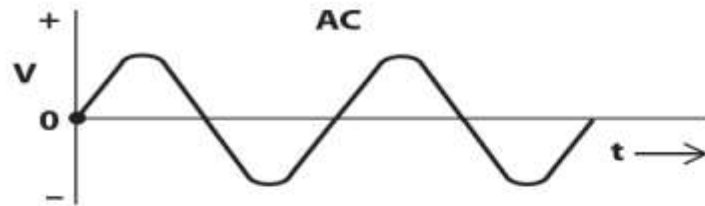

Understanding the Reactive Power Problem and a Mechanical Solution Using Peaking or Retired Generators

Positive Sequence Representation of a Balanced Three Phase System

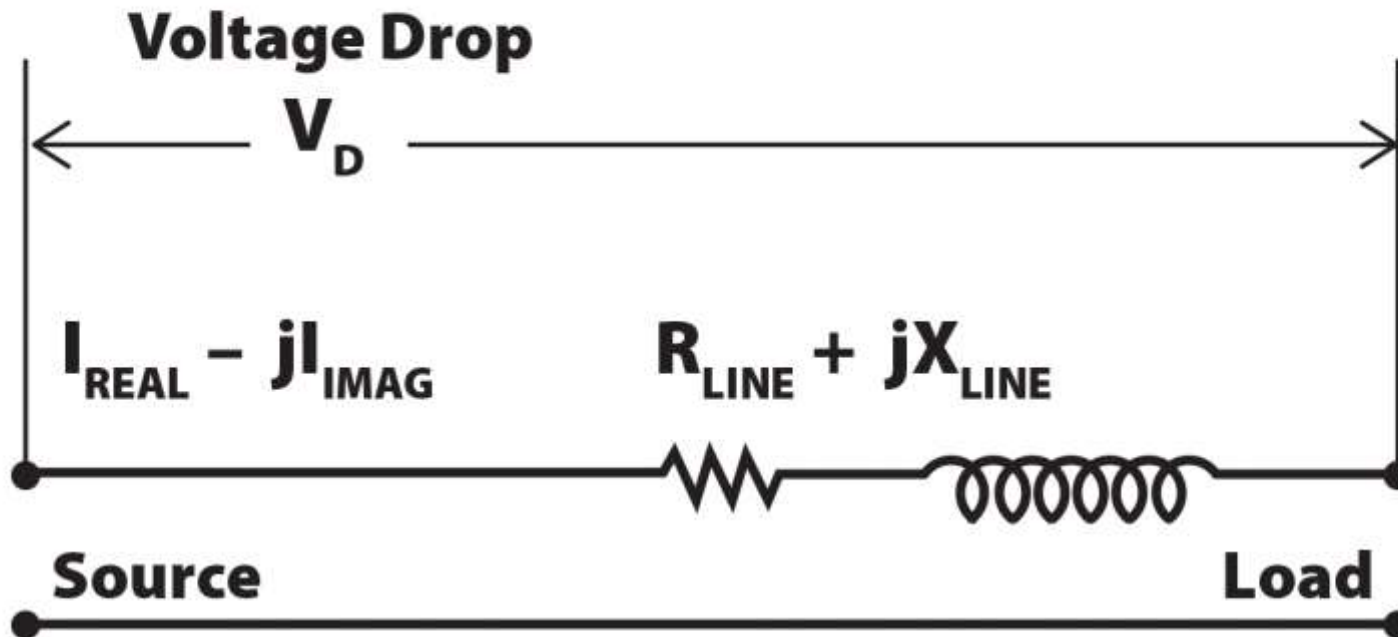

Understanding the Reactive Power Problem and a Mechanical Solution Using Peaking or Retired Generators

With alternating current

- Inductors and capacitors become active and exchange energy.
- The key is a CHANGE in voltage or current. Frequency dependent.
- Described by Maxwell's Equations

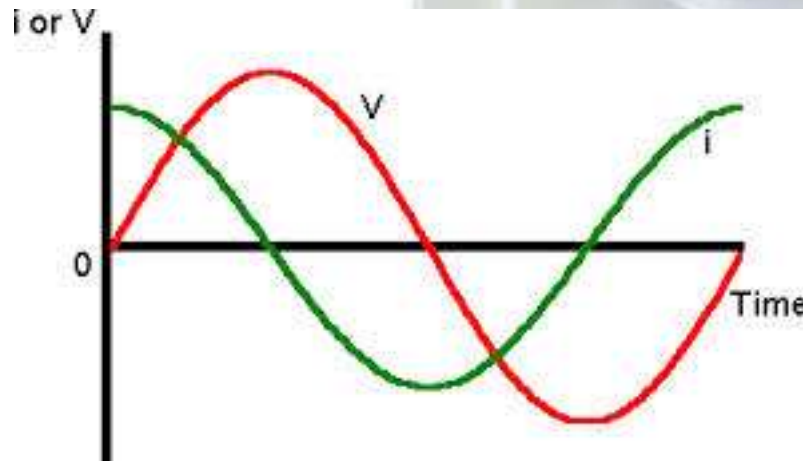
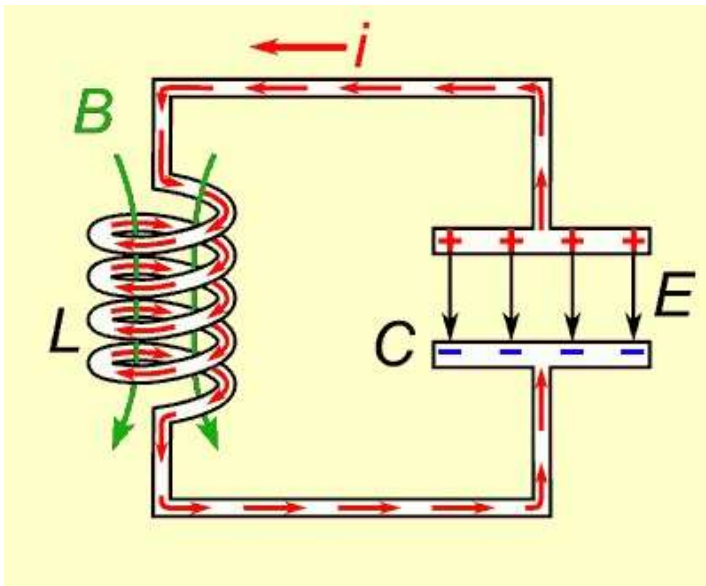

Understanding the Reactive Power Problem and a Mechanical Solution Using Peaking or Retired Generators

Power System Specifics

- **Single Frequency: 60 Hertz = ω Hertz or cycles per second**
- **Inductance (inherent property) = L Henries**
- **Inductive reactance = $j\omega L = jX_L$ ohms**
- **Capacitance (inherent property) = C Farads**
- **Capacitive reactance = $1/(j\omega C) = -jX_C$ ohms**
- **Inductance and capacitance are handled as impedances expressed in imaginary (j) ohms.**



Understanding the Reactive Power Problem and a Mechanical Solution Using Peaking or Retired Generators

Where inductive and capacitive impedances are found



Loads (motors, light ballasts) –
mostly inductive



Transformers – mostly inductive



Electric lines – mostly inductive (in series)
except for cables and high voltage lines
where capacitive reactance (in shunt) is also significant



Understanding the Reactive Power Problem and a Mechanical Solution Using Peaking or Retired Generators

Reactive Load

Power factor: Ratio of real current, or real load to total current, to the total (volts) x (amps)

Lower power factor: more reactive current requirement relative to the real power delivered

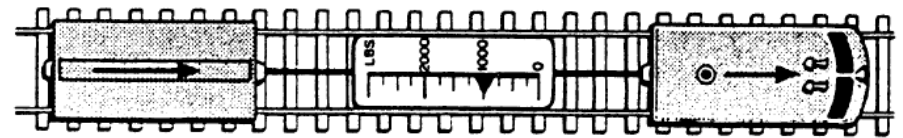
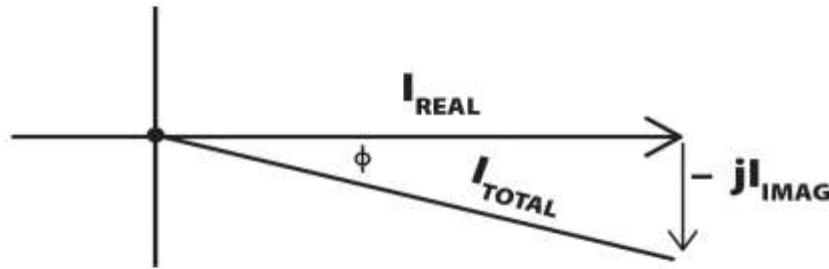

Fig. 1a Force applied in the direction of motion

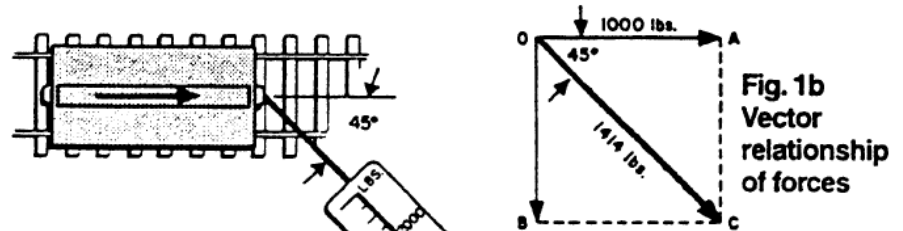

Fig. 1b Vector relationship of forces

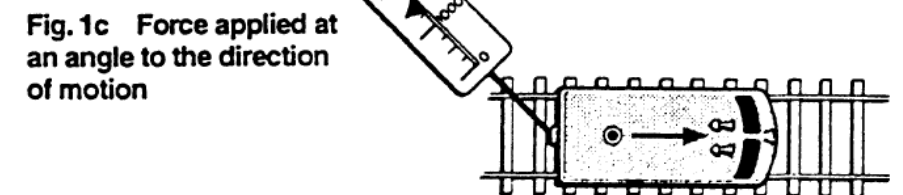
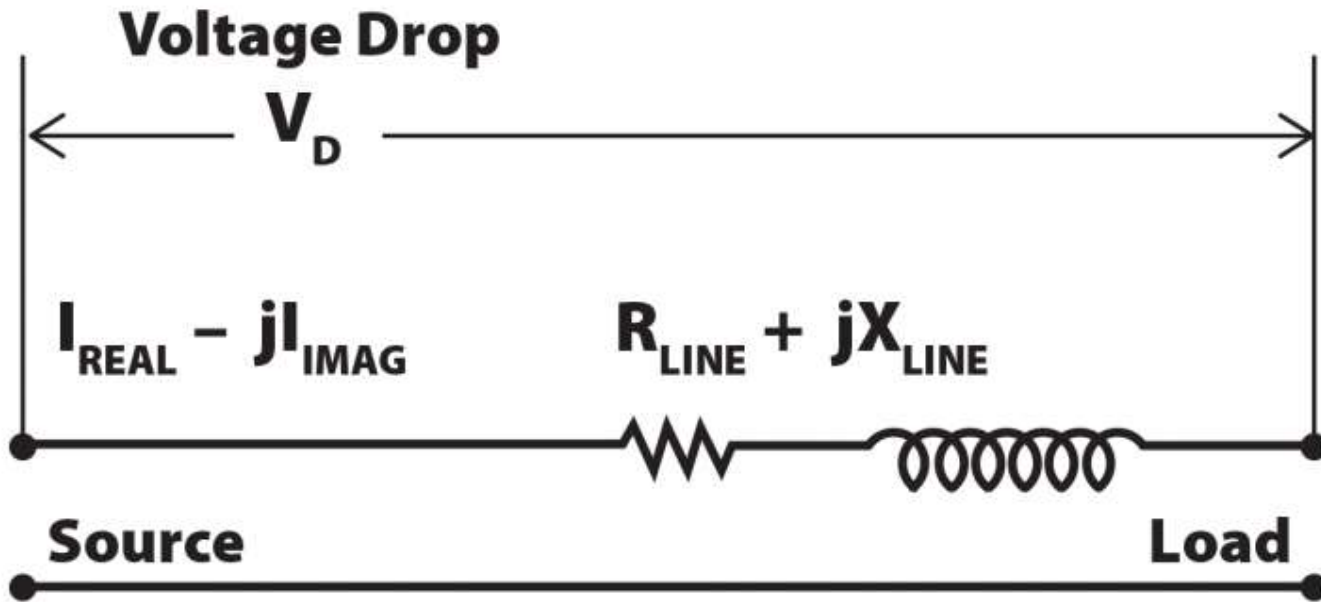

Fig. 1c Force applied at an angle to the direction of motion

Figure 1 - Apparent Versus Actual Power



Understanding the Reactive Power Problem and a Mechanical Solution Using Peaking or Retired Generators



Understanding the Reactive Power Problem and a Mechanical Solution Using Peaking or Retired Generators

Voltage Drop in the delivery system (i.e., electric lines)

$$\begin{aligned}\text{Voltage drop} &= \text{Voltage Drop} = V = I Z_{\text{LINE}} \\ &= (I_{\text{REAL}} - jI_{\text{IMAG}}) (R_{\text{LINE}} + jX_{\text{LINE}}) \\ &= (I_{\text{REAL}})R_{\text{LINE}} + (-jI_{\text{IMAG}}) jX_{\text{LINE}} + j[(I_{\text{REAL}})X_{\text{LINE}} - (I_{\text{IMAG}})R_{\text{LINE}}]\end{aligned}$$

- Real component of Resistive loss: $I_{\text{REAL}} \times R_{\text{LINE}}$
- Real losses due to interaction of reactive current (imaginary) and line reactance (imaginary) = $(-jI_{\text{IMAG}}) jX_{\text{LINE}}$. THIS IS OFTEN THE MAJOR COMPONENT. It directly adds to the real component of resistive loss.
- **Imaginary components** also exist, but they have less of an effect on the voltage overall.



Understanding the Reactive Power Problem and a Mechanical Solution Using Peaking or Retired Generators

Sources of Reactive Current

Generators



Understanding the Reactive Power Problem and a Mechanical Solution Using Peaking or Retired Generators

Sources of Reactive Current

**Capacitors – In Substations
Or Along Distribution Lines**



Understanding the Reactive Power Problem and a Mechanical Solution Using Peaking or Retired Generators

Sources of Reactive Current

Rotating Synchronous Condensers

- Historically Popular prior to development of Capacitors
- Variable output advantage
- Located closer to load than new generating sources
- Can be peaking generators when not used for power production
- Can be retired generators no longer needed for power generation



Dedicated Synchronous Condenser

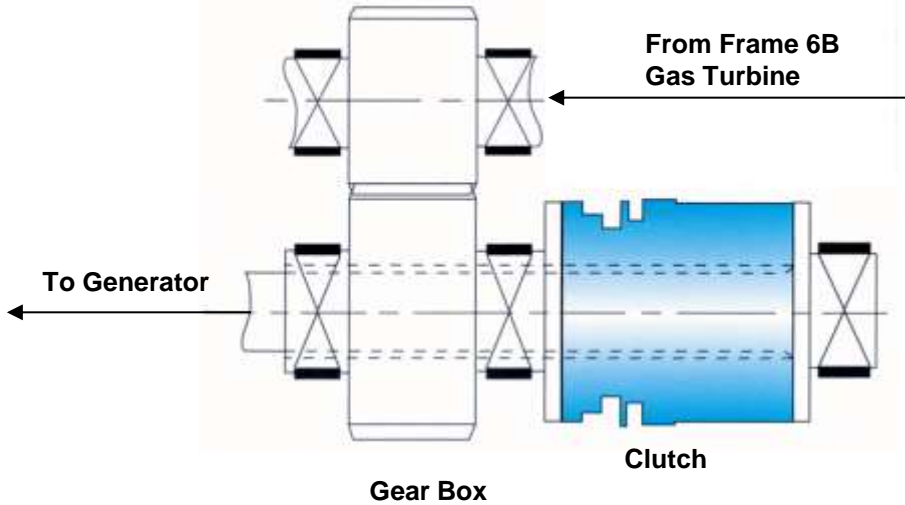

Understanding the Reactive Power Problem and a Mechanical Solution Using Peaking or Retired Generators

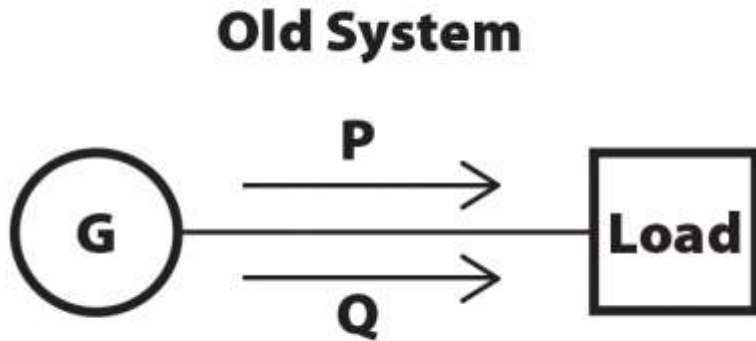

Urban Power Generation
Closer to Load

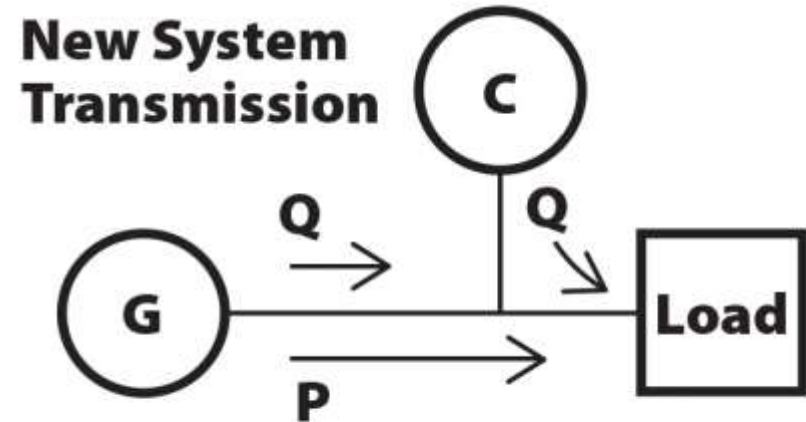

Distant Power Generation
Further From Load

The Mechanical Solutions to Synchronous Condensing High Power Clutches in Power Plant Service

Synchronous Condensing

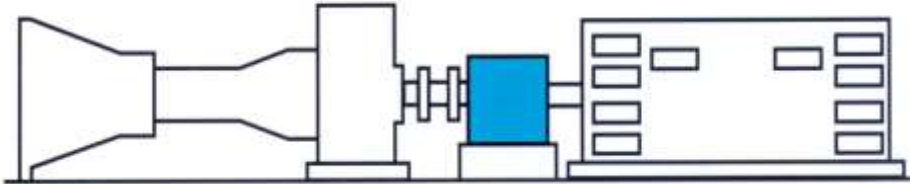

Single Ended Generator

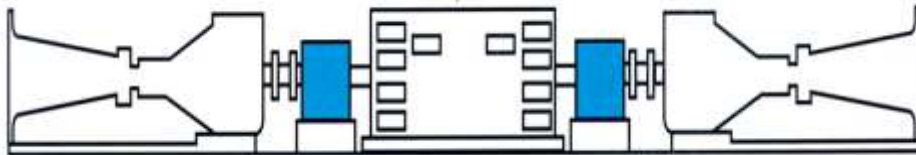

Double Ended Generator

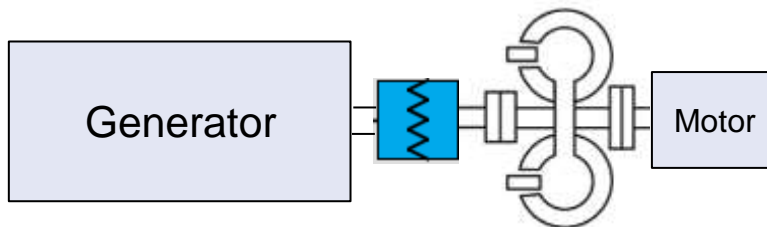

Acceleration Systems

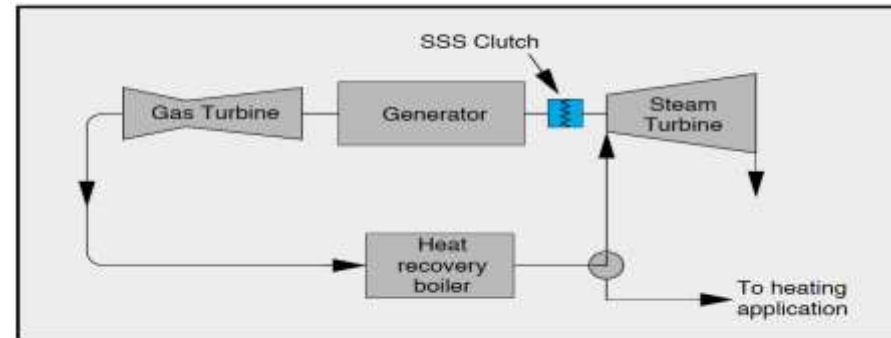

Combined Heat and Power

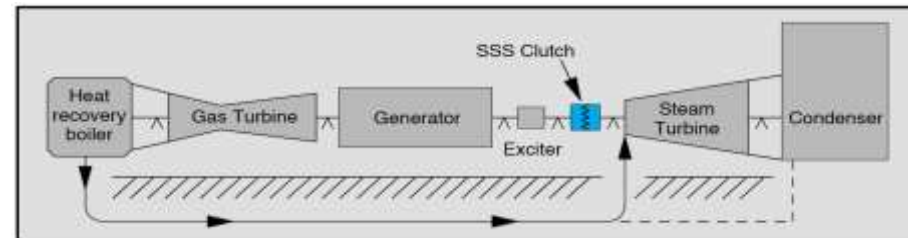

Single Shaft Combined Cycle



High Power Automatic Overrunning Clutches

More Than 65 Years Experience, Powers Up To 330 MW

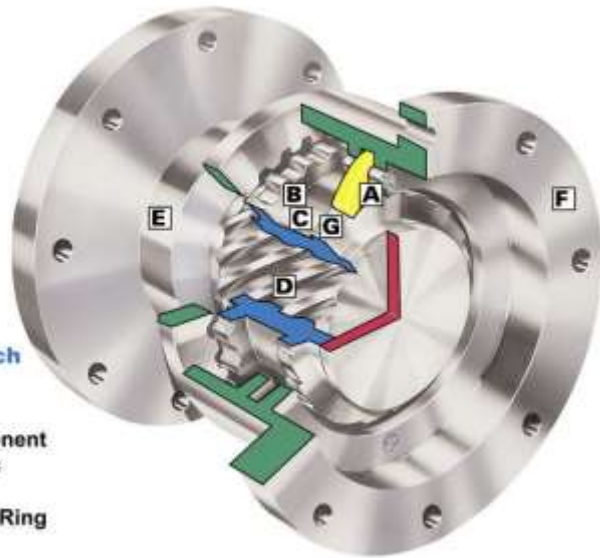

Overrunning Clutch Details

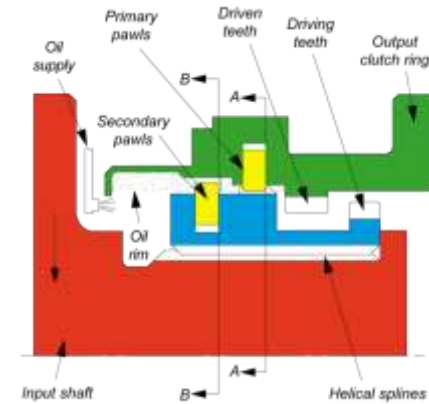

Overrunning Clutch & Diagram Showing Surface Area Contact of Involute Shaped Teeth When Engaged

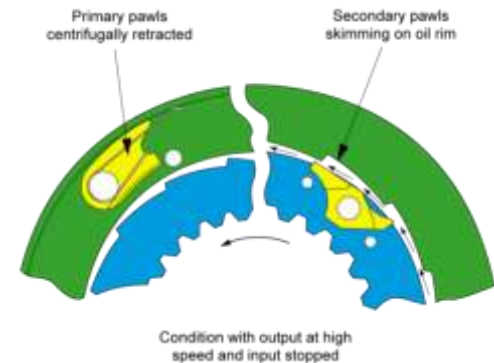
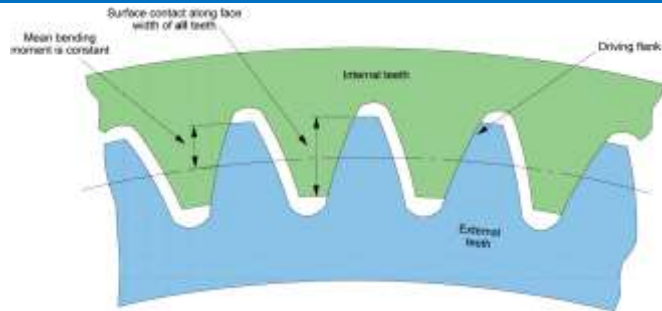

Encased Clutches for GE LMS100 Synchronous Condensing/Synchronized Reserve

One Installed in 2008 — GE LMS100 at Calpine's Cumberland Energy Center, Millville, NJ
Two Installed in 2010 — GE LMS100 at LADWP's Haynes Power Station, Long Beach, CA
Two Supplied in 2014 — GE LMS100 for LADWP's Scattergood Power Station, LA, CA



Two LMS100 Gas Turbine Generators with Encased Clutches at LADWP's Haynes Power Station, Long Beach, CA



LMS100 Gas Turbine Generator with Encased Clutch at Calpine (formerly Conectiv) Cumberland Energy Center, Millville, NJ.



130 MW rated Encased Clutch installed in LMS100.

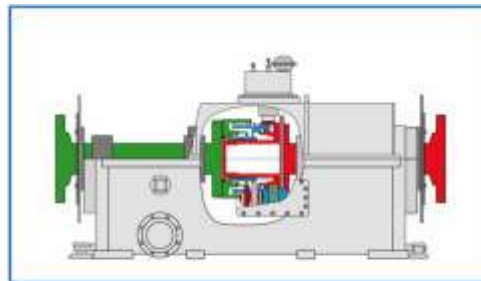

Encased Clutch (with turning gear) to enable synchronous condensing for reactive power or spinning reserve duty

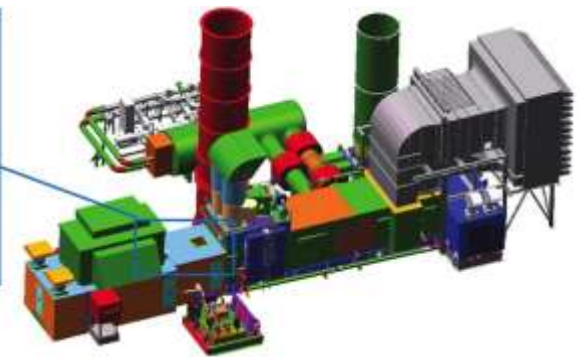

Synchronous Condensing Project Siemens V84.3 for Kansas City Power & Light, Hawthorne Station

Synchronous Condensing Clutch installed between gas turbine and generator in Siemens Westinghouse turbo generator model no. V84.3A, at Hawthorne Station of Kansas City Power & Light, Kansas City, Missouri, USA.

The generator has variable frequency and can be connected to the grid for synchronous condensing without starting the turbine.

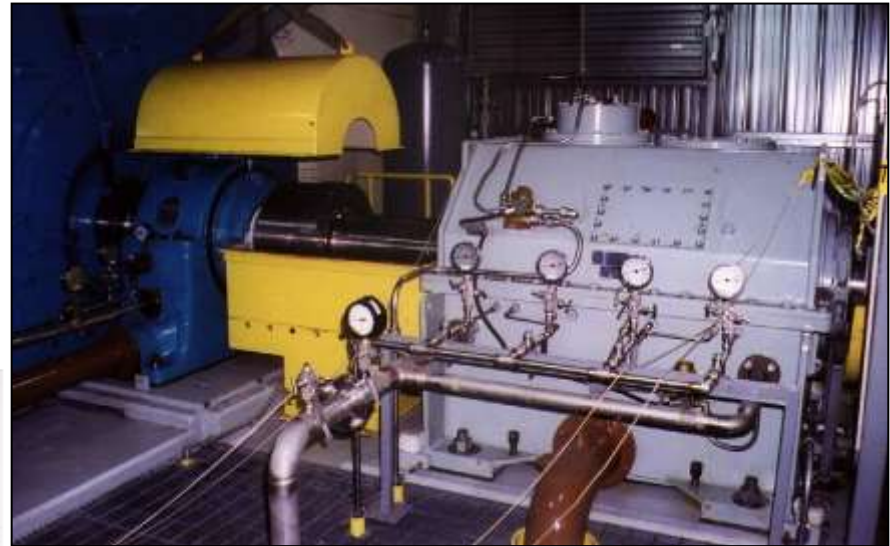

Since plant startup in 1997, its capacity has been **170 MW of power** and, with turbine stopped and generator functioning as a synchronous motor, a **MVAR range of +150 and -87**.



Synchronous Condensing Project for Ankerlig Power Station, Eskom, Cape Town, South Africa

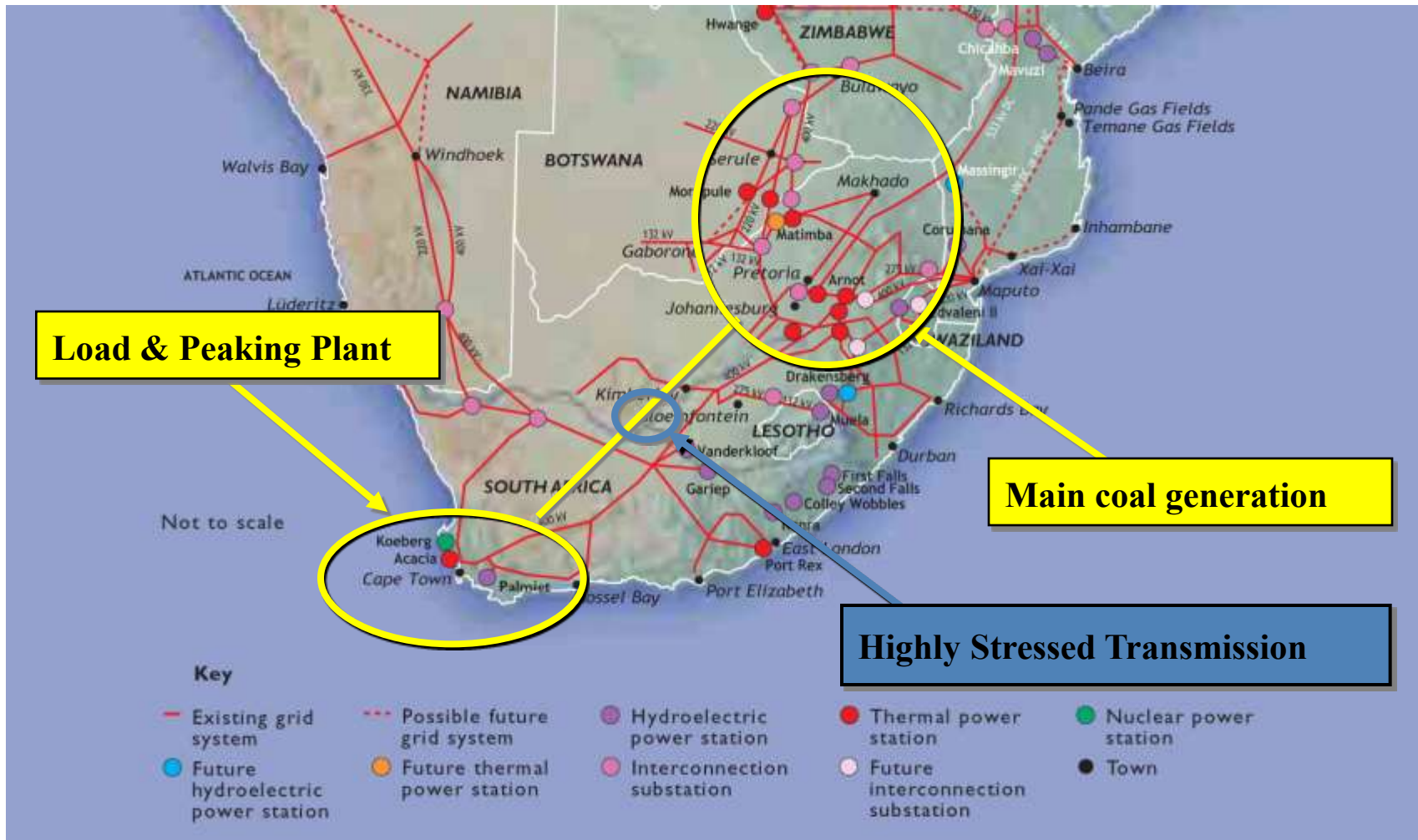

Synchronous Condensing Project for Ankerlig Power Station, Eskom, Cape Town, South Africa

Encased Clutch

- SGT5-2000E (V94.2)
- 176MW/3000rpm
- 7 units supplied in 2006
- 2000 hrs generation to date
- 26,000 hrs synchronous condensing

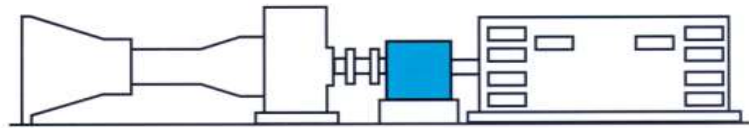
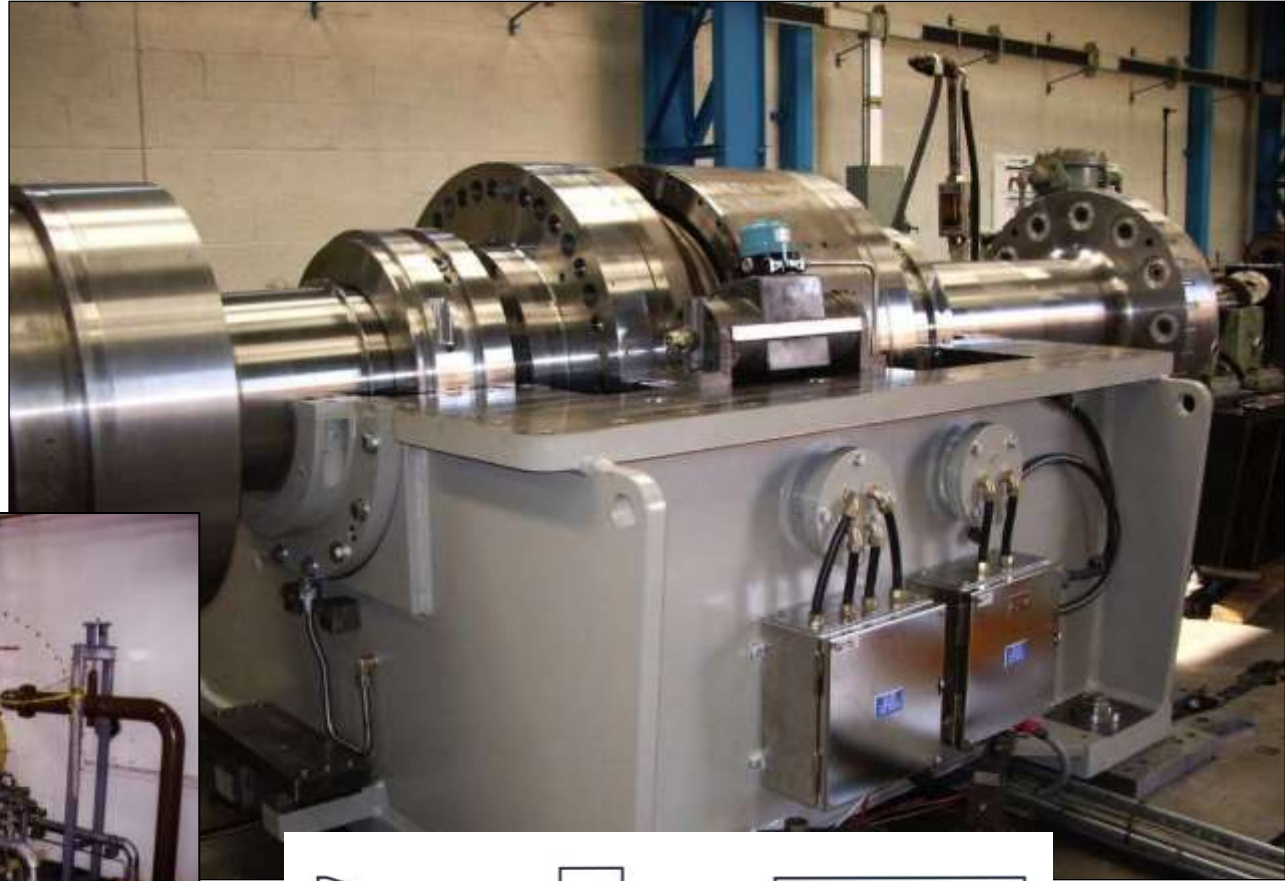

LM6000 with Synchronous Condensing /Spinning Reserve Capability for Sask Power, Yellowhead, Saskatchewan

60 Hertz Market - In North America 33 LM6000s fitted with Clutches Since 1999 for Synchronous Condensing/Spinning Reserve Duty

50 Hertz Market - In Europe one double ended generator with LM6000 and clutch on either end

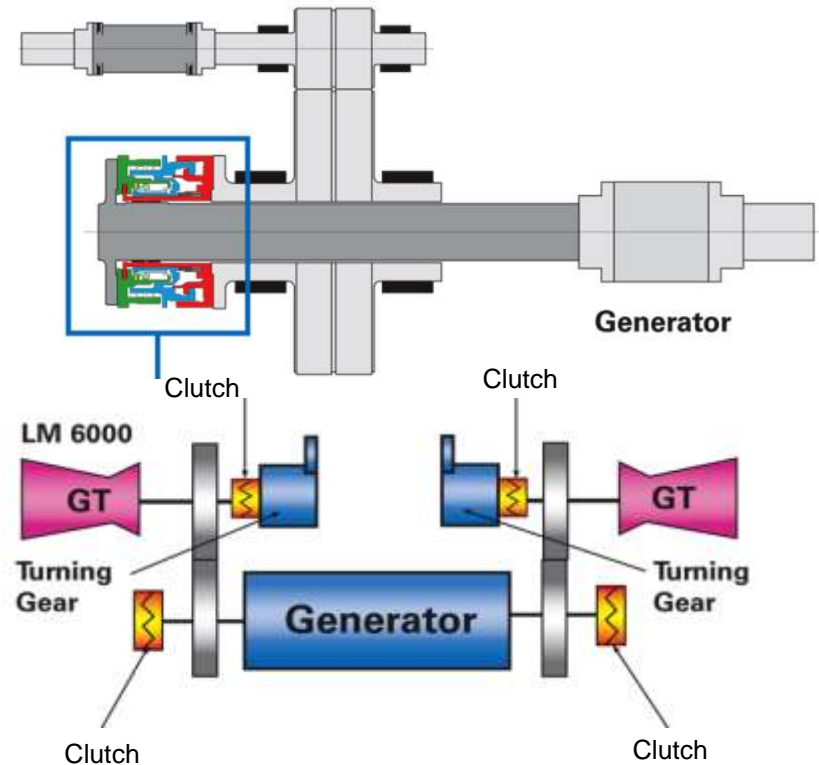

LMS100 with Synchronous Condensing can Maximize the Contribution of Renewable Sources of Energy

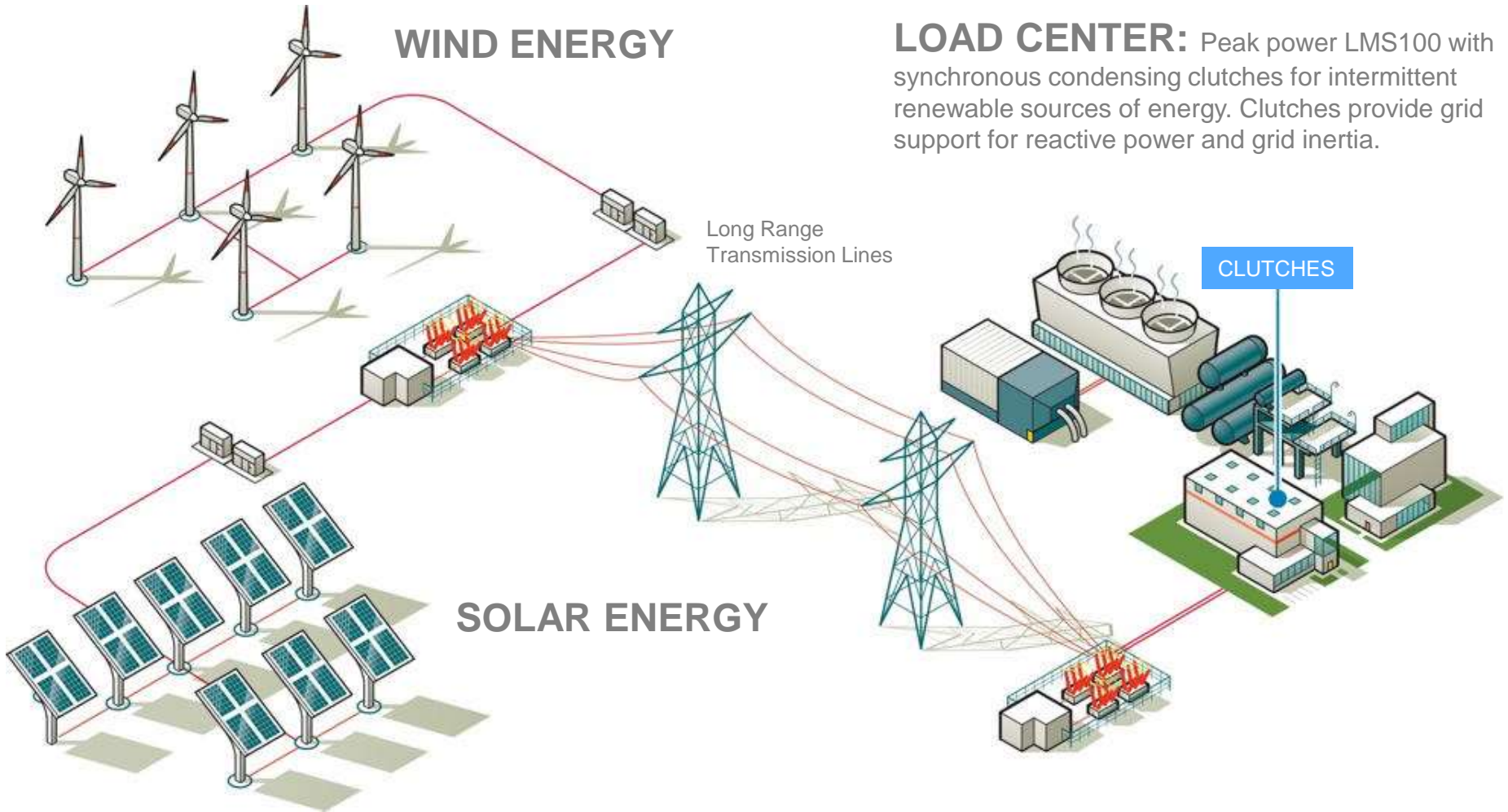

Mechanical Acceleration Systems For Synchronous Condensers

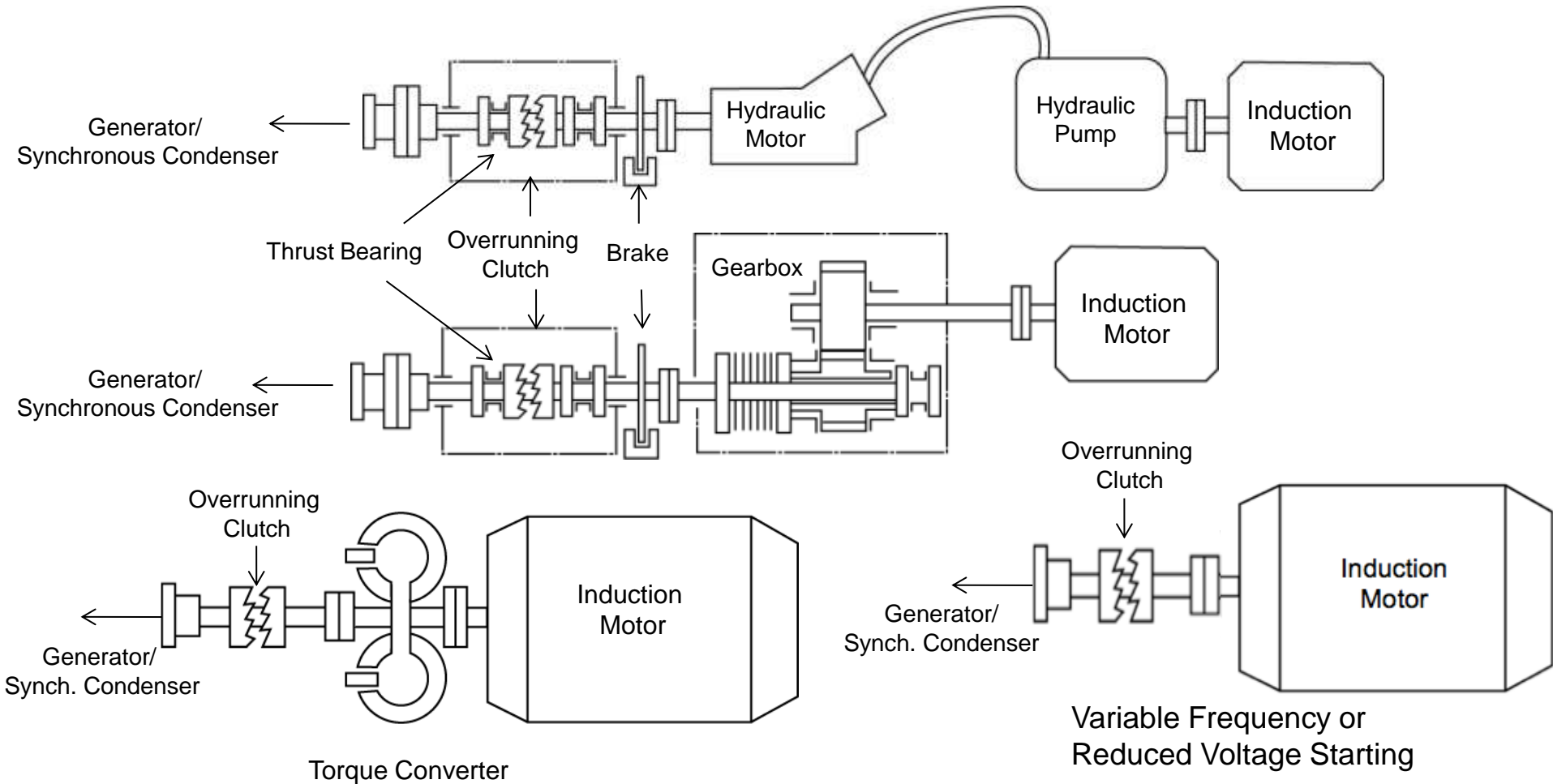

Synchronous Condensing Project: Conversion of a Stand-Alone Generator for City Electric System, Key West, Florida

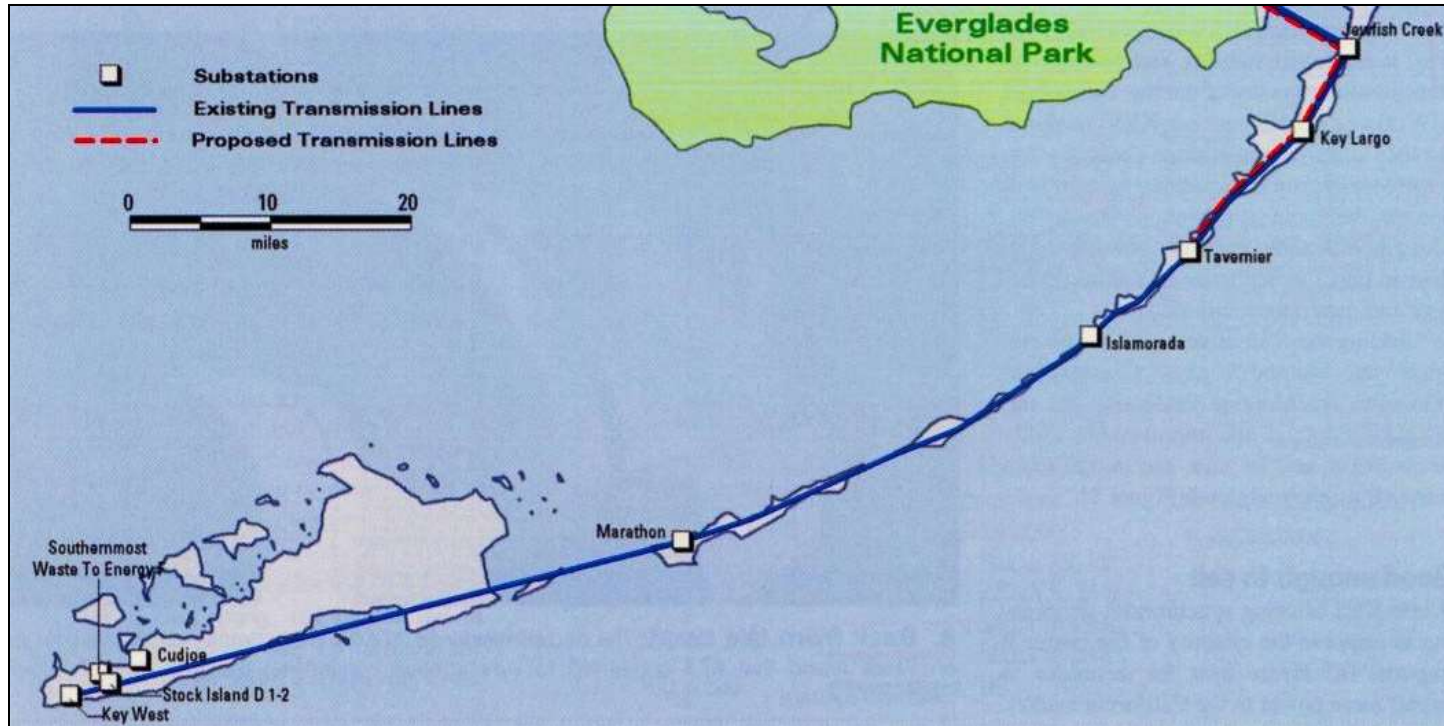

It became necessary for the company to choose between an increase in costly local generation or an increase in MW import capability from the mainland, 185 miles away.

Stand-Alone Generator Turned Into Synchronous Condenser The City of Key West, FL

Graph of transmission capacity before and after conversion of generator to synchronous condenser. Work was completed in July of 1997.

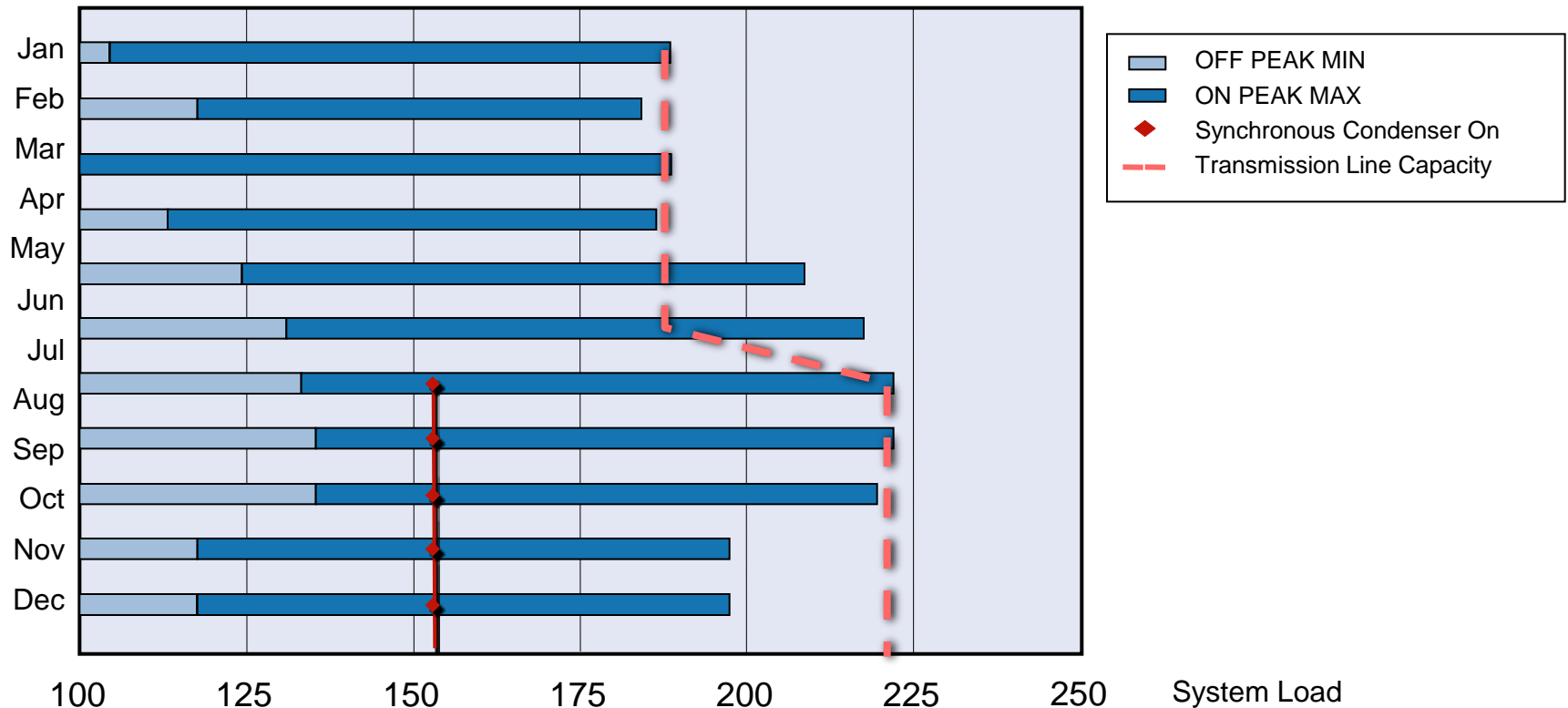

Stand-Alone Generator Turned Into Synchronous Condenser: The City of Key West

Installation of a new Acceleration System in place of steam turbine at end of 44 MVA hydrogen-cooled generator to permit generator to be used for synchronous condensing at Ralph Garcia Generating Station on Stock Island, Florida.

Completed by GE in January, 1998, it can produce 34 MVAR or absorb up to 22 MVAR.

It enables up to 34 MW additional power to be transmitted from Florida mainland to Florida Keys through existing 138 kV transmission line.

Through 2011, this unit has operated as a synchronous condenser for more than 100,000 hours.

A 375 hp motor-driven pump supplies hydraulic oil at pressures up to 5000 psi to an hydraulic motor which is mounted on a size 48T SSS Encased Clutch containing thrust bearing and turning gear for the synchronous condenser.



B.C. Hydro, Vancouver, British Columbia, Canada

B.C. Hydro required a source of variable Vars in their lower mainland network. This was due to power distribution needs in their network and more power being exported/transmitted to The Bonneville Power Authority in the US.

B.C Hydro Generation Capacity:

10,800 MW total
9,700 MW hydro—base
900 MW thermal—peak
140 MW gas turbine
60 MW other generation

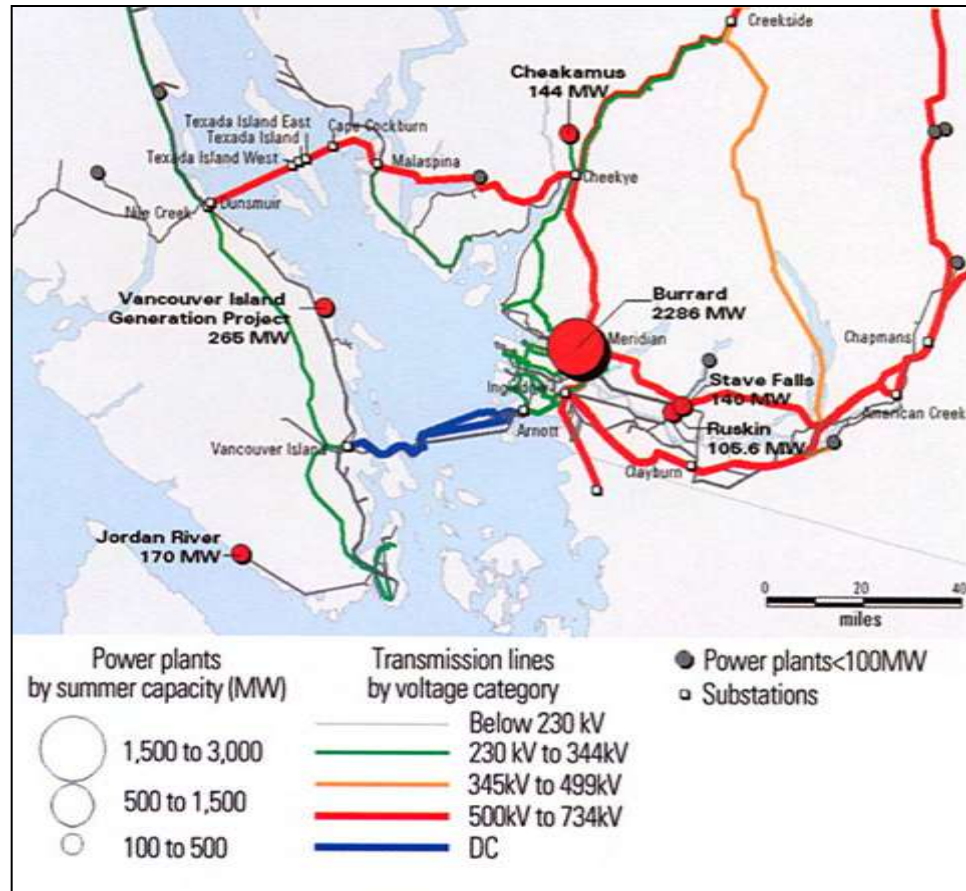

B.C. Hydro Burrard Thermal Plant

Synchronous condensing starting package. Encased clutch contains disconnect clutch for starting system, turning gear with second clutch, and new generator thrust bearing.



Exelon (formerly Commonwealth Edison) Zion Plant Synchronous Condensing Conversion Project

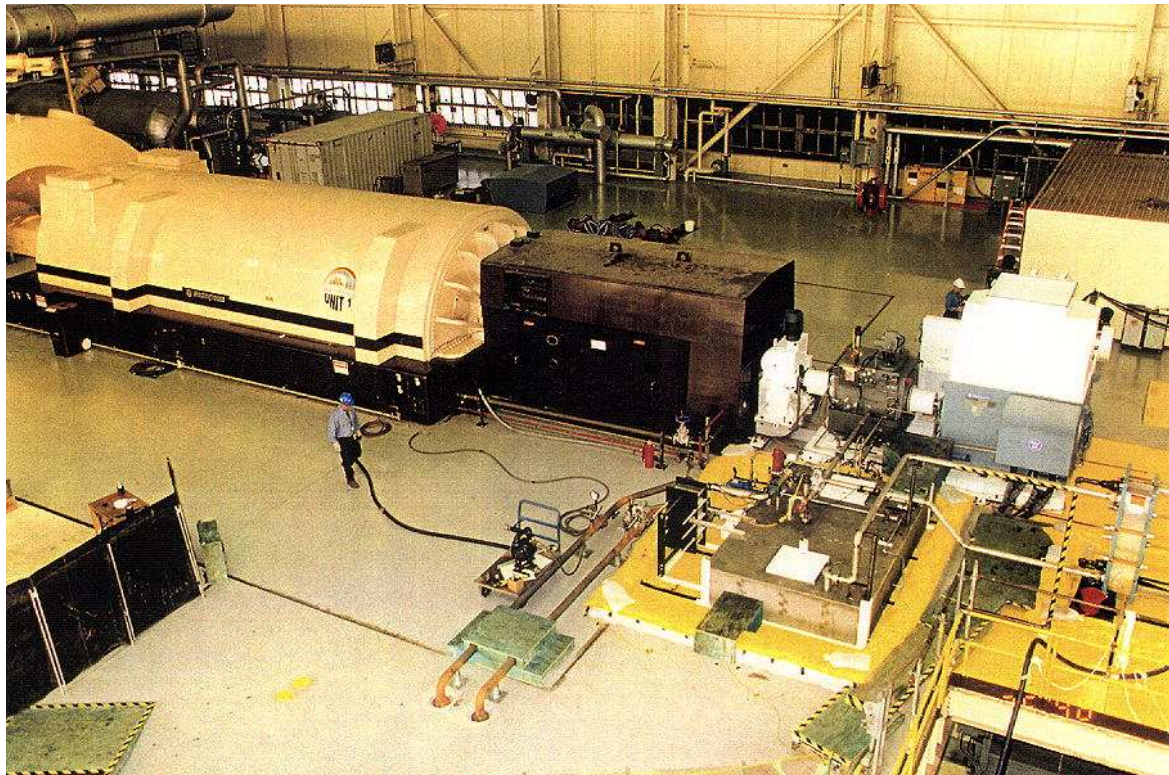

Zion Nuclear Plant: Aerial View of Portable Acceleration Package Arrangement. **The result: production of 825 MVAR per machine, for a total of 1650 MVAR, which stabilizes voltage north of Chicago. Both units run in summer at half VAR capacity and one runs in winter.**



Exelon (Formerly Commonwealth Edison) Zion Plant Synchronous Condensing Conversion Project

Installation of portable 12,000 HP acceleration system with portable oil tank at the exciter end of Zion unit #1 generator. The Clutch and turning gear module is permanently installed, but the 46,000 lbs. acceleration system skid and oil tank when empty can be moved to unit #2.



The torque converter is driven by a 8,000 HP at 3600 rpm electric motor which has 150,000 CFM forced air cooling system.

Motor can be overloaded up to 12,000 HP for 14 minutes to enable the generator to be excited and synchronized.



Looking Towards the Future, Grid Stability – Inertia

- Identify areas that have voltage stability problems(long transmission lines, locally high industrial/manufacturing loads, densely populated areas)
- Identify areas that have or will have significant renewable generation assets that can reduce grid inertia (windmills, solar, and distributed generation)
- Identify assets that can be used for synchronous condensing (peaking units, decommissioned generators)
- Need for consistent ancillary markets to be developed to compensate operators for ancillary services, like the PJM (Synchronized Reserve)
- How to increase flexibility of generation assets to meet current and future market needs: Synchronous Condensing, Synchronized Reserve, Inertia, “Balancing Market”



Looking Towards the Future, Grid Stability – Inertia

Link to article titled:

German Utilities Bail Out Electric Grid at Wind's Mercy

Dated July 25, 2014

<http://www.bloomberg.com/news/2014-07-24/german-utilities-bail-out-electric-grid-at-wind-s-mercy.html>



“The 2013 Renewable Futures Study by the National Renewable energy Laboratory (NREL) predicts that by 2050, 80 percent of the nations energy can come from wind and solar and other renewable sources.”

“In order to accommodate reliably so much clean energy, which can be variable due to unexpected weather, the study also predicts a need for significant, but feasible, increases in system flexibility. “

Dated February 26, 2014



sssgears.co.uk
sssclutch.com

ASMEPOWER

Thank You

Randall M. Attix

Manager Application Engineering – SSS Clutch Co., Inc.

Donald M. Chamberlin, P.E.

Consultant



Clutch Company, Inc.

ASMEPOWER