

DOCKETED

Docket Number:	19-IEPR-04
Project Title:	Transportation
TN #:	228787-6
Document Title:	California ISO - Energy Storage and Distributed Energy Resources Phase 3 - Market & Infrastructure Policy - July 11, 2018
Description:	Draft Final Proposal
Filer:	Wendell Krell
Organization:	California Energy Commission
Submitter Role:	Commission Staff
Submission Date:	6/19/2019 9:22:42 AM
Docketed Date:	6/19/2019



California ISO

Energy Storage and Distributed Energy Resources Phase 3

Draft Final Proposal

July 11, 2018

Market & Infrastructure Policy

Table of Contents

1	Introduction	3
2	Stakeholder Process	4
3	Energy Imbalance Market Classification	4
4	Response to Stakeholder Comments	5
5	Demand Response Resources	9
5.1	Demand response modeling limitations.....	9
5.1.1	Proposal	10
5.2	Removal of the single LSE requirement and default load adjustment.....	13
5.2.1	Proposal	14
5.3	Load Shift Product.....	16
5.3.1	Proposal	17
5.4	Recognition of behind the meter EVSE load curtailment.....	23
5.4.1	Proposal	24
5.5	Multiple-Use Applications.....	25
5.6	Non-Generator Resources	26
6	Future Considerations	27
Appendix A	Acronyms.....	29

1 Introduction

The focus of the California Independent System Operator's (CAISO) energy storage and distributed energy resources (ESDER) initiative is to lower barriers and enhance the abilities for energy storage and distribution-connected resources¹ to participate in the CAISO markets. The growing number and diversity of these resources are beginning to represent an increasingly important part of the future grid.

The ESDER initiative is an omnibus initiative with annual phases covering several related but distinct topics. The second phase of ESDER developed enhancements to demand response (DR), non-generator resources (NGR), multiple-use applications (MUA), and station power for storage resources.

The CAISO published a revised straw proposal on April 30, 2018 identifying the scope for ESDER 3 along with proposed policy. Subsequent to the release of the revised straw proposal, the CAISO has held both a working group meeting and conference call to further develop proposal details with stakeholders. This draft final proposal will be submitted for approval to the CAISO Board of Governors in September. Upon receipt of approval, a tariff filing with FERC will be made.

The following describes the scope of the ESDER 3:

- Demand Response – Four enhancements to current demand response participation models are proposed: (1) new bidding and real-time dispatch options, (2) removal of the single load serving entity (LSE) aggregation requirement along with need for the settlement application of a default load adjustment (DLA), (3) development of an energy storage load shift product, and (4) recognition of sub-metered electric vehicle supply equipment (EVSE) load curtailment separate contribution to resource performance.
- Multiple-Use Application (MUA) – CAISO has yet to identify specific tariff and market design changes that can be proposed within ESDER3 based on current developments in the CPUC working group. While not proposing any changes at this time, the CAISO will continue actively participating in the working group and reevaluate once the final report is submitted to the CPUC commission.
- Non-Generator Resource (NGR) – The CAISO is not proposing any changes to the current NGR participation model.

¹ DERs are those resources on the distribution system on either the utility side or the customer side of the end-use customer meter, including rooftop solar, energy storage, plug-in electric vehicles, and demand response.

2 Stakeholder Process

The CAISO is at the draft final proposal stage in the ESDER 3 stakeholder process. Figure 1 below shows the status of the draft final proposal within the overall ESDER 3 stakeholder process.

The purpose of the draft final proposal is to present the final scope and solutions of issues related to the integration, modeling, and participation of energy storage and DERs in the CAISO market. The CAISO has reviewed stakeholder feedback through comments and working group meetings in developing the final proposal to be presented to the CAISO Board of Governors, Energy Imbalance Market Governing Body, and final tariff approval from FERC.

Figure 1: Stakeholder Process for ESDER 3 Stakeholder Initiative

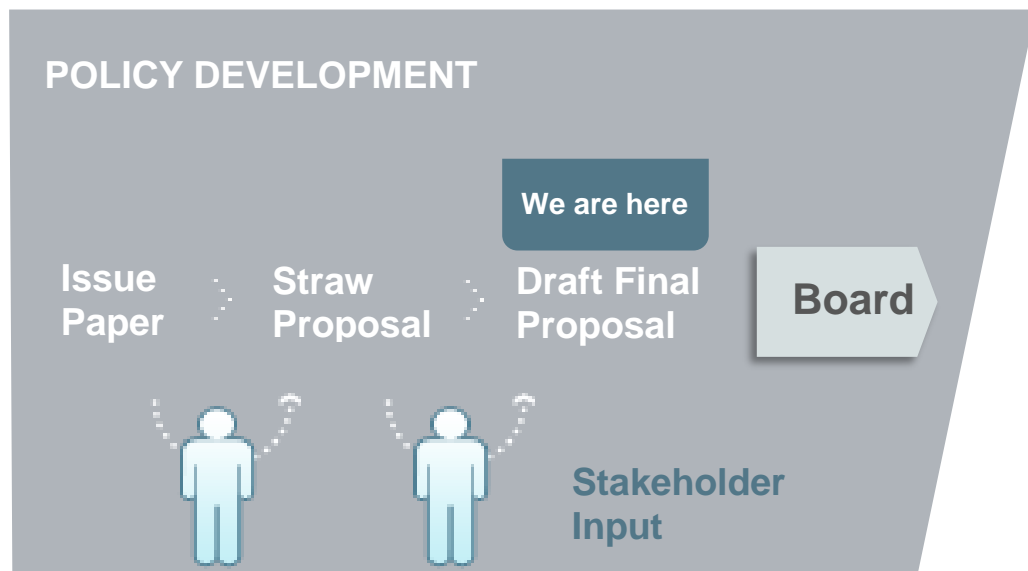

3 Energy Imbalance Market Classification

CAISO staff believes that ESDER 3 involves the Energy Imbalance Market (EIM) Governing Body's advisory role to the Board of Governors (Governing Body – E2 classification). This initiative proposes four changes to the proxy demand resource (PDR) and reliability demand response resource (RDRR) model with the aim of reducing barriers to participation and enhancing their ability to provide services in the day-ahead and real-time markets. While proposed enhancements to the CAISO's demand response participation models will be applicable to demand response participation models utilized by EIM participants, there are no changes specific to EIM balancing authority areas. The demand response enhancements are:

1. PDRs ~~and RDRRs~~ ability to bid as an hourly or 15-minute dispatchable resource to provide real-time dispatch enhancements;
2. Adding a component to allow a PDR to increase consumption by charging behind the meter energy storage (battery);
3. A new performance measurement recognizing Electric Vehicle Supply Equipment as an independent load curtailment contributor participating under the PDR model;
4. Eliminate the requirement for PDR and RDRR resources to be composed of service accounts under one LSE while maintaining the single sub-Lap requirements.

All of the new proposed features would apply generally throughout the ISO market, and thus be advisory for the EIM Governing Body.

4 Response to Stakeholder Comments

The following section provides responses to stakeholder comments since the posting of the revised straw proposal on April 30, 2018.

Section 5.1 – Demand response modeling limitations

The CAISO corrected a description of the hourly bid option in which the resource will be a “price taker” for the full hour and will not receive a guaranteed price in the first 15-minute interval as previously stated. In addition, the proposal updated the new name for the Imbalance Reserve Product in the Day-Ahead Markets Enhancement (DAME) initiative, to the day ahead flexible ramping product (FRP). Lastly, the CAISO is proposing that PDRs with an hourly block bid have the option to be cleared in the day-ahead market but not be considered in RUC.

A majority of stakeholders support the bidding options proposal. CLECA requested clarification on the market award for the hourly bidding option. The CAISO has corrected the proposal to state that a resource will be a “price taker” over the full hour it is scheduled at the 15-minute market price. CLECA also requested the CAISO consider an option to guarantee the first 15-min interval price under the hourly bid option. This option is not feasible since the Hour Ahead Scheduling Process (HASP) runs approximately 45 minutes before the hour and the dispatch is based on advisory prices. Specifically, the resource’s hourly block is scheduled before the first 15-min interval price is set and 22.5 minutes before the first binding interval, therefore, all four pricing intervals of the hour are advisory. Additionally, CLECA submitted comments on the

need for minimum run time changes to the demand response model. The CAISO believes that the proposed bidding options allows for DR resources to receive the advanced notification needed for real time response and enables resources to be dispatched hourly, if needed.

Section 5.2 – Removal of the single LSE requirement and default load adjustment

No major changes were proposed in the draft final proposal.

A majority of stakeholders support the proposal. SCE requested clarification on SIBR treatment of bids at the NBT threshold price. The CAISO has made the clarification in the proposal that SIBR will only accept bids at or above the NBT threshold price.

Section 5.3 – Load Shift Product

The CAISO provided further details on the design of the proxy demand resource - load shift resource (PDR-LSR). The PDR-LSR is a demand response resource providing both load curtailment and dispatchable consumption to provide “energy shift.” To participate, a resource will register two separate resource IDs containing the same service accounts (Resource ID – curtailment, Resource ID- consumption). The CAISO has included an example (see attachment) for the scenario in which a facility and sub-metered energy storage participates as a PDR-LSR. The CAISO has also clarified in its description of the performance evaluation calculation, the need for 15-minute granularity in determining event/non-event intervals.

A majority of stakeholders have either expressed support or have not expressed a position on the proposal. SCE requested further information on the CAISO’s shift from moving to event day to event hours when calculating the baseline for PDRs. The CAISO clarifies that the use of event hours rather than event days was established with the metered generation output (MGO) methodology in ESDER 1 and only applies to development of a baseline to determine the typical use of a sub-metered energy storage device. PDR/RDRRs utilizing the current day matching customer load baseline (CLB) performance methodology will continue to use event days and not event hours. The CAISO moved towards a more granular approach in event intervals to capture the typical use of the energy storage device. The CAISO does not believe an event that occurred at an earlier interval justifies the removal of an entire day. The assessment of 15-minute intervals will only apply to PDR-LSRs. Event hours will continue to remain for PDR/RDRRs utilizing the MGO methodology, and event days for PDR/RDRRs using all other CAISO approved baseline methodologies. Olivine requested the use for “event days” and questioned the rationale behind the separate calculation between a facility’s load curtailment and the development of typical use for a sub-metered storage resource. The CAISO’s rationale for separating the baseline calculation between the

facility load and sub-metered storage resource is because it keeps the treatment consistent with the FERC approved MGO baseline.² In response to SCE's comment on the registration of the PDR-LSR, the CAISO clarified in its proposal that the same service accounts must be used for participation in both curtailment and consumption. SCE has also requested clarification on the consideration of retail charging for the energy storage device in the baseline. The PDR-LSR will consider both non-event charge and discharge values for a given interval, which takes into account retail charging in the calculation of the typical use value. In response to Olivine's clarifying question, PDR-LSRs can buy back day-ahead consumption awards in real-time.

The CAISO Department of Market Monitoring (DMM) detailed potential conflicting dispatch scenarios.³

1. *"Scenario 1: The curtailment resource has a minimum run time of 1 hour and is scheduled through HE21. The curtailment resource is economic in the first two intervals of HE 21 (intervals 00 and 15) and scheduled at 5MW, but is ramped down starting in the third interval of HE 21 (interval 30). The curtailment resource is uneconomic in interval 30, but its ramp rate only enables it to ramp to 1MW by interval 30. Meanwhile, the consumption resource is economically dispatched to consume starting interval 30."*

The CAISO will enforce ramp rates for a PDR-LSR to be fully dispatchable between Pmin and Pmax in either 15 or 5 minutes, depending on its elected bidding option. Enforcing the ramp rate will ensure that each resource (consumption/curtailment) will meet its dispatch in a given interval. In the scenario above, the curtailment resource would need to meet its dispatch by the end of the third interval and the consumption resource would follow the dispatch to increase load.

2. *"Scenario 2: The curtailment resource has a start-up time of 1 hour and receives dispatches starting HE18 for 5MW. The consumption resource is economic during curtailment resource's start-up time. The consumption resource could receive consumption dispatches during HE17 when curtailment resource's start-*

² See ESDER Phase 1 Revised Draft Final Proposal
(<http://www.caiso.com/Documents/RevisedDraftFinalProposal-EnergyStorageDistributedEnergyResources.pdf>)

³ For further details please refer to DMM's comments
(<http://www.caiso.com/Documents/DMMComments-EnergyStorage-DistributedEnergyResourcesPhase3-Jun252018.pdf>)

up time is honored. The curtailment resource requires advanced notice to curtail/generate as specified by its start-up time, but the consumption resource may be dispatched to increase load leading up to the curtailment.”

The PDR-LSR’s design will utilize existing market functionalities. The consumption resource, will be designed in similar fashion to the existing NGR model, which will not have certain parameters such as startup time. In contrast, the curtailment resource ID will reflect the same parameters as PDRs have today.

3. *“Scenario 3: Even if the curtailment resource has a 0 MW Pmin and both IDs have infinite ramp, the curtailment resource and consumption resource can receive two different dispatch instructions in the same interval. Suppose the curtailment resource is scheduled through HE21 and its minimum run time of 1 hour is honored. However, the curtailment resource is no longer economic starting HE21 interval 30 and is dispatched down, sitting at 0MW through the balance of hour. Meanwhile, the consumption resource is economically dispatched to consume through the balance of HE21.*

Starting HE22, the system needs additional supply. The market schedules the curtailment resource to ramp up (curtail/supply) and the consumption resource to reduce consumption.

Starting HE22, the curtailment resource is asked to curtail (supply) 5MW and the consumption resource is asked to curtail (reduce consumption) 5MW. The market schedules 10 MWs of movement on the single resource between HE21 Int45 and HE22 Int00, not just 5MW of supply on curtailment resource.”

The CAISO understands the scenario in which both resource IDs will be expected to respond to a dispatch. The CAISO does not have any operational concerns with the dispatch scenario above because it was a valid decision made by the market optimization system. The CAISO will monitor for this scenario with the implementation of the PDR-LSR.

Section 5.4 – Measurement of EVSE performance

No major changes were proposed in the draft final proposal

A majority of stakeholders supported the EVSE proposal. SCE stated that it “retains its concern on EVSE sub-metering regarding the lack of a dedicated meter for the resource.” The CAISO has understood SCE’s concerns as well as the positions of other stakeholders and have made the decision to move forward with the proposal. But, it will continue to monitor the potential use-cases SCE had presented.

5 Demand Response Resources

The CAISO is proposing the following enhancements to the Proxy Demand Resource (PDR) and Reliability Demand Response Resource (RDRR) participation models.

5.1 Demand response modeling limitations

DR resources are successfully integrated into the CAISO market and aide in meeting system reliability. The CAISO is looking to continue market design enhancements to provide DR resources options to inform the CAISO of its operating characteristics to align the market optimization of these resources in the day-ahead and real-time market processes.

Minimum and Maximum Run-Time Constraints

The CAISO understands the conflict due to a DR resource’s Pmin of 0 MW and the CAISO market optimization. Today, the CAISO market systems will issue a start-up instruction to a DR resource to their Pmin, often 0 MW, well in advance of the commitment hour in the real-time market. This commitment ensures both start-up and minimum runtime constraints are met, however, since the resource is considered “running” at a Pmin of 0 MW, it is available for dispatch whenever the resource’s energy bid is economic. This can result in 5-minute dispatch instructions that have only a 2.5-minute notification time. Certain affected stakeholders have explained that this notification time is infeasible for many PDRs. Figure 2 below represents this scenario.

Figure 2: Commitment of DR resource with a Pmin of 0 MW

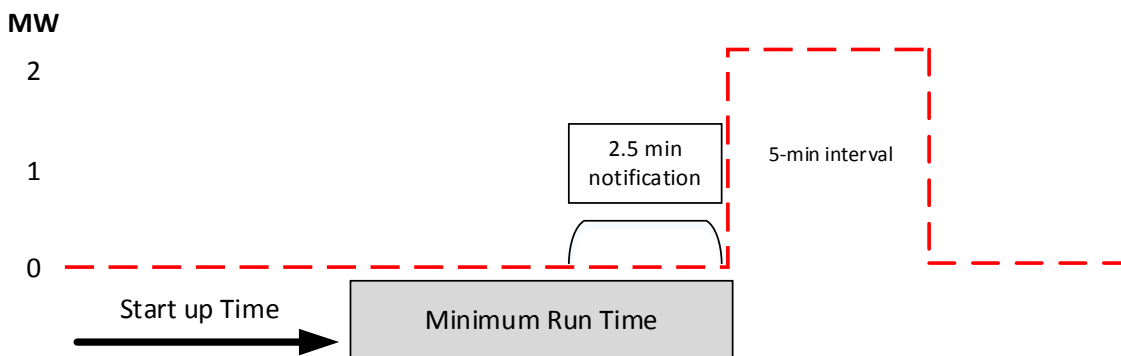

The CAISO respects the resource’s minimum run-time constraint when committing at Pmin, represented in Figure 2 as the gray horizontal bar. However, the minimum run-

time constraint at times may be met while the resource is at a Pmin of 0 MW, which is dispatched above its Pmin, represented as the dashed red line above.⁴ Stakeholders have suggested that the PDR participation model does not effectively recognize two constraints:

- (1) Recognition of the minimum run time when the resource is dispatched above its Pmin of 0 MW;
- (2) Limitation in using the maximum daily energy limit instead of a maximum run time to recognize daily use limitations.

5.1.1 Proposal

Hourly and 15 minute bidding option for PDRs

The CAISO is proposing to offer bidding options for PDRs/~~RDRRs~~ that will provide longer notification times and extended real-time dispatch intervals, similar to what the CAISO currently offers to intertie resources. The CAISO introduced this option and its application to PDRs/~~RDRRs~~ in a joint workshop with the CPUC on October 4, 2017.⁵ Additionally, PDRs that elect the hourly bid option will also be eligible to be cleared in the day-ahead market but not be considered in RUC.⁶

The CAISO believes applying an hourly economic bidding and real-time dispatch model to PDRs/~~RDRRs~~, which require longer notification time or cannot respond to 5-minute dispatches, provides them with an additional alternatives to viably participate in the real-time market. The CAISO's goal is to leverage existing market functionality, where possible, to enable demand response resources to participate more effectively and efficiently in the market.

Pre-Market

⁴ Definition of minimum run time

http://www.caiso.com/Documents/Section34_RealTimeMarket_asof_May2_2017.pdf

⁵ Link to presentation from CAISO-CPUC joint workshop introducing CAISO's 15-minute market and bidding options for real-time imports and exports, slides 51- 59.

http://www.caiso.com/Documents/Presentation_JointISO_CPUCWorkshopSlowResponseLocalCapacityResourceAssessment_Oct42017.pdf

⁶ With the future implementation of the DAME initiative, RUC will be co-optimized with the IFM. The CAISO will award resources that are willing to be dispatched in FMM and/or RTD DA flexible ramping product. PDR resources that cannot be dispatched in FMM and/or RTD can register this limitation, which will prevent the resource from receiving a DA FRP award.

The PDR/~~RDRR~~ will register in Master File if the resource can be scheduled as an hourly block, scheduled in 15-minute intervals, or 5-minute dispatchable. Until implementation of the DAME, if a PDR elects the hourly block bid option, it can also register in Master File the option to not be considered for a RUC. Once the DAME are implemented, the IFM and RUC will be co-optimized in a single market optimization and hourly block resources will be ineligible for DA FRP awards. This option will only apply to PDRs with an hourly block bid, because the resource can only be scheduled in the real-time market during the hour ahead scheduling process (HASP).⁷ The HASP determines the hourly energy schedule by enforcing a constraint that the resources schedule for each advisory 15-minute interval is equal. Since the resource's schedule cannot be determine for each 15-minute interval, the HASP schedule is a price taker in the fifteen minute market (FMM). The process to change Master File characteristics will remain the same under the existing BPM in which changes can take anywhere from 5 to 11 business days.⁸ Once the PDR/~~RDRR~~ has registered the scheduling option, it will be required to submit bids accordingly.⁹ ~~Specific to RDRR, awards from the day-ahead market will be dispatched according to their day-ahead awards and any remaining capacity bid into the real-time market would be held back for emergency response purposes. However, when an RDRR's capacity is "released" into the market after an emergency is called, the RDRR will be dispatched according to its bid parameters.~~

Market

Once the resource elects its scheduling option in Master File, the PDR/~~RDRR~~ resource will follow one of the processes below:

1. **Hourly block** –the SC submits a day-ahead market bid for an entire hour. In the real-time market, the resource will be scheduled via the HASP but will be settled at 15-minute market prices over the operating hour. The binding schedule is communicated to the SC at 52.5 minutes before the flow of energy. Because the resource is scheduled for the full hour, it will settle at the FMM in real time making it a “price-taker” for the full hour. In the example below, the resource is

⁷ PDRs electing the hourly block bid option without a RUC obligation can only be considered as a system RA resource.

⁸ CAISO BPM for Market Instruments, “Master File Update Procedures” Attachment B (<https://bpmcm.caiso.com/Pages/BPMDetails.aspx?BPM=Market%20Instruments>)

⁹ ~~Applicable to RDRRs that elect to economically bid in day-ahead market. All other real-time reliability bidding requirements will remain for RDRRs recognizing their reliability only bidding in the real-time market.~~

a 2 MW resource that opted to bid hourly. The CAISO respected the minimum run time parameter (1 hour) in HE 2 and 3. In HE 2, the CAISO sent a dispatch notification 52.5 minutes before the flow of energy for HE 3.

Following the market design principle laid out in CAISO's FERC 764 tariff compliance, the CAISO will not allow for bid cost recovery (BCR) for PDRs that elect an hourly bid option.¹⁰

Figure 3: Example of hourly bid option

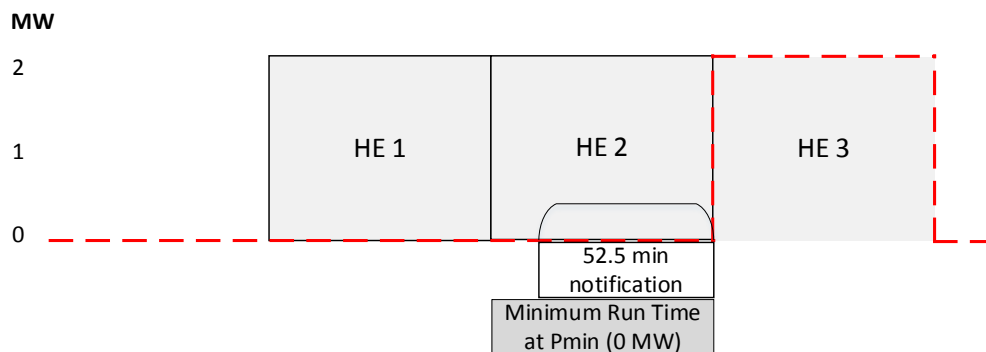

- 2. 15-minute dispatchable** – The SC will submit supply bids in hourly increments in the day-ahead market. In the real-time market, hourly energy bids are submitted no later than 75 minutes prior to the operating hour. If the 15-minute bid is economic, it will be dispatched and receive a binding schedule at the FMM price. The dispatch notification is communicated 22.5 minutes before the flow of energy is expected.

PDRs electing the 15-minute bid option will be eligible for BCR. Bid cost recovery allows a resource committed by the CAISO to recover its startup costs, minimum load costs, ancillary service bids, and energy bids over the course of the day (the 24 hours of that day). In the case that the FMM price does not cover the dispatched resource's bid-in costs, the CAISO will ensure that the resource is compensated for providing energy.

¹⁰ CAISO's tariff compliance filing on FERC Order 764 (see pg. 30-32) (http://www.caiso.com/Documents/Nov26_2013_TariffAmendment-Real-TimeMarketDesignEnhancementsRelated-Order764_ER14-480.pdf)

Figure 4: Example of 15-minute bid option

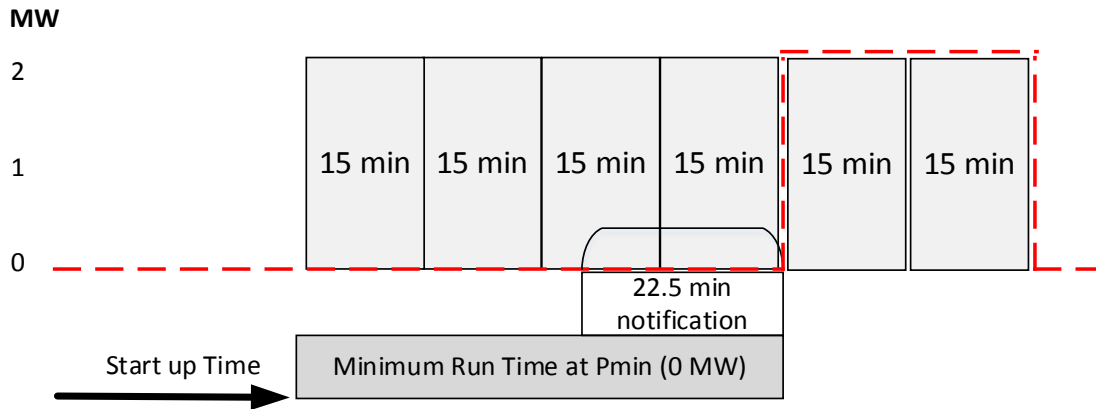

Post-Market

Currently, PDRs are settled on the 5-minute real time Locational Marginal Price (LMP). If a PDR elects an hourly or 15-minute bid option, the CAISO will settle the resource under the FMM LMP. The CAISO established the process for FMM settlement under its FERC Order No. 764 proposal.¹¹ The day-ahead energy schedule will be settled at the day-ahead LMP. Any imbalances between the FMM energy schedule and the day-ahead energy schedule is settled at the FMM LMP.

5.2 Removal of the single LSE requirement and default load adjustment

The CAISO currently requires DR resource aggregations consist of locations under a single LSE, represented by one demand response provider (DRP), and within a single sub-LAP. The CAISO originally established the single LSE requirement in its PDR policy, later replicated in the RDRR policy, to facilitate the settlement application of a LSE specific DLA.¹² This adjustment eliminated the double payment for a decrease in demand when it was not net beneficial to all purchasers in terms of a wholesale market

¹¹ CAISO Draft Final Proposal on FERC Order 764 (see pg. 18-19).
<http://www.caiso.com/Documents/DraftFinalProposal-FERC-Order764MarketChanges.pdf>

¹² The DLA represents the amount of load curtailed, based on a PDR or RDRR demand response energy measurement, within a Default LAP specific to the LSE when the real-time LMP is below the threshold price.

price reduction based on a demand response net benefits test.¹³ This design feature required segmenting a DR program into different aggregations by LSE within a single sub-LAP. DR market participants claimed this segmentation could potentially strand willing customer participants and affect the ability for some PDRs to meet the minimum wholesale market participation size requirement. In more specific cases, DRPs establishing new resource aggregations, or are in the process of developing new ones, have expressed difficulty meeting, or maintaining, the 100 kW minimum participation requirement as customers within their resource aggregations are defaulted or move to new LSEs, such as to a Community Choice Aggregation (CCA).

The DLA settlement mechanism requires PDR and RDRR aggregations to be under a single LSE. The DLA originated from FERC Order 745, which required the CAISO to implement a net benefits test (NBT).¹⁴ The NBT establishes a price threshold at which demand response resources are deemed cost effective. If the real-time market LMP is below the threshold, the DLA is triggered; resulting in the adjustment of the metered load used in the uninstructed imbalance energy (UIE) settlement of the LSE's default load aggregation point (DLAP). This mechanism is utilized to mitigate double payment for demand response services provided in intervals where the threshold price is not met but payment to the PDR or RDRR is made.

5.2.1 Proposal

The CAISO proposes to remove the single LSE requirement for DR aggregations and application of the DLA. The CAISO believes by removing the single LSE requirement, the application of the DLA becomes too complex to implement and manage across multiple LSEs under a single PDR. Additionally, the settlement implications of the DLA have historically been *de minimis* relative to the benefits achieved by eliminating the one LSE per PDR requirement (see Figure 5 and Figure 6 below).

As requested by stakeholders, the CAISO conducted an analysis of the total DLA affected MWs, their settlement impacts, and how frequently the DLA was applied in 2017. On average, the DLA calculation was triggered 4% of the month over the course of a year.¹⁵ The monthly total of demand response resource MWs identified as being provided below the NBT threshold price and settlement charges resulting from the application of

¹³ CAISO Net Benefits Test

http://www.caiso.com/Documents/IssuePaper_DemandResponseNetBenefitsTest.pdf

¹⁴ FERC Order 745 <https://www.ferc.gov/EventCalendar/Files/20110315105757-RM10-17-000.pdf>

¹⁵ Based on the number of intervals DLA was triggered/ total number intervals in a month.

the DLAs to the LSEs, are shown below in Figure 5 and Figure 6. The CAISO’s DLA settlement impact analysis, in part, supports removal of the calculation and that its removal results in a *de minimis* settlement impact. The CAISO maintains that removal of the DLA is necessary to institute an aggregation requirement, highly desirable by stakeholder, allowing multiple LSEs to be represented within a single PDR/RDRR.

Figure 5: 2017 Total Monthly DLA Impact

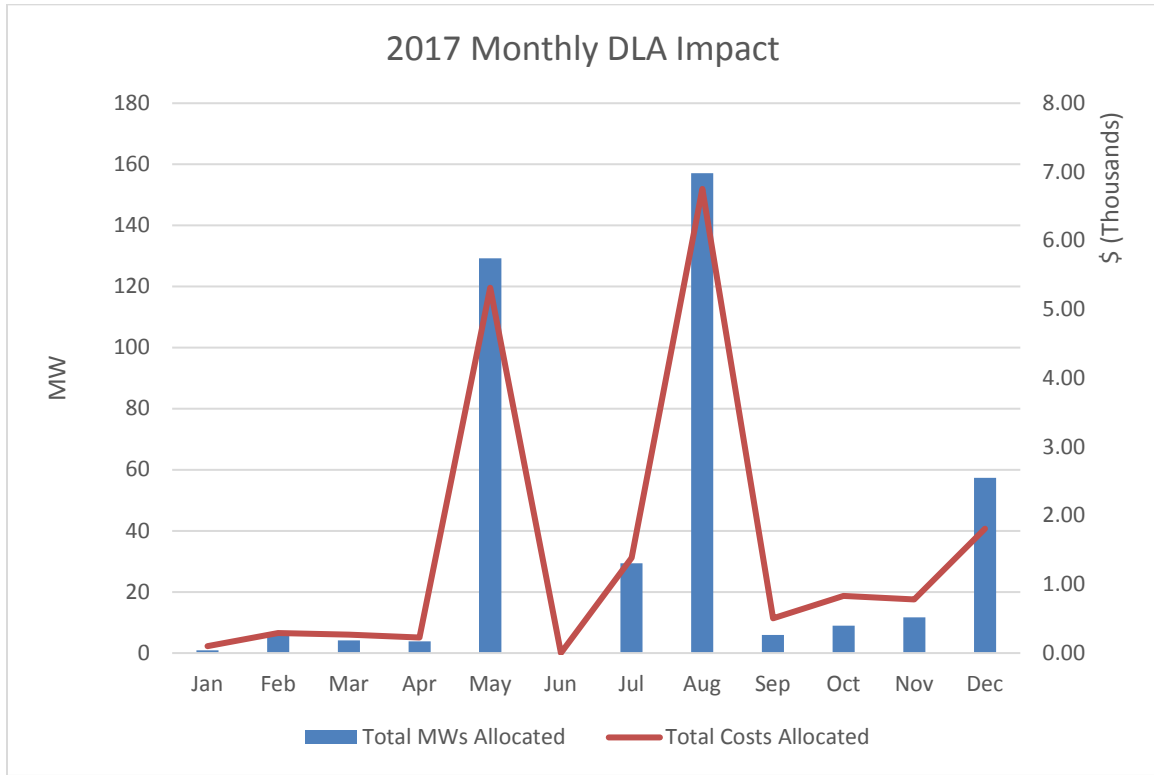
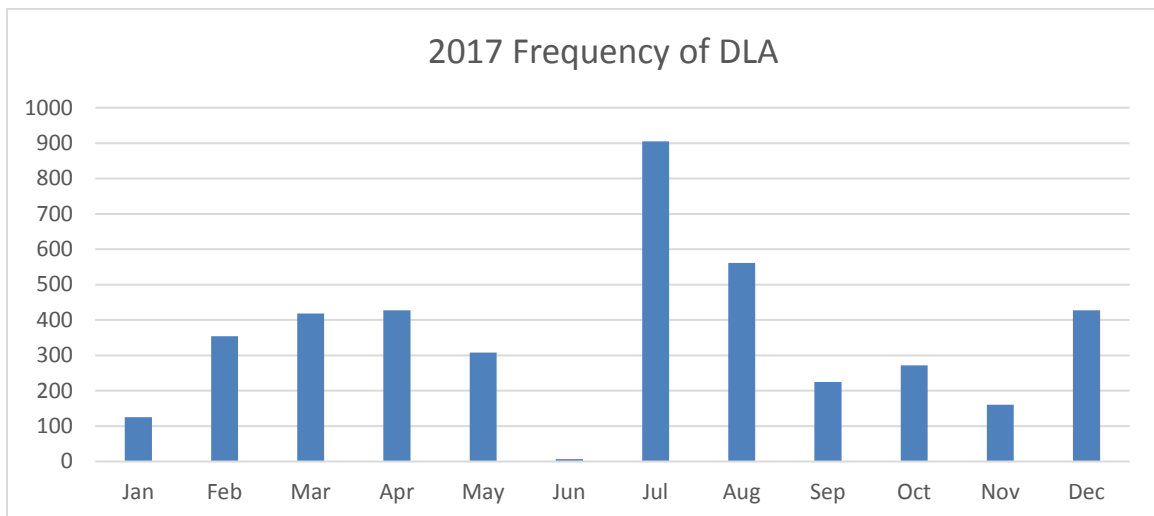

Figure 6: Number of intervals a DLA was triggered per month



Pre-market

Currently, the demand response registration process (DRRS) requires a registration for a PDR or RDRR to be composed of locations with the same LSE service accounts. The CAISO proposes to remove the single LSE aggregation rule and make appropriate changes to the DRRS as well as remove enforcement of the single LSE registration requirement.

Market

The CAISO proposes to utilize the NBT threshold price to screen submitted PDR bids in the CAISO's Software Infrastructure Business Rules (SIBR) in compliance with FERC Order No. 745. SIBR will accept bids only at or above the established net benefits threshold price. This SIBR rule bidding requirement will ensure PDR and RDRR resources are net beneficial to the system when submitting bids to the CAISO rather than an after-the-fact assessment in the settlement system. The CAISO will use the existing monthly calculation of the NBT and its resulting on-peak and off-peak threshold prices in SIBR to validate bid submissions in the day-ahead and real-time markets to ensure all energy prices in the energy bid are at or above the threshold price. If this condition is not met, SIBR will invalidate the bid and a status will be displayed on the SIBR user interface. The SC will have an opportunity to correct and re-submit valid bids until the market closes. An invalid bid cannot overwrite a bid previously submitted within that market. SIBR will continue validating submission of RDRR bids in the real time market against the current rule requiring their bid prices in the energy bid curve to be at or above 95% of the energy bid price ceiling.

Post-market

Today, the DLA application is triggered within an LSE for the intervals in which the real time LMP falls below the NBT threshold price and PDR/RDRR delivers energy. Because the CAISO will accept demand response resource bids only at or above the NBT price threshold, the CAISO will remove the DLA application.

5.3 Load Shift Product

In approving the ESDER 2 proposal, the CAISO Board of Governors requested staff continue working with stakeholders on proposals set out by the original load consumption working group for enhancing the PDR model to provide additional services during oversupply conditions.

5.3.1 Proposal

The CAISO is proposing to develop a load shift product for behind the meter (BTM) storage devices under the PDR participation model. The load shift product will fall under existing PDR policy provisions, but will develop certain functionalities allowing the resource to bid and be dispatched for both load consumption (charging, negative generation) and load curtailment (discharging, generation) from a BTM storage resource. The initial product will allow a PDR to access day-ahead and real-time energy markets for both load curtailment and load consumption capabilities through the use of two separate resource IDs. The proposal will facilitate the provision of “shift” services while maintaining a demand response policy principle that injection or export of BTM energy storage beyond the retail meter is not eligible for wholesale market compensation.

The CAISO is proposing the following features listed below:

- Participation requires direct metering of BTM energy storage
- Resource pays full retail rate for all charging energy
- Energy storage resource will maintain its own state of charge
- Load curtailment resource ID
 - Maintains RA capacity eligibility
 - Non-exporting rule applies
- Load consumption resource ID
 - Ineligible for RA capacity and ancillary services
 - Ability to bid a negative cost for load consumption energy services

Pre-market

The CAISO proposes that the PDR-LSR will facilitate the provision of load curtailment and load consumption by two discrete resources registered in Master File, one resource ID to reflect the operating characteristics of the resources curtailment capabilities and the second resource ID to reflect those of its consumption capabilities. Both resource IDs will be able to register using the same registered service accounts. At least one of the service accounts must have a behind the meter storage to qualify as a PDR-LSR.¹⁶ A

¹⁶ The CAISO at this time, defines “behind the meter storage” as a battery storage resource that can be directly metered.

resource wanting to participate under the PDR-LSR must register with both resource IDs and cannot opt to register for just the consumption functionality. PDR-LSRs may have an RA obligation for the provision of curtailment and will still have a MOO applicable to the PDR-LSR resource ID identified as such. Due to the design of two discrete resource IDs, the resource ID representing curtailment will need to register with a Pmin of 0 MW. The CAISO believes that in addition to specific bidding rules (detailed below), enforcing ramping capabilities for each resource, and the Pmin requirement during registration, will prevent scenarios in which both resource IDs will be given conflicting dispatches.

Market

To ensure that conflicting dispatches will not occur within intervals, the CAISO proposes that the PDR-LSR will be available to bid either as a 15-minute or 5-minute dispatchable resource only. Because the PDR-LSR is a single product with two resource IDs, it must bid both resource IDs consistently and exclusively. For example, if a PDR-LSR elects to be dispatchable on a 5-minute basis under the resource IDs providing consumption, it cannot elect to use the hourly or 15-minute bid option for the resource ID providing load curtailment. The PDR-LSR must maintain symmetric dispatchability for both resources by selecting the same real time bidding options for both load curtailment and consumption resource IDs.

The CAISO also proposes that the load consumption resource ID for the PDR-LSR will only be allowed to bid from the bid floor (-\$150) up to a value less than \$0. Load consumption for the purposes of the load shift product will not be allowed to bid in the positive range to prevent conflicting dispatch signals. The load curtailment resource ID will only bid at or above the NBT price threshold to the bid cap (currently at \$1,000). The CAISO is proposing to prohibit the load consumption resource ID to provide ancillary services because DR resources can only provide spin/non-spin services and not regulation. Table 1 summarizes the bidding rules and services of a PDR-LSR.

Table 1: Bidding and Energy Services

Resource ID	Bid Options ¹⁷	Bid Range	Services
Curtailment	15-min/5-min	NBT Price to Bid Cap	Energy, FRP, DA FRP
Consumption		-(Bid floor) to < \$0	

¹⁷ Bids must be uniform between both resource IDs

A PDR-LSR will be eligible for BCR. The CAISO will calculate BCR as it does today for the load curtailment resource ID. For load consumption, the CAISO will offer BCR because the resource’s bid has indicated a price to consume energy in a given interval, and may have foregone revenues of providing a service outside of the CAISO market. In the course of a day, if the resource was not able to recover its bid costs, the CAISO will make the resource whole. The CAISO will calculate the BCR for both resource IDs separately.¹⁸

Figure 7 illustrates how the resource would bid both resource IDs along with a potential corresponding award in 5-minute intervals.

Figure 7 Load Shift Resource bid stack and awards in the market

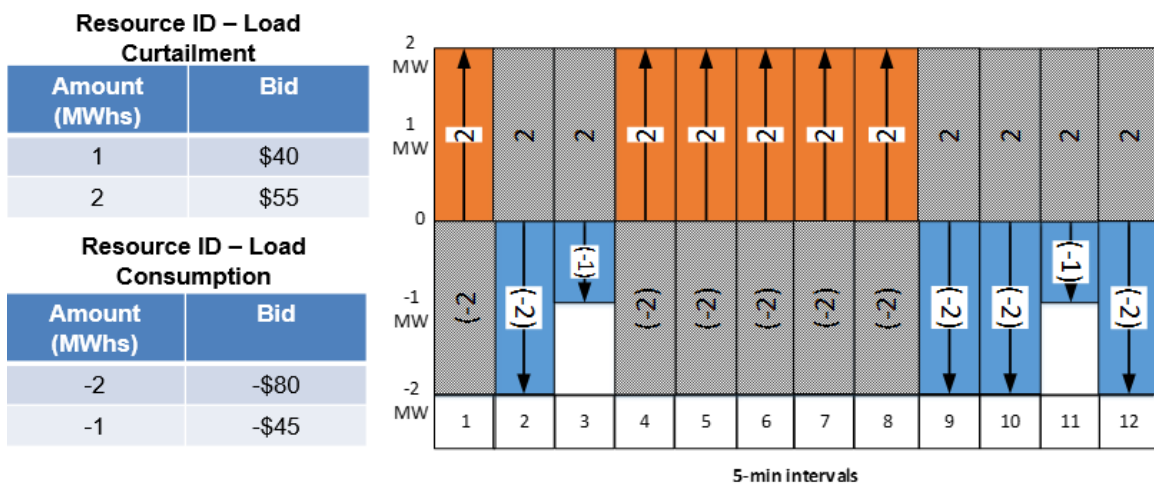

Post-market

The load curtailment resource ID will be settled under the same rules as it is today with slight modifications to how the Demand Response Energy Measurement (DREM) is developed. The load consumption resource ID will follow the same guiding principles under the load curtailment (current PDR settlement); except, the resource will settle as negative generation utilizing a separate performance measurement. The PDR-LSR will follow the same meter data submission requirements for all PDR/RDRRs.

Performance Evaluation Methodology

The SC or DRP will calculate the performance of the PDR-LSR. Each performance methodology will be referenced as either “LSR-curtailment” or “LSR-consumption.” Both methodologies will net out “typical usage” to define the incremental load

¹⁸ Please refer to the CAISO’s Department of Market Monitoring’s example on potential BCR calculation in its revised straw proposal comments (<http://www.aiso.com/Documents/DMMComments-EnergyStorage-DistributedEnergyResourcesPhase3-Jun252018.pdf>)

consumption or curtailment provided. The development of a typical usage adjustment will include both consumption and curtailment behavior of the PDR-LSR resource IDs:

- Established through a look back of both of the PDR-LSR resource IDs, the typical usage will take into account the consumption and curtailment values during non-event 15-minute intervals using a 10-in-10 non-event 15-minute selection method for similar days.
- The look-back period will extend to 45 days and calculate the simple average of the energy consumed or curtailed during the 10 most recent non-event 15-minutes for the same day type and for the same event interval when the PDR-LSR dispatch event occurred. ¹⁹
- Two different day-types are recognized: Weekday (Monday through Friday), Weekend/Holiday (Saturday, Sunday, or NERC holiday).
- An event interval is one in which the PDR-LSR was subject to an Outage or previously provided Demand Response Services (other than capacity awarded for AS) in a given interval.
- A simple average will be limited to represent a typical usage for consumption/curtailment used to establish the point at which the resource is providing net load consumption.

The CAISO is proposing the following to develop a PDR-LSR typical usage:

1. LSR-curtailment (To account for load curtailment of energy storage): 10-in-10 customer load baseline, using 10 non-event hours including both consumption and curtailment in the calculation of the simple average, but only accept a value that is at or above 0 (positive generation = curtailment).
2. LSR-consumption (To account for load consumption of energy storage): 10-in-10 customer load baseline, using 10 non-event hours including both consumption and curtailment in the calculation of the simple average, but only accept a value that is at or below 0 (negative generation = consumption).

The PDR-LSR typical use value will be used to adjust the metered output, generation or load, when calculating its performance attributed to a curtailment or consumption dispatch. Changing the MGO methodology for energy storage participating under the

¹⁹ If the target number of intervals are not reached (Weekdays = 10 intervals; 5 intervals minimum) (Weekend = 4 intervals) the higher value of either the collected intervals or minimum number of intervals will be used. If the minimum number of intervals cannot be found, the value will be set to zero.

PDR-LSR is to account for a resource that is now responding to dispatches for consumption and curtailment. The CAISO believes the “typical use” of an energy storage resource as a PDR-LSR must consider movement in both directions. A participant that opts to provide load curtailment only with a directly metered energy storage device will continue to use the current MGO calculation under PDR, which only considers curtailment values in the 10 non-event hours.

Application of Performance Methodology

Currently, the DRP or SC calculates the performance of a facility’s load curtailment with the option through the FERC approved MGO methodology that recognizes a sub-metered storage device’s contribution to the facility’s overall load curtailment.²⁰ With the proposal of the PDR-LSR performance methodology, the DRP or SC of a PDR-LSR has the ability to calculate the load curtailment of the facility, load curtailment of the sub-metered storage device, and the load consumption from the sub-metered storage device. The following scenarios illustrate the various performance methodology configurations for a PDR with the inclusion of the proposed PDR-LSR methodologies.

1. **PDR** – A PDR resource that only offers load curtailment from the whole premise with no sub-metered devices. The PDR would calculate its performance methodology using a CAISO registered Customer Load Baseline (CLB)

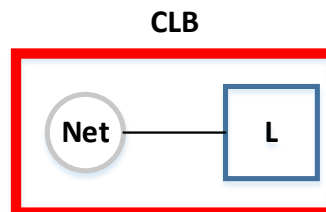

2. **PDR (sub-metered gen device ONLY)** – A PDR with a sub-metered energy storage device that only offers load curtailment. The facility load does not participate as a PDR which results in the sub-metered storage device utilizing the MGO methodology.²¹

²⁰ ESDER Phase 1 Draft Final Proposal describing MGO methodology, pg. 20-31
<http://www.caiso.com/Documents/RevisedDraftFinalProposal-EnergyStorageDistributedEnergyResources.pdf>

²¹ Note, the configuration does not allow for the independent participation of a sub-metered storage device if a facility does participate as a PDR.

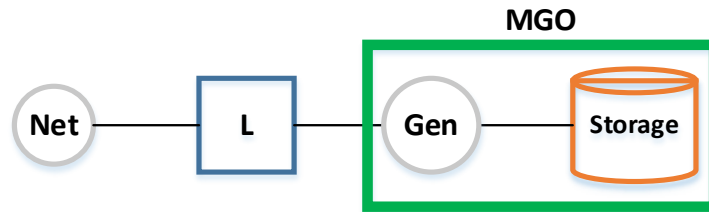

3. **PDR (sub-metered gen device)** – A PDR where the facility load and a sub-metered energy storage device offers load curtailment. Performance evaluation is separated by facility load curtailment and gen device load curtailment. The facility load nets out the sub-metered gen device and utilizes a CAISO registered CLB. The MGO methodology will then apply to the sub-metered gen device. Both values are combined to represent the total performance value of load curtailment provided.

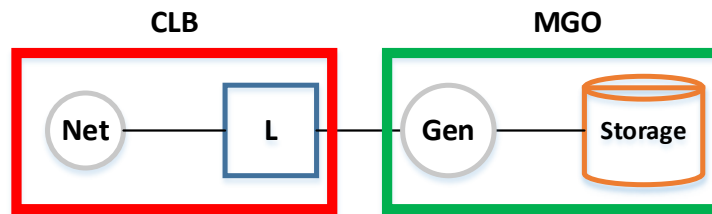

4. **PDR-LSR (sub-metered storage device only)** – A PDR-LSR where the facility load does not participate to provide load curtailment but only the sub-metered energy storage device provides load curtailment and consumption.²² The sub-metered storage device will utilize the proposed PDR-LSR methodologies for load consumption and curtailment.

²² See footnote 21

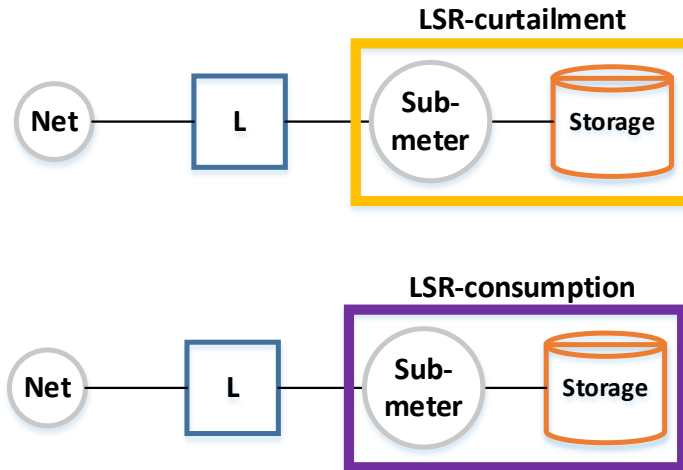

5. **PDR-LSR (Facility and sub-metered storage device)** – A PDR-LSR where the facility load is offering load curtailment and the sub-metered storage device is providing both load consumption and curtailment. The facility load nets out the sub-metered storage device and utilizes a CAISO registered CLB to calculate its load curtailment value. The sub-metered storage device will utilize the LSR-curtailment calculation to combine with the facility load CLB derived value. The LSR-consumption methodology will only apply to the sub-metered storage device. The CAISO has included a numerical example as an attachment to the Draft Final Proposal.

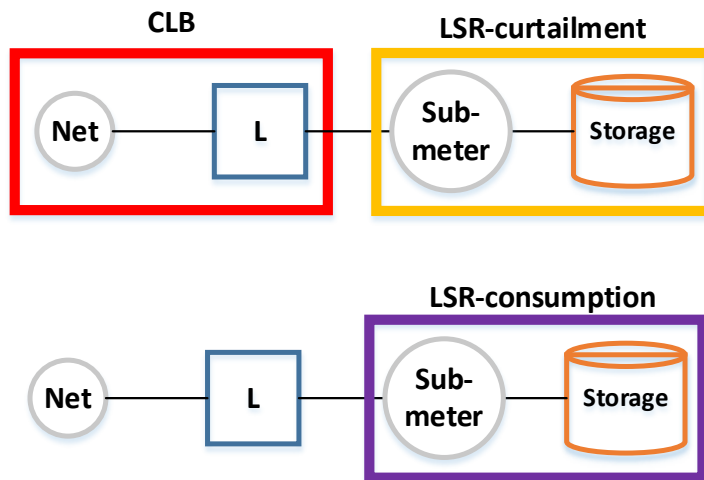

5.4 Recognition of behind the meter EVSE load curtailment

FERC approval of the CAISO ESDER 1 initiative tariff filing resulted in the implementation of the MGO performance measurement, which uniquely recognized a sub-metered

storage device's contribution to a facility's overall load curtailment during a CAISO dispatch event. As part of the ESDER 2 initiative process, comments received from certain stakeholders requested that the MGO concept extend to sub-metered EVSE loads. The design would allow for the recognition and measurement of an EVSE's load curtailment distinct from the facility's load.

5.4.1 Proposal

The CAISO proposes to enable EVSEs sub-metering and extend the MGO performance method for EVSE market participation independent of, or in combination with, its host customer. To be sure, EVSEs or any sub-metered device can already participate using the MGO provisions, but the CAISO currently cannot accommodate a sub-metered resource with a different performance methodology than its host facility load, which many desire for EVSEs. Sub-metering resolves the lack of fifteen-minute interval metering at the host facility for measurement of curtailment in five-minute intervals, enables direct measurement of the actual EV load curtailment achieved, and creates a more tailored market participation model for EVSEs.

Figure 8: CAISO's proposal to capture performance measurement of EVSE

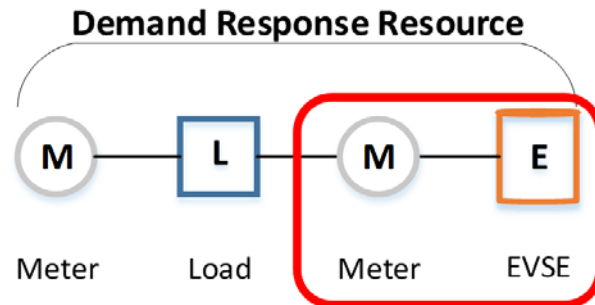

Pre-market

The CAISO proposes to differentiate between an “EVSE residential” designation and an “EVSE non-residential” designation in the DRRS.

1. EVSE residential – Will use a 5-in-10 customer load baseline
2. EVSE non-residential – Will use a 10-in-10 customer load baseline

The CAISO is proposing to support flexibility on metering configurations as long as it complies with the standards defined in the CAISO BPM for Metering, attachment G.²³

²³ CAISO BPM for Metering (<https://bpmcm.caiso.com/Pages/BPMDetails.aspx?BPM=Metering>)

The CAISO has illustrated in Figure 9 and Figure 10 the potential metering constructs for EVSEs.

Figure 9: Single sub-meter in front of aggregation of EVSEs

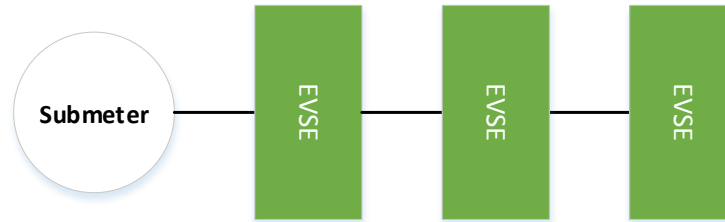
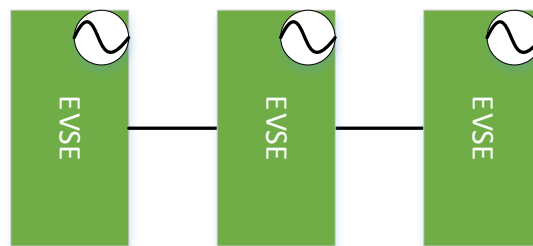

Figure 10: Individual meters embedded in EVSE



Market

The CAISO does not propose any changes to market systems because the proposal is only affecting the performance measurement of an EVSE.

Post-market

The CAISO proposes to apply similar principles of the MGO calculation to the EVSE measurement. The “EVSE residential” will utilize the 5-in-10 CLB methodology and the “EVSE non-residential” will utilize the 10-in-10 CLB methodology. Both CLBs will have a look back period of 45 days using either 5 or 10 of the most recent non-event hours. The demand response energy measurement (DREM) derived using the CLB will be in 5-min granularity with the option that if the sub-metered EVSE generates 15-minute interval data, the SC will transpose the data to three 5-minute intervals. Neither “EVSE residential” nor “EVSE non-residential” will have a load point adjustment (LPA) due to an EVSE’s performance not being weather dependent.

5.5 Multiple-Use Applications

Multiple-Use Applications (MUA) are when resources provide services to and receive compensation from more than one entity (e.g., the CAISO and a UDC) or in more than one domain (customer, distribution, transmission). BTM resources, DERs, and DER aggregations (DERAs) particularly seek to engage in MUAs in order to “stack” services

and revenue streams and thereby optimize their resource's value. Depending on the points of interconnection of the resources and the specific use-case, the resource may provide services to a combination of end-use customers, the distribution system, and the wholesale market and transmission system.

Since early 2016, the CAISO has supported the MUA policy development by collaborating with CPUC staff in its Energy Storage Proceeding Track 2 (R.15-03-011). CAISO and CPUC staff collaborated to produce a report, "Joint Workshop Report and Framework – Multiple-Use Applications for Energy Storage," which the CPUC issued on May 18, 2017 as part of an ALJ ruling seeking comments. The report was discussed at a CPUC workshop on June 2, 2017, followed by two rounds of public comments submitted in July 2017. The CPUC issued a ruling on January 11, 2018 that set forth principles for MUAs. The order also established subsequent working group meetings scheduled for 2018 to develop a final report to the CPUC commission by August 9, 2018 per D.18-03-011.

Since the decision, the CAISO has been actively participating in all working group meetings. At the time of the writing of this draft final proposal, the CAISO has yet to identify and develop a proposal within ESDER 3 that is needed to facilitate the implementation of the MUA framework. The CAISO will assess the adopted MUA rules and recommendations that emerge from the report against changes to tariff and/or market design that should be facilitated as part of a future CAISO initiative.

5.6 Non-Generator Resources

In its revised straw proposal, the CAISO provided an overview of issues that NGRs face while participating in the wholesale market. The revised straw proposal detailed the CAISO's understanding of stakeholders' issues and presented the CAISO's position on those issues. The CAISO will not be submitting any formal proposals to enhance the NGR participation model.

The CAISO understands the stakeholders and the various scenarios that battery storage resources be accommodated in the market. However, the CAISO is tasked with the difficult job of balancing system needs with the integration of fast ramping capabilities of battery storage. The CAISO agrees with stakeholders that an artificial "slower" ramp rate is not the right approach because it does not accurately represent the resource's capabilities. The CAISO agrees with PG&E that, "throughput cannot be perfectly

managed on a daily granularity, but can be managed over time.”²⁴ To go further, the CAISO believes that throughput limits can be expressed by scheduling coordinators through bidding parameters, as PG&E demonstrated with its battery storage resources.

The CAISO also has heard from stakeholders that battery storage resources should qualify as a use-limited resource to help manage excessive cycling. The CAISO understands that a manufacturing warranty may limit the number of battery storage cycles, but the CAISO has not been provided specific contract provisions that battery storage resources must adhere to and how those provisions may compare to current, actual use-limitations. The CAISO desires to explore this issue further with the storage community and is open to developing the process and qualifications for NGRs to qualify as a use-limited resource under the CAISO’s Commitment Cost Enhancements 3 (CCE3). Throughout the initiative, the CAISO requested that impacted stakeholders submit comments that provide potential use-limited qualifying factors and the types of documents a resource owner should provide to the CAISO to justify receiving use-limited status, but did not receive any comments.

To address the second issue on infeasible AGC signals as well as the regulation performance accuracy measurement being set too low, the CAISO staff is working with individual stakeholders to understand and resolve these issues. If a problem with the AGC signal surfaces based on affected stakeholder feedback and engagement, the CAISO would consider modifications to AGC and regulation performance in a separate initiative since such modification would have market wide implications. However, based on discussions and review of known customer issues to date, the CAISO found incorrect AGC signals were related to resources’ own programming errors.

The CAISO stresses the importance of actual data to help demonstrate both throughput and state of charge management issues. The CAISO requests that storage resource operators present data to the CAISO to help CAISO staff understand their specific issues and concerns. Such data and specific instances investigated will help the CAISO to determine if issues are isolated to operators, resources, or market design.

6 Future Considerations

The CAISO is aware of the growing number of energy storage and distributed energy resources and a future in which these resources will play an increasingly important role

²⁴ Slide 3 of PG&E’s Jan 16, 2018 presentation “What Are the Capabilities of the NGR and REM Market Models for Batteries?” <http://www.aiso.com/Documents/Presentation-AlvaSvobodaPG-E.pdf>

in the future grid. The CAISO will continue to work with stakeholders to identify enhancements to the integration of energy storage and DERs through its demand response and NGR participation models. As stated in stakeholder comments, as well as throughout the proposal, certain issues are still to be determined. The CAISO will continue to look at topics under DR, MUA, and NGR to determine if a future initiative is necessary.

Appendix A Acronyms

1. **AGC** – Automatic Generation Control
2. **BCR** – Bid Cost Recovery
3. **BPM** – Business Practice Manual
4. **BTM** – Behind The Meter
5. **CCA** – Community Choice Aggregation
6. **CCDEBE** – Commitment Cost Default Energy Bid Enhancements (policy initiative)
7. **CCE3** – Commitment Cost Enhancements Phase 3 (policy initiative)
8. **CLB** – Customer Load Baseline
9. **DAME** – Day-Ahead Market Enhancements (policy initiative)
10. **DERA** – Distributed Energy Resource Aggregation
11. **DLA** – Default Load Adjustment
12. **DLAP** – Default Load Aggregation Point
13. **DREM** – Demand Response Energy Measurement
14. **DRP** – Demand Response Provider
15. **DRRS** – Demand Response Registration System
16. **EVSE** – Electric Vehicle Supply Equipment
17. **FMM** – Fifteen-Minute Market
18. **IRP** – Imbalance Reserve Product
19. **LMP** – Locational Marginal Price
20. **LPA** – Load Point Adjustment
21. **LSE** – Load Serving Entity
22. **MEC** – Metered Energy Consumption (methodology)
23. **MGO** – Metered Generator Output (methodology)
24. **MOO** – Must Offer Obligation
25. **MUA** – Multiple-Use Application (CPUC Decision)
26. **NBT** – Net Benefits Test
27. **NGR** – Non-Generator Resource
28. **PDR** – Proxy Demand Resource
29. **PDR-LSR** – Proxy Demand Resource-Load Shift Resource
30. **RA** – Resource Adequacy
31. **RDRR** – Reliability Demand Response Resource
32. **RUC** – Residual Unit Commitment
33. **SC** – Scheduling Coordinator
34. **SIBR** – Software Infrastructure Business Rule (system)
35. **SOC** – State of Charge
36. **UIE** – Uninstructed Imbalance Energy