

October 4, 2012

California Energy Commission

DOCKETED
00-AFC-13C

TN # 67538

OCT 05 2012

VIA E-MAIL CHRISTINE.STORA@ENERGY.CA.GOV

Christine Stora
Compliance Project Manager
Siting, Transmission and Environmental Protection (STEP) Division
California Energy Commission
1516 Ninth Street, MS-2000
Sacramento, CA 95814

Re: **Huntington Beach Generation Station Retool Project, Unit 3 and 4**
Docket No. 00-AFC-13C

Dear Ms. Stora:

Attached hereto is Edison Mission Huntington Beach, LLC's **Petition to Amend Final Decision to Convert Generating Units to Synchronous Condensers** in the above-entitled matter. Thank you in advance for your assistance in this matter.

Very truly yours,

DOWNEY BRAND LLP

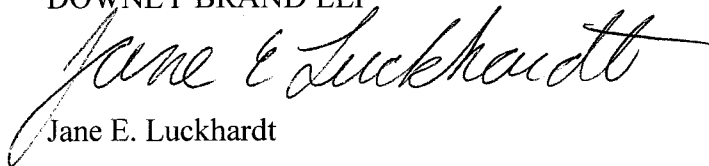

Jane E. Luckhardt

JEL:ln

Enclosure

cc: Chris Marxen, CEC
Docket Office

**STATE OF CALIFORNIA
ENERGY RESOURCES CONSERVATION
AND DEVELOPMENT COMMISSION**

In the Matter of:

**HUNTINGTON BEACH GENERATING
STATION RETOOL PROJECT, UNITS 3
AND 4**

**EDISON MISSION HUNTINGTON
BEACH, LLC**

Docket No. 00-AFC-13C

**PETITION TO AMEND
FINAL DECISION**

**PETITION TO AMEND FINAL DECISION TO CONVERT GENERATING UNITS TO
SYNCHRONOUS CONDENSERS**

October 5, 2012

Jenifer Morris Lee
Edison Mission Huntington Beach, LLC
3 MacArthur Place, Suite 100
Santa Ana, CA 92707
jlee@edisonmission.com
<http://www.edison.com>

Jane Luckhardt
DOWNEY BRAND
621 Capitol Mall, 18th Floor
Sacramento, CA 95814
916/520-5348 Direct
916/520-5748 Fax
jluckhardt@downeybrand.com
<http://www.downeybrand.com>

Attorneys for **EDISON MISSION HUNTINGTON BEACH, LLC**

**STATE OF CALIFORNIA
ENERGY RESOURCES CONSERVATION
AND DEVELOPMENT COMMISSION**

In the Matter of:

**HUNTINGTON BEACH GENERATING
STATION RETOOL PROJECT, UNITS 3
AND 4**

**EDISON MISSION HUNTINGTON
BEACH, LLC**

Docket No. 00-AFC-13C

**PETITION TO AMEND
FINAL DECISION**

I. INTRODUCTION

This Petition to Amend (“Petition”) seeks to amend the Final Decision issued by the California Energy Commission (“Commission”) for the Huntington Beach Generating Station Retool Project, Units 3 and 4, Docket No. 00-AFC-13C; (“HBGS Project”).¹ Pursuant to Title 20, California Code of Regulations §1769(a)(1)² petitioner Edison Mission Huntington Beach, LLC (“EMHB”) submits this Petition to request modifications to the CEC’s Final Decision for the HBGS Project. EMHB also provides analysis of the proposed modifications in the enclosed environmental analysis (“Supplemental Analysis”).

¹ The Commission issued its Final Decision on the HBGS Project application for certification on May 10, 2001 and approved AES-SD’s petition to transfer ownership from AES Huntington Beach to Edison Mission Huntington Beach, LLC on May 5, 2011. Collectively, the 2001 Commission Final Decision and the Order on the transfer of ownership will be referred to as the “Final Decision.”

² “After the final decision is effective under section 1720.4, the applicant shall file with the commission a petition for any modification it proposes to the project design, operation, or performance requirements.” 20 CCR §1769(a)(1). All references to the California Code of Regulations herein refer to Title 20 unless otherwise specified.

II. SUMMARY OF PROPOSED CHANGES

The California Independent System Operator (CAISO) has determined a need for Units 3 and 4 of the Huntington Beach Generating Station to operate as synchronous condensers. (CAISO 2013 Local Capacity Technical Analysis, Addendum to the Final Report and Study Results, at 4-5, August 20, 2012.) In response to the need identified by CAISO, EMHB requests changes to the Final Decision to convert Units 3 and 4 of the HBGS Project to synchronous condensers. Units 3 and 4 will provide needed dynamic voltage support for the Los Angeles Basin. (*Id.* at 5.) EMHB’s request is based on factors that were not known at the time of the Final Decision. Because the operation of the facility will change from an electrical generating facility to a synchronous condenser facility, many of the Conditions of Certification are no longer required. For example, HBGS, as reconfigured, will no longer have air emissions. To that end, EMHB requests that certain Conditions of Certification be deleted or voided. The proposed list of affected Conditions of Certification are set forth below and are discussed in further detail in the accompanying Supplemental Analysis.

Condition Number	Summary	Reason for Change
AQ-1	Operation of Post Combustion Controls	Surrender of Air Permit
AQ-2	Use of Pipeline Quality Natural Gas with less than 0.25 grains/100 cf.	No Fuel Combustion.
AQ-3	Source Test Unit 5	Unit 5 was Decommissioned in 2002
AQ-4	Limits on Contemporaneous Operation of Unit 5 and Units 3 & 4.	Surrender of Title V Permit and Permit to Operate
AQ-5	Feasibility of Installing Ammonia Monitor on Units 1-4.	Surrender of Title V Permit and Permit to Operate

Condition Number	Summary	Reason for Change
AQ-6	Limits on Contemporaneous Commissioning of Units 3 & 4.	Surrender of Title V Permit and Permit to Operate
AQ-7	Limits on Contemporaneous Start Up of Units 3 & 4.	Surrender of Title V Permit and Permit to Operate
AQ-8	Maintain Compliance with District FDOC and PTC/PTO.	Surrender of Title V Permit and Permit to Operate
AQ-9	Maintain Compliance with District Source Test Requirements.	Surrender of Title V Permit and Permit to Operate
AQ-10	Maintain Compliance with District CEMS Requirements.	Surrender of Title V Permit and Permit to Operate
AQ-11	Project Owner Demonstrates Sufficient RTC are Held.	Surrender of Title V Permit and Permit to Operate

III. INFORMATION REQUIRED PURSUANT TO CALIFORNIA CODE OF REGULATIONS SECTION 1769

A. Complete description of the proposed modifications, including new language for any conditions that will be affected. (Section 1769[a][1][A].)

The proposed modifications to the HBGS Project necessitate changes to the Final Decision: that is, this Petition requests the deletion of numerous Conditions of Certification and modifications to the operation of the existing Units 3 and 4. Below is a more thorough overview of these changes. A comprehensive analysis of the proposed changes is presented in the accompanying Supplemental Analysis.

1. Deletion of or Modification to Current Conditions of Certification.

Since operation of Units 3 and 4 as synchronous condensers will eliminate the emission sources covered by AQ-1 to AQ-11, EMHB requests these conditions of certification be deleted. Conditions of Certification AQ-1 to AQ-11 are conditions included in the South Coast Air

Quality Management District's (AQMD) Final Determination of Compliance (FDOC) and federal/local operating air permits. As Units 3 and 4 will no longer have air emissions when operated as synchronous condensers, Conditions AQ-1 to AQ-11 are no longer applicable.

2. Modifications to the Operational Aspect of Units 3 and 4.

The operation of Units 3 and 4 remain unchanged with two exceptions. No fuel combustion will occur in Units 3 and 4. And, the steam turbines will be decoupled from the electric generators to allow the generators to function as electric motors and generate or absorb reactive power as required by the electrical transmission grid.

The expected start of work associated with the proposed modifications is December 1, 2012, with a completion date of May 30, 2013. This will allow the HBGS to begin operating in its new capacity on June 1, 2013, in time for critical summer demand.

B. The Necessity for the Proposed Modification. (Section 1769[a][1][B].)

Section 1769(a)(1)(B) requires a discussion of the necessity of the proposed modifications. The proposed modifications to HBGS and the related Conditions of Certification are necessary to respond to a CAISO identified need for dynamic voltage support.

Consistent with the requirements of the Final Decision that any changes in operation or Conditions of Certification must be presented to the Commission, EMHB requests the herein referenced modifications to the Final Decision.

C. The Proposed Modifications Are Based Upon Information Previously Unknown to EMHB. (Section 1769[a][1][C].)

Section 1769(a)(1)(C) requires a discussion of whether the proposed changes are based on information previously known by EMHB. In this case, EMHB was not aware of the need for the proposed modifications at the time of the original AFC proceeding nor at any time during subsequent proceedings. Specifically, the CAISO only recently approved the 2013 Local

Capacity Technical Analysis, Addendum to the Final Report and Study Results indentifying and approving the need for HBGS Project Units 3 and 4 to operate as synchronous condensers.

D. The Proposed Modifications Do Not Change or Undermine the Assumptions, Rationale, or Other Bases of the Final Decision. (Section 1769[a][1][D].)

The Proposed modifications to the Conditions of Certification and those modifications proposed for the operational aspect of HBGS do not change or undermine the assumptions, rationale, or other bases of the Final Decision approving the HBGS Project or the Commission’s subsequent amendment of the Final Decision. A thorough analysis of the effects of the proposed modifications is set forth in the accompanying Supplemental Analysis.

E. An Analysis of the Impacts the Proposed Modifications May Have on the Environment and Proposed Measures to Mitigate Any Significant Adverse Impacts (Section 1769[a][1][E].)

The proposed modifications will not have a significant adverse impact on the environment. A thorough analysis of the effects of the proposed modifications is set forth in the accompanying Supplemental Analysis.

F. The Impacts of the Modification of the Facility’s Ability to Comply with Applicable LORS (Section 1769[a][1][F].)

EMHB believes the proposed modifications will not impact the HBGS Project’s ability to comply with all applicable laws, ordinances, regulations or standards (“LORS”); an explanation of the Project’s continued compliance with LORS is provided in the accompanying Supplemental Analysis.

G. How the Proposed Modifications May Affect the Public (Section 1769[a][1][G].)

The proposed modifications have a very low potential for an effect on the public. EMHB has conducted a thorough analysis of the proposed modifications, including potential impacts to the public, which is provided in the accompanying Supplemental Analysis. This analysis shows

that proper mitigation measures are in place such that the potential for adverse impacts to the public from the proposed changes is insignificant.

H. Potential Effect on Property Owners, the Public, and the Parties to the Application Proceeding (Section 1769[a][1][H] and Section 1769[a][1][I].)

Nearby property owners are not expected to be affected by the proposed modifications.

A complete analysis of the proposed modifications and potential impact to property owners, the public, and other parties is set forth in the accompanying Supplemental Analysis. As required by Section 1769, a list of potentially affected property owners has been provided in conjunction with this Petition and is included with the Supplemental Analysis in Appendix A.

IV. UPDATES TO THE SERVICE LIST

EMHB requests the Commission update its service list for this proceeding by making the following changes:

Please add

Jenifer Morris Lee
Edison Mission Huntington Beach, LLC
3 MacArthur Place, Suite 100
Santa Ana, California 92707
jlee@edisonmission.com

Heather MacLeod
Edison Mission Huntington Beach, LLC
3 MacArthur Place, Suite 100
Santa Ana, California 92707
hmacleod@edisonmission.com

Larry Kostrzewa
Edison Mission Huntington Beach, LLC
3 MacArthur Place, Suite 100
Santa Ana, California 92707
lkostrzewa@edisonmission.com

Jane Luckhardt
Downey Brand LLP
621 Capitol Mall, 18th Floor
Sacramento, CA 95814
jluckhardt@downeybrand.com

Maggie Fitzgerald
Sierra Research
1801 J Street
Sacramento CA 95814
mfitzgerald@sierraresearch.com

**Please replace the existing contacts for AES Huntington Beach, LLC and
AES Huntington Beach Pacific, Inc. with the following:**

Weikko Wirta
President
AES Huntington Beach, LLC
21730 Newland Street
Huntington Beach, CA 92646
weikko.wirta@aes.com

Stephen O'Kane
Manager
AES Huntington Beach, LLC
690 North Studebaker Road
Long Beach, CA 90803
stephen.okane@aes.com

V. CONCLUSION

For all the reasons above, and as set forth in the accompanying Supplemental Analysis,
EMHB requests the Commission approve the proposed modifications to the HBGS Project.

Dated: Oct. 4th, 2012

By: 
Jenifer Morris Lee
Edison Mission Huntington Beach, LLC

HBGS Units 3 and 4 Synchronous Condenser Supplemental Analysis

Introduction

Consistent with the CEC Siting Regulations Section 1769(a)(1)(A), this section includes a description of the requested project modifications.

The HBGS Project will convert the existing HBGS Units 3 and 4 from electric utility steam generators to synchronous condensers. HBGS is located in the City of Huntington Beach, Orange County, California. The site is located at 21730 Newland Street, southeast of the intersection of Newland Street and the Pacific Coast Highway. The proposed project will be built entirely within the boundaries of the existing HBGS. No additional transmission lines, related transmission facilities or offsite changes or modifications to any related project infrastructure will be required.

The remainder of this document presents a description of the synchronous condenser project, expected environmental and cumulative impacts, and an assessment of impacts to the public and adjacent land owners.

Project Description

The HBGS Units 3 and 4 includes a total of four electrical generators. Unit 3 has a high and a low pressure steam turbine generator which share a common rotor shaft. Likewise, Unit 4 has a high/low pressure and an intermediate/low pressure steam turbine generator which also share a common shaft. The synchronous condenser project will entail the decoupling of the HBGS Units 3 and 4 steam turbines from the electrical generators and the installation of a variable frequency drive (VFD), a 4.16 kilovolt (kV) pony motor, and ancillary equipment to convert the generators into electrical motors. The pony motors (one for Unit 3 and one for Unit 4) are used to turn the converted motors up to speed and synchronized to the transmission grid with the VFD controlling the converted motors as required by the electrical grid operator's requirements for transmission grid voltage support. The ancillary equipment will include the necessary electrical, control, and lubricating systems to safely and efficiently operate the synchronous condensers.

The HBGS Units 3 and 4 generators are located on the steam turbine deck as shown on Figure 1. The pony motors will be located on the turbine deck adjacent to the generators. The pony motor will connect to the steam turbine generator shafts via a new stub shaft, bearing and coupling. The steam turbines will be decoupled from the generators. Figures 2 and 3 present the plan and elevation schematics of the connection of the pony motors to the generator shafts. Units 3 and 4 will be retired and rendered inoperable to satisfy, in part; the emission offset requirements contained in condition of certification AQ-19 of the Final Commission Decision for the Walnut Creek Energy Park (CEC Docket No. 05-AFC-2). The existing steam turbine generator lubricating oil systems will be modified to provide lubricating oil to the pony motors thrust bearings and lubricating pumps will be included as needed. The pony motors will be contained in weather tight enclosures.

The VFDs will also be located on the turbine deck. The VFDs will connect to the pony motors via new cabling. The VFDs will be integrated into the HBGS distributed control system to allow operation of the synchronous condensers from the existing control room.

The proposed project does not require any modification to the generator interconnection to the switchyard. The Applicant has consulted with the California Independent System Operator (CAISO) regarding potential impacts to the transmission system and CAISO concluded "that the project will not cause a transmission system impact nor will it require modifications or upgrades to the system beyond the point of interconnection at the Southern California Edison Huntington Beach switchyard." See Attachment 1 presents a copy of the CAISO correspondence.

The capital cost for the project equipment is approximately \$4.7 million with approximately \$2.25 million in equipment costs and the balance in construction labor (\$2.5 million). Estimates of local purchases are expected to be approximately \$15,000 for the project.

Synchronous Condenser Equipment Installation and Commissioning

The installation of the pony motors, VFDs, and ancillary equipment will occur on the steam turbine deck and no excavation or new underground infrastructure is required. The installation and commission of the synchronous condenser is expected to take approximately 30 days (20 days for construction and 10 for commissioning and start up) with up to 30 workers (including supervisors), 7 tractor trailer truck deliveries, and 14 miscellaneous deliveries (postal, portable sanitary units, construction trailer mobilization/demobilization).

Work is expected to occur during daylight hours and will involve the use of the existing gantry cranes located on the turbine deck. Two construction trailers (36 feet by 10 feet) for project management support and equipment storage will be located in a designated contractor parking area which is already paved. The trailers will interconnected to the HBGS utility system (electric and communication) but will use portable sanitary facilities. Additional construction equipment expected to be used during the installation process is presented in Table 1 below.

TABLE 1

Expected Construction Equipment

Equipment Description	Number
5 Ton All Terrain Forklift	1
30 Foot All Terrain Scissor Lift	2
1-Ton On-Road Work Truck	5
Electric Portable Welding Units	2
Total	10

Relatively small quantities of hazardous materials will be onsite during construction and will be limited to gasoline, diesel fuel, motor oil, hydraulic fluid, solvents, cleaners, sealants, welding flux, various lubricants, paint, and paint thinner. Best management practices will be implemented by contractor personnel. No acutely hazardous substances, as defined in California’s Health and Safety Code, Section 25531, will be used during construction of the project.

Operating HBGS Units 3 and 4 as a synchronous condensers will use the same hazardous materials already in use at the site, including lubricating oils, grease, hydraulic fluid, solvents, cleaners, sealants, welding flux, paint, and paint thinner.

Construction water will be provided by the existing onsite potable water supply and construction water use will be minimal. The major construction water use is expected to be for sanitary purposes for the construction workforce only, however, some construction water could be used for equipment washing. Disposal of construction sanitary wastewater will be discharged to the existing onsite sanitary sewer system and any wastewater generated from equipment washing would be disposed of consistent with existing disposal procedures.

The synchronous condenser operation will require 42,000 gallons per minute of cooling water from the once-through-cooling water system. Cooling water will be used to reject heat from the bearing lubricating oil system and generator’s hydrogen sealing system. This water use represents a decrease in cooling water use for Units 3

and 4 based on the figures reported in the revised implementation plan submitted to the State Water Resources Control Board.¹

The expected noise levels for the pony motors and VFD are expected to be 95 dBA at 4 feet and 85 dBA at 4 feet, respectively. Noise generated from Units 3 and 4 will be substantially decreased compared with operations as electric utility steam generators. Noise emitting equipment associated with the combustion of fuel, production of steam and use of the steam turbines will all be eliminated from Units 3 and 4 including noise from high pressure gas flow, burners, induced/forced draft fans, high pressure steam lines and the low and high pressure steam turbines.

Construction Schedule

Table 2 below presents the construction schedule for the project.

TABLE 2
Synchronous Condenser Schedule

Task	Schedule
Engineering and Procurement	October 2012 to April 2013
Installation	Late April 2013 to Mid May 2013
Commissioning and Start Up	Mid May 2013 to End of May 2013

Environmental Analysis of the Project Change

The Applicant has reviewed the modification proposed herein to determine if the proposed change will result in any environmental impacts that were not originally analyzed by the CEC when it approved the project. As the project does not involve any excavation, resource areas specific to ground disturbing activities have no potential for increased impacts and are therefore not addressed. These resource areas include cultural resources, geological hazards and resources, paleontological resources, and soils and agriculture.

The remaining resource areas, air quality, biological resources, hazardous materials handling, public health, socioeconomics, traffic and transportation, visual resources, waste management, water resources and worker health and safety are addressed below.

Air Quality

Construction Impacts

The proposed project's construction air quality impacts will result from the use of fossil fuel use by construction equipment onsite and from on-road vehicle use for workers and deliveries. No asbestos or lead is expected to be disturbed during construction. Construction equipment to be used onsite include one forklift, two scissor lifts, and five, one-ton on-road trucks. The synchronous condenser construction is expected to require a workforce of up to 30 for approximately 20 days with commissioning and start up lasting another 10 days. Construction equipment/materials are expected to require a total of 7 tractor trailer deliveries and 14 miscellaneous deliveries over the construction (or approximately 1 delivery over the 30 day construction period).

The HBGS Units 3 and 4 were originally assessed for operational impacts including annual boiler maintenance that can last up to 28 days. This maintenance work can require between 30 and 75 workers. Construction equipment used during annual maintenance events include up to four forklifts (2, 2.5, 5 and 10-tons) and 2 mobile cranes (10

¹ http://www.swrcb.ca.gov/water_issues/programs/ocean/cwa316/powerplants/huntington_beach/

and 30-tons). Material deliveries during these annual maintenance events can require between 2 and 10 truck deliveries per day.

Compared to the ongoing maintenance activities at the site, the proposed project's construction air emissions are expected to be less than insignificant and will comply with all applicable laws, ordinances, regulations, and standards (LORS). Also, since no excavation is planned, the volume of fugitive dust generated is also expected to be insignificant. Therefore, the proposed project's construction activities are expected to have a less than significant air quality impact. Furthermore, the construction impacts associated with the proposed project are significantly lower than those analyzed in the Commission Decision for HBGS Units 3 and 4.

Construction would also result in the generation of greenhouse gas (GHG) emissions due to diesel and gasoline combustion. However, due to the very short duration (30 days) and limited numbers of construction equipment expected to be used, GHG emissions and impacts are expected to be less than significant.

The Applicant proposes to implement construction mitigation measures in Conditions of Certification AQ-C1 to AQ-C4 to further minimize construction emissions.

Operational Impacts

The proposed project will not emit air pollutants during operation as no fuel combustion is required. Before the proposed project can proceed, the Applicant will render HBGS Units 3 and 4 inoperable as electric utility steam generators (disconnect fuel line, remove burners, decouple the steam turbines from the generators) and will surrender the AQMD Title V and Permit to Operate. Air emissions resulting from fuel combustion in Units 3 and 4 will be eliminated with the implementation of the synchronous condenser project.

The synchronous condenser operation requires rendering the combustion system of Units 3 and 4 inoperable, eliminating the GHG emission associated with this fuel combustion. This GHG reduction will result in a positive impact to the environment.

Cumulative Impacts

The minimal construction workforce/equipment proposed and the elimination of combustion emissions from Units 3 and 4 are not expected to be cumulatively significant.

Biological Resources

Construction Impacts

The proposed project will not disturb any biological resources as all construction activities will occur on either paved or graveled surfaces. Therefore, surface runoff impacts to the adjacent wetlands are not expected. Additionally, impacts to birds nesting in the wetlands are not expected as construction will occur on the eastern side of the HBGS (far from the wetland) and construction noise is expected to be lower than construction noise levels analyzed in the Commission Decision.

Operational Impacts

Only aquatic resources have the potential to be affected by the operation of the proposed project through the use of once-through cooling (OTC) water due to entrainment, impingement, or thermal affects of biological resources. As noted in the Commission Decision, aquatic impacts are significantly associated with OTC flow rate.² The OTC flow rate for the synchronous condenser operation will be significantly lower than Units 3 and 4 operations as analyzed in the Commission Decision. This is due to the fact that the only water required for the synchronous condenser operation is for lubricating oil and generator cooling (one ocean water circulation pump with a capacity 42,000 gallons per minute is required while operating) and not for condensing of steam (four ocean water circulation pumps with a capacity 42,000 gallons per minute are required for steam condensing while operating). Therefore, aquatic biological resource impacts are expected to be significantly lower than those analyzed in the Commission Decision, resulting in a benefit to biological resources.

² Huntington Beach Generating Station Retool Project, May 2001, (00-AFC-13), P800-01-016, page 43.

Cumulative Impacts

The construction of the synchronous condenser will not result in any biological resource impacts and therefore, combined with other cumulative projects are not expected to be cumulatively significant.

The operational biological impacts are expected to be lower than the existing baseline conditions, resulting in a benefit to biological resources. Therefore, no cumulative biological resource impacts are expected.

Hazardous Materials Handling

Construction Impacts

The construction of the synchronous condenser will require the use of hazardous materials (paints, thinners, fuels, lubricating, oils, and grease) in lower volumes (estimated at 8 gallons or 50 pounds) as are currently use by HBGS Units 3 and 4 for annual maintenance activities. Therefore, construction impacts are expected to less than significant hazardous materials handling impacts and less than those analyzed in the Commission Decision.

Operational Impacts

The operation of the synchronous condenser will require the use of primarily lubricating oil, which is currently licensed for use at HBGS Units 3 and 4. Overall, operational impacts of the synchronous condenser will result in a reduction in the hazardous materials used at the site. Specifically, the use of urea (and any generated ammonia) for the control of air pollutant emissions from the combustion sources will be eliminated and operational impacts are expected to be lower than those analyzed in the Commission Decision.

Cumulative Impacts

During construction, materials used onsite are equivalent (or lower) to existing ongoing maintenance activities. Furthermore, operational hazardous materials use is expected to be reduced after the implementation of the proposed project. Therefore, no cumulative hazardous materials impacts are expected from the construction and operation of the synchronous condenser.

Land Use

Construction Impacts

The proposed project will be constructed wholly within the existing HBGS site. The HBGS site is appropriately zoned (industrial) and the synchronous condenser project is consistent with the existing land use. The construction of the synchronous condenser will comply with applicable City of Huntington Beach LORS and construction land use impact are expected to be less than those analyzed in the Commission Decision.

Operational Impacts

No land use impacts are expected from the synchronous condenser operation due to ongoing operation of the HBGS site as an electrical generating facility.

Cumulative Impacts

No cumulative land use impacts are expected due as construction and operational impacts are less than significant.

Noise

Construction Impacts

Construction of the synchronous condenser project is expected to generate noise through the use of construction equipment. The Commission Decision noted that daytime construction should not create a significant impact at neighboring residential receptors.³ As noted above, the 30 day construction period will require approximately 5 pieces of construction equipment, including two electric welding units, a forklift and two scissor lifts. The HBGS

³ Huntington Beach Generating Station Retool Project, May 2001, (00-AFC-13), P800-01-016, page 76.

Units 3 and 4 currently undergoes an annual boiler maintenance that requires the use of up to four forklifts (2, 2.5, 5 and 10-tons) and 2 mobile cranes (10 and 30-tons). Therefore, construction noise from the synchronous condenser project will be comparable or less than existing noise impacts associated with ongoing plant maintenance. Furthermore, construction noise levels are expected to be lower than those analyzed in the Commission Decision due to the lower level of construction activity proposed for the synchronous condenser.

Construction noise levels are expected to comply with applicable City of Huntington Beach LORS and not impact nearby residential receptors.

However, the Applicant proposes to implement Conditions NOISE-1 and NOISE-6 to further reduce the already low noise levels further.

Operational Impacts

The elimination of the Units 3 and 4 combustion sources and high pressure steam production (induced/forced draft fans, steam ducting, steam turbine and condenser) will result in an overall reduction in noise sources from Units 3 and 4. The synchronous condenser pony motor and VFD expected to have noise levels of 95 dBA and 85 dBA at 4 feet, respectively, and will be housed in a weatherproof enclosure. Noise from these sources are expected to be less than significant and lower than those analyzed in the Commission Decision.

Cumulative Impacts

Construction is not expected to result in offsite noise impacts. In addition, operational noise impacts are expected to be significantly reduced over baseline conditions. Therefore, cumulative noise impacts are expected to be less than significant.

Public Health

Construction Impacts

Due to the low number of construction equipment needed for the project, public health impacts associated with construction of the synchronous condenser will be less than those analyzed in the Commission Decision. Mitigation measures proposed in air quality will reduce the already less than significant public health impacts further.

Operational Impacts

The synchronous condenser operation requires rendering the combustion system of Units 3 and 4 inoperable as steam and electrical generators (disconnect fuel line, remove burners, decouple steam turbines from generators), eliminating the public health impacts identified in the Commission Decision. Therefore, operational public health impacts are expected to result in a beneficial impact to public health.

Cumulative Impacts

The public impacts from the project will result in a beneficial impact to public health (reduction of fuel combustion), therefore, the cumulative public health impacts are expected to be less than significant.

Socioeconomics

Construction Impacts

Capital equipment costs of \$2.25 million for the proposed project may result in a slight increase in the properties assessed value. This potential increase in assessed value would be evaluated against the changes made to Units 3 and 4 rendering them inoperable as electrical generating units. It is not expected that the synchronous condenser project would result in any change in property tax payment to the County. Some of the \$2.5 million labor costs of the project would be expected to be spent within Orange County, contributing to a small, but positive socioeconomic impact.

Due to the short duration of construction (30 days), impacts to utilities, police and fire service, schools, and housing are not expected and are significantly less than those analyzed in the Commission Decision.

Therefore, the socioeconomic impacts of construction are expected to be less than significant and lower than those analyzed in the Commission Decision.

Operational Impacts

The operation of the synchronous condenser project is expected to have no impact on socioeconomics on either the City or Orange County.

Cumulative Impacts

Construction is expected to result in a minimal amount of local expenditures and is expected to have no socioeconomic impact. Therefore, cumulative impacts are expected to be less than significant.

Waste Management

Construction Impacts

The project is expected to generate low volumes of construction waste, primarily associated with packaging materials. No liquid or hazardous wastes are expected to be generated. Additionally, since no excavations are planned, no potentially contaminated soils will be excavated. Lastly, no asbestos or other toxic materials are expected to be encountered during construction. Therefore, waste management impacts are expected to be less than significant and lower than those analyzed in the Commission Decision.

Operational Impacts

The only expected waste material associated with the synchronous condenser operation is lubrication oil for the generator bearings and this waste is currently being generated by the operating Units 3 and 4. Therefore, no operational waste management impacts are expected.

Cumulative Impacts

Construction and operation of the project are expected to have less than significant cumulative impacts.

Water Resources

Construction Impacts

Construction of the synchronous condenser project will use potable water, currently used onsite, for any construction uses. Construction water uses will include primarily sanitary uses with some limited equipment wash water use. Construction water use is not expected to increase above current water use during routine and annual maintenance events.

The construction of the synchronous condenser will not increase stormwater runoff as no excavations or foundation construction is required. Furthermore, construction will not use significant quantities of hazardous materials which could pose a threat to surface waters due to runoff or releases. Finally, all construction work will be performed on paved or graveled areas, covered by existing stormwater engineering controls and operating procedures.

Therefore, construction will not result in significant water resource impacts.

Operational Impacts

During operation, the synchronous condenser operation will require approximately 42,000 gallons per minute of ocean cooling water. This cooling water is used for lubricating oil system and generator cooling. The Commission Decision for HBGS Units 3 and 4 analyzed the effects of using between 176,000 and 352,000 gallons per minute of cooling water. As such, the synchronous condenser project represents a significant reduction of between 76 and 88 percent in total cooling water use over the current HBGS Units 3 and 4 ocean water use.

The only potable water required for the operation of the synchronous condenser will be for primarily sanitary purposes and for occasional equipment washing. However, the synchronous condenser project will eliminate

potable water use by Units 3 and 4 for boiler make up water of between 0.37 and 0.64 million gallons per day.⁴ Overall, the operation of the synchronous condenser project will result in beneficial impacts to water resources.

Finally, the synchronous condenser operation will not increase stormwater runoff as all equipment will be located on the HBGS Units 3 and 4 steam turbine deck and will not require the use of any hazardous materials not currently at the site. The synchronous condenser project will eliminate the use and storage of urea and aqueous ammonia by the HBGS Units 3 and 4.

Therefore, no significant water resource impacts are expected from the construction or operation of the synchronous condenser project.

Cumulative Impacts

The water resource impacts associated with the synchronous condenser project are either neutral or result in an improvement in water resources (reduced OTC and potable water use). Therefore, no cumulative water resource impacts are expected.

Worker Health and Safety

Construction Impacts

The construction of the synchronous condenser project will require approximately 30 construction workers to be onsite for approximately 30 days. Potential worker health and safety impacts will be mitigated by implementation of existing worker health and safety conditions of certification Work Safety-1 and Work Safety-3 to reduce worker health and safety impacts to less than significant levels.

Operational Impacts

The worker health and safety impacts due to operation of the synchronous condenser will be lower than those analyzed in the HBGS Units 3 and 4 Commission Decision, which determined that with the implementation of Worker Safety conditions of certification would be less than significant. The Applicant proposes to implement the applicable Worker Safety conditions of certification during the synchronous condenser operation. Therefore, no significant worker health and safety impacts are expected.

Cumulative Impacts

No significant cumulative worker health and safety impacts are expected due to the very low number and duration of workers required for construction and the fact that the HBGS Units 3 and 4 maintain a well-trained and experienced operating staff to operate the synchronous condenser project.

Compliance with LORS

The synchronous condenser project is expected to comply with all applicable LORS.

Impacts of Adjacent Property Owners

The synchronous condenser project will not result in either construction or operational impacts occurring offsite. Therefore, impacts to adjacent property owners will not occur. Attachment 2 presents a list of the assessor's parcel numbers and owners' names and addresses for all parcels within 1000 feet of the HBGS.

Impacts to the Public

The synchronous condenser project will not result in either construction or operational impacts occurring offsite. Construction activity and traffic will be less than those analyzed in the HBGS Units 3 and 4 Commission Decision. Therefore, impacts to the public will not occur.

⁴ Huntington Beach Generating Station Retool Project, May 2001, (00-AFC-13), P800-01-016, page 263.

Figures

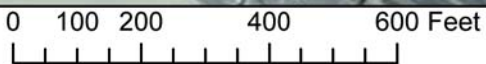

Legend

- Synchronous Condenser Pony Motor
- AES Huntington Beach Generating Station
- Huntington Beach Units 3 and 4
- Southern California Edison 230kV Switchyard



FIGURE 1
General Arrangement
 Synchronous Condenser Project
 HBGS 3 and 4
 Huntington Beach, California

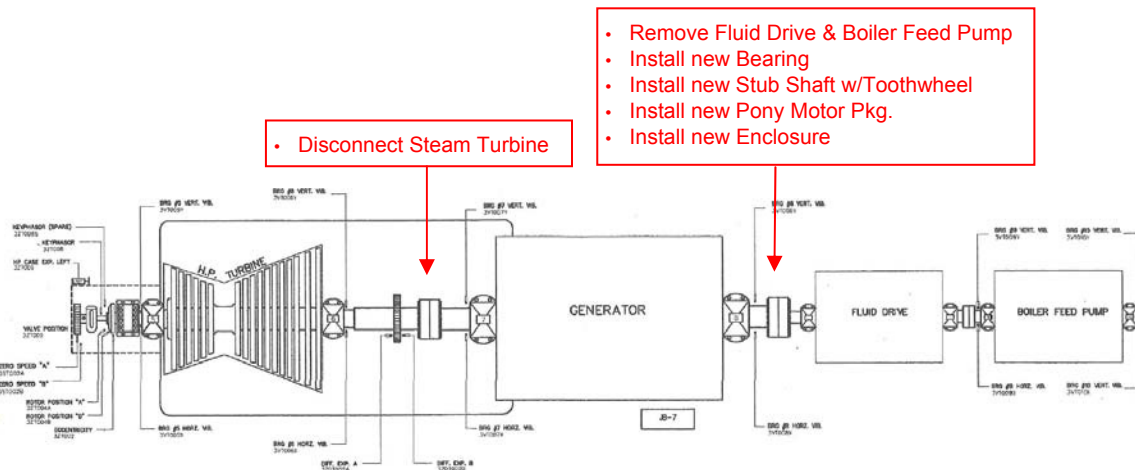

Unit 3 - HP

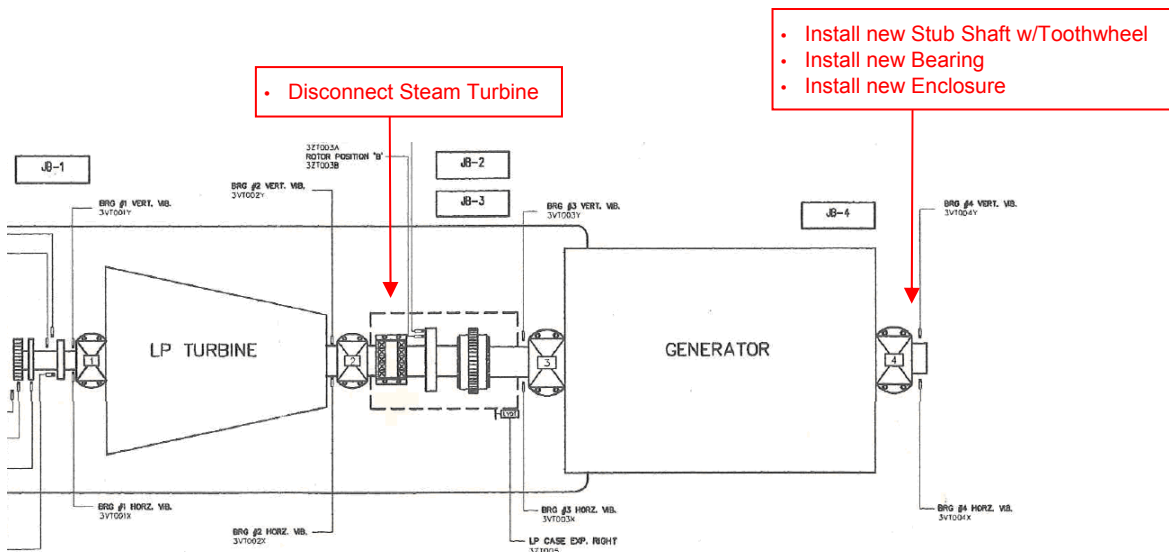

Unit 3 - LP

FIGURE 2a
Pony Motor Installation Plan View
 Synchronous Condenser Project
 HBGS 3 and 4
 Huntington Beach, California

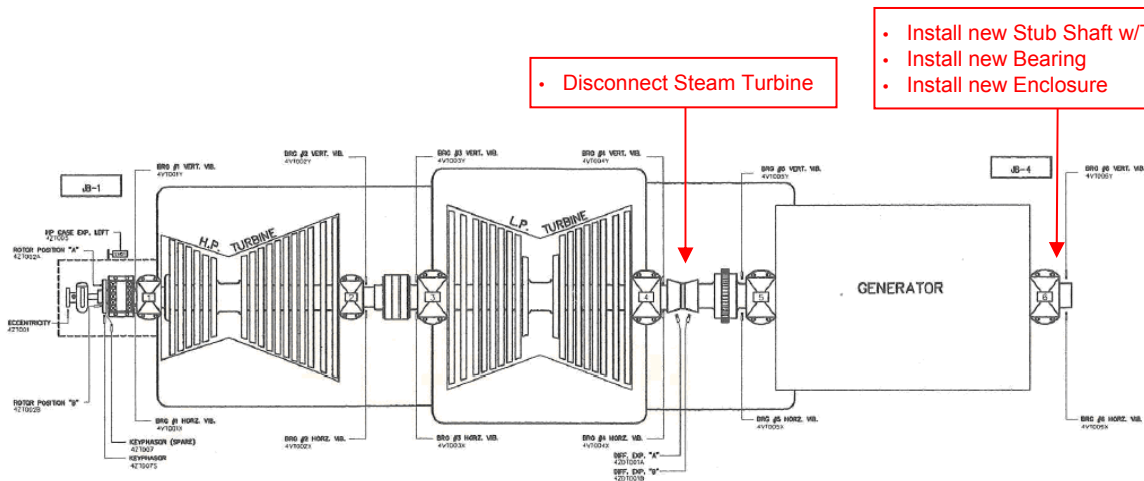

Unit 4 – HP/LP

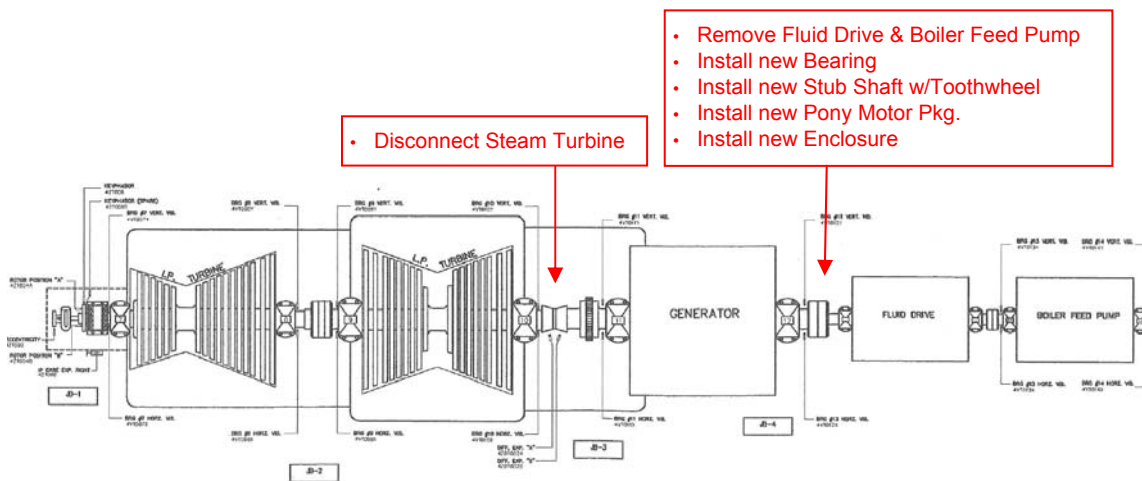

Unit 4 – IP/LP

FIGURE 2b
Pony Motor Installation Plan View
 Synchronous Condenser Project
 HBGS 3 and 4
 Huntington Beach, California

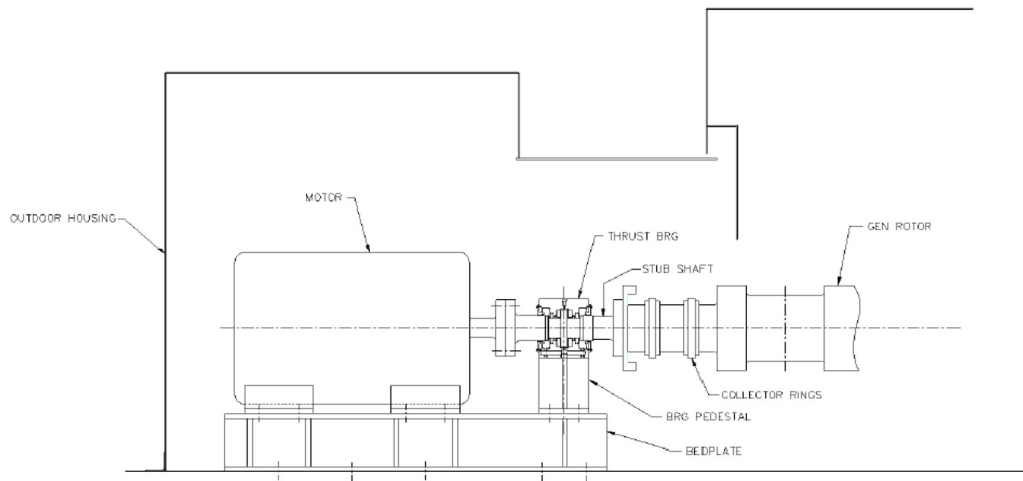

Detail - Pony Motor & Bearing Arrangement
 (1 ea. for Unit 3-HP & Unit 4-IP/LP)

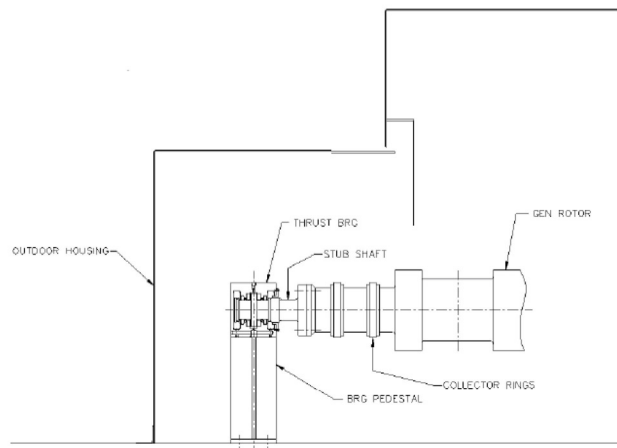

Detail - Bearing Only Arrangement
 (1 ea. for Unit 3-LP & Unit 4-HP/LP)

FIGURE 3
Pony Motor Installation Elevation View
 Synchronous Condenser Project
 HBGS 3 and 4
 Huntington Beach, California

Attachment 1
California Independent System Operator,
October 2, 2012 Letter

October 2, 2012

Ms. Jenifer Lee
Vice President
Edison Mission Huntington Beach, LLC
3 MacArthur Place, Suite 100
Santa Ana, CA 92707

Dear Ms. Lee:

This letter is to confirm that the ISO has reviewed and assessed the proposed synchronous condenser conversion project for Edison Mission Huntington Beach (EMHB) Units 3 and 4 and has concluded that the project will not cause a transmission system impact nor will it require modifications or upgrades to the system beyond the point of interconnection at the Southern California Edison Huntington Beach switchyard. The proposed project is a conversion of the EMHB Units 3 and 4 generators into synchronous condensers to provide continued voltage support in the absence of continued generation from these units. Since this project will result in a reduction of the total potential reactive power available from these units, no new physical constraints in the transmission system would be created and no further modifications to the transmission system are necessary to complete the project.

The EMHB Unit 3 and 4 synchronous condenser conversion project is a high priority and important project for the ISO to maintain system reliability and we look forward to assisting you with the completion of this project. Should you require further information or assistance from us please do not hesitate to call.

Sincerely,



Neil Millar
Executive Director, Infrastructure Development

Cc: K. Edson – ISO
P. Pettingill – ISO
J. Anders - ISO
W. Wirta – AES
S. O’Kane – AES
C. Stora – CEC
C. Marxen - CEC

Attachment 2
List of Property Owners within 1,000 feet of the
Huntington Beach Generating Station Boundaries

APN_D	OWNERNAME	M_HSENO	M_DIR	M_STREET	M_SFX	M_UNIT	M_CITY	M_STATE	M_ZIP
024-150-06	CITY OF HUNTINGTON BEACH			PO BOX 190			HUNTINGTON BEACH	CA	92648
024-150-16	STATE OF CALIFORNIA DEPT OF GENERAL SERVICES	650		HOWE	AVE		SACRAMENTO	CA	95825
024-154-01	MAZEN MUSTAFA ZEIDAN	301		17TH	ST		HUNTINGTON BEACH	CA	92648
024-154-02	SANG H LIM	3810		WILSHIRE	BLVD	911	LOS ANGELES	CA	90010
024-154-03	MORNING JADE CORPORATION	2855		PULLMAN	ST		SANTA ANA	CA	92705
024-154-04	LINDA DIANE BIGGS	125		MANHATTAN BEACH	BLVD		MANHATTAN BEACH	CA	90266
024-154-17	PIERSIDE PAVILION LLC	2633		RIVIERA	DR		LAGUNA BEACH	CA	92651
024-162-01	MAKALLON ATLANTA HUNTINGTON BEACH II LLC	4100		MACARTHUR	BLVD	200	NEWPORT BEACH	CA	92660
024-162-02	HAROLD E TOMKINS	231		1ST	ST	5	HUNTINGTON BEACH	CA	92648
024-162-03	HAROLD E TOMKINS	231		1ST	ST	5	HUNTINGTON BEACH	CA	92648
024-162-04	SUSAN JANE & SUSAN JANE FEE	6418		FORESTER	DR		HUNTINGTON BEACH	CA	92648
024-162-05	KAMRAN SAHBA	1043 S		MATTHEW WY			ANAHEIM	CA	92808
024-162-06	KAMRAN SAHBA	1043 S		MATTHEW WY			ANAHEIM	CA	92808
024-162-07	KAMRAN SAHBA	1043 S		MATTHEW WY			ANAHEIM	CA	92808
024-162-08	RICHARD W JACOBS			PO BOX 13639			ARLINGTON	TX	76094
024-162-09	RICHARD W JACOBS			PO BOX 13639			ARLINGTON	TX	76094
024-162-13	MICHAEL RICHARD COLLINS	419		MAIN	ST	A	HUNTINGTON BEACH	CA	92648
024-162-16	DELHI R WINN	222		2ND	ST		HUNTINGTON BEACH	CA	92648
024-162-17	SON SUK FRANKLIN	220		2ND	ST		HUNTINGTON BEACH	CA	92660
024-162-19	STACEY GDN WYATT DECATUR MITCHELL TRAINOR	2511		SUNFLOWER	AVE	M-1	SANTA ANA	CA	92704
024-162-20	DENNIS W REDMAN	1010 W		AVENUE S14			PALMDALE	CA	93551
024-162-21	JAMES G MELTON	206		2ND	ST		HUNTINGTON BEACH	CA	92648
024-162-22	DELHI WINN	222		2ND	ST		HUNTINGTON BEACH	CA	92648
024-162-23	ALICE PARNAKIAN	205		1ST	ST		HUNTINGTON BEACH	CA	92648
024-162-24	MARK NASHED	412		OLIVE	AVE	#165	HUNTINGTON BEACH	CA	92648
024-162-25	RAY H HUNNICUTT	4776		GREENE	RD		JOHNSON VALLEY	CA	92285
024-162-26	LESLIE ALSENZ	1746		PARK	ST		HUNTINGTON BEACH	CA	92648
024-162-28	LAVKUMAR C BAROT	2100		OHIO	AVE		SIGNAL HILL	CA	90755
024-162-29	THOMAS J MOORE	404 N		BERRY	ST		BREA	CA	92821
024-162-30	TIEN THUY NGUYEN	236		2ND	ST		HUNTINGTON BEACH	CA	92648
024-163-01	CITY OF HUNTINGTON BEACH			PO BOX 190			HUNTINGTON BEACH	CA	92648
024-163-02	MAKALLON ATLANTA HUNTINGTON BEACH II LLC	4100		MACARTHUR	BLVD	200	NEWPORT BEACH	CA	92660
024-163-03	DOMINICK A FIORILLO	11721		VULTEE	AVE		DOWNEY	CA	90241
024-163-08	TKS FAST GRILL INC	110		PACIFIC COAST	HWY		HUNTINGTON BEACH	CA	92648
024-163-09	DOMINICK A FIORILLO	11721		VULTEE	AVE		DOWNEY	CA	90241
024-163-12	ALLEN L NELSON	8404		LEXINGTON	RD		DOWNEY	CA	90241
024-163-13	ALLEN NELSON	11721		VULTEE	AVE		DOWNEY	CA	90241
024-163-14	BANK, FIRST NATL AMES IA FOR D PEASE MARITAL TRUST			P O BOX 846			AMES	IA	50010
024-163-15	MAKALLON ATLANTA HUNTINGTON BEACH II LLC	4100		MACARTHUR	BLVD	200	NEWPORT BEACH	CA	92660
024-165-02	RICHARD W JACOBS			PO BOX 13639			ARLINGTON	TX	76094
024-165-03	KATHRYN J CALVILLO	215		2ND	ST		HUNTINGTON BEACH	CA	92648
024-165-08	ROBERT R ALLEN	327		CREST	AVE		HUNTINGTON BEACH	CA	92648
024-165-09	3 H CONSTRUCTION INC	21902		TOBARRA			MISSION VIEJO	CA	92692
024-165-10	RAMIRO FERNANDEZ	218		3RD	ST		HUNTINGTON BEACH	CA	92648
024-165-11	RAMIRO FERNANDEZ	214		3RD	ST		HUNTINGTON BEACH	CA	92648
024-165-12	RONALD HSUEH	19046		STONEHURST	LN		HUNTINGTON BEACH	CA	92648
024-165-13	JEFFREY ANDRES MASON	825		12TH	ST		HUNTINGTON BEACH	CA	92648
024-165-14	KHANH V VU	214		WALNUT	AVE		HUNTINGTON BEACH	CA	92648
024-165-15	KIM THI VU	11210		LAVENDER	AVE		FOUNTAIN VALLEY	CA	92708
024-165-16	JEFFREY ANDRES MASON	825		12TH	ST		HUNTINGTON BEACH	CA	92648
024-165-18	DEWEY D DAVIDE	209		2ND	ST		HUNTINGTON BEACH	CA	92648
024-165-19	ROBERT V REIDER	211		SECOND	ST		HUNTINGTON BEACH	CA	92648
024-165-20	JEFFREY HANSLER	213		2ND	ST		HUNTINGTON BEACH	CA	92648
024-165-21	RICHARD S & CYNTHIA M BERRY	219		2ND	ST		HUNTINGTON BEACH	CA	92648
024-165-23	HUY L HUYNH	227		2ND	ST		HUNTINGTON BEACH	CA	92648
024-165-25	STEPHEN R ZAJICEK	221		2ND	ST		HUNTINGTON BEACH	CA	92648
024-165-26	DAVID BRIAN MC HOWELL	223		2ND	ST		HUNTINGTON BEACH	CA	92648
024-165-27	JOHNNY NGO	225		2ND	ST		HUNTINGTON BEACH	CA	92648
024-165-28	DEWEY D DAVIDE			P O BOX 911			HUNTINGTON BEACH	CA	92648
024-165-29	DEWEY D DAVIDE			P O BOX 911			HUNTINGTON BEACH	CA	92648
024-165-30	WILLIAM K VOGT	2108		PACIFIC COAST	HWY		HUNTINGTON BEACH	CA	92648
024-166-21									
024-251-01	REDEVELOPMENT AGENCY CITY	2000		MAIN	ST		HUNTINGTON BEACH	CA	92648
024-252-01	REDEVELOPMENT AGENCY CITY	2000		MAIN	ST		HUNTINGTON BEACH	CA	92648
024-252-02	REDEVELOPMENT AGENCY CITY	2000		MAIN	ST		HUNTINGTON BEACH	CA	92648

APN_D	OWNERNAME	M_HSENO	M_DIR	M_STREET	M_SFX	M_UNIT	M_CITY	M_STATE	M_ZIP
024-271-06	ATLANTA HUNTINGTON BEACH LLC	4100		MACARTHUR BL		200	NEWPORT BEACH	CA	92660
024-272-01	ATLANTA HUNTINGTON BEACH LLC	4100		MACARTHUR BL		200	NEWPORT BEACH	CA	92660
024-272-02	ATLANTA HUNTINGTON BEACH LLC	4100		MACARTHUR BL		200	NEWPORT BEACH	CA	92660
024-281-02	CITY OF HUNTINGTON BEACH			PO BOX 190			HUNTINGTON BEACH	CA	92648
024-281-10	CITY OF HUNTINGTON BEACH			PO BOX 190			HUNTINGTON BEACH	CA	92648
024-281-14	CITY OF HUNTINGTON BEACH			PO BOX 190			HUNTINGTON BEACH	CA	92648
024-281-15	HUNTINGTON BEACH CO			P O BOX 285			HOUSTON	TX	77001
024-281-16	MAKALLON ATLANTA HUNTINGTON BEACH II LLC	4100		MACARTHUR	BLVD	200	NEWPORT BEACH	CA	92660
024-281-17	HUNTINGTON BEACH CO			P O BOX 285			HOUSTON	TX	77001
024-281-18	HUNTINGTON BEACH CO			P O BOX 285			HOUSTON	TX	77001
024-291-16	PACIFIC MOBILE HOME PARK LLC	80		HUNTINGTON	ST		HUNTINGTON BEACH	CA	92648
024-291-19	CITY OF HUNTINGTON BEACH			PO BOX 190			HUNTINGTON BEACH	CA	92648
024-291-20	CITY OF HUNTINGTON BEACH			PO BOX 190			HUNTINGTON BEACH	CA	92648
024-311-02	MAYER FINANCIAL, L.P.	611		ANTON BLVD,		1400	COSTA MESA	CA	92626
024-311-03	CITY OF HUNTINGTON BEACH	2000		MAIN	ST		HUNTINGTON BEACH	CA	92648
024-312-14	WATERFRONT COMMUNITY ASSOCIATION	26		CORPORATE PLAZA		100	NEWPORT BEACH	CA	92660
024-312-22	WATERFRONT COMMUNITY ASSOCIATION	16845		VON KARMAN	AVE	200	IRVINE	CA	92606
024-312-23	WATERFRONT COMMUNITY ASSOCIATION	26		CORPORATE PLAZA		100	NEWPORT BEACH	CA	92660
024-312-24	WATERFRONT COMMUNITY ASSOCIATION	16845		VON KARMAN	AVE	200	IRVINE	CA	92606
024-312-25	WATERFRONT COMMUNITY ASSOCIATION	16845		VON KARMAN		200	IRVINE	CA	92606
024-312-26	WILLIAM LYON HOMES INC	4490		VON KARMAN	AVE		NEWPORT BEACH	CA	92660
024-312-27	WATERFRONT COMMUNITY ASSOCIATION	26		CORPORATE PLAZA		100	NEWPORT BEACH	CA	92660
024-312-28	WATERFRONT COMMUNITY ASSOCIATION	26		CORPORATE PLAZA		100	NEWPORT BEACH	CA	92660
024-312-30	WILLIAM LYON HOMES INC	4490		VON KARMAN	AVE		NEWPORT BEACH	CA	92660
024-312-31	WATERFRONT COMMUNITY ASSOCIATION	26		CORPORATE	PLZ		NEWPORT BEACH	CA	92660
024-312-39	WATERFRONT COMMUNITY ASSOCIATION	16845		VON KARMAN		200	IRVINE	CA	92606
024-312-40	WATERFRONT COMMUN ASSOCIATION	16845		VON KARMAN		200	IRVINE	CA	92606
024-312-41	WATERFRONT COMMUNITY ASSOCIATION	26		CORPORATE PLAZA		100	NEWPORT BEACH	CA	92660
024-312-42	WATERFRONT COMMUNITY ASSOCIATION	26		CORPORATE PLAZA		100	NEWPORT BEACH	CA	92660
024-312-43	WATERFRONT COMMUNITY ASSOCIATION	26		CORPORATE PLAZA		100	NEWPORT BEACH	CA	92660
024-312-44	WATERFRONT COMMUNITY ASSN	26		CORPORATE PLAZA		100	NEWPORT BEACH	CA	92660
024-312-45	WATERFRONT COMMUNITY ASSN	16845		VON KARMAN	AVE	200	IRVINE	CA	92606
114-150-28	ORANGE COUNTY FLOOD CONTROL DISTRICT	300	N	FLOWER ST 6TH FLOOR			SANTA ANA	CA	92703
114-150-34	ORANGE COUNTY FLOOD CONTROL DISTRICT	300	N	FLOWER ST 6TH FLOOR			SANTA ANA	CA	92703
114-150-36	PACIFIC TERMINALS LLC	5900		CHERRY	AVE		LONG BEACH	CA	90805
114-150-41	ORANGE COUNTY FLOOD CONTROL DISTRICT	300	N	FLOWER ST 6TH FLOOR			SANTA ANA	CA	92703
114-150-41	ORANGE COUNTY FLOOD CONTROL DISTRICT	300	N	FLOWER ST 6TH FLOOR			SANTA ANA	CA	92703
114-150-50	STATE OF CALIF DEPT OF PUBLIC WORKS			PO BOX 187000			SACRAMENTO	CA	95818
114-150-50	STATE OF CALIF DEPT OF PUBLIC WORKS			PO BOX 187000			SACRAMENTO	CA	95818
114-150-57	ORANGE COUNTY FLOOD CONTROL DISTRICT	300	N	FLOWER ST 6TH FLOOR			SANTA ANA	CA	92703
114-150-57	ORANGE COUNTY FLOOD CONTROL DISTRICT	300	N	FLOWER ST 6TH FLOOR			SANTA ANA	CA	92703
114-150-58	STATE OF CALIFORNIA DEPT OF TRANSPORTATION	3337		MICHELSON	DR	380	IRVINE	CA	92612
114-150-59	STATE OF CALIFORNIA DEPT OF TRANSPORTATION	3337		MICHELSON	DR	380	IRVINE	CA	92612
114-150-59	STATE OF CALIFORNIA DEPT OF TRANSPORTATION	3337		MICHELSON	DR	380	IRVINE	CA	92612
114-150-62	STATE OF CALIFORNIA	3030		AVE DEL PRESIDENTE			SAN CLEMENTE	CA	92672
114-150-63	BEACH WETLANDS CONSERVANCY HUNTINGTON			PO BOX 5903			HUNTINGTON BEACH	CA	92615
114-150-64	ORANGE COUNTY FLOOD CONTROL DISTRICT	300	N	FLOWER ST 6TH FLOOR			SANTA ANA	CA	92703
114-150-72	MILLS LAND & WATER CO	1920		MAIN	ST	1070	IRVINE	CA	92614
114-150-73	MILLS LAND & WATER CO	1920		MAIN	ST	1070	IRVINE	CA	92614
114-150-74	ORANGE COUNTY FLOOD CONTROL DISTRICT	300	N	FLOWER ST 6TH FLOOR			SANTA ANA	CA	92703
114-150-75	CANNERY HAMILTON PROPERTIES LLC	6001		BOLLINGER CANYON	RD		SAN RAMON	CA	94583
114-150-78	CANNERY HAMILTON PROPERTIES LLC	6111		BOLLINGER CANYON	RD		SAN RAMON	CA	94583
114-150-79	CANNERY HAMILTON PROPERTIES LLC	6001		BOLLINGER CANYON	RD		SAN RAMON	CA	94583
114-150-80	CANNERY HAMILTON PROPERTIES LLC	6001		BOLLINGER CANYON	RD		SAN RAMON	CA	94583
114-150-81	BEACH WETLANDS CONSERVANCY HUNTINGTON			P O BOX 5903			HUNTINGTON BEACH	CA	92615
114-150-86	MILLS PCH LLC	430	S	SAN DIMAS	AVE		SAN DIMAS	CA	91773
114-150-86	MILLS PCH LLC	430	S	SAN DIMAS	AVE		SAN DIMAS	CA	91773
114-150-87	STATE OF CALIFORNIA DEPT OF PUBLIC WORKS			PO BOX 187000			SACRAMENTO	CA	95818
114-150-88	STATE OF CALIFORNIA DEPT OF PUBLIC WORKS			PO BOX 187000			SACRAMENTO	CA	95818
114-150-89	STATE OF CALIFORNIA			PO BOX 187000			SACRAMENTO	CA	95818
114-150-90	STATE OF CALIFORNIA			PO BOX 187000			SACRAMENTO	CA	95818
114-150-91	STATE OF CALIFORNIA			PO BOX 187000			SACRAMENTO	CA	95818
114-150-92	STATE OF CALIFORNIA DEPT OF PUBLIC WORKS	1025		P	ST		SACRAMENTO	CA	95814
114-150-93	STATE OF CALIFORNIA DEPT OF PUBLIC WORKS			PO BOX 187000			SACRAMENTO	CA	95818
114-150-94	CITY OF HUNTINGTON BEACH	2000		MAIN	ST		HUNTINGTON BEACH	CA	92648

APN D	OWNERNAME	M_HSENO	M_DIR	M_STREET	M_SFX	M_UNIT	M_CITY	M_STATE	M_ZIP
114-150-95	AES HUNTINGTON BEACH DEVELOPMENT	21730		NEWLAND	ST		HUNTINGTON BEACH	CA	92646
114-150-96	AES HUNTINGTON BEACH DEVELOPMENT	21730		NEWLAND	ST		HUNTINGTON BEACH	CA	92646
114-160-69	BEACH WETLANDS CONSERVANCY HUNTINGTON			PO BOX 5903			HUNTINGTON BEACH	CA	92615
114-160-85	BEACH WETLANDS CONSERVANCY HUNTINGTON			PO BOX 5903			HUNTINGTON BEACH	CA	92615
114-160-86	BEACH WETLANDS CONSERVANCY HUNTINGTON			PO BOX 5903			HUNTINGTON BEACH	CA	92615
114-481-01	TERENCE BOSTON	22001		SUSAN	LN		HUNTINGTON BEACH	CA	92646
114-481-02	LISA L HOWELL	22021		SUSAN	LN		HUNTINGTON BEACH	CA	92646
114-481-03	JAN JAVER DOWNS	315 N		CRESCENT	DR	1014	BEVERLY HILLS	CA	90210
114-481-04	RETA CAROL CAGLE	21572		OAKBROOK			MISSION VIEJO	CA	92692
114-481-05	RAYMOND S & CHARLENE R COLE	22061		SUSAN	LN		HUNTINGTON BEACH	CA	92646
114-481-06	MARINA VALSAMAKIS	1130		LAS OLAS	AVE		SANTA BARBARA	CA	93109
114-481-07	DAVID T & JACQUELINE M ELLIS	22091		SUSAN	LN		HUNTINGTON BEACH	CA	92646
114-481-08	ELLEN S WHITE	22072		HULA	CIR		HUNTINGTON BEACH	CA	92646
114-481-09	JOHN & DANA RYAN	22052		HULA	CIR		HUNTINGTON BEACH	CA	92646
114-481-10	DOROTHY MARIE RILEY	22042		HULA	CIR		HUNTINGTON BEACH	CA	92646
114-481-11	KATHLEEN ANN MOONEY	22022		HULA	CIR		HUNTINGTON BEACH	CA	92646
114-481-12	JOHN TAD GRAVES	22012		HULA	CIR		HUNTINGTON BEACH	CA	92646
114-481-13	CHARLES M LOURTIE	10737		CREBS	AVE		NORTHBRIDGE	CA	91326
114-481-14	GARY L GUMBERT			PO BOX 483			SURFSIDE	CA	90743
114-481-15	JUDY ANN LENIHAN	22021		HULA	CIR		HUNTINGTON BEACH	CA	92646
114-481-16	FRANK R & MICHELLE R GANDARA			PO BOX 5461			HUNTINGTON BEACH	CA	92615
114-481-17	ANNA ZARETSKAYA	22051		HULA	CIR		HUNTINGTON BEACH	CA	92646
114-481-18	KENNETH C KIMBALL	22071		HULA	CIR		HUNTINGTON BEACH	CA	92646
114-481-19	RICHARD W MORTIMER	9002		CHRISTINE	DR		HUNTINGTON BEACH	CA	92646
114-481-20	DAVID S & DEANNA L WAGESTER	9012		CHRISTINE	DR		HUNTINGTON BEACH	CA	92646
114-481-21	KOUROSH & FARIBA JALALI KHAVARI	9022		CHRISTINE	DR		HUNTINGTON BEACH	CA	92646
114-481-22	KEITH D TUCKER	9032		CHRISTINE	DR		HUNTINGTON BEACH	CA	92646
114-481-23	STANLEY W MARRIOTT	9042		CHRISTINE	DR		HUNTINGTON BEACH	CA	92646
114-481-24	PHILIP J & SUZANNE W BEUKEMA	9052		CHRISTINE	DR		HUNTINGTON BEACH	CA	92646
114-481-25	ROBERT G DUTTON	9122		CHRISTINE	DR		HUNTINGTON BEACH	CA	92646
114-481-26	KARL E WYSOCKI	9072		CHRISTINE	DR		HUNTINGTON BEACH	CA	92646
114-481-27	FOAD JAHANSOUZ	9082		CHRISTINE	DR		HUNTINGTON BEACH	CA	92646
114-481-28	JOSEPH JACKSON BOOKOUT	9092		CHRISTINE	DR		HUNTINGTON BEACH	CA	92646
114-481-32	PACIFIC TERMINALS LLC	5900		CHERRY	AVE		LONG BEACH	CA	90805
114-481-34	CITY OF HUNTINGTON BEACH			PO BOX 190			HUNTINGTON BEACH	CA	92648
114-481-35	CITY OF HUNTINGTON BEACH			PO BOX 190			HUNTINGTON BEACH	CA	92648
114-482-01	MARY LOU ARNOLD	22002		SUSAN	LN		HUNTINGTON BEACH	CA	92646
114-482-02	OANH MAI	22022		SUSAN	LN		HUNTINGTON BEACH	CA	92646
114-482-03	AL STEPHEN GABRION	22032		SUSAN	LN		HUNTINGTON BEACH	CA	92646
114-482-04	OLIVER F THAYER	22042		SUSAN	LN		HUNTINGTON BEACH	CA	92646
114-482-05	WAYNE S STEFFIER	22052		SUSAN	LN		HUNTINGTON BEACH	CA	92646
114-482-06	JACK R BYRD	8915		WOODLAWN	DR		GRANBURY	TX	76049
114-482-07	J JOHNSTON			PO BOX 7932			NEWPORT BEACH	CA	92658
114-482-08	SHIGEKO HOSOKAWA	8570		ROCKFISH	CIR		FOUNTAIN VALLEY	CA	92708
114-482-09	MALCOLM L & MARIANNE MAC KENZIE	9071		CHRISTINE	DR		HUNTINGTON BEACH	CA	92646
114-482-10	STEVEN J HAYES	9081		CHRISTINE	DR		HUNTINGTON BEACH	CA	92646
114-482-11	ROBERT H MERRITT	31886		VIA PATO			TRABUCO CANYON	CA	92679
114-482-12	SUSAN ANDERSON	22081		SURFRIDER	LN		HUNTINGTON BEACH	CA	92646
114-482-13	JEANE M FLEMING	22061		SURFRIDER	LN		HUNTINGTON BEACH	CA	92646
114-482-14	THOMAS W & CATHERINE A MORTIMER	22051		SURFRIDER	LN		HUNTINGTON BEACH	CA	92646
114-482-15	RICHARD N MAST	22041		SURFRIDER	LN		HUNTINGTON BEACH	CA	92646
114-482-16	DAVID R CRAGUN	22031		SURFRIDER	LN		HUNTINGTON BEACH	CA	92646
114-482-17	MICHAEL S & DONNA M TRYON	22021		SURFRIDER	LN		HUNTINGTON BEACH	CA	92646
114-482-18	CHRISTOPHER CONDON	9102		PLAYA	DR		HUNTINGTON BEACH	CA	92646
114-482-19	JOE MICHAEL & RITA ALMANZA CROOM	9112		PLAYA	DR		HUNTINGTON BEACH	CA	92646
114-493-28	ROBERT J & KARLA M THOMAS	9152		PLAYA	DR		HUNTINGTON BEACH	CA	92646
114-493-29	NAM VU	9142		PLAYA	DR		HUNTINGTON BEACH	CA	92646
114-493-30	CHRISTOPHER M SPENCE	9132		PLAYA	DR		HUNTINGTON BEACH	CA	92646
114-493-31	QUANG X NGUYEN	9122		PLAYA	DR		HUNTINGTON BEACH	CA	92646
114-494-01	THIERRY DELAPRE	22041		ISLANDER	LN		HUNTINGTON BEACH	CA	92646
114-494-02	DOUGLAS M & ALYSON M ODONNELL	22051		ISLANDER	LN		HUNTINGTON BEACH	CA	92646
114-494-03	BRADLEY MARTIN & JENNIFER BEATTY WALKER	22061		ISLANDER	LN		HUNTINGTON BEACH	CA	92646
114-494-04	FRANK T WALKER	22071		ISLANDER	LN		HUNTINGTON BEACH	CA	92646
114-494-11	RICHARD D SWANSON	9101		CHRISTINE	DR		HUNTINGTON BEACH	CA	92646
114-494-12	JAMES K BERNSSEN	11322		KENSINGTON	RD		LOS ALAMITOS	CA	90720

APN_D	OWNERNAME	M_HSENO	M_DIR	M_STREET	M_SFX	M_UNIT	M_CITY	M_STATE	M_ZIP
114-494-13	G G WOODS	22092		SURFRIDER	LN		HUNTINGTON BEACH	CA	92646
114-494-14	G G WOODS	22092		SURFRIDER	LN		HUNTINGTON BEACH	CA	92646
114-494-15	ROBERT JOHN JANUSKA	22072		SURFRIDER	LN		HUNTINGTON BEACH	CA	92646
114-494-16	ALBERT VIRAY	22062		SURFRIDER	LN		HUNTINGTON BEACH	CA	92646
114-494-17	VICKI WILDER	22052		SURFRIDER	LN		HUNTINGTON BEACH	CA	92646
114-494-18	POUL C ANDERSEN	7		WHITE CAP	DR		CORONA DEL MAR	CA	92625
148-081-01	TERESA J LEE	21901		KIOWA	LN		HUNTINGTON BEACH	CA	92646
148-081-02	STEVE MC KENDRY	8562		SANDY HOOK	DR		HUNTINGTON BEACH	CA	92646
148-081-03	LESLIE L JEPSEN	8552		SANDY HOOK	DR		HUNTINGTON BEACH	CA	92646
148-081-04	RYAN RICHARD & CAROL ANN DRUMM	8542		SANDY HOOK	DR		HUNTINGTON BEACH	CA	92646
148-081-05	CATHY A COWGER	8532		SANDY HOOK	DR		HUNTINGTON BEACH	CA	92646
148-081-06	D AMBRA, CHRISTIAN	8522		SANDY HOOK	DR		HUNTINGTON BEACH	CA	92646
148-081-07	WAYNE A LEWIS	21391		BOWSPRIT	LN		HUNTINGTON BEACH	CA	92646
148-081-08	KELVIN X TRAN	8502		SANDY HOOK	DR		HUNTINGTON BEACH	CA	92646
148-081-09	GAY A BOYER	21441		ANTIGUA	LN		HUNTINGTON BEACH	CA	92646
148-081-10	WALTER P GUNKEL	21431		ANTIGUA	LN		HUNTINGTON BEACH	CA	92646
148-081-11	STANLEY H & LISA L BRYSON	21421		ANTIGUA	LN		HUNTINGTON BEACH	CA	92646
148-086-17	JOANN M DICKENS	8561		SANDY HOOK	DR		HUNTINGTON BEACH	CA	92646
148-086-18	ANDREW J & MARILYN P BUMATAY	8551		SANDY HOOK	DR		HUNTINGTON BEACH	CA	92646
148-086-19	DONALD EDWARD STACK	8541		SANDY HOOK	DR		HUNTINGTON BEACH	CA	92646
148-086-20	JERRY ANNE WELLS	8531		SANDY HOOK	DR		HUNTINGTON BEACH	CA	92646
148-086-21	ALINE M SCHAUM	8521		SANDY HOOK	DR		HUNTINGTON BEACH	CA	92646
148-086-22	JASON M & LEILEN R SHELTON	8522		MILNE	DR		HUNTINGTON BEACH	CA	92646
148-086-23	MICHAEL O DANGOTT	8532		MILNE	DR		HUNTINGTON BEACH	CA	92646
148-121-01	FEIN PROPERTIES LLC	714		OCEANHILL	DR		HUNTINGTON BEACH	CA	92648
148-121-03	TARNUTZER FAMILY LLC	1901		HARRISON ST FL 2ND			OAKLAND	CA	94612
148-121-04	CITY OF HUNTINGTON BEACH								92648
148-121-15	ORANGE COUNTY FLOOD CONTROL DISTRICT	300 N		FLOWER ST 6TH FLOOR			SANTA ANA	CA	92703
148-121-16	ORANGE COUNTY FLOOD CONTROL DISTRICT	300 N		FLOWER ST 6TH FLOOR			SANTA ANA	CA	92703
148-121-17	CITY OF HUNTINGTON BEACH			PO BOX 190			HUNTINGTON BEACH	CA	92648
148-121-18	NUBOARD RECYCLING INC	8601		EDISON	AVE	C	HUNTINGTON BEACH	CA	92646
148-121-19	H & Z INVESTMENT LLC	25352		HILLARY	LN		LAGUNA HILLS	CA	92653
148-121-20	H & Z INVESTS LLC	25352		HILLARY	LN		LAGUNA HILLS	CA	92653
148-121-21	DANIEL R BRIMLOW	1820 NW		CARTY	RD		RIDGEFIELD	WA	98642
148-121-24	ORANGE COUNTY FLOOD CONTROL DISTRICT	300 N		FLOWER ST 6TH FLOOR			SANTA ANA	CA	92703
148-121-27	YVM NEWLAND LLC	21632		NEWLAND	ST		HUNTINGTON BEACH	CA	92646
148-131-07	RP/PLC BLUE CANVAS LLC	19		CORPORATE PLAZA	DR		NEWPORT BEACH	CA	92660
148-131-08	RP/PLC BLUE CANVAS LLC	19		CORPORATE PLAZA	DR		NEWPORT BEACH	CA	92660
148-131-13	RP/PLC BLUE CANVAS LLC	3953		MAPLE	AVE	300	DALLAS	TX	75219
148-131-20	RP/PLC BLUE CANVAS LLC	3953		MAPLE	AVE	300	DALLAS	TX	75219
148-131-21	RP/PLC BLUE CANVAS LLC	3953		MAPLE	AVE	300	DALLAS	TX	75219
148-131-22	RP/PLC BLUE CANVAS LLC	3953		MAPLE	AVE	300	DALLAS	TX	75219
148-131-23	RP/PLC BLUE CANVAS LLC	3953		MAPLE	AVE	300	DALLAS	TX	75219
148-131-26	STATE OF CALIF DEPT OF PUBLIC WORKS			ROOM 7516			LOS ANGELES	CA	90012
148-131-27	STATE OF CALIFORNIA DEPT OF TRANSPORTATION	3337		MICHELSON	DR	380	IRVINE	CA	92612
148-131-28	ORANGE COUNTY FLOOD CONTROL DIST	300 N		FLOWER ST 6TH FLOOR			SANTA ANA	CA	92703
148-131-29	STATE OF CALIFORNIA DEPT OF TRANSPORTATION			P O BOX 2128			SANTA FE SPRINGS	CA	90670
148-131-29	STATE OF CALIFORNIA DEPT OF TRANSPORTATION			P O BOX 2128			SANTA FE SPRINGS	CA	90670
148-131-30	ORANGE COUNTY FLOOD CONTROL DIST	300 N		FLOWER ST 6TH FLOOR			SANTA ANA	CA	92703
149-011-01	DOMINIC MENALDI	9001		BERMUDA	DR		HUNTINGTON BEACH	CA	92646
149-011-02	GUY A ADAMS	9021		BERMUDA	DR		HUNTINGTON BEACH	CA	92646
149-011-03	RONALD CHARLES JETT	9031		BERMUDA	DR		HUNTINGTON BEACH	CA	92646
149-011-04	ALBERT J ASHURST	8886		PLUMAS	CIR	1122C	HUNTINGTON BEACH	CA	92646
149-011-05	STANLEY CHEN	21872		HARBORBREEZE	LN		HUNTINGTON BEACH	CA	92646
149-011-06	JAMES R OLSEN	9081		BERMUDA	DR		HUNTINGTON BEACH	CA	92646
149-011-07	TUAN HUY TRAN	9091		BERMUDA	DR		HUNTINGTON BEACH	CA	92646
149-011-08	ANTHONY P & STELLA A ZOGRAFIDES	9101		BERMUDA	DR		HUNTINGTON BEACH	CA	92646
149-011-09	WILLIAM H STILWELL	9111		BERMUDA	DR		HUNTINGTON BEACH	CA	92646
149-011-10	KENT A MC GARRIGLE	9121		BERMUDA	DR		HUNTINGTON BEACH	CA	92646
149-011-11	KURT A SUHR	9131		BERMUDA	DR		HUNTINGTON BEACH	CA	92646
149-011-12	KEVIN M & MICHELE R COLEMAN	9141		BERMUDA	DR		HUNTINGTON BEACH	CA	92646
149-011-13	CHRIS & ALISE CLEVELY	9151		BERMUDA	DR		HUNTINGTON BEACH	CA	92646
149-011-14	DANIEL F & GERI L GAETA	9161		BERMUDA	DR		HUNTINGTON BEACH	CA	92646
149-011-15	FOAD JAHANSOUZ	9082		CHRISTINE	DR		HUNTINGTON BEACH	CA	92646
149-012-01	SHELLY LORRAINE GAERTNER	21802		KIOWA	LN		HUNTINGTON BEACH	CA	92646

APN_D	OWNERNAME	M_HSENO	M_DIR	M_STREET	M_SFX	M_UNIT	M_CITY	M_STATE	M_ZIP
149-012-02	ALVA L & MAGALI VELOSO REBELO BATTENFIELD	21782		KIOWA	LN		HUNTINGTON BEACH	CA	92646
149-012-03	DONALD J ZALESKI	21772		KIOWA	LN		HUNTINGTON BEACH	CA	92646
149-012-04	ROBERT DAYYAT	9062		BERMUDA	DR		HUNTINGTON BEACH	CA	92646
149-012-05	ROBERT T & CONSTANCE A MCLIN	9082		BERMUDA			HUNTINGTON BEACH	CA	92646
149-012-06	SCOTT TRACY	9092		BERMUDA			HUNTINGTON BEACH	CA	92646
149-012-07	DENNIS READ MC DONALD	9102		BERMUDA	DR		HUNTINGTON BEACH	CA	92646
149-012-08	FREDERICK S WATERFALL	9112		BERMUDA	DR		HUNTINGTON BEACH	CA	92646
149-012-09	MICHAEL JOHN & LORI N MONAGHAN	20542		PAISLEY	LN		HUNTINGTON BEACH	CA	92646
149-012-10	THOMAS D RIDLEY	9132		BERMUDA	DR		HUNTINGTON BEACH	CA	92646
149-012-11	GEORGE RIVADENEYRA	9142		BERMUDA	DR		HUNTINGTON BEACH	CA	92646
149-012-12	BARBARA R CHRISPIN	9152		BERMUDA	DR		HUNTINGTON BEACH	CA	92646
149-012-13	STEVEN R SIMON	9162		BERMUDA	DR		HUNTINGTON BEACH	CA	92646
149-012-14	DIANA WAGNER	9172		BERMUDA	DR		HUNTINGTON BEACH	CA	92646
149-012-17	BRIEN C & ROSALIE BRAUN	9171		KAHULUI	DR		HUNTINGTON BEACH	CA	92646
149-012-18	MAX F LIPPKA	9161		KAHULUI	DR		HUNTINGTON BEACH	CA	92646
149-012-19	GAIL R SUMMERS	9151		KAHULUI			HUNTINGTON BEACH	CA	92646
149-012-20	RANDALL W COCHRAN	9141		KAHULUI	DR		HUNTINGTON BEACH	CA	92646
149-012-21	VIRGINIA M MURPHY	9131		KAHULUI	DR		HUNTINGTON BEACH	CA	92646
149-012-22	OLE OLESON	9121		KAHULUI	DR		HUNTINGTON BEACH	CA	92646
149-012-23	ELIZABETH J PARKOVICH	9111		KAHULUI	DR		HUNTINGTON BEACH	CA	92646
149-012-24	DONALD L & JOAN SCHLIETER	9101		KAHULUI	DR		HUNTINGTON BEACH	CA	92646
149-012-25	WALTER R & CAROLYN S COYLE	9091		KAHULUI	DR		HUNTINGTON BEACH	CA	92646
149-012-26	BRIAN JOHN HUNTER	9081		KAHULUI	DR		HUNTINGTON BEACH	CA	92646
149-012-27	NEAL RIEFFANAUGH	909		TILLER	WAY		CORONA DEL MAR	CA	92625
149-013-01	CLARENCE F BALLENGER	21771		KIOWA	LN		HUNTINGTON BEACH	CA	92646
149-013-02	GRANTHAM, HILDE F TRUST	20772		SKIMMER	LN		HUNTINGTON BEACH	CA	92646
149-013-03	LOUIS D KASTORFF	21801		KIOWA	LN		HUNTINGTON BEACH	CA	92646
149-013-04	MARY ANNE SURPRENANT	21811		KIOWA	LN		HUNTINGTON BEACH	CA	92646
149-013-05	DONALD G HOLMES	21821		KIOWA	LN		HUNTINGTON BEACH	CA	92646
149-013-06	JAMES G WRIGHT	703		CONCORD	ST		SANTA ANA	CA	92701
149-014-01	MICHAEL CARY & JANE ELLEN STRACNER	21822		KIOWA	LN		HUNTINGTON BEACH	CA	92646
149-014-02	KEITH D & AMY B SEWARD	21832		KIOWA	LN		HUNTINGTON BEACH	CA	92646
149-014-03	RICHARD B LOY	9062		KAHULUI	DR		HUNTINGTON BEACH	CA	92646
149-014-04	WILLARD EUGENE TOLLES	10		MARQUETTE		218	IRVINE	CA	92612
149-014-05	MARTHA B MLEYNEK	9092		KAHULUI	DR		HUNTINGTON BEACH	CA	92646
149-014-06	MARK G & BETTINA S CARNAHAN	9102		KAHULUI	DR		HUNTINGTON BEACH	CA	92646
149-014-07	ROSE & MICHAEL THURSTON	9112		KAHULUI	DR		HUNTINGTON BEACH	CA	92646
149-014-08	JOHN F KIRKORN	9122		KAHULUI	DR		HUNTINGTON BEACH	CA	92646
149-014-09	STEVEN W & CLAUDIA G HANSEN	9132		KAHULUI	DR		HUNTINGTON BEACH	CA	92646
149-014-10	JOSEPH D & SANDRA B DEMEO	20112		VIVA	CIR		HUNTINGTON BEACH	CA	92646
149-014-11	EDWARD V GARNETT	9152		KAHULUI	DR		HUNTINGTON BEACH	CA	92646
149-014-12	HOWARD GEOGHEGAN	9162		KAHULUI	DR		HUNTINGTON BEACH	CA	92646
149-014-13	DANIEL BRAUN	9172		KAHULUI	DR		HUNTINGTON BEACH	CA	92646
149-021-01	MATTHEW S & ANGELA D BELLINGER	21842		KIOWA	LN		HUNTINGTON BEACH	CA	92646
149-021-02	JUDE OLIVAS	9061		MAHALO	DR		HUNTINGTON BEACH	CA	92646
149-021-03	ROBERT J FRYE	9081		MAHALO	DR		HUNTINGTON BEACH	CA	92646
149-021-04	DOUGLAS J & LISA AHUERO	9091		MAHALO	DR		HUNTINGTON BEACH	CA	92646
149-021-05	HAROLD EDWARD LOOMIS	9101		MAHALO	DR		HUNTINGTON BEACH	CA	92646
149-021-06	MARIA I LORENTE	1505		TAHITI	AVE		LAGUNA BEACH	CA	92651
149-021-07	ROBERT A & CATHERINE M GINGRAS	1122		EICHHORN	DR		ERIE	CO	80516
149-021-08	CHARLOTTE GILL	9571		YELLOWSTONE	DR		HUNTINGTON BEACH	CA	92646
149-021-09	BRETT L & BRETT L BERGSTROM	9141		MAHALO	DR		HUNTINGTON BEACH	CA	92646
149-021-10	ROBERT J L FISHER	9151		MAHALO	DR		HUNTINGTON BEACH	CA	92646
149-021-11	TIMOTHY C SHIELDS	9161		MAHALO	DR		HUNTINGTON BEACH	CA	92646
149-021-12	PETER T KONISHI	501		CASUDA CANYON	DR		MONTEREY PARK	CA	91754
149-022-01	FRANCES H MARTIN	21882		KIOWA	LN		HUNTINGTON BEACH	CA	92646
149-022-02	MARIA M PRIDDY	21872		KIOWA	LN		HUNTINGTON BEACH	CA	92646
149-022-03	DAVID E NELSON	21862		KIOWA	LN		HUNTINGTON BEACH	CA	92646
149-022-04	JOHN E ENGH	9062		MAHALO	DR		HUNTINGTON BEACH	CA	92646
149-022-05	GINO P & JENNY ANGELICI	9072		MAHALO	DR		HUNTINGTON BEACH	CA	92646
149-022-06	JAMES A FAST	9082		MAHALO	DR		HUNTINGTON BEACH	CA	92646
149-022-07	STEPHEN M BRINKERHOFF	9092		MAHALO	DR		HUNTINGTON BEACH	CA	92646
149-022-08	CHRISTOPHER W BAUER	9102		MAHALO	DR		HUNTINGTON BEACH	CA	92646
149-022-09	PAUL H STRAIN	9112		MAHALO	DR		HUNTINGTON BEACH	CA	92646
149-022-10	WILHELM E KEIMEL	518		BARSBY	ST		VISTA	CA	92084

APN_D	OWNERNAME	M_HSENO	M_DIR	M_STREET	M_SFX	M_UNIT	M_CITY	M_STATE	M_ZIP
149-022-11	DOUGLAS M WATLAND	9142		MAHALO	DR		HUNTINGTON BEACH	CA	92646
149-022-12	LARRY & SUE ANN MC GREGOR	9152		MAHALO	DR		HUNTINGTON BEACH	CA	92646
149-022-13	HELENA R BOWEN	9162		MAHALO	DR		HUNTINGTON BEACH	CA	92646
149-022-14	TODD MICHAEL & MICHELLE LYNNE BULLOCK	9172		MAHALO			HUNTINGTON BEACH	CA	92646
149-022-17	GREGORY FONTES	9171		KAPAA	DR		HUNTINGTON BEACH	CA	92646
149-022-18	GARY GOPYONG CHOUGH	15751		BROOKHURST	ST	126	WESTMINSTER	CA	92683
149-022-19	JAMES R HOOPER	9151		KAPAA	DR		HUNTINGTON BEACH	CA	92646
149-022-20	DEAN L CORDELL	9141		KAPAA	DR		HUNTINGTON BEACH	CA	92646
149-022-21	MORTIMER P & JANICE C SHEA	9121		KAPAA	DR		HUNTINGTON BEACH	CA	92646
149-022-22	PETER CANOVA	1003		VISTA RIDGE	CT		CARSON CITY	NV	89705
149-022-23	DONALD E SWORDS	9101		KAPAA	DR		HUNTINGTON BEACH	CA	92646
149-022-24	KENNETH W WHITEHEAD	9091		KAPAA	DR		HUNTINGTON BEACH	CA	92646
149-022-25	GORDON B EMERSON	9081		KAPAA	DR		HUNTINGTON BEACH	CA	92646
149-022-26	JASON R PYLE	9071		KAPAA	DR		HUNTINGTON BEACH	CA	92646
149-022-27	STEVE P GINGRICH	9061		KAPAA	DR		HUNTINGTON BEACH	CA	92646
149-023-01	MICHAEL E & LEE NORA REGUS	35225		LINDA ROSEA	RD		TEMECULA	CA	92592
149-023-02	VINTON D MARRIOTT	21851		KIOWA	LN		HUNTINGTON BEACH	CA	92646
149-023-03	LILLY WITTMAN	4651	W	CRESTVIEW	CIR		TUCSON	AZ	85745
149-023-04	RICHARD K & CATHY B SVOBODA	21871		KIOWA	LN		HUNTINGTON BEACH	CA	92646
149-023-05	DANIEL E MALLOY	21881		KIOWA	LN		HUNTINGTON BEACH	CA	92646
149-023-06	MICHELE M ERWIN	21891		KIOWA	LN		HUNTINGTON BEACH	CA	92646
149-023-07	TERESA J LEE	21901		KIOWA	LN		HUNTINGTON BEACH	CA	92646
149-023-08	KENNETH T FORRISTER	21911		KIOWA	LN		HUNTINGTON BEACH	CA	92646
149-023-09	FLORENCE B HOWARD	21931		KIOWA	LN		HUNTINGTON BEACH	CA	92646
149-023-10	FARES & NABILA KAZOURA JAHSHAN	21941		KIOWA	LN		HUNTINGTON BEACH	CA	92646
149-023-11	DONALD J MCKINNEY	21961		KIOWA	LN		HUNTINGTON BEACH	CA	92646
149-023-12	RICHARD A KILEKAS	9022		ALOHA	DR		HUNTINGTON BEACH	CA	92646
149-023-13	MANUEL URZUA	9042		ALOHA	DR		HUNTINGTON BEACH	CA	92646
149-023-14	RALPH L OSTERKAMP	9052		ALOHA	DR		HUNTINGTON BEACH	CA	92646
149-023-15	RICHARD TILMON LEGERE	9062		ALOHA	DR		HUNTINGTON BEACH	CA	92646
149-023-16	AMBER N WAGNER	9082		ALOHA	DR		HUNTINGTON BEACH	CA	92646
149-023-17	STEPHEN L WILLERTH	9092		ALOHA	DR		HUNTINGTON BEACH	CA	92646
149-023-18	HERMAN PHILLIP CHENIER	9102		ALOHA	DR		HUNTINGTON BEACH	CA	92646
149-023-19	MARK A & SUSAN R SEMON	9112		ALOHA	DR		HUNTINGTON BEACH	CA	92646
149-023-20	NEIL L & LORI L WELLS	9122		ALOHA	DR		HUNTINGTON BEACH	CA	92646
149-024-01	ALAN BRAMLETT	21932		KIOWA	LN		HUNTINGTON BEACH	CA	92646
149-024-02	KIM KELLNER	21912		KIOWA	LN		HUNTINGTON BEACH	CA	92646
149-024-03	BRENT C & JANET E KOOIMAN	21902		KIOWA	LN		HUNTINGTON BEACH	CA	92646
149-024-04	DANIEL L & SHERI L RAWLINS	9062		KAPAA	DR		HUNTINGTON BEACH	CA	92646
149-024-05	GEORGE ANTHONY MATULICH	9072		KAPAA	DR		HUNTINGTON BEACH	CA	92646
149-024-06	YUNG HSIN PAN			P O BOX 6094			HUNTINGTON BEACH	CA	92615
149-024-07	ALLEN K WACHI	9092		KAPAA	DR		HUNTINGTON BEACH	CA	92646
149-024-08	DONALD L DAVIDSON	9102		KAPAA	DR		HUNTINGTON BEACH	CA	92646
149-024-09	LUDELE JENKINS	9112		KAPAA	DR		HUNTINGTON BEACH	CA	92646
149-024-10	DARLENE J HANSON	9122		KAPAA	DR		HUNTINGTON BEACH	CA	92646
149-024-11	MITCHELL J SMITH	9142		KAPAA	DR		HUNTINGTON BEACH	CA	92646
149-024-12	ROD ALAN RASMUSSEN	9152		KAPAA	DR		HUNTINGTON BEACH	CA	92646
149-024-13	LOIS P BORGARDT	1744		PINE	ST		SANTA MONICA	CA	90405
149-024-14	DEETTA L CORDOVA	9172		KAPAA	DR		HUNTINGTON BEACH	CA	92646
149-024-18	THOMAS G LAMBERT	9161		ALOHA	DR		HUNTINGTON BEACH	CA	92646
149-024-19	NORBERT VILLANYI	9151		ALOHA	DR		HUNTINGTON BEACH	CA	92646
149-024-20	DOLORES E MILLER	9141		ALOHA	DR		HUNTINGTON BEACH	CA	92646
149-024-21	JON GORDON & ALYSON VREELAND	9121		ALOHA	DR		HUNTINGTON BEACH	CA	92646
149-024-22	ALAN M & ERICA M WALENCEWICZ	9111		ALOHA	DR		HUNTINGTON BEACH	CA	92646
149-024-23	MAIDA A SEYMOUR	9101		ALOHA	DR		HUNTINGTON BEACH	CA	92646
149-024-24	JOAN Y KLUBNIK	9091		ALOHA	DR		HUNTINGTON BEACH	CA	92646
149-024-25	SHIRLEE L STRONER	9081		ALOHA	DR		HUNTINGTON BEACH	CA	92646
149-024-26	GEORGE F BULLOCK	9071		ALOHA	DR		HUNTINGTON BEACH	CA	92646
149-024-27	HENRY B KERFOOT	9061		ALOHA	DR		HUNTINGTON BEACH	CA	92646
149-025-14	GREGORY D SNYDER	9152		ALOHA	DR		HUNTINGTON BEACH	CA	92646
149-025-15	PAUL & DONNA METZLER	9142		ALOHA	DR		HUNTINGTON BEACH	CA	92646
149-031-21	EDWARD VELAZQUEZ	9041		BOBBIE	CIR		HUNTINGTON BEACH	CA	92646
149-031-22	HENRY J & TONI BAEZ			PO BOX 5460			HUNTINGTON BEACH	CA	92615
149-031-23	STEVEN A & DEBRA L CLARK	9021		BOBBIE	CIR		HUNTINGTON BEACH	CA	92646
149-031-24	MARGARET J ROZBICKA	18685		MAIN	ST	A382	HUNTINGTON BEACH	CA	92648

APN_D	OWNERNAME	M_HSENO	M_DIR	M_STREET	M_SFX	M_UNIT	M_CITY	M_STATE	M_ZIP
149-031-25	JANET WINELAND	9002		BOBBIE	CIR		HUNTINGTON BEACH	CA	92646
149-031-26	SANDRA L TYLER	9022		BOBBIE	CIR		HUNTINGTON BEACH	CA	92646
149-031-27	SHAWN A & ELISHA A ROTH	9032		BOBBIE	CIR		HUNTINGTON BEACH	CA	92646
149-031-28	ALLEN & SARA KING	9042		BOBBIE	CIR		HUNTINGTON BEACH	CA	92646
149-031-29	JOHN P & SONIA VILLA	9062		BOBBIE	CIR		HUNTINGTON BEACH	CA	92646
149-031-30	KENNETH S ROBERTS	9072		BOBBIE	CIR		HUNTINGTON BEACH	CA	92646
149-031-31	DAVID & KRISTINE WETZEL	9082		BOBBIE	CIR		HUNTINGTON BEACH	CA	92646
149-031-32	WILLIAM E & CAROL J WARD	9092		BOBBIE	CIR		HUNTINGTON BEACH	CA	92646
149-031-33	THOMAS C & CONSTANCE D BOWLES	9091		NIGUEL	CIR		HUNTINGTON BEACH	CA	92646
149-031-34	JOHN SHEEDY	9081		NIGUEL	CIR		HUNTINGTON BEACH	CA	92646
149-031-35	SAMUEL J & PAMELA D LA FATA	9071		NIGUEL	CIR		HUNTINGTON BEACH	CA	92646
149-031-36	DARREN M MAGOT	9061		NIGUEL	CIR		HUNTINGTON BEACH	CA	92646
149-031-37	MICHAEL WHITE	9041		NIGUEL	CIR		HUNTINGTON BEACH	CA	92646
149-031-38	CHRISTOPHER G YOUNG	9031		NIGUEL	CIR		HUNTINGTON BEACH	CA	92646
149-031-39	JAMES H & DEBORAH ZISCH	9021		NIGUEL	CIR		HUNTINGTON BEACH	CA	92646
149-031-40	DEVIN A & DANNA E CHASE	9001		NIGUEL	CIR		HUNTINGTON BEACH	CA	92646
149-033-12	DIANE C ARGE	21602		POLYNESIAN	LN		HUNTINGTON BEACH	CA	92646
149-033-13	MICHAEL F ROSS	21612		POLYNESIAN	LN		HUNTINGTON BEACH	CA	92646
149-041-01	WILLIAM ARTHUR & DARLENE F WALL	9002		NIGUEL	CIR		HUNTINGTON BEACH	CA	92646
149-041-02	CHRISTOPHER W & MAUREN C MOORE	9022		NIGUEL	CIR		HUNTINGTON BEACH	CA	92646
149-041-03	JOHN W OSCHMAN	9032		NIGUEL	CIR		HUNTINGTON BEACH	CA	92646
149-041-04	JAMES P SULLIVAN	9042		NIGUEL	CIR		HUNTINGTON BEACH	CA	92646
149-041-05	DAVID D & PAMELA CHAPMAN	9062		NIGUEL	CIR		HUNTINGTON BEACH	CA	92646
149-041-06	RAYMOND H ZAJAC	9072		NIGUEL	CIR		HUNTINGTON BEACH	CA	92646
149-041-07	JOHN S KAUFMANN	9082		NIGUEL	CIR		HUNTINGTON BEACH	CA	92646
149-041-08	MICHAEL G GROSSMAN	9092		NIGUEL	CIR		HUNTINGTON BEACH	CA	92646
149-041-09	KEVIN M KELLEY	9091		ADELIA	CIR		HUNTINGTON BEACH	CA	92646
149-041-10	EDWARD J & YVETTE G ARANGO	9081		ADELIA	CIR		HUNTINGTON BEACH	CA	92646
149-041-11	ROSEMARY CARSON	9071		ADELIA	CIR		HUNTINGTON BEACH	CA	92646
149-041-12	MAY O ZIRBEL	9061		ADELIA CI			HUNTINGTON BEACH	CA	92646
149-041-13	TIMOTHY F & ROBIN BROGDON	9041		ADELIA	CIR		HUNTINGTON BEACH	CA	92646
149-041-14	PATRICK E BEACHNER	9031		ADELIA	CIR		HUNTINGTON BEACH	CA	92646
149-041-15	DONALD L CHURCHWARD	9021		ADELIA	CIR		HUNTINGTON BEACH	CA	92646
149-041-16	ELIZABETH & EMMY LOU SWANSON	9001		ADELIA	CIR		HUNTINGTON BEACH	CA	92646
149-041-17	KING, LYDIA D TRUST	2266		HILLSIDE	AVE		NORCO	CA	92860
149-041-18	TERRY LYNN FINLEY	9022		ADELIA	CIR		HUNTINGTON BEACH	CA	92646
149-041-19	JERRI I KUNS	9032		ADELIA	CIR		HUNTINGTON BEACH	CA	92646
149-041-20	EDWARD L MOYNAGH	9042		ADELIA	CIR		HUNTINGTON BEACH	CA	92646
149-041-21	CAROLYN S CROCKETT	9062		ADELIA	CIR		HUNTINGTON BEACH	CA	92646
149-041-22	LENORA J RAIA	9072		ADELIA	CIR		HUNTINGTON BEACH	CA	92646
149-041-23	RICHARD J & ROSLYN R BASHORE	1167		AVIEMORE TERRACE			COSTA MESA	CA	92627
149-041-24	BILLY EUGENE STEVENSON	9092		ADELIA	CIR		HUNTINGTON BEACH	CA	92646
149-041-25	WILLIAM H LACEY	9091		RHODESIA	DR		HUNTINGTON BEACH	CA	92646
149-041-26	CHRIS P OGAWA	9081		RHODESIA	DR		HUNTINGTON BEACH	CA	92646
149-041-27	RALPH S SILVA			PO BOX 6756			HUNTINGTON BEACH	CA	92615
149-041-28	ROBERT MARLOW & PAULA R BROWN	9061		RHODESIA	DR		HUNTINGTON BEACH	CA	92646
149-041-29	BRUCE BARROS	9041		RHODESIA	DR		HUNTINGTON BEACH	CA	92646
149-041-30	LUIS M & TERESA C ALARCON	9031		RHODESIA	DR		HUNTINGTON BEACH	CA	92646
149-041-31	JOHN & NICOLE DESMOND	9021		RHODESIA	DR		HUNTINGTON BEACH	CA	92646
149-041-32	TAD D & NANCY BUCHOZ	9001		RHODESIA	DR		HUNTINGTON BEACH	CA	92646
149-041-33	SHIRLEE J EARLEY	9002		RHODESIA	DR		HUNTINGTON BEACH	CA	92646
149-041-34	NASSER & JENNIFER MUSTAFA	9022		RHODESIA	DR		HUNTINGTON BEACH	CA	92646
149-041-35	CRAIG PETERSON	9032		RHODESIA	DR		HUNTINGTON BEACH	CA	92646
149-041-36	ROBERT D NORQUIST	9042		RHODESIA	DR		HUNTINGTON BEACH	CA	92646
149-041-37	SCOTT AARNES SWANSON	9062		RHODESIA			HUNTINGTON BEACH	CA	92646
149-041-38	RICHARD W SMYSER	9072		RHODESIA	DR		HUNTINGTON BEACH	CA	92646
149-041-39	IRENE E IANNITTI	9082		RHODESIA	DR		HUNTINGTON BEACH	CA	92646
149-041-40	BETTY L WELLS	9092		RHODESIA	DR		HUNTINGTON BEACH	CA	92646
149-041-41	MARK & CHRISTINE MC DONELL	9102		RHODESIA	DR		HUNTINGTON BEACH	CA	92646
149-041-42	EVANGELINE RENTAS	9112		RHODESIA	DR		HUNTINGTON BEACH	CA	92646
149-041-43	BERNHARD B & ELKE R MOSKALENKO	78136		HOLLISTER	DR		PALM DESERT	CA	92211
149-041-44	JEVON & NANCY HADLEY	9142		RHODESIA	DR		HUNTINGTON BEACH	CA	92646
149-041-45	SUSAN DEMIRJIAN	4500		CAMPUS	DR	224	NEWPORT BEACH	CA	92660
149-041-46	DAVID T & JEANNE HUGHES	9162		RHODESIA	DR		HUNTINGTON BEACH	CA	92646
149-041-47	MARILYN D ELLISON	9182		RHODESIA	DR		HUNTINGTON BEACH	CA	92646

APN_D	OWNERNAME	M_HSENO	M_DIR	M_STREET	M_SFX	M_UNIT	M_CITY	M_STATE	M_ZIP
149-042-01	RICHARD C CUBBIN	21622		POLYNESIAN	LN		HUNTINGTON BEACH	CA	92646
149-042-02	BRADLEY ALLAN NORMAN	21632		POLYNESIAN	LN		HUNTINGTON BEACH	CA	92646
149-042-03	BETH & MICHAEL DAVIS	21642		POLYNESIAN	LN		HUNTINGTON BEACH	CA	92646
149-042-04	THOMAS M SMITH	21662		POLYNESIAN	LN		HUNTINGTON BEACH	CA	92646
149-042-05	CHESTER BURWICK	21672		POLYNESIAN	LN		HUNTINGTON BEACH	CA	92646
149-042-06	MAIDA F CHEUNG	14882		DAHLQUIST	RD		IRVINE	CA	92604
149-042-07	BARBARA N WEBB	21692		POLYNESIAN	LN		HUNTINGTON BEACH	CA	92646
149-042-08	ODILON C CARDENAS	21702		POLYNESIAN	LN		HUNTINGTON BEACH	CA	92646
149-042-09	DAVID B & TERI A MALPASS	21701		BAHAMA	LN		HUNTINGTON BEACH	CA	92646
149-042-10	JAMES J GILL	21691		BAHAMA	LN		HUNTINGTON BEACH	CA	92646
149-042-11	RICHARD A & YASUKO YOUNG	21681		BAHAMA	LN		HUNTINGTON BEACH	CA	92646
149-042-12	THOMAS BUCHANAN & VIRGINIA LYNN HINKLE	21671		BAHAMA	LN		HUNTINGTON BEACH	CA	92646
149-042-13	RODERICK J & BARBARA MC ISAAC	21661		BAHAMA	LN		HUNTINGTON BEACH	CA	92646
149-042-14	GEORGE E MASON	21641		BAHAMA	LN		HUNTINGTON BEACH	CA	92646
149-042-15	STANLEY E BELITZ	21631		BAHAMA	LN		HUNTINGTON BEACH	CA	92646
149-042-16	GEORGE M JOHNS	21621		BAHAMA	LN		HUNTINGTON BEACH	CA	92646
149-043-04	DAVID A HILL	21672		BAHAMA	LN		HUNTINGTON BEACH	CA	92646
149-043-05	JAMES A GARRISON	21682		BAHAMA	LN		HUNTINGTON BEACH	CA	92646
149-043-06	MARILYNNE M BRODERICK	21692		BAHAMA	LN		HUNTINGTON BEACH	CA	92646
149-043-07	WILLIAM A & JANETTE L STEWART	21702		BAHAMA	LN		HUNTINGTON BEACH	CA	92646
890-122-14	JOHN REGER	80		HUNTINGTON ST SP 214			HUNTINGTON BEACH	CA	92648
890-122-16	TIMOTHY M GANNON	80		HUNTINGTON ST SP 216			HUNTINGTON BEACH	CA	92648
890-122-19	DEBORAH ELAINE MOORE	80		HUNTINGTON ST SP 219			HUNTINGTON BEACH	CA	92648
890-122-53	RUSSELL A NEUMEN			PO BOX 4737			BLUE JAY	CA	92317
890-122-56	MARCIA CINDY WILSON	80		HUNTINGTON ST SP 256			HUNTINGTON BEACH	CA	92648
890-122-57	JENNIFER L MACIAS	80		HUNTINGTON ST SP 257			HUNTINGTON BEACH	CA	92648
890-122-62	BARBARA A CARLSON	80		HUNTINGTON SP 262			HUNTINGTON BEACH	CA	92648
890-122-63	TAMI H HALL	80		HUNTINGTON ST SP 263			HUNTINGTON BEACH	CA	92648
890-122-64	KATHY J WHEELER	80		HUNTINGTON ST SP 264			HUNTINGTON BEACH	CA	92648
890-124-11	SUSAN C CANADAS	80		HUNTINGTON ST SP 411			HUNTINGTON BEACH	CA	92648
890-124-12	PETER WATSON	12510		JAMESTOWN PLACE			CHINO	CA	91710
890-124-14	GLEN J KOTLER	80		HUNTINGTON ST SP 414			HUNTINGTON BEACH	CA	92648
890-124-15	ELEANOR K ECK	9955		BROOKSHIRE	AVE		DOWNEY	CA	90240
890-126-07	THOMAS, BEVERLY A TRUST	80		HUNTINGTON ST SP 607			HUNTINGTON BEACH	CA	92648
890-127-08	BUTTS FAMILY TRUST	80		HUNTINGTON ST SP 708			HUNTINGTON BEACH	CA	92648
890-127-11	PHYLLIS ELLSWORTH			PO BOX 7554			HUNTINGTON BEACH	CA	92615
890-890-01	OCTAVIO A SIORDIC	21851		NEWLAND ST SP 1			HUNTINGTON BEACH	CA	92646
890-890-02	CAROLE JANICE PINON	9600		HAMILTON	AVE	B	HUNTINGTON BEACH	CA	92646
890-890-04	KATHLEEN J MILLAR	21851		NEWLAND ST SP 4			HUNTINGTON BEACH	CA	92646
890-890-05	STEPHEN J CRANE	18702		WINDY KNOLL	DR		YORBA LINDA	CA	92886
890-890-07	JAMES ROBERT MEYLING	21851		NEWLAND ST SP 7			HUNTINGTON BEACH	CA	92646
890-890-10	CYNTHIA MARIE CRAWFORD	21851		NEWLAND ST SP 10			HUNTINGTON BEACH	CA	92646
890-890-11	WYLDE B SIMERSON	21851		NEWLAND	ST	11	HUNTINGTON BEACH	CA	92646
890-890-12	DAWN OLMSTEAD	21851		NEWLAND ST SP 12			HUNTINGTON BEACH	CA	92646
890-890-19	SHELLEY BROWER	21851		NEWLAND ST SP 19			HUNTINGTON BEACH	CA	92646
890-890-20	TAKAHIRO SAITO	21851		NEWLAND ST SP 20			HUNTINGTON BEACH	CA	92646
890-890-21	DIANE K COULTER	21851		NEWLAND ST SP#21			HUNTINGTON BEACH	CA	92646
890-890-23	JULIE A HILDRETH	15041		ETON	CIR		HUNTINGTON BEACH	CA	92647
890-890-25	KURT A HAGAN	21851		NEWLAND ST SP 25			HUNTINGTON BEACH	CA	92646
890-890-27	LUCAS WIMER	21851		NEWLAND ST SPC 27			HUNTINGTON BEACH	CA	92646
890-890-29	JULIE ANN REYES	21851		NEWLAND ST SP 29			HUNTINGTON BEACH	CA	92646
890-890-33	BILLY L WILLIAMS	21851		NEWLAND ST SP 33			HUNTINGTON BEACH	CA	92646
890-890-36	BARBARA J HOWARD	21851		NEWLAND ST SPC 36			HUNTINGTON BEACH	CA	92646
890-890-37	AMY PYLE	21851		NEWLAND ST SP 37			HUNTINGTON BEACH	CA	92646
890-890-38	REBECCA E CROUSE	21851		NEWLAND ST SP 38			HUNTINGTON BEACH	CA	92646
890-890-40	ROBYN R MCKENZIE	21851		NEWLAND ST SP 40			HUNTINGTON BEACH	CA	92646
890-890-43	DOROTHY KELANIE LIU	21851		NEWLAND ST SP 43			HUNTINGTON BEACH	CA	92646
890-890-44	ANTHONY J BELL	821		WALNUT	AVE		LONG BEACH	CA	90813
890-890-46	MILLS HBS LLC	430 S		SAN DIMAS	AVE		SAN DIMAS	CA	91773
890-890-47	TERI BERTONI	21851		NEWLAND ST SP 47			HUNTINGTON BEACH	CA	92646
890-890-48	TOMMASINA T CIRRITO	21851		NEWLAND ST SP 48			HUNTINGTON BEACH	CA	92646
890-890-49	JAN A TORRENCE	13790		SAINT ANDREWS DR UNIT 51			SEAL BEACH	CA	90740
890-890-55	BRUCE G YELVERTON	4225		MOONLIGHT	LN		OCEANSIDE	CA	92056
890-890-56	AMALIA ALTERIO	21851		NEWLAND ST SP 56			HUNTINGTON BEACH	CA	92646
890-890-57	RANDALL L HARINGA	5422		BURLINGAME	AVE		BUENA PARK	CA	90621

APN D	OWNERNAME	M_HSENO	M_DIR	M_STREET	M_SFX	M_UNIT	M_CITY	M_STATE	M_ZIP
890-890-59	MARK GARDNER	7127		WINTERWOOD	LN		HIGHLAND	CA	92346
890-890-60	ART CHAVEZ	21851		NEWLAND ST SP 60			HUNTINGTON BEACH	CA	92646
890-890-61	TERRY P DAVIS	21851		NEWLAND ST SP 61			HUNTINGTON BEACH	CA	92646
890-890-62	SHARON E MCCALL	21851		NEWLAND ST SP 62			HUNTINGTON BEACH	CA	92646
890-890-63	NICOLE M LUCAS	21851		NEWLAND ST SP 63			HUNTINGTON BEACH	CA	92646
890-890-64	MICHAEL R SLATON	21851		NEWLAND SP 64			HUNTINGTON BEACH	CA	92646
890-890-67	LINDA K STODDARD-JOHNSON	21851		NEWLAND ST SP 67			HUNTINGTON BEACH	CA	92646
890-890-69	MAX E STIMAC			W380N8215 ROLLING RIVER			OCONOMOWOC	WI	53066
890-890-70	JERALD CLAUDE UмбаUGH	21851		NEWLAND ST SP 70			HUNTINGTON BEACH	CA	92646
890-890-71	ELIZABETH C HERNANDEZ	21851		NEWLAND ST SP 71			HUNTINGTON BEACH	CA	92646
890-890-74	WILLIAM F TROVER	21851		NEWLAND ST SP 74			HUNTINGTON BEACH	CA	92646
890-890-75	DAVID C WESSON	21851		NEWLAND ST SP 75			HUNTINGTON BEACH	CA	92646
890-890-76	JAN M & IAN C DEADY	21851		NEWLAND ST SP 76			HUNTINGTON BEACH	CA	92646
890-890-77	BARBARA J MCCREDIE	174 W		LINCOLN	AVE		ANEHEIM	CA	92805
890-890-80	BEATRICE S BERG	21851		NEWLAND ST SP 80			HUNTINGTON BEACH	CA	92646
890-890-82	DAVID K HOFFMAN	21851		NEWLAND ST SP 82			HUNTINGTON BEACH	CA	92646
890-890-83	GARY R HERKNER	21851		NEWLAND ST SP 83			HUNTINGTON BEACH	CA	92646
890-890-84	MICHELE TALLMAN	21851		NEWLAND ST SP 84			HUNTINGTON BEACH	CA	92646
890-890-85	MICHAEL P ZAPPEN	21851		NEWLAND ST SP 85			HUNTINGTON BEACH	CA	92646
890-890-86	CYNTHIA A MONTGOMERY	21851		NEWLAND ST SP 86			HUNTINGTON BEACH	CA	92646
890-890-87	DONALD J SNELL	21851		NEWLAND ST SPACE 87			HUNTINGTON BEACH	CA	92646
890-890-90	MICHELE WILSON	21882		SEASIDE	LN		HUNTINGTON BEACH	CA	92646
890-890-91	DALLAS HERROLD	21851		NEWLAND ST SP 91			HUNTINGTON BEACH	CA	92646
890-890-92	PAUL MORROW	21851		NEWLAND SP 92			HUNTINGTON BEACH	CA	92646
890-890-93	RICHARD WESLEY HUSTED	21851		NEWLAND ST SP 93			HUNTINGTON BEACH	CA	92646
890-890-94	VICTORIA A BROWN	21851		NEWLAND	ST		HUNTINGTON BEACH	CA	92646
890-890-96	ALEXANDER JOHN ROCCO	21851		NEWLAND ST SP 96			HUNTINGTON BEACH	CA	92646
890-890-98	JULIE WHITE	1010 W		ACACIA	AVE		ORANGE	CA	92868
890-891-01	KATHRYN M DIXON	21851		NEWLAND ST SP 101			HUNTINGTON BEACH	CA	92646
890-891-04	MARC R TRUJILLO	21851		NEWLAND ST SPC 104			HUNTINGTON BEACH	CA	92646
890-891-05	TANYA CANTARELLA	21851		NEWLAND ST SP 105			HUNTINGTON BEACH	CA	92646
890-891-06	DANIEL R WILLARD	21851		NEWLAND ST SP 106			HUNTINGTON BEACH	CA	92646
890-891-08	RAY C BIGGERSTAFF	21851		NEWLAND ST SP 108			HUNTINGTON BEACH	CA	92646
890-891-09	BRYAN K BOND	40		SALT BUSH			IRVINE	CA	92603
890-891-11	GREG MESSICK	21851		NEWLAND ST SP 111			HUNTINGTON BEACH	CA	92646
890-891-15	KENNETH E MOSS	21851		NEWLAND ST SP 115			HUNTINGTON BEACH	CA	92646
890-891-20	MERIDA PEREZ	21851		NEWLAND ST SP 120			HUNTINGTON BEACH	CA	92646
890-891-21	RICHARD A GOODFELLOW	21851		NEWLAND ST SPC 121			HUNTINGTON BEACH	CA	92646
890-891-24	JACQUELINE ALEXSON	21851		NEWLAND ST SP 124			HUNTINGTON BEACH	CA	92646
890-891-25	DEWAYNE B GOFF	21851		NEWLAND ST SP 125			HUNTINGTON BEACH	CA	92646
890-891-29	JASON WONSER	9611		ERSKINE	DR		HUNTINGTON BEACH	CA	92646
890-891-30	TAICHI MARUYAMA	21851		NEWLAND ST SP 130			HUNTINGTON BEACH	CA	92646
890-891-34	BENJAMIN C BAYSIC	21851		NEWLAND ST SP 134			HUNTINGTON BEACH	CA	92646
890-891-36	YOLANDA O MIGUEZ	21851		NEWLAND ST SP 136			HUNTINGTON BEACH	CA	92646
890-891-40	VICTOR M ONORIO	3240		MISSION INN	AVE		RIVERSIDE	CA	92507
890-891-41	PETER L NISSON			PO BOX 1302			LAGUNA BEACH	CA	92652
890-891-44	ROGER F WILSON	21851		NEWLAND AVE SP 144			HUNTINGTON BEACH	CA	92646
890-891-50	STUART A TEDFORD	21851		NEWLAND SP 150			HUNTINGTON BEACH	CA	92646
890-891-51	WILLIAM DEVORE	2530		VISTA	WAY	F223	OCEANSIDE	CA	92054
890-891-52	MELANIE A REDD	21851		NEWLAND ST SP 152			HUNTINGTON BEACH	CA	92646
890-891-54	SUSAN C FREESTONE	21851		NEWLAND ST SP 154			HUNTINGTON BEACH	CA	92646
890-891-58	MOLLIE R HILL	21851		NEWLAND	ST		HUNTINGTON BEACH	CA	92646
890-891-59	MILLS HBS LLC	430 S		SAN DIMAS	AVE		SAN DIMAS	CA	91773
890-891-61	ANDREW CHAVEZ	21851		NEWLAND ST SP 161			HUNTINGTON BEACH	CA	92646
890-891-62	AMANDA BOYUM	21851		NEWLAND	ST	162	HUNTINGTON BEACH	CA	92646
890-891-63	ANDREW J MCCAFFREY	21851		NEWLAND ST SP 163			HUNTINGTON BEACH	CA	92646
890-891-64	TIMOTHY W LOUGH	21851		NEWLAND ST SP 164			HUNTINGTON BEACH	CA	92646
890-891-66	TIMOTHY IRVING KUROISHI	21851		NEWLAND ST SP 166			HUNTINGTON BEACH	CA	92646
890-891-67	FREDERICK D MARTIN	21851		NEWLAND ST SP 167			HUNTINGTON BEACH	CA	92646
890-891-69	MILLS HBS LLC	430 S		SAN DIMAS	AVE		SAN DIMAS	CA	91773
890-891-70	JACK A HASTINGS	21851		NEWLAND ST SP 170			HUNTINGTON BEACH	CA	92646
890-891-71	ROLAND F BLACKISTON	21851		NEWLAND ST SP 171			HUNTINGTON BEACH	CA	92646
890-891-72	GEORGEANNE M VAUGHAN	21851		NEWLAND ST SP 172			HUNTINGTON BEACH	CA	92646
890-891-75	LONNIE SMITH	21851		NEWLAND	ST	312	HUNTINGTON BEACH	CA	92646
890-891-77	ANNE BISNAR	21851		NEWLAND ST SP 177			HUNTINGTON BEACH	CA	92646

APN_D	OWNERNAME	M_HSENO	M_DIR	M_STREET	M_SFX	M_UNIT	M_CITY	M_STATE	M_ZIP
890-891-81	VICTOR M BEASLEY	21851		NEWLAND ST SP 181			HUNTINGTON BEACH	CA	92646
890-891-82	ERICA CHRISTINE P DEWITT	21851		NEWLAND ST SP 182			HUNTINGTON BEACH	CA	92646
890-891-83	BARBARA R MOORE	21851		NEWLAND ST SP 183			HUNTINGTON BEACH	CA	92646
890-891-84	SUSAN D DEFEEO	21851		NEWLAND ST SP 184			HUNTINGTON BEACH	CA	92646
890-891-86	JAMES W BUCK	21851		NEWLAND ST SP 186			HUNTINGTON BEACH	CA	92646
890-891-91	DAVID POST	21851		NEWLAND ST SP191			HUNTINGTON BEACH	CA	92646
890-891-92	GERALD DAVANZO	21851		NEWLAND ST SP 192			HUNTINGTON BEACH	CA	92646
890-891-93	MELODY A LORD	21851		NEWLAND ST SP 193			HUNTINGTON BEACH	CA	92646
890-891-94	JERRY A WRIGHT	21851		NEWLAND ST SP 194			HUNTINGTON BEACH	CA	92646
890-891-96	CHRIS ALLEN ROTH	21332		COMPASS	LN		HUNTINGTON BEACH	CA	92646
890-891-97	ERIK L ELSTAD	21851		NEWLAND ST SP 197			HUNTINGTON BEACH	CA	92646
890-891-99	PAULA M NEFF	21851		NEWLAND ST SP 199			HUNTINGTON BEACH	CA	92646
890-892-00	PAUL GERARD BAKER	21851		NEWLAND ST SP 200			HUNTINGTON BEACH	CA	92646
890-892-01	VICTORIA L RAYMOND	21851		NEWLAND ST SP 201			HUNTINGTON BEACH	CA	92646
890-892-02	JACK E GREENFIELD	21851		NEWLAND ST SP 202			HUNTINGTON BEACH	CA	92646
890-892-03	LAURIE MAGUIRE	21851		NEWLAND ST SP 203			HUNTINGTON BEACH	CA	92646
890-892-06	CINDY L PELTZ	21851		NEWLAND	ST	224	HUNTINGTON BEACH	CA	92646
890-892-07	ELEANOR D HUTTON	3826		MARRON	AVE		LONG BEACH	CA	90807
890-892-08	JANET L BOYLE	21851		NEWLAND ST SPC 208			HUNTINGTON BEACH	CA	92646
890-892-12	THOMAS PREDEVILLE	21851		NEWLAND ST SP 212			HUNTINGTON BEACH	CA	92646
890-892-14	WENDIE L BRIGHAM	21471		PINATREE	LN		HUNTINGTON BEACH	CA	92646
890-892-18	JOHN H PAUL	21851		NEWLAND ST SP218			HUNTINGTON BEACH	CA	92646
890-892-21	ERYN HARDWICK	21851		NEWLAND ST SP 221			HUNTINGTON BEACH	CA	92646
890-892-23	DONNA M SMITH	21851		NEWLAND SP 223			HUNTINGTON BEACH	CA	92646
890-892-24	NANCY SANSTROM	19415		MACGREGOR	CIR		HUNTINGTON BEACH	CA	92648
890-892-25	BARBARA L AILERON	21851		NEWLAND ST SP 225			HUNTINGTON BEACH	CA	92646
890-892-26	JO MARIE MEIER	21851		NEWLAND ST SP 226			HUNTINGTON BEACH	CA	92646
890-892-27	BLAZER DANA L GRINDLE			PO BOX 8100			HUNTINGTON BEACH	CA	92615
890-892-29	BARBARA SCHREIBER	21851		NEWLAND ST SP 229			HUNTINGTON BEACH	CA	92646
890-892-32	THOMAS J MOFFETT	21851		NEWLAND ST SP 232			HUNTINGTON BEACH	CA	92646
890-892-33	VIKKI GRIFFIN	21851		NEWLAND	ST	233	HUNTINGTON BEACH	CA	92646
890-892-34	LEE ROCKWAY	21851		NEWLAND ST SP 234			HUNTINGTON BEACH	CA	92646
890-892-35	FRANK T FERRARA	21851		NEWLAND ST SP 235			HUNTINGTON BEACH	CA	92646
890-892-37	WILLIAM A RATTRAY	21851		NEWLAND ST SP 237			HUNTINGTON BEACH	CA	92646
890-892-40	SHAWN C NELSON	21851		NEWLAND ST SP 240			HUNTINGTON BEACH	CA	92646
890-892-41	SCOTT O SPRICK	21851		NEWLAND ST SP 241			HUNTINGTON BEACH	CA	92646
890-892-42	MARY J WHALEY WRIGHT	21851		NEWLAND ST SP 242			HUNTINGTON BEACH	CA	92646
890-892-45	DAVID FOLKINS	21851		NEWLAND ST SPC 245			HUNTINGTON BEACH	CA	92646
890-892-46	CHURCH, LAURIE A	21851		NEWLAND ST SP 246			HUNTINGTON BEACH	CA	92646
890-892-47	LARRY A HAIG	21851		NEWLAND ST SP 247			HUNTINGTON BEACH	CA	92646
890-892-51	TRACY MORGAN	21851		NEWLAND ST SP 251			HUNTINGTON BEACH	CA	92646
890-892-52	MARIA E LUX	21851		NEWLAND ST SP 252			HUNTINGTON BEACH	CA	92646
890-892-54	MARIA ELENA BARRERA	21851		NEWLAND SP 254			HUNTINGTON BEACH	CA	92646
890-892-57	STEVEN C WOODWARD	6700		WARNER	AVE	29H	HUNTINGTON BEACH	CA	92647
890-892-59	MARK BRANCO	21851		NEWLAND ST SP 259			HUNTINGTON BEACH	CA	92646
890-892-61	LAWRENCE R NYE	21851		NEWLAND SP 261			HUNTINGTON BEACH	CA	92646
890-892-63	MARTA SULLIVAN	21851		NEWLAND ST SP 263			HUNTINGTON BEACH	CA	92646
890-892-66	BETHEL P COFFMAN	21851		NEWLAND ST SP 266			HUNTINGTON BEACH	CA	92646
890-892-70	AMBER MCCLAIN	21851		NEWLAND ST SP 270			HUNTINGTON BEACH	CA	92646
890-892-72	DAVID KNAPP	21851		NEWLAND ST SP 272			HUNTINGTON BEACH	CA	92646
890-892-73	JOSEPH A GAETA	21851		NEWLAND ST SP 273			HUNTINGTON BEACH	CA	92646
890-892-75	THOMAS A PELK	21851		NEWLAND SP 275			HUNTINGTON BEACH	CA	92646
890-892-76	LARRY J PARILLA	21851		NEWLAND ST SP 276			HUNTINGTON BEACH	CA	92646
890-892-77	KENNETH K GILLILAND	21851		NEWLAND ST SP 277			HUNTINGTON BEACH	CA	92646
890-892-78	NANETTE A BARRESS	21851		NEWLAND ST SP 278			HUNTINGTON BEACH	CA	92646
890-892-79	IWONA MCCARTHU KAZMIERCZAK	21851		NEWLAND ST SP 279			HUNTINGTON BEACH	CA	92646
890-892-81	MICHELLE MC CRACKEN	21851		NEWLAND ST SP 281			HUNTINGTON BEACH	CA	92646
890-892-82	CAROL WOOD	21851		NEWLAND ST SP 282			HUNTINGTON BEACH	CA	92646
890-892-83	RITA JAYNE SADLER	21851		NEWLAND ST SP 283			HUNTINGTON BEACH	CA	92646
890-892-85	GRETE VAN TWIST	21851		NEWLAND ST SP 285			HUNTINGTON BEACH	CA	92646
890-892-89	STEVEN S VANOVER	21851		NEWLAND ST SP 289			HUNTINGTON BEACH	CA	92646
890-892-91	RICHARD ALAN HAMM	21851		NEWLAND ST SP 291			HUNTINGTON BEACH	CA	92646
890-892-92	MICHAEL R SHERIDAN	21851		NEWLAND ST SP 292			HUNTINGTON BEACH	CA	92646
890-892-98	JEFF & JONNICA KAIRN	21851		NEWLAND ST SP 298			HUNTINGTON BEACH	CA	92646
890-892-99	JAMES E PITTMAN	21851		NEWLAND ST SP 299			HUNTINGTON BEACH	CA	92646

APN D	OWNERNAME	M_HSENO	M_DIR	M_STREET	M_SFX	M_UNIT	M_CITY	M_STATE	M_ZIP
890-893-06	THOMAS E DAVIS	21851		NEWLAND ST SP 306			HUNTINGTON BEACH	CA	92646
890-893-10	BETTY LAWRENCE	163		KUALAPA	PL		LAHAINA	HI	96761
890-893-14	BARRY LYNN SHARP	38291		WILLOWICK	DR		MURRIETA	CA	92583
890-893-15	LINDA MARY EGGERS	21851		NEWLAND ST SP 315			HUNTINGTON BEACH	CA	92646
890-893-16	HUNTINGTON BY THE SEA	21851		NEWLAND	ST		HUNTINGTON BEACH	CA	92646
890-893-21	RODNEY DENNIS BARKER	21851		NEWLAND ST SP 1B			HUNTINGTON BEACH	CA	92646
890-898-00	PATRICIA M EMMETT	21851		NEWLAND ST SP 102			HUNTINGTON BEACH	CA	92646
890-899-01	WARREN & SYLVIA HUPP	21851		NEWLAND	ST	146	HUNTINGTON BEACH	CA	92646
890-899-02	ERIC J VANDERKALLEN	17868		US HIGHWAY 18		245	APPLE VALLEY	CA	92307
890-899-04	AUDREY MARATTA	21851		NEWLAND ST SP 280			HUNTINGTON BEACH	CA	92646
890-899-06	EDWIN LEE CALLAWAY	21851		NEWLAND ST SP 28			HUNTINGTON BEACH	CA	92646
890-899-07	DENNIS RUSSO	21851		NEWLAND	ST	265	HUNTINGTON BEACH	CA	92646
890-899-09	MARY MARTIN	21851		NEWLAND SP 15			HUNTINGTON BEACH	CA	92646
890-899-10	JAMES W DICK	21851		NEWLAND SP 305			HUNTINGTON BEACH	CA	92646
890-899-11	DENNIS A ROE	22122		BIANCO			LAGUNA HILLS	CA	92653
890-899-14	JENNIAN BEAVER	21851		NEWLAND ST SP 52			HUNTINGTON BEACH	CA	92646
890-899-15	RICHARD GALLEGOS	21851		NEWLAND ST SP 156			HUNTINGTON BEACH	CA	92646
890-899-16	ANTHONY CAPUTO	21851		NEWLAND ST SP 113			HUNTINGTON BEACH	CA	92646
890-899-17	ERIC B DANIEL	21851		NEWLAND ST SP 215			HUNTINGTON BEACH	CA	92646
890-899-18	TIMOTHY J FITZPATRICK	21851		NEWLAND ST SP 204			HUNTINGTON BEACH	CA	92646
890-899-19	LUCINDA G BREWSTER	21851		NEWLAND	ST	95	HUNTINGTON BEACH	CA	92646
890-899-20	PATRICIA L OSUNA	21851		NEWLAND ST SP 142			HUNTINGTON BEACH	CA	92646
890-899-21	MARILYN R SAMMONS	21851		NEWLAND ST SP 122			HUNTINGTON BEACH	CA	92646
890-899-23	FRANCISCUS J VANDERKALLEN	21851		NEWLAND ST SP 32			HUNTINGTON BEACH	CA	92646
890-899-24	SALVATORE J & DONA PATTI	21851		NEWLAND ST SP 137			HUNTINGTON BEACH	CA	92646
890-899-25	DEBRA LADOUCEUR	21851		NEWLAND	ST	168	HUNTINGTON BEACH	CA	92646
890-899-26	JUDITH BETEAG	21851		NEWLAND ST SP 205			HUNTINGTON BEACH	CA	92646
890-899-27	THOMAS O RUSSELL	21851		NEWLAND ST SP 303			HUNTINGTON BEACH	CA	92646
890-899-28	CHRISTOPHER VU TRAN	21851		NEWLAND ST SP 128			HUNTINGTON BEACH	CA	92646
890-899-29	ROBERT F LANSHAW	21851		NEWLAND ST SP 81			HUNTINGTON BEACH	CA	92646
890-899-31	JACQUELINE C SMITH	21851		NEWLAND SP 153			HUNTINGTON BEACH	CA	92646
890-899-32	TERESA R BARR	21851		NEWLAND ST SP 145			HUNTINGTON BEACH	CA	92646
890-899-33	PAULINE GOBLE	16651		TIBER	LN		HUNTINGTON BEACH	CA	92647
890-899-34	RICHARD LAZAR	21851		NEWLAND ST SP 107			HUNTINGTON BEACH	CA	92646
890-899-35	MARIA PEREZ	21851		NEWLAND ST SP 264			HUNTINGTON BEACH	CA	92646
890-899-36	SAM SALIB	21851		NEWLAND ST SP 269			HUNTINGTON BEACH	CA	92646
890-899-37	JULIE A WILLIAMS-DAVEY	21851		NEWLAND ST SP 143			HUNTINGTON BEACH	CA	92646
890-899-38	EDWARD YORK	21851		NEWLAND ST SP 222			HUNTINGTON BEACH	CA	92646
890-899-40	KAREN SAMPSON	21851		NEWLAND	ST	30	HUNTINGTON BEACH	CA	92646
890-899-41	LORRIE SALEM	21851		NEWLAND ST SP 118			HUNTINGTON BEACH	CA	92646
890-899-43	PAMELA L SAUNDERS	21851		NEWLAND	ST	165	HUNTINGTON BEACH	CA	92646
890-899-44	HENRY M CARGILL	21851		NEWLAND ST SP 26			HUNTINGTON BEACH	CA	92646
890-899-45	PAUL F SULZBY	21851		NEWLAND ST SP 284			HUNTINGTON BEACH	CA	92646
890-899-46	ALICE M MICHICA	21851		NEWLAND ST SP 24			HUNTINGTON BEACH	CA	92646
890-899-47	ROBERT ESTERLINE	21851		NEWLAND ST SP 112			HUNTINGTON BEACH	CA	92646
890-899-48	CHRISTOPHER KENT ABLIN	21851		NEWLAND ST SP 176			HUNTINGTON BEACH	CA	92646
890-899-49	STEPHEN JOHN SANCHEZ	21851		NEWLAND ST SP 110			HUNTINGTON BEACH	CA	92646
890-899-51	MOHAMMED ATIK	21851		NEWLAND ST SP 89			HUNTINGTON BEACH	CA	92646
890-899-52	ALEXANDER ZABRODSKY			PO BOX 580			LAGUNA BEACH	CA	92652
890-899-53	STEPHEN L SUPOLA	21851		NEWLAND ST SP 287			HUNTINGTON BEACH	CA	92646
890-899-54	VELMA M PETERSEN	21851		NEWLAND	ST	256	HUNTINGTON BEACH	CA	92646
890-899-55	JEAN STANTON HERRIN	17643		SANTA ANA	AVE		BLOOMINGTON	CA	92316
890-899-56	CORNELIUS F & LINDA J MCCARTHY	21851		NEWLAND ST SP 312			HUNTINGTON BEACH	CA	92646
890-899-57	HENRY J BRICE	21851		NEWLAND ST SP 262			HUNTINGTON BEACH	CA	92646
890-899-58	JOHN J WENDELL	21851		NEWLAND ST SP 286			HUNTINGTON BEACH	CA	92646
890-899-59	HUNTINGTON BY THE SEA	21851		NEWLAND	ST		HUNTINGTON BEACH	CA	92646
890-899-60	LORA J WALSH	21851		NEWLAND ST SP 138			HUNTINGTON BEACH	CA	92646
890-899-61	LORENE GUTIERREZ	21851		NEWLAND ST SP 238			HUNTINGTON BEACH	CA	92646
890-899-62	KATHRYN A MARKS	21851		NEWLAND ST SP 255			HUNTINGTON BEACH	CA	92646
890-899-63	DOUGLAS B KLAAS	21851		NEWLAND ST SP 248			HUNTINGTON BEACH	CA	92646
890-899-65	TERRY TURRELL	21851		NEWLAND ST S 31			HUNTINGTON BEACH	CA	92646
890-899-66	BERTA RAE CONWAY TRUST	21851		NEWLAND ST SP 116			HUNTINGTON BEACH	CA	92646
890-899-67	DAVID LAVOIE	2125 W		BROWNWOOD	AVE	4	ANAHEIM	CA	92801
890-899-68	DAVID S BROUDY	21851		NEWLAND ST SP 249			HUNTINGTON BEACH	CA	92646
890-899-69	DONNA J GOLEMESKI	21851		NEWLAND ST SP 99			HUNTINGTON BEACH	CA	92646

APN D	OWNERNAME	M_HSENO	M_DIR	M_STREET	M_SFX	M_UNIT	M_CITY	M_STATE	M_ZIP
890-899-70	PAUL MARZULLO	21851		NEWLAND ST SP 58			HUNTINGTON BEACH	CA	92646
890-899-71	LEE GOLDSTEIN	21851		NEWLAND ST SP 132			HUNTINGTON BEACH	CA	92646
890-899-72	ANNE DEVUSSER	21851		NEWLAND ST SP 50			HUNTINGTON BEACH	CA	92646
890-899-73	BARBARA WILLIAMS	21851		NEWLAND ST SP 243			HUNTINGTON BEACH	CA	92646
890-899-74	SARA C TRELLES	21851		NEWLAND ST SPC 713			HUNTINGTON BEACH	CA	92646
890-899-75	GAIL H WOLCOTT	21851		NEWLAND ST SP 131			HUNTINGTON BEACH	CA	92646
890-899-76	ERNEST AVILA	21851		NEWLAND ST SPC 14			HUNTINGTON BEACH	CA	92646
890-899-77	RONALD THOMAS HANES	21851		NEWLAND ST SP 35			HUNTINGTON BEACH	CA	92646
890-899-78	FRANKLIN HARDING	21851		NEWLAND ST SP 34			HUNTINGTON BEACH	CA	92646
890-899-79	EUGENE R MASSOTH	21851		NEWLAND ST SP 51			HUNTINGTON BEACH	CA	92646
890-899-80	RUSSELL R CHRISTENSEN	21851		NEWLAND ST SP 188			HUNTINGTON BEACH	CA	92646
890-899-81	LISA A ROZGA	21851		NEWLAND ST SP 1A			HUNTINGTON BEACH	CA	92646
890-899-82	DAVID L VINCENT	21851		NEWLAND ST SP 73			HUNTINGTON BEACH	CA	92646
890-899-83	JILL CHEYNE-ROY	21851		NEWLAND ST SP 18			HUNTINGTON BEACH	CA	92646
890-899-84	M AND A HISER FAMILY TR	21851		NEWLAND ST SP 114			HUNTINGTON BEACH	CA	92646
890-899-85	RODNEY HANSEN	21851		NEWLAND ST SP 65			HUNTINGTON BEACH	CA	92646
890-899-86	DELIA ESTRADA	21851		NEWLAND ST SP 219			HUNTINGTON BEACH	CA	92646
890-899-89	SANDRA BREWER	21851		NEWLAND ST SP 296			HUNTINGTON BEACH	CA	92646
890-899-90	CALVIN HOLLINGSWORTH	21851		NEWLAND ST SP 250			HUNTINGTON BEACH	CA	92646
890-899-91	WILLIAM T REESER	21851		NEWLAND ST SP 79			HUNTINGTON BEACH	CA	92646
890-899-93	CHRISTOPHER H JONES	1914		BECHELLI	LN		REDDING	CA	96002
890-899-94	JOSEPH JOHN BAKER	21851		NEWLAND ST SP 185			HUNTINGTON BEACH	CA	92646
890-899-95	JEFFERY W STANLEY	21851		NEWLAND ST SP 300			HUNTINGTON BEACH	CA	92646
890-899-96	MELODY A WILBUR	306		REGATTA	WAY		SEAL BEACH	CA	90740
890-899-97	PHILIP D CARUSO	21851		NEWLAND ST SP 290			HUNTINGTON BEACH	CA	92646
890-899-98	ELEANOR C HESS	21851		NEWLAND ST SP 72			HUNTINGTON BEACH	CA	92646
890-899-99	LAUNA J EACH	21851		NEWLAND ST SP 16			HUNTINGTON BEACH	CA	92646
937-19-354	WILLIAM FEATHER	1920		GLENVIEW	DR		LAS VEGAS	NV	89134
937-19-355	DAVID B MITRE	29067		MARCUS	LN		HIGHLAND	CA	92346
937-19-356	VIJAY KUMAR B PATEL	11521		COVENT GARDENS	DR		BAKERSFIELD	CA	93311
937-19-357	SEAN GRANGE & CORIE GRANGE JOINT LIVING TR	225		20TH	ST		HUNTINGTON BEACH	CA	92648
937-19-358	TRAVIS BRASHER	21247		RONDA	CIR		HUNTINGTON BEACH	CA	92648
937-19-359	MATTHEW S & JENNIFER J DINGWALL	21246		ALANIS	CIR		HUNTINGTON BEACH	CA	92648
937-19-360	ROBIN J BRAITHWAITE	73042		BEL AIR	RD		PALM DESERT	CA	92260
937-19-361	CURT B & KELLY S RADETICH	8442		CLARKDALE	DR		HUNTINGTON BEACH	CA	92646
937-19-362	EDWARD WILLIAM & CAROL CHRITINE WYCHE	21262		ALANIS	CIR		HUNTINGTON BEACH	CA	92648
937-19-363	ROGER J & JONETTE L CHILDS	21266		ALANIS	CIR		HUNTINGTON BEACH	CA	92648
937-19-364	WILLIAM R & PAULETTE C MC CULLEY	21270		ALANIS	CIR		HUNTINGTON BEACH	CA	92648
937-19-365	BEACH HOUSE L C HUNTINGTON	7500		GREER LANE			SANDY	UT	84093
937-19-366	PAUL H NGUYEN	21262		RONDA	CIR		HUNTINGTON BEACH	CA	92648
937-19-367	TAYLOR R JENSON	21253		BAEZA	CIR		HUNTINGTON BEACH	CA	92648
937-19-368	KEVIN LEE BAUGHMAN	21261		BAEZA	CIR		HUNTINGTON BEACH	CA	92648
937-19-369	TONY TRANG	16787		BEACH	BLVD	770	HUNTINGTON BEACH	CA	92647
937-19-370	PHILIP J KOHI	21269		BAEZA	CIR		HUNTINGTON BEACH	CA	92648
937-19-371	ROGER GRANT SMITH	21246		BAEZA	CIR		HUNTINGTON BEACH	CA	92648
937-19-372	PAUL THEDE	32		TWILIGHT BLUFF			NEWPORT BEACH	CA	92657
937-19-373	HONG CHEOL KIM	21262		BAEZA	CIR		HUNTINGTON BEACH	CA	92648
937-19-374	KEVIN MINH NGUYEN	21270		BAEZA	CIR		HUNTINGTON BEACH	CA	92648
937-19-376	MARK NASHED	6672		SILENT HARBOR	DR		HUNTINGTON BEACH	CA	92648
937-19-377	KYU SOOK KIM	21263		RONDA	CIR		HUNTINGTON BEACH	CA	92648
937-19-378	JUMA INVESTMENTS INC			PO BOX 408			HUNTINGTON BEACH	CA	92648
937-19-382	PIUS REIGER	6085		TARANT RANCH	RD		LAS VEGAS	NV	89131
937-19-400	SANDI R B & JOHN C BARRY	21323		BALERMA	LN		HUNTINGTON BEACH	CA	92648
937-19-401	GEORGE A & MARCELA PEARSON	16868		A STREET			HUNTINGTON BEACH	CA	92647
937-19-419	YONG WHIE CHO	21330		BALERMA	LN		HUNTINGTON BEACH	CA	92648
937-19-420	KBT ENTERPRISES LLC	7106		CONCHO MOUNTAIN			HOUSTON	TX	77069
937-19-427	GIAU THANH & THERESE DOAN LE	21345		ALCAZAR	LN		HUNTINGTON BEACH	CA	92648
937-19-428	GENO FLAMMA			PO BOX 913			HUNTINGTON BEACH	CA	92648
937-19-437	KY VINH BUU	21355		ANDALUCIA	LN		HUNTINGTON BEACH	CA	92648
937-19-438	MARTIN N & MEDI RYAN	21363		ANDALUCIA	LN		HUNTINGTON BEACH	CA	92648
937-19-443	EZ LOCK UP LLC			PO BOX 7778			CAPISTRANO BEACH	CA	92624
937-19-444	KHANH PHAM	21378		ANDALUCIA	LN		HUNTINGTON BEACH	CA	92648
937-19-445	SEEME HASAN	7780		LORENZO	DR		HUNTINGTON BEACH	CA	92648
937-19-446	DAI QUANG TRAN	7786		LORENZO	DR		HUNTINGTON BEACH	CA	92648
937-19-447	TUNG NGUYEN & CECILIA NGUYEN GIEP	7106		CONCHO	MTN		HOUSTON	TX	77069

APN_D	OWNERNAME	M_HSENO	M_DIR	M_STREET	M_SFX	M_UNIT	M_CITY	M_STATE	M_ZIP
937-19-448	WESTERN PURELAND CORPORATION LLC	9353		BOLSA	AVE	G18	WESTMINSTER	CA	92683
937-19-449	JO-ANN & KENNETH D BUSCARINO	26608		CANYON TERRACE	WAY		SANTA CLARITA	CA	91351
937-19-450	ANH T DUONG	36248		DALI	DR		CATHEDRAL CITY	CA	92234
937-19-451	ERIC S HSIEH	21379		ARMILLA	CIR		HUNTINGTON BEACH	CA	92648
937-19-456	LINDA ROSE FISHER	21366		ESTEPA	CIR		HUNTINGTON BEACH	CA	92648
937-19-457	DOUGLAS J & KAREN G HANSEN	21370		ESTEPA	CIR		HUNTINGTON BEACH	CA	92648
937-19-458	ALAN C SONNE	21378		ESTEPA	CIR		HUNTINGTON BEACH	CA	92648
937-19-459	MARVIN J & CHRISTINA L DIXON	21382		ESTEPA	CIR		HUNTINGTON BEACH	CA	92648
937-19-460	BLOOMINGTON FAMILY LTD PARTNERSHIP	2857		WILLOW CREEK	DR		SANDY	UT	84093
937-19-461	RODNEY W & CYNTHIA M STOUT	21355		ESTEPA	CIR		HUNTINGTON BEACH	CA	92648
937-19-462	BRANDO & ERIN MASSEI	21359		ESTEPA	CIR	120	HUNTINGTON BEACH	CA	92648
937-19-463	MINH & HUNG KIM NGUYEN	21247		LORCA CIRCLE			HUNTINGTON BEACH	CA	92648
937-19-464	DAVID A PARKER	21371		ESTEPA			HUNTINGTON BEACH	CA	92648
937-19-465	THANITRA PICHEDVANICHOK	6		GILLY FLOWER	ST		LADERA RANCH	CA	92694
937-19-466	DONNA MARIE GOULD	21379		ESTEPA	CIR		HUNTINGTON BEACH	CA	92648
937-19-467	HYATT & ROBIN SELIGMAN	21338		CIEZA	CIR		HUNTINGTON BEACH	CA	92648
937-19-468	PHUONG THU TRAN	1517		AUGUSTA	CT		MILPITAS	CA	95035
937-19-469	HUTCHISON LIMITED PARTNERSHIP	2300		SILVER BLUFF	CT		LAS VEGAS	NV	89134
937-19-470	ARARAD & NAIRA BABAIAAN	6424		BERMUDA DUNE	DR		PLANO	TX	75093
937-19-471	ALICIA M GARCIA	21358		CIEZA	CIR		HUNTINGTON BEACH	CA	92648
937-19-472	ALBERT GASPARIAN	21362		CIEZA	CIR		HUNTINGTON BEACH	CA	92648
937-19-474	CHRISTINE VU	2255		FOX HILLS	DR	301	LOS ANGELES	CA	90064
937-19-475	CHRISTIAN & KIMBERLY GILE	4329 S		ALTON	ST		GREENWOOD VILLAGE	CO	80111
937-19-476	HANS K & DINNA J MIZE	2082		BURNT MILL	RD		TUSTIN	CA	92782
937-19-477	JILAYNE GOUVION	7989		ALDEA	CIR		HUNTINGTON BEACH	CA	92648
937-19-478	BRUCE C & SANDRA C BROWN	4605		SILVERTIDE	DR		UNION CITY	CA	94587
937-19-479	BRUCE R BALDWIN	7968		ALDEA	CIR		HUNTINGTON BEACH	CA	92648
937-19-480	CHRIS SWIETON	21		RIVERSIDE			IRVINE	CA	92602
937-19-481	MARY JOSEPH	23272		LAUREL WOOD	ST		LAKE FOREST	CA	92630
937-19-482	ALEXANDER LEE	7984		ALDEA	CIR		HUNTINGTON BEACH	CA	92648
937-19-483	PAULINA CHAU	13024		MAPLE	DR		GARDEN GROVE	CA	92843
937-19-484	SHARYN LYNN GAITHER	7992		ALDEA	CIR		HUNTINGTON BEACH	CA	92648
937-19-485	AGRAWAL HB HOLDINGS LLC	1980		CHERRY CREEK	CIR		LAS VEGAS	NV	89135
937-19-486	WESLEY VINCENT WUCHNER	7973		UBEDA	CIR		HUNTINGTON BEACH	CA	92648
937-19-487	MATTHEW R SULLIVAN	7977		UBEDA	CIR		HUNTINGTON BEACH	CA	92648
937-19-488	CARL M & FRANCES RYAN-WILLIAMS	2305 N		1ST	AVE		UPLAND	CA	91784
937-19-489	GORDON SCOTT CAMERON	7989		UBEDA	CIR		HUNTINGTON BEACH	CA	92648
937-19-490	OSCAR MANGAHAS	17748		LA PASAITA	CT		ROWLAND HEIGHTS	CA	91748
937-19-491	KIMBERLY P VU	7968		UBEDA	CIR		HUNTINGTON BEACH	CA	92648
937-19-492	WILLIAM BARRETO	7972		UBEDA	CIR		HUNTINGTON BEACH	CA	92648
937-19-493	THAO PHUONG THI VU	18797		SINCLAIR	LN		HUNTINGTON BEACH	CA	92648
937-19-494	CHRISTOPHER THIBODEAU	7984		UBEDA	CIR		HUNTINGTON BEACH	CA	92648
937-19-495	RICHARD J KAHN	7988		UBEDA	CIR		HUNTINGTON BEACH	CA	92648
937-19-496	CHEN JING	1651 W		NICKLAUS	AVE		LA HABRA	CA	90631
937-19-497	FLORA ELLEN TOMA	7967		OSUNA	CIR		HUNTINGTON BEACH	CA	92648
937-19-498	JAMES B & BRENDA K ROSS	7973		OSUNA	CIR		HUNTINGTON BEACH	CA	92648
937-19-503	PATRICIA R SIMONIAN	21398		VERA	CIR		HUNTINGTON BEACH	CA	92648
939-48-009	CHRIS MIORELLI	21702		SEASIDE	LN		HUNTINGTON BEACH	CA	92646
939-48-010	NING D YEH	10181		CRAILET	DR		HUNTINGTON BEACH	CA	92646
939-48-011	GERHARD M SCHNUERER	6406 W		OCEANFRONT			NEWPORT BEACH	CA	92663
939-48-012	GENE KRAUS	6502 W		OCEAN FRONT			NEWPORT BEACH	CA	92663
939-48-013	GERHARD M SCHNUERER	6406 W		OCEANFRONT			NEWPORT BEACH	CA	92663
939-48-014	MARK D & KAREN K LYTLE	21572		SURVEYOR	CIR		HUNTINGTON BEACH	CA	92646
939-48-015	DICKY K YEE			PO BOX 5757			HUNTINGTON BEACH	CA	92615
939-50-510	MARK & MARK CANAVAN	16329		SIERRA TRAIL	CT		HACIENDA HEIGHTS	CA	91745
939-50-511	DEREK B FULLER	5000		GREENHAVEN	ST		YORBA LINDA	CA	92887
939-50-512	MICHAEL MING-PING TSAI	17546		EDGEWOOD	LN		YORBA LINDA	CA	92886
939-50-513	LOUIS & MARIA NEMETH			P O BOX 6113			HUNTINGTON BEACH	CA	92615
939-50-514	KATHLEEN MARY CARRERAS	200		PACIFIC COAST HY		105	HUNTINGTON BEACH	CA	92648
939-50-515	GARY C & LORI D BAKER	200		PACIFIC COAST HWY UNIT M			HUNTINGTON BEACH	CA	92648
939-50-516	RUDOLPH J SANCHEZ	1036		LA CRESTA	PL		FULLERTON	CA	92835
939-50-517	FRANCISCO R FABREGAS	18401		HAMPTON	CT		NORTHRIDGE	CA	91326
939-50-518	JOHN A CREWS	13653		BEACH	ST		CERRITOS	CA	90703
939-50-519	GUY DOMINGUEZ	4264		PEPPERWOOD	AVE		LONG BEACH	CA	90808
939-50-520	CHRISTINE A NGUYEN	200		PACIFIC COAST	HWY	#111	HUNTINGTON BEACH	CA	92648

APN D	OWNERNAME	M_HSENO	M_DIR	M_STREET	M_SFX	M_UNIT	M_CITY	M_STATE	M_ZIP
939-50-521	GORGEN G YOUSSEFIAN	40		WILLOWBROOK	LN		POMONA	CA	91766
939-50-522	DAVID R BARTLETT	607		7TH	ST		HUNTINGTON BEACH	CA	92648
939-50-523	MICHAEL S JOHNSON	8065		THROUGHNBRED	ST		ALTA LOMA	CA	91701
939-50-524	ERNEST W HWANG	200		PACIFIC COAST	HWY		HUNTINGTON BEACH	CA	92648
939-50-525	DIERK HALVERSON	200		PACIFIC COAST	HWY	#116	HUNTINGTON BEACH	CA	92648
939-50-526	WILLIAM H GRIFFITH	11986		TILDEN	PL		RIVERSIDE	CA	92505
939-50-527	LAILA WAGUIH MORCOS	200		PACIFIC COAST HWY UNIT 1			HUNTINGTON BEACH	CA	92648
939-50-528	SASHA & MELISSA VICTORINE	200		PACIFIC COAST HWY UNIT 1			HUNTINGTON BEACH	CA	92648
939-50-529	BRIANA A MILLER	8892		BAINFORD	DR		HUNTINGTON BEACH	CA	92646
939-50-530	MARIANO S & LUCITA M CRUZ	12641		MISTY	PL		CERRITOS	CA	90703
939-50-531	KIMBERLY M MEGGISON	200		PACIFIC COAST HWY UNIT 1			HUNTINGTON BEACH	CA	92648
939-50-532	WILLIAM J GARRISI	200		PACIFIC COAST HWY UNIT 1			HUNTINGTON BEACH	CA	92648
939-50-533	WILLIAM & BONNIE COPELAND	2024		9TH STREET			LA VERNE	CA	91750
939-50-534	VIDAL E & MELINDA L ESPELETA	2746 N		VISTA HEIGHTS	AVE		ORANGE	CA	92867
939-50-535	ROZEMARIE SWEET	20071		BIG BEND	LN		HUNTINGTON BEACH	CA	92646
939-50-536	ARMANDO ENRIQUEZ	1932		PINE	ST		HUNTINGTON BEACH	CA	92648
939-50-537	PAUL C & DEBORAH SUE BYRNE	5571		OCEAN TERRACE	DR		HUNTINGTON BEACH	CA	92648
939-50-538	KHANH P TRAN	26541		PASEO CALLADO			SAN JUAN CAPISTRA	CA	92675
939-50-539	JOHN DOUGLAS PARRISH			PO BOX 5670			HUNTINGTON BEACH	CA	92615
939-50-540	ROBERT K HIGA	6111		CANYON ESTATES	CT		RIVERSIDE	CA	92506
939-50-541	MARIAN GRANT	200-132		PACIFIC COAST	HWY		HUNTINGTON BEACH	CA	92648
939-50-542	JOANNE BOHNKE	4927 N		LUIS RIVER	WAY		TUCSON	AZ	85718
939-50-543	RANDOLPH C PAYNE	6201		MORNINGSIDE DRIVE			HUNTINGTON BEACH	CA	92648
939-50-544	ROBERT G & ROSEMARY B STARR			PO BOX 486			SURFSIDE	CA	90743
939-50-545	STEVEN R CHIDESTER	30		SIDRA COVE			NEWPORT COAST	CA	92657
939-50-546	HEATHER V & KEVIN M SHANNON	200		PACIFIC COAST	HWY	#138	HUNTINGTON BEACH	CA	92648
939-50-547	MICHAEL R & LINDA M WOMACK	7205		SHERWOOD	DR		HUNTINGTON BEACH	CA	92648
939-50-548	ROBERT E & SUZANNE E STOOKEY	200		PACIFIC COAST HY		140	HUNTINGTON BEACH	CA	92648
939-50-549	RODNEY L & REGINA A ALBRIGHT	200		PACIFIC COAST HY		141	HUNTINGTON BEACH	CA	92648
939-50-550	DAVID R BARTLETT	607		7TH	ST		HUNTINGTON BEACH	CA	92648
939-50-551	DAVID R BARTLETT	607		7TH	ST		HUNTINGTON BEACH	CA	92648
939-50-552	RONALD LEROY KIMBROUGH	200		PACIFIC COAST HY		144	HUNTINGTON BEACH	CA	92648
939-50-553	SHU MEI TSAI			#145			HUNTINGTON BEACH	CA	92648
939-50-554	MARY TRACY	315		ARLINGTON	AVE	1601	CHARLOTTE	NC	28203
939-50-555	MICHAEL R ROBINSON	8		GIBERTI			IRVINE	CA	92606
939-50-556	RICHARD C THEIL	628		MAIN	ST		HUNTINGTON BEACH	CO	92648
939-50-557	MICHAEL A COLACARRO	23325		53RD AVE S			KENT	WA	98032
939-50-558	TODD C & KELLIE J RYNEARSON	200		PACIFIC COAST HY		150	HUNTINGTON BEACH	CA	92648
939-50-559	DAVID & DEBIE DEGRAZIO	200		PACIFIC COAST HY		206	HUNTINGTON BEACH	CA	92648
939-50-560	JACK M FRYER	200		PACIFIC COAST HY		208	HUNTINGTON BEACH	CA	92648
939-50-561	HUNTINGTON PIER COLONY CONDO ASSN	10801		WALKER	ST	200	CYPRESS	CA	90630
939-50-562	BERYL A AMSPOKER	36449		TIERRA SUBIDA	AVE		PALMDALE	CA	93551
939-50-563	TING-LI CHEN	200		PACIFIC COAST HY		216	HUNTINGTON BEACH	CA	92648
939-50-564	ELBERT K CHANG			#217			HUNTINGTON BEACH	CA	92648
939-50-565	EDMUNDO AGUILAR	6808		GRETNA	AVE		WHITTIER	CA	90606
939-50-566	JULIA ANN NIZNIK	18551		SAN MARCOS			FOUNTAIN VALLEY	CA	92708
939-50-567	ERIC M YAO			PO BOX 17196			IRVINE	CA	92623
939-50-568	MANOUC B SIMSIAN	927 W		CRESCENT	DR		MONROVIA	CA	91016
939-50-569	TBF PROPERTIES LLC	2935		BLUEBELL	AVE		BREA	CA	92821
939-50-570	ALFONSO RAGUS LLACUNA	50		SHOOTING STAR			IRVINE	CA	92604
939-50-571	ADEL & SUHA ALBADAWI	2408		SANTIAGO			LA VERNE	CA	91750
939-50-572	MARIO & LORRAINE RICCIARDI	8004		HAVEN	AVE	200	RANCHO CUCAMONGA	CA	91730
939-50-573	LENA BEDIKIAN	200		PACIFIC COAST	HWY	24	HUNTINGTON BEACH	CA	92648
939-50-574	THEODORE CARL FRANKIEWICZ	200		PACIFIC COAST HWY 245			HUNTINGTON BEACH	CA	92648
939-50-575	ASHKAN TAHVILDARAN	200		PACIFIC COAST	HWY	#250	HUNTINGTON BEACH	CA	92648
939-50-576	HAZEM I SABRY	200		PACIFIC COAST HY		300	HUNTINGTON BEACH	CA	92648
939-50-577	RICHARD A MILLER	19267		SCRIPTS	CT		HUNTINGTON BEACH	CA	92648
939-50-578	JAMES B LIM	1762		SOMBRERO	DR		MONTEREY PARK	CA	91754
939-50-579	DORIS L WARNER	200		PACIFIC COAST	HWY	303	HUNTINGTON BEACH	CA	92648
939-50-580	SCOTT MCKELVEY	200		PACIFIC COAST HY		304	HUNTINGTON BEACH	CA	92648
939-50-581	KATHY ATKINS	200		PACIFIC COAST HY		306	HUNTINGTON BEACH	CA	92648
939-50-582	HOSAMELDIN H & HOSAMELDIN H MADKOUR	15939		MAIDSTONE	ST	200	FOUNTAIN VALLEY	CA	92708
939-50-583	KELLY K DITMORE	200		PACIFIC COAST HY		309	HUNTINGTON BEACH	CA	92648
939-50-584	MICHAEL L MUSCARELLA	200		PACIFIC COAST HY		311	HUNTINGTON BEACH	CA	92648
939-50-585	ANDREW MC DONALD	113		6TH	ST		HUNTINGTON BEACH	CA	92648

APN D	OWNERNAME	M_HSENO	M_DIR	M_STREET	M_SFX	M_UNIT	M_CITY	M_STATE	M_ZIP
939-50-586	DONALD M HARDY	1484	S	JOHNSON	ST		LAKEWOOD	CO	80232
939-50-587	EDWARD E HAHN	2904	E	ECHO HILL	WAY		ORANGE	CA	92867
939-50-588	MARK S & VIOLET ANDERSON	200		PACIFIC COAST	HWY	#315	HUNTINGTON BEACH	CA	92648
939-50-589	JAMIE L & MICHAEL A DIFIORI	200		HWY 316			HUNTINGTON BEACH	CA	92648
939-50-590	MARK ANTHONY MILLER	200		PACIFIC COAST HWY UNIT		317	HUNTINGTON BEACH	CA	92648
939-50-591	EDMUND SALGADO EVANGELISTA	200		PACIFIC COAST HY		319	HUNTINGTON BEACH	CA	92648
939-50-592	JEFFREY SMITH	200		PACIFIC COAST HY		320	HUNTINGTON BEACH	CA	92648
939-50-593	MICHAEL WILLIAM BARSOM	1558	N	PACIFIC	AVE		GLENDALE	CA	91202
939-50-594	GAIL P PICKART	7		SAN MATEO	WAY		CORONA DEL MAR	CA	92625
939-50-595	MAMDOUH Y & EBTESAM A KHALED	200		PACIFIC COAST HWY UNIT 3			HUNTINGTON BEACH	CA	92648
939-50-596	IRWIN P TING	200		PACIFIC COAST HY		325	HUNTINGTON BEACH	CA	92648
939-50-597	WAYNE W & THERESA R RYLSKI	730		13TH	ST		HUNTINGTON BEACH	CA	92648
939-50-598	BARRY C & DONNA K COLE	1500	E	KATELLA	AVE	SONE	ORANGE	CA	92867
939-50-599	JAMES PATRICK DAVIDSON	1343		CADENCE	ST		HENDERSON	NV	89052
939-50-600	MICHAEL SCOTT METKO	200		PACIFIC COAST HY		332	HUNTINGTON BEACH	CA	92648
939-50-601	SYLVIA SUE MOHUNDRO	6435		BEACHVIEW	DR		HUNTINGTON BEACH	CA	92648
939-50-602	RANDOLPH C PAYNE	6201		MORNINGSIDE	DR		HUNTINGTON BEACH	CA	92648
939-50-603	ERNEST & RUTH FELD	1957		MALCOLM	AVE		LOS ANGELES	CA	90025
939-50-604	QUAN & TRANG DOAN DUONG	4962		RUTTNER	CT		SAN JOSE	CA	95111
939-50-605	OKACHI SHOJI CO LTD	359		SAN MIGUEL	DR	100	NEWPORT BEACH	CA	92660
939-50-606	JACK T PARKS	42524		SHERRY	LN		MURRIETA	CA	92562
939-50-607	STEVEN & GAY SACHAROFF	200		PACIFIC COAST HWY UNIT 3			HUNTINGTON BEACH	CA	92648
939-50-608	RICHARD A ROSENBERG	200		PACIFIC COAST HY		343	HUNTINGTON BEACH	CA	92648
939-50-609	WILDCAT PROPERTIES LLC	4800		COLEGE	BLVD	204	FARMINGTON	NM	87402
939-50-610	SUSAN J DE GUIDE	200		PACIFIC COAST HIGHWAY UN			HUNTINGTON BEACH	CA	92648
939-50-611	PATRICK H NIXON			PO BOX 237			MONROVIA	CA	91017
939-50-612	ROBERT B BRYANT	200		PACIFIC COAST HY		348	HUNTINGTON BEACH	CA	92648
939-50-613	PAUL H STRAIN	9112		MAHALO	DR		HUNTINGTON BEACH	CA	92646
939-50-614	LIN WU LAN	200		PACIFIC COAST HWY UNIT 3			HUNTINGTON BEACH	CA	92648
939-50-615	LUCAS DUSTIN GERARD	935	NW	VALLEY VIEW	DR		GRANTS PASS	OR	97526
939-50-616	ADAM LOUCKS			#404			HUNTINGTON BEACH	CA	92648
939-50-617	JOSEPH L SANDERS	200		PACIFIC COAST HY		406	HUNTINGTON BEACH	CA	92648
939-50-618	DAVID L ABU	200		PACIFIC COAST HY		408	HUNTINGTON BEACH	CA	92648
939-50-619	LOUIS S & MARGARET L CHAVEZ	1267	W	KILDARE			LANCASTER	CA	93534
939-50-620	EUGENE V IANSITI	200		PACIFIC COAST HY		413	HUNTINGTON BEACH	CA	92648
939-50-621	LINDA M SCOTT	18608		SANTA ISADORA			FOUNTAIN VALLEY	CA	92708
939-50-622	RODOLFO G & ELOISA V NONATO	200		PACIFIC COAST HY		416	HUNTINGTON BEACH	CA	92648
939-50-623	JEFF SANDERSON	1		BOBBY JONES	LN		COTO DE CAZA	CA	92679
939-50-624	THOMAS CONNOLLY	19744		BEACH	BLVD	209	HUNTINGTON BEACH	CA	92648
939-50-625	VALERIE HOLWERDA			PO BOX 49958			LOS ANGELES	CA	90049
939-50-626	THOMAS E & CAROL M MC CANN	200		PACIFIC COAST HY		426	HUNTINGTON BEACH	CA	92648
939-50-627	THOMAS EDWARD & CAROL MEREDITH MC CANN	200		PACIFIC COAST HY		426	HUNTINGTON BEACH	CA	92648
939-50-628	MARY SEIF	1200		IMPERIAL	DR		GLENDALE	CA	91207
939-50-629	PERRI SOFIAN PUTRASAHAN	937		CREEK VIEW	LN		REDLANDS	CA	92373
939-50-630	ADEL ZEIDAN	7586		OCEAN POINT	LN		HUNTINGTON BEACH	CA	92648
939-50-631	LESLIE & JUDITH PINCHUK	11425		DONA EVITA	DR		STUDIO CITY	CA	91604
939-50-632	ROBERT & MARY LEE LAN	16346		BROOKSTONE	CIR		LA MIRADA	CA	90638
939-50-633	SONNY J RUBIN	200		PACIFIC COAST	HWY	44	HUNTINGTON BEACH	CA	92648
939-50-634	GASTON VILLALBA	200		PACIFIC COAST HWY M-9			HUNTINGTON BEACH	CA	92648
939-50-635	SANTIAGO ORTIZ	200		PACIFIC COAST HWY UNIT M			HUNTINGTON BEACH	CA	92648
939-50-636	KELLY & STEVE WIERE	1641		CALLE YUCCA			THOUSAND OAKS	CA	91360
939-50-637	JANET B DELANEY	200		PACIFIC COAST HWY UNIT M			HUNTINGTON BEACH	CA	92648
939-50-638	GARY C & LORI D BAKER	200		PACIFIC CAOST	HWY	M40	HUNTINGTON BEACH	CA	92648
939-50-639	JERALD L CARPENTER	22580		GREEN MOUNT	PL		YORBA LINDA	CA	92887