

**DOCKET**

**08-SPPE-1**

DATE DEC 16 2008

RECD. DEC 17 2008

**ALLAN J. THOMPSON**  
ATTORNEY AT LAW  
21 'C' ORINDA WAY #314  
ORINDA, CA 94563  
(925) 258-9962  
CELL: (925) 708-0363  
E-MAIL: ALLANORI@COMCAST.NET

December 16, 2008

Karen Douglas, Commissioner and Presiding Member  
James D. Boyd, Commissioner and Associate Member  
California Energy Commission  
1516 Ninth Street  
Sacramento, CA 95814-5512

Re: RERC Prepared Testimony and Exhibits

Commissioners Douglas and Boyd;

Pursuant to the "Notice of Prehearing Conference and Evidentiary Hearing and Prehearing Conference Order", dated December 3, 2008, Applicant hereby submits its Prepared Direct Testimony and Exhibits. Applicant is hopeful that this filing satisfies the filing requirements as enumerated for the December 17 and December 22 filings.

Please note that exhibit 1, SPPE Application and exhibit 2, Responses to CEC Data Requests, are not being served on all parties. There is a notation in the exhibit package that informs the parties that these documents are available on the Commission's website.

Today's filing includes:

- (1) Applicant's Prehearing Conference Statement with attachments,
- (2) A copy of each of Applicant's exhibits (except #1 and #2), numbered, and
- (3) A copy of the Prepared Direct Testimony of each witness with the individual's resume attached.

December 16, 2008

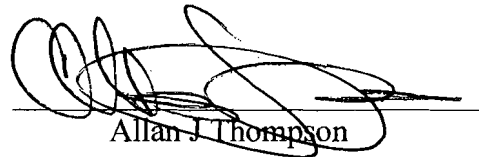
  
Allan J. Thompson

STATE OF CALIFORNIA  
California Energy Commission

In the Matter of:	)	
Application for a Small Power	)	
Plant Exemption for the	)	Docket No. 08-SPPE-1
Riverside Energy Resources Center	)	
Units 3 & 4	)	
<hr/>		

APPLICANT'S  
PREHEARING CONFERENCE STATEMENT

On December 3, 2008 the Committee assigned to the above-referenced proceeding issued a "Notice of Prehearing Conference and Evidentiary Hearing and Prehearing Conference Order". In that document, the Committee directed Applicant, and other parties, to file and serve a Prehearing Conference Statement no later than 3:00 pm on December 22, 2008. The order directed the parties to respond to certain informational requirements as follows:

1. The topic areas that are complete and ready to proceed to evidentiary hearing  
  
Applicant is prepared to proceed to hearing on all topic areas.
2. The topic areas that are not complete and not yet ready to proceed to evidentiary hearing, and the reasons therefore.  
  
Applicant believes there are no areas that are not yet ready to proceed to hearings.
3. The topic areas that remain disputed and require adjudication, and the precise nature of the dispute for each topic.  
  
Applicant believes there are no areas that are disputed and require adjudication.
4. The identity of each witness sponsored by each party (NOTE: witnesses must have professional expertise in the discipline of their testimony); the topic area(s) which each witness will present; a brief summary of the testimony to be offered by each witness; qualifications of each witness; and the time required to present direct testimony by each witness;

Applicant's projection of witnesses, areas of testimony, summary and time required or indication that testimony will be placed into the record by Declaration is attached

(Attachment 1). Note that Applicant anticipates a single witness (Steve Badgett) in person, with the testimony of the remainder placed into the record by Declaration.

5. Topic areas upon which a party desires to cross-examine witnesses, a summary of the scope of each such cross-examination, and the time desired for each such cross-examination

Applicant does not intend to cross-examine any witnesses.

6. A list identifying exhibits and declarations that each party intends to offer into evidence and the technical topics to which they apply (see following section on formats).

A list of exhibits, witnesses and declarations is attached hereto (Attachment 2)

7. Proposals for briefing deadlines, impact of vacation schedules, and other scheduling matters; and

Applicant does not believe there is a need for briefs.

8. For all topics, any proposed modifications to the proposed Conditions of Exemption listed in the initial study based upon enforceability, ease of comprehension, and consistency with the evidence.

Applicant does not propose any changes to the Staff proposed Conditions of Exemption.

Dated: December 16, 2008



Allan J Thompson  
21 "C" Orinda Way #314  
Orinda, CA 94563  
(925) 258-9962  
[allanori@comcast.net](mailto:allanori@comcast.net)

One of Counsel:  
City of Riverside, RPU

Attachment 1

RERC 3 & 4 Witnesses

<u>Witness</u>	<u>Topic Areas</u>	<u>Summary</u>	<u>Time</u>
Mike Tatterson Power Engineers	Executive Summary Project Description Transmission Safety & Nuisance Geology Agriculture and Soils Water	Summary of SPPE Description of project Transmission impacts  Geologic impacts from project Ag and soils impacts Project water use	Declaration
Dave Tateosian Power Engineers	Alternatives Engineering	Project alternatives description Operating hours and SCR	Declaration
Harry Hall Power Engineers	Engineering Efficiency Transmission Description	Project process engineering Efficiency of units Transmission engineering Project Location and schedule	Declaration
John Squire Power Engineers	Transmission	Subtransmission system	Declaration
Karl Lany SCEC	Air Quality Public Health	Air quality conformance Impacts on public health	Declaration
Kevin Everett Power Engineers	Land Use Socioeconomics Hazardous materials	Conformance with land use policies Socioeconomic impacts of project Handling of hazardous materials	Declaration
Michael Tuma SWCA	Biology	Impacts on biological resources	Declaration
Caprice Harper SWCA	Cultural	Impacts on Cultural resources	Declaration

Cara Corsetti SWCA	Paleontology	Impacts on paleontological resources	Declaration
Jonathon Higginson Wieland	Noise	Noise impacts from project	Declaration
Roger Pelayo KOA	Traffic	Traffic impacts from project	Declaration
John Paez Power Engineers	Visual	Visual impacts of project	Declaration
Steve Badgett Riverside RPU	Need and utility information	RERC acceptance of conditions of certification	10 min

Attachment 2

<u>Exhibit</u>	<u>Technical Topic Areas</u>	<u>Declaration/ Sponsor</u>
1	SPPE Application	
	Section 1 – Executive Summary	M Tatterson
	Section 1.2 – Need	S Badgett
	Section 2 – Project and Facility Description	
	Section 2.1 – Introduction	S Badgett
	Section 2.2 – Site Location and Layout	H Hall
	Section 2.3 – Alternative Sites	M Tatterson
	Section 2.4 – Schedule	H Hall
	Section 2.5 – Process Description	H Hall
	Section 2.6 – Fuel System	H Hall
	Section 2.7 – Water Supply and Use	H Hall
	Section 2.8 – Wastewater	H Hall
	Section 2.9 – Hazardous Materials Handling	M Tatterson
	Section 2.10 – Plant Auxiliaries	H Hall
	Section 2.11 – Electrical System	H Hall
	Section 2.12 – Transmission System	M Tatterson
	Section 2.13 – Plant Controls	H Hall
	Section 2.14 – Facility Closure	M Tatterson
	Section 3 – Energy Efficiency	H Hall
	Section 4 – Transmission Line Safety and Nuisance	M Tatterson
	Section 5 – Transmission System Engineering	
	Section 5.1 – Introduction	H Hall
	Section 5.2 – Project Description	H Hall
	Section 5.3 – Laws, Ordinances, Regulations and Standards	H Hall
	Section 5.4 – Subtransmission Facilities	H Hall
	Section 5.5 – Subtransmission Interconnection Engineering	J Squire
	Section 6 – Environmental Considerations	
	Section 6.1 – Air Quality	K Lany
	Section 6.2 – Land Use	K Everett
	Section 6.3 – Biological Resources	M Tuma
	Section 6.4 – Cultural Resources	C Harper
	Section 6.5 – Geologic Resources and Hazards	M Tatterson
	Section 6.6 – Paleontologic Resources	C Corsetti
	Section 6.7 – Noise	J Higginson
	Section 6.8 – Public Health and Safety	K Lany

<u>Exhibit</u>	<u>Technical Topic Areas</u>	<u>Declaration Sponsor</u>
	Section 6.9 – Traffic and Transportation	R Pelayo
	Section 6.10 – Agriculture and Soils	M Tatterson
	Section 6.11 – Visual Resources	J Paez
	Section 6.12 – Socioeconomics	K Everett
	Section 6.13 – Water	M Tatterson
	Section 6.14 – Hazardous Materials	K Everett
	Section 7 – Alternatives	D Tateosian
2	Responses to CEC Data Requests 1-71	
	Responses 1,2 Air Quality	K Lany
	Responses 3,4 Air Quality	D Tateosian
	Responses 5-22 Air Quality	K Lany
	Responses 23-29 Biology	M Tuma
	Responses 30-31 Geology	M Tatterson
	Response 32 Hazardous Materials	K Everett
	Response 33-36 Hazardous Materials	M Tatterson
	Responses 37-38 Hazardous Materials	K Everett
	Responses 39-43 Land Use	K Everett
	Responses 44-46 Socioeconomics	K Everett
	Responses 47-54 Transmission System Engineering	H Hall
	Responses 55-57 Visual	J Paez
	Responses 58-63 Waste Management	K Everett
	Responses 64-71 Water	M Tatterson
3	Letter to F Miller with RPU Planning Criteria, July 22, 2008	H Hall
4	Sketches ECGSK-2 and ECGSK-3, duct banks, July 22, 2008	H Hall
5	Drawing depicting 69kV network, July 22, 2008	H Hall
6	RPU plans for future 69kV Network Improvements, August 12, 2008	H Hall
7	RPU letter describing transmission system, September 4, 2008	H Hall

Prepared Direct Testimony and Resume

of

Michael Tatterson  
(Power Engineers)

RERC

CEC Docket No. 08-SPPE-1



Prepared Direct Testimony  
of  
Michael Tatterson

1. Please state your name and place of employment.

My name is Mike Tatterson and I am employed by Power Engineers.

2. What are your responsibilities with regard to the RERC 3&4 project?

I am the Project Permitting Lead. I am responsible for the preparation of documents, studies and reports which support the SPPE application.

3. What is the purpose of your testimony in this proceeding?

The purpose of my testimony is to identify my role in the proposed project and to specify those exhibits I am sponsoring as stated below.

4. Are you sponsoring any exhibits in this proceeding?

Yes. I am sponsoring the following:

Exhibit 1	Section 1	Executive Summary [except Section 1.2 Need]
	Section 2	Project and RERC Facility Description
		2.3 Alternate Sites
		2.9 Hazardous Materials Management
		2.12 Transmission System
		2.14 Facility Closure
	Section 4	Transmission Line Safety and Nuisance
	Section 6.5	Geologic Resources and Hazards
	Section 6.10	Agriculture and Soils
	Section 6.13	Water Resources
Exhibit 2	Data Request Responses 30-31	Geology and Attachments 1-3
	Data Request Responses 33-36	Hazardous Materials and Attachments 1-3
	Data Request Responses 64-71	Water Resources and Attachments 1-2

I Michael Tatterson hereby swear that the foregoing is true and correct to the best of my knowledge

12/12/08

Date



Michael Tatterson

## **MICHAEL TATTERSON, CPSSC**

### **ENVIRONMENTAL SPECIALIST**

#### **YEARS OF EXPERIENCE**

23

#### **EDUCATION**

- > B.S., Range Ecology, Colorado State University, 1985
- > Concentrated Study in Soil Science
- > Concentrated Study in Disturbed Lands Reclamation

#### **SPECIAL TRAINING**

- > Certified Professional Soil Scientist No. 4334
- > 40-Hour HAZWOPPER Trained
- > 8-Hour MSHA Surface Mine Safety Trained

#### **AREAS OF EXPERTISE**

- > Multiple project management
- > Soil resource inventories
- > Technical document preparation and review
- > Power Plant Siting and Permitting
- > Soil stabilization, erosion control, and disturbed land reclamation
- > Project environmental permitting
- > Negotiation with federal and state agencies
- > Litigation support including written and oral depositions and direct testimony
- > NEPA related issues, contaminated site remediation, waste water sampling and permitting, low-level radioactive materials permitting, stormwater permitting, endangered species issues, cultural resource issues

#### **EXPERIENCE SUMMARY**

Mr. Tatterson has experience in environmental permitting, applied field studies, and regulatory oversight. He has extensive experience in linear project permitting; soil resource inventories and related studies, surface mine permitting, reclamation and field research; and wetland-related permitting. Additionally, he has experience in environmental issues related to power plants and similar facilities.

#### **Public Utility District No. 1 of Snohomish County, Granite Falls 115 kV Transmission Loop Routing Study, Washington**

Lead Environmental Scientist on a routing study for a 115 kV radial line to loop Snohomish's service to the community of Granite Falls. Participated in agency scoping and responsible for data collection, environmental sensitivity analysis, corridor analysis, and report preparation. The new line will increase service reliability by completing the looped system. POWER conducted agency scoping, identified alternative routes, performed impact analysis and identified the preferred route. The routing report analyzed the project's impacts on wetlands, fisheries, cultural resources, water quality, special status species, sensitive properties, wildlife habitat, migratory birds, EMF exposure, visual resources, and aesthetic considerations. POWER's engineering staff also provided cost estimates to construct, operate, and maintain the line.

#### **NV Energy, 500 kV Harry Allen-Northwest EA, Nevada**

Environmental Specialist responsible for a soil resources inventory and impact assessment for the Environmental Assessment (EA) under NEPA for this 30-mile-long transmission line. Environmental approvals completed include resource surveys, a Biological Assessment and Section 7 consultation for federally listed species, cultural resources surveys and consultations, and the preparation of a Utility Environmental Protection Agency permit from the Nevada Public Service Commission, and all other federal, state and local (e.g., conditional use permit for Clark County) permits. The findings of these services were used to assess the impacts of the project in the EA. The BLM was the lead federal agency. Construction for this fast-track project was approved in May 2002, less than 10 months after starting the project.

#### **NV Energy, 500 kV Harry Allen-Mead EA, Nevada**

Environmental Specialist responsible for soil resources inventory and impact assessment for the Environmental Assessment for a 48-mile 500kV transmission line between the Harry Allen and Mead substations. A siting study to identify alternative routes was completed initially and the EA was completed with BLM as the lead federal agency and Western Area Power Administration as a cooperating agency. POWER also prepared a plan of development for construction, operations, mitigation and monitoring procedures.

---

**NorthWestern Energy, Three Rivers to Jackrabbit Transmission Line EA, Montana**

---

Soil Specialist for the preparation of a siting study report and Environmental Assessment on plans to replace an existing transmission line in southwestern Montana. The 161/50 kV line would be a new double-circuit line within the right of way of an existing 50 kV line. The study and EA analyzed three alternative routes of approximately 30 miles each under the requirements of the Montana Environmental Policy Act. Montana DEQ was the lead agency. POWER prepared the EA to analyze the project's visual effects and impacts to wildlife, threatened and endangered species, cultural resources, land use and recreation, water resources, soils, and socioeconomics.

---

**Raft River Rural Electric Cooperative, C.J. Strike to Riddle 138 kV Transmission Line, Idaho**

---

Soils Resource Analyst for a project to provide routing, permitting, right of way and design for a new 67-mile 138 kV transmission line. Analyzed reclamation, revegetation, erosion and sedimentation issues. The project included a routing study and preparation of an Environmental Assessment to secure a BLM right of way grant. The new line replaces an old 69 kV line as the only source of electric power to the Duck Valley Indian Reservation and Mountain City.

---

**San Diego Gas and Electric, Valley-Rainbow 500 kV Interconnect, California**

---

Soil Specialist for a Proponent's Environmental Assessment (PEA) and permitting. The studies and PEA were prepared during the 2000/2001 energy crisis in California in less than nine months and filed with the California Public Utilities Commission (CPUC). The overall project scope included a new 35-mile 500 kV transmission line, a new substation, 52 miles of 230 kV transmission upgrades, a new 7-mile 69 kV transmission line, and five substation upgrades to bolster transmission capacity in SDG&E's fast-growing service territory. POWER completed environmental siting and permitting services and preliminary engineering.

---

**Wind Hunter, LLC, Valley County Wind Energy Project MFSA/ER/EA, Montana**

---

Soil Specialist for the environmental planning and permitting services for a planned 500 MW (170 MW approved) wind development in northeastern Montana. POWER's environmental specialists conducted resource studies and identified alternative transmission line corridors and routes to connect the power with regional electrical delivery systems. From the resource studies, POWER conducted an environmental impact evaluation of the proposed project and prepared the Major Facility Siting Act application in Montana and the Environmental Assessment for federal and state agencies.

---

**Tacoma Power, Tacoma Narrows Environmental Consulting, Washington**

---

Environmental Specialist for a contract to provide environmental consulting services for a transmission line replacement project. Responsible for

---

identifying and describing soil resources in the project area and evaluating project impacts to those resources. The project replaced the 80-year-old 115 kV transmission line crossing the Tacoma Narrows with a new 230 kV design. As Owner's Environmental Consultant, POWER led the public involvement process, evaluated biological resources, obtained several environmental permits, and served as Owner's Reviewer for contractor design and construction processes.

---

**Sunflower Electric Power Corporation, Rhodes to Phillipsburg 115 kV Routing Study, Kansas**

---

Soil Specialist responsible for inventory and impacts analysis of soils and prime farmlands for a routing study for a new 115 kV transmission line in northwest Kansas. POWER analyzed impacts on 35 miles of primary route and 21 miles of alternative routes under NEPA/RUS guidelines. Key resources and issues analyzed were air quality, soils and prime farmland, special status species, wildlife, botanical, cultural resources, land use and ownership, recreation, socio-economic, public facilities and utilities, visual resources, water and wetlands, and transportation. Sunflower used the report to gain approval for the project from state and federal agencies.

---

**NorthWestern Energy, Lewis and Clark Loop EA, Montana**

---

Soil Specialist for an EA under NEPA to obtain a special use permit for a 10 mile, 12 inch natural gas pipeline through the Lewis and Clark National Forest and Flathead National Forest adjacent to the Glacier National Park. POWER performed the full range of services for the EA including resource analyses for wetlands, endangered species, cultural resource, and biological resource studies, and a Biological Assessment to comply with Section 7 requirements of the Endangered Species Act. The Lewis and Clark National Forest was the lead federal agency.

---

**Nebraska Public Power District, Transmission Line Reliability Project Routing Study, Nebraska**

---

Soil Specialist responsible for inventory and impacts analysis of soils and prime farmlands for an Environmental Report on a new 345 kV transmission line east-central Nebraska. POWER collected data on the study area and evaluated route corridors. The fast-track project determined the project study area and selected the preferred route for the approximately 80-mile-long transmission line from Columbus to Lincoln. The report assessed the project's impacts on land uses, visual resources, cultural resources, and biological resources and identified engineering constraints.

---

**City of Riverside, Energy Resource Center Permitting, Units 3 & 4, California**

---

Project Coordinator responsible for coordinating permitting efforts and the preparation of an application for Small Power Plant Exemption (SPPE) for the California Energy Commission (CEC). POWER is overseeing the permitting efforts for a new 95 MW peaking plant as part of complete Owner's Engineer services for units 3 and 4 of the City's new Energy Resource Center. POWER prepared an Application for Small Power Plant Exemption (SPPE) for the California Energy Commission (CEC) to obtain a Mitigated Negative Declaration under the California Environmental Quality Act (CEQA)

regulations. POWER was responsible for air quality permits, Storm Water Pollution Prevention Plan (SWPPP) preparation, photo simulations and coordination with local agencies and jurisdictions. POWER was also responsible for overseeing site surveys and geotechnical analyses.

---

**City of Riverside, Energy Resource Center Permitting, Units 1 & 2, California**

---

Project Coordinator who supported preparation of an application for Small Power Plant Exemption (SPPE) for the California Energy Commission (CEC). POWER oversaw the permitting efforts for a new 96 MW peaking plant as part of complete Owner's Engineer services for units 1 and 2 of the City's Energy Resource Center. POWER was responsible for air quality permits, Storm Water Pollution Prevention Plan (SWPPP) preparation, photo simulations and coordination with local agencies and jurisdictions. POWER was also responsible for overseeing site surveys and geotechnical analyses. POWER prepared an Application for Small Power Plant Exemption (SPPE) for the California Energy Commission (CEC) in a successful effort to obtain a Mitigated Negative Declaration under the California Environmental Quality Act (CEQA) regulations.

---

**Bryan Texas Utilities, Texas A&M Routing Study and Permitting, Texas**

---

Project Coordinator for a routing study for the overhead portions of a 138 kV line that would be routed as an overhead line through the City of Bryan and underground through the Texas A&M University campus. The new line would increase the reliability of the campus electrical system. Also responsible for project permitting activities including highway and railroad crossings, FAA notice of obstruction, NPDES storm water general permit, and City requirements.

---

**Avista Utilities, Benewah-Shawnee 230 kV Line, Washington**

---

Environmental Coordinator responsible for producing a transmission line routing study report including extensive data acquisition and an alternative routes analysis with existing resource inventory and impact evaluation. POWER performed siting, environmental studies, permitting support, right of way acquisition assistance and engineering for a new 230 kV transmission line. The Palouse Upgrade Project entailed the construction of approximately 22 miles of new 230 kV single steel pole line and the reconstruction of over 40 miles of existing H-frame wood line to a 230 kV double-circuit transmission line on single-pole steel structures. The new line crosses prime agriculture land in the region. It is one of several transmission system upgrade projects implemented to free up transmission bottlenecks in the Pacific Northwest.

---

**Continental Energy Services, Silver Bow Project, Montana**

---

Soil Specialist who developed a preliminary conceptual topsoil salvage and long-term site reclamation plan. POWER provided services for the development of a Montana Major Facility Siting Act (MFSA) application to the Montana Department of Environmental Quality for the proposed Silver Bow 500 MW natural gas generation facility. Subsequently, POWER provided lead production of the draft and final Environmental Impact Statement. The effort included analysis of 100-plus miles of pipeline expansion and related

upgrades to fuel the new facility. Resources analyzed included wildlife, vegetation, land uses, visual impacts, socioeconomics, air quality, cultural resources, fisheries, water resources, wetlands, and noise.

---

**Kenya Power and Lighting Company, Transmission Projects Feasibility Study, Kenya**

---

Environmental Specialist for a study to assess Kenya's transmission grid and develop options for adding power infrastructure. Responsible for environmental analysis relating to route selection and risk analysis. POWER's review and analysis was needed to assess and prioritize four transmission system projects and help acquire the funding to build them. The project involved developing a computer model of the entire KPLC bulk electric generation and transmission system and performing load flow, short circuit and dynamic stability studies to determine system performance and requirements to reliably serve load.

---

**Idaho Power Company, Cambridge-McCall 138 kV Transmission Line EA/Permitting, Idaho**

---

Soil Specialist responsible for assessing potential impacts to the soil resource as part of an EA for a proposed new 138 kV transmission line in west-central Idaho. Conducted a soils inventory of the project area, analyzed the project's impacts to soils and developed an erosion control strategy to prevent soil loss from construction and maintenance activities. The EA was developed under the NEPA process with the Forest Service as the lead agency. The new line will provide additional power to the McCall resort and ski area on Payette Lake. The proposed line would run from the West Cambridge Substation to the West McCall Substation, a distance of 57 miles. As proposed, the line would cross public lands managed by the BLM and Forest Service as well as private agricultural tracts.

---

**Idaho Power Company, Brownlee-Oxbow 230 kV Transmission Line EA, Idaho**

---

Soil Specialist for an Environmental Assessment for the Bureau of Land Management for a proposed new 11-mile, double-circuit 230 kV transmission line on the perimeter of the Hells Canyon of the Snake River. Responsibilities included a soil resources inventory and impact assessment. The project route has significant aesthetic and recreational values and was found to be a nesting area for the bald eagle. POWER prepared the Biological Assessment for Endangered Species Act compliance (Section 7), a Conditional Use Permit application through county planning and a Plan of Development specifying construction, operation and maintenance procedures for the project.

---

**AmerenIP, Prairie State 345 kV Interconnect, Illinois**

---

Project Coordinator responsible for route analysis and selection. Also Soils Specialist responsible for soil resources inventory and analysis. The project involves construction of three new transmission lines to connect area generating plants to the AmerenIP transmission system. The lines include a 27-mile single-circuit 345 kV line and two short 345 kV tie lines, 1.5 and 7.5 miles long. POWER's scope includes route selection and siting of facilities, environmental studies, structure design and line design.

---

**St. Luke's Regional Medical Center, Wood River Hospital, Idaho**

---

Project Coordinator responsible for U.S. Army Corps of Engineers permit compliance. Compliance duties included semi-annual mitigation area evaluation and reporting, and vegetation planting and maintenance.

---

**AEP / West Texas Utilities, Putnam Three-Mile Tap, Texas**

---

Project Manager responsible for producing a route evaluation and environmental analysis. The analysis assessed specific impacts to the existing environment for this 138 kV project

---

**Touch America, Yakima to Burien Fiber Optic Line, Washington**

---

Project Specialist for environmental studies, impact analysis, mitigation, permitting and licensing for a new 180-mile long fiber optic line running between Yakima and Burien, Washington. Mr. Tatterson conducted field activities and prepared various local and state permits addressing shoreline protection, land use, and water resources.

---

**AEP / SWEPCO, Rogers to East Rogers Transmission Line Project, Arkansas**

---

Project Manager, responsible for providing a route evaluation and environmental analysis for 1.2 miles of 161 kV transmission line. This analysis evaluated the proposed route and the project's potential effects to the existing environmental.

---

**AEP / SWEPCO, Tontitown to Lowell Transmission Line Projects, Arkansas**

---

Project Manager responsible for producing a route evaluation and environmental analysis for approximately 10 miles of new 161 kV transmission line. This analysis evaluated the proposed route and the project's potential affects to the existing environment.

---

**Central Power and Light Company, Coletto Creek Power Station to Pawnee 345 kV Transmission Line, Texas**

---

Environmental Coordinator for an approximately 50-mile-long overhead transmission line. Responsible for an alternative routing analysis, US Army Corps of Engineers permitting, stormwater permitting, cultural resources investigation and clearance, and threatened and endangered species clearance. Also supported the environmental aspects of a contested Certificate of Convenience and Necessity before the Public Utilities of Texas Commission.

---

**Southwestern Electric Power Company, Mena to Craig Junction 138 kV Transmission Line Project, Arkansas and Oklahoma**

---

Environmental Coordinator for an approximately 50-mile-long overhead transmission line. Responsible for the routing assessment, US Army Corps of Engineers permitting, stormwater permitting, cultural resources investigation and clearance, and threatened and endangered species clearance.

---

---

**Central Power and Light Company, SKYGEN 138 kV Transmission Line Project, Texas**

---

Environmental Coordinator for four interrelated overhead transmission lines totaling approximately 35 miles. Responsible for an alternative routing analysis to support a Public Utilities of Texas Commission Certificate of Convenience and Necessity, US Army Corps of Engineers permitting, stormwater permitting, cultural resources investigation and clearance, and coordinating hazardous waste disposal.

---

**Southwestern Electric Power Company, EASTEX 138 kV Transmission Line Project, Texas**

---

Environmental Coordinator for an approximately 10-mile-long overhead transmission line. Responsible for an alternative routing analysis to support a Public Utilities Commission of Texas Certificate of Convenience and Necessity, US Army Corps of Engineers permitting, stormwater permitting, cultural resources investigation and clearance, and threatened and endangered species clearance.

---

**Southwestern Electric Power Company, Welsh Power Plant Intake Dredging, Texas**

---

Responsible for obtaining a US Army Corps of Engineers Letter of Permission and coordinating threatened and endangered species clearance.

---

**Central Power and Light Company, Whitepoint 345/138 kV Transmission Line Project, Texas**

---

Environmental Coordinator for three interrelated overhead transmission lines totaling approximately 30 miles. Responsible for an alternative routing analysis to support a Public Utilities Commission of Texas Certificate of Convenience and Necessity, US Army Corps of Engineers coordination, stormwater permitting, cultural resources investigation and clearance, and threatened and endangered species clearance.

---

**West Texas Utilities Company, Oak Creek Power Plant Intake Dredging, Texas**

---

Responsible for obtaining a US Army Corps of Engineers Letter of Permission and coordinating threatened and endangered species clearance.

---

**Central Power and Light Company, Chase Field 69 kV Transmission Line Project, Texas**

---

Responsible for an alternative routing analysis to support a Public Utilities Commission of Texas Certificate of Convenience and Necessity, landowner negotiations related to environmental issues, and coordination with federal and state agencies.

---

**West Texas Utilities Company, Paint Creek Power Plant Emergency Intake Dredging, Texas**

---



Responsible for obtaining a US Army Corps of Engineers Letter of Permission and coordinating threatened and endangered species clearance.

---

**Southwestern Electric Power Company, Longview 69/138 kV Transmission Line Project, Texas**

---

Environmental Coordinator for two interrelated overhead transmission lines. Responsible for an alternative routing analysis to support a Public Utilities Commission of Texas Certificate of Convenience and Necessity, US Army Corps of Engineers coordination, cultural resources investigation and clearance, and threatened and endangered species clearance.

---

**Central Power and Light Company, Mustang Island 69 kV Transmission Line Project, Texas**

---

Environmental Coordinator for an approximately two-mile-long overhead transmission line. Responsible for an alternative routing analysis, US Army Corps of Engineers permitting, threatened and endangered species clearance, and disturbance mitigation negotiations with several federal and state agencies.

---

**West Texas Utilities Company, North Laredo 138 kV Transmission Line Project, Texas**

---

Environmental Coordinator for an approximately two-mile-long overhead transmission line. Responsible for an alternative routing analysis to support a Public Utilities Commission of Texas Certificate of Convenience and Necessity, a phase I property assessment, and US Army Corps of Engineers coordination.

---

**Southwestern Electric Power Company, Fayetteville 69 kV Transmission Line Project, Texas**

---

Responsible for developing and submitting a US Army Corps of Engineers Pre-Construction Notification and subsequent negotiations with the Corps.

---

**Southwestern Electric Power Company, Knox Lee Power Plant, Texas**

---

Developed and presented to the public a power plant property reforestation and landscaping plan. Additionally, developed an erosion control and wildlife access plan for the power plant discharge canal.

---

**Southwestern Electric Power Company, Clarksville to Chambers Spring 345 kV Transmission Line Project, Texas**

---

Environmental Coordinator for an approximately 72-mile-long overhead transmission line. Responsible for an alternative routing analysis, US Army Corps of Engineers permitting, cultural resources investigation and clearance, and threatened and endangered species clearance.

---

**Central Power and Light Company, LG&E 138 kV Transmission Line Project, Texas**

---

Environmental coordinator for an overhead transmission line. Responsible for

an alternative routing analysis to support a Public Utilities Commission of Texas Certificate of Convenience and Necessity, US Army Corps of Engineers permitting, and threatened and endangered species clearance.

---

**Central and South West Services, South Hallsville No. 1 Lignite Mine, Texas**

---

Responsibilities included research plot design, installation and management; mine site compliance inspections; interface with federal and state regulators; technical document preparation and review; and consulting services for soils, vegetation, erosion related issues, and wetland permitting and mitigation.

---

**Central and South West Services, Dolet Hills Lignite Mine, Louisiana**

---

Responsibilities included research plot design, installation and management; mine site compliance inspections; interface with federal and state regulators; technical document preparation and review; and consulting services for soils, vegetation, and erosion related issues.

---

**Central and South West Services, Rogers Coal Mine, Oklahoma**

---

Responsibilities included mine site compliance inspections, interface with federal and state regulators, and preparation of a final reclamation plan.

---

**Southwestern Electric Power Company, Pirkey Power Plant Ash Disposal Mitigation Project, Texas**

---

Developed and implemented a wetland mitigation plan to compensate for unavoidable impacts resulting from the construction of an ash disposal pond. Negotiations with the US Army Corps of Engineers resulted in a mitigation plan consisting of wetlands creation, enhancement and preservation.

---

**Central and South West Services, Ash Creek Coal Mine, Wyoming**

---

Environmental Coordinator for an inactive surface coal mine near Sheridan, Wyoming. Responsibilities included technical document preparation, interface with state regulators, and preparation of a final reclamation plan.

Prepared Direct Testimony and Resume

of

David Tateosian  
(Power Engineers)

RERC

CEC Docket No. 08-SPPE-1

Prepared Direct Testimony  
of  
David Tateosian

Q Please state your name and place of employment.

My name is David Tateosian and I am a Senior Project Manager with POWER Engineers

Q What are your responsibilities with regard to the RERC 3 & 4 project?

I am responsible for the overall execution of the permitting and design activities for the project.

Q What is the purpose of your testimony in this proceeding?

My testimony is intended to support the engineering for the RERC project and to sponsor certain exhibits.

Q. What exhibits are you sponsoring?

I am sponsoring the following:

Exhibit 1 SPPE Application  
Section 7 Alternatives

Exhibit 2 Responses to Staff Data Requests  
Response 3 – Net operating hours and net generation  
Response 4 – GE SCR sodium poisoning

I, Dave Tateosian, hereby swear that the foregoing is true and correct to the best of my knowledge.

December 11, 2008  
Date

David Tateosian  
David Tateosian

## **DAVID TATEOSIAN, P.E.**

### **SENIOR PROJECT MANAGER**

#### **YEARS OF EXPERIENCE**

28

#### **EDUCATION**

- > M.S., Nuclear Engineering, University of California at Berkeley, 1980
- > B.S., Mechanical and Nuclear Engineering, University of California at Berkeley, 1979

#### **LICENSING**

- > Mechanical Engineer: California

#### **AREAS OF EXPERTISE**

- > Multidiscipline engineering team management
- > Consultation on generation plant permitting, engineering and operations
- > Engineering project management – greenfield and plant upgrades
- > Design production and supervision for mechanical, electrical and I&C systems

#### **AFFILIATIONS**

- > ANS
- > ASHRAE
- > ASME
- > IEEE
- > ISA
- > NFPA

#### **PUBLICATIONS**

- > "Cost Effectively Meeting California's Zero Liquid Discharge Requirements," POWER-Gen, December 2006
- > "Hot Times in the City: A Survey of Generation Plant Developments and Technology Approaches Being Undertaken by Municipal Utilities in California," POWER-Gen, December 2004
- > "Experience-Based Interview Process for Power Plant Management – With a Pilot Application to Aging of Outage Support Equipment," EPRI TR-1110089, March 1999

#### **EXPERIENCE SUMMARY**

Mr. Tateosian has extensive multidisciplinary technical and leadership experience in power generation permitting and engineering, as well as engineering management, in both utility and consulting environments. His background includes extensive experience in plant permitting, design, construction, operation, and evaluation of operating events from both a field and office perspective. In addition, he has participated in and led high-level process improvement teams as well as organizational development, engineering and operations management.

#### **DG Power, PG&E 2008 RFO Projects, California**

Project Manager and senior consultant responsible for POWER's Owner's Engineer services in support of projects developed and bid into PG&E's 2008 All Source Request for Offers. Services included site assessment, interconnect support, permitting assessment, negotiation with the power island and EPC vendors, and permitting through the California Energy Commission and local air districts.

#### **Ausra, Various Projects, Arizona, Nevada**

Project Manager and senior consultant responsible for providing Owner's Engineering services for development, conceptual design, and permitting of several hundred megawatts of solar thermal power plants.

#### **Ausra, Kimberlina Solar Demonstration Project, California**

Project Manager and senior consultant responsible for providing detailed design engineering services to support construction of Ausra's 5 MW solar thermal power demonstration project.

#### **Ausra, Carrizo Solar Energy Farm, California**

Project Manager and senior consultant responsible for providing Owner's Engineering services to develop the detailed conceptual design and support permitting through the California Energy Commission for 177 MW solar thermal power project.

#### **City of Riverside, Riverside Energy Resource Center Units 3&4, Permitting, Detailed Design & Construction Management, Riverside, California**

Project Manager and senior consultant responsible for POWER's services to permit, design, and provide construction management services for two additional units at the Riverside Public Utilities' Riverside Energy Resource Center. Scope of services included conceptual plant design, permitting through

the California Energy Commission and South Coast Air Quality Management District, power block equipment specification, construction specification, vendor and contractor negotiation and coordination, and supporting the Owner through construction.

---

**San Diego Gas and Electric, Siting Studies**

---

Project Manager and Senior Consultant responsible for the provision of Owner's Engineer services to assess two sites for potential generation project development to be permitted through the California Energy Commission. Assessments addressed suitable technologies, interconnection issues, initial conceptual designs, permitting issues, and development strategy.

---

**Imperial Irrigation District, El Centro Unit 3 Repower, California**

---

Project Manager and senior consultant responsible for providing Owner's Engineering services to the Imperial Irrigation District. The El Centro Unit 3 project involved the replacement of the 1957-era Unit 3 boiler with a new GE 7EA Dry Low NOx gas turbine with evaporative inlet air cooling and HRSG and reusing the existing Unit 3 steam turbine. Scope of services included conceptual plant design, support for the California Energy Commission and Imperial County AQMD, power block equipment specification and EPC specification.

---

**San Diego Gas and Electric, Miramar II Owners Engineering**

---

Project Manager and Senior Consultant responsible for the provision of Owner's Engineer services providing negotiation support for the development and EPC contract, providing technical support related to the major equipment procurements, and reviewing the EPC's final plant design.

---

**Imperial Irrigation District, Niland Gas Turbine Plant, California**

---

Project Manager and senior consultant responsible for providing Owner's Engineering services to the Imperial Irrigation District to install two 50 MW GE LM6000 NxGen gas turbines with SPRINT and dry low Nox combustors fitted with SCR and CO emissions control systems. Scope of services included conceptual plant design, permitting support for the California Energy Commission and Imperial County AQMD, power block equipment specification; EPC specification, vendor and contractor negotiation and coordination, detailed design reviews, visual simulations and supporting the Owner through construction.

---

**San Diego Gas and Electric, 2006 Generation Request for Offers**

---

Project Manager and Senior Consultant responsible for the provision of Owner's Engineer services developing the technical specifications for SDG&E's 2006 RFO for BOT and PPA generation as well as supporting subsequent technical and bid evaluations.

---

**City of Riverside, Riverside Energy Resource Center Units 1 & 2 Owner Engineering Services, Riverside, California**

---

Project Manager and senior consultant responsible for POWER's Owner's Engineering services for Riverside Public Utilities' new Riverside Energy

Resource Center. Scope of services included conceptual design, permitting through the California Energy Commission and South Coast AQMD, major equipment specification and selection, EPC specification and selection, vendor and contractor negotiation and coordination, detailed design reviews, visual simulations and supporting the Owner through construction.

---

**Sacramento Municipal Utility District, Sacramento and the Sierras, California**

---

Project Manager and senior consultant responsible for supporting a series of projects through a multi-year general services agreement for SMUD's generation assets. Projects included:

- > Various natural gas pipeline metering station upgrades
- > An assessment of various options to increase stream release capability at hydro generation facilities in support of FERC relicensing
- > A feasibility study for a new gas transmission line including development of the pipeline routing and identification of permitting issues and strategies.
- > Cathodic protection evaluation at the Cosumnes Power Plant

---

**Pacific Gas and Electric, Humboldt Bay, Hunters Point, Helms and Spaulding Power Plants, California**

---

Project Manager and senior consultant for a series of projects including:

- > Identifying the root cause of liquid fuel systems performance problems for a FT4 TwinPak combustion turbine peaking plant
- > Project management for the replacement of the generator step-up transformers and upgrades to the associated control and protection systems for the Spaulding Unit 3 hydro power plant
- > Technical evaluation, conceptual design and project cost estimates for the installation of a SERGI transformer protector system at Helms Pumped Storage Project
- > Upgrading Humboldt Bay Unit 2 for the installation of opacity monitors on the main stack

---

**Texas-Ohio Energy Company, Linden Steam/Reciprocating Plant, Linden, Guyana**

---

Project Manager and Senior Consultant hired to provide a study for Linden Power and the Guyana government, reviewing the power plant systems and operations for the Linden alumina mining operations and power system operation in Guyana. The project involved the upgrade of existing thermal and reciprocating generation plants at two sites associated with the Linden Bauxite mining operations. Site facility inspections and evaluation of existing and candidate replacement equipment were also part of the project. POWER reviewed repowering options for the systems, which uses a combination of oil-fired thermal generation (15 MW) and reciprocating generation (7MW) to run its operations and supply the local grid. The mining operations posed a considerable challenge because of large periodic loads occasioned by the operation on the Linden dragline, the world's second largest shovel.

---

**BF Goodrich, Chula Vista, California**

---

Mechanical Engineer responsible for providing mechanical engineering services for a 14 MW reciprocating engine based cogeneration plant generating hot water for process use.

---

**Other Projects**

---

- > Assessment of various industrial facilities both recip and combustion turbine-based cogeneration applications generating chilled water
- > Owner's engineering for a 120 MW combined cycle power plant focused on development of the EPC technical and commercial requirements
- > Assessment of plant configuration and permitting for a 50 MW combined cycle plant
- > Evaluation of wind and solar renewable power proposals for a western utility that were submitted in response to their RFO
- > Project management and mechanical engineering for various pipeline projects including the meter and receiving stations for a fuel oil pipeline

**PREVIOUS WORK HISTORY (OTHER FIRMS):**

---

**Director and Manager, Altran Corporation, San Francisco, California**

---

*Director:* Managed the 35-professional San Francisco office and the Controls Systems product line. Responsibilities included marketing and business development, project management, and consulting projects.

*Engineering Programs Group Manager:* Managed the Control Systems/Electrical and Risk and Reliability groups for a 140-person engineering and management consulting firm serving the power generation and pharmaceutical sectors.

- > Failure analysis of a 12 kV bus at a nuclear power plant
- > Management of a nuclear power plant piping reanalysis and upgrade project
- > Consulting services for resolution of plant design basis inconsistencies
- > Assessment of the effectiveness of a plant engineering program.
- > Project Manager for a complete reverification of a nuclear power plant motor operated valve design basis program. As Project Manager worked directly with the client at their plant site for one year integrating and managing a multi-office consultant team plus a site testing group.
- > Development of an Electric Power Research Institute (EPRI) application guide for experience-based interviews to address equipment problems and system upgrades for power plants. Project included interviews with plant staff at several sites to elicit experience and develop best practices.

---

**Engineering Manager and Engineer, Pacific Gas & Electric, San Francisco, California**

---

*Manager:* Reporting to the Vice President of Nuclear Technical Services, managed the Design Engineering Services department consisting of approximately 200 design professionals providing multidisciplinary design engineering for a large two-unit nuclear power plant and a smaller fossil/nuclear plant. The department's mission was to own and maintain the plant design basis, develop and engineer plant upgrade projects ranging up to several million dollars in value, support of immediate and longer-term operational issues, technical support of licensing and permitting of plant activities, failure analysis, and engineering programs such as configuration control and plant aging. Also served as a member of the Business Unit Management Team. Specific responsibilities included:



- > Management of staffing, budget, and performance of the department.
- > Led a working group of the western nuclear power plants Engineering Managers to submit comments on the Nuclear Regulatory Commission's proposed changes to 10CFR50.59 that governs a plant's ability to make changes without explicit regulatory approval.
- > Worked with other members of the Business Unit Management Team and direct reports to develop a plan for the engineering support function to align with future business needs in a deregulated environment. Our efforts resulted in a decision to close the San Francisco department and consolidate its functions into a plant-based engineering department. Implemented a comprehensive knowledge transfer process, relocation of engineers interested in moving, and de-staffing the department while assisting displaced people find subsequent employment. Through these efforts, in the end, only a few people in the department were left without future employment.
- > Developed and implemented an innovative plan to help address the loss of talent and human impact resulting from the closure of the department and the loss of key people who would not relocate. Gathered senior management support and identified engineering firms interested in attracting the key employees who would otherwise be lost to the company, then led a cross-functional diagonal slice team to evaluate the interested firms and develop a recommendation for senior officers as to the best firm. The recommendation was accepted in whole, resulting in a win-win-win for PG&E, the departing employees, and the successful engineering firm.
- > Served as a member of the Senior Management Training Oversight Committee, which provided oversight of training and qualification activities.

*Assistant to Senior Vice President and Business Unit General Manager:*

Reported to the Business Unit Manager, served as the senior Change Agent for the Business Unit working on process improvement, business strategy, competitiveness, employee issues, and communication issues. Specific projects:

- > Led a group of internal Organizational Design/Behavior consultants providing consulting within the Business Unit. This group was a primary resource for senior management, facilitating the cultural change within the business unit as part of a broader strategy to prepare for deregulation. Our team supported these efforts by providing leadership training at all levels of supervision, facilitating process improvement/re-engineering efforts, and other efforts.
- > Managed a project using a "Big 6" consulting firm to perform a "gap analysis" to understand the current and future business, and develop strategies for re-engineering the business to operate profitably in a deregulated environment. Developed a set of strategies that served as the basis for a subsequent re-engineering of the business unit.
- > Business Unit representative on a corporate-level team to re-design, communicate and implement a revised compensation system. The re-design addressed job titling and structure, base salary structure, incentive compensation, and recognition systems. Developed input on business needs, participated in the re-design, and communicated the results throughout the business unit in a series of workshops.
- > Served on the working committee of a collaborative effort among three utilities investigating the formation of a joint services company. Identified areas for synergy and cost savings, and developed recommended pilot projects for review by the senior officers that laid the foundations for current ongoing work.
- > Worked with Human Resources and the other two VP Assistants within the

Business Unit to identify internal placement opportunities for employees displaced as a result of cost reductions.

*Assistant to Vice President for Nuclear Technical Services:* Reported to the VP for Nuclear Technical Services, served as a Change Agent for the Business Unit working on process improvement, business strategy, competitiveness, employee issues, and communication issues. Specific projects:

- > Member of the consultant team deploying the General Electric Workout re-engineering process. Responsibilities included helping management frame the problem for a reengineering event, facilitating the events, and supporting the implementation teams through completion.
- > Worked on a project with a major vendor for the Business Unit to increase the effectiveness of the relationship while reducing cost.
- > Worked with HR and the other two VP Assistants within the Business Unit to identify internal placement opportunities for employees displaced as a result of cost reductions.

*Supervising Mechanical Engineer:* Team leader for the Design Change Process Improvement Project. This was a cross-functional team of people from within the Business Unit to re-engineer the design change process. Our team developed a more flexible and simplified process that reduced cost and increased quality of design changes. The results have stood the test of time, and the basic process continues to be used with enhancements as business needs change.

*Supervising Mechanical Engineer:* Responsible for the overall project, technical and financial performance of the Mechanical Systems Group. This group, composed of approximately 50 engineers, was responsible for providing mechanical systems and component design engineering services. The group provided support for existing designs, developing and implementing new design projects, plant operational support, and regulatory support. Projects ranged in size from small emerging projects, ongoing support of various programs such as fire protection and design basis management, to major capital projects of several million dollars in value.

*Senior Mechanical Engineer:* Led a succession of groups of 7-20 engineers in the areas of piping, mechanical systems and control systems. Worked closely with the engineers to provide services that met our client's needs including helping to develop solutions to problems, and assisting engineers in developing skills and career potential. In the course of these assignments, working at the corporate office and at a power plant, supported the plant through construction, start-up and operation. Provided engineering leadership for investigation and resolution of several operational issues and developed lasting solutions. Examples included chronic condenser tube leakage, damaging water hammers, improving performance of the water treatment system, pump performance issues, and equipment qualification. Also developed and implemented an innovative idea of using larger condenser manways as a way to achieve cost savings during condenser upgrades; these manways remain the standard means for access. In addition, I led a team of people from different utilities and power plants to develop a consensus approach on how to treat instrument, electrical and mechanical set-point uncertainties. Our results were later incorporated into an industry-wide standard (ISA 67.04).

*Mechanical Engineer:* Responsible for the design and analysis of piping systems, associated supports, and components. Undertook a 9 month field

assignment to support field design and resolve construction issues. Worked on special projects related to licensing activities with the NRC to investigate various technical issues, develop testimony, and manage supporting consultant efforts.

Prepared Direct Testimony and Resume

of

Harry Hall  
(Power Engineers)

RERC

CEC Docket No. 08-SPPE-1

Prepared Direct Testimony  
of  
Harry Hall

Q. Please state your name and place of employment.

My name is Harry Hall and I am employed by POWER Engineers, Inc.

Q. What are your responsibilities with regard to the RERC 3 & 4 project?

I am a professional engineer and the Project Manager responsible for the RERC 3&4 project design.

Q. What is the purpose of your testimony in this proceeding?

I am submitting testimony to support the engineering parts of the permit application and to sponsor certain documents that have been submitted in the proceeding.

Q. Please identify the exhibits you are sponsoring

Yes. I am sponsoring the following:

Exhibit 1	Section 2	Project and RERC Facility Description
	2.2	Site Location and Layout
	2.4	Schedule
	2.5	Process Description
	2.6	Fuel System
	2.7	Water Supply and Use
	2.8	Wastewater
	2.10	Plant Auxiliaries
	2.11	Electrical System
	2.13	Plant Controls
	Section 3	Energy Efficiency
	Section 5	Transmission System Engineering
	5.1	Introduction
	5.2	Project Description
	5.3	Laws, Ordinances, Regulations and Standards
	5.4	Sub Transmission Facilities
Exhibit 2	Data Request Responses 47-54 and Attachments 1-5	
Exhibit 3	Letter to F. Miller with RPU planning criteria July 22, 2008	
Exhibit 4	Sketches ECGSKE-02 and ECGSKE-3, 7/22/08	

- Exhibit 5 Drawing Depicting 69kV switchyard sections, 7/22/08
- Exhibit 6 RPU plans for future 69kV network, 8/12/08
- Exhibit 7 RERC 3&4 Transmission Supplement, 9/4/08

I, Harry Hall, hereby swear that the foregoing is true and correct to the best of my knowledge.

12/15/08

Date



Harry Hall

## **HARRY HALL**

### **SENIOR PROJECT MANAGER**

#### **YEARS OF EXPERIENCE**

31

#### **EDUCATION**

- > M.B.A., Michigan State University, East Lansing, Michigan, 1979
- > B.S., Mechanical Engineering, Clemson University, South Carolina, 1972

#### **LICENSING**

- > Mechanical Engineer: Alaska
- > Mechanical Engineer: Idaho
- > Mechanical Engineer: Georgia
- > Mechanical Engineer: Montana
- > Mechanical Engineer: Washington
- > Mechanical Engineer: Wyoming

#### **AREAS OF EXPERTISE**

- > Management and direction of multidisciplinary engineering for power plants.
- > Supervising technical staff, performing conceptual and detailed engineering, and reviewing and approving design documents.
- > Project Manager and/or Project Engineer for several projects ranging from a \$3 million repowering to a \$200 million cogeneration project.
- > conceptual engineering, environmental assessment and engineering research.
- > Use of project schedules and budgets to manage projects.
- > Preparation and use of discounted cash flow economic analysis to determine NPV, IRR, payback period, tax treatments, and financing alternatives in support of management decisions.
- > Management of staff, consultants and contractors for large and multiple projects.

#### **EXPERIENCE SUMMARY**

Harry Hall is a professional mechanical engineer with more than 30 years of high-level design, consulting, design management and development experience on power plant projects: design, permitting construction, start-up, and operations. His background includes coal, biomass, hydroelectric, natural gas (steam and combustion turbine), transmission and nuclear facilities. Career history includes leadership positions with Entergy, Fletcher Challenge, the Idaho PUC, and Ebasco, as well as consulting service to Foster Wheeler, KFx, Effective Energy Corp., Yanke Energy, and QVL.

As Director of Development Latin America for Entergy Power Group, Mr. Hall set up and staffed the Latin American office and directed the development of projects there. As Vice President for Fletcher Challenge Power generation, he managed two offices in the Pacific Northwest and successfully developed a large cogeneration facility; and as Executive Director managed the contracting, financing, construction and start-up of two combined cycle cogeneration projects in Las Vegas. Business experience includes service as a corporate director, creating partnerships, developing projects, performing economic analyses for acquisitions, startups, contract negotiation, and project financing.

#### **University of California, San Francisco, Gas Turbine Cogeneration Study, California**

Project Manager and Engineer responsible for project definition gas turbine cogeneration study. Work included determination of annual electric and steam load duration curves, matching and evaluation of gas and steam turbine options and recommendation of a selected technology.

#### **City of Riverside, Riverside Energy Resource Center Units 3&4 Owner Engineering Services, Riverside, California**

Project Manager for the design of a two unit LM6000 NxGen project at RPU's RERC. Scope of work included design support for permitting with the California Energy Commission (CEC), detail design of the plant for a design/construct project, specification and procurement support for city purchase of all major equipment and engineering support during construction and start-up.

#### **San Diego Gas and Electric, Site and Technology Selection Study, California**

Project Engineer for a site and technology selection study for a 100MW (nominal) gas turbine peaking project to be built at one of two SDG&E-owned sites. Work included environmental and physical characterization of three sites and development of conceptual design for three technologies followed by evaluation and recommendation of a site and technology.

---

**Principal Owner and Consultant, S & H Consulting, Boise, Idaho**

---

Provided consulting on natural gas and oil fired gas turbine projects, biomass cogeneration projects and other projects involving operational issues, fuel supply and power sales agreements. Non-electric generation projects include transmission studies for Okanogan PUD as a sub-consultant to Foster Wheeler Environmental and coal beneficiation research for KFx.

---

**Director of Development, Latin America, Entergy Power Group, Ft. Lauderdale, Florida**

---

Responsibilities included 1) establishing and staffing the Florida office; 2) working with European and South American energy companies to create partnerships and develop projects; 3) Evaluating and screening projects, partners and investment opportunities; and 4) serving as a Member of the Board of Directors of Edegel (Peruvian power company), Edesur (Buenos Aires power company) and Transener (Argentinean transmission line owner-operator).

---

**Officer in Charge of North American Utility Operations, Fletcher Challenge Limited, Seattle, Washington**

---

Directed and managed the development of a CDN\$220 million gas-turbine based electrical cogeneration partnership on Vancouver Island in British Columbia. Negotiated agreements and ran the due diligence and acquisition of a 25 percent interest in a high-technology turbine manufacturing venture. Continued as the officer responsible for managing FCL's interest in the investment and, as a board member, led the successful search for a CFO, participated in finding a VP marketing and was key member of new CEO search team.

---

**Development Director, Bonneville Pacific Corporation, Salt Lake City, Utah**

---

Responsible for evaluating, packaging and selling existing operations in Hawaii, Washington and Canada. Executive Director responsible to a Board consisting of Texaco Cogeneration and Power and Bonneville Pacific for the successful development, contracting, financing, construction and operation of a \$200 million six unit electric gas turbine cogeneration project involving two sites near Las Vegas, Nevada.

---

**Supervisor and Project Manager, Ebasco Services Incorporated, Bellevue, Washington**

---

Responsible for securing and ensuring profitability of engineering contracts including one with Tacoma City Light which resulted in the successful conversion of retired generating assets to useful waste conversion facilities. Successfully managed several consulting projects involving construction, engineering, economic and financial evaluation, cost and schedule controls, and contracting at waste handling and reduction facilities, coal fired power plants and hydroelectric facilities.



Prepared Direct Testimony and Resume

of

John Squire  
(Power Engineers)

RERC  
CEC Docket No. 08-SPPE-1

Prepared Direct Testimony  
of  
John Squire

Q Please state your name and place of employment

My name is John Squire and I am an electrical engineer with Power Engineers

Q What are your responsibilities with regard to the RERC 3 & 4 project?

I have provided engineering support and analysis for the Electrical Transmission Impact Study detailing the system load flow and short circuit impact of to the RERC 3 & 4 project. Additionally, I am responsible for information on the Riverside transmission system.

Q What is the purpose of your testimony in this proceeding?

The purpose of my testimony is to identify my role in providing information on the RERC 3 & 4 project and to sponsor certain exhibits.

Q. What exhibits are you sponsoring?

I am sponsoring the following:

Exhibit 1

Section 5.5 Sub transmission Interconnection Engineering

I, John Squire, hereby swear that the foregoing is true and correct to the best of my knowledge

12/15/2008

Date

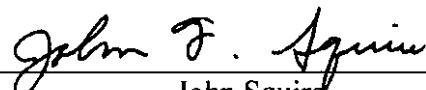
  
John Squire



## **JOHN SQUIRE**

### **SENIOR ELECTRICAL SYSTEM STUDIES ENGINEER**

#### **YEARS OF EXPERIENCE**

11

#### **EDUCATION**

- > B.S., Electrical Engineering, Montana State University, 1997

#### **SPECIAL TRAINING**

- > SEL-421 Protection, Automation, and Control System Certified

#### **LICENSING**

- > Engineer in Training: Idaho

#### **HARDWARE/SOFTWARE**

- > Stoner and Associates' DPA/G and SynerGEE Electric
- > Electrocon's CAPE (Computer Aided Protection Engineering)
- > ASPEN OneLiner and DistriView
- > MathCAD
- > SKM Power Tools
- > Milsoft
- > Power Technologies, Inc. (PTI) PSS/E
- > Safe Engineering Services (SES) CDEGS (Current Distribution, Electromagnetic Interference, Grounding and Soil Structure Analysis)

#### **EXPERIENCE SUMMARY**

Mr. Squire is experienced in a broad range electrical system studies and analyses. These include transmission and distribution protective device coordination, modeling and analysis of transmission and distribution systems, fault and load flow studies, sectionalizing studies, long range plans, and construction work plans. Additionally, Mr. Squire has completed certification requirements for working directly with the SEL-421 Protection, Automation, and Control System.

#### **City of Riverside, Transmission Reliability Project-Phase I, California**

---

Studies Engineer for the project definition phase for a proposed new 230 kV interconnection into the Southern California Edison (SCE) transmission system. Analyzed the existing 69 kV transmission system for equipment loading and voltage drop to determine if upgrades were required. Analysis of the system was then performed with the system split between the existing 230/69 kV intertie and a new 230/69 kV intertie. Equipment loading and voltage drop for the split system were analyzed, with multiple upgrade options reviewed to mitigate problems found. A final list of suggested 69 kV system upgrades was delivered, along with a proposed construction sequence. The Riverside Transmission Reliability Project (RTRP) includes a new 230 kV transmission line, new 230 kV substation, 69 kV tie lines to the Riverside Public Utilities electrical grid and electrical upgrades to existing 69 kV lines and substations within Riverside's electrical system. POWER provided project scoping, conceptual engineering and permitting services.

#### **City of Riverside, Relay Replacement Study, California**

---

System Protection Engineer for the development of a modern relaying package for the City's 69 kV transmission lines. Reviewed available relays and prepared a report outlining recommendations. POWER recommended a simple modern numerical line differential relay plus one full featured numerical line distance relay that provides not only step-distance and communication aided line protection but also breaker failure and synch check functions for both breakers in a breaker-and-a-half or ring bus substation. The use of only two relays reduced panel space, simplified wiring, and reduced cost. POWER prepared typical single line, three line, and DC schematic drawings for the protective relaying terminal.

#### **Mitsubishi Electric Power Products, Rector Substation SVC, California**

---

Studies Engineer responsible for protective relaying including the transformer differential and overcurrent relaying, bus differential, zig-zag grounding bank, thyristor controlled reactor (TCR), thyristor switched capacitor (TSC), and 3rd, 5th, and 7th harmonic capacitor filter banks. POWER was a subcontractor to

Mitsubishi Electric Power Products, the EPC contractor. The new system provides -120 to +200 Mvar continuous compensation. POWER's scope included complete physical arrangement, busing, foundation, structures, static protection, lighting, grounding, protection and control, wiring, control shelter, station service, relay settings, testing and commissioning, and fiber optic communications with SCE.

---

**City of Vernon, Matheson Tri-Gas 66 kV Switching Station, California**

---

Lead Studies Engineer responsible for supervision of ground grid analysis, and ensuring compliance with QA/QC procedures for the study. POWER provided design for physical, civil, structural and electrical aspects of the project. The project included a two terminal, radially fed switching station with one breaker, switches and metering for a new facility substation.

---

**Trinity County PUD, System Modeling, California**

---

Studies Engineer responsible for modeling all distribution feeders of the Trinity County PUD system. The system was modeled in Advantica's SynerGEE Electric software and included system loads, voltage regulators, capacitor, reclosers, relays, and transmission voltage fuses. The models were all created to be geographically correct to be more useful to PUD personnel. Once the system was modeled short circuit and load flow analyses were run, with capacitor placement analysis then run on those feeders that exhibited voltage problems. Upon completion of the short circuit and load flow analysis, a protective device coordination study was performed. The coordination was performed in SynerGEE, and proceeded from the high side of the substation transformers through the feeder breakers and out to the end of each feeder.

---

**PG&E, Protective Relaying, California**

---

Engineer responsible for the protective relaying on a project to add a new 252/336/420 MVA, 230/115 kV autotransformer. The protective relay settings required conformance with utility guidelines and working closely with the utility protection engineers. Multi-function relays were used, with relay front panel push buttons and relay logic used to perform functions typically done with discrete panel mounted switches and lockout relays. The protection for the new transformer included redundant transformer differential relays, an overcurrent relay in the tertiary, a distance backup relay and an overcurrent relay backup. Bus protection was included in one of the transformer differential relay zones, with backup protection being provided by overcurrent and distance relays. A synch check and reclosing relay was used along with breaker failure relays on the circuit breakers.

---

**Silicon Valley Power, Mathew Substation and South Loop Coordination, California**

---

Engineer responsible for protective device coordination for the new 60 kV-12.47 kV Mathew substation and the existing South Loop. Substation coordination included phase and ground time overcurrent and differential elements. South Loop coordination included line differential and directional overcurrent protection between seven looped substations. Relays included SEL-267, Westinghouse CR & IR.

---

**Calpine Corp, 230 kV Relay Coordination, California**

---

Engineer on this protective device coordination study for a 230kV Line. Coordination included a DCB scheme (primary & secondary), as well as backup phase and ground overcurrent elements. Relays included SEL-279, SEL-321, REL-512.

---

**Pacific Gas & Electric, Grounding Analyses for Various 115 kV Substations, California**

---

Studies Engineer responsible for grid testing and grounding analyses of various PG&E substations, performed under an open-ended General Services Agreement.

---

**Calpine, Metcalf Energy Center, California**

---

Engineer responsible for reviewing protective relay settings for transformer differential, high impedance bus differential, and breaker failure relays. The plant capacity is 726 MVA and connected to a PG&E 230 kV system.

---

**Public Utility District No. 1 of Douglas County, 115 kV and 230 kV Relay Coordination, Washington**

---

Studies Engineer for a protective device coordination study of the 115kV and 230kV transmission system line and substation relaying. Coordination included primary and secondary POTT schemes (using MIRRORRED BITS™ communications via microwave and fiber) primary and secondary distance, phase and ground overcurrent, differential, breaker failure and reclosing elements. Relays included SEL-311C, SEL-321, SEL-351A, and SEL-587. Recommendations were developed to improve the system protection and interface with the District's modern fiber optic communication network and SCADA system.

---

**Public Utility District No. 1 of Douglas County, Foster Creek Substation Relay Coordination, Washington**

---

Studies Engineer for a protective device coordination study at the Foster Creek Substation. Douglas County PUD hired POWER to prepare the study after the PUD replaced breakers in the 115 kV portion and replaced old relays with modern electronic devices. The coordination study included primary and secondary distance and phase and ground overcurrent elements.

---

**Public Utility District No. 1 of Douglas County, Three-Year Construction Work Plan and Long Range Plan, Washington**

---

Studies Engineer for a construction work plan and long range plan. Duties included system modeling, load flows, short circuit analysis, protective device coordination, and evaluation of the electric power system in Stoner Associates DPA/G software. Responsible for recommending system improvements and detailing associated costs. POWER modeled, analyzed and evaluated the electric power system and recommended system improvements with associated costs. POWER also prepared a long range plan of loads projected 5, 10 and 20 years from the time of the study and made recommendations for system improvements.

---

---

**Public Service of New Hampshire, Scobie Pond 115 kV Substation, New Hampshire**

---

Engineer responsible for modeling the substation grounding grid and performing analysis to achieve electrical safety, assure equipment protection and minimize risk to personnel. Made recommendations for meeting IEEE 80 standards for step and touch potentials. POWER was responsible for design and construction support for a new four bay 115 kV breaker and a half station to replace an aging station on the same site. The project had significant permitting and site grading issues and required staged construction and cutover of circuits from the existing station to the new facility. The project included design and commissioning of the new protection and control and SCADA and automation systems.

---

**Princeton University, Campus Electrical Distribution Study, New Jersey**

---

Engineer responsible for reviewing the studies reports and protective device coordination. Made suggestions for modifications in device coordination. The study encompassed an existing system analysis and near-term and long-term plan that identified major facilities upgrades and modifications required to meet anticipated load growth during the plan period. The studies provided a means for determining how well the distribution system performs under various operating conditions and the areas of the system requiring improvements. The analysis included examination of the systems load flow, voltage levels, short circuit currents and protective device settings and coordination. It also examined the use of a SCADA system for data collection and control of the electrical system facilities. A report describing the near-term and long-term recommendations for improving the campus system's reliability was prepared from the results of the study.

---

**PECO Energy, Tuna 138-69-13.8 kV Substation, Pennsylvania**

---

Studies Engineer responsible for protective relaying for this new substation in downtown Philadelphia.

---

**Perini Corporation, Buzurgan Substation, Amarah, Iraq**

---

Studies Engineer on the protective device coordination study for the fast-track development of the new 132kV Burzurgan Substation in southern Iraq. This U.S. Army Corps of Engineers project was part of the Iraq reconstruction effort. The substation is a five-breaker ring bus configuration designed to interconnect a new combustion turbine generating facility (also designed by POWER) with three existing transmission lines. POWER provided project management, physical and electrical design, equipment procurement, relay coordination, testing of relay panels, field engineering and construction inspection. Design and material purchase were completed in eight weeks.

---

**Perini Corporation, Nasiriyah Substation, Nasiriyah, Iraq**

---

Electrical Engineer responsible for relay coordination for the interconnection of a new POWER-designed 50 MW power plant with an existing 132kV substation located at a gas-fired thermal generating facility. The U.S. Army Corps of Engineers project was part of the effort to restore the Iraqi electricity infrastructure. POWER's scope of work included modification of the existing

---

20-year-old, Russian-built substation, design of the terminations at the new generating plant and the existing substation, and design of 3 km of 132 kV underground connecting cable.

---

**Public Utility District No. 1 of Ferry County, Long Range Plan, Washington**

---

Project Engineer for development of a long-range plan to meet present and future demands. POWER prepared a load forecast, long-range plan, construction work plan, and environmental report under RUS guidelines. The distribution and sub-distribution systems were modeled and analyzed using Advantica's SynerGEE Electric software. Load flow analysis was performed at four intervals of the 10-year plan, with system loading based on the developed load forecast. Mitigation options were proposed for system overloads and low voltages. Recommended system improvements consisted of installation of new line voltage regulators, reconductoring of lines, installation of 2nd and 3rd phases, and improvements to metering and reclosing equipment that will facilitate the development of a SCADA system.

---

**Sulphur Springs Valley Electric Cooperative, Bonita Substation Protective Relaying Set Coordination, Arizona**

---

Project Engineer responsible for relay settings and checking. POWER performed a complete review of the relay settings and protection schemes at Bonita Substation, an existing 69/12.47 kV substation containing one power transformer, with four 12.47 kV feeders. POWER verified that the relays were properly set and coordinated and made required modifications. Settings verification included enforcing utility and IEEE capacitor switching time delays, transformer differential settings, and verifying feeder coordination with downstream devices and auxiliary generator breakers. All existing relays were SEL including an SEL-587, SEL-551, SEL-351-7 on the transformer and SEL-351S relays on each of the feeders and capacitor banks.

---

**Sulphur Springs Valley Electric Cooperative, Tombstone 69-24.9 kV Substation, Arizona**

---

Project Engineer responsible for Quality Assurance / Quality Control as well as technical oversight for the multi-function relaying work for a new 60-24.9 kV substation. Performed detailed reviews of relaying and design philosophy as well as calculations and relay setpoints and logic. POWER provided electrical design and drawings, SCADA design and implementation, protective relaying schemes and settings, and testing and energization on this greenfield distribution substation. The substation configuration includes a 69-24.9 kV power transformer, three 25 kV voltage regulators, four 25 kV circuit breakers and associated switches and busing.

---

**U.S. Air Force, Master Planning Study, Altus AFB Electrical Distribution System, Oklahoma**

---

Studies Engineer responsible for load flow and short circuit studies for a project to evaluate the primary electrical distribution for the base. Also worked on the coordination for the protective devices. POWER conducted an independent economic and engineering study of the base's electrical distribution system, including substations and flood/area/street lighting systems. The scope of work included a distribution system inventory and

mapping, computer modeling, and load flow/short circuit analyses to determine existing conditions and make recommendations for the future system with projected load growth. POWER computerized the inventory using Global Position Satellite location equipment and transferred the system data into a GIS database. The electrical system equipment data is now available in electronic media with hard copy output available in tabular and/or geographic one-line map format.

---

**U.S. Air Force, Master Planning Study, Luke AFB Electrical Distribution System, Arizona**

---

Studies Engineer responsible for analysis of the protective device settings. Also performed short circuit and load flow analysis. POWER conducted an independent economic and engineering study of the base's electrical distribution system, including substations and flood/area/street lighting systems. The scope of work included a distribution system inventory and mapping, computer modeling, and load flow/short circuit analyses to determine existing conditions and make recommendations for the future system with projected load growth. POWER computerized the inventory using Global Positioning System location equipment and transferred the system data into a GIS database. The electrical system equipment data is now available in electronic media with hard copy output available in tabular and/or geographic one-line map format.

---

**Sulphur Springs Valley Electric Cooperative, San Simon 69-24.9 kV Substation, Arizona**

---

Electrical Engineer responsible for developing protective relay settings. POWER provided civil/structural, physical, electrical, and SCADA design. The substation configuration includes a 69-24.9 kV power transformer, three 25 kV regulators, three 25 kV breakers and associated switches and busing. POWER also helped to procure steel for construction and wrote the construction bid contract.

---

**Sulphur Springs Valley Electric Cooperative, Mobile Substation Upgrade, Arizona**

---

Studies Engineer responsible for QA/QC checks on protective relaying philosophy and device settings, and provided technical support to field personnel during testing and commissioning. POWER was responsible for upgrading Mobile Substation with new microprocessor relaying, installing an Orion SCADA unit and wiring the new circuit switcher. POWER worked with SSVEC to provide an updated protection scheme using an SEL-387, which allowed for setting groups to be changed easily for the different connection voltages. POWER provided a SCADA design and communication system as well as testing support of Mobile Substation and commissioning of the SCADA communication system.

---

**Sulphur Springs Valley Electric Cooperative, Fort Huachuca Distribution System Sectionalizing Study, Arizona**

---

Project Engineer responsible for technical oversight including checking calculations, analysis and deliverables. POWER performed a sectionalizing study of the 13.8 kV delta-connected Fort Huachuca distribution system. Tasks included data analysis and review both off- and on-site, system modeling,



protection philosophy development, protective device coordination and settings, and detailed feeder summary reporting. The project included analysis of 14 feeders consisting of combinations of overhead and underground loads and lines, capacitor protection, coordination and device selection involving transformer and Cooper SMU PME fuses, SEL-351R recloser controls, and SEL-351S feeder protection relays.

---

**Sulphur Springs Valley Electric Cooperative, Hawes 69-24.9 kV Substation, Arizona**

---

Electrical Engineer responsible for developing protective relay settings. POWER provided civil/structural, physical, electrical, and SCADA design. The substation configuration includes two 69-24.9 kV power transformer, three 25 kV regulators and three 25 kV breakers from each transformer, bus tie breaker, and associated switches and busing. POWER also helped to procure steel for construction and wrote the construction bid contract.

---

**PECO Energy, Plymouth Meeting Substation Expansion, Pennsylvania**

---

Studies Engineer responsible for protective relaying for this substation expansion project. Two new distribution transformers were added to this aging substation.

---

**PacifiCorp, Harrison-Lincoln Line Study, Oregon**

---

Studies Engineer responsible for running the power flow cases with and without n-1 outage contingencies. Reviewed results and determined the feasibility of each route. Also responsible for detailing construction costs for each route option and creating drawings showing the routes. POWER conducted a study of a Portland-area transmission system to determine feasibility and costs estimates for five options for providing a second source of power to a substation serving downtown Portland. The alternatives included rebuilding an existing 115 kV line that crosses the Willamette River, building a new line, replacing the line with cable attached to bridges, construction of a new underground line, and directional drilling under the river.

---

**Coos-Curry Electric Cooperative, Sectionalizing Study, Oregon**

---

Project Engineer responsible for the development of a system-wide protective device coordination study. The entire CCEC system, which included 53 miles of 115 kV transmission line, 1500 miles of distribution line, and 42 feeders supplied from 15 substations, was modeled using the ASPEN DistriView software package. Recommendations for new equipment and/or settings were provided.

---

**City of Hurricane, Five-Year Work Plan, Hurricane, Utah**

---

Studies Engineer for a comprehensive five-year work plan of the City's existing and projected 12.47 kV distribution system. POWER conducted computer power flow analysis using SynerGEE software. Based on the results of the analysis, POWER made recommendations for system upgrades and verified on the computer model the results of these improvements. In addition, POWER performed a comprehensive short circuit and coordination study and made recommendations for recloser settings and fusc sizes.

---

**Aragonne Wind LLC, Aragonne Mesa Wind Farm, New Mexico**

---

Studies Engineer responsible for reviewing protection scheme and relay settings including a 34.5 kV underground collection system, a 34.5 kV/138 kV collection substation, 20 miles of 138 kV line, and a 138 kV/345 kV interconnect substation. The scheme involved providing distribution feeder, power factor correction equipment, bus, transformer and dual redundant high speed line protection, as well as a custom restoration scheme for restoring most of the system for line faults. Various relays were used in the protection scheme including SEL-352, SEL-387A, SEL-311C, SEL-311L, SEL-587Z and SEL-351A relays. Aragonne Wind LLC initiated the EPC development of the 90 MW Aragonne Wind generation facility on Aragonne Mesa, New Mexico. POWER was responsible for complete design of the 90 x 1 MW Mitsubishi turbine farm. In detail, POWER was responsible for complete civil design, 40 miles of gravel roads, turbine foundation design, O&M building design, transformer and equipment foundations and structures, 34.5 kV underground electrical system, 100 MVA 34.5/138 kV substation, SCADA and protective relaying, 23 miles of 138 kV transmission line, 1000 ft of UG 138 kV line and 138/345 kV interconnection substation.

---

**Bryan Texas Utilities, Atkins Substation Project, Texas**

---

Studies Engineer responsible for the protective device coordination study associated with a substation expansion project. POWER provided engineering and design services for the expansion of the Atkins Substation to provide additional 138 kV sources into BTU's system and voltage support during the peak summer months. POWER's scope included the design of a new 138 kV five breaker ring bus scheme and capacitor bank addition, a complete 69-12 kV breaker and relaying upgrade, and relocation of five 69 kV lines and two 138 kV lines.

---

**CenterPoint Energy, Glenwood Substation E+PC Rebuild, Texas**

---

Studies Engineer responsible for relay and control design. POWER performed engineering design, procurement and construction (E+PC) for the rebuild of the 138/12.47 kV Glenwood substation. The project provides Centerpoint with an upgraded station that is easily expandable for future needs. The rebuilt station consists of two 20 MVA power transformers, a six breaker ring bus, new control house with updated relaying and SCADA, and installation of two 138 kV potential transformers.

---

**Emerald Performance Materials, LLC, Breaker Rating and Arc Flash Study, Washington**

---

Project Engineer responsible for modeling the distribution system as part of a study to determine the potential for arc flash hazards at the facility. POWER was contracted to gather data (field survey, old studies, system drawings, etc.), and to create a computer model of the system. POWER then used the model to calculate the fault currents at each bus (480 V and higher) in the system. These results were compared to device ratings to identify insufficiently rated equipment. The fault currents, along with the nominal breaker ratings, were used to calculate the arc flash energy that could be seen if a breaker were to fail (based on IEEE-1584 and NFPA equations). The protective clothing required for each of these energy levels was then listed.

---

**Interstate Construction, Elmendorf Air Force Base Electrical Upgrade, Alaska**

---

Studies Engineer responsible for modeling, performing short-circuit and load-flow analysis, protective device coordination and grounding analysis. Coordination included differential, phase and ground overcurrent, directional and distance elements. POWER performed engineering services for this design-build contract to install four 15 kV underground distribution circuits, two 35 kV underground subtransmission circuits, and one dual bay 14MVA 35 kV-15 kV substation as specified by the Army Corps of Engineers.

---

**Mitsubishi Heavy Industries, Mindanao II Geothermal Power Plant, Philippines**

---

Studies Engineer responsible for geothermal plant protective device coordination. Coordination included differential, phase and ground overcurrent, distance, directional, under/over voltage, under/over frequency, synch check and breaker failure elements. POWER was responsible for design work for this geothermal project, the companion plant to the Mindanao I plant. This project involved design and construction of a separate low-pressure flash plant. POWER's design scope included site design, plant facilities, a substation, generation and distribution controls, a cooling tower, and plant piping and pump systems. POWER also provided procurement and on-site construction support.

---

**Montana Alberta Tie Limited, Marias Switchyard, Montana**

---

Studies Engineer responsible for overseeing the grounding analyses to achieve electrical safety and assure equipment protection and minimize risk to personnel. Performed analyses using Safe Engineering Service's CDEGS software to verify that the grounding system at this substation was within IEEE Standard 80-2000 guidelines for step and touch potentials. POWER is responsible for an engineer-procure-construct (EPC) contract for the Marias Switchyard, a key component of the Montana Alberta Tie Ltd. (MATL) transmission line, a 215 mile, 230 kV AC transmission line that will interconnect the energy markets of Alberta and the U.S. Marias Switchyard serves as the interconnect point for 300 MW of wind generation and provides voltage control for the project with two series capacitor banks, 150 Mvar and 84 Mvar, and four 40 Mvar shunt capacitor banks.

---

**Northern Lights, Long Range Plan, Idaho**

---

Project Engineer responsible for supervising the modeling and analysis on this long range plan. Also provided technical expertise on mitigation or system upgrade options, as well as review of analysis and recommendations. This long range plan covered a ten year span, 15 substations and 27 feeders.

---

**Mitsubishi Heavy Industries, Cerro Prieto 100 MW Geothermal Plant and 161 kV Substation, Mexicali, North Baja, Mexico**

---

Studies Engineer responsible for protective device coordination of geothermal power plant. Coordination included transformer and generator differential, directional, under/over voltage, phase and ground overcurrent, distance, under/over frequency, synch check and breaker failure elements. Relays

---

included SEL-321, SEL-221F, SEL-2BFR, SEL-387, SEL-587, SEL-300G, ABB 87B. The 100 MW generation plant consists of four 25 MW turbine-generator units, a 161 kV plant substation, a plant control room, a cooling tower and ancillary facilities and systems. POWER's responsibilities included plant layout and design, plant substation design, preparation of design and construction documentation, design criteria and purchase specifications, equipment expediting and tracking, project scheduling, construction support, and equipment testing. The Cerro Prieto complex is owned and operated by Comision Federal de Electricidad (CFE), the national utility of Mexico.

---

#### **Kenya Power and Lighting Company, Transmission Projects Feasibility Study, Kenya**

---

Studies Engineer for a study to assess Kenya's transmission grid and develop options for adding power infrastructure. Responsibilities included load flow and short circuit analysis, optimum transmission voltage report and performance requirements. POWER's review and analysis was needed to assess and prioritize four transmission system projects and help acquire the funding to build them. The project involved developing a computer model of the entire KPLC bulk electric generation and transmission system and performing load flow, short circuit and dynamic stability studies to determine system performance and requirements to reliably serve load.

---

#### **Mirant, Arc Flash Hazard Analysis, Multiple Sites**

---

Lead Studies Engineer responsible for providing direct supervision for engineers building models and performing analysis. Also served as technical reference, coordinated review processes and coordinated with plant personnel to acquire data as needed. POWER provided arc flash, coordination and device evaluation analysis for ten of Mirant's major generating facilities. Tasks included on-site data acquisition and development of plant electrical models. Short circuit analysis were performed to evaluate protective device ratings. Arc flash analysis was performed to identify incident energies and personal protective equipment (PPE) levels for working near energized equipment. Changes to protective device equipment and settings were recommended.

---

#### **AMC Engineers, Providence Alaska Medical Center Cogen, Anchorage, Alaska**

---

Studies Engineer for this stability study. Produced a dynamic stability model using PTI's PSS/E software. Analyzed stability when hospital generator was connected and disconnected from the main power grid. POWER was selected by AMC Engineers as a partner firm for the initial feasibility study work and installation designs for a gas turbine-cogeneration unit at Providence Alaska medical Center (PAMC) in Anchorage. The plant was designed to supply the hospital with 2,800 kW of electrical power, with excess power exported to the municipal grid, and up to 54,000 lbs/hr of process steam for the facility.

---

#### **Mortenson, Sweetwater Wind Power 4 Project, Texas**

---

Engineer responsible for developing relay settings for the 230 MW phase four of a wind generation project including two 345 kV/34.5 kV auto-transformer protection schemes and protection of the 34.5 kV collection system. This scheme involved protection of the auto transformers using SEL-387As and SEL-587Zs, a fast bus tripping scheme for the 34.5 kV bus and collection

---

feeders using SEL-351A relays.

---

**Nippon Paper USA, Load Flow, Arc Flash, Coordination, Washington**

---

Project Engineer responsible for modeling the Nippon Paper Mill distribution system. The models included cable lengths, cable sizes, distribution transformers, motors, loads, and breaker/relay settings and ratings. All data was field verified by POWER. This model was used to perform a load flow and short circuit study. The results of these studies were then used to perform a system wide coordination study. Once the coordination study was completed, an arc-flash analysis was performed. The arc-flash analysis looked at the highest set (slowest operating) device on a given MCC. Arc-flash values for that MCC were then calculated based on the actual settings and fault currents for this device.

---

**Perini Corp, Substation and Plant Relaying, Iraq**

---

Studies Engineer on this protective device coordination study for the 132 kV bus and line, as well as the 11.5 kV generation bus and distribution transformers. Coordination included primary and secondary distance relays, bus differential relaying, primary and secondary transformer differentials, phase and ground overcurrent, breaker failure, and reclosing. Relays included SEL-387, SEL-311C, SEL-421, Multilin 745, G.E. T-60.

---

**Entergy Jacinto-Area Relaying Analysis, Texas**

---

Engineer responsible for analyzing the affects of a 230 kV series capacitor on 138 kV distance and directional relaying in the Jacinto area. Analysis was preformed by Electrocon International and POWER Engineers using CAPE, and by POWER Engineers using ASPEN OneLiner and EMTF. Expected mis-operation of 138 kV distance and directional relays for faults close in to the series capacitor were determined and solutions / mitigation proposed.

---

**Alaska Electric Light & Power, Juneau/Greens Creek/Hoonah Intertie, Alaska**

---

System Engineer responsible for the study of a transmission system in southeastern Alaska. Conducted numerous load flow studies to determine alternatives interconnecting the AEL&P system serving the Juneau area to the Greens Creek Mine and Hoonah areas. Study involved modifying an existing PTI PSS/E database to include 18-30 miles of overhead and 35 miles of undersea cable. Voltages considered included 34.5 kV and 69 kV. Determined conductor sizing and operational constraints such as shunt reactor sizing and locations.

---

**American Transmission Company (ATC), System Modeling, Wisconsin**

---

Studies Engineer responsible for calculating line, transformer, and generator impedances for the 69 kV, 138 kV, 230 kV, and 345 kV ATC transmission system, and updating the existing ASPEN Oneliner transmission model. The system data was exported out of ASPEN and merged with an existing CAPE model. The existing relay settings in CAPE were reviewed and updated where necessary. CAPE was then used to perform a coordination study for the ATC

transmission system. Relays included Westinghouse KD, SEL-221F, SEL-501, SEL-351, SEL-321, SEL-311C, G.E. REL-302.

---

**Madison Gas & Electric (MG&E), Substation Relaying, Wisconsin**

---

Studies Engineer responsible for reviewing and updating the substation relaying in a SynerGEE model containing 122 distribution feeders. The existing relay settings, including differential, reclosing, and overcurrent, were reviewed to ensure protection. SynerGEE was then used to perform a coordination study on these 122 distribution feeders. Relays included SEL-501, SEL-351, SEL-587.

---

**Copper Valley Electric Association, Relay Coordination Study, Alaska**

---

Studies Engineer responsible for a short circuit study and relay settings for Copper Valley Electric Association's (CVEA's) 138 kV transmission system and 24.9 kV distribution system in Valdez, Alaska. Relays for the system included four sets of SEL-121 transmission distance relays, backup electro-mechanical relaying, transformer differential protection, and distribution SEL-221 distance relays. Selected and set the SEL distance relays to accommodate various operating modes of the 12 MW Solomon Gulch hydroelectric plant in conjunction with other generation sources.

---

**PacifiCorp, Load Flow Studies, Oregon**

---

Systems Engineer responsible for performing PTI load flows to determine the effect on the PacifiCorp and PGE transmission systems for various outage situations. Determined the necessity of a specific tie line and multiple options for routing of the tie line, including construction costs.

---

**Lakehead Pipeline Company, Oil Pumping Substations, Wisconsin**

---

Systems Engineer for performing load flows on new oil pumping substations for Lakehead Pipeline Company's new pipeline extension. Responsibilities included system evaluation and design recommendations for the power supply to implement the addition of 10 MW of pumping load at each facility.

---

**City Public Service, Grounding System Studies, Texas**

---

Studies Engineer responsible for grounding analyses of various CPS substations to achieve electrical safety and assure equipment protection and minimize risk to personnel. Made recommendations for meeting IEEE 80 standards for step and touch potentials.

---

**Ketchikan Public Utilities, Power System Protective Devices Study, Alaska**

---

Studies Engineer responsible for performing load flow and short circuit calculations for the 34.5 kV transmission and 12.47/4.16 kV distribution system. Tabulated system load and fault currents for the location of each protective device. Performed coordination of the directional and non-directional time overcurrent relays that were installed on the system, and developed recommendations for settings and equipment upgrades to improve performance.

---

**Wayne-White Counties Electric Cooperative, Sectionalizing Study, Illinois**

---

Studies Engineer responsible for review and modification of a system wide transmission model for load flow analysis. Multiple load flow cases were analyzed for conductor ampacity as well as to remedy existing voltage problems that Wayne-White were experiencing on their transmission system.

---

**Lehigh Portland Cement Corporation, Union Bridge Modernization, Maryland**

---

Systems Engineer responsible for modeling the LPCC system from the 138 kV supply point down to the 480 V system including motors, transformers, and cables. Performed load flow, short circuit, and motor starting calculations for the system. Applied the utility's stated inrush and voltage dip limitations to determine which motors required a VFD for starting. The short circuit calculations were used to determine which of the 34.5 kV – 4.16 kV transformers could be paralleled without exceeding the bus and breaker MVA ratings.

---

**Wolverine Power Supply Cooperative, Relay Coordination Study, Michigan**

---

Studies Engineer responsible for relay coordination study. Duties included verifying protective device coordination for all 44 kV, 69 kV, and 138 kV transmission lines and substations. Phase and ground time overcurrent and directional overcurrent elements, fuses, phase and ground distance elements, and reclosers were coordinated using the CAPE software. Relay setting and coordination changes were recommended where necessary. SEL-121F, SEL 221-F, SEL-2PG10, Westinghouse KD. This project included Wolverine's entire transmission system that covers 45 transmission substations, 15 interconnections, 1,650 miles of 138 kV and 69 kV transmission lines, 127 distribution substations and multiple generation plants.

---

**Citizens Communications Co, Coordination Study, Arizona**

---

Studies Engineer on this protective device coordination study for a new 230 kV - 69 kV substation. Coordination and complete settings were performed for all 69 kV and 230 kV relays (SEL of various types). Included in this project was SCADA control of the breakers through the new relays.

---

**Citizens Utilities Company, Sonoita & Valencia 115 kV Substations, Arizona**

---

Studies Engineer responsible for protective device coordination for the 115 kV Sonoita Substation. Coordination included primary and secondary transmission line distance relays to include synch check and automatic reclosing, phase and ground overcurrent, and differential elements.

---

**Idaho Power, Capacitor Bank Placement Study, Idaho**

---

Studies Engineer on this multi-feeder project, which included fielding, modeling, and analyzing the electrical systems. Responsible for detailing placement and switching of capacitors to improve voltage levels.

---

---

**Nevada Power Company, Substation Grounding Analysis, Nevada**

---

Studies Engineer responsible for grid testing, modeling and analysis of Nevada Power transition stations. Made recommendations for meeting IEEE standards and oversaw the construction company performing grid tests.

---

**Arizona Electric Power Cooperative, Topock Substation Coordination, Arizona**

---

Engineer responsible for protective device coordination for the 230 kV-69 kV Topock substation. Coordination included primary and secondary distance, phase and ground overcurrent and differential elements.

---

**Total Petroleum, Short Circuit and Coordination Study, Oklahoma**

---

Studies Engineer for development of short circuit and protective device coordination study for the Ardmore Refinery. Study included all devices from the 138 kV and 69 kV sources down through the 480 V MCCs.

---

**AMC, Providence Hospital, Alaska**

---

Studies Engineer for this stability study. Produced a dynamic stability model using PTI's PSS/E software. Analyzed stability when hospital generator was connected and disconnected from the main power grid.

---

**Wells Rural Electric Company, Construction Work Plan, Nevada**

---

Work included computer modeling of the circuits and updating of model with current loading. Also conducted load flow analysis of the system using numerous feeder and circuit configurations.

---

**Citizens Utilities Company, Capacitor Placement Study, Arizona**

---

Modeled circuit and analyzed load flows. Capacitors were placed at various locations and configurations within the model to minimize voltage drop problems. These configurations were analyzed to provide the best protection against voltage loss.

---

**Lincoln County Public Utility District, Nebraska**

---

Systems Engineer responsible for system modeling on Stoner and Associates DPA/G software. Performed load flow and short circuit analysis. Analyzed and recommended protective device settings, sizes, and placement for system coordination.

---

**Sulphur Springs Valley Electric Cooperative, Bella Vista 69/25 kV Substation, Arizona**

---

Electrical Engineer responsible for developing protective relay settings. POWER provided civil/structural, physical, electrical, and SCADA design. The substation configuration includes a 69/24.5 kV power transformer, three 25 kV regulators, four 25 kV breakers and associated switches and busing. POWER also helped to procure steel for construction and wrote the construction bid contract.



Prepared Direct Testimony and Resume

of

Karl Lany  
(SCEC)

RERC

CEC Docket No. 08-SPPE-1

Prepared Direct Testimony  
of  
Karl Lany

Q. Please state your name and place of employment.

My name is Karl Lany and I am a project manager with SCEC, a consulting firm specializing in air quality permitting and analyses.

Q What are your responsibilities with regard to the RERC 3 & 4 project?

SCEC was retained to perform air quality analysis and determine conformance with all applicable air quality regulations. I oversaw the required calculations and model analyses and am primarily responsible for the air quality section of the SPPE application and the application to the South Coast Air Quality Management District.

Q What is the purpose of your testimony in this proceeding?

The purpose of my testimony is to identify my role in the RERC project and to identify the exhibits that I am sponsoring.

Q. Please identify the exhibits you are sponsoring

I am sponsoring the following:

Exhibit 1 SPPE Application  
Section 6.1 Air Quality plus attachments 6.1A - 6.1H  
Section 6.8 Public Health plus attachments 6.8A – 6.8C

Exhibit 2 Data Request responses 1, 2, and 5-22 plus attachments 1-9

I, Karl Lany, hereby swear that the foregoing is true and correct to the best of my knowledge.

December 12, 2008  
Date

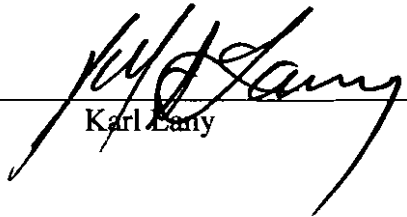
  
Karl Lany

## **Karl A. Lany**

SCEC

Vice President, Manager Regulatory Services

**Specialization** Air Quality Engineering and Compliance Support.

**Background** As Vice President and Manager of Operations, Mr. Lany is responsible for a variety of duties to ensure compliance with air quality regulations. Mr. Lany's clients include leaders in a variety of industries as well as utilities and government agencies.

Prior to joining SCEC, Mr. Lany was on staff at South Coast Air Quality Management District (SCAQMD). Mr. Lany has worked closely with regulators and industry representatives to ensure the viability of regulatory programs at the lowest possible cost to the regulated community. He coordinated the development of rules governing operating requirements and market participation requirements for the first large-scale environmental regulatory program in southern California to effectively incorporate market incentives (the RECLAIM program). He also evaluated methods used by local industries to comply with South Coast Air Quality Management District recordkeeping requirements for paint, ink and solvent processes.

Mr. Lany is presently a member of the SCAQMD Best Available Control Technology Scientific Review Committee. This committee is responsible for identifying technology and emission standards for new sources in the Los Angeles area.

### **Project Experience**

Project/Client	Location	Position
100 MW Peaking Plant Power Engineers City of Riverside	Riverside Energy Resource Center Riverside, California	Project Manager

**Responsibilities:** Client needed to secure construction permits in an expedited manner for a 100 MW peaking plant. SCEC prepared applications to South Coast Air Quality Management District (SCAQMD) and to California Energy Commission(CEC). SCEC provided ongoing support to the City in identifying regulatory requirements, technology alternatives, permitting timeframes and regulatory costs. SCEC coordinated negotiations between the City and SCAQMD in defining the proposed plant as a separate and discreet facility from the City's nearby wastewater treatment plant and airport. SCEC developed construction emission inventory and health risk assessment. The result of SCEC's work is reduced emission offset requirements, streamlined permitting and reduced regulatory costs.

Project/Client	Location	Position
Construction Equipment Construction Industry Air Quality Coalition (CIAQC)	California	Project Manager

**Responsibilities:** Client required technical and regulatory guidance in negotiating with California Air Resources Board during the development of the statewide air toxics control measure for portable equipment. SCEC served as a liaison between CIAQC, regulators and other regulatory consultants. SCEC advised CIAQC of the implications of proposed regulations and also advised of components of the regulation that may require modifications, including applicability, compliance deadlines, monitoring and reporting sections of the regulation. SCEC conducted technology assessments to determine how engines used in various operations can be modified or replaced to comply with proposed regulatory requirements. SCEC identified technical obstacles to compliance for existing crane engines and coordinated the establishment of delayed compliance deadlines for crane engines.

Project/Client	Location	Position
Air Quality Engineering Services & Regulatory Policy Guidance/ Caterpillar, Inc.	Southwestern US	Project Manager

**Responsibilities:** SCEC provides ongoing regulatory guidance and permitting support to Caterpillar and its dealers in California and Arizona. SCEC's services include in-depth analysis of the impact of existing and proposed local, state and federal regulatory programs on the internal combustion engine market. SCEC provided guidance to Caterpillar during US EPA's development of federal standards for on-highway trucks and for nonroad engines. SCEC is Caterpillar's primary air quality liaison to California regulators for stationary and construction engines. SCEC manages permitting and regulatory compliance strategies for a fleet of approximately 200 engines on behalf of Peterson Power Systems, Caterpillar's dealer in the San Francisco area. SCEC is also responsible for certifying compliance for Caterpillar and Perkins engines through the South Coast Air Quality Management District (SCAQMD) certified equipment program.

Project/Client	Location	Position
CEC Construction ARB Construction Baldwin Cranes Calpine, Inc. Professional Pipeline Co. Texaco, Inc.	California	Project Manager

**Responsibilities:** California Energy Commission (CEC) requires that construction equipment used during the building of a CEC-permitted power plant undergo emissions control suitability analyses and be retrofitted with emission control systems when deemed to be suitable. SCEC conducted suitability analyses for several CEC-permitted plants, including Sunrise, Elk Hills and Otay Mesa. SCEC evaluated engine operating specifications, operating parameters and operating schedule to determine if diesel oxidization catalysts or particulate filters can be effectively utilized. SCEC changes to construction equipment inventories and identified suitable applications for emission control systems. SCEC prepared suitability reports for submittal to CEC. SCEC served as a liaison between equipment vendors and operators to ensure timely procurement and installation of emission control devices. SCEC also conducted site audits to ensure that emission control systems were installed and working properly and submitted installation reports for submittal to CEC.

Project/Client	Location	Position
40 MW Peaking Plants Alliance Power, LLC	Drews and Century Substations Colton, California	Project Manager

**Responsibilities:** Client needed to secure construction permits in an expedited manner and needed to operate peaking turbines before emission control equipment could be installed. SCEC prepared permit application packages for submittal to California Energy Commission (CEC) and South Coast Air Quality Management District (SCAQMD) for two peaking plants in Colton, California. SCEC negotiated permitting flexibility to allow delayed implementation of BACT while client researched alternative emission control systems. SCEC staff conducted air quality impact analyses and health risk analyses for the sites and provided ongoing liaison services between client, city and permitting agencies. SCEC prepared continuous emission monitoring applications and quality assurance plans for the sites. Once the plants were constructed, SCEC conducted all engineering and compliance emission source tests.

Project/Client	Location	Position
40 MW Peaking Plant Alliance Power, LLC	Springs Substation Riverside, CA	Project Manager

**Responsibilities:** Prepared permit application packages to South Coast Air Quality Management District (SCAQMD) for a peaking plant owned and operated by the City of Riverside. Prepared CEQA documentation for air quality aspects of the project and gave expert testimony before the City's planning Commission. Advised the City on the procurement and management of emission offset credits needed to operate the facility. SCEC continues to provide ongoing compliance management support for the City of Riverside.

Project/Client	Location	Position
Environmental Audits Covanta Energy	California	Project Manager

**Responsibilities:** Managed an audit team performing comprehensive multimedia environmental audits at numerous power facilities throughout California. Audits cover air quality, wastewater, hazardous materials and hazardous waste management practices.

Project/Client	Location	Position
Yellow Grease Combustion Baker Commodities, Inc.	Kerman and Los Angeles, California	Project Manager

**Responsibilities:** Abnormally high natural gas prices forced client to consider burning alternative fuels in regulated industrial boilers and afterburners. Client had access to an ample supply of yellow grease, but permits for boilers did not allow the combustion of alternative fuels. SCEC evaluated the feasibility of modifying existing air permits to include the use of yellow grease as an alternative fuel to natural gas and diesel fuel. SCEC then prepared permit applications and negotiated permit conditions that allow for continued plant operations with yellow grease combustion, even during periods of high fuel market prices. The results of SCEC's work serve as a model for similar modifications elsewhere in the United States and for alternative fuel incentive programs.

Project/Client	Location	Position
Point Loma Wastewater Plant Hawthorne Power Systems	San Diego, CA	Project Manager

**Responsibilities:** Conducted BACT analysis and negotiated permit requirements with San Diego APCD for a large cogeneration project. Conducted ambient air quality impact analysis and determined emission offset requirements. Provided ongoing support for client while negotiating a significant emission offset purchase.

Project/Client	Location	Position
Misc. Cogeneration Projects in California Chevron Energy Solutions	California	Project Manager

**Responsibilities:** Conducted feasibility analyses for potential distributed power projects in various California air districts. Analyses included BACT analyses, coordination with

equipment vendors in specifying engines and control equipment for the project, identifying ongoing compliance management, and providing economic impact analyses to project sponsors. SCEC's overall objective is to ensure that environmental and regulatory costs are adequately considered in project selection and that permits can be obtained in a reasonable manner. For projects that are feasible, SCEC proceeded to prepare applications to construct and coordination with local regulators to obtain construction permits in an expedited manner.

Project/Client	Location	Position
Regional Plant I Expansion Inland Empire Utilities Agency	Fontana, CA	Project Manager

**Responsibilities:** Provided regulatory compliance support. Prepared SCAQMD permit applications for cogeneration engines and boilers in support of plant expansion.

Project/Client	Location	Position
Nabisco	Buena Park, CA	Scientist

**Responsibilities:** Provided regulatory compliance support. Identified regulatory standards for the installation of a continuous emissions monitoring system (CEMS). Provided guidance to Nabisco staff in the development, installation and operation of new process technology intended to reduce emissions and operating costs.

Project/Client	Location	Position
Distributed Generation Navigant Consulting, Inc.	Lancaster, CA	Project Manager

**Responsibilities:** The City of Lancaster desired to ensure an adequate supply of power in anticipation of regional growth. SCEC worked with the City and the client to identify permit feasibility for various potential sites and projects from 40 to 240 MW. Once potential power plant developers were identified, SCEC then prepared permit applications to be submitted to California Energy Commission (CEC) and Antelope Valley Air Pollution Control District (AVAPCD).

Project/Client	Location	Position
Fresno - Clovis Wastewater Plant City of Fresno	Fresno, CA	Project Manager

**Responsibilities:** Prepared application for permit to operate a cogeneration system at a local wastewater treatment facility. The process utilizes waste gas from the treatment facility as well as waste gas from two landfills and supplemental natural gas to produce process heat and electricity.

Project/Client	Location	Position
Develop Compliance Audit System Edison International	Rosemead, CA	Project Manager

**Responsibilities:** Coordinated the development of an audit system containing over 1,000 required compliance activities for the Continuous Emissions Monitoring Systems (CEMS) at Edison Power Plants in California and Nevada. Conducted comprehensive scoping meetings with Edison staff to define how various user groups with differing needs and levels of expertise will use the system and how the system will be maintained in response to continuously changing environmental regulations. Tested the functionality of the system by conducting regulatory audits at selected Edison facilities in California and Nevada and refined the system to increase its usefulness for various levels of Edison staff.

Project/Client	Location	Position
Regulatory Support Expert Testimony Graseby, STI	California	Project Manager

**Responsibilities:** Client developed continuous emissions monitoring system (CEMS) for a manufacturing plant in California. The plant owner claimed that the CEMS did not meet regulatory requirements and filed claims for compensatory damages. SCEC investigated the merits of the claim and provided assistance to client's legal counsel during court depositions. SCEC also attended all settlement negotiations and provided economic data to ensure that the settlement was fair to SCEC's client.



Project/Client	Location	Position
Air Quality Engineering Services National Renewable Energy Laboratory	Los Angeles	Project Manager

**Responsibilities:** Secured operating permit for a high solids anaerobic digester research project. Completed control technology analysis and projected emissions calculations.

Project/Client	Location	Position
Evaluation of Alternative Emission Control Strategies/ Caterpillar, Inc.	Peoria, IL	Scientist

**Responsibilities:** Identify local, state and federal emission inventory forecasting procedures. Develop procedures to determine effective control strategies proposed by industry as alternatives to measures specified by regulators. Evaluate potential effects of proposed national emission standards for heavy-duty vehicles & non-road equipment.

Project/Client	Location	Position
Title V & Air Emissions Inventory & Permit Application/ US Navy Southwest Div.	29 Palms, CA San Diego, CA	Scientist

**Responsibilities:** Completed survey of emission sources, determined applicability of local, state & federal regulation to all significant sources at site. Identified permit modifications to increase operating flexibility and ensure compliance with existing local regulations and Title V of the Federal Clean Air Act.

Project/Client	Location	Position
Compliance Management & Regulatory Policy Guidance/ Crestline Lake Arrowhead Water Agency	Crestline, CA	Scientist

**Responsibilities:** Completed an in-depth analysis of federal and state clean air act applicability for a region in southern California. Evaluated the viability of pursuing changes to air

district and air basin boundaries to provide regulatory relief. Determined Title V applicability and identified steps by which Title V requirements can be minimized. Identified and secured modifications to existing air permits to ensure compliance with regulations and increase operating flexibility.

---

## **Qualifications**

Education: M.S., Environmental Studies, California State University, Fullerton  
B.S., Civil Engineering Technology, Colorado State University, Pueblo, 1983  
B.S., Business Administration - Finance, Colorado State University, Pueblo, 1983

Specialization Certification: Certified Permitting Professional, SCAQMD

Professional Associations: Air & Waste Management Association

Year Joined SCEC: 1994

## Presentations

Title	Presented To	Date
California Air Toxic Control Measures for Diesel Engines	California Association of Sanitation Agencies Palm Springs, CA	Jan. 2003
California Air Toxic Control Measures for Diesel Engines	American Water Works Association Reno, NV	Nov. 2002
Federal, State & Local Emissions Inventory Projection Methodology	Caterpillar, Inc. Peoria, IL	Apr. 1995
Incorporating Market Strategies into the RECLAIM Compliance Plan	Institute of Business Law, Los Angeles	Feb. 1994
Incorporating Market Strategies into the RECLAIM Compliance Plan	Executive Enterprises, Los Angeles San Francisco	Oct. 1993 Feb. 1994
Regional Clean Air Incentives Market, A New Regulatory Program for the South Coast Air Basin	86th Air & Waste Management Association Annual Meeting Denver, CO	Jun. 1993

Prepared Direct Testimony and Resume

of

Michael Tuma  
(SWCA)

RERC

CEC Docket No. 08-SPPE-1

Prepared Direct Testimony  
of  
Michael Tuma

Q. Please state your name and place of employment

My name is Michael Tuma and I am a Senior Biologist with SWCA Environmental Consultants.

Q. What are your responsibilities with regard to the RERC 3 & 4 project?

SWCA was retained to evaluate the projects impacts upon the biological, cultural and paleontological resources in the project area. My specific responsibilities included the evaluation of biological impacts.

Q. What is the purpose of your testimony in this proceeding?

The purpose of my testimony is to identify my role in the proposed project and to specify the exhibits that are my responsibility.

Q. What exhibits are you sponsoring?

Exhibit 1 SPPE Application  
Section 6.3 Biology and attachments 6.3 A-D

Exhibit 2 Data Request Responses 23-29 and attachments 1-6

I, Michael Tuma, hereby swear that the foregoing is true and correct to the best of my knowledge.

December 12, 2008

Date



Michael Tuma

### Education

- M.S., Zoology, Eastern Illinois University, 1993
- M.S., Anthropology, University of Southern Mississippi, 1998
- B.S., Zoology, Truman State University, Missouri, 1991

### Expertise

- Herpetology
- Wildlife biology
- Population biology
- Conservation biology

### Registration / Certification

- USFWS 10(a)(1)(A), USFWS 10(a) Recovery Permit: desert tortoise
- CDFG Scientific Collecting Permit: desert tortoise (MOU holder), western pond turtle
- Rare, Threatened, and Endangered Plant Voucher Collecting Permit

### Selected Projects

- Rancho California Water District's Santa Rosa Water Reclamation Facility Solar Energy Expansion, San Bernardino County, California
- Riverside Energy Resource Center Units 1-4 – assessments and compliance for SPPE application with California Energy Commission; Riverside Public Utilities, City of Riverside, Riverside County, California
- Kessler Springs Ranch desert tortoise survey in support of Section 7 consultation; National Park Service, Mojave National Preserve, San Bernardino County, California

Mr. Tuma is currently employed as Natural Resources Program Manager for SWCA's Pasadena office. He is responsible for project and personnel management, and oversight of technical aspects for projects involving biological resources. His responsibilities include mentoring staff and providing QA/QC for all biological technical reports produced by SWCA's Pasadena Office.

Mr. Tuma has extensive experience in all phases of biological study, including protocol presence/absence surveys, field data collection, long-term monitoring of sensitive biological resources, habitat restoration, statistical analysis, data interpretation, technical report writing, and agency consultation. He is completely familiar with California's flora and fauna. Mr. Tuma has extensive experience in project management, having managed over 100 projects in the southern California region over the past six years. He is a proficient manager of staff and clients, has numerous resource agency contacts, and is particularly adept in consultations and negotiations with resource agency personnel. He has authored numerous biological reports, including technical biological reports in support of Environmental Impact Reports/Statements (EIR/EIS), Habitat Assessments for projects with the potential to support habitat for federally listed species, and Biological Assessments in support of projects requiring Section 7 consultation.

Mr. Tuma's research interests include herpetology, ecology, and conservation biology. He is particularly interested in the conservation and management of endangered reptiles and amphibians, and is actively engaged within the herpetological scientific community. He serves as Adjunct Research Associate at UCLA, where he works with Professor Ken Nagy's laboratory investigating the ecology and conservation of head-started juvenile desert tortoises at the Fort Irwin Study Site. He has published, and continues to publish, research articles in several peer-reviewed scientific journals regarding the conservation and management of turtles and tortoises, including the state endangered yellow mud turtle in northwestern Illinois, the federally threatened gopher tortoise in southern Mississippi, and the desert tortoise in the western Mojave. He serves as Assistant Editor to the peer-reviewed journal *Herpetological Conservation and Biology*, and has provided peer review for a number of articles for other scientific journals.

Prepared Direct Testimony and Resume

of

Kevin Everett  
(Power Engineers)

RERC

CEC Docket No. 08-SPPE-1



Prepared Direct Testimony  
of  
Kevin Everett

Q. Please state your name and place of employment

My name is Kevin Everett and I am a Land Planner with Power Engineers

Q. What are your responsibilities with regard to the RERC 3 & 4 project?

I am responsible for the evaluating the Land Use, Socioeconomic and Waste Management impacts that would result from project construction and operation.

Q. What is the purpose of your testimony?

The purpose of my testimony is to identify my role in proposed project and identify the exhibits I am prepared.

Q. Please identify the exhibits you are sponsoring

I am sponsoring the following exhibits:

Exhibit 1      SPPE Application  
                  Section 6.2    Land Use  
                  Section 6.12   Socioeconomics  
                  Section 6.14   Hazardous Materials and attachments 1-2

Exhibit 2      Data Request Responses 32, 37 and 38 and attachments 1-3  
                  Data Request Responses 39-43 and attachments 1-5  
                  Data Request Responses 44-46  
                  Data Request Responses 58-63 and attachments 1-3

I, Kevin Everett, hereby swear that the foregoing is true and correct to the best of my knowledge.

12/12/2008  
Date

Kevin Everett  
Kevin Everett

## **KEVIN EVERETT**

### **LAND DEVELOPMENT PLANNER**

#### **YEARS OF EXPERIENCE**

38

#### **EDUCATION**

- > B.S., Urban Geography, California State University, Fullerton, 1970
- > Graduate Work, Planning Design, California Polytechnic University
- > Graduate Work, Urban and Regional Planning, University of California, Irvine

#### **AREAS OF EXPERTISE**

- > Land planning
- > Land development
- > Environmental planning and permitting
- > Project management

#### **EXPERIENCE SUMMARY**

Mr. Everett is a land development planner with extensive experience in sustainable development planning, permitting, and construction. During his broad career in the field he has served in a variety of planning roles including president and senior project manager of a private land planning firm, international planning consultant working with Asian governments and corporations, development consultant for foreign land investors, and environmental planner for city, county, and regional governments. Mr. Everett has overseen the land acquisition, planning, design, construction, and sale of several large-scale sustainable master planned communities. His duties have included leading multi-disciplinary project teams, obtaining state and federal environmental permits, developing environmental impact reports, preparing land use plans, budgets, proformas and cost estimates, and organizing community facilities districts, homeowner associations and restrictive covenants for the new development projects. Several of these projects had profit levels in excess of \$100 million.

#### **NorthWestern Energy, Mountain States 500 kV Transmission Intertie Environmental Report, Montana**

---

Public Involvement Coordinator and Project Planner responsible for agency contacts and a public outreach program. Conducted face-to-face briefings with elected officials and community leaders in 15 Montana and Idaho counties. Coordinated the production of mailing lists, press releases, a project website, and newsletters. POWER is completing the detailed corridor analysis and environmental studies for a new 430-mile, 500 kV transmission intertie from Townsend, Montana, to Midpoint Substation in southern Idaho. POWER will prepare a Montana Major Facilities Siting Application and an Environmental Report to facilitate the subsequent environmental review processes under NEPA and MEPA, and to gain permits and approvals from federal, state, and local agencies. POWER's scope includes development of cost estimates for line route alternatives, design criteria, equipment specifications, and design documents to support the environmental analysis. The BLM or Forest Service will be the federal lead agency for the process, which will analyze alternative routes and select a preferred route and substation sites for the project. The environmental analysis includes land use, visual, cultural, biological, water, and earth resources.

#### **Los Angeles Department of Water & Power, Barren Ridge Renewable Transmission Project EIS/EIR, California**

---

Environmental Specialist responsible for preparing an agency contact list and contacting agencies of LADWP's intent to prepare a joint EIS/EIR under NEPA and CEQA to analyze the impacts of the 230 kV transmission upgrade project. The project would provide the city with access to wind- and solar-generated power in the Tehachapi Mountain and Mojave Desert areas of southern California. It would improve system reliability and help the city meet

its Renewable Portfolio Standard obligations mandated by the state of California and the city. The project includes new and upgraded double circuit lines over a distance of 200 miles.

---

**City of Riverside, Transmission Reliability Project-Phase II  
Environmental Services, California**

---

Environmental Coordinator responsible for permitting new and upgraded transmission facilities for the City of Riverside's electric delivery system. Responsible for staffing the analysis of environmental resources, preparation of draft and final Environmental Impact Reports, and other permitting activities. Coordinating public involvement, impact assessment, mitigation planning, preferred route selection, and agency review. POWER is providing public involvement, urban resource impact analysis, and permitting services for a new 230 kV interconnection with the SCE transmission system. The environmental analysis addresses the construction of a 230 kV transmission line, six 69 kV transmission lines, two new 230 kV substations, and the upgrade of eight 69 kV substations. POWER is preparing the Environmental Impact Report under CEQA with the City of Riverside as the lead agency. Southern California Edison will construct the 230 kV portion of the project following the issuance of a Certificate of Public Convenience and Necessity (CPCN) from the California Public Utilities Commission (CPUC). The CPUC is a Responsible Agency and will adopt the certified EIR when completed for the construction of the 230 kV interconnection.

---

**Fiesta USA, Stoneridge Development, California**

---

Senior Project Manager responsible for the development approach, land planning concepts, design standards, state and federal permitting, construction oversight, and general project management for this 2,000-unit sustainable development project located near the City of Perris. The project was designed to be sensitive to wildlife habitat and open space concerns. It incorporated walking access to schools, parks, a community center, and the project's town center. The town center integrated high-density low rise residential units with neighborhood and community commercial centers. The entire site was linked with a system of greenbelts, trails, and paths. The project supplied significant regional water, sewer, reclaimed water, roads, bridges, and flood control infrastructure.

---

**Fiesta USA, Oak Valley Development, California**

---

Senior Project Manager responsible for the development approach, land planning concepts, design standards, state and federal permitting, construction oversight, and general project management for this 3,000-unit sustainable development project. The project's architectural and landscape guidelines stressed that the design be integrated with schools, fire stations, parks, community centers, commercial areas and the project's town centers. Another unique feature of the project is that construction was allowed only on the tops of the plateaus, which ensured that all hillsides and valley bottoms were maintained as permanent open space, thus saving over 1,000 mature oak trees.

---

**Bundy Canyon Development Company, Cottonwood Creek  
Development, California**

---

Senior Project Manager responsible for the development approach, land

planning concepts, design standards, state and federal permitting, construction oversight, and general project management for this 1,100-unit sustainable community development. The project was geared towards expanding urban infrastructure into an in-fill area between three existing cities and will be a cornerstone of the soon to be formed City of Wildomar. The walk-to community was designed to link the town center to the parks, community center, schools, assisted living center, and office complexes within or adjacent to the development. The project is framed by a system of parks, trails, greenbelts, and paths and was designed to minimize impact to riparian areas and the surrounding hillsides.

---

**Fiesta USA, Cimmaron Ridge Development, California**

---

Senior Project Manager responsible for the development approach, land planning concepts, design standards, state and federal permitting, construction oversight, and general project management for this 888-unit development located near the retirement community of Sun City. The project integrated a sustainable community into a senior citizen community. The approach was to supply walk-to services to the project residents that incorporated a system of greenbelts, parks, and a community center.

---

**The Keith Companies / Ashby USA / Investment Partners Inc., Roripaugh Ranch Development, California**

---

Project Manager responsible for a multi-disciplinary team that designed this award-winning sustainable community. This 800-acre project was designed as a completely self-contained sustainable community. The 2,100 unit project included a mix of residential units and walk-to commercial and office centers. The project also included both elementary and middle schools, two enormous community centers, a fire station, three parks, a system of trails and paths, and over 200 acres of permanently dedicated wildlife habitat.

---

**The Keith Companies / Johnson Development, Walker Basin Development, California**

---

Project Manager responsible for a multi-disciplinary team that designed this award-winning sustainable community. This 785-acre golf resort project included 735 custom view lots linked to a community center, elementary school, and a commercial center.

---

**The Keith Companies / Firestone Development Company, Villages of Old Town Temecula, California**

---

Project Manager responsible for a multi-disciplinary team that designed this award-winning sustainable community. This mixed-use, 280-acre, infill project included 1,800 high-density residential units surrounding a town square park. The residential units were stacked over the commercial businesses. The project was linked to the Temecula's old town historic district by a linear greenbelt and a trolley system.

Prepared Direct Testimony and Resume

of

Caprice Harper  
(SWCA)

RERC

CEC Docket No. 08-SPPE-1

Prepared Direct Testimony  
of  
Caprice "Kip" Harper

Q Please state your name and place of employment

I am employed by SWCA Environmental Consulting as a Senior Cultural Resource Specialist.

Q. What are your responsibilities with regard to the RERC 3 & 4 project?

Although SWCA is retained to evaluate the project's impacts upon biological, paleontological and cultural resources, I am responsible for the Cultural analysis.

Q What is the purpose of your testimony in this proceeding?

The purpose of my testimony is to identify my role in the evaluation of the project and to identify the exhibits for which I am responsible

Q Please identify the exhibits you are sponsoring

I am sponsoring the following:

Exhibit 1 SPPE Application  
Section 6.4 Cultural and attachments 6.4 A-C

I, Caprice Harper, hereby swear that the foregoing is true and correct to the best of my knowledge.

12/11/08

Date

  
Caprice Harper

## Education

- M.A., Anthropology, California State University, Los Angeles, 1997
- B.A., Anthropology, California State University, Los Angeles, 1992
- A.A., Humanities, Pasadena City College, Pasadena, 1989

## Registration / Certification

- Registered Professional Archaeologist, 2003
- Certified Archaeological Consultant, County of Riverside (Certification #236)

## Expertise

- Section 106/NHPA, NEPA, and CEQA compliance studies
- Prehistoric archaeology of California
- Native American consultation
- Built-environment studies
- Artifact curation of prehistoric California and historic material culture

## Selected Projects

- Senior Cultural Resource Specialist, RERC Units 3 & 4; City of Riverside, Riverside County, CA, 2008
- Cultural Resources Project Manager/Project Archaeologist, Chevron Victor Valley Community College Wind Turbine; Victorville, San Bernardino County, CA, 2007-2008
- Project Archaeologist, Mill Creek Circuit Archaeological Survey; San Bernardino National Forest; San Bernardino County, CA, 2003
- Cultural Resource Specialist, California Emergency Siting Peaker Power Plant Permitting Project; Various Projects throughout CA, 2001

Ms. Harper is a Senior Cultural Resource Specialist in SWCA's Pasadena office. She meets and exceeds the Secretary of the Interior's Professional Qualification Standards in prehistoric archaeology and is a Registered Professional Archaeologist (RPA), with more than 12 years of professional experience in cultural resource management and environmental consulting in California. Over the course of her career Ms. Harper has served as a project manager, assistant project manager, field director, and researcher for private environmental planning firms, government agencies (state and federal), museums, and academic institutions.

Prior to joining SWCA, Ms. Harper assisted the Energy Facilities Siting and Environmental Protection Division of the California Energy Commission (CEC) with the California Emergency Siting Peaker Power Plant Permitting Project in 2001. In her capacity as a Cultural Resource Specialist, Ms. Harper reviewed power plant applications and cultural resource documentation prepared by cultural resources consultants in support of peaker power plant applications on behalf of CEC staff in Sacramento. During her 10-month tenure at the CEC, Ms. Harper prepared cultural resources findings for various peaker power plant applications for submittal to CEC commissioners, and compiled a model CEC Cultural Resources Monitoring and Mitigation Plan (CRMMP) to be provided as an aid to outside consultants. All work was completed in consultation with CEC cultural resource staff.

Ms. Harper's archaeological experience includes recording and evaluating prehistoric- and historic-era archaeological sites throughout California, including over 360 prehistoric sites on San Nicolas Island, and various historic period archaeological sites. She has recorded and evaluated a historic bypassed segment of Interstate 10 in Coachella, Riverside County, a historic homestead at Vasquez Rocks, Los Angeles County, a historic orange grove irrigation system in San Bernardino County, recording various historic mining camps and other historic period sites in the Stanislaus National Forest, Central California, and various historic trash scatters and other historic period sites throughout southern California.

Additionally, Ms. Harper has taken course work in California history, and has conducted historical research and performed historic significance evaluations of built-environment resources with Senior Architectural Historians.

Prepared Direct Testimony and Resume

of

Cara Corsetti  
(SWCA)

RERC

CEC Docket No. 08-SPPE-1



Prepared Direct Testimony  
of  
Cara Corsetti

Q. Please state your name and place of employment

My name is Cara Corsetti and I am a Paleontology Program Director with SWCA Environmental Consultants.

Q. What are your responsibilities with regard to the RERC 3 & 4 project?

My responsibilities include the analysis of the project's impacts upon Paleontological resources in the project area.

Q. What is the purpose of your testimony in this proceeding?

The purpose of my testimony is to identify my role in the proposed project and to identify the exhibits for which I am responsible.

Q. Please identify the exhibits you are sponsoring

I am sponsoring the following:

Exhibit 1 SPPE Application  
Section 6.6 Paleontology and attachments

I, Cara Corsetti, hereby swear that the foregoing is true and correct to the best of my knowledge.

12/12/08

Date



Cara Corsetti

### **Education**

- M.S., Geological Sciences (Paleobiology), University of California, Santa Barbara, 2007
- B.A., Creative Studies (Biology/Paleontology), University of California, Santa Barbara, 1999

### **Training / Certification**

- NHPA, Section 106 Training, University of Nevada, Reno
- NEPA and CEQA Regulatory Compliance, Association for Environmental Professionals

### **Expertise**

- Paleontological Assessments and Field Survey
- Paleontological Resource Management
- Monitoring and Mitigation Plans, Paleontological Treatment Plans
- CEQA/NEPA Documentation

### **Selected Projects**

- Paleontological Resource Specialist, Victorville Hybrid Power Project (VV2), San Bernardino County, CA (563 MW Natural Gas and Solar)
- Paleontological Resource Specialist, Palmdale Hybrid Power Project, Los Angeles County, CA (570 MW Natural Gas and Solar)
- Paleontological Resource Specialist, Beacon Solar Energy Project (BSEP), Kern County, CA (250 MW Solar)
- Project Manager, Paleontological Resource Studies for Williams-Kern River Gas Pipeline, San Bernardino County, CA (CEC/BLM)
- Paleontological Resource Specialist, Harper Lake Solar Project, San Bernardino County, CA (250 MW Solar)

As a Program Director for SWCA, Ms. Corsetti oversees all paleontological projects assigned to the California region. Her current responsibilities include agency and client coordination; program development; proposal writing and project management; budget preparation and oversight; managing and coordinating the tasks of the paleontological staff; paleontological monitoring and mitigation plan design; conducting environmental assessments; and the production and editing of technical reports. She also functions as the Office Director for SWCA's Pasadena Office.

With over 16 years of management experience, Ms. Corsetti has been involved in over 200 projects throughout California, Nevada, Colorado, Wyoming and Utah, and has successfully worked with various lead agencies such as the Federal Energy Regulatory Commission (FERC), the Bureau of Land Management (BLM), and the California Energy Commission (CEC). She has experience working on a multitude of energy projects, including oil and gas pipelines, transmission lines, wind generation projects, geothermal projects, and natural gas and photovoltaic powered plants.

Ms. Corsetti is certified through the California Energy Commission (CEC) as a Paleontological Resource Specialist (PRS). She is a member of the following professional organizations: Society of Vertebrate Paleontology; Society for Sedimentary Geology (SEPM); Geological Society of America; and Association for Environmental Professionals.

Prepared Direct Testimony and Resume

of

Jonathon Higginson  
(Weiland Associates)

RERC

CEC Docket No. 08-SPPE-1

Prepared Direct Testimony  
of  
Jonathan Higginson

Q Please state your name and place of employment.

My name is Jonathan Higginson and I am a Senior Consultant with Wieland Acoustics, Inc. (formerly Wieland Associates, Inc.), an acoustical consulting firm specializing in the evaluation of noise.

Q What are your responsibilities with regard to the RERC 3 & 4 project?

I am responsible for evaluating the noise impacts resulting from project construction and operation.

Q. What is the purpose of your testimony in this proceeding?

The purpose of my testimony is to identify my role in the proposed project and to identify the exhibits for which I am responsible.

Q. Please identify the exhibits for which you are responsible

I am responsible for the following:

Exhibit 1 SPPE Application  
Section 6.7 Noise and attachments A-B

I, Jonathan Higginson, hereby swear that the foregoing is true and correct to the best of my knowledge.

12/11/2008

Date

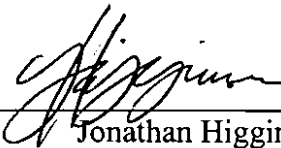
  
Jonathan Higginson

## ***Jonathan L. Higginson, Senior Consultant***

---

### ***AFFILIATIONS***

Member, Institute of Noise Control Engineering (INCE)

### ***EDUCATION***

Bachelor of Engineering Degree (with Honors), in Acoustical Engineering  
Institute of Sound and Vibration Research, University of Southampton, Great Britain  
Principles of Vibration; Measurement and Analysis, Brüel & Kjær University  
Hands-On Architectural and Building Acoustics, Brüel & Kjær Continuing Education

### ***EXPERIENCE***

Mr. Higginson has six years' experience in acoustics. His project responsibilities have included obtaining, recording, and reporting on-site noise and vibration measurements, the development of computer noise and vibration models, the development and preparation of noise contour maps, conducting computer analyses of exterior and interior noise and vibration levels, and the preparation of noise study reports, including mitigation recommendations. Mr. Higginson supervises associate staff and technicians, and has represented Wieland Acoustics in project presentations.

### ***REPRESENTATIVE PROJECT AREAS***

- Acoustical studies for projects in over 50 municipalities in California, Arizona, Nevada, Louisiana, and Mexico.
- Sound wall design studies, including the Rt. 91/Van Buren Blvd. interchange, Riverside, CA and for a residential development in San Jose del Cabo, Mexico.
- Noise Element Technical Updates for six cities in California.
- Noise sections of more than 10 environmental impact reports.
- Over 75 noise ordinance enforcement projects, including a cogeneration plant in San Diego, and an emergency generator in Laguna Beach, CA.
- Room acoustics studies, including a cyber warfare room in Redondo Beach, CA.
- Noise studies for commercial and industrial facilities, including a car dealership in Vacaville, a fire station in Poway, a 273,000 square foot shopping center development in Riverside County, and two college campuses in Long Beach, CA.
- Field testing of floor/ceiling and party wall assemblies in multifamily projects.
- Street widening projects, including Alessandro Boulevard in Riverside, CA.
- Train noise and vibration studies, including work/live rental units in Ontario, CA, and a residential development in Torrance, CA.
- OSHA testing at industrial facilities in Orange, CA.
- Noise studies for daycare/preschool facilities in Irvine and Rancho Cucamonga, CA.
- Noise studies for over 35 residential projects including custom homes, multi- and single-family developments and mixed-use developments.



**WIELAND**  
**ACOUSTICS**  
noise & vibration consultants

Prepared Direct Testimony and Resume

of

John Paez  
(Power Engineers)

RERC

CEC Docket No. 08-SPPE-1

Prepared Direct Testimony  
Of  
John Paez

Q Please state your name and place of employment.

My name is John Paez and I am an Environmental Planner/Visual Resource Specialist with Power Engineers.

Q What are your responsibilities with regard to the RERC 3 & 4 project?

I am responsible for analyzing the visual impacts resulting from project construction.

Q What is the purpose of your testimony in this proceeding?

The purpose of my testimony is to identify my role in the project and to specify the exhibits for which I am responsible.

Q. What exhibits are you sponsoring?

Exhibit 1 SPPE Application Section 6.11 Visual and attachments 1-7

Exhibit 2 Data Request Responses 55-57 and attachments 1-7

I, John Paez, hereby swear that the foregoing is true and correct to the best of my knowledge.

12/11/08  
Date

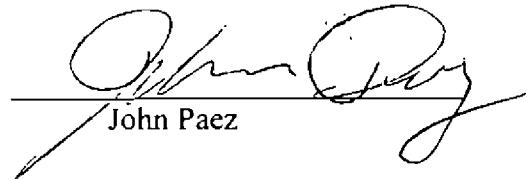
  
John Paez

## JOHN PAEZ

### ENVIRONMENTAL PLANNER / VISUAL RESOURCES SPECIALIST

#### **YEARS OF EXPERIENCE**

21

#### **EDUCATION**

- > M.L.A., Landscape Architecture, California State Polytechnic University, 1986
- > B.A., Social Ecology/Urban Planning, Policy & Design, University of California, 1981

#### **AREAS OF EXPERTISE**

- > Land planning
- > Landscape architecture
- > Architectural CAD
- > 3D design
- > Construction documents
- > Development entitlement
- > Project presentations
- > CAD/GIS design applications
- > 3D virtual study models
- > Scale models

#### **HARDWARE/SOFTWARE**

- > AutoCAD
- > 3DS Max
- > Adobe PhotoShop
- > Surfer
- > EasySite-EasySurf
- > InDesign

#### **EXPERIENCE SUMMARY**

Mr. Paez has extensive experience in land use planning, landscape architecture, urban design development and visual analysis. He has significant studio background on numerous large-land residential, resort, commercial, urban and mixed-use projects. He has managed complex projects and developed plans, graphics and construction documents for landscape architecture, land use planning, and jurisdictional entitlement projects. Mr. Paez has contributed to and been employed by such esteemed, nationally recognized design teams as POD, FORMA, EDAW, SWA, I.M. Pei, and Disney, and has worked directly for builders/developers such as The Irvine Company, Lennar, Pulte, Newhall Ranch, Tejon Ranch and Wynn Hotels, among others.

#### **City of Riverside, Subtransmission Project, Environmental Services, California**

---

Environmental Planner responsible for project coordination of the Initial Study and Mitigated Negative Declaration document under CEQA with the City of Riverside as the lead agency. Specific responsibilities included document preparation, project description and analysis, sub-consultant coordination, document quality control, visual/aesthetics resources, development of alternative routes, selection of environmentally superior route, analysis of construction methods and client/project management. The project addressed the need for new double circuit 69 kV subtransmission lines connecting existing substations as well as upgrades to eight 69 kV substations.

#### **City of Riverside, Riverside Transmission Reliability Project-Phase II Environmental Services, California**

---

Environmental Planner responsible for completing the assessment of the preferred transmission route and its complex aesthetic impacts within urban, suburban and rural environments. POWER is providing public involvement, urban resource impact analysis, and permitting services for a new 230 kV interconnection with the SCE transmission system. The environmental analysis addresses the construction of a 230 kV transmission line, six 69 kV transmission lines, two new 230 kV substations, and the upgrade of eight 69 kV substations. POWER is preparing the Environmental Impact Report under CEQA with the City of Riverside as the lead agency. Southern California Edison will construct the 230 kV portion of the project following the issuance of a Certificate of Public Convenience and Necessity (CPCN) from the California Public Utilities Commission (CPUC). The CPUC is a Responsible Agency and will adopt the certified EIR when completed for the construction of the 230 kV interconnection.



---

### **Coopeguanacaste R.L., Nuevo Colon-Tamarindo-Guayabal 230 kV Line & Station, Costa Rica**

---

Visual Resource Specialist responsible for assisting with line siting, preferred route selection, visual impact study and permitting for this 230 kV line and substation project. POWER was responsible for the siting study, preferred route selection, public and community meetings, and environmental analysis for a 60 km 230 kV transmission line to serve the growing resort area of Tamarindo. Issues identified include existing land uses, protected tree species, sensitive species migration corridors, wetlands, flood-prone areas and visual impacts. A determination was made that an ESiA would not be required because of the extensive studies and public outreach completed for the project.

---

### **Los Angeles Department of Water & Power, Barren Ridge Renewable Transmission Project EIS/EIR, California**

---

Environmental Specialist responsible for assessing impacts of the 230 kV transmission upgrade project on land use and visual resources for a joint federal and state EIS/EIR under NEPA and CEQA. The project would provide the city with access to wind- and solar-generated power in the Tehachapi Mountain and Mojave Desert areas of southern California. It would improve system reliability and help the city meet its Renewable Portfolio Standard obligations mandated by the state of California and the city. The project includes new and upgraded double circuit lines over a distance of 200 miles.

---

### **City of Riverside, Energy Resource Center Peaking Plant Units 3 & 4, California**

---

Visual Resource Specialist responsible for visual aesthetic analysis for the application to the California Energy Commission (CEC) for the permitting of units 3 and 4 of a peaking power gas turbine generation plant. This phase of the project has as its primary goal to perform all activities associated with permitting the project from preparing the CEC and SCAQMD applications through construction surveillance and post-completion surveys that may be required by regulatory agencies.

### **PREVIOUS WORK HISTORY (OTHER FIRMS):**

---

#### **The Irvine Company, Shady Canyon, California**

---

Visual Impact Design Specialist responsible for visual simulation and 3-dimensional studies to guide mass grading concepts, site specific grading, site planning, architectural massing, signage, color selection, lighting, marketing materials and landscape design for visual analysis testing and project communication with city and other public agencies. Additional studies included water reservoir impacts, golf course grading design, bridge design testing, adjacent neighbor's impact concerns, golf course clubhouse architecture, guard-gate entry design simulations and more.

---

#### **The Irvine Company, Turtle Ridge, California**

---

Visual Impact Design Specialist responsible for directing planners and civil engineers to incorporate heroic earthen berms into natural terrain to successfully blend homes and communities into canyons in order to preserve

---

natural perceptions. Supported traffic design to establish low impact corridors for major circulation within communities. Visual analysis for community involvement for grading, architecture, lighting and park design. Critical presentation analysis graphics for project entitlement and communications with neighboring homeowners and city agencies.

---

**Disney Corporation, Euro-Disneyland Paris, Disneyland California, Toontown and Flextown**

---

Land Use Planner responsible for landscape architecture design and construction documents including 3-dimensional visualization studies. Performed a key team designer role for POD, Inc. as master land planner for Euro Disney in Paris, France. The perception, vision and site planning for the concept for a European Disneyland. Landscape architect for the design and construction drawings for Anaheim Disneyland's Toontown and Flextown villages. CAD manager for working drawings and 3-dimensional design testing.

---

**Home Savings of America, Ahmanson Ranch, California**

---

Land planner for the specific plan community design, GIS analysis and document graphics. This 5,400-acre community design consisted of over 3,000 homes, 2 schools, 2 hotels, 2 golf courses and over 400,000 square feet of commercial/industrial development. An environmentally diverse project in undisturbed natural environments, the project encountered widespread opposition and unprecedented design, approval and entitlement challenges.

---

**Lennar Corporation, Newhall Ranch, California**

---

Land use planner responsible for site planning, landscape concepts, visual studies, specific plan design documents and 3-dimensional visualization modeling. The largest single development in Los Angeles county history, a 12,000-acre new community project within 2 significant ecological areas. The project projects 68,000 residents within up to 24,000 homes, 350 acres of industrial/business development and a new wastewater treatment plant. The environmentally sensitive property is mostly mountainous with over a 5 mile length of the Santa Clara River within the project boundaries.

Prepared Direct Testimony and Resume

of

Roger Pelayo  
(KOA)

RERC

CÉC Docket No. 08-SPPE-1

Prepared Direct Testimony  
of  
Rogelio Pelayo

Q. Please state your name and place of employment.

My name is Rogelio Pelayo and I am a Transportation Planner with KOA Corporation, a company which specializes in traffic analysis.

Q. What are your responsibilities with regard to the RERC 3 & 4 project?

KOA is retained to provide traffic consulting services for the project. I am primarily responsible for the conduct of those studies.

Q. What is the purpose of your testimony in this proceeding?

The purpose of my testimony is to identify my role in the analysis of project impacts and to identify the exhibit sections for which I am responsible.

Q. Which exhibits are you sponsoring?

I am sponsoring the following:

Exhibit I SPPE Application  
Section 6.9 Traffic and attachments A-C

I, Rogelio Pelayo, hereby swear that the foregoing is true and correct to the best of my knowledge.

December 12, 2008  
Date

  
Rogelio Pelayo

**ROGELIO PELAYO**

**Assistant Transportation Planner**

**Professional Experience**

Rogelio Pelayo is an Assistant Transportation Planner at KOA Corporation with experience in transportation planning, traffic impact and parking analysis. He has prepared traffic impact, circulation and parking studies for public and private developments throughout Southern California. He has helped in the data collection and graphic design for many of the studies undertaken by the corporation, and has worked on numerous traffic impact studies. He is also proficient in intersection capacity software and has experience in General Plan assessment and Project Study reports.

**Education**

B.S., Urban & Regional Planning,  
Cal Poly Pomona, 2007  
Minor, Geographic Information Systems,  
Cal Poly Pomona, 2007

**Years of Experience**

2 Years Transportation Planning - School,  
Travel Time Analysis, SR2S, Private and  
Municipal experience

**Affiliations**

American Planning Association (APA)

**Project Experience**

**Two Bunch Palms Trail Residential Development Traffic Impact Study, Desert Hot Springs, California (2007) - Project Planner.** KOA Corporation was retained to prepare a traffic impact study for a 155-unit residential development including both single- and multi-family home sites. The project is located on the northwest corner of Two Bunch Palms Trail and West Drive. The study was completed to determine project impacts at seven area intersections and the project driveways. A gate queuing analysis was also completed for the driveways to measure necessary length between the major roadways and the gated access points. Various mitigations were proposed for two of the subject intersections and fair share funding was developed for the recommended improvements.

**Strategic Plan for Relieving Traffic Congestion and Signal Synchronization, Rancho Cucamonga, California (2007) - Project Planner.** KOA Corporation was retained to prepare a plan that had three parts as follows: traffic signal system study, strategic plan of traffic congestion, and Red Hill Traffic Study. Mr. Pelayo prepared SR2S maps for 22 Elementary Schools, 9 Junior High Schools, and 4 High Schools. The routes were prepared based on logical pedestrian paths and the proposed circulation and school access locations. Mr. Pelayo also participated in the preparation of maps that reflected an inventory of the City's existing Econolite Aries monitoring system and proposed communications infrastructure.

**Riverside Energy Resource Center Units 3 & 4, City of Riverside, California (2007) - Project Planner.** KOA Corporation was retained to prepare a traffic impact study for the expansion of an existing power plant facility in the city of Riverside. Mr. Pelayo prepared a traffic study to meet the expected traffic impact analysis requirements of the City of Riverside. The proposed site is owned by the City of Riverside and is located adjacent to and on the east side of the City of Riverside's Regional Water Quality Control Plant (WQCP) in a light industrial/manufacturing area. The proposed expansion involved construction of two simple cycle units. The project will interconnect to the City of Riverside's sixty-nine (69) kV high-voltage transmission system at the existing RERC Switchyard. The project expansion is located on the northeast side of Acorn Street. The traffic study was prepared to meet the

traffic study requirements of the California Energy Commission. The study addressed existing and future traffic conditions, project-related traffic, and potential traffic impacts on the surrounding street system both during construction and after completion of the expansion project.

**Traffic Study for a Business Park/Distribution Center, Banning, California (2007-2008) – Project Manager.** Mr. Pelayo prepared a traffic impact study for a major development that had three different land use components. The project is located on the east side of Hathaway Street, between Wilson Street and Ramsey Street in the city of Banning. The proposed project consisted of 12 buildings that total 1,207,593 square feet. The project analyzed 11 nearby intersections and mitigation measures were recommended for some of the intersections. A near-term and a build-out year were both studied. The project also addressed truck queuing concerns at freeway on/off ramps as well as truck turning radius at major intersections.

**Covenant Commercial Shared Parking Study, Murrieta, California (2008) – Project Manager.** Mr. Pelayo analyzed parking for the proposed retail/meeting hall project located in the city of Murrieta. The project consists of three buildings, including two industrial buildings, with a total of 46,176 square feet and a building known as “The Hub” to be developed with various uses, including a bookstore, coffee and pastry store, offices, a small library, and various meeting and assembly areas. A shared parking analysis was conducted to determine parking demand during various hours of the day in which parking demand by a certain land use would be high while another land use’s parking demand is low. The results of this analysis concluded that the site will actually require a total of 224 stalls before 6pm to meet parking demand, and after 6pm 240 stalls will be required where an additional 11 parking stalls become available on the adjacent street south of the project site, bringing the total available to 242 stalls.

**Ontario Christian High School Study, Ontario, California (2008) - Project Manager.** Mr. Pelayo prepared a traffic impact analysis for a proposed expansion to the Ontario Christian High School located on the south side of Philadelphia Street between Cypress Avenue and Mountain Avenue. The project consisted of the expansion of the existing Ontario Christian High School, which has a current enrollment of 700 students, to a maximum enrollment of 1,200 students by Year 2015. The study analyzed eleven intersections, including four entrances to the campus, and two important freeway interchanges. The analysis also included the development of on site circulation and a site distance analysis.

**Red Hill Country Club Cut-through Traffic and Travel Time Analysis, Rancho Cucamonga, California (Ongoing) – Project Planner.** KOA Corporation was retained to conduct a traffic survey and analysis for the proposed closure of Red Hill Country Club Drive near Foothill Boulevard. A license plate survey sampling was conducted to quantify the amount of “cut-through” traffic that utilizes Red Hill Country Club Drive to travel between Foothill Boulevard and Base Line Road. A travel time survey was also conducted in order to quantify the travel time impacts to the Red Hill Country Club residents as well as patrons of the Country Club as a result of the proposed street closure. Mr. Pelayo participated in the data processing, report preparation, and recommendations that will be presented to the community.

Prepared Direct Testimony and Resume

of

Steve Badgett  
(City of Riverside RPU)

RERC

CEC Docket No. 08-SPPE-1

Prepared Direct Testimony  
of  
Stephen H. Badgett

Q. Please state your name and place of employment

My name is Steve Badgett and I am Deputy General Manager of the Riverside Public Utilities, City of Riverside.

Q. What are your responsibilities with regard to the RERC 3 & 4 project?

I am responsible for the development of the project, which is intended to meet City of Riverside electrical customers' load requirements in the future. The engineers and consultants responsible for assisting in the development of information for the city's application and responding to information inquiries, have been retained under my direction.

Q. What is the purpose of your testimony in this proceeding?

I am testifying to the City of Riverside, Riverside Public Utilities acceptance of the conclusions and conditions of certification contained in the Staff Final Initial Study. Additionally, I am sponsoring certain parts of our exhibits.

Q. Which exhibits are you sponsoring?

I am sponsoring the following parts of Exhibit 1:  
Section 1.2, of the Executive Summary - Need;  
Section 2.1 Introduction and Appendices 2.6A (Gas Will Serve Letter) and 2.7A  
(Water Will Serve Letter)

I, Stephen H. Badgett hereby swear that the foregoing is true and correct to the best of my knowledge.

12/11/08

\_\_\_\_\_  
Date



\_\_\_\_\_  
Stephen H. Badgett



# **STEPHEN H. BADGETT**

**24957 Tyler Place – Murrieta, CA 92562**

**951.231.4487**

**stephenhbadgett@gmail.com**

## **SUMMARY OF QUALIFICATIONS**

- 33 years experience in Electric Gas & Water Utility Industry
- Customer service oriented
- Proven manager and negotiator
- Proactive and flexible to change
- Outstanding productivity as an engineer, supervisor, manager, and director
- Politically astute, yet not political
- Excellent communicator and facilitator
- Positive working relationships within a culturally diverse environment
- Gentleman – Honest – Loyal – Forward Thinker – Leader

## **PROFESSIONAL EXPERIENCE**

### **Riverside Public Utilities – Riverside, CA**

*December 2000 – Present, Deputy General Manager*

Manage 225 employees in all aspects of the Energy Delivery Division and Legislative Affairs for the organization. Plan and direct design, construction, operations and maintenance of the electric and communication systems with a service territory of 80 square miles and a population of over 300,000. Close working relationships with Mayor and City Council, appointed Board of Public Utilities, City Executive Staff, Employees and Organized Labor, and the community to ensure customer satisfaction with the highest quality water and electric services. Other activities include:

- Develop and Implement Department and Division Policies, Procedures, Goals and Strategic Plan to improve efficiency, reliability and quality of service within budget guidelines.
- Strong interaction with City Manager, Mayor and City Council, and Board of Public Utilities through direct discussion, presentations and reports.
- Develop and Manage the Operating and Capital Improvement Budgets with significant infrastructure projects totaling over \$100 million per year.
- Attract, Develop and Retain Quality Employees
- Create and Present community outreach programs including water and electric rate adjustments resulting in strong community support and approval.
- Provide testimony and participate significantly with regional, state and federal legislative officials, regulatory agencies and joint powers agencies to ensure best outcomes from proposed legislation or regulation.
- Develop and Present fiscal positions to Credit Rating Agencies with successful up-rates.
- Successful negotiation of multi-year contracts with Labor Organizations representing Trades and Clerical employees.
- Repeated National Recognition for Department's Success and Operational Effectiveness.

# **STEPHEN H. BADGETT**

*October 1998 – December 2000, Principal Electrical Engineer, Capital Projects*

Managed engineering function and coordinated construction of the organization to better align with project construction and Capital Improvement Program Goals including:

- Reorganization into functional responsibilities.
- Instituted a Consultant Panel to provide engineering and subject matter expert resources on an as-needed basis.
- Created a Contractor's Panel to provide depth and streamline processes for quick deployment of construction resources.
- Initiated an Incident Response Program to minimize risk and losses.

*June 1990 – October 1998, Senior Electrical Engineer, Capital Projects*

- Reorganized department and out-sourced several functions to more efficiently utilize resources and reduce costs.
- Introduced and implemented design and construction philosophies to improve reliability and customer satisfaction and reduce costs.
- Project Manager on several large, highly sensitive projects with successful Environmental Reports and on-time, within budget.

**Memphis Light, Gas and Water – Memphis, TN**

*November 1974 – June 1990, Planning Engineer*

- Responsible for planning of electrical distribution & transmission facilities for nation's largest three service utility.
- Developed numerous design, material, equipment and safety standards.
- Directed and/or managed numerous studies and programs funded by others.

## **EDUCATION**

BSEE, Memphis State University

ASET, Tennessee State Technical Institute

Executive Management Program, University of California Riverside Graduate School of Management

# **STEPHEN H. BADGETT**

## **Recent Professional Accomplishments**

- Platinum Status APPA Reliable Public Power Provider – 2006 & 2008
- 220 kV Transmission Interconnection with ISO Grid - Under development - \$185M
- 100 MW Generation Expansion – Under Development - \$120M
- IBEW Labor Negotiations – October 2006
- 100 MW Riverside Energy Resource Center (RERC) - March 2006 - \$82M
- Energy Control Center nationally recognized for Excellence by WECC – 2005, 2006, 2007
- Essential Service Restoration Plan -2003
- 40 MW Springs Peaking Generation Plant (40MW - \$40M – 40 weeks) - 2002
- Emergency Response Plan -2002
- Public Utility Safety Manual – 2002

## **Professional Committees & Boards**

- American Public Power Association's Reliable Public Power Panel
- American Public Power Association's New Generation Group
- Southern California Public Power Authority Legislative Committee
- California Municipal Utilities Association Legislative Affairs Committee
- CAISO Operations Transmission Maintenance Coordination Committee
- Western Municipal Water District Customer Advisory Committee
- 2003 -2005 Chair Southern California Public Power Authority T&D Committee
- 2003- 2005 Member of Board of Directors - Western Energy Institute

## **Community Involvement**

- Greater Riverside Chamber of Commerce Leadership Steering Committee
- Executive Board of Directors, ywca of Greater Riverside County
- Board of Directors of Prime Vintage (American Heart Association)
- 2006 Leadership Riverside Graduate

RERC 3 & 4  
Docket 08-SPPE-1

**Applicant's Proposed Exhibit List**

<u>Exh.</u>	<u>CEC Log</u>	<u>Date</u>	<u>Description</u>	<u>Topic</u>	<u>Witness</u>
1	45678	3/19/08	Application for SPPE	Various	Various
2	46637	7/10/08	Responses to Staff Data Requests 1-71	Various	Various
3	47179	7/22/08	Letter from RPU regarding Planning Criteria	Transmission	Hall
4	47203	7/22/08	Sketches ECGSK-2 and ECGSK-3	Transmission	Hall
5	47205	7/22/08	Drawing Depicting 69kV Network	Transmission	Hall
6	47628	8/12/08	RPU Plans for future 69kV Network	Transmission	Hall
7	47917	9/4/08	RERC 3&4 Transmission Supplement	Transmission	Hall

# EXHIBIT 1

Application for Small Power Plant Exemption

March 19, 2008

SPPE is on CEC Website

Witness: Various

## EXHIBIT 2

Responses to Staff Data Requests 1-71

July 10, 2008

Data Request Responses are on CEC Website

Witness: Various

EXHIBIT 3

Letter to F Miller from Riverside RPU Regarding Planning Criteria

July 22, 2008

Witness: H Hall

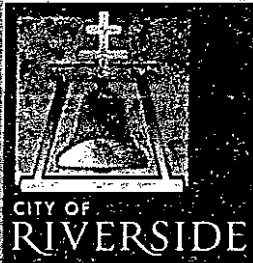

Public Utilities Department  
Administration

July 22, 2008

Felicia Miller  
Project Manager  
California Energy Commission  
Energy Facility Siting Division  
1516 9<sup>th</sup> Street, MS-15  
Sacramento, California 95814-5512

REF: ADMIN 08-047

Subject:

Dear Ms. Miller:

Due to an unexpected increase in power usage among existing customers, Riverside Public Utilities' (RPU) 69 kV system is projected to experience unprecedented overloads on some of its N-1 Contingencies in the 2009 Heavy Summer Peak case. The additions of RERC 3 & 4 will be beneficial to the RPU 69 kV system to reduce the overloads from sixteen (16) down to seven (7) occurrences, as demonstrated in the system studies. RPU acknowledges that the Mountainview-Vista transmission line would experience increased loading rates as a result of the addition of RERC Units 3 & 4. If necessary, RPU would initiate the mitigation measures described below to relieve unacceptable line loading.

Mindful of applicable NERC Standards, RPU will adhere to all relevant NERC Reliability Standards, Regional, sub regional, and Power Pool facility connection requirements and its own transmission System Planning criteria. When mitigating for transmission equipment overloads, the RPU System Dispatchers have the authority to sectionalize the system as necessary to protect the transmission equipment. In addition, the Riverside System Dispatchers have the authority to initiate load shedding to protect transmission system equipment from exceeding emergency equipment ratings, as well as, to bring loadings back down to nominal ratings within allowable time frames.

Sincerely,

Stephen H. Badgett  
Utilities Deputy General Manager/Energy Delivery

RG/SHB:gsg  
h:user\Corres\Badgett\Letters\2008\07-22 CEC 08.047.doc

cc: Bob Gill, Principal Engineer/Project Manager

*Riverside Public Utilities is Committed to the Highest Quality Water and Electric Services at the Lowest Possible Rates to Benefit the Community*

3901 Orange Street • Riverside, CA 92501 • 951.826.5781 • fax 951.826.2450 • [www.riversidepublicutilities.com](http://www.riversidepublicutilities.com)







PUBLIC UTILITIES DEPARTMENT - ELECTRIC ENGINEERING DIVISION  
PLANNING AND SUBSTATION DESIGN 603 SECTION

TRANSMISSION SYSTEM PLANNING CRITERIA

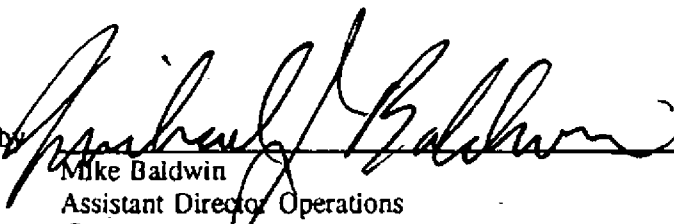
City of Riverside  
June 1992

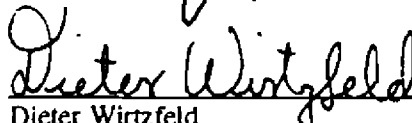
Approved by  Date 7/13/92  
Mike Baldwin  
Assistant Director Operations

Approved by  Date 7/10/92  
Dieter Wirtzfeld  
Assistant Director Engineering Resources

Approved by  Date 7/10/92  
Dave Redding  
Electrical Engineering Manager

Approved by  Date 6/25/92  
Don Colgan  
Principal Supervising Engineer

**CITY OF RIVERSIDE**  
**TRANSMISSION SYSTEM PLANNING CRITERIA**

**1.0 OBJECTIVE**

The objective of these criteria is to provide guidelines for designing the electric transmission system to serve City of Riverside electrical load in a reliable manner and, at the same time, provide the service at an economical cost to the customer.

It is intended that the electric system will be designed to meet the criteria. However, in order to maintain reasonable consumer electrical rates, some exceptions to the criteria may be necessary due to high capital costs for system improvements. These exceptions shall be well documented in appropriate transmission studies.

Comparison of these criteria to the criteria used in the 1987 R.W. Beck Transmission Study is contained in the Addendum, Page D-1.

**2.0 DEFINITIONS**

**Transmission System Components** - Transmission voltage is defined as 66kV and 33kV. Components include transmission lines and pole switches, circuit breakers, disconnect switches, substation bus work, 66-33kV autotransformers and capacitors (future).

**Operating Capacity/Emergency Capacity** - See Addendum (Page A-1) for a listing of Transmission System Component capacities.

**Normal Conditions** - Normal Conditions are those which the City of Riverside electrical network will experience during the normal course of events, including Peak Load conditions.

**Peak Load** - Peak Load is defined as the forecasted annual peak load.

**Single Outage Event** - An outage involving only one Transmission System Component.

**Common-Mode Outage Event** - An outage of two or more transmission lines initiated by a single incident, where the lines share a common pole, or poles.

**Multiple Outage Event** - An outage of any two Transmission System Components where the time interval between the commencement of each outage is not sufficient for corrective action to be taken (such as load transfer).

**Likely Outage Condition** - A Likely Outage Condition is a subset of a Single Outage Event, since it is limited to the outage of one transmission line. This outage can occur during Normal Conditions.

**Unlikely Outage Condition** - An Unlikely Outage Condition is one which is less probable than a Likely Outage Condition. It includes:

- A Multiple Outage Event of two transmission lines.

- A Common-Mode Outage Event of two or more transmission lines.
- A Single Outage Event involving one Transmission System Component other than a transmission line. This includes circuit breakers, substation busses, transformers and autotransformers.

Note that, historically, an Unlikely Outage Condition has never occurred during Peak Load conditions, based on available records since 1968. See the Addendum, Page B-1, for a discussion of Likely and Unlikely Outage Conditions.

### 3.0 CRITERIA

To meet the following criteria, it may be necessary to plan capital projects, including the rearranging, reconductoring or bundling of existing lines or constructing new lines or capacitor banks:

#### 3.1 Normal Conditions

- 3.1.1 Under these conditions, with all Transmission System Components in service, the electric system shall be designed such that no Transmission System Component is loaded above its Operating Capacity.
- 3.1.2 Transmission System Components shall operate within equipment design voltage limits.
- 3.1.3 Transmission voltage profiles shall allow substation load bus voltages (12 and 4kV) to be within normal ranges (see Addendum, Page C-1).

#### 3.2 Likely Outage Conditions

The most recent 11-year history of 104 Likely Outages shows that none occurred at more than 92% of forecasted Peak Load. Therefore, to provide additional margin, the planning of transmission expansion will be done based on studies using 100% of forecasted Peak Load (see Addendum, Page B-1).

- 3.2.1 No transmission line shall be loaded in excess of 110% of its Operating Capacity.
- 3.2.2 No autotransformer shall be loaded in excess of its Emergency Capacity.
- 3.2.3 No other Transmission System Component shall be loaded in excess of its Operating Capacity.
- 3.2.4 Voltage at a transmission bus which serves a non-LTC transformer shall not drop more than 3.5% below the pre-outage voltage level. Voltage at a bus which serves an LTC transformer shall not drop more than 3.5% plus the expected percent LTC reserve at the time of the outage, but shall not drop more than 5.5%, regardless of LTC reserve (see Addendum, Page C-1).

### 3.3. Unlikely Outage Conditions

The most recent 11-year history of 19 Unlikely Outages shows that none occurred at more than 70% of forecasted Peak Load. Therefore, the planning of large capital projects will be done based on studies using 80% of forecasted Peak Load (see Addendum, Page B-1).

#### 3.3.1 At 80% of Forecasted Peak Load

3.3.1.1 Under Unlikely Outage Conditions, no Transmission System Component shall be loaded in excess of its Emergency Capacity., except for Common-Mode Outages. No transmission line following a Common-Mode Outage shall be loaded in excess of 110% of its Operating Capacity.

3.3.1.2 Voltage at a transmission bus which serves a non-LTC transformer shall not drop more than 5.8% below the pre-outage voltage level. Voltage at a bus which serves an LTC transformer shall not drop more than 5.8% plus the expected percent LTC reserve at the time of the outage, but shall not drop more than 7.8% regardless of LTC reserve.

The probability of an Unlikely Outage occurring at 100% of Peak Load approaches zero. Nonetheless, an outage at Peak Load can happen under rare circumstances, and the equipment loading restrictions described under 80% of Forecasted Peak Load will still apply. Therefore, the consequences of an Unlikely Outage occurring at 100% Peak Load will be considered by planning less-expensive remedial action plans.

#### 3.3.2 At 100% of Forecasted Peak Load

Protect equipment from damage during Unlikely Outage Conditions by implementing some type of remedial action scheme, such as:

3.3.2.1 Load dropping through operator intervention, using SCADA.

3.3.2.2 Load dropping through the use of thermal relays.

3.3.2.3 Load dropping through the use of undervoltage relays.

-----

1 May 1992

**CITY OF RIVERSIDE**  
**TRANSMISSION PLANNING CRITERIA**

**ADDENDUM**

TABLE OF CONTENTS

Transmission Component Ratings .....	Page A-1
Likely/Unlikely Outage Conditions .....	Page B-1
Voltage Criteria .....	Page C-1
Comparison of Criteria .....	Page D-1

-----



### TRANSMISSION COMPONENT RATINGS

Transmission Component Ratings are based on manufacturer information and City of Riverside design practices. Maximum line and bus loading in amperes, for each transmission study, will be reported to the Substation Design group to permit the upgrading of terminal equipment, as necessary. Likewise, Transmission Engineering will be informed of any cases where pole switch ratings are exceeded. See Table 1 for a listing of individual transmission line ratings.

#### Transmission Line Conductor Ratings - 66kV

Conductor	Operating Capacity Ampere Rating(1)	Emergency Capacity Ampere Rating(2)
653.9 MCM ACSR, 18/3	850	1060
954 MCM SAC	1000	1250

#### Transmission Line Conductor Ratings - 33kV

Conductor	Operating Capacity Ampere Rating(1)	Emergency Capacity Ampere Rating(2)
1/0 ACSR, 6/1 str.	230	290
2/0 Copper, 7 str.	360	450
336.4 ACSR, 18/1	560	700
653.9 MCM ACSR, 18/3	850	1060

#### Pole Switch Ratings - 33 & 66kV

Refer to Table 1 for individual pole switch ratings. According to manufacturer's data, pole switches do not have an overload capability. Therefore, the Operating and Emergency Capacities are the same.

#### Circuit Breaker Ratings - 33 & 66kV

Based on manufacturer data, the City's 33 and 66kV circuit breakers, as presently equipped, have no overload capability.

Voltage	Operating Capacity Amps	Emergency Capacity Amps
66	1200	1200
33	1200	1200
33	600	600

### Disconnect Switch Ratings - 33 & 66kV

According to manufacturers, 33 and 66kV disconnect switches have 133% overload capability.

Operating Capacity (Amps)	Emergency Capacity (Amps)
600	800
1200	1600

### Substation Bus Ratings - 33 & 66kV

Due to the short spans of conductor/tubing, busses probably have substantial overload capability. However, no specific emergency ratings have been developed at this time. In the absence of specific ratings; manufacturer conductor/tube ratings will be used.

### 69-34.5kV Autotransformer Ratings

Operating Capacity	Emergency Capacity
24.0 MVA/402 Amps	40.0 MVA/670 Amps

**Notes:**

- (1) *These ratings have been used by the City of Riverside and Southern California Edison for many years. They assumed a maximum conductor temperature of 90° C (50° C rise over a 40° C ambient and a wind speed of 2 feet per second (fps). The recently-published IEEE Standard No. 738-1986 standardizes the method for calculating conductor temperature and ampacity. Based on that method, the ampacity of 653.9 MCM and 954 MCM is actually 779 and 974 amperes, respectively for the above given conditions. While the difference for 954 MCM is not significant (2.7%), the difference for 653.9 MCM is 9.1%. The higher rating of 850 amperes results in a conductor temperature of 99° C, using the IEEE method. While the maximum allowable conductor temperature is somewhat subjective, 99° C is at the high-end of an acceptable range, based on a brief survey of industry practice.*

*In 1989, Edison changed its assumed wind speed to 4 fps. This resulted in an increased rating for 653.9 and 954 MCM of 920 and 1090 amperes, respectively. Edison used the IEEE method to arrive at the ampere values.*

*The 2-foot-per-second and 99° C temperature assumptions will be used by the City for the near future until a more thorough review of available weather data and transmission line profiles can be conducted.*



- (2) *The emergency rating is assumed to be 125% of the operating rating for a period not to exceed one half hour. Of the 32 multiple outage events experienced by the City over a 24-year period, 26 events ended in less than 30 minutes. Four additional events were prolonged based on operator judgment; they were not permanent faults and did not occur at heavy load periods. The remaining two were Common-Mode Outages. These outages will be limited to 110%, based on this Criteria.*

-----

**TABLE 1**  
**TRANSMISSION LINE RATINGS**

Transmission Line	Pole Switch No.	Pole Switch Operating & Emergency Capacity (Amps)	Conductor Operating Capacity (Amps)	Conductor Emergency Capacity (Amps)
<b>66kV Lines</b>				
1. Vista - Alumax - Hunter	69-9 69-10	1200 1200	1000	1250
2. Vista - Hunter	432	800	850	1060
3. Vista - La Colina	434 69-3(r)	1200 800	850	1060
4. Vista - Mountain View	433	<del>800</del> 1200	850	1060
5. Vista - Riverside No.1	331	1200	850	1060
6. Vista - Riverside No.2 (1)	69-11 <sup>332</sup>	1200 <sup>1,200</sup>	1000	1250
7. Freeman - H.Lynn - Kaiser	69-13 69-14	1200 1200	850	1060
8. Freeman - Mountain View	69-5(r)	800	850	1060
9. Freeman - Orangecrest			850	1060
10. Harvey Lynn - Mtn. View	69-4(r)	800	850	1060
11. Hunter - Riverside			850	1060
12. Hunter - University (2)	69-1(u)	600	850	1060
13. La Colina - Orangecrest			850	1060
14. La Colina - Springs			1000	1250
15. La Colina - Univ. (2)	69-2(u)	600	850	1060
16. Mountain View - Plaza			850	1060
17. Mtn. View - Riverside (1)			850	1060
18. Orangecrest - Sprgs (3)			1000	1250
19. Plaza - Riverside	69-8(r)	600	850	1060
<b>33kV Lines</b>				
1. Casa Blanca - Freeman	33-2	600	850	1060
2. Casa B. - Mag. - School	33-3 33-4	600 600	360	450
3. Magnolia - Riverside			850	1060
4. Riv. - Industrial No.1			230	290
5. Riv. - Industrial No.2			360	450

## TABLE 1, Cont.

- Notes:
- (1) *This line will be formed following the loop-in of the Vista-Mountain View-Riverside line at Riverside Substation.*
  - (2) *Formed when Hunter-La Colina-University line is looped into University Substation.*
  - (3) *The planned Orangecrest-Springs line is assumed to be 954 SAC conductor, or equivalent ampere capacity.*
  - (r) *Per Transmission Engineering, these pole switches will be removed.*
  - (u) *Per Transmission Engineering, these pole switches will be uprated to 1200 amps.*
-

## DISCUSSION OF LIKELY/UNLIKELY OUTAGE CONDITIONS

### 1.0 Introduction

A study of forced single and multiple outage events experienced by the City has been completed as a part of formulating the Transmission Planning Criteria. Only 66kV lines, terminal equipment, busses and transformers were considered in this review since the 33kV system is basically being contained with no intention of expansion. The data for lines, circuit breakers and busses covered a period of 24 years, from 1966 through 1991, excluding two years where insufficient data was available. The 66 kV transformer outage data covered a 30-year period, 1962 through 1991.

### 2.0 Likely Outage Conditions

Forced single outages of transmission lines for the 24-year period are summarized in Table 2, by month and year of occurrence. The forced single outage rate for lines is 8.67 events per year. Also summarized in the Table is the cause for the outages, with weather (rain, wind lightning, and fog) being the predominant factor. Weather and relay misoperation represent 51% of the total.

In addition to this, forced single line outages were also analyzed with respect to the magnitude of City load present at the time of the outage. Note that this kind of analysis can be done for eleven years only (1981 - 1991), since the City's hourly load data is not readily available prior to 1981. Figure 1 is a plot of this data in the form of a probability distribution function. During the analysis, it became clear that outages due to the hot-washing of lines occurred at higher system loading, on the average, than did other outages. Therefore, this type of forced outage was separated from the other causes. While details of every event are not complete, the majority of hot-washing outages were a result of Southern California Edison washing the source lines out of Vista Substation.

Based on this limited eleven-year history, one might conclude that we would not expect a forced outage to occur when the system load exceeded 92% of the forecasted peak load (with hot-washing as the cause), or 85% (due to other causes). A cursory analysis of the other data (1966 - 1980) also suggests that the City has not experienced an outage at Peak Load, based on the hour of day, the month and the weather conditions at the time of the outage. However, to provide some margin for unexpectedly high temperatures and to provide margin for required maintenance of lines, the system load used in studies shall be 100% of the forecasted Peak Load.

### 3.0 Unlikely Outage Conditions

#### 3.1 Forced Multiple Outages On Transmission Lines

Table 2 includes a summary of forced multiple outages of transmission lines, in addition to the forced single outages. The forced multiple outage rate is about 1.3 events per year. The summary of causes indicates again, as it did for single outages, that weather is a predominate factor, as is relay misoperation. These two factors, by themselves or in combination, represent 69% of the outages.

A more detailed listing is given in Table 3. A review of these outages reveals that there were six outages which lasted roughly 30 minutes, or longer. The remaining ones were generally less than ten minutes. Of the six lengthy outages, two were a result of patrolling the lines prior to reclosing. In both of these cases, the reclosing was successful. Of the remaining four, two were a result of the lines being on a common structure: wind-damaged pole in one case (Table 3, Jan.20, 1987) and fire under the lines in the other case (Table 3, Oct.8, 1990).

### 3.1.I Common-Mode Outage

A review of the criteria used by Southern California Edison and the criteria used by R. W. Beck in their 1987 study indicates that the Common-Mode Outage of two transmission lines on the same pole is considered a Likely Outage Condition under special circumstances:

- 3.1.1.1 When the pole is exposed to vehicular traffic and the two lines are the sole supply for a substation (Edison).
- 3.1.1.2 When the pole is exposed to heavy vehicular or airline traffic (R. W. Beck).

The City has one example described by the Edison criteria (Orangecrest Substation), but this will be eliminated when the Orangecrest - Springs line is completed in 1993. There are several examples of the circumstance described in Beck's criteria. Table 4 details those areas on City's system where two or more transmission lines share the same supporting structure, which is exposed to vehicular traffic.

Of the 32 multiple outages experienced by the City over a 24-year period, six were prolonged outages, two of which resulted from lines being on a common structure. Due to the infrequent occurrence, this type of event will therefore be considered as an Unlikely Outage Condition. However, since Common-Mode Outages tend to be of long duration, a line overload will be limited to 110% of its Operating Capacity.

### 3.1.2 Criteria At 80% of Forecasted Peak Load

As was done for single outages, forced multiple outages were analyzed with respect to the magnitude of City load present at the time of the outage. This data is included in the right three columns of Table 3 and is shown graphically in Figure 1 as a distribution function. Figure 1 shows that for the 11-year period from 1981 through 1991, the City load never exceeded 70% of the forecasted peak during any forced multiple line outage. Thus, a multiple outage might not be expected when City load exceeds 70% of the forecasted peak. Reconductoring, rearrangement or bundling of existing lines or addition of new lines will need to be considered when studying multiple outage events at an appropriate load level. Therefore, to provide some margin for unexpectedly high temperatures and to provide margin for required maintenance of lines, the system load used in studies shall be 80% of the forecasted Peak Load.

### 3.1.3 Remedial Action At 100% of Forecasted Peak Load

While the probability of experiencing an outage at Peak Load approaches zero, the consequences (including a cascading blackout) are severe enough that the event must be addressed in some fashion. Building or reconductoring lines for such an improbable event cannot be justified. Therefore, as insurance against a cascading situation, some form of remedial action scheme should be implemented (such as load dropping through the use of thermal or voltage relays, or manual intervention). Based on typical annual load data for the City, this 80% load level will be exceeded only 2.5% of the year (see Table 5). Thus, remedial action schemes will be relied upon for a comparatively small amount of time. This will not seriously degrade service reliability to the City's electrical customers. The transmission system will be studied at 100% of the forecasted peak load to determine what remedial actions are appropriate for forced multiple outage conditions.

## 3.2 Forced Single Outages of Circuit Breakers, Transformers and Substation Busses

Forced outages of these Transmission System Components is limited to only those cases which impact the transfer capability of the transmission system. For example, the failure of a transformer which has no 66kV circuit breaker may result in the opening of one or more transmission line circuit breakers to clear the transformer. On the other hand, if the transformer does have a highside circuit breaker, its failure would not interrupt the transmission of power to other stations, and would not be considered in this analysis. Based on available records, the following is observed:

### 3.2.1 Circuit Breaker Outage History

There has been only one failure of a 66kV circuit breaker during the 24-year period, which resulted in the interruption of transmission lines (see Table 3, Jan. 20, 1987). This event began when two lines faulted due to a damaged common pole. When one circuit breaker at Mountain View failed to open, four additional lines were opened, dropping Mountain View Substation load. Thus, the forced outage rate for circuit breakers is .04 events per year.

### 3.2.2 Transformer Outage History

In the past 30 years, there have been five 66-12/4 kV transformer failures (see Table 6). Only one of these resulted in the interruption of a transmission line: the outage of the Plaza No.1 bank which open-ended the Riverside 66kV line. The forced outage rate for transformers is .03 events per year.

### 3.2.3 Substation Bus Outage History

In the 24-year history, there is no record of a substation bus outage which affected power transmission on the 66kV system.

Based on the low probability of these events, they will be considered as Unlikely Outages.

3.3 Forced Multiple Outages of Circuit Breakers, Transformers and Substation Busses

In the 24-year history, there is no record of these multiple outages occurring. Based on the low expectation of these events ever occurring, they are not included in the Criteria.

-----

EXHIBIT 4

Sketches ECGSK-2 and ECGSK-3

July 22, 2008

Witness: H Hall







RERC 69KV UG T-LINE UNITS 3&4

UNIT-PHASE	CONDUCTOR TEMPERATURES AT DESIGN AMPACITIES
U4-1	604A AT 86°C
U4-2	604A AT 87°C
U4-3	604A AT 89°C
U3-1	604A AT 86°C
U3-2	604A AT 87°C
U3-3	604A AT 89°C

EACH CABLE CONSISTS OF 1-1750KCMIL AL (69KV), XLPE

TARGET AMPACITY - 604A (70MVA). THIS AMPACITY, WITH THE 13.8 KV CROSS CONNECT BETWEEN THE UNITS, PROVIDES THE ABILITY TO OPERATE BOTH UNITS AT REDUCED CAPACITY OR ONE UNIT FULL CAPACITY AND ONE UNIT REDUCED CAPACITY IN THE EVENT THAT ONE OF THE GSU IS NOT AVAILABLE.

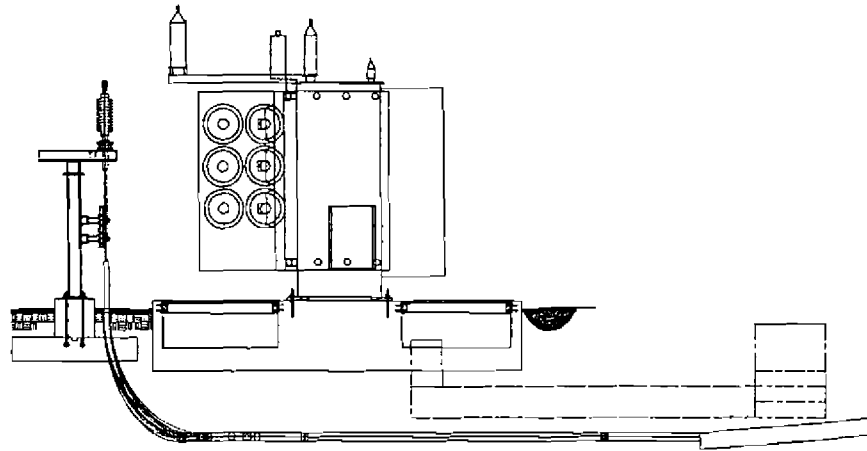

GSU TRANSFORMER (3)

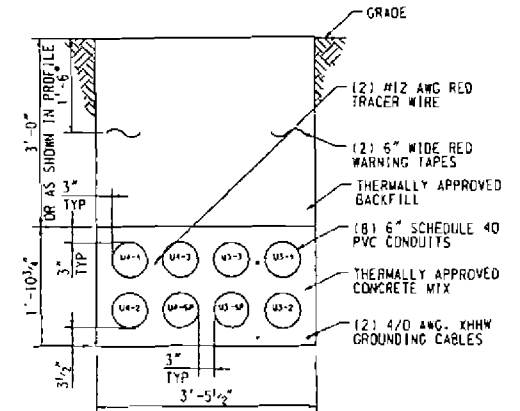

SECTION  
SCALE: NTS  
(AHEAD STATION VIEW)

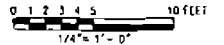

NEW DRAWING

RIVERSIDE ENERGY RESOURCE CENTER UNITS 3&4  
GSU AND LINE SIDE CUBICAL  
UNDERGROUND DUCT BANK



NO.	DESCRIPTION	DATE	BY	CHKD

DATE	1/14/2008	BY	
SCALE	1/2" = 1' - 0"	NO.	
PROJECT NO.	113580	DATE	07
ISSUED FOR PERMITTING PURPOSE ONLY		CHKD	
		NO.	1 OF 1
		DATE	07/04/08
		BY	ECKSK-3

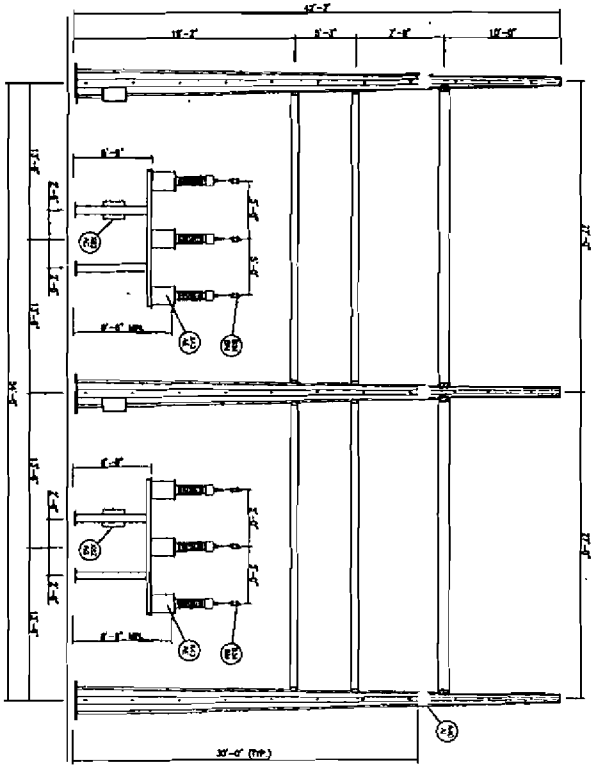

EXHIBIT 5

Drawing Depicting 69kV Network

July 22, 2008

Witness: H Hall



SECTION G-G

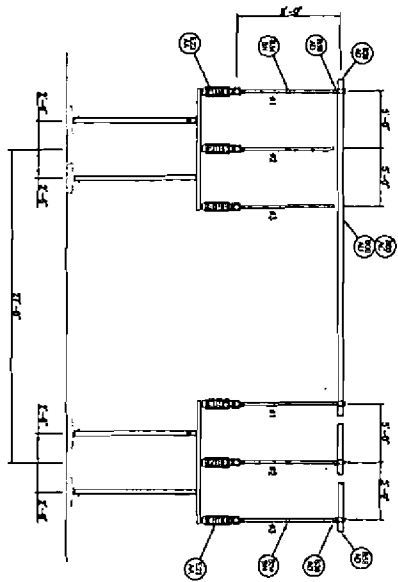

SECTION H-H

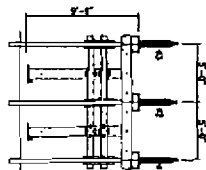

SECTION J-J

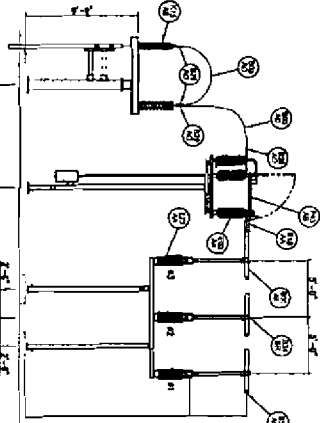

SECTION K-K

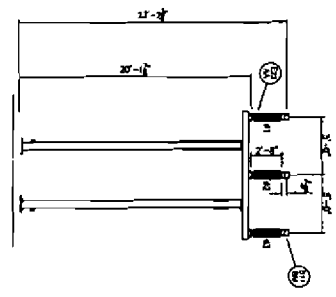

SECTION L-L



**POWER ENGINEERS**

**RIVERSIDE ENERGY RESOURCE CENTER**  
 88KV SWITCHYARD  
 SECTION G-G, K-K, J-J, K-K AND L-L

NO.	DATE	DESCRIPTION	BY	CHECKED
1	3/7/01	ISSUED FOR REVIEW		
2	3/7/01			
3	3/7/01			
4	3/7/01			
5	3/7/01			
6	3/7/01			
7	3/7/01			
8	3/7/01			
9	3/7/01			
10	3/7/01			
11	3/7/01			
12	3/7/01			
13	3/7/01			
14	3/7/01			
15	3/7/01			
16	3/7/01			
17	3/7/01			
18	3/7/01			
19	3/7/01			
20	3/7/01			
21	3/7/01			
22	3/7/01			
23	3/7/01			
24	3/7/01			
25	3/7/01			
26	3/7/01			
27	3/7/01			
28	3/7/01			
29	3/7/01			
30	3/7/01			
31	3/7/01			
32	3/7/01			
33	3/7/01			
34	3/7/01			
35	3/7/01			
36	3/7/01			
37	3/7/01			
38	3/7/01			
39	3/7/01			
40	3/7/01			
41	3/7/01			
42	3/7/01			
43	3/7/01			
44	3/7/01			
45	3/7/01			
46	3/7/01			
47	3/7/01			
48	3/7/01			
49	3/7/01			
50	3/7/01			
51	3/7/01			
52	3/7/01			
53	3/7/01			
54	3/7/01			
55	3/7/01			
56	3/7/01			
57	3/7/01			
58	3/7/01			
59	3/7/01			
60	3/7/01			
61	3/7/01			
62	3/7/01			
63	3/7/01			
64	3/7/01			
65	3/7/01			
66	3/7/01			
67	3/7/01			
68	3/7/01			
69	3/7/01			
70	3/7/01			
71	3/7/01			
72	3/7/01			
73	3/7/01			
74	3/7/01			
75	3/7/01			
76	3/7/01			
77	3/7/01			
78	3/7/01			
79	3/7/01			
80	3/7/01			
81	3/7/01			
82	3/7/01			
83	3/7/01			
84	3/7/01			
85	3/7/01			
86	3/7/01			
87	3/7/01			
88	3/7/01			
89	3/7/01			
90	3/7/01			
91	3/7/01			
92	3/7/01			
93	3/7/01			
94	3/7/01			
95	3/7/01			
96	3/7/01			
97	3/7/01			
98	3/7/01			
99	3/7/01			
100	3/7/01			

EC5004101-08

**NEW DRAWING**

**SPARKS**

EXHIBIT 6

RPU Plans for Future 69kV Network

August 12, 2008

Witness: H Hall

# **RIVERSIDE PUBLIC UTILITIES PLANS FOR FUTURE 69 KV NETWORK IMPROVEMENTS**

**August 13, 2008**

Riverside Public Utilities (RPU) operates a 69 kV network that supplies electric energy to the 100,000+ customers within the City of Riverside (see Attachment A). There are a number of improvements planned for the network in the next several years that will allow RPU to meet its Planning Criteria.

## **“STP” – Sub-transmission Project**

This project comprises the construction of about 3 ½ miles of new double-circuit 69 kV line, plus several re-arrangements of 69 kV lines within the RPU network (see Attachment B). The elements of this project were originally a part of RTRP (defined below), until it became evident that the operating date for RTRP would be delayed. The expected operating date for the STP improvements is the spring of 2010.

## **“RTRP” – Riverside Transmission Reliability Project**

This project will establish a new transmission interconnection for the City of Riverside, and will result in the division of the existing RPU network into two “sub-systems”. One sub-system will be served from the existing Vista 230-69 kV Substation, and the other will be served from the new Wilderness 230-69 kV Substation (see Attachment C). Construction will include a new 230 kV double-circuit line to Wilderness Substation from Southern California Edison’s transmission network. There will also be a number of miles of new 69 kV line construction within the City, to facilitate the division of the network, as well as to re-enforce deficient areas. The expected operating date for these improvements is the spring of 2012.

# Attachment A

CITY OF RIVERSIDE 69KV NETWORK  
SINGLE-LINE DIAGRAM

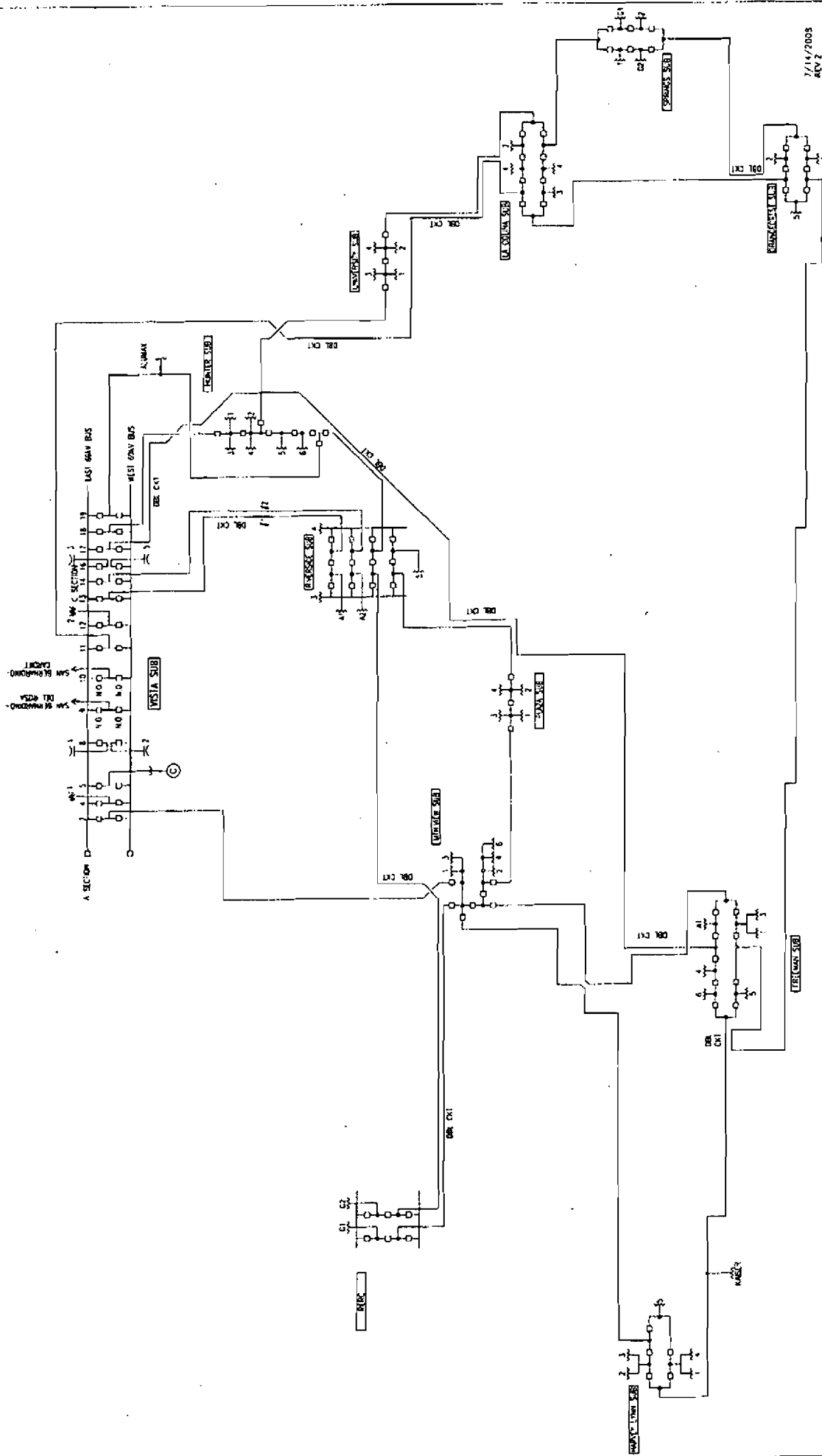

# Attachment B

CITY OF RIVERSIDE 69KV NETWORK  
 PROPOSED "SIP" 69 KV LINE IMPROVEMENTS  
 SINGLE-LINE DIAGRAM

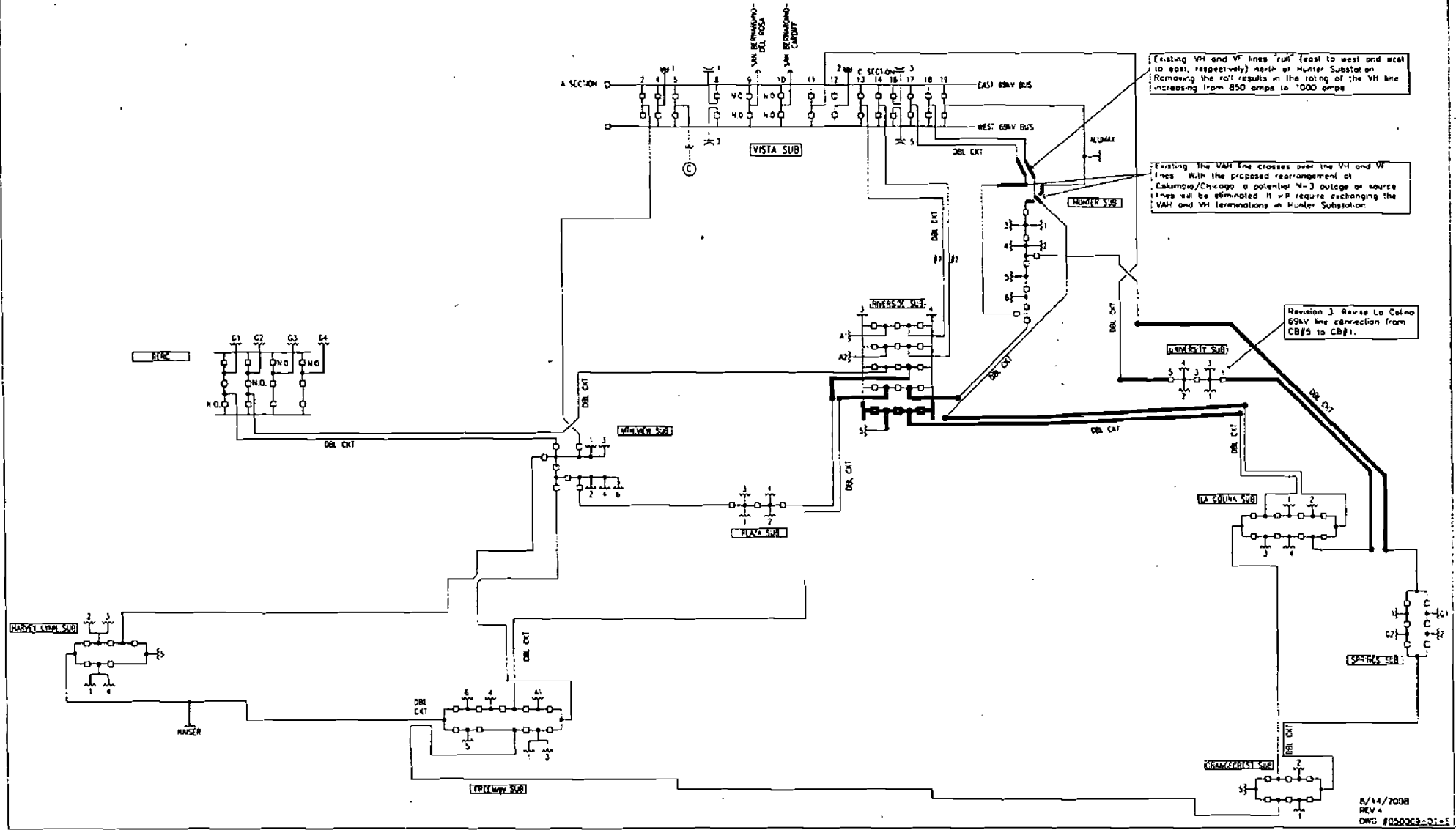

8/14/7008  
 REV 4  
 DWG #050303-01-5



# Attachment C

FUTURE VISTA AND WILDERNESS 69KV NETWORKS  
SINGLE-LINE DIAGRAM  
POST-"STP"

**Proposed**

**LEGEND**

- EXISTING ELECTRIC FACILITIES
- PROPOSED ELECTRIC FACILITIES TO BE CONSTRUCTED

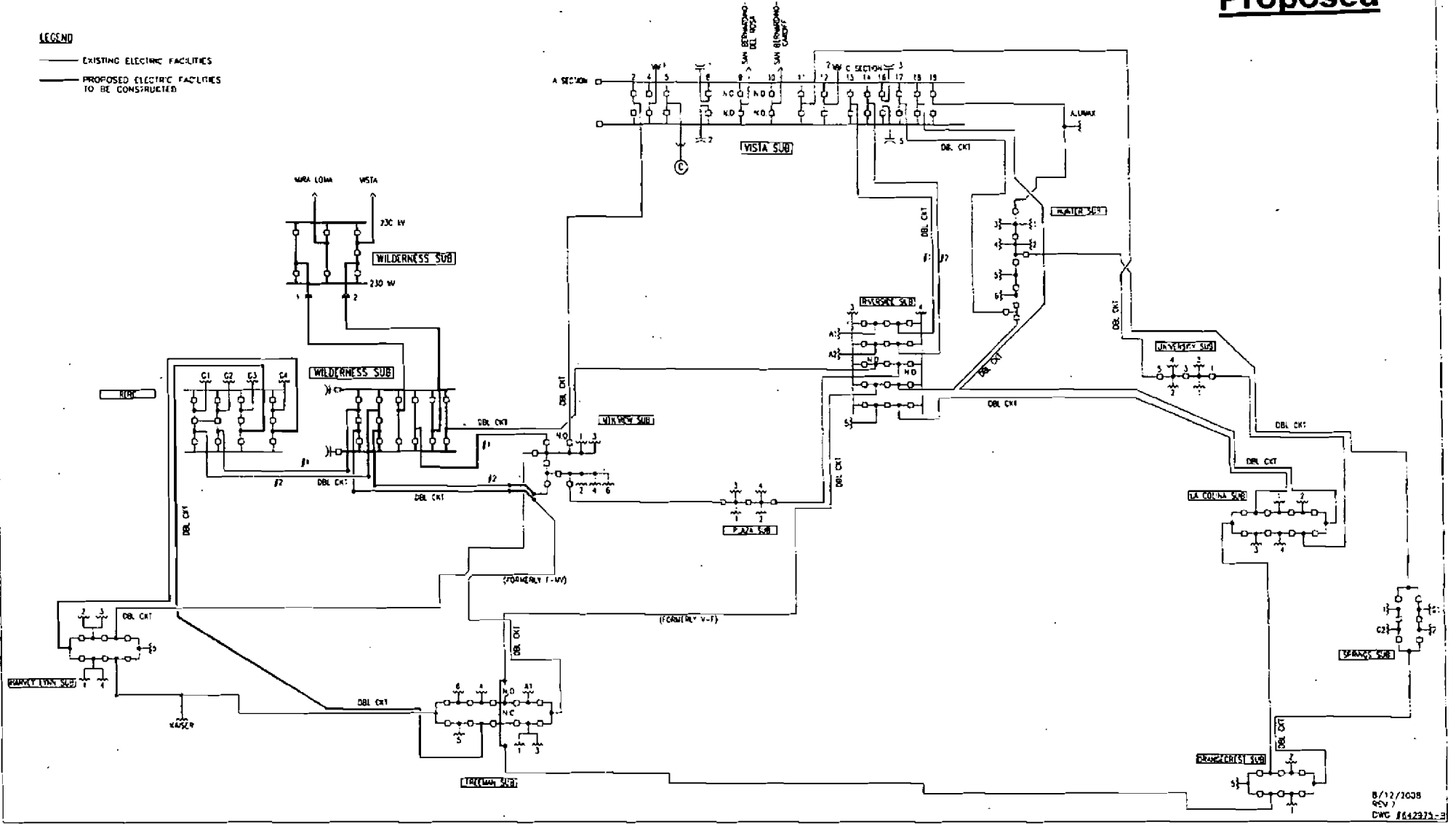

8/12/2008  
REV 7  
DWG #642971-3

EXHIBIT 7

RERC 3 & 4 Transmission Supplement

September 4, 2008

Witness: H Hall

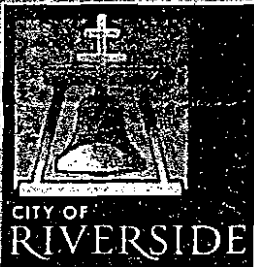

Public Utilities Department  
Administration

September 4, 2008

Felicia Miller  
Project Manager  
California Energy Commission  
Energy Facility Siting Division  
1516 9<sup>th</sup> Street, MS-15  
Sacramento, California 95814-5512

REF: ADMIN 08-052

Subject: Riverside Energy Resource Center Units 3 & 4 Power Plant Licensing Case; Docket Number 08-SPPE-1

Dear Ms. Miller:

As we have expressed previously and as outlined below, the operational date for RERC Units 3 & 4 is critical to the ability of the City of Riverside, through its Public Utilities Department (Riverside), to serve its customers with reliable energy. As understood during Riverside staff's August 27, 2008, conference call with you, the additional information included with this letter should close out requests for information required for transmission engineering and allow the draft Initial Study to be finalized by the CEC staff. Riverside is confident that we have responded to all of CEC staff's requests and now expect that the CEC shall be able to issue its Initial Study within the next two weeks. Please let us know if our understanding is incorrect. Riverside, if necessary, can answer any further questions regarding transmission engineering by filing testimony that describes the system and the upgrades RPU will make to the system.

The following facts illustrate why RERC Units 3 & 4 are so critical to Riverside. All power to serve Riverside customers comes from the state transmission grid through a single point of interconnection, via the Southern California Edison (SCE) Vista Substation. Not only is this connection at capacity, interruption to the delivery of energy through the one point of interconnection leaves the City wholly reliant on internal generation.

First, the capacity at Vista is 560 megawatts (MW). Energy can also be provided by the 96 MW RERC Units 1 & 2 and the 40 MW Springs Generating Station. Both facilities are peaking units and are licensed to run only a limited number of hours per year. Increased demand on Riverside's system has led to higher and more frequent peaks. Historically, Riverside's system expansion has been approximately 6-7% every five years, both in number of meter connections and customer energy usage. The most recent five-year period has seen a 31% increase in customer energy usage (5% per year), although the number of meter connections has increased at the historical rate of 1-2% per year. Riverside's 2007 system peak of 610 MW is already 50 MW above the 560 MW import capability of the Vista Substation. Rolling blackouts would have already occurred had Riverside not recently added internal generation capacity. Despite the recent economic downturn, Riverside has added 1,112 new meters (1% growth rate) with nearly 20 MW of customer capacity in fiscal year 2007-08, a one year capacity increase of 3.5%.

If the current load growth continues at historical levels, by summer 2010 Vista's import capacity, plus Riverside's internal generation at RERC and Springs (approximately 696 MW), will not meet our customer's energy needs. When peak energy demand exceeds 696 MW, Riverside will not have sufficient capacity to deliver energy requirements. This will result in rolling blackouts during peak usage - typically Monday through Friday between noon and 5 p.m. The additional power from RERC Units 3 & 4 by 2009 would fill this shortfall pending the construction of the second interconnection to the state grid. In addition, if RERC 3 & 4 is not available, any requirement to reduce load from the state grid in peak periods, which occurs most summers, would not be able to be made up with internal generation as adequate capacity will not exist.

Second, Riverside has long been concerned that having a single point of interconnection to import the bulk of the City's energy requirements was too tenuous and represented a risk to the provision of uninterrupted power to its citizens. To highlight Riverside's concern, the Vista substation lost five of its seven lines serving Riverside on October 26, 2007 due to one local SCE grid disturbance. The remaining two lines tripped on overload, leaving the City completely without power. Riverside was black for a short period of time, and solely reliant on its internal generation. The additional internal generation provided by RERC Units 3 & 4 will allow Riverside to restore power to essential services in a timelier manner.

The unanticipated growth in peak demand, coupled with the tenuous nature of the single point of interconnection for the importation of power, makes it imperative that Riverside develop additional internal generation in a timely manner.

The only issue that appears to remain open is transmission engineering. Since approximately the third week of July, Riverside staff has been diligently responding to requests from CEC staff for information detailing Riverside's system planning and reliability criteria for its internal 69 kV transmission system. We continue to receive verbal requests for additional information related to the Riverside transmission system. Our concern is that these additional requests are not helping to clarify or bring the issue to closure and in fact are potentially diverting attention into areas that may be outside CEC jurisdiction, e.g., Riverside transmission system planning and operation. The original July 11<sup>th</sup> date for the issuance of the draft Initial Study has been delayed by this issue.

At this time, Riverside believes it has responded to all of CEC staff's requests and now expects that the CEC should be able to issue its Initial Study within the next two weeks.

Thank you for your attention to this very important matter. Riverside looks forward to the successful completion of the SPPE process.

Sincerely,

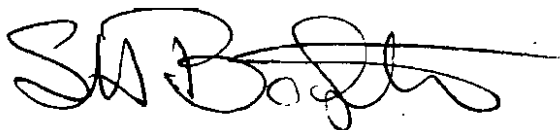

Stephen H. Badgett  
Utilities Deputy General Manager/Energy Delivery

SHB:gsg

h:\user\Corres\Badgett\Letters\2008\09-04 Felicia Miller-CEC-RERC 3 & 4 08.052.doc

STATE OF CALIFORNIA  
CALIFORNIA ENERGY COMMISSION

In the Matter of: )  
Application for Small Power Plant )  
Exemption for the Riverside Energy )  
Resource Center, Units 3 & 4 )  
\_\_\_\_\_ )

Docket No. 08-SPPE-1  
Proof of Service

PROOF OF SERVICE

CALIFORNIA ENERGY COMMISSION  
Attn: Docket No. 08-SPPE-1  
1516 Ninth Street, MS-4  
Sacramento, CA 95814-5512

Applicant

Stephen H. Badgett  
Deputy General Manager  
Riverside Public Utilities  
3900 Main Street  
Riverside, CA 92522  
[sbadgett@riversideca.gov](mailto:sbadgett@riversideca.gov)

Robert B. Gill  
Principal Electrical Engineer  
Riverside Public Utilities  
3900 Main Street  
Riverside, CA 92522  
[rbg@riversideca.gov](mailto:rbg@riversideca.gov)

Counsel For Applicant

Allan J. Thompson, Esq.  
Attorney for Applicant  
21 "C" Orinda Way #314  
Orinda, CA 94563  
[allanori@comcast.net](mailto:allanori@comcast.net)

Susan Wilson  
Deputy City Attorney  
City of Riverside  
3900 Main Street  
Riverside, CA 92522  
[SWilson@riversideca.gov](mailto:SWilson@riversideca.gov)

Applicant's Consultants

Mike Tatterson  
Project Manager  
Power Engineers, Inc.  
P. O. Box 1066  
Hailey, ID 83333  
[mtatterson@powereng.com](mailto:mtatterson@powereng.com)

Energy Commission

Karen Douglas  
Presiding Member  
[KMcDonne@energy.state.ca.us](mailto:KMcDonne@energy.state.ca.us)

James D. Boyd  
Associate Member  
[jboyd@energy.state.ca.us](mailto:jboyd@energy.state.ca.us)

Raoul Renaud  
Hearing Officer  
[rrenaud@energy.state.ca.us](mailto:rrenaud@energy.state.ca.us)

Felicia Miller  
Project Manager  
[fmiller@energy.state.ca.us](mailto:fmiller@energy.state.ca.us)

Deborah Dyer  
Staff Counsel  
[ddyer@energy.state.ca.us](mailto:ddyer@energy.state.ca.us)

Public Advisors Office  
[publicadviser@energy.state.ca.us](mailto:publicadviser@energy.state.ca.us)

California ISO  
[e-receipt@caiso.com](mailto:e-receipt@caiso.com)

Intervenor  
Alliance for a Cleaner Tomorrow  
Arthur S. Moreau, Esq.  
Klinedinst PC  
501 West Broadway, Suite 600  
San Diego, CA 92101

Declaration of Service

I, Allan J Thompson, declare that on December 16, 2008, I deposited copies of the attached (1) Applicant's Prehearing Conference Statement with two attachments, (2) Prepared Direct Testimony and resumes of its witnesses, and (3) Exhibit List and Exhibits posted in first class mail with first-class postage thereon fully prepaid, or delivered via overnight delivery, to those identified on the Proof of Service list above

I declare under penalty of perjury that the foregoing is true and correct.

December 16, 2008

  
Allan J. Thompson