

WINSTON & STRAWN LLP

214 NORTH TRYON STREET
CHARLOTTE, NORTH CAROLINA 28202-1078

35 WEST WACKER DRIVE
CHICAGO, ILLINOIS 60601-9703

43 RUE DU RHÔNE
1204 GENEVA, SWITZERLAND

15 QUEEN'S ROAD CENTRAL
HONG KONG

99 GRESHAM STREET
LONDON EC2V 7NG

333 SOUTH GRAND AVENUE
LOS ANGELES, CALIFORNIA 90071-1543

101 CALIFORNIA STREET
SAN FRANCISCO, CALIFORNIA 94111-5894

(415) 591-1000

FACSIMILE (415) 591-1400

www.winston.com

4 STASOVOY ULITSA
119071 MOSCOW, RUSSIAN FEDERATION

200 PARK AVENUE
NEW YORK, NEW YORK 10166-4193

ONE RIVERFRONT PLAZA
NEWARK, NEW JERSEY 07102-5401

25, AVENUE MARCEAU
CS 31621
75773 PARIS CEDEX 16

1700 K STREET, N.W.
WASHINGTON, D.C. 20006-3817

August 10, 2010

VIA FEDERAL EXPRESS

California Energy Commission
Docket Office
1516 Ninth Street, MS-4
Sacramento, CA 95814

DOCKET	
08-AFC-3	
DATE	<u>AUG 10 2010</u>
RECD.	<u>AUG 10 2010</u>

Re: Docket No. 08-AFC-3 - Marsh Landing Generating Station Project

To the Docket Office:

Enclosed for docketing in the above-referenced proceeding is a copy of the Transition Cluster Phase II Interconnection Study Report for the interconnection of the Marsh Landing Generating Station and the other projects in the Transition Cluster. Please file this document in Docket No. 08-AFC-3.

Thank you for your assistance.

Very truly yours,



Lisa A. Cottle

cc: Proof of service list for Docket No. 08-AFC-3 (via electronic mail only)

July 30, 2010

Mr. Chuck Hicklin
Engineering Manager
Mirant Delta, LLC
696 West Tenth Street
Pittsburg, CA 94565

Subject: Marsh Landing Generating Station Project Transition Cluster Phase II Interconnection Study

Dear Chuck:

Attached is the Transition Cluster Phase II Interconnection Study Report for the interconnection of the proposed Marsh Landing Generating Station Project to the CAISO Controlled Grid. The CAISO and PG&E performed the Phase II Interconnection Study in accordance with the CAISO's LGIP tariff.

The study identified the cost of Network Upgrades assigned to the Project in accordance with the CAISO's LGIP tariff. The cost for Network Upgrades assigned to the Project is \$ [REDACTED]. In addition, the study report provides a non-binding cost estimate of the Interconnection Facilities to interconnect the Project to the CAISO Controlled Grid.

Please review the report and prepare comments and questions for the Results Meeting. The Phase II Interconnection Study Results Meeting will be coordinated and scheduled within 30 calendar days following receipt of this Phase II Interconnection Study report.

Sincerely,

Original signed by

Gary DeShazo
Director – Regional Transmission North

Attachment

via e-mail:

Chuck Hicklin (Chuck.hicklin@mirant.com)
John Vardanian (JAV7@pge.com)

CAISO via email:

Edward Fishback (EFishback@caiso.com)
CAISO Regional Transmission North

Transition Cluster Phase II Interconnection Study Report

Group Report in PG&E's Greater Bay Area

Final Report



California ISO
Your Link to Power

July 30, 2010

This study has been completed in coordination with Pacific Gas & Electric per CAISO Tariff Appendix Y Large Generator Interconnection Procedures (LGIP) for Interconnection Requests in a Queue Cluster Window

Table of Contents

1.	Executive Summary	1
2.	Transition Cluster Interconnection Information	2
3.	Study Objectives	3
4.	Study Assumptions	5
4.1	Power flow base cases	5
4.2	Load and Import.....	5
4.3	Generation Dispatch.....	6
4.4	New Transmission Projects	7
4.5	Pre-Transition Cluster Generation Projects	8
4.6	Other SPSs and Operator Actions	10
5.	Study Criteria and Methodology.....	10
5.1	Steady State Study Criteria	10
5.2	Short Circuit Duty Criteria.....	11
5.3	Transient Stability Criteria	12
5.4	Post-Transient Voltage Stability Criteria.....	13
5.5	Reactive Margin Criteria.....	13
5.6	Power Factor Criteria.....	14
6.	Deliverability Assessment.....	15
6.1	Results	15
7.	Steady State Assessment	16
7.1	Study Results.....	17
8.	Short Circuit Duty Assessment	20
8.1	Results	20
9.	Transient Stability Analysis.....	21

9.1	Transient Stability Study Scenarios.....	21
9.2	Parameters Monitored to Evaluate System Stability Performance.....	21
9.3	Results	22
10.	Mitigation of Overloaded Facilities	23
10.1	Mitigation for Category “A” Normal Overloads.....	23
10.2	Mitigation for New Category “B” Overloads	26
10.3	Mitigation for New Category “C” Overloads	27
10.4	Mitigation for Transient Stability issues	29
10.5	Mitigation for Fault Duty.....	29
11.	Environmental Evaluation / Permitting.....	30
11.1	CPUC General Order 131-D.....	30
11.2	CPUC Section 851	31
12.	Upgrades, Cost and Time to Construct Estimates	32
13.	Coordination with Affected Systems.....	35

Appendices:

- A. Individual Project Report**
- B. Contingency Lists for Outages**
- C. Deliverability Assessment Results**
- D. Steady State Power Flow Plots**
- E. Short Circuit Calculation Study Results**

Definitions

AVR	Automatic Voltage Regulation
CAISO	California Independent System Operator Corporation
COD	Commercial Operation Date
Deliverability Assessment	CAISO's Deliverability Assessment
DTT	Direct Transfer Trip
EO	Energy Only Deliverability Status
FC	Full Capacity Deliverability Status
FERC	Federal Energy Regulatory Commission
IC	Interconnection Customer
LGIA	Large Generator Interconnection Agreement
LGIP	Large Generator Interconnection Procedures
Max	Maximum generation output
NERC	North American Electric Reliability Corporation
NQC	Net Qualifying Capacity as modeled in the Deliverability Assessment: Solar thermal projects dispatched at maximum generation output, all other solar projects dispatched at 85% of maximum output, and wind projects dispatched at 40% of their maximum output.
NQCRS	NQC as modeled in the Reliability Study: All solar projects dispatched at maximum generation output and wind projects dispatched at 40% of their maximum output
PG&E	Pacific Gas and Electric Company
Phase I Study	Cluster 1 Phase I Study
Phase II Study	Transition Cluster Phase II Study
PTO	Participating Transmission Owner
RA	Resource Adequacy
RAS	Remedial Action Scheme (also known as SPS)
POI	Point of Interconnection
POS	Plan of Service
SCE	Southern California Edison Company
SDG&E	San Diego Gas & Electric Company
SPS	Special Protection System (also known as RAS)
SVC	Static VAr Compensator
TPP	CAISO's Transmission Planning Process
WECC	Western Electricity Coordinating Council

1. Executive Summary

In accordance with the Federal Energy Regulatory Commission (FERC) approved Large Generator Interconnection Procedures (LGIP) for Interconnection Requests in a Queue Cluster Window (CAISO Appendix Y), this Transition Cluster Phase II study was initiated to determine the combined impact of all the Transition Cluster projects on the CAISO Controlled Grid.

Based on their geographical locations, the Transition Cluster projects were grouped together in clusters for study purposes. There were six (6) generation projects that were assigned to the Greater Bay Area Transition Cluster Group for the Phase II Study. This study report provides the following:

1. Transmission system impacts caused by the addition of Greater Bay Area Transition Cluster Group projects,
2. System reinforcements necessary to mitigate the adverse impacts of Greater Bay Area Transition Cluster Group projects under various system conditions, and
3. A list of required facilities and a good faith estimate of cost responsibility and time to construct these facilities.

To determine the system impacts caused by Greater Bay Area Transition Cluster Group projects, the following studies were performed:

- Steady State Power Flow Analyses
- Short Circuit Duty Analyses
- Transient Stability Analyses
- Reactive Power Deficiency Analyses
- Deliverability Assessment
- Operational Studies

The results of above studies indicated that Greater Bay Area Transition Cluster Group projects are responsible for the overloading of several transmission facilities and overstressing of one circuit breaker in PG&E's service territory. Network Upgrades¹ to mitigate identified problems have been proposed in this report. The following tables show a summary of the proposed Network Upgrades along with an estimated cost.

¹ The transmission facilities, beyond the Point of interconnection (POI), necessary to interconnect the Project, which would not have been necessary but for the interconnection of the Project.

Table A – Delivery Network Upgrades

1	Reconductor Contra Costa PP – Delta Pumps 230 kV Line (Contra Costa – Windmaster)	\$0
2	Reconductor Contra Costa PP – Delta Pumps 230 kV Line (Windmaster – Delta Pumps)	\$0
3	Reconductor Kelso – Tesla 230 kV Line (Kelso – USWP Ralph)	\$0
4	Reconductor Kelso – Tesla 230 kV Line (USWP Ralph – Tesla)	\$0
5	Reconductor Los Positas – Newark 230 kV Line	\$0
TOTAL		\$0

Table B – Reliability Network Upgrades

1	SPS Mitigation - Birds Landing – Contra Costa 230 kV Line	\$0
2	SPS Mitigation - Contra Costa PP – Contra Costa Sub 230 kV Line	
3	SPS Mitigation - Vaca – Lambie 230 kV Line	
4	SPS Mitigation - Lambie – Birds Landing 230 kV Line	
5	Re-rate of Lone Tree – Cayetano 230 kV Line (USWP JW Ranch – Lone Tree)	\$0
6	Replace overstressed breaker(s)	\$0
TOTAL		\$0

Given the magnitude of above upgrades, a good faith estimate to engineer, license, procure, and construct these facilities could be 24-36 months from the execution of the LGIA.

2. Transition Cluster Interconnection Information

Six (6) generation projects totaling a maximum output of 1158.9 MW are included in the PG&E Greater Bay Area Transition Cluster Group. Table 2-1 lists all the generator projects with essential data obtained from the CAISO Generation Interconnection Queue.

Table 2-1: PG&E Transition Cluster Projects

CAISO Queue	Point of Interconnection	Full Capacity Energy Only	Fuel	Max MW	Commercial Operation Date
222	Birds Landing Switching Station	FC	Wind	78	12/31/2011
258	Contra Costa Substation 230 kV Bus	FC	Natural Gas	651	12/1/2013
320	Contra Costa PP 230 kV switchyard	FC	Natural Gas	100	5/1/2013
334	Kelso Substation 230 kV Bus	FC	Natural Gas	195.9	7/1/2012
378	Los Esteros Substation 115 kV Bus	FC	Natural Gas	120	6/1/2013
417	Pittsburg-Tesla 230 kV Line	FC	Wind	14	9/30/2010
Total Phase II Transition Cluster Generation				1158.9	

² Assuming that this SPS can mitigate these overloads caused by several outages around Contra Costa substation. See section 7 for

3. Study Objectives

This Phase II Interconnection study was performed in accordance with Section 7.1 of Appendix Y of the CAISO tariff, which states:

The Phase II Interconnection Study shall:

- (i) update, as necessary, analyses performed in the Phase I Interconnection Studies to account for the withdrawal of Interconnection Requests,
- (ii) identify final Reliability Network Upgrades needed to physically interconnect the Large Generating Facilities,
- (iii) assign responsibility for financing the identified final Reliability Network Upgrades,
- (iv) identify, following coordination with the CAISO's Transmission Planning Process, final Delivery Network Upgrades needed to interconnect those Large Generating Facilities selecting Full Capacity Deliverability Status,
- (v) assign responsibility for financing Delivery Network Upgrades needed to interconnect those Large Generating Facilities selecting Full Capacity Deliverability Status,
- (vi) identify for each Interconnection Request final Point of Interconnection and Participating TO's Interconnection Facilities,
- (vii) provide a +/-20% estimate for each Interconnection Request of the final Participating TO's Interconnection Facilities,
- (viii) optimize in-service timing requirements based on operational studies in order to maximize achievement of the Commercial Operation Dates of the Large Generating Facilities, and
- (ix) if it is determined that the Delivery Network Upgrades cannot be completed by the Interconnection Customer's identified Commercial Operation Date, provide that operating procedures necessary to allow the Large Generating Facility to interconnect as an energy-only resource, on an interim-only basis, will be developed and utilized until the Delivery Network Upgrades for the Large Generating Facility are completed and placed into service.

This same section continues and further states that the Phase II Interconnection Study shall:

- (x) specify and estimate the cost of the equipment, engineering, procurement and construction work, including the financial impacts (i.e., on Local Furnishing Bonds), if any, and schedule for effecting remedial measures that address such financial impacts, needed on the CAISO Controlled Grid to implement the conclusions of the updated Phase II Interconnection Study technical analyses in accordance with Good Utility Practice to physically and electrically connect the Interconnection Customer's Interconnection Facilities to the CAISO Controlled Grid.
- (xi) also identify the electrical switching configuration of the connection equipment, including, without limitation: the transformer, switchgear,

meters, and other station equipment; the nature and estimated cost of any Participating TO's Interconnection Facilities and Network Upgrades necessary to accomplish the interconnection; and an estimate of the time required to complete the construction and installation of such facilities.

All the required analysis was completed to identify the Interconnection Facilities and Network Upgrades necessary to safely and reliably interconnect the Transition Cluster projects into the CAISO Controlled Grid. An estimated cost and construction schedule for these facilities has also been provided in this report.

4. Study Assumptions

4.1 Power flow base cases

The Phase II Study used four power flow base cases; two for Deliverability Assessment and two for Reliability Assessment, representing summer peak 2013 and summer off-peak 2013 system conditions. These base cases included all CAISO approved transmission projects that are scheduled to be in service by 2013. Also, Transition Cluster generation projects with associated Network Upgrades and Special Protection Systems were modeled.

4.2 Load and Import

The Deliverability Assessment On-Peak case modeled a 28,759 MW load (1-in-5 load forecast) in PG&E's electric system with an import target as shown in Table 4-1. The Off-Peak case modeled a 14,038 MW load in PG&E system with power flow on major paths are shown in Table 4-2.

Table 4-1: On-Peak Deliverability Assessment Import Target

Branch Group (BG) Name	BG Import Direction	Net Import MW	Import Unused ETC MW
Lugo_victrville_BG	N-S	1047	523
COI_BG	N-S	3770	548
BLYTHE_BG	E-W	106	0
CASCADE_BG	N-S	23	0
CFE_BG	S-N	-154	0
ELDORADO_BG	E-W	935	0
IID-SCE_BG	E-W	268	0
IID-SDGE_BG	E-W	-174	163
INYO_BG	E-W	0	0
LAUGHLIN_BG	E-W	0	0
MCCULLGH_BG	E-W	-15	316
MEAD_BG	E-W	539	516
MERCHANT_BG	E-W	425	0
N.GILABK4_BG	E-W	-170	168
NOB_BG	N-S	1449	0
PALOVRDE_BG	E-W	2984	233
PARKER_BG	E-W	66	52
SILVERPK_BG	E-W	9	0
SUMMIT_BG	E-W	-32	15
SYLMAR-AC_BG	E-W	-351	471
Total		10726	3005

Table 4-2: On-Peak Deliverability Assessment Import Target

Path	Flow (MW)
Path 26 (N-S)	2548
Path 66 (N-S)	3963
Path 15 (N-S)	848
PDCI	2900
SCIT	11312

The Reliability Assessment 2013 Heavy Summer case modeled a 28,882 MW load (1-in-10 load forecast) in PG&E service territory. Approximately 4,800 MW on path 66 and 4,000 MW on path 26 north-to-south flow were modeled in the base case. The Summer Off-Peak case represented about 50% of summer peak load with adjustment in generation dispatch and import levels to create a load / generation balance.

While it is impractical to study all combinations of system load and generation levels during all seasons and at all times of the day, the base cases were developed to represent stressed scenarios of loading and generation conditions for the study group area.

4.3 Generation Dispatch

Generation dispatch for 2013 Summer peak conditions, for the Greater Bay Area in the PG&E system is shown in Table 4-2. This dispatch is prior to adding Transition Cluster projects in the system. After adding Transition Cluster projects, the generator output in other local areas or in other PTO systems was decreased by an equal amount to maintain generation / load balance in the power flow case.

Table 4-2: Existing Greater Bay Area Generation

Generation unit	Size (MW)
Solano Wind Project Phase 1 and 2	150
Pittsburg PP	1320
Valero I Cogen	52
Vaca Dixon	49
FPLE High Wind	162
Lambie Energy	46
Goosehaven	46
Creed	46
Shiloh I	150
Shiloh Phase II	150
Wolfskill Energy Center	50
Oakland CTs	150
Alameda CTs	46
Delta Energy Center	880
Los Medanos Energy Center	500
Contra Costa PP	0

Gateway Generating Station	590
Riverview Energy Center	50
Potrero	150
Hunters Point	0
Ox Mountain Landfill	14
Ellsworth	2
Gilroy Cogen	123
Gilroy Peaker I	147
Los Esteros Critical Energy Facility	200
Metcalf Energy Center	560
Duke Moss Landing	1040
Moss Landing 6 & 7	1400
Helms	282
Total	8,355

For the summer off-peak case, the load level was about 50% of the summer peak load, and the generation was adjusted accordingly.

4.4 New Transmission Projects

All CAISO approved projects as shown in Table 4-3 were modeled in the base cases.

Table 4-3: Planned PG&E System Additions and Upgrades

Project
California Ave. - Sanger 70 kV to 115 kV Conversion Project
Carbona Reliability Project
Caruthers - Kingsburg 70 kV Line Reconductoring Project
Clearlake 60 kV System Reinforcement
Contra Costa - Moraga 230 kV Reconductoring Project
Cooley Landing - Los Altos 60 kV Reconductoring Project
Del Monte - Fort Ord 60 kV Lines Reconductoring
Evergreen - Mabury Voltage Conversion
Fulton - Fitch Mountain 60 kV Line Reconductoring
Garberville Reactive Support
Glenn 60 kV Line No.1 Reconductoring
Guernsey - Henrietta Reconductoring Project
Henrietta Transformer Bank No.3 Regulator Replacement
Herndon 230/115 kV Transformer 3
Herndon Circuit Breaker Replacement Project
Horseshoe - Gold Hill 115 kV Lines Reconductoring
Humboldt 115/60 kV Transformer Replacements
Jefferson Transformer 230/60 kV No. 1 Replacement

Kern - Old River 70 kV Line Reconductoring
Kyoho E20T Load Interconnection
Lakeville No. 2 60 kV Line Switch Upgrade
Larkin Substation Circuit Breaker 192 Project
Lodi - Industrial 60kV Line Switch Upgrade
Maple Creek Reactive Support
Menlo Area 60 kV Switch Replacements
Midway - Renfro 115 kV Line Reconductoring
Natividad 115 kV Distribution Station
Nicolaus - Marysville Reconductoring
Occidental of Elk Hills 230kV Interconnection
Palermo Circuit Breaker Replacement Project
Pease Regulator # 2 Replacement
Placer - Horseshoe 115 kV Reconductoring Project
Port of Stockton Wholesale Customer
Ravenswood - Cooley Landing 115 kV Nos. 1 and 2 Reconductoring
Salado - Newman 60 kV Line No. 2 Reconductoring
Salinas 115 kV Breaker and a Half Project
San Justo Substation
San Mateo - Bair 60 kV Reconductoring Project
Sanger - Reedley 70 kV to 115 kV Conversion Project
Santa Cruz 115 kV Reinforcement Project
Shepherd Substation Interconnection
Sobrante - El Cerrito G 115 kV Line Switch Replacement
South of San Mateo 230 kV Capacity upgrade
Stockton 'A' - Weber 60 kV Line Nos. 1 and 2 Rerate
Table Mountain - Palermo Reconductoring Project
Tesla 115 kV Reconductoring Project
Tri-Valley Voltage Control
Valley Springs 230/60 kV Transmission Addition
Watsonville 115 kV Voltage Conversion

4.5 Pre-Transition Cluster Generation Projects

All pre-Transition Cluster generation projects (serial projects), as listed in Table 4-4, were modeled in the base cases. However, some generation projects were either turned off or modeled with reduced generation to create a more stressed case for the Reliability Study.

Table 4-4: Pre-Transition Cluster Generation Projects

Queue Position	Point of Interconnection
6	Tesla Substation
16	Divide – Cabrillo #2 115 kV Line
22	Birds Landing Switching Station
37	Tesla Substation
38	Humboldt Power Plant Substation
39	Birds Landing Switching Station
42	McCall Substation 115 kV Bus
45	Eastshore Substation
57	Cottonwood – Vaca Dixon 230 kV lines
60	Kern Oil Substation 115 kV
67	Eastshore 230 kV Bus
74	Pit 3 – Round Mountain 230 kV Line
108	Lambie – Contra Costa 230 kV
111	Chevron 70 kV Tap
113	Birds Landing Switching Station
166	Morro Bay – Midway 230 kV Line
172	Tesla – Bellota 230 kV Line
184	Geysers #3 – Cloverdale 115 kV Line
194	Morro Bay – Midway 230 kV Lines
212	Rio Dell Substation 60 kV
248	Tesla – Bellota 230 kV Line
267	Gold Hill – Eight Mile 230 kV Line
268	Tesla - Manteca 115 kV Line Via Schulte Swyd

Reliability Network Upgrades and Delivery Network Upgrades that are associated with these projects were also modeled in the base cases. These upgrades are listed in Table 4-5.

Table 4-5: Network Upgrades for Pre-Transition Cluster Projects

Network Upgrade Projects
Eight Mile Road - Tesla 230 kV Line Reconductoring
Stagg - Tesla 230kV Line Reconductoring
East Shore-San Mateo 230 kV Line Reconductoring
East Shore-Dumbarton 115 kV Line Reconductoring
East Shore 230/115 kV Bank 2 Replacement
Wilson-Gregg 230 kV Line Reconductoring between Storey and Gregg

4.6 Other SPSs and Operator Actions

There are no SPSs or Operation Actions that are modeled in the base cases.

4.6.1 Operating Procedures

Operating procedures, which may include curtailing the output of the Transition Cluster projects during planned or extended forced outages may be required for reliable operation of the transmission system. These procedures, if needed, will be developed before the projects' Commercial Operation Date.

5. Study Criteria and Methodology

The CAISO Controlled Grid Reliability Criteria, which incorporate the Western Electricity Coordinating Council (WECC) and the North American Electric Reliability Council (NERC) planning criteria, were used to evaluate the impact of Transition Cluster projects on the CAISO Controlled Grid.

5.1 Steady State Study Criteria

5.1.1 Normal Overloads

Normal overloads are those that exceed 100 percent of normal facility ratings. The CAISO Controlled Grid Reliability Criteria requires the loading of all transmission system facilities be within their normal ratings. Normal overloads refer to overloads that occur during normal operating conditions (no contingency).

5.1.2 Emergency Overloads

Emergency overloads are those that exceed 100 percent of emergency ratings. Emergency overloads refer to overloads that occur during single element contingencies (Category "B") and multiple element contingencies (Category "C").

5.1.3 Voltage Violations

Single element contingencies (Category "B") and multiple element contingencies (Category "C") were analyzed to identify any reactive power deficiency.

Voltage violations will occur if voltage deviations exceed +/- 5% of the pre-disturbance level for Category "B" contingencies and +/- 10% for Category "C" contingencies.

5.1.4 Contingencies

The contingencies used in this analysis are provided in Appendix B. The various categories of the contingencies used are summarized in Table 5-1:

Table 5-1: Power flow contingencies

Contingencies	Description
CAISO Category "A" (No contingency)	All facilities in service – Normal Conditions
CAISO Category "B"	<ul style="list-style-type: none"> • B1 - All single generator outages. • B2 - All single transmission circuit outages. • B3 - All single transformer outages. • Selected overlapping single generator and transmission circuit outages.
CAISO Category "C"	<ul style="list-style-type: none"> • C1 - SLG Fault, with Normal Clearing: Bus outages (60-230 kV) • C2 - SLG Fault, with Normal Clearing: Breaker failures (excluding bus tie and sectionalizing breakers) at the same bus section above. • C3 - Combination of any two-generator/transmission line/transformer outages. • C4 - Bipolar (dc) Line • C5 - Outages of double circuit tower lines (60-230 kV) • C6 - SLG Fault, with Delayed Clearing: Generator • C7 - SLG Fault, with Delayed Clearing: Transmission Line • C8 - SLG Fault, with Delayed Clearing: Transformer • C9 - SLG Fault, with Delayed Clearing: Bus Section

- Although most of the Category "C" contingencies were considered as part of this study, it is impractical to study all possible combinations of any two elements throughout the system. Therefore, as allowed under NERC standard TPL-003-0 R1.3.1, only selected critical Category "C" contingencies (C1 – C9) that were deemed most severe were evaluated in this study.

5.2 Short Circuit Duty Criteria

Short circuit studies are performed to determine the maximum fault duty on the adjacent buses to the Transition Cluster projects in the PG&E service territory. This study determines the impact of increased fault current resulting from Transition Cluster projects. Short circuit results will allocate costs for overstressed breakers to each cluster, which are formed from generation projects with a fault contribution above a threshold value. The Aspen OneLiner Version 10.11 program was used to conduct the detailed short circuit studies with three phase line-to-ground (3LG) and single phase line-to-ground (LG) faults.

PG&E uses the following policy to allocate transmission circuit breaker replacement responsibility for projects that overstress or increase overstress on existing circuit breakers:

- If a breaker is not overstressed before the project, and the project results in an overstressed condition of the breaker, then the project is responsible for the cost of replacement.
- If a breaker is already overstressed, and a project increases the overstress by 5% or more, or the post-project overstress level exceeds 25%, then the project is responsible for the cost of replacement.
- If the overstress level exceeds 25% before the project, and for all other circumstances, PG&E or other generation projects will be responsible for any replacement costs.

5.3 Transient Stability Criteria

Transient stability analysis is a time-based simulation that assesses the performance of the power system during (and shortly following) a contingency. Transient stability studies are performed to ensure system stability following critical faults on the system.

The system is considered stable if the following conditions are met:

1. All machines in the WECC interconnected system must remain in synchronism as demonstrated by relative rotor angles (unless modeling problems are identified and concurrence is reached that a problem does not really exist).
2. A stability simulation will be deemed to exhibit positive damping if a line defined by the peaks of the machine relative rotor angle swing curves tends to intersect a second line connecting the valleys of the curves with the passing of time.
3. Corresponding lines on bus voltage swing curves will likewise tend to intersect. A stability simulation, which satisfies these conditions, will be defined as stable.
4. Duration of a stability simulation run will be ten seconds unless a longer time is required to ascertain damping.
5. The transient performance analysis will start immediately after the fault clearing and conclude at the end of the simulation.
6. A case will be defined as marginally stable if it appears to have zero percent damping and the voltage dips are within (or at) the WECC Reliability Criteria limits.

Performance of the transmission system is measured against the WECC Reliability Criteria and the NERC Planning Standards. Table 5-2 illustrates

the NERC/WECC Reliability Criteria. The reliability and performance criteria are applied to the entire WECC transmission system.

Table 5-2: WECC Disturbance-Performance Table of Allowable Effects on Other Systems
 (in addition to NERC requirements)

NERC and WECC Categories	Outage Frequency Associated with the Performance Category (Outage/Year)	Transient Voltage Dip Standard	Minimum Transient Frequency Standard	Post-Transient Voltage Deviation Standard (See Note 1)
A	Not Applicable	Nothing in Addition to NERC		
B	≥ 0.33	Not to exceed 25% at load buses or 30% at non-load buses. Not to exceed 20% for more than 20 cycles at load buses.	Not below 59.6 Hz for 6 cycles or more at a load bus	Not to exceed 5% at any bus
C	0.033 – 0.33	Not to exceed 30% at any bus. Not to exceed 20% for more than 40 cycles at load buses.	Not below 59.0 Hz for 6 cycles or more at a load bus	Not to exceed 10% at any bus
D	< 0.033	Nothing in Addition to NERC		

Note 1: As an example in applying the WECC Disturbance-Performance Table, Category B disturbance in one system shall not cause a transient voltage dip in another system that is greater than 20% for more than 20 cycles at load buses, or exceed 25% at load buses or 30% at non-load buses at any time other than during the fault.

5.4 Post-Transient Voltage Stability Criteria

The last column of the above Table 5-2 illustrates the Post-Transient Voltage Stability Criteria. For some large generator contingencies, the governor power flow is utilized to test for the post-transient voltage deviation criteria.

5.5 Reactive Margin Criteria

Table 5-3 summarizes the voltage support and reactive power criteria in the NERC/WECC Planning Standards.

The system performance will be evaluated according to the NERC/WECC planning criteria.

Table 5-3: Reactive Margin Analysis Criteria Summary

Performance Level/Category	Disturbance	Reactive Power Deficiency Criteria
B	Generator One Circuit One Transformer DC Single Pole Block	Governor power flow to reach convergence at 105% of load level or operational transfer capability
C	Two Generators Two Circuits DC Bipolar Block	Governor power flow to reach convergence at 102.5% of load level or operational transfer capability

5.6 Power Factor Criteria

Table 5-4 summarizes the power factor criteria per the CAISO tariff. The voltage at the POI must be within criteria under normal and contingency conditions.

Table 5-4: Power Factor Analysis Criteria Summary

Generation Type	Power Factor Criteria
Wind Generator	0.95 lagging to 0.95 leading at the POI
All other Generator Types	0.90 lagging to 0.95 leading at Generator terminals

6. Deliverability Assessment

The Deliverability Assessment was performed by the CAISO according to the On-Peak and Off-Peak Deliverability Assessment Methodologies posted on the CAISO website at: <http://www.caiso.com/1c44/1c44b5c31cce0.html>.

This assessment was done for generation projects that requested Full Capacity status only. Generation projects requesting Energy Only status were modeled with zero (0) MW output in the Deliverability Assessment base cases.

During the summer peak, the dispatch for solar thermal or solar PV projects was assumed to be able to reach 100% of the nameplate capacity. The starting dispatch for wind projects was modeled according to historical output of the units in the same area during summer peak conditions.

The Deliverability Assessment also analyzed an Off-Peak scenario, in which the wind generators were dispatched at 100% of the maximum generation output. All types of solar generators were dispatched at 85% of their maximum generation output. Table 6-1 lists the Full Capacity projects with their corresponding Off-Peak dispatch levels.

Table 6-1: Deliverability Assessment (Off-Peak) - Full Capacity Projects

CAISO Queue	Point of Interconnection	Full Capacity Energy Only	Fuel	Max MW	Pgen MW
222	Birds Landing Switching Station	FC	Wind	78	78
417	Pittsburg-Tesla 230 kV Line	FC	Wind	14	14
Subtotal Full Capacity Wind				92.2	92.2
258	Contra Costa Substation 230 kV Bus	FC	Natural Gas	651	553.35
320	Contra Costa PP 230 kV switchyard	FC	Natural Gas	100	85
334	Kelso Substation 230 kV Bus	FC	Natural Gas	195.9	166.515
378	Los Esteros Substation 115 kV Bus	FC	Natural Gas	120	102
Subtotal Full Capacity Natural Gas				1066.9	906.865
Total Deliverability Assessment Generation				1158.9	999.065

6.1 Results

The Deliverability Assessment results for Category A, B and C contingencies are provided in detail under Appendix C.

7. Steady State Assessment

This assessment is comprised of Power Flow Analysis and Reactive Power Deficiency Analysis.

Power flow analysis was performed to ensure that PG&E's transmission system remains in full compliance with North American Reliability Corporation (NERC) reliability standards TPL-001, 002, 003 and 004 with the proposed interconnection. The results of these power flow analyses will serve as documentation that an evaluation of the reliability impact of new facilities and their connections on interconnected transmission systems is performed. If a NERC reliability problem exists as a result of this interconnection, it is PG&E's responsibility to identify the problem and develop an appropriate corrective action plan to comply with NERC reliability standards.

As part of PG&E's obligations with NERC as the registered Transmission Owner for the PG&E transmission system, the study results for this interconnection will be communicated to the CAISO, or other neighboring entities that may be impacted, for coordination and incorporation of its transmission assessments. Input from the CAISO and other neighboring entities are solicited to ensure coordination of transmission systems.

Two power flow base cases were used to evaluate the transmission system impacts of Transition Cluster projects. While it is impractical to study all combinations of system load and generation levels during all seasons and at all times of the day, these two base cases represented extreme loading and generation conditions for the study area.

The CAISO and PG&E cannot guarantee that Transition Cluster projects can operate at maximum rated output 24 hours a day, year round, without adverse system impacts, nor can the CAISO and PG&E guarantee that these projects would not have adverse system impacts during the times and seasons not studied in the Phase II Study.

The following power flow base cases were used for the analysis in the Phase II Study:

- **2013 Summer Peak Full Loop Base Case:**

Power flow analyses were performed using PG&E's 2013 summer peak full loop base case (in General Electric Power Flow format). This base case was developed from 2009 base case series. It has a 1-in-10 year adverse weather load level for the Greater Bay Area.

- **2013 Summer Off-Peak Full Loop Base Case:**

Power flow analyses were also performed using the 2013 off peak full loop base case in order to evaluate the potential congestion on transmission facilities during light load conditions. A Saturday morning on a summer day was chosen to represent an off peak

load. The summer 2014 off peak loads were about 50% of the summer peak loads.

These base cases modeled all CAISO approved PG&E transmission projects that would be operational by 2013. The base cases also modeled all proposed generation projects that were higher than the Transition Cluster projects in the CAISO Generation Interconnection Queue. These generation projects were modeled along with their estimated transmission upgrades necessary for their interconnection. However, some generation projects that are electrically far from the Transition Cluster projects were either turned off or modeled with reduced generation to balance the loads and resources in the power flow model.

7.1 Study Results

The overloads caused by the Greater Bay Area Transition Cluster Group projects and associated power flow plots are shown in Appendix D. The worst overloads for each facility are summarized in Tables 7-1, 7-2, and 7-3.

7.1.1 Normal Overloads (Category "A")

Under projected 2013 summer peak conditions, the Greater Bay Area Transition Cluster Group projects caused eight (8) Category "A" normal overloads. Under projected 2013 summer off-peak conditions, the Greater Bay Area Transition Cluster Group projects caused two (2) new normal overloads which are also found in the summer peak conditions. These overloads are summarized in Table 7-1.

Table 7-1: Summer Peak and Summer Off-Peak Category "A" Normal overloads

Over Loaded Component	Rating (Amps)	Pre- Project Loading(Amps %Rating)	Post- Project Loading(Amps %Rating)	% Change from Pre-Project Loading	Mitigation
Category A Normal Overloads – 2013 Summer Peak					
Contra Costa PP – Contra Costa Sub 230 kV Line	1600	641 40%	1854 116%	76%	Congestion Management
Contra Costa – Brentwood 230 kV Line	826	678 82%	885 107%	25%	Congestion Management
Contra Costa PP – Delta Pumps 230 kV Line (Contra Costa – Windmaster)	826	588 71%	1007 122%	51%	Reconductor with high capacity conductor (17 miles)
Contra Costa PP – Delta Pumps 230 kV Line (Windmaster – Delta Pumps)	826	585 71%	1004 122%	51%	Reconductor with high capacity conductor (2 miles)
Delta Pumps - Tesla 230kV Line (Delta Pumps - Altamont Midway)	996	582 58%	1002 101%	43%	Congestion Management
Delta Pumps - Tesla 230kV Line (Altamont Midway - Tesla)	996	582 58%	1001 101%	43%	Congestion Management
Kelso - Tesla 230kV Line (Kelso - USWP Ralph)	997	362 36%	1049 105%	69%	Reconductor with high capacity conductor (3 miles)

Kelso - Tesla 230kV Line (USWP Ralph - Tesla)	997	375	38%	1065	107%	69%	Reconductor with high capacity conductor (5 miles)
Las Positas - Newark 230kV Line	743	632	85%	842	113%	31%	Reconductor with high capacity conductor (21 miles)
Category A Normal Overloads – 2013 Summer Off-Peak							
Contra Costa - Delta Pumps 230 kV Line (Contra Costa - Windmaster)	826	203	25%	926	112%	87%	Reconductor with high capacity conductor (17 miles)
Contra Costa - Delta Pumps 230 kV Line (Windmaster - Delta Pumps)	826	115	14%	835	101%	87%	Reconductor with high capacity conductor (2 miles)

7.1.2 Emergency Overloads (Category “B”)

Under projected 2013 summer peak conditions, the Greater Bay Area Transition Cluster Group projects caused five (5) new Category “B” overloads. Under projected 2013 summer off-peak conditions, the Greater Bay Area Transition Cluster Group projects caused one (1) new Category “B” overload which is also found in the summer peak conditions. These overloads are summarized in Table 7-2.

Table 7-2: Summer Peak and Summer Off-Peak, Category "B" Overloads

Over Loaded Component	Contingency	Rating (Amps)	Pre- Project Loading (Amps)	%Rating	Post-Project Loading (Amps)	%Rating	% Change from Pre-Project Loading	Mitigation
Worst Category B Emergency Overloads - 2013 Summer Peak								
Birds Landing-Contra Costa 230 kV Line	Contra Costa – Contra Costa Sub 230 kV Line and Gateway PP	1893	1740	92%	2442	129%	37%	Install SPS to drop generation at Q258
Contra Costa PP – Contra Costa Sub 230 kV Line	Birds Landing – Contra Costa 230 kV Line and Gateway PP	1600	1624	101%	2733	171%	70%	Install SPS to drop generation at Q258
Lone Tree – Cayetano 230 kV Line (Lone Tree – USWP JW Ranch)	Contra Costa – Las Positas Line	1005	869	86%	1054	105%	19%	Congestion Management
Lone Tree - Cayetano 230kV Line (USWP JW Ranch - Cayetano)	Contra Costa - Las Positas 230 kV Line	1005	866	86%	1046	104%	18%	Line Re-rate
Newark 230/115kV Bank #11	Newark 230/115kV Bank #7	462 MVA	445 MVA	96%	462 MVA	100%	4%	Congestion Management
Worst Category B Emergency Overloads - 2013 Summer Off-Peak								
Contra Costa PP - Contra Costa Sub 230kV Line	Birds Landing - Contra Costa 230 kV Line and Gateway PP	1600	1317	82%	2098	131%	49%	Install SPS to drop generation at Q258

7.1.3 Emergency Overloads (Category “C”)

Under the projected 2013 summer peak conditions, the Greater Bay

Area Transition Cluster Group projects caused six (6) new Category “C” overloads. Under the projected 2013 summer off-peak conditions, the Greater Bay Area Transition Cluster Group projects caused two (2) new Category “C” overloads which are also found in the summer peak conditions. These overloads are summarized in Table 7-3.

Table 7-3: Summer Peak and Spring Off-Peak, Category "C" Overloads

Over Loaded Component	Contingency	Rating(Amps)	Pre- Project Loading (Amps %Rating)		Post-Project Loading (Amps %Rating)		% Change from Pre-Project Loading	Mitigation
Worst Category C Emergency Overloads - 2013 Summer Peak								
Castro Valley - Newark 230kV Line	Contra Costa - Las Positas and Contra Costa - Lonetree 230 kV Lines	851	750	88%	910	107%	19%	Congestion Management
Lambie - Birds Landing 230kV Line	Contra Costa Sub - Contra Costa and Birds Landing - Contra Costa 230 kV Lines	1893	1183	63%	2249	119%	56%	Install SPS to drop generation at Q258
Moraga - Castro Valley 230kV Line	Contra Costa - Las Positas and Contra Costa - Lonetree 230 kV Lines	1021	934	91%	1092	107%	16%	Congestion Management
North Dublin - Cayetano 230kV Line	Contra Costa - Brentwood and Contra Costa - Delta Pumps 230 kV Lines	1004	794	79%	1020	102%	23%	Congestion Management
Trimble-San Jose "B" 115kV Line	Metcalf - El Patio #1 and #2 115 kV Lines	924	893	97%	1009	109%	12%	Congestion Management
Vaca - Lambie 230kV Line	Contra Costa Sub - Contra Costa and Birds Landing - Contra Costa 230 kV Lines	1893	1531	81%	2596	137%	56%	Install SPS to drop generation at Q258
Worst Category C Emergency Overloads - 2013 Summer Off-Peak								
Lambie - Birds Landing 230kV Line	Contra Costa Sub - Contra Costa and Birds Landing - Contra Costa 230 kV Lines	1893	1368	72%	2433	129%	57%	Install SPS to drop generation at Q258
Vaca - Lambie 230kV Line	Contra Costa Sub - Contra Costa and Birds Landing - Contra Costa 230 kV Lines	1893	1368	72%	2433	129%	57%	Install SPS to drop generation at Q258

Reactive Power Deficiency Analysis indicated that the Greater Bay Area Transition Cluster Group projects did not cause voltage drops of 5% or more from the pre-project levels or cause the PG&E system to fail to meet applicable voltage criteria.

8. Short Circuit Duty Assessment

Short circuit studies were performed to determine the impact of adding the Greater Bay Area Transition Cluster projects to the transmission system. These studies are also needed to perform relay coordination among adjacent substations. The fault duties were calculated before and after Transition Cluster projects to identify any equipment overstress conditions. The fault duties were calculated once again after mitigation plan was added in the base case.

Three line-to-ground (3LG) and single line-to-ground (SLG) faults were simulated without the Transition Cluster projects, with Transition Cluster projects, and with Transition Cluster projects plus mitigation plan.

8.1 Results

The available short circuit duty at the buses electrically adjacent to the Greater Bay Area Transition Cluster Group projects is listed in Appendix E. These results indicate one circuit breaker will be overstressed due to the Greater Bay Area Transition Cluster Group projects and needs to be mitigated.

9. Transient Stability Analysis

Transient stability analysis was conducted using the 2013 summer peak full loop base cases to ensure that the transmission system remains in operating equilibrium, as well as operating in a coordinated fashion through abnormal operating conditions after Transition Cluster projects begin operation. The generator dynamic data used for the study is confidential in nature and is provided with each individual project report. Consequently, more details of the dynamic study results such as rotor angle, bus voltage plots are provided with the individual project reports

9.1 Transient Stability Study Scenarios

Disturbance simulations were performed for a study period of 10 seconds to determine whether the Greater Bay Area Transition Cluster Group projects will create any system instability during a variety of line and generator outages. For each Project, selected line and generator outages in the vicinity of that project were evaluated. The outages were consistent with Category B and Category C requirements (single element and multiple element outages).

9.2 Parameters Monitored to Evaluate System Stability Performance

9.2.1 Rotor Angle

The rotor angle plots provide a measure for determining how the proposed generation units would swing with respect to one another. The plots also provide a measure of how the units would swing with respect to other generation units in the area.

9.2.2 Bus Voltage

The bus voltage plots, in conjunction with the relative rotor angle plots, also shown in, provide a means of detecting out-of-step conditions. The bus voltage plots are useful in assessing the magnitude and the duration of post disturbance voltage dips and peak-to-peak voltage oscillations. The bus voltage plots also give an indication of system damping and the level to which voltages are expected to recover in steady state conditions.

9.2.3 Bus Frequency

The bus frequency plots, also shown in provide information on the magnitude and the duration of post fault frequency swings with the Project in service. These plots indicate the extent of possible over-frequency or under-frequency, which can occur because of the imbalance between the generation and load within an area.

9.2.4 Other Parameters

The following parameters can also be monitored when required:

- Generator Terminal Power
- Generator Terminal Voltage
- Generator Rotor Speed
- Generator Field Voltage
- Bus Angle
- Line Flow
- Voltage Spread
- Frequency Spread

9.3 Results

The study concluded that the Project would not cause the transmission system to go unstable under Category “B” and Category “C” outages.

- The results of the study are provided in the form of plots.

10. Mitigation of Overloaded Facilities

Depending on the category of contingencies that cause the overloads and conditions of the overloads, several methods can be used to as mitigation plans. For example, one plan is to reconnector the overloaded transmission lines with higher capacity conductors. A SPS can be used to mitigate overloads under contingency conditions as long as it complies with the planning standards and SPS guidelines. In some cases, congestion management may be used depending upon the conditions of the overloads.

For CAISO Category “C” contingencies, the overloads may be mitigated by load shedding or generation dropping as allowed under NERC/WECC reliability criteria. PG&E or CAISO or both may require new generators to take part in and be responsible for the costs of operating procedures and/or Special Protection Systems (SPS) for Category “C” overloads caused by the Transition Cluster projects. Only new Category “C” overload mitigation will be provided in this report.

10.1 Mitigation for Category “A” Normal Overloads

10.1.1 Contra Costa PP – Contra Costa Sub 230 kV Line

Limiting Factor		1600 Amps Normal/Emergency at 2 fps wind speed summer coastal rating	
Pre-project Normal Loading	641 Amps (40%)	Post-project Normal Loading	1854 Amps (116%)
Worst Contingency		Normal Conditions	
Worst Overload Condition		2013 Summer Peak	

Solution: Congestion management. This overload is contributed by resources located north of Contra Costa Substation. Among these resources, there are a number of intermittence resources that, according to the historical data, did not generate at nameplate level during the summer peak conditions. In addition, there are also a number of thermal resources in the area that can be used to mitigate the overload as well.

10.1.2 Contra Costa - Brentwood 230 kV Line

Limiting Factor		826/1130 Amps Normal/Emergency at 2 fps wind speed summer coastal rating	
Pre-project Normal Loading	678 Amps (82%)	Post-project Normal Loading	885 Amps (107%)
Worst Contingency		Normal Conditions	
Worst Overload Condition		2013 Summer Peak	

Solution: Congestion management. This overload is contributed by resources located north of Contra Costa Substation. Among these resources, there are a number of intermittence resources that, according to the historical data, did not generate at nameplate level during the summer peak conditions. In addition, there are also a

number of thermal resources in the area that can be used to mitigate the overload as well.

10.1.3 Contra Costa PP – Delta Pumps 230 kV Line (Contra Costa – Windmaster)

Limiting Factor		826/1130 Amps Normal/Emergency at 2 fps wind speed summer coastal rating	
Pre-project Normal Loading	588 Amps (71%)	Post-project Normal Loading	1007 Amps (122%)
Worst Contingency		Normal Conditions	
Worst Overload Condition		2013 Summer Peak	

Solution: Reconductor 16.5 miles of the Contra Costa PP – Delta Pumps 230 kV Line (Contra Costa – Windmaster) with a high capacity conductor. Substation terminal equipment will also be upgraded to match or exceed the ampacity ratings of the new conductors.

Unit Cost: \$ [REDACTED]

10.1.4 Contra Costa PP – Delta Pumps 230 kV Line (Windmaster – Delta Pumps)

Limiting Factor		826/1130 Amps Normal/Emergency at 2 fps wind speed summer coastal rating	
Pre-project Normal Loading	585 Amps (71%)	Post-project Normal Loading	1004 Amps (122%)
Worst Contingency		Normal Conditions	
Worst Overload Condition		2013 Summer Peak	

Solution: Reconductor 1.8 miles of the Contra Costa PP – Delta Pumps 230 kV Line (Windmaster – Delta Pumps) with a high capacity conductor. Substation terminal equipment will also be upgraded to match or exceed the ampacity ratings of the new conductors.

Unit Cost: \$ [REDACTED]

10.1.5 Delta Pumps - Tesla 230 kV Line (Delta Pumps – Altamont Midway)

Limiting Factor		996/1130 Amps Normal/Emergency at 2 fps wind speed summer coastal rating	
Pre-project Normal Loading	582 Amps (58%)	Post-project Normal Loading	1002 Amps (101%)
Worst Contingency		Normal Conditions	
Worst Overload Condition		2013 Summer Peak	

Solution: Congestion management. This overload is contributed by resources located north of Contra Costa Substation. Among these resources, there are a number of intermittence resources that,

according to the historical data, did not generate at nameplate level during the summer peak conditions. In addition, there are also a number of thermal resources in the area that can be used to mitigate the overload as well.

10.1.6 Delta Pumps - Tesla 230 kV Line (Altamont Midway – Tesla)

Limiting Factor		996/1130 Amps Normal/Emergency at 2 fps wind speed summer coastal rating	
Pre-project Normal Loading	582 Amps (58%)	Post-project Normal Loading	1001 Amps (101%)
Worst Contingency		Normal Conditions	
Worst Overload Condition		2013 Summer Peak	

Solution: Congestion management. This overload is contributed by resources located north of Contra Costa Substation. Among these resources, there are a number of intermittence resources that, according to the historical data, did not generate at nameplate level during the summer peak conditions. In addition, there are also a number of thermal resources in the area that can be used to mitigate the overload as well.

10.1.7 Kelso – Tesla 230 kV Line (Kelso – USWP Ralph)

Limiting Factor		997/1129 Amps Normal/Emergency at 2 fps wind speed summer coastal rating	
Pre-project Normal Loading	362 Amps (36%)	Post-project Normal Loading	1049 Amps (105%)
Worst Contingency		Normal Conditions	
Worst Overload Condition		2013 Summer Peak	

Solution: Reconductor 3.3 miles of the Kelso – Tesla 230 kV Line (Kelso – USWP Ralph) with a high capacity conductor. Substation terminal equipment will also be upgraded to match or exceed the ampacity ratings of the new conductors.

Unit Cost: \$ [REDACTED]

10.1.8 Kelso – Tesla 230 kV Line (USWP Ralph – Tesla)

Limiting Factor		997/1129 Amps Normal/Emergency at 2 fps wind speed summer coastal rating	
Pre-project Normal Loading	375 Amps (38%)	Post-project Normal Loading	1065 Amps (107%)
Worst Contingency		Normal Conditions	
Worst Overload Condition		2013 Summer Peak	

Solution: Reconductor 4.7 miles of the Kelso – Tesla 230 kV Line (USWP Ralph – Tesla) with a high capacity conductor. Substation

terminal equipment will also be upgraded to match or exceed the ampacity ratings of the new conductors.

Unit Cost: \$ [REDACTED]

10.1.9 Las Positas – Newark 230 kV Line

Limiting Factor		743/851 Amps Normal/Emergency at 2 fps wind speed summer coastal rating	
Pre-project Normal Loading	632 Amps (85%)	Post-project Normal Loading	842 Amps (113%)
Worst Contingency		Normal Conditions	
Worst Overload Condition		2013 Summer Peak	

Solution: Reconductor 21.2 miles of the Los Positas – Newark 230 kV Line with a high capacity conductor. Substation terminal equipment will also be upgraded to match or exceed the ampacity ratings of the new conductors.

Unit Cost: \$ [REDACTED]

10.2 Mitigation for New Category “B” Overloads

The mitigations for new Category “B” overloads listed below are in addition to the mitigations for the new Category “A” normal overloads described in Section 11.1 which also mitigate the Category “B” emergency overloads.

10.2.1 Birds Landing – Contra Costa 230 kV Line

Limiting Factor		1893 Amps Emergency at 2 fps wind speed summer coastal rating	
Pre-project Emergency Loading	1740 Amps (92%)	Post-project Emergency Loading	2442 Amps (129%)
Worst Contingency		Contra Costa - Contra Costa Sub 230 kV Line and Gateway PP	
Overload Condition		2013 Summer Peak	

Solution: Install SPS to drop generation at Q258

Unit cost: \$ [REDACTED]

10.2.2 Contra Costa PP – Contra Costa Sub 230 kV Line

Limiting Factor		1600 Amps Emergency at 2 fps wind speed summer coastal rating	
Pre-project Emergency Loading	1624 Amps (101%)	Post-project Emergency Loading	2733 Amps (170%)
Worst Contingency		Birds Landing - Contra Costa 230 kV Line and Gateway PP	
Overload Condition		2013 Summer Peak	

Solution: Install SPS to drop generation at Q258

Unit Cost: \$ [REDACTED]

10.2.3 Lone Tree – Cayetano 230 kV Line (Lone Tree – USWP JW Ranch)

Limiting Factor		1005 Amps Emergency at 2 fps wind speed summer coastal rating	
Pre-project Emergency Loading	869 Amps (86%)	Post-project Emergency Loading	1054 Amps (105%)
Worst Contingency		Contra Costa - Las Positas 230 kV Line	
Overload Condition		2013 Summer Peak	

Solution: Congestion management. This overload is contributed by resources located north of Contra Costa Substation. Among these resources, there are a number of intermittence resources that, according to the historical data, did not generate at nameplate level during the summer peak conditions. In addition, there are also a number of thermal resources in the area that can be used to mitigate the overload as well.

10.2.4 Lone Tree – Cayetano 230 kV Line (USWP JW Ranch – Cayetano)

Limiting Factor		1005 Amps Emergency at 2 fps wind speed summer coastal rating	
Pre-project Emergency Loading	866 Amps (86%)	Post-project Emergency Loading	1052 Amps (105%)
Worst Contingency		Contra Costa - Las Positas 230 kV Line	
Overload Condition		2013 Summer Peak	

Solution: Transmission line re-rates of 3.5 miles of overhead conductor and 2.3 miles of underground cable.

Unit Cost: \$ [REDACTED]

10.2.5 Newark 230/115 kV Bank #11

Limiting Factor		462 MVA Emergency	
Pre-project Emergency Loading	445 MVA (96%)	Post-project Emergency Loading	462 Amps (100%)
Worst Contingency		Newark 230/115 kV Bank #7	
Overload Condition		2013 Summer Peak	

Solution: Congestion management. The study results show loading on this transformer at 100% of emergency loading. Effective generator can be used to mitigate the overload.

10.3 Mitigation for New Category “C” Overloads

The mitigations for the new Category “C” overload listed below are in addition to the mitigations for the new Category “A” normal overloads and Category

“B” emergency overloads described in Sections 11.1 and 11.2, respectively, which also mitigate the Category “C” emergency overloads.

10.3.1 Castro Valley – Newark 230 kV Line

Limiting Factor		851 Amps Emergency at 2 fps wind speed summer coastal rating	
Pre-project Emergency Loading	851 Amps (88%)	Post-project Emergency Loading	910 Amps (107%)
Worst Contingency		Contra Costa - Las Positas and Contra Costa - Lonetree 230 kV Lines	
Overload Condition		2013 Summer Peak	

Solution: Congestion management. This overload is contributed by resources located north of Contra Costa Substation and other generators in the areas that can be used to mitigate the overload.

10.3.2 Lambie – Birds Landing 230 kV Line

Limiting Factor		1893 Amps Emergency at 2 fps wind speed summer coastal rating	
Pre-project Emergency Loading	1183 Amps (63%)	Post-project Emergency Loading	2249 Amps (119%)
Worst Contingency		Contra Costa Sub - Contra Costa and Birds Landing - Contra Costa 230 kV Lines	
Overload Condition		2013 Summer Peak	

Solution: Install SPS (the same SPS shown in 10.2.1)

10.3.3 Moraga – Castro Valley 230 kV Line

Limiting Factor		1021 Amps Emergency at 2 fps wind speed summer coastal rating	
Pre-project Emergency Loading	934 Amps (91%)	Post-project Emergency Loading	1092 Amps (107%)
Worst Contingency		Contra Costa - Las Positas and Contra Costa - Lonetree 230 kV Lines	
Overload Condition		2013 Summer Peak	

Solution: Congestion management (similar to 10.3.1)

10.3.4 North Dublin – Cayetano 230 kV Line

Limiting Factor		1004 Amps Emergency at 2 fps wind speed summer coastal rating	
Pre-project Emergency Loading	794 Amps (79%)	Post-project Emergency Loading	1020 Amps (102%)
Worst Contingency		Contra Costa - Brentwood and Contra Costa - Delta Pumps 230 kV Lines	
Overload Condition		2013 Summer Peak	

Solution: Congestion management (similar to 10.3.1)

10.3.5 Trimble – San Jose “B” 115 kV Line

Limiting Factor		924 Amps Emergency at 2 fps wind speed summer coastal rating	
Pre-project Emergency Loading	893 Amps (97%)	Post-project Emergency Loading	1009 Amps (109%)
Worst Contingency		Metcalf - El Patio #1 and #2 115 kV Lines	
Overload Condition		2013 Summer Peak	

Solution: Congestion management. This overload is contributed by existing and project in the transition cluster³. The study results show that this overload can be mitigated by curtailing the output from Q#378 following the outages of Metcalf – El Patio #1 and #2 115 kV Lines. Therefore, congestion management may be used if the project Q#378 is obligated to follow dispatch instruction from the ISO and this contingency and facility are included in the congestion management scheme. However, if the congestion management is not possible, project Q#378 may be responsible for the cost of SPS to trip its output under this contingency condition.

10.3.6 Vaca – Lambie 230 kV Line

Limiting Factor		1893 Amps Emergency at 2 fps wind speed summer coastal rating	
Pre-project Emergency Loading	1531 Amps (81%)	Post-project Emergency Loading	2596 Amps (137%)
Worst Contingency		Contra Costa Sub - Contra Costa and Birds Landing - Contra Costa 230 kV Lines	
Overload Condition		2013 Summer Peak	

Solution: Install SPS (the same SPS shown in 10.2.1)

10.4 Mitigation for Transient Stability issues

No transient stability issues identified.

10.5 Mitigation for Fault Duty

Replace overstressed circuit breakers at the following substations:

- Pittsburg PP Switching Station (Breaker 672)

³ Using 5% distribution factor as the threshold

11. Environmental Evaluation / Permitting

11.1 CPUC General Order 131-D

PG&E is subject to the jurisdiction of the California Public Utilities Commission (CPUC) and must comply with CPUC General Order 131-D (Order) on the construction, modification, alteration, or addition of all electric transmission facilities (i.e., lines, substations, switchyards, etc.). This includes facilities to be constructed by others and deeded to PG&E. In most cases where PG&E's electric facilities are under 200 kV and are part of a larger project (i.e., electric generation plant), the Order exempts PG&E from obtaining an approval from the CPUC provided its planned facilities have been included in the larger project's California Environmental Quality Act (CEQA) review, the review has included circulation with the State Clearinghouse, and the project's lead agency (i.e., California Energy Commission) finds no significant unavoidable environmental impacts. PG&E or the project developer may proceed with construction once PG&E has filed notice with the CPUC and the public on the project's exempt status, and the public has had a chance to protest PG&E's claim of exemption. If PG&E facilities are not included in the larger project's CEQA review, or if the project does not qualify for the exemption, PG&E may need to seek approval from the CPUC (i.e., Permit to Construct) taking as much as 18 months or more since the CPUC would need to conduct its own environmental evaluation (i.e., Negative Declaration or Environmental Impact Report).

When PG&E's transmission lines are designed for immediate or eventual operation at 200 kV or more, the Order requires PG&E to obtain a Certificate of Public Convenience and Necessity (CPCN) from the CPUC unless one of the following exemptions applies: the replacement of existing power line facilities or supporting structures with equivalent facilities or structures, the minor relocation of existing facilities, the conversion of existing overhead lines (greater than 200 kV) to underground, or the placing of new or additional conductors, insulators, or their accessories on or replacement of supporting structures already built. Obtaining a CPCN can take as much as 18 months or more if the CPUC needs to conduct its own CEQA review, while a CPCN with the environmental review already done takes only 4-6 months or less.

Regardless of the voltage of PG&E's interconnection facilities, PG&E recommends that the project proponent include those facilities in its project description and application to the lead agency performing CEQA review on the project. The lead agency must consider the environmental impacts of the interconnection electric facility, whether built by the developer with the intent to transfer ownership to PG&E or to be built and owned by PG&E directly. If the lead agency makes a finding of no significant unavoidable environmental impacts from construction of substation or under-200 kV power line facilities, PG&E may be able to file an Advice Letter with the CPUC and publish public notice of the proposed construction of the facilities. The noticing process takes about 90 days if no protests are filed, but should be done as early as possible so that a protest does not delay construction. PG&E has no control

over the time it takes the CPUC to respond when issues arise. If the protest is granted, PG&E may then need to apply for a formal permit to construct the project (i.e., Permit to Construct). Facilities built under this procedure must also be designed to include consideration of electric and magnetic field (EMF) mitigation measures pursuant to PG&E “EMF Design Guidelines for New Electrical Facilities: Transmission, Substation and Distribution”. For projects that are not eligible for the Advice Letter/notice process but have already undergone CEQA review, PG&E would likely be able to file a “short-form” CPCN or PTC application, which takes about 4-6 months to process.

Please see Section III, in General Order 131-D. This document can be found in the CPUC’s web page at:

http://www.cpuc.ca.gov/PUBLISHED/GENERAL_ORDER/589.htm

11.2 CPUC Section 851

Because PG&E is subject to the jurisdiction of the CPUC, it must also comply with Public Utilities Code Section 851. Among other things, this code provision requires PG&E to obtain CPUC approval of leases and licenses to use PG&E property, including rights-of-way granted to third parties for Interconnection Facilities. Obtaining CPUC approval for a Section 851 application can take several months, and requires compliance with the California Environmental Quality Act (CEQA). PG&E recommends that Section 851 issues be identified as early as possible so that the necessary application can be prepared and processed. As with GO 131-D compliance, PG&E recommends that the project proponent include any facilities that may be affected by Section 851 in the lead agency CEQA review so that the CPUC does not need to undertake additional CEQA review in connection with its Section 851 approval.

12. Upgrades, Cost and Time to Construct Estimates

The cost estimates are based on the published unit costs, when applicable. Customized costs were developed when the unit costs did not reflect the unique circumstances of a project. The customized costs include: anticipated purchase of land rights, licensing, environmental mitigation, looping lines into substations, new switchyards, substation upgrades not included in unit costs, and PTO's Interconnection Facilities.

The Commercial Operation Dates of the generation projects in Transition Cluster are dependent on the completed construction and energizing of the identified Network Upgrades. Without these upgrades, the new generators may be subject to CAISO's congestion management, including generation tripping. Based on the needed time for permitting, design, and construction, it may not be feasible to complete all the upgrades needed for this cluster before the requested Commercial Operation Dates.

Costs for each generation project are confidential and are not published in the main body of this report. Each IC is receiving a separate report, specific only to that generation project, containing the details of the IC's cost responsibilities.

The estimated cost of **Reliability Network Upgrades** identified in this Group Study is assigned to all Interconnection Requests in that Group Study according to the following rules: (a) short circuit related Reliability Network Upgrades will be assigned pro rata on the basis of the short circuit duty contribution of each Large Generating Facility, (b) for all other Reliability Network Upgrades, the cost will be assigned pro rata on the basis of the maximum megawatt electrical output of each proposed new Large Generating Facility or the amount of megawatt increase in the generating capacity of each existing Generating Facility as listed by the Interconnection Customer in its Interconnection Request.

The estimated cost of all **Delivery Network Upgrades** identified in the Deliverability Assessment are assigned to all Interconnection Requests selecting Full Capacity Deliverability Status based on the flow impact of each such Large Generating Facility on the Delivery Network Upgrades as determined by the generation distribution factor methodology.

The estimated cost of all **Interconnection Facilities** is assigned to each Interconnection Request individually. The cost estimates for the Interconnection Facilities are all site specific and details are provided in each individual project report.

The estimated cost of Distribution Upgrades is developed by PG&E and is not mandated by CAISO tariff. The developer should negotiate with PG&E on any issues related to this cost.

The total cost of the CAISO mitigation plan on the PG&E system for the Greater Bay Area Cluster Group is \$ [REDACTED] as shown in Table 12-1 below.

Table 12-1: Upgrades, Estimated Costs, and Estimated Time to Construct Summary

Type of Upgrade	Upgrade	Description	Estimated Cost x 1,000	Estimated Time to Construct <i>(Note 1)</i>
Delivery Network Upgrades	Contra Costa PP – Delta Pumps 230 kV Line (Contra Costa – Windmaster)	<ul style="list-style-type: none"> • Reconductor 16.5 miles of transmission line with a high capacity conductor 	\$█	18-24 months
	Contra Costa PP – Delta Pumps 230 kV Line (Windmaster – Delta Pumps)	<ul style="list-style-type: none"> • Reconductor 1.8 miles of transmission line with a high capacity conductor 	\$█	18-24 months
	Kelso – Tesla 230 kV Line (Kelso – USWP Ralph)	<ul style="list-style-type: none"> • Reconductor 3.3 miles of transmission line with a high capacity conductor 	\$█	18-24 months
	Kelso – Tesla 230 kV Line (USWP Ralph - Tesla)	<ul style="list-style-type: none"> • Reconductor 4.7 miles of transmission line with a high capacity conductor 	\$█	18-24 months
	Los Positas – Newark 230 kV Line	<ul style="list-style-type: none"> • Reconductor 21 miles of transmission line with a high capacity conductor 	\$█	18-24 months
Reliability Network Upgrades	Contra Costa PP – Contra Costa Sub 230 kV Line	<ul style="list-style-type: none"> • Install SPS to drop generation at Q258 	\$█	12 months
	Birds Landing – Contra Costa 230 kV Line			
	Vaca – Lambie 230 kV Line			
	Lambie – Birds Landing 230 kV Line			
	Replace overstressed breaker(s)	<ul style="list-style-type: none"> • Pittsburg PP Switching Station (CB 672) 	\$█	18-24 months
	Lone Tree – Cayetano 230 kV Line (USWP JW Ranch - Cayetano)	<ul style="list-style-type: none"> • Line re-rate (Note 4) 	\$█	12 months
	Contra Costa PP – Contra Costa Sub 230 kV Line	<ul style="list-style-type: none"> • Congestion management 	N/A	N/A
	Contra Costa – Brentwood 230 kV Line			
	Delta Pumps – Tesla 230 kV Line (Delta Pumps – Altamont Midway)			
	Delta Pumps – Tesla 230 kV Line (Altamont Midway - Tesla)			
	Lone Tree – Cayetano 230 kV Line (Lone Tree – USWP JW Ranch)			
	Newark 230 kV Bank #11			
	Castro Valley – Newark 230 kV Line			
	Moraga – Castro Valley 230 kV Line			
	North Dublin – Cayetano 230 kV Line			
Trimble – San Jose “B” 115 kV Line				
Total			\$█	

The non-binding construction schedule to engineer and construct the facilities identified in this report will be project-specific and will be based upon the assumption that the environmental permitting obtained by the IC is adequate for permitting all PG&E activities.

It is assumed that the IC will include the PG&E Interconnection Facilities and Network Upgrades work scope, as they apply to work within public domains, in its environmental impact report to the CPUC. However, note that CPUC may still require PG&E to obtain a Permit to Construct (PTC) or a Certificate of Public Convenience and Necessity (CPCN) for the generator tie line and Network Upgrades work associated with the Project. Hence, the facilities needed for the project interconnection could require an additional two to three years to complete. The cost for obtaining any of this type of permitting is not included in the above estimates.

Notes associated with the estimated costs in Table 12-1 are as follows:

Note 1 – General comments for Construction Schedules:

The schedule provided is the estimated schedule for PG&E to complete only the construction activities for the specified facility. This is based upon the assumption that the environmental permitting obtained by the IC is adequate for permitting all PG&E activities.

The construction schedule includes only the time required to obtain permits anticipated in Section 11.1. Additional permits required beyond those anticipated will impact the Project's schedule.

Note that if CPUC requires PG&E to obtain a Permit to Construct (PTC) or a Certificate of Public Convenience and Necessity (CPCN) for any work associated with the Project, the Project could require an additional two to three years to complete. The cost for obtaining any of this type of permitting is not included in the above estimates.

Note 2 – General comments for the Reconductoring:

The reconductoring estimates assume that there is no need for additional right-of-way and assume the upgrades are exempt from licensing.

Note 3 – SPS Classification:

All Special Protection Systems are classified as Reliability Network Upgrades because their cost is less than \$ [REDACTED]. This is to prevent overburdening of CAISO's congestion management system which can increase processing time to a point that could create reliability concerns.

Presently, PG&E uses a Remedial Action Scheme (RAS) that trips California Department of Water Resources (CDWR) pumps, generation and /or load, and bypasses series capacitors during certain contingencies to maintain the transfer capability of its transmission system. These contingencies include transmission line outages on the California-Oregon Intertie (Path 66), Pacific DC Intertie (PDCI), and the Midway - Los Banos (Path 15).

Due to the various project locations, the generation facilities may be added to the existing 500 kV (Path 15) RAS or other special protection schemes, as necessary, to mitigate any adverse impacts on the system caused by the addition of the Project to the transmission system.

The SPS cost provided here covers the bulk of the PTO's SPS cost which is essentially a one time set up and equipment cost. It includes the equipment required on the PTO's system as well as the logic board that would be provided to the IC for installation at their project's substation. (Note: The SPS costs do not include installation costs at the project's substation or any work necessary within the generator project such as fiber-optic/communication/control lines that the IC needs to include as part of the gen-tie and to the trip points within their project.)

Note 4 – Lone Tree – Cayetano 230 kV Line

PG&E is evaluating the feasibility of re-rating this line. This transmission line consists of overhead conductor and underground cables. There is no guarantee that PG&E can re-rate the Lone Tree – Cayetano 230 kV Line. If the project to re-rate this line is not possible, other mitigation plan such as congestion management may be used to mitigate this overload.

13. Coordination with Affected Systems

CAISO LGIP tariff Appendix Y section 3.7 requires coordinating with any affected systems that have any potential impact of Transition Cluster projects.

This study concluded that no neighboring systems connecting to PG&E are affected due to the Greater Bay Area Transition Cluster Group projects.

Appendix A – Q320

Mirant Delta, LLC

Marsh Landing Generating Station

Final Report



California ISO
Your Link to Power

July 30, 2010

This study has been completed in coordination with Pacific Gas & Electric Company per CAISO Tariff Appendix Y Large Generator Interconnection Procedures (LGIP) for Interconnection Requests in a Queue Cluster Window

Table of Contents

1.	Executive Summary	2
2.	Project and Interconnection Information	3
3.	Study Assumptions.....	5
4.	Power Flow Analysis	6
4.1	Overloaded Transmission Facilities.....	6
5.	Short Circuit Analysis	7
5.1	Short Circuit Study Input Data.....	7
5.2	Results.....	7
5.3	Preliminary Protection Requirements.....	7
6.	Reactive Power Deficiency Analysis.....	8
7.	Transient Stability Evaluation	8
7.1	Transient Stability Study Scenarios	8
7.2	Results.....	9
8.	Deliverability Assessment.....	9
8.1	On Peak Deliverability Assessment.....	9
8.2	Off- Peak Deliverability Assessment.....	9
9.	Operational Studies	10
10.	Environmental Evaluation/Permitting	11
10.1	CPUC General Order 131-D	11
10.2	CPUC Section 851.....	12
11.	Upgrades, Cost Estimates and Construction schedule estimates	12
12.	Operational Requirements.....	13
13.	Items not covered in this study	15

Attachments:

- 1. Generator Machine Dynamic Data**
- 2. Dynamic Stability Plots**
- 3. Preliminary Protection Requirement**
- 4. Short Circuit Calculation Study Results**
- 5. Deliverability Assessment Results**
- 6. Allocation of Network Upgrades for Cost Estimates**
- 7. Results of Operational Studies**

1. Executive Summary

Mirant Delta, LLC, an Interconnection Customer (IC), has submitted a completed Interconnection Request (IR) to the California Independent System Operator Corporation (CAISO) for their proposed Marsh Landing Generating Station (Project). The IC intends to retire existing Contra Costa Units #6 and #7 prior to the Project Commercial Operation Date (COD) of May 1, 2013. Contra Costa Units #6 and #7 have been determined to have a deliverable capacity of 337 MW each, for a total of 674 MW. The Project will consist of four (4) simple cycle units each having a net capacity of 222 MW during winter and 193.5 MW during summer. Based on the Project net capacities and the retiring of Contra Costa Units #6 and #7, the Project will have a maximum net output to the CAISO Controlled Grid will of 100 MW during the summer and 214 MW during the winter. The Project will be interconnected to the Pacific Gas and Electric Company's (PG&E's) Contra Costa Power Plant (PP) Switchyard 230 kV bus in Contra Costa County, CA. The IC also selected an alternative POI, which is PG&E's Contra Costa Substation 230 kV bus.

In accordance with Federal Energy Regulatory Commission (FERC) approved Large Generator Interconnection Procedures (LGIP) for Interconnection Requests in a Queue Cluster Window (CAISO Appendix Y), this project was grouped with "Greater Bay Area Transition Cluster Group" projects (Transition Cluster Phase II Study or Phase II study) to determine the impacts of the group as well as impacts of this Project on the CAISO Controlled Grid.

The group report has been prepared separately identifying the combined impacts of all projects in the group on the CAISO Controlled Grid. This report focuses only on the impacts of this project.

The report provides the following:

1. Transmission system impacts caused by the Project,
2. System reinforcements necessary to mitigate the adverse impacts caused by the Project under various system conditions,
3. A list of required facilities and a non-binding, good faith estimate of this Project's cost responsibility and time to construct these facilities.

The Phase 1 study results have determined that the Project contributes to overloading of four transmission facilities for which mitigation plans have been proposed. In addition, the Project is also partly responsible for overstressing one circuit breaker at Pittsburg PP Switching Station.

The Project did not violate any parts of voltage criteria and hence caused no adverse voltage impacts on the grid. Also, the Project did not significantly impact the transmission system's transient stability performance following selected contingencies.

The non-binding cost estimate of Interconnection Facilities¹ to interconnect the Project would be approximately \$ [REDACTED] exclusive of ITCC². The non-binding cost estimate for the Network Upgrades³ to interconnect the Project would be approximately \$ [REDACTED].

The non-binding construction schedule to engineer and construct the facilities is approximately 18-24 months from the signing of the Large Generator Interconnection Agreement (LGIA).

2. Project and Interconnection Information

Table 2-1 provides general information about the Project.

Table 2-1: Project General Information

Project Location	Contra Costa County, California
PG&E Planning Area	Greater Bay Area
Number and Type of Generators	Four simple cycle units (each rated for 222 MW winter and 193.5 MW summer)
Interconnection Voltage	230 kV
Maximum Generator Output	888 MW winter, 774 MW summer
Generator Auxiliary Load	1.7 MW
Maximum Net Output to Grid	214 MW winter, 100 MW summer (includes subtraction of 674 MW after Contra Costa Units #6 and #7 are retired)
Power Factor Range	0.85 leading 0.85 lagging ⁴
Step-up Transformer	Four three-phase 16.5/230 kV transformers, each rated 190/253/317 MVA
Point of Interconnection	Contra Costa PP Switchyard 230 kV bus
Alternative Point of Interconnection	Contra Costa Substation 230 kV bus
Commercial Operation Date	May 1, 2013

Figure 2-1 provides the map for the Project and the transmission facilities in the vicinity. Figure 2-2 shows the conceptual single line diagram of the Project.

¹ The transmission facilities necessary to physically and electrically interconnect the Project to the CAISO Controlled Grid at the point of interconnection.

² Income Tax Component of Contribution (currently at 34%)

³ The transmission facilities, other than Interconnection Facilities, beyond the point of interconnection necessary to physically and electrically interconnect the Project safely and reliably to the CAISO Controlled Grid.

⁴ PG&E's Interconnection Handbook requires that the Project be able to meet power factor requirements of 90 percent lagging and 95 percent leading.

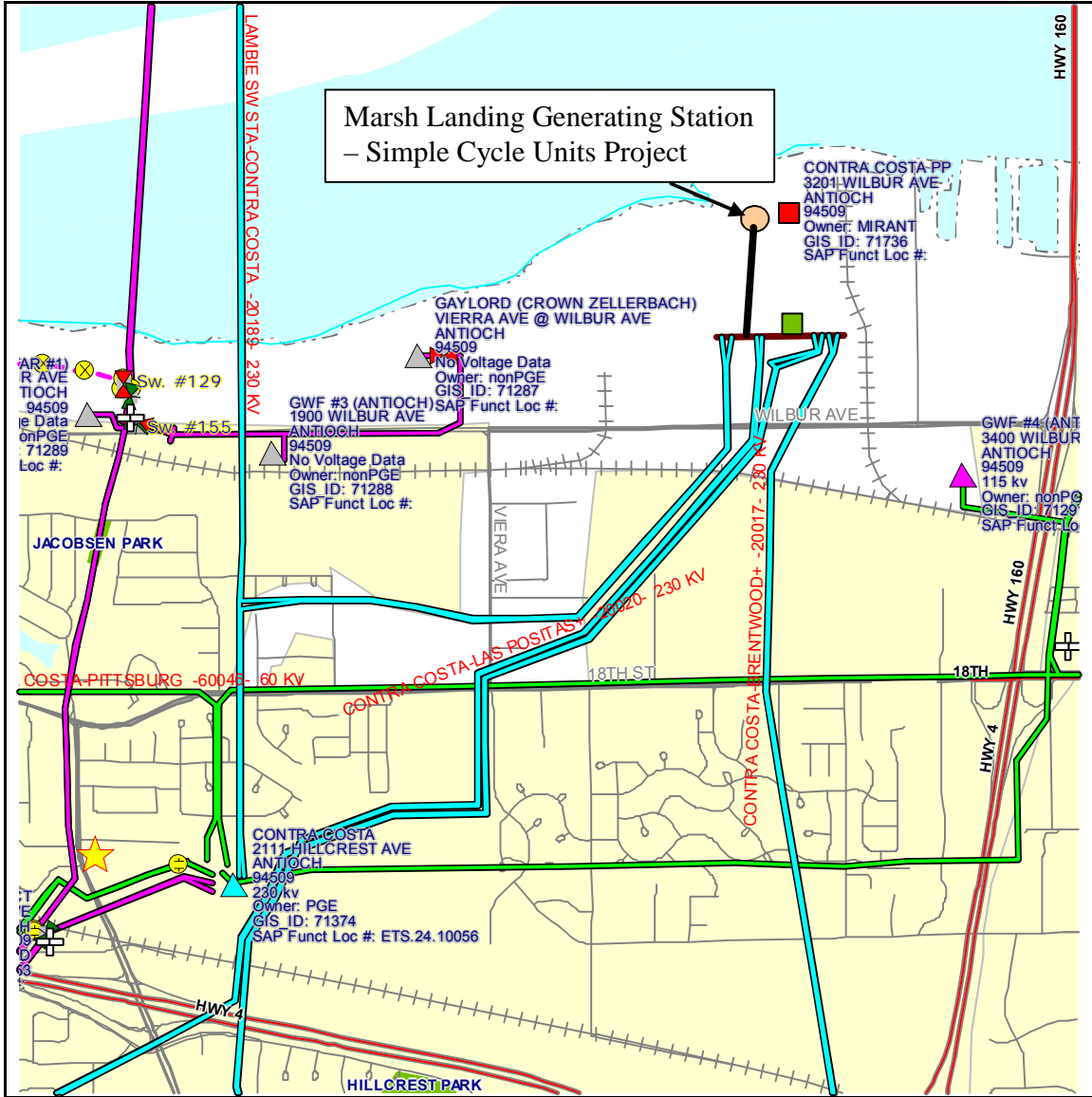

Figure 2-1: Vicinity Map

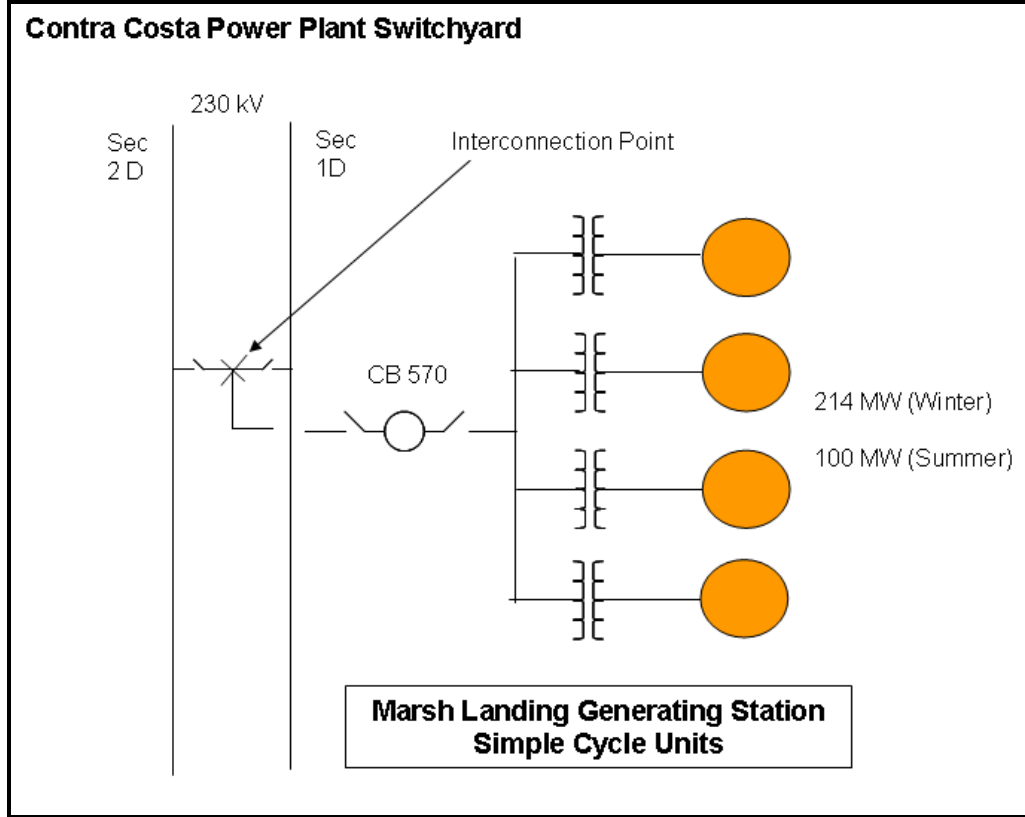

Figure 2-2: Proposed Single Line Diagram

3. Study Assumptions

For detailed assumptions, please refer to the main report. The following assumptions are only specific to this Project:

1. The Project consists of four simple cycle turbines each rated for 193.5 MW summer and 222 MW winter. With Contra Costa Units #6 and #7 (674 MW total) being retiring prior to the COD, the maximum net output to the CAISO controlled-grid is 100 MW during summer and 214 MW during winter.
2. The expected Commercial Operation Date of the Project is May 1, 2013.
3. The IC will engineer, procure, construct, own, operate and maintain its project facility, including the generator tie line from Contra Costa PP Switchyard to the Project facility. The generator tie line is approximately 0.16 miles long and comprised of 1590 kcmil ACSR conductor or equivalent (Note that this is not a PG&E standard supply transmission line conductor).

4. The Project generating units will be connected to the 230 kV bus at the Contra Costa Power Plant Switchyard by occupying CB 570 that will be vacated by Mirant's Contra Costa Power Plant Unit #3.

4. Power Flow Analysis

The group study indicated that this project is contributing into overloading of the following transmission facilities. The details of the analysis and overload levels are provided in the group study.

4.1 Overloaded Transmission Facilities

4.1.1 Category "A" Overloads

- Contra Costa - Brentwood 230kV Line
- Contra Costa PP - Delta Pumps 230kV Line (Contra Costa - Windmaster)
- Contra Costa PP - Delta Pumps 230kV Line (Windmaster - Delta Pumps)
- Delta Pumps - Tesla 230kV Line (Delta Pumps - Altamont Midway)
- Delta Pumps - Tesla 230kV Line (Altamont Midway - Tesla)
- Kelso - Tesla 230kV Line (Kelso - USWP Ralph)
- Kelso - Tesla 230kV Line (USWP Ralph - Tesla)
- Las Positas - Newark 230kV Line

4.1.2 Category "B" Overloads

- Birds Landing - Contra Costa 230 kV Line
- Contra Costa PP - Contra Costa Sub 230kV Line
- Lone Tree - Cayetano 230kV Line (Lone Tree - USWP JW Ranch)
- Lone Tree - Cayetano 230kV Line (USWP JW Ranch - Cayetano)
- Newark 230/115kV Bank #11

4.1.3 Category "C" Overloads

- Castro Valley - Newark 230kV Line
- Lambie - Birds Landing 230kV Line
- Moraga - Castro Valley 230kV Line
- North Dublin - Cayetano 230kV Line
- Vaca - Lambie 230kV Line

5. Short Circuit Analysis

Short circuit studies were performed to determine the fault duty impact of adding the Greater Bay Area Transition Cluster Group projects to the transmission system. These studies are also needed to perform relay coordination among adjacent substations. The fault duties were calculated with and without the projects to identify any equipment overstress conditions. Once overstressed circuit breakers are identified, the fault current contribution from each individual project in Transition Cluster is determined. If the fault current contribution of any project is higher than the threshold value of 100 amperes, that project will be responsible for its share of the upgrade cost based on the rules set forth in CAISO Tariff Appendix Y.

5.1 Short Circuit Study Input Data

The following input data provided by the Applicant of this Project was used in this study:

Short Circuit Data at 285 MVA Base:

- Positive Sequence subtransient reactance ($X''1$) = 0.193p.u.
- Negative Sequence subtransient reactance ($X''2$) = 0.193p.u.
- Zero Sequence subtransient reactance ($X''0$) = 0.116p.u.

Station Step-up Transformers (total of four)

- Each transformer is a three-phase 16.5/230 kV rated for 190/253/317 MVA OA/FA/FA at 65 degree C temperature rise with an impedance of 9% at 190 MVA base.

5.2 Results

The available short circuit duty at the buses electrically adjacent to Transition Cluster projects is listed in [Attachment 4](#). This data was used to determine if any equipment is overstressed by the interconnection of the Transition Cluster projects.

Using these short-circuit study results, an initial breaker evaluation found that this Project contributes more than the threshold value of 100 Amps to the following overstressed circuit breaker:

- Pittsburg PP 230 kV Switching Station CB 672

5.3 Preliminary Protection Requirements

Per Section G2.1 of the PG&E Interconnection Handbook, PG&E protection requirements are designed and intended to protect PG&E's system only. The applicant is responsible for the protection of its own system and equipment

and must meet the requirements in the PG&E Interconnection Handbook.

These Preliminary Protection Requirements are based upon an interconnection plan as shown in Figure 2-2. The Preliminary Protection Requirements are detailed in [Attachment 3](#).

Protection requirements may include, but are not limited to, direct transfer trip schemes installed at PG&E and IC facilities. The IC is responsible for installing the leased lines used for direct transfer trip communication and the necessary direct transfer trip transmitters.

6. Reactive Power Deficiency Analysis

The power flow studies of Category “B” and Category “C” contingencies indicate that the Transition Cluster projects did not cause voltage drops of 5% or more from the pre-project levels, or cause the PG&E system to fail to meet applicable voltage criteria. This project, therefore, did not cause any adverse voltage impacts on the

7. Transient Stability Evaluation

Transient Stability studies were conducted using the 2013 summer peak full loop base cases to ensure that the transmission system remains in operating equilibrium, as well as operating in a coordinated fashion, through abnormal operating conditions after the Transition Cluster projects begin operation. The generator dynamic data used in the study for this Project is shown in [Attachment 1](#).

7.1 Transient Stability Study Scenarios

Disturbance simulations were performed for a study period of 10 seconds to determine whether the Transition Cluster projects will create any system instability during a variety of line and generator outages. For this Project, the following line and generator outages were evaluated:

7.1.1 Category “B” Contingencies:

- Full load rejection of 774 MW at the Contra Costa PP 230 kV Switchyard.
- Three-phase fault on Birds Landing Switching Station – Contra Costa PP 230 kV Line at Contra Costa PP 230 kV bus with normal clearing time followed by the loss of the Birds Landing Switching Station – Contra Costa PP 230 kV Line.
- Three-phase fault on Birds Landing Switching Station – Contra Costa PP 230 kV Line at Birds Landing Switching Station 230 kV bus with normal clearing time followed by the loss of the Birds Landing Switching Station – Contra Costa PP 230 kV Line.

- Three-phase fault on Contra Costa PP – Contra Costa Sub 230 kV Line at Contra Costa PP 230 kV bus with normal clearing time followed by the loss of the Contra Costa PP – Contra Costa Sub 230 kV Line.
- Three-phase fault on Contra Costa PP – Contra Costa Sub 230 kV Line at Contra Costa Sub 230 kV bus with normal clearing time followed by the loss of the Contra Costa PP – Contra Costa Sub 230 kV Line.

7.1.2 Category “C” Contingencies:

- Three-phase fault on the Contra Costa PP 230 kV bus with normal clearing time.
- Three-phase fault on the Contra Costa Sub 230 kV bus with normal clearing time.

7.2 Results

The study concluded that the Project would not cause the transmission system to go unstable under Category “B” and Category “C” outages.

- The results of the study are provided in the form of plots in [Attachment 2](#).

8. Deliverability Assessment

8.1 On Peak Deliverability Assessment

CAISO performed an On-Peak Deliverability Assessment on the 2013 Summer Peak conditions to determine the capability of the projects to be deliverable to the aggregated of load. The study was conducted using the assumptions and methodologies described in the Off-Peak Deliverability Assessment Methodology which is available on the CAISO website at <http://www.caiso.com/23d7/23d7e41c14580.pdf>.

The power flow study results for Category “A”, “B”, and “C” are detailed in [Attachment 5](#).

8.2 Off- Peak Deliverability Assessment

A modified version of the power flow 2013 Summer Off-Peak base case was created to perform the off-peak deliverability assessment of the Transition Cluster projects. The study was conducted using the assumptions and methodologies described in the Off-Peak Deliverability Assessment Methodology which is available on the CAISO website at <http://www.caiso.com/23d7/23d7e46815090.pdf>.

The impacts of this project are shown in [Attachment 5](#).

9. Operational Studies

Operational studies including Power Flow, Short Circuit, Transient Stability, and Voltage assessment were performed on a year-by-year basis by adding projects in the base cases based on their Commercial Operation Date (COD). The purpose of these studies was to determine whether or not the required Reliability Network Upgrades and Delivery Network Upgrades can be constructed in a timely manner to safely and reliably interconnect this Project on the CAISO Controlled Grid.

The detailed results of the Operational studies are shown in [Attachment 7](#). A summary of analyses related to this Project's COD is presented in the following paragraphs:

Power flow analysis indicated that the following facilities will be overloaded:

1. Contra Costa - Brentwood 230kV Line
2. Contra Costa PP - Delta Pumps 230kV Line
3. Delta Pumps - Tesla 230kV Line
4. Kelso - Tesla 230kV Line
5. Las Positas - Newark 230kV Line
6. Birds Landing - Contra Costa 230 kV Line
7. Contra Costa PP - Contra Costa Sub 230kV Line
8. Lone Tree - Cayetano 230kV Line
9. Newark 230/115kV Bank #11
10. Castro Valley - Newark 230kV Line
11. Lambie - Birds Landing 230kV Line
12. Moraga - Castro Valley 230kV Line
13. North Dublin - Cayetano 230kV Line
14. Trimble-San Jose "B" 115kV Line
15. Vaca - Lambie 230kV Line

Short Circuit analysis indicated that some circuit breakers will be overstressed at the following substations:

1. Pittsburg PP (Breaker 672)

Transient Stability analysis indicated that the system will remain stable under the selected disturbances in the vicinity of the project and no adverse stability impacts were found.

Voltage Assessment indicated that the Transmission System voltages under Category "B" and Category "C" contingency conditions were well within the PG&E operating guidelines, and the voltage deviations were within the allowable NERC/WECC criteria.

Based on the estimated construction time for the above overloaded facilities, PG&E cannot guarantee that those facilities will be in service to meet the IC's COD. However, the CAISO believes that congestion management and/or operating procedures can be applicable in the interim period until the upgrades are completed. The Project will be treated as an "Energy Only" project during this interim period.

10. Environmental Evaluation/Permitting

10.1 CPUC General Order 131-D

PG&E is subject to the jurisdiction of the California Public Utilities Commission (CPUC) and must comply with CPUC General Order 131-D (Order) on the construction, modification, alteration, or addition of all electric transmission facilities (i.e., lines, substations, switchyards, etc.). This includes facilities to be constructed by others and deeded to PG&E. In most cases where PG&E's electric facilities are under 200 kV and are part of a larger project (i.e., electric generation plant), the Order exempts PG&E from obtaining an approval from the CPUC provided its planned facilities have been included in the larger project's California Environmental Quality Act (CEQA) review, the review has included circulation with the State Clearinghouse, and the project's lead agency (i.e., California Energy Commission) finds no significant unavoidable environmental impacts. PG&E or the project developer may proceed with construction once PG&E has filed notice with the CPUC and the public on the project's exempt status, and the public has had a chance to protest PG&E's claim of exemption. If PG&E facilities are not included in the larger project's CEQA review, or if the project does not qualify for the exemption, PG&E may need to seek approval from the CPUC (i.e., Permit to Construct) taking as much as 18 months or more since the CPUC would need to conduct its own environmental evaluation (i.e., Negative Declaration or Environmental Impact Report).

When PG&E's transmission lines are designed for immediate or eventual operation at 200 kV or more, the Order requires PG&E to obtain a Certificate of Public Convenience and Necessity (CPCN) from the CPUC unless one of the following exemptions applies: the replacement of existing power line facilities or supporting structures with equivalent facilities or structures, the minor relocation of existing facilities, the conversion of existing overhead lines (greater than 200 kV) to underground, or the placing of new or additional conductors, insulators, or their accessories on or replacement of supporting structures already built. Obtaining a CPCN can take as much as 18 months or more if the CPUC needs to conduct its own CEQA review, while a CPCN with the environmental review already done takes only 4-6 months or less.

Regardless of the voltage of PG&E's interconnection facilities, PG&E recommends that the project proponent include those facilities in its project description and application to the lead agency performing CEQA review on the project. The lead agency must consider the environmental impacts of the interconnection electric facility, whether built by the developer with the intent to transfer ownership to PG&E or to be built and owned by PG&E directly. If the lead agency makes a finding of no significant unavoidable environmental impacts from construction of substation or under-200 kV power line facilities, PG&E may be able to file an Advice Letter with the CPUC and publish public notice of the proposed construction of the facilities. The noticing process takes about 90 days if no protests are filed, but should be done as early as possible so that a protest does not delay construction. PG&E has no control

over the time it takes the CPUC to respond when issues arise. If the protest is granted, PG&E may then need to apply for a formal permit to construct the project (i.e., Permit to Construct). Facilities built under this procedure must also be designed to include consideration of electric and magnetic field (EMF) mitigation measures pursuant to PG&E “EMF Design Guidelines for New Electrical Facilities: Transmission, Substation and Distribution”. For projects that are not eligible for the Advice Letter/notice process but have already undergone CEQA review, PG&E would likely be able to file a “short-form” CPCN or PTC application, which takes about 4-6 months to process.

Please see Section III, in General Order 131-D. This document can be found in the CPUC’s web page at:

http://www.cpuc.ca.gov/PUBLISHED/GENERAL_ORDER/589.htm

10.2 CPUC Section 851

Because PG&E is subject to the jurisdiction of the CPUC, it must also comply with Public Utilities Code Section 851. Among other things, this code provision requires PG&E to obtain CPUC approval of leases and licenses to use PG&E property, including rights-of-way granted to third parties for Interconnection Facilities. Obtaining CPUC approval for a Section 851 application can take several months, and requires compliance with CEQA. PG&E recommends that Section 851 issues be identified as early as possible so that the necessary application can be prepared and processed. As with GO 131-D compliance, PG&E recommends that the project proponent include any facilities that may be affected by Section 851 in the lead agency CEQA review so that the CPUC does not need to undertake additional CEQA review in connection with its Section 851 approval.

11. Upgrades, Cost Estimates and Construction schedule estimates

To determine the cost responsibility of each generation project in Transition Cluster, the CAISO developed cost allocation factors based on the individual contribution of each project ([Attachment 6](#)). The cost allocation for the Interconnection Facilities and Network Upgrades for which this Project is solely responsible is as follows:

Table 11-1: Upgrades, Estimated Costs, and Estimated Time to Construct Summary

Type of Upgrade	Upgrade	Description	Cost Allocation Factor	Estimated Cost x 1000	Estimated Time to Construct (Note 1)
PTO’s Interconnection Facilities (Note 2)	Work at the IC’s site	<ul style="list-style-type: none"> Pre-parallel inspection, testing, SCADA/EMS setup, meters, etc. Land engineering support and permitting activities 	█%	\$█	12-18 Months
Reliability	Communications	<ul style="list-style-type: none"> SCADA/EMS, programming, testing, screening at TOC and Switching Center 	█%	\$█	12 Months

Network Upgrades	SPS to mitigate overloads on 1) Contra Costa PP – Contra Costa Sub 230 kV Line, 2) Birds Landing – Contra Costa 230 kV Line, 3) Vaca – Lambie 230 kV Line, and 4) Lambie – Birds Landing 230 kV Line	<ul style="list-style-type: none"> Install SPS to drop generation at Q258 	█%	\$█	12 months
Delivery Network Upgrades	Contra Costa PP – Delta Pumps 230 kV Line (Contra Costa – Windmaster)	<ul style="list-style-type: none"> Reconductor 16.5 miles of transmission line with a high capacity conductor 	█%	\$█	18-24 months
	Contra Costa PP – Delta Pumps 230 kV Line (Windmaster – Delta Pumps)	<ul style="list-style-type: none"> Reconductor 1.8 miles of transmission line with a high capacity conductor 	█%	\$█	18-24 months
	Kelso – Tesla 230 kV Line (Kelso – USWP Ralph)	<ul style="list-style-type: none"> Reconductor 3.3 miles of transmission line with a high capacity conductor 	█%	\$█	18-24 months
	Kelso – Tesla 230 kV Line (USWP Ralph - Tesla)	<ul style="list-style-type: none"> Reconductor 4.7 miles of transmission line with a high capacity conductor 	█%	\$█	18-24 months
	Los Positas – Newark 230 kV Line	<ul style="list-style-type: none"> Reconductor 21 miles of transmission line with a high capacity conductor 	█%	\$█	18-24 months
Total				\$█	

Note 1: The Estimated Time to Construct is the schedule for the PTO to complete the construction activities only.

Note 2: The Interconnection Customer is obligated to fund these upgrades and will not be reimbursed.

The non-binding construction schedule to engineer and construct the facilities is based on the assumptions outlined in [Section 3](#) of this report, and is applicable from the signing of the Large Generator Interconnection Agreement (LGIA). This is also based upon the assumption that the environmental permitting obtained by the IC is adequate for permitting all PG&E activities.

It is assumed that the IC will include the PG&E Interconnection Facilities and Network Upgrades work scope, as they apply to work within public domains, in its environmental impact report to the CPUC. However, note that CPUC may still require PG&E to obtain a Permit to Construct (PTC) or a Certificate of Public Convenience and Necessity (CPCN) for the generator tie line and Network Upgrades work associated with the Project. Hence, the facilities needed for the project interconnection could require an additional two to three years to complete. The cost for obtaining any of this type of permitting is not included in the above estimates.

12. Technical Requirements

The PG&E Interconnection Handbook explain the technical requirements for interconnection of loads and generators to PG&E’s transmission system. The Interconnection Handbook documents facility connection requirements to the PG&E system as required in NERC Standard FAC-001-0. They are based on applicable

⁵ \$█ if includes PTO’s Interconnection Facilities

FERC and CPUC rules and tariffs (e.g., Electric Rules 2, 21 and 22), as well as accepted industry practices and standards. In addition to providing reliability, these technical requirements are consistent with safety for PG&E workers and the public.

The PG&E Interconnection Handbook applies to Retail and Wholesale Entities, which own or operate generation, transmission, and end user facilities that are physically connected to, or desire to physically connect to PG&E's electric system. All technical requirements described or referred to in the Handbook apply to new or re-commissioned Generation Facilities. The Generation Interconnection Handbook comprising sections G-1 through G-5 applies to Generation Entities.

PG&E has established standard operating, metering and equipment protection requirements for loads and generators. The Interconnection Handbook covers such requirements for all transmission-level load and generation entities wishing to interconnect with PG&E's electric system. Additional, project-specific requirements may apply and are documented in this SIS report.

The PG&E Interconnection Handbook includes, but is not limited to such operating requirements as the following:

- The Project must be able to meet the power factor requirements of 90 percent lagging and 95 percent leading.
- The Project must have Automatic Voltage Regulation (AVR) and be able to maintain the generator voltage under steady-state conditions within ± 0.5 percent of any voltage level between 95 percent and 105 percent of the rated generator voltage.

Generators must also meet all applicable CAISO, NERC, and Western Electric Coordinating Council (WECC) standards. NERC and WECC standards include, but are not limited to such requirements as the following:

- The Project must be able to remain on line during voltage disturbances up to the time periods and associated voltage levels as required by the WECC Low Voltage Ride Through (LVRT) standards that are in-line with FERC Order No. 161-A. The WECC LVRT standard is available on the WECC web site at:

<http://www.wecc.biz/committees/StandingCommittees/PCC/TSS/Shared%20Documents/Voltage%20Ride%20Through%20White%20Paper.pdf>

- Currently NERC is working on a Voltage Ride Through standard, PRC-024-1, that would be applicable to all generators interconnecting to the transmission grid. Until PRC-024-1 is effective, PG&E and the CAISO will require that all generators comply with the existing WECC LVRT requirements. The PRC-024-1 standard Draft 1 can be found on the NERC web site at

http://www.nerc.com/docs/standards/sar/PRC-024-1_Draft1_2009Feb17.pdf

All generators must satisfy the requirements of the PG&E's Interconnection Handbook and meet all applicable CAISO, NERC, and WECC standards. PG&E will

not agree to interconnect any new generators unless all technical and contractual requirements are met.

The IC should be aware that the information in the PG&E Interconnection Handbook is subject to change. Parties interconnecting to the PG&E electric system should verify with their PG&E representative that they have the latest versions. The PG&E Interconnection Handbook is available on the PG&E web site at:

<http://www.pge.com/about/rates/tariffbook/ferc/tih/>

13. Items not covered in this study

The Phase II Study does not address any requirements for standby power that the Project may require. The IC should contact their PG&E Generation Interconnection Services representative regarding this service.

Note: The IC is urged to contact their PG&E Generation Interconnection Services representative promptly regarding stand-by service in order to ensure its availability for the project's start-up date.

Appendix B

Contingency Lists for Outages

Autocon Input Files

Greater Bay Area Cluster

APPENDIX B – CAISO CATEGORY B AUTOCON INPUT FILE

```

# PG&E TCP2 Greater Bay Area 2013 category b contingency list
# North Bay, East Bay, Diablo, San Francisco, Peninsula, Mission, DeAnza and San Jose Divisions
# Zones 306, 307, 308, 309, 310, 316, 317, 318 and selected outages from Sacramento/Sierra 304/311
#
# 2013 category b contingency list
# selected Sacramento/Sierra outages
#
#
# (1) B2 LINE OUTAGE (BREAKER-TO-BREAKER)
#
1 30460 30472 "1 " 0 # line from VACA-DIX 230.00 BRKR to BRKR PEABODY 230.00
0
#
#
# (2) B2 LINE OUTAGE (BREAKER-TO-BREAKER)
#
1 30460 30478 "1 " 0 # line from VACA-DIX 230.00 BRKR to BRKR LAMBIE 230.00
0
#
#
# (3) B2 LINE OUTAGE (BREAKER-TO-BREAKER)
#
1 30472 30479 "1 " 0 # line from PEABODY 230.00 BRKR to BRKR BDLWSTA 230.00
0
#
#
# (4) B2 LINE OUTAGE (BREAKER-TO-BREAKER)
#
1 30478 30479 "1 " 0 # line from LAMBIE 230.00 BRKR to BRKR BDLWSTA 230.00
0
#
#
# (5) B2 LINE OUTAGE (BREAKER-TO-BREAKER)
#
1 30330 30482 "1 " 0 # line from RIO OSO 230.00 BRKR to BRKR LOCKFORD 230.00
0
#
#
# (6) B2 LINE OUTAGE (BREAKER-TO-BREAKER)
#
1 30337 30622 "1 " 0 # line from GOLDHILL 230.00 BRKR to BRKR EIGHT MI 230.00
0
#
#
# (7) B2 LINE OUTAGE (BREAKER-TO-BREAKER)
#
1 30348 30500 "1 " 0 # line from BRIGHTON 230.00 BRKR to BRKR BELLOTA 230.00
0
#
#
# (8) B2 LINE OUTAGE (BREAKER-TO-BREAKER)
#
1 30482 30500 "1 " 0 # line from LOCKFORD 230.00 BRKR to BRKR BELLOTA 230.00
0
#
#
# (9) B2 LINE OUTAGE (BREAKER-TO-BREAKER)
#
1 30485 30487 "1 " 0 # line from TIGR CRK 230.00 BRKR to BRKR ELECTRA 230.00
0
#
#
# (10) B2 LINE OUTAGE (BREAKER-TO-BREAKER)
#
1 30485 30490 "1 " 0 # line from TIGR CRK 230.00 BRKR to BRKR VLLY SPS 230.00
0
#
#
# (11) B2 LINE OUTAGE (BREAKER-TO-BREAKER)
#
1 30487 30500 "1 " 0 # line from ELECTRA 230.00 BRKR to BRKR BELLOTA 230.00
0
#
#
# (12) B2 LINE OUTAGE (BREAKER-TO-BREAKER)
#
1 30489 30624 "1 " 0 # line from STAGG-J2 230.00 (2) to BRKR TESLA E 230.00
1 30489 30499 "1 " 0 # line from STAGG-J2 230.00 (2) to BRKR STAGG-E 230.00

```

APPENDIX B – CAISO CATEGORY B AUTOCON INPUT FILE

```

0
#
#
# (13) B2 LINE OUTAGE (BREAKER-TO-BREAKER)
#
1 30490 30500 "1 " 0 # line from VLLY SPS 230.00 BRKR to BRKR BELLOTA 230.00
0
#
#
# (14) B2 LINE OUTAGE (BREAKER-TO-BREAKER)
#
1 30500 30503 "1 " 0 # line from BELLOTA 230.00 BRKR to BRKR COLLERVL 230.00
0
#
#
# (15) B2 LINE OUTAGE (BREAKER-TO-BREAKER)
#
1 30500 30503 "2 " 0 # line from BELLOTA 230.00 BRKR to BRKR COLLERVL 230.00
0
#
#
# (16) B2 LINE OUTAGE (BREAKER-TO-BREAKER)
#
1 30500 30505 "1 " 0 # line from BELLOTA 230.00 BRKR to BRKR WEBER 230.00
0
#
#
# (17) B2 LINE OUTAGE (BREAKER-TO-BREAKER)
#
1 30500 30888 "1 " 0 # line from BELLOTA 230.00 BRKR to BRKR Q172 230.00
0
#
#
# (18) B2 LINE OUTAGE (BREAKER-TO-BREAKER)
#
1 30500 38206 "1 " 0 # line from BELLOTA 230.00 BRKR to (2) COTTLE A 230.00
1 38206 37563 "1 " 0 # line from COTTLE A 230.00 (2) to BRKR MELONES 230.00
4 38206 0 "1 " 0 # LOAD-DROP COTTLE A 230.00 LOAD==20.21(0.91)
0
#
#
# (19) B2 LINE OUTAGE (BREAKER-TO-BREAKER)
#
1 30500 38208 "1 " 0 # line from BELLOTA 230.00 BRKR to (2) COTTLE B 230.00
1 38208 30515 "1 " 0 # line from COTTLE B 230.00 (2) to BRKR WARNERVL 230.00
4 38208 0 "2 " 0 # LOAD-DROP COTTLE B 230.00 LOAD==23.24(1.04)
0
#
#
# (20) B2 LINE OUTAGE (BREAKER-TO-BREAKER)
#
1 30505 30888 "1 " 0 # line from WEBER 230.00 BRKR to BRKR Q172 230.00
0
#
#
# (21) B2 LINE OUTAGE (BREAKER-TO-BREAKER)
#
1 30527 30595 "1 " 0 # line from PITSBG E 230.00 BRKR to (3) FLOWIND2 230.00
2 30595 30640 "1 " 0 # line from FLOWIND2 230.00 (3) to BRKR TESLA C 230.00
2 30595 33840 "1 " 0 # TRAN from FLOWIND2 230.00 (3) to (1) FLOWD3-6 9.11
4 33840 0 "SG" 0 # LOAD-DROP FLOWD3-6 9.11 LOAD==0.70(0.34)
3 33840 0 "1 " 0 # GEN-DROP FLOWD3-6 9.11 GEN==1.30(0.00)
3 33840 0 "4 " 0 # GEN-DROP FLOWD3-6 9.11 GEN==1.10(0.00)
0
#
#
# (22) B2 LINE OUTAGE (BREAKER-TO-BREAKER)
#
1 30565 30569 "1 " 0 # line from BRENTWOD 230.00 BRKR to BRKR KELSO 230.00
0
#
#
# (23) B2 LINE OUTAGE (BREAKER-TO-BREAKER)
#
1 30569 30570 "1 " 0 # line from KELSO 230.00 BRKR to (4) USWP-RLF 230.00
1 30570 30571 "1 " 0 # line from USWP-RLF 230.00 (4) to (2) ALTALAND 230.00
1 30570 30625 "1 " 0 # line from USWP-RLF 230.00 (4) to BRKR TESLA D 230.00
2 30570 33836 "1 " 0 # TRAN from USWP-RLF 230.00 (4) to (1) USWP_#4 9.11
2 30571 33832 "1 " 0 # TRAN from ALTALAND 230.00 (2) to (1) COG.CAPT 9.11

```

APPENDIX B – CAISO CATEGORY B AUTOCON INPUT FILE

```

4 33836      0 "SG"      0      # LOAD-DROP      USWP_#4      9.11      LOAD==0.34(0.21)
3 33836      0 "3 "      0      # GEN-DROP      USWP_#4      9.11      GEN==4.50(0.00)
3 33832      0 "1 "      0      # GEN-DROP      COG.CAPT     9.11      GEN==4.30(6.60)
0
#
#
# (24) B2 LINE OUTAGE (BREAKER-TO-BREAKER)
#
1 30580 30625 "1 "      0      # line from      ALTM MDW 230.00      (3) to BRKR      TESLA D 230.00
1 30580 38610 "1 "      0      # line from      ALTM MDW 230.00      (3) to BRKR      DELTAPMP 230.00
2 30580 33175 "1 "      0      # TRAN from      ALTM MDW 230.00      (3) to (1)      ALTAMONT 9.11
0
#
#
# (25) B2 LINE OUTAGE (BREAKER-TO-BREAKER)
# pre and post-project outage
1 30527 30600 "2 "      0      # line from      PITSBG E 230.00      BRKR to (4)      TRES VAQ 230.00
1 30600 30640 "2 "      0      # line from      TRES VAQ 230.00      (4) to BRKR      TESLA C 230.00
2 30600 33195 "1 "      0      # TRAN from      TRES VAQ 230.00      (4) to (1)      T417 34.50
4 33195      0 "ss"      0      # LOAD-DROP      T417 34.50      LOAD==0.10(0.06)
3 33195      0 "1 "      0      # GEN-DROP      T417 34.50      GEN==42.10(0.00)
0
#
#
# (26) B2 LINE OUTAGE (BREAKER-TO-BREAKER)
#
1 30622 30495 "1 "      0      # line from      EIGHT MI 230.00      BRKR to BRKR      STAGG 230.00
0
#
#
# (27) B2 LINE OUTAGE (BREAKER-TO-BREAKER)
#
1 30622 30624 "1 "      0      # line from      EIGHT MI 230.00      BRKR to BRKR      TESLA E 230.00
0
#
#
# (28) B2 LINE OUTAGE (BREAKER-TO-BREAKER)
#
1 30624 30630 "1 "      0      # line from      TESLA E 230.00      BRKR to BRKR      NEWARK D 230.00
0
#
#
# (29) B2 LINE OUTAGE (BREAKER-TO-BREAKER)
#
1 30624 30670 "1 "      0      # line from      TESLA E 230.00      BRKR to BRKR      WESTLEY 230.00
0
#
#
# (30) B2 LINE OUTAGE (BREAKER-TO-BREAKER)
#
1 30624 30888 "1 "      0      # line from      TESLA E 230.00      BRKR to BRKR      Q172 230.00
0
#
#
# (31) B2 LINE OUTAGE (BREAKER-TO-BREAKER)
#
1 30624 30888 "2 "      0      # line from      TESLA E 230.00      BRKR to BRKR      Q172 230.00
0
#
#
# (32) B2 LINE OUTAGE (BREAKER-TO-BREAKER)
#
1 30632 30624 "1 "      0      # line from      TESL_GEN 230.00      BRKR to BRKR      TESLA E 230.00
0
#
#
# (33) B2 LINE OUTAGE (BREAKER-TO-BREAKER)
#
1 30632 30624 "2 "      0      # line from      TESL_GEN 230.00      BRKR to BRKR      TESLA E 230.00
0
#
#
# (34) B2 LINE OUTAGE (BREAKER-TO-BREAKER)
#
1 30640 30655 "2 "      0      # line from      TESLA C 230.00      BRKR to (3)      ADCC 230.00
1 30655 30631 "2 "      0      # line from      ADCC 230.00      (3) to BRKR      NEWARK E 230.00
2 30655 35310 "1 "      0      # TRAN from      ADCC 230.00      (3) to (1)      LFC FIN+ 9.11
0
#

```

APPENDIX B – CAISO CATEGORY B AUTOCON INPUT FILE

```

#
# (35) B2 LINE OUTAGE (BREAKER-TO-BREAKER)
#
1 30640 30703 "1 " 0 # line from TESLA C 230.00 BRKR to BRKR RAVENSWD 230.00
0
#
#
# (36) B1 GENERATOR OUTAGE
#
3 33813 0 "1" 0 # T334CT1 13.80 PGEN=49.98 QGEN=4.90
0
#
#
# (37) B1 GENERATOR OUTAGE
#
3 32179 0 "1" 0 # T222 0.69 PGEN=78.2 QGEN=0.00
0
#
#
# 2013 category b contingency list
# North Bay Division Zone 306
#
#
# (38) B2 LINE OUTAGE (BREAKER-TO-BREAKER)
#
1 30430 30445 "1 " 0 # line from FULTON 230.00 BRKR to BRKR IGNACIO 230.00
0
#
#
# (39) B2 LINE OUTAGE (BREAKER-TO-BREAKER)
#
1 30433 30445 "2 " 0 # line from T22_93B 230.00 (2) to BRKR IGNACIO 230.00
1 30433 30435 "2 " 0 # line from T22_93B 230.00 (2) to BRKR LAKEVILLE 230.00
0
#
#
# (40) B2 LINE OUTAGE (BREAKER-TO-BREAKER)
#
1 30435 30445 "1 " 0 # line from LAKEVILLE 230.00 BRKR to BRKR IGNACIO 230.00
0
#
#
# (41) B2 LINE OUTAGE (BREAKER-TO-BREAKER)
#
1 30437 30445 "1 " 0 # line from CROCKETT 230.00 (3) to BRKR IGNACIO 230.00
1 30437 30438 "1 " 0 # line from CROCKETT 230.00 (3) to (2) C&H 230.00
1 30437 30540 "1 " 0 # line from CROCKETT 230.00 (3) to BRKR SOBRANTE 230.00
2 30438 32900 "1 " 0 # TRAN from C&H 230.00 BRKR to (1) CRCKTCOG 18.00
4 30438 0 "1 " 0 # LOAD-DROP C&H 230.00 LOAD==3.32(0.76)
3 32900 0 "1 " 0 # GEN-DROP CRCKTCOG 18.00 GEN==240.00(40.82)
0
#
#
# (42) B2 LINE OUTAGE (BREAKER-TO-BREAKER)
#
1 30460 30465 "1 " 0 # line from VACA-DIX 230.00 BRKR to BRKR BAHIA 230.00
0
#
#
# (43) B2 LINE OUTAGE (BREAKER-TO-BREAKER)
#
1 30460 30467 "1 " 0 # line from VACA-DIX 230.00 BRKR to BRKR PARKWAY 230.00
0
#
#
# (44) B2 LINE OUTAGE (BREAKER-TO-BREAKER)
#
1 30465 30550 "1 " 0 # line from BAHIA 230.00 BRKR to BRKR MORAGA 230.00
0
#
#
# (45) B2 LINE OUTAGE (BREAKER-TO-BREAKER)
#
1 30467 30550 "1 " 0 # line from PARKWAY 230.00 BRKR to BRKR MORAGA 230.00
0
#
#
# (46) B2 LINE OUTAGE (BREAKER-TO-BREAKER)
#

```

APPENDIX B – CAISO CATEGORY B AUTOCON INPUT FILE

```

1 31258 32564 "1 " 0 # line from SONOMA 115.00 BRKR to BRKR PUEBLO 115.00
0
#
#
# (47) B2 LINE OUTAGE (BREAKER-TO-BREAKER)
#
1 31264 32553 "1 " 0 # line from STHELNJ2 115.00 (2) to (3) MNTCLOJ2 115.00
1 31264 32549 "1 " 0 # line from STHELNJ2 115.00 BRKR to BRKR SILVRDJ2 115.00
1 32553 32554 "1 " 0 # line from MNTCLOJ2 115.00 (3) to (1) MONTCLLO 115.00
1 32553 32559 "1 " 0 # line from MNTCLOJ2 115.00 (3) to (2) MTCLPHJ2 115.00
1 32559 32560 "1 " 0 # line from MTCLPHJ2 115.00 (2) to (2) MNTCLOPH 115.00
2 32560 32700 "1 " 0 # TRAN from MNTCLOPH 115.00 (2) to (1) MONTICLO 9.11
4 32554 0 "1 " 0 # LOAD-DROP MONTCLLO 115.00 LOAD==6.93(0.99)
3 32700 0 "1 " 0 # GEN-DROP MONTICLO 9.11 GEN==4.70(0.00)
3 32700 0 "2 " 0 # GEN-DROP MONTICLO 9.11 GEN==4.70(0.00)
0
#
#
# (48) B2 LINE OUTAGE (BREAKER-TO-BREAKER)
#
1 31265 32555 "1 " 0 # line from STHELNJ1 115.00 (3) to (2) MNTCLOJ1 115.00
1 31265 32562 "1 " 0 # line from STHELNJ1 115.00 (3) to (2) PUEBLOJT 115.00
1 31265 32551 "1 " 0 # line from STHELNJ1 115.00 (3) to (2) SILVRDJ1 115.00
1 32555 32561 "1 " 0 # line from MNTCLOJ1 115.00 (2) to (1) MTCLPHJ1 115.00
1 32562 32564 "1 " 0 # line from PUEBLOJT 115.00 (2) to BRKR PUEBLO 115.00
1 32551 31251 "1 " 0 # line from SILVRDJ1 115.00 (2) to (2) RINCONJ1 115.00
1 31251 31236 "1 " 0 # line from RINCONJ1 115.00 (2) to BRKR FULTON 115.00
0
#
#
# (49) B2 LINE OUTAGE (BREAKER-TO-BREAKER)
#
1 32549 32550 "1 " 0 # line from SILVRDJ2 115.00 (3) to (1) SILVERDO 115.00
1 32549 31218 "1 " 0 # line from SILVRDJ2 115.00 (3) to (3) ER_FTNJT 115.00
1 32549 31264 "1 " 0 # line from SILVRDJ2 115.00 BRKR to BRKR STHELNJ2 115.00
1 31218 31219 "1 " 0 # line from ER_FTNJT 115.00 (3) to (2) ERFT5_25 115.00
1 31218 31249 "1 " 0 # line from ER_FTNJT 115.00 (3) to (3) RINCONJ2 115.00
1 31219 31220 "1 " 0 # line from ERFT5_25 115.00 (2) to BRKR EGLE RCK 115.00
1 31249 31236 "1 " 0 # line from RINCONJ2 115.00 (3) to BRKR FULTON 115.00
1 31249 31250 "1 " 0 # line from RINCONJ2 115.00 (3) to (1) RINCON 115.00
4 32550 0 "1 " 0 # LOAD-DROP SILVERDO 115.00 LOAD==21.67(3.09)
4 32550 0 "2 " 0 # LOAD-DROP SILVERDO 115.00 LOAD==27.99(3.99)
4 31250 0 "1 " 0 # LOAD-DROP RINCON 115.00 LOAD==19.57(2.79)
4 31250 0 "2 " 0 # LOAD-DROP RINCON 115.00 LOAD==17.92(2.55)
1 31251 31250 "1 " 1 # close Line from RINCONJ1 115.00 to RINCON 115.00
4 31250 0 "3 " 1 # restore all loads to RINCON 115.00 (Eagle Rock-Fulton-Silverado 115 kV)
1 32551 32550 "1 " 1 # close Line from SILVRDJ1 115.00 to SILVERDO 115.00
4 32550 0 "3 " 1 # restore all loads to SILVERDO 115.00 (Eagle Rock-Fulton-Silverado 115 k
0
#
#
# (50) B2 LINE OUTAGE (BREAKER-TO-BREAKER)
#
1 32568 32569 "1 " 0 # line from IGNACIO 115.00 BRKR to (2) HMLT_WET 115.00
1 32569 32578 "1 " 0 # line from HMLT_WET 115.00 (2) to (2) SKGGS J2 115.00
1 32578 32586 "1 " 0 # line from SKGGS J2 115.00 (2) to (3) HGHWY J2 115.00
1 32586 31956 "1 " 0 # line from HGHWY J2 115.00 (3) to (2) CORDELLT 115.00
1 32586 32590 "1 " 0 # line from HGHWY J2 115.00 (3) to BRKR HIGHWAY 115.00
1 31956 32598 "1 " 0 # line from CORDELLT 115.00 (2) to (2) NTWR ALT 115.00
1 32598 32608 "1 " 0 # line from NTWR ALT 115.00 (2) to (2) CRQNZTP2 115.00
1 32608 32616 "1 " 0 # line from CRQNZTP2 115.00 (2) to (1) MEYERTP2 115.00
4 32569 0 "1 " 0 # LOAD-DROP HMLT_WET 115.00 LOAD==15.00(9.30)
4 32590 0 "1 " 0 # LOAD-DROP HIGHWAY 115.00 LOAD==20.67(2.94)
4 32590 0 "2 " 0 # LOAD-DROP HIGHWAY 115.00 LOAD==25.37(3.61)
1 32588 32590 "1 " 1 # LINE-TRANSFER HGHWY J2 115.00 to HGHWY J1 115.00
4 32590 0 "3 " 1 # RESTORE HIGHWAY load
0
#
#
# (51) B2 LINE OUTAGE (BREAKER-TO-BREAKER)
#
1 32568 32570 "3 " 0 # line from IGNACIO 115.00 BRKR to BRKR LS GLLNS 115.00
0
#
#
# (52) B2 LINE OUTAGE (BREAKER-TO-BREAKER)
#
1 32568 32574 "1 " 0 # line from IGNACIO 115.00 BRKR to BRKR SAN RAFL 115.00
0

```

APPENDIX B – CAISO CATEGORY B AUTOCON INPUT FILE

```

#
#
# (53) B2 LINE OUTAGE (BREAKER-TO-BREAKER)
#
1 32568 32576 "1 " 0 # line from IGNACIO 115.00 BRKR to (3) SKGGS J1 115.00
1 32576 32580 "1 " 0 # line from SKGGS J1 115.00 (3) to (1) SKAGGS 115.00
1 32576 32588 "1 " 0 # line from SKGGS J1 115.00 (3) to (2) HGHWY J1 115.00
1 32588 32593 "1 " 0 # line from HGHWY J1 115.00 (2) to (3) JCPMPJCT 115.00
1 32593 32595 "1 " 0 # line from JCPMPJCT 115.00 (3) to (1) JMScNPMP 115.00
1 32593 32604 "1 " 0 # line from JCPMPJCT 115.00 (3) to (2) MREIS JC 115.00
1 32604 32612 "1 " 0 # line from MREIS JC 115.00 (2) to (3) CRQNZTP1 115.00
1 32612 32610 "1 " 0 # line from CRQNZTP1 115.00 (3) to BRKR MRE IS-Q 115.00
1 32612 32614 "1 " 0 # line from CRQNZTP1 115.00 (3) to (3) MEYERTP1 115.00
1 32614 32600 "1 " 0 # line from MEYERTP1 115.00 (3) to BRKR MEYERS 115.00
1 32614 32606 "1 " 0 # line from MEYERTP1 115.00 (3) to BRKR CARQUINZ 115.00
4 32610 0 "1 " 0 # LOAD-DROP MRE IS-Q 115.00 LOAD==4.25(0.86)
4 32600 0 "1 " 0 # LOAD-DROP MEYERS 115.00 LOAD==0.24(0.05)
4 32606 0 "1 " 0 # LOAD-DROP CARQUINZ 115.00 LOAD==13.23(1.89)
4 32606 0 "2 " 0 # LOAD-DROP CARQUINZ 115.00 LOAD==11.26(1.60)
1 32616 32606 "1 " 1 # LINE-TRANSFER MEYERTP1 115.00 to MEYERTP2 115.00
4 32606 0 "***" 1 # RESTORE CARQUINEZ load
0
#
#
# (54) B2 LINE OUTAGE (BREAKER-TO-BREAKER)
#
1 32570 32574 "3 " 0 # line from LS GLLNS 115.00 BRKR to BRKR SAN RAFL 115.00
0
#
#
# (55) B2 LINE OUTAGE (BREAKER-TO-BREAKER)
#
1 32602 32620 "1 " 0 # line from NRTH TWR 115.00 BRKR to (2) NTWRJCT2 115.00
1 32620 32778 "1 " 0 # line from NTWRJCT2 115.00 (2) to (3) MRTNZJCT 115.00
1 32778 32754 "1 " 0 # line from MRTNZJCT 115.00 (3) to BRKR OLEUM 115.00
1 32778 32756 "1 " 0 # line from MRTNZJCT 115.00 (3) to BRKR CHRISTIE 115.00
4 32602 0 "1 " 0 # LOAD-DROP NRTH TWR 115.00 LOAD==14.43(2.06)
4 32602 0 "2 " 0 # LOAD-DROP NRTH TWR 115.00 LOAD==9.58(1.37)
4 32602 0 "3 " 0 # LOAD-DROP NRTH TWR 115.00 LOAD==6.08(0.87)
4 32602 0 "4 " 0 # LOAD-DROP NRTH TWR 115.00 LOAD==2.85(0.41)
1 32602 32618 "1 " 1 # LINE-TRANSFER NTWRJCT2 115.00 to NTWRJCT1 115.00
4 32602 0 "***" 1 # RESTORE NORTH TOWER load
0
#
#
# (56) B2 LINE OUTAGE (BREAKER-TO-BREAKER)
#
1 32618 32020 "1 " 0 # line from NTWRJCT1 115.00 (1) to (3) JMSN JCT 115.00
1 32020 31996 "1 " 0 # line from JMSN JCT 115.00 (3) to (3) HALE J1 115.00
1 32020 32010 "1 " 0 # line from JMSN JCT 115.00 (3) to BRKR JAMESON 115.00
1 31996 31995 "1 " 0 # line from HALE J1 115.00 (3) to (2) HALE 115.00
1 31996 32006 "1 " 0 # line from HALE J1 115.00 (3) to (3) VCVLLE1J 115.00
1 31995 32013 "1 " 0 # line from HALE 115.00 (2) to (1) HALE2 115.00
1 32006 31998 "1 " 0 # line from VCVLLE1J 115.00 (3) to BRKR VACA-DIX 115.00
1 32006 32000 "1 " 0 # line from VCVLLE1J 115.00 (3) to BRKR VACAVLL1 115.00
4 32010 0 "1 " 0 # LOAD-DROP JAMESON 115.00 LOAD==35.07(1.57)
4 31995 0 "1 " 0 # LOAD-DROP HALE 115.00 LOAD==2.36(1.40)
4 32000 0 "1 " 0 # LOAD-DROP VACAVLL1 115.00 LOAD==27.49(1.23)
1 32002 32000 "1" 1 #Line transfer VACAVLL1 115kV TO VACAVLL2 115kV
4 32000 0 "***" 1 #Restore VACAVLL1 load
1 32012 32013 "1" 1 #Transfer load to HALE alternate
4 31995 0 "***" 1 #Restore load at HALE
1 32010 32009 "1 " 1 # LINE-TRANSFER JMSN JCT 115.00 to JAMESN-A 115.00
4 32010 0 "***" 1 # RESTORE JAMESON load
0
#
#
# (57) B2 LINE OUTAGE (BREAKER-TO-BREAKER)
#
1 32650 32652 "1 " 0 # line from ST.HELNA 60.00 (2) to BRKR CALISTGA 60.00
1 32650 31378 "1 " 0 # line from ST.HELNA 60.00 (2) to BRKR FULTON 60.00
4 32652 0 "1 " 0 # LOAD-DROP CALISTGA 60.00 LOAD==18.46(2.63)
0
#
#
# (58) B2 LINE OUTAGE (BREAKER-TO-BREAKER)
#
1 32654 32655 "1 " 0 # line from TULUCAY 60.00 BRKR to (2) TULCAY1 60.00
1 32655 32662 "1 " 0 # line from TULCAY1 60.00 (2) to (4) TULCY JT 60.00

```

APPENDIX B – CAISO CATEGORY B AUTOCON INPUT FILE

```

1 32662 32077 "1 " 0 # line from TULCY JT 60.00 (4) to (1) CORD PMP 60.00
1 32662 32656 "1 " 0 # line from TULCY JT 60.00 (4) to BRKR NAPA 60.00
1 32662 32093 "1 " 0 # line from TULCY JT 60.00 (4) to (3) CRD-JCT 60.00
1 32093 32091 "1 " 0 # line from CRD-JCT 60.00 (3) to (1) CRD_INTR 60.00
1 32093 32074 "1 " 0 # line from CRD-JCT 60.00 (3) to (1) CORDELIA 60.00
4 32077 0 "1 " 0 # LOAD-DROP CORD PMP 60.00 LOAD==4.74(1.56)
4 32091 0 "1 " 0 # LOAD-DROP CRD_INTR 60.00 LOAD==2.80(0.90)
4 32074 0 "4 " 0 # LOAD-DROP CORDELIA 60.00 LOAD==11.94(0.53)
1 32662 32656 "1 " 1 # close Line from TULCY JT 60.00 to NAPA 60.00
1 32662 32077 "1 " 1 # close Line from TULCY JT 60.00 to CORD PMP 60.00
1 32077 32074 "1 " 1 # close Line from CORD PMP 60.00 to CORDELIA 60.00
4 32077 0 "***" 1 # restore all loads to CORD PMP 60.00
4 32074 0 "***" 1 # restore all loads to CORDELIA 60.00 (Tulucay - Napa #1 60 kV)
0
#
#
# (59) B2 LINE OUTAGE (BREAKER-TO-BREAKER)
#
1 32654 32660 "1 " 0 # line from TULUCAY 60.00 BRKR to (3) BSLT TAP 60.00
1 32660 32656 "1 " 0 # line from BSLT TAP 60.00 (3) to BRKR NAPA 60.00
1 32660 32658 "1 " 0 # line from BSLT TAP 60.00 (3) to (1) BASALT 60.00
4 32658 0 "1 " 0 # LOAD-DROP BASALT 60.00 LOAD==3.68(0.53)
4 32658 0 "2 " 0 # LOAD-DROP BASALT 60.00 LOAD==20.76(2.96)
1 32655 32658 "1 " 1 # close Line from TULUCAY 60.00 to BASALT 60.00
4 32658 0 "***" 1 # restore all loads to BASALT 60.00 (Tulucay - Napa #2 60 kV)
0
#
#
# (60) B2 LINE OUTAGE (BREAKER-TO-BREAKER)
#
1 32664 32667 "1 " 0 # line from IGNACO A 60.00 BRKR to (3) IG JCT 60.00
1 32667 32678 "1 " 0 # line from IG JCT 60.00 (3) to (2) SAN RFLJ 60.00
1 32667 32668 "1 " 0 # line from IG JCT 60.00 (3) to BRKR NOVATO 60.00
1 32678 32680 "1 " 0 # line from SAN RFLJ 60.00 (2) to BRKR GREENBRE 60.00
0
#
#
# (61) B2 LINE OUTAGE (BREAKER-TO-BREAKER)
#
1 32664 32676 "1 " 0 # line from IGNACO A 60.00 BRKR to (2) HMLTN FD 60.00
1 32676 32686 "1 " 0 # line from HMLTN FD 60.00 (2) to (2) ALTOJT2 60.00
1 32686 32682 "1 " 0 # line from ALTOJT2 60.00 (2) to BRKR ALTO 60.00
1 32676 32677 "1 " 1 # LINE-TRANSFER HMLTN FD 60.00 to HMLTNBFD 60.00
4 32676 0 "***" 1 # RESTORE HMLTN FD load
0
#
#
# (62) B2 LINE OUTAGE (BREAKER-TO-BREAKER)
#
1 32664 32677 "1 " 0 # line from IGNACO A 60.00 BRKR to (2) HMLTNBFD 60.00
1 32677 32684 "1 " 0 # line from HMLTNBFD 60.00 (2) to (3) ALTOJT1 60.00
1 32684 32682 "1 " 0 # line from ALTOJT1 60.00 (3) to BRKR ALTO 60.00
1 32684 32688 "1 " 0 # line from ALTOJT1 60.00 (3) to BRKR SAUSALTO 60.00
4 32688 0 "2 " 0 # LOAD-DROP SAUSALTO 60.00 LOAD==10.92(1.56)
1 32688 32686 "1 " 1 # LINE-TRANSFER SAUSALTO 60.00 to ALTOJT2 60.00
4 32688 0 "***" 1 # RESTORE SAUSALTO load
0
#
#
# (63) B2 LINE OUTAGE (BREAKER-TO-BREAKER)
#
1 32666 32669 "1 " 0 # line from IGNACO B 60.00 BRKR to (3) STAF_JCT 60.00
1 32669 32673 "1 " 0 # line from STAF_JCT 60.00 (3) to (3) TOCA_JCT 60.00
1 32669 32670 "1 " 0 # line from STAF_JCT 60.00 (3) to BRKR STAFFORD 60.00
1 32673 32672 "1 " 0 # line from TOCA_JCT 60.00 (3) to BRKR OLEMA 60.00
1 32673 32675 "1 " 0 # line from TOCA_JCT 60.00 (3) to (1) TOCALOMA 60.00
4 32670 0 "1 " 0 # LOAD-DROP STAFFORD 60.00 LOAD==10.16(1.45)
4 32670 0 "2 " 0 # LOAD-DROP STAFFORD 60.00 LOAD==10.61(1.51)
1 32670 32665 "1 " 1 # LINE-TRANSFER STAF_JCT 60.00 to NVTO JCT 60.00
4 32670 0 "***" 1 # RESTORE STAFFORD load
0
#
#
# (64) B2 LINE OUTAGE (BREAKER-TO-BREAKER)
#
1 32666 32674 "1 " 0 # line from IGNACO B 60.00 BRKR to (2) WOODACRE 60.00
1 32674 32671 "1 " 0 # line from WOODACRE 60.00 (2) to BRKR BOLINAS 60.00
4 32674 0 "1 " 0 # LOAD-DROP WOODACRE 60.00 LOAD==7.94(1.13)
0

```

APPENDIX B – CAISO CATEGORY B AUTOCON INPUT FILE

```

#
#
# (65) B2 LINE OUTAGE (BREAKER-TO-BREAKER)
#
1 32672 32671 "1 " 0 # line from OLEMA 60.00 BRKR to BRKR BOLINAS 60.00
0
#
#
# (66) B2 LINE OUTAGE (BREAKER-TO-BREAKER)
#
1 32680 32682 "1 " 0 # line from GREENBRE 60.00 BRKR to BRKR ALTO 60.00
0
#
#
# (67) B3 TRANSFORMER OUTAGE (BREAKER-TO-BREAKER)
#
2 30464 30465 "1 " 0 # TRAN from EXXON_BH 12.47 (3) to BRKR BAHIA 230.00
2 30464 30465 "2 " 0 # TRAN from EXXON_BH 12.47 (3) to BRKR BAHIA 230.00
2 30464 30465 "3 " 0 # TRAN from EXXON_BH 12.47 (3) to BRKR BAHIA 230.00
4 30464 0 "SG" 0 # LOAD-DROP EXXON_BH 12.47 LOAD==47.30(30.55)
3 30464 0 "1 " 0 # GEN-DROP EXXON_BH 12.47 GEN==52.00(19.25)
0
#
#
# (68) B3 TRANSFORMER OUTAGE (BREAKER-TO-BREAKER)
#
2 32568 30445 "4 " 0 # TRAN from IGNACIO 115.00 BRKR to BRKR IGNACIO 230.00
0
#
#
# (69) B3 TRANSFORMER OUTAGE (BREAKER-TO-BREAKER)
#
2 32568 30445 "6 " 0 # TRAN from IGNACIO 115.00 BRKR to BRKR IGNACIO 230.00
0
#
#
# (70) B3 TRANSFORMER OUTAGE (BREAKER-TO-BREAKER)
#
2 32654 30440 "1 " 0 # TRAN from TULUCAY 60.00 BRKR to BRKR TULUCAY 230.00
0
#
#
# (71) B3 TRANSFORMER OUTAGE (BREAKER-TO-BREAKER)
#
2 32654 30440 "3 " 0 # TRAN from TULUCAY 60.00 BRKR to BRKR TULUCAY 230.00
0
#
#
# (72) B3 TRANSFORMER OUTAGE (BREAKER-TO-BREAKER)
#
2 32666 32568 "1 " 0 # TRAN from IGNACO B 60.00 BRKR to BRKR IGNACIO 115.00
0
#
#
# (73) B3 TRANSFORMER OUTAGE (BREAKER-TO-BREAKER)
#
2 32666 32568 "3 " 0 # TRAN from IGNACO B 60.00 BRKR to BRKR IGNACIO 115.00
0
#
#
# (74) B1 GENERATOR OUTAGE
#
3 30464 0 "1 " 0 # EXXON_BH 12.47 PGEN=52.00 QGEN=19.25
0
#
#
# (75) B1 GENERATOR OUTAGE
#
3 32900 0 "1 " 0 # CRCKTCOG 18.00 PGEN=240.00 QGEN=40.82
0
#
#
# (76) L-1/G-1 OVERLAPPING OUTAGE
# Fulton - Ignacio 230 kV Line and Crockett Cogen
1 30430 30445 "1 " 0 # line from FULTON 230.00 BRKR to BRKR IGNACIO 230.00
#
3 32900 0 "1 " 0 # CRCKTCOG 18.00 PGEN=240.00 QGEN=40.82
0
#

```

APPENDIX B – CAISO CATEGORY B AUTOCON INPUT FILE

```

#
# (77) L-1/G-1 OVERLAPPING OUTAGE
# Lakeville - Ignacio #2 230 kV Line and Crockett Cogen
1 30433 30445 "2 " 0 # line from T22_93B 230.00 (2) to BRKR IGNACIO 230.00
1 30433 30435 "2 " 0 # line from T22_93B 230.00 (2) to BRKR LAKEVILLE 230.00
#
3 32900 0 "1 " 0 # CRCKTCOG 18.00 PGEN=240.00 QGEN=40.82
0
#
#
# (78) L-1/G-1 OVERLAPPING OUTAGE
# Lakeville - Ignacio #1 230 kV Line and Crockett Cogen
1 30435 30445 "1 " 0 # line from LAKEVILLE 230.00 BRKR to BRKR IGNACIO 230.00
#
3 32900 0 "1 " 0 # CRCKTCOG 18.00 PGEN=240.00 QGEN=40.82
0
#
#
# (79) L-1/G-1 OVERLAPPING OUTAGE
# Vaca-Dixon - Bahia 230 kV Line and Crockett Cogen
1 30460 30465 "1 " 0 # line from VACA-DIX 230.00 BRKR to BRKR BAHIA 230.00
#
3 32900 0 "1 " 0 # CRCKTCOG 18.00 PGEN=240.00 QGEN=40.82
0
#
#
# (80) L-1/G-1 OVERLAPPING OUTAGE
# Vaca-Dixon - Parkway 230 kV Line and Crockett Cogen
1 30460 30467 "1 " 0 # line from VACA-DIX 230.00 BRKR to BRKR PARKWAY 230.00
#
3 32900 0 "1 " 0 # CRCKTCOG 18.00 PGEN=240.00 QGEN=40.82
0
#
#
# (81) L-1/G-1 OVERLAPPING OUTAGE
# Bahia - Moraga 230 kV Line and Crockett Cogen
1 30465 30550 "1 " 0 # line from BAHIA 230.00 BRKR to BRKR MORAGA 230.00
#
3 32900 0 "1 " 0 # CRCKTCOG 18.00 PGEN=240.00 QGEN=40.82
0
#
#
# (82) L-1/G-1 OVERLAPPING OUTAGE
# Parkway - Moraga 230 kV Line and Crockett Cogen
1 30467 30550 "1 " 0 # line from PARKWAY 230.00 BRKR to BRKR MORAGA 230.00
#
3 32900 0 "1 " 0 # CRCKTCOG 18.00 PGEN=240.00 QGEN=40.82
0
#
#
# 2013 category b contingency list
# East Bay Division Zone 307
#
#
# (83) B2 LINE OUTAGE (BREAKER-TO-BREAKER)
#
1 32740 33006 "1 " 0 # line from HILLSIDE 115.00 BRKR to (3) GRIZLYJ1 115.00
1 33006 33010 "1 " 0 # line from GRIZLYJ1 115.00 (3) to BRKR SOBRANTE 115.00
1 33006 33012 "1 " 0 # line from GRIZLYJ1 115.00 (3) to BRKR EST PRTL 115.00
1 32770 32740 "1 " 0 # include GRIZZLY2 115.00 BRKR to HILLSIDE 115.00 ckt 1
0
#
#
# (84) B2 LINE OUTAGE (BREAKER-TO-BREAKER)
#
1 32740 33008 "2 " 0 # line from HILLSIDE 115.00 BRKR to (3) GRIZLYJ2 115.00
1 33008 32780 "2 " 0 # line from GRIZLYJ2 115.00 (3) to BRKR CLARMNT 115.00
1 33008 33010 "2 " 0 # line from GRIZLYJ2 115.00 (3) to BRKR SOBRANTE 115.00
1 32770 32740 "2 " 0 # include GRIZZLY2 115.00 BRKR to HILLSIDE 115.00 ckt 2
0
#
#
# (85) B2 LINE OUTAGE (BREAKER-TO-BREAKER)
#
1 32748 32750 "1 " 0 # line from PP STEEL 115.00 BRKR to (3) PPSTLTAP 115.00
1 32750 32774 "1 " 0 # line from PPSTLTAP 115.00 (3) to (3) PTPNLTAP 115.00
1 32750 32760 "1 " 0 # line from PPSTLTAP 115.00 (3) to (1) PT PINLE 115.00
1 32774 32762 "1 " 0 # line from PTPNLTAP 115.00 (3) to BRKR STD. OIL 115.00
1 32774 32808 "1 " 0 # line from PTPNLTAP 115.00 (3) to (2) SNPBLTP2 115.00

```

APPENDIX B – CAISO CATEGORY B AUTOCON INPUT FILE

```

1 32808 33010 "1 " 0 # line from SNPBLTP2 115.00 (2) to BRKR SOBRANTE 115.00
4 32748 0 "1 " 0 # LOAD-DROP PP STEEL 115.00 LOAD==0.19(0.25)
4 32760 0 "1 " 0 # LOAD-DROP PT PINLE 115.00 LOAD==14.78(3.36)
0
#
#
# (86) B2 LINE OUTAGE (BREAKER-TO-BREAKER)
#
1 32754 32802 "1 " 0 # line from OLEUM 115.00 BRKR to (3) VLYVWTP1 115.00
1 32802 32764 "1 " 0 # line from VLYVWTP1 115.00 (3) to BRKR VALLY VW 115.00
1 32802 32766 "1 " 0 # line from VLYVWTP1 115.00 (3) to BRKR EL CRRTO 115.00
4 32764 0 "1 " 0 # LOAD-DROP VALLY VW 115.00 LOAD==7.65(1.74)
4 32764 0 "2 " 0 # LOAD-DROP VALLY VW 115.00 LOAD==15.69(3.58)
1 32764 32804 "2 " 1 # LINE-TRANSFER VLYVWTP1 to VLYVWTP2
4 32764 0 "***" 1 # RESTORE VALLEY VIEW load
0
#
#
# (87) B2 LINE OUTAGE (BREAKER-TO-BREAKER)
#
1 32754 32804 "2 " 0 # line from OLEUM 115.00 BRKR to (2) VLYVWTP2 115.00
1 32804 32766 "2 " 0 # line from VLYVWTP2 115.00 (2) to BRKR EL CRRTO 115.00
0
#
#
# (88) B2 LINE OUTAGE (BREAKER-TO-BREAKER)
#
1 32754 32849 "1 " 0 # line from OLEUM 115.00 BRKR to (2) CON25 115.00
1 32849 32754 "2 " 0 # line from CON25 115.00 (2) to BRKR OLEUM 115.00
4 32849 0 "1 " 0 # LOAD-DROP CON25 115.00 LOAD==25.00(15.56)
0
#
#
# (89) B2 LINE OUTAGE (BREAKER-TO-BREAKER)
#
1 32756 33010 "1 " 0 # line from CHRISTIE 115.00 BRKR to BRKR SOBRANTE 115.00
0
#
#
# (90) B2 LINE OUTAGE (BREAKER-TO-BREAKER)
#
1 32765 33010 "1 " 0 # line from ELCRTJ1 115.00 (2) to BRKR SOBRANTE 115.00
1 32765 32766 "1 " 0 # line from ELCRTJ1 115.00 (2) to BRKR EL CRRTO 115.00
0
#
#
# (91) B2 LINE OUTAGE (BREAKER-TO-BREAKER)
#
1 32766 33010 "2 " 0 # line from EL CRRTO 115.00 BRKR to BRKR SOBRANTE 115.00
0
#
#
# (92) B2 LINE OUTAGE (BREAKER-TO-BREAKER)
#
1 32767 33010 "1 " 0 # line from ELCRTJ2 115.00 (2) to BRKR SOBRANTE 115.00
1 32767 32768 "1 " 0 # line from ELCRTJ2 115.00 (2) to BRKR RICHMOND 115.00
0
#
#
# (93) B2 LINE OUTAGE (BREAKER-TO-BREAKER)
#
1 32768 33010 "2 " 0 # line from RICHMOND 115.00 BRKR to BRKR SOBRANTE 115.00
0
#
#
# (94) B2 LINE OUTAGE (BREAKER-TO-BREAKER)
#
1 32770 32740 "1 " 0 # line from GRIZZLY2 115.00 BRKR to BRKR HILLSIDE 115.00
0
#
#
# (95) B2 LINE OUTAGE (BREAKER-TO-BREAKER)
#
1 32770 32740 "2 " 0 # line from GRIZZLY2 115.00 BRKR to BRKR HILLSIDE 115.00
0
#
#
# (96) B2 LINE OUTAGE (BREAKER-TO-BREAKER)
#

```

APPENDIX B – CAISO CATEGORY B AUTOCON INPUT FILE

```

1 32780 32782 "1 " 0 # line from CLARMNT 115.00 BRKR to BRKR STATIN D 115.00
0
#
#
# (97) B2 LINE OUTAGE (BREAKER-TO-BREAKER)
#
1 32780 32782 "2 " 0 # line from CLARMNT 115.00 BRKR to BRKR STATIN D 115.00
0
#
#
# (98) B2 LINE OUTAGE (BREAKER-TO-BREAKER)
#
1 32782 32788 "1 " 0 # line from STATIN D 115.00 BRKR to BRKR STATIN L 115.00
0
#
#
# (99) B2 LINE OUTAGE (BREAKER-TO-BREAKER)
#
1 32786 32788 "1 " 0 # line from OAK C115 115.00 BRKR to BRKR STATIN L 115.00
0
#
#
# (100) B2 LINE OUTAGE (BREAKER-TO-BREAKER)
#
1 32786 32790 "2 " 0 # line from OAK C115 115.00 BRKR to BRKR STATIN X 115.00
0
#
#
# (101) B2 LINE OUTAGE (BREAKER-TO-BREAKER)
#
1 32786 32790 "3 " 0 # line from OAK C115 115.00 BRKR to BRKR STATIN X 115.00
0
#
#
# (102) B2 LINE OUTAGE (BREAKER-TO-BREAKER)
#
1 32786 32793 "1 " 0 # line from OAK C115 115.00 BRKR to (2) SCHNITZ 115.00
1 32793 32794 "1 " 0 # line from SCHNITZ 115.00 (2) to BRKR MARITIME 115.00
4 32793 0 "1 " 0 # LOAD-DROP SCHNITZ 115.00 LOAD==9.29(4.50)
4 32794 0 "1 " 0 # LOAD-DROP MARITIME 115.00 LOAD==0.95(1.11)
0
#
#
# (103) B2 LINE OUTAGE (BREAKER-TO-BREAKER)
#
1 32786 32904 "1 " 0 # line from OAK C115 115.00 BRKR to (3) OAKLND23 115.00
2 32904 32902 "8 " 0 # TRAN from OAKLND23 115.00 (3) to (1) OAKLND 2 13.80
2 32904 32903 "9 " 0 # TRAN from OAKLND23 115.00 (3) to (1) OAKLND 3 13.80
3 32902 0 "1 " 0 # GEN-DROP OAKLND 2 13.80 GEN==50.00(0.70)
3 32903 0 "1 " 0 # GEN-DROP OAKLND 3 13.80 GEN==50.00(-0.08)
0
#
#
# (104) B2 LINE OUTAGE (BREAKER-TO-BREAKER)
#
1 32786 38026 "1 " 0 # line from OAK C115 115.00 BRKR to (4) ALAMEDCT 115.00
1 38026 38022 "1 " 0 # line from ALAMEDCT 115.00 (4) to BRKR CARTWRT 115.00
2 38026 38118 "1 " 0 # TRAN from ALAMEDCT 115.00 (4) to (1) ALMDACT1 13.80
2 38026 38119 "1 " 0 # TRAN from ALAMEDCT 115.00 (4) to (1) ALMDACT2 13.80
4 38022 0 "1 " 0 # LOAD-DROP CARTWRT 115.00 LOAD==23.04(4.31)
4 38022 0 "2 " 0 # LOAD-DROP CARTWRT 115.00 LOAD==23.04(4.31)
3 38118 0 "1 " 0 # GEN-DROP ALMDACT1 13.80 GEN==22.60(12.40)
3 38119 0 "1 " 0 # GEN-DROP ALMDACT2 13.80 GEN==22.60(12.40)
0
#
#
# (105) B2 LINE OUTAGE (BREAKER-TO-BREAKER)
#
1 32792 32798 "1 " 0 # line from STATIN J 115.00 BRKR to (2) OWENSTAP 115.00
1 32798 32800 "1 " 0 # line from OWENSTAP 115.00 (2) to BRKR OWNBKRWY 115.00
4 32800 0 "1 " 0 # LOAD-DROP OWNBKRWY 115.00 LOAD==9.29(5.51)
0
#
#
# (106) B2 LINE OUTAGE (BREAKER-TO-BREAKER)
#
1 32792 32814 "1 " 0 # line from STATIN J 115.00 BRKR to (3) EDESTAP1 115.00
1 32814 32810 "1 " 0 # line from EDESTAP1 115.00 (3) to BRKR EDES 115.00
1 32814 35113 "1 " 0 # line from EDESTAP1 115.00 (3) to (2) DMTAR_SL 115.00

```

APPENDIX B – CAISO CATEGORY B AUTOCON INPUT FILE

```

1 35113 35101 "1 " 0 # line from DMTAR_SL 115.00 (2) to BRKR SN LNDRO 115.00
4 32810 0 "2 " 0 # LOAD-DROP EDES 115.00 LOAD==18.85(4.29)
4 32810 0 "3 " 0 # LOAD-DROP EDES 115.00 LOAD==29.45(6.71)
4 35113 0 "1 " 0 # LOAD-DROP DMTAR_SL 115.00 LOAD==3.61(2.24)
1 32810 32812 "1 " 1 # LINE-TRANSFER EDESTAP1 to EDS GRNT
4 32810 0 "***" 1 # RESTORE EDES load
0
#
#
# (107) B2 LINE OUTAGE (BREAKER-TO-BREAKER)
#
1 32792 38024 "1 " 0 # line from STATIN J 115.00 BRKR to BRKR JENNY 115.00
4 38024 0 "1 " 0 # LOAD-DROP JENNY 115.00 LOAD==33.37(6.27)
1 38024 38022 "1 " 1 # LINE-TRANSFER ALAMDA J to ALAMDA C
4 38024 0 "***" 1 # RESTORE ALAMDA J load
0
#
#
# (108) B2 LINE OUTAGE (BREAKER-TO-BREAKER)
#
1 32806 32758 "1 " 0 # line from SNPBLTP1 115.00 (3) to BRKR SAN PBLO 115.00
1 32806 32762 "2 " 0 # line from SNPBLTP1 115.00 (3) to BRKR STD. OIL 115.00
1 32806 33010 "2 " 0 # line from SNPBLTP1 115.00 (3) to BRKR SOBRANTE 115.00
4 32758 0 "1 " 0 # LOAD-DROP SAN PBLO 115.00 LOAD==19.98(4.55)
1 32758 32808 "2 " 1 # LINE-TRANSFER SNPBLTP1 to SNPBLTP2
4 32758 0 "***" 1 # RESTORE SAN PABLO load
0
#
#
# (109) B2 LINE OUTAGE (BREAKER-TO-BREAKER)
#
1 32812 35104 "1 " 0 # line from EDS GRNT 115.00 (1) to BRKR GRANT 115.00
0
#
#
# (110) B2 LINE OUTAGE (BREAKER-TO-BREAKER)
#
1 32850 32852 "1 " 0 # line from UNIN CHM 60.00 (3) to BRKR CHRISTIE 60.00
1 32850 32860 "1 " 0 # line from UNIN CHM 60.00 (3) to BRKR FRKLNALT 60.00
2 32850 32920 "1 " 0 # TRAN from UNIN CHM 60.00 (3) to (1) UNION CH 9.11
4 32920 0 "SG" 0 # LOAD-DROP UNION CH 9.11 LOAD==2.35(0.54)
3 32920 0 "1 " 0 # GEN-DROP UNION CH 9.11 GEN==20.40(-9.00)
0
#
#
# (111) B2 LINE OUTAGE (BREAKER-TO-BREAKER)
#
1 32852 32856 "2 " 0 # line from CHRISTIE 60.00 BRKR to (2) FRANKLIN 60.00
1 32856 32858 "1 " 0 # line from FRANKLIN 60.00 (2) to (1) SEQUOIA 60.00
4 32856 0 "1 " 0 # LOAD-DROP FRANKLIN 60.00 LOAD==16.51(3.76)
4 32856 0 "2 " 0 # LOAD-DROP FRANKLIN 60.00 LOAD==16.30(3.72)
1 32856 32860 "1 " 1 # LINE-TRANSFER FRANKLIN to FRKLNALT
4 32856 0 "***" 1 # RESTORE FRANKLIN load
0
#
#
# (112) B2 LINE OUTAGE (BREAKER-TO-BREAKER)
#
1 32852 33067 "1 " 0 # line from CHRISTIE 60.00 BRKR to (3) PCBRICK 60.00
1 33067 32854 "1 " 0 # line from PCBRICK 60.00 (3) to (1) PRT CSTA 60.00
1 33067 33066 "1 " 0 # line from PCBRICK 60.00 (3) to (3) STAUFFER 60.00
1 33066 33065 "1 " 0 # line from STAUFFER 60.00 (3) to (2) URICH 60.00
2 33066 33139 "1 " 0 # TRAN from STAUFFER 60.00 (3) to (1) STAUFER 9.11
1 33065 33064 "1 " 0 # line from URICH 60.00 (2) to (2) SFPP CNC 60.00
1 33064 33091 "1 " 0 # line from SFPP CNC 60.00 (2) to (2) TAP GWF5 60.00
2 33091 33135 "1 " 0 # TRAN from TAP GWF5 60.00 (2) to (1) GWF #5 13.80
4 32854 0 "1 " 0 # LOAD-DROP PRT CSTA 60.00 LOAD==0.28(0.25)
4 33065 0 "1 " 0 # LOAD-DROP URICH 60.00 LOAD==1.99(1.23)
4 33139 0 "SG" 0 # LOAD-DROP STAUFER 9.11 LOAD==2.23(0.32)
4 33064 0 "1 " 0 # LOAD-DROP SFPP CNC 60.00 LOAD==8.05(4.78)
4 33135 0 "SG" 0 # LOAD-DROP GWF #5 13.80 LOAD==2.77(0.63)
3 33139 0 "1 " 0 # GEN-DROP STAUFER 9.11 GEN==2.00(-1.00)
3 33135 0 "1 " 0 # GEN-DROP GWF #5 13.80 GEN==18.90(3.52)
0
#
#
# (113) B2 LINE OUTAGE (BREAKER-TO-BREAKER)
#
1 32911 32754 "1 " 0 # line from UNOCAL2 115.00 (3) to BRKR OLEUM 115.00

```

APPENDIX B – CAISO CATEGORY B AUTOCON INPUT FILE

```

1 32911 32754 "2 " 0 # line from UNOCAL2 115.00 (3) to BRKR OLEUM 115.00
2 32911 32910 "1 " 0 # TRAN from UNOCAL2 115.00 (3) to BRKR UNOCAL 12.00
4 32910 0 "SG" 0 # LOAD-DROP UNOCAL 12.00 LOAD==20.81(12.90)
3 32910 0 "1 " 0 # GEN-DROP UNOCAL 12.00 GEN==15.70(6.59)
3 32910 0 "2 " 0 # GEN-DROP UNOCAL 12.00 GEN==15.70(6.59)
3 32910 0 "3 " 0 # GEN-DROP UNOCAL 12.00 GEN==15.70(6.59)
0
#
#
# (114) B2 LINE OUTAGE (BREAKER-TO-BREAKER)
#
1 33012 32780 "1 " 0 # line from EST PRTL 115.00 BRKR to BRKR CLARMNT 115.00
0
#
#
# (115) B2 LINE OUTAGE (BREAKER-TO-BREAKER)
#
1 33016 32754 "1 " 0 # line from ALHAMTP2 115.00 (2) to BRKR OLEUM 115.00
1 33016 32990 "1 " 0 # line from ALHAMTP2 115.00 (2) to BRKR MARTNZ D 115.00
0
#
#
# (116) B2 LINE OUTAGE (BREAKER-TO-BREAKER)
#
1 33020 32780 "1 " 0 # line from MORAGA 115.00 BRKR to BRKR CLARMNT 115.00
0
#
#
# (117) B2 LINE OUTAGE (BREAKER-TO-BREAKER)
#
1 33020 32780 "2 " 0 # line from MORAGA 115.00 BRKR to BRKR CLARMNT 115.00
0
#
#
# (118) B2 LINE OUTAGE (BREAKER-TO-BREAKER)
#
1 33020 32790 "1 " 0 # line from MORAGA 115.00 BRKR to BRKR STATIN X 115.00
0
#
#
# (119) B2 LINE OUTAGE (BREAKER-TO-BREAKER)
#
1 33020 32790 "2 " 0 # line from MORAGA 115.00 BRKR to BRKR STATIN X 115.00
0
#
#
# (120) B2 LINE OUTAGE (BREAKER-TO-BREAKER)
#
1 33020 32790 "3 " 0 # line from MORAGA 115.00 BRKR to BRKR STATIN X 115.00
0
#
#
# (121) B2 LINE OUTAGE (BREAKER-TO-BREAKER)
#
1 33020 32790 "4 " 0 # line from MORAGA 115.00 BRKR to BRKR STATIN X 115.00
0
#
#
# (122) B2 LINE OUTAGE (BREAKER-TO-BREAKER)
#
1 33020 32792 "1 " 0 # line from MORAGA 115.00 BRKR to BRKR STATIN J 115.00
0
#
#
# (123) B3 TRANSFORMER OUTAGE (BREAKER-TO-BREAKER)
#
2 32786 32908 "1 " 0 # TRAN from OAK C115 115.00 BRKR to BRKR OAK C12 12.00
0
#
#
# (124) B3 TRANSFORMER OUTAGE (BREAKER-TO-BREAKER)
#
2 32786 32908 "2 " 0 # TRAN from OAK C115 115.00 BRKR to BRKR OAK C12 12.00
0
#
#
# (125) B3 TRANSFORMER OUTAGE (BREAKER-TO-BREAKER)
#
2 32786 32908 "3 " 0 # TRAN from OAK C115 115.00 BRKR to BRKR OAK C12 12.00

```

APPENDIX B – CAISO CATEGORY B AUTOCON INPUT FILE

```

0
#
#
# (126) B3 TRANSFORMER OUTAGE (BREAKER-TO-BREAKER)
#
2 32852 32756 "1 " 0 # TRAN from CHRISTIE 60.00 BRKR to BRKR CHRISTIE 115.00
0
#
#
# (127) B1 GENERATOR OUTAGE
#
3 32740 0 "1" 0 # HILLSIDE 115.00 PGEN=26.00 QGEN=-8.70
0
#
#
# (128) B1 GENERATOR OUTAGE
#
3 32901 0 "1" 0 # OAKLND 1 13.80 PGEN=50.00 QGEN=-8.40
0
#
#
# (129) B1 GENERATOR OUTAGE
#
3 32902 0 "1" 0 # OAKLND 2 13.80 PGEN=50.00 QGEN=0.70
0
#
#
# (130) B1 GENERATOR OUTAGE
#
3 32903 0 "1" 0 # OAKLND 3 13.80 PGEN=50.00 QGEN=0.70
0
#
#
# (131) B1 GENERATOR OUTAGE
#
3 32910 0 "1" 0 # UNOCAL 12.00 PGEN=15.70 QGEN=8.37
0
#
#
# (132) B1 GENERATOR OUTAGE
#
3 32920 0 "1" 0 # UNION CH 9.11 PGEN=20.40 QGEN=-9.00
0
#
#
# (133) B1 GENERATOR OUTAGE
#
3 32921 0 "1" 0 # ChevGen1 13.80 PGEN=54.00 QGEN=34.20
0
#
#
# (134) L-1/G-1 OVERLAPPING OUTAGE
# Ignacio - Sobrante 230 kV Line and Oakland CT1
1 30437 30445 "1 " 0 # line from CROCKETT 230.00 (3) to BRKR IGNACIO 230.00
1 30437 30438 "1 " 0 # line from CROCKETT 230.00 (3) to (2) C&H 230.00
1 30437 30540 "1 " 0 # line from CROCKETT 230.00 (3) to BRKR SOBRANTE 230.00
2 30438 32900 "1 " 0 # TRAN from C&H 230.00 BRKR to (1) CRCKTCOG 18.00
4 30438 0 "1 " 0 # LOAD-DROP C&H 230.00 LOAD==3.32(0.76)
3 32900 0 "1 " 0 # GEN-DROP CRCKTCOG 18.00 GEN==240.00(40.82)
#
3 32901 0 "1" 0 # OAKLND 1 13.80 PGEN=50.00 QGEN=-8.40
0
#
#
# (135) L-1/G-1 OVERLAPPING OUTAGE
# Sobrante - Grizzly - East Portal #1 115 kV Line and Oakland CT1
1 32740 33006 "1 " 0 # line from HILLSIDE 115.00 BRKR to (3) GRIZLYJ1 115.00
1 33006 33010 "1 " 0 # line from GRIZLYJ1 115.00 (3) to BRKR SOBRANTE 115.00
1 33006 33012 "1 " 0 # line from GRIZLYJ1 115.00 (3) to BRKR EST PRTL 115.00
1 32770 32740 "1 " 0 # include GRIZZLY2 115.00 BRKR to HILLSIDE 115.00 ckt 1
#
3 32901 0 "1" 0 # OAKLND 1 13.80 PGEN=50.00 QGEN=-8.40
0
#
#
# (136) L-1/G-1 OVERLAPPING OUTAGE
# Sobrante - Grizzly - Claremont #2 115 kV Line and Oakland CT1
1 32740 33008 "2 " 0 # line from HILLSIDE 115.00 BRKR to (3) GRIZLYJ2 115.00
1 33008 32780 "2 " 0 # line from GRIZLYJ2 115.00 (3) to BRKR CLARMNT 115.00

```

APPENDIX B – CAISO CATEGORY B AUTOCON INPUT FILE

```

1 33008 33010 "2 " 0 # line from GRIZLYJ2 115.00 (3) to BRKR SOBRANTE 115.00
1 32770 32740 "2 " 0 # include GRIZZLY2 115.00 BRKR to HILLSIDE 115.00 ckt 2
#
3 32901 0 "1" 0 # OAKLND 1 13.80 PGEN=50.00 QGEN=-8.40
0
#
#
# (137) L-1/G-1 OVERLAPPING OUTAGE
# Claremont - Oakland D #1 115 kV Line and Oakland CT1
1 32780 32782 "1 " 0 # line from CLARMNT 115.00 BRKR to BRKR STATIN D 115.00
#
3 32901 0 "1" 0 # OAKLND 1 13.80 PGEN=50.00 QGEN=-8.40
0
#
#
# (138) L-1/G-1 OVERLAPPING OUTAGE
# Claremont - Oakland D #2 115 kV Line and Oakland CT1
1 32780 32782 "2 " 0 # line from CLARMNT 115.00 BRKR to BRKR STATIN D 115.00
#
3 32901 0 "1" 0 # OAKLND 1 13.80 PGEN=50.00 QGEN=-8.40
0
#
#
# (139) L-1/G-1 OVERLAPPING OUTAGE
# Oakland D - Oakland L 115 kV Line and Oakland CT1
1 32782 32788 "1 " 0 # line from STATIN D 115.00 BRKR to BRKR STATIN L 115.00
#
3 32901 0 "1" 0 # OAKLND 1 13.80 PGEN=50.00 QGEN=-8.40
0
#
#
# (140) L-1/G-1 OVERLAPPING OUTAGE
# Oakland C - Oakland L 115 kV Line and Oakland CT1
1 32786 32788 "1 " 0 # line from OAK C115 115.00 BRKR to BRKR STATIN L 115.00
#
3 32901 0 "1" 0 # OAKLND 1 13.80 PGEN=50.00 QGEN=-8.40
0
#
#
# (141) L-1/G-1 OVERLAPPING OUTAGE
# Oakland C - Oakland X #2 115 kV Line and Oakland CT1
1 32786 32790 "2 " 0 # line from OAK C115 115.00 BRKR to BRKR STATIN X 115.00
#
3 32901 0 "1" 0 # OAKLND 1 13.80 PGEN=50.00 QGEN=-8.40
0
#
#
# (142) L-1/G-1 OVERLAPPING OUTAGE
# Oakland C - Oakland X #3 115 kV Line and Oakland CT1
1 32786 32790 "3 " 0 # line from OAK C115 115.00 BRKR to BRKR STATIN X 115.00
#
3 32901 0 "1" 0 # OAKLND 1 13.80 PGEN=50.00 QGEN=-8.40
0
#
#
# (143) L-1/G-1 OVERLAPPING OUTAGE
# Oakland C - Maritime 115 kV Line and Oakland CT1
1 32786 32793 "1 " 0 # line from OAK C115 115.00 BRKR to (2) SCHNITZ 115.00
1 32793 32794 "1 " 0 # line from SCHNITZ 115.00 (2) to BRKR MARITIME 115.00
4 32793 0 "1 " 0 # LOAD-DROP SCHNITZ 115.00 LOAD==9.29(4.50)
4 32794 0 "1 " 0 # LOAD-DROP MARITIME 115.00 LOAD==0.95(1.11)
#
3 32901 0 "1" 0 # OAKLND 1 13.80 PGEN=50.00 QGEN=-8.40
0
#
#
# (144) L-1/G-1 OVERLAPPING OUTAGE
# Oakland C - Oakland CTS 115 kV Line and Oakland CT1
1 32786 32904 "1 " 0 # line from OAK C115 115.00 BRKR to (3) OAKLND23 115.00
2 32904 32902 "8 " 0 # TRAN from OAKLND23 115.00 (3) to (1) OAKLND 2 13.80
2 32904 32903 "9 " 0 # TRAN from OAKLND23 115.00 (3) to (1) OAKLND 3 13.80
3 32902 0 "1 " 0 # GEN-DROP OAKLND 2 13.80 GEN==50.00(0.70)
3 32903 0 "1 " 0 # GEN-DROP OAKLND 3 13.80 GEN==50.00(-0.08)
#
3 32901 0 "1" 0 # OAKLND 1 13.80 PGEN=50.00 QGEN=-8.40
0
#
#
# (145) L-1/G-1 OVERLAPPING OUTAGE

```

APPENDIX B – CAISO CATEGORY B AUTOCON INPUT FILE

```

# Oakland C - Alameda 115 kV Line and Oakland CT1
1 32786 38026 "1 " 0 # line from OAK C115 115.00 BRKR to (4) ALAMEDCT 115.00
1 38026 38022 "1 " 0 # line from ALAMEDCT 115.00 (4) to BRKR CARTWRT 115.00
2 38026 38118 "1 " 0 # TRAN from ALAMEDCT 115.00 (4) to (1) ALMDACT1 13.80
2 38026 38119 "1 " 0 # TRAN from ALAMEDCT 115.00 (4) to (1) ALMDACT2 13.80
4 38022 0 "1 " 0 # LOAD-DROP CARTWRT 115.00 LOAD==23.04(4.31)
4 38022 0 "2 " 0 # LOAD-DROP CARTWRT 115.00 LOAD==23.04(4.31)
3 38118 0 "1 " 0 # GEN-DROP ALMDACT1 13.80 GEN==22.60(12.40)
3 38119 0 "1 " 0 # GEN-DROP ALMDACT2 13.80 GEN==22.60(12.40)
#
3 32901 0 "1" 0 # OAKLND 1 13.80 PGEN=50.00 QGEN=-8.40
0
#
#
# (146) L-1/G-1 OVERLAPPING OUTAGE
# Oakland J - Owens Brockway 115 kV Line and Oakland CT1
1 32792 32798 "1 " 0 # line from STATIN J 115.00 BRKR to (2) OWENSTAP 115.00
1 32798 32800 "1 " 0 # line from OWENSTAP 115.00 (2) to BRKR OWNBKWKY 115.00
4 32800 0 "1 " 0 # LOAD-DROP OWNBKWKY 115.00 LOAD==9.29(5.51)
#
3 32901 0 "1" 0 # OAKLND 1 13.80 PGEN=50.00 QGEN=-8.40
0
#
#
# (147) L-1/G-1 OVERLAPPING OUTAGE
# San Leandro - Oakland J 115 kV Line and Oakland CT1
1 32792 32814 "1 " 0 # line from STATIN J 115.00 BRKR to (3) EDESTAP1 115.00
1 32814 32810 "1 " 0 # line from EDESTAP1 115.00 (3) to BRKR EDES 115.00
1 32814 35113 "1 " 0 # line from EDESTAP1 115.00 (3) to (2) DMTAR_SL 115.00
1 35113 35101 "1 " 0 # line from DMTAR_SL 115.00 (2) to BRKR SN LNDRO 115.00
4 32810 0 "2 " 0 # LOAD-DROP EDES 115.00 LOAD==18.85(4.29)
4 32810 0 "3 " 0 # LOAD-DROP EDES 115.00 LOAD==29.45(6.71)
4 35113 0 "1 " 0 # LOAD-DROP DMTAR_SL 115.00 LOAD==3.61(2.24)
1 32810 32812 "1 " 1 # LINE-TRANSFER EDESTAP1 to EDS GRNT
4 32810 0 "3" 1 # RESTORE EDES load
#
3 32901 0 "1" 0 # OAKLND 1 13.80 PGEN=50.00 QGEN=-8.40
0
#
#
# (148) L-1/G-1 OVERLAPPING OUTAGE
# Oakland J - Alameda 115 kV Line and Oakland CT1
1 32792 38024 "1 " 0 # line from STATIN J 115.00 BRKR to BRKR JENNY 115.00
4 38024 0 "1 " 0 # LOAD-DROP JENNY 115.00 LOAD==33.37(6.27)
1 38024 38022 "1 " 1 # LINE-TRANSFER ALAMDA J to ALAMDA C
4 38024 0 "3" 1 # RESTORE ALAMDA J load
#
3 32901 0 "1" 0 # OAKLND 1 13.80 PGEN=50.00 QGEN=-8.40
0
#
#
# (149) L-1/G-1 OVERLAPPING OUTAGE
# Sobrante - Standard Oil #1 115 kV Line and Standard Oil Unit 1
1 32748 32750 "1 " 0 # line from PP STEEL 115.00 BRKR to (3) PPSTLTAP 115.00
1 32750 32774 "1 " 0 # line from PPSTLTAP 115.00 (3) to (3) PTPNLTAP 115.00
1 32750 32760 "1 " 0 # line from PPSTLTAP 115.00 (3) to (1) PT PINLE 115.00
1 32774 32762 "1 " 0 # line from PTPNLTAP 115.00 (3) to BRKR STD. OIL 115.00
1 32774 32808 "1 " 0 # line from PTPNLTAP 115.00 (3) to (2) SNPBLTP2 115.00
1 32808 33010 "1 " 0 # line from SNPBLTP2 115.00 (2) to BRKR SOBRANTE 115.00
4 32748 0 "1 " 0 # LOAD-DROP PP STEEL 115.00 LOAD==0.19(0.25)
4 32760 0 "1 " 0 # LOAD-DROP PT PINLE 115.00 LOAD==14.78(3.36)
#
3 32921 0 "1" 0 # ChevGen1 13.80 PGEN=54.00 QGEN=34.20
0
#
#
# (150) L-1/G-1 OVERLAPPING OUTAGE
# Sobrante - Standard Oil #2 115 kV Line and Standard Oil Unit 1
1 32806 32758 "1 " 0 # line from SNPBLTP1 115.00 (3) to BRKR SAN PBLO 115.00
1 32806 32762 "2 " 0 # line from SNPBLTP1 115.00 (3) to BRKR STD. OIL 115.00
1 32806 33010 "2 " 0 # line from SNPBLTP1 115.00 (3) to BRKR SOBRANTE 115.00
4 32758 0 "1 " 0 # LOAD-DROP SAN PBLO 115.00 LOAD==19.98(4.55)
1 32758 32808 "2 " 1 # LINE-TRANSFER SNPBLTP1 to SNPBLTP2
4 32758 0 "3" 1 # RESTORE SAN PABLO load
#
3 32921 0 "1" 0 # ChevGen1 13.80 PGEN=54.00 QGEN=34.20
0
#
#

```

APPENDIX B – CAISO CATEGORY B AUTOCON INPUT FILE

```

# (151) L-1/G-1 OVERLAPPING OUTAGE
# Oleum - El Cerrito #1 115 kV Line and Oleum Unit 1
1 32754 32802 "1 " 0 # line from OLEUM 115.00 BRKR to (3) VLYVWTP1 115.00
1 32802 32764 "1 " 0 # line from VLYVWTP1 115.00 (3) to BRKR VALLY VW 115.00
1 32802 32766 "1 " 0 # line from VLYVWTP1 115.00 (3) to BRKR EL CRRTO 115.00
4 32764 0 "1 " 0 # LOAD-DROP VALLY VW 115.00 LOAD==7.65(1.74)
4 32764 0 "2 " 0 # LOAD-DROP VALLY VW 115.00 LOAD==15.69(3.58)
1 32764 32804 "2 " 1 # LINE-TRANSFER VLYVWTP1 to VLYVWTP2
4 32764 0 "***" 1 # RESTORE VALLEY VIEW load
#
3 32910 0 "1" 0 # UNOCAL 12.00 PGEN=15.70 QGEN=8.37
0
#
#
# (152) L-1/G-1 OVERLAPPING OUTAGE
# Oleum - El Cerrito #2 115 kV Line and Oleum Unit 1
1 32754 32804 "2 " 0 # line from OLEUM 115.00 BRKR to (2) VLYVWTP2 115.00
1 32804 32766 "2 " 0 # line from VLYVWTP2 115.00 (2) to BRKR EL CRRTO 115.00
#
3 32910 0 "1" 0 # UNOCAL 12.00 PGEN=15.70 QGEN=8.37
0
#
#
# (153) L-1/G-1 OVERLAPPING OUTAGE
# Oleum - Martinez 115 kV Line and Oleum Unit 1
1 33016 32754 "1 " 0 # line from ALHAMTP2 115.00 (2) to BRKR OLEUM 115.00
1 33016 32990 "1 " 0 # line from ALHAMTP2 115.00 (2) to BRKR MARTNZ D 115.00
#
3 32910 0 "1" 0 # UNOCAL 12.00 PGEN=15.70 QGEN=8.37
0
#
#
# (154) L-1/G-1 OVERLAPPING OUTAGE
# Oleum - North Tower - Christie 115 kV Line and Oleum Unit 1
1 32620 32778 "1 " 0 # line from NTRWJCT2 115.00 (2) to (3) MRTNZJCT 115.00
1 32620 32602 "1 " 0 # line from NTRWJCT2 115.00 (2) to BRKR NRTH TWR 115.00
1 32778 32754 "1 " 0 # line from MRTNZJCT 115.00 (3) to BRKR OLEUM 115.00
1 32778 32756 "1 " 0 # line from MRTNZJCT 115.00 (3) to BRKR CHRISTIE 115.00
4 32602 0 "1 " 0 # LOAD-DROP NRTH TWR 115.00 LOAD==14.43(2.06)
4 32602 0 "2 " 0 # LOAD-DROP NRTH TWR 115.00 LOAD==9.58(1.37)
4 32602 0 "3 " 0 # LOAD-DROP NRTH TWR 115.00 LOAD==6.08(0.87)
4 32602 0 "4 " 0 # LOAD-DROP NRTH TWR 115.00 LOAD==2.85(0.41)
1 32602 32618 "1 " 1 # LINE-TRANSFER NTRWJCT2 115.00 to NTRWJCT1 115.00
4 32602 0 "***" 1 # RESTORE NORTH TOWER load
#
3 32910 0 "1" 0 # UNOCAL 12.00 PGEN=15.70 QGEN=8.37
0
#
#
# 2013 category b contingency list
# Diablo Division Zone 308
#
#
# (155) B2 LINE OUTAGE (BREAKER-TO-BREAKER)
#
1 30479 30523 "1 " 0 # line from BDLWSSTA 230.00 BRKR to BRKR CC SUB 230.00
0
#
#
# (156) B2 LINE OUTAGE (BREAKER-TO-BREAKER)
#
1 30520 30525 "1 " 0 # line from GATEWAY 230.00 BRKR to BRKR C.COSTA 230.00
0
#
#
# (157) B2 LINE OUTAGE (BREAKER-TO-BREAKER)
#
1 30523 30525 "1 " 0 # line from CC SUB 230.00 BRKR to BRKR C.COSTA 230.00
0
#
#
# (158) B2 LINE OUTAGE (BREAKER-TO-BREAKER)
#
1 30525 30479 "1 " 0 # line from C.COSTA 230.00 BRKR to BRKR BDLWSSTA 230.00
0
#
#
# (159) B2 LINE OUTAGE (BREAKER-TO-BREAKER)
#

```

APPENDIX B – CAISO CATEGORY B AUTOCON INPUT FILE

```

1 30525 30543 "1 " 0 # line from C.COSTA 230.00 BRKR to (3) ROSSTAP1 230.00
1 30543 30545 "1 " 0 # line from ROSSTAP1 230.00 (3) to BRKR ROSSMOOR 230.00
1 30543 30550 "1 " 0 # line from ROSSTAP1 230.00 (3) to BRKR MORAGA 230.00
4 30545 0 "1 " 0 # LOAD-DROP ROSSMOOR 230.00 LOAD==36.95(8.42)
4 30545 0 "2 " 0 # LOAD-DROP ROSSMOOR 230.00 LOAD==32.85(7.49)
1 30544 30545 "2 " 1 # LINE-TRANSFER ROSSTAP1 230.00 TO ROSSTAP2 230.00
4 30545 0 "***" 1 # RESTORE ROSSMOOR load
0
#
#
# (160) B2 LINE OUTAGE (BREAKER-TO-BREAKER)
#
1 30525 30544 "2 " 0 # line from C.COSTA 230.00 BRKR to (2) ROSSTAP2 230.00
1 30544 30550 "2 " 0 # line from ROSSTAP2 230.00 (2) to BRKR MORAGA 230.00
0
#
#
# (161) B2 LINE OUTAGE (BREAKER-TO-BREAKER)
#
1 30525 30565 "1 " 0 # line from C.COSTA 230.00 BRKR to BRKR BRENTWOD 230.00
0
#
#
# (162) B2 LINE OUTAGE (BREAKER-TO-BREAKER)
#
1 30525 30567 "1 " 0 # line from C.COSTA 230.00 BRKR to BRKR LONETREE 230.00
0
#
#
# (163) B2 LINE OUTAGE (BREAKER-TO-BREAKER)
#
1 30525 30575 "1 " 0 # line from C.COSTA 230.00 BRKR to (3) WND MSTR 230.00
1 30575 38610 "1 " 0 # line from WND MSTR 230.00 (3) to BRKR DELTAPMP 230.00
2 30575 33170 "1 " 0 # TRAN from WND MSTR 230.00 (3) to (1) WINDMSTR 9.11
0
#
#
# (164) B2 LINE OUTAGE (BREAKER-TO-BREAKER)
#
1 30525 30585 "1 " 0 # line from C.COSTA 230.00 BRKR to BRKR LS PSTAS 230.00
0
#
#
# (165) B2 LINE OUTAGE (BREAKER-TO-BREAKER)
#
1 30526 30555 "1 " 0 # line from PITSBG D 230.00 BRKR to BRKR SANRAMON 230.00
0
#
#
# (166) B2 LINE OUTAGE (BREAKER-TO-BREAKER)
#
1 30526 30561 "1 " 0 # line from PITSBG D 230.00 BRKR to BRKR TASSAJAR 230.00
0
#
#
# (167) B2 LINE OUTAGE (BREAKER-TO-BREAKER)
#
1 30527 30535 "1 " 0 # line from PITSBG E 230.00 BRKR to BRKR TIDEWATR 230.00
0
#
#
# (168) B2 LINE OUTAGE (BREAKER-TO-BREAKER)
#
1 30527 30536 "1 " 0 # line from PITSBG E 230.00 BRKR to BRKR TESORO 230.00
0
#
#
# (169) B2 LINE OUTAGE (BREAKER-TO-BREAKER)
#
1 30535 30540 "1 " 0 # line from TIDEWATR 230.00 BRKR to BRKR SOBRANTE 230.00
0
#
#
# (170) B2 LINE OUTAGE (BREAKER-TO-BREAKER)
#
1 30536 30540 "1 " 0 # line from TESORO 230.00 BRKR to BRKR SOBRANTE 230.00
0
#
#

```

APPENDIX B – CAISO CATEGORY B AUTOCON INPUT FILE

```

# (171) B2 LINE OUTAGE (BREAKER-TO-BREAKER)
#
1 30550 30554 "1 " 0 # line from MORAGA 230.00 BRKR to BRKR CASTROVL 230.00
0
#
#
# (172) B2 LINE OUTAGE (BREAKER-TO-BREAKER)
#
1 30550 30555 "1 " 0 # line from MORAGA 230.00 BRKR to BRKR SANRAMON 230.00
0
#
#
# (173) B2 LINE OUTAGE (BREAKER-TO-BREAKER)
#
1 30560 30527 "1 " 0 # line from E. SHORE 230.00 BRKR to BRKR PITSBG E 230.00
0
#
#
# (174) B2 LINE OUTAGE (BREAKER-TO-BREAKER)
#
1 30561 30562 "1 " 0 # line from TASSAJAR 230.00 BRKR to (3) TES JCT 230.00
1 30562 30563 "1 " 0 # line from TES JCT 230.00 (3) to BRKR RESEARCH 230.00
1 30562 30631 "1 " 0 # line from TES JCT 230.00 (3) to BRKR NEWARK E 230.00
4 30563 0 "1 " 0 # LOAD-DROP RESEARCH 230.00 LOAD==37.05(8.44)
0
#
#
# (175) B2 LINE OUTAGE (BREAKER-TO-BREAKER)
#
1 30567 30590 "1 " 0 # line from LONETREE 230.00 BRKR to (3) USWP-JRW 230.00
1 30590 30530 "1 " 0 # line from USWP-JRW 230.00 (3) to BRKR CAYETANO 230.00
2 30590 33838 "1 " 0 # TRAN from USWP-JRW 230.00 (3) to (1) USWP_#3 9.11
4 33838 0 "SG" 0 # LOAD-DROP USWP_#3 9.11 LOAD==0.50(0.20)
0
#
#
# (176) B2 LINE OUTAGE (BREAKER-TO-BREAKER)
#
1 30700 30527 "1 " 0 # line from SANMATEO 230.00 BRKR to BRKR PITSBG E 230.00
0
#
#
# (177) B2 LINE OUTAGE (BREAKER-TO-BREAKER)
#
1 30526 30528 "1 " 0 # line from PITSBG D 230.00 BRKR to BRKR DEC PTSG 230.00
3 33108 0 "***" 0 # GEN-DROP DEC CTG1 18.00
0
#
#
# (178) B2 LINE OUTAGE (BREAKER-TO-BREAKER)
#
1 30526 30528 "2 " 0 # line from PITSBG D 230.00 BRKR to BRKR DEC PTSG 230.00
3 33108 0 "***" 0 # GEN-DROP DEC CTG1 18.00
0
#
#
# (179) B2 LINE OUTAGE (BREAKER-TO-BREAKER)
#
1 30521 30523 "1 " 0 # line from T258 230.00 (4) to BRKR CC SUB 230.00
2 30521 33181 "1 " 0 # TRAN from T258 230.00 (4) to (1) T258CT1 18.00
2 30521 33182 "1 " 0 # TRAN from T258 230.00 (4) to (1) T258CT2 18.00
2 30521 33183 "1 " 0 # TRAN from T258 230.00 (4) to (1) T258ST1 18.00
4 33181 0 "ss" 0 # LOAD-DROP T258CT1 18.00 LOAD==10.65(3.14)
4 33182 0 "ss" 0 # LOAD-DROP T258CT2 18.00 LOAD==10.65(3.14)
3 33181 0 "1 " 0 # GEN-DROP T258CT1 18.00 GEN==222.00(43.00)
3 33182 0 "2 " 0 # GEN-DROP T258CT2 18.00 GEN==222.00(43.00)
3 33183 0 "3 " 0 # GEN-DROP T258ST1 18.00 GEN==228.00(44.92)
0
#
#
# (180) B2 LINE OUTAGE (BREAKER-TO-BREAKER)
#
1 32950 32970 "1 " 0 # line from PITSBURG 115.00 BRKR to BRKR CLAYTN 115.00
0
#
#
# (181) B2 LINE OUTAGE (BREAKER-TO-BREAKER)
#
1 32950 32970 "4 " 0 # line from PITSBURG 115.00 BRKR to BRKR CLAYTN 115.00

```

APPENDIX B – CAISO CATEGORY B AUTOCON INPUT FILE

```

0
#
#
# (182) B2 LINE OUTAGE (BREAKER-TO-BREAKER)
#
1 32950 32978 "1 " 0 # line from PITTSBURG 115.00 BRKR to BRKR LMEC 115.00
0
#
#
# (183) B2 LINE OUTAGE (BREAKER-TO-BREAKER)
#
1 32950 32978 "2 " 0 # line from PITTSBURG 115.00 BRKR to BRKR LMEC 115.00
0
#
#
# (184) B2 LINE OUTAGE (BREAKER-TO-BREAKER)
#
1 32950 32992 "2 " 0 # line from PITTSBURG 115.00 BRKR to (2) BOLLMAN2 115.00
1 32992 33043 "2 " 0 # line from BOLLMAN2 115.00 (2) to (3) IMHOFF_2 115.00
1 33043 32991 "2 " 0 # line from IMHOFF_2 115.00 (3) to BRKR MARTNZ E 115.00
1 33043 33041 "2 " 0 # line from IMHOFF_2 115.00 (3) to (2) IMHOFF 115.00
2 33041 33136 "1 " 0 # TRAN from IMHOFF 115.00 (2) to (1) CCCSD 12.47
4 33136 0 "SG" 0 # LOAD-DROP CCCSD 12.47 LOAD==3.37(0.77)
3 33136 0 "1 " 0 # GEN-DROP CCCSD 12.47 GEN==4.40(0.53)
0
#
#
# (185) B2 LINE OUTAGE (BREAKER-TO-BREAKER)
#
1 32950 32993 "1 " 0 # line from PITTSBURG 115.00 BRKR to (2) W.P.BART 115.00
1 32993 33040 "1 " 0 # line from W.P.BART 115.00 (2) to (3) BOLLMAN1 115.00
1 33040 32994 "1 " 0 # line from BOLLMAN1 115.00 (3) to (1) BOLLMAN 115.00
1 33040 33042 "1 " 0 # line from BOLLMAN1 115.00 (3) to (2) IMHOFF_1 115.00
1 33042 32991 "1 " 0 # line from IMHOFF_1 115.00 (2) to BRKR MARTNZ E 115.00
4 32993 0 "1 " 0 # LOAD-DROP W.P.BART 115.00 LOAD==7.29(1.48)
4 32993 0 "3 " 0 # LOAD-DROP W.P.BART 115.00 LOAD==13.49(3.07)
4 32994 0 "1 " 0 # LOAD-DROP BOLLMAN 115.00 LOAD==2.59(1.36)
4 32994 0 "2 " 0 # LOAD-DROP BOLLMAN 115.00 LOAD==2.59(1.36)
0
#
#
# (186) B2 LINE OUTAGE (BREAKER-TO-BREAKER)
#
1 32950 33030 "1 " 0 # line from PITTSBURG 115.00 BRKR to (2) COLSTJTT1 115.00
1 33030 33036 "1 " 0 # line from COLSTJTT1 115.00 (2) to (3) LINDETP1 115.00
1 33036 32954 "1 " 0 # line from LINDETP1 115.00 (3) to (2) DOW TAP1 115.00
1 33036 32961 "1 " 0 # line from LINDETP1 115.00 (3) to (3) GWF2 TAP 115.00
1 32954 32956 "1 " 0 # line from DOW TAP1 115.00 (2) to (2) DOW MTR 115.00
2 32956 33160 "1 " 0 # TRAN from DOW MTR 115.00 (2) to (4) DOW CHEM 13.80
1 33160 33161 "1 " 0 # line from DOW CHEM 13.80 (4) to (1) DOWCHEM1 13.80
1 33160 33162 "1 " 0 # line from DOW CHEM 13.80 (4) to (1) DOWCHEM2 13.80
1 33160 33163 "1 " 0 # line from DOW CHEM 13.80 (4) to (1) DOWCHEM3 13.80
1 32961 32960 "1 " 0 # line from GWF2 TAP 115.00 (3) to (2) GWF#2 HS 115.00
1 32961 33038 "1 " 0 # line from GWF2 TAP 115.00 (3) to (2) LINDEFJCT 115.00
2 32960 33132 "1 " 0 # TRAN from GWF#2 HS 115.00 (2) to (1) GWF #2 13.80
1 33038 32957 "1 " 0 # line from LINDEFJCT 115.00 (2) to BRKR PRAXAIR 115.00
4 33160 0 "SG" 0 # LOAD-DROP DOW CHEM 13.80 LOAD==15.00(9.30)
4 33132 0 "SG" 0 # LOAD-DROP GWF #2 13.80 LOAD==2.81(0.64)
4 32957 0 "1 " 0 # LOAD-DROP PRAXAIR 115.00 LOAD==20.67(4.61)
3 33161 0 "1 " 0 # GEN-DROP DOWCHEM1 13.80 GEN==15.30(6.00)
3 33162 0 "1 " 0 # GEN-DROP DOWCHEM2 13.80 GEN==22.00(5.29)
3 33163 0 "1 " 0 # GEN-DROP DOWCHEM3 13.80 GEN==22.00(5.29)
3 33132 0 "1 " 0 # GEN-DROP GWF #2 13.80 GEN==12.30(3.13)
0
#
#
# (187) B2 LINE OUTAGE (BREAKER-TO-BREAKER)
#
1 32950 33032 "3 " 0 # line from PITTSBURG 115.00 BRKR to (2) KIRKTAP1 115.00
1 33032 32970 "3 " 0 # line from KIRKTAP1 115.00 (2) to BRKR CLAYTN 115.00
0
#
#
# (188) B2 LINE OUTAGE (BREAKER-TO-BREAKER)
#
1 32950 33033 "1 " 0 # line from PITTSBURG 115.00 BRKR to (3) KIRKTAP2 115.00
1 33033 32951 "1 " 0 # line from KIRKTAP2 115.00 (3) to BRKR KIRKER 115.00
1 33033 33031 "1 " 0 # line from KIRKTAP2 115.00 (3) to (2) COLSTJTT2 115.00
1 33031 33037 "1 " 0 # line from COLSTJTT2 115.00 (2) to (2) LINDETP2 115.00

```

APPENDIX B – CAISO CATEGORY B AUTOCON INPUT FILE

```

1 33037 32955 "1 " 0 # line from LINDETP2 115.00 (2) to (1) DOW TAP2 115.00
4 32951 0 "1 " 0 # LOAD-DROP KIRKER 115.00 LOAD==38.02(7.72)
4 32951 0 "2 " 0 # LOAD-DROP KIRKER 115.00 LOAD==44.19(8.97)
4 32951 0 "3 " 0 # LOAD-DROP KIRKER 115.00 LOAD==53.77(10.92)
1 33032 32951 "1 " 1 # LINE-TRANSFER KIRKTAP2 115.00 TO KIRKTAP1
4 32951 0 "***" 1 # RESTORE KIRKER load
0
#
#
# (189) B2 LINE OUTAGE (BREAKER-TO-BREAKER)
#
1 32970 32971 "1 " 0 # line from CLAYTN 115.00 BRKR to BRKR MEDW LNE 115.00
0
#
#
# (190) B2 LINE OUTAGE (BREAKER-TO-BREAKER)
#
1 32970 32974 "2 " 0 # line from CLAYTN 115.00 BRKR to BRKR LAKEWD-M 115.00
0
#
#
# (191) B2 LINE OUTAGE (BREAKER-TO-BREAKER)
#
1 32970 33035 "1 " 0 # line from CLAYTN 115.00 BRKR to (3) LKWD_JCT 115.00
1 33035 32972 "1 " 0 # line from LKWD_JCT 115.00 (3) to (2) EBMUDGRY 115.00
1 33035 32973 "1 " 0 # line from LKWD_JCT 115.00 (3) to BRKR LAKEWD-C 115.00
1 32972 32971 "1 " 0 # line from EBMUDGRY 115.00 (2) to BRKR MEDW LNE 115.00
4 32972 0 "1 " 0 # LOAD-DROP EBMUDGRY 115.00 LOAD==5.67(1.86)
0
#
#
# (192) B2 LINE OUTAGE (BREAKER-TO-BREAKER)
#
1 32974 32976 "9 " 0 # line from LAKEWD-M 115.00 BRKR to (2) LK_REACT 115.00
1 32976 33020 "1 " 0 # line from LK_REACT 115.00 (2) to BRKR MORAGA 115.00
0
#
#
# (193) B2 LINE OUTAGE (BREAKER-TO-BREAKER)
#
1 32990 33014 "1 " 0 # line from MARTNZ D 115.00 BRKR to (3) ALHAMTP1 115.00
1 33014 33010 "1 " 0 # line from ALHAMTP1 115.00 (3) to BRKR SOBRANTE 115.00
1 33014 33011 "1 " 0 # line from ALHAMTP1 115.00 (3) to BRKR ALHAMBRA 115.00
4 33011 0 "1 " 0 # LOAD-DROP ALHAMBRA 115.00 LOAD==10.29(2.34)
4 33011 0 "2 " 0 # LOAD-DROP ALHAMBRA 115.00 LOAD==9.17(2.09)
1 33016 33011 "1 " 1 # LINE-TRANSFER ALHAMTP1 115.00 TO ALHAMTP2 115.00
4 33011 0 "***" 1 # RESTORE ALHAMBRA load
0
#
#
# (194) B2 LINE OUTAGE (BREAKER-TO-BREAKER)
#
1 32996 32990 "1 " 0 # line from SHELLJ1 115.00 (3) to BRKR MARTNZ D 115.00
2 32996 33141 "7 " 0 # TRAN from SHELLJ1 115.00 (3) to BRKR SHELL 1 12.47
2 32996 33143 "6 " 0 # TRAN from SHELLJ1 115.00 (3) to BRKR SHELL 3 12.47
0
#
#
# (195) B2 LINE OUTAGE (BREAKER-TO-BREAKER)
#
1 32997 32991 "2 " 0 # line from SHELLJ2 115.00 (3) to BRKR MARTNZ E 115.00
2 32997 33141 "6 " 0 # TRAN from SHELLJ2 115.00 (3) to BRKR SHELL 1 12.47
2 32997 33143 "7 " 0 # TRAN from SHELLJ2 115.00 (3) to BRKR SHELL 3 12.47
0
#
#
# (196) B2 LINE OUTAGE (BREAKER-TO-BREAKER)
#
1 33000 33046 "1 " 0 # line from CC SUB 115.00 BRKR to (3) FIBRJCT2 115.00
1 33046 33001 "1 " 0 # line from FIBRJCT2 115.00 (3) to BRKR DOMTAR 115.00
1 33046 33044 "1 " 0 # line from FIBRJCT2 115.00 (3) to (2) FIBRBJCT 115.00
1 33044 33002 "1 " 0 # line from FIBRBJCT 115.00 (2) to (2) CROWN Z 115.00
2 33002 33133 "1 " 0 # TRAN from CROWN Z 115.00 (2) to (1) GWF #3 13.80
4 33001 0 "1 " 0 # LOAD-DROP DOMTAR 115.00 LOAD==2.40(2.12)
4 33133 0 "SG" 0 # LOAD-DROP GWF #3 13.80 LOAD==2.84(0.65)
3 33133 0 "1 " 0 # GEN-DROP GWF #3 13.80 GEN==19.00(4.33)
0
#
#

```

APPENDIX B – CAISO CATEGORY B AUTOCON INPUT FILE

```

# (197) B2 LINE OUTAGE (BREAKER-TO-BREAKER)
#
1 33000 33047 "1 " 0 # line from CC SUB 115.00 BRKR to (2) CC JCT 115.00
1 33047 33045 "1 " 0 # line from CC JCT 115.00 (2) to (2) FIBRJCT1 115.00
1 33045 33048 "1 " 0 # line from FIBRJCT1 115.00 (2) to (2) RVECTP 115.00
1 33048 33049 "1 " 0 # line from RVECTP 115.00 (2) to BRKR RVEC 115.00
0
#
#
# (198) B2 LINE OUTAGE (BREAKER-TO-BREAKER)
#
1 33020 33010 "1 " 0 # line from MORAGA 115.00 BRKR to BRKR SOBRANTE 115.00
0
#
#
# (199) B2 LINE OUTAGE (BREAKER-TO-BREAKER)
#
1 33020 35101 "1 " 0 # line from MORAGA 115.00 BRKR to BRKR SN LNDRO 115.00
0
#
#
# (200) B2 LINE OUTAGE (BREAKER-TO-BREAKER)
#
1 33020 35101 "2 " 0 # line from MORAGA 115.00 BRKR to BRKR SN LNDRO 115.00
0
#
#
# (201) B2 LINE OUTAGE (BREAKER-TO-BREAKER)
#
1 33020 35101 "3 " 0 # line from MORAGA 115.00 BRKR to BRKR SN LNDRO 115.00
0
#
#
# (202) B2 LINE OUTAGE (BREAKER-TO-BREAKER)
#
1 33050 33080 "1 " 0 # line from CC SUB 60.00 BRKR to (3) WILBRTAP 60.00
1 33080 33051 "1 " 0 # line from WILBRTAP 60.00 (3) to BRKR DU PONT 60.00
2 33080 33134 "1 " 0 # TRAN from WILBRTAP 60.00 (3) to (1) GWF #4 13.80
4 33051 0 "1 " 0 # LOAD-DROP DU PONT 60.00 LOAD==2.00(2.16)
4 33134 0 "SG" 0 # LOAD-DROP GWF #4 13.80 LOAD==2.88(0.66)
3 33134 0 "1 " 0 # GEN-DROP GWF #4 13.80 GEN==18.60(3.34)
1 33051 33081 "1 " 1 # LINE-TRANSFER WILBRTAP 60.00 TO DUPNTJCT 60.00
4 33051 0 "***" 1 # RESTORE DU PONT load
0
#
#
# (203) B2 LINE OUTAGE (BREAKER-TO-BREAKER)
#
1 33050 33081 "1 " 0 # line from CC SUB 60.00 BRKR to (2) DUPNTJCT 60.00
1 33081 33082 "1 " 0 # line from DUPNTJCT 60.00 (2) to (3) BALFRJCT 60.00
1 33082 33052 "1 " 0 # line from BALFRJCT 60.00 (3) to (2) MARSH 60.00
1 33082 33054 "1 " 0 # line from BALFRJCT 60.00 (3) to BRKR BALFOUR 60.00
1 33052 33053 "1 " 0 # line from MARSH 60.00 (2) to (1) BRIONES 60.00
4 33054 0 "1 " 0 # LOAD-DROP BALFOUR 60.00 LOAD==4.00(0.81)
4 33053 0 "1 " 0 # LOAD-DROP BRIONES 60.00 LOAD==3.90(1.84)
1 33083 33054 "1 " 1 # LINE-TRANSFER BALFRJCT 60.00 TO MDLRVRJT 60.00
4 33054 0 "***" 1 # RESTORE BALFOUR load
0
#
#
# (204) B2 LINE OUTAGE (BREAKER-TO-BREAKER)
#
1 33055 33084 "1 " 0 # line from BIXLER 60.00 (1) to (3) BXLRTAP 60.00
1 33084 33083 "1 " 0 # line from BXLRTAP 60.00 (3) to (2) MDLRVRJT 60.00
1 33084 33778 "1 " 0 # line from BXLRTAP 60.00 (3) to (2) MDL_RIVR 60.00
1 33083 33774 "1 " 0 # line from MDLRVRJT 60.00 (2) to (3) HRDLNJCT 60.00
1 33774 33770 "1 " 0 # line from HRDLNJCT 60.00 (3) to BRKR HERDLYN 60.00
1 33774 33782 "1 " 0 # line from HRDLNJCT 60.00 (3) to (1) WEST SDE 60.00
1 33778 33780 "1 " 0 # line from MDL_RIVR 60.00 (2) to (1) MCD_ISLE 60.00
4 33055 0 "1 " 0 # LOAD-DROP BIXLER 60.00 LOAD==2.00(0.97)
4 33778 0 "1 " 0 # LOAD-DROP MDL_RIVR 60.00 LOAD==4.84(0.22)
4 33782 0 "1 " 0 # LOAD-DROP WEST SDE 60.00 LOAD==1.90(0.40)
4 33780 0 "1 " 0 # LOAD-DROP MCD_ISLE 60.00 LOAD==5.76(0.82)
0
#
#
# (205) B2 LINE OUTAGE (BREAKER-TO-BREAKER)
#
1 33060 33050 "1 " 0 # line from ANTIOCH 60.00 (1) to BRKR CC SUB 60.00

```

APPENDIX B – CAISO CATEGORY B AUTOCON INPUT FILE

```

4 33060      0 "1 "  0      # LOAD-DROP  ANTIOCH  60.00  LOAD==1.93(0.39)
0
#
#
# (206) B2 LINE OUTAGE (BREAKER-TO-BREAKER)
#
1 33062 33090 "1 "  0      # line from SHLL CHM  60.00  (2) to (3)  SHLLCHMT  60.00
1 33062 33063 "1 "  0      # line from SHLL CHM  60.00  (2) to BRKR  WLLW PSS  60.00
1 33090 33050 "1 "  0      # line from SHLLCHMT  60.00  (3) to BRKR  CC SUB   60.00
1 33090 33061 "1 "  0      # line from SHLLCHMT  60.00  (3) to (2)   PITTSBRG  60.00
2 33061 33131 "1 "  0      # TRAN from PITTSBRG  60.00  (2) to (1)   GWF #1    9.11
4 33062      0 "1 "  0      # LOAD-DROP  SHLL CHM  60.00  LOAD==2.27(1.41)
4 33063      0 "1 "  0      # LOAD-DROP  WLLW PSS  60.00  LOAD==9.78(2.23)
4 33061      0 "1 "  0      # LOAD-DROP  PITTSBRG  60.00  LOAD==0.64(0.13)
4 33131      0 "SG"  0      # LOAD-DROP  GWF #1    9.11  LOAD==2.56(0.58)
3 33131      0 "1 "  0      # GEN-DROP   GWF #1    9.11  GEN==12.70(-2.78)
1 33091 33063 "1 "  1      # LINE-TRANSFER SHLL CHM  60.00  TO TAP GWF5  60.00
4 33063      0 "***" 1      # RESTORE WILLOW PASS load
0
#
#
# (207) B3 TRANSFORMER OUTAGE (BREAKER-TO-BREAKER)
#
2 32950 30526 "12"  0      # TRAN from PITTSBURG 115.00  BRKR to BRKR  PITSBG D 230.00
0
#
#
# (208) B3 TRANSFORMER OUTAGE (BREAKER-TO-BREAKER)
#
2 32950 30526 "13"  0      # TRAN from PITTSBURG 115.00  BRKR to BRKR  PITSBG D 230.00
0
#
#
# (209) B3 TRANSFORMER OUTAGE (BREAKER-TO-BREAKER)
#
2 32950 30526 "14"  0      # TRAN from PITTSBURG 115.00  BRKR to BRKR  PITSBG D 230.00
0
#
#
# (210) B3 TRANSFORMER OUTAGE (BREAKER-TO-BREAKER)
#
2 32990 33142 "2 "  0      # TRAN from MARTNZ D 115.00  BRKR to BRKR  SHELL 2  12.47
0
#
#
# (211) B3 TRANSFORMER OUTAGE (BREAKER-TO-BREAKER)
#
2 32991 33142 "1 "  0      # TRAN from MARTNZ E 115.00  BRKR to BRKR  SHELL 2  12.47
0
#
#
# (212) B3 TRANSFORMER OUTAGE (BREAKER-TO-BREAKER)
#
2 33000 30523 "3 "  0      # TRAN from CC SUB   115.00  BRKR to BRKR  CC SUB   230.00
0
#
#
# (213) B3 TRANSFORMER OUTAGE (BREAKER-TO-BREAKER)
#
2 33010 30540 "1 "  0      # TRAN from SOBRANTE 115.00  BRKR to BRKR  SOBRANTE 230.00
0
#
#
# (214) B3 TRANSFORMER OUTAGE (BREAKER-TO-BREAKER)
#
2 33010 30540 "2 "  0      # TRAN from SOBRANTE 115.00  BRKR to BRKR  SOBRANTE 230.00
0
#
#
# (215) B3 TRANSFORMER OUTAGE (BREAKER-TO-BREAKER)
#
# **** 3-WINDING TRANSFORMER 33020 (30551) 30550 33121 :
2 33020 30550 "1 "  0      # TRAN from MORAGA  115.00  BRKR to (1)  MORAGA  230.00
0
#
#
# (216) B3 TRANSFORMER OUTAGE (BREAKER-TO-BREAKER)
#
# **** 3-WINDING TRANSFORMER 33020 (30552) 30550 33122 :

```

APPENDIX B – CAISO CATEGORY B AUTOCON INPUT FILE

```

2 33020 30550 "2 " 0 # TRAN from MORAGA 115.00 BRKR to (1) MORAGA 230.00
0
#
#
# (217) B3 TRANSFORMER OUTAGE (BREAKER-TO-BREAKER)
#
# **** 3-WINDING TRANSFORMER 33020 (30553) 30550 33123 :
2 33020 30550 "3 " 0 # TRAN from MORAGA 115.00 BRKR to (1) MORAGA 230.00
0
#
#
# (218) B3 TRANSFORMER OUTAGE (BREAKER-TO-BREAKER)
#
2 33050 33000 "1 " 0 # TRAN from CC SUB 60.00 BRKR to BRKR CC SUB 115.00
0
#
#
# (219) B3 TRANSFORMER OUTAGE (BREAKER-TO-BREAKER)
#
2 33151 30535 "1 " 0 # TRAN from FOSTER W 12.47 BRKR to BRKR TIDEWATR 230.00
0
#
#
# (220) B3 TRANSFORMER OUTAGE (BREAKER-TO-BREAKER)
#
2 33151 30535 "2 " 0 # TRAN from FOSTER W 12.47 BRKR to BRKR TIDEWATR 230.00
0
#
#
# (221) B3 TRANSFORMER OUTAGE (BREAKER-TO-BREAKER)
#
3 38950 0 "1 " 0 # GEN-DROP VSC_PTSB 180.50 GEN== -413.00(-91.10)
3 38951 0 "1 " 0 # GEN-DROP VSC_POTR 180.50 GEN== 401.40(155.40)
0
#
#
# (222) B1 GENERATOR OUTAGE
#
3 33118 0 "1" 0 # GATEWAY1 18.00 PGEN=200.00 QGEN=-7.87
0
#
#
# (223) B1 GENERATOR OUTAGE
#
3 33118 0 "1" 0 # GATEWAY1 18.00 PGEN=200.00 QGEN=-7.87
3 33119 0 "1" 0 # GATEWAY2 18.00 PGEN=195.00 QGEN=-6.21
3 33120 0 "1" 0 # GATEWAY3 18.00 PGEN=195.00 QGEN=-6.21
0
#
#
# (224) B1 GENERATOR OUTAGE
#
3 33178 0 "1" 0 # RVEC_GEN 13.80 PGEN=50.00 QGEN=4.37
0
#
#
# (225) B1 GENERATOR OUTAGE
#
3 33107 0 "1" 0 # DEC STG1 24.00 PGEN=280.00 QGEN=81.62
3 33108 0 "1" 0 # DEC CTG1 18.00 PGEN=200.00 QGEN=58.29
3 33109 0 "1" 0 # DEC CTG2 18.00 PGEN=200.00 QGEN=58.29
3 33110 0 "1" 0 # DEC CTG3 18.00 PGEN=200.00 QGEN=58.29
0
#
#
# (226) B1 GENERATOR OUTAGE
#
3 33111 0 "1" 0 # LMECCT2 18.00 PGEN=150.00 QGEN=6.48
3 33112 0 "1" 0 # LMECCT1 18.00 PGEN=150.00 QGEN=6.48
3 33113 0 "1" 0 # LMECST1 18.00 PGEN=200.00 QGEN=10.61
0
#
#
# (227) B1 GENERATOR OUTAGE
#
3 33134 0 "1" 0 # GWF #4 13.80 PGEN=18.60 QGEN=3.72
0
#
#

```

APPENDIX B – CAISO CATEGORY B AUTOCON INPUT FILE

```

# (228) B1 GENERATOR OUTAGE
#
3 33141      0 "1"      0      # SHELL 1  12.47      PGEN=20.00  QGEN=2.12
0
#
#
# (229) B1 GENERATOR OUTAGE
#
3 33122      0 "1"      0      # MRAGA 2T  13.20      PGEN=0.00  QGEN=48.00
0
#
#
# (230) B1 GENERATOR OUTAGE
#
3 33123      0 "1"      0      # MRAGA 3T  13.20      PGEN=0.00  QGEN=41.53
0
#
#
# (231) B1 GENERATOR OUTAGE
#
3 33143      0 "1"      0      # SHELL 3   12.47      PGEN=40.00  QGEN=2.19
0
#
#
# (232) B1 GENERATOR OUTAGE
#
3 33121      0 "1"      0      # MRAGA 1T  13.20      PGEN=0.00  QGEN=48.00
0
#
#
# (233) B1 GENERATOR OUTAGE
#
3 33142      0 "1"      0      # SHELL 2   12.47      PGEN=40.00  QGEN=2.20
0
#
#
# (234) B1 GENERATOR OUTAGE
#
3 33132      0 "1"      0      # GWF #2    13.80      PGEN=12.30  QGEN=5.65
0
#
#
# (235) B1 GENERATOR OUTAGE
#
3 33116      0 "1"      0      # C.COS 6   18.00      PGEN=330.00 QGEN=145.77
0
#
#
# (236) B1 GENERATOR OUTAGE
#
3 33117      0 "1"      0      # C.COS 7   18.00      PGEN=330.00 QGEN=145.77
0
#
#
# (237) B1 GENERATOR OUTAGE
#
3 33105      0 "1"      0      # PTSB 5    18.00      PGEN=310.00 QGEN=122.68
0
#
#
# (238) B1 GENERATOR OUTAGE
#
3 33106      0 "1"      0      # PTSB 6    18.00      PGEN=310.00 QGEN=113.24
0
#
#
# (239) B1 GENERATOR OUTAGE
#
3 30000      0 "1"      0      # PTSB 7    20.00      PGEN=700.00 QGEN=219.50
0
#
#
# (240) B1 GENERATOR OUTAGE
#
3 33151      0 "1"      0      # FOSTER W  12.47      PGEN=45.40  QGEN=24.97
0
#
#
# (241) B1 GENERATOR OUTAGE

```

APPENDIX B – CAISO CATEGORY B AUTOCON INPUT FILE

```

#
3 33151      0  "2"      0      # FOSTER W  12.47      PGEN=45.40  QGEN=24.97
0
#
#
# (242) B1 GENERATOR OUTAGE
#
3 33151      0  "3"      0      # FOSTER W  12.47      PGEN=35.00  QGEN=21.00
0
#
#
# (243) B1 GENERATOR OUTAGE
#
3 33161      0  "1"      0      # DOWCHEM1  13.80      PGEN=15.30  QGEN=3.06
0
#
#
# (244) B1 GENERATOR OUTAGE
#
3 33133      0  "1"      0      # GWF #3    13.80      PGEN=19.00  QGEN=4.93
0
#
#
# (245) B1 GENERATOR OUTAGE
#
3 33139      0  "1"      0      # STAUFER   9.11       PGEN=2.00   QGEN=-1.00
0
#
#
# (246) B1 GENERATOR OUTAGE
#
3 33131      0  "1"      0      # GWF #1    9.11       PGEN=12.70  QGEN=-2.20
0
#
#
# (247) B1 GENERATOR OUTAGE
#
3 33135      0  "1"      0      # GWF #5    13.80      PGEN=18.90  QGEN=4.22
0
#
#
# (248) B1 GENERATOR OUTAGE
#
3 33162      0  "1"      0      # DOWCHEM2  13.80      PGEN=22.00  QGEN=8.00
0
#
#
# (249) B1 GENERATOR OUTAGE
#
3 33163      0  "1"      0      # DOWCHEM3  13.80      PGEN=22.00  QGEN=8.00
0
#
#
# (250) B1 GENERATOR OUTAGE
#
3 33136      0  "1"      0      # CCCSD     12.47      PGEN=4.40   QGEN=0.94
0
#
#
# (251) B1 GENERATOR OUTAGE
#
3 33181      0  "1"      0      # T258CT1   18.00      PGEN=222.00 QGEN=43.00
0
#
#
# (252) B1 GENERATOR OUTAGE
#
3 33183      0  "3"      0      # T258ST1   18.00      PGEN=228.00 QGEN=44.92
0
#
#
# (253) B1 GENERATOR OUTAGE
#
3 33188      0  "1"      0      # T320GT1   16.50      PGEN=193.50 QGEN=30.38
0
#
#
# (254) B1 GENERATOR OUTAGE
#

```

APPENDIX B – CAISO CATEGORY B AUTOCON INPUT FILE

```

3 33195      0 "1"      0      # T417      34.50      PGEN=42.10 QGEN=0.00
0
#
#
# (255) L-1/G-1 OVERLAPPING OUTAGE
# Lakeville - Sobrante #2 230 kV Line and DEC
1 30435 30540 "2 "      0      # line from LAKEVILLE 230.00 BRKR to BRKR SOBRANTE 230.00
#
3 33107      0 "1"      0      # DEC STG1 24.00      PGEN=280.00 QGEN=81.62
3 33108      0 "1"      0      # DEC CTG1 18.00      PGEN=200.00 QGEN=58.29
3 33109      0 "1"      0      # DEC CTG2 18.00      PGEN=200.00 QGEN=58.29
3 33110      0 "1"      0      # DEC CTG3 18.00      PGEN=200.00 QGEN=58.29
0
#
#
# (256) L-1/G-1 OVERLAPPING OUTAGE
# Ignacio - Sobrante 230 kV Line and DEC
1 30437 30445 "1 "      0      # line from CROCKETT 230.00 (3) to BRKR IGNACIO 230.00
1 30437 30438 "1 "      0      # line from CROCKETT 230.00 (3) to (2) C&H 230.00
1 30437 30540 "1 "      0      # line from CROCKETT 230.00 (3) to BRKR SOBRANTE 230.00
2 30438 32900 "1 "      0      # TRAN from C&H 230.00 BRKR to (1) CRCKTCOG 18.00
4 30438      0 "1"      0      # LOAD-DROP C&H 230.00 LOAD==3.32(0.76)
3 32900      0 "1"      0      # GEN-DROP CRCKTCOG 18.00 GEN==240.00(40.82)
#
3 33107      0 "1"      0      # DEC STG1 24.00      PGEN=280.00 QGEN=81.62
3 33108      0 "1"      0      # DEC CTG1 18.00      PGEN=200.00 QGEN=58.29
3 33109      0 "1"      0      # DEC CTG2 18.00      PGEN=200.00 QGEN=58.29
3 33110      0 "1"      0      # DEC CTG3 18.00      PGEN=200.00 QGEN=58.29
0
#
#
# (257) L-1/G-1 OVERLAPPING OUTAGE
# Bahia - Moraga 230 kV Line and DEC
1 30465 30550 "1 "      0      # line from BAHIA 230.00 BRKR to BRKR MORAGA 230.00
#
3 33107      0 "1"      0      # DEC STG1 24.00      PGEN=280.00 QGEN=81.62
3 33108      0 "1"      0      # DEC CTG1 18.00      PGEN=200.00 QGEN=58.29
3 33109      0 "1"      0      # DEC CTG2 18.00      PGEN=200.00 QGEN=58.29
3 33110      0 "1"      0      # DEC CTG3 18.00      PGEN=200.00 QGEN=58.29
0
#
#
# (258) L-1/G-1 OVERLAPPING OUTAGE
# Parkway - Moraga 230 kV Line and DEC
1 30467 30550 "1 "      0      # line from PARKWAY 230.00 BRKR to BRKR MORAGA 230.00
#
3 33107      0 "1"      0      # DEC STG1 24.00      PGEN=280.00 QGEN=81.62
3 33108      0 "1"      0      # DEC CTG1 18.00      PGEN=200.00 QGEN=58.29
3 33109      0 "1"      0      # DEC CTG2 18.00      PGEN=200.00 QGEN=58.29
3 33110      0 "1"      0      # DEC CTG3 18.00      PGEN=200.00 QGEN=58.29
0
#
#
# (259) L-1/G-1 OVERLAPPING OUTAGE
# Birds Landing - Contra Costa Sub 230 kV Line and DEC
1 30479 30523 "1 "      0      # line from BDLSWSTA 230.00 BRKR to BRKR CC SUB 230.00
#
3 33107      0 "1"      0      # DEC STG1 24.00      PGEN=280.00 QGEN=81.62
3 33108      0 "1"      0      # DEC CTG1 18.00      PGEN=200.00 QGEN=58.29
3 33109      0 "1"      0      # DEC CTG2 18.00      PGEN=200.00 QGEN=58.29
3 33110      0 "1"      0      # DEC CTG3 18.00      PGEN=200.00 QGEN=58.29
0
#
#
# (260) L-1/G-1 OVERLAPPING OUTAGE
# Contra Costa - Contra Costa Sub 230 kV Line and DEC
1 30523 30525 "1 "      0      # line from CC SUB 230.00 BRKR to BRKR C.COSTA 230.00
#
3 33107      0 "1"      0      # DEC STG1 24.00      PGEN=280.00 QGEN=81.62
3 33108      0 "1"      0      # DEC CTG1 18.00      PGEN=200.00 QGEN=58.29
3 33109      0 "1"      0      # DEC CTG2 18.00      PGEN=200.00 QGEN=58.29
3 33110      0 "1"      0      # DEC CTG3 18.00      PGEN=200.00 QGEN=58.29
0
#
#
# (261) L-1/G-1 OVERLAPPING OUTAGE
# Birds Landing - Contra Costa 230 kV Line and DEC
1 30525 30479 "1 "      0      # line from C.COSTA 230.00 BRKR to BRKR BDLSWSTA 230.00
#

```

APPENDIX B – CAISO CATEGORY B AUTOCON INPUT FILE

```

3 33107      0 "1"    0 # DEC STG1  24.00      PGEN=280.00 QGEN=81.62
3 33108      0 "1"    0 # DEC CTG1  18.00      PGEN=200.00 QGEN=58.29
3 33109      0 "1"    0 # DEC CTG2  18.00      PGEN=200.00 QGEN=58.29
3 33110      0 "1"    0 # DEC CTG3  18.00      PGEN=200.00 QGEN=58.29
0
#
#
# (262) L-1/G-1 OVERLAPPING OUTAGE
# Contra Costa - Moraga #1 230 kV Line and DEC
1 30525 30543 "1 "    0 # line from C.COSTA 230.00 BRKR to (3) ROSSTAP1 230.00
1 30543 30545 "1 "    0 # line from ROSSTAP1 230.00 (3) to BRKR ROSSMOOR 230.00
1 30543 30550 "1 "    0 # line from ROSSTAP1 230.00 (3) to BRKR MORAGA 230.00
4 30545      0 "1"    0 # LOAD-DROP ROSSMOOR 230.00 LOAD==36.95(8.42)
4 30545      0 "2"    0 # LOAD-DROP ROSSMOOR 230.00 LOAD==32.85(7.49)
1 30544 30545 "2 "    1 # LINE-TRANSFER ROSSTAP1 230.00 TO ROSSTAP2 230.00
4 30545      0 "***"  1 # RESTORE ROSSMOOR load
#
3 33107      0 "1"    0 # DEC STG1  24.00      PGEN=280.00 QGEN=81.62
3 33108      0 "1"    0 # DEC CTG1  18.00      PGEN=200.00 QGEN=58.29
3 33109      0 "1"    0 # DEC CTG2  18.00      PGEN=200.00 QGEN=58.29
3 33110      0 "1"    0 # DEC CTG3  18.00      PGEN=200.00 QGEN=58.29
0
#
#
# (263) L-1/G-1 OVERLAPPING OUTAGE
# Contra Costa - Moraga #2 230 kV Line and DEC
1 30525 30544 "2 "    0 # line from C.COSTA 230.00 BRKR to (2) ROSSTAP2 230.00
1 30544 30550 "2 "    0 # line from ROSSTAP2 230.00 (2) to BRKR MORAGA 230.00
#
3 33107      0 "1"    0 # DEC STG1  24.00      PGEN=280.00 QGEN=81.62
3 33108      0 "1"    0 # DEC CTG1  18.00      PGEN=200.00 QGEN=58.29
3 33109      0 "1"    0 # DEC CTG2  18.00      PGEN=200.00 QGEN=58.29
3 33110      0 "1"    0 # DEC CTG3  18.00      PGEN=200.00 QGEN=58.29
0
#
#
# (264) L-1/G-1 OVERLAPPING OUTAGE
# Contra Costa - Brentwood 230 kV Line and DEC
1 30525 30565 "1 "    0 # line from C.COSTA 230.00 BRKR to BRKR BRENTWOD 230.00
#
3 33107      0 "1"    0 # DEC STG1  24.00      PGEN=280.00 QGEN=81.62
3 33108      0 "1"    0 # DEC CTG1  18.00      PGEN=200.00 QGEN=58.29
3 33109      0 "1"    0 # DEC CTG2  18.00      PGEN=200.00 QGEN=58.29
3 33110      0 "1"    0 # DEC CTG3  18.00      PGEN=200.00 QGEN=58.29
0
#
#
# (265) L-1/G-1 OVERLAPPING OUTAGE
# Contra Costa - Lonetree 230 kV Line and DEC
1 30525 30567 "1 "    0 # line from C.COSTA 230.00 BRKR to BRKR LONETREE 230.00
#
3 33107      0 "1"    0 # DEC STG1  24.00      PGEN=280.00 QGEN=81.62
3 33108      0 "1"    0 # DEC CTG1  18.00      PGEN=200.00 QGEN=58.29
3 33109      0 "1"    0 # DEC CTG2  18.00      PGEN=200.00 QGEN=58.29
3 33110      0 "1"    0 # DEC CTG3  18.00      PGEN=200.00 QGEN=58.29
0
#
#
# (266) L-1/G-1 OVERLAPPING OUTAGE
# Contra Costa - Delta Pumps 230 kV Line and DEC
1 30525 30575 "1 "    0 # line from C.COSTA 230.00 BRKR to (3) WND MSTR 230.00
1 30575 38610 "1 "    0 # line from WND MSTR 230.00 (3) to BRKR DELTAPMP 230.00
2 30575 33170 "1 "    0 # TRAN from WND MSTR 230.00 (3) to (1) WINDMSTR 9.11
#
3 33107      0 "1"    0 # DEC STG1  24.00      PGEN=280.00 QGEN=81.62
3 33108      0 "1"    0 # DEC CTG1  18.00      PGEN=200.00 QGEN=58.29
3 33109      0 "1"    0 # DEC CTG2  18.00      PGEN=200.00 QGEN=58.29
3 33110      0 "1"    0 # DEC CTG3  18.00      PGEN=200.00 QGEN=58.29
0
#
#
# (267) L-1/G-1 OVERLAPPING OUTAGE
# Contra Costa - Las Positas 230 kV Line and DEC
1 30525 30585 "1 "    0 # line from C.COSTA 230.00 BRKR to BRKR LS PSTAS 230.00
#
3 33107      0 "1"    0 # DEC STG1  24.00      PGEN=280.00 QGEN=81.62
3 33108      0 "1"    0 # DEC CTG1  18.00      PGEN=200.00 QGEN=58.29
3 33109      0 "1"    0 # DEC CTG2  18.00      PGEN=200.00 QGEN=58.29
3 33110      0 "1"    0 # DEC CTG3  18.00      PGEN=200.00 QGEN=58.29

```

APPENDIX B – CAISO CATEGORY B AUTOCON INPUT FILE

```

0
#
#
# (268) L-1/G-1 OVERLAPPING OUTAGE
# Pittsburg - San Ramon 230 kV Line and DEC
1 30526 30555 "1 " 0 # line from PITSBG D 230.00 BRKR to BRKR SANRAMON 230.00
#
3 33107 0 "1" 0 # DEC STG1 24.00 PGEN=280.00 QGEN=81.62
3 33108 0 "1" 0 # DEC CTG1 18.00 PGEN=200.00 QGEN=58.29
3 33109 0 "1" 0 # DEC CTG2 18.00 PGEN=200.00 QGEN=58.29
3 33110 0 "1" 0 # DEC CTG3 18.00 PGEN=200.00 QGEN=58.29
0
#
#
# (269) L-1/G-1 OVERLAPPING OUTAGE
# Pittsburg - Tassajara 230 kV Line and DEC
1 30526 30561 "1 " 0 # line from PITSBG D 230.00 BRKR to BRKR TASSAJAR 230.00
#
3 33107 0 "1" 0 # DEC STG1 24.00 PGEN=280.00 QGEN=81.62
3 33108 0 "1" 0 # DEC CTG1 18.00 PGEN=200.00 QGEN=58.29
3 33109 0 "1" 0 # DEC CTG2 18.00 PGEN=200.00 QGEN=58.29
3 33110 0 "1" 0 # DEC CTG3 18.00 PGEN=200.00 QGEN=58.29
0
#
#
# (270) L-1/G-1 OVERLAPPING OUTAGE
# Pittsburg - Tidewater 230 kV Line and DEC
1 30527 30535 "1 " 0 # line from PITSBG E 230.00 BRKR to BRKR TIDEWATR 230.00
#
3 33107 0 "1" 0 # DEC STG1 24.00 PGEN=280.00 QGEN=81.62
3 33108 0 "1" 0 # DEC CTG1 18.00 PGEN=200.00 QGEN=58.29
3 33109 0 "1" 0 # DEC CTG2 18.00 PGEN=200.00 QGEN=58.29
3 33110 0 "1" 0 # DEC CTG3 18.00 PGEN=200.00 QGEN=58.29
0
#
#
# (271) L-1/G-1 OVERLAPPING OUTAGE
# Pittsburg - Tesoro 230 kV Line and DEC
1 30527 30536 "1 " 0 # line from PITSBG E 230.00 BRKR to BRKR TESORO 230.00
#
3 33107 0 "1" 0 # DEC STG1 24.00 PGEN=280.00 QGEN=81.62
3 33108 0 "1" 0 # DEC CTG1 18.00 PGEN=200.00 QGEN=58.29
3 33109 0 "1" 0 # DEC CTG2 18.00 PGEN=200.00 QGEN=58.29
3 33110 0 "1" 0 # DEC CTG3 18.00 PGEN=200.00 QGEN=58.29
0
#
#
# (272) L-1/G-1 OVERLAPPING OUTAGE
# Pittsburg - Tesla #1 230 kV Line and DEC
1 30527 30595 "1 " 0 # line from PITSBG E 230.00 BRKR to (3) FLOWIND2 230.00
1 30595 30640 "1 " 0 # line from FLOWIND2 230.00 (3) to BRKR TESLA C 230.00
2 30595 33840 "1 " 0 # TRAN from FLOWIND2 230.00 (3) to (1) FLOWD3-6 9.11
4 33840 0 "SG" 0 # LOAD-DROP FLOWD3-6 9.11 LOAD==0.70(0.34)
3 33840 0 "1 " 0 # GEN-DROP FLOWD3-6 9.11 GEN==1.30(0.00)
3 33840 0 "4 " 0 # GEN-DROP FLOWD3-6 9.11 GEN==1.10(0.00)
#
3 33107 0 "1" 0 # DEC STG1 24.00 PGEN=280.00 QGEN=81.62
3 33108 0 "1" 0 # DEC CTG1 18.00 PGEN=200.00 QGEN=58.29
3 33109 0 "1" 0 # DEC CTG2 18.00 PGEN=200.00 QGEN=58.29
3 33110 0 "1" 0 # DEC CTG3 18.00 PGEN=200.00 QGEN=58.29
0
#
#
# (273) L-1/G-1 OVERLAPPING OUTAGE
# Pittsburg - Tesla #2 230 kV Line and DEC pre and post-project outage
1 30527 30600 "2 " 0 # line from PITSBG E 230.00 BRKR to (4) TRES VAQ 230.00
1 30600 30640 "2 " 0 # line from TRES VAQ 230.00 (4) to BRKR TESLA C 230.00
2 30600 33195 "1 " 0 # TRAN from TRES VAQ 230.00 (4) to (1) T417 34.50
4 33195 0 "ss" 0 # LOAD-DROP T417 34.50 LOAD==0.10(0.06)
3 33195 0 "1 " 0 # GEN-DROP T417 34.50 GEN==42.10(0.00)
#
3 33107 0 "1" 0 # DEC STG1 24.00 PGEN=280.00 QGEN=81.62
3 33108 0 "1" 0 # DEC CTG1 18.00 PGEN=200.00 QGEN=58.29
3 33109 0 "1" 0 # DEC CTG2 18.00 PGEN=200.00 QGEN=58.29
3 33110 0 "1" 0 # DEC CTG3 18.00 PGEN=200.00 QGEN=58.29
0
#
#
# (274) L-1/G-1 OVERLAPPING OUTAGE

```

APPENDIX B – CAISO CATEGORY B AUTOCON INPUT FILE

```

# Tidewater - Sobrante 230 kV Line and DEC
1 30535 30540 "1 " 0 # line from TIDEWATR 230.00 BRKR to BRKR SOBRANTE 230.00
#
3 33107 0 "1" 0 # DEC STG1 24.00 PGEN=280.00 QGEN=81.62
3 33108 0 "1" 0 # DEC CTG1 18.00 PGEN=200.00 QGEN=58.29
3 33109 0 "1" 0 # DEC CTG2 18.00 PGEN=200.00 QGEN=58.29
3 33110 0 "1" 0 # DEC CTG3 18.00 PGEN=200.00 QGEN=58.29
0
#
#
# (275) L-1/G-1 OVERLAPPING OUTAGE
# Tesoro - Sobrante 230 kV Line and DEC
1 30536 30540 "1 " 0 # line from TESORO 230.00 BRKR to BRKR SOBRANTE 230.00
#
3 33107 0 "1" 0 # DEC STG1 24.00 PGEN=280.00 QGEN=81.62
3 33108 0 "1" 0 # DEC CTG1 18.00 PGEN=200.00 QGEN=58.29
3 33109 0 "1" 0 # DEC CTG2 18.00 PGEN=200.00 QGEN=58.29
3 33110 0 "1" 0 # DEC CTG3 18.00 PGEN=200.00 QGEN=58.29
0
#
#
# (276) L-1/G-1 OVERLAPPING OUTAGE
# Moraga - Castro Valley 230 kV Line and DEC
1 30550 30554 "1 " 0 # line from MORAGA 230.00 BRKR to BRKR CASTROVL 230.00
#
3 33107 0 "1" 0 # DEC STG1 24.00 PGEN=280.00 QGEN=81.62
3 33108 0 "1" 0 # DEC CTG1 18.00 PGEN=200.00 QGEN=58.29
3 33109 0 "1" 0 # DEC CTG2 18.00 PGEN=200.00 QGEN=58.29
3 33110 0 "1" 0 # DEC CTG3 18.00 PGEN=200.00 QGEN=58.29
0
#
#
# (277) L-1/G-1 OVERLAPPING OUTAGE
# Moraga - San Ramon 230 kV Line and DEC
1 30550 30555 "1 " 0 # line from MORAGA 230.00 BRKR to BRKR SANRAMON 230.00
#
3 33107 0 "1" 0 # DEC STG1 24.00 PGEN=280.00 QGEN=81.62
3 33108 0 "1" 0 # DEC CTG1 18.00 PGEN=200.00 QGEN=58.29
3 33109 0 "1" 0 # DEC CTG2 18.00 PGEN=200.00 QGEN=58.29
3 33110 0 "1" 0 # DEC CTG3 18.00 PGEN=200.00 QGEN=58.29
0
#
#
# (278) L-1/G-1 OVERLAPPING OUTAGE
# Pittsburg - East Shore 230 kV Line and DEC
1 30560 30527 "1 " 0 # line from E. SHORE 230.00 BRKR to BRKR PITSBG E 230.00
#
3 33107 0 "1" 0 # DEC STG1 24.00 PGEN=280.00 QGEN=81.62
3 33108 0 "1" 0 # DEC CTG1 18.00 PGEN=200.00 QGEN=58.29
3 33109 0 "1" 0 # DEC CTG2 18.00 PGEN=200.00 QGEN=58.29
3 33110 0 "1" 0 # DEC CTG3 18.00 PGEN=200.00 QGEN=58.29
0
#
#
# (279) L-1/G-1 OVERLAPPING OUTAGE
# Tassajara - Newark 230 kV Line and DEC
1 30561 30562 "1 " 0 # line from TASSAJAR 230.00 BRKR to (3) TES JCT 230.00
1 30562 30563 "1 " 0 # line from TES JCT 230.00 (3) to BRKR RESEARCH 230.00
1 30562 30631 "1 " 0 # line from TES JCT 230.00 (3) to BRKR NEWARK E 230.00
4 30563 0 "1 " 0 # LOAD-DROP RESEARCH 230.00 LOAD==37.05(8.44)
#
3 33107 0 "1" 0 # DEC STG1 24.00 PGEN=280.00 QGEN=81.62
3 33108 0 "1" 0 # DEC CTG1 18.00 PGEN=200.00 QGEN=58.29
3 33109 0 "1" 0 # DEC CTG2 18.00 PGEN=200.00 QGEN=58.29
3 33110 0 "1" 0 # DEC CTG3 18.00 PGEN=200.00 QGEN=58.29
0
#
#
# (280) L-1/G-1 OVERLAPPING OUTAGE
# Brentwood - Kelso 230 kV Line and DEC
1 30565 30569 "1 " 0 # line from BRENTWOD 230.00 BRKR to BRKR KELSO 230.00
#
3 33107 0 "1" 0 # DEC STG1 24.00 PGEN=280.00 QGEN=81.62
3 33108 0 "1" 0 # DEC CTG1 18.00 PGEN=200.00 QGEN=58.29
3 33109 0 "1" 0 # DEC CTG2 18.00 PGEN=200.00 QGEN=58.29
3 33110 0 "1" 0 # DEC CTG3 18.00 PGEN=200.00 QGEN=58.29
0
#
#

```

APPENDIX B – CAISO CATEGORY B AUTOCON INPUT FILE

```

# (281) L-1/G-1 OVERLAPPING OUTAGE
# Lonetree - Cayetano 230 kV Line and DEC
1 30567 30590 "1 " 0 # line from LONETREE 230.00 BRKR to (3) USWP-JRW 230.00
1 30590 30530 "1 " 0 # line from USWP-JRW 230.00 (3) to BRKR CAYETANO 230.00
2 30590 33838 "1 " 0 # TRAN from USWP-JRW 230.00 (3) to (1) USWP_#3 9.11
4 33838 0 "SG" 0 # LOAD-DROP USWP_#3 9.11 LOAD==0.50(0.20)
#
3 33107 0 "1" 0 # DEC STG1 24.00 PGEN=280.00 QGEN=81.62
3 33108 0 "1" 0 # DEC CTG1 18.00 PGEN=200.00 QGEN=58.29
3 33109 0 "1" 0 # DEC CTG2 18.00 PGEN=200.00 QGEN=58.29
3 33110 0 "1" 0 # DEC CTG3 18.00 PGEN=200.00 QGEN=58.29
0
#
#
# (282) L-1/G-1 OVERLAPPING OUTAGE
# Pittsburg - San Mateo 230 kV Line and DEC
1 30700 30527 "1 " 0 # line from SANMATEO 230.00 BRKR to BRKR PITSBG E 230.00
#
3 33107 0 "1" 0 # DEC STG1 24.00 PGEN=280.00 QGEN=81.62
3 33108 0 "1" 0 # DEC CTG1 18.00 PGEN=200.00 QGEN=58.29
3 33109 0 "1" 0 # DEC CTG2 18.00 PGEN=200.00 QGEN=58.29
3 33110 0 "1" 0 # DEC CTG3 18.00 PGEN=200.00 QGEN=58.29
0
#
#
# (283) L-1/G-1 OVERLAPPING OUTAGE
# Lakeville - Sobrante #2 230 kV Line and Gateway PP
1 30435 30540 "2 " 0 # line from LAKEVILLE 230.00 BRKR to BRKR SOBRANTE 230.00
#
3 33118 0 "1" 0 # GATEWAY1 18.00 PGEN=200.00 QGEN=-7.87
3 33119 0 "1" 0 # GATEWAY2 18.00 PGEN=195.00 QGEN=-6.21
3 33120 0 "1" 0 # GATEWAY3 18.00 PGEN=195.00 QGEN=-6.21
0
#
#
# (284) L-1/G-1 OVERLAPPING OUTAGE
# Ignacio - Sobrante 230 kV Line and Gateway PP
1 30437 30445 "1 " 0 # line from CROCKETT 230.00 (3) to BRKR IGNACIO 230.00
1 30437 30438 "1 " 0 # line from CROCKETT 230.00 (3) to (2) C&H 230.00
1 30437 30540 "1 " 0 # line from CROCKETT 230.00 (3) to BRKR SOBRANTE 230.00
2 30438 32900 "1 " 0 # TRAN from C&H 230.00 BRKR to (1) CRCKTCOG 18.00
4 30438 0 "1 " 0 # LOAD-DROP C&H 230.00 LOAD==3.32(0.76)
3 32900 0 "1 " 0 # GEN-DROP CRCKTCOG 18.00 GEN==240.00(40.82)
#
3 33118 0 "1" 0 # GATEWAY1 18.00 PGEN=200.00 QGEN=-7.87
3 33119 0 "1" 0 # GATEWAY2 18.00 PGEN=195.00 QGEN=-6.21
3 33120 0 "1" 0 # GATEWAY3 18.00 PGEN=195.00 QGEN=-6.21
0
#
#
# (285) L-1/G-1 OVERLAPPING OUTAGE
# Bahia - Moraga 230 kV Line and Gateway PP
1 30465 30550 "1 " 0 # line from BAHIA 230.00 BRKR to BRKR MORAGA 230.00
#
3 33118 0 "1" 0 # GATEWAY1 18.00 PGEN=200.00 QGEN=-7.87
3 33119 0 "1" 0 # GATEWAY2 18.00 PGEN=195.00 QGEN=-6.21
3 33120 0 "1" 0 # GATEWAY3 18.00 PGEN=195.00 QGEN=-6.21
0
#
#
# (286) L-1/G-1 OVERLAPPING OUTAGE
# Parkway - Moraga 230 kV Line and Gateway PP
1 30467 30550 "1 " 0 # line from PARKWAY 230.00 BRKR to BRKR MORAGA 230.00
#
3 33118 0 "1" 0 # GATEWAY1 18.00 PGEN=200.00 QGEN=-7.87
3 33119 0 "1" 0 # GATEWAY2 18.00 PGEN=195.00 QGEN=-6.21
3 33120 0 "1" 0 # GATEWAY3 18.00 PGEN=195.00 QGEN=-6.21
0
#
#
# (287) L-1/G-1 OVERLAPPING OUTAGE
# Birds Landing - Contra Costa Sub 230 kV Line and Gateway PP
1 30479 30523 "1 " 0 # line from BDLSWSTA 230.00 BRKR to BRKR CC SUB 230.00
#
3 33118 0 "1" 0 # GATEWAY1 18.00 PGEN=200.00 QGEN=-7.87
3 33119 0 "1" 0 # GATEWAY2 18.00 PGEN=195.00 QGEN=-6.21
3 33120 0 "1" 0 # GATEWAY3 18.00 PGEN=195.00 QGEN=-6.21
0
#

```

APPENDIX B – CAISO CATEGORY B AUTOCON INPUT FILE

```

#
# (288) L-1/G-1 OVERLAPPING OUTAGE
# Contra Costa - Contra Costa Sub 230 kV Line and Gateway PP
1 30523 30525 "1 " 0 # line from CC SUB 230.00 BRKR to BRKR C.COSTA 230.00
#
3 33118 0 "1" 0 # GATEWAY1 18.00 PGEN=200.00 QGEN=-7.87
3 33119 0 "1" 0 # GATEWAY2 18.00 PGEN=195.00 QGEN=-6.21
3 33120 0 "1" 0 # GATEWAY3 18.00 PGEN=195.00 QGEN=-6.21
0
#
#
# (289) L-1/G-1 OVERLAPPING OUTAGE
# Birds Landing - Contra Costa 230 kV Line and Gateway PP
1 30525 30479 "1 " 0 # line from C.COSTA 230.00 BRKR to BRKR BDLSWSTA 230.00
#
3 33118 0 "1" 0 # GATEWAY1 18.00 PGEN=200.00 QGEN=-7.87
3 33119 0 "1" 0 # GATEWAY2 18.00 PGEN=195.00 QGEN=-6.21
3 33120 0 "1" 0 # GATEWAY3 18.00 PGEN=195.00 QGEN=-6.21
0
#
#
# (290) L-1/G-1 OVERLAPPING OUTAGE
# Contra Costa - Moraga #1 230 kV Line and Gateway PP
1 30525 30543 "1 " 0 # line from C.COSTA 230.00 BRKR to (3) ROSSTAP1 230.00
1 30543 30545 "1 " 0 # line from ROSSTAP1 230.00 (3) to BRKR ROSSMOOR 230.00
1 30543 30550 "1 " 0 # line from ROSSTAP1 230.00 (3) to BRKR MORAGA 230.00
4 30545 0 "1 " 0 # LOAD-DROP ROSSMOOR 230.00 LOAD==36.95(8.42)
4 30545 0 "2 " 0 # LOAD-DROP ROSSMOOR 230.00 LOAD==32.85(7.49)
1 30544 30545 "2 " 1 # LINE-TRANSFER ROSSTAP1 230.00 TO ROSSTAP2 230.00
4 30545 0 "***" 1 # RESTORE ROSSMOOR load
#
3 33118 0 "1" 0 # GATEWAY1 18.00 PGEN=200.00 QGEN=-7.87
3 33119 0 "1" 0 # GATEWAY2 18.00 PGEN=195.00 QGEN=-6.21
3 33120 0 "1" 0 # GATEWAY3 18.00 PGEN=195.00 QGEN=-6.21
0
#
#
# (291) L-1/G-1 OVERLAPPING OUTAGE
# Contra Costa - Moraga #2 230 kV Line and Gateway PP
1 30525 30544 "2 " 0 # line from C.COSTA 230.00 BRKR to (2) ROSSTAP2 230.00
1 30544 30550 "2 " 0 # line from ROSSTAP2 230.00 (2) to BRKR MORAGA 230.00
#
3 33118 0 "1" 0 # GATEWAY1 18.00 PGEN=200.00 QGEN=-7.87
3 33119 0 "1" 0 # GATEWAY2 18.00 PGEN=195.00 QGEN=-6.21
3 33120 0 "1" 0 # GATEWAY3 18.00 PGEN=195.00 QGEN=-6.21
0
#
#
# (292) L-1/G-1 OVERLAPPING OUTAGE
# Contra Costa - Brentwood 230 kV Line and Gateway PP
1 30525 30565 "1 " 0 # line from C.COSTA 230.00 BRKR to BRKR BRENTWOD 230.00
#
3 33118 0 "1" 0 # GATEWAY1 18.00 PGEN=200.00 QGEN=-7.87
3 33119 0 "1" 0 # GATEWAY2 18.00 PGEN=195.00 QGEN=-6.21
3 33120 0 "1" 0 # GATEWAY3 18.00 PGEN=195.00 QGEN=-6.21
0
#
#
# (293) L-1/G-1 OVERLAPPING OUTAGE
# Contra Costa - Lonetree 230 kV Line and Gateway PP
1 30525 30567 "1 " 0 # line from C.COSTA 230.00 BRKR to BRKR LONETREE 230.00
#
3 33118 0 "1" 0 # GATEWAY1 18.00 PGEN=200.00 QGEN=-7.87
3 33119 0 "1" 0 # GATEWAY2 18.00 PGEN=195.00 QGEN=-6.21
3 33120 0 "1" 0 # GATEWAY3 18.00 PGEN=195.00 QGEN=-6.21
0
#
#
# (294) L-1/G-1 OVERLAPPING OUTAGE
# Contra Costa - Delta Pumps 230 kV Line and Gateway PP
1 30525 30575 "1 " 0 # line from C.COSTA 230.00 BRKR to (3) WND MSTR 230.00
1 30575 38610 "1 " 0 # line from WND MSTR 230.00 (3) to BRKR DELTAPMP 230.00
2 30575 33170 "1 " 0 # TRAN from WND MSTR 230.00 (3) to (1) WINDMSTR 9.11
#
3 33118 0 "1" 0 # GATEWAY1 18.00 PGEN=200.00 QGEN=-7.87
3 33119 0 "1" 0 # GATEWAY2 18.00 PGEN=195.00 QGEN=-6.21
3 33120 0 "1" 0 # GATEWAY3 18.00 PGEN=195.00 QGEN=-6.21
0
#

```

APPENDIX B – CAISO CATEGORY B AUTOCON INPUT FILE

```

#
# (295) L-1/G-1 OVERLAPPING OUTAGE
# Contra Costa - Las Positas 230 kV Line and Gateway PP
1 30525 30585 "1 " 0 # line from C.COSTA 230.00 BRKR to BRKR LS PSTAS 230.00
#
3 33118 0 "1" 0 # GATEWAY1 18.00 PGEN=200.00 QGEN=-7.87
3 33119 0 "1" 0 # GATEWAY2 18.00 PGEN=195.00 QGEN=-6.21
3 33120 0 "1" 0 # GATEWAY3 18.00 PGEN=195.00 QGEN=-6.21
0
#
#
# (296) L-1/G-1 OVERLAPPING OUTAGE
# Pittsburg - San Ramon 230 kV Line and Gateway PP
1 30526 30555 "1 " 0 # line from PITSBG D 230.00 BRKR to BRKR SANRAMON 230.00
#
3 33118 0 "1" 0 # GATEWAY1 18.00 PGEN=200.00 QGEN=-7.87
3 33119 0 "1" 0 # GATEWAY2 18.00 PGEN=195.00 QGEN=-6.21
3 33120 0 "1" 0 # GATEWAY3 18.00 PGEN=195.00 QGEN=-6.21
0
#
#
# (297) L-1/G-1 OVERLAPPING OUTAGE
# Pittsburg - Tassajara 230 kV Line and Gateway PP
1 30526 30561 "1 " 0 # line from PITSBG D 230.00 BRKR to BRKR TASSAJAR 230.00
#
3 33118 0 "1" 0 # GATEWAY1 18.00 PGEN=200.00 QGEN=-7.87
3 33119 0 "1" 0 # GATEWAY2 18.00 PGEN=195.00 QGEN=-6.21
3 33120 0 "1" 0 # GATEWAY3 18.00 PGEN=195.00 QGEN=-6.21
0
#
#
# (298) L-1/G-1 OVERLAPPING OUTAGE
# Pittsburg - Tidewater 230 kV Line and Gateway PP
1 30527 30535 "1 " 0 # line from PITSBG E 230.00 BRKR to BRKR TIDEWATR 230.00
#
3 33118 0 "1" 0 # GATEWAY1 18.00 PGEN=200.00 QGEN=-7.87
3 33119 0 "1" 0 # GATEWAY2 18.00 PGEN=195.00 QGEN=-6.21
3 33120 0 "1" 0 # GATEWAY3 18.00 PGEN=195.00 QGEN=-6.21
0
#
#
# (299) L-1/G-1 OVERLAPPING OUTAGE
# Pittsburg - Tesoro 230 kV Line and Gateway PP
1 30527 30536 "1 " 0 # line from PITSBG E 230.00 BRKR to BRKR TESORO 230.00
#
3 33118 0 "1" 0 # GATEWAY1 18.00 PGEN=200.00 QGEN=-7.87
3 33119 0 "1" 0 # GATEWAY2 18.00 PGEN=195.00 QGEN=-6.21
3 33120 0 "1" 0 # GATEWAY3 18.00 PGEN=195.00 QGEN=-6.21
0
#
#
# (300) L-1/G-1 OVERLAPPING OUTAGE
# Pittsburg - Tesla #1 230 kV Line and Gateway PP
1 30527 30595 "1 " 0 # line from PITSBG E 230.00 BRKR to (3) FLOWIND2 230.00
1 30595 30640 "1 " 0 # line from FLOWIND2 230.00 (3) to BRKR TESLA C 230.00
2 30595 33840 "1 " 0 # TRAN from FLOWIND2 230.00 (3) to (1) FLOWD3-6 9.11
4 33840 0 "SG" 0 # LOAD-DROP FLOWD3-6 9.11 LOAD==0.70(0.34)
3 33840 0 "1 " 0 # GEN-DROP FLOWD3-6 9.11 GEN==1.30(0.00)
3 33840 0 "4 " 0 # GEN-DROP FLOWD3-6 9.11 GEN==1.10(0.00)
#
3 33118 0 "1" 0 # GATEWAY1 18.00 PGEN=200.00 QGEN=-7.87
3 33119 0 "1" 0 # GATEWAY2 18.00 PGEN=195.00 QGEN=-6.21
3 33120 0 "1" 0 # GATEWAY3 18.00 PGEN=195.00 QGEN=-6.21
0
#
#
# (301) L-1/G-1 OVERLAPPING OUTAGE
# Pittsburg - Tesla #2 230 kV Line and Gateway PP pre and post-project outage
1 30527 30600 "2 " 0 # line from PITSBG E 230.00 BRKR to (4) TRES VAQ 230.00
1 30600 30640 "2 " 0 # line from TRES VAQ 230.00 (4) to BRKR TESLA C 230.00
2 30600 33195 "1 " 0 # TRAN from TRES VAQ 230.00 (4) to (1) T417 34.50
4 33195 0 "ss" 0 # LOAD-DROP T417 34.50 LOAD==0.10(0.06)
3 33195 0 "1 " 0 # GEN-DROP T417 34.50 GEN==42.10(0.00)
#
3 33118 0 "1" 0 # GATEWAY1 18.00 PGEN=200.00 QGEN=-7.87
3 33119 0 "1" 0 # GATEWAY2 18.00 PGEN=195.00 QGEN=-6.21
3 33120 0 "1" 0 # GATEWAY3 18.00 PGEN=195.00 QGEN=-6.21
0
#

```

APPENDIX B – CAISO CATEGORY B AUTOCON INPUT FILE

```

#
# (302) L-1/G-1 OVERLAPPING OUTAGE
# Tidewater - Sobrante 230 kV Line and Gateway PP
1 30535 30540 "1 " 0 # line from TIDEWATR 230.00 BRKR to BRKR SOBRANTE 230.00
#
3 33118 0 "1" 0 # GATEWAY1 18.00 PGEN=200.00 QGEN=-7.87
3 33119 0 "1" 0 # GATEWAY2 18.00 PGEN=195.00 QGEN=-6.21
3 33120 0 "1" 0 # GATEWAY3 18.00 PGEN=195.00 QGEN=-6.21
0
#
#
# (303) L-1/G-1 OVERLAPPING OUTAGE
# Tesoro - Sobrante 230 kV Line and Gateway PP
1 30536 30540 "1 " 0 # line from TESORO 230.00 BRKR to BRKR SOBRANTE 230.00
#
3 33118 0 "1" 0 # GATEWAY1 18.00 PGEN=200.00 QGEN=-7.87
3 33119 0 "1" 0 # GATEWAY2 18.00 PGEN=195.00 QGEN=-6.21
3 33120 0 "1" 0 # GATEWAY3 18.00 PGEN=195.00 QGEN=-6.21
0
#
#
# (304) L-1/G-1 OVERLAPPING OUTAGE
# Moraga - Castro Valley 230 kV Line and Gateway PP
1 30550 30554 "1 " 0 # line from MORAGA 230.00 BRKR to BRKR CASTROVL 230.00
#
3 33118 0 "1" 0 # GATEWAY1 18.00 PGEN=200.00 QGEN=-7.87
3 33119 0 "1" 0 # GATEWAY2 18.00 PGEN=195.00 QGEN=-6.21
3 33120 0 "1" 0 # GATEWAY3 18.00 PGEN=195.00 QGEN=-6.21
0
#
#
# (305) L-1/G-1 OVERLAPPING OUTAGE
# Moraga - San Ramon 230 kV Line and Gateway PP
1 30550 30555 "1 " 0 # line from MORAGA 230.00 BRKR to BRKR SANRAMON 230.00
#
3 33118 0 "1" 0 # GATEWAY1 18.00 PGEN=200.00 QGEN=-7.87
3 33119 0 "1" 0 # GATEWAY2 18.00 PGEN=195.00 QGEN=-6.21
3 33120 0 "1" 0 # GATEWAY3 18.00 PGEN=195.00 QGEN=-6.21
0
#
#
# (306) L-1/G-1 OVERLAPPING OUTAGE
# Pittsburg - East Shore 230 kV Line and Gateway PP
1 30560 30527 "1 " 0 # line from E. SHORE 230.00 BRKR to BRKR PITSBG E 230.00
#
3 33118 0 "1" 0 # GATEWAY1 18.00 PGEN=200.00 QGEN=-7.87
3 33119 0 "1" 0 # GATEWAY2 18.00 PGEN=195.00 QGEN=-6.21
3 33120 0 "1" 0 # GATEWAY3 18.00 PGEN=195.00 QGEN=-6.21
0
#
#
# (307) L-1/G-1 OVERLAPPING OUTAGE
# Tassajara - Newark 230 kV Line and Gateway PP
1 30561 30562 "1 " 0 # line from TASSAJAR 230.00 BRKR to (3) TES JCT 230.00
1 30562 30563 "1 " 0 # line from TES JCT 230.00 (3) to BRKR RESEARCH 230.00
1 30562 30631 "1 " 0 # line from TES JCT 230.00 (3) to BRKR NEWARK E 230.00
4 30563 0 "1 " 0 # LOAD-DROP RESEARCH 230.00 LOAD==37.05(8.44)
#
3 33118 0 "1" 0 # GATEWAY1 18.00 PGEN=200.00 QGEN=-7.87
3 33119 0 "1" 0 # GATEWAY2 18.00 PGEN=195.00 QGEN=-6.21
3 33120 0 "1" 0 # GATEWAY3 18.00 PGEN=195.00 QGEN=-6.21
0
#
#
# (308) L-1/G-1 OVERLAPPING OUTAGE
# Brentwood - Kelso 230 kV Line and Gateway PP
1 30565 30569 "1 " 0 # line from BRENTWOD 230.00 BRKR to BRKR KELSO 230.00
#
3 33118 0 "1" 0 # GATEWAY1 18.00 PGEN=200.00 QGEN=-7.87
3 33119 0 "1" 0 # GATEWAY2 18.00 PGEN=195.00 QGEN=-6.21
3 33120 0 "1" 0 # GATEWAY3 18.00 PGEN=195.00 QGEN=-6.21
0
#
#
# (309) L-1/G-1 OVERLAPPING OUTAGE
# Lonetree - Cayetano 230 kV Line and Gateway PP
1 30567 30590 "1 " 0 # line from LONETREE 230.00 BRKR to (3) USWP-JRW 230.00
1 30590 30530 "1 " 0 # line from USWP-JRW 230.00 (3) to BRKR CAYETANO 230.00
2 30590 33838 "1 " 0 # TRAN from USWP-JRW 230.00 (3) to (1) USWP_#3 9.11

```

APPENDIX B – CAISO CATEGORY B AUTOCON INPUT FILE

```

4 33838      0 "SG"      0      # LOAD-DROP      USWP_#3      9.11      LOAD==0.50(0.20)
#
3 33118      0 "1"        0      # GATEWAY1      18.00      PGEN=200.00      QGEN=-7.87
3 33119      0 "1"        0      # GATEWAY2      18.00      PGEN=195.00      QGEN=-6.21
3 33120      0 "1"        0      # GATEWAY3      18.00      PGEN=195.00      QGEN=-6.21
0
#
#
# (310) L-1/G-1 OVERLAPPING OUTAGE
# Pittsburg - San Mateo 230 kV Line and Gateway PP
1 30700 30527 "1 "      0      # line from      SANMATEO 230.00      BRKR to BRKR      PITSBG E 230.00
#
3 33118      0 "1"        0      # GATEWAY1      18.00      PGEN=200.00      QGEN=-7.87
3 33119      0 "1"        0      # GATEWAY2      18.00      PGEN=195.00      QGEN=-6.21
3 33120      0 "1"        0      # GATEWAY3      18.00      PGEN=195.00      QGEN=-6.21
0
#
#
# 2013 category b contingency list
# San Francisco Division Zone 309
#
#
# (311) B2 LINE OUTAGE (BREAKER-TO-BREAKER)
#
1 30695 30685 "2 "      0      # line from      MARTIN C 230.00      BRKR to BRKR      EMBRCDRD 230.00
4 30685      0 "1 "      0      # LOAD-DROP      EMBRCDRD 230.00      LOAD==64.01(11.21)
4 30685      0 "2 "      0      # LOAD-DROP      EMBRCDRD 230.00      LOAD==71.45(12.52)
1 30685 30690 "1 "      1      # LINE-TRANSFER MARTIN C to EMBRCDRD
4 30685      0 "***"    1      # RESTORE EMBRCDRD load
0
#
#
# (312) B2 LINE OUTAGE (BREAKER-TO-BREAKER)
#
1 30695 30690 "1 "      0      # line from      MARTIN C 230.00      BRKR to BRKR      EMBRCDRD 230.00
4 30690      0 "3 "      0      # LOAD-DROP      EMBRCDRD 230.00      LOAD==71.45(12.52)
4 30690      0 "5 "      0      # LOAD-DROP      EMBRCDRD 230.00      LOAD==64.01(11.21)
1 30690 30685 "1 "      1      # LINE-TRANSFER MARTIN C to EMBRCDRD
4 30690      0 "***"    1      # RESTORE EMBRCDRD load
0
#
#
# (313) B2 LINE OUTAGE (BREAKER-TO-BREAKER)
#
1 30696 30695 "1 "      0      # line from      MRT RCTR 230.00      (2) to BRKR      MARTIN C 230.00
1 30696 30717 "1 "      0      # line from      MRT RCTR 230.00      (2) to (2)      TRAN230B 230.00
1 30717 30716 "1 "      0      # line from      TRAN230B 230.00      (2) to (2)      TRAN230A 230.00
1 30716 30714 "1 "      0      # line from      TRAN230A 230.00      (2) to (2)      JMDAMCX2 230.00
1 30714 30713 "1 "      0      # line from      JMDAMCX2 230.00      (2) to (2)      JMDAMCX1 230.00
1 30713 30715 "1 "      0      # line from      JMDAMCX1 230.00      (2) to BRKR      JEFFERSN 230.00
0
#
#
# (314) B2 LINE OUTAGE (BREAKER-TO-BREAKER)
#
1 30700 30695 "1 "      0      # line from      SANMATEO 230.00      BRKR to BRKR      MARTIN C 230.00
0
#
#
# (315) B2 LINE OUTAGE (BREAKER-TO-BREAKER)
#
1 33200 33204 "1 "      0      # line from      LARKIN D 115.00      (3) to BRKR      POTRERO 115.00
2 33200 33218 "1 "      0      # TRAN from      LARKIN D 115.00      (3) to BRKR      LARKIN 1 12.00
2 33200 33219 "2 "      0      # TRAN from      LARKIN D 115.00      (3) to BRKR      LARKIN 2 12.00
0
#
#
# (316) B2 LINE OUTAGE (BREAKER-TO-BREAKER)
#
1 33201 33203 "1 "      0      # line from      LARKIN E 115.00      (4) to BRKR      MISSON 115.00
0
#
#
# (317) B2 LINE OUTAGE (BREAKER-TO-BREAKER)
#
1 33201 33204 "2 "      0      # line from      LARKIN E 115.00      BRKR to BRKR      POTRERO 115.00
0
#
#

```

APPENDIX B – CAISO CATEGORY B AUTOCON INPUT FILE

```

# (318) B2 LINE OUTAGE (BREAKER-TO-BREAKER)
#
1 33203 33204 "1 " 0 # line from MISSON 115.00 BRKR to BRKR POTRERO 115.00
0
#
#
# (319) B2 LINE OUTAGE (BREAKER-TO-BREAKER)
#
1 33203 33205 "1 " 0 # line from MISSON 115.00 BRKR to BRKR HNTRS PT 115.00
0
#
#
# (320) B2 LINE OUTAGE (BREAKER-TO-BREAKER)
#
1 33203 33205 "2 " 0 # line from MISSON 115.00 BRKR to BRKR HNTRS PT 115.00
0
#
#
# (321) B2 LINE OUTAGE (BREAKER-TO-BREAKER)
#
1 33204 33205 "1 " 0 # line from POTRERO 115.00 BRKR to BRKR HNTRS PT 115.00
0
#
#
# (322) B2 LINE OUTAGE (BREAKER-TO-BREAKER)
#
1 33206 33204 "1 " 0 # line from BAYSHOR1 115.00 (2) to BRKR POTRERO 115.00
4 33206 33208 "1 " 0 # line from BAYSHOR1 115.00 (2) to BRKR MARTIN C 115.00
4 33206 0 "1 " 0 # LOAD-DROP BAYSHOR1 115.00 LOAD==4.75(0.68)
0
#
#
# (323) B2 LINE OUTAGE (BREAKER-TO-BREAKER)
#
1 33207 33204 "2 " 0 # line from BAYSHOR2 115.00 (2) to BRKR POTRERO 115.00
1 33207 33208 "2 " 0 # line from BAYSHOR2 115.00 (2) to BRKR MARTIN C 115.00
4 33207 0 "2 " 0 # LOAD-DROP BAYSHOR2 115.00 LOAD==6.65(0.95)
0
#
#
# (324) B2 LINE OUTAGE (BREAKER-TO-BREAKER)
#
1 33208 33202 "1 " 0 # line from MARTIN C 115.00 BRKR to (3) LARKIN F 115.00
2 33202 33218 "5 " 0 # TRAN from LARKIN F 115.00 (3) to BRKR LARKIN 1 12.00
2 33202 33219 "6 " 0 # TRAN from LARKIN F 115.00 (3) to BRKR LARKIN 2 12.00
0
#
#
# (325) B2 LINE OUTAGE (BREAKER-TO-BREAKER)
#
1 33208 33205 "1 " 0 # line from MARTIN C 115.00 BRKR to BRKR HNTRS PT 115.00
0
#
#
# (326) B2 LINE OUTAGE (BREAKER-TO-BREAKER)
#
1 33208 33205 "3 " 0 # line from MARTIN C 115.00 BRKR to BRKR HNTRS PT 115.00
0
#
#
# (327) B2 LINE OUTAGE (BREAKER-TO-BREAKER)
#
1 33208 33205 "4 " 0 # line from MARTIN C 115.00 BRKR to BRKR HNTRS PT 115.00
0
#
#
# (328) B2 LINE OUTAGE (BREAKER-TO-BREAKER)
#
1 33208 33300 "1 " 0 # line from MARTIN C 115.00 BRKR to BRKR DALY CTY 115.00
0
#
#
# (329) B2 LINE OUTAGE (BREAKER-TO-BREAKER)
#
1 33208 33301 "2 " 0 # line from MARTIN C 115.00 BRKR to (3) DLY CTYP 115.00
1 33301 33300 "2 " 0 # line from DLY CTYP 115.00 (3) to BRKR DALY CTY 115.00
1 33301 33302 "1 " 0 # line from DLY CTYP 115.00 (3) to BRKR SERRMNTTE 115.00
4 33302 0 "1 " 0 # LOAD-DROP SERRMNTTE 115.00 LOAD==11.42(2.60)
0

```

APPENDIX B – CAISO CATEGORY B AUTOCON INPUT FILE

```

#
#
# (330) B2 LINE OUTAGE (BREAKER-TO-BREAKER)
#
1 33208 33303 "2 " 0 # line from MARTIN C 115.00 BRKR to BRKR EST GRND 115.00
0
#
#
# (331) B2 LINE OUTAGE (BREAKER-TO-BREAKER)
#
1 33208 33307 "1 " 0 # line from MARTIN C 115.00 BRKR to BRKR MILLBRAE 115.00
0
#
#
# (332) B2 LINE OUTAGE (BREAKER-TO-BREAKER)
#
1 33208 33310 "3 " 0 # line from MARTIN C 115.00 BRKR to BRKR SANMATEO 115.00
0
#
#
# (333) B2 LINE OUTAGE (BREAKER-TO-BREAKER)
#
1 33208 33322 "5 " 0 # line from MARTIN C 115.00 BRKR to (3) UAL TAP 115.00
1 33322 33306 "5 " 0 # line from UAL TAP 115.00 (3) to BRKR SFIA 115.00
1 33322 33323 "1 " 0 # line from UAL TAP 115.00 (3) to (3) SFASWSTA 115.00
1 33323 33304 "1 " 0 # line from SFASWSTA 115.00 (3) to (2) UAL COGN 115.00
2 33304 33466 "1 " 0 # TRAN from UAL COGN 115.00 BRKR to (1) UNTED CO 9.11
3 33466 0 "1 " 0 # GEN-DROP UNTED CO 9.11 GEN==28.20(11.16)
0
#
#
# (334) B2 LINE OUTAGE (BREAKER-TO-BREAKER)
#
1 33209 33347 "1 " 0 # line from MARTIN 60.00 BRKR to (2) SNTH JCT 60.00
1 33347 33346 "1 " 0 # line from SNTH JCT 60.00 (2) to (3) SNTH TP2 60.00
1 33346 33389 "1 " 0 # line from SNTH TP2 60.00 (3) to (1) PACIFJCT 60.00
1 33346 33350 "1 " 0 # line from SNTH TP2 60.00 (3) to BRKR SNTH LNE 60.00
4 33350 0 "1 " 0 # LOAD-DROP SNTH LNE 60.00 LOAD==7.61(1.73)
4 33350 0 "2 " 0 # LOAD-DROP SNTH LNE 60.00 LOAD==9.62(2.19)
1 33350 33345 "1 " 1 # LINE-TRANSFER SNTH LNE 60.00 TO SNTH TP 60.00
4 33350 0 "***" 1 # RESTORE SNEATH LANE LOAD
0
#
#
# (335) B2 LINE OUTAGE (BREAKER-TO-BREAKER)
#
1 33210 33204 "1 " 0 # line from POT_SVC 115.00 (1) to BRKR POTRERO 115.00
0
#
#
# (336) B2 LINE OUTAGE (BREAKER-TO-BREAKER)
#
1 33305 33208 "6 " 0 # line from SHAWROAD 115.00 (2) to BRKR MARTIN C 115.00
1 33305 33310 "6 " 0 # line from SHAWROAD 115.00 (2) to BRKR SANMATEO 115.00
4 33305 33309 "1 " 1 # LOAD-TRANSFER SHAWROAD 115.00 TO SANPAULA 115.00 LOAD==9.00(1.83)
0
#
#
# (337) B2 LINE OUTAGE (BREAKER-TO-BREAKER)
#
1 33356 33208 "4 " 0 # line from BURLNGME 115.00 BRKR to BRKR MARTIN C 115.00
0
#
#
# (338) B3 TRANSFORMER OUTAGE (BREAKER-TO-BREAKER)
#
2 33208 30695 "7 " 0 # TRAN from MARTIN C 115.00 BRKR to BRKR MARTIN C 230.00
0
#
#
# (339) B3 TRANSFORMER OUTAGE (BREAKER-TO-BREAKER)
#
2 33208 30695 "8 " 0 # TRAN from MARTIN C 115.00 BRKR to BRKR MARTIN C 230.00
0
#
#
# (340) B3 TRANSFORMER OUTAGE (BREAKER-TO-BREAKER)
#
2 33209 33208 "6 " 0 # TRAN from MARTIN 60.00 BRKR to BRKR MARTIN C 115.00

```

APPENDIX B – CAISO CATEGORY B AUTOCON INPUT FILE

```

0
#
#
# (341) B1 GENERATOR OUTAGE
#
3 33252      0 "1"      0      # POTRERO3  20.00      PGEN=210.0  QGEN=63.00
0
#
#
# (342) B1 GENERATOR OUTAGE
#
3 33253      0 "1"      0      # POTRERO4  13.80      PGEN=50.00  QGEN=-10.10
0
#
#
# (343) L-1/G-1 OVERLAPPING OUTAGE
# Jefferson - Martin 230 kV Line and Potrero 4
1 30696 30695 "1 "      0      # line from  MRT RCTR 230.00  (2) to BRKR  MARTIN C 230.00
1 30696 30717 "1 "      0      # line from  MRT RCTR 230.00  (2) to (2)   TRAN230B 230.00
1 30717 30716 "1 "      0      # line from  TRAN230B 230.00  (2) to (2)   TRAN230A 230.00
1 30716 30714 "1 "      0      # line from  TRAN230A 230.00  (2) to (2)   JMDAMCX2 230.00
1 30714 30713 "1 "      0      # line from  JMDAMCX2 230.00  (2) to (2)   JMDAMCX1 230.00
1 30713 30715 "1 "      0      # line from  JMDAMCX1 230.00  (2) to BRKR  JEFFERSN 230.00
#
3 33253      0 "1"      0      # POTRERO4  13.80      PGEN=50.00  QGEN=-10.10
0
#
#
# (344) L-1/G-1 OVERLAPPING OUTAGE
# San Mateo - Martin 230 kV Line and Potrero 4
1 30700 30695 "1 "      0      # line from  SANMATEO 230.00  BRKR to BRKR  MARTIN C 230.00
#
3 33253      0 "1"      0      # POTRERO4  13.80      PGEN=50.00  QGEN=-10.10
0
#
#
# (345) L-1/G-1 OVERLAPPING OUTAGE
# Larkin - Potrero #1 115 kV Line and Potrero 4
1 33200 33204 "1 "      0      # line from  LARKIN D 115.00  (3) to BRKR  POTRERO  115.00
2 33200 33218 "1 "      0      # TRAN from  LARKIN D 115.00  (3) to BRKR  LARKIN 1   12.00
2 33200 33219 "2 "      0      # TRAN from  LARKIN D 115.00  (3) to BRKR  LARKIN 2   12.00
#
3 33253      0 "1"      0      # POTRERO4  13.80      PGEN=50.00  QGEN=-10.10
0
#
#
# (346) L-1/G-1 OVERLAPPING OUTAGE
# Larkin - Mission 115 kV Line and Potrero 4
1 33201 33203 "1 "      0      # line from  LARKIN E 115.00  (4) to BRKR  MISSON   115.00
#
3 33253      0 "1"      0      # POTRERO4  13.80      PGEN=50.00  QGEN=-10.10
0
#
#
# (347) L-1/G-1 OVERLAPPING OUTAGE
# Larkin - Potrero #2 115 kV Line and Potrero 4
1 33201 33204 "2 "      0      # line from  LARKIN E 115.00  BRKR to BRKR  POTRERO  115.00
#
3 33253      0 "1"      0      # POTRERO4  13.80      PGEN=50.00  QGEN=-10.10
0
#
#
# (348) L-1/G-1 OVERLAPPING OUTAGE
# Mission - Potrero 115 kV Line and Potrero 4
1 33203 33204 "1 "      0      # line from  MISSON   115.00  BRKR to BRKR  POTRERO  115.00
#
3 33253      0 "1"      0      # POTRERO4  13.80      PGEN=50.00  QGEN=-10.10
0
#
#
# (349) L-1/G-1 OVERLAPPING OUTAGE
# Mission - Hunters Point #1 115 kV Line and Potrero 4
1 33203 33205 "1 "      0      # line from  MISSON   115.00  BRKR to BRKR  HNTRS PT 115.00
#
3 33253      0 "1"      0      # POTRERO4  13.80      PGEN=50.00  QGEN=-10.10
0
#
#
# (350) L-1/G-1 OVERLAPPING OUTAGE

```

APPENDIX B – CAISO CATEGORY B AUTOCON INPUT FILE

```

# Mission - Hunters Point #2 115 kV Line and Potrero 4
1 33203 33205 "2 " 0 # line from MISSON 115.00 BRKR to BRKR HNTRS PT 115.00
#
3 33253 0 "1" 0 # POTRERO4 13.80 PGEN=50.00 QGEN=-10.10
0
#
#
# (351) L-1/G-1 OVERLAPPING OUTAGE
# Potrero - Hunters Point #1 115 kV Line and Potrero 4
1 33204 33205 "1 " 0 # line from POTRERO 115.00 BRKR to BRKR HNTRS PT 115.00
#
3 33253 0 "1" 0 # POTRERO4 13.80 PGEN=50.00 QGEN=-10.10
0
#
#
# (352) L-1/G-1 OVERLAPPING OUTAGE
# Potrero - Martin #1 115 kV Line and Potrero 4
1 33206 33204 "1 " 0 # line from BAYSHOR1 115.00 (2) to BRKR POTRERO 115.00
1 33206 33208 "1 " 0 # line from BAYSHOR1 115.00 (2) to BRKR MARTIN C 115.00
4 33206 0 "1 " 0 # LOAD-DROP BAYSHOR1 115.00 LOAD==4.75(0.68)
#
3 33253 0 "1" 0 # POTRERO4 13.80 PGEN=50.00 QGEN=-10.10
0
#
#
# (353) L-1/G-1 OVERLAPPING OUTAGE
# Potrero - Martin #2 115 kV Line and Potrero 4
1 33207 33204 "2 " 0 # line from BAYSHOR2 115.00 (2) to BRKR POTRERO 115.00
1 33207 33208 "2 " 0 # line from BAYSHOR2 115.00 (2) to BRKR MARTIN C 115.00
4 33207 0 "2 " 0 # LOAD-DROP BAYSHOR2 115.00 LOAD==6.65(0.95)
#
3 33253 0 "1" 0 # POTRERO4 13.80 PGEN=50.00 QGEN=-10.10
0
#
#
# (354) L-1/G-1 OVERLAPPING OUTAGE
# Larkin - Martin 115 kV Line and Potrero 4
1 33208 33202 "1 " 0 # line from MARTIN C 115.00 BRKR to (3) LARKIN F 115.00
2 33202 33218 "5 " 0 # TRAN from LARKIN F 115.00 (3) to BRKR LARKIN 1 12.00
2 33202 33219 "6 " 0 # TRAN from LARKIN F 115.00 (3) to BRKR LARKIN 2 12.00
#
3 33253 0 "1" 0 # POTRERO4 13.80 PGEN=50.00 QGEN=-10.10
0
#
#
# (355) L-1/G-1 OVERLAPPING OUTAGE
# Hunters Point - Martin #1 115 kV Line and Potrero 4
1 33208 33205 "1 " 0 # line from MARTIN C 115.00 BRKR to BRKR HNTRS PT 115.00
#
3 33253 0 "1" 0 # POTRERO4 13.80 PGEN=50.00 QGEN=-10.10
0
#
#
# (356) L-1/G-1 OVERLAPPING OUTAGE
# Hunters Point - Martin #3 115 kV Line and Potrero 4
1 33208 33205 "3 " 0 # line from MARTIN C 115.00 BRKR to BRKR HNTRS PT 115.00
#
3 33253 0 "1" 0 # POTRERO4 13.80 PGEN=50.00 QGEN=-10.10
0
#
#
# (357) L-1/G-1 OVERLAPPING OUTAGE
# Hunters Point - Martin #4 115 kV Line and Potrero 4
1 33208 33205 "4 " 0 # line from MARTIN C 115.00 BRKR to BRKR HNTRS PT 115.00
#
3 33253 0 "1" 0 # POTRERO4 13.80 PGEN=50.00 QGEN=-10.10
0
#
#
# (358) L-1/G-1 OVERLAPPING OUTAGE
# Martin - East Grand 115 kV Line and Potrero 4
1 33208 33303 "2 " 0 # line from MARTIN C 115.00 BRKR to BRKR EST GRND 115.00
#
3 33253 0 "1" 0 # POTRERO4 13.80 PGEN=50.00 QGEN=-10.10
0
#
#
# (359) L-1/G-1 OVERLAPPING OUTAGE
# Martin - Millbrae 115 kV Line and Potrero 4

```

APPENDIX B – CAISO CATEGORY B AUTOCON INPUT FILE

```

1 33208 33307 "1 " 0 # line from MARTIN C 115.00 BRKR to BRKR MILLBRAE 115.00
#
3 33253 0 "1" 0 # POTRERO4 13.80 PGEN=50.00 QGEN=-10.10
0
#
#
# (360) L-1/G-1 OVERLAPPING OUTAGE
# Martin - San Mateo #3 115 kV Line and Potrero 4
1 33208 33310 "3 " 0 # line from MARTIN C 115.00 BRKR to BRKR SANMATEO 115.00
#
3 33253 0 "1" 0 # POTRERO4 13.80 PGEN=50.00 QGEN=-10.10
0
#
#
# (361) L-1/G-1 OVERLAPPING OUTAGE
# Martin - SF Airport 115 kV Line and Potrero 4
1 33208 33322 "5 " 0 # line from MARTIN C 115.00 BRKR to (3) UAL TAP 115.00
1 33322 33306 "5 " 0 # line from UAL TAP 115.00 (3) to BRKR SFIA 115.00
1 33322 33323 "1 " 0 # line from UAL TAP 115.00 (3) to (3) SFASWSTA 115.00
1 33323 33304 "1 " 0 # line from SFASWSTA 115.00 (3) to (2) UAL COGN 115.00
2 33304 33466 "1 " 0 # TRAN from UAL COGN 115.00 BRKR to (1) UNTED CO 9.11
3 33466 0 "1 " 0 # GEN-DROP UNTED CO 9.11 GEN==28.20(11.16)
#
3 33253 0 "1" 0 # POTRERO4 13.80 PGEN=50.00 QGEN=-10.10
0
#
#
# (362) L-1/G-1 OVERLAPPING OUTAGE
# Martin - San Mateo #6 115 kV Line and Potrero 4
1 33305 33208 "6 " 0 # line from SHAWROAD 115.00 (2) to BRKR MARTIN C 115.00
1 33305 33310 "6 " 0 # line from SHAWROAD 115.00 (2) to BRKR SANMATEO 115.00
4 33305 33309 "1 " 1 # LOAD-TRANSFER SHAWROAD 115.00 TO SANPAULA 115.00 LOAD==9.00(1.83)
#
3 33253 0 "1" 0 # POTRERO4 13.80 PGEN=50.00 QGEN=-10.10
0
#
#
# (363) L-1/G-1 OVERLAPPING OUTAGE
# Martin - Burlingame 115 kV Line and Potrero 4
1 33356 33208 "4 " 0 # line from BURLINGME 115.00 BRKR to BRKR MARTIN C 115.00
#
3 33253 0 "1" 0 # POTRERO4 13.80 PGEN=50.00 QGEN=-10.10
0
#
#
# (364) L-1/G-1 OVERLAPPING OUTAGE
# Trans Bay HVDC Cable and Potrero 4
3 38950 0 "1 " 0 # GEN-DROP VSC_PTSB 180.50 GEN==413.00(-91.10)
3 38951 0 "1 " 0 # GEN-DROP VSC_POTR 180.50 GEN==401.40(155.40)
#
3 33253 0 "1" 0 # POTRERO4 13.80 PGEN=50.00 QGEN=-10.10
0
#
#
# 2013 category b contingency list
# Peninsula Division Zone 310
#
#
# (365) B2 LINE OUTAGE (BREAKER-TO-BREAKER)
#
1 30560 30700 "1 " 0 # line from E. SHORE 230.00 BRKR to BRKR SANMATEO 230.00
0
#
#
# (366) B2 LINE OUTAGE (BREAKER-TO-BREAKER)
#
1 30630 30703 "1 " 0 # line from NEWARK D 230.00 BRKR to BRKR RAVENSWD 230.00
0
#
#
# (367) B2 LINE OUTAGE (BREAKER-TO-BREAKER)
#
1 30703 30700 "1 " 0 # line from RAVENSWD 230.00 BRKR to BRKR SANMATEO 230.00
0
#
#
# (368) B2 LINE OUTAGE (BREAKER-TO-BREAKER)
#
1 30703 30700 "2 " 0 # line from RAVENSWD 230.00 BRKR to BRKR SANMATEO 230.00

```

APPENDIX B – CAISO CATEGORY B AUTOCON INPUT FILE

```

0
#
#
# (369) B2 LINE OUTAGE (BREAKER-TO-BREAKER)
#
1 30705 30710 "1 " 0 # line from MONTAVIS 230.00 BRKR to (3) SLACTAP1 230.00
1 30710 30711 "1 " 0 # line from SLACTAP1 230.00 (3) to BRKR S.L.A.C. 230.00
1 30710 30715 "1 " 0 # line from SLACTAP1 230.00 (3) to BRKR JEFFERSN 230.00
4 30711 0 "1 " 0 # LOAD-DROP S.L.A.C. 230.00 LOAD==58.00(11.78)
1 30711 30712 "1 " 1 # LINE-TRANSFER SLACTAP1 to SLACTAP2
4 30711 0 "***" 1 # RESTORE S.L.A.C. load
0
#
#
# (370) B2 LINE OUTAGE (BREAKER-TO-BREAKER)
#
1 30705 30712 "2 " 0 # line from MONTAVIS 230.00 BRKR to (2) SLACTAP2 230.00
1 30712 30715 "2 " 0 # line from SLACTAP2 230.00 (2) to BRKR JEFFERSN 230.00
0
#
#
# (371) B2 LINE OUTAGE (BREAKER-TO-BREAKER)
#
1 33306 33310 "5 " 0 # line from SFIA 115.00 BRKR to BRKR SANMATEO 115.00
0
#
#
# (372) B2 LINE OUTAGE (BREAKER-TO-BREAKER)
#
1 33307 33310 "1 " 0 # line from MILLBRAE 115.00 BRKR to BRKR SANMATEO 115.00
0
#
#
# (373) B2 LINE OUTAGE (BREAKER-TO-BREAKER)
#
1 33308 33303 "2 " 0 # line from SFIA-MA 115.00 (2) to BRKR EST GRND 115.00
1 33308 33310 "2 " 0 # line from SFIA-MA 115.00 (2) to BRKR SANMATEO 115.00
4 33308 33306 "1 " 1 # LOAD-TRANSFER SFIA-MA 115.00 TO SFIA 115.00 LOAD==20.20(4.10)
0
#
#
# (374) B2 LINE OUTAGE (BREAKER-TO-BREAKER)
#
1 33309 33307 "1 " 0 # line from SANPAULA 115.00 (1) to BRKR MILLBRAE 115.00
4 33309 33305 "1 " 1 # LOAD-TRANSFER SANPAULA 115.00 TO SHAWROAD 115.00 LOAD==8.00(1.62)
0
#
#
# (375) B2 LINE OUTAGE (BREAKER-TO-BREAKER)
#
1 33310 33311 "1 " 0 # line from SANMATEO 115.00 BRKR to BRKR BAY MDWS 115.00
0
#
#
# (376) B2 LINE OUTAGE (BREAKER-TO-BREAKER)
#
1 33310 33311 "2 " 0 # line from SANMATEO 115.00 BRKR to BRKR BAY MDWS 115.00
0
#
#
# (377) B2 LINE OUTAGE (BREAKER-TO-BREAKER)
#
1 33310 33312 "1 " 0 # line from SANMATEO 115.00 BRKR to BRKR BELMONT 115.00
0
#
#
# (378) B2 LINE OUTAGE (BREAKER-TO-BREAKER)
#
1 33310 33321 "1 " 0 # line from SANMATEO 115.00 BRKR to BRKR RVNSWD D 115.00
0
#
#
# (379) B2 LINE OUTAGE (BREAKER-TO-BREAKER)
#
1 33310 33356 "4 " 0 # line from SANMATEO 115.00 BRKR to BRKR BURLINGME 115.00
0
#
#
# (380) B2 LINE OUTAGE (BREAKER-TO-BREAKER)

```

APPENDIX B – CAISO CATEGORY B AUTOCON INPUT FILE

```

#
1 33312 33313 "1 " 0 # line from BELMONT 115.00 BRKR to BRKR BAIR 115.00
0
#
#
# (381) B2 LINE OUTAGE (BREAKER-TO-BREAKER)
#
1 33313 33319 "2 " 0 # line from BAIR 115.00 BRKR to (3) SHREDJCT 115.00
1 33319 33314 "1 " 0 # line from SHREDJCT 115.00 (3) to (2) SHREDDER 115.00
1 33319 33321 "2 " 0 # line from SHREDJCT 115.00 (3) to BRKR RVNSWD D 115.00
1 33314 33320 "1 " 0 # line from SHREDDER 115.00 (2) to (1) LONESTAR 115.00
4 33314 0 "1 " 0 # LOAD-DROP SHREDDER 115.00 LOAD==4.77(5.43)
4 33320 0 "1 " 0 # LOAD-DROP LONESTAR 115.00 LOAD==2.57(3.43)
0
#
#
# (382) B2 LINE OUTAGE (BREAKER-TO-BREAKER)
#
1 33315 33316 "2 " 0 # line from RVNSWD E 115.00 BRKR to BRKR CLY LND2 115.00
0
#
#
# (383) B2 LINE OUTAGE (BREAKER-TO-BREAKER)
#
1 33315 35350 "1 " 0 # line from RVNSWD E 115.00 BRKR to BRKR AMES BS1 115.00
0
#
#
# (384) B2 LINE OUTAGE (BREAKER-TO-BREAKER)
#
1 33315 35351 "2 " 0 # line from RVNSWD E 115.00 BRKR to BRKR AMES BS2 115.00
0
#
#
# (385) B2 LINE OUTAGE (BREAKER-TO-BREAKER)
#
1 33315 38028 "1 " 0 # line from RVNSWD E 115.00 BRKR to BRKR PLO ALTO 115.00
0
#
#
# (386) B2 LINE OUTAGE (BREAKER-TO-BREAKER)
#
1 33315 38028 "2 " 0 # line from RVNSWD E 115.00 BRKR to BRKR PLO ALTO 115.00
0
#
#
# (387) B2 LINE OUTAGE (BREAKER-TO-BREAKER)
#
1 33316 38028 "1 " 0 # line from CLY LND2 115.00 BRKR to BRKR PLO ALTO 115.00
0
#
#
# (388) B2 LINE OUTAGE (BREAKER-TO-BREAKER)
#
1 33321 33313 "1 " 0 # line from RVNSWD D 115.00 BRKR to BRKR BAIR 115.00
0
#
#
# (389) B2 LINE OUTAGE (BREAKER-TO-BREAKER)
#
1 33321 33317 "1 " 0 # line from RVNSWD D 115.00 BRKR to BRKR CLY LND 115.00
0
#
#
# (390) B2 LINE OUTAGE (BREAKER-TO-BREAKER)
#
1 33348 33359 "1 " 0 # line from CAROLD1 60.00 (3) to BRKR CAROLNDS 60.00
1 33348 33391 "1 " 0 # line from CAROLD1 60.00 (3) to (2) TRAN-60 60.00
1 33348 33396 "1 " 0 # line from CAROLD1 60.00 (3) to (3) HILDAL49 60.00
1 33391 33392 "1 " 0 # line from TRAN-60 60.00 (2) to (1) MLLBTP97 60.00
1 33396 33361 "1 " 0 # line from HILDAL49 60.00 (3) to (3) HLLSDLJT 60.00
1 33396 33397 "1 " 0 # line from HILDAL49 60.00 (3) to (2) RLSTN35 60.00
1 33361 33360 "1 " 0 # line from HLLSDLJT 60.00 BRKR to BRKR HILLSdle 60.00
1 33361 33394 "1 " 0 # line from HLLSDLJT 60.00 (3) to BRKR OXMTN_TP 60.00
1 33397 33378 "1 " 0 # line from RLSTN35 60.00 (2) to (3) WTRSHDTP 60.00
1 33378 33379 "1 " 0 # line from WTRSHDTP 60.00 (3) to (1) WATRSHEd 60.00
1 33378 33400 "1 " 0 # line from WTRSHDTP 60.00 (3) to BRKR JEFrSN_E 60.00
4 33359 0 "1 " 0 # LOAD-DROP CAROLNDS 60.00 LOAD==2.65(0.60)
4 33359 0 "2 " 0 # LOAD-DROP CAROLNDS 60.00 LOAD==4.88(1.11)

```

APPENDIX B – CAISO CATEGORY B AUTOCON INPUT FILE

```

4 33379 33363 "1 " 1 # LOAD-TRANSFER WATRSHEd 60.00 TO RALSTON 60.00 LOAD==0.70(0.32)
1 33349 33359 "1 " 1 # LINE-TRANSFER CAROLNDS 60.00 TO CAROLD2 60.00
4 33359 0 "***" 1 # RESTORE CAROLANDS load
0
#
#
# (391) B2 LINE OUTAGE (BREAKER-TO-BREAKER)
#
1 33349 33362 "1 " 0 # line from CAROLD2 60.00 (1) to (2) CRYSTLSG 60.00
1 33362 33399 "1 " 0 # line from CRYSTLSG 60.00 (2) to (2) HILDAL47 60.00
1 33399 33398 "1 " 0 # line from HILDAL47 60.00 (2) to (3) RLSTN45 60.00
1 33398 33363 "1 " 0 # line from RLSTN45 60.00 (3) to BRKR RALSTON 60.00
1 33398 33400 "1 " 0 # line from RLSTN45 60.00 (3) to BRKR JEFRSN_E 60.00
4 33362 0 "1 " 0 # LOAD-DROP CRYSTLSG 60.00 LOAD==3.00(0.61)
1 33397 33363 "1 " 1 # LINE-TRANSFER RLSTN35 60.00 TO RALSTON 60.00
4 33363 0 "***" 1 # RESTORE RALSTON LOAD
0
#
#
# (392) B2 LINE OUTAGE (BREAKER-TO-BREAKER)
#
1 33351 33345 "1 " 0 # line from SN BRNOT 60.00 (2) to (2) SNTH TP1 60.00
1 33351 33352 "1 " 0 # line from SN BRNOT 60.00 (2) to (2) SNANDRES 60.00
1 33345 33355 "1 " 0 # line from SNTH TP1 60.00 (2) to BRKR PACIFICA 60.00
1 33352 33354 "1 " 0 # line from SNANDRES 60.00 (2) to (2) MLLBRETTP 60.00
1 33354 33353 "1 " 0 # line from MLLBRETTP 60.00 (2) to BRKR MILLBRAE 60.00
4 33351 0 "1 " 0 # LOAD-DROP SN BRNOT 60.00 LOAD==3.36(0.77)
4 33352 0 "1 " 0 # LOAD-DROP SNANDRES 60.00 LOAD==1.80(0.37)
4 33355 0 "1 " 0 # LOAD-DROP PACIFICA 60.00 LOAD==9.92(2.26)
4 33355 0 "2 " 0 # LOAD-DROP PACIFICA 60.00 LOAD==5.61(1.28)
1 33355 33389 "1 " 1 # LINE-TRANSFER PACIFICA 60.00 TO PACIFJCT 60.00
4 33355 0 "***" 1 # RESTORE PACIFICA LOAD
0
#
#
# (393) B2 LINE OUTAGE (BREAKER-TO-BREAKER)
#
1 33357 33358 "1 " 0 # line from SAN MATO 60.00 BRKR to BRKR BERESFRD 60.00
0
#
#
# (394) B2 LINE OUTAGE (BREAKER-TO-BREAKER)
#
1 33357 33364 "1 " 0 # line from SAN MATO 60.00 BRKR to (2) ORACLE60 60.00
1 33364 33365 "1 " 0 # line from ORACLE60 60.00 (2) to BRKR SAN CRLS 60.00
4 33364 0 "1 " 0 # LOAD-DROP ORACLE60 60.00 LOAD==11.86(5.40)
0
#
#
# (395) B2 LINE OUTAGE (BREAKER-TO-BREAKER)
#
1 33358 33360 "1 " 0 # line from BERESFRD 60.00 BRKR to BRKR HILLSDLLE 60.00
0
#
#
# (396) B2 LINE OUTAGE (BREAKER-TO-BREAKER)
#
1 33360 33361 "1 " 0 # line from HILLSDLLE 60.00 BRKR to BRKR HLLSDLJTT 60.00
0
#
#
# (397) B2 LINE OUTAGE (BREAKER-TO-BREAKER)
#
1 33365 33367 "1 " 0 # line from SAN CRLS 60.00 BRKR to BRKR BAIR 60.00
0
#
#
# (398) B2 LINE OUTAGE (BREAKER-TO-BREAKER)
#
1 33367 33368 "1 " 0 # line from BAIR 60.00 BRKR to (2) REDWDTP1 60.00
1 33368 33373 "1 " 0 # line from REDWDTP1 60.00 (2) to (3) BLHVNTTP1 60.00
1 33373 33372 "1 " 0 # line from BLHVNTTP1 60.00 (3) to (1) BLLE HVN 60.00
1 33373 33375 "1 " 0 # line from BLHVNTTP1 60.00 (3) to BRKR CLY LNDG 60.00
4 33372 0 "1 " 0 # LOAD-DROP BLLE HVN 60.00 LOAD==7.52(1.71)
4 33372 0 "2 " 0 # LOAD-DROP BLLE HVN 60.00 LOAD==8.46(1.93)
4 33372 0 "3 " 0 # LOAD-DROP BLLE HVN 60.00 LOAD==15.39(3.51)
4 33372 0 "4 " 0 # LOAD-DROP BLLE HVN 60.00 LOAD==14.12(3.21)
4 33372 0 "5 " 0 # LOAD-DROP BLLE HVN 60.00 LOAD==29.05(6.62)
1 33372 33374 "2 " 1 # LINE-TRANSFER BLHVNTTP1 60.00 TO BLHVNTTP2 60.00

```

APPENDIX B – CAISO CATEGORY B AUTOCON INPUT FILE

```

4 33372      0  "***"  1      # RESTORE BELLE HAVEN load
0
#
#
# (399) B2 LINE OUTAGE (BREAKER-TO-BREAKER)
#
1 33367 33369 "2 "  0      # line from BAIR      60.00 BRKR to (3) REDWDTP2 60.00
1 33369 33370 "2 "  0      # line from REDWDTP2 60.00 (3) to BRKR REDWOOD 60.00
1 33369 33374 "2 "  0      # line from REDWDTP2 60.00 (3) to (2) BLHVNT2 60.00
1 33374 33371 "2 "  0      # line from BLHVNT2 60.00 (2) to (2) RAYCHEM 60.00
1 33371 33375 "2 "  0      # line from RAYCHEM 60.00 (2) to BRKR CLY LNDG 60.00
4 33370      0 "1 "  0      # LOAD-DROP REDWOOD 60.00 LOAD==11.80(2.69)
4 33370      0 "2 "  0      # LOAD-DROP REDWOOD 60.00 LOAD==5.12(1.17)
4 33370      0 "3 "  0      # LOAD-DROP REDWOOD 60.00 LOAD==8.98(2.05)
4 33370      0 "4 "  0      # LOAD-DROP REDWOOD 60.00 LOAD==8.44(1.93)
4 33370      0 "5 "  0      # LOAD-DROP REDWOOD 60.00 LOAD==30.43(6.94)
4 33371      0 "1 "  0      # LOAD-DROP RAYCHEM 60.00 LOAD==7.48(5.22)
1 33368 33370 "1 "  1      # LINE-TRANSFER REDWDTP2 60.00 TO REDWDTP1 60.00
4 33370      0 "***"  1      # RESTORE REDWOOD CITY load
0
#
#
# (400) B2 LINE OUTAGE (BREAKER-TO-BREAKER)
#
1 33375 33382 "1 "  0      # line from CLY LNDG 60.00 BRKR to (3) S.R.I. 60.00
1 33382 33381 "1 "  0      # line from S.R.I. 60.00 (3) to BRKR GLENWOOD 60.00
2 33382 33468 "1 "  0      # TRAN from S.R.I. 60.00 (3) to (1) SRI INTL 9.11
4 33468      0 "1 "  0      # LOAD-DROP SRI INTL 9.11 LOAD==4.12(0.84)
3 33468      0 "1 "  0      # GEN-DROP SRI INTL 9.11 GEN==4.30(3.00)
3 33463      0 "1"  0      # GEN-DROP CARDINAL 12.97
3 33463      0 "2"  0      # GEN-DROP CARDINAL 12.97
4 33386      0 "***"  0      # LOAD-DROP STANFORD 60.00
0
#
#
# (401) B2 LINE OUTAGE (BREAKER-TO-BREAKER)
#
1 33375 35454 "1 "  0      # line from CLY LNDG 60.00 BRKR to (3) WSTNG JT 60.00
1 35454 35451 "1 "  0      # line from WSTNG JT 60.00 (3) to (1) L.ALTS J 60.00
1 35454 35453 "1 "  0      # line from WSTNG JT 60.00 (3) to (1) NRTHGRUM 60.00
4 35453      0 "1 "  0      # LOAD-DROP NRTHGRUM 60.00 LOAD==5.99(4.18)
0
#
#
# (402) B2 LINE OUTAGE (BREAKER-TO-BREAKER)
#
1 33376 33387 "1 "  0      # line from LAS PLGS 60.00 BRKR to BRKR WOODSIDE 60.00
4 33376      0 "1 "  0      # LOAD-DROP LAS PLGS 60.00 LOAD==3.30(0.75)
4 33376      0 "2 "  0      # LOAD-DROP LAS PLGS 60.00 LOAD==3.30(0.75)
1 33376 33393 "1 "  1      # LOAD-TRANSFER LAS PLGS 60.00 TO LSPLGSJT 60.00
4 33376      0 "***"  1      # RESTORE LAS PULGAS load
0
#
#
# (403) B2 LINE OUTAGE (BREAKER-TO-BREAKER)
#
1 33377 33380 "1 "  0      # line from EMRLD LE 60.00 (2) to BRKR JEFRSN_D 60.00
1 33377 33393 "1 "  0      # line from EMRLD LE 60.00 (2) to (2) LSPLGSJT 60.00
1 33393 33385 "1 "  0      # line from LSPLGSJT 60.00 (2) to (3) MNLOJCT2 60.00
1 33385 33383 "1 "  0      # line from MNLOJCT2 60.00 (3) to BRKR MENLO 60.00
1 33385 33388 "1 "  0      # line from MNLOJCT2 60.00 (3) to (1) S.L.A.C. 60.00
4 33377      0 "1 "  0      # LOAD-DROP EMRLD LE 60.00 LOAD==5.54(1.26)
0
#
#
# (404) B2 LINE OUTAGE (BREAKER-TO-BREAKER)
#
1 33380 33387 "1 "  0      # line from JEFRSN_D 60.00 BRKR to BRKR WOODSIDE 60.00
1 33376 33393 "1 "  1      # LINE-TRANSFER LAS PLGS 60.00 TO LSPLGSJT 60.00
1 33376 33387 "1 "  1      # LINE-TRANSFER LAS PLGS 60.00 TO WOODSIDE 60.00
4 33387      0 "***"  1      # RESTORE WOODSIDE load
4 33376      0 "***"  1      # RESTORE LAS PLGS load
0
#
#
# (405) B2 LINE OUTAGE (BREAKER-TO-BREAKER)
#
1 33380 33400 "1 "  0      # line from JEFRSN_D 60.00 BRKR to BRKR JEFRSN_E 60.00
0

```

APPENDIX B – CAISO CATEGORY B AUTOCON INPUT FILE

```

#
#
# (406) B2 LINE OUTAGE (BREAKER-TO-BREAKER)
#
1 33381 33384 "1 " 0 # line from GLENWOOD 60.00 BRKR to (3) MNLO JCT 60.00
1 33384 33386 "1 " 0 # line from MNLO JCT 60.00 (3) to BRKR STANFORD 60.00
1 33384 33390 "1 " 0 # line from MNLO JCT 60.00 (3) to BRKR MENLO G 60.00
3 33463 0 "***" 0 # GEN-DROP CARDINAL 12.97
1 33388 33386 "1 " 1 # LINE-TRANSFER MNLO JCT 60.00 TO S.L.A.C. 60.00
4 33386 0 "***" 1 # RESTORE STANFORD load
0
#
#
# (407) B2 LINE OUTAGE (BREAKER-TO-BREAKER)
#
1 33394 33366 "1 " 0 # line from OXMTN_TP 60.00 BRKR to BRKR HLF MNBY 60.00
4 33366 0 "1 " 0 # LOAD-DROP HLF MNBY 60.00 LOAD==8.02(1.82)
4 33366 0 "2 " 0 # LOAD-DROP HLF MNBY 60.00 LOAD==8.73(1.99)
4 33366 0 "3 " 0 # LOAD-DROP HLF MNBY 60.00 LOAD==9.64(2.19)
1 33366 33389 "1 " 1 # LINE-TRANSFER HLLSDLJT 60.00 TO PACIFJCT 60.00
4 33366 0 "***" 1 # RESTORE HALF MOON BAY load
0
#
#
# (408) B2 LINE OUTAGE (BREAKER-TO-BREAKER)
#
1 33394 33395 "1 " 0 # line from OXMTN_TP 60.00 BRKR to (2) OX_MTN60 60.00
2 33395 33469 "1 " 0 # TRAN from OX_MTN60 60.00 (2) to (1) OX_MTN 4.16
3 33469 0 "1 " 0 # GEN-DROP OX_MTN 4.16 GEN==1.90(0.85)
3 33469 0 "2 " 0 # GEN-DROP OX_MTN 4.16 GEN==1.90(0.85)
3 33469 0 "3 " 0 # GEN-DROP OX_MTN 4.16 GEN==1.90(0.85)
3 33469 0 "4 " 0 # GEN-DROP OX_MTN 4.16 GEN==1.90(0.85)
3 33469 0 "5 " 0 # GEN-DROP OX_MTN 4.16 GEN==1.90(0.85)
3 33469 0 "6 " 0 # GEN-DROP OX_MTN 4.16 GEN==1.90(0.85)
3 33469 0 "7 " 0 # GEN-DROP OX_MTN 4.16 GEN==1.90(0.85)
0
#
#
# (409) B3 TRANSFORMER OUTAGE (BREAKER-TO-BREAKER)
#
2 33307 33353 "5 " 0 # TRAN from MILLBRAE 115.00 BRKR to BRKR MILLBRAE 60.00
0
#
#
# (410) B3 TRANSFORMER OUTAGE (BREAKER-TO-BREAKER)
#
# ***** 3-WINDING TRANSFORMER 33310 (30701) 30700 33460 :
2 33310 30700 "5 " 0 # TRAN from SANMATEO 115.00 BRKR to (1) SANMATEO 230.00
0
#
#
# (411) B3 TRANSFORMER OUTAGE (BREAKER-TO-BREAKER)
#
# ***** 3-WINDING TRANSFORMER 33310 (30702) 30700 33461 :
2 33310 30700 "6 " 0 # TRAN from SANMATEO 115.00 BRKR to (1) SANMATEO 230.00
0
#
#
# (412) B3 TRANSFORMER OUTAGE (BREAKER-TO-BREAKER)
#
# ***** 3-WINDING TRANSFORMER 33310 (30704) 30700 33462 :
2 33310 30700 "7 " 0 # TRAN from SANMATEO 115.00 BRKR to (1) SANMATEO 230.00
0
#
#
# (413) B3 TRANSFORMER OUTAGE (BREAKER-TO-BREAKER)
#
2 33310 33318 "3 " 0 # TRAN from SANMATEO 115.00 BRKR to (2) SMATEO3M 115.00
2 33318 33357 "3 " 0 # TRAN from SMATEO3M 115.00 (2) to BRKR SAN MATO 60.00
0
#
#
# (414) B3 TRANSFORMER OUTAGE (BREAKER-TO-BREAKER)
#
2 33315 30703 "1 " 0 # TRAN from RVNSWD E 115.00 BRKR to BRKR RAVENSWD 230.00
0
#
#
# (415) B3 TRANSFORMER OUTAGE (BREAKER-TO-BREAKER)

```

APPENDIX B – CAISO CATEGORY B AUTOCON INPUT FILE

```

#
2 33321 30703 "2 " 0 # TRAN from RVNSWD D 115.00 BRKR to BRKR RAVENSWD 230.00
0
#
#
# (416) B3 TRANSFORMER OUTAGE (BREAKER-TO-BREAKER)
#
2 33357 33310 "8 " 0 # TRAN from SAN MATO 60.00 BRKR to BRKR SANMATEO 115.00
0
#
#
# (417) B3 TRANSFORMER OUTAGE (BREAKER-TO-BREAKER)
#
2 33367 33313 "1 " 0 # TRAN from BAIR 60.00 BRKR to BRKR BAIR 115.00
0
#
#
# (418) B3 TRANSFORMER OUTAGE (BREAKER-TO-BREAKER)
#
2 33375 33316 "2 " 0 # TRAN from CLY LNDG 60.00 BRKR to BRKR CLY LND2 115.00
0
#
#
# (419) B3 TRANSFORMER OUTAGE (BREAKER-TO-BREAKER)
#
2 33375 33317 "1 " 0 # TRAN from CLY LNDG 60.00 BRKR to BRKR CLY LND 115.00
0
#
#
# (420) B3 TRANSFORMER OUTAGE (BREAKER-TO-BREAKER)
#
2 33400 30715 "2 " 0 # TRAN from JEFERSN_E 60.00 BRKR to BRKR JEFFERSN 230.00
0
#
#
# (421) B3 TRANSFORMER OUTAGE (BREAKER-TO-BREAKER)
#
2 33463 33386 "1 " 0 # TRAN from CARDINAL 12.47 (1) to BRKR STANFORD 60.00
3 33463 0 "1 " 0 # GEN-DROP CARDINAL 12.47 GEN==31.00(12.13)
3 33463 0 "2 " 0 # GEN-DROP CARDINAL 12.47 GEN==10.00(3.91)
0
#
#
# (422) B1 GENERATOR OUTAGE
#
3 33469 0 "1" 0 # OX_MTN 4.16 PGEN=1.90 QGEN=0.85
0
#
#
# (423) B1 GENERATOR OUTAGE
#
3 33460 0 "1" 0 # SMATO2SC 13.20 PGEN=0.00 QGEN=22.88
0
#
#
# (424) B1 GENERATOR OUTAGE
#
3 33461 0 "1" 0 # SMATO3SC 13.20 PGEN=0.00 QGEN=23.33
0
#
#
# (425) B1 GENERATOR OUTAGE
#
3 33462 0 "1" 0 # SMATO1SC 13.20 PGEN=0.00 QGEN=25.00
0
#
#
# (426) B1 GENERATOR OUTAGE
#
3 33466 0 "1" 0 # UNTED CO 9.11 PGEN=28.20 QGEN=11.18
0
#
#
# (427) B1 GENERATOR OUTAGE
#
3 33468 0 "1" 0 # SRI INTL 9.11 PGEN=4.30 QGEN=3.00
0
#
#

```

APPENDIX B – CAISO CATEGORY B AUTOCON INPUT FILE

```

# (428) B1 GENERATOR OUTAGE
#
3 33463      0 "1"      0      # CARDINAL  12.47      PGEN=31.00  QGEN=12.01
0
#
#
# (429) B1 GENERATOR OUTAGE
#
3 33463      0 "2"      0      # CARDINAL  12.47      PGEN=10.00  QGEN=3.43
0
#
#
# (430) L-1/G-1 OVERLAPPING OUTAGE
# East Shore - San Mateo 230 kV Line and United Cogen
1 30560 30700 "1 "      0      # line from  E. SHORE 230.00  BRKR to BRKR  SANMATEO 230.00
#
3 33466      0 "1"      0      # UNTED CO   9.11      PGEN=28.20  QGEN=11.18
0
#
#
# (431) L-1/G-1 OVERLAPPING OUTAGE
# Newark - Ravenswood 230 kV Line and United Cogen
1 30630 30703 "1 "      0      # line from  NEWARK D 230.00  BRKR to BRKR  RAVENSWD 230.00
#
3 33466      0 "1"      0      # UNTED CO   9.11      PGEN=28.20  QGEN=11.18
0
#
#
# (432) L-1/G-1 OVERLAPPING OUTAGE
# Tesla - Ravenswood 230 kV Line and United Cogen
1 30640 30703 "1 "      0      # line from  TESLA C   230.00  BRKR to BRKR  RAVENSWD 230.00
#
3 33466      0 "1"      0      # UNTED CO   9.11      PGEN=28.20  QGEN=11.18
0
#
#
# (433) L-1/G-1 OVERLAPPING OUTAGE
# Pittsburg - San Mateo 230 kV Line and United Cogen
1 30700 30527 "1 "      0      # line from  SANMATEO 230.00  BRKR to BRKR  PITSBG E 230.00
#
3 33466      0 "1"      0      # UNTED CO   9.11      PGEN=28.20  QGEN=11.18
0
#
#
# (434) L-1/G-1 OVERLAPPING OUTAGE
# Martin - San Mateo 230 kV Line and United Cogen
1 30700 30695 "1 "      0      # line from  SANMATEO 230.00  BRKR to BRKR  MARTIN C 230.00
#
3 33466      0 "1"      0      # UNTED CO   9.11      PGEN=28.20  QGEN=11.18
0
#
#
# (435) L-1/G-1 OVERLAPPING OUTAGE
# San Mateo - Ravenswood #1 230 kV Line and United Cogen
1 30703 30700 "1 "      0      # line from  RAVENSWD 230.00  BRKR to BRKR  SANMATEO 230.00
#
3 33466      0 "1"      0      # UNTED CO   9.11      PGEN=28.20  QGEN=11.18
0
#
#
# (436) L-1/G-1 OVERLAPPING OUTAGE
# San Mateo - Ravenswood #2 230 kV Line and United Cogen
1 30703 30700 "2 "      0      # line from  RAVENSWD 230.00  BRKR to BRKR  SANMATEO 230.00
#
3 33466      0 "1"      0      # UNTED CO   9.11      PGEN=28.20  QGEN=11.18
0
#
#
# (437) L-1/G-1 OVERLAPPING OUTAGE
# Monta Vista - Jefferson #1 230 kV Line and United Cogen
1 30705 30710 "1 "      0      # line from  MONTAVIS 230.00  BRKR to (3)  SLACTAP1 230.00
1 30710 30711 "1 "      0      # line from  SLACTAP1 230.00  (3) to BRKR  S.L.A.C. 230.00
1 30710 30715 "1 "      0      # line from  SLACTAP1 230.00  (3) to BRKR  JEFFERSN 230.00
4 30711      0 "1 "      0      # LOAD-DROP   S.L.A.C. 230.00  LOAD==58.00(11.78)
1 30711 30712 "1 "      1      # LINE-TRANSFER SLACTAP1 to SLACTAP2
4 30711      0 "***"    1      # RESTORE S.L.A.C. load
#
3 33466      0 "1"      0      # UNTED CO   9.11      PGEN=28.20  QGEN=11.18
0

```

APPENDIX B – CAISO CATEGORY B AUTOCON INPUT FILE

```

#
#
# (438) L-1/G-1 OVERLAPPING OUTAGE
# Monta Vista - Jefferson #2 230 kV Line and United Cogen
1 30705 30712 "2 " 0 # line from MONTAVIS 230.00 BRKR to (2) SLACTAP2 230.00
1 30712 30715 "2 " 0 # line from SLACTAP2 230.00 (2) to BRKR JEFFERSN 230.00
#
3 33466 0 "1" 0 # UNTED CO 9.11 PGEN=28.20 QGEN=11.18
0
#
#
# (439) L-1/G-1 OVERLAPPING OUTAGE
# Martin - Jefferson 230 kV Line and United Cogen
1 30713 30714 "1 " 0 # line from JMDAMCX1 230.00 (2) to (2) JMDAMCX2 230.00
1 30713 30715 "1 " 0 # line from JMDAMCX1 230.00 (2) to BRKR JEFFERSN 230.00
1 30714 30716 "1 " 0 # line from JMDAMCX2 230.00 (2) to (2) TRAN230A 230.00
1 30716 30717 "1 " 0 # line from TRAN230A 230.00 (2) to (2) TRAN230B 230.00
1 30717 30696 "1 " 0 # line from TRAN230B 230.00 (2) to (2) MRT RCTR 230.00
1 30696 30695 "1 " 0 # line from MRT RCTR 230.00 (2) to BRKR MARTIN C 230.00
#
3 33466 0 "1" 0 # UNTED CO 9.11 PGEN=28.20 QGEN=11.18
0
#
#
# (440) L-1/G-1 OVERLAPPING OUTAGE
# Martin - East Grand 115 kV Line and United Cogen
1 33208 33303 "2 " 0 # line from MARTIN C 115.00 BRKR to BRKR EST GRND 115.00
#
3 33466 0 "1" 0 # UNTED CO 9.11 PGEN=28.20 QGEN=11.18
0
#
#
# (441) L-1/G-1 OVERLAPPING OUTAGE
# Martin - Millbrae 115 kV Line and United Cogen
1 33208 33307 "1 " 0 # line from MARTIN C 115.00 BRKR to BRKR MILLBRAE 115.00
#
3 33466 0 "1" 0 # UNTED CO 9.11 PGEN=28.20 QGEN=11.18
0
#
#
# (442) L-1/G-1 OVERLAPPING OUTAGE
# Martin - San Mateo #3 115 kV Line and United Cogen
1 33208 33310 "3 " 0 # line from MARTIN C 115.00 BRKR to BRKR SANMATEO 115.00
#
3 33466 0 "1" 0 # UNTED CO 9.11 PGEN=28.20 QGEN=11.18
0
#
#
# (443) L-1/G-1 OVERLAPPING OUTAGE
# Martin - San Mateo #6 115 kV Line and United Cogen
1 33305 33208 "6 " 0 # line from SHAWROAD 115.00 (2) to BRKR MARTIN C 115.00
1 33305 33310 "6 " 0 # line from SHAWROAD 115.00 (2) to BRKR SANMATEO 115.00
4 33305 33309 "1 " 1 # LOAD-TRANSFER SHAWROAD 115.00 TO SANPAULA 115.00 LOAD==9.00(1.83)
#
3 33466 0 "1" 0 # UNTED CO 9.11 PGEN=28.20 QGEN=11.18
0
#
#
# (444) L-1/G-1 OVERLAPPING OUTAGE
# SF Airport - San Mateo 115 kV Line and United Cogen
1 33306 33310 "5 " 0 # line from SFIA 115.00 BRKR to BRKR SANMATEO 115.00
#
3 33466 0 "1" 0 # UNTED CO 9.11 PGEN=28.20 QGEN=11.18
0
#
#
# (445) L-1/G-1 OVERLAPPING OUTAGE
# Millbrae - San Mateo 115 kV Line and United Cogen
1 33307 33310 "1 " 0 # line from MILLBRAE 115.00 BRKR to BRKR SANMATEO 115.00
#
3 33466 0 "1" 0 # UNTED CO 9.11 PGEN=28.20 QGEN=11.18
0
#
#
# (446) L-1/G-1 OVERLAPPING OUTAGE
# East Grand - San Mateo 115 kV Line and United Cogen
1 33308 33303 "2 " 0 # line from SFIA-MA 115.00 (2) to BRKR EST GRND 115.00
1 33308 33310 "2 " 0 # line from SFIA-MA 115.00 (2) to BRKR SANMATEO 115.00
4 33308 33306 "1 " 1 # LOAD-TRANSFER SFIA-MA 115.00 TO SFIA 115.00 LOAD==20.20(4.10)

```

APPENDIX B – CAISO CATEGORY B AUTOCON INPUT FILE

```

#
3 33466      0 "1"      0      # UNITED CO   9.11      PGEN=28.20  QGEN=11.18
0
#
#
# (447) L-1/G-1 OVERLAPPING OUTAGE
# Millbrae - Santa Paula 115 kV Line and United Cogen
1 33309 33307 "1 "      0      # line from  SANPAULA 115.00  (1) to BRKR  MILLBRAE 115.00
4 33309 33305 "1 "      1      # LOAD-TRANSFER  SANPAULA 115.00  TO SHAWROAD 115.00  LOAD==8.00(1.62)
#
3 33466      0 "1"      0      # UNITED CO   9.11      PGEN=28.20  QGEN=11.18
0
#
#
# (448) L-1/G-1 OVERLAPPING OUTAGE
# Belmont - San Mateo 115 kV Line and United Cogen
1 33310 33312 "1 "      0      # line from  SANMATEO 115.00  BRKR to BRKR  BELMONT  115.00
#
3 33466      0 "1"      0      # UNITED CO   9.11      PGEN=28.20  QGEN=11.18
0
#
#
# (449) L-1/G-1 OVERLAPPING OUTAGE
# Ravenswood - San Mateo 115 kV Line and United Cogen
1 33310 33321 "1 "      0      # line from  SANMATEO 115.00  BRKR to BRKR  RVNSWD D 115.00
#
3 33466      0 "1"      0      # UNITED CO   9.11      PGEN=28.20  QGEN=11.18
0
#
#
# (450) L-1/G-1 OVERLAPPING OUTAGE
# Burlingame - San Mateo 115 kV Line and United Cogen
1 33310 33356 "4 "      0      # line from  SANMATEO 115.00  BRKR to BRKR  BURLNGME 115.00
#
3 33466      0 "1"      0      # UNITED CO   9.11      PGEN=28.20  QGEN=11.18
0
#
#
# (451) L-1/G-1 OVERLAPPING OUTAGE
# Belmont - Bair 115 kV Line and United Cogen
1 33312 33313 "1 "      0      # line from  BELMONT  115.00  BRKR to BRKR  BAIR      115.00
#
3 33466      0 "1"      0      # UNITED CO   9.11      PGEN=28.20  QGEN=11.18
0
#
#
# (452) L-1/G-1 OVERLAPPING OUTAGE
# Ravenswood - Bair 115 kV Line and United Cogen
1 33313 33319 "2 "      0      # line from  BAIR      115.00  BRKR to (3)  SHREDJCT 115.00
1 33319 33314 "1 "      0      # line from  SHREDJCT 115.00  (3) to (2)  SHREDDER 115.00
1 33319 33321 "2 "      0      # line from  SHREDJCT 115.00  (3) to BRKR  RVNSWD D 115.00
1 33314 33320 "1 "      0      # line from  SHREDDER 115.00  (2) to (1)  LONESTAR 115.00
4 33314      0 "1 "      0      # LOAD-DROP   SHREDDER 115.00  LOAD==4.77(5.43)
4 33320      0 "1 "      0      # LOAD-DROP   LONESTAR 115.00  LOAD==2.57(3.43)
#
3 33466      0 "1"      0      # UNITED CO   9.11      PGEN=28.20  QGEN=11.18
0
#
#
# (453) L-1/G-1 OVERLAPPING OUTAGE
# Ravenswood - Cooley Landing #2 115 kV Line and United Cogen
1 33315 33316 "2 "      0      # line from  RVNSWD E 115.00  BRKR to BRKR  CLY LND2 115.00
#
3 33466      0 "1"      0      # UNITED CO   9.11      PGEN=28.20  QGEN=11.18
0
#
#
# (454) L-1/G-1 OVERLAPPING OUTAGE
# Ravenswood - Ames #1 115 kV Line and United Cogen
1 33315 35350 "1 "      0      # line from  RVNSWD E 115.00  BRKR to BRKR  AMES BS1 115.00
#
3 33466      0 "1"      0      # UNITED CO   9.11      PGEN=28.20  QGEN=11.18
0
#
#
# (455) L-1/G-1 OVERLAPPING OUTAGE
# Ravenswood - Ames #2 115 kV Line and United Cogen
1 33315 35351 "2 "      0      # line from  RVNSWD E 115.00  BRKR to BRKR  AMES BS2 115.00
#

```

APPENDIX B – CAISO CATEGORY B AUTOCON INPUT FILE

```

3 33466      0 "1"      0      # UNITED CO   9.11      PGEN=28.20  QGEN=11.18
0
#
#
# (456) L-1/G-1 OVERLAPPING OUTAGE
# Ravenswood - Palo Alto #1 115 kV Line and United Cogen
1 33315 38028 "1 "      0      # line from  RVNSWD E 115.00  BRKR to BRKR  PLO ALTO 115.00
#
3 33466      0 "1"      0      # UNITED CO   9.11      PGEN=28.20  QGEN=11.18
0
#
#
# (457) L-1/G-1 OVERLAPPING OUTAGE
# Ravenswood - Palo Alto #2 115 kV Line and United Cogen
1 33315 38028 "2 "      0      # line from  RVNSWD E 115.00  BRKR to BRKR  PLO ALTO 115.00
#
3 33466      0 "1"      0      # UNITED CO   9.11      PGEN=28.20  QGEN=11.18
0
#
#
# (458) L-1/G-1 OVERLAPPING OUTAGE
# Cooley Landing - Palo Alto 115 kV Line and United Cogen
1 33316 38028 "1 "      0      # line from  CLY LND2 115.00  BRKR to BRKR  PLO ALTO 115.00
#
3 33466      0 "1"      0      # UNITED CO   9.11      PGEN=28.20  QGEN=11.18
0
#
#
# (459) L-1/G-1 OVERLAPPING OUTAGE
# Ravenswood - Bair 115 kV Line and United Cogen
1 33321 33313 "1 "      0      # line from  RVNSWD D 115.00  BRKR to BRKR  BAIR      115.00
#
3 33466      0 "1"      0      # UNITED CO   9.11      PGEN=28.20  QGEN=11.18
0
#
#
# (460) L-1/G-1 OVERLAPPING OUTAGE
# Ravenswood - Cooley Landing #1 115 kV Line and United Cogen
1 33321 33317 "1 "      0      # line from  RVNSWD D 115.00  BRKR to BRKR  CLY LND  115.00
#
3 33466      0 "1"      0      # UNITED CO   9.11      PGEN=28.20  QGEN=11.18
0
#
#
# 2013 category b contingency list
# Mission Division Zone 316
#
#
# (461) B2 LINE OUTAGE (BREAKER-TO-BREAKER)
#
1 30530 30537 "1 "      0      # line from  CAYETANO 230.00  BRKR to BRKR  NDUBLIN  230.00
0
#
#
# (462) B2 LINE OUTAGE (BREAKER-TO-BREAKER)
#
1 30538 35228 "1 "      0      # line from  NDBC322 230.00  BRKR to BRKR  VINCB212 230.00
0
#
#
# (463) B2 LINE OUTAGE (BREAKER-TO-BREAKER)
#
1 30554 30631 "1 "      0      # line from  CASTROVL 230.00  BRKR to BRKR  NEWARK E  230.00
0
#
#
# (464) B2 LINE OUTAGE (BREAKER-TO-BREAKER)
#
1 30560 30559 "1 "      0      # line from  E. SHORE 230.00  BRKR to BRKR  RCEC      230.00
0
#
#
# (465) B2 LINE OUTAGE (BREAKER-TO-BREAKER)
#
1 30560 30559 "2 "      0      # line from  E. SHORE 230.00  BRKR to BRKR  RCEC      230.00
0
#
#
# (466) B2 LINE OUTAGE (BREAKER-TO-BREAKER)

```

APPENDIX B – CAISO CATEGORY B AUTOCON INPUT FILE

```

#
1 30585 30630 "1 " 0 # line from LS PSTAS 230.00 BRKR to BRKR NEWARK D 230.00
0
#
#
# (467) B2 LINE OUTAGE (BREAKER-TO-BREAKER)
#
1 30631 30635 "1 " 0 # line from NEWARK E 230.00 BRKR to BRKR NWK DIST 230.00
0
#
#
# (468) B2 LINE OUTAGE (BREAKER-TO-BREAKER)
#
1 30635 30731 "1 " 0 # line from NWK DIST 230.00 BRKR to BRKR LS ESTRS 230.00
0
#
#
# (469) B2 LINE OUTAGE (BREAKER-TO-BREAKER)
#
1 35104 35105 "1 " 0 # line from GRANT 115.00 BRKR to BRKR EASTSHRE 115.00
0
#
#
# (470) B2 LINE OUTAGE (BREAKER-TO-BREAKER)
#
1 35104 35105 "2 " 0 # line from GRANT 115.00 BRKR to BRKR EASTSHRE 115.00
0
#
#
# (471) B2 LINE OUTAGE (BREAKER-TO-BREAKER)
#
1 35105 35106 "1 " 0 # line from EASTSHRE 115.00 BRKR to BRKR MT EDEN 115.00
0
#
#
# (472) B2 LINE OUTAGE (BREAKER-TO-BREAKER)
#
1 35105 35106 "2 " 0 # line from EASTSHRE 115.00 BRKR to BRKR MT EDEN 115.00
0
#
#
# (473) B2 LINE OUTAGE (BREAKER-TO-BREAKER)
#
1 35105 35107 "1 " 0 # line from EASTSHRE 115.00 BRKR to BRKR DUMBARTN 115.00
0
#
#
# (474) B2 LINE OUTAGE (BREAKER-TO-BREAKER)
#
1 35107 35120 "1 " 0 # line from DUMBARTN 115.00 BRKR to BRKR NEWARK D 115.00
0
#
#
# (475) B2 LINE OUTAGE (BREAKER-TO-BREAKER)
#
1 35120 35111 "1 " 0 # line from NEWARK D 115.00 BRKR to BRKR JARVIS 115.00
0
#
#
# (476) B2 LINE OUTAGE (BREAKER-TO-BREAKER)
#
1 35120 35124 "2 " 0 # line from NEWARK D 115.00 BRKR to (2) NUMI JCT 115.00
1 35124 35111 "2 " 0 # line from NUMI JCT 115.00 (2) to BRKR JARVIS 115.00
0
#
#
# (477) B2 LINE OUTAGE (BREAKER-TO-BREAKER)
#
1 35120 36851 "1 " 0 # line from NEWARK D 115.00 BRKR to BRKR NRS 400 115.00
0
#
#
# (478) B2 LINE OUTAGE (BREAKER-TO-BREAKER)
#
1 35120 38446 "3 " 0 # line from NEWARK D 115.00 BRKR to (3) OAK-TAP1 115.00
1 38446 38432 "1 " 0 # line from OAK-TAP1 115.00 (3) to (4) OAKDLTID 115.00
1 38446 36962 "3 " 0 # line from OAK-TAP1 115.00 (3) to BRKR MOCCASIN 115.00
1 38432 38420 "1 " 0 # line from OAKDLTID 115.00 (4) to BRKR TUOLUMN 115.00
1 38432 38420 "2 " 0 # line from OAKDLTID 115.00 (4) to BRKR TUOLUMN 115.00

```

APPENDIX B – CAISO CATEGORY B AUTOCON INPUT FILE

```

1 38432 38448 "2 " 0 # line from OAKDLTID 115.00 (4) to (3) OAK-TAP2 115.00
1 38448 35120 "4 " 0 # line from OAK-TAP2 115.00 (3) to BRKR NEWARK D 115.00
1 38448 36962 "4 " 0 # line from OAK-TAP2 115.00 (3) to BRKR MOCCASIN 115.00
0
#
#
# (479) B2 LINE OUTAGE (BREAKER-TO-BREAKER)
#
1 35121 35110 "1 " 0 # line from NEWARK E 115.00 BRKR to BRKR FREMNT 115.00
0
#
#
# (480) B2 LINE OUTAGE (BREAKER-TO-BREAKER)
#
1 35121 35110 "2 " 0 # line from NEWARK E 115.00 BRKR to BRKR FREMNT 115.00
0
#
#
# (481) B2 LINE OUTAGE (BREAKER-TO-BREAKER)
#
1 35121 35350 "1 " 0 # line from NEWARK E 115.00 BRKR to BRKR AMES BS1 115.00
0
#
#
# (482) B2 LINE OUTAGE (BREAKER-TO-BREAKER)
#
1 35121 35350 "3 " 0 # line from NEWARK E 115.00 BRKR to BRKR AMES BS1 115.00
0
#
#
# (483) B2 LINE OUTAGE (BREAKER-TO-BREAKER)
#
1 35121 35351 "2 " 0 # line from NEWARK E 115.00 BRKR to BRKR AMES BS2 115.00
0
#
#
# (484) B2 LINE OUTAGE (BREAKER-TO-BREAKER)
#
1 35122 35126 "1 " 0 # line from NEWARK F 115.00 BRKR to (2) NUMI TAP 115.00
1 35126 35127 "1 " 0 # line from NUMI TAP 115.00 (2) to (2) WESTRN_D 115.00
1 35127 35112 "1 " 0 # line from WESTRN_D 115.00 (2) to BRKR NUMMI 115.00
4 35127 0 "1 " 0 # LOAD-DROP WESTRN_D 115.00 LOAD==6.80(4.25)
4 35112 0 "1 " 0 # LOAD-DROP NUMMI 115.00 LOAD==30.88(8.14)
0
#
#
# (485) B2 LINE OUTAGE (BREAKER-TO-BREAKER)
#
1 35122 35357 "1 " 0 # line from NEWARK F 115.00 BRKR to (3) LCKHD J1 115.00
1 35357 35358 "1 " 0 # line from LCKHD J1 115.00 (3) to (3) MFT.FD J 115.00
1 35357 35363 "1 " 0 # line from LCKHD J1 115.00 (3) to BRKR LAWRENCE 115.00
1 35358 35359 "1 " 0 # line from MFT.FD J 115.00 (3) to (1) MOFT.FLD 115.00
1 35358 35361 "1 " 0 # line from MFT.FD J 115.00 (3) to BRKR LOCKHD 1 115.00
4 35359 0 "1 " 0 # LOAD-DROP MOFT.FLD 115.00 LOAD==4.46(1.12)
4 35361 0 "3 " 0 # LOAD-DROP LOCKHD 1 115.00 LOAD==17.45(14.46)
1 35361 35362 "1 " 1 # close LOCKHD 1 115.00 LOCKHD 2 115.00
4 35361 0 "1 " 1 # restore all loads to LOCKHD 1
0
#
#
# (486) B2 LINE OUTAGE (BREAKER-TO-BREAKER)
#
1 35122 35360 "1 " 0 # line from NEWARK F 115.00 BRKR to (3) LCKHD J2 115.00
1 35360 35362 "1 " 0 # line from LCKHD J2 115.00 (3) to BRKR LOCKHD 2 115.00
1 35360 35365 "1 " 0 # line from LCKHD J2 115.00 (3) to (3) AMD JCT 115.00
1 35365 35364 "1 " 0 # line from AMD JCT 115.00 (3) to BRKR A.M.D 115.00
1 35365 35369 "1 " 0 # line from AMD JCT 115.00 (3) to BRKR APP MAT 115.00
4 35362 0 "1 " 0 # LOAD-DROP LOCKHD 2 115.00 LOAD==7.56(1.72)
4 35362 0 "2 " 0 # LOAD-DROP LOCKHD 2 115.00 LOAD==3.42(0.78)
4 35362 0 "4 " 0 # LOAD-DROP LOCKHD 2 115.00 LOAD==16.21(12.58)
4 35364 0 "1 " 0 # LOAD-DROP A.M.D 115.00 LOAD==1.67(1.17)
1 35361 35362 "1 " 1 # close LOCKHD 1 115.00 LOCKHD 2 115.00
4 35362 0 "1 " 1 # restore all loads to LOCKHD 2
0
#
#
# (487) B2 LINE OUTAGE (BREAKER-TO-BREAKER)
#
1 35122 35600 "1 " 0 # line from NEWARK F 115.00 BRKR to BRKR DIXON LD 115.00

```

APPENDIX B – CAISO CATEGORY B AUTOCON INPUT FILE

```

0
#
#
# (488) B2 LINE OUTAGE (BREAKER-TO-BREAKER)
#
1 35122 35602 "1 " 0 # line from NEWARK F 115.00 BRKR to (3) ZNKER J2 115.00
1 35602 35604 "1 " 0 # line from ZNKER J2 115.00 (3) to (3) ZANKER 115.00
1 35602 36850 "1 " 0 # line from ZNKER J2 115.00 (3) to BRKR KRS 115.00
2 35604 35861 "1 " 0 # TRAN from ZANKER 115.00 (3) to (2) SJ-SCL W 9.11
2 35604 35861 "2 " 0 # TRAN from ZANKER 115.00 (3) to (2) SJ-SCL W 9.11
4 35861 0 "SG" 0 # LOAD-DROP SJ-SCL W 9.11 LOAD==6.17(2.09)
3 35861 0 "1 " 0 # GEN-DROP SJ-SCL W 9.11 GEN==5.00(0.00)
0
#
#
# (489) B2 LINE OUTAGE (BREAKER-TO-BREAKER)
#
1 35122 35603 "1 " 0 # line from NEWARK F 115.00 BRKR to (3) ZNKER J1 115.00
1 35603 35605 "1 " 0 # line from ZNKER J1 115.00 (3) to (1) AGNEW J 115.00
1 35603 35612 "1 " 0 # line from ZNKER J1 115.00 (3) to BRKR TRIMBLE 115.00
0
#
#
# (490) B2 LINE OUTAGE (BREAKER-TO-BREAKER)
#
1 35122 35624 "1 " 0 # line from NEWARK F 115.00 BRKR to BRKR MILPITAS 115.00
0
#
#
# (491) B2 LINE OUTAGE (BREAKER-TO-BREAKER)
#
1 35122 35624 "2 " 0 # line from NEWARK F 115.00 BRKR to BRKR MILPITAS 115.00
0
#
#
# (492) B2 LINE OUTAGE (BREAKER-TO-BREAKER)
#
1 35122 36853 "2 " 0 # line from NEWARK F 115.00 BRKR to BRKR NRS 300 115.00
0
#
#
# (493) B2 LINE OUTAGE (BREAKER-TO-BREAKER)
#
1 35200 35204 "1 " 0 # line from SEAWEST 60.00 (3) to (3) ZONDWD 60.00
1 35200 35218 "1 " 0 # line from SEAWEST 60.00 (3) to (2) FLOWIND1 60.00
2 35200 35312 "1 " 0 # TRAN from SEAWEST 60.00 (3) to (1) SEAWESTF 9.11
1 35204 35208 "1 " 0 # line from ZONDWD 60.00 (3) to (3) USWP-FRK 60.00
2 35204 35316 "1 " 0 # TRAN from ZONDWD 60.00 (3) to (1) ZOND SYS 9.11
2 35218 35318 "1 " 0 # TRAN from FLOWIND1 60.00 (2) to (1) FLOWDPTR 9.11
1 35208 35210 "1 " 0 # line from USWP-FRK 60.00 (3) to (3) VASCJCT. 60.00
2 35208 35320 "1 " 0 # TRAN from USWP-FRK 60.00 (3) to (1) USW FRIC 12.00
1 35210 35201 "1 " 0 # line from VASCJCT. 60.00 (3) to BRKR VASCO 60.00
1 35210 35220 "1 " 0 # line from VASCJCT. 60.00 (3) to BRKR LPOSTAS 60.00
4 35201 0 "1 " 0 # LOAD-DROP VASCO 60.00 LOAD==6.00(1.37)
4 35201 0 "2 " 0 # LOAD-DROP VASCO 60.00 LOAD==8.78(2.00)
3 35312 0 "1 " 0 # GEN-DROP SEAWESTF 9.11 GEN==0.10(0.00)
3 35320 0 "1 " 0 # GEN-DROP USW FRIC 12.00 GEN==2.60(0.00)
1 35211 35201 "1 " 1 # LINE-TRANSFER VASCJCT. 60.00 TO ALTAMONT 60.00
4 35201 0 "***" 1 # RESTORE VASCO load
0
#
#
# (494) B2 LINE OUTAGE (BREAKER-TO-BREAKER)
#
1 35202 33776 "1 " 0 # line from USWP-WKR 60.00 (3) to (2) SOUTH BY 60.00
1 35202 35211 "1 " 0 # line from USWP-WKR 60.00 (3) to (1) ALTAMONT 60.00
2 35202 35314 "1 " 0 # TRAN from USWP-WKR 60.00 (3) to (1) WALKER+ 9.11
1 33776 33775 "1 " 0 # line from SOUTH BY 60.00 (2) to (2) TOSCO-PP 60.00
1 33775 33773 "1 " 0 # line from TOSCO-PP 60.00 (2) to (2) ALTA-CGE 60.00
1 33773 33772 "1 " 0 # line from ALTA-CGE 60.00 (2) to (2) B.BTHNY- 60.00
1 33772 33770 "1 " 0 # line from B.BTHNY- 60.00 (2) to BRKR HERDLYN 60.00
4 33776 0 "1 " 0 # LOAD-DROP SOUTH BY 60.00 LOAD==23.00(0.00)
4 33775 0 "1 " 0 # LOAD-DROP TOSCO-PP 60.00 LOAD==0.98(0.89)
4 33772 0 "1 " 0 # LOAD-DROP B.BTHNY- 60.00 LOAD==1.94(0.44)
3 33773 0 "1 " 0 # GEN-DROP ALTA-CGE 60.00 GEN==4.00(-1.00)
0
#
#
# (495) B2 LINE OUTAGE (BREAKER-TO-BREAKER)

```

APPENDIX B – CAISO CATEGORY B AUTOCON INPUT FILE

```

#
1 35203 35220 "1 " 0 # line from LIVERMRE 60.00 BRKR to BRKR LPOSTAS 60.00
0
#
#
# (496) B2 LINE OUTAGE (BREAKER-TO-BREAKER)
#
1 35203 35222 "1 " 0 # line from LIVERMRE 60.00 BRKR to (2) CALMAT60 60.00
1 35222 35205 "1 " 0 # line from CALMAT60 60.00 (2) to BRKR RADUM 60.00
4 35222 0 "1 " 0 # LOAD-DROP CALMAT60 60.00 LOAD==6.62(4.10)
0
#
#
# (497) B2 LINE OUTAGE (BREAKER-TO-BREAKER)
#
1 35205 35227 "1 " 0 # line from RADUM 60.00 BRKR to (2) VINEYARD 60.00
1 35227 35212 "1 " 0 # line from VINEYARD 60.00 (2) to (2) IUKA 60.00
1 35212 35213 "1 " 0 # line from IUKA 60.00 (2) to BRKR VALLECTS 60.00
4 35212 0 "1 " 0 # LOAD-DROP IUKA 60.00 LOAD==3.34(2.95)
0
#
#
# (498) B2 LINE OUTAGE (BREAKER-TO-BREAKER)
#
1 35209 35221 "1 " 0 # line from SAN RAMN 60.00 BRKR to (2) E DUBLIN 60.00
1 35221 35223 "1 " 0 # line from E DUBLIN 60.00 (2) to (3) PARKS TP 60.00
1 35223 35205 "1 " 0 # line from PARKS TP 60.00 (3) to BRKR RADUM 60.00
1 35223 35207 "1 " 0 # line from PARKS TP 60.00 (3) to (1) PARKS 60.00
4 35221 0 "1 " 0 # LOAD-DROP E DUBLIN 60.00 LOAD==2.20(0.45)
0
#
#
# (499) B2 LINE OUTAGE (BREAKER-TO-BREAKER)
#
1 35213 35214 "1 " 0 # line from VALLECTS 60.00 BRKR to (2) SUNOL 60.00
1 35214 35216 "1 " 0 # line from SUNOL 60.00 (2) to (2) DCTO JCT 60.00
1 35216 35217 "1 " 0 # line from DCTO JCT 60.00 (2) to BRKR NEWARK 60.00
4 35214 0 "1 " 0 # LOAD-DROP SUNOL 60.00 LOAD==6.87(1.57)
0
#
#
# (500) B2 LINE OUTAGE (BREAKER-TO-BREAKER)
#
1 35219 30630 "1 " 0 # line from VINEYARD 230.00 BRKR to BRKR NEWARK D 230.00
0
#
#
# (501) B2 LINE OUTAGE (BREAKER-TO-BREAKER)
#
1 35225 35217 "1 " 0 # line from LIVRMR_2 60.00 BRKR to BRKR NEWARK 60.00
0
#
#
# (502) B2 LINE OUTAGE (BREAKER-TO-BREAKER)
#
1 35349 35121 "1 " 0 # line from AMES DST 115.00 BRKR to BRKR NEWARK E 115.00
0
#
#
# (503) B3 TRANSFORMER OUTAGE (BREAKER-TO-BREAKER)
#
2 35105 30560 "1 " 0 # TRAN from EASTSHRE 115.00 BRKR to BRKR E. SHORE 230.00
0
#
#
# (504) B3 TRANSFORMER OUTAGE (BREAKER-TO-BREAKER)
#
2 35105 30560 "2 " 0 # TRAN from EASTSHRE 115.00 BRKR to BRKR E. SHORE 230.00
0
#
#
# (505) B3 TRANSFORMER OUTAGE (BREAKER-TO-BREAKER)
#
#
# ***** 3-WINDING TRANSFORMER 35120 (30627) 30630 35301 :
2 35120 30630 "9 " 0 # TRAN from NEWARK D 115.00 BRKR to (1) NEWARK D 230.00
0
#
#
# (506) B3 TRANSFORMER OUTAGE (BREAKER-TO-BREAKER)

```

APPENDIX B – CAISO CATEGORY B AUTOCON INPUT FILE

```

#
2 35120 35109 "1 " 0 # TRAN from NEWARK D 115.00 BRKR to (2) NWRK 2 M 115.00
2 35109 35217 "1 " 0 # TRAN from NWRK 2 M 115.00 (2) to BRKR NEWARK 60.00
0
#
#
# (507) B3 TRANSFORMER OUTAGE (BREAKER-TO-BREAKER)
#
# **** 3-WINDING TRANSFORMER 35121 (30626) 30630 35303 :
2 35121 30630 "7 " 0 # TRAN from NEWARK E 115.00 BRKR to (1) NEWARK D 230.00
0
#
#
# (508) B3 TRANSFORMER OUTAGE (BREAKER-TO-BREAKER)
#
# **** 3-WINDING TRANSFORMER 35122 (30628) 30631 35300 :
2 35122 30631 "11" 0 # TRAN from NEWARK F 115.00 BRKR to (1) NEWARK E 230.00
0
#
#
# (509) B3 TRANSFORMER OUTAGE (BREAKER-TO-BREAKER)
#
2 35209 30555 "1 " 0 # TRAN from SAN RAMN 60.00 BRKR to BRKR SANRAMON 230.00
0
#
#
# (510) B3 TRANSFORMER OUTAGE (BREAKER-TO-BREAKER)
#
2 35220 30585 "4 " 0 # TRAN from LPOSTAS 60.00 BRKR to BRKR LS PSTAS 230.00
0
#
#
# (511) B1 GENERATOR OUTAGE
#
3 35312 0 "1" 0 # SEAWESTF 9.11 PGEN=0.10 QGEN=0.00
0
#
#
# (512) B1 GENERATOR OUTAGE
#
3 35320 0 "1" 0 # USW FRIC 12.00 PGEN=2.60 QGEN=0.00
0
#
#
# (513) B1 GENERATOR OUTAGE
#
3 35304 0 "1" 0 # RCECCTG1 15.00 PGEN=180.00 QGEN=24.99
0
#
#
# (514) B1 GENERATOR OUTAGE
#
3 35305 0 "2" 0 # RCECCTG2 15.00 PGEN=180.00 QGEN=24.99
0
#
#
# (515) B1 GENERATOR OUTAGE
#
3 35306 0 "3" 0 # RCECSTG1 18.00 PGEN=254.00 QGEN=36.45
0
#
#
# (516) L-1/G-1 OVERLAPPING OUTAGE
# Contra Costa - Las Positas 230 kV Line and RCEC STG1
1 30525 30585 "1 " 0 # line from C.COSTA 230.00 BRKR to BRKR LS PSTAS 230.00
#
3 35306 0 "3" 0 # RCECSTG1 18.00 PGEN=254.00 QGEN=36.45
0
#
#
# (517) L-1/G-1 OVERLAPPING OUTAGE
# Pittsburg - San Ramon 230 kV Line and RCEC STG1
1 30526 30555 "1 " 0 # line from PITSBG D 230.00 BRKR to BRKR SANRAMON 230.00
#
3 35306 0 "3" 0 # RCECSTG1 18.00 PGEN=254.00 QGEN=36.45
0
#
#
# (518) L-1/G-1 OVERLAPPING OUTAGE

```

APPENDIX B – CAISO CATEGORY B AUTOCON INPUT FILE

```

# Cayetano - North Dublin 230 kV Line and RCEC STG1
1 30530 30537 "1 " 0 # line from CAYETANO 230.00 BRKR to BRKR NDUUBLIN 230.00
#
3 35306 0 "3" 0 # RCECSTG1 18.00 PGEN=254.00 QGEN=36.45
0
#
#
# (519) L-1/G-1 OVERLAPPING OUTAGE
# North Dublin - Vineyard 230 kV Line and RCEC STG1
1 30538 35228 "1 " 0 # line from NDBC322 230.00 BRKR to BRKR VINC212 230.00
#
3 35306 0 "3" 0 # RCECSTG1 18.00 PGEN=254.00 QGEN=36.45
0
#
#
# (520) L-1/G-1 OVERLAPPING OUTAGE
# Moraga - Castro Valley 230 kV Line and RCEC STG1
1 30550 30554 "1 " 0 # line from MORAGA 230.00 BRKR to BRKR CASTROVL 230.00
#
3 35306 0 "3" 0 # RCECSTG1 18.00 PGEN=254.00 QGEN=36.45
0
#
#
# (521) L-1/G-1 OVERLAPPING OUTAGE
# Moraga - San Ramon 230 kV Line and RCEC STG1
1 30550 30555 "1 " 0 # line from MORAGA 230.00 BRKR to BRKR SANRAMON 230.00
#
3 35306 0 "3" 0 # RCECSTG1 18.00 PGEN=254.00 QGEN=36.45
0
#
#
# (522) L-1/G-1 OVERLAPPING OUTAGE
# Castro Valley - Newark 230 kV Line and RCEC STG1
1 30554 30631 "1 " 0 # line from CASTROVL 230.00 BRKR to BRKR NEWARK E 230.00
#
3 35306 0 "3" 0 # RCECSTG1 18.00 PGEN=254.00 QGEN=36.45
0
#
#
# (523) L-1/G-1 OVERLAPPING OUTAGE
# Pittsburg - East Shore 230 kV Line and RCEC STG1
1 30560 30527 "1 " 0 # line from E. SHORE 230.00 BRKR to BRKR PITSBG E 230.00
#
3 35306 0 "3" 0 # RCECSTG1 18.00 PGEN=254.00 QGEN=36.45
0
#
#
# (524) L-1/G-1 OVERLAPPING OUTAGE
# East Shore - San Mateo 230 kV Line and RCEC STG1
1 30560 30700 "1 " 0 # line from E. SHORE 230.00 BRKR to BRKR SANMATEO 230.00
#
3 35306 0 "3" 0 # RCECSTG1 18.00 PGEN=254.00 QGEN=36.45
0
#
#
# (525) L-1/G-1 OVERLAPPING OUTAGE
# Tassajara - Newark 230 kV Line and RCEC STG1
1 30562 30631 "1 " 0 # line from TES JCT 230.00 (3) to BRKR NEWARK E 230.00
1 30562 30561 "1 " 0 # line from TES JCT 230.00 (3) to BRKR TASSAJAR 230.00
1 30562 30563 "1 " 0 # line from TES JCT 230.00 (3) to BRKR RESEARCH 230.00
4 30563 0 "1 " 0 # LOAD-DROP RESEARCH 230.00 LOAD==37.05(8.44)
#
3 35306 0 "3" 0 # RCECSTG1 18.00 PGEN=254.00 QGEN=36.45
0
#
#
# (526) L-1/G-1 OVERLAPPING OUTAGE
# Lonetree - Cayetano 230 kV Line and RCEC STG1
1 30567 30590 "1 " 0 # line from LONETREE 230.00 BRKR to (3) USWP-JRW 230.00
1 30590 30530 "1 " 0 # line from USWP-JRW 230.00 (3) to BRKR CAYETANO 230.00
2 30590 33838 "1 " 0 # TRAN from USWP-JRW 230.00 (3) to (1) USWP_#3 9.11
4 33838 0 "SG" 0 # LOAD-DROP USWP_#3 9.11 LOAD==0.50(0.20)
#
3 35306 0 "3" 0 # RCECSTG1 18.00 PGEN=254.00 QGEN=36.45
0
#
#
# (527) L-1/G-1 OVERLAPPING OUTAGE
# Las Positas - Newark 230 kV Line and RCEC STG1

```

APPENDIX B – CAISO CATEGORY B AUTOCON INPUT FILE

```

1 30585 30630 "1 " 0 # line from LS PSTAS 230.00 BRKR to BRKR NEWARK D 230.00
#
3 35306 0 "3" 0 # RCECSTG1 18.00 PGEN=254.00 QGEN=36.45
0
#
#
# (528) L-1/G-1 OVERLAPPING OUTAGE
# Tesla - Newark #1 230 kV Line and RCEC STG1
1 30624 30630 "1 " 0 # line from TESLA E 230.00 BRKR to BRKR NEWARK D 230.00
#
3 35306 0 "3" 0 # RCECSTG1 18.00 PGEN=254.00 QGEN=36.45
0
#
#
# (529) L-1/G-1 OVERLAPPING OUTAGE
# Newark - Ravenswood 230 kV Line and RCEC STG1
1 30630 30703 "1 " 0 # line from NEWARK D 230.00 BRKR to BRKR RAVENSWD 230.00
#
3 35306 0 "3" 0 # RCECSTG1 18.00 PGEN=254.00 QGEN=36.45
0
#
#
# (530) L-1/G-1 OVERLAPPING OUTAGE
# Newark - Newark Distribution 230 kV Line and RCEC STG1
1 30631 30635 "1 " 0 # line from NEWARK E 230.00 BRKR to BRKR NWK DIST 230.00
#
3 35306 0 "3" 0 # RCECSTG1 18.00 PGEN=254.00 QGEN=36.45
0
#
#
# (531) L-1/G-1 OVERLAPPING OUTAGE
# Newark Distribution - Los Esteros 230 kV Line and RCEC STG1
1 30635 30731 "1 " 0 # line from NWK DIST 230.00 BRKR to BRKR LS ESTRS 230.00
#
3 35306 0 "3" 0 # RCECSTG1 18.00 PGEN=254.00 QGEN=36.45
0
#
#
# (532) L-1/G-1 OVERLAPPING OUTAGE
# Tesla - Newark #2 230 kV Line and RCEC STG1
1 30655 30631 "2 " 0 # line from ADCC 230.00 (3) to BRKR NEWARK E 230.00
1 30655 30640 "2 " 0 # line from ADCC 230.00 (3) to BRKR TESLA C 230.00
2 30655 35310 "1 " 0 # TRAN from ADCC 230.00 (3) to (1) LFC FIN+ 9.11
#
3 35306 0 "3" 0 # RCECSTG1 18.00 PGEN=254.00 QGEN=36.45
0
#
#
# (533) L-1/G-1 OVERLAPPING OUTAGE
# Vineyard - Newark 230 kV Line and RCEC STG1
1 35219 30630 "1 " 0 # line from VINEYARD 230.00 BRKR to BRKR NEWARK D 230.00
#
3 35306 0 "3" 0 # RCECSTG1 18.00 PGEN=254.00 QGEN=36.45
0
#
#
# 2013 category b contingency list
# DeAnza Division Zone 317
#
#
# (534) B2 LINE OUTAGE (BREAKER-TO-BREAKER)
#
1 30705 30720 "1 " 0 # line from MONTAVIS 230.00 BRKR to BRKR SARATOGA 230.00
0
#
#
# (535) B2 LINE OUTAGE (BREAKER-TO-BREAKER)
#
1 30705 30730 "1 " 0 # line from MONTAVIS 230.00 BRKR to BRKR HICKS 230.00
0
#
#
# (536) B2 LINE OUTAGE (BREAKER-TO-BREAKER)
#
1 30720 30733 "1 " 0 # line from SARATOGA 230.00 BRKR to BRKR VASONA 230.00
0
#
#
# (537) B2 LINE OUTAGE (BREAKER-TO-BREAKER)

```

APPENDIX B – CAISO CATEGORY B AUTOCON INPUT FILE

```

#
1 30733 30735 "1 " 0 # line from VASONA 230.00 BRKR to BRKR METCALF 230.00
0
#
#
# (538) B2 LINE OUTAGE (BREAKER-TO-BREAKER)
#
1 30735 30705 "3 " 0 # line from METCALF 230.00 BRKR to BRKR MONTAVIS 230.00
0
#
#
# (539) B2 LINE OUTAGE (BREAKER-TO-BREAKER)
#
1 30741 30705 "4 " 0 # line from CAL MEC 230.00 BRKR to BRKR MONTAVIS 230.00
0
#
#
# (540) B2 LINE OUTAGE (BREAKER-TO-BREAKER)
#
1 35351 35349 "1 " 0 # line from AMES BS2 115.00 BRKR to BRKR AMES DST 115.00
0
#
#
# (541) B2 LINE OUTAGE (BREAKER-TO-BREAKER)
#
1 35352 35356 "1 " 0 # line from WHISMAN 115.00 BRKR to BRKR MNTA VSA 115.00
0
#
#
# (542) B2 LINE OUTAGE (BREAKER-TO-BREAKER)
#
1 35353 35356 "1 " 0 # line from MT VIEW 115.00 BRKR to BRKR MNTA VSA 115.00
0
#
#
# (543) B2 LINE OUTAGE (BREAKER-TO-BREAKER)
#
1 35354 35355 "1 " 0 # line from STELLING 115.00 BRKR to BRKR WOLFE 115.00
0
#
#
# (544) B2 LINE OUTAGE (BREAKER-TO-BREAKER)
#
1 35354 35356 "1 " 0 # line from STELLING 115.00 BRKR to BRKR MNTA VSA 115.00
0
#
#
# (545) B2 LINE OUTAGE (BREAKER-TO-BREAKER)
#
1 35355 35356 "1 " 0 # line from WOLFE 115.00 BRKR to BRKR MNTA VSA 115.00
0
#
#
# (546) B2 LINE OUTAGE (BREAKER-TO-BREAKER)
#
1 35356 35367 "1 " 0 # line from MNTA VSA 115.00 BRKR to (3) PHLPS_JT 115.00
1 35367 35363 "1 " 0 # line from PHLPS_JT 115.00 (3) to BRKR LAWRENCE 115.00
1 35367 35366 "1 " 0 # line from PHLPS_JT 115.00 (3) to BRKR PHILLIPS 115.00
4 35366 0 "1 " 0 # LOAD-DROP PHILLIPS 115.00 LOAD==1.25(0.00)
0
#
#
# (547) B2 LINE OUTAGE (BREAKER-TO-BREAKER)
#
1 35356 35368 "1 " 0 # line from MNTA VSA 115.00 BRKR to BRKR BRITTN 115.00
0
#
#
# (548) B2 LINE OUTAGE (BREAKER-TO-BREAKER)
#
1 35368 35369 "1 " 0 # line from BRITTN 115.00 BRKR to BRKR APP MAT 115.00
0
#
#
# (549) B2 LINE OUTAGE (BREAKER-TO-BREAKER)
#
1 35370 35353 "1 " 0 # line from AMES J1A 115.00 (2) to BRKR MT VIEW 115.00
1 35370 35371 "1 " 0 # line from AMES J1A 115.00 (2) to (2) AMES J1B 115.00
1 35371 35352 "1 " 0 # line from AMES J1B 115.00 (2) to BRKR WHISMAN 115.00

```

APPENDIX B – CAISO CATEGORY B AUTOCON INPUT FILE

```

0
#
#
# (550) B2 LINE OUTAGE (BREAKER-TO-BREAKER)
#
1 35450 35452 "1 " 0 # line from LOS ALTS 60.00 (1) to BRKR LOYOLA 60.00
4 35450 0 "1 " 0 # LOAD-DROP LOS ALTS 60.00 LOAD==1.89(0.43)
4 35450 0 "2 " 0 # LOAD-DROP LOS ALTS 60.00 LOAD==9.73(2.22)
4 35450 0 "3 " 0 # LOAD-DROP LOS ALTS 60.00 LOAD==11.00(2.51)
1 35450 35451 "1 " 1 # close Line from LOS ALTS 60.00 to L.ALTS J (Los Altos - Loyola)
4 35450 0 "3*" 1 # restore all loads to LOS ALTS 60.00 (Monta Vista - Loyola)
0
#
#
# (551) B2 LINE OUTAGE (BREAKER-TO-BREAKER)
#
1 35452 35455 "1 " 0 # line from LOYOLA 60.00 BRKR to BRKR MNTA VSA 60.00
1 35450 35451 "1 " 1 # close Line from LOS ALTS to L.ALTS J (Monta Vista - Loyola)
0
#
#
# (552) B2 LINE OUTAGE (BREAKER-TO-BREAKER)
#
1 35455 35456 "1 " 0 # line from MNTA VSA 60.00 BRKR to (2) PRMNT J3 60.00
1 35456 36000 "1 " 0 # line from PRMNT J3 60.00 (2) to (2) BIG BASN 60.00
1 36000 36001 "1 " 0 # line from BIG BASN 60.00 (2) to (3) BURNS J1 60.00
1 36001 36002 "1 " 0 # line from BURNS J1 60.00 (3) to BRKR BURNS 60.00
1 36001 36003 "1 " 0 # line from BURNS J1 60.00 (3) to BRKR BURNS J2 60.00
4 36000 0 "1 " 0 # LOAD-DROP BIG BASN 60.00 LOAD==6.71(0.96)
0
#
#
# (553) B2 LINE OUTAGE (BREAKER-TO-BREAKER)
#
1 35455 35458 "1 " 0 # line from MNTA VSA 60.00 BRKR to (2) PRMNT J1 60.00
1 35458 35459 "1 " 0 # line from PRMNT J1 60.00 (2) to (2) PRMNT J2 60.00
1 35459 35457 "1 " 0 # line from PRMNT J2 60.00 (2) to BRKR PERMNTTE 60.00
4 35457 0 "1 " 0 # LOAD-DROP PERMNTTE 60.00 LOAD==29.94(20.90)
0
#
#
# (554) B2 LINE OUTAGE (BREAKER-TO-BREAKER)
#
1 35455 35460 "1 " 0 # line from MNTA VSA 60.00 BRKR to (2) LOS GATS 60.00
1 35460 35757 "1 " 0 # line from LOS GATS 60.00 (2) to BRKR ALMADEN 60.00
4 35460 0 "1 " 0 # LOAD-DROP LOS GATS 60.00 LOAD==20.79(4.74)
4 35460 0 "2 " 0 # LOAD-DROP LOS GATS 60.00 LOAD==17.01(3.88)
1 35757 35460 "1 " 1 # close Los Gatos to Almaden (Monta Vista - Los Gatos 60 kV)
4 35460 0 "3*" 1 # restore all loads to LOS GATS (Monta Vista - Los Gatos 60 kV)
0
#
#
# (555) B3 TRANSFORMER OUTAGE (BREAKER-TO-BREAKER)
#
2 35356 30705 "2 " 0 # TRAN from MNTA VSA 115.00 BRKR to BRKR MONTAVIS 230.00
0
#
#
# (556) B3 TRANSFORMER OUTAGE (BREAKER-TO-BREAKER)
#
2 35356 30705 "3 " 0 # TRAN from MNTA VSA 115.00 BRKR to BRKR MONTAVIS 230.00
0
#
#
# (557) B3 TRANSFORMER OUTAGE (BREAKER-TO-BREAKER)
#
2 35356 30705 "4 " 0 # TRAN from MNTA VSA 115.00 BRKR to BRKR MONTAVIS 230.00
0
#
#
# (558) B3 TRANSFORMER OUTAGE (BREAKER-TO-BREAKER)
#
2 35455 30705 "5 " 0 # TRAN from MNTA VSA 60.00 BRKR to BRKR MONTAVIS 230.00
0
#
#
# (559) B3 TRANSFORMER OUTAGE (BREAKER-TO-BREAKER)
#
2 35455 35356 "6 " 0 # TRAN from MNTA VSA 60.00 BRKR to BRKR MNTA VSA 115.00

```

APPENDIX B – CAISO CATEGORY B AUTOCON INPUT FILE

```

0
#
#
# (560) L-1/G-1 OVERLAPPING OUTAGE
# Monta Vista - Jefferson #1 230 kV Line and MEC
1 30705 30710 "1 " 0 # line from MONTAVIS 230.00 BRKR to (3) SLACTAP1 230.00
1 30710 30711 "1 " 0 # line from SLACTAP1 230.00 (3) to BRKR S.L.A.C. 230.00
1 30710 30715 "1 " 0 # line from SLACTAP1 230.00 (3) to BRKR JEFFERSN 230.00
4 30711 0 "1 " 0 # LOAD-DROP S.L.A.C. 230.00 LOAD==58.00(11.78)
1 30711 30712 "1 " 1 # LINE-TRANSFER SLACTAP1 to SLACTAP2
4 30711 0 "***" 1 # RESTORE S.L.A.C. load
#
3 35881 0 "1" 0 # MEC CTG1 18.00 PGEN=180.00 QGEN=61.41
3 35882 0 "1" 0 # MEC CTG2 18.00 PGEN=180.00 QGEN=61.41
3 35883 0 "1" 0 # MEC STG1 18.00 PGEN=200.00 QGEN=62.96
0
#
#
# (561) L-1/G-1 OVERLAPPING OUTAGE
# Monta Vista - Jefferson #2 230 kV Line and MEC
1 30705 30712 "2 " 0 # line from MONTAVIS 230.00 BRKR to (2) SLACTAP2 230.00
1 30712 30715 "2 " 0 # line from SLACTAP2 230.00 (2) to BRKR JEFFERSN 230.00
#
3 35881 0 "1" 0 # MEC CTG1 18.00 PGEN=180.00 QGEN=61.41
3 35882 0 "1" 0 # MEC CTG2 18.00 PGEN=180.00 QGEN=61.41
3 35883 0 "1" 0 # MEC STG1 18.00 PGEN=200.00 QGEN=62.96
0
#
#
# (562) L-1/G-1 OVERLAPPING OUTAGE
# Monta Vista - Jefferson #2 230 kV Line and MEC
1 30705 30720 "1 " 0 # line from MONTAVIS 230.00 BRKR to BRKR SARATOGA 230.00
#
3 35881 0 "1" 0 # MEC CTG1 18.00 PGEN=180.00 QGEN=61.41
3 35882 0 "1" 0 # MEC CTG2 18.00 PGEN=180.00 QGEN=61.41
3 35883 0 "1" 0 # MEC STG1 18.00 PGEN=200.00 QGEN=62.96
0
#
#
# (563) L-1/G-1 OVERLAPPING OUTAGE
# Monta Vista - Hicks 230 kV Line and MEC
1 30705 30730 "1 " 0 # line from MONTAVIS 230.00 BRKR to BRKR HICKS 230.00
#
3 35881 0 "1" 0 # MEC CTG1 18.00 PGEN=180.00 QGEN=61.41
3 35882 0 "1" 0 # MEC CTG2 18.00 PGEN=180.00 QGEN=61.41
3 35883 0 "1" 0 # MEC STG1 18.00 PGEN=200.00 QGEN=62.96
0
#
#
# (564) L-1/G-1 OVERLAPPING OUTAGE
# Saratoga - Vasona 230 kV Line and MEC
1 30720 30733 "1 " 0 # line from SARATOGA 230.00 BRKR to BRKR VASONA 230.00
#
3 35881 0 "1" 0 # MEC CTG1 18.00 PGEN=180.00 QGEN=61.41
3 35882 0 "1" 0 # MEC CTG2 18.00 PGEN=180.00 QGEN=61.41
3 35883 0 "1" 0 # MEC STG1 18.00 PGEN=200.00 QGEN=62.96
0
#
#
# (565) L-1/G-1 OVERLAPPING OUTAGE
# Vasona - Metcalf 230 kV Line and MEC
1 30733 30735 "1 " 0 # line from VASONA 230.00 BRKR to BRKR METCALF 230.00
#
3 35881 0 "1" 0 # MEC CTG1 18.00 PGEN=180.00 QGEN=61.41
3 35882 0 "1" 0 # MEC CTG2 18.00 PGEN=180.00 QGEN=61.41
3 35883 0 "1" 0 # MEC STG1 18.00 PGEN=200.00 QGEN=62.96
0
#
#
# (566) L-1/G-1 OVERLAPPING OUTAGE
# Monta Vista - Metcalf #3 230 kV Line and MEC
1 30735 30705 "3 " 0 # line from METCALF 230.00 BRKR to BRKR MONTAVIS 230.00
#
3 35881 0 "1" 0 # MEC CTG1 18.00 PGEN=180.00 QGEN=61.41
3 35882 0 "1" 0 # MEC CTG2 18.00 PGEN=180.00 QGEN=61.41
3 35883 0 "1" 0 # MEC STG1 18.00 PGEN=200.00 QGEN=62.96
0
#
#

```

APPENDIX B – CAISO CATEGORY B AUTOCON INPUT FILE

```

# (567) L-1/G-1 OVERLAPPING OUTAGE
# Monta Vista - Coyote Sw Sta 230 kV Line and MEC
1 30741 30705 "4 " 0 # line from CAL MEC 230.00 BRKR to BRKR MONTAVIS 230.00
#
3 35881 0 "1" 0 # MEC CTG1 18.00 PGEN=180.00 QGEN=61.41
3 35882 0 "1" 0 # MEC CTG2 18.00 PGEN=180.00 QGEN=61.41
3 35883 0 "1" 0 # MEC STG1 18.00 PGEN=200.00 QGEN=62.96
0
#
#
# 2013 category b contingency list
# San Jose Division Zone 318
#
#
# (568) B2 LINE OUTAGE (BREAKER-TO-BREAKER)
#
1 30731 38901 "1 " 0 # line from LS ESTRS 230.00 BRKR to (2) SSS 230.00
1 38901 36893 "1 " 0 # line from SSS 230.00 (2) to (3) NRSriser 230.00
1 36893 38900 "1 " 0 # line from NRSriser 230.00 (3) to (3) NRS 230.00
1 36893 38900 "2 " 0 # line from NRSriser 230.00 (3) to (3) NRS 230.00
2 38900 36851 "1 " 0 # TRAN from NRS 230.00 (3) to BRKR NRS 400 115.00
0
#
#
# (569) B2 LINE OUTAGE (BREAKER-TO-BREAKER)
#
1 30735 30730 "1 " 0 # line from METCALF 230.00 BRKR to BRKR HICKS 230.00
0
#
#
# (570) B2 LINE OUTAGE (BREAKER-TO-BREAKER)
#
1 30735 30731 "1 " 0 # line from METCALF 230.00 BRKR to BRKR LS ESTRS 230.00
0
#
#
# (571) B2 LINE OUTAGE (BREAKER-TO-BREAKER)
#
1 30735 30741 "4 " 0 # line from METCALF 230.00 BRKR to BRKR CAL MEC 230.00
0
#
#
# (572) B2 LINE OUTAGE (BREAKER-TO-BREAKER)
#
1 30735 30750 "1 " 0 # line from METCALF 230.00 BRKR to BRKR MOSSLND2 230.00
0
#
#
# (573) B2 LINE OUTAGE (BREAKER-TO-BREAKER)
#
1 30735 30755 "1 " 0 # line from METCALF 230.00 BRKR to BRKR MOSSLND1 230.00
0
#
#
# (574) B2 LINE OUTAGE (BREAKER-TO-BREAKER)
#
1 35600 35629 "1 " 0 # line from DIXON LD 115.00 BRKR to (3) MABURY J 115.00
1 35629 35626 "1 " 0 # line from MABURY J 115.00 (3) to BRKR MCKEE 115.00
1 35629 35630 "1 " 0 # line from MABURY J 115.00 (3) to BRKR MABURY 115.00
4 35630 0 "2 " 0 # LOAD-DROP MABURY 115.00 LOAD==19.00(4.33)
0
#
#
# (575) B2 LINE OUTAGE (BREAKER-TO-BREAKER)
#
1 35612 35610 "1 " 0 # line from TRIMBLE 115.00 BRKR to BRKR MONTAGUE 115.00
0
#
#
# (576) B2 LINE OUTAGE (BREAKER-TO-BREAKER)
#
1 35612 35616 "1 " 0 # line from TRIMBLE 115.00 BRKR to BRKR SJ B E 115.00
0
#
#
# (577) B2 LINE OUTAGE (BREAKER-TO-BREAKER)
#
1 35613 35614 "1 " 0 # line from ELPT_SJ1 115.00 (3) to (3) ELPT_SJ2 115.00
1 35613 35614 "2 " 0 # line from ELPT_SJ1 115.00 (3) to (3) ELPT_SJ2 115.00

```

APPENDIX B – CAISO CATEGORY B AUTOCON INPUT FILE

```

1 35613 35618 "1 " 0 # line from ELPT_SJ1 115.00 (3) to BRKR SN JSE A 115.00
1 35614 35620 "1 " 0 # line from ELPT_SJ2 115.00 (3) to BRKR EL PATIO 115.00
0
#
#
# (578) B2 LINE OUTAGE (BREAKER-TO-BREAKER)
#
1 35615 35616 "1 " 0 # line from FMC 115.00 BRKR to BRKR SJ B E 115.00
0
#
#
# (579) B2 LINE OUTAGE (BREAKER-TO-BREAKER)
#
1 35615 35617 "1 " 0 # line from FMC 115.00 BRKR to (2) FMC JCT 115.00
1 35617 36850 "1 " 0 # line from FMC JCT 115.00 (2) to BRKR KRS 115.00
0
#
#
# (580) B2 LINE OUTAGE (BREAKER-TO-BREAKER)
#
1 35618 35619 "1 " 0 # line from SN JSE A 115.00 BRKR to BRKR SJ B F 115.00
0
#
#
# (581) B2 LINE OUTAGE (BREAKER-TO-BREAKER)
#
1 35619 35631 "1 " 0 # line from SJ B F 115.00 BRKR to (3) MARKHM J 115.00
1 35631 35632 "1 " 0 # line from MARKHM J 115.00 (3) to (2) MARKHAM 115.00
1 35631 35636 "1 " 0 # line from MARKHM J 115.00 (3) to BRKR EVRGRN 1 115.00
2 35632 35863 "1 " 0 # TRAN from MARKHAM 115.00 BRKR to (1) CATALYST 9.11
4 35863 0 "1 " 0 # LOAD-DROP CATALYST 9.11 LOAD==9.12(3.09)
3 35863 0 "1 " 0 # GEN-DROP CATALYST 9.11 GEN==2.30(0.00)
1 35632 36420 "1 " 1 # close Markham to Stone
2 35632 35863 "1 " 1 # restore TRAN from MARKHAM 115.00 to CATALYST 9.11
4 35863 0 "1 " 1 # restore all loads to CATALYST
0
#
#
# (582) B2 LINE OUTAGE (BREAKER-TO-BREAKER)
#
1 35620 35621 "1 " 0 # line from EL PATIO 115.00 BRKR to (2) IBM-HR J 115.00
1 35621 35642 "1 " 0 # line from IBM-HR J 115.00 (2) to BRKR MTCALF D 115.00
0
#
#
# (583) B2 LINE OUTAGE (BREAKER-TO-BREAKER)
#
1 35620 35651 "2 " 0 # line from EL PATIO 115.00 BRKR to (2) BAILY J3 115.00
1 35651 35642 "2 " 0 # line from BAILY J3 115.00 (2) to BRKR MTCALF D 115.00
0
#
#
# (584) B2 LINE OUTAGE (BREAKER-TO-BREAKER)
#
1 35622 35624 "1 " 0 # line from SWIFT 115.00 BRKR to BRKR MILPITAS 115.00
0
#
#
# (585) B2 LINE OUTAGE (BREAKER-TO-BREAKER)
#
1 35622 35643 "1 " 0 # line from SWIFT 115.00 BRKR to BRKR MTCALF E 115.00
0
#
#
# (586) B2 LINE OUTAGE (BREAKER-TO-BREAKER)
#
1 35625 35645 "1 " 0 # line from MARKHMJ2 115.00 (2) to (3) EVRGRN J 115.00
1 35625 35634 "1 " 0 # line from MARKHMJ2 115.00 (2) to (2) STONE J 115.00
1 35645 35633 "2 " 0 # line from EVRGRN J 115.00 (3) to BRKR EVRGRN 2 115.00
1 35645 35643 "2 " 0 # line from EVRGRN J 115.00 (3) to BRKR MTCALF E 115.00
1 35634 36420 "1 " 0 # line from STONE J 115.00 (2) to BRKR STONE 115.00
4 36420 0 "1 " 0 # LOAD-DROP STONE 115.00 LOAD==35.69(8.13)
4 36420 0 "2 " 0 # LOAD-DROP STONE 115.00 LOAD==14.87(3.39)
0
#
#
# (587) B2 LINE OUTAGE (BREAKER-TO-BREAKER)
#
1 35626 35656 "1 " 0 # line from MCKEE 115.00 BRKR to BRKR PIERCY 115.00

```

APPENDIX B – CAISO CATEGORY B AUTOCON INPUT FILE

```

0
#
#
# (588) B2 LINE OUTAGE (BREAKER-TO-BREAKER)
#
1 35636 35643 "1 " 0 # line from EVRGRN 1 115.00 BRKR to BRKR MTCALF E 115.00
0
#
#
# (589) B2 LINE OUTAGE (BREAKER-TO-BREAKER)
#
1 35637 35649 "1 " 0 # line from IBM-CTLE 115.00 (1) to (3) EDNVL J3 115.00
1 35649 35638 "1 " 0 # line from EDNVL J3 115.00 (3) to BRKR EDENVALE 115.00
1 35649 35641 "1 " 0 # line from EDNVL J3 115.00 BRKR to (1) EDNVL J1 115.00
4 35637 0 "1 " 0 # LOAD-DROP IBM-CTLE 115.00 LOAD==28.58(22.18)
0
#
#
# (590) B2 LINE OUTAGE (BREAKER-TO-BREAKER)
#
1 35638 35653 "1 " 0 # line from EDENVALE 115.00 BRKR to (3) BAILY J2 115.00
1 35653 35642 "1 " 0 # line from BAILY J2 115.00 (3) to BRKR MTCALF D 115.00
1 35653 35652 "1 " 0 # line from BAILY J2 115.00 (3) to (2) BAILY J1 115.00
1 35652 35640 "1 " 0 # line from BAILY J1 115.00 (2) to BRKR IBM-BALY 115.00
4 35640 0 "1 " 0 # LOAD-DROP IBM-BALY 115.00 LOAD==5.63(3.04)
0
#
#
# (591) B2 LINE OUTAGE (BREAKER-TO-BREAKER)
#
1 35639 35641 "1 " 0 # line from IBM-HRRS 115.00 BRKR to (3) EDNVL J1 115.00
1 35641 35642 "1 " 0 # line from EDNVL J1 115.00 (3) to BRKR MTCALF D 115.00
1 35641 35649 "1 " 0 # line from EDNVL J1 115.00 (3) to BRKR EDNVL J3 115.00
4 35639 0 "1 " 0 # LOAD-DROP IBM-HRRS 115.00 LOAD==2.43(1.63)
4 35639 0 "2 " 0 # LOAD-DROP IBM-HRRS 115.00 LOAD==2.43(1.63)
1 35621 35639 "1 " 1 # close IBM Harry to Metcalf-El Patio
4 35639 0 "3 " 1 # restore all loads to IBM HRRS
0
#
#
# (592) B2 LINE OUTAGE (BREAKER-TO-BREAKER)
#
1 35642 35646 "1 " 0 # line from MTCALF D 115.00 BRKR to BRKR MRGN HIL 115.00
0
#
#
# (593) B2 LINE OUTAGE (BREAKER-TO-BREAKER)
#
1 35642 35654 "1 " 0 # line from MTCALF D 115.00 BRKR to (2) MORGN J1 115.00
1 35654 35655 "1 " 0 # line from MORGN J1 115.00 (2) to (2) MORGN J2 115.00
1 35655 35648 "1 " 0 # line from MORGN J2 115.00 (2) to BRKR LLAGAS 115.00
0
#
#
# (594) B2 LINE OUTAGE (BREAKER-TO-BREAKER)
#
1 35643 35644 "1 " 0 # line from MTCALF E 115.00 BRKR to BRKR CYTE PMP 115.00
4 35644 0 "1 " 0 # LOAD-DROP CYTE PMP 115.00 LOAD==4.90(1.12)
0
#
#
# (595) B2 LINE OUTAGE (BREAKER-TO-BREAKER)
#
1 35646 35648 "1 " 0 # line from MRGN HIL 115.00 BRKR to BRKR LLAGAS 115.00
0
#
#
# (596) B2 LINE OUTAGE (BREAKER-TO-BREAKER)
#
1 35648 35660 "1 " 0 # line from LLAGAS 115.00 BRKR to (4) GILROYTP 115.00
1 35660 35647 "1 " 0 # line from GILROYTP 115.00 (4) to BRKR GILROY 115.00
1 35660 35650 "1 " 0 # line from GILROYTP 115.00 (4) to (1) GILROY F 115.00
1 35660 35661 "1 " 0 # line from GILROYTP 115.00 (4) to (4) GILROYPK 115.00
2 35661 35851 "1 " 0 # TRAN from GILROYPK 115.00 (4) to (1) GROYPKR1 13.80
2 35661 35852 "1 " 0 # TRAN from GILROYPK 115.00 (4) to (1) GROYPKR2 13.80
2 35661 35853 "1 " 0 # TRAN from GILROYPK 115.00 (4) to (1) GROYPKR3 13.80
4 35650 0 "1 " 0 # LOAD-DROP GILROY F 115.00 LOAD==8.88(7.83)
3 35851 0 "1 " 0 # GEN-DROP GROYPKR1 13.80 GEN==48.70(-6.28)
3 35852 0 "1 " 0 # GEN-DROP GROYPKR2 13.80 GEN==48.70(-6.28)

```

APPENDIX B – CAISO CATEGORY B AUTOCON INPUT FILE

```

3 35853      0 "1 "    0      # GEN-DROP      GROYPKR3  13.80  GEN==48.70(-6.28)
0
#
#
# (597) B2 LINE OUTAGE (BREAKER-TO-BREAKER)
#
1 35656 35643 "1 "    0      # line from PIERCY  115.00  BRKR to BRKR  MTCALF E 115.00
0
#
#
# (598) B2 LINE OUTAGE (BREAKER-TO-BREAKER)
# post-project outage
1 35657 35658 "1 "    0      # line from CP LECEF 115.00  BRKR to BRKR  LS ESTRS 115.00
0
#
#
# (599) B2 LINE OUTAGE (BREAKER-TO-BREAKER)
# post-project outage
1 35657 35658 "2 "    0      # line from CP LECEF 115.00  BRKR to BRKR  LS ESTRS 115.00
0
#
#
# (600) B2 LINE OUTAGE (BREAKER-TO-BREAKER)
#
1 35658 35606 "1 "    0      # line from LS ESTRS 115.00  BRKR to BRKR  AGNEW      115.00
0
#
#
# (601) B2 LINE OUTAGE (BREAKER-TO-BREAKER)
#
1 35658 35610 "1 "    0      # line from LS ESTRS 115.00  BRKR to BRKR  MONTAGUE 115.00
0
#
#
# (602) B2 LINE OUTAGE (BREAKER-TO-BREAKER)
#
1 35658 35612 "1 "    0      # line from LS ESTRS 115.00  BRKR to BRKR  TRIMBLE   115.00
0
#
#
# (603) B2 LINE OUTAGE (BREAKER-TO-BREAKER)
# pre-project outage
1 35659 35666 "1 "    0      # line from NORTECH 115.00  BRKR to (3)  LECEFTAP 115.00
1 35666 35657 "1 "    0      # line from LECEFTAP 115.00  (3) to BRKR  CP LECEF  115.00
1 35666 35658 "1 "    0      # line from LECEFTAP 115.00  (3) to BRKR  LS ESTRS  115.00
0
#
#
# (604) B2 LINE OUTAGE (BREAKER-TO-BREAKER)
# post-project outage
1 35658 35659 "1 "    0      # line from LS ESTRS 115.00  BRKR to BRKR  NORTECH   115.00
0
#
#
# (605) B2 LINE OUTAGE (BREAKER-TO-BREAKER)
#
1 35659 36853 "1 "    0      # line from NORTECH 115.00  BRKR to BRKR  NRS 300   115.00
0
#
#
# (606) B2 LINE OUTAGE (BREAKER-TO-BREAKER)
#
1 35630 35752 "1 "    0      # line from MABURY  115.00  BRKR to (3)  JENING J  115.00
1 35752 35633 "1 "    0      # line from JENING J 115.00  (3) to BRKR  EVRGRN 2  115.00
1 35752 35751 "1 "    0      # line from JENING J 115.00  (3) to BRKR  JENNINGS  115.00
4 35751      0 "1 "    0      # LOAD-DROP      JENNINGS 115.00  LOAD==0.71(0.77)
0
#
#
# (607) B2 LINE OUTAGE (BREAKER-TO-BREAKER)
#
1 35753 35756 "1 "    0      # line from EVERGREN 60.00  BRKR to (2)  SENTER J  60.00
1 35756 35757 "1 "    0      # line from SENTER J 60.00  (2) to BRKR  ALMADEN   60.00
1 35757 35460 "1 "    1      # close Almaden to Los Gatos (Evergreen - Los Gatos 60 kV)
4 35757 0      "***"  1      # restore all loads to ALMADEN (Evergreen - Los Gatos 60 kV)
0
#
#
# (608) B3 TRANSFORMER OUTAGE (BREAKER-TO-BREAKER)

```

APPENDIX B – CAISO CATEGORY B AUTOCON INPUT FILE

```

#
2 30735 30042 "11" 0 # TRAN from METCALF 230.00 BRKR to BRKR METCALF 500.00
0
#
#
# (609) B3 TRANSFORMER OUTAGE (BREAKER-TO-BREAKER)
#
2 30735 30042 "12" 0 # TRAN from METCALF 230.00 BRKR to BRKR METCALF 500.00
0
#
#
# (610) B3 TRANSFORMER OUTAGE (BREAKER-TO-BREAKER)
#
2 30735 30042 "13" 0 # TRAN from METCALF 230.00 BRKR to BRKR METCALF 500.00
0
#
#
# (611) B3 TRANSFORMER OUTAGE (BREAKER-TO-BREAKER)
#
2 35642 30735 "1 " 0 # TRAN from MTCALF D 115.00 BRKR to BRKR METCALF 230.00
0
#
#
# (612) B3 TRANSFORMER OUTAGE (BREAKER-TO-BREAKER)
#
2 35642 30735 "4 " 0 # TRAN from MTCALF D 115.00 BRKR to BRKR METCALF 230.00
0
#
#
# (613) B3 TRANSFORMER OUTAGE (BREAKER-TO-BREAKER)
#
2 35643 30735 "2 " 0 # TRAN from MTCALF E 115.00 BRKR to BRKR METCALF 230.00
0
#
#
# (614) B3 TRANSFORMER OUTAGE (BREAKER-TO-BREAKER)
#
2 35643 30735 "3 " 0 # TRAN from MTCALF E 115.00 BRKR to BRKR METCALF 230.00
0
#
#
# (615) B3 TRANSFORMER OUTAGE (BREAKER-TO-BREAKER)
#
2 35658 30731 "3 " 0 # TRAN from LS ESTRS 115.00 BRKR to BRKR LS ESTRS 230.00
0
#
#
# (616) B3 TRANSFORMER OUTAGE (BREAKER-TO-BREAKER)
#
2 35658 30731 "4 " 0 # TRAN from LS ESTRS 115.00 BRKR to BRKR LS ESTRS 230.00
0
#
#
# (617) B3 TRANSFORMER OUTAGE (BREAKER-TO-BREAKER)
#
2 35753 35633 "1 " 0 # TRAN from EVERGREN 60.00 BRKR to BRKR EVRGRN 2 115.00
1 35756 35757 "1 " 0 # open ALMADEN to SENTER J (Evergreen 115/60 kV Bank)
1 35757 35460 "1 " 1 # close Almaden to Los Gatos (Evergreen 115/60 kV Bank)
0
#
#
# (618) B3 TRANSFORMER OUTAGE (BREAKER-TO-BREAKER)
#
2 35850 35647 "1 " 0 # TRAN from GLRY COG 13.80 (1) to BRKR GILROY 115.00
4 35850 0 "SG" 0 # LOAD-DROP GLRY COG 13.80 LOAD==1.73(1.43)
3 35850 0 "1 " 0 # GEN-DROP GLRY COG 13.80 GEN==80.50(20.69)
3 35850 0 "2 " 0 # GEN-DROP GLRY COG 13.80 GEN==41.50(10.67)
0
#
#
# (619) B1 GENERATOR OUTAGE
#
3 35850 0 "1" 0 # GLRY COG 13.80 PGEN=80.50 QGEN=15.86
0
#
#
# (620) B1 GENERATOR OUTAGE
#
3 35850 0 "2" 0 # GLRY COG 13.80 PGEN=41.50 QGEN=15.86

```

APPENDIX B – CAISO CATEGORY B AUTOCON INPUT FILE

```

0
#
#
# (621) B1 GENERATOR OUTAGE
#
3 35851      0 "1"      0      # GROYPKR1  13.80      PGEN=48.70  QGEN=-6.01
0
#
#
# (622) B1 GENERATOR OUTAGE
#
3 35852      0 "1"      0      # GROYPKR2  13.80      PGEN=48.70  QGEN=-6.01
0
#
#
# (623) B1 GENERATOR OUTAGE
#
3 35853      0 "1"      0      # GROYPKR3  13.80      PGEN=48.70  QGEN=-6.01
0
#
#
# (624) B1 GENERATOR OUTAGE
#
3 35854      0 "1"      0      # LECEFGT1  13.80      PGEN=50.00  QGEN=29.91
0
#
#
# (625) B1 GENERATOR OUTAGE
#
3 35855      0 "1"      0      # LECEFGT2  13.80      PGEN=50.00  QGEN=29.91
0
#
#
# (626) B1 GENERATOR OUTAGE
#
3 35856      0 "1"      0      # LECEFGT3  13.80      PGEN=50.00  QGEN=29.91
0
#
#
# (627) B1 GENERATOR OUTAGE
#
3 35857      0 "1"      0      # LECEFGT4  13.80      PGEN=50.00  QGEN=29.91
0
#
#
# (628) B1 GENERATOR OUTAGE
#
3 35860      0 "1"      0      # OLS-AGNE   9.11      PGEN=29.60  QGEN=6.64
0
#
#
# (629) B1 GENERATOR OUTAGE
#
3 35861      0 "1"      0      # SJ-SCL W   9.11      PGEN=5.00   QGEN=0.00
0
#
#
# (630) B1 GENERATOR OUTAGE
#
3 35863      0 "1"      0      # CATALYST   9.11      PGEN=2.30   QGEN=0.00
0
#
#
# (631) B1 GENERATOR OUTAGE
#
3 35881      0 "1"      0      # MEC CTG1   18.00     PGEN=180.00 QGEN=61.41
3 35882      0 "1"      0      # MEC CTG2   18.00     PGEN=180.00 QGEN=61.41
3 35883      0 "1"      0      # MEC STG1   18.00     PGEN=200.00 QGEN=62.96
0
#
#
# (632) B1 GENERATOR OUTAGE
#
3 35858      0 "1"      0      # T378ST1   13.80     PGEN=120.00 QGEN=-2.05
0
#
#
# (633) L-1/G-1 OVERLAPPING OUTAGE
# Newark Distribution - Los Esteros 230 kV Line and MEC

```

APPENDIX B – CAISO CATEGORY B AUTOCON INPUT FILE

```

1 30635 30731 "1 " 0 # line from NWK DIST 230.00 BRKR to BRKR LS ESTRS 230.00
#
3 35881 0 "1" 0 # MEC CTG1 18.00 PGEN=180.00 QGEN=61.41
3 35882 0 "1" 0 # MEC CTG2 18.00 PGEN=180.00 QGEN=61.41
3 35883 0 "1" 0 # MEC STG1 18.00 PGEN=200.00 QGEN=62.96
0
#
#
# (634) L-1/G-1 OVERLAPPING OUTAGE
# Los Esteros - NRS 230 kV Line and MEC
1 30731 38901 "1 " 0 # line from LS ESTRS 230.00 BRKR to (2) SSS 230.00
1 38901 36893 "1 " 0 # line from SSS 230.00 (2) to (3) NRSriser 230.00
1 36893 38900 "1 " 0 # line from NRSriser 230.00 (3) to (3) NRS 230.00
1 36893 38900 "2 " 0 # line from NRSriser 230.00 (3) to (3) NRS 230.00
2 38900 36851 "1 " 0 # TRAN from NRS 230.00 (3) to BRKR NRS 400 115.00
#
3 35881 0 "1" 0 # MEC CTG1 18.00 PGEN=180.00 QGEN=61.41
3 35882 0 "1" 0 # MEC CTG2 18.00 PGEN=180.00 QGEN=61.41
3 35883 0 "1" 0 # MEC STG1 18.00 PGEN=200.00 QGEN=62.96
0
#
#
# (635) L-1/G-1 OVERLAPPING OUTAGE
# Los Esteros - Metcalf 230 kV Line and MEC
1 30735 30731 "1 " 0 # line from METCALF 230.00 BRKR to BRKR LS ESTRS 230.00
#
3 35881 0 "1" 0 # MEC CTG1 18.00 PGEN=180.00 QGEN=61.41
3 35882 0 "1" 0 # MEC CTG2 18.00 PGEN=180.00 QGEN=61.41
3 35883 0 "1" 0 # MEC STG1 18.00 PGEN=200.00 QGEN=62.96
0
#
#
# (636) L-1/G-1 OVERLAPPING OUTAGE
# Coyote Sw Sta - Metcalf 230 kV Line and MEC
1 30735 30741 "4 " 0 # line from METCALF 230.00 BRKR to BRKR CAL MEC 230.00
#
3 35881 0 "1" 0 # MEC CTG1 18.00 PGEN=180.00 QGEN=61.41
3 35882 0 "1" 0 # MEC CTG2 18.00 PGEN=180.00 QGEN=61.41
3 35883 0 "1" 0 # MEC STG1 18.00 PGEN=200.00 QGEN=62.96
0
#
#
# (637) L-1/G-1 OVERLAPPING OUTAGE
# Metcalf - Moss Landing #2 230 kV Line and MEC
1 30735 30750 "1 " 0 # line from METCALF 230.00 BRKR to BRKR MOSSLND2 230.00
#
3 35881 0 "1" 0 # MEC CTG1 18.00 PGEN=180.00 QGEN=61.41
3 35882 0 "1" 0 # MEC CTG2 18.00 PGEN=180.00 QGEN=61.41
3 35883 0 "1" 0 # MEC STG1 18.00 PGEN=200.00 QGEN=62.96
0
#
#
# (638) L-1/G-1 OVERLAPPING OUTAGE
# Metcalf - Moss Landing #1 230 kV Line and MEC
1 30735 30755 "1 " 0 # line from METCALF 230.00 BRKR to BRKR MOSSLND1 230.00
#
3 35881 0 "1" 0 # MEC CTG1 18.00 PGEN=180.00 QGEN=61.41
3 35882 0 "1" 0 # MEC CTG2 18.00 PGEN=180.00 QGEN=61.41
3 35883 0 "1" 0 # MEC STG1 18.00 PGEN=200.00 QGEN=62.96
0
#
#
# (639) L-1/G-1 OVERLAPPING OUTAGE
# Newark Distribution - Los Esteros 230 kV Line and LECEF GT1
1 30635 30731 "1 " 0 # line from NWK DIST 230.00 BRKR to BRKR LS ESTRS 230.00
#
3 35854 0 "1" 0 # LECEFGT1 13.80 PGEN=50.00 QGEN=29.91
0
#
#
# (640) L-1/G-1 OVERLAPPING OUTAGE
# Los Esteros - NRS 230 kV Line and LECEF GT1
1 30731 38901 "1 " 0 # line from LS ESTRS 230.00 BRKR to (2) SSS 230.00
1 38901 36893 "1 " 0 # line from SSS 230.00 (2) to (3) NRSriser 230.00
1 36893 38900 "1 " 0 # line from NRSriser 230.00 (3) to (3) NRS 230.00
1 36893 38900 "2 " 0 # line from NRSriser 230.00 (3) to (3) NRS 230.00
2 38900 36851 "1 " 0 # TRAN from NRS 230.00 (3) to BRKR NRS 400 115.00
#
3 35854 0 "1" 0 # LECEFGT1 13.80 PGEN=50.00 QGEN=29.91

```

APPENDIX B – CAISO CATEGORY B AUTOCON INPUT FILE

```

0
#
#
# (641) L-1/G-1 OVERLAPPING OUTAGE
# Los Esteros - Metcalf 230 kV Line and LECEF GT1
1 30735 30731 "1 " 0 # line from METCALF 230.00 BRKR to BRKR LS ESTRS 230.00
#
3 35854 0 "1" 0 # LECEFGT1 13.80 PGEN=50.00 QGEN=29.91
0
#
#
# (642) L-1/G-1 OVERLAPPING OUTAGE
# Newark - Dixon Landing 115 kV Line and LECEF GT1
1 35122 35600 "1 " 0 # line from NEWARK F 115.00 BRKR to BRKR DIXON LD 115.00
#
3 35854 0 "1" 0 # LECEFGT1 13.80 PGEN=50.00 QGEN=29.91
0
#
#
# (643) L-1/G-1 OVERLAPPING OUTAGE
# Newark - Kifer 115 kV Line and LECEF GT1
1 35122 35602 "1 " 0 # line from NEWARK F 115.00 BRKR to (3) ZNKER J2 115.00
1 35602 35604 "1 " 0 # line from ZNKER J2 115.00 (3) to (3) ZANKER 115.00
1 35602 36850 "1 " 0 # line from ZNKER J2 115.00 (3) to BRKR KRS 115.00
2 35604 35861 "1 " 0 # TRAN from ZANKER 115.00 (3) to (2) SJ-SCL W 9.11
2 35604 35861 "2 " 0 # TRAN from ZANKER 115.00 (3) to (2) SJ-SCL W 9.11
4 35861 0 "SG" 0 # LOAD-DROP SJ-SCL W 9.11 LOAD==6.17(2.09)
3 35861 0 "1 " 0 # GEN-DROP SJ-SCL W 9.11 GEN==5.00(0.00)
#
3 35854 0 "1" 0 # LECEFGT1 13.80 PGEN=50.00 QGEN=29.91
0
#
#
# (644) L-1/G-1 OVERLAPPING OUTAGE
# Newark - Trimble 115 kV Line and LECEF GT1
1 35122 35603 "1 " 0 # line from NEWARK F 115.00 BRKR to (3) ZNKER J1 115.00
1 35603 35605 "1 " 0 # line from ZNKER J1 115.00 (3) to (1) AGNEW J 115.00
1 35603 35612 "1 " 0 # line from ZNKER J1 115.00 (3) to BRKR TRIMBLE 115.00
#
3 35854 0 "1" 0 # LECEFGT1 13.80 PGEN=50.00 QGEN=29.91
0
#
#
# (645) L-1/G-1 OVERLAPPING OUTAGE
# Newark - Milpitas #1 115 kV Line and LECEF GT1
1 35122 35624 "1 " 0 # line from NEWARK F 115.00 BRKR to BRKR MILPITAS 115.00
#
3 35854 0 "1" 0 # LECEFGT1 13.80 PGEN=50.00 QGEN=29.91
0
#
#
# (646) L-1/G-1 OVERLAPPING OUTAGE
# Newark - Milpitas #2 115 kV Line and LECEF GT1
1 35122 35624 "2 " 0 # line from NEWARK F 115.00 BRKR to BRKR MILPITAS 115.00
#
3 35854 0 "1" 0 # LECEFGT1 13.80 PGEN=50.00 QGEN=29.91
0
#
#
# (647) L-1/G-1 OVERLAPPING OUTAGE
# Dixon Landing - McKee 115 kV Line and LECEF GT1
1 35600 35629 "1 " 0 # line from DIXON LD 115.00 BRKR to (3) MABURY J 115.00
1 35629 35626 "1 " 0 # line from MABURY J 115.00 (3) to BRKR MCKEE 115.00
1 35629 35630 "1 " 0 # line from MABURY J 115.00 (3) to BRKR MABURY 115.00
4 35630 0 "2 " 0 # LOAD-DROP MABURY 115.00 LOAD==19.00(4.33)
#
3 35854 0 "1" 0 # LECEFGT1 13.80 PGEN=50.00 QGEN=29.91
0
#
#
# (648) L-1/G-1 OVERLAPPING OUTAGE
# Montague - Trimble 115 kV Line and LECEF GT1
1 35612 35610 "1 " 0 # line from TRIMBLE 115.00 BRKR to BRKR MONTAGUE 115.00
#
3 35854 0 "1" 0 # LECEFGT1 13.80 PGEN=50.00 QGEN=29.91
0
#
#
# (649) L-1/G-1 OVERLAPPING OUTAGE

```

APPENDIX B – CAISO CATEGORY B AUTOCON INPUT FILE

```

# Trimble - San Jose B 115 kV Line and LECEF GT1
1 35612 35616 "1 " 0 # line from TRIMBLE 115.00 BRKR to BRKR SJ B E 115.00
#
3 35854 0 "1" 0 # LECEFGT1 13.80 PGEN=50.00 QGEN=29.91
0
#
#
# (650) L-1/G-1 OVERLAPPING OUTAGE
# El Patio - San Jose A 115 kV Line and LECEF GT1
1 35613 35614 "1 " 0 # line from ELPT_SJ1 115.00 (3) to (3) ELPT_SJ2 115.00
1 35613 35614 "2 " 0 # line from ELPT_SJ1 115.00 (3) to (3) ELPT_SJ2 115.00
1 35613 35618 "1 " 0 # line from ELPT_SJ1 115.00 (3) to BRKR SN JSE A 115.00
1 35614 35620 "1 " 0 # line from ELPT_SJ2 115.00 (3) to BRKR EL PATIO 115.00
#
3 35854 0 "1" 0 # LECEFGT1 13.80 PGEN=50.00 QGEN=29.91
0
#
#
# (651) L-1/G-1 OVERLAPPING OUTAGE
# FMC - San Jose B 115 kV Line and LECEF GT1
1 35615 35616 "1 " 0 # line from FMC 115.00 BRKR to BRKR SJ B E 115.00
#
3 35854 0 "1" 0 # LECEFGT1 13.80 PGEN=50.00 QGEN=29.91
0
#
#
# (652) L-1/G-1 OVERLAPPING OUTAGE
# Kifer - FMC 115 kV Line and LECEF GT1
1 35615 35617 "1 " 0 # line from FMC 115.00 BRKR to (2) FMC JCT 115.00
1 35617 36850 "1 " 0 # line from FMC JCT 115.00 (2) to BRKR KRS 115.00
#
3 35854 0 "1" 0 # LECEFGT1 13.80 PGEN=50.00 QGEN=29.91
0
#
#
# (653) L-1/G-1 OVERLAPPING OUTAGE
# San Jose B - San Jose A 115 kV Line and LECEF GT1
1 35618 35619 "1 " 0 # line from SN JSE A 115.00 BRKR to BRKR SJ B F 115.00
#
3 35854 0 "1" 0 # LECEFGT1 13.80 PGEN=50.00 QGEN=29.91
0
#
#
# (654) L-1/G-1 OVERLAPPING OUTAGE
# Evergreen - San Jose A 115 kV Line and LECEF GT1
1 35619 35631 "1 " 0 # line from SJ B F 115.00 BRKR to (3) MARKHM J 115.00
1 35631 35632 "1 " 0 # line from MARKHM J 115.00 (3) to (2) MARKHAM 115.00
1 35631 35636 "1 " 0 # line from MARKHM J 115.00 (3) to BRKR EVRGRN 1 115.00
2 35632 35863 "1 " 0 # TRAN from MARKHAM 115.00 BRKR to (1) CATALYST 9.11
4 35863 0 "1 " 0 # LOAD-DROP CATALYST 9.11 LOAD==9.12(3.09)
3 35863 0 "1 " 0 # GEN-DROP CATALYST 9.11 GEN==2.30(0.00)
1 35632 36420 "1 " 1 # close Markham to Stone
2 35632 35863 "1 " 1 # restore TRAN from MARKHAM 115.00 to CATALYST 9.11
4 35863 0 "***" 1 # restore all loads to CATALYST
#
3 35854 0 "1" 0 # LECEFGT1 13.80 PGEN=50.00 QGEN=29.91
0
#
#
# (655) L-1/G-1 OVERLAPPING OUTAGE
# Metcalf - El Patio #1 115 kV Line and LECEF GT1
1 35620 35621 "1 " 0 # line from EL PATIO 115.00 BRKR to (2) IBM-HR J 115.00
1 35621 35642 "1 " 0 # line from IBM-HR J 115.00 (2) to BRKR MTCALF D 115.00
#
3 35854 0 "1" 0 # LECEFGT1 13.80 PGEN=50.00 QGEN=29.91
0
#
#
# (656) L-1/G-1 OVERLAPPING OUTAGE
# Metcalf - El Patio #2 115 kV Line and LECEF GT1
1 35620 35651 "2 " 0 # line from EL PATIO 115.00 BRKR to (2) BAILY J3 115.00
1 35651 35642 "2 " 0 # line from BAILY J3 115.00 (2) to BRKR MTCALF D 115.00
#
3 35854 0 "1" 0 # LECEFGT1 13.80 PGEN=50.00 QGEN=29.91
0
#
#
# (657) L-1/G-1 OVERLAPPING OUTAGE
# Milpitas - Swift 115 kV Line and LECEF GT1

```

APPENDIX B – CAISO CATEGORY B AUTOCON INPUT FILE

```

1 35622 35624 "1 " 0 # line from SWIFT 115.00 BRKR to BRKR MILPITAS 115.00
#
3 35854 0 "1" 0 # LECEFGT1 13.80 PGEN=50.00 QGEN=29.91
0
#
#
# (658) L-1/G-1 OVERLAPPING OUTAGE
# Swift - Metcalf 115 kV Line and LECEF GT1
1 35622 35643 "1 " 0 # line from SWIFT 115.00 BRKR to BRKR MTCALF E 115.00
#
3 35854 0 "1" 0 # LECEFGT1 13.80 PGEN=50.00 QGEN=29.91
0
#
#
# (659) L-1/G-1 OVERLAPPING OUTAGE
# Metcalf - Evergreen #2 115 kV Line and LECEF GT1
1 35625 35645 "1 " 0 # line from MARKHMJ2 115.00 (2) to (3) EVRGRN J 115.00
1 35625 35634 "1 " 0 # line from MARKHMJ2 115.00 (2) to (2) STONE J 115.00
1 35645 35633 "2 " 0 # line from EVRGRN J 115.00 (3) to BRKR EVRGRN 2 115.00
1 35645 35643 "2 " 0 # line from EVRGRN J 115.00 (3) to BRKR MTCALF E 115.00
1 35634 36420 "1 " 0 # line from STONE J 115.00 (2) to BRKR STONE 115.00
4 36420 0 "1 " 0 # LOAD-DROP STONE 115.00 LOAD==35.69(8.13)
4 36420 0 "2 " 0 # LOAD-DROP STONE 115.00 LOAD==14.87(3.39)
#
3 35854 0 "1" 0 # LECEFGT1 13.80 PGEN=50.00 QGEN=29.91
0
#
#
# (660) L-1/G-1 OVERLAPPING OUTAGE
# Mc Kee - Piercy 115 kV Line and LECEF GT1
1 35626 35656 "1 " 0 # line from MCKEE 115.00 BRKR to BRKR PIERCY 115.00
#
3 35854 0 "1" 0 # LECEFGT1 13.80 PGEN=50.00 QGEN=29.91
0
#
#
# (661) L-1/G-1 OVERLAPPING OUTAGE
# Metcalf - Evergreen #1 115 kV Line and LECEF GT1
1 35636 35643 "1 " 0 # line from EVRGRN 1 115.00 BRKR to BRKR MTCALF E 115.00
#
3 35854 0 "1" 0 # LECEFGT1 13.80 PGEN=50.00 QGEN=29.91
0
#
#
# (662) L-1/G-1 OVERLAPPING OUTAGE
# Piercy - Metcalf 115 kV Line and LECEF GT1
1 35656 35643 "1 " 0 # line from PIERCY 115.00 BRKR to BRKR MTCALF E 115.00
#
3 35854 0 "1" 0 # LECEFGT1 13.80 PGEN=50.00 QGEN=29.91
0
#
#
# (663) L-1/G-1 OVERLAPPING OUTAGE
# Los Esteros - Agnew 115 kV Line and LECEF GT1
1 35658 35606 "1 " 0 # line from LS ESTRS 115.00 BRKR to BRKR AGNEW 115.00
#
3 35854 0 "1" 0 # LECEFGT1 13.80 PGEN=50.00 QGEN=29.91
0
#
#
# (664) L-1/G-1 OVERLAPPING OUTAGE
# Los Esteros - Montague 115 kV Line and LECEF GT1
1 35658 35610 "1 " 0 # line from LS ESTRS 115.00 BRKR to BRKR MONTAGUE 115.00
#
3 35854 0 "1" 0 # LECEFGT1 13.80 PGEN=50.00 QGEN=29.91
0
#
#
# (665) L-1/G-1 OVERLAPPING OUTAGE
# Los Esteros - Trimble 115 kV Line and LECEF GT1
1 35658 35612 "1 " 0 # line from LS ESTRS 115.00 BRKR to BRKR TRIMBLE 115.00
#
3 35854 0 "1" 0 # LECEFGT1 13.80 PGEN=50.00 QGEN=29.91
0
#
#
# (666) L-1/G-1 OVERLAPPING OUTAGE
# Los Esteros - Nortech 115 kV Line and LECEF GT1 post-project outage
1 35658 35659 "1 " 0 # line from LS ESTRS 115.00 BRKR to BRKR NORTECH 115.00

```

APPENDIX B – CAISO CATEGORY B AUTOCON INPUT FILE

```

#
3 35854      0 "1"      0      # LECEFGT1 13.80      PGEN=50.00 QGEN=29.91
0
#
#
# (667) L-1/G-1 OVERLAPPING OUTAGE
# Nortech - NRS 115 kV Line and LECEF GT1
1 35659 36853 "1 "      0      # line from NORTECH 115.00 BRKR to BRKR NRS 300 115.00
#
3 35854      0 "1"      0      # LECEFGT1 13.80      PGEN=50.00 QGEN=29.91
0
#
#
# (668) L-1/G-1 OVERLAPPING OUTAGE
# Metcalf - Morgan Hill 115 kV Line and Gilroy Energy 1
1 35642 35646 "1 "      0      # line from MTCALF D 115.00 BRKR to BRKR MRGN HIL 115.00
#
3 35850      0 "1"      0      # GLRY COG 13.80      PGEN=80.50 QGEN=15.86
0
#
#
# (669) L-1/G-1 OVERLAPPING OUTAGE
# Metcalf - Llagas 115 kV Line and Gilroy Energy 1
1 35642 35654 "1 "      0      # line from MTCALF D 115.00 BRKR to (2) MORGN J1 115.00
1 35654 35655 "1 "      0      # line from MORGN J1 115.00 (2) to (2) MORGN J2 115.00
1 35655 35648 "1 "      0      # line from MORGN J2 115.00 (2) to BRKR LLAGAS 115.00
#
3 35850      0 "1"      0      # GLRY COG 13.80      PGEN=80.50 QGEN=15.86
0
#
#
# (670) L-1/G-1 OVERLAPPING OUTAGE
# Morgan Hill - Llagas 115 kV Line and Gilroy Energy 1
1 35646 35648 "1 "      0      # line from MRGN HIL 115.00 BRKR to BRKR LLAGAS 115.00
#
3 35850      0 "1"      0      # GLRY COG 13.80      PGEN=80.50 QGEN=15.86
0
#
#
-1
# EOF

```

APPENDIX B – CAISO CATEGORY C AUTOCON INPUT FILE

```

# PG&E TCP2 Greater Bay Area 2013 category c contingency list (dctl and bus outages)
# North Bay, East Bay, Diablo, San Francisco, Peninsula, Mission, DeAnza and San Jose Divisions
# Zones 306, 307, 308, 309, 310, 316, 317, 318 and selected outages from Sacramento/Sierra 304/311
#
# 2013 category c contingency list (dctl and bus outages)
# selected Sacramento/Sierra outages
#
#
# (1) C5 DCTL OUTAGE
# Vaca-Dixon - Lambie and Vaca-Dixon - Peabody 230 kV Lines
1 30460 30472 "1 " 0 # line from VACA-DIX 230.00 BRKR to BRKR PEABODY 230.00
#
1 30460 30478 "1 " 0 # line from VACA-DIX 230.00 BRKR to BRKR LAMBIE 230.00
0
#
#
# (2) C5 DCTL OUTAGE
# Lambie - Birds Landing and Peabody - Birds Landing 230 kV Lines
1 30478 30479 "1 " 0 # line from LAMBIE 230.00 BRKR to BRKR BDLSWSTA 230.00
#
1 30472 30479 "1 " 0 # line from PEABODY 230.00 BRKR to BRKR BDLSWSTA 230.00
0
#
#
# (3) C5 DCTL OUTAGE
# Vaca-Dixon - Tesla 500 kV and Peabody - Birds Landing 230 kV Lines
1 30030 30040 "1 " 0 # line from VACA-DIX 500.00 BRKR to BRKR TESLA 500.00
#
1 30472 30479 "1 " 0 # line from PEABODY 230.00 BRKR to BRKR BDLSWSTA 230.00
0
#
#
# 2013 category c contingency list (dctl and bus outages)
# North Bay Division Zone 306
#
#
# (4) C5 DCTL OUTAGE
# Lakeville - Ignacio #1 and Lakeville - Sobrante #2 230 kV Lines
1 30435 30445 "1 " 0 # line from LAKEVILLE 230.00 BRKR to BRKR IGNACIO 230.00
#
1 30435 30540 "2 " 0 # line from LAKEVILLE 230.00 BRKR to BRKR SOBRANTE 230.00
0
#
#
# (5) C5 DCTL OUTAGE
# Lakeville - Ignacio #1 and Ignacio - Sobrante 230 kV Lines
1 30435 30445 "1 " 0 # line from LAKEVILLE 230.00 BRKR to BRKR IGNACIO 230.00
#
1 30437 30445 "1 " 0 # line from CROCKETT 230.00 (3) to BRKR IGNACIO 230.00
1 30437 30438 "1 " 0 # line from CROCKETT 230.00 (3) to (2) C&H 230.00
1 30437 30540 "1 " 0 # line from CROCKETT 230.00 (3) to BRKR SOBRANTE 230.00
2 30438 32900 "1 " 0 # TRAN from C&H 230.00 BRKR to (1) CRCKTCOG 18.00
4 30438 0 "1 " 0 # LOAD-DROP C&H 230.00 LOAD==3.32(0.76)
3 32900 0 "1 " 0 # GEN-DROP CRCKTCOG 18.00 GEN==240.00(40.82)
0
#
#
# (6) C5 DCTL OUTAGE
# Lakeville - Ignacio #2 and Ignacio - Sobrante 230 kV Lines
1 30433 30445 "2 " 0 # line from T22_93B 230.00 (2) to BRKR IGNACIO 230.00
1 30433 30435 "2 " 0 # line from T22_93B 230.00 (2) to BRKR LAKEVILLE 230.00
#
1 30437 30445 "1 " 0 # line from CROCKETT 230.00 (3) to BRKR IGNACIO 230.00
1 30437 30438 "1 " 0 # line from CROCKETT 230.00 (3) to (2) C&H 230.00
1 30437 30540 "1 " 0 # line from CROCKETT 230.00 (3) to BRKR SOBRANTE 230.00
2 30438 32900 "1 " 0 # TRAN from C&H 230.00 BRKR to (1) CRCKTCOG 18.00
4 30438 0 "1 " 0 # LOAD-DROP C&H 230.00 LOAD==3.32(0.76)
3 32900 0 "1 " 0 # GEN-DROP CRCKTCOG 18.00 GEN==240.00(40.82)
0
#
#
# (7) C5 DCTL OUTAGE
# Lakeville - Ignacio #2 and Fulton - Ignacio 230 kV Lines
1 30433 30445 "2 " 0 # line from T22_93B 230.00 (2) to BRKR IGNACIO 230.00
1 30433 30435 "2 " 0 # line from T22_93B 230.00 (2) to BRKR LAKEVILLE 230.00
#
1 30430 30445 "1 " 0 # line from FULTON 230.00 BRKR to BRKR IGNACIO 230.00
0

```

APPENDIX B – CAISO CATEGORY C AUTOCON INPUT FILE

```

#
#
# (8) C5 DCTL OUTAGE
# Vaca-Dixon - Bahia and Vaca-Dixon - Parkway 230 kV Lines
1 30460 30465 "1 " 0 # line from VACA-DIX 230.00 BRKR to BRKR BAHIA 230.00
#
1 30460 30467 "1 " 0 # line from VACA-DIX 230.00 BRKR to BRKR PARKWAY 230.00
0
#
#
# (9) C5 DCTL OUTAGE
# Vaca-Dixon - Bahia and Parkway - Moraga 230 kV Lines
1 30460 30465 "1 " 0 # line from VACA-DIX 230.00 BRKR to BRKR BAHIA 230.00
#
1 30467 30550 "1 " 0 # line from PARKWAY 230.00 BRKR to BRKR MORAGA 230.00
0
#
#
# (10) C5 DCTL OUTAGE
# Bahia - Moraga and Parkway - Moraga 230 kV Lines
1 30465 30550 "1 " 0 # line from BAHIA 230.00 BRKR to BRKR MORAGA 230.00
#
1 30467 30550 "1 " 0 # line from PARKWAY 230.00 BRKR to BRKR MORAGA 230.00
0
#
#
# (11) C5 DCTL OUTAGE
# Ignacio - San Rafael #1 and Ignacio - Las Gallinas #3 115 kV Lines
1 32568 32574 "1 " 0 # line from IGNACIO 115.00 BRKR to BRKR SAN RAFL 115.00
#
1 32568 32570 "3 " 0 # line from IGNACIO 115.00 BRKR to BRKR LS GLLNS 115.00
0
#
#
# (12) C5 DCTL OUTAGE
# Ignacio - San Rafael #1 and Las Gallinas - San Rafael #3 115 kV Lines
1 32568 32574 "1 " 0 # line from IGNACIO 115.00 BRKR to BRKR SAN RAFL 115.00
#
1 32570 32574 "3 " 0 # line from LS GLLNS 115.00 BRKR to BRKR SAN RAFL 115.00
0
#
#
# (13) C5 DCTL OUTAGE
# Ignacio - Mare Island #1 and #2 115 kV Lines
1 32568 32576 "1 " 0 # line from IGNACIO 115.00 BRKR to (3) SKGGS J1 115.00
1 32576 32580 "1 " 0 # line from SKGGS J1 115.00 (3) to (1) SKAGGS J2 115.00
1 32576 32588 "1 " 0 # line from SKGGS J1 115.00 (3) to (2) HGHWY J1 115.00
1 32588 32593 "1 " 0 # line from HGHWY J1 115.00 (2) to (3) JCPMPJCT 115.00
1 32593 32595 "1 " 0 # line from JCPMPJCT 115.00 (3) to (1) JMCSNPMP 115.00
1 32593 32604 "1 " 0 # line from JCPMPJCT 115.00 (3) to (2) MREIS JC 115.00
1 32604 32612 "1 " 0 # line from MREIS JC 115.00 (2) to (3) CRQNZTP1 115.00
1 32612 32610 "1 " 0 # line from CRQNZTP1 115.00 (3) to BRKR MRE IS-Q 115.00
1 32612 32614 "1 " 0 # line from CRQNZTP1 115.00 (3) to (3) MEYERTP1 115.00
1 32614 32600 "1 " 0 # line from MEYERTP1 115.00 (3) to BRKR MEYERS 115.00
1 32614 32606 "1 " 0 # line from MEYERTP1 115.00 (3) to BRKR CARQUINZ 115.00
4 32610 0 "1 " 0 # LOAD-DROP MRE IS-Q 115.00 LOAD==4.25(0.86)
4 32600 0 "1 " 0 # LOAD-DROP MEYERS 115.00 LOAD==0.24(0.05)
4 32606 0 "1 " 0 # LOAD-DROP CARQUINZ 115.00 LOAD==13.23(1.89)
4 32606 0 "2 " 0 # LOAD-DROP CARQUINZ 115.00 LOAD==11.26(1.60)
1 32616 32606 "1 " 1 # LINE-TRANSFER MEYERTP1 115.00 to MEYERTP2 115.00
4 32606 0 "***" 1 # RESTORE CARQUINEZ load
#
1 32568 32569 "1 " 0 # line from IGNACIO 115.00 BRKR to (2) HMLT_WET 115.00
1 32569 32578 "1 " 0 # line from HMLT_WET 115.00 (2) to (2) SKGGS J2 115.00
1 32578 32586 "1 " 0 # line from SKGGS J2 115.00 (2) to (3) HGHWY J2 115.00
1 32586 31956 "1 " 0 # line from HGHWY J2 115.00 (3) to (2) CORDELLT 115.00
1 32586 32590 "1 " 0 # line from HGHWY J2 115.00 (3) to BRKR HIGHWAY 115.00
1 31956 32598 "1 " 0 # line from CORDELLT 115.00 (2) to (2) NTWR ALT 115.00
1 32598 32608 "1 " 0 # line from NTWR ALT 115.00 (2) to (2) CRQNZTP2 115.00
1 32608 32616 "1 " 0 # line from CRQNZTP2 115.00 (2) to (1) MEYERTP2 115.00
4 32569 0 "1 " 0 # LOAD-DROP HMLT_WET 115.00 LOAD==15.00(9.30)
4 32590 0 "1 " 0 # LOAD-DROP HIGHWAY 115.00 LOAD==20.67(2.94)
4 32590 0 "2 " 0 # LOAD-DROP HIGHWAY 115.00 LOAD==25.37(3.61)
1 32588 32590 "1 " 1 # LINE-TRANSFER HGHWY J2 115.00 to HGHWY J1 115.00
4 32590 0 "***" 1 # RESTORE HIGHWAY load
0
#
#
# (14) C5 DCTL OUTAGE

```

APPENDIX B – CAISO CATEGORY C AUTOCON INPUT FILE

```

# Vaca-Vacaville-Jameson-North Tower and Ignacio - Mare Island #2 115 kV Lines
1 32618 32020 "1 " 0 # line from NTRWJCT1 115.00 (1) to (3) JMSN JCT 115.00
1 32020 31996 "1 " 0 # line from JMSN JCT 115.00 (3) to (3) HALE J1 115.00
1 32020 32010 "1 " 0 # line from JMSN JCT 115.00 (3) to BRKR JAMESON 115.00
1 31996 31995 "1 " 0 # line from HALE J1 115.00 (3) to (2) HALE 115.00
1 31996 32006 "1 " 0 # line from HALE J1 115.00 (3) to (3) VCVLLE1J 115.00
1 31995 32013 "1 " 0 # line from HALE 115.00 (2) to (1) HALE2 115.00
1 32006 31998 "1 " 0 # line from VCVLLE1J 115.00 (3) to BRKR VACA-DIX 115.00
1 32006 32000 "1 " 0 # line from VCVLLE1J 115.00 (3) to BRKR VACAVLL1 115.00
4 32010 0 "1 " 0 # LOAD-DROP JAMESON 115.00 LOAD==35.07(1.57)
4 31995 0 "1 " 0 # LOAD-DROP HALE 115.00 LOAD==2.36(1.40)
4 32000 0 "1 " 0 # LOAD-DROP VACAVLL1 115.00 LOAD==27.49(1.23)
1 32002 32000 "1" 1 #Line transfer VACAVLL1 115kV TO VACAVLL2 115kV
4 32000 0 "***" 1 #Restore VACAVLL1 load
1 32012 32013 "1" 1 #Transfer load to HALE alternate
4 31995 0 "***" 1 #Restore load at HALE
1 32010 32009 "1 " 1 # LINE-TRANSFER JMSN JCT 115.00 to JAMESN-A 115.00
4 32010 0 "***" 1 # RESTORE JAMESON load
#
1 32568 32569 "1 " 0 # line from IGNACIO 115.00 BRKR to (2) HMLT_WET 115.00
1 32569 32578 "1 " 0 # line from HMLT_WET 115.00 (2) to (2) SKGGS J2 115.00
1 32578 32586 "1 " 0 # line from SKGGS J2 115.00 (2) to (3) HGHWY J2 115.00
1 32586 31956 "1 " 0 # line from HGHWY J2 115.00 (3) to (2) CORDELLT 115.00
1 32586 32590 "1 " 0 # line from HGHWY J2 115.00 (3) to BRKR HIGHWAY 115.00
1 31956 32598 "1 " 0 # line from CORDELLT 115.00 (2) to (2) NTRW ALT 115.00
1 32598 32608 "1 " 0 # line from NTRW ALT 115.00 (2) to (2) CRQNZTP2 115.00
1 32608 32616 "1 " 0 # line from CRQNZTP2 115.00 (2) to (1) MEYERTP2 115.00
4 32569 0 "1 " 0 # LOAD-DROP HMLT_WET 115.00 LOAD==15.00(9.30)
4 32590 0 "1 " 0 # LOAD-DROP HIGHWAY 115.00 LOAD==20.67(2.94)
4 32590 0 "2 " 0 # LOAD-DROP HIGHWAY 115.00 LOAD==25.37(3.61)
1 32588 32590 "1 " 1 # LINE-TRANSFER HGHWY J2 115.00 to HGHWY J1 115.00
4 32590 0 "***" 1 # RESTORE HIGHWAY load
0
#
#
# (15) C5 DCTL OUTAGE
# Ignacio - San Rafael #1 115 kV and Ignacio - Alto 60 kV Lines
1 32568 32574 "1 " 0 # line from IGNACIO 115.00 BRKR to BRKR SAN RAFL 115.00
#
1 32664 32667 "1 " 0 # line from IGNACO A 60.00 BRKR to (3) IG JCT 60.00
1 32667 32678 "1 " 0 # line from IG JCT 60.00 (3) to (2) SAN RFLJ 60.00
1 32667 32668 "1 " 0 # line from IG JCT 60.00 (3) to BRKR NOVATO 60.00
1 32678 32680 "1 " 0 # line from SAN RFLJ 60.00 (2) to BRKR GREENBRE 60.00
0
#
#
# (16) C5 DCTL OUTAGE
# Ignacio - Alto - Sausalito #1 and #2 60 kV Lines
1 32664 32676 "1 " 0 # line from IGNACO A 60.00 BRKR to (2) HMLTN FD 60.00
1 32676 32686 "1 " 0 # line from HMLTN FD 60.00 (2) to (2) ALTOJT2 60.00
1 32686 32682 "1 " 0 # line from ALTOJT2 60.00 (2) to BRKR ALTO 60.00
1 32676 32677 "1 " 1 # LINE-TRANSFER HMLTN FD 60.00 to HMLTNBFD 60.00
4 32676 0 "***" 1 # RESTORE HMLTN FD load
#
1 32664 32677 "1 " 0 # line from IGNACO A 60.00 BRKR to (2) HMLTNBFD 60.00
1 32677 32684 "1 " 0 # line from HMLTNBFD 60.00 (2) to (3) ALTOJT1 60.00
1 32684 32682 "1 " 0 # line from ALTOJT1 60.00 (3) to BRKR ALTO 60.00
1 32684 32688 "1 " 0 # line from ALTOJT1 60.00 (3) to BRKR SAUSALTO 60.00
4 32688 0 "2 " 0 # LOAD-DROP SAUSALTO 60.00 LOAD==10.92(1.56)
1 32688 32686 "1 " 1 # LINE-TRANSFER SAUSALTO 60.00 to ALTOJT2 60.00
4 32688 0 "***" 1 # RESTORE SAUSALTO load
0
#
#
# (17) BUS FAULT 30445 "IGNACIO" Ignacio 230 kV Bus Section 1
#
1 30445 30430 "1" 0 # LINE from IGNACIO 230.00 to FULTON 230.00
2 30445 32568 "6" 0 # TRAN from IGNACIO 230.00 to IGNACIO 115.00
0
#
#
# (18) BUS FAULT 30445 "IGNACIO" Ignacio 230 kV Bus Section 2
#
1 30445 30433 "2" 0 # LINE from IGNACIO 230.00 to T22_93B 230.00
1 30445 30435 "1" 0 # LINE from IGNACIO 230.00 to LAKEVILE 230.00
1 30445 30437 "1" 0 # LINE from IGNACIO 230.00 to CROCKETT 230.00
2 30445 32568 "4" 0 # TRAN from IGNACIO 230.00 to IGNACIO 115.00
0
#

```

APPENDIX B – CAISO CATEGORY C AUTOCON INPUT FILE

```

#
# (19) BUS FAULT 30465 "BAHIA"
#
1 30465 30460 "1" 0 # LINE from BAHIA 230.00 to VACA-DIX 230.00
1 30465 30550 "1" 0 # LINE from BAHIA 230.00 to MORAGA 230.00
2 30465 30464 "1" 0 # TRAN from BAHIA 230.00 to EXXON_BH 12.47
2 30465 30464 "2" 0 # TRAN from BAHIA 230.00 to EXXON_BH 12.47
2 30465 30464 "3" 0 # TRAN from BAHIA 230.00 to EXXON_BH 12.47
4 30465 0 "1 " 0 # LOAD-DROP BAHIA 230.00 LOAD==30.11(4.29)
4 30465 0 "2 " 0 # LOAD-DROP BAHIA 230.00 LOAD==19.06(2.72)
0
#
#
# (20) BUS FAULT 30467 "PARKWAY"
#
1 30467 30460 "1" 0 # LINE from PARKWAY 230.00 to VACA-DIX 230.00
1 30467 30550 "1" 0 # LINE from PARKWAY 230.00 to MORAGA 230.00
4 30467 0 "1 " 0 # LOAD-DROP PARKWAY 230.00 LOAD==32.48(4.63)
0
#
#
# (21) BUS FAULT 32564 "PUEBLO"
#
1 32564 31258 "1" 0 # LINE from PUEBLO 115.00 to SONOMA 115.00
1 32564 32562 "1" 0 # LINE from PUEBLO 115.00 to PUEBLOJT 115.00
4 32564 0 "1 " 0 # LOAD-DROP PUEBLO 115.00 LOAD==48.17(6.86)
4 32564 0 "2 " 0 # LOAD-DROP PUEBLO 115.00 LOAD==38.82(5.53)
0
#
#
# (22) BUS FAULT 32568 "IGNACIO" Ignacio 115 kV Bus Section D
#
1 32568 32574 "1" 0 # LINE from IGNACIO 115.00 to SAN RAFL 115.00
1 32568 32576 "1" 0 # LINE from IGNACIO 115.00 to SKGGS J1 115.00
2 32568 30445 "4" 0 # TRAN from IGNACIO 115.00 to IGNACIO 230.00
2 32568 32666 "3" 0 # TRAN from IGNACIO 115.00 to IGNACO B 60.00
0
#
#
# (23) BUS FAULT 32568 "IGNACIO" Ignacio 115 kV Bus Section E
#
1 32568 32569 "1" 0 # LINE from IGNACIO 115.00 to HMLT_WET 115.00
1 32568 32570 "3" 0 # LINE from IGNACIO 115.00 to LS GLLNS 115.00
2 32568 30445 "6" 0 # TRAN from IGNACIO 115.00 to IGNACIO 230.00
2 32568 32666 "1" 0 # TRAN from IGNACIO 115.00 to IGNACO B 60.00
4 32568 0 "2 " 0 # LOAD-DROP IGNACIO 115.00 LOAD==15.92(2.27)
4 32568 0 "5 " 0 # LOAD-DROP IGNACIO 115.00 LOAD==16.10(2.29)
0
#
#
# (24) BUS FAULT 32570 "LS GLLNS"
#
1 32570 32568 "3" 0 # LINE from LS GLLNS 115.00 to IGNACIO 115.00
1 32570 32574 "3" 0 # LINE from LS GLLNS 115.00 to SAN RAFL 115.00
4 32570 0 "1 " 0 # LOAD-DROP LS GLLNS 115.00 LOAD==14.53(2.07)
4 32570 0 "2 " 0 # LOAD-DROP LS GLLNS 115.00 LOAD==9.81(1.40)
4 32570 0 "3 " 0 # LOAD-DROP LS GLLNS 115.00 LOAD==10.97(1.56)
0
#
#
# (25) BUS FAULT 32574 "SAN RAFL"
#
1 32574 32568 "1" 0 # LINE from SAN RAFL 115.00 to IGNACIO 115.00
1 32574 32570 "3" 0 # LINE from SAN RAFL 115.00 to LS GLLNS 115.00
4 32574 0 "1 " 0 # LOAD-DROP SAN RAFL 115.00 LOAD==26.66(3.80)
4 32574 0 "2 " 0 # LOAD-DROP SAN RAFL 115.00 LOAD==25.42(3.62)
4 32574 0 "3 " 0 # LOAD-DROP SAN RAFL 115.00 LOAD==17.66(2.52)
0
#
#
# (26) BUS FAULT 32590 "HIGHWAY"
#
1 32590 32586 "1" 0 # LINE from HIGHWAY 115.00 to HGHWY J2 115.00
1 32590 32588 "1" 0 # LINE from HIGHWAY 115.00 to HGHWY J1 115.00
4 32590 0 "1 " 0 # LOAD-DROP HIGHWAY 115.00 LOAD==20.67(2.94)
4 32590 0 "2 " 0 # LOAD-DROP HIGHWAY 115.00 LOAD==25.37(3.61)
0
#
#

```

APPENDIX B – CAISO CATEGORY C AUTOCON INPUT FILE

```

# (27) BUS FAULT 32600 "MEYERS"
#
1 32600 32614 "1" 0 # LINE from MEYERS 115.00 to MEYERTP1 115.00
1 32600 32616 "1" 0 # LINE from MEYERS 115.00 to MEYERTP2 115.00
4 32600 0 "1 " 0 # LOAD-DROP MEYERS 115.00 LOAD==0.24(0.05)
0
#
#
# (28) BUS FAULT 32602 "NRTH TWR"
#
1 32602 32618 "1" 0 # LINE from NRTH TWR 115.00 to NTWRJCT1 115.00
1 32602 32620 "1" 0 # LINE from NRTH TWR 115.00 to NTWRJCT2 115.00
4 32602 0 "1 " 0 # LOAD-DROP NRTH TWR 115.00 LOAD==14.43(2.06)
4 32602 0 "2 " 0 # LOAD-DROP NRTH TWR 115.00 LOAD==9.58(1.37)
4 32602 0 "3 " 0 # LOAD-DROP NRTH TWR 115.00 LOAD==6.08(0.87)
4 32602 0 "4 " 0 # LOAD-DROP NRTH TWR 115.00 LOAD==2.85(0.41)
0
#
#
# (29) BUS FAULT 32606 "CARQUINZ"
#
1 32606 32614 "1" 0 # LINE from CARQUINZ 115.00 to MEYERTP1 115.00
1 32606 32616 "1" 0 # LINE from CARQUINZ 115.00 to MEYERTP2 115.00
4 32606 0 "1 " 0 # LOAD-DROP CARQUINZ 115.00 LOAD==13.23(1.89)
4 32606 0 "2 " 0 # LOAD-DROP CARQUINZ 115.00 LOAD==11.26(1.60)
0
#
#
# (30) BUS FAULT 32652 "CALISTGA"
#
1 32652 31342 "1" 0 # LINE from CALISTGA 60.00 to MIDDLETWN 60.00
1 32652 32650 "1" 0 # LINE from CALISTGA 60.00 to ST.HELNA 60.00
4 32652 0 "1 " 0 # LOAD-DROP CALISTGA 60.00 LOAD==18.46(2.63)
0
#
#
# (31) BUS FAULT 32654 "TULUCAY"
#
1 32654 32655 "1" 0 # LINE from TULUCAY 60.00 to TULCAY1 60.00
1 32654 32660 "1" 0 # LINE from TULUCAY 60.00 to BSLT TAP 60.00
2 32654 30440 "1" 0 # TRAN from TULUCAY 60.00 to TULUCAY 230.00
2 32654 30440 "3" 0 # TRAN from TULUCAY 60.00 to TULUCAY 230.00
4 32654 0 "2 " 0 # LOAD-DROP TULUCAY 60.00 LOAD==11.77(1.68)
0
#
#
# (32) BUS FAULT 32656 "NAPA"
#
1 32656 32660 "1" 0 # LINE from NAPA 60.00 to BSLT TAP 60.00
1 32656 32662 "1" 0 # LINE from NAPA 60.00 to TULCY JT 60.00
4 32656 0 "1 " 0 # LOAD-DROP NAPA 60.00 LOAD==19.68(2.80)
4 32656 0 "2 " 0 # LOAD-DROP NAPA 60.00 LOAD==16.99(2.42)
0
#
#
# (33) BUS FAULT 32664 "IGNACO A"
#
1 32664 32666 "1" 0 # LINE from IGNACO A 60.00 to IGNACO B 60.00
1 32664 32667 "1" 0 # LINE from IGNACO A 60.00 to IG JCT 60.00
1 32664 32676 "1" 0 # LINE from IGNACO A 60.00 to HMLTN FD 60.00
1 32664 32677 "1" 0 # LINE from IGNACO A 60.00 to HMLTNBFD 60.00
0
#
#
# (34) BUS FAULT 32666 "IGNACO B"
#
1 32666 32664 "1" 0 # LINE from IGNACO B 60.00 to IGNACO A 60.00
1 32666 32669 "1" 0 # LINE from IGNACO B 60.00 to STAF_JCT 60.00
1 32666 32674 "1" 0 # LINE from IGNACO B 60.00 to WOODACRE 60.00
2 32666 32568 "1" 0 # TRAN from IGNACO B 60.00 to IGNACIO 115.00
2 32666 32568 "3" 0 # TRAN from IGNACO B 60.00 to IGNACIO 115.00
0
#
#
# (35) BUS FAULT 32668 "NOVATO"
#
1 32668 32665 "1" 0 # LINE from NOVATO 60.00 to NVTO JCT 60.00
1 32668 32667 "1" 0 # LINE from NOVATO 60.00 to IG JCT 60.00
4 32668 0 "1 " 0 # LOAD-DROP NOVATO 60.00 LOAD==5.04(0.72)

```

APPENDIX B – CAISO CATEGORY C AUTOCON INPUT FILE

```

4 32668      0 "2 "  0      # LOAD-DROP   NOVATO    60.00  LOAD==15.47(2.20)
0
#
#
# (36) BUS FAULT  32670  "STAFFORD"
#
1 32670  32665  "1"  0      # LINE from  STAFFORD  60.00  to  NVTO_JCT  60.00
1 32670  32669  "1"  0      # LINE from  STAFFORD  60.00  to  STAF_JCT  60.00
4 32670      0 "1 "  0      # LOAD-DROP   STAFFORD  60.00  LOAD==10.16(1.45)
4 32670      0 "2 "  0      # LOAD-DROP   STAFFORD  60.00  LOAD==10.61(1.51)
0
#
#
# (37) BUS FAULT  32671  "BOLINAS"
#
1 32671  32674  "1"  0      # LINE from  BOLINAS   60.00  to  WOODACRE  60.00
1 32671  32672  "1"  0      # LINE from  BOLINAS   60.00  to  OLEMA     60.00
4 32671      0 "1 "  0      # LOAD-DROP   BOLINAS   60.00  LOAD==1.48(0.21)
0
#
#
# (38) BUS FAULT  32672  "OLEMA"
#
1 32672  32671  "1"  0      # LINE from  OLEMA     60.00  to  BOLINAS   60.00
1 32672  32673  "1"  0      # LINE from  OLEMA     60.00  to  TOCA_JCT  60.00
4 32672      0 "1 "  0      # LOAD-DROP   OLEMA     60.00  LOAD==3.24(0.46)
0
#
#
# (39) BUS FAULT  32680  "GREENBRE"
#
1 32680  32678  "1"  0      # LINE from  GREENBRE  60.00  to  SAN RFLJ  60.00
1 32680  32682  "1"  0      # LINE from  GREENBRE  60.00  to  ALTO     60.00
4 32680      0 "1 "  0      # LOAD-DROP   GREENBRE  60.00  LOAD==10.09(1.44)
4 32680      0 "2 "  0      # LOAD-DROP   GREENBRE  60.00  LOAD==13.05(1.86)
0
#
#
# (40) BUS FAULT  32682  "ALTO"
#
1 32682  32680  "1"  0      # LINE from  ALTO     60.00  to  GREENBRE  60.00
1 32682  32684  "1"  0      # LINE from  ALTO     60.00  to  ALTOJT1  60.00
1 32682  32686  "1"  0      # LINE from  ALTO     60.00  to  ALTOJT2  60.00
4 32682      0 "1 "  0      # LOAD-DROP   ALTO     60.00  LOAD==17.21(2.45)
4 32682      0 "3 "  0      # LOAD-DROP   ALTO     60.00  LOAD==18.42(2.62)
0
#
#
# (41) BUS FAULT  32688  "SAUSALTO"
#
1 32688  32684  "1"  0      # LINE from  SAUSALTO  60.00  to  ALTOJT1  60.00
1 32688  32686  "1"  0      # LINE from  SAUSALTO  60.00  to  ALTOJT2  60.00
4 32688      0 "2 "  0      # LOAD-DROP   SAUSALTO  60.00  LOAD==10.92(1.56)
0
#
#
# 2013 category c contingency list (dctl and bus outages)
# East Bay Division Zone 307
#
#
# (42) C5 DCTL OUTAGE
# Ignacio - Sobrante and Lakeville - Sobrante 230 kV Lines
1 30437 30445 "1 "  0      # line from  CROCKETT 230.00 (3) to BRKR  IGNACIO 230.00
1 30437 30438 "1 "  0      # line from  CROCKETT 230.00 (3) to (2)  C&H    230.00
1 30437 30540 "1 "  0      # line from  CROCKETT 230.00 (3) to BRKR  SOBRANTE 230.00
2 30438 32900 "1 "  0      # TRAN from  C&H      230.00 BRKR to (1)  CRCKTCOG 18.00
4 30438      0 "1 "  0      # LOAD-DROP   C&H      230.00  LOAD==3.32(0.76)
3 32900      0 "1 "  0      # GEN-DROP    CRCKTCOG  18.00  GEN==240.00(40.82)
#
1 30435 30540 "2 "  0      # line from  LAKEVILLE 230.00 BRKR to BRKR  SOBRANTE 230.00
0
#
#
# (43) C5 DCTL OUTAGE
# Christie - Sobrante and Martinez - Sobrante 115 kV Lines
1 32756 33010 "1 "  0      # line from  CHRISTIE 115.00 BRKR to BRKR  SOBRANTE 115.00
#
1 32990 33014 "1 "  0      # line from  MARTNZ D 115.00 BRKR to (3)  ALHAMTP1 115.00
1 33014 33010 "1 "  0      # line from  ALHAMTP1 115.00 (3) to BRKR  SOBRANTE 115.00

```

APPENDIX B – CAISO CATEGORY C AUTOCON INPUT FILE

```

1 33014 33011 "1 " 0 # line from ALHAMTP1 115.00 (3) to BRKR ALHAMBRA 115.00
4 33011 0 "1 " 0 # LOAD-DROP ALHAMBRA 115.00 LOAD==10.29(2.34)
4 33011 0 "2 " 0 # LOAD-DROP ALHAMBRA 115.00 LOAD==9.17(2.09)
1 33016 33011 "1 " 1 # LINE-TRANSFER ALHAMTP1 115.00 TO ALHAMTP2 115.00
4 33011 0 "***" 1 # RESTORE ALHAMBRA load
0
#
#
# (44) C5 DCTL OUTAGE
# Sobrante - El Cerrito #1 and #2 115 kV Lines
1 32765 33010 "1 " 0 # line from ELCRTJ1 115.00 (2) to BRKR SOBRANTE 115.00
1 32765 32766 "1 " 0 # line from ELCRTJ1 115.00 (2) to BRKR EL CRRTO 115.00
#
1 32766 33010 "2 " 0 # line from EL CRRTO 115.00 BRKR to BRKR SOBRANTE 115.00
0
#
#
# (45) C5 DCTL OUTAGE
# Sobrante - Richmond #1 and #2 115 kV Lines
1 32767 33010 "1 " 0 # line from ELCRTJ2 115.00 (2) to BRKR SOBRANTE 115.00
1 32767 32768 "1 " 0 # line from ELCRTJ2 115.00 (2) to BRKR RICHMOND 115.00
#
1 32768 33010 "2 " 0 # line from RICHMOND 115.00 BRKR to BRKR SOBRANTE 115.00
0
#
#
# (46) C5 DCTL OUTAGE
# Sobrante - Standard Oil #1 and #2 115 kV Lines
1 32748 32750 "1 " 0 # line from PP STEEL 115.00 BRKR to (3) PPSTLTAP 115.00
1 32750 32774 "1 " 0 # line from PPSTLTAP 115.00 (3) to (3) PTPNLTAP 115.00
1 32750 32760 "1 " 0 # line from PPSTLTAP 115.00 (3) to (1) PT PINLE 115.00
1 32774 32762 "1 " 0 # line from PTPNLTAP 115.00 (3) to BRKR STD. OIL 115.00
1 32774 32808 "1 " 0 # line from PTPNLTAP 115.00 (3) to (2) SNPBLTP2 115.00
1 32808 33010 "1 " 0 # line from SNPBLTP2 115.00 (2) to BRKR SOBRANTE 115.00
4 32748 0 "1 " 0 # LOAD-DROP PP STEEL 115.00 LOAD==0.19(0.25)
4 32760 0 "1 " 0 # LOAD-DROP PT PINLE 115.00 LOAD==14.78(3.36)
#
1 32806 32758 "1 " 0 # line from SNPBLTP1 115.00 (3) to BRKR SAN PBLO 115.00
1 32806 32762 "2 " 0 # line from SNPBLTP1 115.00 (3) to BRKR STD. OIL 115.00
1 32806 33010 "2 " 0 # line from SNPBLTP1 115.00 (3) to BRKR SOBRANTE 115.00
4 32758 0 "1 " 0 # LOAD-DROP SAN PBLO 115.00 LOAD==19.98(4.55)
1 32758 32808 "2 " 1 # LINE-TRANSFER SNPBLTP1 to SNPBLTP2
4 32758 0 "***" 1 # RESTORE SAN PABLO load
0
#
#
# (47) C5 DCTL OUTAGE
# Oleum - North Tower - Christie and Martinez - Sobrante 115 kV Lines
1 32620 32778 "1 " 0 # line from NTRWJCT2 115.00 (2) to (3) MRTNZJCT 115.00
1 32620 32602 "1 " 0 # line from NTRWJCT2 115.00 (2) to BRKR NRTH TWR 115.00
1 32778 32754 "1 " 0 # line from MRTNZJCT 115.00 (3) to BRKR OLEUM 115.00
1 32778 32756 "1 " 0 # line from MRTNZJCT 115.00 (3) to BRKR CHRISTIE 115.00
4 32602 0 "1 " 0 # LOAD-DROP NRTH TWR 115.00 LOAD==14.43(2.06)
4 32602 0 "2 " 0 # LOAD-DROP NRTH TWR 115.00 LOAD==9.58(1.37)
4 32602 0 "3 " 0 # LOAD-DROP NRTH TWR 115.00 LOAD==6.08(0.87)
4 32602 0 "4 " 0 # LOAD-DROP NRTH TWR 115.00 LOAD==2.85(0.41)
1 32602 32618 "1 " 1 # LINE-TRANSFER NTRWJCT2 115.00 to NTRWJCT1 115.00
4 32602 0 "***" 1 # RESTORE NORTH TOWER load
#
1 32990 33014 "1 " 0 # line from MARTNZ D 115.00 BRKR to (3) ALHAMTP1 115.00
1 33014 33010 "1 " 0 # line from ALHAMTP1 115.00 (3) to BRKR SOBRANTE 115.00
1 33014 33011 "1 " 0 # line from ALHAMTP1 115.00 (3) to BRKR ALHAMBRA 115.00
4 33011 0 "1 " 0 # LOAD-DROP ALHAMBRA 115.00 LOAD==10.29(2.34)
4 33011 0 "2 " 0 # LOAD-DROP ALHAMBRA 115.00 LOAD==9.17(2.09)
1 33016 33011 "1 " 1 # LINE-TRANSFER ALHAMTP1 115.00 TO ALHAMTP2 115.00
4 33011 0 "***" 1 # RESTORE ALHAMBRA load
0
#
#
# (48) C5 DCTL OUTAGE
# Oleum - Martinez and Martinez - Sobrante 115 kV Lines
1 33016 32754 "1 " 0 # line from ALHAMTP2 115.00 (2) to BRKR OLEUM 115.00
1 33016 32990 "1 " 0 # line from ALHAMTP2 115.00 (2) to BRKR MARTNZ D 115.00
#
1 32990 33014 "1 " 0 # line from MARTNZ D 115.00 BRKR to (3) ALHAMTP1 115.00
1 33014 33010 "1 " 0 # line from ALHAMTP1 115.00 (3) to BRKR SOBRANTE 115.00
1 33014 33011 "1 " 0 # line from ALHAMTP1 115.00 (3) to BRKR ALHAMBRA 115.00
4 33011 0 "1 " 0 # LOAD-DROP ALHAMBRA 115.00 LOAD==10.29(2.34)
4 33011 0 "2 " 0 # LOAD-DROP ALHAMBRA 115.00 LOAD==9.17(2.09)

```

APPENDIX B – CAISO CATEGORY C AUTOCON INPUT FILE

```

1 33016 33011 "1 " 1 # LINE-TRANSFER ALHAMTP1 115.00 TO ALHAMTP2 115.00
4 33011 0 "***" 1 # RESTORE ALHAMBRA load
0
#
#
# (49) C5 DCTL OUTAGE
# Oleum - North Tower - Christie and Oleum - Martinez 115 kV Lines
1 32620 32778 "1 " 0 # line from NTRWJCT2 115.00 (2) to (3) MRTNZJCT 115.00
1 32620 32602 "1 " 0 # line from NTRWJCT2 115.00 (2) to BRKR NRTH TWR 115.00
1 32778 32754 "1 " 0 # line from MRTNZJCT 115.00 (3) to BRKR OLEUM 115.00
1 32778 32756 "1 " 0 # line from MRTNZJCT 115.00 (3) to BRKR CHRISTIE 115.00
4 32602 0 "1 " 0 # LOAD-DROP NRTH TWR 115.00 LOAD==14.43(2.06)
4 32602 0 "2 " 0 # LOAD-DROP NRTH TWR 115.00 LOAD==9.58(1.37)
4 32602 0 "3 " 0 # LOAD-DROP NRTH TWR 115.00 LOAD==6.08(0.87)
4 32602 0 "4 " 0 # LOAD-DROP NRTH TWR 115.00 LOAD==2.85(0.41)
1 32602 32618 "1 " 1 # LINE-TRANSFER NTRWJCT2 115.00 to NTRWJCT1 115.00
4 32602 0 "***" 1 # RESTORE NORTH TOWER load
#
1 33016 32754 "1 " 0 # line from ALHAMTP2 115.00 (2) to BRKR OLEUM 115.00
1 33016 32990 "1 " 0 # line from ALHAMTP2 115.00 (2) to BRKR MARTNZ D 115.00
0
#
#
# (50) C5 DCTL OUTAGE
# Oleum - El Cerrito #1 and #2 115 kV Lines
1 32754 32802 "1 " 0 # line from OLEUM 115.00 BRKR to (3) VLYVWTP1 115.00
1 32802 32764 "1 " 0 # line from VLYVWTP1 115.00 (3) to BRKR VALLY VW 115.00
1 32802 32766 "1 " 0 # line from VLYVWTP1 115.00 (3) to BRKR EL CRRTO 115.00
4 32764 0 "1 " 0 # LOAD-DROP VALLY VW 115.00 LOAD==7.65(1.74)
4 32764 0 "2 " 0 # LOAD-DROP VALLY VW 115.00 LOAD==15.69(3.58)
1 32764 32804 "2 " 1 # LINE-TRANSFER VLYVWTP1 to VLYVWTP2
4 32764 0 "***" 1 # RESTORE VALLEY VIEW load
#
1 32754 32804 "2 " 0 # line from OLEUM 115.00 BRKR to (2) VLYVWTP2 115.00
1 32804 32766 "2 " 0 # line from VLYVWTP2 115.00 (2) to BRKR EL CRRTO 115.00
0
#
#
# (51) C5 DCTL OUTAGE
# Moraga - Claremont #1 and #2 115 kV Lines
1 33020 32780 "1 " 0 # line from MORAGA 115.00 BRKR to BRKR CLARMNT 115.00
#
1 33020 32780 "2 " 0 # line from MORAGA 115.00 BRKR to BRKR CLARMNT 115.00
0
#
#
# (52) C5 DCTL OUTAGE
# Moraga - Oakland X #1 and #2 115 kV Lines
1 33020 32790 "1 " 0 # line from MORAGA 115.00 BRKR to BRKR STATIN X 115.00
#
1 33020 32790 "2 " 0 # line from MORAGA 115.00 BRKR to BRKR STATIN X 115.00
0
#
#
# (53) C5 DCTL OUTAGE
# Moraga - Oakland X #3 and #4 115 kV Lines
1 33020 32790 "3 " 0 # line from MORAGA 115.00 BRKR to BRKR STATIN X 115.00
#
1 33020 32790 "4 " 0 # line from MORAGA 115.00 BRKR to BRKR STATIN X 115.00
0
#
#
# (54) C5 DCTL OUTAGE
# Moraga - Oakland J and Moraga - San Leandro #3 115 kV Lines
1 33020 32792 "1 " 0 # line from MORAGA 115.00 BRKR to BRKR STATIN J 115.00
#
1 33020 35101 "3 " 0 # line from MORAGA 115.00 BRKR to BRKR SN LNDRO 115.00
0
#
#
# (55) C5 DCTL OUTAGE
# Moraga - Oakland J and San Leandro - Oakland J 115 kV Lines
1 33020 32792 "1 " 0 # line from MORAGA 115.00 BRKR to BRKR STATIN J 115.00
#
1 32792 32814 "1 " 0 # line from STATIN J 115.00 BRKR to (3) EDESTAP1 115.00
1 32814 32810 "1 " 0 # line from EDESTAP1 115.00 (3) to BRKR EDES 115.00
1 32814 35113 "1 " 0 # line from EDESTAP1 115.00 (3) to (2) DMTAR_SL 115.00
1 35113 35101 "1 " 0 # line from DMTAR_SL 115.00 (2) to BRKR SN LNDRO 115.00
4 32810 0 "2 " 0 # LOAD-DROP EDES 115.00 LOAD==18.85(4.29)

```

APPENDIX B – CAISO CATEGORY C AUTOCON INPUT FILE

```

4 32810      0 "3 "  0 # LOAD-DROP  EDES      115.00  LOAD==29.45(6.71)
4 35113      0 "1 "  0 # LOAD-DROP  DMTAR_SL  115.00  LOAD==3.61(2.24)
1 32810 32812 "1 "  1 # LINE-TRANSFER EDESTAP1 to EDS GRNT
4 32810      0 "***" 1 # RESTORE EDES load
0
#
#
# (56) BUS FAULT 32740 "HILLSIDE"
#
1 32740 33006 "1"  0 # LINE from HILLSIDE 115.00 to GRIZLYJ1 115.00
1 32740 33008 "2"  0 # LINE from HILLSIDE 115.00 to GRIZLYJ2 115.00
1 32740 32770 "1"  0 # LINE from HILLSIDE 115.00 to GRIZZLY2 115.00
1 32740 32770 "2"  0 # LINE from HILLSIDE 115.00 to GRIZZLY2 115.00
4 32740      0 "SG"  0 # LOAD-DROP  HILLSIDE 115.00  LOAD==30.51(18.91)
3 32740      0 "1 "  0 # GEN-DROP   HILLSIDE 115.00  GEN==26.00(-8.70)
0
#
#
# (57) BUS FAULT 32748 "PP STEEL"
#
1 32748 32750 "1"  0 # LINE from PP STEEL 115.00 to PPSTLTAP 115.00
4 32748      0 "1 "  0 # LOAD-DROP  PP STEEL 115.00  LOAD==0.19(0.25)
0
#
#
# (58) BUS FAULT 32754 "OLEUM" Oleum 115 kV Bus Section E
#
1 32754 32778 "1"  0 # LINE from OLEUM    115.00 to MRTNZJCT 115.00
1 32754 32849 "2"  0 # LINE from OLEUM    115.00 to CON25    115.00
1 32754 32911 "2"  0 # LINE from OLEUM    115.00 to UNOCAL2  115.00
1 32754 33016 "1"  0 # LINE from OLEUM    115.00 to ALHAMTP2 115.00
0
#
#
# (59) BUS FAULT 32754 "OLEUM" Oleum 115 kV Bus Section F
#
1 32754 32802 "1"  0 # LINE from OLEUM    115.00 to VLYVWTP1 115.00
1 32754 32804 "2"  0 # LINE from OLEUM    115.00 to VLYVWTP2 115.00
1 32754 32849 "1"  0 # LINE from OLEUM    115.00 to CON25    115.00
1 32754 32911 "1"  0 # LINE from OLEUM    115.00 to UNOCAL2  115.00
0
#
#
# (60) BUS FAULT 32756 "CHRISTIE"
#
1 32756 32778 "1"  0 # LINE from CHRISTIE 115.00 to MRTNZJCT 115.00
1 32756 33010 "1"  0 # LINE from CHRISTIE 115.00 to SOBRANTE 115.00
2 32756 32852 "1"  0 # TRAN from CHRISTIE 115.00 to CHRISTIE  60.00
0
#
#
# (61) BUS FAULT 32758 "SAN PBLO"
#
1 32758 32806 "1"  0 # LINE from SAN PBLO 115.00 to SNPBLTP1 115.00
1 32758 32808 "2"  0 # LINE from SAN PBLO 115.00 to SNPBLTP2 115.00
4 32758      0 "1 "  0 # LOAD-DROP  SAN PBLO 115.00  LOAD==19.98(4.55)
0
#
#
# (62) BUS FAULT 32764 "VALLY VW"
#
1 32764 32802 "1"  0 # LINE from VALLY VW 115.00 to VLYVWTP1 115.00
1 32764 32804 "2"  0 # LINE from VALLY VW 115.00 to VLYVWTP2 115.00
4 32764      0 "1 "  0 # LOAD-DROP  VALLY VW 115.00  LOAD==7.65(1.74)
4 32764      0 "2 "  0 # LOAD-DROP  VALLY VW 115.00  LOAD==15.69(3.58)
0
#
#
# (63) BUS FAULT 32766 "EL CRRTO" El Cerrito 115 kV Bus Section D
#
1 32766 32765 "1"  0 # LINE from EL CRRTO 115.00 to ELCRTJ1  115.00
1 32766 32802 "1"  0 # LINE from EL CRRTO 115.00 to VLYVWTP1 115.00
4 32766      0 "5 "  0 # LOAD-DROP  EL CRRTO 115.00  LOAD==7.10(1.44)
0
#
#
# (64) BUS FAULT 32766 "EL CRRTO" El Cerrito 115 kV Bus Section E
#
1 32766 33010 "2"  0 # LINE from EL CRRTO 115.00 to SOBRANTE 115.00

```

APPENDIX B – CAISO CATEGORY C AUTOCON INPUT FILE

```

1 32766 32804 "2" 0 # LINE from EL CRRTO 115.00 to VLYVWTP2 115.00
4 32766 0 "6 " 0 # LOAD-DROP EL CRRTO 115.00 LOAD==6.90(1.40)
0
#
#
# (65) BUS FAULT 32766 "EL CRRTO" El Cerrito 115 kV Bus Section Loads 1 & 2
#
4 32766 0 "1 " 0 # LOAD-DROP EL CRRTO 115.00 LOAD==25.48(5.81)
4 32766 0 "2 " 0 # LOAD-DROP EL CRRTO 115.00 LOAD==31.69(7.22)
0
#
#
# (66) BUS FAULT 32766 "EL CRRTO" El Cerrito 115 kV Bus Section Load 4
#
4 32766 0 "4 " 0 # LOAD-DROP EL CRRTO 115.00 LOAD==55.53(12.65)
0
#
#
# (67) BUS FAULT 32768 "RICHMOND" Richmond 115 kV Bus Section 1
#
1 32768 32767 "1" 0 # LINE from RICHMOND 115.00 to ELCRTJ2 115.00
4 32768 0 "2 " 0 # LOAD-DROP RICHMOND 115.00 LOAD==18.34(4.18)
0
#
#
# (68) BUS FAULT 32768 "RICHMOND" Richmond 115 kV Bus Section 2
#
1 32768 33010 "2" 0 # LINE from RICHMOND 115.00 to SOBRANTE 115.00
4 32768 0 "1 " 0 # LOAD-DROP RICHMOND 115.00 LOAD==37.70(8.59)
0
#
#
# (69) BUS FAULT 32770 "GRIZZLY2"
#
1 32770 32740 "1" 0 # LINE from GRIZZLY2 115.00 to HILLSIDE 115.00
1 32770 32740 "2" 0 # LINE from GRIZZLY2 115.00 to HILLSIDE 115.00
4 32770 0 "1 " 0 # LOAD-DROP GRIZZLY2 115.00 LOAD==4.37(0.77)
0
#
#
# (70) BUS FAULT 32780 "CLARMNT" Claremont 115 kV Bus Section 1
#
1 32780 32782 "1" 0 # LINE from CLARMNT 115.00 to STATIN D 115.00
1 32780 33012 "1" 0 # LINE from CLARMNT 115.00 to EST PRTL 115.00
1 32780 33020 "1" 0 # LINE from CLARMNT 115.00 to MORAGA 115.00
0
#
#
# (71) BUS FAULT 32780 "CLARMNT" Claremont 115 kV Bus Section 2
#
1 32780 32782 "2" 0 # LINE from CLARMNT 115.00 to STATIN D 115.00
1 32780 33008 "2" 0 # LINE from CLARMNT 115.00 to GRIZLYJ2 115.00
1 32780 33020 "2" 0 # LINE from CLARMNT 115.00 to MORAGA 115.00
4 32780 0 "2 " 0 # LOAD-DROP CLARMNT 115.00 LOAD==19.48(4.44)
0
#
#
# (72) BUS FAULT 32782 "STATIN D"
#
1 32782 32780 "1" 0 # LINE from STATIN D 115.00 to CLARMNT 115.00
1 32782 32780 "2" 0 # LINE from STATIN D 115.00 to CLARMNT 115.00
1 32782 32788 "1" 0 # LINE from STATIN D 115.00 to STATIN L 115.00
4 32782 0 "3 " 0 # LOAD-DROP STATIN D 115.00 LOAD==26.13(5.95)
4 32782 0 "4 " 0 # LOAD-DROP STATIN D 115.00 LOAD==39.73(9.05)
4 32782 0 "5 " 0 # LOAD-DROP STATIN D 115.00 LOAD==43.68(9.96)
0
#
#
# (73) BUS FAULT 32786 "OAK C115" Oakland C 115 kV Bus Section D
#
1 32786 32788 "1" 0 # LINE from OAK C115 115.00 to STATIN L 115.00
2 32786 32908 "3" 0 # TRAN from OAK C115 115.00 to OAK C12 12.00
4 32786 0 "5 " 0 # LOAD-DROP OAK C115 115.00 LOAD==10.40(2.11)
0
#
#
# (74) BUS FAULT 32786 "OAK C115" Oakland C 115 kV Bus Section E
#
1 32786 32790 "2" 0 # LINE from OAK C115 115.00 to STATIN X 115.00

```

APPENDIX B – CAISO CATEGORY C AUTOCON INPUT FILE

```

1 32786 32790 "3" 0 # LINE from OAK C115 115.00 to STATIN X 115.00
1 32786 32793 "1" 0 # LINE from OAK C115 115.00 to SCHNITZ 115.00
1 32786 32904 "1" 0 # LINE from OAK C115 115.00 to OAKLND23 115.00
1 32786 38026 "1" 0 # LINE from OAK C115 115.00 to ALAMEDCT 115.00
2 32786 32908 "1" 0 # TRAN from OAK C115 115.00 to OAK C12 12.00
2 32786 32908 "2" 0 # TRAN from OAK C115 115.00 to OAK C12 12.00
4 32786 0 "6 " 0 # LOAD-DROP OAK C115 115.00 LOAD==4.23(0.86)
0
#
#
# (75) BUS FAULT 32788 "STATIN L"
#
1 32788 32782 "1" 0 # LINE from STATIN L 115.00 to STATIN D 115.00
1 32788 32786 "1" 0 # LINE from STATIN L 115.00 to OAK C115 115.00
4 32788 0 "1 " 0 # LOAD-DROP STATIN L 115.00 LOAD==18.05(4.11)
4 32788 0 "3 " 0 # LOAD-DROP STATIN L 115.00 LOAD==18.05(4.11)
4 32788 0 "5 " 0 # LOAD-DROP STATIN L 115.00 LOAD==18.05(4.11)
0
#
#
# (76) BUS FAULT 32790 "STATIN X" Oakland X 115 kV Bus Section 1
#
1 32790 32786 "3" 0 # LINE from STATIN X 115.00 to OAK C115 115.00
1 32790 33020 "2" 0 # LINE from STATIN X 115.00 to MORAGA 115.00
1 32790 33020 "3" 0 # LINE from STATIN X 115.00 to MORAGA 115.00
4 32790 0 "2 " 0 # LOAD-DROP STATIN X 115.00 LOAD==21.01(4.79)
0
#
#
# (77) BUS FAULT 32790 "STATIN X" Oakland X 115 kV Bus Section 1
#
1 32790 32786 "2" 0 # LINE from STATIN X 115.00 to OAK C115 115.00
1 32790 33020 "1" 0 # LINE from STATIN X 115.00 to MORAGA 115.00
1 32790 33020 "4" 0 # LINE from STATIN X 115.00 to MORAGA 115.00
4 32790 0 "3 " 0 # LOAD-DROP STATIN X 115.00 LOAD==17.34(3.95)
4 32790 0 "4 " 0 # LOAD-DROP STATIN X 115.00 LOAD==16.12(3.67)
0
#
#
# (78) BUS FAULT 32792 "STATIN J" Oakland J 115 kV Bus Section D
#
1 32792 32798 "1" 0 # LINE from STATIN J 115.00 to OWENSTAP 115.00
1 32792 38024 "1" 0 # LINE from STATIN J 115.00 to JENNY 115.00
4 32792 0 "1 " 0 # LOAD-DROP STATIN J 115.00 LOAD==38.21(8.71)
0
#
#
# (79) BUS FAULT 32792 "STATIN J" Oakland J 115 kV Bus Section E
#
1 32792 32814 "1" 0 # LINE from STATIN J 115.00 to EDESTAP1 115.00
1 32792 33020 "1" 0 # LINE from STATIN J 115.00 to MORAGA 115.00
4 32792 0 "2 " 0 # LOAD-DROP STATIN J 115.00 LOAD==17.16(3.91)
4 32792 0 "5 " 0 # LOAD-DROP STATIN J 115.00 LOAD==28.89(6.58)
0
#
#
# (80) BUS FAULT 32794 "MARITIME"
#
1 32794 32793 "1" 0 # LINE from MARITIME 115.00 to SCHNITZ 115.00
4 32794 0 "1 " 0 # LOAD-DROP MARITIME 115.00 LOAD==0.95(1.11)
0
#
#
# (81) BUS FAULT 32800 "OWNBRKWY"
#
1 32800 32798 "1" 0 # LINE from OWNBRKWY 115.00 to OWENSTAP 115.00
4 32800 0 "1 " 0 # LOAD-DROP OWNBRKWY 115.00 LOAD==9.29(5.51)
0
#
#
# (82) BUS FAULT 32810 "EDES" Edes 115 kV Bus Section E
#
1 32810 32812 "1" 0 # LINE from EDES 115.00 to EDS GRNT 115.00
4 32810 0 "2 " 0 # LOAD-DROP EDES 115.00 LOAD==18.85(4.29)
0
#
#
# (83) BUS FAULT 32810 "EDES" Edes 115 kV Bus Section H
#

```

APPENDIX B – CAISO CATEGORY C AUTOCON INPUT FILE

```

1 32810 32814 "1" 0 # LINE from EDES 115.00 to EDESTAP1 115.00
4 32810 0 "3" 0 # LOAD-DROP EDES 115.00 LOAD==29.45(6.71)
0
#
#
# (84) BUS FAULT 32852 "CHRISTIE"
#
1 32852 32850 "1" 0 # LINE from CHRISTIE 60.00 to UNIN CHM 60.00
1 32852 32856 "2" 0 # LINE from CHRISTIE 60.00 to FRANKLIN 60.00
1 32852 33067 "1" 0 # LINE from CHRISTIE 60.00 to PCBRICK 60.00
2 32852 32756 "1" 0 # TRAN from CHRISTIE 60.00 to CHRISTIE 115.00
0
#
#
# (85) BUS FAULT 32860 "FRKLNALT"
#
1 32860 32850 "1" 0 # LINE from FRKLNALT 60.00 to UNIN CHM 60.00
1 32860 32856 "1" 0 # LINE from FRKLNALT 60.00 to FRANKLIN 60.00
0
#
#
# 2013 category c contingency list (dctl and bus outages)
# Diablo Division Zone 308
#
#
# (86) C5 DCTL OUTAGE
# Contra Costa #1 and #2 115 kV Lines
1 33000 33047 "1" 0 # line from CC SUB 115.00 BRKR to (2) CC JCT 115.00
1 33047 33045 "1" 0 # line from CC JCT 115.00 (2) to (2) FIBRJCT1 115.00
1 33045 33048 "1" 0 # line from FIBRJCT1 115.00 (2) to (2) RVECTP 115.00
1 33048 33049 "1" 0 # line from RVECTP 115.00 (2) to BRKR RVEC 115.00
#
1 33000 33046 "1" 0 # line from CC SUB 115.00 BRKR to (3) FIBRJCT2 115.00
1 33046 33001 "1" 0 # line from FIBRJCT2 115.00 (3) to BRKR DOMTAR 115.00
1 33046 33044 "1" 0 # line from FIBRJCT2 115.00 (3) to (2) FIBRBJCT 115.00
1 33044 33002 "1" 0 # line from FIBRBJCT 115.00 (2) to (2) CROWN Z 115.00
2 33002 33133 "1" 0 # TRAN from CROWN Z 115.00 (2) to (1) GWF #3 13.80
4 33001 0 "1" 0 # LOAD-DROP DOMTAR 115.00 LOAD==2.40(2.12)
4 33133 0 "SG" 0 # LOAD-DROP GWF #3 13.80 LOAD==2.84(0.65)
3 33133 0 "1" 0 # GEN-DROP GWF #3 13.80 GEN==19.00(4.33)
0
#
#
# (87) C5 DCTL OUTAGE
# Contra Costa - DuPont and Contra Costa - Balfour 60 kV Lines
1 33050 33080 "1" 0 # line from CC SUB 60.00 BRKR to (3) WILBRTAP 60.00
1 33080 33051 "1" 0 # line from WILBRTAP 60.00 (3) to BRKR DU PONT 60.00
2 33080 33134 "1" 0 # TRAN from WILBRTAP 60.00 (3) to (1) GWF #4 13.80
4 33051 0 "1" 0 # LOAD-DROP DU PONT 60.00 LOAD==2.00(2.16)
4 33134 0 "SG" 0 # LOAD-DROP GWF #4 13.80 LOAD==2.88(0.66)
3 33134 0 "1" 0 # GEN-DROP GWF #4 13.80 GEN==18.60(3.34)
1 33051 33081 "1" 1 # LINE-TRANSFER WILBRTAP 60.00 TO DUPNTJCT 60.00
4 33051 0 "***" 1 # RESTORE DU PONT load
#
1 33050 33081 "1" 0 # line from CC SUB 60.00 BRKR to (2) DUPNTJCT 60.00
1 33081 33082 "1" 0 # line from DUPNTJCT 60.00 (2) to (3) BALFRJCT 60.00
1 33082 33052 "1" 0 # line from BALFRJCT 60.00 (3) to (2) MARSH 60.00
1 33082 33054 "1" 0 # line from BALFRJCT 60.00 (3) to BRKR BALFOUR 60.00
1 33052 33053 "1" 0 # line from MARSH 60.00 (2) to (1) BRIONES 60.00
4 33054 0 "1" 0 # LOAD-DROP BALFOUR 60.00 LOAD==4.00(0.81)
4 33053 0 "1" 0 # LOAD-DROP BRIONES 60.00 LOAD==3.90(1.84)
1 33083 33054 "1" 1 # LINE-TRANSFER BALFRJCT 60.00 TO MDLRVRJT 60.00
4 33054 0 "***" 1 # RESTORE BALFOUR load
0
#
#
# (88) C5 DCTL OUTAGE
# Pittsburg - Martinez #1 and #2 115 kV Lines
1 32950 32993 "1" 0 # line from PITTSBURG 115.00 BRKR to (2) W.P.BART 115.00
1 32993 33040 "1" 0 # line from W.P.BART 115.00 (2) to (3) BOLLMAN1 115.00
1 33040 32994 "1" 0 # line from BOLLMAN1 115.00 (3) to (1) BOLLMAN 115.00
1 33040 33042 "1" 0 # line from BOLLMAN1 115.00 (3) to (2) IMHOFF_1 115.00
1 33042 32991 "1" 0 # line from IMHOFF_1 115.00 (2) to BRKR MARTINZ E 115.00
4 32993 0 "1" 0 # LOAD-DROP W.P.BART 115.00 LOAD==7.29(1.48)
4 32993 0 "3" 0 # LOAD-DROP W.P.BART 115.00 LOAD==13.49(3.07)
4 32994 0 "1" 0 # LOAD-DROP BOLLMAN 115.00 LOAD==2.59(1.36)
4 32994 0 "2" 0 # LOAD-DROP BOLLMAN 115.00 LOAD==2.59(1.36)
#
1 32950 32992 "2" 0 # line from PITTSBURG 115.00 BRKR to (2) BOLLMAN2 115.00

```

APPENDIX B – CAISO CATEGORY C AUTOCON INPUT FILE

```

1 32992 33043 "2 " 0 # line from BOLLMAN2 115.00 (2) to (3) IMHOFF_2 115.00
1 33043 32991 "2 " 0 # line from IMHOFF_2 115.00 (3) to BRKR MARTNZ E 115.00
1 33043 33041 "2 " 0 # line from IMHOFF_2 115.00 (3) to (2) IMHOFF 115.00
2 33041 33136 "1 " 0 # TRAN from IMHOFF 115.00 (2) to (1) CCCSD 12.47
4 33136 0 "SG" 0 # LOAD-DROP CCCSD 12.47 LOAD==3.37(0.77)
3 33136 0 "1 " 0 # GEN-DROP CCCSD 12.47 GEN==4.40(0.53)
0
#
#
# (89) C5 DCTL OUTAGE
# Pittsburg - Clayton #3 and #4 115 kV Lines
1 32950 33032 "3 " 0 # line from PITSBURG 115.00 BRKR to (2) KIRKTAP1 115.00
1 33032 32970 "3 " 0 # line from KIRKTAP1 115.00 (2) to BRKR CLAYTN 115.00
#
1 32950 32970 "4 " 0 # line from PITSBURG 115.00 BRKR to BRKR CLAYTN 115.00
0
#
#
# (90) C5 DCTL OUTAGE
# Pittsburg - Columbia Steel and Pittsburg - Kirker - Columbia Steel 115 kV Lines
1 32950 33030 "1 " 0 # line from PITSBURG 115.00 BRKR to (2) COLSTJTT1 115.00
1 33030 33036 "1 " 0 # line from COLSTJTT1 115.00 (2) to (3) LINDETP1 115.00
1 33036 32954 "1 " 0 # line from LINDETP1 115.00 (3) to (2) DOW TAP1 115.00
1 33036 32961 "1 " 0 # line from LINDETP1 115.00 (3) to (3) GWF2 TAP 115.00
1 32954 32956 "1 " 0 # line from DOW TAP1 115.00 (2) to (2) DOW MTR 115.00
2 32956 33160 "1 " 0 # TRAN from DOW MTR 115.00 (2) to (4) DOW CHEM 13.80
1 33160 33161 "1 " 0 # line from DOW CHEM 13.80 (4) to (1) DOWCHEM1 13.80
1 33160 33162 "1 " 0 # line from DOW CHEM 13.80 (4) to (1) DOWCHEM2 13.80
1 33160 33163 "1 " 0 # line from DOW CHEM 13.80 (4) to (1) DOWCHEM3 13.80
1 32961 32960 "1 " 0 # line from GWF2 TAP 115.00 (3) to (2) GWF#2 HS 115.00
1 32961 33038 "1 " 0 # line from GWF2 TAP 115.00 (3) to (2) LINDEJCT 115.00
2 32960 33132 "1 " 0 # TRAN from GWF#2 HS 115.00 (2) to (1) GWF #2 13.80
1 33038 32957 "1 " 0 # line from LINDEJCT 115.00 (2) to BRKR PRAXAIR 115.00
4 33160 0 "SG" 0 # LOAD-DROP DOW CHEM 13.80 LOAD==15.00(9.30)
4 33132 0 "SG" 0 # LOAD-DROP GWF #2 13.80 LOAD==2.81(0.64)
4 32957 0 "1 " 0 # LOAD-DROP PRAXAIR 115.00 LOAD==20.67(4.61)
3 33161 0 "1 " 0 # GEN-DROP DOWCHEM1 13.80 GEN==15.30(6.00)
3 33162 0 "1 " 0 # GEN-DROP DOWCHEM2 13.80 GEN==22.00(5.29)
3 33163 0 "1 " 0 # GEN-DROP DOWCHEM3 13.80 GEN==22.00(5.29)
3 33132 0 "1 " 0 # GEN-DROP GWF #2 13.80 GEN==12.30(3.13)
#
1 32950 33033 "1 " 0 # line from PITSBURG 115.00 BRKR to (3) KIRKTAP2 115.00
1 33033 32951 "1 " 0 # line from KIRKTAP2 115.00 (3) to BRKR KIRKER 115.00
1 33033 33031 "1 " 0 # line from KIRKTAP2 115.00 (3) to (2) COLSTJTT2 115.00
1 33031 33037 "1 " 0 # line from COLSTJTT2 115.00 (2) to (2) LINDETP2 115.00
1 33037 32955 "1 " 0 # line from LINDETP2 115.00 (2) to (1) DOW TAP2 115.00
4 32951 0 "1 " 0 # LOAD-DROP KIRKER 115.00 LOAD==38.02(7.72)
4 32951 0 "2 " 0 # LOAD-DROP KIRKER 115.00 LOAD==44.19(8.97)
4 32951 0 "3 " 0 # LOAD-DROP KIRKER 115.00 LOAD==53.77(10.92)
1 33032 32951 "1 " 1 # LINE-TRANSFER KIRKTAP2 115.00 TO KIRKTAP1
4 32951 0 "***" 1 # RESTORE KIRKER load
0
#
#
# (91) C5 DCTL OUTAGE
# Sobrante - Grizzly - East Portal and Sobrante - Grizzly - Claremont #2 115 kV Lines
1 32740 33006 "1 " 0 # line from HILLSIDE 115.00 BRKR to (3) GRIZLYJ1 115.00
1 33006 33010 "1 " 0 # line from GRIZLYJ1 115.00 (3) to BRKR SOBRANTE 115.00
1 33006 33012 "1 " 0 # line from GRIZLYJ1 115.00 (3) to BRKR EST PRTL 115.00
1 32770 32740 "1 " 0 # include GRIZZLY2 115.00 BRKR to HILLSIDE 115.00 ckt 1
#
1 32740 33008 "2 " 0 # line from HILLSIDE 115.00 BRKR to (3) GRIZLYJ2 115.00
1 33008 32780 "2 " 0 # line from GRIZLYJ2 115.00 (3) to BRKR CLARMNT 115.00
1 33008 33010 "2 " 0 # line from GRIZLYJ2 115.00 (3) to BRKR SOBRANTE 115.00
1 32770 32740 "2 " 0 # include GRIZZLY2 115.00 BRKR to HILLSIDE 115.00 ckt 2
0
#
#
# (92) C5 DCTL OUTAGE
# East Portal - Claremont and Sobrante - Grizzly - Claremont #2 115 kV Lines
1 33012 32780 "1 " 0 # line from EST PRTL 115.00 BRKR to BRKR CLARMNT 115.00
#
1 32740 33008 "2 " 0 # line from HILLSIDE 115.00 BRKR to (3) GRIZLYJ2 115.00
1 33008 32780 "2 " 0 # line from GRIZLYJ2 115.00 (3) to BRKR CLARMNT 115.00
1 33008 33010 "2 " 0 # line from GRIZLYJ2 115.00 (3) to BRKR SOBRANTE 115.00
1 32770 32740 "2 " 0 # include GRIZZLY2 115.00 BRKR to HILLSIDE 115.00 ckt 2
0
#
#

```

APPENDIX B – CAISO CATEGORY C AUTOCON INPUT FILE

```

# (93) C5 DCTL OUTAGE
# Lakewood - Clayton #2 and Lakewood - Meadow Lane - Clayton 115 kV Lines
1 32970 32974 "2 " 0 # line from CLAYTN 115.00 BRKR to BRKR LAKEWD-M 115.00
#
1 32970 33035 "1 " 0 # line from CLAYTN 115.00 BRKR to (3) LKWD_JCT 115.00
1 33035 32972 "1 " 0 # line from LKWD_JCT 115.00 (3) to (2) EBMUDGRY 115.00
1 33035 32973 "1 " 0 # line from LKWD_JCT 115.00 (3) to BRKR LAKEWD-C 115.00
1 32972 32971 "1 " 0 # line from EBMUDGRY 115.00 (2) to BRKR MEDW LINE 115.00
4 32972 0 "1 " 0 # LOAD-DROP EBMUDGRY 115.00 LOAD==5.67(1.86)
0
#
#
# (94) C5 DCTL OUTAGE
# Birds Landing - Contra Costa Sub and Birds Landing - Contra Costa 230 kV Lines
1 30479 30523 "1 " 0 # line from BDLSWSTA 230.00 BRKR to BRKR CC SUB 230.00
#
1 30525 30479 "1 " 0 # line from C.COSTA 230.00 BRKR to BRKR BDLSWSTA 230.00
0
#
#
# (95) C5 DCTL OUTAGE
# Contra Costa Sub - Contra Costa and Birds Landing - Contra Costa 230 kV Lines
1 30523 30525 "1 " 0 # line from CC SUB 230.00 BRKR to BRKR C.COSTA 230.00
#
1 30525 30479 "1 " 0 # line from C.COSTA 230.00 BRKR to BRKR BDLSWSTA 230.00
0
#
#
# (96) C5 DCTL OUTAGE
# Contra Costa - Moraga #1 and #2 230 kV Lines
1 30525 30543 "1 " 0 # line from C.COSTA 230.00 BRKR to (3) ROSSTAP1 230.00
1 30543 30545 "1 " 0 # line from ROSSTAP1 230.00 (3) to BRKR ROSSMOOR 230.00
1 30543 30550 "1 " 0 # line from ROSSTAP1 230.00 (3) to BRKR MORAGA 230.00
4 30545 0 "1 " 0 # LOAD-DROP ROSSMOOR 230.00 LOAD==36.95(8.42)
4 30545 0 "2 " 0 # LOAD-DROP ROSSMOOR 230.00 LOAD==32.85(7.49)
1 30544 30545 "2 " 1 # LINE-TRANSFER ROSSTAP1 230.00 TO ROSSTAP2 230.00
4 30545 0 "***" 1 # RESTORE ROSSMOOR load
#
1 30525 30544 "2 " 0 # line from C.COSTA 230.00 BRKR to (2) ROSSTAP2 230.00
1 30544 30550 "2 " 0 # line from ROSSTAP2 230.00 (2) to BRKR MORAGA 230.00
0
#
#
# (97) C5 DCTL OUTAGE
# Contra Costa - Brentwood and Contra Costa - Delta Pumps 230 kV Lines
1 30525 30565 "1 " 0 # line from C.COSTA 230.00 BRKR to BRKR BRENTWOD 230.00
#
1 30525 30575 "1 " 0 # line from C.COSTA 230.00 BRKR to (3) WND MSTR 230.00
1 30575 38610 "1 " 0 # line from WND MSTR 230.00 (3) to BRKR DELTAPMP 230.00
2 30575 33170 "1 " 0 # TRAN from WND MSTR 230.00 (3) to (1) WINDMSTR 9.11
0
#
#
# (98) C5 DCTL OUTAGE
# Brentwood - Kelso and Contra Costa - Delta Pumps 230 kV Lines
1 30565 30569 "1 " 0 # line from BRENTWOD 230.00 BRKR to BRKR KELSO 230.00
#
1 30525 30575 "1 " 0 # line from C.COSTA 230.00 BRKR to (3) WND MSTR 230.00
1 30575 38610 "1 " 0 # line from WND MSTR 230.00 (3) to BRKR DELTAPMP 230.00
2 30575 33170 "1 " 0 # TRAN from WND MSTR 230.00 (3) to (1) WINDMSTR 9.11
0
#
#
# (99) C5 DCTL OUTAGE
# Contra Costa - Las Positas and Contra Costa - Lonetree 230 kV Lines
1 30525 30585 "1 " 0 # line from C.COSTA 230.00 BRKR to BRKR LS PSTAS 230.00
#
1 30525 30567 "1 " 0 # line from C.COSTA 230.00 BRKR to BRKR LONETREE 230.00
0
#
#
# (100) C5 DCTL OUTAGE
# Contra Costa - Las Positas and Lonetree - Cayetano 230 kV Lines
1 30525 30585 "1 " 0 # line from C.COSTA 230.00 BRKR to BRKR LS PSTAS 230.00
#
1 30567 30590 "1 " 0 # line from LONETREE 230.00 BRKR to (3) USWP-JRW 230.00
1 30590 30530 "1 " 0 # line from USWP-JRW 230.00 (3) to BRKR CAYETANO 230.00
2 30590 33838 "1 " 0 # TRAN from USWP-JRW 230.00 (3) to (1) USWP_#3 9.11
4 33838 0 "SG" 0 # LOAD-DROP USWP_#3 9.11 LOAD==0.50(0.20)

```

APPENDIX B – CAISO CATEGORY C AUTOCON INPUT FILE

```

0
#
#
# (101) C5 DCTL OUTAGE
# Contra Costa - Las Positas and North Dublin - Vineyard 230 kV Lines
1 30525 30585 "1 " 0 # line from C.COSTA 230.00 BRKR to BRKR LS PSTAS 230.00
#
1 30538 35228 "1 " 0 # line from NDBC322 230.00 BRKR to BRKR VINCB212 230.00
0
#
#
# (102) C5 DCTL OUTAGE
# Cayetano - North Dublin and Lonetree - Cayetano 230 kV Lines
1 30530 30537 "1 " 0 # line from CAYETANO 230.00 BRKR to BRKR NDUBLIN 230.00
#
1 30567 30590 "1 " 0 # line from LONETREE 230.00 BRKR to (3) USWP-JRW 230.00
1 30590 30530 "1 " 0 # line from USWP-JRW 230.00 (3) to BRKR CAYETANO 230.00
2 30590 33838 "1 " 0 # TRAN from USWP-JRW 230.00 (3) to (1) USWP_#3 9.11
4 33838 0 "SG" 0 # LOAD-DROP USWP_#3 9.11 LOAD==0.50(0.20)
0
#
#
# (103) C5 DCTL OUTAGE
# Pittsburg - Tidewater and Pittsburg - Tesoro 230 kV Lines
1 30527 30535 "1 " 0 # line from PITSBG E 230.00 BRKR to BRKR TIDEWATR 230.00
#
1 30527 30536 "1 " 0 # line from PITSBG E 230.00 BRKR to BRKR TESORO 230.00
0
#
#
# (104) C5 DCTL OUTAGE
# Tidewater - Sobrante and Tesoro - Sobrante 230 kV Lines
1 30535 30540 "1 " 0 # line from TIDEWATR 230.00 BRKR to BRKR SOBRANTE 230.00
#
1 30536 30540 "1 " 0 # line from TESORO 230.00 BRKR to BRKR SOBRANTE 230.00
0
#
#
# (105) C5 DCTL OUTAGE
# Pittsburg - San Mateo and Pittsburg - East Shore 230 kV Lines
1 30700 30527 "1 " 0 # line from SANMATEO 230.00 BRKR to BRKR PITSBG E 230.00
#
1 30560 30527 "1 " 0 # line from E. SHORE 230.00 BRKR to BRKR PITSBG E 230.00
0
#
#
# (106) C5 DCTL OUTAGE
# Pittsburg - Tesla #1 and #2 230 kV Lines pre and post-project outage
1 30527 30595 "1 " 0 # line from PITSBG E 230.00 BRKR to (3) FLOWIND2 230.00
1 30595 30640 "1 " 0 # line from FLOWIND2 230.00 (3) to BRKR TESLA C 230.00
2 30595 33840 "1 " 0 # TRAN from FLOWIND2 230.00 (3) to (1) FLOWD3-6 9.11
4 33840 0 "SG" 0 # LOAD-DROP FLOWD3-6 9.11 LOAD==0.70(0.34)
3 33840 0 "1 " 0 # GEN-DROP FLOWD3-6 9.11 GEN==1.30(0.00)
3 33840 0 "4 " 0 # GEN-DROP FLOWD3-6 9.11 GEN==1.10(0.00)
#
1 30527 30600 "2 " 0 # line from PITSBG E 230.00 BRKR to (4) TRES VAQ 230.00
1 30600 30640 "2 " 0 # line from TRES VAQ 230.00 (4) to BRKR TESLA C 230.00
2 30600 33195 "1 " 0 # TRAN from TRES VAQ 230.00 (4) to (1) T417 34.50
4 33195 0 "ss" 0 # LOAD-DROP T417 34.50 LOAD==0.10(0.06)
3 33195 0 "1 " 0 # GEN-DROP T417 34.50 GEN==42.10(0.00)
0
#
#
# (107) C5 DCTL OUTAGE
# Pittsburg - San Ramon and Pittsburg - Tassajara 230 kV Lines
1 30526 30555 "1 " 0 # line from PITSBG D 230.00 BRKR to BRKR SANRAMON 230.00
#
1 30526 30561 "1 " 0 # line from PITSBG D 230.00 BRKR to BRKR TASSAJAR 230.00
0
#
#
# (108) C5 DCTL OUTAGE
# Moraga - Castro Valley and San Ramon - Moraga 230 kV Lines
1 30550 30554 "1 " 0 # line from MORAGA 230.00 BRKR to BRKR CASTROVL 230.00
#
1 30550 30555 "1 " 0 # line from MORAGA 230.00 BRKR to BRKR SANRAMON 230.00
0
#
#

```

APPENDIX B – CAISO CATEGORY C AUTOCON INPUT FILE

```

# (109) C5 DCTL OUTAGE
# Castro Valley - Newark and San Ramon - Moraga 230 kV Lines
1 30554 30631 "1" 0 # line from CASTROVL 230.00 BRKR to BRKR NEWARK E 230.00
#
1 30550 30555 "1" 0 # line from MORAGA 230.00 BRKR to BRKR SANRAMON 230.00
0
#
#
# (110) BUS FAULT 30523 "CC SUB" Contra Costa Sub 230 kV Bus Section 1
#
1 30523 30479 "1" 0 # LINE from CC SUB 230.00 to BDLSWSTA 230.00
2 30523 33000 "3" 0 # TRAN from CC SUB 230.00 to CC SUB 115.00
4 30523 0 "9" 0 # LOAD-DROP CC SUB 230.00 LOAD==77.62(15.76)
0
#
#
# (111) BUS FAULT 30523 "CC SUB" Contra Costa Sub 230 kV Bus Section 2
#
1 30523 30525 "1" 0 # LINE from CC SUB 230.00 to C.COSTA 230.00
4 30523 0 "8" 0 # LOAD-DROP CC SUB 230.00 LOAD==71.78(14.58)
0
#
#
# (112) BUS FAULT 30525 "C.COSTA" Contra Costa 230 kV Bus Section 1D
#
1 30525 30523 "1" 0 # LINE from C.COSTA 230.00 to CC SUB 230.00
0
#
#
# (113) BUS FAULT 30525 "C.COSTA" Contra Costa 230 kV Bus Section 2D
#
1 30525 30479 "1" 0 # LINE from C.COSTA 230.00 to BDLSWSTA 230.00
0
#
#
# (114) BUS FAULT 30525 "C.COSTA" Contra Costa 230 kV Bus Section 1E
#
1 30525 30585 "1" 0 # LINE from C.COSTA 230.00 to LS PSTAS 230.00
0
#
#
# (115) BUS FAULT 30525 "C.COSTA" Contra Costa 230 kV Bus Section 2E
#
1 30525 30567 "1" 0 # LINE from C.COSTA 230.00 to LONETREE 230.00
0
#
#
# (116) BUS FAULT 30525 "C.COSTA" Contra Costa 230 kV Bus Section 1F
#
1 30525 30543 "1" 0 # LINE from C.COSTA 230.00 to ROSSTAP1 230.00
1 30525 30565 "1" 0 # LINE from C.COSTA 230.00 to BRENTWOD 230.00
2 30525 33116 "1" 0 # TRAN from C.COSTA 230.00 to C.COS 6 18.00
0
#
#
# (117) BUS FAULT 30525 "C.COSTA" Contra Costa 230 kV Bus Section 2F
#
1 30525 30544 "2" 0 # LINE from C.COSTA 230.00 to ROSSTAP2 230.00
1 30525 30575 "1" 0 # LINE from C.COSTA 230.00 to WND MSTR 230.00
2 30525 33117 "1" 0 # TRAN from C.COSTA 230.00 to C.COS 7 18.00
0
#
#
# (118) BUS FAULT 30526 "PITSBG D" Pittsburg 230 kV Bus Section 1D
#
1 30526 30561 "1" 0 # LINE from PITSBG D 230.00 to TASSAJAR 230.00
1 30526 30528 "1" 0 # LINE from PITSBG D 230.00 to DEC PTSG 230.00
2 30526 32950 "13" 0 # TRAN from PITSBG D 230.00 to PITSBURG 115.00
0
#
#
# (119) BUS FAULT 30526 "PITSBG D" Pittsburg 230 kV Bus Section 2D
#
1 30526 30555 "1" 0 # LINE from PITSBG D 230.00 to SANRAMON 230.00
1 30526 30528 "2" 0 # LINE from PITSBG D 230.00 to DEC PTSG 230.00
2 30526 32950 "12" 0 # TRAN from PITSBG D 230.00 to PITSBURG 115.00
0
#
#

```

APPENDIX B – CAISO CATEGORY C AUTOCON INPUT FILE

```

# (120) BUS FAULT 30527 "PITSBG E" Pittsburg 230 kV Bus Section 1E
#
1 30527 30535 "1" 0 # LINE from PITSBG E 230.00 to TIDEWATR 230.00
1 30527 30560 "1" 0 # LINE from PITSBG E 230.00 to E. SHORE 230.00
1 30527 30595 "1" 0 # LINE from PITSBG E 230.00 to FLOWIND2 230.00
2 30527 33105 "1" 0 # TRAN from PITSBG E 230.00 to PTSB 5 18.00
2 30527 33105 "2" 0 # TRAN from PITSBG E 230.00 to PTSB 5 18.00
0
#
#
# (121) BUS FAULT 30527 "PITSBG E" Pittsburg 230 kV Bus Section 2E
#
1 30527 30536 "1" 0 # LINE from PITSBG E 230.00 to TESORO 230.00
1 30527 30600 "2" 0 # LINE from PITSBG E 230.00 to TRES VAQ 230.00
1 30527 30700 "1" 0 # LINE from PITSBG E 230.00 to SANMATEO 230.00
0
#
#
# (122) BUS FAULT 30535 "TIDEWATR"
#
1 30535 30527 "1" 0 # LINE from TIDEWATR 230.00 to PITSBG E 230.00
1 30535 30540 "1" 0 # LINE from TIDEWATR 230.00 to SOBRANTE 230.00
2 30535 33151 "1" 0 # TRAN from TIDEWATR 230.00 to FOSTER W 12.47
2 30535 33151 "2" 0 # TRAN from TIDEWATR 230.00 to FOSTER W 12.47
4 30535 0 "1" 0 # LOAD-DROP TIDEWATR 230.00 LOAD==72.24(16.46)
4 30535 0 "2" 0 # LOAD-DROP TIDEWATR 230.00 LOAD==59.79(13.63)
0
#
#
# (123) BUS FAULT 30536 "TESORO"
#
1 30536 30527 "1" 0 # LINE from TESORO 230.00 to PITSBG E 230.00
1 30536 30540 "1" 0 # LINE from TESORO 230.00 to SOBRANTE 230.00
4 30536 0 "1" 0 # LOAD-DROP TESORO 230.00 LOAD==9.01(5.35)
0
#
#
# (124) BUS FAULT 30540 "SOBRANTE" Sobrante 230 kV Bus Section 1
#
1 30540 30437 "1" 0 # LINE from SOBRANTE 230.00 to CROCKETT 230.00
1 30540 30535 "1" 0 # LINE from SOBRANTE 230.00 to TIDEWATR 230.00
2 30540 33010 "1" 0 # TRAN from SOBRANTE 230.00 to SOBRANTE 115.00
0
#
#
# (125) BUS FAULT 30540 "SOBRANTE" Sobrante 230 kV Bus Section 2
#
1 30540 30435 "2" 0 # LINE from SOBRANTE 230.00 to LAKEVILE 230.00
1 30540 30536 "1" 0 # LINE from SOBRANTE 230.00 to TESORO 230.00
2 30540 33010 "2" 0 # TRAN from SOBRANTE 230.00 to SOBRANTE 115.00
0
#
#
# (126) BUS FAULT 30545 "ROSSMOOR"
#
1 30545 30543 "1" 0 # LINE from ROSSMOOR 230.00 to ROSSTAP1 230.00
1 30545 30544 "2" 0 # LINE from ROSSMOOR 230.00 to ROSSTAP2 230.00
4 30545 0 "1" 0 # LOAD-DROP ROSSMOOR 230.00 LOAD==36.95(8.42)
4 30545 0 "2" 0 # LOAD-DROP ROSSMOOR 230.00 LOAD==32.85(7.49)
0
#
#
# (127) BUS FAULT 30550 "MORAGA" Moraga 230 kV Bus Section 1
#
1 30550 30467 "1" 0 # LINE from MORAGA 230.00 to PARKWAY 230.00
1 30550 30543 "1" 0 # LINE from MORAGA 230.00 to ROSSTAP1 230.00
1 30550 30555 "1" 0 # LINE from MORAGA 230.00 to SANRAMON 230.00
2 30550 30553 "3" 0 # TRAN from MORAGA 230.00 to MRAGA_3M 13.20
0
#
#
# (128) BUS FAULT 30550 "MORAGA" Moraga 230 kV Bus Section 2
#
1 30550 30465 "1" 0 # LINE from MORAGA 230.00 to BAHIA 230.00
1 30550 30544 "2" 0 # LINE from MORAGA 230.00 to ROSSTAP2 230.00
1 30550 30554 "1" 0 # LINE from MORAGA 230.00 to CASTROVL 230.00
2 30550 30551 "1" 0 # TRAN from MORAGA 230.00 to MRAGA_1M 13.20
2 30550 30552 "2" 0 # TRAN from MORAGA 230.00 to MRAGA_2M 13.20
0

```

APPENDIX B – CAISO CATEGORY C AUTOCON INPUT FILE

```

#
#
# (129) BUS FAULT 30561 "TASSAJAR"
#
1 30561 30526 "1" 0 # LINE from TASSAJAR 230.00 to PITSBG D 230.00
1 30561 30562 "1" 0 # LINE from TASSAJAR 230.00 to TES JCT 230.00
4 30561 0 "1 " 0 # LOAD-DROP TASSAJAR 230.00 LOAD==53.13(12.11)
4 30561 0 "2 " 0 # LOAD-DROP TASSAJAR 230.00 LOAD==82.91(18.90)
0
#
#
# (130) BUS FAULT 30563 "RESEARCH"
#
1 30563 30562 "1" 0 # LINE from RESEARCH 230.00 to TES JCT 230.00
4 30563 0 "1 " 0 # LOAD-DROP RESEARCH 230.00 LOAD==37.05(8.44)
0
#
#
# (131) BUS FAULT 30565 "BRENTWOD"
#
1 30565 30525 "1" 0 # LINE from BRENTWOD 230.00 to C.COSTA 230.00
1 30565 30569 "1" 0 # LINE from BRENTWOD 230.00 to KELSO 230.00
4 30565 0 "1 " 0 # LOAD-DROP BRENTWOD 230.00 LOAD==41.07(8.34)
4 30565 0 "2 " 0 # LOAD-DROP BRENTWOD 230.00 LOAD==38.95(7.91)
4 30565 0 "3 " 0 # LOAD-DROP BRENTWOD 230.00 LOAD==42.75(8.68)
0
#
#
# (132) BUS FAULT 30567 "LONETREE"
#
1 30567 30525 "1" 0 # LINE from LONETREE 230.00 to C.COSTA 230.00
1 30567 30590 "1" 0 # LINE from LONETREE 230.00 to USWP-JRW 230.00
4 30567 0 "1 " 0 # LOAD-DROP LONETREE 230.00 LOAD==23.91(5.44)
4 30567 0 "2 " 0 # LOAD-DROP LONETREE 230.00 LOAD==23.91(5.44)
4 30567 0 "3 " 0 # LOAD-DROP LONETREE 230.00 LOAD==23.91(5.44)
0
#
#
# (133) BUS FAULT 32950 "PITTSBURG" Pittsburg 115 kV Bus Section 1D
#
1 32950 33032 "3" 0 # LINE from PITTSBURG 115.00 to KIRKTAP1 115.00
1 32950 32970 "4" 0 # LINE from PITTSBURG 115.00 to CLAYTN 115.00
1 32950 33030 "1" 0 # LINE from PITTSBURG 115.00 to COLSTJT1 115.00
0
#
#
# (134) BUS FAULT 32950 "PITTSBURG" Pittsburg 115 kV Bus Section 2D
#
1 32950 33033 "1" 0 # LINE from PITTSBURG 115.00 to KIRKTAP2 115.00
0
#
#
# (135) BUS FAULT 32950 "PITTSBURG" Pittsburg 115 kV Bus Section 1E
#
1 32950 32993 "1" 0 # LINE from PITTSBURG 115.00 to W.P.BART 115.00
0
#
#
# (136) BUS FAULT 32950 "PITTSBURG" Pittsburg 115 kV Bus Section 2E
#
1 32950 32970 "1" 0 # LINE from PITTSBURG 115.00 to CLAYTN 115.00
1 32950 32992 "2" 0 # LINE from PITTSBURG 115.00 to BOLLMAN2 115.00
2 32950 30526 "12" 0 # TRAN from PITTSBURG 115.00 to PITSBG D 230.00
0
#
#
# (137) BUS FAULT 32951 "KIRKER"
#
1 32951 33032 "1" 0 # LINE from KIRKER 115.00 to KIRKTAP1 115.00
1 32951 33033 "1" 0 # LINE from KIRKER 115.00 to KIRKTAP2 115.00
4 32951 0 "1 " 0 # LOAD-DROP KIRKER 115.00 LOAD==38.02(7.72)
4 32951 0 "2 " 0 # LOAD-DROP KIRKER 115.00 LOAD==44.19(8.97)
4 32951 0 "3 " 0 # LOAD-DROP KIRKER 115.00 LOAD==53.77(10.92)
0
#
#
# (138) BUS FAULT 32953 "CLMBA_ST"
#
1 32953 32954 "1" 0 # LINE from CLMBA_ST 115.00 to DOW TAP1 115.00

```

APPENDIX B – CAISO CATEGORY C AUTOCON INPUT FILE

```

1 32953 32955 "1" 0 # LINE from CLMBA_ST 115.00 to DOW TAP2 115.00
0
#
#
# (139) BUS FAULT 32957 "PRAXAIR"
#
1 32957 33038 "1" 0 # LINE from PRAXAIR 115.00 to LINDEJCT 115.00
4 32957 0 "1 " 0 # LOAD-DROP PRAXAIR 115.00 LOAD==20.67(4.61)
0
#
#
# (140) BUS FAULT 32970 "CLAYTN" Clayton 115 kV Bus Section 1
#
1 32970 32971 "1" 0 # LINE from CLAYTN 115.00 to MEDW LNE 115.00
1 32970 32974 "2" 0 # LINE from CLAYTN 115.00 to LAKEWD-M 115.00
1 32970 33032 "3" 0 # LINE from CLAYTN 115.00 to KIRKTAP1 115.00
0
#
#
# (141) BUS FAULT 32970 "CLAYTN" Clayton 115 kV Bus Section 2
#
1 32970 32950 "1" 0 # LINE from CLAYTN 115.00 to PITTSBURG 115.00
1 32970 32950 "4" 0 # LINE from CLAYTN 115.00 to PITTSBURG 115.00
1 32970 33035 "1" 0 # LINE from CLAYTN 115.00 to LKWD_JCT 115.00
0
#
#
# (142) BUS FAULT 32971 "MEDW LNE"
#
1 32971 32970 "1" 0 # LINE from MEDW LNE 115.00 to CLAYTN 115.00
1 32971 32972 "1" 0 # LINE from MEDW LNE 115.00 to EBMUDGRY 115.00
4 32971 0 "1 " 0 # LOAD-DROP MEDW LNE 115.00 LOAD==39.33(8.97)
4 32971 0 "2 " 0 # LOAD-DROP MEDW LNE 115.00 LOAD==46.84(10.68)
4 32971 0 "3 " 0 # LOAD-DROP MEDW LNE 115.00 LOAD==43.88(10.00)
0
#
#
# (143) BUS FAULT 32973 "LAKEWD-C"
#
1 32973 33035 "1" 0 # LINE from LAKEWD-C 115.00 to LKWD_JCT 115.00
1 32973 32974 "1" 0 # LINE from LAKEWD-C 115.00 to LAKEWD-M 115.00
4 32973 0 "5 " 0 # LOAD-DROP LAKEWD-C 115.00 LOAD==19.48(4.44)
4 32973 0 "6 " 0 # LOAD-DROP LAKEWD-C 115.00 LOAD==44.20(10.08)
0
#
#
# (144) BUS FAULT 32974 "LAKEWD-M"
#
1 32974 32970 "2" 0 # LINE from LAKEWD-M 115.00 to CLAYTN 115.00
1 32974 32973 "1" 0 # LINE from LAKEWD-M 115.00 to LAKEWD-C 115.00
1 32974 32976 "0" 0 # LINE from LAKEWD-M 115.00 to LK_REACT 115.00
1 32974 32976 "2" 0 # LINE from LAKEWD-M 115.00 to LK_REACT 115.00
1 32974 32976 "4" 0 # LINE from LAKEWD-M 115.00 to LK_REACT 115.00
1 32974 32976 "7" 0 # LINE from LAKEWD-M 115.00 to LK_REACT 115.00
1 32974 32976 "9" 0 # LINE from LAKEWD-M 115.00 to LK_REACT 115.00
4 32974 0 "1 " 0 # LOAD-DROP LAKEWD-M 115.00 LOAD==38.07(8.68)
4 32974 0 "2 " 0 # LOAD-DROP LAKEWD-M 115.00 LOAD==25.72(5.86)
4 32974 0 "4 " 0 # LOAD-DROP LAKEWD-M 115.00 LOAD==48.09(10.96)
4 32974 0 "LW" 0 # LOAD-DROP LAKEWD-M 115.00 LOAD==5.66(1.15)
0
#
#
# (145) BUS FAULT 32990 "MARTNZ D"
#
1 32990 33014 "1" 0 # LINE from MARTNZ D 115.00 to ALHAMTP1 115.00
1 32990 33016 "1" 0 # LINE from MARTNZ D 115.00 to ALHAMTP2 115.00
1 32990 32991 "1" 0 # LINE from MARTNZ D 115.00 to MARTNZ E 115.00
1 32990 32996 "1" 0 # LINE from MARTNZ D 115.00 to SHELLJ1 115.00
2 32990 33142 "2" 0 # TRAN from MARTNZ D 115.00 to SHELL 2 12.47
4 32990 0 "5 " 0 # LOAD-DROP MARTNZ D 115.00 LOAD==45.86(10.45)
0
#
#
# (146) BUS FAULT 32991 "MARTNZ E"
#
1 32991 32990 "1" 0 # LINE from MARTNZ E 115.00 to MARTNZ D 115.00
1 32991 33042 "1" 0 # LINE from MARTNZ E 115.00 to IMHOFF_1 115.00
1 32991 33043 "2" 0 # LINE from MARTNZ E 115.00 to IMHOFF_2 115.00
1 32991 32997 "2" 0 # LINE from MARTNZ E 115.00 to SHELLJ2 115.00

```

APPENDIX B – CAISO CATEGORY C AUTOCON INPUT FILE

```

2 32991 33142 "1" 0 # TRAN from MARTNZ E 115.00 to SHELL 2 12.47
0
#
#
# (147) BUS FAULT 33000 "CC SUB" Contra Costa Sub 115 kV Bus Section 1
#
1 33000 33047 "1" 0 # LINE from CC SUB 115.00 to CC JCT 115.00
2 33000 30523 "3" 0 # TRAN from CC SUB 115.00 to CC SUB 230.00
2 33000 33050 "1" 0 # TRAN from CC SUB 115.00 to CC SUB 60.00
4 33000 0 "4 " 0 # LOAD-DROP CC SUB 115.00 LOAD==42.14(8.55)
0
#
#
# (148) BUS FAULT 33000 "CC SUB" Contra Costa Sub 115 kV Bus Section 2
#
1 33000 33046 "1" 0 # LINE from CC SUB 115.00 to FIBRJCT2 115.00
2 33000 33050 "2" 0 # TRAN from CC SUB 115.00 to CC SUB 60.00
0
#
#
# (149) BUS FAULT 33001 "DOMTAR"
#
1 33001 33046 "1" 0 # LINE from DOMTAR 115.00 to FIBRJCT2 115.00
4 33001 0 "1 " 0 # LOAD-DROP DOMTAR 115.00 LOAD==2.40(2.12)
0
#
#
# (150) BUS FAULT 33010 "SOBRANTE" Sobrante 115 kV Bus Section 1
#
1 33010 32756 "1" 0 # LINE from SOBRANTE 115.00 to CHRISTIE 115.00
1 33010 32765 "1" 0 # LINE from SOBRANTE 115.00 to ELCRTJ1 115.00
1 33010 32767 "1" 0 # LINE from SOBRANTE 115.00 to ELCRTJ2 115.00
1 33010 32808 "1" 0 # LINE from SOBRANTE 115.00 to SNPBLTP2 115.00
1 33010 33006 "1" 0 # LINE from SOBRANTE 115.00 to GRIZLYJ1 115.00
1 33010 33014 "1" 0 # LINE from SOBRANTE 115.00 to ALHAMTP1 115.00
1 33010 33020 "1" 0 # LINE from SOBRANTE 115.00 to MORAGA 115.00
0
#
#
# (151) BUS FAULT 33010 "SOBRANTE" Sobrante 115 kV Bus Section 2
#
1 33010 32766 "2" 0 # LINE from SOBRANTE 115.00 to EL CRRTO 115.00
1 33010 32768 "2" 0 # LINE from SOBRANTE 115.00 to RICHMOND 115.00
1 33010 32806 "2" 0 # LINE from SOBRANTE 115.00 to SNPBLTP1 115.00
1 33010 33008 "2" 0 # LINE from SOBRANTE 115.00 to GRIZLYJ2 115.00
2 33010 30540 "1" 0 # TRAN from SOBRANTE 115.00 to SOBRANTE 230.00
2 33010 30540 "2" 0 # TRAN from SOBRANTE 115.00 to SOBRANTE 230.00
0
#
#
# (152) BUS FAULT 33011 "ALHAMBRA"
#
1 33011 33014 "1" 0 # LINE from ALHAMBRA 115.00 to ALHAMTP1 115.00
1 33011 33016 "1" 0 # LINE from ALHAMBRA 115.00 to ALHAMTP2 115.00
4 33011 0 "1 " 0 # LOAD-DROP ALHAMBRA 115.00 LOAD==10.29(2.34)
4 33011 0 "2 " 0 # LOAD-DROP ALHAMBRA 115.00 LOAD==9.17(2.09)
0
#
#
# (153) BUS FAULT 33012 "EST PRTL"
#
1 33012 33006 "1" 0 # LINE from EST PRTL 115.00 to GRIZLYJ1 115.00
1 33012 32780 "1" 0 # LINE from EST PRTL 115.00 to CLARMNT 115.00
4 33012 0 "1 " 0 # LOAD-DROP EST PRTL 115.00 LOAD==7.66(1.55)
0
#
#
# (154) BUS FAULT 33020 "MORAGA" Moraga 115 kV Bus Section 1D
#
1 33020 32780 "1" 0 # LINE from MORAGA 115.00 to CLARMNT 115.00
1 33020 32790 "1" 0 # LINE from MORAGA 115.00 to STATIN X 115.00
1 33020 33010 "1" 0 # LINE from MORAGA 115.00 to SOBRANTE 115.00
2 33020 30551 "1" 0 # TRAN from MORAGA 115.00 to MRAGA_1M 13.20
0
#
#
# (155) BUS FAULT 33020 "MORAGA" Moraga 115 kV Bus Section 2D
#
1 33020 32780 "2" 0 # LINE from MORAGA 115.00 to CLARMNT 115.00

```

APPENDIX B – CAISO CATEGORY C AUTOCON INPUT FILE

```

1 33020 32790 "2" 0 # LINE from MORAGA 115.00 to STATIN X 115.00
1 33020 32976 "1" 0 # LINE from MORAGA 115.00 to LK_REACT 115.00
2 33020 30552 "2" 0 # TRAN from MORAGA 115.00 to MRAGA_2M 13.20
0
#
#
# (156) BUS FAULT 33020 "MORAGA" Moraga 115 kV Bus Section 1E
#
1 33020 32790 "3" 0 # LINE from MORAGA 115.00 to STATIN X 115.00
1 33020 35101 "1" 0 # LINE from MORAGA 115.00 to SN LNDRO 115.00
1 33020 35101 "3" 0 # LINE from MORAGA 115.00 to SN LNDRO 115.00
0
#
#
# (157) BUS FAULT 33020 "MORAGA" Moraga 115 kV Bus Section 2E
#
1 33020 32790 "4" 0 # LINE from MORAGA 115.00 to STATIN X 115.00
1 33020 32792 "1" 0 # LINE from MORAGA 115.00 to STATIN J 115.00
1 33020 35101 "2" 0 # LINE from MORAGA 115.00 to SN LNDRO 115.00
0
#
#
# (158) BUS FAULT 33049 "RVEC"
#
1 33049 33048 "1" 0 # LINE from RVEC 115.00 to RVECTP 115.00
2 33049 33178 "1" 0 # TRAN from RVEC 115.00 to RVEC_GEN 13.80
0
#
#
# (159) BUS FAULT 33050 "CC SUB" Contra Costa Sub 60 kV Bus Section 1
#
1 33050 33081 "1" 0 # LINE from CC SUB 60.00 to DUPNTJCT 60.00
1 33050 33060 "1" 0 # LINE from CC SUB 60.00 to ANTIOCH 60.00
2 33050 33000 "1" 0 # TRAN from CC SUB 60.00 to CC SUB 115.00
0
#
#
# (160) BUS FAULT 33050 "CC SUB" Contra Costa Sub 60 kV Bus Section 2
#
1 33050 33080 "1" 0 # LINE from CC SUB 60.00 to WILBRTAP 60.00
1 33050 33090 "1" 0 # LINE from CC SUB 60.00 to SHLLCHMT 60.00
2 33050 33000 "2" 0 # TRAN from CC SUB 60.00 to CC SUB 115.00
0
#
#
# (161) BUS FAULT 33051 "DU PONT"
#
1 33051 33080 "1" 0 # LINE from DU PONT 60.00 to WILBRTAP 60.00
1 33051 33081 "1" 0 # LINE from DU PONT 60.00 to DUPNTJCT 60.00
4 33051 0 "1" 0 # LOAD-DROP DU PONT 60.00 LOAD==2.00(2.16)
0
#
#
# (162) BUS FAULT 33054 "BALFOUR"
#
1 33054 33082 "1" 0 # LINE from BALFOUR 60.00 to BALFRJCT 60.00
1 33054 33083 "1" 0 # LINE from BALFOUR 60.00 to MDLRVRJT 60.00
4 33054 0 "1" 0 # LOAD-DROP BALFOUR 60.00 LOAD==4.00(0.81)
0
#
#
# (163) BUS FAULT 33063 "WLLW PSS"
#
1 33063 33062 "1" 0 # LINE from WLLW PSS 60.00 to SHLL CHM 60.00
1 33063 33091 "1" 0 # LINE from WLLW PSS 60.00 to TAP GWF5 60.00
4 33063 0 "1" 0 # LOAD-DROP WLLW PSS 60.00 LOAD==9.78(2.23)
0
#
#
# 2013 category c contingency list (dctl and bus outages)
# San Francisco Division Zone 309
#
#
# (164) C5 DCTL OUTAGE
# Martin - Daly City #1 and #2 115 kV Lines
1 33208 33300 "1" 0 # line from MARTIN C 115.00 BRKR to BRKR DALY CTY 115.00
#
1 33208 33301 "2" 0 # line from MARTIN C 115.00 BRKR to (3) DLY CTYP 115.00
1 33301 33300 "2" 0 # line from DLY CTYP 115.00 (3) to BRKR DALY CTY 115.00

```

APPENDIX B – CAISO CATEGORY C AUTOCON INPUT FILE

```

1 33301 33302 "1 " 0 # line from DLY CTYP 115.00 (3) to BRKR SERRMNTTE 115.00
4 33302 0 "1 " 0 # LOAD-DROP SERRMNTTE 115.00 LOAD==11.42(2.60)
0
#
#
# (165) C5 DCTL OUTAGE
# Martin - East Grand and Martin - San Mateo #3 115 kV Lines
1 33208 33303 "2 " 0 # line from MARTIN C 115.00 BRKR to BRKR EST GRND 115.00
#
1 33208 33310 "3 " 0 # line from MARTIN C 115.00 BRKR to BRKR SANMATEO 115.00
0
#
#
# (166) C5 DCTL OUTAGE
# Martin - Millbrae and Martin - San Mateo #6 115 kV Lines
1 33208 33307 "1 " 0 # line from MARTIN C 115.00 BRKR to BRKR MILLBRAE 115.00
#
1 33305 33208 "6 " 0 # line from SHAWROAD 115.00 (2) to BRKR MARTIN C 115.00
1 33305 33310 "6 " 0 # line from SHAWROAD 115.00 (2) to BRKR SANMATEO 115.00
4 33305 33309 "1 " 1 # LOAD-TRANSFER SHAWROAD 115.00 TO SANPAULA 115.00 LOAD==9.00(1.83)
0
#
#
# (167) C5 DCTL OUTAGE
# Burlingame - San Mateo and Martin - San Mateo #3 115 kV Lines
1 33310 33356 "4 " 0 # line from SANMATEO 115.00 BRKR to BRKR BURLNGME 115.00
#
1 33208 33310 "3 " 0 # line from MARTIN C 115.00 BRKR to BRKR SANMATEO 115.00
0
#
#
# (168) C5 DCTL OUTAGE
# Martin - Burlingame and Martin - San Mateo #3 115 kV Lines
1 33356 33208 "4 " 0 # line from BURLNGME 115.00 BRKR to BRKR MARTIN C 115.00
#
1 33208 33310 "3 " 0 # line from MARTIN C 115.00 BRKR to BRKR SANMATEO 115.00
0
#
#
# (169) C5 DCTL OUTAGE
# SF Airport - San Mateo and Martin - San Mateo #3 115 kV Lines
1 33306 33310 "5 " 0 # line from SFIA 115.00 BRKR to BRKR SANMATEO 115.00
#
1 33208 33310 "3 " 0 # line from MARTIN C 115.00 BRKR to BRKR SANMATEO 115.00
0
#
#
# (170) C5 DCTL OUTAGE
# Martin - SF Airport and Martin - San Mateo #6 115 kV Lines
1 33208 33322 "5 " 0 # line from MARTIN C 115.00 BRKR to (3) UAL TAP 115.00
1 33322 33306 "5 " 0 # line from UAL TAP 115.00 (3) to BRKR SFIA 115.00
1 33322 33323 "1 " 0 # line from UAL TAP 115.00 (3) to (3) SFASWSTA 115.00
1 33323 33304 "1 " 0 # line from SFASWSTA 115.00 (3) to (2) UAL COGN 115.00
2 33304 33466 "1 " 0 # TRAN from UAL COGN 115.00 BRKR to (1) UNTED CO 9.11
3 33466 0 "1 " 0 # GEN-DROP UNTED CO 9.11 GEN==28.20(11.16)
#
1 33305 33208 "6 " 0 # line from SHAWROAD 115.00 (2) to BRKR MARTIN C 115.00
1 33305 33310 "6 " 0 # line from SHAWROAD 115.00 (2) to BRKR SANMATEO 115.00
4 33305 33309 "1 " 1 # LOAD-TRANSFER SHAWROAD 115.00 TO SANPAULA 115.00 LOAD==9.00(1.83)
0
#
#
# (171) BUS FAULT 33204 "POTRERO" Potrero 115 kV Bus Section 1D
#
1 33204 33200 "1" 0 # LINE from POTRERO 115.00 to LARKIN D 115.00
1 33204 33203 "1" 0 # LINE from POTRERO 115.00 to MISSON 115.00
1 33204 33206 "1" 0 # LINE from POTRERO 115.00 to BAYSHOR1 115.00
2 33204 33252 "1" 0 # TRAN from POTRERO 115.00 to POTRERO3 20.00
2 33204 33252 "2" 0 # TRAN from POTRERO 115.00 to POTRERO3 20.00
4 33204 0 "1" 0 # LOAD-DROP POTRERO 115.00 LOAD==43.69(8.87)
4 33204 0 "2" 0 # LOAD-DROP POTRERO 115.00 LOAD==43.69(3.92)
0
#
#
# (172) BUS FAULT 33204 "POTRERO" Potrero 115 kV Bus Section 2D
#
1 33204 33207 "2" 0 # LINE from POTRERO 115.00 to BAYSHOR2 115.00
2 33204 33253 "1" 0 # TRAN from POTRERO 115.00 to POTRERO4 13.80
2 33204 33254 "1" 0 # TRAN from POTRERO 115.00 to POTRERO5 13.80

```

APPENDIX B – CAISO CATEGORY C AUTOCON INPUT FILE

```

2 33204 33255 "1" 0 # TRAN from POTRERO 115.00 to POTRERO6 13.80
4 33204 0 "10" 0 # LOAD-DROP POTRERO 115.00 LOAD==43.69(8.87)
0
#
#
# (173) BUS FAULT 33204 "POTRERO" Potrero 115 kV Bus Section 1E
#
1 33204 33205 "1" 0 # LINE from POTRERO 115.00 to HNTRS PT 115.00
1 33204 33210 "1" 0 # LINE from POTRERO 115.00 to POT_SVC 115.00
0
#
#
# (174) BUS FAULT 33204 "POTRERO" Potrero 115 kV Bus Section 2E
#
1 33204 33201 "2" 0 # LINE from POTRERO 115.00 to LARKIN E 115.00
6 33204 0 "v " 0 # SVD-DROP POTRERO 115.00
0
#
#
# (175) BUS FAULT 33208 "MARTIN C" Martin 115 kV Bus Section 1E
#
1 33208 33205 "1" 0 # LINE from MARTIN C 115.00 to HNTRS PT 115.00
1 33208 33300 "1" 0 # LINE from MARTIN C 115.00 to DALY CTY 115.00
1 33208 33303 "2" 0 # LINE from MARTIN C 115.00 to EST GRND 115.00
4 33208 0 "4 " 0 # LOAD-DROP MARTIN C 115.00 LOAD==32.54(2.06)
6 33208 0 "v " 0 # SVD-DROP MARTIN C 115.00
0
#
#
# (176) BUS FAULT 33208 "MARTIN C" Martin 115 kV Bus Section 2E
#
1 33208 33207 "2" 0 # LINE from MARTIN C 115.00 to BAYSHOR2 115.00
1 33208 33301 "2" 0 # LINE from MARTIN C 115.00 to DLY CTYP 115.00
1 33208 33310 "3" 0 # LINE from MARTIN C 115.00 to SANMATEO 115.00
0
#
#
# (177) BUS FAULT 33208 "MARTIN C" Martin 115 kV Bus Section 1D
#
1 33208 33206 "1" 0 # LINE from MARTIN C 115.00 to BAYSHOR1 115.00
1 33208 33305 "6" 0 # LINE from MARTIN C 115.00 to SHAWROAD 115.00
1 33208 33322 "5" 0 # LINE from MARTIN C 115.00 to UAL TAP 115.00
1 33208 33356 "4" 0 # LINE from MARTIN C 115.00 to BURLNGME 115.00
0
#
#
# (178) BUS FAULT 33208 "MARTIN C" Martin 115 kV Bus Section 2D
#
1 33208 33202 "1" 0 # LINE from MARTIN C 115.00 to LARKIN F 115.00
1 33208 33307 "1" 0 # LINE from MARTIN C 115.00 to MILLBRAE 115.00
1 33208 33205 "3" 0 # LINE from MARTIN C 115.00 to HNTRS PT 115.00
2 33208 33209 "6" 0 # TRAN from MARTIN C 115.00 to MARTIN 60.00
4 33208 0 "1B" 0 # LOAD-DROP MARTIN C 115.00 LOAD==32.54(2.06)
0
#
#
# (179) BUS FAULT 33209 "MARTIN"
#
1 33209 33347 "1" 0 # LINE from MARTIN 60.00 to SNTH JCT 60.00
2 33209 33208 "6" 0 # TRAN from MARTIN 60.00 to MARTIN C 115.00
0
#
#
# 2013 category c contingency list (dctl and bus outages)
# Peninsula Division Zone 310
#
#
# (180) C5 DCTL OUTAGE
# Pittsburg - San Mateo and East Shore - San Mateo 230 kV Lines
1 30700 30527 "1 " 0 # line from SANMATEO 230.00 BRKR to BRKR PITSBG E 230.00
#
1 30560 30700 "1 " 0 # line from E. SHORE 230.00 BRKR to BRKR SANMATEO 230.00
0
#
#
# (181) C5 DCTL OUTAGE
# Newark - Ravenswood and Tesla - Ravenswood 230 kV Lines
1 30630 30703 "1 " 0 # line from NEWARK D 230.00 BRKR to BRKR RAVENSWD 230.00
#

```

APPENDIX B – CAISO CATEGORY C AUTOCON INPUT FILE

```

1 30640 30703 "1 " 0 # line from TESLA C 230.00 BRKR to BRKR RAVENSWD 230.00
0
#
#
# (182) C5 DCTL OUTAGE
# Ravenswood - San Mateo #1 and #2 230 kV Lines
1 30703 30700 "1 " 0 # line from RAVENSWD 230.00 BRKR to BRKR SANMATEO 230.00
#
1 30703 30700 "2 " 0 # line from RAVENSWD 230.00 BRKR to BRKR SANMATEO 230.00
0
#
#
# (183) C5 DCTL OUTAGE
# Monta Vista - Jefferson #1 and #2 230 kV Lines
1 30705 30710 "1 " 0 # line from MONTAVIS 230.00 BRKR to (3) SLACTAP1 230.00
1 30710 30711 "1 " 0 # line from SLACTAP1 230.00 (3) to BRKR S.L.A.C. 230.00
1 30710 30715 "1 " 0 # line from SLACTAP1 230.00 (3) to BRKR JEFFERSN 230.00
4 30711 0 "1 " 0 # LOAD-DROP S.L.A.C. 230.00 LOAD==58.00(11.78)
1 30711 30712 "1 " 1 # LINE-TRANSFER SLACTAP1 to SLACTAP2
4 30711 0 "***" 1 # RESTORE S.L.A.C. load
#
1 30705 30712 "2 " 0 # line from MONTAVIS 230.00 BRKR to (2) SLACTAP2 230.00
1 30712 30715 "2 " 0 # line from SLACTAP2 230.00 (2) to BRKR JEFFERSN 230.00
0
#
#
# (184) C5 DCTL OUTAGE
# Jefferson - Ralston and Millbrae - Pacifica 115 kV Lines
1 33349 33362 "1 " 0 # line from CAROLD2 60.00 (1) to (2) CRYSTLSG 60.00
1 33362 33399 "1 " 0 # line from CRYSTLSG 60.00 (2) to (2) HILDAL47 60.00
1 33399 33398 "1 " 0 # line from HILDAL47 60.00 (2) to (3) RLSTN45 60.00
1 33398 33363 "1 " 0 # line from RLSTN45 60.00 (3) to BRKR RALSTON 60.00
1 33398 33400 "1 " 0 # line from RLSTN45 60.00 (3) to BRKR JEFRSN_E 60.00
4 33362 0 "1 " 0 # LOAD-DROP CRYSTLSG 60.00 LOAD==3.00(0.61)
1 33397 33363 "1 " 1 # LINE-TRANSFER RLSTN35 60.00 TO RALSTON 60.00
4 33363 0 "***" 1 # RESTORE RALSTON LOAD
#
1 33351 33345 "1 " 0 # line from SN BRNOT 60.00 (2) to (2) SNTH TP1 60.00
1 33351 33352 "1 " 0 # line from SN BRNOT 60.00 (2) to (2) SNANDRES 60.00
1 33345 33355 "1 " 0 # line from SNTH TP1 60.00 (2) to BRKR PACIFICA 60.00
1 33352 33354 "1 " 0 # line from SNANDRES 60.00 (2) to (2) MLLBRETTP 60.00
1 33354 33353 "1 " 0 # line from MLLBRETTP 60.00 (2) to BRKR MILLBRAE 60.00
4 33351 0 "1 " 0 # LOAD-DROP SN BRNOT 60.00 LOAD==3.36(0.77)
4 33352 0 "1 " 0 # LOAD-DROP SNANDRES 60.00 LOAD==1.80(0.37)
4 33355 0 "1 " 0 # LOAD-DROP PACIFICA 60.00 LOAD==9.92(2.26)
4 33355 0 "2 " 0 # LOAD-DROP PACIFICA 60.00 LOAD==5.61(1.28)
1 33355 33389 "1 " 1 # LINE-TRANSFER PACIFICA 60.00 TO PACIFJCT 60.00
4 33355 0 "***" 1 # RESTORE PACIFICA LOAD
0
#
#
# (185) C5 DCTL OUTAGE
# Jefferson - Ralston and Jefferson - Hillsdale Jct 115 kV Lines
1 33349 33362 "1 " 0 # line from CAROLD2 60.00 (1) to (2) CRYSTLSG 60.00
1 33362 33399 "1 " 0 # line from CRYSTLSG 60.00 (2) to (2) HILDAL47 60.00
1 33399 33398 "1 " 0 # line from HILDAL47 60.00 (2) to (3) RLSTN45 60.00
1 33398 33363 "1 " 0 # line from RLSTN45 60.00 (3) to BRKR RALSTON 60.00
1 33398 33400 "1 " 0 # line from RLSTN45 60.00 (3) to BRKR JEFRSN_E 60.00
4 33362 0 "1 " 0 # LOAD-DROP CRYSTLSG 60.00 LOAD==3.00(0.61)
1 33397 33363 "1 " 1 # LINE-TRANSFER RLSTN35 60.00 TO RALSTON 60.00
4 33363 0 "***" 1 # RESTORE RALSTON LOAD
#
1 33348 33359 "1 " 0 # line from CAROLD1 60.00 (3) to BRKR CAROLNDS 60.00
1 33348 33391 "1 " 0 # line from CAROLD1 60.00 (3) to (2) TRAN-60 60.00
1 33348 33396 "1 " 0 # line from CAROLD1 60.00 (3) to (3) HILDAL49 60.00
1 33391 33392 "1 " 0 # line from TRAN-60 60.00 (2) to (1) MLLBTP97 60.00
1 33396 33361 "1 " 0 # line from HILDAL49 60.00 (3) to (3) HLLSDLJT 60.00
1 33396 33397 "1 " 0 # line from HILDAL49 60.00 (3) to (2) RLSTN35 60.00
1 33361 33360 "1 " 0 # line from HLLSDLJT 60.00 BRKR to BRKR HILLSLE 60.00
1 33361 33394 "1 " 0 # line from HLLSDLJT 60.00 (3) to BRKR OXMTN_TP 60.00
1 33397 33378 "1 " 0 # line from RLSTN35 60.00 (2) to (3) WTRSHDTP 60.00
1 33378 33379 "1 " 0 # line from WTRSHDTP 60.00 (3) to (1) WATRSHED 60.00
1 33378 33400 "1 " 0 # line from WTRSHDTP 60.00 (3) to BRKR JEFRSN_E 60.00
4 33359 0 "1 " 0 # LOAD-DROP CAROLNDS 60.00 LOAD==2.65(0.60)
4 33359 0 "2 " 0 # LOAD-DROP CAROLNDS 60.00 LOAD==4.88(1.11)
4 33379 33363 "1 " 1 # LOAD-TRANSFER WATRSHED 60.00 TO RALSTON 60.00 LOAD==0.70(0.32)
1 33349 33359 "1 " 1 # LINE-TRANSFER CAROLNDS 60.00 TO CAROLD2 60.00
4 33359 0 "***" 1 # RESTORE CAROLANDS load
0

```

APPENDIX B – CAISO CATEGORY C AUTOCON INPUT FILE

```

#
#
# (186) C5 DCTL OUTAGE
# Millbrae - San Mateo and East Grand - San Mateo 115 kV Lines
1 33307 33310 "1 " 0 # line from MILLBRAE 115.00 BRKR to BRKR SANMATEO 115.00
#
1 33308 33303 "2 " 0 # line from SFIA-MA 115.00 (2) to BRKR EST GRND 115.00
1 33308 33310 "2 " 0 # line from SFIA-MA 115.00 (2) to BRKR SANMATEO 115.00
4 33308 33306 "1 " 1 # LOAD-TRANSFER SFIA-MA 115.00 TO SFIA 115.00 LOAD==20.20(4.10)
0
#
#
# (187) C5 DCTL OUTAGE
# San Mateo - Bay Meadows #1 and #2 115 kV Lines
1 33310 33311 "1 " 0 # line from SANMATEO 115.00 BRKR to BRKR BAY MDWS 115.00
#
1 33310 33311 "2 " 0 # line from SANMATEO 115.00 BRKR to BRKR BAY MDWS 115.00
0
#
#
# (188) C5 DCTL OUTAGE
# San Mateo - Belmont and Ravenswood - San Mateo 115 kV Lines
1 33310 33312 "1 " 0 # line from SANMATEO 115.00 BRKR to BRKR BELMONT 115.00
#
1 33310 33321 "1 " 0 # line from SANMATEO 115.00 BRKR to BRKR RVNSWD D 115.00
0
#
#
# (189) C5 DCTL OUTAGE
# San Mateo - Belmont 115 kV and San Mateo - San Carlos 60 kV Lines
1 33310 33312 "1 " 0 # line from SANMATEO 115.00 BRKR to BRKR BELMONT 115.00
#
1 33357 33364 "1 " 0 # line from SAN MATO 60.00 BRKR to (2) ORACLE60 60.00
1 33364 33365 "1 " 0 # line from ORACLE60 60.00 (2) to BRKR SAN CRLS 60.00
4 33364 0 "1 " 0 # LOAD-DROP ORACLE60 60.00 LOAD==11.86(5.40)
0
#
#
# (190) C5 DCTL OUTAGE
# Ravenswood - Bair #2 and Ravenswood - San Mateo 115 kV Lines
1 33313 33319 "2 " 0 # line from BAIR 115.00 BRKR to (3) SHREDJCT 115.00
1 33319 33314 "1 " 0 # line from SHREDJCT 115.00 (3) to (2) SHREDDER 115.00
1 33319 33321 "2 " 0 # line from SHREDJCT 115.00 (3) to BRKR RVNSWD D 115.00
1 33314 33320 "1 " 0 # line from SHREDDER 115.00 (2) to (1) LONESTAR 115.00
4 33314 0 "1 " 0 # LOAD-DROP SHREDDER 115.00 LOAD==4.77(5.43)
4 33320 0 "1 " 0 # LOAD-DROP LONESTAR 115.00 LOAD==2.57(3.43)
#
1 33310 33321 "1 " 0 # line from SANMATEO 115.00 BRKR to BRKR RVNSWD D 115.00
0
#
#
# (191) C5 DCTL OUTAGE
# Belmont - Bair 115 kV and San Carlos - Bair 60 kV Lines
1 33312 33313 "1 " 0 # line from BELMONT 115.00 BRKR to BRKR BAIR 115.00
#
1 33365 33367 "1 " 0 # line from SAN CRLS 60.00 BRKR to BRKR BAIR 60.00
0
#
#
# (192) C5 DCTL OUTAGE
# Ravenswood - Bair #1 and #2 115 kV Lines
1 33321 33313 "1 " 0 # line from RVNSWD D 115.00 BRKR to BRKR BAIR 115.00
#
1 33313 33319 "2 " 0 # line from BAIR 115.00 BRKR to (3) SHREDJCT 115.00
1 33319 33314 "1 " 0 # line from SHREDJCT 115.00 (3) to (2) SHREDDER 115.00
1 33319 33321 "2 " 0 # line from SHREDJCT 115.00 (3) to BRKR RVNSWD D 115.00
1 33314 33320 "1 " 0 # line from SHREDDER 115.00 (2) to (1) LONESTAR 115.00
4 33314 0 "1 " 0 # LOAD-DROP SHREDDER 115.00 LOAD==4.77(5.43)
4 33320 0 "1 " 0 # LOAD-DROP LONESTAR 115.00 LOAD==2.57(3.43)
0
#
#
# (193) C5 DCTL OUTAGE
# Ravenswood - Cooley Landing #1 and #2 115 kV Lines
1 33321 33317 "1 " 0 # line from RVNSWD D 115.00 BRKR to BRKR CLY LND 115.00
#
1 33315 33316 "2 " 0 # line from RVNSWD E 115.00 BRKR to BRKR CLY LND2 115.00
0
#

```

APPENDIX B – CAISO CATEGORY C AUTOCON INPUT FILE

```

#
# (194) C5 DCTL OUTAGE
# Ravenswood - Ames #1 and #2 115 kV Lines
1 33315 35350 "1 " 0 # line from RVNSWD E 115.00 BRKR to BRKR AMES BS1 115.00
#
1 33315 35351 "2 " 0 # line from RVNSWD E 115.00 BRKR to BRKR AMES BS2 115.00
0
#
#
# (195) C5 DCTL OUTAGE
# Ravenswood - Palo Alto #1 and #2 115 kV Lines
1 33315 38028 "1 " 0 # line from RVNSWD E 115.00 BRKR to BRKR PLO ALTO 115.00
#
1 33315 38028 "2 " 0 # line from RVNSWD E 115.00 BRKR to BRKR PLO ALTO 115.00
0
#
#
# (196) C5 DCTL OUTAGE
# Ravenswood - Palo Alto #1 and Cooley Landing - Palo Alto 115 kV Lines
1 33315 38028 "1 " 0 # line from RVNSWD E 115.00 BRKR to BRKR PLO ALTO 115.00
#
1 33316 38028 "1 " 0 # line from CLY LND2 115.00 BRKR to BRKR PLO ALTO 115.00
0
#
#
# (197) C5 DCTL OUTAGE
# Bair - Cooley Landing #1 and #2 60 kV Lines
1 33367 33368 "1 " 0 # line from BAIR 60.00 BRKR to (2) REDWDTP1 60.00
1 33368 33373 "1 " 0 # line from REDWDTP1 60.00 (2) to (3) BLHVNTTP1 60.00
1 33373 33372 "1 " 0 # line from BLHVNTTP1 60.00 (3) to (1) BLLE HVN 60.00
1 33373 33375 "1 " 0 # line from BLHVNTTP1 60.00 (3) to BRKR CLY LNDG 60.00
4 33372 0 "1 " 0 # LOAD-DROP BLLE HVN 60.00 LOAD==7.52(1.71)
4 33372 0 "2 " 0 # LOAD-DROP BLLE HVN 60.00 LOAD==8.46(1.93)
4 33372 0 "3 " 0 # LOAD-DROP BLLE HVN 60.00 LOAD==15.39(3.51)
4 33372 0 "4 " 0 # LOAD-DROP BLLE HVN 60.00 LOAD==14.12(3.21)
4 33372 0 "5 " 0 # LOAD-DROP BLLE HVN 60.00 LOAD==29.05(6.62)
1 33372 33374 "2 " 1 # LINE-TRANSFER BLHVNTTP1 60.00 TO BLHVNTTP2 60.00
4 33372 0 "***" 1 # RESTORE BELLE HAVEN load
#
1 33367 33369 "2 " 0 # line from BAIR 60.00 BRKR to (3) REDWDTP2 60.00
1 33369 33370 "2 " 0 # line from REDWDTP2 60.00 (3) to BRKR REDWOOD 60.00
1 33369 33374 "2 " 0 # line from REDWDTP2 60.00 (3) to (2) BLHVNTTP2 60.00
1 33374 33371 "2 " 0 # line from BLHVNTTP2 60.00 (2) to (2) RAYCHEM 60.00
1 33371 33375 "2 " 0 # line from RAYCHEM 60.00 (2) to BRKR CLY LNDG 60.00
4 33370 0 "1 " 0 # LOAD-DROP REDWOOD 60.00 LOAD==11.80(2.69)
4 33370 0 "2 " 0 # LOAD-DROP REDWOOD 60.00 LOAD==5.12(1.17)
4 33370 0 "3 " 0 # LOAD-DROP REDWOOD 60.00 LOAD==8.98(2.05)
4 33370 0 "4 " 0 # LOAD-DROP REDWOOD 60.00 LOAD==8.44(1.93)
4 33370 0 "5 " 0 # LOAD-DROP REDWOOD 60.00 LOAD==30.43(6.94)
4 33371 0 "1 " 0 # LOAD-DROP RAYCHEM 60.00 LOAD==7.48(5.22)
1 33368 33370 "1 " 1 # LINE-TRANSFER REDWDTP2 60.00 TO REDWDTP1 60.00
4 33370 0 "***" 1 # RESTORE REDWOOD CITY load
0
#
#
# (198) C5 DCTL OUTAGE
# Martin - Sneath Lane and Millbrae - Pacifica 60 kV Lines
1 33209 33347 "1 " 0 # line from MARTIN 60.00 BRKR to (2) SNTH JCT 60.00
1 33347 33346 "1 " 0 # line from SNTH JCT 60.00 (2) to (3) SNTH TP2 60.00
1 33346 33389 "1 " 0 # line from SNTH TP2 60.00 (3) to (1) PACIFJCT 60.00
1 33346 33350 "1 " 0 # line from SNTH TP2 60.00 (3) to BRKR SNTH LNE 60.00
4 33350 0 "1 " 0 # LOAD-DROP SNTH LNE 60.00 LOAD==7.61(1.73)
4 33350 0 "2 " 0 # LOAD-DROP SNTH LNE 60.00 LOAD==9.62(2.19)
1 33350 33345 "1 " 1 # LINE-TRANSFER SNTH LNE 60.00 TO SNTH TP 60.00
4 33350 0 "***" 1 # RESTORE SNEATH LANE LOAD
#
1 33351 33345 "1 " 0 # line from SN BRNOT 60.00 (2) to (2) SNTH TP1 60.00
1 33351 33352 "1 " 0 # line from SN BRNOT 60.00 (2) to (2) SNANDRES 60.00
1 33345 33355 "1 " 0 # line from SNTH TP1 60.00 (2) to BRKR PACIFICA 60.00
1 33352 33354 "1 " 0 # line from SNANDRES 60.00 (2) to (2) MLLBRETTP 60.00
1 33354 33353 "1 " 0 # line from MLLBRETTP 60.00 (2) to BRKR MLLBRAE 60.00
4 33351 0 "1 " 0 # LOAD-DROP SN BRNOT 60.00 LOAD==3.36(0.77)
4 33352 0 "1 " 0 # LOAD-DROP SNANDRES 60.00 LOAD==1.80(0.37)
4 33355 0 "1 " 0 # LOAD-DROP PACIFICA 60.00 LOAD==9.92(2.26)
4 33355 0 "2 " 0 # LOAD-DROP PACIFICA 60.00 LOAD==5.61(1.28)
1 33355 33389 "1 " 1 # LINE-TRANSFER PACIFICA 60.00 TO PACIFJCT 60.00
4 33355 0 "***" 1 # RESTORE PACIFICA LOAD
0
#

```

APPENDIX B – CAISO CATEGORY C AUTOCON INPUT FILE

```

#
# (199) C5 DCTL OUTAGE
# Martin - Sneath Lane and Jefferson - Hillsdale Jct 60 kV Lines
1 33209 33347 "1 " 0 # line from MARTIN 60.00 BRKR to (2) SNTH JCT 60.00
1 33347 33346 "1 " 0 # line from SNTH JCT 60.00 (2) to (3) SNTH TP2 60.00
1 33346 33389 "1 " 0 # line from SNTH TP2 60.00 (3) to (1) PACIFJCT 60.00
1 33346 33350 "1 " 0 # line from SNTH TP2 60.00 (3) to BRKR SNTH LNE 60.00
4 33350 0 "1 " 0 # LOAD-DROP SNTH LNE 60.00 LOAD==7.61(1.73)
4 33350 0 "2 " 0 # LOAD-DROP SNTH LNE 60.00 LOAD==9.62(2.19)
1 33350 33345 "1 " 1 # LINE-TRANSFER SNTH LNE 60.00 TO SNTH TP 60.00
4 33350 0 "3" 1 # RESTORE SNEATH LANE LOAD
#
1 33348 33359 "1 " 0 # line from CAROLD1 60.00 (3) to BRKR CAROLNDS 60.00
1 33348 33391 "1 " 0 # line from CAROLD1 60.00 (3) to (2) TRAN-60 60.00
1 33348 33396 "1 " 0 # line from CAROLD1 60.00 (3) to (3) HILDAL49 60.00
1 33391 33392 "1 " 0 # line from TRAN-60 60.00 (2) to (1) MLLBTP97 60.00
1 33396 33361 "1 " 0 # line from HILDAL49 60.00 (3) to (3) HLLSDLJT 60.00
1 33396 33397 "1 " 0 # line from HILDAL49 60.00 (3) to (2) RLSTN35 60.00
1 33361 33360 "1 " 0 # line from HLLSDLJT 60.00 BRKR to BRKR HILLSDLJ 60.00
1 33361 33394 "1 " 0 # line from HLLSDLJT 60.00 (3) to BRKR OXMTN_TP 60.00
1 33397 33378 "1 " 0 # line from RLSTN35 60.00 (2) to (3) WTRSHDTP 60.00
1 33378 33379 "1 " 0 # line from WTRSHDTP 60.00 (3) to (1) WATRSHED 60.00
1 33378 33400 "1 " 0 # line from WTRSHDTP 60.00 (3) to BRKR JEFERSN_E 60.00
4 33359 0 "1 " 0 # LOAD-DROP CAROLNDS 60.00 LOAD==2.65(0.60)
4 33359 0 "2 " 0 # LOAD-DROP CAROLNDS 60.00 LOAD==4.88(1.11)
4 33379 33363 "1 " 1 # LOAD-TRANSFER WATRSHED 60.00 TO RALSTON 60.00 LOAD==0.70(0.32)
1 33349 33359 "1 " 1 # LINE-TRANSFER CAROLNDS 60.00 TO CAROLD2 60.00
4 33359 0 "3" 1 # RESTORE CAROLANDS load
0
#
#
# (200) BUS FAULT 30700 "SANMATEO" San Mateo 230 kV Bus Section 1E
#
1 30700 30703 "2" 0 # LINE from SANMATEO 230.00 to RAVENSWD 230.00
6 30700 0 "v " 0 # SVD-DROP SANMATEO 230.00
0
#
#
# (201) BUS FAULT 30700 "SANMATEO" San Mateo 230 kV Bus Section 2E
#
1 30700 30703 "1" 0 # LINE from SANMATEO 230.00 to RAVENSWD 230.00
0
#
#
# (202) BUS FAULT 30700 "SANMATEO" San Mateo 230 kV Bus Section 1D
#
1 30700 30527 "1" 0 # LINE from SANMATEO 230.00 to PITSBG E 230.00
2 30700 30701 "5" 0 # TRAN from SANMATEO 230.00 to SMATEO5M 13.20
0
#
#
# (203) BUS FAULT 30700 "SANMATEO" San Mateo 230 kV Bus Section 2D
#
1 30700 30560 "1" 0 # LINE from SANMATEO 230.00 to E. SHORE 230.00
2 30700 30702 "6" 0 # TRAN from SANMATEO 230.00 to SMATEO6M 13.20
0
#
#
# (204) BUS FAULT 30711 "S.L.A.C."
#
1 30711 30710 "1" 0 # LINE from S.L.A.C. 230.00 to SLACTAP1 230.00
1 30711 30712 "1" 0 # LINE from S.L.A.C. 230.00 to SLACTAP2 230.00
4 30711 0 "1 " 0 # LOAD-DROP S.L.A.C. 230.00 LOAD==58.00(11.78)
0
#
#
# (205) BUS FAULT 30715 "JEFFERSN"
#
1 30715 30710 "1" 0 # LINE from JEFFERSN 230.00 to SLACTAP1 230.00
1 30715 30712 "2" 0 # LINE from JEFFERSN 230.00 to SLACTAP2 230.00
1 30715 30713 "1" 0 # LINE from JEFFERSN 230.00 to JMDAMCX1 230.00
2 30715 33380 "1" 0 # TRAN from JEFFERSN 230.00 to JEFERSN_D 60.00
2 30715 33400 "2" 0 # TRAN from JEFFERSN 230.00 to JEFERSN_E 60.00
0
#
#
# (206) BUS FAULT 33300 "DALY CTY"
#
1 33300 33208 "1" 0 # LINE from DALY CTY 115.00 to MARTIN C 115.00

```

APPENDIX B – CAISO CATEGORY C AUTOCON INPUT FILE

```

1 33300 33301 "2" 0 # LINE from DALY CTY 115.00 to DLY CTYP 115.00
4 33300 0 "1 " 0 # LOAD-DROP DALY CTY 115.00 LOAD==50.29(11.46)
4 33300 0 "2 " 0 # LOAD-DROP DALY CTY 115.00 LOAD==30.35(6.92)
0
#
#
# (207) BUS FAULT 33302 "SERRMNTTE"
#
1 33302 33301 "1" 0 # LINE from SERRMNTTE 115.00 to DLY CTYP 115.00
4 33302 0 "1 " 0 # LOAD-DROP SERRMNTTE 115.00 LOAD==11.42(2.60)
0
#
#
# (208) BUS FAULT 33303 "EST GRND"
#
1 33303 33208 "2" 0 # LINE from EST GRND 115.00 to MARTIN C 115.00
1 33303 33308 "2" 0 # LINE from EST GRND 115.00 to SFIA-MA 115.00
4 33303 0 "1 " 0 # LOAD-DROP EST GRND 115.00 LOAD==58.02(13.22)
4 33303 0 "4 " 0 # LOAD-DROP EST GRND 115.00 LOAD==38.34(8.74)
4 33303 0 "5 " 0 # LOAD-DROP EST GRND 115.00 LOAD==35.32(8.05)
0
#
#
# (209) BUS FAULT 33306 "SFIA"
#
1 33306 33310 "5" 0 # LINE from SFIA 115.00 to SANMATEO 115.00
1 33306 33322 "5" 0 # LINE from SFIA 115.00 to UAL TAP 115.00
4 33306 33308 "1 " 1 # LOAD-TRANSFER SFIA 115.00 TO SFIA-MA 115.00 LOAD==18.70(3.80)
4 33306 33308 "2 " 1 # LOAD-TRANSFER SFIA 115.00 TO SFIA-MA 115.00 LOAD==18.70(3.80)
0
#
#
# (210) BUS FAULT 33307 "MILLBRAE" Millbrae 115 kV Bus Section 1
#
1 33307 33208 "1" 0 # LINE from MILLBRAE 115.00 to MARTIN C 115.00
1 33307 33309 "1" 0 # LINE from MILLBRAE 115.00 to SANPAULA 115.00
4 33307 0 "4 " 0 # LOAD-DROP MILLBRAE 115.00 LOAD==22.69(5.18)
0
#
#
# (211) BUS FAULT 33307 "MILLBRAE" Millbrae 115 kV Bus Section 2
#
1 33307 33310 "1" 0 # LINE from MILLBRAE 115.00 to SANMATEO 115.00
2 33307 33353 "5" 0 # TRAN from MILLBRAE 115.00 to MILLBRAE 60.00
4 33307 0 "3 " 0 # LOAD-DROP MILLBRAE 115.00 LOAD==23.03(5.25)
0
#
#
# (212) BUS FAULT 33310 "SANMATEO" San Mateo 115 kV Bus Section 1E
#
1 33310 33208 "3" 0 # LINE from SANMATEO 115.00 to MARTIN C 115.00
1 33310 33306 "5" 0 # LINE from SANMATEO 115.00 to SFIA 115.00
2 33310 30702 "6" 0 # TRAN from SANMATEO 115.00 to SMATEO6M 13.20
2 33310 33357 "8" 0 # TRAN from SANMATEO 115.00 to SAN MATO 60.00
4 33310 0 "9 " 0 # LOAD-DROP SANMATEO 115.00 LOAD==18.54(4.22)
0
#
#
# (213) BUS FAULT 33310 "SANMATEO" San Mateo 115 kV Bus Section 2E
#
1 33310 33305 "6" 0 # LINE from SANMATEO 115.00 to SHAWROAD 115.00
1 33310 33356 "4" 0 # LINE from SANMATEO 115.00 to BURLNGME 115.00
1 33310 33321 "1" 0 # LINE from SANMATEO 115.00 to RVNSWD D 115.00
1 33310 33311 "2" 0 # LINE from SANMATEO 115.00 to BAY MDWS 115.00
1 33310 33312 "1" 0 # LINE from SANMATEO 115.00 to BELMONT 115.00
0
#
#
# (214) BUS FAULT 33310 "SANMATEO" San Mateo 115 kV Bus Section 1D
#
1 33310 33307 "1" 0 # LINE from SANMATEO 115.00 to MILLBRAE 115.00
1 33310 33311 "1" 0 # LINE from SANMATEO 115.00 to BAY MDWS 115.00
0
#
#
# (215) BUS FAULT 33310 "SANMATEO" San Mateo 115 kV Bus Section 2D
#
1 33310 33308 "2" 0 # LINE from SANMATEO 115.00 to SFIA-MA 115.00
2 33310 30701 "5" 0 # TRAN from SANMATEO 115.00 to SMATEO5M 13.20

```

APPENDIX B – CAISO CATEGORY C AUTOCON INPUT FILE

```

0
#
#
# (216) BUS FAULT 33311 "BAY MDWS"
#
1 33311 33310 "1" 0 # LINE from BAY MDWS 115.00 to SANMATEO 115.00
1 33311 33310 "2" 0 # LINE from BAY MDWS 115.00 to SANMATEO 115.00
4 33311 0 "1 " 0 # LOAD-DROP BAY MDWS 115.00 LOAD==43.91(10.01)
4 33311 0 "2 " 0 # LOAD-DROP BAY MDWS 115.00 LOAD==34.54(7.87)
4 33311 0 "3 " 0 # LOAD-DROP BAY MDWS 115.00 LOAD==20.42(4.66)
4 33311 0 "5 " 0 # LOAD-DROP BAY MDWS 115.00 LOAD==19.08(4.35)
0
#
#
# (217) BUS FAULT 33312 "BELMONT"
#
1 33312 33310 "1" 0 # LINE from BELMONT 115.00 to SANMATEO 115.00
1 33312 33313 "1" 0 # LINE from BELMONT 115.00 to BAIR 115.00
4 33312 0 "1 " 0 # LOAD-DROP BELMONT 115.00 LOAD==37.28(8.49)
4 33312 0 "2 " 0 # LOAD-DROP BELMONT 115.00 LOAD==9.80(2.23)
4 33312 0 "3 " 0 # LOAD-DROP BELMONT 115.00 LOAD==31.91(7.27)
0
#
#
# (218) BUS FAULT 33313 "BAIR"
#
1 33313 33312 "1" 0 # LINE from BAIR 115.00 to BELMONT 115.00
1 33313 33319 "2" 0 # LINE from BAIR 115.00 to SHREDJCT 115.00
1 33313 33321 "1" 0 # LINE from BAIR 115.00 to RVNSWD D 115.00
2 33313 33367 "1" 0 # TRAN from BAIR 115.00 to BAIR 60.00
4 33313 0 "2 " 0 # LOAD-DROP BAIR 115.00 LOAD==16.67(3.80)
0
#
#
# (219) BUS FAULT 33315 "RVNSWD E" Ravenswood 115 kV Bus Section 1E
#
1 33315 35350 "1" 0 # LINE from RVNSWD E 115.00 to AMES BS1 115.00
1 33315 38028 "1" 0 # LINE from RVNSWD E 115.00 to PLO ALTO 115.00
0
#
#
# (220) BUS FAULT 33315 "RVNSWD E" Ravenswood 115 kV Bus Section 2E
#
1 33315 33316 "2" 0 # LINE from RVNSWD E 115.00 to CLY LND2 115.00
1 33315 35351 "2" 0 # LINE from RVNSWD E 115.00 to AMES BS2 115.00
1 33315 38028 "2" 0 # LINE from RVNSWD E 115.00 to PLO ALTO 115.00
0
#
#
# (221) BUS FAULT 33316 "CLY LND2"
#
1 33316 33315 "2" 0 # LINE from CLY LND2 115.00 to RVNSWD E 115.00
1 33316 38028 "1" 0 # LINE from CLY LND2 115.00 to PLO ALTO 115.00
1 33316 33317 "1" 0 # LINE from CLY LND2 115.00 to CLY LND 115.00
2 33316 33375 "2" 0 # TRAN from CLY LND2 115.00 to CLY LNDG 60.00
0
#
#
# (222) BUS FAULT 33317 "CLY LND"
#
1 33317 33316 "1" 0 # LINE from CLY LND 115.00 to CLY LND2 115.00
1 33317 33321 "1" 0 # LINE from CLY LND 115.00 to RVNSWD D 115.00
2 33317 33375 "1" 0 # TRAN from CLY LND 115.00 to CLY LNDG 60.00
0
#
#
# (223) BUS FAULT 33321 "RVNSWD D" Ravenswood 115 kV Bus Section 1D
#
1 33321 33313 "1" 0 # LINE from RVNSWD D 115.00 to BAIR 115.00
1 33321 33317 "1" 0 # LINE from RVNSWD D 115.00 to CLY LND 115.00
0
#
#
# (224) BUS FAULT 33321 "RVNSWD D" Ravenswood 115 kV Bus Section 1D
#
1 33321 33310 "1" 0 # LINE from RVNSWD D 115.00 to SANMATEO 115.00
1 33321 33319 "2" 0 # LINE from RVNSWD D 115.00 to SHREDJCT 115.00
0
#

```

APPENDIX B – CAISO CATEGORY C AUTOCON INPUT FILE

```

#
# (225) BUS FAULT 33350 "SNTH LNE"
#
1 33350 33345 "1" 0 # LINE from SNTH LNE 60.00 to SNTH TP1 60.00
1 33350 33346 "1" 0 # LINE from SNTH LNE 60.00 to SNTH TP2 60.00
4 33350 0 "1 " 0 # LOAD-DROP SNTH LNE 60.00 LOAD==7.61(1.73)
4 33350 0 "2 " 0 # LOAD-DROP SNTH LNE 60.00 LOAD==9.62(2.19)
0
#
#
# (226) BUS FAULT 33353 "MILLBRAE"
#
1 33353 33354 "1" 0 # LINE from MILLBRAE 60.00 to MLLBRETP 60.00
2 33353 33307 "5" 0 # TRAN from MILLBRAE 60.00 to MILLBRAE 115.00
4 33353 0 "1 " 0 # LOAD-DROP MILLBRAE 60.00 LOAD==5.16(1.18)
0
#
#
# (227) BUS FAULT 33355 "PACIFICA"
#
1 33355 33345 "1" 0 # LINE from PACIFICA 60.00 to SNTH TP1 60.00
1 33355 33389 "1" 0 # LINE from PACIFICA 60.00 to PACIFJCT 60.00
4 33355 0 "1 " 0 # LOAD-DROP PACIFICA 60.00 LOAD==9.92(2.26)
4 33355 0 "2 " 0 # LOAD-DROP PACIFICA 60.00 LOAD==5.61(1.28)
0
#
#
# (228) BUS FAULT 33356 "BURLNGME"
#
1 33356 33310 "4" 0 # LINE from BURLNGME 115.00 to SANMATEO 115.00
1 33356 33208 "4" 0 # LINE from BURLNGME 115.00 to MARTIN C 115.00
4 33356 0 "1 " 0 # LOAD-DROP BURLNGME 115.00 LOAD==10.08(2.30)
0
#
#
# (229) BUS FAULT 33357 "SAN MATO" San Mateo 60 kV Bus Section 1
#
1 33357 33358 "1" 0 # LINE from SAN MATO 60.00 to BERESFRD 60.00
2 33357 33318 "3" 0 # TRAN from SAN MATO 60.00 to SMATEO3M 115.00
0
#
#
# (230) BUS FAULT 33357 "SAN MATO" San Mateo 60 kV Bus Section 2
#
1 33357 33364 "1" 0 # LINE from SAN MATO 60.00 to ORACLE60 60.00
2 33357 33310 "8" 0 # TRAN from SAN MATO 60.00 to SANMATEO 115.00
4 33357 0 "4 " 0 # LOAD-DROP SAN MATO 60.00 LOAD==8.55(1.94)
0
#
#
# (231) BUS FAULT 33358 "BERESFRD"
#
1 33358 33357 "1" 0 # LINE from BERESFRD 60.00 to SAN MATO 60.00
1 33358 33360 "1" 0 # LINE from BERESFRD 60.00 to HILLSDLE 60.00
4 33358 0 "1 " 0 # LOAD-DROP BERESFRD 60.00 LOAD==5.80(1.32)
4 33358 0 "2 " 0 # LOAD-DROP BERESFRD 60.00 LOAD==4.07(0.93)
0
#
#
# (232) BUS FAULT 33359 "CAROLNDS"
#
1 33359 33348 "1" 0 # LINE from CAROLNDS 60.00 to CAROLD1 60.00
1 33359 33349 "1" 0 # LINE from CAROLNDS 60.00 to CAROLD2 60.00
4 33359 0 "1 " 0 # LOAD-DROP CAROLNDS 60.00 LOAD==2.65(0.60)
4 33359 0 "2 " 0 # LOAD-DROP CAROLNDS 60.00 LOAD==4.88(1.11)
0
#
#
# (233) BUS FAULT 33360 "HILLSDLE"
#
1 33360 33358 "1" 0 # LINE from HILLSDLE 60.00 to BERESFRD 60.00
1 33360 33361 "1" 0 # LINE from HILLSDLE 60.00 to HLLSDLJT 60.00
4 33360 0 "1 " 0 # LOAD-DROP HILLSDLE 60.00 LOAD==7.32(1.67)
0
#
#
# (234) BUS FAULT 33363 "RALSTON"
#
1 33363 33397 "1" 0 # LINE from RALSTON 60.00 to RLSTN35 60.00

```

APPENDIX B – CAISO CATEGORY C AUTOCON INPUT FILE

```

1 33363 33398 "1" 0 # LINE from RALSTON 60.00 to RLSTN45 60.00
4 33363 33379 "1 " 1 # LOAD-TRANSFER RALSTON 60.00 TO WATRSHED 60.00 LOAD==6.53(1.49)
4 33363 33379 "2 " 1 # LOAD-TRANSFER RALSTON 60.00 TO WATRSHED 60.00 LOAD==3.37(0.77)
0
#
#
# (235) BUS FAULT 33365 "SAN CRLS"
#
1 33365 33364 "1" 0 # LINE from SAN CRLS 60.00 to ORACLE60 60.00
1 33365 33367 "1" 0 # LINE from SAN CRLS 60.00 to BAIR 60.00
4 33365 0 "1 " 0 # LOAD-DROP SAN CRLS 60.00 LOAD==12.95(2.95)
4 33365 0 "2 " 0 # LOAD-DROP SAN CRLS 60.00 LOAD==19.09(4.35)
4 33365 0 "3 " 0 # LOAD-DROP SAN CRLS 60.00 LOAD==9.80(2.23)
0
#
#
# (236) BUS FAULT 33366 "HLF MNBY"
#
1 33366 33389 "1" 0 # LINE from HLF MNBY 60.00 to PACIFJCT 60.00
1 33366 33394 "1" 0 # LINE from HLF MNBY 60.00 to OXMTN_TP 60.00
4 33366 0 "1 " 0 # LOAD-DROP HLF MNBY 60.00 LOAD==8.02(1.82)
4 33366 0 "2 " 0 # LOAD-DROP HLF MNBY 60.00 LOAD==8.73(1.99)
4 33366 0 "3 " 0 # LOAD-DROP HLF MNBY 60.00 LOAD==9.64(2.19)
0
#
#
# (237) BUS FAULT 33367 "BAIR"
#
1 33367 33365 "1" 0 # LINE from BAIR 60.00 to SAN CRLS 60.00
1 33367 33368 "1" 0 # LINE from BAIR 60.00 to REDWDTP1 60.00
1 33367 33369 "2" 0 # LINE from BAIR 60.00 to REDWDTP2 60.00
2 33367 33313 "1" 0 # TRAN from BAIR 60.00 to BAIR 115.00
0
#
#
# (238) BUS FAULT 33370 "REDWOOD"
#
1 33370 33368 "1" 0 # LINE from REDWOOD 60.00 to REDWDTP1 60.00
1 33370 33369 "2" 0 # LINE from REDWOOD 60.00 to REDWDTP2 60.00
4 33370 0 "1 " 0 # LOAD-DROP REDWOOD 60.00 LOAD==11.80(2.69)
4 33370 0 "2 " 0 # LOAD-DROP REDWOOD 60.00 LOAD==5.12(1.17)
4 33370 0 "3 " 0 # LOAD-DROP REDWOOD 60.00 LOAD==8.98(2.05)
4 33370 0 "4 " 0 # LOAD-DROP REDWOOD 60.00 LOAD==8.44(1.93)
4 33370 0 "5 " 0 # LOAD-DROP REDWOOD 60.00 LOAD==30.43(6.94)
0
#
#
# (239) BUS FAULT 33375 "CLY LNDG" Cooley Landing 60 kV Bus Section 1
#
1 33375 33373 "1" 0 # LINE from CLY LNDG 60.00 to BLHVNTP1 60.00
1 33375 33382 "1" 0 # LINE from CLY LNDG 60.00 to S.R.I. 60.00
2 33375 33317 "1" 0 # TRAN from CLY LNDG 60.00 to CLY LND 115.00
0
#
#
# (240) BUS FAULT 33375 "CLY LNDG" Cooley Landing 60 kV Bus Section 1
#
1 33375 33371 "2" 0 # LINE from CLY LNDG 60.00 to RAYCHEM 60.00
1 33375 35454 "1" 0 # LINE from CLY LNDG 60.00 to WSTNG JT 60.00
2 33375 33316 "2" 0 # TRAN from CLY LNDG 60.00 to CLY LND2 115.00
0
#
#
# (241) BUS FAULT 33376 "LAS PLGS"
#
1 33376 33387 "1" 0 # LINE from LAS PLGS 60.00 to WOODSIDE 60.00
1 33376 33393 "1" 0 # LINE from LAS PLGS 60.00 to LSPGLSJT 60.00
4 33376 0 "1 " 0 # LOAD-DROP LAS PLGS 60.00 LOAD==3.30(0.75)
4 33376 0 "2 " 0 # LOAD-DROP LAS PLGS 60.00 LOAD==3.30(0.75)
0
#
#
# (242) BUS FAULT 33380 "JEFRSN_D" Jefferson 60 kV Bus Section 1D
#
1 33380 33377 "1" 0 # LINE from JEFRSN_D 60.00 to EMRLD LE 60.00
1 33380 33400 "1" 0 # LINE from JEFRSN_D 60.00 to JEFRSN_E 60.00
0
#
#

```

APPENDIX B – CAISO CATEGORY C AUTOCON INPUT FILE

```

# (243) BUS FAULT 33380 "JEFRSN_D" Jefferson 60 kV Bus Section 2D and 2E
#
1 33380 33387 "1" 0 # LINE from JEFRSN_D 60.00 to WOODSIDE 60.00
2 33380 30715 "1" 0 # TRAN from JEFRSN_D 60.00 to JEFFERSN 230.00
1 33400 33378 "1" 0 # LINE from JEFRSN_E 60.00 to WTRSHDTP 60.00
0
#
#
# (244) BUS FAULT 33381 "GLENWOOD"
#
1 33381 33382 "1" 0 # LINE from GLENWOOD 60.00 to S.R.I. 60.00
1 33381 33384 "1" 0 # LINE from GLENWOOD 60.00 to MNLO JCT 60.00
4 33381 0 "1 " 0 # LOAD-DROP GLENWOOD 60.00 LOAD==10.42(2.37)
4 33381 0 "2 " 0 # LOAD-DROP GLENWOOD 60.00 LOAD==7.20(1.64)
4 33381 0 "3 " 0 # LOAD-DROP GLENWOOD 60.00 LOAD==9.03(2.06)
0
#
#
# (245) BUS FAULT 33383 "MENLO"
#
1 33383 33385 "1" 0 # LINE from MENLO 60.00 to MNLOJCT2 60.00
1 33383 33390 "1" 0 # LINE from MENLO 60.00 to MENLO G 60.00
4 33383 0 "1 " 0 # LOAD-DROP MENLO 60.00 LOAD==4.91(1.12)
4 33383 0 "3 " 0 # LOAD-DROP MENLO 60.00 LOAD==14.12(3.21)
0
#
#
# (246) BUS FAULT 33386 "STANFORD"
#
1 33386 33384 "1" 0 # LINE from STANFORD 60.00 to MNLO JCT 60.00
1 33386 33388 "1" 0 # LINE from STANFORD 60.00 to S.L.A.C. 60.00
2 33386 33463 "1" 0 # TRAN from STANFORD 60.00 to CARDINAL 12.47
4 33386 0 "SG" 0 # LOAD-DROP STANFORD 60.00 LOAD==30.83(6.26)
0
#
#
# (247) BUS FAULT 33387 "WOODSIDE"
#
1 33387 33376 "1" 0 # LINE from WOODSIDE 60.00 to LAS PLGS 60.00
1 33387 33380 "1" 0 # LINE from WOODSIDE 60.00 to JEFRSN_D 60.00
4 33387 0 "1 " 0 # LOAD-DROP WOODSIDE 60.00 LOAD==12.61(2.87)
4 33387 0 "2 " 0 # LOAD-DROP WOODSIDE 60.00 LOAD==10.53(2.40)
4 33387 0 "3 " 0 # LOAD-DROP WOODSIDE 60.00 LOAD==10.53(2.40)
0
#
#
# (248) BUS FAULT 33390 "MENLO G"
#
1 33390 33383 "1" 0 # LINE from MENLO G 60.00 to MENLO 60.00
1 33390 33384 "1" 0 # LINE from MENLO G 60.00 to MNLO JCT 60.00
4 33390 0 "2 " 0 # LOAD-DROP MENLO G 60.00 LOAD==5.32(1.21)
4 33390 0 "4 " 0 # LOAD-DROP MENLO G 60.00 LOAD==14.35(3.27)
0
#
#
# (249) BUS FAULT 33394 "OXMTN_TP"
#
1 33394 33361 "1" 0 # LINE from OXMTN_TP 60.00 to HLLSDLJT 60.00
1 33394 33366 "1" 0 # LINE from OXMTN_TP 60.00 to HLF MNBY 60.00
1 33394 33395 "1" 0 # LINE from OXMTN_TP 60.00 to OX_MTN60 60.00
0
#
#
# (250) BUS FAULT 33400 "JEFRSN_E" Jefferson 60 kV Bus Section 1E
#
1 33400 33380 "1" 0 # LINE from JEFRSN_E 60.00 to JEFRSN_D 60.00
1 33400 33398 "1" 0 # LINE from JEFRSN_E 60.00 to RLSTN45 60.00
2 33400 30715 "2" 0 # TRAN from JEFRSN_E 60.00 to JEFFERSN 230.00
0
#
#
# 2013 category c contingency list (dctl and bus outages)
# Mission Division Zone 316
#
#
# (251) C5 DCTL OUTAGE
# Tassajara - Newark and San Ramon - Moraga 230 kV Lines
1 30562 30631 "1 " 0 # line from TES JCT 230.00 (3) to BRKR NEWARK E 230.00
1 30562 30561 "1 " 0 # line from TES JCT 230.00 (3) to BRKR TASSAJAR 230.00

```

APPENDIX B – CAISO CATEGORY C AUTOCON INPUT FILE

```

1 30562 30563 "1 " 0 # line from TES JCT 230.00 (3) to BRKR RESEARCH 230.00
4 30563 0 "1 " 0 # LOAD-DROP RESEARCH 230.00 LOAD==37.05(8.44)
#
1 30550 30555 "1 " 0 # line from MORAGA 230.00 BRKR to BRKR SANRAMON 230.00
0
#
#
# (252) C5 DCTL OUTAGE
# Tassajara - Newark and Castro Valley - Newark 230 kV Lines
1 30562 30631 "1 " 0 # line from TES JCT 230.00 (3) to BRKR NEWARK E 230.00
1 30562 30561 "1 " 0 # line from TES JCT 230.00 (3) to BRKR TASSAJAR 230.00
1 30562 30563 "1 " 0 # line from TES JCT 230.00 (3) to BRKR RESEARCH 230.00
4 30563 0 "1 " 0 # LOAD-DROP RESEARCH 230.00 LOAD==37.05(8.44)
#
1 30554 30631 "1 " 0 # line from CASTROVL 230.00 BRKR to BRKR NEWARK E 230.00
0
#
#
# (253) C5 DCTL OUTAGE
# Moraga - San Leandro #1 and #2 115 kV Lines
1 33020 35101 "1 " 0 # line from MORAGA 115.00 BRKR to BRKR SN LNDRO 115.00
#
1 33020 35101 "2 " 0 # line from MORAGA 115.00 BRKR to BRKR SN LNDRO 115.00
0
#
#
# (254) C5 DCTL OUTAGE
# Grant - East Shore #1 and #2 115 kV Lines
1 35104 35105 "1 " 0 # line from GRANT 115.00 BRKR to BRKR EASTSHRE 115.00
#
1 35104 35105 "2 " 0 # line from GRANT 115.00 BRKR to BRKR EASTSHRE 115.00
0
#
#
# (255) C5 DCTL OUTAGE
# East Shore - Mt Eden #1 and #2 115 kV Lines
1 35105 35106 "1 " 0 # line from EASTSHRE 115.00 BRKR to BRKR MT EDEN 115.00
#
1 35105 35106 "2 " 0 # line from EASTSHRE 115.00 BRKR to BRKR MT EDEN 115.00
0
#
#
# (256) C5 DCTL OUTAGE
# Newark - Jarvis #1 and #2 115 kV Lines
1 35120 35111 "1 " 0 # line from NEWARK D 115.00 BRKR to BRKR JARVIS 115.00
#
1 35120 35124 "2 " 0 # line from NEWARK D 115.00 BRKR to (2) NUMI JCT 115.00
1 35124 35111 "2 " 0 # line from NUMI JCT 115.00 (2) to BRKR JARVIS 115.00
0
#
#
# (257) C5 DCTL OUTAGE
# Newark - Northern #1 and #2 115 kV Lines
1 35120 36851 "1 " 0 # line from NEWARK D 115.00 BRKR to BRKR NRS 400 115.00
#
1 35122 36853 "2 " 0 # line from NEWARK F 115.00 BRKR to BRKR NRS 300 115.00
0
#
#
# (258) C5 DCTL OUTAGE
# Newark - Fremont #1 and #2 115 kV Lines
1 35121 35110 "1 " 0 # line from NEWARK E 115.00 BRKR to BRKR FREMNT 115.00
#
1 35121 35110 "2 " 0 # line from NEWARK E 115.00 BRKR to BRKR FREMNT 115.00
0
#
#
# (259) C5 DCTL OUTAGE
# Newark - Ames #1 and #2 115 kV Lines
1 35121 35350 "1 " 0 # line from NEWARK E 115.00 BRKR to BRKR AMES BS1 115.00
#
1 35121 35351 "2 " 0 # line from NEWARK E 115.00 BRKR to BRKR AMES BS2 115.00
0
#
#
# (260) C5 DCTL OUTAGE
# Newark - Ames #3 and Newark - Ames Distribution 115 kV Lines
1 35121 35350 "3 " 0 # line from NEWARK E 115.00 BRKR to BRKR AMES BS1 115.00
#

```

APPENDIX B – CAISO CATEGORY C AUTOCON INPUT FILE

```

1 35349 35121 "1 " 0 # line from AMES DST 115.00 BRKR to BRKR NEWARK E 115.00
0
#
#
# (261) C5 DCTL OUTAGE
# Newark - Nummi 115 kV and Newark - Livermore 60 kV Lines
1 35122 35126 "1 " 0 # line from NEWARK F 115.00 BRKR to (2) NUMI TAP 115.00
1 35126 35127 "1 " 0 # line from NUMI TAP 115.00 (2) to (2) WESTRN_D 115.00
1 35127 35112 "1 " 0 # line from WESTRN_D 115.00 (2) to BRKR NUMMI 115.00
4 35127 0 "1 " 0 # LOAD-DROP WESTRN_D 115.00 LOAD==6.80(4.25)
4 35112 0 "1 " 0 # LOAD-DROP NUMMI 115.00 LOAD==30.88(8.14)
#
1 35225 35217 "1 " 0 # line from LIVRMR_2 60.00 BRKR to BRKR NEWARK 60.00
0
#
#
# (262) C5 DCTL OUTAGE
# Newark - Lawrence and Newark - Applied Materials 115 kV Lines
1 35122 35357 "1 " 0 # line from NEWARK F 115.00 BRKR to (3) LCKHD J1 115.00
1 35357 35358 "1 " 0 # line from LCKHD J1 115.00 (3) to (3) MFT.FD J 115.00
1 35357 35363 "1 " 0 # line from LCKHD J1 115.00 (3) to BRKR LAWRENCE 115.00
1 35358 35359 "1 " 0 # line from MFT.FD J 115.00 (3) to (1) MOFT.FLD 115.00
1 35358 35361 "1 " 0 # line from MFT.FD J 115.00 (3) to BRKR LOCKHD 1 115.00
4 35359 0 "1 " 0 # LOAD-DROP MOFT.FLD 115.00 LOAD==4.46(1.12)
4 35361 0 "3 " 0 # LOAD-DROP LOCKHD 1 115.00 LOAD==17.45(14.46)
1 35361 35362 "1 " 1 # close LOCKHD 1 115.00 LOCKHD 2 115.00
4 35361 0 "3 " 1 # restore all loads to LOCKHD 1
#
1 35122 35360 "1 " 0 # line from NEWARK F 115.00 BRKR to (3) LCKHD J2 115.00
1 35360 35362 "1 " 0 # line from LCKHD J2 115.00 (3) to BRKR LOCKHD 2 115.00
1 35360 35365 "1 " 0 # line from LCKHD J2 115.00 (3) to (3) AMD JCT 115.00
1 35365 35364 "1 " 0 # line from AMD JCT 115.00 (3) to BRKR A.M.D 115.00
1 35365 35369 "1 " 0 # line from AMD JCT 115.00 (3) to BRKR APP MAT 115.00
4 35362 0 "1 " 0 # LOAD-DROP LOCKHD 2 115.00 LOAD==7.56(1.72)
4 35362 0 "2 " 0 # LOAD-DROP LOCKHD 2 115.00 LOAD==3.42(0.78)
4 35362 0 "4 " 0 # LOAD-DROP LOCKHD 2 115.00 LOAD==16.21(12.58)
4 35364 0 "1 " 0 # LOAD-DROP A.M.D 115.00 LOAD==1.67(1.17)
1 35361 35362 "1 " 1 # close LOCKHD 1 115.00 LOCKHD 2 115.00
4 35362 0 "3 " 1 # restore all loads to LOCKHD 2
0
#
#
# (263) C5 DCTL OUTAGE
# Newark - Dixon Landing and Newark - Milpitas #1 115 kV Lines
1 35122 35600 "1 " 0 # line from NEWARK F 115.00 BRKR to BRKR DIXON LD 115.00
#
1 35122 35624 "1 " 0 # line from NEWARK F 115.00 BRKR to BRKR MILPITAS 115.00
0
#
#
# (264) C5 DCTL OUTAGE
# Newark - Kifer and Newark - Trimble 115 kV Lines
1 35122 35602 "1 " 0 # line from NEWARK F 115.00 BRKR to (3) ZNKER J2 115.00
1 35602 35604 "1 " 0 # line from ZNKER J2 115.00 (3) to (3) ZANKER 115.00
1 35602 36850 "1 " 0 # line from ZNKER J2 115.00 (3) to BRKR KRS 115.00
2 35604 35861 "1 " 0 # TRAN from ZANKER 115.00 (3) to (2) SJ-SCL W 9.11
2 35604 35861 "2 " 0 # TRAN from ZANKER 115.00 (3) to (2) SJ-SCL W 9.11
4 35861 0 "SG" 0 # LOAD-DROP SJ-SCL W 9.11 LOAD==6.17(2.09)
3 35861 0 "1 " 0 # GEN-DROP SJ-SCL W 9.11 GEN==5.00(0.00)
#
1 35122 35603 "1 " 0 # line from NEWARK F 115.00 BRKR to (3) ZNKER J1 115.00
1 35603 35605 "1 " 0 # line from ZNKER J1 115.00 (3) to (1) AGNEW J 115.00
1 35603 35612 "1 " 0 # line from ZNKER J1 115.00 (3) to BRKR TRIMBLE 115.00
0
#
#
# (265) BUS FAULT 30554 "CASTROVL"
#
1 30554 30550 "1" 0 # LINE from CASTROVL 230.00 to MORAGA 230.00
1 30554 30556 "1" 0 # LINE from CASTROVL 230.00 to CV BART 230.00
1 30554 30631 "1" 0 # LINE from CASTROVL 230.00 to NEWARK E 230.00
4 30554 0 "1 " 0 # LOAD-DROP CASTROVL 230.00 LOAD==38.34(8.74)
4 30554 0 "2 " 0 # LOAD-DROP CASTROVL 230.00 LOAD==34.68(7.90)
0
#
#
# (266) BUS FAULT 30555 "SANRAMON" San Ramon 230 kV Bus Section 1
#
1 30555 30526 "1" 0 # LINE from SANRAMON 230.00 to PITSBG D 230.00

```

APPENDIX B – CAISO CATEGORY C AUTOCON INPUT FILE

```

2 30555 35209 "1" 0 # TRAN from SANRAMON 230.00 to SAN RAMN 60.00
0
#
#
# (267) BUS FAULT 30555 "SANRAMON" San Ramon 230 kV Bus Section 2
#
1 30555 30550 "1" 0 # LINE from SANRAMON 230.00 to MORAGA 230.00
0
#
#
# (268) BUS FAULT 30585 "LS PSTAS"
#
1 30585 30525 "1" 0 # LINE from LS PSTAS 230.00 to C.COSTA 230.00
1 30585 30630 "1" 0 # LINE from LS PSTAS 230.00 to NEWARK D 230.00
2 30585 35220 "4" 0 # TRAN from LS PSTAS 230.00 to LPOSTAS 60.00
4 30585 0 "1 " 0 # LOAD-DROP LS PSTAS 230.00 LOAD==22.20(5.06)
4 30585 0 "2 " 0 # LOAD-DROP LS PSTAS 230.00 LOAD==51.40(11.71)
4 30585 0 "3 " 0 # LOAD-DROP LS PSTAS 230.00 LOAD==33.99(7.75)
0
#
#
# (269) BUS FAULT 30630 "NEWARK D" Newark 230 kV Bus Section 1D
#
1 30630 30585 "1" 0 # LINE from NEWARK D 230.00 to LS PSTAS 230.00
1 30630 30624 "1" 0 # LINE from NEWARK D 230.00 to TESLA E 230.00
1 30630 30703 "1" 0 # LINE from NEWARK D 230.00 to RAVENSWD 230.00
2 30630 30626 "7" 0 # TRAN from NEWARK D 230.00 to NWRK_7M 13.20
0
#
#
# (270) BUS FAULT 30630 "NEWARK D" Newark 230 kV Bus Section 2D
#
1 30630 30631 "1" 0 # LINE from NEWARK D 230.00 to NEWARK E 230.00
1 30630 35219 "1" 0 # LINE from NEWARK D 230.00 to VINEYARD 230.00
6 30630 0 "v " 0 # SVD-DROP NEWARK D 230.00
0
#
#
# (271) BUS FAULT 30631 "NEWARK E" Newark 230 kV Bus Section 1E
#
1 30631 30554 "1" 0 # LINE from NEWARK E 230.00 to CASTROVL 230.00
1 30631 30635 "1" 0 # LINE from NEWARK E 230.00 to NWK DIST 230.00
0
#
#
# (272) BUS FAULT 30631 "NEWARK E" Newark 230 kV Bus Section 2E
#
1 30631 30562 "1" 0 # LINE from NEWARK E 230.00 to TES JCT 230.00
1 30631 30655 "2" 0 # LINE from NEWARK E 230.00 to ADCC 230.00
2 30631 30628 "11" 0 # TRAN from NEWARK E 230.00 to NWRK_11M 13.20
6 30631 0 "v " 0 # SVD-DROP NEWARK E 230.00
0
#
#
# (273) BUS FAULT 35101 "SN LNDRO" San Leandro 115 kV Bus Section D
#
1 35101 33020 "2" 0 # LINE from SN LNDRO 115.00 to MORAGA 115.00
1 35101 33020 "3" 0 # LINE from SN LNDRO 115.00 to MORAGA 115.00
4 35101 0 "3 " 0 # LOAD-DROP SN LNDRO 115.00 LOAD==26.45(6.03)
4 35101 0 "SL" 0 # LOAD-DROP SN LNDRO 115.00 LOAD==7.80(1.58)
0
#
#
# (274) BUS FAULT 35101 "SN LNDRO" San Leandro 115 kV Bus Section E
#
1 35101 33020 "1" 0 # LINE from SN LNDRO 115.00 to MORAGA 115.00
1 35101 35113 "1" 0 # LINE from SN LNDRO 115.00 to DMTAR_SL 115.00
4 35101 0 "1 " 0 # LOAD-DROP SN LNDRO 115.00 LOAD==26.90(6.13)
4 35101 0 "2 " 0 # LOAD-DROP SN LNDRO 115.00 LOAD==37.54(8.55)
0
#
#
# (275) BUS FAULT 35104 "GRANT"
#
1 35104 32812 "1" 0 # LINE from GRANT 115.00 to EDS GRNT 115.00
1 35104 35105 "1" 0 # LINE from GRANT 115.00 to EASTSHRE 115.00
1 35104 35105 "2" 0 # LINE from GRANT 115.00 to EASTSHRE 115.00
4 35104 0 "1 " 0 # LOAD-DROP GRANT 115.00 LOAD==23.95(5.46)
4 35104 0 "2 " 0 # LOAD-DROP GRANT 115.00 LOAD==26.01(5.93)

```

APPENDIX B – CAISO CATEGORY C AUTOCON INPUT FILE

```

0
#
#
# (276) BUS FAULT 35105 "EASTSHRE" East Shore 115 kV Bus Section D
#
1 35105 35104 "2" 0 # LINE from EASTSHRE 115.00 to GRANT 115.00
1 35105 35106 "1" 0 # LINE from EASTSHRE 115.00 to MT EDEN 115.00
2 35105 30560 "1" 0 # TRAN from EASTSHRE 115.00 to E. SHORE 230.00
0
#
#
# (277) BUS FAULT 35105 "EASTSHRE" East Shore 115 kV Bus Section E
#
1 35105 35104 "1" 0 # LINE from EASTSHRE 115.00 to GRANT 115.00
1 35105 35106 "2" 0 # LINE from EASTSHRE 115.00 to MT EDEN 115.00
1 35105 35107 "1" 0 # LINE from EASTSHRE 115.00 to DUMBARTN 115.00
2 35105 30560 "2" 0 # TRAN from EASTSHRE 115.00 to E. SHORE 230.00
0
#
#
# (278) BUS FAULT 35106 "MT EDEN"
#
1 35106 35105 "1" 0 # LINE from MT EDEN 115.00 to EASTSHRE 115.00
1 35106 35105 "2" 0 # LINE from MT EDEN 115.00 to EASTSHRE 115.00
4 35106 0 "1 " 0 # LOAD-DROP MT EDEN 115.00 LOAD==38.61(8.80)
4 35106 0 "2 " 0 # LOAD-DROP MT EDEN 115.00 LOAD==36.10(8.23)
4 35106 0 "3 " 0 # LOAD-DROP MT EDEN 115.00 LOAD==34.77(7.93)
0
#
#
# (279) BUS FAULT 35107 "DUMBARTN"
#
1 35107 35105 "1" 0 # LINE from DUMBARTN 115.00 to EASTSHRE 115.00
1 35107 35120 "1" 0 # LINE from DUMBARTN 115.00 to NEWARK D 115.00
4 35107 0 "1 " 0 # LOAD-DROP DUMBARTN 115.00 LOAD==24.42(5.57)
4 35107 0 "2 " 0 # LOAD-DROP DUMBARTN 115.00 LOAD==25.84(5.89)
4 35107 0 "3 " 0 # LOAD-DROP DUMBARTN 115.00 LOAD==31.54(7.19)
0
#
#
# (280) BUS FAULT 35110 "FREMNT"
#
1 35110 35121 "1" 0 # LINE from FREMNT 115.00 to NEWARK E 115.00
1 35110 35121 "2" 0 # LINE from FREMNT 115.00 to NEWARK E 115.00
4 35110 0 "1 " 0 # LOAD-DROP FREMNT 115.00 LOAD==31.72(7.23)
4 35110 0 "2 " 0 # LOAD-DROP FREMNT 115.00 LOAD==19.38(4.41)
4 35110 0 "3 " 0 # LOAD-DROP FREMNT 115.00 LOAD==27.52(6.27)
0
#
#
# (281) BUS FAULT 35111 "JARVIS"
#
1 35111 35115 "1" 0 # LINE from JARVIS 115.00 to JV BART 115.00
1 35111 35116 "1" 0 # LINE from JARVIS 115.00 to CRYOGEN 115.00
1 35111 35120 "1" 0 # LINE from JARVIS 115.00 to NEWARK D 115.00
1 35111 35124 "2" 0 # LINE from JARVIS 115.00 to NUMI JCT 115.00
4 35111 0 "1 " 0 # LOAD-DROP JARVIS 115.00 LOAD==17.70(4.03)
4 35111 0 "2 " 0 # LOAD-DROP JARVIS 115.00 LOAD==26.59(6.06)
4 35111 0 "3 " 0 # LOAD-DROP JARVIS 115.00 LOAD==34.15(7.78)
0
#
#
# (282) BUS FAULT 35112 "NUMMI"
#
1 35112 35127 "1" 0 # LINE from NUMMI 115.00 to WESTRN_D 115.00
4 35112 0 "1 " 0 # LOAD-DROP NUMMI 115.00 LOAD==30.88(8.14)
0
#
#
# (283) BUS FAULT 35120 "NEWARK D" Newark 115 kV Bus Section 1D
#
1 35120 35111 "1" 0 # LINE from NEWARK D 115.00 to JARVIS 115.00
1 35120 36851 "1" 0 # LINE from NEWARK D 115.00 to NRS 400 115.00
1 35120 38446 "3" 0 # LINE from NEWARK D 115.00 to OAK-TAP1 115.00
4 35120 0 "3 " 0 # LOAD-DROP NEWARK D 115.00 LOAD==25.84(5.89)
0
#
#
# (284) BUS FAULT 35120 "NEWARK D" Newark 115 kV Bus Section 2D

```

APPENDIX B – CAISO CATEGORY C AUTOCON INPUT FILE

```

#
1 35120 35107 "1" 0 # LINE from NEWARK D 115.00 to DUMBARTN 115.00
1 35120 35124 "2" 0 # LINE from NEWARK D 115.00 to NUMI JCT 115.00
1 35120 38448 "4" 0 # LINE from NEWARK D 115.00 to OAK-TAP2 115.00
2 35120 35109 "1" 0 # TRAN from NEWARK D 115.00 to NWRK 2 M 115.00
4 35120 0 "4 " 0 # LOAD-DROP NEWARK D 115.00 LOAD==24.33(5.54)
6 35120 0 "v " 0 # SVD-DROP NEWARK D 115.00
0
#
#
# (285) BUS FAULT 35121 "NEWARK E" Newark 115 kV Bus Section 1E
#
1 35121 35110 "1" 0 # LINE from NEWARK E 115.00 to FREMNT 115.00
1 35121 35350 "1" 0 # LINE from NEWARK E 115.00 to AMES BS1 115.00
1 35121 35350 "3" 0 # LINE from NEWARK E 115.00 to AMES BS1 115.00
0
#
#
# (286) BUS FAULT 35121 "NEWARK E" Newark 115 kV Bus Section 2E
#
1 35121 35110 "2" 0 # LINE from NEWARK E 115.00 to FREMNT 115.00
1 35121 35351 "2" 0 # LINE from NEWARK E 115.00 to AMES BS2 115.00
1 35121 35349 "1" 0 # LINE from NEWARK E 115.00 to AMES DST 115.00
2 35121 30626 "7" 0 # TRAN from NEWARK E 115.00 to NWRK_7M 13.20
0
#
#
# (287) BUS FAULT 35122 "NEWARK F" Newark 115 kV Bus Section 1F
#
1 35122 35357 "1" 0 # LINE from NEWARK F 115.00 to LCKHD J1 115.00
1 35122 35603 "1" 0 # LINE from NEWARK F 115.00 to ZNKER J1 115.00
1 35122 35624 "1" 0 # LINE from NEWARK F 115.00 to MILPITAS 115.00
1 35122 35624 "2" 0 # LINE from NEWARK F 115.00 to MILPITAS 115.00
0
#
#
# (288) BUS FAULT 35122 "NEWARK F" Newark 115 kV Bus Section 1F
#
1 35122 35126 "1" 0 # LINE from NEWARK F 115.00 to NUMI TAP 115.00
1 35122 35360 "1" 0 # LINE from NEWARK F 115.00 to LCKHD J2 115.00
1 35122 35600 "1" 0 # LINE from NEWARK F 115.00 to DIXON LD 115.00
1 35122 35602 "1" 0 # LINE from NEWARK F 115.00 to ZNKER J2 115.00
1 35122 36853 "2" 0 # LINE from NEWARK F 115.00 to NRS 300 115.00
0
#
#
# (289) BUS FAULT 35201 "VASCO"
#
1 35201 35210 "1" 0 # LINE from VASCO 60.00 to VASCJCT. 60.00
1 35201 35211 "1" 0 # LINE from VASCO 60.00 to ALTAMONT 60.00
4 35201 0 "1 " 0 # LOAD-DROP VASCO 60.00 LOAD==6.00(1.37)
4 35201 0 "2 " 0 # LOAD-DROP VASCO 60.00 LOAD==8.78(2.00)
0
#
#
# (290) BUS FAULT 35203 "LIVERMRE"
#
1 35203 35220 "1" 0 # LINE from LIVERMRE 60.00 to LPOSTAS 60.00
1 35203 35222 "1" 0 # LINE from LIVERMRE 60.00 to CALMAT60 60.00
1 35203 35225 "1" 0 # LINE from LIVERMRE 60.00 to LIVRMR_2 60.00
4 35203 0 "1 " 0 # LOAD-DROP LIVERMRE 60.00 LOAD==10.62(2.42)
0
#
#
# (291) BUS FAULT 35205 "RADUM"
#
1 35205 35222 "1" 0 # LINE from RADUM 60.00 to CALMAT60 60.00
1 35205 35227 "1" 0 # LINE from RADUM 60.00 to VINEYARD 60.00
1 35205 35223 "1" 0 # LINE from RADUM 60.00 to PARKS TP 60.00
4 35205 0 "1 " 0 # LOAD-DROP RADUM 60.00 LOAD==9.13(2.08)
4 35205 0 "2 " 0 # LOAD-DROP RADUM 60.00 LOAD==10.18(2.32)
0
#
#
# (292) BUS FAULT 35209 "SAN RAMN"
#
1 35209 35221 "1" 0 # LINE from SAN RAMN 60.00 to E DUBLIN 60.00
2 35209 30555 "1" 0 # TRAN from SAN RAMN 60.00 to SANRAMON 230.00

```

APPENDIX B – CAISO CATEGORY C AUTOCON INPUT FILE

```

0
#
#
# (293) BUS FAULT 35213 "VALLECTS"
#
1 35213 35212 "1" 0 # LINE from VALLECTS 60.00 to IUKA 60.00
1 35213 35214 "1" 0 # LINE from VALLECTS 60.00 to SUNOL 60.00
4 35213 0 "1" 0 # LOAD-DROP VALLECTS 60.00 LOAD==1.16(0.20)
0
#
#
# (294) BUS FAULT 35217 "NEWARK"
#
1 35217 35216 "1" 0 # LINE from NEWARK 60.00 to DCTO JCT 60.00
1 35217 35225 "1" 0 # LINE from NEWARK 60.00 to LIVRMR_2 60.00
2 35217 35109 "1" 0 # TRAN from NEWARK 60.00 to NWRK 2 M 115.00
0
#
#
# (295) BUS FAULT 35220 "LPOSTAS"
#
1 35220 35203 "1" 0 # LINE from LPOSTAS 60.00 to LIVERMRE 60.00
1 35220 35210 "1" 0 # LINE from LPOSTAS 60.00 to VASCJCT. 60.00
2 35220 30585 "4" 0 # TRAN from LPOSTAS 60.00 to LS PSTAS 230.00
0
#
#
# (296) BUS FAULT 35225 "LIVRMR_2"
#
1 35225 35203 "1" 0 # LINE from LIVRMR_2 60.00 to LIVERMRE 60.00
1 35225 35217 "1" 0 # LINE from LIVRMR_2 60.00 to NEWARK 60.00
4 35225 0 "2" 0 # LOAD-DROP LIVRMR_2 60.00 LOAD==13.57(3.09)
0
#
#
# 2013 category c contingency list (dctl and bus outages)
# DeAnza Division Zone 317
#
#
# (297) C5 DCTL OUTAGE
# Monta Vista - Saratoga and Monta Vista - Hicks 230 kV Lines
1 30705 30720 "1" 0 # line from MONTAVIS 230.00 BRKR to BRKR SARATOGA 230.00
#
1 30705 30730 "1" 0 # line from MONTAVIS 230.00 BRKR to BRKR HICKS 230.00
0
#
#
# (298) C5 DCTL OUTAGE
# Saratoga - Vasona and Monta Vista - Hicks 230 kV Lines
1 30720 30733 "1" 0 # line from SARATOGA 230.00 BRKR to BRKR VASONA 230.00
#
1 30705 30730 "1" 0 # line from MONTAVIS 230.00 BRKR to BRKR HICKS 230.00
0
#
#
# (299) C5 DCTL OUTAGE
# Monta Vista - Metcalf and Monta Vista - Coyote Sw Sta 230 kV Lines
1 30735 30705 "3" 0 # line from METCALF 230.00 BRKR to BRKR MONTAVIS 230.00
#
1 30741 30705 "4" 0 # line from CAL MEC 230.00 BRKR to BRKR MONTAVIS 230.00
0
#
#
# (300) C5 DCTL OUTAGE
# Newark - Ames #3 and Ames - Ames Distribution 115 kV Lines
1 35121 35350 "3" 0 # line from NEWARK E 115.00 BRKR to BRKR AMES BS1 115.00
#
1 35351 35349 "1" 0 # line from AMES BS2 115.00 BRKR to BRKR AMES DST 115.00
0
#
#
# (301) C5 DCTL OUTAGE
# Whisman - Monta Vista and Mountain View - Monta Vista 115 kV Lines
1 35352 35356 "1" 0 # line from WHISMAN 115.00 BRKR to BRKR MNTA VSA 115.00
#
1 35353 35356 "1" 0 # line from MT VIEW 115.00 BRKR to BRKR MNTA VSA 115.00
0
#
#

```

APPENDIX B – CAISO CATEGORY C AUTOCON INPUT FILE

```

# (302) C5 DCTL OUTAGE
# Whisman - Monta Vista and Mountain View - Whisman 115 kV Lines
1 35352 35356 "1 " 0 # line from WHISMAN 115.00 BRKR to BRKR MNTA VSA 115.00
#
1 35370 35353 "1 " 0 # line from AMES J1A 115.00 (2) to BRKR MT VIEW 115.00
1 35370 35371 "1 " 0 # line from AMES J1A 115.00 (2) to (2) AMES J1B 115.00
1 35371 35352 "1 " 0 # line from AMES J1B 115.00 (2) to BRKR WHISMAN 115.00
0
#
#
# (303) C5 DCTL OUTAGE
# Stelling - Monta Vista and Monta Vista - Wolfe 115 kV Lines
1 35354 35356 "1 " 0 # line from STELLING 115.00 BRKR to BRKR MNTA VSA 115.00
#
1 35355 35356 "1 " 0 # line from WOLFE 115.00 BRKR to BRKR MNTA VSA 115.00
0
#
#
# (304) C5 DCTL OUTAGE
# Stelling - Wolfe and Monta Vista - Wolfe 115 kV Lines
1 35354 35355 "1 " 0 # line from STELLING 115.00 BRKR to BRKR WOLFE 115.00
#
1 35355 35356 "1 " 0 # line from WOLFE 115.00 BRKR to BRKR MNTA VSA 115.00
0
#
#
# (305) C5 DCTL OUTAGE
# Lawrence - Monta Vista and Britton - Monta Vista 115 kV Lines
1 35356 35367 "1 " 0 # line from MNTA VSA 115.00 BRKR to (3) PHLPS_JT 115.00
1 35367 35363 "1 " 0 # line from PHLPS_JT 115.00 (3) to BRKR LAWRENCE 115.00
1 35367 35366 "1 " 0 # line from PHLPS_JT 115.00 (3) to BRKR PHILLIPS 115.00
4 35366 0 "1 " 0 # LOAD-DROP PHILLIPS 115.00 LOAD==1.25(0.00)
#
1 35356 35368 "1 " 0 # line from MNTA VSA 115.00 BRKR to BRKR BRITTN 115.00
0
#
#
# (306) C5 DCTL OUTAGE
# Lawrence - Monta Vista and Britton - Applied Materials 115 kV Lines
1 35356 35367 "1 " 0 # line from MNTA VSA 115.00 BRKR to (3) PHLPS_JT 115.00
1 35367 35363 "1 " 0 # line from PHLPS_JT 115.00 (3) to BRKR LAWRENCE 115.00
1 35367 35366 "1 " 0 # line from PHLPS_JT 115.00 (3) to BRKR PHILLIPS 115.00
4 35366 0 "1 " 0 # LOAD-DROP PHILLIPS 115.00 LOAD==1.25(0.00)
#
1 35368 35369 "1 " 0 # line from BRITTN 115.00 BRKR to BRKR APP MAT 115.00
0
#
#
# (307) C5 DCTL OUTAGE
# Lawrence - Monta Vista and Newark - Applied Materials 115 kV Lines
1 35356 35367 "1 " 0 # line from MNTA VSA 115.00 BRKR to (3) PHLPS_JT 115.00
1 35367 35363 "1 " 0 # line from PHLPS_JT 115.00 (3) to BRKR LAWRENCE 115.00
1 35367 35366 "1 " 0 # line from PHLPS_JT 115.00 (3) to BRKR PHILLIPS 115.00
4 35366 0 "1 " 0 # LOAD-DROP PHILLIPS 115.00 LOAD==1.25(0.00)
#
1 35122 35360 "1 " 0 # line from NEWARK F 115.00 BRKR to (3) LCKHD J2 115.00
1 35360 35362 "1 " 0 # line from LCKHD J2 115.00 (3) to BRKR LOCKHD 2 115.00
1 35360 35365 "1 " 0 # line from LCKHD J2 115.00 (3) to (3) AMD JCT 115.00
1 35365 35364 "1 " 0 # line from AMD JCT 115.00 (3) to BRKR A.M.D 115.00
1 35365 35369 "1 " 0 # line from AMD JCT 115.00 (3) to BRKR APP MAT 115.00
4 35362 0 "1 " 0 # LOAD-DROP LOCKHD 2 115.00 LOAD==7.56(1.72)
4 35362 0 "2 " 0 # LOAD-DROP LOCKHD 2 115.00 LOAD==3.42(0.78)
4 35362 0 "4 " 0 # LOAD-DROP LOCKHD 2 115.00 LOAD==16.21(12.58)
4 35364 0 "1 " 0 # LOAD-DROP A.M.D 115.00 LOAD==1.67(1.17)
1 35361 35362 "1 " 1 # close LOCKHD 1 115.00 LOCKHD 2 115.00
4 35362 0 "3" 1 # restore all loads to LOCKHD 2
0
#
#
# (308) C5 DCTL OUTAGE
# Monta Vista - Burns and Monta Vista - Permanente 60 kV Lines
1 35455 35456 "1 " 0 # line from MNTA VSA 60.00 BRKR to (2) PRMNT J3 60.00
1 35456 36000 "1 " 0 # line from PRMNT J3 60.00 (2) to (2) BIG BASN 60.00
1 36000 36001 "1 " 0 # line from BIG BASN 60.00 (2) to (3) BURNS J1 60.00
1 36001 36002 "1 " 0 # line from BURNS J1 60.00 (3) to BRKR BURNS 60.00
1 36001 36003 "1 " 0 # line from BURNS J1 60.00 (3) to BRKR BURNS J2 60.00
4 36000 0 "1 " 0 # LOAD-DROP BIG BASN 60.00 LOAD==6.71(0.96)
#
1 35455 35458 "1 " 0 # line from MNTA VSA 60.00 BRKR to (2) PRMNT J1 60.00

```

APPENDIX B – CAISO CATEGORY C AUTOCON INPUT FILE

```

1 35458 35459 "1" 0 # line from PRMNT J1 60.00 (2) to (2) PRMNT J2 60.00
1 35459 35457 "1" 0 # line from PRMNT J2 60.00 (2) to BRKR PERMNTE 60.00
4 35457 0 "1" 0 # LOAD-DROP PERMNTE 60.00 LOAD==29.94(20.90)
0
#
#
# (309) BUS FAULT 30705 "MONTAVIS" Monta Vista 230 kV Bus Section 1
#
1 30705 30710 "1" 0 # LINE from MONTAVIS 230.00 to SLACTAP1 230.00
1 30705 30720 "1" 0 # LINE from MONTAVIS 230.00 to SARATOGA 230.00
1 30705 30735 "3" 0 # LINE from MONTAVIS 230.00 to METCALF 230.00
2 30705 35356 "2" 0 # TRAN from MONTAVIS 230.00 to MNTA VSA 115.00
6 30705 0 "v" 0 # SVD-DROP MONTAVIS 230.00
0
#
#
# (310) BUS FAULT 30705 "MONTAVIS" Monta Vista 230 kV Bus Section 2
#
1 30705 30712 "2" 0 # LINE from MONTAVIS 230.00 to SLACTAP2 230.00
1 30705 30730 "1" 0 # LINE from MONTAVIS 230.00 to HICKS 230.00
1 30705 30741 "4" 0 # LINE from MONTAVIS 230.00 to CAL MEC 230.00
2 30705 35356 "3" 0 # TRAN from MONTAVIS 230.00 to MNTA VSA 115.00
2 30705 35356 "4" 0 # TRAN from MONTAVIS 230.00 to MNTA VSA 115.00
2 30705 35455 "5" 0 # TRAN from MONTAVIS 230.00 to MNTA VSA 60.00
0
#
#
# (311) BUS FAULT 30720 "SARATOGA"
#
1 30720 30705 "1" 0 # LINE from SARATOGA 230.00 to MONTAVIS 230.00
1 30720 30733 "1" 0 # LINE from SARATOGA 230.00 to VASONA 230.00
4 30720 0 "1" 0 # LOAD-DROP SARATOGA 230.00 LOAD==43.58(9.93)
4 30720 0 "2" 0 # LOAD-DROP SARATOGA 230.00 LOAD==50.15(11.43)
4 30720 0 "3" 0 # LOAD-DROP SARATOGA 230.00 LOAD==40.33(9.19)
0
#
#
# (312) BUS FAULT 30733 "VASONA"
#
1 30733 30720 "1" 0 # LINE from VASONA 230.00 to SARATOGA 230.00
1 30733 30735 "1" 0 # LINE from VASONA 230.00 to METCALF 230.00
4 30733 0 "1" 0 # LOAD-DROP VASONA 230.00 LOAD==39.49(9.00)
4 30733 0 "2" 0 # LOAD-DROP VASONA 230.00 LOAD==19.54(4.45)
0
#
#
# (313) BUS FAULT 35349 "AMES DST"
#
1 35349 35121 "1" 0 # LINE from AMES DST 115.00 to NEWARK E 115.00
1 35349 35351 "1" 0 # LINE from AMES DST 115.00 to AMES BS2 115.00
4 35349 0 "1" 0 # LOAD-DROP AMES DST 115.00 LOAD==14.75(3.36)
0
#
#
# (314) BUS FAULT 35350 "AMES BS1"
#
1 35350 33315 "1" 0 # LINE from AMES BS1 115.00 to RVNSWD E 115.00
1 35350 35121 "1" 0 # LINE from AMES BS1 115.00 to NEWARK E 115.00
1 35350 35121 "3" 0 # LINE from AMES BS1 115.00 to NEWARK E 115.00
1 35350 35351 "1" 0 # LINE from AMES BS1 115.00 to AMES BS2 115.00
1 35350 35370 "1" 0 # LINE from AMES BS1 115.00 to AMES J1A 115.00
1 35350 35371 "1" 0 # LINE from AMES BS1 115.00 to AMES J1B 115.00
4 35350 0 "1" 0 # LOAD-DROP AMES BS1 115.00 LOAD==43.14(0.00)
0
#
#
# (315) BUS FAULT 35351 "AMES BS2"
#
1 35351 33315 "2" 0 # LINE from AMES BS2 115.00 to RVNSWD E 115.00
1 35351 35121 "2" 0 # LINE from AMES BS2 115.00 to NEWARK E 115.00
1 35351 35350 "1" 0 # LINE from AMES BS2 115.00 to AMES BS1 115.00
1 35351 35349 "1" 0 # LINE from AMES BS2 115.00 to AMES DST 115.00
4 35351 0 "2" 0 # LOAD-DROP AMES BS2 115.00 LOAD==43.14(0.00)
0
#
#
# (316) BUS FAULT 35352 "WHISMAN"
#
1 35352 35356 "1" 0 # LINE from WHISMAN 115.00 to MNTA VSA 115.00

```

APPENDIX B – CAISO CATEGORY C AUTOCON INPUT FILE

```

1 35352 35371 "1" 0 # LINE from WHISMAN 115.00 to AMES J1B 115.00
4 35352 0 "1 " 0 # LOAD-DROP WHISMAN 115.00 LOAD==22.33(5.09)
4 35352 0 "2 " 0 # LOAD-DROP WHISMAN 115.00 LOAD==24.02(5.47)
4 35352 0 "3 " 0 # LOAD-DROP WHISMAN 115.00 LOAD==20.34(4.63)
0
#
#
# (317) BUS FAULT 35353 "MT VIEW"
#
1 35353 35356 "1" 0 # LINE from MT VIEW 115.00 to MNTA VSA 115.00
1 35353 35370 "1" 0 # LINE from MT VIEW 115.00 to AMES J1A 115.00
4 35353 0 "1 " 0 # LOAD-DROP MT VIEW 115.00 LOAD==30.30(6.90)
4 35353 0 "2 " 0 # LOAD-DROP MT VIEW 115.00 LOAD==32.19(7.34)
4 35353 0 "3 " 0 # LOAD-DROP MT VIEW 115.00 LOAD==29.11(6.63)
0
#
#
# (318) BUS FAULT 35354 "STELLING"
#
1 35354 35355 "1" 0 # LINE from STELLING 115.00 to WOLFE 115.00
1 35354 35356 "1" 0 # LINE from STELLING 115.00 to MNTA VSA 115.00
4 35354 0 "1 " 0 # LOAD-DROP STELLING 115.00 LOAD==31.51(7.18)
4 35354 0 "2 " 0 # LOAD-DROP STELLING 115.00 LOAD==32.14(7.32)
4 35354 0 "3 " 0 # LOAD-DROP STELLING 115.00 LOAD==32.89(7.50)
0
#
#
# (319) BUS FAULT 35355 "WOLFE"
#
1 35355 35354 "1" 0 # LINE from WOLFE 115.00 to STELLING 115.00
1 35355 35356 "1" 0 # LINE from WOLFE 115.00 to MNTA VSA 115.00
4 35355 0 "1 " 0 # LOAD-DROP WOLFE 115.00 LOAD==25.27(5.76)
4 35355 0 "2 " 0 # LOAD-DROP WOLFE 115.00 LOAD==31.85(7.26)
4 35355 0 "3 " 0 # LOAD-DROP WOLFE 115.00 LOAD==16.40(3.74)
0
#
#
# (320) BUS FAULT 35356 "MNTA VSA" Monta Vista 115 kV Bus Section 1
#
1 35356 35352 "1" 0 # LINE from MNTA VSA 115.00 to WHISMAN 115.00
1 35356 35354 "1" 0 # LINE from MNTA VSA 115.00 to STELLING 115.00
1 35356 35367 "1" 0 # LINE from MNTA VSA 115.00 to PHLPS_JT 115.00
2 35356 30705 "2" 0 # TRAN from MNTA VSA 115.00 to MONTAVIS 230.00
2 35356 30705 "3" 0 # TRAN from MNTA VSA 115.00 to MONTAVIS 230.00
0
#
#
# (321) BUS FAULT 35356 "MNTA VSA" Monta Vista 115 kV Bus Section 2
#
1 35356 35353 "1" 0 # LINE from MNTA VSA 115.00 to MT VIEW 115.00
1 35356 35355 "1" 0 # LINE from MNTA VSA 115.00 to WOLFE 115.00
1 35356 35368 "1" 0 # LINE from MNTA VSA 115.00 to BRITTN 115.00
2 35356 30705 "4" 0 # TRAN from MNTA VSA 115.00 to MONTAVIS 230.00
2 35356 35455 "6" 0 # TRAN from MNTA VSA 115.00 to MNTA VSA 60.00
0
#
#
# (322) BUS FAULT 35361 "LOCKHD 1"
#
1 35361 35358 "1" 0 # LINE from LOCKHD 1 115.00 to MFT.FD J 115.00
1 35361 35362 "1" 0 # LINE from LOCKHD 1 115.00 to LOCKHD 2 115.00
4 35361 0 "3 " 0 # LOAD-DROP LOCKHD 1 115.00 LOAD==17.45(14.46)
0
#
#
# (323) BUS FAULT 35362 "LOCKHD 2"
#
1 35362 35360 "1" 0 # LINE from LOCKHD 2 115.00 to LCKHD J2 115.00
1 35362 35361 "1" 0 # LINE from LOCKHD 2 115.00 to LOCKHD 1 115.00
4 35362 0 "1 " 0 # LOAD-DROP LOCKHD 2 115.00 LOAD==7.56(1.72)
4 35362 0 "2 " 0 # LOAD-DROP LOCKHD 2 115.00 LOAD==3.42(0.78)
4 35362 0 "4 " 0 # LOAD-DROP LOCKHD 2 115.00 LOAD==16.21(12.58)
0
#
#
# (324) BUS FAULT 35363 "LAWRENCE"
#
1 35363 35357 "1" 0 # LINE from LAWRENCE 115.00 to LCKHD J1 115.00
1 35363 35367 "1" 0 # LINE from LAWRENCE 115.00 to PHLPS_JT 115.00

```

APPENDIX B – CAISO CATEGORY C AUTOCON INPUT FILE

```

4 35363      0 "1 "  0      # LOAD-DROP  LAWRENCE 115.00  LOAD==50.73(11.56)
4 35363      0 "2 "  0      # LOAD-DROP  LAWRENCE 115.00  LOAD==20.08(4.58)
4 35363      0 "3 "  0      # LOAD-DROP  LAWRENCE 115.00  LOAD==35.41(8.07)
0
#
#
# (325) BUS FAULT  35364  "A.M.D"
#
1 35364 35365 "1"  0      # LINE from  A.M.D   115.00  to  AMD JCT 115.00
4 35364      0 "1 "  0      # LOAD-DROP  A.M.D   115.00  LOAD==1.67(1.17)
0
#
#
# (326) BUS FAULT  35366  "PHILLIPS"
#
1 35366 35367 "1"  0      # LINE from  PHILLIPS 115.00  to  PHLPS_JT 115.00
4 35366      0 "1 "  0      # LOAD-DROP  PHILLIPS 115.00  LOAD==1.25(0.00)
0
#
#
# (327) BUS FAULT  35368  "BRITTN"
#
1 35368 35356 "1"  0      # LINE from  BRITTN   115.00  to  MNTA VSA 115.00
1 35368 35369 "1"  0      # LINE from  BRITTN   115.00  to  APP MAT  115.00
4 35368      0 "1 "  0      # LOAD-DROP  BRITTN   115.00  LOAD==27.96(6.37)
4 35368      0 "2 "  0      # LOAD-DROP  BRITTN   115.00  LOAD==47.94(10.93)
4 35368      0 "3 "  0      # LOAD-DROP  BRITTN   115.00  LOAD==23.61(5.38)
0
#
#
# (328) BUS FAULT  35369  "APP MAT"
#
1 35369 35368 "1"  0      # LINE from  APP MAT 115.00  to  BRITTN   115.00
1 35369 35365 "1"  0      # LINE from  APP MAT 115.00  to  AMD JCT 115.00
4 35369      0 "1 "  0      # LOAD-DROP  APP MAT 115.00  LOAD==10.11(2.53)
0
#
#
# (329) BUS FAULT  35452  "LOYOLA"
#
1 35452 35450 "1"  0      # LINE from  LOYOLA   60.00  to  LOS ALTS 60.00
1 35452 35455 "1"  0      # LINE from  LOYOLA   60.00  to  MNTA VSA 60.00
4 35452      0 "1 "  0      # LOAD-DROP  LOYOLA   60.00  LOAD==4.43(1.01)
4 35452      0 "2 "  0      # LOAD-DROP  LOYOLA   60.00  LOAD==21.57(4.92)
0
#
#
# (330) BUS FAULT  35455  "MNTA VSA" Monta Vista 60 kV Bus Section 1
#
1 35455 35452 "1"  0      # LINE from  MNTA VSA 60.00  to  LOYOLA   60.00
1 35455 35458 "1"  0      # LINE from  MNTA VSA 60.00  to  PRMNT J1 60.00
2 35455 30705 "5"  0      # TRAN from  MNTA VSA 60.00  to  MONTAVIS 230.00
0
#
#
# (331) BUS FAULT  35455  "MNTA VSA" Monta Vista 60 kV Bus Section 2
#
1 35455 35456 "1"  0      # LINE from  MNTA VSA 60.00  to  PRMNT J3 60.00
1 35455 35460 "1"  0      # LINE from  MNTA VSA 60.00  to  LOS GATS 60.00
2 35455 35356 "6"  0      # TRAN from  MNTA VSA 60.00  to  MNTA VSA 115.00
0
#
#
# (332) BUS FAULT  35457  "PERMNNTE"
#
1 35457 35458 "1"  0      # LINE from  PERMNNTE 60.00  to  PRMNT J1 60.00
1 35457 35459 "1"  0      # LINE from  PERMNNTE 60.00  to  PRMNT J2 60.00
4 35457      0 "1 "  0      # LOAD-DROP  PERMNNTE 60.00  LOAD==29.94(20.90)
0
#
#
# 2013 category c contingency list (dctl and bus outages)
# San Jose Division Zone 318
#
#
# (333) C5 DCTL OUTAGE
# Saratoga - Metcalf and Hicks - Metcalf 230 kV Lines
1 30733 30735 "1 "  0      # line from  VASONA  230.00  BRKR to BRKR  METCALF 230.00
#

```

APPENDIX B – CAISO CATEGORY C AUTOCON INPUT FILE

```

1 30735 30730 "1 " 0 # line from METCALF 230.00 BRKR to BRKR HICKS 230.00
0
#
#
# (334) C5 DCTL OUTAGE
# Newark Distribution - Los Esteros and Los Esteros - Metcalf 230 kV Lines
1 30635 30731 "1 " 0 # line from NWK DIST 230.00 BRKR to BRKR LS ESTRS 230.00
#
1 30735 30731 "1 " 0 # line from METCALF 230.00 BRKR to BRKR LS ESTRS 230.00
0
#
#
# (335) C5 DCTL OUTAGE
# Metcalf - Moss Landing #1 and #2 230 kV Lines
1 30735 30755 "1 " 0 # line from METCALF 230.00 BRKR to BRKR MOSSLND1 230.00
#
1 30735 30750 "1 " 0 # line from METCALF 230.00 BRKR to BRKR MOSSLND2 230.00
0
#
#
# (336) C5 DCTL OUTAGE
# Dixon Landing - McKee and Newark - Milpitas #1 115 kV Lines
1 35600 35629 "1 " 0 # line from DIXON LD 115.00 BRKR to (3) MABURY J 115.00
1 35629 35626 "1 " 0 # line from MABURY J 115.00 (3) to BRKR MCKEE 115.00
1 35629 35630 "1 " 0 # line from MABURY J 115.00 (3) to BRKR MABURY 115.00
4 35630 0 "2 " 0 # LOAD-DROP MABURY 115.00 LOAD==19.00(4.33)
#
1 35122 35624 "1 " 0 # line from NEWARK F 115.00 BRKR to BRKR MILPITAS 115.00
0
#
#
# (337) C5 DCTL OUTAGE
# Dixon Landing - McKee and Milpitas - Swift 115 kV Lines
1 35600 35629 "1 " 0 # line from DIXON LD 115.00 BRKR to (3) MABURY J 115.00
1 35629 35626 "1 " 0 # line from MABURY J 115.00 (3) to BRKR MCKEE 115.00
1 35629 35630 "1 " 0 # line from MABURY J 115.00 (3) to BRKR MABURY 115.00
4 35630 0 "2 " 0 # LOAD-DROP MABURY 115.00 LOAD==19.00(4.33)
#
1 35622 35624 "1 " 0 # line from SWIFT 115.00 BRKR to BRKR MILPITAS 115.00
0
#
#
# (338) C5 DCTL OUTAGE
# McKee - Piercy and Milpitas - Swift 115 kV Lines
1 35626 35656 "1 " 0 # line from MCKEE 115.00 BRKR to BRKR PIERCY 115.00
#
1 35622 35624 "1 " 0 # line from SWIFT 115.00 BRKR to BRKR MILPITAS 115.00
0
#
#
# (339) C5 DCTL OUTAGE
# Swift - Metcalf and Piercy - Metcalf 115 kV Lines
1 35622 35643 "1 " 0 # line from SWIFT 115.00 BRKR to BRKR MTCALF E 115.00
#
1 35656 35643 "1 " 0 # line from PIERCY 115.00 BRKR to BRKR MTCALF E 115.00
0
#
#
# (340) C5 DCTL OUTAGE
# Los Esteros - Trimble and Los Esteros - Montague 115 kV Lines
1 35658 35612 "1 " 0 # line from LS ESTRS 115.00 BRKR to BRKR TRIMBLE 115.00
#
1 35658 35610 "1 " 0 # line from LS ESTRS 115.00 BRKR to BRKR MONTAGUE 115.00
0
#
#
# (341) C5 DCTL OUTAGE
# Los Esteros - Trimble and Montague - Trimble 115 kV Lines
1 35658 35612 "1 " 0 # line from LS ESTRS 115.00 BRKR to BRKR TRIMBLE 115.00
#
1 35612 35610 "1 " 0 # line from TRIMBLE 115.00 BRKR to BRKR MONTAGUE 115.00
0
#
#
# (342) C5 DCTL OUTAGE
# Los Esteros - Montague and Montague - Trimble 115 kV Lines
1 35658 35610 "1 " 0 # line from LS ESTRS 115.00 BRKR to BRKR MONTAGUE 115.00
#
1 35612 35610 "1 " 0 # line from TRIMBLE 115.00 BRKR to BRKR MONTAGUE 115.00

```

APPENDIX B – CAISO CATEGORY C AUTOCON INPUT FILE

```

0
#
#
# (343) C5 DCTL OUTAGE
# Trimble - San Jose B and FMC - San Jose B 115 kV Lines
1 35612 35616 "1 " 0 # line from TRIMBLE 115.00 BRKR to BRKR SJ B E 115.00
#
1 35615 35616 "1 " 0 # line from FMC 115.00 BRKR to BRKR SJ B E 115.00
0
#
#
# (344) C5 DCTL OUTAGE
# Trimble - San Jose B and Kifer - FMC 115 kV Lines
1 35612 35616 "1 " 0 # line from TRIMBLE 115.00 BRKR to BRKR SJ B E 115.00
#
1 35615 35617 "1 " 0 # line from FMC 115.00 BRKR to (2) FMC JCT 115.00
1 35617 36850 "1 " 0 # line from FMC JCT 115.00 (2) to BRKR KRS 115.00
0
#
#
# (345) C5 DCTL OUTAGE
# Newark - Kifer and Kifer - FMC 115 kV Lines
1 35122 35602 "1 " 0 # line from NEWARK F 115.00 BRKR to (3) ZNKER J2 115.00
1 35602 35604 "1 " 0 # line from ZNKER J2 115.00 (3) to (3) ZANKER 115.00
1 35602 36850 "1 " 0 # line from ZNKER J2 115.00 (3) to BRKR KRS 115.00
2 35604 35861 "1 " 0 # TRAN from ZANKER 115.00 (3) to (2) SJ-SCL W 9.11
2 35604 35861 "2 " 0 # TRAN from ZANKER 115.00 (3) to (2) SJ-SCL W 9.11
4 35861 0 "SG" 0 # LOAD-DROP SJ-SCL W 9.11 LOAD==6.17(2.09)
3 35861 0 "1 " 0 # GEN-DROP SJ-SCL W 9.11 GEN==5.00(0.00)
#
1 35615 35617 "1 " 0 # line from FMC 115.00 BRKR to (2) FMC JCT 115.00
1 35617 36850 "1 " 0 # line from FMC JCT 115.00 (2) to BRKR KRS 115.00
0
#
#
# (346) C5 DCTL OUTAGE
# Newark - Trimle and Kifer - FMC 115 kV Lines
1 35122 35603 "1 " 0 # line from NEWARK F 115.00 BRKR to (3) ZNKER J1 115.00
1 35603 35605 "1 " 0 # line from ZNKER J1 115.00 (3) to (1) AGNEW J 115.00
1 35603 35612 "1 " 0 # line from ZNKER J1 115.00 (3) to BRKR TRIMBLE 115.00
#
1 35615 35617 "1 " 0 # line from FMC 115.00 BRKR to (2) FMC JCT 115.00
1 35617 36850 "1 " 0 # line from FMC JCT 115.00 (2) to BRKR KRS 115.00
0
#
#
# (347) C5 DCTL OUTAGE
# Metcalf - El Patio #1 and #2 115 kV Lines
1 35620 35621 "1 " 0 # line from EL PATIO 115.00 BRKR to (2) IBM-HR J 115.00
1 35621 35642 "1 " 0 # line from IBM-HR J 115.00 (2) to BRKR MTCALF D 115.00
#
1 35620 35651 "2 " 0 # line from EL PATIO 115.00 BRKR to (2) BAILY J3 115.00
1 35651 35642 "2 " 0 # line from BAILY J3 115.00 (2) to BRKR MTCALF D 115.00
0
#
#
# (348) C5 DCTL OUTAGE
# Metcalf - El Patio #1 and #2 115 kV Lines
1 35636 35643 "1 " 0 # line from EVRGRN 1 115.00 BRKR to BRKR MTCALF E 115.00
#
1 35625 35645 "1 " 0 # line from MARKHMJ2 115.00 (2) to (3) EVRGRN J 115.00
1 35625 35634 "1 " 0 # line from MARKHMJ2 115.00 (2) to (2) STONE J 115.00
1 35645 35633 "2 " 0 # line from EVRGRN J 115.00 (3) to BRKR EVRGRN 2 115.00
1 35645 35643 "2 " 0 # line from EVRGRN J 115.00 (3) to BRKR MTCALF E 115.00
1 35634 36420 "1 " 0 # line from STONE J 115.00 (2) to BRKR STONE 115.00
4 36420 0 "1 " 0 # LOAD-DROP STONE 115.00 LOAD==35.69(8.13)
4 36420 0 "2 " 0 # LOAD-DROP STONE 115.00 LOAD==14.87(3.39)
0
#
#
# (349) C5 DCTL OUTAGE
# Metcalf - Morgan Hill and Metcalf - Llagas 115 kV Lines
1 35642 35646 "1 " 0 # line from MTCALF D 115.00 BRKR to BRKR MRGN HIL 115.00
#
1 35642 35654 "1 " 0 # line from MTCALF D 115.00 BRKR to (2) MORGN J1 115.00
1 35654 35655 "1 " 0 # line from MORGN J1 115.00 (2) to (2) MORGN J2 115.00
1 35655 35648 "1 " 0 # line from MORGN J2 115.00 (2) to BRKR LLAGAS 115.00
0
#

```

APPENDIX B – CAISO CATEGORY C AUTOCON INPUT FILE

```

#
# (350) C5 DCTL OUTAGE
# Morgan Hill - Llagas and Metcalf - Llagas 115 kV Lines
1 35646 35648 "1 " 0 # line from MRGN HIL 115.00 BRKR to BRKR LLAGAS 115.00
#
1 35642 35654 "1 " 0 # line from MTCALF D 115.00 BRKR to (2) MORGN J1 115.00
1 35654 35655 "1 " 0 # line from MORGN J1 115.00 (2) to (2) MORGN J2 115.00
1 35655 35648 "1 " 0 # line from MORGN J2 115.00 (2) to BRKR LLAGAS 115.00
0
#
#
# (351) BUS FAULT 30730 "HICKS"
#
1 30730 30705 "1" 0 # LINE from HICKS 230.00 to MONTAVIS 230.00
1 30730 30735 "1" 0 # LINE from HICKS 230.00 to METCALF 230.00
4 30730 0 "1 " 0 # LOAD-DROP HICKS 230.00 LOAD==36.06(8.22)
4 30730 0 "2 " 0 # LOAD-DROP HICKS 230.00 LOAD==41.64(9.49)
4 30730 0 "3 " 0 # LOAD-DROP HICKS 230.00 LOAD==50.98(11.62)
4 30730 0 "5 " 0 # LOAD-DROP HICKS 230.00 LOAD==36.06(8.22)
0
#
#
# (352) BUS FAULT 30735 "METCALF" Metcalf 230 kV Bus Section 1D
#
1 30735 30733 "1" 0 # LINE from METCALF 230.00 to VASONA 230.00
2 30735 35642 "1" 0 # TRAN from METCALF 230.00 to MTCALF D 115.00
6 30735 0 "v " 0 # SVD-DROP METCALF 230.00
0
#
#
# (353) BUS FAULT 30735 "METCALF" Metcalf 230 kV Bus Section 2D
#
1 30735 30730 "1" 0 # LINE from METCALF 230.00 to HICKS 230.00
1 30735 30731 "1" 0 # LINE from METCALF 230.00 to LS ESTRS 230.00
2 30735 35642 "4" 0 # TRAN from METCALF 230.00 to MTCALF D 115.00
0
#
#
# (354) BUS FAULT 30735 "METCALF" Metcalf 230 kV Bus Section 1E
#
1 30735 30705 "3" 0 # LINE from METCALF 230.00 to MONTAVIS 230.00
1 30735 30755 "1" 0 # LINE from METCALF 230.00 to MOSSLND1 230.00
2 30735 35643 "3" 0 # TRAN from METCALF 230.00 to MTCALF E 115.00
0
#
#
# (355) BUS FAULT 30735 "METCALF" Metcalf 230 kV Bus Section 2E
#
1 30735 30741 "4" 0 # LINE from METCALF 230.00 to CAL MEC 230.00
1 30735 30750 "1" 0 # LINE from METCALF 230.00 to MOSSLND2 230.00
2 30735 35643 "2" 0 # TRAN from METCALF 230.00 to MTCALF E 115.00
0
#
#
# (356) BUS FAULT 35600 "DIXON LD"
#
1 35600 35122 "1" 0 # LINE from DIXON LD 115.00 to NEWARK F 115.00
1 35600 35629 "1" 0 # LINE from DIXON LD 115.00 to MABURY J 115.00
4 35600 0 "1 " 0 # LOAD-DROP DIXON LD 115.00 LOAD==28.68(6.54)
4 35600 0 "2 " 0 # LOAD-DROP DIXON LD 115.00 LOAD==19.33(4.40)
4 35600 0 "3 " 0 # LOAD-DROP DIXON LD 115.00 LOAD==15.35(3.50)
0
#
#
# (357) BUS FAULT 35606 "AGNEW"
#
1 35606 35605 "1" 0 # LINE from AGNEW 115.00 to AGNEW J 115.00
1 35606 35658 "1" 0 # LINE from AGNEW 115.00 to LS ESTRS 115.00
2 35606 35860 "1" 0 # TRAN from AGNEW 115.00 to OLS-AGNE 9.11
4 35606 0 "1 " 0 # LOAD-DROP AGNEW 115.00 LOAD==31.91(7.27)
4 35606 0 "2 " 0 # LOAD-DROP AGNEW 115.00 LOAD==42.41(9.66)
0
#
#
# (358) BUS FAULT 35610 "MONTAGUE"
#
1 35610 35612 "1" 0 # LINE from MONTAGUE 115.00 to TRIMBLE 115.00
1 35610 35658 "1" 0 # LINE from MONTAGUE 115.00 to LS ESTRS 115.00
4 35610 0 "1 " 0 # LOAD-DROP MONTAGUE 115.00 LOAD==37.77(8.61)

```

APPENDIX B – CAISO CATEGORY C AUTOCON INPUT FILE

```

4 35610      0 "2 "      0      # LOAD-DROP      MONTAGUE 115.00  LOAD==42.11(9.60)
4 35610      0 "3 "      0      # LOAD-DROP      MONTAGUE 115.00  LOAD==34.14(7.78)
0
#
#
# (359) BUS FAULT 35612 "TRIMBLE" Trimble 115 kV Bus Section D
#
1 35612 35610 "1"      0      # LINE from TRIMBLE 115.00 to MONTAGUE 115.00
1 35612 35658 "1"      0      # LINE from TRIMBLE 115.00 to LS ESTRS 115.00
4 35612      0 "1 "      0      # LOAD-DROP      TRIMBLE 115.00  LOAD==29.68(6.77)
0
#
#
# (360) BUS FAULT 35612 "TRIMBLE" Trimble 115 kV Bus Section E
#
1 35612 35616 "1"      0      # LINE from TRIMBLE 115.00 to SJ B E 115.00
4 35612      0 "2 "      0      # LOAD-DROP      TRIMBLE 115.00  LOAD==33.72(7.68)
0
#
#
# (361) BUS FAULT 35612 "TRIMBLE" Trimble 115 kV Bus Section F
#
1 35612 35603 "1"      0      # LINE from TRIMBLE 115.00 to ZNKER J1 115.00
4 35612      0 "3 "      0      # LOAD-DROP      TRIMBLE 115.00  LOAD==43.92(10.01)
4 35612      0 "5 "      0      # LOAD-DROP      TRIMBLE 115.00  LOAD==35.64(8.12)
0
#
#
# (362) BUS FAULT 35615 "FMC"
#
1 35615 35616 "1"      0      # LINE from FMC 115.00 to SJ B E 115.00
1 35615 35617 "1"      0      # LINE from FMC 115.00 to FMC JCT 115.00
4 35615      0 "1 "      0      # LOAD-DROP      FMC 115.00  LOAD==21.65(4.93)
4 35615      0 "3 "      0      # LOAD-DROP      FMC 115.00  LOAD==28.54(6.51)
0
#
#
# (363) BUS FAULT 35616 "SJ B E" San Jose B 115 kV Bus Section E
#
1 35616 35612 "1"      0      # LINE from SJ B E 115.00 to TRIMBLE 115.00
1 35616 35615 "1"      0      # LINE from SJ B E 115.00 to FMC 115.00
1 35616 35619 "1"      0      # LINE from SJ B E 115.00 to SJ B F 115.00
4 35616      0 "1 "      0      # LOAD-DROP      SJ B E 115.00  LOAD==45.43(10.35)
4 35616      0 "4 "      0      # LOAD-DROP      SJ B E 115.00  LOAD==40.44(9.21)
0
#
#
# (364) BUS FAULT 35618 "SN JSE A"
#
1 35618 35613 "1"      0      # LINE from SN JSE A 115.00 to ELPT_SJ1 115.00
1 35618 35619 "1"      0      # LINE from SN JSE A 115.00 to SJ B F 115.00
4 35618      0 "1 "      0      # LOAD-DROP      SN JSE A 115.00  LOAD==8.60(1.96)
4 35618      0 "2 "      0      # LOAD-DROP      SN JSE A 115.00  LOAD==9.00(2.05)
4 35618      0 "3 "      0      # LOAD-DROP      SN JSE A 115.00  LOAD==39.97(9.10)
0
#
#
# (365) BUS FAULT 35619 "SJ B F" San Jose B 115 kV Bus Section F
#
1 35619 35616 "1"      0      # LINE from SJ B F 115.00 to SJ B E 115.00
1 35619 35618 "1"      0      # LINE from SJ B F 115.00 to SN JSE A 115.00
1 35619 35631 "1"      0      # LINE from SJ B F 115.00 to MARKHM J 115.00
4 35619      0 "2 "      0      # LOAD-DROP      SJ B F 115.00  LOAD==43.89(10.00)
4 35619      0 "3 "      0      # LOAD-DROP      SJ B F 115.00  LOAD==45.67(10.41)
0
#
#
# (366) BUS FAULT 35620 "EL PATIO"
#
1 35620 35614 "1"      0      # LINE from EL PATIO 115.00 to ELPT_SJ2 115.00
1 35620 35621 "1"      0      # LINE from EL PATIO 115.00 to IBM-HR J 115.00
1 35620 35651 "2"      0      # LINE from EL PATIO 115.00 to BAILY J3 115.00
4 35620      0 "1 "      0      # LOAD-DROP      EL PATIO 115.00  LOAD==45.08(10.28)
4 35620      0 "2 "      0      # LOAD-DROP      EL PATIO 115.00  LOAD==41.19(9.39)
4 35620      0 "3 "      0      # LOAD-DROP      EL PATIO 115.00  LOAD==41.00(9.34)
0
#
#
# (367) BUS FAULT 35622 "SWIFT"

```

APPENDIX B – CAISO CATEGORY C AUTOCON INPUT FILE

```

#
1 35622 35624 "1" 0 # LINE from SWIFT 115.00 to MILPITAS 115.00
1 35622 35643 "1" 0 # LINE from SWIFT 115.00 to MTCALF E 115.00
4 35622 0 "1 " 0 # LOAD-DROP SWIFT 115.00 LOAD==32.49(7.41)
4 35622 0 "2 " 0 # LOAD-DROP SWIFT 115.00 LOAD==32.21(7.34)
4 35622 0 "3 " 0 # LOAD-DROP SWIFT 115.00 LOAD==43.51(9.91)
0
#
#
# (368) BUS FAULT 35624 "MILPITAS" Milpitas 115 kV Bus Section E
#
1 35624 35122 "1" 0 # LINE from MILPITAS 115.00 to NEWARK F 115.00
4 35624 0 "3 " 0 # LOAD-DROP MILPITAS 115.00 LOAD==19.80(4.51)
4 35624 0 "6 " 0 # LOAD-DROP MILPITAS 115.00 LOAD==38.57(8.79)
0
#
#
# (369) BUS FAULT 35624 "MILPITAS" Milpitas 115 kV Bus Section F
#
1 35624 35122 "2" 0 # LINE from MILPITAS 115.00 to NEWARK F 115.00
1 35624 35622 "1" 0 # LINE from MILPITAS 115.00 to SWIFT 115.00
4 35624 0 "1 " 0 # LOAD-DROP MILPITAS 115.00 LOAD==42.72(9.74)
4 35624 0 "2 " 0 # LOAD-DROP MILPITAS 115.00 LOAD==35.14(8.01)
0
#
#
# (370) BUS FAULT 35626 "MCKEE"
#
1 35626 35629 "1" 0 # LINE from MCKEE 115.00 to MABURY J 115.00
1 35626 35656 "1" 0 # LINE from MCKEE 115.00 to PIERCY 115.00
4 35626 0 "1 " 0 # LOAD-DROP MCKEE 115.00 LOAD==39.23(8.94)
4 35626 0 "2 " 0 # LOAD-DROP MCKEE 115.00 LOAD==24.48(5.57)
4 35626 0 "3 " 0 # LOAD-DROP MCKEE 115.00 LOAD==35.43(8.08)
0
#
#
# (371) BUS FAULT 35630 "MABURY"
#
1 35630 35629 "1" 0 # LINE from MABURY 115.00 to MABURY J 115.00
4 35630 0 "2 " 0 # LOAD-DROP MABURY 115.00 LOAD==19.00(4.33)
0
#
#
# (372) BUS FAULT 35633 "EVRGRN 2"
#
1 35633 35636 "1" 0 # LINE from EVRGRN 2 115.00 to EVRGRN 1 115.00
1 35633 35645 "2" 0 # LINE from EVRGRN 2 115.00 to EVRGRN J 115.00
2 35633 35753 "1" 0 # TRAN from EVRGRN 2 115.00 to EVERGREN 60.00
0
#
#
# (373) BUS FAULT 35636 "EVRGRN 1"
#
1 35636 35631 "1" 0 # LINE from EVRGRN 1 115.00 to MARKHM J 115.00
1 35636 35633 "1" 0 # LINE from EVRGRN 1 115.00 to EVRGRN 2 115.00
1 35636 35643 "1" 0 # LINE from EVRGRN 1 115.00 to MTCALF E 115.00
4 35636 0 "2 " 0 # LOAD-DROP EVRGRN 1 115.00 LOAD==48.55(11.07)
4 35636 0 "3 " 0 # LOAD-DROP EVRGRN 1 115.00 LOAD==16.81(3.83)
0
#
#
# (374) BUS FAULT 35639 "IBM-HRRS"
#
1 35639 35621 "1" 0 # LINE from IBM-HRRS 115.00 to IBM-HR J 115.00
1 35639 35641 "1" 0 # LINE from IBM-HRRS 115.00 to EDNVL J1 115.00
4 35639 0 "1 " 0 # LOAD-DROP IBM-HRRS 115.00 LOAD==2.43(1.63)
4 35639 0 "2 " 0 # LOAD-DROP IBM-HRRS 115.00 LOAD==2.43(1.63)
0
#
#
# (375) BUS FAULT 35640 "IBM-BALY"
#
1 35640 35652 "1" 0 # LINE from IBM-BALY 115.00 to BAILY J1 115.00
4 35640 0 "1 " 0 # LOAD-DROP IBM-BALY 115.00 LOAD==5.63(3.04)
0
#
#
# (376) BUS FAULT 35642 "MTCALF D" Metcalf 115 kV Bus Section 1D
#

```

APPENDIX B – CAISO CATEGORY C AUTOCON INPUT FILE

```

1 35642 35641 "1" 0 # LINE from MTCALF D 115.00 to EDNVL J1 115.00
1 35642 35621 "1" 0 # LINE from MTCALF D 115.00 to IBM-HR J 115.00
1 35642 35654 "1" 0 # LINE from MTCALF D 115.00 to MORGN J1 115.00
0
#
#
# (377) BUS FAULT 35642 "MTCALF D" Metcalf 115 kV Bus Section 2D
#
1 35642 35651 "2" 0 # LINE from MTCALF D 115.00 to BAILY J3 115.00
1 35642 35653 "1" 0 # LINE from MTCALF D 115.00 to BAILY J2 115.00
1 35642 35646 "1" 0 # LINE from MTCALF D 115.00 to MRGN HIL 115.00
0
#
#
# (378) BUS FAULT 35643 "MTCALF E" Metcalf 115 kV Bus Section 1E
#
1 35643 35645 "2" 0 # LINE from MTCALF E 115.00 to EVRGRN J 115.00
1 35643 35656 "1" 0 # LINE from MTCALF E 115.00 to PIERCY 115.00
0
#
#
# (379) BUS FAULT 35643 "MTCALF E" Metcalf 115 kV Bus Section 2E
#
1 35643 35622 "1" 0 # LINE from MTCALF E 115.00 to SWIFT 115.00
1 35643 35636 "1" 0 # LINE from MTCALF E 115.00 to EVRGRN 1 115.00
1 35643 35644 "1" 0 # LINE from MTCALF E 115.00 to CYTE PMP 115.00
0
#
#
# (380) BUS FAULT 35644 "CYTE PMP"
#
1 35644 35643 "1" 0 # LINE from CYTE PMP 115.00 to MTCALF E 115.00
4 35644 0 "1" 0 # LOAD-DROP CYTE PMP 115.00 LOAD==4.90(1.12)
0
#
#
# (381) BUS FAULT 35646 "MRGN HIL"
#
1 35646 35642 "1" 0 # LINE from MRGN HIL 115.00 to MTCALF D 115.00
1 35646 35648 "1" 0 # LINE from MRGN HIL 115.00 to LLAGAS 115.00
4 35646 0 "1" 0 # LOAD-DROP MRGN HIL 115.00 LOAD==26.52(6.04)
4 35646 0 "2" 0 # LOAD-DROP MRGN HIL 115.00 LOAD==22.86(5.21)
4 35646 0 "3" 0 # LOAD-DROP MRGN HIL 115.00 LOAD==44.34(10.10)
0
#
#
# (382) BUS FAULT 35647 "GILROY"
#
1 35647 35660 "1" 0 # LINE from GILROY 115.00 to GILROYTP 115.00
2 35647 35850 "1" 0 # TRAN from GILROY 115.00 to GLRY COG 13.80
0
#
#
# (383) BUS FAULT 35648 "LLAGAS"
#
1 35648 35646 "1" 0 # LINE from LLAGAS 115.00 to MRGN HIL 115.00
1 35648 35655 "1" 0 # LINE from LLAGAS 115.00 to MORGN J2 115.00
1 35648 35660 "1" 0 # LINE from LLAGAS 115.00 to GILROYTP 115.00
4 35648 0 "1" 0 # LOAD-DROP LLAGAS 115.00 LOAD==30.40(6.92)
4 35648 0 "2" 0 # LOAD-DROP LLAGAS 115.00 LOAD==24.51(5.58)
4 35648 0 "3" 0 # LOAD-DROP LLAGAS 115.00 LOAD==31.19(7.11)
0
#
#
# (384) BUS FAULT 35656 "PIERCY"
#
1 35656 35626 "1" 0 # LINE from PIERCY 115.00 to MCKEE 115.00
1 35656 35643 "1" 0 # LINE from PIERCY 115.00 to MTCALF E 115.00
4 35656 0 "3" 0 # LOAD-DROP PIERCY 115.00 LOAD==35.37(8.06)
0
#
#
# (385) BUS FAULT 35659 "NORTECH"
#
1 35659 35658 "1" 0 # LINE from NORTECH 115.00 to LS ESTRS 115.00
1 35659 35666 "1" 0 # LINE from NORTECH 115.00 to LECEFTAP 115.00
1 35659 36853 "1" 0 # LINE from NORTECH 115.00 to NRS 300 115.00
4 35659 0 "3" 0 # LOAD-DROP NORTECH 115.00 LOAD==15.25(3.48)
0

```

APPENDIX B – CAISO CATEGORY C AUTOCON INPUT FILE

```

#
#
# (386) BUS FAULT 35750 "MABURY"
#
1 35630 35629 "1" 0 # LINE from MABURY 115.00 to MABURY J 115.00
1 35630 35752 "1" 0 # LINE from MABURY 115.00 to JENING J 115.00
4 35630 0 "1 " 0 # LOAD-DROP MABURY 115.00 LOAD==17.10(3.90)
4 35630 0 "2 " 0 # LOAD-DROP MABURY 115.00 LOAD==19.00(4.33)
0
#
#
# (387) BUS FAULT 35751 "JENNINGS"
#
1 35751 35752 "1" 0 # LINE from JENNINGS 115.00 to JENING J 115.00
4 35751 0 "1 " 0 # LOAD-DROP JENNINGS 115.00 LOAD==0.71(0.77)
0
#
#
# (388) BUS FAULT 35753 "EVERGREN"
#
1 35753 35756 "1" 0 # LINE from EVERGREN 60.00 to SENTER J 60.00
2 35753 35633 "1" 0 # TRAN from EVERGREN 60.00 to EVRGRN 2 115.00
0
#
#
# (389) BUS FAULT 35755 "SENER"
#
1 35755 35756 "1" 0 # LINE from SENTER 60.00 to SENTER J 60.00
0
#
#
# (390) BUS FAULT 35757 "ALMADEN"
#
1 35757 35756 "1" 0 # LINE from ALMADEN 60.00 to SENTER J 60.00
1 35757 35460 "1" 0 # LINE from ALMADEN 60.00 to LOS GATS 60.00
4 35757 0 "1 " 0 # LOAD-DROP ALMADEN 60.00 LOAD==18.96(4.32)
0
#
#
# (391) BUS FAULT 36420 "STONE"
#
1 36420 35632 "1" 0 # LINE from STONE 115.00 to MARKHAM 115.00
1 36420 35634 "1" 0 # LINE from STONE 115.00 to STONE J 115.00
4 36420 0 "1 " 0 # LOAD-DROP STONE 115.00 LOAD==35.69(8.13)
4 36420 0 "2 " 0 # LOAD-DROP STONE 115.00 LOAD==14.87(3.39)
0
#
#
-1
# EOF

```

Appendix C			
Table 1: Transition Cluster Deliverability Study Results-- Greater Bay Area (Summer Peak)			
Overloaded Facility	Worst Contingency	Catg	Mitigation
30523 CC SUB 230.00 kV to 30525 C.COSTA 230.00 kV CCT 1	Trip the Line From: 30478 LAMBIE 230.0 kV To: 30479 BDLSWSTA 230.0 kV Ckt 1 Trip the Line From: 30472 PEABODY 230.0 kV To: 30479 BDLSWSTA 230.0 kV Ckt 1	C	SPS
30521 T258 230.00 kV to 30523 CC SUB 230.00 kV CCT 1	N/A	A	Reconductor this line This is a gen-tie
30518 T320 230.00 kV to 30525 C.COSTA 230.00 kV CCT 1	N/A	A	Reconductor this line This is a gen-tie
30525 C.COSTA 230.00 kV to 30575 WND MSTR 230.00 kV CCT 1	Trip the Line From: 30525 C.COSTA 230.0 kV To: 30585 LS PSTAS 230.0 kV Ckt 1 Trip the Line From: 30525 C.COSTA 230.0 kV To: 30567 LONETREE 230.0 kV Ckt 1	C	Reconductor this line
30575 WND MSTR 230.00 kV to 38610 DELTAPMP 230.00 kV CCT 1	Trip the Line From: 30525 C.COSTA 230.0 kV To: 30585 LS PSTAS 230.0 kV Ckt 1 Trip the Line From: 30525 C.COSTA 230.0 kV To: 30567 LONETREE 230.0 kV Ckt 1	C	Reconductor this line
30570 USWP-RLF 230.00 kV to 30625 TESLA D 230.00 kV CCT 1	Trip the Line From: 30525 C.COSTA 230.0 kV To: 30585 LS PSTAS 230.0 kV Ckt 1 Trip the Line From: 30525 C.COSTA 230.0 kV To: 30567 LONETREE 230.0 kV Ckt 1	C	Reconductor this line
30585 LS PSTAS 230.00 kV to 30630 NEWARK D 230.00 kV CCT 1	Trip the Line From: 30525 C.COSTA 230.0 kV To: 30565 BRENTWOD 230.0 kV Ckt 1 Trip the Line From: 30525 C.COSTA 230.0 kV To: 30575 WND MSTR 230.0 kV Ckt 1 Trip the Line From: 30575 WND MSTR 230.0 kV To: 38610 DELTAPMP 230.0 kV Ckt 1 Trip the Bank From: 30575 WND MSTR 230.0 kV To: 33170 WINDMSTR 9.1 kV Ckt 1	C	Reconductor this line
Table 2: Transition Cluster Deliverability Study Results-- Greater Bay Area (Summer Off-Peak)			
31231 T250TAP1 115 kV to 31950 CORTINA 115 kV CCT1	Normal	A	Reconductor this line
	line from SILVRDJ2 115.00 (3) to (1) SILVERDO 115.00 line from SILVRDJ2 115.00 (3) to (3) ER_FTNJT 115.00 line from SILVRDJ2 115.00 BRKR to BRKR STELHJ2 115.00 line from ER_FTNJT 115.00 (3) to (2) ERFT5_25 115.00 line from ER_FTNJT 115.00 (3) to (3) RINCONJ2 115.00 line from ERFT5_25 115.00 (2) to BRKR EGLE RCK 115.00 line from RINCONJ2 115.00 (3) to BRKR FULTON 115.00 line from RINCONJ2 115.00 (3) to (1) RINCON 115.00 LOAD-DROP SILVERDO 115.00 LOAD==21.67(3.09) LOAD-DROP SILVERDO 115.00 LOAD==27.99(3.99) LOAD-DROP RINCON 115.00 LOAD==19.57(2.79) LOAD-DROP RINCON 115.00 LOAD==17.92(2.55) close Line from RINCONJ1 115.00 to RINCON 115.00 restore all loads to RINCON 115.00 (Eagle Rock-Fulton-Silverado 115 kV close Line from SILVRDJ1 115.00 to SILVERDO 115.00 restore all loads to SILVERDO 115.00 (Eagle Rock-Fulton-Silverado 115 kV	B	

Appendix D

Steady State Power Flow Plots

APPENDIX D-STEADY STATE POWER FLOW PLOTS

PG&E TCP2 Greater Bay Area Cluster Power Flow Plots

Plot	Description
Plot #1	2013 Summer Peak Pre-Project: Normal Conditions (MW/MVAr)
Plot #2	2013 Summer Peak Pre-Project: Normal Conditions (Amps/% Rate)
Plot #3	2013 Summer Peak Post-Project: Normal Conditions (MW/MVAr)
Plot #4	2013 Summer Peak Post-Project: Normal Conditions (Amps/% Rate)
Plot #5	2013 Summer Off Peak Pre-Project: Normal Conditions (MW/MVAr)
Plot #6	2013 Summer Off Peak Pre-Project: Normal Conditions (Amps/% Rate)
Plot #7	2013 Summer Off Peak Post-Project: Normal Conditions (MW/MVAr)
Plot #8	2013 Summer Off Peak Post-Project: Normal Conditions (Amps/% Rate)
Plot #9	2013 Summer Peak Pre-Project : Contra Costa-Las Positas 230 kV Line and RCEC STG1 Outage (MW/MVAr)
Plot #10	2013 Summer Peak Pre-Project: Contra Costa-Las Positas 230 kV Line and RCEC STG1 Outage (Amps/% Rate)
Plot #11	2013 Summer Peak Post-Project : Contra Costa-Las Positas 230 kV Line and RCEC STG1 Outage (MW/MVAr)
Plot #12	2013 Summer Peak Post-Project: Contra Costa-Las Positas 230 kV Line and RCEC STG1 Outage (Amps/% Rate)
Plot #13	2013 Summer Peak Pre-Project : Contra Costa-Lonetree 230 kV Line Outage (MW/MVAr)
Plot #14	2013 Summer Peak Pre-Project: Contra Costa-Lonetree 230 kV Line Outage (Amps/% Rate)
Plot #15	2013 Summer Peak Post-Project : Contra Costa-Lonetree 230 kV Line Outage (MW/MVAr)
Plot #16	2013 Summer Peak Post-Project: Contra Costa-Lonetree 230 kV Line Outage (Amps/% Rate)
Plot #17	2013 Summer Peak Pre-Project : Birds Landing-Contra Costa 230 kV Line & Gateway PP Outage (MW/MVAr)
Plot #18	2013 Summer Peak Pre-Project: Birds Landing-Contra Costa 230 kV Line & Gateway PP Outage (Amps/% Rate)
Plot #19	2013 Summer Peak Post-Project : Birds Landing-Contra Costa 230 kV Line & Gateway PP Outage (MW/MVAr)
Plot #20	2013 Summer Peak Post-Project: Birds Landing-Contra Costa 230 kV Line & Gateway PP Outage (Amps/% Rate)
Plot #21	2013 Summer Peak Pre-Project : Kelso-Tesla 230 kV Line Outage (MW/MVAr)
Plot #22	2013 Summer Peak Pre-Project: Kelso-Tesla 230 kV Line Outage (Amps/% Rate)
Plot #23	2013 Summer Peak Post-Project : Kelso-Tesla 230 kV Line Outage (MW/MVAr)
Plot #24	2013 Summer Peak Post-Project: Kelso-Tesla 230 kV Line Outage (Amps/% Rate)
Plot #25	2013 Summer Off Peak Pre-Project : Kelso-Tesla 230 kV Line Outage (MW/MVAr)
Plot #26	2013 Summer Off Peak Pre-Project: Kelso-Tesla 230 kV Line Outage (Amps/% Rate)
Plot #27	2013 Summer Off Peak Post-Project : Kelso-Tesla 230 kV Line Outage (MW/MVAr)
Plot #28	2013 Summer Off Peak Post-Project: Kelso-Tesla 230 kV Line Outage (Amps/% Rate)
Plot #29	2013 Summer Peak Pre-Project : Contra Costa-Delta Pumps 230 kV Line Outage (MW/MVAr)
Plot #30	2013 Summer Peak Pre-Project: Contra Costa-Delta Pumps 230 kV Line Outage (Amps/% Rate)
Plot #31	2013 Summer Peak Post-Project : Contra Costa-Delta Pumps 230 kV Line Outage (MW/MVAr)

APPENDIX D-STEADY STATE POWER FLOW PLOTS

Plot	Description
Plot #32	2013 Summer Peak Post-Project: Contra Costa-Delta Pumps 230 kV Line Outage (Amps/% Rate)
Plot #33	2013 Summer Off Peak Pre-Project : Contra Costa-Delta Pumps 230 kV Line Outage (MW/MVAr)
Plot #34	2013 Summer Off Peak Pre-Project: Contra Costa-Delta Pumps 230 kV Line Outage (Amps/% Rate)
Plot #35	2013 Summer Off Peak Post-Project : Contra Costa-Delta Pumps 230 kV Line Outage (MW/MVAr)
Plot #36	2013 Summer Off Peak Post-Project: Contra Costa-Delta Pumps 230 kV Line Outage (Amps/% Rate)

APPENDIX D - STEADY STATE POWER FLOW PLOTS

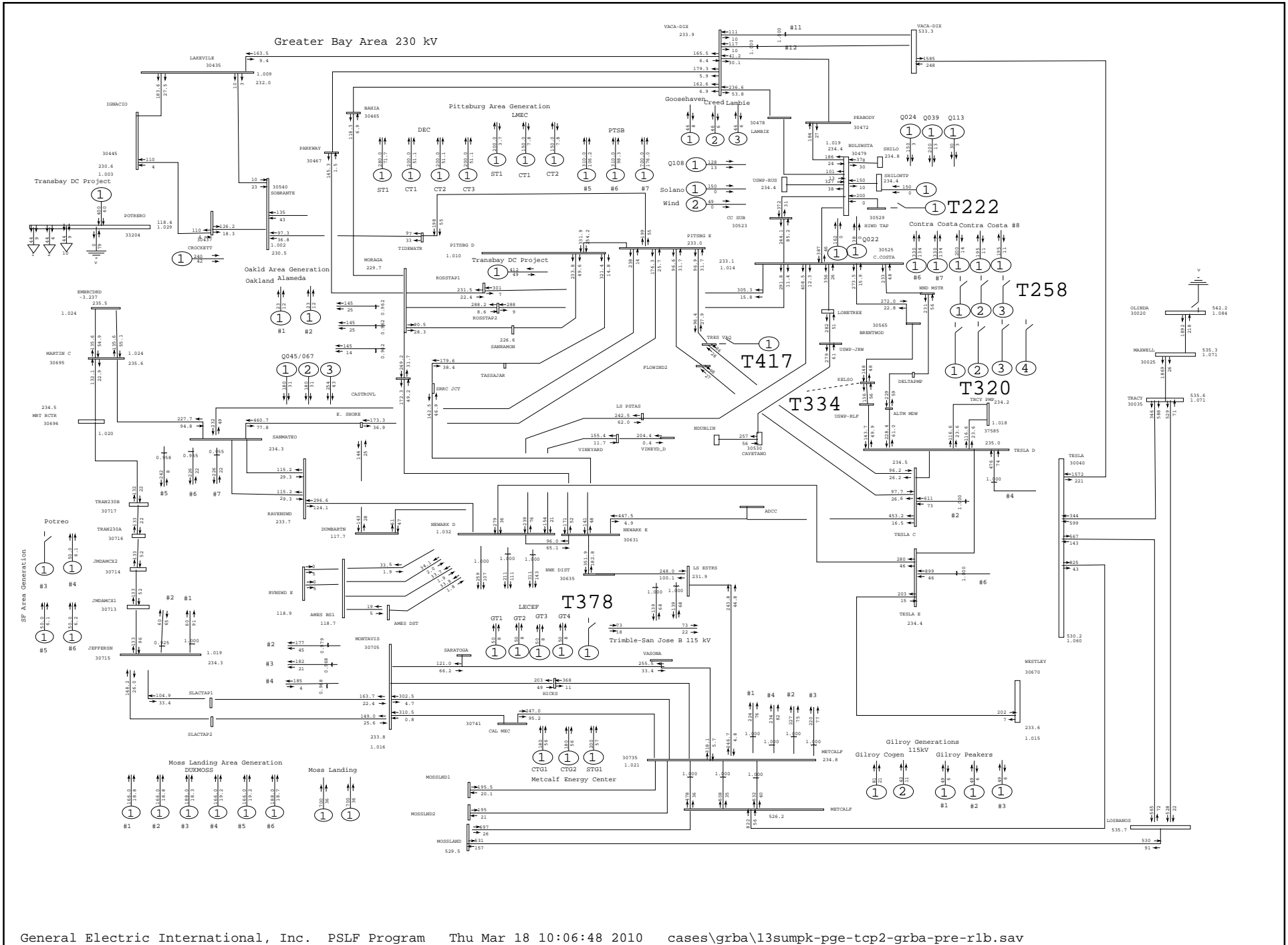

General Electric International, Inc. PSLF Program Thu Mar 18 10:06:48 2010 cases\grba\13sumpk-pge-tcp2-grba-pre-r1b.sav

 <p>PG&E 2008 CASE SERIES: 2013 Greater Bay Area Summer Peak Case (1-in-10 load) PATH15= -777 MW(S-N) PATH26= 3939 MW(N-S) PDCI= 3097 MW(N-S) COI= 4749 MW(N-S) PG&E TCP2 Greater Bay Area Summer Peak Transition Cluster Pre-Project Case</p>	<p>Plot 001: Normal Conditions</p>	<p>MW/MVAR draw\grba\pge-tcp2-grba- Rating = 1</p>
--------------------------------------------------------------------------------------------------------------------------------------------------------------------------------------------------------------------------------------------------------------------------------------------------------------------------------------------------------------------	------------------------------------	------------------------------------------------------------------------------

APPENDIX D - STEADY STATE POWER FLOW PLOTS

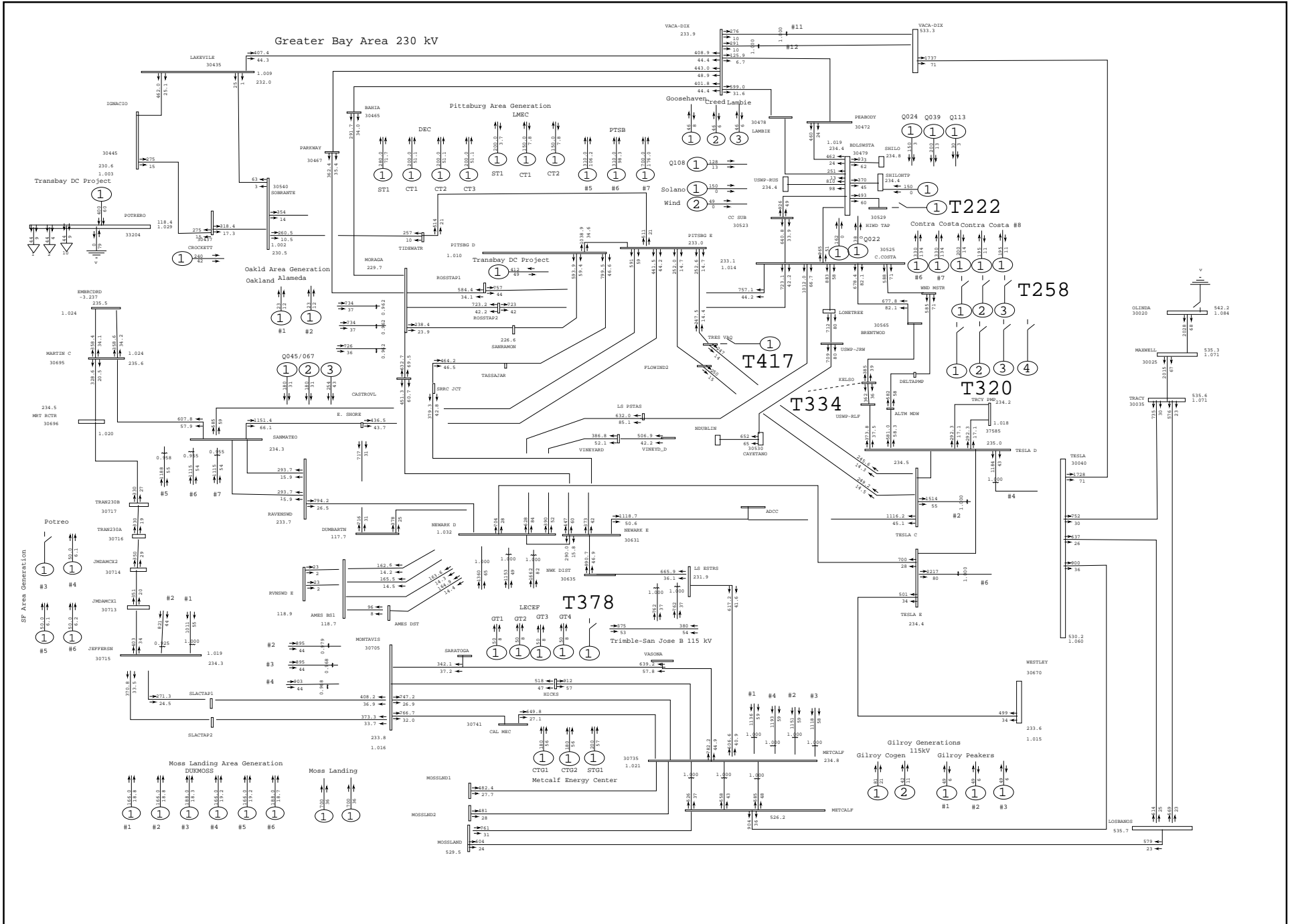

General Electric International, Inc. PSLF Program Thu Mar 18 10:06:48 2010 cases\grba\13sumpk-pge-tcp2-grba-pre-r1b.sav

 <p>PG&E 2008 CASE SERIES: 2013 Greater Bay Area Summer Peak Case (1-in-10 load) PATH15= -777 MW(S-N) PATH26= 3939 MW(N-S) PDCI= 3097 MW(N-S) COI= 4749 MW(N-S) PG&E TCP2 Greater Bay Area Summer Peak Transition Cluster Pre-Project Case</p>	<p>Plot 002: Normal Conditions</p>	<p>amps/rate draw\grba\pge-tcp2-grba- Rating = 1</p>
--------------------------------------------------------------------------------------------------------------------------------------------------------------------------------------------------------------------------------------------------------------------------------------------------------------------------------------------------------------------	------------------------------------	--------------------------------------------------------------------------------

APPENDIX D - STEADY STATE POWER FLOW PLOTS

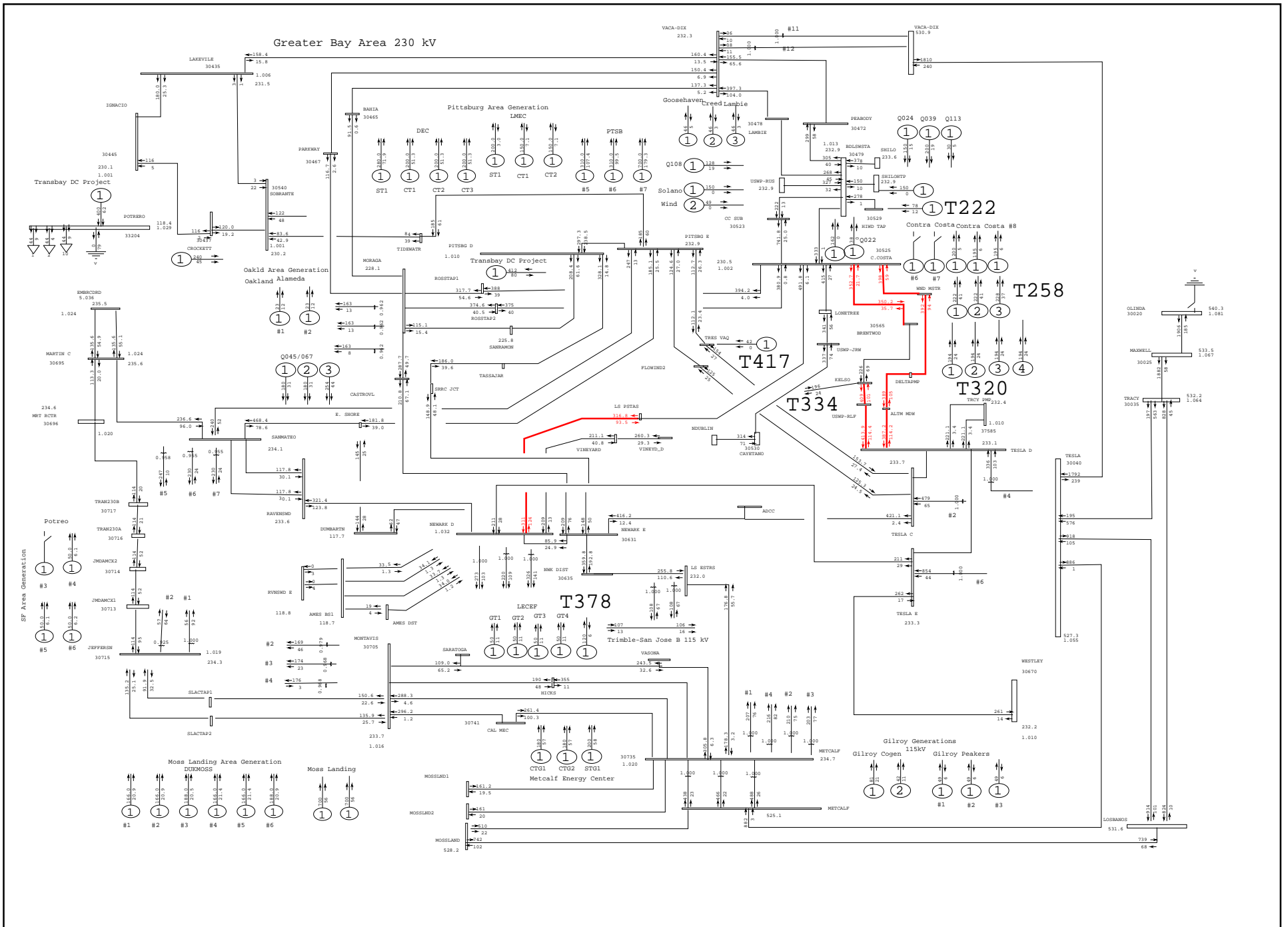

General Electric International, Inc. PSLF Program Thu Mar 18 10:06:49 2010 cases\grba\13sumpk-pge-tcp2-grba-pst-r1b.sav

	PG&E 2008 CASE SERIES: 2013 Greater Bay Area Summer Peak Case (1-in-10 load)
	PATH15=-1850 MW(N-S) PATH26= 3860 MW(N-S) PDCI= 3093 MW(N-S) COI= 4670 MW(N-S)
	PG&E TCP2 Greater Bay Area Summer Peak Transition Cluster Post-Project Case

Plot 003: Normal Conditions

MW/MVAR
 draw\grba\pge-tcp2-grba-
 Rating = 1

APPENDIX D - STEADY STATE POWER FLOW PLOTS

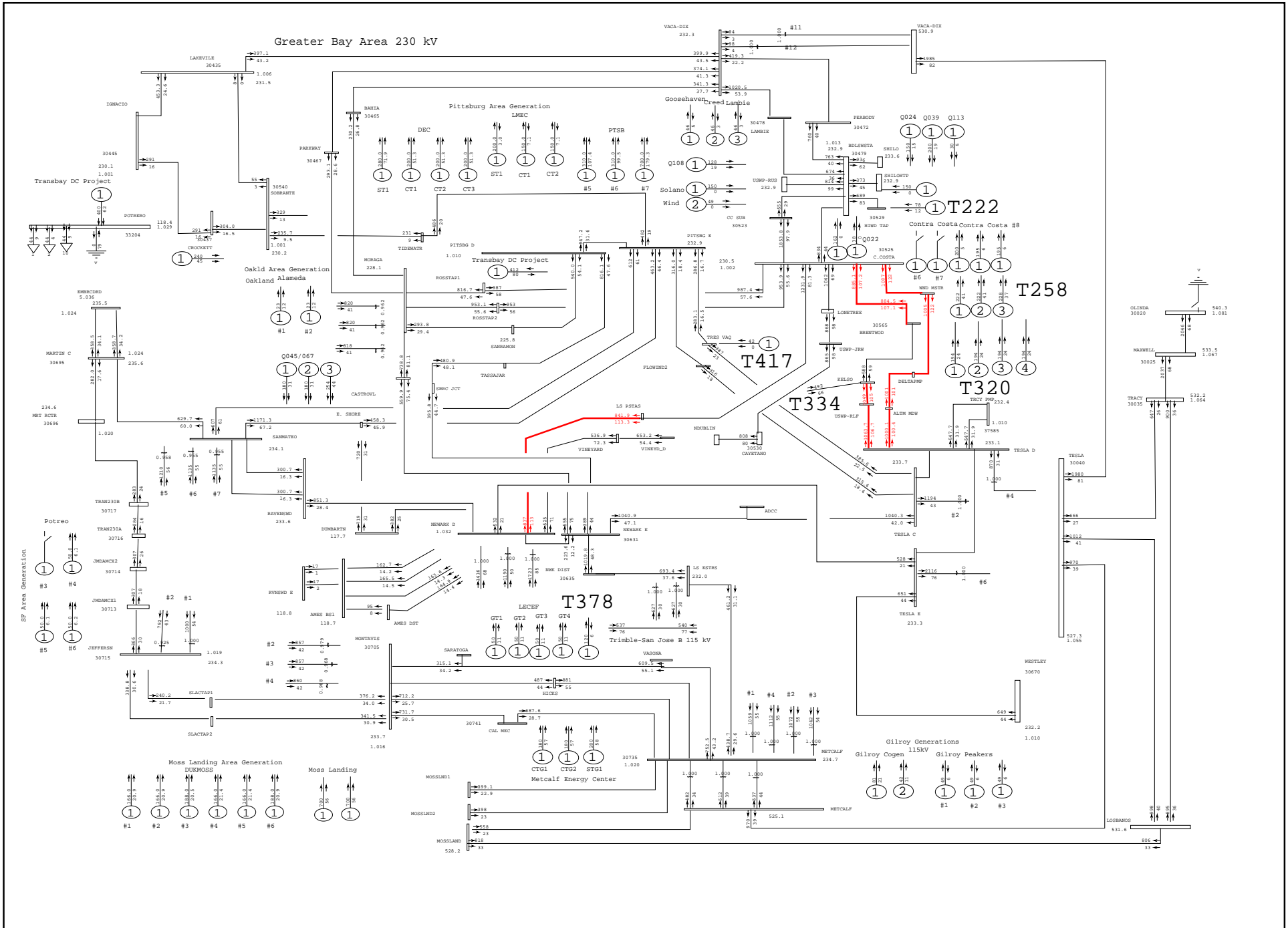

General Electric International, Inc. PSLF Program Thu Mar 18 10:06:49 2010 cases\grba\13sumpk-pge-tcp2-grba-pst-r1b.sav

 <p>PG&E 2008 CASE SERIES: 2013 Greater Bay Area Summer Peak Case (1-in-10 load) PATH15=-1850 MW(N-S) PATH26= 3860 MW(N-S) PDCI= 3093 MW(N-S) COI= 4670 MW(N-S) PG&E TCP2 Greater Bay Area Summer Peak Transition Cluster Post-Project Case</p>	<p>Plot 004: Normal Conditions</p>	<p>amps/rate draw\grba\pge-tcp2-grba- Rating = 1</p>
---------------------------------------------------------------------------------------------------------------------------------------------------------------------------------------------------------------------------------------------------------------------------------------------------------------------------------------------------------------------	------------------------------------	--------------------------------------------------------------------------------

APPENDIX D - STEADY STATE POWER FLOW PLOTS

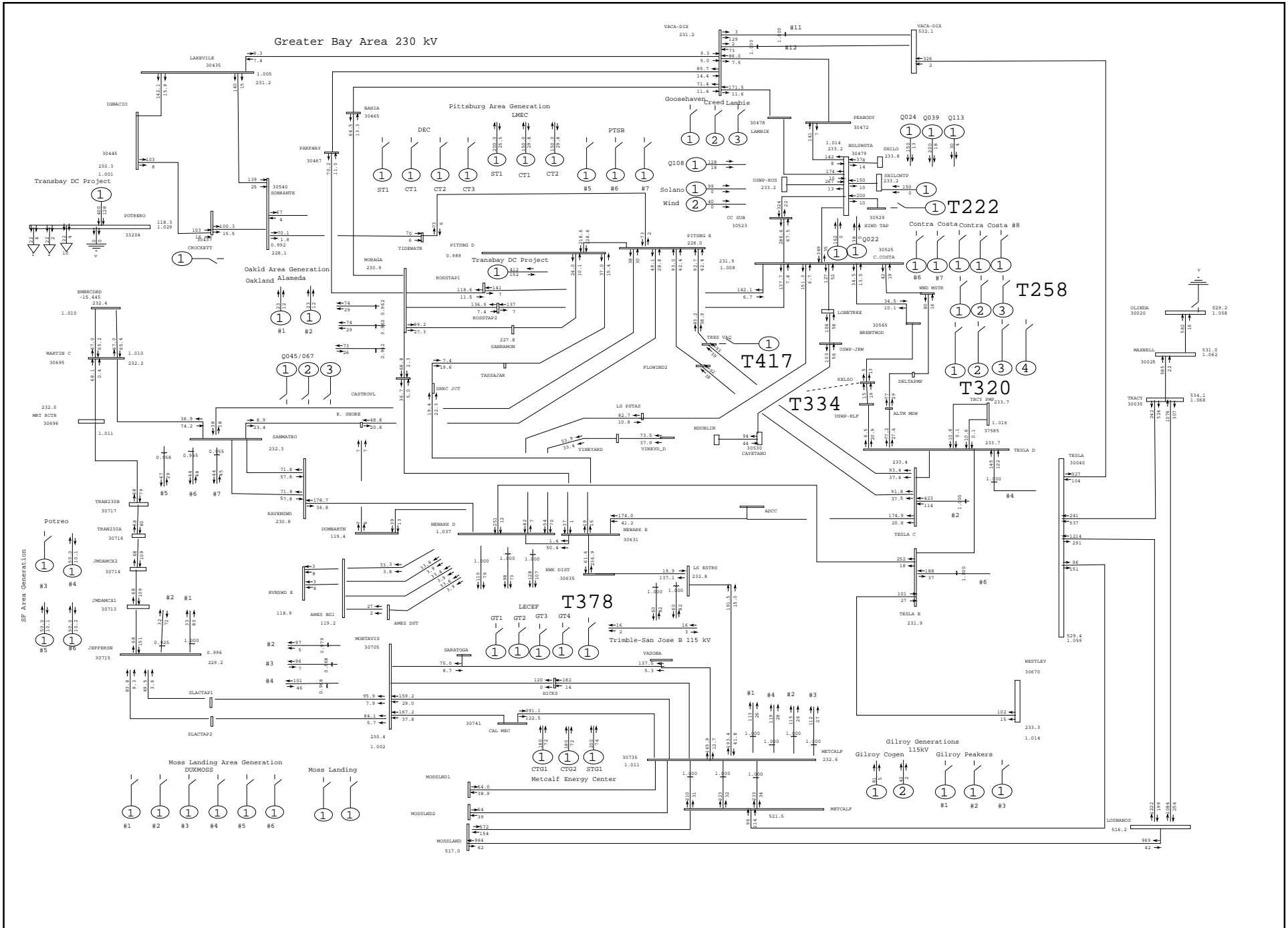

 <p>PG&E 2008 CASE SERIES: 2013 Summer Off Peak Case PATH15= 5181 MW(N-S) PATH26=-1643 MW(N-S) PDCI=-1846 MW(N-S) COI=-3590 MW(N-S) PG&E TCP2 Greater Bay Area Summer Off Peak Transition Cluster Pre-Project Case</p>	<p>Plot 005: Normal Conditions</p>	<p>MW/MVAR draw\grba\pge-tcp2-grba- Rating = 1</p>
--------------------------------------------------------------------------------------------------------------------------------------------------------------------------------------------------------------------------------------------------------------------------------------------------------------------------------------------	------------------------------------	------------------------------------------------------------------------------

APPENDIX D - STEADY STATE POWER FLOW PLOTS

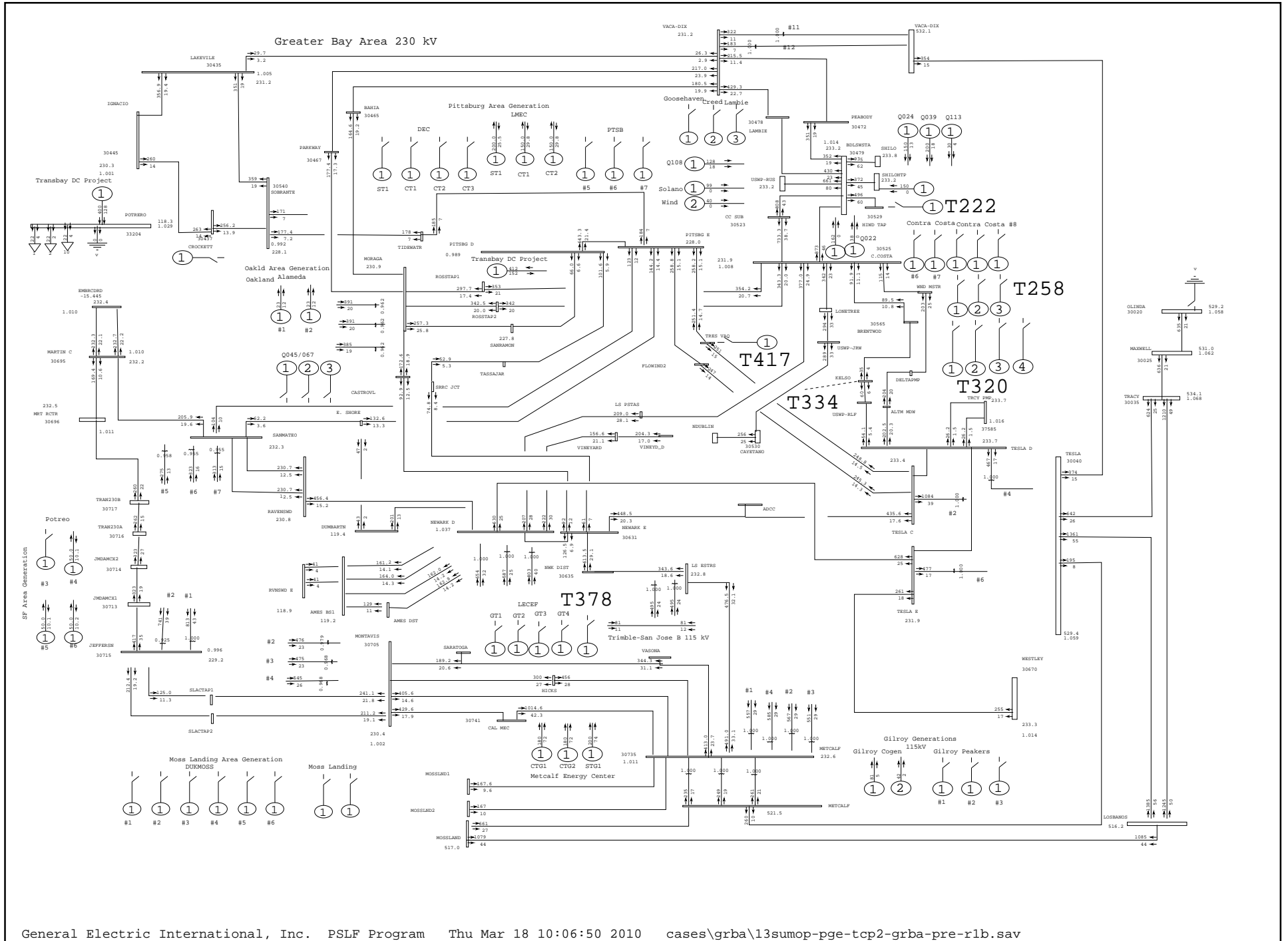

General Electric International, Inc. PSLF Program Thu Mar 18 10:06:50 2010 cases\grba\13sumop-pge-tcp2-grba-pre-r1b.sav

 <p>PG&E 2008 CASE SERIES: 2013 Summer Off Peak Case PATH15= 5181 MW(N-S) PATH26=-1643 MW(N-S) PDCI=-1846 MW(N-S) COI=-3590 MW(N-S) PG&E TCP2 Greater Bay Area Summer Off Peak Transition Cluster Pre-Project Case</p>	<p>Plot 006: Normal Conditions</p>	<p>amps/rate draw\grba\pge-tcp2-grba- Rating = 1</p>
--------------------------------------------------------------------------------------------------------------------------------------------------------------------------------------------------------------------------------------------------------------------------------------------------------------------------------------------	------------------------------------	--------------------------------------------------------------------------------

APPENDIX D - STEADY STATE POWER FLOW PLOTS

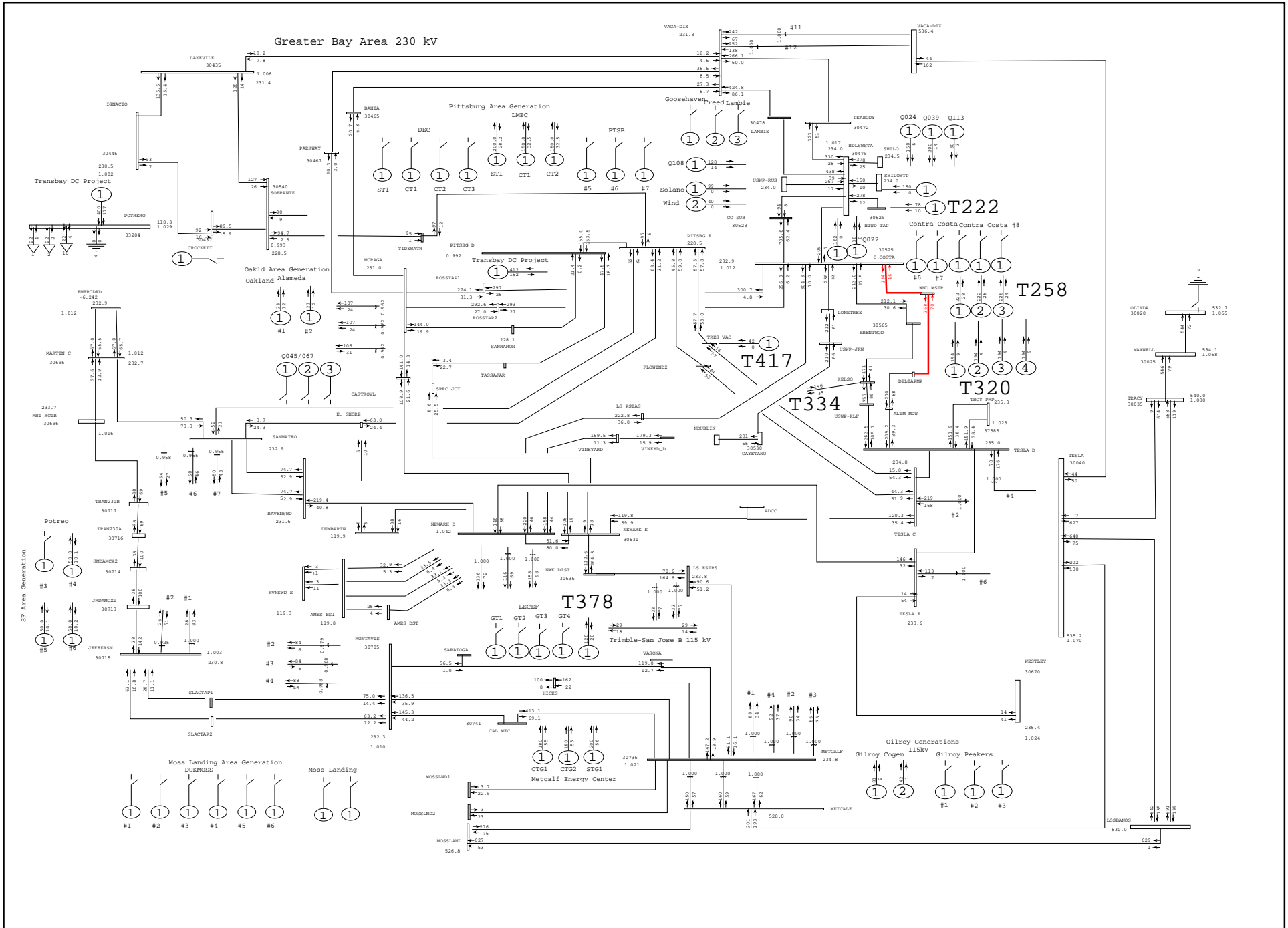

General Electric International, Inc. PSLF Program Thu Mar 18 10:06:51 2010 cases\grba\13sumop-pge-tcp2-grba-pst-r1b.sav

 <p>PG&E 2008 CASE SERIES: 2013 Summer Off Peak Case PATH15= 3429 MW(N-S) PATH26= -231 MW(N-S) PDCI=-1846 MW(N-S) COI=-3674 MW(N-S) PG&E TCP2 Greater Bay Area Summer Off Peak Transition Cluster Post-Project Case</p>	<p>Plot 007: Normal Conditions</p>	<p>MW/MVAR draw\grba\pge-tcp2-grba- Rating = 1</p>
---------------------------------------------------------------------------------------------------------------------------------------------------------------------------------------------------------------------------------------------------------------------------------------------------------------------------------------------	------------------------------------	------------------------------------------------------------------------------

APPENDIX D - STEADY STATE POWER FLOW PLOTS

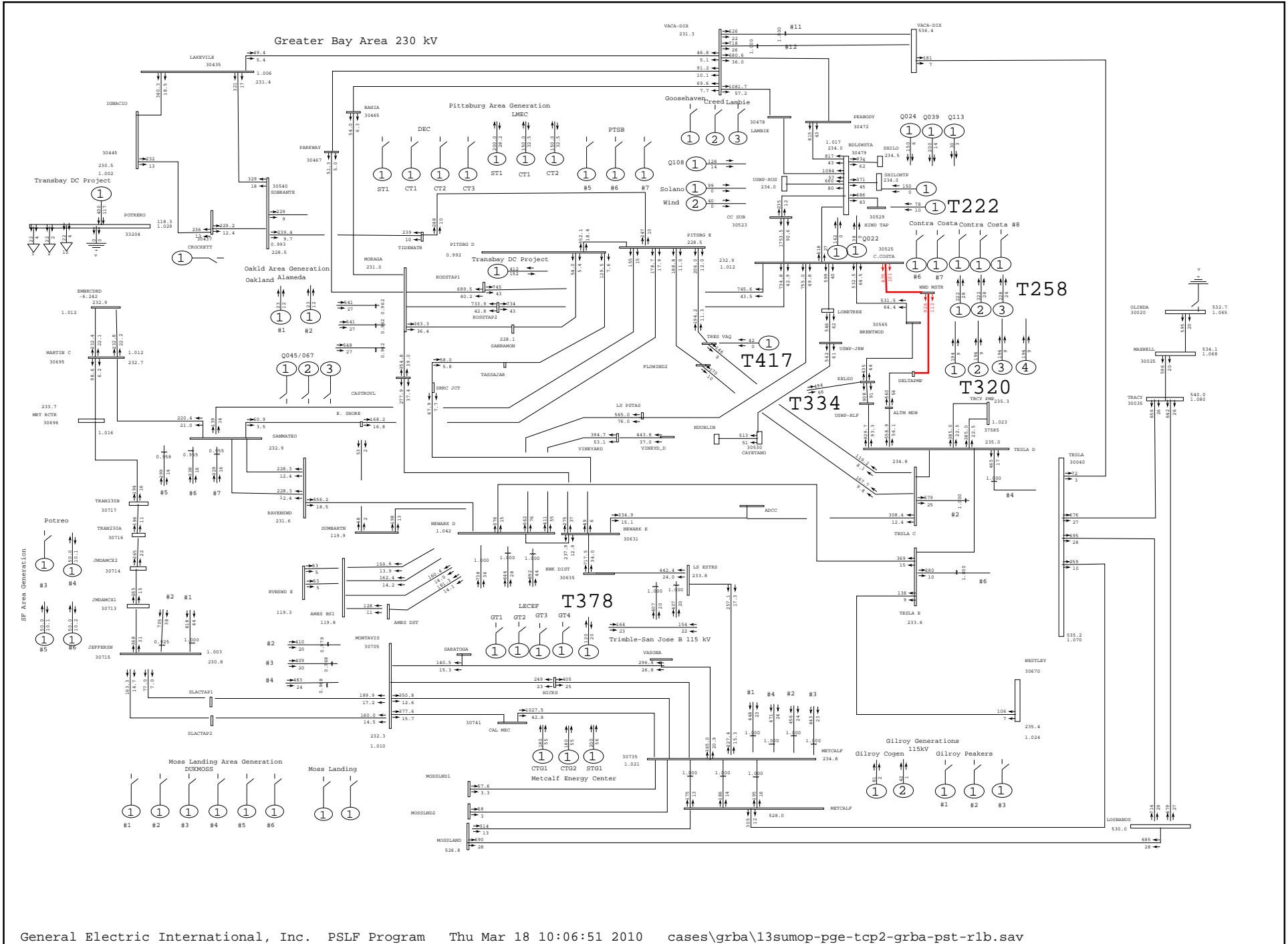

General Electric International, Inc. PSLF Program Thu Mar 18 10:06:51 2010 cases\grba\13sumop-pge-tcp2-grba-pst-r1b.sav

 <p>PG&E 2008 CASE SERIES: 2013 Summer Off Peak Case PATH15= 3429 MW(N-S) PATH26= -231 MW(N-S) PDCI=-1846 MW(N-S) COI=-3674 MW(N-S) PG&E TCP2 Greater Bay Area Summer Off Peak Transition Cluster Post-Project Case</p>	<p>Plot 008: Normal Conditions</p>	<p>amps/rate draw\grba\pge-tcp2-grba- Rating = 1</p>
---------------------------------------------------------------------------------------------------------------------------------------------------------------------------------------------------------------------------------------------------------------------------------------------------------------------------------------------	------------------------------------	--------------------------------------------------------------------------------

APPENDIX D - STEADY STATE POWER FLOW PLOTS

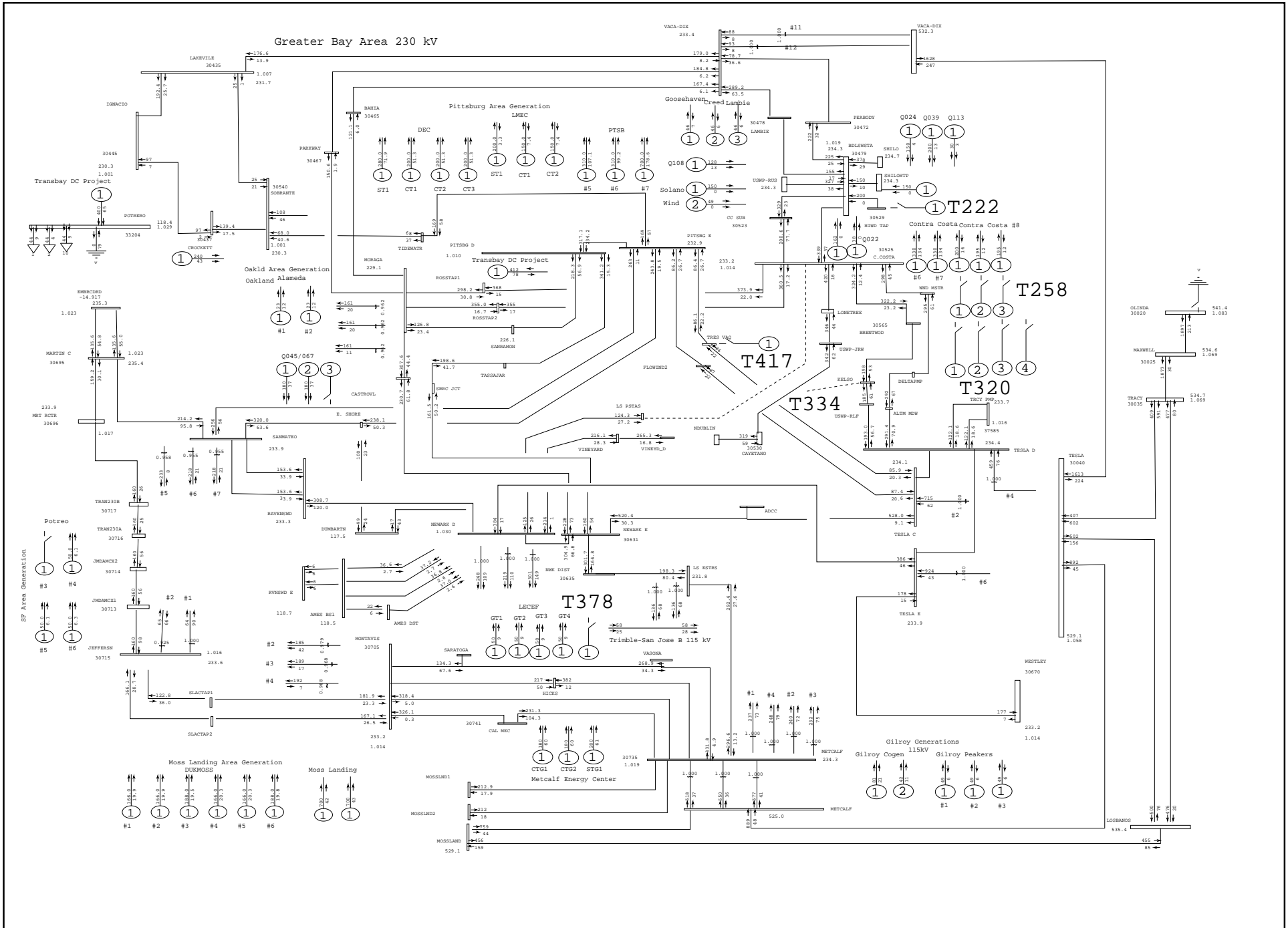

General Electric International, Inc. PSLF Program Thu Mar 18 10:06:53 2010 cases\grba\13sumpk-pge-tcp2-grba-pre-r1b.sav

 <p>PG&E 2008 CASE SERIES: 2013 Greater Bay Area Summer Peak Case (1-in-10 load) PATH15= -777 MW(S-N) PATH26= 3939 MW(N-S) PDCI= 3097 MW(N-S) COI= 4749 MW(N-S) PG&E TCP2 Greater Bay Area Summer Peak Transition Cluster Pre-Project Case</p>	<p>Plot 009: Contra Costa-Las Positas 230 kV Line and RCEC STG1 Outage</p>	<p>MW/MVAR draw\grba\pge-tcp2-grba- Rating = 2</p>
--------------------------------------------------------------------------------------------------------------------------------------------------------------------------------------------------------------------------------------------------------------------------------------------------------------------------------------------------------------------	----------------------------------------------------------------------------	------------------------------------------------------------------------------

APPENDIX D - STEADY STATE POWER FLOW PLOTS

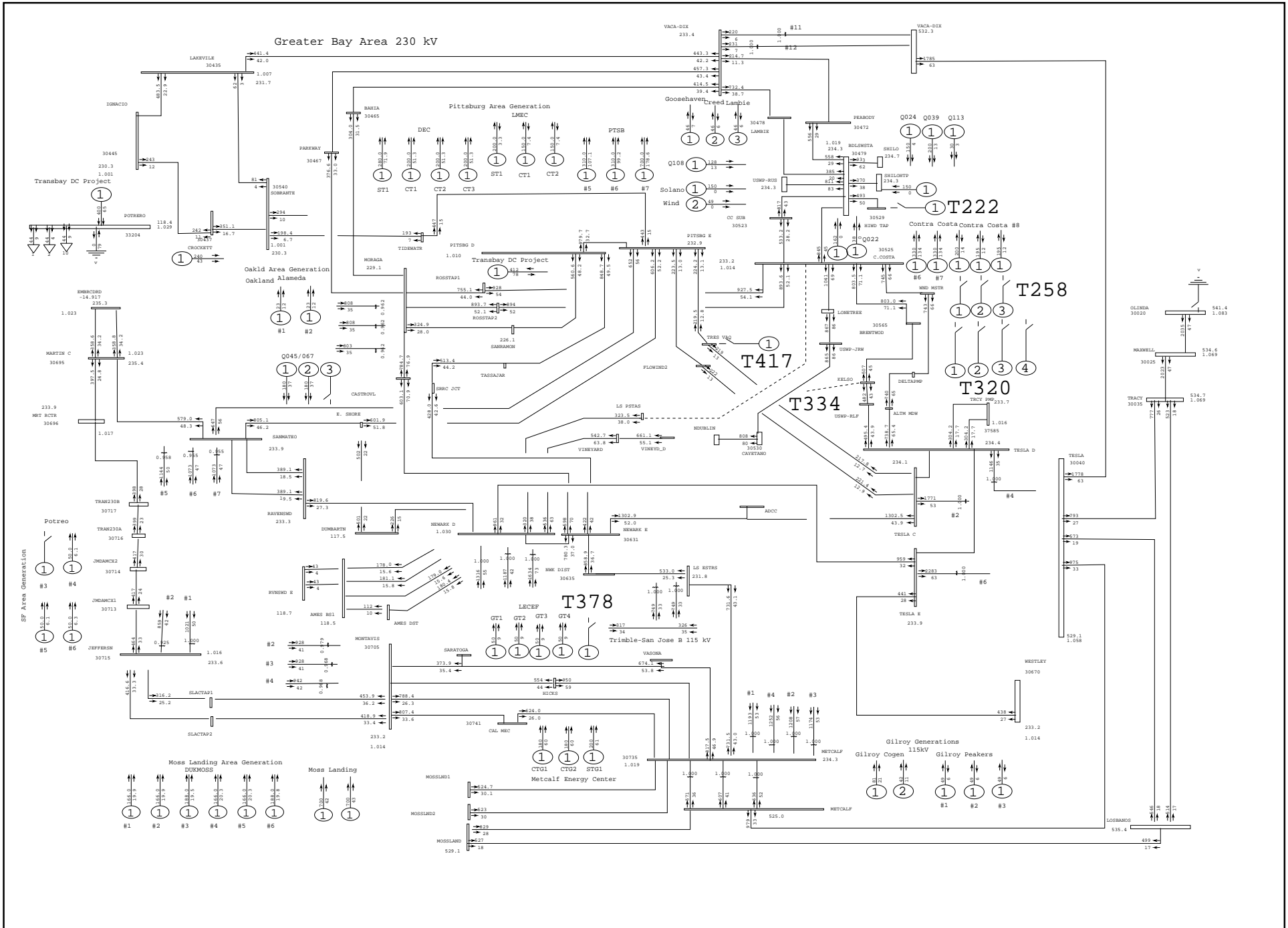

General Electric International, Inc. PSLF Program Thu Mar 18 10:06:53 2010 cases\grba\13sumpk-pge-tcp2-grba-pre-r1b.sav

 <p>PG&E 2008 CASE SERIES: 2013 Greater Bay Area Summer Peak Case (1-in-10 load) PATH15= -777 MW(S-N) PATH26= 3939 MW(N-S) PDCI= 3097 MW(N-S) COI= 4749 MW(N-S) PG&E TCP2 Greater Bay Area Summer Peak Transition Cluster Pre-Project Case</p>	<p>Plot 010: Contra Costa-Las Positas 230 kV Line and RCEC STG1 Outage</p>	<p>amps/rate draw\grba\pge-tcp2-grba- Rating = 2</p>
--------------------------------------------------------------------------------------------------------------------------------------------------------------------------------------------------------------------------------------------------------------------------------------------------------------------------------------------------------------------	----------------------------------------------------------------------------	--------------------------------------------------------------------------------

APPENDIX D - STEADY STATE POWER FLOW PLOTS

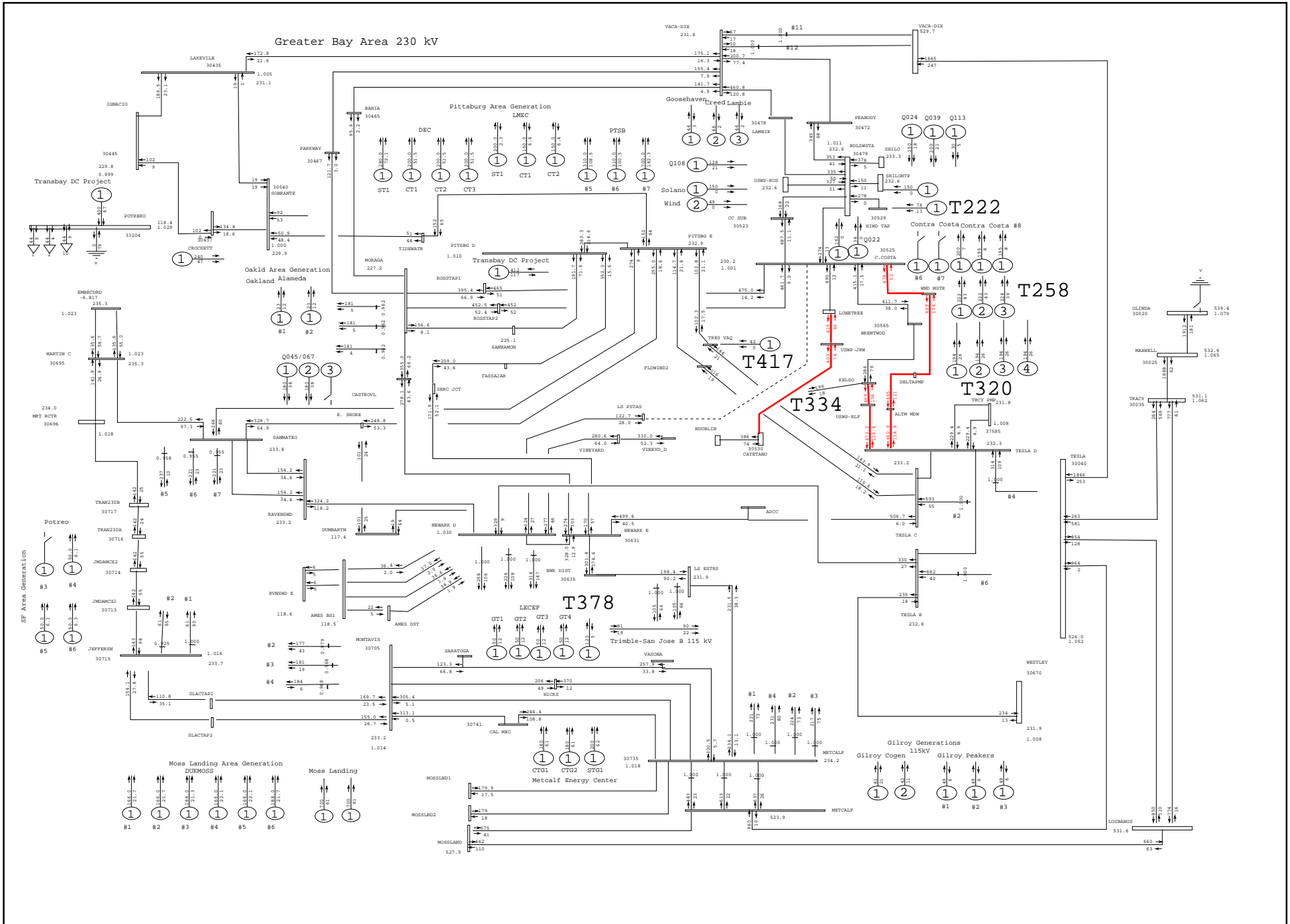

General Electric International, Inc. PSLF Program Thu Mar 18 10:06:55 2010 cases\grba\13sumpk-pge-tcp2-grba-pst-r1b.sav

 <p>PG&E 2008 CASE SERIES: 2013 Greater Bay Area Summer Peak Case (1-in-10 load) PATH15=-1850 MW(N-S) PATH26= 3860 MW(N-S) PDCI= 3093 MW(N-S) COI= 4670 MW(N-S) PG&E TCP2 Greater Bay Area Summer Peak Transition Cluster Post-Project Case</p>	<p>Plot 011: Contra Costa-Las Positas 230 kV Line and RCEC STG1 Outage</p>	<p>MW/MVAR draw\grba\pge-tcp2-grba- Rating = 2</p>
---------------------------------------------------------------------------------------------------------------------------------------------------------------------------------------------------------------------------------------------------------------------------------------------------------------------------------------------------------------------	----------------------------------------------------------------------------	------------------------------------------------------------------------------

APPENDIX D - STEADY STATE POWER FLOW PLOTS

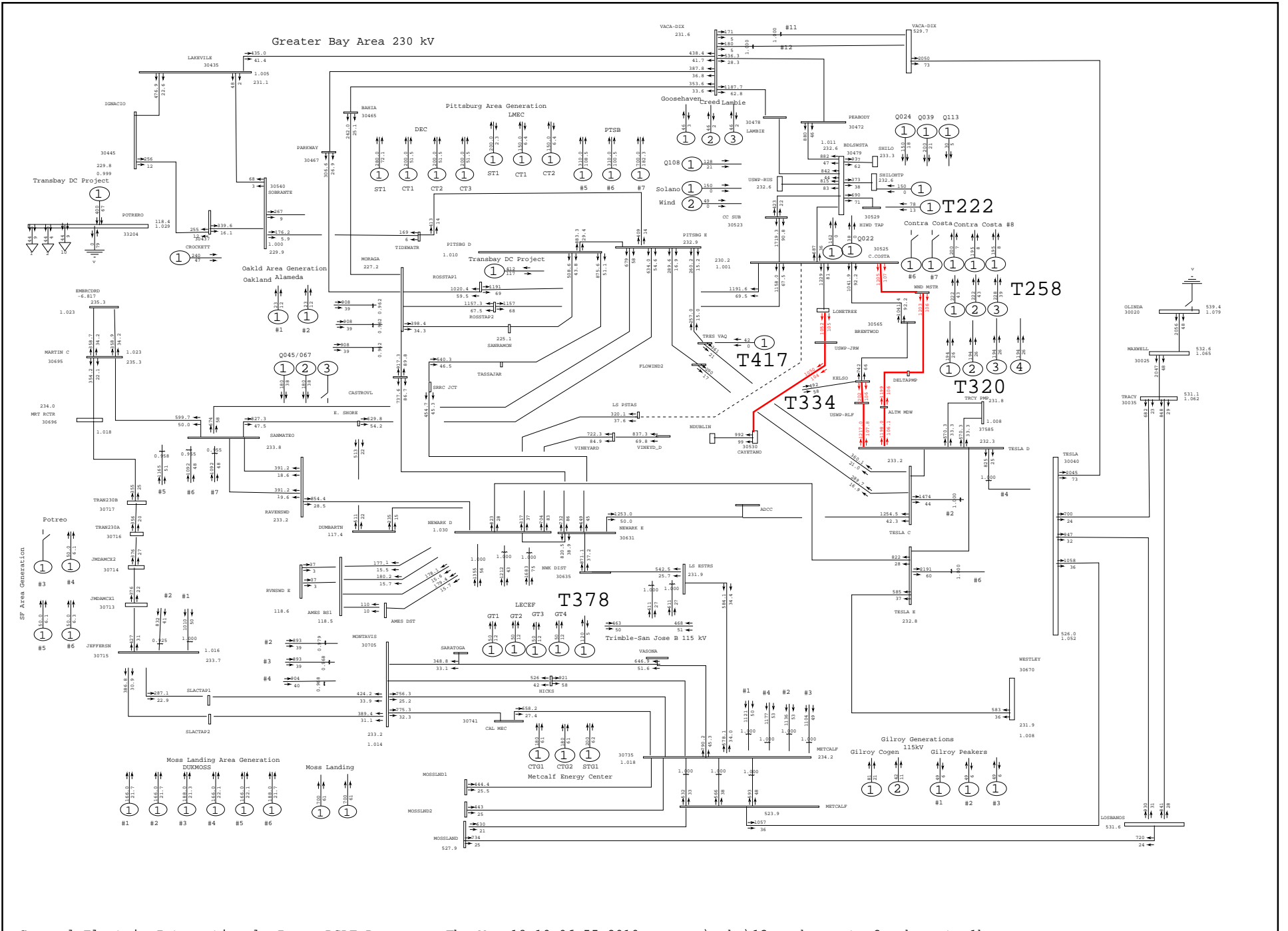

General Electric International, Inc. PSLF Program Thu Mar 18 10:06:55 2010 cases\grba\13sumpk-pge-tcp2-grba-pst-r1b.sav

PG&E 2008 CASE SERIES: 2013 Greater Bay Area Summer Peak Case (1-in-10 load)
 PATH15=-1850 MW(S-N) PATH26= 3860 MW(N-S) PDCI= 3093 MW(N-S) COI= 4670 MW(N-S)
 PG&E TCP2 Greater Bay Area Summer Peak Transition Cluster Post-Project Case

Plot 012: Contra Costa-Las Positas 230 kV Line and RCEC STG1 Outage

amps/rate
 draw\grba\pge-tcp2-grba-
 Rating = 2

APPENDIX D - STEADY STATE POWER FLOW PLOTS

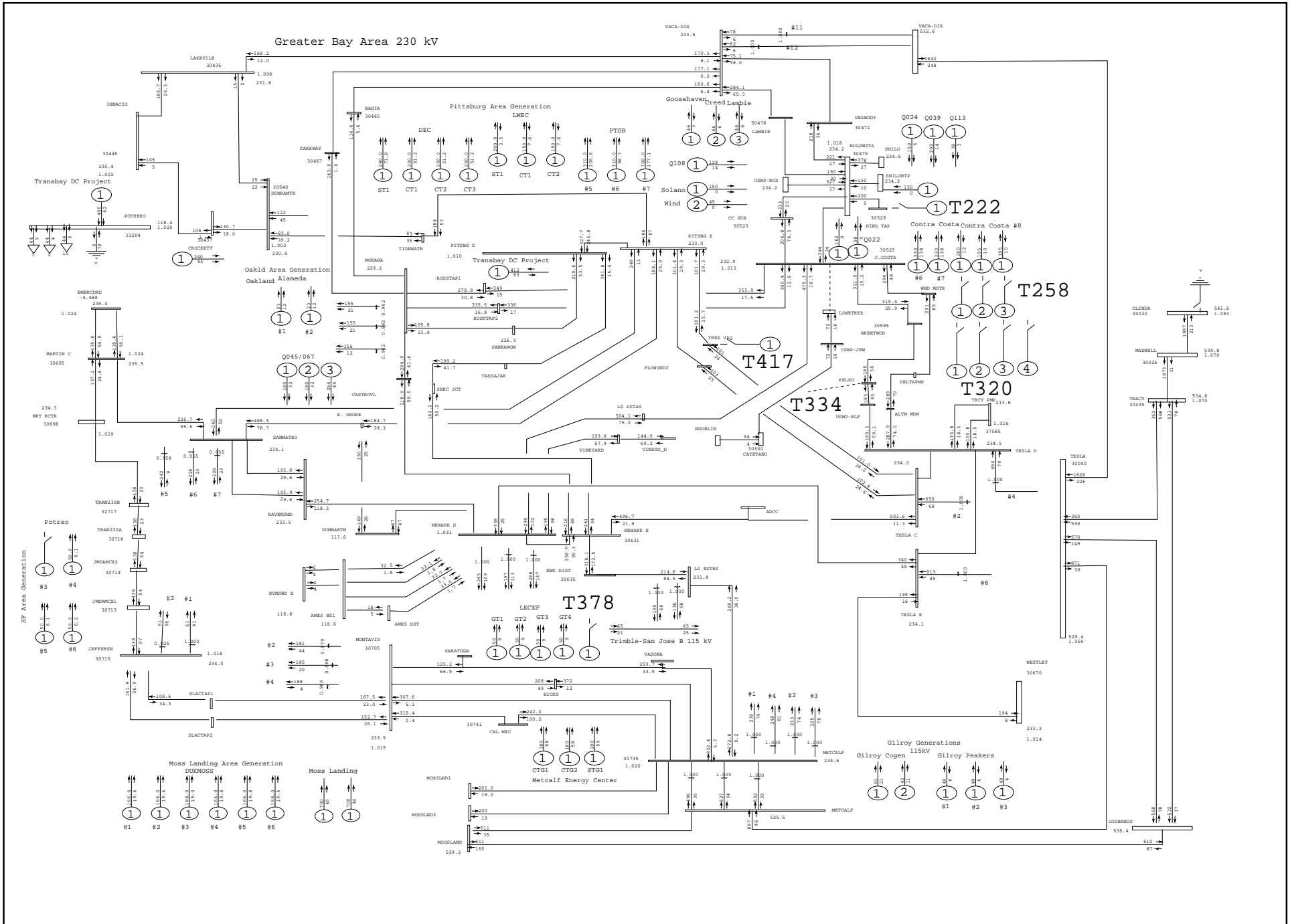

General Electric International, Inc. PSLF Program Thu Mar 18 10:06:57 2010 cases\grba\13sumpk-pge-tcp2-grba-pre-r1b.sav

PG&E 2008 CASE SERIES: 2013 Greater Bay Area Summer Peak Case (1-in-10 load)
 PATH15= -777 MW(S-N) PATH26= 3939 MW(N-S) PDCI= 3097 MW(N-S) COI= 4749 MW(N-S)
 PG&E TCP2 Greater Bay Area Summer Peak Transition Cluster Pre-Project Case

Plot 013: Contra Costa-Lonetree 230 kV Line Outage

MW/MVAR
 draw\grba\pge-tcp2-grba-
 Rating = 2

APPENDIX D - STEADY STATE POWER FLOW PLOTS

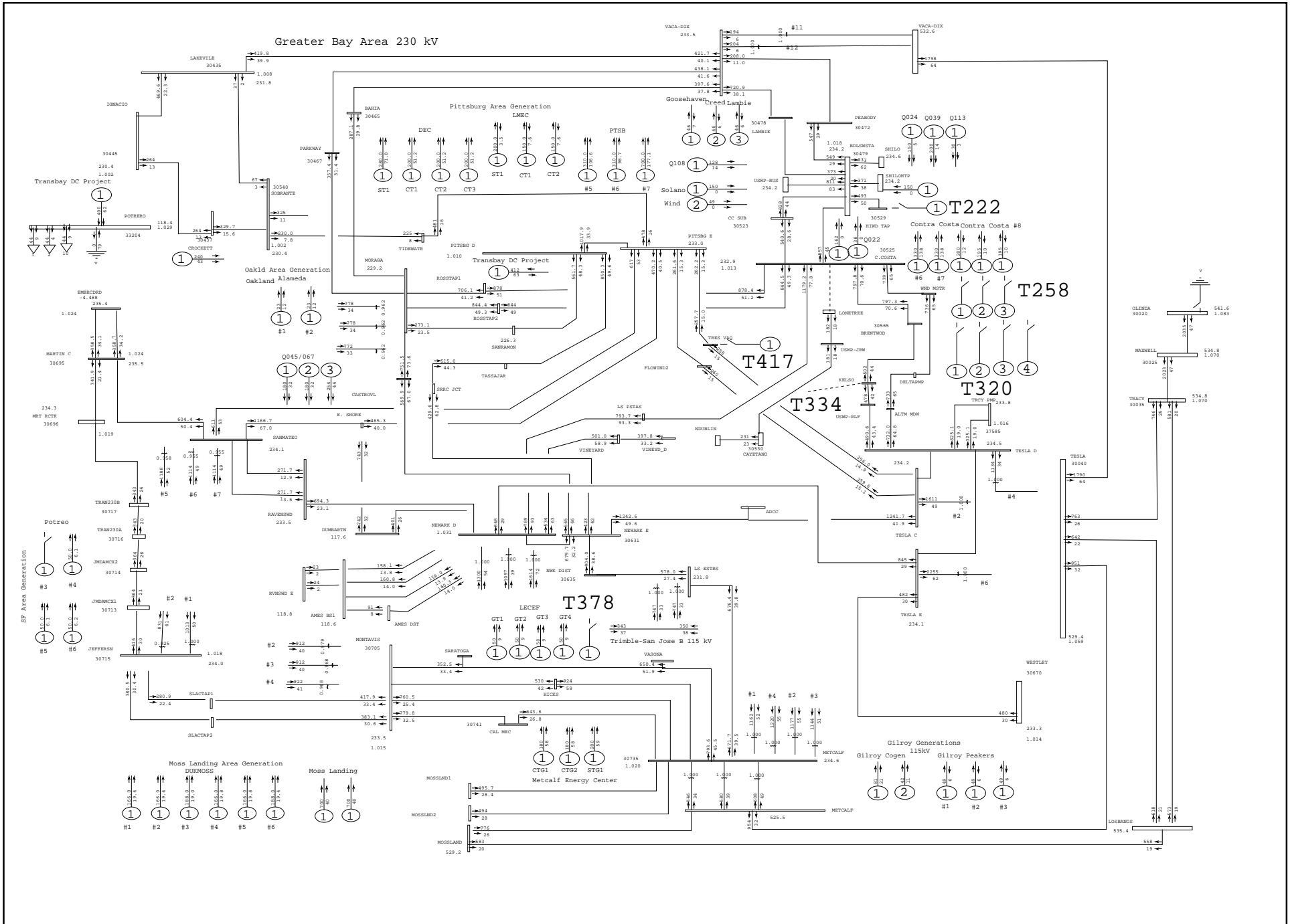

General Electric International, Inc. PSLF Program Thu Mar 18 10:06:58 2010 cases\grba\13sumpk-pge-tcp2-grba-pre-r1b.sav

PG&E 2008 CASE SERIES: 2013 Greater Bay Area Summer Peak Case (1-in-10 load) PATH15= -777 MW(N-S) PATH26= 3939 MW(N-S) PDCI= 3097 MW(N-S) COI= 4749 MW(N-S) PG&E TCP2 Greater Bay Area Summer Peak Transition Cluster Pre-Project Case	Plot 014: Contra Costa-Lonetree 230 kV Line Outage	amps/rate draw\grba\pge-tcp2-grba- Rating = 2
----------------------------------------------------------------------------------------------------------------------------------------------------------------------------------------------------------------------------------------------	----------------------------------------------------	-----------------------------------------------------

APPENDIX D - STEADY STATE POWER FLOW PLOTS

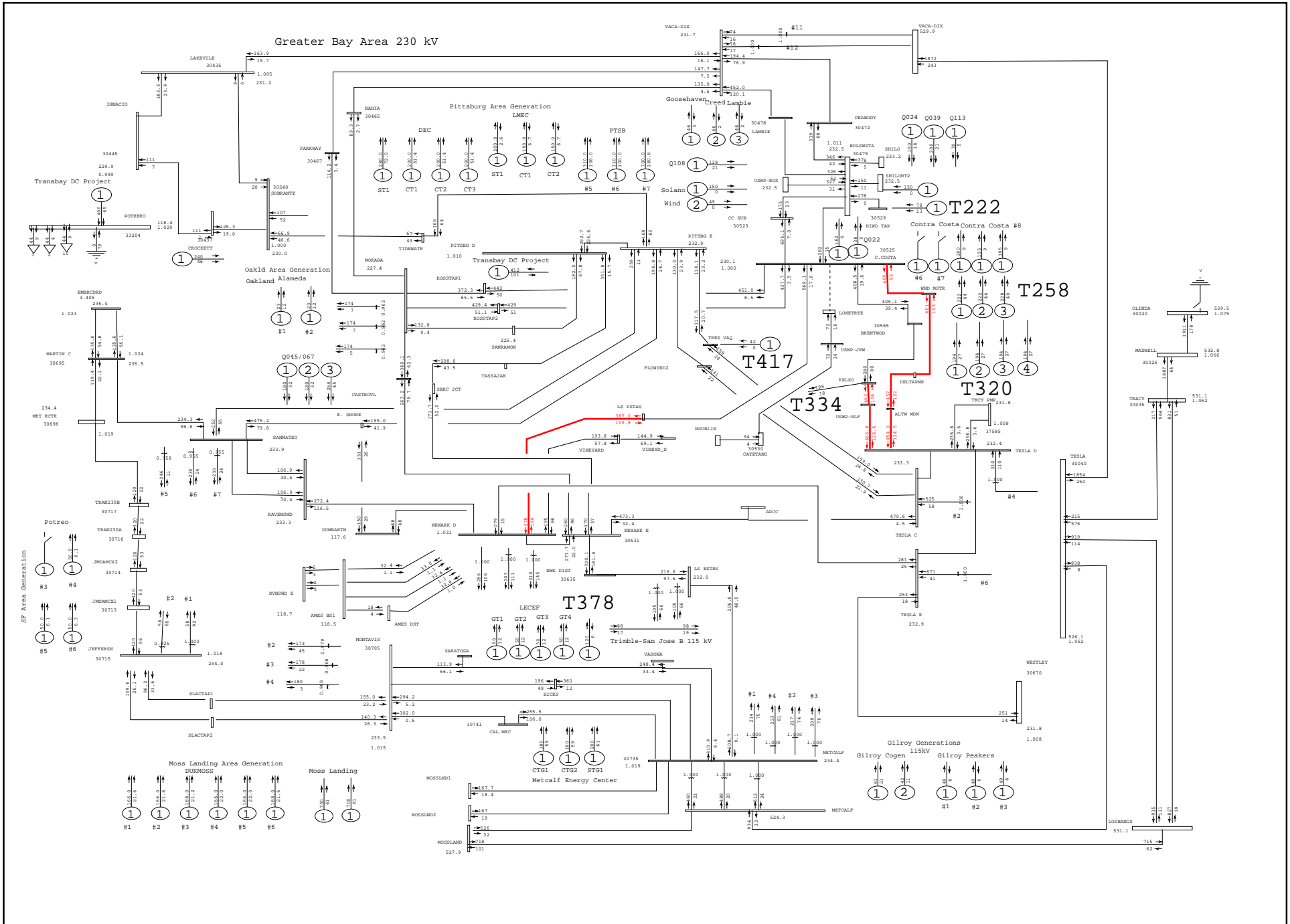

General Electric International, Inc. PSLF Program Thu Mar 18 10:07:00 2010 cases\grba\13sumpk-pge-tcp2-grba-pst-r1b.sav

 <p>PG&E 2008 CASE SERIES: 2013 Greater Bay Area Summer Peak Case (1-in-10 load) PATH15=-1850 MW(N-S) PATH26= 3860 MW(N-S) PDCI= 3093 MW(N-S) COI= 4670 MW(N-S) PG&E TCP2 Greater Bay Area Summer Peak Transition Cluster Post-Project Case</p>	<p>Plot 015: Contra Costa-Lonetree 230 kV Line Outage</p>	<p>MW/MVAR draw\grba\pge-tcp2-grba- Rating = 2</p>
---------------------------------------------------------------------------------------------------------------------------------------------------------------------------------------------------------------------------------------------------------------------------------------------------------------------------------------------------------------------	-----------------------------------------------------------	------------------------------------------------------------------------------

APPENDIX D - STEADY STATE POWER FLOW PLOTS

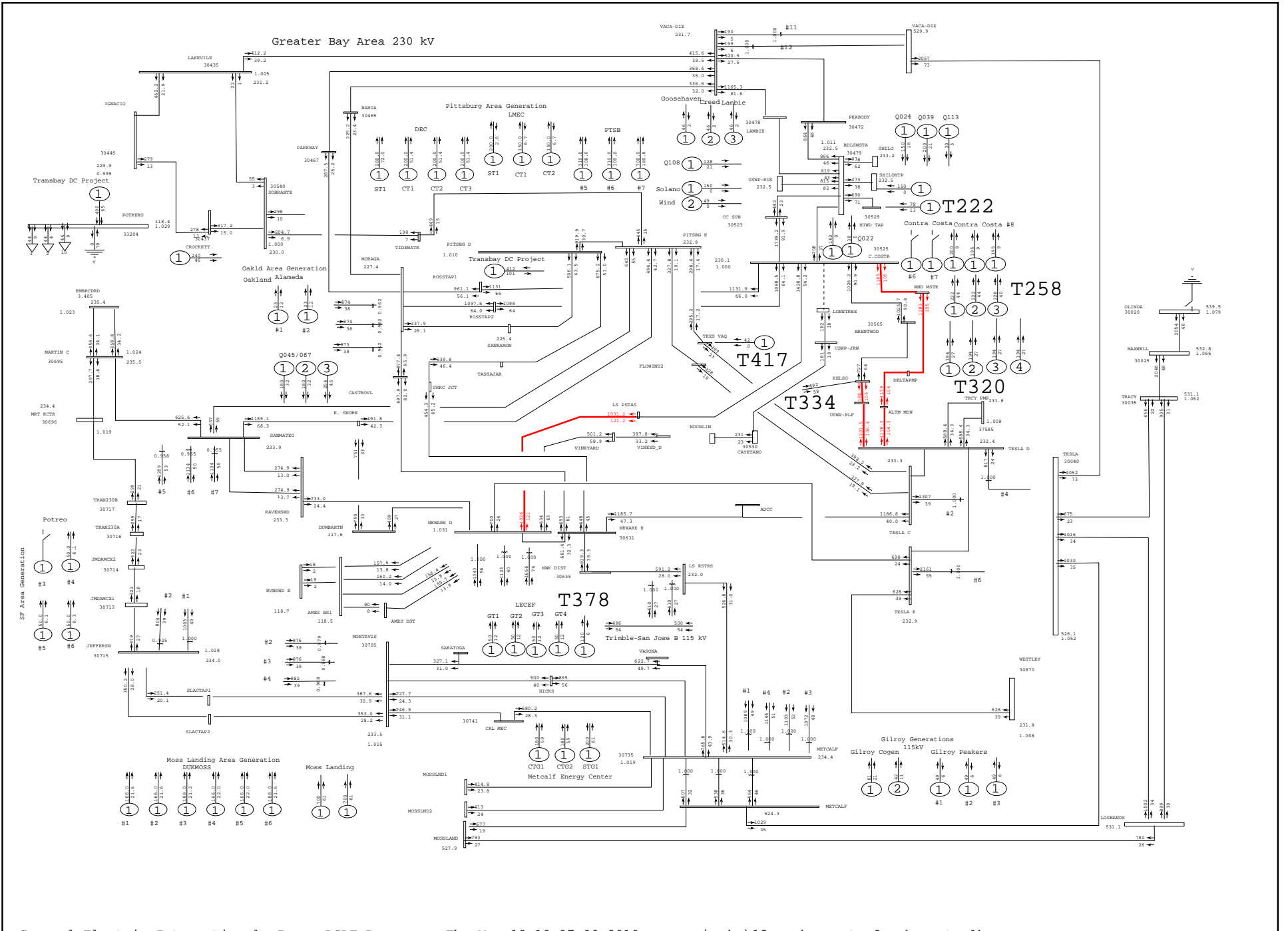

General Electric International, Inc. PSLF Program Thu Mar 18 10:07:00 2010 cases\grba\13sumpk-pge-tcp2-grba-pst-r1b.sav

PG&E 2008 CASE SERIES: 2013 Greater Bay Area Summer Peak Case (1-in-10 load)
 PATH15=-1850 MW(S-N) PATH26= 3860 MW(N-S) PDCI= 3093 MW(N-S) COI= 4670 MW(N-S)
 PG&E TCP2 Greater Bay Area Summer Peak Transition Cluster Post-Project Case

Plot 016 Contra Costa-Lonetree 230 kV Line Outage

amps/rate
 draw\grba\pge-tcp2-grba-
 Rating = 2

APPENDIX D - STEADY STATE POWER FLOW PLOTS

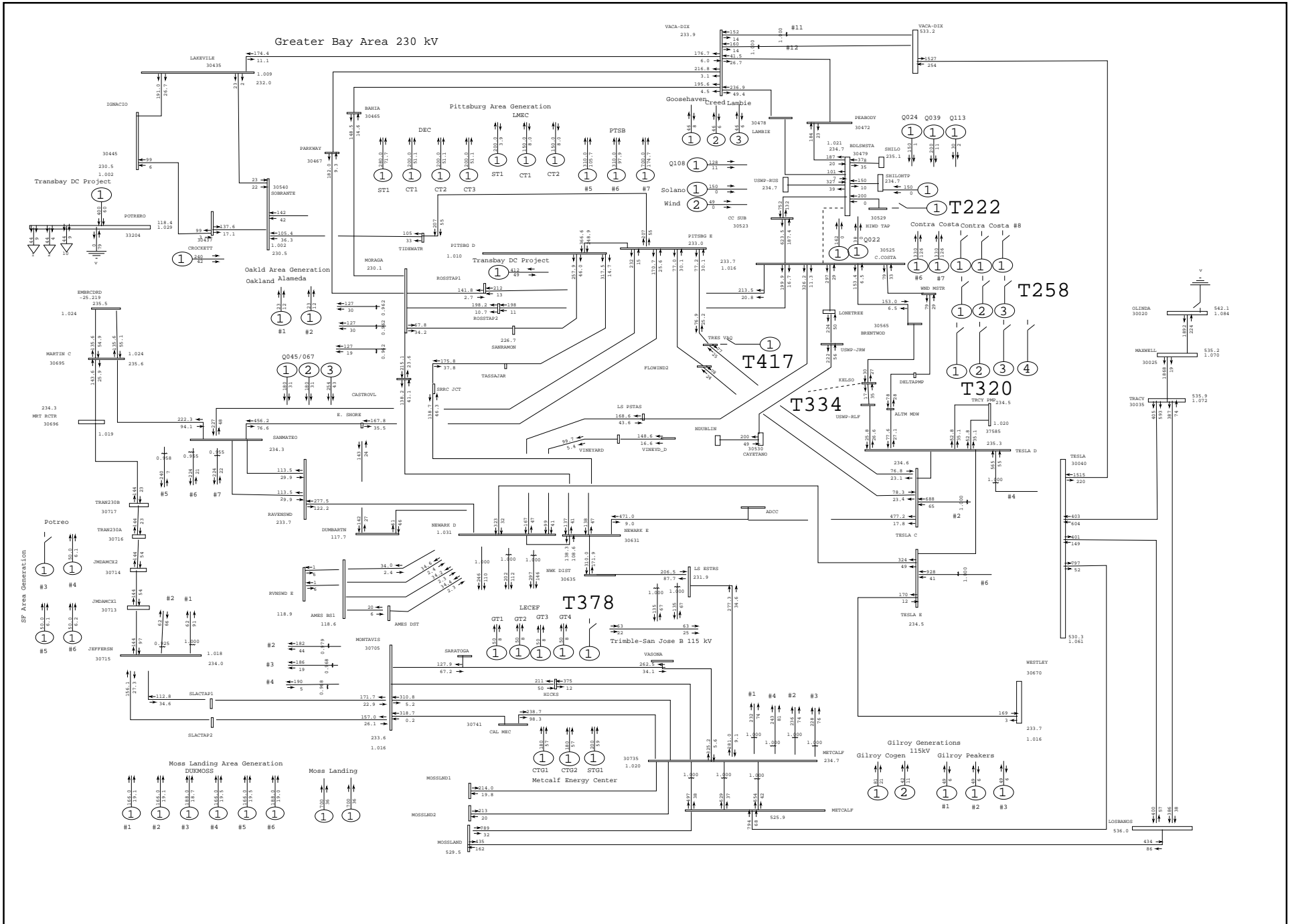

General Electric International, Inc. PSLF Program Thu Mar 18 10:07:02 2010 cases\grba\13sumpk-pge-tcp2-grba-pre-r1b.sav

PG&E 2008 CASE SERIES: 2013 Greater Bay Area Summer Peak Case (1-in-10 load)
 PATH15= -777 MW(S-N) PATH26= 3939 MW(N-S) PDCI= 3097 MW(N-S) COI= 4749 MW(N-S)
 PG&E TCP2 Greater Bay Area Summer Peak Transition Cluster Pre-Project Case

Plot 017: Birds Landing-Contra Costa 230 kV Line & Gateway PP Outage
 MW/MVAR
 draw\grba\pge-tcp2-grba-
 Rating = 2

APPENDIX D - STEADY STATE POWER FLOW PLOTS

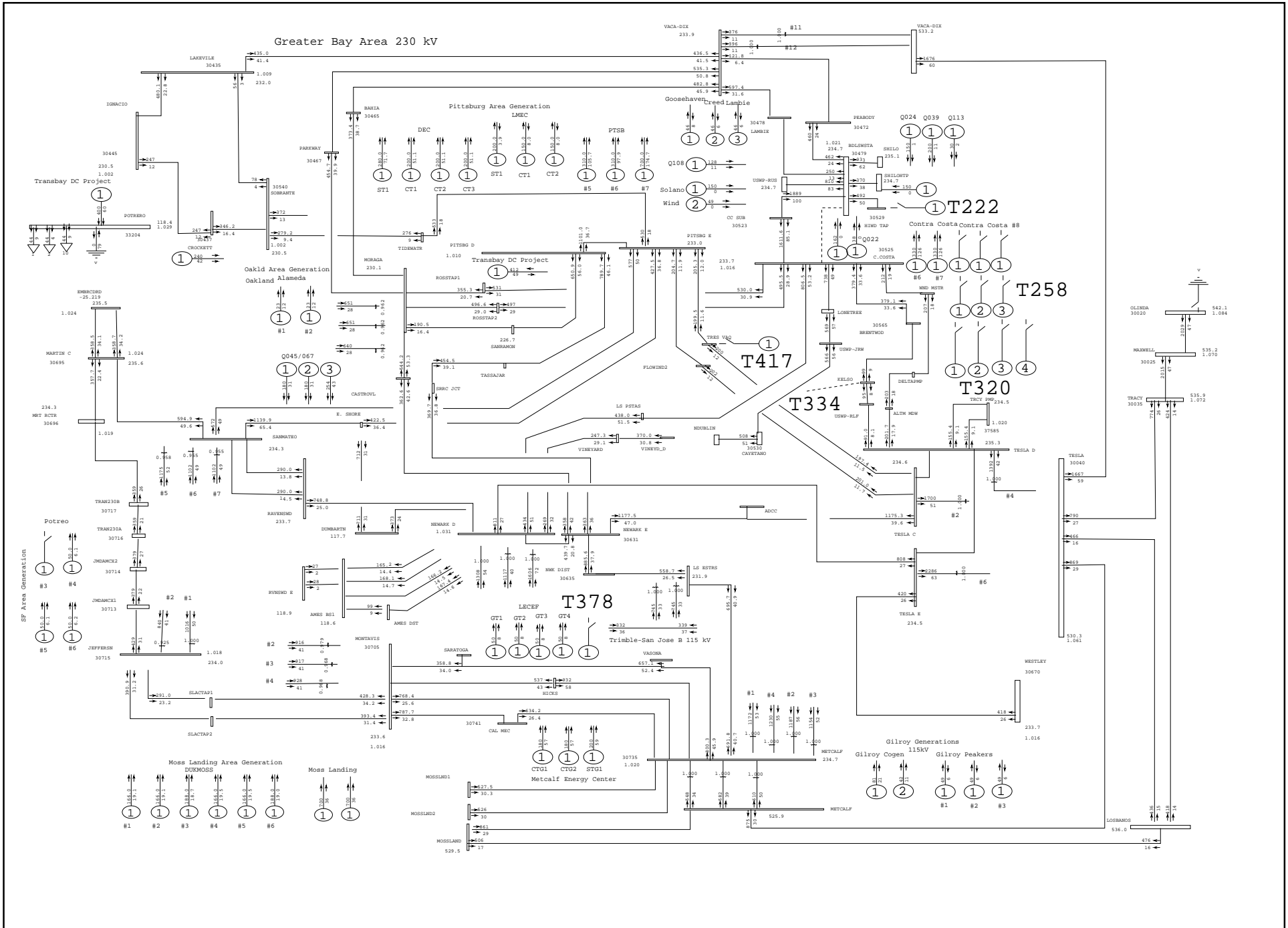

General Electric International, Inc. PSLF Program Thu Mar 18 10:07:02 2010 cases\grba\13sumpk-pge-tcp2-grba-pre-r1b.sav

 <p>PG&E 2008 CASE SERIES: 2013 Greater Bay Area Summer Peak Case (1-in-10 load) PATH15= -777 MW(S-N) PATH26= 3939 MW(N-S) PDCI= 3097 MW(N-S) COI= 4749 MW(N-S) PG&E TCP2 Greater Bay Area Summer Peak Transition Cluster Pre-Project Case</p>	<p>Plot 018: Birds Landing-Contra Costa 230 kV Line & Gateway PP Outage</p>	<p>amps/rate draw\grba\pge-tcp2-grba- Rating = 2</p>
--------------------------------------------------------------------------------------------------------------------------------------------------------------------------------------------------------------------------------------------------------------------------------------------------------------------------------------------------------------------	---------------------------------------------------------------------------------	--------------------------------------------------------------------------------

APPENDIX D - STEADY STATE POWER FLOW PLOTS

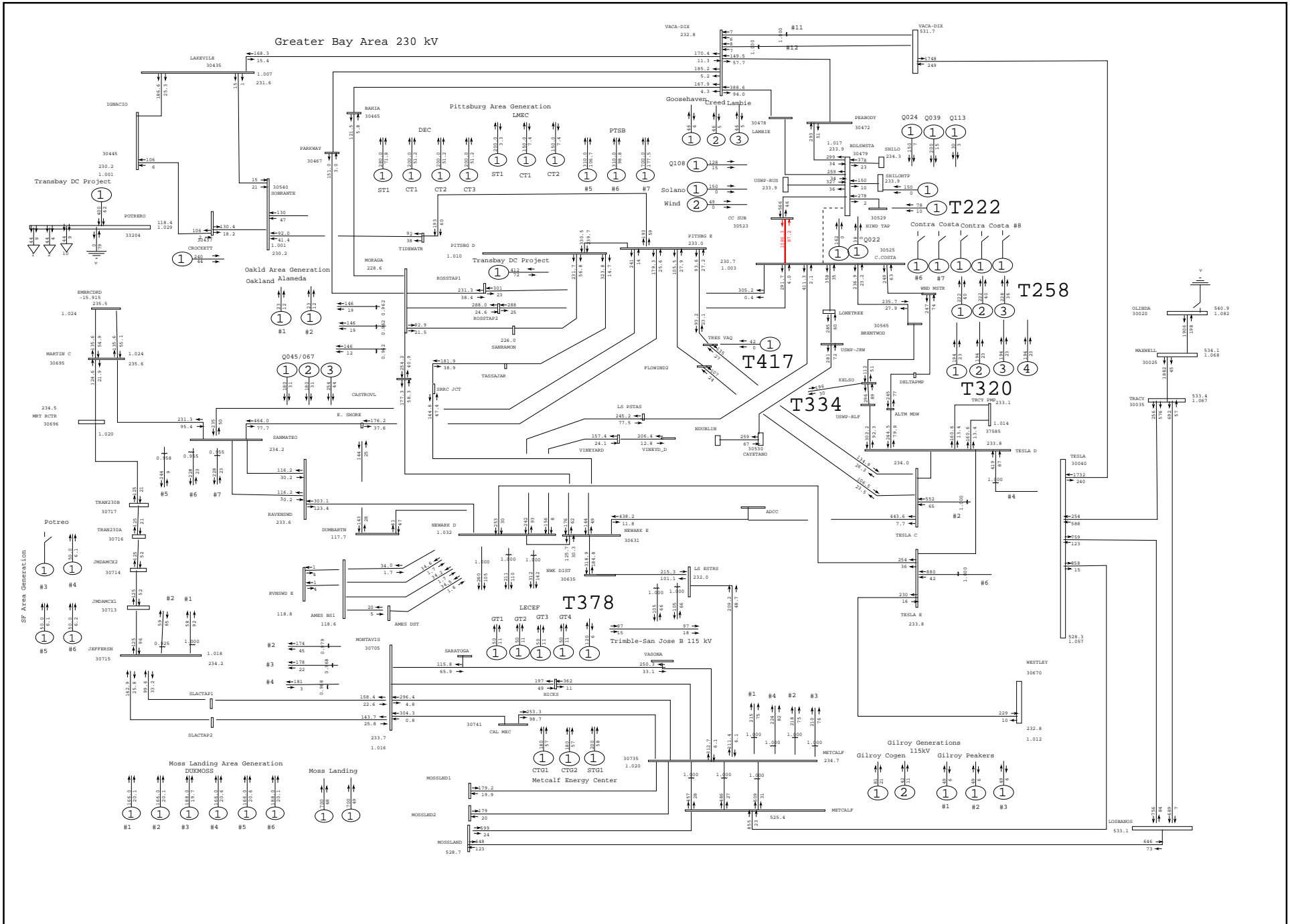

General Electric International, Inc. PSLF Program Thu Mar 18 10:07:04 2010 cases\grba\13sumpk-pge-tcp2-grba-pst-r1b.sav

 <p>PG&E 2008 CASE SERIES: 2013 Greater Bay Area Summer Peak Case (1-in-10 load) PATH15=-1850 MW(N-S) PATH26= 3860 MW(N-S) PDCI= 3093 MW(N-S) COI= 4670 MW(N-S) PG&E TCP2 Greater Bay Area Summer Peak Transition Cluster Post-Project Case</p>	<p>Plot 019: Birds Landing-Contra Costa 230 kV Line & Gateway PP Outage</p>	<p>MW/MVAR draw\grba\pge-tcp2-grba- Rating = 2</p>
---------------------------------------------------------------------------------------------------------------------------------------------------------------------------------------------------------------------------------------------------------------------------------------------------------------------------------------------------------------------	---------------------------------------------------------------------------------	------------------------------------------------------------------------------

APPENDIX D - STEADY STATE POWER FLOW PLOTS

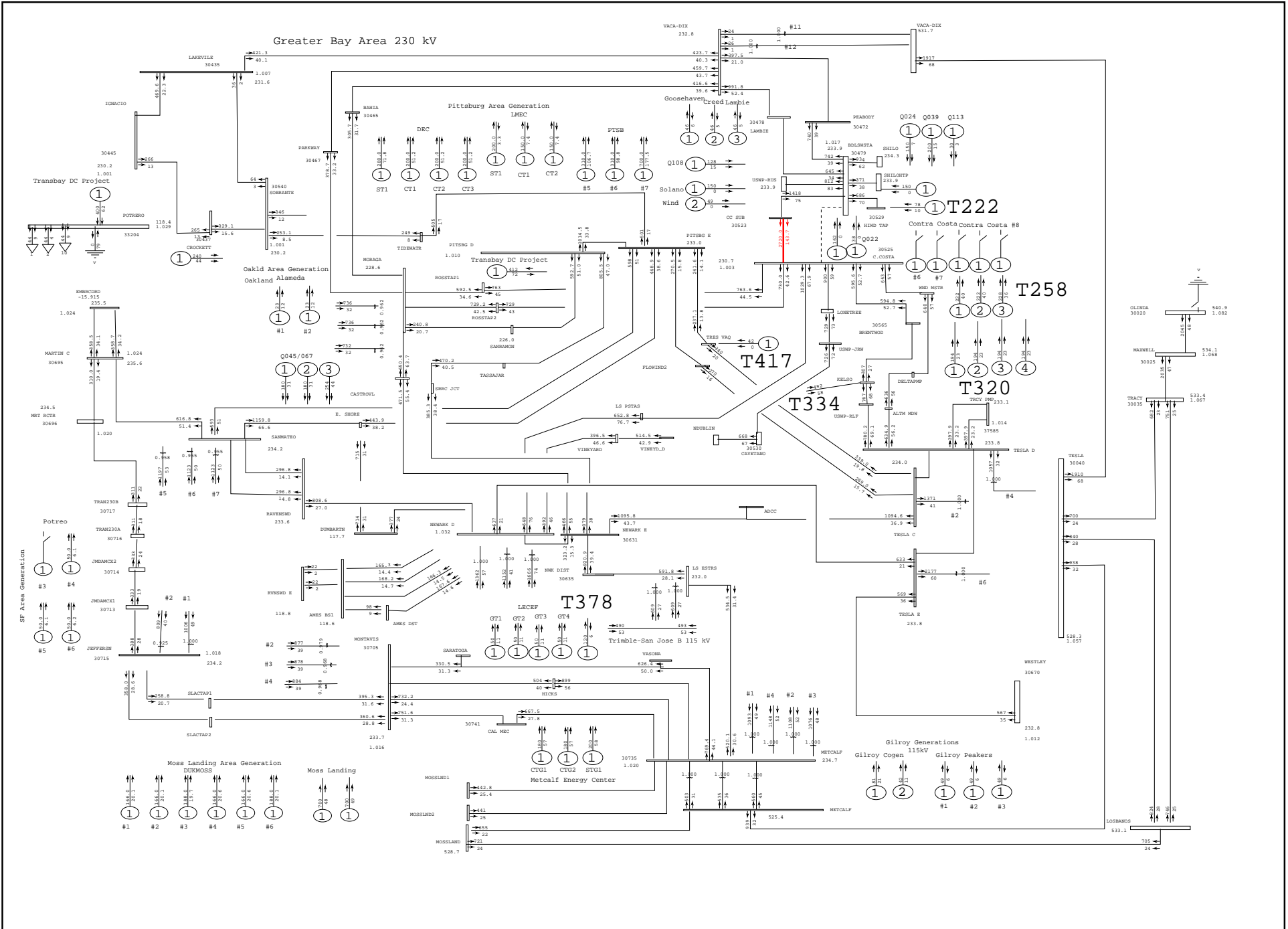

General Electric International, Inc. PSLF Program Thu Mar 18 10:07:05 2010 cases\grba\13sumpk-pge-tcp2-grba-pst-r1b.sav

PG&E 2008 CASE SERIES: 2013 Greater Bay Area Summer Peak Case (1-in-10 load)
 PATH15=-1850 MW(N-S) PATH26= 3860 MW(N-S) PDCI= 3093 MW(N-S) COI= 4670 MW(N-S)
 PG&E TCP2 Greater Bay Area Summer Peak Transition Cluster Post-Project Case

Plot 020: Birds Landing-Contra Costa 230 kV Line & Gateway PP Outage

amps/rate
 draw\grba\pge-tcp2-grba-
 Rating = 2

APPENDIX D - STEADY STATE POWER FLOW PLOTS

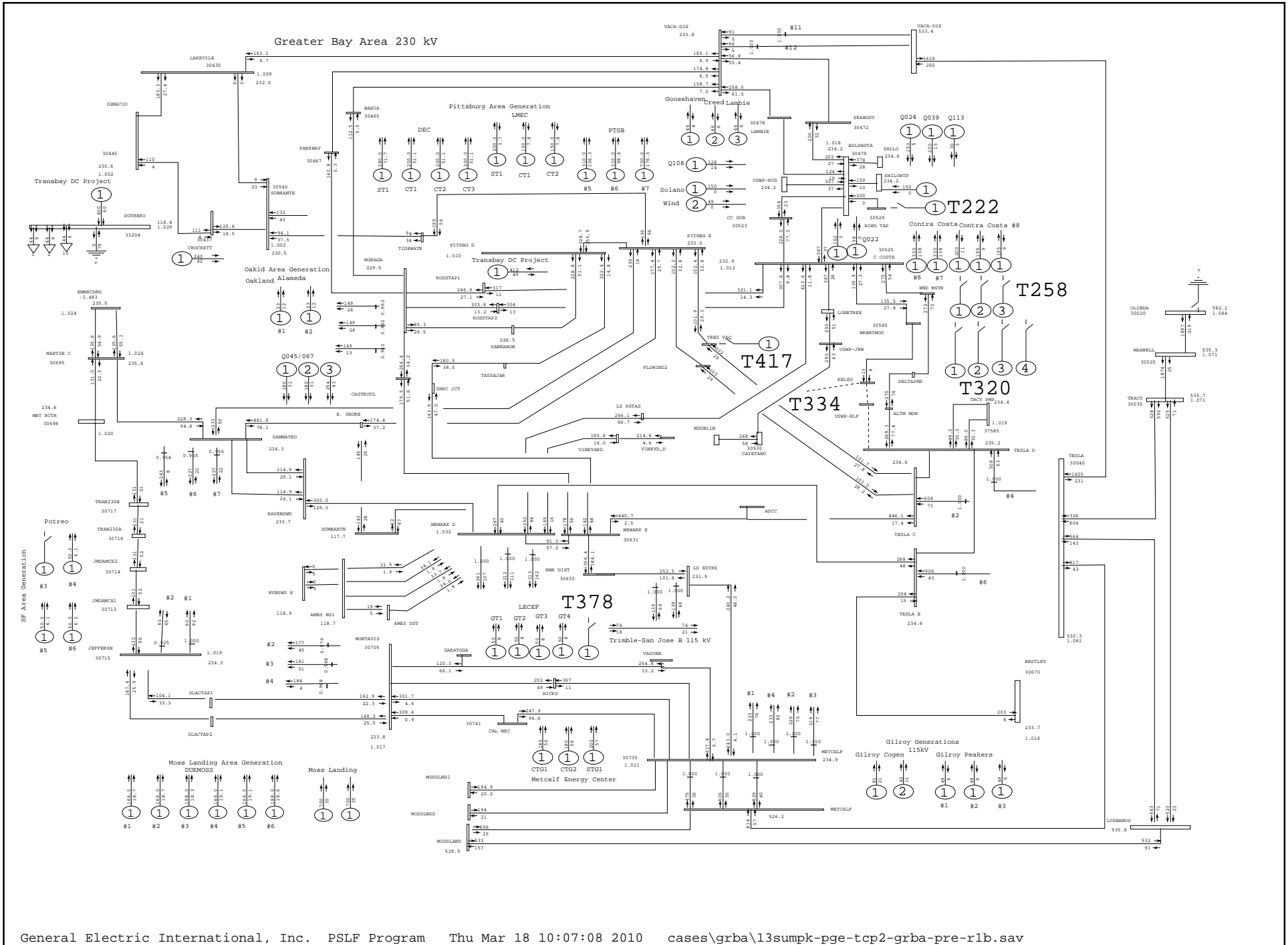

General Electric International, Inc. PSLF Program Thu Mar 18 10:07:08 2010 cases\grba\13sumpk-pge-tcp2-grba-pre-r1b.sav

 <p>PG&E 2008 CASE SERIES: 2013 Greater Bay Area Summer Peak Case (1-in-10 load) PATH15= -777 MW(S-N) PATH26= 3939 MW(N-S) PDCI= 3097 MW(N-S) COI= 4749 MW(N-S) PG&E TCP2 Greater Bay Area Summer Peak Transition Cluster Pre-Project Case</p>	<p>Plot 021: Kelso-Tesla 230 kV Line Outage</p>	<p>MW/MVAR draw\grba\pge-tcp2-grba- Rating = 2</p>
--------------------------------------------------------------------------------------------------------------------------------------------------------------------------------------------------------------------------------------------------------------------------------------------------------------------------------------------------------------------	-------------------------------------------------	------------------------------------------------------------------------------

APPENDIX D - STEADY STATE POWER FLOW PLOTS

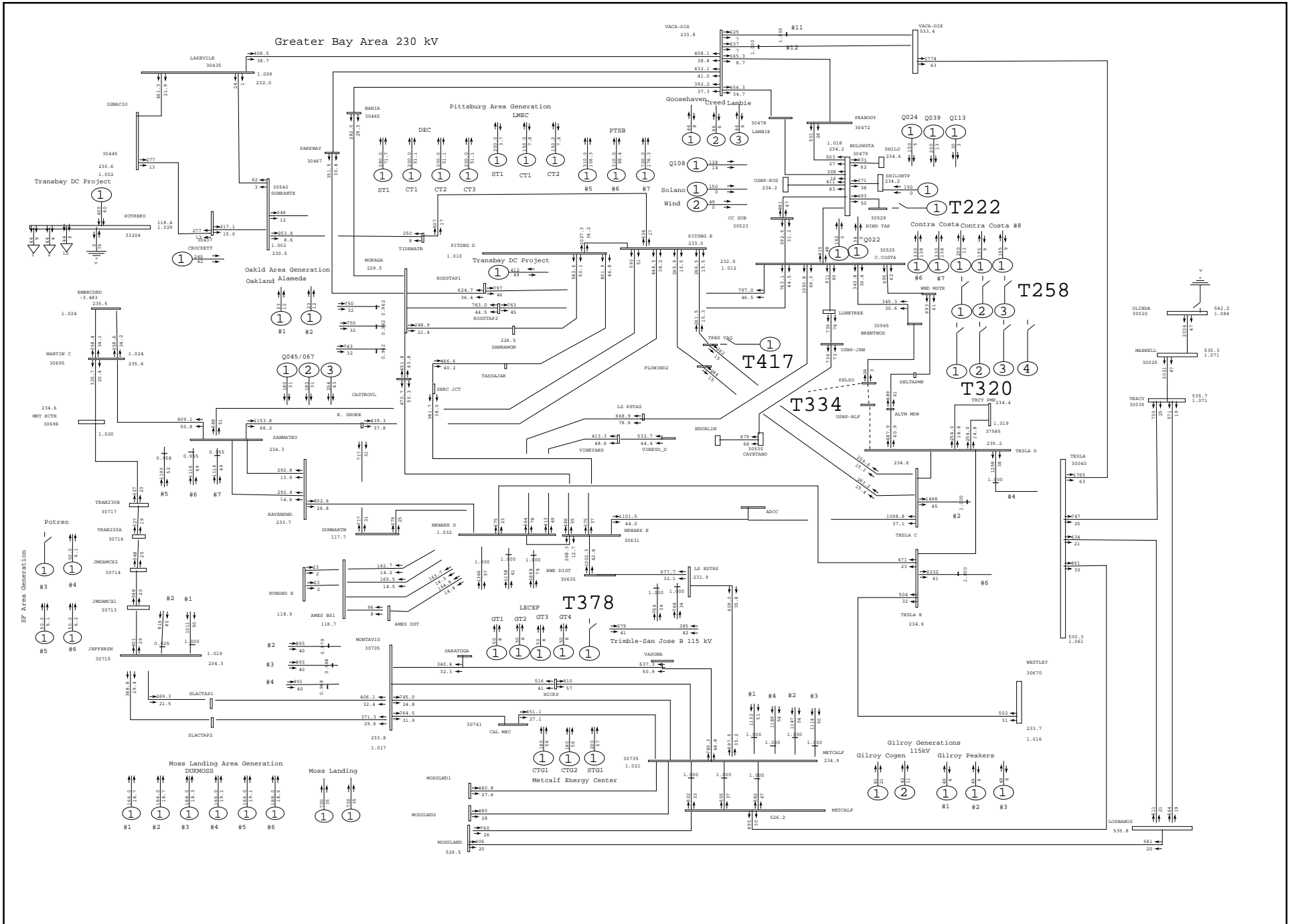

General Electric International, Inc. PSLF Program Thu Mar 18 10:07:09 2010 cases\grba\13sumpk-pge-tcp2-grba-pre-r1b.sav

 <p>PG&E 2008 CASE SERIES: 2013 Greater Bay Area Summer Peak Case (1-in-10 load) PATH15= -777 MW(S-N) PATH26= 3939 MW(N-S) PDCI= 3097 MW(N-S) COI= 4749 MW(N-S) PG&E TCP2 Greater Bay Area Summer Peak Transition Cluster Pre-Project Case</p>	<p>Plot 022: Kelso-Tesla 230 kV Line Outage</p>	<p>amps/rate draw\grba\pge-tcp2-grba- Rating = 2</p>
--------------------------------------------------------------------------------------------------------------------------------------------------------------------------------------------------------------------------------------------------------------------------------------------------------------------------------------------------------------------	-------------------------------------------------	--------------------------------------------------------------------------------

APPENDIX D - STEADY STATE POWER FLOW PLOTS

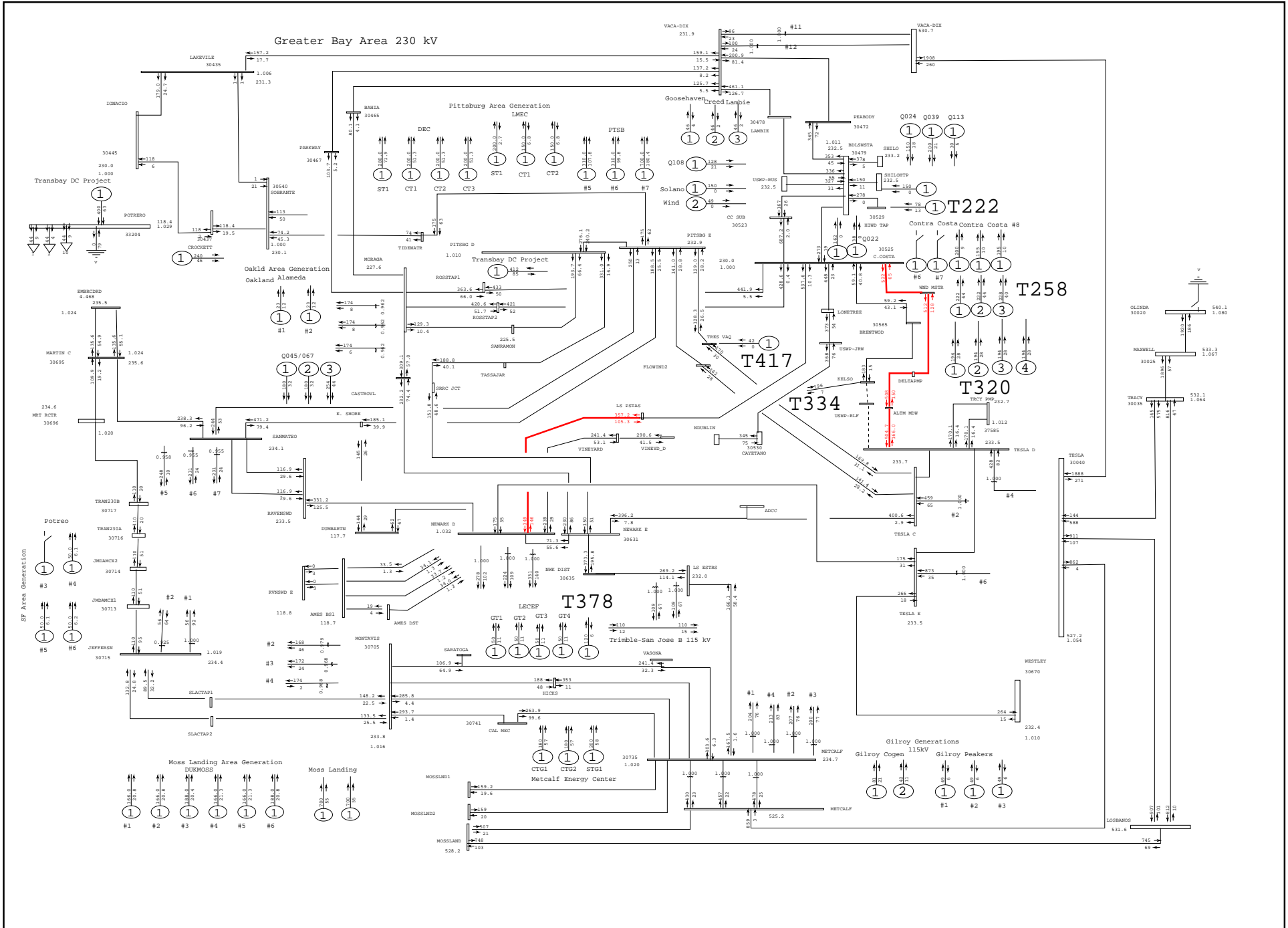

General Electric International, Inc. PSLF Program Thu Mar 18 10:07:12 2010 cases\grba\13sumpk-pge-tcp2-grba-pst-r1b.sav

 <p>PG&E 2008 CASE SERIES: 2013 Greater Bay Area Summer Peak Case (1-in-10 load) PATH15=-1850 MW(N-S) PATH26= 3860 MW(N-S) PDCI= 3093 MW(N-S) COI= 4670 MW(N-S) PG&E TCP2 Greater Bay Area Summer Peak Transition Cluster Post-Project Case</p>	<p>Plot 023: Kelso-Tesla 230 kV Line Outage</p>	<p>MW/MVAR draw\grba\pge-tcp2-grba- Rating = 2</p>
---------------------------------------------------------------------------------------------------------------------------------------------------------------------------------------------------------------------------------------------------------------------------------------------------------------------------------------------------------------------	-------------------------------------------------	------------------------------------------------------------------------------

APPENDIX D - STEADY STATE POWER FLOW PLOTS

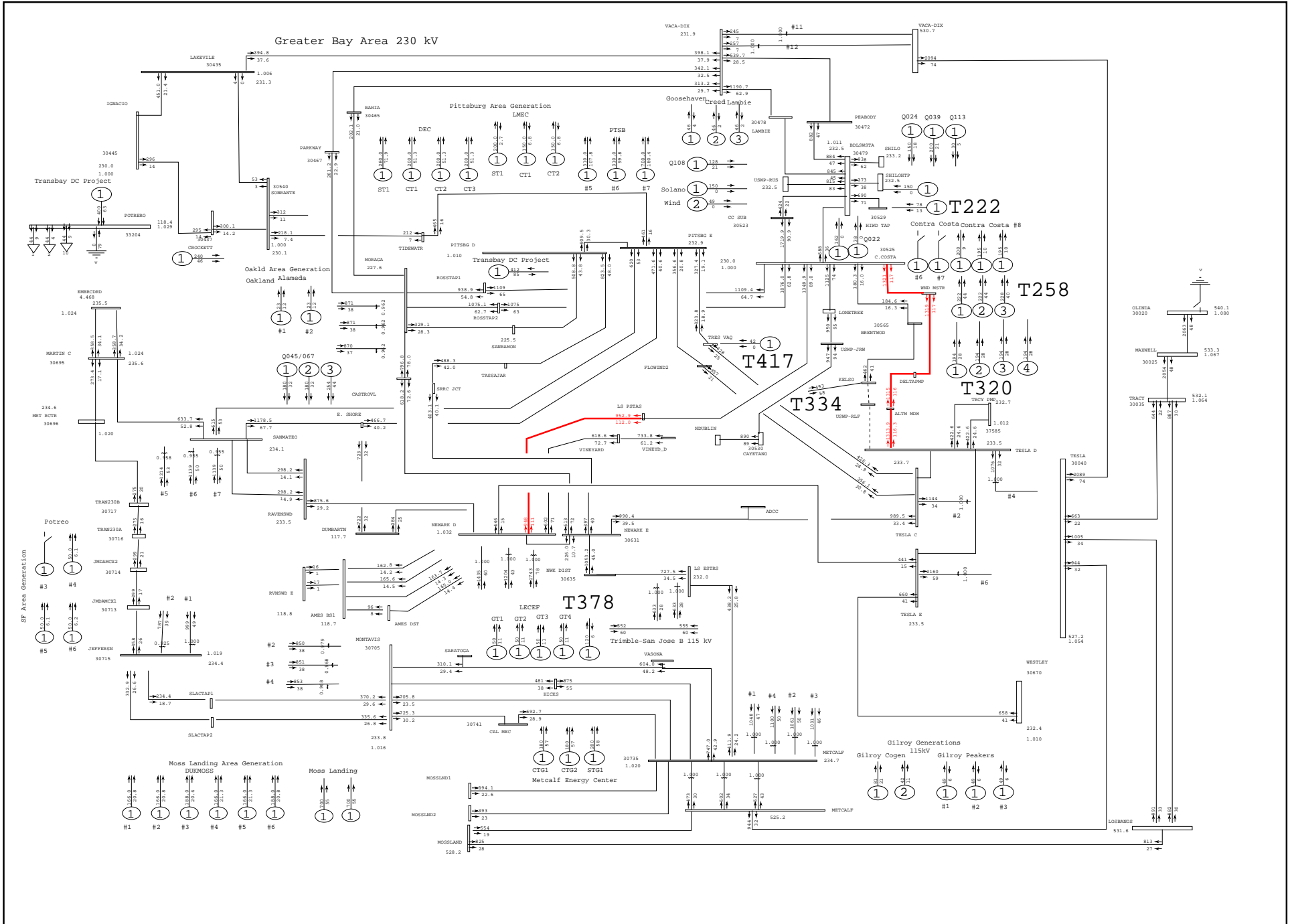

General Electric International, Inc. PSLF Program Thu Mar 18 10:07:12 2010 cases\grba\13sumpk-pge-tcp2-grba-pst-r1b.sav

 <p>PG&E 2008 CASE SERIES: 2013 Greater Bay Area Summer Peak Case (1-in-10 load) PATH15=-1850 MW(N-S) PATH26= 3860 MW(N-S) PDCI= 3093 MW(N-S) COI= 4670 MW(N-S) PG&E TCP2 Greater Bay Area Summer Peak Transition Cluster Post-Project Case</p>	<p>Plot 024: Kelso-Tesla 230 kV Line Outage</p>	<p>amps/rate draw\grba\pge-tcp2-grba- Rating = 2</p>
---------------------------------------------------------------------------------------------------------------------------------------------------------------------------------------------------------------------------------------------------------------------------------------------------------------------------------------------------------------------	-------------------------------------------------	--------------------------------------------------------------------------------

APPENDIX D - STEADY STATE POWER FLOW PLOTS

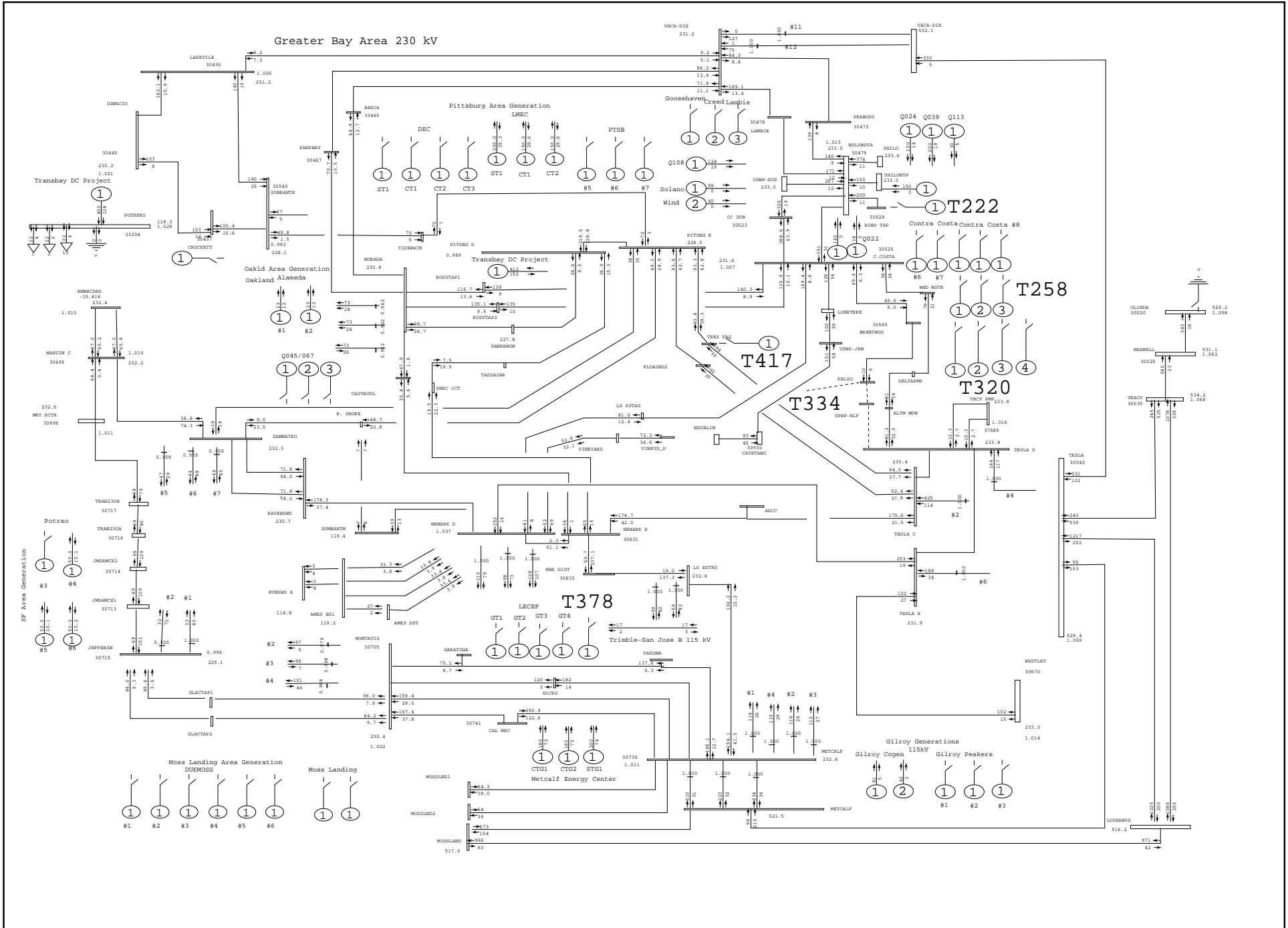

General Electric International, Inc. PSLF Program Thu Mar 18 10:07:16 2010 cases\grba\13sumop-pge-tcp2-grba-pre-r1b.sav

 <p>PG&E 2008 CASE SERIES: 2013 Summer Off Peak Case PATH15= 5181 MW(N-S) PATH26=-1643 MW(N-S) PDCI=-1846 MW(N-S) COI=-3590 MW(N-S) PG&E TCP2 Greater Bay Area Summer Off Peak Transition Cluster Pre-Project Case</p>	<p>Plot 025: Kelso-Tesla 230 kV Line Outage</p>	<p>MW/MVAR draw\grba\pge-tcp2-grba- Rating = 2</p>
--------------------------------------------------------------------------------------------------------------------------------------------------------------------------------------------------------------------------------------------------------------------------------------------------------------------------------------------	-------------------------------------------------	------------------------------------------------------------------------------

APPENDIX D - STEADY STATE POWER FLOW PLOTS

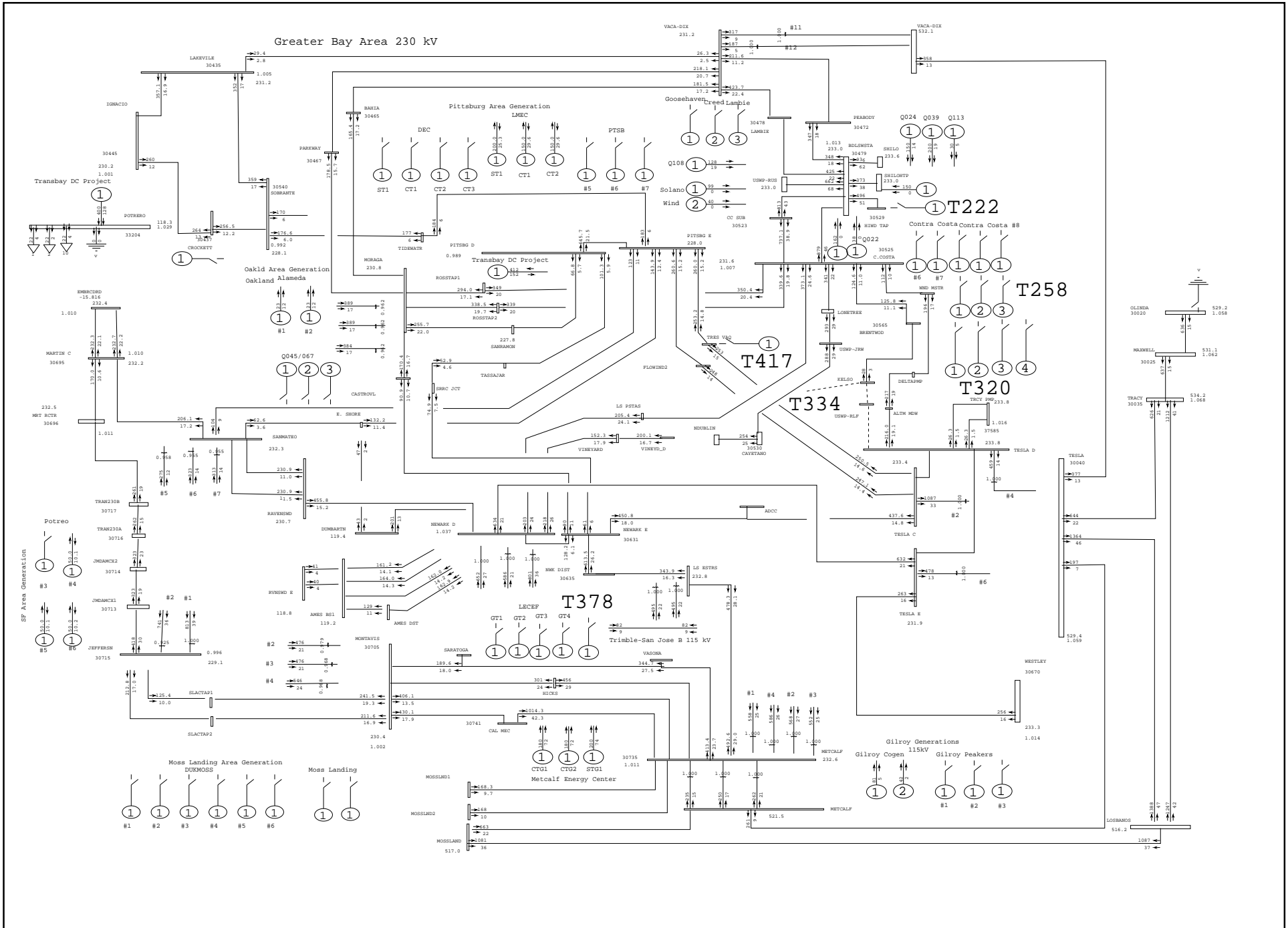

General Electric International, Inc. PSLF Program Thu Mar 18 10:07:17 2010 cases\grba\13sumop-pge-tcp2-grba-pre-r1b.sav

	PG&E 2008 CASE SERIES: 2013 Summer Off Peak Case
	PATH15= 5181 MW(N-S) PATH26=-1643 MW(N-S) PDCI=-1846 MW(N-S) COI=-3590 MW(N-S)
	PG&E TCP2 Greater Bay Area Summer Off Peak Transition Cluster Pre-Project Case

Plot 026: Kelso-Tesla 230 kV Line Outage
amps/rate
draw\grba\pge-tcp2-grba-
Rating = 2

APPENDIX D - STEADY STATE POWER FLOW PLOTS

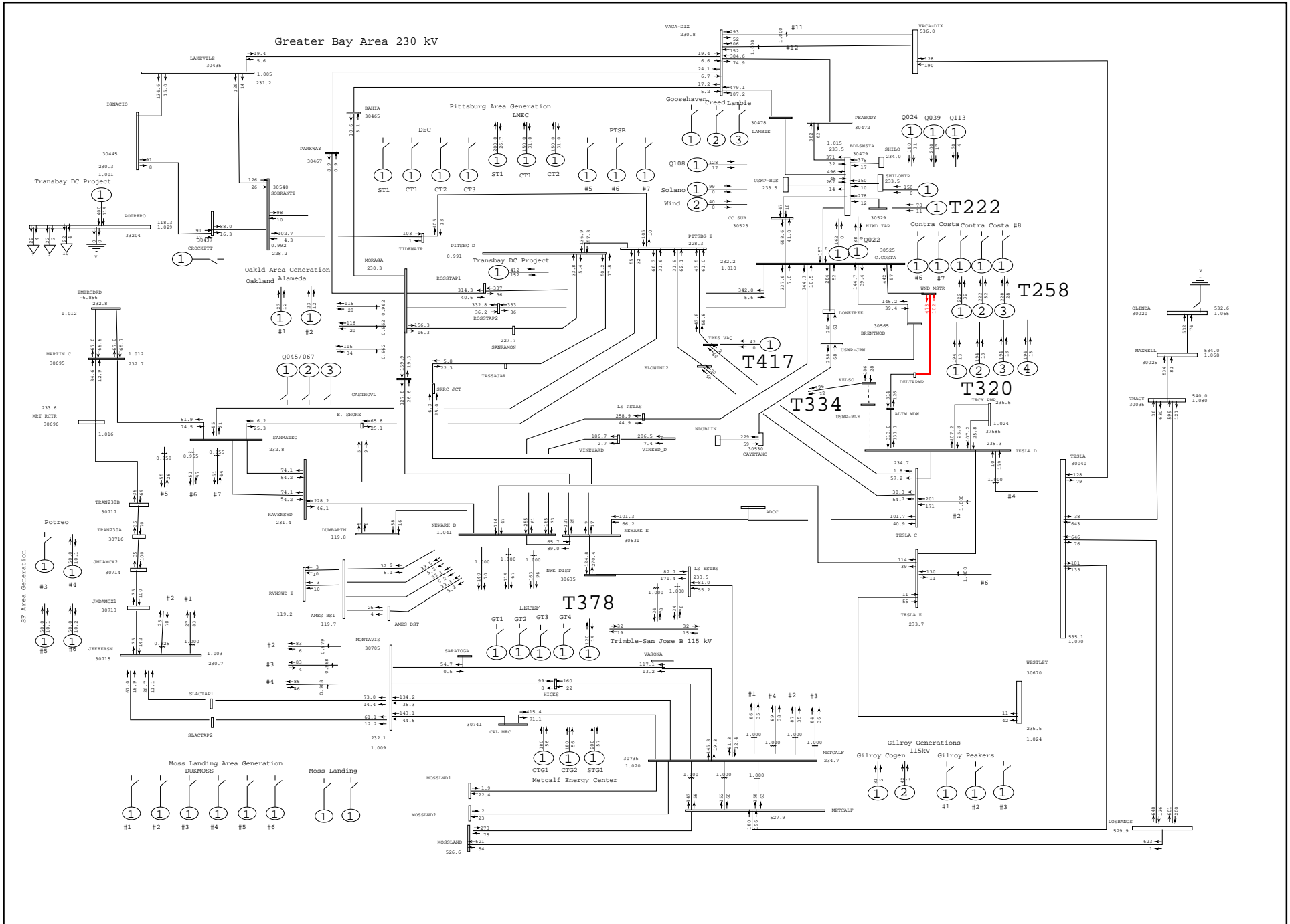

General Electric International, Inc. PSLF Program Thu Mar 18 10:07:20 2010 cases\grba\13sumop-pge-tcp2-grba-pst-r1b.sav

 <p>PG&E 2008 CASE SERIES: 2013 Summer Off Peak Case PATH15= 3429 MW(N-S) PATH26= -231 MW(N-S) PDCI=-1846 MW(N-S) COI=-3674 MW(N-S) PG&E TCP2 Greater Bay Area Summer Off Peak Transition Cluster Post-Project Case</p>	<p>Plot 027: Kelso-Tesla 230 kV Line Outage</p>	<p>MW/MVAR draw\grba\pge-tcp2-grba- Rating = 2</p>
---------------------------------------------------------------------------------------------------------------------------------------------------------------------------------------------------------------------------------------------------------------------------------------------------------------------------------------------	-------------------------------------------------	------------------------------------------------------------------------------

APPENDIX D - STEADY STATE POWER FLOW PLOTS

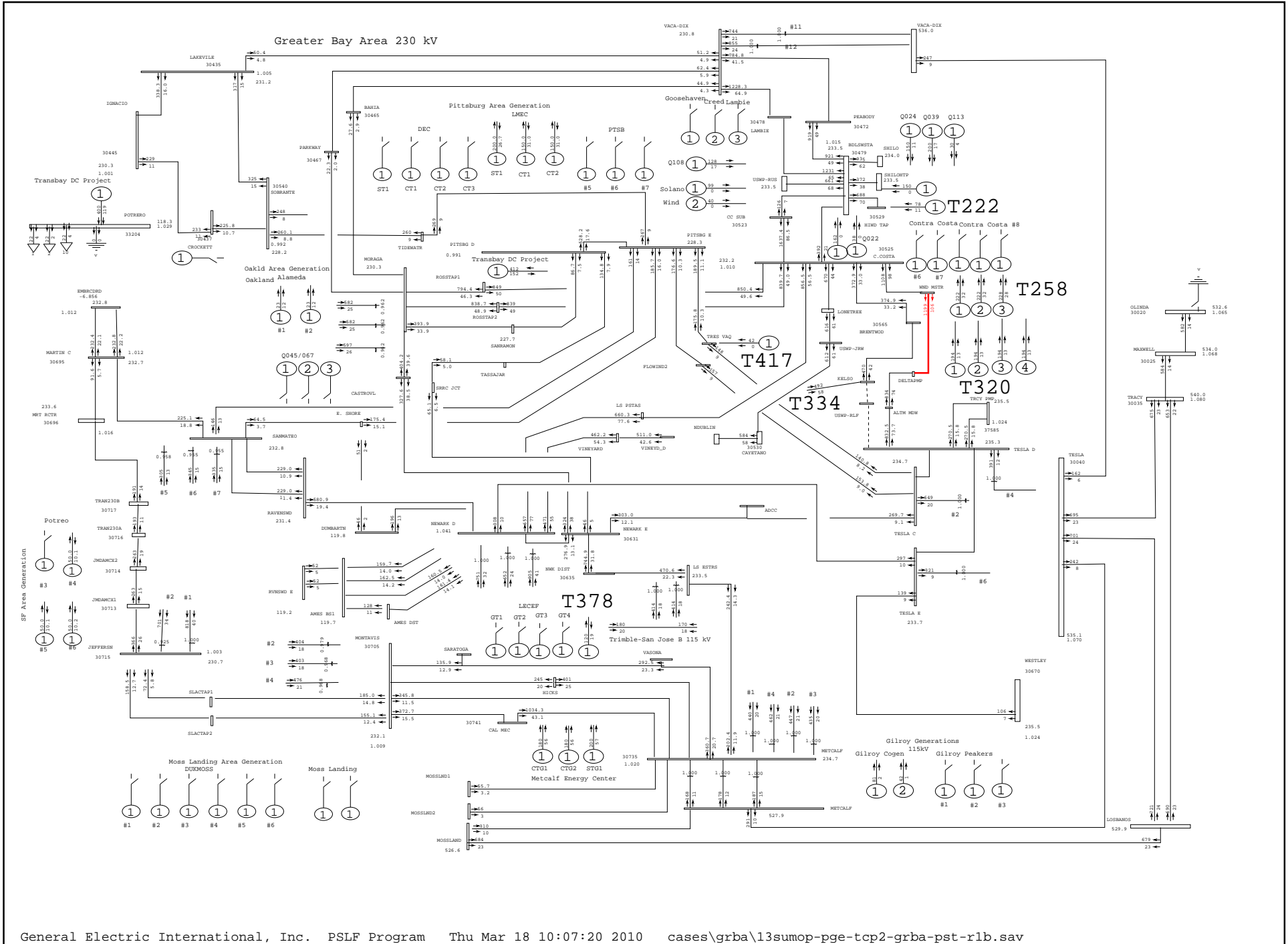

General Electric International, Inc. PSLF Program Thu Mar 18 10:07:20 2010 cases\grba\13sumop-pge-tcp2-grba-pst-r1b.sav

 <p>PG&E 2008 CASE SERIES: 2013 Summer Off Peak Case PATH15= 3429 MW(N-S) PATH26= -231 MW(N-S) PDCI=-1846 MW(N-S) COI=-3674 MW(N-S) PG&E TCP2 Greater Bay Area Summer Off Peak Transition Cluster Post-Project Case</p>	<p>Plot 028: Kelso-Tesla 230 kV Line Outage</p>	<p>amps/rate draw\grba\pge-tcp2-grba- Rating = 2</p>
---------------------------------------------------------------------------------------------------------------------------------------------------------------------------------------------------------------------------------------------------------------------------------------------------------------------------------------------	-------------------------------------------------	--------------------------------------------------------------------------------

APPENDIX D - STEADY STATE POWER FLOW PLOTS

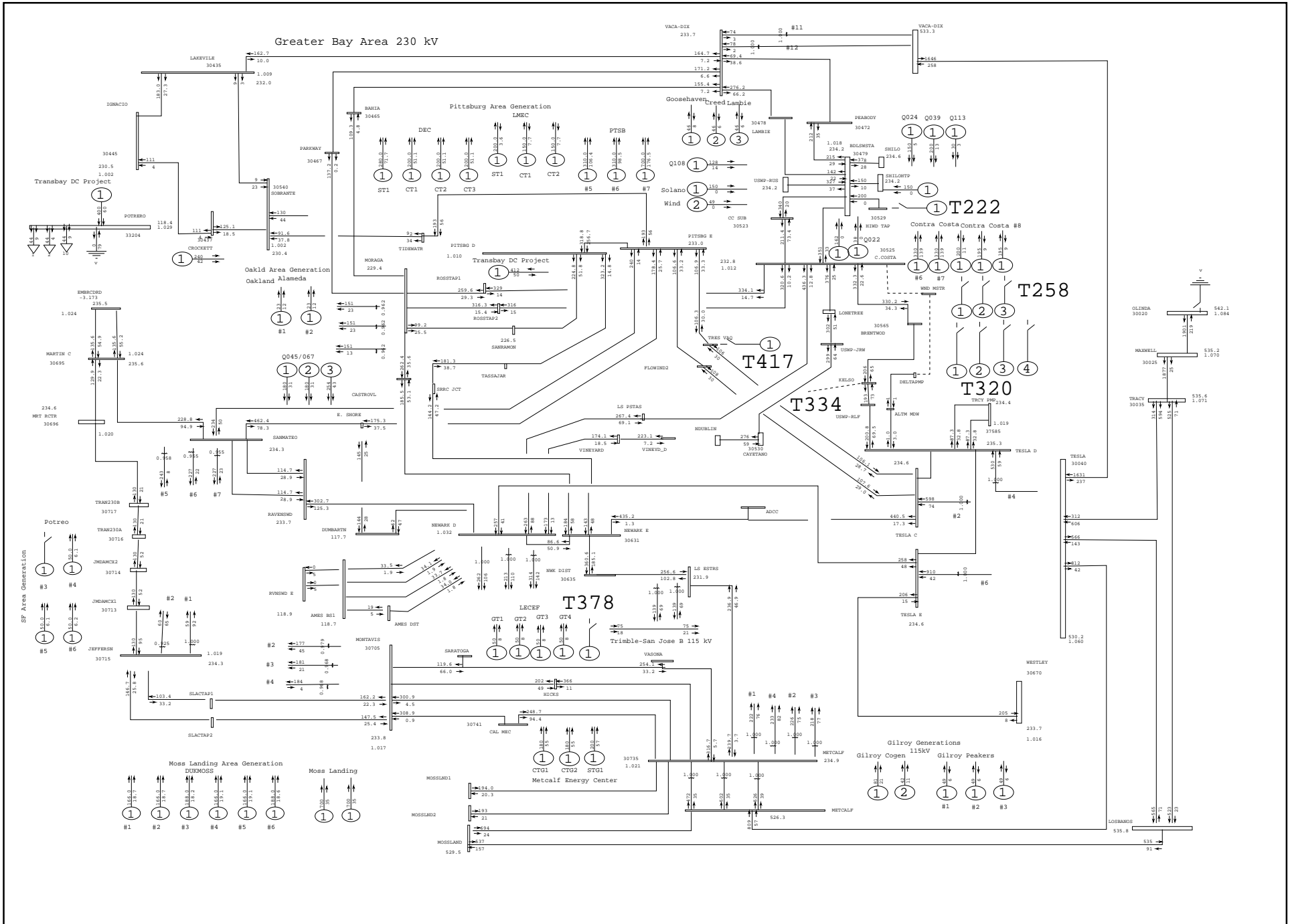

General Electric International, Inc. PSLF Program Thu Mar 18 10:07:22 2010 cases\grba\13sumpk-pge-tcp2-grba-pre-r1b.sav

 <p>PG&E 2008 CASE SERIES: 2013 Greater Bay Area Summer Peak Case (1-in-10 load) PATH15= -777 MW(S-N) PATH26= 3939 MW(N-S) PDCI= 3097 MW(N-S) COI= 4749 MW(N-S) PG&E TCP2 Greater Bay Area Summer Peak Transition Cluster Pre-Project Case</p>	<p>Plot 029: Contra Costa-Delta Pumps 230 kV Line Outage</p>	<p>MW/MVAR draw\grba\pge-tcp2-grba- Rating = 2</p>
--------------------------------------------------------------------------------------------------------------------------------------------------------------------------------------------------------------------------------------------------------------------------------------------------------------------------------------------------------------------	--------------------------------------------------------------	------------------------------------------------------------------------------

APPENDIX D - STEADY STATE POWER FLOW PLOTS

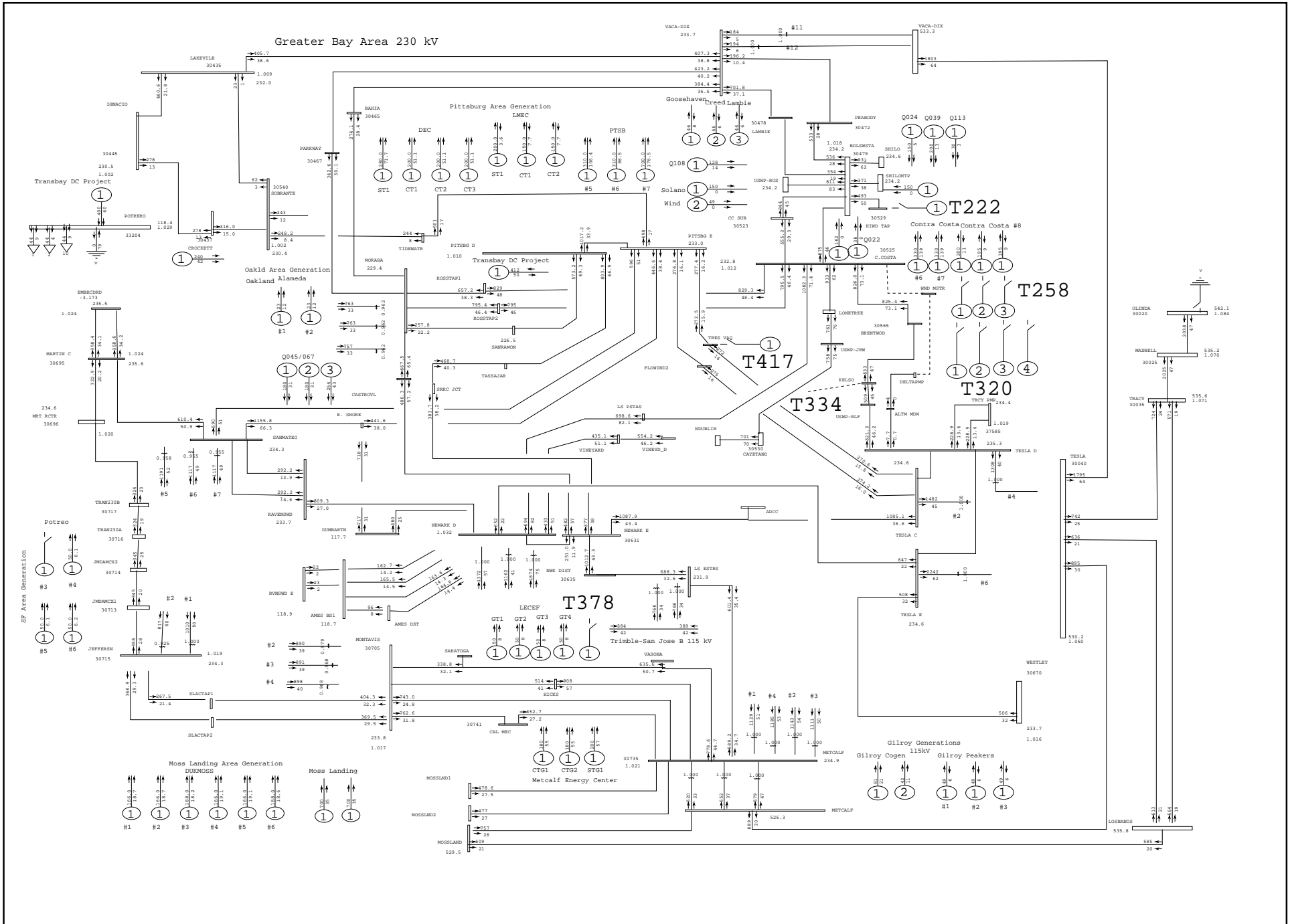

General Electric International, Inc. PSLF Program Thu Mar 18 10:07:23 2010 cases\grba\13sumpk-pge-tcp2-grba-pre-r1b.sav

	<p>PG&E 2008 CASE SERIES: 2013 Greater Bay Area Summer Peak Case (1-in-10 load) PATH15= -777 MW(S-N) PATH26= 3939 MW(N-S) PDCI= 3097 MW(N-S) COI= 4749 MW(N-S) PG&E TCP2 Greater Bay Area Summer Peak Transition Cluster Pre-Project Case</p>	<p>Plot 030: Contra Costa-Delta Pumps 230 kV Line Outage</p>	<p>amps/rate draw\grba\pge-tcp2-grba- Rating = 2</p>
--	---------------------------------------------------------------------------------------------------------------------------------------------------------------------------------------------------------------------------------------------------------------------------------	--------------------------------------------------------------	--------------------------------------------------------------------------------

APPENDIX D - STEADY STATE POWER FLOW PLOTS

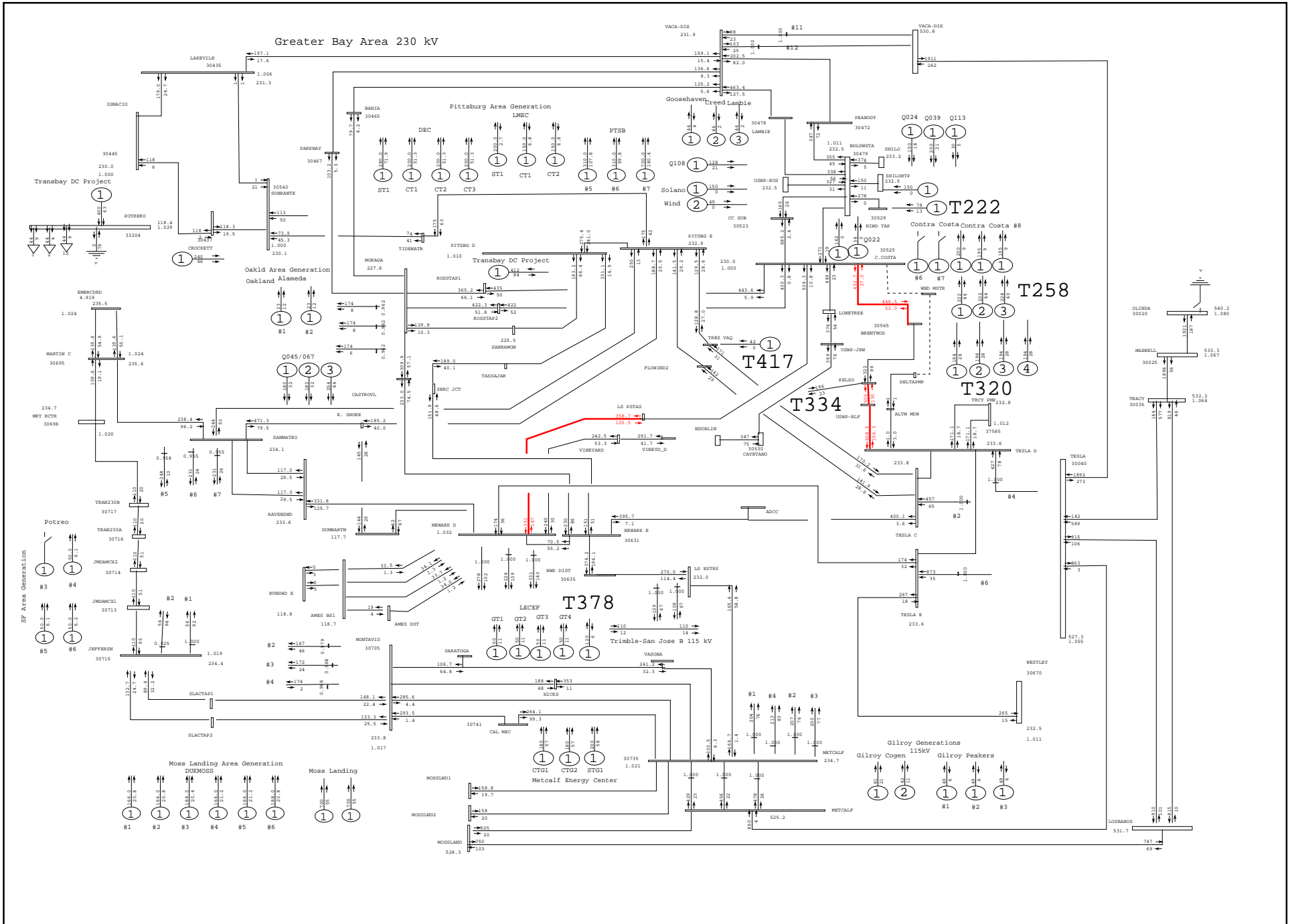

General Electric International, Inc. PSLF Program Thu Mar 18 10:07:24 2010 cases\grba\13sumpk-pge-tcp2-grba-pst-r1b.sav

 <p>PG&E 2008 CASE SERIES: 2013 Greater Bay Area Summer Peak Case (1-in-10 load) PATH15=-1850 MW(N-S) PATH26= 3860 MW(N-S) PDCI= 3093 MW(N-S) COI= 4670 MW(N-S) PG&E TCP2 Greater Bay Area Summer Peak Transition Cluster Post-Project Case</p>	<p>Plot 031: Contra Costa-Delta Pumps 230 kV Line Outage</p>	<p>MW/MVAR draw\grba\pge-tcp2-grba- Rating = 2</p>
---------------------------------------------------------------------------------------------------------------------------------------------------------------------------------------------------------------------------------------------------------------------------------------------------------------------------------------------------------------------	--------------------------------------------------------------	------------------------------------------------------------------------------

APPENDIX D - STEADY STATE POWER FLOW PLOTS

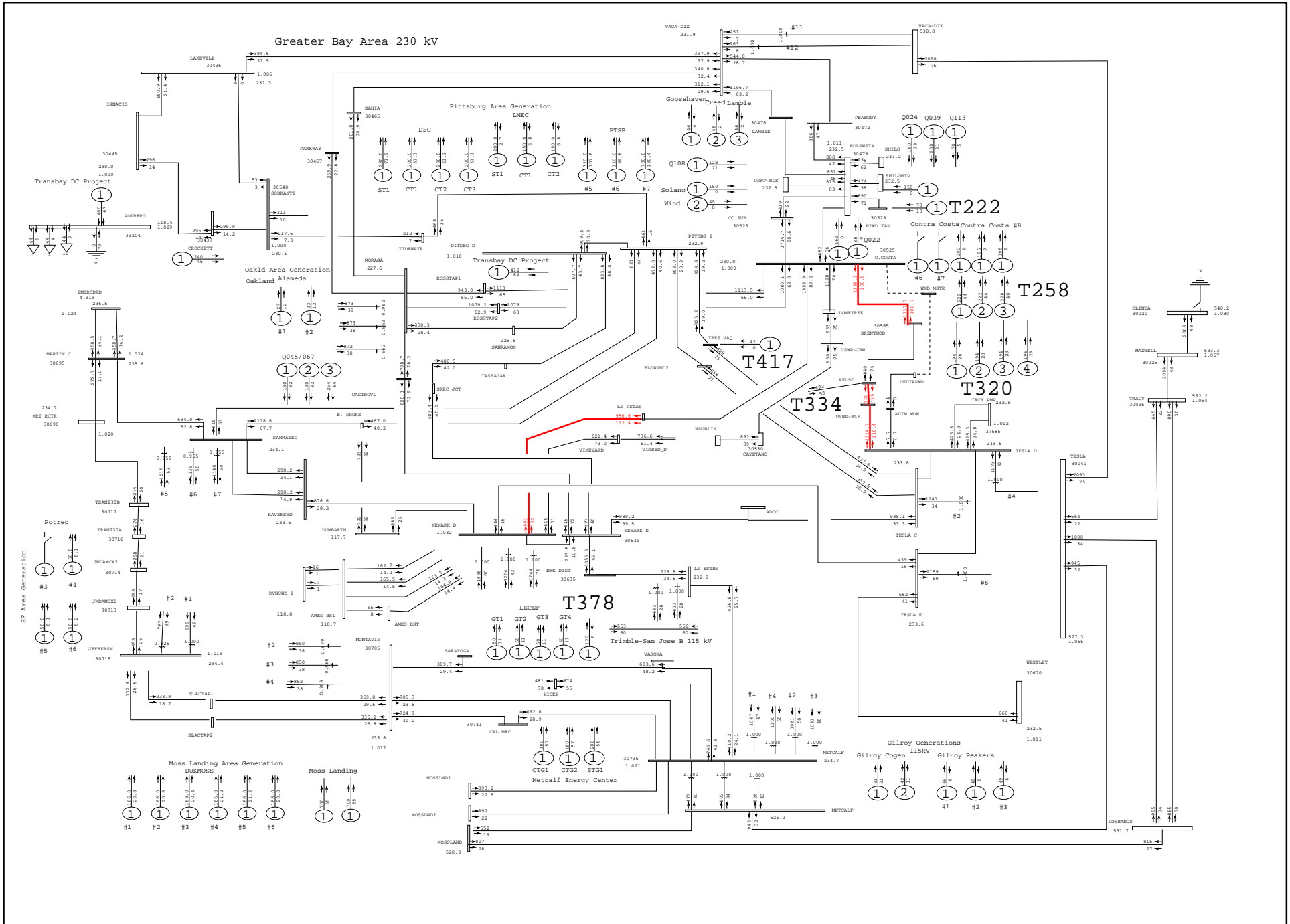

General Electric International, Inc. PSLF Program Thu Mar 18 10:07:25 2010 cases\grba\13sumpk-pge-tcp2-grba-pst-r1b.sav

PG&E 2008 CASE SERIES: 2013 Greater Bay Area Summer Peak Case (1-in-10 load) PATH15=-1850 MW(S-N) PATH26= 3860 MW(N-S) PDCI= 3093 MW(N-S) COI= 4670 MW(N-S) PG&E TCP2 Greater Bay Area Summer Peak Transition Cluster Post-Project Case	Plot 032: Contra Costa-Delta Pumps 230 kV Line Outage	amps/rate draw\grba\pge-tcp2-grba- Rating = 2
-----------------------------------------------------------------------------------------------------------------------------------------------------------------------------------------------------------------------------------------------	-------------------------------------------------------	-----------------------------------------------------

APPENDIX D - STEADY STATE POWER FLOW PLOTS

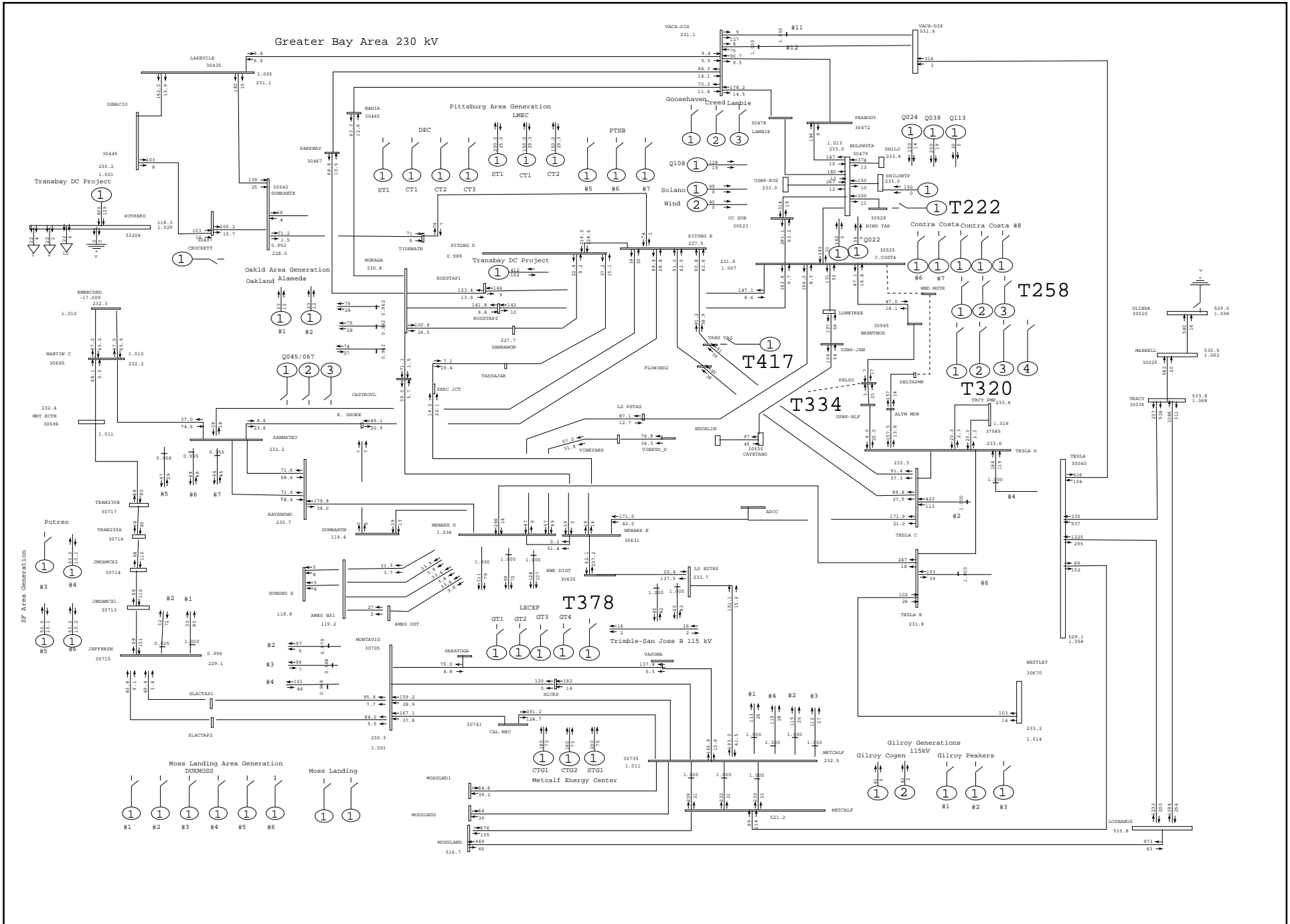

General Electric International, Inc. PSLF Program Thu Mar 18 10:07:28 2010 cases\grba\13sumop-pge-tcp2-grba-pre-r1b.sav

Pacific Gas and Electric Company
 PG&E 2008 CASE SERIES: 2013 Summer Off Peak Case
 PATH15= 5181 MW(S-N) PATH26=-1643 MW(N-S) PDCI=-1846 MW(N-S) COI=-3590 MW(N-S)
 PG&E TCP2 Greater Bay Area Summer Off Peak Transition Cluster Pre-Project Case

Plot 033: Contra Costa-Delta Pumps 230 kV Line Outage

MW/MVAR
 draw\grba\pge-tcp2-grba-
 Rating = 2

APPENDIX D - STEADY STATE POWER FLOW PLOTS

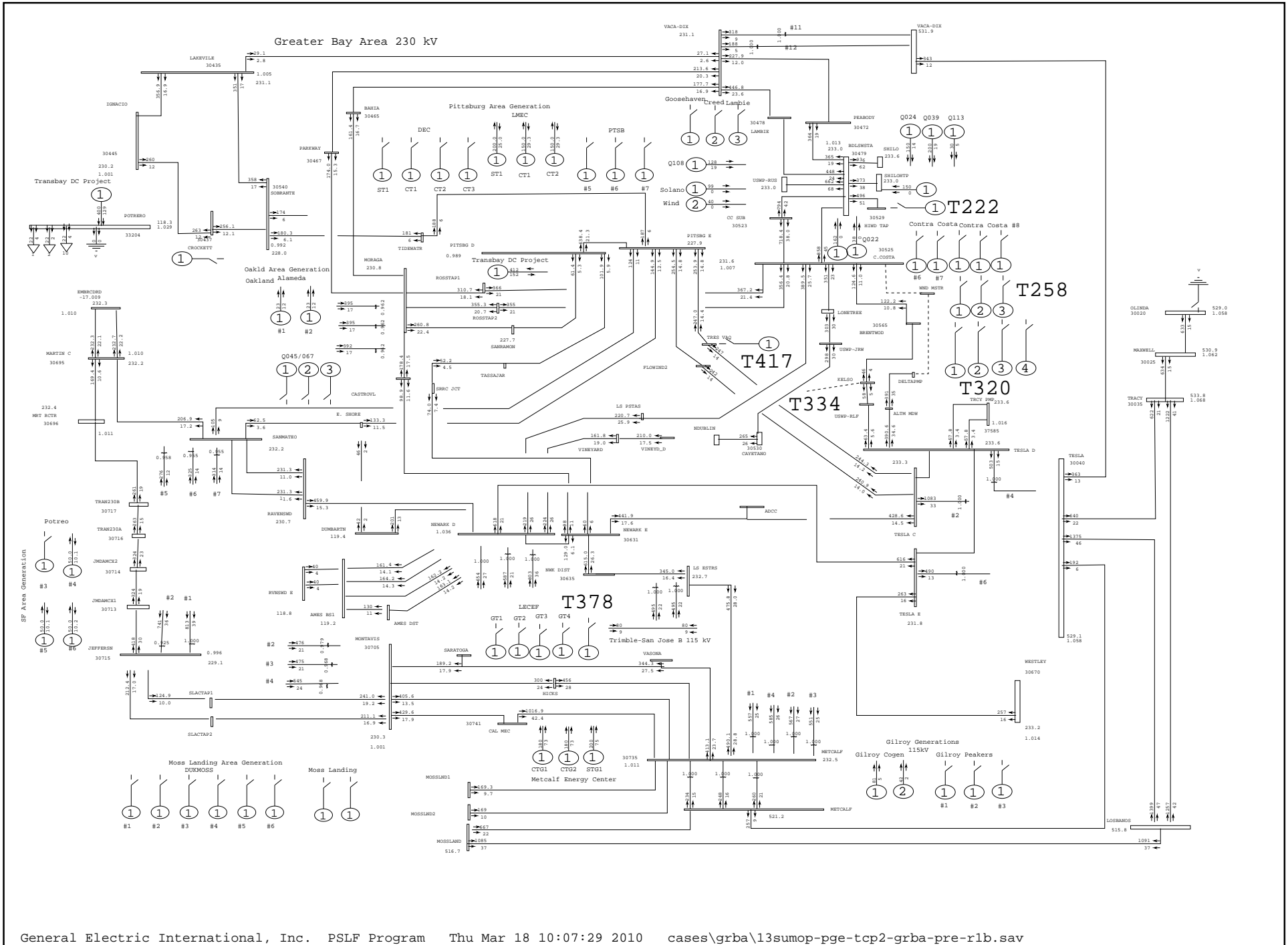

General Electric International, Inc. PSLF Program Thu Mar 18 10:07:29 2010 cases\grba\13sumop-pge-tcp2-grba-pre-r1b.sav

PG&E 2008 CASE SERIES: 2013 Summer Off Peak Case PATH15= 5181 MW(N-S) PATH26=-1643 MW(N-S) PDCI=-1846 MW(N-S) COI=-3590 MW(N-S) PG&E TCP2 Greater Bay Area Summer Off Peak Transition Cluster Pre-Project Case	Plot 034: Contra Costa-Delta Pumps 230 kV Line Outage amps/rate draw\grba\pge-tcp2-grba- Rating = 2
----------------------------------------------------------------------------------------------------------------------------------------------------------------------------------------------------------------------	------------------------------------------------------------------------------------------------------------------

APPENDIX D - STEADY STATE POWER FLOW PLOTS

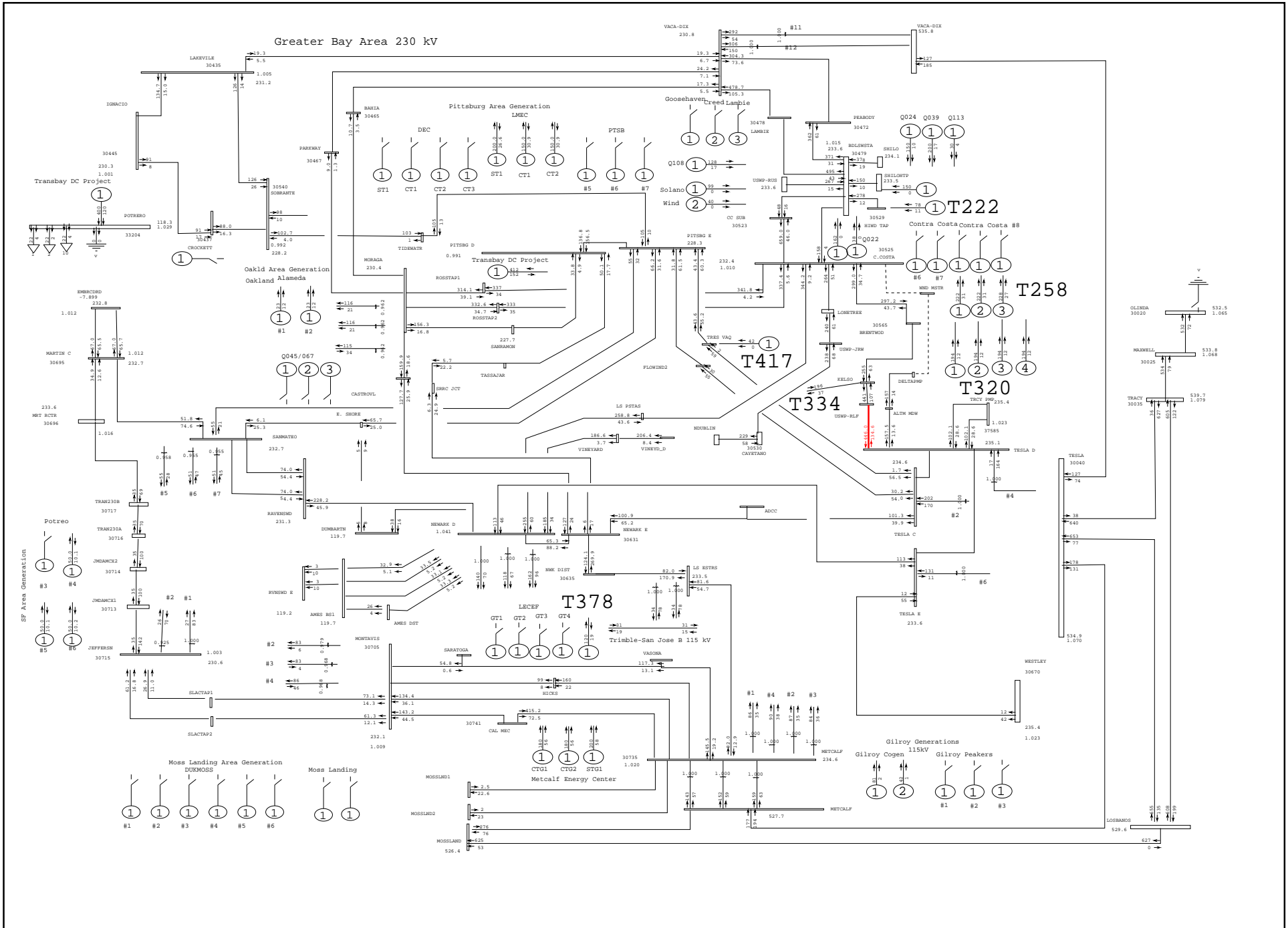

General Electric International, Inc. PSLF Program Thu Mar 18 10:07:32 2010 cases\grba\13sumop-pge-tcp2-grba-pst-r1b.sav

 <p>PG&E 2008 CASE SERIES: 2013 Summer Off Peak Case PATH15= 3429 MW(N-S) PATH26= -231 MW(N-S) PDCI=-1846 MW(N-S) COI=-3674 MW(N-S) PG&E TCP2 Greater Bay Area Summer Off Peak Transition Cluster Post-Project Case</p>	<p>Plot 035: Contra Costa-Delta Pumps 230 kV Line Outage</p>	<p>MW/MVAR draw\grba\pge-tcp2-grba- Rating = 2</p>
---------------------------------------------------------------------------------------------------------------------------------------------------------------------------------------------------------------------------------------------------------------------------------------------------------------------------------------------	--------------------------------------------------------------	------------------------------------------------------------------------------

APPENDIX D - STEADY STATE POWER FLOW PLOTS

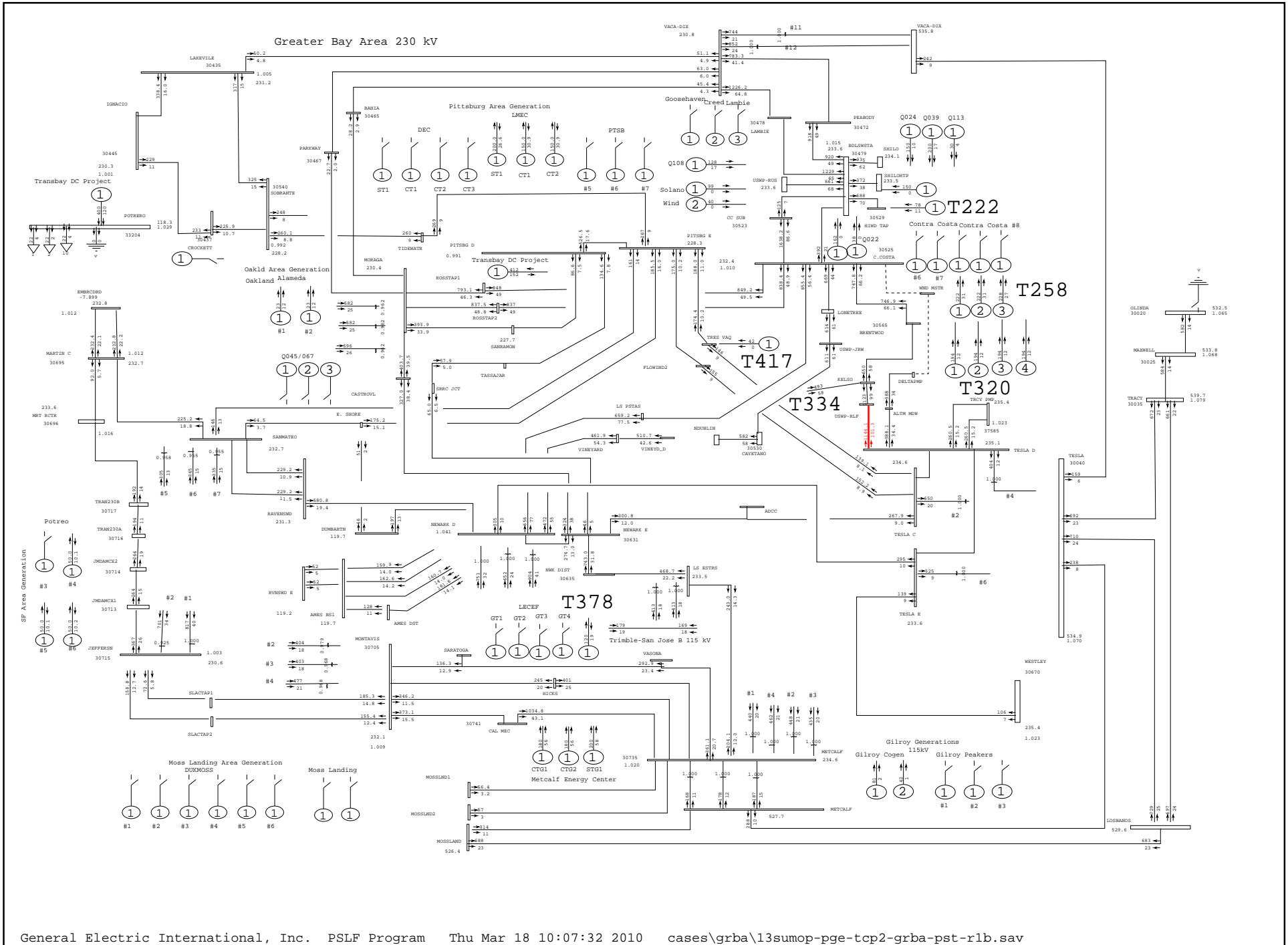

General Electric International, Inc. PSLF Program Thu Mar 18 10:07:32 2010 cases\grba\13sumop-pge-tcp2-grba-pst-r1b.sav

 <p>PG&E 2008 CASE SERIES: 2013 Summer Off Peak Case PATH15= 3429 MW(N-S) PATH26= -231 MW(N-S) PDCI=-1846 MW(N-S) COI=-3674 MW(N-S) PG&E TCP2 Greater Bay Area Summer Off Peak Transition Cluster Post-Project Case</p>	<p>Plot 036: Contra Costa-Delta Pumps 230 kV Line Outage</p>	<p>amps/rate draw\grba\pge-tcp2-grba- Rating = 2</p>
---------------------------------------------------------------------------------------------------------------------------------------------------------------------------------------------------------------------------------------------------------------------------------------------------------------------------------------------	--------------------------------------------------------------	--------------------------------------------------------------------------------

Appendix E

Short Circuit Calculation Study Results

BUS	BIRDSLANDING		COCO PP D&E		GATES		GATES		KELSO SUB		KINGSB CGN		LOS ESTEROS		PITTSBURG E2		TESLA BUS C	
KV	230		230		70		230		230		115		115		230		230	
	3LG(A)	1LG(A)	3LG(A)	1LG(A)	3LG(A)	1LG(A)	3LG(A)	1LG(A)	3LG(A)	1LG(A)	3LG(A)	1LG(A)	3LG(A)	1LG(A)	3LG(A)	1LG(A)	3LG(A)	1LG(A)
ALL ON	29,514	29,058	50,949	56,170	11,181	12,070	37,483	35,059	22,460	16,265	13,273	9,820	46,218	50,825	51,572	57,091	42,750	41,273
Bay Area																		
Q222	29,514	28,842	50,949	56,164	11,181	12,070	37,483	35,059	22,460	16,265	13,273	9,820	46,218	50,825	51,572	57,091	42,750	41,273
Difference	0	216	0	6	0	0	0	0	0	0	0	0	0	0	0	0	0	0
% Decrease	0.0%	-0.7%	0.0%	0.0%	0.0%	0.0%	0.0%	0.0%	0.0%	0.0%	0.0%	0.0%	0.0%	0.0%	0.0%	0.0%	0.0%	0.0%
Q0258	28,379	28,281	45,582	48,919	11,181	12,070	37,481	35,058	22,292	16,206	13,273	9,820	46,159	50,780	51,467	57,007	42,619	41,194
Difference	1,135	777	5,367	7,251	0	0	2	1	168	59	0	0	60	45	105	84	131	79
% Decrease	-4.0%	-2.7%	-11.8%	-14.8%	0.0%	0.0%	0.0%	0.0%	-0.8%	-0.4%	0.0%	0.0%	-0.1%	-0.1%	-0.2%	-0.1%	-0.3%	-0.2%
Q0320	28,607	28,435	46,601	50,068	11,181	12,070	37,481	35,058	22,326	16,218	13,273	9,820	46,171	50,789	51,488	57,024	42,646	41,210
Difference	908	623	4,348	6,102	0	0	2	1	134	47	0	0	48	36	83	67	104	63
% Decrease	-3.2%	-2.2%	-9.3%	-12.2%	0.0%	0.0%	0.0%	0.0%	-0.6%	-0.3%	0.0%	0.0%	-0.1%	-0.1%	-0.2%	-0.1%	-0.2%	-0.2%
Q0334	29,499	29,048	50,887	56,119	11,181	12,070	37,482	35,058	22,062	15,742	13,273	9,820	46,214	50,821	51,565	57,084	42,718	41,248
Difference	15	10	62	51	0	0	1	1	398	523	0	0	5	4	7	6	31	26
% Decrease	-0.1%	0.0%	-0.1%	-0.1%	0.0%	0.0%	0.0%	0.0%	-1.8%	-3.3%	0.0%	0.0%	0.0%	0.0%	0.0%	0.0%	-0.1%	-0.1%
Q0378	29,507	29,055	50,916	56,146	11,181	12,071	37,483	35,059	22,456	16,265	13,273	9,820	43,147	45,337	51,540	57,067	42,693	41,242
Difference	7	3	33	24	0	0	0	-1	5	0	0	0	3,071	5,488	32	24	56	31
% Decrease	0.0%	0.0%	-0.1%	0.0%	0.0%	0.0%	0.0%	0.0%	0.0%	0.0%	0.0%	0.0%	-7.1%	-12.1%	-0.1%	0.0%	-0.1%	-0.1%
Q0417	29,510	29,055	50,937	56,161	11,181	12,070	37,482	35,058	22,454	16,257	13,273	9,820	46,210	50,818	51,458	56,984	42,485	41,007
Difference	4	3	12	10	0	0	1	0	6	8	0	0	9	7	114	106	265	266
% Decrease	0.0%	0.0%	0.0%	0.0%	0.0%	0.0%	0.0%	0.0%	0.0%	-0.1%	0.0%	0.0%	0.0%	0.0%	-0.2%	-0.2%	-0.6%	-0.6%



Attachment 1

Generator Machine Dynamic Data

Machine Data for GT Units 1-2:

Model: GENROU

Variable	Description	Value
Tdop	D-axis transient rotor time constant, set	10.119
Tppdo	D-axis sub-transient rotor time constant, sec	0.047
Tpgo	Q-axis transient rotor time constant, sec	1.124
Tppgo	Q-axis sub-transient rotor time constant, sec	0.081
H	Inertia constant, sec	5.32
D	Damping factor, pu	0.00
Ld	D-axis synchronous reactance, pu	2.078
Lq	Q-axis synchronous reactance, pu	2.024
Lpd	D-axis transient synchronous reactance, pu	0.269
Lpq	Q-axis transient synchronous reactance, pu	0.455
Lppd	D-axis subtransient synchronous reactance, pu	0.203
Ll	Stator leakage reactance, pu	0.173
s1	Saturation factor at 1 pu flux	0.067
s12	Saturation factor at 1.2 pu flux	0.206
Ra	Stator resistance, pu	0.002
Rcomp	Compounding resistance voltage control, pu	0.00
Xcomp	Compounding reactance voltage control, pu	0.00

Excitation Data for GT Units 1-2:

Model: REXS

Variable	Description	Value
Tr	Voltage transducer time constant, sec	0.1
Kvp	Voltage regulator proportional gain	8.0
Kvi	Voltage regulator integral gain	13.
Vimax	Voltage regulator input limit, p.u.	999.
Ta	Voltage regulator time constant, sec	0.0
Tb1	Lag time constant, sec	0.0
Tc1	Lead time constant, sec	0.0
Tb2	Lag time constant, sec	0.0
Tc2	Lead time constant, sec	0.0
Vrmax	Maximum controller output, p.u.	15.4
Vrmin	Minimum controller output, p.u.	-12.3
Kf	Rate feedback gain	0.02
Tf	Rate feedback time constant, sec	0.70
Tf1	Feedback lead time constant, sec	0.0
Tf2	Feedback lag time constant, sec	0.0
Fbf	Rate feedback signal flag	1
Kip	Field current regulator proportional gain	20.0
Kii	Field current regulator integral gain	10.0
Tp	Field current bridge time constant, sec	0.02
Vfmax	Maximum exciter field current, p.u.	15.4
Vfmin	Minimum exciter field current, p.u.	-12.3
Kh	Field voltage controller feedback gain	1.0
Ke	Exciter field proportional constant	0.50
Te	Exciter field time constant, sec	0.70
Kc	Rectifier regulation factor, p.u.	0.10
Kd	Exciter regulation factor, p.u.	0.50
E1	Exciter flux at knee of curve, p.u.	2.525
Se1	Saturation factor at knee	0.10
E2	Maximum exciter, p.u.	3.367
Se2	Saturation factor at max flux	0.23
Rcomp	Not used	0
Xcomp	Not used	0
Nvphz	Pickup speed of v/Hz limiter, p.u	0
Kvphz	V/Hz limiter gain	0
Flimf	Limit type flag	1
Xc	Exciter compounding reactance, p.u.	0.0
Vcmax	Maximum compounding voltage, p.u.	0.0
Kefd	Field voltage feedback gain	0

Governor Data for GT Units 1-2:

Model:

GGOV1

Variable	Description	Value
R	Permanent droop, p.u.	0.04
rselect	Selection for feedback signal for droop	1
tpelec	Electrical power transducer time constant, sec	2.5
maxerr	Maximum value for speed error signal	0.004
minerr	Minimum value for speed error signal	-1.0
kpgov	Governor proportional gain	4.0
kigov	Governor integral gain	0.45
kdgov	Governor derivative gain	0.0
tdgov	Governor derivative controller time constant, sec	1.0
vmax	Maximum valve position limit	1.00
vmin	Minimum valve position limit	0.175
Tact	Actuator time constant, sec	0.40
Kturb	Turbine gain	1.9168
wfnl	No load fuel flow, p.u.	0.187
Tb	Turbine lag time constant, sec	0.1
Tc	Turbine lead time constant, sec	0.0
Flag	Switch for turbine output	0.0
Teng	Transport lag time constant for diesel engine	0
Tfload	Load limiter time constant, sec	3.0
kpload	Load limiter proportional gain for PI controller	1.00
kiload	Load limiter integral gain for PI controller	1.00
Ldref	Load limiter reference value, p.u.	1.00
Dm	Mechanical damping coefficient, p.u.	0.00
Ropen	Maximum valve opening rate, p.u./sec.	99.0
Rclose	Minimum valve opening rate, p.u./sec.	-99.0
Kimw	Power controller gain	0.0
Pmwset	Power controller setpoint, MW	15.52
Asset	Acceleration limiter setpoint, p.u./sec.	10.0
Ka	Acceleration limiter gain	10.0
Ta	Acceleration limiter time constant, sec.	1.0
Db	Speed governor dead band	0.0
Tsa	Temperature detection lead time constant, sec.	1.0
Tsb	Temperature detection lag time constant, sec.	1.0
Rup	Maximum rate of load limit increase	99.0
Rdown	Maximum rate of load limit decrease	-99.0
Tbd	Speed ratio valve and fuel supply lag time constant, sec.	0.0
Tcd	Speed ratio valve and fuel supply lead time constant, sec.	0.0

PSS Data for GT Units 1-2:

Model: PSS2a

Variable	Description	Value
j1	Input signal #1 code	3
k1	Input signal #1 remote bus number	0
j2	Input signal #2 code	3
k2	Input signal #2 remote bus number	0
tw1	First washout on signal #1, sec	0.2
tw2	First washout on signal #1, sec	0
tw3	First washout on signal #2, sec	0.2
tw4	First washout on signal #2, sec	0
t6	Time constant on signal #1, sec	0.02
t7	Time constant on signal #2, sec	2.0
ks2	Gain signal #2	0
ks3	Gain signal #2	0
ks4	Gain signal #2	0
t8	Lead of ramp tracking filter	0
t9	Lag of ramp tracking filter	0.427
N	Order of ramp tracking filter	1
M	Order of ramp tracking filter	1
ks1	Stabilizer gain	-2.0
t1	Lead/lag time constants, sec	0.28
t2	Lead/lag time constants, sec	0.43
t3	Lead/lag time constants, sec	0.28
t4	Lead/lag time constants, sec	1.16
vstmax	Stabilizer output max limit, p.u.	0.10
vstmin	Stabilizer output min limit, p.u.	-0.10

Attachment 2

Dynamic Stability Plots

Q320 TCP2 ISIS

Selected PG&E Bus Voltage Plots Adjacent to Fault

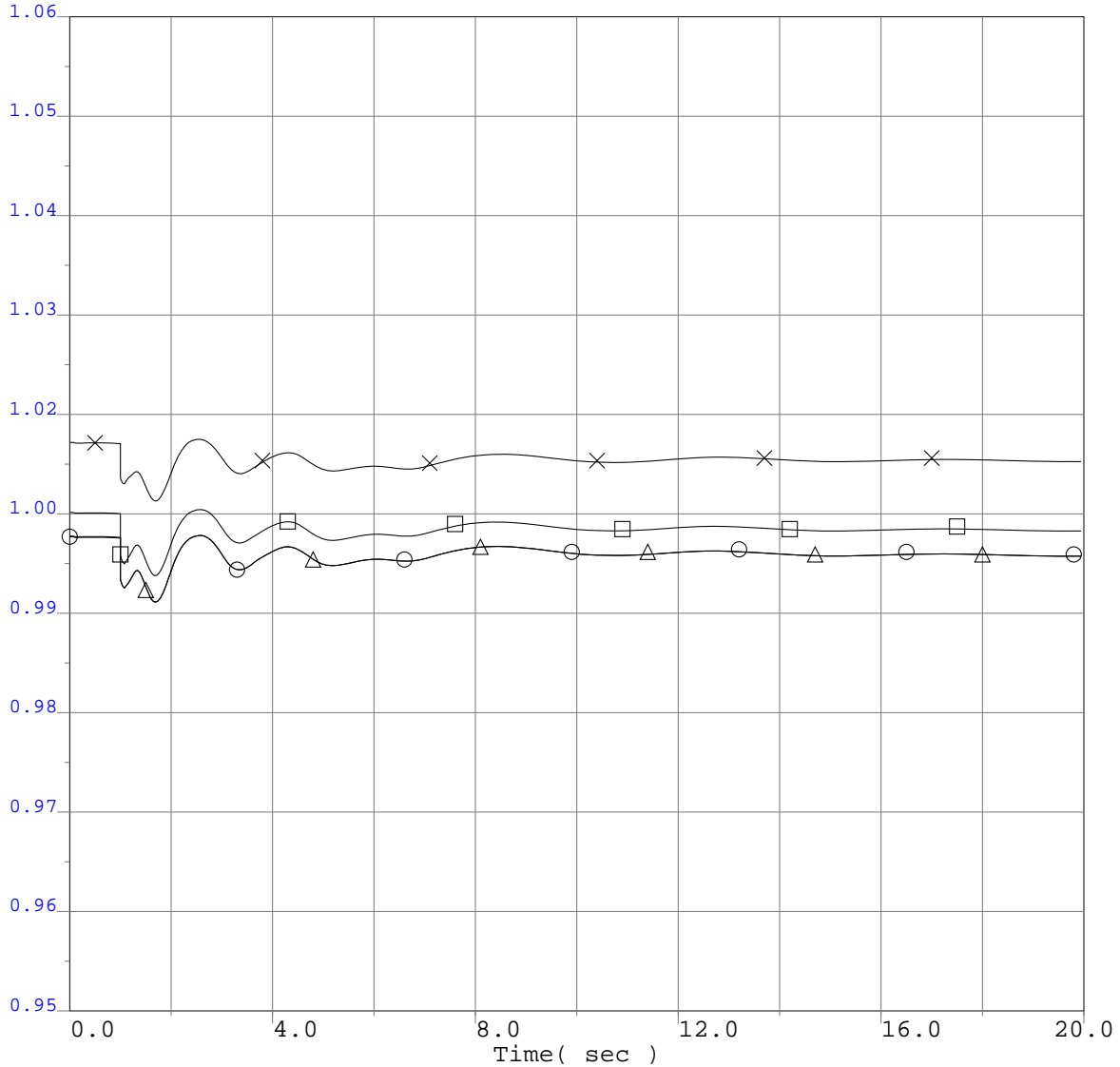

○	0.9500 vbus	30525	C.COSTA 230.0	0	0.0	***	1	1.0600
□	0.9500 vbus	30479	BDLSWSTA 230.0	0	0.0	***	1	1.0600
○	0.9500 vbus	30523	CC SUB 230.0	0	0.0	***	1	1.0600
△	0.9500 vbus	30518	T320 230.0	0	0.0	***	1	1.0600



Q320 TCP2 ISIS
 2013 Greater Bay Area Summer Peak Base Case
 Q320 @ 772MW
 Q320 Load Rejection
 No Fault Load Rejection

Q320 TCP2 ISIS

Selected PG&E Bus Frequency Plots Adjacent to Fault

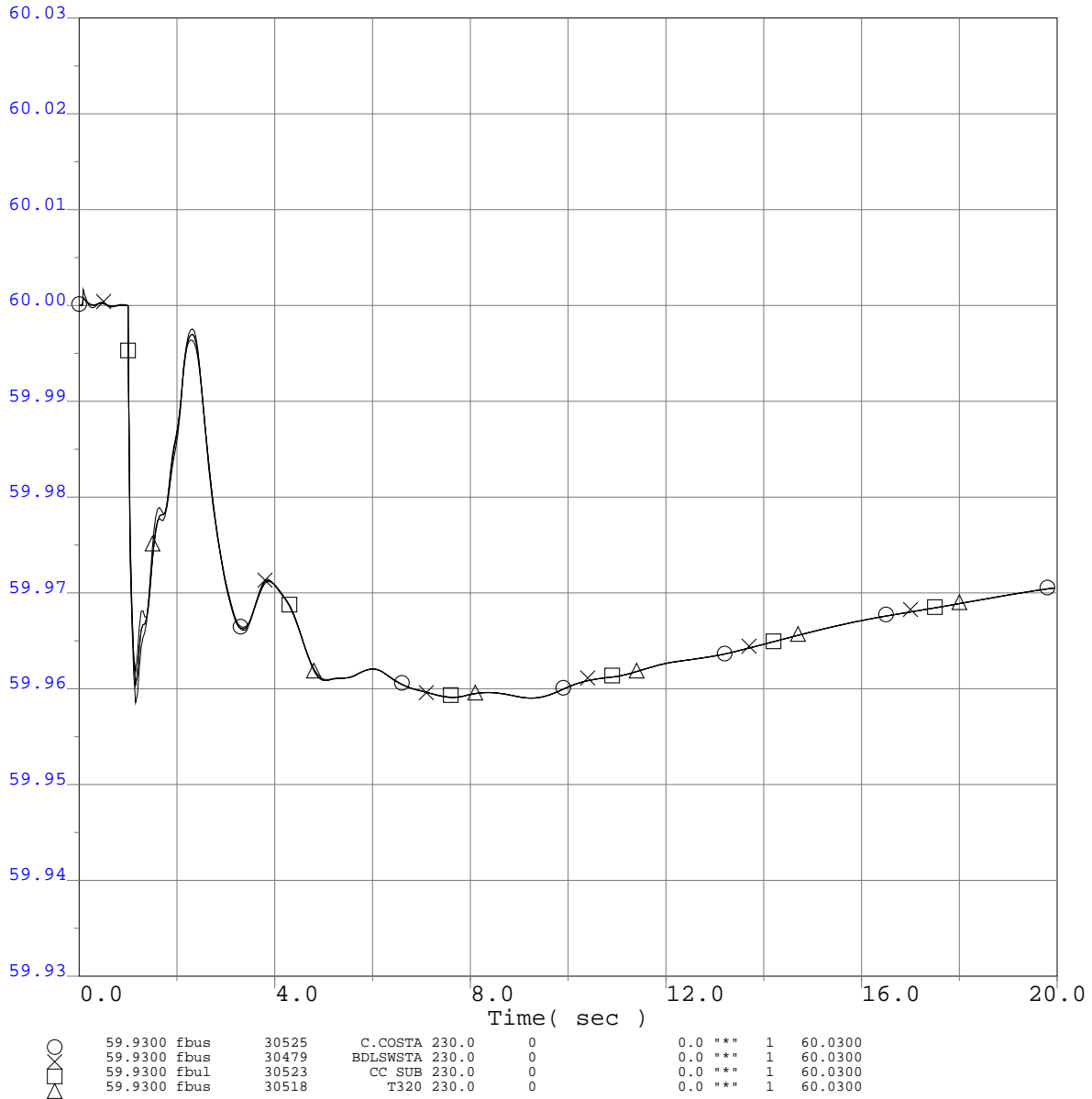

Q320 TCP2 ISIS
 2013 Greater Bay Area Summer Peak Base Case
 Q320 @ 772MW
 Q320 Load Rejection
 No Fault Load Rejection

Q320 TCP2 ISIS

Project Generator Terminal Voltages (P.U.)

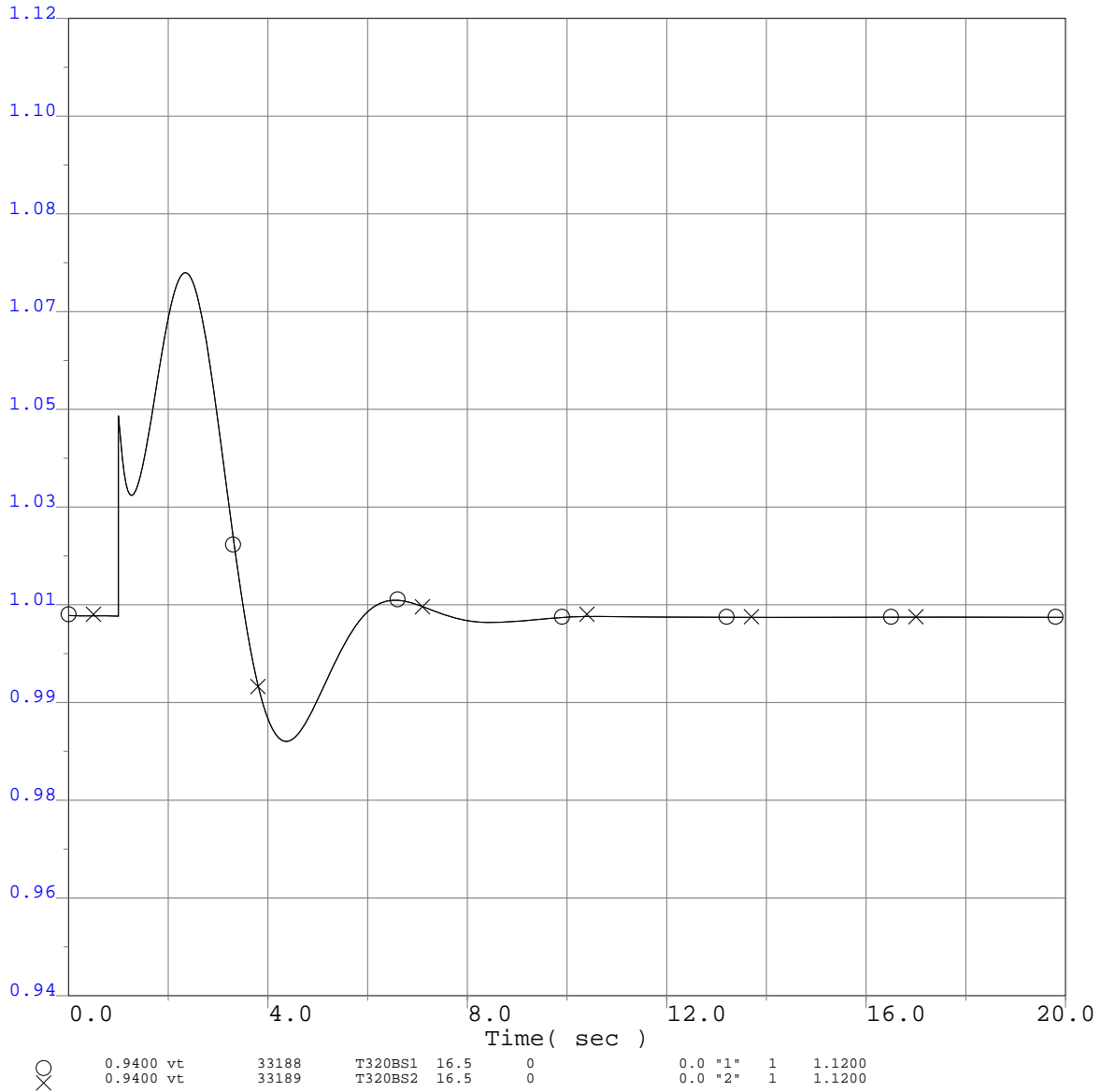

○	0.9400 vt	33188	T320BS1	16.5	0	0.0 "1"	1	1.1200
×	0.9400 vt	33189	T320BS2	16.5	0	0.0 "2"	1	1.1200

Q320 TCP2 ISIS
 2013 Greater Bay Area Summer Peak Base Case
 Q320 @ 772MW
 Q320 Load Rejection
 No Fault Load Rejection

Q320 TCP2 ISIS

Project Generator Terminal Voltages (P.U.)

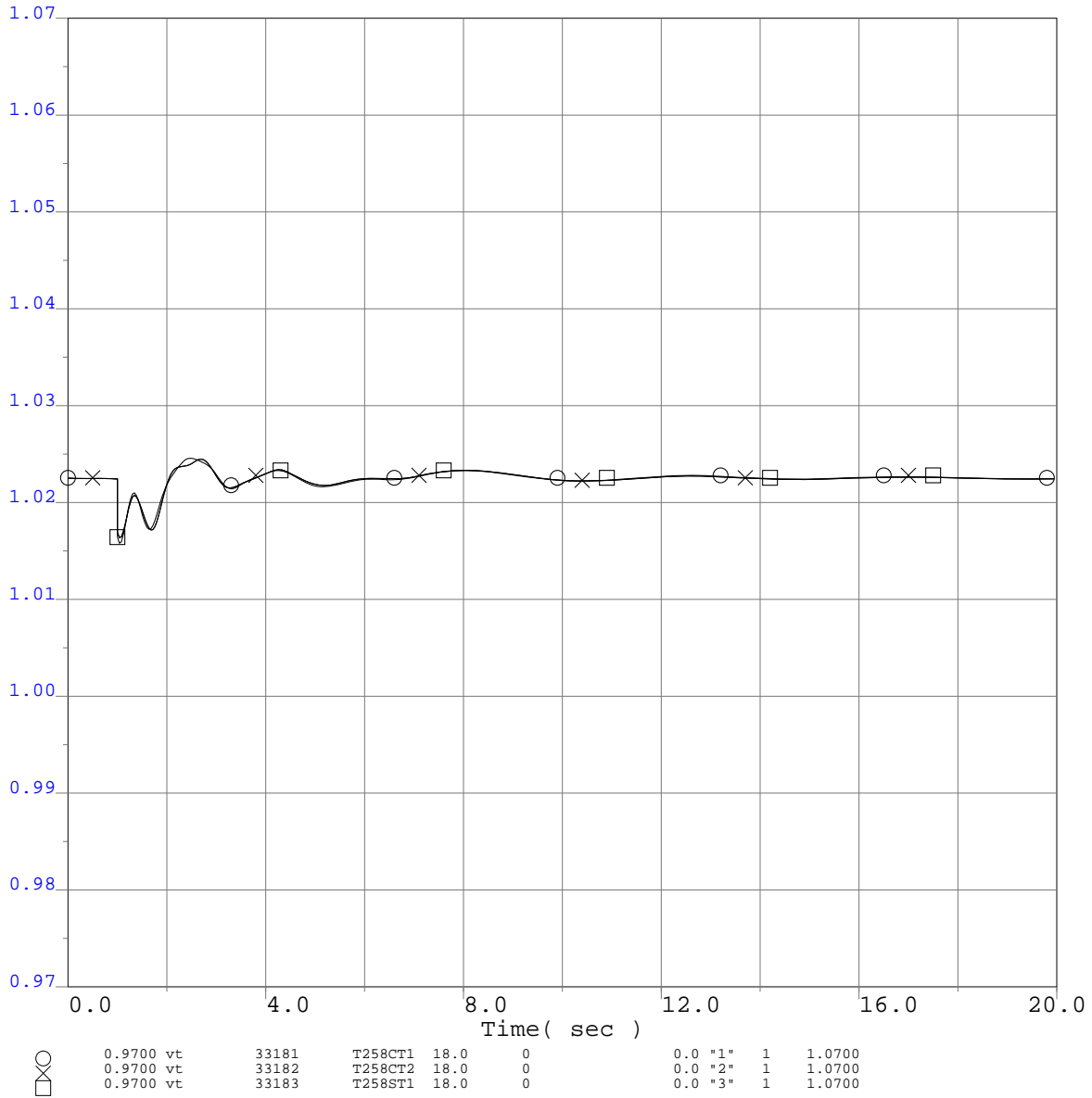

Q320 TCP2 ISIS
 2013 Greater Bay Area Summer Peak Base Case
 Q320 @ 772MW
 Q320 Load Rejection
 No Fault Load Rejection

Q320 TCP2 ISIS

Project Generator Speed (P.U.)

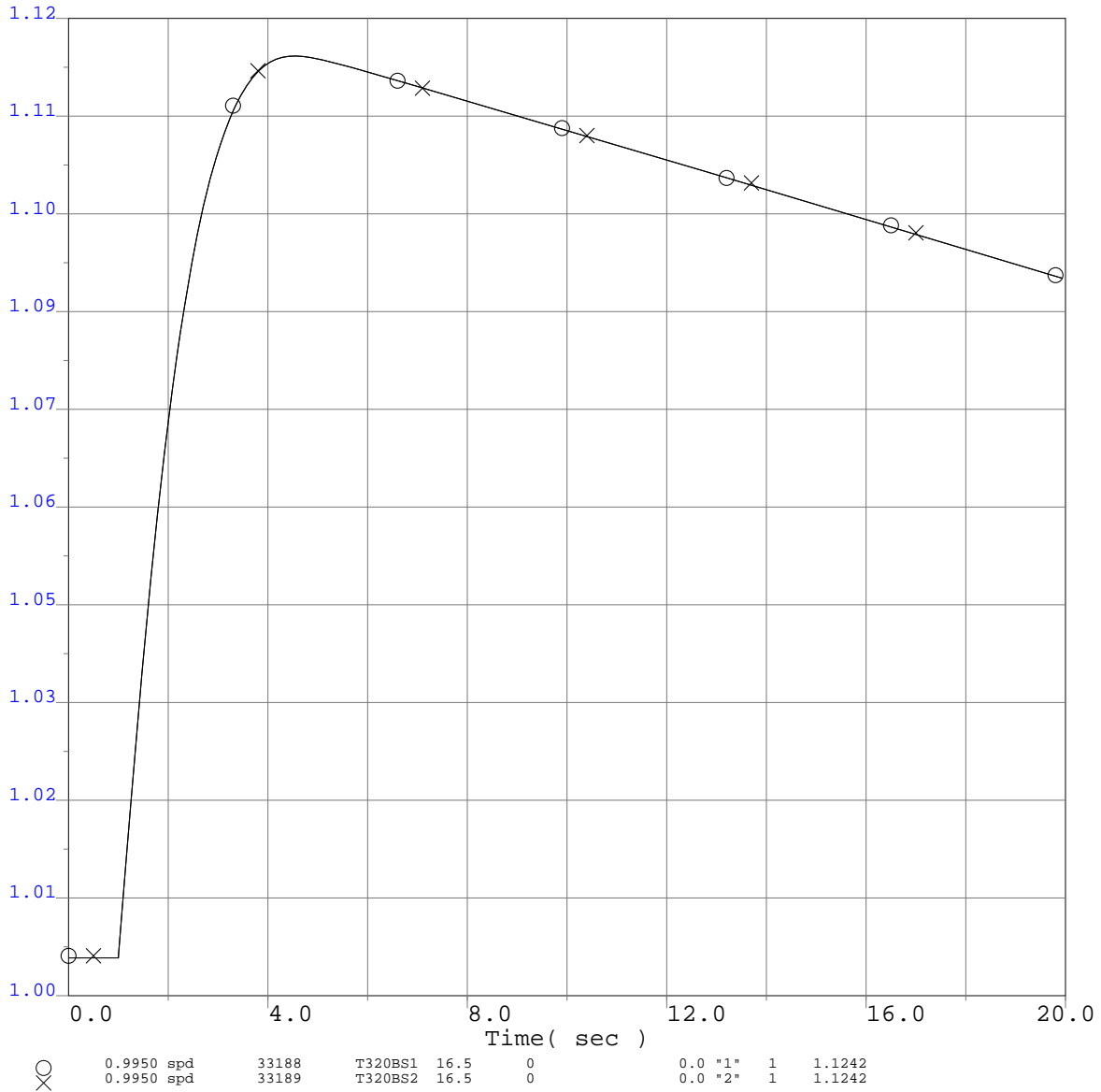

Q320 TCP2 ISIS
 2013 Greater Bay Area Summer Peak Base Case
 Q320 @ 772MW
 Q320 Load Rejection
 No Fault Load Rejection

Q320 TCP2 ISIS

Project Generator Speed (P.U.)

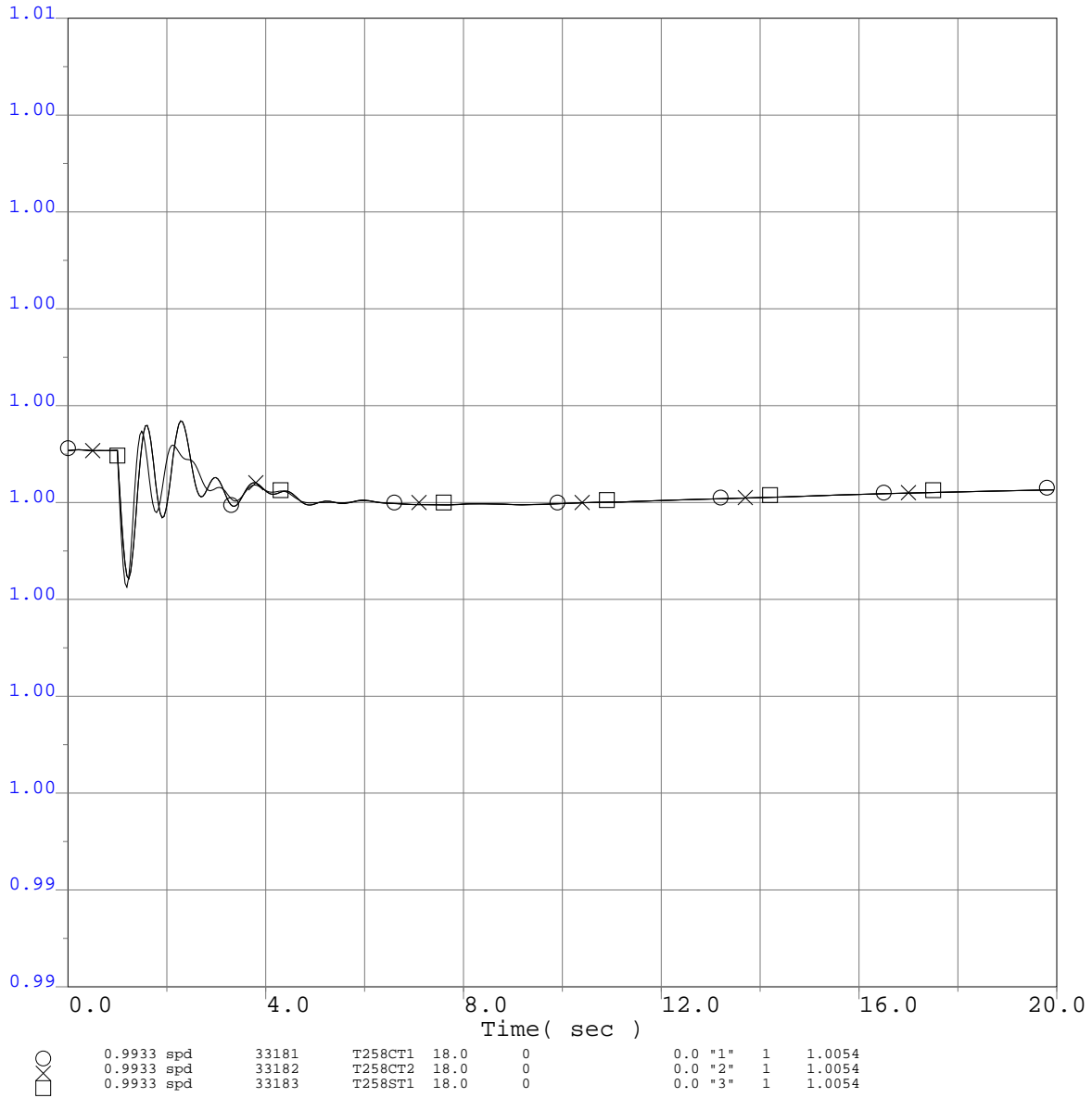

Q320 TCP2 ISIS
 2013 Greater Bay Area Summer Peak Base Case
 Q320 @ 772MW
 Q320 Load Rejection
 No Fault Load Rejection

Q320 TCP2 ISIS

Project Generator Terminal Power (MW)

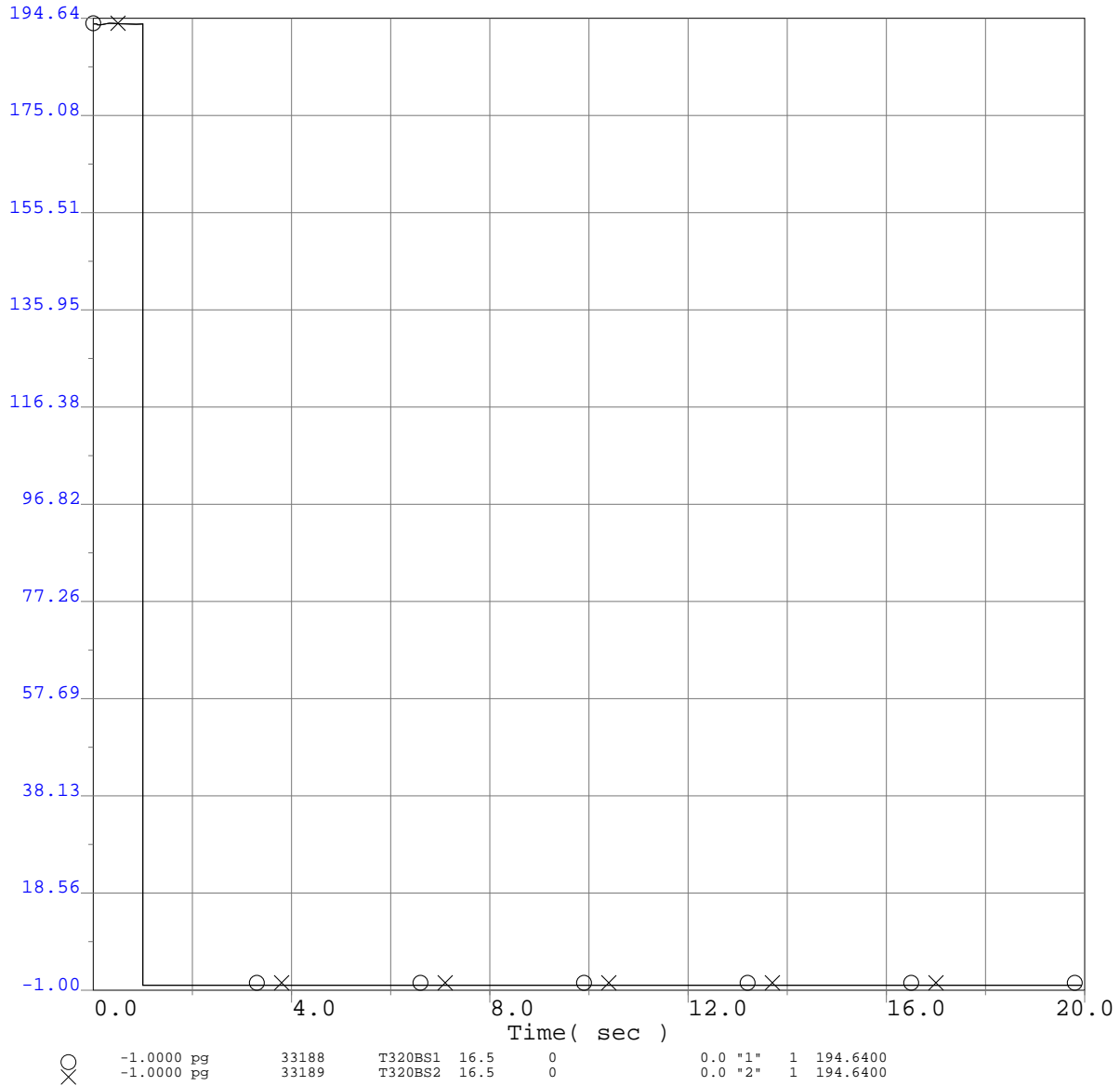

Q320 TCP2 ISIS
 2013 Greater Bay Area Summer Peak Base Case
 Q320 @ 772MW
 Q320 Load Rejection
 No Fault Load Rejection

Q320 TCP2 ISIS

Project Generator Terminal Power (MW)

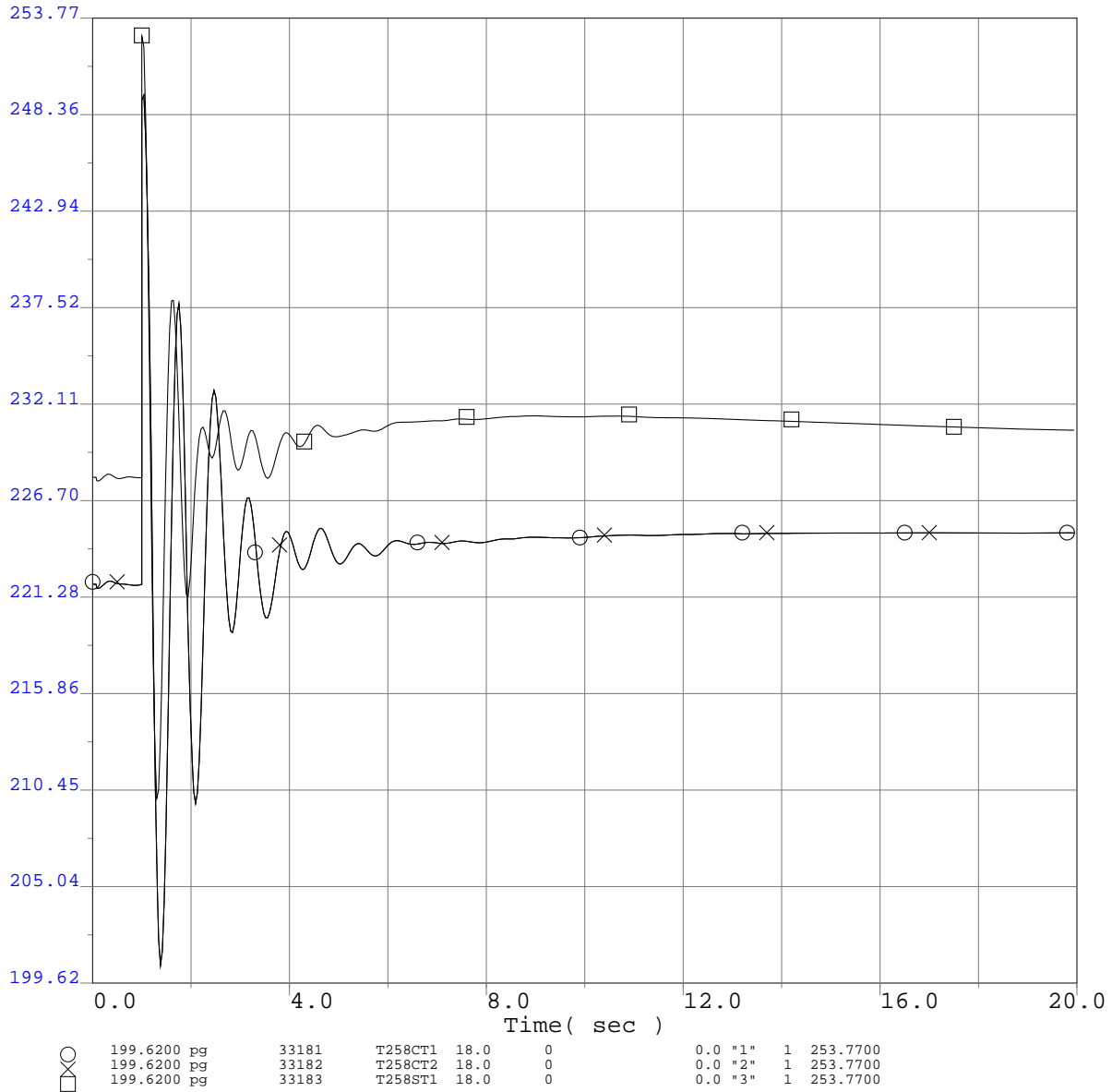

○	199.6200 pg	33181	T258CT1	18.0	0	0.0 "1"	1	253.7700
×	199.6200 pg	33182	T258CT2	18.0	0	0.0 "2"	1	253.7700
□	199.6200 pg	33183	T258ST1	18.0	0	0.0 "3"	1	253.7700

Q320 TCP2 ISIS
 2013 Greater Bay Area Summer Peak Base Case
 Q320 @ 772MW
 Q320 Load Rejection
 No Fault Load Rejection

Q320 TCP2 ISIS

Project Generator Terminal Reactive Power (MVar)

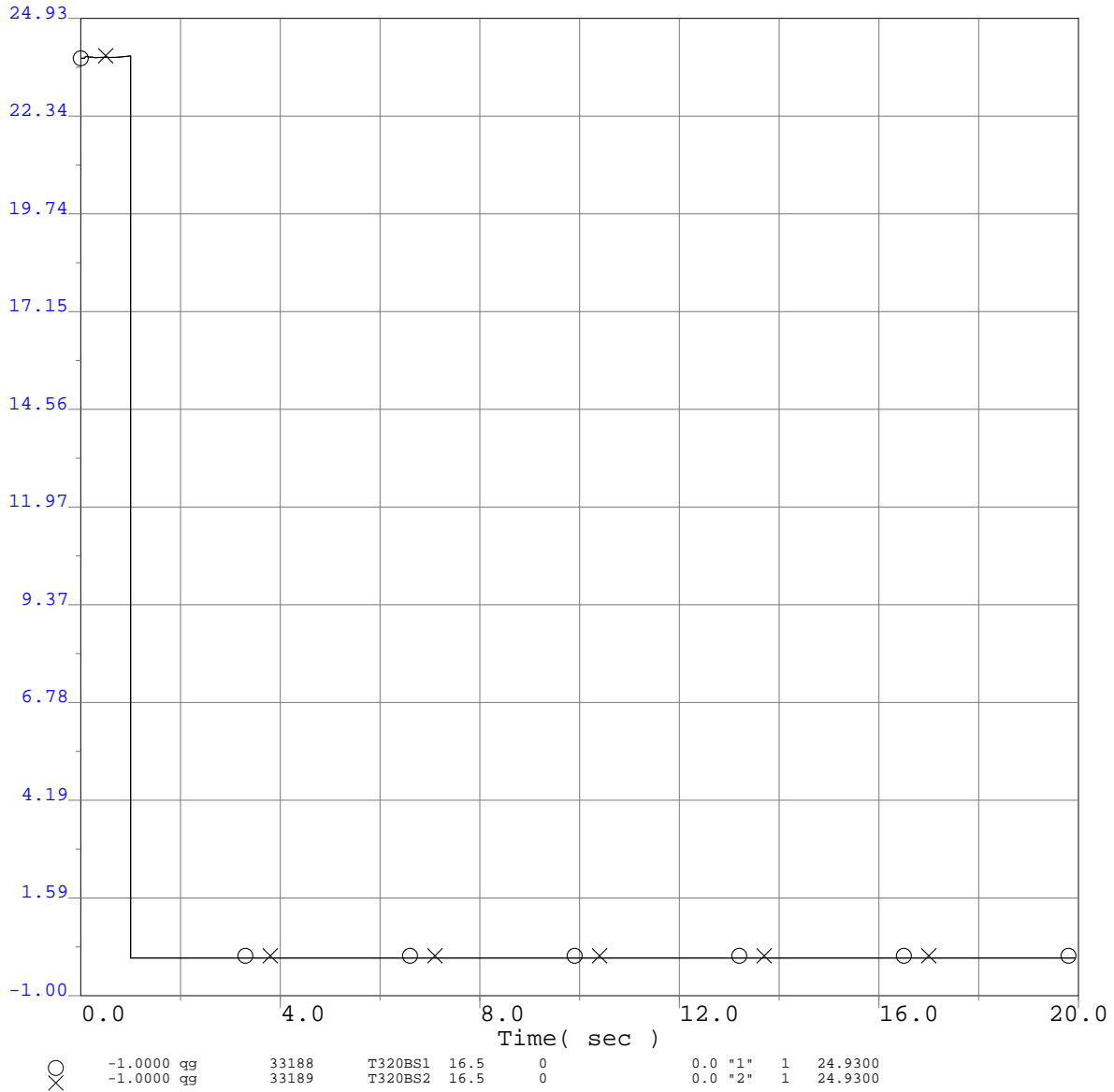

Q320 TCP2 ISIS
 2013 Greater Bay Area Summer Peak Base Case
 Q320 @ 772MW
 Q320 Load Rejection
 No Fault Load Rejection

Q320 TCP2 ISIS

Project Generator Terminal Reactive Power (MVar)

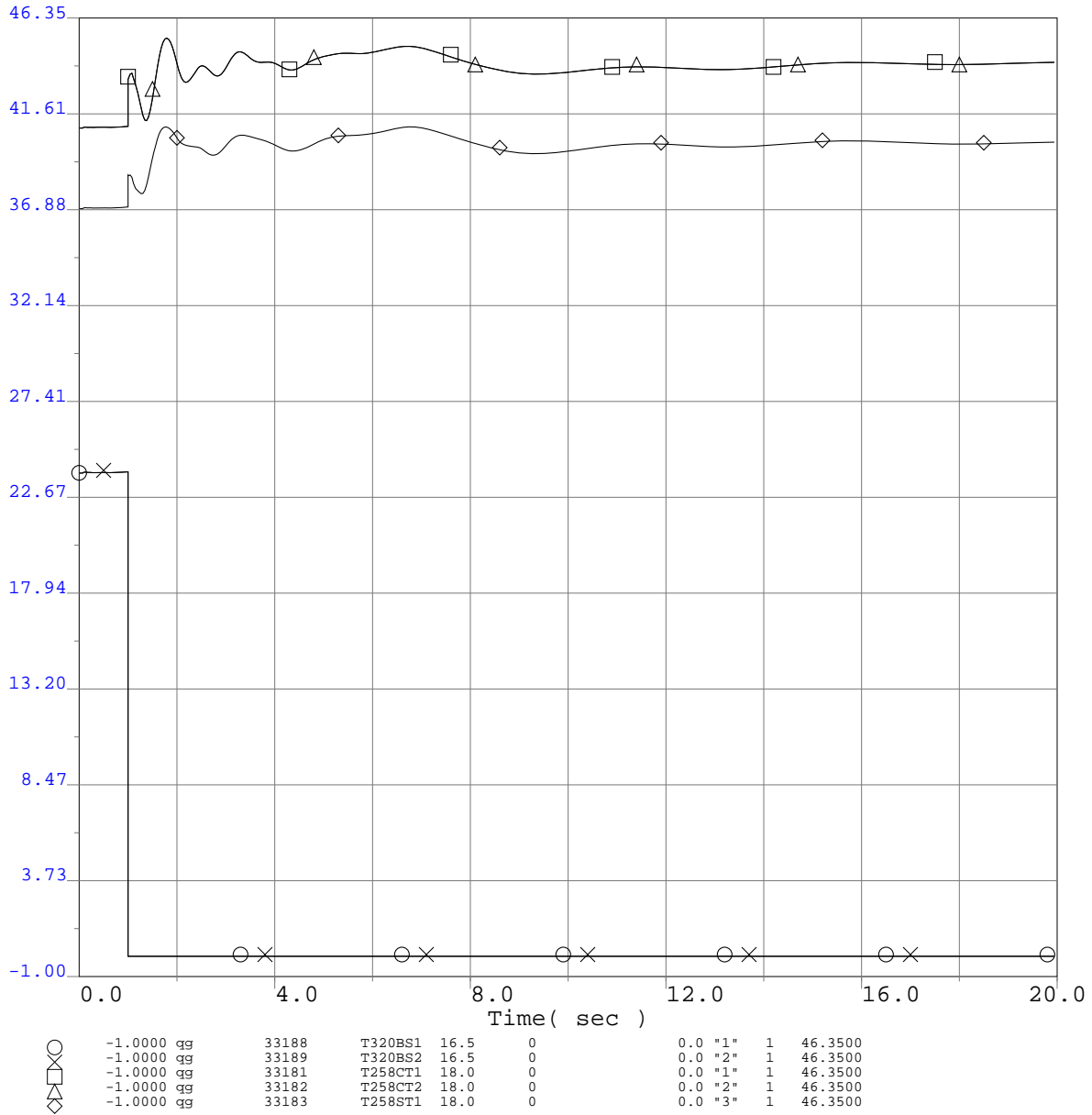

Q320 TCP2 ISIS
 2013 Greater Bay Area Summer Peak Base Case
 Q320 @ 772MW
 Q320 Load Rejection
 No Fault Load Rejection

Q320 TCP2 ISIS

Selected WECC Bus Voltage Plots

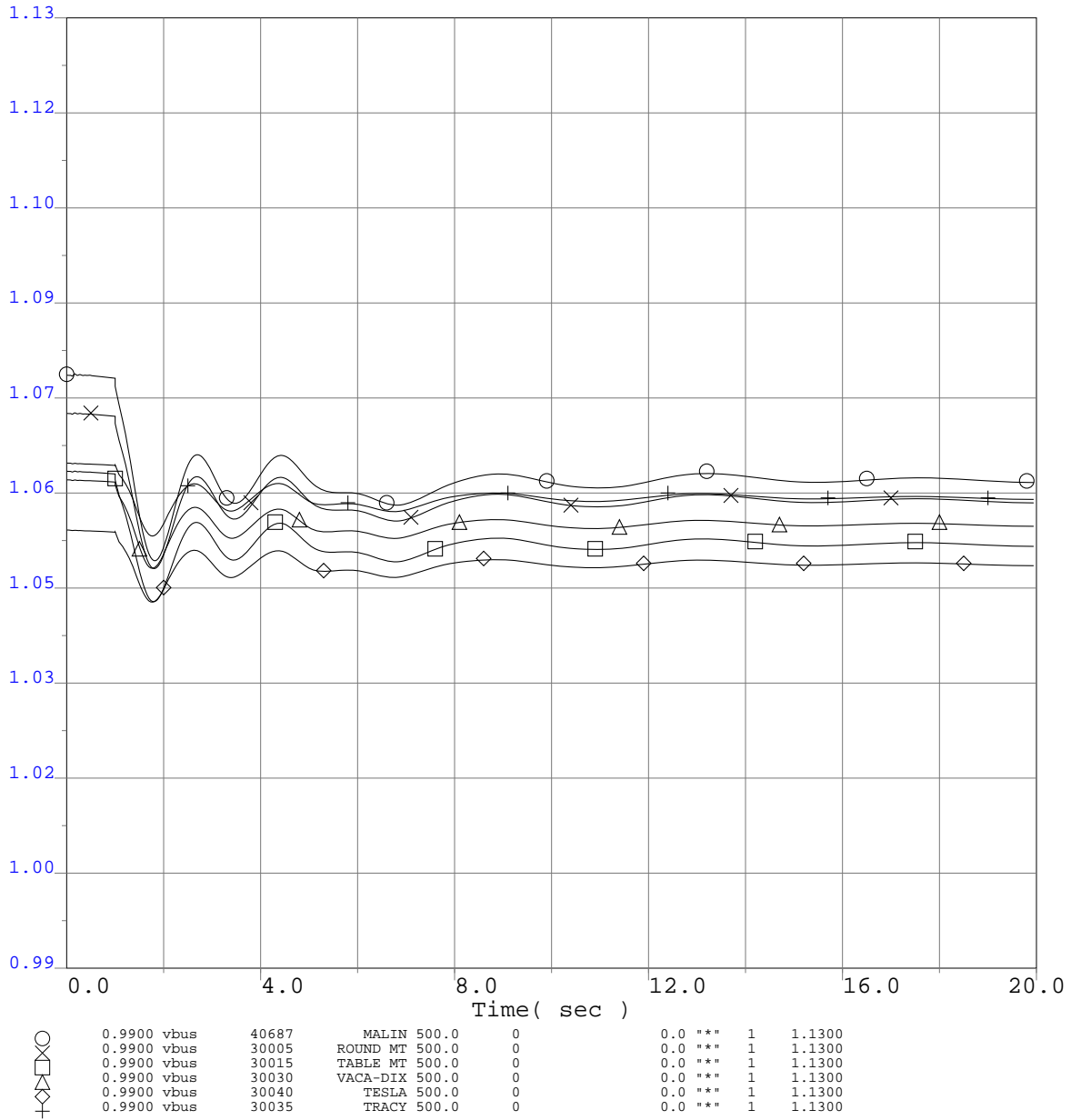

Q320 TCP2 ISIS
 2013 Greater Bay Area Summer Peak Base Case
 Q320 @ 772MW
 Q320 Load Rejection
 No Fault Load Rejection

Q320 TCP2 ISIS

Selected WECC Bus Voltage Plots

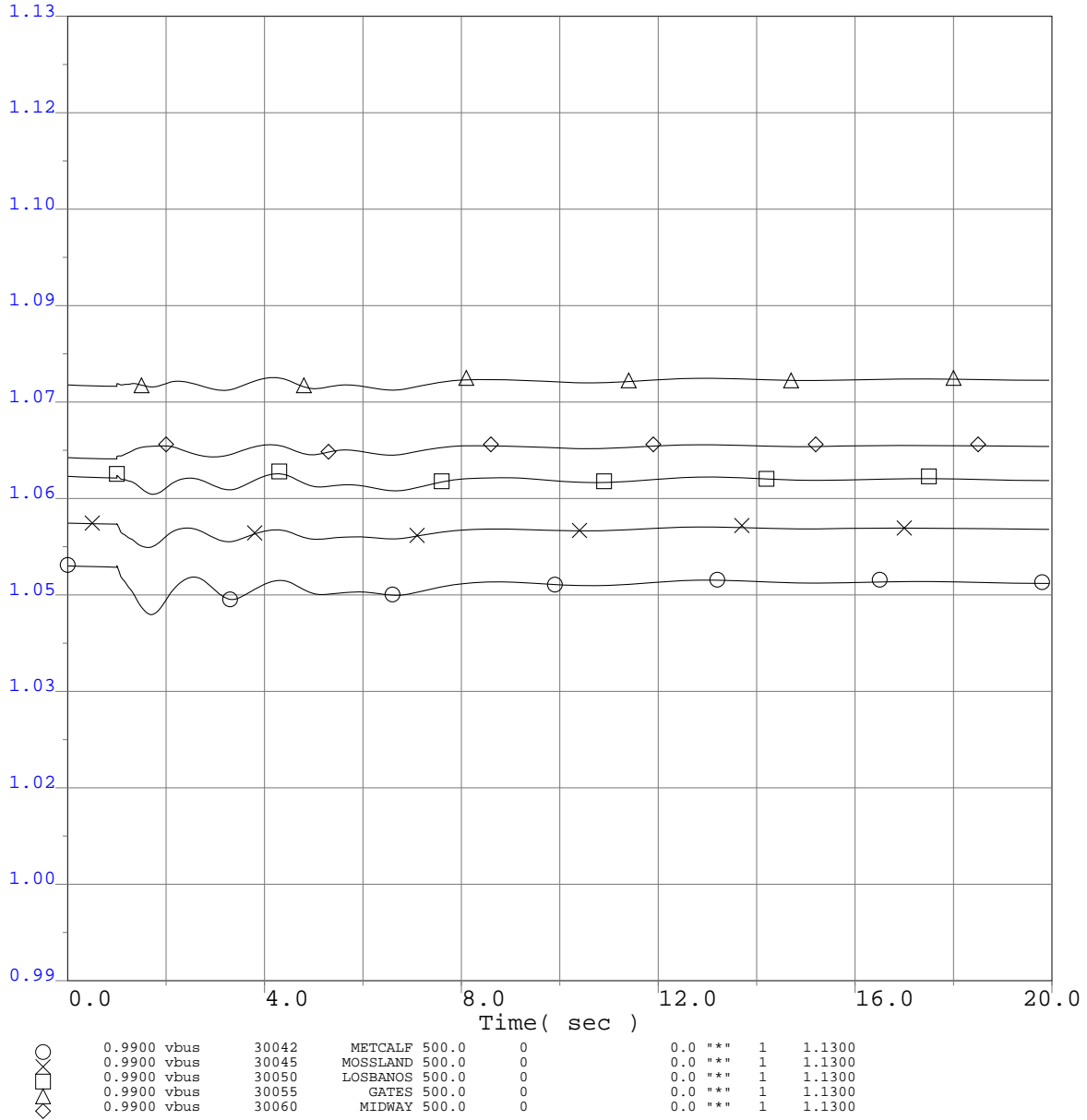

Q320 TCP2 ISIS
 2013 Greater Bay Area Summer Peak Base Case
 Q320 @ 772MW
 Q320 Load Rejection
 No Fault Load Rejection

Q320 TCP2 ISIS

Selected WECC Bus Voltage Plots

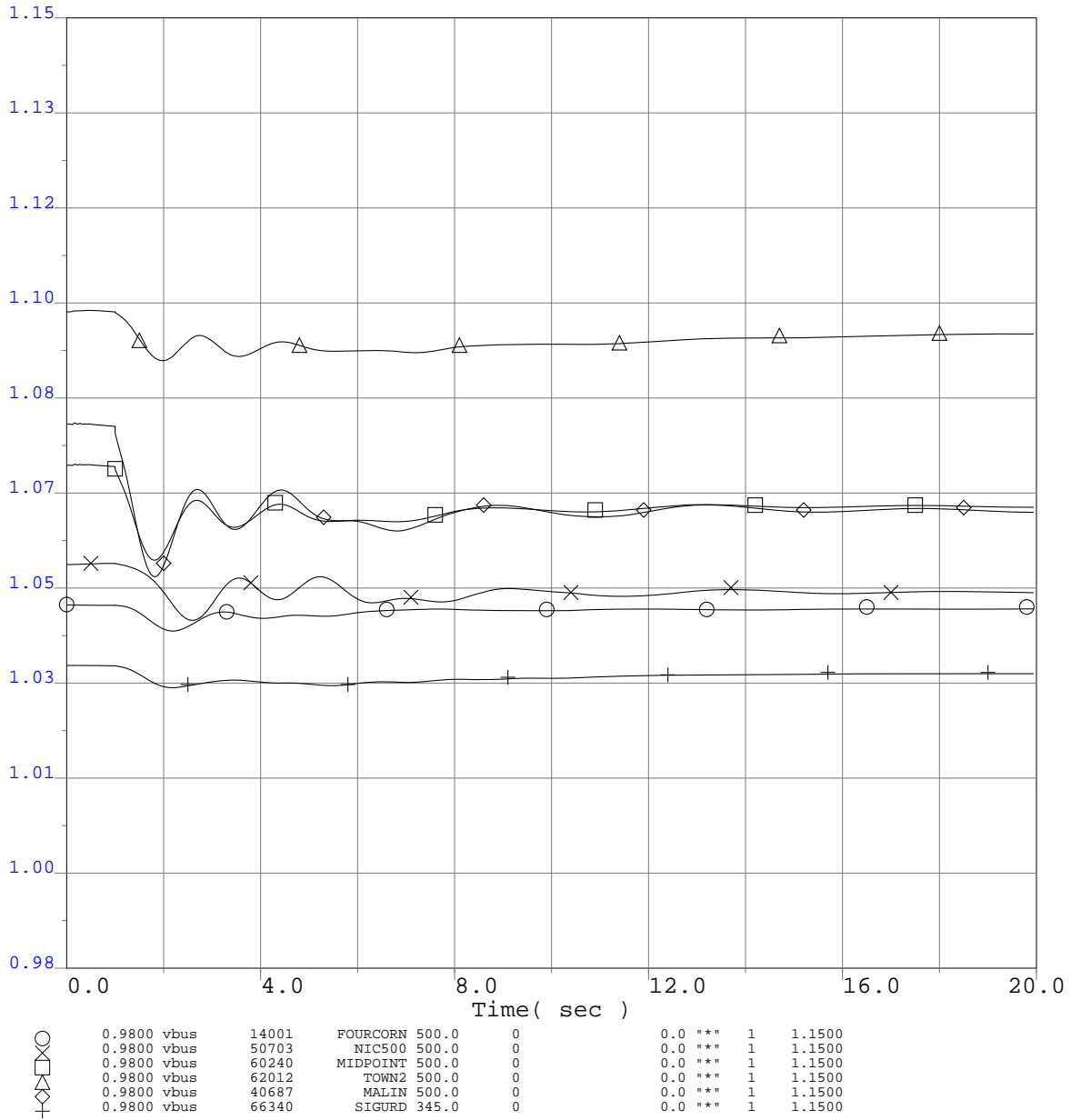

Q320 TCP2 ISIS
 2013 Greater Bay Area Summer Peak Base Case
 Q320 @ 772MW
 Q320 Load Rejection
 No Fault Load Rejection

Q320 TCP2 ISIS

Selected WECC Bus Voltage Plots

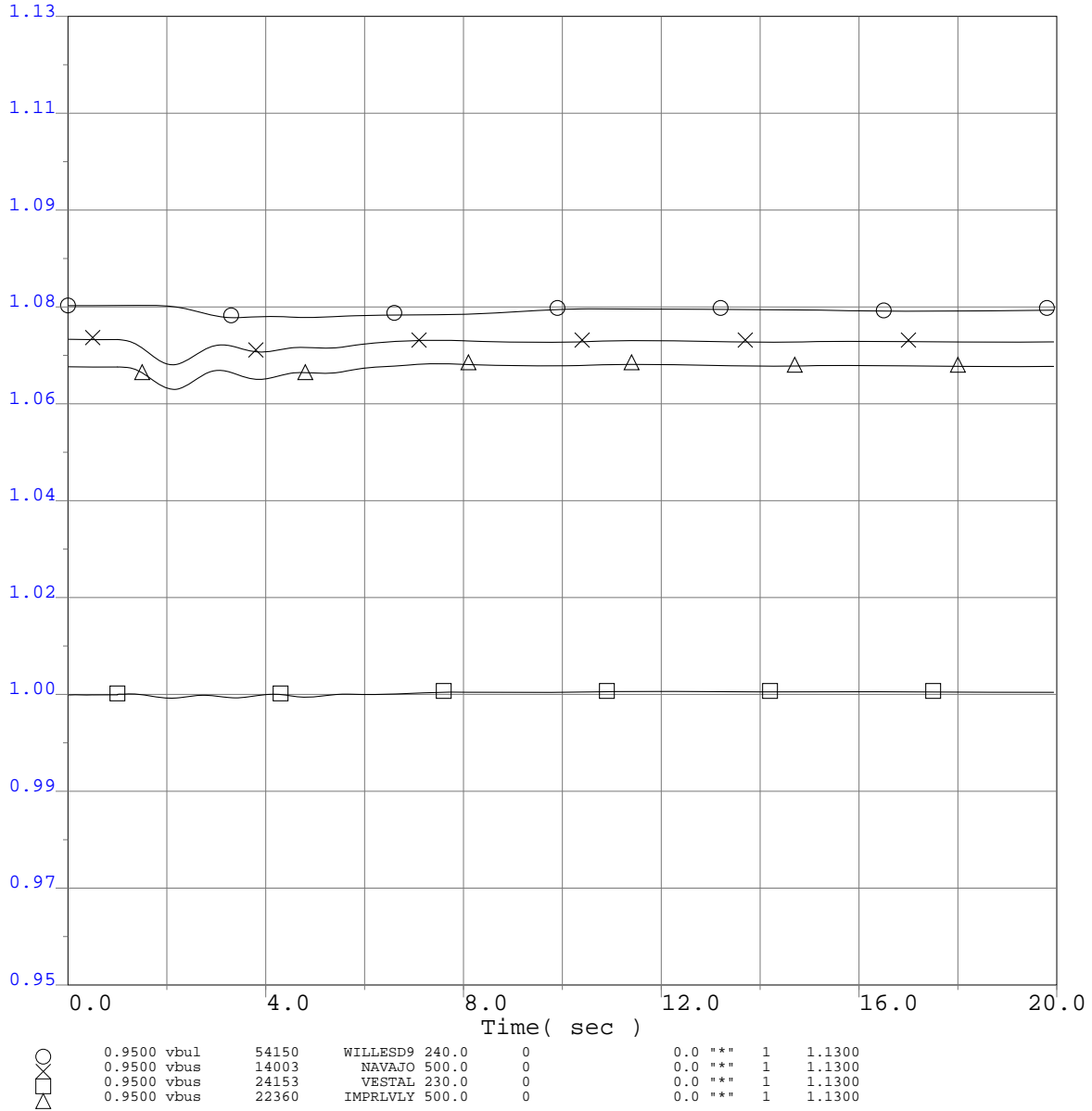

Q320 TCP2 ISIS
 2013 Greater Bay Area Summer Peak Base Case
 Q320 @ 772MW
 Q320 Load Rejection
 No Fault Load Rejection

Q320 TCP2 ISIS

Selected WECC Bus Frequency Plots

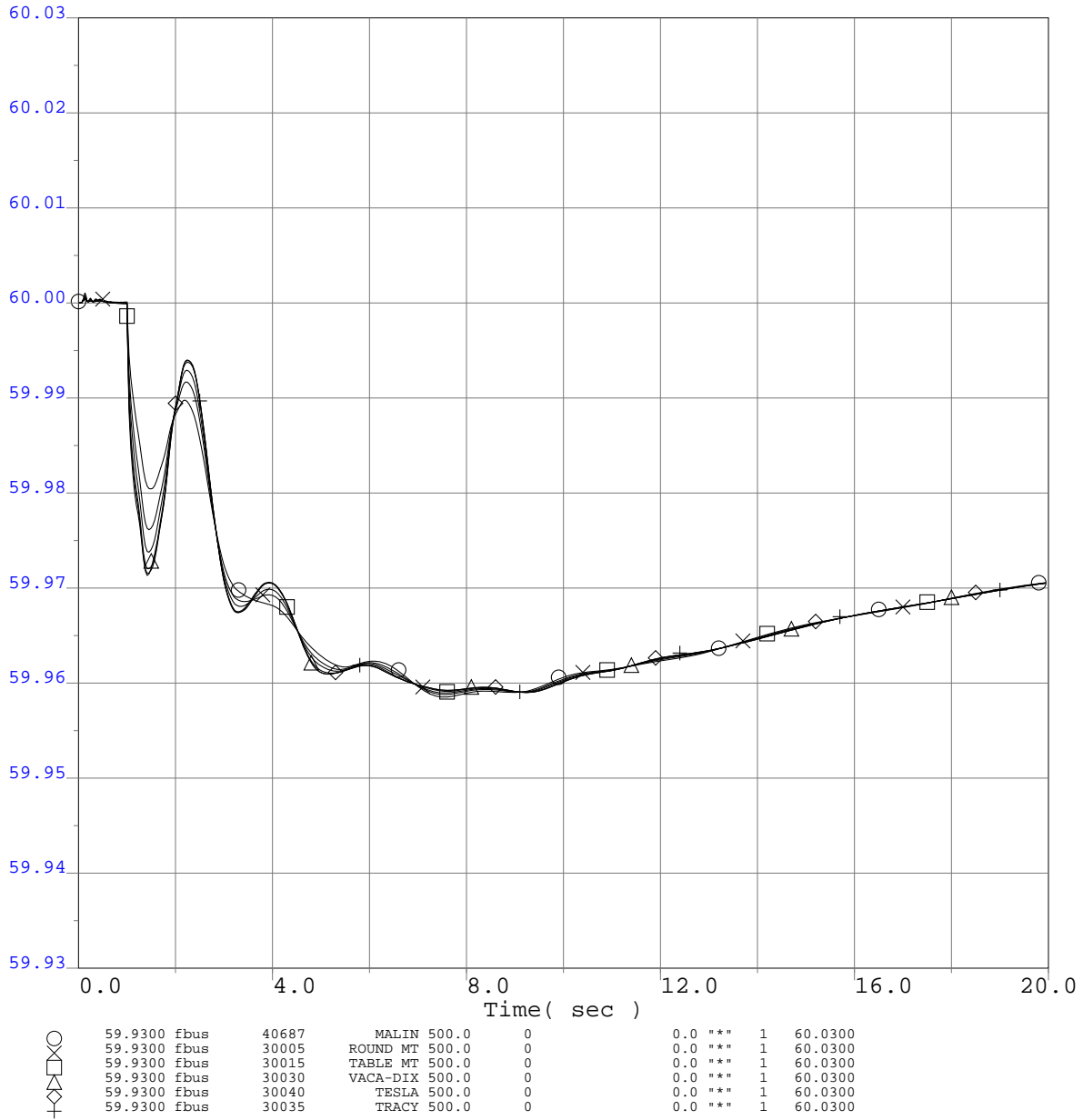

Q320 TCP2 ISIS
 2013 Greater Bay Area Summer Peak Base Case
 Q320 @ 772MW
 Q320 Load Rejection
 No Fault Load Rejection

Q320 TCP2 ISIS

Selected WECC Bus Frequency Plots

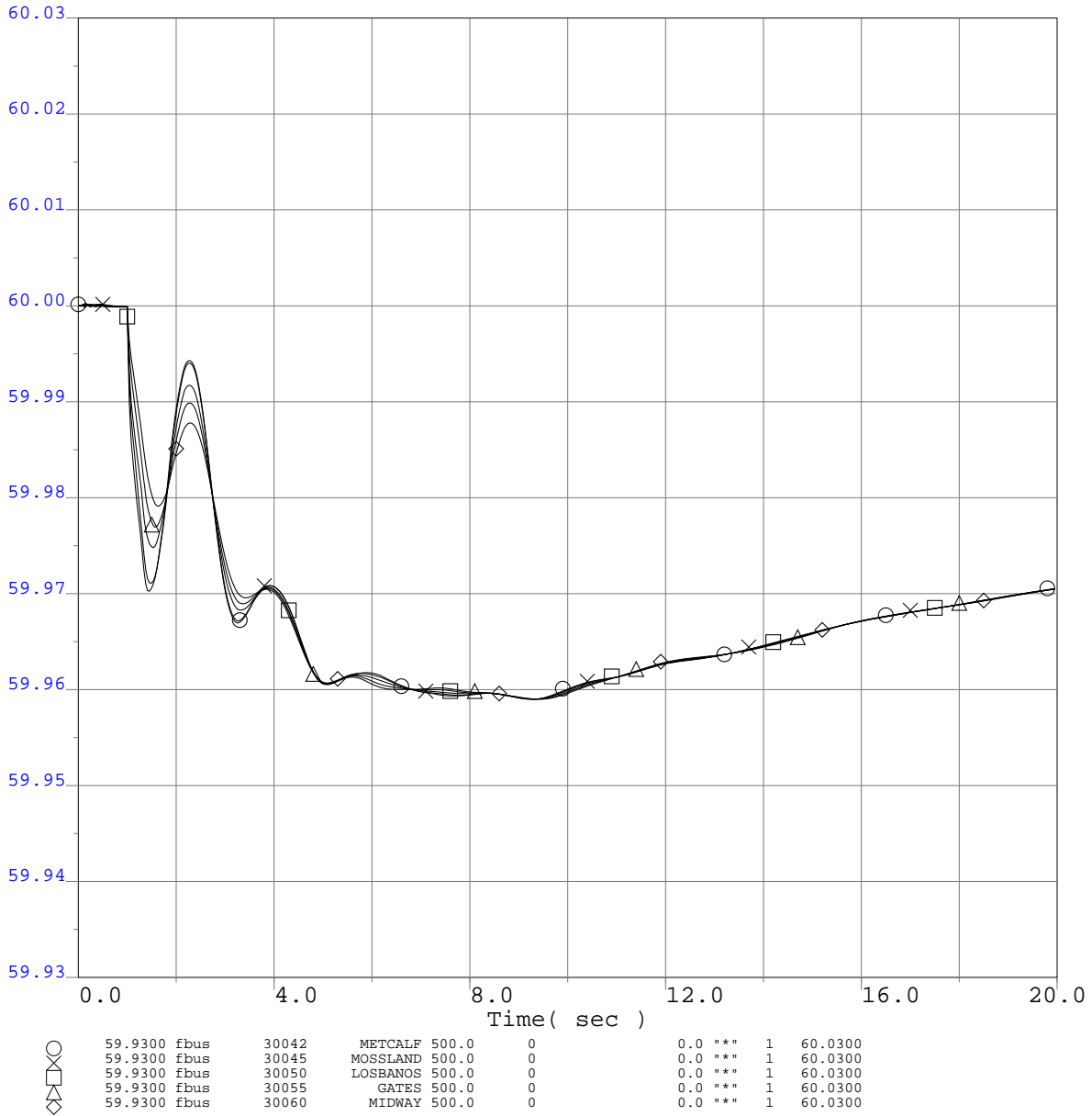

Q320 TCP2 ISIS
 2013 Greater Bay Area Summer Peak Base Case
 Q320 @ 772MW
 Q320 Load Rejection
 No Fault Load Rejection

Q320 TCP2 ISIS

Selected WECC Bus Frequency Plots

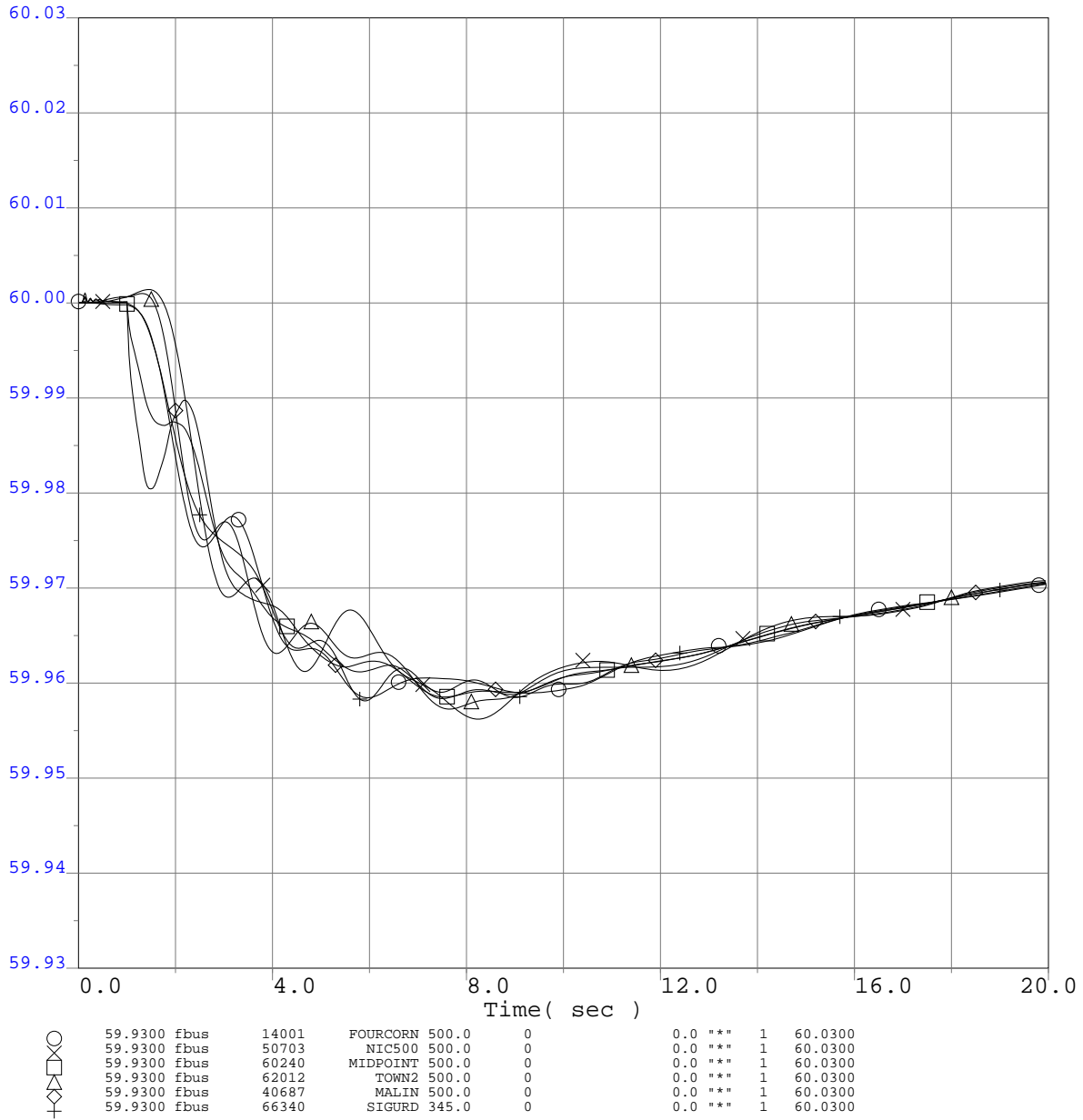

Q320 TCP2 ISIS
 2013 Greater Bay Area Summer Peak Base Case
 Q320 @ 772MW
 Q320 Load Rejection
 No Fault Load Rejection

Q320 TCP2 ISIS

Selected WECC Bus Frequency Plots

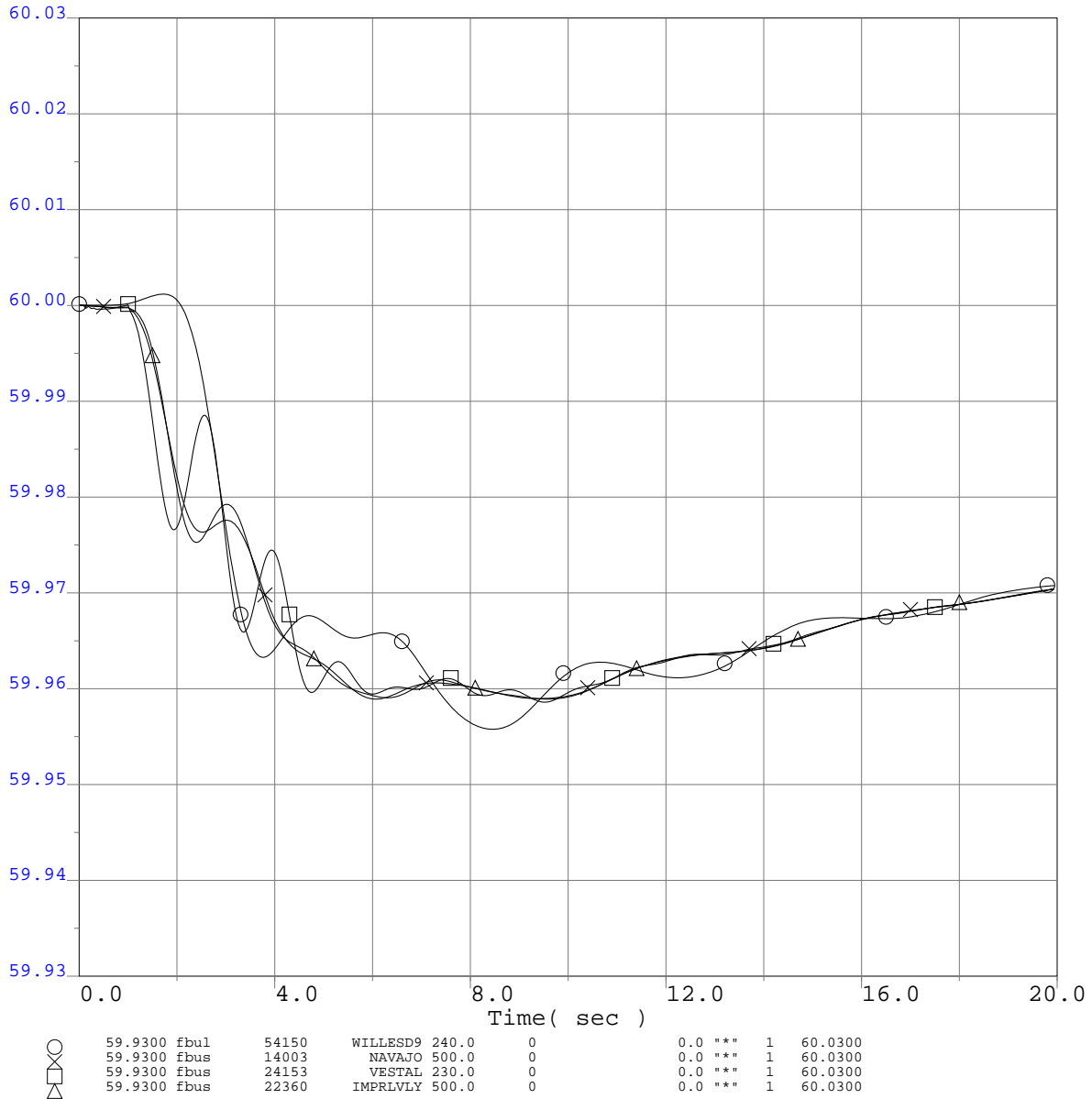

Q320 TCP2 ISIS
 2013 Greater Bay Area Summer Peak Base Case
 Q320 @ 772MW
 Q320 Load Rejection
 No Fault Load Rejection

Q320 TCP2 ISIS

WECC Generator Rotor Angle

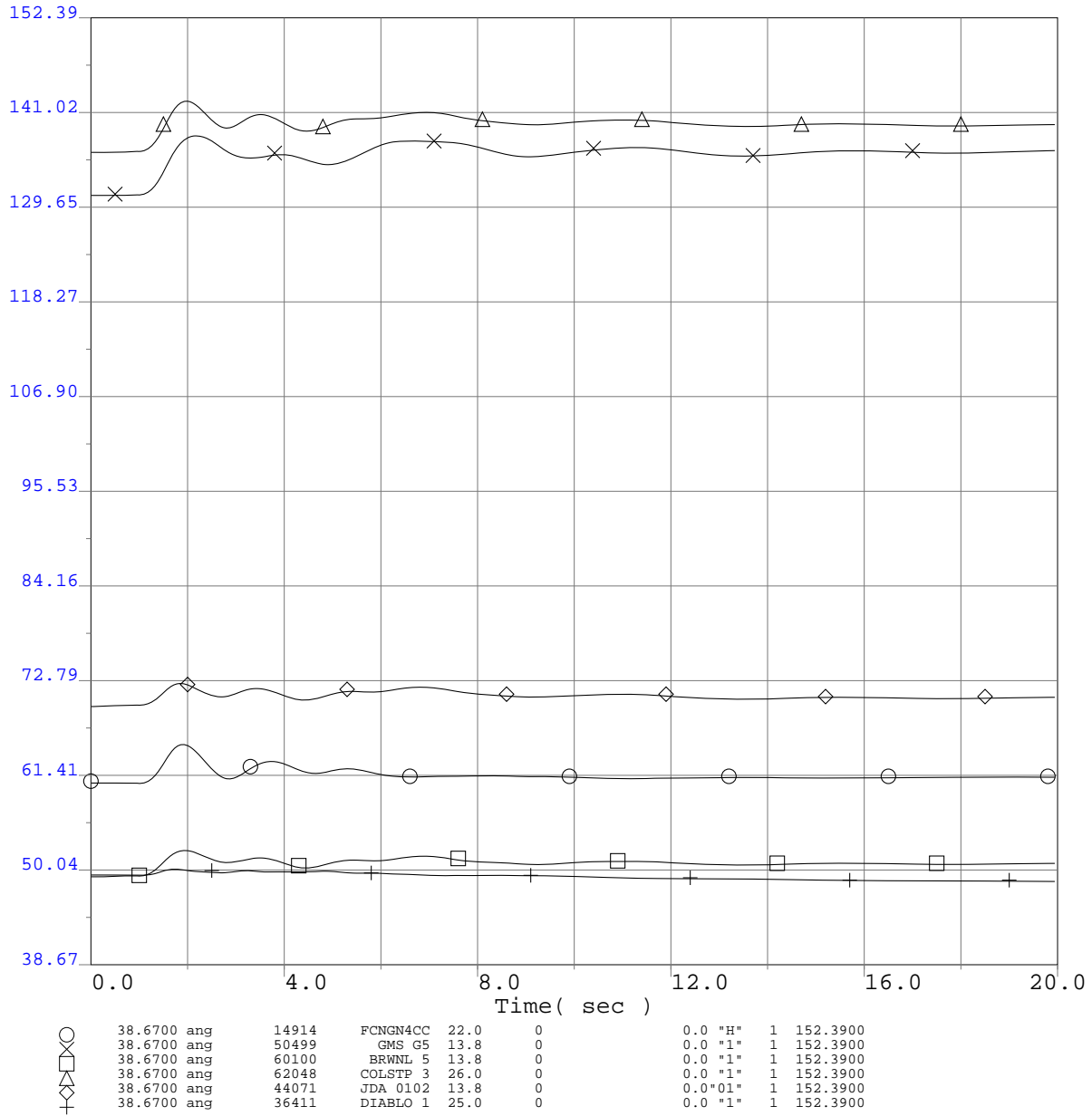

Q320 TCP2 ISIS
 2013 Greater Bay Area Summer Peak Base Case
 Q320 @ 772MW
 Q320 Load Rejection
 No Fault Load Rejection

Q320 TCP2 ISIS

WECC Generator Rotor Angle

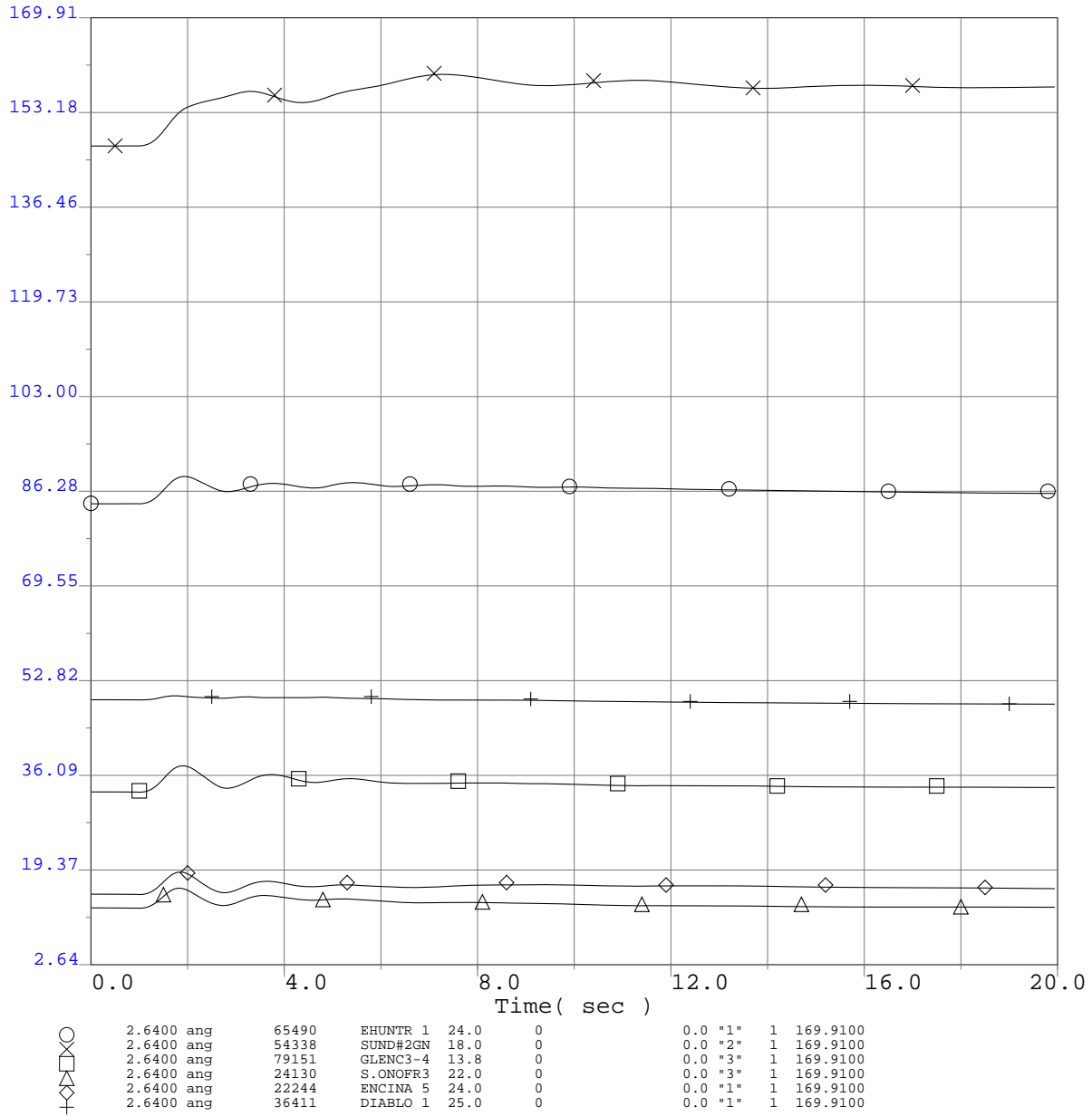

Q320 TCP2 ISIS
 2013 Greater Bay Area Summer Peak Base Case
 Q320 @ 772MW
 Q320 Load Rejection
 No Fault Load Rejection

Q320 TCP2 ISIS

Selected PG&E Transmission Line Flows (MW)

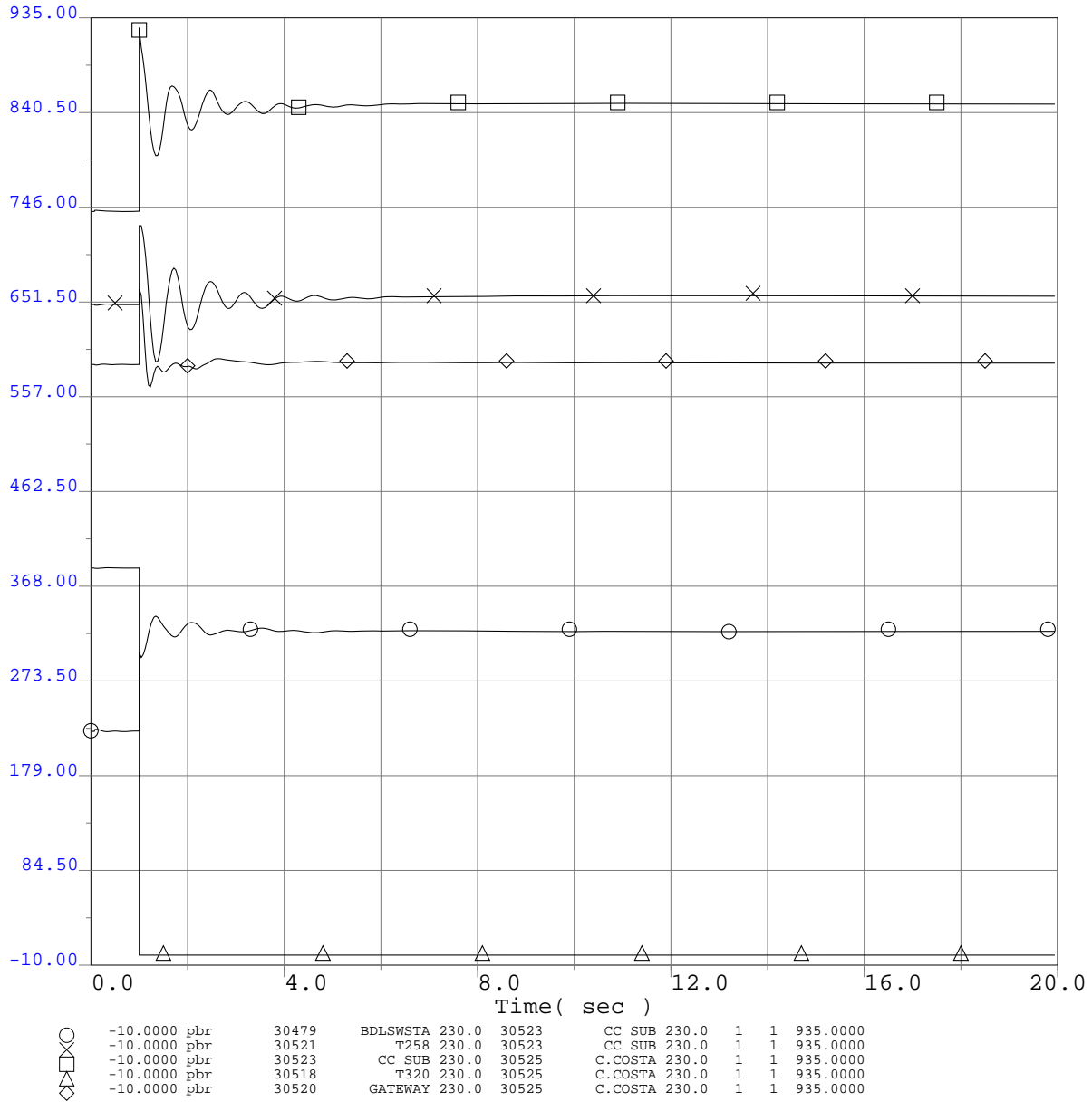

Q320 TCP2 ISIS
 2013 Greater Bay Area Summer Peak Base Case
 Q320 @ 772MW
 Q320 Load Rejection
 No Fault Load Rejection

Q320 TCP2 ISIS

Selected PG&E Transmission Line Flows (MW)

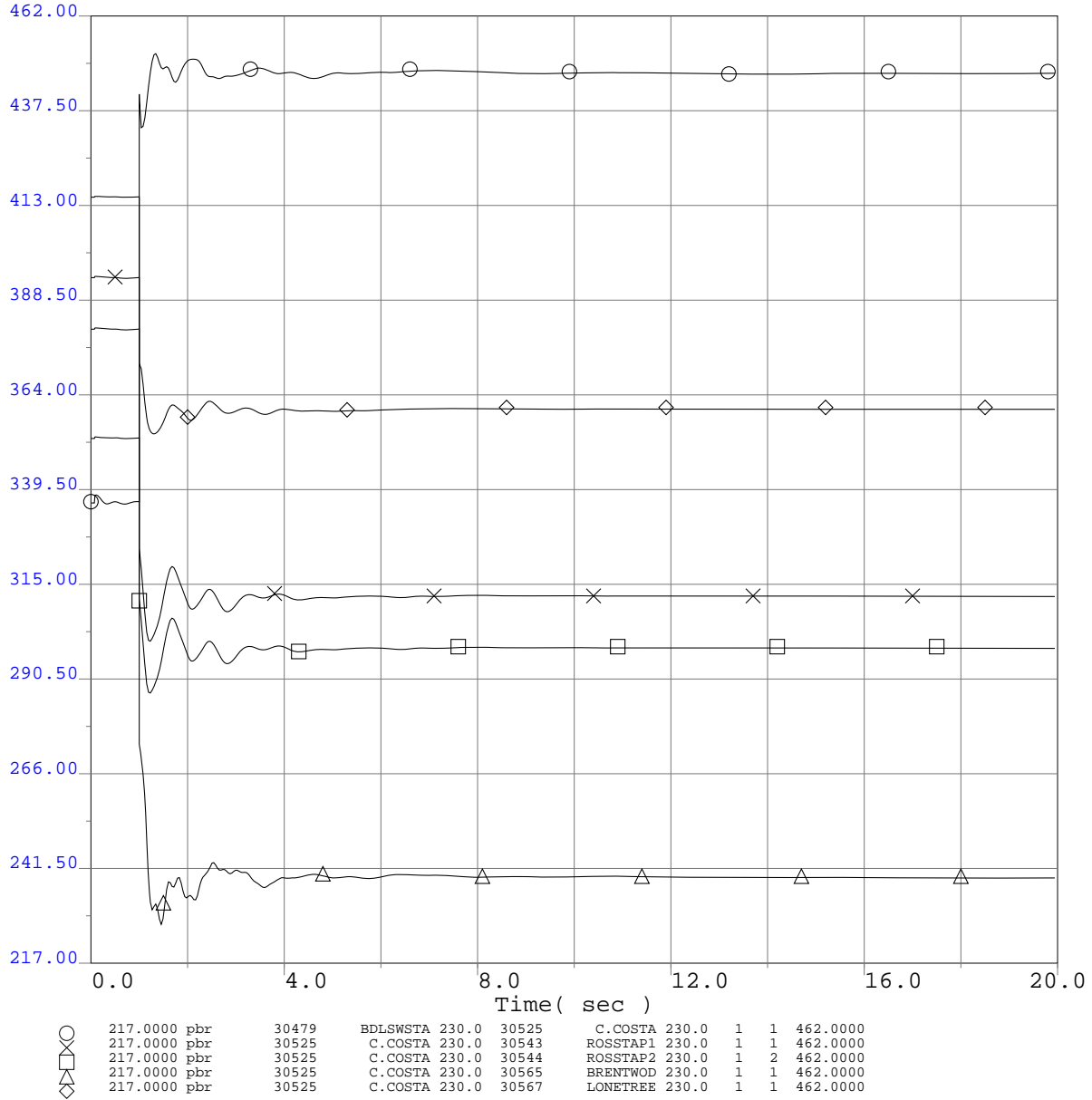

Q320 TCP2 ISIS
 2013 Greater Bay Area Summer Peak Base Case
 Q320 @ 772MW
 Q320 Load Rejection
 No Fault Load Rejection

Q320 TCP2 ISIS

Selected PG&E Transmission Line Flows (MW)

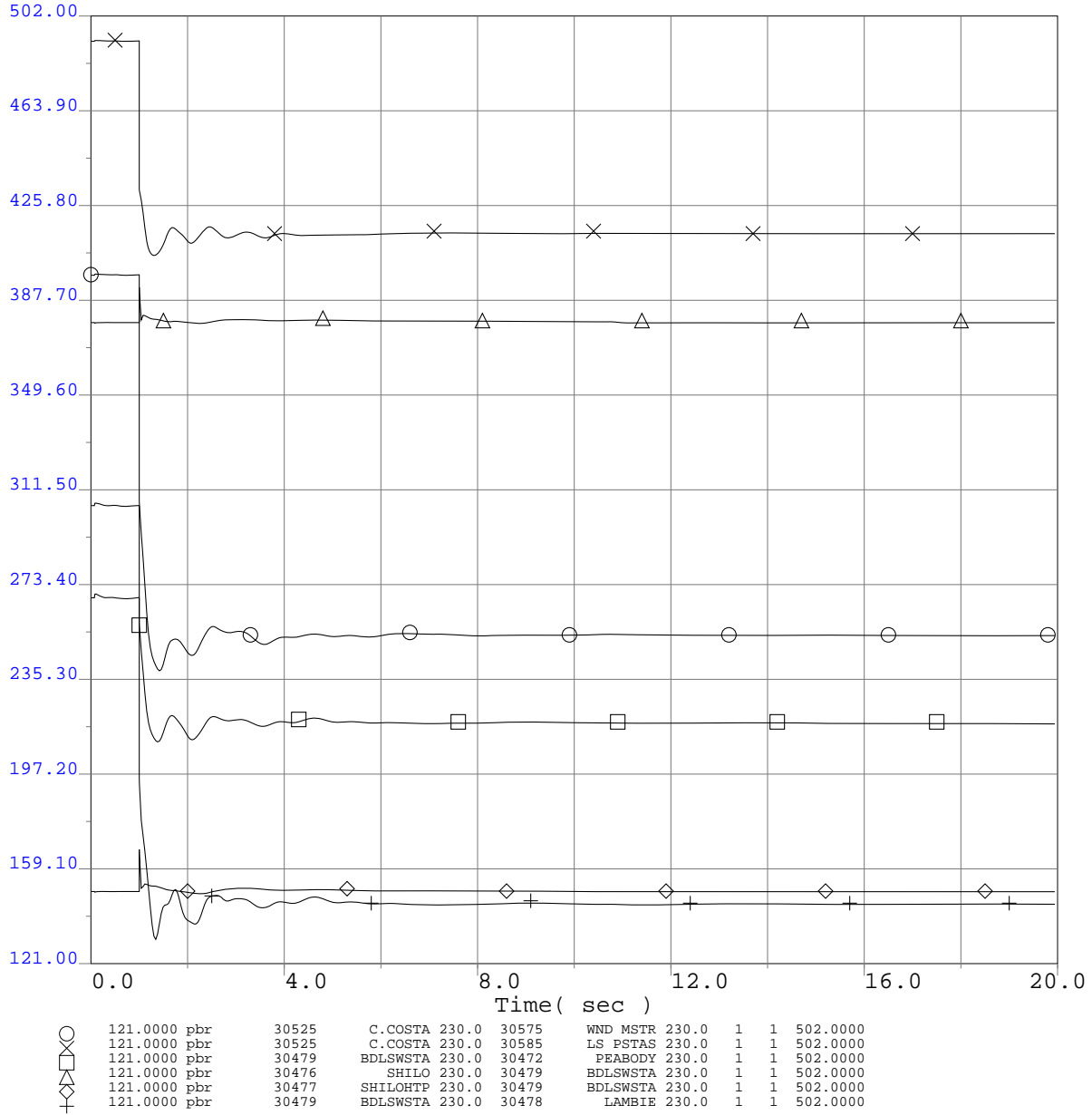

Q320 TCP2 ISIS
 2013 Greater Bay Area Summer Peak Base Case
 Q320 @ 772MW
 Q320 Load Rejection
 No Fault Load Rejection

Q320 TCP2 ISIS

Selected PG&E Transmission Line Flows (MW)

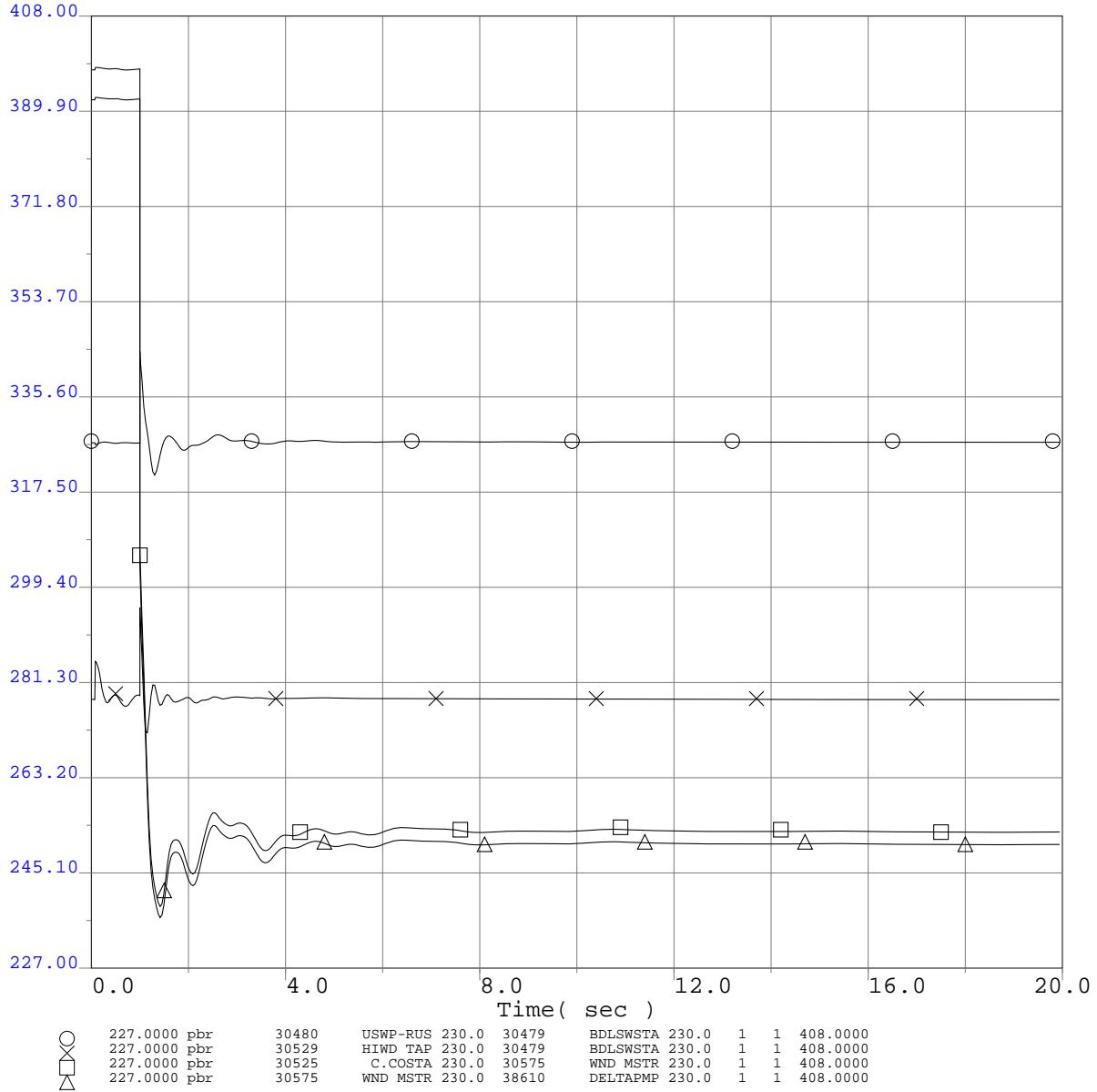

Q320 TCP2 ISIS
 2013 Greater Bay Area Summer Peak Base Case
 Q320 @ 772MW
 Q320 Load Rejection
 No Fault Load Rejection

Q320 TCP2 ISIS

Selected PG&E Bus Voltage Plots Adjacent to Fault

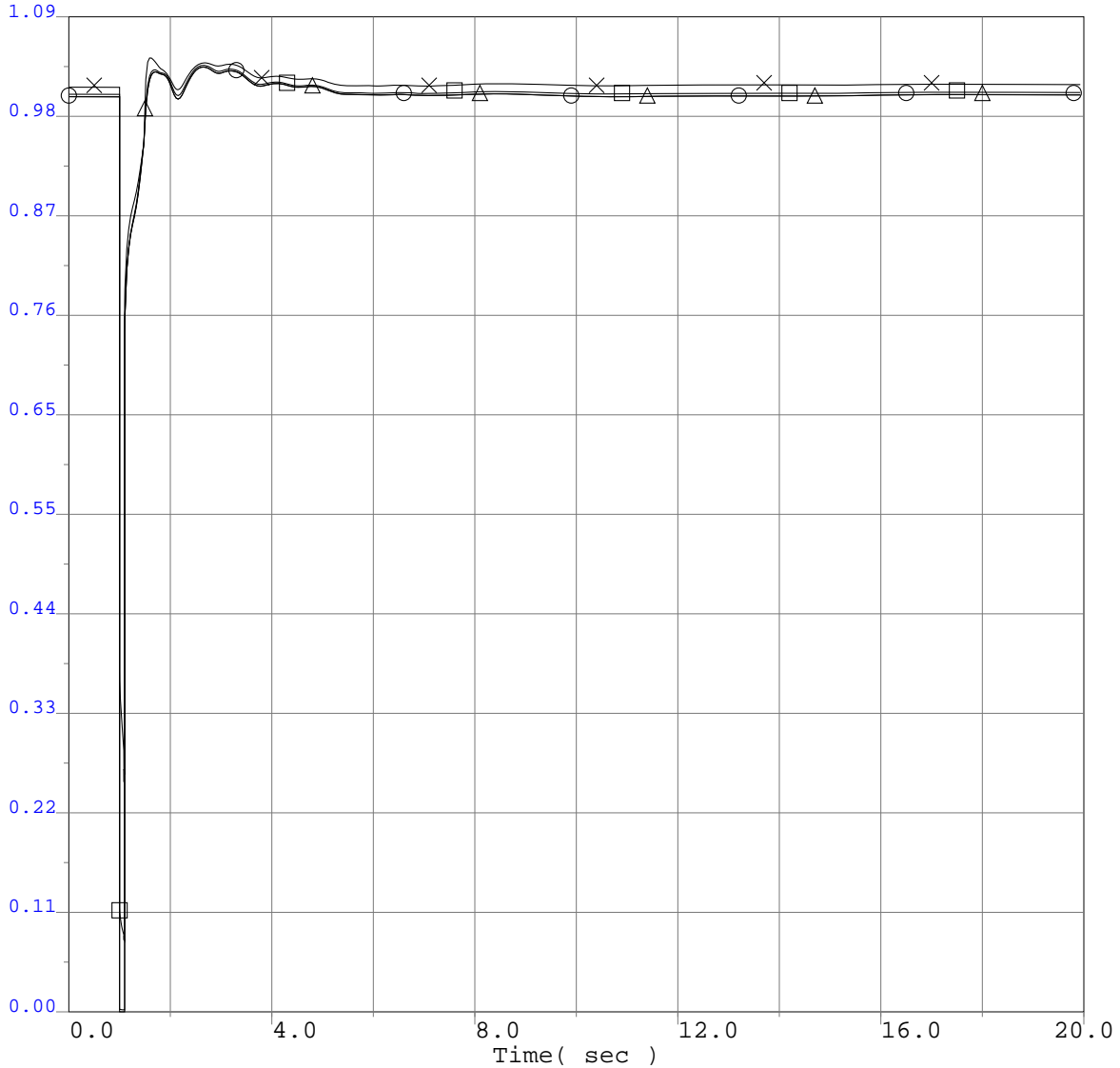

○	0.0000 vbus	30525	C.COSTA 230.0	0	0.0	***	1	1.0900
□	0.0000 vbus	30479	BDLWSTA 230.0	0	0.0	***	1	1.0900
△	0.0000 vbus	30523	CC SUB 230.0	0	0.0	***	1	1.0900
△	0.0000 vbus	30518	T320 230.0	0	0.0	***	1	1.0900



Q320 TCP2 ISIS
 2013 Greater Bay Area Summer Peak Base Case
 Q320 @ 772MW
 CCPP-Birds Landing 230kV Line Outage
 3-ph 6 cyc flt @ the CCPP 230kV bus & clr the CCPP-Birds Landing 230kV line

Q320 TCP2 ISIS

Selected PG&E Bus Frequency Plots Adjacent to Fault

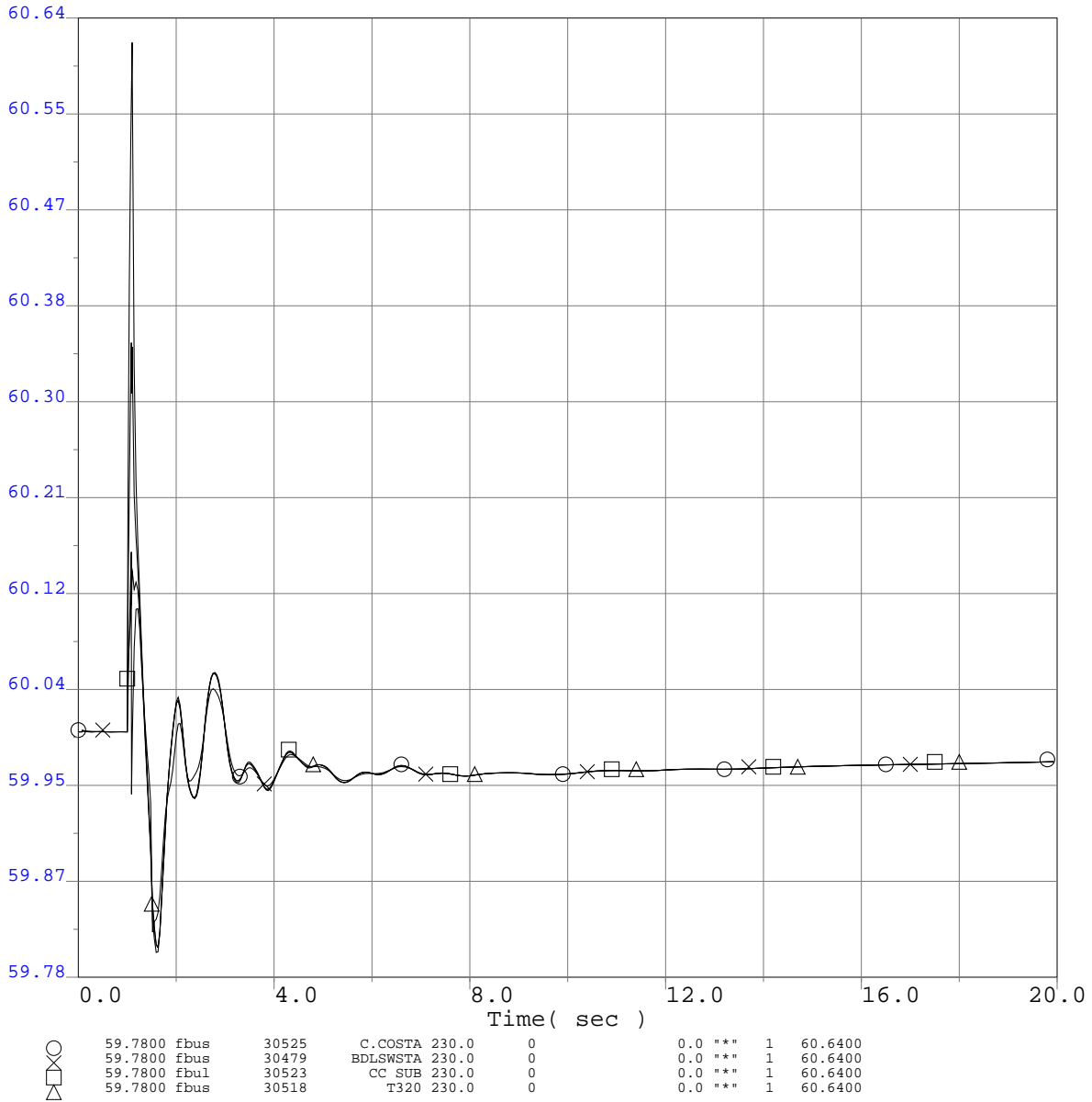

Q320 TCP2 ISIS
 2013 Greater Bay Area Summer Peak Base Case
 Q320 @ 772MW
 CCPP-Birds Landing 230kV Line Outage
 3-ph 6 cyc flt @ the CCPP 230kV bus & clr the CCPP-Birds Landing 230kV line

Q320 TCP2 ISIS

Project Generator Terminal Voltages (P.U.)

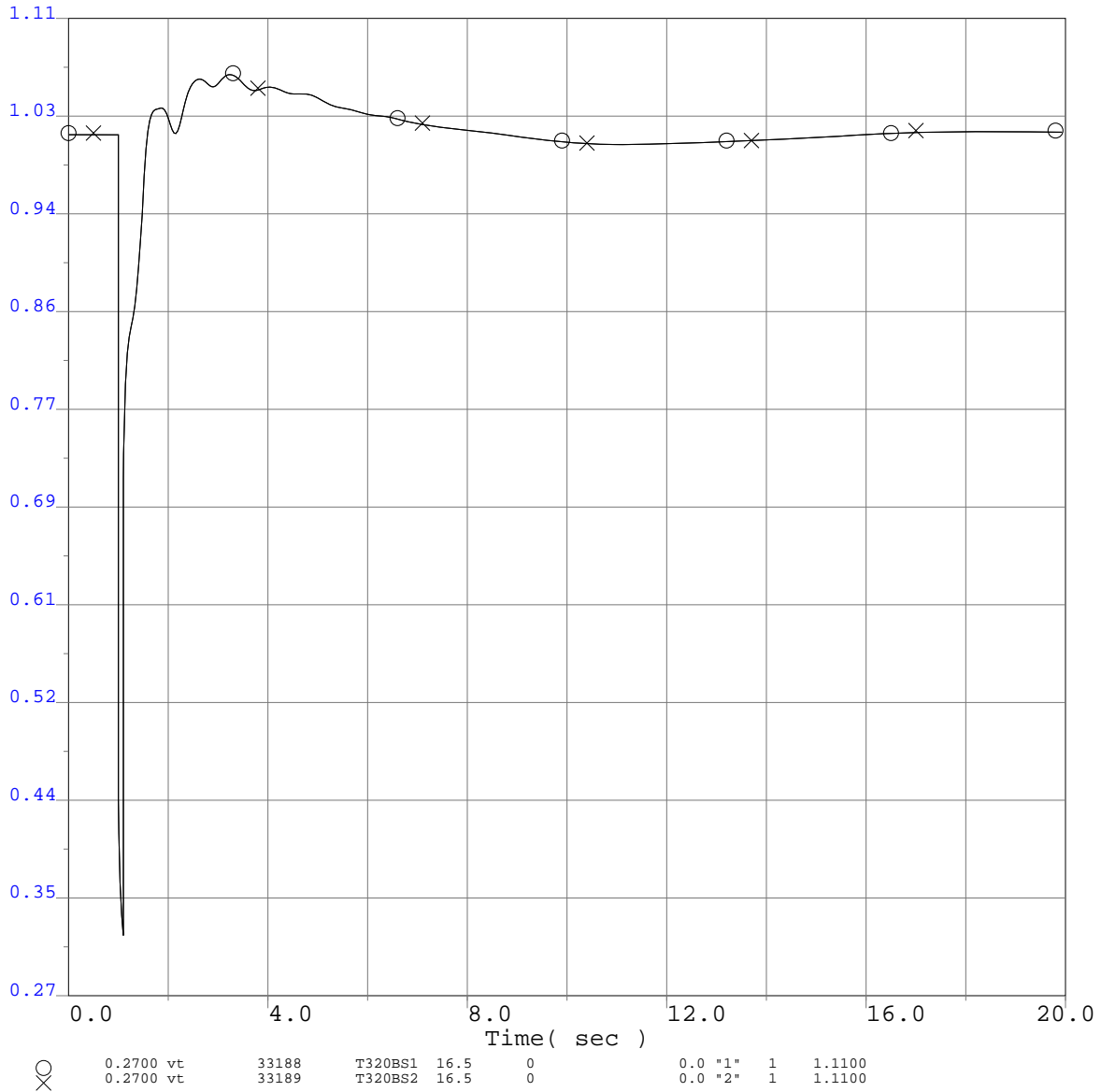

Q320 TCP2 ISIS
 2013 Greater Bay Area Summer Peak Base Case
 Q320 @ 772MW
 CCPP-Birds Landing 230kV Line Outage
 3-ph 6 cyc flt @ the CCPP 230kV bus & clr the CCPP-Birds Landing 230kV line

Q320 TCP2 ISIS

Project Generator Terminal Voltages (P.U.)

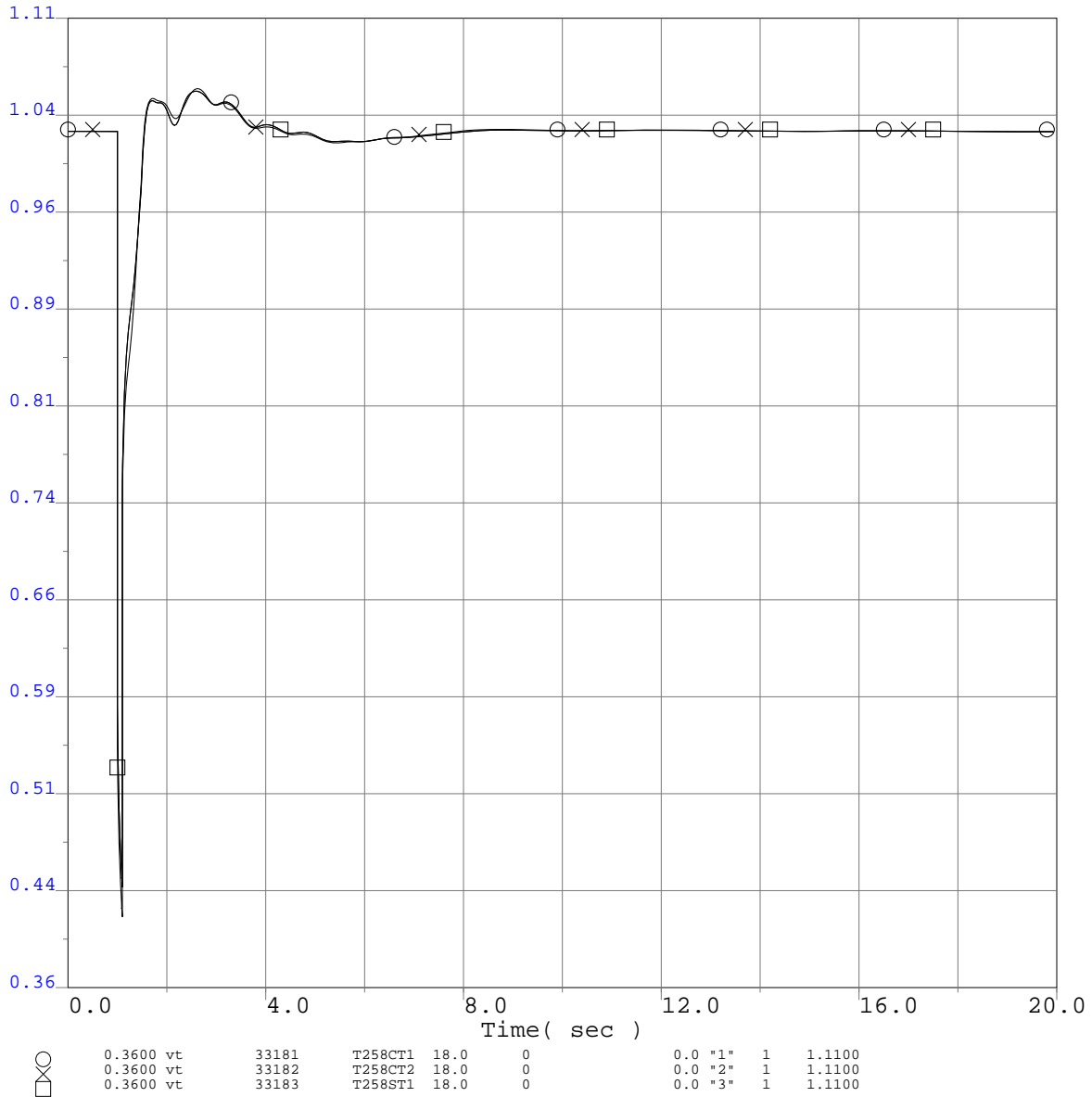

Q320 TCP2 ISIS
 2013 Greater Bay Area Summer Peak Base Case
 Q320 @ 772MW
 CCPP-Birds Landing 230kV Line Outage
 3-ph 6 cyc flt @ the CCPP 230kV bus & clr the CCPP-Birds Landing 230kV line

Q320 TCP2 ISIS

Project Generator Speed (P.U.)

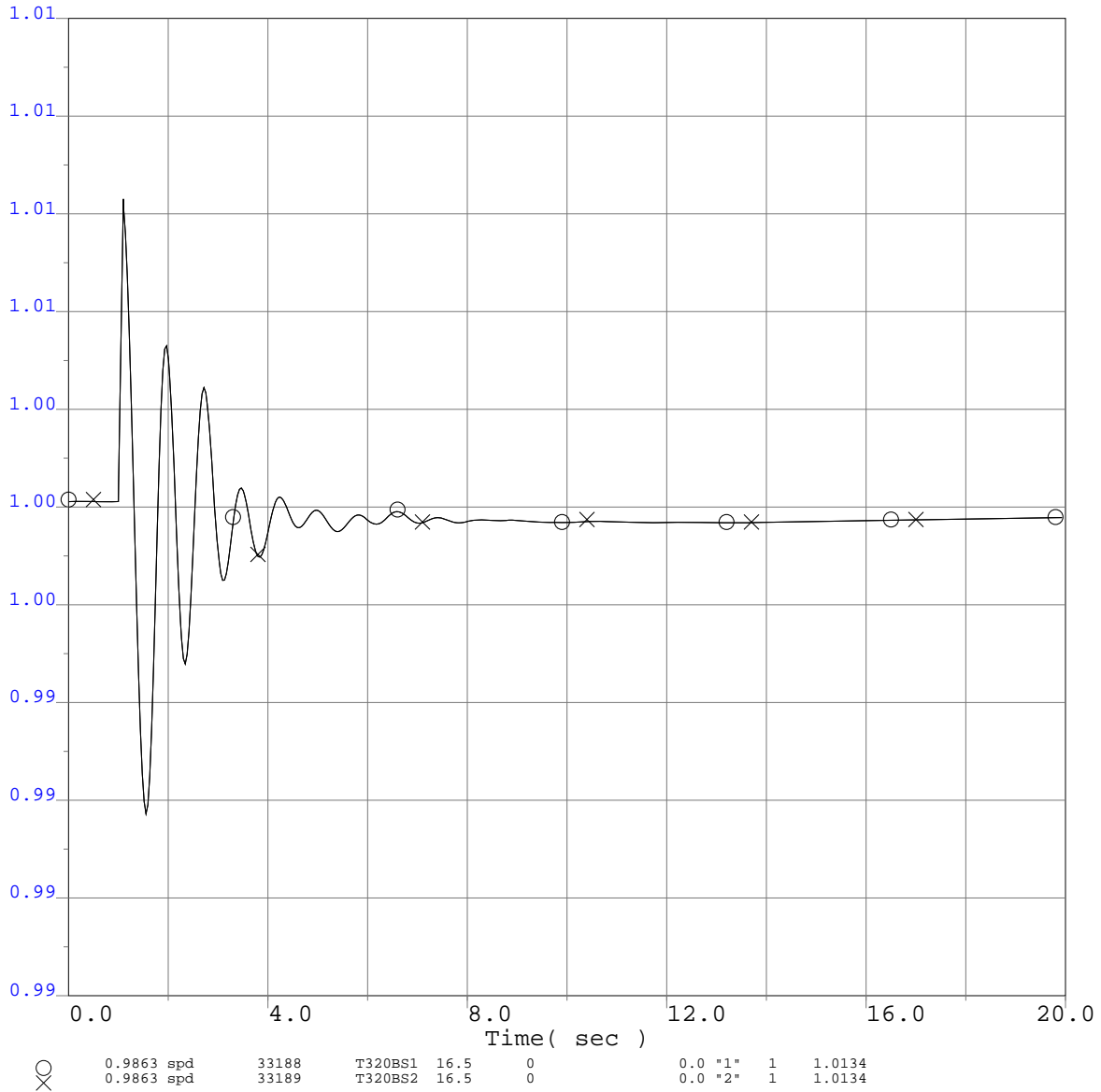

○	0.9863 spd	33188	T320BS1	16.5	0	0.0 "1"	1	1.0134
×	0.9863 spd	33189	T320BS2	16.5	0	0.0 "2"	1	1.0134

Q320 TCP2 ISIS
 2013 Greater Bay Area Summer Peak Base Case
 Q320 @ 772MW
 CCPP-Birds Landing 230kV Line Outage
 3-ph 6 cyc flt @ the CCPP 230kV bus & clr the CCPP-Birds Landing 230kV line

Q320 TCP2 ISIS

Project Generator Speed (P.U.)

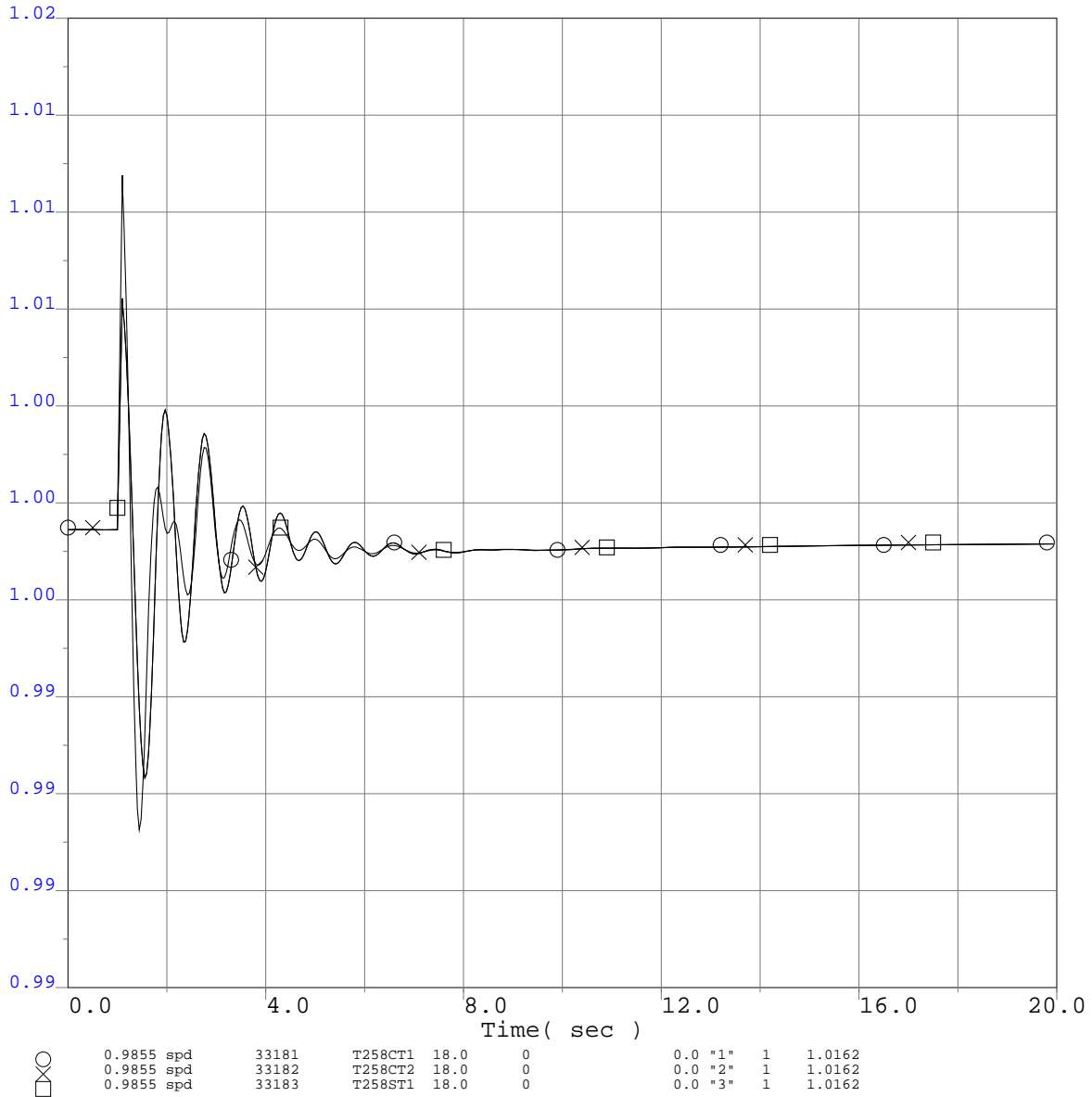

○	0.9855 spd	33181	T258CT1	18.0	0	0.0 "1"	1	1.0162
×	0.9855 spd	33182	T258CT2	18.0	0	0.0 "2"	1	1.0162
□	0.9855 spd	33183	T258ST1	18.0	0	0.0 "3"	1	1.0162

Q320 TCP2 ISIS
 2013 Greater Bay Area Summer Peak Base Case
 Q320 @ 772MW
 CCPP-Birds Landing 230kV Line Outage
 3-ph 6 cyc flt @ the CCPP 230kV bus & clr the CCPP-Birds Landing 230kV line

Q320 TCP2 ISIS

Project Generator Terminal Power (MW)

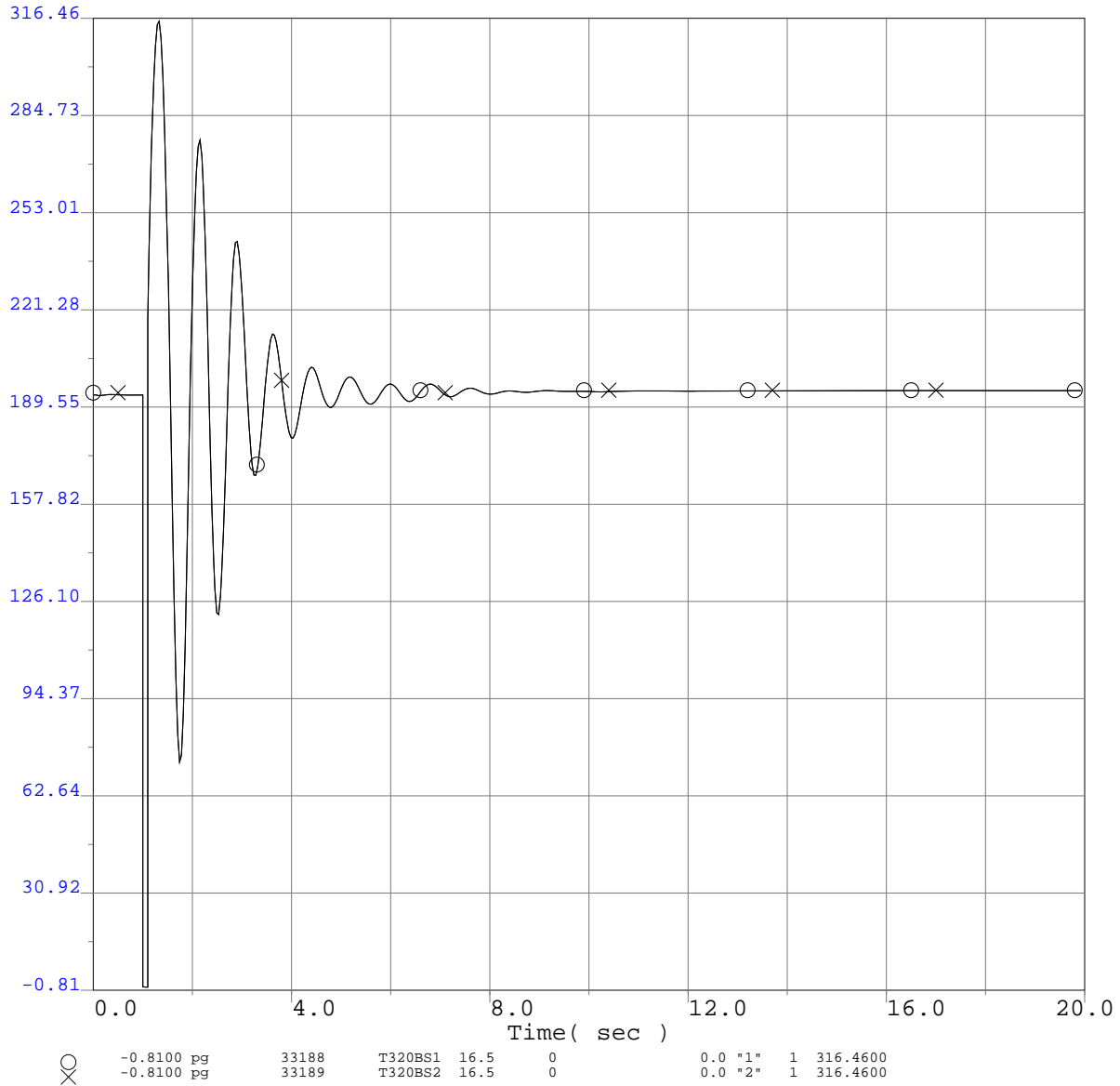

Q320 TCP2 ISIS
 2013 Greater Bay Area Summer Peak Base Case
 Q320 @ 772MW
 CCPP-Birds Landing 230kV Line Outage
 3-ph 6 cyc flt @ the CCPP 230kV bus & clr the CCPP-Birds Landing 230kV line

Q320 TCP2 ISIS

Project Generator Terminal Power (MW)

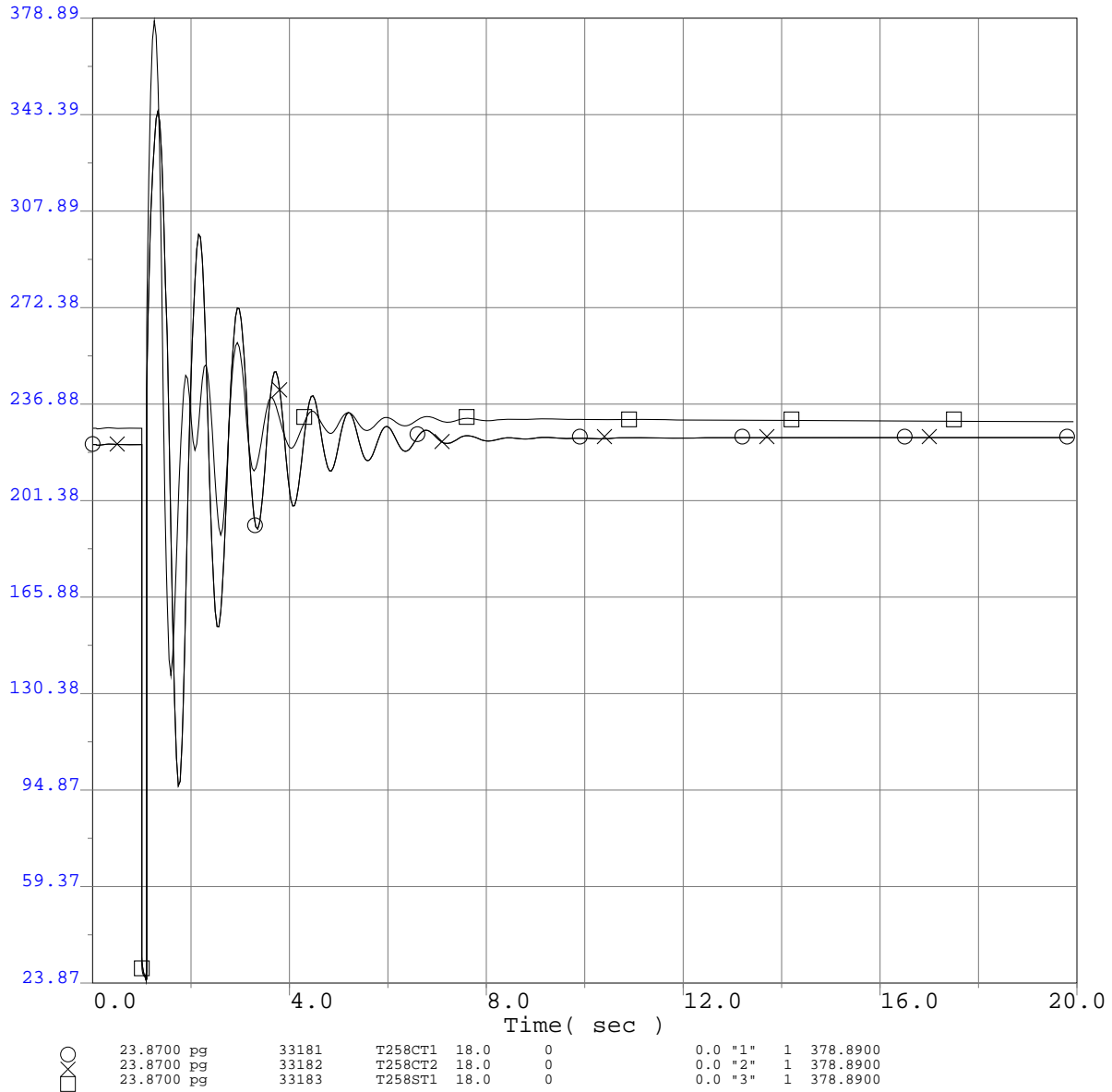

○	23.8700 pg	33181	T258CT1	18.0	0	0.0 "1"	1	378.8900
○	23.8700 pg	33182	T258CT2	18.0	0	0.0 "2"	1	378.8900
□	23.8700 pg	33183	T258ST1	18.0	0	0.0 "3"	1	378.8900

Q320 TCP2 ISIS
 2013 Greater Bay Area Summer Peak Base Case
 Q320 @ 772MW
 CCPP-Birds Landing 230kV Line Outage
 3-ph 6 cyc flt @ the CCPP 230kV bus & clr the CCPP-Birds Landing 230kV line

Q320 TCP2 ISIS

Project Generator Terminal Reactive Power (MVA_r)

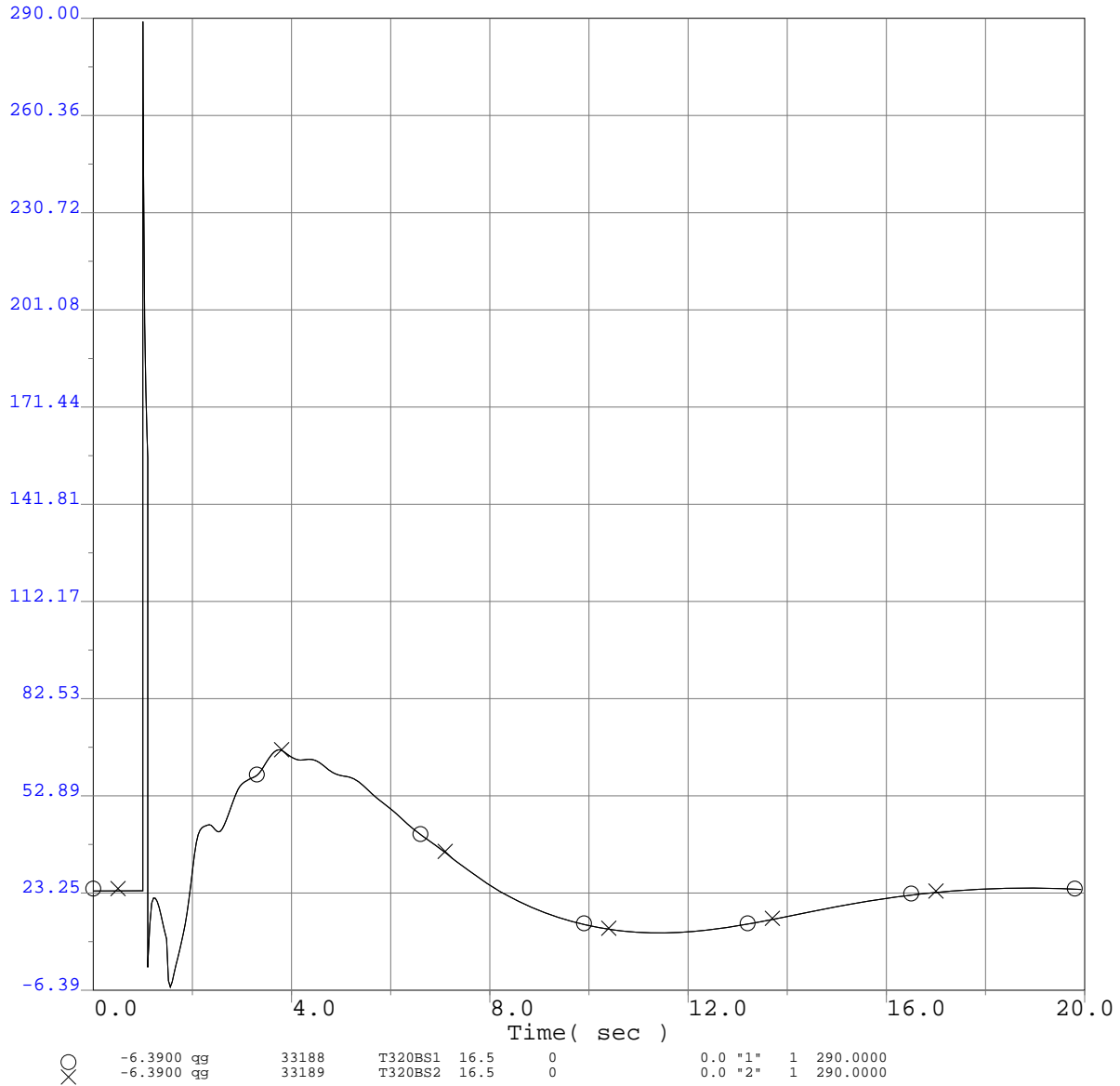

Q320 TCP2 ISIS
 2013 Greater Bay Area Summer Peak Base Case
 Q320 @ 772MW
 CCPP-Birds Landing 230kV Line Outage
 3-ph 6 cyc flt @ the CCPP 230kV bus & clr the CCPP-Birds Landing 230kV line

Q320 TCP2 ISIS

Project Generator Terminal Reactive Power (MVar)

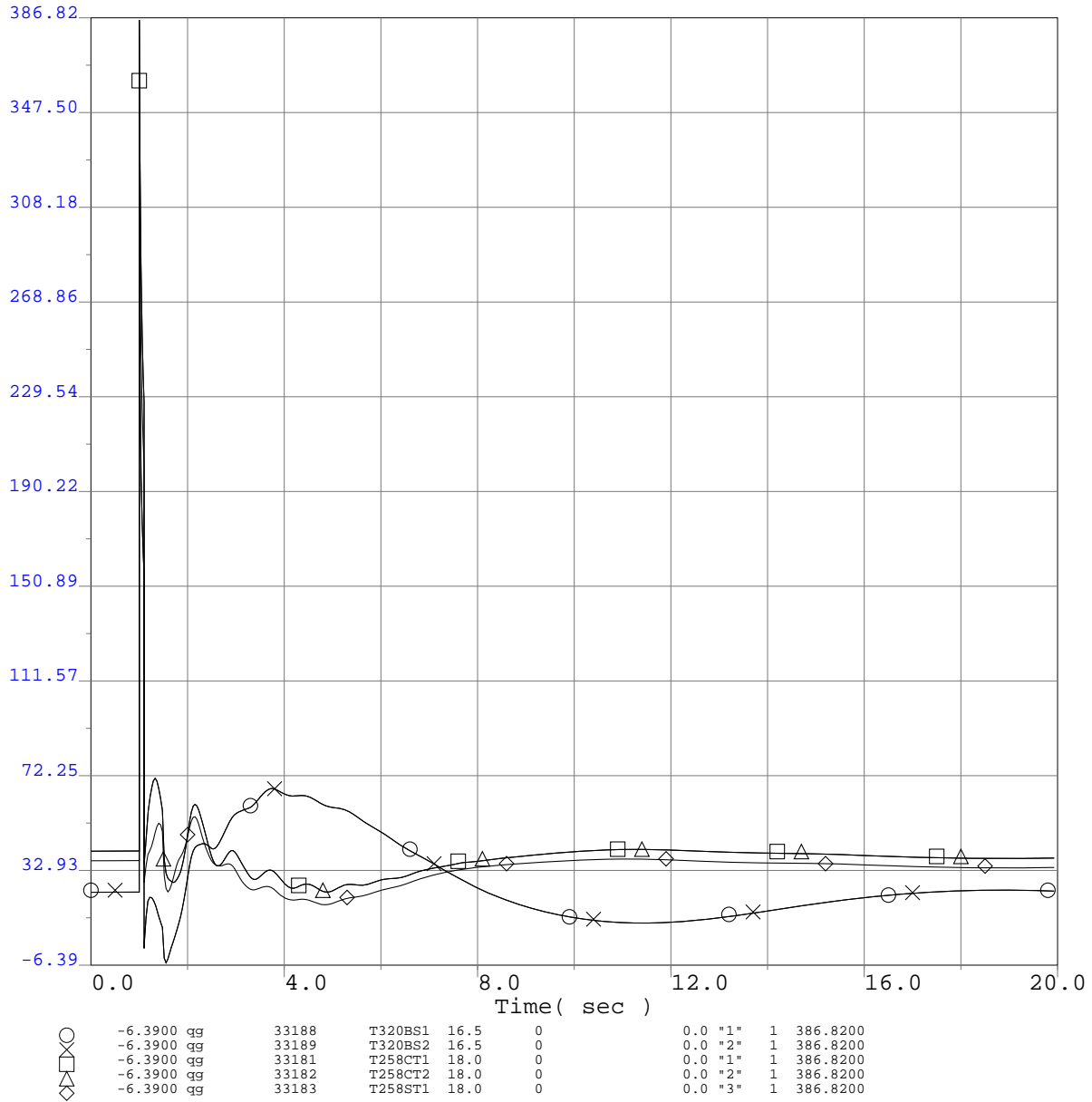

Q320 TCP2 ISIS
 2013 Greater Bay Area Summer Peak Base Case
 Q320 @ 772MW
 CCPP-Birds Landing 230kV Line Outage
 3-ph 6 cyc flt @ the CCPP 230kV bus & clr the CCPP-Birds Landing 230kV line

Q320 TCP2 ISIS

Selected WECC Bus Voltage Plots

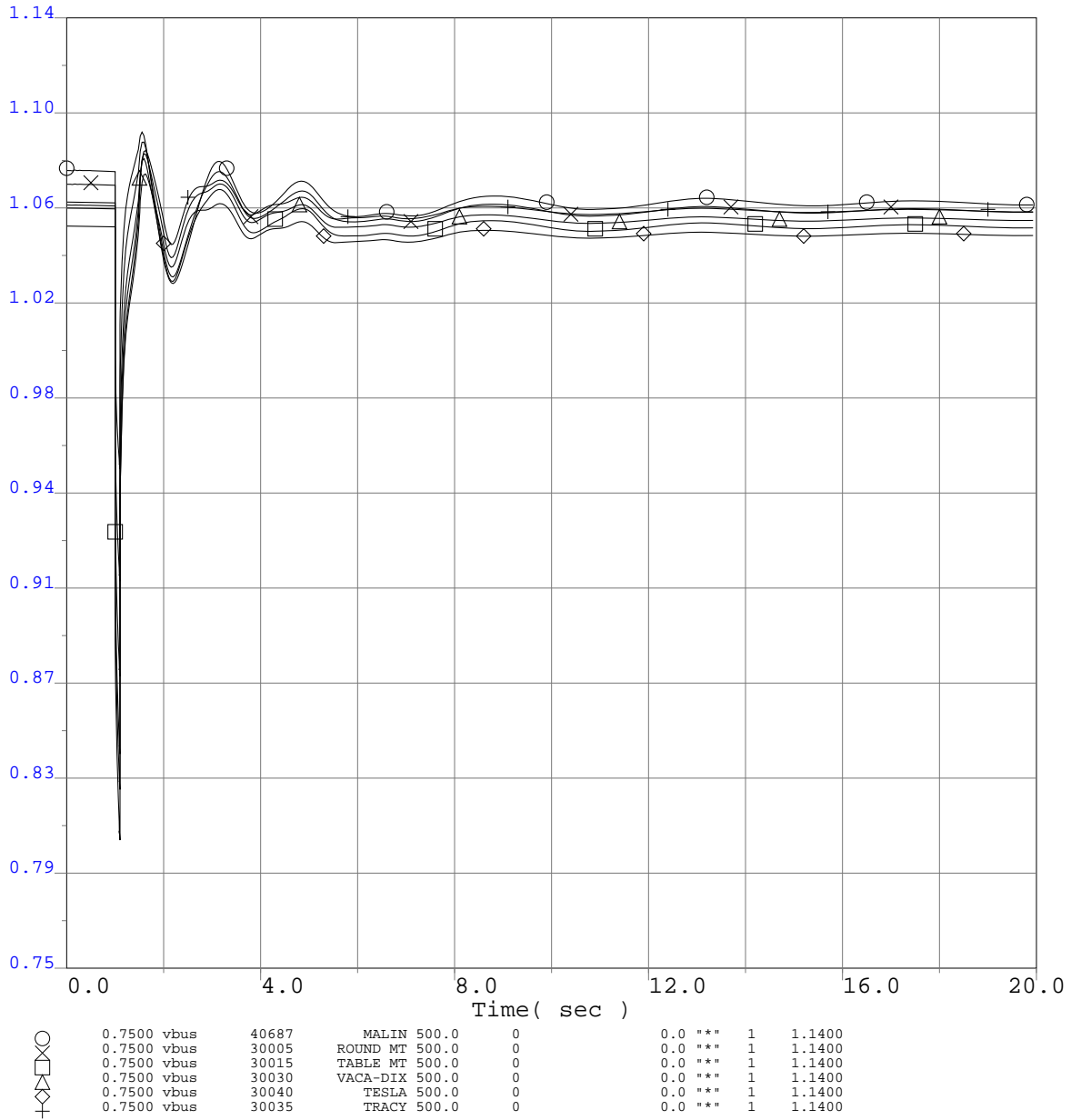

Q320 TCP2 ISIS
 2013 Greater Bay Area Summer Peak Base Case
 Q320 @ 772MW
 CCPP-Birds Landing 230kV Line Outage
 3-ph 6 cyc flt @ the CCPP 230kV bus & clr the CCPP-Birds Landing 230kV line

Q320 TCP2 ISIS

Selected WECC Bus Voltage Plots

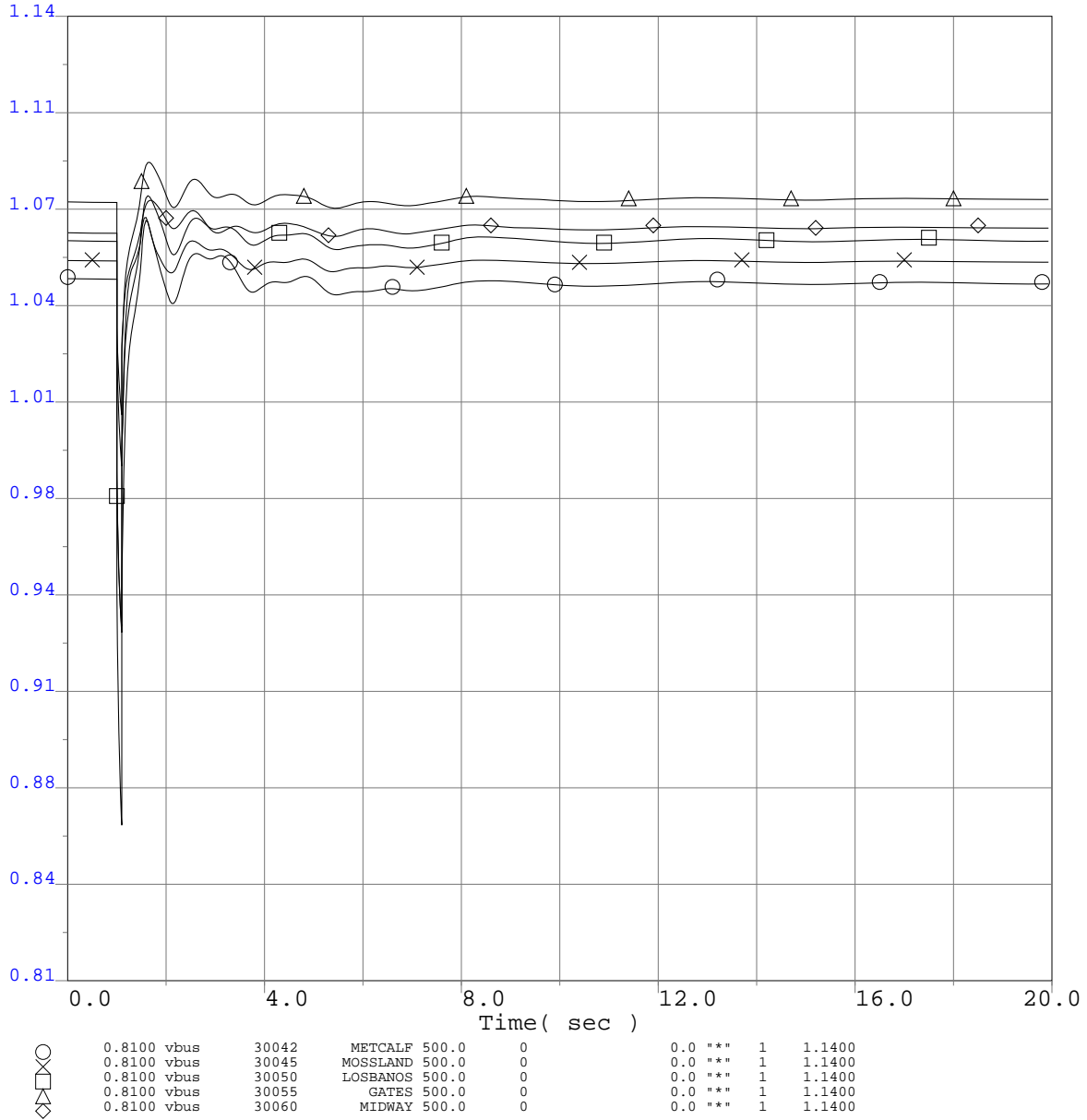

Q320 TCP2 ISIS
 2013 Greater Bay Area Summer Peak Base Case
 Q320 @ 772MW
 CCPP-Birds Landing 230kV Line Outage
 3-ph 6 cyc flt @ the CCPP 230kV bus & clr the CCPP-Birds Landing 230kV line

Q320 TCP2 ISIS

Selected WECC Bus Voltage Plots

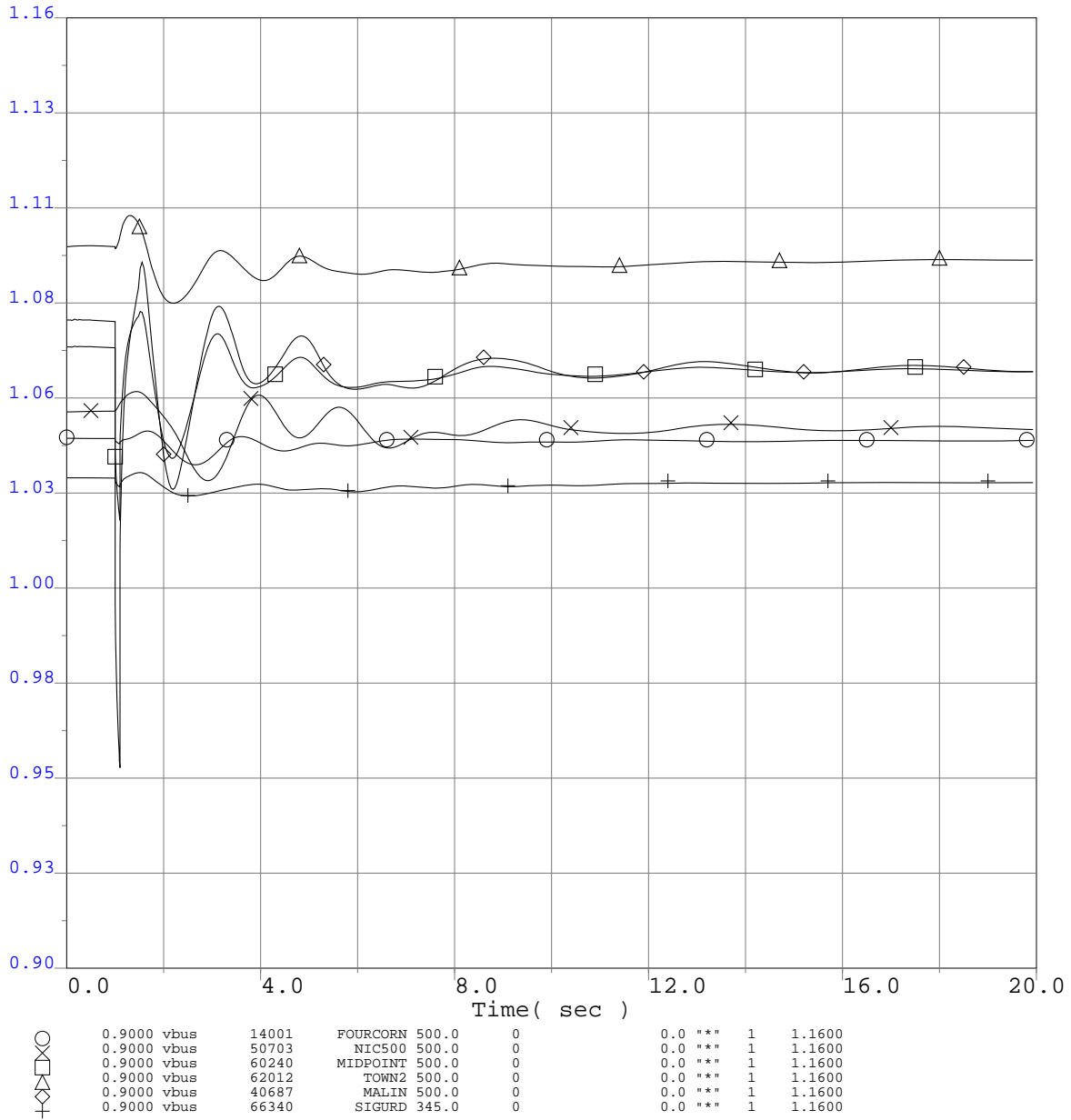

Q320 TCP2 ISIS
 2013 Greater Bay Area Summer Peak Base Case
 Q320 @ 772MW
 CCPP-Birds Landing 230kV Line Outage
 3-ph 6 cyc flt @ the CCPP 230kV bus & clr the CCPP-Birds Landing 230kV line

Q320 TCP2 ISIS

Selected WECC Bus Voltage Plots

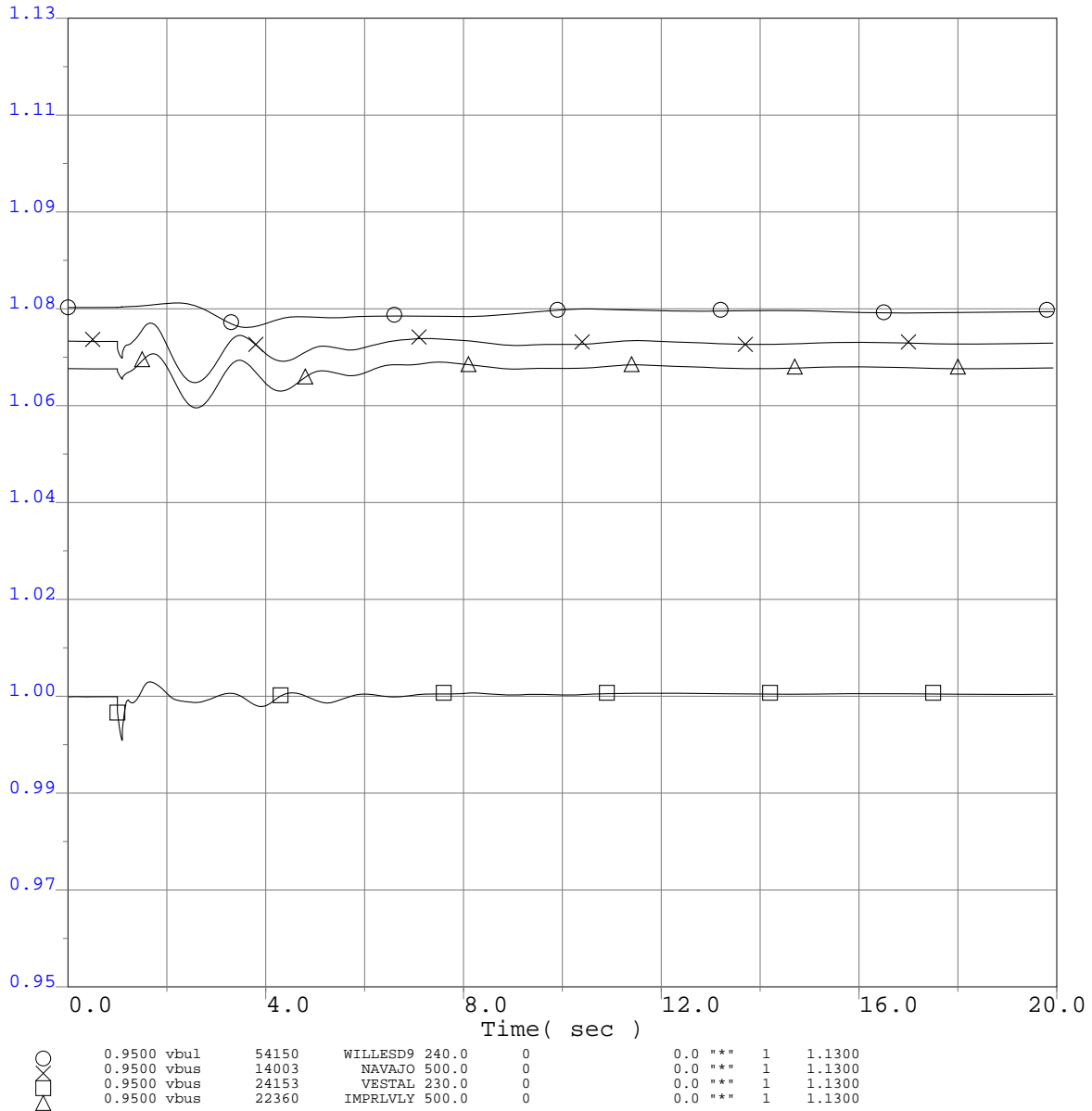

Q320 TCP2 ISIS
 2013 Greater Bay Area Summer Peak Base Case
 Q320 @ 772MW
 CCPP-Birds Landing 230kV Line Outage
 3-ph 6 cyc flt @ the CCPP 230kV bus & clr the CCPP-Birds Landing 230kV line

Q320 TCP2 ISIS

Selected WECC Bus Frequency Plots

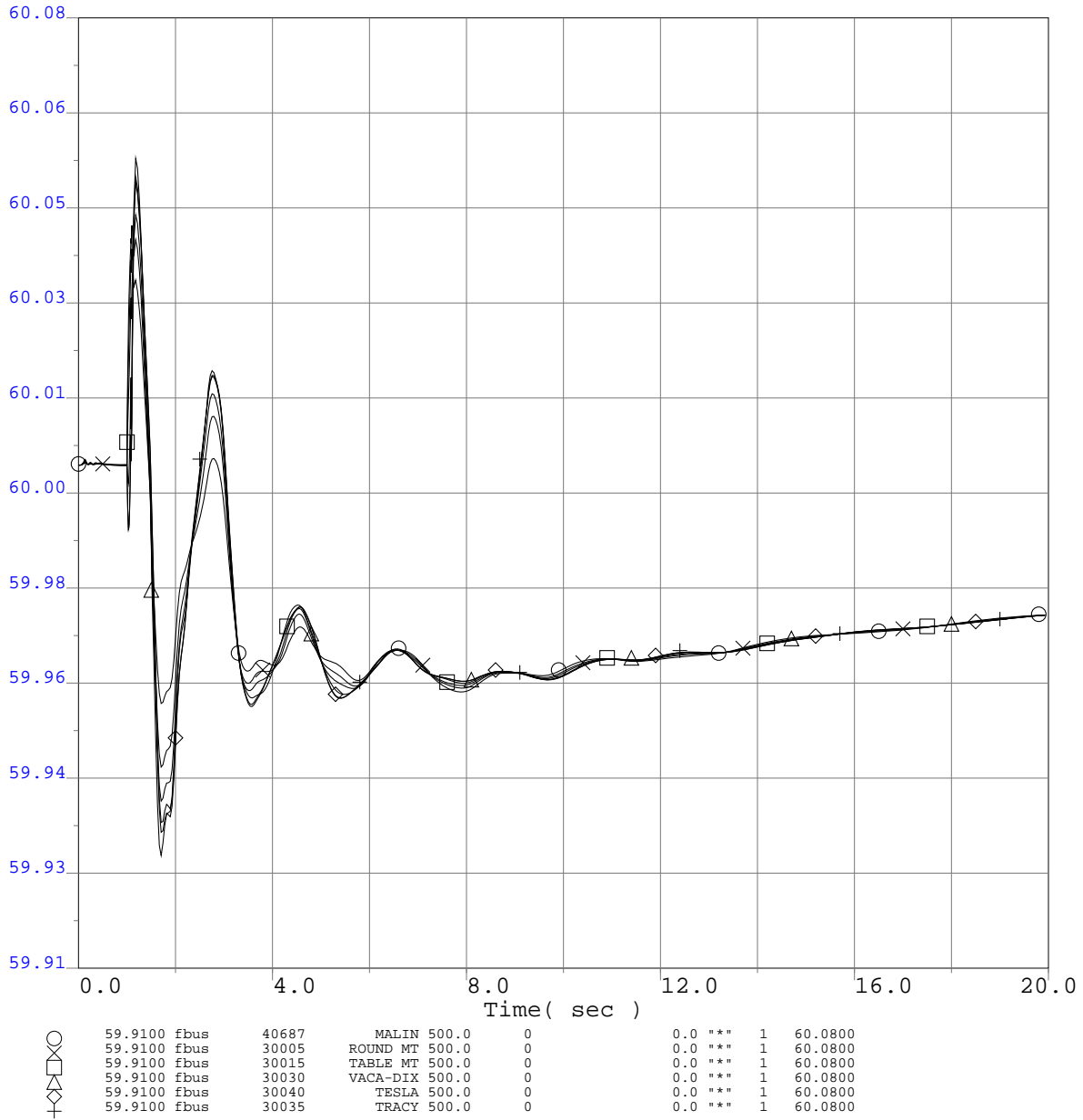

Q320 TCP2 ISIS
 2013 Greater Bay Area Summer Peak Base Case
 Q320 @ 772MW
 CCPP-Birds Landing 230kV Line Outage
 3-ph 6 cyc flt @ the CCPP 230kV bus & clr the CCPP-Birds Landing 230kV line

Q320 TCP2 ISIS

Selected WECC Bus Frequency Plots

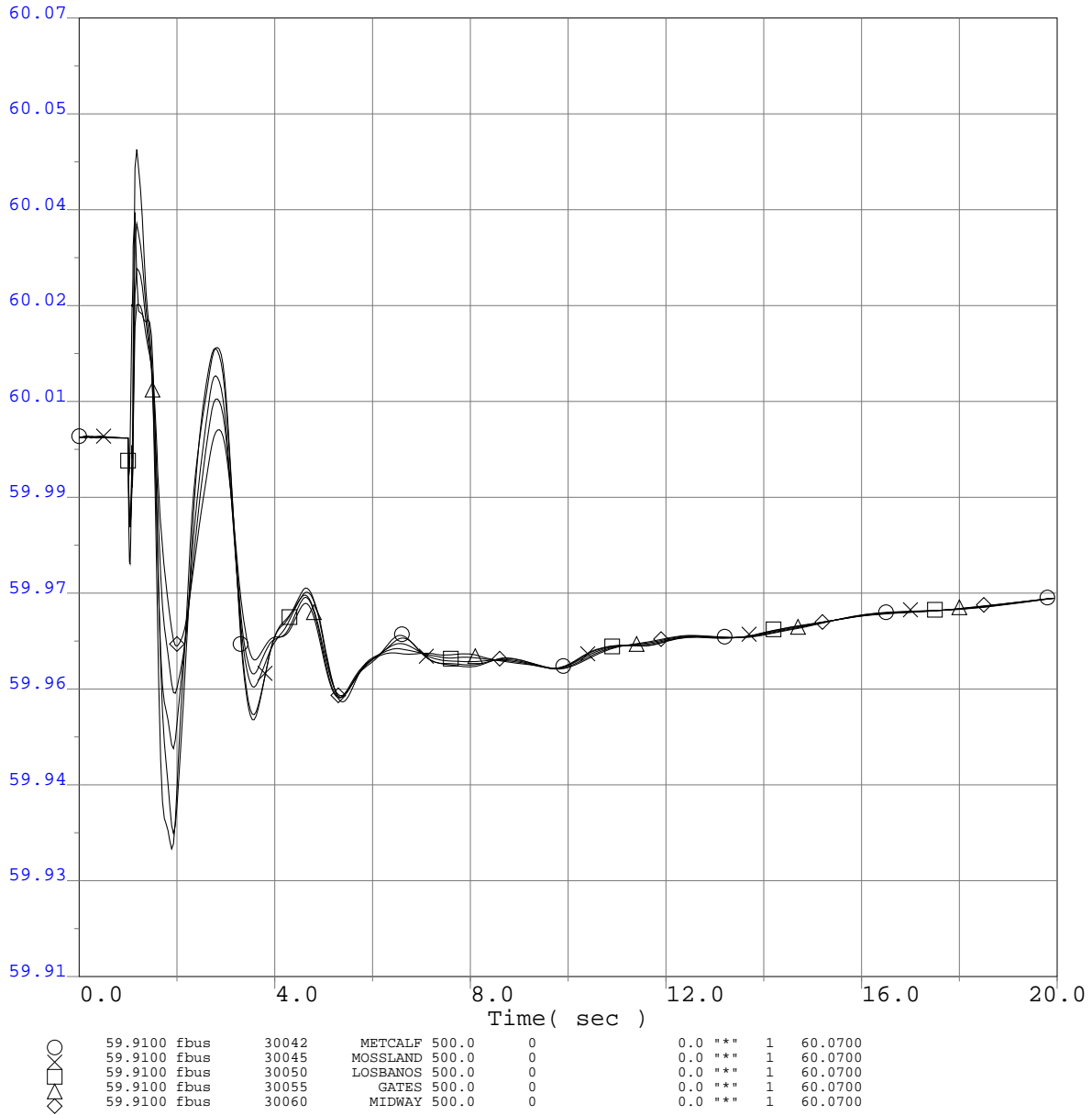

Q320 TCP2 ISIS
 2013 Greater Bay Area Summer Peak Base Case
 Q320 @ 772MW
 CCPP-Birds Landing 230kV Line Outage
 3-ph 6 cyc flt @ the CCPP 230kV bus & clr the CCPP-Birds Landing 230kV line

Q320 TCP2 ISIS

Selected WECC Bus Frequency Plots

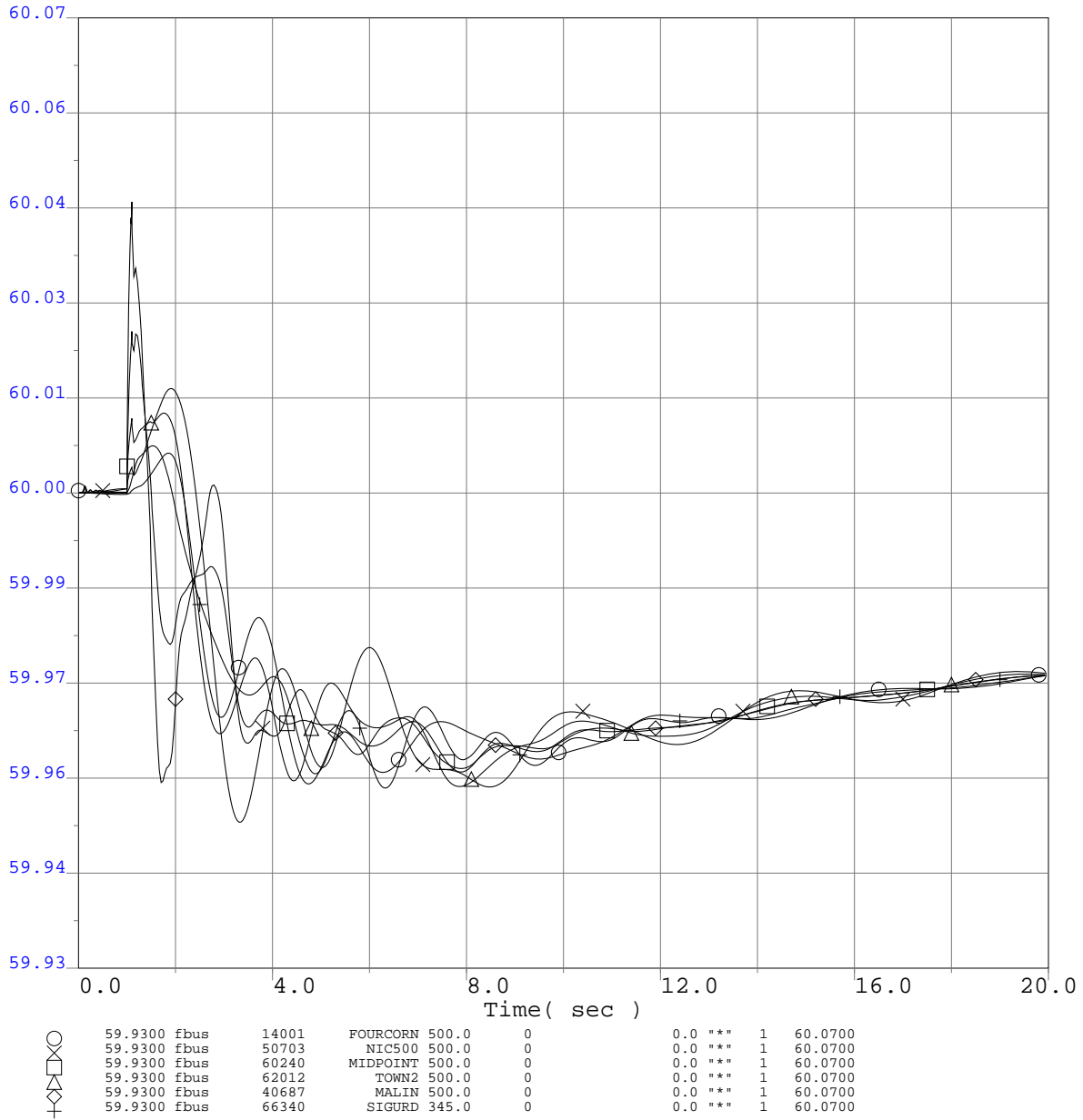

Q320 TCP2 ISIS
 2013 Greater Bay Area Summer Peak Base Case
 Q320 @ 772MW
 CCPP-Birds Landing 230kV Line Outage
 3-ph 6 cyc flt @ the CCPP 230kV bus & clr the CCPP-Birds Landing 230kV line

Q320 TCP2 ISIS

Selected WECC Bus Frequency Plots

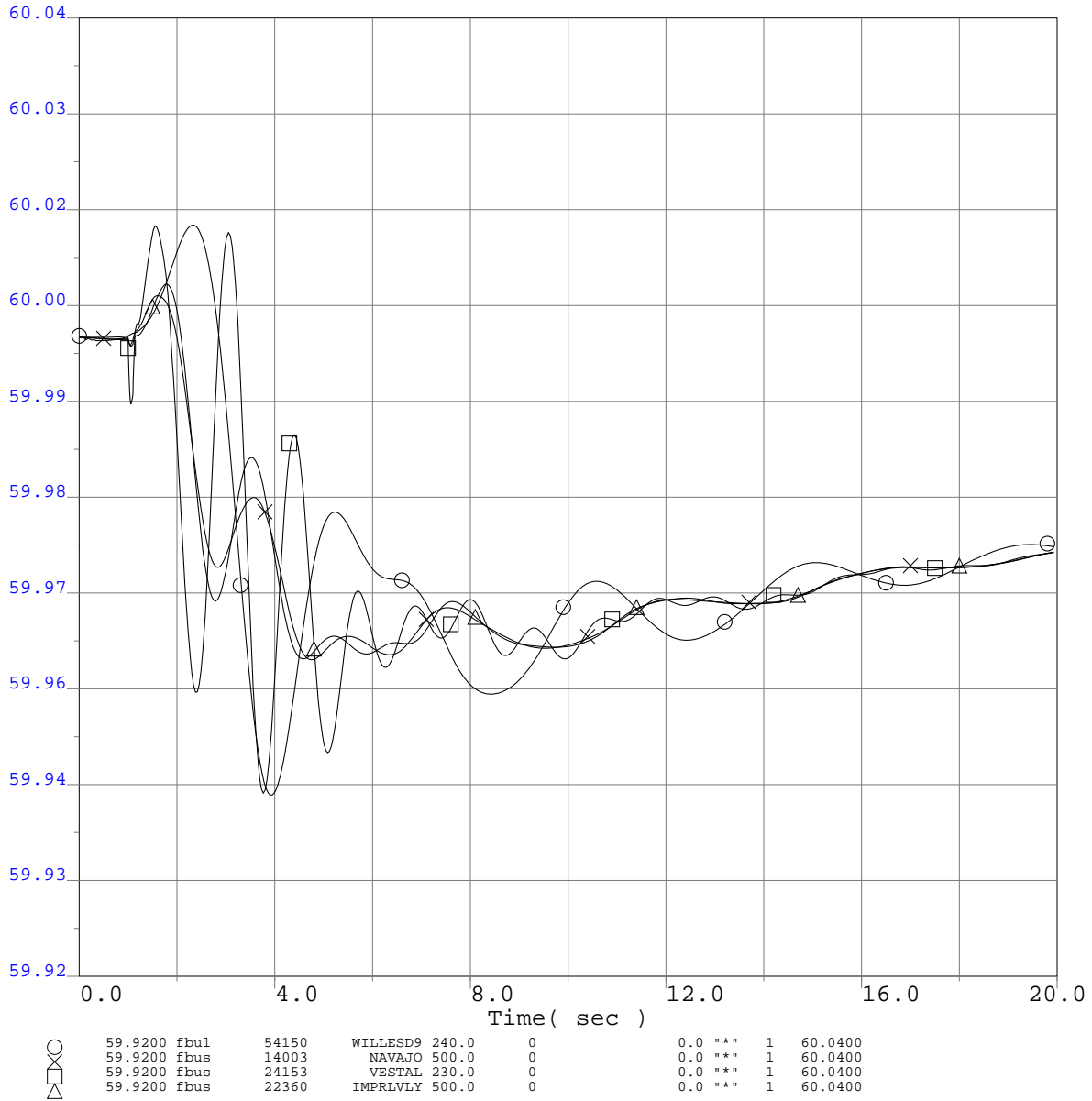

Q320 TCP2 ISIS
 2013 Greater Bay Area Summer Peak Base Case
 Q320 @ 772MW
 CCPP-Birds Landing 230kV Line Outage
 3-ph 6 cyc flt @ the CCPP 230kV bus & clr the CCPP-Birds Landing 230kV line

Q320 TCP2 ISIS

WECC Generator Rotor Angle

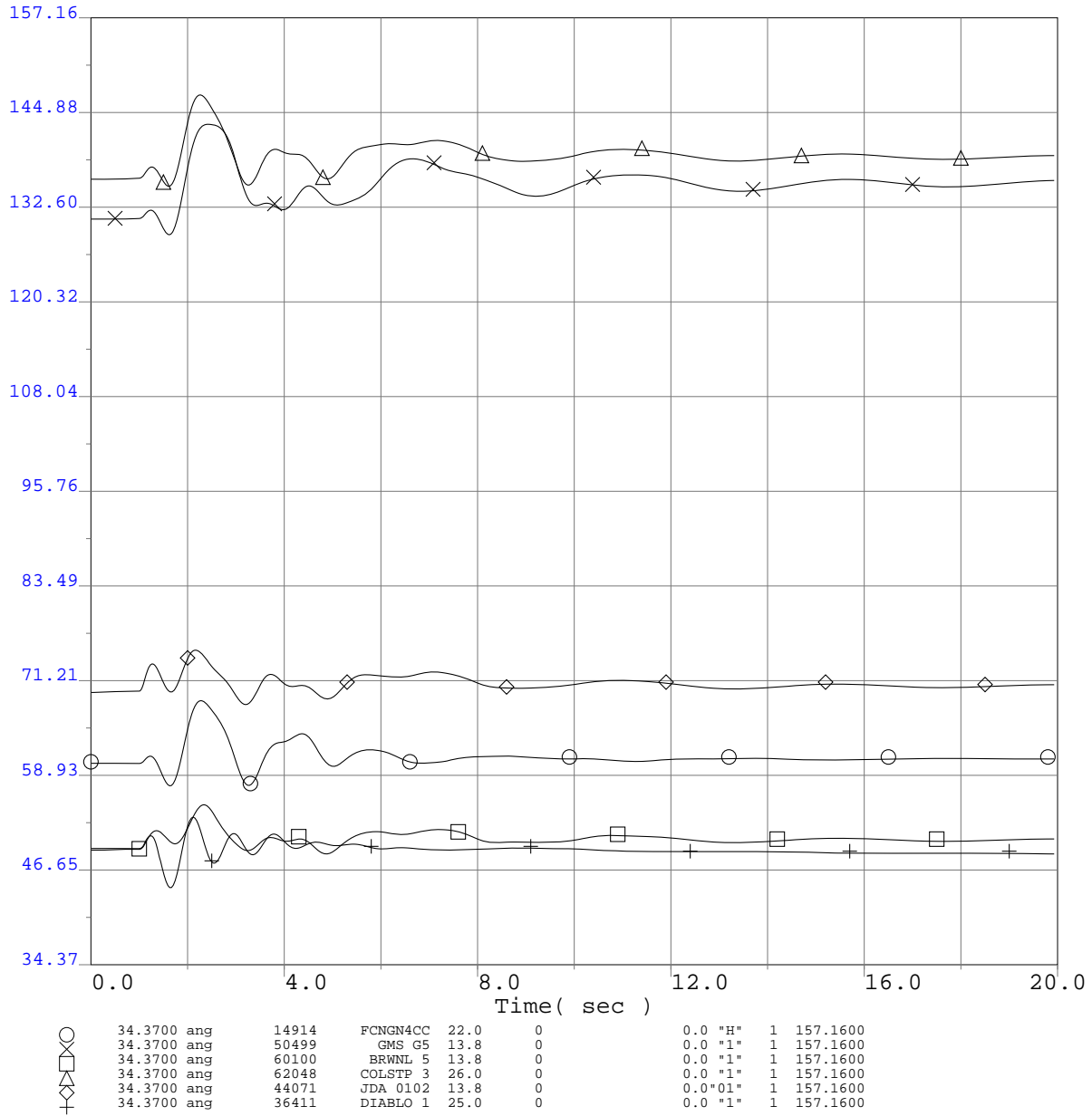

Q320 TCP2 ISIS
 2013 Greater Bay Area Summer Peak Base Case
 Q320 @ 772MW
 CCPP-Birds Landing 230kV Line Outage
 3-ph 6 cyc flt @ the CCPP 230kV bus & clr the CCPP-Birds Landing 230kV line

Q320 TCP2 ISIS

WECC Generator Rotor Angle

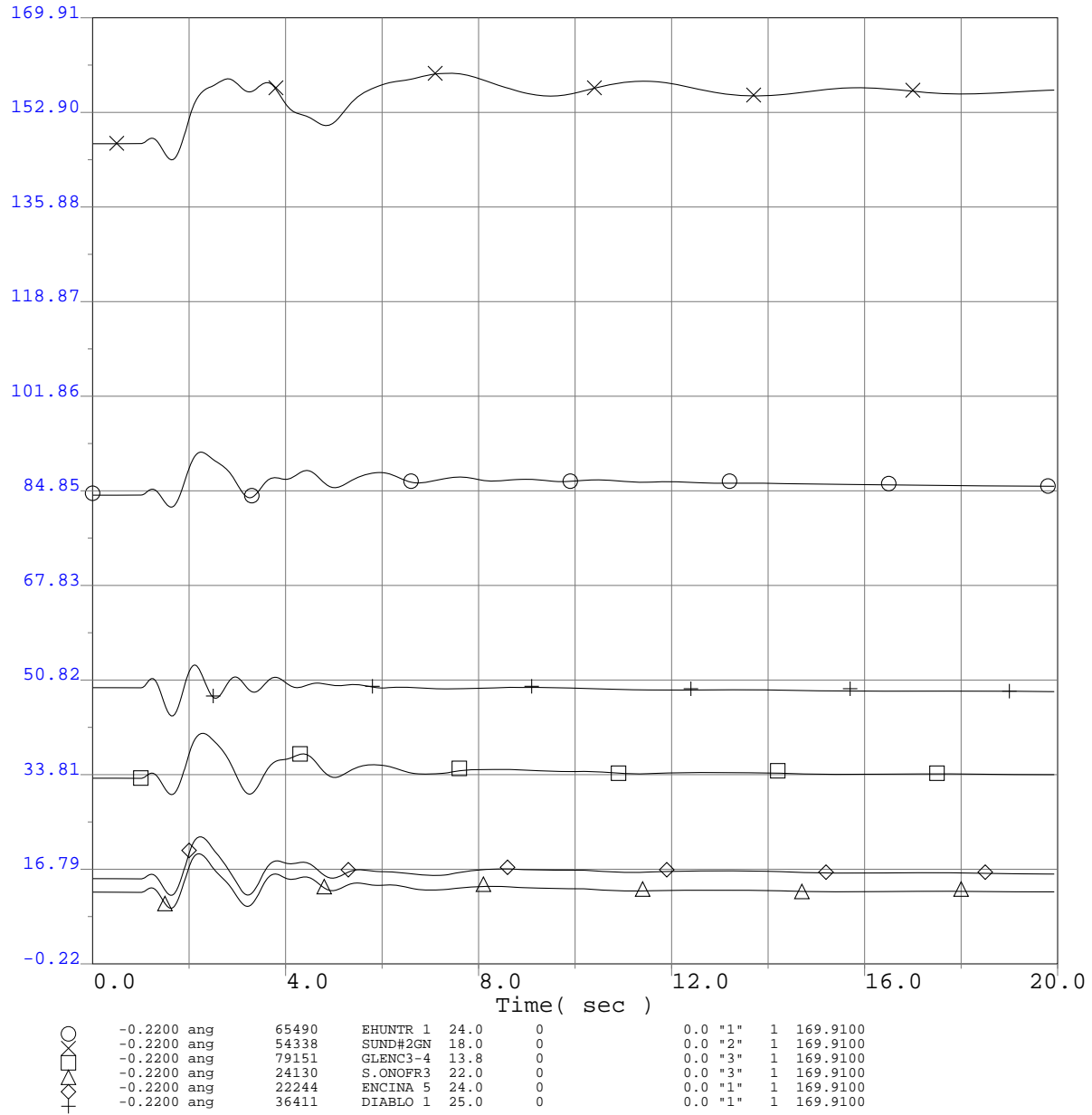

Q320 TCP2 ISIS
 2013 Greater Bay Area Summer Peak Base Case
 Q320 @ 772MW
 CCPP-Birds Landing 230kV Line Outage
 3-ph 6 cyc flt @ the CCPP 230kV bus & clr the CCPP-Birds Landing 230kV line

Q320 TCP2 ISIS

Selected PG&E Transmission Line Flows (MW)

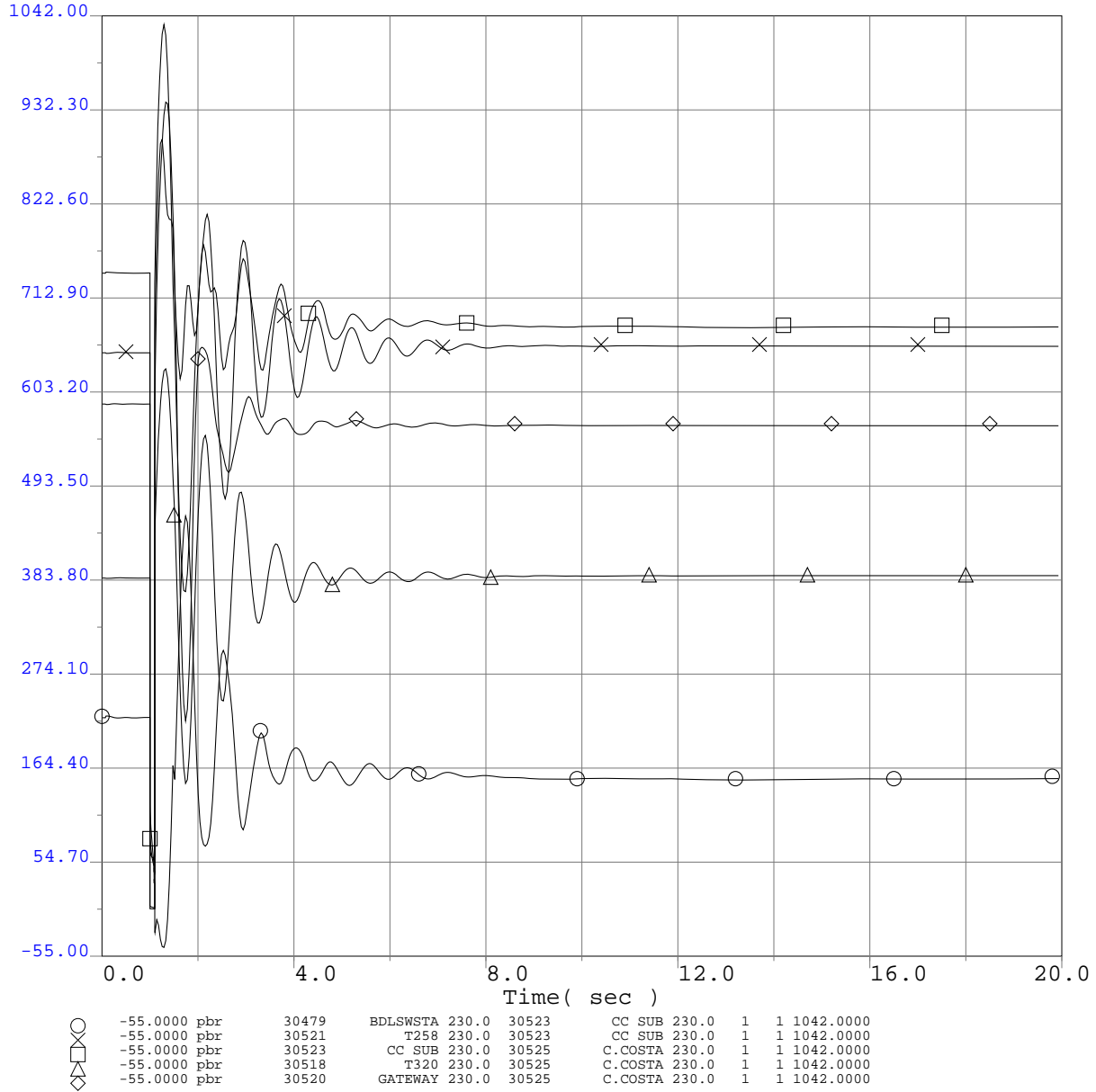

Q320 TCP2 ISIS
 2013 Greater Bay Area Summer Peak Base Case
 Q320 @ 772MW
 CCPP-Birds Landing 230kV Line Outage
 3-ph 6 cyc flt @ the CCPP 230kV bus & clr the CCPP-Birds Landing 230kV line

Q320 TCP2 ISIS

Selected PG&E Transmission Line Flows (MW)

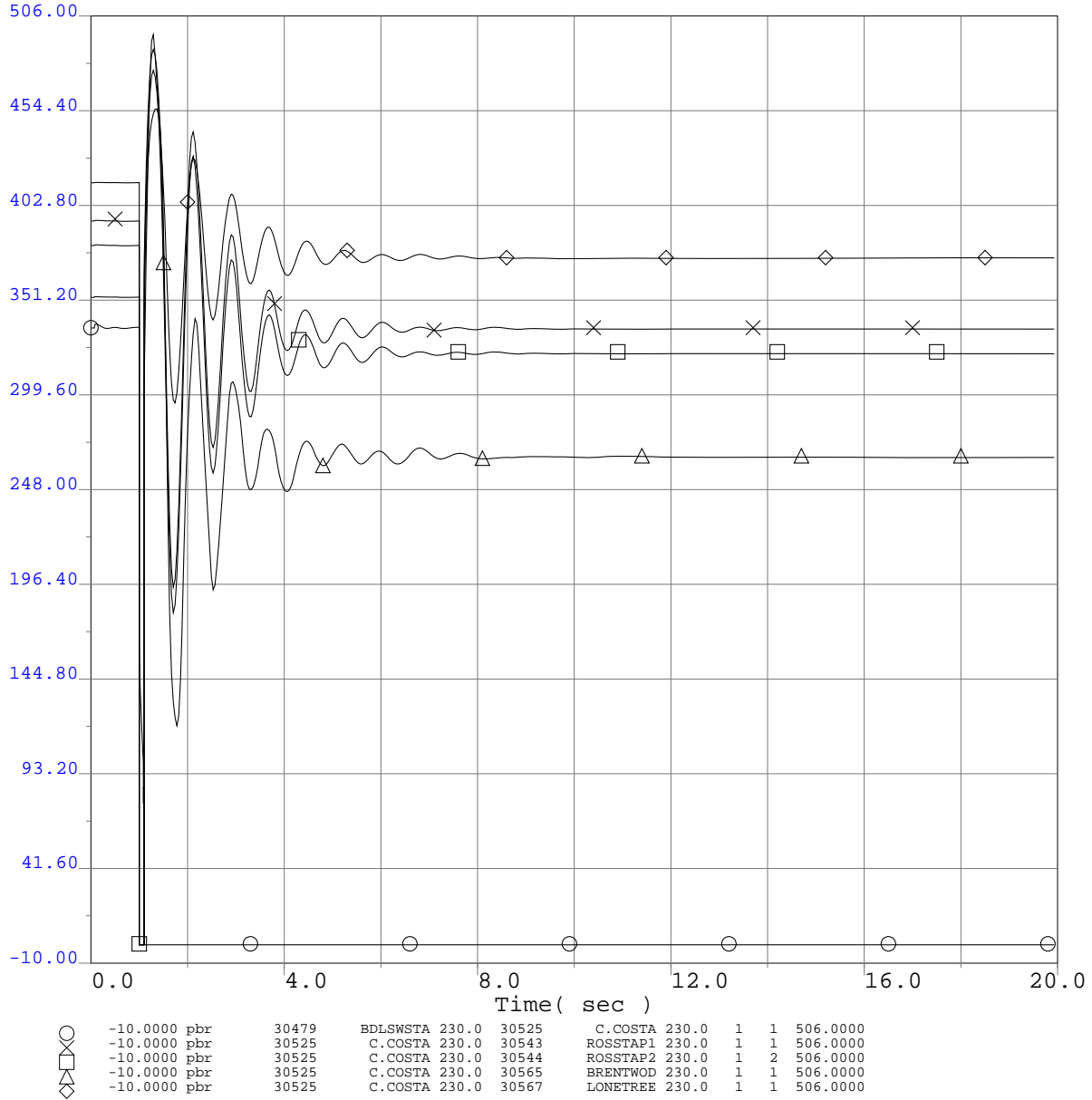

Q320 TCP2 ISIS
 2013 Greater Bay Area Summer Peak Base Case
 Q320 @ 772MW
 CCPP-Birds Landing 230kV Line Outage
 3-ph 6 cyc flt @ the CCPP 230kV bus & clr the CCPP-Birds Landing 230kV line

Q320 TCP2 ISIS

Selected PG&E Transmission Line Flows (MW)

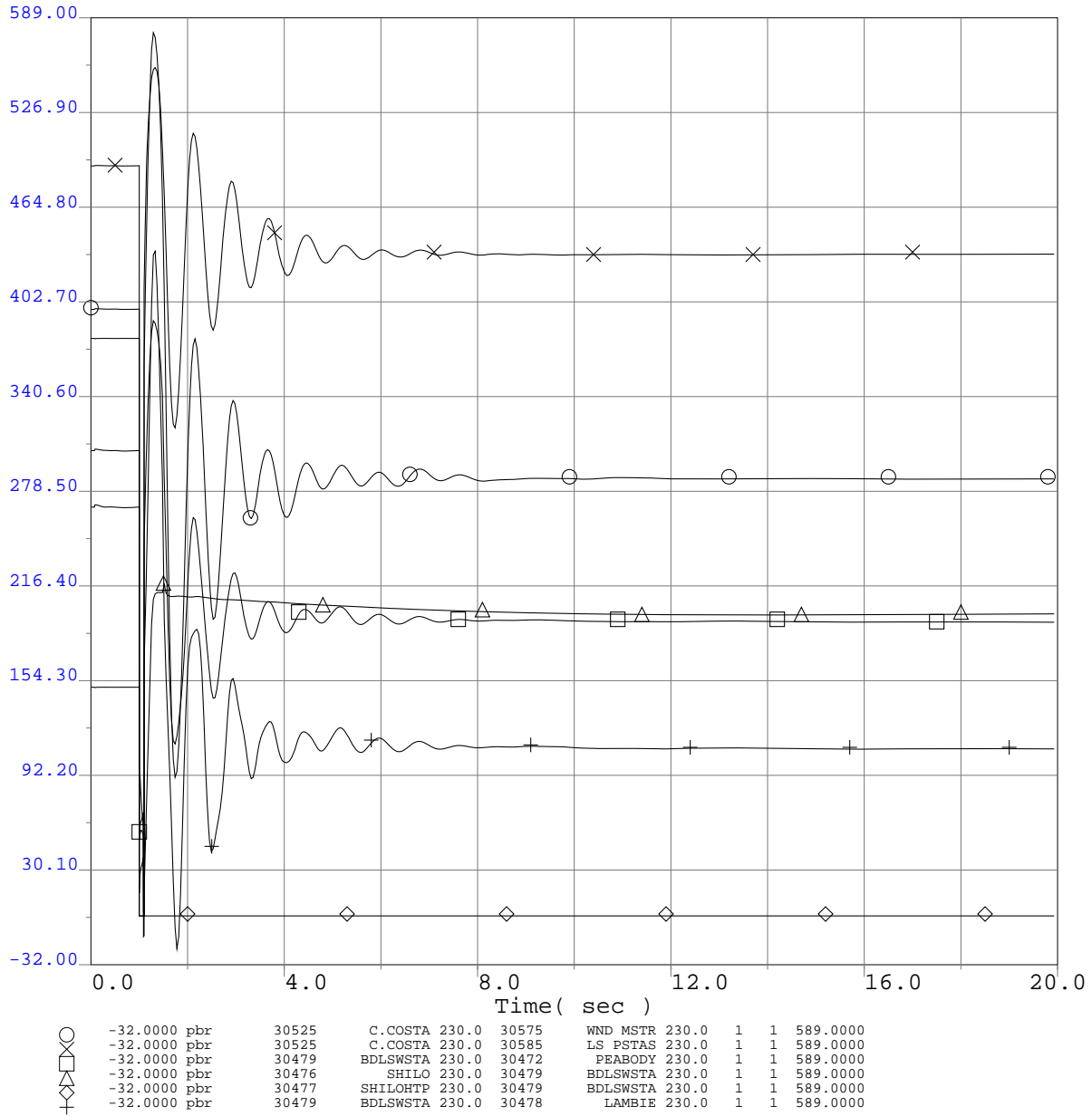

Q320 TCP2 ISIS
 2013 Greater Bay Area Summer Peak Base Case
 Q320 @ 772MW
 CCPP-Birds Landing 230kV Line Outage
 3-ph 6 cyc flt @ the CCPP 230kV bus & clr the CCPP-Birds Landing 230kV line

Q320 TCP2 ISIS

Selected PG&E Transmission Line Flows (MW)

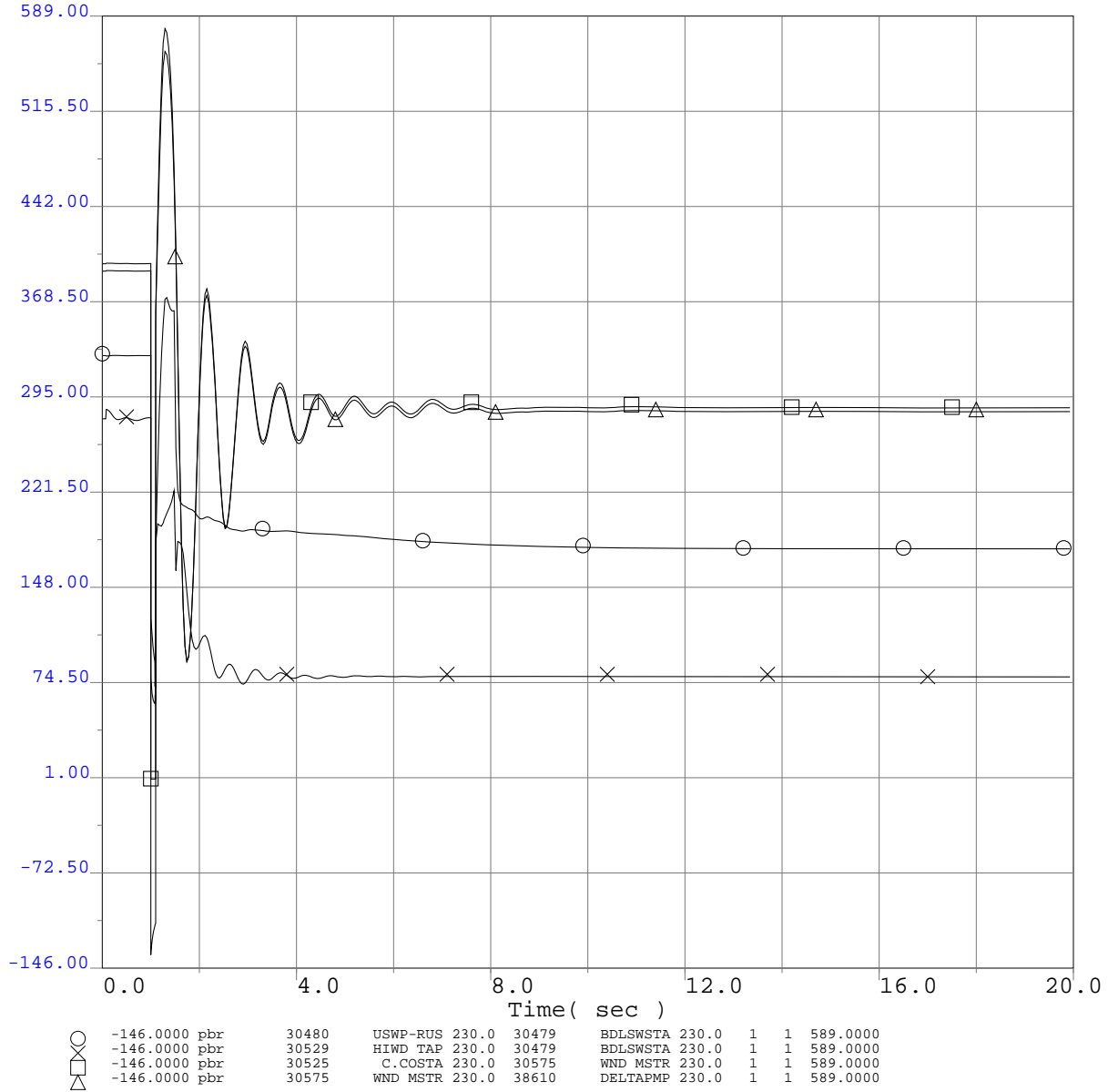

○	-146.0000 pbr	30480	USWP-RUS	230.0	30479	BDLSWSTA	230.0	1	1	589.0000
□	-146.0000 pbr	30529	HIWD TAP	230.0	30479	BDLSWSTA	230.0	1	1	589.0000
△	-146.0000 pbr	30525	C.COSTA	230.0	30575	WND MSTR	230.0	1	1	589.0000
×	-146.0000 pbr	30575	WND MSTR	230.0	38610	DELTAPMP	230.0	1	1	589.0000

Q320 TCP2 ISIS
 2013 Greater Bay Area Summer Peak Base Case
 Q320 @ 772MW
 CCPP-Birds Landing 230kV Line Outage
 3-ph 6 cyc flt @ the CCPP 230kV bus & clr the CCPP-Birds Landing 230kV line

Q320 TCP2 ISIS

Selected PG&E Bus Voltage Plots Adjacent to Fault

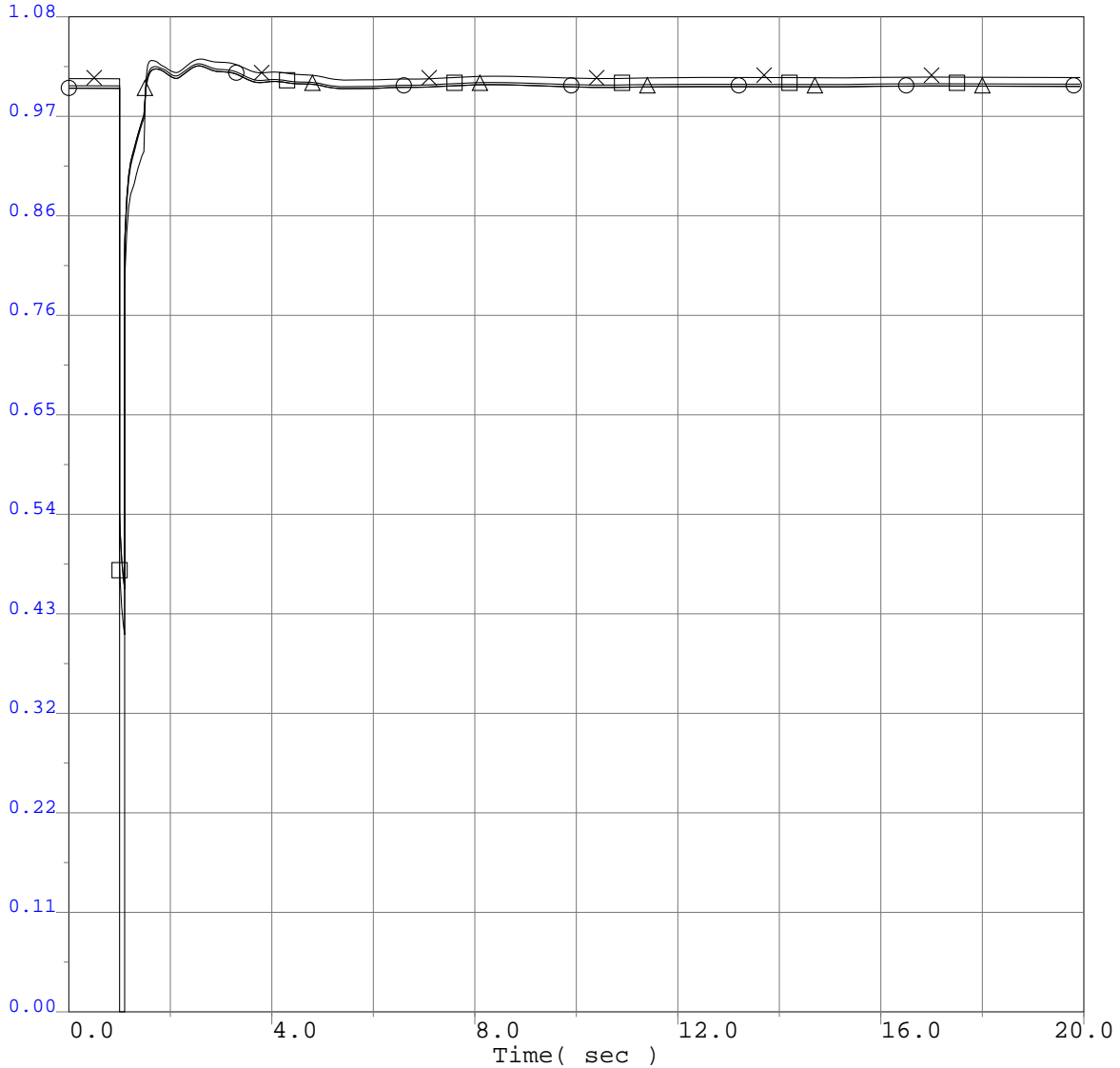

○	0.0000 vbus	30525	C.COSTA 230.0	0	0.0	***	1	1.0800
□	0.0000 vbus	30479	BDLWSTA 230.0	0	0.0	***	1	1.0800
△	0.0000 vbus	30523	CC SUB 230.0	0	0.0	***	1	1.0800
○	0.0000 vbus	30518	T320 230.0	0	0.0	***	1	1.0800



Q320 Project GIPR Phase 1 Interconnection System Impact Study
 2013 Greater Bay Area Summer Peak Base Case
 Q320 @484MW
 CCPP-Birds Landing 230kV Line Outage
 3-ph 6 cyc flt @ the Birds Landing 230kV bus & clr the CCPP-Birds Landing 230kV

Q320 TCP2 ISIS

Selected PG&E Bus Frequency Plots Adjacent to Fault

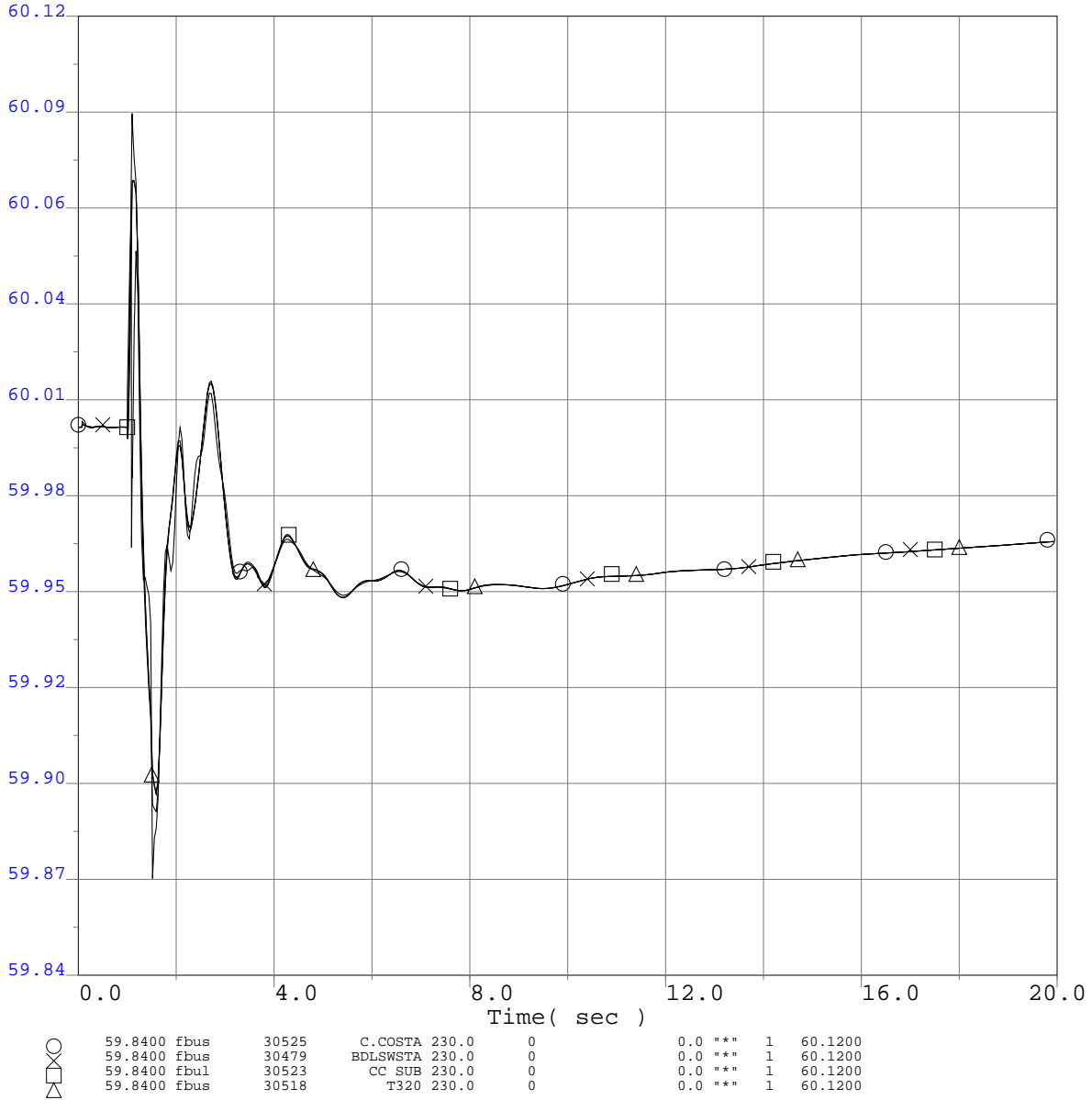

Q320 Project GIPR Phase 1 Interconnection System Impact Study
 2013 Greater Bay Area Summer Peak Base Case
 Q320 @484MW
 CCPP-Birds Landing 230kV Line Outage
 3-ph 6 cyc flt @ the Birds Landing 230kV bus & clr the CCPP-Birds Landing 230kV

Q320 TCP2 ISIS

Project Generator Terminal Voltages (P.U.)

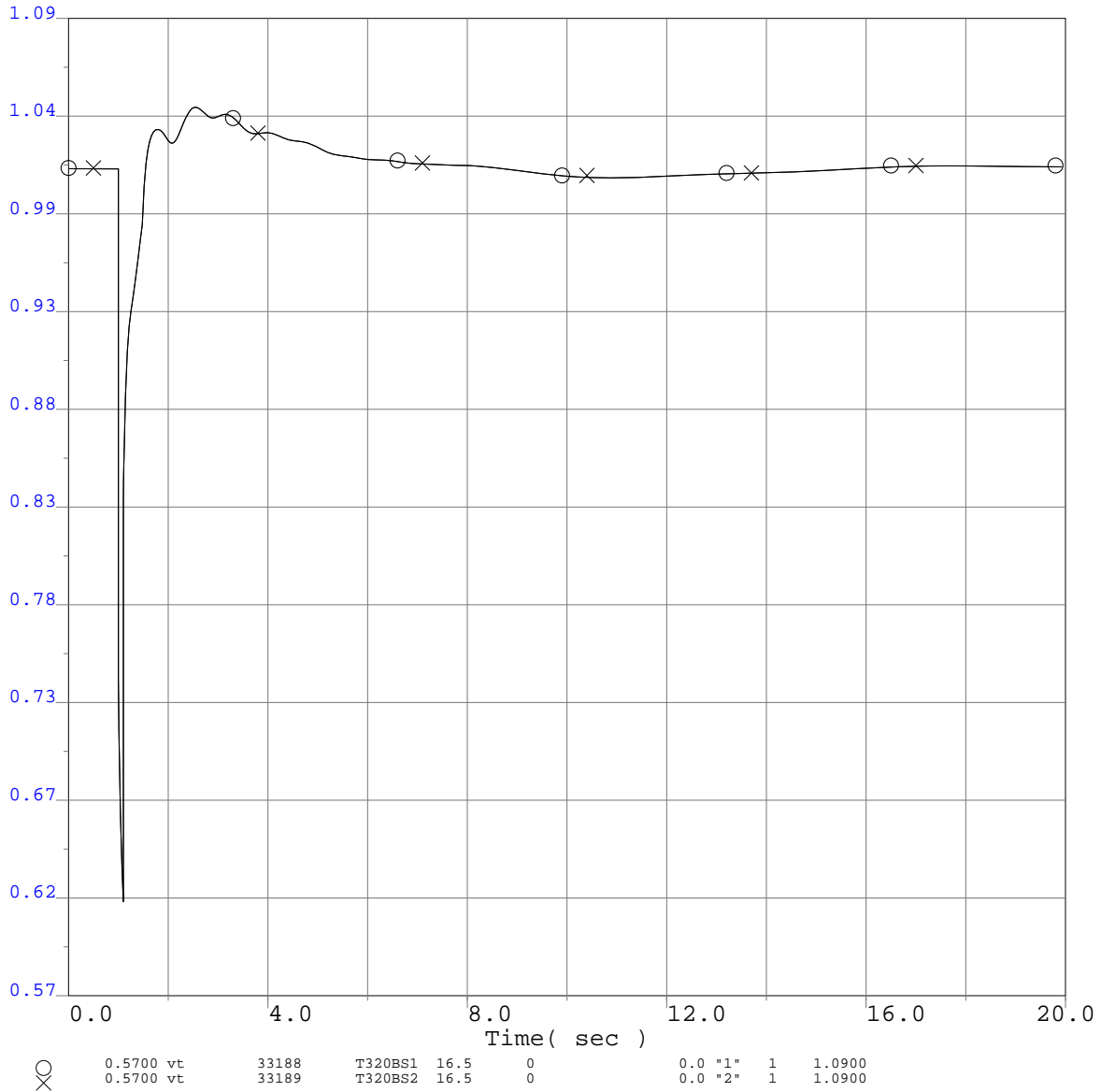

Q320 Project GIPR Phase 1 Interconnection System Impact Study
 2013 Greater Bay Area Summer Peak Base Case
 Q320 @484MW
 CCPP-Birds Landing 230kV Line Outage
 3-ph 6 cyc flt @ the Birds Landing 230kV bus & clr the CCPP-Birds Landing 230kV

Q320 TCP2 ISIS

Project Generator Terminal Voltages (P.U.)

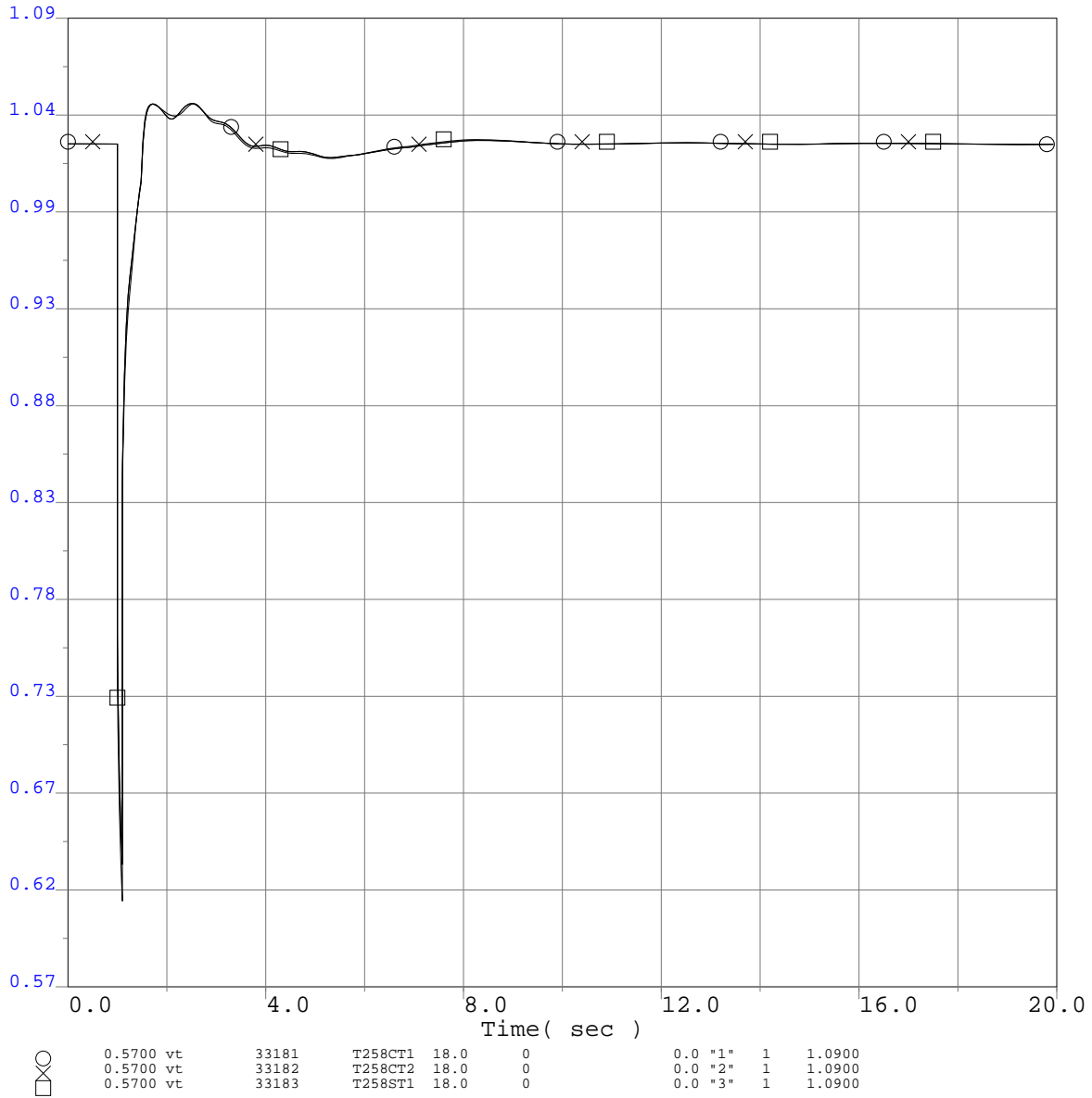

Q320 Project GIPR Phase 1 Interconnection System Impact Study
 2013 Greater Bay Area Summer Peak Base Case
 Q320 @484MW
 CCPP-Birds Landing 230kV Line Outage
 3-ph 6 cyc flt @ the Birds Landing 230kV bus & clr the CCPP-Birds Landing 230kV

Q320 TCP2 ISIS

Project Generator Speed (P.U.)

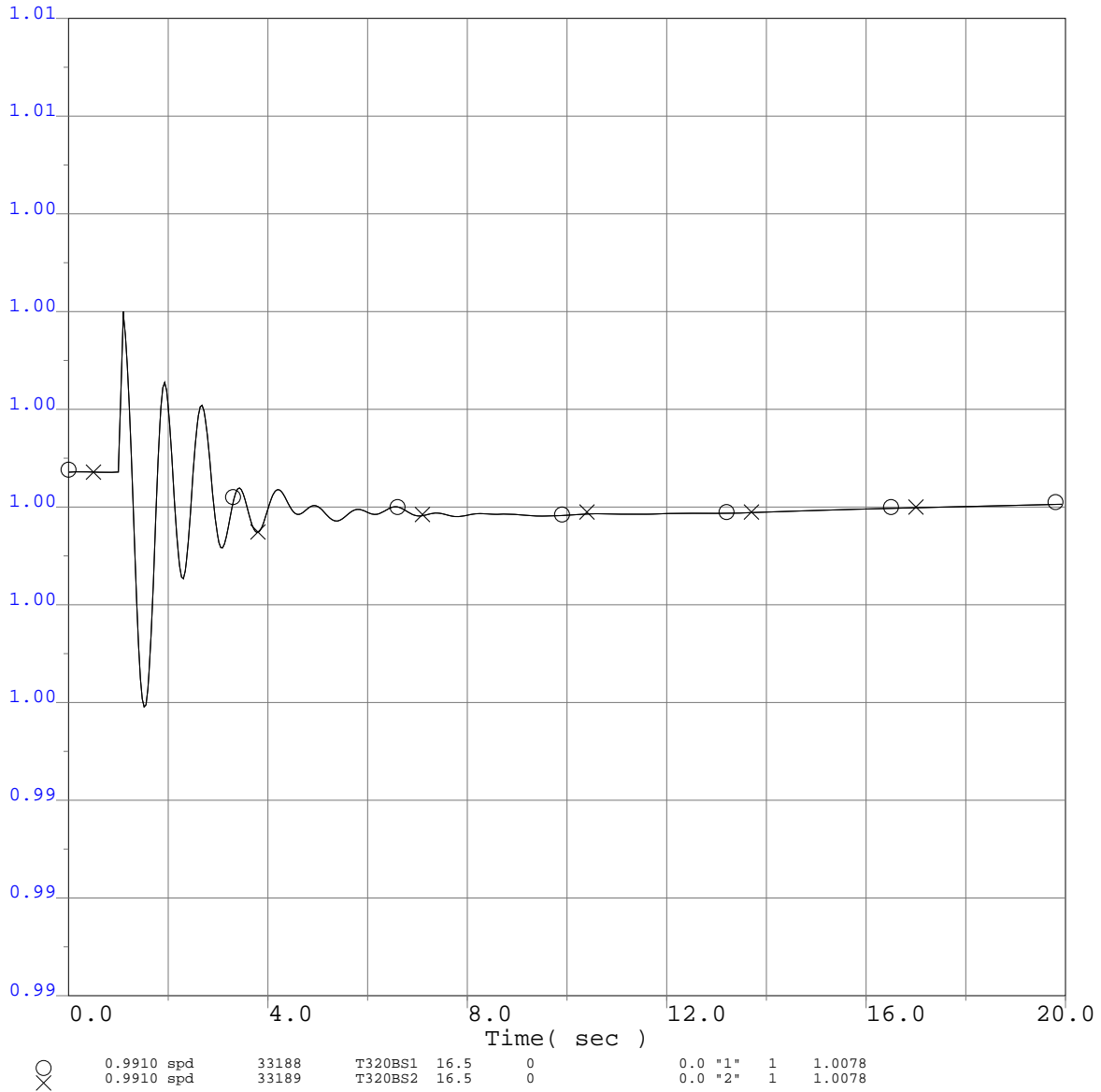

Q320 Project GIPR Phase 1 Interconnection System Impact Study
 2013 Greater Bay Area Summer Peak Base Case
 Q320 @484MW
 CCPP-Birds Landing 230kV Line Outage
 3-ph 6 cyc flt @ the Birds Landing 230kV bus & clr the CCPP-Birds Landing 230kV

Q320 TCP2 ISIS

Project Generator Speed (P.U.)

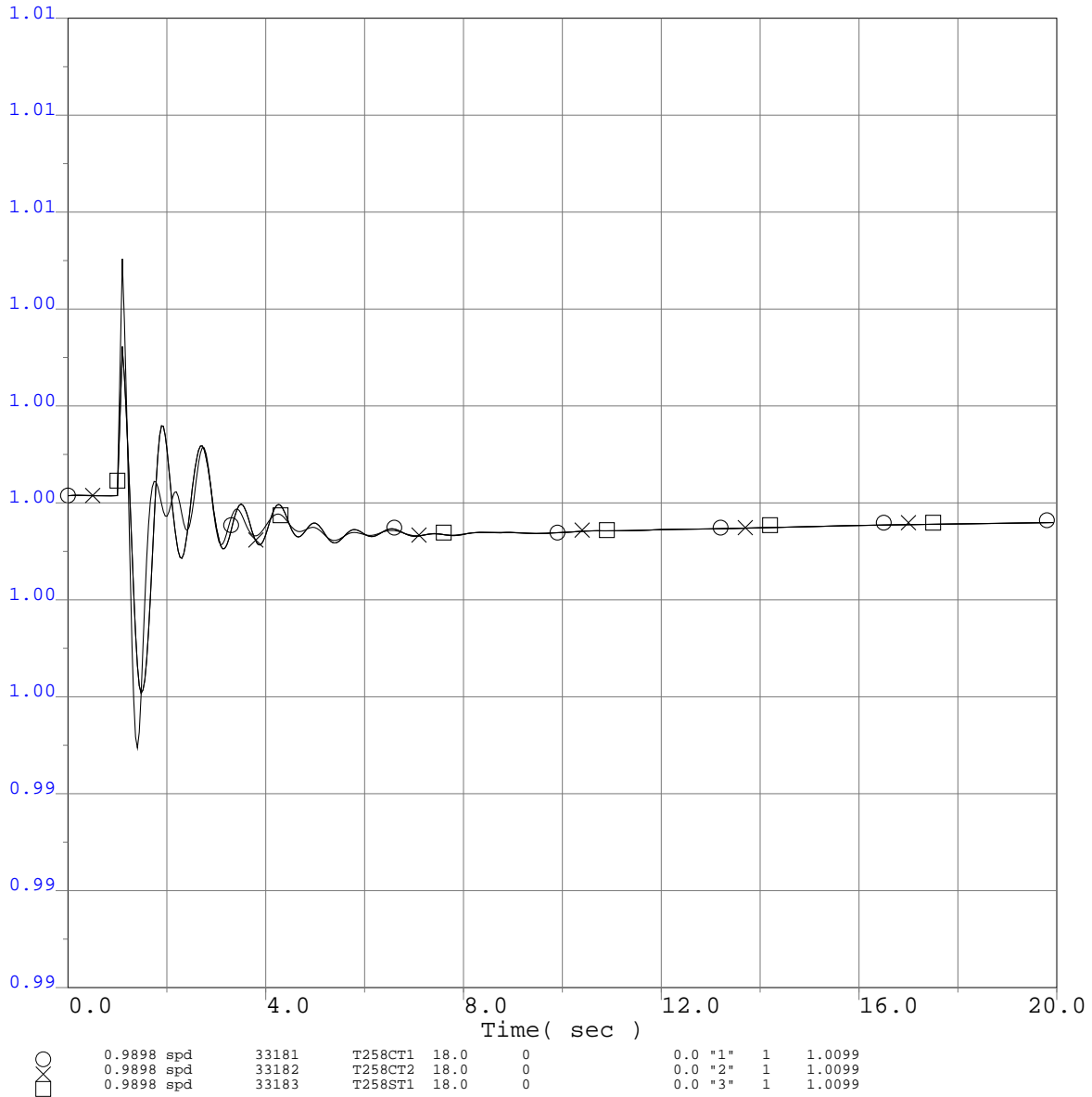

Q320 Project GIPR Phase 1 Interconnection System Impact Study
 2013 Greater Bay Area Summer Peak Base Case
 Q320 @484MW
 CCPP-Birds Landing 230kV Line Outage
 3-ph 6 cyc flt @ the Birds Landing 230kV bus & clr the CCPP-Birds Landing 230kV

Q320 TCP2 ISIS

Project Generator Terminal Power (MW)

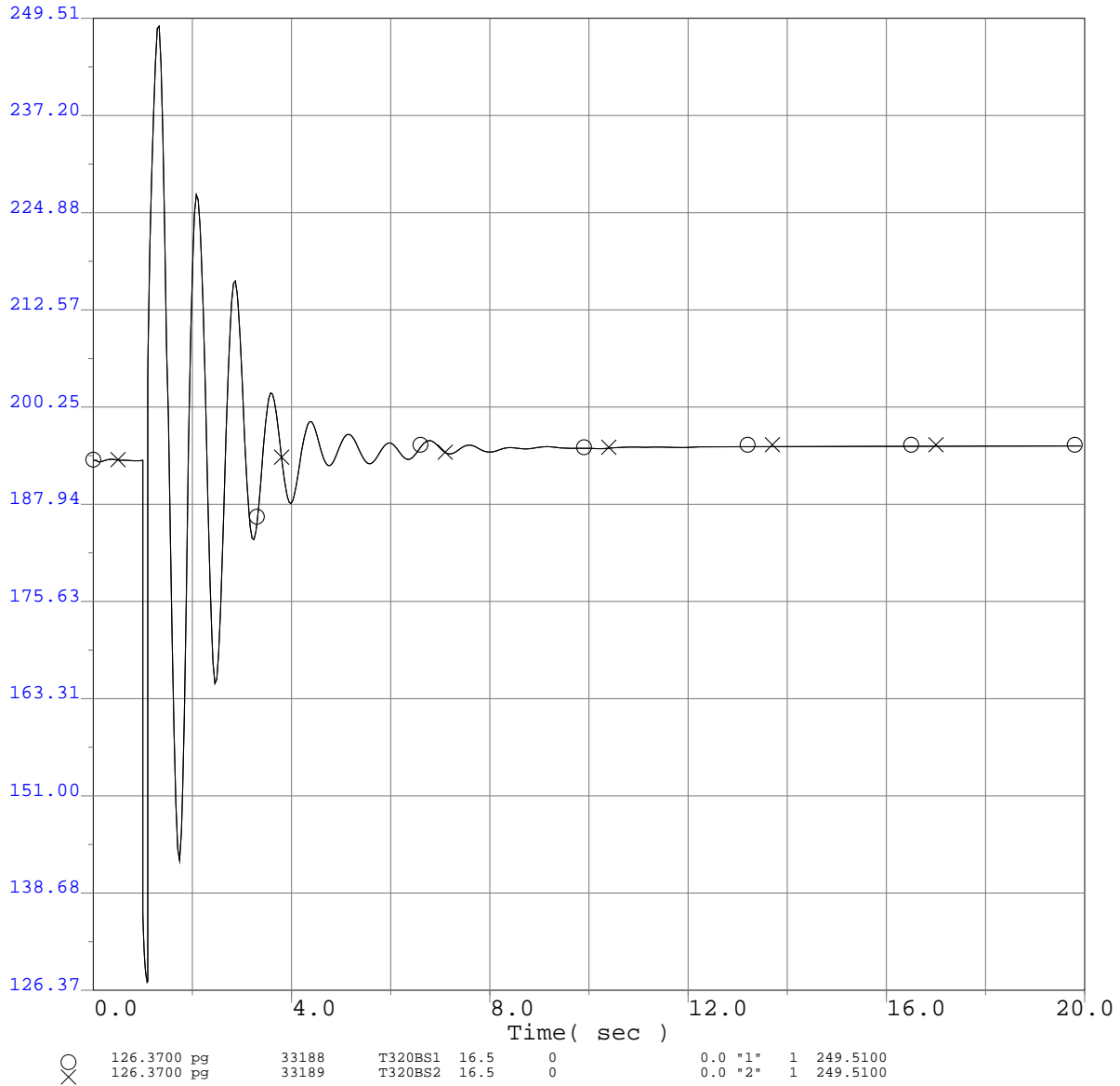

○	126.3700 pg	33188	T320BS1	16.5	0	0.0 "1"	1	249.5100
×	126.3700 pg	33189	T320BS2	16.5	0	0.0 "2"	1	249.5100

Q320 Project GIPR Phase 1 Interconnection System Impact Study
 2013 Greater Bay Area Summer Peak Base Case
 Q320 @484MW
 CCPP-Birds Landing 230kV Line Outage
 3-ph 6 cyc flt @ the Birds Landing 230kV bus & clr the CCPP-Birds Landing 230kV

Q320 TCP2 ISIS

Project Generator Terminal Power (MW)

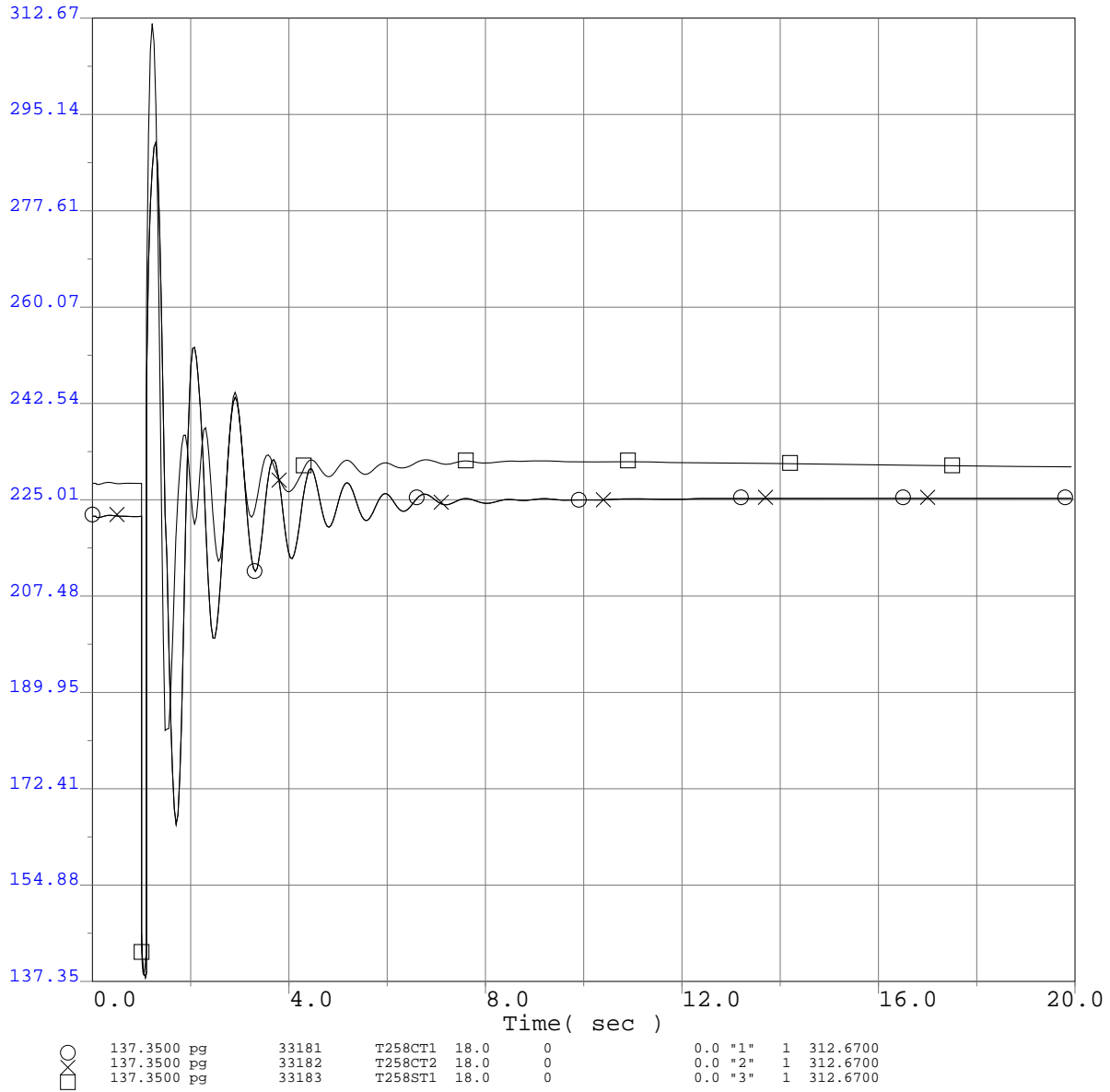

○	137.3500 pg	33181	T258CT1	18.0	0	0.0 "1"	1	312.6700
×	137.3500 pg	33182	T258CT2	18.0	0	0.0 "2"	1	312.6700
□	137.3500 pg	33183	T258ST1	18.0	0	0.0 "3"	1	312.6700

Q320 Project GIPR Phase 1 Interconnection System Impact Study
 2013 Greater Bay Area Summer Peak Base Case
 Q320 @484MW
 CCPP-Birds Landing 230kV Line Outage
 3-ph 6 cyc flt @ the Birds Landing 230kV bus & clr the CCPP-Birds Landing 230kV

Q320 TCP2 ISIS

Project Generator Terminal Reactive Power (MVA_r)

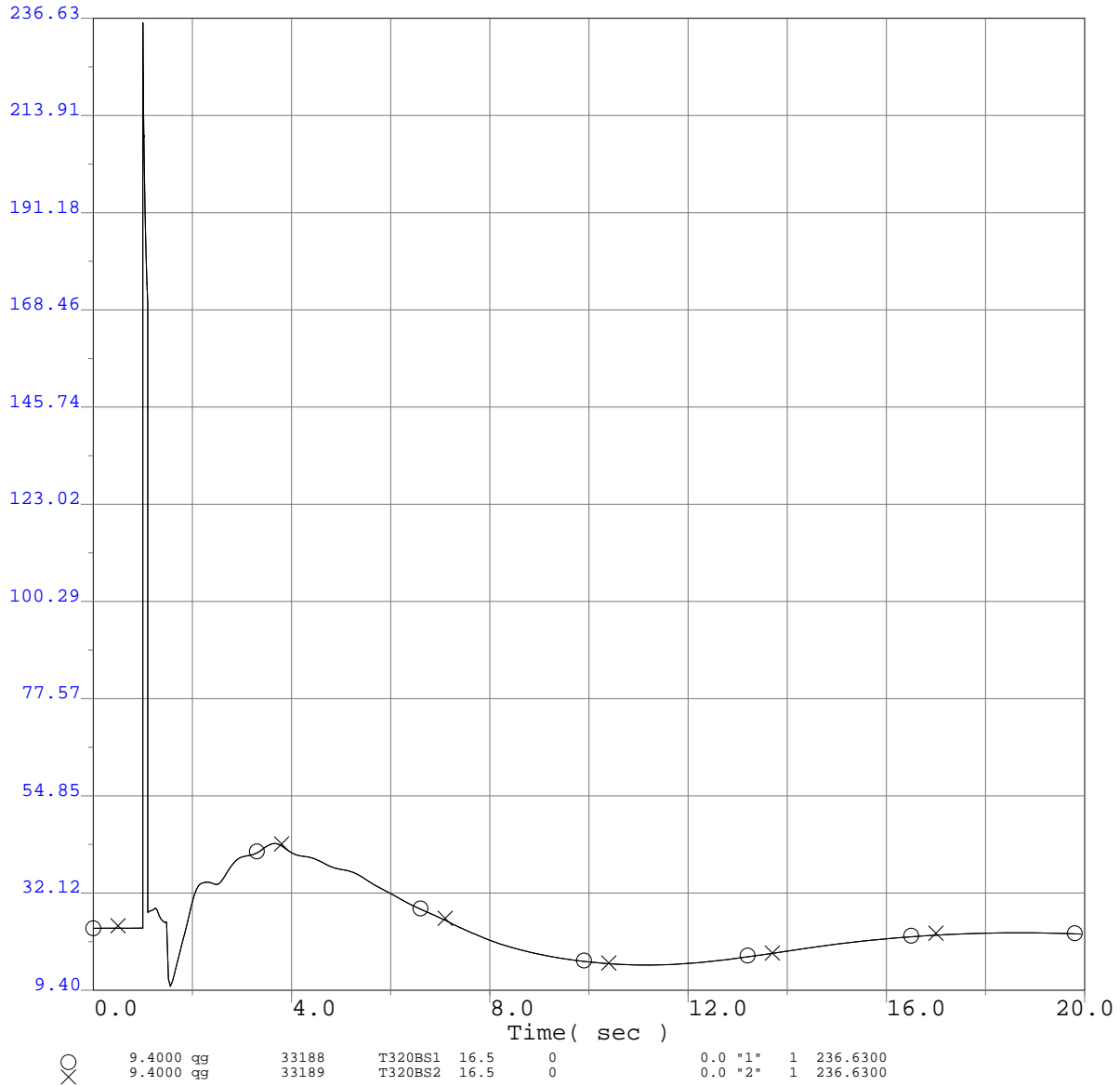

Q320 Project GIPR Phase 1 Interconnection System Impact Study
 2013 Greater Bay Area Summer Peak Base Case
 Q320 @484MW
 CCPP-Birds Landing 230kV Line Outage
 3-ph 6 cyc flt @ the Birds Landing 230kV bus & clr the CCPP-Birds Landing 230kV

Q320 TCP2 ISIS

Project Generator Terminal Reactive Power (MVA_r)

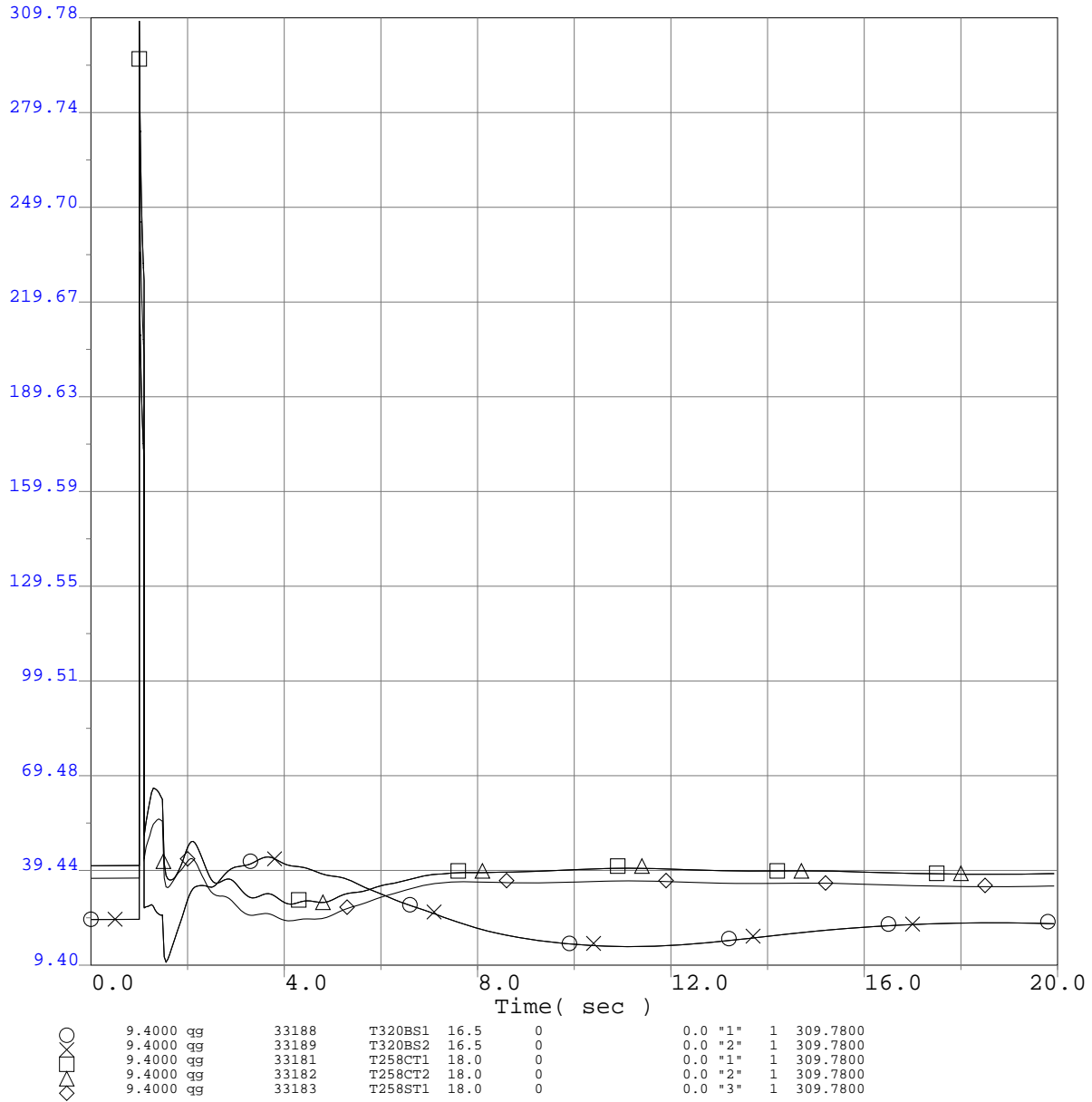

Q320 Project GIPR Phase 1 Interconnection System Impact Study
 2013 Greater Bay Area Summer Peak Base Case
 Q320 @484MW
 CCPP-Birds Landing 230kV Line Outage
 3-ph 6 cyc flt @ the Birds Landing 230kV bus & clr the CCPP-Birds Landing 230kV

Q320 TCP2 ISIS

Selected WECC Bus Voltage Plots

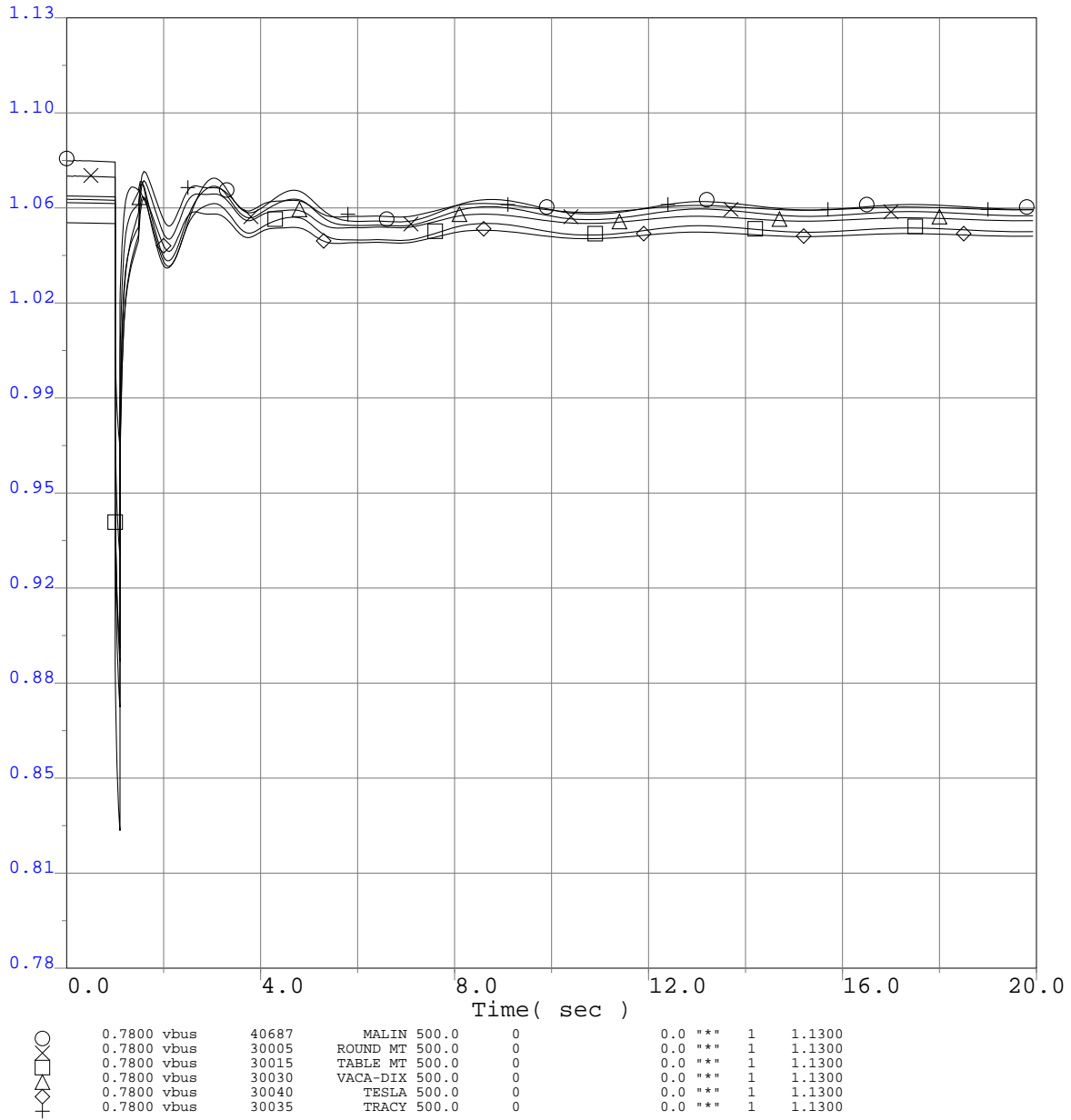

Q320 Project GIPR Phase 1 Interconnection System Impact Study
 2013 Greater Bay Area Summer Peak Base Case
 Q320 @484MW
 CCPP-Birds Landing 230kV Line Outage
 3-ph 6 cyc flt @ the Birds Landing 230kV bus & clr the CCPP-Birds Landing 230kV

Q320 TCP2 ISIS

Selected WECC Bus Voltage Plots

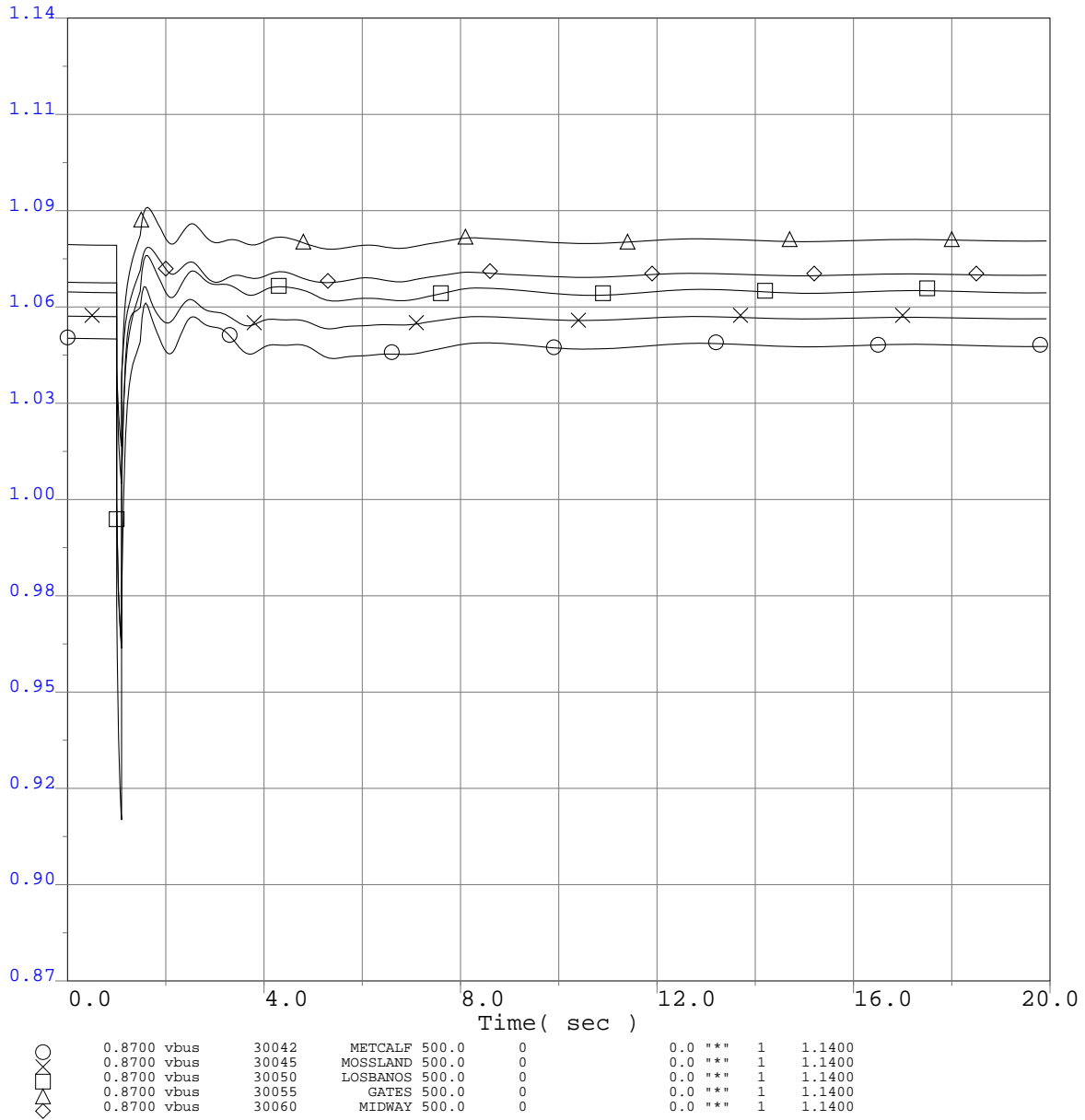

Q320 Project GIPR Phase 1 Interconnection System Impact Study
 2013 Greater Bay Area Summer Peak Base Case
 Q320 @484MW
 CCPP-Birds Landing 230kV Line Outage
 3-ph 6 cyc flt @ the Birds Landing 230kV bus & clr the CCPP-Birds Landing 230kV

Q320 TCP2 ISIS

Selected WECC Bus Voltage Plots

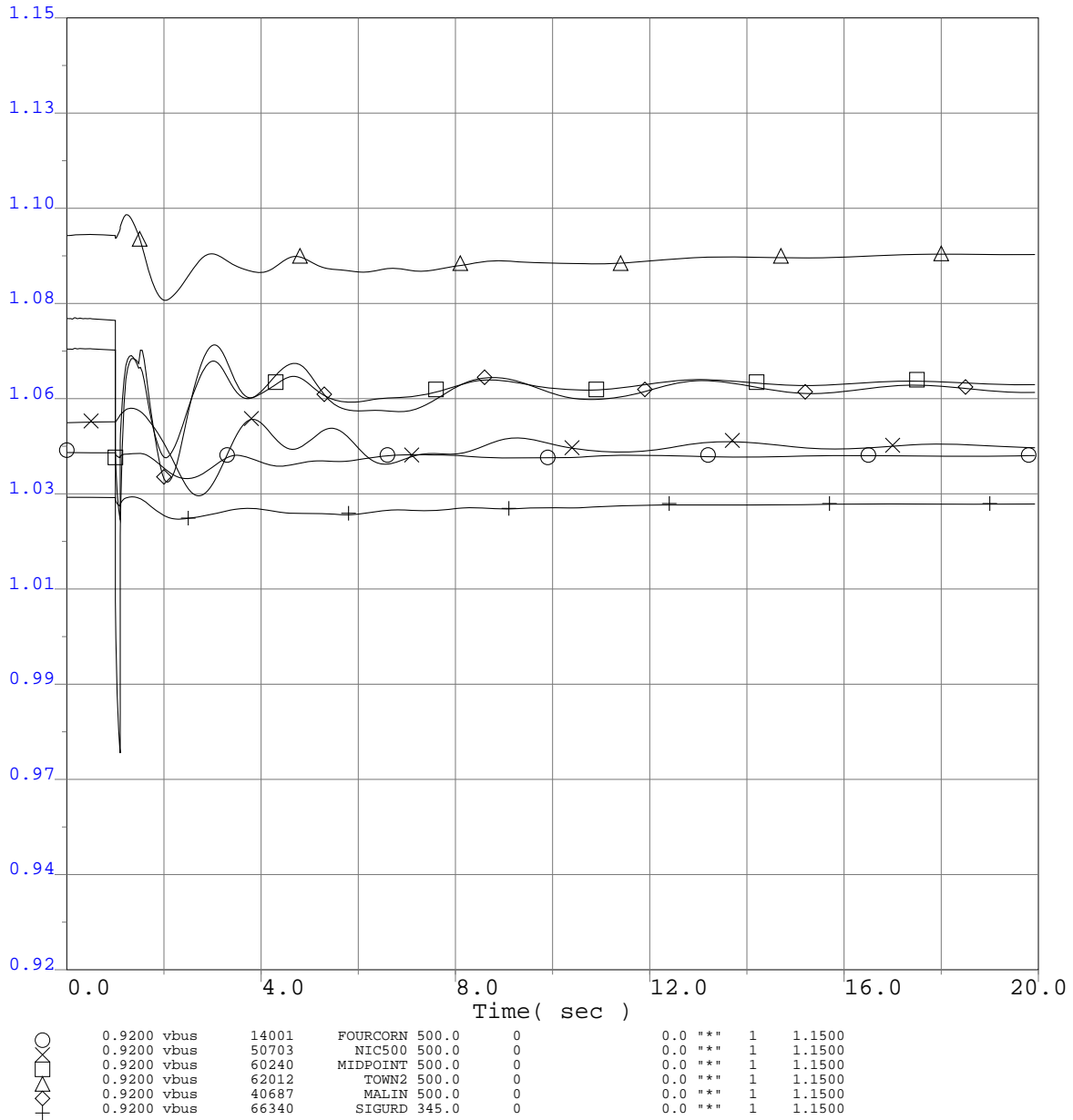

Q320 Project GIPR Phase 1 Interconnection System Impact Study
 2013 Greater Bay Area Summer Peak Base Case
 Q320 @484MW
 CCPP-Birds Landing 230kV Line Outage
 3-ph 6 cyc flt @ the Birds Landing 230kV bus & clr the CCPP-Birds Landing 230kV

Q320 TCP2 ISIS

Selected WECC Bus Voltage Plots

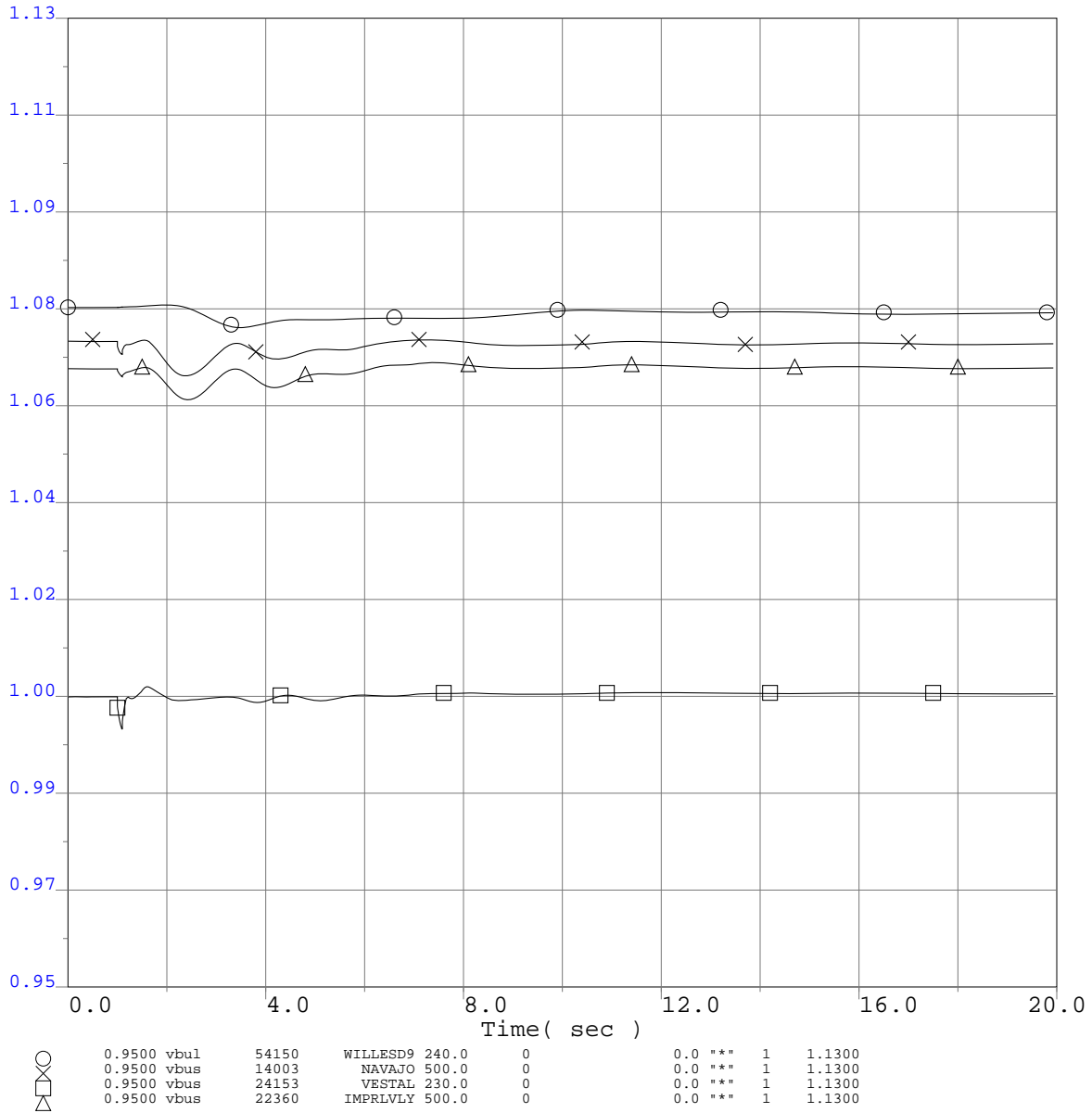

Q320 Project GIPR Phase 1 Interconnection System Impact Study
 2013 Greater Bay Area Summer Peak Base Case
 Q320 @484MW
 CCPP-Birds Landing 230kV Line Outage
 3-ph 6 cyc flt @ the Birds Landing 230kV bus & clr the CCPP-Birds Landing 230kV

Q320 TCP2 ISIS

Selected WECC Bus Frequency Plots

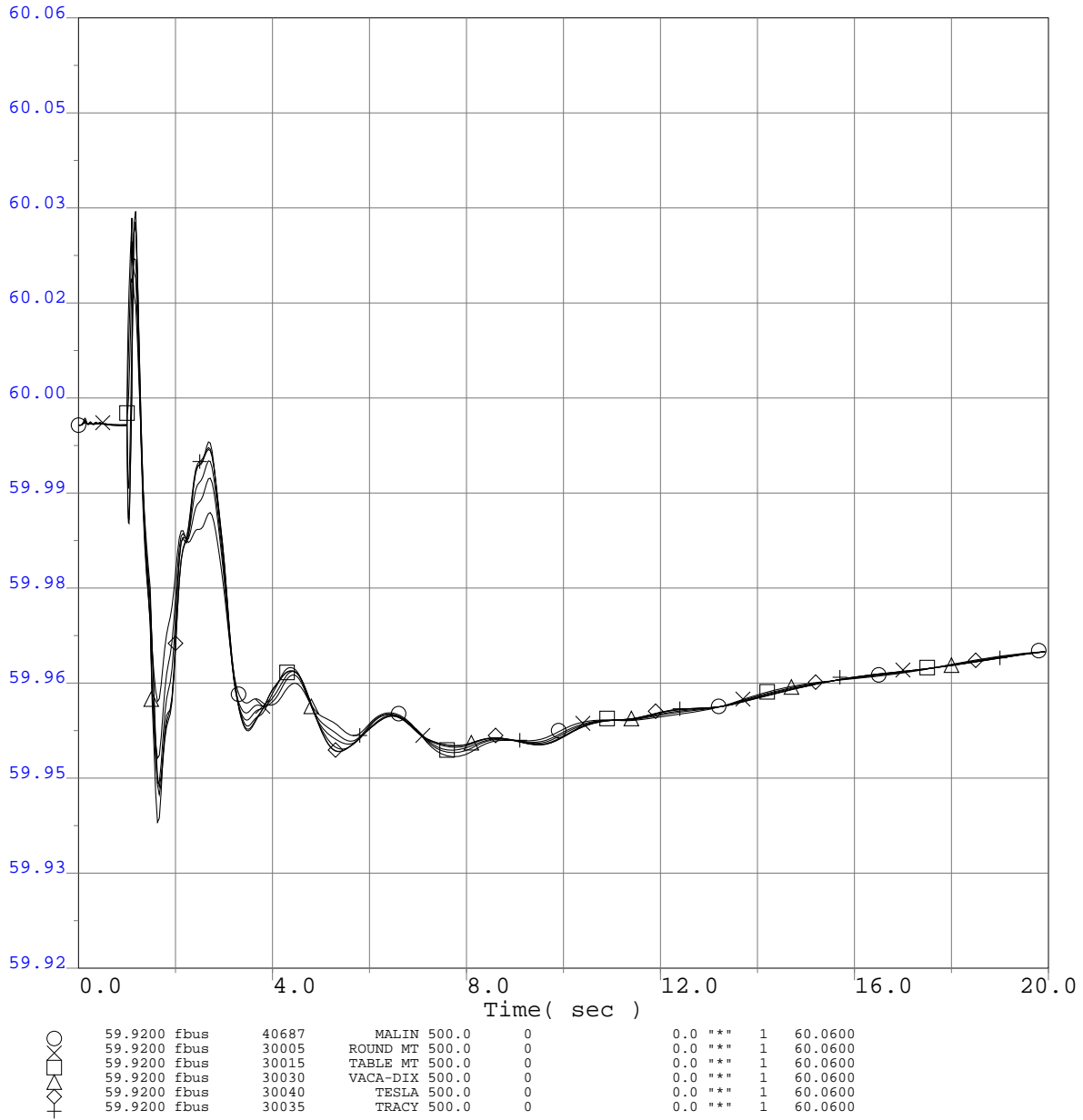

Q320 Project GIPR Phase 1 Interconnection System Impact Study
 2013 Greater Bay Area Summer Peak Base Case
 Q320 @484MW
 CCPP-Birds Landing 230kV Line Outage
 3-ph 6 cyc flt @ the Birds Landing 230kV bus & clr the CCPP-Birds Landing 230kV

Q320 TCP2 ISIS

Selected WECC Bus Frequency Plots

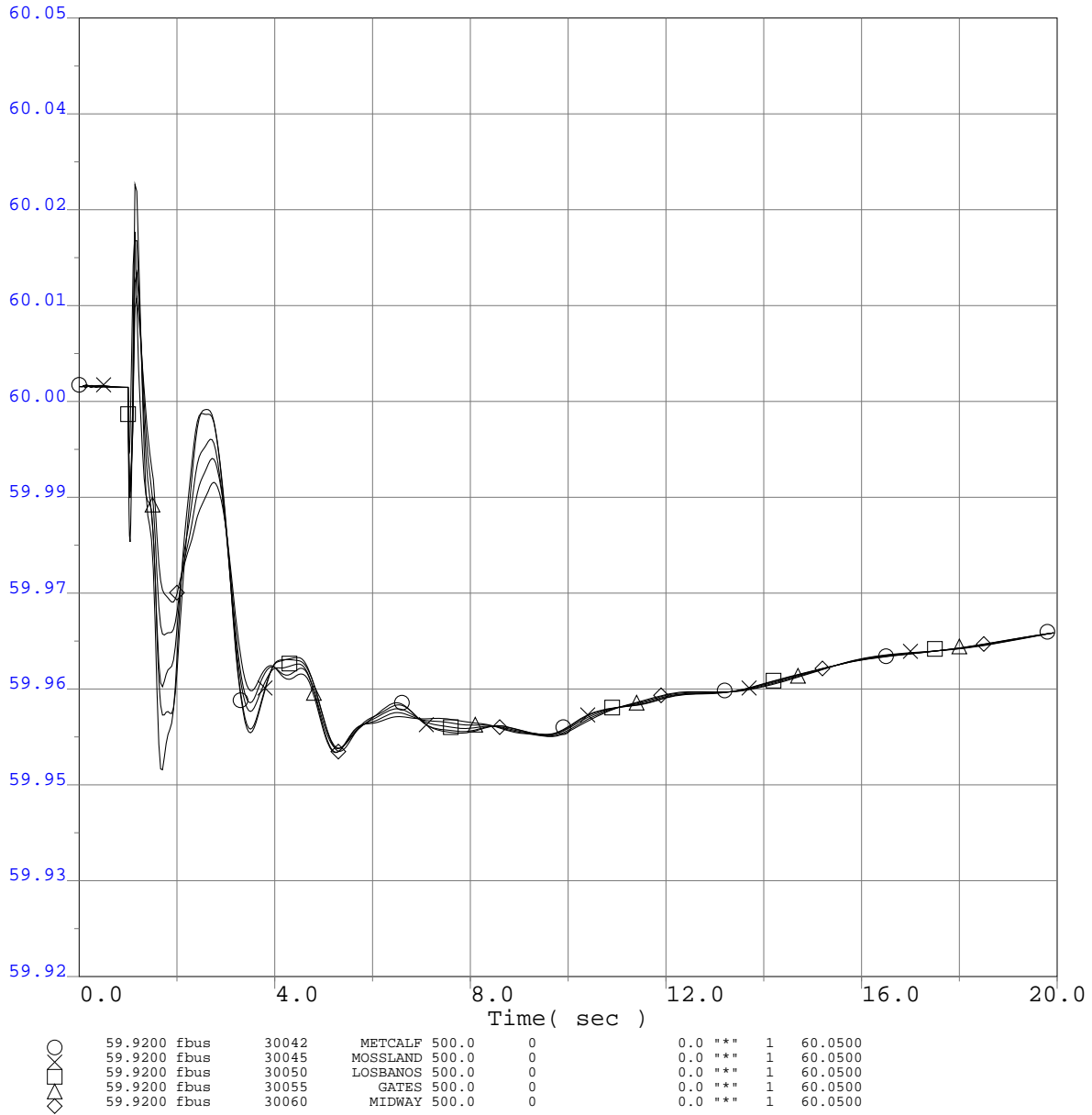

Q320 Project GIPR Phase 1 Interconnection System Impact Study
 2013 Greater Bay Area Summer Peak Base Case
 Q320 @484MW
 CCPP-Birds Landing 230kV Line Outage
 3-ph 6 cyc flt @ the Birds Landing 230kV bus & clr the CCPP-Birds Landing 230kV

Q320 TCP2 ISIS

Selected WECC Bus Frequency Plots

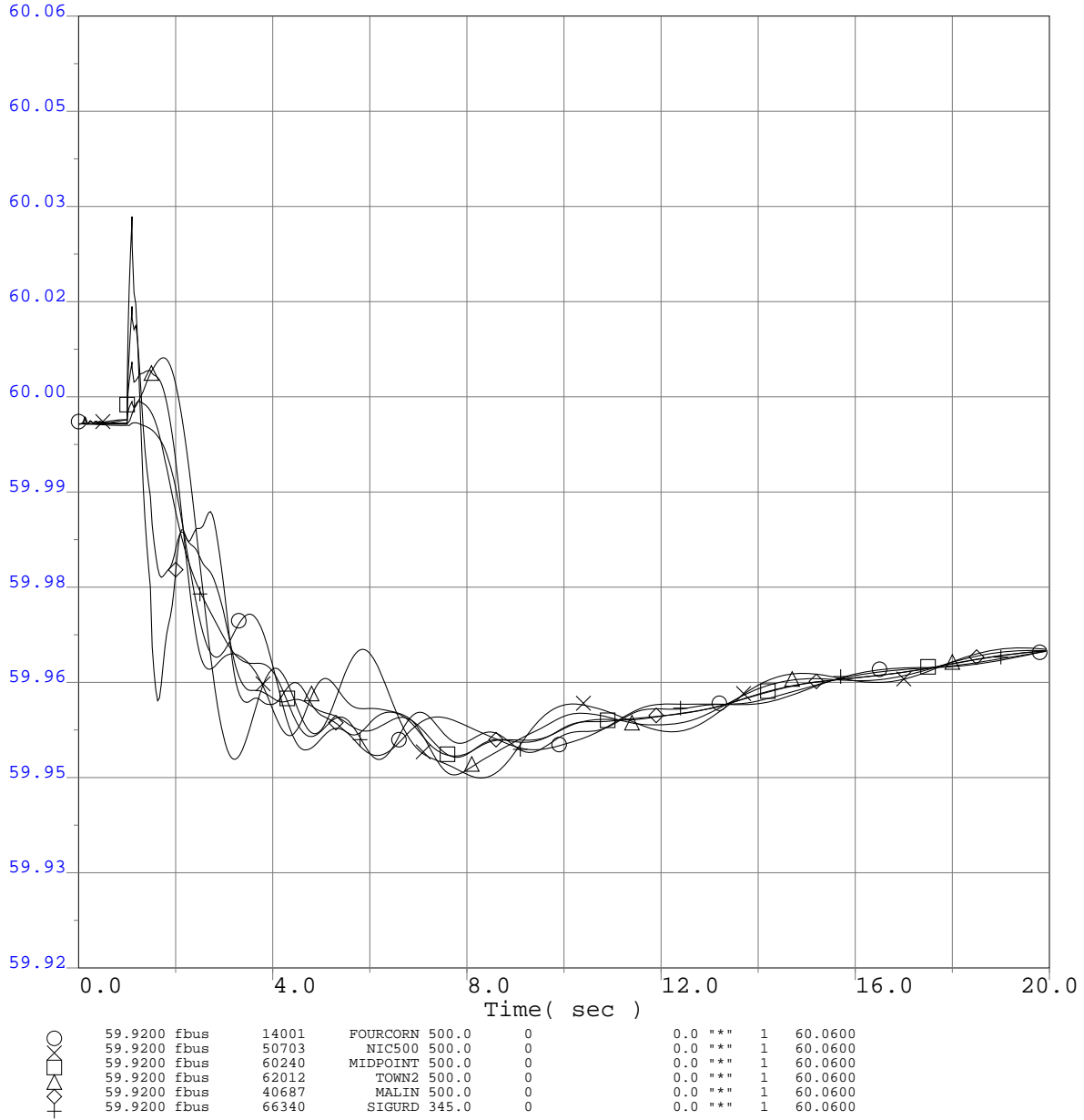

Q320 Project GIPR Phase 1 Interconnection System Impact Study
 2013 Greater Bay Area Summer Peak Base Case
 Q320 @484MW
 CCPP-Birds Landing 230kV Line Outage
 3-ph 6 cyc flt @ the Birds Landing 230kV bus & clr the CCPP-Birds Landing 230kV

Q320 TCP2 ISIS

Selected WECC Bus Frequency Plots

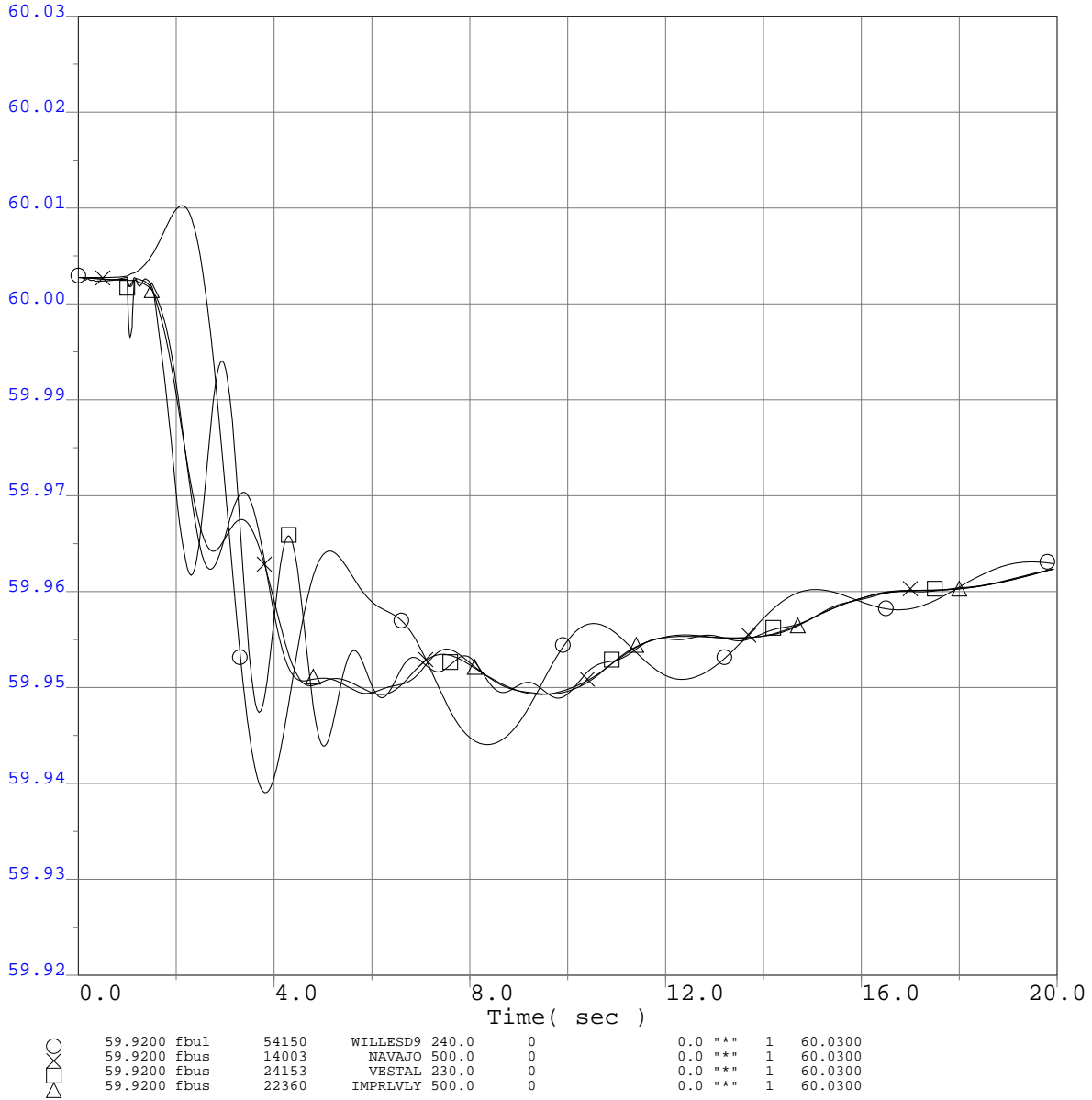

Q320 Project GIPR Phase 1 Interconnection System Impact Study
 2013 Greater Bay Area Summer Peak Base Case
 Q320 @484MW
 CCPP-Birds Landing 230kV Line Outage
 3-ph 6 cyc flt @ the Birds Landing 230kV bus & clr the CCPP-Birds Landing 230kV

Q320 TCP2 ISIS

WECC Generator Rotor Angle

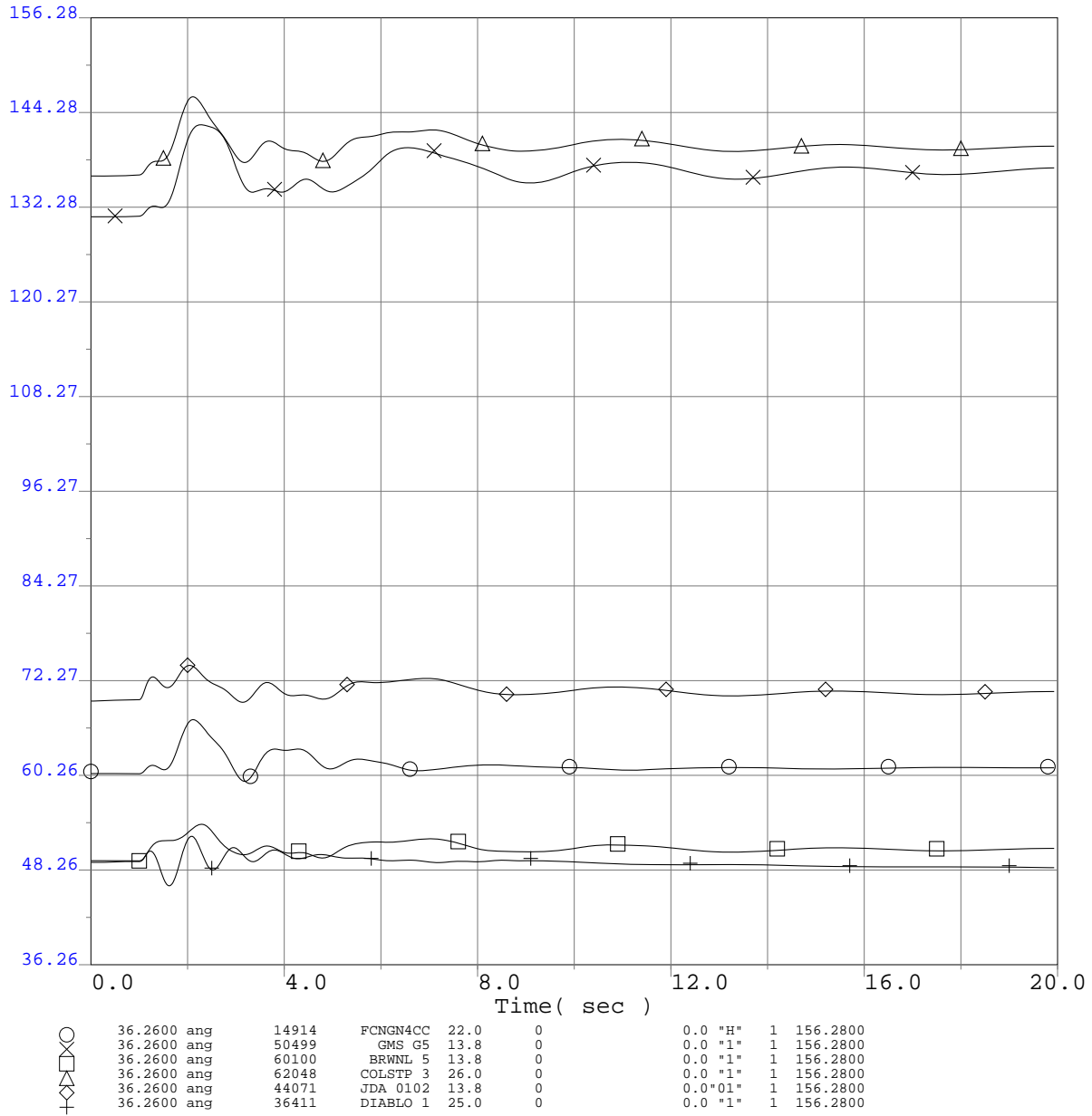

Q320 Project GIPR Phase 1 Interconnection System Impact Study
 2013 Greater Bay Area Summer Peak Base Case
 Q320 @484MW
 CCPP-Birds Landing 230kV Line Outage
 3-ph 6 cyc flt @ the Birds Landing 230kV bus & clr the CCPP-Birds Landing 230kV

Q320 TCP2 ISIS

WECC Generator Rotor Angle

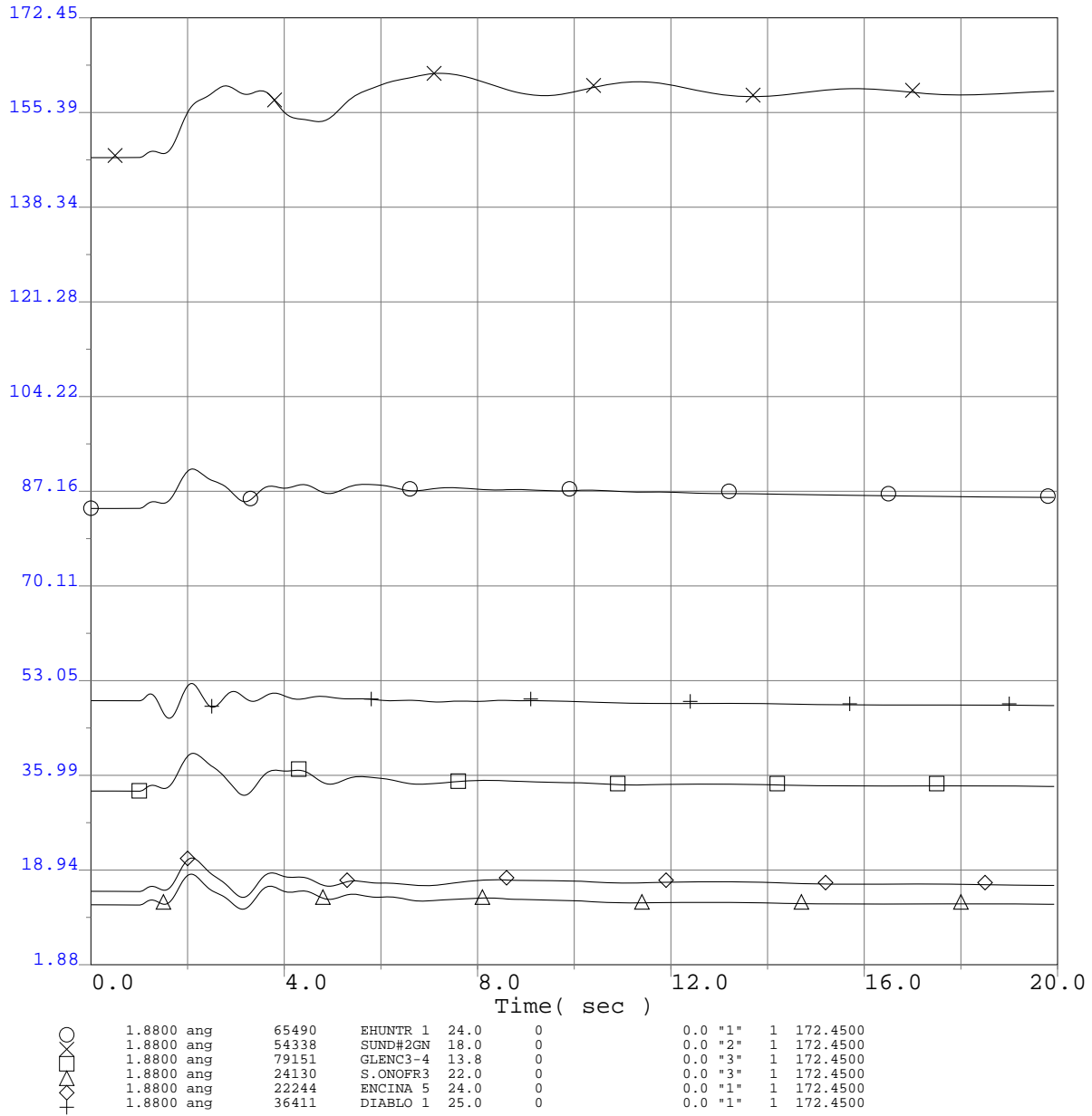

Q320 Project GIPR Phase 1 Interconnection System Impact Study
 2013 Greater Bay Area Summer Peak Base Case
 Q320 @484MW
 CCPP-Birds Landing 230kV Line Outage
 3-ph 6 cyc flt @ the Birds Landing 230kV bus & clr the CCPP-Birds Landing 230kV

Q320 TCP2 ISIS

Selected PG&E Transmission Line Flows (MW)

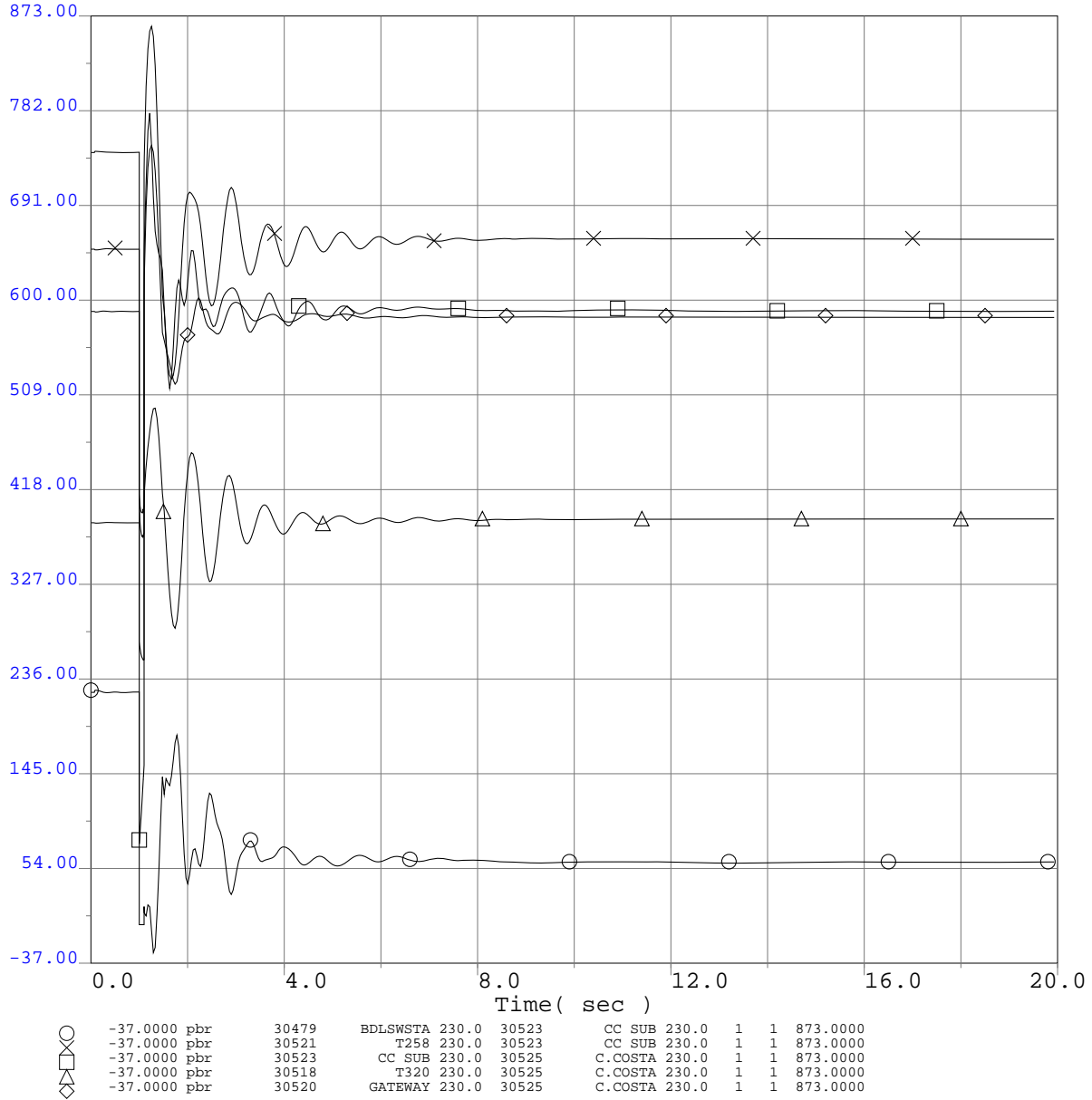

Q320 Project GIPR Phase 1 Interconnection System Impact Study
 2013 Greater Bay Area Summer Peak Base Case
 Q320 @484MW
 CCPP-Birds Landing 230kV Line Outage
 3-ph 6 cyc flt @ the Birds Landing 230kV bus & clr the CCPP-Birds Landing 230kV

Q320 TCP2 ISIS

Selected PG&E Transmission Line Flows (MW)

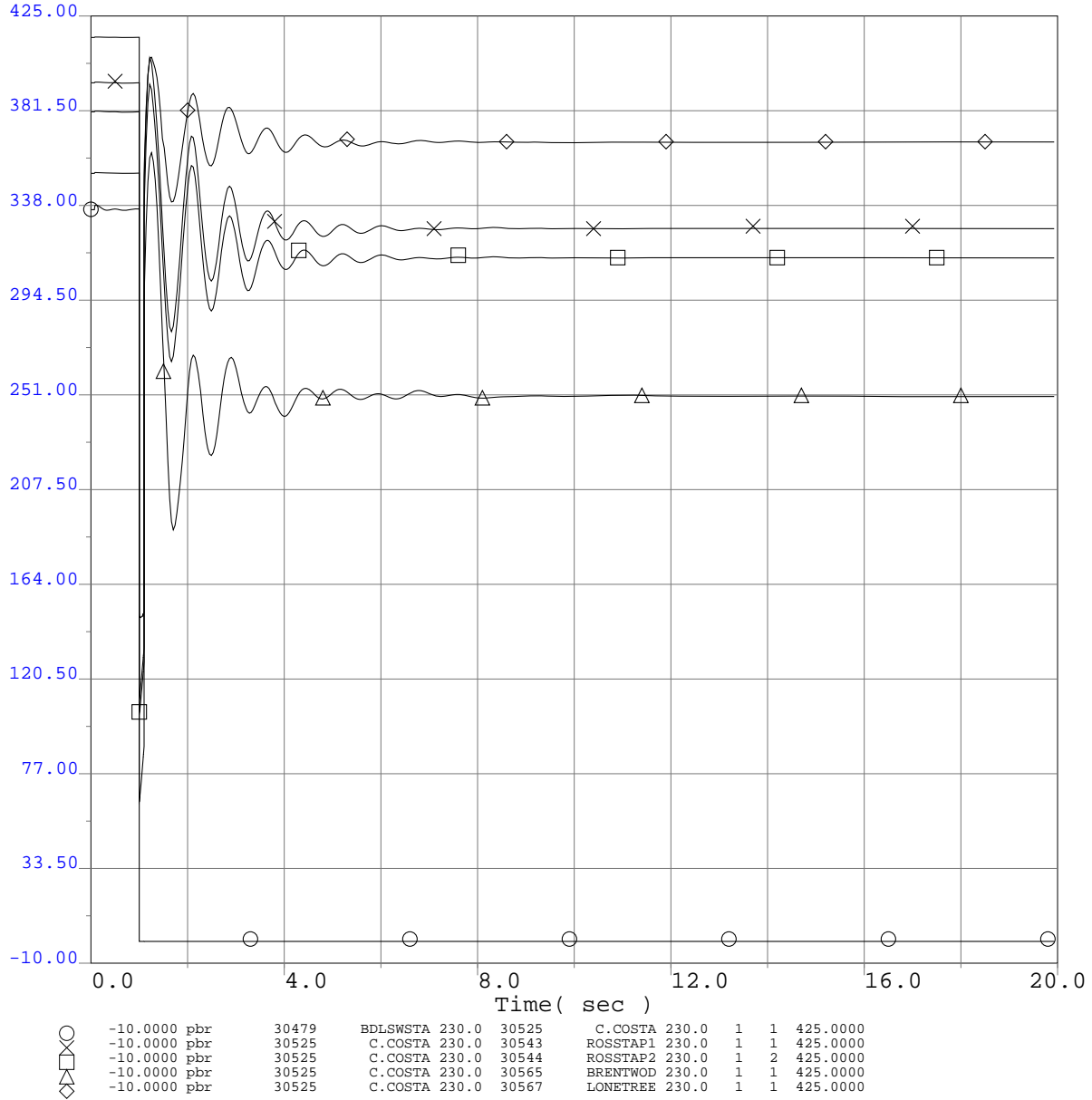

Q320 Project GIPR Phase 1 Interconnection System Impact Study
 2013 Greater Bay Area Summer Peak Base Case
 Q320 @484MW
 CCPP-Birds Landing 230kV Line Outage
 3-ph 6 cyc flt @ the Birds Landing 230kV bus & clr the CCPP-Birds Landing 230kV

Q320 TCP2 ISIS

Selected PG&E Transmission Line Flows (MW)

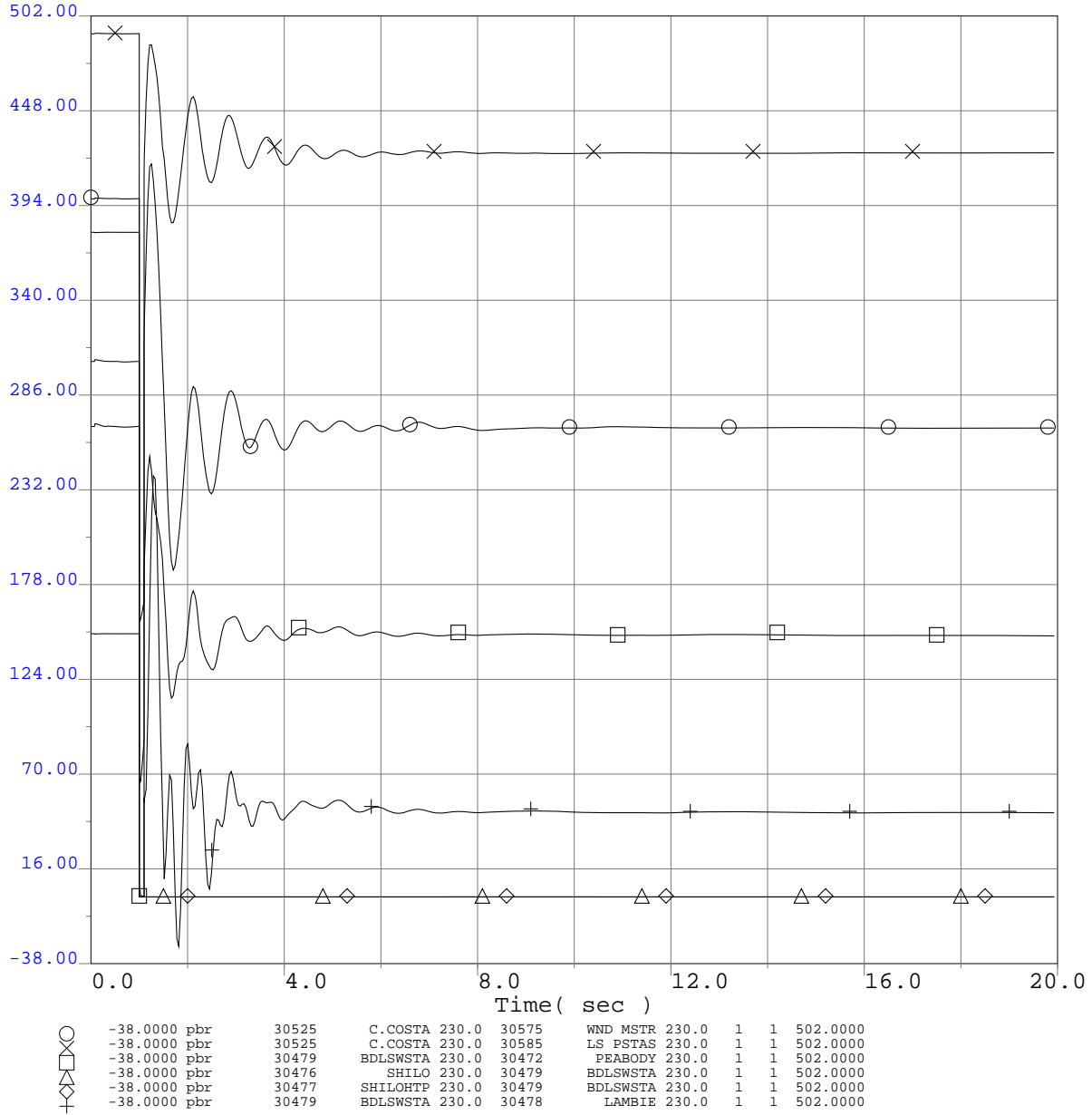

Q320 Project GIPR Phase 1 Interconnection System Impact Study
 2013 Greater Bay Area Summer Peak Base Case
 Q320 @484MW
 CCPP-Birds Landing 230kV Line Outage
 3-ph 6 cyc flt @ the Birds Landing 230kV bus & clr the CCPP-Birds Landing 230kV

Q320 TCP2 ISIS

Selected PG&E Transmission Line Flows (MW)

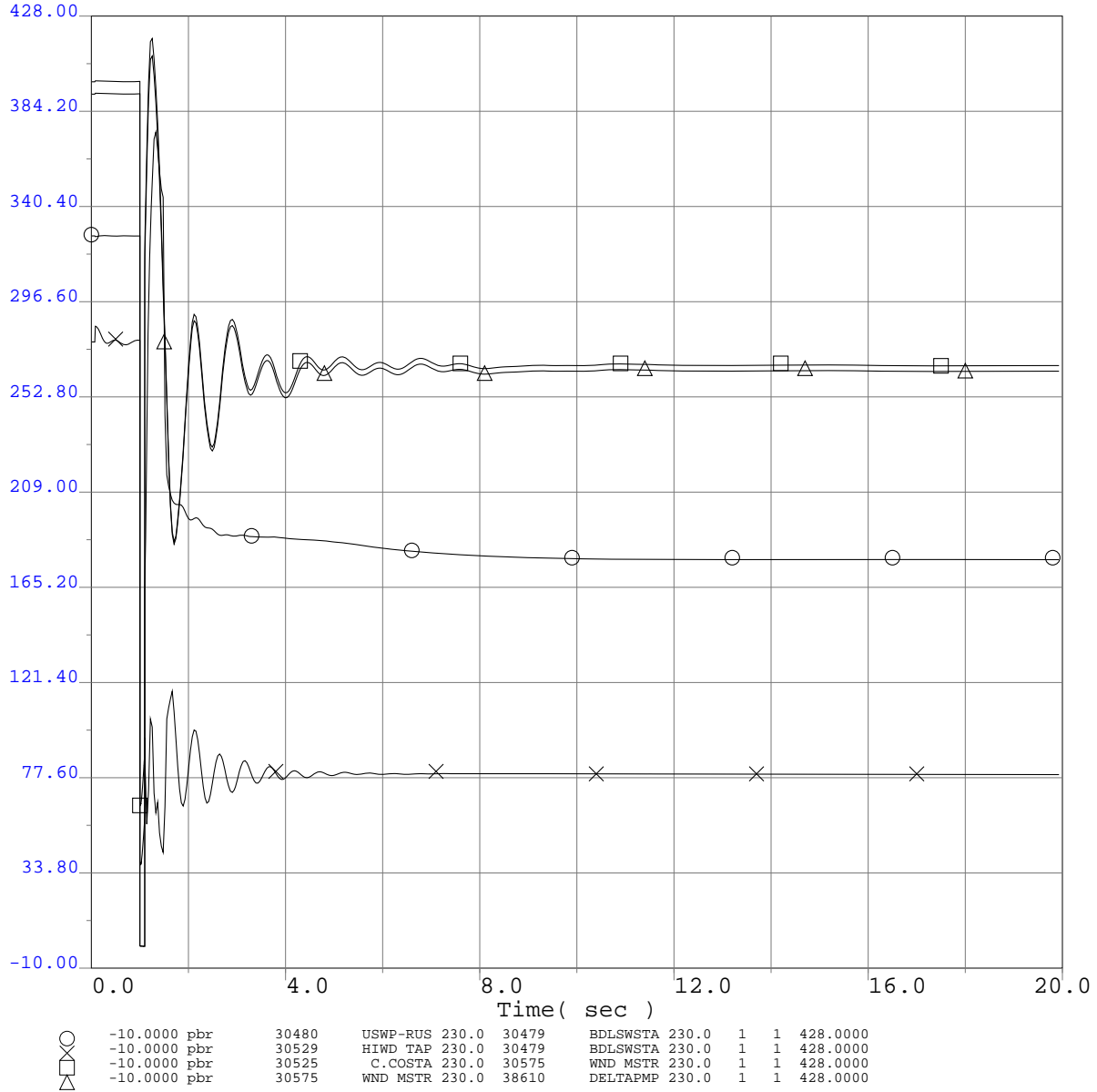

Q320 Project GIPR Phase 1 Interconnection System Impact Study
 2013 Greater Bay Area Summer Peak Base Case
 Q320 @484MW
 CCPP-Birds Landing 230kV Line Outage
 3-ph 6 cyc flt @ the Birds Landing 230kV bus & clr the CCPP-Birds Landing 230kV

Q320 TCP2 ISIS

Selected PG&E Bus Voltage Plots Adjacent to Fault

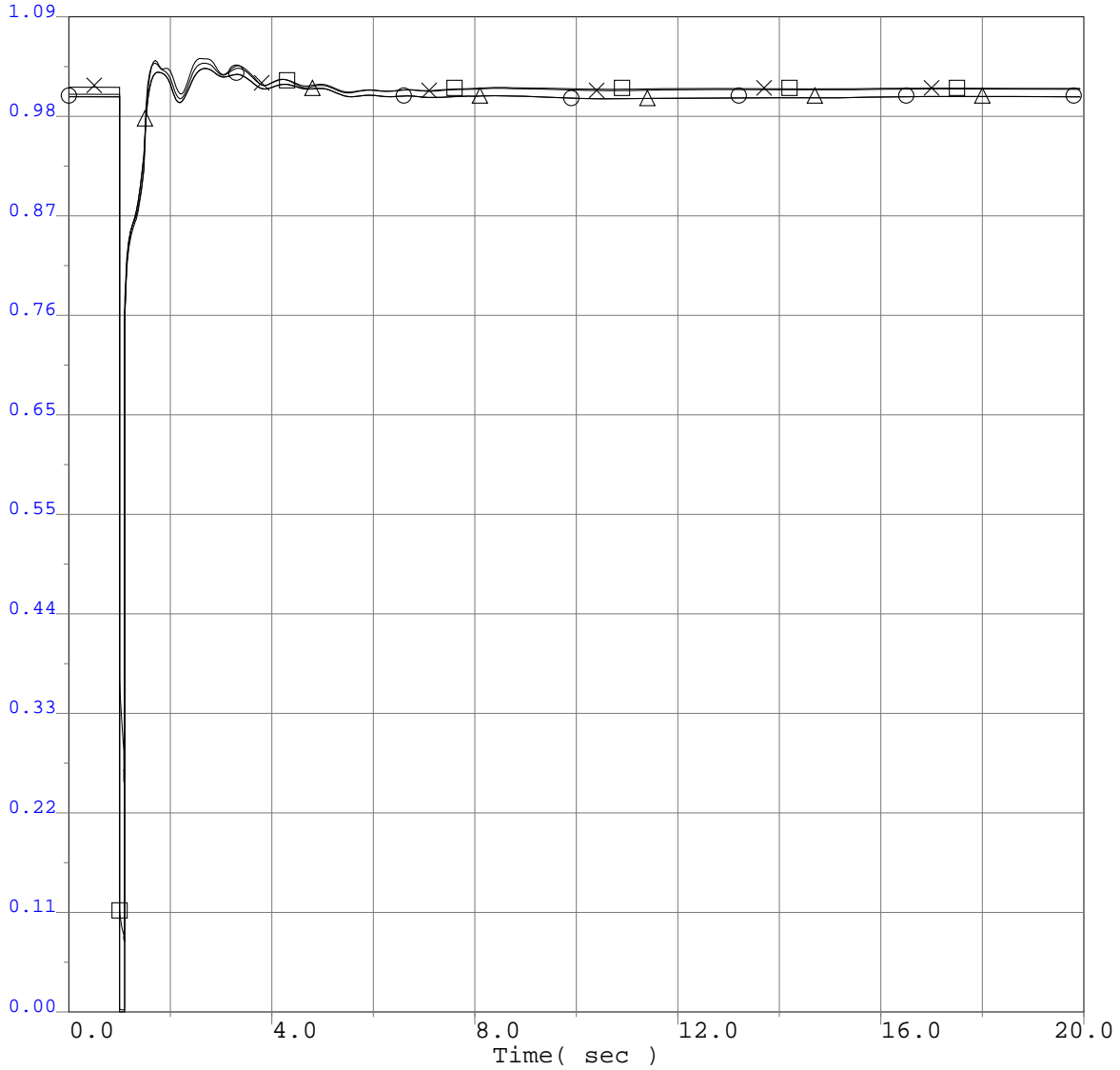

○	0.0000	vbus	30525	C.COSTA 230.0	0	0.0	***	1	1.0900
□	0.0000	vbus	30479	BDLSWSTA 230.0	0	0.0	***	1	1.0900
×	0.0000	vbul	30523	CC SUB 230.0	0	0.0	***	1	1.0900
△	0.0000	vbus	30518	T320 230.0	0	0.0	***	1	1.0900



Q320 TCP2 ISIS
 2013 Greater Bay Area Summer Peak Base Case
 Q320 @ 772MW
 CCPP-CC Sub 230kV Line Outage
 3-ph 6 cyc flt @ the CCPP 230kV bus & clr the CCPP-CC Sub 230kV line

Q320 TCP2 ISIS

Selected PG&E Bus Frequency Plots Adjacent to Fault

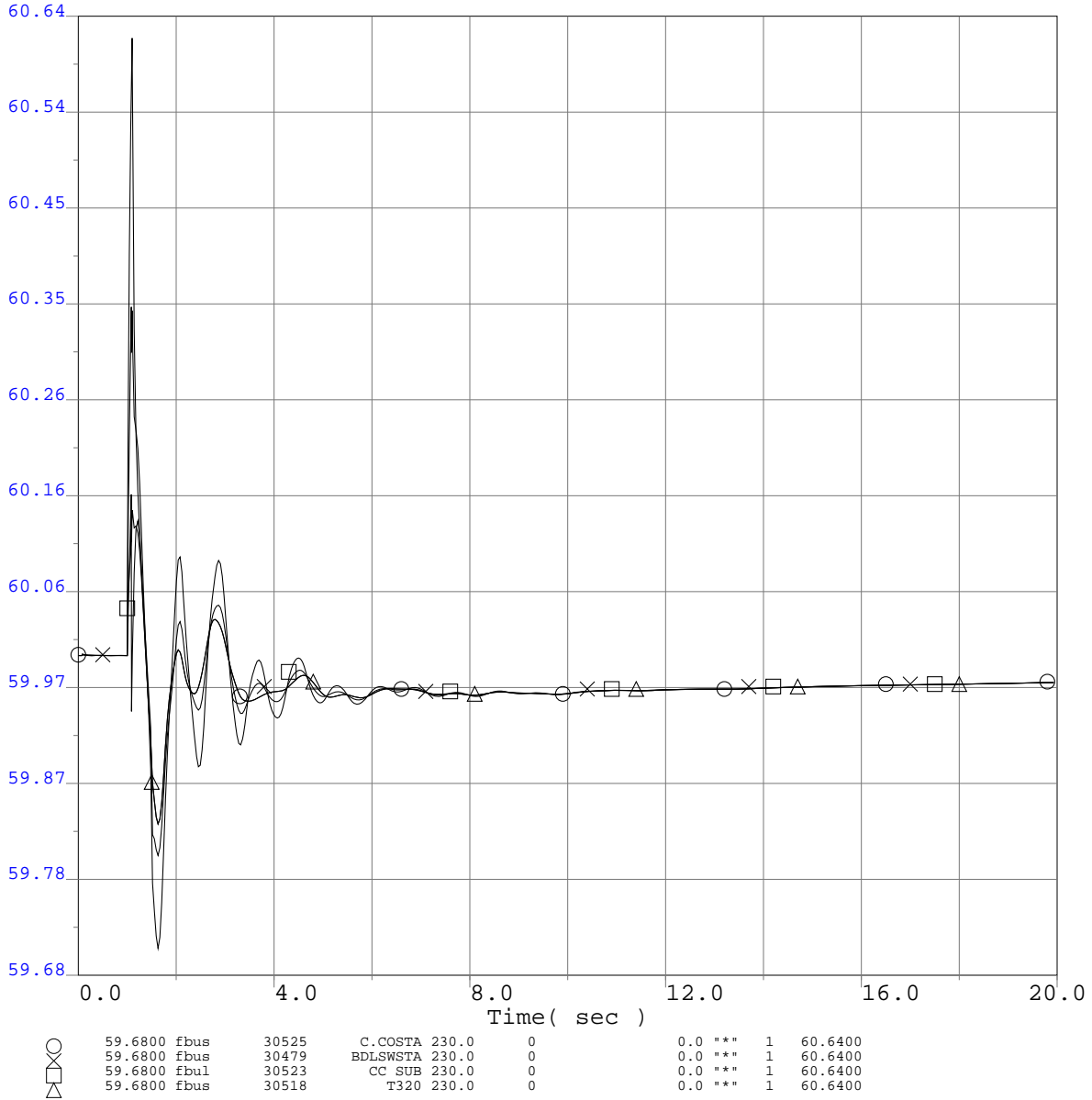

Q320 TCP2 ISIS
 2013 Greater Bay Area Summer Peak Base Case
 Q320 @ 772MW
 CCPP-CC Sub 230kV Line Outage
 3-ph 6 cyc flt @ the CCPP 230kV bus & clr the CCPP-CC Sub 230kV line

Q320 TCP2 ISIS

Project Generator Terminal Voltages (P.U.)

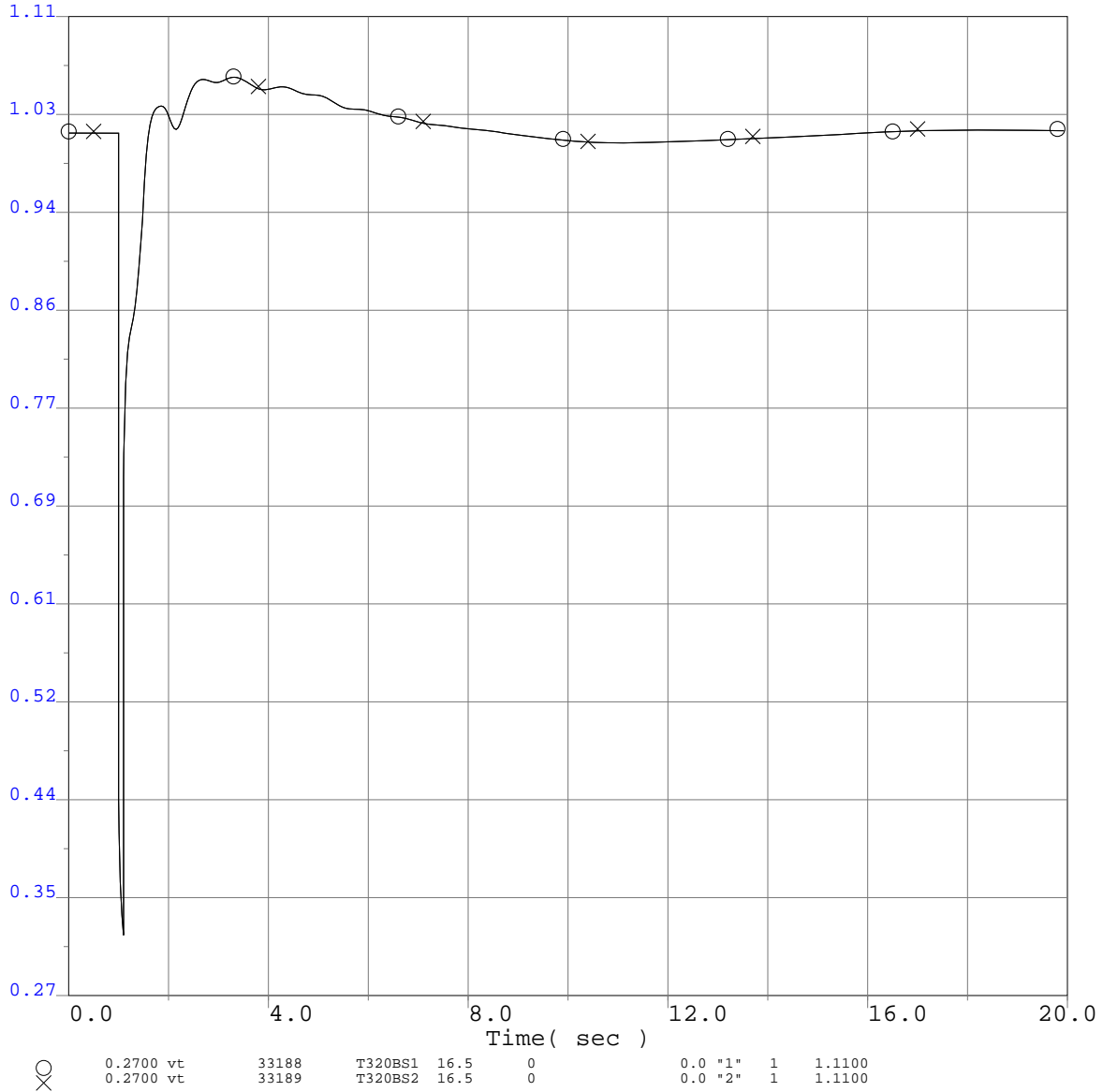

Q320 TCP2 ISIS
 2013 Greater Bay Area Summer Peak Base Case
 Q320 @ 772MW
 CCPP-CC Sub 230kV Line Outage
 3-ph 6 cyc flt @ the CCPP 230kV bus & clr the CCPP-CC Sub 230kV line

Q320 TCP2 ISIS

Project Generator Terminal Voltages (P.U.)

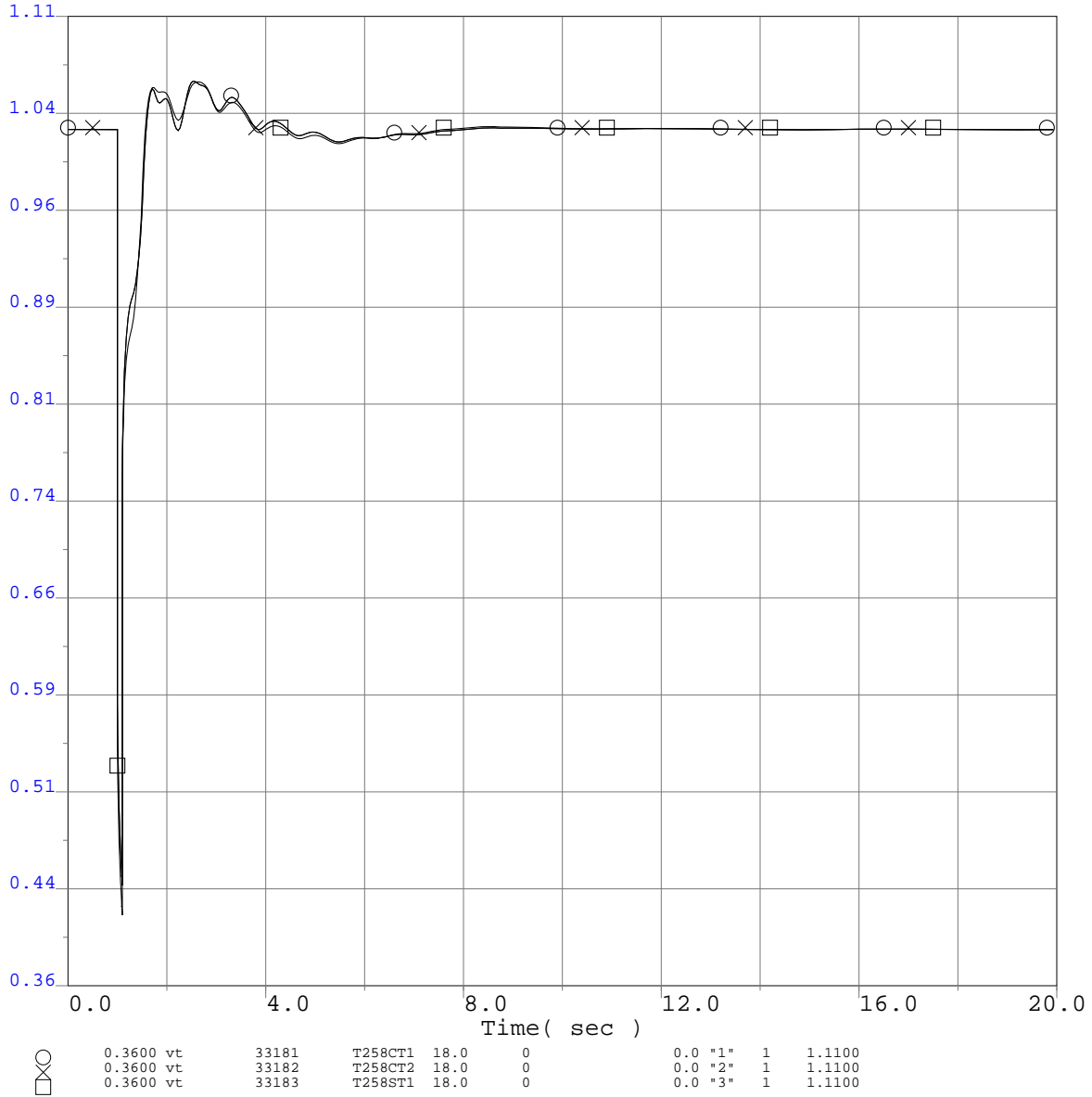

Q320 TCP2 ISIS
 2013 Greater Bay Area Summer Peak Base Case
 Q320 @ 772MW
 CCPP-CC Sub 230kV Line Outage
 3-ph 6 cyc flt @ the CCPP 230kV bus & clr the CCPP-CC Sub 230kV line

Q320 TCP2 ISIS

Project Generator Speed (P.U.)

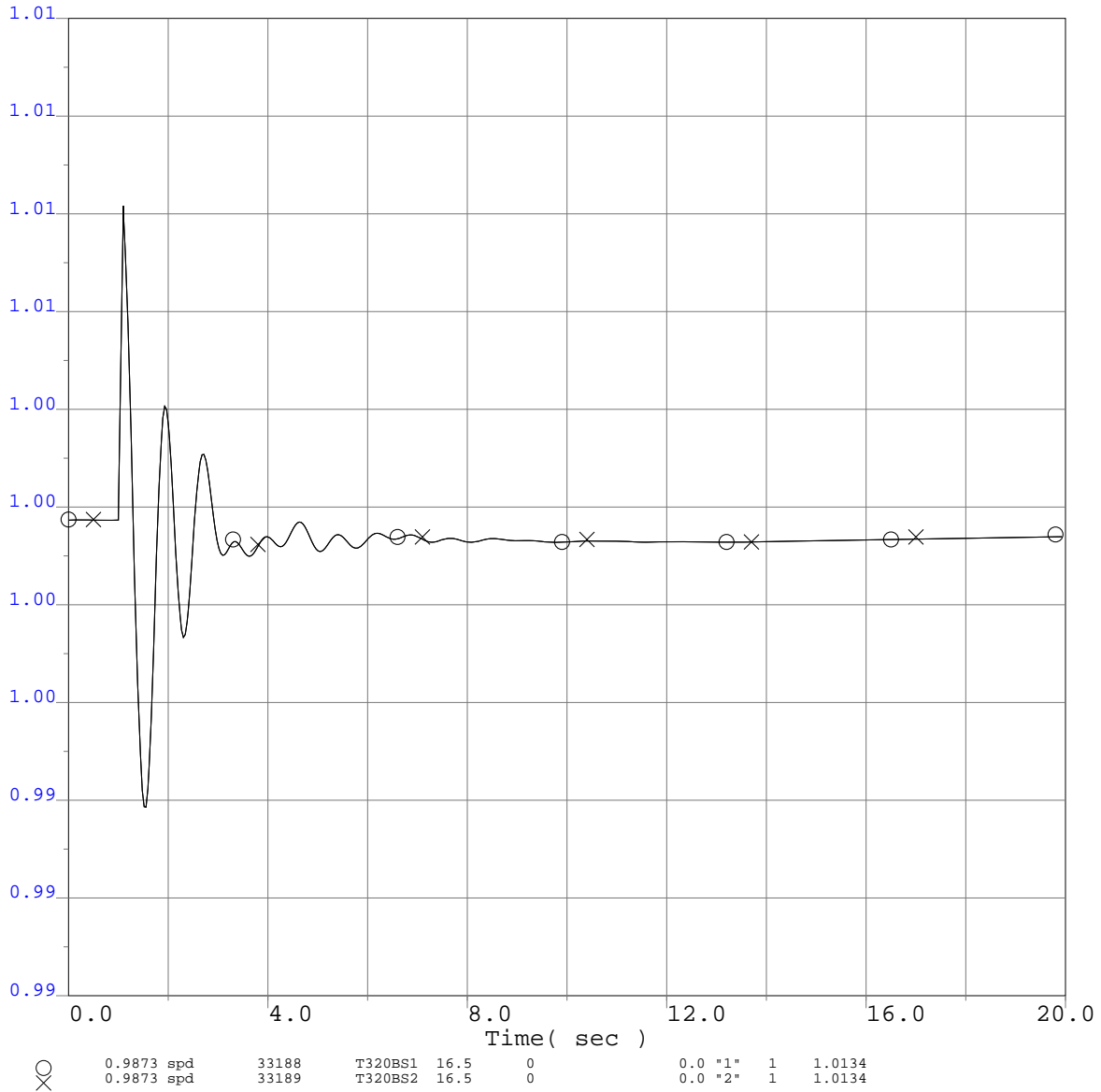

○	0.9873 spd	33188	T320BS1	16.5	0	0.0 "1"	1	1.0134
×	0.9873 spd	33189	T320BS2	16.5	0	0.0 "2"	1	1.0134

Q320 TCP2 ISIS
 2013 Greater Bay Area Summer Peak Base Case
 Q320 @ 772MW
 CCPP-CC Sub 230kV Line Outage
 3-ph 6 cyc flt @ the CCPP 230kV bus & clr the CCPP-CC Sub 230kV line

Q320 TCP2 ISIS

Project Generator Speed (P.U.)

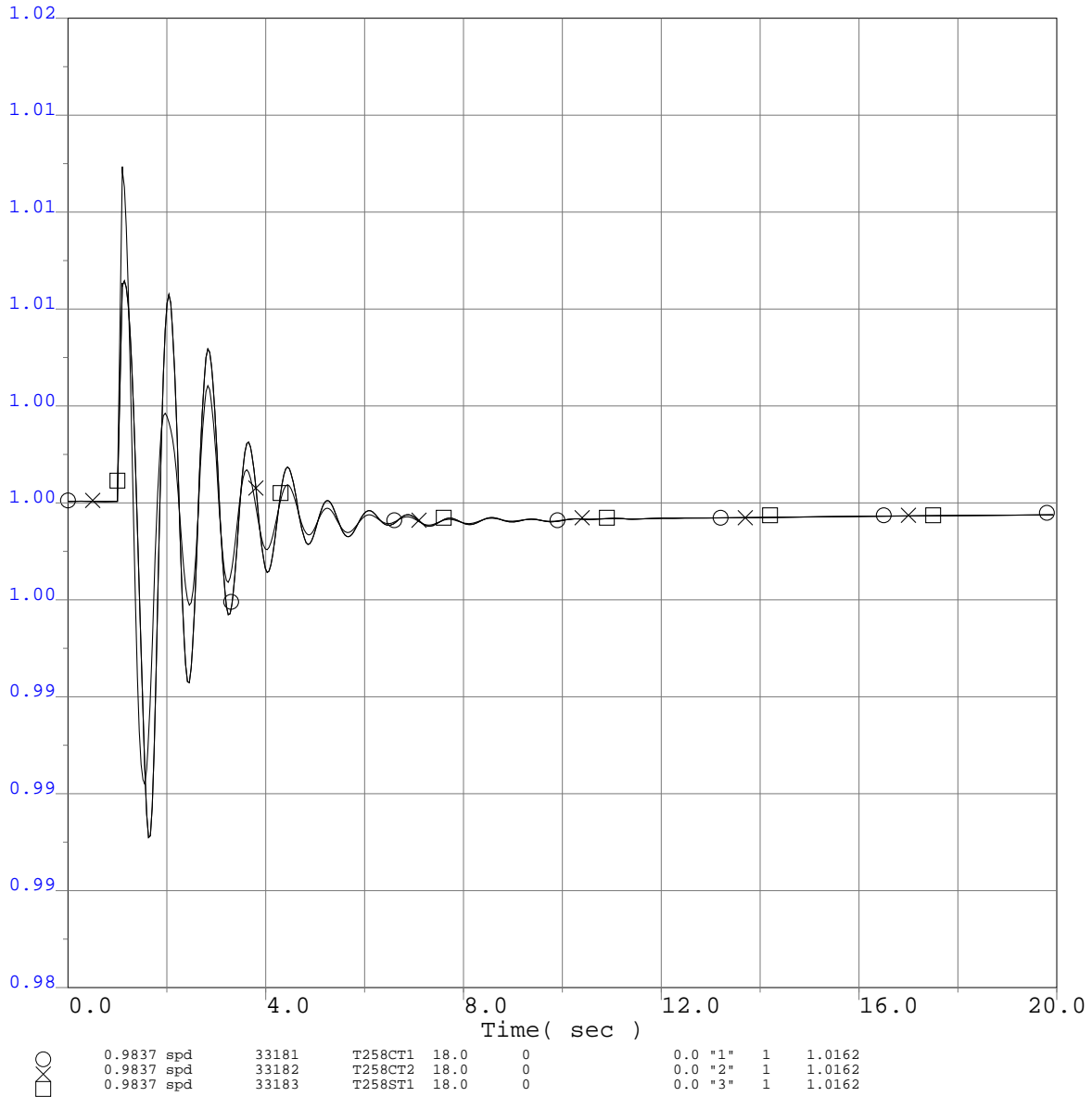

Q320 TCP2 ISIS
 2013 Greater Bay Area Summer Peak Base Case
 Q320 @ 772MW
 CCPP-CC Sub 230kV Line Outage
 3-ph 6 cyc flt @ the CCPP 230kV bus & clr the CCPP-CC Sub 230kV line

Q320 TCP2 ISIS

Project Generator Terminal Power (MW)

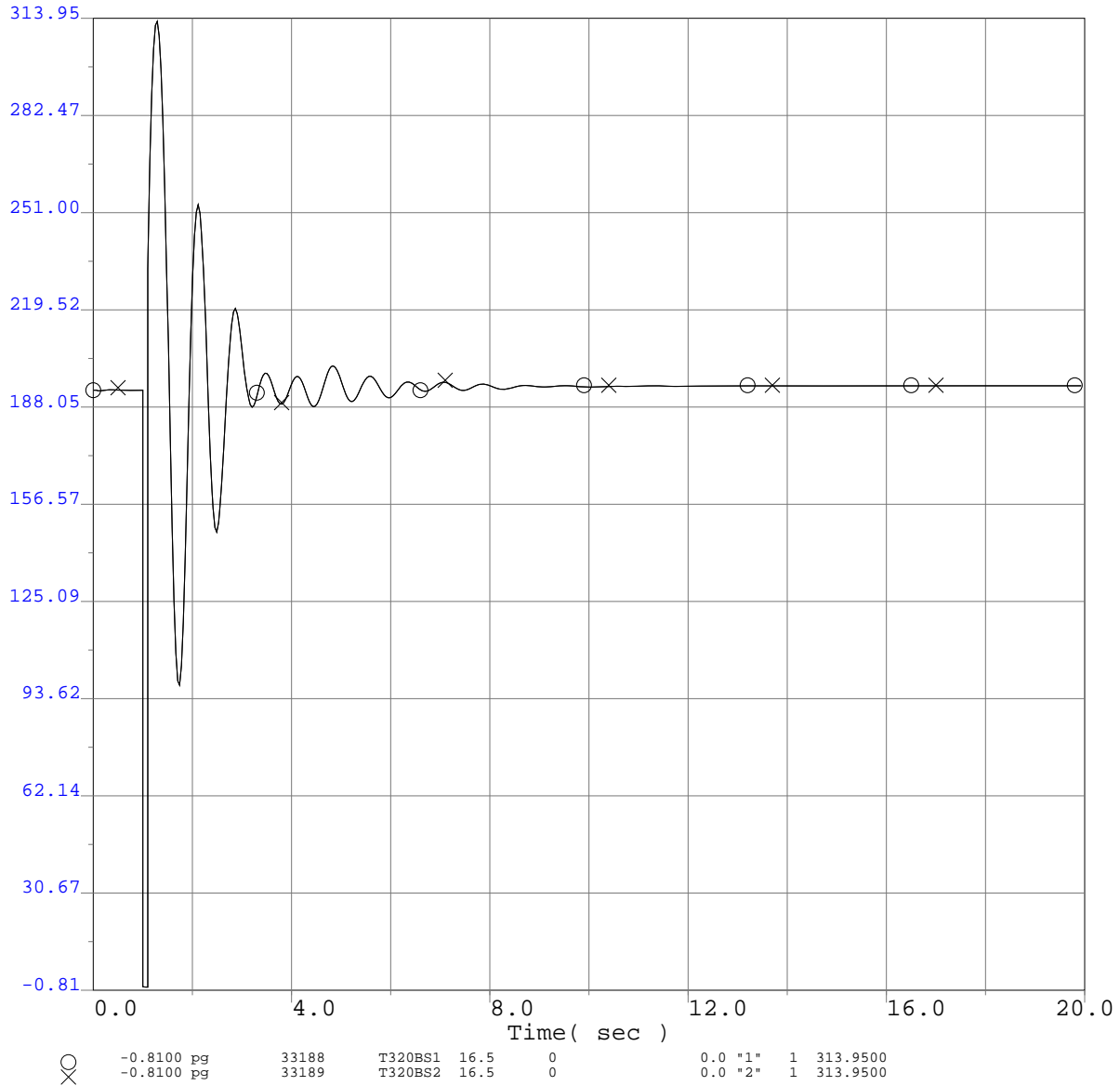

Q320 TCP2 ISIS
 2013 Greater Bay Area Summer Peak Base Case
 Q320 @ 772MW
 CCPP-CC Sub 230kV Line Outage
 3-ph 6 cyc flt @ the CCPP 230kV bus & clr the CCPP-CC Sub 230kV line

Q320 TCP2 ISIS

Project Generator Terminal Power (MW)

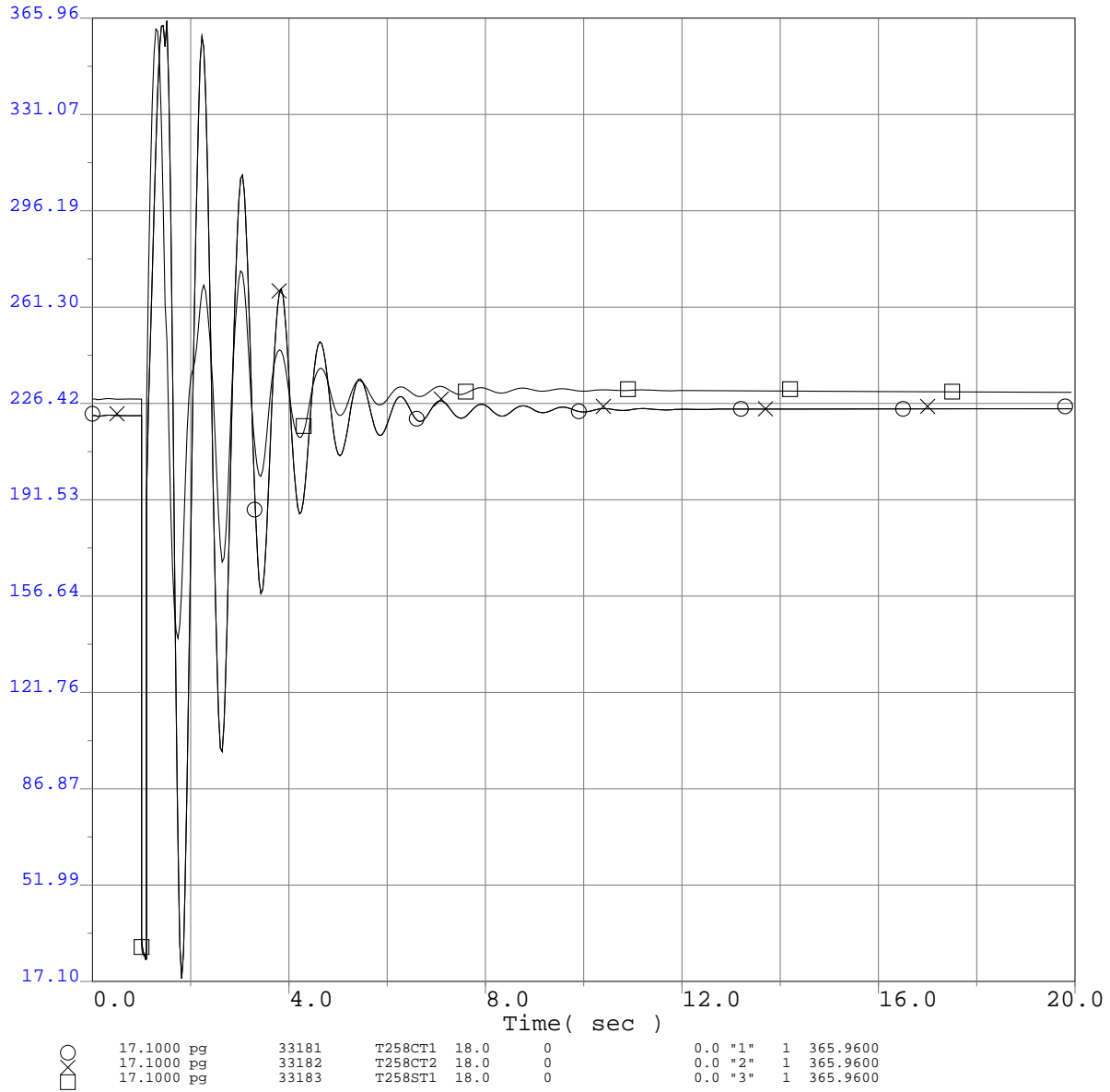

Q320 TCP2 ISIS
 2013 Greater Bay Area Summer Peak Base Case
 Q320 @ 772MW
 CCPP-CC Sub 230kV Line Outage
 3-ph 6 cyc flt @ the CCPP 230kV bus & clr the CCPP-CC Sub 230kV line

Q320 TCP2 ISIS

Project Generator Terminal Reactive Power (MVA_r)

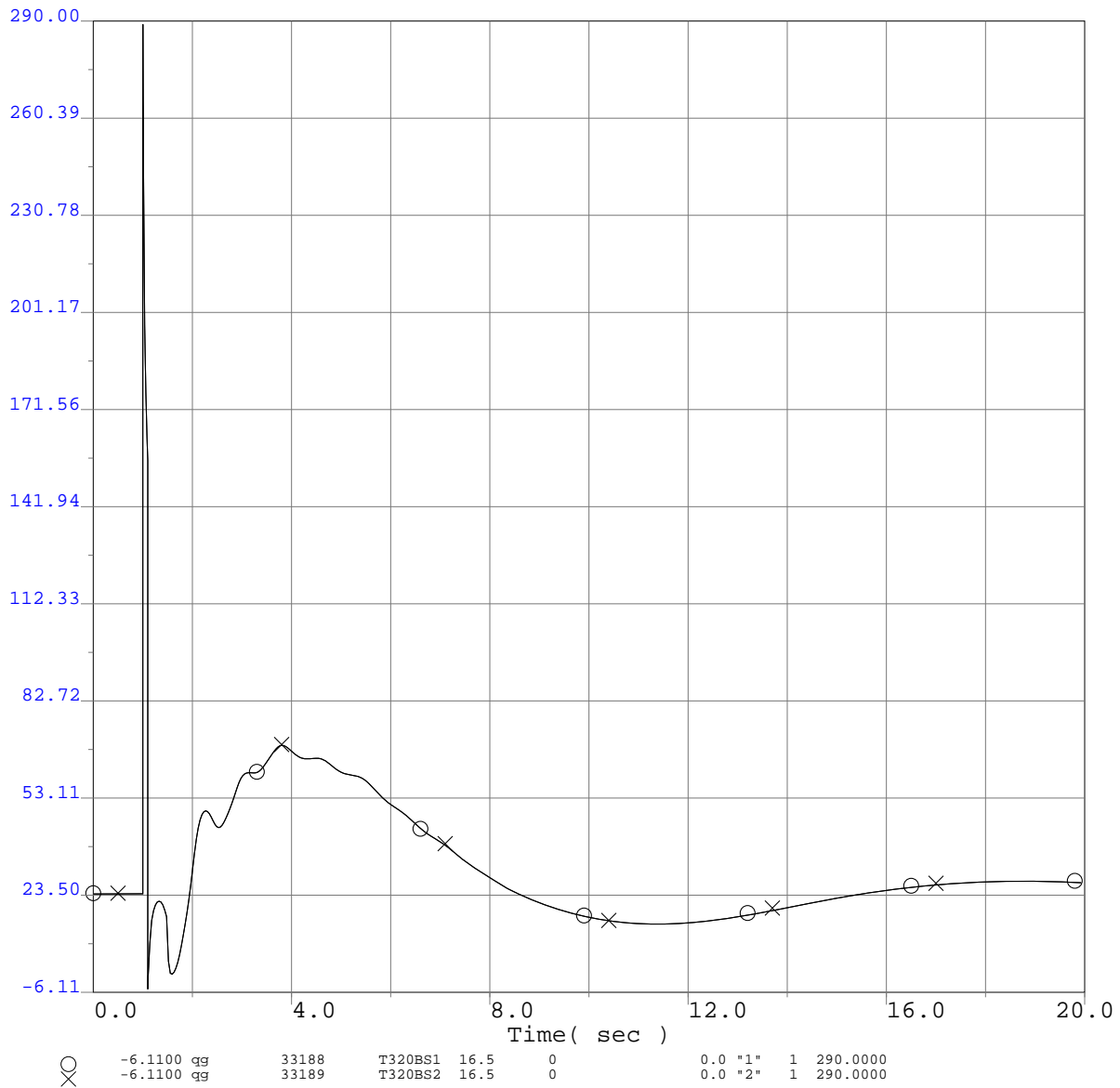

Q320 TCP2 ISIS
 2013 Greater Bay Area Summer Peak Base Case
 Q320 @ 772MW
 CCPP-CC Sub 230kV Line Outage
 3-ph 6 cyc flt @ the CCPP 230kV bus & clr the CCPP-CC Sub 230kV line

Q320 TCP2 ISIS

Project Generator Terminal Reactive Power (MVar)

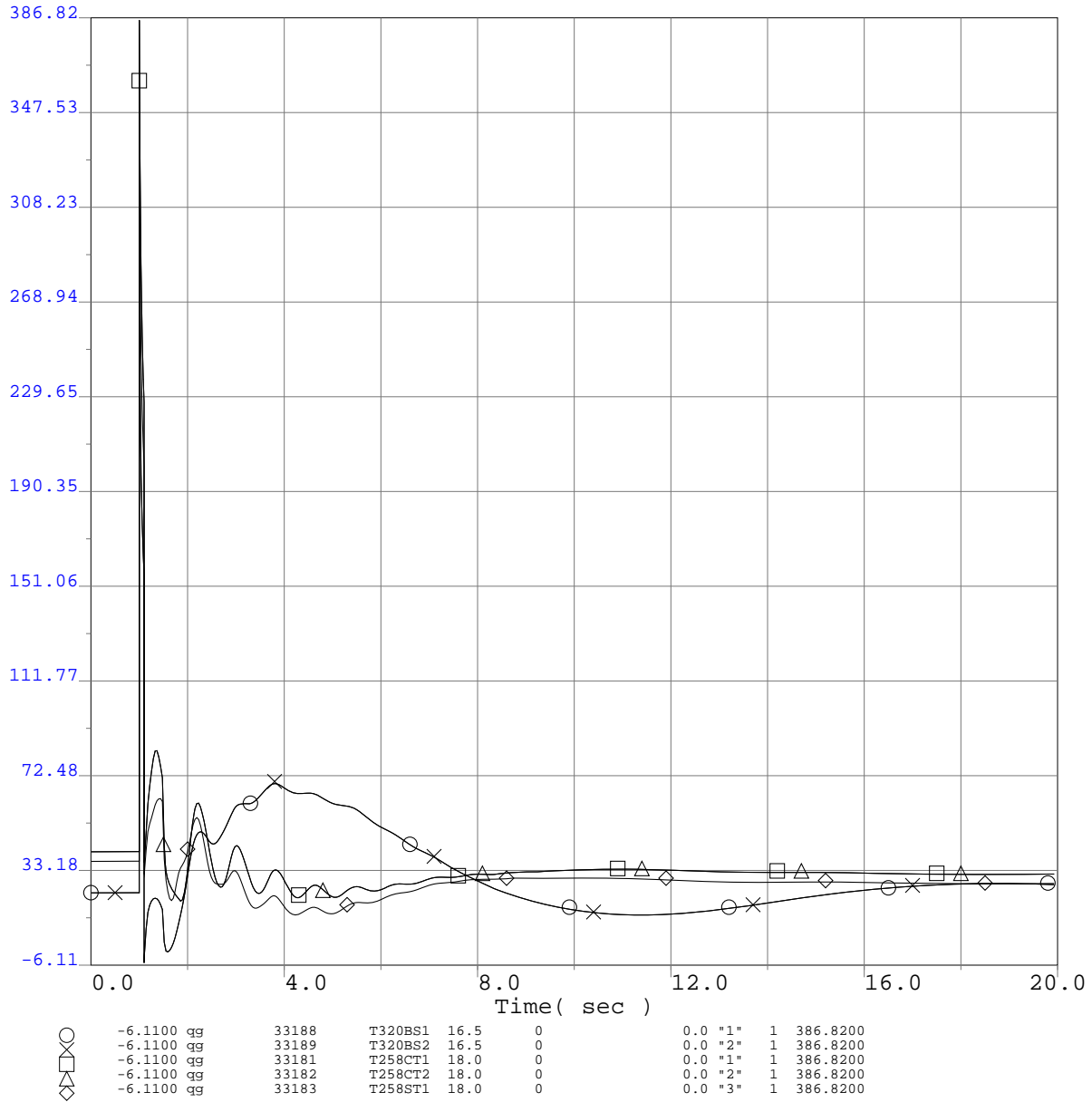

Q320 TCP2 ISIS
 2013 Greater Bay Area Summer Peak Base Case
 Q320 @ 772MW
 CCPP-CC Sub 230kV Line Outage
 3-ph 6 cyc flt @ the CCPP 230kV bus & clr the CCPP-CC Sub 230kV line

Q320 TCP2 ISIS

Selected WECC Bus Voltage Plots

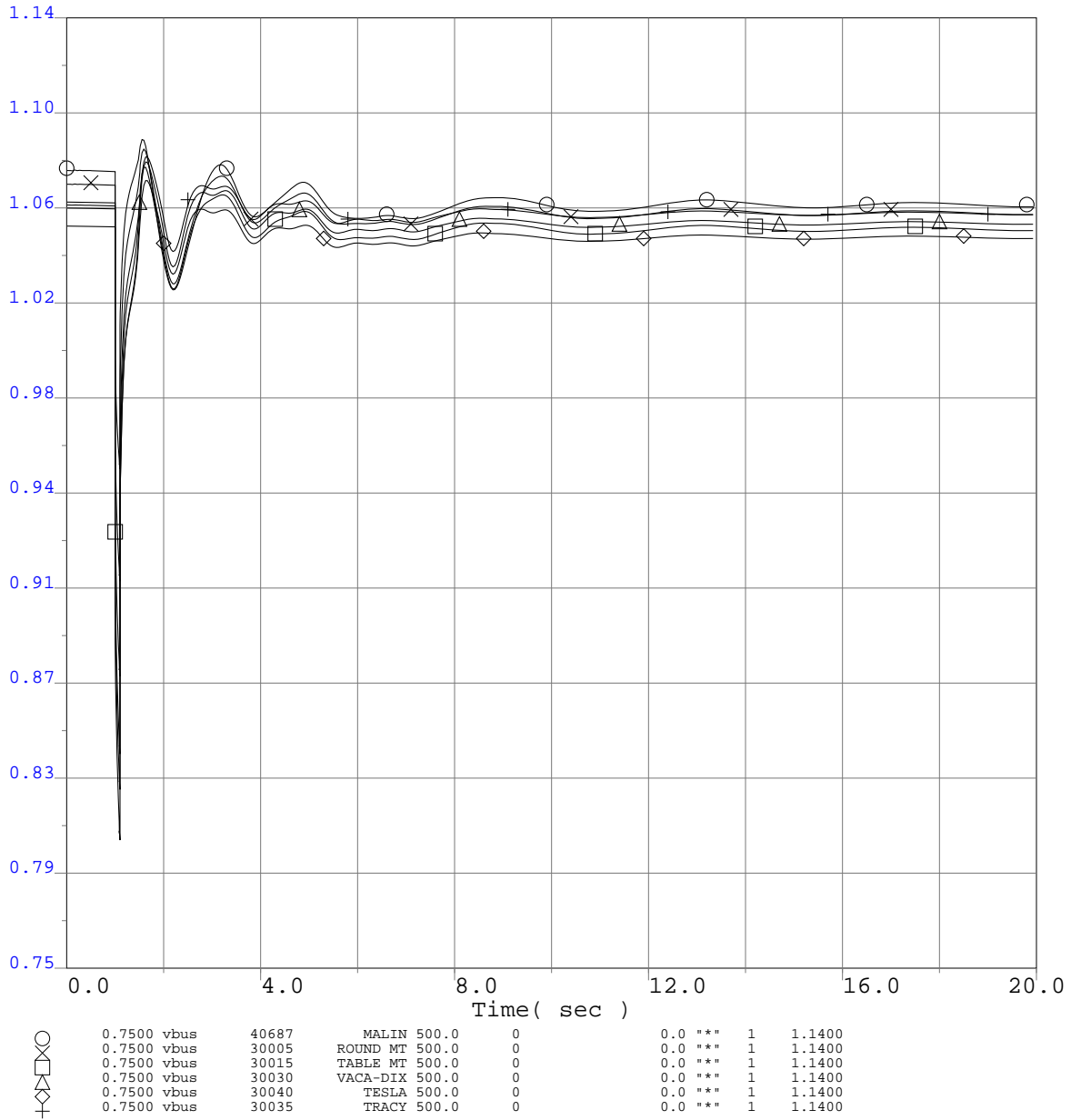

Q320 TCP2 ISIS
 2013 Greater Bay Area Summer Peak Base Case
 Q320 @ 772MW
 CCPP-CC Sub 230kV Line Outage
 3-ph 6 cyc flt @ the CCPP 230kV bus & clr the CCPP-CC Sub 230kV line

Q320 TCP2 ISIS

Selected WECC Bus Voltage Plots

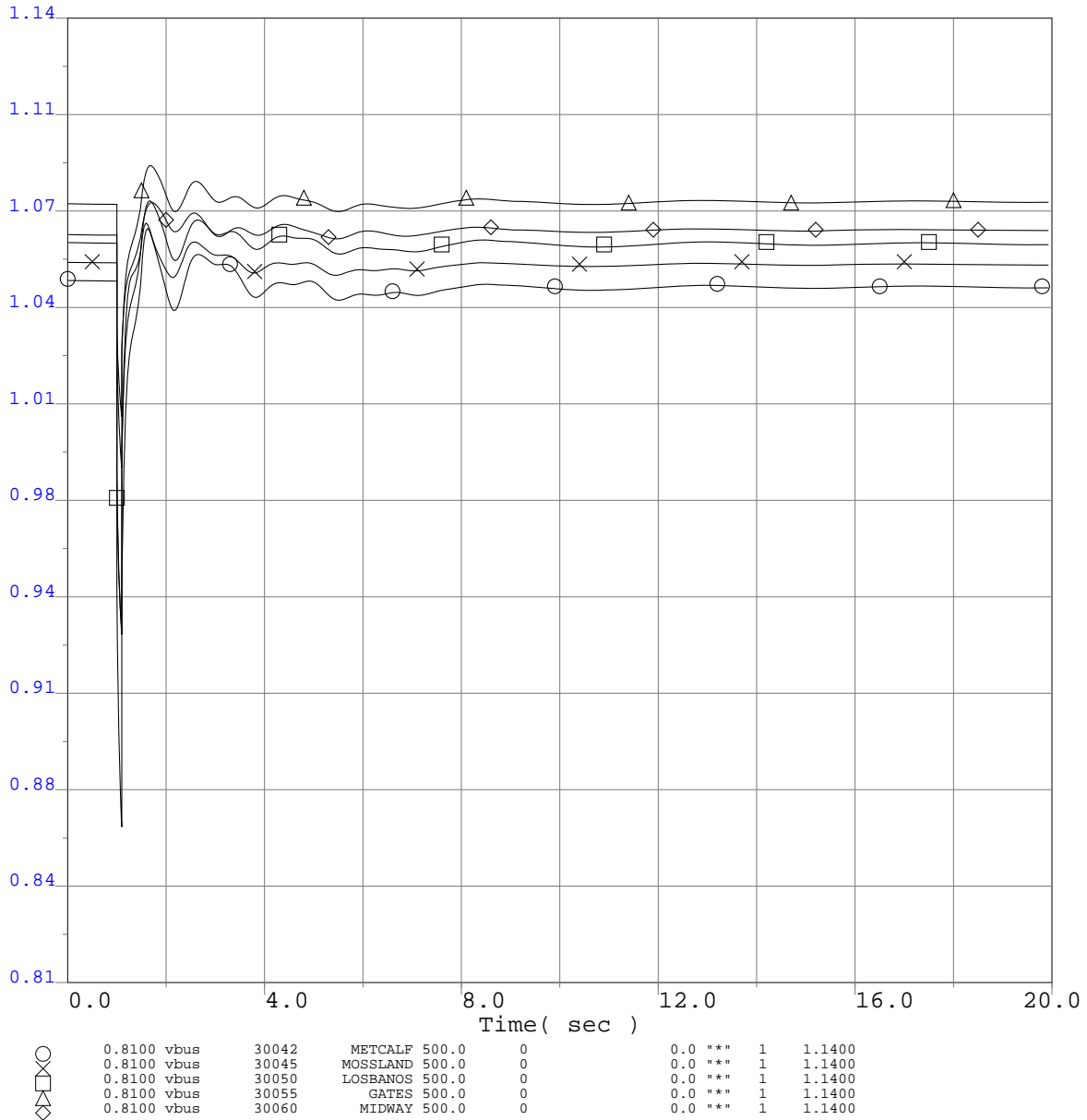

Q320 TCP2 ISIS
 2013 Greater Bay Area Summer Peak Base Case
 Q320 @ 772MW
 CCPP-CC Sub 230kV Line Outage
 3-ph 6 cyc flt @ the CCPP 230kV bus & clr the CCPP-CC Sub 230kV line

Q320 TCP2 ISIS

Selected WECC Bus Voltage Plots

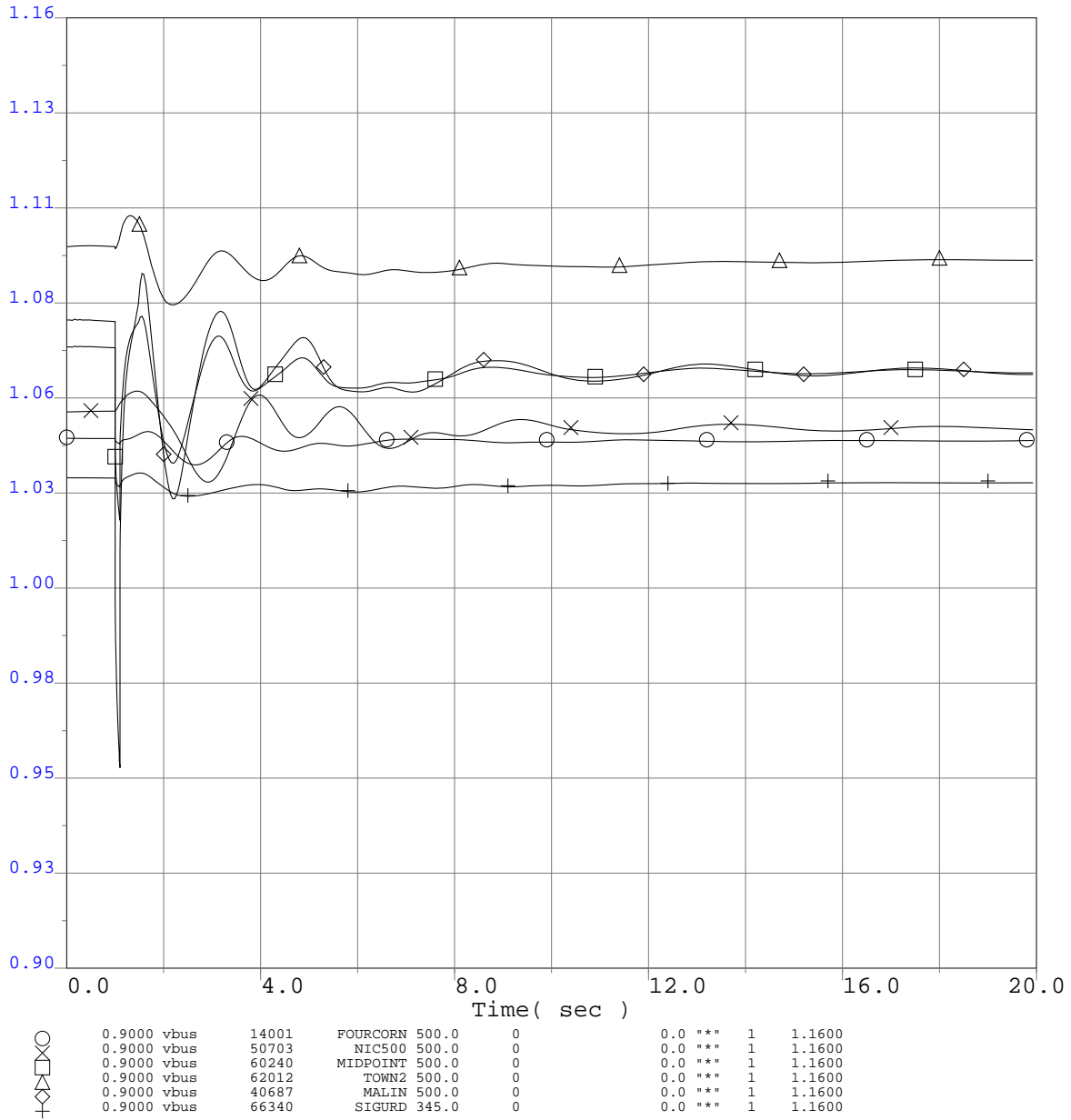

Q320 TCP2 ISIS
 2013 Greater Bay Area Summer Peak Base Case
 Q320 @ 772MW
 CCPP-CC Sub 230kV Line Outage
 3-ph 6 cyc flt @ the CCPP 230kV bus & clr the CCPP-CC Sub 230kV line

Q320 TCP2 ISIS

Selected WECC Bus Voltage Plots

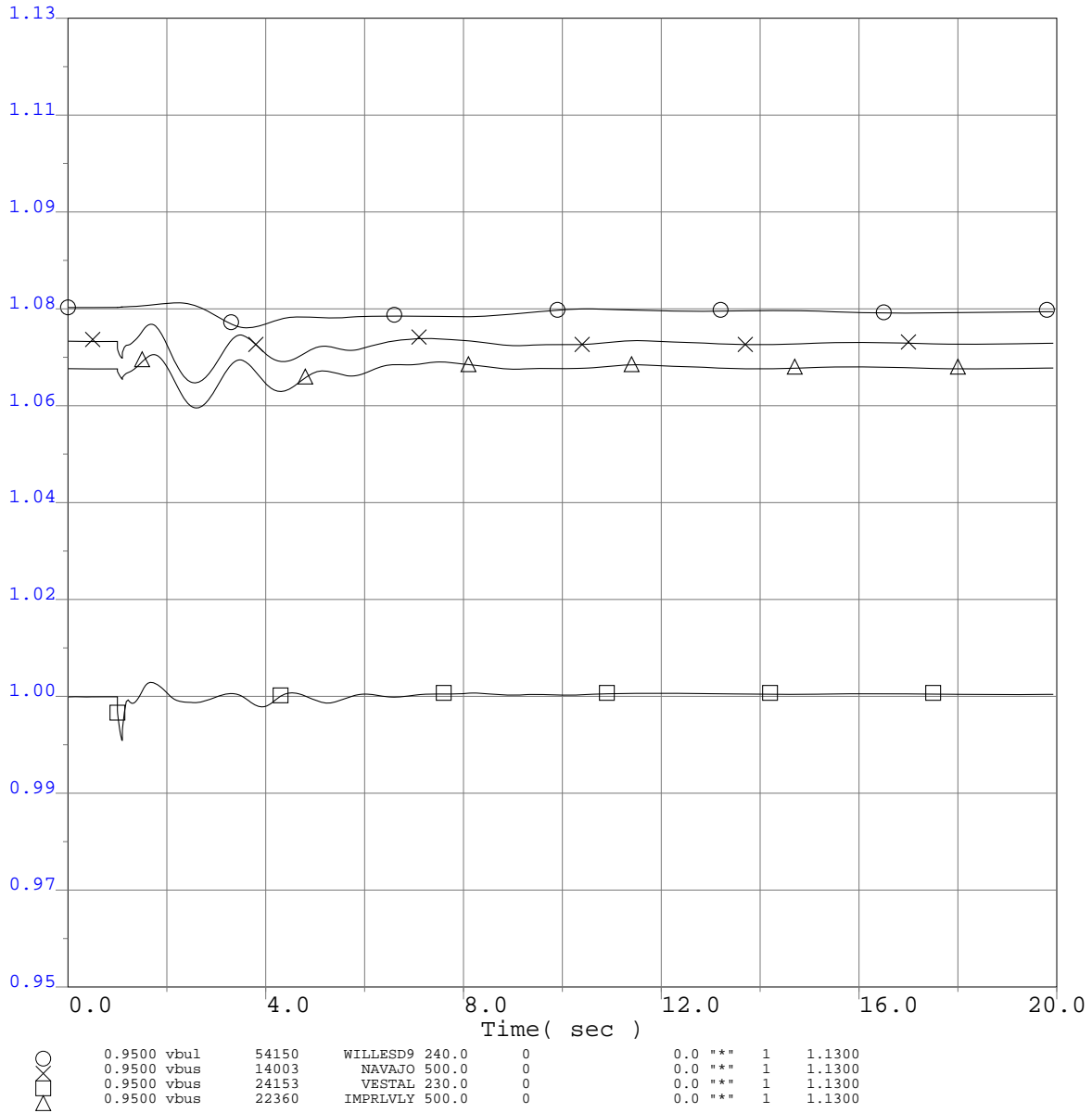

Q320 TCP2 ISIS
 2013 Greater Bay Area Summer Peak Base Case
 Q320 @ 772MW
 CCPP-CC Sub 230kV Line Outage
 3-ph 6 cyc flt @ the CCPP 230kV bus & clr the CCPP-CC Sub 230kV line

Q320 TCP2 ISIS

Selected WECC Bus Frequency Plots

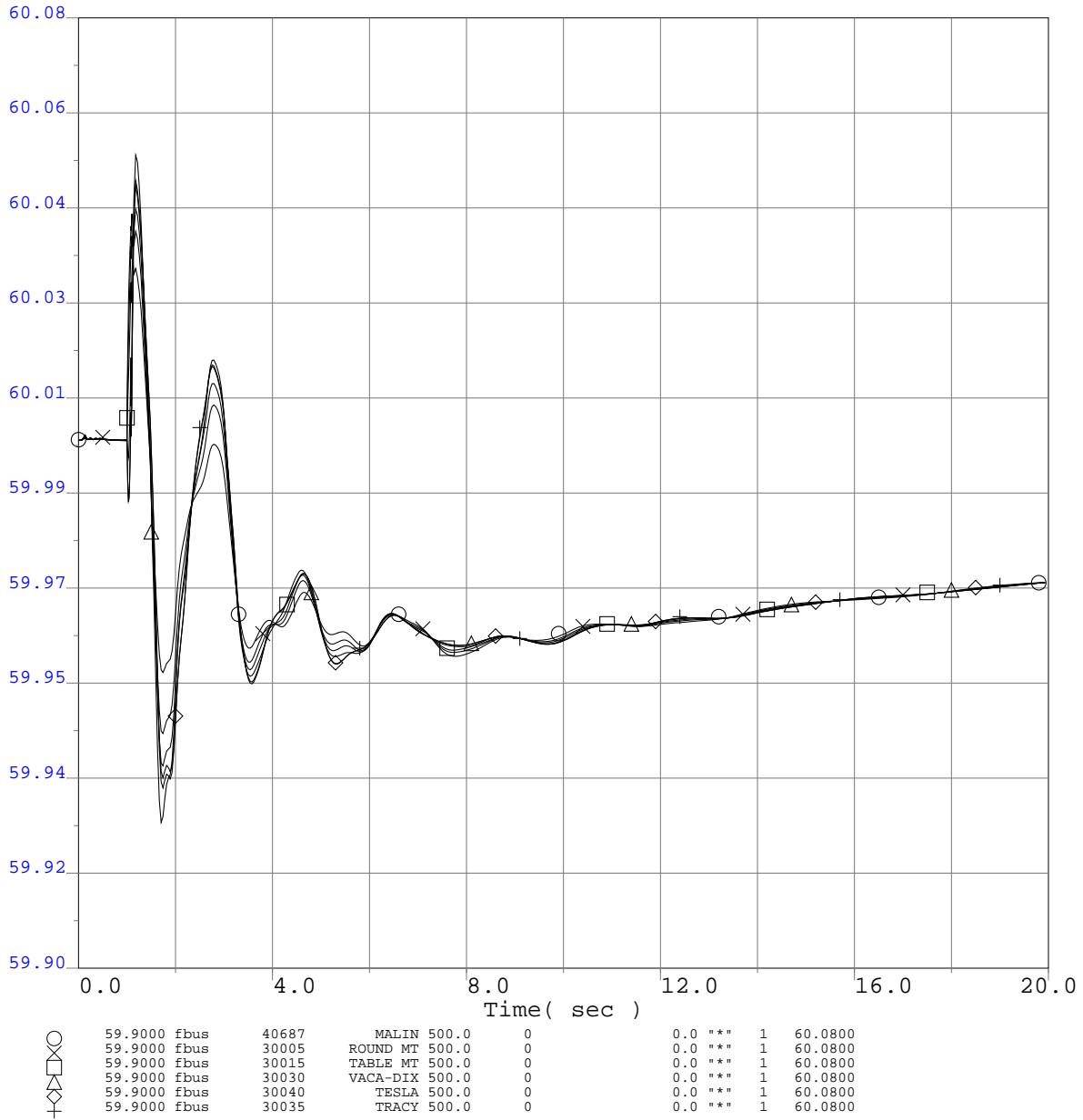

Q320 TCP2 ISIS
 2013 Greater Bay Area Summer Peak Base Case
 Q320 @ 772MW
 CCPP-CC Sub 230kV Line Outage
 3-ph 6 cyc flt @ the CCPP 230kV bus & clr the CCPP-CC Sub 230kV line

Q320 TCP2 ISIS

Selected WECC Bus Frequency Plots

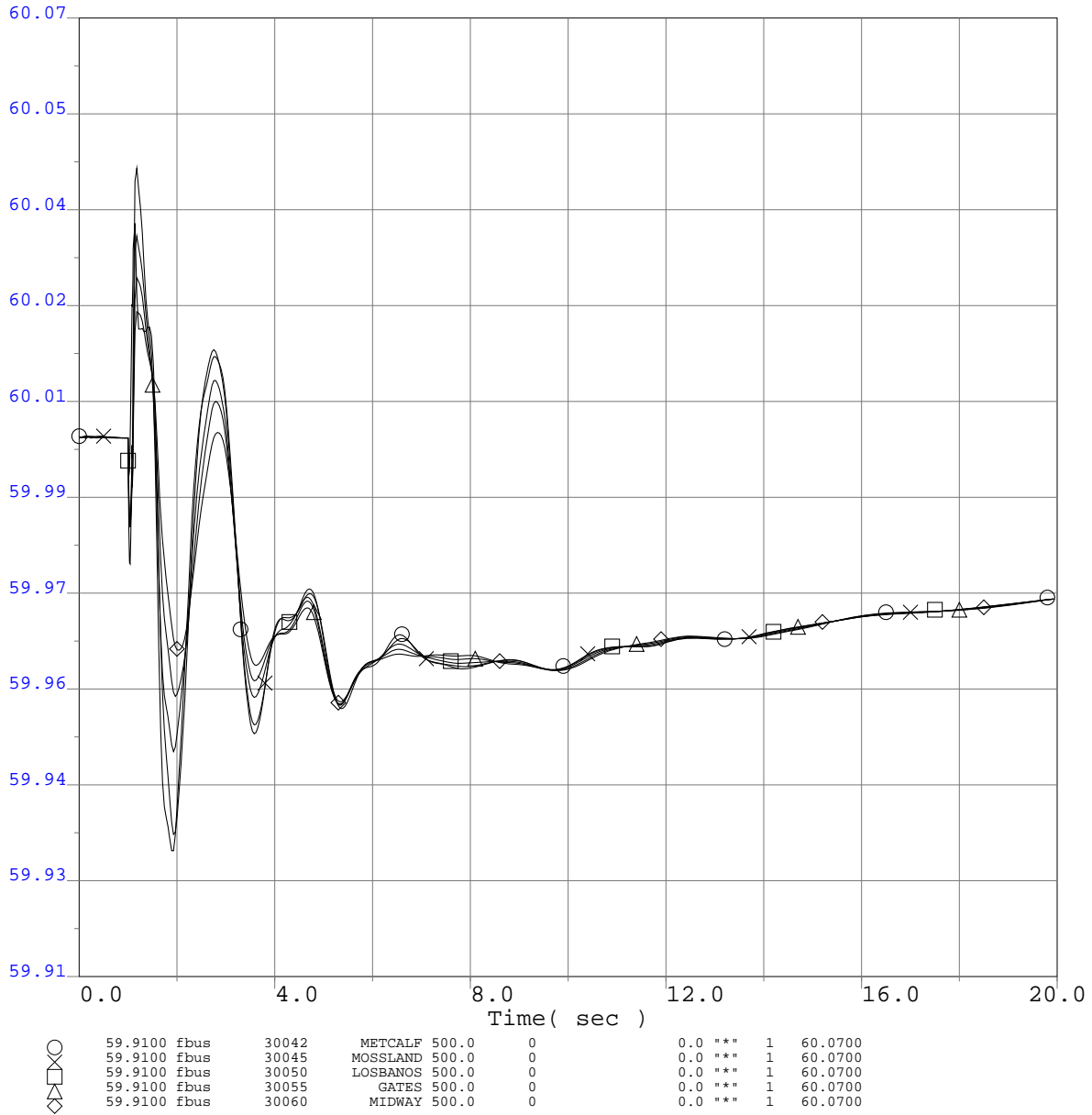

Q320 TCP2 ISIS
 2013 Greater Bay Area Summer Peak Base Case
 Q320 @ 772MW
 CCPP-CC Sub 230kV Line Outage
 3-ph 6 cyc flt @ the CCPP 230kV bus & clr the CCPP-CC Sub 230kV line

Q320 TCP2 ISIS

Selected WECC Bus Frequency Plots

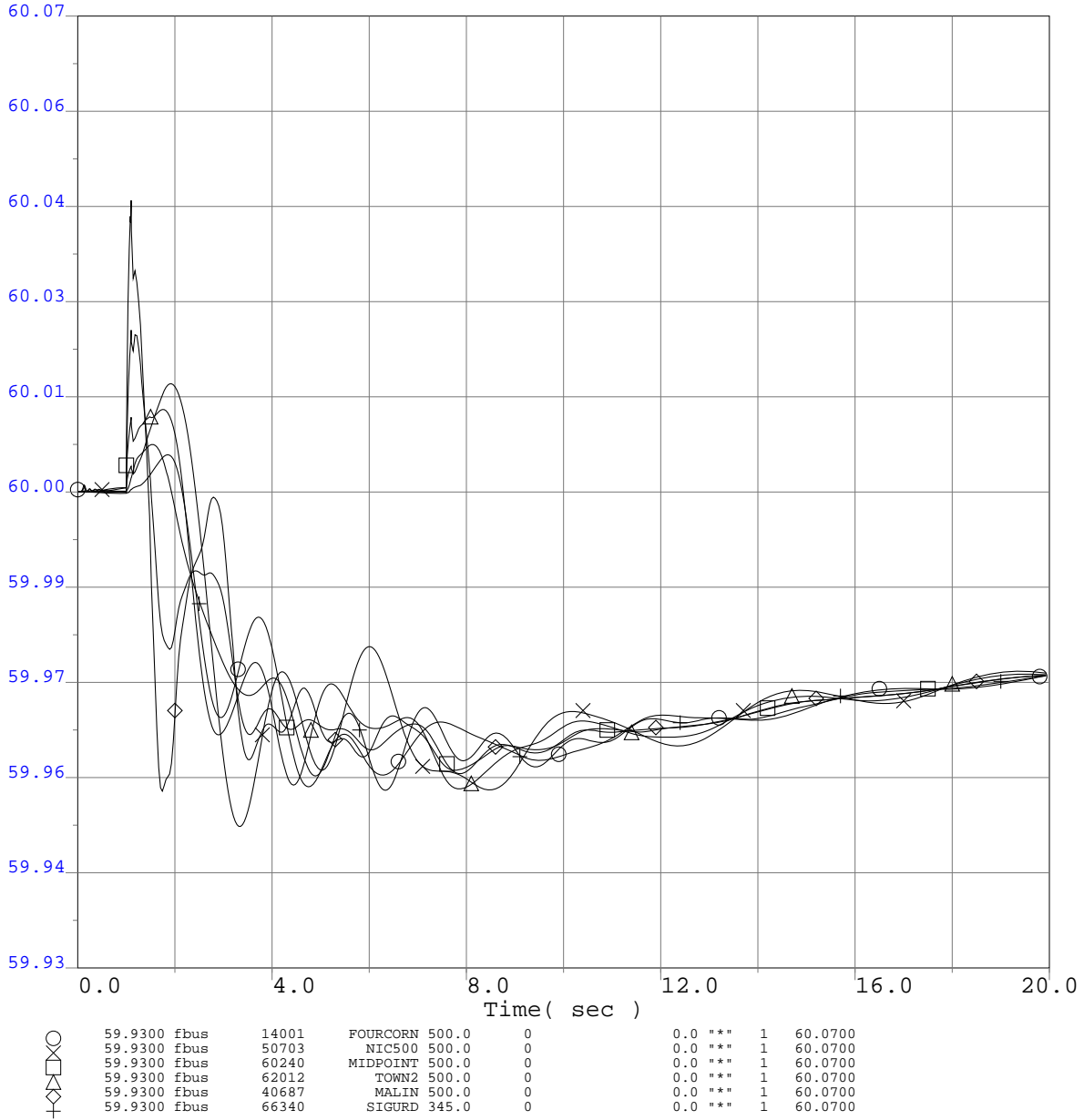

Q320 TCP2 ISIS
 2013 Greater Bay Area Summer Peak Base Case
 Q320 @ 772MW
 CCPP-CC Sub 230kV Line Outage
 3-ph 6 cyc flt @ the CCPP 230kV bus & clr the CCPP-CC Sub 230kV line

Q320 TCP2 ISIS

Selected WECC Bus Frequency Plots

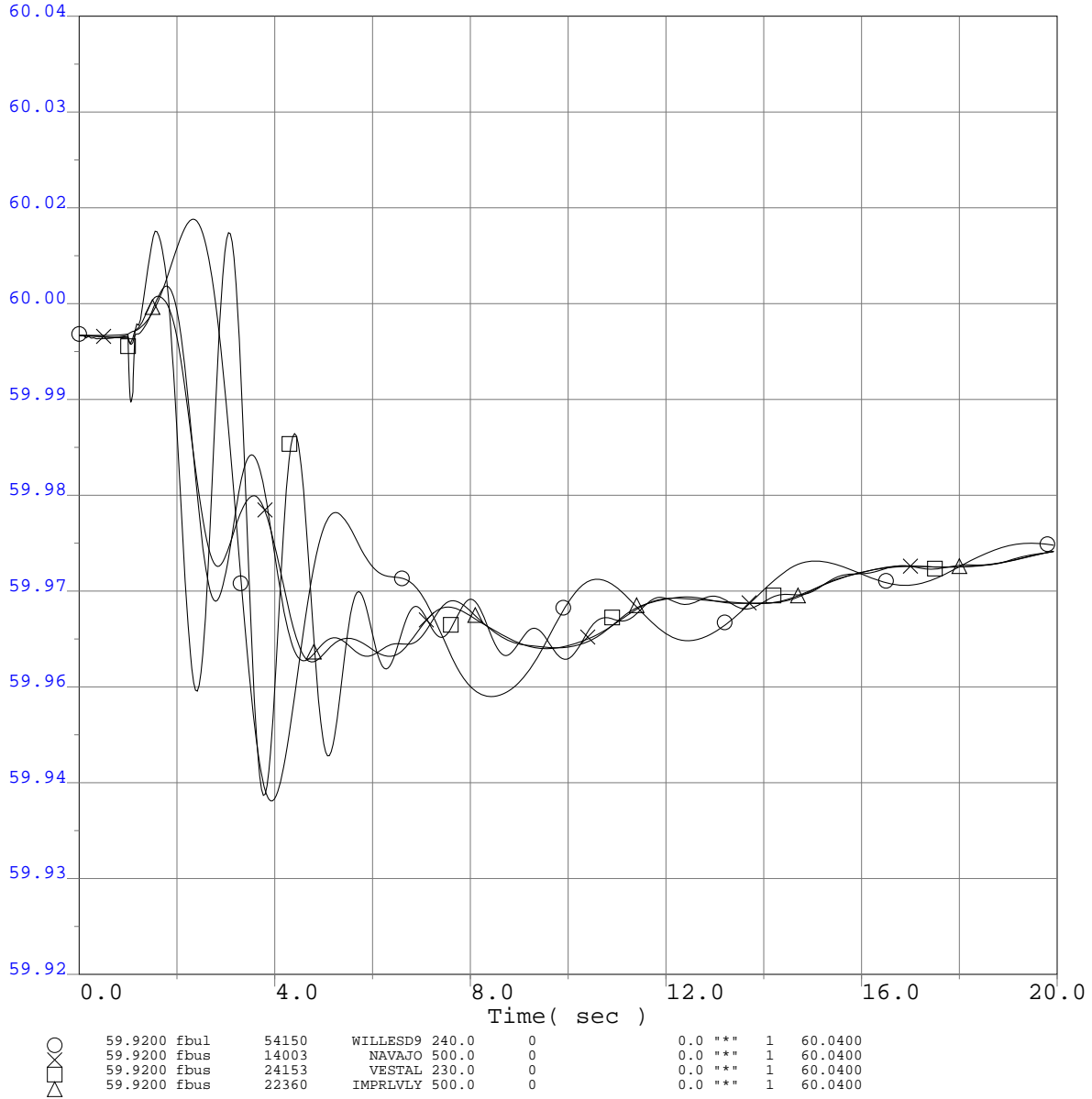

Q320 TCP2 ISIS
 2013 Greater Bay Area Summer Peak Base Case
 Q320 @ 772MW
 CCPP-CC Sub 230kV Line Outage
 3-ph 6 cyc flt @ the CCPP 230kV bus & clr the CCPP-CC Sub 230kV line

Q320 TCP2 ISIS

WECC Generator Rotor Angle

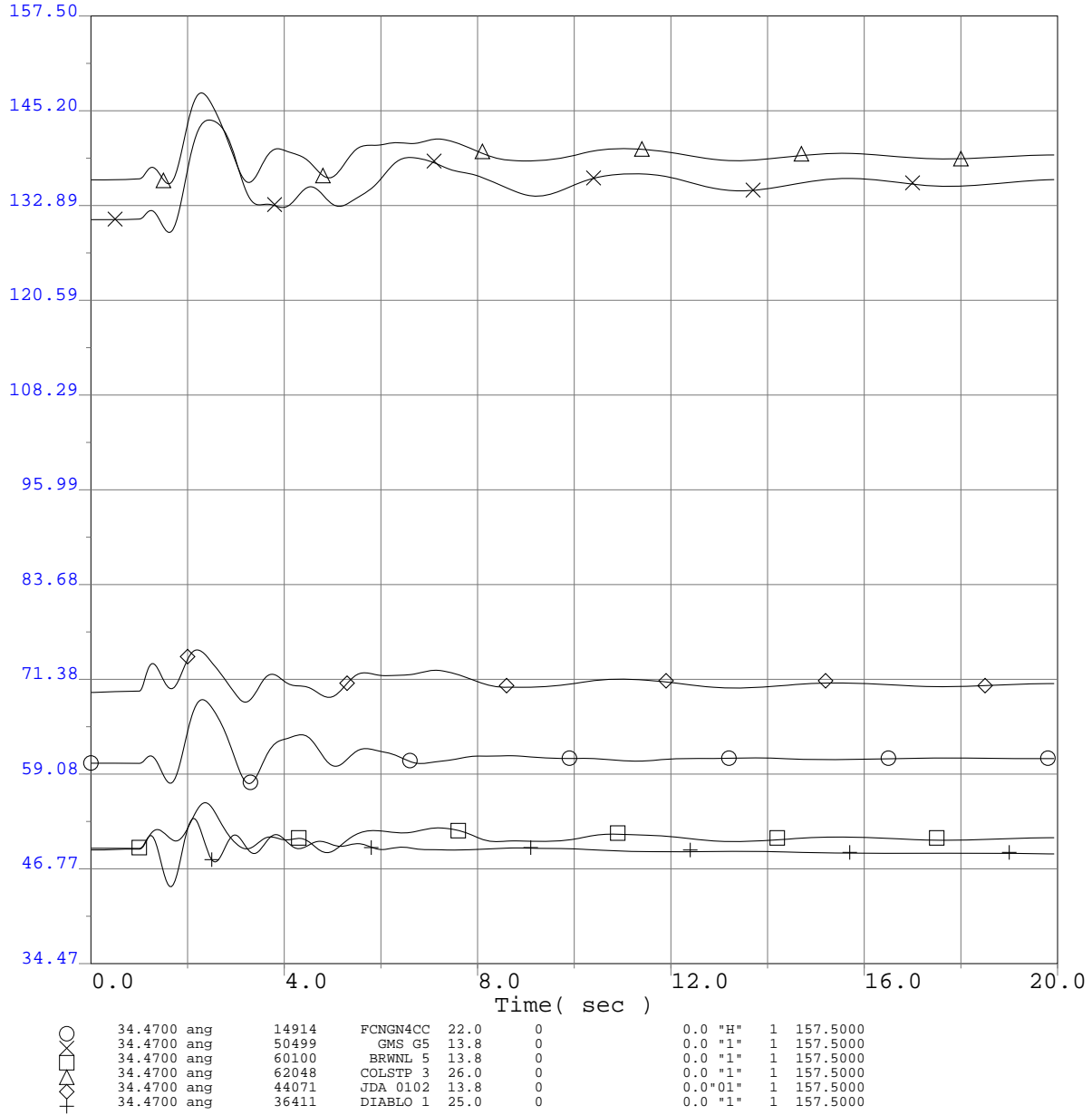

Q320 TCP2 ISIS
 2013 Greater Bay Area Summer Peak Base Case
 Q320 @ 772MW
 CCPP-CC Sub 230kV Line Outage
 3-ph 6 cyc flt @ the CCPP 230kV bus & clr the CCPP-CC Sub 230kV line

Q320 TCP2 ISIS

WECC Generator Rotor Angle

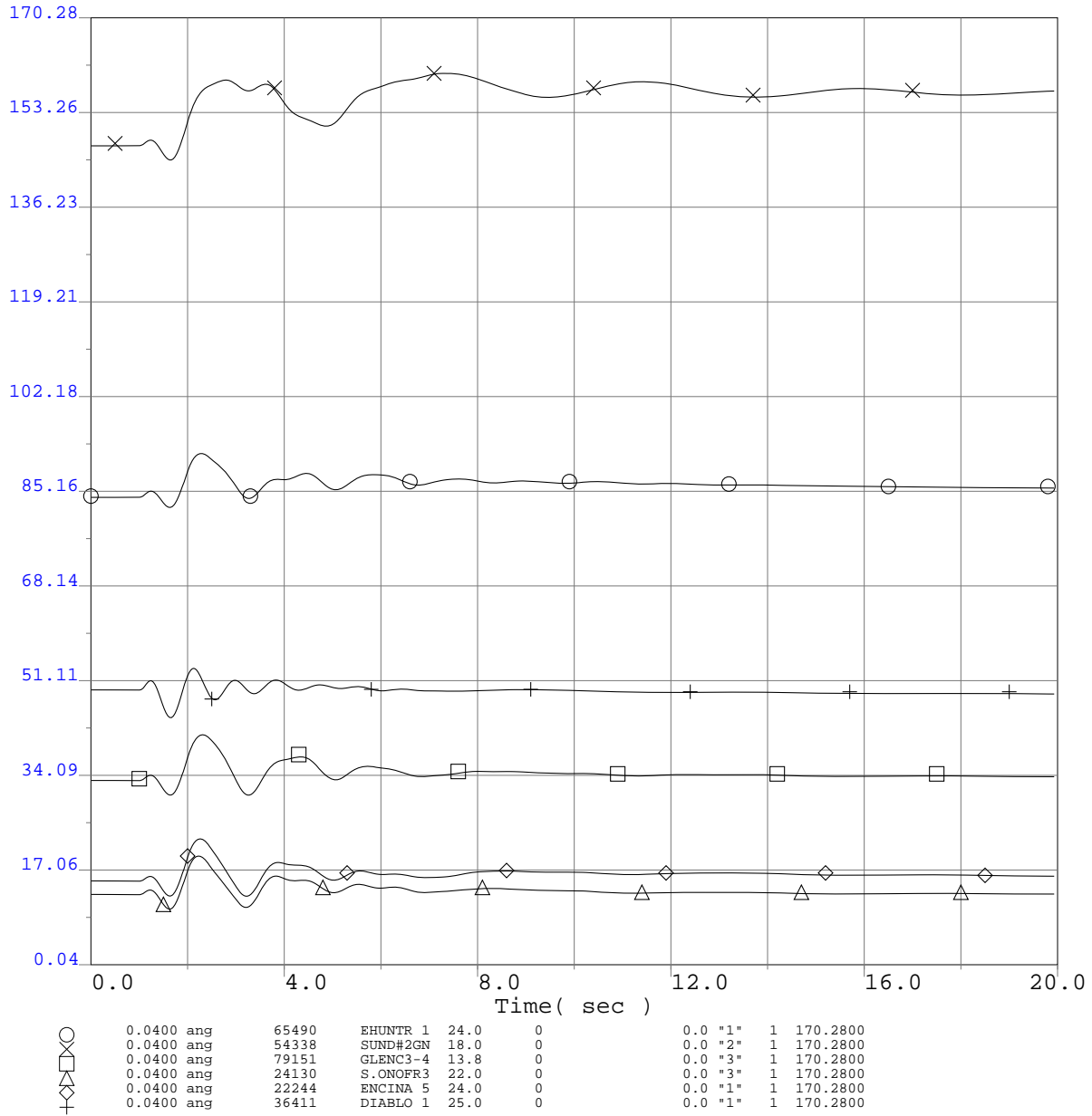

Q320 TCP2 ISIS
 2013 Greater Bay Area Summer Peak Base Case
 Q320 @ 772MW
 CCPP-CC Sub 230kV Line Outage
 3-ph 6 cyc flt @ the CCPP 230kV bus & clr the CCPP-CC Sub 230kV line

Q320 TCP2 ISIS

Selected PG&E Transmission Line Flows (MW)

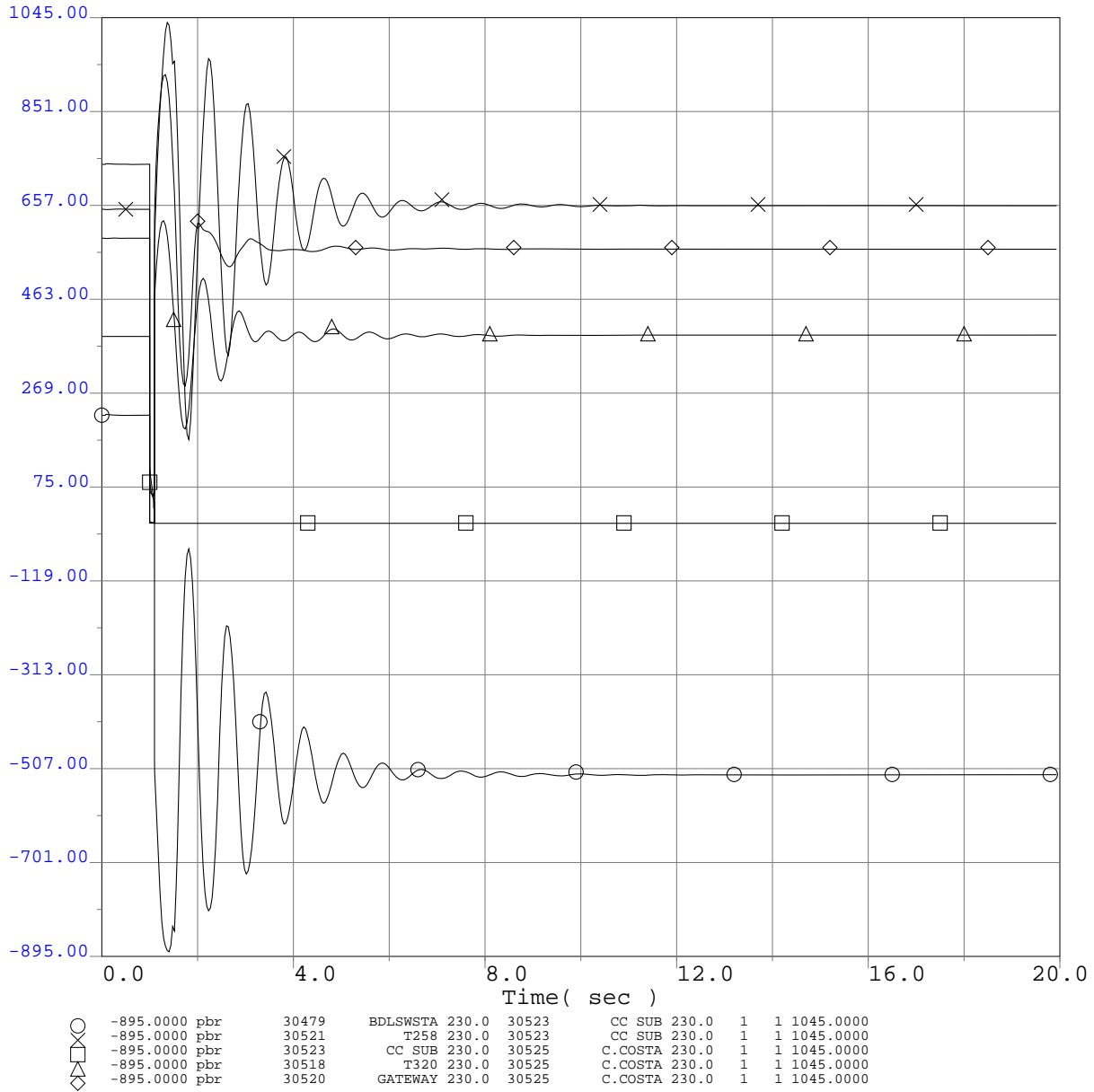

Q320 TCP2 ISIS
 2013 Greater Bay Area Summer Peak Base Case
 Q320 @ 772MW
 CCPP-CC Sub 230kV Line Outage
 3-ph 6 cyc flt @ the CCPP 230kV bus & clr the CCPP-CC Sub 230kV line

Q320 TCP2 ISIS

Selected PG&E Transmission Line Flows (MW)

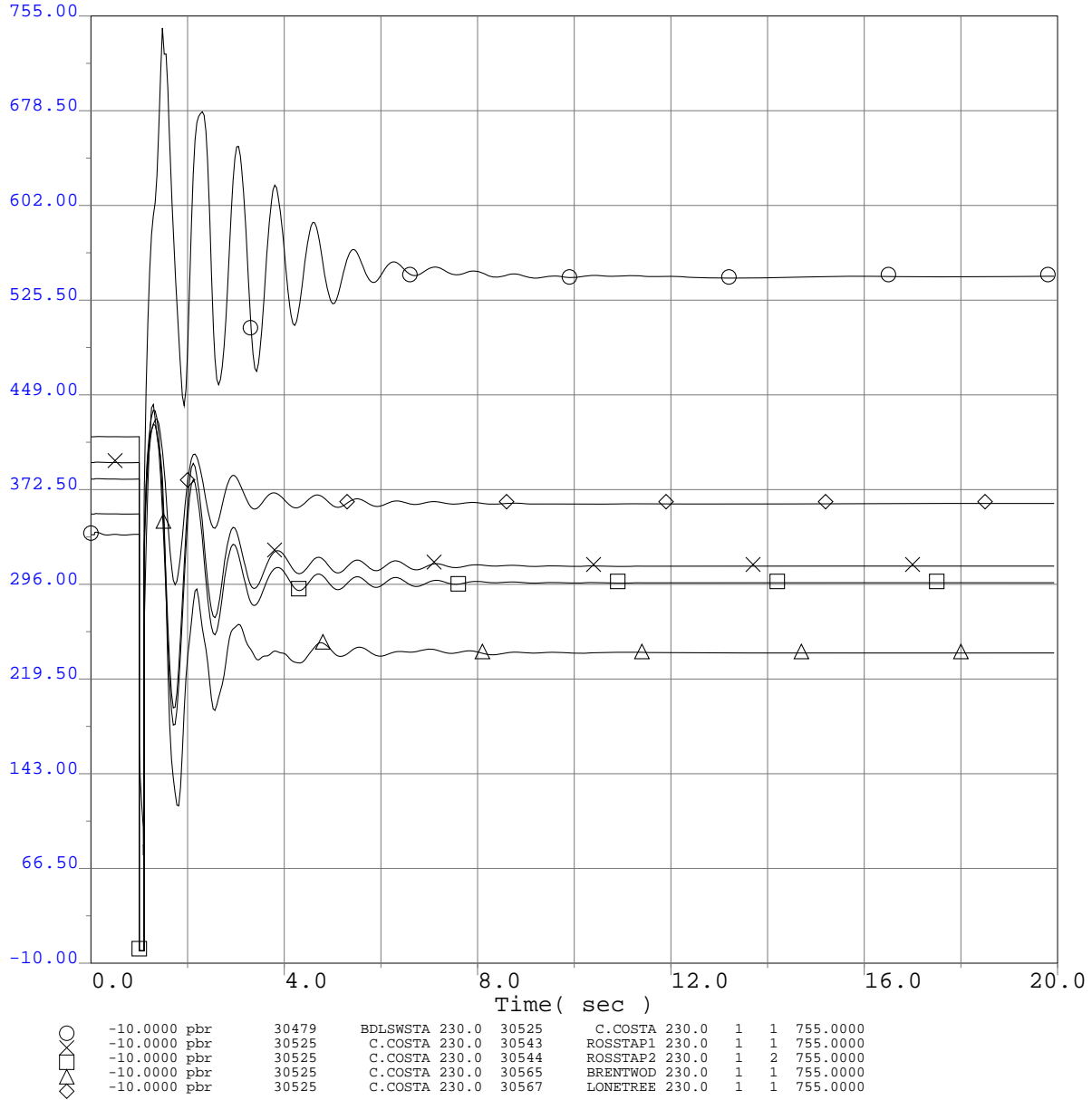

Q320 TCP2 ISIS
 2013 Greater Bay Area Summer Peak Base Case
 Q320 @ 772MW
 CCPP-CC Sub 230kV Line Outage
 3-ph 6 cyc flt @ the CCPP 230kV bus & clr the CCPP-CC Sub 230kV line

Q320 TCP2 ISIS

Selected PG&E Transmission Line Flows (MW)

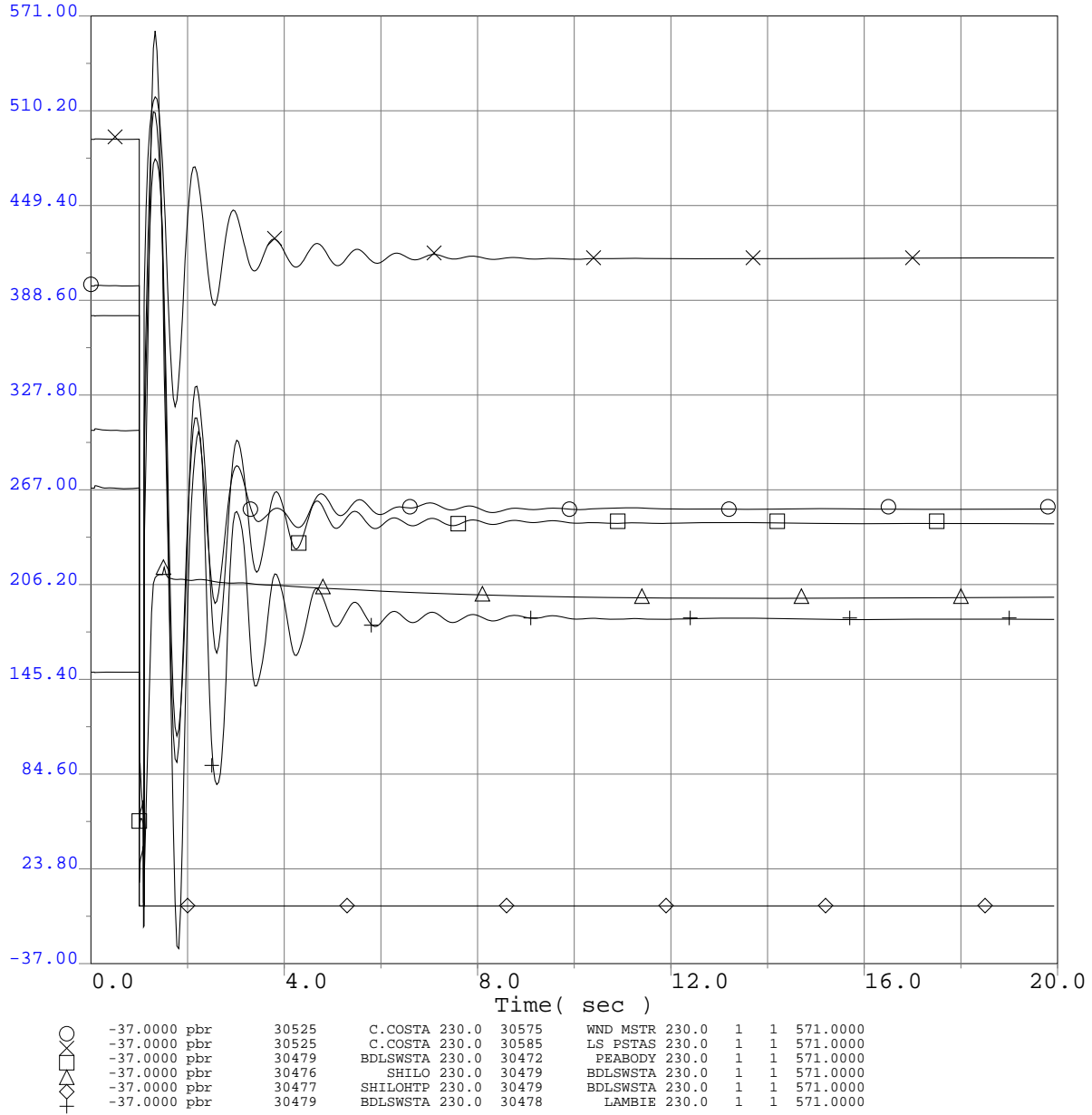

Q320 TCP2 ISIS
 2013 Greater Bay Area Summer Peak Base Case
 Q320 @ 772MW
 CCPP-CC Sub 230kV Line Outage
 3-ph 6 cyc flt @ the CCPP 230kV bus & clr the CCPP-CC Sub 230kV line

Q320 TCP2 ISIS

Selected PG&E Transmission Line Flows (MW)

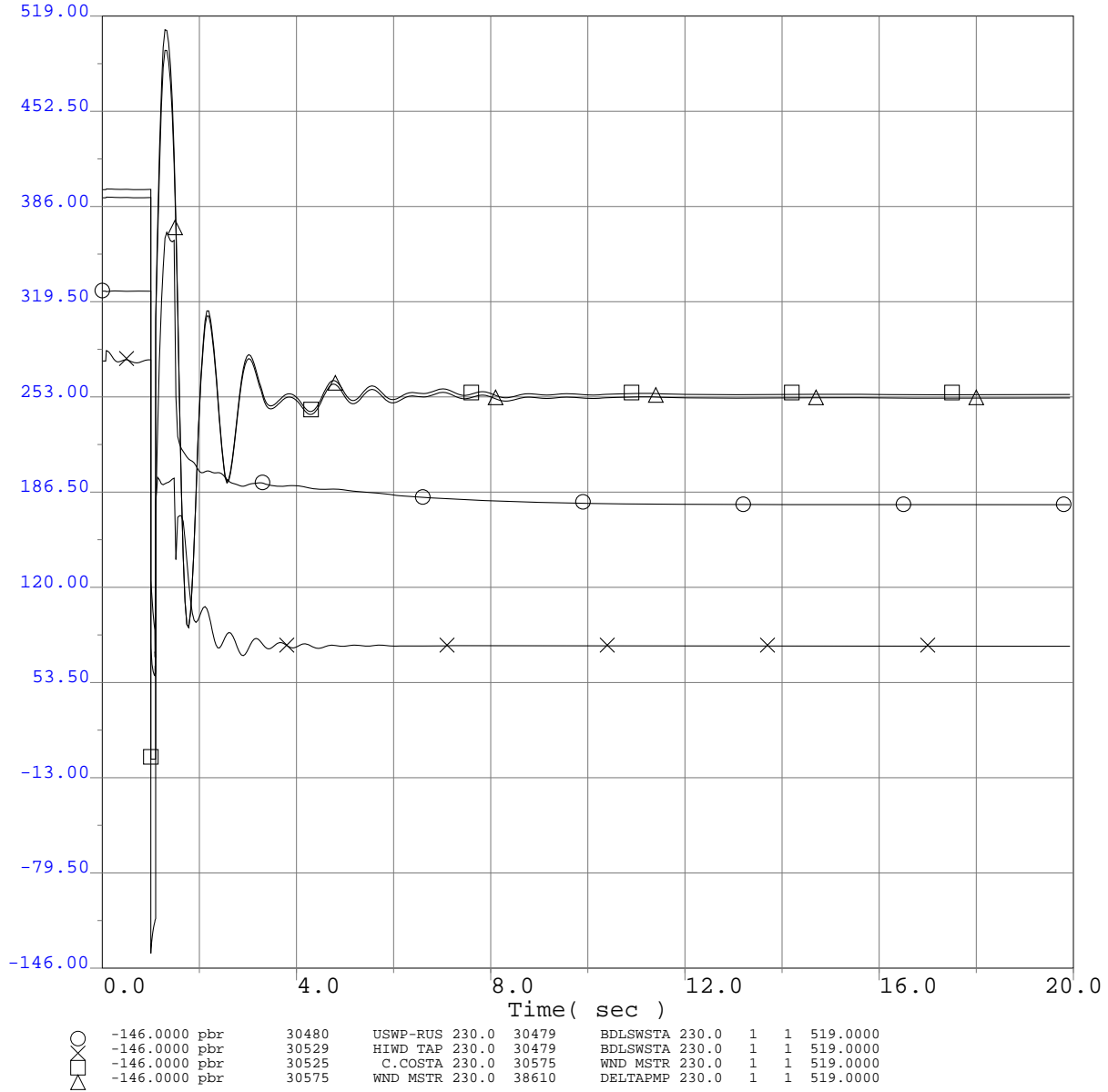

Q320 TCP2 ISIS
 2013 Greater Bay Area Summer Peak Base Case
 Q320 @ 772MW
 CCPP-CC Sub 230kV Line Outage
 3-ph 6 cyc flt @ the CCPP 230kV bus & clr the CCPP-CC Sub 230kV line

Q320 TCP2 ISIS

Selected PG&E Bus Voltage Plots Adjacent to Fault

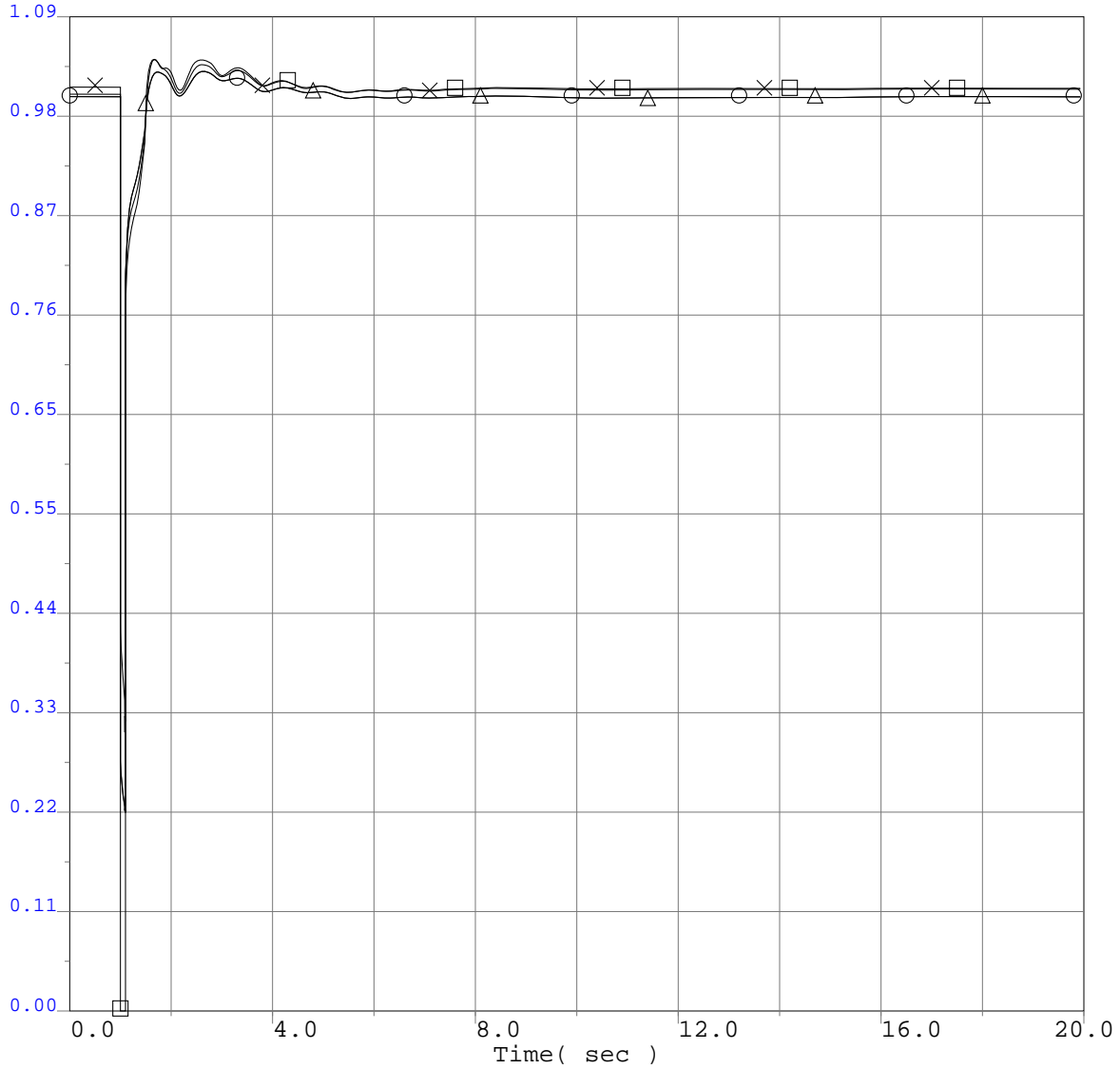

○	0.0000 vbus	30525	C.COSTA 230.0	0	0.0	***	1	1.0900
□	0.0000 vbus	30479	BDLSWSTA 230.0	0	0.0	***	1	1.0900
×	0.0000 vbul	30523	CC SUB 230.0	0	0.0	***	1	1.0900
△	0.0000 vbus	30518	T320 230.0	0	0.0	***	1	1.0900



Q320 TCP2 ISIS
 2013 Greater Bay Area Summer Peak Base Case
 Q320 @ 772MW
 CAPP-CC Sub 230kV Line Outage
 3-ph 6 cyc flt @ the CC Sub 230kV bus & clr the CAPP-CC Sub 230kV line

Q320 TCP2 ISIS

Selected PG&E Bus Frequency Plots Adjacent to Fault

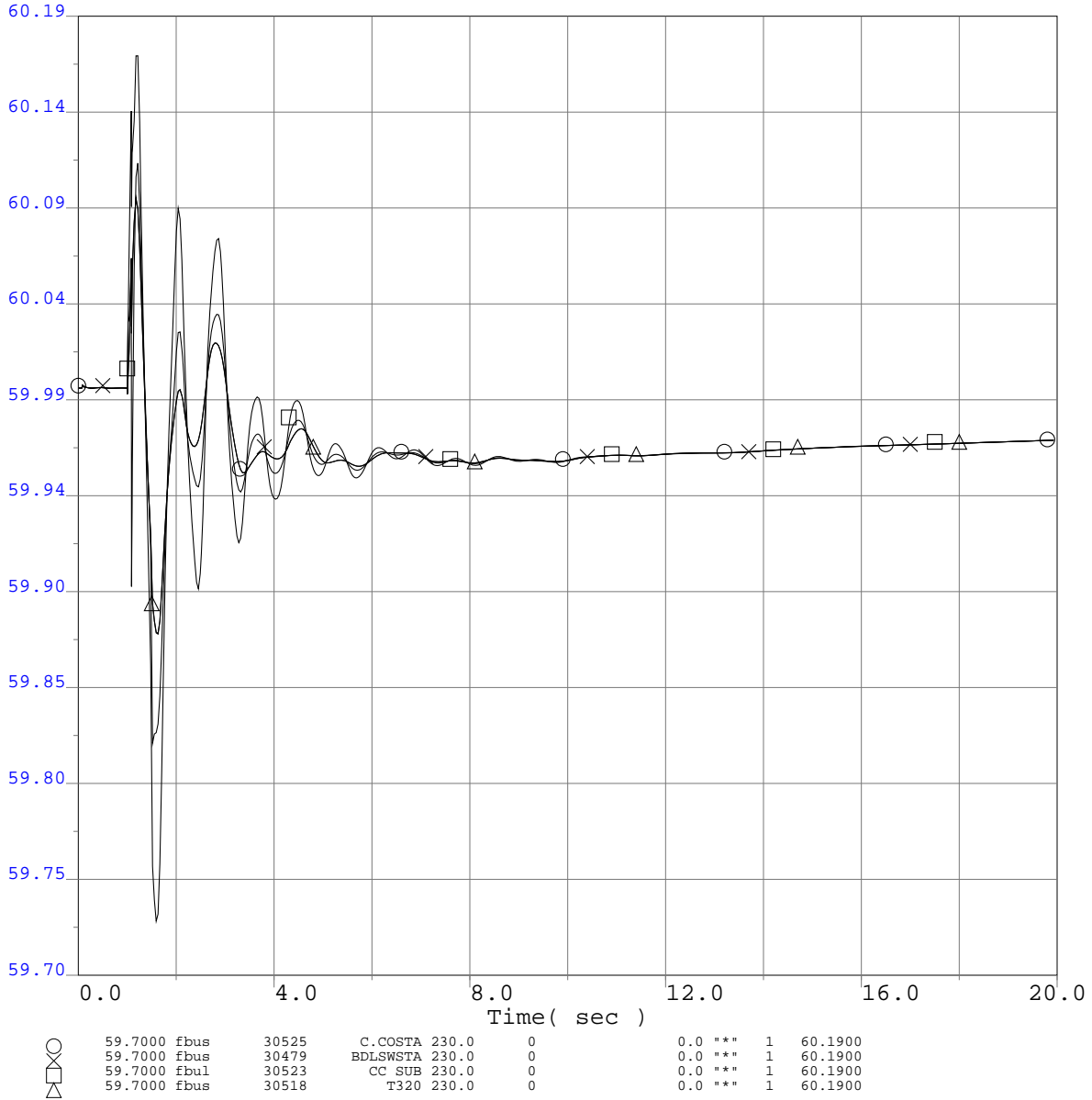

Q320 TCP2 ISIS
 2013 Greater Bay Area Summer Peak Base Case
 Q320 @ 772MW
 CAPP-CC Sub 230kV Line Outage
 3-ph 6 cyc flt @ the CC Sub 230kV bus & clr the CAPP-CC Sub 230kV line

Q320 TCP2 ISIS

Project Generator Terminal Voltages (P.U.)

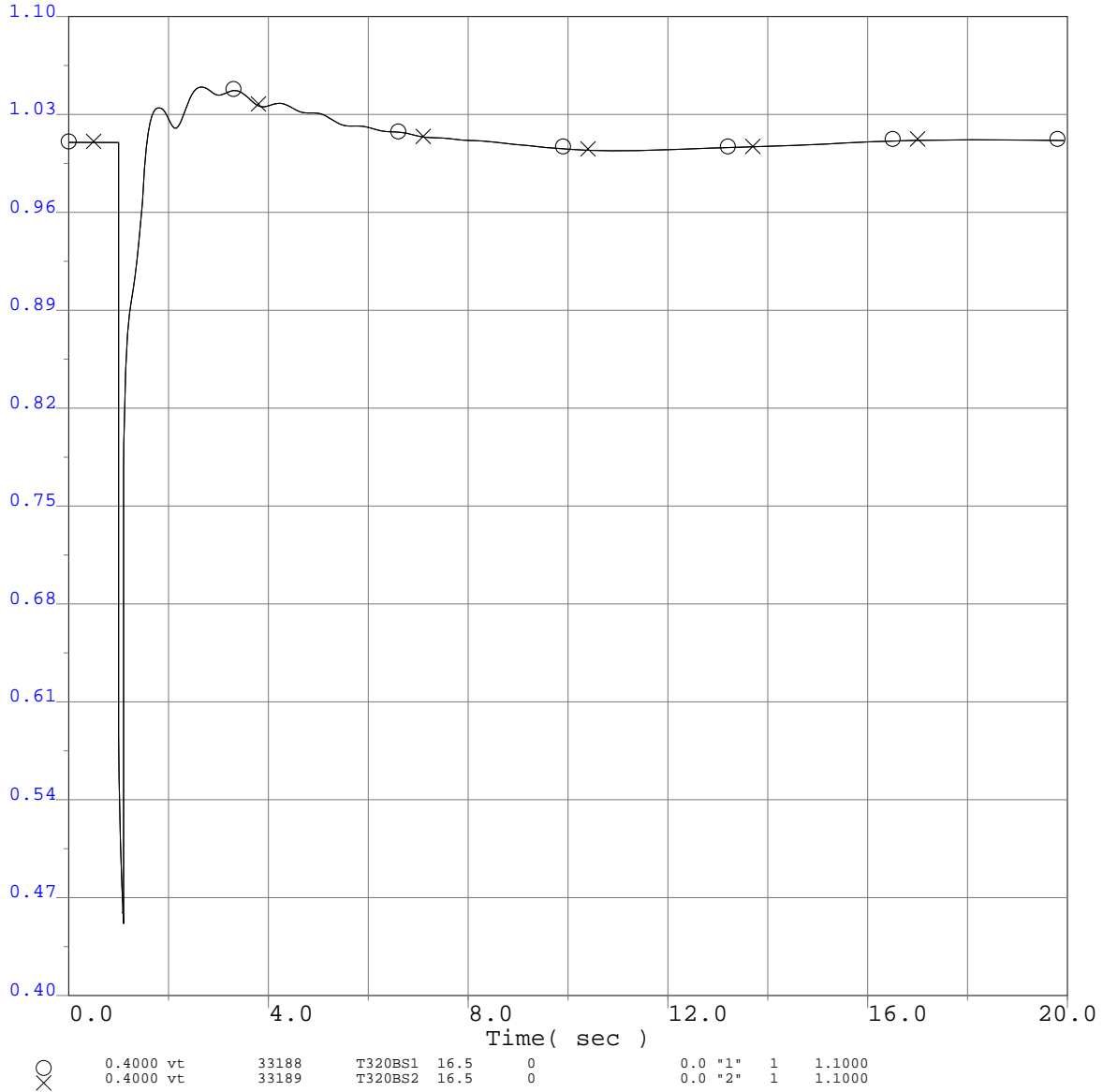

Q320 TCP2 ISIS
 2013 Greater Bay Area Summer Peak Base Case
 Q320 @ 772MW
 CCPP-CC Sub 230kV Line Outage
 3-ph 6 cyc flt @ the CC Sub 230kV bus & clr the CCPP-CC Sub 230kV line

Q320 TCP2 ISIS

Project Generator Terminal Voltages (P.U.)

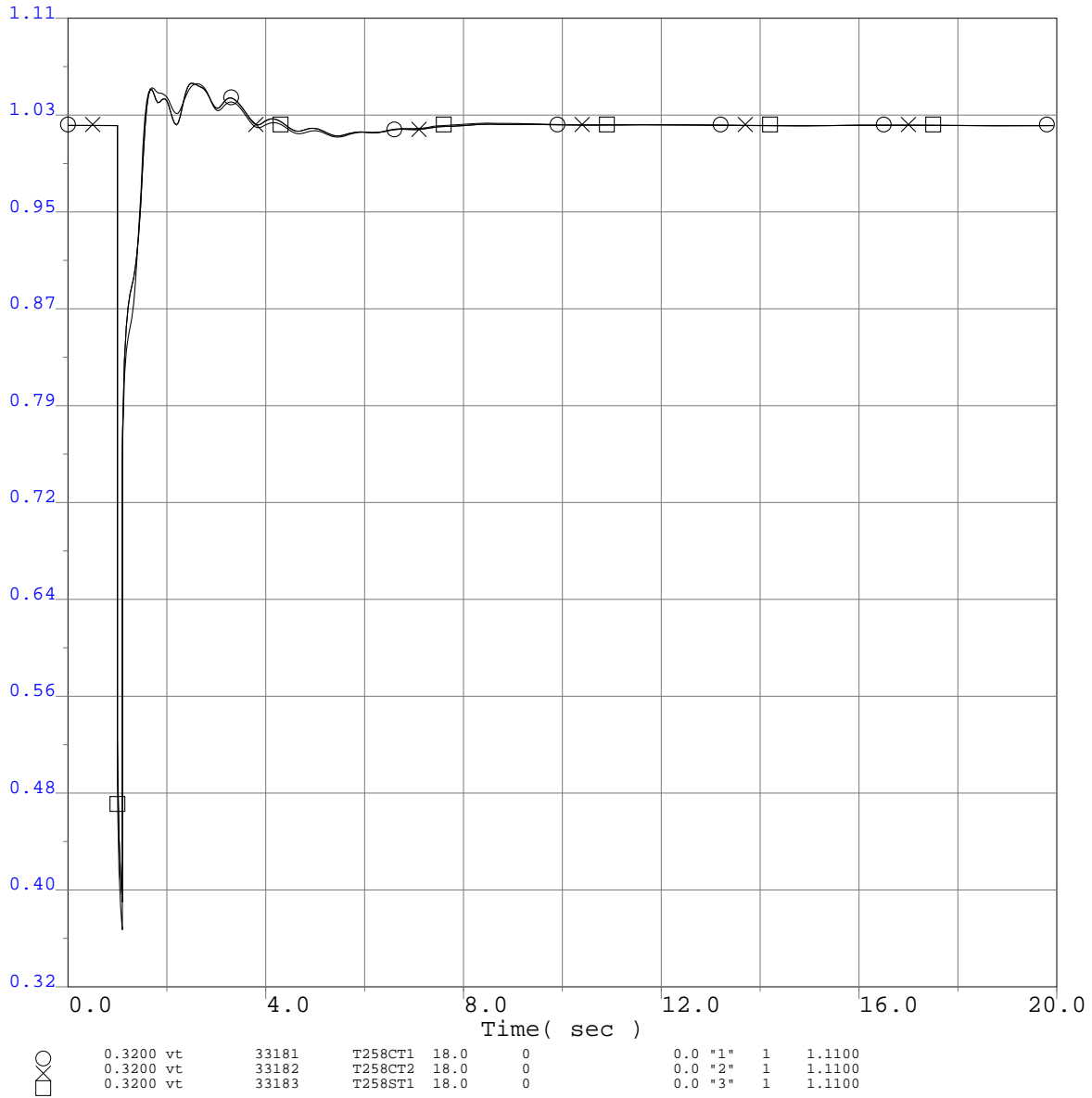

Q320 TCP2 ISIS
 2013 Greater Bay Area Summer Peak Base Case
 Q320 @ 772MW
 CCPP-CC Sub 230kV Line Outage
 3-ph 6 cyc flt @ the CC Sub 230kV bus & clr the CCPP-CC Sub 230kV line

Q320 TCP2 ISIS

Project Generator Speed (P.U.)

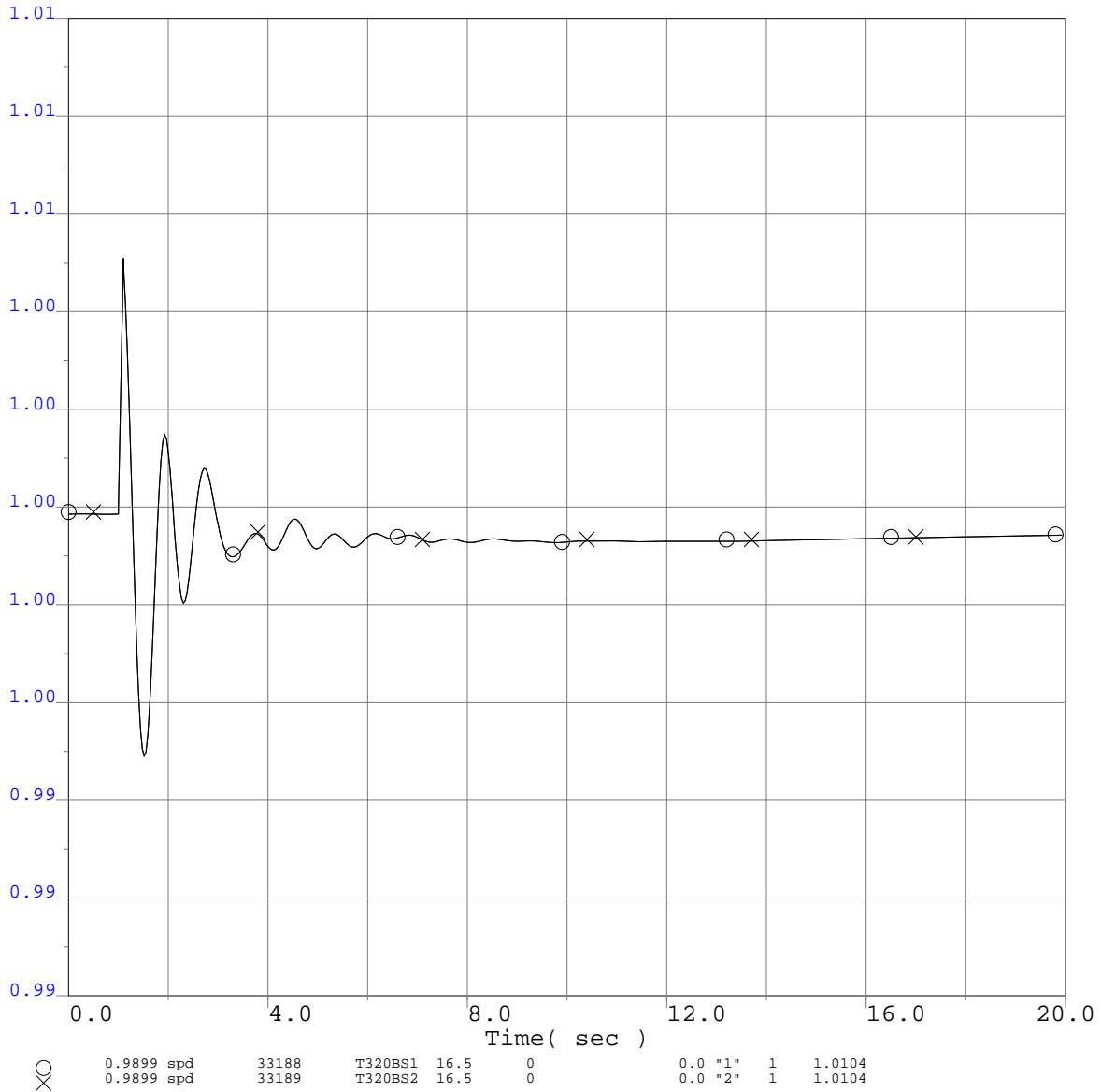

Q320 TCP2 ISIS
 2013 Greater Bay Area Summer Peak Base Case
 Q320 @ 772MW
 CCPP-CC Sub 230kV Line Outage
 3-ph 6 cyc flt @ the CC Sub 230kV bus & clr the CCPP-CC Sub 230kV line

Q320 TCP2 ISIS

Project Generator Speed (P.U.)

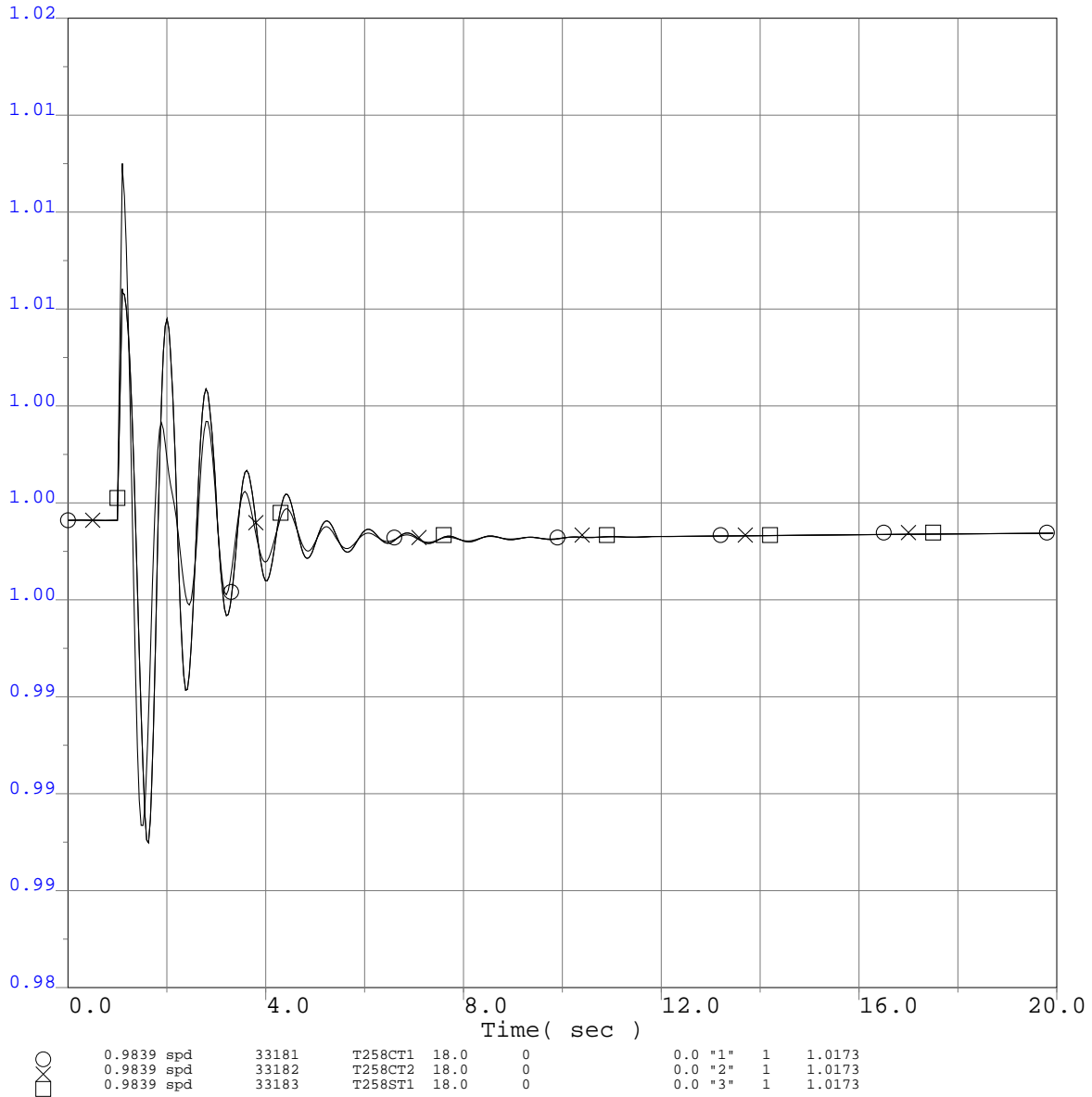

Q320 TCP2 ISIS
 2013 Greater Bay Area Summer Peak Base Case
 Q320 @ 772MW
 CCPP-CC Sub 230kV Line Outage
 3-ph 6 cyc flt @ the CC Sub 230kV bus & clr the CCPP-CC Sub 230kV line

Q320 TCP2 ISIS

Project Generator Terminal Power (MW)

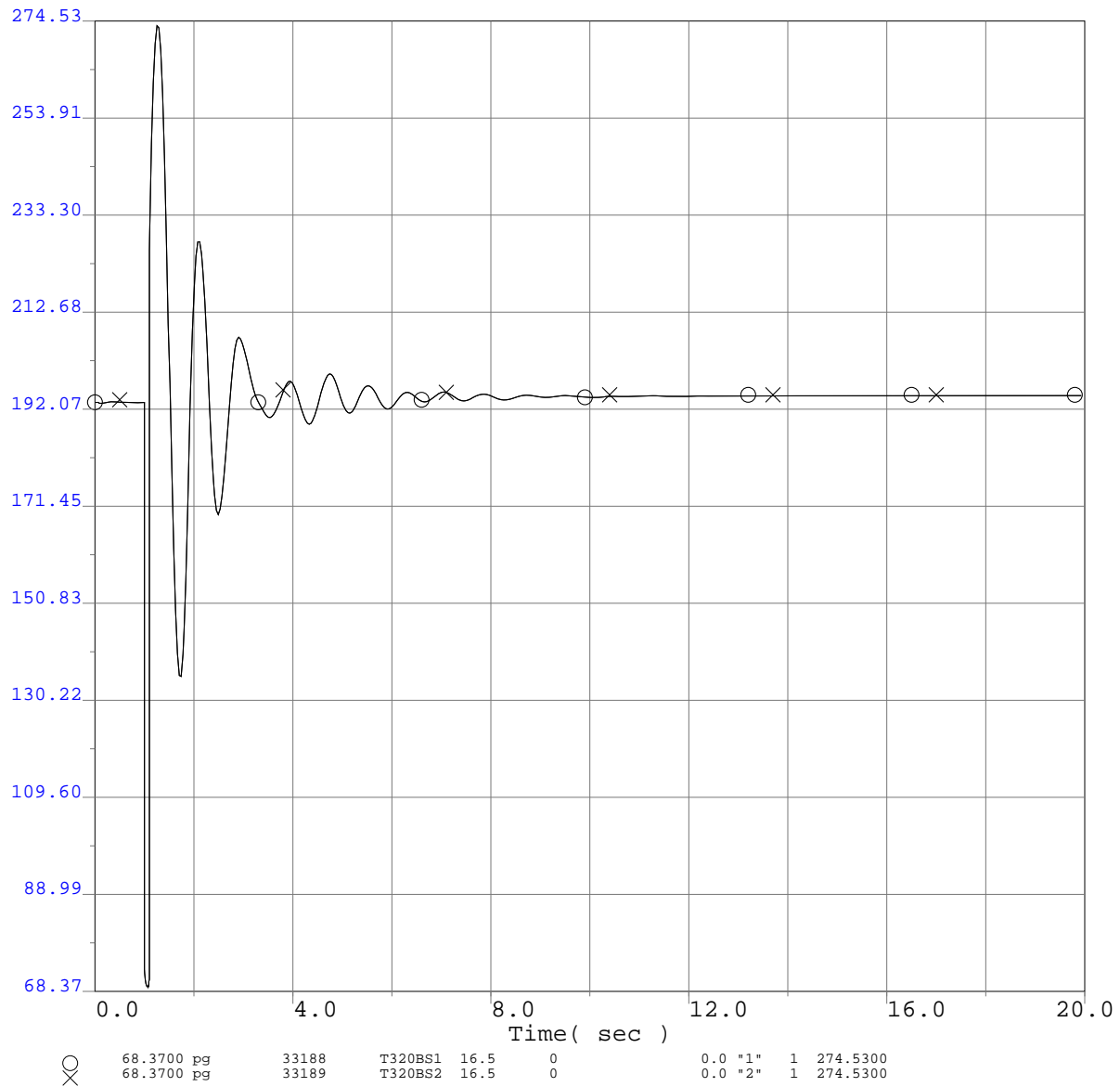

Q320 TCP2 ISIS
 2013 Greater Bay Area Summer Peak Base Case
 Q320 @ 772MW
 CCPP-CC Sub 230kV Line Outage
 3-ph 6 cyc flt @ the CC Sub 230kV bus & clr the CCPP-CC Sub 230kV line

Q320 TCP2 ISIS

Project Generator Terminal Power (MW)

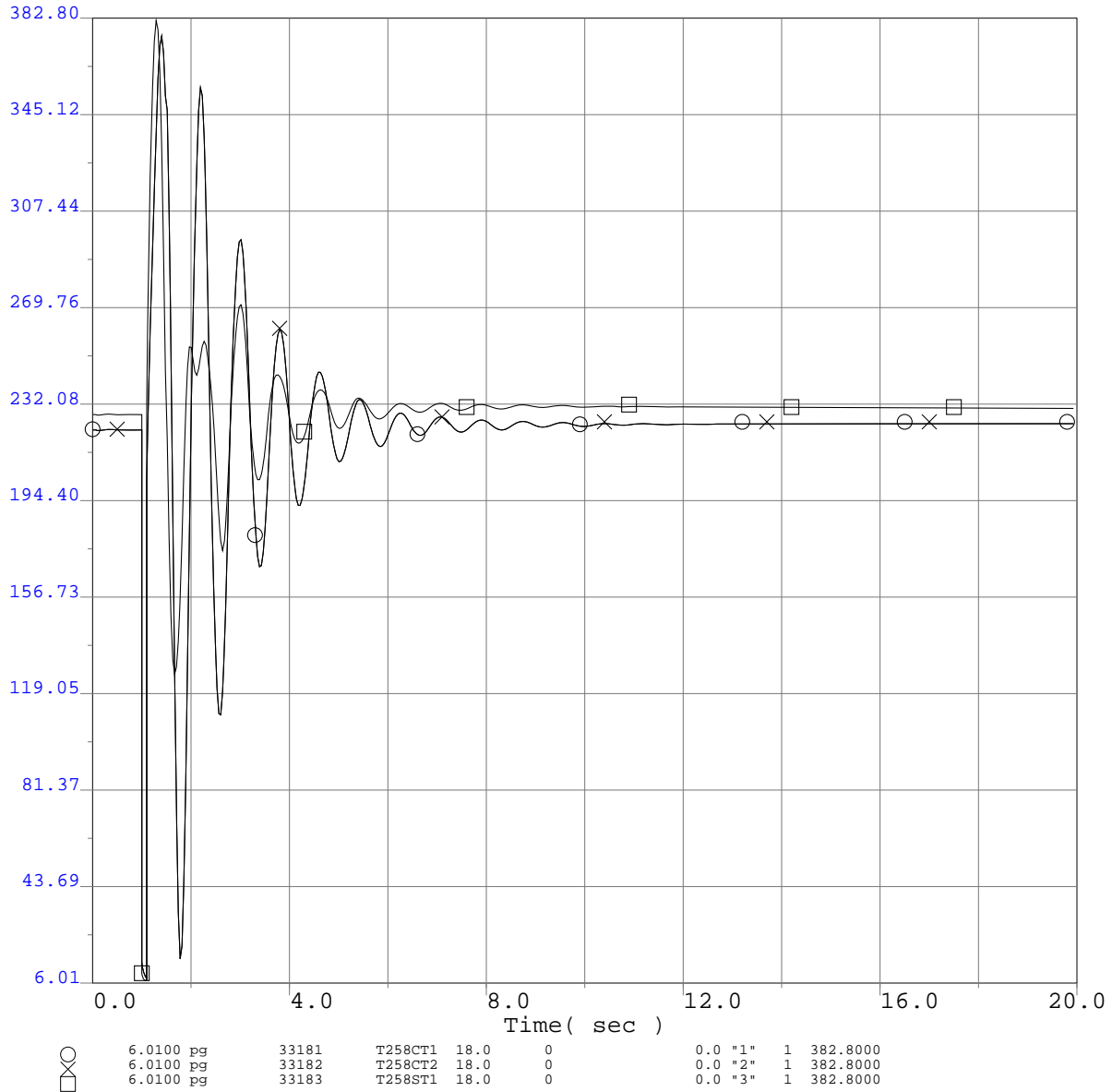

○	6.0100 pg	33181	T258CT1	18.0	0	0.0 "1"	1	382.8000
×	6.0100 pg	33182	T258CT2	18.0	0	0.0 "2"	1	382.8000
□	6.0100 pg	33183	T258ST1	18.0	0	0.0 "3"	1	382.8000

Q320 TCP2 ISIS
 2013 Greater Bay Area Summer Peak Base Case
 Q320 @ 772MW
 CCPP-CC Sub 230kV Line Outage
 3-ph 6 cyc flt @ the CC Sub 230kV bus & clr the CCPP-CC Sub 230kV line

Q320 TCP2 ISIS

Project Generator Terminal Reactive Power (MVA_r)

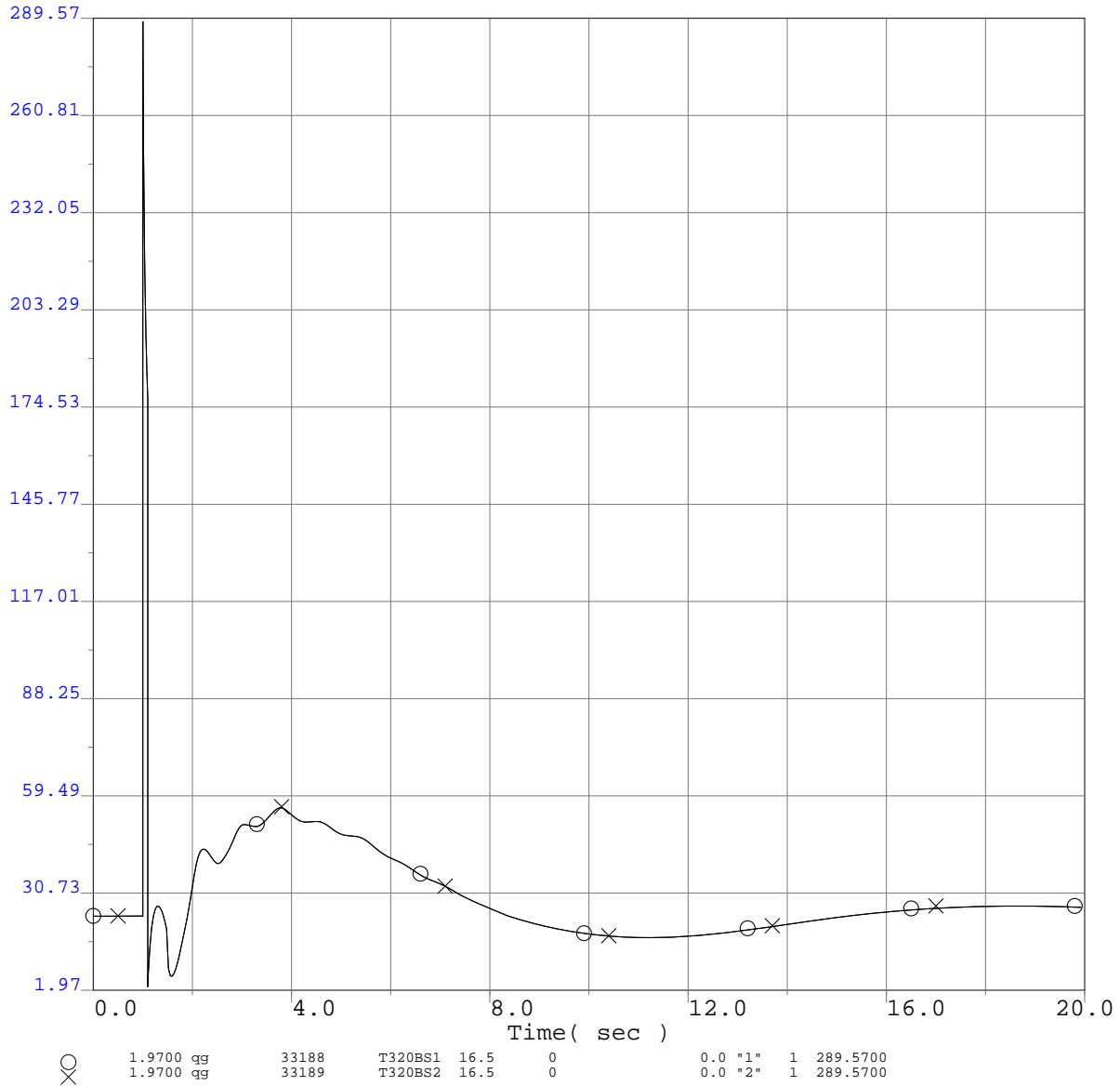

Q320 TCP2 ISIS
 2013 Greater Bay Area Summer Peak Base Case
 Q320 @ 772MW
 CCPP-CC Sub 230kV Line Outage
 3-ph 6 cyc flt @ the CC Sub 230kV bus & clr the CCPP-CC Sub 230kV line

Q320 TCP2 ISIS

Project Generator Terminal Reactive Power (MVar)

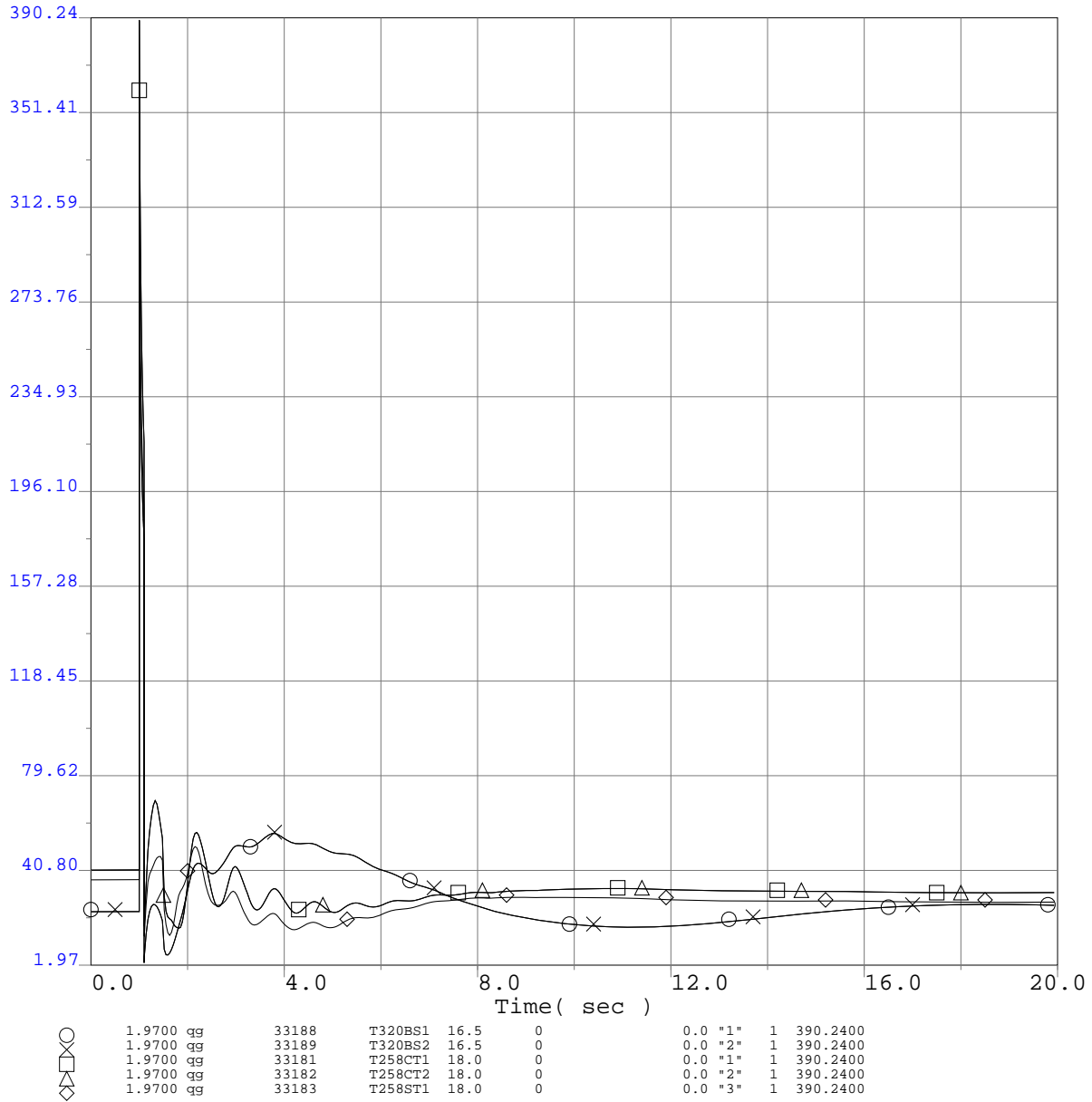

Q320 TCP2 ISIS
 2013 Greater Bay Area Summer Peak Base Case
 Q320 @ 772MW
 CCPP-CC Sub 230kV Line Outage
 3-ph 6 cyc flt @ the CC Sub 230kV bus & clr the CCPP-CC Sub 230kV line

Q320 TCP2 ISIS

Selected WECC Bus Voltage Plots

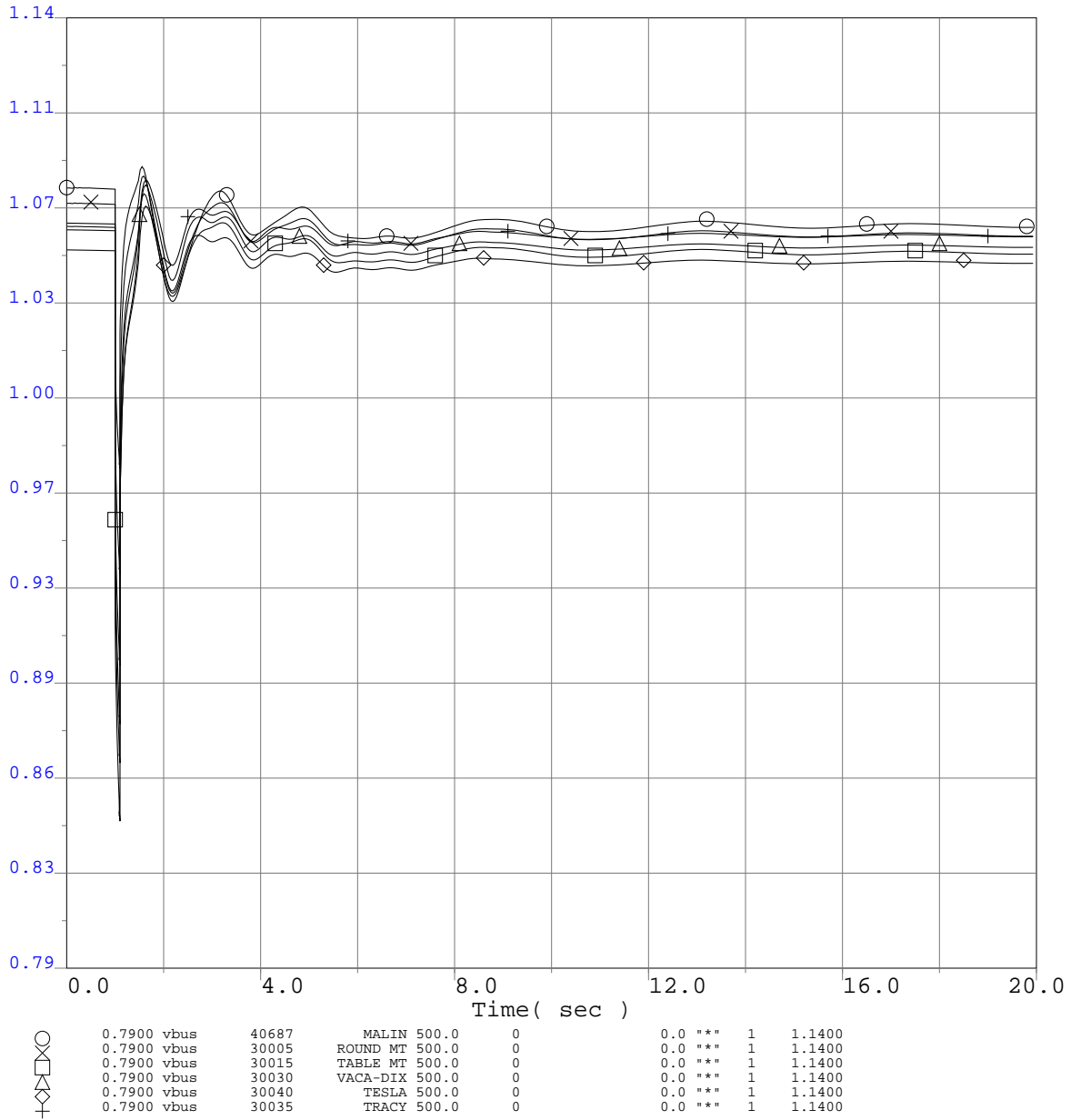

Q320 TCP2 ISIS
 2013 Greater Bay Area Summer Peak Base Case
 Q320 @ 772MW
 CCPP-CC Sub 230kV Line Outage
 3-ph 6 cyc flt @ the CC Sub 230kV bus & clr the CCPP-CC Sub 230kV line

Q320 TCP2 ISIS

Selected WECC Bus Voltage Plots

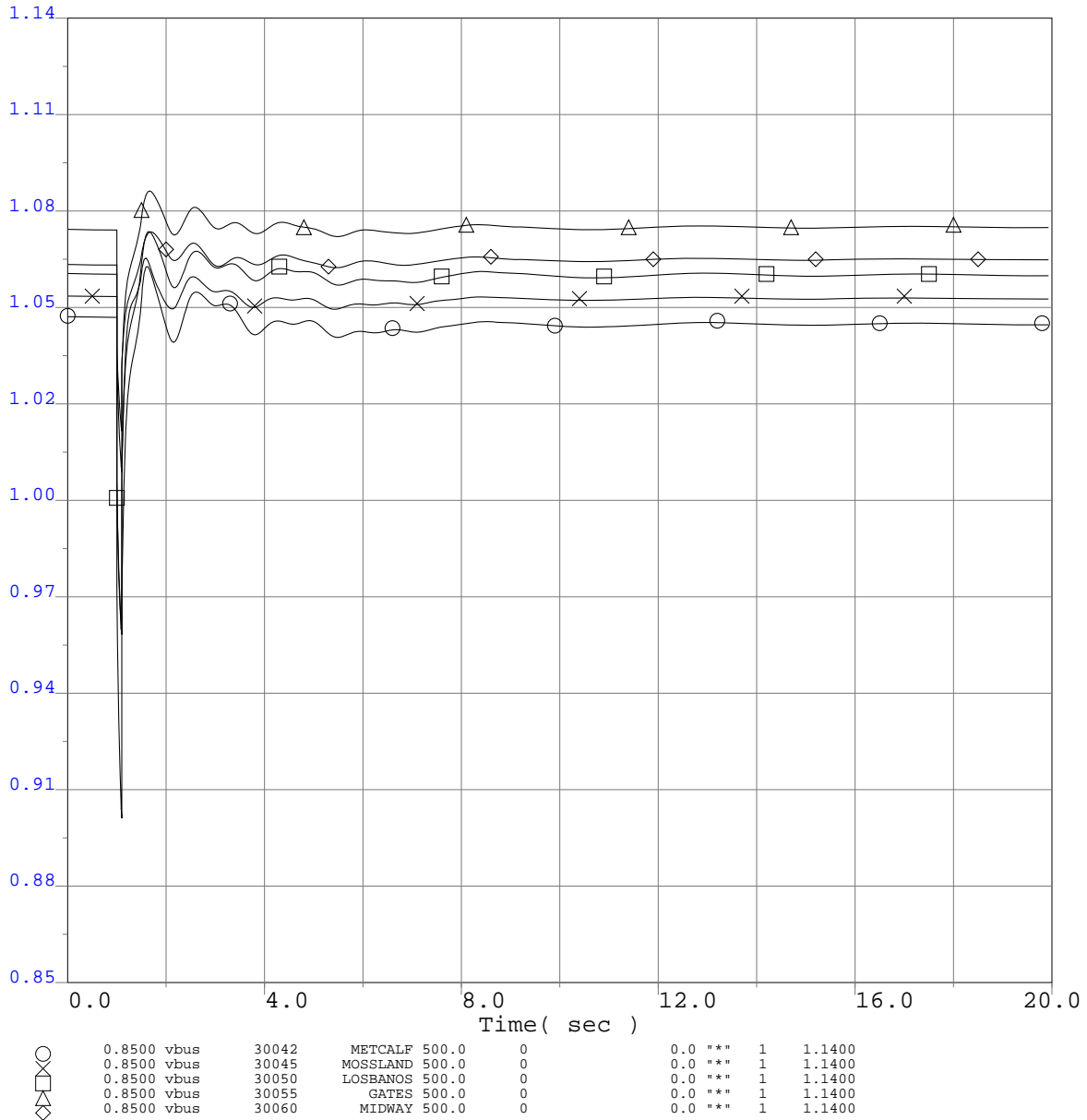

Q320 TCP2 ISIS
 2013 Greater Bay Area Summer Peak Base Case
 Q320 @ 772MW
 CAPP-CC Sub 230kV Line Outage
 3-ph 6 cyc flt @ the CC Sub 230kV bus & clr the CAPP-CC Sub 230kV line

Q320 TCP2 ISIS

Selected WECC Bus Voltage Plots

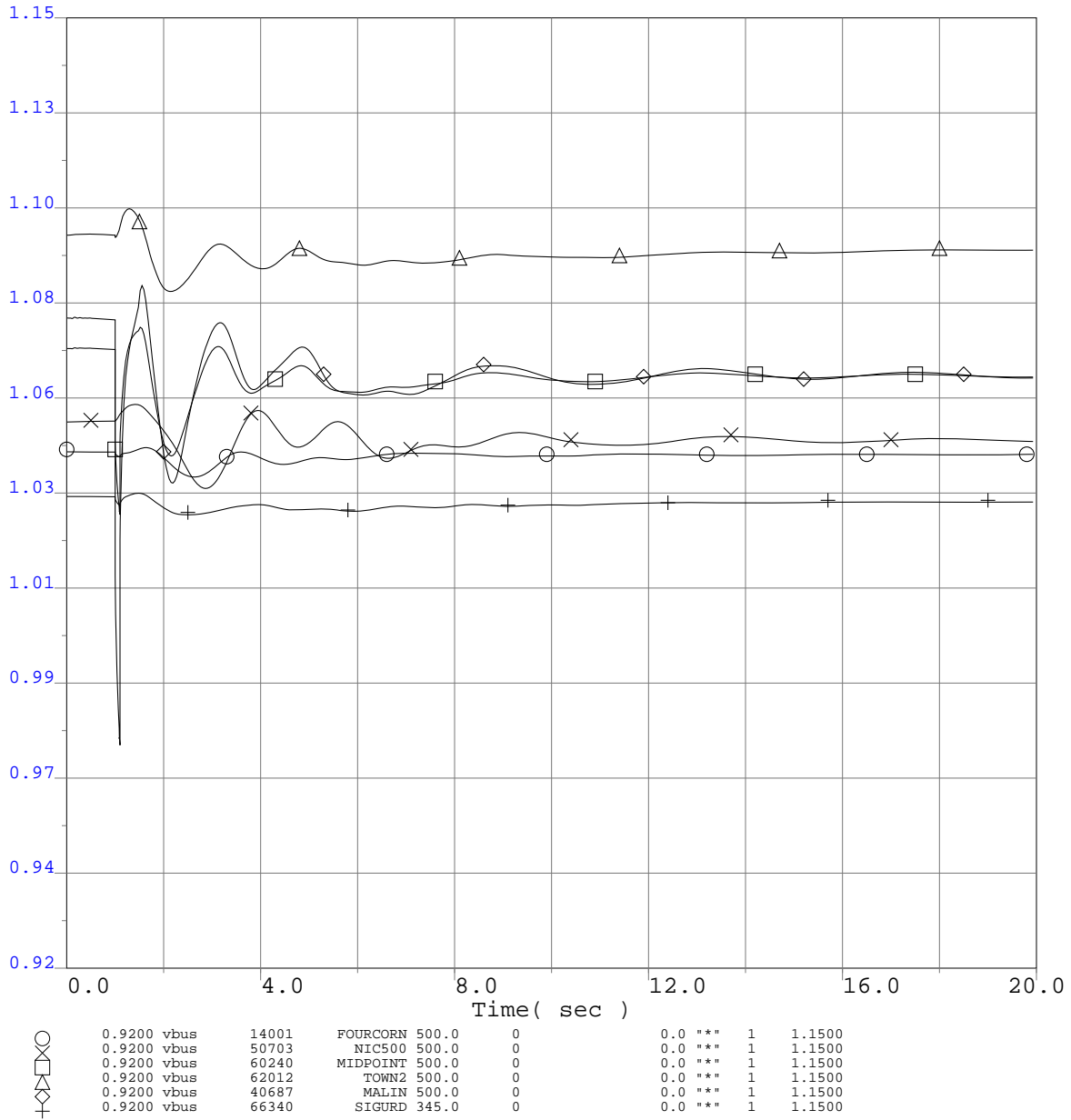

Q320 TCP2 ISIS
 2013 Greater Bay Area Summer Peak Base Case
 Q320 @ 772MW
 CAPP-CC Sub 230kV Line Outage
 3-ph 6 cyc flt @ the CC Sub 230kV bus & clr the CAPP-CC Sub 230kV line

Q320 TCP2 ISIS

Selected WECC Bus Voltage Plots

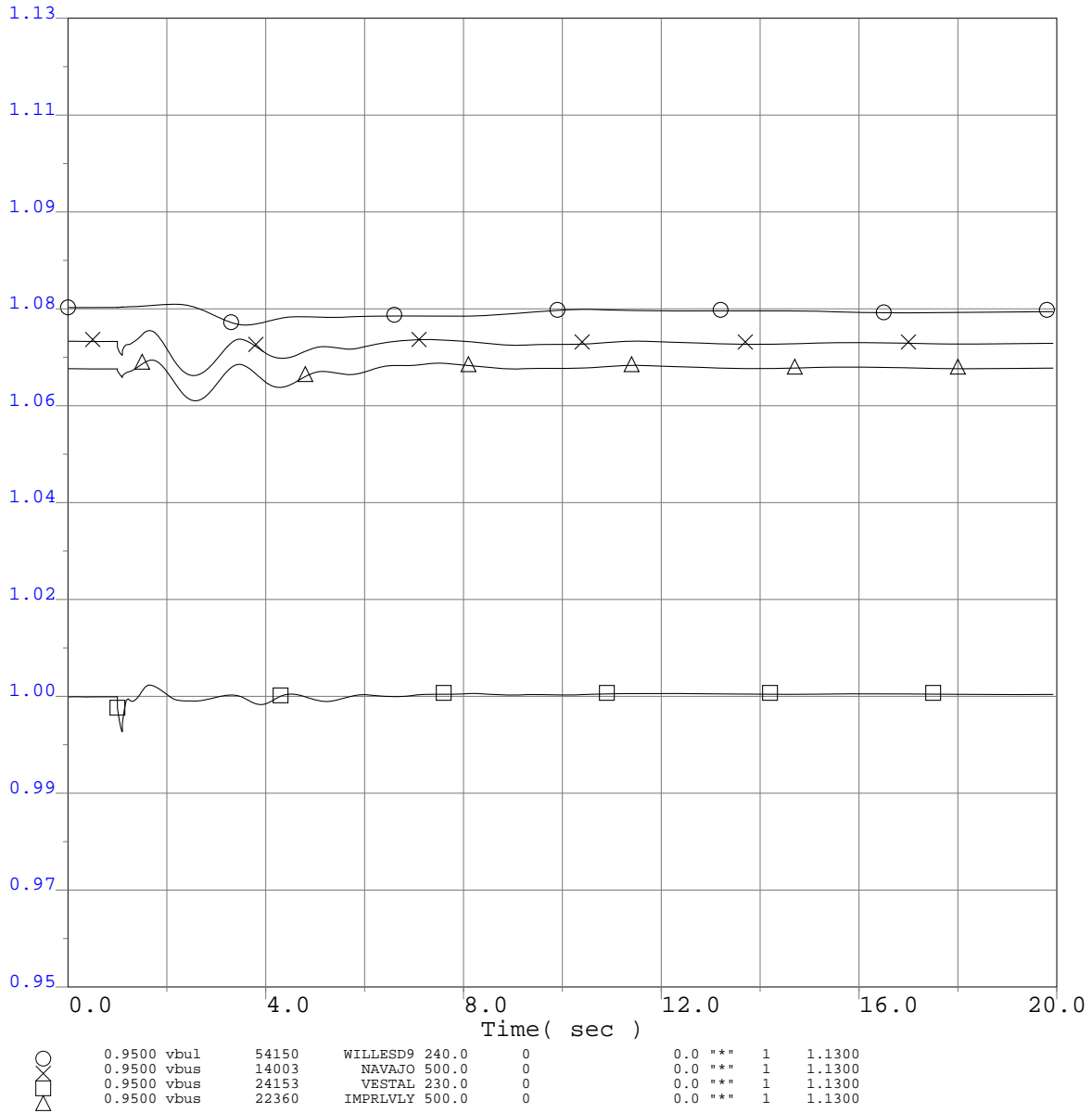

Q320 TCP2 ISIS
 2013 Greater Bay Area Summer Peak Base Case
 Q320 @ 772MW
 CCPP-CC Sub 230kV Line Outage
 3-ph 6 cyc flt @ the CC Sub 230kV bus & clr the CCPP-CC Sub 230kV line

Q320 TCP2 ISIS

Selected WECC Bus Frequency Plots

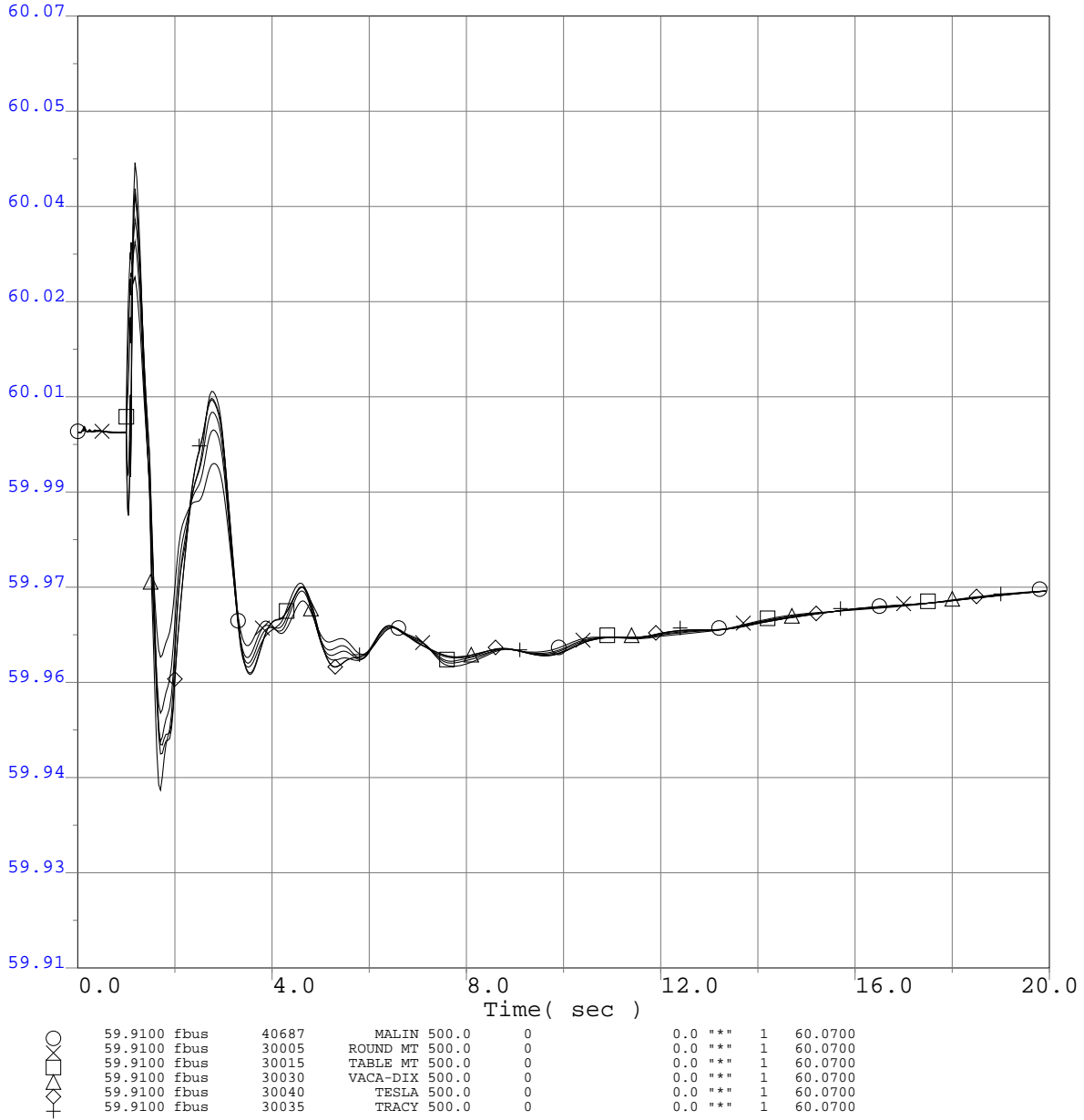

Q320 TCP2 ISIS
 2013 Greater Bay Area Summer Peak Base Case
 Q320 @ 772MW
 CAPP-CC Sub 230kV Line Outage
 3-ph 6 cyc flt @ the CC Sub 230kV bus & clr the CAPP-CC Sub 230kV line

Q320 TCP2 ISIS

Selected WECC Bus Frequency Plots

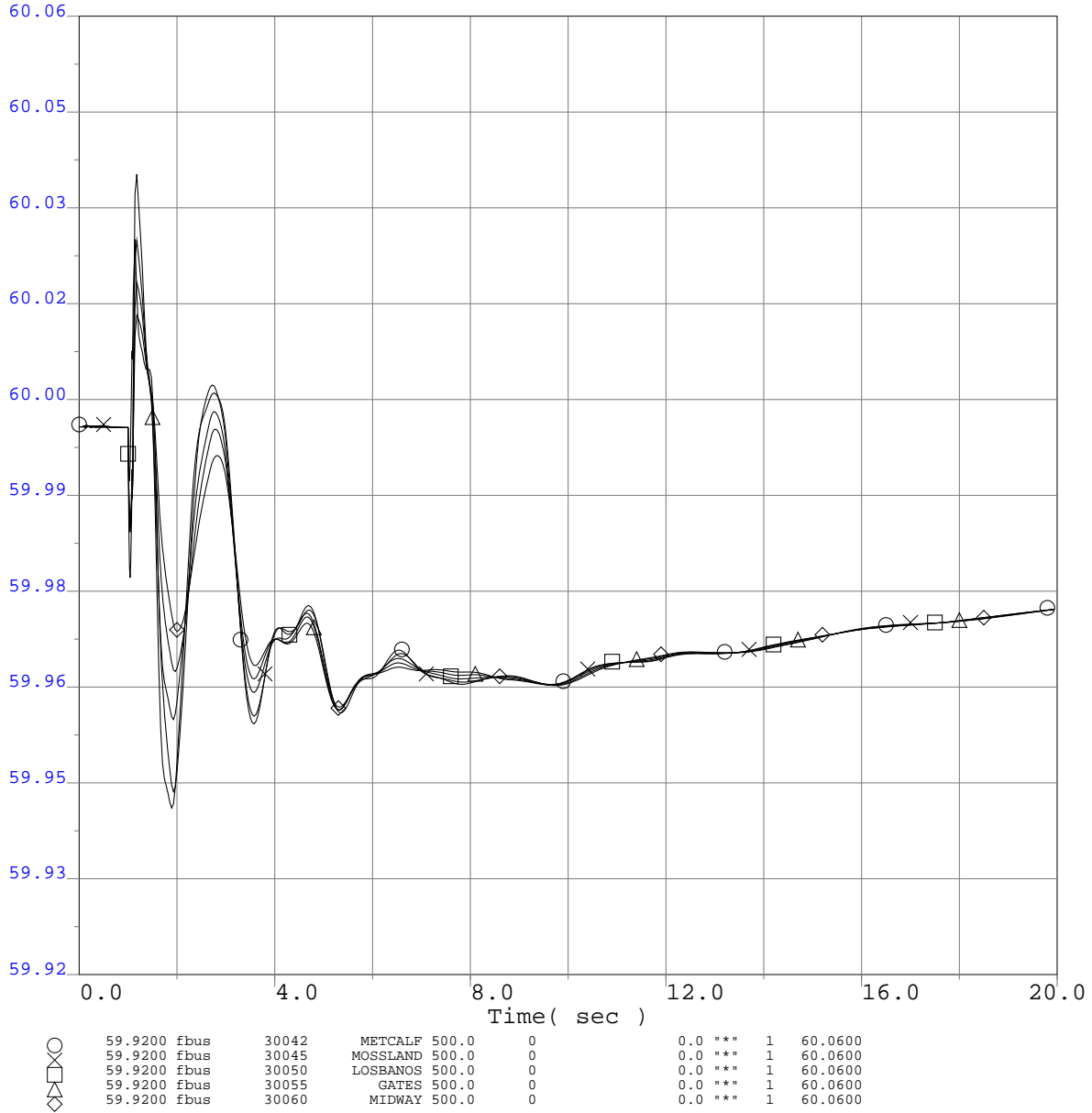

Q320 TCP2 ISIS
 2013 Greater Bay Area Summer Peak Base Case
 Q320 @ 772MW
 CAPP-CC Sub 230kV Line Outage
 3-ph 6 cyc flt @ the CC Sub 230kV bus & clr the CAPP-CC Sub 230kV line

Q320 TCP2 ISIS

Selected WECC Bus Frequency Plots

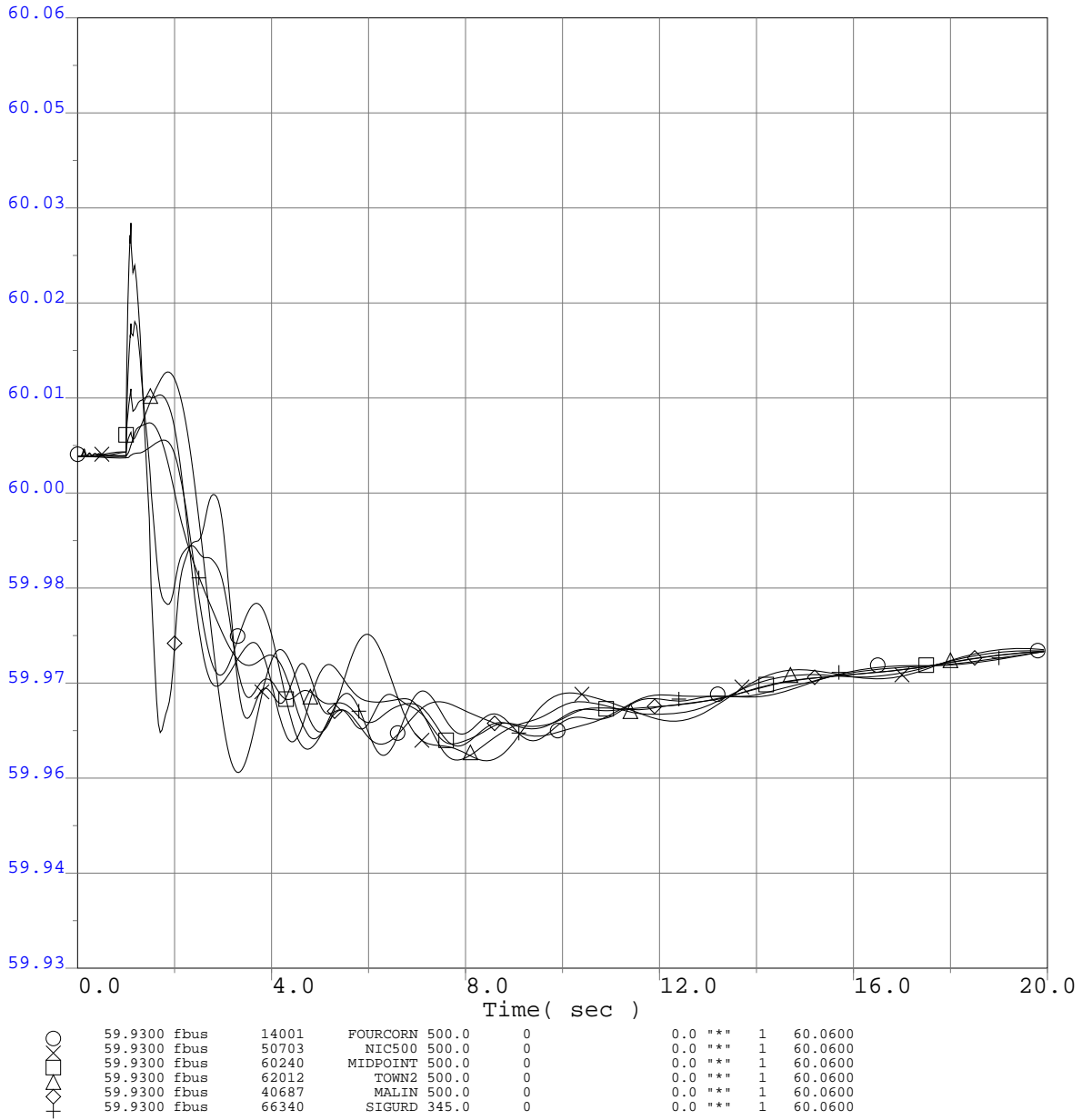

Q320 TCP2 ISIS
 2013 Greater Bay Area Summer Peak Base Case
 Q320 @ 772MW
 CCPP-CC Sub 230kV Line Outage
 3-ph 6 cyc flt @ the CC Sub 230kV bus & clr the CCPP-CC Sub 230kV line

Q320 TCP2 ISIS

Selected WECC Bus Frequency Plots

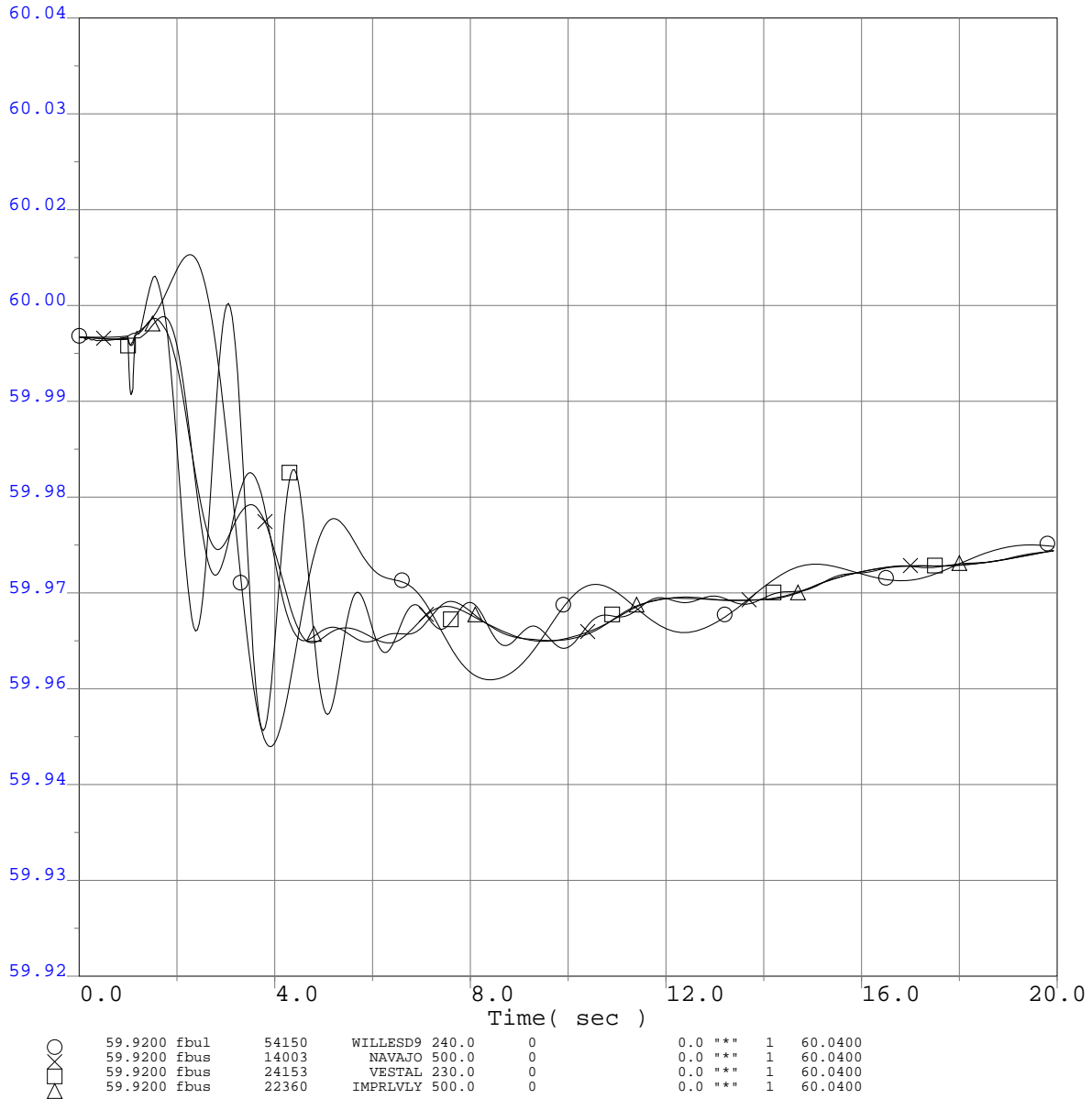

Q320 TCP2 ISIS
 2013 Greater Bay Area Summer Peak Base Case
 Q320 @ 772MW
 CCPP-CC Sub 230kV Line Outage
 3-ph 6 cyc flt @ the CC Sub 230kV bus & clr the CCPP-CC Sub 230kV line

Q320 TCP2 ISIS

WECC Generator Rotor Angle

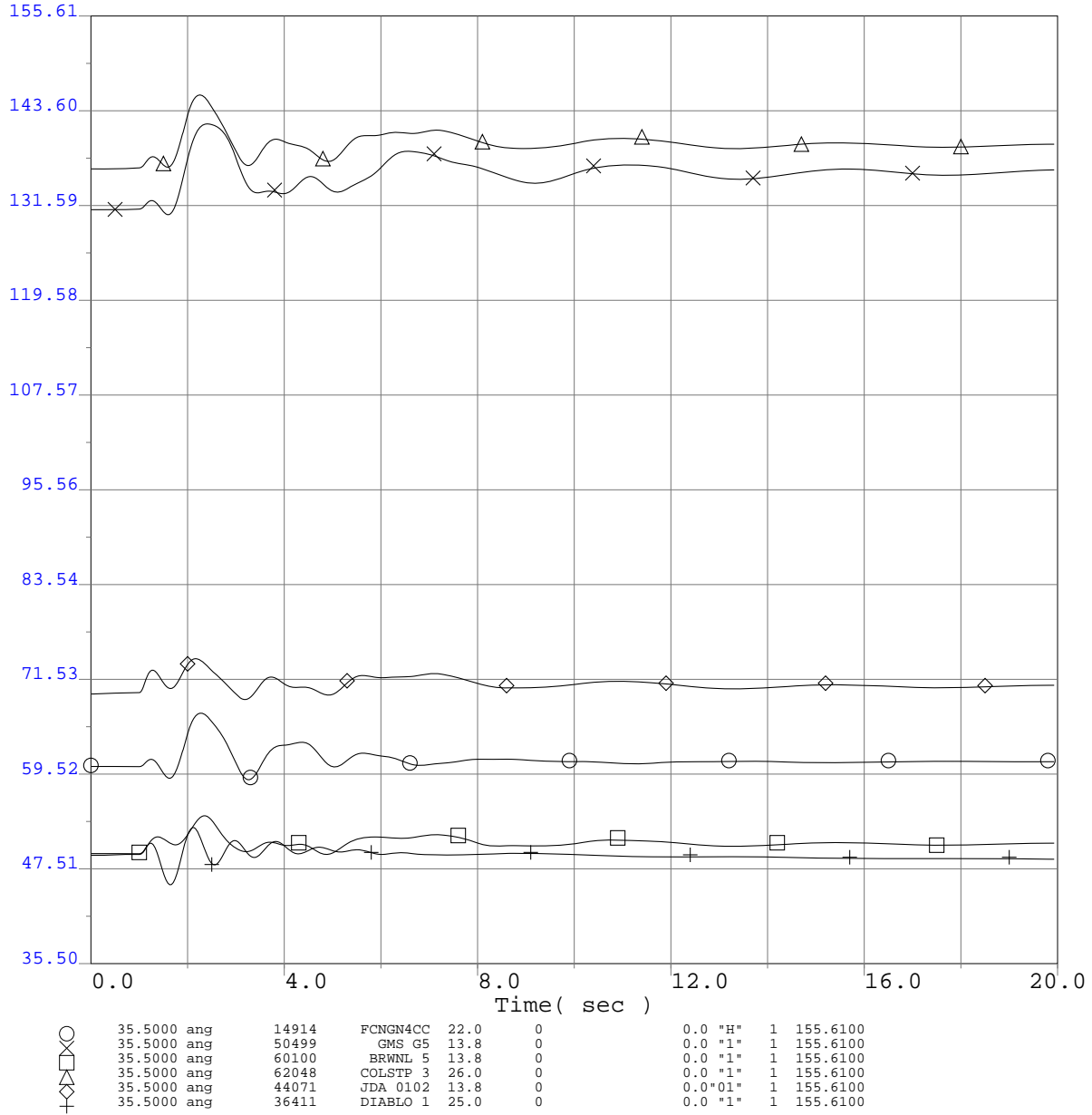

Q320 TCP2 ISIS
 2013 Greater Bay Area Summer Peak Base Case
 Q320 @ 772MW
 CCPP-CC Sub 230kV Line Outage
 3-ph 6 cyc flt @ the CC Sub 230kV bus & clr the CCPP-CC Sub 230kV line

Q320 TCP2 ISIS

WECC Generator Rotor Angle

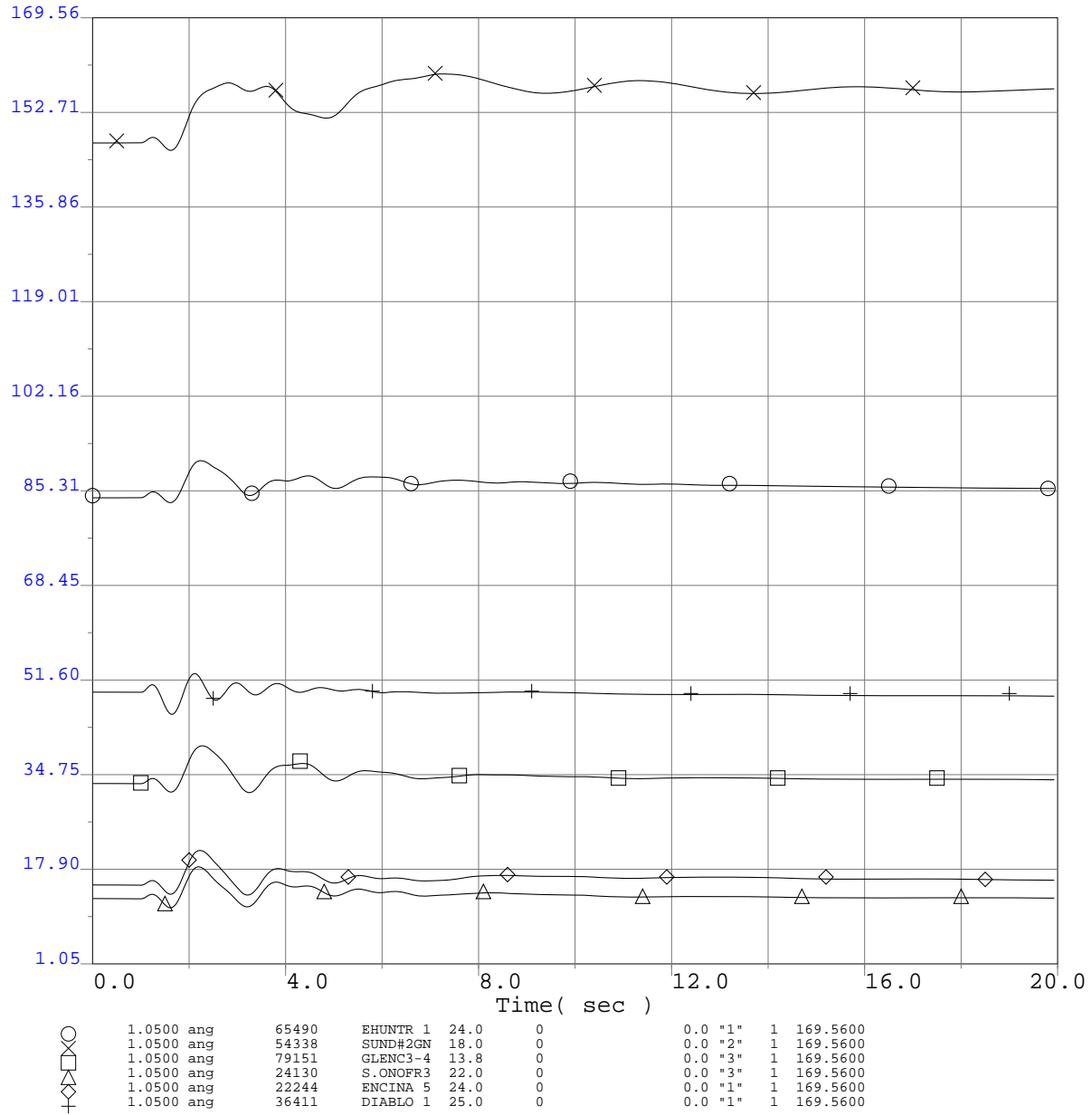

Q320 TCP2 ISIS
 2013 Greater Bay Area Summer Peak Base Case
 Q320 @ 772MW
 CCPP-CC Sub 230kV Line Outage
 3-ph 6 cyc flt @ the CC Sub 230kV bus & clr the CCPP-CC Sub 230kV line

Q320 TCP2 ISIS

Selected PG&E Transmission Line Flows (MW)

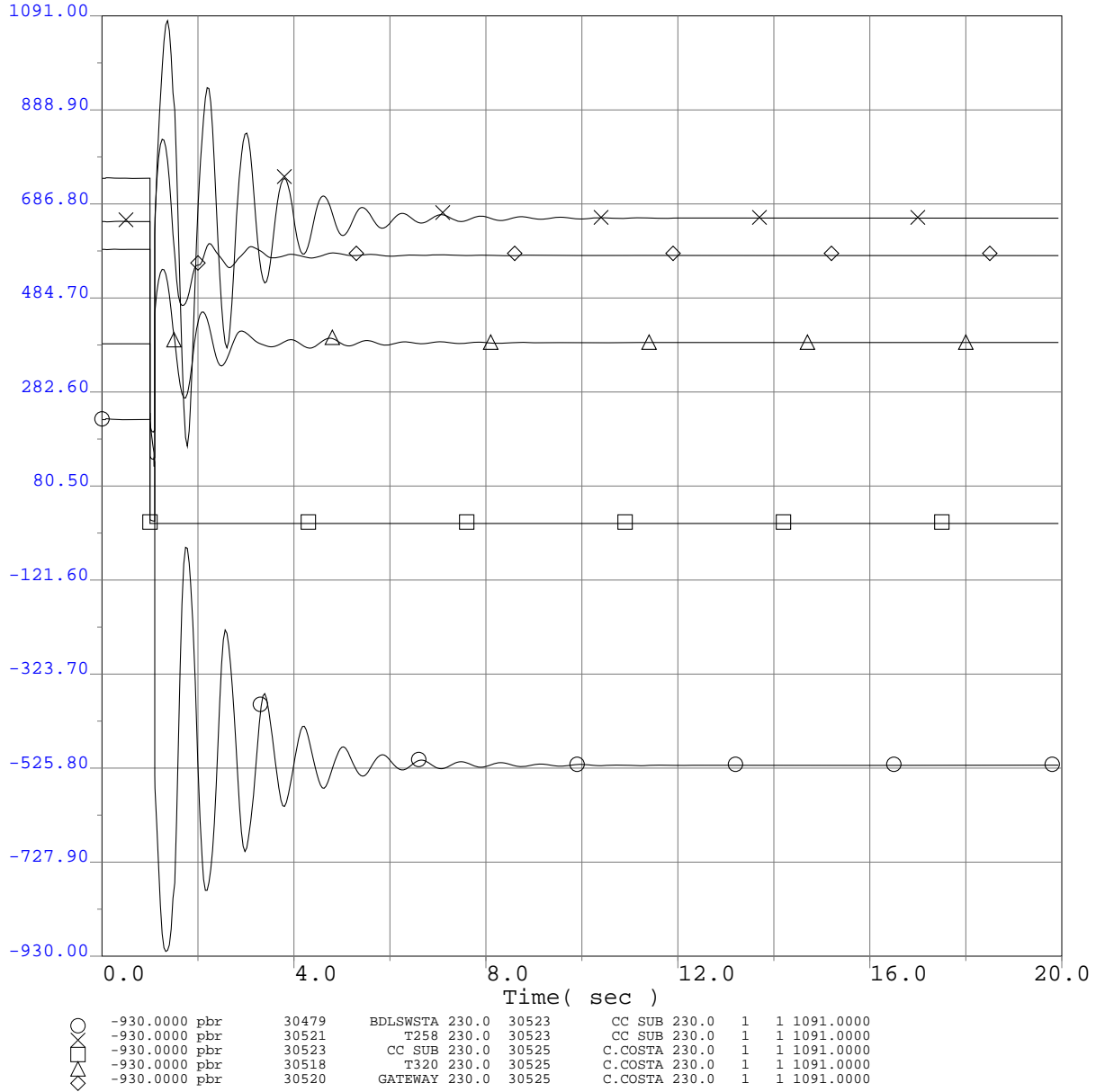

Q320 TCP2 ISIS
 2013 Greater Bay Area Summer Peak Base Case
 Q320 @ 772MW
 CAPP-CC Sub 230kV Line Outage
 3-ph 6 cyc flt @ the CC Sub 230kV bus & clr the CAPP-CC Sub 230kV line

Q320 TCP2 ISIS

Selected PG&E Transmission Line Flows (MW)

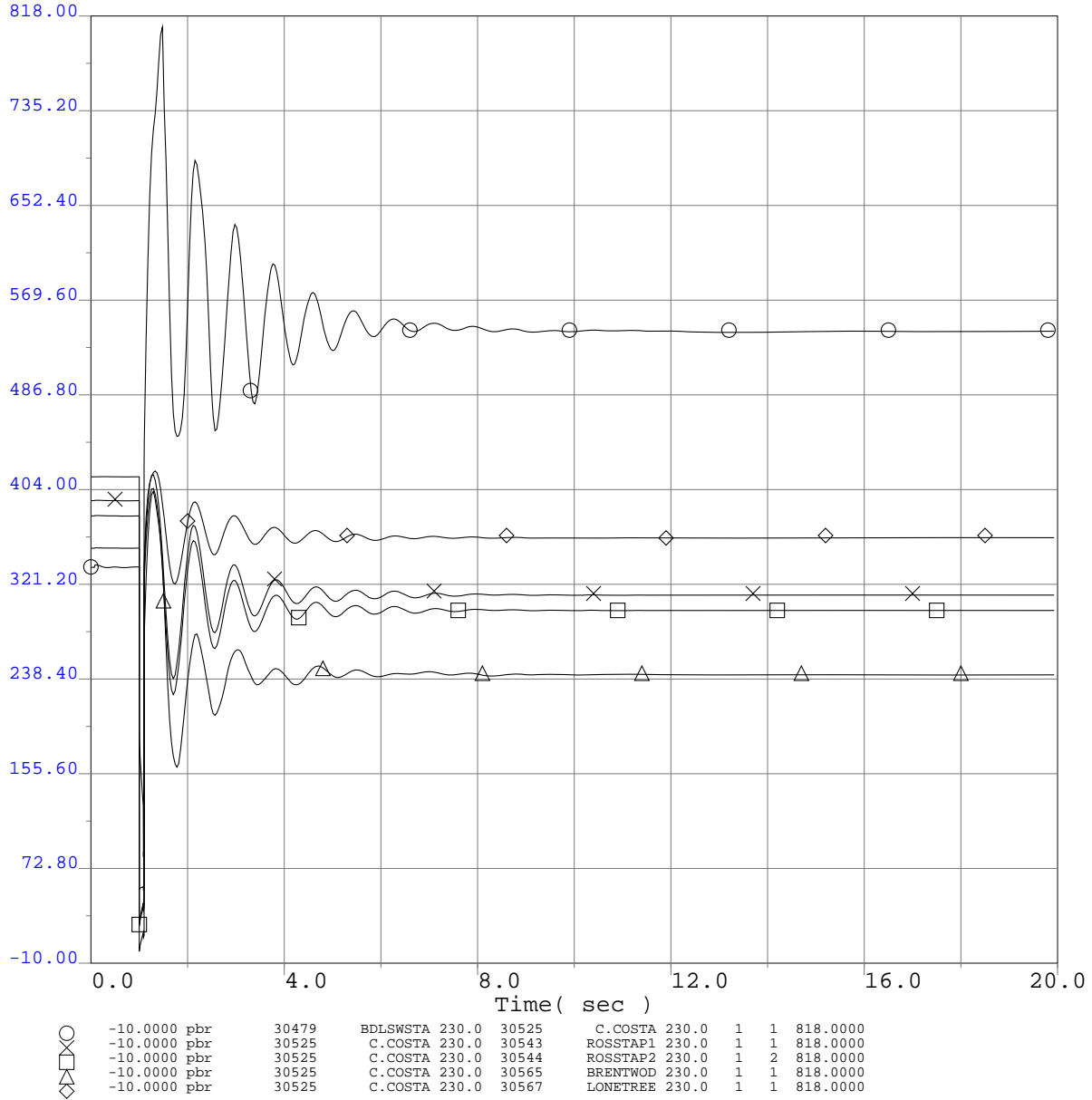

Q320 TCP2 ISIS
 2013 Greater Bay Area Summer Peak Base Case
 Q320 @ 772MW
 CCPP-CC Sub 230kV Line Outage
 3-ph 6 cyc flt @ the CC Sub 230kV bus & clr the CCPP-CC Sub 230kV line

Q320 TCP2 ISIS

Selected PG&E Transmission Line Flows (MW)

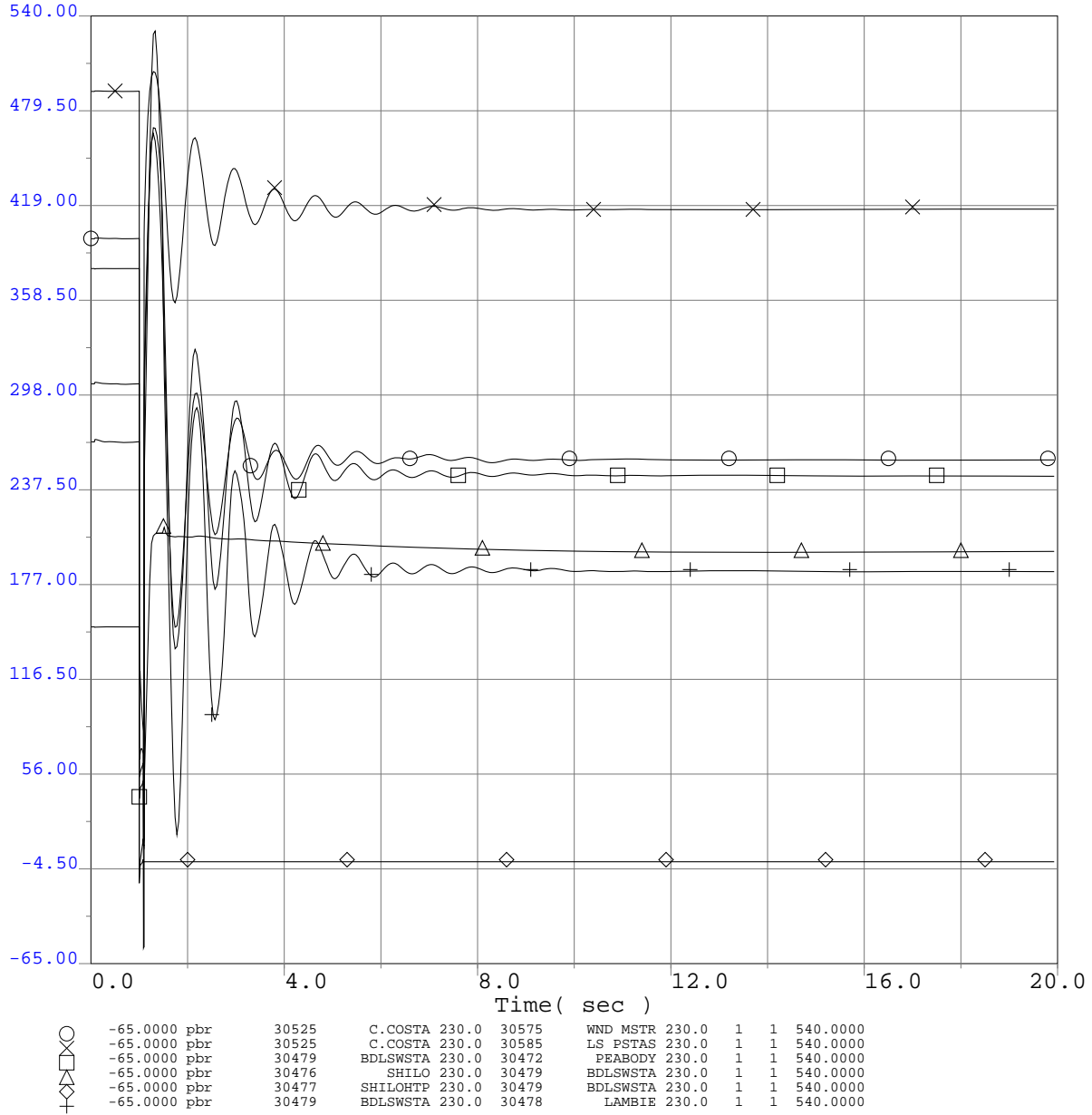

Q320 TCP2 ISIS
 2013 Greater Bay Area Summer Peak Base Case
 Q320 @ 772MW
 CCPP-CC Sub 230kV Line Outage
 3-ph 6 cyc flt @ the CC Sub 230kV bus & clr the CCPP-CC Sub 230kV line

Q320 TCP2 ISIS

Selected PG&E Transmission Line Flows (MW)

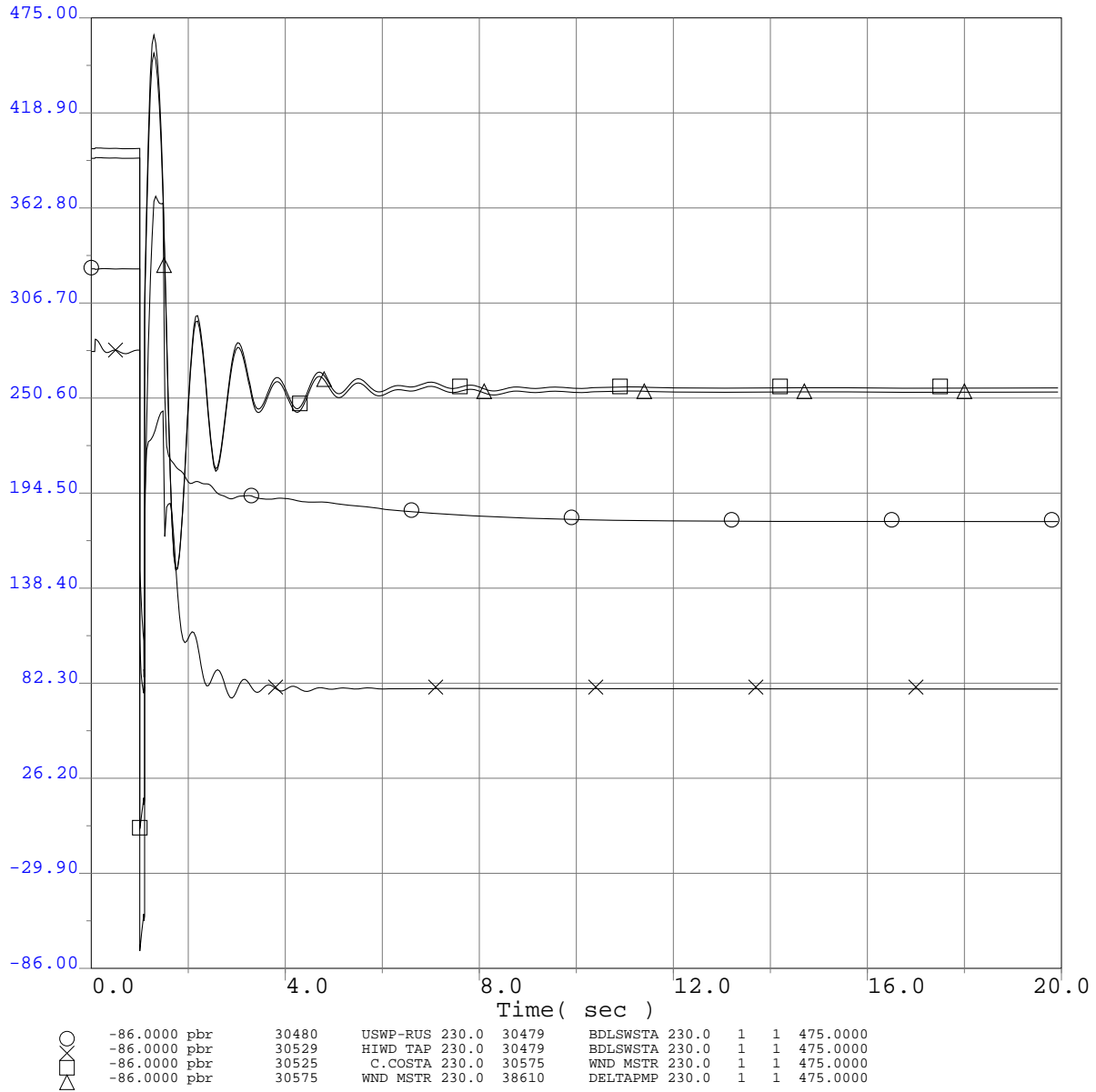

Q320 TCP2 ISIS
 2013 Greater Bay Area Summer Peak Base Case
 Q320 @ 772MW
 CAPP-CC Sub 230kV Line Outage
 3-ph 6 cyc flt @ the CC Sub 230kV bus & clr the CAPP-CC Sub 230kV line

Q320 TCP2 ISIS

Selected PG&E Bus Voltage Plots Adjacent to Fault

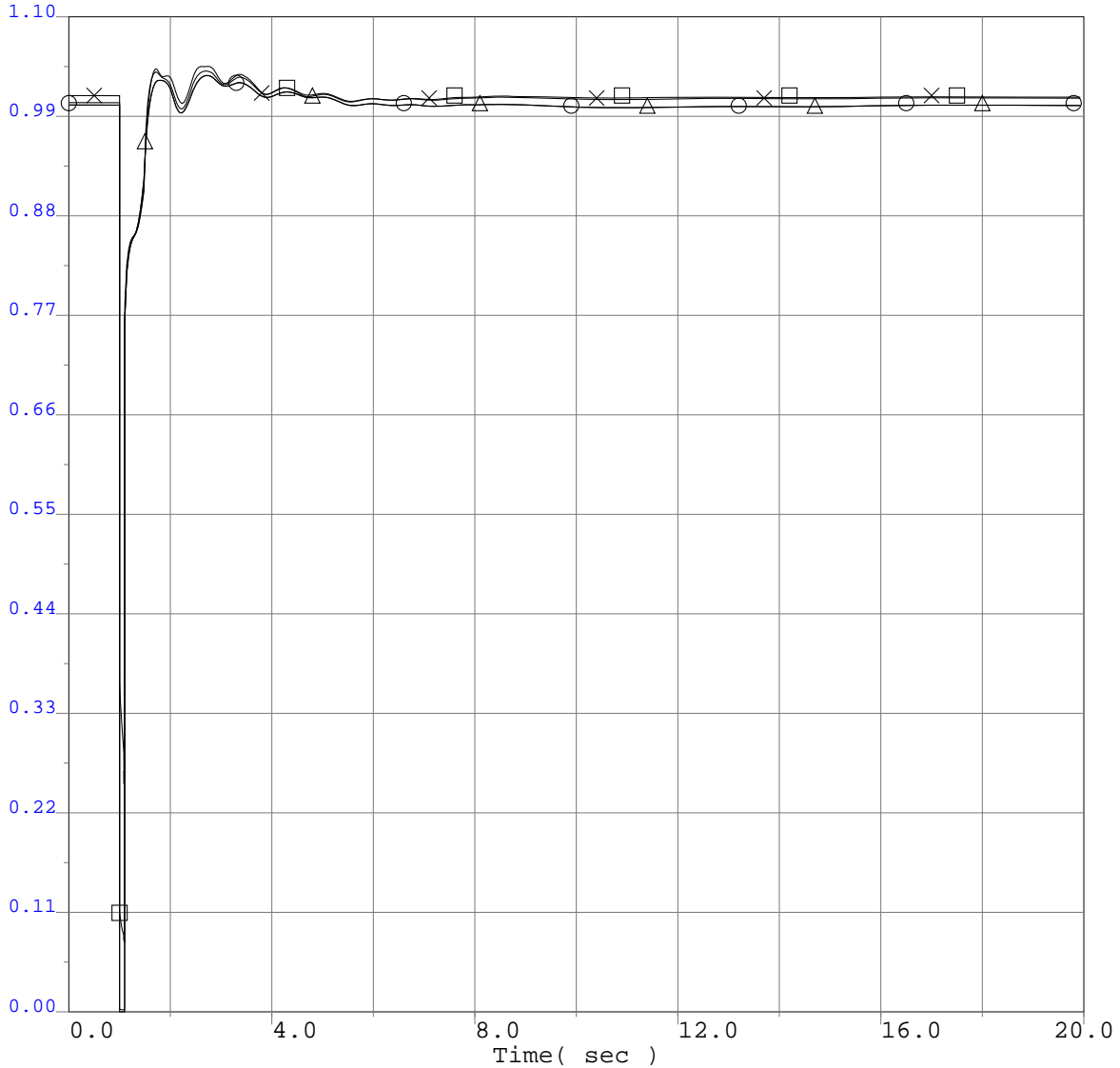

○	0.0000 vbus	30525	C.COSTA 230.0	0	0.0	***	1	1.1000
□	0.0000 vbus	30479	BDLSWSTA 230.0	0	0.0	***	1	1.1000
△	0.0000 vbus	30523	CC SUB 230.0	0	0.0	***	1	1.1000
×	0.0000 vbus	30518	T320 230.0	0	0.0	***	1	1.1000



Q320 TCP2 ISIS
 2013 Greater Bay Area Summer Peak Base Case
 Q320 @ 772MW
 CCPP 230kV Bus 1D Outage
 3-ph 6 cyc flt @ the CCPP 230kV bus & clr the CCPP 230kV Bus 1D Outage

Q320 TCP2 ISIS

Selected PG&E Bus Frequency Plots Adjacent to Fault

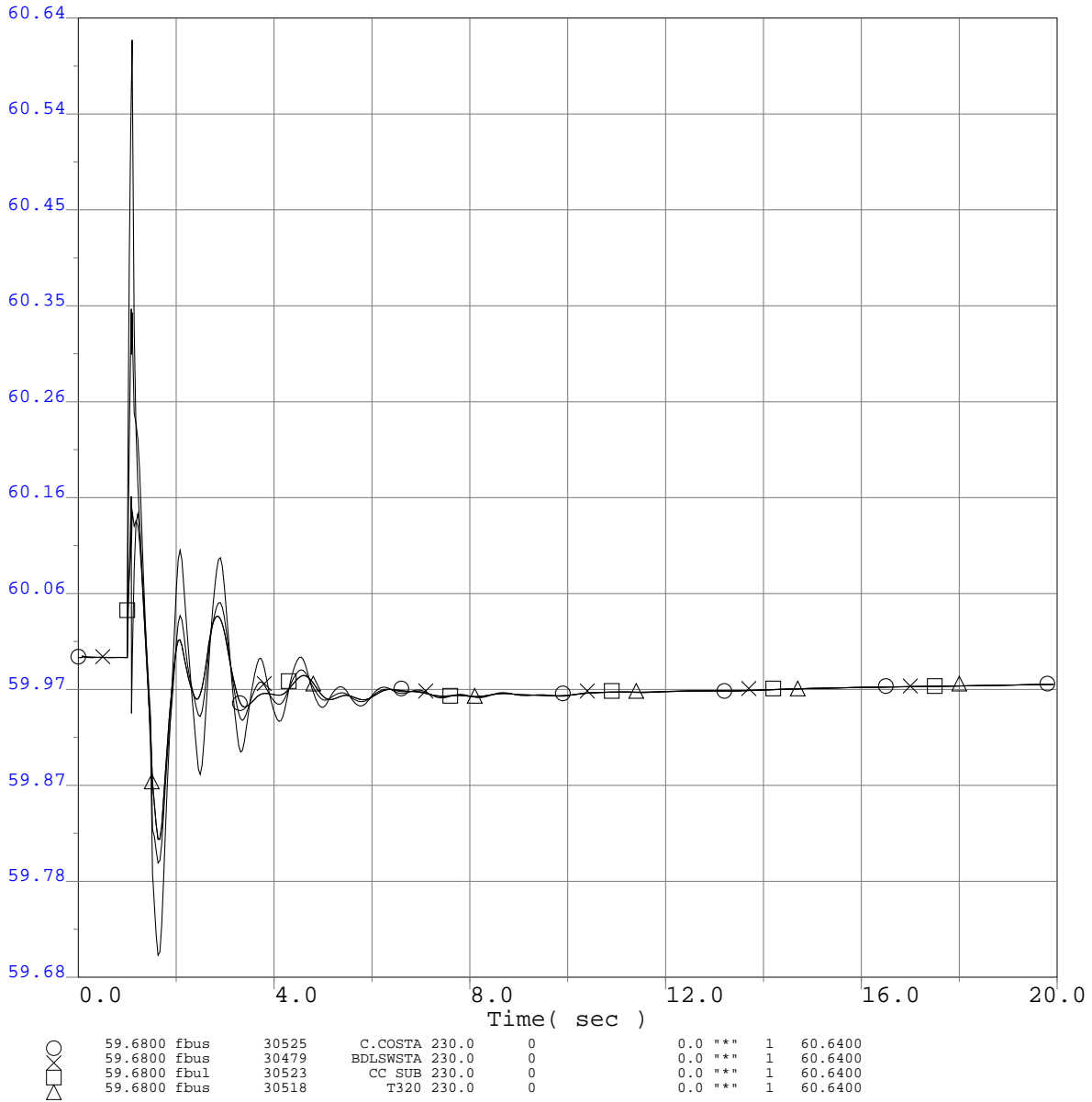

Q320 TCP2 ISIS
 2013 Greater Bay Area Summer Peak Base Case
 Q320 @ 772MW
 CCPP 230kV Bus 1D Outage
 3-ph 6 cyc flt @ the CCPP 230kV bus & clr the CCPP 230kV Bus 1D Outage

Q320 TCP2 ISIS

Project Generator Terminal Voltages (P.U.)

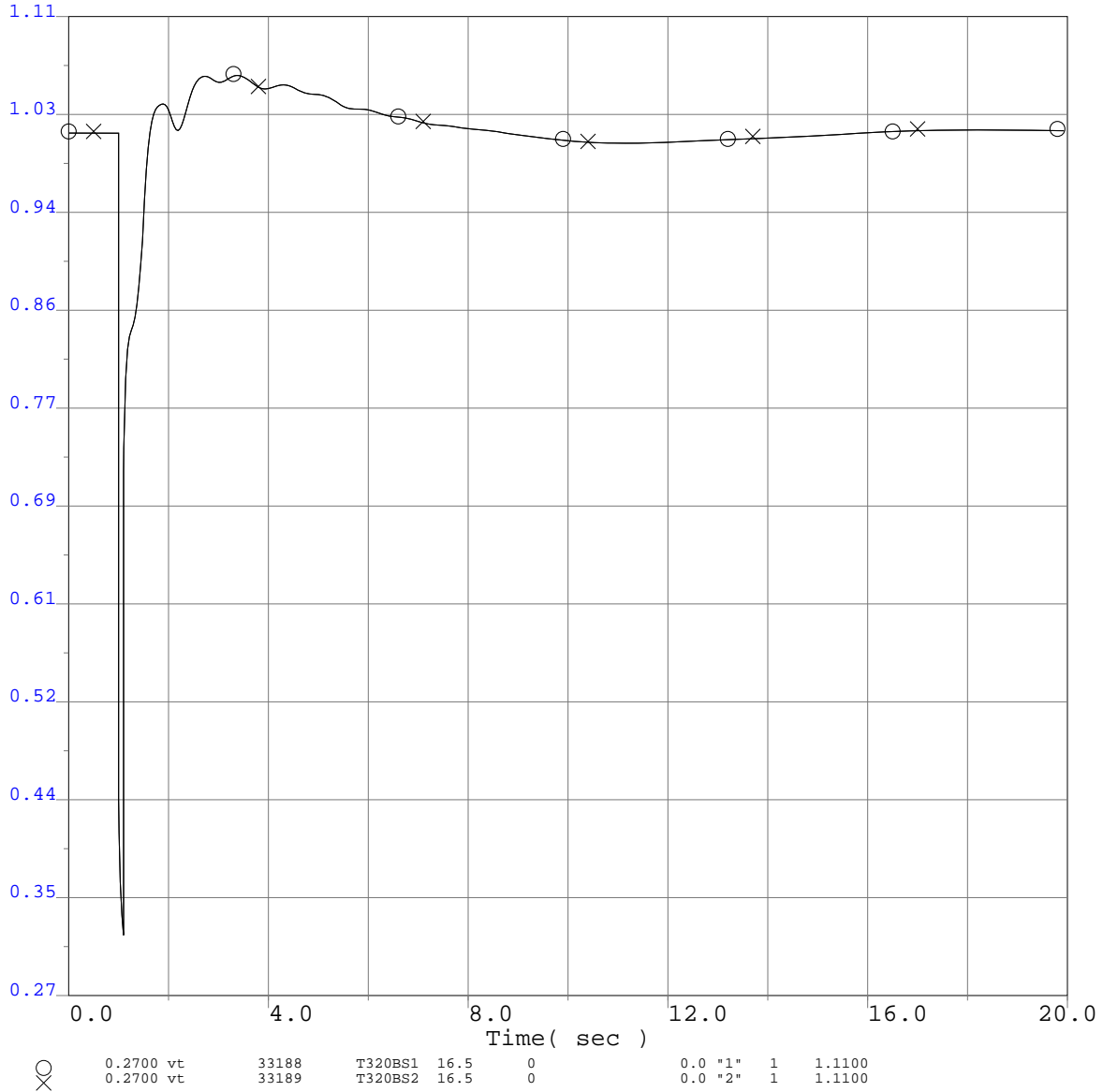

Q320 TCP2 ISIS
 2013 Greater Bay Area Summer Peak Base Case
 Q320 @ 772MW
 CCPP 230kV Bus 1D Outage
 3-ph 6 cyc flt @ the CCPP 230kV bus & clr the CCPP 230kV Bus 1D Outage

Q320 TCP2 ISIS

Project Generator Terminal Voltages (P.U.)

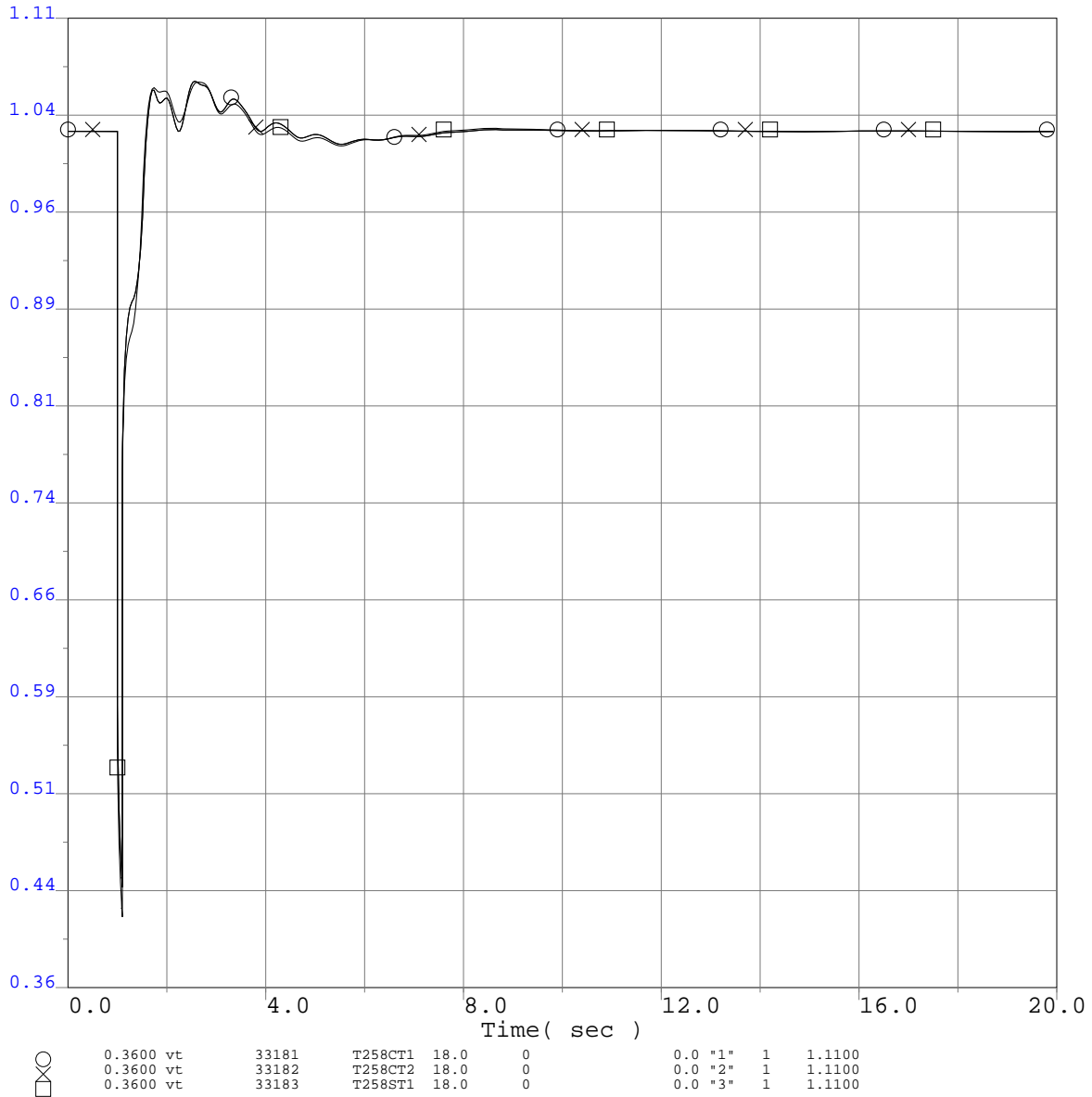

○	0.3600 vt	33181	T258CT1	18.0	0	0.0 "1"	1	1.1100
×	0.3600 vt	33182	T258CT2	18.0	0	0.0 "2"	1	1.1100
□	0.3600 vt	33183	T258ST1	18.0	0	0.0 "3"	1	1.1100

Q320 TCP2 ISIS
 2013 Greater Bay Area Summer Peak Base Case
 Q320 @ 772MW
 CCPP 230kV Bus 1D Outage
 3-ph 6 cyc flt @ the CCPP 230kV bus & clr the CCPP 230kV Bus 1D Outage

Q320 TCP2 ISIS

Project Generator Speed (P.U.)

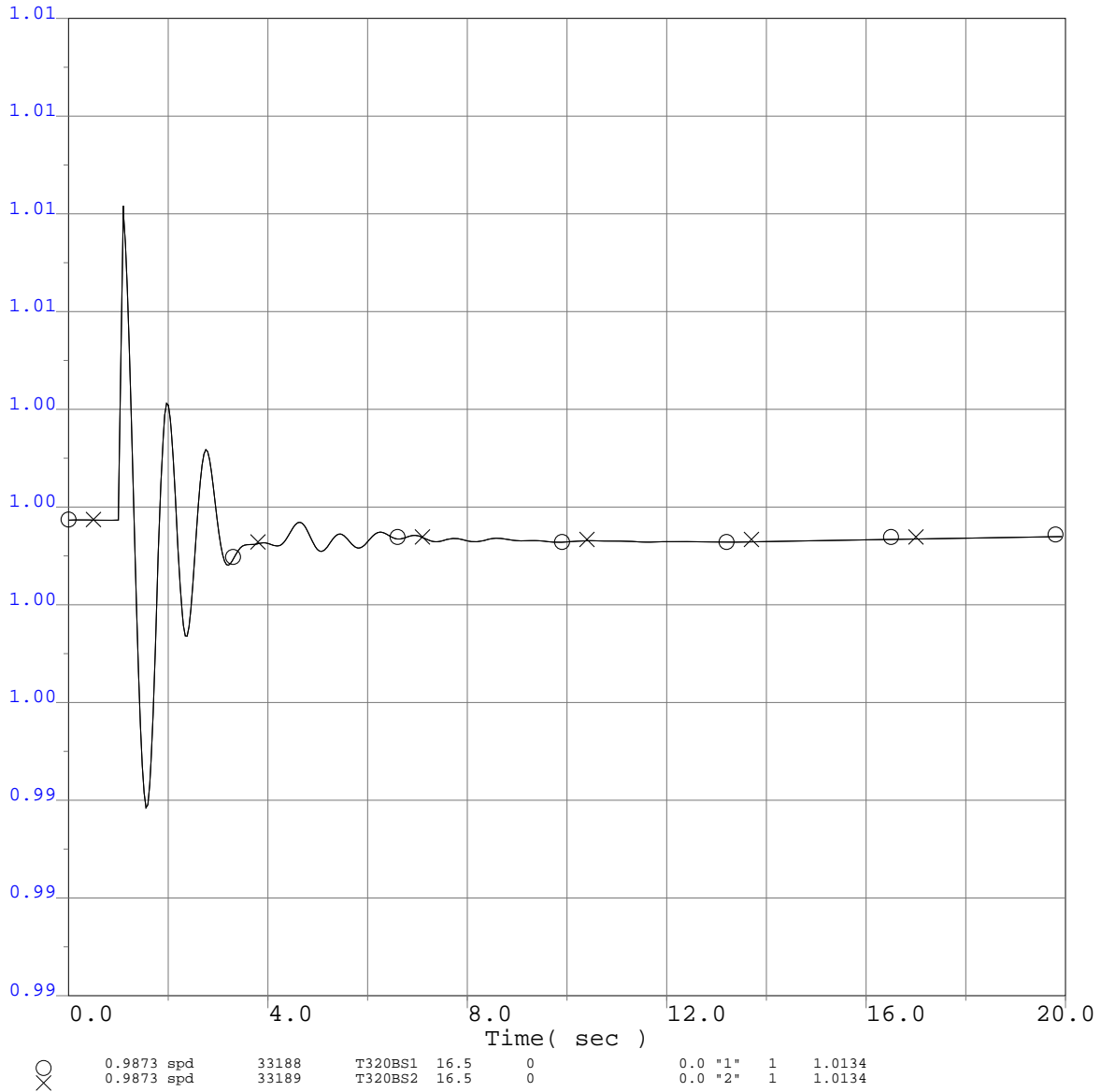

Q320 TCP2 ISIS
 2013 Greater Bay Area Summer Peak Base Case
 Q320 @ 772MW
 CCPP 230kV Bus 1D Outage
 3-ph 6 cyc flt @ the CCPP 230kV bus & clr the CCPP 230kV Bus 1D Outage

Q320 TCP2 ISIS

Project Generator Speed (P.U.)

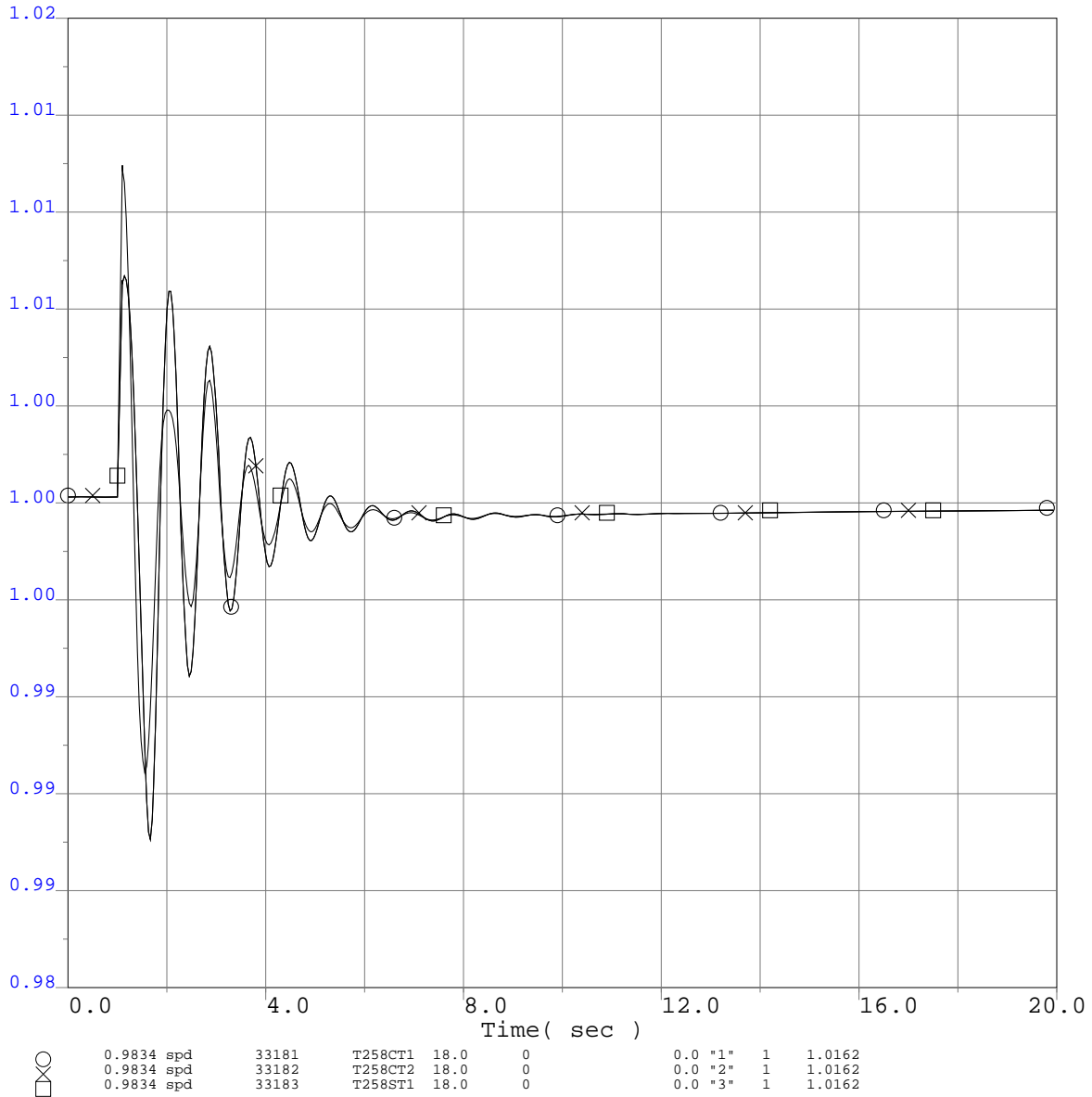

Q320 TCP2 ISIS
 2013 Greater Bay Area Summer Peak Base Case
 Q320 @ 772MW
 CCPP 230kV Bus 1D Outage
 3-ph 6 cyc flt @ the CCPP 230kV bus & clr the CCPP 230kV Bus 1D Outage

Q320 TCP2 ISIS

Project Generator Terminal Power (MW)

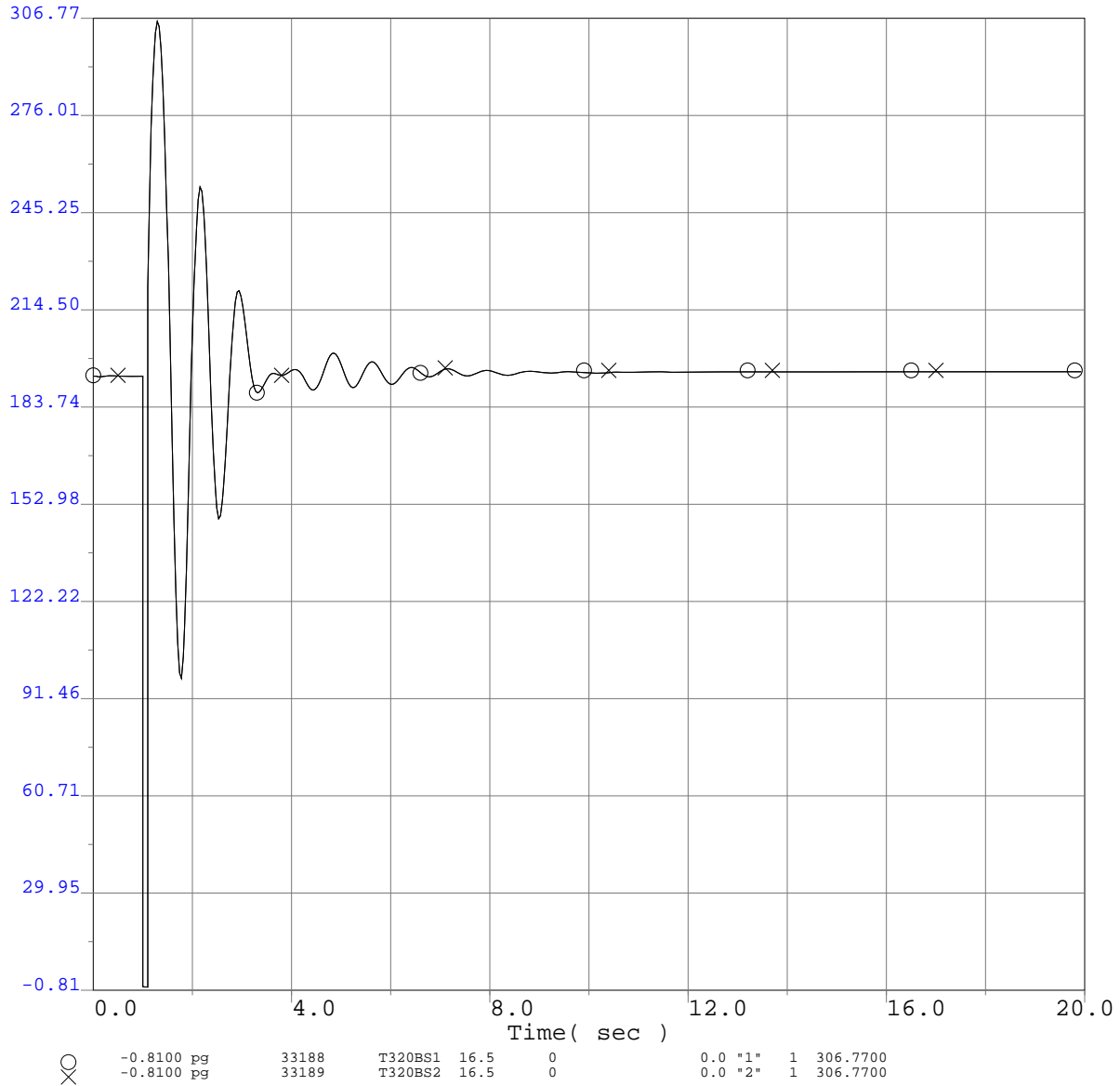

○	-0.8100 pg	33188	T320BS1	16.5	0	0.0 "1"	1	306.7700
×	-0.8100 pg	33189	T320BS2	16.5	0	0.0 "2"	1	306.7700

Q320 TCP2 ISIS
 2013 Greater Bay Area Summer Peak Base Case
 Q320 @ 772MW
 CCPP 230kV Bus 1D Outage
 3-ph 6 cyc flt @ the CCPP 230kV bus & clr the CCPP 230kV Bus 1D Outage

Q320 TCP2 ISIS

Project Generator Terminal Power (MW)

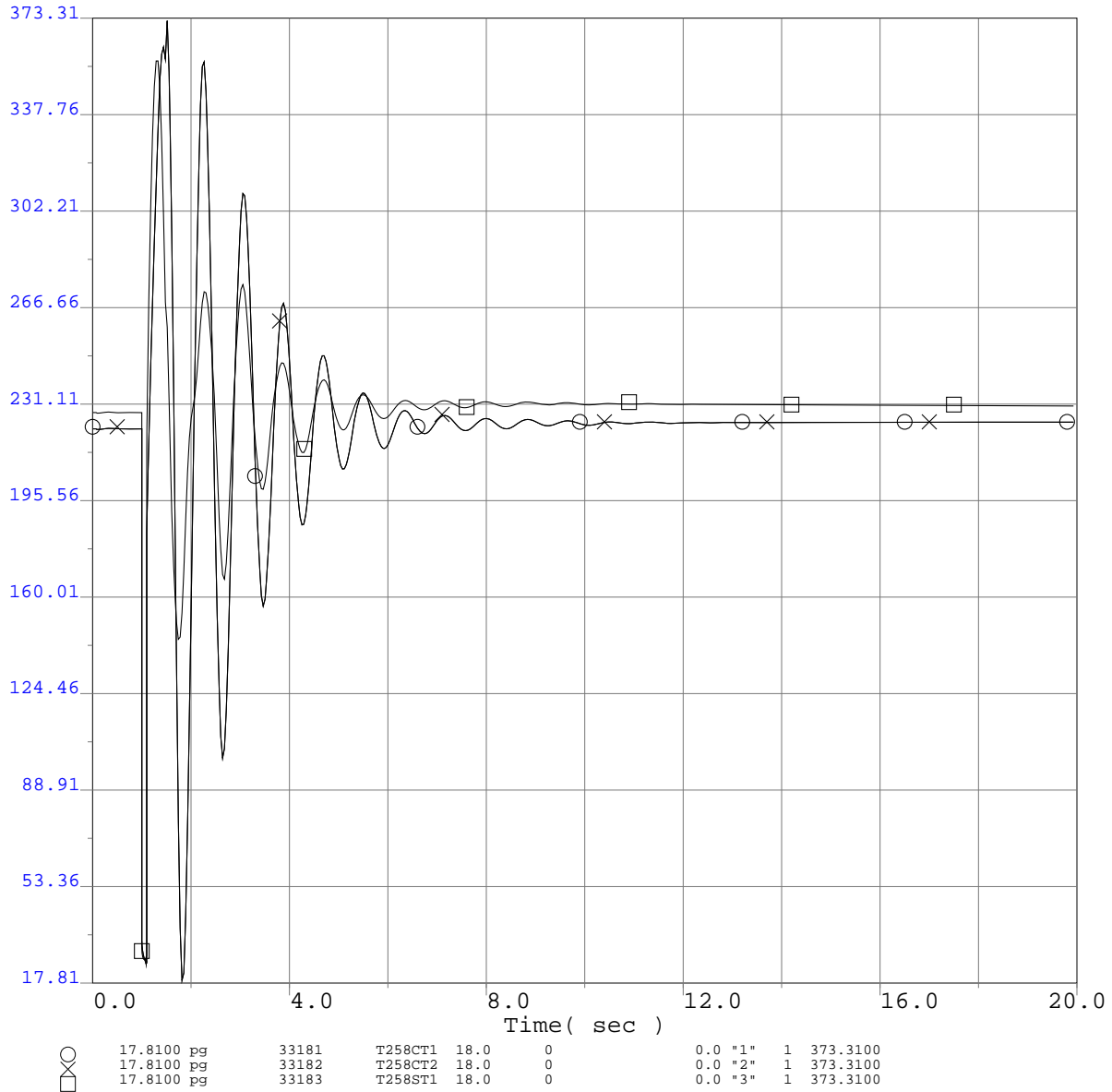

Q320 TCP2 ISIS
 2013 Greater Bay Area Summer Peak Base Case
 Q320 @ 772MW
 CCPP 230kV Bus 1D Outage
 3-ph 6 cyc flt @ the CCPP 230kV bus & clr the CCPP 230kV Bus 1D Outage

Q320 TCP2 ISIS

Project Generator Terminal Reactive Power (MVar)

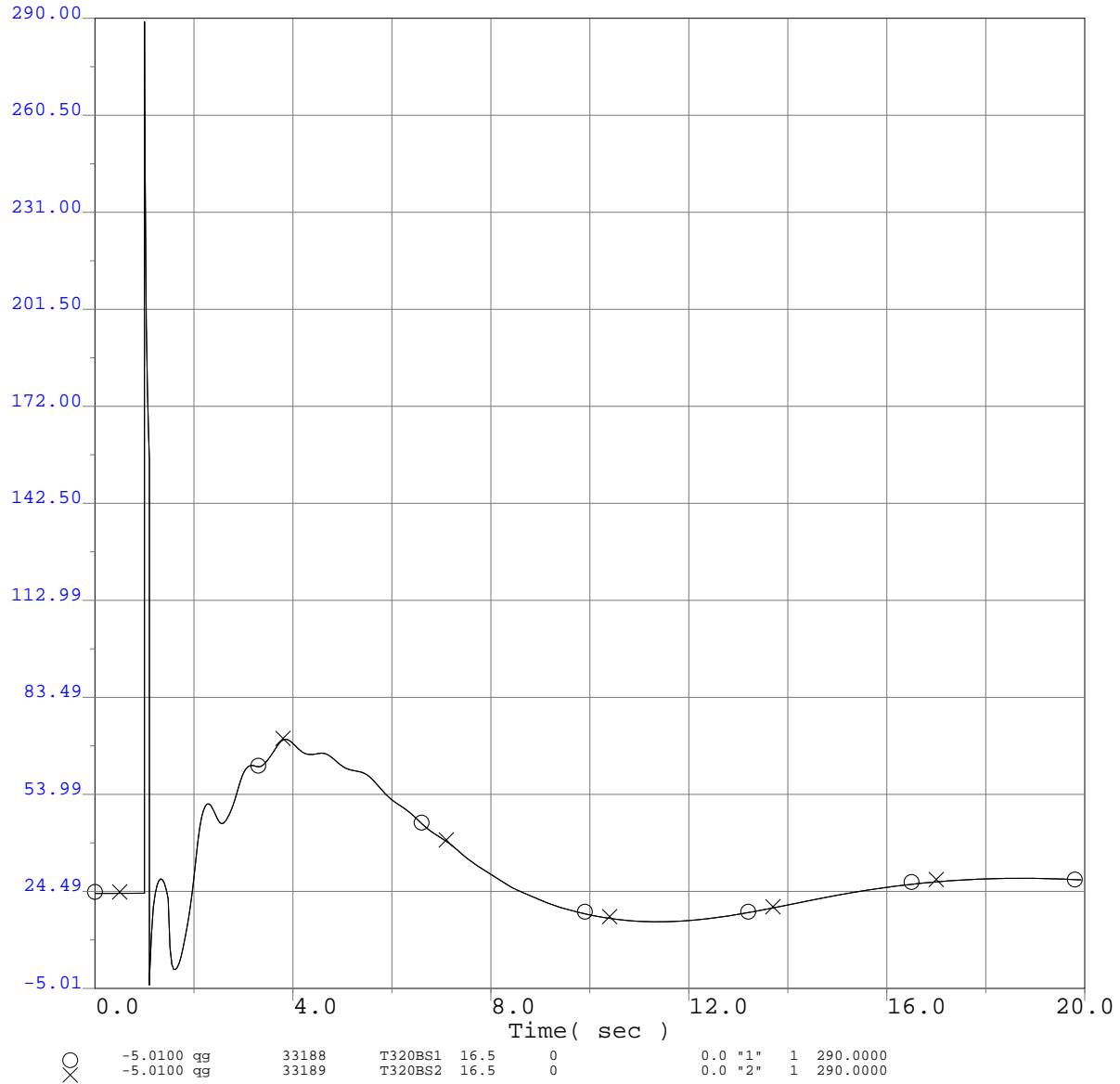

Q320 TCP2 ISIS
 2013 Greater Bay Area Summer Peak Base Case
 Q320 @ 772MW
 CCPP 230kV Bus 1D Outage
 3-ph 6 cyc flt @ the CCPP 230kV bus & clr the CCPP 230kV Bus 1D Outage

Q320 TCP2 ISIS

Project Generator Terminal Reactive Power (MVar)

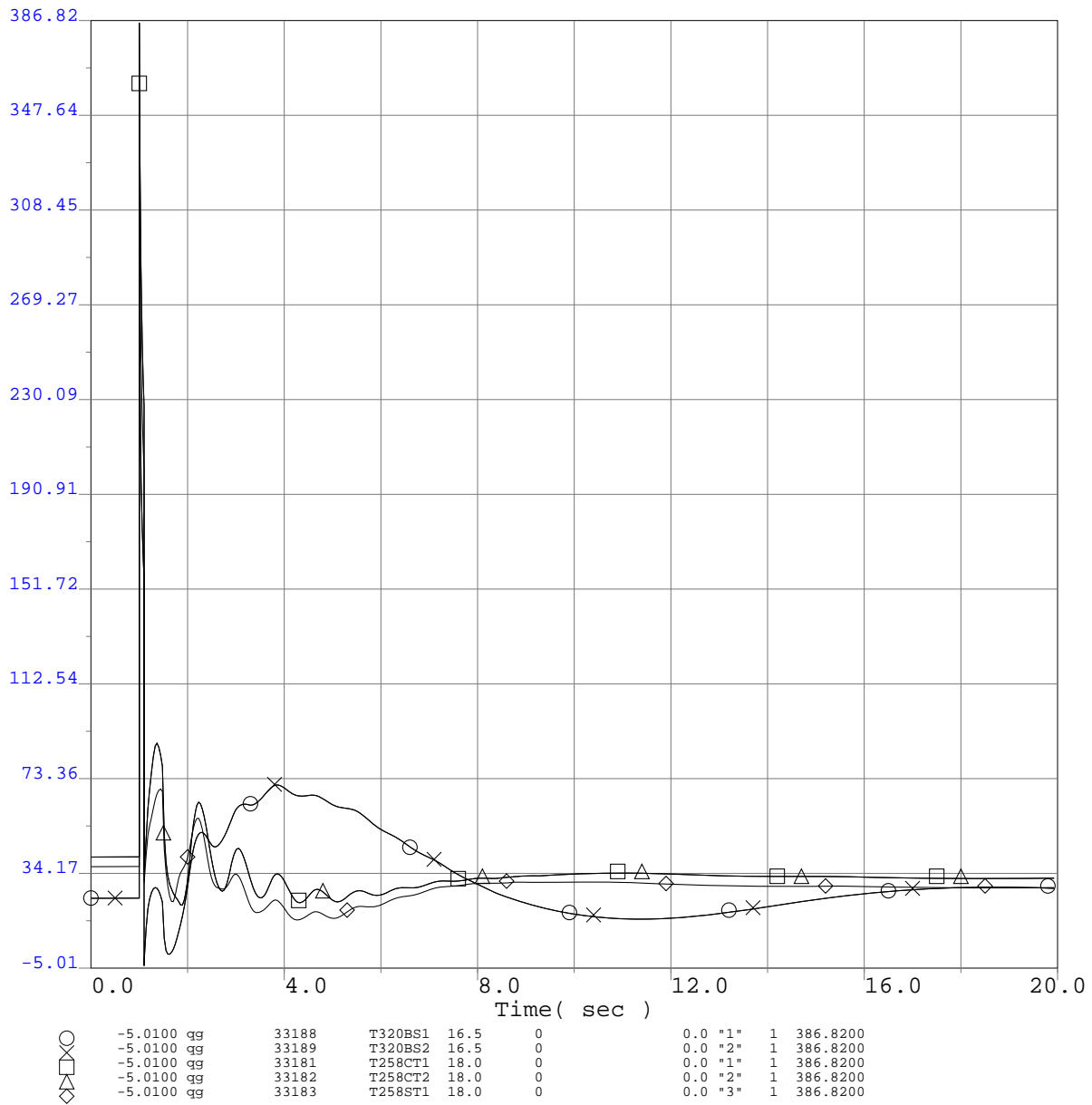

Q320 TCP2 ISIS
 2013 Greater Bay Area Summer Peak Base Case
 Q320 @ 772MW
 CCPP 230kV Bus 1D Outage
 3-ph 6 cyc flt @ the CCPP 230kV bus & clr the CCPP 230kV Bus 1D Outage

Q320 TCP2 ISIS

Selected WECC Bus Voltage Plots

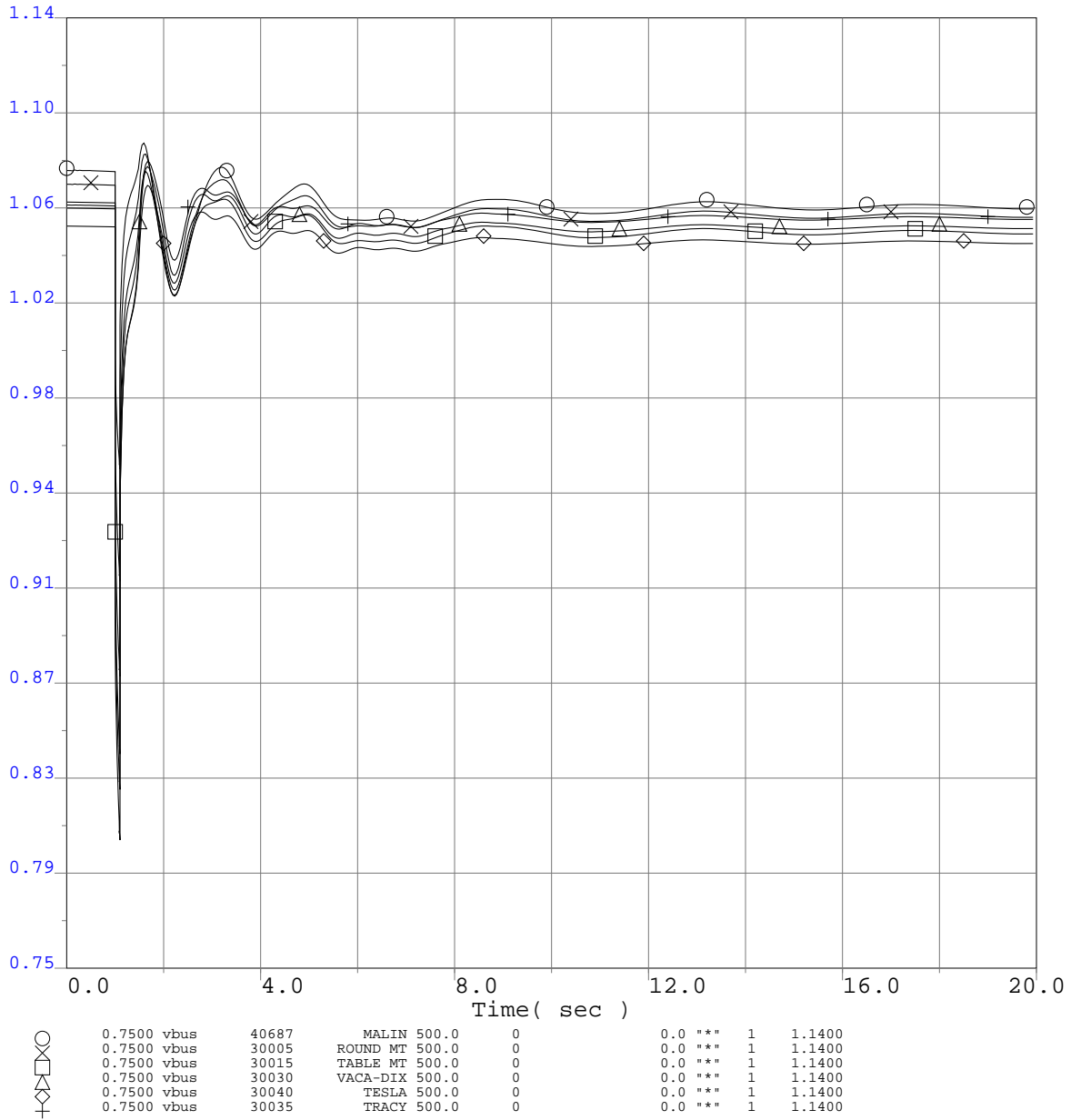

Q320 TCP2 ISIS
 2013 Greater Bay Area Summer Peak Base Case
 Q320 @ 772MW
 CCPP 230kV Bus 1D Outage
 3-ph 6 cyc flt @ the CCPP 230kV bus & clr the CCPP 230kV Bus 1D Outage

Q320 TCP2 ISIS

Selected WECC Bus Voltage Plots

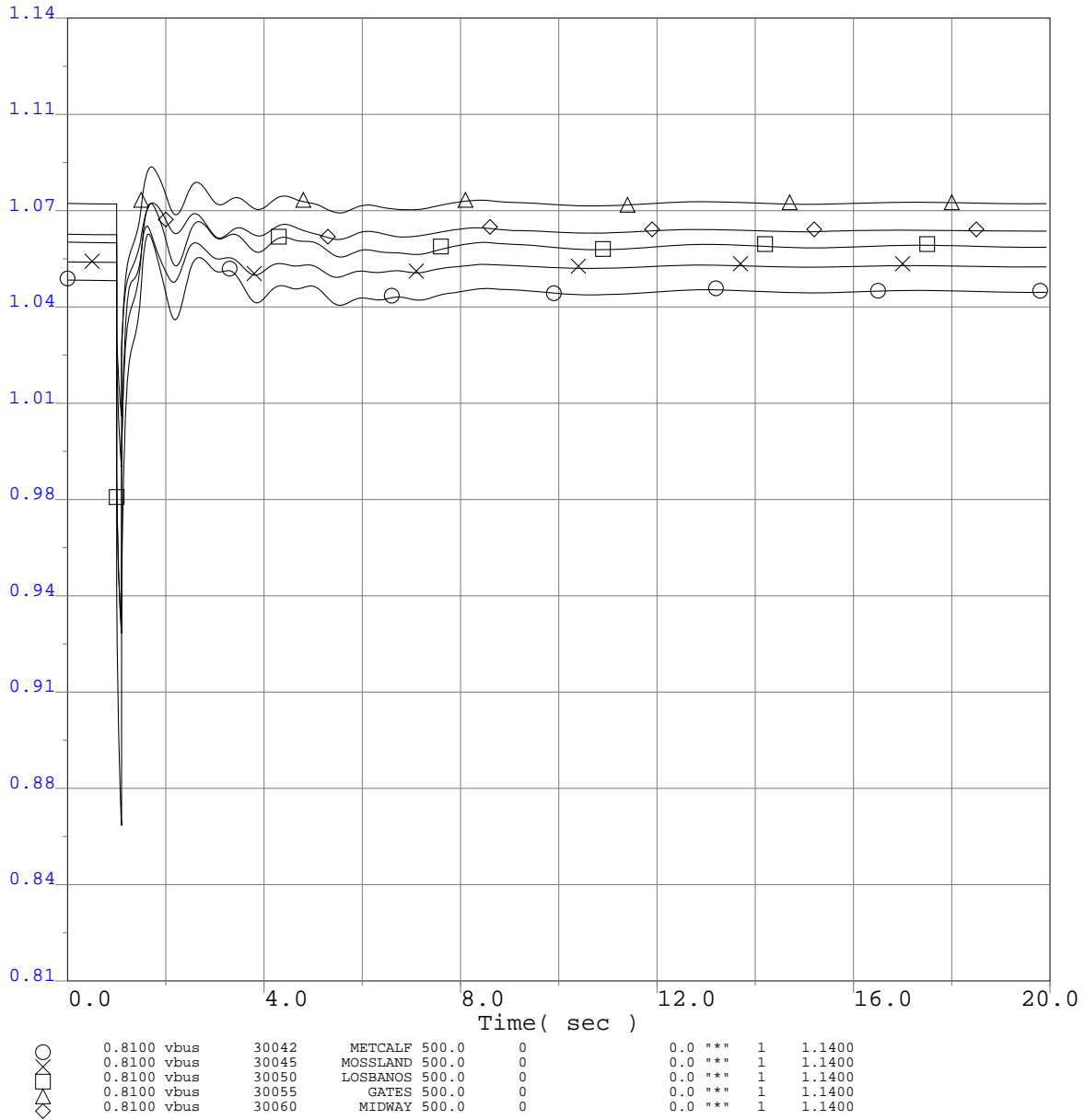

Q320 TCP2 ISIS
 2013 Greater Bay Area Summer Peak Base Case
 Q320 @ 772MW
 CCPP 230kV Bus 1D Outage
 3-ph 6 cyc flt @ the CCPP 230kV bus & clr the CCPP 230kV Bus 1D Outage

Q320 TCP2 ISIS

Selected WECC Bus Voltage Plots

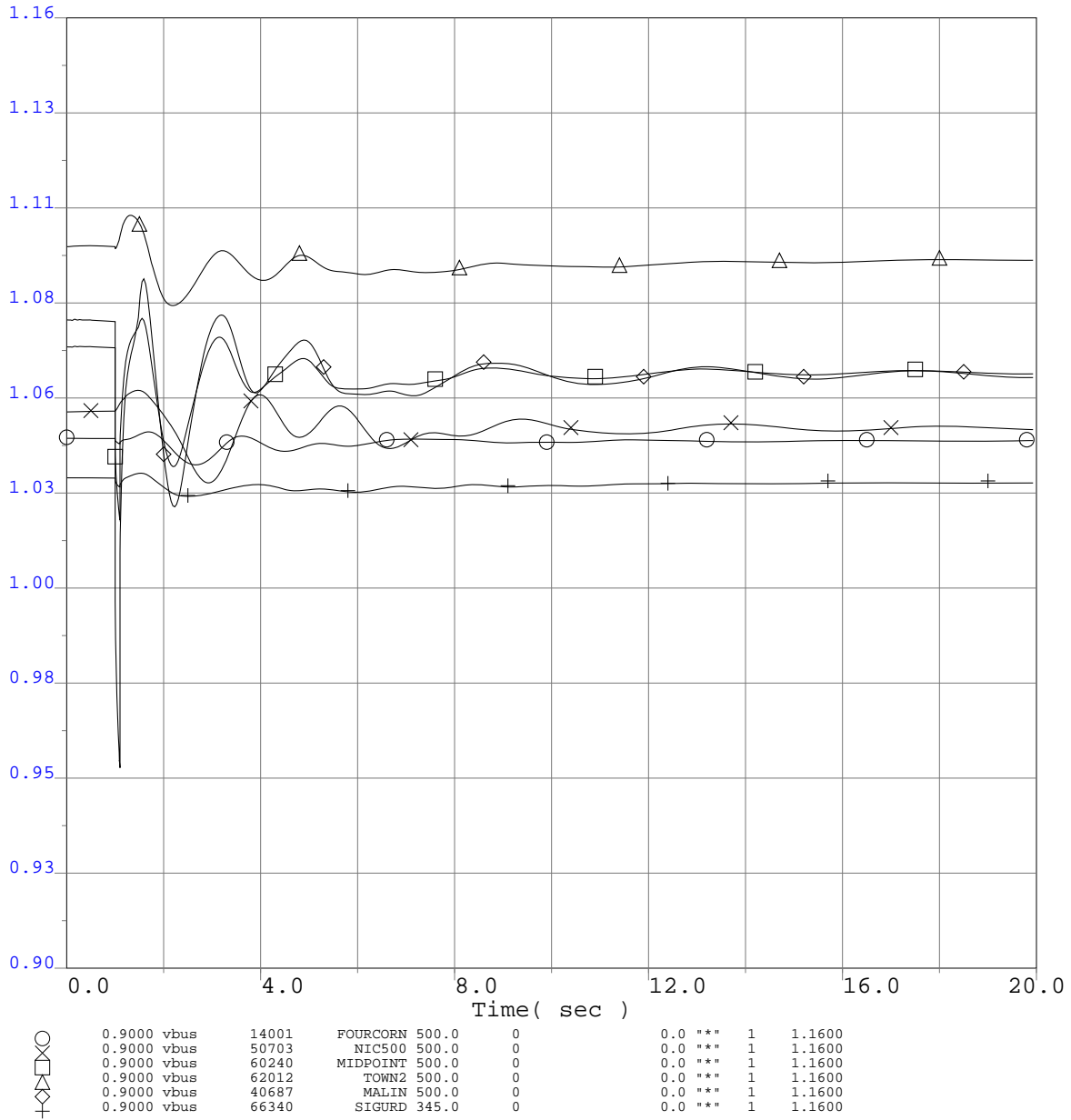

Q320 TCP2 ISIS
 2013 Greater Bay Area Summer Peak Base Case
 Q320 @ 772MW
 CCPP 230kV Bus 1D Outage
 3-ph 6 cyc flt @ the CCPP 230kV bus & clr the CCPP 230kV Bus 1D Outage

Q320 TCP2 ISIS

Selected WECC Bus Voltage Plots

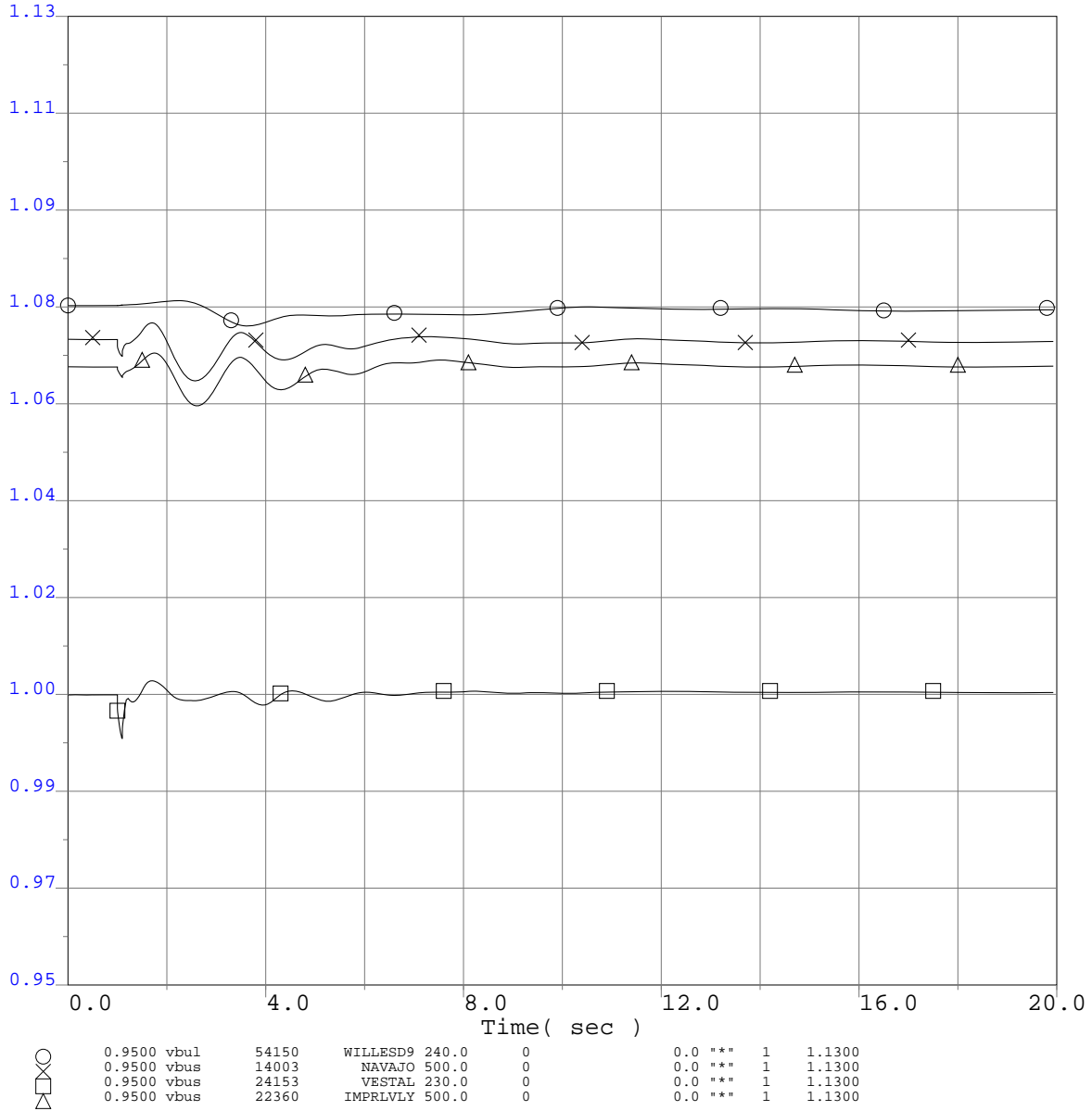

Q320 TCP2 ISIS
 2013 Greater Bay Area Summer Peak Base Case
 Q320 @ 772MW
 CCPP 230kV Bus 1D Outage
 3-ph 6 cyc flt @ the CCPP 230kV bus & clr the CCPP 230kV Bus 1D Outage

Q320 TCP2 ISIS

Selected WECC Bus Frequency Plots

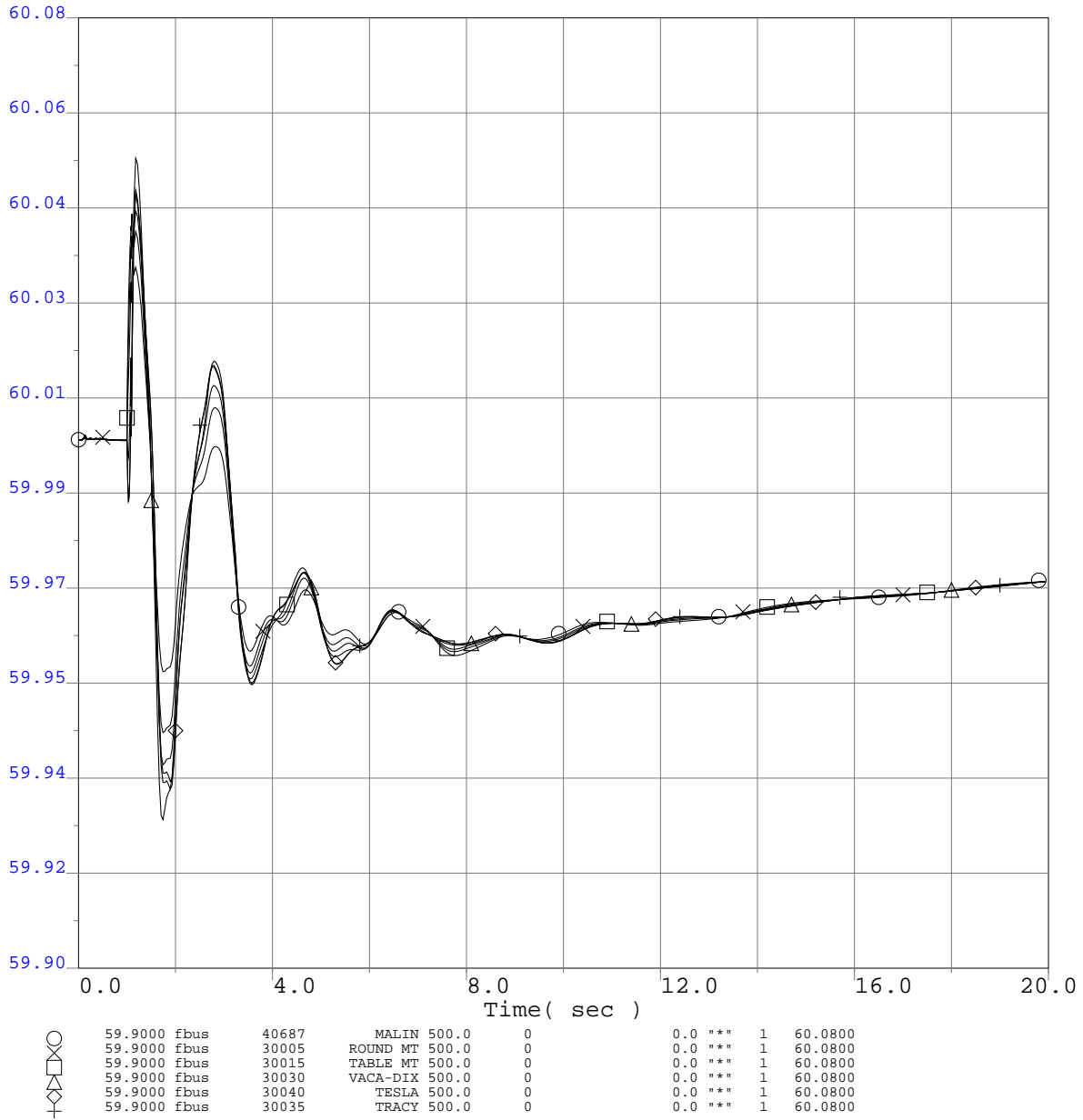

Q320 TCP2 ISIS
 2013 Greater Bay Area Summer Peak Base Case
 Q320 @ 772MW
 CCPP 230kV Bus 1D Outage
 3-ph 6 cyc flt @ the CCPP 230kV bus & clr the CCPP 230kV Bus 1D Outage

Q320 TCP2 ISIS

Selected WECC Bus Frequency Plots

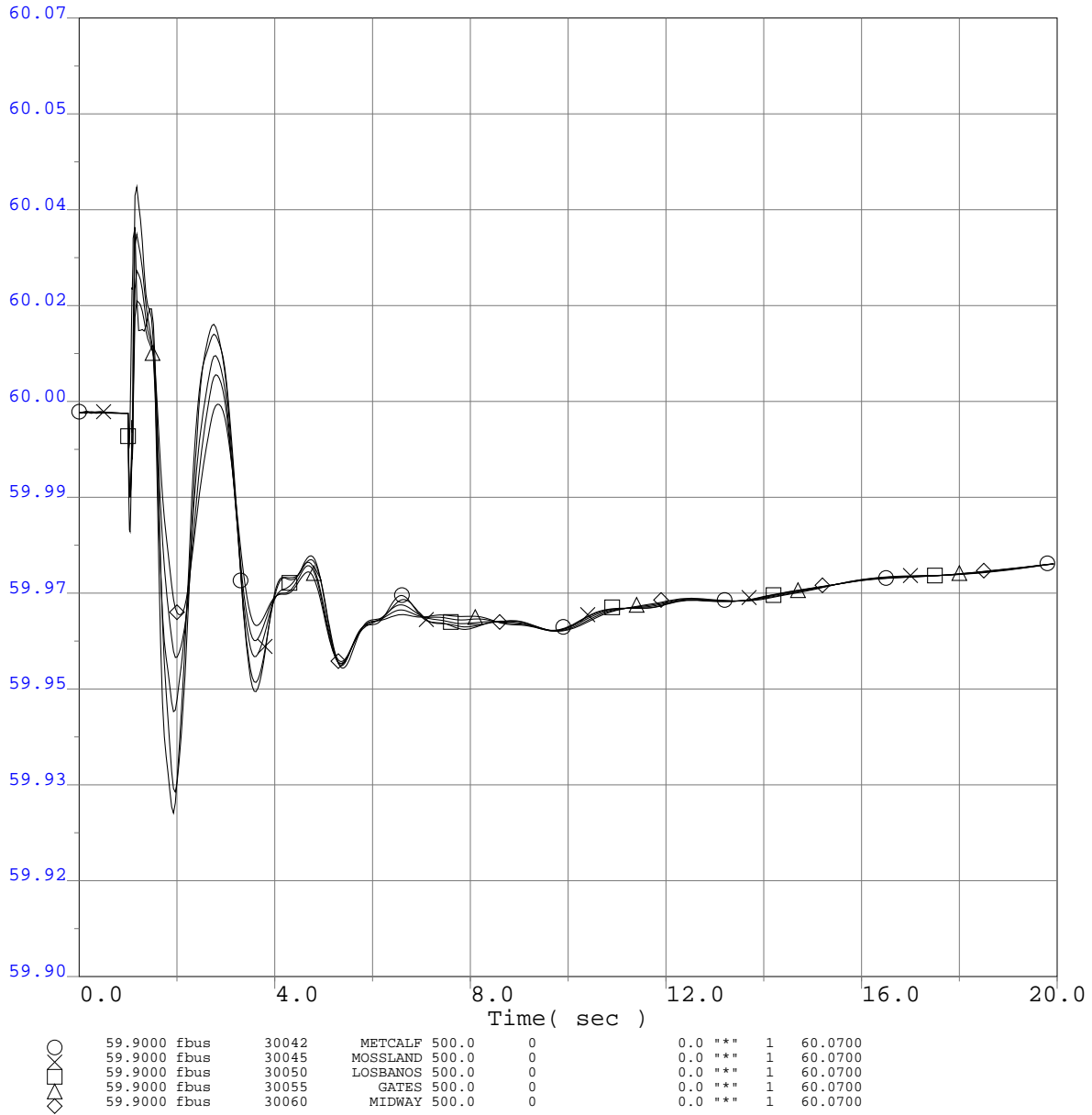

Q320 TCP2 ISIS
 2013 Greater Bay Area Summer Peak Base Case
 Q320 @ 772MW
 CCPP 230kV Bus 1D Outage
 3-ph 6 cyc flt @ the CCPP 230kV bus & clr the CCPP 230kV Bus 1D Outage

Q320 TCP2 ISIS

Selected WECC Bus Frequency Plots

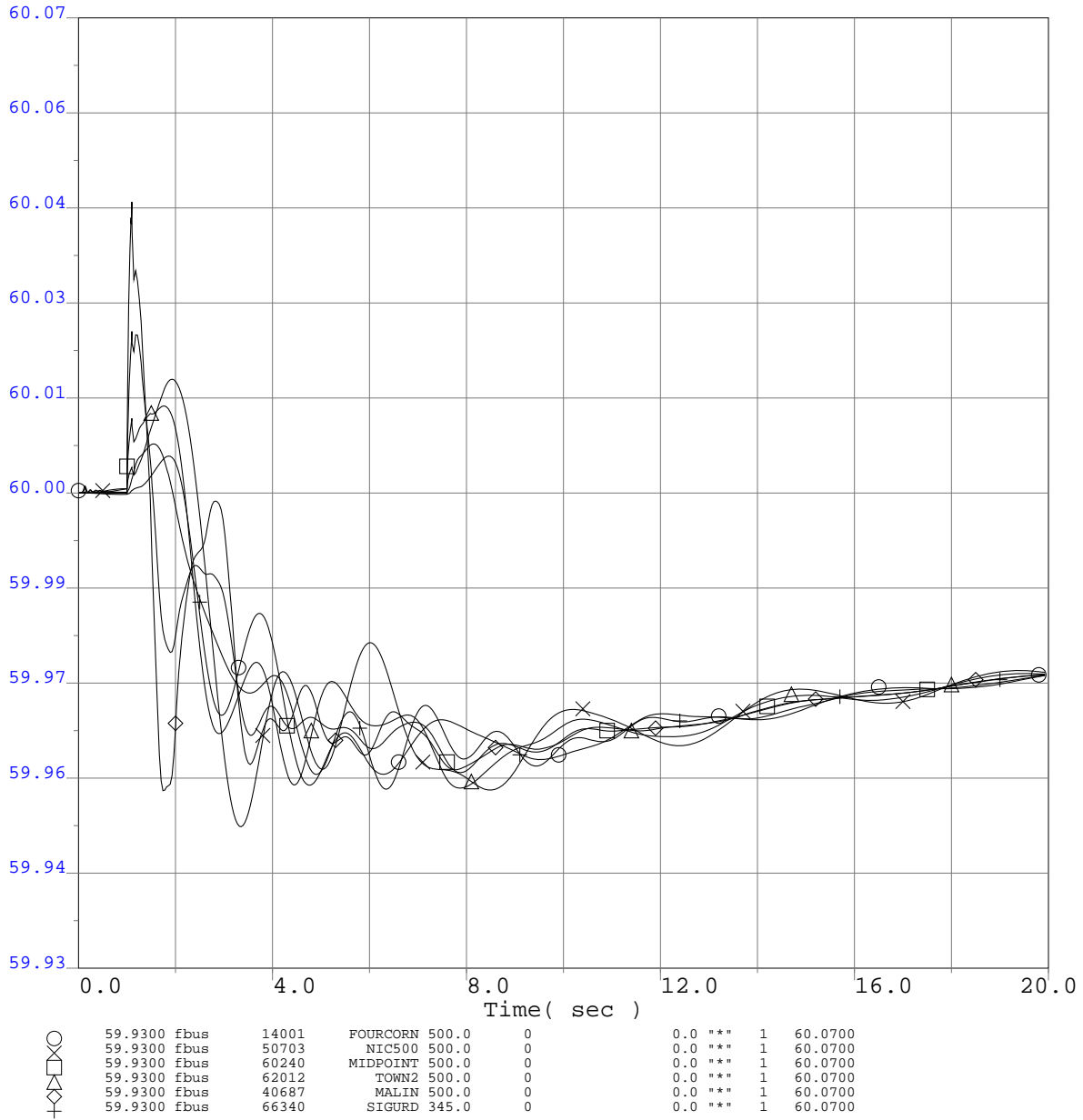

Q320 TCP2 ISIS
 2013 Greater Bay Area Summer Peak Base Case
 Q320 @ 772MW
 CCPP 230kV Bus 1D Outage
 3-ph 6 cyc flt @ the CCPP 230kV bus & clr the CCPP 230kV Bus 1D Outage

Q320 TCP2 ISIS

Selected WECC Bus Frequency Plots

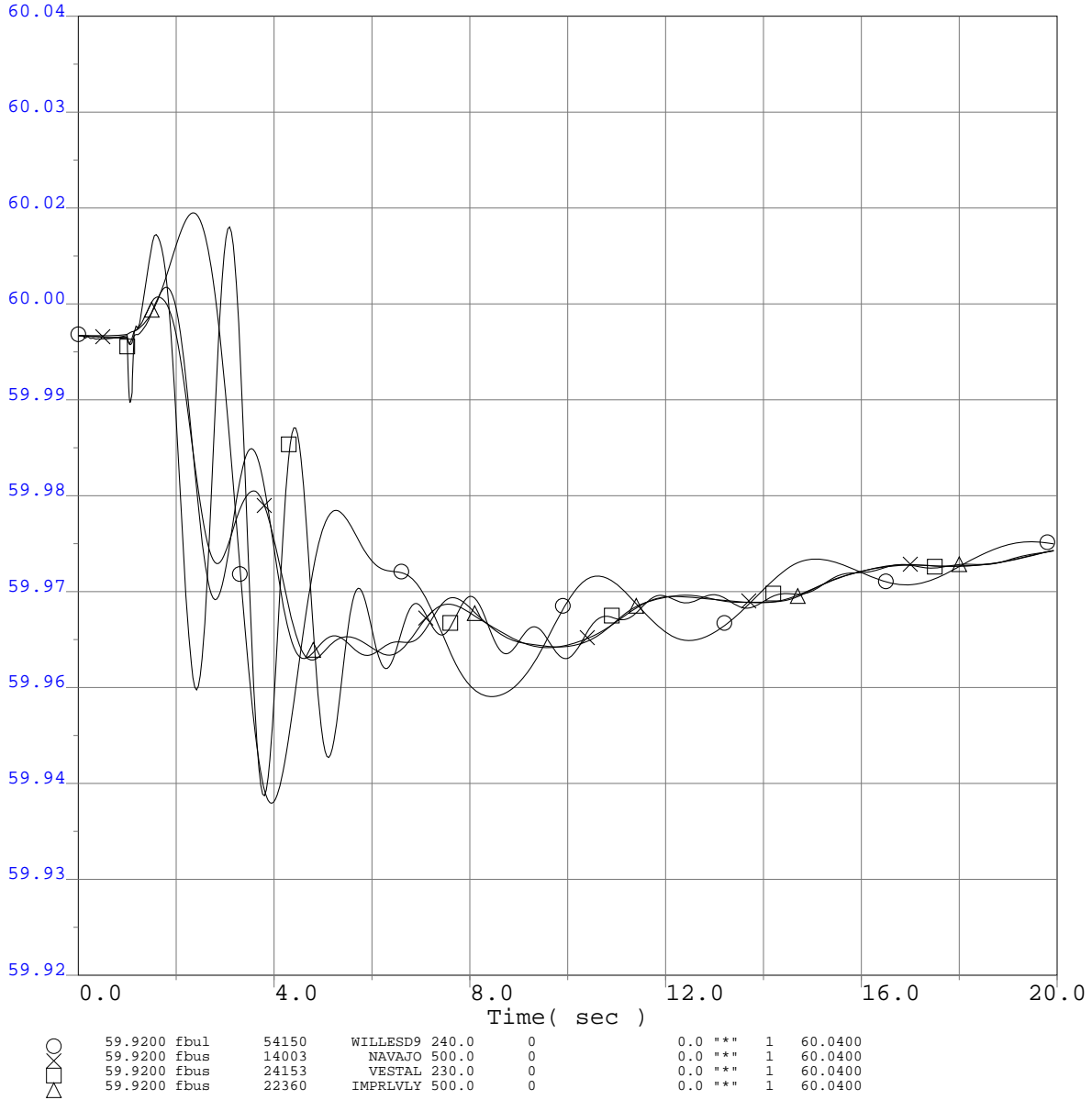

Q320 TCP2 ISIS
 2013 Greater Bay Area Summer Peak Base Case
 Q320 @ 772MW
 CCPP 230kV Bus 1D Outage
 3-ph 6 cyc flt @ the CCPP 230kV bus & clr the CCPP 230kV Bus 1D Outage

Q320 TCP2 ISIS

WECC Generator Rotor Angle

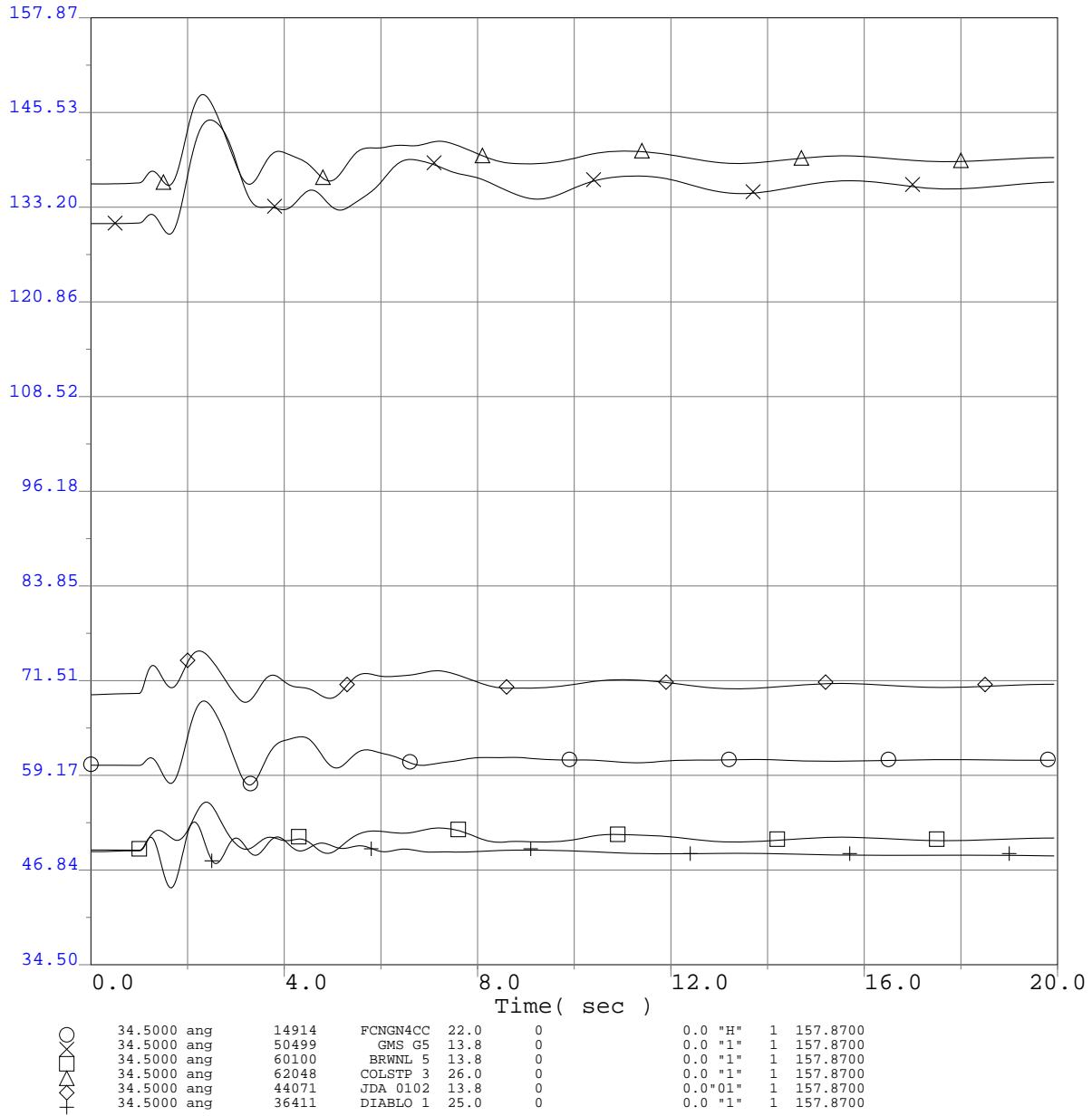

Q320 TCP2 ISIS
 2013 Greater Bay Area Summer Peak Base Case
 Q320 @ 772MW
 CCPP 230kV Bus 1D Outage
 3-ph 6 cyc flt @ the CCPP 230kV bus & clr the CCPP 230kV Bus 1D Outage

Q320 TCP2 ISIS

WECC Generator Rotor Angle

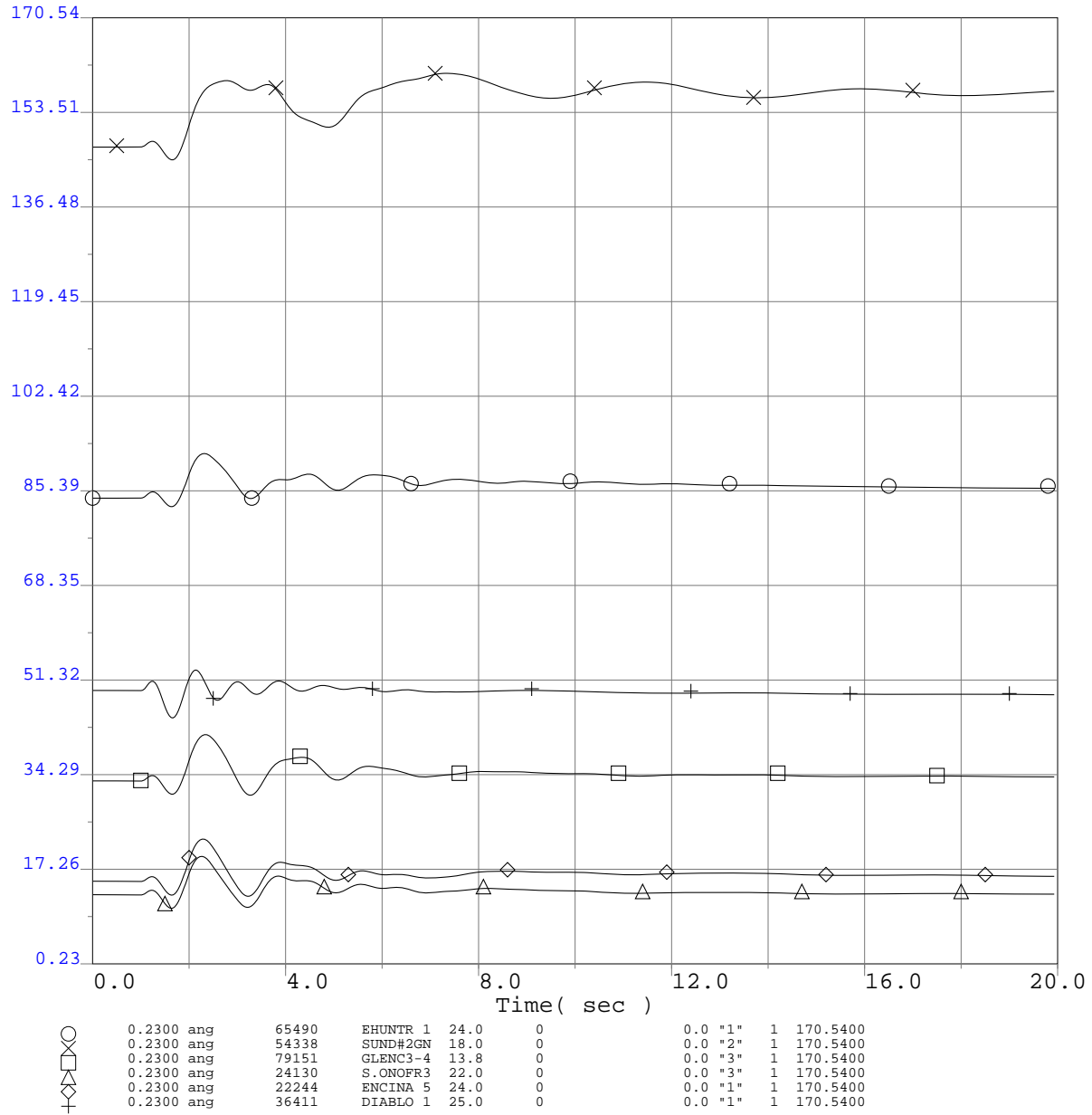

Q320 TCP2 ISIS
 2013 Greater Bay Area Summer Peak Base Case
 Q320 @ 772MW
 CCPP 230kV Bus 1D Outage
 3-ph 6 cyc flt @ the CCPP 230kV bus & clr the CCPP 230kV Bus 1D Outage

Q320 TCP2 ISIS

Selected PG&E Transmission Line Flows (MW)

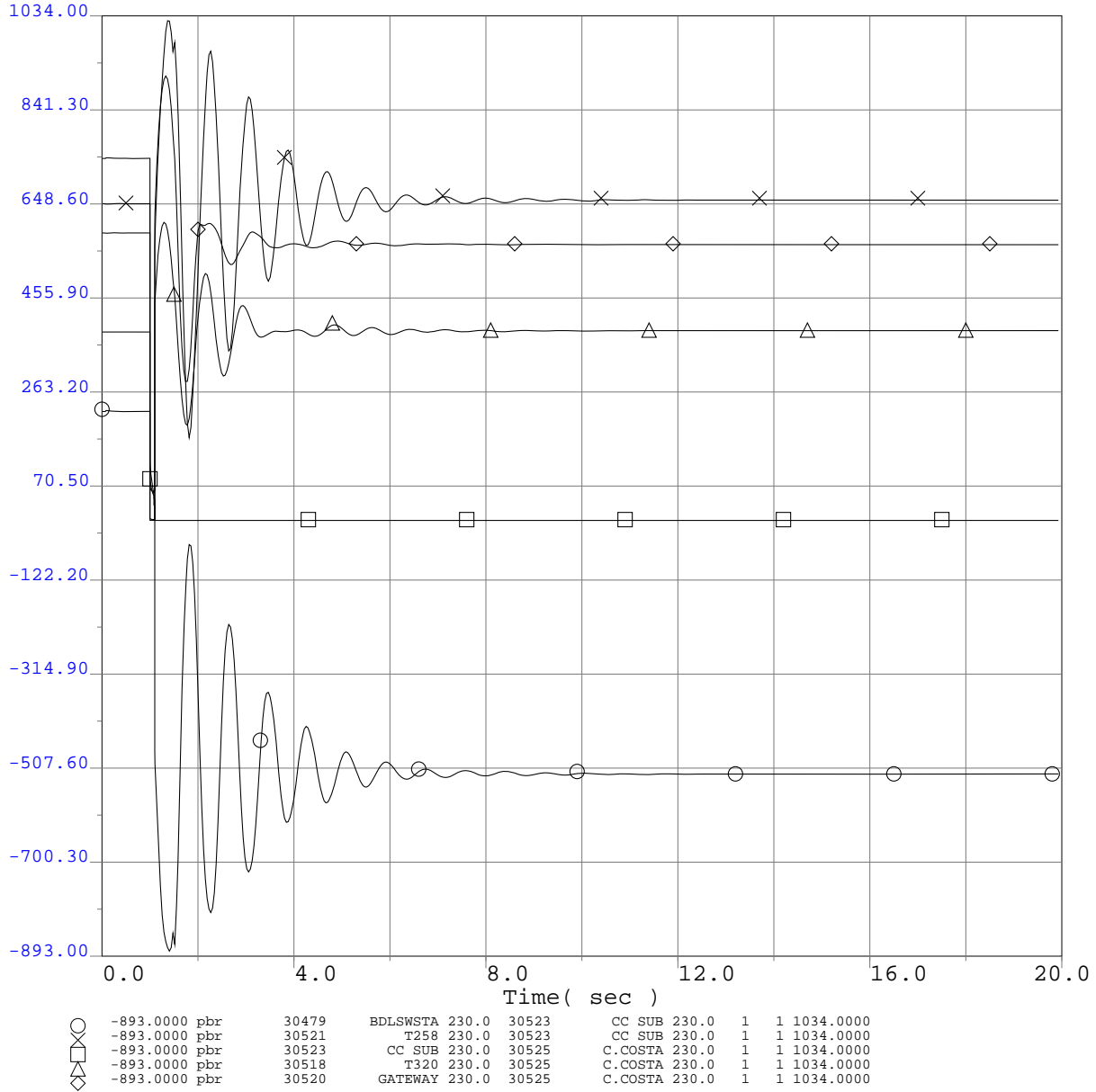

Q320 TCP2 ISIS
 2013 Greater Bay Area Summer Peak Base Case
 Q320 @ 772MW
 CCPP 230kV Bus 1D Outage
 3-ph 6 cyc flt @ the CCPP 230kV bus & clr the CCPP 230kV Bus 1D Outage

Q320 TCP2 ISIS

Selected PG&E Transmission Line Flows (MW)

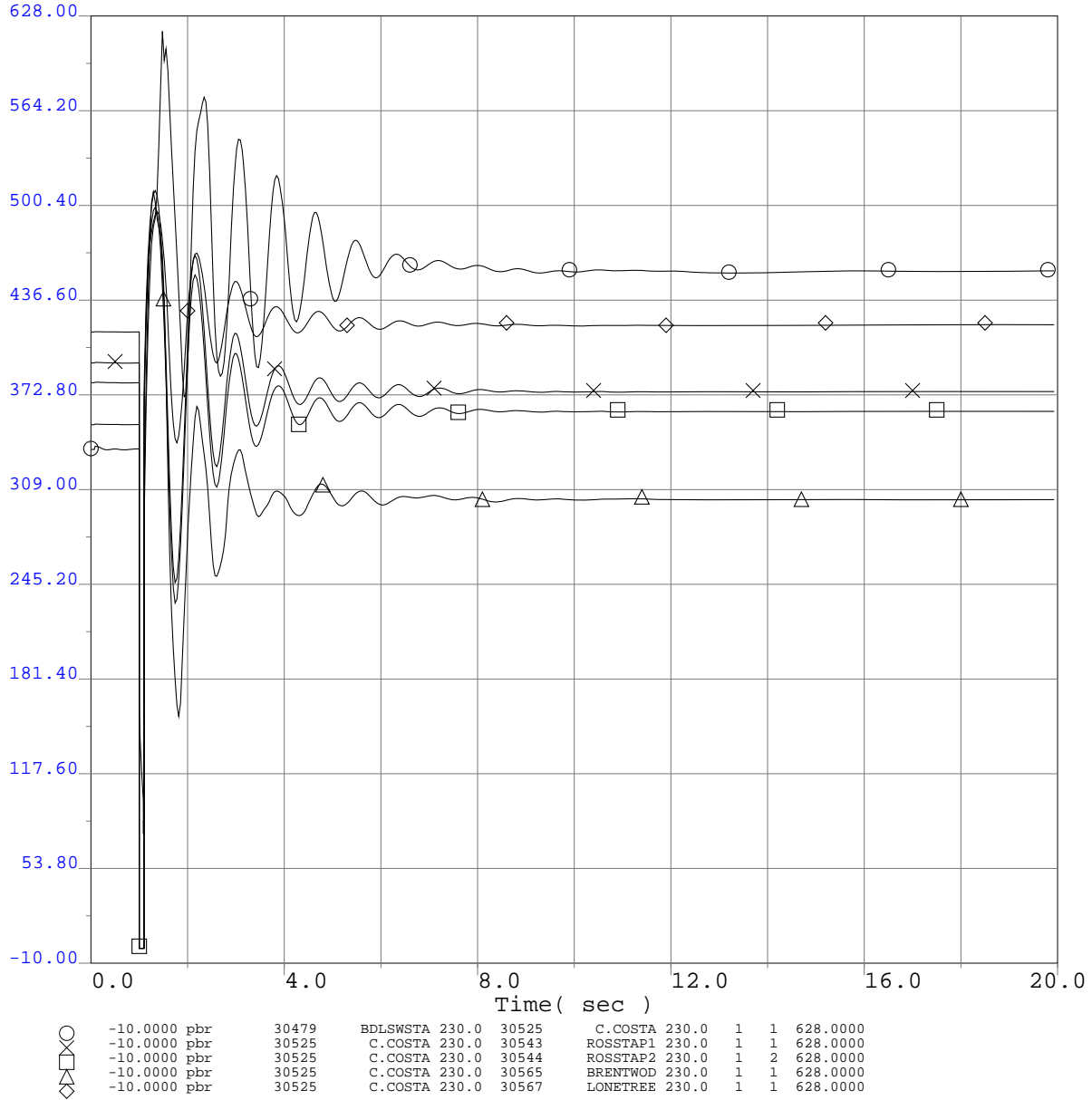

Q320 TCP2 ISIS
 2013 Greater Bay Area Summer Peak Base Case
 Q320 @ 772MW
 CCPP 230kV Bus 1D Outage
 3-ph 6 cyc flt @ the CCPP 230kV bus & clr the CCPP 230kV Bus 1D Outage

Q320 TCP2 ISIS

Selected PG&E Transmission Line Flows (MW)

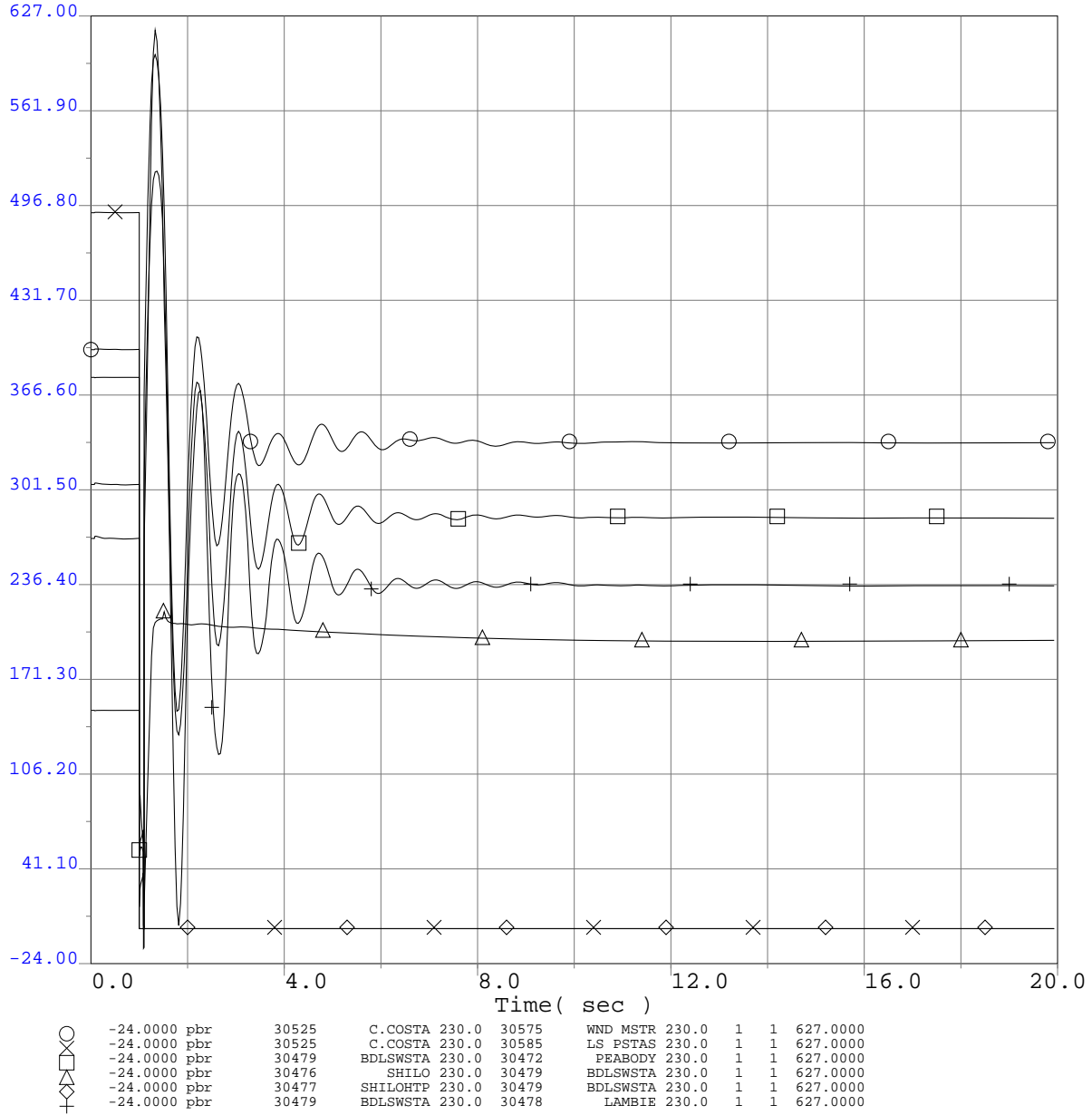

Q320 TCP2 ISIS
 2013 Greater Bay Area Summer Peak Base Case
 Q320 @ 772MW
 CCPP 230kV Bus 1D Outage
 3-ph 6 cyc flt @ the CCPP 230kV bus & clr the CCPP 230kV Bus 1D Outage

Q320 TCP2 ISIS

Selected PG&E Transmission Line Flows (MW)

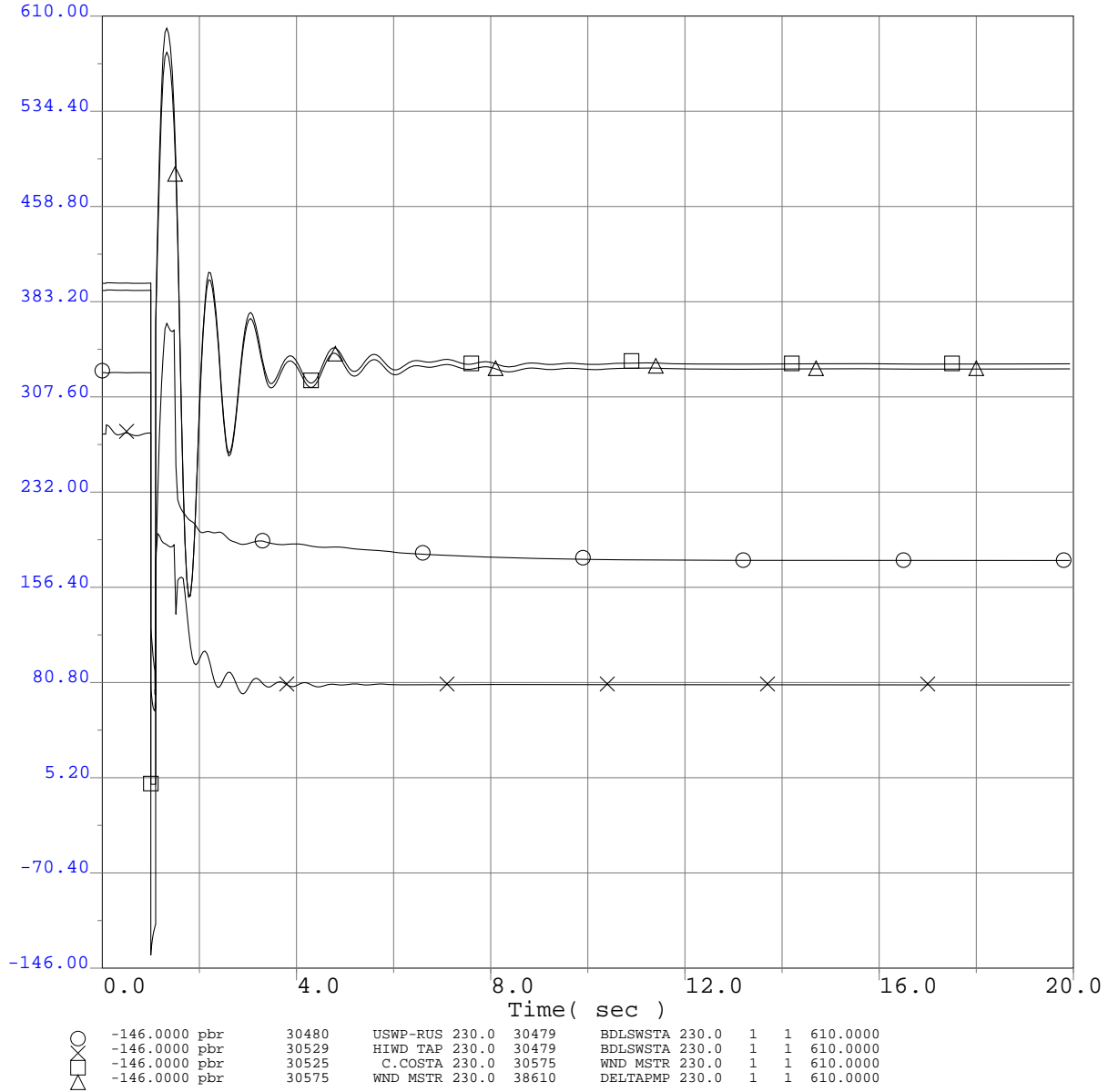

Q320 TCP2 ISIS
 2013 Greater Bay Area Summer Peak Base Case
 Q320 @ 772MW
 CCPP 230kV Bus 1D Outage
 3-ph 6 cyc flt @ the CCPP 230kV bus & clr the CCPP 230kV Bus 1D Outage

Q320 TCP2 ISIS

Selected PG&E Bus Voltage Plots Adjacent to Fault

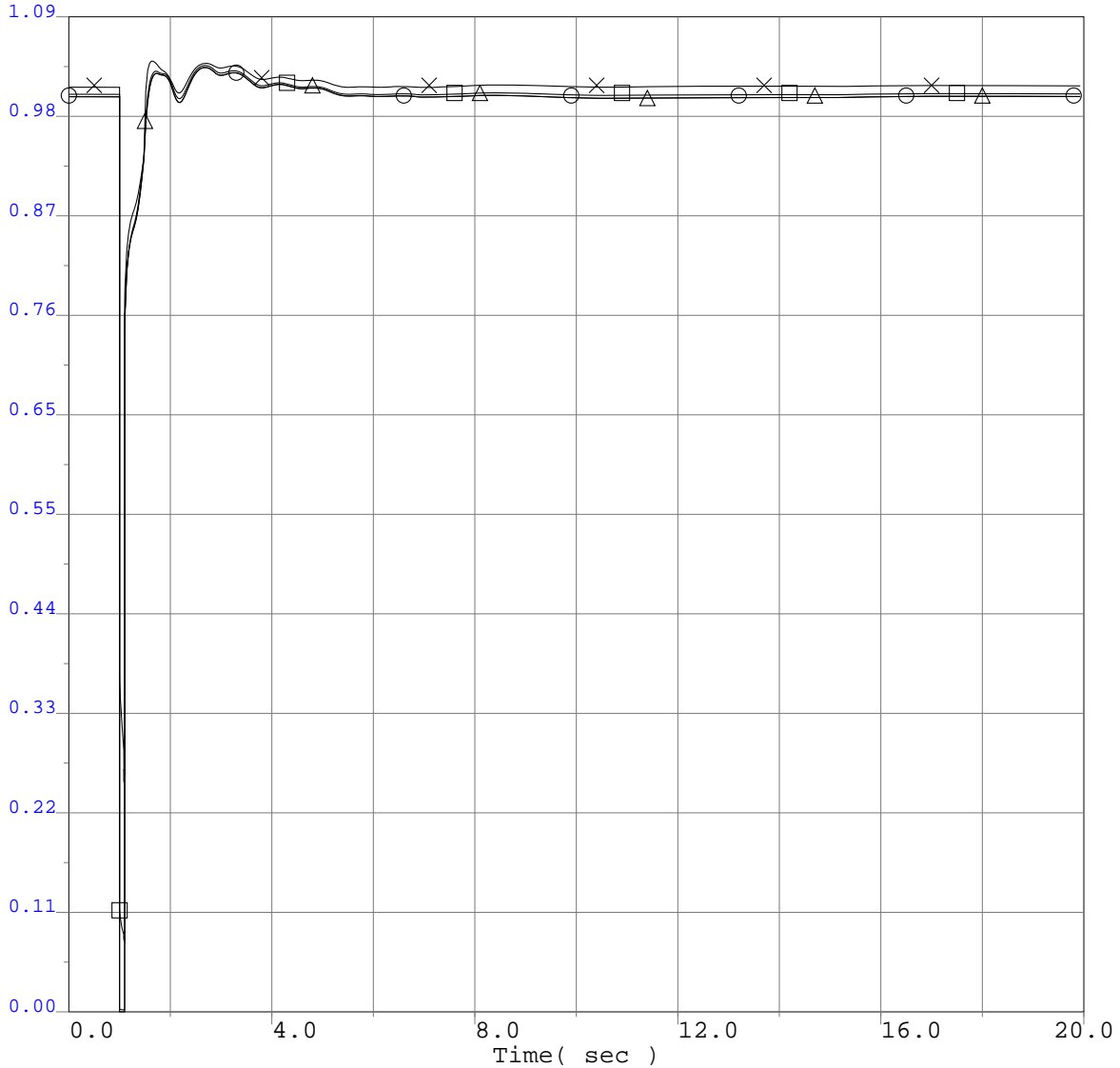

○	0.0000 vbus	30525	C.COSTA 230.0	0	0.0	***	1	1.0900
□	0.0000 vbus	30479	BDLSWSTA 230.0	0	0.0	***	1	1.0900
△	0.0000 vbus	30523	CC SUB 230.0	0	0.0	***	1	1.0900
△	0.0000 vbus	30518	T320 230.0	0	0.0	***	1	1.0900



Q320 TCP2 ISIS
 2013 Greater Bay Area Summer Peak Base Case
 Q320 @ 772MW
 CCPP 230kV Bus 2D Outage
 3-ph 6 cyc flt @ the CCPP 230kV bus & clr the CCPP 230kV Bus 2D Outage

Q320 TCP2 ISIS

Selected PG&E Bus Frequency Plots Adjacent to Fault

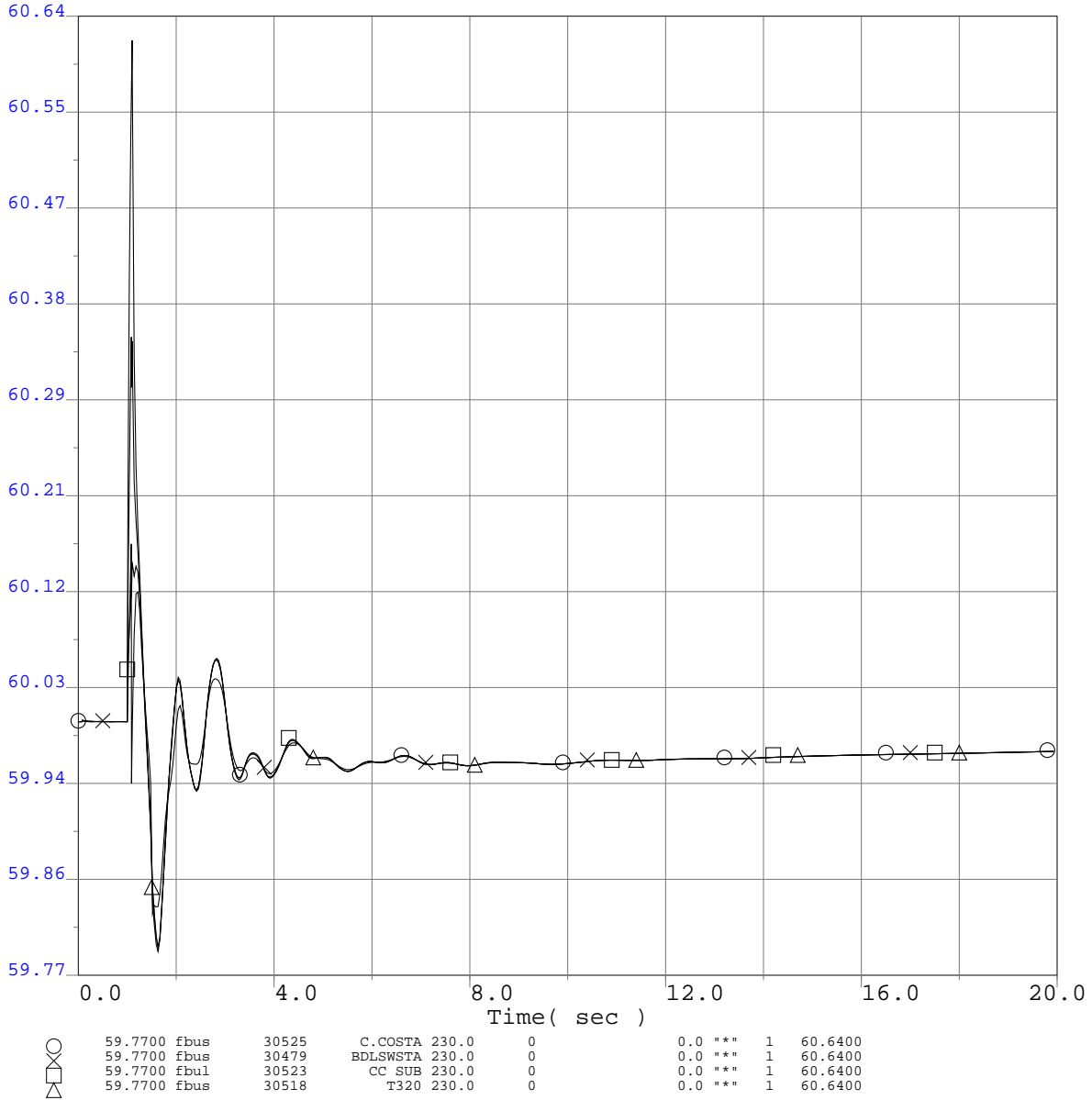

Q320 TCP2 ISIS
 2013 Greater Bay Area Summer Peak Base Case
 Q320 @ 772MW
 CCPP 230kV Bus 2D Outage
 3-ph 6 cyc flt @ the CCPP 230kV bus & clr the CCPP 230kV Bus 2D Outage

Q320 TCP2 ISIS

Project Generator Terminal Voltages (P.U.)

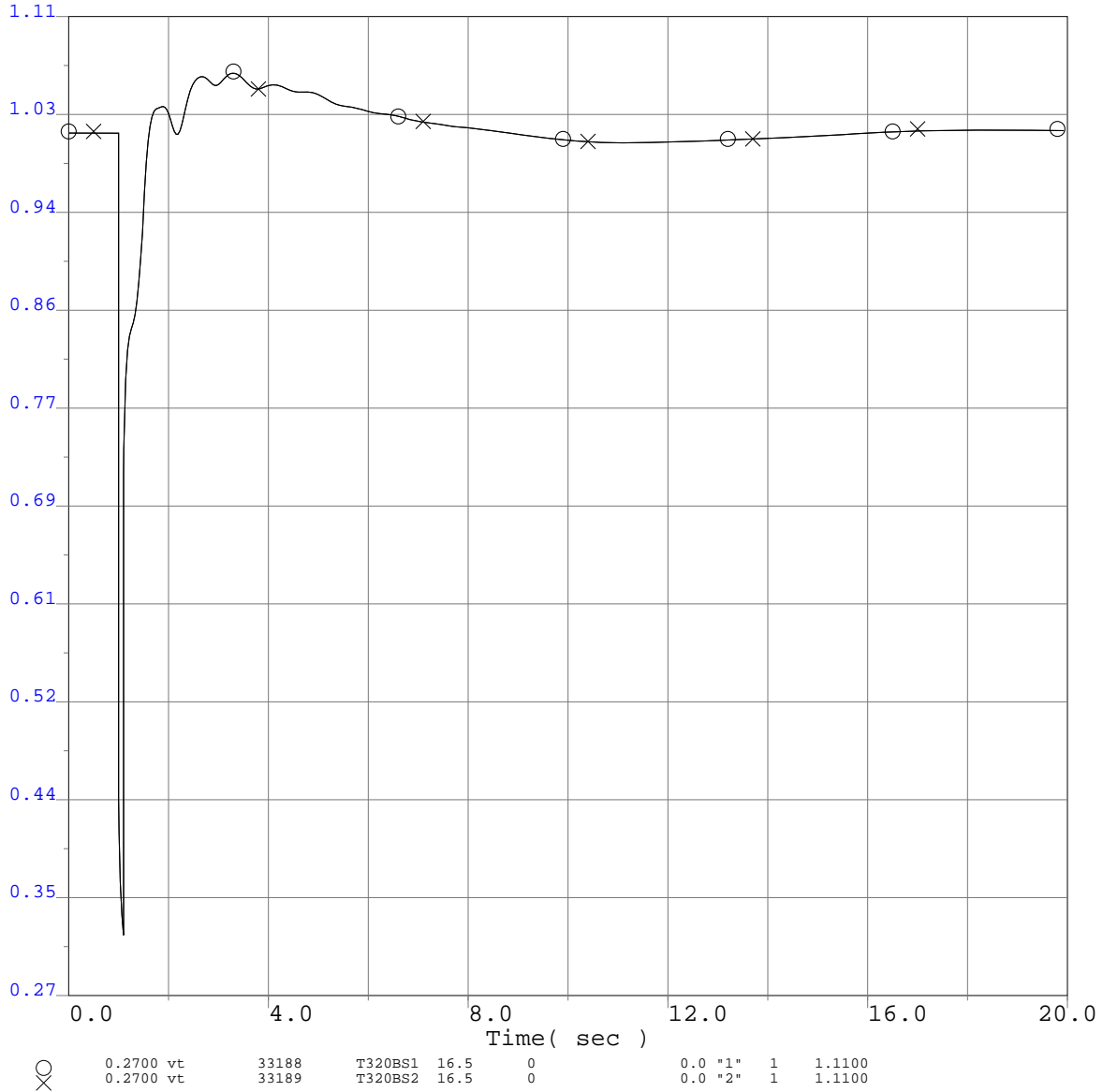

Q320 TCP2 ISIS
 2013 Greater Bay Area Summer Peak Base Case
 Q320 @ 772MW
 CCPP 230kV Bus 2D Outage
 3-ph 6 cyc flt @ the CCPP 230kV bus & clr the CCPP 230kV Bus 2D Outage

Q320 TCP2 ISIS

Project Generator Terminal Voltages (P.U.)

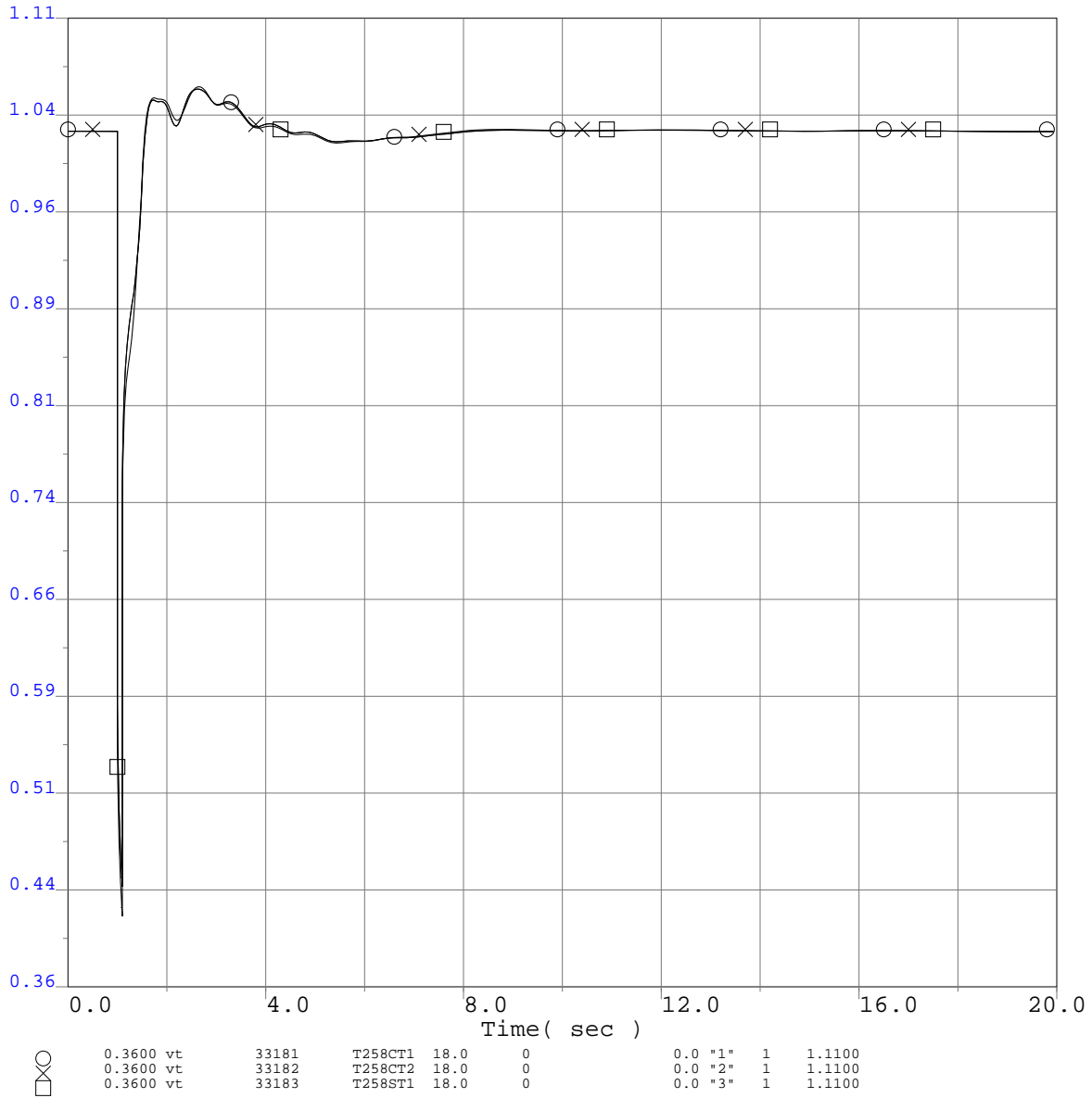

○	0.3600 vt	33181	T258CT1	18.0	0	0.0 "1"	1	1.1100
×	0.3600 vt	33182	T258CT2	18.0	0	0.0 "2"	1	1.1100
□	0.3600 vt	33183	T258ST1	18.0	0	0.0 "3"	1	1.1100

Q320 TCP2 ISIS
 2013 Greater Bay Area Summer Peak Base Case
 Q320 @ 772MW
 CCPP 230kV Bus 2D Outage
 3-ph 6 cyc flt @ the CCPP 230kV bus & clr the CCPP 230kV Bus 2D Outage

Q320 TCP2 ISIS

Project Generator Speed (P.U.)

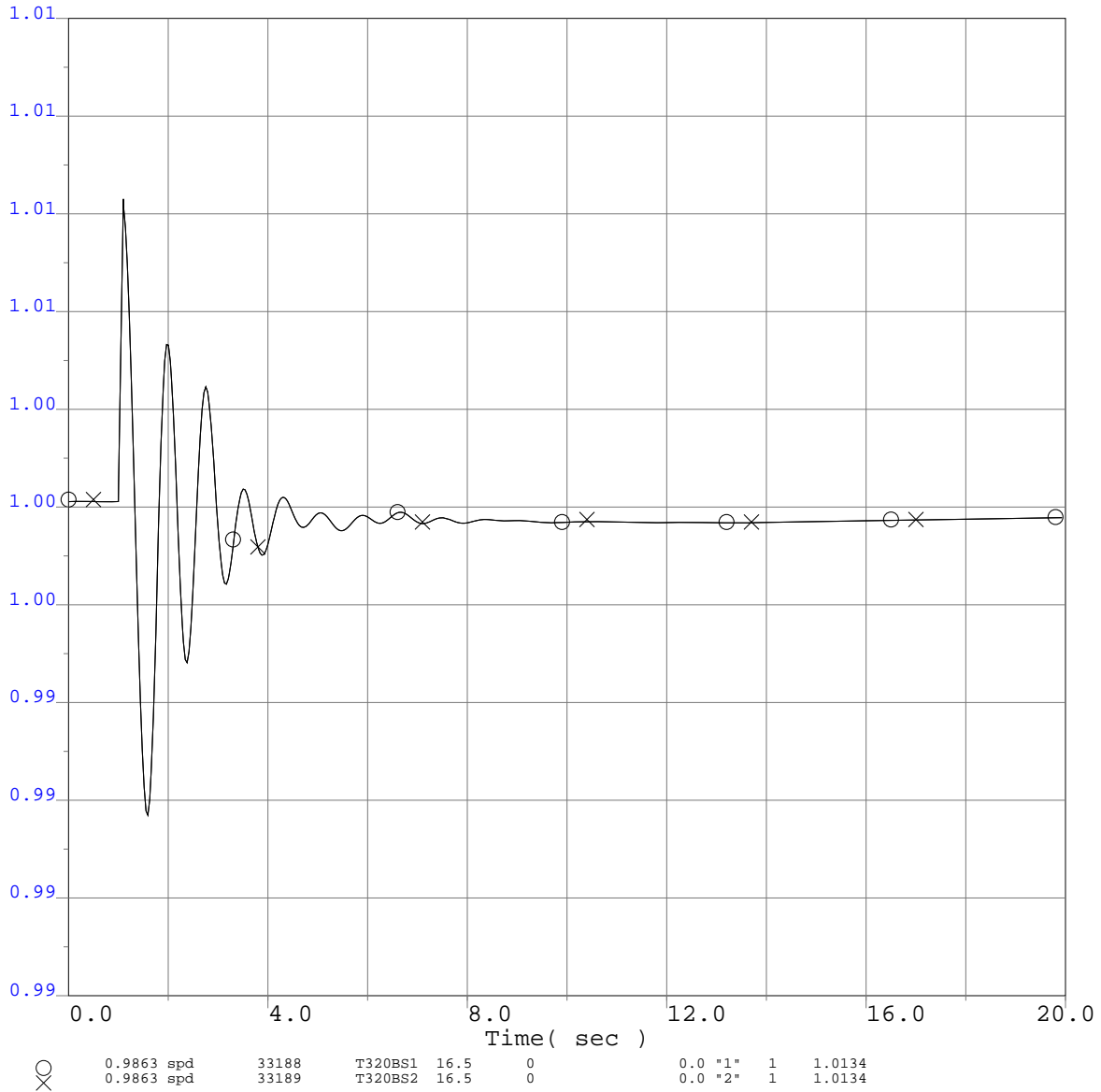

Q320 TCP2 ISIS
 2013 Greater Bay Area Summer Peak Base Case
 Q320 @ 772MW
 CCPP 230kV Bus 2D Outage
 3-ph 6 cyc flt @ the CCPP 230kV bus & clr the CCPP 230kV Bus 2D Outage

Q320 TCP2 ISIS

Project Generator Speed (P.U.)

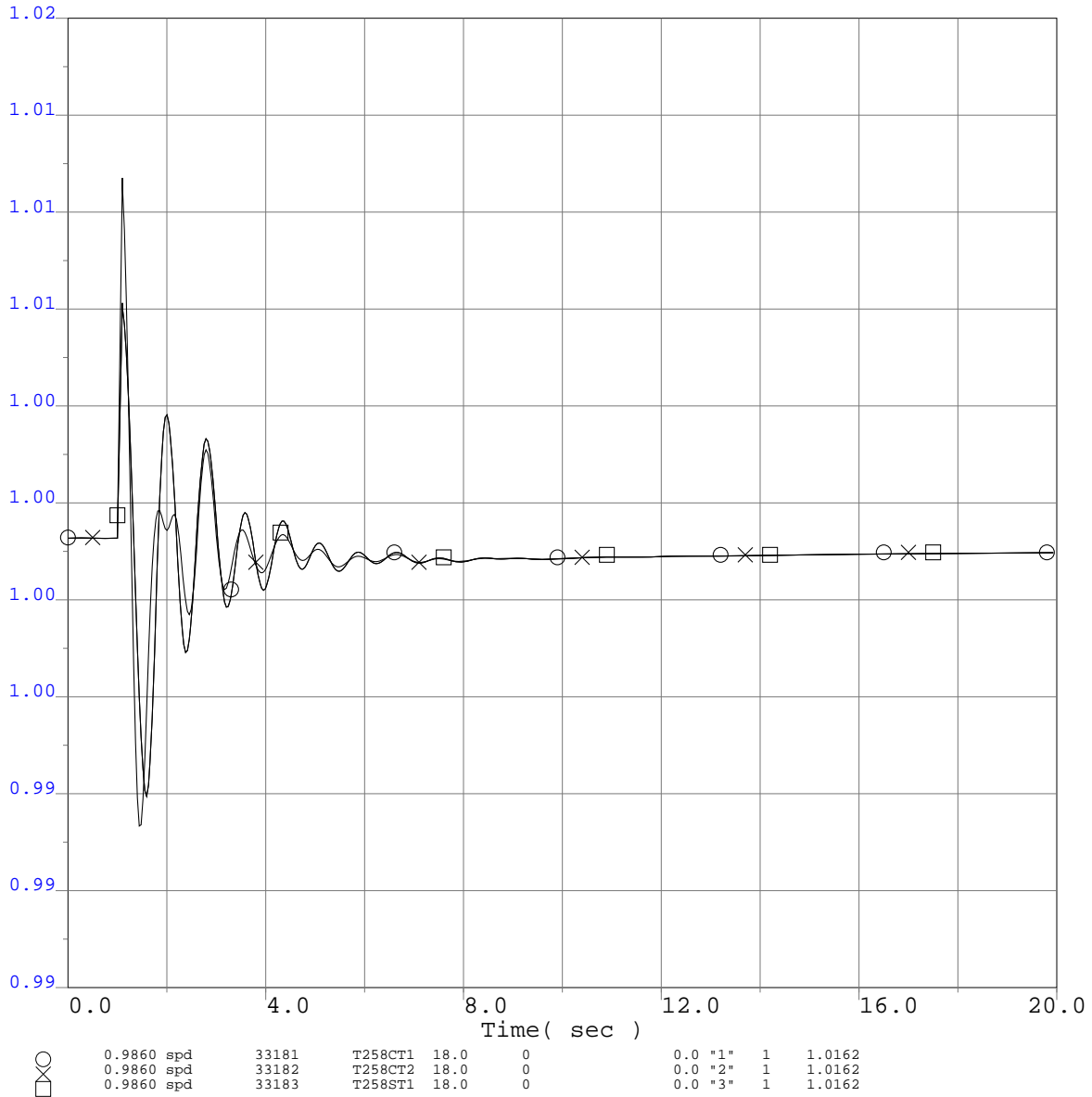

Q320 TCP2 ISIS
 2013 Greater Bay Area Summer Peak Base Case
 Q320 @ 772MW
 CCPP 230kV Bus 2D Outage
 3-ph 6 cyc flt @ the CCPP 230kV bus & clr the CCPP 230kV Bus 2D Outage

Q320 TCP2 ISIS

Project Generator Terminal Power (MW)

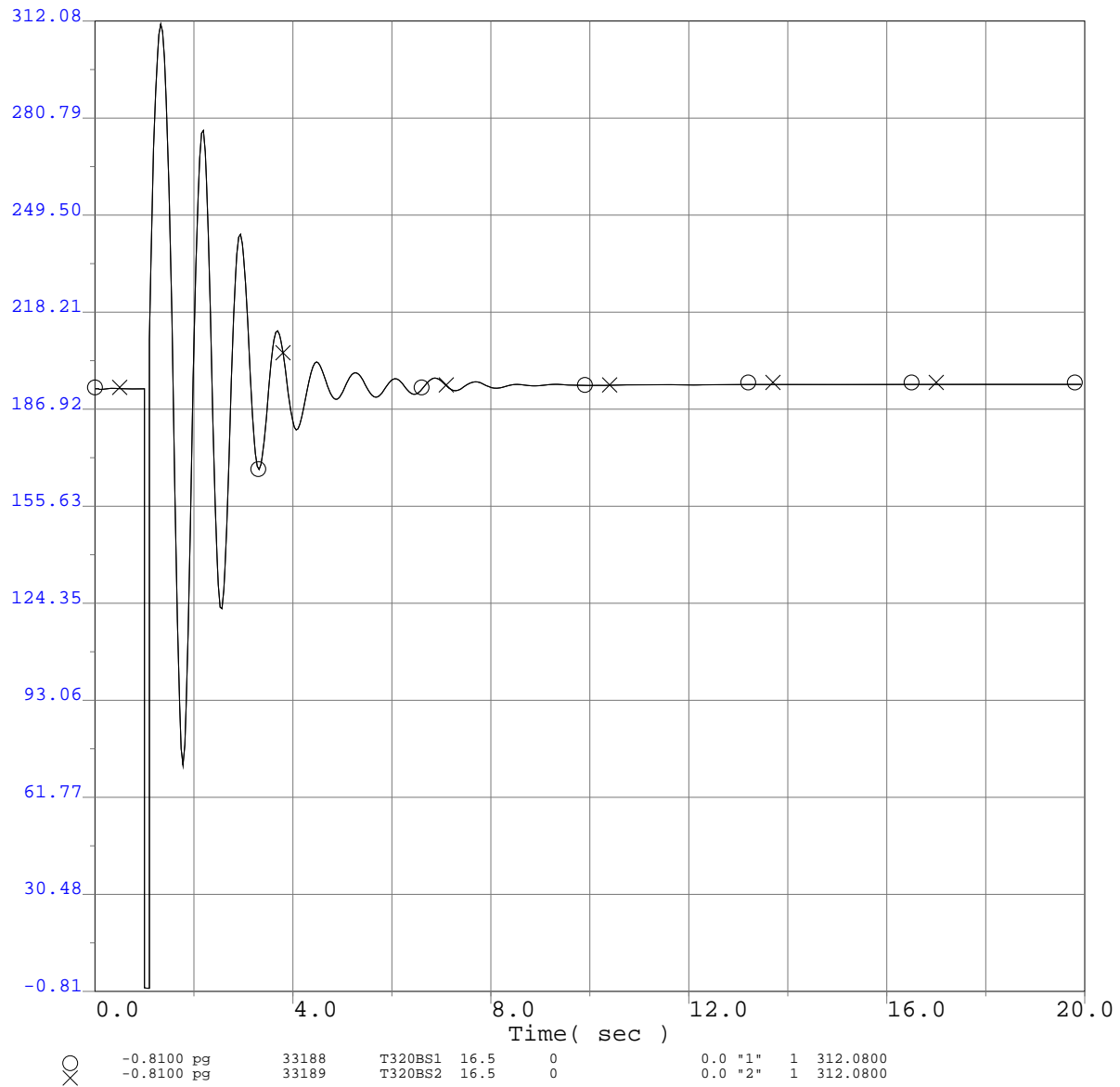

Q320 TCP2 ISIS
 2013 Greater Bay Area Summer Peak Base Case
 Q320 @ 772MW
 CCPP 230kV Bus 2D Outage
 3-ph 6 cyc flt @ the CCPP 230kV bus & clr the CCPP 230kV Bus 2D Outage

Q320 TCP2 ISIS

Project Generator Terminal Power (MW)

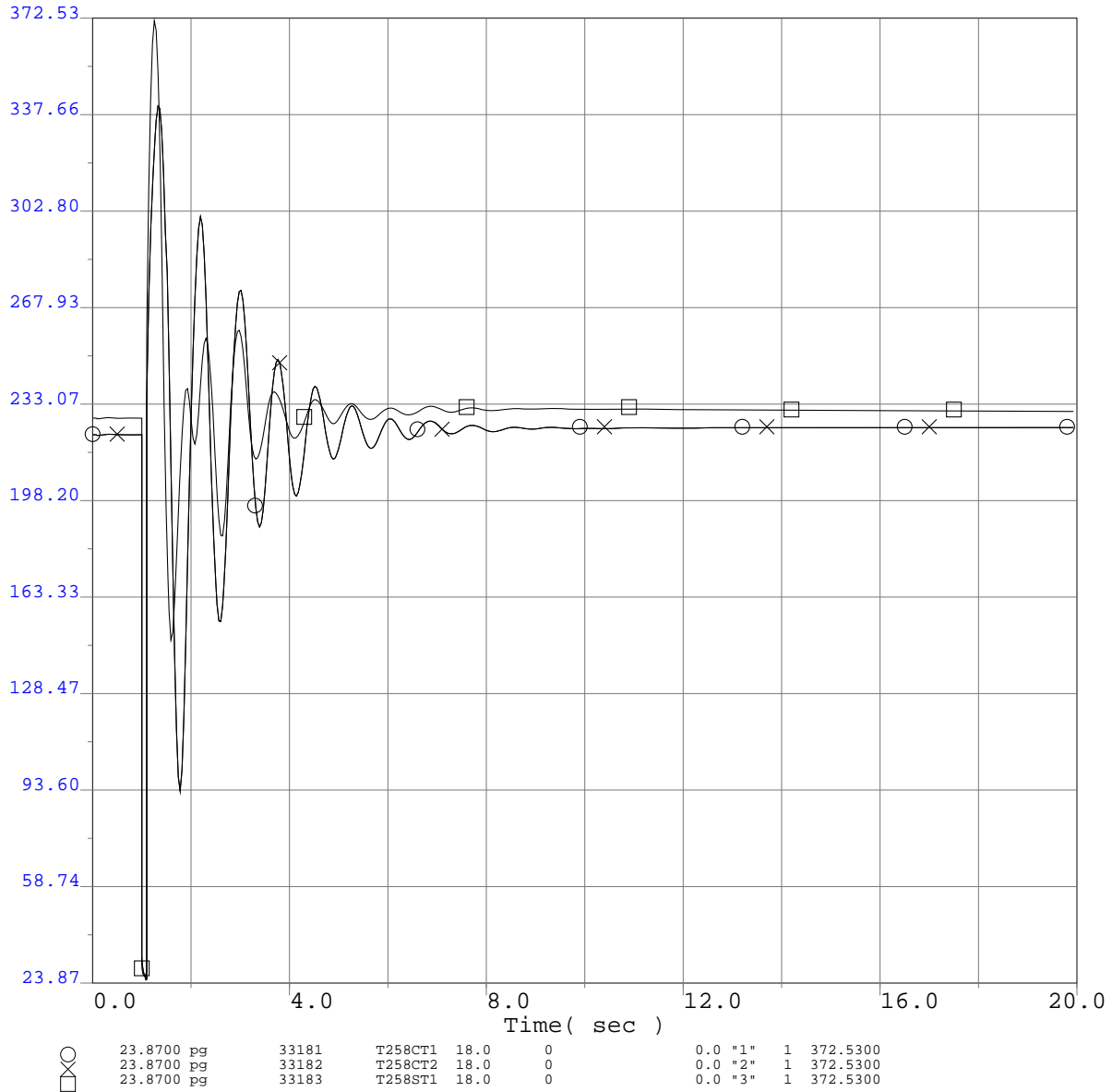

Q320 TCP2 ISIS
 2013 Greater Bay Area Summer Peak Base Case
 Q320 @ 772MW
 CCPP 230kV Bus 2D Outage
 3-ph 6 cyc flt @ the CCPP 230kV bus & clr the CCPP 230kV Bus 2D Outage

Q320 TCP2 ISIS

Project Generator Terminal Reactive Power (MVA_r)

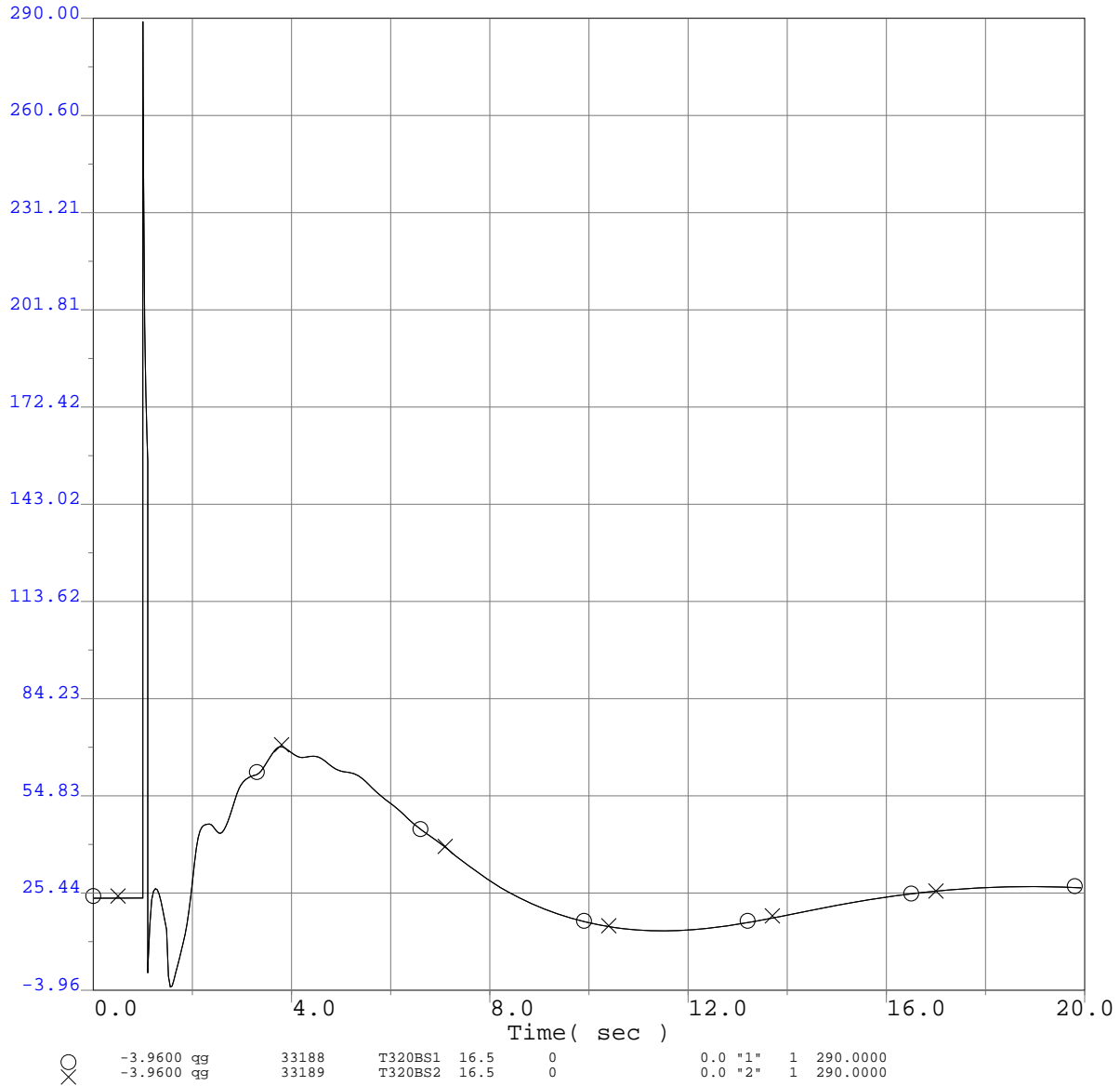

Q320 TCP2 ISIS
 2013 Greater Bay Area Summer Peak Base Case
 Q320 @ 772MW
 CCPP 230kV Bus 2D Outage
 3-ph 6 cyc flt @ the CCPP 230kV bus & clr the CCPP 230kV Bus 2D Outage

Q320 TCP2 ISIS

Project Generator Terminal Reactive Power (MVar)

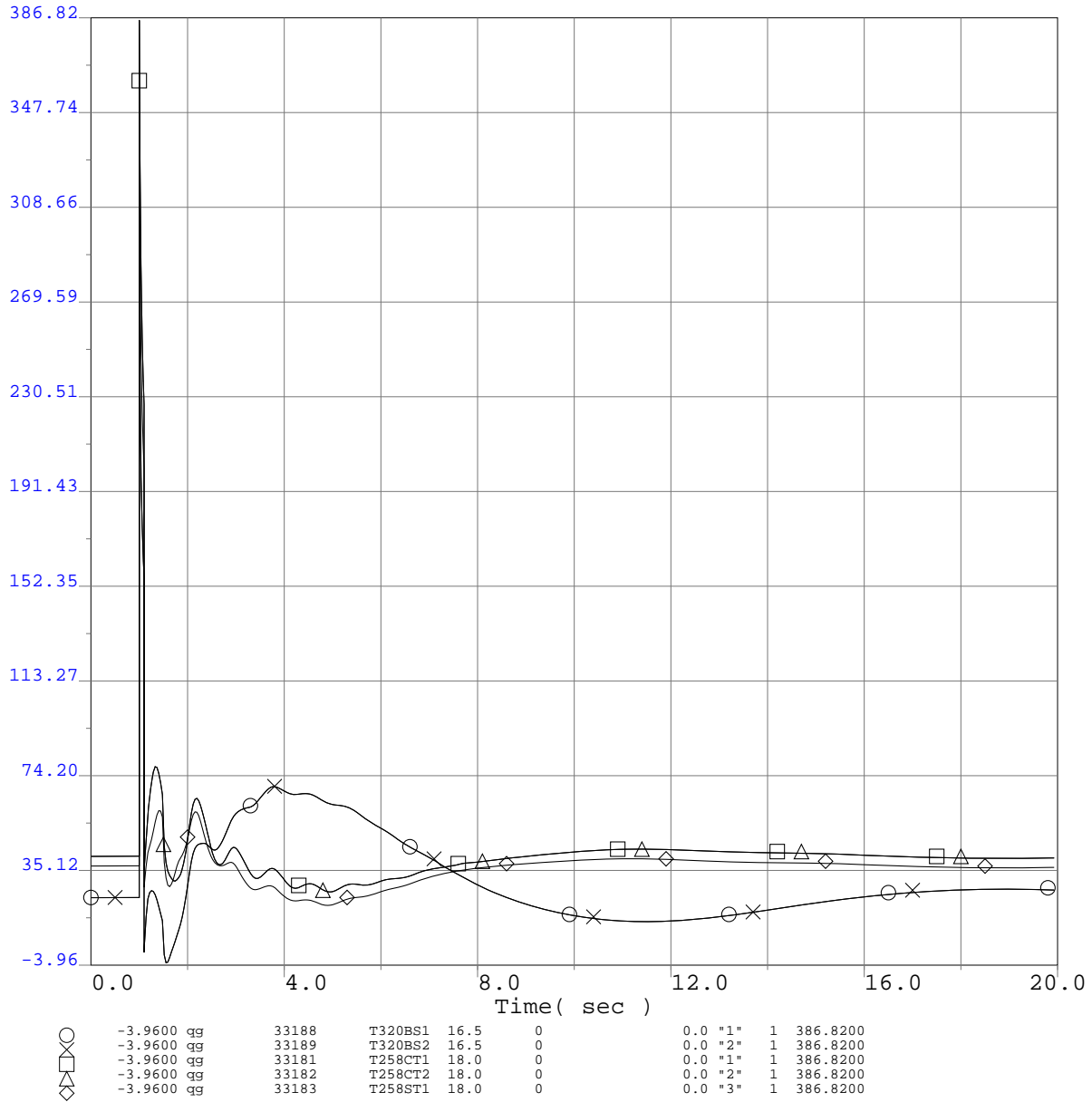

Q320 TCP2 ISIS
 2013 Greater Bay Area Summer Peak Base Case
 Q320 @ 772MW
 CCPP 230kV Bus 2D Outage
 3-ph 6 cyc flt @ the CCPP 230kV bus & clr the CCPP 230kV Bus 2D Outage

Q320 TCP2 ISIS

Selected WECC Bus Voltage Plots

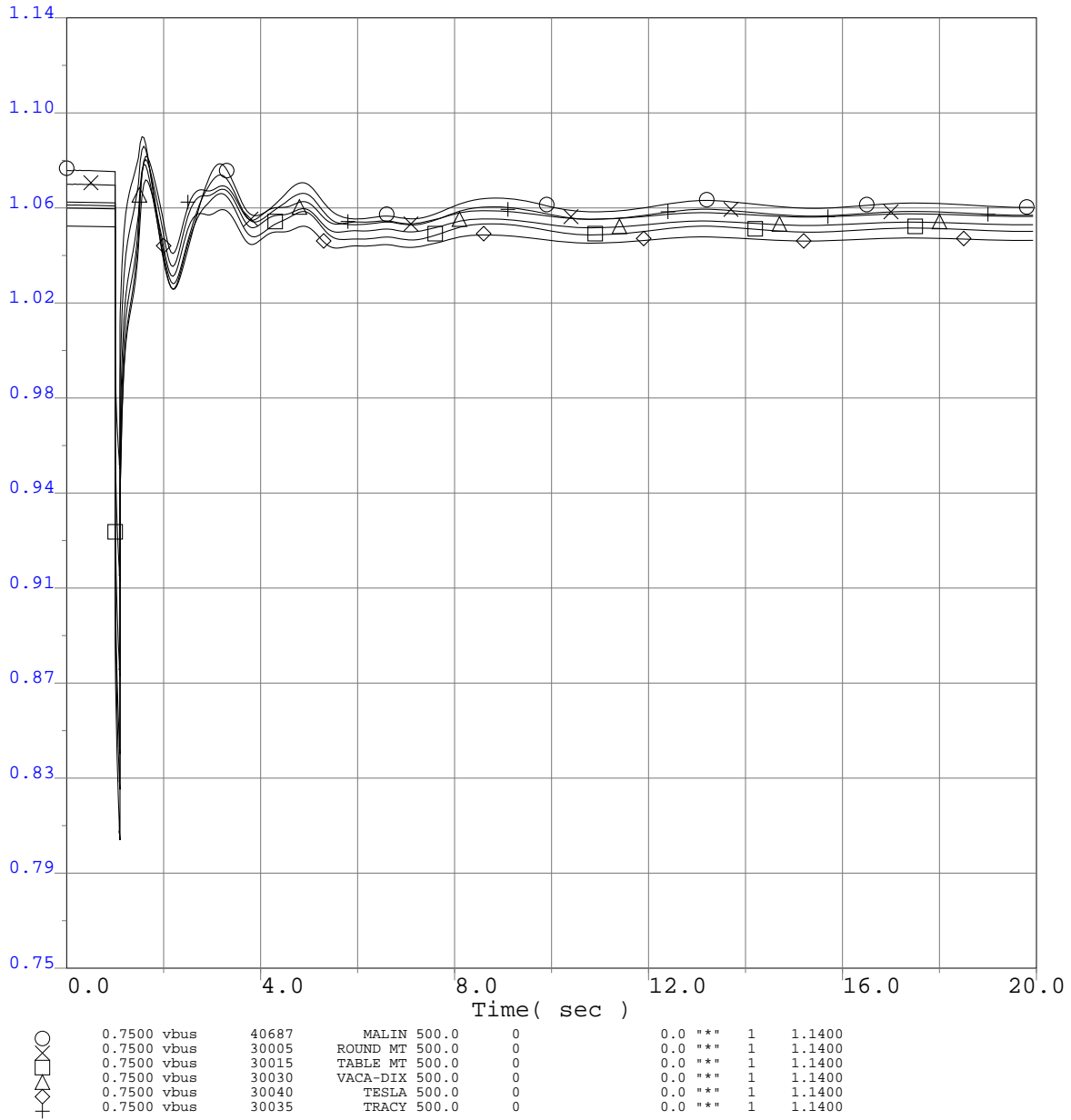

Q320 TCP2 ISIS
 2013 Greater Bay Area Summer Peak Base Case
 Q320 @ 772MW
 CCPP 230kV Bus 2D Outage
 3-ph 6 cyc flt @ the CCPP 230kV bus & clr the CCPP 230kV Bus 2D Outage

Q320 TCP2 ISIS

Selected WECC Bus Voltage Plots

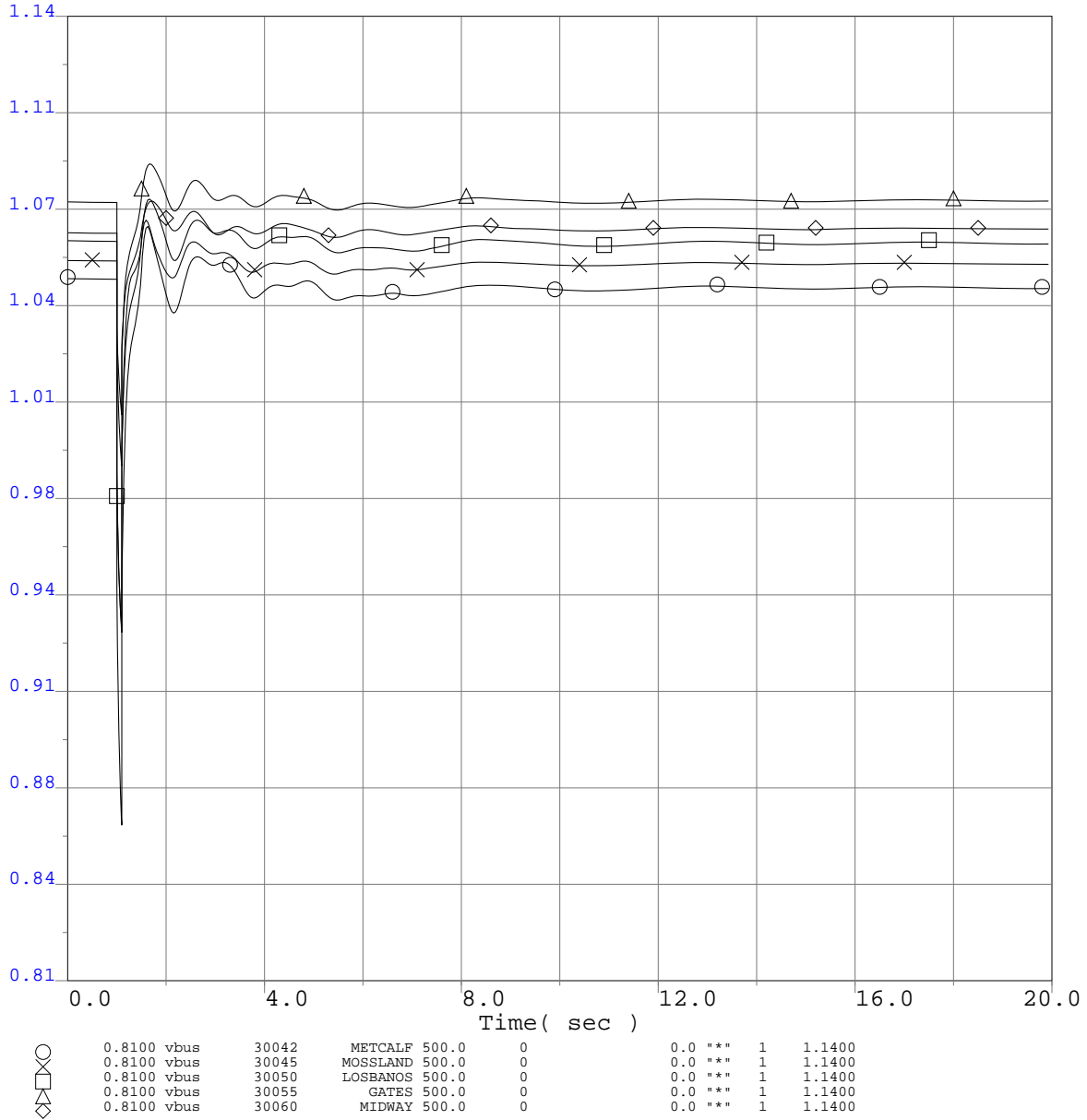

Q320 TCP2 ISIS
 2013 Greater Bay Area Summer Peak Base Case
 Q320 @ 772MW
 CCPP 230kV Bus 2D Outage
 3-ph 6 cyc flt @ the CCPP 230kV bus & clr the CCPP 230kV Bus 2D Outage

Q320 TCP2 ISIS

Selected WECC Bus Voltage Plots

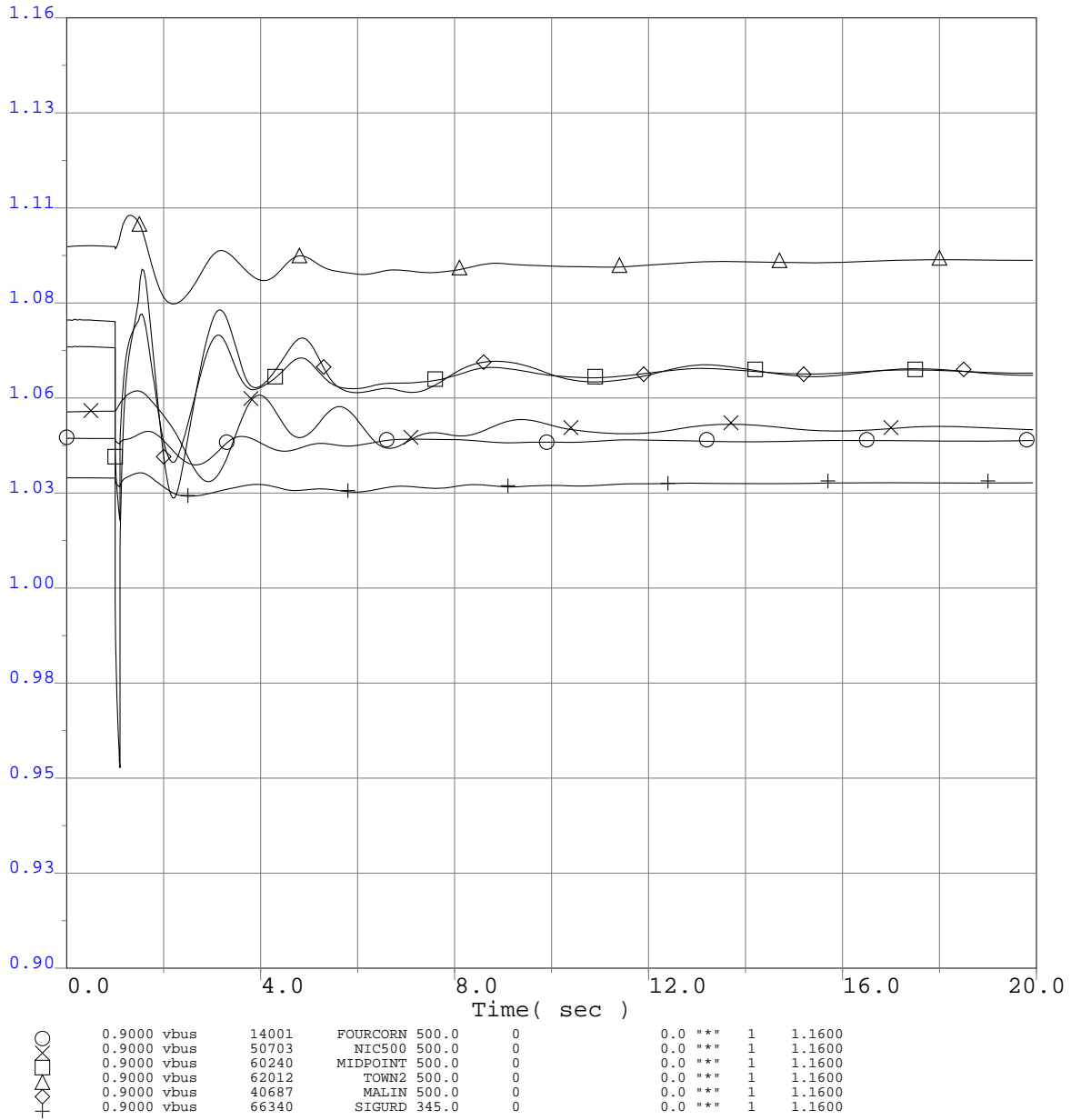

Q320 TCP2 ISIS
 2013 Greater Bay Area Summer Peak Base Case
 Q320 @ 772MW
 CCPP 230kV Bus 2D Outage
 3-ph 6 cyc flt @ the CCPP 230kV bus & clr the CCPP 230kV Bus 2D Outage

Q320 TCP2 ISIS

Selected WECC Bus Voltage Plots

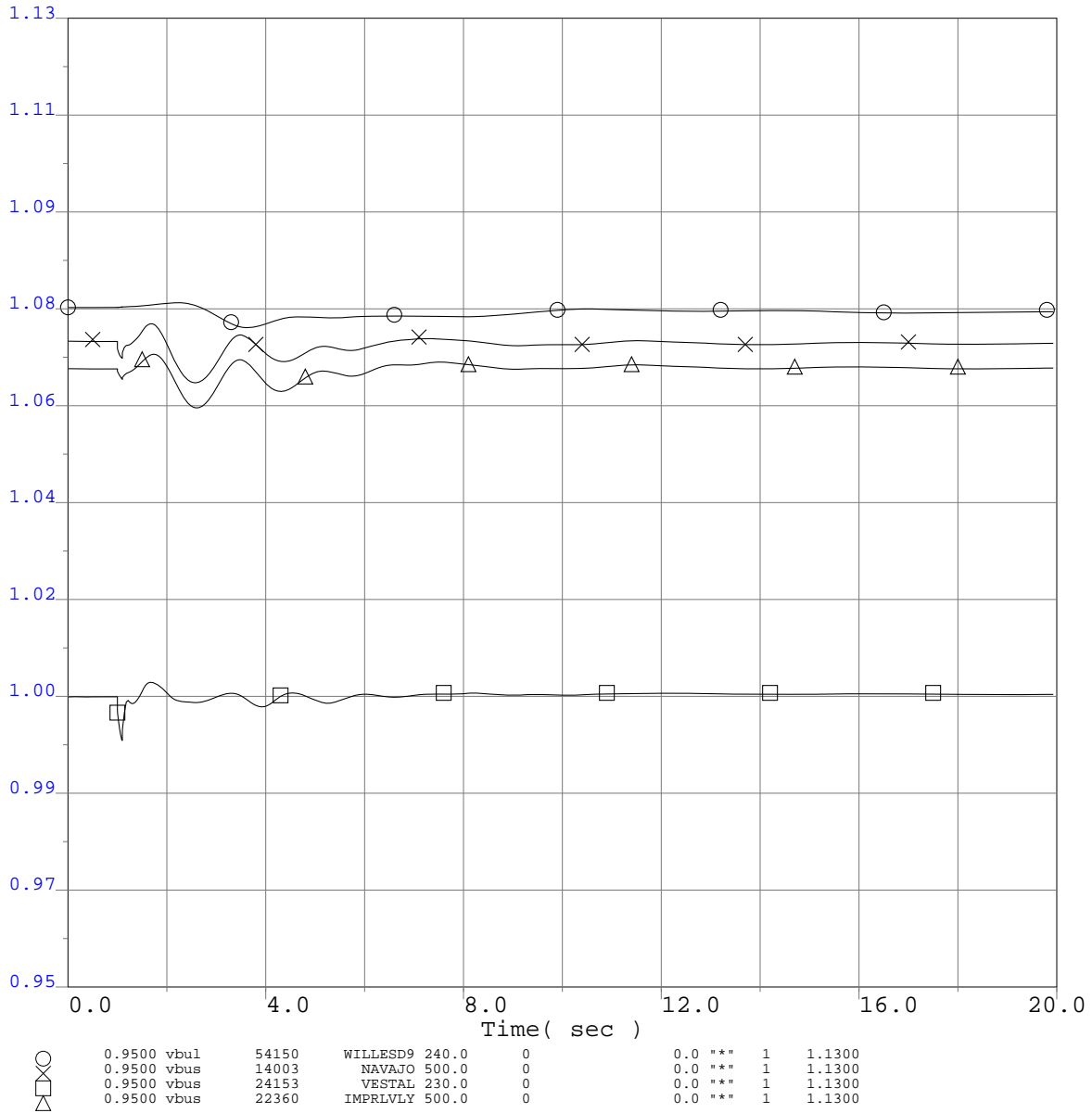

Q320 TCP2 ISIS
 2013 Greater Bay Area Summer Peak Base Case
 Q320 @ 772MW
 CCPP 230kV Bus 2D Outage
 3-ph 6 cyc flt @ the CCPP 230kV bus & clr the CCPP 230kV Bus 2D Outage

Q320 TCP2 ISIS

Selected WECC Bus Frequency Plots

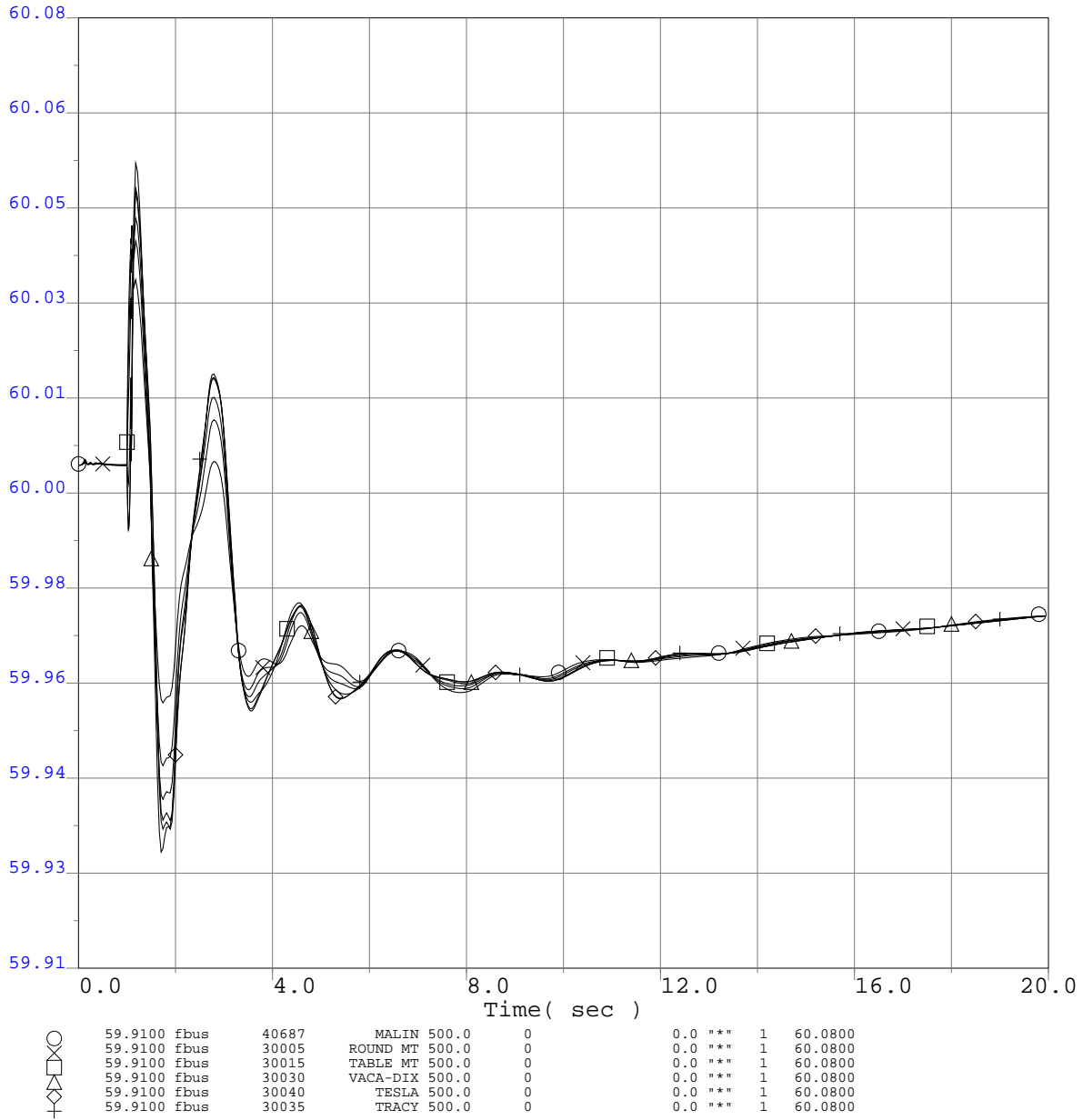

Q320 TCP2 ISIS
 2013 Greater Bay Area Summer Peak Base Case
 Q320 @ 772MW
 CCPP 230kV Bus 2D Outage
 3-ph 6 cyc flt @ the CCPP 230kV bus & clr the CCPP 230kV Bus 2D Outage

Q320 TCP2 ISIS

Selected WECC Bus Frequency Plots

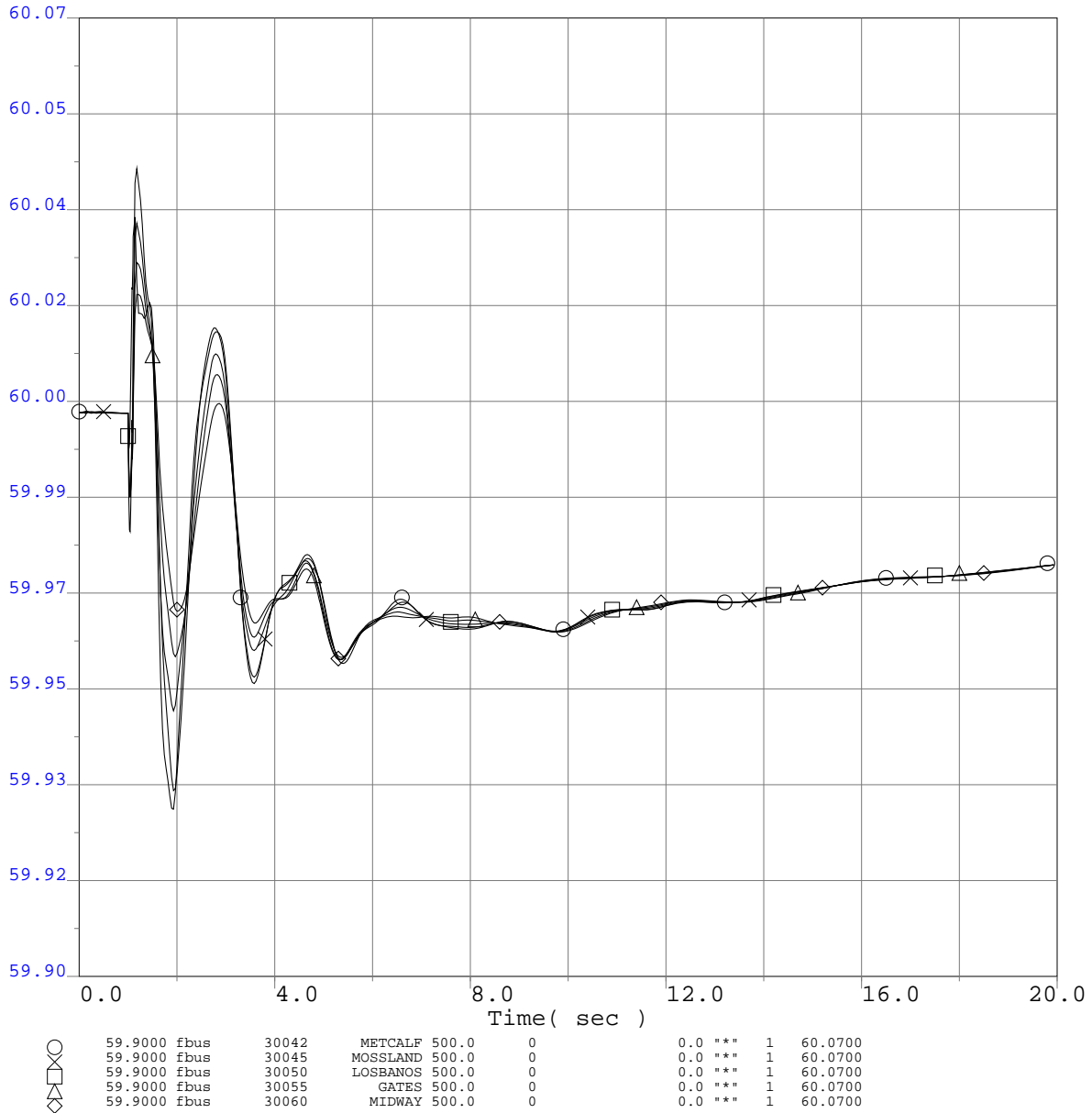

Q320 TCP2 ISIS
 2013 Greater Bay Area Summer Peak Base Case
 Q320 @ 772MW
 CCPP 230kV Bus 2D Outage
 3-ph 6 cyc flt @ the CCPP 230kV bus & clr the CCPP 230kV Bus 2D Outage

Q320 TCP2 ISIS

Selected WECC Bus Frequency Plots

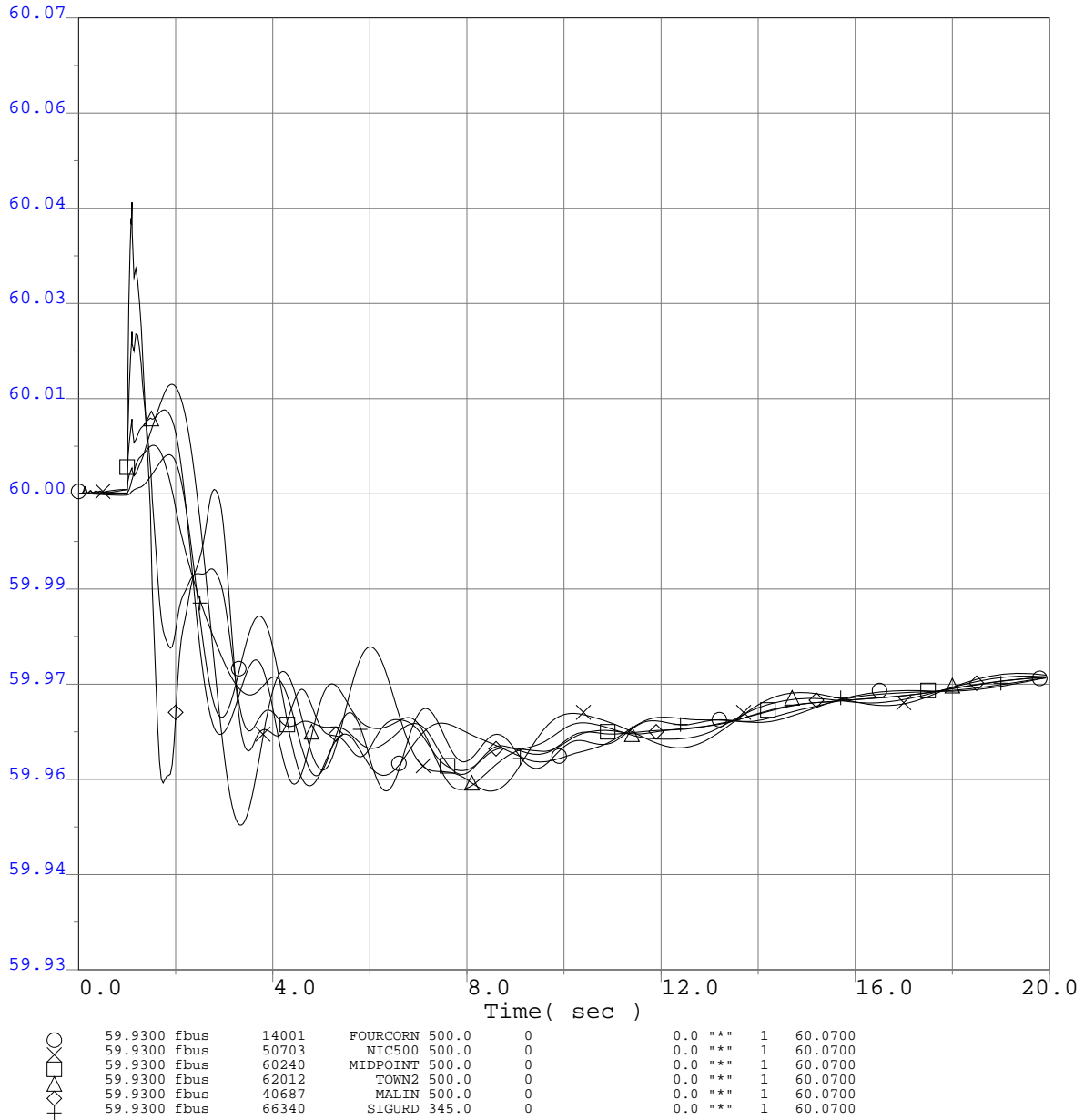

Q320 TCP2 ISIS
 2013 Greater Bay Area Summer Peak Base Case
 Q320 @ 772MW
 CCPP 230kV Bus 2D Outage
 3-ph 6 cyc flt @ the CCPP 230kV bus & clr the CCPP 230kV Bus 2D Outage

Q320 TCP2 ISIS

Selected WECC Bus Frequency Plots

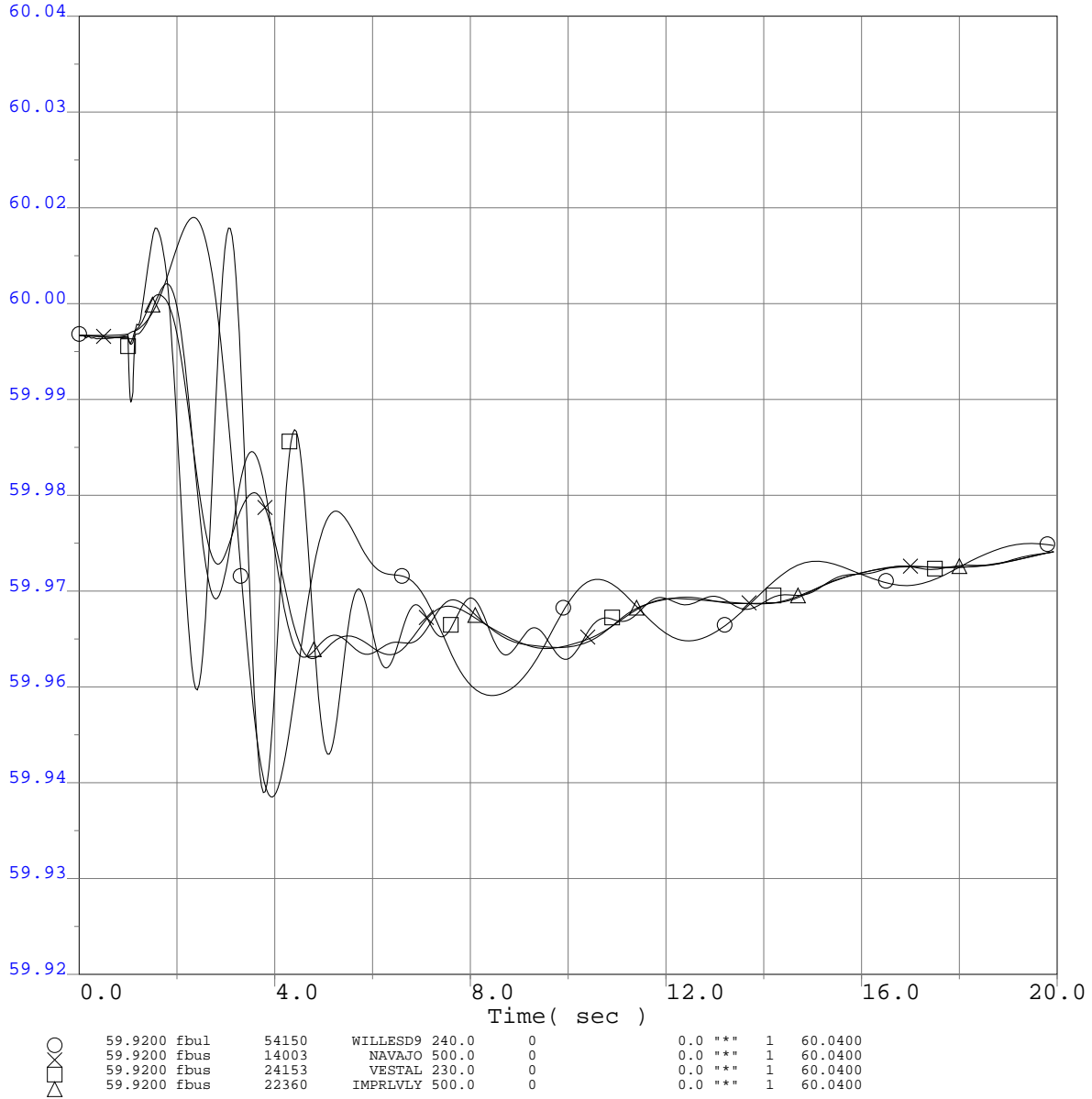

Q320 TCP2 ISIS
 2013 Greater Bay Area Summer Peak Base Case
 Q320 @ 772MW
 CCPP 230kV Bus 2D Outage
 3-ph 6 cyc flt @ the CCPP 230kV bus & clr the CCPP 230kV Bus 2D Outage

Q320 TCP2 ISIS

WECC Generator Rotor Angle

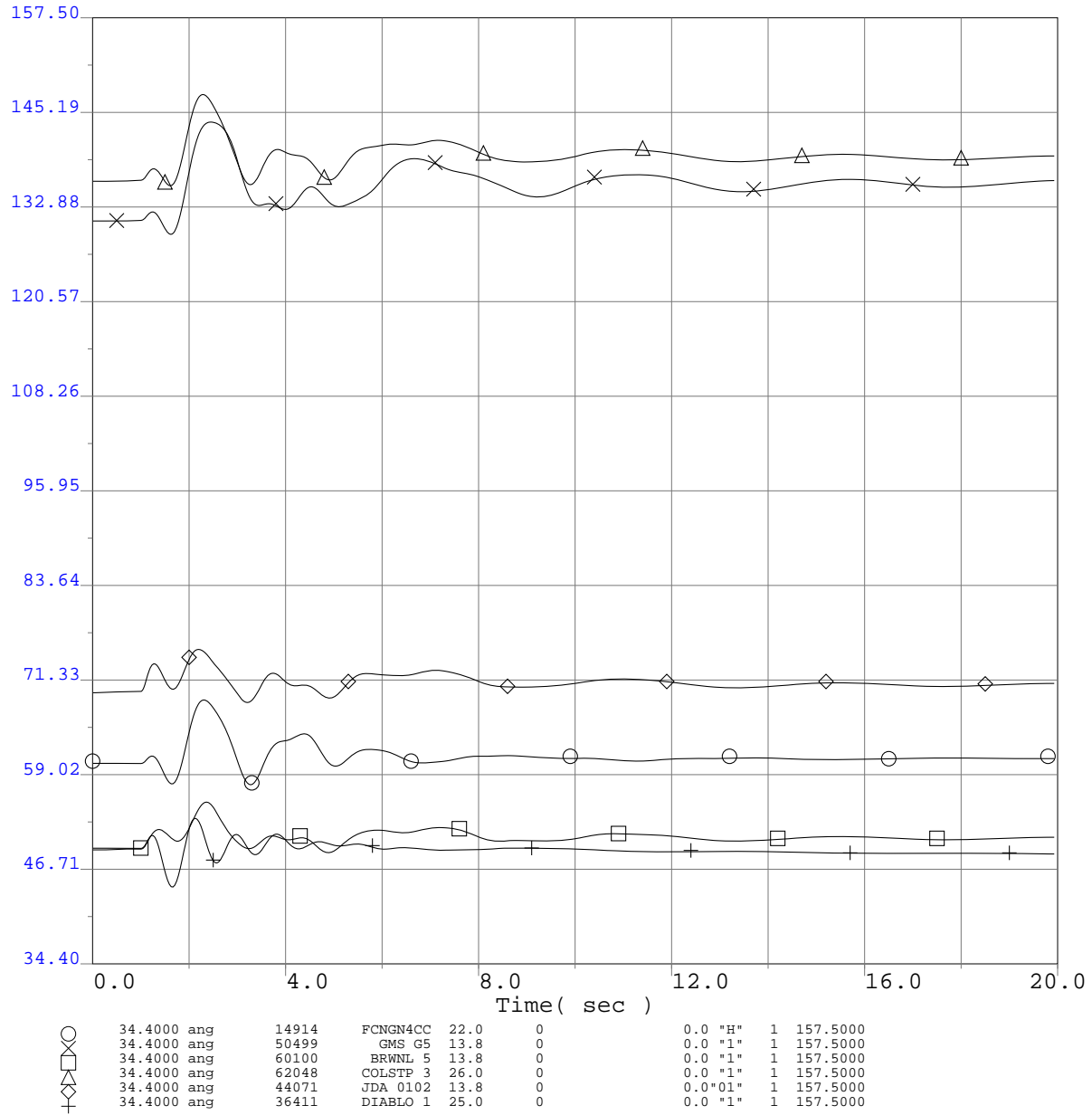

Q320 TCP2 ISIS
 2013 Greater Bay Area Summer Peak Base Case
 Q320 @ 772MW
 CCPP 230kV Bus 2D Outage
 3-ph 6 cyc flt @ the CCPP 230kV bus & clr the CCPP 230kV Bus 2D Outage

Q320 TCP2 ISIS

WECC Generator Rotor Angle

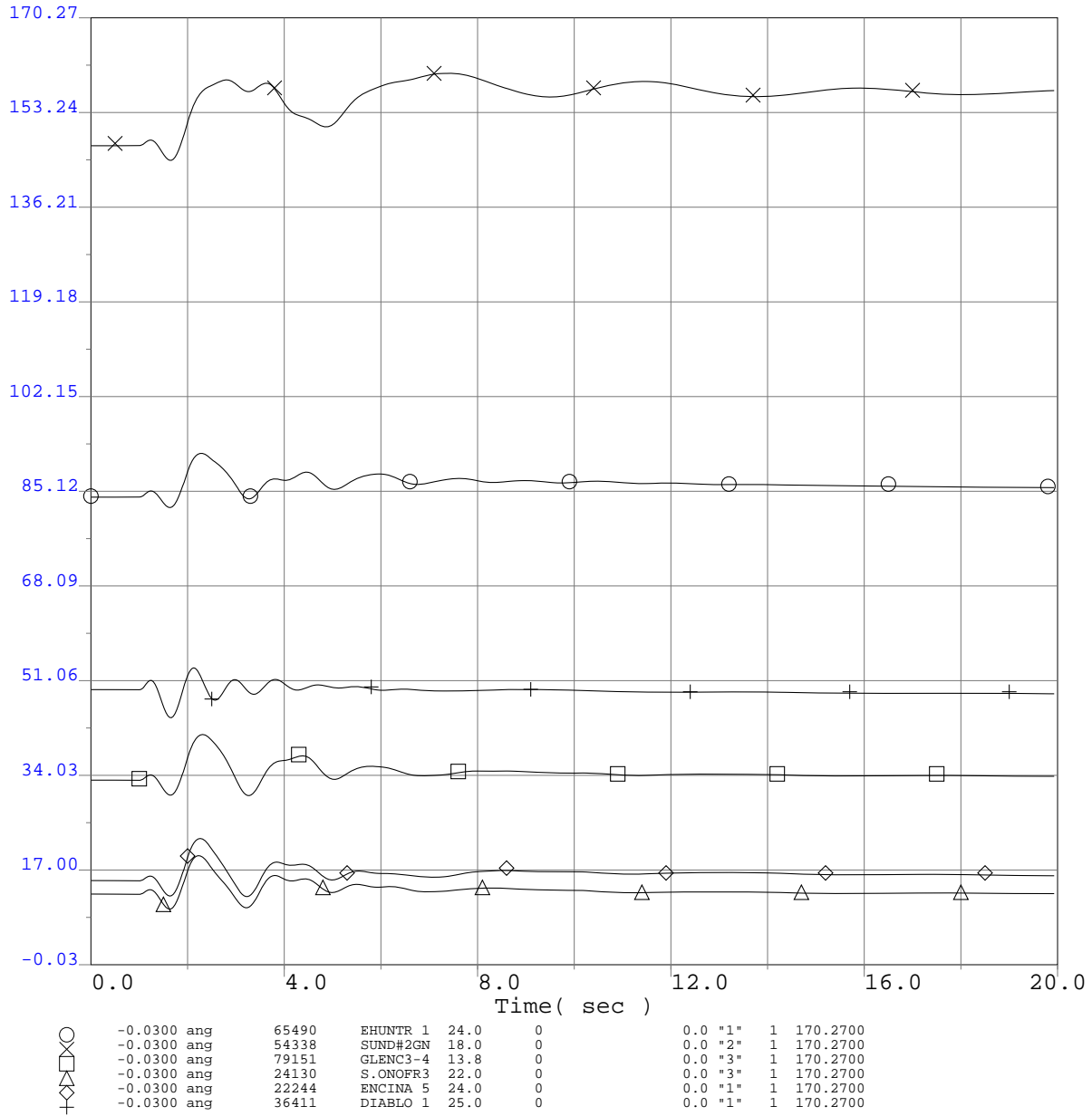

Q320 TCP2 ISIS
 2013 Greater Bay Area Summer Peak Base Case
 Q320 @ 772MW
 CCPP 230kV Bus 2D Outage
 3-ph 6 cyc flt @ the CCPP 230kV bus & clr the CCPP 230kV Bus 2D Outage

Q320 TCP2 ISIS

Selected PG&E Transmission Line Flows (MW)

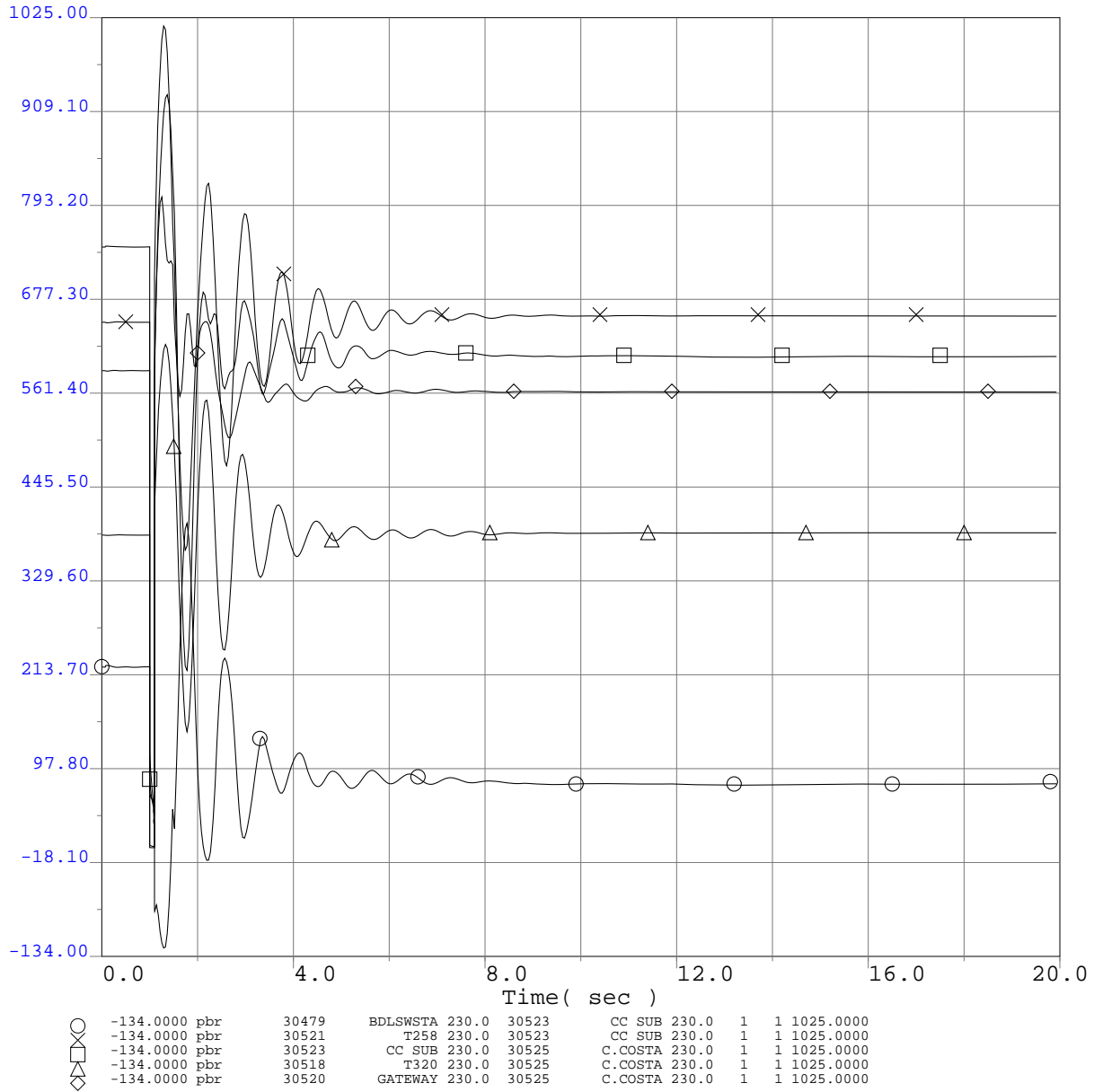

Q320 TCP2 ISIS
 2013 Greater Bay Area Summer Peak Base Case
 Q320 @ 772MW
 CCPP 230kV Bus 2D Outage
 3-ph 6 cyc flt @ the CCPP 230kV bus & clr the CCPP 230kV Bus 2D Outage

Q320 TCP2 ISIS

Selected PG&E Transmission Line Flows (MW)

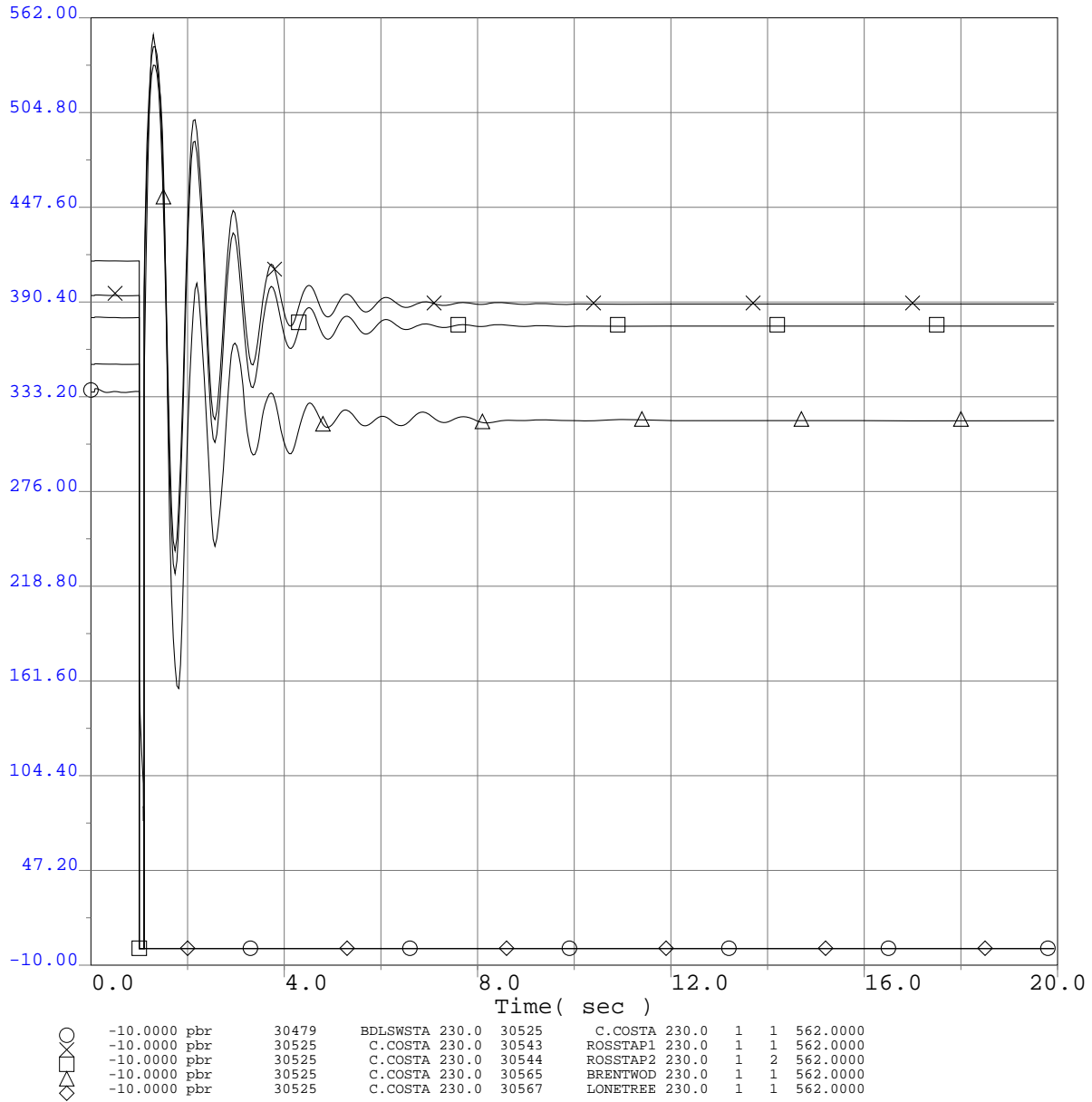

Q320 TCP2 ISIS
 2013 Greater Bay Area Summer Peak Base Case
 Q320 @ 772MW
 CCPP 230kV Bus 2D Outage
 3-ph 6 cyc flt @ the CCPP 230kV bus & clr the CCPP 230kV Bus 2D Outage

Q320 TCP2 ISIS

Selected PG&E Transmission Line Flows (MW)

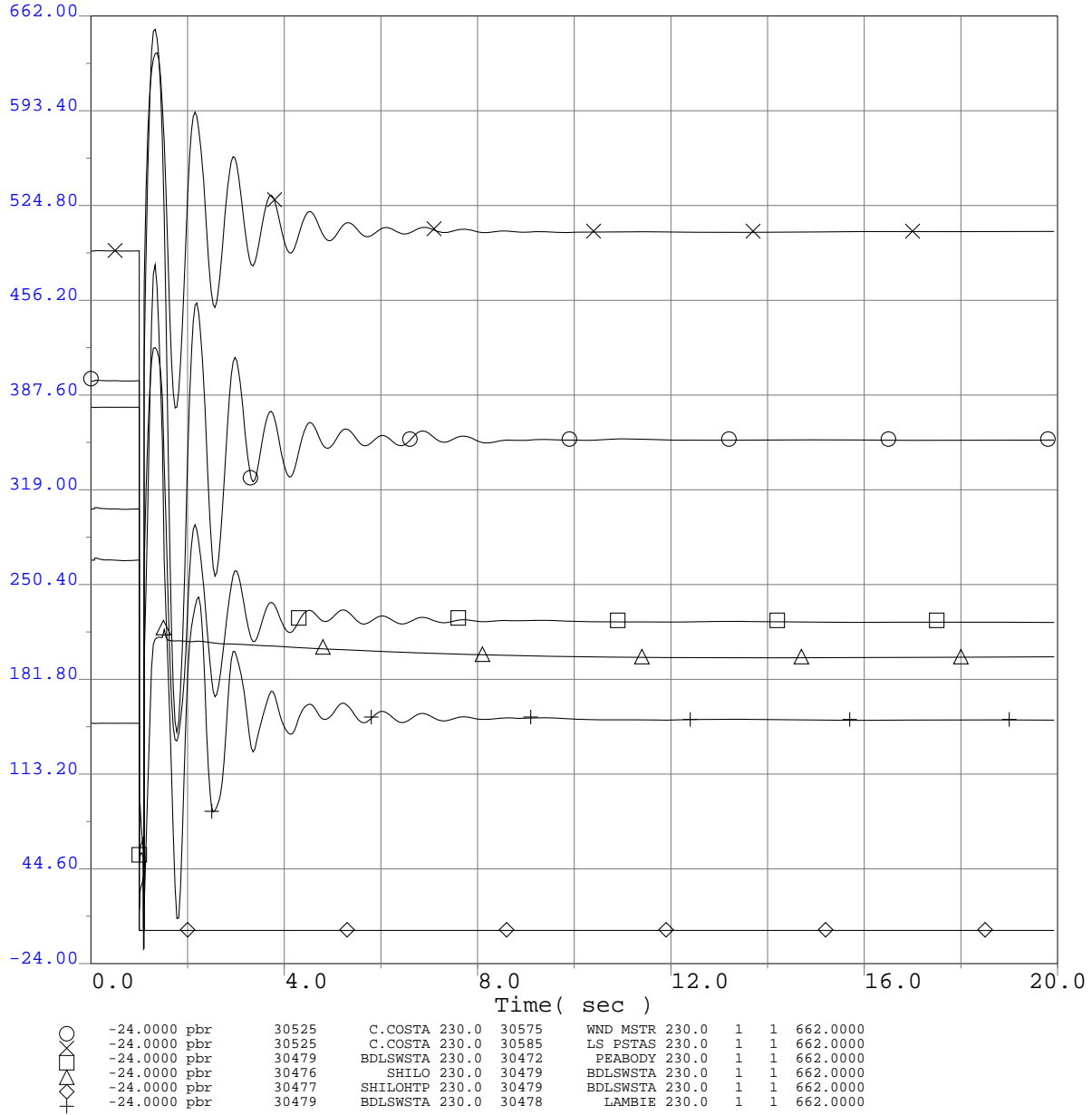

Q320 TCP2 ISIS
 2013 Greater Bay Area Summer Peak Base Case
 Q320 @ 772MW
 CCPP 230kV Bus 2D Outage
 3-ph 6 cyc flt @ the CCPP 230kV bus & clr the CCPP 230kV Bus 2D Outage

Q320 TCP2 ISIS

Selected PG&E Transmission Line Flows (MW)

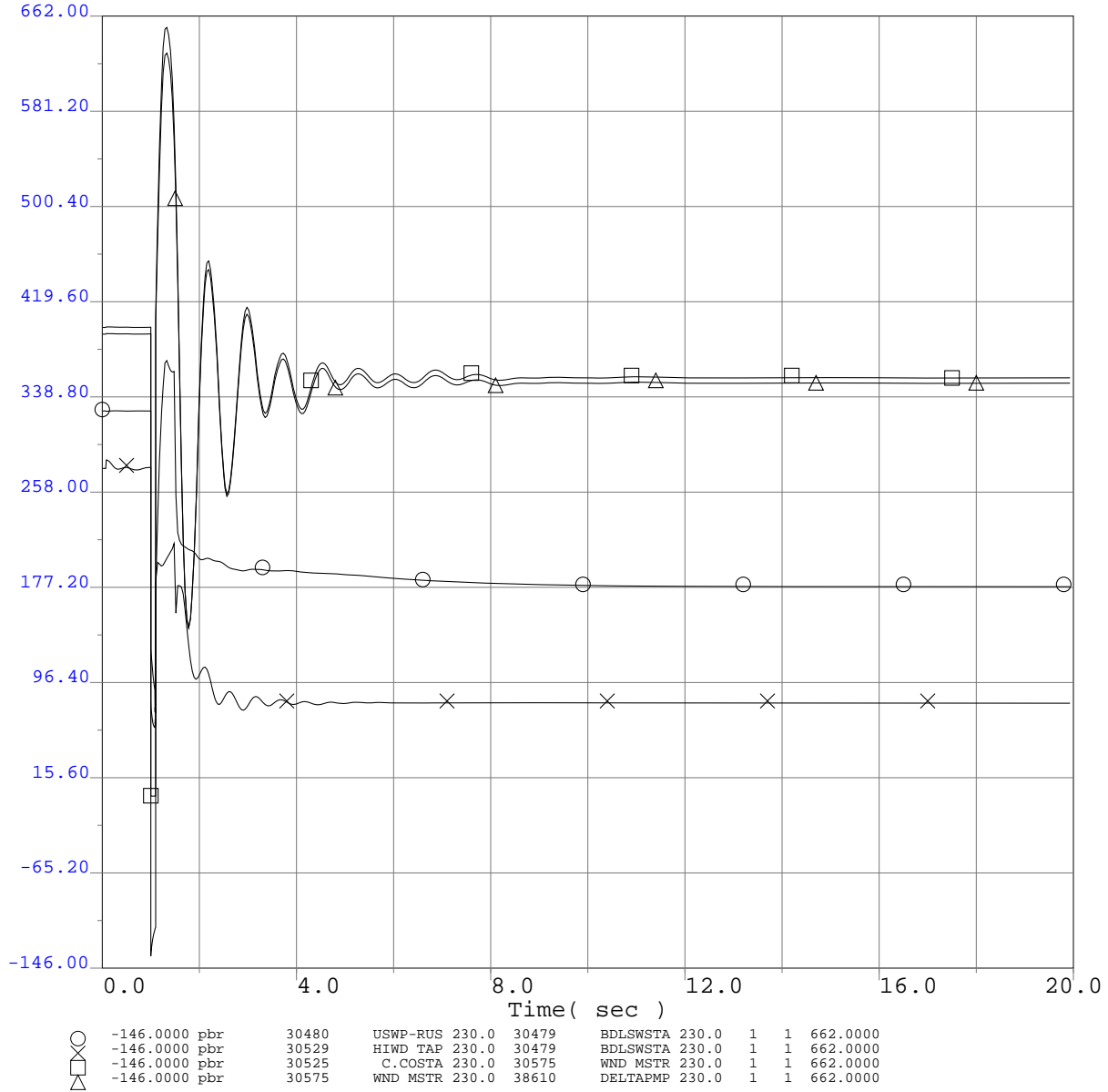

Q320 TCP2 ISIS
 2013 Greater Bay Area Summer Peak Base Case
 Q320 @ 772MW
 CCPP 230kV Bus 2D Outage
 3-ph 6 cyc flt @ the CCPP 230kV bus & clr the CCPP 230kV Bus 2D Outage

Q320 TCP2 ISIS

Selected PG&E Bus Voltage Plots Adjacent to Fault

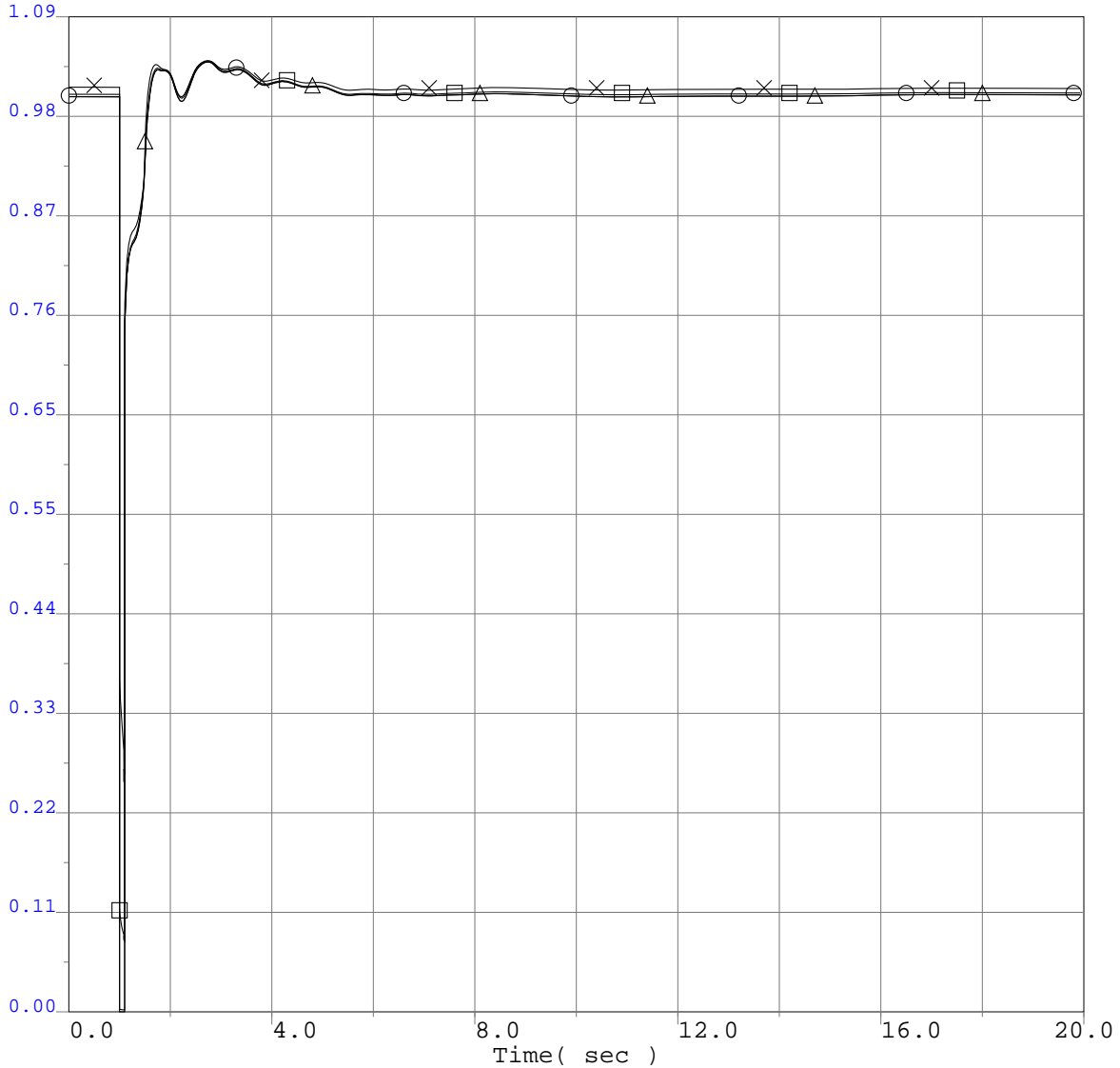

○	0.0000 vbus	30525	C.COSTA 230.0	0	0.0	***	1	1.0900
□	0.0000 vbus	30479	BDLSWSTA 230.0	0	0.0	***	1	1.0900
△	0.0000 vbus	30523	CC SUB 230.0	0	0.0	***	1	1.0900
△	0.0000 vbus	30518	T320 230.0	0	0.0	***	1	1.0900



Q320 TCP2 ISIS
 2013 Greater Bay Area Summer Peak Base Case
 Q320 @ 772MW
 CCPP 230kV Bus 1E Outage
 3-ph 6 cyc flt @ the CCPP 230kV bus & clr the CCPP 230kV Bus 1E Outage

Q320 TCP2 ISIS

Selected PG&E Bus Frequency Plots Adjacent to Fault

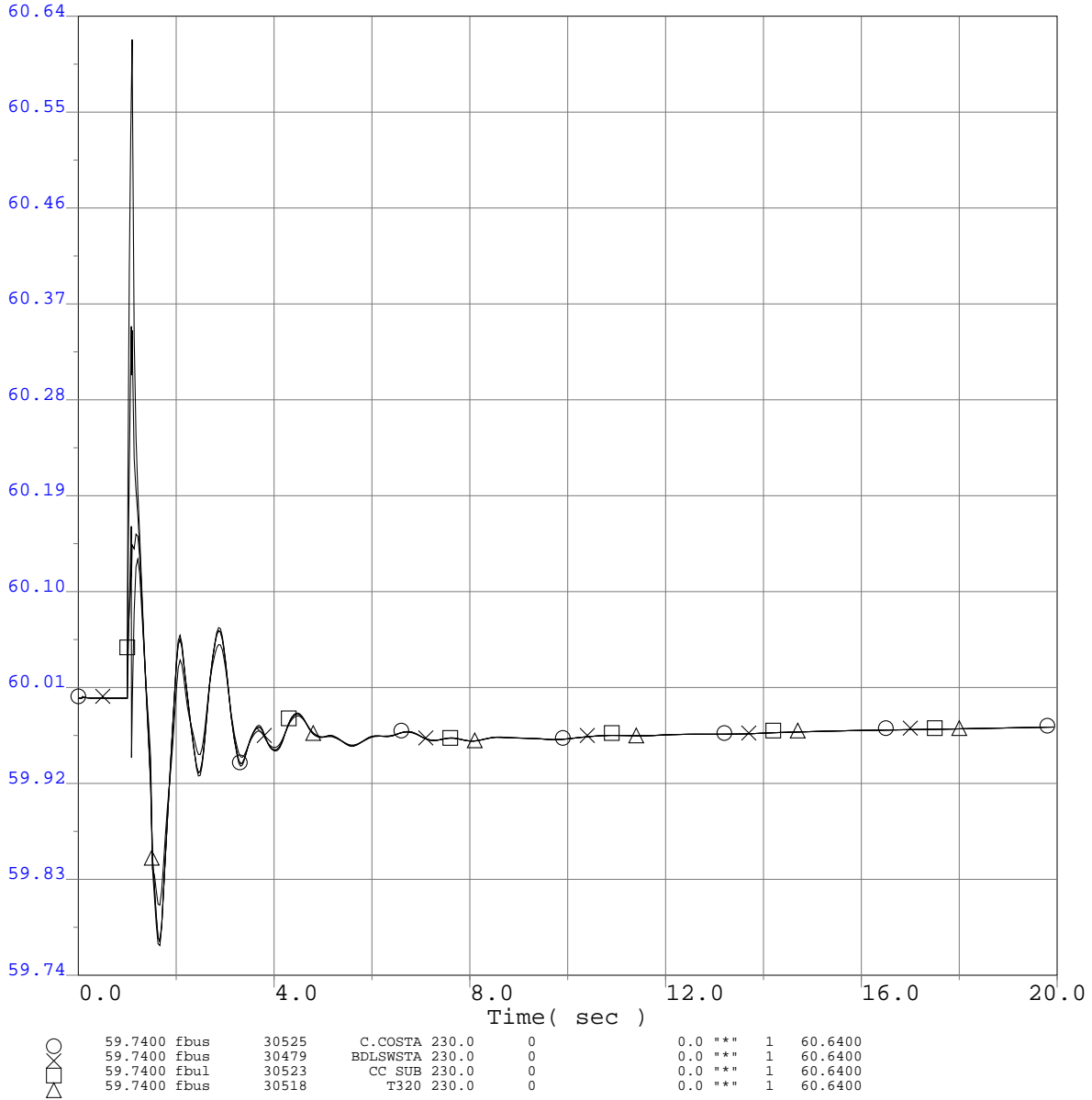

Q320 TCP2 ISIS
 2013 Greater Bay Area Summer Peak Base Case
 Q320 @ 772MW
 CCPP 230kV Bus 1E Outage
 3-ph 6 cyc flt @ the CCPP 230kV bus & clr the CCPP 230kV Bus 1E Outage

Q320 TCP2 ISIS

Project Generator Terminal Voltages (P.U.)

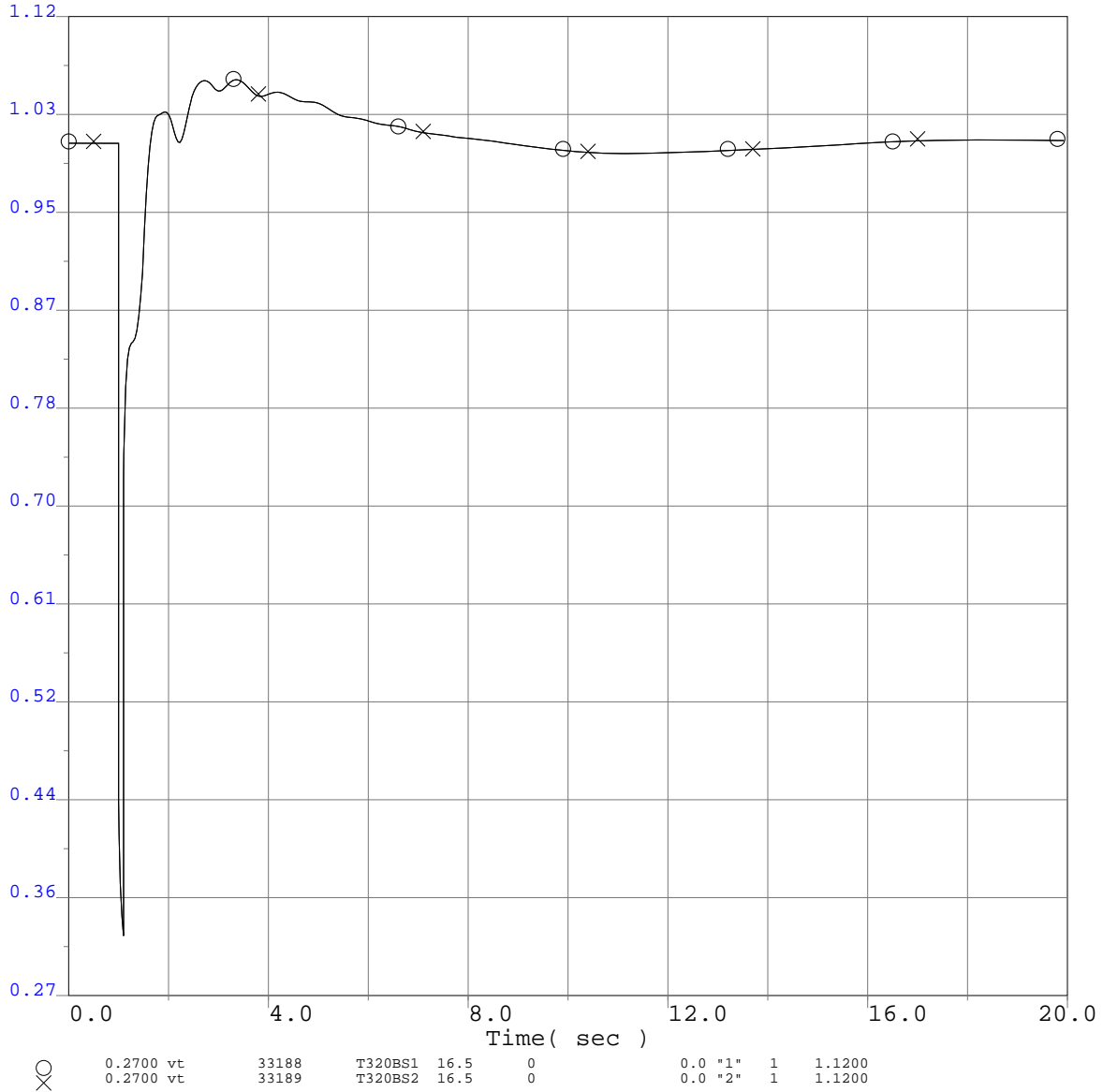

Q320 TCP2 ISIS
 2013 Greater Bay Area Summer Peak Base Case
 Q320 @ 772MW
 CCPP 230kV Bus 1E Outage
 3-ph 6 cyc flt @ the CCPP 230kV bus & clr the CCPP 230kV Bus 1E Outage

Q320 TCP2 ISIS

Project Generator Terminal Voltages (P.U.)

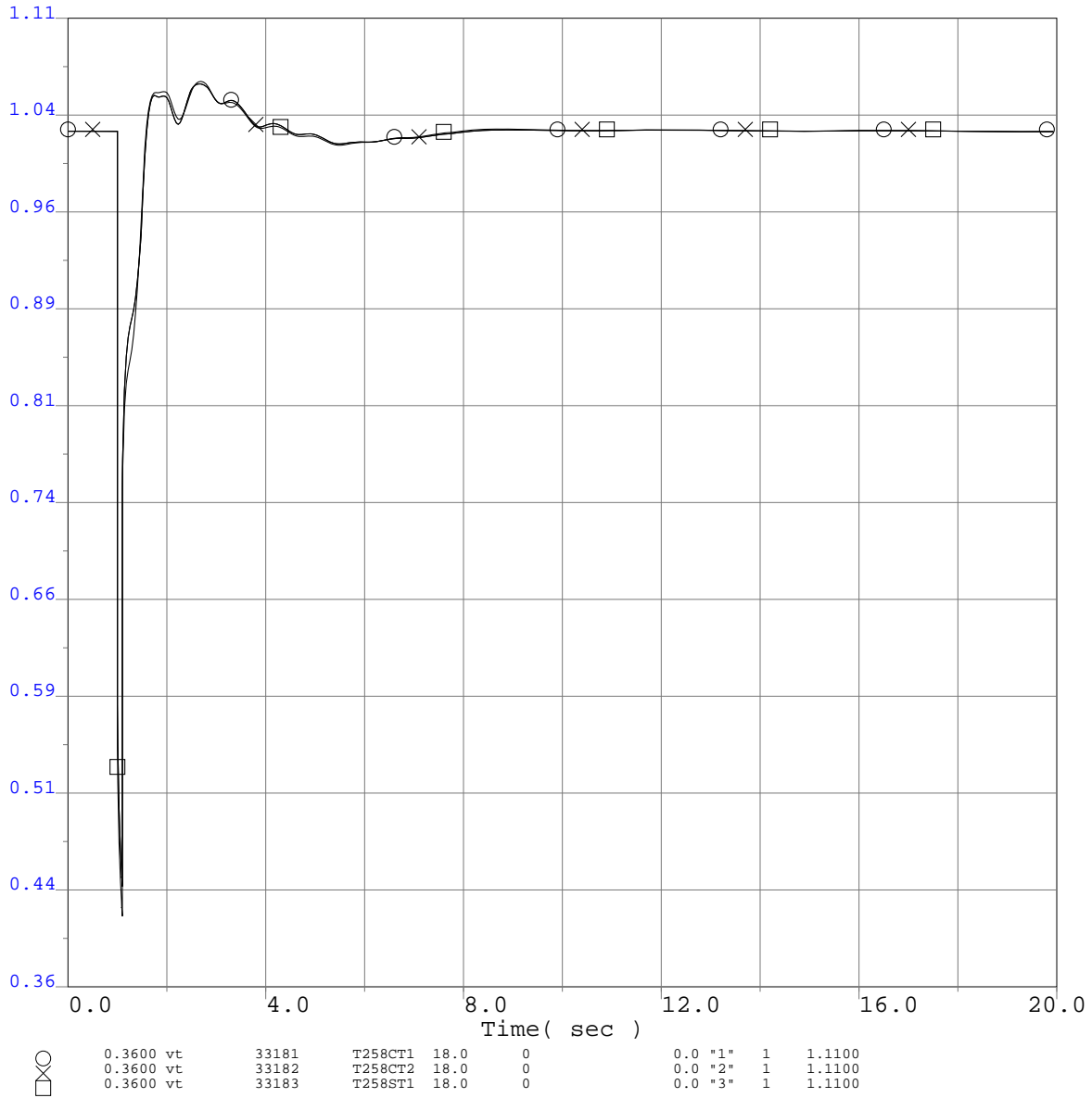

Q320 TCP2 ISIS
 2013 Greater Bay Area Summer Peak Base Case
 Q320 @ 772MW
 CCPP 230kV Bus 1E Outage
 3-ph 6 cyc flt @ the CCPP 230kV bus & clr the CCPP 230kV Bus 1E Outage

Q320 TCP2 ISIS

Project Generator Speed (P.U.)

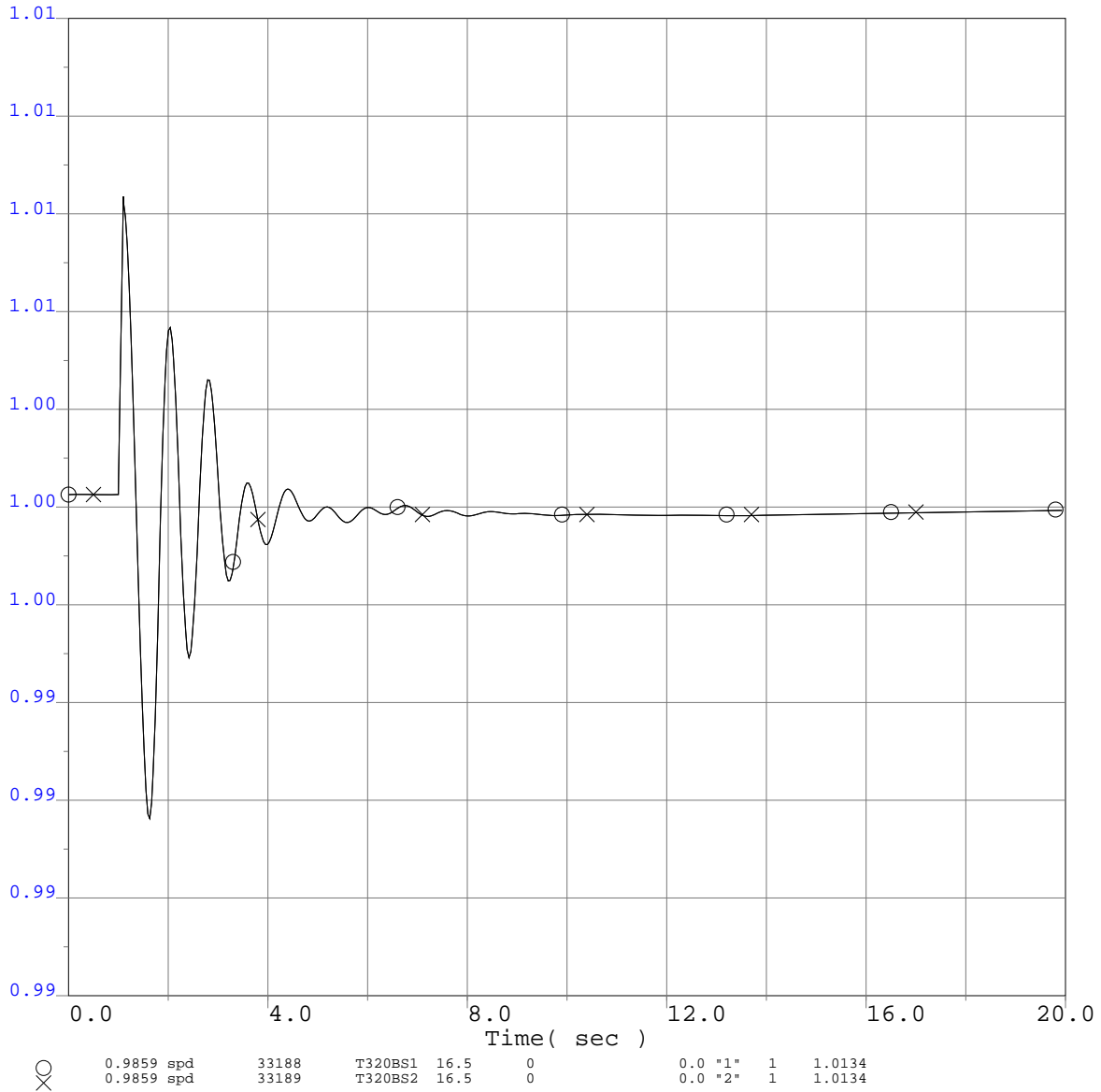

○	0.9859 spd	33188	T320BS1	16.5	0	0.0 "1"	1	1.0134
×	0.9859 spd	33189	T320BS2	16.5	0	0.0 "2"	1	1.0134

Q320 TCP2 ISIS
 2013 Greater Bay Area Summer Peak Base Case
 Q320 @ 772MW
 CCPP 230kV Bus 1E Outage
 3-ph 6 cyc flt @ the CCPP 230kV bus & clr the CCPP 230kV Bus 1E Outage

Q320 TCP2 ISIS

Project Generator Speed (P.U.)

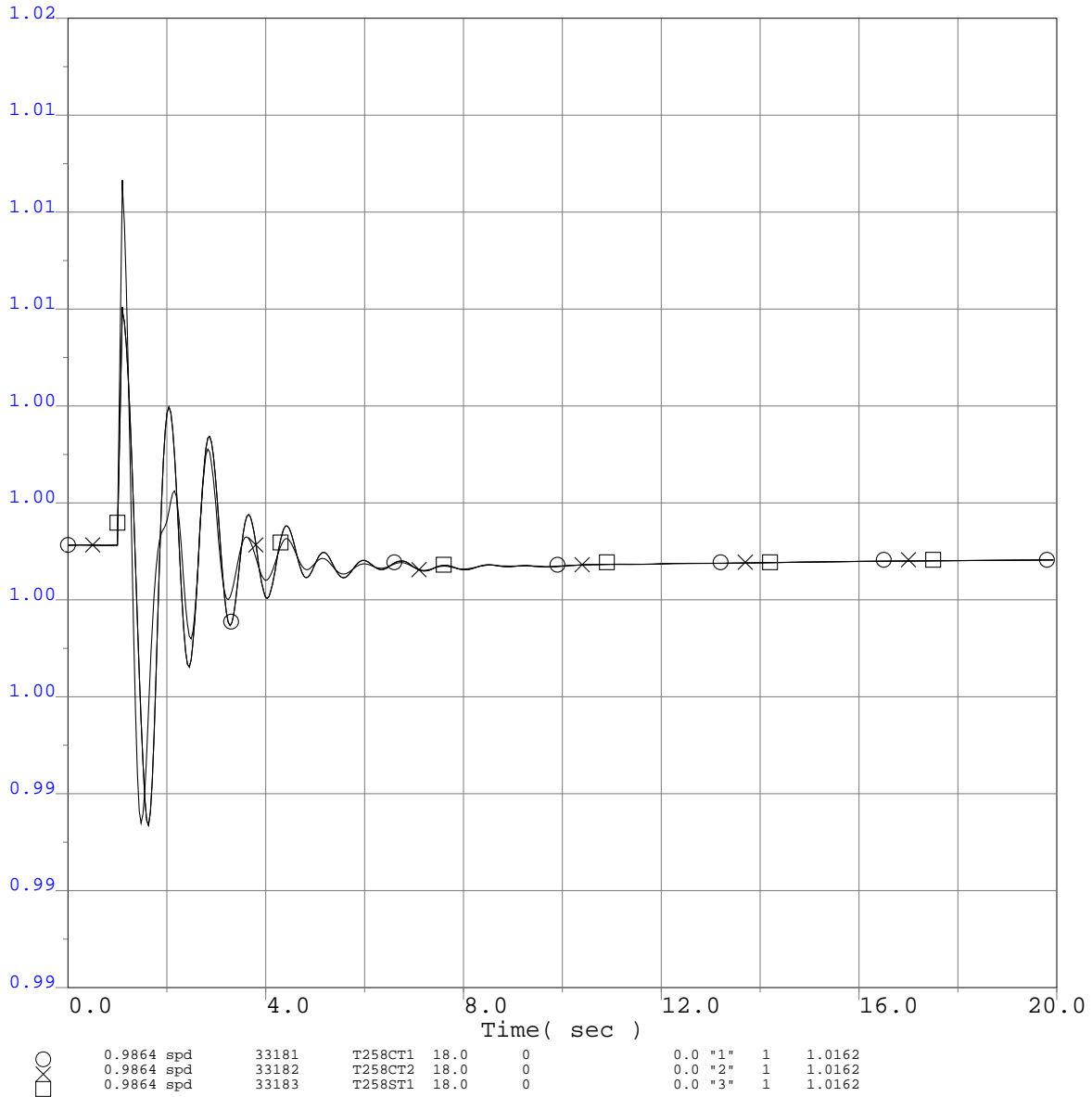

○	0.9864 spd	33181	T258CT1	18.0	0	0.0 "1"	1	1.0162
×	0.9864 spd	33182	T258CT2	18.0	0	0.0 "2"	1	1.0162
□	0.9864 spd	33183	T258ST1	18.0	0	0.0 "3"	1	1.0162

Q320 TCP2 ISIS
 2013 Greater Bay Area Summer Peak Base Case
 Q320 @ 772MW
 CCPP 230kV Bus 1E Outage
 3-ph 6 cyc flt @ the CCPP 230kV bus & clr the CCPP 230kV Bus 1E Outage

Q320 TCP2 ISIS

Project Generator Terminal Power (MW)

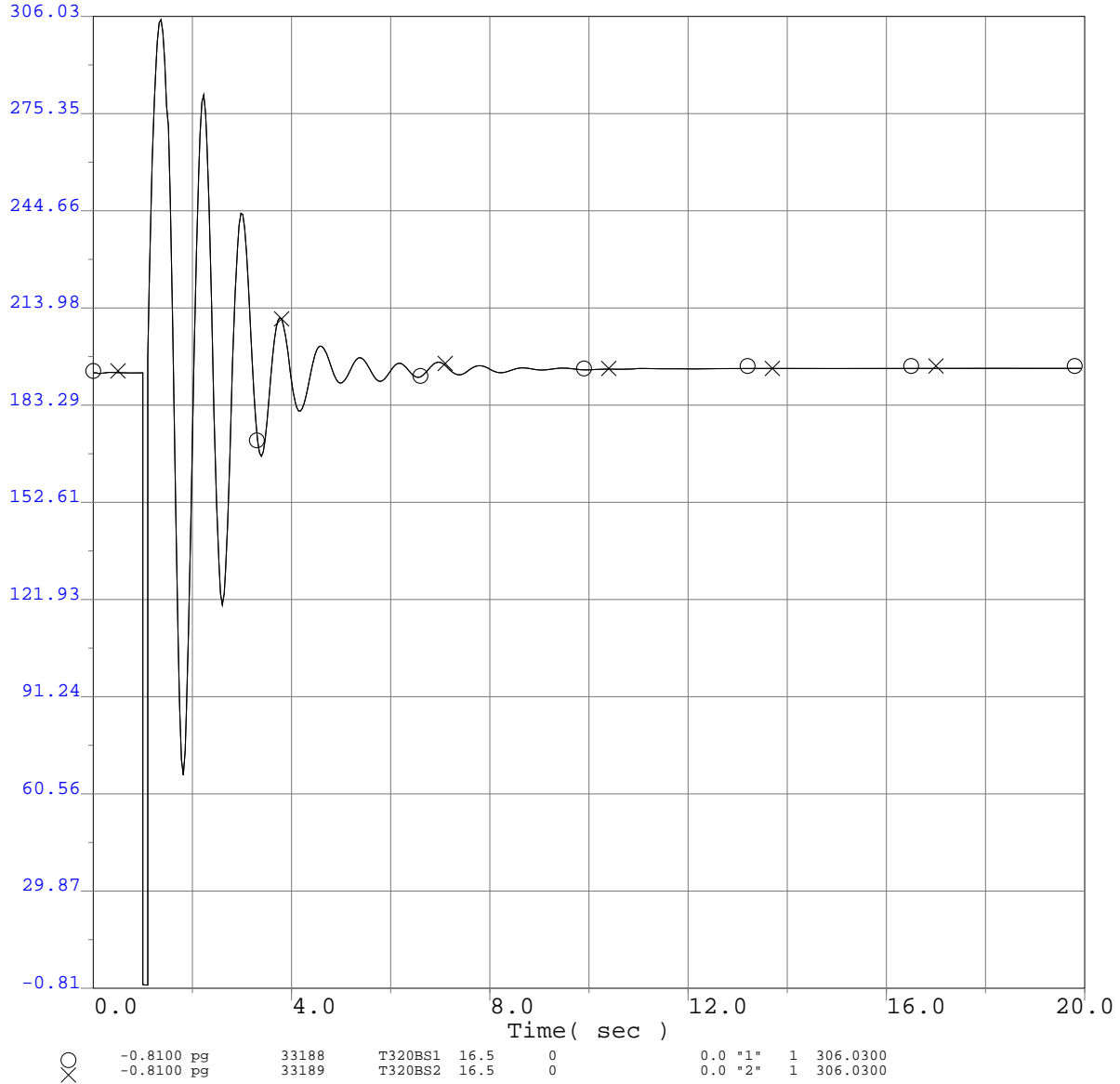

Q320 TCP2 ISIS
 2013 Greater Bay Area Summer Peak Base Case
 Q320 @ 772MW
 CCPP 230kV Bus 1E Outage
 3-ph 6 cyc flt @ the CCPP 230kV bus & clr the CCPP 230kV Bus 1E Outage

Q320 TCP2 ISIS

Project Generator Terminal Power (MW)

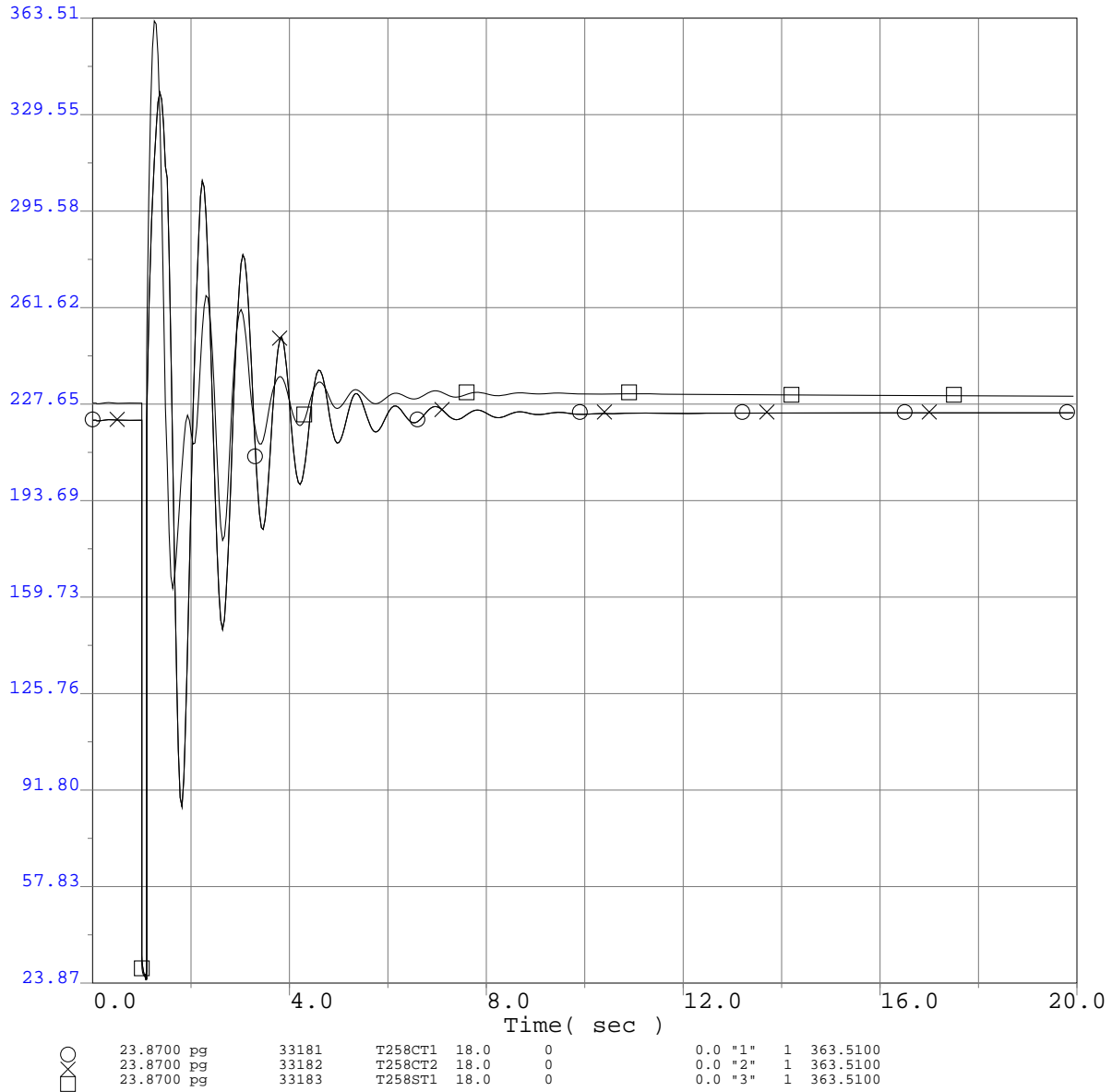

Q320 TCP2 ISIS
 2013 Greater Bay Area Summer Peak Base Case
 Q320 @ 772MW
 CCPP 230kV Bus 1E Outage
 3-ph 6 cyc flt @ the CCPP 230kV bus & clr the CCPP 230kV Bus 1E Outage

Q320 TCP2 ISIS

Project Generator Terminal Reactive Power (MVA_r)

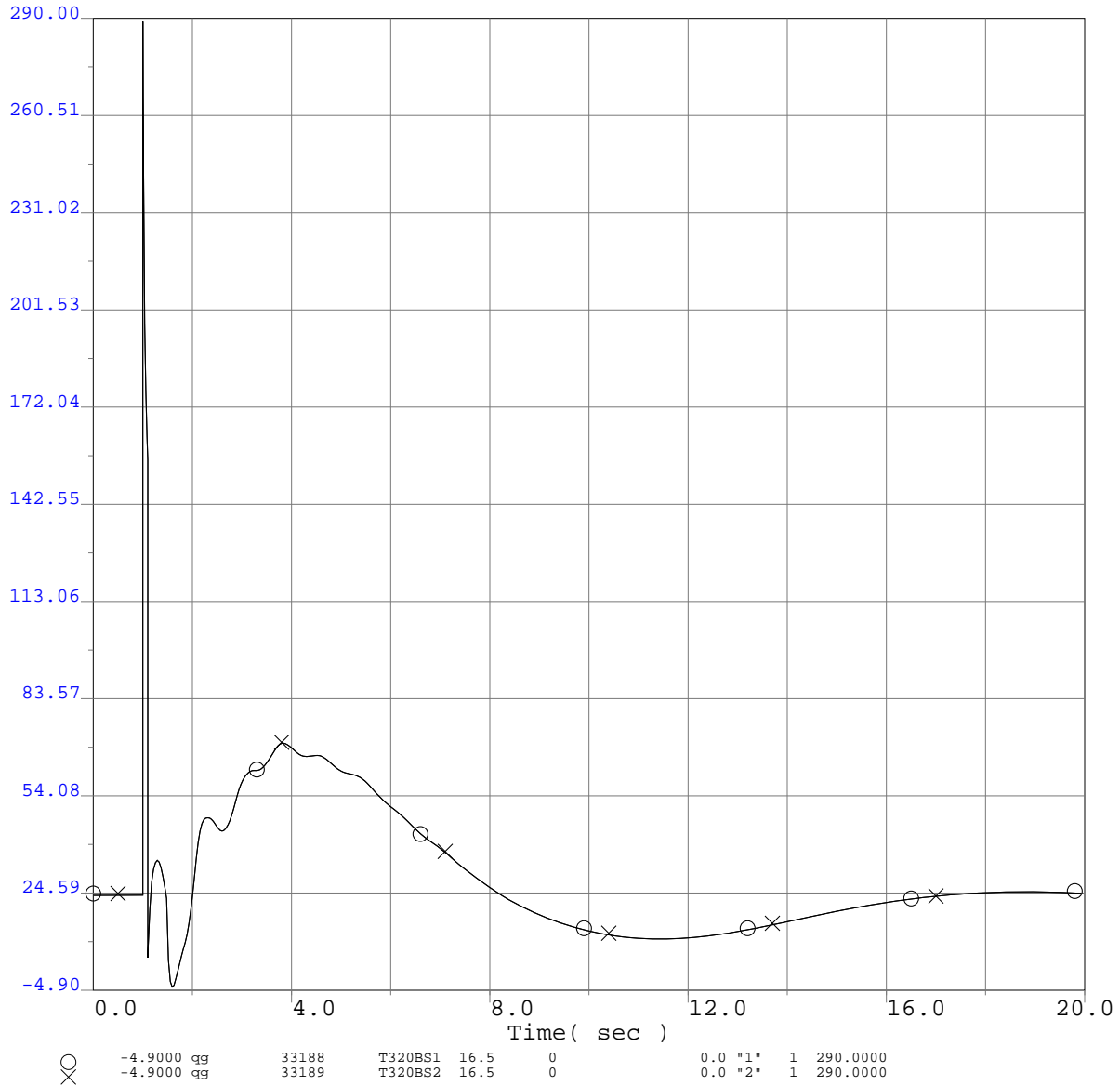

Q320 TCP2 ISIS
 2013 Greater Bay Area Summer Peak Base Case
 Q320 @ 772MW
 CCPP 230kV Bus 1E Outage
 3-ph 6 cyc flt @ the CCPP 230kV bus & clr the CCPP 230kV Bus 1E Outage

Q320 TCP2 ISIS

Project Generator Terminal Reactive Power (MVar)

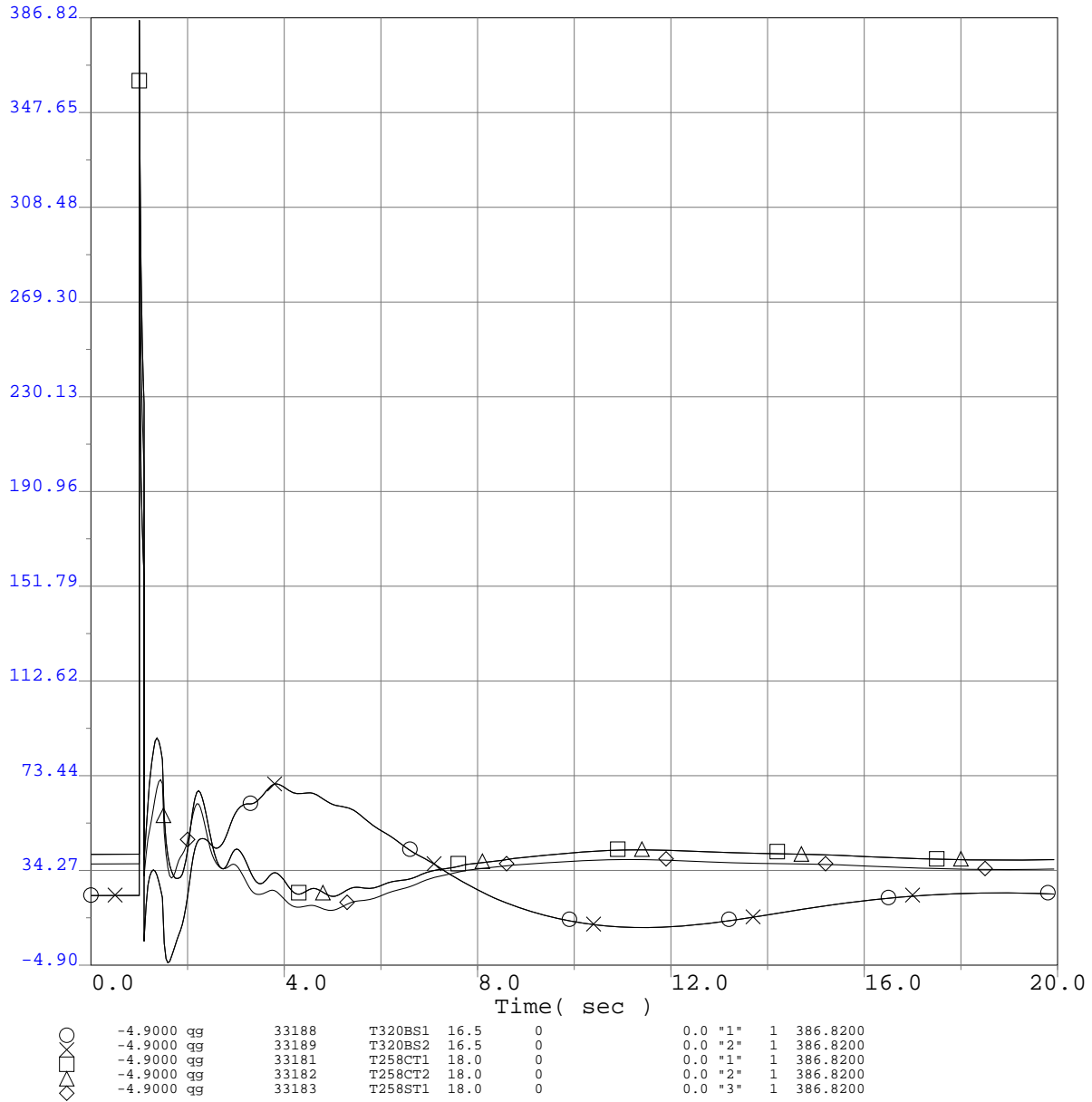

Q320 TCP2 ISIS
 2013 Greater Bay Area Summer Peak Base Case
 Q320 @ 772MW
 CCPP 230kV Bus 1E Outage
 3-ph 6 cyc flt @ the CCPP 230kV bus & clr the CCPP 230kV Bus 1E Outage

Q320 TCP2 ISIS

Selected WECC Bus Voltage Plots

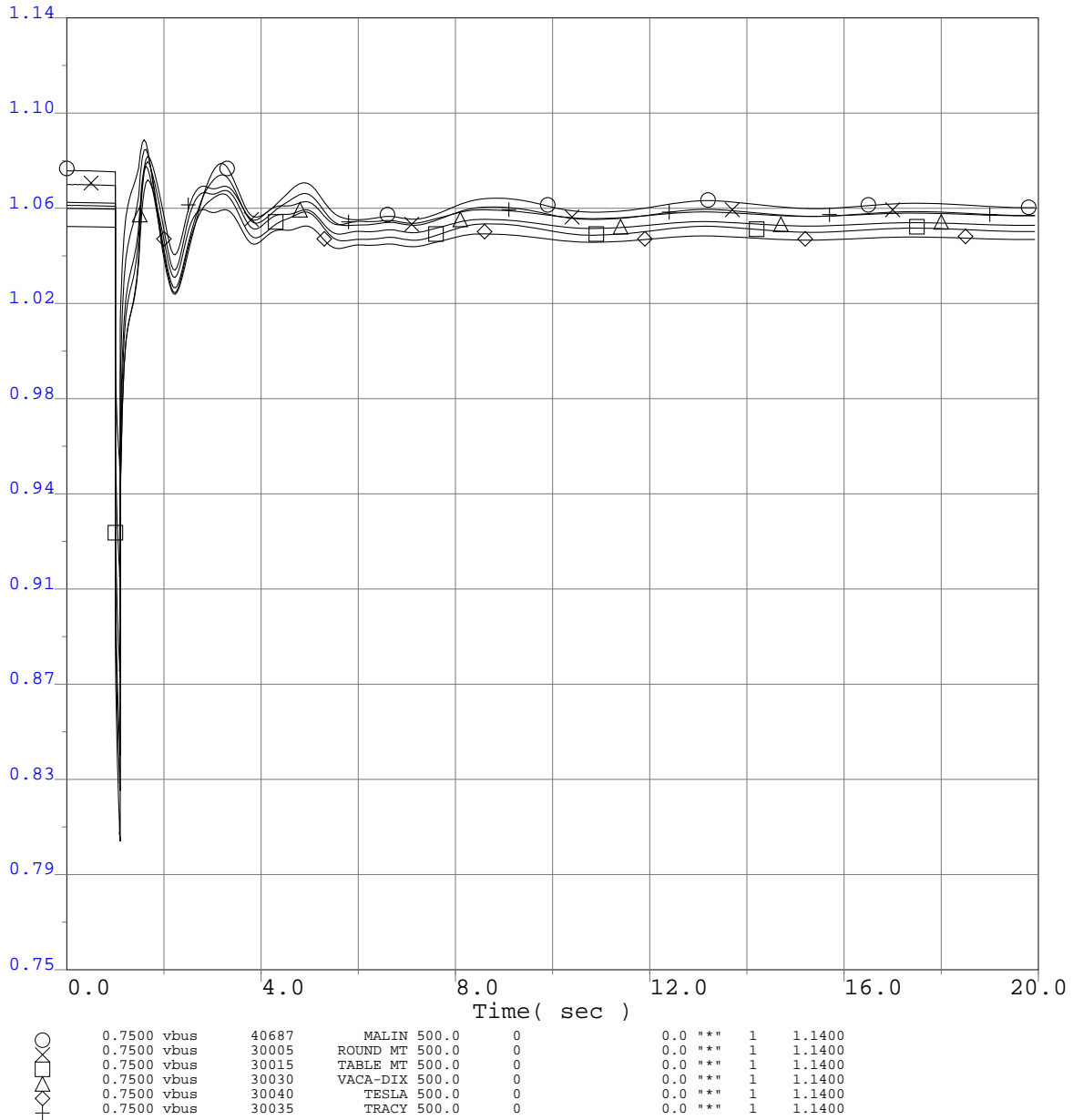

Q320 TCP2 ISIS
 2013 Greater Bay Area Summer Peak Base Case
 Q320 @ 772MW
 CCPP 230kV Bus 1E Outage
 3-ph 6 cyc flt @ the CCPP 230kV bus & clr the CCPP 230kV Bus 1E Outage

Q320 TCP2 ISIS

Selected WECC Bus Voltage Plots

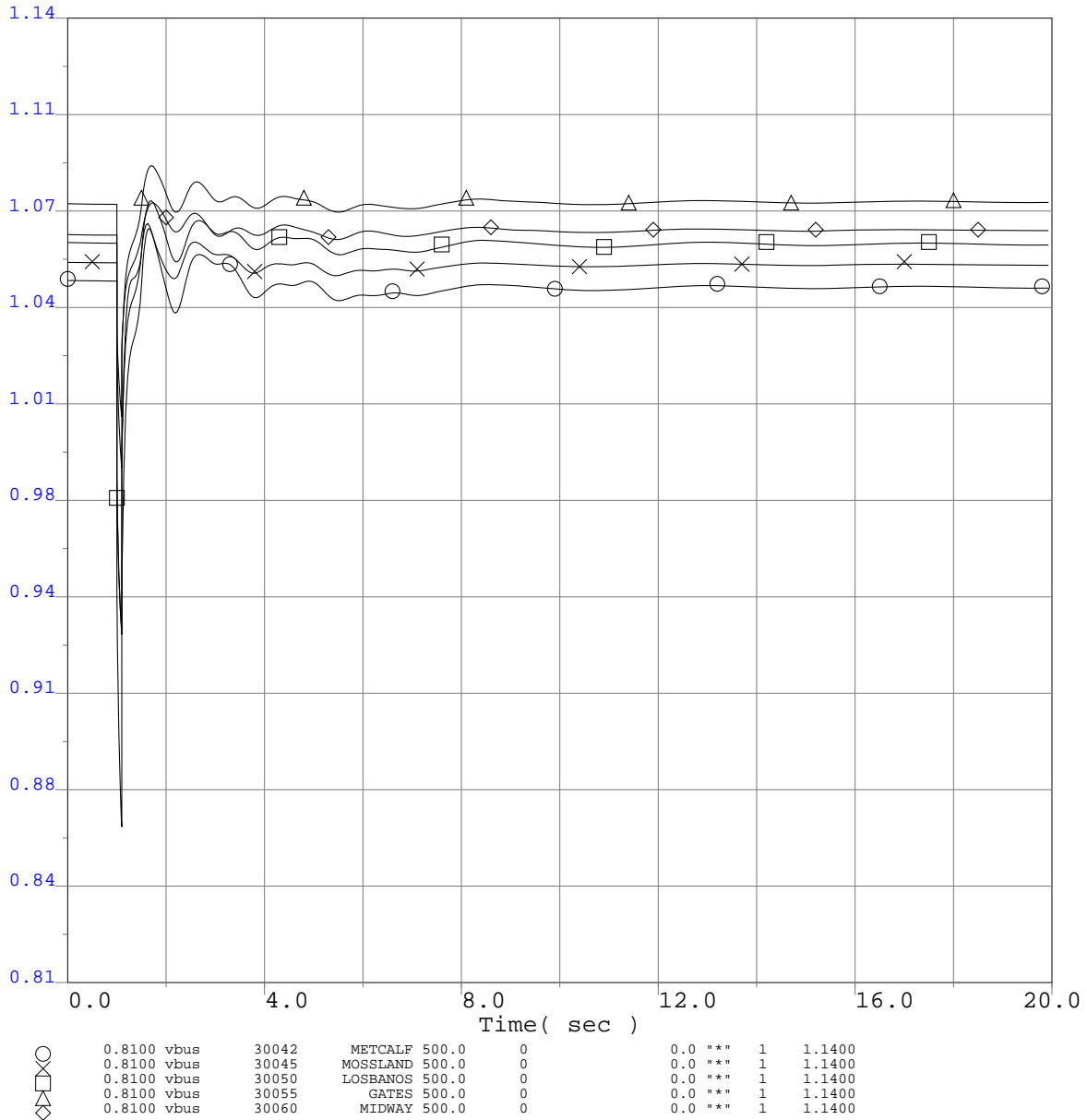

Q320 TCP2 ISIS
 2013 Greater Bay Area Summer Peak Base Case
 Q320 @ 772MW
 CCPP 230kV Bus 1E Outage
 3-ph 6 cyc flt @ the CCPP 230kV bus & clr the CCPP 230kV Bus 1E Outage

Q320 TCP2 ISIS

Selected WECC Bus Voltage Plots

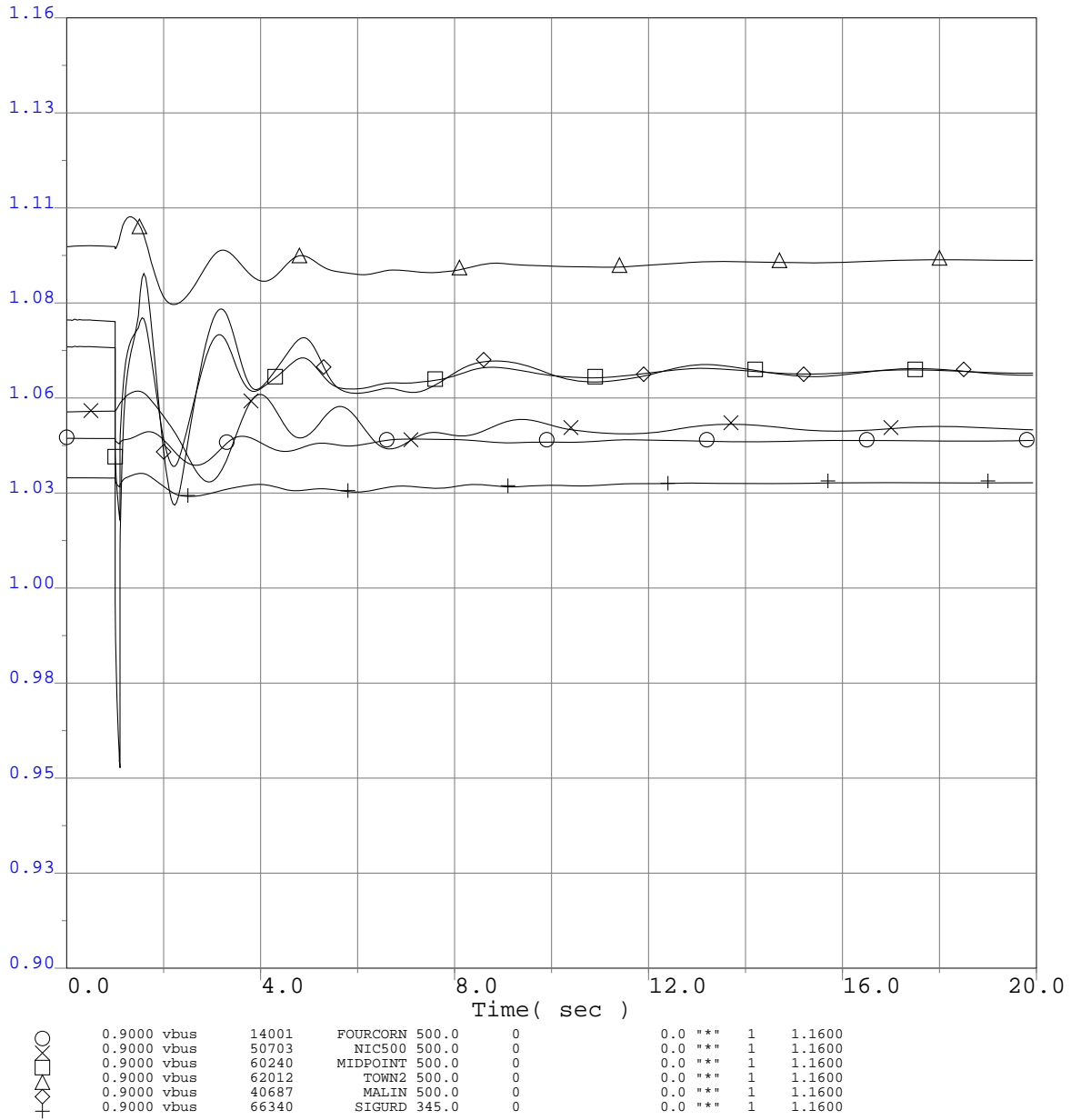

Q320 TCP2 ISIS
 2013 Greater Bay Area Summer Peak Base Case
 Q320 @ 772MW
 CCPP 230kV Bus 1E Outage
 3-ph 6 cyc flt @ the CCPP 230kV bus & clr the CCPP 230kV Bus 1E Outage

Q320 TCP2 ISIS

Selected WECC Bus Voltage Plots

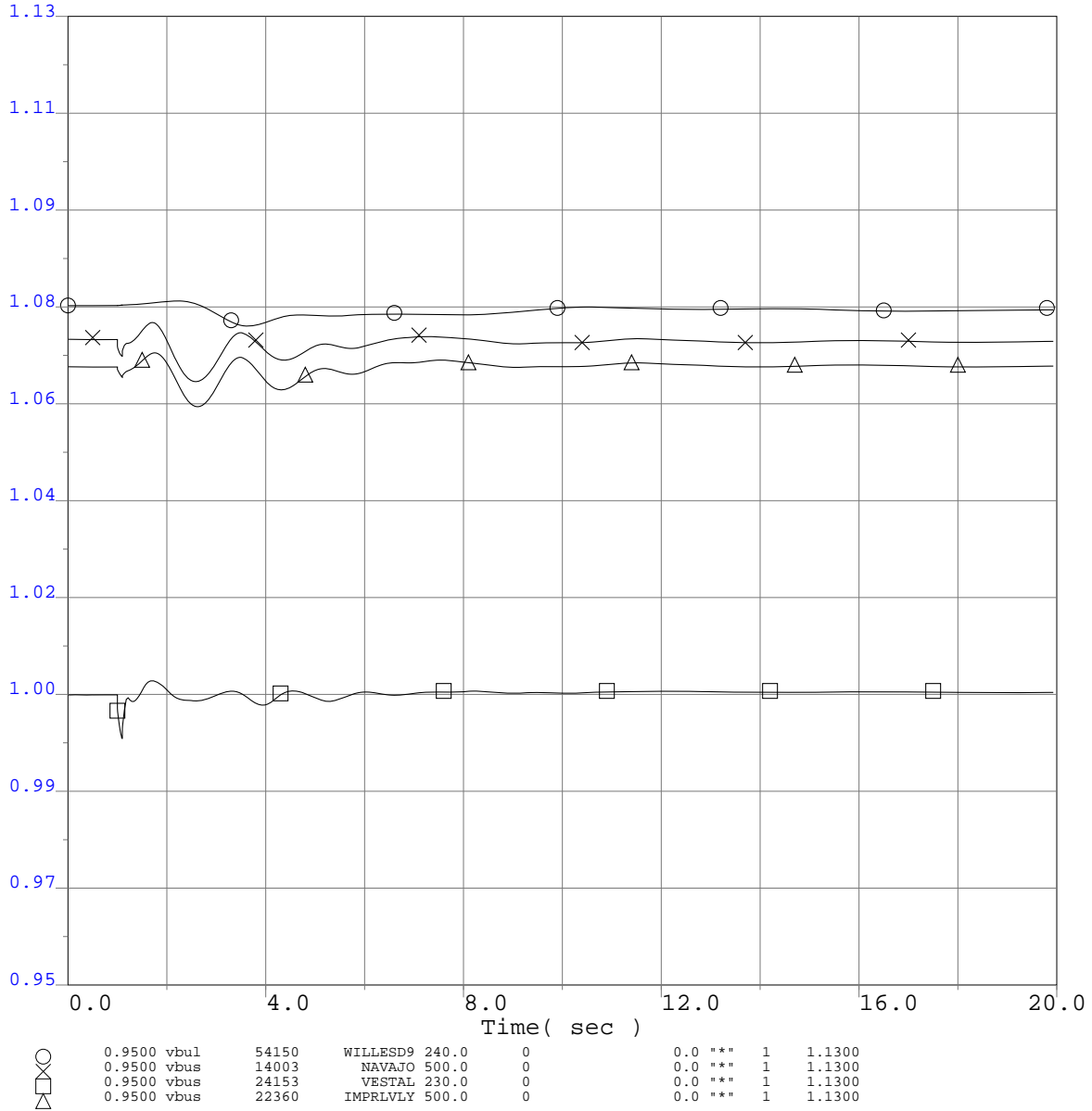

Q320 TCP2 ISIS
 2013 Greater Bay Area Summer Peak Base Case
 Q320 @ 772MW
 CCPP 230kV Bus 1E Outage
 3-ph 6 cyc flt @ the CCPP 230kV bus & clr the CCPP 230kV Bus 1E Outage

Q320 TCP2 ISIS

Selected WECC Bus Frequency Plots

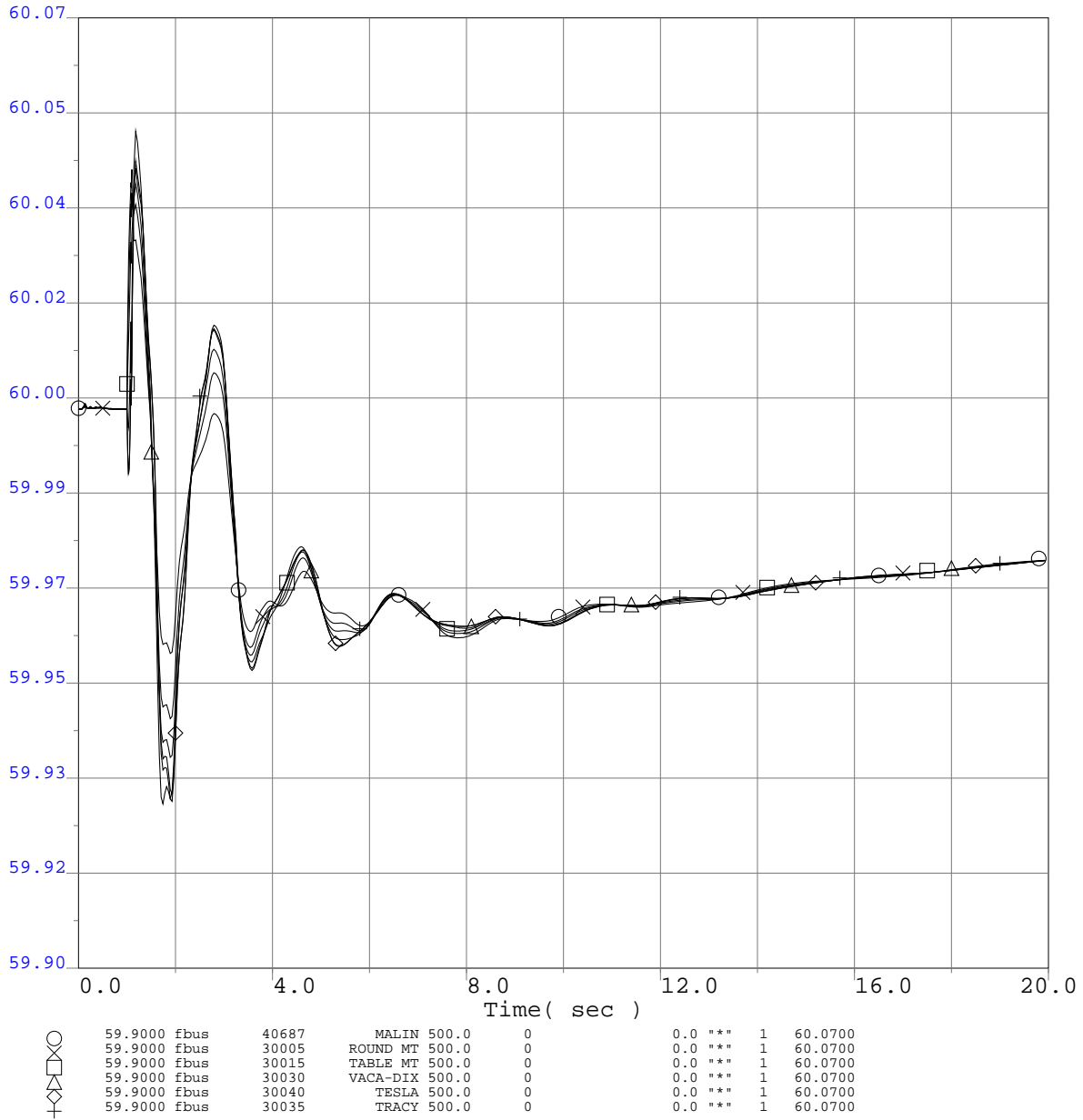

Q320 TCP2 ISIS
 2013 Greater Bay Area Summer Peak Base Case
 Q320 @ 772MW
 CCPP 230kV Bus 1E Outage
 3-ph 6 cyc flt @ the CCPP 230kV bus & clr the CCPP 230kV Bus 1E Outage

Q320 TCP2 ISIS

Selected WECC Bus Frequency Plots

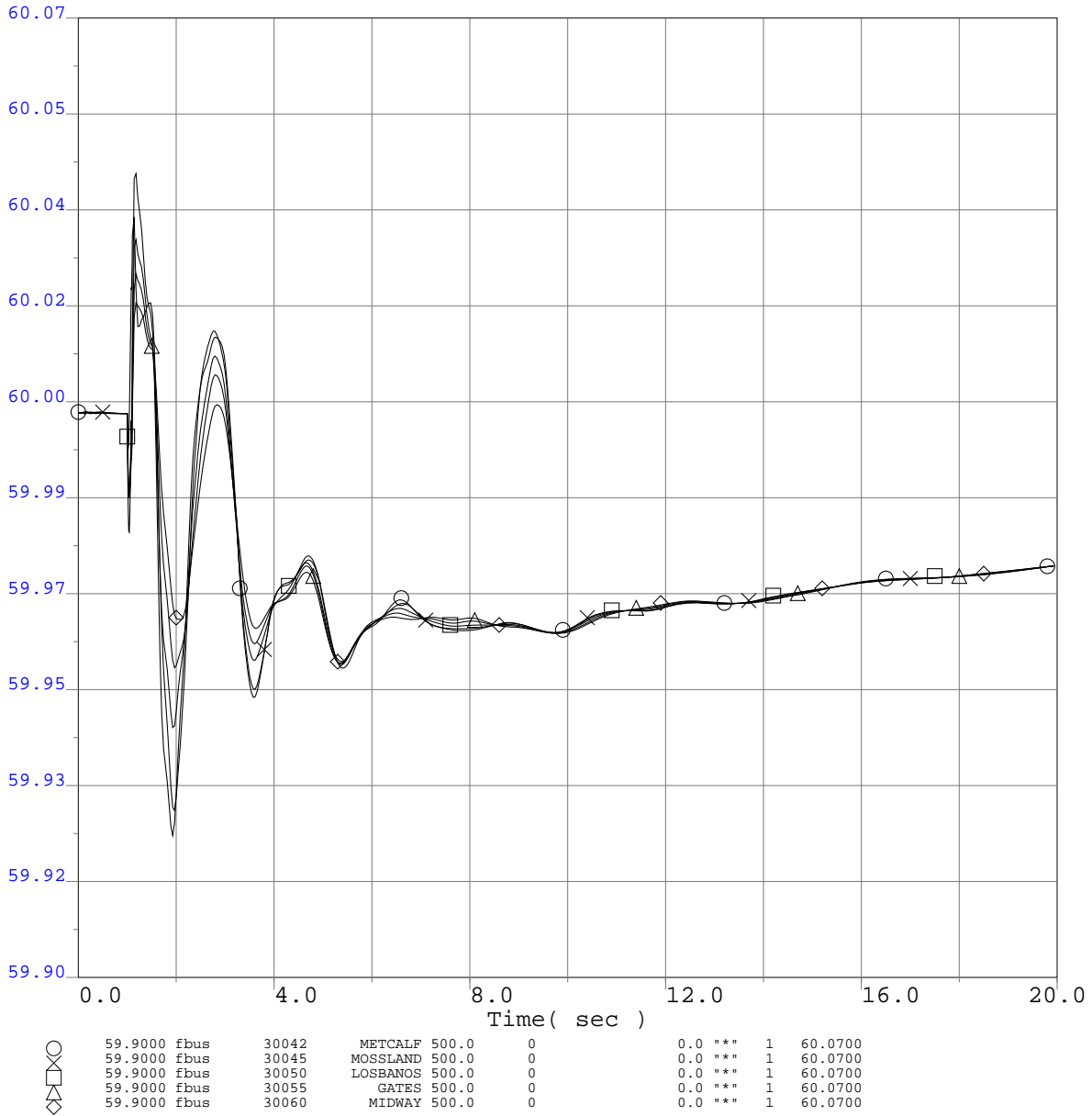

Q320 TCP2 ISIS
 2013 Greater Bay Area Summer Peak Base Case
 Q320 @ 772MW
 CCPP 230kV Bus 1E Outage
 3-ph 6 cyc flt @ the CCPP 230kV bus & clr the CCPP 230kV Bus 1E Outage

Q320 TCP2 ISIS

Selected WECC Bus Frequency Plots

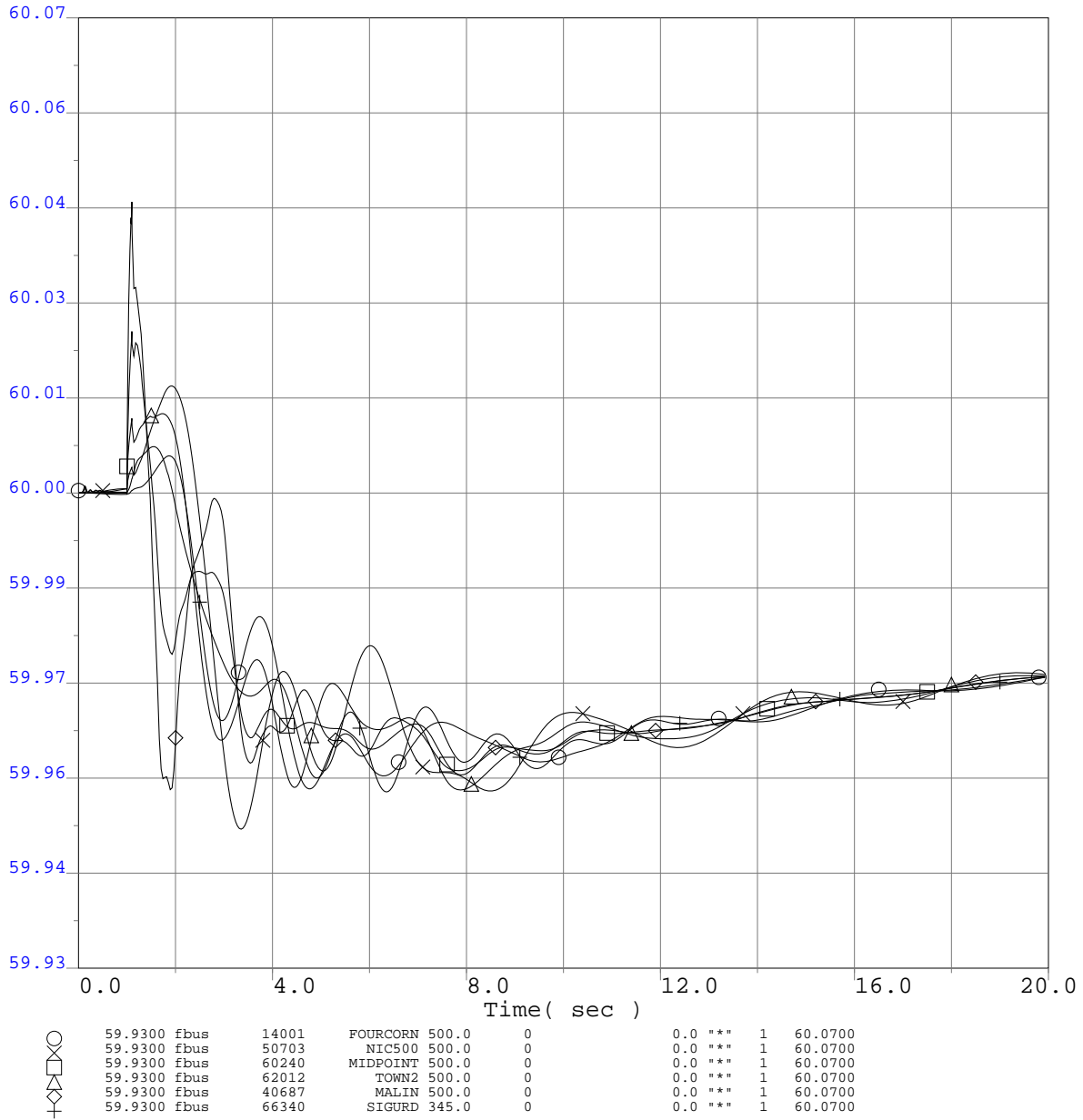

Q320 TCP2 ISIS
 2013 Greater Bay Area Summer Peak Base Case
 Q320 @ 772MW
 CCPP 230kV Bus 1E Outage
 3-ph 6 cyc flt @ the CCPP 230kV bus & clr the CCPP 230kV Bus 1E Outage

Q320 TCP2 ISIS

Selected WECC Bus Frequency Plots

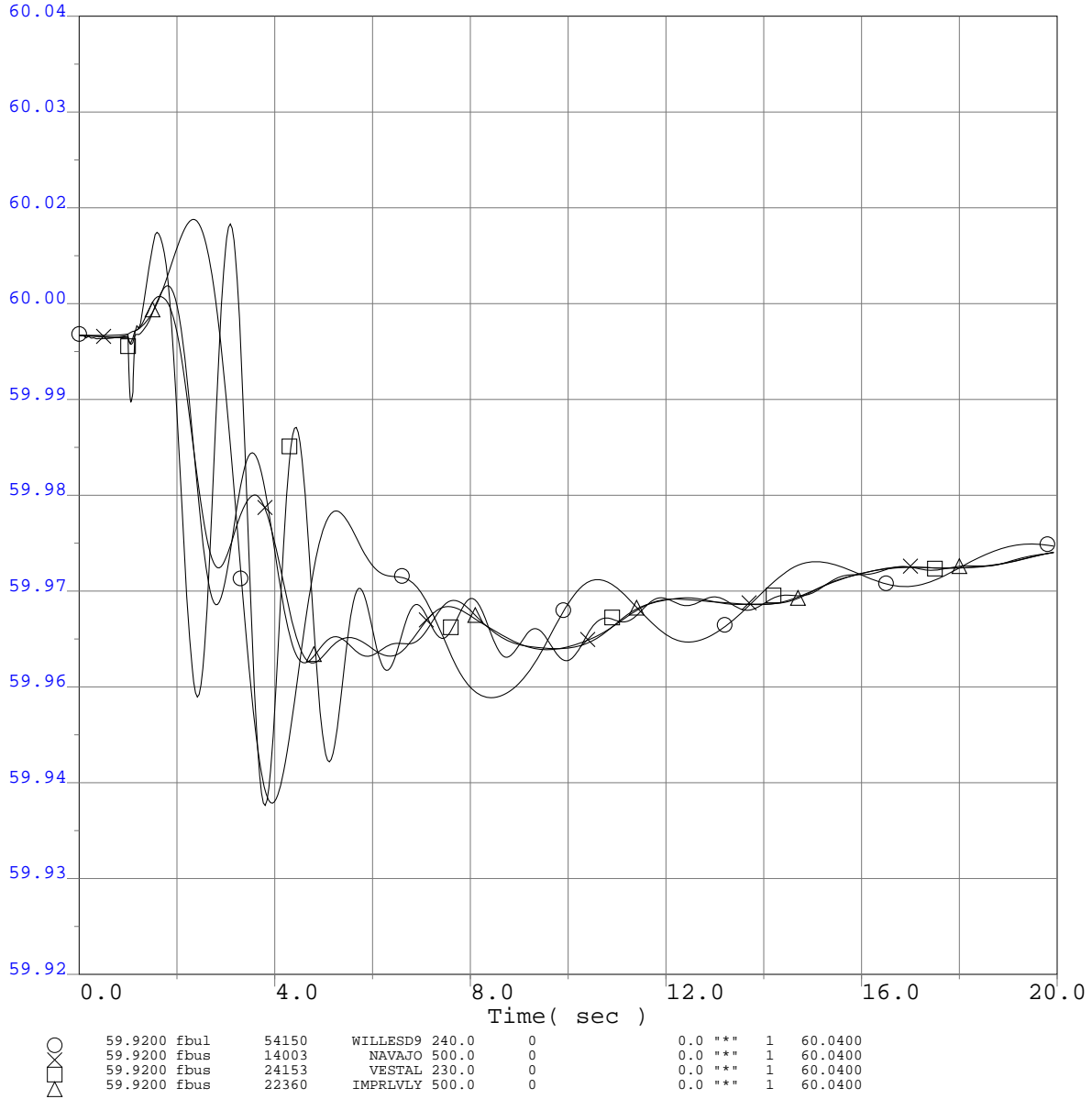

○	59.9200 Fbul	54150	WILLES9 240.0	0	0.0	***	1	60.0400
□	59.9200 Fbus	14003	NAVAJO 500.0	0	0.0	***	1	60.0400
×	59.9200 Fbus	24153	VESTAL 230.0	0	0.0	***	1	60.0400
△	59.9200 Fbus	22360	IMPRLVLY 500.0	0	0.0	***	1	60.0400

Q320 TCP2 ISIS
 2013 Greater Bay Area Summer Peak Base Case
 Q320 @ 772MW
 CCPP 230kV Bus 1E Outage
 3-ph 6 cyc flt @ the CCPP 230kV bus & clr the CCPP 230kV Bus 1E Outage

Q320 TCP2 ISIS

WECC Generator Rotor Angle

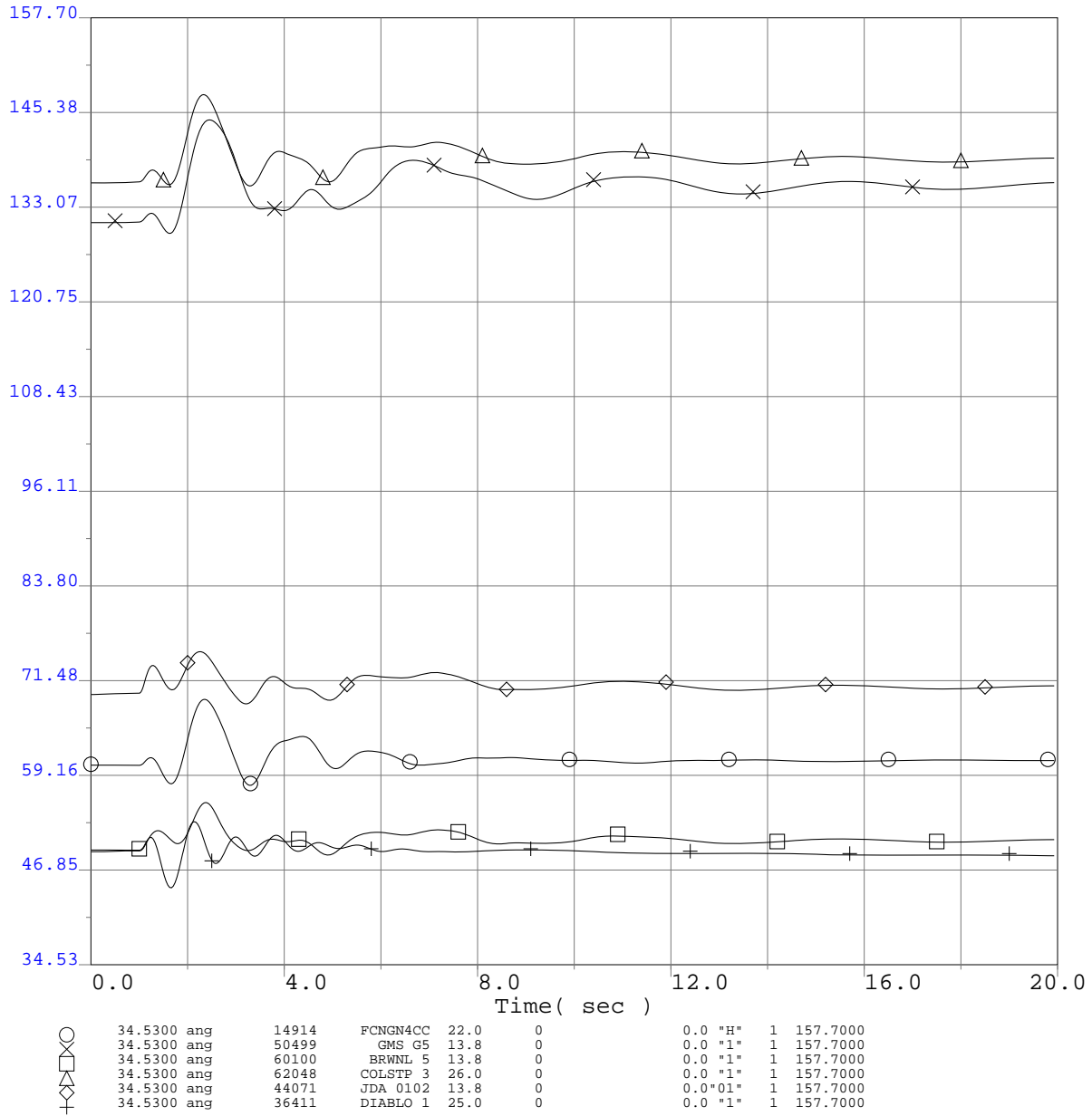

○	34.5300 ang	14914	FCNGN4CC	22.0	0	0.0 "H"	1	157.7000
□	34.5300 ang	50499	GMS G5	13.8	0	0.0 "1"	1	157.7000
◇	34.5300 ang	60100	BRWNL 5	13.8	0	0.0 "1"	1	157.7000
△	34.5300 ang	62048	COLSTP 3	26.0	0	0.0 "1"	1	157.7000
○	34.5300 ang	44071	JDA 0102	13.8	0	0.0"01"	1	157.7000
+	34.5300 ang	36411	DIABLO 1	25.0	0	0.0 "1"	1	157.7000

Q320 TCP2 ISIS
 2013 Greater Bay Area Summer Peak Base Case
 Q320 @ 772MW
 CCPP 230kV Bus 1E Outage
 3-ph 6 cyc flt @ the CCPP 230kV bus & clr the CCPP 230kV Bus 1E Outage

Q320 TCP2 ISIS

WECC Generator Rotor Angle

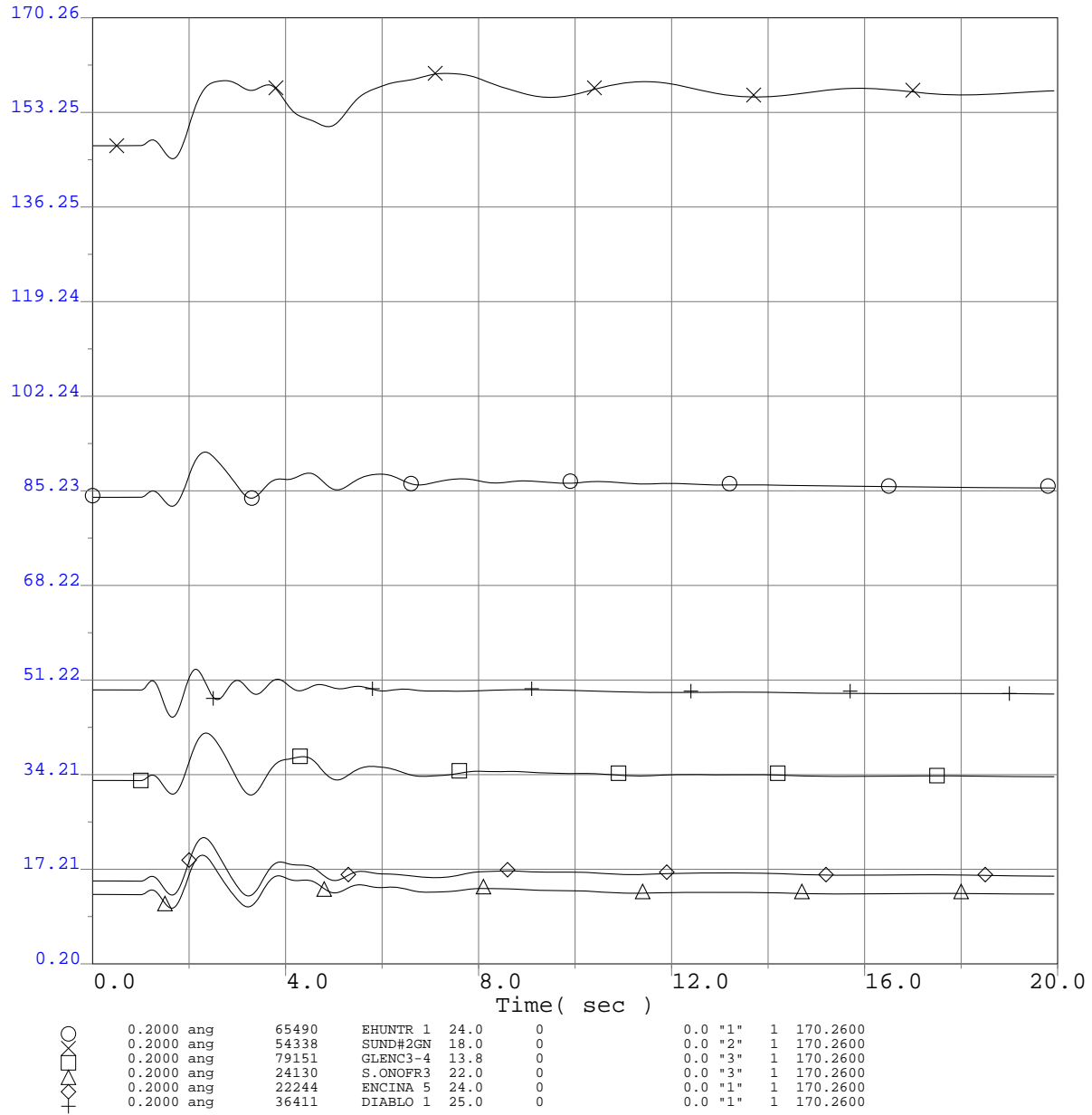

○	0.2000 ang	65490	EHUNTR 1	24.0	0	0.0 "1"	1	170.2600
□	0.2000 ang	54338	SUND#2GN	18.0	0	0.0 "2"	1	170.2600
◇	0.2000 ang	79151	GLENC3-4	13.8	0	0.0 "3"	1	170.2600
△	0.2000 ang	24130	S.ONOFR3	22.0	0	0.0 "3"	1	170.2600
◇	0.2000 ang	22244	ENCINA 5	24.0	0	0.0 "1"	1	170.2600
+	0.2000 ang	36411	DIABLO 1	25.0	0	0.0 "1"	1	170.2600

Q320 TCP2 ISIS
 2013 Greater Bay Area Summer Peak Base Case
 Q320 @ 772MW
 CCPP 230kV Bus 1E Outage
 3-ph 6 cyc flt @ the CCPP 230kV bus & clr the CCPP 230kV Bus 1E Outage

Q320 TCP2 ISIS

Selected PG&E Transmission Line Flows (MW)

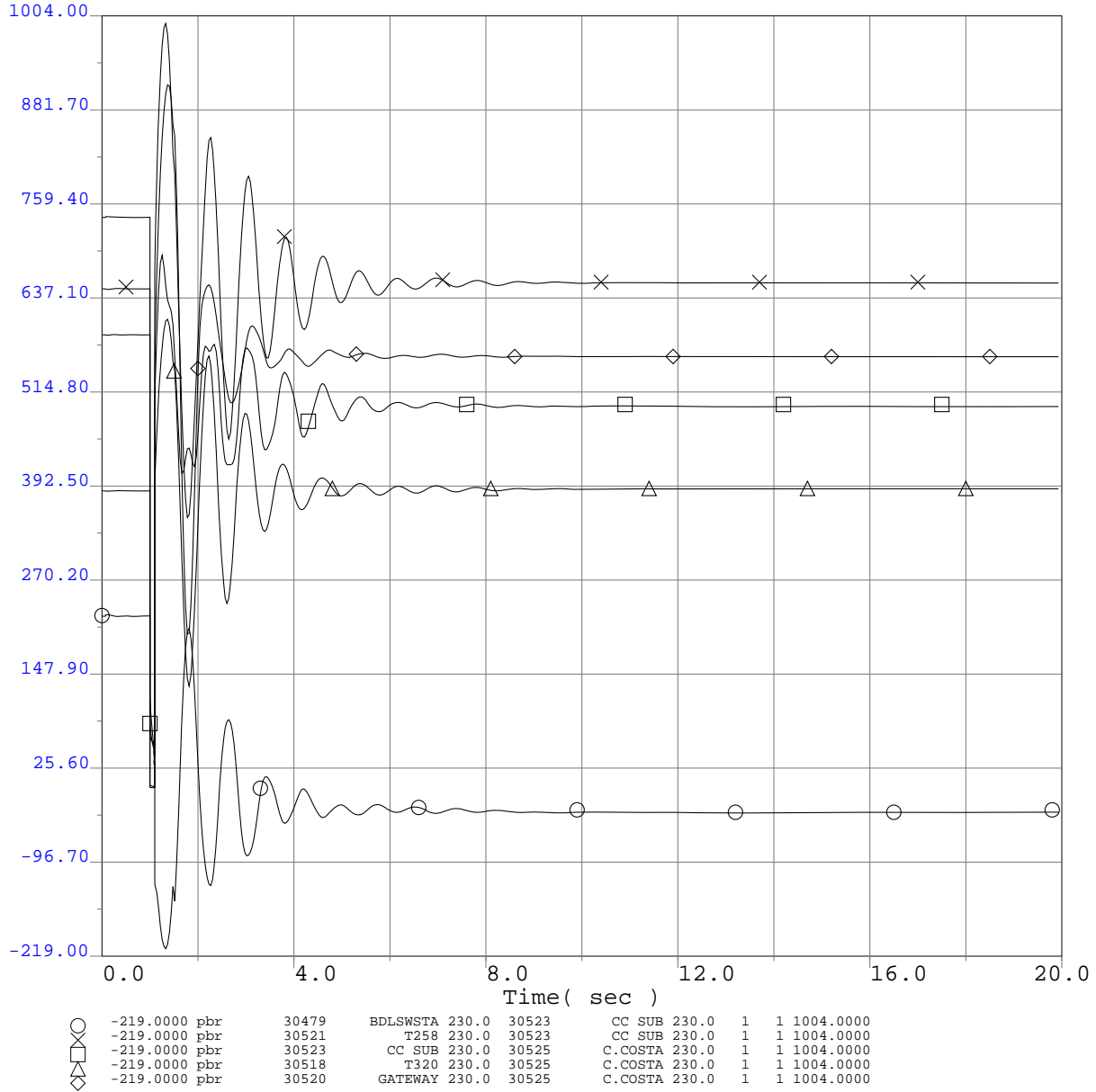

Q320 TCP2 ISIS
 2013 Greater Bay Area Summer Peak Base Case
 Q320 @ 772MW
 CCPP 230kV Bus 1E Outage
 3-ph 6 cyc flt @ the CCPP 230kV bus & clr the CCPP 230kV Bus 1E Outage

Q320 TCP2 ISIS

Selected PG&E Transmission Line Flows (MW)

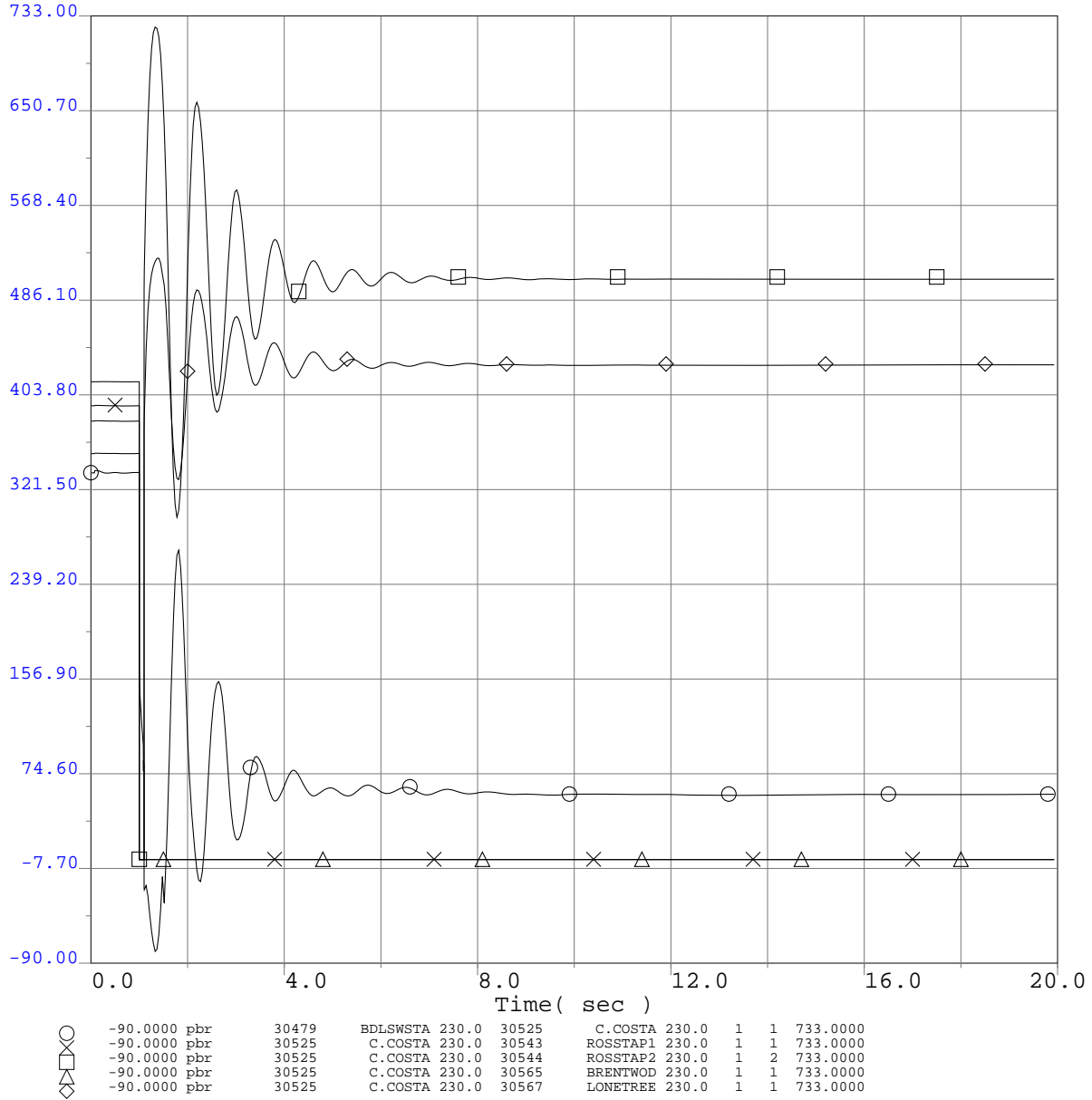

Q320 TCP2 ISIS
 2013 Greater Bay Area Summer Peak Base Case
 Q320 @ 772MW
 CCPP 230kV Bus 1E Outage
 3-ph 6 cyc flt @ the CCPP 230kV bus & clr the CCPP 230kV Bus 1E Outage

Q320 TCP2 ISIS

Selected PG&E Transmission Line Flows (MW)

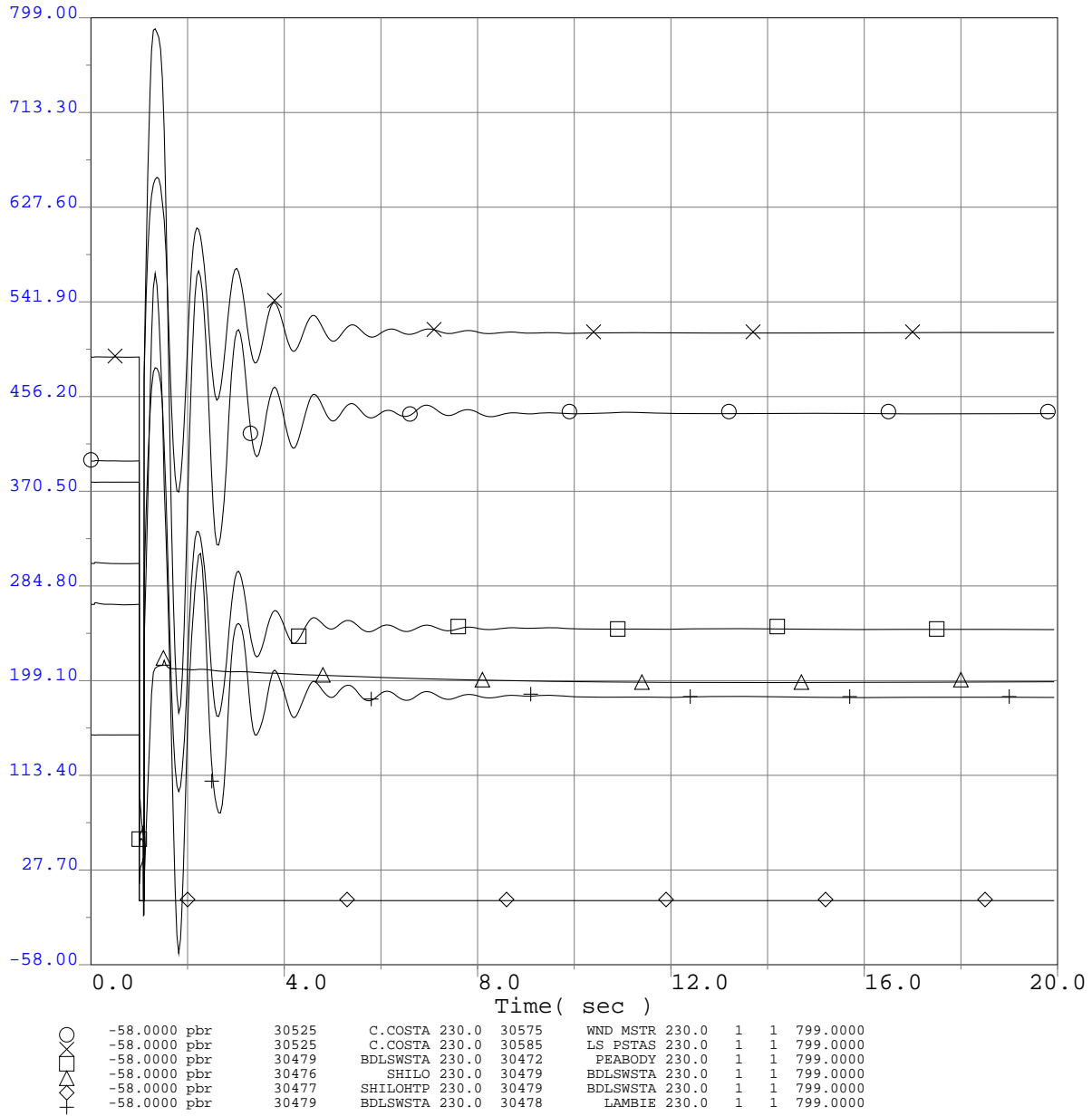

Q320 TCP2 ISIS
 2013 Greater Bay Area Summer Peak Base Case
 Q320 @ 772MW
 CCPP 230kV Bus 1E Outage
 3-ph 6 cyc flt @ the CCPP 230kV bus & clr the CCPP 230kV Bus 1E Outage

Q320 TCP2 ISIS

Selected PG&E Transmission Line Flows (MW)

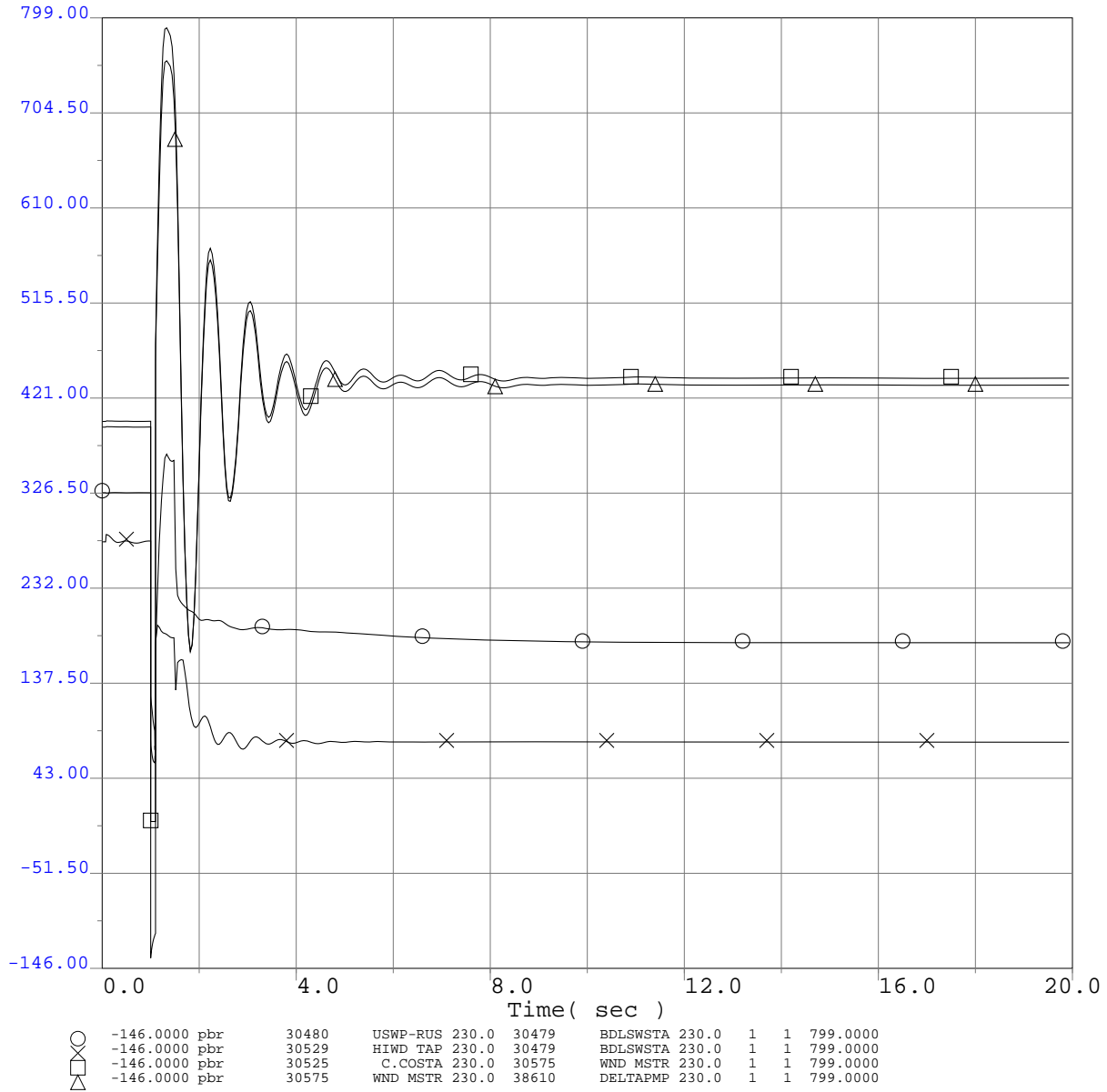

Q320 TCP2 ISIS
 2013 Greater Bay Area Summer Peak Base Case
 Q320 @ 772MW
 CCPP 230kV Bus 1E Outage
 3-ph 6 cyc flt @ the CCPP 230kV bus & clr the CCPP 230kV Bus 1E Outage

Q320 TCP2 ISIS

Selected PG&E Bus Voltage Plots Adjacent to Fault

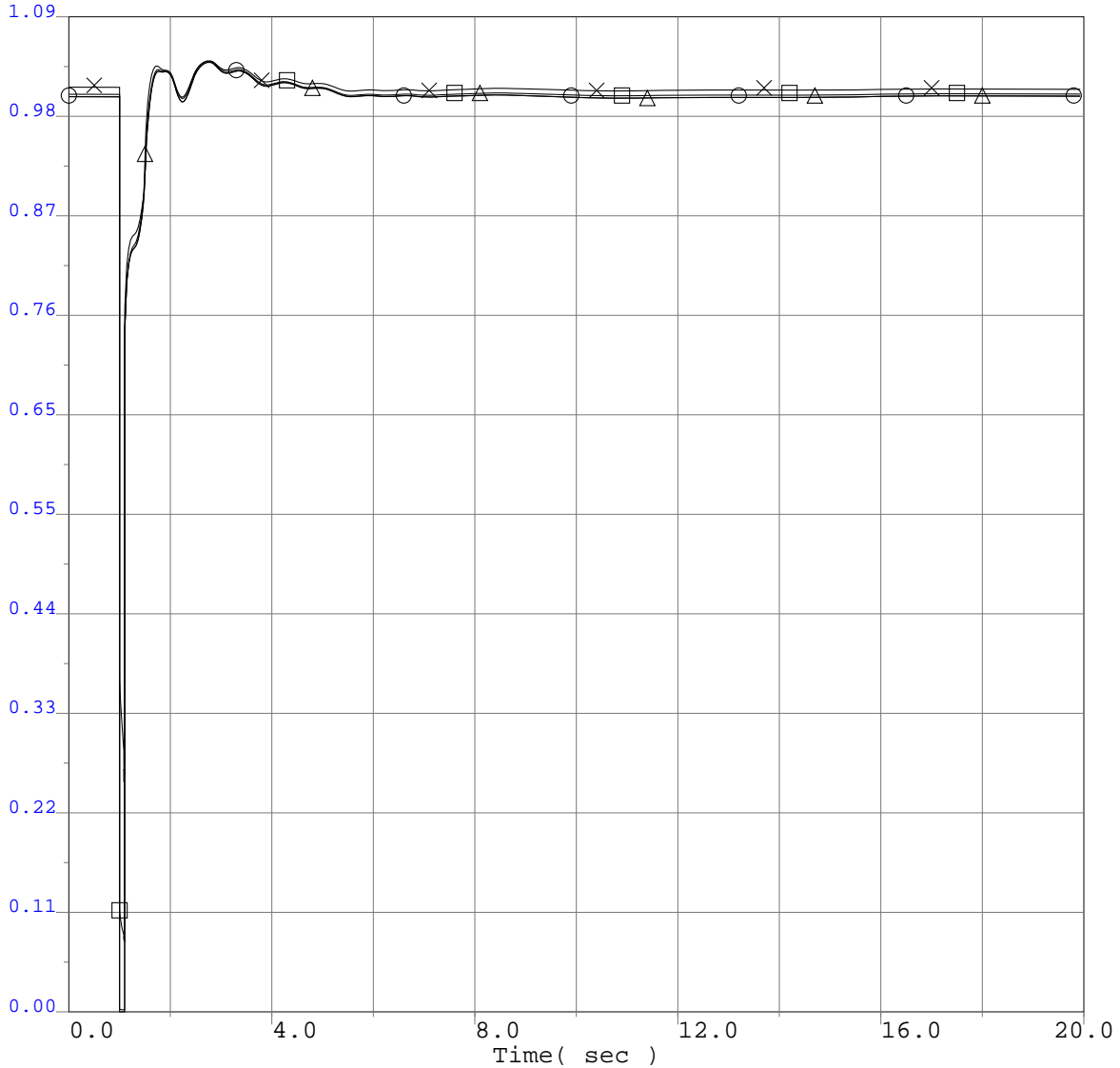

○	0.0000	vbus	30525	C.COSTA	230.0	0	0.0	***	1	1.0900
□	0.0000	vbus	30479	BDLSWSTA	230.0	0	0.0	***	1	1.0900
×	0.0000	vbul	30523	CC SUB	230.0	0	0.0	***	1	1.0900
△	0.0000	vbus	30518	T320	230.0	0	0.0	***	1	1.0900



Q320 TCP2 ISIS
 2013 Greater Bay Area Summer Peak Base Case
 Q320 @ 772MW
 CCPP 230kV Bus 2E Outage
 3-ph 6 cyc flt @ the CCPP 230kV bus & clr the CCPP 230kV Bus 2E Outage

Q320 TCP2 ISIS

Selected PG&E Bus Frequency Plots Adjacent to Fault

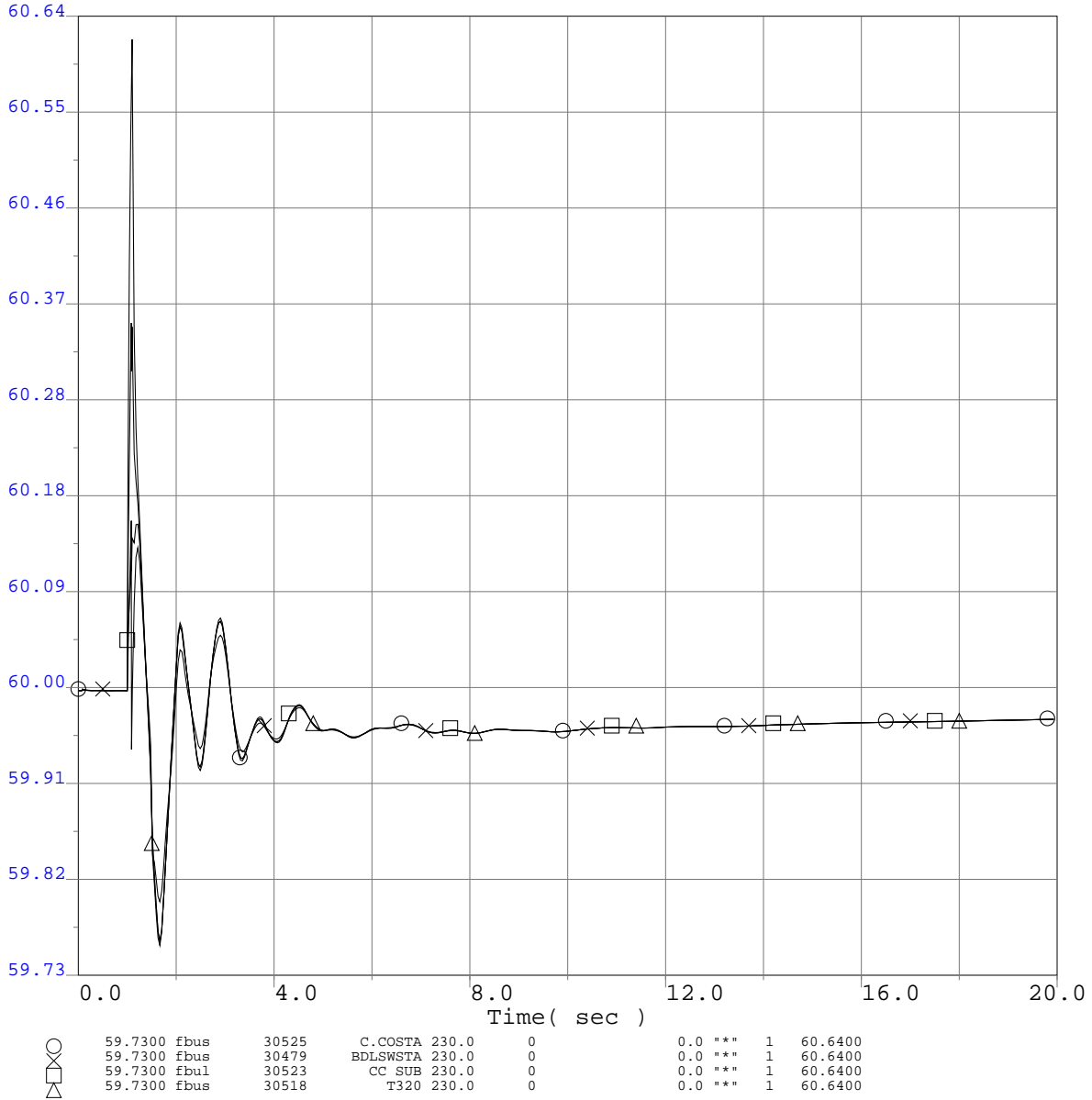

Q320 TCP2 ISIS
 2013 Greater Bay Area Summer Peak Base Case
 Q320 @ 772MW
 CCPP 230kV Bus 2E Outage
 3-ph 6 cyc flt @ the CCPP 230kV bus & clr the CCPP 230kV Bus 2E Outage

Q320 TCP2 ISIS

Project Generator Terminal Voltages (P.U.)

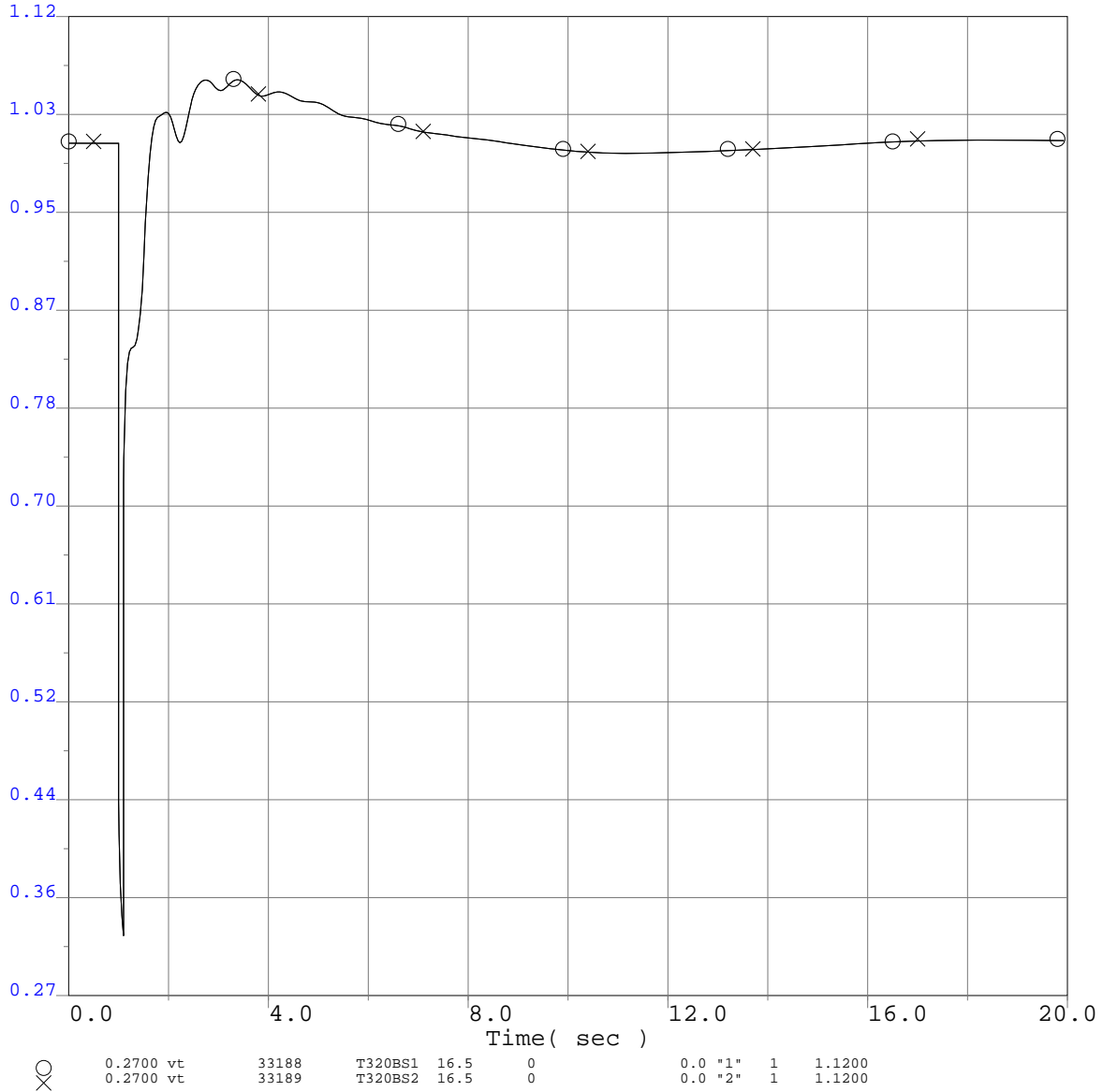

Q320 TCP2 ISIS
 2013 Greater Bay Area Summer Peak Base Case
 Q320 @ 772MW
 CCPP 230kV Bus 2E Outage
 3-ph 6 cyc flt @ the CCPP 230kV bus & clr the CCPP 230kV Bus 2E Outage

Q320 TCP2 ISIS

Project Generator Terminal Voltages (P.U.)

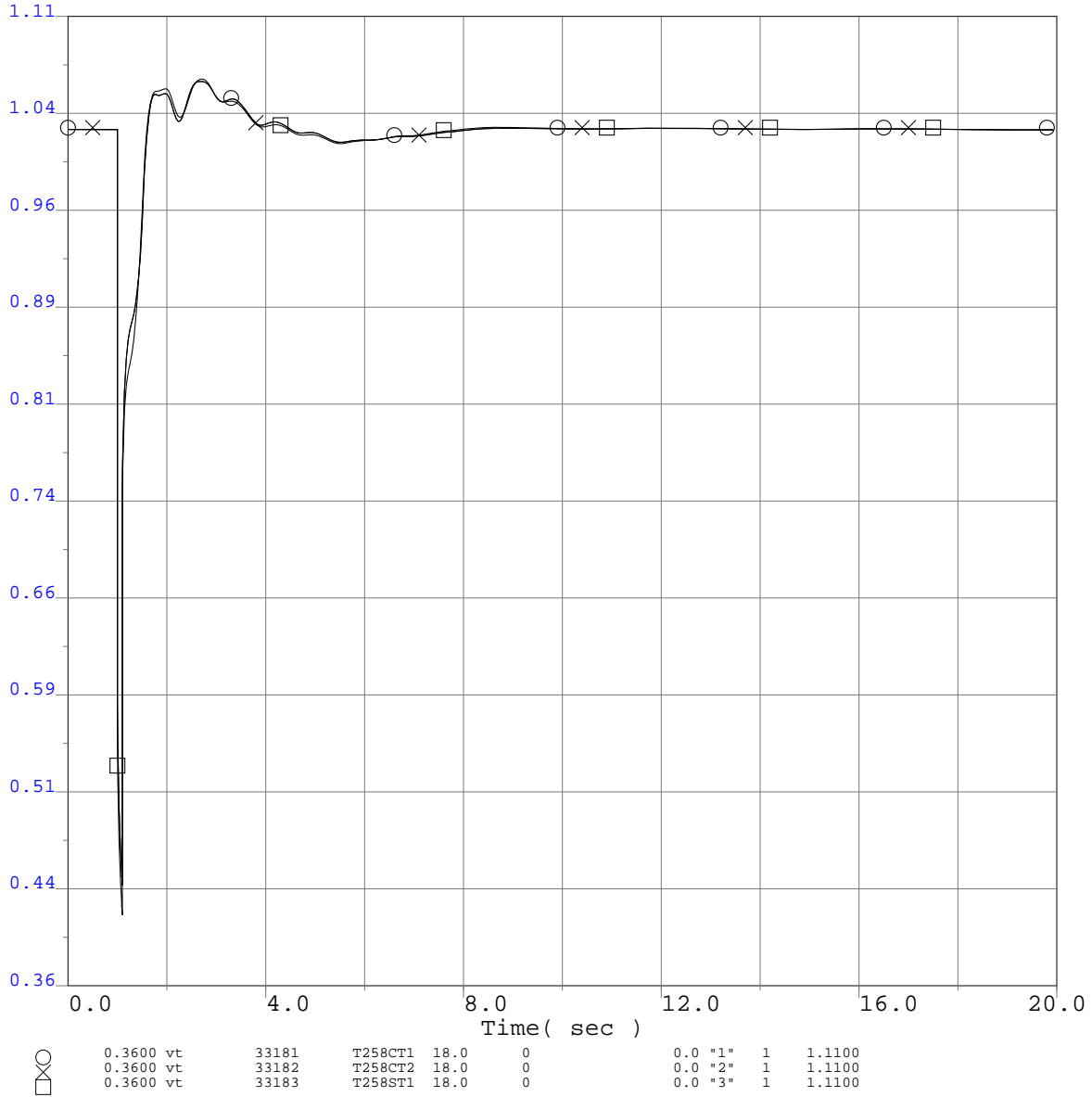

Q320 TCP2 ISIS
 2013 Greater Bay Area Summer Peak Base Case
 Q320 @ 772MW
 CCPP 230kV Bus 2E Outage
 3-ph 6 cyc flt @ the CCPP 230kV bus & clr the CCPP 230kV Bus 2E Outage

Q320 TCP2 ISIS

Project Generator Speed (P.U.)

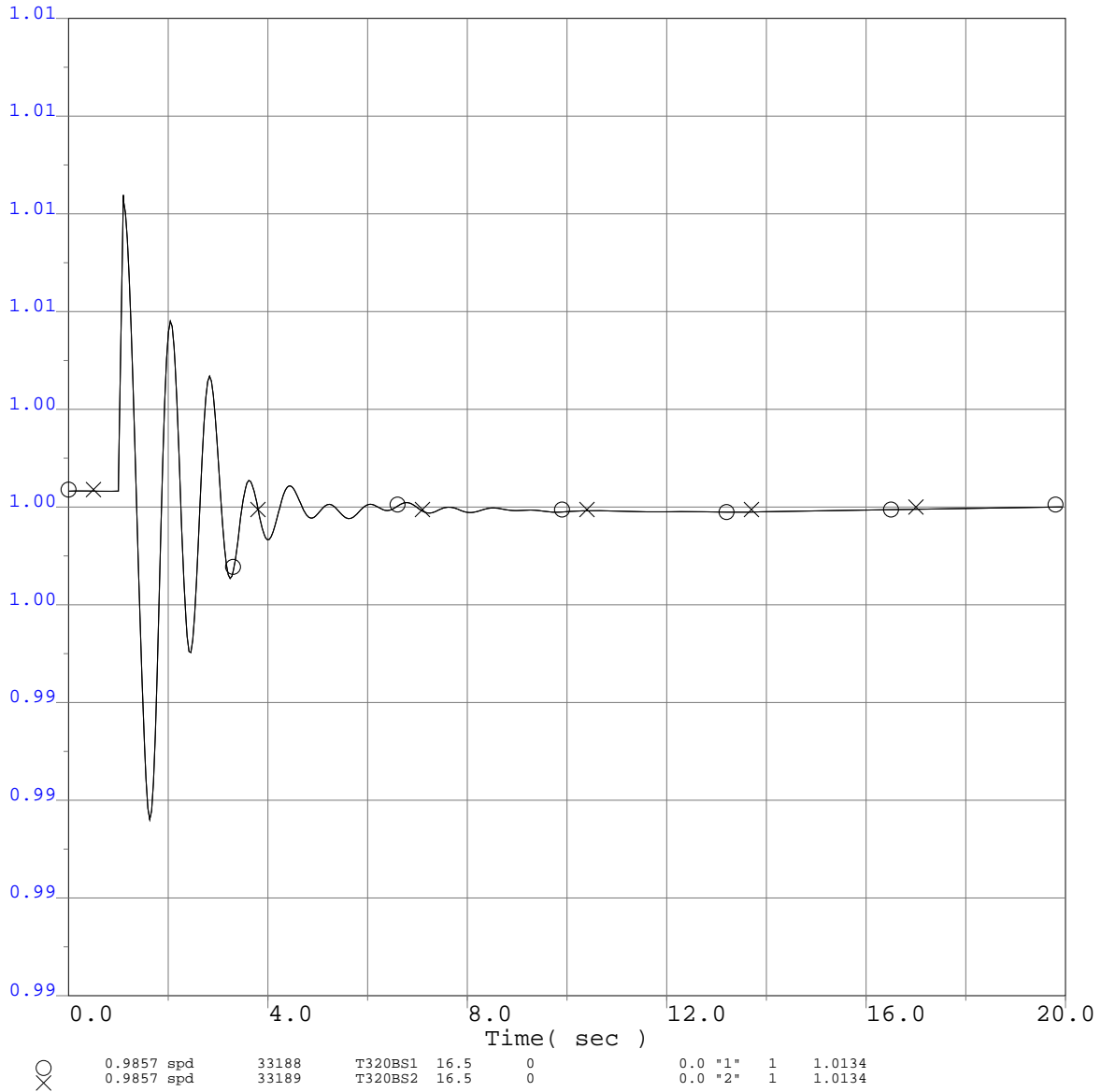

Q320 TCP2 ISIS
 2013 Greater Bay Area Summer Peak Base Case
 Q320 @ 772MW
 CCPP 230kV Bus 2E Outage
 3-ph 6 cyc flt @ the CCPP 230kV bus & clr the CCPP 230kV Bus 2E Outage

Q320 TCP2 ISIS

Project Generator Speed (P.U.)

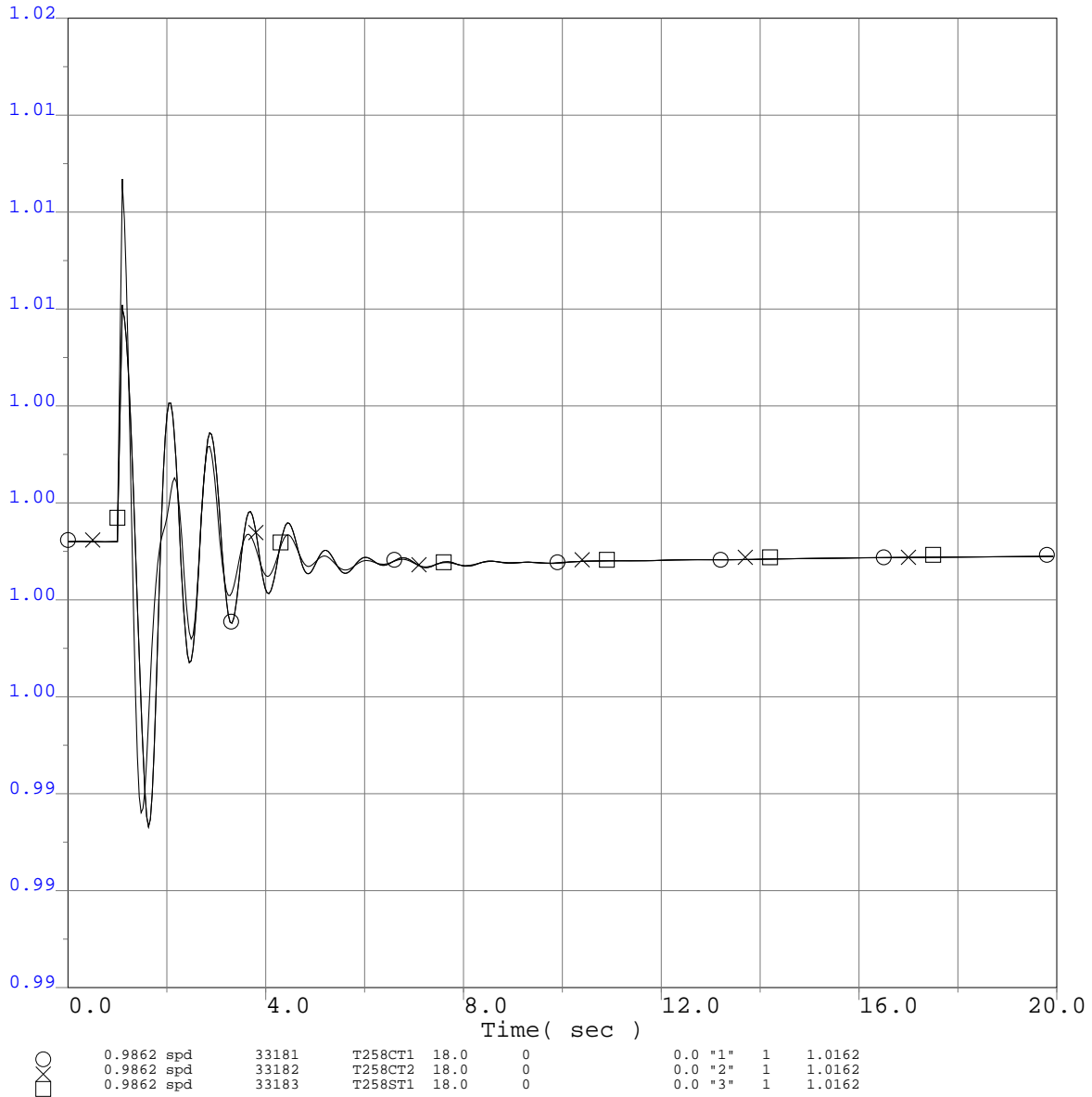

○	0.9862 spd	33181	T258CT1	18.0	0	0.0 "1"	1	1.0162
□	0.9862 spd	33182	T258CT2	18.0	0	0.0 "2"	1	1.0162
×	0.9862 spd	33183	T258ST1	18.0	0	0.0 "3"	1	1.0162

Q320 TCP2 ISIS
 2013 Greater Bay Area Summer Peak Base Case
 Q320 @ 772MW
 CCPP 230kV Bus 2E Outage
 3-ph 6 cyc flt @ the CCPP 230kV bus & clr the CCPP 230kV Bus 2E Outage

Q320 TCP2 ISIS

Project Generator Terminal Power (MW)

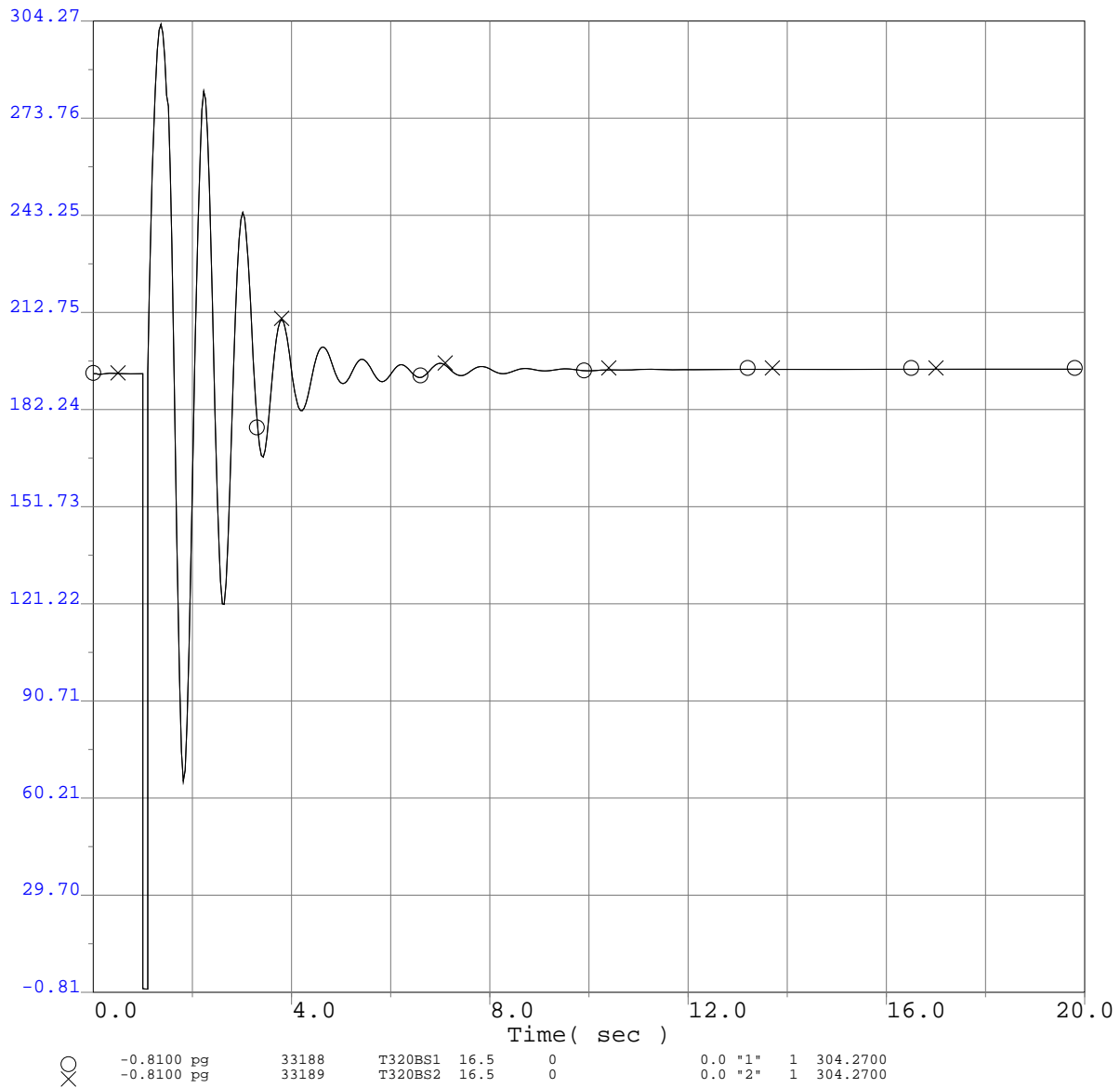

○	-0.8100 pg	33188	T320BS1	16.5	0	0.0 "1"	1	304.2700
×	-0.8100 pg	33189	T320BS2	16.5	0	0.0 "2"	1	304.2700

Q320 TCP2 ISIS
 2013 Greater Bay Area Summer Peak Base Case
 Q320 @ 772MW
 CCPP 230kV Bus 2E Outage
 3-ph 6 cyc flt @ the CCPP 230kV bus & clr the CCPP 230kV Bus 2E Outage

Q320 TCP2 ISIS

Project Generator Terminal Power (MW)

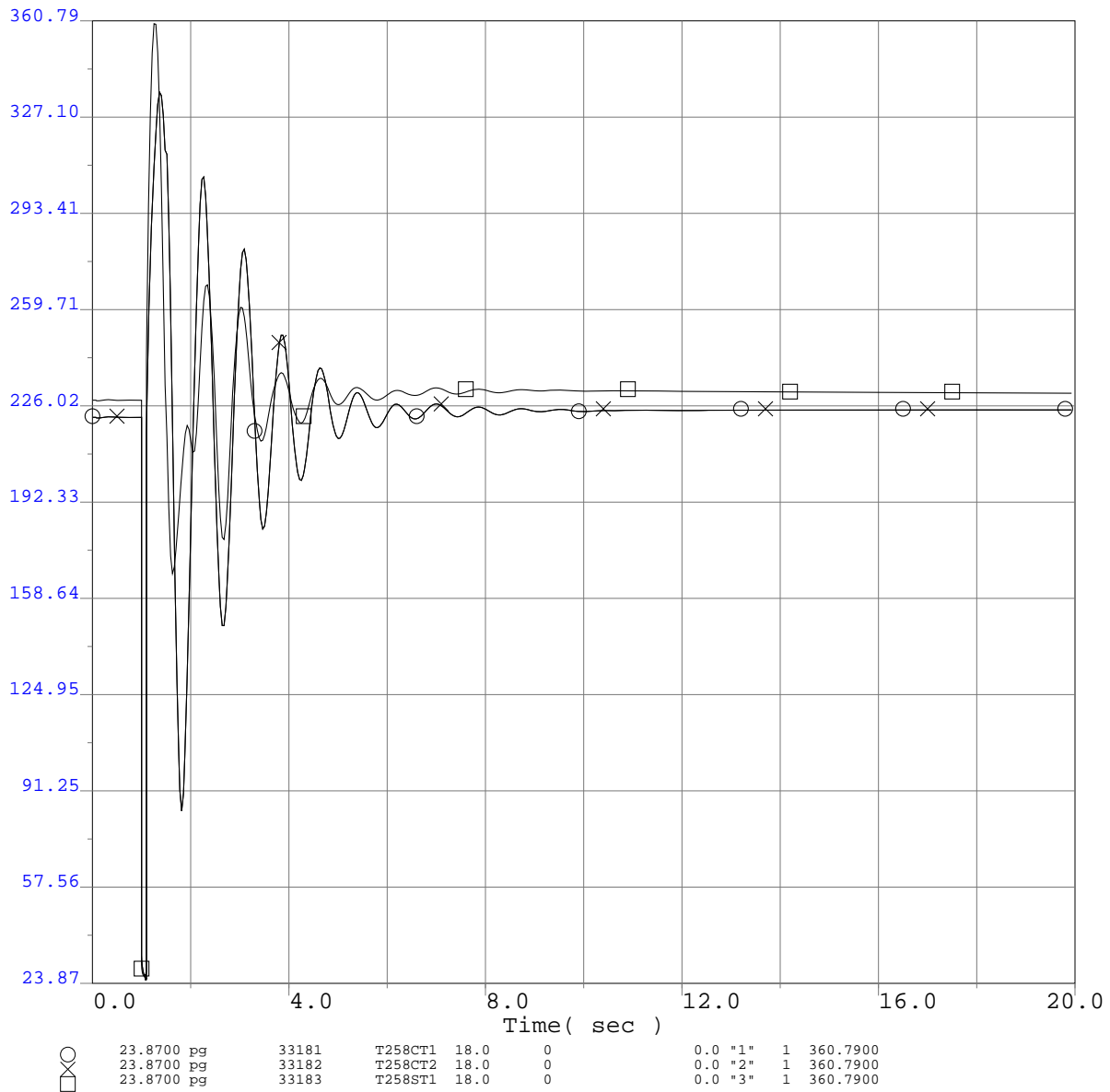

Q320 TCP2 ISIS
 2013 Greater Bay Area Summer Peak Base Case
 Q320 @ 772MW
 CCPP 230kV Bus 2E Outage
 3-ph 6 cyc flt @ the CCPP 230kV bus & clr the CCPP 230kV Bus 2E Outage

Q320 TCP2 ISIS

Project Generator Terminal Reactive Power (MVA_r)

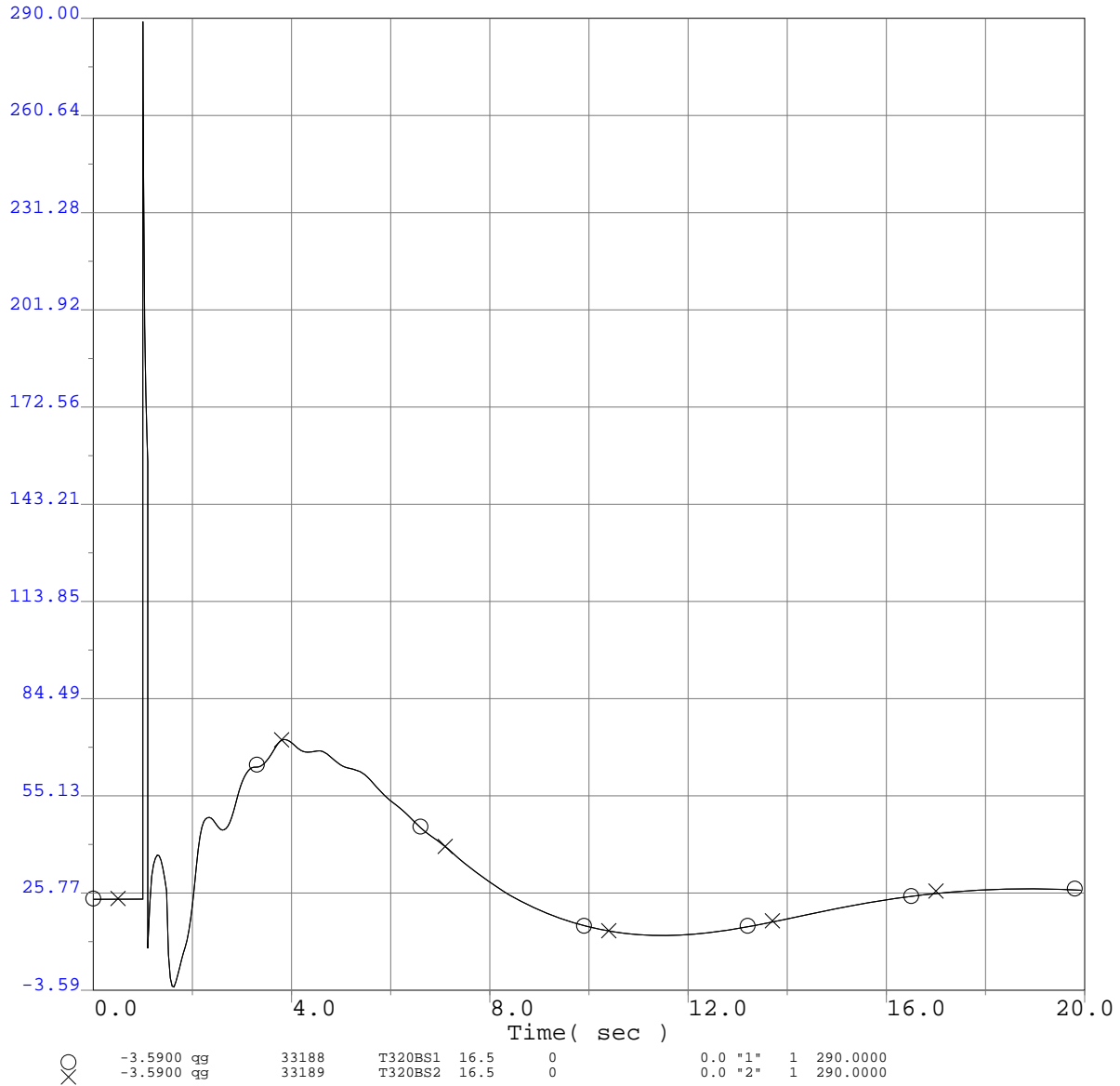

Q320 TCP2 ISIS
 2013 Greater Bay Area Summer Peak Base Case
 Q320 @ 772MW
 CCPP 230kV Bus 2E Outage
 3-ph 6 cyc flt @ the CCPP 230kV bus & clr the CCPP 230kV Bus 2E Outage

Q320 TCP2 ISIS

Project Generator Terminal Reactive Power (MVA_r)

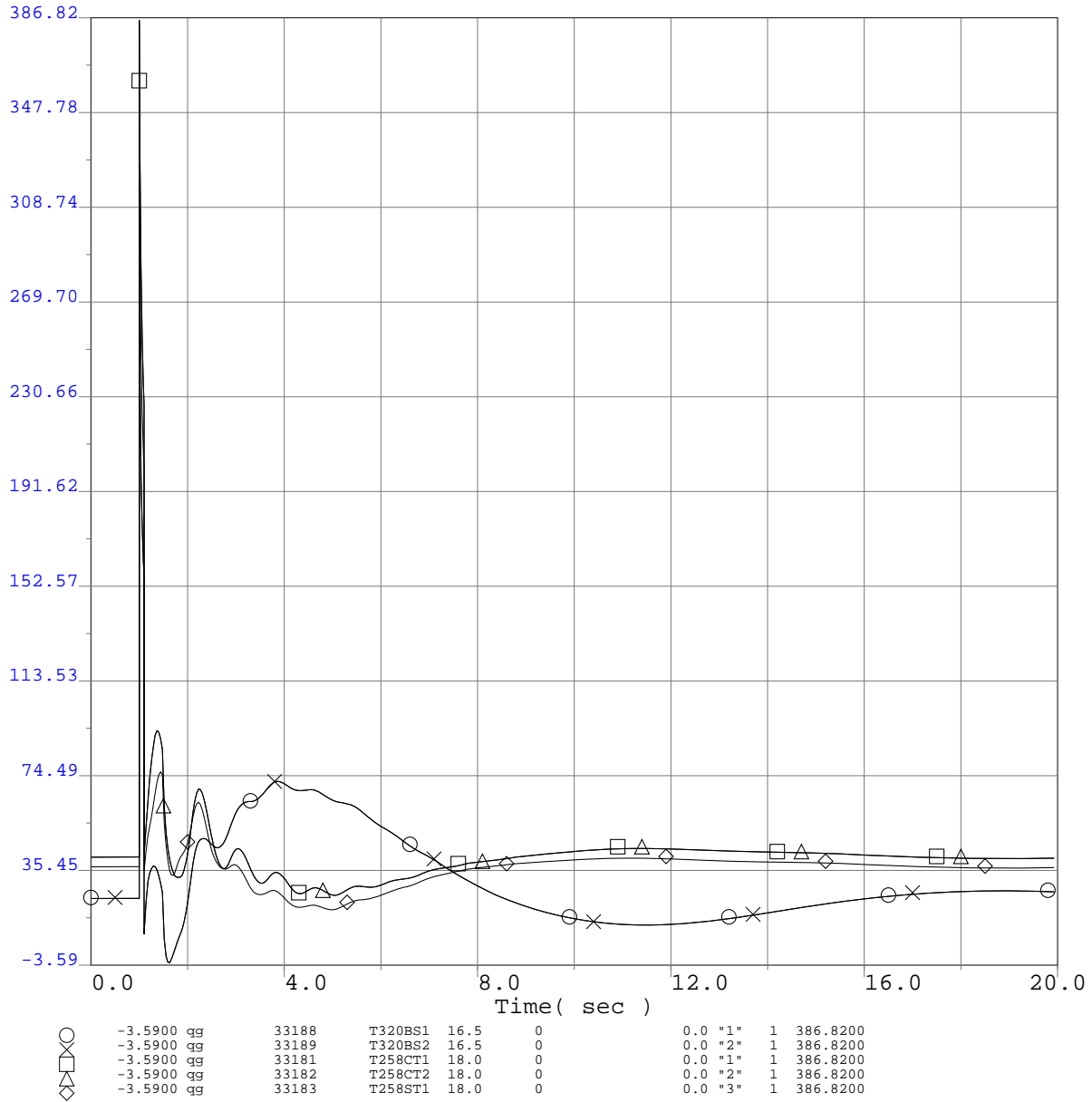

Q320 TCP2 ISIS
 2013 Greater Bay Area Summer Peak Base Case
 Q320 @ 772MW
 CCPP 230kV Bus 2E Outage
 3-ph 6 cyc flt @ the CCPP 230kV bus & clr the CCPP 230kV Bus 2E Outage

Q320 TCP2 ISIS

Selected WECC Bus Voltage Plots

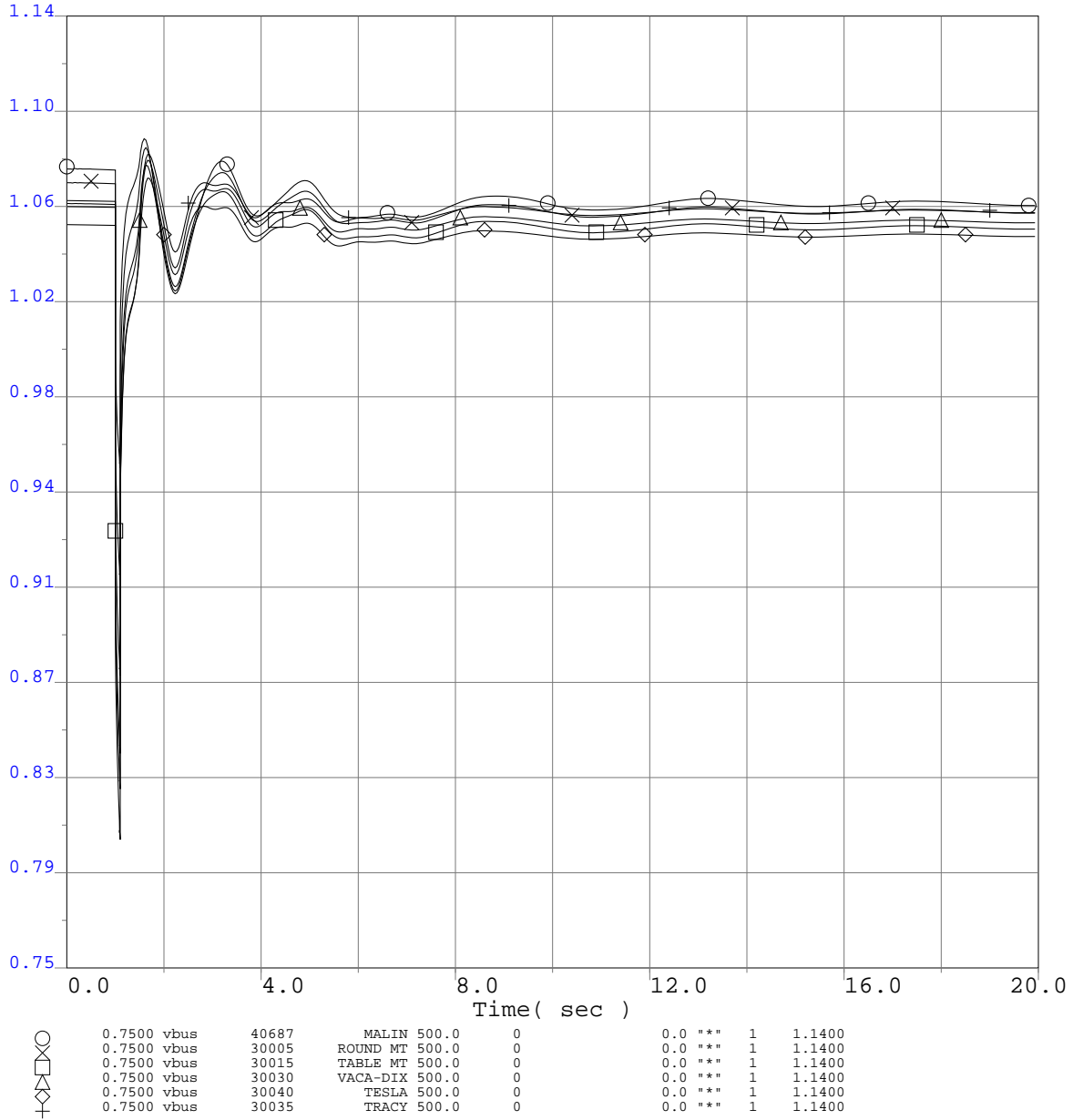

Q320 TCP2 ISIS
 2013 Greater Bay Area Summer Peak Base Case
 Q320 @ 772MW
 CCPP 230kV Bus 2E Outage
 3-ph 6 cyc flt @ the CCPP 230kV bus & clr the CCPP 230kV Bus 2E Outage

Q320 TCP2 ISIS

Selected WECC Bus Voltage Plots

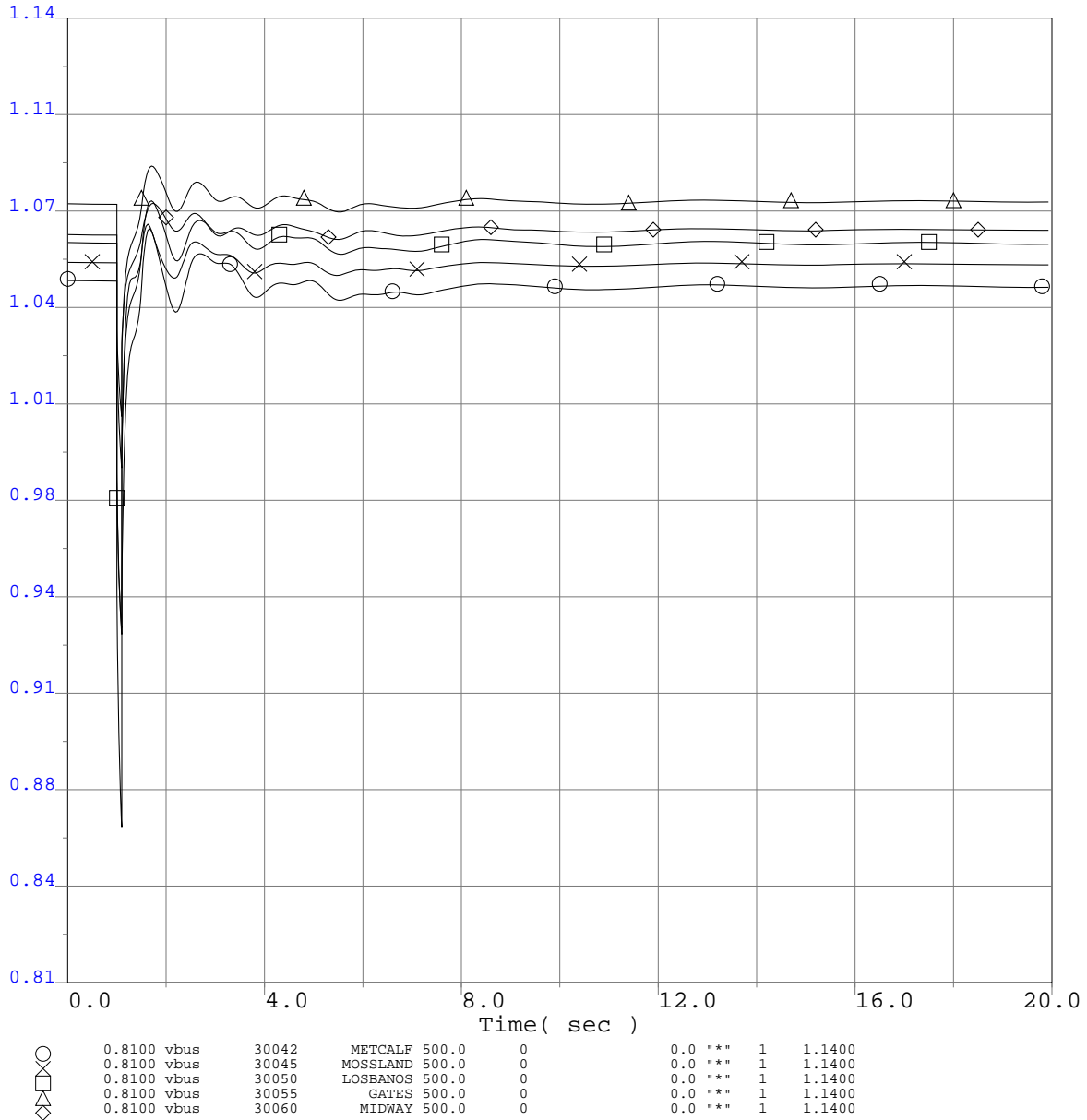

○	0.8100 vbus	30042	METCALF 500.0	0	0.0	***	1	1.1400
□	0.8100 vbus	30045	MOSSLAND 500.0	0	0.0	***	1	1.1400
×	0.8100 vbus	30050	LOSBANOS 500.0	0	0.0	***	1	1.1400
△	0.8100 vbus	30055	GATES 500.0	0	0.0	***	1	1.1400
◇	0.8100 vbus	30060	MIDWAY 500.0	0	0.0	***	1	1.1400

Q320 TCP2 ISIS
 2013 Greater Bay Area Summer Peak Base Case
 Q320 @ 772MW
 CCPP 230kV Bus 2E Outage
 3-ph 6 cyc flt @ the CCPP 230kV bus & clr the CCPP 230kV Bus 2E Outage

Q320 TCP2 ISIS

Selected WECC Bus Voltage Plots

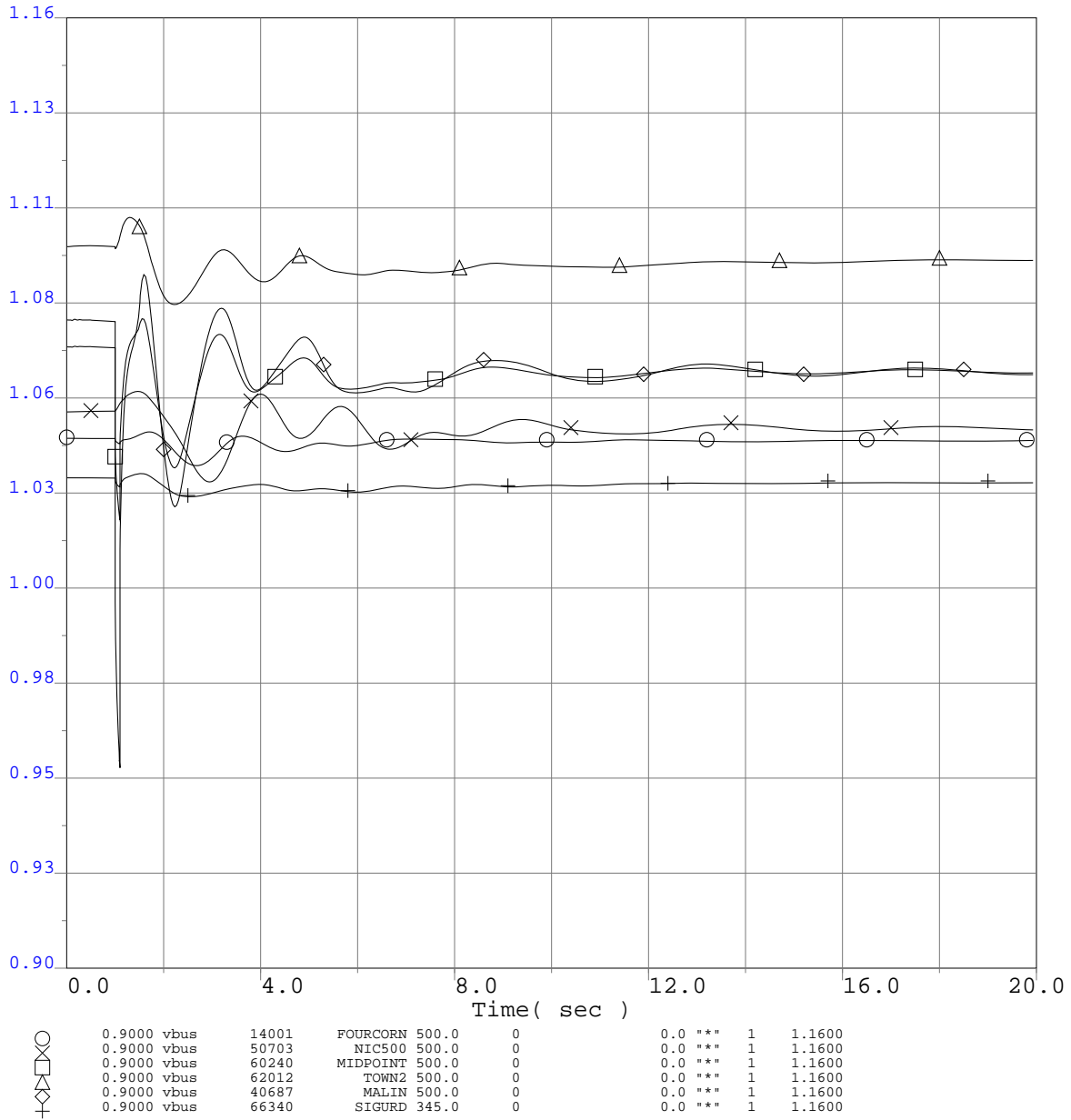

Q320 TCP2 ISIS
 2013 Greater Bay Area Summer Peak Base Case
 Q320 @ 772MW
 CCPP 230kV Bus 2E Outage
 3-ph 6 cyc flt @ the CCPP 230kV bus & clr the CCPP 230kV Bus 2E Outage

Q320 TCP2 ISIS

Selected WECC Bus Voltage Plots

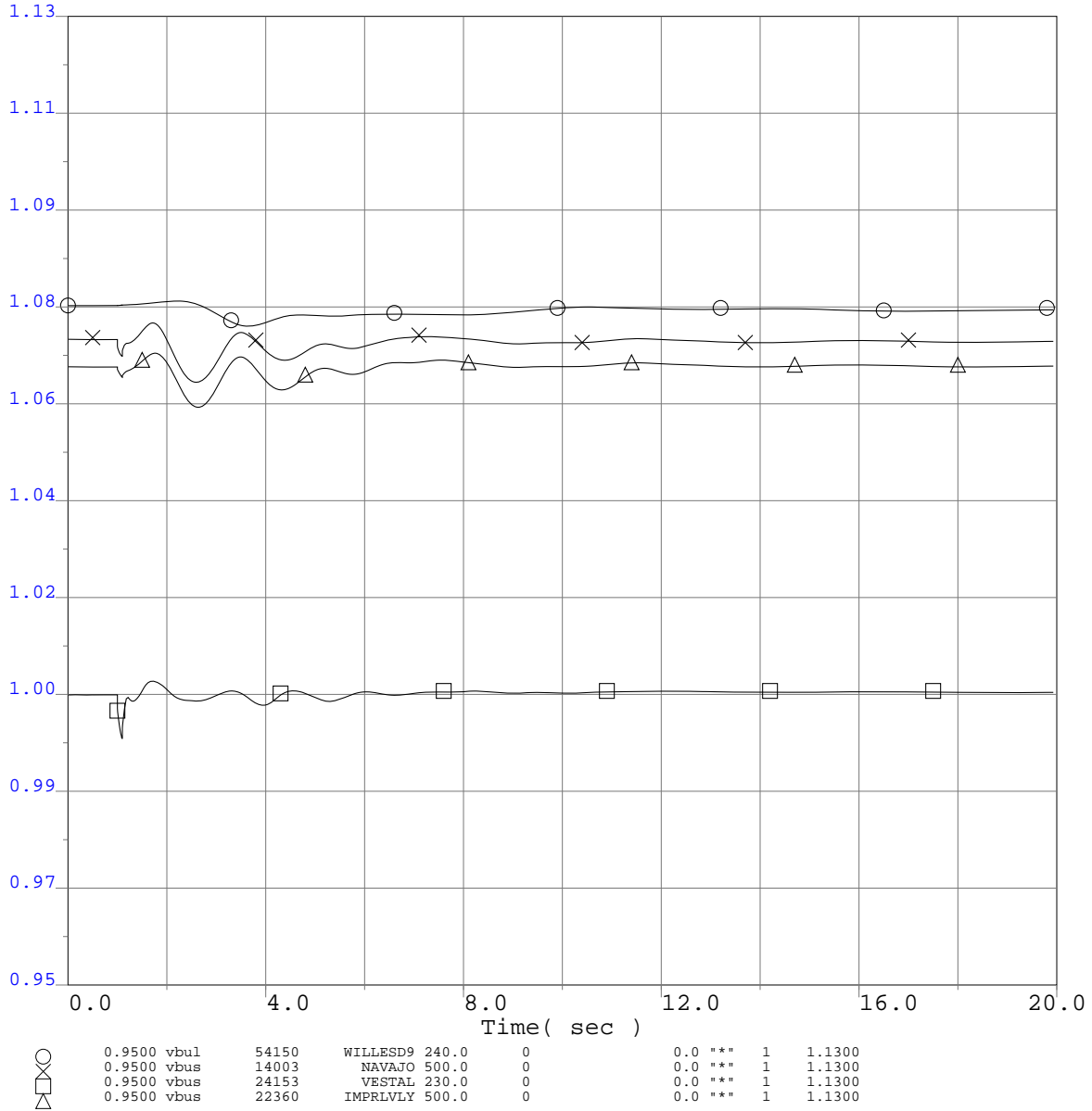

Q320 TCP2 ISIS
 2013 Greater Bay Area Summer Peak Base Case
 Q320 @ 772MW
 CCPP 230kV Bus 2E Outage
 3-ph 6 cyc flt @ the CCPP 230kV bus & clr the CCPP 230kV Bus 2E Outage

Q320 TCP2 ISIS

Selected WECC Bus Frequency Plots

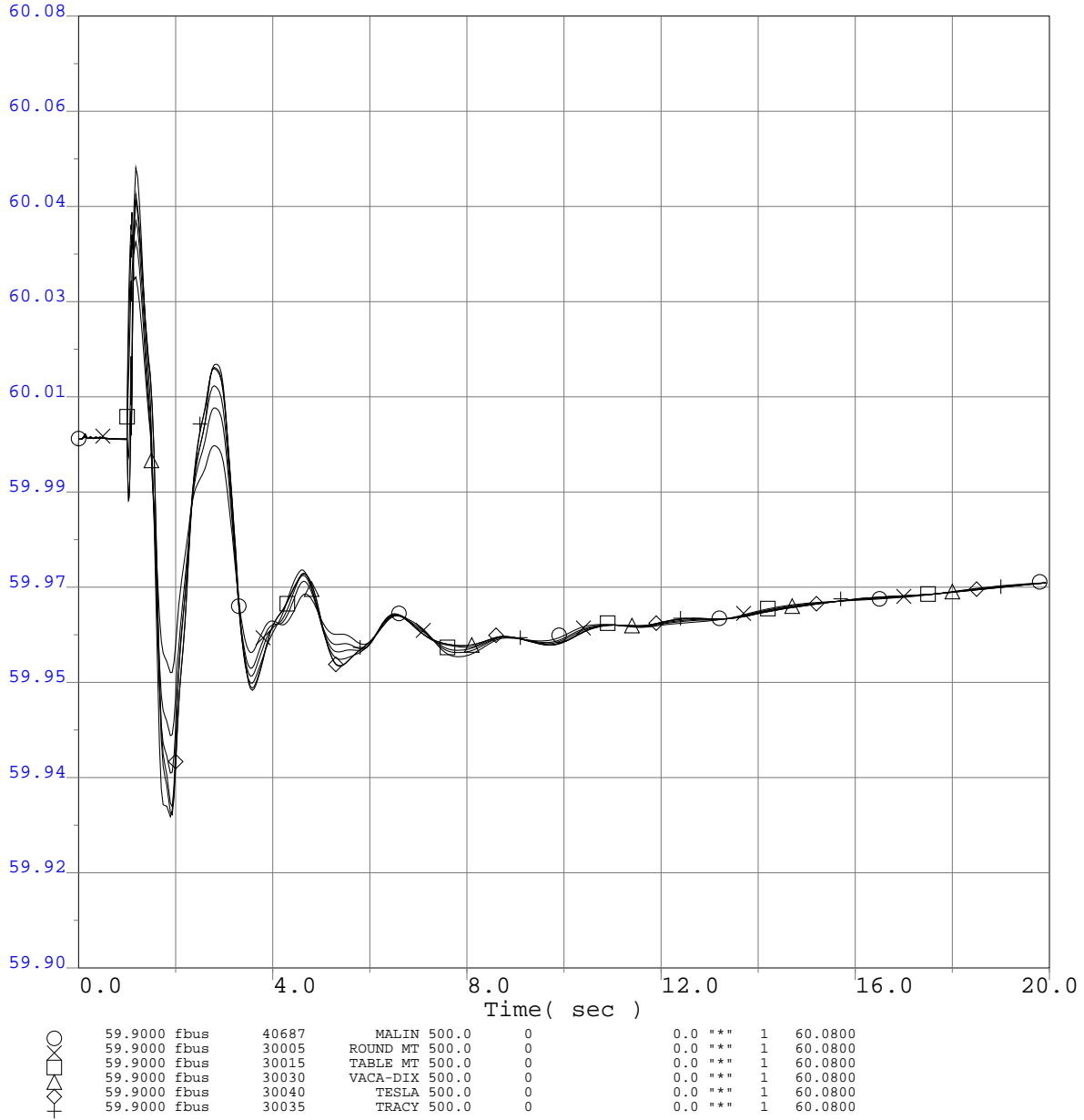

Q320 TCP2 ISIS
 2013 Greater Bay Area Summer Peak Base Case
 Q320 @ 772MW
 CCPP 230kV Bus 2E Outage
 3-ph 6 cyc flt @ the CCPP 230kV bus & clr the CCPP 230kV Bus 2E Outage

Q320 TCP2 ISIS

Selected WECC Bus Frequency Plots

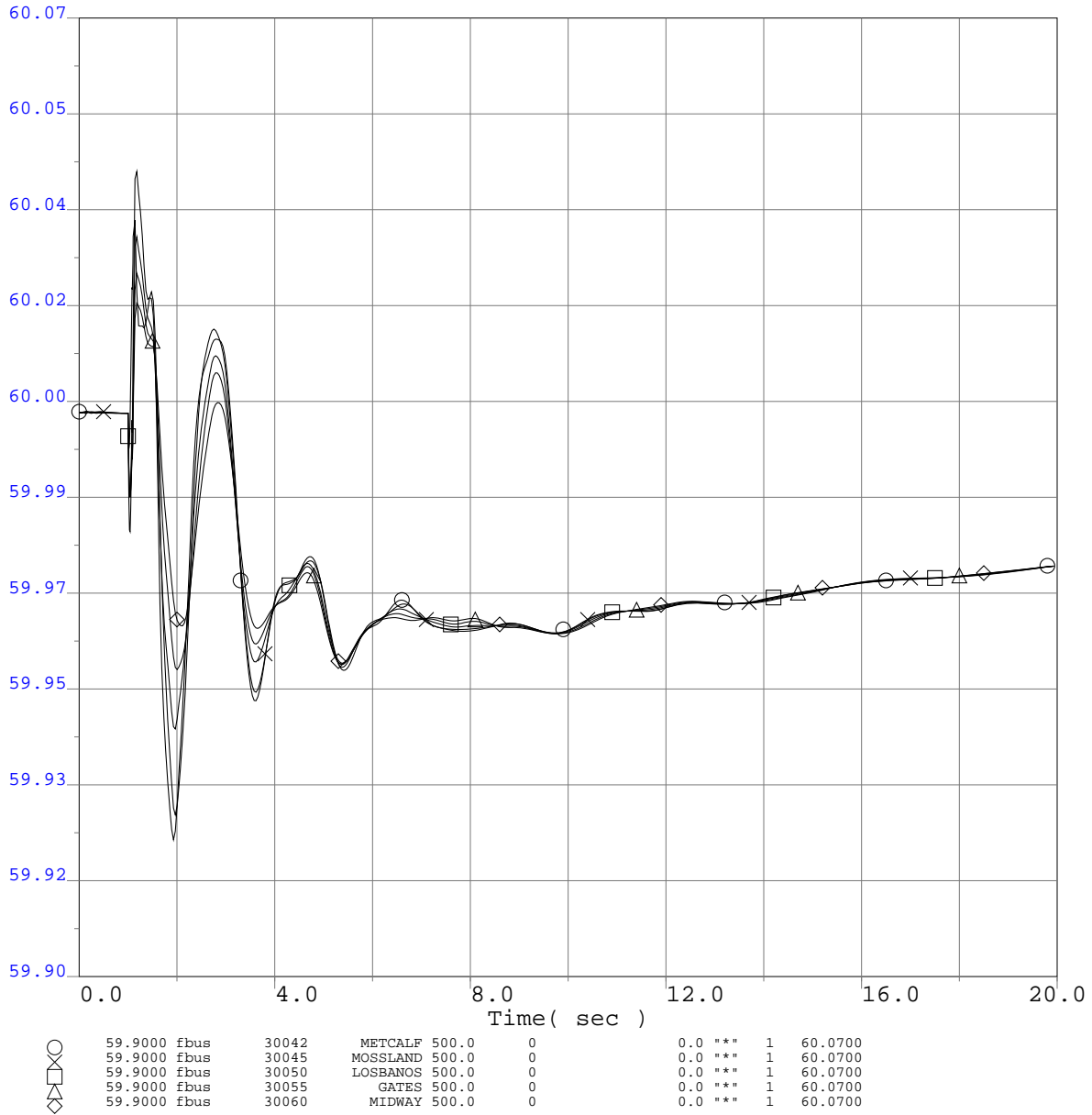

○	59.9000 Fbus	30042	METCALF 500.0	0	0.0	***	1	60.0700
□	59.9000 Fbus	30045	MOSSLAND 500.0	0	0.0	***	1	60.0700
△	59.9000 Fbus	30050	LOSBANOS 500.0	0	0.0	***	1	60.0700
◇	59.9000 Fbus	30055	GATES 500.0	0	0.0	***	1	60.0700
◇	59.9000 Fbus	30060	MIDWAY 500.0	0	0.0	***	1	60.0700

Q320 TCP2 ISIS
 2013 Greater Bay Area Summer Peak Base Case
 Q320 @ 772MW
 CCPP 230kV Bus 2E Outage
 3-ph 6 cyc flt @ the CCPP 230kV bus & clr the CCPP 230kV Bus 2E Outage

Q320 TCP2 ISIS

Selected WECC Bus Frequency Plots

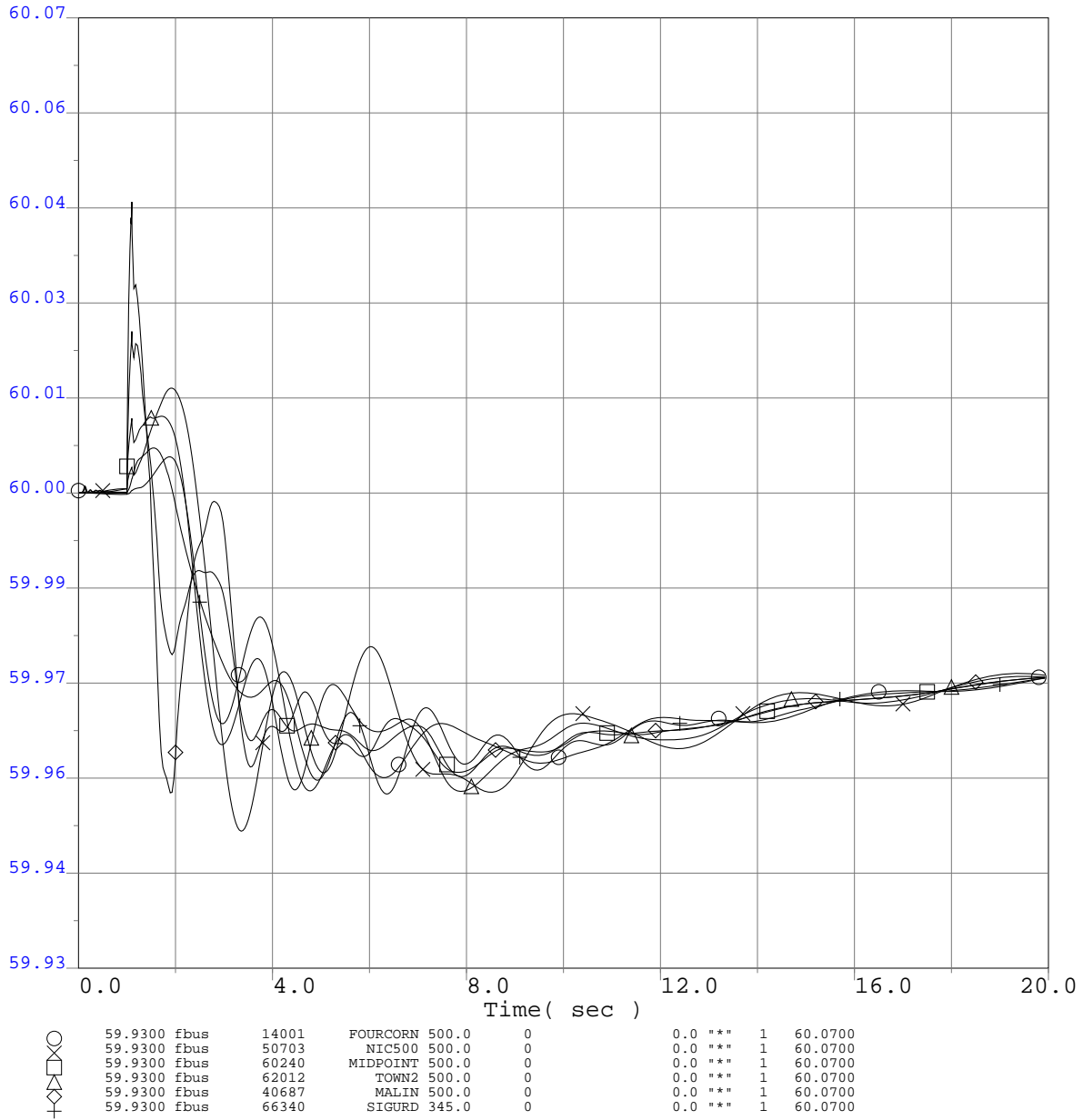

Q320 TCP2 ISIS
 2013 Greater Bay Area Summer Peak Base Case
 Q320 @ 772MW
 CCPP 230kV Bus 2E Outage
 3-ph 6 cyc flt @ the CCPP 230kV bus & clr the CCPP 230kV Bus 2E Outage

Q320 TCP2 ISIS

Selected WECC Bus Frequency Plots

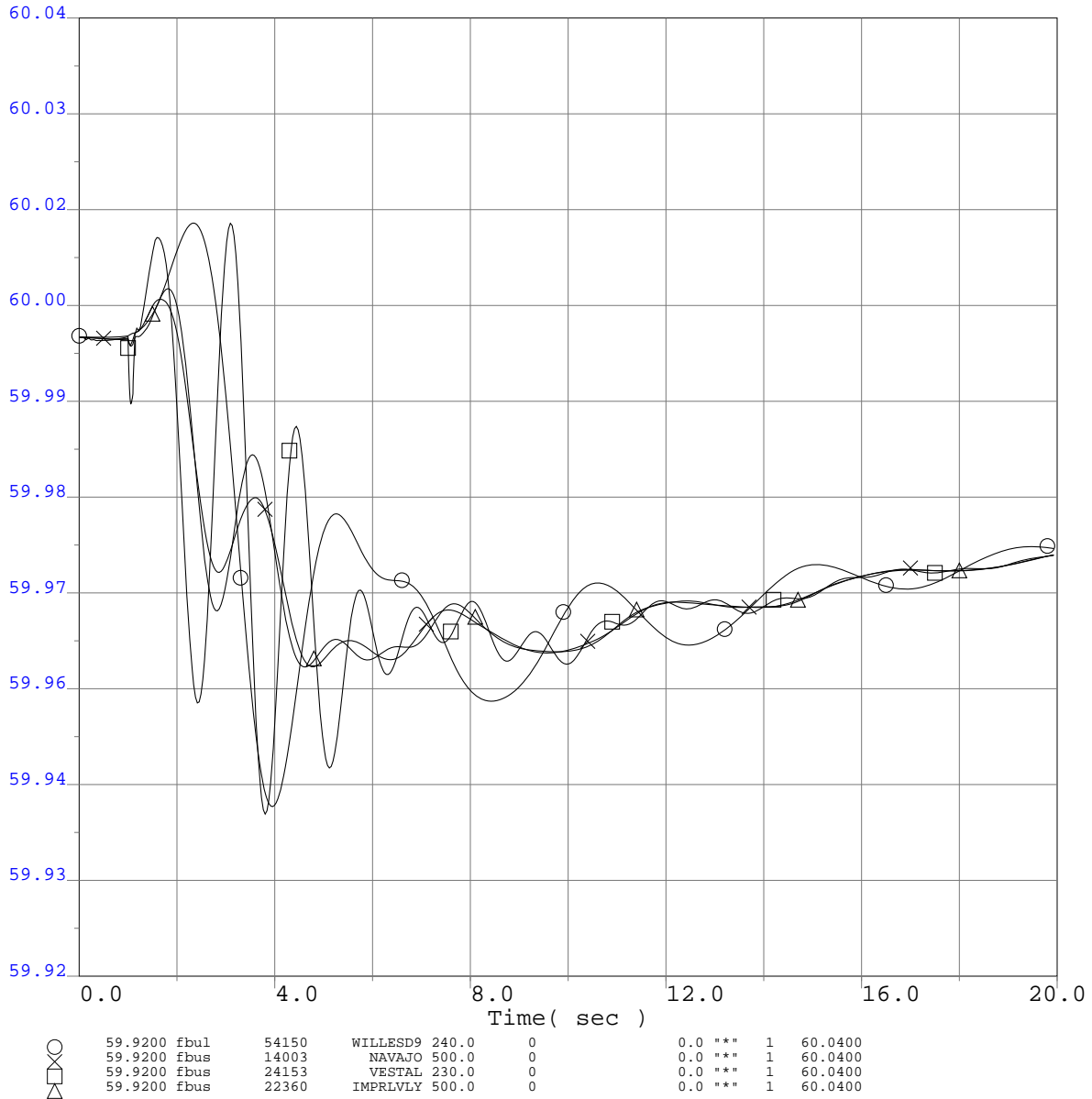

Q320 TCP2 ISIS
 2013 Greater Bay Area Summer Peak Base Case
 Q320 @ 772MW
 CCPP 230kV Bus 2E Outage
 3-ph 6 cyc flt @ the CCPP 230kV bus & clr the CCPP 230kV Bus 2E Outage

Q320 TCP2 ISIS

WECC Generator Rotor Angle

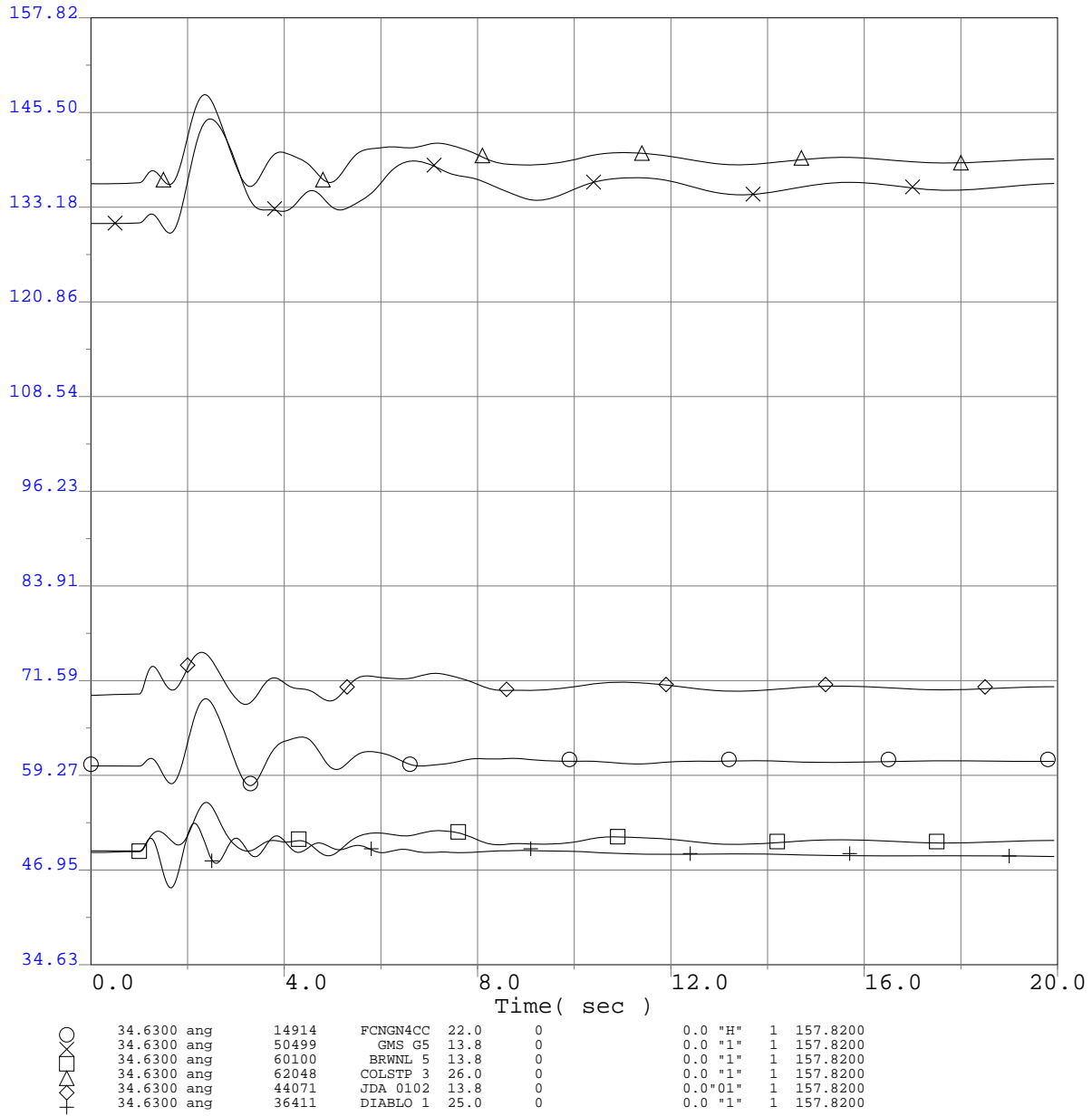

Q320 TCP2 ISIS
 2013 Greater Bay Area Summer Peak Base Case
 Q320 @ 772MW
 CCPP 230kV Bus 2E Outage
 3-ph 6 cyc flt @ the CCPP 230kV bus & clr the CCPP 230kV Bus 2E Outage

Q320 TCP2 ISIS

WECC Generator Rotor Angle

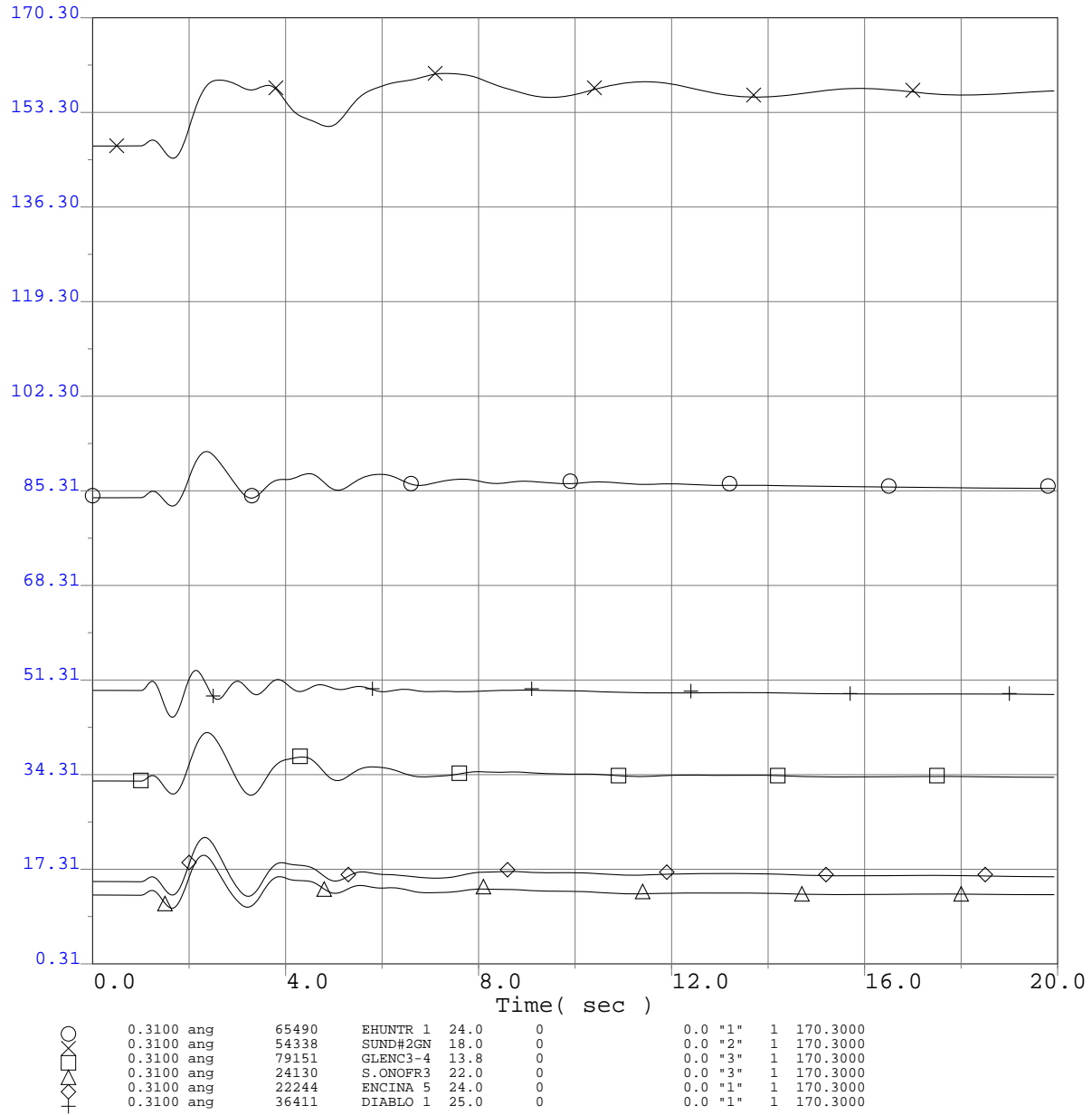

Q320 TCP2 ISIS
 2013 Greater Bay Area Summer Peak Base Case
 Q320 @ 772MW
 CCPP 230kV Bus 2E Outage
 3-ph 6 cyc flt @ the CCPP 230kV bus & clr the CCPP 230kV Bus 2E Outage

Q320 TCP2 ISIS

Selected PG&E Transmission Line Flows (MW)

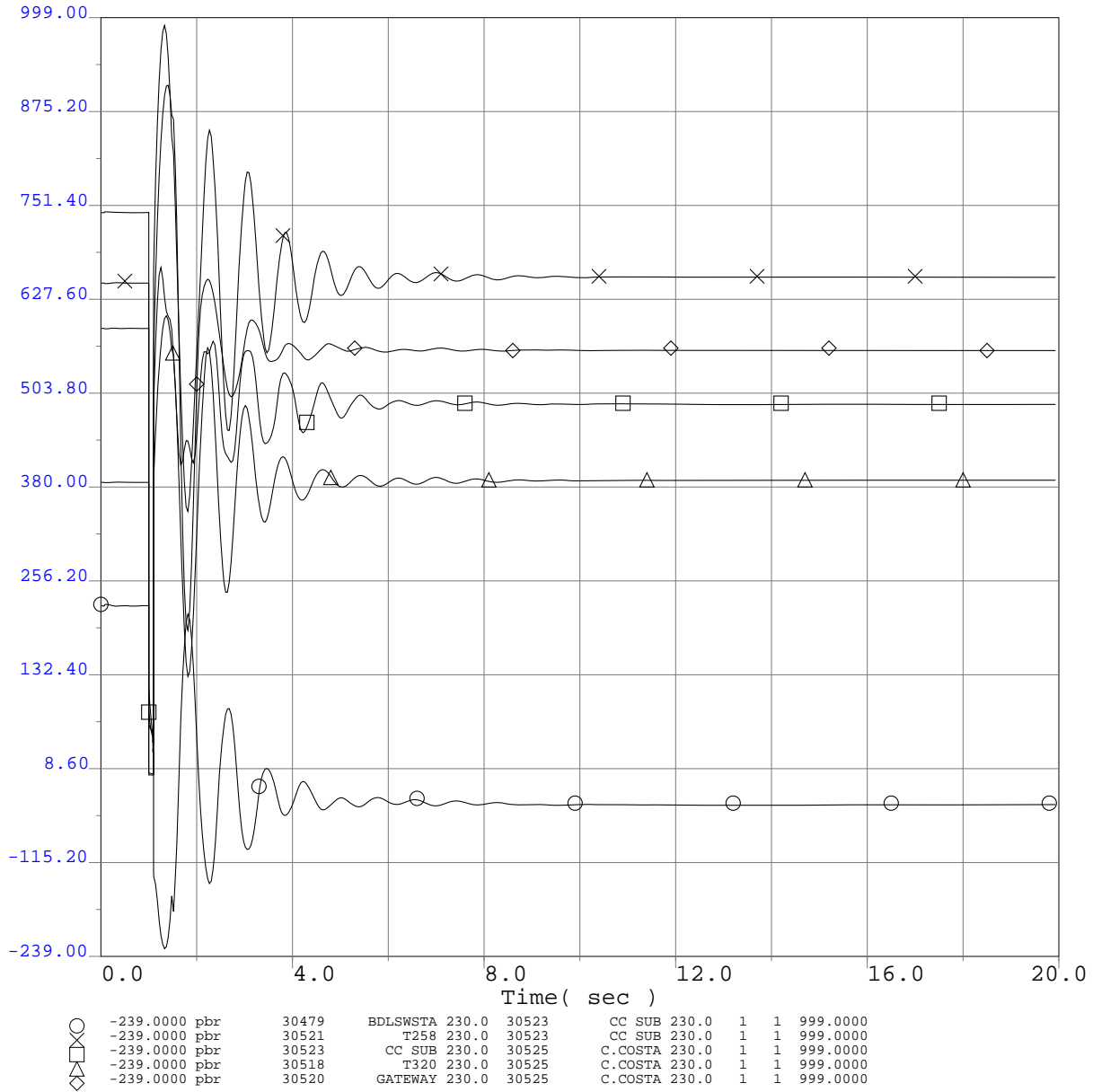

Q320 TCP2 ISIS
 2013 Greater Bay Area Summer Peak Base Case
 Q320 @ 772MW
 CCPP 230kV Bus 2E Outage
 3-ph 6 cyc flt @ the CCPP 230kV bus & clr the CCPP 230kV Bus 2E Outage

Q320 TCP2 ISIS

Selected PG&E Transmission Line Flows (MW)

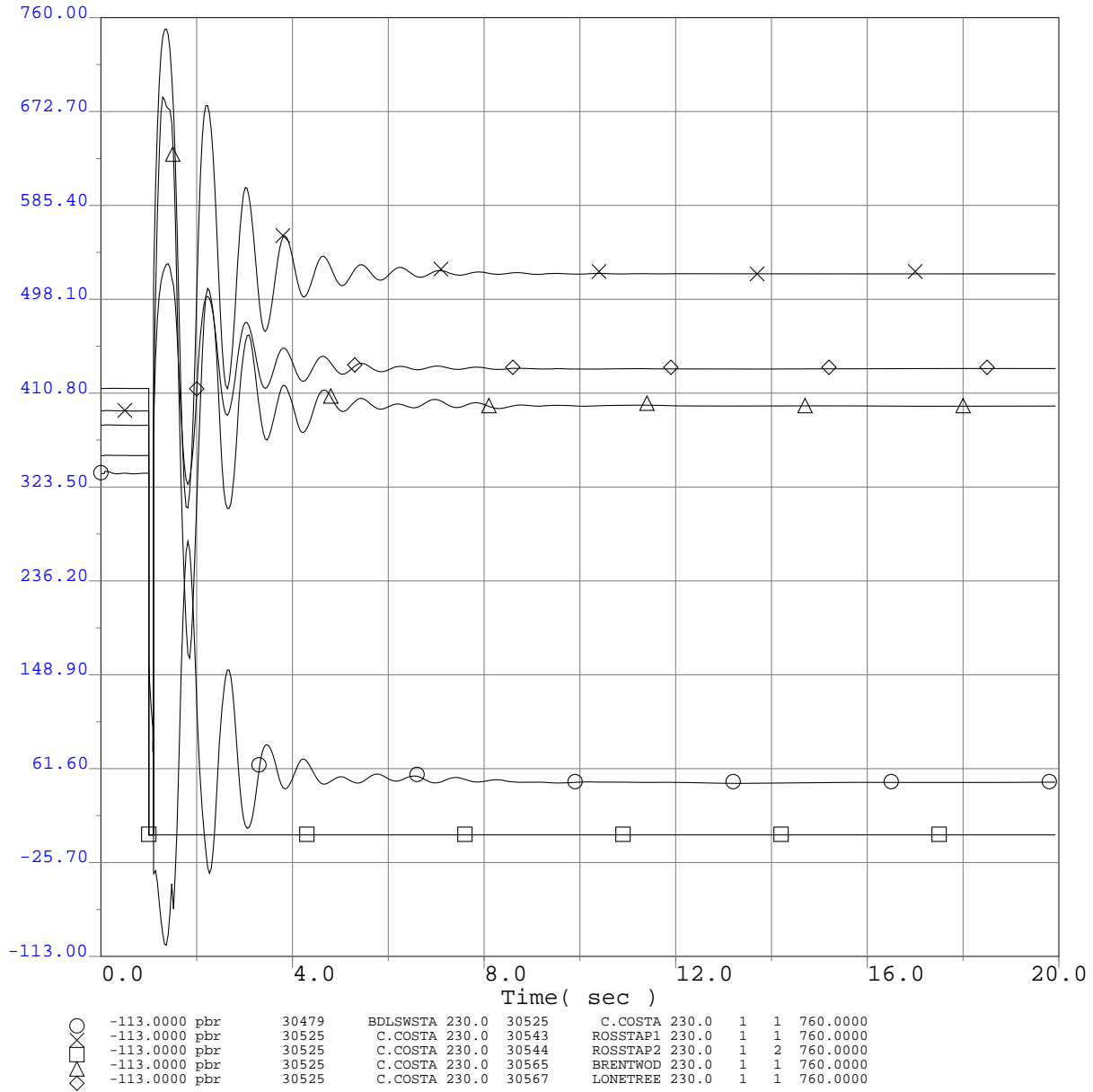

Q320 TCP2 ISIS
 2013 Greater Bay Area Summer Peak Base Case
 Q320 @ 772MW
 CCPP 230kV Bus 2E Outage
 3-ph 6 cyc flt @ the CCPP 230kV bus & clr the CCPP 230kV Bus 2E Outage

Q320 TCP2 ISIS

Selected PG&E Transmission Line Flows (MW)

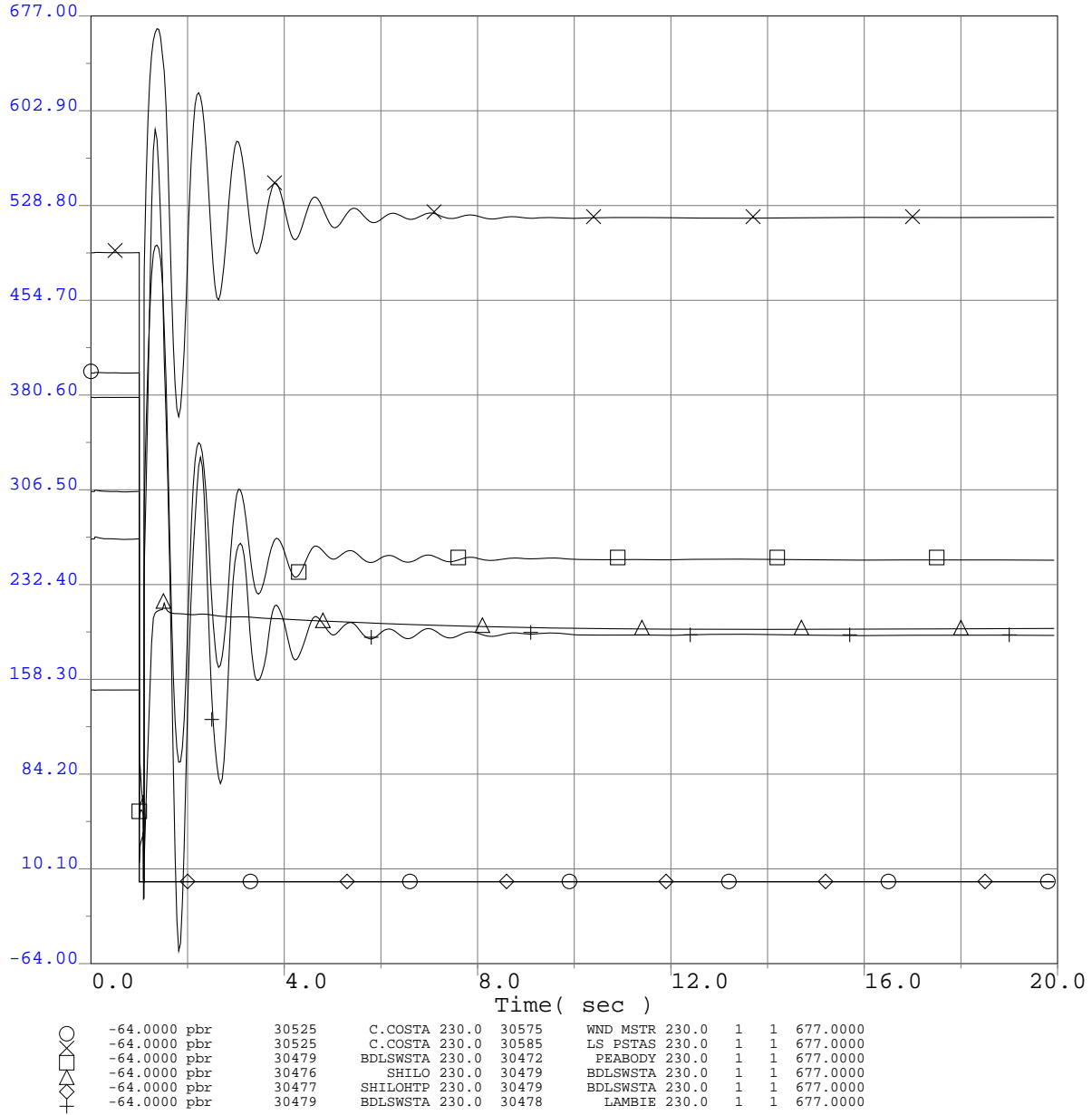

Q320 TCP2 ISIS
 2013 Greater Bay Area Summer Peak Base Case
 Q320 @ 772MW
 CCPP 230kV Bus 2E Outage
 3-ph 6 cyc flt @ the CCPP 230kV bus & clr the CCPP 230kV Bus 2E Outage

Q320 TCP2 ISIS

Selected PG&E Transmission Line Flows (MW)

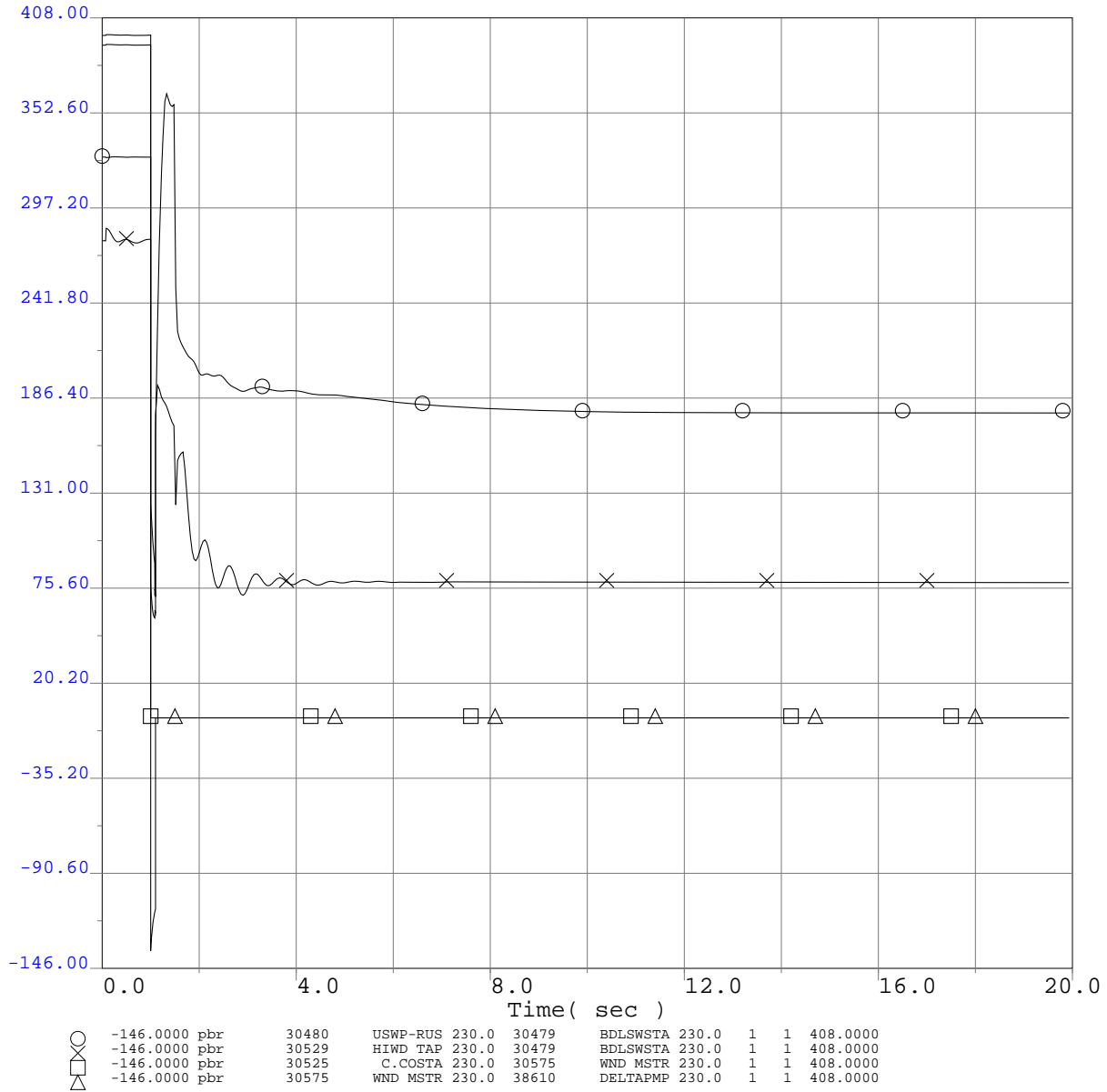

Q320 TCP2 ISIS
 2013 Greater Bay Area Summer Peak Base Case
 Q320 @ 772MW
 CCPP 230kV Bus 2E Outage
 3-ph 6 cyc flt @ the CCPP 230kV bus & clr the CCPP 230kV Bus 2E Outage

Q320 TCP2 ISIS

Selected PG&E Bus Voltage Plots Adjacent to Fault

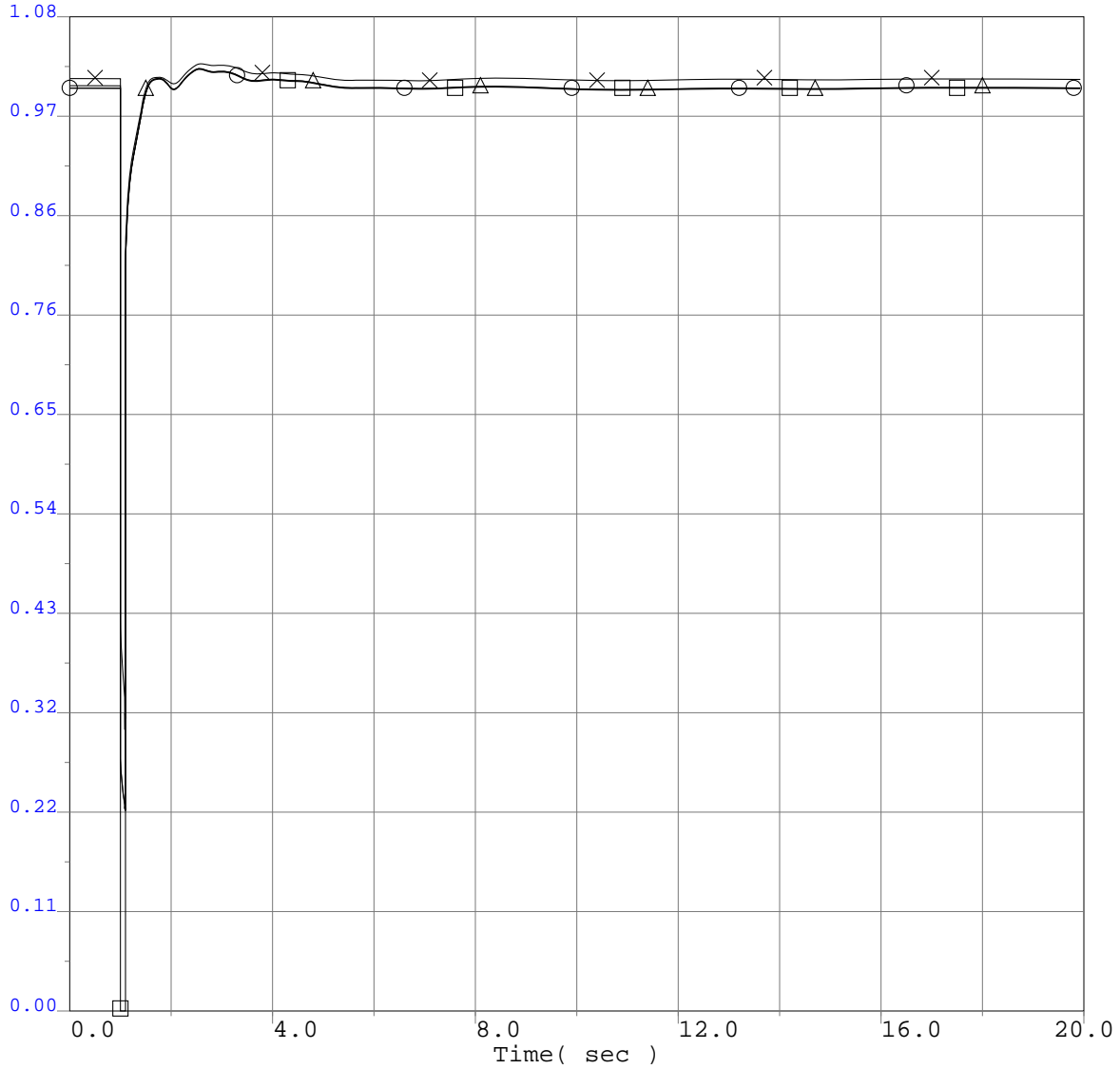

Q320 TCP2 ISIS
 2013 Greater Bay Area Summer Peak Base Case
 Q320 @ 772MW
 CC Sub 230kV Bus 1 Outage
 3-ph 6 cyc flt @ the CC Sub 230kV bus & clr the CC Sub 230kV Bus 1 Outage

Q320 TCP2 ISIS

Selected PG&E Bus Frequency Plots Adjacent to Fault

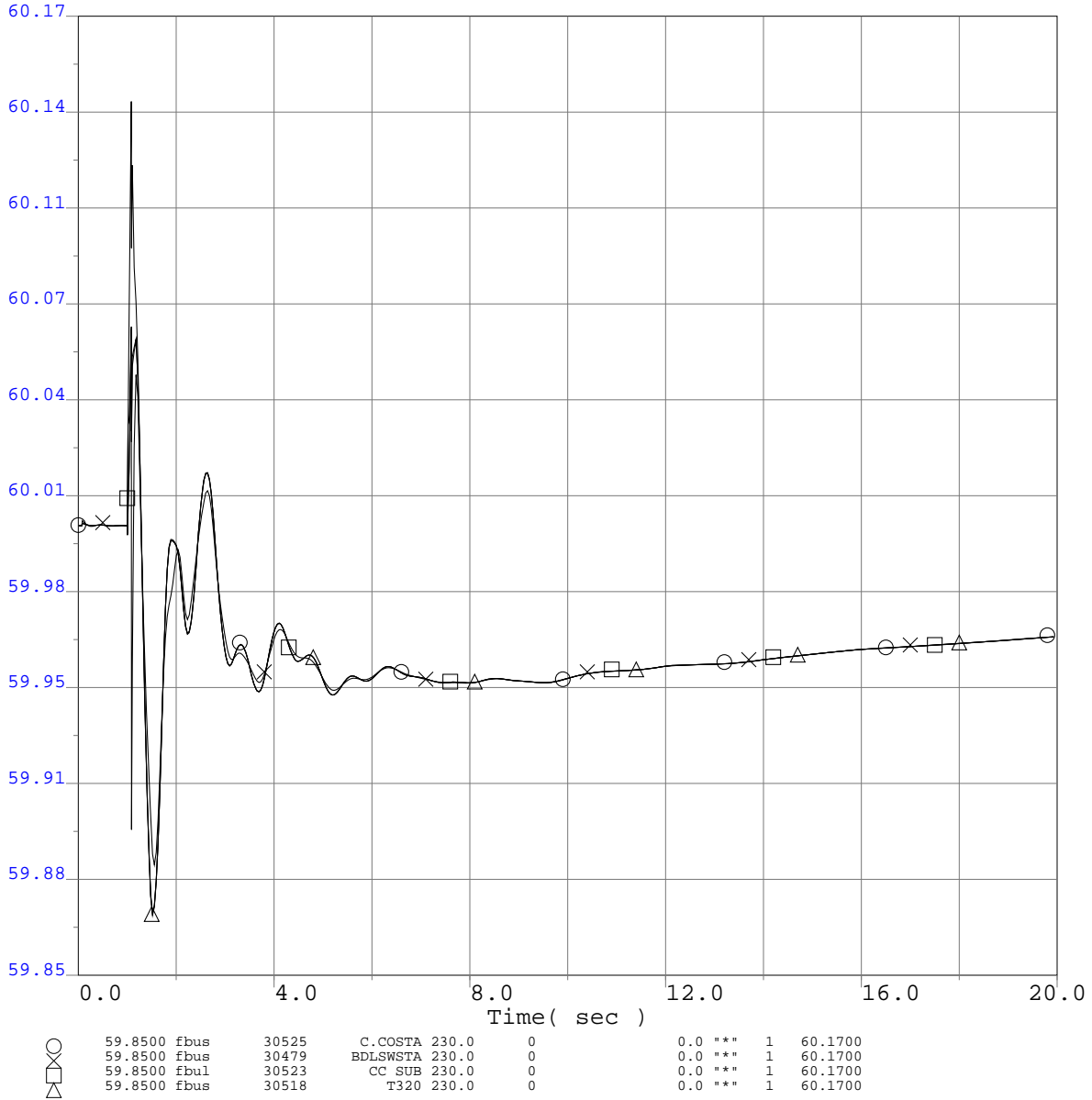

Q320 TCP2 ISIS
 2013 Greater Bay Area Summer Peak Base Case
 Q320 @ 772MW
 CC Sub 230kV Bus 1 Outage
 3-ph 6 cyc flt @ the CC Sub 230kV bus & clr the CC Sub 230kV Bus 1 Outage

Q320 TCP2 ISIS

Project Generator Terminal Voltages (P.U.)

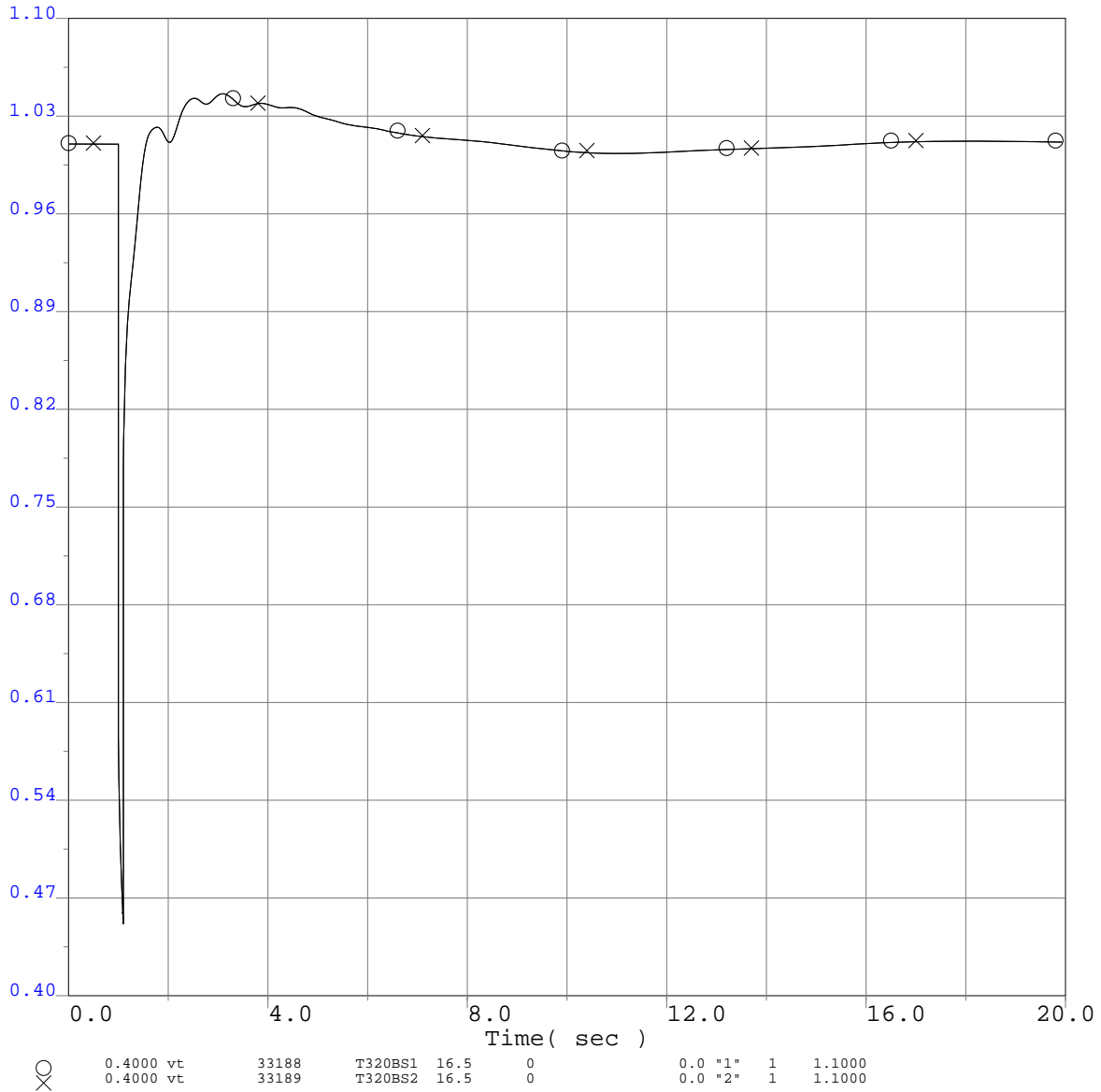

Q320 TCP2 ISIS
 2013 Greater Bay Area Summer Peak Base Case
 Q320 @ 772MW
 CC Sub 230kV Bus 1 Outage
 3-ph 6 cyc flt @ the CC Sub 230kV bus & clr the CC Sub 230kV Bus 1 Outage

Q320 TCP2 ISIS

Project Generator Terminal Voltages (P.U.)

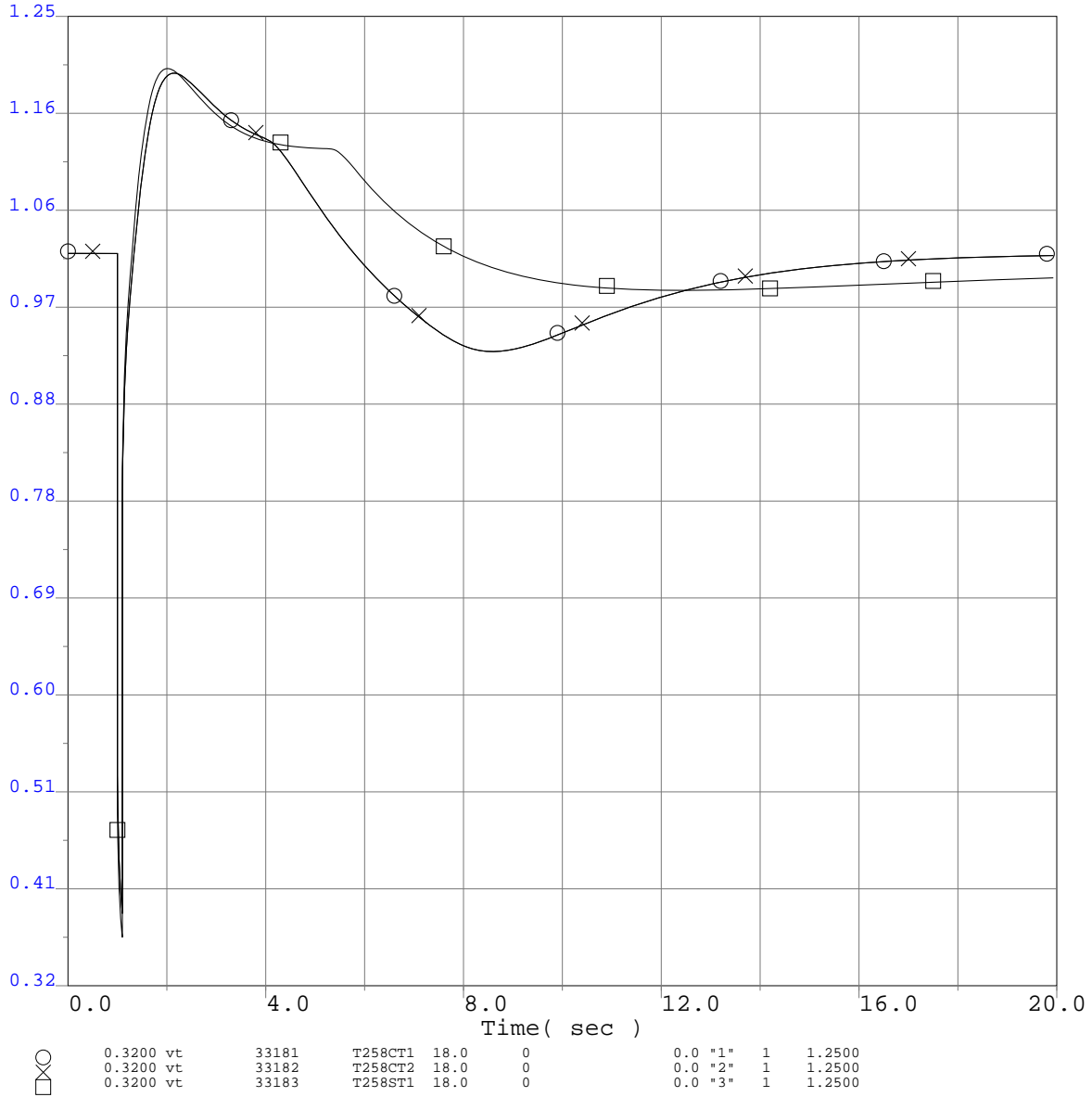

Q320 TCP2 ISIS
 2013 Greater Bay Area Summer Peak Base Case
 Q320 @ 772MW
 CC Sub 230kV Bus 1 Outage
 3-ph 6 cyc flt @ the CC Sub 230kV bus & clr the CC Sub 230kV Bus 1 Outage

Q320 TCP2 ISIS

Project Generator Speed (P.U.)

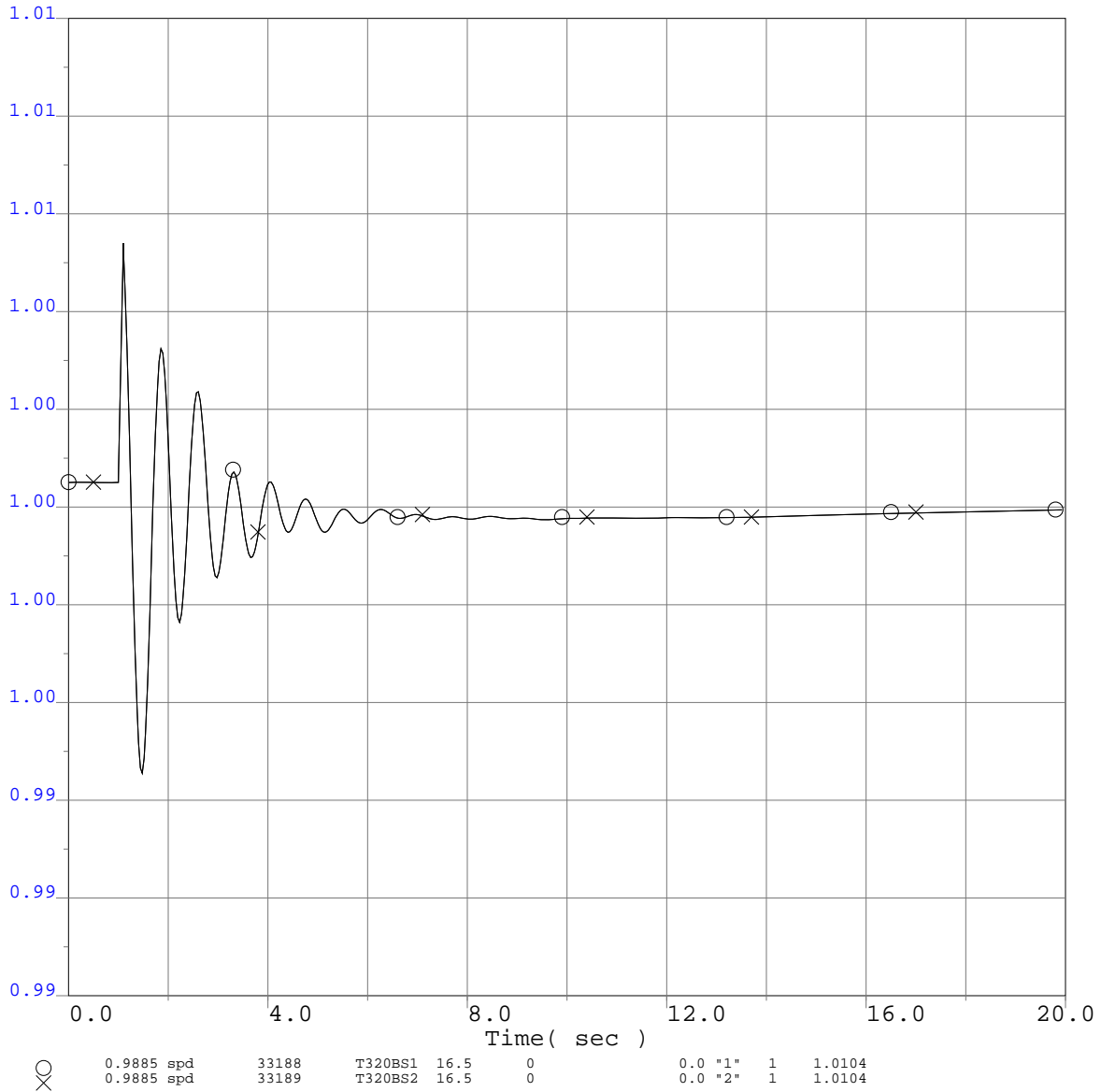

Q320 TCP2 ISIS
 2013 Greater Bay Area Summer Peak Base Case
 Q320 @ 772MW
 CC Sub 230kV Bus 1 Outage
 3-ph 6 cyc flt @ the CC Sub 230kV bus & clr the CC Sub 230kV Bus 1 Outage

Q320 TCP2 ISIS

Project Generator Speed (P.U.)

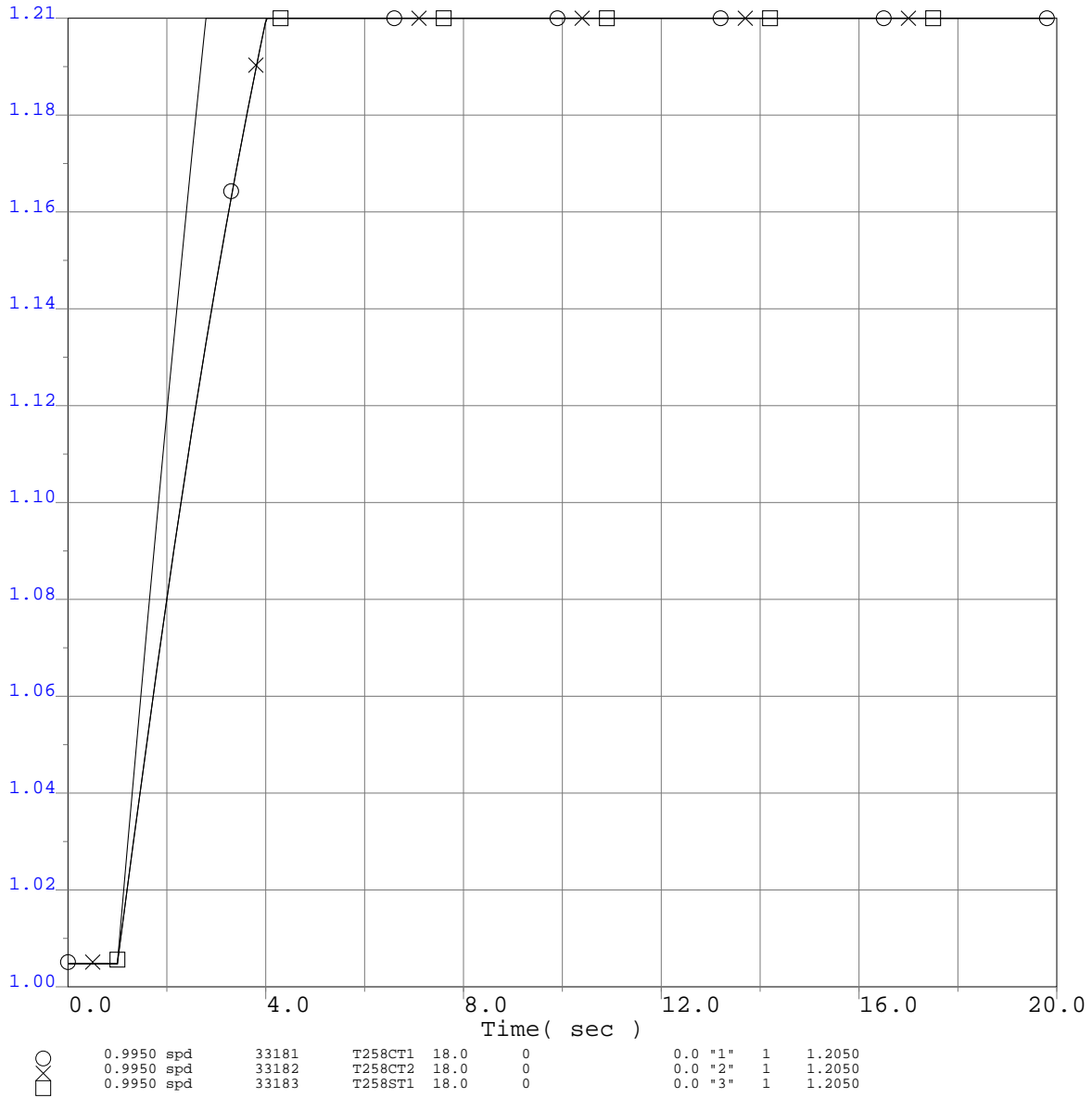

Q320 TCP2 ISIS
 2013 Greater Bay Area Summer Peak Base Case
 Q320 @ 772MW
 CC Sub 230kV Bus 1 Outage
 3-ph 6 cyc flt @ the CC Sub 230kV bus & clr the CC Sub 230kV Bus 1 Outage

Q320 TCP2 ISIS

Project Generator Terminal Power (MW)

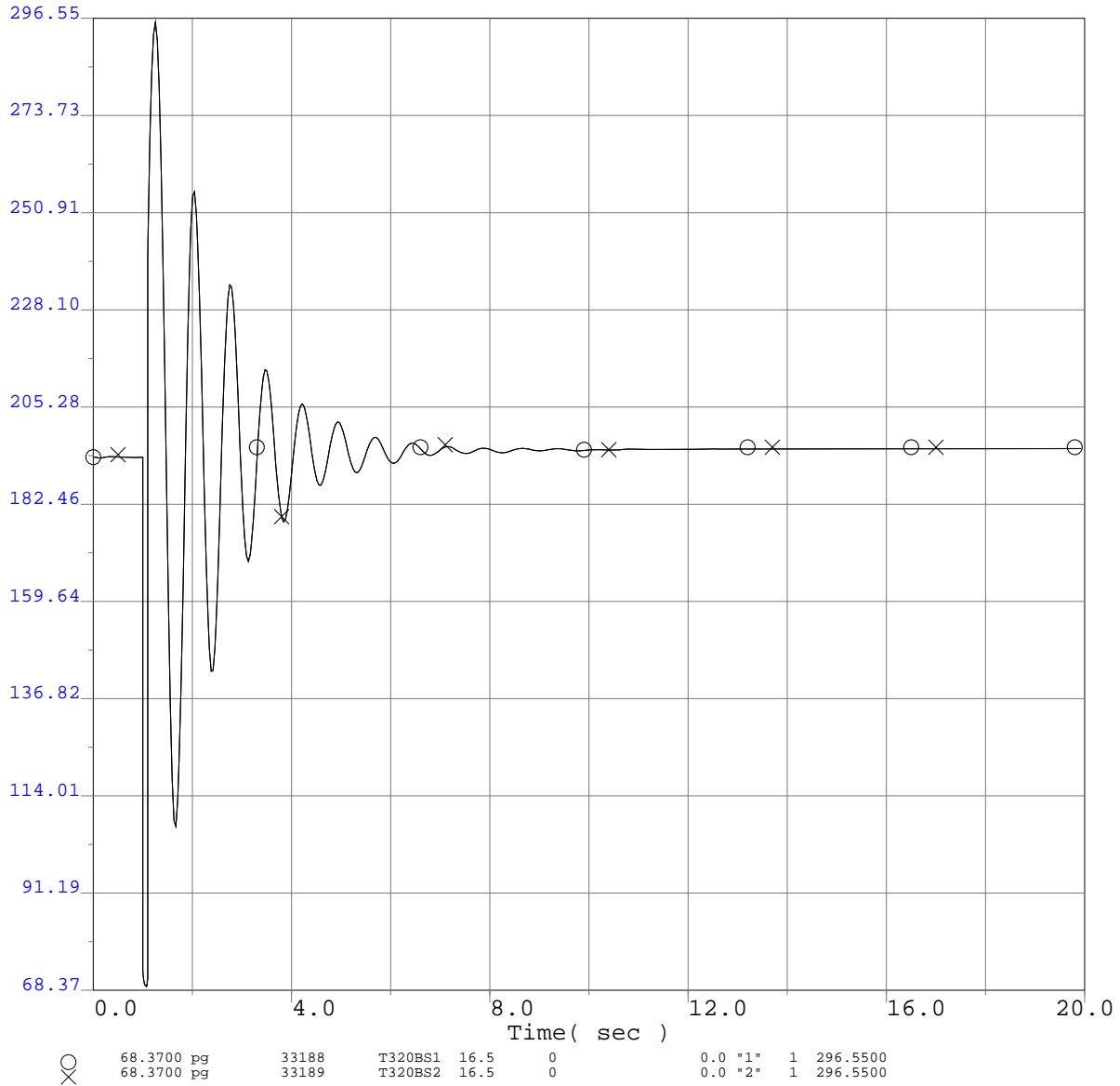

○	68.3700 pg	33188	T320BS1	16.5	0	0.0 "1"	1	296.5500
×	68.3700 pg	33189	T320BS2	16.5	0	0.0 "2"	1	296.5500

Q320 TCP2 ISIS
 2013 Greater Bay Area Summer Peak Base Case
 Q320 @ 772MW
 CC Sub 230kV Bus 1 Outage
 3-ph 6 cyc flt @ the CC Sub 230kV bus & clr the CC Sub 230kV Bus 1 Outage

Q320 TCP2 ISIS

Project Generator Terminal Power (MW)

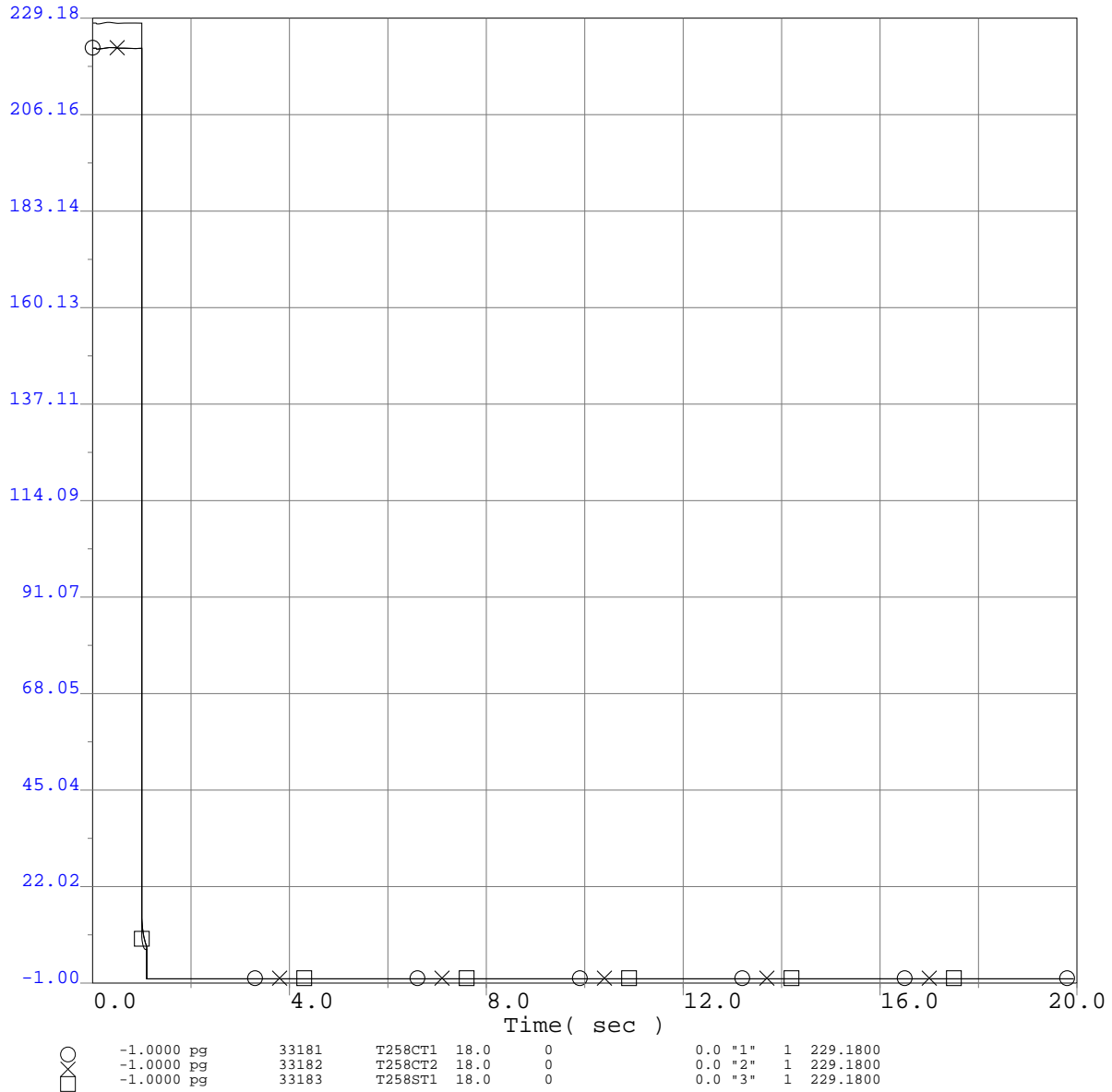

Q320 TCP2 ISIS
 2013 Greater Bay Area Summer Peak Base Case
 Q320 @ 772MW
 CC Sub 230kV Bus 1 Outage
 3-ph 6 cyc flt @ the CC Sub 230kV bus & clr the CC Sub 230kV Bus 1 Outage

Q320 TCP2 ISIS

Project Generator Terminal Reactive Power (MVar)

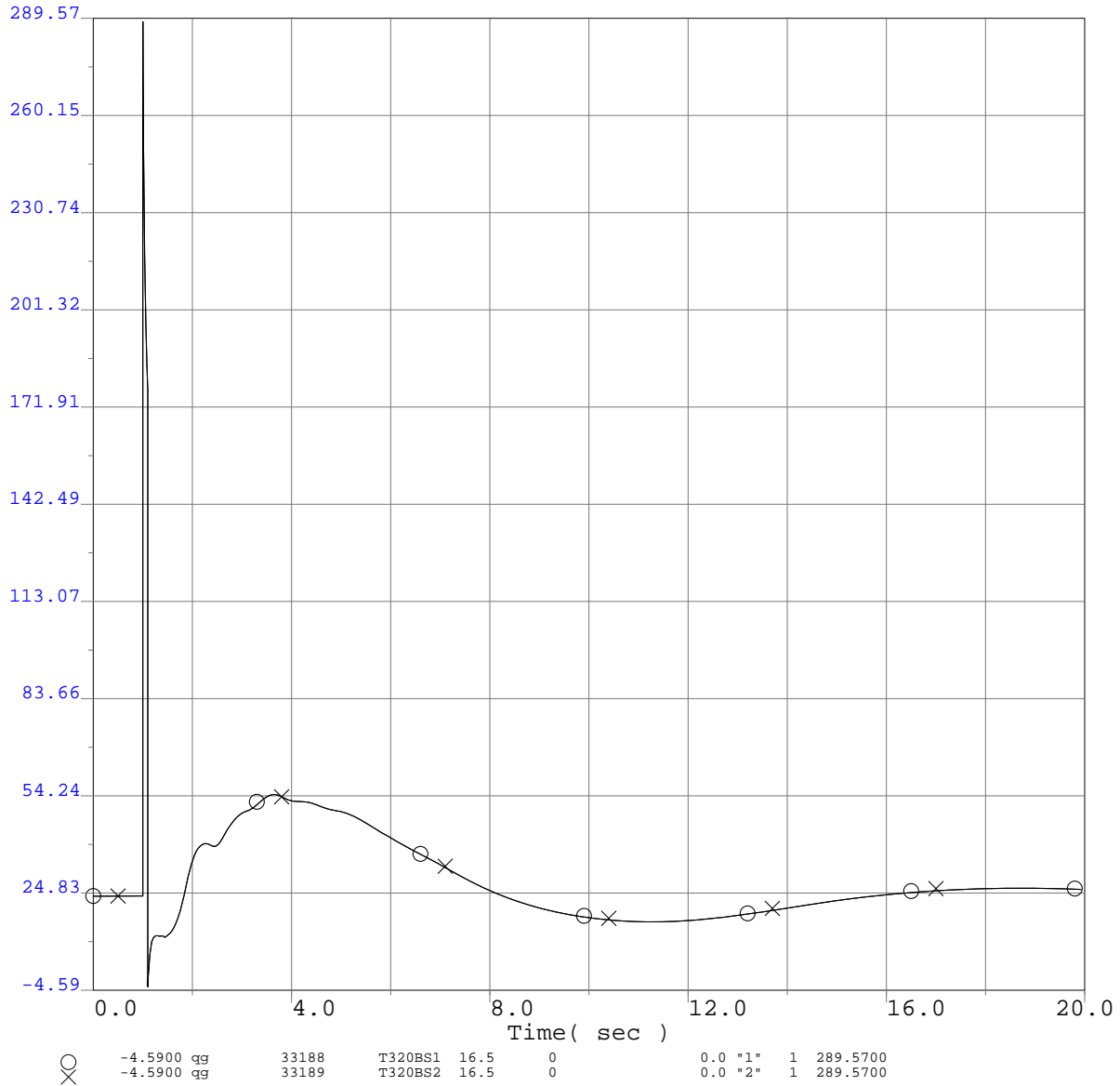

Q320 TCP2 ISIS
 2013 Greater Bay Area Summer Peak Base Case
 Q320 @ 772MW
 CC Sub 230kV Bus 1 Outage
 3-ph 6 cyc flt @ the CC Sub 230kV bus & clr the CC Sub 230kV Bus 1 Outage

Q320 TCP2 ISIS

Project Generator Terminal Reactive Power (MVar)

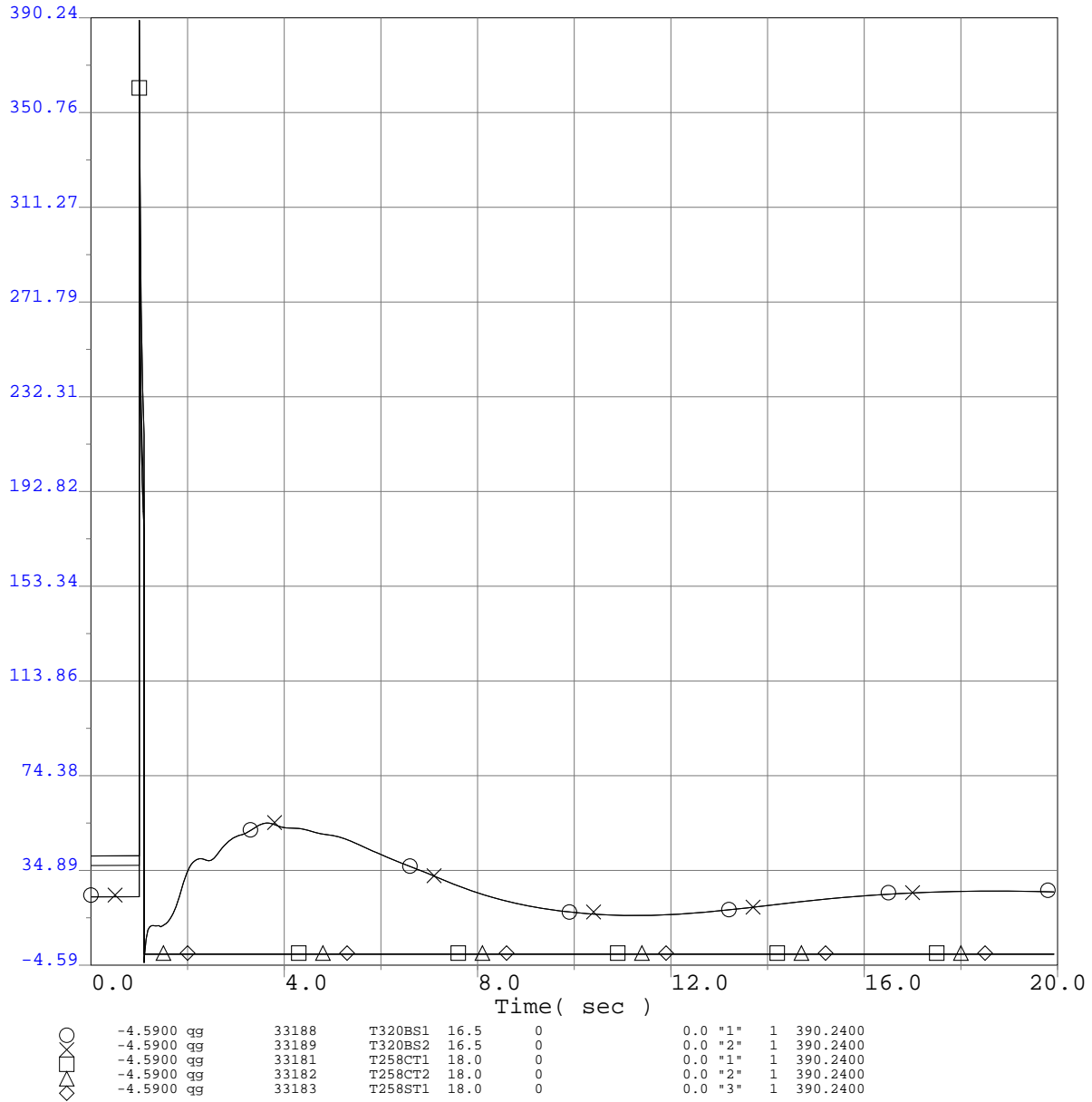

Q320 TCP2 ISIS
 2013 Greater Bay Area Summer Peak Base Case
 Q320 @ 772MW
 CC Sub 230kV Bus 1 Outage
 3-ph 6 cyc flt @ the CC Sub 230kV bus & clr the CC Sub 230kV Bus 1 Outage

Q320 TCP2 ISIS

Selected WECC Bus Voltage Plots

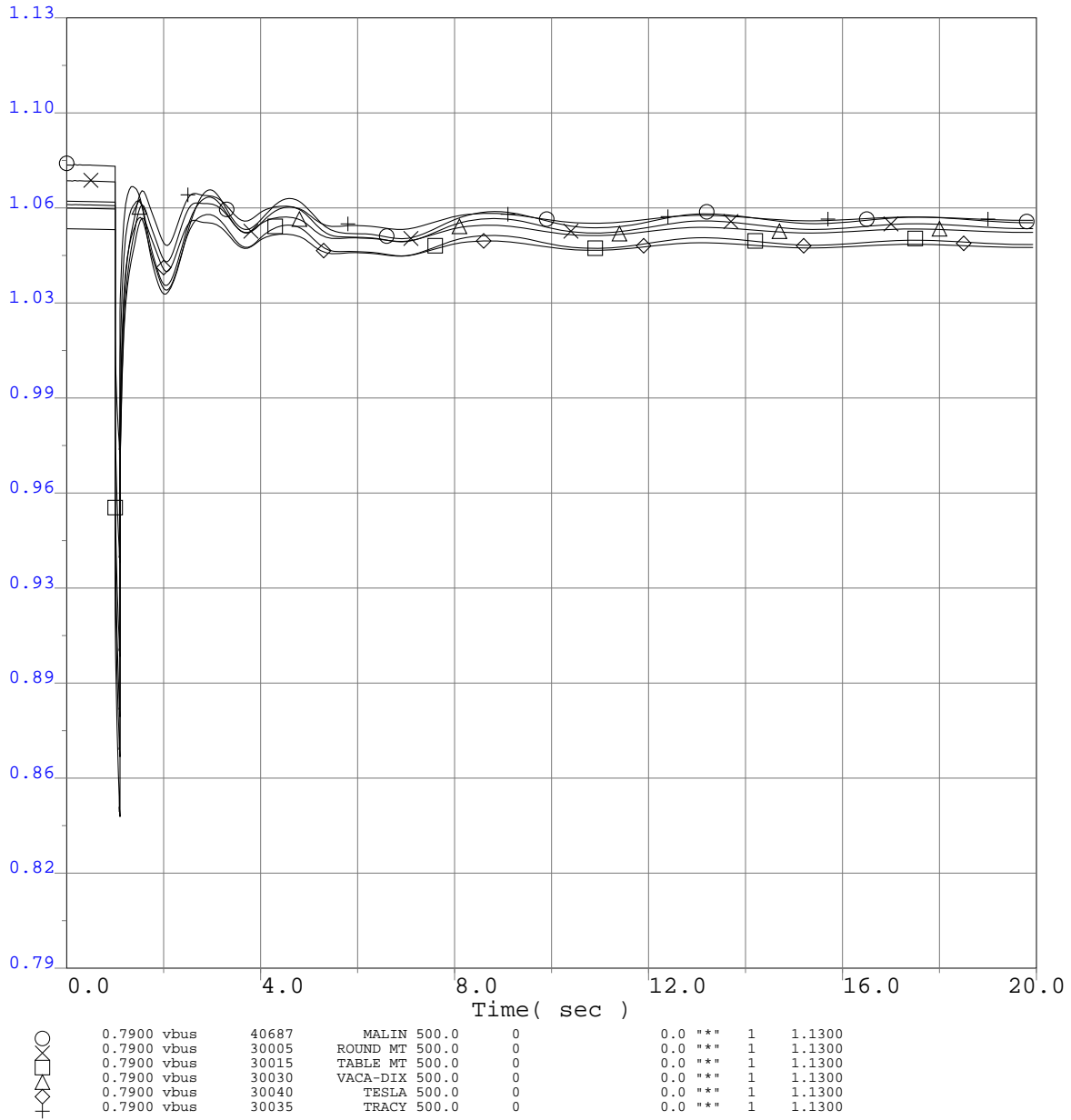

Q320 TCP2 ISIS
 2013 Greater Bay Area Summer Peak Base Case
 Q320 @ 772MW
 CC Sub 230kV Bus 1 Outage
 3-ph 6 cyc flt @ the CC Sub 230kV bus & clr the CC Sub 230kV Bus 1 Outage

Q320 TCP2 ISIS

Selected WECC Bus Voltage Plots

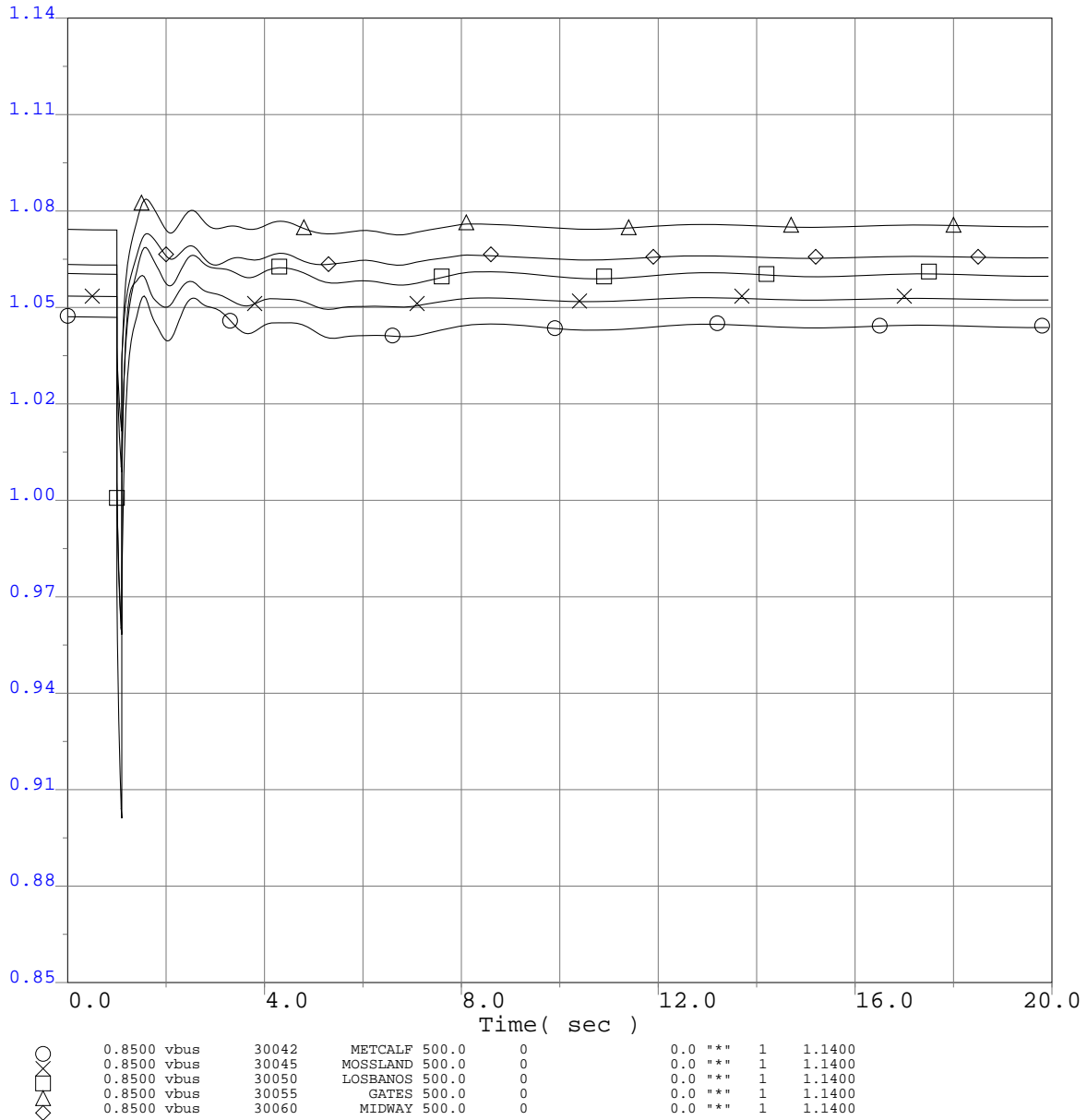

Q320 TCP2 ISIS
 2013 Greater Bay Area Summer Peak Base Case
 Q320 @ 772MW
 CC Sub 230kV Bus 1 Outage
 3-ph 6 cyc flt @ the CC Sub 230kV bus & clr the CC Sub 230kV Bus 1 Outage

Q320 TCP2 ISIS

Selected WECC Bus Voltage Plots

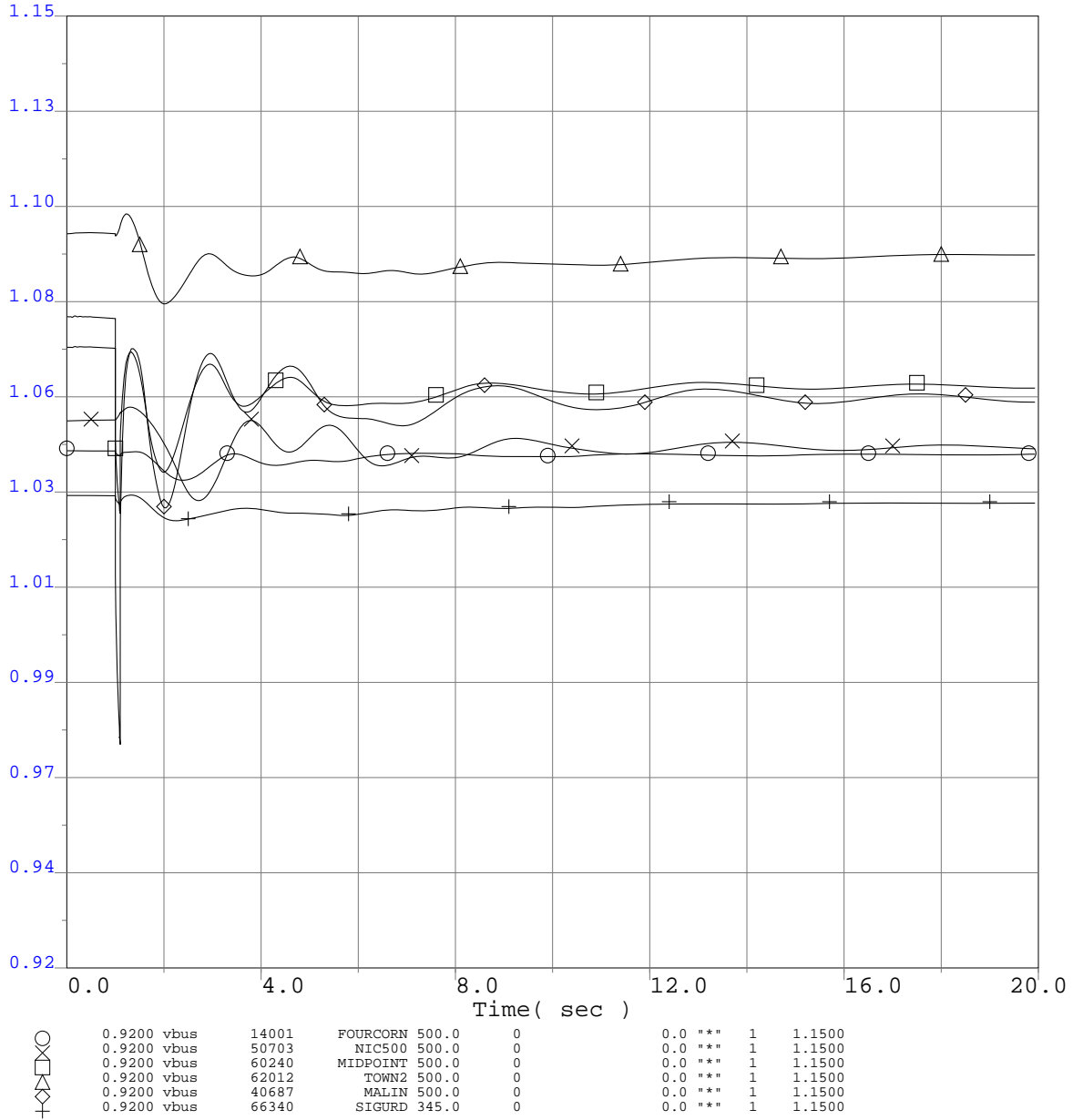

Q320 TCP2 ISIS
 2013 Greater Bay Area Summer Peak Base Case
 Q320 @ 772MW
 CC Sub 230kV Bus 1 Outage
 3-ph 6 cyc flt @ the CC Sub 230kV bus & clr the CC Sub 230kV Bus 1 Outage

Q320 TCP2 ISIS

Selected WECC Bus Voltage Plots

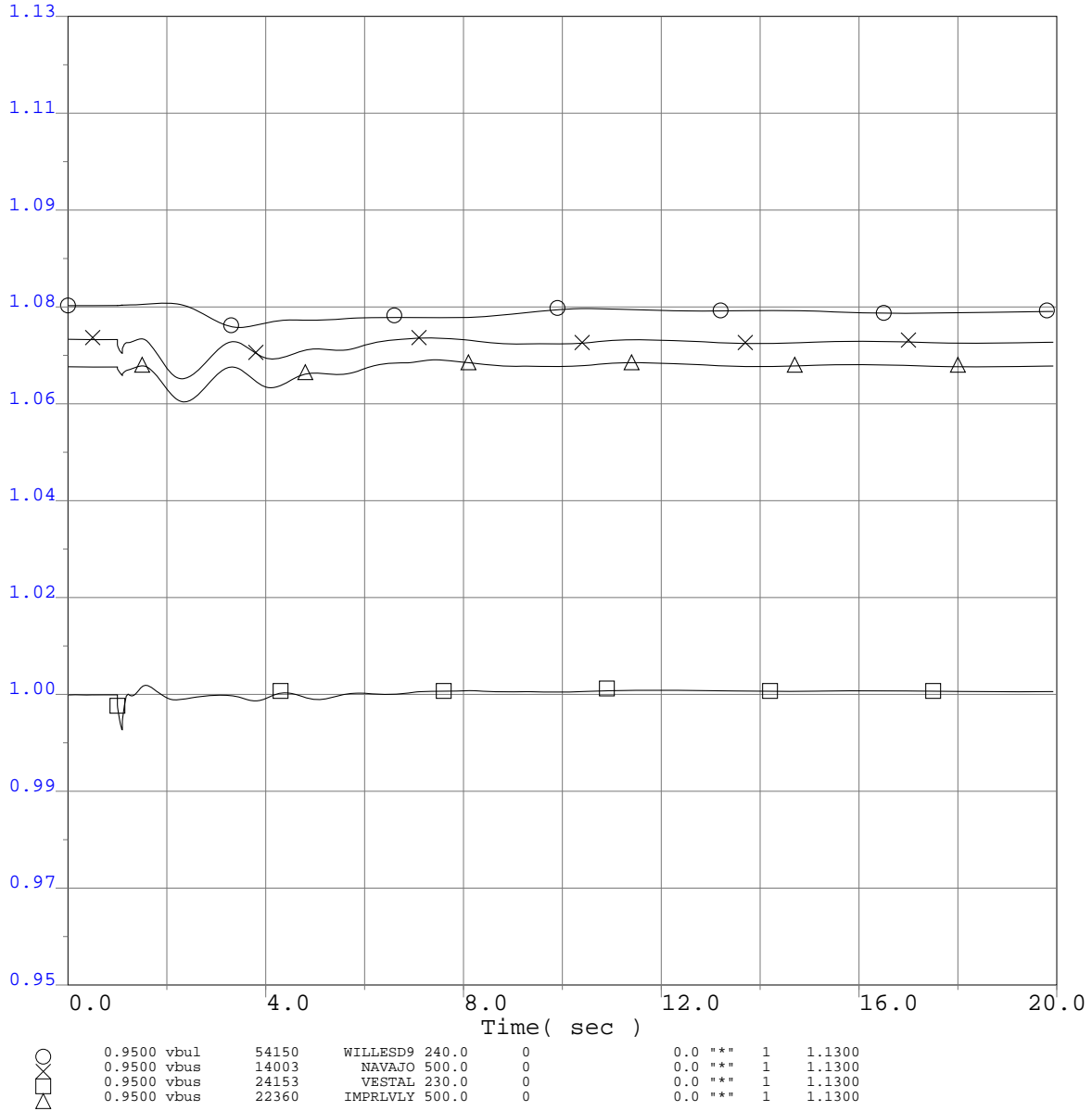

Q320 TCP2 ISIS
 2013 Greater Bay Area Summer Peak Base Case
 Q320 @ 772MW
 CC Sub 230kV Bus 1 Outage
 3-ph 6 cyc flt @ the CC Sub 230kV bus & clr the CC Sub 230kV Bus 1 Outage

Q320 TCP2 ISIS

Selected WECC Bus Frequency Plots

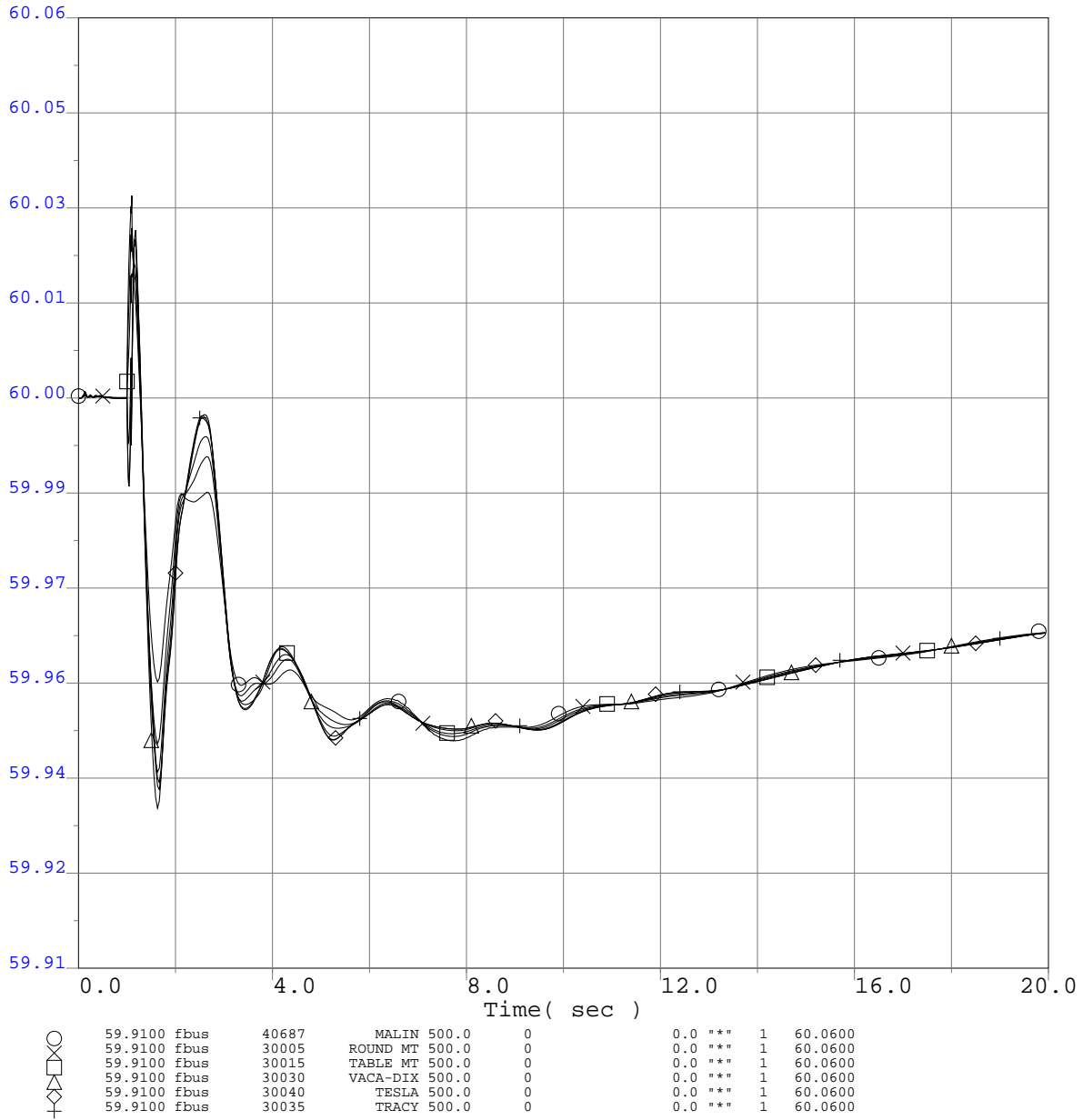

Q320 TCP2 ISIS
 2013 Greater Bay Area Summer Peak Base Case
 Q320 @ 772MW
 CC Sub 230kV Bus 1 Outage
 3-ph 6 cyc flt @ the CC Sub 230kV bus & clr the CC Sub 230kV Bus 1 Outage

Q320 TCP2 ISIS

Selected WECC Bus Frequency Plots

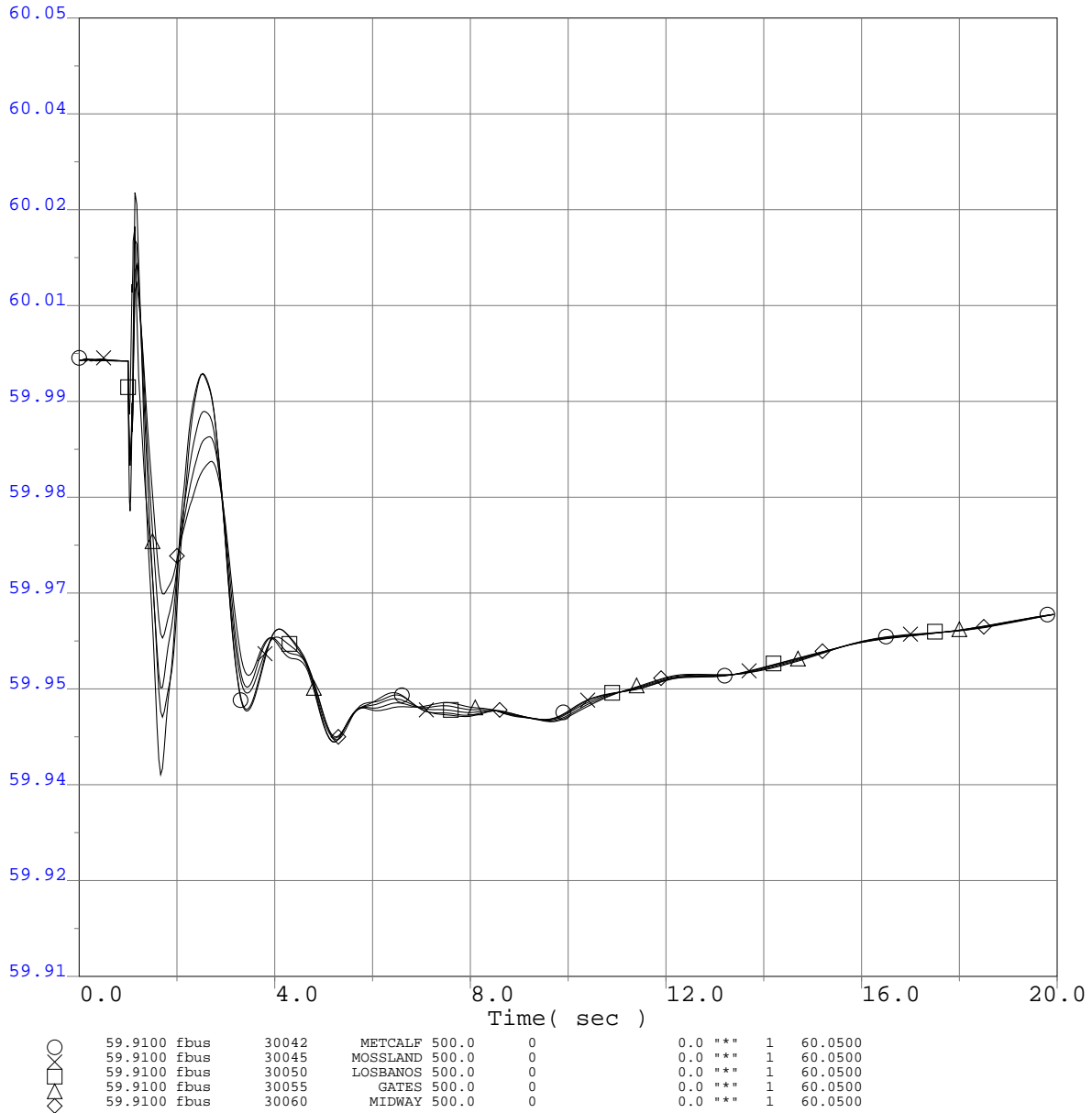

○	59.9100 Fbus	30042	METCALF 500.0	0	0.0	***	1	60.0500
□	59.9100 Fbus	30045	MOSSLAND 500.0	0	0.0	***	1	60.0500
△	59.9100 Fbus	30050	LOSBANOS 500.0	0	0.0	***	1	60.0500
◇	59.9100 Fbus	30055	GATES 500.0	0	0.0	***	1	60.0500
◇	59.9100 Fbus	30060	MIDWAY 500.0	0	0.0	***	1	60.0500

Q320 TCP2 ISIS
 2013 Greater Bay Area Summer Peak Base Case
 Q320 @ 772MW
 CC Sub 230kV Bus 1 Outage
 3-ph 6 cyc flt @ the CC Sub 230kV bus & clr the CC Sub 230kV Bus 1 Outage

Q320 TCP2 ISIS

Selected WECC Bus Frequency Plots

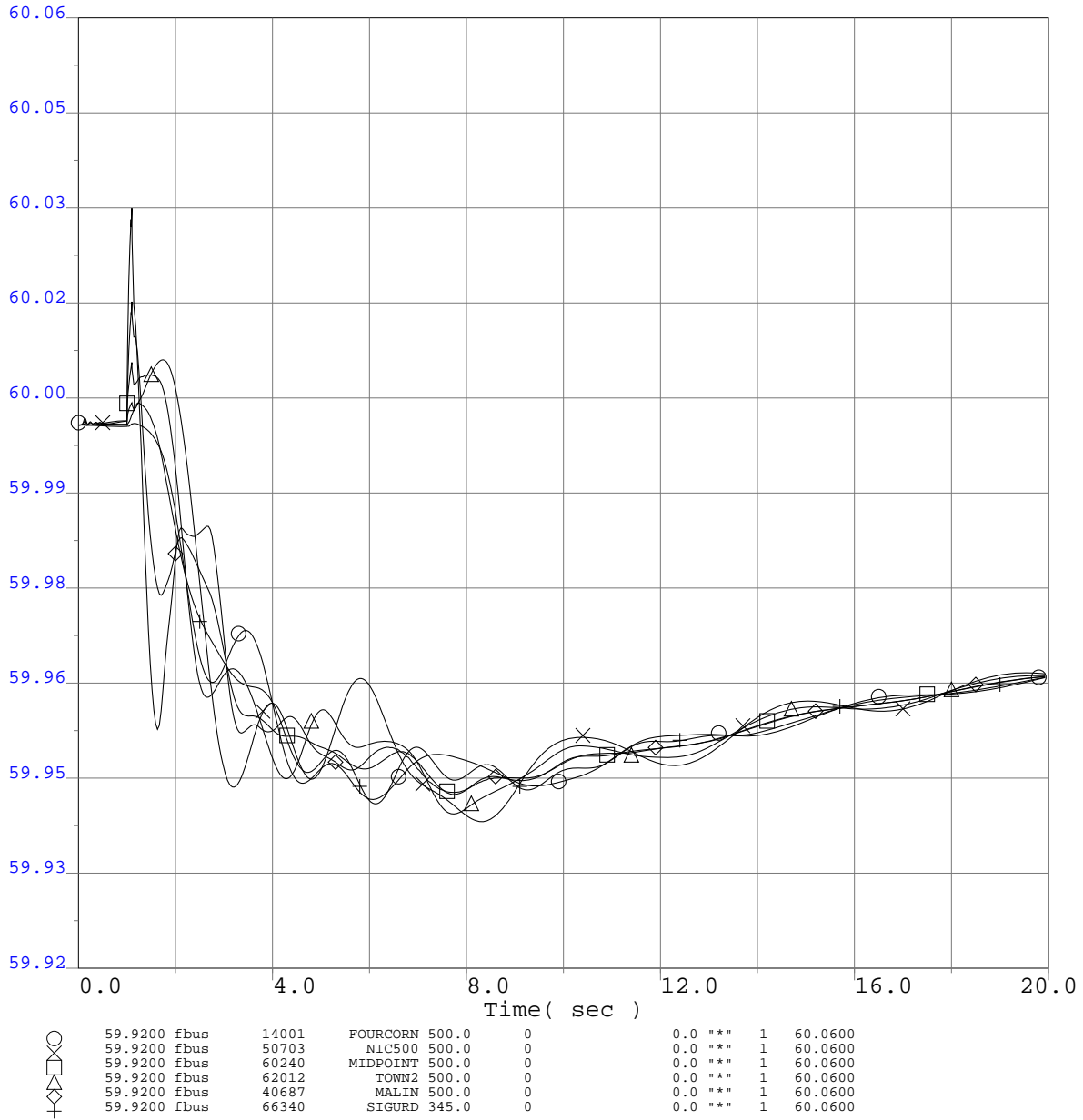

Q320 TCP2 ISIS
 2013 Greater Bay Area Summer Peak Base Case
 Q320 @ 772MW
 CC Sub 230kV Bus 1 Outage
 3-ph 6 cyc flt @ the CC Sub 230kV bus & clr the CC Sub 230kV Bus 1 Outage

Q320 TCP2 ISIS

Selected WECC Bus Frequency Plots

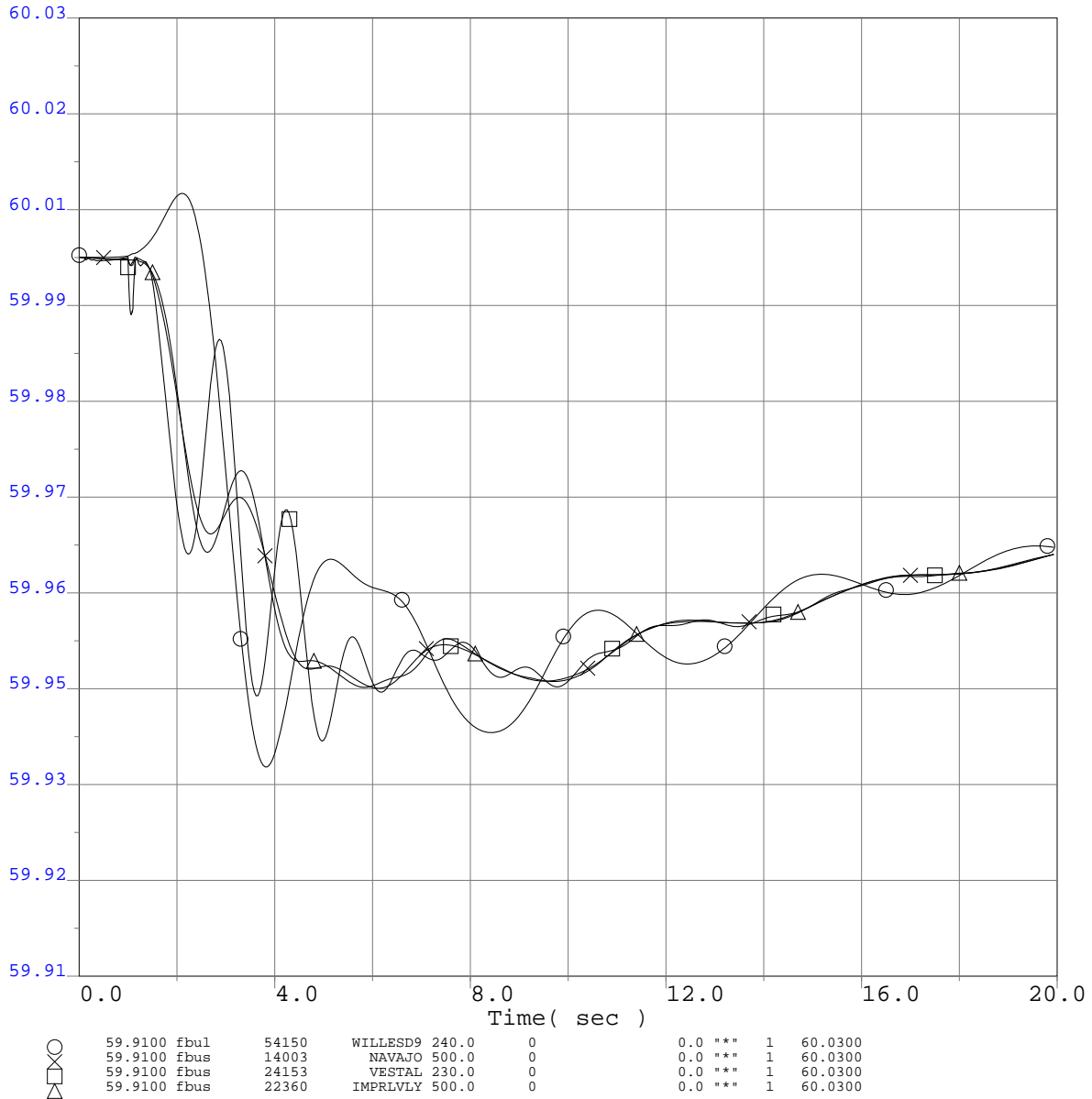

Q320 TCP2 ISIS
 2013 Greater Bay Area Summer Peak Base Case
 Q320 @ 772MW
 CC Sub 230kV Bus 1 Outage
 3-ph 6 cyc flt @ the CC Sub 230kV bus & clr the CC Sub 230kV Bus 1 Outage

Q320 TCP2 ISIS

WECC Generator Rotor Angle

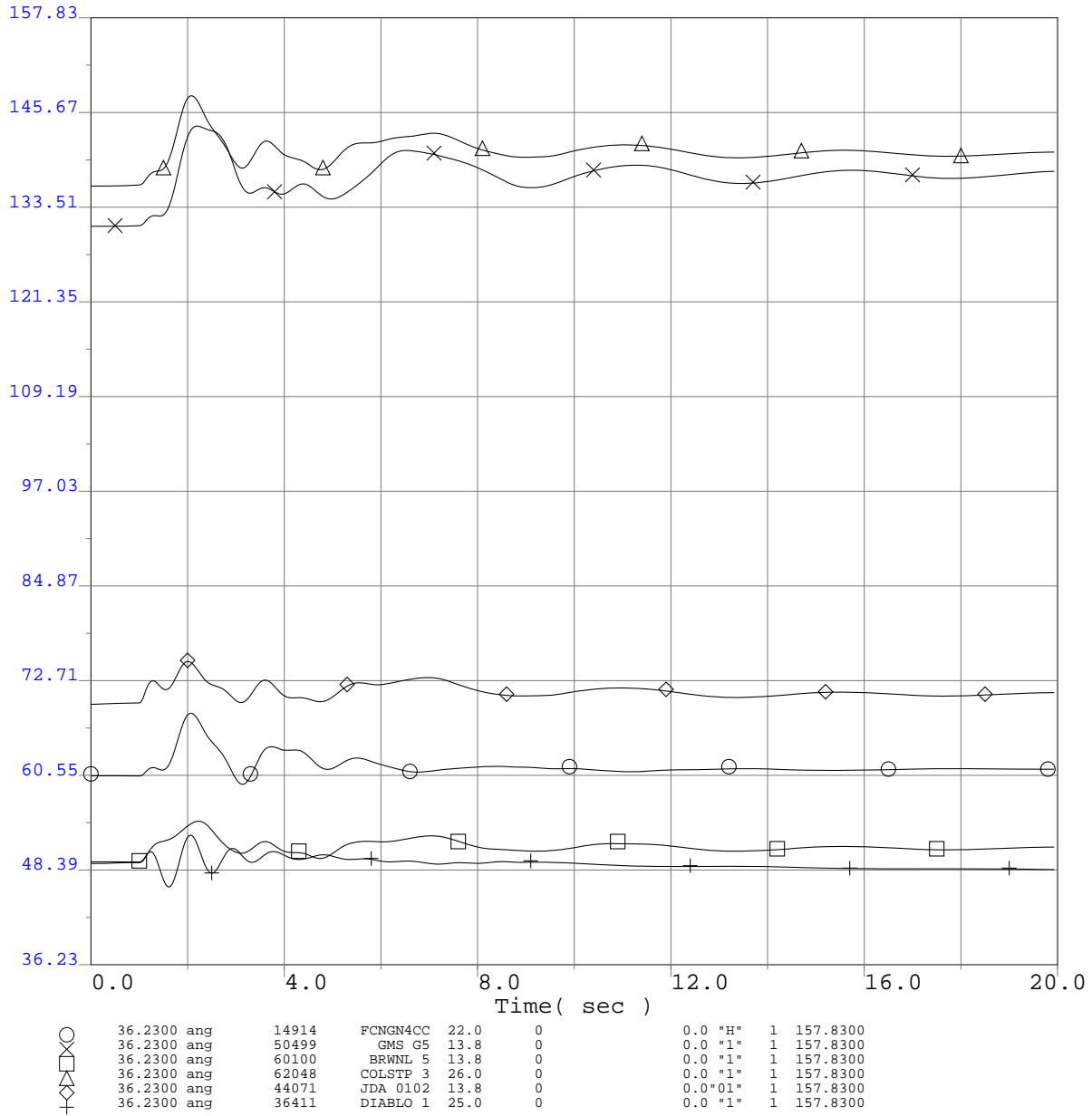

Q320 TCP2 ISIS
 2013 Greater Bay Area Summer Peak Base Case
 Q320 @ 772MW
 CC Sub 230kV Bus 1 Outage
 3-ph 6 cyc flt @ the CC Sub 230kV bus & clr the CC Sub 230kV Bus 1 Outage

Q320 TCP2 ISIS

WECC Generator Rotor Angle

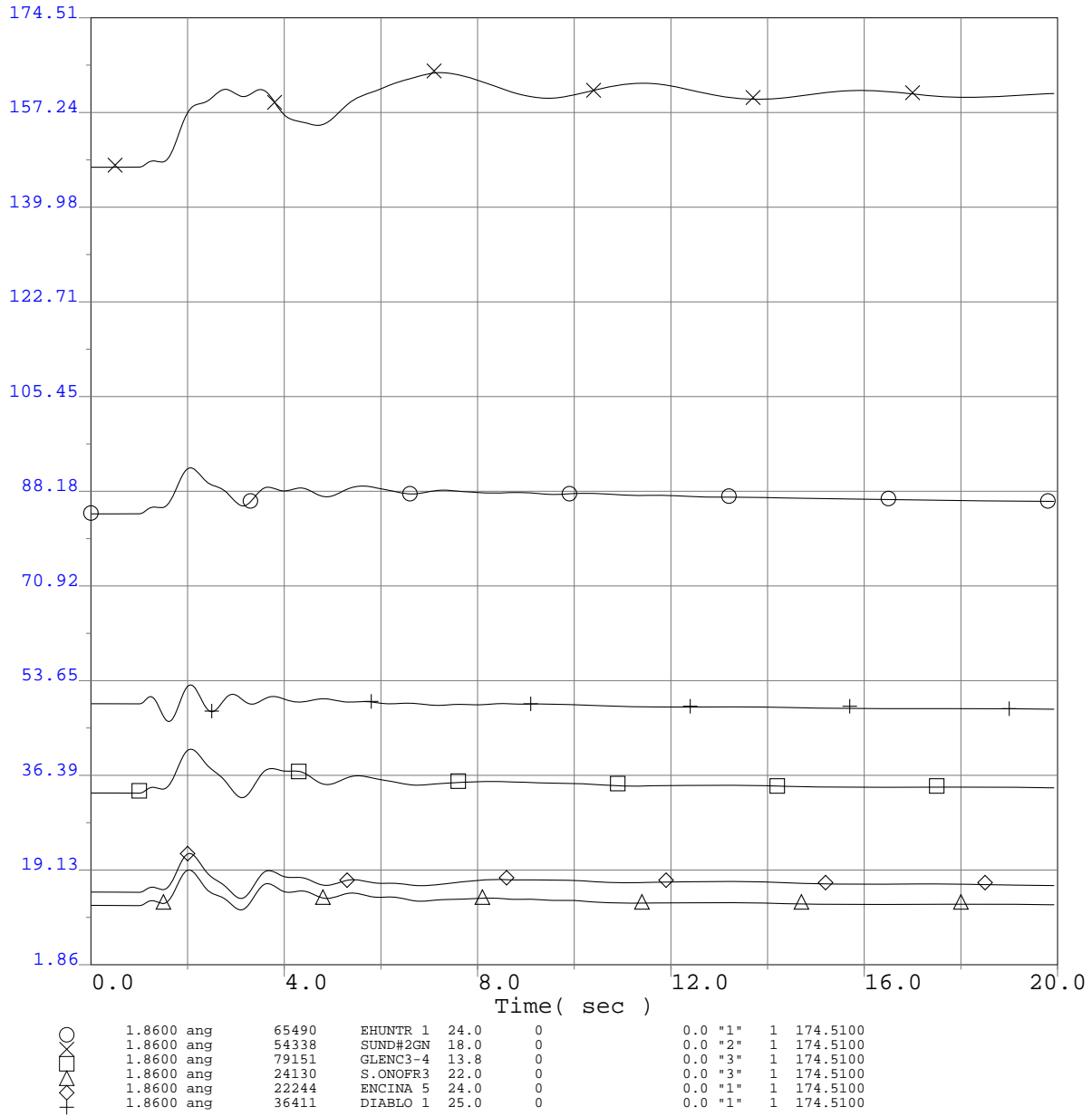

Q320 TCP2 ISIS
 2013 Greater Bay Area Summer Peak Base Case
 Q320 @ 772MW
 CC Sub 230kV Bus 1 Outage
 3-ph 6 cyc flt @ the CC Sub 230kV bus & clr the CC Sub 230kV Bus 1 Outage

Q320 TCP2 ISIS

Selected PG&E Transmission Line Flows (MW)

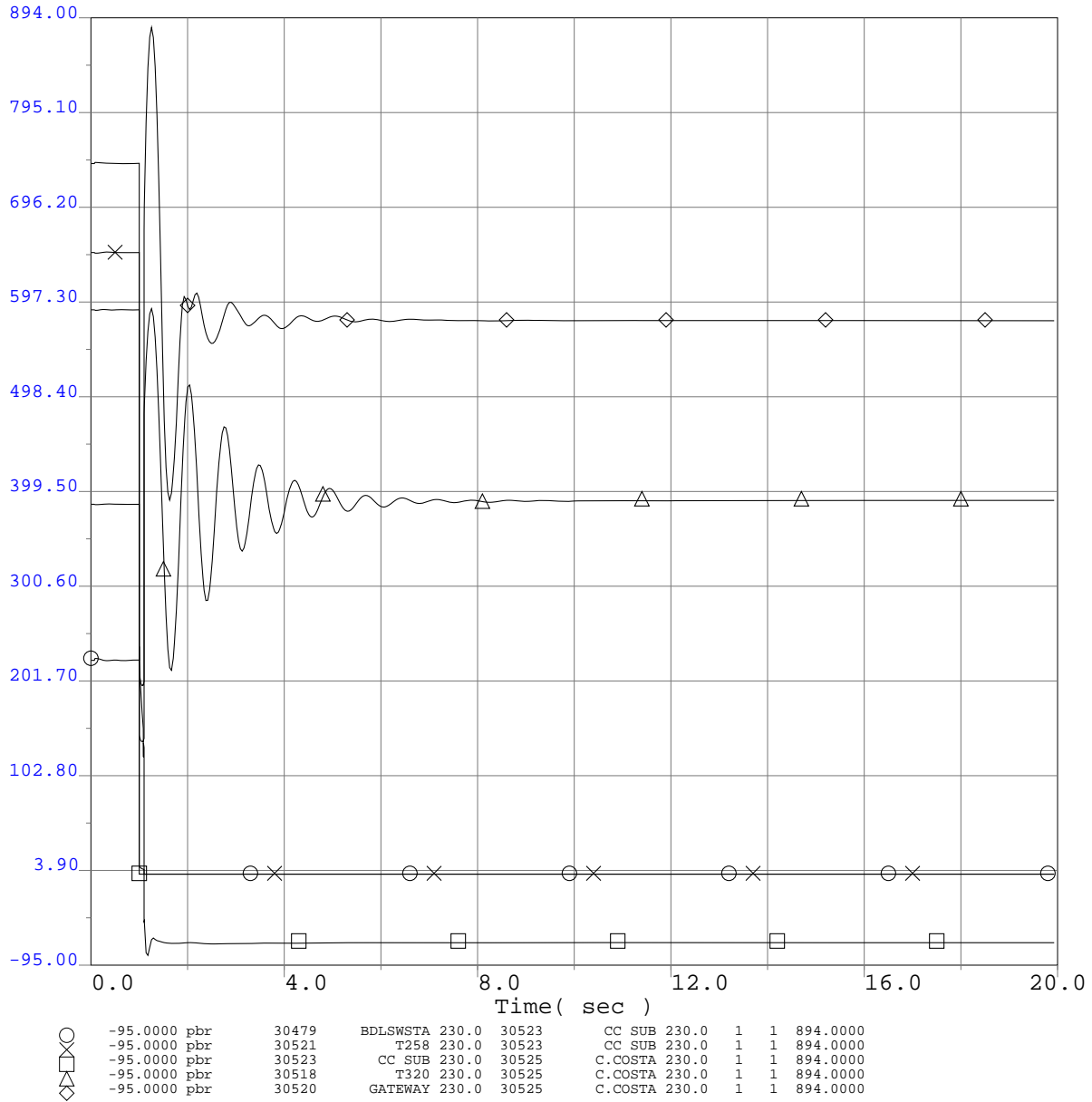

Q320 TCP2 ISIS
 2013 Greater Bay Area Summer Peak Base Case
 Q320 @ 772MW
 CC Sub 230kV Bus 1 Outage
 3-ph 6 cyc flt @ the CC Sub 230kV bus & clr the CC Sub 230kV Bus 1 Outage

Q320 TCP2 ISIS

Selected PG&E Transmission Line Flows (MW)

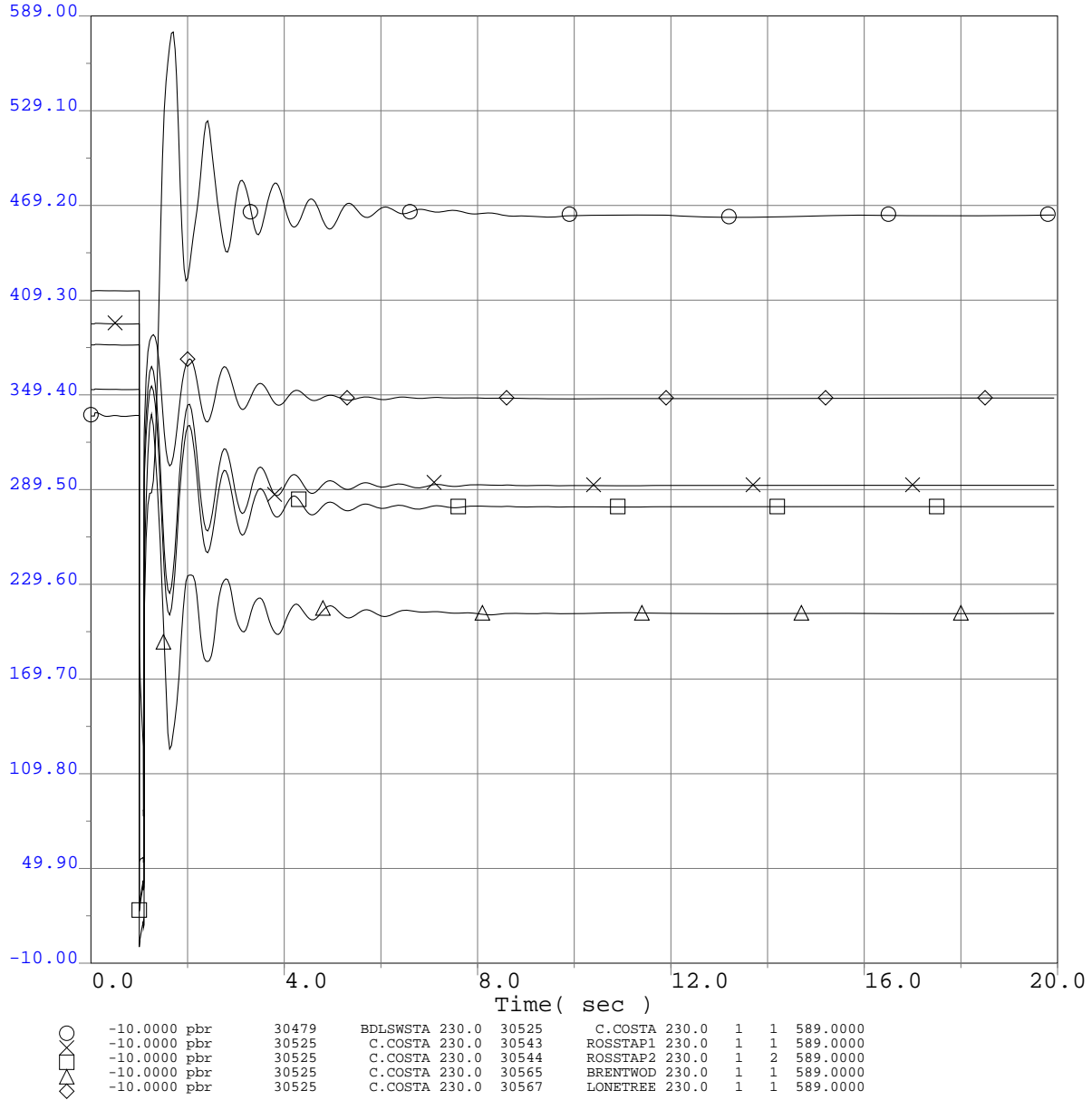

Q320 TCP2 ISIS
 2013 Greater Bay Area Summer Peak Base Case
 Q320 @ 772MW
 CC Sub 230kV Bus 1 Outage
 3-ph 6 cyc flt @ the CC Sub 230kV bus & clr the CC Sub 230kV Bus 1 Outage

Q320 TCP2 ISIS

Selected PG&E Transmission Line Flows (MW)

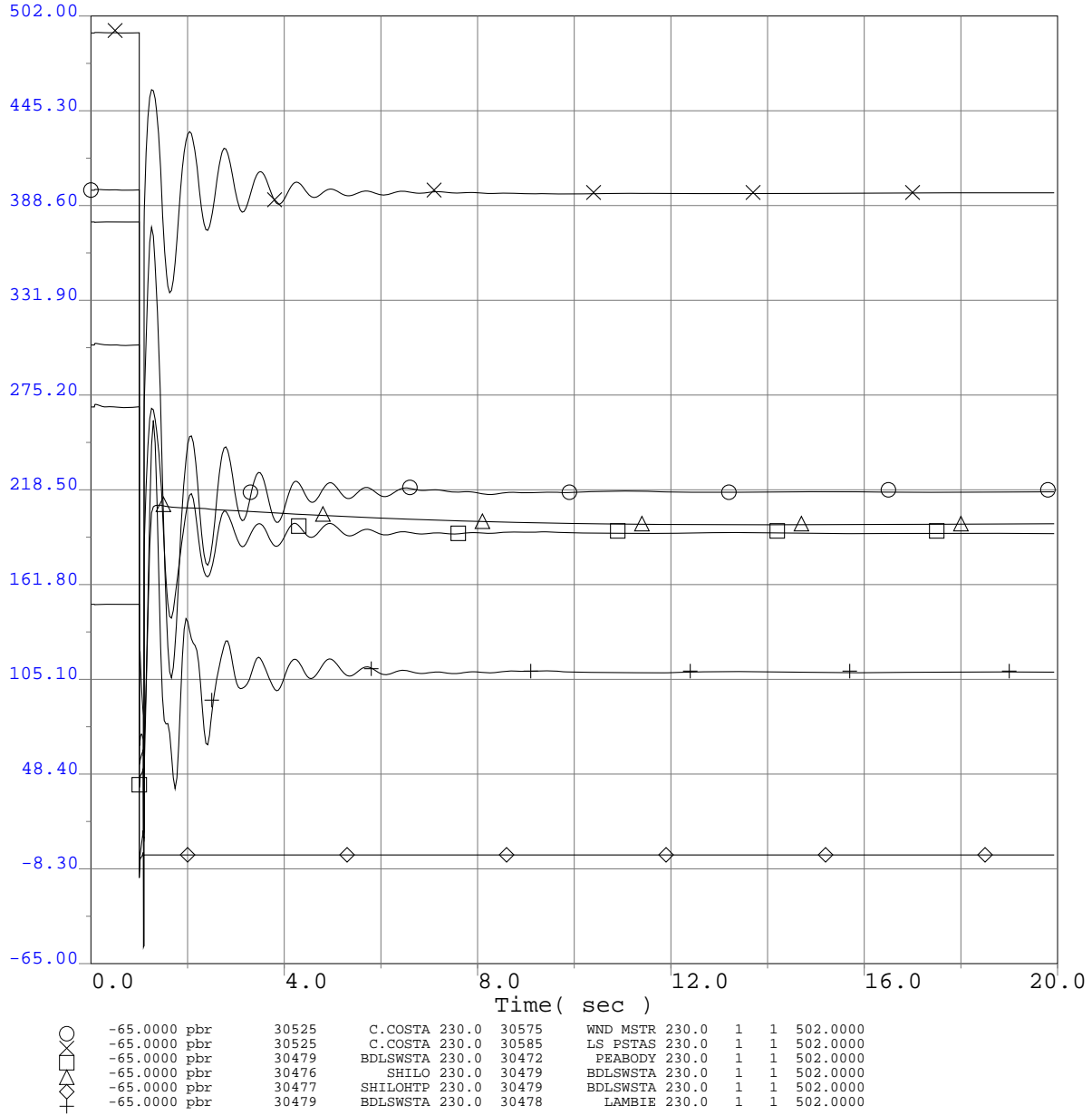

Q320 TCP2 ISIS
 2013 Greater Bay Area Summer Peak Base Case
 Q320 @ 772MW
 CC Sub 230kV Bus 1 Outage
 3-ph 6 cyc flt @ the CC Sub 230kV bus & clr the CC Sub 230kV Bus 1 Outage

Q320 TCP2 ISIS

Selected PG&E Transmission Line Flows (MW)

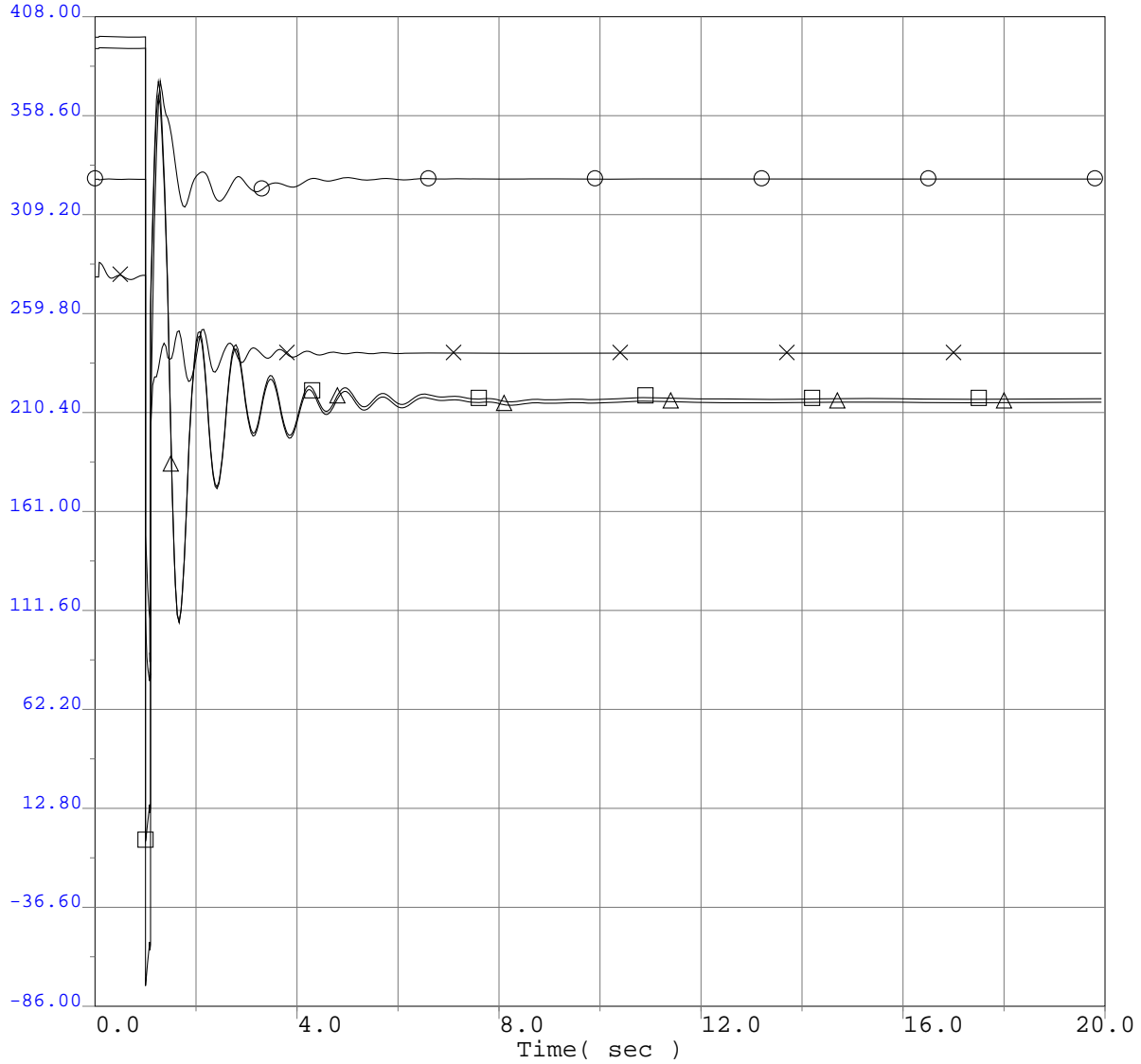

○	-86.0000 pbr	30480	USWP-RUS 230.0	30479	BDLSWSTA 230.0	1	1	408.0000
□	-86.0000 pbr	30529	HIWD TAP 230.0	30479	BDLSWSTA 230.0	1	1	408.0000
×	-86.0000 pbr	30525	C.COSTA 230.0	30575	WND MSTR 230.0	1	1	408.0000
△	-86.0000 pbr	30575	WND MSTR 230.0	38610	DELTAPMP 230.0	1	1	408.0000

Q320 TCP2 ISIS
 2013 Greater Bay Area Summer Peak Base Case
 Q320 @ 772MW
 CC Sub 230kV Bus 1 Outage
 3-ph 6 cyc flt @ the CC Sub 230kV bus & clr the CC Sub 230kV Bus 1 Outage

Q320 TCP2 ISIS

Selected PG&E Bus Voltage Plots Adjacent to Fault

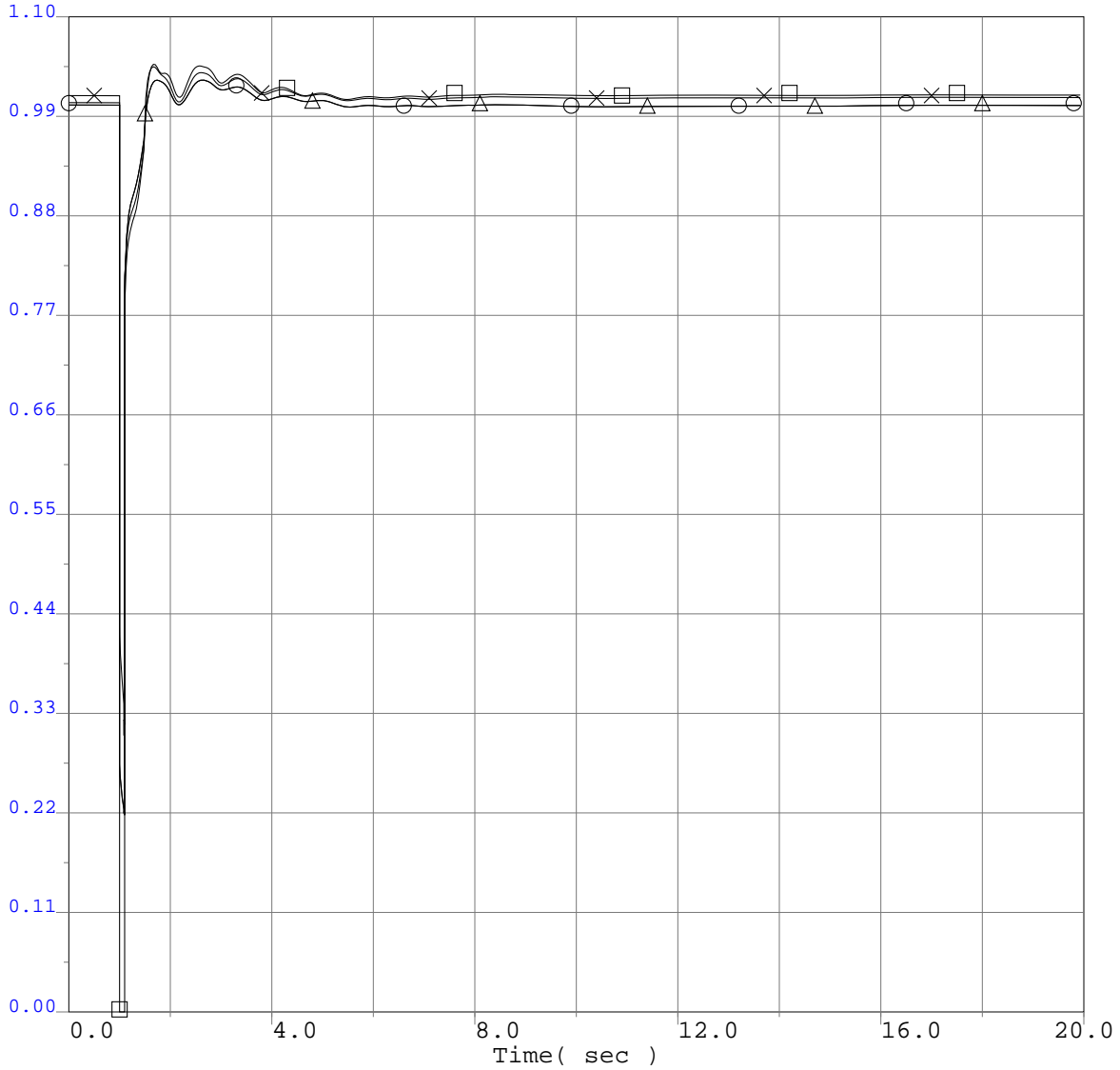

○	0.0000	vbus	30525	C.COSTA	230.0	0	0.0	***	1	1.1000
□	0.0000	vbus	30479	BDLSWSTA	230.0	0	0.0	***	1	1.1000
×	0.0000	vbul	30523	CC SUB	230.0	0	0.0	***	1	1.1000
△	0.0000	vbus	30518	T320	230.0	0	0.0	***	1	1.1000



Q320 TCP2 ISIS
 2013 Greater Bay Area Summer Peak Base Case
 Q320 @ 772MW
 CC Sub 230kV Bus 2 Outage
 3-ph 6 cyc flt @ the CC Sub 230kV bus & clr the CC Sub 230kV Bus 2 Outage

Q320 TCP2 ISIS

Selected PG&E Bus Frequency Plots Adjacent to Fault

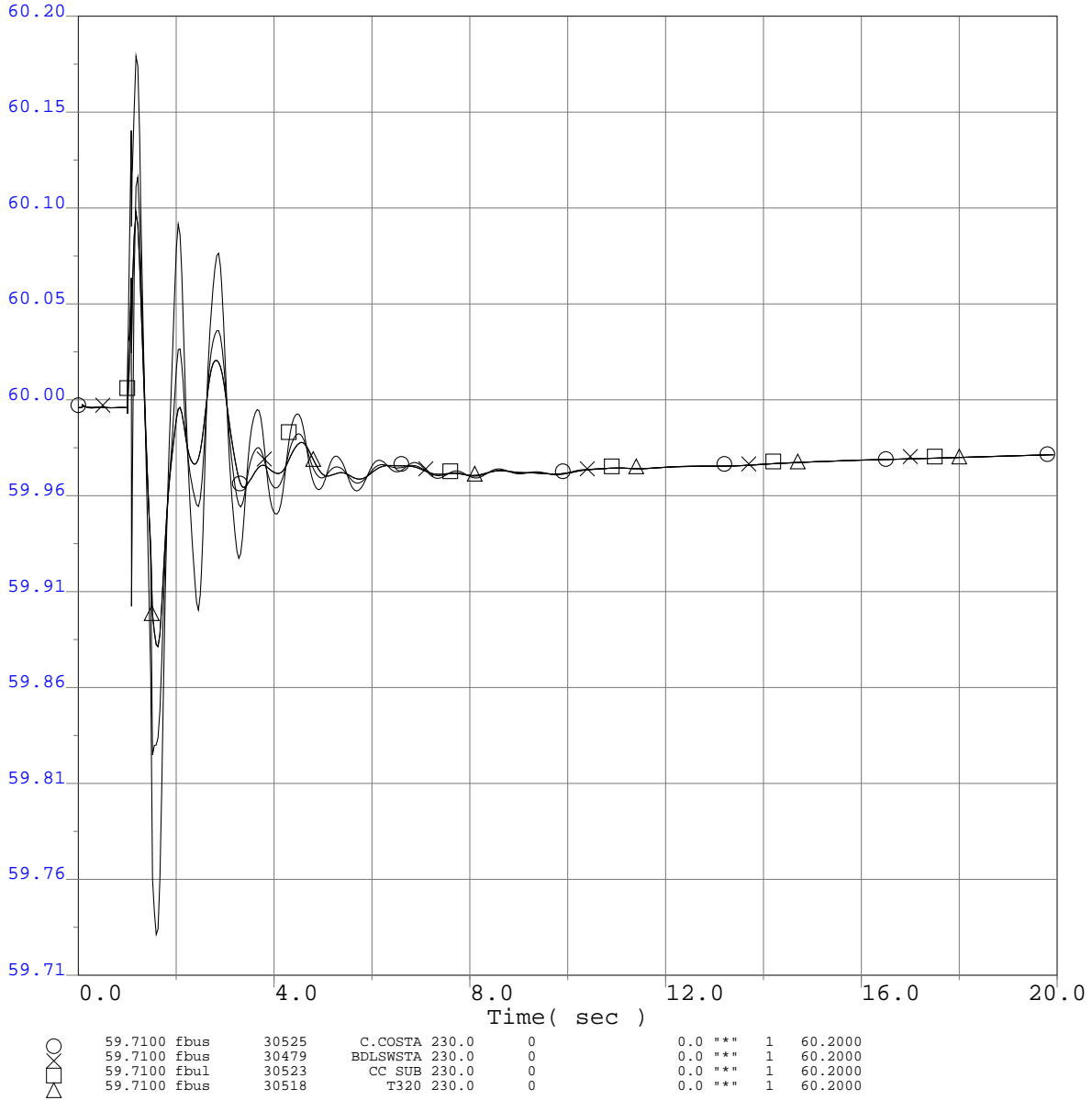

Q320 TCP2 ISIS
 2013 Greater Bay Area Summer Peak Base Case
 Q320 @ 772MW
 CC Sub 230kV Bus 2 Outage
 3-ph 6 cyc flt @ the CC Sub 230kV bus & clr the CC Sub 230kV Bus 2 Outage

Q320 TCP2 ISIS

Project Generator Terminal Voltages (P.U.)

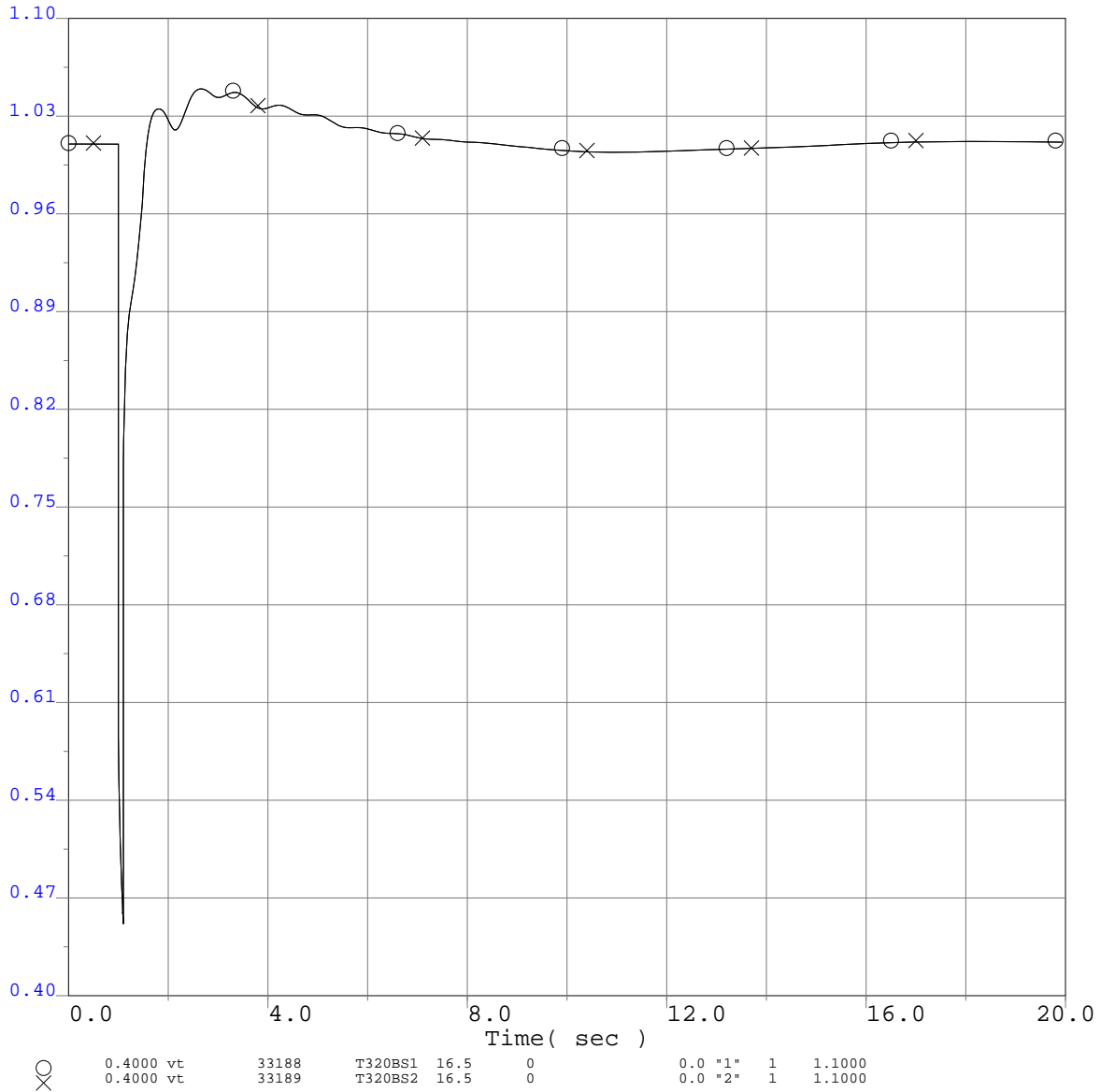

Q320 TCP2 ISIS
 2013 Greater Bay Area Summer Peak Base Case
 Q320 @ 772MW
 CC Sub 230kV Bus 2 Outage
 3-ph 6 cyc flt @ the CC Sub 230kV bus & clr the CC Sub 230kV Bus 2 Outage

Q320 TCP2 ISIS

Project Generator Terminal Voltages (P.U.)

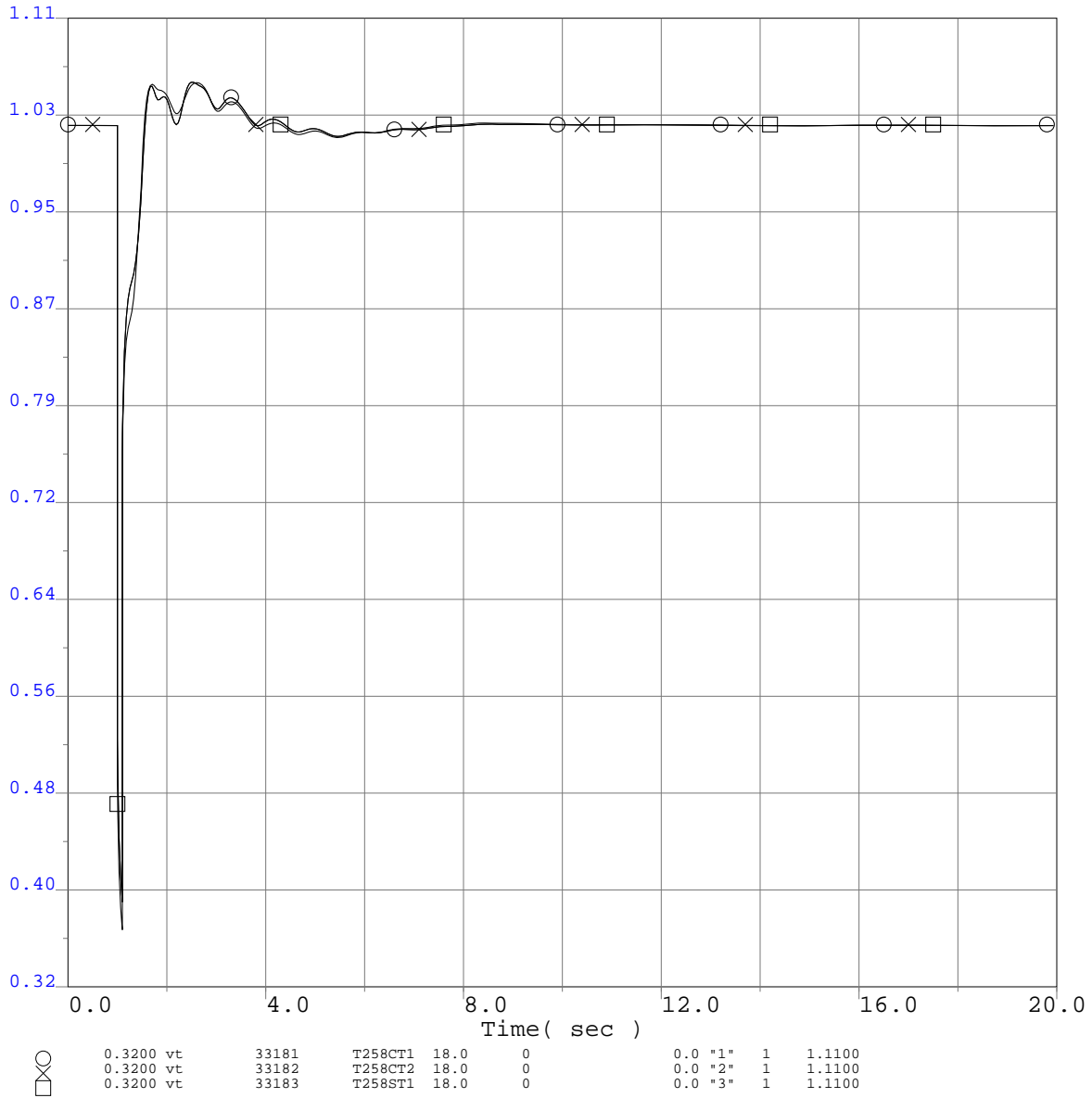

Q320 TCP2 ISIS
 2013 Greater Bay Area Summer Peak Base Case
 Q320 @ 772MW
 CC Sub 230kV Bus 2 Outage
 3-ph 6 cyc flt @ the CC Sub 230kV bus & clr the CC Sub 230kV Bus 2 Outage

Q320 TCP2 ISIS

Project Generator Speed (P.U.)

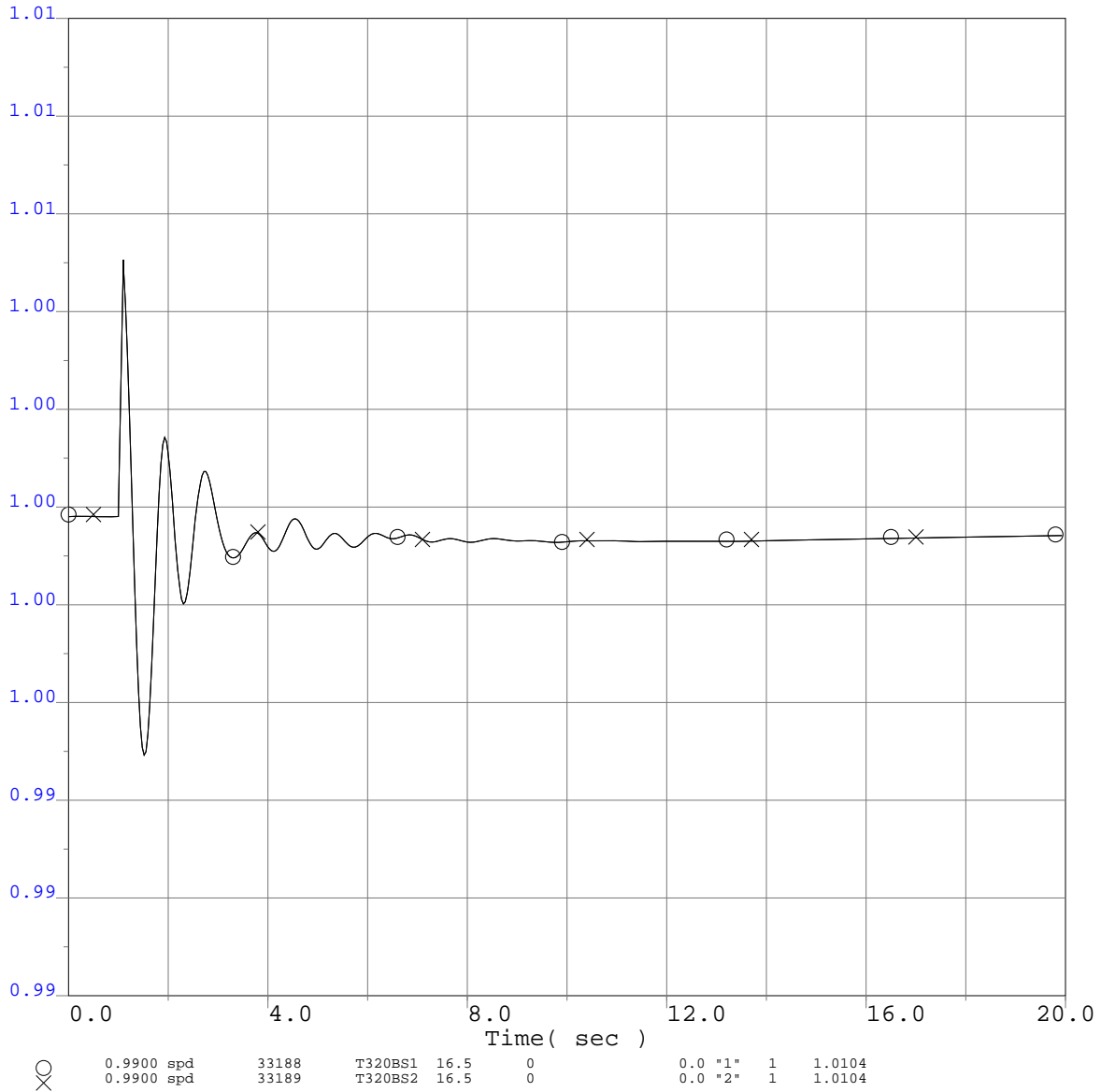

Q320 TCP2 ISIS
 2013 Greater Bay Area Summer Peak Base Case
 Q320 @ 772MW
 CC Sub 230kV Bus 2 Outage
 3-ph 6 cyc flt @ the CC Sub 230kV bus & clr the CC Sub 230kV Bus 2 Outage

Q320 TCP2 ISIS

Project Generator Speed (P.U.)

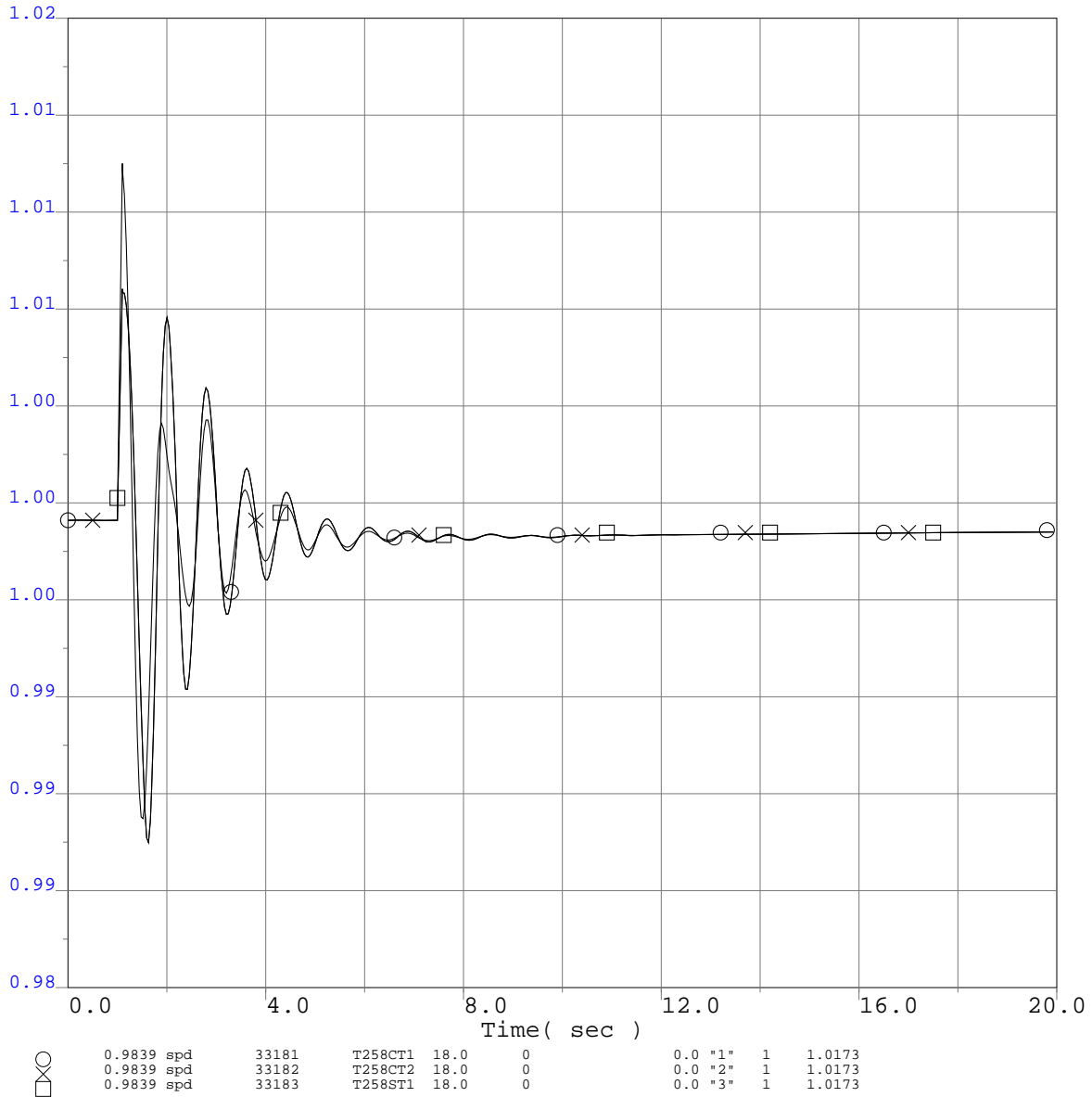

Q320 TCP2 ISIS
 2013 Greater Bay Area Summer Peak Base Case
 Q320 @ 772MW
 CC Sub 230kV Bus 2 Outage
 3-ph 6 cyc flt @ the CC Sub 230kV bus & clr the CC Sub 230kV Bus 2 Outage

Q320 TCP2 ISIS

Project Generator Terminal Power (MW)

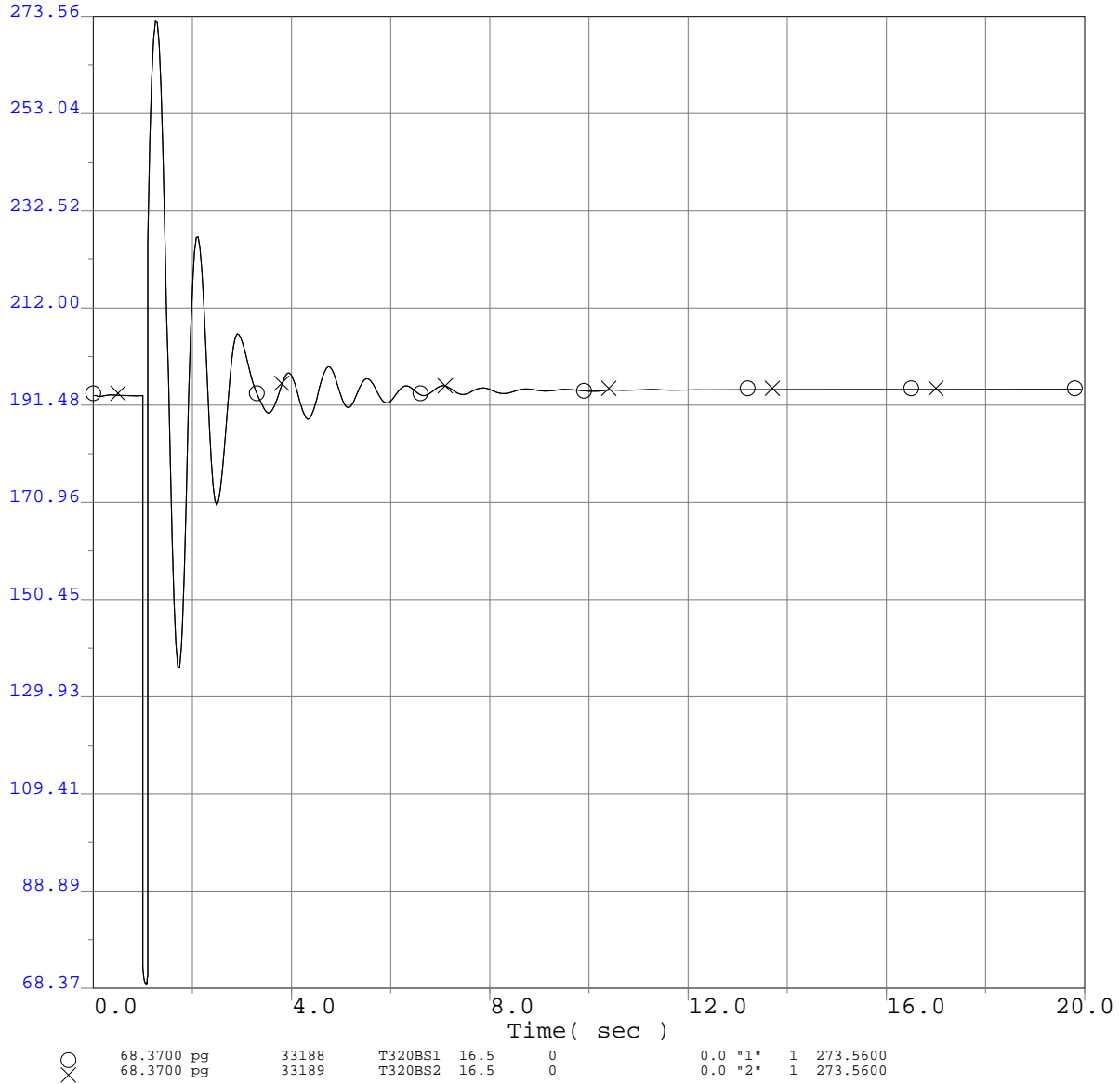

Q320 TCP2 ISIS
 2013 Greater Bay Area Summer Peak Base Case
 Q320 @ 772MW
 CC Sub 230kV Bus 2 Outage
 3-ph 6 cyc flt @ the CC Sub 230kV bus & clr the CC Sub 230kV Bus 2 Outage

Q320 TCP2 ISIS

Project Generator Terminal Power (MW)

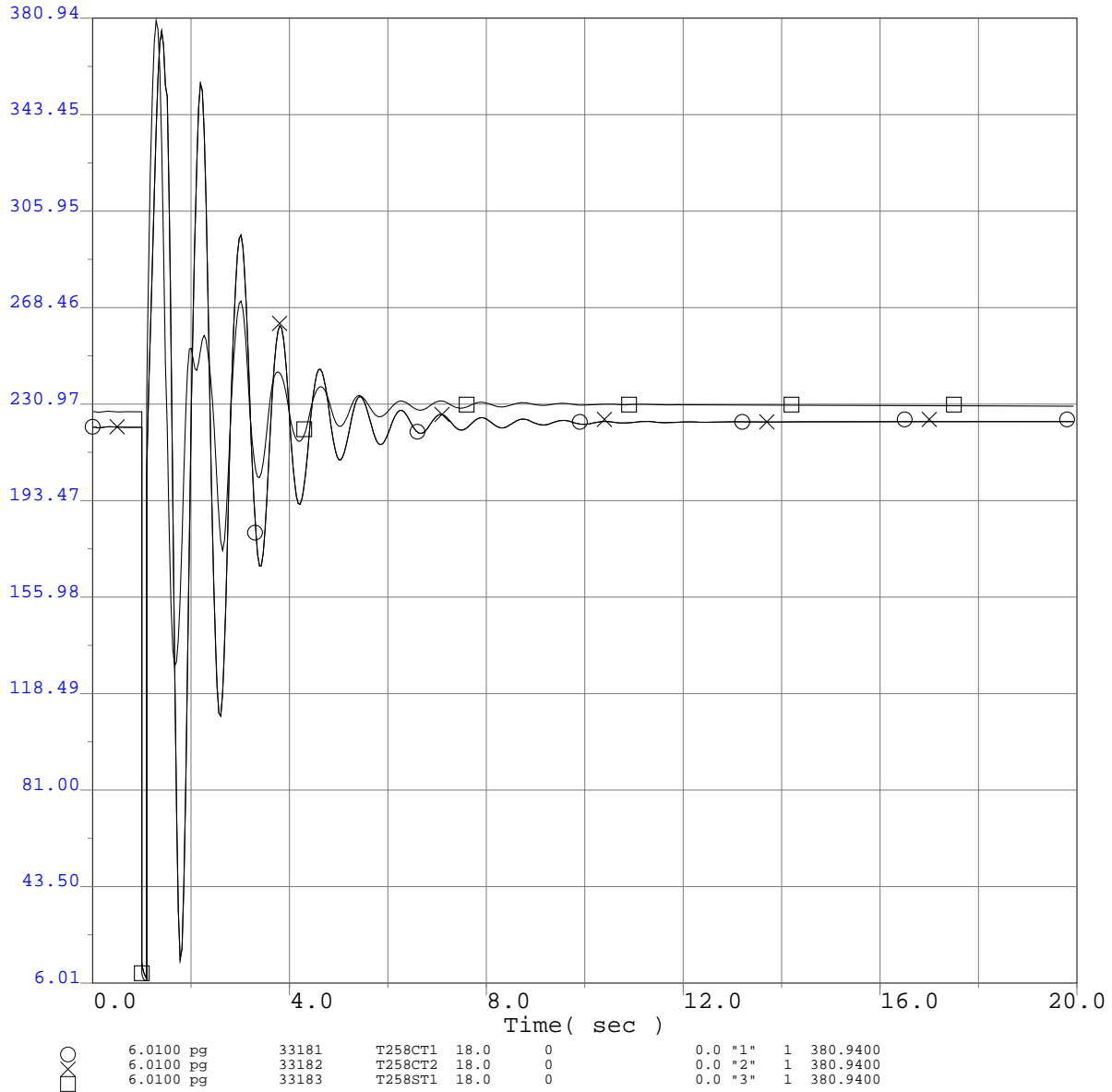

Q320 TCP2 ISIS
 2013 Greater Bay Area Summer Peak Base Case
 Q320 @ 772MW
 CC Sub 230kV Bus 2 Outage
 3-ph 6 cyc flt @ the CC Sub 230kV bus & clr the CC Sub 230kV Bus 2 Outage

Q320 TCP2 ISIS

Project Generator Terminal Reactive Power (MVA_r)

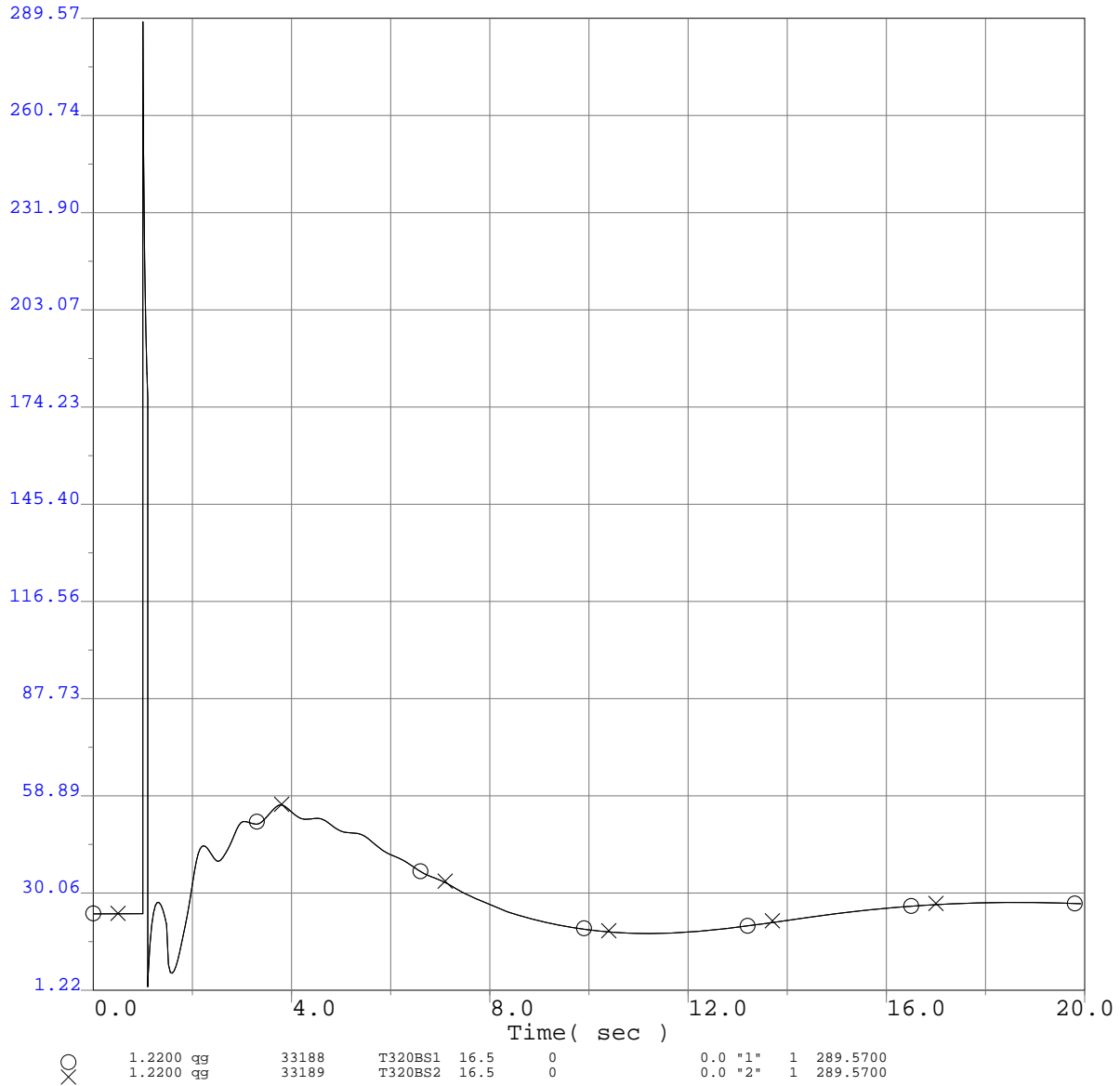

Q320 TCP2 ISIS
 2013 Greater Bay Area Summer Peak Base Case
 Q320 @ 772MW
 CC Sub 230kV Bus 2 Outage
 3-ph 6 cyc flt @ the CC Sub 230kV bus & clr the CC Sub 230kV Bus 2 Outage

Q320 TCP2 ISIS

Project Generator Terminal Reactive Power (MVA_r)

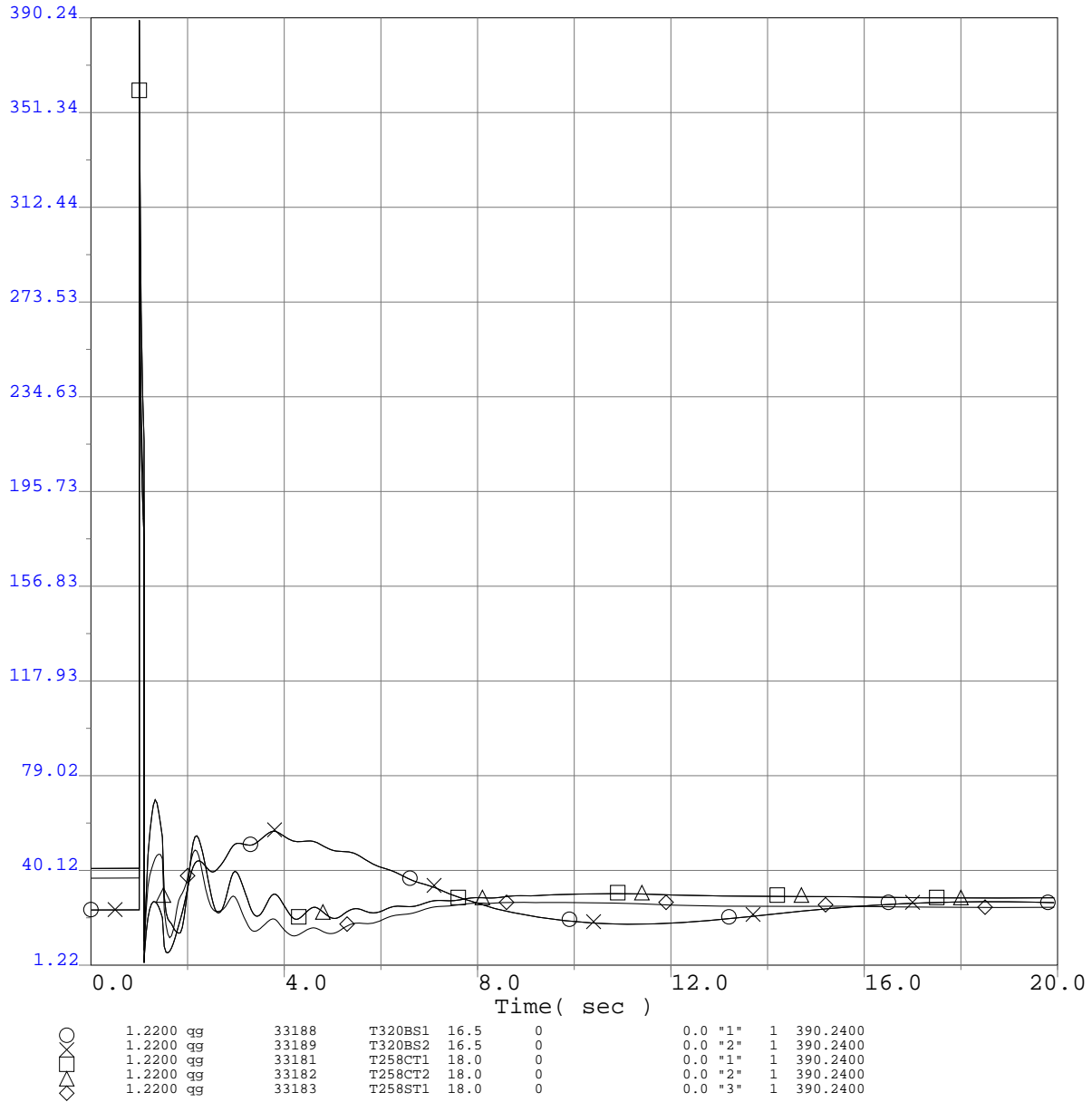

Q320 TCP2 ISIS
 2013 Greater Bay Area Summer Peak Base Case
 Q320 @ 772MW
 CC Sub 230kV Bus 2 Outage
 3-ph 6 cyc flt @ the CC Sub 230kV bus & clr the CC Sub 230kV Bus 2 Outage

Q320 TCP2 ISIS

Selected WECC Bus Voltage Plots

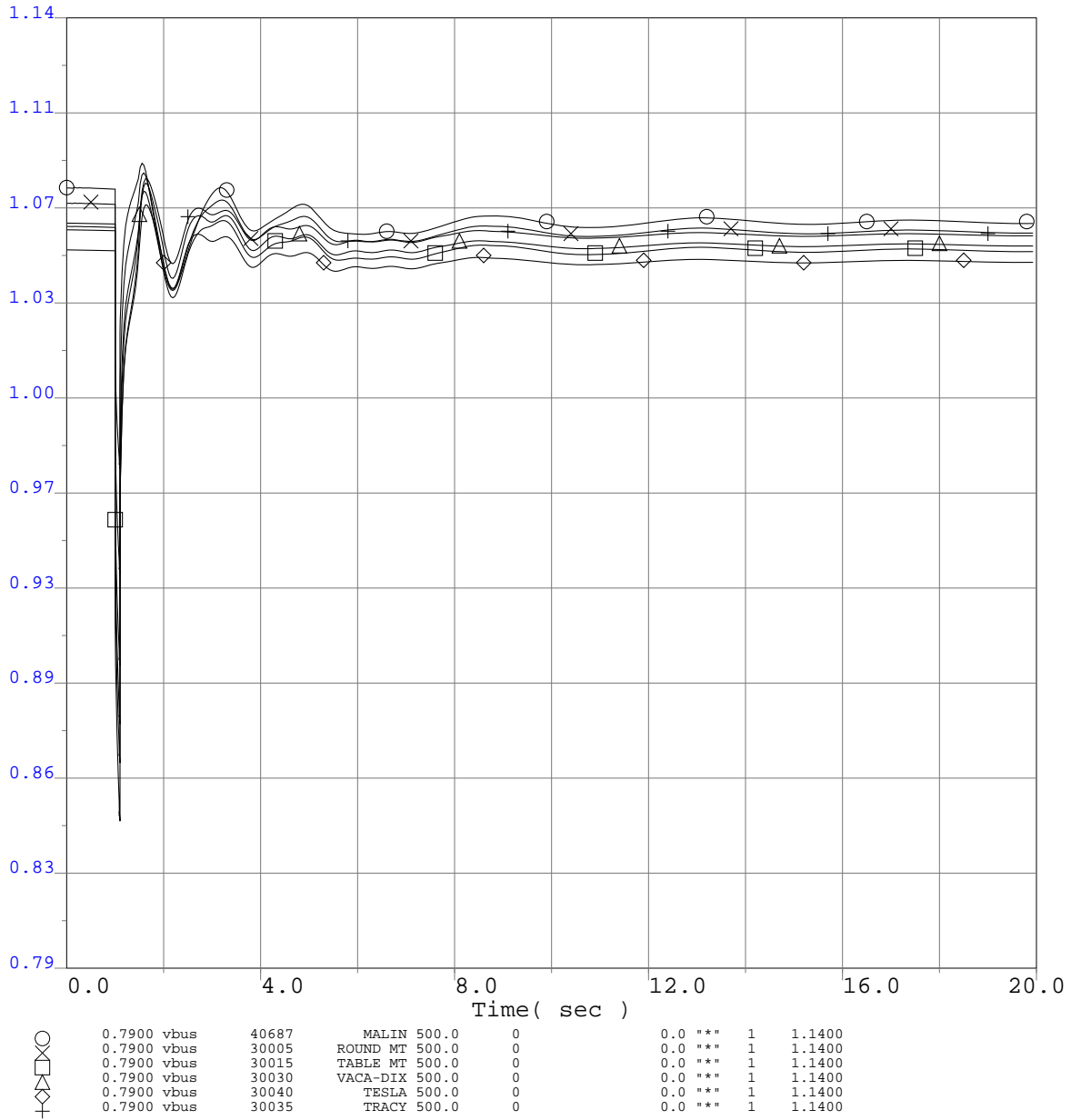

Q320 TCP2 ISIS
 2013 Greater Bay Area Summer Peak Base Case
 Q320 @ 772MW
 CC Sub 230kV Bus 2 Outage
 3-ph 6 cyc flt @ the CC Sub 230kV bus & clr the CC Sub 230kV Bus 2 Outage

Q320 TCP2 ISIS

Selected WECC Bus Voltage Plots

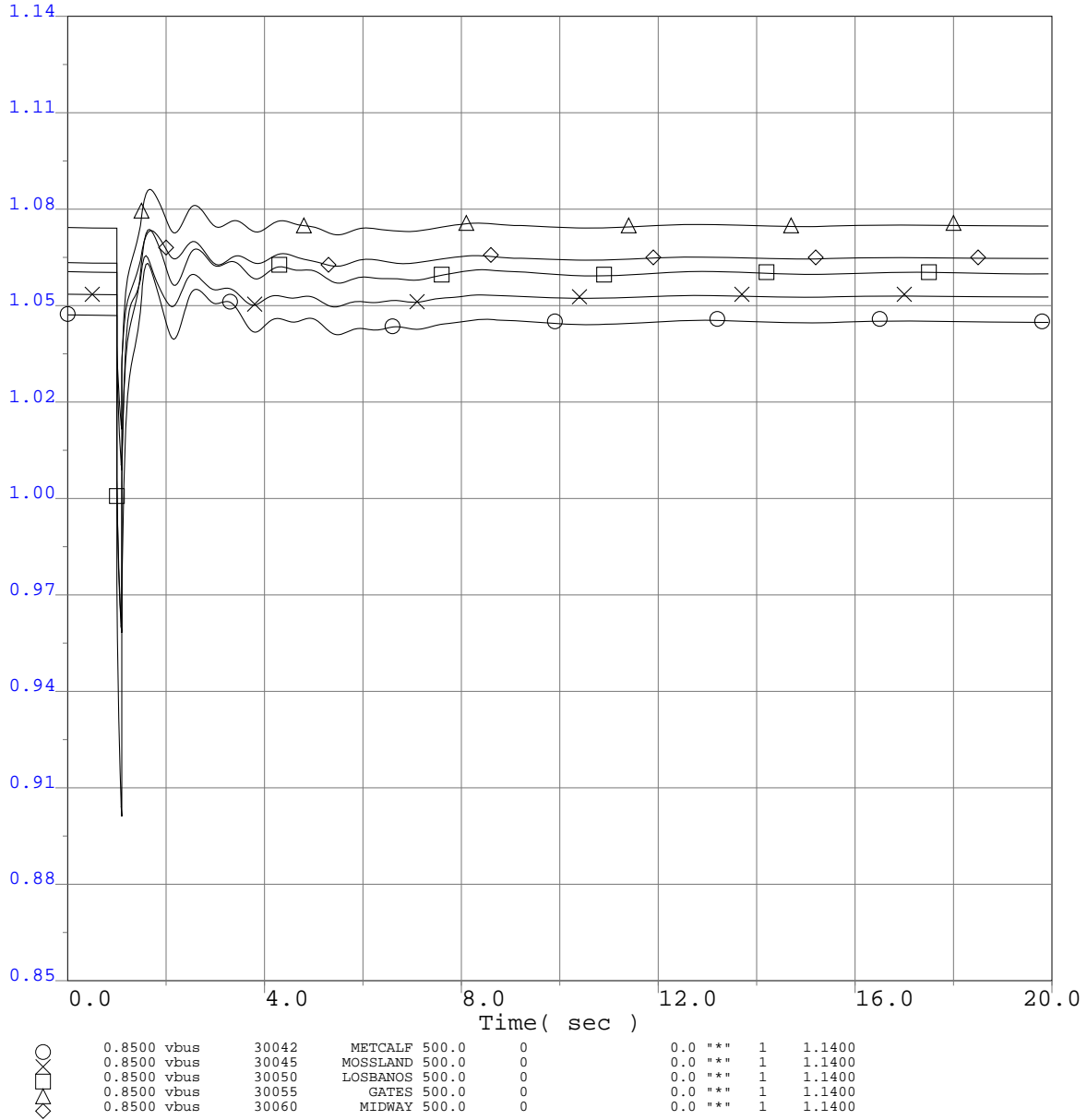

Q320 TCP2 ISIS
 2013 Greater Bay Area Summer Peak Base Case
 Q320 @ 772MW
 CC Sub 230kV Bus 2 Outage
 3-ph 6 cyc flt @ the CC Sub 230kV bus & clr the CC Sub 230kV Bus 2 Outage

Q320 TCP2 ISIS

Selected WECC Bus Voltage Plots

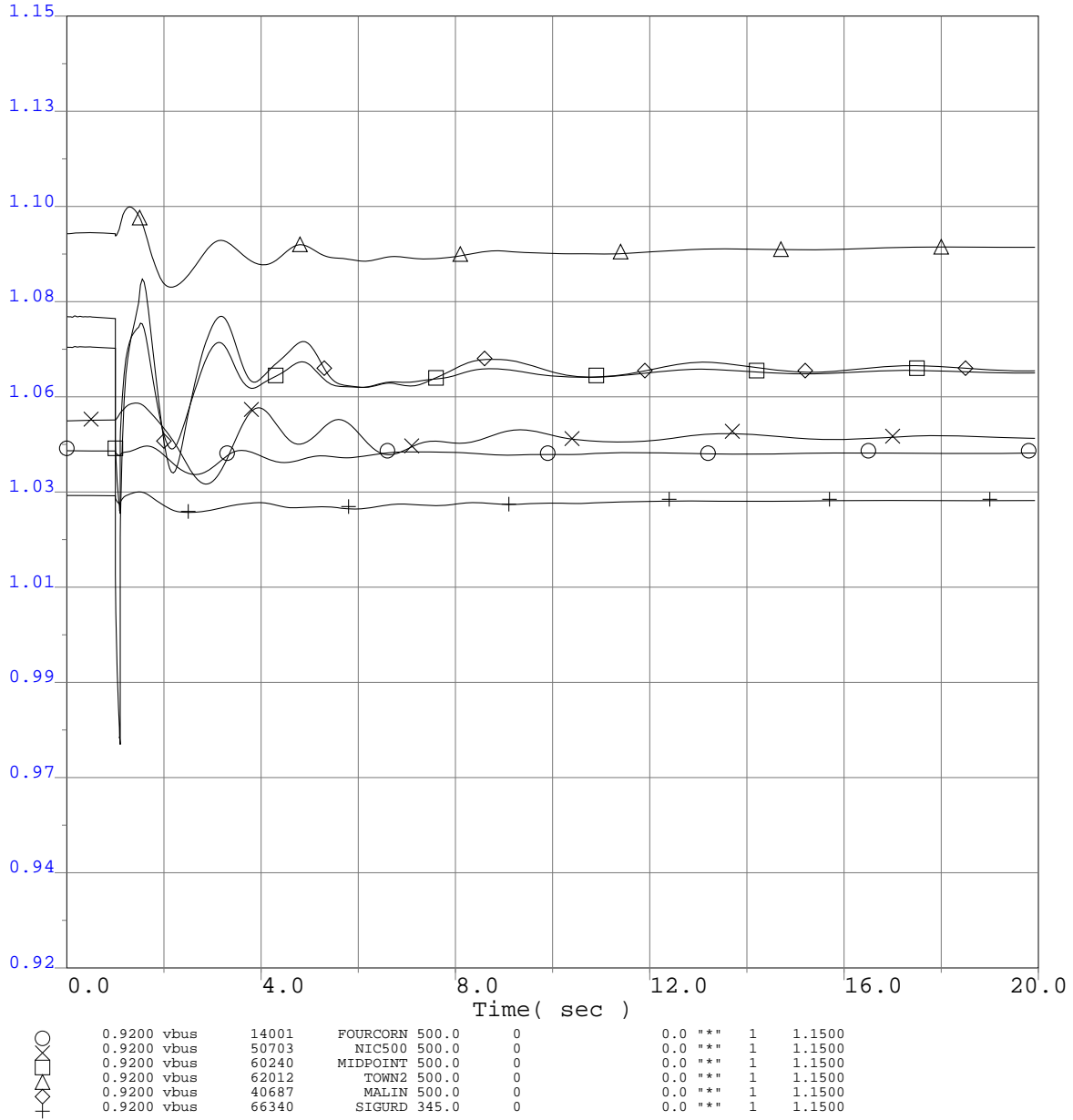

Q320 TCP2 ISIS
 2013 Greater Bay Area Summer Peak Base Case
 Q320 @ 772MW
 CC Sub 230kV Bus 2 Outage
 3-ph 6 cyc flt @ the CC Sub 230kV bus & clr the CC Sub 230kV Bus 2 Outage

Q320 TCP2 ISIS

Selected WECC Bus Voltage Plots

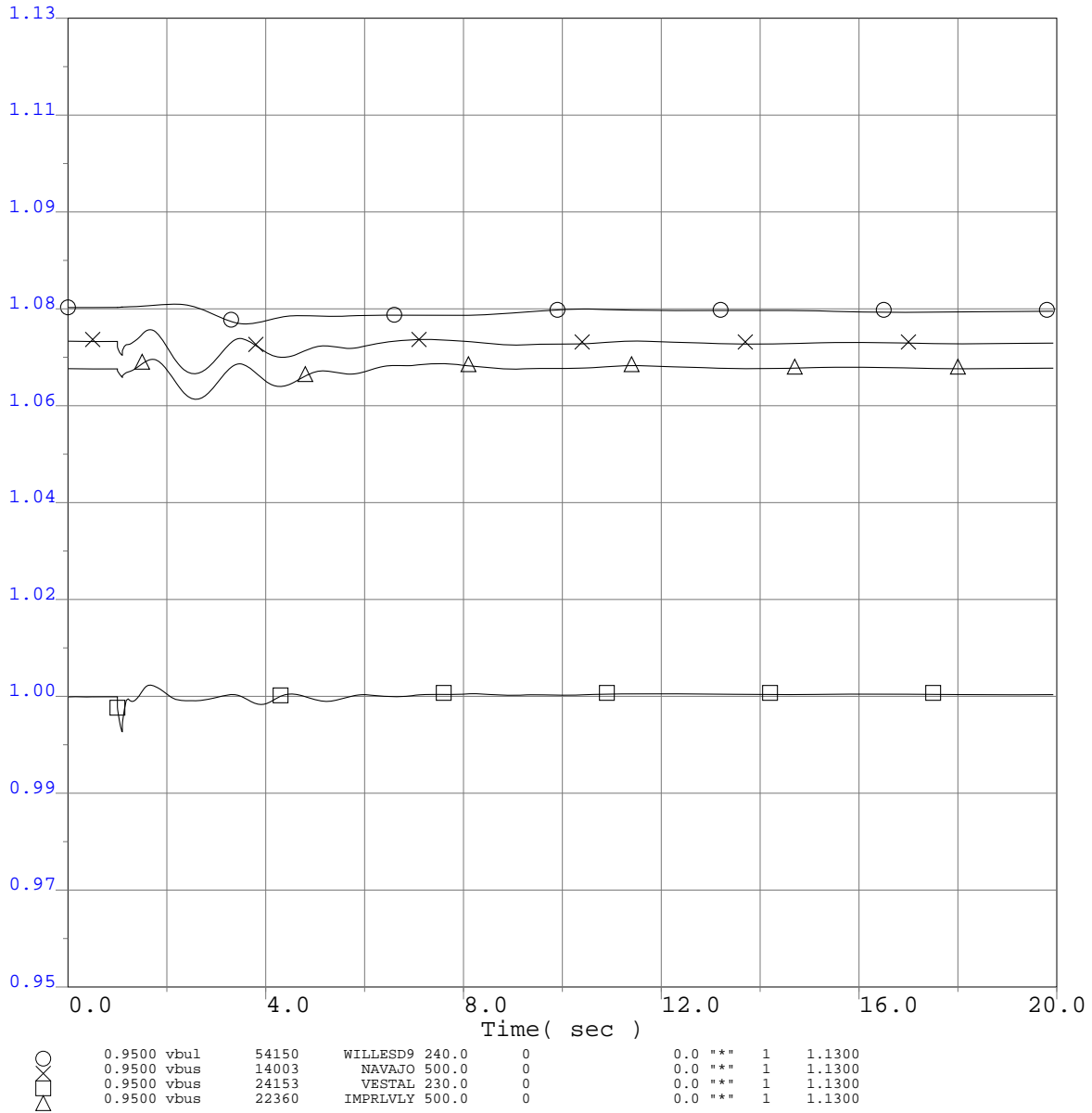

Q320 TCP2 ISIS
 2013 Greater Bay Area Summer Peak Base Case
 Q320 @ 772MW
 CC Sub 230kV Bus 2 Outage
 3-ph 6 cyc flt @ the CC Sub 230kV bus & clr the CC Sub 230kV Bus 2 Outage

Q320 TCP2 ISIS

Selected WECC Bus Frequency Plots

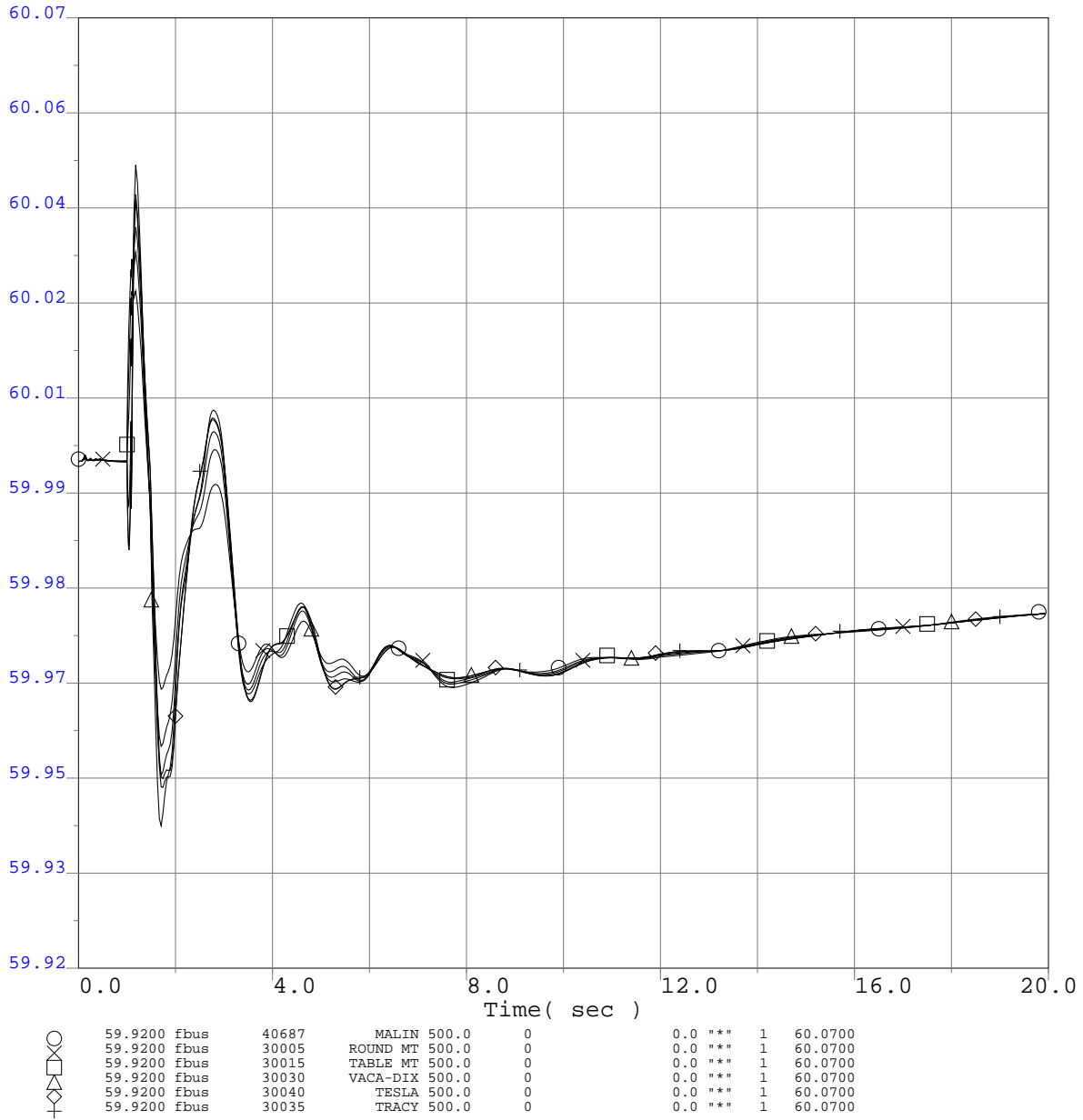

Q320 TCP2 ISIS
 2013 Greater Bay Area Summer Peak Base Case
 Q320 @ 772MW
 CC Sub 230kV Bus 2 Outage
 3-ph 6 cyc flt @ the CC Sub 230kV bus & clr the CC Sub 230kV Bus 2 Outage

Q320 TCP2 ISIS

Selected WECC Bus Frequency Plots

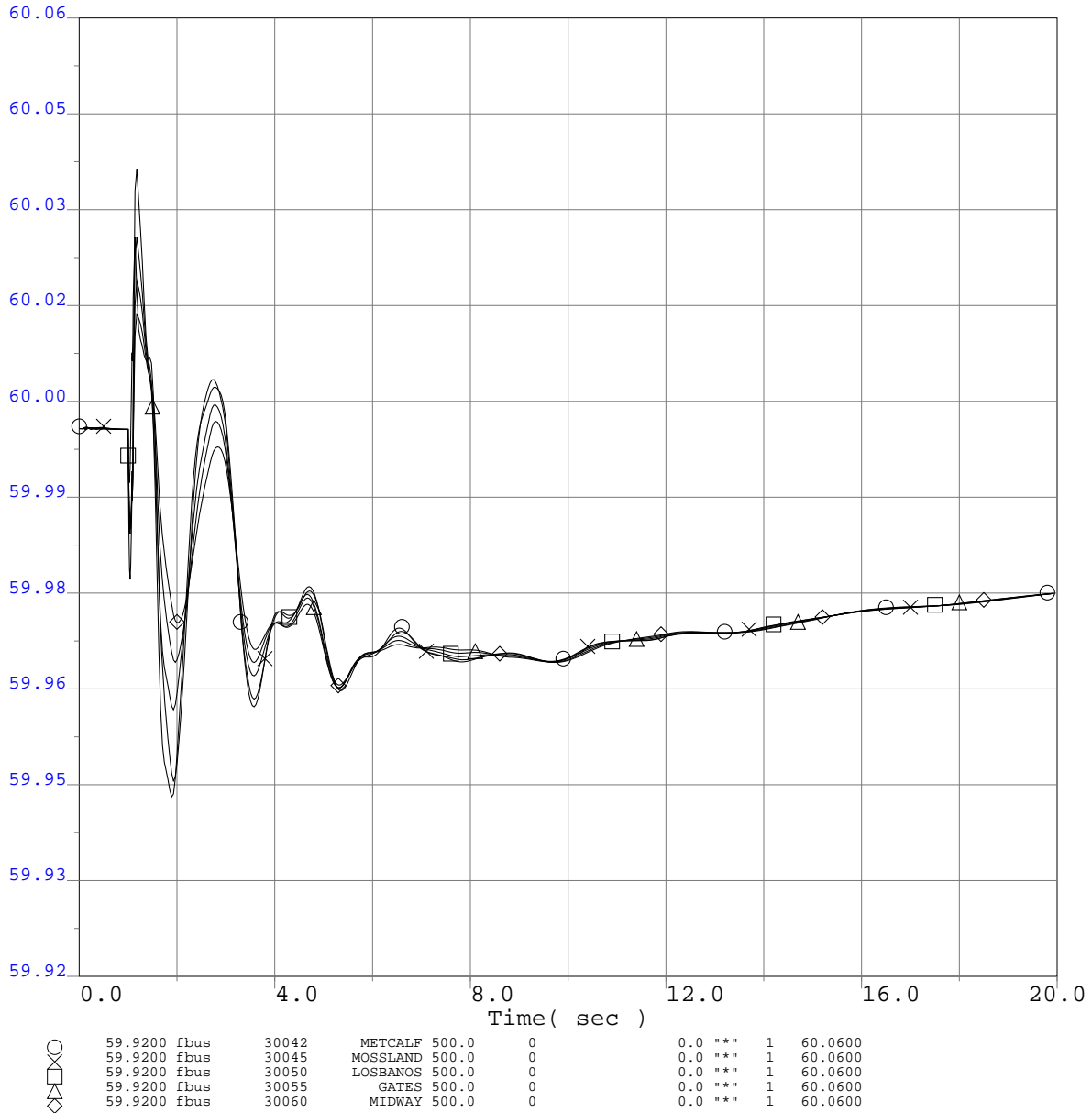

Q320 TCP2 ISIS
 2013 Greater Bay Area Summer Peak Base Case
 Q320 @ 772MW
 CC Sub 230kV Bus 2 Outage
 3-ph 6 cyc flt @ the CC Sub 230kV bus & clr the CC Sub 230kV Bus 2 Outage

Q320 TCP2 ISIS

Selected WECC Bus Frequency Plots

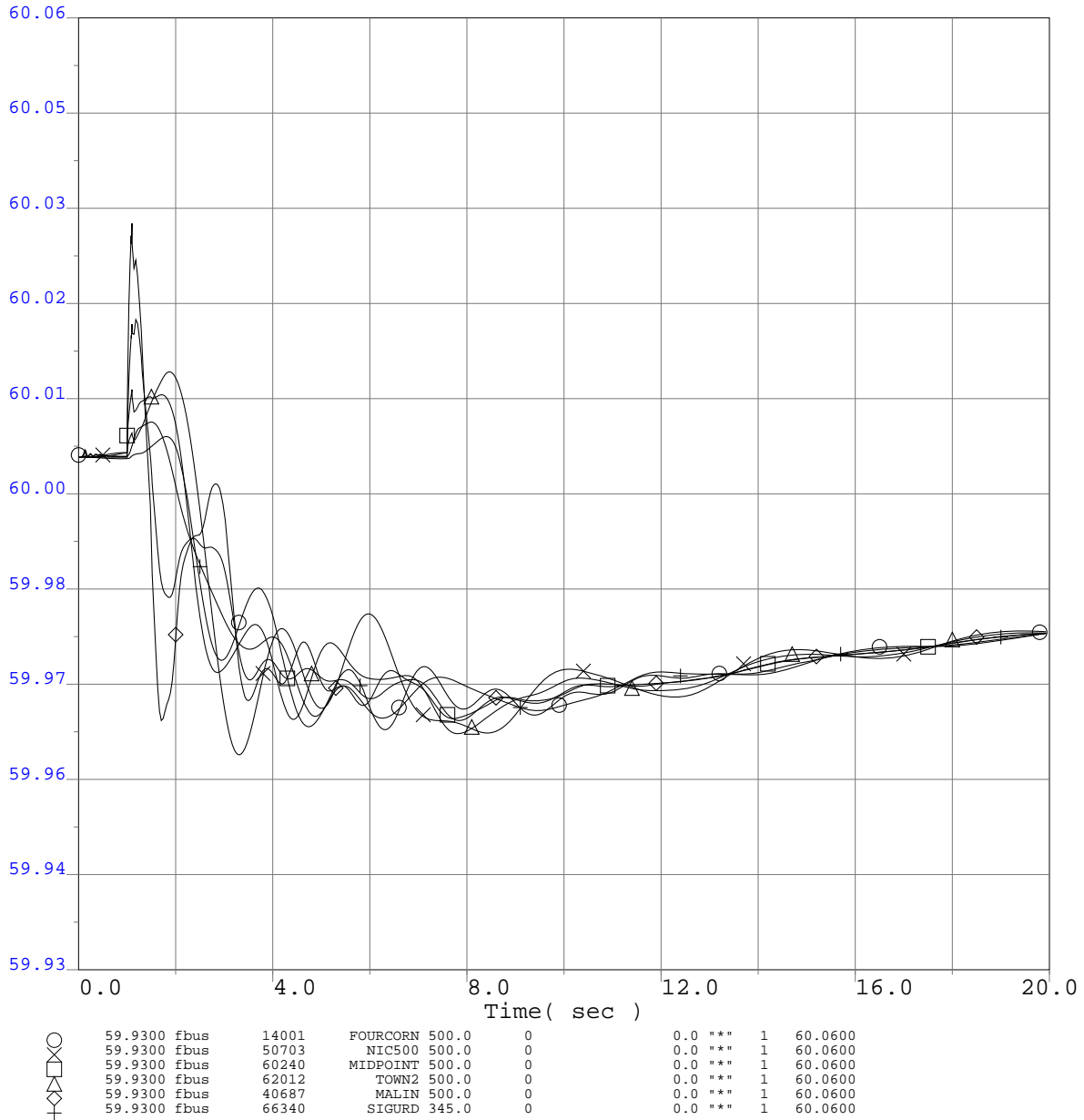

Q320 TCP2 ISIS
 2013 Greater Bay Area Summer Peak Base Case
 Q320 @ 772MW
 CC Sub 230kV Bus 2 Outage
 3-ph 6 cyc flt @ the CC Sub 230kV bus & clr the CC Sub 230kV Bus 2 Outage

Q320 TCP2 ISIS

Selected WECC Bus Frequency Plots

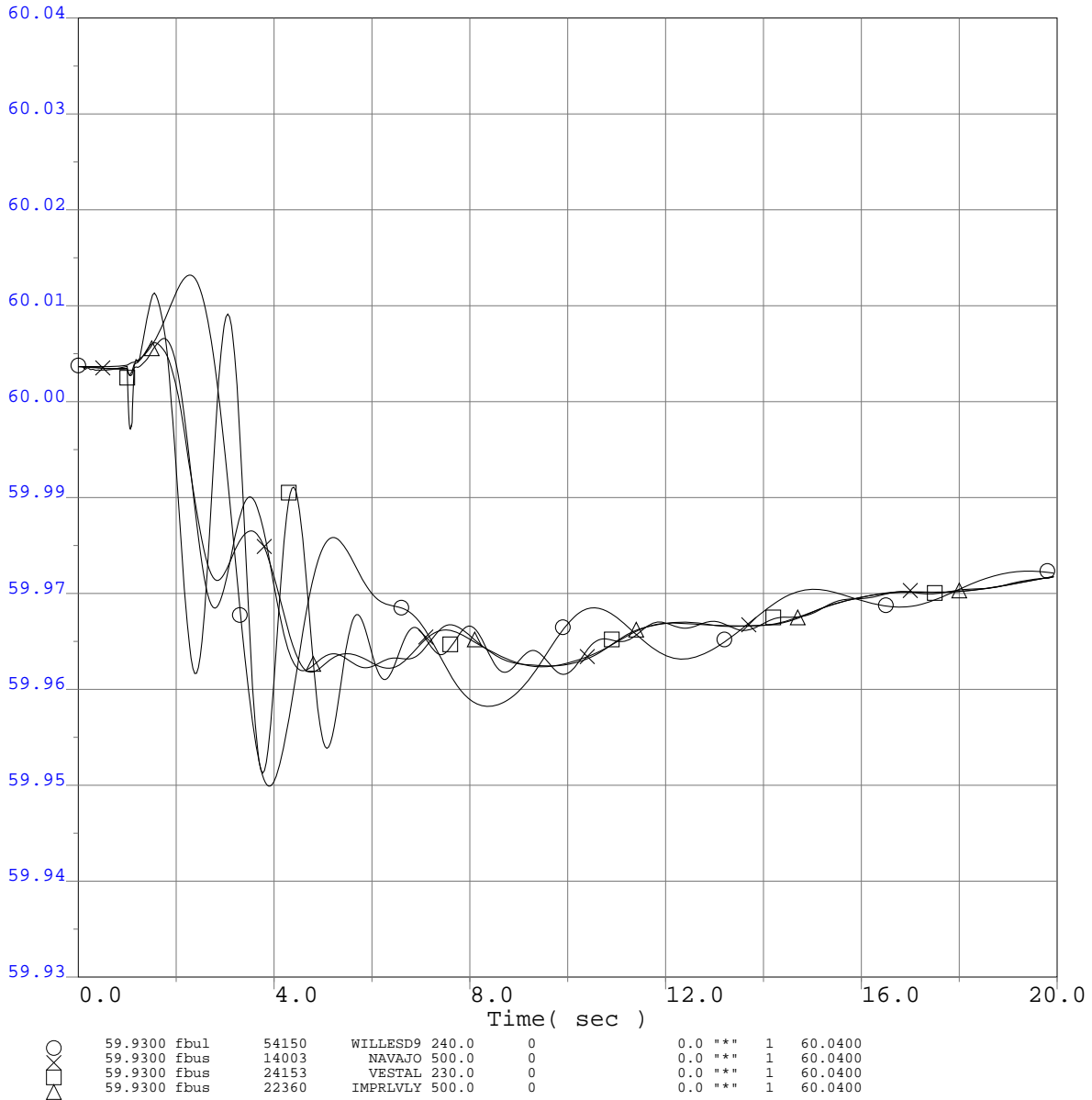

Q320 TCP2 ISIS
 2013 Greater Bay Area Summer Peak Base Case
 Q320 @ 772MW
 CC Sub 230kV Bus 2 Outage
 3-ph 6 cyc flt @ the CC Sub 230kV bus & clr the CC Sub 230kV Bus 2 Outage

Q320 TCP2 ISIS

WECC Generator Rotor Angle

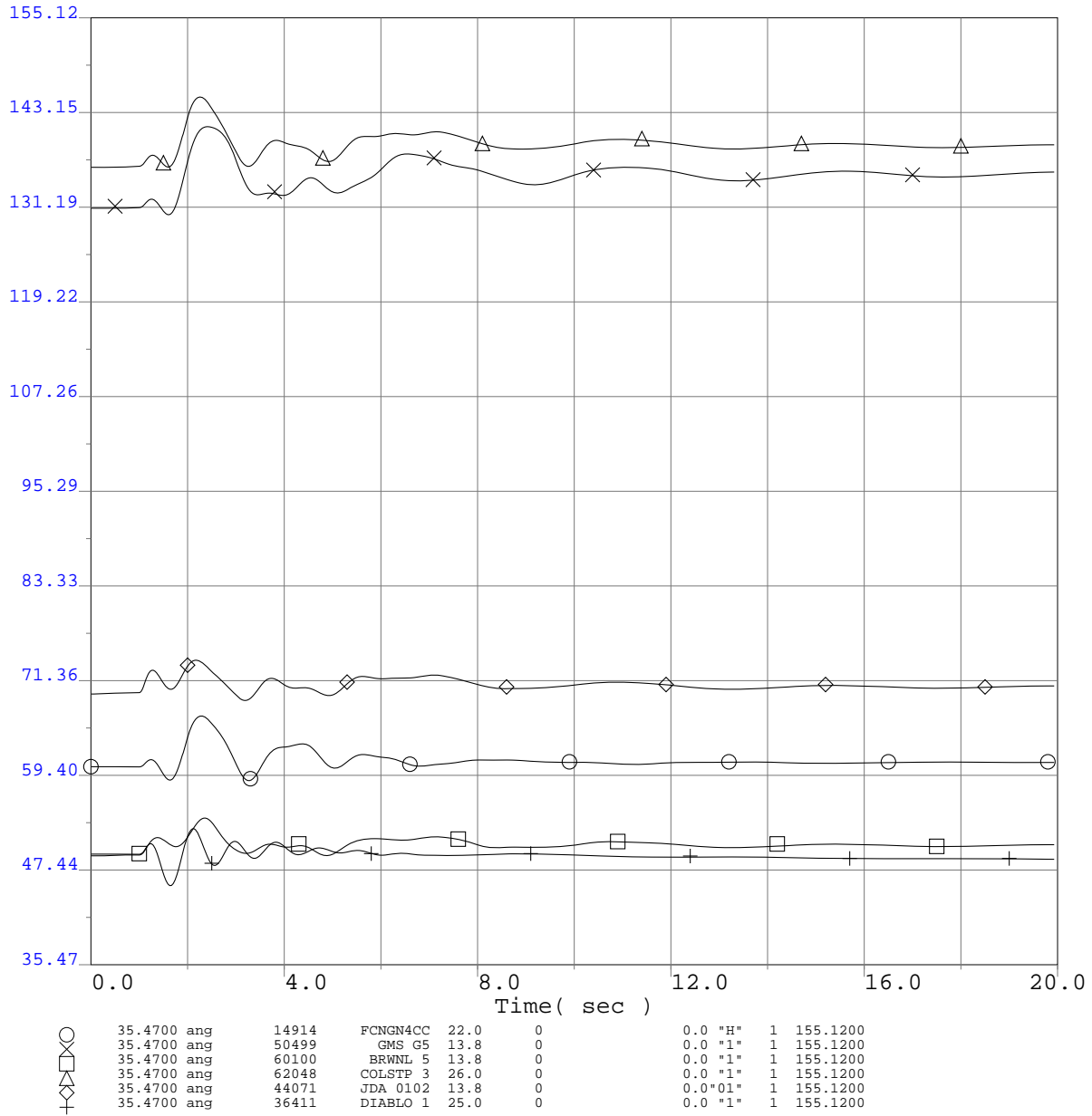

Q320 TCP2 ISIS
 2013 Greater Bay Area Summer Peak Base Case
 Q320 @ 772MW
 CC Sub 230kV Bus 2 Outage
 3-ph 6 cyc flt @ the CC Sub 230kV bus & clr the CC Sub 230kV Bus 2 Outage

Q320 TCP2 ISIS

WECC Generator Rotor Angle

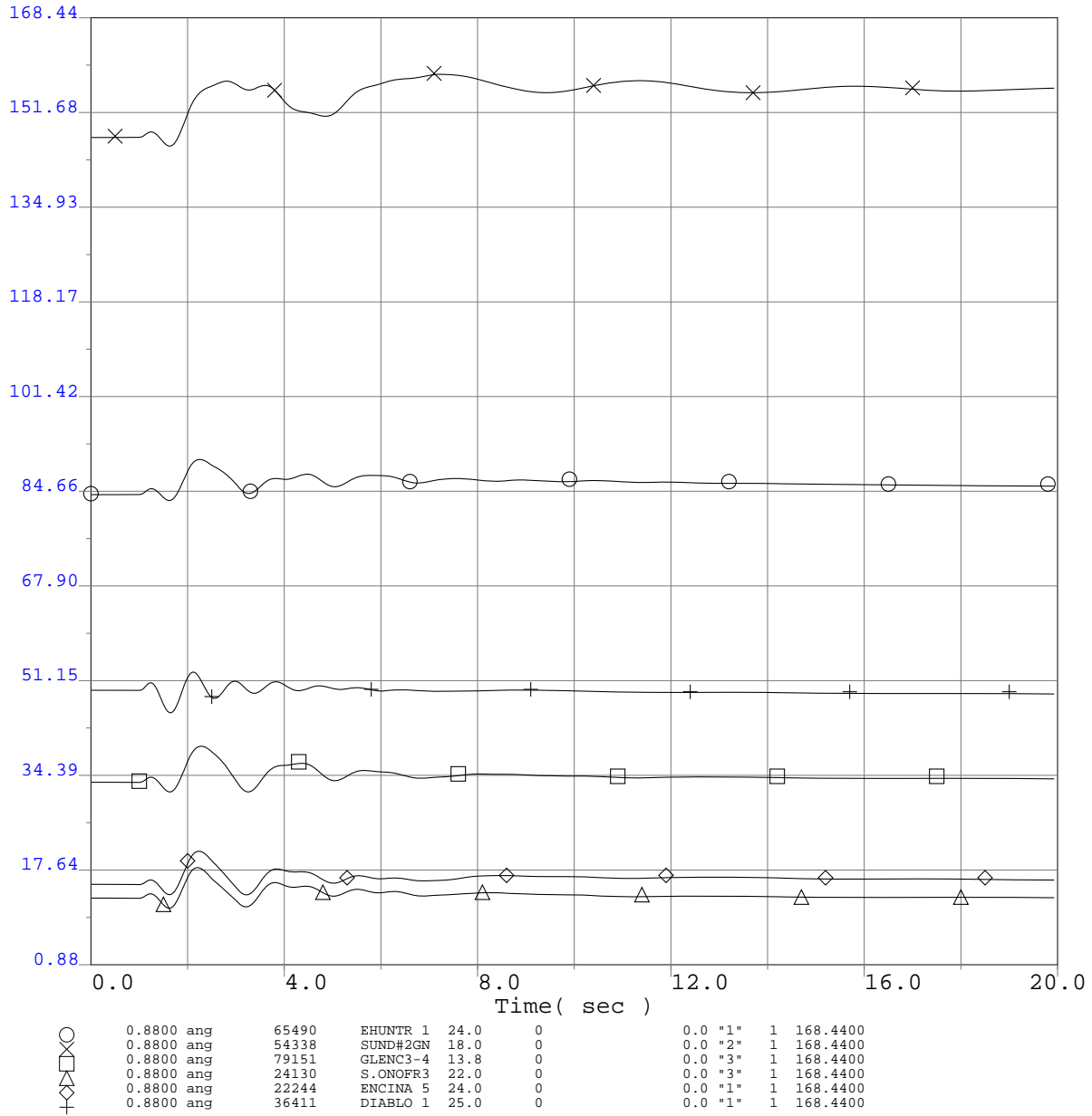

Q320 TCP2 ISIS
 2013 Greater Bay Area Summer Peak Base Case
 Q320 @ 772MW
 CC Sub 230kV Bus 2 Outage
 3-ph 6 cyc flt @ the CC Sub 230kV bus & clr the CC Sub 230kV Bus 2 Outage

Q320 TCP2 ISIS

Selected PG&E Transmission Line Flows (MW)

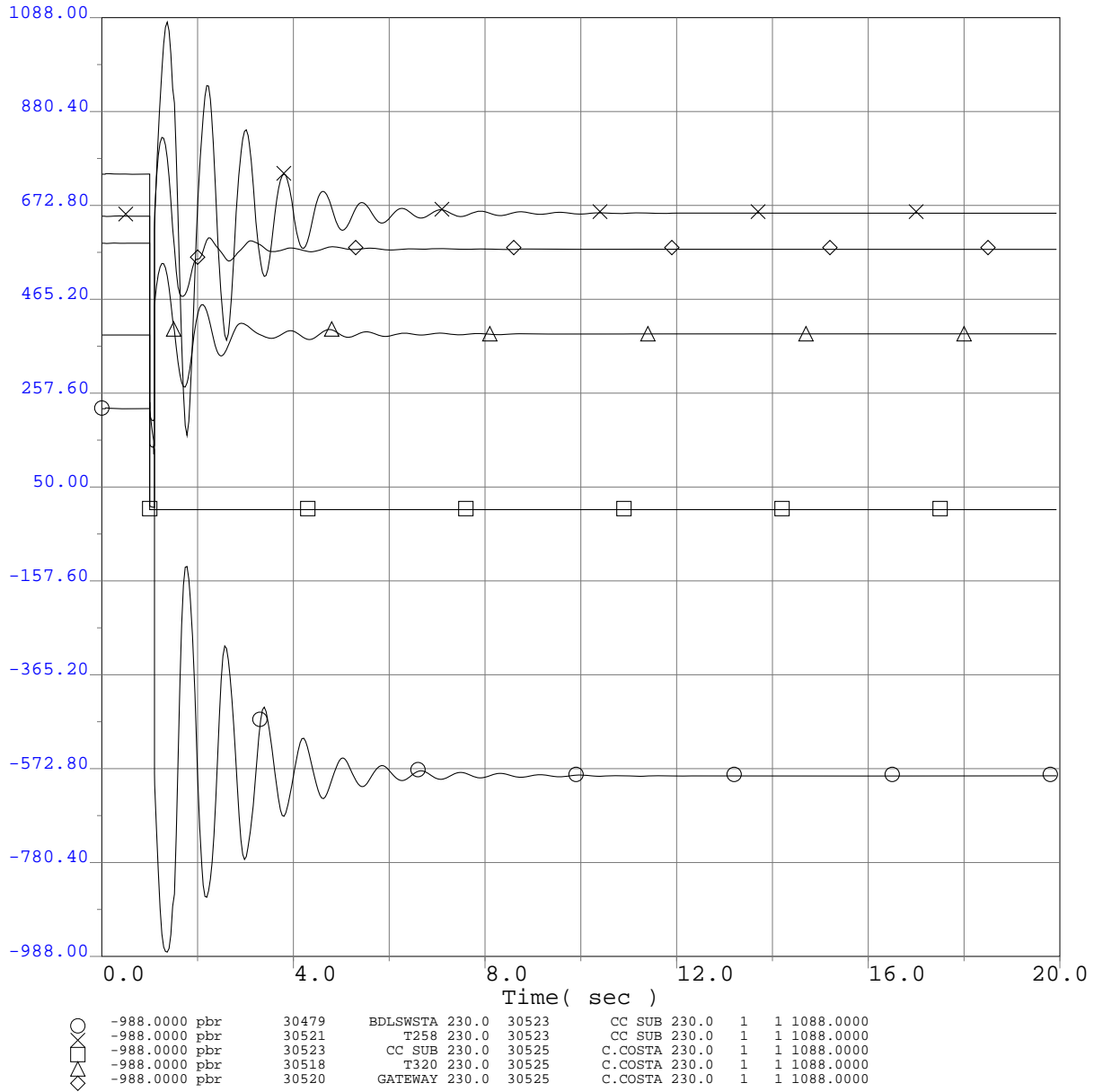

Q320 TCP2 ISIS
 2013 Greater Bay Area Summer Peak Base Case
 Q320 @ 772MW
 CC Sub 230kV Bus 2 Outage
 3-ph 6 cyc flt @ the CC Sub 230kV bus & clr the CC Sub 230kV Bus 2 Outage

Q320 TCP2 ISIS

Selected PG&E Transmission Line Flows (MW)

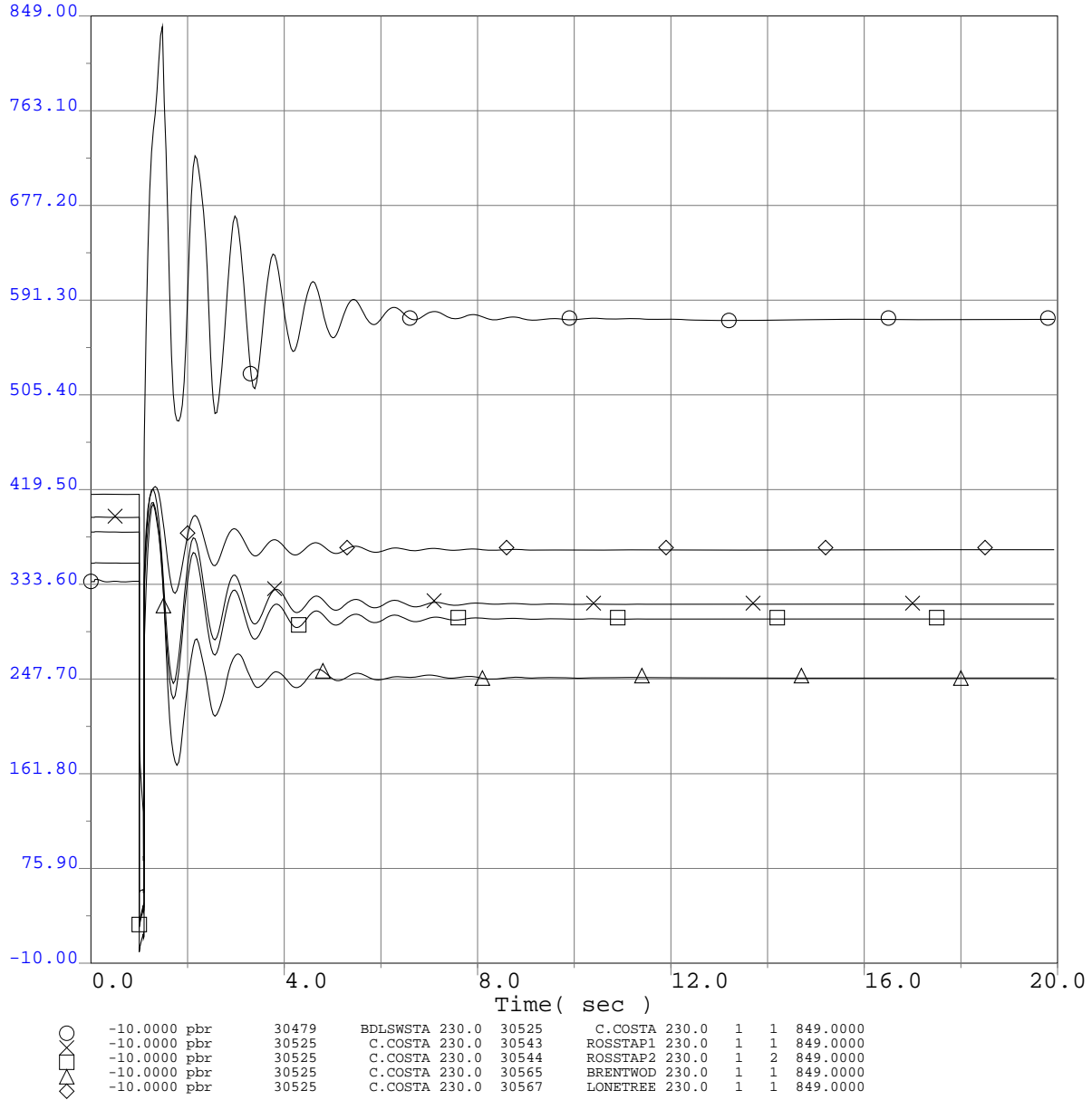

Q320 TCP2 ISIS
 2013 Greater Bay Area Summer Peak Base Case
 Q320 @ 772MW
 CC Sub 230kV Bus 2 Outage
 3-ph 6 cyc flt @ the CC Sub 230kV bus & clr the CC Sub 230kV Bus 2 Outage

Q320 TCP2 ISIS

Selected PG&E Transmission Line Flows (MW)

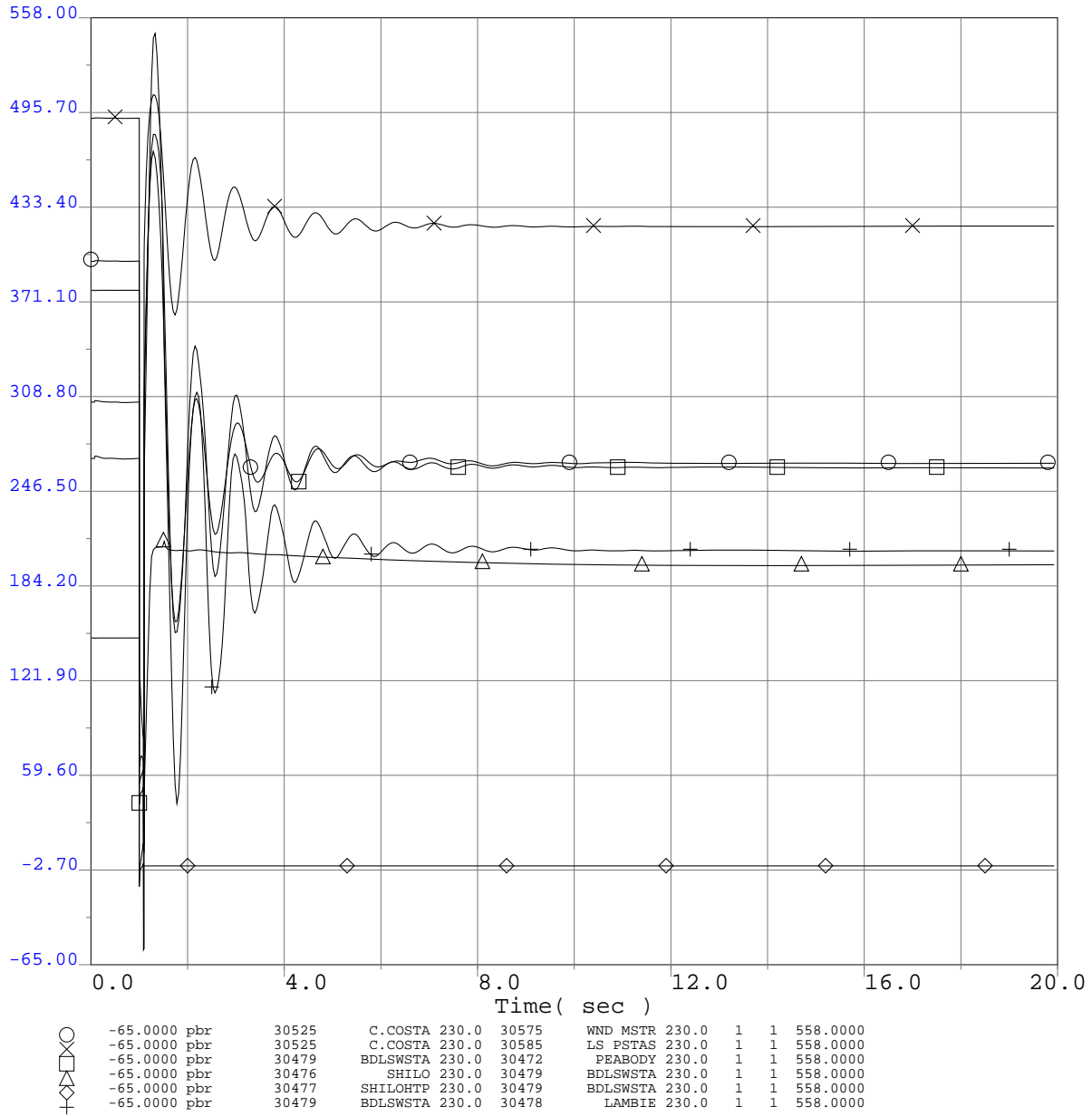

Q320 TCP2 ISIS
 2013 Greater Bay Area Summer Peak Base Case
 Q320 @ 772MW
 CC Sub 230kV Bus 2 Outage
 3-ph 6 cyc flt @ the CC Sub 230kV bus & clr the CC Sub 230kV Bus 2 Outage

Q320 TCP2 ISIS

Selected PG&E Transmission Line Flows (MW)

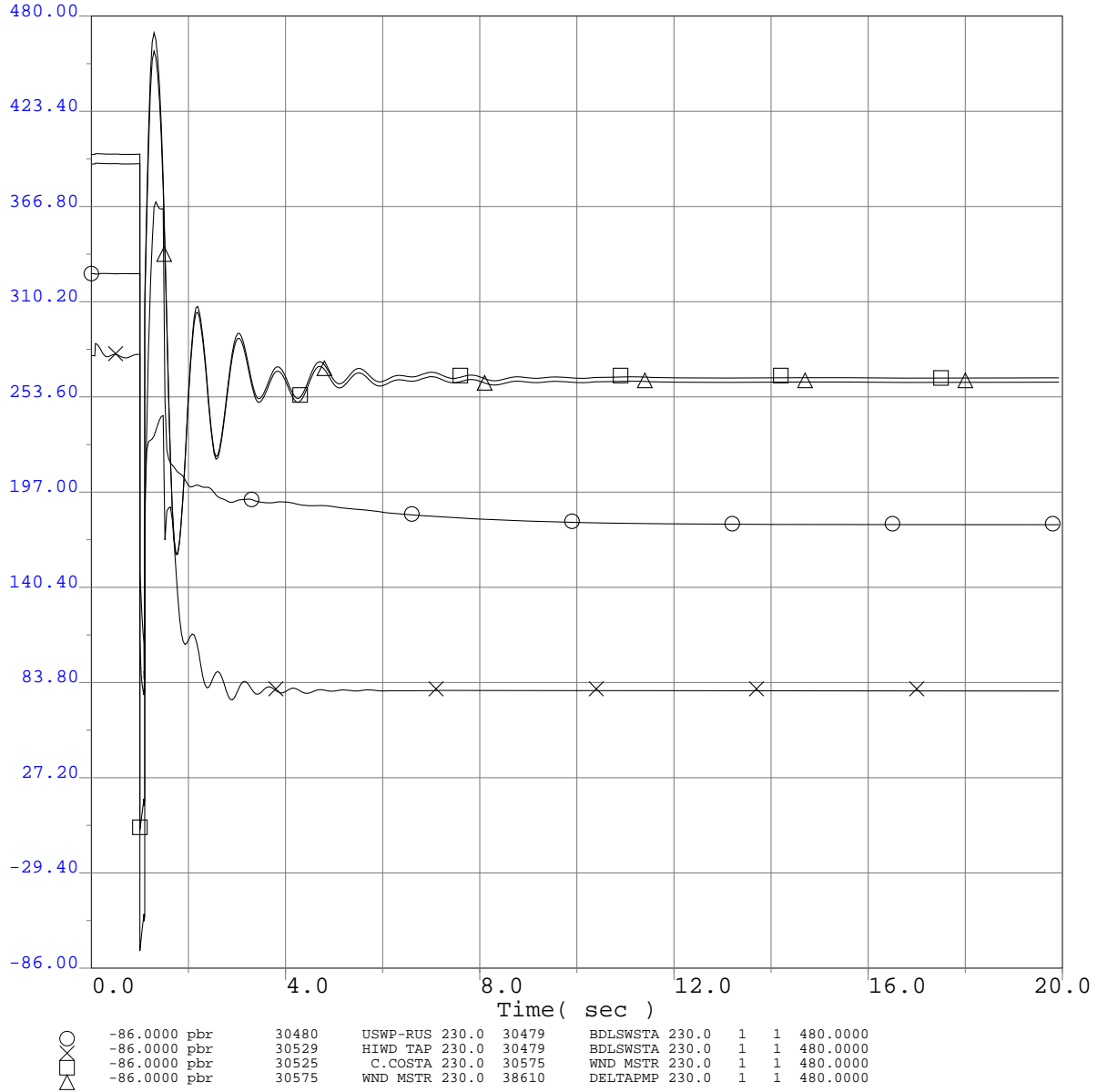

Q320 TCP2 ISIS
 2013 Greater Bay Area Summer Peak Base Case
 Q320 @ 772MW
 CC Sub 230kV Bus 2 Outage
 3-ph 6 cyc flt @ the CC Sub 230kV bus & clr the CC Sub 230kV Bus 2 Outage

Attachment 4

Short Circuit Calculation Study Results

BUS KV	BIRDSLANDING 230		COCO PP D&E 230		GATES 70		GATES 230		KELSO SUB 230		KINGSB CGN 115		LOS ESTEROS 115		PITTSBURG E2 230		TESLA BUS C 230	
	3LG(A)	1LG(A)	3LG(A)	1LG(A)	3LG(A)	1LG(A)	3LG(A)	1LG(A)	3LG(A)	1LG(A)	3LG(A)	1LG(A)	3LG(A)	1LG(A)	3LG(A)	1LG(A)	3LG(A)	1LG(A)
ALL ON	29,514	29,058	50,949	56,170	11,181	12,070	37,483	35,059	22,460	16,265	13,273	9,820	46,218	50,825	51,572	57,091	42,750	41,273

Bay Area																		
Q0320	28,607	28,435	46,601	50,068	11,181	12,070	37,481	35,058	22,326	16,218	13,273	9,820	46,171	50,789	51,488	57,024	42,646	41,210
Difference %	908	623	4,348	6,102	0	0	2	1	134	47	0	0	48	36	83	67	104	63
Decrease	-3.2%	-2.2%	-9.3%	-12.2%	0.0%	0.0%	0.0%	0.0%	-0.6%	-0.3%	0.0%	0.0%	-0.1%	-0.1%	-0.2%	-0.1%	-0.2%	-0.2%

Attachment 5			
Table 1: Transition Cluster Deliverability Study Results-- Greater Bay Area (Summer Peak)			
Overloaded Facility	Worst Contingency	Catg	Mitigation
30523 CC SUB 230.00 kV to 30525 C.COSTA 230.00 kV CCT 1	Trip the Line From: 30478 LAMBIE 230.0 kV To: 30479 BDLSWSTA 230.0 kV Ckt 1 Trip the Line From: 30472 PEABODY 230.0 kV To: 30479 BDLSWSTA 230.0 kV Ckt 1	C	SPS
30521 T258 230.00 kV to 30523 CC SUB 230.00 kV CCT 1	N/A	A	Reconductor this line This is a gen-tie
30518 T320 230.00 kV to 30525 C.COSTA 230.00 kV CCT 1	N/A	A	Reconductor this line This is a gen-tie
30479 BDLSWSTA 230.00 kV to 30525 C.COSTA 230.00 kV CCT 1	Trip the Line From: 30523 CC SUB 230.0 kV To: 30525 C.COSTA 230.0 kV Ckt 1 Remove unit 1 from bus 33118 GATEWAY1 18.0 160.0 MW dispatch Remove unit 1 from bus 33119 GATEWAY2 18.0 156.0 MW dispatch Remove unit 1 from bus 33120 GATEWAY3 18.0 156.0 MW dispatch	B	N/A
30525 C.COSTA 230.00 kV to 30575 WND MSTR 230.00 kV CCT 1	Trip the Line From: 30525 C.COSTA 230.0 kV To: 30585 LS PSTAS 230.0 kV Ckt 1 Trip the Line From: 30525 C.COSTA 230.0 kV To: 30567 LONETREE 230.0 kV Ckt 1	C	Reconductor this line
30575 WND MSTR 230.00 kV to 38610 DELTAPMP 230.00 kV CCT 1	Trip the Line From: 30525 C.COSTA 230.0 kV To: 30585 LS PSTAS 230.0 kV Ckt 1 Trip the Line From: 30525 C.COSTA 230.0 kV To: 30567 LONETREE 230.0 kV Ckt 1	C	Reconductor this line
30569 KELSO 230.00 kV to 30570 USWP-RLF 230.00 kV CCT 1	Trip the Line From: 30525 C.COSTA 230.0 kV To: 30585 LS PSTAS 230.0 kV Ckt 1 Trip the Line From: 30525 C.COSTA 230.0 kV To: 30567 LONETREE 230.0 kV Ckt 1	C	N/A
30570 USWP-RLF 230.00 kV to 30625 TESLA D 230.00 kV CCT 1	Trip the Line From: 30525 C.COSTA 230.0 kV To: 30585 LS PSTAS 230.0 kV Ckt 1 Trip the Line From: 30525 C.COSTA 230.0 kV To: 30567 LONETREE 230.0 kV Ckt 1	C	Reconductor this line
30585 LS PSTAS 230.00 kV to 30630 NEWARK D 230.00 kV CCT 1	Trip the Line From: 30525 C.COSTA 230.0 kV To: 30565 BRENTWOD 230.0 kV Ckt 1 Trip the Line From: 30525 C.COSTA 230.0 kV To: 30575 WND MSTR 230.0 kV Ckt 1 Trip the Line From: 30575 WND MSTR 230.0 kV To: 38610 DELTAPMP 230.0 kV Ckt 1 Trip the Bank From: 30575 WND MSTR 230.0 kV To: 33170 WINDMSTR 9.1 kV Ckt 1	C	Reconductor this line
Table 2: Transition Cluster Deliverability Study Results-- Greater Bay Area (Summer Off-Peak)			
	Normal	A	
31231 T250TAP1 115 kV to 31950 CORTINA 115 kV CCT1	line from SILVRDJ2 115.00 (3) to (1) SILVERDO 115.00 line from SILVRDJ2 115.00 (3) to (3) ER_FTNJT 115.00 line from SILVRDJ2 115.00 BRKR to BRKR STHELNJ2 115.00 line from ER_FTNJT 115.00 (3) to (2) ERFT5_25 115.00 line from ER_FTNJT 115.00 (3) to (3) RINCONJ2 115.00 line from ERFT5_25 115.00 (2) to BRKR EGLE RCK 115.00 line from RINCONJ2 115.00 (3) to BRKR FULTON 115.00 line from RINCONJ2 115.00 (3) to (1) RINCON 115.00 LOAD-DROP SILVERDO 115.00 LOAD==21.67(3.09) LOAD-DROP SILVERDO 115.00 LOAD==27.99(3.99) LOAD-DROP RINCON 115.00 LOAD==19.57(2.79) LOAD-DROP RINCON 115.00 LOAD==17.92(2.55) close Line from RINCONJ1 115.00 to RINCON 115.00 restore all loads to RINCON 115.00 (Eagle Rock-Fulton-Silverado 115 kV close Line from SILVRDJ1 115.00 to SILVERDO 115.00 restore all loads to SILVERDO 115.00 (Eagle Rock-Fulton-Silverado 115 kV	B	Reconductor this line

Attachment 7
Results of Operational Studies

**BEFORE THE ENERGY RESOURCES CONSERVATION AND DEVELOPMENT
COMMISSION OF THE STATE OF CALIFORNIA**

Application for Certification for the
Mirant Marsh Landing Generating Station Project

Docket No. 08-AFC-3

DECLARATION OF SERVICE

I, Lisa A. Cottle, declare that on August 10, 2010, I served and filed copies of the attached ***CAISO Transition Cluster Phase II Interconnection Study Report (Docket No. 08-AFC-3)***. The original document filed with the Docket Unit is accompanied by a copy of the most recent Proof of Service list, located at the web page for this project at **<http://www.energy.ca.gov/sitingcases/marshlanding/index.html>**. The document has been sent to both the other parties in this proceeding (as shown on the Proof of Service list) and to the Commission's Docket Unit, in the following manner:

- For service to all other parties: Sent electronically to all email addresses on the Proof of Service list;

AND

- For filing with the Energy Commission: Sent an original paper copy and one electronic copy, via overnight delivery and emailed respectively, to the address below:

CALIFORNIA ENERGY COMMISSION

Attn: Docket No. 08-AFC-3
1516 Ninth Street, MS-4
Sacramento, CA 95814-5512
docket@energy.state.ca.us

I declare under penalty of perjury that the foregoing is true and correct.



Lisa A. Cottle



BEFORE THE ENERGY RESOURCES CONSERVATION AND DEVELOPMENT
COMMISSION OF THE STATE OF CALIFORNIA
1516 NINTH STREET, SACRAMENTO, CA 95814
1-800-822-6228 – WWW.ENERGY.CA.GOV

**APPLICATION FOR CERTIFICATION
FOR THE MARSH LANDING
GENERATING STATION**

Docket No. 08-AFC-3

**PROOF OF SERVICE
(Revised 7/14/2010)**

APPLICANT

Chuck Hicklin, Project Manager
Mirant Corporation
P.O. Box 192
Pittsburg, CA 94565
E-mail preferred
chuck.hicklin@mirant.com

Jonathan Sacks, Project Director
Steven Nickerson
Mirant Corporation
1155 Perimeter Center West
Atlanta, GA, 30338
E-mail preferred
jon.sacks@mirant.com
steve.nickerson@mirant.com

CONSULTANTS

Anne Connell
Dale Shileikis
URS Corporation
Post Montgomery Center
One Montgomery Street, Suite 900
San Francisco, CA 94104-4538
E-mail preferred
Anne_Connell@URSCorp.com
Dale_shileikis@URSCorp.com

COUNSEL FOR APPLICANT

Lisa Cottle
Takako Morita
Winston & Strawn LLP
101 California Street
San Francisco, CA 94111-5802
E-mail preferred
lcottle@winston.com
tmorita@winston.com

INTERESTED AGENCIES

California ISO
E-mail Preferred
e-recipient@caiso.com

INTERVENORS

*California Unions for Reliable
Energy ("CURE")
Marc D. Joseph
Adams Broadwell Joseph & Cardozo
601 Gateway Boulevard, Suite 1000
South San Francisco, California
94080
gsmith@adamsbroadwell.com
mdjoseph@adamsbroadwell.com

ENERGY COMMISSION

JAMES D. BOYD
Vice Chair & Presiding Member
jboyd@energy.state.ca.us

KAREN DOUGLAS
Chair & Associate Member
kldougla@energy.state.ca.us

Paul Kramer
Hearing Officer
pkramer@energy.state.ca.us

Mike Monasmi
Project Manager
mmonasmi@energy.state.ca.us

Kerry Willis
Staff Counsel
kwillis@energy.state.ca.us

Jennifer Jennings
Public Adviser
publicadviser@energy.state.ca.us