



1615 Murray Canyon Road, Suite 1000  
San Diego, CA 92108  
Phone: (619) 294-9400  
Fax: (619) 293-7920

---

**LETTER OF TRANSMITTAL**

**TO:** Docket Unit

**DATE:** January 8, 2010

**PROJECT:** SES Solar One

<b>DOCKET</b>	
<b>08-AFC-13</b>	
DATE	JAN 08 2010
RECD.	JAN 08 2010

---

**Enclosed/Attached please find the following:**

- The Applicant's Submittal of CAISO Reports
- The Applicant's Submittal of the Corridor Conflict Analysis
- The Applicant's Submittal of the Geotechnical Engineering Report
- The Applicant's Submittal of Responses to the CURE letter dated 12/28/2009

---

**For:**  Review and Comment  As Requested  
 Signature and Return  For Your Use  
 Appropriate Action

---

**Remarks:**

The materials included in this submittal are listed below:

- 12 hard copies of the Applicant's Submittal of the CAISO Reports
- 1 hard copy of the Applicant's Submittal of Responses to the CURE letter dated 12/28/2009

If you have any questions or need any further information, please feel free to call. Thank you!

---

Kindly,

Corinne Lytle  
Assistant Project Manager



January 6, 2010

Mr. Christopher Meyer  
CEC Project Manager  
Attn: Docket No. 08-AFC-13  
California Energy Commission  
1516 Ninth Street  
Sacramento, CA 95814-5512

Mr. Jim Stobaugh  
BLM Project Manager  
Attn: Docket No. 08-AFC-13  
Bureau of Land Management  
P.O. Box 12000  
Reno, NV 89520

RE: SES Solar One Project  
Applicant's Submittal of CAISO Reports

Dear Mr. Meyer and Mr. Stobaugh,

Tessera Solar hereby submits California Independent System Operator (CAISO) reports for the Solar One Project in response to CURE's request. Contained in this document are the LGIP Optional Interconnection Study Report, dated January 9, 2008, the Final Interconnection Facilities Study Report, dated November 6, 2008, Technical Assessment II (provided as Exhibit B to the Final Interconnection Facilities Study Report), and the Interconnection Optional Study, dated October 12, 2009. I certify under penalty of perjury that the foregoing is true, correct, and complete to the best of my knowledge.

Sincerely,

Felicia L. Bellows  
Vice President of Development

---

# LGIP Optional Interconnection Study Report

---

SES Solar One Project

LGIP Optional Interconnection Study: 275 MW On-Line by 2010



California ISO  
Your Link to Power

January 9, 2008

**This study has been completed in coordination with Southern California Edison (SCE) per the Large Generator Interconnection Procedures (LGIP). Jorge Chacon with SCE and Donna Jordan with CAISO worked on this coordinated effort.**

## TABLE OF CONTENTS

I.	EXECUTIVE SUMMARY	1
II.	SES SOLAR ONE PROJECT DESCRIPTION	3
III.	ASSUMPTIONS	7
IV.	STUDY RESULTS	8
V.	REQUIRED FACILITIES FOR “EARLY” INTERCONNECTION	12
VI.	ORDER OF MAGNITUDE COST ESTIMATES	13

### **FIGURES AND TABLES**

FIGURE 1-1	BULK TRANSMISSION SYSTEM ONE-LINE DIAGRAM	4
FIGURE 1-2	230 kV COLLECTOR SUBSTATION ONE-LINE DIAGRAM	5
FIGURE 1-3	34.5 kV DISTRIBUTION FEEDER ONE-LINE DIAGRAM	6
FIGURE 1-4	1.25 MW SOLAR CLUSTERS	6
FIGURE 2-1	ESTIMATED LUGO-PISGAH NO.1 230 kV POWER FLOW	8
FIGURE 2-2	ESTIMATED LUGO 500/230 kV TRANSFORMER FLOWS	9
FIGURE 2-3	ESTIMATED LUGO-PISGAH N-1 230 kV POWER FLOW	10
FIGURE 2-2	ESTIMATED LUGO 500/230 kV T-1 TRANSFORMER FLOW	10
TABLE 2-1	THREE-PHASE-TO-GROUND SHORT-CIRCUIT DUTY	11
TABLE 2-2	SINGLE-PHASE-TO-GROUND SHORT-CIRCUIT DUTY	11
TABLE 2-3	ORDER OF MAGNITUDE COST ESTIMATES	14

## I. EXECUTIVE SUMMARY

Southern California Edison Company (SCE) performed a System Impact Study for the SES Solar One 850 MW project as requested by Stirling Energy Systems (SES), Inc. The study report, dated March 7, 2006, identified the impacts associated with the interconnection of the new 850 megawatt (MW) solar generation project (Project) and determined that a number of facility upgrades will be required to interconnect the Project's 850MW output to the SCE's Pisgah Substation. In addition, SCE performed a separate Technical Assessment as part of the SES' Facilities Study work scope to evaluate transient stability performance associated with the new dynamic models prepared for the Project.<sup>1</sup> Congestion management was recommended to mitigate increases to the South of Lugo transmission until the completion of the currently planned Mira Loma-Vincent 500 kV transmission line (Segments 6, 7, and 8 of SCE's Tehachapi Renewable Transmission Project). The Technical Assessment report further determined that use of the revised dynamic model representation resulted in acceptable system performance under faulted system conditions and did not change the short-circuit duty contributions identified in the System Impact Study. Consequently, it was determined that the Project's 850MW output could be interconnected with the implementation of the System Impact Study recommended facility upgrades. Specific conceptual upgrades identified for the Project include expansion of the existing Pisgah Substation to become a Pisgah 500 kV substation, 500 kV transmission upgrades between the Lugo and Pisgah substations including a new Lugo-Pisgah 500 kV transmission line, and corresponding telecommunication upgrades associated with the complete 850MW plan of service required to support transmission line protection and the use of a special protection system.<sup>2</sup>

Because of the lead times associated with permitting and constructing new 500 kV transmission facilities, SES requested SCE to evaluate the possibility of interconnecting a portion of the Project in advance of constructing the required transmission upgrades to support the Project's 850MW output. SES provided to SCE a proposed phased construction schedule. Based on this schedule, the interconnection facilities would need to be in-service by the end of 2009 to meet the requested in-service date for interconnecting the first 115 MW of the Project. This optional study evaluated system performance for delivering up to 275 MW by the end of 2010, as requested by SES. The results of this optional study identified that the 275 MW can be accommodated with the expansion of the Pisgah 230 kV switchyard, the implementation of a special protection system (SPS) to trip the 275 MW under specific outage conditions. Substantial telecommunication facilities will be needed to support both the system protection and the required SPS for loss of a Lugo 500/230 kV transformer bank, loss of a Lugo-Pisgah 230 kV transmission line, or loss of both Lugo-Pisgah 230 kV transmission lines.

---

<sup>1</sup> A restudy of SES' System Impact Study is currently underway to address higher queued project withdrawals and to incorporate SES' revised project data. The revised SIS results will be incorporated within SES' Facilities Study.

<sup>2</sup> The proposed conceptual results for SES' System Impact Study are under review as part of the SIS restudy currently in progress.

Although a temporary plan of service could be accommodated via construction of the facilities listed above, it is important to note several complexities associated with meeting the requested in-service date. These complexities include the following:

1. SES' capacity request of 275MW requires the expansion of SCE's Pisgah 230kV Substation (Substation) beyond its existing property boundary, which would require an environmental assessment. In addition, the proposed telecommunication facilities could also be subject to an environmental assessment if additional modifications to the existing tower structures or new facilities are required to support the telecommunication requirements. Thus, an environmental assessment would likely need to be performed for the proposed expansion of the Pisgah Substation and the installation of OPGW.
2. The Pisgah Substation expansion and corresponding telecommunication facilities required for the interconnection of up to 275 MW are also part of the proposed plan of service for the Project's 850MW capacity request. Therefore, pursuant to the California Environmental Quality Act (CEQA), the substation expansion and corresponding telecommunication upgrades would be viewed as part and parcel of the overall project (i.e., the transmission upgrades required for the 850MW plan of service) and cannot be divided into separate environmental assessments.
3. Based upon preliminary estimates, it would require approximately two years to construct and procure all necessary telecommunication and substation expansion facilities to support early interconnection after receipt of all required regulatory approvals.<sup>3</sup>
4. To support the required Special Protection System the two following telecommunication facilities will be required:
  - a. Replacement of a portion of existing Eldorado-Lugo 500 kV OHGW with new OPGW between the Lugo and Pisgah Substations

Replacement of a portion of existing overhead ground wire with optical ground wire on the existing Eldorado-Lugo 500 kV transmission line between the Lugo and Pisgah Substations can be accommodated but would require some tower reinforcements. Detailed engineering review will be needed to ascertain exact number of tower reinforcements required. This option is also subject to SCE's ability to secure the long-term outage of the Eldorado-Lugo 500 kV transmission line from the CAISO in order to reinforce necessary towers and replace existing OHGW with OPGW.

- b. Installment of new Fiber Cable coupled with use of existing Microwave

New fiber-optic cable facilities between the Pisgah Substation and the Cool Water Substation facilities can be accommodated by utilizing approximately 20-miles of existing distribution facilities. This alternative would require conduits at each of

---

<sup>3</sup> Construction estimates provided within this report should be viewed as preliminary and subject to confirmation of final proposed man-hour requirements.

the respective substations (Pisgah, Cady, Gale, and Cool Water) to bring the fiber-optic from the closest power pole of each of the distribution lines into the substation. To complete telecommunication circuitry back to Lugo, existing SCE microwave can be used at the Cool Water Substation.

The purpose of this optional study was not to examine the viability of meeting the requested in-service date but rather to determine if the system could accommodate such a request assuming the in-service date could be met. Additional engineering review will be required to develop a suitable schedule and establish appropriate in-service dates for the proposed set of transmission facilities needed to facilitate the interconnection of the partial project (275 MW) as requested by SES in this Optional Study. Such review would need to be addressed under a separate engineering and design agreement if requested by SES.

## **II. SES SOLAR ONE PROJECT DESCRIPTION**

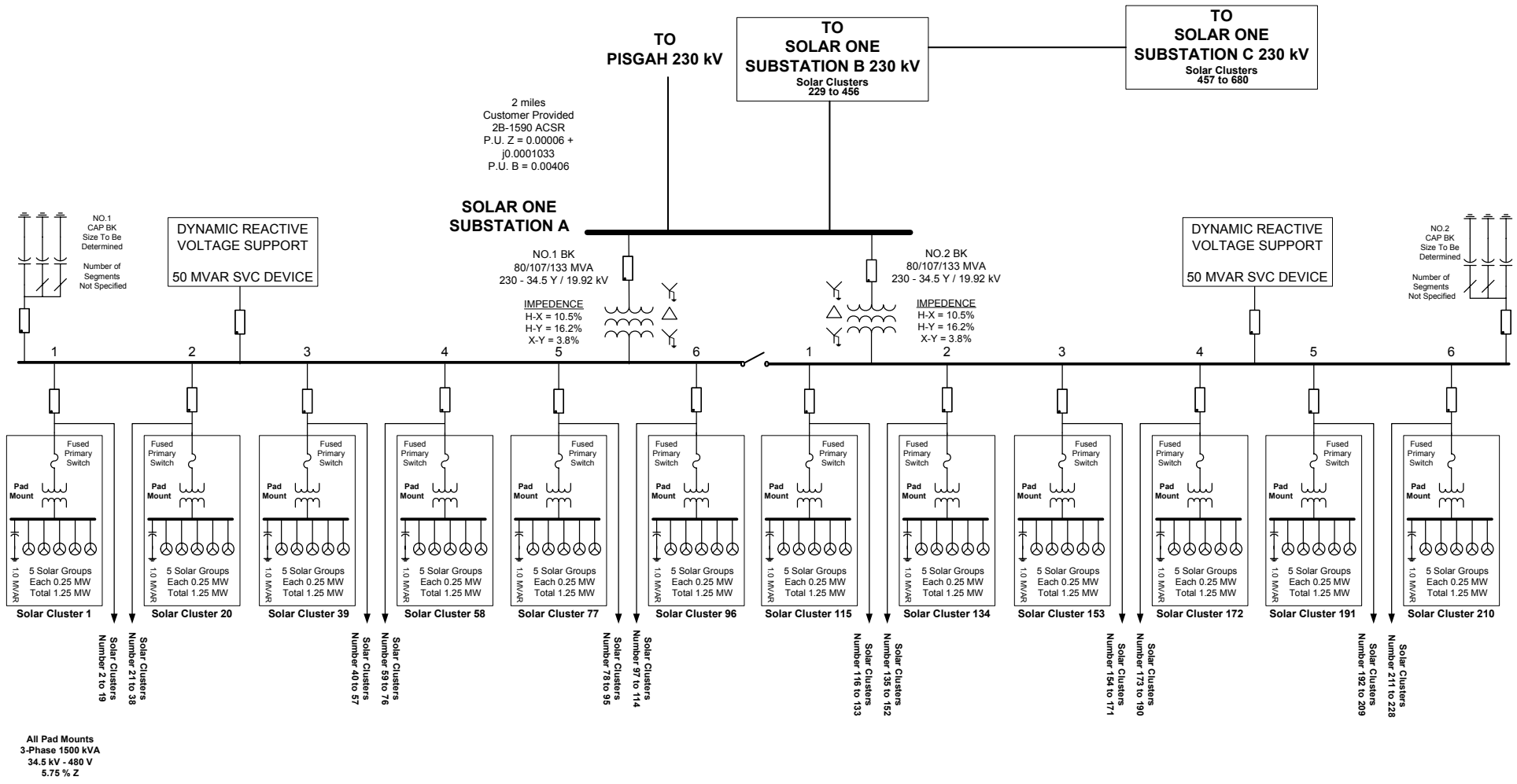
As represented within the System Impact Study report, the initial design of the proposed Project consisted of approximately 34,000 solar dish Stirling systems grouped into 680 1.25 MW arrays and spread throughout an estimated nine square-miles. Based upon the information provided by SES for incorporation within this Optional Study Report, the Project is to be located approximately two miles north of the existing Pisgah Substation and is proposed to be constructed over a period of four to five years beginning in 2009. The existing Pisgah Substation is a 230 kV switching station connecting two 230 kV transmission lines from Eldorado and two 230 kV transmission lines from Lugo. To connect the Project to the existing Pisgah Substation, the developer originally proposed to construct one new 230 kV generation dedicated radial transmission line (gen-tie) with three solar generation collector substations as shown below in Figure 1-1.

Each of the three substations was to include two 230/34.5 kV transformers with twelve distribution feeders, six per transformer bank as shown below in Figure 1-2. Connected to each 34.5 kV distribution feeder are nineteen 1.25 MW solar groups made of five 25 kW induction generator Stirling dish systems or a total of 23.75 MW as shown in Figure 1-3 and Figure 1-4. This data was provided by SES as part of the initial 850 MW project application and is included in Appendix A. Recently, SES identified several changes to the proposed Project. These modifications will not change the results of this Optional Study since the facilities studied under the Optional Study are basically the same prior to the data modification. As far as changes associated with full development of the 850 MW Project, a material modification review was undertaken and a conclusion was made that the modifications proposed by SES did not rise to the level of significant and thus no additional impacts are anticipated. At this time, a restudy of the SIS is currently underway due to queued ahead project withdrawal and is being performed with the revised project configuration consistent with data provided by SES.

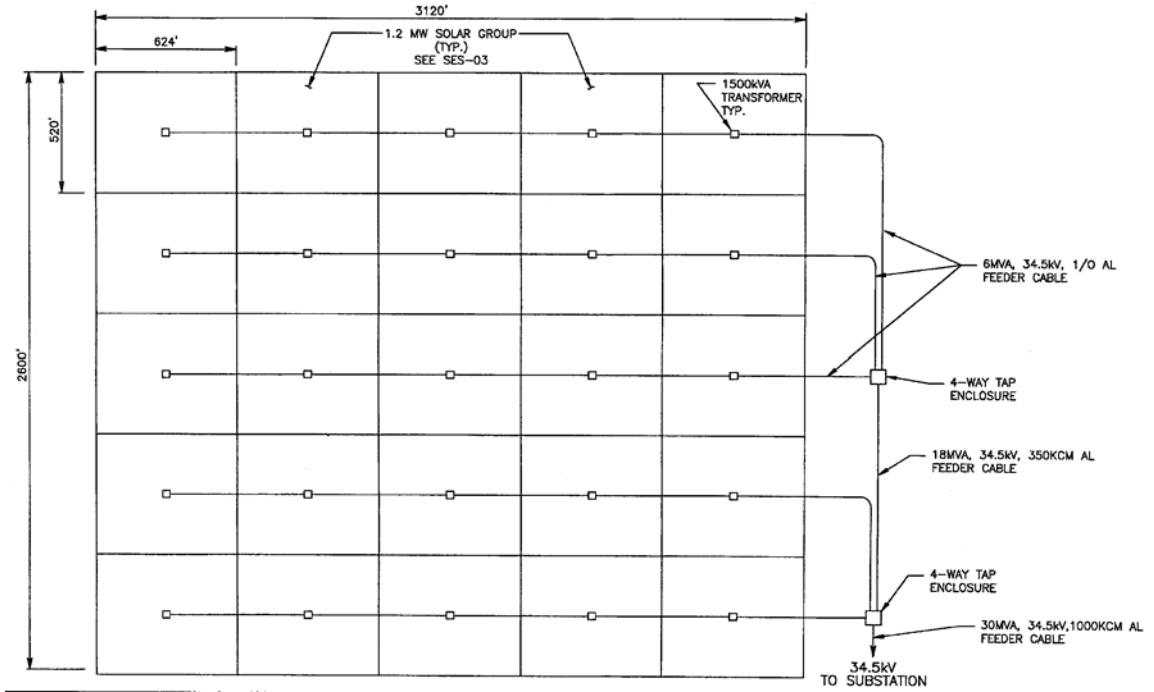




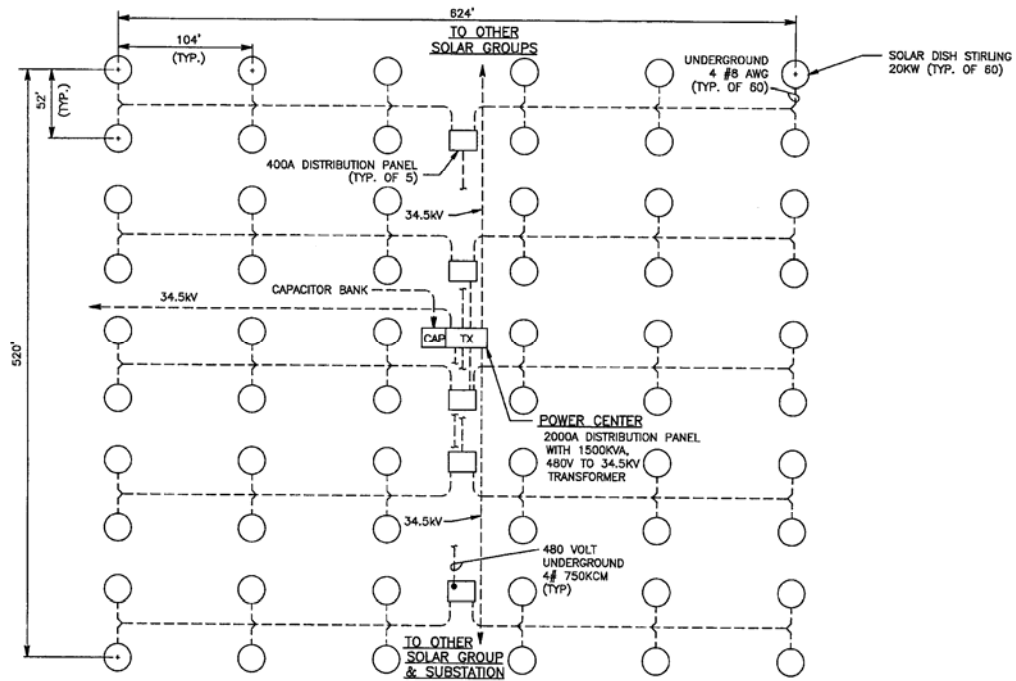
**FIGURE 1-2**  
**SES SOLAR ONE PROJECT**  
**230 kV COLLECTOR SUBSTATION ONE-LINE DIAGRAM**



**FIGURE 1-3  
SES SOLAR ONE PROJECT  
34.5 kV DISTRIBUTION FEEDER ONE-LINE DIAGRAM**



**FIGURE 1-4  
SES SOLAR ONE PROJECT  
1.25 MW SOLAR CLUSTERS**



### III. ASSUMPTIONS

#### Gen-Tie Facilities Modeled

For the purpose of conducting this Optional Study, the Project was assumed to be phased-in over a period of time (275 MW by 2010) as requested by the developer. The modeling of the 275 MW by 2010 was done by assuming the initial construction of gen-tie facilities were limited to those associated with the first of three SES 230 kV Substation collector sites, illustrated in Figure 1-2 as Substation A, and the one-mile 230 kV transmission line into the existing Substation. Within the construction of 275 MW of the total 285 MW identified for Substation A, the gen-tie facilities modeled included power factor correction at the 34.5 kV substation voltage level, two 50 MVAR Static VAR Compensators (one for each transformer bank, and one 60 MVAR 230 kV capacitor bank. These facilities are consistent with those identified in the System Impact and Technical Studies for each of the three SES Solar substation locations. The purpose of these facilities was identified to allow the project to meet both the power factor correction and under-voltage ride-through requirements.

#### System Conditions

Power flow studies for this Optional Study reflect system conditions that are anticipated for the test year of 2010. These conditions included increased West-of-River WECC Path flows with the addition of the new Devers-Palo Verde No.2 500 kV transmission line, which was planned to be in-service by 2010 but may be delayed. Because the transmission lines from Eldorado to Lugo are part of the West-of-River WECC Path, flows on the two Lugo-Pisgah 230 kV transmission lines are expected to slightly increase with the addition of the Devers-Palo Verde No.2 500 kV transmission line. Consequently, modeling this line in-service would yield more conservative results.

Heavy Summer and Light Spring power flow cases were examined to determine if the 275 MW partial project development could be accommodated in advance of the 500 kV transmission facilities required to integrate the full 850 MW. In addition, several sensitivity studies were conducted to examine maximum loading conditions on the critical transmission facilities. These sensitivity studies included scenarios consistent with those examined for the Devers-Palo Verde No. 2 Transmission Project (i.e. East-of-River set to 10,000 MW and West-of-River set to 11,000 MW).

#### Historical Data Review

Year 2006 historical metered data was reviewed and adjusted to reflect expected increases on the critical transmission facilities that would limit the amount of Project that could be interconnected in advance of constructing the permanent transmission facilities. These facilities include the two existing Lugo-Pisgah 230 kV transmission lines, each rated at 289 MVA and can load up to approximately 275 MW due to reactive losses, and two existing Lugo 500/230 kV transformer banks, each rated at 1120 MVA and can load up to approximately 1,000 MW due to reactive losses. Based on review of several power flow studies performed for the DPV2 project, flows on each of the two Lugo-Pisgah 220 kV transmission lines was found to increase anywhere from

5% to 10%. For purposes of this study, SCE utilized the conservative value of 10% when examining historical metered data. The purpose of reviewing and utilizing historical data was as a means of validating power flow study assumptions.

#### IV. STUDY RESULTS

##### Power Flow Study

No base case overloads were identified on the critical transmission facilities that would limit the amount of SES’s requested 275 MW that could be interconnected in advance of constructing the transmission facilities identified in the System Impact Study. Expected power flow on these critical facilities, the Lugo-Pisgah 220 kV transmission lines and Lugo 500/230 kV transformer banks, are shown below in Figure 2-1 and Figure 2-2. However, the added generation will result in increasing power flow on an already constrained portion of the SCE Bulk Power System - the south of Lugo transmission corridor. This condition was also identified in the System Impact Study (pages 24-25, 33) and the recommendation was made to utilize congestion management protocols, subject to CAISO concurrence, to limit south of Lugo power flow to within the limits of the existing transmission (page 34). SCE continues to recommend the use of congestion management protocols, subject to CAISO concurrence, for mitigating increased power flow on transmission south of Lugo.

Figure 2-1  
 Estimated Lugo-Pisgah No.1 230 kV Power Flows  
 Under Base Case Conditions Based on 2006 Historical Data  
 (Similar Flows on Lugo-Pisgah No.2 230 kV)

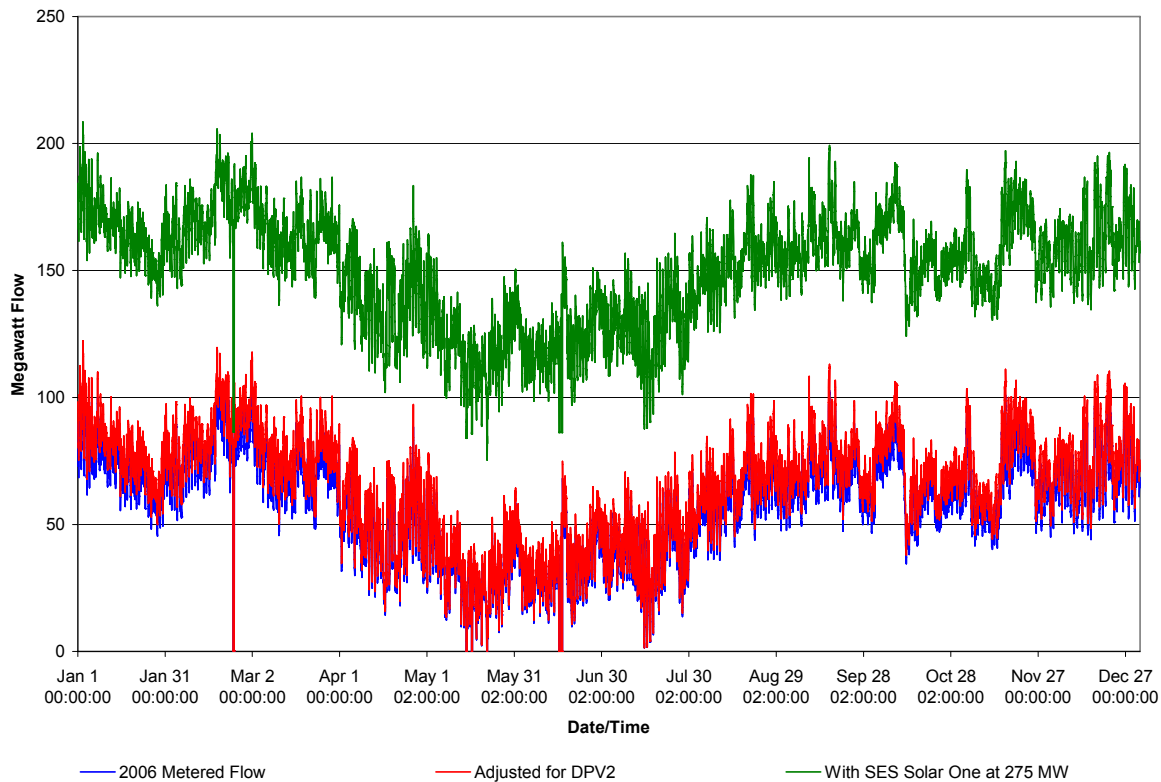
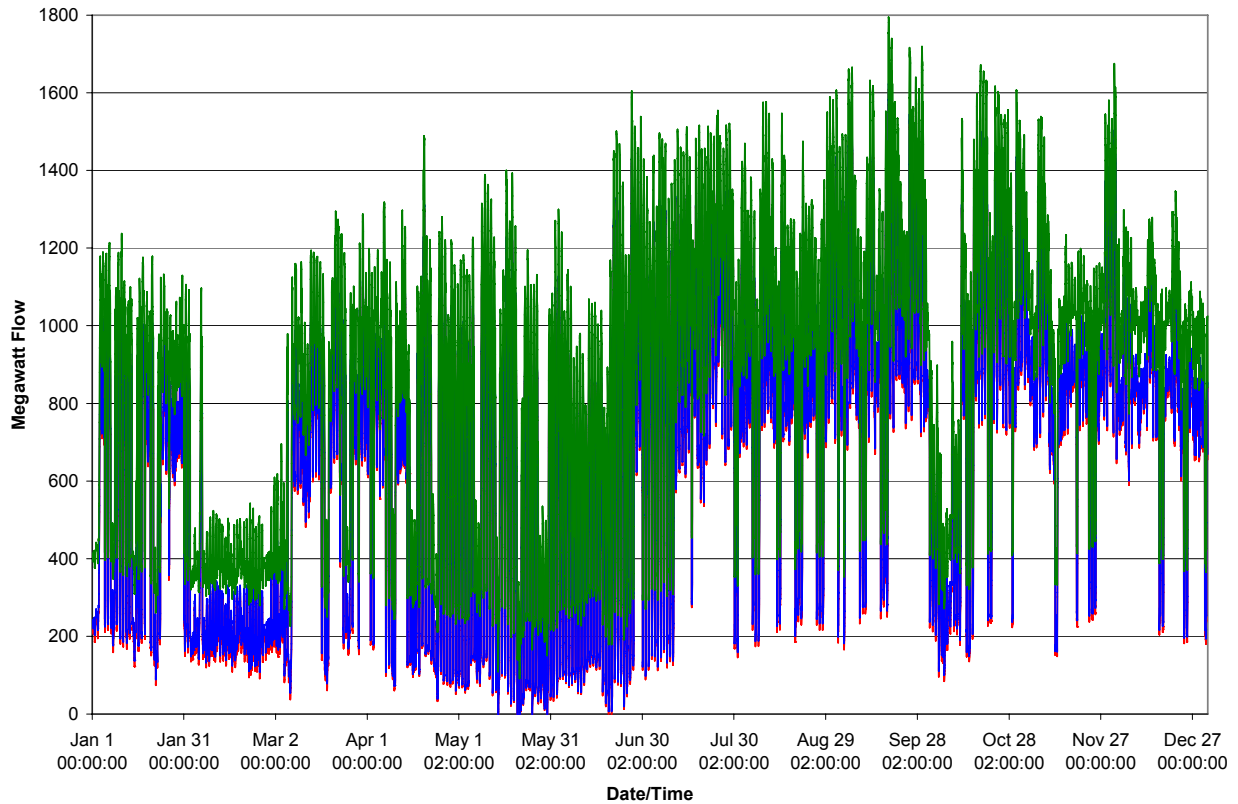


Figure 2-2  
 Estimated Lugo 500/230 kV No.1 and No.2 Transformer Bank Power Flows  
 Under Base Case Conditions Based on 2006 Historical Data



As far as outage conditions, the study determined that the requested interconnection of the partial Project (275 MW) requires the implementation of a special protection system. This requirement is to mitigate thermal overload on both the Lugo-Pisgah 230 kV transmission lines and Lugo substation transformer banks. Such condition was also previously identified in the System Impact Study, where a determination was made that a special protection system (SPS) would be required to mitigate thermal overloads under loss of one Lugo 500/230 kV transformer bank (page 26 of SIS). Under loss of one Lugo-Pisgah 230 kV transmission line, loading on the remaining transmission line is expected to increase from approximately 65% up to 115% of maximum allowable limits. Under loss of one Lugo 500/230 kV transformer bank, loading on the remaining transformer bank is expected to increase from 160% up to 185% of normal limits. Today, an existing SPS protects for loss of one Lugo 500/230 kV transformer bank by tripping the High Desert Power Project. Because the addition of new generation resources located north or east of the Lugo Substation on the 230 kV side of the transformer significantly increases both the frequency and magnitude of the arming thresholds, any new generation projects added that aggravate this existing condition will need to be added to the SPS. This includes the 275 MW partial development of the Solar One Project. The expected power flow on the overloaded facilities, the Lugo-Pisgah 220 kV transmission lines and Lugo 500/230 kV transformer banks, are shown below in Figure 2-3 and Figure 2-4.

Figure 2-3  
 Estimated Lugo-Pisgah 230 kV Power Flows  
 Under Loss of Other Lugo-Pisgah 230 kV Line  
 (Based on 2006 Historical Data)

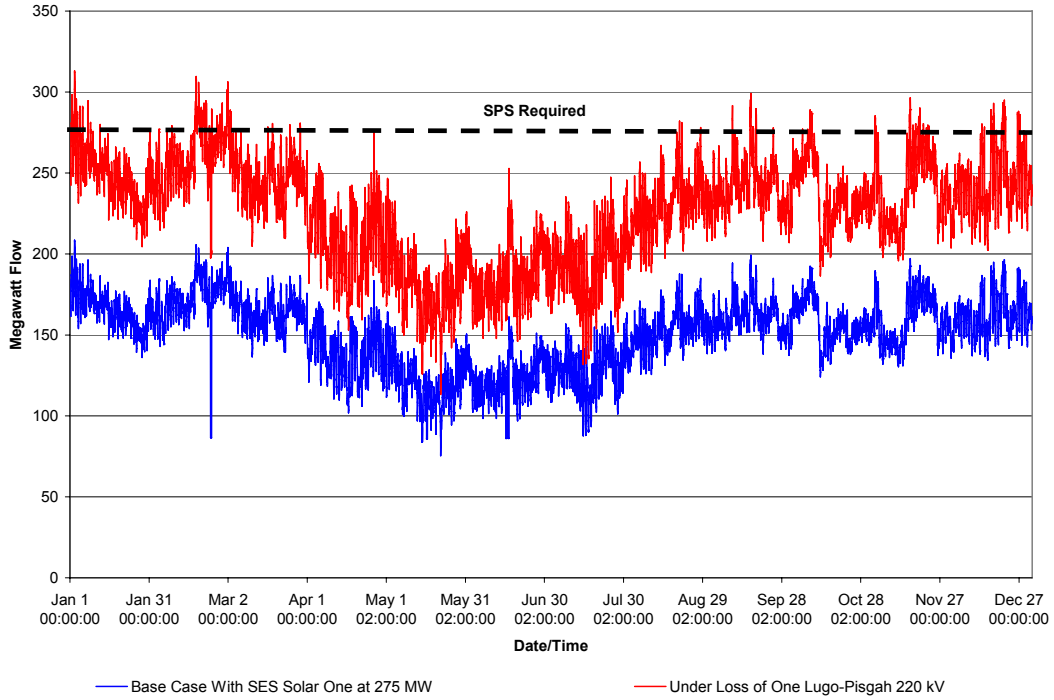
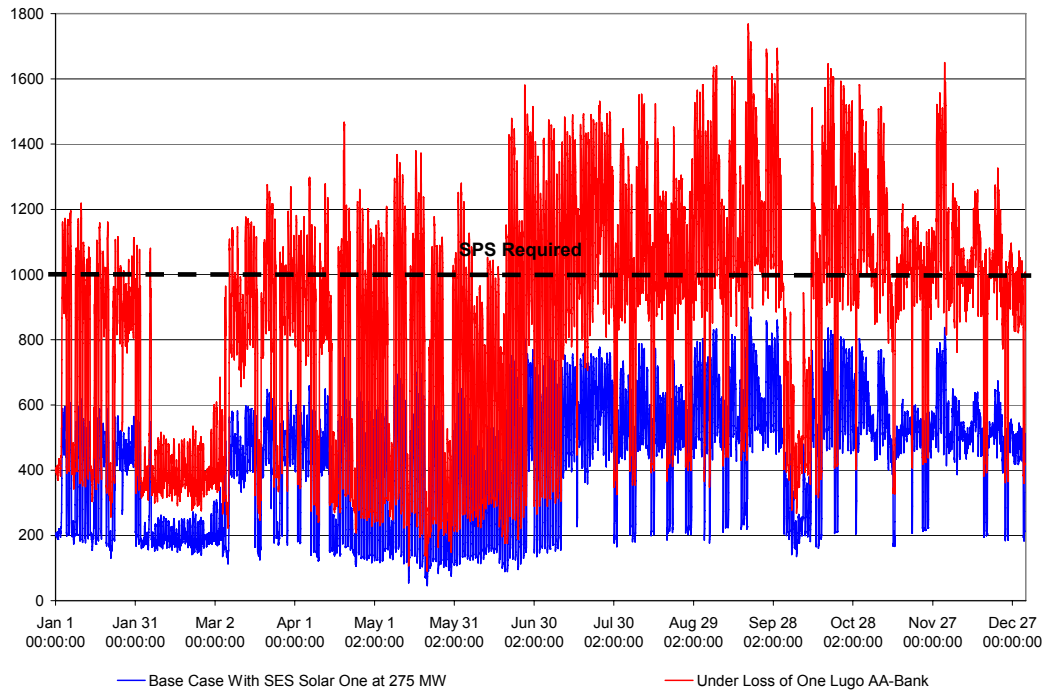


Figure 2-4  
 Estimated Lugo 500/230 kV Transformer Bank Power Flows  
 Under Loss of Other Lugo 500/230 kV Transformer  
 (Based on 2006 Historical Data)



## Short-Circuit Duty

The short-circuit duty study was performed based on the customer proposed operational date of 2010. As shown below in Table 2-1, the three-phase-to-ground short-circuit duty study identified two 500 kV, five 230 kV, and one 115 kV substation locations that require specific breaker evaluation for replacement. Shown below in Table 2-2, the single-phase-to-ground short-circuit duty study identified one 500 kV and six 230 kV substation locations that require specific breaker evaluation for replacement. These locations were flagged based on the review criteria of the project increasing short-circuit duty by more than 0.1 kA at locations where duty is in excess of 60% of the minimum circuit breaker rating.

Table 2-1  
Three-Phase-to-Ground Short-Circuit Duty Results

Bus Name	Bus KV	PRE CASE		POST CASE		DELTA KA
		X/R	KA	X/R	KA	
Eldorado	500	19.3	40.5	19.3	40.6	0.1
Lugo	500	22.3	46.3	22.4	46.4	0.1
Eldorado	230	19.8	55.7	19.8	55.9	0.2
Etiwanda	230	26.6	59.0	26.6	59.1	0.1
Lugo	230	28.7	40.1	28.6	40.5	0.4
Victor	230	18.3	27.8	18.2	27.9	0.1
Walnut	230	16.8	35.9	16.8	36.0	0.1
Victor	115	18.2	18.0	18.2	18.1	0.1

Table 2-2  
Single-Phase-to-Ground Short-Circuit Duty Results

Bus Name	Bus KV	PRE CASE		POST CASE		DELTA KA
		X/R	KA	X/R	KA	
Lugo	500	11.7	36.2	11.7	36.3	0.1
Eldorado	230	15.1	50.8	15.1	50.9	0.1
Lugo	230	22.3	40.1	22.1	40.5	0.4
Mira Loma A	230	12.7	54.8	12.7	54.9	0.1
Sylmar (SCE)	230	12.7	64.3	12.7	64.4	0.1
Victor	230	13.5	24.8	13.5	24.9	0.1
Vincent A	230	16.3	55.4	16.3	55.5	0.1

Breaker evaluation at all these locations identified the need for 17 circuit breaker upgrades and three circuit breaker replacement all at the Etiwanda 230 kV Substation. All of these breaker replacements and breaker upgrades were triggered by a project queued ahead of the SES Project.

## **V. REQUIRED FACILITIES FOR SES' PROPOSED 275MW INTERCONNECTION IDENTIFIED IN THE OPTIONAL STUDY**

The Optional Study results discussed above indicate that the requested 275 MW output of the Project's proposed 850 MW could be interconnected with a subset of the facility upgrades identified in the System Impact Study performed for the 850 MW Project. This subset involves the expansion of the Pisgah 230 kV switchyard, the implementation of a special protection system (SPS) to trip the 275 MW under the loss of a Lugo 500/230 kV transformer bank, loss of a Lugo-Pisgah 230 kV transmission line, or loss of both Lugo-Pisgah 230 kV transmission lines, the installation of substantial telecommunication facilities needed to support both the system protection and the required SPS, and the replacement of three circuit breakers and upgrade of 17 circuit breakers at the Etiwanda 230 kV Substation.<sup>4</sup> Although a temporary plan of service could be accommodated via construction of the subset of facilities, it is important to note several complexities associated with meeting the requested in-service date. These complexities include the following:

1. SES' capacity request of 275 MW requires the expansion of SCE's Pisgah 230 kV Substation (Substation) beyond its existing property boundary, which would require an environmental assessment. In addition, the proposed telecommunication facilities could also be subject to an environmental assessment if additional modifications to the existing tower structures or new facilities are required to support the telecommunication requirements. Thus, an environmental assessment would need to be performed for the proposed Substation expansion and corresponding telecommunication facilities.
2. The Pisgah Substation expansion and corresponding telecommunication facilities required for the interconnection of up to 275 MW are also part of the proposed plan of service for the Project's 850 MW capacity request. Therefore, pursuant to the California Environmental Quality Act (CEQA), the Substation expansion and corresponding telecommunication upgrades would likely be viewed as part and parcel of the overall project (i.e., the transmission upgrades required for the 850 MW plan of service), and thus, could not be divided into a separate environmental assessment.
3. Based upon preliminary estimates, it would require approximately two years to construct and procure all necessary telecommunication and substation expansion facilities to support early interconnection after receipt of all required regulatory approvals.
4. To support the required Special Protection System the two following telecommunication facilities will be required:

---

<sup>4</sup> Additional engineering review will be required to develop a suitable schedule and establish appropriate in-service dates for the proposed set of transmission facilities needed to facilitate the interconnection of the partial project (275 MW) as requested by SES in this Optional Study. Such review would need to be addressed under a separate engineering and design agreement if requested by SES.



- a. Replacement of a portion of existing Eldorado-Lugo 500 kV OHGW with new OPGW between the Lugo and Pisgah Substations

Replacement of a portion of existing overhead ground wire with optical ground wire on the existing Eldorado-Lugo 500 kV transmission line between the Lugo and Pisgah Substations can be accommodated but would require some tower reinforcements. Detailed engineering review will be needed to ascertain exact number of tower reinforcements required. This option is also subject to SCE's ability to secure the long-term outage of the Eldorado-Lugo 500 kV transmission line from the CAISO in order to reinforce necessary towers and replace existing OHGW with OPGW.

- b. Installment of new Fiber Cable coupled with use of existing Microwave

New fiber-optic cable facilities between the Pisgah Substation and the Cool Water Substation facilities can be accommodated by utilizing approximately 20-miles of existing distribution facilities. This alternative would require conduits at each of the respective substations (Pisgah, Cady, Gale, and Cool Water) to bring the fiber-optic from the closest power pole of each of the distribution lines into the substation. To complete telecommunication circuitry back to Lugo, existing SCE microwave can be used at the Cool Water Substation.

## **VI. ORDER OF MAGNITUDE COST ESTIMATES**

Order of Magnitude (OOM) cost estimates provided below in Table 2-3 were developed based on the subset of facilities identified above. These facilities include the expansion of the Pisgah 230 kV switchyard, the implementation of a special protection system (SPS), and the installation of substantial telecommunication facilities needed. Further, the results of the short circuit analysis identified that the replacement of three circuit breakers and upgrade of 17 circuit breakers at the Etiwanda 230 kV Substation (triggered by a higher-queued project) is required.

Table 2-3  
Order of Magnitude Cost Estimates Provided in Millions

Facility Upgrade	Pre SES 275 MW	Post SES 275 MW
Pisgah Substation Expansion - Sufficient land for 500 kV Facilities - Install Minimal 230 kV Facilities Only	-	\$18.0 <sup>5</sup>
Replace OHGW with OPGW on existing portion of Eldorado-Lugo 500 kV T/L between Lugo and Pisgah (cost estimate excludes cost to reinforce several 500 kV towers since detailed engineering is needed to identify proper mitigation)	-	\$5.0
New Fiber-Optic Cable between Pisgah and Cool Water Substations (cost for upgrades to existing microwave is included in this estimate)	-	\$12.0
Protection needed to support SPS	-	\$1.0
Replace three and upgrade seventeen 230 kV circuit breakers at the Etiwanda Substation	\$4.5	-

---

<sup>5</sup> This estimate is based on a very limited scope at Pisgah assuming such facilities can be “piece-mealed” from the upgrades required to support the full 850 MW project and is provided for informational purposes only in accordance with the Optional Interconnection Study Provisions of Section 10.2 of FERC’s Large Generator Interconnection Procedures. Refined cost estimates would need to be developed as part of separate engineering and design agreement if requested by SES.

---

# **Final Interconnection Facilities Study Report**

Generation Interconnection

---

**Stirling Energy Systems, Inc.**

**SES Solar One Project**



**California ISO**  
Your Link to Power

November 6, 2008

This study has been completed in coordination with Southern California Edison  
per the Large Generator Interconnection Procedures

November 6, 2008

Mr. Robert Liden  
Executive Vice President & General Manager  
Stirling Energy Systems, Inc.  
2920 E Camelback Road, Suite 150  
Phoenix, AZ 85016

**Subject: SES Solar One Project - Final Interconnection Facilities Study Report**

Dear Mr. Liden:

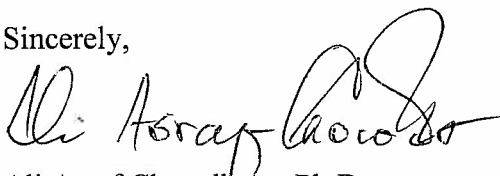
Attached please find the Final Interconnection Facilities Study (IFAS) Report for the interconnection of the proposed 850 MW SES Solar One (SES1) Project to the Southern California Edison (SCE) Pisgah 230 kV Substation, via a new customer-owned 230 kV generation tie line. The SES1 Project will be located in San Bernardino County, approximately 35 miles east of Barstow, California.

The IFAS was performed in accordance with the California ISO's LGIP Tariff. The IFAS Report provides the estimated cost and time to construct the Network Upgrades and Interconnection Facilities. Although the Project requested a COD of December 31, 2010, the IFAS Report estimates the Project's COD for 2015 due to permitting and licensing requirements and time to construct the required Network Upgrades and Interconnection Facilities to interconnect the Project and deliver the Project's 850 MW output to the grid.

The results meeting to discuss the Draft IFAS Report was held on November 5, 2008. As a product of the results meeting, the Final Interconnection Facilities Study Report is attached for your records.

Should you have any questions regarding the next step, which is the LGIA process, please contact Judy Brown, the CAISO Project Manager, at (916) 608-7602 ([JBrown@caiso.com](mailto:JBrown@caiso.com)) or Donna Jordan at (916) 351-2339 ([DJordan@caiso.com](mailto:DJordan@caiso.com)).

Sincerely,



Ali Asraf Chowdhury, Ph.D.  
Director of Regional Transmission - South

Attachment

via e-mail:

Robert Liden ([RLiden@StirlingEnergy.com](mailto:RLiden@StirlingEnergy.com))  
Robert Lugo ([Robert.Lugo@sce.com](mailto:Robert.Lugo@sce.com))  
Steve Mavis ([Steven.Mavis@sce.com](mailto:Steven.Mavis@sce.com))  
Gordon Brown ([Gordon.Brown@sce.com](mailto:Gordon.Brown@sce.com))  
Jorge Chacon ([Jorge.Chacon@sce.com](mailto:Jorge.Chacon@sce.com))

CAISO via email:

Judy Brown ([JBrown@caiso.com](mailto:JBrown@caiso.com))  
Donna Jordan ([DJordan@caiso.com](mailto:DJordan@caiso.com))  
Steve Rutty ([SRutty@caiso.com](mailto:SRutty@caiso.com))  
Ali Asraf Chowdhury ([ACHowdhury@caiso.com](mailto:ACHowdhury@caiso.com))  
CAISO Regional Transmission - South

STIRLING ENERGY SYSTEMS, INC.  
SES SOLAR ONE PROJECT  
FINAL INTERCONNECTION FACILITIES STUDY REPORT

**Interconnection Facilities Study**

**Table of Contents**

Description	Page
I. Executive Summary.....	3
II. Technical Assessment II Results.....	4
III. Facilities Study Assumptions.....	5
IV. Facilities Study Scope and Cost Estimate.....	6
IV – A Facilities Study Scope.....	6
IV – B Facilities Study Cost Estimate.....	8
V. Conclusions.....	9
VI. Exhibits	
Exhibit A	SES I Project Interconnection
Exhibit B	Technical Assessment II – Executive Summary
Exhibit C	WECC Generator Testing Requirements
Exhibit D	Pisgah Substation – 500kV Transmission Lines – Telecommunication Circuits
Exhibit E	Facilities Study Scope – Details
Exhibit F	Cost Summary

STIRLING ENERGY SYSTEMS, INC.  
SES SOLAR ONE PROJECT  
FINAL INTERCONNECTION FACILITIES STUDY REPORT

**I. Executive Summary**

Stirling Energy System, Inc. (SES) applied to the California Independent System Operator (CAISO) for the interconnection of their 850MW Solar One Project to the CAISO Grid at the existing SCE Pisgah Substation 220kV Bus pursuant to Section 3.5 of the Large Generator Interconnection Procedures (“LGIP”) issued under the CAISO Tariff.

SES will install 34,000 – 25kW Stirling System Solar Dishes with associated induction generators, two 500MVA 220/34.5kV substations and a new “Three – Point” 220kV Generation Tie Line connecting the substations to the SCE Pisgah Substation.

For the purpose of this study the new SES facilities will be called as follows:

- SES Solar One Substation A
- SES Solar One Substation B
- SES 220kV Gen Tie Line

**SEE EXHIBIT A: SES 1 PROJECT INTERCONNECTION**

SES has requested an Interconnection Date of December 31, 2010.

However, due to the magnitude of the upgrades required to the SCE System and the fact that many of these upgrades would require environmental studies prior to licensing and permitting, at this time SCE estimates that the earliest possible Interconnection Date would be sometime in the year 2015.

SCE prepared a System Impact Study (SIS) dated March 7, 2006 to analyze the impact of the 850MW Project to the SCE Transmission System.

In addition, SCE prepared a Technical Study (TAS I) to analyze Transient Stability Studies.

Both the SIS and the TAS I identified the impacts to the SCE System associated with the interconnection of the SES1 Project and determined that a number of facility upgrades will be required in order to interconnect and deliver the full output of the project.

Subsequent to these two studies, a number of queued ahead generation projects withdrew from the CAISO Interconnection Queue resulting in a need to perform a complete reassessment of the impacts originally identified in the SIS and the TAS I.

SCE prepared a new Technical Assessment II (TAS II) dated June 13, 2008 to analyze the impact of the 850MW Project to the SCE Transmission System. This study incorporates the recent project withdrawals and presents corresponding results.

**This Facilities Study Report addresses the results of the TAS II dated June 13, 2008.**

**The TAS II concluded that, in spite of the withdrawal of earlier Generation Applications, the required System Upgrades remained the same as those addressed on the earlier SIS and TAS I Reports.**

**SEE EXHIBIT B: TAS II – EXECUTIVE SUMMARY & OVERLOAD TABLES**

STIRLING ENERGY SYSTEMS, INC.  
SES SOLAR ONE PROJECT  
FINAL INTERCONNECTION FACILITIES STUDY REPORT

**II. Technical Assessment II Results**

The SIS analyzed the System assuming the following interconnections on the “North of Lugo” area on line and all related System Upgrades associated with these interconnections, placed ahead of the Project in the Application Queue, are in place:

<u>Application</u>	<u>Interconnection Point</u>	<u>MW</u>	<u>Operating Date</u>
SCE WDAT 112	Casa Diablo Sub. 115kV Bus	17	2007 (Not on line)
CAISO #11	<u>New</u> Wheaton Sub 115kV Bus	63	Suspended - TBD
CAISO #33	Control Sub. 115kV Bus	10	In Service
SCE WDAT 164	<u>New</u> Seaggett Sub. 115kV Bus	80	2009
CAISO #58	Control 15kV Bus	62	2009
CAISO #68	Pisgah Sub. 220kV Bus	850	2010 - <b>Note</b>

**NOTE:** Based on the estimated time required for licensing and permitting activities SCE estimates an Energization Date in the Year 2015.

The TAS II concluded that the existing SCE Transmission System is not adequate to support the Project and identified upgrades required for the 850MW Generation.

**Power Flow Analysis:**

**Base Case:**

**Four Base Case Overloads triggered by the Project as follows:**

1. Lugo – Pisgah No.1 220kV T/L	Rated 725A	Loaded to 812A	(112%)
2. Lugo – Pisgah No.2 220kV T/L	Rated 725A	Loaded to 808A	(111%)
3. Lugo No.1 500/220 Tr. Bk.	Rated 1120MVA	Loaded to 1160MVA	(103%)
4. Lugo No.2 500/220 Tr. Bk.	Rated 1120MVA	Loaded to 1168MVA	(104%)

**NOTE:** The 605KCMIL ACSR Conductors on the Lugo – Pisgah No.1 & No.2 220kV T/L’s are rated 885A for Normal Conditions, 1020A for N–1 and 1190A for N–2. However, these two lines have been de-rated to 725A for both Normal and Emergency conditions due to restrictions on the line-to-ground clearances.

**Proposed Solution:**

- Transfer the increased load flow triggered by the Project from the 220kV to the 500kV System as follows:
- Expand the existing Pisgah 220kV Interconnection Facility and install a new 2240MVA 500/220kV Substation with two 1120MVA Transformer Banks.
- Loop the existing Eldorado – Lugo 500kV T/L into the expanded Pisgah Substation and form the two new Eldorado – Pisgah and Lugo – Pisgah No.1 500kV T/L’s.
- Install a new Lugo – Pisgah No.2 500kV T/L by removing the existing Lugo – Pisgah No.2 220kV T/L, widening the existing Right-of-Way where needed and constructing the new 500kV Structures within the vacated R/W.

**Contingencies:**

- The installation of the upgrades described above to eliminate Base Case Overloads will require a new Special Protection Scheme (SPS) to trip off the Project under the simultaneous outages of both the Lugo – Pisgah No.1 and No.2 500kV T/L’s to eliminate overloading the new Eldorado – Pisgah 500kV T/L.



STIRLING ENERGY SYSTEMS, INC.  
SES SOLAR ONE PROJECT  
FINAL INTERCONNECTION FACILITIES STUDY REPORT

**Transient Stability Analysis:**

The TAS II concluded that, with the existing Kramer RAS and High Desert Power Project (HDPP) RAS operating as designed when required and the new SPS proposed for this Project there are no additional upgrades to the SCE System required. However, the Project will need to provide 300MVAR of dynamic reactive support.

SCE must be included in the review process of all technical specifications to determine the Static VAR Compensator (SVC) parameters.

**Post – Transient Voltage Analysis:**

The TAS II concluded that, with the proposed upgrades in place, the Project would not trigger any new post transient criteria violations.

**Short Circuit Study Analysis:**

The TAS II identified the following six 500kV, nineteen 220kV, and three 66kV locations where the Project causes the Three Phase and / or the Single Phase to Ground Short Circuit Duties to increase by 0.1kA or more and requested that all circuit breakers at those locations be evaluated.

500kV:

Eldorado	Lugo	Mira Loma	Rancho Vista	Serrano	Vincent
----------	------	-----------	--------------	---------	---------

220kV:

Alamitos	Barre	Center	Chino	Eldorado	Etiwanda
Hunt. Bch.	La Fresa	Lewis	Lighthipe	Mesa	Mira Loma
Ormond Bch.	Rancho Vista	Serrano	Sylmar	Villa Park	Vincent

Wildlife (Formerly Jurupa)

66kV:

Chino	Ellis	Padua
-------	-------	-------

The Circuit Breaker evaluations concluded that the Project does not trigger any CB replacements or upgrades but aggravates pre-project conditions that require fifteen replacements and seventeen upgrades of 220kV CB's at the Etiwanda Gen. Sta. 220kV Switchyard and Mira Loma Substation. The increased Short Circuit Duty at Mira Loma Substation also requires the 220kV Switchyard be upgraded to 80kA Rating.

**III. Facilities Study Assumptions**

- A. The SES 220kV Gen Tie Line from the SES Solar One Substations A and B to the last structure outside the SCE Pisgah Substation perimeter fence will be installed by SES and is not included in the Facilities Study.
- B. The SES 220kV Gen Tie Line must be equipped with Optical Ground Wire (OPGW) to provide one of the two telecommunication paths required for the line protection scheme and the SPS. The cost of the OPGW will be included in the cost of the line and is not included in the Facilities Study.
- C. It is expected that the last structure of the SES 220kV Gen Tie line outside the SCE Pisgah Substation perimeter fence would be close enough to the 220kV Switchyard that would require only one span of conductors to reach the proposed 220kV Line Position. In this case, the last span of conductors from the last SES Structure to the Pisgah Substation 220kV Switchyard will be installed by SCE and it is included in the Facilities Study.

STIRLING ENERGY SYSTEMS, INC.  
SES SOLAR ONE PROJECT  
FINAL INTERCONNECTION FACILITIES STUDY REPORT

- D. All required CAISO metering equipment at the Generating Facility will be provided by SES and is not included in the Facilities Study.
- E. The following line protection relays, to be installed at each one of the termination points of the SES Gen Tie Line at the SES Solar One Substations A and B will be specified by SCE and provided by SES and are not included in the Facilities Study.
- One G.E. L90 Current Differential Relays with dual dedicated digital communication channels to Pisgah Substation.
  - One SEL 311L Current Differential Relays with dual dedicated digital communication channels to Pisgah Substation.
- F. The following SPS Relays, to be installed at each one of the termination points of the SES Gen Tie Line at the SES Solar One Substations A and B will be specified by SCE and provided by SES and are not included in the Facilities Study.
- Two N60 relays (One each for SPS A and B) to trip the Main Generator Breaker.
  - One SEL – 2407 Satellite Synchronized Clock.
- G. The Optical Ground Wires to be installed on the Lugo – Pisgah No.1 and No.2 500kV T/L's do not require the installation of any Optical Repeater Sites between the two substations.
- H. The required Remote Terminal Units (RTU's) to be installed at the SES Solar One Substations A and B will be installed by SCE and they are included in the Facilities Study.
- I. The required Microwave Dishes to be mounted on the Antenna Towers to be installed at the SES Solar One Substations A and B to provide the second digital communication channels required for the line protection relays on the SES 220kV Gen Tie Line will be installed by SCE and they are included in the Facilities Study.
- SES must provide the Microwave Antenna Towers and an approximate area of 20 Ft. by 40 Ft. within their Control Rooms at each one of the SES Solar Substations A and B for SCE to install the required Telecommunications Terminal Equipment.
- SES must also provide AC and DC Power Supply for all Terminal Equipment.
- J. The actual cost of the land to be purchased for the space required to expand Pisgah Substation and construct the 500kV Line Loop and the section of new Right-of-Way required for the Lugo – Pisgah No.2 500kV T/L, has not been estimated at this time and, therefore, is not included in the Facilities Study.
- K. The cost to support all SCE activities required for the Environmental Impact Statement and/or Environmental Impact Report and all other regulatory filings required for the Project are not included in the Facilities Study.

#### **IV. Facilities Study Scope and Cost Estimate**

##### **IV – A Facilities Study Scope**

Pursuant to FERC's orders 2006-A (Small Generators) and 2003-A (Large Generators) all Facilities Studies are required to provide the customer with its "maximum possible funding exposure", which shall include the costs of upgrades that are reasonably allocable to the Interconnection Customer at the time the estimate is made, and the costs of any upgrades not yet constructed that were assumed in the interconnection studies for the Interconnection Customer but are, at the time of the estimate, an obligation of an entity other than the Interconnection Customer."

STIRLING ENERGY SYSTEMS, INC.  
SES SOLAR ONE PROJECT  
FINAL INTERCONNECTION FACILITIES STUDY REPORT

To comply with the FERC orders, the Scope of Work and Cost Estimate for all elements required for the interconnection are presented for the following two cases:

**CASE A: All facilities required exclusively by the Project**

And

**CASE B: All additional facilities that may be required by the Project**

The facilities included in Case B are those additional facilities required to remedy reliability violations caused by higher-queued Projects, placed ahead of the Project in the Application Queue, and are expected to be implemented by those higher-queued projects.

However, in the event that any of these higher-queued projects withdraw their Application, the Project may become responsible for any or all of these additional facilities.

**CASE A:**

1. SES 220kV Gen Tie Line: Install Rack Span into Pisgah Substation.
2. Eldorado – Lugo 500kV T/L: Loop the line into the expanded Pisgah Substation and form the two new Eldorado – Pisgah and Lugo – Pisgah No.1 500kV T/L's.  
In addition: After the loop is completed, replace one of the two existing OHGW's on the Lugo – Pisgah No.1 500kV T/L with new OPGW.
3. Lugo – Pisgah No.2 500kV T/L: Remove sixty five miles of existing Lugo – Pisgah No.2 220kV T/L and construct a new 500kV Line on the existing Right-of-Way.  
This work will require widening of some sections of the existing Right of Way.
4. Lugo – Pisgah No.1 500kV T/L: Replace one of the two existing ½-In. Steel Overhead Ground Wires with new Optical Ground Wire (OPGW).
5. Pisgah Substation: Expand the existing station and install a new 2240MVA 500/220kV Substation with two Transformer Banks, three 500kV Lines and two 220kV Lines.  
Also upgrade the Line Protection Relays on the remaining Lugo and the existing Cima – Eldorado No.1 and No.2 220kV Line Positions and install all required SPS Relays.
6. Eldorado Substation: Upgrade Line Protection on the Lugo 500kV Line Position (Future Pisgah) and the Cima – Pisgah No.1 and No.2 220kV Line Positions.
7. Lugo Substation: Install a 500kV Line Position to terminate the new Pisgah No.2 500kV T/L.  
Also upgrade Line Protection on the Eldorado 500kV Line Position (Future Pisgah No.1 500kV) and the Cima – Pisgah No.1 220kV Line Position (Future Pisgah 220kV) and install all required SPS Relays.

STIRLING ENERGY SYSTEMS, INC.  
 SES SOLAR ONE PROJECT  
 FINAL INTERCONNECTION FACILITIES STUDY REPORT

- |                           |   |
|---------------------------|---|
| 8. Telecommunications     | Install new digital channels and associated terminal equipment to support the Line Protection Relays for the new SES 220kV Gen Tie Line, the SPS Relays and the new RTU's to be installed at the SES Solar One Substations A and B. |
| 9. Power System Control   | Install new RTU's at the SES Solar Substations A and B and replace the existing RTU's at Pisgah and Lugo Substations.   |
| 10. Corporate Real Estate | Perform all required functions to obtain permits and land acquisition for the expansion of Pisgah Substation and the 500kV T/L Loop plus the replacements of the existing Lugo – Pisgah No.2 220kV T/L with a new 500kV T/L.        |

**CASE B:**

- |  |   |
|--|---|
| 1. Etiwanda Gen. Station<br>220kV Switchyard | Replace three 47.3kA 220kV CB's with new 63kA Rated units and upgrade seventeen 56.6kA 220kV CB's to 63kA Rating. |
| 2. Mira Loma Substation:                     | Replace twelve 63kA 220kV CB's with 80kA Rated units and upgrade the 220kV Switchyard to 80kA Rating.             |

**FOR ADDITIONAL DETAIL REFER TO THE FOLLOWING EXHIBITS:**

- **EXHIBIT D: PISGAH SUBSTATION – 500kV TRANSMISSION LINES – TELECOMMUNICATIONS CIRCUITS**
- **EXHIBIT E: FACILITIES STUDY SCOPE – DETAILS**

**IV – B Facilities Study Cost Estimate**

**CASE A** Identifies the cost of all facilities that are required exclusively by the Project.

**CASE B** Identifies the cost of all upgrades required that were triggered by higher-queued Applicants placed ahead of the Project in the Application Queue.

In the event that any Applicant, presently placed ahead of the Project in the Application Queue, withdraws its Application, the system would need to be re-evaluated. The new evaluation may conclude that the Project would now trigger any of these upgrades and would then become responsible for some or all of the upgrades identified in Case B.

The total estimated cost of all elements of the interconnection as identified above in the Facilities Study Scope is as follows:

CASE A:	\$388,519,000
CASE B ( <u>May</u> be added to Case A):	<u>\$ 32,902,000</u>
POSSIBLE MAXIMUM COST EXPOSURE:	\$421,421,000

**SEE EXHIBIT F: COST SUMMARY**

STIRLING ENERGY SYSTEMS, INC.  
SES SOLAR ONE PROJECT  
FINAL INTERCONNECTION FACILITIES STUDY REPORT

**V. Conclusions**

- A. The estimated cost for the Interconnection is approximately \$388,519,000 for Case A with the potential additional cost of \$32,902,000 for Case B for a total Maximum Cost Exposure of \$421,421,000.
- B. The time required to complete the proposed project will be approximately seven years after receiving project authorization and funding, subject to availability of resources.  
This estimate of time is based on the following elements:
- Approximately five years required for all necessary permitting and licensing required for the installation of the new Pisgah Substation and the 500kV Line Loop into the station plus the removal of the existing Lugo – Pisgah No.2 220kV T/L and construction of the new Lugo – Pisgah No.2 500kV T/L in its place.
  - Approximately two years required for the engineering, design, purchase of materials and construction of the elements addressed above.
- C. The costs indicated in the attached tables are shown 2015 Dollars and are not firm. These are only preliminary estimates based on conceptual engineering and system unit costs, and are subject to change based on the final design and actual material costs. This Facilities Study and cost estimates as presented are valid for a period of 150 days.
- D. The estimated Project Cost will be reconciled to actual costs upon closure of the subject work orders. The necessary billing adjustments will be made at that time.

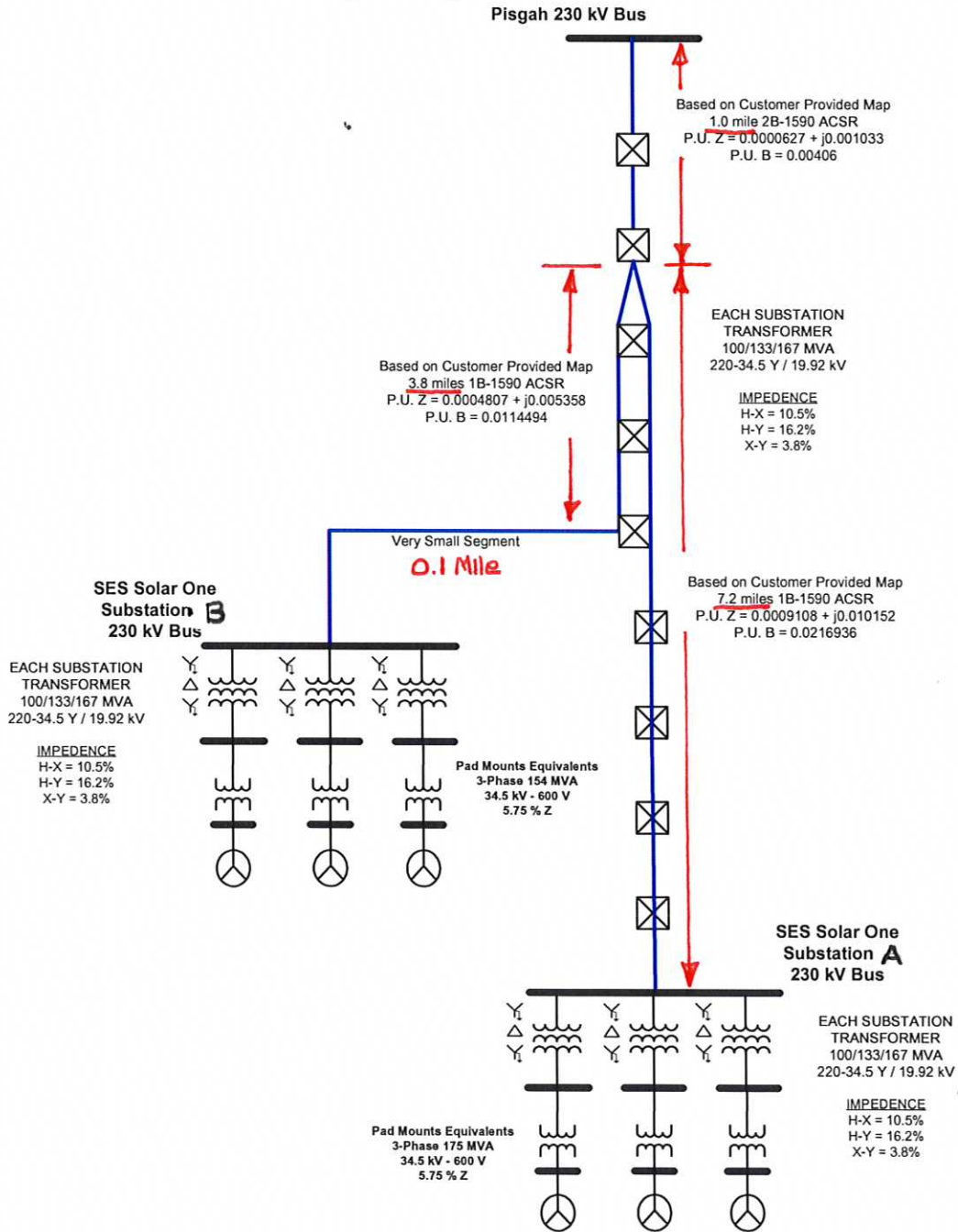
## **EXHIBIT A**

# **SES I PROJECT INTERCONNECTION**

SES1 Project Interconnection

SES has requested an in-service date of December 31, 2010 for the SES1 Project. SES proposed to interconnect the SES1 Project to the Pisgah 230 kV Substation by constructing a radial generation-tie line that would connect two solar collector substations, each with three 230/34.5 kV transformers as shown below in Figure 1-2.

**Figure 1-2  
SES1 Project Proposed Interconnection**



**EXHIBIT B**

**TECHNICAL ASSESSMENT II**

**EXECUTIVE SUMMARY**



STIRLING ENERGY SYSTEMS, INC.  
SOLAR ONE PROJECT

TECHNICAL ASSESSMENT II

June 13, 2008



SOUTHERN CALIFORNIA  
**EDISON**  
An *EDISON INTERNATIONAL*<sup>SM</sup> Company

Prepared by

Jorge Chacon

Southern California Edison Company

---

**Steven E. Mavis**  
**Manager, Generation**  
**Interconnection Planning**

## EXECUTIVE SUMMARY

Southern California Edison Company (SCE) performed a System Impact Study for the Stirling Solar One 850 MW project as requested by Stirling Energy Systems (SES), Inc. In addition, a Technical Study was performed to complete required follow-up transient stability studies which incorporated specific custom dynamic models developed to represent the Stirling units. Both of these reports identified the impacts associated with the interconnection of the new 850 megawatt (MW) solar generation project (SES Solar One Project) and determined that a number of facility upgrades will be required to interconnect and deliver the full SES Solar One Project output to the Lugo Substation.

Subsequent to these two studies, a number of queued ahead generation projects withdrew from the CAISO Interconnection Queue resulting in a need to perform a complete reassessment of the impacts identified in the System Impact Study and initial Technical Assessment. This study incorporates the recent project withdrawals and presents corresponding results which did not result in changes to the previous recommendation of required facility upgrades triggered by the addition of the SES Solar One Project.

Results of this second Technical Assessment (TAS II) will be used as the basis to determine appropriate project cost allocation for facility upgrades in the Facilities Study. ***The study accuracy and results for the assessment of the system adequacy are contingent on the accuracy of the technical data provided by Stirling Energy Systems.*** Any changes from the data provided could void the study results. The Study Report provides detailed Study assumptions and conditions of the system in which the Study was conducted.

**Please be aware that a restudy may be required to reflect the system configuration if a higher queued generation or transmission project that was modeled in the system impact study withdraws or is modified in accordance with applicable tariff allowances.**

## CONCLUSION

Based on the revised study results, the existing SCE transmission facilities are not adequate to accommodate the SES Solar One Project without facility upgrades. The same transmission facilities previously identified to result in thermal loading beyond the maximum allowable limits (clearance limited) were again identified to load beyond the maximum limits. In addition, the same system voltage impacts previously identified without the installation of adequate power factor correction equipment were again identified. Consequently, the previous facility upgrade recommendations were found to still be required in order to reliability interconnect the SES Solar One Project. These upgrades include:

1. Expansion of the existing SCE Pisgah 230 kV Substation, sized to accommodate 500/230 kV facilities, with one initial 500/230 kV transformer and a spare phase, or two 500/230 kV transformers to eliminate the need for a (T-1) SPS.

2. Removal of one existing Lugo-Pisgah 230 kV transmission line and replacement with a new Lugo-Pisgah 500 kV transmission line.<sup>1</sup>
3. Looping the existing Eldorado-Lugo 500 kV transmission line into the new 500 kV portion of the expanded Pisgah Substation, by “cutting” the line near the Pisgah Substation and connecting each portion to the Pisgah Substation, forming the new Lugo-Pisgah and Pisgah-Eldorado 500 kV lines.
4. Installation of appropriate, fully redundant and diverse telecommunication facilities to support both a special protection system (SPS) that would trip the SES Solar One Project under the following specific outage contingencies:
  - a. Loss of Pisgah 500/230 kV transformer bank (if only one bank is installed)
  - b. Simultaneous outage of both Lugo-Pisgah 500 kV transmission lines

### **Power Flow Study Results**

Based on the steady-state power flow study results, the existing SCE transmission facilities without the above set of facility upgrades are inadequate to accommodate the SES1 Project. Thermal overload violations on the two Lugo 500/230 kV transformer banks and two Lugo-Pisgah 230 kV transmission lines were identified to still be triggered by the SES1 Project.

### **Transient Stability Study Results**

Transient stability studies did not indicate any additional need for facilities upgrades beyond those identified for thermal overload problems.

### **Short –Circuit Duty Results**

Given the fact that short-circuit duty has been reduced with the project withdrawals, review of the four substation locations previously identified as locations requiring either circuit breaker upgrades or circuit breaker replacement will need to be performed to ensure that the three locations qualified as “Case B” upgrades are not transferred to “Case A” and to ensure that the “Case A” upgrade is still required and triggered by the SES1 Project. The four locations are as follows:

- Barre Substation – Upgrades to eight (8) circuit-breakers were previously identified as triggered by a project in queue ahead of the SES1 Project
- Etiwanda Substation – Replacement of twenty-four (24) circuit breakers and upgrade to substation design from 63 kA to 80 kA previously identified to be triggered by the SES1 Project

---

<sup>1</sup> Actual design of the transmission upgrades will depend on many factors including the development of upgrade alternatives necessary to support a Proponent’s Environmental Assessment (PEA) and an Application for a Certificate of Public Convenience and Necessity (CPCN). Some of the alternatives that would be considered include, but are not limited to, the removal of both existing circuits and replacement with a new 500 kV double-circuit, and the construction of a new single-circuit on new right-of-way, without removing any of the existing facilities.

- Mira Loma (East) Substation – Replacement of twelve (12) circuit breakers and upgrade to substation design from 63 kA to 80 kA previously identified to be triggered by a project in queue ahead of the SES1 Project
- Vincent Substation – Upgrade to one (1) circuit-breaker were previously identified as triggered by a project in queue ahead of the SES1 Project

Detailed results of revised short-circuit duty are provided in Table 2-2 and Table 2-3 for three-phase-to-ground and single-phase-to-ground respectively.

In addition to review of the bulk power substation locations, the Technical Assessment II identified the need for Field Engineering (FE) to review circuit breakers at Chino, Ellis and Padua Subtransmission Systems in order to determine if any 66 kV circuit breaker replacements are triggered by the addition of the SES1 Project. Detailed information required for FE to perform the necessary review is provided in Table 2-4.

## **EXHIBIT C**

# **WECC GENERATOR TESTING REQUIREMENTS**

## WECC GENERATOR TESTING REQUIREMENTS

Current WECC generating unit model validation policy is intended to ensure that models of generators and associated controls that are used in grid simulations are accurate and up-to-date. Within the context of the WECC policy, “validation” is used synonymously with verification and refers to the process of selecting parameters for the appropriate WECC-approved models for generating units and demonstrating that the model behavior is consistent with the generating unit behavior by comparison of simulation to test recording. The generating unit model validation policy applies to generating facilities that connect to the WECC transmission grid at 60-kV or higher voltage (both new and existing, synchronous and non-synchronous) with single unit capacity of 10 MVA and larger, or facilities with aggregate capacity of 20 MVA and larger. The exact policy can be found on the WECC website ([www.wecc.biz](http://www.wecc.biz)).

The dynamic models provided by the developer for use in this study relied on the use of dynamic models that were sufficient for use in the GE PSLF program but have not been approved by the Western Electricity Coordinating Council (WECC) Modeling and Validation Work Group (MVWG). Therefore, at this time, sufficient modeling data to satisfy WECC generating unit model validation policy has not been provided. It will be the responsibility of the developer to ensure that the requirements in the WECC generating unit model validation policy are met within the timelines stipulated in the policy. This can be done by either (a) securing MVWG approval of the models that have been used in the interconnection study, (b) providing alternative WECC-approved models of the generation project that are equivalent to those used in the interconnection study, or (c) receiving an exemption from WECC from the requirements established in the generating unit model validation policy.

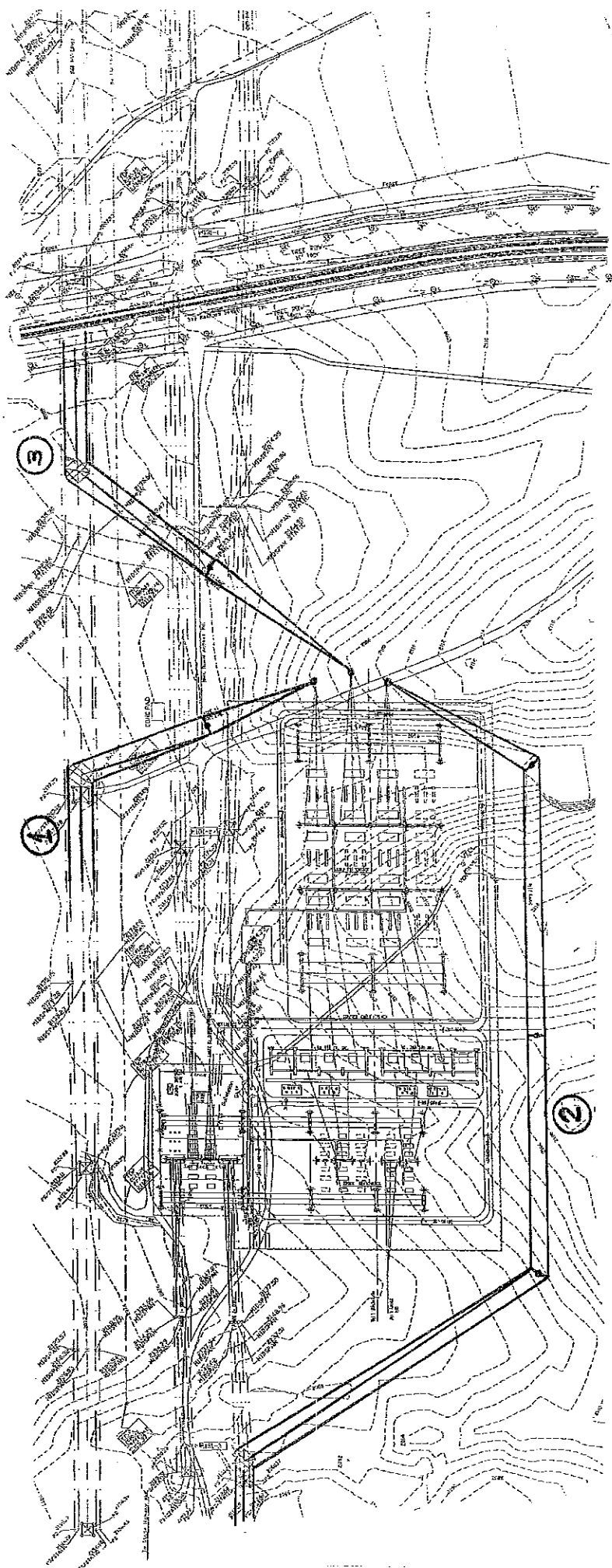
## **EXHIBIT D**

**PISGAH SUBSTATION  
500kV TRANSMISSION LINES  
TELECOMMUNICATIONS CHANNELS**









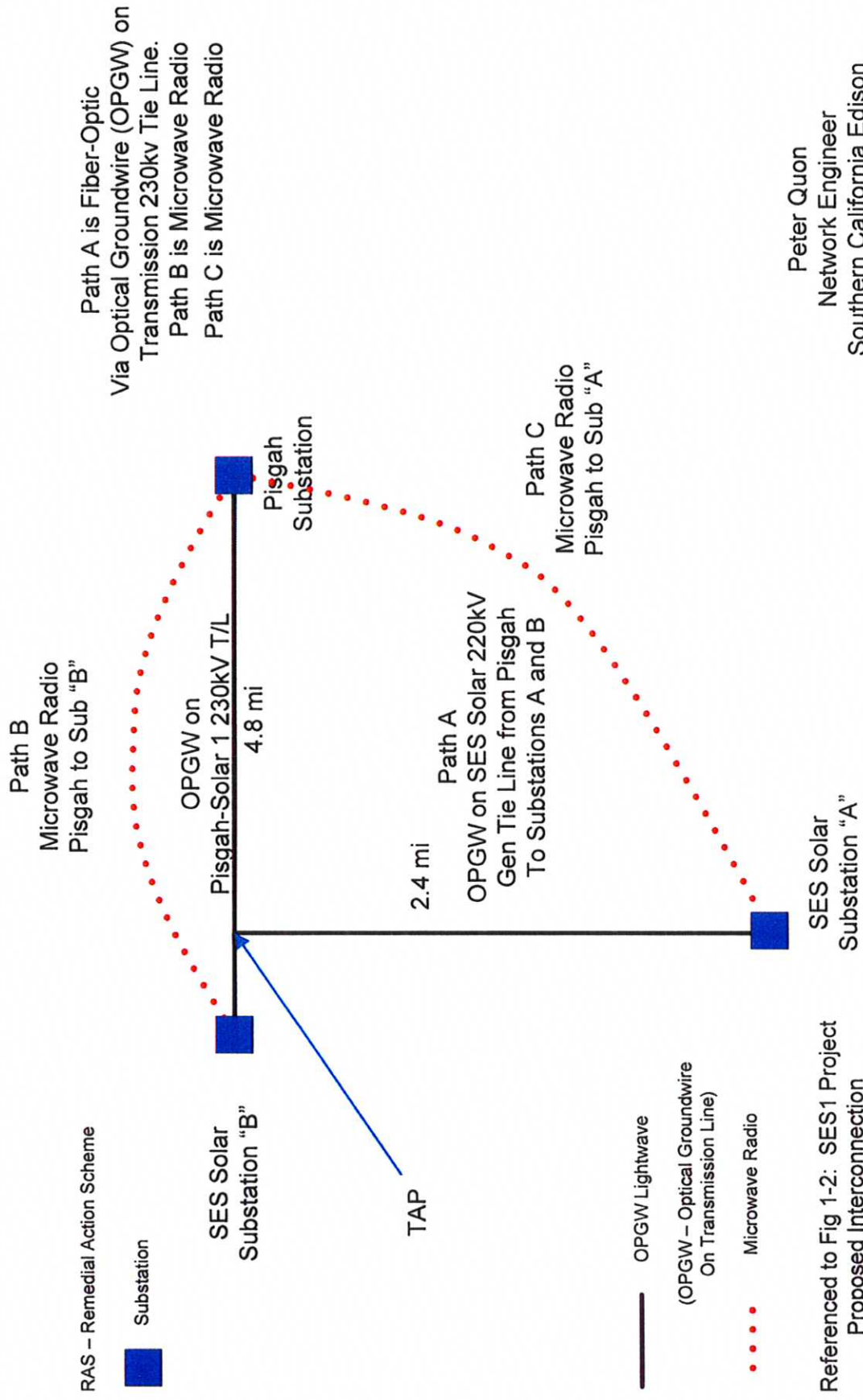
1 LUGO – PISGAH No.1 500KV T/L

2 LUGO – PISGAH No.2 500KV T/L

3 ELDORADO – PISGAH 500KV T/L

**Pisgah Sub – SES Solar One Sub ‘A’ - SES Solar One Sub ‘B’  
Three Terminal 230kv line**

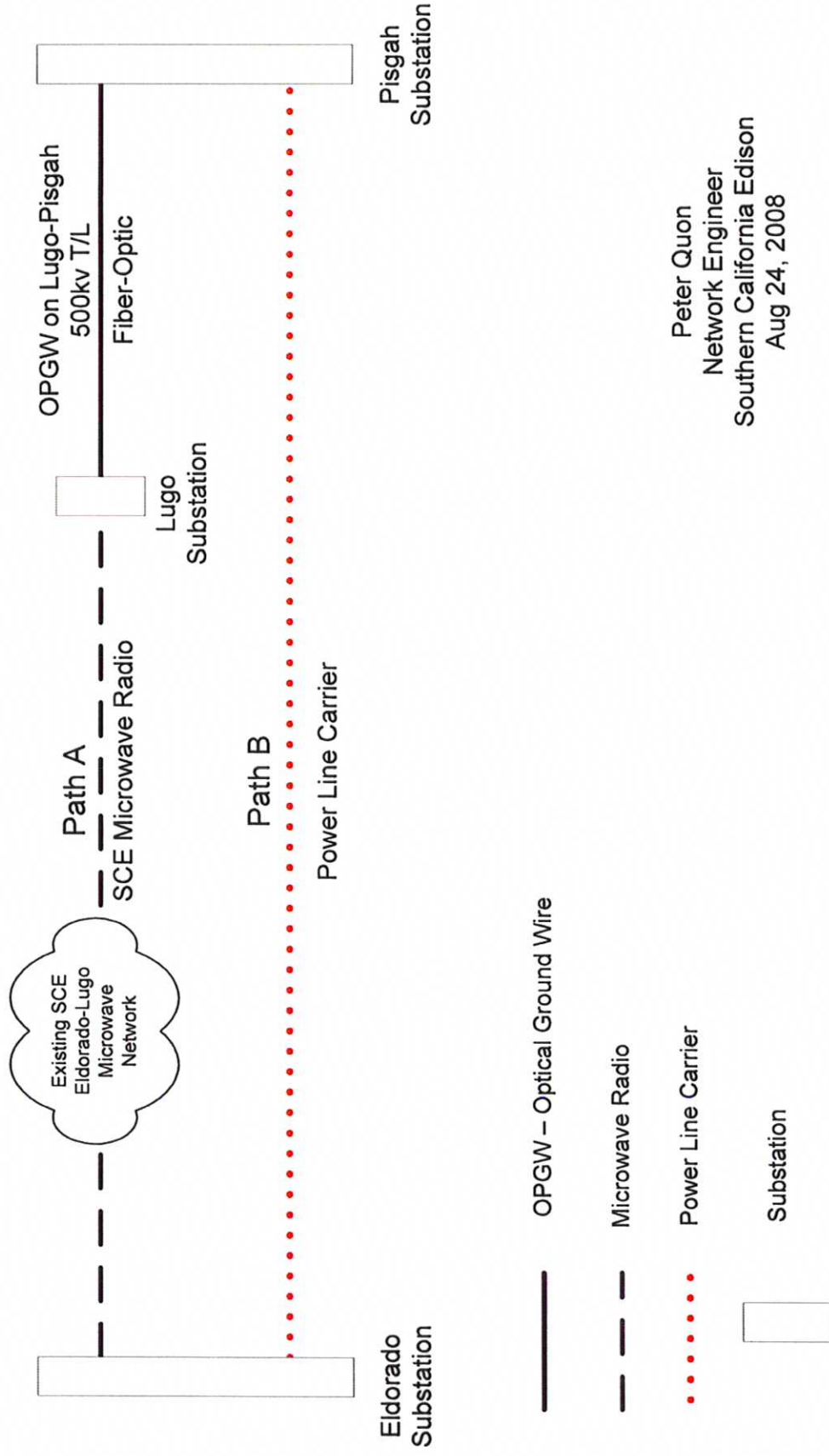
**Telecomm Proposal for Line Protection and RAS**



Referenced to Fig 1-2: SES1 Project Proposed Interconnection

Peter Quon  
Network Engineer  
Southern California Edison  
Aug 25, 2008

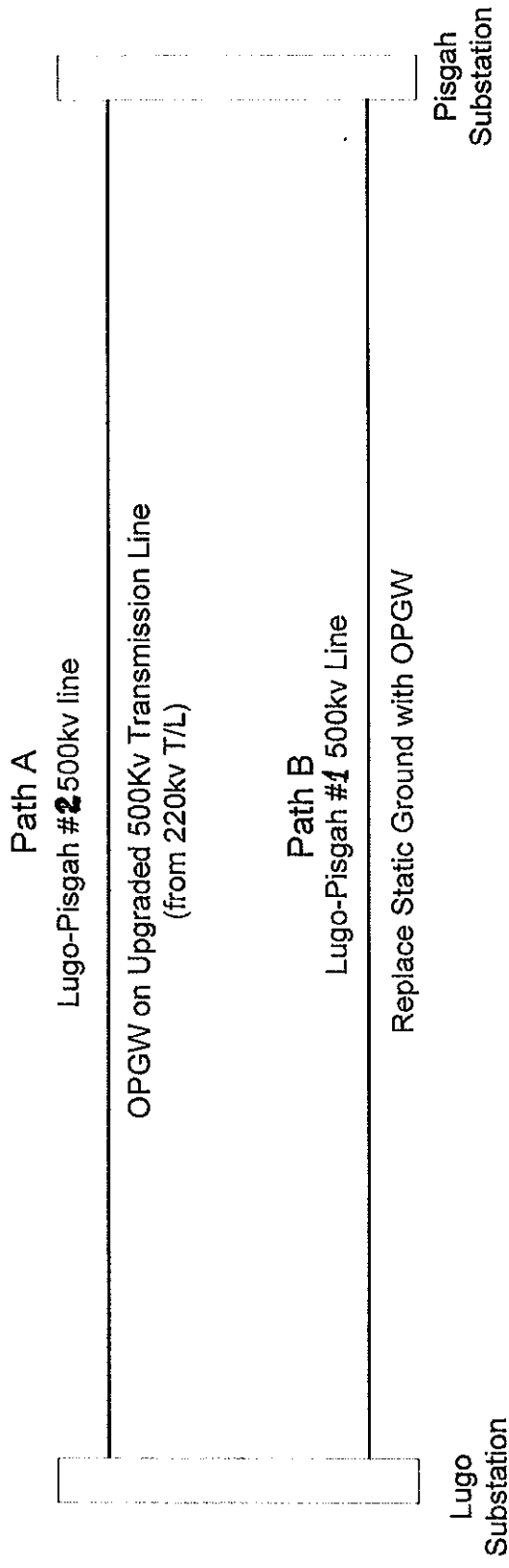
# Protection Routes for Eldorado-Pisgah 500kV



Peter Quon  
 Network Engineer  
 Southern California Edison  
 Aug 24, 2008

# Protection and RAS Routes for Lugo-Pisgah 500Kv

Dual Diverse Path Fiber Routes



Peter Quon  
Network Engineer  
Southern California Edison  
Aug 20, 2008

## **EXHIBIT E**

# **FACILITIES STUDY SCOPE – DETAILS**

**SOLAR ONE PROJECT**  
**FACILITIES STUDY SCOPE – DETAILS**  
**CASE A – ELEMENTS REQUIRED FOR THE PROJECT**

**A. Transmission:**

**1. SES Solar 220kV Generation Tie Line**

Install one span of conductors and six dead end insulator / hardware assemblies between the last SES Dead – End Tower and the Substation Dead – End Structure at the 220kV Switchyard.

**2. Lugo – Eldorado 500kV T/L**

Loop the existing 500kV T/L into the expanded Pisgah Substation and form the two new Lugo – Pisgah No.1 and Eldorado – Pisgah 500kV T/L's.

This work requires the installation of two Dead End Lattice Structures to intersect the existing line and four tubular steel poles to direct the conductors into the station and the removal of one existing Suspension Lattice Structure.

It also requires the installation of forty two hardware / insulator dead – end assemblies with polymer insulators and approximately 2,400 Circuit Ft. of new 2-2156KCMIL ACSR Conductors and ½ - Inch HSS Overhead Ground Wire.

**3. Lugo – Pisgah No.2 500kV T/L**

Install approximately sixty five miles of new 500kV T/L construction.

This installation requires approximately one hundred and ninety eight Suspension Lattice Structures, thirty Dead – End Lattice structures and five Tubular Steel Poles.

The line will be equipped with 2-2156KCMIL ACSR Conductors per phase, one ½-In. High Strength Steel (HSS) Overhead Ground Wire (OHGW) and one Fiber Optic Ground Wire (OPGW).

The new construction requires the removal of sixty five miles of the existing Lugo – Pisgah No.2 220kV T/L to allow the new 500kV T/L to be installed on its place for approximately fifty two miles.

The removal involves two hundred and thirty three lattice structures and sixty five circuit miles of 605KCMIL ACSR Conductors and Steel Overhead Ground Wires.

The new 500kV T/L requires approximately thirteen miles of new 200 Ft. wide Right of Way (R/W) starting at Lugo Substation. The existing 220kV R/W on this segment can't be widened as required for the 500kV T/L.

**4. Relocations of 500kV Rack Spans at Lugo Substation**

At this time it has been determined that the best possible way to terminate the new Lugo – Pisgah No.2 500kV T/L would be to use the existing Position 2 presently occupied by the termination of the Eldorado 500kV T/L.

This requires the following relocation of rack spans:

- Relocate the rack span of the Eldorado 500kV T/L from Pos.2 to Pos.1
- Relocate the rack span of the Mohave 500kV T/L from Pos.1 to Pos.1-X

## 5. Lugo – Pisgah No.1 500kV T/L

Replace one of the two existing OHGW's with new OPGW on approximately sixty five miles of line. It is estimated at this time, without the benefit of final engineering, that approximately seventy structures will require structural modifications to reinforce the ground wire peaks and / or the upper bodies.

### B. Substations:

#### 1. Pisgah Substation – Substation Expansion

Expand the existing station to a 2240MVA 500/220kV Substation with three 500kV Line Positions, four 220kV Line Positions and two Transformer Banks with 500kV and 220kV Bank Positions.

The station layout should allow the construction of the expansion with the minimum possible outage time.

This work requires the installation of the following equipment:

- Two 500KV Operating Buses covering four positions
- One 500kV Position to terminate both the Lugo No.1 and Eldorado 500kV T/L's
- One 500kV Position to terminate the Lugo No.2 500kV T/L
- Two 500kV Positions to connect the No.1AA and No.2AA Tr. Bk's.
- Two 1120MVA 500/220kV Transformer Banks consisting of seven 373MVA Single-Phase Units (Includes one spare unit)
- Four 220kV Positions to terminate the Lugo, Eldorado – Cima No.1 and No.2 and the Solar Generation Tie Line 220kV T/L's
- Two 220kV Positions to connect the No.1AA and No.2AA Tr. Bk's.

#### Installation Details:

##### 500kV Switchyard

##### Operating Buses

Install 500kV North and South Buses as follows:

- Install six Bus Dead End Structures (60 Ft. High x 90 Ft. Wide)
- Install twenty four Bus Dead-End Insulator Assemblies
- Six 500kV Potential Devices
- Install four 180 Ft. sections of 3-2156KCMIL ACSR Bus Conductors (Approximately 6500Ft. of Conductor)

##### Position 1:

Install one Three-Breaker Line Position on a Breaker-and-a-Half Configuration to terminate both the Lugo No.1 and Eldorado 500kV T/L's as follows:

- Two Dead-End Structures (108 Ft. High x 90 Ft. Wide)
- Three 500kV – 3000A – 40kA Circuit Breakers
- Six 500kV Horizontal-Mounted Group-Operated Disconnect Switches – Two of them equipped with Grounding Attachments.
- Six 500kV Bus Supports
- Six 500kV CCVT Potential Devices
- Six 500kV Surge Arresters
- Two 500kV 3000A Wave Traps and Line Tuners (on the Eldorado Line)
- Six Line Tie-Downs with 2-2156KCMIL ACSR Conductors
- Three 660 Ft. sections of 2-2156KCMIL ACSR Bus Conductors (Approximately 4000Ft. of Conductor)



**Position 2:**

Install one Double Breaker Line Position on a Breaker-and-a-Half Configuration to connect the No.1AA Tr. Bk. as follows:

- One Dead-End Structure (108 Ft. High x 90 Ft. Wide)
- Two 500kV – 3000A – 40kA Circuit Breakers
- Four 500kV Horizontal-Mounted Group-Operated Disconnect Switches – One of them equipped with Grounding Attachments.
- Thirty three 500kV Bus Supports
- Three Line Tie-Downs with 2-2156KCMIL ACSR Conductors
- Three 660 Ft. sections of 2-2156KCMIL ACSR Bus Conductors (Approximately 4000Ft. of Conductor)

**Position 3:**

Install one Double Breaker Line Position on a Breaker-and-a-Half Configuration to terminate the Lugo No.2 500kV T/L as follows:

- One Dead-End Structure (108 Ft. High x 90 Ft. Wide)
- Two 500kV – 3000A – 40kA Circuit Breakers
- Four 500kV Horizontal-Mounted Group-Operated Disconnect Switches – One of them equipped with Grounding Attachments.
- Thirty three 500kV Bus Supports
- Three 500kV CCVT Potential Devices
- Three 500kV Surge Arresters
- Three 500kV 4000A Wave Traps and Line Tuners
- Three Line Tie-Downs with 2-2156KCMIL ACSR Conductors
- Three 660 Ft. sections of 2-2156KCMIL ACSR Bus Conductors (Approximately 4000Ft. of Conductor)

**Position 4:**

Install one Double Breaker Line Position on a Breaker-and-a-Half Configuration to connect the No.1AA Tr. Bk. as follows:

- One Dead-End Structure (108 Ft. High x 90 Ft. Wide)
- Two 500kV – 3000A – 40kA Circuit Breakers
- Four 500kV Horizontal-Mounted Group-Operated Disconnect Switches – One of them equipped with Grounding Attachments.
- Thirty three 500kV Bus Supports
- Three Line Tie-Downs with 2-2156KCMIL ACSR Conductors
- Three 660 Ft. sections of 2-2156KCMIL ACSR Bus Conductors (Approximately 4000Ft. of Conductor)

**500/220kV Transformer Banks:**

Install two 1120MVA 500/220kV Transformer Banks as follows:

- Seven 373MVA 500/161-220kV Single-Phase units, including one spare unit.
- Six 500kV Surge Arresters
- Six 220kV Surge Arresters
- One standard transformer structure with all the required 500kV and 220kV bus-work to allow for the Grounded Wye / Delta connection of the Single-Phase units and placement of the spare unit.
- Two 13.8kV Tertiary Buses. Each Bus equipped as follows:
- Five 13.8kV – 2000A – 17kA Circuit Breakers
- Fifteen 13.8kV Hook-Stick Disconnect Switches
- Five 13.8kV 45MVAR Reactors

- One Ground Bank Detector (3 - 5kVA 14400-120/240V Transformers)
- One 14400-120V Voltmeter Potential Transformer
- One Voltmeter
- Three 40E Standard Size 4 S&C Type Fuses
- Six 450 Ft. spans of 2-2156KCMIL ACSR Conductors for the 500kV Transformer Leads. (Approximately 5500Ft. of Conductor)
- Six 250 Ft. spans of 2-2156KCMIL ACSR Conductors for the 220kV Transformer Leads. (Approximately 3000Ft. of Conductor)

## **220kV Switchyard**

### **Operating Buses**

Replace two existing 145 Circuit Ft. of 605KCMIL ACSR Bus with new 2-1590KCMIL ACSR Conductors and extend 220kV North and South Buses as follows:

- Install ten Bus Dead End Structures (38 Ft. High x 43 Ft. Wide)
- Install forty eight Bus Dead-End Insulator Assemblies
- Six 220kV Potential Devices
- Install two 665 Ft. sections of 2-1590KCMIL ACSR Bus Conductors (Approximately 8000Ft. of Conductor)
- Remove twelve 45 Ft. High lattice poles presently used as bus dead-ends

### **Position 1:**

This position presently terminates the Lugo No.1 220kV T/L connecting the line directly to the North Bus.

This line will become the Lugo 220kV T/L (No line number) after the existing Lugo No.2 220kV T/L is replaced by the new Lugo No.2 500kV T/L.

Equip the position as a Double Breaker Line Position by installing the following equipment and connecting the line to both the North and South Buses:

- Two 220kV – 3000A – 50kA Circuit Breakers
- Four 220kV Horizontal-Mounted Group-Operated Disconnect Switches – One of them with Grounding Attachments
- Three 220kV CCVT Potential Devices
- One 220kV 3000A Wave Trap and Line Tuner
- Three 215 Ft. sections of 1590KCMIL ACSR Bus Conductors (Approximately 650 Ft. of Conductor)

### **Position 2:**

This position is presently configured as a Double Breaker line Position to terminate the Cima – Eldorado No.1 220kV T/L.

The only work required at this position is to make new connections from the bus disconnect switches to each one of the upgraded North and South Buses.

### **Position 3:**

This position is presently configured as a Double Breaker line Position to terminate the Cima – Eldorado No.2 220kV T/L.

The only work required at this position is to make new connections from the bus disconnect switches to each one of the upgraded North and South Buses.

### **Position 4:**

This position presently terminates the Lugo No.2 220kV T/L connecting the line directly to the South Bus.

Remove the following equipment and leave position vacant for future use:

- Three 110 Ft. sections of 605KCMIL ACSR Conductors (330 Ft. of Conductors)
- Three sets of Bus Supports (Nine Supports) and associated support structures
- Three bus Supports and associated individual support pedestals

**Position 5:**

Install one Double Breaker Line Position to connect the No.1AA Tr. Bk. as follows:

- One Dead-End Structure (60 Ft. High x 45 Ft. Wide)
- Two 220kV – 3000A – 40kA Circuit Breakers
- Four 220kV Horizontal-Mounted Group-Operated Disconnect Switches – One of them equipped with Grounding Attachments.
- Two 220kV Bus Supports

**Position 6:**

Position left vacant for future 220kV T/L.

**Position 7**

Position left vacant for future 220kV T/L.

**Position 8**

Install one Double Breaker Line Position to terminate the new 220kV Solar Generation Tie Line as follows:

- One Dead-End Structure (60 Ft. High x 45 Ft. Wide)
- Two 220kV – 3000A – 40kA Circuit Breakers
- Four 220kV Horizontal-Mounted Group-Operated Disconnect Switches – One of them equipped with Grounding Attachments.
- Two 220kV Bus Supports
- Three 220kV CCVT Potential Devices
- One 220kV 3000A Wave Trap and Line Tuner

**Position 9:**

Install one Double Breaker Line Position to connect the No.2AA Tr. Bk. as follows:

- One Dead-End Structure (60 Ft. High x 45 Ft. Wide)
- Two 220kV – 3000A – 40kA Circuit Breakers
- Four 220kV Horizontal-Mounted Group-Operated Disconnect Switches – One of them equipped with Grounding Attachments.
- Two 220kV Bus Supports

**Mechanical - Electrical Equipment Room (MEER):**

Install a new 30 Ft. x 20 Ft. MEER Building to house the following equipment:

- Batteries and Battery Charger
- Light & Power Selector Switch
- Light & Power Panel
- A.C. Distribution Panel
- D.C. Distribution Panel

**PROTECTION RELAYS**

**500 kV Buses:**

- Twelve GE SBD11B Bus Differential Relays

**500kV T/L's:**

Install the following relays at each one of the three T/L's:

- Two GE C60 Breaker Management Relays
- One SEL-421 Distance Relay (with RFL 9780 PLCC)
- One GE L90 Line Current Differential (Digital Communication Channel)
- One GE D60 Distance Relay (Digital Communication Channel)
- One RFL 9745 Tele-protection Channel DTT (Digital F.O. Channel)
- One RFL 9780 FSK Power Line Carrier DTT.

**500/220kV Tr. Bk's:**

Install the following relays at each one of the two Tr. Bk's:

- Two GE C60 Breaker Failure Relay
- One GE T60 Transformer Differential Relay.
- One SEL-387 Transformer Differential Relay.
- One GE C30 Transformer/Ground Bank Sudden Pressure Aux. Relay

**220 kV Buses:**

- Twelve GE SBD11B Bus Differential Relays

**220kV T/L:**

Install the following relays at each one of the four T/L's:

- Two GE C60 Breaker Management Relay
- One GE L90 Line Current Differential (Digital Communication Channel)
- One SEL-311L Line Current Differential Relay (Digital Comm. Channel)
- Also: Remove Two SEL-311C relays from each one of the Cima – Eldorado Nos.1 and 2 220kV T/L's – Total of four relays removed)

Also install the following SPS Relays:

- Two N60 sensing relays on the Lugo No.1 and No.2 500kV T/L's.
- One SEL – 2407 Satellite Synchronized Clock.

Also install one Digital Fault Recorder

**Other Station Elements to be Installed:**

- 3675 Linear Feet of 8 Ft. perimeter fence with double barbed wire to cover a 1350 Ft. by 675 Ft. area expansion to the existing station.
- One 20 Ft. Double Door driveway gates
- Grounding Grid to cover a 1356 Ft. by 681 Ft. area (3 Ft. outside the perimeter fence)
- Grading and site preparation of a 1370 Ft. by 695 Ft. area (10 Ft. outside the perimeter fence)
- Approximately 4600 Linear Feet of 25 Ft. paved driveway
- Approximately 3000 Linear Feet of control cable trench

**Site Preparation**

**Site Information:**

Parcel area	= (not included in survey)
Area within existing fence line	= 1.6 acres
Area within proposed fence line	= 20.9 acres
Area of limits of grading	= 26.1 acres

**Earthwork:**

- Strip upper 6-inches of existing surface over the limits of grading. Remove vegetation and screen loose soil. Approximately 21,000 cubic yards. Estimate 30% waste to be hauled to green waste site = 6,000 cubic yards. Stockpile remaining 15,000 cubic yards for future use.
- Over-excavate and re-compact to 90% compaction, upper 1 foot. Approximately 42,000 cubic yards.
- Construct a berm around substation perimeter with dimensions of 4 feet high by 20 feet wide (at base). 3,000 linear feet, approximately 5,000 cubic yards (obtained from stockpile).
- Relocate existing drainage channel near southeast corner of new substation. Approximately 1,000 linear feet. Approximately 15,000 cubic yards of earth moved. Fill in existing channel adjacent to substation with remaining stockpiled soils. Provide new 16-foot wide concrete wet crossing at existing maintenance road.

**Interior driveways:**

5,000 linear feet of 25 foot wide asphalt pavement

- Over-excavate 2 Ft. and re-compact to 95% = 10,000 cubic yards
- Import Class II base at 6 inch thick = 2,500 cubic yards
- Asphalt concrete paving at 4 inch thick = 1,700 cubic yards

**Concrete drainage structures:**

- 3000 feet concrete swale 4 feet wide, 6 inches thick, with welded wire fabric at center. Approximate volume of concrete = 250 cubic yards.

**Rock surfacing:**

- 4 inches of rock surfacing over remainder of substation not covered by asphalt paving, equipment, or foundations.
- Approximately 9,000 cubic yards of crushed rock per ASTM C-131.

**2. Eldorado Substation – Protection Upgrades**

Install the following relays to upgrade the Lugo 500kV Line Protection as needed to change the line to the new Pisgah No.2 500kV T/L:

- One GE L90 Line Current Differential Relay (Digital Comm. Channel)
- One GE D60 Distance Relay (Digital Comm. Channel)
- One SEL-421 Distance Relay (RFL 9780 PLCC)
- One RFL 9745 DTT Protection Channel (Digital Comm. Channel)
- Two RFL 9780 DTT Protection Channel (FSK-PLCC)

Also install the following relays on each one of the two Cima – Pisgah No.1 and No.2 220kV T/L's to upgrade the Line Protection:

- One GE L90 Line Current Differential Relay (Digital Comm. Channel)
- One SEL-311 Line Current Differential Relay (Digital Comm. Channel)

**3. Lugo Substation – Protection Upgrades**

Install the following relays to upgrade the Eldorado 500kV Line Protection as needed to change the line to the new Pisgah No.1 500kV T/L:

- One GE L90 Line Current Differential Relay (Digital Comm. Channel)
- One GE D60 Distance Relay (Digital Comm. Channel)
- One SEL-421 Distance Relay (RFL 9780 PLCC)

- One RFL 9745 DTT Protection Channel (Digital Comm. Channel)
- Two RFL 9780 DTT Protection Channel (FSK-PLCC)

Also install the following relays on the Pisgah No.1 220kV T/L to upgrade the Line Protection:

- One GE L90 Line Current Differential Relay (Digital Comm. Channel)
- One SEL-311 Line Current Differential Relay (Digital Comm. Channel)

**NOTE:**

This line will become the Lugo – Pisgah 220kV T/L (No Number) after the existing Lugo – Pisgah No.2 220kV T/L is replaced by the Lugo – Pisgah No.2 500kV T/L

Also install the following SPS Relays:

- Two N60 sensing relays on the Pisgah No.1 and No.2 500kV T/L's.
- One SEL – 2407 Satellite Synchronized Clock.

**4. Lugo Substation – New 500kV Line Position**

Install one Double Breaker Line Position on a Breaker-and-a-Half Configuration to terminate the Pisgah No.1 500kV T/L as follows:

- Two 500kV – 3000A – 40kA Circuit Breakers
- Four 500kV Horizontal-Mounted Group-Operated Disconnect Switches – One of them equipped with Grounding Attachments.
- Thirty three 500kV Bus Supports
- Three 500kV CCVT Potential Devices
- Three 500kV Surge Arresters
- Three 500kV 4000A Wave Traps and Line Tuners
- Three Line Tie-Downs with 2-2156KCMIL ACSR Conductors
- Three 660 Ft. sections of 2-2156KCMIL ACSR Bus Conductors (Approximately 4000Ft. of Conductor)

Also install the following Line Protection Relays:

- Two GE C60 Breaker Management Relays
- One SEL-421 Distance Relay (with RFL 9780 PLCC)
- One GE L90 Line Current Differential (Digital Communication Channel)
- One GE D60 Distance Relay (Digital Communication Channel)
- One RFL 9745 Tele-protection Channel DTT (Digital F.O. Channel)
- One RFL 9780 FSK Power Line Carrier DTT.

**NOTE:**

At this time it has been determined that the best possible way to terminate this line would be at Position 2. This requires the relocation of the Mohave 500kV Line Position from Pos.1 to Pos.1-X and the Eldorado Line Position from Pos.2 to Pos.1.

This relocation requires the installation of one Dead End Structure (108 Ft. High x 90 Ft. Wide) at Pos. 1-X

### C. Telecommunications:

Install dual communication channels on separate routes to support the Line Protection and SPS Relays related to the following elements:

- Line Protection Relays for the Three – Terminal SES 220kV Generation Tie Line
- Line Protection Relays for the Lugo – Pisgah No.1 and No.2 500kV T/L's
- Line Protection Relays for the Eldorado – Pisgah 500kV T/L
- SPS Relays required to trip the Project under the simultaneous outages of both the Lugo – Pisgah No.1 and No.2 500kV T/L's.

The dual paths required between line terminations will be provided by a combination of new Fiber Optic Cables and new and existing Microwave Radio Channels as follows:

SES 220kV Generation Tie Line:	OPGW on the new SES 220kV Gen Tie Line between Pisgah Substation and SES Solar Substation A with a short tap to SES Solar Substation B <u>and</u> new Microwave Channels between Pisgah Sub. and both SES Solar Substations A and B.
Eldorado – Pisgah 500kV T/L:	Existing Eldorado – Lugo MW Network <u>plus</u> new OPGW on Lugo – Pisgah No.2 500kV T/L <u>and</u> new Power Line Carrier on the new Eldorado – Pisgah 500kV T/L.
Lugo – Pisgah 1 & 2 500kV T/L's:	New OPGW to be installed by replacing one of the two existing OHGW's on the Lugo – Pisgah No.1 500kV T/L with OPGW <u>and</u> the OPGW to be installed on the new Lugo – Pisgah No.2 500kV T/L .

**NOTE:** The installations described above will also satisfy the requirements to provide a telecommunications link between the RTU's to be installed at Pisgah Substation and the SES Solar Substations A and B and Lugo Substation.

#### The following work is required:

##### 1. Pisgah Substation:

Install a new 185 Ft. Microwave Antenna Tower to provide channels to SES Solar Substations A and B and associated dishes, microwave radio terminals and terminal equipment.

Transmission will install OPGW on the SCE owned rack span of the SES 220kV Gen Tie Line and Substations will install tranches and / or conduits to bring the Fiber Optic Cable from the 220kV Switchyard into the new Communications Room.

##### 2. Lugo Substation:

Install all required terminal equipment and channel banks.

Substations will install tranches and / or conduits to bring the Fiber Optic Cable from the 220kV Switchyard into the new Communications Room.

##### 3. Eldorado Substation:

Install all required terminal equipment and channel banks.

#### **4. SES Solar Substations A and B:**

Install a new 125 Ft. Microwave Antenna Tower at each location to provide channels to SCE Pisgah and associated dishes, microwave radio terminals and terminal equipment.

#### **SES 220kV Gen Tie Line and Solar Substations A and B:**

**NOTE:** The following elements are to be provided by SES.

The cost of these elements is not included in this Facilities Study but their description is included in this document to clarify the scope.

#### **SES 220kV Gen Tie Line:**

Install approximately 12.1 Miles of Optical Ground wire on the SES 220kV Gen Tie Line running for approximately 12 Miles between Pisgah Sub. and SES Solar Substation A with a 0.1 Mile Tap to SES Solar Substation B.

#### **SES Solar Substations A and B:**

SES will provide space for the SCE M/W Antenna Towers at each location.

The Towers shall be installed next or as close as possible to the Communications Room.

SES will provide conduits or trays (depending on the layout of their facilities) for SCE to install all required cables from the Antenna Towers to the Communications Room and the Protection Relays.

SES will provide a space of approximately 30 Ft. by 15 Ft. in their Communications Room for SCE to install the required terminal equipment.

SES will also provide AC and DC Power Supplies for the SCE Terminal Equipment.

#### **D. Power System Control**

Install four Remote Terminal Units (RTU's) as follows:

- Replace the existing RTU at Pisgah Substation with a new unit to monitor the typical Bulk Power elements such as MW, MVAR, and Phase Amps at each line and also kV at lines and buses and all circuit breaker status / control, Protection Relays Status and Alarms. This RTU will also support the proposed SPS.
- Install one at RTU at each one of the SES Solar Substations A and B to monitor the typical Generation elements such as MW, MVAR, terminal Voltage and Circuit Breaker Status at each Generating Unit and the Plant Auxiliary Load.
- Install a new RTU at Lugo Substation to support the proposed SPS.

The telecommunication circuits from required to support the required RTU's have been included in the scope of telecommunications.

#### **E. Corporate Real Estate:**

Survey the area surrounding the new Pisgah Substation and the 500kV Line Loop and prepare topo maps and line profiles to support the engineering and design activities.

Also perform all required activities to obtain new Right of Way for the 13-Mile segment out of Lugo Substation for the new Lugo – Pisgah No.2 500kV T/L.

These activities will include, but not be limited to mapping, surveying, appraisals and title work,



**SOLAR ONE PROJECT**  
**FACILITIES STUDY SCOPE – DETAILS**  
**ADDITIONAL ELEMENTS FOR CASE B**

**A. Substations:**

**1. Etiwanda Gen. Sta. 220kV Switchyard**

Replace three 45.6kA 220kV CB's with new 63kA Rated units and Install sixteen sets of TRV Line to Ground Capacitors (Total of forty eight units) to upgrade seventeen 50kA 220kV CB's to 63kA Rating.

**2. Mira Loma Substation**

Replace twelve 63kA 220kV CB's with new 80kA Rated units and upgrade the station 220kV Switchyard to 80kA Rating.

**NOTE:**

- The scope of work for the Switchyard upgrade has not been completed at this time.
- A scope of work and cost estimate has been prepared for the upgrade of a similar facility.
- At this time it is expected that the type of upgrades for this location would be very similar to those already scoped and estimated for the similar facility.
- Based on this assumption, it is expected that, in addition to the replacement of the circuit breakers, the following upgrades would be required:
  1. Replace twelve 220kV Circuit Breakers.
  2. Replace twenty four 220kV Disconnect Switches.
  3. Replace seven 220kV Surge Arresters.
  4. Replace all line and bank vertical risers with tubular conductors.
  5. Replace all 4/0CU connections to the ground grid with new 350KCMIL ACSR.
  6. Install new sections of 350KCMIL ACSR Ground Grid and connect to the existing 4/0CU Grid.

**E. A. Romero**

**09/24/08**

**EXHIBIT F**

**COST SUMMARY**

# SES SOLAR ONE PROJECT - Elements for Case A

Cost Estimate Summary (2015 Dollars)

**Scope:**

Interconnect 850MW of Solar Generation to the SCE Pisgah Substation. The interconnection requires the expansion of Pisgah Substation to a 2240MVA 500/220kV facility, the looping of the Eldorado - Lugo 500kV T/L into Pisgah Sub. and the replacement of the Lugo - Pisgah No.2 220kV T/L with a new 500kV T/L plus the installation of a new SPS and RTU's at both SES Substations A and B. It also requires the installation of new Telecommunication Channels between Pisgah, Lugo, Eldorado and SES Substations A and B.

ELEMENT	INTERCONNECTION FACILITIES		RELIABILITY UPGRADES		Income Tax Component of Contribution *	ONE TIME PAYMENT
	Subject to O&M	Not Subject to O&M	Not Subject to O&M	Income Tax Component of Contribution *		
SES 220kV Gen Tie Line - Rack Span into Pisgah Sub.	\$ 80,000	\$ -	\$ -	\$ 28,000	\$	108,000
Eldorado - Lugo 500kV T/L - Line Loop	\$ -	\$ 6,973,000	\$ 6,973,000	\$ -	\$	6,973,000
Lugo - Pisgah No.1 500kV T/L	\$ -	\$ 219,081,000	\$ 219,081,000	\$ -	\$	219,081,000
Lugo - Pisgah No.1 500kV T/L - Replace one OHGW with OPGW	\$ -	\$ 18,965,000	\$ 18,965,000	\$ -	\$	18,965,000
Relocation of 500kV Rack Spans at Lugo Sub.	\$ -	\$ 161,000	\$ 161,000	\$ -	\$	161,000
Pisgah Substation - Substation Expansion and SPSRelays	\$ 843,000	\$ -	\$ 120,653,000	\$ 295,000	\$	121,791,000
Eldorado Substation - Protection Upgrades	\$ -	\$ 724,000	\$ 724,000	\$ -	\$	724,000
Lugo Substation - Protection Upgrades	\$ -	\$ 573,000	\$ 573,000	\$ -	\$	573,000
Lugo Substation - New 500kV Line Position and SPS Relays	\$ -	\$ 12,263,000	\$ 12,263,000	\$ -	\$	12,263,000
Telecommunications - Line Protection - 220kV Gen Tie Line and RTU	\$ 2,325,000	\$ -	\$ -	\$ 814,000	\$	3,139,000
Telecommunications - Line Protection for SCE Lines and SPS	\$ -	\$ 2,890,000	\$ 2,890,000	\$ -	\$	2,890,000
Power Systems Control - RTU's at SES Solar Substations A and B	\$ 90,000	\$ -	\$ -	\$ 32,000	\$	122,000
Power Systems Control - Replacement of RTU's at Pisgah & Lugo Sub's	\$ -	\$ 122,000	\$ 122,000	\$ -	\$	122,000
Corporate Real Estate - Pisgah Sub. - 500kV Line Loop & New 500kV T/L ***	\$ -	\$ 1,607,000	\$ 1,607,000	\$ -	\$	1,607,000
<b>TOTAL</b>	<b>\$ 3,338,000</b>	<b>\$ 384,012,000</b>	<b>\$ 384,012,000</b>	<b>\$ 1,169,000</b>	<b>\$</b>	<b>388,519,000</b>

# Additional Elements for Case B

**Scope:**

Additional potential requirements to replace fifteen and upgrade seventeen 220kV CB's at two locations and upgrade one 220kV Switchyard to 80kA Rating.

ELEMENT	INTERCONNECTION FACILITIES		RELIABILITY UPGRADES		Income Tax Component of Contribution *	ONE TIME PAYMENT
	Subject to O&M	Not Subject to O&M	Not Subject to O&M	Income Tax Component of Contribution *		
Etiwanda Gen. Sta. 220kV Switchyard - Replace 3 & Upgrade 17 220kV CB's	\$ -	\$ -	\$ 5,466,000	\$ -	\$	5,466,000
Mira Loma Sub. - Replace 12 220kV CB's	\$ -	\$ -	\$ 11,368,000	\$ -	\$	11,368,000
Mira Loma Sub. - Upgrade 220kV Switchyard to 80kA Rating **	\$ -	\$ -	\$ 16,068,000	\$ -	\$	16,068,000
<b>TOTAL</b>	<b>\$ -</b>	<b>\$ -</b>	<b>\$ 32,902,000</b>	<b>\$ -</b>	<b>\$</b>	<b>32,902,000</b>

This document includes confidential trade secrets and proprietary information of Southern California Edison, to be used only by SES in connection with its evaluation of this Facility Study Proposal. Southern California Edison retains all rights to maintain the confidentiality of this information and requests that SES preserve its confidentiality.

\* ITCC tax (calculated at 35%) is collected via Letter of Credit.

\*\* Pursuant to FERC Order 2003A, there will be no ITCC collected on Reliability Upgrades.

\*\*\* The costs of upgrading the Mira Loma Substation 220kV Switchyards to 80kA Rating is only an approximate value based on an exiting estimate prepared for a similar facility.

\*\*\*\* The CRE Cost is only an approximation for the activities required to support the new facilities and it does not include land cost.

---

# Interconnection Optional Study

## Generation Interconnection

---

Stirling Energy Systems, Inc.  
Solar One Project Temporary 275MW Interconnection

Exhibits A, B, C, D, E, and F are included in the preceding Final Interconnection Facilities Study Report, dated November 6, 2008.



California ISO  
Your Link to Power

October 12, 2009

This study has been completed in coordination with Southern California Edison Company per the Large Generator Interconnection Procedures.

## Table of Contents

Description	Page
I. Background Information.....	3
II. Reason for Optional Study.....	3
III. LGIP Optional Interconnection Study (LGIP OIS) Results.....	4
IV. Facilities Study Assumptions.....	5
V. Facilities Study Scopes of Work.....	6
V – A Facilities Study Scope of Work – Alternative 1.....	7
V – B Facilities Study Scope of Work – Alternative 2.....	8
VI. Facilities Cost Estimates.....	8
VI – A Facilities Study Cost Estimate – Alternative 1.....	9
VI – B Facilities Study Cost Estimate – Alternative 2.....	9
VII. Conclusions.....	9
VIII. Exhibits	
Exhibit A	SES I Project Interconnection
Exhibit B	Technical Assessment II – Executive Summary
Exhibit C	WECC Generator Testing Requirements
Exhibit D	Pisgah Substation – 500kV Transmission Lines – Telecommunication Circuits
Exhibit E	Facilities Study Scope – Details
Exhibit F	Cost Summaries

STIRLING ENERGY SYSTEMS, INC.  
SOLAR ONE PROJECT – TEMPORARY 275MW INTERCONNECTION  
OPTIONAL STUDY

**I. Background Information:**

Stirling Energy System, Inc. (SES) applied to the California Independent System Operator (CAISO) for the interconnection of their 850MW Solar One Project to the CAISO Grid at the existing SCE Pisgah Substation 220kV Bus under the terms of SCE's Transmission Owner (TO) Tariff.

SCE prepared a System Impact Study (SIS) dated March 7, 2006 to analyze the impact of the 850MW Project to the SCE Transmission System.

In addition, SCE prepared a Technical Study (TAS I) to analyze Transient Stability Studies.

Subsequent to these two studies, a number of queued ahead generation projects withdrew from the CAISO Interconnection Queue resulting in a need to perform a complete reassessment of the impacts originally identified in the SIS and the TAS I.

SCE prepared a new Technical Assessment II (TAS II) dated June 13, 2008 to analyze the impact of the 850MW Project to the SCE Transmission System. This study incorporates the recent project withdrawals and presents corresponding results.

In September 2008 SCE prepared a Facilities Study addressing the scope of work and the cost estimate for the construction of all the Interconnection Facilities and System Upgrades required for the interconnection.

**NOTE:**

All Reports addressed above determined that the 850MW Interconnection would require the expansion of the existing Pisgah Substation, presently configured as a 220kV Switching Station, to a full 500/220kV Substation with two Transformer Banks and the installation of new 500kV Transmission Facilities.

**II. Reason for Optional Study:**

During the preparation of the several Reports addressed earlier, SES Solar requested SCE to investigate the possibility of interconnecting a portion of the 850MW Generation to the existing Pisgah Substation and the related 220kV System before the completion of the 500kV upgrades sometime in the Year 2010.

To comply with this request SCE prepared an Optional Interconnection Study Report to analyze the maximum amount of Generation that could be interconnected to the existing Pisgah 220kV Bus and related 220kV Transmission Lines and transmitted the Report to the CAISO on January 2008.

On January 9, 2008 the CAISO issued an LGIP Optional Interconnection Study Report which determined that a maximum of 275MW generation could be interconnected to the existing Pisgah 220kV Bus and related 220kV System contingent on the installation of a new Special Protection Scheme to trip-off the generation under certain contingencies.

It is the intent of this Interconnection that the 275MW would be a Temporary Interconnection until the 500kV System Upgrades are on line and the full 850MW Generation be connected to the upgraded system.

On July 17, 2009 SES Solar One executed an Optional Facilities Study Agreement for SCE to prepare a Report to provide Scope of Work and Cost Estimate for the Interconnection of 275MW of SES Solar One Generation to the existing Pisgah Substation 220kV Bus and related 220kV Transmission Lines.

STIRLING ENERGY SYSTEMS, INC.  
SOLAR ONE PROJECT – TEMPORARY 275MW INTERCONNECTION  
OPTIONAL STUDY

At this time, SCE estimates that the engineering and design, material procurement and construction activities for the expansion of the existing Pisgah Substation and the installation of the telecommunications channels required for the SPS would require approximately two years.

In addition, it is still uncertain the amount of time required to obtain all regulatory approvals that may be required for the expansion of Pisgah Substation and the installation of new telecommunications fiber optic cable required for the new SPS.

For these reasons, SCE does not believe it would be possible to interconnect the Project in the Year 2010 as requested. A detailed Project Schedule will be prepared after a more detailed investigation is finalized to determine the number of regulatory activities required and the time needed for their completion.

At this time, for the purpose of providing a Cost Estimate with the proper escalation factors,, this Report would assume an Interconnection Date of December 1, 2011.

### III. LGIP Optional Interconnection Study (LGIP OIS) Results

The LGIP OIS concluded that the existing SCE Transmission System is not adequate to support the Project and identified upgrades required for the 275MW Interconnection.

Although the Project does not trigger any Base case Overloads it requires a new Special Protection Scheme to eliminate two Single Contingency (N – 1) overloads as follows:

#### Two N – 1 Overloads triggered by the Project:

1. Lugo – Pisgah No.1 220kV T/L                      Rated 725A                      Loaded to 835A                      (115%)  
    Under the outage of the Lugo – Pisgah No.2 220kV T/L
2. Lugo – Pisgah No.2 220kV T/L                      Rated 725A                      Loaded to 835A                      (115%)  
    Under the outage of the Lugo – Pisgah No.1 220kV T/L

#### Two Pre-Project N – 1 Overloads aggravated by the Project:

3. Lugo No.1AA 500/220kV Tr. Bk.                      Rated 725A  
    Pre-Project Overload of 1790MVA (160%) aggravated to 2070 (185%)  
    Under the outage of the Lugo No.2AA 500/220kV Tr. Bk.
4. Lugo No.2AA 500/220kV Tr. Bk.                      Rated 725A  
    Pre-Project Overload of 1790MVA (160%) aggravated to 2070 (185%)  
    Under the outage of the Lugo No.1AA 500/220kV Tr. Bk.

Proposed Solution:    Install a new SPS to trip the Project under either one of the outages described above.

#### NOTE:

There is an existing SPS in place which trips the High Desert Power Project under the outage of either Lugo No.1AA or No.2AA Tr. Bk. to eliminate overloading the remaining unit.

However, the existing SPS is not adequate to accept the addition of the SES Solar 275MW Project. For this reason, SES Solar would be responsible for the new SPS described above.

STIRLING ENERGY SYSTEMS, INC.  
SOLAR ONE PROJECT – TEMPORARY 275MW INTERCONNECTION  
OPTIONAL STUDY

The LGIP OIS identified the following two 500kV, seven 220kV, and one 115kV locations where the Project causes the Three Phase and / or the Single Phase to Ground Short Circuit Duties to increase by 0.1kA or more and requested that all circuit breakers at those locations be evaluated.

500kV:

Eldorado        Lugo

220kV:

Eldorado        Etiwanda        Lugo                Mira Loma        Victor    Vincent        Walnut

115kV:

Victor

The Circuit Breaker evaluations concluded that the Project does not trigger any CB replacements or upgrades but aggravates pre-project conditions that require the replacement of twelve 220kV CB's at Mira Loma Substation.

**For additional detail refer to:**

**EXHIBIT A: LGIP OPTIONAL INTERCONNECTION STUDY – EXECUTIVE SUMMARY**

**IV. Facilities Study Assumptions**

- A. The SES 220kV Gen Tie Line from the SES Generating Facility to the last structure outside the SCE Pisgah Substation property line will be installed by SES and is not included in the Facilities Study.
- B. The SES 220kV Gen Tie Line must be equipped with Optical Ground Wire (OPGW) to provide one of the two telecommunication paths required for the line protection scheme and the SPS. The cost of the OPGW will be included in the cost of the line and is not included in the Facilities Study.
- B. The second telecommunication path will be provided by SCE by installing a new Fiber Optic Cable between Pisgah Substation and the SES Generating Facility and this cost is included in the Facilities Study.
- C. It is expected that the last structure of the SES 220kV Gen Tie line outside the SCE Pisgah Substation perimeter fence would be close enough to the 220kV Switchyard that would require only one span of conductors to reach the proposed 220kV Line Position. In this case, the last span of conductors from the last SES Structure to the Pisgah Substation 220kV Switchyard will be installed by SCE and it is included in the Facilities Study.
- D. All required CAISO metering equipment at the Generating Facility will be provided by SES and is not included in the Facilities Study.
- E. The following line protection relays, to be installed at the termination points of the SES 220kV Gen Tie Line at the SES Generating Facility will be specified by SCE and provided by SES and are not included in the Facilities Study.
  - One G.E. L90 Current Differential Relays with dual dedicated digital communication channels to Pisgah Substation.
  - One SEL 311L Current Differential Relays with dual dedicated digital communication channels to Pisgah Substation.



STIRLING ENERGY SYSTEMS, INC.  
SOLAR ONE PROJECT – TEMPORARY 275MW INTERCONNECTION  
OPTIONAL STUDY

- F. The following SPS Relays, to be installed at the SES Generating Facility will be specified by SCE and provided by SES and are not included in the Facilities Study.
- Two N60 relays (One each for SPS A and B) to trip the Main Generator Breaker.
  - One SEL – 2407 Satellite Synchronized Clock.
- G. The required Remote Terminal Unit (RTU's) to be installed at the SES Generating Facility will be installed by SCE and it is included in the Facilities Study.
- H. Any cost of easements and / or land acquisition that may be required for the new Pisgah – Gale Fiber Optic Cable and the new Distribution Circuit to serve the Optical Repeater Site is not included in the Facilities Study.
- I. The cost to support all SCE activities required for the Environmental Impact Statement and/or Environmental Impact Report and all other regulatory filings required for the Project is not included in the Facilities Study.
- J. The possible installation of additional 220kV Circuit Breakers at the existing Lugo No.1 and No.2 220kV line Positions at Pisgah Substation to upgrade the station to the present Line and Bus Criteria will be performed by SCE and is not included in the Facilities Study.

**V. Facilities Study Scopes of Work**

Pursuant to FERC's orders 2006-A (Small Generators) and 2003-A (Large Generators) all Facilities Studies are required to provide the customer with its "maximum possible funding exposure", which shall include the costs of upgrades that are reasonably allocable to the Interconnection Customer at the time the estimate is made, and the costs of any upgrades not yet constructed that were assumed in the interconnection studies for the Interconnection Customer but are, at the time of the estimate, an obligation of an entity other than the Interconnection Customer."

To comply with the FERC orders, the Scope of Work and Cost Estimate for all elements required for the interconnection are presented for the following two cases:

**CASE A: All facilities required exclusively by the Project**

And

**CASE B: All additional facilities that may be required by the Project**

The facilities included on Case B are those additional facilities required to remedy situations caused by earlier Projects, placed ahead of the Project in the Application Queue, and are expected to be implemented by them.

However, in the event that any of these earlier Projects withdraws their Application, the Project may become responsible for any or all of these additional facilities.

**Classification of Facilities Under Two Possible Alternative Scenarios:**

The original Facilities Study for the 850MW Interconnection addresses the need to expand the existing Pisgah Substation from its present 220kV Switchyard Configuration to a full 2240MVA 500/220kV Substation and it assumes that the expansion would be constructed at the present location.

However, there is a possibility that, in SCE's determination, the existing site may not be suitable for the expansion required for the new 500/220kV Substation.

If this was the case it is expected that SCE would install a "New Pisgah" Substation at a site located relatively close to the "Existing Pisgah" Substation and the existing facilities would be

STIRLING ENERGY SYSTEMS, INC.  
SOLAR ONE PROJECT – TEMPORARY 275MW INTERCONNECTION  
OPTIONAL STUDY

removed from service.

This situation creates the following two possible Alternative Scenarios:

**ALTERNATIVE 1: Pisgah Substation Expanded at its Present Location**

Under this alternative, all the facilities required for the Temporary 275MW Interconnection would remain in place for the Final 850MW Interconnection.

**ALTERNATIVE 2: New Pisgah Substation at a New Location**

Under this alternative some of the facilities required for the Temporary 275MW Interconnection will no longer be required when the Final 850MW Interconnection is installed at the “New Pisgah” Substation.

**Under this Alternative SES Solar would be responsible for the cost of the installation and subsequent removal of all Temporary Facilities.**

**V – A Facilities Study Scope of Work – Alternative 1**

The following elements required for the Temporary 275MW Interconnection at the existing Pisgah Substation will remain in place and be utilized for the Final 850MW Interconnection.

**CASE A:**

1. SES 220kV Gen Tie Line: Install Rack Span into Pisgah Substation.
2. Lugo – Pisgah No.1 500kV T/L: Replace one of the two existing ½-In. Steel Overhead Ground Wires with new Optical Ground Wire (OPGW).
3. Pisgah Substation: Expand the existing station and install a new Double Breaker 220kV Line Position to terminate the new SES Solar 220kV Gen Tie Line.  
Also install Motorized Disconnect Switches at each one of the existing Lugo No.1 and No.2 220kV line Positions.  
Also install SPS Relays.
4. Lugo Substation Install SPS Relays
5. Telecommunications Install new digital channels and associated terminal equipment to support the Line Protection Relays for the new SES 220kV Gen Tie Line, the SPS Relays and the new RTU's to be installed at the SES Generating Facility.  
This work requires the installation of new Fiber Optic Cables from Pisgah Substation to the SES Generating Facility and the SCE Gale Substation.  
Install a new Optical Repeater Site to amplify the OPGW signal at a location close to the midpoint between Lugo and Pisgah Substations.
6. Distribution Install a new Distribution Circuit and the required Pole Top Transformer to provide an AC Power Source to the new Telecommunications Optical Repeater Site.  
Relocate existing Distribution Circuit presently providing the required Light and Power Source to Pisgah

STIRLING ENERGY SYSTEMS, INC.  
SOLAR ONE PROJECT – TEMPORARY 275MW INTERCONNECTION  
OPTIONAL STUDY

- Substation around the western side of the substation expansion.
7. Power System Control      Install new RTU's at the SES Generating Facility and Pisgah Sub. and two new RTU's at Lugo Sub.  
Also upgrade existing RTU at Lugo Substation.

**CASE B:**

8. Mira Loma Substation:      Replace twelve 63kA 220kV Circuit Breakers with new 80kA Rated units.

**V – B Facilities Study Scope of Work – Alternative 2**

The following elements required for the Temporary 275MW Interconnection at the existing Pisgah Substation will no longer be required when the Final 850MW Interconnection is installed at the “New Pisgah” Substation.

Under this Alternative SES Solar would be responsible for the installation and removal of the following Temporary Facilities:

1. SES 220kV Gen Tie Line: Installation of the Rack Span into Pisgah Substation.
2. Pisgah Substation:      Expansion of the existing station and installation of the new Double Breaker 220kV Line Position to terminate the new SES Solar 220kV Gen Tie Line and SPS Relays and Motorized Disconnect Switches..

**NOTES:**

- The relocation of the existing Distribution Circuit presently providing the required Light and Power Source to Pisgah Substation around the western side of the substation expansion will be left in place.
- The new Fiber Optic Cables between the existing Pisgah Substation and the Generating Facility and Gale Substation will be left in place and extended to the “New Pisgah” Substation for the Final 850MW Interconnection.

**FOR ADDITIONAL DETAIL REFER TO THE FOLLOWING EXHIBITS:**

- **EXHIBIT B: PISGAH SUBSTATION and TELECOMMUNICATIONS CIRCUITS**
- **EXHIBIT C: OPTIONAL FACILITIES STUDY – SCOPE DETAILS**

**VI. Facilities Study Cost Estimates**

**CASE A**      Identifies the cost of all facilities that are required exclusively by the Project.

**CASE B**      Identifies the cost of all upgrades required that were triggered by earlier Applicants placed ahead of the Project in the Application Queue.

In the event that any Applicant, presently placed ahead of the Project in the Application Queue, withdraws its Application, the system would need to be re-evaluated. The new evaluation may conclude that the Project would now trigger any of these upgrades and would then become responsible for some or all of the upgrades identified on Case B.

**VI – A Facilities Study Cost Estimate – Alternative 1**

STIRLING ENERGY SYSTEMS, INC.  
SOLAR ONE PROJECT – TEMPORARY 275MW INTERCONNECTION  
OPTIONAL STUDY

The total estimated cost for the installation of all required for the Temporary 275MW Interconnection which will be left in place for the Final 850MW Interconnection is as follows:

CASE A:	\$48,613,000
CASE B ( <u>May</u> be added to Case A):	<u>\$ 9,887,000</u>
POSSIBLE MAXIMUM COST EXPOSURE:	\$58,500,000

The total estimated \$42,727,000 would be accounted for as a portion of the ultimate cost for the Final 850MW Interconnection.

#### **VI – B Facilities Study Scope of Work – Alternative 2**

The total estimated cost for the installation of all required for the Temporary 275MW Interconnection plus the removal of all elements which will no longer be required when the final 850MW Interconnection is installed at the “New Pisgah” Substation is as follows:

CASE A:	\$48,613,000
CASE A – Removal:	\$ 1,229,000
CASE B ( <u>May</u> be added to Case A):	<u>\$ 9,887,000</u>
POSSIBLE MAXIMUM COST EXPOSURE:	\$59,729,000

A total of \$7,698,000 of this estimated \$59,729,000 addressed above will be the direct responsibility of SES Solar and would not be accounted for as a portion of the ultimate cost for the Final 850MW Interconnection.

This \$7,698,000 is the Sunk Cost for the elements required for the Temporary 275MW Interconnection at the existing Pisgah Substation which will no longer be required when the Final 850MW Interconnection is installed at the “New Pisgah” Substation.

#### **SEE EXHIBIT D: COST SUMMARIES**

### **VII. Conclusions**

- A. The estimated cost for the Temporary 275MW Interconnection – Alternative 1 is approximately \$48,613,000 for Case A with the potential additional cost of \$9,887,000 for Case B for a total Maximum Cost Exposure of \$58,500,000.

This cost would be allocated as a portion of the of the ultimate cost for the Final 850MW Interconnection.

- B. The estimated cost for the Temporary 275MW Interconnection – Alternative 2 is approximately \$49,842,000 for Case A with the potential additional cost of \$9,887,000 for Case B for a total Maximum Cost Exposure of \$59,729,000.

SES Solar would be responsible for a Sunk Cost of \$7,698,000 required for Temporary Facilities which will no longer be required when the Final 850MW Interconnection is installed at the “New Pisgah” Substation.

STIRLING ENERGY SYSTEMS, INC.  
SOLAR ONE PROJECT – TEMPORARY 275MW INTERCONNECTION  
OPTIONAL STUDY

- C. The Cost Estimates addressed on Items A and B above do not include any possible easements and / or land acquisition that may be required for the new Pisgah – Gale Fiber Optic Cable and the new Distribution Circuit to serve the Optical Repeater Site.

In addition, the Cost Estimates do not include activities required to obtain additional easements, licenses or permits and to conduct any environmental activities related to the expansion of Pisgah Substation, the new Pisgah – Gale Fiber Optic Cable and the new Distribution Circuit to serve the Optical repeater Site.

- D. The time required to complete the proposed project will be approximately two years after receiving project authorization and funding, subject to availability of resources.

Please note that this time frame is required exclusively for the engineering, design, purchase of materials and construction of the elements addressed in this Report.

This time frame does not include any possible activities that may be required to obtain additional easements, licenses or permits and to conduct any environmental related activities.

- E. The costs indicated in the attached tables are shown in 2011 Dollars and are not firm.

These are only preliminary estimates based on conceptual engineering and system unit costs, and are subject to change based on the final design and actual material costs.

This Facilities Study and cost estimates as presented are valid for a period of 150 days.

- F. The estimated Project Cost will be reconciled to actual costs upon closure of the subject work orders. The necessary billing adjustments will be made at that time.

**EXHIBIT A**

**LGIP OPTIONAL  
INTERCONNECTION STUDY**

**EXECUTIVE SUMMARY**

---

# **LGIP Optional Interconnection Study Report**

---

## **SES Solar One Project**

LGIP Optional Interconnection Study: 275 MW On-Line by 2010



**California ISO**  
Your Link to Power

January 9, 2008

This study has been completed in coordination with Southern California Edison (SCE) per the Large Generator Interconnection Procedures (LGIP). Jorge Chacon with SCE and Donna Jordan with CAISO worked on this coordinated effort.

## I. EXECUTIVE SUMMARY

Southern California Edison Company (SCE) performed a System Impact Study for the SES Solar One 850 MW project as requested by Stirling Energy Systems (SES), Inc. The study report, dated March 7, 2006, identified the impacts associated with the interconnection of the new 850 megawatt (MW) solar generation project (Project) and determined that a number of facility upgrades will be required to interconnect the Project's 850MW output to the SCE's Pisgah Substation. In addition, SCE performed a separate Technical Assessment as part of the SES' Facilities Study work scope to evaluate transient stability performance associated with the new dynamic models prepared for the Project.<sup>1</sup> Congestion management was recommended to mitigate increases to the South of Lugo transmission until the completion of the currently planned Mira Loma-Vincent 500 kV transmission line (Segments 6, 7, and 8 of SCE's Tehachapi Renewable Transmission Project). The Technical Assessment report further determined that use of the revised dynamic model representation resulted in acceptable system performance under faulted system conditions and did not change the short-circuit duty contributions identified in the System Impact Study. Consequently, it was determined that the Project's 850MW output could be interconnected with the implementation of the System Impact Study recommended facility upgrades. Specific conceptual upgrades identified for the Project include expansion of the existing Pisgah Substation to become a Pisgah 500 kV substation, 500 kV transmission upgrades between the Lugo and Pisgah substations including a new Lugo-Pisgah 500 kV transmission line, and corresponding telecommunication upgrades associated with the complete 850MW plan of service required to support transmission line protection and the use of a special protection system.<sup>2</sup>

Because of the lead times associated with permitting and constructing new 500 kV transmission facilities, SES requested SCE to evaluate the possibility of interconnecting a portion of the Project in advance of constructing the required transmission upgrades to support the Project's 850MW output. SES provided to SCE a proposed phased construction schedule. Based on this schedule, the interconnection facilities would need to be in-service by the end of 2009 to meet the requested in-service date for interconnecting the first 115 MW of the Project. This optional study evaluated system performance for delivering up to 275 MW by the end of 2010, as requested by SES. The results of this optional study identified that the 275 MW can be accommodated with the expansion of the Pisgah 230 kV switchyard, the implementation of a special protection system (SPS) to trip the 275 MW under specific outage conditions. Substantial telecommunication facilities will be needed to support both the system protection and the required SPS for loss of a Lugo 500/230 kV transformer bank, loss of a Lugo-Pisgah 230 kV transmission line, or loss of both Lugo-Pisgah 230 kV transmission lines.

<sup>1</sup> A restudy of SES' System Impact Study is currently underway to address higher queued project withdrawals and to incorporate SES' revised project data. The revised SIS results will be incorporated within SES' Facilities Study.

<sup>2</sup> The proposed conceptual results for SES' System Impact Study are under review as part of the SIS restudy currently in progress.



Although a temporary plan of service could be accommodated via construction of the facilities listed above, it is important to note several complexities associated with meeting the requested in-service date. These complexities include the following:

1. SES' capacity request of 275MW requires the expansion of SCE's Pisgah 230kV Substation (Substation) beyond its existing property boundary, which would require an environmental assessment. In addition, the proposed telecommunication facilities could also be subject to an environmental assessment if additional modifications to the existing tower structures or new facilities are required to support the telecommunication requirements. Thus, an environmental assessment would likely need to be performed for the proposed expansion of the Pisgah Substation and the installation of OPGW.
2. The Pisgah Substation expansion and corresponding telecommunication facilities required for the interconnection of up to 275 MW are also part of the proposed plan of service for the Project's 850MW capacity request. Therefore, pursuant to the California Environmental Quality Act (CEQA), the substation expansion and corresponding telecommunication upgrades would be viewed as part and parcel of the overall project (i.e., the transmission upgrades required for the 850MW plan of service) and cannot be divided into separate environmental assessments.
3. Based upon preliminary estimates, it would require approximately two years to construct and procure all necessary telecommunication and substation expansion facilities to support early interconnection after receipt of all required regulatory approvals.<sup>3</sup>
4. To support the required Special Protection System the two following telecommunication facilities will be required:
  - a. Replacement of a portion of existing Eldorado-Lugo 500 kV OHGW with new OPGW between the Lugo and Pisgah Substations

Replacement of a portion of existing overhead ground wire with optical ground wire on the existing Eldorado-Lugo 500 kV transmission line between the Lugo and Pisgah Substations can be accommodated but would require some tower reinforcements. Detailed engineering review will be needed to ascertain exact number of tower reinforcements required. This option is also subject to SCE's ability to secure the long-term outage of the Eldorado-Lugo 500 kV transmission line from the CAISO in order to reinforce necessary towers and replace existing OHGW with OPGW.

- b. Installment of new Fiber Cable coupled with use of existing Microwave

New fiber-optic cable facilities between the Pisgah Substation and the Cool Water Substation facilities can be accommodated by utilizing approximately 20-miles of existing distribution facilities. This alternative would require conduits at each of

---

<sup>3</sup> Construction estimates provided within this report should be viewed as preliminary and subject to confirmation of final proposed man-hour requirements.

the respective substations (Pisgah, Cady, Gale, and Cool Water) to bring the fiber-optic from the closest power pole of each of the distribution lines into the substation. To complete telecommunication circuitry back to Lugo, existing SCE microwave can be used at the Cool Water Substation.

The purpose of this optional study was not to examine the viability of meeting the requested in-service date but rather to determine if the system could accommodate such a request assuming the in-service date could be met. Additional engineering review will be required to develop a suitable schedule and establish appropriate in-service dates for the proposed set of transmission facilities needed to facilitate the interconnection of the partial project (275 MW) as requested by SES in this Optional Study. Such review would need to be addressed under a separate engineering and design agreement if requested by SES.

**EXHIBIT B**

**PISGAH SUBSTATION  
and  
TELECOMMUNICATION CIRCUITS**



CALLLED NORTH

Existing pole with Station Service and Trans formers and Station Drop will remain in place

DISTRIBUTION CIRCUIT TO be relocated around West side of expansion or underground

270'

100'

LUGO N#1

LUGO N#2

Approximate Station Expansion

CIMA-ELDORADO N#1

CIMA-ELDORADO N#2

PROPOSED EXPANSION

SCALE: THIS DRAWING SUPERSEDES ALL PREVIOUS DRAWINGS

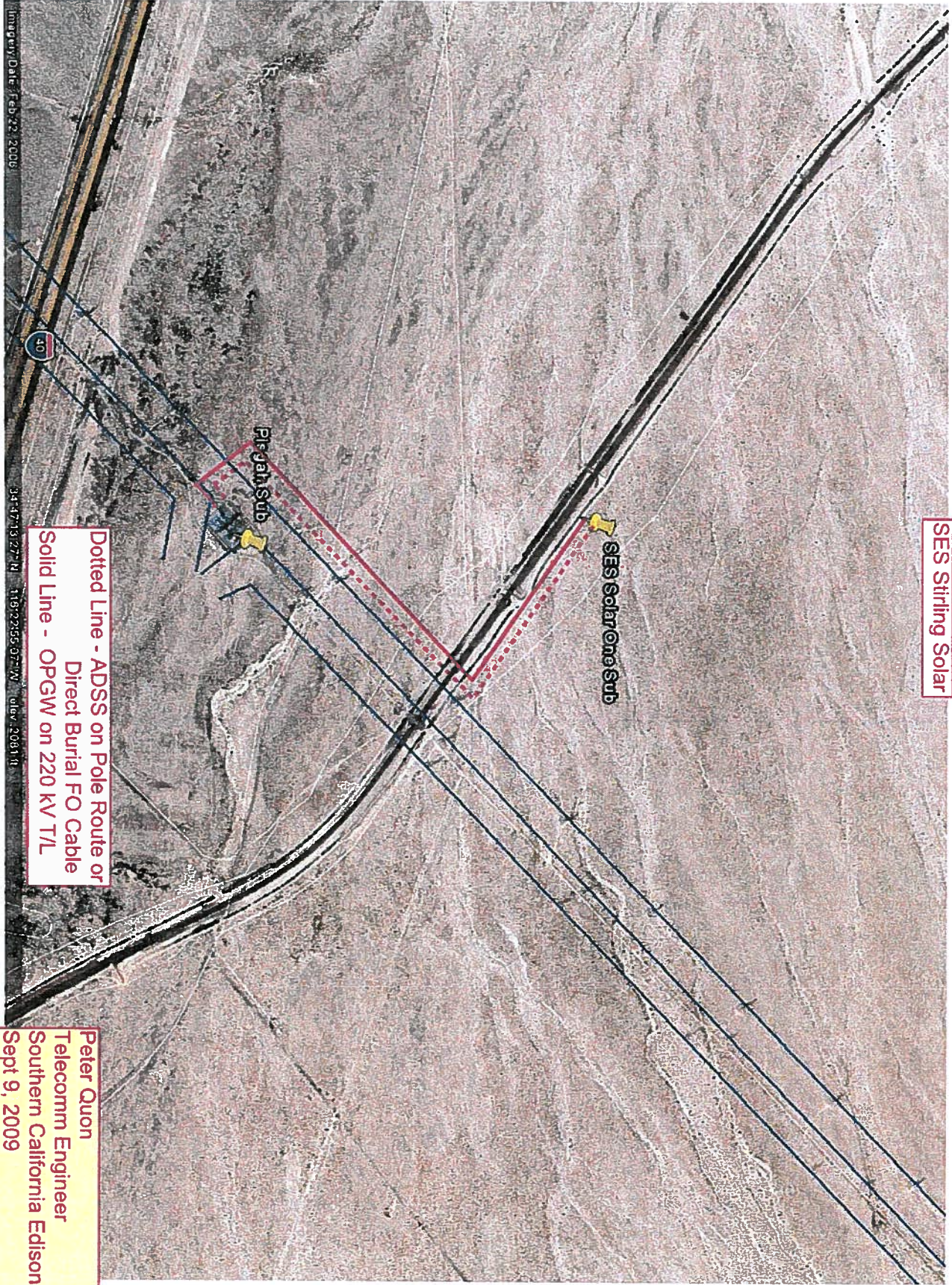
NO.	DATE	BY	CHKD.	APP'D.	REVISION
1	10/15/52	J. H. ...	...	...	...
2	...	...	...	...	...
3	...	...	...	...	...
4	...	...	...	...	...
5	...	...	...	...	...
6	...	...	...	...	...
7	...	...	...	...	...
8	...	...	...	...	...
9	...	...	...	...	...
10	...	...	...	...	...
11	...	...	...	...	...
12	...	...	...	...	...
13	...	...	...	...	...
14	...	...	...	...	...
15	...	...	...	...	...
16	...	...	...	...	...
17	...	...	...	...	...
18	...	...	...	...	...
19	...	...	...	...	...
20	...	...	...	...	...
21	...	...	...	...	...
22	...	...	...	...	...
23	...	...	...	...	...
24	...	...	...	...	...
25	...	...	...	...	...
26	...	...	...	...	...
27	...	...	...	...	...
28	...	...	...	...	...
29	...	...	...	...	...
30	...	...	...	...	...
31	...	...	...	...	...
32	...	...	...	...	...
33	...	...	...	...	...
34	...	...	...	...	...
35	...	...	...	...	...
36	...	...	...	...	...
37	...	...	...	...	...
38	...	...	...	...	...
39	...	...	...	...	...
40	...	...	...	...	...
41	...	...	...	...	...
42	...	...	...	...	...
43	...	...	...	...	...
44	...	...	...	...	...
45	...	...	...	...	...
46	...	...	...	...	...
47	...	...	...	...	...
48	...	...	...	...	...
49	...	...	...	...	...
50	...	...	...	...	...

522560-12

REVISE ELECTRONICALLY ONLY

20-45





SES Stirling Solar

SES Solar One Sub

Piegan Sub

Dotted Line - ADSS on Pole Route or Direct Burial FO Cable  
Solid Line - OPGW on 220 kV T/L

Peter Quon  
Telecomm Engineer  
Southern California Edison  
Sept 9, 2009

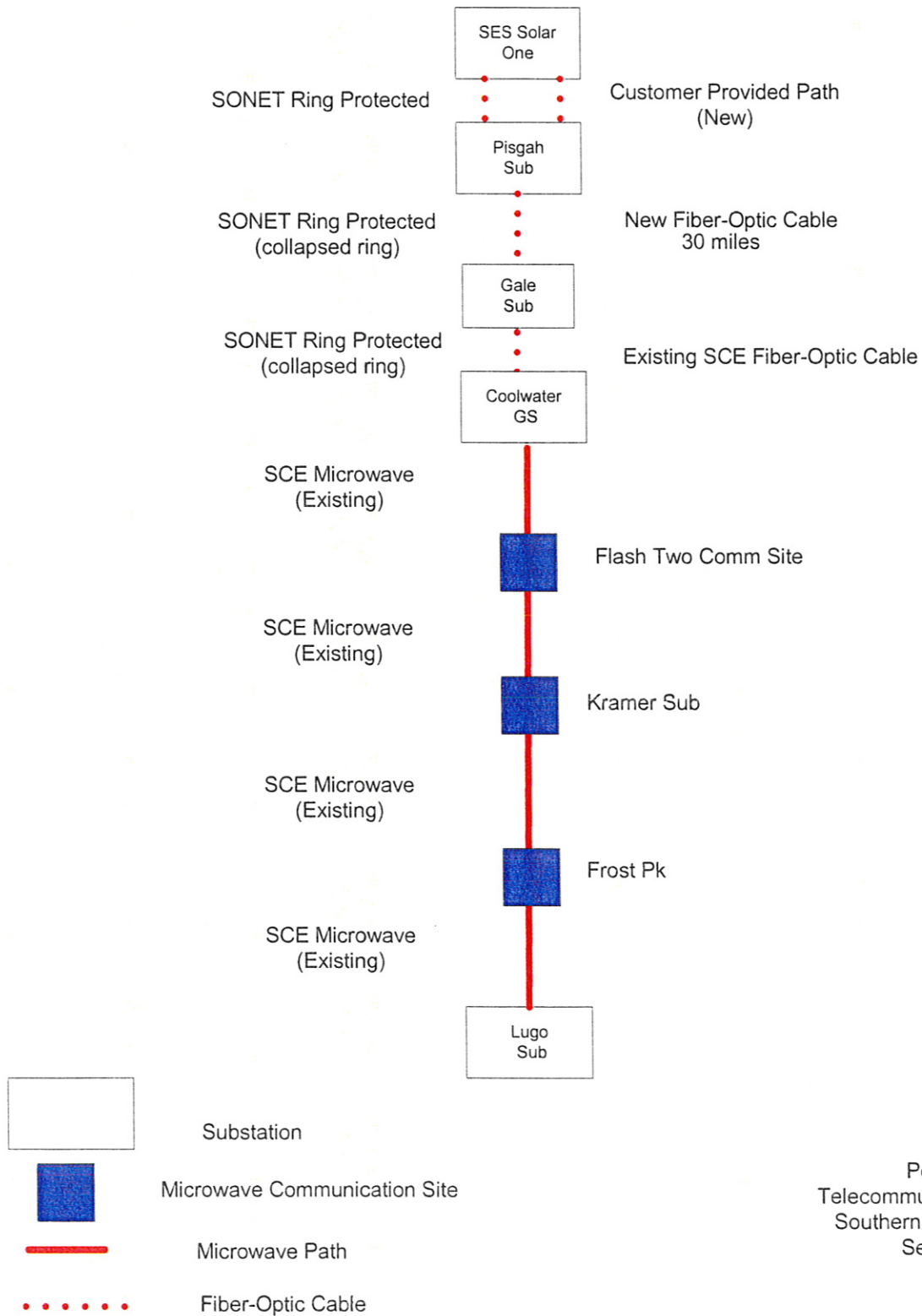
Imagery Date: Feb 22, 2009

34°17'13.27" N 119°22'55.07" W elev: 2081 ft

40

# SES Stirling Solar – Optional Study Early Interconnect

## RAS 'A' Path

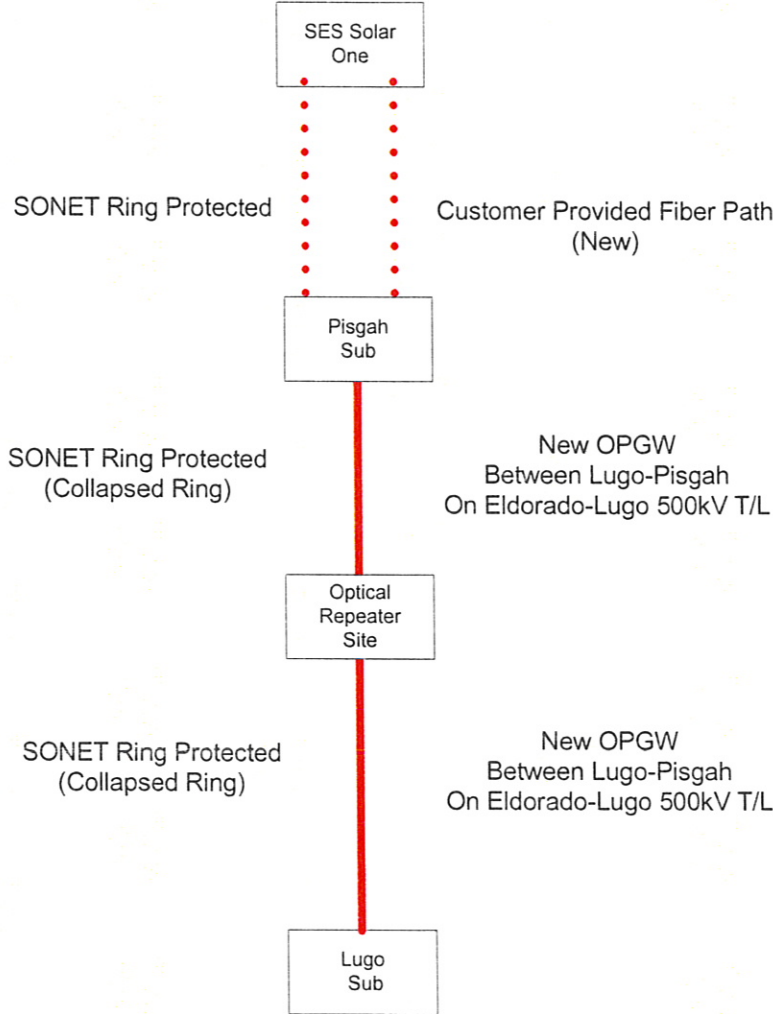


Peter Quon  
Telecommunications Engineer  
Southern California Edison  
Sept 9, 2009



# SES Stirling Solar – Optional Study Early Interconnect

## RAS 'B' Path



Substation



Fiber-Optic Cable



Optical Ground Wire (OPGW)

Peter Quon  
Telecommunications Engineer  
Southern California Edison  
Sept 9, 2009

**EXHIBIT C**

**OPTIONAL FACILITIES STUDY  
SCOPE DETAILS**

**SOLAR ONE PROJECT - TEMPORARY 275MW INTERCONNECTION  
FACILITIES STUDY SCOPE – DETAILS  
CASE A – ELEMENTS REQUIRED FOR THE PROJECT**

**A. Transmission:**

**1. SES Solar 220kV Generation Tie Line**

Install one span of 2-1033KCMIL ACSR Conductors and six dead end insulator / hardware assemblies between the last SES Dead – End Tower and the Substation Dead – End Structure at the 220kV Switchyard.

**2. Eldorado – Lugo 500kV T/L**

Replace one of the two existing Overhead Ground Wires (OHGW's) with new Optical Ground wire (OPGW) on the sixty five mile segment from Lugo Substation to Pisgah Substation. At this time, without the benefit of final engineering, it is estimated that approximately seventy structures will require structural modifications to reinforce the ground wire peaks and / or the upper bodies.

**B. Substations:**

**1. Pisgah Substation – Substation Expansion**

Expand the south west area of the station approximately 100Ft. and create a new area of approximately 270Ft. by 100Ft.

Extend the existing 220kV North and South buses 80Ft. to the West and install a new Double Breaker Line Position to terminate the new SES 220kV Gen Tie line.

Also install new 220kV Motorized Disconnect Switches on the Lugo No.1 220kV Line connection to the North Bus and the Lugo No.1 220kV Line connection to the North Bus.

**Installation Details:**

**220kV Switchyard**

**Operating Buses**

Extend the existing 605KCMIL ACSR Bus Conductors on the North and South 220kVBuses 80Ft. to the West as follows:

- Install two new Bus Dead End Structures (38 Ft. High x 43 Ft. Wide)
- Install twelve Bus Dead-End Insulator Assemblies
- Install six 80Ft. sections of 605KCMIL ACSR Bus Conductors (Approximately 500Ft. of Conductor)
- Modify the top section of the six existing Lattice Pole Bus Dead-Ends at the west end of the existing buses.
- Install six new 220kV Post Insulators on top of the existing Lattice Bus Dead-End Poles and make jumpers between the existing and new sections of each Bus.

**Position 2 – New Position:**

Install one Double Breaker Line Position to terminate the new 220kV Solar Generation Tie Line as follows:

- One Dead-End Structure (60 Ft. High x 50 Ft. Wide)
- Two 220kV – 3000A – 50A Circuit Breakers
- Four 220kV Horizontal-Mounted Group-Operated Disconnect Switches – One of them equipped with Grounding Attachments.
- Three Tie Downs equipped with 2-1033KCMIL ACSR Conductors

- Two 220kV Bus Supports
- Three 220kV CCVT Potential Devices
- Equip the position with 2-1033KCMIL ACSR Conductors

**Position 3:**

This position is presently configured to terminate the Lugo No.1 220kV T/L with a direct connection to the North 220kV Bus.

- Install a Motorized Disconnect Switch and corresponding Support Structure to re-configure the Line to Bus Connection

The only work required at this position is to make new connections from the bus disconnect switches to each one of the upgraded North and South Buses.

**Position 6:**

This position is presently configured to terminate the Lugo No.2 220kV T/L with a direct connection to the South 220kV Bus.

- Install a Motorized Disconnect Switch and corresponding Support Structure to re-configure the Line to Bus Connection

**Protection Relays:**

Install the following new relays inside the existing building:

SES 220kV Gen Tie line Protection:

- Two GE C60 Breaker Management Relay
- One GE L90 Line Current Differential (Digital Communication Channel)
- One SEL-311L Line Current Differential Relay (Digital Comm. Channel)

SPS Relays:

- Two GE N60 Line Monitoring Relays on the Lugo No.1 and No.2 220kV T/L's.
- One SEL – 2407 Satellite Synchronized Clock.

**Other Station Elements to be Installed:**

- 470 Linear Feet of new 8Ft. perimeter fence with double barbed wire to cover the new 270Ft. by 100Ft. expansion to the existing station.
- Two 20 Ft. Double Door driveway gates
- Grounding Grid to cover a 276Ft. by 103Ft. area (3 Ft. outside the perimeter fence)
- Grading and site preparation of a 290Ft. by 110Ft. area (10 Ft. outside the perimeter fence)

**2. Lugo Substation – SPS Relays**

Install the following relays on the Pisgah No.1 and No.2 220kV T/L's and the No.1AA and No.2AA 500/220kV Transformer Banks to support the required SPS:

- Six GE N60 Relays for lines status and banks status monitoring, central logic processing and sending of generator tripping signals.
- One SEL – 2407 Satellite Synchronized Clock.

### **C. Telecommunications:**

Install dual communication channels on separate routes to support the Line Protection and SPS Relays related to the following elements:

- Line Protection Relays for the SES 220kV Gen Tie Line
- SPS Relays required to trip the Project under either one of the following four Single Contingencies (N – 1):
  1. Lugo – Pisgah No.1 220kV T/L.
  2. Lugo – Pisgah No.2 220kV T/L.
  3. Lugo No.1AA 500/220kV Tr. Bk.
  4. Lugo No.2AA 500/220kV Tr. Bk.

The dual paths required between line terminations will be provided by a combination of new Fiber Optic Cables and new and existing Microwave Radio Channels as follows:

#### **C.1 Combined SES 220kV Generation Tie Line Protection and SPS:**

Install approximately two miles of new All Dielectric Self Supported (ADSS) fiber Optic Cable from Pisgah Substation to the SES Generating Facility to provide one of the two channels required for the SES 220kV Gen Tie Line and SPS.

Also install all required Telecommunications Lightwave and Channel Terminal Equipment to interface with the Gen Tie Line Protection and SPS Relays at both Pisgah Substation and the SES Generating Facility.

The remaining channel will be provided by SES by installing OPGW on their new SES 220kV Gen Tie Line and it is not included in this report.

#### **C.2 Facilities Exclusively Dedicated to the SPS:**

Install two diverse path channels from Pisgah Substation to Lugo Substation as follows:

##### **Lugo – Pisgah Path A:**

This path requires the replacement of one of the two OHGW's on the Lugo – Pisgah Segment of the existing Eldorado – Lugo 500kV T/L with new OPGW.

This replacement is a Transmission Line element and has been addressed on Item A-2 on Page 1 of this document.

- Install a new Optical Repeater Site for signal amplification at a location to be determined close to the center of the new 65-Mile OPGW between Lugo and Pisgah Substation. The amplification is required due to the length of the new OPGW.
- Install all required Telecommunications Lightwave and Channel Terminal Equipment to interface with the SPS Relays at both Pisgah and Lugo Substations.

##### **Lugo – Pisgah Path B:**

- Install approximately thirty miles of new ADSS Fiber Optic Cable on existing distribution poles from Pisgah substation to Gale Substation.
- The new Pisgah – Gale Fiber Optic channel will be incorporated into the following existing Telecommunications Infrastructure between Gale and Lugo Substation to close the Pisgah – Lugo Path B.
  - Existing Gale to Cool Water Fiber Optic Cable
  - Existing Cool Water to Kramer M/W Path via Flash Two Communications Site
  - Existing Kramer to Lugo M/W Path via Frost Peak Communications Site
- Install all required Telecommunications Lightwave and Channel Terminal Equipment to interface with the SPS Relays at both Gale Sub. and the Cool Water Gen. Sta.

#### **D. Distribution**

Install a new Distribution Circuit and the required Pole Top Transformer to provide an AC Power Source to the new Telecommunications Optical Repeater Site.

##### **NOTE:**

At this time the possible location of the Optical Repeater Site is very approximate so it is not possible to estimate the Distribution Circuit with any degree of accuracy.

Also relocate the existing Distribution Circuit presently providing the required Light and Power Source to Pisgah Substation around the western side of the substation expansion.

#### **E. Power System Control**

Install four Remote Terminal Units (RTU's) as follows:

- Install one at RTU at the SES Generating Facility to monitor the typical Generation elements such as MW, MVAR, terminal Voltage and Circuit Breaker Status at the Generating Unit and the Plant Auxiliary Load.
- Replace the existing USAT RTU at Pisgah Substation with a new unit to monitor the typical Bulk Power elements such as MW, MVAR, and Phase Amps at each line and also kV at lines and buses and all circuit breaker status / control, Protection Relays Status and Alarms. This RTU will also support the proposed SPS.
- Install two new redundant RTU's at Lugo Substation to support the proposed SPS.

The telecommunication circuits required to support the required RTU's have been included in the scope of telecommunications addressed on Item C on Page 3 of this document.

### **ADDITIONAL ELEMENTS FOR CASE B**

#### **A. Substations:**

##### **Mira Loma Substation**

Replace twelve 63kA 220kV CB's with new 80kA Rated units.

**E. A. Romero**

**09/23/09**

**EXHIBIT D**  
**COST SUMMARIES**

# SES Solar One - Temporary 275MW Interconnection - COST for ALT.1

## Cost Estimate Summary (2011 Dollars)

**Scope:** Interconnect 275MW of Solar Generation to the existing SCE Pisgah Substation 220kV Bus. The interconnection requires the expansion of Pisgah Substation plus the installation of a new SPS with two diverse path telecommunication curcuits between Pisgah and Lugo Substations.

No.	ELEMENT	INTERCONNECTION FACILITIES (Subject to ITCC)	DISTRIBUTION UPGRADES (Subject to ITCC)	RELIABILITY UPGRADES* (Not Subject to ITCC)	ITCC** (35%)	TOTAL
<b>Transmission</b>						
1	Gen Tie Line into Pisgah Sub.	\$ 164,000	\$ -	\$ -	\$ 57,000	\$ 221,000
2	Replace one OHGW with OPGW	\$ -	\$ -	\$ 34,300,000	\$ -	\$ 34,300,000
<b>Substation</b>						
3	Pisgah Sub 200kV Line Position & Station Expansion	\$ 761,000	\$ -	\$ 5,221,000	\$ 266,000	\$ 6,248,000
4	Lugo Sub SPS Relays	\$ -	\$ -	\$ 747,000	\$ -	\$ 747,000
<b>Telecommunications</b>						
5	Gen Tie Line Protection	\$ 808,000	\$ -	\$ -	\$ 282,800	\$ 1,090,800
6	SPS Elements (Other than Pisgah - Gale F.O.)	\$ -	\$ -	\$ 2,718,000	\$ -	\$ 2,718,000
7	Fiber Optic Pisgah Sub to Gale Sub.	\$ -	\$ -	\$ 2,649,000	\$ -	\$ 2,649,000
<b>Distribution</b>						
8	Circuit to Optical Repeater Site	\$ -	\$ 100,000	\$ -	\$ 35,000	\$ 135,000
9	Relocation Around Pisgah Sub. Expansion	\$ -	\$ 250,000	\$ -	\$ 88,000	\$ 338,000
<b>Power System Control</b>						
10	RTU at Solar One Sub	\$ 38,000	\$ -	\$ -	\$ 13,000	\$ 51,000
11	RTU at Pisgah Lugo 220kV	\$ -	\$ -	\$ 51,000	\$ -	\$ 51,000
12	Twin RTUs and RTU upgrade at Lugo Sub	\$ -	\$ -	\$ 49,000	\$ -	\$ 49,000
13	Pisgah RTU/USAT Removal	\$ -	\$ -	\$ 16,000	\$ -	\$ 16,000
14		\$ -	\$ -	\$ -	\$ -	\$ -
<b>Totals</b>		\$ 1,771,000	\$ 350,000	\$ 45,751,000	\$ 741,800	\$ 48,613,800

## Additional Elements for Case B

### Cost Estimate Summary (2011 Dollars)

**Scope:** Additional potential requirements to replace fifteen and upgrade seventeen 220kV CB's at two locations and upgrade on 220kV Switchyard to 80kA Rating.

No.	ELEMENT	INTERCONNECTION FACILITIES (Subject to ITCC)	DISTRIBUTION UPGRADES (Subject to ITCC)	RELIABILITY UPGRADES* (Not Subject to ITCC)	ITCC** (35%)	TOTAL
15	Mira Loma Sub. Replace 12 - 220kV CB's	\$ -	\$ -	\$ 9,887,000	\$ -	\$ 9,887,000
<b>Totals</b>		\$ -	\$ -	\$ 9,887,000	\$ -	\$ 9,887,000

This document includes confidential trade secrets and proprietary information of Southern California Edison, to be used only by the Interconnection Customer in connection with its evaluation of this Facility Study Proposal. Southern California Edison retains all rights to maintain the confidentiality of this information and requests the Interconnection Customer preserve its confidentiality.

\* Pursuant to FERC Order 2003A, ITCC is not collected on Reliability Upgrades and One Time Costs.

\*\* ITCC cost may be satisfied with a letter of credit in accordance with the tax provisions of the LGIA.



# SES Solar One - Temporary 275MW Interconnection - SUNK COST for ALT.2

## Cost Estimate Summary (2011 Dollars)

**Scope:** Interconnect 275MW of Solar Generation to the existing SCE Pisgah Substation 220kV Bus. Installation and Removal Cost for 220kV Gen Tie Rack Span and Pisgah Substation Elements.

No.	ELEMENT	INTERCONNECTION FACILITIES (Subject to ITCC)	RELIABILITY UPGRADES * (Not Subject to ITCC)	ITCC ** (35%)	REMOVAL COST (Not Subject to ITCC)	TOTAL
	Transmission					
1	Gen Tie Line into Pisgah Sub.	\$ 184,000	\$ -	\$ 57,000	\$ 33,000	\$ 254,000
	Substation					
2	Pisgah Sub 200kV Line Position & Station Expansio	\$ 761,000	\$ 5,221,000	\$ 266,000	\$ 1,196,000	\$ 7,444,000
	<b>Totals</b>	\$ <b>925,000</b>	\$ <b>5,221,000</b>	\$ <b>323,000</b>	\$ <b>1,229,000</b>	\$ <b>7,698,000</b>

This document includes confidential trade secrets and proprietary information of Southern California Edison, to be used only by the Interconnection Customer in connection with its evaluation of this Facility Study Proposal. Southern California Edison retains all rights to maintain the confidentiality of this information and requests the Interconnection Customer preserve its confidentiality.

\* Pursuant to FERC Order 2003A, ITCC is not collected on Reliability Upgrades and One Time Costs.

\*\* ITCC cost may be satisfied with a letter of credit in accordance with the tax provisions of the LGIA.



**BEFORE THE ENERGY RESOURCES CONSERVATION AND DEVELOPMENT  
COMMISSION OF THE STATE OF CALIFORNIA  
1516 NINTH STREET, SACRAMENTO, CA 95814  
1-800-822-6228 – WWW.ENERGY.CA.GOV**

**APPLICATION FOR CERTIFICATION  
For the SES SOLAR ONE PROJECT**

**Docket No. 08-AFC-13**

**PROOF OF SERVICE**

*(Revised 12/2/09)*

**APPLICANT**

Felicia Bellows,  
Vice President of Development  
Tessera Solar  
4800 North Scottsdale Road,  
Ste. 5500  
Scottsdale, AZ 85251  
[felicia.bellows@tesseractosolar.com](mailto:felicia.bellows@tesseractosolar.com)

Camille Champion  
Project Manager  
Tessera Solar  
4800 North Scottsdale Road,  
Suite 5500  
Scottsdale, AZ 85251  
[camille.champion@tesseractosolar.com](mailto:camille.champion@tesseractosolar.com)

**CONSULTANT**

\*Angela Leiba  
AFC Project Manager  
URS Corporation  
1615 Murray Canyon Rd.,  
Ste. 1000  
San Diego, CA 92108  
[Angela\\_Leiba@URSCorp.com](mailto:Angela_Leiba@URSCorp.com)

**APPLICANT'S COUNSEL**

Allan J. Thompson  
Attorney at Law  
21 C Orinda Way #314  
Orinda, CA 94563  
[allanori@comcast.net](mailto:allanori@comcast.net)

**INTERESTED AGENCIES**

California ISO  
[e-recipient@caiso.com](mailto:e-recipient@caiso.com)

Jim Stobaugh  
BLM – Nevada State Office  
P.O. Box 12000  
Reno, NV 89520  
[jim\\_stobaugh@blm.gov](mailto:jim_stobaugh@blm.gov)

Rich Rotte, Project Manager  
Bureau of Land Management  
Barstow Field Office  
2601 Barstow Road  
Barstow, CA 92311  
[Richard\\_Rotte@blm.gov](mailto:Richard_Rotte@blm.gov)

Becky Jones  
California Department of  
Fish & Game  
36431 41st Street East  
Palmdale, CA 93552  
[dfgpalm@adelphia.net](mailto:dfgpalm@adelphia.net)

**INTERVENORS**

California Unions for Reliable  
Energy (CURE)  
Loulena A. Miles,  
Marc D. Joseph  
Adams Broadwell Joseph &  
Cardozo  
601 Gateway Boulevard,  
Ste. 1000  
South San Francisco, CA 94080  
[lmiles@adamsbroadwell.com](mailto:lmiles@adamsbroadwell.com)

Defenders of Wildlife  
Joshua Basofin  
1303 J Street, Suite 270  
Sacramento, California 95814  
e-mail service preferred  
[jbasofin@defenders.org](mailto:jbasofin@defenders.org)

Basin and Range Watch  
Laura Cunningham  
Kevin Emmerich  
P.O. Box 70  
Beatty, NV 89003  
[atomicoadranch@netzero.net](mailto:atomicoadranch@netzero.net)

Patrick C. Jackson  
600 N. Darwood Avenue  
San Dimas, CA 91773  
e-mail service preferred  
[ochsjack@earthlink.net](mailto:ochsjack@earthlink.net)

**ENERGY COMMISSION**

JAMES D. BOYD  
Vice Chair and Presiding Member  
[jboyd@energy.state.ca.us](mailto:jboyd@energy.state.ca.us)

JEFFREY D. BYRON  
Commissioner and Associate Member  
[jbyron@energy.state.ca.us](mailto:jbyron@energy.state.ca.us)

Paul Kramer  
Hearing Officer  
[pkramer@energy.state.ca.us](mailto:pkramer@energy.state.ca.us)

Caryn Holmes, Staff Counsel  
1516 9<sup>th</sup> Street, MS-14  
Sacramento, California 95814  
[cholmes@energy.state.ca.us](mailto:cholmes@energy.state.ca.us)

Christopher Meyer  
Project Manager  
[cmeyer@energy.state.ca.us](mailto:cmeyer@energy.state.ca.us)

Public Adviser  
[publicadviser@energy.state.ca.us](mailto:publicadviser@energy.state.ca.us)

**DECLARATION OF SERVICE**

I Corinne Lytle, declare that on January 7, 2010, I served and filed copies of the attached Applicant's Submittal of CAISO Reports. The original document, filed with the Docket Unit, is accompanied by a copy of the most recent Proof of Service list, located on the web page for this project at: [[www.energy.ca.gov/sitingcases/solarone](http://www.energy.ca.gov/sitingcases/solarone)].

The documents have been sent to both the other parties in this proceeding (as shown on the Proof of Service list) and to the Commission's Docket Unit, in the following manner:

**(Check all that Apply)**

**FOR SERVICE TO ALL OTHER PARTIES:**

\_\_\_\_\_ sent electronically to all email addresses on the Proof of Service list;

\_\_\_\_\_ by personal delivery or by depositing in the United States mail at \_\_\_\_\_ with first-class postage thereon fully prepaid and addressed as provided on the Proof of Service list above to those addresses **NOT** marked "email preferred."

**AND**

**FOR FILING WITH THE ENERGY COMMISSION:**

\_\_\_\_\_ sending an original paper copy and one electronic copy, mailed and emailed respectively, to the address below (***preferred method***);

**OR**

\_\_\_\_\_ depositing in the mail an original and 12 paper copies, as follows:

**CALIFORNIA ENERGY COMMISSION**

Attn: Docket No. 08-AFC-13  
1516 Ninth Street, MS-4  
Sacramento, CA 95814-5512  
[docket@energy.state.ca.us](mailto:docket@energy.state.ca.us)

I declare under penalty of perjury that the foregoing is true and correct.

original signed by

\_\_\_\_\_  
Corinne Lytle