



DOCKET

07-AFC-5

DATE June 29 2009

RECD. June 30 2009

CH2M HILL

2485 Natomas Park Drive

Suite 600

Sacramento, CA 95833

Tel 916-920-0300

Fax 916-920-8463

June 29, 2009
File No.: 04.02.06.02
Project No. 357891

Mr. John Kessler, Project Manager
California Energy Commission
Systems Assessment and Facilities Siting Division
1516 9th Street, MS 15
Sacramento, CA 95814-5504

RE: Data Response, Set 2K
Ivanpah Solar Electric Generating System (07-AFC-5)

Dear Mr. Kessler:

On behalf of Solar Partners I, LLC, Solar Partners II, LLC, Solar Partners IV, LLC, and Solar Partners VIII, LLC (Applicant), please find attached one original and 12 hard copies of Data Response, Set 2K, which provides a Revised Draft Closure and Revegetation Plan and Response to Comments received on the January 28, 2009 version.

Please call me if you have any questions.

Sincerely,

CH2M HILL

A handwritten signature in blue ink that reads "John L. Carrier".

John L. Carrier, J.D.
Program Manager

Enclosure
c: POS List
Project File

Draft

**Attachment DR125-3B
Closure, Revegetation, and Rehabilitation
Plan for the Ivanpah Solar Electric
Generating System
Eastern Mojave Desert
San Bernardino County, California**

Prepared for
Ivanpah Solar Electric Generating System

June 2009

CH2MHILL
2485 Natomas Park Drive
Sacramento, California 95833

Introduction

Attached are Solar Partners I, LLC, Solar Partners II, LLC, Solar Partners IV, LLC, and Solar Partners VIII, LLC (Applicant) responses to the California Energy Commission (CEC) Staff's data requests for the Ivanpah Solar Electric Generating System (Ivanpah SEGS) Project (07-AFC-5). The CEC Staff served these data requests on May 8, 2008, as part of the discovery process for Ivanpah SEGS. The responses are grouped by individual discipline or topic area. Within each discipline area, the responses are presented in the same order as CEC Staff presented them and are keyed to the Data Request numbers. Attachments as well as new graphics or tables are numbered in reference to the Data Request number. For example, the first table used in response to Data Request 125 would be numbered Table DR125-1. The first figure used in response to Data Request 125 would be Figure DR125-1, and so on. The first Attachment would be numbered DR125-1A, if revised it would be DR125-1B; but a different attachment in response to that data request would be numbered DR125-2A.

Additional tables, figures, or documents submitted in response to a data request (supporting data, stand-alone documents such as plans, folding graphics, etc.) are found at the end of a discipline-specific section and may not be sequentially page-numbered consistently with the remainder of the document, though they may have their own internal page numbering system.

The Applicant looks forward to working cooperatively with the CEC and BLM staff as the Ivanpah SEGS Project proceeds through the siting process. We trust that these responses address the Staff's questions and remain available to have any additional dialogue the Staff may require.

Closure and Restoration (125)

BACKGROUND

Section 5.2.11.1, Mitigation Measure 1 – Site Rehabilitation Plan, addresses closure of the project following the cessation of facility operations and discusses elements of a closure plan. Data Request 30 asked for description of the likely components of a closure plan addressing decommissioning methods, timing of any proposed habitat restoration and restoration performance criteria. Applicant's response suggests that each project owner file a closure plan for review and approval at least 12-months prior to commencing the closure activities. BLM believes that the applicant must prepare a plan that addresses closure and restoration activities and that waiting to address the issues at the end of the useful life of the facility, will not ensure satisfactory restoration of the site in the fragile desert environment. In addition, the project design and footprint may need to accommodate vegetation salvage and/or propagation study plots. Further, the plan needs to recognize that closure activities may not only occur at the end of a 30 or 50 year life of the facility, but could happen at intermediate times during the project life.

DATA REQUEST

125. BLM requests the applicant develop a plan that will guide site restoration and closure activities. Initially the plan will describe the anticipated methods applicant proposes for revegetation of disturbed areas using native plant species including perennials, and will include methods used to monitor restoration of and evaluate success of revegetation efforts. The initial site restoration and closure plan will evaluate existing information gathered by applicant and other relevant studies to determine if existing data is sufficient to guide restoration of disturbed lands or if additional research is necessary to determine the most effective means to restore and revegetate the site at closure. The plan must address preconstruction salvage and relocation of succulent vegetation from the site to either an onsite or nearby nursery facility for study and propagation of seed sources to reclaim the disturbed area. In the case of unexpected closure, the plan should assume restoration activities could possibly take place prior to the anticipated lifespan of the plant. Specifically the closure and restoration plan must address the following:

- Develop a revegetation research program based on information provided by a qualified expert in desert flora and revegetation. The program would include a review of available materials describing methods and success rates of revegetation programs in the Eastern Mojave Desert at similar elevations.

- A program to evaluate existing native plant vegetation data from the current inventories and identify proposed representative study plot locations within and adjacent to the project area for each of the four vegetative community subtypes cited in the AFC, Appendix 5.2B. This data will be used to identify dominant species to be used in revegetation. Baseline vegetation measurements from the project area and from surrounding non-disturbed areas must be established prior to any surface disturbing activities and will be used to evaluate and monitor vegetation trends and changing conditions over the life of the project that could be considered impediments to restoration activities (e.g. sustained drought). Prepare and submit a protocol to identify study plots and methodology to evaluate trends to BLM for review and approval prior to beginning studies.
- Identify the extent of succulent plant species to be salvaged and maintained in nursery areas either on site or in close proximity, that would be used for future transplanting and/or in propagation studies for seed sources.
- Monitoring and treatment of invasive species over the life of the project.
- Ground preparation procedures that would be needed to effectively reclaim the area.
- Implementation of monitoring programs after closure to verify revegetation results based upon the established goals for density and diversity.
- Provide yearly updates to agencies of progress achieved in connection to revegetation research.
- Identify, with justification, the vegetation considered unnecessary for revegetation or reclamation research that would be lost during construction that could be made available for public collection through plant salvage sales conducted by BLM.

Response: A Draft Closure, Revegetation and Rehabilitation Plan (CR&R Plan) was provided as Attachment DR125-3A to Data Response Set 2G on January 28, 2009. On March 23, 2009, BLM and the CEC filed comments on the Draft CR&R Plan. Attachment DR125-3B contains a revised Draft CR&R Plan (Revision 1), which incorporates the comments received. Since the CR&R is intended to be a complete and living document, it includes the following four appendixes that have previously been filed as separated documents. Due to their size, they are not being reprinted and resubmitted again with this CR&R Plan. However, if any of the parties are missing these documents, or would like a complete copy of the CR&R Plan, a CD-ROM version will be mailed to them upon request.

- Appendix B - Weed Management plan for the Ivanpah Solar Electric Generating System (Attachment DR13-1A, Data Response Set 1F, filed on August 6, 2008)
- Appendix C - Construction Stormwater Pollution Prevention Plan (AFC Appendix 5.15A2, Supplemental Data Response Set 2B, filed on May 13, 2009)

- Appendix D - Technical Basis Document for Revegetation and Reclamation Planning (Attachment DR125-1A, Data Response Set 2 B, filed on July 22, 2008)
- Appendix F - Drainage, Erosion, and Sediment Control Plan (Attachment DR140-1B, Data Response Set 2H, filed on May 13, 2009)

In addition, Attachment DR125-4A is a response to the comments received on the January 28, 2009 version of the CR&R Plan.

Draft

**Attachment DR125-3A
Closure, Revegetation, and Rehabilitation
Plan for the Ivanpah Solar Electric
Generating System
Eastern Mojave Desert
San Bernardino County, California**

Prepared for
Ivanpah Solar Electric Generating System

June 2009

CH2MHILL
2485 Natomas Park Drive
Sacramento, California 95833

Contents

Section	Page
Acronyms and Abbreviations	ix
1. Introduction.....	1-1
1.1 Plan Purpose.....	1-1
1.2 Document Contents.....	1-1
1.3 Project Description	1-2
1.3.1 Project Elements.....	1-7
1.3.2 Low-Impact Design and Construction	1-17
1.3.3 Closure, Revegetation, and Rehabilitation Plan Goals and Objectives	1-20
1.3.4 Conformance with Agency Requirements	1-20
1.3.5 Integral Documents	1-22
1.4 Conservation and Management Plans.....	1-25
1.4.1 California Desert Conservation Area Plan.....	1-25
1.4.2 Northern and Eastern Mojave Coordinated Management Plan	1-25
1.4.3 Bureau of Land Management’s Herbicide Usage Guidelines ...	1-26
2. Rehabilitation Logistics	2-1
2.2 Construction Period	2-1
2.2.1 Construction Phase 1: Ivanpah 1 and Shared Facilities.....	2-1
2.2.2 Construction Phase 2: Ivanpah 2	2-2
2.2.3 Construction Phase 3: Ivanpah 3	2-3
2.2.4 Rehabilitation of Temporary Construction Impact Areas	2-4
2.3 Operations Phase	2-5
2.4 Decommissioning	2-5
3. Existing Site Conditions.....	3-1
3.2 Project Location and Jurisdiction	3-1
3.3 Physiographic Setting	3-1
3.4 Local Environmental Factors	3-2
3.4.1 Soils.....	3-2
3.4.2 Climate and Water Resources.....	3-5
3.5 Vegetation Resources	3-8
3.5.1 Biogeography	3-8
3.5.2 Vegetation Zonation.....	3-9
3.5.3 Local Plant Associations	3-9
3.5.4 Vegetation Surveys.....	3-11
3.5.5 Discussion of Vegetation Survey Results	3-14
4. Native Plant Salvage and Reuse	4-1
4.1 Cacti and Yucca of the Project Area	4-1

4.1.1	Growth Forms.....	4-1
4.2	Ecophysiologically Relevant Notes	4-3
4.3	Relevant Laws, Ordinances, Regulations, and Standards.....	4-3
4.3.1	Federal LORS	4-3
4.3.2	State and Local LORS	4-4
4.3.3	Standards.....	4-4
4.4	Succulents to be Salvaged	4-4
4.5	Salvage Techniques.....	4-6
4.5.1	Flagging during Tortoise Clearance	4-6
4.5.2	Succulent Salvage and Cleaning	4-6
4.5.3	Transplanting, Temporary Storage, and Long-term Stockpiling	4-7
4.6	Succulent Reuse, Donation, or Sale	4-8
4.7	Salvage Protocol	4-9
4.7.1	Flagging.....	4-9
4.7.2	Salvaging Cylindrocacti	4-9
4.7.3	Salvaging Opuntia	4-9
4.7.4	Short-term Storage	4-10
4.7.5	Long-term Stockpiling.....	4-10
4.7.6	Transplanting.....	4-11
5.	Surface Management Plan.....	5-1
5.1	Erosion and Sediment Control	5-1
5.2	Postconstruction Site Stabilization.....	5-2
5.3	Heliostat Washing.....	5-3
5.4	Wildlife and Habitat Management.....	5-4
5.4.1	Heliostat Fields and Perimeters	5-4
5.4.2	Power Blocks and Built Facilities	5-5
5.5	Succulent Storage and Stockpile Area.....	5-5
6.	Preliminary Landscape Design	6-1
6.1	Landscape Design	6-1
6.1.1	Planting Design	6-1
6.1.2	Plant Palette	6-1
6.2	Planting Requirements	6-2
6.2.1	Plant Stock.....	6-2
6.2.2	Soil Preparation	6-2
6.2.3	Fertilizers and Additives.....	6-2
6.2.4	Mulch	6-2
6.3	Irrigation Requirements	6-2
6.4	Operations and Maintenance	6-2
6.4.1	Weeding.....	6-2
6.4.2	Pruning	6-3
6.4.3	Soil Monitoring.....	6-3
7.	Site Rehabilitation Plan.....	7-1
7.1	Introduction	7-1
7.2	Soil Rehabilitation	7-1

7.2.1	Baseline Condition.....	7-1
7.2.2	Soil Testing/ Augmentation	7-2
7.2.3	Topsoil Storage.....	7-2
7.2.4	Temporary Construction Impacts	7-3
7.2.5	Soil Rehabilitation Protocol.....	7-4
7.3	Plant Materials and Handling.....	7-7
7.3.1	Plant Species Selection	7-7
7.3.2	Seed and Native Stock Collection and Storage.....	7-11
7.3.3	Protocol for Collection and Storage	7-17
7.3.4	Propagation	7-19
7.4	Applicable Planting Techniques.....	7-20
7.4.1	Seeding.....	7-21
7.4.2	Mulch.....	7-23
7.4.3	Container-grown Plants.....	7-23
7.4.4	Natural Colonization.....	7-24
7.4.5	Planting Protocol	7-24
7.5	Irrigation and Natural Precipitation	7-25
7.5.1	Water Demand	7-25
7.5.2	Irrigation	7-25
7.5.3	Natural Precipitation Approach.....	7-26
7.5.4	Rainwater Capture Methods.....	7-26
7.5.5	Proposed Approach.....	7-26
7.6	Herbivory and Granivory.....	7-27
7.7	Weed Management.....	7-27
7.8	Revegetation Monitoring.....	7-28
7.8.1	Criteria for Progress	7-28
7.8.2	Field Monitoring	7-29
7.8.3	Data Analysis	7-31
7.9	Revegetation Criteria	7-31
7.10	Revegetation Site Management	7-32
7.11	Recordkeeping and Reporting.....	7-32
8.	Closure, Decommissioning and Rehabilitation	8-1
8.1	Facility Closure Plan	8-1
8.1.1	Accommodating Uncertainty and Affirming Requirements.....	8-2
8.1.2	Assessment and Affirmation.....	8-2
8.1.3	Assumptions in This Document	8-3
8.1.4	Final Closure Plan.....	8-4
8.2	Decommissioning Plan	8-4
8.2.1	Decommissioning Objectives.....	8-4
8.2.2	Pre-demolition Activities.....	8-5
8.2.3	Demolition of Aboveground Structures.....	8-6
8.2.4	Belowground Facilities and Utilities.....	8-6
8.2.5	Demolition Debris Management, Disposal, and Recycling.....	8-7
8.2.6	Soils Cleanup and Excavation.....	8-7
8.2.7	Recontouring.....	8-7
8.2.8	Areas Disturbed by Decommissioning Activities.....	8-8

8.2.9	Hazardous Waste Management.....	8-8
8.2.10	Worker Safety	8-9
8.3	Rehabilitation Plan.....	8-9
8.4	Financing Decommissioning and Restoration	8-11
8.4.1	Cost Estimate	8-11
8.4.2	Performance Bond.....	8-11
9.	References.....	9-1

Appendixes

A	Project Drawings
B	Weed Management Plan
C	Construction Stormwater Pollution Prevention Plan
D	Technical Basis Document
E	Vegetation Survey and Results
F	Drainage, Erosion, and Sediment Control Plan
G	Conceptual Decommissioning and Reclamation Plan

Tables

1-1	Detailed Breakdown of Ivanpah SEGS Components.....	1-27
1-2	Areas of Permanent Disturbance	1-3
1-3	Areas of Long-Term Disturbance	1-4
1-4	Areas of Temporary Disturbance	1-6
1-5	Power Block Equipment List	1-10
3-1	Soil Pedon Descriptions	3-3
3-2	Summary of Precipitation Data for Two Nearby Stations and Estimates for Ivanpah SEGS.....	3-6
3-3	Summary of Temperature Data for Two Nearby Stations and Estimates for Ivanpah SEGS.....	3-7
3-4	Mean Vegetation Data Findings for the Shrub Strata from Vegetation Surveys	3-13
3-5	Succulent Density in Disturbed and Undisturbed Sites at Ivanpah SEGS	3-13
3-6	Mean Vegetation Data Findings for the Herbaceous Strata from Vegetation Surveys	3-14
4-1	Succulents Found Growing Within the Ivanpah SEGS Project Area.....	4-2
4-2	Succulents to be Salvaged by Transplanting the Entire Individual.....	4-5
4-3	Succulents to be Salvaged Using Pads or Joints Removed from the Plant	4-5
5-1	Estimated Wash Water Quality and 50-Year Buildup	5-3
5-2	Functional Requirements of the SSSA and Corresponding Features or Constructs.....	5-6

6-1 Preliminary Plant Palette, Ivanpah 1 Landscaped Areas..... 6-1

7-1 Seeds Targeted for Collection in Support of Revegetation, Ivanpah SEGS 7-10

7-2 Native Seed Vendors Potentially Servicing the Southwest United States..... 7-15

7-3 Preliminary Seeding Plan for Ivanpah SEGS, Temporarily Disturbed Areas.... 7-16

7-4 Construction Disturbance Areas at Ivanpah SEGS and Preliminary Estimated Seed Requirements 7-16

7-5 Mulch Material Bulk Density Measurements..... 7-23

7-6 Revegetation Criteria, Ivanpah SEGS..... 7-32

8-1 Hazardous Materials to be Handled During Closure 8-9

Figures

1-1 Vicinity Map

1-2 Site Plan and Linear Facilities

1-3 Features to Remain After Plant Decommissioning

1-4 Conceptual Mower

1-5 Conceptual Pylon Driving Machine

1-6 Lightweight All-terrain Vehicle

1-7 Mirror Installation Crane

1-8 Mirror Installation Sequence

1-9 Conceptual Mirror Washing Machine

1-10 Trails

1-11 Permanent Tortoise Guard

1-12 Tortoise Exclusion Fence

6-1 Conceptual Landscape Plan and Palette for the Administrative/Warehouse Building

Acronyms and Abbreviations

§	Section
°F	degrees Fahrenheit
µS/cm	microsiemens per centimeter
AFC	Application for Certification
afy	acre feet per year
BLM	Bureau of Land Management
BMP	best management practices
C:N	carbon to nitrogen ratio
CaCO ₃	calcium carbonate
CDCA	California Desert Conservation Area
CDFG	California Department of Fish and Game
CEC	California Energy Commission
CLA	Construction Logistics Area
COC	conditions of certification
DESCP	Drainage, Erosion, and Sediment Control Plan
DR	data report
dS/m	decisiemens per meter
FESA	Federal Endangered Species Act
FLPMA	Federal Land Policy and Management Act of 1976
gen-tie	generation tie line
gpm	gallons per minute
GPS	geographic positioning system
HDPE	high-density polyethylene
HP	high pressure
IP	intermediate pressure
Ivanpah SEGS	Ivanpah Solar Electric Generating Station
KRGT	Kern River Gas Transmission

kV	kilovolt
lbs/ac	pounds per acre
LID	Low Impact Design and Construction
LORS	laws, ordinances, regulations, and standards
LP	low pressure
mg/L	milligrams per liter
MW	megawatt
MWH	megawatt-hour
NEMO	Northern and Eastern Mojave Coordinated Management Plan
NFPA	National Fire Protection Association
NPPA	Native Plant Protection Act
NW	northwest
oz	fluid ounce
PEIS	<i>Final Programmatic Environmental Impact Statement Vegetation Treatments Using Herbicides on Bureau of Land Management Lands in 17 Western States</i>
Plan	Site Rehabilitation and Revegetation Plan
POD	plan of development
PVC	polyvinyl chloride
RH	relative humidity
ROW	right-of-way
SCE	Southern California Edison
SE	southeast
SPCC	Spill Containment and Countermeasures Plan
SPT	solar power tower
SRB	solar receiver boiler
SSSA	Succulent Storage and Stockpile Area
STG	steam turbine generator
SWPPP	stormwater pollution prevention plan

TBD	<i>Technical Basis Document for Revegetation and Reclamation Planning, Ivanpah Solar Electric Generating System, Eastern Mojave Desert, San Bernardino County, California</i>
USFWS	U.S. Fish and Wildlife Service
WMP	<i>Weed Management Plan for the Ivanpah Solar Electric Generating System (CH2M HILL, 2008c)</i>

Introduction

1.1 Plan Purpose

The purpose of this site closure, rehabilitation, and revegetation plan (Plan) is to set forth the procedures and practices that will be employed by the project owner to meet federal and state requirements for the revegetation of sites temporarily affected during construction of the Ivanpah Solar Electric Generating Station (Ivanpah SEGS) and for the rehabilitation and revegetation of the project site after decommissioning. This includes fulfilling the relevant mitigation measures identified in the conditions of certification required by the California Energy Commission (CEC) license and the right-of-way (ROW) grant conditions imposed by Bureau of Land Management (BLM). Hence, this plan will be updated once all of those conditions are known. For now, the responsible agencies, including BLM, the United States Fish and Wildlife Service (USFWS), the California Department of Fish and Game (CDFG), and the CEC will use this Plan as a basis to review and evaluate the rehabilitation program at Ivanpah SEGS. Figure 1-1 (all figures are located at the end of their respective sections) shows the general location of the Ivanpah SEGS project. Appendix A contains engineering drawings that provide additional information on the civil aspects of the project. Appendix A Figures 2, 4, and 21 show the site plan and linear facilities associated with the project.

The nature and size of the disturbed areas described in this Plan are based on the Plan of Development (POD) Project Description (Attachment DR130-2B, Data Response Set 2I, filed May 18, 2009), for the Ivanpah SEGS project. As with any large, multiyear project, there are always potential changes in the POD and the operating measures that will be occasioned by unanticipated operational exigencies or external factors. Because these changes could affect the rehabilitation and revegetation measures and anticipated schedules, this Plan should be viewed as subject to ongoing modifications in coordination with responsible parties. This Plan also includes procedures for modifying methods or criteria, if the project owner and the responsible agencies agree upon the need to do so.

1.2 Document Contents

Section 1 of this document provides background information, including the project description of the proposed action, a description of other integral and relevant documents, and relevant conservation and management plans. Section 2 describes specific action areas that will require rehabilitation and revegetation. Section 3 describes existing site conditions that pertain to rehabilitation and revegetation, including soils, climate and water resources, and biological resources. This section also provides the results of specific vegetation sampling to characterize onsite vegetation resources and recently disturbed sites in the vicinity in support of revegetation criteria development. Section 4 describes the proposed native plant salvage and reuse for succulents. Section 5 provides the surface management plan during construction and operations. Section 6 provides the native plant landscaping plan for onsite facilities during the operations phase. Section 7 provides the site rehabilitation plan for all temporary disturbance areas during construction, including soil

rehabilitation, revegetation, and revegetation monitoring. Section 8 provides the site closure plan for site decommissioning.

Additional material appended to this document and thereby incorporated into the Plan includes:

- Appendix A – Ivanpah SEGS Drawings produced by Tetra Tech
- Appendix B – Weed Management Plan for the Ivanpah Solar Electric Generating System (Attachment DR13-1A, Data Response Set 1F, filed on August 6, 2008)
- Appendix C – Construction Stormwater Pollution Prevention Plan (AFC Appendix 5.15A2, Supplemental Data Response Set 2B, filed on May 13, 2009)
- Appendix D – Technical Basis Document for Revegetation and Reclamation Planning (Attachment DR125-1A, Data Response Set 2 B, filed on July 22, 2008)
- Appendix E – Vegetation Survey Results
- Appendix F -- Drainage, Erosion, and Sediment Control Plan (Attachment DR140-1B, Data Response Set 2H, filed on May 13, 2009)
- Appendix G -- Conceptual Decommissioning and Reclamation Plan

1.3 Project Description

The Ivanpah SEGS will consist of three independent solar thermal electric generating facilities (or plants) that will be colocated approximately 1.6 miles west of the Ivanpah Dry Lake and 4.5 miles southwest of Primm, Nevada, in San Bernardino County, California (Figure 1-2). The project site will be located on federal property managed by BLM. The three Ivanpah SEGS facilities will have a combined net rating of approximately 400 megawatt (MW). The total Ivanpah SEGS project area consists of approximately 4,062 acres. Ivanpah 1 will require approximately 914 acres (1.43 square miles); Ivanpah 2 will require approximately 921 acres (1.44 square miles); and Ivanpah 3 is larger and will require approximately 1,836 acres (2.9 square miles). The developed areas for Ivanpah 1, 2, and 3 will cover a total of 3,671 acres (5.7 square miles). A detailed breakdown of the Ivanpah SEGS project components is provided in Table 1-1 (located at end of section due to its size).

Following completion of low-impact design (LID) and issuance of permits, the proposed project will be constructed in three phases, and completed within 48 months (target completion by December 2013). Construction is planned in the following order: (1) Ivanpah 1 (the southernmost site; nominal 100 MW) and shared facilities; (2) Ivanpah 2 (the middle site; nominal 100 MW); and (3) Ivanpah 3 (the northern site, nominal 200 MW). Alternative sequencing of the facilities is a possibility, but in each case the shared facilities (administration/storage building, groundwater production wells, and portions of linear facilities) will be constructed in connection with the first plant's construction. For purposes of this plan, impacts have been placed into three categories.

1. **Permanently disturbed areas:** This includes those features that would remain after the project's 50-year span¹. They would include the Southern California Edison (SCE) substation and the paved portion of Colosseum Road from the Golf Club to the substation; the rerouted trails (i.e., the gravel road from the end of the paved portion of the rerouted Colosseum Road to where it connects with the Colosseum dirt road, the rerouted access tracks around the top of Ivanpah 3; and stabilized channel crossings.
2. **Long-term disturbance areas:** This includes facilities that will remain in place for the duration of the project. Examples include the solar plants, administration/warehouse building, water supply wells, monitoring well, and utility lines. Areas affected by these facilities will be revegetated following closure, which would be the same order as construction, with the exception that the shared facilities would be handled as part of the last phase that is closed.
3. **Temporary disturbance areas:** This includes areas that will be revegetated within 5 years from the time of disturbance. Facilities that fall into this category include the utility and roadway construction corridors and lightly graded areas within Ivanpah 2 and Ivanpah 3 (which will be revegetated within 1 year of completion of construction) and those areas within the Construction Logistics Area (CLA) that are used for construction (which will be revegetated once construction of all three solar plants is completed).

A breakdown of the project's permanent and long-term disturbance areas is presented in Tables 1-2 and 1-3. Most of the temporary disturbance will occur in the CLA between Ivanpah 1 and 2 (approximately 377 acres in size, see Appendix A, Figure 19) and the graded areas within Ivanpah 2 and Ivanpah 3 (see Appendix A, Figure 11, Overall Grading Plan). However it will include the SCE substation (permanent disturbance), the administration/warehouse building, and shared utilities (long-term disturbances). Portions of the CLA will be used during construction for staging, laydown, heliostat fabrication, and temporary offices. Once construction has been completed, only the shared facilities will remain in this area. In addition to the CLA, temporary impacts would occur to approximately 8.6 acres that will be used for construction of the gas line tap station at the existing Kern River Gas Transmission (KRGT) pipeline, construction of the approximately 2,000-foot-long gas pipeline north of Ivanpah 3, and construction of the gas metering set for Ivanpah 1 and 2. A breakdown of the temporary disturbance areas is provided in Table 1-4.

TABLE 1-2
Areas of Permanent Disturbance

Components	Linear Feet	Acres
Ivanpah 3		
12' dirt road from gas line to trail 699226 (east side of Ivanpah 3)	6,752	1.86
12' dirt road from trail 699198 to asphalt road between Units 1 & 2	1,572	0.43
12' rerouted trail 699226 from gas line west side	6,906	1.90
30' asphalt road between Ivanpah Units 2 & 3	4,751	3.93

¹ The BLM right-of-way lease will be for 50 years, which includes construction and decommissioning/restoration. Therefore, the plant's operating life will be between 40 and 45 years.

TABLE 1-2
Areas of Permanent Disturbance

Components	Linear Feet	Acres
12' dirt trail to mining claim	1,492	0.41
Ivanpah 2		
12' rerouted trail 699198 (along west side of Ivanpah 2)	3,115	0.86
CLA including improvements to Colosseum Road		
30' asphalt improved Colosseum Rd.	8,442	6.98
30' asphalt re-routed Colosseum Road	4,343	3.59
12' gravel road re-routed Colosseum to where it exits the CLA	2,452	0.68
24' access road to substation	1,761	1.21
Substation		16.10
Diversion berms & channel around Substation		8.30
TOTAL AREAS OF PERMANENT DISTURBANCE		46.25

TABLE 1-3
Areas of Long-Term Disturbance

Components	Linear Feet	Acres
Kern River Gas Transmission Line (KRG T)		
Tap Station		0.34
12' dirt service road from tap point to top of Ivanpah 3	2,011	0.55
Ivanaph 3		
12' dirt road from trail 699226 to trail 699198	7,103	1.96
Ivanpah 3 Metering set		0.01
24' asphalt road to PB	3,872	2.67
Power block (PB)		14.96
Solar Power Towers		3.74
15' dirt road from PB to the four SPTs	10,300	3.55
12' dirt road from SPTs to corners	25,617	7.06
12' perimeter road around Ivanpah 3	40,778	11.23
Set back from property line		17.50
10' heliostat maintenance paths		210.98
Heliostat field		1150.18
Gen-tie towers from PB to top of Ivanpah 2		0.006
Ivanpah 3 fill stockpiles		3.98

TABLE 1-3
Areas of Long-Term Disturbance

Components	Linear Feet	Acres
Ivanpah 2		
30' asphalt road from Ivanpah 3 to Colosseum	7,247	5.99
24' asphalt road to PB	2,229	1.54
Power block (PB)		13.17
12' dirt service road from PB to corners	15,176	4.18
Gen-tie towers along south side of Ivanpah 2		0.004
Ivanpah 3 gen-tie along west side of Ivanpah 2		0.007
Ivanpah 2 gen-tie from PB to end of Ivanpah 2 (4 tower footprints)		0.004
12' perimeter road around Ivanpah 2	24,167	6.66
Set back from property line		4.71
10' heliostat maintenance road	629,528	144.52
Heliostat field		729.16
12' dirt trail along southwest corner of Ivanpah 2	4,148	1.14
Ivanpah 2 channel crossings		0.31
Ivanpah 2 fill stockpiles		2.03
CLA including Improvements to Colosseum Road		
12' dirt service road for double-circuit gen-tie line	1,898	0.52
Double-circuit gen-tie towers (area of 4 tower footprints)		0.004
Gas meter set for Ivanpah 1 & 2		0.02
24' asphalt road from re-routed Colosseum to Ivanpah 1	2,153	1.48
Admin Building (incl. entrance road)		8.90
12' dirt service road for monitoring well	866	0.24
Monitoring well		0.002
12' dirt service road for production wells	1,075	0.30
Production wells		0.005
12' dirt service road from Ivanpah 1 to Substation	2,867	0.79
Gen-tie towers from Ivanpah 1 to Substation		0.005
40-acre succulent storage & stockpile area		40.00
CLA fill stockpile		0.91
Ivanpah 1		
24' asphalt road from edge of Ivanpah 1 to PB	3,361	2.31
Gas & water line corridor to PB	3,361	0.00

TABLE 1-3
Areas of Long-Term Disturbance

Components	Linear Feet	Acres
Power block (PB)		13.54
Gen-tie towers from PB to Ivanpah 1 (area of 6 tower footprints)		0.005
12' dirt service road from PB to corners	12,020	3.31
12' perimeter road around Ivanpah 1	23,857	6.57
Set back from property line		8.79
10' heliostat maintenance road	636,325	146.08
Heliostat field		731.49
Ivanpah 1 fill stockpiles		1.57
TOTAL AREAS OF LONG-TERM DISTURBANCE		3,308.98

TABLE 1-4
Areas of Temporary Disturbance

Components	Linear Feet	Acres
Kern River Gas Transmission Line (KRGT)		
Tap Station Construction Area		0.92
Gas Liine from tap point to top of I-3	2,011	1.75
Ivanaph 3		
Gas Line Corridor 50' construction area (east side)	15,427	13.46
Construction corridor for 30' asphalt road between Units 2 & 3	4,751	1.53
Construction corridor for 24' asphalt road to PB	3,872	1.24
Gas line from metering set to PB	5,823	0.00
Water line from metering set to PB	5,785	0.00
Construction corridor for gas & water line	5,823	3.74
Gen-tie corridor from PB to top of Unit 2	4,065	0.36
Ivanpah 3 graded areas		380.00
Ivanpah 2		
Construction corridor for 30' asphalt road from Ivanpah 3 to Colosseum	7,247	2.33
Gas & water line corridor to PB	3,972	2.55
Construction corridor for 24' asphalt road to PB	2,229	0.72
Ivanpah 3 gen-tie along south side of Ivanpah 2	3,296	0.25
Ivanpah 3 gen-tie along west side of Ivanpah 2	5,371	0.38

TABLE 1-4
Areas of Temporary Disturbance

Components	Linear Feet	Acres
Ivanpah 2 gen-tie from PB to end of Unit 2	2,322	0.20
Graded areas		123.00
CLA Including improvements to Colosseum Road		
30' asphalt improved Colosseum Rd.	8,442	
Construction corridor for 30' asphalt improved Colosseum Rd.	8,442	2.71
Tire wash/concrete washout off Colosseum		1.04
Construction corridor for 30' asphalt re-routed Colosseum Road	4,343	1.40
Construction corridor for 24' access road to substation	1,761	0.57
Ivanpah 2 & 3 gen-tie to substation construction corridor	1,898	0.35
Construction area for gas meter set for Ivanpah 1 & 2		0.92
Construction corridor for 24' asphalt road from re-routed Colosseum to Ivanpah 1	2,153	0.69
Gen-tie line from Ivanpah 1 to Substation	2,867	0.53
Construction of gen-tie towers from Ivanpah 1 to Sub		0.32
Construction parking		1.53
Contractor Trailer area		18.57
Equipment Laydown		20.46
CLA area available for construction use		248.79
Ivanpah 1		
Construction corridor for 24' asphalt road from edge to PB	3,361	1.08
Construction of gen-tie towers from PB to end of Ivanpah 1		0.29
TOTAL AREAS OF TEMPORARY DISTURBANCE		831.88

1.3.1 Project Elements

Each of the three proposed solar plants will consist of heliostat fields surrounding a power block, which is supplied with the necessary utilities through a utility corridor (see Appendix A, Figure 15.). Each of the power blocks will be connected to SCE's planned step-up substation, which will in turn tie into SCE's electric-power transmission network (or grid) through an existing 115-kilovolt (kV) transmission line that runs through the CLA between Ivanpah 1 and Ivanpah 2. Construction of each project phase will result in temporary land disturbances, with site rehabilitation and revegetation in temporary-disturbance areas occurring as soon as practical upon completion of construction. Other project elements are associated with long-term facilities (e.g., structures and access roads, see Table 1-3), and site rehabilitation and revegetation of these areas will occur after closure and decommissioning following the planned 50-year period of operation. With few

exceptions for the permanent facilities, these impacted areas will require some degree of rehabilitation and revegetation.

The sections that follow describe each project element germane to this rehabilitation and revegetation plan, including the heliostat (mirror) fields and collectors, the power blocks, water supply and treatment facility, wastewater treatment facility, shared and individual (plant-specific) utility corridors, substation and switchyard, access roads and maintenance paths, and the administration and maintenance complex. The project specifically includes LID methods, which will reduce the rehabilitation effort that will be required to restore the sites.

Heliostat Fields

The 100-MW plants (Ivanpah 1 and 2) will each have heliostat arrays consisting of up to 55,000 heliostats. The 200-MW plant (Ivanpah 3) will have heliostat arrays consisting of up to 104,000 heliostats. The heliostat arrays would be arranged around a single centralized solar power tower (SPT). The heliostats would automatically track the sun during the day and reflect the solar energy to the boiler on top of the SPT.

Each of the heliostat mirrors is 7.2 feet high by 10.5 feet wide (2.2 meters by 3.2 meters) yielding a reflecting surface of 75.6 square feet (7.0 square meters). Each heliostat consists of two mirrors mounted on a single pylon, along with a computer-programmed aiming control system that directs the motion of the heliostat to track the movement of the sun. Communication cables connecting the heliostats between one another will be strung aboveground.

Heliostat Field Preparation. Consistent with the LID approach to this project, vegetation clearing in the heliostat fields will occur only where necessary to allow for equipment access and stormwater management. In areas where grading is not required for access or construction, the vegetation will not be removed.

An approximate 12-foot-wide linear swath of vegetation along the outer edge of each heliostat field will be cleared to create an internal perimeter path for installation and maintenance of the combined tortoise and security fence. Additional vegetation clearing will be performed in areas where the existing terrain will not permit access of installation equipment and materials during construction without leveling or grading. Appendix A, Figure 11 shows the areas where grading will likely occur. Elsewhere vegetation will remain, but will be cut to a height that will allow clearance for heliostat function while leaving the root structures intact. The vegetation will be cut with a flail-type mower mounted on skids that will be mounted on a low-ground pressure tractor (approximately 4.2 pounds per square inch [psi]). Figure 1-4, shows the type of equipment that may be used. Occasional cutting of the vegetation may be required to control plant regrowth that could affect heliostat mirror movement.

Installation of Heliostats. The heliostats will be installed in two steps. Initially, the support pylons will be installed using a sonic (vibratory) technology, and then the mirrors and aiming system are mounted to the pylon. The vibratory installation allows the 6-inch diameter pylons to be embedded in the ground without the use of conventional drilling techniques or generation of drill cuttings. As a result of the LID, a majority of the project site will maintain the original grades and natural drainage features, and therefore construction

will require machines that are maneuverable and can negotiate the terrain. Installation of the 6-inch galvanized heliostat pylons is presently planned to be done with a rubber tire hydraulic machine manufactured by ABI (see Figure 1-5). The machine will be stabilized with outriggers, then the pylons will be vibrated into the ground. The siting of pylons will be guided by global positioning system (GPS) technology. Pylons will be delivered by an all-terrain vehicle, such as the one in Figure 1-6, and trailer.

Installation of the heliostat mirrors will be accomplished with a rough terrain crane. The machine presently planned is a Grove 540E, shown in Figure 1-7. The crane will be able to mount mirrors on more than 20 pylons before moving to the next location (Figure 1-8). In addition, an aboveground communications cable will be strung linking the heliostats. The cable installation will be done manually.

Maintenance Washing of Heliostat Mirrors. Operation requirements necessitate the washing of some portion of the project's solar heliostats on a nightly basis. Individual heliostats are washed about once every 2 weeks (biweekly). The application rate per heliostat would be 2.5 gallons once every 2 weeks. Heliostat wash water requirements for Ivanpah 1 and 2 will be 3,575,000 gallons per year or 10.97 acre-feet per year (afy) and 6,760,000 gallons or about 20.75 afy for Ivanpah 3, for total deionized water consumption of 42.7 afy after project build-out.

Because of dust created during site grading, it is possible that this washing cycle may need to be more frequent during the first 5 months of construction of Ivanpah 3, when Ivanpah 1 is operating. The amount of additional water needed for mirror washing during this 5-month period depends on several factors such as the frequency, speed, and direction of wind and the amount of dust created by the grading activities. Additionally, during construction of Ivanpah 3 (as with the other units), dust suppression (water or soil binders) will be used to minimize wind erosion. Also considering that the closest points between Ivanpah 1 and Ivanpah 3 exceed 1.5 miles, it is not likely that any additional mirror washing will be needed. However, it was conservatively estimated that the frequency of mirror washing would, at most, double (i.e., weekly washing). If washing frequency is doubled, the amount of water required would be: 55,000 heliostats x 2.5 gallons per heliostat x 22 weeks or 3,025,000 gallons (or about 9.3 acre-feet). Therefore, the amount of additional water required is estimated not to exceed 4.6 acre-feet.

High quality deionized water containing only minimal iron and copper from the water piping will be used for heliostat mirror washing. Assuming uniform dispersion of the 1.25 gallons of water across the mirror surface and no evaporation, runoff onto the ground will be about 0.17 gal, or about 22 fluid ounces per linear foot per washing episode. Given such small amounts, no water will run offsite as a result of heliostat washing. Due to the high evaporation rates in the area, and the minimal amount of runoff water used, it is likely that wash water will evaporate at or just below the ground surface in most seasons.² The area underneath the mirrors will be inspected for weeds and addressed per the requirements of the Weed Management Plan (Appendix B).

Mirror washing will be performed biweekly (once every other week) by a machine currently under design. A concept of the washing machine is shown in Figure 1-9. The washer will

² At an estimated 1.8 oz of water per inch every other week, the potential for the wash water to stimulate weed growth is minimal.

haul at least 500 gallons of water. Continued research and development for a mirror washing machine is in progress. Therefore, the size and type of machine may change. The mirror washing machine will drive on the path created between every other heliostat row.

Power Block

Each solar power plant will have a power block located in the approximate center of the heliostat array. The power block includes an SPT, a receiver boiler, a steam turbine generator (STG) set, air-cooled condensers, and other auxiliary systems. The size of both Ivanpah 1 and 2 power blocks will be 13.5 and 13.2 acres, respectively; the Ivanpah 3 power block will be approximate 15 acres. Acreage estimates include the power block perimeter road, stormwater diversion channel and berm, and concrete holding basin. Each power block will contain, but is not limited to, the equipment listed below in Table 1-5. The power block footprint will be graded to create level pad elevations with approximately balanced cut and fill earthwork for each power block. In addition to the equipment listed in Table 1-5, Ivanpah 3 will have a system of steam pipelines connecting the four outlying SPTs to the power block. The SPTs will be within the power block at Ivanpah 1 and 2.

TABLE 1-5
Power Block Equipment List

Steam Turbine	Power Tower*
Generator	Switchyard
Auxiliary Boiler	Generator Step-up Transformer
Air-cooled Condenser	Unit Auxiliary Transformer
Feed Water Heaters	SUS Transformer
Boiler Feed Pumps	Raw Water/Fire Water Tank
Plant Services Building	Demineralized Water Tank
Water Treatment Equipment Area	Raw Water Forwarding Pumps
Underground Gas Pipeline	Demineralized Water Forwarding Pumps
Condensate Tank/Pump	115 kV Generation Tie Line
Emergency Generator	Concrete Holding Basins
Local Control Building	Access Roadway
Solar Superheater/Reheater Receiver	

*Ivanpah 3 will have four solar power towers in addition to the solar reheat tower in the Power Block

Stormwater runoff and runoff will be diverted around the power blocks. Two concrete-lined (or an approved alternate lining system) holding basins of about 40 feet by 60 feet by 6 feet deep are included in the power block area. They will be used for boiler commissioning and serve as an emergency outfall from any of the processes. No waste streams will be discharged to the concrete holding basins.

Water Supply and Treatment

Two new groundwater production wells will be drilled and developed to provide raw water for the Ivanpah SEGS project. The two wells will be located in the CLA near the

northwest corner of Ivanpah 1 (see Appendix A, Figure 3). These wells will supply all three solar plants and will be used for make-up water, mirror-wash water (each plant will include a water treatment and deionizing facility in the power block structure), and for domestic uses. The combined 400-MW capacity of the three plants will require up to 46 gallons per minute (gpm) of raw water from the groundwater production wells, or about 74.2 afy. However, to provide adequate operating flexibility, 100 afy of water is being requested.

Make-up water for the steam system will be treated by means of a mixed-bed ion-exchange system to produce feedwater-quality water for use in the boiler system. The ion exchange resins will be sent offsite for regeneration. Water will be distributed to the plants via underground high-density polyethylene (HDPE) or polyvinyl chloride (PVC) pipe. The pipe will be installed underground in utility corridors leading to the power blocks from the two supply wells. Each power block will contain a 250,000 gallon raw water tank. A portion of the raw water stored in the tank (about 100,000 gallons) will be designated for plant use, while the majority will be reserved for fire water.

The groundwater production wells will be accessed by a 12-foot-wide dirt access road. As shown in Appendix A, Figure 4, the water supply line will go from the wells along the paved access road on the northwest corner of Ivanpah 1, where it would connect to the water main. The water main would run north to the administration and maintenance complex, and then to Ivanpah 2 and Ivanpah 3 in the same corridor as the gas pipeline to those plants. A water pipeline will also extend southeast to the Ivanpah 1 power block along the paved access road leading to the power block.

Monitoring Well. A monitoring well will be installed southeast of the administration and maintenance complex near the northwest corner of Ivanpah 1 (see Appendix A, Figure 4). The permanent area required for the installation of the monitoring well (10 feet x 10 feet) and access to it via an 866-foot-long, 8-foot-wide dirt road is 0.2 acre.

Domestic Water Use and Wastewater Management

A small filtration and purification system will be used to provide potable water for domestic including sanitary uses (sinks, showers, and toilets) at the Administration/warehouse Building. Drinking water may also be trucked to the site. The power block sites will have porta-potties, self contained hand wash stations, and use bottled water.

A package treatment plant will be used at the administration and maintenance complex to treat wastewater. Portable toilets will be placed in the power block areas of each of the three solar facilities. Portable toilets will be serviced by a waste management firm on a regular basis, depending on the number of toilets and staff at each facility.

Utility Corridors

Within each solar facility, an overhead electrical utility corridor will contain the overhead electrical lines from the individual power block switchyards to the SCE substation. In addition, the roadway and underground utility corridor will contain a water pipeline and a natural gas pipeline. These underground corridors will run parallel to local access roads between the power blocks and CLA where the water and gas supply interconnects will be located (Appendix A, Figure 21). The electrical utility corridors will be routed to the SCE substation in a manner as to avoid interfering with heliostat functioning (Appendix A, Figures 4 and 21).

To maintain separation of the pipelines in the utility corridors, the water line will be on the west side of each access road, and the gas supply pipeline on the east side of the road. If open trench construction is used, the pipeline installation will include excavation of two open trenches, each approximately 3 feet wide and at least 3 feet deep. With loose soil, a trench up to 8 feet wide at the top and 3 feet wide at the bottom may be required. During construction of the water line, a 40-foot-wide corridor could be disturbed. This construction corridor will be used to temporarily store the excavated soil and provide access for equipment, vehicles, and space for fitting the pipeline prior to installation and backfill. At the completion of construction, a portion of this corridor will be prepared with road base and paved to provide an all-weather access road to the power blocks of each unit.

Disturbance within the utility corridors will include vegetation mowing, trench excavation, soil compaction, dust suppression activities, preparation and paving of the asphalt road or dirt road (depending on the location), and restoration of the non-road portion of the corridor. The temporary construction disturbance area for the utility corridors within the Construction Logistics Area, is presented in Table 1-4.

Shared Utilities

Each of the Ivanpah SEGS units will be separately owned and operated. However, in many cases, all or portions of the utilities including natural gas pipeline, water supply line, and transmission lines will be shared among the owners. Further details are provided below.

Electrical Transmission. Ivanpah 1, 2, and 3 would be interconnected to an existing SCE grid through an upgraded SCE 115-kV line passing between Ivanpah 1 and 2 on a northeast-southwest utility corridor. SCE will upgrade the existing 115-kV transmission line between the new Ivanpah substation and the El Dorado substation to a double-circuit 220 kV transmission line. This SCE upgrade is a separate project to serve a number of developments planned in the general vicinity, and is not being built specifically for the Ivanpah SEGS project, but will provide sufficient capacity for the Ivanpah SEGS project as well as other projects anticipated by SCE. A substation will be constructed in the CLA between Ivanpah 1 and 2 that will be used to connect Ivanpah SEGS to the electrical grid (see Appendix A, Figure 3). The transmission lines entering the new Ivanpah Substation will be 220 kV coming in from the east and 115 kV to the west.

The 115-kV transmission generation tie line (gen-tie line) from the edge of the Ivanpah 1 solar field to the substation will be over 2,850 feet long. The Ivanpah 2 and 3 gen-tie lines extend approximately 2,322 feet and 12,732 feet, respectively, from their switchyards at the power block before coming together. The combined gen-tie line (double-circuit) will then extend approximately 1,900 feet from the southern end of Ivanpah 2 to the substation. There will be a 12-foot-wide dirt service road running alongside the gen-tie lines. Each circuit will be supported by single-pole structure at appropriate intervals (approximately 750 feet apart) with final heights to be determined during detailed design. The shared gen-tie line for Ivanpah 2 and 3 will be carried on a double-circuit single pole line.

The 115-kV gen-tie poles, insulators, conductors, and other equipment will be delivered to a construction laydown area or marshalling yard located either within the CLA, near the switchyard at the power block of the unit under construction. Construction crews will deliver the poles and other equipment from the laydown area to the individual pole locations. In most locations, the poles will be placed on the side of the 12-foot-wide dirt

access roads. Construction vehicles will follow a route between the substation and the heliostat field. At most, 4 or 5 vehicles will need to use this access route to erect the poles. Construction activity will be confined to the electrical easement with little or no disturbance to the adjacent lands. An area approximately 100 feet by 20 feet may be temporarily disturbed at each pole site during pole setting activities. Where poles with concrete foundations are located (angle locations), the maximum area of temporary construction disturbance will be approximately 100 feet by 30 feet.

For each embedded pole location, crews will auger a hole approximately 10 feet deep. The soil will be backfilled and compacted around the pole. Soil that is excavated and is determined to be surplus will be used as fill elsewhere on the Ivanpah SEGS site. Poles with a concrete foundation would require an excavation 20 to 30 feet deep and less than 7 feet in diameter. Where the soils are sandy, approved soil stabilizers may be needed to prevent the soil from sloughing back into the pits. A circular cage of rebar, up to 6 feet in diameter, would be assembled and lowered into the pit, and a concrete foundation would be poured and allowed to cure for 7 days or longer. The steel pole would then be mounted and bolted to the foundation.

To string the conductors onto the poles, the construction crew would first pull a rope through travelers or pulleys, which would be attached to the insulators on the structures. Three ropes would be used – one for each conductor phase. Each rope will then be attached to its respective conductor. Reel trucks and tensioners would be used to pull the conductors and set the proper sag. Temporary disturbance at each pulling location will be approximately 100 feet by 40 feet for tensioner and reel truck positioning.

Substation. As noted above, Ivanpah 1, 2, and 3 will be interconnected to the existing electrical grid through an upgraded El Dorado-Baker-Coolwater-Dunn Siding-Mountain Pass 115/220-kV line passing between Ivanpah 1 and 2 in a northeast-southwest utility corridor. A 115/220-kV substation will be constructed by SCE in the CLA between Ivanpah 1 and 2 that will be used to connect Ivanpah SEGS to the electrical grid. (Portions of the substation, where the gen-tie lines enter, will be owned by the separate project owners – the majority will be owned by SCE.) The approximate location of the substation is shown in Appendix A, Figures 3 and 21. The substation dimensions will be about 830 feet wide by 850 feet long, approximately 16.1 acres in size. In addition, a 24-foot-wide asphalt road about 1,760 feet long will be needed to connect the substation to the rerouted Colosseum Road on the south side of Ivanpah 2.

Substation construction will be performed by SCE (or its contractor) and will consist of grading and site preparation, foundation excavation and pouring, equipment delivery and installation, and wiring and testing. In addition, a permanent berm and stormwater diversion channel (about 8.3 acres in size) will be constructed around the substation to protect it from stormwater runoff (see Appendix A, Figure 13).

Grading of the approximate 16.1-acre substation site and construction of the stormwater berm/diversion channel is estimated to require 3 to 5 weeks. In addition, a 5-foot-wide graded apron will extend outside the boundary fence around the substation's perimeter. Once graded, the area will be graveled and dunnage will be used for equipment and material storage during construction of the substation. The substation site is large enough to

provide for laydown of substation construction materials and equipment as well as construction parking within it.

Equipment and materials for substation construction would be delivered and stored in the 16.1-acre site. Hazardous materials such as paints, epoxies, grease, and compounds would be stored in lockers or covered containers within these areas. Transformer oil and caustic electrolyte (battery fluid) would be delivered after the electrical equipment is in place.

Telecommunication Line. The Ivanpah Substation will require new telecommunication infrastructure to be installed to provide protective relay circuits, Supervisory Control and Data Acquisition (SCADA) circuits, Special Protection System (SPS) circuits and telephone services. These telecommunications lines will be owned by SCE. The primary telecommunication line will be an optical ground wire strung on the new double-circuit 220 kV transmission line. A second redundant telecommunication line will be installed consisting of microwave radio from the new Ivanpah substation to the town of Nipton. From there a 5-mile underground fiber optic cable will be installed along Highway 164 to the Eldorado - Lugo 500 kV line where 25 miles of optical ground wire will be strung all the way to Eldorado substation.

To facilitate an interim 115 kV interconnection another telecommunication path will be added. This telecommunication path from the new Ivanpah substation to the local carrier facility interface in the Mountain Pass area to the west consists of approximately 8 miles of fiber optic cable to be installed overhead on existing poles and new underground conduits to be constructed in the substation and at the telecom carrier interface point. This fiber optic route consists of two segments. The first segment is from the new Ivanpah substation to the existing Mountain Pass Substation using the existing Nipton 33-kV distribution line poles built along the transmission line corridor that crosses between Ivanpah 1 and 2. The second segment will be from the Mountain Pass substation to the telecommunications facility on the east end of Mohawk Ridge, approximately 1.5 miles away from the Mountain Pass Substation. The fiber optic cable between these two points will be installed on the existing Earth 12 kV distribution line poles. The overhead cable will be installed by attaching cross arms on existing distribution poles. Overhead fiber optic cable stringing will occur onto cross arms. Fiber optic cable pulls typically occur every 10,000 to 20,000 feet over flat or mountainous terrain. The dimensions of the area needed for stringing setups varies depending upon the terrain; however, a typical stringing set up is 40 feet by 60 feet. Poles that are not accessible from existing dirt service roads will have fiber optic cable installed by workers on foot; SCE estimates that approximately 20 poles are not accessible from the existing dirt service roads.

Natural Gas System

Each phase of the project includes a small package natural-gas fired startup boiler to provide heat for solar plant startup and during temporary periods of cloud cover. Natural gas will be obtained by the construction of an approximately 6-mile-long, 4- to 6-inch-diameter distribution pipeline from the existing Kern River Gas Transmission (KRGT) pipeline, which is located approximately 0.5 mile north of the Ivanpah 3 site (see Appendix A, Figure 21). A long-term gas metering tap station (100 feet x 150 feet) and a temporary construction area (200 feet x 200 feet) will be located at the point of connection along the existing KRGT ROW. From the tap station, the natural gas line will head south

along the eastern edge of Ivanpah 3 to a metering set (10 feet x 40 feet) near its southeast corner. (The gas line and metering sets will be located outside the project's fenced heliostat fields.) A dirt access road will follow the pipeline for maintenance access from the KRGT tap station along the eastern edge of Ivanpah 3, past the Ivanpah 3 metering set, to the southeast corner of Ivanpah 3 where the pipeline will meet with the asphalt road leading to the Ivanpah 3 solar plant and power block. From the southeast corner of Ivanpah 3, the gas line will follow along the east side of the asphalt road to the 20-foot by 40-foot metering set for Ivanpah 1 and 2. The gas line to Ivanpah 1 will continue from the metering set alongside the paved access road that goes from Colosseum Road past the Administration/warehouse Building to the Ivanpah 1 solar fields and power block.

Construction of Gas Pipeline. The construction contractor will determine which method to use to install the natural gas pipeline—a trench or trenchless method. The most common method of pipeline construction includes excavation of an open trench approximately 36 inches wide and at least 3 feet deep. With loose soil, a trench up to 8 feet wide at the top and 3 feet wide at the bottom may be required. The pipeline will be buried to provide a minimum cover of 36 inches. During construction, a 50-foot-wide construction corridor will be disturbed. This temporary construction corridor will be used to store the excavated soil, provide access for equipment and vehicles, and allow space for fitting the pipeline prior to installation and backfill via backhoe. Once completed, a 12-foot-wide dirt service road or other road access will be maintained.

Construction will require temporary disturbance of the ROW (e.g., vegetation clearing, trench excavation, soil compaction, dust generation, and restoration). The temporary construction disturbance area for the KRGT tap station will be 200 feet by 200 feet. Construction activities related to the tap station and metering station and metering sets will include grading a pad and installing aboveground and belowground gas piping, metering equipment, gas conditioning, pressure regulation, and pigging facilities. Construction of the Ivanpah 3 metering set will use a temporary laydown area within the Ivanpah 3 site; whereas, construction of the Ivanpah 1 and 2 metering set will use a temporary 5-acre triangular area just south of the metering set.

Access Roads, Maintenance Paths, and Rerouted Trails

Project access will be from Colosseum Road to the project entrance road (Appendix A, Figure 2). Colosseum Road is an existing paved and dirt road, which will be paved (30 feet wide, 2 lanes) for a 1.6-mile³ distance from the Primm Valley Golf Club to the project site. The project will reroute a portion of Colosseum Road around the southern end of the Ivanpah 2 plant site for a distance of 0.6 miles. It will continue as a 30-foot paved 2-lane road along the southern perimeter of Ivanpah 2 (the northern periphery of the CLA) to the point where the asphalt road turns north toward the Ivanpah 2 power block. From that point the road will continue about 0.46 miles as a dirt road to where it meets with the existing Colosseum dirt road where it exits the CLA (see Appendix A, Figures 2 and 19).

The internal roadway and utility corridors for each heliostat field and its power block will contain a 24-foot-wide paved access road from the entrance of the solar plant site to the power block and then around the power block. The paved access roads (and utility

³ A portion of which—from the Golf Club to their wells, about 5,000 feet—was recently paved, but lacks adequate road base for project use.

corridors) for Ivanpah 1 and 2 are located in the CLA (Appendix A, Figures 2, 15, and 19). The Ivanpah 3 roadway and utility corridor begins where the improved Colosseum Road reaches the Ivanpah 2 solar field. The 30-foot-wide asphalt road will turn north and continue along the eastern side of the Ivanpah 2 solar field, then turn west to follow between Ivanpah 2 and 3, where at the northwest corner of Ivanpah 2 it turns north into the Ivanpah 3 solar field. At that point it will continue as a 24-foot wide road to the Ivanpah 3 power block. The total distance from Colosseum Road to the entrance of Ivanpah 3 is about 12,000 feet (about 2.25 miles). It also serves as the gas pipeline access route along the east side of the Ivanpah 2 boundary fence.

Along with the main paved 24-foot-wide access road to the Ivanpah 3 power block, four 15-foot-wide dirt roads will radiate out from the power block to provide access to the four additional solar power towers that are components of the larger 200 MW Ivanpah 3 facility. From the SPTs, the dirt roads will continue 12 feet wide to the corners of the heliostat field. The dirt road from the southeast corner of Ivanpah 3 to the power block will also serve as the utility corridor for the water and gas lines (see Appendix A, Figures 2 and 21). The 15-foot-wide dirt roads will also host the steam pipelines that will be transferring steam from the SPTs back to the reheat tower at the power block.

Within the heliostat fields, 10-foot-wide paths will be located concentrically around the power block, or concentrically around the SPTs in the case of Ivanpah 3, to provide access to the heliostat mirrors for maintenance and cleaning. The paths will be located between every other row of heliostats and will not be graded except where topography necessitates limited cut and fill such as on the margins of incised washes. There will also be 12-foot-wide maintenance paths on the inside perimeter of the project boundary fence, which will be used for plant security and to monitor and maintain perimeter and tortoise fencing. These paths will be mowed but not graded except where necessary to cross washes.

Existing dirt trails that traverse the site will be rerouted either around the project site or to a proposed paved access road. Each rerouted dirt trail will be 8 to 12 feet wide (to match the existing trail) and will be reconnected to the original dirt trail on the other side of the project site (see Figure 1-10). Permanent tortoise guards will be installed to prevent tortoises from entering internal roads (see Figure 1-11).

Construction of Roads and Trails. New asphalt roadways (such as the improvements made to Colosseum Road) will be constructed in accordance with approved local and federal standards using an engineered road base with either aggregate or bituminous concrete surface. Trails that are rerouted as well as interior dirt roads and maintenance paths will be mowed to reduce the height of the vegetation but not bladed. Blading will only occur where topography necessitates limited cut and fill such as on the margins of incised washes.

Construction Logistics Area

An administration, warehouse, and maintenance complex will be located in the eastern portion of CLA between the relocated Colosseum Road and the entrance to the Ivanpah 1 solar plant. It will include parking and landscape areas. The complex will require about 8.9 acres and will be served by power from the Ivanpah Substation, water from the water supply wells, and gas from the main gas trunk line running from the KRGT tap point to the Ivanpah 1 power block (Appendix A, Figures 3 and 4). The CLA will also contain the main construction parking areas, construction trailers, tire cleaning station, fabrication buildings,

and other construction support facilities. Its surface will be stabilized and dust suppression maximized with a layer of crushed stone in areas subject to heavy daily traffic. Permanent parking areas will be provided at each of the facility's power blocks (see Appendix A, Figure 17 for a typical layout of the power block). An asphalt-paved parking lot will be constructed at the administration/warehouse building. An asphalt parking area may be provided at the new SCE electrical substation and installed by SCE.

Fences and Gates

Security fencing will be 8-foot-tall, galvanized steel, chain link topped with four razor-wire strands. Fencing will be positioned around the outer perimeter of each facility, the substation, and the administration/warehouse building. Tortoise barrier fencing will be combined with the perimeter security fence. In some cases, such as along the public perimeter road as well as the gas pipeline immediately east of Ivanpah 2 and 3, the security fence and tortoise fence will be separated. The tortoise fence will be installed to the east of that corridor, and the security fence to the west on the actual perimeter of the heliostat fields. The tortoise fence will be buried a minimum of 12 inches below ground level as shown in Figure 1-12.

1.3.2 Low-Impact Design and Construction

To date most solar energy facilities have approached the construction of their projects in the same fashion as most other industries. Initial site preparation includes "clearing and grubbing" followed by grading, which results in a surface that is level and clear and therefore optimum for construction. It is also devoid of life and frequently possesses hydrologic characteristics, such as increased potential for runoff, that require yet further engineering to mitigate. BrightSource Energy (BSE) believes that this is no longer an appropriate approach to take in construction, and that attributes of the natural landscape in and of themselves possess properties that will assist in mitigating construction effects. The LID adopted for this project incorporates several approaches to reduce environmental impacts and take advantage of the site's natural attributes. These include the following.

- Cutting vegetation to a height that will not interfere with construction and operation of the heliostat fields but not clearing or grading
- Restricting clearing and grading activities to areas where foundations, drainage facilities, and all-weather roads must be placed
- Taking advantage of the natural permeability of the alluvium at the site by minimizing compaction and decompacting soils where necessary
- Implementing a revegetation and rehabilitation program to accelerate the return of areas that have been temporarily disturbed to a vegetated state
- Implementing a stormwater control design that promotes sheet flow and greater infiltration, rather than channelization and concentration of stormwaters

This R&R Plan provides the background as well as methods to implement components of BSE's LID philosophy during construction as well as decommissioning of the project.

Vegetation Clearing and Cutting

The estimated size of each power generation facility is 914 acres for Ivanpah 1, 921 acres for Ivanpah 2, and 1,836 acres for Ivanpah 3. To construct the heliostat array fields located within these sites, some vegetation clearing will occur but only where necessary to allow for equipment access and stormwater management. In areas where general site grading is not required, vegetation clearing will not occur. The overall grading plan shown in Appendix A, Figure 11 shows the areas that may require grading.

An approximate 12-foot-wide linear swath of vegetation along the entire outer edge of the area to be developed will be mowed (but not graded) to create an internal perimeter path for installation of the tortoise and security fencing. Vegetation clearing, with leveling or grading limited to arroyo walls will be performed throughout the sites beneath the heliostats where the existing vegetative cover will not permit access of installation equipment and materials. Off of access roads and maintenance tracks, vegetation will be cut to a height of approximately 1.0 to 1.5 feet to allow clearance for heliostat function and at the same time leave the soil surface and root structures intact. As noted earlier, the vegetation will be cut with a flail-type mower mounted on a low-ground pressure tractor. Occasional trimming of the vegetation may be required during the approximately 50-year operational phase of the project to control plant regrowth that could affect heliostat mirror movement.

Clearing and grubbing, where shrubs including roots are removed, will be performed for asphalt access roads for each facility, the power blocks, in CLA where existing topography must be modified to make suitable parking and laydown areas; in areas to be graded in Ivanpah 2 and 3; and to provide access for installation equipment and materials during construction (areas requiring leveling by grading). For all other areas, existing vegetation (and root systems) will be maintained to anchor the soil and reduce the potential for erosion. Where existing site topography is favorable, the natural drainage features will be maintained.

General Grading and Leveling

At some washes, slopes will be close to vertical, too steep for equipment, and therefore cuts into the side of the existing embankments will be necessary (a detail is provided on drawings in Appendix A; Figures 10 and 22). Surface rocks and boulders will need to be relocated to allow proper installation of heliostats and facilities when they cannot be avoided. These rocks and boulders will be harvested using LID construction techniques to minimize any necessary clearing or grading. Boulders will be harvested using a Caterpillar 950 (gross vehicle weight of 40,000 pounds [lbs] or similar), front-end loader with high floatation tires. The tires will generate much less impact than standard Caterpillar tires. The loader will be equipped with a skeleton bucket to harvest rocks larger than about 10 inches in diameter.

The highest concentration of large rocks occurs in the northeastern 156-acre area of Ivanpah 3 where the rocks and boulders will be used for rip-rap and other uses where possible. Site grading will be designed to maintain all local materials onsite and attempt to minimize the import of offsite material. To the extent possible, the site's excavation and embankment volumes will be approximately balanced to eliminate or minimize the import of material to the site. Light grading for equipment access and boulder clearing, including rock harvesting, is anticipated in a 380-acre area in Ivanpah 3, there may be up to 187,000

cubic yards (yd³) of material graded and rock harvested. These areas of light grading will be compacted to allow for existing infiltration rates.

Reusable local materials will be hauled to lay-down areas for reuse or placed directly in the fill or backfill locations. A stone crusher facility may be used onsite for the production of subgrade materials (gravel) from local stone. Stockpiles of local materials shall be neatly shaped and free to drain. Material that does not meet the requirements for fill, backfill, or subgrade shall be disposed of onsite in locations designated by BSE.

Heavy to medium grading will be performed within the solar project's proposed receiver tower and power block areas, for the substation, and within the administration/maintenance building area. The deepest excavations will be restricted to foundations and drainage diversion channels. Within each of these individual areas, BSE will approximately balance earthwork cuts and fills. The total quantity of cut anticipated for these areas is approximately 245,000 yd³. The majority of earthwork in the power block and common areas will be excavated and compacted with Caterpillar D-9 size bulldozers and sheepsfoot compactors. These areas will be compacted to the recommendations of the geotechnical report.

The surface soil grade of each facility will be designed to provide the minimum requirements for access of installation equipment and materials during site construction and operations. Most of the natural drainage features will be maintained and any grading required will be designed to promote sheet flow where possible. Areas disturbed by grading and other ground disturbance will be protected from erosion by implementation of appropriate best management practices (BMPs) that will be identified in the project's Stormwater Pollution Prevention Plan (SWPPP), provided as Appendix C to this document.

Storm Drainage System

The majority of the project site will maintain the original grades and natural drainage features and, therefore, will require no added storm drainage control. In limited areas, such as the power blocks, substation, and administrative areas, a storm drainage system will be designed using diversions channels, bypass channels, or swales to direct runoff flow from up-slope areas and runoff flow through and around each facility. Diversion channels will be designed so that a minimum ground surface slope of 0.5 percent will be provided to allow positive, puddle-free drainage. To reduce erosion, storm drainage channels may be lined with a nonerrodible material such as compacted rip-rap, geo-synthetic matting, or engineered vegetation. The design will be developed for sheet flow for all storm events less than or equal to a 100-year, 24-hour storm event.

All surface runoff during and after construction will be controlled in accordance with the requirements of the National Pollutant Discharge Elimination System (NPDES) stormwater permit for construction activities, the requirements of the San Bernardino Water Quality Management Plan manual, and all other applicable laws, ordinances, regulations, and standards (LORS).

Erosion and Sediment Control Measures

Protection of soil resources will be an important factor in the design of Ivanpah SEGS erosion and sedimentation controls. To minimize wind and water erosion, open spaces will be preserved and left undisturbed maintaining existing vegetation (to the extent possible

with respect to site topography and access requirements). To reduce runoff from compacted surfaces, infiltration rates will be returned to natural rates after construction.

Stone filters and check dams will be strategically placed throughout the project site to provide areas for sediment deposition and to promote the sheet flow of stormwater prior to leaving the project site boundary. Where available, native materials (rock and gravel) will be used for the construction of the stone filter and check dams. A rock crusher may be provided onsite to use local stone for the production of gravel. Diversion berms will be used to redirect stormwater as required.

Periodic maintenance will be conducted as required after major storm events and when the volume of material behind the check dams exceeds 50 percent of the original volume. Stone filters and check dams are not intended to alter drainage patterns but to minimize soil erosion and promote sheet flow.

1.3.3 Closure, Revegetation, and Rehabilitation Plan Goals and Objectives

The overarching goal of this plan is to present detailed vegetation and surface management measures to implement the LID approach. It provides guidelines, methods, and criteria for measuring the progress of revegetation of areas temporarily disturbed during project construction management of the site surface at Ivanpah SEGS, during its planned operation, and rehabilitation and revegetation of the project site upon facility decommissioning. Complimentary objectives can be summarized as follows.

- Describe the methods for rehabilitation and revegetation of temporary disturbance areas that will create natural-appearing topography and reduce potential for erosion, especially through deflation.
- Implement a practical revegetation program that will accelerate natural vegetation succession and, over time, promote the establishment of a plant community dominated by native perennials.
- Establish a weed management program applicable to the construction, operation, and decommissioning of the project site that will identify the non-native species requiring eradication and the means to accomplish that eradication.
- Identify means and methods that will minimize, to the extent practicable, long-term maintenance and support requirements such as irrigation, weeding, or reseeding.
- Reduce the visual contrasts between temporary disturbed areas and adjacent undisturbed areas through revegetation.
- Anticipate wildlife management needs as habitat suitable to support cover and breeding opportunities for desert fauna development in temporary disturbed areas, in operational areas of the Ivanpah SEGS, and after decommissioning.

1.3.4 Conformance with Agency Requirements

This plan complies with BLM and CEC requests to provide a site revegetation and closure plan as stated in Data Request 30 (CEC, 2007), which was later revised with Data Request 125 (CEC, 2008). Both data requests are provided below.

BACKGROUND

AFC section 5.2.11.1, Mitigation Measure 1 – Site Rehabilitation Plan, addresses closure of the project following the cessation of facility operations and discusses elements of a project closure plan. Permanent closure is an issue of concern regarding biological resources due to the proposed facility location on a relatively large and undisturbed habitat area as well as the potential threats to biological resources posed by abandoned equipment and hazardous materials.

Data Request

30. Please describe the likely components of a closure plan (e.g., decommissioning methods, timing of any proposed habitat restoration, restoration performance criteria), and discuss each relative to biological resources and specifically to desert tortoise and its habitat.

BACKGROUND

Section 5.2.11.1, Mitigation Measure 1 – Site Rehabilitation Plan, addresses closure of the project following the cessation of facility operations and discusses elements of a closure plan. Data Request 30 asked for description of the likely components of a closure plan addressing decommissioning methods, timing of any proposed habitat restoration and restoration performance criteria. Applicant's response suggests that each project owner file a closure plan for review and approval at least 12-months prior to commencing the closure activities. BLM believes that the applicant must prepare a plan that addresses closure and restoration activities and that waiting to address the issues at the end of the useful life of the facility, will not ensure satisfactory restoration of the site in the fragile desert environment. In addition, the project design and footprint may need to accommodate vegetation salvage and/or propagation study plots. Further, the plan needs to recognize that closure activities may not only occur at the end of a 30 or 50 year life of the facility, but could happen at intermediate times during the project life.

DATA REQUEST

125. BLM requests the applicant develop a plan that will guide site restoration and closure activities. Initially the plan will describe the anticipated methods applicant proposes for revegetation of disturbed areas using native plant species including perennials, and will include methods used to monitor restoration of and evaluate success of revegetation efforts.

The initial site restoration and closure plan will evaluate existing information gathered by applicant and other relevant studies to determine if existing data is sufficient to guide restoration of disturbed lands or if additional research is necessary to determine the most effective means to restore and revegetate the site at closure⁴.

The plan must address preconstruction salvage and relocation of succulent vegetation from the site to either an onsite or nearby nursery facility for study and propagation of seed sources⁵ to reclaim the disturbed area. In the case of unexpected closure, the plan should assume restoration activities could possibly take place prior to the anticipated lifespan of the plant. Specifically the closure and restoration plan must address the following:

⁴ This has been accomplished by the previously submitted *Technical Basis Document for Revegetation and Reclamation Planning* included by reference in this document as Appendix B (originally filed as Attachment DR125-1A, Data Response Set 2B, filed on July 22, 2008.)

⁵ As described more thoroughly in the *Technical Basis Document* succulent salvage is recommended neither for seed sourcing nor for research, since neither is required to develop effective revegetation strategies and methods.

- Develop a revegetation research program based on information provided by a qualified expert in desert flora and revegetation. The program would include a review of available materials describing methods and success rates of revegetation programs in the Eastern Mojave Desert at similar elevations.
- A program to evaluate existing native plant vegetation data from the current inventories and identify proposed representative study plot locations within and adjacent to the project area for each of the four vegetative community subtypes cited in the AFC, Appendix 5.2B. This data will be used to identify dominant species to be used in revegetation⁶.
- Baseline vegetation measurements from the project area and from surrounding non-disturbed areas must be established prior to any surface disturbing activities and will be used to evaluate and monitor vegetation trends and changing conditions over the life of the project that could be considered impediments to restoration activities (e.g. sustained drought). Prepare and submit a protocol to identify study plots and methodology to evaluate trends to BLM for review and approval prior to beginning studies.
- Identify the extent of succulent plant species to be salvaged and maintained in nursery areas either on site, or in close proximity, that would be used for future transplanting and/or in propagation studies for seed sources.
- Monitoring and treatment of invasive species⁷ over the life of the project.
- Ground preparation procedures that would be needed to effectively reclaim the area.
- Implementation of monitoring programs after closure to verify revegetation results based upon the established goals for density and diversity.
- Provide yearly updates to agencies of progress achieved in connection to revegetation research.
- Identify, with justification, the vegetation considered unnecessary for revegetation or reclamation research that would be lost during construction that could be made available for public collection through plant salvage sales conducted by BLM.

The *Technical Basis Document for Revegetation and Reclamation Planning, Ivanpah Solar Electric Generating System, Eastern Mojave Desert, San Bernardino County, California (TBD)*, included as Appendix D, demonstrates that there is sufficient information on the ecological dynamics of revegetation, as well as the applicable techniques that can be used to accelerate revegetation. Therefore, a research program is unnecessary.

1.3.5 Integral Documents

Other documents pertaining to rehabilitation and revegetation planning that were previously prepared for the Ivanpah SEGS project were used in development of this Plan. They are described in this section.

⁶ As noted in the *Technical Basis Document* this activity is unnecessary. Native plant species most suitable for revegetation of the area have been identified according to the manner described in the *Technical Basis Document*.

⁷ This has been accomplished by the previously submitted *Weed Management Plan for the Ivanpah Solar Electric Generating System* included by reference in this document as Appendix C (originally filed as Attachment DR13-1A, Data Response Set 1F, filed on August 6, 2008).

The Technical Basis Document and Revegetation Methods

The TBD is divided into two main sections. The first section provides some detail on the ecological dynamics of vegetation succession (natural revegetation) in desert scrub ecosystems, focusing on the findings of previous studies in the Mojave Desert. The second section provides a summary of the revegetation techniques used in different projects in the Mojave Desert, and assessment of the methods identifying which are most practicable, and which are least likely to yield satisfactory results.

The TBD arrived at several findings integral to this Plan and to its compliance with Data Request 125. Those findings are summarized here, with additional conclusions based on review input to the first draft of this R&R Plan. They are then developed as appropriate later in this document. Specific commitments of this Plan are provided as bulletized lists following each section.

A research program is unnecessary to identify revegetation methodology, appropriate revegetation plant taxa, soil preparation and management, and other details of a revegetation program because these methods have been thoroughly vetted in revegetation sites and programs throughout the Mojave Desert. This includes the extensive revegetation research and implementation program at the Castle Mountain Mine, as well as other programs. Vegetation succession after disturbance can be accelerated by taking advantage of the means and methods of vegetation propagation developed by these other projects in the Mojave Desert. The plant species that are adapted to ground disturbance and, therefore, are most appropriate for revegetation, as well as the late successional and climax species at Ivanpah SEGS, are known and published studies are available to support these determinations.

Revegetation goals can be stated in terms of the rates and components of successional processes. Criteria for revegetation success need to be established on the basis of successional plant associations. Suitable criteria have been developed for the Ivanpah SEGS sites based on empirical measurements of sites in the Ivanpah Valley that have been previously disturbed, and are now successfully recovering. These criteria, and the data that support them, are presented later in this document. An open-air Succulent Storage and Stockpile Area (SSSA) would be employed for succulent salvage, but no more elaborate facility is otherwise needed to support the revegetation effort.

The plant species most appropriate to revegetation efforts can be identified with the available information on the flora of Ivanpah SEGS. Disturbance-adapted winter annuals were identified during the survey of the project site, as well as perennials that favor the poor soils and disturbed habitats of washes and roadsides. Different propagation methods have also been tried and were challenged by the extremely rigorous environment of the Mojave Desert. However, there are data to identify the methods that represent the best balance of practicality, environmental realism, and economics. An example of environmental realism is avoiding the use of prolonged irrigation to establish plants for revegetation. As could be expected in this Mojave Desert environment, such plants experience a very high mortality rate at the end of the irrigation period.

Soil salvage and site preparation are needed for desert restoration sites. Measures used include (1) topsoil stockpiling and subsequent redistribution to enhance revegetation efforts; (2) windrowing mulched vegetation, topsoil, and subsoil in separate rows; (3) mulching the

site using windrowed vegetation to increase moisture retention and reduce erosion; (4) deep ripping (where compaction is severe) and spading (when compaction is less severe) to provide decompaction after construction activities, and to provide a rough surface for seed catchment; and (5) surface shaping to create pits, swales, or microcatchments to capture water and enhance plant reestablishment, insect colonization, and seed capture (Bainbridge, 2007). Prior to ground disturbance, soil physical and chemical characteristics at the site will be measured to provide a baseline for future soil rehabilitation.

Finally, seed collection and plant propagation through broadcast seeding are likely to be the most practical for revegetation in most cases. Seed collection needs to be from target species occurring within 25 miles of the site to ensure that local ecotypes adapted to local climate, soil, and other site conditions are employed. Bulk seed can be collected by direct harvest from plants, underneath shrubs, and from windblown debris caught in depressions and washes; areas near roadsides or invasive plants would be avoided. The advantages of bulk seed include acquiring seed that may naturally be inoculated with beneficial microorganisms, acquiring a larger diversity of seed, including annuals, and acquiring seeds that can be sown immediately without concern for dormancy.

Fall seeding is recommended, although seeding has been conducted throughout the winter. Broadcast seeding can be effective, but should be followed with a drag device to provide some soil disturbance and to bury the seed. Hydroseeding is not recommended because presoaked seed will fail in the absence of further irrigation. Seeds are especially vulnerable to predation by rodents, ants, birds, or other organisms, and methods (e.g., drill seeding) to protect seed by burying can be beneficial. Mulching appears to contribute to seeding success. Cleared vegetation from the site can be mulched or straw mulch used.

The Weed Management Plan

The *Weed Management Plan for the Ivanpah Solar Electric Generating System* (Attachment DR13-1A, Data Response Set 1F) describes the weed species that occur or are likely to occur in the project site and prescribes management actions that may be taken to monitor for an eradicate-specified species. It also discriminates between ubiquitous species and those species that are currently rare or absent in the project site. The former are beyond complete eradication, and can be expected to be present as elements of the postdisturbance successional flora at Ivanpah SEGS. Appropriate management thresholds for weeds, including ubiquitous species, are provided in the *Weed Management Plan for the Ivanpah Solar Electric Generating System* (WMP) (CH2M HILL, 2008c). The WMP also describes applicable regulations for the use of herbicides on federally managed lands in California, and provides the basis for proper control of herbicides at Ivanpah SEGS.

Other Plans and Documents

The *Biological Assessment* (to be prepared by BLM), the Data Responses for the Ivanpah SEGS (all sets of data responses), and the *Preliminary and Final Staff Assessment/Draft and Final Environmental Impact Statement* for the Ivanpah SEGS are additional documents that provide relevant data, context information, and guidance for this Plan. (They have not been finalized at the time of this writing.)

1.4 Conservation and Management Plans

This section discusses the conservation and management plans relevant to surface management and noxious weed control at Ivanpah SEGS. These plans were developed either in response to regulatory mandates or following internal agency guidance.

1.4.1 California Desert Conservation Area Plan

The California Desert Conservation Area (CDCA) comprises one of two national conservation areas established by Congress at the time of the passage of the Federal Land and Policy Management Act (FLPMA). FLPMA outlines how the BLM will manage public lands and its overarching multiple use goals. Congress specifically provided guidance for the management of the CDCA and directed the development of the 1980 CDCA Plan (BLM, 1980). The 1980 CDCA Plan does not provide specifics on revegetation of disturbed sites, but specifies limits on manipulation of vegetation for purposes of noxious weed management, forage production, or wildlife management.

Specifically, the 1980 CDCA Plan limits the use of mechanical and chemical control of noxious weeds, as well as exclosures and prescribed burning, to certain land designations, and typically after a site-specific management plan is developed. In addition, the plan limits actions with adverse impacts on wetland and riparian areas and requires initiation of programs to rehabilitate those areas in a deteriorated condition.

1.4.2 Northern and Eastern Mojave Coordinated Management Plan

As an amendment to the 1980 CDCA Plan, the BLM produced the Northern and Eastern Mojave Coordinated Management Plan (NEMO; BLM, 2002). This document consists of proposed management actions and alternatives for public lands in the NEMO Planning Area which encompasses 3.3 million acres, and includes the Ivanpah SEGS project. The area borders Nevada on the east, Fort Irwin and the West Mojave (WEMO) Planning Area on the west, and I-40 and the Northern and Eastern Colorado⁸³ (NECO) Planning Area on the south. The identified goals for the NEMO Planning Area include the following.

- Adopt standards for public land health and guidelines for grazing management
- Identify management actions to conserve and recover threatened and endangered (T&E) species, including the Mojave population of the desert tortoise (*Gopherus agassizii*)
- Adopt a strategy for route designation in the NEMO Planning Area consistent with 43 CFR 8342.1

This NEMO planning effort was developed in part in response to the USFWS recovery plan for the federal- and State of California-listed desert tortoise. The NEMO plan adopted the goals of both recovery plans and the recovery objectives for the desert tortoise. This planning effort has developed strategies that vary in some respects from the recommended actions in the USFWS recovery plan. These differences are based on identifying recovery unit and Desert Wildlife Management Area specific alternatives to meet the goals of the USFWS recovery plan.

³ In California, the floristically defined Lower Colorado Valley subdivision of the Sonoran Desert (Shreve, 1964), lying in extreme southeastern California and adjacent Arizona and Mexico, is frequently called the "Colorado Desert."

1.4.3 Bureau of Land Management's Herbicide Usage Guidelines

The BLM prepared the *Final Programmatic Environmental Impact Statement Vegetation Treatments Using Herbicides on Bureau of Land Management Lands in 17 Western States* (PEIS; USDI, 2007). This document incorporates extensive public input and outlines the specific decisions, standard operating procedures, and mitigation measures for the use of herbicides on BLM-managed lands. The selected alternative (Alternative B) identifies the herbicide active ingredients approved for use on BLM-managed lands. It also identifies herbicide active ingredients that are no longer approved for use. The record of decision for the PEIS defers to approved land use plans to determine the number of acres to be treated through the BLM's integrated pest management program.

The PEIS includes information in Appendix B (Herbicide Treatment Standard Operating Procedures) regarding management of noxious weeds and application of pesticides on BLM land. Table B-1, Prevention Measures, specifies avoidance measures to limit noxious weed infestation. This table can also be found in the WMP (Appendix B).

TABLE 1-1
Detailed Breakdown of Ivanpah SEGS Components

Components	Linear Feet	Acres			Total	Comments
		Temp	Long-Term	Permanent		
AREA NORTH OF IVANPAH 3						
Tap Station			0.34		0.34	Tap Station is 100' x 150'.
Tap Station Construction Area		0.92			0.92	Construction area is 200' x 200'
Gas Line from tap point to top of I-3	2,011	1.75			1.75	50' construction area corridor along gas line, less 12' dirt service road = 38' revegetated
Gas Line from tap point to top of I-3	2,011		0.55		0.55	12' dirt service road
SUBTOTAL AREA NORTH OF IVANPAH 3		2.67	0.90	0.00	3.57	
Ivanpah 3						
Gas Line Corridor 50' construction area (east side)	15,427	13.46			13.46	50' construction area corridor along gas line east side, less 12' dirt road = 38' revegetated
Gas Line Corridor (east side)	6,752			1.86	1.86	12' dirt road from gas line to trail 699226
Gas Line Corridor (east side)	7,103		1.96		1.96	12' dirt road from trail 699226 to trail 699198
Gas Line Corridor (east side)	1,572			0.43	0.43	12' dirt road from trail 699198 to asphalt road between Units 1 & 2
12' rerouted trail 699226 from gas line west side	6,906			1.90	1.90	12' dirt road from gas line to trail 699226 (west side of Ivanpah 3). No construction corridor since trail is just mowed.
Ivanpah 3 Metering set			0.01		0.01	Ivanpah 3 metering set 10' x 40' (construction area within the 50' construction area for gas & water line)
30' asphalt road between Ivanpah 2 & 3	4,751			3.93	3.93	SE corner of Ivanpah 3 to asphalt road going to PB (30' asphalt and 3' shoulder each side)
Asphalt road construction corridor	4,751	1.53			1.53	Between Units 2 & 3: 50' Corridor (30' road + 3' shoulder = 7' construction area on each side – 14' revegetated)
24' asphalt road to Power block (PB)	3,872		2.67		2.67	24' road + 3' shoulder on each side = 30' roadway

TABLE 1-1
Detailed Breakdown of Ivanpah SEGS Components

Components	Linear Feet	Acres			Total	Comments
		Temp	Long-Term	Permanent		
Asphalt road construction corridor	3,872	1.24			1.24	44' corridor (30' roadway +3' shoulders = 7' construction area on each sides of road)
Power block (PB)			14.96		14.96	Includes road around PB, diversion berm and channel
Solar Power Towers			3.74		3.74	4 SPTs in the heliostat field
15' dirt road from PB to the four SPTs	10,300		3.55		3.55	
12' dirt road from SPTs to corners	25,617		7.06		7.06	
12' perimeter road	40,778		11.23		11.23	
Set back from property line			17.50		17.50	Undeveloped set back from any property line
10' heliostat maintenance paths (estimated at 15.5% of heliostat field) ⁹	NA		210.98		210.98	Detailed information is not available.
Heliostat field			1,150.18		1,150.18	Remaining area within Ivanpah 3
Gas line from metering set to PB	5,823	0.0			0.00	Line will follow dirt road. No Additional Impact
Water line from metering set to PB	5,785	0.0			0.00	Line will follow dirt road. No Additional Impact
Construction corridor for gas & water line	5,823	3.74			3.74	40' construction corridor for gas & water line (40' corridor – 12' dirt road = 28' revegetation corridor)
Gen-tie corridor from PB to top of Ivanpah 2	4,065	0.36			0.36	Gen-tie line will follow asphalt road. 2 turning towers, 5 embedded towers
Gen-tie towers			0.006		0.006	Area of the tower footprints
Graded areas		380.00			380.00	Includes rock relocation area
Fill stockpiles			3.98		3.98	4' high fill stockpile, for use in decommissioning

⁹ Heliostat maintenance paths for Ivanpah 1 and 2 comprise about 16.5 percent of the heliostat field. Because of the larger area of Ivanpah 3, greater distance between some heliostat rows, and unused areas 15.5 percent was determined to be a reasonable assumption.

TABLE 1-1
Detailed Breakdown of Ivanpah SEGS Components

Components	Linear Feet	Acres			Total	Comments
		Temp	Long-Term	Permanent		
12' dirt trail to mining claim	1,492			0.41	0.41	
SUBTOTAL IVANPAH 3		400.33	1,427.81	8.53	1,836.68	Includes 1836.3 ac for Ivanpah 3 and 0.41 ac for mining access
(less heliostat field)			-1,150.18			
Ivanpah 3 Revegetation Area		400.33	277.64		677.97	
Ivanpah 2						
30' asphalt road from Ivanpah 3 to Colosseum Road	7,247		5.99		5.99	30' asphalt + 3' shoulder on either side = 36' roadway
Asphalt road construction corridor	7,247	2.33			2.33	50' construction corridor - 36' roadway = 7' construction area on each side of road = 14' revegetation
Gas & water line corridor to PB	3,972	2.55			2.55	40' construction corridor - 12' dirt access road from PB to corner = 28' revegetation
24' asphalt road to PB	2,229		1.54		1.54	From re-routed Colosseum Rd to PB (24' road + 3' shoulders = 30' roadway)
Asphalt road construction corridor	2,229	0.72			0.72	44' construction corridor - 30' roadway = 7' construction area on each side = 14' revegetation
Power block (PB)			13.17		13.17	Includes road around PB, diversion berm and channel
12' dirt service road from PB to corners	15,176		4.18		4.18	
Ivanpah 3 gen-tie along south side of Ivanpah 2	3,296	0.25			0.25	Construction corridor for 1 turning tower + 4 embedded towers (access along dirt perimeter road)
Ivanpah 3 gen-tie along south side of Ivanpah 2			0.004		0.004	Area of the 5 tower footprints
Ivanpah 3 gen-tie along west side of Ivanpah 2	5,371	0.38			0.38	Access along dirt perimeter road
Ivanpah 3 gen-tie along west side of Ivanpah 2			0.007		0.01	Area of the 8 tower footprints

TABLE 1-1
Detailed Breakdown of Ivanpah SEGS Components

Components	Linear Feet	Acres			Total	Comments
		Temp	Long-Term	Permanent		
Ivanpah 2 gen-tie from PB to junction with Ivanpah 3 gen-tie	2,322	0.20			0.20	Construction corridor for 1 turning tower +3 embedded towers (access along paved road)
Ivanpah 2 gen-tie from PB to junction with Ivanpah 3 gen-tie			0.004		0.004	Area of the 4 tower footprints
12' perimeter road	24,167		6.66		6.66	
Set back from property line			4.71		4.71	undeveloped set back from property line
10' heliostat maintenance paths	629,528		144.52		144.52	
Heliostat field			729.16		729.16	Remaining area within Ivanpah 2 (includes graded area)
12' dirt trail along west side of Ivanpah 2	3,115			0.86	0.86	Rerouted trail 699198
12' dirt trail along southwest corner of Ivanpah 2	4,148		1.14		1.14	12' dirt road around west perimeter from trail 699198 to relocated Colosseum Road
Channel crossings			0.31		0.31	
Graded areas		123.00			123.00	
Fill stockpiles			2.03		2.03	4' high fill stockpile, for use in decommissioning
SUBTOTAL IVANPAH 2		129.43	790.43	0.86	920.72	
(less heliostat field)			-729.16			
Ivanpah 2 Revegetation Area		129.43	184.27		313.70	
Construction Logistics Area (incl. improvements to Colosseum Road)						
30' asphalt improved Colosseum Rd.	8,442			6.98	6.98	From Golf Club to T-intersection at Ivanpah 2 (30' asphalt road + 3' dirt shoulders = 36' roadway)
Asphalt road construction corridor	8,442	2.71			2.71	50' construction corridor - 36' roadway = 7' construction area each side = 14' revegetation

TABLE 1-1
Detailed Breakdown of Ivanpah SEGS Components

Components	Linear Feet	Acres			Total	Comments
		Temp	Long-Term	Permanent		
Tire wash/concrete washout, off Colosseum Road		1.04			1.04	Area for turnouts and wash areas
30' asphalt re-routed Colosseum Road	4,343			3.59	3.59	From T-intersection with Colosseum around south end of Ivanpah 2 to road to PB (30' asphalt road + 3' dirt shoulders = 36' roadway)
Asphalt road construction corridor	4,343	1.40			1.40	50' construction corridor - 36' roadway = 7' construction area each side = 14' revegetation
12' gravel road to re-routed Colosseum trail	2,452			0.68	0.68	From end of asphalt section to where it exits the CLA on to connect to Colosseum dirt road
24' asphalt road to substation	1,761			1.21	1.21	24' asphalt + 3' dirt shoulders = 30' roadway
Asphalt road construction corridor	1,761	0.57			0.57	44' construction corridor - 30' roadway = 7' construction area on each side = 14' revegetation
Substation				16.10	16.10	Will remain post-project
Diversion berms & channel for substation				8.30	8.30	Will remain post-project
Ivanpah 2 & 3 T-line to substation construction corridor	1,898	0.35			0.35	20' construction corridor for double-circuit T-line -12' service road = 8' revegetation
12' dirt service road for dbl-circuit t-line	1,898		0.52		0.52	From Ivanpah 2 to Substation
Construction of double-circuit towers		0.20			0.20	Construction corridor for 1 turning tower + 3 embedded towers (access along dirt road)
Double-circuit gen-tie towers			0.004		0.00	Area of the 4 tower footprints
Gas meter set for Ivanpah 1 & 2			0.02		0.02	20' x 40' area on southeast corner of Ivanpah 2
Gas meter set construction area		0.92			0.92	200' x 200'
24' asphalt road from re-routed Colosseum Road to Ivanpah 1	2,153		1.48		1.48	24' asphalt from Ivanpah 2 to Ivanpah 1 + 3' dirt shoulders ea. side = 30' roadway

TABLE 1-1
Detailed Breakdown of Ivanpah SEGS Components

Components	Linear Feet	Acres			Total	Comments
		Temp	Long-Term	Permanent		
Asphalt road construction corridor	2,153	0.69			0.69	44' Construction Corridor - 30' roadway = 7' construction area on ea. side = 14' revegetation
Gas & water line corridor to Unit 1	2,153				0.00	Runs along 24' asphalt road, no additional Impact
Administration/warehouse Building			8.90		8.90	Includes entrance road
12' dirt service road for monitoring well	866		0.24		0.24	12' road is just mowed, no construction area
Monitoring well			0.00		0.00	10' x 10' area
12' dirt service road for production wells	1,075		0.30		0.30	12' road is just mowed, no construction area
Production wells			0.00		0.00	10' x 10' area for each well
T-line from Ivanpah 1 to Substation	2,867	0.53			0.53	20' construction corridor for T-line. -12' service road = 8' reveg
12' service road from Ivanpah 1 to Sub	2,867		0.79		0.79	12' road is just mowed, no construction area
Construction of gen-tie towers		0.32			0.32	Construction corridor for 2 turning towers + 4 embedded towers (access along dirt road)
Gen-tie towers			0.005		0.005	Area of the 6 tower footprints
Construction parking		1.53			1.53	Assume 12' x 20' area for 39, 15-passenger vans & 192 personal vehicles + 20% additional area for access
Contractor Trailer area		18.57			18.57	Includes construction parking area
Equipment Laydown		20.46			20.46	Does not include tire wash, which is above
Area available for construction use		248.79			248.79	Additional area that can be used if needed
40-ac succulent storage & stockpile area			40.00		40.00	
Fill stockpiles			0.91		0.91	4' high fill stockpile, for use in decommissioning
SUBTOTAL CLA & Colosseum Rd		298.07	53.18	36.85	387.19	Includes CLA (377.5 ac) + Colosseum Road (9.69 ac)

TABLE 1-1
Detailed Breakdown of Ivanpah SEGS Components

Components	Linear Feet	Acres			Total	Comments
		Temp	Long-Term	Permanent		
Ivanpah 1						
24' Asphalt road from edge to PB	3,361		2.31		2.31	Portion within Ivanpah 1 (24' road + 3' dirt shoulders = 30'-roadway)
Asphalt road construction corridor	3,361	1.08			1.08	44' construction corridor - 30' roadway = 7' construction area on each side = 14' revegetation
Gas & water line corridor to PB	3,361		0.00		0.00	Road corridor used to construct utilities on each side
Power block (PB)			13.54		13.54	Includes road around PB, diversion berm and channel
Gen-tie line from PB to end of Ivanpah 1	3,510				0.00	Asphalt road can be used as service access for transmission line
Construction of gen-tie towers		0.29			0.29	Construction corridor for 1 turning tower + 5 embedded towers
Gen-tie towers			0.005		0.01	Area of the 6 tower footprints
12' dirt service road from PB to corners	12,020		3.31		3.31	
12' perimeter road	23,857		6.57		6.57	
Set back from property line			8.79		8.79	undeveloped set back from property line
10' heliostat maintenance paths	636,325		146.08		146.08	
Heliostat field			731.49		731.49	Remaining area within Ivanpah 1
Fill stockpiles			1.57		1.57	4' high fill stockpile, for use in decommissioning
SUBTOTAL IVANPAH 1		1.08	912.41	0.0	913.49	
(less heliostat field)			-731.49			
Ivanpah 1 Revegetation Area		1.08	180.62			

Note: These numbers are based on the best available information at the time of preparation and are subject to change in the final design drawings.

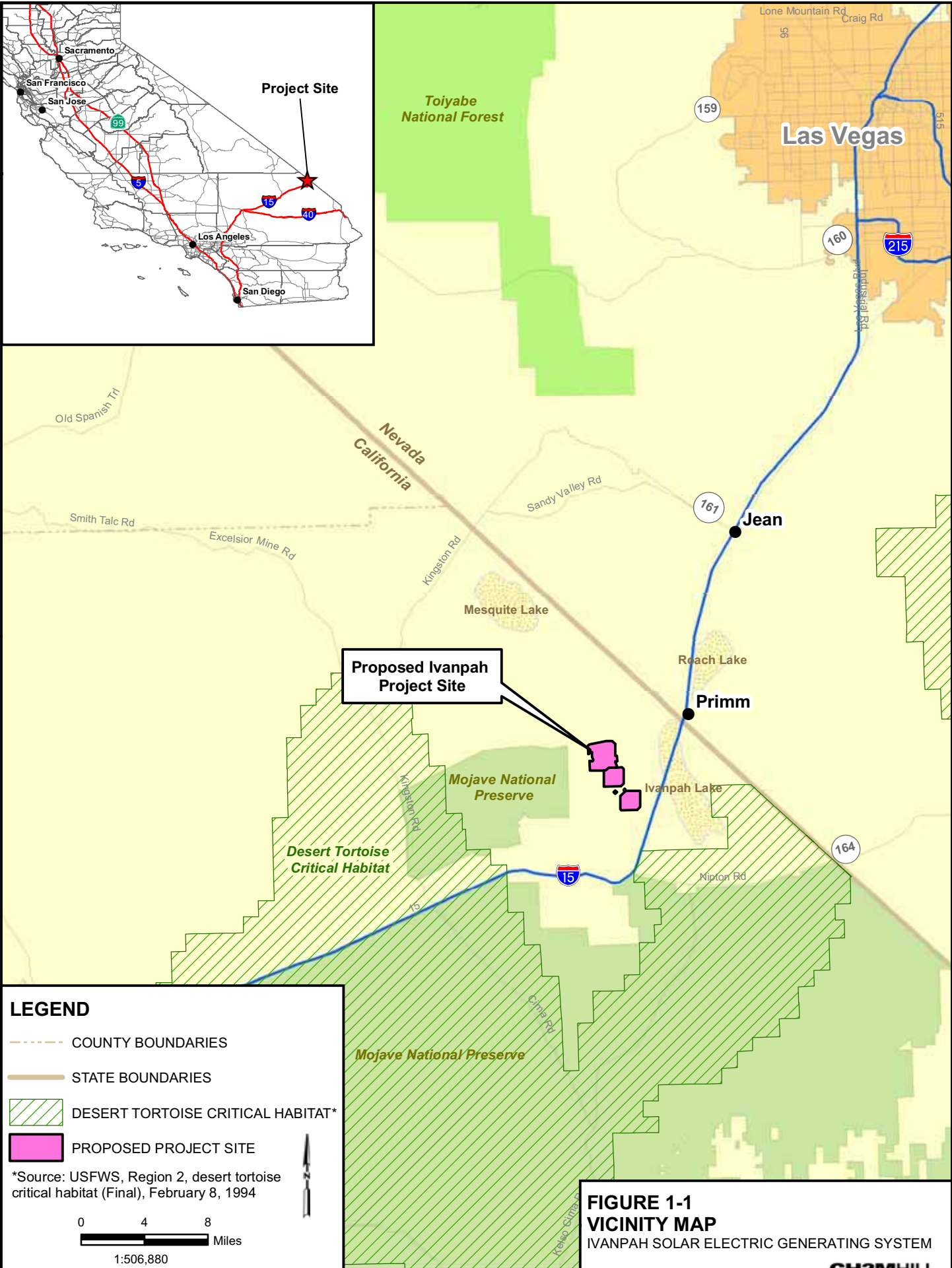

**FIGURE 1-1
VICINITY MAP
IVANPAH SOLAR ELECTRIC GENERATING SYSTEM**

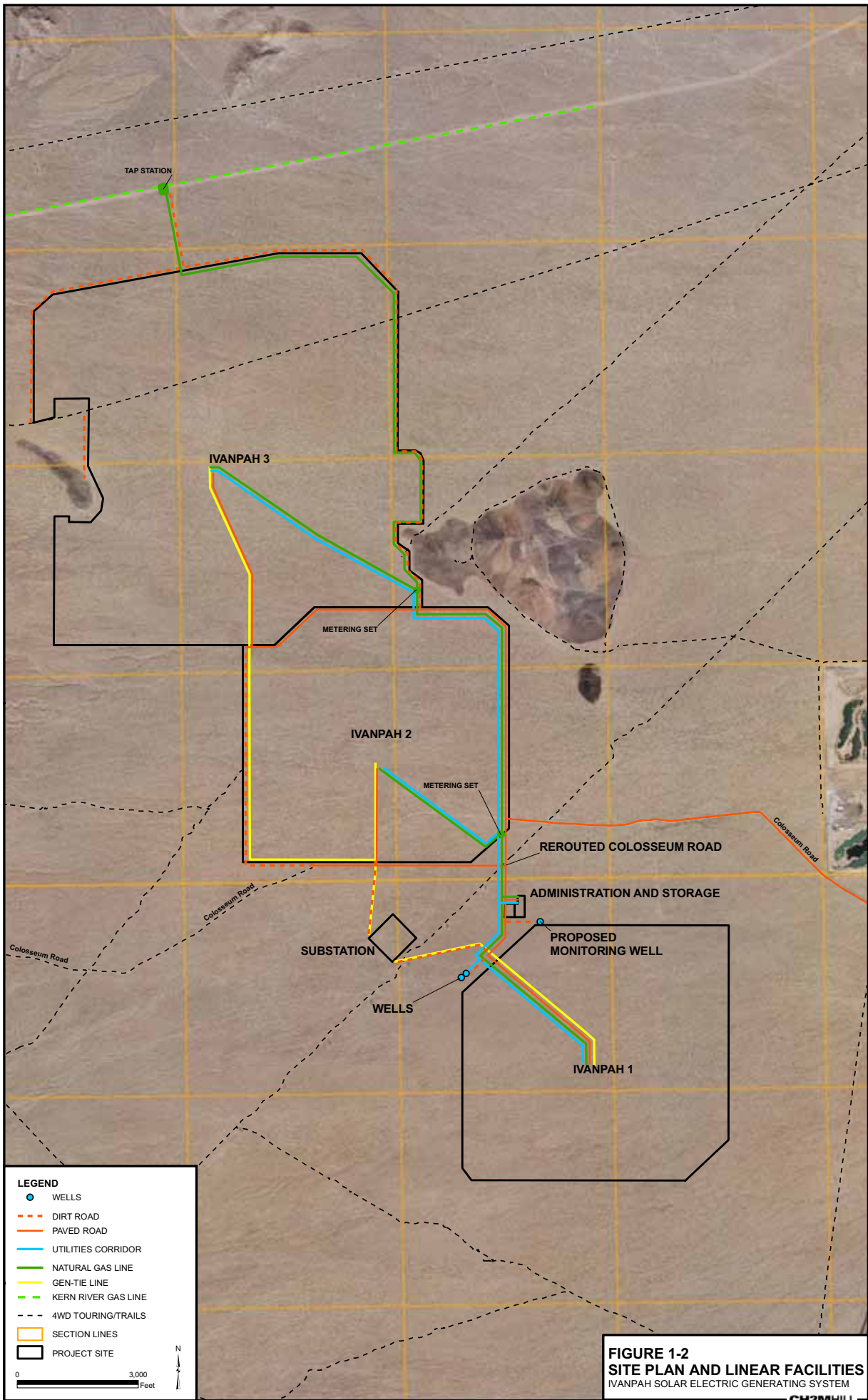

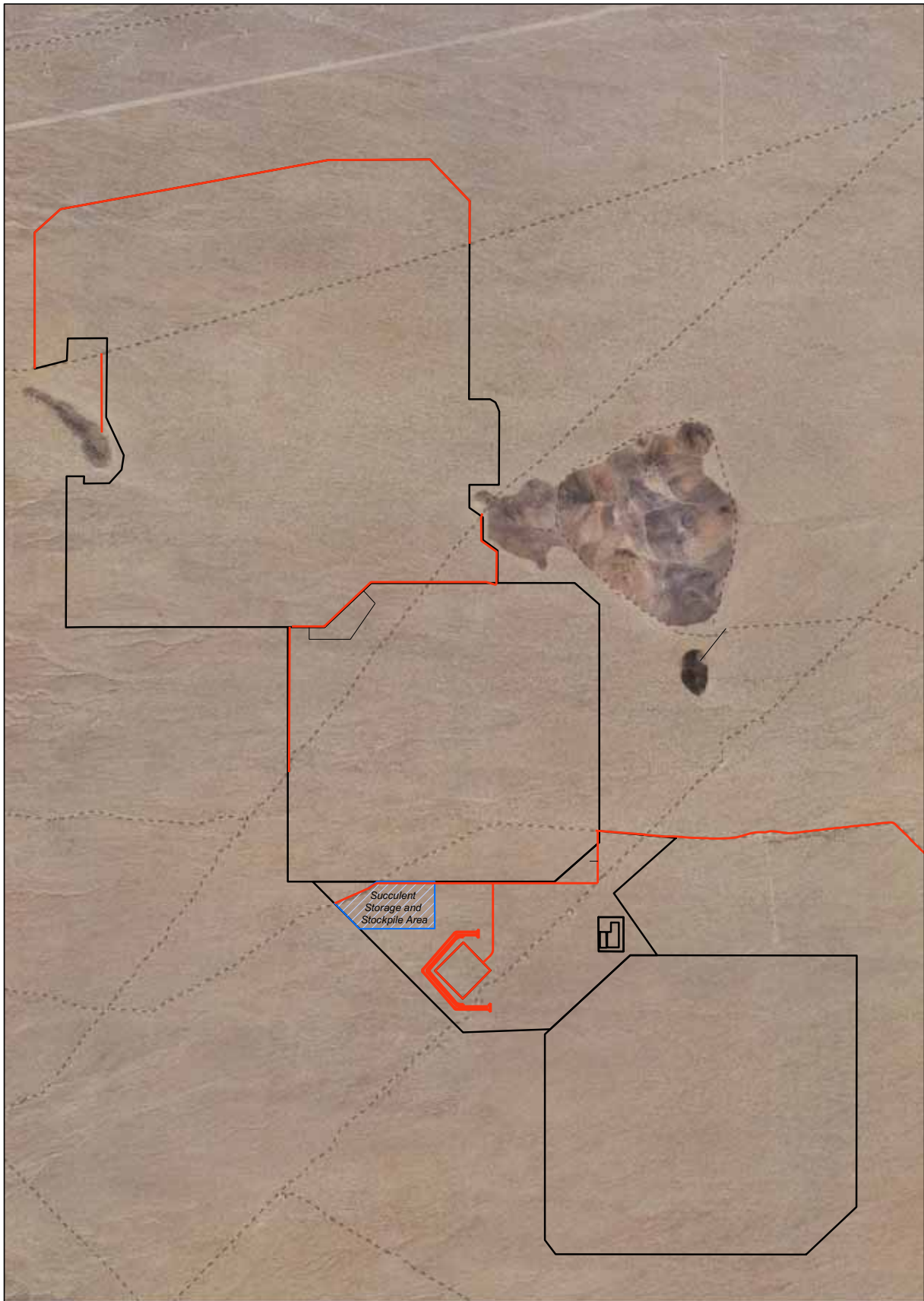

LEGEND

- Remaining Site Features
- - - Existing Trails
- Succulent Storage and Stockpile Area
- Project Site

Notes:

1. Succulent Storage and Stockpile Area will be used for revegetation following decommissioning.

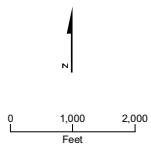

Figure 1-3
Features to Remain After
Plant Decommissioning

Ivanpah Solar Electric Generating System Project
 San Bernardino County, CA

GT-25XP

HEAVY-DUTY MULCHER



LEAN GREEN MULCHING MACHINES!

With a 260-horsepower tier III turbo diesel engine, powerful hydraulic pumps and our latest Cutter-head technology, performance, productivity and lack of profitability will NEVER be an issue with Gyro-Trac's heavy-duty GT-25XP.

The GT-25XP, a 260-horsepower, 23,500 pound heavy-duty mulching machine out-performs any 40,000 pound, or heavier, 400-600 HP mulcher with steel tracks and carbide-tipped hammer teeth by a margin of at least 2 to 1! Plus, unlike many hammer-mill type mulchers than cannot even power their way through some extreme hardwoods, the GT-25XP chips away at hardwoods and softwoods of almost any size, including difficult Ironwood, Hickory, Australian hardwoods, petrified Oak and more!



866-800-3900
www.GYROTRAC.com



DIMENSIONS		
Track Width	28"	71 cm
Overall Length	236"	599 cm
Cutting Width	88"	224 cm
Overall Width	102"	259 cm
Overall Height	110"	279 cm
Weight	23,500 lbs.	10,659 kg
Ground Clearance	14"	356 cm
Ground Pressure	4.2 psi	28.96 kPa

ENGINE		
Cummins Turbo Diesel (QSB 6.7 L Tier-III)		
No. of Cylinders	6	
HP @ 2200 RPM	260 HP	
Torque @ 1400 RPM	730 ft.-lb	990 N.m

CAPACITIES			
Fuel Tank	97 US Gal.	81 Imp. Gal.	368L
Hydraulic Tank	60 US Gal.	50 Imp. Gal.	227 L
Total Hyd. Sys.	72 US Gal.	60 Imp. Gal.	273 L

- | STANDARD FEATURES |
|---|
| <ul style="list-style-type: none"> Low-profile, fully-enclosed, tilt-cab Comfortable suspension seat 6 halogen lights Lexan™ safety windshield 15,000 lb. winch Pressurized cabin (to keep out dust and smoke) Hydraulic Guide-Bar to assist falling trees |

- | CUTTER-HEAD |
|--|
| <ul style="list-style-type: none"> Exclusive patented spiral-tooth design with a controlled bite that increases productivity with less HP, fuel and weight Variable displacement dual hydraulic work head power supply Individually-mounted teeth replace in just minutes Drum speed: 2350 RPM Optional carbide-tipped hammer teeth for rockier terrain |

- | TRACK SYSTEM |
|---|
| <ul style="list-style-type: none"> Six ply (6) nylon and polyester reinforced rubber tracks, assembled with heat-treated steel crosslinks Captive-Track system makes throwing a track nearly impossible |

- | HYDRAULICS |
|---|
| <ul style="list-style-type: none"> Closed-system Sauer-Danfoss Series 90™ pumps and Rexroth motors Computerized monitoring and control system optimizes performance while it protects equipment from damage |

- | STEERING |
|---|
| <ul style="list-style-type: none"> Hydrostatic drive/steer system with single joystick control |

printed in the U.S.A. Copyright © MMVIII Gyro-Trac, Inc. All rights reserved. VER.20080912

* All specifications are preliminary and are subject to change without notice.

FIGURE 1-4
CONCEPTUAL MOWER
IVANPAH SOLAR ELECTRIC GENERATING SYSTEM

CH2MHILL



**FIGURE 1-5
CONCEPTUAL PYLON DRIVING MACHINE**



**FIGURE 1-6
LIGHTWEIGHT ALL-TERRAIN VEHICLE**



FIGURE 1-7
MIRROR INSTALLATION CRANE
IVANPAH SOLAR ELECTRIC GENERATING SYSTEM

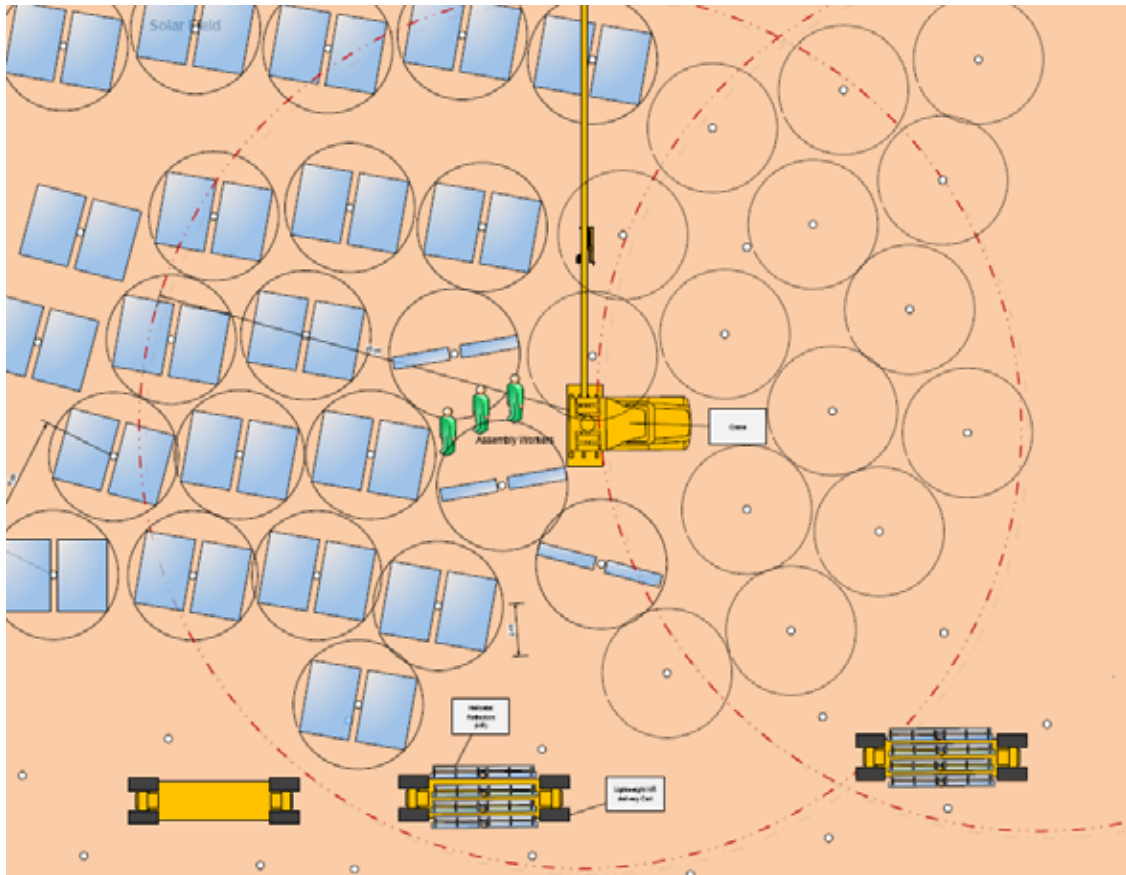

FIGURE 1-8
MIRROR INSTALLATION SEQUENCE
 IVANPAH SOLAR ELECTRIC GENERATING SYSTEM



FIGURE 1-9
CONCEPTUAL MIRROR WASHING MACHINE
IVANPAH SOLAR ELECTRIC GENERATING SYSTEM

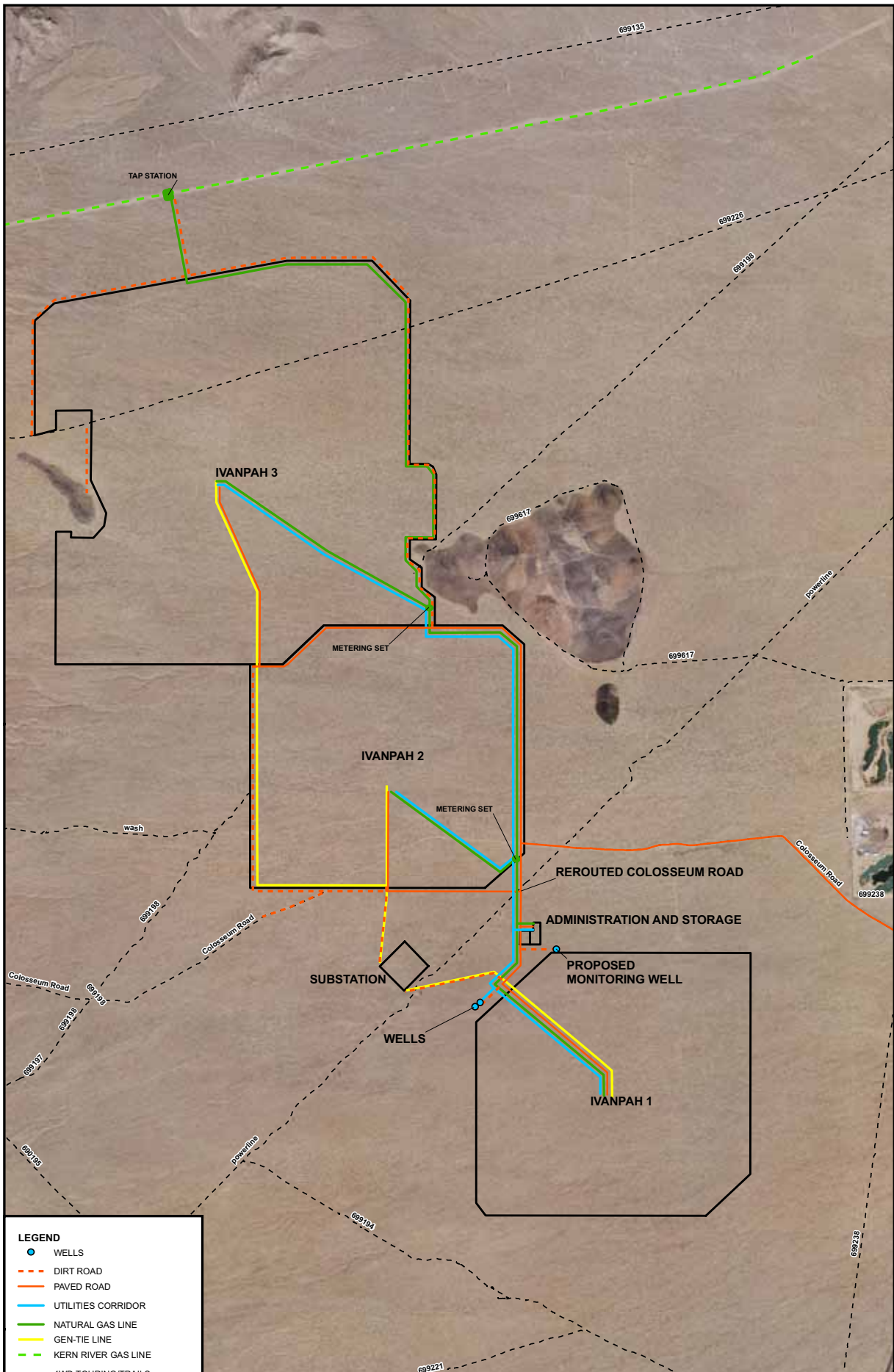
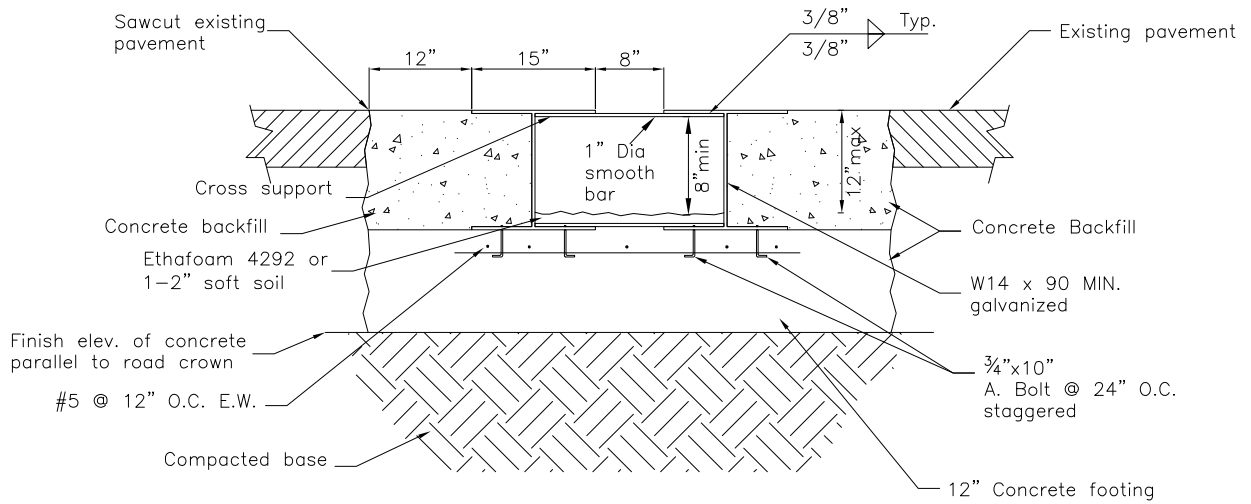
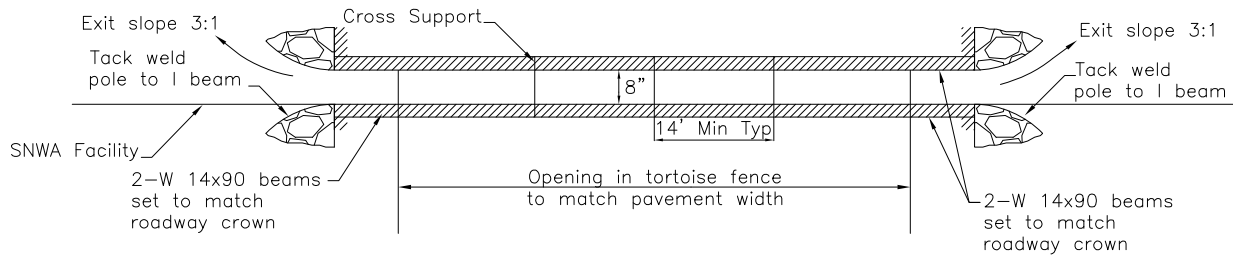

FIGURE 1-10
TRAILS
 IVANPAH SOLAR ELECTRIC GENERATING SYSTEM

CROSS SECTION



TOP VIEW



NOTE:
All metal should be galvanized per spec 05500, paragraph 3.3

FIGURE 1-11
PERMANENT TORTOISE GUARD
IVANPAH SOLAR ELECTRIC GENERATING SYSTEM

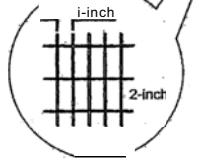
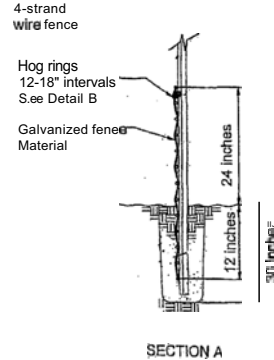
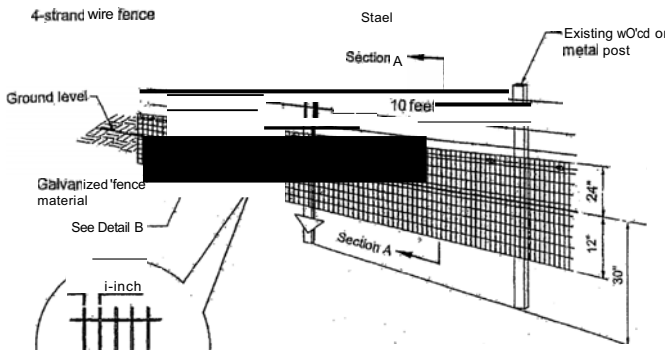

DETAIL A

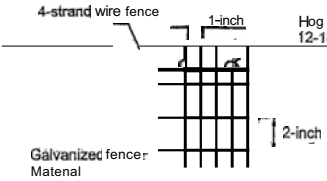

DETAIL B

RECOMMENDED DESIGN FOR DESERT TORTOISE EXCLUSION FENCE
GENERAL NOTES:

1. Ensure that fence posts and materials conform to the standards approved by the U.S. Fish and Wildlife Service.
2. Ensure that the height above ground level is no less than 18 inches and no higher than 24 inches.
3. Ensure that the depth of fence material below ground level is about 12 inches but no less than 6 inches. (See SECTION A above)
4. Install additional steel posts when between existing fence posts exceed 10 feet.
5. Attach fence material to existing fence or wire using hog rings at 12-inch intervals.
6. Fasten fence material to posts with 3 tie wires with a wire near the top, bottom, and center of the fence material.
7. Backfill trenches with excavated material and compact the material.
8. Attach fence material to all gates. Ensure that clearance at base of gate achieves zero ground clearance.
9. Substitute smooth wire for barbed wire if additional support wires are necessary.
10. The number placement of support wires may be modified to allow sheep and deer to pass safely.
11. Erosion at the edge of the fence material where the fence crosses washes may occur and requires appropriate and timely monitoring and repair.
12. Tie the fence into existing culverts and cattleguards when determined necessary to allow desert tortoise passage underneath roadways.

FOR BEDROCK OR CALICHE SUBSTRATE

1. Use this fence design (see below) only for that portion of the fence where fence material cannot be placed 6 inches below existing ground level due to presence of bedrock, large rocks or caliche substrate.
2. Ensure that the fence height above ground level is no less than 22 inches.
3. Ensure that there is a zero to 2-inch ground clearance at the bend.
4. Ensure that the bent portion of the fence is lying on the ground and pointed in the direction of desert tortoise habitat.
5. Cover the portion of the fence that is flush with the ground with cobble (rocks placed on top of the fence material to a vertical thickness up to 4 inches).
6. When substrate no longer is composed of bedrock or caliche, install fence using design shown above.

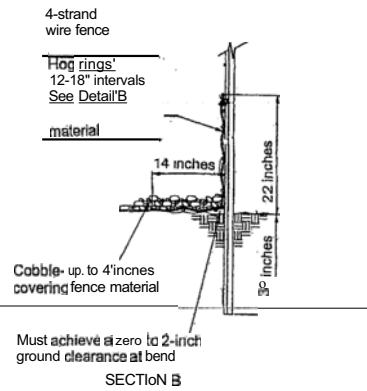
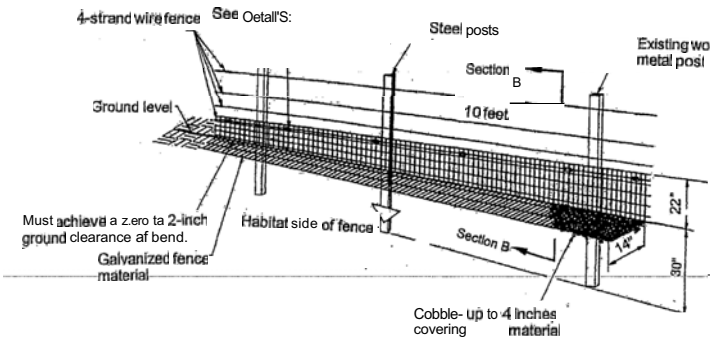

FIGURE 1-12
TORTOISE EXCLUSION FENCE
IVANPAH SOLAR ELECTRIC GENERATING SYSTEM

SECTION 2

Rehabilitation Logistics

Rehabilitation as used in this Plan refers to the removal of temporary or long-term structures, mechanical recontouring of the surface, mechanical measures to enhance soil conditions such as compaction or decompaction, and surface stabilization through revegetation. The rehabilitation activities discussed in this Plan address the three major periods of the Ivanpah SEGS project: construction, operations, and ultimate decommissioning. Temporary disturbance areas are those areas that receive short-term, construction-related disturbance, but soils will be not covered with impervious surfaces. After construction is completed, these areas will be rehabilitated and revegetated, as necessary, to return the areas to preproject conditions to the extent practicable. Long-term disturbances are those associated with relatively permanent structures and facilities, such as power block foundations and paved roads. These disturbed areas will be rehabilitated and revegetated following the planned 50-year lifespan of the project. Areas associated with both temporary and long-term disturbance are identified and quantified in Tables 1-2 and 1-3.

Rehabilitation and revegetation will be conducted for temporary impact areas as construction activities are completed for each project phase. For areas with long-term impacts (i.e., over the 50-year life of the project), rehabilitation and revegetation will be conducted as part of closure of each plant. During project operations, rehabilitation activities will be performed if erosion or sedimentation from storm events occur that threaten landscape stability. Rehabilitation logistics for each period of the project are described below.

2.2 Construction Period

Ivanpah SEGS consists of three separate facilities that will be built sequentially, Ivanpah 1, 2, and 3. Facilities that will be shared among the three phases will be built with Ivanpah 1. Facilities and structures to be constructed with each phase include the following bulleted items. For a thorough description of each item, please refer to the project description in Section 1.

2.2.1 Construction Phase 1: Ivanpah 1 and Shared Facilities

Phase 1 of construction will entail the following (not necessarily in the order listed).

- Prior to the start of all construction activities, if not done previously, install combined security/tortoise fencing or temporary tortoise fencing (depending on the location and activity) and conduct tortoise clearance surveys. Install permanent tortoise guards where appropriate to prevent tortoise from entering a cleared area.
- Install erosion and sediment control BMPs in accordance with the Construction Stormwater Pollution Prevention Plan (SWPPP).

- Construct water supply wells and groundwater monitoring well; mow dirt access roads to wells.
- Construct paved roads: Colosseum Road from the Golf Club around the south side of Ivanpah 2; with an access road going south to the SCE Substation, and a road going south to the Administration/warehouse Building and on to the Ivanpah 1 power block.
- Construct gravel road to connect the paved section of the realigned Colosseum Road to the existing Colosseum Road dirt trail through the CLA.
- Construct an equipment washing station off Colosseum Road prior to the project entrance.
- Clear and grade sections of the CLA; store topsoil in designated stockpile area; create areas for parking, stockpiling, trailers, heliostat fabrication, and materials storage.
- Construct the KRGT tap station and 6-mile natural gas pipeline from tap station to the Ivanpah 1 power block.
- Remove any large boulders that would impede construction access and heliostat placement, and stockpile in designated location within the CLA.
- Salvage succulents and move them to the succulent storage and stockpile area.
- Mow vegetation to create access roads that run diagonally through Ivanpah 1 and follow existing contours.
- Install permanent combined security/tortoise fencing and construct substation.
- Construct administration/maintenance building.
- Construct Ivanpah 1 power block and appurtenant facilities.
- Construct stormwater berms and diversion channels around the substation and administration building.
- Construct water pipeline to administration building and to Ivanpah 1 power block.
- Construct overhead transmission line from Ivanpah 1 power block to substation.
- Mow heliostat maintenance paths and install heliostats.
- Install heliostat control mechanism and string conduit command and control wiring. Wiring for heliostat control will be installed aboveground.
- Rehabilitate and stabilize areas with temporary construction-related disturbance, once construction is completed.

2.2.2 Construction Phase 2: Ivanpah 2

Phase 2 of construction will entail the following.

- Prior to the start of all construction activities, if not done previously, install combined security/tortoise fencing or temporary tortoise fencing (depending on the location and

activity) and conduct tortoise clearance surveys. Install permanent tortoise guards where appropriate to prevent tortoise from entering a cleared area.

- Mow vegetation to create internal perimeter path on Ivanpah 2; install fencing.
- Install erosion and sediment control BMPs in accordance with the project SWPPP.
- Construct paved road from realigned Colosseum Road to Ivanpah 2 power block.
- Reroute trail (699198) on the north side of Ivanpah 2 to follow the solar field perimeter to where it reconnects with the existing trail (see Figure 1-10).
- Construct crossings over ephemeral washes and stabilized channel crossings.
- Remove large boulders that would impede construction access and heliostat placement, and stockpile in designated location within CLA.
- Salvage succulents and move them to the succulent storage and stockpile area.
- Mow vegetation to create dirt access roads that run diagonally following existing topography through Ivanpah 2.
- Perform light grading according to project grading plans; store topsoil in designated stockpile area.
- Construct Ivanpah 2 power block and appurtenant facilities.
- Construct storm water diversion channel and rock filters (if needed).
- Construct water and gas pipelines to serve power block.
- Construct overhead transmission line from Ivanpah 2 power block to substation.
- Mow heliostat maintenance paths and install heliostats.
- Install heliostat control mechanism and string conduit command and control wiring. Wiring for heliostat control will installed aboveground.
- Rehabilitate and stabilize areas with temporary construction-related disturbance.

2.2.3 Construction Phase 3: Ivanpah 3

Phase 3 of construction will entail the following.

- Prior to the start of all construction activities, if not done previously, install combined security/tortoise fencing or temporary tortoise fencing (depending on the location and activity) and conduct tortoise clearance surveys. Install permanent tortoise guards where appropriate to prevent tortoise from entering a cleared area.
- Install erosion and sediment control BMPs in accordance with the project SWPPP.
- Construct paved road from power block to Colosseum Road at southeast corner of Ivanpah 2.

- Reroute trail (699226) around the north end of Ivanpah 3; construct new mining access road.
- Mow vegetation to create internal perimeter path on Ivanpah 3; install fencing.
- Construct crossings over ephemeral washes.
- Remove large boulders that would impede construction access and heliostat placement, and stockpile in designated location within the CLA or Ivanpah 3.
- Salvage succulents and move them to the succulent storage and stockpile area.
- Mow vegetation to create access roads that run diagonally through Ivanpah 3 and follow existing contours.
- Perform light grading according to project grading plans; store topsoil in designated stockpile area.
- Construct Ivanpah 3 power block and appurtenant facilities.
- Construct storm water diversion channel and holding basins.
- Construct water and gas pipelines to serve power block.
- Construct overhead transmission line from Ivanpah 3 power block to substation.
- Construct heliostat maintenance paths and install heliostats.
- Install heliostat control mechanism and string conduit command and control wiring. Wiring for heliostat control will be installed aboveground.
- Rehabilitate and stabilize areas with temporary construction-related disturbance.

2.2.4 Rehabilitation of Temporary Construction Impact Areas

Rehabilitation and revegetation of temporary disturbance areas will occur as soon as practical following completion of construction activities in the affected area. For example, rehabilitation of the natural gas pipeline impact area during construction of Phase 1 will begin as soon as pipeline construction is completed, even if construction of other project elements is still underway. The CLA will be located between Ivanpah 1 and 2 and will be used throughout construction of Ivanpah 1, 2, and 3. Therefore, rehabilitation and revegetation of this area will not occur until construction of Ivanpah 3 is complete.

Methods of soil rehabilitation for temporary construction impacts associated with each project element and criteria for revegetation are discussed in Section 7, Site Rehabilitation Plan.

2.3 Operations Phase

Rehabilitation activities during the operational phase of Ivanpah SEGS will include the following.

- Rehabilitation of areas that have been affected by erosion and sedimentation resulting from flood events that are a dominant geomorphic element on this bajada.
- Weed management per criteria and requirements of the WMP (Appendix B).

Any affected areas will be rehabilitated and revegetated according to the procedures outlined in Section 7, Site Rehabilitation Plan. Other surface management activities implemented during the operations phase are described in Section 5, Surface Management Plan.

2.4 Decommissioning

Decommissioning of the facility will occur sequentially in the order of construction, with Ivanpah 1 being the first to be decommissioned, followed by Ivanpah 2, then Ivanpah 3 and the shared facilities. Decommissioning activities will likely require coverage under the State's General Construction Permit, since the area of ground disturbance will be more than 1 acre. A decommissioning logistics area will be required, and likely the CLA will be used for that purpose.

Site rehabilitation will include the following general activities (not necessarily in the order listed below).

- Access roads that are no longer required by the land management agencies will be rehabilitated (see Figure 1-3). Asphalt will be removed, soils will be decompacted, and the roadway areas will be revegetated.
- Physical components of the generation facilities and appurtenant utilities will be removed using practicable methods that are least disruptive to soils and surrounding habitat to a depth that will not impede growth of vegetative cover.
- Poles and wiring will be removed with the transmission wiring spooled for transport to the recycler. Transmission pole foundations will be removed to a depth of approximately 4 feet.
- Heliostat command and control wiring will be aboveground and will simply be picked up for recycling.
- The substation, its diversion berm and channels, and access from Colosseum Road will remain (see Figure 1-3).
- Stormwater diversion channels no longer needed will be filled using soil materials from adjacent berms. The concrete holding basins will also be filled.
- Water supply wells will be abandoned and pipelines will be sealed off and abandoned in place.

- Stabilized channel crossings will be left in place.
- Surfaces will be recontoured, the soil environment rehabilitated, and the revegetation protocol using native species implemented as described in Section 7.
- Temporary disturbance areas from decommissioning activities will also be rehabilitated and revegetated.
- The revegetated areas will be monitored for noxious weeds, for unacceptable densities of invasive species, and for reasonable progress in the vegetation succession. Section 8 describes the site closure plan, which includes a more detailed description of decommissioning activities.

Existing Site Conditions

3.2 Project Location and Jurisdiction

The three solar thermal plants collectively referred to as Ivanpah SEGS would be located in the Ivanpah Valley in southern California's Mojave Desert, near the Nevada border, to the west of Ivanpah Dry Lake (Figure 1-1). The project would be located in San Bernardino County, California, on federal land managed by the BLM. It lies a few miles north of the I-15 corridor, and a few miles east of the boundary of the Mojave National Preserve managed by the National Park Service. The BLM's management responsibilities under FLPMA include ensuring that lands under its jurisdiction are available for multiple uses, including appropriate economic pursuits such as mining, grazing, and energy development.

3.3 Physiographic Setting

The Ivanpah Valley lies in the Basin and Range physiographic province of the western United States. Hydrographically, it is part of the Great Basin because it possesses no drainage outlet to the sea. The Ivanpah Valley is typical of Basin and Range valleys in that it is much longer north-south than it is wide east-west, and it lies at a relatively high altitude with base elevations on the playa of more than a half-mile above sea level. It lies about 45 miles west of the trough of the Colorado River.

The Ivanpah Valley is a topographically closed basin, and surface water drainage that does not evaporate or infiltrate reaches the valley axis, where it evaporates on Ivanpah Dry Lake or Roach Dry Lake. These playas possess a substantial drainage basin that extends about 50 miles from the southern flank of Potosi Mountain, Nevada, in the northeast, to the eastern flank of Cima Dome, California, in the southwest. This drainage basin includes parts of the southern Spring Range, the Lucy Grey and Mescal ranges, the New York and Ivanpah mountains, the Clark Mountains including Clark Mountain proper, and the Mid Hills. Some of these orographic features extend to elevations above 7,000 feet and, together with the size of the drainage basin, generates the capacity for considerable runoff.

The Ivanpah SEGS project area extends over the eastern bajada of Clark Mountain, from an elevation of about 3,400 feet on its western boundary to about 2,800 feet on its eastern boundary. The bajada is composed of a number of coalescing alluvial fans that issue from different canyons on the east side of Clark Mountain. The bajada extends east to the edge of Ivanpah playa, descending over 5.5 to 6 miles from about 4,000 feet above mean sea level at the toe of the mountain, to about 2,610 feet on the edge of the playa. As is typical of these surfaces, the alluvium ranges from coarse, bouldery material near the fan head (also termed the apex or proximal portion of the fan), to fine sands and silts at the toe or distal portion of the fan.

3.4 Local Environmental Factors

From the point of view of the biota of the Ivanpah SEGS project area, the most significant limiting factor in this ecosystem is drought, or the lack of free water available to plants and animals. Every organism native to this locality is adapted to drought conditions brought on by aridity typical of the Mojave Desert. Other important limiting factors include high temperatures in the summer months, especially high surface temperatures (sustained in excess of 120 degrees Fahrenheit [$^{\circ}$ F]), sustained intense solar radiation, and the occurrence of winter freezes.

3.4.1 Soils

Bainbridge (2007) suggests that two major soil classifications may be representative of most soils in the Mojave Desert: young undifferentiated soils, such as those occurring on flood deposits, and highly structured older soils. Older soils often contain caliche layers that effectively block moisture movement and root penetration, while younger soils can transmit water into deeper horizons. Field reconnaissance suggests that this classification is too simplistic, however, and largely disregards the gradient that exists with intermediate, moderately developed soils also being present at the Ivanpah SEGS.

From a geomorphological perspective, the alluvial fan complex, or bajada, over which the Ivanpah SEGS extends is not a stabilized surface. Relatively recent erosional land forms in the form of channels, bar-and-swale topography, and areas of recent sheet flow typify much of the Clark Mountain bajada. The channels originate not only near the head of the bajada but also along its middle reaches, and extend across its toe, suggesting that the fan surfaces there are also not aggradational. Ongoing dissection across the bajada shows that its current morphology is best classified as erosional. Data also indicate that more than 80 percent of the surface has been subject to relatively recent scour or deposition from washes originating in the hills to the west (CH2M HILL, 2008b).

Older alluvial surfaces at the Ivanpah SEGS are covered by desert pavement. Desert pavement surface is composed of closely packed, interlocking angular or rounded pebble to cobble-sized clasts. Older desert pavement surfaces are darker than younger surfaces lacking desert pavement because the clasts composed of resistant mineralogies support a dark coating of desert varnish. Fine, eolian silt often underlies desert pavement, and once the pavement crust is broken by heavy equipment, disruption of this landscape surface exposes the silt layer, leading to greater wind and water erosion in the absence of mitigation measures. Furthermore, high salt concentrations are typically found in soils underlying desert pavement having small-sized clasts. Therefore, disruption of this type of surface can lead to mobilization of salts, including nitrate (Graham et al., 2008).

The soil types that are primarily affected by the Ivanpah SEGS are Arizo loamy sand, 2 to 8 percent slopes, and Popups sandy loam, 4 to 30 percent slopes. Table 3-1 provides typical pedon descriptions (a pedon is the smallest three-dimensional sampling unit that displays the full range of characteristics of a particular soil, and typically occupies an area ranging from about 1 to 10 square meters (m^2) of land area [Brady and Weil, 2002]).

TABLE 3-1
Soil Pedon Descriptions

Soil Unit	Horizon	Depth (inches)	Color	Description
Arizo Series (Map unit 3520): These are very deep, excessively drained soils that formed in mixed alluvium. Soils are usually dry, moist throughout for short periods from December through March. Periodically moist in upper part during July through October.	A	0 to 8	Light brownish gray (10R 6/2) dry; dark grayish brown (10YR 4/2) moist	Very gravelly fine sand, weak coarse platy structure; slightly hard, very friable, nonsticky and nonplastic; few fine and medium roots; few fine vesicular and many very fine and fine interstitial pores; 35 percent pebbles; strongly effervescent; moderately alkaline (pH 8.2); abrupt wavy boundary
	Bk	8 to 36	Light brownish gray (10YR 6/2) dry; dark grayish brown (10YR 4/2) moist	Extremely gravelly sand; single grained; loose, nonsticky and nonplastic; few fine and medium roots; many very fine and fine interstitial pores; 60 percent pebbles and 10 percent cobbles; few very thin coats of calcium carbonate on undersides of pebbles; strongly effervescent; moderately alkaline (pH 8.2); gradual wavy boundary
	C	36 to 62	Light brownish gray (10YR 6/2) dry; dark grayish brown (10YR 4/2) moist	Extremely gravelly sand; single grained; loose, nonsticky and nonplastic; few very fine and fine roots; many very fine and fine, and few medium interstitial pores; 60 percent pebbles, 20 percent cobbles and 3 percent stones; strongly effervescent; moderately alkaline (pH 8.2).
Popups Series (Map Unit 4122): These are moderately deep to a duripan, well-drained above the duripan	A	0 to 2	Brown (10YR 5/3) dry; dark brown (10YR 3/3) moist	Very gravelly sandy loam; weak medium platy structure; slightly hard, very friable, nonsticky and nonplastic; common very fine and few fine roots; common fine interstitial pores and few very fine and fine tubular pores; 45 percent gravel; noneffervescent; slightly alkaline (pH 7.6); abrupt smooth boundary

TABLE 3-1
Soil Pedon Descriptions

Soil Unit	Horizon	Depth (inches)	Color	Description
	Bw	2 to 12	Yellowish brown (10YR 5/4) dry; dark yellowish brown (10YR 4/4) moist	Gravelly sandy loam, weak medium subangular blocky structure; slightly hard, very friable, nonsticky and nonplastic; common very fine and few fine and medium roots; few very fine and fine tubular pores; 30 percent gravel; noneffervescent; slightly alkaline (pH 7.6); gradual wavy boundary.
	Btk	12 to 33	Light brown (7.5YR 6/4) dry; brown (7.6YR 4/4) moist	Gravelly sandy loam, moderate coarse sub-angular blocky structure; very hard, very friable, slightly sticky and slightly plastic; common very fine and few fine and medium roots; common very fine and few fine interstitial and tubular pores; many discontinuous faint clay skins on ped faces and sand and gravel coats; few fine irregular soft seams of lime; 15 percent gravel, 3 percent cobbles, and 5 percent stones; strongly effervescent; moderately alkaline (pH 8.0); clear wavy boundary
	Bkqm	33 to 60	Very pale brown (10YR 8/2) dry; pale brown (10YR 6/3) moist	Weakly cemented duripan, massive; very hard, very firm, brittle; violently effervescent. Has about 0 to 0.5 percent organic matter; 10 to 18 percent clay; depth to duripan is 20 to 40 inches

Source: NRCS, 2008.

Erosion potential of each Ivanpah facility from water is considered to be negligible to medium; and moderate to high through wind erosion (AFC, Soils Section). Soil map units are identified on a landscape scale. Dominant soil types typically occupy about 75 to 85 percent of the soil map unit; however, other soils that could have dissimilar characteristics can occupy 15 to 25 percent. Across the Ivanpah SEGS, there is also substantial variation in the mineralogy of alluvial parent material, including granitic and metamorphic rocks, Paleozoic limestone, and dolomite. See Section 7 for details on evaluation of soil baseline conditions at the site.

Desert soil temperatures can reach up to 160°F in the summer, and bare soils can exceed ambient air temperature by up to 25 to 32°F. These temperatures can inhibit plant growth; however, some plant species provide sufficient shade such that soil temperatures are reduced

to survivable levels for other species rooted beneath their canopies. Soil temperatures in the spring and fall generally range between 70 to 86°F, which is conducive to plant establishment and growth. Soil temperatures are also moderated by summer rains, and some species, such as the cacti, can rapidly extend rootlet systems to take advantage of these periods of high soil moisture and lower temperatures.

Desert soils generally have low fertility, with limited organic matter, low levels of nitrate nitrogen and plant-available phosphorus (Bainbridge, 2007). Because most nutrients are located in surface soils, it is particularly important to prevent erosion and topsoil loss. The high soil pH of desert soils (generally approximately pH 8.3 if calcium carbonate is present) further limits availability of many nutrients. Most desert perennials have been shown to be mycorrhizal (Bainbridge, 2007), and the root-zone symbiosis between these plants and the mycorrhizae can significantly increase the plant's ability to take up nutrients (especially phosphorus) and water. Only some desert plant species (e.g., mesquite) are able to fix nitrogen by reducing atmospheric nitrogen to ammonia in root nodules formed in association with rhizobial bacteria, and there is no habitat in the project area suitable for mesquite.

3.4.2 Climate and Water Resources

Ivanpah Valley is an arid to semiarid, topographically closed basin in the eastern Mojave Desert, about 50 miles west of the Colorado River trough. There are no meteorological stations at or near the Ivanpah SEGS. The closest meteorological station is at Mountain Pass 7 miles to the southwest. At about 4,800 feet elevation, it receives more precipitation and is colder year-round than Ivanpah SEGS, which lies between 2,800 and 3,400 feet elevation. The Ivanpah SEGS AFC provides the precipitation data for Searchlight, Nevada, 32 miles to the east-southeast, as representative of the project site. At an elevation of about 3,540 feet it is near the elevation of Ivanpah SEGS. However, some analyses indicate that precipitation values for Searchlight are likely to be excessive relative to the project site. Although Searchlight is near the elevation of Ivanpah SEGS, its position farther east means that it receives more summer precipitation than comparable elevations to the west (Winograd and Thordarson, 1975).

To estimate the temperature and precipitation of the project site, lapse rate calculations were used based on the meteorological data from Las Vegas, Nevada, a low elevation station about 40 miles to the north-northwest, and from Mountain Pass. These calculations were based on long-term averages, as well as the 1971 through 2000 normalized period of measurement (Tables 3-2 and 3-3). They supersede those values published in the AFC as representative of the Ivanpah SEGS area. The estimated average annual and monthly precipitation and temperature for Ivanpah SEGS are presented as values for the lowest part of the project area (the northeast corner of Ivanpah 1 at ca. 2,760 feet elevation), and for the highest (the northwest corner of Ivanpah 3 at ca. 3,410 feet elevation). This approximately 650-foot elevation gain across the project area results in differences in estimated annual precipitation of more than an inch, and about 1.3°F in mean annual temperature. The differences in estimated monthly precipitation between high and low elevations across the site are largest in the summer because lapse rates of precipitation with elevation are greater in the summer. This reflects the tendency of orographically-induced summer thunderstorms to nucleate over high topography and for higher elevations to receive proportionately more precipitation during this season.

TABLE 3-2
Summary of Precipitation Data for Two Nearby Stations and Estimates for Ivanpah SEGS

Average:	Jan	Feb	Mar	Apr	May	Jun	Jul	Aug	Sep	Oct	Nov	Dec	Annual
Long-Term period (Las Vegas, 1937 through 2007; Mountain Pass, 1955 through 2005)													
Las Vegas; 2,165 feet elevation	0.5	0.58	0.46	0.21	0.15	0.07	0.44	0.45	0.33	0.26	0.37	0.39	4.19
Mountain Pass; 4,790 feet elevation	0.94	0.91	0.89	0.47	0.27	0.2	1.04	1.23	0.59	0.52	0.69	0.64	8.40
Ivanpah SEGS SE (2,760 feet elevation)	0.59	0.65	0.55	0.27	0.18	0.10	0.57	0.62	0.39	0.32	0.44	0.44	5.08
Ivanpah SEGS NW (3,410 feet elevation)	0.71	0.74	0.67	0.34	0.21	0.13	0.73	0.83	0.46	0.39	0.53	0.51	6.24
Normalized period 1971 through 2000													
Las Vegas; 2,165 feet elevation	0.6	0.68	0.49	0.23	0.23	0.11	0.38	0.51	0.28	0.24	0.33	0.43	4.51
Mountain Pass; 4,790 feet elevation	1.07	1.19	1.03	0.5	0.36	0.33	0.95	1.27	0.65	0.43	0.74	0.83	9.34
Ivanpah SEGS SE (2,760 feet elevation)	0.70	0.79	0.60	0.29	0.26	0.16	0.50	0.67	0.36	0.28	0.42	0.51	5.53
Ivanpah SEGS NW (3,410 feet elevation)	0.83	0.93	0.75	0.36	0.29	0.22	0.66	0.88	0.46	0.33	0.53	0.62	6.86

Notes:

Grey-shaded values are estimates based on elevational lapse rates.

All values are in inches.

NW = northwest

SE = southeast

Source: Desert Research Institute, n.d.

TABLE 3-3
Summary of Temperature Data for Two Nearby Stations and Estimates for Ivanpah SEGS

Average of Daily Means:	Jan	Feb	Mar	Apr	May	Jun	Jul	Aug	Sep	Oct	Nov	Dec	Annual Average
Long-Term period (Las Vegas, 1937 through 2007; Mountain Pass, 1955 through 2005)													
Las Vegas; 2,165 feet elevation	45.7	50.6	56.8	64.9	74.7	84.2	90.4	88.4	80.5	67.8	54.1	46.0	67.0
Mountain Pass; 4,790 feet elevation	39.9	43	47.4	53.7	63	73.1	79.7	77.3	70.2	59.3	47.6	40.6	57.9
Ivanpah SEGS SE (2,720 feet elevation)	44.5	49.0	54.8	62.5	72.2	81.8	88.1	86.0	78.3	66.0	52.7	44.9	65.1
Ivanpah SEGS NW (3,445 feet elevation)	42.9	46.9	52.2	59.4	69.0	78.8	85.2	83.0	75.5	63.7	50.9	43.4	62.6
Normalized period 1971 through 2000													
Las Vegas; 2,165 feet elevation	47.0	52.2	58.3	66.0	75.4	85.6	91.2	89.3	81.3	68.7	55.0	47.0	68.1
Mountain Pass; 4,790 feet elevation	39.4	42.6	47.2	54	62.5	73.7	79.5	77.6	70.5	59.1	47.4	39.9	57.8
Ivanpah SEGS SE (2,720 feet elevation)	45.39	50.16	55.94	63.45	72.66	83.07	88.72	86.82	79.01	66.66	53.39	45.49	65.91
Ivanpah SEGS NW (3,445 feet elevation)	43.30	47.52	52.89	60.15	69.11	79.80	85.50	83.60	76.04	64.02	51.30	43.54	63.08

Notes:

Grey-shaded values are estimates based on elevational lapse rates.

All values are in degrees Fahrenheit.

NW = northwest

SE = southeast

Source: Desert Research Institute, n.d.

The average monthly precipitation values show that most of the precipitation in the project site falls as winter rain during December through March, and as summer rains during the monsoon season of the Southwest, in July through September. This bimodal (winter-summer) precipitation regime is shared with the rest of the eastern Mojave Desert (Beatley, 1976), but not with regions farther west in the central and western Mojave Desert, where there is no predictable summer rainfall. Winter rains are associated with frontal systems moving inland from the Pacific Ocean and can result in periods of cloudiness and intermittent precipitation lasting for days. Summer rains are the product of thunderstorms that result from the thermal convection and orographic uplift of maritime tropical air advected into the desert interior from the south and southeast. They are brief and frequently intense rainfall events that can produce considerable runoff.

The estimated rainfall for a 100-year 24-hour event is 3.28 inches, and 2.83 inches for a 6-hour event; a 10-year 24-hour event is 1.92 inches, and 1.60 inches for a 6-hour event. Intense rain events in Southern California deserts can deliver the annual average rainfall in a short period of time, causing extensive sheet erosion and flash floods. The amount of moisture held within the soil depends on the amount of precipitation, rate of infiltration and retention, ground cover, and soil texture. Surface soils can be moist for only short periods of time during the year, and water typically evaporates before it can percolate deeper into the vadose zone. This process also results in the deposition of calcium carbonate leached from the surface, leading to thick caliche or calcrete horizons in older soils. Most water recharge occurs in desert washes, where sufficient moisture could remain to allow for establishment and survival of tree seedlings (Bainbridge, 2007). In the immediate vicinity of Ivanpah SEGS, the arborescent flora of the desert riparian vegetation is restricted to sparse catclaw acacia (*Acacia greggii*) and desert willow (*Chilopsis linearis*).

Episodes of inundation of Ivanpah Dry Lake are relatively frequent, although the water seldom exceeds a few inches in depth and concentrates in the lowest, northern end of the basin. There are numerous springs along the faults bordering the Clark and Mescal mountains, and the ephemeral washes of the flanking bajadas are innumerable. Groundwater from the deep Paleozoic carbonate aquifer (Winograd and Thordarson, 1975) is currently pumped from two well sites on the Clark Mountain bajada to supply the Primm Valley Golf Club. This groundwater will be used to supply potable water and process water to the Ivanpah SEGS. As could be expected, this water is relatively high in dissolved carbonates and silica.

3.5 Vegetation Resources¹

3.5.1 Biogeography

The Ivanpah SEGS project area lies entirely within Mojave Desert scrub vegetation. The Mojave Desert is one of the three warm deserts of North America; the Chihuahuan and Sonoran Deserts are the other two. The Mojave Desert is a temperate desert with cold winters as well as warm summers. In considering its latitudinal position, it is comparatively

¹The following section on biogeography through vegetation zonation were prepared by W.G. Spaulding. Dr. Spaulding is a former Research Professor of Botany with more than 25 years experience in the study of Mojave Desert phytogeography and plant ecology. Prior to joining private industry, he published extensively on the effects if environmental change on desert scrub plant communities.

far to the north. The frequency and severity of winter freezes in this area is one of the principal limiting factors preventing the occurrence of a suite of warm-desert species typical of the Colorado Desert, not more than 100 miles to the south. These include distinctive forms such as smoke tree (*Psoralea argophylla*), palo verde (*Cercidium microphyllum*, *C. floridum*), and ocotillo (*Fouquieria splendens*). Catclaw acacia and desert willow are two arborescent desert plants that range far enough north to occur in and near the project site.

3.5.2 Vegetation Zonation

From the point of view of elevationally controlled vegetation zonation lying between about 2,700 and 3,445 feet elevation, the Ivanpah SEGS project area is near the upper limit of creosote bush (*Larrea tridentata*)-burrobush (*Ambrosia dumosa*) desert scrub. While creosote bush occurs at an elevation as high as 6,000 feet on south-facing slopes near its northern limit, creosote bush-dominated scrub does not typically extend above about 3,600 feet. The relative diversity of creosote bush-burrobush scrub here reflects its mesic character. At slightly higher elevations, mixed desert scrub is found, in which several woody perennials maintain codominance. Above this mixed desert scrub, generally between about 4,800 and 6,000 feet, blackbrush (*Coleogyne ramosissima*) scrub is the typical vegetation cover on alluvial slopes. Above this elevation, woodland can be found especially in mesic habitats. On the lower flanks and piedmont of Clark Mountain, the hallmark of the lower edge of woodland is the California juniper (*Juniperus californica*), which gives way at higher elevations to the more mesophytic Utah juniper (*J. osteosperma*)-pinyon (*Pinus monophylla*) woodland.

The hallmark of the Mojave Desert, the Joshua tree (*Yucca brevifolia*), does not occur on the bajada extending from the edge of Ivanpah Dry Lake to the flanks of Clark Mountain. It occurs about 12 miles to the southwest near Mountain Pass, as well as in the southern Ivanpah Valley along the Cima Road. Its absence in the project site is a manifestation of the Joshua tree's typically patchy distribution (Rowlands, 1978). Recent reconnaissance located Joshua trees on the piedmont of Clark Mountain to the west, where it occurs primarily as an associate of woodland at elevations exceeding about 4,800 feet.

3.5.3 Local Plant Associations

The creosote bush-burrobush desert scrub of the Ivanpah SEGS project area is itself composed of several different plant associations that describe a continuum from xeric, low diversity scrub to mesophytic, mixed desert scrub at high elevations, and from disturbance-adapted scrub of recently scoured washes to the mature scrub of stable interfluves. Creosote bush is usually the visually prominent shrub species, while burrobush is usually the more abundant but smaller shrub. Common shrub and subshrub associates, especially at higher elevations near the transition with mixed desert scrub, include the following.

- Box-thorn or wolfberry (*Lycium andersonii*; *L. cooperi*)
- Ratany (*Krameria erecta*)
- Ground thorn (*Menodora spinescens*)
- California buckwheat (*Eriogonum fasciculatum*)
- Paddle-leaf sage (*Salvia dorrii*)
- Virgin River brittlebush (*Encelia virginensis*)
- Mormon tea (*Ephedra nevadensis*; *E. torreyana*)

Different succulent species occur in the project site and are distributed throughout the creosote bush-burrobush desert scrub. A few are visually prominent because of their size, such as the Mojave yucca (*Yucca schidigera*) and the staghorn cholla (*Opuntia acanthocarpa*). Barrel cacti present include both the California barrel cactus (*Ferocactus cylindraceus* var. *lecontei*) that ranges chiefly into the southern Mojave and Colorado deserts, and the cotton-top barrel cactus (*Echinocactus polycephalus*) of the northern Mojave. Prickly-pear cacti include the relatively common beavertail prickly-pear (*Opuntia basilaris*), as well as the flapjack prickly-pear (*Opuntia chlorotica*) and the grizzly bear prickly-pear (*O. erinacea*), both of which have affinities with higher elevation desert scrub. Cholla species also include the diamond cholla (*Opuntia ramosissima*), the Mojave silver cholla (*O. echinocarpa*), and the club cholla (*O. parishii*). There appears to be a higher diversity and density of cacti on alluvial surfaces composed primarily of limestone clasts or older surfaces that appear underlain by a well-developed carbonate horizon.

There is a diverse annual and short-lived biennial flora in the Ivanpah SEGS project area. The annual habit is an effective adaptation to desert environments. For most of the year and for most years, the plant remains as a seed in the soil, germinating and flowering only on those rare occasions when soil moisture is high and sustained for a sufficient period of time. Most are winter annuals (e.g. *Bromus madritensis*, *Cryptantha* spp., *Eriogonum* spp., *Erodium cicutarium*, and *Lepidium* spp.), while a smaller proportion are summer annuals (*Kallestroemia* spp., and *Tribulis terrestris*).

Disturbance-Adapted Plant Associations

There is a different and distinct desert scrub plant association that occupies recently disturbed areas, such as the washes and arroyos that occur in abundance throughout the desert west (Bradley and Deacon, 1967; Thorne et al., 1981; Spaulding, 1981). Ephemeral washes have poorly developed soils and usually support a distinctive, disturbance-adapted flora. The following perennials, although adapted chiefly to such desert riparian habitats, also occasionally occur on the interfluves on more mature soils.

- Cheesebush (*Hymenoclea salsola*)
- Black-band rabbitbrush (*Chrysothamnus paniculatus*)
- Desert almond (*Prunus fasciculata*)
- Woolly bursage (*Ambrosia eriocentra*)
- Bladder-sage (*Salazaria mexicana*)
- Catclaw acacia (*Acacia greggii*)
- Desert willow (*Chilopsis linearis*)

Catclaw acacia and desert willow are the only two small trees that occur near the Ivanpah SEGS.

Weedy Flora

The WMP (Appendix B) lists the weed species that occur or could occur in the project area. There are a few woody perennials such as salt cedar (*Tamarix ramosissima*), tree-of-heaven (*Ailanthus altissima*), and camel thorn (*Alhagi camelorum*), but most are annual plants. The annual weeds include several species that have become well-naturalized in the region; that is, they occur in many different habitats and in areas far removed from human disturbance. Ubiquitous weed species in the region include the following.

- Red brome or red chess (*Bromus madritensis* ssp. *rubens*)
- Filaree or storksbill (*Erodium cicutarium*)
- Mediterranean grass (*Schismus arabicus*, *S. barbatus*)
- Tumble-weed or Russian thistle (*Salsola tragus*)

The term “weed” is normally applied to non-native plant species that typically colonize recently disturbed ground, but certain native annuals also share the trait of being adapted to recently disturbed soil. These include members of the Polygonaceae, especially species in the genus *Eriogonum*, some annual Asteraceae such as *Malacothrix* and *Geraea*, and the globe mallow *Sphaeralcea ambigua*.

While in portions of the Mojave Dessert some of the species above may contribute to fire hazard, that is generally not the case in the Ivanpah SEGS area, where even in a wet season these species may only reach 2 to 3 inches in height, and densities less than 10 or 15 percent (see Vegetation Survey Results, Appendix E). In addition, they are typically at comparable canopy densities in either disturbed or undisturbed sites.

3.5.4 Vegetation Surveys

Site vegetation surveys and analyses were conducted at Ivanpah SEGS and surrounding areas in April 2009 to characterize existing vegetation conditions and in support of rehabilitation and revegetation efforts. The full report of these surveys and findings are provided in Appendix E, Vegetation Survey and Results.

Survey Objectives

The objectives of these surveys were as follows.

1. To characterize vegetation at sites within Ivanpah Valley with a disturbance history comparable to the disturbance that will occur at the Ivanpah SEGS site
2. To collect vegetation data at disturbed and adjacent undisturbed sites, including species composition, percent cover, species abundance, species diversity, species density, weedy species composition, and individual vigor
3. To identify and document vegetation conditions at sites in varying stages of recovery based on differing dates of disturbance
4. To document species composition and diversity within the footprint of the proposed Ivanpah SEGS and, specifically, to estimate the number and diversity of all succulent species, which had previously not been determined
5. To identify and develop appropriate criteria for revegetation progress based on conditions and findings at comparable revegetation sites and to identify temporal expectations of progress
6. To identify and develop appropriate criteria and thresholds for weed management based on risks to native vegetation development and establishment

Survey Protocol

Sample sites were chosen at areas with known disturbance history and regime, along with adjacent undisturbed habitats (relatively). Additional sampling was conducted within each of the three Ivanpah units. Sampling for abundance, density, percent cover, diversity (Smith, 1992), and richness were conducted using a combination of line transects, belt transects, and circular relevé plots. Sampling at disturbed sites included three 30-meter-long line and belt transects, with independent sampling of shrub and herbaceous strata. In adjacent undisturbed sites, a comparative 30-meter line transect and one 12-meter radius relevé (a term used in vegetation ecology for an arbitrarily assigned vegetation sampling plot) (CNPS, 2000) were sampled in the undisturbed desert adjacent to each disturbed site. Within the undisturbed areas in the Ivanpah units, three 12-meter radius relevés per unit were sampled.

Sample locations were as follows.

- The borrow pit (BP) site is located between Ivanpah Unit 1 and I-15 where material was most likely taken between 1960 and 1965 to build the I-15 Yates Well Road exit; it is assumed that there were no revegetation efforts, only natural recovery.
- Two other disturbed sites were sampled on the KRGT ROW. KRGT 1 is located northeast of Ivanpah Unit 3, and KRGT 2 is located within the Ivanpah SEGS proposed transmission corridor. The KRGT ROW was disturbed around year 2000 and appears to have been revegetated using seeding with native species and soil manipulation.
- Three additional sites were sampled within the Ivanpah units, one each on Ivanpah 1, Ivanpah 2, and Ivanpah 3 (I1, I2, I3, respectively).

Survey Findings

Complete data findings are reported in Appendix E, including raw data and summary tables. Findings are summarized here.

Shrub Strata

The most abundant shrub in the three disturbed sites is cheesebush (*Hymenoclea salsola*). In two of the disturbed sites (BP and KRGT1), burrobush (*Ambrosia dumosa*) is the next most common shrub. Burrobush and creosote bush (*Larrea tridentata*) are the most common shrubs in the undisturbed sites, including the sites on Ivanpah 1, 2, and 3.

Shrub cover, density, diversity, and richness are provided in Table 3-4. Data presented are the means of up to three samples at each location. Shrub density in the disturbed sites was lowest at the BP site and highest at the KRGT2 site, where a high number of cheesebush were present. Within the undisturbed sites, density of shrubs was greater in the lower elevation sites in the southern portion of the valley (Borrow Pit, Ivanpah 1), generally owing to a greater number of burrobush, with an overall reduced diversity of shrubs. The disturbed sites sampled generally had a lower percent shrub cover (13 to 18 percent) than the undisturbed sites (14 to 31 percent); however, in KRGT1, the disturbed sites sampled had a higher mean shrub cover (18 percent) than the undisturbed site (14 percent). The range of shrub cover in disturbed sites (9 to 33 percent) was greater than in undisturbed sites (14 to 31 percent) (see Appendix E).

Shrub diversity and richness are greater in two of the disturbed sites (BP and KRGT1) than in the associated undisturbed sites. In KRGT2, shrub diversity and richness are greater in the undisturbed site. Within undisturbed sites, there appeared to be a consistent increase in diversity and richness trending from the lower elevation sample sites at BP and Ivanpah 1 near the bottom of the valley, toward the higher elevation sites to the north at the head of the bajada, and at the base of the foothills.

TABLE 3-4
Mean Vegetation Data Findings for the Shrub Strata from Vegetation Surveys

Site	Cover (percent)		Density (plants/acre)		Diversity (Simpson's Index of Diversity)		Richness (number)	
	Disturbed	Undisturbed	Disturbed	Undisturbed	Disturbed	Undisturbed	Disturbed	Undisturbed
Borrow Pit	13	23	2,341	3,849	0.55	0.27	7	3
KRGT1	18	14	3,506	3,009	0.66	0.56	13	11
KRGT2	18	31	4,743	2,359	0.2	0.67	6	19
Ivanpah 1	---	---	---	4,053	---	0.40	---	12
Ivanpah 2	---	---	---	3,195	---	0.45	---	15
Ivanpah 3	---	---	---	2,421	---	0.62	---	19

Succulents

Succulents encountered during surveys at all sites included *Opuntia acanthocarpa*, *O. ramosissima*, *O. basilaris*, *O. echinocarpa*, *Echinocactus polycephalus*, *Ferocactus cylindraceus*, and *Yucca schidigera*. The barrel cacti (*Echinocactus*, *Ferocactus*) were mapped across the Ivanpah sites during early botanical surveys in support of the AFC. These data would represent undisturbed sites within the proposed footprint of Ivanpah SEGS.

Table 3-5 shows data from vegetation surveys and the original barrel cacti mapping. As evidenced in the comparative density between barrel cacti and density of all succulents, barrel cacti represent only a minor portion of the succulent community. Within undisturbed sites, density of succulents appeared to increase with increasing elevation, generally trending from the southern most sampling sites (Ivanpah 1, BP) to the northern sites at the base of the foothills and at the head of the bajada (KRGT, Ivanpah 3).

TABLE 3-5
Succulent Density in Disturbed and Undisturbed Sites at Ivanpah SEGS

Site	Total Succulent Density from Vegetation Surveys (plants/acre)	
	Disturbed*	Undisturbed
Borrow Pit	10.1	8.1
KRGT1	20.3	153.3
KRGT2	0	314.7
Ivanpah 1*	---	91.4
Ivanpah 2*	---	134.5

TABLE 3-5
Succulent Density in Disturbed and Undisturbed Sites at Ivanpah SEGS

Ivanpah 3*	---	156.0
Barrel Cacti Density from Botanical Surveys (plants/acre)		
Ivanpah 1		0.8
Ivanpah 2		0.6
Ivanpah 3		1.6
TOTAL		1.2

*Value represents a mean of three replicates.

Herbaceous Strata

The most abundant herbs in the disturbed sites are redstem filaree (*Erodium cicutarium*), bluegrass (*Poa bigelovii*), and Mediterranean grass (*Schismus* sp.). The most common herbs in the undisturbed sites are pepperweed (*Lepidium* sp.), bluegrass, redstem filaree, and Mediterranean grass.

Herbaceous cover at all sampling plots (including native herbaceous cover) and canopy height are provided in Table 3-6. In the herbaceous layer, results for canopy cover are varied. The most notable difference was at the KRGT2 site, where herbaceous cover was substantially greater in the disturbed site (15 percent) than the undisturbed (7 percent). At this latter site, the native bluegrass was abundant, representing between 30 and 80 percent of the herbaceous cover.

TABLE 3-6
Mean Vegetation Data Findings for the Herbaceous Strata from Vegetation Surveys

Site	Total (Native) Cover (Percent)		Canopy Height (m)	
	Disturbed	Undisturbed	Disturbed	Undisturbed
Borrow Pit	3.4 (0.5%)	2.0 (0.4%)	0.030	0.050
KRGT1	8.7 (4.2%)	15.3 (5.0%)	0.043	0.030
KRGT2	21.0 (15.3%)	6.8 (6.5%)	0.053	0.070

3.5.5 Discussion of Vegetation Survey Results

Although the variability is high (13 to 31 percent) shrub cover in this area (Table 3-4) is generally greater than that expected for desert ecosystems on a global basis, where cover is normally less than 10 percent (Spaulding, et al., 1983). This reflects the relatively high altitude of the project area and increased effective moisture relative to desert lowlands, which in turn support a density of shrubs that would technically meet the criterion for steppe vegetation, and not desert scrub. Nonetheless, since the term steppe is rarely used in

North America, we will not employ it here. Rather we note that the natural vegetation of the project area is relatively dense relative to most desert scrub communities.

Revegetation

As expected (see Section 3.4.3), the disturbed sites are dominated by native disturbance-adapted, early successional species (*Hymenoclea salsola*); whereas, the undisturbed sites are dominated by native late successional, climax species (*Ambrosia dumosa* and *Larrea tridentata*). Succession over the last 40 to 50 years at the disturbed Borrow Pit site (BP) has resulted in late successional/climax species (*A. dumosa* and *L. tridentata*) as the second and third most common species. Even at disturbed site KRGT1, which has had less than 10 years to recover, late successional, climax species are becoming dominant (*A. dumosa* is the second most common species). In addition, *L. tridentata* were establishing on the site in low numbers.

In two of the three sites, shrub cover has not returned to predisturbance levels. Disturbed site BP has undergone 40 to 50 years of natural succession, yet still does not have the same shrub cover as the adjacent undisturbed area (13 percent vs. 23 percent). One of the two KRGT sites that underwent active revegetation efforts has returned to greater than undisturbed shrub cover levels. This suggests that revegetation efforts accelerate and improve shrub cover recovery. In establishing shrub cover criteria, it is important to note that even in undisturbed habitats shrub cover is naturally low and can be variable (ranging from 14 to 31 percent).

Succulent density was much lower on disturbed sites along the KRGT ROW than adjacent undisturbed sites. Judging from the low number of succulents, it can be surmised that no or very few succulent transplants occurred during the KRGT revegetation. Given the generally accepted success rates of succulent transplants, this approach as proposed for Ivanpah SEGS would be expected to improve revegetation results.

As indicated, shrub diversity and richness within undisturbed transects at the BP, KRGT1, and KRGT2 sites showed a steady increase with elevation (Table 3-4), which increased between the three sites (2685 feet, 2834 feet, and 3270 feet, respectively), with the higher elevation sites (KRGT 1 and 2) trending toward the northern foothills and the head of the bajada. A similar trend is evident in the relevé data from the Ivanpah sites, with an increase in diversity and richness from Ivanpah 1 to Ivanpah 2, and then to Ivanpah 3. Again, these sites are successively higher in elevation (means are 2830 feet, 3019 feet, and 3126 feet) and trend from south to north towards the head of the bajada. Interestingly, the density data show an inverse trend and decreases with elevation in the two sets of undisturbed plots. This appears to be due to fewer burrobush in the canopy in the higher sites. At these sites, a number of other shrubs make up a greater portion of the shrub canopy, but they grow in reduced densities compared to burrobush (Table 3-4). While insufficient data is available to determine causative factors or establish relationships, consideration of the difference in natural diversity and richness is necessary in establishing criteria for these parameters.

Exotic Weeds

Exotic weed species are present in both the disturbed and undisturbed sites. *Schismus* sp. and *E. cicutarium* are present in both the disturbed and undisturbed sites. *B. madritensis* is only present in the disturbed sites; however, it is not a dominant species in the herbaceous

layer. Total herbaceous cover is 21 percent or less in both the disturbed and undisturbed sites. KRGT2 was the only site where there was a noticeably higher percent of herbaceous cover in the disturbed than the undisturbed, but the dominant herbaceous species was a native grass (*Poa bigelovii*). Generally, the exotic proportion of the herbaceous layer is dominated by small annual plants with average heights of 0.03 to 0.07 meters and cover less than 10 percent. This is comparable to exotic species present in undisturbed sites.

Based on the percent cover and short stature of the canopy, it is anticipated that the exotic weed growth in disturbed areas is not likely to pose an elevated fire risk compared to the undisturbed areas. This represents conditions during a relatively wet year (as described earlier). During drier than normal years, the herbaceous strata would be expected to have even less cover or stature, or be absent altogether.

Native Plant Salvage and Reuse

As further discussed in the Technical Basis Document (TBD, Appendix D) it is rarely the practice to salvage desert shrubs for later transplant because those transplant efforts generally experience a low success rate. Therefore, Ivanpah SEGS will not salvage shrubs, not because they are unnecessary, but because such salvage efforts would be impractical. Certain succulent species (especially some cacti) are exceptions that are not only of relatively high aesthetic value, but have physiological adaptations that result in a significantly higher success rate on attempts to salvage and maintain. Within each subsection, preliminary background information is presented on the topic, followed by a subsection on the proposed protocol, including a numbered list of proposed actions to which the project proponent is committed.

4.1 Cacti and Yucca of the Project Area

4.1.1 Growth Forms

The cacti and yucca (collectively termed “succulents”) of the project site are all native species; there are no introduced non-native succulents in the area. All share the trait of storing moisture in plant tissues above the ground, and in some (barrel cacti), their entire aboveground biomass can be thought of as a single water storage organ; hence, the name succulent. Cacti are also leafless, and their chlorophyllous surfaces consist of the tissue covering their stems. Most taxa are heavily armed with stout siliceous spines. Many species of *Opuntia* are also armed with glochids, which are millimeter-scale spines that readily detach and penetrate the skin. Cactus species readily generate rootlets and root systems in response to seasonal increases in soil moisture. However, even with these commonalities, there are several distinct morphologies among the Mojave Desert succulents that are relevant to their handling and salvage.

4.1.1.1 Single-stemmed Cacti

The single-stemmed cacti, or cylindrocacti, are those cactus species characterized by a single stem, usually slightly inflated. They range from very large barrel cacti (for example, the California barrel cactus [*Ferocactus leontii* var. *cylindraceus*], the cotton-top barrel cactus [*Echinocactus polycephalus*]), to slightly small pincushion and fishhook cacti (*Coryphantha chlorantha*, *Mammillaria microcarpa*). One plant can be composed of a single stem, such as the California barrel cactus, or there can be up to a dozen stems sprouting out to make up one individual, such as the many-headed barrel cactus and the hedgehog cactus (*Echinocereus engelmannii*). However, these stems always branch from the ground-level perennating (that is, persistent from year-to-year) buds, and the stems neither branch nor are they segmented.

4.1.1.2 Segmented Cacti

Segmented cacti in the Ivanpah SEGS include prickly-pears (*Opuntia* subgen. *Platyopuntia*) and chollas (*Opuntia* subgen. *Cylindropuntia*), the latter also including *Grusonia* (Table 4-1),

which is doubtfully distinct from *Opuntia* (Hickman, 1993). Prickly-pears are ascendant plants with an architecture composed of flat, jointed, succulent pads. Some prickly-pears (*Opuntia chlorotica*) can grow up to 5 feet in this area, while other taxa (*O. basilaris*) can be diminutive and consist of a few to approximately a dozen pads that do not branch extensively. Chollas are more typically ascendant and shrublike, although their branching architecture consists of succulent, cylindrical joints. Buckhorn chollas (*Opuntia acanthocarpa*) can exceed 5 feet in height and, with dense golden spines, can be more visually appealing compared to the nondescript and smaller silver cholla (*O. echinocarpa*). Cholla joints are cylindrical, and those of most species are relatively short and detach easily from the mother plant with no injury to the plant. Their spines are typically sheathed with microscopic recurved barbs and are of a design that allows the joints to “hitchhike” once they attach to the foot of an animal. Accordingly, cholla cacti often reproduce vegetatively as dropped joints are scattered beyond the parent plant, and then take root.

TABLE 4-1
Succulents Found Growing Within the Ivanpah SEGS Project Area

Taxon	Common Name	Notes
Cactaceae		
<i>Coryphantha chlorantha</i> ; <i>C. vivipara</i>	Desert pincushion	C; cryptic
<i>Echinocactus polycephalus</i>	Cotton-top or clustered barrel cactus	C
<i>Echinocereus engelmannii</i>	Hedgehog cactus	C
<i>Ferocactus cylindraceus</i> var. <i>lecontei</i>	California barrel cactus	C; highly valued as a landscaping element
<i>Grusonia</i> [<i>Opuntia</i>] <i>parishii</i>	Parish club-cholla	S; the only cholla with a prostrate habit
<i>Mammillaria tetrancistra</i>	fish-hook cactus	C; cryptic
<i>Opuntia acanthocarpa</i> var. <i>coloradensis</i>	buckhorn cholla	S
<i>Opuntia basilaris</i> var. <i>basilaris</i>	beavertail prickly-pear	S
<i>Opuntia chlorotica</i>	pancake prickly-pear	S; more common in higher elevation mixed scrub habitats
<i>Opuntia echinocarpa</i>	silver cholla	S
<i>Opuntia echinocarpa</i> x <i>O. ramosissima</i>	hybrid silver x pencil cholla	S
<i>Opuntia erinacea</i>	Mojave prickly-pear	S
<i>Opuntia ramosissima</i>	pencil or diamond cholla	S
Liliaceae		
<i>Yucca schidigera</i>	Mojave yucca	Y

Notes:

C = cylindrocacti (single-stemmed cacti)

S = segmented or jointed cacti

Y = yucca

4.1.1.3 Yucca

Although technically succulents, yucca species are unrelated to cacti. They are actually perennial monocots (grasses and allies) and are classified in the lily family (Table 4-1). There are several yucca native to the Mojave Desert although only one species, the Mojave yucca (*Yucca schidigera*), occurs in the Ivanpah SEGS project area. Younger Mojave yucca plants lack trunks and possess stout, inflexible leaves that are more than 24 inches long with sharp, piercing tips. Older Mojave yucca possess single or simple-branching trunks sheathed in dead leaves, with a rosette of live leaves at the top of the trunk. Leaves of these older plants are generally less than 18 inches long, but still quite stout and sharp-pointed.

4.2 Ecophysiologicaly Relevant Notes

The ecophysiology of North American cacti was a principal subject of study during the first decades of the 20th Century, as summarized by McGinnies (1981). Cacti resist desiccation partly because they lack leaves and have a very small surface-to-mass ratio. Their cuticle is also thick, with stomata that close tightly during the day, open after dark, and respire at night to reduce moisture loss. Their root systems can also grow rapidly in response to increases in soil moisture, and rootlets also dieback readily, minimizing moisture loss caused by soil desiccation. Injuries, whether to the stem or root system of cacti, also callous quickly in the absence of fungi or other pathogens. Cacti are also rich in water and nutrients.

Many of the physiological adaptations of succulents to desert environments also mean that they are relatively easy to transplant successfully if appropriate measures are taken. Some of these measures anticipate the vulnerability of cacti to soil pathogens. Rooted primarily in dry soils, cacti typically do not have the resistance to fungal pathogens possessed by most plants of more humid habitats.

The transplant success rates for yucca species are significantly below those for cactus species.

4.3 Relevant Laws, Ordinances, Regulations, and Standards

4.3.1 Federal LORS

The Federal Endangered Species Act, Section 7 (FESA; 16 United States Code, Section [§] 1531 et seq., 50 *Code of Federal Regulations* §17.1 et seq.) provides for the designation and protection of threatened and endangered plant, as well as animal species, and habitat critical to their survival. The FESA authorizes the USFWS to review a proposed federal action to assess potential impacts on listed species. Listed species are those that have been determined to be endangered or threatened after study, and have been listed in the *Federal Register*. The FESA prohibits the “take” of listed species. The FESA and implementing regulations define “take” to include mortality and other actions that could result in adverse impacts such as harassment, harm, or loss of critical habitat. No succulent species, federally listed as threatened or endangered, were observed during comprehensive biological surveys at the Ivanpah SEGS, and none are anticipated to occur at the project site.

4.3.2 State and Local LORS

The Native Plant Protection Act (NPPA) of the 1977 Fish and Game Code (Sections 1900 through 1913) directed the CDFG to carry out the Legislature's intent to "preserve, protect and enhance rare and endangered plants in this State." The NPPA gave the California Fish and Game Commission the power to designate native plants as "endangered" or "rare" and protect endangered and rare plants from take.

The California Desert Native Plants Act of 1983 (Division 23 [commencing with Section 80001]) of the Food and Agricultural Code is intended to protect California desert plants from unlawful harvesting on both public and privately held lands, and to provide information necessary to legally harvest native plants. This code allows removal of certain nonlisted desert plants under permits issued by the county agricultural commissioner or sheriff. The Act specifically defines plants that may have limited harvest with appropriate landowner approval and permitting. "Landowner" includes the public agency administering any public lands within the areas subject to this division. The county agricultural commissioner may establish specific cutting, harvesting, and plant care criteria that would include the most favorable and practical horticultural methods and seasons to ensure the survivability of the plants, as well as to ensure compliance with existing local, state, and federal regulations.

Title 8 of the San Bernardino County Development Code, Division 9, Plant Protection and Management, includes regulations on removing and salvaging desert plants. Chapter 4, Desert Native Plant Protection, prohibits removal of protected desert plants, except as approved by the State Department of Food and Agriculture, and as specified in the Desert Native Plant Act of 1983, as amended. The San Bernardino County Agricultural Commissioner will be responsible for issuing the appropriate tags, seals, and permits required by the state. However, this regulation generally applies only to private lands, or unincorporated county land, and does not apply to federal government lands.

4.3.3 Standards

The BLM does not allow the collection or the take of cacti and yucca on federally managed lands without a special use or other applicable permit. Although most cactus species are not on the BLM's Sensitive Plant List (2004), the BLM typically requires some level of salvage of succulent species in the Mojave Desert of California and adjacent Nevada. These standards usually follow a hierarchy of perceived horticultural value, whereby those species most valued by landscapers and collectors (hence those most commonly lost as a result of poaching on federal lands) are most frequently identified for salvage.

4.4 Succulents to be Salvaged

Table 4-1 lists the succulents within the Ivanpah SEGS project area and notes their growth forms and other information. During biological surveys of the project site, the locations of barrel cacti (both cotton-top and California barrels) were recorded with handheld geographic positioning system (GPS) units. The data indicate that there are several thousand barrel cacti within the Ivanpah SEGS project area, although densities do not appear high at less than 15 plants per acre, as discussed in the Ivanpah SEGS *Draft Biological Assessment for the Ivanpah Solar Electric Generating Station* (Ivanpah SEGS, 2008). More recent

analysis of density and diversity of perennial species in vegetation plots within and adjacent to the Ivanpah SEGS project boundary confirms the low frequency of occurrence of succulent species in this Mojave Desert scrub (Appendix E).

The species listed in Table 4-2 will be salvaged by transplanting (removing the entire plant) in cases where they will be threatened with destruction by construction activities (blading, crushing, or flail mowing). These cylindrocacti are not adapted to vegetative propagation like species of the genus *Opuntia*. Therefore, their salvage will involve transplantation of whole plants.

TABLE 4-2
Succulents to be Salvaged by Transplanting the Entire Individual

Genus and Species	Common Name(s)	ID Code
<i>Coryphantha chlorantha</i> ; <i>C. vivipara</i>	desert pincushion	Coch; Covi
<i>Echinocactus polycephalus</i>	cotton-top or clustered barrel cactus	Ecpo
<i>Echinocereus engelmannii</i>	hedgheg cactus	Ecen
<i>Ferocactus cylindraceus</i> var. <i>lecontei</i>	California barrel cactus	Fecy
<i>Mammillaria tetrancistra</i>	fish-hook cactus	Mate

The species listed in Table 4-3 can be vegetatively propagated and, therefore, their salvage will be primarily through the recovery of cuttings of pads (prickly-pears) or joints (chollas).

TABLE 4-3
Succulents to be Salvaged Using Pads or Joints Removed from the Plant

Genus and Species	Common Name(s)	ID Code
<i>Grusonia</i> [<i>Opuntia</i>] <i>parishii</i>	Parish club-cholla	Oppa
<i>Opuntia acanthocarpa</i> var. <i>coloradensis</i>	buckhorn cholla	Opac
<i>Opuntia basilaris</i> var. <i>basilaris</i>	beavertail prickly-pear	Opba
<i>Opuntia chlorotica</i>	pancake prickly-pear	Opch
<i>Opuntia echinocarpa</i>	silver cholla	Opec
<i>Opuntia erinacea</i>	Mojave prickly-pear	Oper
<i>Opuntia ramosissima</i>	diamond or pencil cholla	Opra

Yuccas (including *Yucca schidigera*) are also often transplanted on desert restoration sites. They are a common element of the flora at Ivanpah SEGS, occurring in much higher densities than barrel cacti. However, survivorship is notably reduced in yucca transplants compared to other succulents, and the costs may be much higher (Bainbridge, 2007; Bamberg Ecological, 2006). At Castle Mountain Mine, transplanted Mojave yucca (*Yucca schidigera*) mortality within 3 years after planting was reported from 30 to over 50 percent. Subsequent years saw higher mortality rates, and in the end, the transplant program for

yuccas was not considered successful (Bamberg Ecological, 2005; Bamberg Ecological, 2006). In a study reported by Abella and Newton (2009), double-transplanted *Y. schidigera* had survival rates of only 39 to 53 percent over the limited (2-year) monitoring period; rainfall was potentially above average for the study period. For these reasons, salvage of yuccas is not proposed for the Ivanpah SEGS project.

4.5 Salvage Techniques

All personnel engaged in succulent salvage will wear appropriate protective clothing and receive safety training that will include coaching regarding how best to avoid *Opuntia* glochids and the crushing hazard posed by the weight of a mature barrel cactus.

4.5.1 Flagging during Tortoise Clearance

Qualified field technicians will be responsible for locating and flagging succulents during the sweeps of areas to be disturbed before construction kickoff. The scheduling of areas to be flagged for succulent salvage will be the same as that for the desert tortoise clearance activities. The surveyor's tape to be used will bear a specific color/stripping scheme to distinguish it from the marking tapes used by other crews, such as the tortoise biologists. Particularly small cacti, such as the pincushion and fish-hook cacti, will be marked with a 3-foot lathe to which the appropriate flagging will be affixed.

For all areas except the heliostat fields and the Construction Logistics Area (CLA), all succulents located will be salvaged. For the heliostat fields and the Shared Facilities area, succulents will be salvaged only from those areas where clearing, blading and/or crushing will occur. In the heliostat fields where flail-mowing is planned, succulents less than approximately 1 foot in height will not be salvaged, but will be allowed to remain. Succulents higher than 1 foot to 1.5 feet occurring where flail-mowing is planned (for example, mature California barrel cacti and mature staghorn cholla) will be salvaged according to the methods described in Section 4.5.2.

4.5.2 Succulent Salvage and Cleaning

4.5.2.1 Cylindrocacti

Prior field work included the recording the location of all barrel cacti within the project area on a GPS system, and these data will be used for planning and relocation. The larger cylindrocacti, such as the larger California and cotton-top barrel cacti, will be salvaged using a three-man crew, a small bobcat-style front-end loader, and a flatbed utility truck. The plant will first be wrapped with burlap, and a guide rope will be affixed, if necessary. The bucket of the front-end loader will then scoop the plant (including the proximal portion of the root mass) out of the ground. The plant will then be carried to the flatbed truck and heeled over on the bed of the truck. The base of the single-stemmed succulents will be brushed with a coarse fiber brush or broom to remove excess dirt. Roots will then be clipped manually to a length not to exceed 4 inches. Care will be taken to minimize subsequent disturbance to the root mass, and to minimize damage to the plant from truck transportation. Succulents will be arrayed just one layer thick during transportation to avoid damage and to accommodate the great weight of mature barrel cacti.

Smaller single-stemmed succulents will be salvaged using two-man crews with shovels. The succulent will be manually dug out of the ground, taking care to minimize damage to the roots proximal to the plant. The plant will then be heeled over onto a pallet and the roots clipped to within 2 inches of the plant. When full, the pallet will be secured with burlap. When a number of secured pallets are ready, they will be picked up by a forklift-equipped bobcat and placed in a flatbed utility truck for transport to the stockpile area. The base of the single-stemmed succulents will be brushed with a coarse fiber brush or broom to remove excess dirt. The roots and rootlets will be trimmed with clippers to a length of 2 to 6 inches from the mother plant. This will allow the root system to callous and dry, thereby minimizing the chance of fungal growth. Each plant will bear a metal or ceramic tag identifying its provenance and date of harvest. For efficiency, the tags can be color-coded and labeled prior to the beginning of each day's work.

4.5.2.2 *Opuntia* Species

Because they grow readily from cuttings (actual cuttings, or just joints or pads removed from the plant), most species of *Opuntia* (Table 4-3) can be more efficiently salvaged by removing parts of the plant, rather than transplanting the entire plant. This also allows for economy of scale to the extent that one plant can yield a number of new plants depending on how many of its cuttings are propagated. Two to four cuttings will be recovered from each plant.

Prickly-pear species will be salvaged by taking cuttings of the pads, or by breaking off pads if they detach readily. Prickly-pears that are too young to branch, and most beavertail that never branch, will be transplanted in the same fashion as the small cylindrocacti. For most of the chollas, the easily detachable joints will be simply broken off. In the case of the diamond cholla, which has joints that do not detach easily, cuttings of 6-inch to 10-inch segments of the branches will be made. The perenating bud at the tip of the branch must be included for each diamond cholla cutting.

Simple paper bags will be used for transport and storage of cuttings. The bag will be labeled with the four-letter code for the species (Tables 4-2 and 4-3), the number of the cutting and total number of cuttings (for example, "3/4" for the third of four cuttings), and the work area. The paper bags allow easy handling and labeling of the specimens, and allow the specimens to dry and detachment points to callous without promoting fungal growth. This drying is an important component of succulent recovery because succulents are very susceptible to fungal attack.

4.5.3 Transplanting, Temporary Storage, and Long-term Stockpiling

4.5.3.1 Short-term Storage

The salvaged succulents and cuttings will be logged into the short-term succulent storage area if the plants are not immediately donated or transferred to another party and transported offsite. An open-air nursery, used to house a short-term succulent storage area and a long-term succulent stockpile, will be separately designated and fenced. Short-term succulent storage is an important component of salvage and is intended prior to transplanting; it allows the damaged roots and the base of cuttings to callous over and the base of entire plants to dry, thereby minimizing the chance of fungal growth, which is frequently fatal to cacti. Cacti to be temporarily stored will first need their roots trimmed as

previously described. The plant will then be gently laid on its side on a pallet and allowed to air dry for at least 2 weeks but not longer than 6 months. Cuttings (cholla joints and prickly-pear pads) should also be allowed to dry under cover for a period of one to several weeks. Because they are generally smaller, cuttings as well as the pincushion and fish-hook cacti, cannot be subject to desiccation for as long as the large cylindrocacti, and should be replanted within 4 months of harvesting. Storage areas can be simple wooden pallets elevated at least 10 inches off the ground surface. Shading will be provided by simple canvas or heavy-duty plastic cover anchored effectively against the occasional strong desert winds and will include extra awning projection to the south and west to protect from intense afternoon sun.

4.5.3.2 Long-Term Stockpiling

For long-term stockpiling, required for long-term revegetation, cacti will be planted in windrows created by excavating a linear trench; and then heeling one cactus into the trench at generally regular intervals so that each cactus is spaced sufficiently (1.5 to 3 feet) to allow maintenance activities and mechanical recovery of the plant with no injury to adjacent plants. Larger plants (for example, barrel cacti) can be heeled into the ground with the use of a backhoe and an assistant with a shovel. The cactus should be buried so that its base is underground. The soil to be used will be the native soil screened to remove cobble-sized and larger rocks. The succulents planted for long-term stockpiling in pre-dug linear trenches will not be watered unless it is determined that there has been a significant rainfall deficit at the nursery site for more than 4 months. A single pass with a watering truck every 3 months should be sufficient to permit most plants to survive. Each plant will bear a metal or ceramic tag identifying its provenance, date of collection, and date of planting into the stockpile.

The basic features and functions of the Succulent Storage and Stockpile Area are described in Section 5.

4.6 Succulent Reuse, Donation, or Sale

Although it has been suggested for this project that salvaged succulents could be used for seed source, this practice is not widely used in revegetation in the arid west because vegetative propagation of cacti is simple and effective. Cuttings of *Opuntia* species (prickly-pear and cholla) and transplants of single-stem cacti are far more hardy than cactus seedlings. Cacti planted in the open-air nursery for long-term stockpiling can be accessed to collect seed in favorable years after they set fruit. Their close proximity in the nursery should promote good pollination.

Approved donation or approved sale of cacti may be identified by Ivanpah SEGS and the BLM as appropriate manners of disposition of the cacti in long-term stockpiles, in addition to use for revegetation. There would be some use for cacti in revegetation of temporary disturbance areas, but this use would be limited. Succulents will be transplanted into recently seeded areas to provide increased microhabitat heterogeneity. Nevertheless, there would be large areas occupied by Ivanpah SEGS that would not be available for revegetation until after decommissioning, which is planned to occur about a half-century after build-out. Ivanpah SEGS will maintain a long-term stockpile of succulents for use in revegetation after decommissioning.

4.7 Salvage Protocol

4.7.1 Flagging

1. Flag succulents species to be salvaged as listed in Tables 4-2 and 4-3. For all areas except the heliostat fields and the CLA, all succulents located will be salvaged. For the heliostat fields and CLA, succulents will be salvaged only from those areas where clearing, blading or crushing will occur.
2. In the heliostat fields where flail-mowing is planned, succulents less than 1 foot tall will not be salvaged, but will be allowed to remain. Succulents taller than 1 foot occurring where flail-mowing is planned will be salvaged.
3. Mark succulents with flagging (and/or stakes for smaller, less visible plants).

4.7.2 Salvaging Cylindrocacti

1. Salvage larger cylindrocacti using a three-man crew; wrap plant with burlap, and affix guide rope if necessary.
2. Scoop the plant (including the proximal portion of the root mass) out of the ground using the bucket of a small front-end loader; load plant onto flatbed truck and heel over in the bed of the truck. Array plants just one layer thick during transportation to avoid damage and to accommodate the great weight of mature barrel cacti.
3. Brush base of single-stemmed succulents with a coarse fiber brush or broom to remove excess dirt; clip roots manually to a length not to exceed 4 inches; minimize subsequent disturbance to the root mass.
4. Salvage smaller single-stemmed succulents using two-man crews with shovels. Manually dig succulent out of the ground, taking care to minimize damage to the roots proximal to the plant.
5. Heel plant over onto a pallet and clip roots to within 2 inches of the plant; secure pallet with burlap when fully loaded.
6. Pick up pallets with a forklift-equipped bobcat, and place pallets on a flatbed utility truck for transport to the stockpile area.
7. Brush the base of the single-stemmed succulents with a coarse fiber brush or broom to remove excess dirt; trim roots and rootlets with clippers to a length of 2 to 6 inches from the plant; allow root system to callous and dry.
8. Provide each plant with a metal or ceramic tag identifying its provenance and date of harvest.

4.7.3 Salvaging Opuntia

1. Salvage two to four cuttings from each opuntia plant; salvage prickly-pear species by taking cuttings of the pads or by breaking off pads if they detach readily.
2. Salvage prickly-pears that are too young to branch and beavertail that never branch in the same fashion as the small cylindrocacti, as previously described.

3. Break off easily detachable joints on cholla; on diamond cholla, make cuttings of 6-inch to 10-inch segments of branches; for each diamond cholla cutting, including the perenating bud at the tip of the branch.
4. Transport and store cuttings in simple paper bags; on bag, note species, the number of the cutting and total number of cuttings (for example, "3/4" for the third of four cuttings), and the collection and work area.

4.7.4 Short-term Storage

1. Create open-air nursery separately designated and fenced, and use it to house a short-term succulent storage area and a long-term succulent stockpile. Log salvaged succulents and cuttings into short-term succulent storage area if plants are not immediately donated or transferred.
2. Construct storage areas on simple wooden palettes elevated at least 10 inches off the ground surface; provide shading by simple canvas or heavy-duty plastic cover anchored effectively against strong winds; provide extra awning protection to the south and west to protect from afternoon sun.
3. Ensure cacti for temporary storage have roots trimmed as previously described; lay plant on its side on a pallet and allow to air dry for at least 2 weeks but not longer than 6 months.
4. Allow cuttings (cholla joints and prickly-pear pads) to dry under cover for a period of one to several weeks, but not longer than 4 months; for smaller cuttings, replant within 4 months of harvesting.

4.7.5 Long-term Stockpiling

1. For stockpiling longer than time periods specified for short-term storage, plant cacti in windrows; excavate a linear trench, and then heel cacti into the trench at regular intervals with minimum spacing (1.5 to 3 feet or more); space each cactus is sufficiently to allow maintenance activities and mechanical recovery of the plant with no injury to adjacent plants.
2. Heel larger plants (for example, barrel cacti) into the trench with the use of a backhoe; assist with shovel as needed.
3. Bury cacti so that the base is underground; cover cacti base with native soil screened to remove cobble-sized and larger rocks.
4. Do not water succulents planted for long-term stockpiling unless it is determined that there has been a significant rainfall deficit at the nursery site for more than 4 months; water with a maximum of a single pass with a watering truck every 3 months.
5. Provide each plant with a metal or ceramic tag identifying its provenance, date of collection, and of planting into the stockpile.

4.7.6 Transplanting

1. For transplanting (removal and replanting) of succulents stored in short-term storage or long-term stockpiling, implement methods as already described for succulent removal or planting.

Surface Management Plan

5.1 Erosion and Sediment Control

Because the proposed site is located on federal land managed by the BLM, the project is not under the direct authority of San Bernardino County. However, for design purposes, erosion and sedimentation control BMPs will be engineered to meet the requirements of San Bernardino County, subject to review by the BLM and CEC. Because stormwater runoff from the project site potentially discharges into Ivanpah Dry Lake, a water body under federal jurisdiction, project construction is subject to requirements of the NPDES General Permit for Stormwater Discharges Associated with Construction Activities (the Construction General Permit), which has been adopted by the State Water Resources Control Board (SWRCB). BMPs will be developed and implemented to provide an effective combination of erosion and sediment controls, as provided in the project's SWPPP (Appendix C) and Drainage, Erosion, and Sediment Control Plan (DESCP, Appendix F). The SWPPP and DESCP are incorporated into this plan by reference.

Because LID practices are incorporated into the project design, construction, and operation, the sediment yield from the project site is not expected to be substantially greater than preproject conditions. In the heliostat fields, vegetation height will be controlled with mowing. Clearing and grubbing (which removes plant roots) will only be performed in areas that require foundations for long-term structures. By limiting disturbance of existing vegetation surface, stability will be maintained and vegetation will continue to anchor the soil.

Source controls and structural controls are proposed for managing erosion and sedimentation, and include the following (see Appendices F and G for structural BMPs along with their sizing and placement location will be finalized by the Engineering, Procurement and Construction (EPC) contractor during final design). BMPs that will be implemented during construction include but are not limited to the following.

- Existing vegetation will be mowed, and root systems will be left in place to minimize wind and water erosion, except where land is required for structural foundations or access.
- Stone filters and check dams will be strategically placed throughout the project site to provide areas for sediment deposition and to promote stormwater runoff by sheet flow. Where available, native materials (rock and gravel) will be used to construct the stone filter and check dams. A stone crusher may be provided onsite to allow for use of local stone to produce gravel during construction.
- Storm flows in ephemeral washes that convey offsite drainage onto the project site toward critical facilities, such as the power blocks, will be redirected via berms into diversion channels to control velocities and redirect flows. Diversion channels will be armored with rip-rap to prevent erosion and scouring.

- Where roads cross major drainages, measures will be implemented to stabilize channels and prevent erosion and scour.
- Calculations will be performed to verify stormwater velocities and size diversion channels and riprap.
- Silt fences and other sediment control BMPs will be used extensively during each phase of construction. Silt fence locations will be provided on the 90 percent engineering drawings.
- To reduce fugitive dust emissions, construction parking areas and other high traffic areas will be graveled and principal access roads paved.
- Stockpiles will be stabilized to prevent loss of soil during storms and in high winds.
- Inspections of stormwater BMPs will occur following storm events, and maintenance will be conducted as required after major storm events and when the volume of material behind the check dams exceeds 50 percent of the original volume, based on visual observations. Stone filters and check dams are not intended to alter drainage patterns but to minimize sediment transport and promote sheet flow.
- Erosion and sedimentation control BMP design will be in accordance with applicable federal, state, and local codes and standards.

5.2 Postconstruction Site Stabilization

Postconstruction BMPs will minimize erosion and sedimentation following completion of construction activities. Permanent stabilization is required before termination of the Construction General Permit. Minimization of dust generation through wind erosion is important to the function of the facility as well. Dust fallout on the heliostats can substantially reduce the efficiency of power generation. Site areas disturbed during construction will be permanently stabilized with source and structural controls including the following.

- Areas that will be frequently used during operation, such as access roads and parking lots, will be covered with aggregate paving, bituminous paving, or gravel.
- For disturbed areas that will not receive use during operation, the surfaces will be prepared and then revegetated with native plant species.
- Equipment traffic will be confined to access roads and maintenance paths to minimize landscape and vegetation disturbance, which otherwise would lead to accelerated erosion.
- The speed limit for vehicular traffic on dirt roads and service tracks will be 15 miles per hour to minimize dust generation.
- Stabilization measures will be implemented at channel crossings and on embankments, as identified in the DESCP, to reduce scour and erosion within channels.

5.3 Heliostat Washing

Heliostat washing will occur at night and will use high-quality deionized water at a rate of 2.5 gallons per heliostat (1.25 gallons per each of the two, 75.6-square-foot mirrors in one heliostat), at 2-week intervals. An estimate of mirror wash water quality is provided in Table 5-1, along with the estimated loading of each constituent over the 50-year life of the project. These extremely low concentrations will not affect rehabilitation efforts; at less than a pound per acre over 50 years, mineral loading will be negligible. Although the wash water is alkaline (pH = 8.5), it is not substantially different than the existing soil pH (about 8.2).

TABLE 5-1
Estimated Wash Water Quality and 50-Year Buildup

Constituent	Concentration	Estimated 50-year Buildup (lbs/ac)
Hardness as CaCO ₃	0.005 mg/L	0.008
Copper	0.01 mg/L	0.016
Iron	0.03 mg/L	0.047
Silica	0.3 mg/L	0.474
Conductivity	<1 μS/cm (<.001 dS/m)	
pH	8.5	—

Source: (Table DR137-1 from Data Response, Set 2B)

Notes:

μS/cm = microSiemens/cm
CaCO₃ = calcium carbonate
dS/m = deciSiemens per meter
lbs/ac = pounds per acre
mg/L = milligrams per liter

Evaporation will leave a minimal amount of residual salt accumulation. The wash water is not expected to have an adverse effect on soil permeability because sodium concentrations are negligible and soils have a gravelly sand texture.

Assuming uniform dispersion of the water across the mirror surface from the washer, and no evaporation of the 1.25 gallons per 7.2-foot-wide mirror surface, runoff onto the ground will be about 0.17 gal, (~22 fluid ounces) per linear foot, or a little less than 2 ounces of liquid per inch per washing episode. Due to the high evaporation rates in the area (annual pan evaporation in the Mojave Desert can exceed 100 inches), the unsaturated nature of the soils column, and the minimal amount of runoff, it is likely that wash water will evaporate at or just below the ground surface and leave no water available to promote weed establishment.

However, if growth of weedy species is promoted by mirror washing to the extent that they pose a fire hazard, appropriate control measures will be taken pursuant to the WMP. Chemical weed control, if needed, would likely be required only once per year, in the spring, and would be implemented according to the protocol specified in the approved WMP for this project (Appendix B).

5.4 Wildlife and Habitat Management

As previously noted, the LID approach to project development will limit the extent of major grading onsite. On most of the site, no grading will occur, access tracks will be unimproved, and vegetation height will be controlled by flail mowing only where necessary along the heliostat rows. Therefore, substantial populations of small vertebrates and insects will persist within the boundaries of the heliostat fields. Burrows would remain at least partly intact, and persistence of many shrubs after flail mowing is expected. Therefore, ecosystem function will persist within the heliostat fields during the operational phase of the Ivanpah SEGS. The fauna of the Ivanpah SEGS heliostat fields is likely to include packrats (*Neotoma lepida*), kangaroo rats (*Dipodomys* sp.), smaller rodents such as pocket mice and deer mice (*Perognathus* sp., *Peromyscus* sp.), snakes including rattlesnakes (*Crotalus* sp.), a number of lizard species, and a variety of insects. Desert tortoise will be removed prior to construction, and larger vertebrates would likely be kept out of the heliostat fields by the tortoise and security fencing. This is likely to include larger predators including the ubiquitous coyote (*Canis latrans*), but perhaps not the smaller predators such as the kit fox (*Vulpes macrotis*) or the badger (*Taxidea taxus*). Measures to manage the ecosystem within the boundaries of Ivanpah 1, 2, and 3 should be guided by a hands-off principal as much as is practical and consistent with health and safety concerns. The water from nocturnal mirror washing may attract small vertebrates, but these are expected to congregate after the washing device passes. Should there be high population growth rates of small vertebrates within the fence line, it could attract predators and some, such as the badgers, are industrious diggers. Therefore, careful and frequent monitoring of the tortoise fence will be necessary.

The flowing planning measures will be implemented to anticipate the opportunities and effects of LID during the operational phase. In most cases these will be green measures if at all feasible. For example, many communications and substation facilities in the Mountain Pass area – not far to the west – use lethal rodent traps to minimize the potential of rodent damage to electrical circuitry from gnawing and burrowing. Ivanpah SEGS would use such measures only as a last resort.

5.4.1 Heliostat Fields and Perimeters

- Ivanpah SEGS will retain a BLM-approved wildlife management specialist to assist with wildlife management opportunities and issues during the operational phase of the project
- Tortoise-proof guards as well as fencing will be installed.
- All tortoise-proof fencing will be inspected biweekly during the summer half-year, and bimonthly during the winter half-year.
- Heliostat wash crews and other workers with out-of-doors duties will receive special wildlife awareness training.

5.4.2 Power Blocks and Built Facilities

- All doors except garage doors will be rodent-proof.
- Night-time lighting will be limited to that required for safety and will be of a wavelength to minimize insect attraction.
- Night-time lighting will be designed to be turned off when not in use.
- Walk-in doors to garages and maintenance bays will be rodent-proof.
- Storage cabinets, electrical boxes, and electronics modules will be rodent proof or placed in sealed rodent-proof containers and interconnected through a rodent- and insect-proof conduit.
- Special measures to mitigate potential rodent gnawing of conduit and the effects of harvester ants (if any) will be incorporated at the final design phase.
- To the extent practicable, packrat nests will not be allowed to accumulate in or under stored materials or buildings; they will be dismantled and the packrat driven off humanely.
- To minimize the creation of new habitats for small vertebrates and arthropods, all outdoor storage will be off the ground on racks and stacks, except for large steel items.
- Wherever possible, clearances in storage areas, equipment yards, and in and around built facilities will be high enough to allow easy access for maintenance and clearing.

Aside from their legendary habit of making off with personal property including small tools and electronic components, packrats (primarily *Neotoma lepida* in this area) typically host a number of parasites, which in turn can be vectors for a number of serious illnesses. They also prefer sheltered areas in which to construct their dens (Spaulding et al., 1990).

Therefore, there is a health and safety basis for preventing the built facilities from becoming packrat habitat.

A strict policy of trash and refuse collection and sequestration will be enforced throughout the Ivanpah SEGS facilities operation. This includes removing and bagging any material, including tumbleweed or tumbledustard plants that have fetched-up on fences as a result of high winds.

5.5 Succulent Storage and Stockpile Area

In this section storage refers to activities focused on the temporary (5 years or less) retention of biological materials. "Stockpiling" as used in this section refers to the long-term (up to 60 years) retention of cacti and yucca. The reader is referred to Section 4 for more details on the Ivanpah SEGS succulent salvage program.

In the CLA northwest of the SCE switchyard and south of the Ivanpah 2 perimeter fence, 40 acres is to be set aside for the Succulent Storage and Stockpile Area (SSSA). It will be accessed chiefly by Colosseum Road that is to be rerouted through the CLA (see Figure 1-3). Some clearing of the area to be used will be necessary, but that will be minimized to the extent feasible. The functions required of the SSSA and the features to be constructed or

assembled to meet those requirements are listed in Table 5-2, below. They range from racks for the temporary storage of succulent cuttings and small cacti, to plantation rows for long-term succulent stockpiling.

TABLE 5-2
Functional Requirements of the SSSA and Corresponding Features or Constructs

Function	Feature or Construct
Preparing and Sorting Salvaged Material	Cleared area with portable tables for cutting processing, and a 200-foot x 200-foot area for preparation of larger succulents prior to stockpiling. ^a
Temporary Storage of Cuttings and Small Succulents	Open-air racks 2 to 3 feet wide ^b , elevated at least 1.5 feet above the ground. The material will be protected from direct sunlight by an awning, and from high winds by flexible screen curtain fixed to each rack when not in use.
Temporary Storage of Large Succulents (> 1 foot in length and/or >10 lbs in weight)	Windrows of drying succulents placed with a bobcat-style front-end loader and crew. If not to be used immediately after drying for up to 3 months they will be planted in trenches dug immediately in front of the row.
Succulent Stockpiling	Plantation rows of succulents no closer to one another than 2 feet, staggered placement, with service tracks between every 2 to 3 rows.
Soil Amendment Supplies	Individual stockpiles of organic mulch and sand, stabilized by tarpaulins weighted with reclaimed tires.
Storage for Tools and Materials	One or two shipping containers elevated at least 1.5 feet off the desert floor, and painted a neutral color such as light tan or light grey, and appropriately vented to allow superheated air to escape during the summer.

^aPreparation can include cleaning and trimming the root mass, replacing or removing protective covers, and mixing soil amendments.

^bThe steel pipe and plank makeup of construction scaffolding would serve well for this and should be easily obtainable in Las Vegas.

Some safety features would be shared by all the constructed facilities within the SSSA. These include stabilization with guy wires, or by other means, against the occasional destructively strong desert winds that are typical of the area and elevation of the constructed facilities above the desert floor. This latter measure is to accommodate sheet flow that will occur during episodic downpours and to allow periodic inspection and clearing of the spaces under structures to prevent packrat dens and other debris from accumulating in these sheltered spaces.

SECTION 6

Preliminary Landscape Design

It is anticipated that some onsite facilities would require landscaping. This section describes appropriate low water use conceptual landscaping plans that provide soil stabilization, aesthetic benefits, and microhabitat improvement at plant facilities. Areas that would benefit from landscape improvements include the Administrative/Warehouse Building, and potentially the facility entrance plaza. These landscape plans would require minimal irrigation (with recycled plant water), consist of California natives present in the region, and provide some shade and visual relief.

6.1 Landscape Design

6.1.1 Planting Design

The landscape design goal is to produce a robust and manageable desert landscape. The landscaping would use an entirely native palette using natural clumping patterns with select plants used as highlights. The design will include small desert trees, accents, shrubs, and groundcovers and may be seasonally enhanced with native wildflowers. Ongoing management of the landscape would ensure a relatively manicured appearance appropriate for developed facilities. Supplemental irrigation using recycled water will be available, as needed, to minimize normal seasonal diebacks.

6.1.2 Plant Palette

The plant palette for landscaping will consist of all native California desert plants, primarily consisting of those found onsite during the biological investigation, and all naturally present in the desert region near the Ivanpah SEGS project area. This is required by the resource agencies and committed to in the AFC. Table 6-1 provides the proposed conceptual plant palette.

TABLE 6-1
Preliminary Plant Palette, Ivanpah 1 Landscaped Areas

Botanical Epithet	Common Name
<i>Acacia greggii</i>	catclaw acacia
<i>Ambrosia dumosa</i>	burrobush
<i>Chilopsis linearis</i> var. <i>arcuata</i>	desert willow
<i>Echinocactus polycephalus</i>	cotton-top barrel cactus
<i>Encelia virginensis</i>	Virgin River brittlebush
<i>Eriogonum deflexum</i>	flat-topped buckwheat
<i>Eriogonum fasciculatum</i> ssp. <i>polifolium</i>	California buckwheat
<i>Ferocactus cylindraceus</i> var. <i>lecontei</i>	California barrel cactus
<i>Hymenoclea salsola</i>	Cheesebush
<i>Yucca schidigera</i>	Mojave yucca
<i>Salvia dorrii</i>	desert sage

Figure 6-1 provides a conceptual planting plan for the administrative/warehouse building and the adjacent parking area.

6.2 Planting Requirements

6.2.1 Plant Stock

Plant material used for facility landscaping would include salvaged material from developed sites (succulents), along with native plant material acquired locally or contract-grown for landscaping.

6.2.2 Soil Preparation

Soil preparation will require native topsoils to be banked during construction and replaced to a depth of 2 to 3 inches. Prior to topsoil replacement, decompaction will be implemented, if needed, to loosen lower soil horizons after parking and building construction activities are complete.

6.2.3 Fertilizers and Additives

Mycorrhizae inoculum may be used to increase plant growth; however, native soils may have adequate inoculum depending on duration of stockpiling. Native plants are normally adapted to low nutrient conditions, and fertilizers are generally not required. However, if necessary, low doses of organic fertilizer supplements can be used. To discourage weed growth, no chemical fertilizers will be used.

6.2.4 Mulch

Vegetation cleared from the site during construction may be shredded and used as mulch. Alternatively, decorative gravel soil coverings are sometimes used in desert landscaping.

6.3 Irrigation Requirements

The limited landscape planting areas are proposed to use treated wastewater for supplemental irrigation to extend growth and flowering periods for the desert palette. Irrigation would be applied through drip tubing directly to the base of plants. In general, irrigation requirements are anticipated to be small, and application should be monitored to avoid overwatering, which can damage dry-adapted desert vegetation.

6.4 Operations and Maintenance

Typical operations and maintenance requirements for native landscapes are low, once established. Anticipated measures include weeding, annual pruning, and soil monitoring.

6.4.1 Weeding

Weeding would occur frequently, typically weekly, during the initial growth period to ensure that invasive plants do not mature and set seed. Weeding activities will follow the

approved WMP. Once the native materials are established, weeding frequency would drop to a quarterly interval.

6.4.2 Pruning

Pruning dead vegetation for plant health would occur annually, or as desired, to maintain plant health and aesthetic value.

6.4.3 Soil Monitoring

Treated wastewater often has a mild salt content. Soil monitoring would occur on a yearly basis to ensure that irrigation application is appropriate and to manage salt accumulation in soils.

LANDSCAPE PALETTE		
Botanical Epithet	Common name	Form
<i>Acacia greggii</i>	catclaw acacia	Tree
<i>Ambrosia dumosa</i>	burrobush, white bursage	Shrub
<i>Chilopsis linearis var. arcuata</i>	desert willow	Tree
<i>Echinocactus polycephalus</i>	cotton-top barrel cactus	Accent
<i>Encelia farinosa</i>	Brittle bush	Shrub
<i>Encelia virginensis</i>	Virgin River brittlebush	Shrub
<i>Eriogonum deflexum</i>	flat-topped buckwheat	Groundcover
<i>Eriogonum fasciculatum ssp. polifolium</i>	California buckwheat	Shrub
<i>Ferocactus cylindraceus var. lecontei</i>	California barrel cactus	Accent
<i>Hymenoclea salsola</i>	cheesebush	Shrub
<i>Yucca schidigera</i>	Mojave yucca	Accent
<i>Salvia dorrii</i>	desert sage	Accent

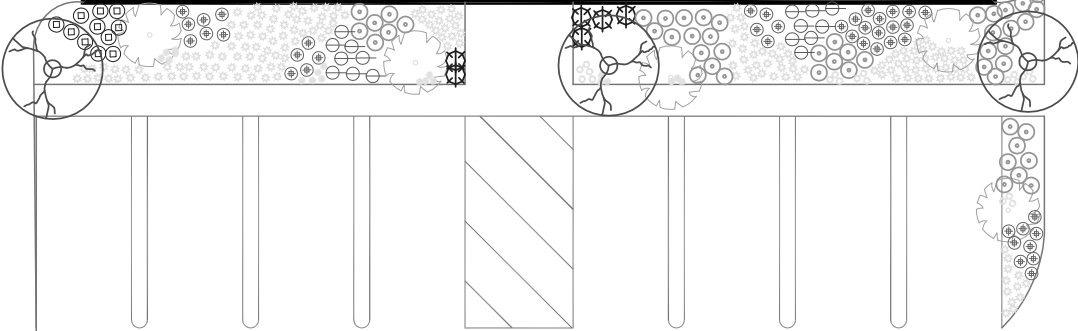
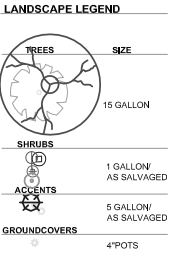

FIGURE 6-1
CONCEPTUAL LANDSCAPE PLAN
AND PALETTE FOR THE
ADMINISTRATIVE/WAREHOUSE
BUILDING
 IVANPAH SOLAR ELECTRIC GENERATING SYSTEM
CH2MHILL

Site Rehabilitation Plan

7.1 Introduction

This section provides the detailed methodology to proposed rehabilitation and revegetation of temporarily disturbed sites at Ivanpah SEGS. The approach presented here is developed on principles provided in the Technical Basis Document (TBD, Appendix D), which is only briefly summarized here. Within each subsection, preliminary background information is presented on the topic, with a subsequent subsection on the proposed protocol, including a numbered list of proposed actions to which the project proponent is committed.

The sections that follow describe soil rehabilitation and plant revegetation tasks that will be performed for temporarily impacted areas (that is, those affected by construction activities). Areas impacted in the long-term (during the life of the solar plant) may receive the same or similar treatments, but precise commitments for long-term impacts will be provided in the *Final Closure, Revegetation and Rehabilitation Plan (Final Closure Plan)*, which will be reviewed and approved by the agencies involved (assumed to be CEC and BLM) prior to final closure and decommissioning (Section 8, Closure, Decommissioning and Rehabilitation, for more detail on this). If a Final Closure Plan is not approved prior to the start of closure activities, then the relevant treatments in this section and elsewhere in this Draft Plan will be followed.

7.2 Soil Rehabilitation

Soil characteristics that must be considered to ensure successful rehabilitation of the site include potential for water and wind erosion; soil structure; potential for water to infiltrate the soil; soil texture; fertility, organic matter; soil organisms; and soil crusts. Because project construction will disrupt the fragile, undisturbed soil environment, surface management during implementation of rehabilitation activities and project operations should be conducted with the goal to speed recovery of native soil functions, by encouraging restoration of soil biological activity and encouraging plant establishment (Bainbridge, 2007).

Soils associated with short-term, temporary construction impacts will be rehabilitated immediately upon completion of construction activities. Areas with temporary impacts include the pipeline construction corridor, lightly graded areas within heliostat fields, and laydown areas (Table 1-4). Long-term impacts to soils that will involve rehabilitation following the approximate 50-year lifetime of each phase of the project include footprints of structures and paved roads, as well as drainage and erosion control features (Table 1-3).

7.2.1 Baseline Condition

Mapped soils on the sites for Ivanpah 1, 2, and 3 are primarily in the Arizo series, which are poorly developed soils with a very gravelly, fine sand texture from a depth of 0 to 8 inches. Subsoils are extreme gravelly sand to a depth of over 60 inches, and calcium carbonate may be present between the 8- to 36-inch depth. Because natural variation occurs within

individual soil map units, soils at the Ivanpah SEGS will be initially characterized to set a baseline with which: (1) soil physical and chemical properties at the end of the 50-year project lifetime will be compared to determine whether soil decompaction or other activities will need to be performed to facilitate rehabilitation; and (2) rehabilitation and revegetation success can be evaluated over time.

7.2.2 Soil Testing/Augmentation

Baseline soil testing to determine reference conditions in the soil will be conducted, with the primary objective to characterize and preserve data on soil conditions prior to disturbance. Additional testing will be limited to compaction tests performed within temporary disturbance areas in support of rehabilitation work; no additional testing beyond this is anticipated to be required as part of soil rehabilitation efforts.

While baseline data on soils will be preserved for the life of the project, initial need for the data is limited to evaluation of compaction results both within undisturbed (baseline) and postconstruction (disturbed) conditions. Substantial deviations from baseline conditions will trigger the need for decompaction. Generally, soil augmentation will be limited to mulch addition; in addition, other types of augmentation will be evaluated as an option during long-term rehabilitation monitoring if revegetation criteria are not being met. Augmentation with fertilizers is generally avoided in native revegetation for the following reasons: (1) nitrogen additions will encourage vegetative growth such that soil moisture could be depleted too early in the growing season and, thus, hinder plant establishment; (2) addition of nutrients reduces mycorrhizal activity; (3) increasing plant nutrients can indirectly increase plant herbivory by making the plant material more attractive as food items; and (4) fertilization can favor weeds over native plants. On the other hand, it may be desirable to add organic matter that has a high carbon to nitrogen (C:N) ratio. Addition of wood chips or mulched woody debris will encourage microbial activity as well as termite activity and, thus, improve soil structure.

Proposed soil testing protocol are provided in Section 7.2.5, Soil Rehabilitation Protocol.

7.2.3 Topsoil Storage

The top 2 inches of desert soils generally contain the majority of seeds, nutrients, biotic crust organisms, and organic matter (Scoles-Sciulla and DeFalco, 2009). Therefore, to facilitate soil rehabilitation and plant reestablishment in temporary disturbance areas, the topsoil will be removed and stockpiled, and then returned to the surface when earthwork is complete. Removal and stockpiling of topsoil can cause changes in soil properties, and care will be taken to limit adverse effects. For example, stockpiling has been shown to reduce organic carbon (especially at the surface), and reduce microbial activity and mycorrhizal inoculum potential for vesicular-arbuscular mycorrhizae (Bainbridge, 2007). Wet stockpiles show a greater reduction of vesicular arbuscular mycorrhizae propagules than dry stockpiles (Bainbridge, 2007); therefore stockpiles will be maintained in a dry condition as much as possible. Nutrients, organic matter, and the seed bank will be diluted if topsoil is mixed with subsoil material, so care will be taken to ensure a minimum thickness of topsoil is removed and stockpiled, and topsoil will not be stored together with subsoil. Long-term storage of soil material generally destroys the seed bank and biological activity (Scoles-Sciulla and DeFalco, 2009). Therefore, long-term stockpiling over the 50-year lifetime of the project will be detrimental with respect to viability of the seed bank, and the practice

will be limited to the soil from temporary disturbance areas created as a result of construction-phase activities.

In those few areas where trenching or ground clearance will be required in the context of LID, prior to topsoil removal, vegetation will be removed by mechanical clearing. To ensure soil function remains as similar to that of undisturbed soils as possible, some plant material will be left unstripped prior to soil salvaging to reduce losses of organic carbon and to maintain healthier microbial communities. For construction of pipelines and other linear features, topsoil will be stockpiled in windrows adjacent to the alignment for ease of replacement once grading activities are completed.

Stockpiles will be sized such that impacts to underlying topsoil are minimized. In general, it is anticipated that topsoil (and subsoil) stockpiles may be placed over uncleared desert scrub to minimize long-term impacts to stockpile footprints. While some damage to vegetation may occur during placement, storage, or removal, impacts will be lesser than with complete clearing for stockpile storage. Stockpile footprints will subsequently be subjected to rehabilitation after soil removal using the same methods and criteria as revegetation areas, but recovery will be expected to be more rapid than completely clearing and stripping areas.

7.2.4 Temporary Construction Impacts

7.2.4.1 Pipelines

Each phase of the project will include installation of gas and water pipelines (Table 1-3). The initial phase will include installation of the main gas pipeline and tap station, with a maximum 50-foot-wide construction corridor for the gas line. Water pipelines will have a maximum 40-foot-wide construction corridor. Where feasible, linear construction corridors will be reduced to minimum width required for trenching, stockpiling, and equipment access. As indicated above, stockpile areas will not be cleared prior to depositing soils to maximize potential for subsequent rapid recovery.

Subsequent pipeline phases will include the installation of gas metering sets along the main gas line that runs from the KGRT tap to the power block of Ivanpah 1, gas lines from the metering set to the power block, and a water supply line.

Pipeline installation for the individual Ivanpah generation units will be in the same corridor as that used for the all-weather access roads to the power blocks; and the service road for the gas line will use the asphalt road whenever they are adjacent to each other. Assuming an open trench construction method is used, preparation of these roadway utility corridors will entail mowing vegetation within the construction corridor and clearing vegetation immediately over the trench and roadway bed. This will be followed by removing and stockpiling topsoil, trenching, installing the pipelines, refilling the trench, and paving the road (or leaving it as a dirt road). Generally, the soil removed will be able to be placed back in the trench. However, any extra subsoil or topsoil will be placed in the cleared areas not taken by the roadway and compacted/decompact to a similar density as undisturbed soils. Once soil replacement and preparation is complete, the temporary disturbance area will be revegetated (see below).

7.2.4.2 Heliostat Arrays

The heliostat fields will consist of concentric linear arrays of heliostats alternately separated by undisturbed habitat and service roads. The majority of Ivanpah 1, 2, and 3 will not be cleared and will remain ungraded. Vegetation will be flail-mowed where necessary but otherwise left in place to the extent possible. After construction and during project operations, shrub height will be managed by mowing or hand trimming.

Access roads and maintenance paths will receive minimal grading, and vegetation clearing only within the direct roadbed itself, if the road is to be paved. Some limited grading within heliostat fields will be implemented to level or contour for individual heliostat or array placement. In general, this will be limited to the most incongruous landscapes, where significant relief is present, such as in landscapes dissected by deep washes. Other areas may receive minor grading for flood control. Areas proposed for grading are shown in Attachment 1, Figure 11, and the areal extent of grading for each phase is provided in Tables 1-1 and 1-2. Temporary topsoil stockpile locations will be immediately adjacent to graded areas, but physically separated from subsoil, which will be used for onsite fill or exported.

Large rocks and boulders will be removed, as necessary, to allow for construction and maintenance access and heliostat placement. Where feasible, rocks and boulders will be moved to immediately adjacent areas and placed in natural patterns to avoid interference with facilities, or they may be crushed and used to stabilize soil in washes. The largest area with rocks and boulders to be removed is in the northeastern 170 acres of Ivanpah 3, with up to 135,000 cubic yards of material to be graded and rocks removed.

7.2.4.3 Construction Logistics Area/Laydown Areas

The CLA is located between Ivanpah 1 and 2 and will be used for staging during construction of all three project phases (see Attachment 1, Figure 19). Other construction laydown areas will be associated with construction of the KRGT Tap Station (0.9 acre) and the construction laydown area for the Ivanpah 1 and 2 metering sets¹ (0.9 acre). These areas will be mowed but not graded.

Following construction, soils may be compacted as the result of equipment traffic and material storage. Compaction can reduce the ability of water to enter the soil and inhibit root growth of plants; and therefore, decompaction may be necessary for successful revegetation. The method of decompaction will depend on how compacted the soil has become following construction of the project, based on test results. For areas that have minor to moderate compaction, a spader will be used. Spaders can reach a depth of about 8 inches (that is, the approximate thickness of the A horizon in the Arizo soils), and can break up the soil without inverting it (Bainbridge, 2007). Where compaction is severe, deep ripping to a depth of at least 24 inches will be implemented. Soil testing and decompaction will be implemented on all temporary disturbance areas as needed, with the extent and method of decompaction determined from soil testing results.

7.2.5 Soil Rehabilitation Protocol

This section provides specific measures to be implemented to provide soil protection and/or rehabilitation on temporarily disturbed soils. In addition to the measures presented here,

¹ Construction of the Ivanpah 3 metering set will use the 50-foot-wide construction corridor for the gas line construction.

additional soil/site rehabilitation measures to capture rainwater are proposed, and described in Section 7.5, Irrigation and Natural Precipitation, including natural catchments and imprinting.

7.2.5.1 Soil Baseline Characterization

A soil baseline characterization will be conducted as described below.

1. A baseline soil characterization will be performed prior to construction-related disturbance on each of the sites, within an area anticipated to receive temporary impacts. A total of one test per 10 acres of disturbance will be conducted and will include the following:
 - a. Profile description of three representative pedons. (A pedon is the smallest three-dimensional sampling unit displaying the full range of characteristics of a particular soil and typically occupies an area ranging from about 1 to 10 square yards [Brady and Weil, 2002]).
 - b. Characterization of surface condition (that is, is desert pavement or cryptogamic crust present)
 - c. Documentation of soil biota (that is, presence of ants, termites)
 - d. Soil texture (that is, percent sand, silt, and clay)
 - e. Bulk density
 - f. Fertility (that is, nutrient status, electrical conductivity, sodium adsorption ratio)
 - g. Organic matter content and total carbon and nitrogen content
2. Physical and chemical properties will be measured on one composite sample obtained by combining subsamples taken from the three representative pedons at each site. Subsamples will be obtained from two depths: 0 to 3 inches and 18 inches.
3. The soil baseline characterization records will be kept on file through the 50-year lifetime of the project.

7.2.5.2 Soil Protection and Rehabilitation Protocol

The following measures will be performed to avoid adverse effects to soils during construction of pipelines, heliostat fields, and construction laydown areas, and to rehabilitate soils to allow for revegetation following completion of construction activities. No construction activities will commence until the area is properly secured to prevent harm to the desert tortoise and the preconstruction activities described in the most recent version of the Draft Desert Tortoise Translocation/Relocation Plan have been implemented.

1. Measures to reduce impacts to soils that are identified in the DESCP (Appendix F) and Construction SWPPP (Appendix C) will be followed. Measures will include appropriate erosion and sediment controls; appropriate storage of chemicals and construction materials; and spill controls.

2. Temporary construction areas requiring soil disturbance (that is, the pipelines, portions of the heliostat fields, and CLA) will be flagged or staked prior to earth disturbance. No construction activities will occur outside the flagged area.
3. Low Impact Design (LID) measures to minimize soil disturbance include minimizing vegetation impacts. Instead of clearing vegetation, the native desert scrub will be left in place wherever feasible; it will be mowed where reduction of height is needed, or driven over without removal where feasible.
4. Subsoil and topsoil stockpile areas will be stored directly on or within existing vegetation. Where necessary because of tall plants or dense vegetation, vegetation will be mowed. Storage and removal of temporarily stockpiled soils will be implemented in a way to minimize damage to vegetation as feasible, such as through use of small, bobcat style equipment or long-armed excavators that operate from the side of stockpile areas.
5. Rocks and boulders that impede site construction and maintenance access or facility placement will be handled as follows, in order of preference, based on practicality: (1) relocated to adjacent areas, where they will be placed in natural, random patterns; (2) placed in drainages for grade control or bank stabilization per design requirements; (3) to an onsite storage location for distribution and replacement after completion of construction or final plant closure; or (4) crushed into gravel for placement on dirt roads to control dust.
6. Woody plant material generated during clearing and grubbing operations will be preserved (windrowed) onsite as mulch for later use in soil rehabilitation of temporary impact areas. Prior to use, windrowed vegetation will be chipped or shredded to a large particle size (1 to 3 inches).
7. Following vegetation reduction, the top 2 to 3 inches of topsoil will be carefully removed by an experienced operator using a dragline, excavator, scraper, or dozer. Topsoil will be removed only from areas where subsurface disturbance will occur (that is, trenched areas), or areas proposed for significant surface disturbance (for example, roads, parking areas). Topsoil will be stored in shallow windrows adjacent to the removal area. Topsoil stockpiles will be kept separate from stockpiles of subsoil material.
8. To minimize impacts to existing vegetation and soil structure in topsoil and subsoil stockpile areas, soil will be stored directly on or within existing native vegetation. Where necessary because of tall plants or dense vegetation, vegetation will be mowed. Storage and removal of temporarily stockpiled soils will be implemented in a way to minimize damage to vegetation where feasible, such as through use of small, bobcat style equipment or long-armed excavators that operate from the side of stockpile areas. Vegetation that breaks off and mixes with topsoil will be left within the topsoil when replaced.
9. Measures will be taken to ensure vehicle traffic over stockpiles does not occur. Topsoil stockpiles will be kept dry during storage by covering with tarps. All stockpiles will be stabilized by spraying with a tackifier (that is, soil stabilizer) or by covering with tarps.
10. Following site clearing, excavation, and facility (for example, pipeline) construction activities, subsoil will be carefully replaced and compacted to achieve a similar bulk

density as native subsoil (that is, soil B or C horizons). For cut and fill areas within the heliostat arrays, care will be taken to achieve soil layering that, to the extent practicable, is similar to that of undisturbed soils (that is, materials conforming to A and B horizons should be layered accordingly).

11. Soil bulk density will be measured following construction completion at the soil surface and at a depth of 18 inches and compared to baseline soil bulk density. If measured bulk density is greater than 1.6 g/cm³ or more than 15 percent greater than the baseline condition at either depth, then soil decompaction will be performed prior to revegetation.
12. If compaction is severe², deep ripping will be performed to a depth of up to 24 inches. Organic material (stored woody plant residue, if available) will be incorporated prior to or during decompaction activities. Following soil decompaction and site preparation, bulk density will not exceed 1.6 g/cm³.
13. For areas that have minor to moderate compaction³ but less than severe (as defined in No. 12), a spader will be used to a depth of up to 8 inches to break up the soil without inverting it.
14. To the extent possible, spading, deep ripping, or other decompaction techniques will avoid creating linear, preferential paths of water movement and revegetation patterns.
15. Following decompaction, the soil surface will be shaped with fine grading to provide small pits, swales, or microcatchments to capture water, as described below.
16. Topsoil will be placed over subsoil to achieve a final thickness of approximately 2 inches at grade. Using appropriate disc or harrowing equipment, soil will be chopped into the subsoil to improve hydraulic connectivity with underlying materials. Topsoil will be compacted to achieve a bulk density similar to the undisturbed surface soils, but in no instance will bulk density be greater than 1.6 g/cm³.
17. Temporary impact areas will be revegetated in accordance with the revegetation procedures described below.

7.3 Plant Materials and Handling

7.3.1 Plant Species Selection

After vegetation and soil disturbance in the Mojave Desert, in the vicinity of the proposed project, even in the absence of human intervention, recolonization by pioneer plant species (in some cases, non-native weeds) typically occurs within a year, and the first successional perennials are usually present within 2 to 3 years. A practical, attainable approach to revegetation at Ivanpah SEGS will be to accelerate the natural successional process by emphasizing seeding of early successional native plants (Appendix D, TBD). This strategy

² Severe compaction is where average bulk density is greater than 15 percent of baseline condition, or bulk density greater than 1.6 g/cm³ occurs to a depth greater than 8 inches; or compaction in the surface soil (top 8 inches) is greater than 2 g/cm³.

³ Minor to moderate compaction is where bulk density is greater than 1.6 g/cm³ but less than 2g/cm³, or within 15 percent of baseline condition; or compaction is limited to surface soils and subsurface bulk density is less than 1.6 g/cm³ or similar to baseline condition.

maximizes the probability of success; it has been used on comparable desert areas. The primary challenge with seeding in the Mojave (and other arid climates) is the highly variable and typically sparse rainfall; additional challenges include seed predation (Appendix D; Bainbridge, 2007). However, if the seedbank persists for some years after sowing, chances of survival until an ample rainfall year occurs are increased.

The plant species most appropriate to revegetation efforts can be identified with the available information on the flora of Ivanpah SEGS. The last 2 years of vegetation surveys are sufficient to identify the native species adapted to ground disturbance present in the area, as well as late successional and climax species; published studies are available to support these determinations. Focused vegetation surveys of disturbed and adjacent undisturbed sites were conducted in April 2009, as reported in Section 3, Existing Site Conditions, and Appendix E, Vegetation Survey and Results. These surveys confirm conclusions about site successional vegetation, and support the selection of successional plant species for seed collection and revegetation. The following sections detail the proposed approach based on this information.

7.3.1.1 Succession after Disturbance

As detailed in the TBD (Appendix D), studies have affirmed a basic feature of vegetation recovery after disturbance in desert environs. After vegetation has been removed from an area, “pioneer species” are the first to establish on the barren ground. In the Mojave Desert, pioneer species typically include weedy, non-native species such as tumbleweed or Russian thistle (*Salsola* spp.), filaree or storksbill (*Erodium cicutarium*), and red brome (*Bromus madritensis* ssp. *rubens*). Native pioneer species include skeleton weed (*Eriogonum deflexum*, *E. inflatum*), plantain (*Plantago jonesii*), and spurge (*Euphorbia albomarginata*). These plants, often annuals, are the first to naturally colonize disturbed sites. Seeds of non-native pioneer species will *not* be included in revegetation seed mixes, and where management is necessary, they will be managed according to the Weed Management Plan (Appendix B). As time passes, additional species naturally colonize disturbed Mojave Desert sites, typically consisting of early-successional perennial species. At Ivanpah SEGS, early-successional perennial species identified during botanical surveys included fourwing saltbush (*Atriplex canescens*), cheesebush (*Hymenoclea salsola*), black-banded rabbitbrush (*Chrysothamnus paniculatus*), and others. These species are ideal candidates for seeding, and will be emphasized in revegetation seed mix.

Species typical of late-successional stages of vegetation succession after disturbance in low desert habitats typically include creosote bush (*Larrea tridentata*), burrobush (*Ambrosia dumosa*), and ratany (*Krameria erecta*) (Appendix D). Because they represent plants that are not as well adapted to disturbed soil conditions, success rates using these plants to revegetate disturbed areas can be expected to be lower, although inclusion of such species in revegetation plans is nevertheless common in the region. For Ivanpah SEGS, it is recognized that these species are less likely to colonize the revegetation sites in timeframes relevant to the site rehabilitation, and they will not be emphasized in the revegetation approach. However, because seed will be partly collected in bulk or opportunistically, some late-successional plants will be included in the seed mix.

An exception to this general pattern of succession might be seen on sites with consistent surface moisture or high groundwater, where the woody perennial Mediterranean tamarisk

or saltcedar (*Tamarix ramosissima*) is often the first to invade after disturbance, and which can also establish dense stands that preclude establishment of any subsequent vegetation types. This is effectively achieved through aggressive competition for light and water resources, altered soil chemistry (that is, increased salinity), and a heavy litter layer that precludes seeds of most other desert vegetation from germinating (Shafroth et al. 2005; Glenn and Nager, 2005; Ryan, 2006). Revegetation sites at Ivanpah SEGS will not have surface or ground moisture suitable to support Mediterranean tamarisk, and this species is not anticipated to be a problem.

These findings and the revegetation approach proposed for Ivanpah SEGS are supported by recent research in success of Mojave desert revegetation efforts. Abella and Newton (2009) provide a review of species performance and treatment effectiveness for various published Mojave Desert revegetation projects. In studies that relied on seeding for revegetation, as proposed at Ivanpah SEGS, creosote bush established in only one of the four sites it was seeded in, and in an apparently very low survival rate within that site. Species that became well established with good survival rates included *Eriogonum fasciculatum*, *Atriplex canescens*, *A. polycarpa*, and *Ambrosia dumosa*. Cheesebush was apparently not included in seed mixes in any of the studies. Failure of creosote bush seeding was generally attributed to restrictive germination and seedling survival requirements, which are rarely met in natural communities, and even less in disturbed environments.

7.3.1.2 Plant Species and Genetic Diversity

Promoting species diversity in the revegetation approach has various benefits, such as: (1) different species are adapted to slightly different microsites and physical conditions; (2) plant community stressors, such as periods of excessive drought, could affect different species with differential survival; and (3) greater diversity can provide a more acceptable visual landscape and promote more suitable wildlife habitat. A wide range of perennial and annual plants were identified in the Ivanpah SEGS botanical surveys, as reported in the AFC (CH2M HILL, 2007). Promoting genetic diversity within species is also important to ensure seed supply reflects individual plants adapted to the range of soil and site conditions (Bainbridge, 2007). Therefore, seed collection from many well-dispersed parent plants is necessary.

7.3.1.3 Local Ecotypes

The use of seeds from onsite or adjacent lands or from the nearest vendor providing locally harvested seeds is important, because seed from distant or unidentified sources could have genotypes that are less likely to survive conditions on the site (Bossard et al., 2000; Bainbridge, 2007). To achieve this objective on remote revegetation sites like that at Ivanpah SEGS, it is often necessary to collect local seed specifically for the project or contract with a seed vendor. Seed should be collected within 25 miles of the site and at similar elevations and conditions as those found at the Ivanpah SEGS project area.

7.3.1.4 Selected Plants for Seeding

Seed collection will be performed in support of the Ivanpah SEGS project. This will be conducted by contract with a native seed collection company, according to the project owner's specifications. Seed will be collected primarily from individual plants, but may be augmented on an opportunistic basis from bulk seed deposits, such as in depressions or other natural catchments. As a result, the seed collection will have a built-in diversity.

However, collection will occur, both at individual early-successional perennial shrubs, or adjacent to plant communities that have a high proportion of early-successional perennial shrubs. Some additional late-successional species may also be collected, where seed production is substantial and easily collected, or where ready opportunities are identified during seed collection efforts.

Species targeted for collection and, therefore, revegetation, are described in Table 7-1. These species have a diverse array of growth forms, and are generally disturbance-adapted plant species. These represent target species identified for seed collection; however, the ultimate seed collection will be highly dependent on availability and ease of collection during collection periods.

TABLE 7-1

Seeds Targeted for Collection in Support of Revegetation, Ivanpah SEGS

Scientific Name	Common Name	Normal Successional Stage	Remarks
Perennials (Shrubs 1 to 3 feet tall at Maturity)			
<i>Ambrosia eriocentra</i>	Wooly bursage	Early	A late-successional shrub often codominant with creosote bush in desert scrub communities. It is included here because it produces profuse seeds that are easy to collect, and some establishment in disturbed communities may be achieved.
<i>Atriplex canescens</i>	Four-wing saltbush	Early – late	Disturbance-adapted, versatile species. Saltbush is adapted not only to disturbed soils and, therefore, a robust early-successional species, but (as its name implies) it is also adapted to poor-quality soils high in sulfates and chlorides.
<i>Crysothamnus paniculatus</i>	Desert rabbitbrush	Early	A successional shrub common in the washes of the area.
<i>Eriogonum fasciculatum</i> ssp. <i>polifolium</i>	California buckwheat	Early – late	Found throughout the proposed project site.
<i>Hymenoclea Salsola</i>	Cheesebush	Early	A common disturbance-adapted species on the project site. Dominant or codominant in all disturbed sites surveyed in Ivanpah Valley.
<i>Salazaria mexicana</i>	Bladder sage	Early – mid	An early to mid-successional shrub common in washes.
Annuals or Short-Lived Biennials (a few inches to 2 feet tall)			
<i>Baileya multiradiata</i>	Desert marigold	Early	Provides showy flowers early in its life cycle.
<i>Camissonia boothii</i>	Primrose; woody bottlewasher	Early	Depending on availability and cost, may be desirable.
<i>Eriogonum deflexum</i> ; <i>E. inflatum</i>	Flat-topped buckwheat; desert trumpet	Early	Several potentially suitable annual species of buckwheat occur onsite; all are disturbance adapted.
<i>Lepidium lasiocarpum</i>	Modest peppergrass	Early	A common annual of the Mojave Desert.
<i>Plantago insularis</i>	Plantain	Early	Grass-like species, propagates well on disturbed soils, often less costly than many other species

Notes:

Seeds of these species will be in addition to those contained in the conserved topsoil to be respread back across the site and those that will be dispersed naturally to the site over time from offsite sources.

7.3.1.5 Selected Plants for Transplanting

Attempts at transplanting desert plants have often met with unsatisfactory results. Even when supported by the extensive research and testing facilities at Castle Mountain Mine, transplant success was reported as very low and generally ineffective (Bamberg Ecological, 2006). Even efforts initially reported as successful were clouded by later reports of high mortality after several years of monitoring. However, because of their ecophysiological adaptations, transplanting succulents can be quite successful. This includes barrel cacti (*Echinocactus*; *Ferocactus*) and various species of cholla and prickly-pear (*Opuntia*), which establish well from individual joints and pads. These transplants can be especially advantageous in acting as “nurse plants,” that is, grown plants in revegetation areas that provide beneficial modifications to the microclimate, such as shading or wind protection, which can enhance establishment of seeded plant species (Kigel, 1995).

Yuccas (*Yucca schidigera*) are also often transplanted on desert restoration sites. They are a common element of the flora at Ivanpah SEGS, occurring in much higher densities than barrel cacti. However, survivorship is notably reduced in yucca transplants compared to other succulents, and the costs may be much higher (Bainbridge, 2007; Bamberg Ecological, 2006). At Castle Mountain Mine, transplanted *Yucca schidigera* mortality within 3 years after planting was reported from 30 to over 50 percent. Subsequent years saw higher mortality rates, and in the end, the transplant program for yuccas was not considered successful (Bamberg Ecological, 2005; Bamberg Ecological, 2006). In a study reported by Abella and Newton (2009), double-transplanted *Y. schidigera* had survival rates of only 39 to 53 percent over the limited (2-year) monitoring period; rainfall was potentially above average for the study period. For these reasons, salvage of yuccas is not proposed for the Ivanpah SEGS project.

Transplanting of succulents is proposed on Ivanpah SEGS revegetation sites, as described in more detail in Section 4.

7.3.2 Seed and Native Stock Collection and Storage

7.3.2.1 Seed Bank Protection

In temporary disturbance areas at Ivanpah SEGS, the existing seed bank will have a substantial contribution to successful revegetation. This seed has advantages over subsequently sown seed in that it has originated locally, and is best adapted to the local microclimate and site conditions; and secondly, it has resided in the topsoil and/or litter for some unknown period of time, during which seed dormancy may have been broken.

However, soil disturbance is likely to excessively disrupt the position of seeds in the soil column, and seed buried at depths greater than 2 to 3 centimeters might not emerge (Kigel, 1995). Measures have been proposed for vegetation windrowing, which will capture seed still on the plant, and topsoil salvage and banking, as described above. These measures will, to some extent, preserve at least a portion of the seed bank intact.

7.3.2.2 Seed Supply

Production of native seeds is highly cyclical, depending largely on annual precipitation timing and amount, but may be affected by other factors such as untimely storms during pollination (Bainbridge, 2007). However, in general, soil moisture is the limiting factor in desert ecosystems, and will ultimately determine the extent to which: (1) annual plants

germinate; (2) germinated plants mature to produce fruit and set seeds; (3) perennial plants produce fruit and set seed; and (4) seed crop is productive and viable (Delph, 1986; Kigel, 1995). For optimal seed collection of perennials, a relatively wet rainy season will result in higher seed production. However, even a single, large rain occurring during late fall or early winter can result in annual germination and seed production; however, soil moisture must persist long enough for plants to mature and set seeds. When plants are able to germinate earlier in the normal germination season (fall and winter), they generally produce a higher seed crop (Narita, 1998; Kigel, 1995). However, if heavy rains occur too early in the fall, and annual plants respond by germinating, they can be vulnerable to subsequent heat and desiccation.

Because it requires responding to precipitation events that are not effectively predictable, advanced planning of seed collection will be required to ensure early and continuous seed collection, as needed, up to the time of planting. A seed collection program will be initiated as soon as the CEC license and BLM grant are received, and continue through until revegetation seed broadcast is complete. This will allow for some variation in annual seed production while still ensuring a robust collection. If sufficient seed are not recovered prior to the start of ground disturbance of areas that will need to be restored first, the collection area will be expanded to the surrounding area until sufficient seed quantity has been collected.

7.3.2.3 Seed Viability and Testing

Seed production can vary widely in both quantity and quality, and seed viability may show enormous variability depending on the year of collection (Bainbridge, 2007). Quality of seed collected is also influenced by the maturity at collection, which must be closely monitored. Seed production, quality, and maturity should be monitored ahead of and throughout the collection season to ensure collection is valuable. Ongoing testing will be performed as collections are obtained (for example, cut tests, described below), to gauge maturity and viability of seed. Testing may include the following (Bainbridge, 2007):

- Filled seed percentage will be conducted by cut tests, where a sampling of seeds is cut open and inspected for seed filling, maturity, or insect damage. Cut tests must include comparisons with data on expected filled seed percentages per species.
- X-ray evaluation will provide information on filled seed percentage, insect damage, physical damage, and potentially tissue condition and maturity. X-ray evaluation is generally performed by skilled technicians familiar with wild seed evaluations.
- Seed weight, purity, and germination analysis are typically performed on commercial seed, and include the 1,000-seed weight, purity (proportion of seed to impurities such as chaff, other seed species, and debris), and percent germination. Germination tests must be performed by skilled technicians familiar with the challenges of germinating arid land seed.

7.3.2.4 Seed Collection

Seed collection will be initiated as soon as the CEC license and BLM grant are received, or at least 2 years prior to ground disturbing activity, as needed to ensure adequate collection quantities, and will continue until adequate seed has been acquired for site revegetation, or until revegetation is complete. Seed collection is intended to support all revegetation efforts,

including temporary disturbance areas where reclamation and revegetation will occur after construction is complete, but during continued facility operations, or reclamation and revegetation upon site closure and decommissioning. Long-term seed storage (that is, greater than 5 to 10 years) is not proposed; rather, seed will be collected only far enough in advance to ensure availability at the time of seeding requirements based on concluding construction or initiating closure plans.

The seed to be collected will be of local origin, collected preferably at the site, but no farther than 25 miles from the Ivanpah SEGS project area, and at similar elevations and vegetation conditions. Under the following conditions, seed will be collected directly from the Ivanpah SEGS project area before site disturbance: (1) appropriate early successional species are available within the proposed disturbance area; and (2) seeds from these species meet collection criteria—specifically, criteria on filled seed percentage and maturity, to be developed per species and as described in Section 7.5.3, Protocol for Seed Collection and Storage.

A seed “collection” will represent seed collected from a single “collection area” (generally defined to be no more than a 0.25-mile radius) on a single day. Mature seed will be collected from healthy, robust stands. To increase genetic diversity, no more than 10 percent of each collection will come from an individual plant. Bulk seed (that is, accumulated in depressions or at the base of shrubs) will also be collected, focusing on locations where a high proportion of early-successional native plants are present and seed is sufficiently mature. The plants targeted for direct seed collection are listed in Table 7-1.

To avoid overharvest of a specific area, no more than 40 percent of seeding plants in a collection area will be harvested. A collection area will only be harvested one year for the duration of the collection effort. Each collection area will be visited as frequently as necessary during the seed production period of the year, staying within these specified parameters. Access to collection areas will be via open, well-traveled routes, or on foot, with no cross-county vehicle travel. The only exception to these access limitations will be for seed collections within the Ivanpah SEGS construction areas proposed for vegetation clearing within a 2-year period following seed collection. In these areas, no limits to the amount of seed or method of seed collection will be placed on seed collection efforts, because all vegetation will be removed during construction, and maintaining natural seed stock for a self-perpetuating plant community will not be necessary. However, the limits of these areas will be flagged prior to seed collection efforts. Total quantity of anticipated seed for temporary revegetation areas is provided below in the section on Seed Quantity.

Diversity will be achieved in the seed mix by collecting bulk seed from locations where it accumulates, such as depressions or at the base of shrubs. Additional seed, which is easy to collect, may be added from late-successional species, such as burro bush. Site characteristics and seed-lot tracking will be performed, including notes on collection date, dominant species, stand conditions, and expected species composition of seed. Seed will not be collected from areas with noxious weeds present, unless collected directly from native plants in the area. Bulk seed will be handled, processed, and applied independent of single-species seed collections, as described in sections that follow.

7.3.2.5 Seed Processing

Cleaning, dewinging, and upgrading seed before storage can: (1) reduce weight and bulk, (2) improve storage life, and (3) increase germination. Seed processing may include removal of leaves, twigs, and other debris, and rubbing seed to free it from the fruiting structure. Sieving seed can separate debris. Commercial threshers, dehullers, and harvesters are available (Bainbridge, 2007). Seed processing for single-species lots will be implemented by skilled technicians knowledgeable about individual species requirements, because some treatments can damage seed.

Native seed vendors who are familiar with native, wild desert seed collection will be contracted to collect, process, and store seed for the Ivanpah SEGS project.

Bulk seed collections will not be processed. These collections will be applied as collected and as available in addition to single-species seed quantity specified in this Plan to increase diversity, and add additional litter and debris to the seed application.

7.3.2.6 Native Seed Vendors

Native seed vendors will be contracted to collect seeds as specified in this Plan. Under this Plan, federal certification content of seed will be negotiated to include, at a minimum, collection location, collection date, and approximate seed content by species, purity, germination, origin, test data, and net weight (as pure live seed). Seed must contain a zero percent noxious weed seed to be acceptable. Tests performed by vendors will be specified in contract documents, and are outlined in sections to follow.

Native seed vendors that may serve this project are provided in Table 7-2. Vendors will be brought under contract so that collection can begin once the project obtains a license from the CEC and a ROW grant from BLM, ideally at least 2 years prior to ground-disturbing activities. Vendors will be responsible to ensure appropriate permitting for seed collection on BLM land within the Ivanpah SEGS site, or other public and private lands in the area. Vendors will be responsible for handling, processing, and storing native seed per the requirements of this plan.

7.3.2.7 Seed Quantity

Table 7-3 provides a preliminary seeding plan on a per acre basis for temporarily disturbed areas, and provides estimates of quantities of seed that will be applied to meet target application rates. Where bulk seed is collected, it will not be distinguished by species, nor cleaned or processed, but it will be used to augment single-species seed quantity as previously discussed to increase diversity.

Based on seeding rates of 22 lbs/ac, total anticipated seed required for temporary disturbance areas is provided in Table 7-4. This represents a preliminary estimate and will be revised based on final impact acres and seed availability.

TABLE 7-2
Native Seed Vendors Potentially Servicing the Southwest United States

Company	Name	City	State	Web Site
	Constance Vadheim	Redondo Beach	CA	www.nativeseednetwork.org/viewuser?id=10696
Arkansas Valley Seed	Richard Avila	Denver	CO	avseeds.com
Armenta Seed	Ray Armenta	Gilbert	AZ	
Autumn Seeds, LLC	Roger Williamson	Spokane Valley	WA	www.autumnseeds.com
Clearwater Seed	Mark Mustoe	Spokane	WA	
Comstock Seed	Ed Kleiner	Gardnerville	NV	www.comstockseed.com
Detwiler's Native Grass Seed Co.	Joe Detwiler	Bonham	TX	
Granite Seed Company	Daryle Bennett	Lehi	UT	www.graniteseed.com
Great Basin Seed	Jason Stevens	Ephraim	UT	www.greatbasinseeds.com
Intermountain Seed Co.	Eric Christensen	Ephraim	UT	
Los milagros de Lara	A. Subero	Loxahatchee	FL	
Mimbres Valley Sweetwater Farms	Brooke Feldman	Mimbres	NM	
Native and Xeric Plants	Stew Churchwell	Emmett	ID	www.nxplants.com
Native Seed Network	Rob Fiegner	Corvallis	OR	
Noorani Seeds	Usman Hayat	Hyderabad Sindh, Pakistan		www.nooraniseeds.com
RECON Native Plants	Ryan West	San Diego	CA	www.reconnativeplants.com
Seeds Trust, High Altitude Gardens	Bill McDorman	Cornville	AZ	seedstrust.com
S&S Seeds	Jodi Miller	Carpinteria	CA	www.ssseeds.com
Stevenson Intermountain Seed, Inc.	Ron Stevenson	Ephraim	UT	www.stevensonintermountainseed.com
Stock Seed Farms, Inc	John Shipp	Murdock	NE	www.stockseed.com
Stover Seed Company	Stephen Knutson	Los Angeles	CA	www.stoverseed.com

Source: <http://www.nativeseednetwork.org/>

TABLE 7-3
Preliminary Seeding Plan for Ivanpah SEGS, Temporarily Disturbed Areas

Scientific Name	Common Name	Bulk lbs/ Acre	~Live Seeds/ Bulk lb	Total Live Seeds/Acre	Total Live Seeds/m ²
<i>Ambrosia eriocentra</i>	Wooly bursage	2	30,000	60,000	14.8
<i>Atriplex canescens</i>	Four-wing saltbush	10	26,000	260,000	64.2
<i>Crysothamnus paniculatus</i>	Desert rabbitbrush	1	65,000	65,000	16.1
<i>Eriogonum fasciculatum ssp. polifolium</i>	California buckwheat	3	35,000	105,000	25.9
<i>Hymenoclea Salsola</i>	Cheesebush	6	35,000	210,000	51.9
TOTAL		22		700,000	173.0

TABLE 7-4
Construction Disturbance Areas at Ivanpah SEGS and Preliminary Estimated Seed Requirements

Project Component/ Phase	Temporary Disturbance (Reclamation within 5 Years, Acres)	Seed Requirement for Temporary Impact Area (Total Bulk lbs)*	Long-term Disturbance (Reclamation after Decommissioning, Acres)	Seed Requirement for Long-term Impact Area (Total Bulk lbs)	TOTAL AREA (Temporary + Long-term)	TOTAL SEED
KRGT Line Area	2.67	59	0.90	20	3.57	79
Ivanpah 3	400.33	8807	277.64	6108	686.50	14915
Ivanpah 2	129.43	2848	184.27	4054	314.56	6901
CLA	298.07	6558	53.18	1170	388.10	7727
Ivanpah 1	1.37	30	182.19	4008	183.56	4038
TOTAL	831.88	18301	698.17	15360	1576.30	33661

* Assumes seeding rate of 22 pounds per acre.

7.3.2.8 Seed Storage

The seeds of many native plants can lose their viability quickly if they are not stored under controlled conditions. Because seeds are hygroscopic (that is, they pick up and release moisture from the air), their moisture content can increase to a point where they are vulnerable to storage fungi or mold. Seed moisture content of 10 percent or less is preferred (Elias et al., 2002) and can be achieved by drying seed and maintaining low storage temperature and relative humidity. Seeds in storage must also be protected from rodents and insect pests, such as weevils.

Seed for Ivanpah SEGS will be dried to less than 10 percent moisture using air flow methods with no heat (Bainbridge, 2007), and stored immediately in seed storage units, which may include walk-in freezers or temperature and humidity controlled rooms or vaults. Seed should not be frozen unless first dried. Seed should be stored in sealed containers to keep out insect pests. Native seed vendors will be responsible for appropriate seed storage in compliance with contract documents.

Dormancy is common in the seeds of many native species. Specialized methods, or specific storage conditions, are often necessary to break seed dormancy effectively. This can be complicated by year-to-year and plant-to-plant variation.

The seed storage approach at Ivanpah SEGS will include packing seeds in sealed containers and storing in temperature and humidity controlled seed storage units until 2 months prior to use. Prior to use, seeds will be relocated to mesh covered containers to keep insects out, stored within rodent proof cages. These will be placed at ground level at the actual revegetation sites in an effort to break dormancy. Bulk, unprocessed seed collections will be stored using same methods for single-species seed collections.

Long-term seed storage (that is, greater than 5 to 10 years) is not proposed; rather, seed will be collected only far enough in advance to ensure availability at the time of seeding requirements based on site development or closure plans.

7.3.3 Protocol for Collection and Storage

7.3.3.1 Seed Collection

1. Seed collection will be implemented as soon as the CEC license and BLM grant are received or a minimum of 2 years prior to ground disturbing activity; and continue until adequate seed has been acquired for site revegetation, or until revegetation is complete. Adequate seed quantity is based on Table 7-4.
2. Seed of local origin will be collected within 25 miles of the Ivanpah SEGS project area and at similar elevations and vegetation conditions. Seed will be collected directly from the Ivanpah SEGS project area before site disturbance where conditions permit.
3. The contractor will define a seed "collection" to represent seed collected from a single "collection area" (generally defined to be no more than a 0.25-mile radius) on a single day and label as such.
4. To avoid overharvest of a specific area, no more than 40 percent of seeding plants in a collection area will be harvested. A collection area will only be harvested 1 year for the duration of the collection effort. Each collection area will be visited as frequently as

necessary during the seed production period of the year, staying within these specified parameters. The only exception will be for seed collections within the Ivanpah SEGS construction areas proposed for vegetation clearing within a 2-year period following seed collection. At these locations, there will be no limits on overharvest because vegetation will be removed during construction.

5. Access to collection areas will be via open, well-traveled routes, or on foot, with no cross-county vehicle travel.
6. Contractor will collect mature seed from healthy, robust stands. To increase genetic diversity, collect no more than 10 percent by weight of each collection from an individual plant.
7. Contractor will collect from a minimum of 20 collection areas.
8. Contractor will collect single-species seed, focusing on locations where a high proportion of early-successional native plants (Table 7-1) with sufficiently mature seed are present.
9. Contractor will collect additional seed from directly beneath plants or collect bulk seed to increase diversity from locations where it accumulates, such as depressions or at the base of shrubs.
10. Contractor will opportunistically collect high concentrations of ripe seed from native annuals or perennials, where available, while collecting target successional species.
11. Contractor will perform site characterization and seed-lot tracking, including notes on collection date, collection location, elevation, dominant species at location, stand conditions, approximate seed content by species, purity, germination, origin, test data, and net weight (as pure live seed).
12. Contractor will not collect from areas with noxious weeds present, unless collected directly from native plants in the area.

7.3.3.2 Seed Testing

1. For single-species collections, Bright Source Energy will develop criteria for filled seed percentage based on literature review, preliminary field findings, and independent review for each species. Criteria will be standard for seed collections, and collection quantity will be adjusted appropriately where filled seed percentage criteria are not met.
2. For single-species collections, contractor will sample and perform field tests prior to and during seed collection. Field testing will include the following:
 - Filled seed percentage conducted by cut tests, sampling a minimum of 50 seeds from each species at each collection area; all results per seed collection will be documented and reported.
 - Seed maturity conducted by field observations and cut tests. All results per seed collection will be documented and reported.
3. For single-species collections, contractor will sample and perform laboratory tests on each seed collection to document seed weight (1000-seed weight), purity, and

germination. A minimum of 1 percent of each collection will be sampled by weight, by species, and by randomly selecting a minimum of 3 samples from each collection. All results per seed collection will be documented and reported.

7.3.3.3 Seed Processing

1. For single-species collections, contractor will clean seed of leaves, twigs, and other debris; free seed from fruiting structures, and sieve seed as appropriate for individual species of seed, and to do so in a way that does not damage seed.
2. Bulk seed collections are not to be processed.

7.3.3.4 Seed Storage

1. After collection and processing, Contractor will dry seeds using forced air and no heat, to a moisture content of 10 percent or less, and store in airtight storage containers.
2. Contractor will store seed in a temperature-controlled seed storage unit until 2 months prior to sowing at a constant temperature of 55°F or less and a controlled relative humidity (RH) of 45 percent or less.
3. If seed storage is required for more than 1 year, storage temperature will be reduced to 50°F or less, and RH will be reduced to 40 percent or less.
4. Prior to sowing, seeds will be relocated in paper bags, stored within nylon mesh (for example bug netting, nylon stockings) and rodent-proof cages. Seeds will be stored at ground level at the site of revegetation for a minimum period of 2 months in an effort to break dormancy. Within storage cages, seed lots will be covered with burlap.
5. Bulk seed collections will be stored identically to single-species seed collections.
6. Seeds will be stored a maximum of 10 years; seed stores will be replenished based on anticipated need thus precluding the need to store beyond 10 years.
7. Salvage plant storage is addressed in Section 4, Native Plant Salvage and Reuse.

7.3.4 Propagation

7.3.4.1 Germination

Germination is the most vulnerable phase in plant development, representing the risky transition from seeds, which are the most resistant to drought and temperature extremes, to seedlings, which are the most sensitive. Hence, complex adaptations have developed in plants to regulate germination in arid environments (Kigel, 1995). This ensures that when germination occurs, there is likely to be ample soil moisture to support the developing plant, and temperatures will be favorable to plant growth. In desert annuals, a successful germination strategy will lead to rapid flower and seed production. In perennials, this strategy will lead to better chances of seedling survival and long-term plant establishment.

Mass germination occurs only after a certain threshold of precipitation occurs (effective rain), and typically in desert environments, that can vary depending on microtopography, substrate permeability, and evaporation. Rain events less than the needed threshold can result in patchy germination, primarily where runoff has collected. Multiple mass germination events can occur throughout the season if episodic rain events occur, resulting

in different cohorts of developing plants. Generally, early germinants will have a competitive advantage, unless an extended drought period occurs after the early-germination effective rain, in which case, high mortality could occur among early germinants (Kigel, 1995).

7.3.4.2 Dormancy

Moisture availability is not the only factor in determining germination of seeds in arid areas. Seeds of arid land plants often have an inherent dormancy and will not germinate even in a controlled setting until that dormancy is broken. Dormancy can be either intrinsic to the embryo, or imposed by the coat of the seed or the dispersal mechanism (Kigel, 1995). It can result from chemical inhibitors that are released upon initial seed hydration, but could take additional water to ultimately leach away. Mechanical or physical barriers can also be imposed by the seed or dispersal mechanism coat that: (1) prevent embryo growth or root elongation, (2) are impermeable to water or gases, or (3) release chemical inhibitors (Kigel, 1995).

Because multiple dormancy mechanisms are often present, methods for breaking dormancy can be complex and are commonly species-specific. Chemical inhibition to germination can often be broken by repeated leaching (Bainbridge et al., 1995; Kigel, 1995); however, this could also be affected by seed age, which plays a role in breaking physical dormancy. Changes in the physical environment, such as temperature or photoperiod changes (termed stratification), or physical alteration of the seed coat (scarification), can play a critical role in releasing dormancy in some desert plants (Bamberg Ecological, 2005).

Rinsing seeds prior to seeding to remove inhibiting chemicals is a commonly used practice to improve germination success rates for some species. Rinsing is particularly effective for creosote to remove inhibiting chemicals (Bainbridge et al., 1995). Scarification can be achieved by physically roughening seed coats by tumbling with sand, or chemically attacking seed coats with compounds such as sulfuric acid. Stratification can be achieved by storage under cold-moist or warm-moist conditions. Requirements of some seeds may include remaining in the soil for 1 or more years before they are able to germinate (Bamberg Ecological, 2005). Capon and Van Asdall (1967) found that annuals native to the Mojave and Sonora deserts reached maximum germination when subjected to up to 5 weeks of higher temperatures (122°F) prior to planting. Daily temperature fluctuations are reported as an important requirement for breaking dormancy in arid and semi-arid species of hard-seeded annuals (Kigel, 1995).

Because seed will not be irrigated in the field, but left to germinate with natural precipitation, dormancy may be broken by natural conditions after sowing. The targeted early-successional species tend to have less rigorous requirements for breaking dormancy than late-successional species (Bamberg Ecological, 1995). Treatment implemented on seed supplies to break dormancy will include: (1) storing seeds in the field prior to sowing to affect a natural warm and cold regime, which may result in stratification; and (2) sowing seeds in the fall when field conditions should be optimal to break dormancy naturally.

7.4 Applicable Planting Techniques

The seeding techniques discussed in this section are restricted to those that will be applicable at the Ivanpah SEGS. Other techniques are not discussed. For example,

hydroseeding is rarely used in desert restoration; Bainbridge et al. (1995) strongly discourage its use for any desert revegetation, primarily because precipitation or irrigation must follow seeding, or the pre-soaked seed will fail. In addition, large quantities of water are needed. These are consistent with the findings of other desert revegetation studies.

7.4.1 Seeding

Relative to other project costs, seed is a small component, and seeding rates should be high to account for the potential for poor germination as well as predator loss. Specific challenges with seeding and appropriate remedies to those challenges are summarized in this section.

A major drawback of seeds is that they are very vulnerable to predation from mice, birds, and seed-eating insects. Up to 95 percent of seed sown can be expected to be lost to predation prior to germination and establishment. Ants, in particular, are a significant factor in the loss of seeds prior to germination in the Mojave (Anderson and Ostler, 2002). A possible approach to reducing ant predation is to apply cracked wheat to the soil surface prior to seeding so the ants are satiated; however, where germination relies on natural rainfall, this method might not be effective because it could be a period of one or more years from seeding to germination (Bainbridge et al., 1995).

Compensating for variability in annual rainfall by ensuring seed are persistent once sown increases chances of germination. Effective rainfall events might not occur every year, but chances substantially increase over a 2- to 3-year period. Ensuring seed persistency requires reducing predation by burying seed, which can be achieved by dragging seed with a light drag or drilling seed with a rangeland seed driller. While buried seed may also be predated, it is likely to persist at greater rates than surface seed. Surface seed not predated by ants can be collected by wind in basins and depressions, where if discovered by rodents, it becomes a concentrated resource visited continuously. Kangaroo rats (*Dipodomys* spp.) are adapted to exploit concentrated seed collections (such as shedding plants or seeds collected in depressions). Alternatively, pocket mice (*Perognathus* spp.) are better adapted to sift surface soils for shallowly buried seeds.

The low cost of a seeding approach relative to vegetative container-grown plants will be, at least partially, offset by the lower expected success rate. It takes many seeds to result in one plant seedling. For most species, seeding rates of 100 to 500 seeds per square meter are recommended (Bainbridge et al., 1995; Bainbridge, 2007).

Most desert seeds under natural conditions are located at or near the soil surface. As many as 80 or 90 percent of the seedbank is within 2 centimeters of the soil surface with many located within millimeters of the surface or in surface litter. Seedlings of many desert annuals cannot emerge from depths greater than 1 centimeter, and desert shrubs usually do not emerge from depths greater than 4 centimeters (Kigel, 1995). These data are important in planning seed broadcasting. However, the depth of seed placement must be balanced against the risks of predation.

Typical seed application methods are summarized in the following sections.

7.4.1.1 Imprint Seeding

Placing seeds in a pattern of small mechanically created depressions is a potentially useful technology for areas with finer textured soils. Seeds remain trapped in depressions, which

subsequently capture water during rainfall events or irrigation. Imprinting is not useful on loose and sandy soils, where erosive forces may quickly relevel the surface (Bainbridge et al., 1995). Imprinting may be most effective in areas where infiltration is limited by surface crusts and areas with summer and winter rains (Bainbridge et al., 1995).

Imprint seeding is not proposed for Ivanpah SEGS, primarily because imprinted seed is still exposed to surface predation, and seed might not persist over the long time periods that may be required for natural germination. Imprint seeding was successfully used during revegetation efforts at Edwards Air Force Base, but irrigation was used in that effort (CH2M HILL, 2006). However, post-seeding imprinting is proposed in limited instances at Ivanpah SEGS to increase water retention.

7.4.1.2 Broadcast Seeding

Broadcast seeding can be a viable approach for desert restoration. Seeding can be distributed by hand, by manual wheeled devices, or by seeding equipment. On large sites, seed has also been aerial broadcast by cropdusters (Bainbridge et al., 1995). An implement that can lightly disturb the soil surface is needed after seeding for incorporation (covering the seeds with soil). One example of equipment effective at incorporating seed is a drag consisting of a flat framework supporting small tines that disturb the soil. Seeding rates should be 50 to 100 percent higher for broadcast as compared with drill seeding because predation losses tend to be greater for broadcast seed than for drilled seed (Bainbridge et al., 1995).

7.4.1.3 Rangeland Drill Seeding

A rangeland drill is a seeding implement designed to open a slot in the soil, place seeds in the slot, and firmly cover the seeds with soil. Rangeland drill seeding is effective on relatively level terrain; but debris and rocks could be problematic, and a rangeland drill might not operate in rough or rocky terrain. In addition, resulting seeding may be in rows when germination occurs, and may not appear natural. The appearance of rows diminishes with time. Using multiple seed bins on the drill may be required to accommodate differences in seed characteristics.

7.4.1.4 Pitting and Seeding

Bainbridge (2007) described sowing seeds in pits as a means to improve germination and seedling establishment. Pits can be created with machinery designed for the task, or by hand. Pit size varies depending on the equipment, but may be from a few to 8 inches deep, and up to 16 inches square. Seed is sown directly into each pit, and mulch or other material can be placed into the pit to increase moisture retention. Pits have been created by modified disk plows, and specialized equipment is also available that both pits and seeds simultaneously (for example, the Kimseed camel pitter-seeder).

Limitations to this approach are comparable to imprintin – that is, seed is not buried during the pitting process, but is left exposed (or covered with light mulch) in the bottom of the pit. Unburied seed runs the highest risk of predation. It is not proposed at Ivanpah SEGS, because the approach of waiting for natural precipitation to germinate seed requires seed persistence.

7.4.2 Mulch

Distribution of mulch after or during seeding allows for protection of the soil surface from erosion, could provide some seed protection, and may enhance water infiltration and retention (Bainbridge, 2007). While weed-free certified mulch is available from commercial vendors, the recommendation for Ivanpah SEGS is that mulch be shredded from existing windrowed vegetation or mowed vegetation from the heliostat fields. This material will potentially be supplemented with commercial products with high carbon to nitrogen ratios (C:N), as excess nitrogen can favor weed growth. Suitable products may include barley or wheat straw, rice hulls, wood chips, corn cobs, or bark. Only weed-free certified products from commercial vendors will be used, and only if material collected from onsite sources is substantially insufficient in quantity. Between 10 and 20 cubic yards (cy) of mulch per acre (approximately 0.5 to 4 tons per acre of dry mulch, depending on product) represents a light mulch application with scattered coverage that will collect in depressions or rough spots, appropriate for desert applications where mulch degrades slowly. Mulch applied at this rate will be expected to collect in pockets of low soil along with seed, and where water will also concentrate after rain events, maximizing potential for resource conditions that will promote vegetation establishment. Table 7-5 provides data on bulk density of select mulch products.

TABLE 7-5
Mulch Material Bulk Density Measurements

Product	Material Moisture	Bulk Density (lbs/cy)	Bulk Density (cy/ton)
Alfalfa hay	Low	202	9.9
Hop straw	Low	60	33.0
Wood chips	~30%	424	4.7
Cereal straw	Low	60	33.0
Shredded paper	Low	60	33.0
Newsprint	Low	220	9.1
Sawdust/shavings	~40%	424	4.7

Source: Granatstein et al., 2002

7.4.3 Container-grown Plants

Container-grown plants have been used on desert revegetation projects, although this practice is generally confined to relatively small restoration areas (CH2M HILL, 2006). Container stock installation requires an associated irrigation method to supply irrigation through the first year at a minimum. While container-grown stock could provide rapid cover in the short-term, it may not provide any greater cover or density over the long-term compared with other seeding approaches to warrant the additional expense. In addition, the irrigation required provides additional challenges in remote locations, as described in Section 7.5, Irrigation and Natural Precipitation. For this reason, installation of container-stock is not proposed at Ivanpah SEGS, except for landscaping with native vegetation around some facilities, as described in Section 6.

7.4.4 Natural Colonization

This alternative relies only on natural processes, such as viable seeds that may remain in the topsoil after disturbance or seeds that blow in or are transported by animals to revegetate the site. Revegetation will ultimately occur through natural colonization, or at a slower rate than seeding approaches and with less predictable results. This approach is particularly hampered by the loss of a portion of the natural seed bank during soil disturbance. As such, this approach is not considered viable at Ivanpah SEGS.

7.4.5 Planting Protocol

Planting protocol will consist of augmenting the native seed bank with additional seed, as summarized in this section:

1. Topsoil will be reapplied to temporary disturbance areas prior to seed application.
2. All soil rehabilitation and preparation will be completed prior to seed application.
3. Seed will be removed from site stratification storage at the time of seeding.
4. Seed from multiple lots will be thoroughly blended into a single application batch. Seed count in pure live seed by weight will be determined in the application batch from individual seed lot statistics contributing to the batch.
5. Seed will be distributed in rates as specified in Table 7-4, or at a minimum rate of 150 seeds per square meter of seeded area. Final seed type and application rates will be consistent with intent of Table 7-3, but will be based on local availability and collections at the time of seeding and a minimum seeding rate of 150 seeds per square meter.
6. Seed will be distributed using a rangeland drill seeder through two passes. One half of the seed application will be drilled into the soil to a depth no greater than 0.5 inch. The second half of the seed application will be applied with a rangeland drill seeder with no disk openers or press wheels (essentially dropping the seed on the ground as a broadcast seeding).
7. The drill seeder will be followed with a light drag constructed from chain link fence, or otherwise harrowed to incorporate the seed into the top 0.5 inch of topsoil. Under no circumstances will seed be left exposed for more than 4 hours without dragging or harrowing. No seed will be buried greater than 1 inch.
8. Seeding will occur between October 15 and December 15.
9. Windrowed vegetation or mown vegetation will be preserved and stockpiled. Vegetation will be mulched to a large particle size (1 to 3 inches) using a chipper and preserved onsite under tarps. Apply mulch to temporary revegetation areas at a rate of 20 cy/ac after seed has been applied and dragged or furrowed.
10. If mulched vegetation quantity is not sufficient to apply 20 cy/ac, apply as available to a minimum of 10 cy/ac. If mulched vegetation quantity is not sufficient to apply 10 cy/ac, supplement to a 10 cy/ac application with certified weed-free straw mulch, sawdust, or other material as approved.

7.5 Irrigation and Natural Precipitation

Even desert-adapted plants require water. Once established, plants have a transpiration demand, whereby they take up water by the roots and move it through the plant until it exits through the leaves. Some species are better able to reduce transpiration demand in dry periods or have other water-saving strategies such as storing water in leaves as with succulents. Regardless of the species, without water there is no germination, growth, and survival. Because of this, many desert revegetation efforts introduce additional water using irrigation techniques. This section discusses the relative merits, limitations, and typical methods of ensuring sufficient water on desert revegetation sites.

7.5.1 Water Demand

Water to support plant germination, growth, and survival must either come from precipitation or irrigation, unless plant roots can access groundwater. Supplemental irrigation is often a revegetation strategy on smaller desert revegetation sites. Where irrigation is used, it is needed during the key establishment period of the first year and generally extends into the second year. Where planting consists of seeding, irrigation may be used to germinate seed and establish seedlings, along with supporting young plants through the first one or two seasons. Where planting consists of container stock, irrigation is always used to establish the plants through the first summer, at a minimum, and potentially into the second year. The objective is to provide greater predictability in the initial establishment period, while ensuring perennial vegetation can develop to the point where it relies on natural precipitation. Where there is enough precipitation during key establishment periods, little or no supplemental irrigation is needed.

7.5.2 Irrigation

Irrigation approaches used in desert revegetation include truck irrigation, portable irrigation systems, and temporary pipe irrigation. These approaches all face challenges on larger desert revegetation efforts, and irrigation systems are generally not practical on desert revegetation projects greater than a few acres. Major challenges and disadvantages of irrigation on large desert sites include the following:

- Extensive pipe irrigation systems in remote locations are subjected to vandalism and rodent damage.
- Truck and portable irrigation systems are generally only able to supply smaller sites practicably, up to a few acres.
- Costs of providing and maintaining irrigation on larger or remote sites can be significant, and results may not be any better than nonirrigation approaches.
- Approaches that rely on irrigation could promote vegetation growth during periods of drought, when desert plants are normally in a period of inactivity, or are persisting in a seed stage that is most resistant to drought.
- Irrigation may not allow plants to become sufficiently hardened to persist after irrigation is turned off, or if sufficient irrigation is not provided.

- Irrigation promotes greater establishment of noxious weeds, which often outcompete natives in enhanced resource conditions, such as with increased water supply.

To minimize water efficiency, and to conform to the environmental conditions of the Mojave Desert, no irrigation is planned for revegetation of the Ivanpah SEGS.

7.5.3 Natural Precipitation Approach

A detailed discussion of local climate is provided in Section 3. At about 5.1 to 6.2 inches (Table 3-2) per year, the amount of precipitation falling on the project area is low, with approximately one-third occurring as summer rains during the Southwest's monsoon (July through September) and a half falling during the winter season (November through March). During the Mojave Desert's arid foresummer (May through June), almost no precipitation can be expected while daily surface temperatures often exceed 110°F. As is typical of all deserts, rainfall varies dramatically from year to year. Sometimes there is scant rainfall for more than a year. The irregularity of rainfall is as much a feature of the precipitation climatology of Ivanpah SEGS as is the scant amount of rainfall received.

In wetter than normal years, rainfall is sufficient to trigger the germination and allow the establishment of annual and perennial plants. In normal to drier than normal years, seeds are unlikely to germinate, and they remain dormant in the soil, persisting until sufficient rainfall occurs. This form of adaptation to aridity (avoidance of drought by remaining dormant in the seed stage) is shared by virtually all annual plant species that occur in the Ivanpah SEGS project area. An important implication for revegetation is that seed, once broadcast and incorporated into the soils column, can persist until climatic conditions are favorable for germination and growth, even if it takes years (Shreve, 1964).

To maximize potential for seed to encounter favorable rainfall conditions for germination and establishment at Ivanpah SEGS, it will be lightly buried where it may persist for years. Under those conditions, when a wet year does occur, seed will still be available in the seed bank to establish a good cohort of perennial shrubs.

7.5.4 Rainwater Capture Methods

Methods of soil preparation suitable to increase rainwater capture and management have been described by Bainbridge (2007). These methods include: (1) decompaction through deep ripping or surface scarification promoting infiltration; (2) surface shaping including microcatchments, swales, imprinting, pitting, furrowing or other methods; (3) soil pitting achieved through hand shaping or equipment specialized for this purpose, such as a disk plower with cutoff or elliptical discs; (4) imprinting (achieved by a rolling disk with teeth), which may create small depressions with less disruption to the topsoil, and effective water penetration; and, (5) rainwater harvesting through surface aprons or check dams, which may be effective to provide irrigation on small sites.

7.5.5 Proposed Approach

To maximize potential for increased infiltration at Ivanpah SEGS, the following measures will be implemented:

1. Decompaction, where determined necessary by soil testing, will be implemented as described above.

2. In final recontouring of temporary disturbance areas, small basins or microcatchments will be shaped into the landscape, consisting of approximately 100 square foot depressions and creation of up to 100 to 200 depressions per acre; basins will be no deeper than 4 inches with slopes of 10 feet horizontal to 1 foot vertical (10:1) or less.
3. A light imprinting device will be passed over revegetation areas with suitable soils (loams or loamy sand) after distribution and dragging of seed. This will be anticipated to provide additional infiltration while still allowing seed to remain buried.

7.6 Herbivory and Granivory

Revegetation sites are vulnerable to predation, herbivory, and other forms of animal damage. Specific problems include: (1) predation on seeds from ants, rodents, birds, or other granivores; (2) damage to irrigation lines, which would not be a problem because Ivanpah SEGS is not proposing irrigation; or (3) herbivory on seedlings or establishing plants.

Seed predation by ants and rodents is a major issue on seeded sites. To mitigate the effects of this predation, shallow burying is implemented, achieved through drill seeding combined with broadcast seeding and a drag or furrowing device being used to disperse seed and bury it in the top 1 to 2 centimeters of soil.

The concern of herbivory on seedlings and young growing plants can be lessened when relying on natural precipitation to germinate and establish seedlings. This is because the revegetation site will be established under the same precipitation regime as adjacent non-disturbed habitats. When effective-rain events occur, germination of annuals and perennials will be widespread throughout the entire area, providing an abundance of growing vegetation for herbivores and generally satiating the herbivore population. Therefore, grazing pressure on the revegetation site will be less than if it was irrigated, in which case the revegetated site will be the only actively growing site during dry periods.

Fencing of portions of the active facility is proposed to exclude wildlife. However, fencing is not proposed for temporary disturbance areas not within the active facility, for example, along the gas pipeline route. In these locations, continued herbivory of plants may occur. However, because the project relies on natural rainfall, herbivory is expected to be less, as described previously.

7.7 Weed Management

The *Weed Management Plan for the Ivanpah Solar Electric Generating System* (Appendix B) describes the weed species that occur or are likely to occur in the project site and prescribes management actions that may be taken to monitor for an eradicate-specified species. Appropriate management thresholds for weeds are provided in the Weed Management Plan (WMP). The WMP also describes applicable regulations for the use of herbicides on federally managed lands in California and provides the basis for proper control of herbicides at Ivanpah SEGS.

The WMP is focused on “noxious weeds,” defined as any plant or plant product that can directly or indirectly injure or cause damage to crops, livestock, poultry, or other interests of agriculture; irrigation; navigation; the natural resources of the United States; the public health; or the environment. Noxious weeds are typically characterized by non-native plants

that aggressively colonize new areas and can grow to dominate or otherwise influence native plant communities if uncontrolled. This plan includes a list and an assessment of noxious weeds that could potentially occur, or do occur, in the project site; a target list of weeds that will be controlled; survey methods for weed presence during construction and operation; weed control methods; and reporting requirements. Weeds are further classified by their levels of impassivity to: (1) eradication, (2) suppression, or (3) containment.

Special consultations with respect to ubiquitous exotic species (for example, *Bromus madritensis* ssp. *rubens*, *Erodium cicutarium*, *Schismus* spp.) are anticipated because control of these may be impractical. These species are present throughout the Ivanpah Valley region in both disturbed and undisturbed habitats. In general, in this portion of the Mojave Desert, they do not exert excessive influence on the perennial shrub plant community structure either through dominance or potential fire hazard. However, they are a common component of the herbaceous strata in low to moderate density.

General measures to prevent the spread of weed propagules and inhibit their germination in the WMP include the following:

- Managing soil to promote native plant establishment
- Limiting disturbance areas by defining ingress and egress routes
- Worker environmental training
- Maintaining vehicle wash and inspection stations
- Reestablishing vegetation as quickly as practicable on disturbed sites
- Monitoring weed infestations
- Rapid implementation of weed management measures

The WMP is provided as Appendix B, and the requirements of the WMP are fully incorporated into the requirements of this document.

7.8 Revegetation Monitoring

Monitoring and adaptive management of revegetation sites is generally necessary to ensure long-term native plant community establishment. Data collected prior to site development at Ivanpah SEGS is reported in Appendix E, Field Vegetation Sampling. This, in addition to reference site data that will be collected adjacent to revegetation sites in undisturbed areas, will support long-term evaluation of revegetation targets and results. The data will chronicle predisturbance conditions. While these conditions are not specifically targeted (per discussion of succession in the TBD), documenting these conditions beforehand will provide long-term data to evaluate changes in vegetation communities in the region resulting from other factors, including climate change, not related to the Project itself.

7.8.1 Criteria for Progress

Reference sites representing intact, native vegetative communities with similar composition and conditions, and near the area being revegetated, can be used as a standard of comparison for determining revegetation success. In this approach, revegetation success can be evaluated based on how similar the structure and function of the revegetated plant community is to the structure and function of the plant community in the reference area. There is utility to this approach in humid to subhumid ecosystems where vegetational succession takes place on the scales of years to decades. However, as noted in the TBD, no

such rapid response can be expected with Mojave Desert scrub vegetation, where vegetation succession occurs on the scale of decades to centuries. Monitoring of a reference site can theoretically be used to understand the effects of climatic trends (Bainbridge, 2007). For example, if a severe drought occurs in undisturbed areas, native plants die, and poor seedling establishment is observed, it will be unreasonable to expect more from the restored site. However, in this region where drought is more the rule than the exception, reference to climate data from regional meteorological stations will be sufficient.

At the Ivanpah SEGS project area, revegetation will occur through seeding with pioneer and early-successional species, in addition to seedling establishment resulting from dispersal of the native seedbank and, for temporary disturbance areas, transplanting salvaged succulent species. Therefore, the species composition of the revegetated sites will not be directly comparable to any reference site in a mature desert scrub community. Success will be realistically linked to seedling establishment and survival, increase in the cover and species richness of perennial shrubs, and evolution of the site toward a mature, climax community. To realistically measure the establishment of plants in this harsh environment, poor results during dry years will not be considered to reflect poor progress in revegetation.

7.8.2 Field Monitoring

Field monitoring will be conducted using line or belt transects as well as quadrat or circular plot techniques. Line transects will provide effective cover data, while data from quadrats or circular plots more effectively evaluate density, richness, and diversity of the plant community. The transect length and quadrat/plot area will be representative of the plant community and large enough to capture 90 percent of the species that are present in the immediate vicinity (the association). Initially, the California Native Plant Society (CNPS) methodology recommendation of a 400 square meter (m²) plot for richness data within shrublands (CNPS, 2000) will be followed. Field sampling efforts at Ivanpah used circular plots with a 12 meter radius (450 m²) and the results (Appendix D; also summarized in Section 3.4.4) indicate that adequate quantitative representations were collected of the associations present.

7.8.2.1 Schedule

Monitoring will be conducted for a period of 9 years from the date of revegetation, except at sites where revegetation is not proceeding satisfactorily. In that case, monitoring may be extended on a year-by-year basis until success criteria are met. Monitoring will be performed annually during the first 3 years following revegetation, and biannually thereafter. Monitoring sessions will occur between March 15 and April 15.

The monitoring term will be conducted independently to all revegetation areas including revegetation of temporary disturbance areas and revegetation following cessation of operations.

7.8.2.2 Survey Methods

Visual inspections will be conducted to document germination, growth, and survival of seeded species, and growth and survival of transplanted succulents. Data collected will include species composition and cover, general size and vigor of the plants, percent live versus dead plants for succulents, observed soil erosion, evidence of wildlife use, and any

other information that will be useful in evaluating success. The following factors will be evaluated on revegetated sites, and where appropriate, adjacent undisturbed reference sites.

Germination and Survivorship

The first monitoring event will occur at the end of the winter/spring rainy season, several months following seeding. At that time, percent seed germination will be estimated based on the known seeding rate. The populations present at the first sampling (t_0) define the original cohort. Survivorship will be set to 1.0 for the original cohort and will be equal to the proportion of the population surviving at subsequent monitoring dates (Barbour et al., 1987). Species density measurements (that is, number of live individuals present per unit area for each species) will be used to estimate survivorship for perennials. Numbers of live versus dead individuals observed for each species will be recorded along with overall plant vitality and size.

Cover and Density

Density refers to the number of individuals per unit area (for example, individual plants per hectare), while diversity refers to the number of species present per unit area. Cover refers to the measured area along a linear transect or within a quadrat that is occupied by a particular species' canopy. It can be measured or expressed as percent cover of the total vegetated canopy (relevant), or more relevant for desert communities, as the percent cover of the total transect (absolute).

For Ivanpah SEGS, preliminary field data has been collected on existing undisturbed and disturbed sites in the area through a combination of line, belt, and circular relevé plots (see Appendix E, Field Vegetation Sampling). Within disturbed and undisturbed areas, similar methods were employed. They included a minimum of three, 30-meter line transects, a 30-meter by 4-meter-wide belt transect, and a 12-meter radius relevé plot at each sampling location. Herbaceous and shrub cover were recorded independently along each line transect as absolute percent of total transect. Shrub richness was recorded within the belt transect centered along each line transect as the number of individuals of each shrub species located within the belt. Shrub diversity was measured within each relevé plot by counting the number of individuals of each species in the plot and analyzing against total number of individuals.

At revegetation sites, a minimum of one sampling location will be established within each 10 acres of revegetation area, with an adjacent sampling location in undisturbed, reference habitat. Each sample location will contain the suite of sampling methods described above, including a 30-meter line transect, a 30-meter by 4-meter belt transect, and a 12-meter radius relevé plot. These permanent monitoring locations within the revegetation area and adjacent undisturbed areas will be recorded using GPS and will be staked in the field. A map will be created, using an aerial photograph as a base layer, showing each monitoring site and photo stations within the sites.

Species Richness and Diversity

Species richness refers to the number of different species per unit area within a given community. Diversity can be described as the total number of species in the sample (Barbour et al., 1987) relative to the total number of individuals. Shrub species diversity will be calculated from Simpson's Index of Diversity, using the following formula:

$$1 - D = 1 - \frac{\sum n(n - 1)}{N(N - 1)}$$

Where,

1 - D = Index of diversity

N = Total number of individual shrubs

n = Number of individuals of a particular species

Species richness is the total number of unique shrub species at each site. This value is totaled over three 120-m² belt transects in the disturbed sites and one 452-m² relevé in the associated undisturbed sites.

Photographic Documentation

At each revegetation site, multiple permanent photo locations will be identified and recorded using GPS. Photo locations will be shown on maps of the monitoring sites and permanently marked in the field. Whenever feasible, a meter stick or range pole will be used as a scale to illustrate the relative size of plants in photographs.

7.8.3 Data Analysis

Data that will be collected at each revegetation monitoring site include the following. Generally, information will be collected by strata (limited to herbaceous and shrub).

- Percent cover by species (of total transect length)
- Percent vegetative cover (all species combined, of total transect length)
- Exotic and/or noxious weed cover
- Species density
- Species richness and diversity
- Mean canopy height, by species
- Evidence of biological activity (for example, ant mounds, rodent disturbance, fecal pellets)
- Evidence of erosion

7.9 Revegetation Criteria

Based on the site findings, as previously reported in Section 3, Existing Conditions, and Appendix E, criteria for revegetation are proposed. Table 7-6 provides criteria to be met at years 2, 5, and 10.

TABLE 7-6.
Revegetation Criteria, Ivanpah SEGS

Parameter	2-year	5-year	10-year
Shrub Cover	No cover criteria; however, a minimum of 1,500 shrubs per acre establishing	8%	12%
Shrub Diversity*	0.10	0.20	0.40
Shrub Richness	3	5	10
Non-native Herbaceous – Cover	< 15%	< 15%	< 15%
Weed Management Criteria	Manage per WMP	Manage per WMP	Manage per WMP

*Simpson's Index of Diversity

7.10 Revegetation Site Management

Where revegetation criteria are not met, remediation measures will be implemented. Remediation measures will be developed based on specific deficiencies, but are anticipated to include the following, in combinations, as appropriate:

- Soil testing; specifically for compaction
- Ripping, discing, furrowing as needed
- Import and distribution of topsoil if cleared and available from other permanent facility development areas at Ivanpah SEGS
- Enhancement of water capture characteristics of site through microcontouring, imprinting, vertical mulch, or other appropriate techniques
- Reseeding with seed per original specifications
- Mulching with natural vegetation debris or appropriate imported mulch materials

Remediated areas will be more intensively monitored to gauge success of remediation. Monitoring frequency will increase to annual evaluations of seed germination and success, in addition to other required monitoring information. The duration of monitoring will be extended where remediation is necessary to ensure the full 10-year criteria are met prior to cessation of monitoring.

7.11 Recordkeeping and Reporting

Annual monitoring and management reports will be prepared, to include all relevant data, findings, and management actions. Contents will include:

- Maps showing revegetation areas and monitoring locations, including photo-documentation points

- For each monitoring site, information including original plant community type; site preparation; method of application; source, purity, and application rate; type and quantity of soil amendment; type and quantity of mulch; total acreage treated for each site; date of backfilling; date of seeding; results of any prior monitoring at the site
- For each monitoring site, the data and analyses as collected and analyzed (as described above)
- Results and trends will be shown graphically with statistics applied, as applicable
- Any corrective or remedial actions that were taken, and results
- Status of revegetation relevant to interim and final criteria, and proposed measures to implement to remediate substandard performance, to be implemented in the year following the report
- Field data sheets or other relevant documents, included as appendices

The report will be submitted annually to the following entities:

Bureau of Land Management
Needles Field Office, California Desert Conservation Area
1303 South U.S. Highway 95
Needles, CA 92363

California Energy Commission
07-AFC-5C
1516 Ninth Street (MS-2000)
Sacramento, CA 95814

Closure, Decommissioning and Rehabilitation

8.1 Facility Closure Plan

Facility closure can be temporary or permanent. Temporary closure is a shutdown for a period exceeding the time required for normal maintenance, including closure for overhaul or replacement of a steam turbine. Causes for temporary closure could include disruption in the supply of natural gas, damage to an integral component from natural events such as earthquake or flood, or a radical change in the market for electrical energy. Permanent closure is defined as a cessation in operations with no intent to restart operations because of plant age, damage to the plant beyond repair, economic conditions, or other reasons. Temporary closures are not discussed in this Plan, because it assumes that the plant will be restarted once repairs are made or the condition causing the temporary closure is corrected. However, it is possible for a temporary closure to become a permanent closure. Although there may be every intention of resuming operations, if a temporary closure continues for longer than 3 years, then unless the project owner can present reasonable evidence of its plan to resume operations, BLM can assume permanent closure and ask the project owner to begin the decommissioning and restoration process, or access the performance bond funds and begin the process itself (see Section 8.4.2, below).

Because the conditions that would affect the decommissioning decision and overall goals for rehabilitation are uncertain, this Plan will be reviewed at least 5 years prior to planned permanent closure and a *Final Closure Plan* will be prepared. The activities and processes described in Section 7 for revegetation and restoration of the construction areas will be updated and incorporated into the *Final Closure Plan*. However, if unplanned closure occurs, and a Final Closure Plan is not prepared, the relevant processes in Section 7 will be implemented unless, in the judgment of the regulatory agencies, the process has become outmoded.

It is also assumed that decommissioning would take place in the same sequence as project construction, with Ivanpah 1 being the first to be decommissioned, followed by Ivanpah 2, then the Ivanpah 3 along with the shared facilities being part of the final phase. Because the BLM ROW grant is anticipated to be for a 50-year duration, decommissioning of each phase would begin sometime after 40 years of operation so that construction, operation, decommissioning and restoration do not exceed the term of the 50-year grant.

In general, the decommissioning plan for the facility would attempt to maximize the recycling of all facility components. The project owner would attempt to sell unused chemicals back to the suppliers or other purchasers or users. Equipment containing chemicals would be drained and shut down to ensure public health and safety and to protect the environment. All nonhazardous wastes would be collected and disposed of in appropriate landfills or waste collection facilities. Hazardous wastes would be disposed of according to all applicable laws, ordinances, regulations, and standards (LORS). The site would be secured 24 hours per day during the decommissioning activities.

For the purpose of this Plan, it is assumed that the removal of all equipment and appurtenant facilities would be required, and would be achieved in conformance with all applicable LORS and local/regional plans. Aboveground structures would be removed through mechanical or other approved methods, and trucked offsite. Foundations would be physically removed to a depth of 3 feet through excavation, breakup, and pulling. Once all structural elements are removed, the ground surface would be recontoured to minimize the topographic variability between onsite and offsite areas, and to ensure that the gradient across the alluvial fans is restored. Pipelines would be closed off and removed.

As used here, “closure” is synonymous with decommissioning and includes removal of the facilities and materials that were employed to support the operation of the Ivanpah SEGS, and the physical operations necessary to return the surface to a condition wherein the revegetation and rehabilitation activities such as those described in Section 7 may then take place. Based on the terms of the current lease being negotiated between the project owners and the BLM, and assuming a full lease lifetime, this process will begin more than 40 years after the beginning of commercial operation of the first component of the project, Ivanpah 1. With construction estimated to begin in 2010, closure of Ivanpah 1 would commence as early as 2037 or as late as 2058 and be completed in approximately 2 years.

8.1.1 Accommodating Uncertainty and Affirming Requirements

Given current circumstances and the history of vast changes in the landscape of the American west in the last century, it would be unrealistic to assume that closure of the Ivanpah SEGS, beginning in 27 to 47 years, would involve wholesale decommissioning and dismantling of the facility, followed by rehabilitation and revegetation efforts to return the landscape to desert scrub similar to what exists at the site in 2008. Energy transmission facilities exist within a few miles of Ivanpah SEGS that are much older than 50 years, and there are of course hydroelectric facilities that are of the same age and that can be anticipated to be in operation for at least decades to come. It is also possible that other development may occur in this portion of the Ivanpah Valley in response to regional economic priorities and societal demands. Finally, it is widely acknowledged among scientists that global climate change is accelerating with impacts that are now measurable (e.g. Barnett et al., 2008; Westerling et al., 2006), and therefore, the constraints of the physical environment on everything from energy demand to potential natural vegetation will be substantively different 27-50 years in the future compared with the present and recent past. Therefore, adopting the components of an adaptive management approach to the decommissioning of the Ivanpah SEGS is important to address these uncertainties. These include a programmed assessment of circumstances, and reaffirmation of goals and requirements, and then the preparation of a *Final Closure Plan* to implement those goals as well as all relevant requirements.

8.1.2 Assessment and Affirmation

Not less than 5 years prior to the required beginning of closure activities, or as currently planned, the project owners will meet with the state and federal agencies responsible for land management and oversight of decommissioning to confirm the overarching goals of decommissioning and site rehabilitation. These goals and objectives will then be codified in the *Final Closure Plan*, which will be reviewed and approved by the agencies involved

(assumed to be CEC and BLM). The two fundamental questions to be addressed should include, but not necessarily be restricted to, the following:

- Is the required action moving forward with the decommissioning of this energy generation facility?
- If so, then is the desired goal of closure and rehabilitation the return of the land to desert scrub vegetation?

The answers to these two questions will frame the context of the decommissioning of the Ivanpah SEGS, as well as subsequent reclamation and revegetation activities and result in amendments to processes described in this Plan. Obviously, if in the next 27-50 years urbanization has spread to this valley, then it would be incorrect to assume that the goal of reclamation would be the return of this land to desert scrub. To follow this hypothetical line of reasoning, the best use of the land may then be for residential, commercial, or industrial development. Therefore, this meeting to assess circumstances in the mid or late 21st Century and affirm appropriate goals of closure and rehabilitation will be an appropriate and important action considering the uncertainty involved in predicting the future.

8.1.3 Assumptions in This Document

This document is not the *Final Closure, Revegetation and Rehabilitation Plan*; nor, given the uncertainty of the future, could a closure plan be written that would adequately anticipate the circumstances that need to be addressed more than half a century from now.

Nevertheless, there are some basic assumptions made in this document to address current agency requirements for a closure plan, as well as the actions that are necessary and appropriate to effect rehabilitation and revegetation of temporarily disturbed areas that will be created during construction activities. These will, to a certain extent, appear to be at odds with the prudent uncertainty articulated above, but they serve to provide goals and objectives that can be used as benchmarks, or a baseline, in the latter half of this century during the development of the *Final Closure, Revegetation and Rehabilitation Plan*.

This Draft Plan has been prepared with the primary objective of returning the land to desert scrub habitat in as close a condition to its present state as reasonably possible. If, based on the response to the two questions above, it is determined that another course of action would better benefit the objectives of the land owner, then the following actions will be revised accordingly. To satisfy the primary objective of returning the land to desert scrub habitat in as close a condition to its present state as reasonably possible, the project owner will do the following:

- All facility components within 3 feet of the recontoured grade and all pipelines will be physically removed from Ivanpah SEGS.
- Clean concrete debris will be used as contour fill material at depths greater than 3 feet from final grade.
- All service roads (except those used to connect existing trails) would be abandoned and the land surface recontoured where necessary to make it similar with the surrounding topography.

- The land surface would be rehabilitated preparatory to revegetation activities that would occur, as previously described in Sections 5 and 7.
- Revegetation measures would be implemented such as those described in Sections 5 and 7.

As noted, events in the next 5 decades may render one or more of these assumptions invalid or inappropriate. Their articulation nevertheless addresses current agency requirements, gives appropriate guidance and methodologies should they indeed prove to be valid. It also provides a baseline from which plan changes in 50 years can be described.

8.1.4 Final Closure Plan

The *Final Closure Plan* for the Site facilities will include the following major elements:

- The establishment and continuing implementation of worker health, safety and environmental protection procedures through out the decommissioning and restoration process.
- Complete rehabilitation planning pursuant to Section 8.1 that addresses the closure and rehabilitation objectives. That is, will the objective be a return to desert scrub or another objective that better meets the federal government's plans for the area?
- A plan for conducting pre-closure activities such as seed collection for revegetation efforts and establish timing of habitat restoration.
- Revision of any elements of this Plan (such as Sections 5, and 7) so that they are relevant and conform with practices and procedures in place at the time closure commences, and are consistent with the final restoration objectives of BLM.
- Review success criteria to ensure final objectives are clearly stated and measureable.

8.2 Decommissioning Plan

This section follows closely and incorporates portions of the *Conceptual Decommissioning and Reclamation Plan* for the Ivanpah SEGS developed by Process Unlimited (2009, Appendix G). This section provides more detail on the physical steps that will be taken to effect closure and decommissioning of Ivanpah SEGS, as part of the effort to return the land to a status consistent with land management policies and priorities as they may exist at the time of closure.

8.2.1 Decommissioning Objectives

The project goals for Site decommissioning include:

- Removal of all improvements within 3 feet of final grade; remove all pipelines
- Restoration of the lines and grades in the disturbed areas of the Ivanpah SEGS site to match the gradients of the surround land
- Do so in such a manner so as to facilitate the effectiveness of the reclamation and revegetation procedures outlined in this Plan.

The proposed implementation strategies to achieve these goals include:

- Use industry standard demolition means and methods to decrease personnel and environmental safety exposures by minimizing time and keeping personnel from close proximity to actual demolition activities to the extent practical.
- Plan each component of the decommissioning project such that personnel and environmental safety are maintained while efficiently executing the work.
- Train field personnel for decommissioning actions to be taken in proportion to the personnel, project or environmental risk for those actions.
- Demolition of the aboveground structures (dismantling and removal of improvements and materials) in a phased approach while still using some facilities until close to the end of the project. For instance, the water supply, administrative facilities, and some electrical power components will be modified to be used until very late in the restoration process.
- Demolition and removal of belowground facilities (floor slabs, footings, and underground utilities) as needed to meet the decommissioning goals.
- Soils cleanup, if needed, with special attention applied to retention pond and hazardous materials use/storage areas to ensure that clean closure is achieved.
- Disposal of materials in appropriate facilities for treatment/disposal or recycling.
- Recontouring of lines and grades to match the natural gradient and function of the alluvial fan, as reflected by current or planned land uses at the time of Final Closure.
- Evaluate the execution of the *Final Closure Plan* through project oversight and quality assurance.
- Document implementation of the *Final Closure Plan* and compliance with environmental requirements.

8.2.2 Pre-demolition Activities

Pre-decommissioning activities consist of preparing the Site area for demolition. These activities include removal of remaining residues such as in the boilers, as well as products such as diesel fuel, hydraulic, lubricating, and mineral oils, and other materials in order to reduce personnel health and environmental risk. All operational liquids and chemicals are expected to be removed at this time as well, such as boiler feed/condensate waters, laboratory equipment and chemicals, boiler/condensate addition chemicals as well as any maintenance lubricants, and solvents, etc. Hazardous material and petroleum containers and pipelines will be rinsed clean when feasible and the rinsate collected for offsite disposal. In general, these materials will be placed directly into tanker trucks or other transport vessels and removed from the site at the point of generation to minimize the need for hazardous material and waste storage at the Site.

Decommissioning operations of the site are assumed to span several years, and will, therefore, leave access, fencing, electrical power, and raw/sanitary water facilities available for limited use by the decommissioning and restoration workers.

8.2.3 Demolition of Aboveground Structures

Various types of decommissioning/demolition equipment will be used to dismantle each type of structure or facility, and dismantling will proceed according to the following general staging process: The dismantling and demolition of aboveground structures will be followed by concrete removal as needed to ensure that no concrete structure remains within 3 feet of final grade (i.e., floor slabs, belowground walls, and footings). The third stage consists of removal/dismantling of underground utilities, followed by excavation and removal of soils as needed, and then final site contouring.

Demolition entails breakdown and removal of aboveground structures and facilities, including transmission lines and overland piping between the reheat tower and collecting tower at Ivanpah 3. Residual materials from these activities will be transported via heavy haul dump truck to a central recycling/staging area where the debris will be processed for transport to an offsite recycler. A project recycle center (either within each solar field as the work progresses or in the heliostat field of Ivanpah 1) will be established to:

- Size reduce and stage metals and mirrors for transport to an offsite recycler
- Crush concrete and remove rebar
- Stage rebar for transport to an offsite recycler
- Temporarily store and act as a shipping point for any hazardous materials to an approved treatment, storage or disposal facility

During demolition, mechanized equipment and trained personnel will be used to safely dismantle and remove aboveground structures including:

- Heliostats, their support pylons and control equipment
- Collector and reheat towers using explosives to put the towers on the ground, then conventional heavy equipment to size-reduce and transport for recycling (this is the industry standard for safe demolition of large towers and massive concrete structures)
- Removal of the turbine generators, condensers and related equipment, transmission lines and towers, and aboveground pipelines
- Near the very end of the project (after initial revegetation efforts have been completed), the removal of site-related fencing and tortoise gates that are no longer necessary

8.2.4 Belowground Facilities and Utilities

The belowground facilities to be removed include concrete slabs and footings that would be removed to a depth of 3 feet below grade after final contouring. Pipelines would be closed off and removed. These materials will be excavated and transported to the onsite processing area(s) for processing and transport for ultimate recycling. Any resulting cavities will be backfilled with suitable material of similar consistency and permeability as the surrounding native materials and compacted according to the guidelines for revegetation described in Section 7 (as updated), while all access roads will be decompact according to Section 7 guidelines.

8.2.5 Demolition Debris Management, Disposal, and Recycling

Demolition debris will be placed in temporary onsite storage area(s) pending treatment at the processing area, and final transportation and disposal/recycling according to the procedures listed below. The sequential phasing of decommissioning will be used such that a portion of the decommissioned Ivanpah 1 heliostat field will be used to accommodate the onsite storage areas needed to process the materials from Ivanpah 2 and 3, as well.

The demolition debris and removed equipment will be cut or dismantled into pieces that can be safely lifted or carried with the onsite equipment being used. The vast majority of glass and steel will be processed for transportation and delivery to an offsite recycling center. Some specific equipment such as boilers, transformers, turbine and generators may be transported as intact components, or sized-reduced onsite with cutting torches or similar equipment.

A front-end loader, backhoe, or other appropriate equipment will be used to crush or compact compressible materials. These materials will be laid out in a processing area to facilitate crushing or compacting with equipment prior to transport for disposal/recycling. steel, glass and other materials will be temporarily stockpiled at or near the processing location pending transport to an appropriate offsite recycling facility. Concrete foundations will be removed to a depth of at least 3 feet below final grade. Upon removal of the rebar material from concrete rubble, the residual crushed concrete will be layered beneath the ground surface to fill cavities but only at locations that will remain greater than 3 feet below the final grade elevation. This will reduce waste volume and transportation requirements.

8.2.6 Soils Cleanup and Excavation

The need for, depth and extent of, contaminated soil excavation will be based on observation of conditions and analysis of soil samples after removal of the hazardous materials storage areas, and upon closure of the temporary recycling center(s) and waste storage areas using during decommissioning. Removal will be conducted to the extent required to meet regulatory cleanup criteria for the protection of groundwater and the environment. If contaminated soil removal occurs, the resulting excavations would be backfilled with native soil of similar permeability and consistency as the surrounding materials and compacted and revegetated according to the guidelines provided in Section 7, as updated in the *Final Closure Plan*.

8.2.7 Recontouring

Recontouring of affected areas of the site (such as the power blocks) will be conducted using standard grading equipment to return the land to match (within reason) the surrounding terrain topography and function at that time. Grading activities will be limited to previously disturbed areas that require recontouring. Efforts will be made to disturb as little of the natural drainage and vegetation as possible. Concrete rubble, crushed to approximately 2-inches in diameter or smaller (2-inch minus size), will be placed in the lower portions of fills, at depths at least 3 feet below final grade. Fills will be compacted to approximately 85 percent relative compaction by wheel or track rolling to avoid over-compaction of the soils. To the extent feasible and if consistent with revegetation prescriptions, efforts will be made to place a layer of coarser materials at the ground surface to add stability.

Revegetation and habitat rehabilitation will be implemented as discussed in Section 7 and this Section 8.

8.2.8 Areas Disturbed by Decommissioning Activities

The decommissioning activities involve the use of heavy machinery to disassemble and remove buildings and fixtures used during operations. To the extent possible, these activities are to use existing disturbed areas rather than vegetated areas. For example, the recycling center described above, should not be located in the CLA which was revegetated following the conclusion of plant construction. Rather, it should be located in a part of Ivanpah 1, or other area that has been disturbed, but not yet restored. Regardless of taking pains to reduce impacts to vegetated areas, there are likely some areas will require recontouring or will otherwise be impacted during the decommissioning process. These areas will need to be included in the *Final Closure Plan*, which will include a requirement that areas disturbed during decommissioning be identified and included for restoration and revegetation.

8.2.9 Hazardous Waste Management

Hazardous materials expected to be handled during the decommissioning process are listed in Table 8-1. These materials included lead-acid batteries, sulfur hexafluoride, diesel, hydraulic oil, lubricating oil, and mineral oil. Any other operational chemicals listed as hazardous in the AFC will be removed as part of the decommissioning activities.

Fuel, hydraulic fluids and oils will be transferred directly to a tanker truck from the respective tanks and vessels. Storage tanks/vessels will be rinsed and rinsate will also be transferred to tanker trucks. Other items that are not feasible to remove at the point of generation, such as smaller containers lubricants, paints, thinners, solvents, cleaners, batteries and sealants will be kept in a locked utility building with integral secondary containment, meeting all requirements for hazardous waste storage until removal for proper disposal. It is anticipated that all oils and batteries will be recycled offsite at an appropriately licensed facility. Site personnel involved in handling these materials will be trained to properly handle them. Containers used to store hazardous materials will be inspected regularly for any signs of failure or leakage.

As part of the preparation for closure, the Spill Containment and Countermeasures Plan (SPCC) for the site will be updated to cover spill prevention and countermeasures for handling of these materials during decommissioning. Procedures to decrease the potential for release of contaminants to the environment and contact with stormwater will be specified in the SWPPP.

TABLE 8-1
Hazardous Materials to be Handled During Closure

Material	Site Use	Location & Estimated Quantity	D&R Project Strategy
Lead-Acid Batteries (Sulfuric Acid and Lead) size of batteries approx 10cm x 5cm x 7cm	Electrical power	Heliostats 214,000 batteries	Remove prior to heliostat stanchion processing or demolition
Sulfur hexafluoride	Switchyard / switchgear devices	Contained within equipment 200 lbs.	Remove prior to switchgear removal
Diesel No 2	Fuel for pump engine/generators	Near fire pump; max quantity 9,000 gallons.	
Hydraulic Oil	Used in turbine starter system, turbine control valve actuators.	Contained within equipment; max quantity onsite 500 gallons.	Drain liquid from equipment prior to removal. Triple-rinse tanks and piping prior to processing and recycling. Rinsate fluid will be disposed offsite.
Lubricating Oil	Used to lubricate rotating equipment.	Contained within equipment; max quantity onsite 30,000 gallons.	
Mineral Oil	Used in transformers	Contained within transformers; max quantity onsite 105,000 gallons	

Source: WorleyParsons, 2008.

8.2.10 Worker Safety

A site-specific Health and Safety Plan will also be prepared to specify requirements for establishing and maintaining a safe working environment during the implementation of the planned closure and rehabilitation activities.

8.3 Rehabilitation Plan

The Rehabilitation Plan provides guidelines, methods, and criteria for measuring the progress of rehabilitation and revegetation of the project site upon facility decommissioning either at the end of the project's planned 50-year life, or upon unplanned premature closure. The goals of the Rehabilitation Plan are to restore the land to a pre-project condition; establish quality habitat for desert tortoise and other fauna; and to minimize potential erosion through proper restoration activities and implementation of appropriate BMPs.

Rehabilitation Plan objectives can be summarized as follows:

- Describe the methods for rehabilitation and revegetation of disturbance areas that will create natural-appearing topography, and reduce potential for erosion, especially through deflation.

- Implement a practical revegetation program that will accelerate natural vegetation succession and, over time, promote the establishment of a plant community dominated by native perennials.
- Establish a weed management program applicable to the decommissioning of the project site that will identify the non-native species requiring eradication, and the means to accomplish that eradication.
- Identify means and methods that will minimize, to the extent practicable, long-term maintenance and support requirements, such as irrigation, weeding, or reseeded.
- Reduce the visual contrasts between disturbed areas that have been decommissioned and adjacent undisturbed areas through revegetation.
- Anticipate wildlife management needs as habitat suitable to support cover and breeding opportunities for desert fauna development in reclaimed areas.

The proposed implementation strategies to achieve these objectives include:

- At least 5 years prior to planned closure, a *Final Closure Plan* will be prepared and submitted to BLM and CEC for review and approval. That Plan will include, among other things, the timing for seed collection, as described in Section 7.3.2, to ensure that sufficient seed stock is available for restoration efforts.
- Once areas have been decommissioned and facilities and structures removed, the surface will contoured to match the lines and grades of the natural gradient of the surrounding area. An updated Construction SWPPP will be prepared and appropriate BMPs will be implemented to provide an effective combination of erosion and sediment control until revegetation efforts have sufficiently stabilized the soil.
- Final surface preparation (unless revised in the *Final Closure Plan*) will be in concert with reseeded and other revegetation activities described in Section 7.2.6.
- A practically attainable approach to revegetation at Ivanpah SEGS will be to accelerate the natural successional process by emphasizing seeding of early successional native plants (Appendix D). This strategy maximizes the probability of success; it has been used on comparable desert areas and is considered viable. However, if new techniques have been demonstrated to be viable prior to the initiation of closure, the *Final Closure Plan* will be prepared so that it incorporates those techniques.
- Unless revised in the *Final Closure Plan*, revegetation efforts will commence as described in Section 7.4. Prior to seeding succulents in excess of 200 lbs and therefore requiring heavy equipment to move will be retrieved from the Succulent Storage and Stockpile Area for transplanting in the area being reclaimed. Smaller succulents that can be handled by a 3-person crew, or fewer, will be planted after seeding to avoid their potential damage during final seeding and ground preparation activities. Succulents will be planted in such a way as to be representative of the density and diversity that existed prior to construction.
- Unless revised in the *Final Closure Plan*, weed management will be implemented as described in Section 7.7.

- At the conclusion of the restoration activities, fences and tortoise guards will be removed and the area will be opened to wildlife for use as habitat. (No restoration work will occur outside of fenced areas without the presence of an Authorized Biologist or Tortoise Monitor.)
- Unless revised in the *Final Closure Plan*, revegetation monitoring will be implemented as described in Section 7.8 to ensure that revegetation efforts meet or exceed the criteria set forth in Section 7.9. If revegetation does not meet these criteria, remediation measures would be implemented as described in Section 7.10, unless revised in the *Final Closure Plan*.
- Subject to confirmation in the *Final Closure Plan*, during the 2-, 5- and 10- year monitoring episodes any and all desert tortoise sign noted in the vegetation plots, as well as elsewhere within the boundaries of the decommissioned project, will be recorded and reported.

8.4 Financing Decommissioning and Restoration

8.4.1 Cost Estimate

BrightSource Energy is in the process of preparing a cost estimate that covers both decommissioning and restoration. On the decommissioning side, the cost estimate addresses the pre-decommissioning activities; the dismantling of equipment and demolition of aboveground structures; removal of belowground facilities and utilities; debris management, disposal, and recycling; recontouring of the land; and hazardous waste management. In addition, decommissioning costs are offset by revenues that can be obtained by recycling materials and obtaining salvage values for the sale of used plant equipment. On the restoration side, the cost estimate addresses the cost of site preparation; succulent salvage; facility landscaping; seed collection, testing, storage and preparation; and site revegetation. Due to the nature of these cost estimates, they will only be provided to BLM under cover of confidentiality.

8.4.2 Performance Bond

As required by BLM, the Applicant will purchase a performance bond, which will be issued either by an insurance company or a financial institution to guarantee the satisfactory decommissioning and restoration of the project site. The bond will be obtained prior to start of construction and will be structured so the funds will be returned to the project owner upon completion of the decommissioning and restoration activities (with an amount held in reserve until the restoration monitoring is completed). It will also be structured in such a manner that BLM will be able access those funds to pay for the decommissioning and restoration of the site, in the event that the project owner becomes insolvent, or that the duration of a temporary closure continues so long, that the closure is considered permanent, as described in Section 8.1.

SECTION 9

References

- Abella, S.R., A.C. Newton. 2009. A Systematic Review of Species Performance and Treatment Effectiveness for Revegetation in the Mojave Desert, USA. In: *Arid Environments*. Editors: A. Fernandez-Bernal et al. Nova Science Publishers, Inc.
- Anderson, D.C. and W.K. Ostler. 2002. Revegetation of Degraded Lands at U.S. Department of Energy and U.S. Department of Defense Installations: Strategies and Successes. *Arid Land Research and Management*. 16:197-212.
- Bainbridge, D., R. Franson, C.A. Williams, L. Lippitt, R. MacAller, and M. Fidelibus. 1995. *A Beginner's Guide to Desert Restoration*. U.S. Department of the Interior (USDI), National Park Service, Denver Service Center.
- Bainbridge, D.R. 2007. *A Guide for Desert and Dryland Restoration: New Hope for Arid Lands*. Island Press, Washington, D.C. 391 pp.
- Bamberg Ecological. 2005. Castle Mountain Mine, San Bernardino County, California, Research and Reclamation, 1990-2005, Summary Report. Prepared for Viceroy Gold Corporation, Castle Mountain Mine. December.
- Bamberg Ecological. 2006. 2005 Report, Fourth Revegetation Monitoring Report, Castle Mountain Mine, San Bernardino County, California. Prepared for Viceroy Gold Corporation, Castle Mountain Mine. December.
- Barbour, M.G., J.H. Burk, and W.D. Pitts. 1987. *Terrestrial Plant Ecology*. 2nd Edition. The Benjamin/Cummings Publishing Company, Inc., Menlo Park, CA. 634 pp.
- Barnett, T.P., D.W. Piece, H.G. Hidalgo, *et al.* 2008. Human-induced changes in the Hydrology of the Western United States. *Science* 319: 1080- 1083.
- Beatley, J.C. 1976. *Vascular plants of the Nevada Test Site, and central-southern Nevada*. National Technical Information Service Report TID-26881, 308 p.
- BLM- see U.S.D.I. Bureau of Land Management, below.
- Bossard, C. C., J.M. Randall, and M.C. Hoshovsky. 2000. *Invasive Plants of California's Wildlands*. University of California Press. Berkeley, California.
- Bradley, W.G., and Deacon, J.E. 1967. The biotic communities of southern Nevada. In *Pleistocene studies in southern Nevada* (H.M. Wormington and D. Ellis, Eds.), pp. 129-200. Nevada State Museum Anthropological Papers 13.
- Brady, N.C. and R.R. Weil. 2002. *The Nature and Properties of Soils*, 13th edition. Prentice Hall, Upper Saddle River, New Jersey. 960 pp.
- California Energy Commission (CEC). 2007. Data Requests 1 through 116 for the Ivanpah Solar Electric Generating System (ISEGS) (07-AFC-5). Sacramento, California. December 12.

- California Energy Commission (CEC). 2008. Data Requests 117 through 151 for the Ivanpah Solar Electric Generating System (ISEGS) (07-AFC-5). Sacramento, California. May 8.
- California Native Plant Society (CNPS). 2000. Relevé Protocol. CNPS Vegetation Committee. October 20 (Revised 2/5/03).
- Capon, B. and W. Van Asdall. 1967. Heat Pre-Treatment as a Means of Increasing Germination of Desert Annual Seeds. *Ecology* 48-2: 305-306.
- CH2M HILL. 2006. Henderson Landfill Response Program Revegetation Evaluation. Technical Memorandum to City of Henderson. June.
- CH2M HILL. 2007. Application for Certification for the Ivanpah Solar Electric Generating System. Prepared by CH2M HILL. Sacramento, California.
- CH2M HILL. 2008a. *Technical Basis Document for Revegetation and Reclamation Planning Ivanpah Solar Electric Generating System, Eastern Mojave Desert, San Bernardino County, California*. Prepared on behalf of BrightSource Energy, Inc. Sacramento, California.
- CH2M HILL. 2008b. *Data Response No. 40*. Submitted to the California Energy Commission on behalf of BrightSource Energy, Inc. Sacramento, California.
- CH2M HILL. 2008c. *Weed Management Plan for the Ivanpah Solar Electric Generating System Eastern Mojave Desert San Bernardino County, California*. Prepared on behalf of BrightSource Energy, Inc. Sacramento, California.
- Clements, F.E. 1916. *Plant Succession*. Carnegie Institute Miscellaneous Publication 242, Washington, D.C. 512 pp.
- Delph, L.F. 1986. Factors regulating fruit and seed production in the desert annual *Lesquerella gordonii*. *Oecologia* 69-3: 471-476.
- Desert Research Institute (n.d.). Western regional Climate Data Center. <http://www.wrcc.dri.edu/summary/Climsmnv.html>
- Elias, S., A. Garay, B. Young, and T. Chastain. 2002. Maintaining Seed Viability in Storage: A brief review of management principles with emphasis on grass seeds stored in Oregon. Oregon State University Seed Laboratory – Technical Brochures. http://www.seedlab.oscs.orst.edu/Page_Technical_Brochures/MaintainingSeedViabilityInStorage.htm
- Glenn, E.P. and P.L. Nagler. 2005. Comparative ecophysiology of *Tamarix ramosissima* and native trees in western U.S. riparian zones. *Journal of Arid Environments* 61:419–446.
- Graham, R.C., Hirmas, D.R., Wood, Y. A., and Amrhein, C. 2008. Large near-surface nitrate pools in soils capped by desert pavement in the Mojave Desert, California. *Geology*. 36:259-262.
- Granatstein, D., E. Kirby, and L. VanWechel. 2002. Availability of Mulch Material for Orchards in Central Washington - 2002. Center for Sustaining Agriculture and Natural Resources, Washington State University, Wenatchee, WA. Feb 10.

- Hickman, J. C. (Ed.) 1993. *The Jepson Manual: Higher plants of California*. University of California Press, Berkeley.
- Ivanpah Solar Electric Generating System (Ivanpah ISEGS). 2008. *Draft Biological Assessment for the Ivanpah Solar Electric Generating System*.
- Kigel, J. 1995. Seed germination in arid and semi-arid environments. In: Kigel, J. and G. Galili. 1995. *Seed Development and Germination*. CRC Press. 872 pp.
- McGinnies, W. G. 1981. *Discovering the Desert*. University of Arizona Press, Tucson.
- Milton, S.J. 1995. Effect of rain, sheep, and tephritid flies on seed production of two arid Karoo shrubs in South Africa. *Journal of Applied Ecology*. 32: 137-144.
- Narita, K. 1998. Effects of seed release timing on plant life-history and seed production in a population of a desert annual, shape *Blepharis sindica* (Acanthaceae). *Plant Ecology*. 136-2: 195.
- Prigge, B. A. 1975. *Flora of the Clark Mountain Range, San Bernardino County, California*. M.S. Thesis, California State University at Los Angeles.
- Rowlands, P. G. 1978. *The vegetation dynamics of the Joshua tree (Yucca brevifolia) in the southwestern United States of America*. Ph.D. dissertation, University of California, Riverside. 192 pp.
- Ryan, T. 2006. *Water Augmentation through Tamarisk Management and Its Potential Usefulness to the Colorado River Basin States*. Colorado River Basin States Review Draft. Metropolitan Water District of Southern California, Los Angeles, California.
- Scoles-Sciulla, S.J. and L.A. DeFalco. 2009. Seed reserves diluted during surface soil reclamation in eastern Mojave Desert. *Arid Land Research and Management*. 23:1-13.
- Shafroth, P.B., J.R. Cleverly, et al. 2005. Control of tamarix in the western United States: Implications for water salvage, wildlife use, and riparian restoration. *Environmental Management*. 35(3):231-246.
- Shreve, Forrest. 1964. Vegetation of the Sonoran Desert, in Shreve, F. and I. L. Wiggins, *Vegetation and flora of the Sonoran Desert*. pp. 9-187. Stanford University Press, California.
- Smith, R.L. 1992. *Elements of Ecology*, 3rd Ed. HarperCollins Publishers, Inc. New York. p. 304.
- Spaulding, W.G. 1981. *The late Quaternary vegetation of a southern Nevada mountain range*. Ph.D. thesis, University of Arizona, Tucson.
- Spaulding, W. G., E. B. Leopold, and T. R. Van Devender. 1983. Late Wisconsin paleoecology of the American Southwest. in S.C. Porter, ed., *The Late Pleistocene*. University of Minnesota Press, Minneapolis. pp. 259-293.
- Spaulding, W. G., J.L. Betancourt, K.L. Cole, and L.K. Croft. 1990. Packrat middens: Their composition and methods of analysis. In *Packrat middens: The last 40,000 years of biotic change* (J.L. Betancourt, P.S. Martin, and T.R. Van Devender, Eds.). University of Arizona Press, Tucson. pp. 59-84.

Thorne, R. F., B. A. Prigge, and J. Henrickson, 1981. A flora of the higher ranges and the Kelso Dunes of the eastern Mojave Desert in California. *Aliso* 10(1): 71-186.

U.S. Department of Agriculture, Natural Resources Conservation Services. 2008. Official Soil Series Descriptions (OSD) with Series Extent Mapping Capabilities. <http://soils.usda.gov/technical/classification/osd/index.html>. Accessed July 24, 2008.

U.S.D.I., Bureau of Land Management (BLM). 1980 (amended 1999). *California Desert Conservation Area Plan*. U.S. Department of the Interior, Bureau of Land Management, California Desert District, Riverside.

U.S.D.I., Bureau of Land Management (BLM). 2002. *Northern and Eastern Mojave Desert Management Plan*. U.S. Department of the Interior, Bureau of Land Management, California Desert District, Riverside.

U.S. Department of the Interior (USDI). 2007. *Final Programmatic Environmental Impact Statement Vegetation Treatments Using Herbicides on Bureau of Land Management Lands in 17 Western States*. Washington, D.C.

Westerling, A.L., H.G. Hidalgo, D.R. Cayan, and T.W. Swetnam. 2006. Warming and Early Spring increase Western U.S. Forest Wildfire Activity. *Science* 313: 940-943.

Winograd, I.J., and W. Thordarson. 1975. *Hydrogeologic and Hydrochemical framework, south-central Great Basin, with special reference to the Nevada Test Site*. U.S. Geological Survey Professional Paper 712-C. Denver, Colorado.

WorleyParsons. 2008. *Conceptual Decommissioning and Reclamation Plan for the Ivanpah Solar Electric Generating System Eastern Mojave Desert San Bernadino (sic) County, California*. WorleyParsons Infrastructure and Environment, Folsom, California. 5 September.

APPENDIX A

Project Drawings

APPENDIX A

Project Drawings

Appendix A, Project Drawings was submitted as Appedix A to Attachment DR130-2B, filed as Data Response Set 2I to the California Energy Commission on May 18, 2009. Electronic copies will be provided upon request.

APPENDIX B

Weed Management Plan

APPENDIX B

Weed Management Plan

Appendix B, Weed Management Plan, was submitted as Attachment DR13-1A to the California Energy Commission as Data Response Set 1F on August 6, 2008. Electronic copies will be provided upon request.

APPENDIX C

Construction Stormwater Pollution Prevention Plan

APPENDIX C

Construction Stormwater Pollution Prevention Plan

Appendix C, Construction Stormwater Pollution Prevention Plan was submitted as Appendix 5.15A2 to the California Energy Commission in Supplemental Data Response Set 2B, filed on May 13, 2009. Electronic copies will be provided upon request.

APPENDIX D

Technical Basis Document

APPENDIX D

Technical Basis Document

Appendix D, Technical Basis Document for Revegetation and Reclamation Planning, was submitted to the California Energy Commission as Attachment DR125-1A in Data Response Set 2B, filed on July 22, 2008. Electronic copies will be provided upon request.

APPENDIX E

Vegetation Survey and Results

Site Vegetation Surveys

Survey Objectives

Site vegetation surveys and analyses were conducted at Ivanpah Solar Electric Generating System (Ivanpah SEGS) and surrounding areas in April 2009 to characterize existing vegetation conditions, and in support of planning rehabilitation and revegetation efforts. The objectives of these surveys were as follows:

1. Identify and characterize vegetation at sites within Ivanpah Valley with a disturbance history comparable to the disturbance that will occur at the Ivanpah SEGS site.
2. Collect data at disturbed and adjacent undisturbed sites, including species composition, percent cover, species abundance, species diversity, species density, weedy species composition, and individual vigor.
3. Identify and document vegetation conditions at sites in varying stages of recovery resulting from differing dates of disturbance.
4. Sample species composition and diversity within the footprint of the proposed Ivanpah SEGS, and gather data on the number and diversity of cholla and prickly-pear, which had previously not been determined in inventory of cacti.
5. Identify appropriate criteria for revegetation progress based on conditions and findings at comparable revegetation sites, and to identify temporal expectations of progress.
6. Develop appropriate criteria and thresholds for weed management based on risks to native vegetation development and establishment.

Survey Protocol

Sampling Dates and Staff

Preliminary site selection and review was conducted by CH2M HILL senior ecologists and biologists Geof Spaulding, James Gorham, and Cindy Newman on April 21, 2009. Sampling was conducted by CH2M HILL biologists Cindy Newman and Megan Karl over a period of four days between April 23 and April 28, 2009.

Disturbance Sample Sites

Sample sites were chosen at areas with known disturbance history and regime, along with adjacent relatively “undisturbed” habitats. Three disturbed sites were sampled. The borrow pit (BP) site at 2,685 ft elevation is located between Ivanpah Unit 1 and Interstate 15 (I-15). Material (sand and gravel) was most likely taken from this site between 1960 and 1965 and used to build the I-15 Yates Well Road exit, and the cut area serves as a drainage detention/diversion for the I-15 roadway. It is assumed that there were no revegetation efforts and that the site has been in the process of natural succession since the disturbance.

The other two disturbed sites are located within the Kern River Gas Transmission (KRGT) Right-of-Way (ROW). KRGT 1 (2,834 ft elevation) is located northeast of Ivanpah Unit 3. KRGT 2 (3,270 ft elevation) is located within the Ivanpah SEGS proposed transmission corridor. The KRGT ROW was disturbed around year 2000 and appears to have been revegetated using seeding with native species and soil manipulation. Figure E-1 shows the sampling site locations.

At each site, three 30 meter (m) long line and belt transects were randomly placed within the disturbed area. Herbaceous and shrub cover were recorded independently along each 30 m line transect. Shrub diversity was recorded within a 4 m wide belt transect centered along each 30 m line transect. Number of individuals of each shrub species located within the belt was recorded.

One comparative 30 m line transect and one 12 m radius relevé plot (CNPS 2000) were sampled in the undisturbed desert adjacent to each disturbed site. The line transects and relevé plots were co-located and centered on a cactus, or if none were available, randomly placed. Herbaceous and shrub cover were recorded independently along each 30 m line transect. Data to support analysis of shrub diversity and density was collected within each relevé plot by counting the number of individuals of each species in the plot.

Ivanpah SEGS Sampling Sites

Areas directly within the Ivanpah SEGS footprint were also sampled, one within each of the three solar plants. Three 12 m radius relevé plots were sampled within each Ivanpah unit (Ivanpah 1, 2, and 3 at average elevations of 2,830, 3,019 and 3,126 ft, respectively). Relevé plots were centered on a cactus, or if none are available, randomly placed. Relevé plots were sampled for shrub diversity and density by counting the number of individuals of each species in the plot.

Rainfall Analysis

To estimate the temperature and precipitation of the project site, lapse rate calculations were used based on the meteorological data from a Las Vegas, Nevada, low elevation station about 40 miles to the north-northwest, and from Mountain Pass, along I-15 a few miles west of the Ivanpah Valley. These calculations were based on long-term averages, as well as the 1971 through 2000 “normalized” period of measurement. These data were reported in the Rehabilitation and Revegetation Plan to which this document is an appendix. Data for precipitation from these same stations from October 2008 to April 2009 were collected to evaluate precipitation during the portion of the rainfall year (October to April) when annual vegetation sampled in this study would have germinated and developed. These data are provided in Table E-1. As indicated, a higher than normal rainfall year was documented at the Mountain Pass station for this time period (October to April; 7.25 inches, or 125 percent of normal), but a lower than normal rainfall year was documented at Las Vegas (2.5 inches, or 83 percent of normal). This data is relevant in evaluating herbaceous plant establishment and growth, as reflected in percent cover, canopy height, and other data collected for this stratum. While rainfall at the sample sites was not recorded, their proximity to Mountain Pass suggests it can be expected to be within the range of 100 to 125 percent of normal.

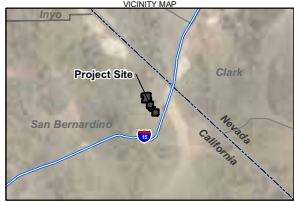
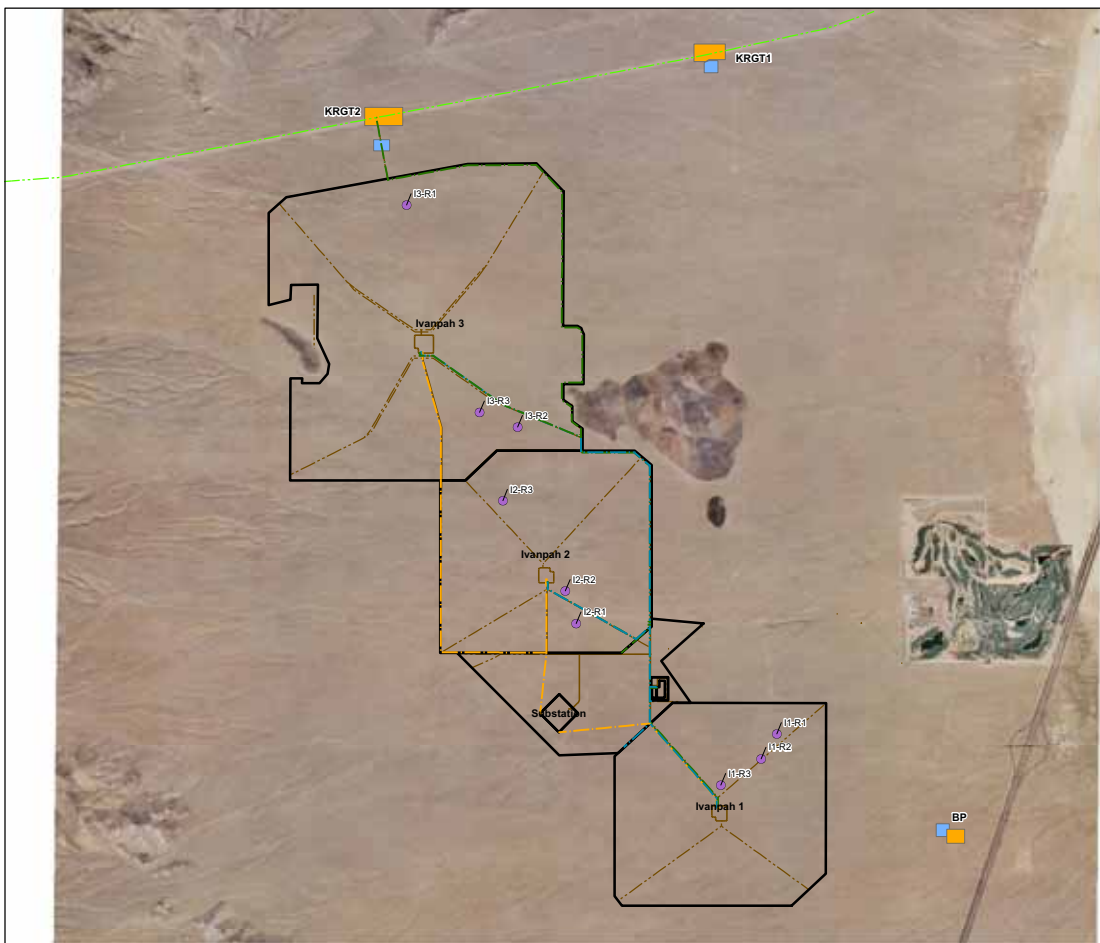

- LEGEND**
- Ivanpah Unit Sampling
 - Kern River Gas Line
 - Proposed Gas Line
 - Proposed Transmission Lines
 - Proposed Water Lines
 - Proposed Dirt Roads
 - Proposed Paved Roads
 - Disturbed Sites
 - Undisturbed Sites
 - Project Site

Notes:
 KRG1: Kern River Gas Transmission Site 1
 KRG2: Kern River Gas Transmission Site 2
 BP: Borrow Pit

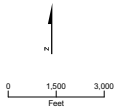

FIGURE E-1
Vegetation Sampling Sites
 Ivanpah Solar Electric Generating System Project
 San Bernardino County, CA

TABLE E-1

2009 and Average Precipitation Data for Weather Stations in Ivanpah SEGS Vicinity

	Elevation	Oct	Nov	Dec	Jan	Feb	Mar	Apr	Oct-Apr	Wat-Yr
Mountain Pass (2008-2009) ^a	4,730'	1.27	1.13	0.76	0.60	1.96	1.03	0.50	7.25	9.82
Mountain Pass (Normalized ^b)		0.43	0.74	0.83	1.07	1.19	1.03	0.50	5.79	9.34
Las Vegas (2008-2009) ^c	2,165'	0.01	0.47	1.15	0.04	0.78	T	0.05	2.50	---
Las Vegas (Normalized ^b)		0.24	0.33	0.43	0.60	0.68	0.49	0.23	3.00	4.51

Sources:

^aDept. of Water Resources, California Data Exchange Center, <http://cdec.water.ca.gov/cgi-progs/precip/PRECIPOUT>^bNormalized period 1971 through 2000. See DRAFT Closure, Revegetation and Rehabilitation Plan for the Ivanpah Solar Electric Generating System, Eastern Mojave Desert, San Bernardino County, California; CH2M HILL, January, 2009^cNational Weather Service Forecast Office, Las Vegas, NV, <http://www.nws.noaa.gov/climate/index.php?wfo=vef>

Survey Findings

Data from the three disturbed sites (BP, KRGT1, and KRGT2), associated undisturbed sites, and the three Ivanpah units (I1, I2, and I3) are summarized below. Data summary tables are provided in Attachment E-1.

Species Composition

Table E-2 provides the most abundant vegetation at sampled sites based on percent cover, provided for each strata (shrub and herbaceous), and generally indicates the dominant vegetation for that strata. The most abundant shrub in the three disturbed sites is cheesebush (*Hymenoclea salsola*). In two of the disturbed sites (BP and KRGT1), burrobush (*Ambrosia dumosa*) is the next most common shrub. Burrobush and creosote bush (*Larrea tridentata*) are the most common shrubs in the undisturbed sites.

The most abundant herbs in the disturbed sites are redstem filaree (*Erodium cicutarium*), bluegrass (*Poa bigelovii*), and Mediterranean grass (*Schismus* sp.). The most common herbs in the undisturbed sites are pepperweed (*Lepidium* sp.), bluegrass, redstem filaree, and Mediterranean grass.

TABLE E-2

The Most Common Taxa in Disturbed and Undisturbed Sites by Percent Cover at Ivanpah SEGS

Site	Shrub Layer		Herbaceous Layer	
	Disturbed	Undisturbed	Disturbed	Undisturbed
Borrow Pit (BP); 2,685 ft elevation				
1	<i>Hymenoclea salsola</i>	<i>Ambrosia dumosa</i>	<i>Erodium cicutarium</i>	<i>Erodium cicutarium</i>
2	<i>Ambrosia dumosa</i>	<i>Larrea tridentata</i>	<i>Pectocarya sp.</i>	<i>Lepidium sp.</i>
3	<i>Larrea tridentata</i>	N/A	<i>Lepidium sp.</i>	<i>Schismus sp.</i>
Kern River Gas Transmission – Site 1 (KRG1); 2,834 ft elevation				
1	<i>Hymenoclea salsola</i>	<i>Larrea tridentata</i>	<i>Schismus sp.</i>	<i>Lepidium sp.</i>
2	<i>Ambrosia dumosa</i>	<i>Ambrosia dumosa</i>	<i>Poa bigelovii</i>	<i>Poa bigelovii</i>
3	<i>Atriplex canescens</i>	<i>Krameria erecta</i>	<i>Erodium cicutarium</i>	<i>Schismus sp.</i>
Kern River Gas Transmission – Site 2 (KRG2); 3,126 ft elevation				
1	<i>Hymenoclea salsola</i>	<i>Ambrosia dumosa</i>	<i>Poa bigelovii</i>	<i>Poa bigelovii</i>
2	<i>Eriogonum fasciculatum</i>	<i>Ephedra torreyana</i>	<i>Erodium cicutarium</i>	<i>Erioneuron pulchellum</i>
3	<i>Encelia farinosa</i>	<i>Yucca schidigera</i>	<i>Schismus sp.</i>	<i>Xylorhiza tortifolia</i>

Shrub Density

Shrub density was determined as plants per hectare based on shrub numbers in each sampling unit. In determining shrub density, shrubs were counted as separate individuals when clumps of stems protruded from distinctly different locations on the ground. This was most common for creosote bush and burrobrush. Each Mojave yucca (*Yucca schidigera*) stem was counted as a separate individual. Shrub density is provided in Table E-3. Shrub density in the disturbed sites was lowest at the BP site and highest at the KRG2 site. A high number cheesebush are responsible for the high shrub density values at the KRG2 site.

Within the undisturbed sites, density of shrubs was greater in the lower elevation sites in the southern portion of the valley (Borrow Pit, Ivanpah 1 at 2,685 and 2,830 ft elevation, respectively) than at higher elevation sites in the northern portion of the valley (KRG1, KRG2, Ivanpah2, Ivanpah 3 at 2,834, 3,126, 3,019 and 3,126 ft respectively), generally owing to a greater number of burrobrush, and an overall reduced diversity of shrubs.

TABLE E-3

Shrub Density in Disturbed and Undisturbed Sites at Ivanpah SEGS

Site	Shrub Density (plants/hectare)	
	Disturbed*	Undisturbed
Borrow Pit	6,417	10,549
KRG1	9,611	8,249
KRG2	13,000	8,824
Ivanpah 1*	---	11,110
Ivanpah 2*	---	8,758
Ivanpah 3*	---	6,635

*Value represents a mean of three replicates

Succulent Density

Succulents encountered on site surveys in all sites included the following: *Opuntia acanthocarpa*, *O. ramosissima*, *O. basilaris*, *O. echinocarpa*, *Echinocactus polycephalus*, *Ferocactus cylindraceus*, and *Yucca schidigera*. Succulent density was determined as plants per hectare based on succulent numbers in each sampling unit. In determining density, succulents were counted as separate individuals when clumps of stems protruded from distinctly different locations on the ground, more specifically, each *Yucca schidigera* stem was counted as a separate individual. Succulent density is provided in Table E-4A.

The barrel cacti (*Echinocactus*, *Ferocactus*) were mapped across the Ivanpah sites during early botanical surveys in support of the AFC. These data were analyzed to determine density of these genera based on site-wide surveys, and are provided in Table E-4B. These data represent undisturbed sites within the proposed footprint of Ivanpah SEGS. Comparing the density of barrel cacti to the density of all succulents, it can be seen that barrel cacti represent only a minor portion of the succulent community.

Within undisturbed sites, density of succulents appeared to increase with increasing elevation, generally trending from the southern most sampling sites (Ivanpah 1, BP) to the northern sites at the base of the foothills and nearer the head of the bajada (KRGT, Ivanpah 3).

TABLE E-4A
Succulent Density in Disturbed and Undisturbed Sites at Ivanpah SEGS

Site	Succulent Density (plants/hectare)	
	Disturbed*	Undisturbed
Borrow Pit	27.8	22.1
KRGT1	55.6	420.2
KRGT2	0.0	862.5
Ivanpah 1*	---	250.6
Ivanpah 2*	---	368.6
Ivanpah 3*	---	427.6

*Value represents a mean of three replicates

TABLE E-4B

Barrel Cactus Observed Within the Ivanpah SEGS

California barrel cactus (<i>Ferocactus cylindraceus</i> var. <i>lecontei</i>)				
Location Observed	Number of Localities	Number of Individuals	Hectares	Density (Plants/Hectare)
Ivanpah 1	40	74	344	0.22
Ivanpah 2	279	389	344	1.13
Ivanpah 3	906	1,615	672	2.40
Total California barrel cactus	1,294	2,206	1,360	1.62
Clustered barrel cactus (<i>Echinocactus polycephalus</i>)				
Ivanpah 1	516	706	344	2.05
Ivanpah 2	127	156	344	0.45
Ivanpah 3	901	1,353	672	2.01
Total Clustered barrel cactus	1,674	2,430	1,360	1.79
TOTAL BARREL CACTUS	2,968	4,636	1,360	3.41

Live Plant Cover

The disturbed sites sampled generally had a lower percent shrub cover (13 to 18 percent) than the undisturbed sites (14 to 31 percent); however, in KRGT1, the disturbed sites sampled had a higher mean shrub cover (18 percent) than the undisturbed site (14 percent) (Table E-3). The range of shrub cover in disturbed sites (9 to 33 percent) was greater than in undisturbed sites (14 to 31 percent) (see Attachment E-1).

In the herbaceous layer, results are mixed, with disturbed cover greater or lesser than undisturbed cover varying by sample site. At the borrow pit, results between disturbed and undisturbed sites were comparable (3 percent and 2 percent, respectively). Herbaceous cover was greater in the undisturbed KRGT1 site (15 percent) versus the disturbed site (9 percent). However, at the KRGT2 site, herbaceous cover was substantially greater in the disturbed site (15 percent) than the undisturbed (7 percent). At this latter site, the native bluegrass *Poa bigelovii* was abundant, representing between 30 and 80 percent of the herbaceous cover (Table E-5).

TABLE E-5

Percent Shrub and Herbaceous Cover in Disturbed and Undisturbed Sites at Ivanpah SEGS

Site	Shrub Layer Total Percent Cover ¹		Herbaceous Layer Total (Native) Percent Cover	
	Disturbed ²	Undisturbed	Disturbed ²	Undisturbed
Borrow Pit	13.4	22.9	3.4 (0.5)	2.0 (0.4)
KRGT1	17.6	13.8	8.7 (4.2)	15.3 (5.0)
KRGT2	17.5	30.7	21.0 (15.3)	6.8 (6.5)

Notes

¹All shrubs documented on the sample sites were native²Represents a mean of three replicates

Species Diversity and Richness

Shrub species diversity was calculated from Simpson's Index of Diversity (Smith, 1992), using the following formula:

$$Diversity = 1 - \frac{\sum n(n-1)}{N(N-1)}$$

Where,

N = Total number of individual shrubs

n = Number of individuals of a particular species

Species richness is the total number of unique shrub species at each site. This value is totaled over three 120 m² belt transects in the disturbed sites, one 452 m² relevé in the associated undisturbed sites, and three 452 m² relevés in each Ivanpah unit. Because sampling area was different at each site, and between disturbed and undisturbed, data can't be directly compared. However, sample size may have been sufficient to capture and illustrate trends.

Shrub diversity and richness is presented in Table E-6 for each site. Shrub diversity and richness appear to be greater in two of the disturbed sites (BP and KRGT1) than in the associated undisturbed sites. In KRGT2, shrub diversity and richness appear to be greater in the undisturbed site. The results were relatively homogeneous within the three belt transects at each disturbed site in terms of diversity. Simpson's Index of Diversity ranges from 0.52 to 0.57 in disturbed site BP, from 0.64 to 0.69 in disturbed site KRGT1, and from 0.15 to 0.27 in disturbed site KRGT2 (see Attachment E-1). As with succulent density, species diversity and richness appear to increase with elevation.

Shrub diversity was more heterogeneous between the relevés in the Ivanpah units than between belt transects in the disturbed sites (however, areas were different, so this must be interpreted with caution). Simpson's Index of Diversity ranges from 0.29 to 0.5 in Site I1, from 0.39 to 0.52 in Site I2, and from 0.37 to 0.80 in Site I3.

TABLE E-6
Shrub Diversity and Richness in Disturbed and Undisturbed Sites at Ivanpah SEGS

Site	Simpson's Index of Diversity ^a		Species Richness ^b	
	Disturbed ^c	Undisturbed	Disturbed ^c	Undisturbed
Borrow Pit	0.55	0.27	7	3
KRGT1	0.66	0.56	13	11
KRGT2	0.20	0.67	6	19
Ivanpah 1 ^c	---	0.40	---	12
Ivanpah 2 ^c	---	0.45	---	15
Ivanpah 3 ^c	---	0.62	---	19

Notes:

^aIndex of diversity was averaged among the three belt transects or three relevés at a site; The higher the index of diversity, the greater the diversity at a site. Shrubs were counted as separate individuals when clumps of stems protruded from distinctly different locations on the ground. This was most common for *Larrea tridentata* and *Ambrosia dumosa*. Each *Yucca schidigera* stem was counted as a separate individual. *Baileya multiradiata* was present, but not included in the shrub diversity count in Kern River Gas Transmission Site 2, Disturbed plots 2 and 3.

^bSpecies richness calculated as the total number of species per site (360 m² per disturbed site, 452 m² per associated undisturbed site, 1,357 m² per Ivanpah unit).

^cValue represents a mean of three replicates

Canopy Height

The typical maximum height of the shrub and herbaceous canopies is similar between disturbed and undisturbed sites (Table E-7). The typical maximum height of the shrub strata (0.45 m) is an order of magnitude greater than the height of the herbaceous strata (0.046 m).

TABLE E-7
Typical Maximum Canopy Height in Disturbed and Undisturbed Sites at Ivanpah SEGS

Site	Shrub Canopy Height (m)		Herbaceous Canopy Height (m)	
	Disturbed*	Undisturbed	Disturbed*	Undisturbed
Borrow Pit	0.51	0.46	0.030	0.050
KRGT1	0.43	0.40	0.043	0.030
KRGT2	0.35	0.53	0.053	0.070

*Represents a mean of three replicates

Discussion

Succession

As expected, the disturbed sites are dominated by native disturbance-adapted, early successional species (*Hymenoclea salsola*), whereas the undisturbed sites are dominated by native late successional (“climax”) species (*Ambrosia dumosa* and *Larrea tridentata*). Succession over the last 40-50 years at disturbed site BP has resulted in late successional, climax species (*A. dumosa* and *L. tridentata*) as the second and third most common species. Even at disturbed site KRGT1, which has had less than 10 years to recover, late successional, climax species are becoming dominant (*A. dumosa* is the second most common species). In addition, *L. tridentata* were establishing on the site in low numbers.

Cover and Diversity

In two of the three disturbed sites, shrub cover has not returned to pre-disturbance levels. Disturbed site BP has undergone 40-50 years of natural succession, yet still does not have the same shrub cover as the adjacent undisturbed area (13 percent vs. 23 percent). One of the two KRGT sites that underwent active revegetation efforts has returned to greater-than-undisturbed shrub cover levels. This suggests that revegetation efforts accelerate and improve shrub cover recovery. In establishing shrub cover criteria, it is important to note that even in undisturbed habitats in the area, shrub cover is naturally low in this Mojave Desert scrub vegetation (ranging from 14 to 31 percent).

Succulent density was much lower on disturbed sites along the KRGT ROW than adjacent undisturbed sites. Judging from the low number of succulents, it can be surmised that no succulent transplants occurred during the KRGT revegetation. Given the generally accepted success rates of succulent transplants, this approach as proposed for Ivanpah SEGS would be expected to improve revegetation results.

Shrub diversity and species richness within undisturbed transects at the BP, KRGT1, and KRGT2 sites (diversity – 0.27, 0.56, 0.67 respectively; richness – 3, 11, 19 respectively) showed a steady increase with elevation, which increased between the three sites (2,685 ft, 2,834 ft, 3,270 ft elevation, respectively), with the higher sites (KRGT 1 & 2) trending toward the northern foothills and the head of the bajada. A similar trend is evident in the relevé data from the Ivanpah sites, with an increase in diversity and species richness between Ivanpah 1, 2, and 3 (diversity 0.40, 0.45, 0.62 respectively; richness – 12, 15, 19 respectively). Succulent diversity also increases. Again, these sites are successively higher in elevation (means of the relevés at 2,830 ft, 3,019 ft, 3,126 ft, respectively), and trend from south to north towards the head of the bajada. While insufficient data is available to determine causative factors (increased precipitation and lowered evapotranspiration with increased elevation no doubt play a role) or establish relationships, consideration of the difference in natural diversity and richness is necessary in establishing criteria for these parameters. Not knowing exactly how site parameters may affect diversity and richness, criteria are established at the lower range of possibilities for undisturbed sites.

Achieving natural shrub diversity, cover, and canopy height appeared to be more challenged on the KRGT2 site than on the KRGT1 site. Nine years after revegetation, KRGT1 had recovered to greater than pre-disturbance diversity, richness, cover, and canopy height.

However, KRGT2 was deficient in all these parameters when compared to the adjacent undisturbed transect. The KRGT2 site was dominated by cheesebush, with few other shrub species contributing to the canopy. However, cover was still 18 percent, which is within the range of cover found on undisturbed sites (14 to 31 percent), and the density of cheesebush exceeded shrub densities in nearby undisturbed habitats, and in fact was the highest shrub density in all sampling conducted (mean 13,000 plants/hectare). In addition, a significant stand of the native grass *Poa bigelovii* was present (21 percent cover); this may improve conditions over the long haul to make the site more suitable for native shrubs.

Exotic Weeds

Exotic weed species are present in both the disturbed and undisturbed sites. *Schismus* sp. and *E. cicutarium* are present in both the disturbed and undisturbed sites. *B. madritensis* is only present in the disturbed sites; however it is not a dominant species in the herbaceous layer. Total herbaceous cover is 21% or less in both the disturbed and undisturbed sites. KRGT2 was the only site where there was a noticeably higher percent of herbaceous cover in the disturbed than the undisturbed, but the dominant herbaceous species was a native grass (*Poa bigelovii*). Generally, the exotic proportion of the herbaceous layer is dominated by small annual plants with average heights of 0.03 – 0.07 m, and percent cover less than 10 percent. This is comparable to exotic species present in undisturbed sites.

Based on the percent cover and short stature of the canopy, it is anticipated that the exotic weed growth in disturbed areas is not likely to pose an elevated fire risk compared to the undisturbed areas. We note that these results represent conditions during a relatively wet year (as described earlier). During drier than normal years, the herbaceous strata would be expected to have even less cover and stature, or be absent altogether.

Revegetation and Weed Management Criteria

Based on these site findings, criteria for revegetation are proposed. Table E-8 provides criteria to be met at years 2, 5, and 10.

TABLE E-8
Revegetation Criteria, Ivanpah SEGS

Parameter	2-year	5-year	10-year
Shrub Cover	No cover criteria; however, a minimum of 1,500 shrubs per acre establishing	8 percent	12 percent
Shrub Diversity*	0.10	0.20	0.40
Shrub Richness	3	5	10
Non-native Herbaceous – Cover	< 15%	< 15%	< 15%
Weed Management Criteria	Manage per Weed Control Plan	Manage per Weed Control Plan	Manage per Weed Control Plan

*Simpson's Index of Diversity

Revegetation Site Management

Where revegetation criteria are not met, remediation measures would be implemented. Remediation measures will be developed based on specific deficiencies, but are anticipated to include the following, in combinations as appropriate:

- Soil testing; specifically for compaction;
- Ripping, discing, furrowing as needed;
- Import and distribution of topsoil if cleared and available from other permanent facility development areas at Ivanpah SEGS;
- Enhancement of water capture characteristics of site through microcontouring, imprinting, vertical mulch, or other appropriate techniques;
- Reseeding with seed per original specifications;
- Mulching with natural vegetation debris or appropriate imported mulch materials.

Remediated areas would be more intensively monitored to gauge success of remediation. Monitoring frequency would increase to annual evaluations of seed germination and success, in addition to other required monitoring information. The duration of monitoring would be extended where remediation was necessary to ensure the full 10-year criteria were met prior to cessation of monitoring.

References

California Native Plant Society (CNPS). 2000. Relevé Protocol. CNPS Vegetation Committee. October 20 (Revised 2/5/03).

Smith, R.L. 1992. *Elements of Ecology*, 3rd Ed. HarperCollins Publishers, Inc. New York. p. 304.

Attachment E-1

Exhibit E-1, Table 1

Vegetation Sampling: Shrub and Herbaceous Vegetation Data

Parameter	BP-D1	BP-D2	BP-D3	BP-Mean	BP-UD1	KRGT1-D1	KRGT1-D2	KRGT1-D3	KRGT1 - Mean	KRGT1-UD	KRGT2-D1	KRGT2-D2	KRGT2-D3	KRGT2 - Mean	KRGT2-UD
Shrub Layer															
Live shrub cover	16.6%	11.0%	12.7%	13.4%	22.9%	9.2%	11.0%	32.6%	17.6%	13.8%	14.3%	14.2%	24.0%	17.5%	30.7%
Dead shrub cover	1.3%	0.0%	3.3%	1.5%	0.0%	1.4%	0.0%	1.8%	1.1%	0.6%	2.0%	2.3%	0.0%	1.4%	0.0%
Shrub height (m)	0.52	0.43	0.58	0.5	0.46	0.43	0.43	0.42	0.4	0.4	0.34	0.38	0.33	0.4	0.53
Shrub density (count/hectare)	5667	8167	5417	6417	10549	10167	6750	11917	9611	8249	12333	11917	14750	13000	8824
Succulent density (count/hectare)	83.3	0.0	0.0	27.8	22.1	0.0	83.3	83.3	55.6	420.2	0.0	0.0	0.0	0.0	862.5
Species with greatest cover	AMDU	HYSA	HYSA	HYSA	AMDU	ATCA	HYSA	AMDU	HYSA	LATR	HYSA	HYSA	HYSA	HYSA	AMDU
	8.9%	10.5%	9.2%	11.9%	3.9%	10.5%	7.2%	4.3%	12.1%	10.2%	23.7%				13.9%
Species with 2nd greatest cover	LATR	AMDU	LATR	AMDU	LATR	AMDU	AMDU	ATCA	AMDU	ENFA	ERFA	BAMU		ERFA	EPTO
	7.7%	0.5%	1.7%	11.0%	3.6%	0.5%	5.8%	4.2%	2.0%	4.0%	0.3%				5.8%
Species with 3rd greatest cover	N/A	N/A	AMDU	LATR	N/A	HYSA	N/A	HYSA	ATCA	KRER	ERFA	LATR	N/A	ENFA	YUSC
	N/A	N/A	1.70%		N/A	1.70%	N/A	1.90%		1.3	0.2	0.10%	N/A		6.30%
Herbaceous Layer															
Live herb cover	1.9%	4.9%	3.4%	3.4%	2.0%	11.2%	4.9%	9.9%	8.7%	15.3%	35.5%	19.2%	8.3%	21.0%	6.8%
Native herb cover	0.1%	0.9%	0.3%	0.5%	0.4%	4.7%	0.9%	7.1%	4.2%	5.0%	33.0%	7.0%	6.0%	15.3%	6.5%
Mean herb height (m)	0.03	0.03	0.03	0.03	0.05	0.04	0.03	0.06	0.04	0.03	0.05	0.06	0.05	0.05	0.07
Species with greatest cover	ERCI	ERCI	ERCI	ERCI	ERCI	SCSP	ERCI	POSP	SCSP	LESP	POSP	POSP	POSP	POSP	POSP
	1.40%	2.20%	2.10%	0.70%	10.70%	2.20%	2.50%	6.50%	29.10%	5.70%	5.30%				3%
Species with 2nd greatest cover	LESP	PESP	LESP	PESP	LESP	POSP	SCSP	PESP	POSP	POSP	ERCI	ERCI	SCSP	ERCI	ERPO
	0.20%	0.80%	0.60%	0.60%	0.45%	0.80%	1.20%	2%	0.80%	3.20%	1.20%				1.50%
Species with 3rd greatest cover	PESP	SCSP	PESP	LESP	SCSP	LESP	LESP	ERPO	ERCI	SCSP	SCSP	SCSP	CRAN	SCSP	XYTO
	0.10%	0.80%	0.20%	0.40%	0.30%	0.70%	0.70%		0.80%	0.70%	3.20%	0.80%			1.70%

Notes:

N/A - Not applicable

See text for sample site codes

Species Codes-

AMDU - <i>Ambrosia dumosa</i>	ERCI - <i>Erodium cicutarium</i>	LESP - <i>Lepidium sp.</i>
ATCA - <i>Atriplex canescens</i>	ERFA - <i>Eriogonum fasciculatum</i>	PESP - <i>Pectocarya sp.</i>
BAMU - <i>Baileya multiradiata</i>	ERPO - <i>Erioneuron pulchellum</i>	POSP - <i>Poa secunda</i>
CRAN - <i>Cryptantha angustifolia</i>	HYSA - <i>Hymenoclea salsola</i>	SCSP - <i>Schismus sp.</i>
ENFA - <i>Encelia farinosa</i>	KRER - <i>Krameria erecta</i>	XYTO - <i>Xylorhiza tortifolia</i>
EPTO - <i>Ephedra torreyana</i>	LATR - <i>Larrea tridentata</i>	YUSC - <i>Yucca schidigera</i>

Exhibit E-1, Table 2

Vegetation Sampling: Shrub and Succulent Species Density

Site	Shrub Density (plants/hectare)	Succulent Density (plants/hectare)	Mean Shrub Density (plants/hectare)	Mean Succulent Density (plants/hectare)
Ivanpah Unit 1			11,110	251
I1-R1	10,947	310		
I1-R2	10,505	288		
I1-R3	11,876	155		
Ivanpah Unit 2			8,758	369
I2-R1	8,382	310		
I2-R2	10,660	619		
I2-R3	7,232	177		
Ivanpah Unit 3			6,635	428
I3-R1	7,166	686		
I3-R2	8,537	221		
I3-R3	4,202	376		
OVERALL MEAN			8,834	349

Notes:

1. Shrubs were counted as separate individuals when clumps of stems protruded from distinctly different locations on the ground. This was most common for *Larrea tridentata* and *Ambrosia dumosa*.
2. Each *Yucca schidigera* stem was counted as a separate individual.

Exhibit E-1, Table 3

Vegetation Sampling: Shrub Species Diversity and Richness

Site	Simpson's Index of Diversity (1-D)	Mean Site Diversity	Species Richness	Mean Species Richness
Borrow Pit Disturbed		0.55		4.7
BP-D1	0.52		4	
BP-D2	0.57		5	
BP-D3	0.56		5	
Borrow Pit Undisturbed		0.27		3.0
BP-UD	0.27		3	
Kern River Gas Transmission Site 1, Disturbed		0.66		7.0
KRGT1-D1	0.64		7	
KRGT1-D2	0.65		6	
KRGT1-D3	0.69		8	
Kern River Gas Transmission Site 1, Undisturbed		0.56		11.0
KRGT1-UD	0.56		11	
Kern River Gas Transmission Site 2, Disturbed		0.20		5.0
KRGT2-D1	0.18		6	
KRGT2-D2	0.27		6	
KRGT2-D3	0.15		3	
Kern River Gas Transmission Site 2, Undisturbed		0.67		19.0
KRGT2-UD	0.67		19	
Ivanpah Unit 1		0.40		8.7
I1-R1	0.50		9	
I1-R2	0.40		11	
I1-R3	0.29		6	
Ivanpah Unit 2		0.45		9.3
I2-R1	0.39		9	
I2-R2	0.52		10	
I2-R3	0.43		9	
Ivanpah Unit 3		0.62		12.0
I3-R1	0.80		16	
I3-R2	0.37		8	
I3-R3	0.70		12	

Notes:

1. Shrubs were counted as separate individuals when clumps of stems protruded from distinctly different locations on the ground. This was most common for *Larrea tridentata* and *Ambrosia dumosa*.
2. Each *Yucca schidigera* stem was counted as a separate individual.
3. *Baileya multiradiata* was present, but not included in the shrub diversity count in Kern River Gas Transmission Site 2, Disturbed plots 2 and 3.
4. Raw species richness calculated as number of species found per belt transect or releve'
5. Adjusted species richness calculated by adjusting for the number of sq. meters sampled and presented per 100 sq. m. Belt transects were 120 sq. m and releve' were 452 sq. m.

APPENDIX F

Drainage, Erosion, and Sediment Control Plan

APPENDIX F

Drainage, Erosion, and Sediment Control Plan

Appendix F, Drainage, Erosion, and Sediment Control Plan, was submitted to the California Energy Commission as Attachment DR140-1B in Data Response Set 2H, filed on May 13, 2009. Electronic copies will be provided upon request.

APPENDIX G

Conceptual Decommissioning and Reclamation Plan



Conceptual Decommissioning and Reclamation Plan

Ivanpah Solar Electric Generating System

Eastern Mojave Desert

San Bernadino County, California

June 2009

**CONCEPTUAL DECOMMISSIONING AND RECLAMATION PLAN, IVANPAH SEGS
IVANPAH BASIN, CALIFORNIA**

_____, a Professional Engineer in the State of California as an employee of Processes Unlimited International, Inc., has reviewed the report with the title **Conceptual Decommissioning and Reclamation Plan, Ivanpah SEGS**. His stamp and signature appears below.

_____, PE
May 2009

PROJECT 52003207 – CONCEPTUAL DECOMMISSIONING AND RECLAMATION PLAN							
REV	DESCRIPTION	ORIG	REVIEW	PROU APPROVAL	DATE	CLIENT APPROVAL	DATE
B	Submittal Draft	_____	_____	_____	_____	_____	_____
		_____	_____	_____	_____	_____	_____
		_____	_____	_____	_____	_____	_____

**CONCEPTUAL DECOMMISSIONING AND RECLAMATION PLAN, IVANPAH SEGS
IVANPAH BASIN, CALIFORNIA**

Disclaimer

The information presented in this document was compiled and interpreted exclusively for the purposes stated in Section 1 of the document. This document was originally prepared by WorleyParsons for Luz II, Inc.

This revision consists of a compilation of the following documents into one summary document:

- Conceptual Decommissioning and Reclamation Plan, Ivanpah SEGS, Rev. A 5-Sept-08 by Worley Parsons
- Memorandum – “Scrap Value Evaluation” for Ivanpah SEGS, 23-Jan-09 by Worley Parsons
- Memorandum – “Nevada Reclamation Cost Estimator Comparison” for Ivanpah SEGS, 26-Jan-09 by Worley Parsons
- Report – “BrightSource Ivanpah SEGS Closure Costs, 30-Mar-09 by ProU.
- Report – “Addendum to Conceptual Decommissioning and Reclamation Plan, 1-May-2009 by ProU

This summary document is intended to combine the above listed documents in to a single, updated Conceptual Decommissioning and Reclamation Plan for Ivanpah SEGS. Updates from the Worley Parsons Rev. A Plan include the following:

- Incorporate the value of scrap commodities as determined by Worley Parsons into the Plan
- Incorporate the Nevada SRCE cost basis as determined by Worley Parsons into the Plan
- Incorporate estimates for value of used equipment sales into the plan as prepared by Processes Unlimited.
- Incorporate the fact that no detention ponds in the solar field are anticipated.
- The anticipated ROW grant for the land is 50 years. The PPA’s for the facility are 25 years, so a 25 year plant equipment life is assumed.

CONTENTS

1. INTRODUCTION4

2. SITE CONDITIONS5

 2.1 Location and Land Use 5

 2.2 Topography 5

 2.3 Geology 5

 2.4 Climate and Hydrology 6

 2.5 Area Hydrogeology 6

3. IVANPAH SEGS DESCRIPTION AND STRUCTURES7

4. RECLAMATION AND DECOMMISSIONING CRITERIA AND PLANNING8

5. PLANT DECOMMISSIONING9

 5.1 Decommissioning Objectives 9

 5.2 Decommissioning Strategy 10

 5.2.1 Health and Safety Procedures 11

 5.2.2 Used Equipment Marketing Activities 11

 5.2.3 Pre-Decommissioning Activities..... 11

 5.2.4 Dismantling of Equipment and Demolition of Above-Ground Structures..... 11

 5.2.5 Below-Ground Facilities and Utilities 12

 5.2.6 Soils Cleanup and Excavation 12

 5.2.7 Demolition Debris Management, Disposal, and Recycling 13

 5.2.8 Recontouring..... 13

6. HAZARDOUS WASTE MANAGEMENT 14

7. SALVAGE VALUES 16

8. USED EQUIPMENT STUDY20

 8.1 Used Equipment Market 20

 8.2 Marketing Strategy 21

 8.3 Dismantling Strategy 21

 8.4 Effects of Equipment Sales on Closure Costs 21

**CONCEPTUAL DECOMMISSIONING AND RECLAMATION PLAN, IVANPAH SEGS
IVANPAH BASIN, CALIFORNIA**

8.5	Used Equipment Value Analysis	22
9.	COST ESTIMATE	24
9.1	Purpose	24
9.2	Project Scope and Sequencing Description	24
9.3	Methodology	24
9.4	Summary and Approach	24
9.5	Estimate Classification	25
9.6	Design Basis	25
9.7	Planning Basis	25
9.8	Assumptions	26
9.9	Exclusions and Exceptions	26
9.10	Risks and Opportunities	26
9.11	Contingencies	26
9.12	Management Reserve	26
9.13	Reconciliation	27
9.14	Benchmarking	27
9.15	Estimated Quality Assurance	27
9.16	Cost Tables	27
10.	REFERENCES	28

Figures

- FIGURE 1 VICINITY MAP
- FIGURE 2 SITE PLAN

1. INTRODUCTION

This report presents a Conceptual Decommissioning and Reclamation Plan for three proposed solar energy plants and shared facilities, collectively known as the Ivanpah Solar Electric Generating System (SEGS), located in San Bernardino County, California, and hereinafter referred to as “the Site”. This plan was prepared for Luz II, a subsidiary of Brightsource Energy, Inc. The three solar plants will be separately owned and operated by Solar Partners I, LLC; Solar Partners II, LLC; and Solar Partners VIII, LLC. The shared facilities will be owned by Solar Partners IV, LLC. These four limited liability companies are also subsidiaries of Brightsource Energy, Inc. An Application for Certification (AFC) for the Ivanpah SEGS was submitted to the California Energy Commission on August 31, 2007. An Application for Right of Way (Form 299) was submitted to the United States Department of the Interior, Bureau of Land Management (BLM) on November 16, 2006, and a Plan of Development (POD) was submitted to the BLM on October 8, 2007.

This Decommissioning and Reclamation Plan includes the following components:

- A summary of applicable regulatory requirements and standards;
- A facility description, including major plant features and equipment, unit quantities and unit areas affected;
- Conceptual procedures for demolition and removal of equipment and for site reclamation;
- Procedures for management of each material/waste stream, including rough order of magnitude estimates of anticipated quantities, handling procedures, and disposition (disposal and recycling);
- Procedures for Health, Safety and Environment (HSE) management, including identification and management of hazardous waste substances and use of low impact methods; and
- An indicative cost estimate based on assumed exit quantities, labor/equipment costs and disposal costs using an existing data base not specific to the Site.

This Decommissioning and Reclamation Plan is intended to be a companion to the *Closure, Revegetation and Rehabilitation Plan* prepared for the Site by CH2M Hill, dated May 2009 (CH2M Hill, 2009). This plan presents procedures for decommissioning and removal of the proposed improvements associated with the Ivanpah SEGS; whereas, the companion document by CH2M Hill outlines procedures for Site revegetation and habitat rehabilitation.

2. SITE CONDITIONS

2.1 Location and Land Use

The Site is located in an unincorporated area of San Bernardino County in the Ivanpah Valley, which is 4.5 miles southwest of Primm, Nevada and 3.1 miles west of the California/Nevada border (**Figure 1**). The Site is located in Township 17 North, Range 14 East, and Township 16 North, Range 14 East on land which is administered by the Bureau of Land Management (BLM). The total area required for construction and operation of all three solar plant sites including the shared infrastructure is approximately 4,073 acres (minus the acreage for existing established dirt roads equals about 4,065 acres, net). This includes approximately 3,723 acres of permanent effects and approximately 313 acres¹ of work area that would be subject to restoration following construction. The Site is currently undeveloped, vacant land, and under federal jurisdiction.

2.2 Topography

The Site is situated in the eastern Mohave Desert in Ivanpah Valley, a north-trending elongate valley near the California-Nevada border in northeast San Bernardino County. The elevation of the valley floor ranges from 2,595 feet at Ivanpah (dry) Lake to approximately 4,000 feet above mean sea level at the south end of the valley. The valley is bordered by the Ivanpah Range on the west, the New York Mountains on the southeast, and the Clark Mountains on the northwest (Waring, 1920; DWR, 1964). Ivanpah Valley is a topographically closed basin ringed by broad, coalescing alluvial fans (bajadas) that extend from canyons draining the surrounding mountains to the playa deposits of Ivanpah Lake. The Site is located on the west side of the valley on a bajada that runs along the eastern foot of Clark Mountain, and has a relatively uniform natural slope from east to west of approximately 5 percent. The Site elevation ranges from about 3,200 feet on its western boundary to about 2,900 feet on its eastern boundary.

2.3 Geology

The Site lies within the Basin and Range Geomorphic Province, an area characterized by block faulted north-northwest trending mountain ranges that are separated by down-dropped alluvial valleys. Several small faults, including the Ivanpah and Stateline faults, are located in the area. The mountain ranges and basement rocks underlying Ivanpah Valley consist largely of Precambrian and Paleozoic limestone and dolomite. Valley fill consists of Recent and Quaternary unconsolidated alluvial and playa deposits. The Site is underlain by Recent and Quaternary alluvial fan deposits (Jennings, 1961). As is typical of these deposits, the alluvium ranges from coarse, bouldery material near the fan head (also termed the apex or proximal portion of the fan), to fine sands and silts at the toe or distal portion of the fan. Deposits at the Site may be characterized as mid-fan facies.

The alluvial fan deposits underlying the Site consist of both Older and Younger alluvial deposits, which are distinguished based on the formation of desert pavement (an interlocking crust of pebbles and rocks formed as finer sediment is removed from near surface deposits by wind and rain, and the coarser deposits consolidate). However, both the Older and Younger alluvium are dissected by numerous active washes and signs of recent sheet flow reportedly typify much of the Clark Mountain bajada (CH2M Hill, 2008). Ongoing dissection across the bajada

¹ These numbers may change once the stormwater plan is completed.

CONCEPTUAL DECOMMISSIONING AND RECLAMATION PLAN, IVANPAH SEGS IVANPAH BASIN, CALIFORNIA

shows that its current morphology is best classified as “erosional.” Data indicate that more than 80 percent of the surface has been subject to relatively recent scour or deposition from washes originating in the hills to the west. Additional information regarding the near surface soils at the Site is presented in the *Closure, Revegetation and Rehabilitation Plan* prepared by CH2M Hill, dated May 2009 (CH2M Hill, 2009).

2.4 Climate and Hydrology

The Ivanpah Valley is located in the eastern Mojave Desert, and is arid to semi-arid. The annual average precipitation in the basin ranges from approximately 4 to 10 inches (Jennings, 1961). In this region of California, temperatures are extreme with cold winters accompanied by sporadic rainfall from Pacific frontal storms, and hot, dry summers with infrequent, but occasionally intense monsoonal thunderstorms. There are no perennial streams in Ivanpah Valley, and surface flow in channels generally occurs only after local thunderstorms or, more commonly, a strong winter storm. Precipitation enters the valley from incised canyons in the surrounding mountains and runs off rapidly from hillslopes and alluvial fans. Runoff usually infiltrates into the ground before reaching the playas at the low points in the valley, but in some years water temporarily ponds in these usually dry lake beds. The valley is a closed basin in terms of surface drainage, and the playas along the valley axis represent terminal lakes. Additional information regarding the climatic and hydrologic setting of the Site is presented in the *Closure, Revegetation and Rehabilitation Plan* prepared by CH2M Hill, dated June 2009 (CH2M Hill, 2009).

2.5 Area Hydrogeology

Quaternary alluvium forms the primary water-bearing unit within the Ivanpah Valley Groundwater Basin. This alluvium includes unconsolidated younger alluvial fan material, which overlays a semi-consolidated, older alluvium. The alluvium has a maximum thickness of at least 825 feet (DWR, 1964). There are several northwest-trending faults that may impede the flow and movement of groundwater. Among these are the State Line, Ivanpah, and Clark Mountain faults (Jennings, 1961; DWR, 1964).

The primary source of recharge to the basin is the percolation of runoff via alluvial deposits found in Wheaton Wash and at the base of the bordering mountains. Recharge may also be derived from the infiltration of precipitation that falls on the floor surface of the valley. Both surface runoff and groundwater in the alluvium move toward Ivanpah Lake, where there is an existing pressure zone beneath subsurface lacustrine and deposits. From Ivanpah Lake, groundwater migrates towards the Nevada side of the basin (Waring, 1920; DWR, 1964).

3. IVANPAH SEGS DESCRIPTION AND STRUCTURES

Three solar energy plants are proposed to be constructed at the Site. The project will be comprised of two 100-megawatt (MW) plants and one 200-MW plant utilizing thermal concentrating solar power generation technology, as well as shared facilities (Figure 2). Each plan consists of a field of heliostat mirrors that focus the sun's energy on a central receiver tower, where the heat is used to produce steam that in turn powers a steam turbine generator. The total area required for construction and operation of all three solar plant sites including the shared infrastructure is approximately 4,073 acres (minus the acreage for existing established dirt roads equals about 4,065 acres, net). This includes approximately 3,723 acres of permanent effects and approximately 313 acres² of work area that would be subject to restoration following construction.

The heliostat (or mirror) fields, which are the basis of the solar technology, are arranged in an array around power tower receivers near the center of each of the heliostat arrays. The solar field and power generators will be started up each morning after sunrise and will be shut down in the evenings. Per the AFC, each of the three plants will consist of the following components:

- Heliostat fields (the 100-MW plants will each have one array; the 200-MW plant will have five arrays);
- Power block containing a Rankine-cycle reheat steam turbine, solar reheating tower, package boiler, condenser, deaerator, water storage tanks, emergency generator, diesel fire pump, and switchyard;
- A transmission line connecting to a substation to be constructed by Southern California Edison (SCE);
- A gas metering set;
- An air-cooled condenser to minimize the use of water in the desert; and
- A perimeter access/maintenance road.

Shared Site improvements include an administrative and maintenance complex, a natural gas distribution pipeline, two water supply wells and shared access roads. Prior to construction, portions of the Site will be cleared and graded. Clearing and grubbing (roots to be removed) of the site is to be performed as required for each facility and in common areas where the existing topography requires modification in order to provide access for installation equipment and materials during construction (areas requiring leveling or grading). Grading and leveling will be performed as needed for building site preparation and for construction and maintenance access. Where existing site topography is favorable the natural drainage features and grades will be maintained; however, grades of at least 2 percent will be maintained away from building walls and equipment. A Low Impact Development (LID) strategy that minimizes grading in the solar field and makes use of the natural terrain including existing washes and small swales to allow storm water to travel over the site rather than capturing and metering the water with massive retention ponds.

All of the components and improvements mentioned will be dismantled, regraded, and/or removed during the decommissioning and reclamation process with the intention of removing all improvements within 3 feet of the final grade and restoring the ground surface to match the natural alluvial fan gradient.

² These numbers may change once the stormwater plan is completed.

4. RECLAMATION AND DECOMMISSIONING CRITERIA AND PLANNING

The Site is located on land managed by the U.S. Department of the Interior, Bureau of Land Management (BLM), which is responsible to process right-of-way applications for projects on its land, conduct the federal environmental review under the National Environmental Policy Act (NEPA) and administer resulting requirements and mitigation. Additionally, the CEC reviews all applications to construct and/or operate thermal electric power plants in California that are 50 MW and greater, conducts the state environmental review under the California Environmental Quality Act (CEQA) and administers the resulting mitigation measures (Conditions of Certification). In addition, the CEC assures compliance with its Power Plant Site Certification Regulations (March 2007).

All activities will be in compliance with the requirements of the federal right-of-way grant, CEC power plant licensing and associated environmental reviews. Requirements pertinent to this Decommissioning and Reclamation Plan include the following.

Final Decommissioning and Reclamation Plan – Because conditions can change during the course of a 25-year project life, a final Decommissioning and Reclamation Plan will be submitted for BLM and CEC review and approval based on conditions as found at the time of facility closure.

Health and Safety Plan - In order to comply with regulations set forth by the Occupational Health and Safety Administration (OSHA), a project-specific Health and Safety Plan (HASP) will be prepared, which will document health and safety requirements for establishing and maintaining a safe working environment during the implementation of the planned Site activities.

Construction Stormwater Pollution Prevention Plan (SPPP). – The project will comply with the requirements of the National Pollutant Discharge Elimination System (NPDES) through preparation and implementation of a SWPPP and filing of a Notice of Intent (NOI) to comply with the General Construction Stormwater NPDES Permit. The plan will include procedures to be followed during construction to prevent erosion and sedimentation, non-stormwater discharges, and contact between stormwater and potentially polluting substances.

Dust Control – Per the requirements of the Mojave Desert AQMD, standard dust control mitigation measures will be implemented to reduce dust particulate emissions during demolition and grading activities.

Hazardous Materials Business Plan (HMBP) – A closure plan will be filed with the San Bernadino County Fire Department detailing procedures for closure of the facility's HMBP including removal of hazardous substances from the site, their handling during removal, their ultimate disposition, and any required confirmation soil sampling.

Spill Prevention Control and Countermeasure Plan (SPCC) - The SPCC Plan for the Site will be amended to include spill prevention and countermeasures procedures to be implemented during the removal of petroleum and hazardous substances from the Site. The Plan is comprised of several key items, including (but not limited to) a spill record (if applicable), description of facilities, spill response procedures, personnel training and spill prevention.

Surface Impoundment Closure Plan – A plan will be submitted to the California Integrated Water Management Board (CIWMB) and the Regional Water Quality Control Board (RWQCB) for clean closure of the evaporation pond through removal of all residue that has accumulated, all liner and containment systems, and any underlying impacted soils, as required.

Construction Fire Prevention Plan – A plan will be prepared that outlines procedures and equipment to be used for fire detection and prevention.

Transportation Plan – A transportation plan will be prepared that outlines approved routes of travel and times and procedures for permit-required loads, as well as procedures to comply with Department of Transportation (DOT) regulations.

County Permits – The required planning and building permits normally required from the County of San Bernadino, are subsumed under the CEC permitting process.

5. PLANT DECOMMISSIONING

The procedures described for decommissioning are designed to ensure public health and safety, environmental protection, and compliance with applicable regulations. It is assumed that decommissioning would begin 25 years after the commercial operation date of the solar plant. It is also assumed that decommissioning of the facility would occur in a phased sequential manner. That is, work would start at Ivanpah 1, followed by similar work at Ivanpah 2 and then Ivanpah 3, while the later phases of demolition / restoration work are finished and Ivanpah 1 and Ivanpah 2. In this way, the work would pass sequentially across all three units, with phases of work occurring at the same time at different locations. The shared facilities in the central administration area will be used to support the decommissioning work and therefore are expected to be some of the last to be decommissioned. Decommissioning of these facilities would be accomplished as they become available. The current plans for decommissioning of the Ivanpah SEGS would last a total of 2-3 years including the used equipment marketing process. They are outlined below.

5.1 Decommissioning Objectives

The project goals for Site decommissioning are as follows:

- Remove all improvements within 3 feet of final grade;
- Restore the lines and grades in the disturbed area of the Ivanpah SEGS site to match the natural gradients of the alluvial fan; and
- Facilitate the effectiveness of the reclamation and restoration procedures outlined in the *Draft Closure, Revegetation and Rehabilitation Plan* prepared for the Site by CH2M Hill, dated June 2009 (CH2M Hill, 2009).

The proposed implementation strategy to achieve the goals for Site decommissioning is as follows:

- Use industry standard demolition means and methods to decrease personnel and environmental safety exposures by minimizing time and keeping personnel from close proximity to actual demolition activities to the extent practical;
- Plan each component of the decommissioning project such that personnel and environmental safety are maintained while efficiently executing the work;
- The final decommissioning plan will specify in detail how each major effort will be performed and integrated to achieve the project goals.
- Train field personnel for decommissioning actions to be taken in proportion to the personnel, project or environmental risk for those actions;

**CONCEPTUAL DECOMMISSIONING AND RECLAMATION PLAN, IVANPAH SEGS
IVANPAH BASIN, CALIFORNIA**

- Evaluate the execution of the decommissioning and restoration plan through project oversight and quality assurance;
- Document implementation of the plan and compliance with environmental requirements.

5.2 Decommissioning Strategy

The decommissioning plan for the Site facilities consists of the following major elements:

- Documentation and establishment of health and safety procedures;
- Used equipment marketing activities
- Conducting pre-decommissioning activities such as final decommissioning and restoration planning that addresses the “as-found” site conditions at the start of the project. Also included are planning activities for marketing and showing used equipment;
- Dismantling of equipment items that are to be sold on the used equipment market;
- Demolition of the above-ground structures (dismantling and removal of improvements and materials) in a phased approach while still using some items until close to the end of the project. For instance, the water supply, administrative building and some electrical power components will be modified so as to continue use until very late in the decommissioning project;
- Demolition and removal of below-ground facilities (floor slabs, footings, and underground utilities) as needed to meet the decommissioning goals;
- Soils cleanup, if needed, with special attention applied to retention pond and hazardous materials use/storage areas to ensure that clean closure is achieved;
- Disposal of materials in appropriate facilities for treatment / disposal or recycling; and
- Recontouring of lines and grades to match the natural gradient and function of the alluvial fan.

Although various types of decommissioning / demolition equipment will be utilized to dismantle each type of structure or equipment, dismantling will proceed according to the following general staging process. The first stage consists of dismantling and demolition of above-ground structures. The second stage consists of concrete removal as needed to ensure that no concrete structure remains within 3 feet of final grade (i.e., floor slabs, below-ground walls, and footings). The third stage consists of removal/dismantling of underground utilities within 3 feet of final grade. The fourth stage is excavation and removal of soils, and final site contouring to return the originally disturbed area of the Site to near original conditions while disturbing as little of the other Site areas as is practical.

5.2.1 Health and Safety Procedures

The health and safety procedures to be established prior to decommissioning are listed below.

- General safety and hazard responsibilities;
- Establishment of an effective hazard communications program;
- Task hazard analysis and control;
- Personal protection equipment (PPE) requirements;
- Occupational and environmental monitoring requirements;
- Medical and other emergency procedures;
- Operational issues;
- Personnel training;
- Incident reporting; and
- Self audit and compliance procedures.

5.2.2 Used Equipment Marketing Activities

Prior to cessation of plant operations, final details and implementation of an equipment sales plan will be initiated. Activities will consist of equipment dealer/broker selections and showing equipment to prospective end users. More information on this subject can be found in section 8.

5.2.3 Pre-Decommissioning Activities

Pre-decommissioning activities consist of preparing the Site area for demolition. These activities include removal of remaining residues (such as boilers or storage tanks), and products such as diesel fuel, hydraulic oil, lubricating oil, and mineral oils, and other materials (where feasible) in order to reduce potential personnel and environmental exposure and to facilitate decommissioning. All operational liquids and chemicals are expected to be removed at this time as well, such as boiler feed / condensate waters, laboratory equipment and chemicals, boiler / condensate addition chemicals as well as any maintenance lubricants, and solvents, etc. Hazardous material and petroleum containers and pipelines will be rinsed clean when feasible and the rinsate collected for off-site disposal. In general, these materials will be placed directly into tanker trucks or other transport vessels and removed from the site at the point of generation to reduce the need for hazardous material and waste storage at the Site.

Terminal operations of the site are assumed to leave electrical power, raw / sanitary water available for limited use by the decommissioning project team.

5.2.4 Dismantling of Equipment and Demolition of Above-Ground Structures

Prior to general demolition, equipment that is to be sold on the used equipment market will be dismantled and removed from the site in an orderly fashion.

**CONCEPTUAL DECOMMISSIONING AND RECLAMATION PLAN, IVANPAH SEGS
IVANPAH BASIN, CALIFORNIA**

General demolition entails breakdown and removal of above-ground structures and facilities, including transmission lines (Generator Tie Lines) and overland piping between the reheat tower and collecting tower at Unit 3. Residual materials from these activities will be transported via heavy haul dump truck to a central recycling / staging area where the debris will be processed for transport to an off-site recycler. A project recycle center (either at each power unit as the work progresses or at the central admin area) will be established to:

- Size reduce and stage metals and mirrors for transport to an off-site recycler;
- Crush concrete and remove rebar;
- Stockpile concrete for later use at the Site;
- Stage rebar for transport to an off-site recycler; and
- Temporarily store and act as a shipping point for any hazardous materials to an approved TSD facility.

The strategy for demolition consists of using mechanized equipment and trained personnel in the safe dismantling and removal of the following above-ground structure.

- Heliostats and related equipment using low environmental impact equipment;
- Collector and reheat towers using explosives to put the towers on the ground, then conventional heavy equipment to size reduce and transport for recycling (this is the industry standard for safe demolition of large towers and massive concrete structures);
- Removal of remaining equipment, transmission lines and towers, and aboveground pipelines using conventional demolition equipment and techniques; and
- Near the very end of the project, the removal of site-related fencing.

5.2.5 Below-Ground Facilities and Utilities

The below-ground facilities to be removed include concrete slabs and footings that would remain within 3 feet of final grade at the end of the project. It is anticipated (though Agencies may recommend some or all of these facilities to be abandoned in place to minimize soil disturbance) that any and all Site related piping and utilities, including water lines, below ground electric / control / communication lines, and gas lines will be completely removed, regardless of the depth below final grade. These materials will be excavated and transported to the recycling area(s) for processing and ultimate recycling. The resulting trenches will be backfilled with suitable material of similar consistency and permeability as the surrounding native materials and compacted to 85 percent relative compaction.

5.2.6 Soils Cleanup and Excavation

The need for, depth and extent of contaminated soil excavation will be based on observation of conditions and analysis of soil samples after removal of the concrete holding basins and hazardous materials storage areas, and upon closure of the recycling center(s) and waste storage areas used during decommissioning. At this time, removal of contaminated soil is assumed to not be needed. If required, removal will be conducted to the extent feasible and as required to meet regulatory cleanup criteria for the protection of groundwater and the environment. If contaminated soil removal is required, the resulting excavations would be backfilled with native soil of similar permeability and consistency as the surrounding materials and compacted to 85 percent relative compaction.

5.2.7 Demolition Debris Management, Disposal, and Recycling

Demolition debris will be placed in temporary onsite storage area(s) or piled onsite pending processing at the recycling center and transportation/disposal/recycling according to the procedures listed below.

- The demolition debris and removed equipment will be cut or dismantled into pieces that can be safely lifted or carried with the onsite equipment being utilized. The vast majority of glass, steel and concrete rubble will be processed at the recycling center but some specific equipment, e.g. boilers, etc. may be transported as intact components or size reduced on site with cutting torches or similar equipment.
- A front-end loader, backhoe, or equivalent appropriate equipment will be utilized to crush or compact compressible materials. These materials will be laid out in a staging area or other approved area to facilitate crushing or compacting with equipment pending disposal/recycling.
- Materials such as steel, glass and other materials will be temporarily stockpiled at or near the processing location pending transport to an appropriate off site recycling facility.
- Concrete foundations will be removed to a depth of at least three feet below (final) grade. Upon removal of the rebar material from concrete rubble, the residual crushed concrete will be layered beneath the ground surface but only at locations that will remain greater than 3 feet below the final grade elevation. This will reduce waste volume and transportation.

5.2.8 Recontouring

Recontouring of the Site will be conducted using standard grading equipment to return the land to match within reason the previously existing surface and surrounding alluvial fan grade and function. Grading activities will be limited to previously disturbed areas that require recontouring. Efforts will be made to disturb as little of the natural drainage and vegetation as possible. Concrete rubble, crushed to approximately 2-inch minus size, will be placed in the lower portions of fills, at depths at least 3 feet below final grade. Fills will be compacted to approximately 85 percent relative compaction by wheel or track rolling to avoid over-compaction of the soils. To the extent feasible, efforts will be made to place a layer of coarser materials at the ground surface to add stability. Revegetation and habitat restoration is discussed in the *Draft Closure, Revegetation, and Rehabilitation Plan*, dated June 2009 by CH2M Hill (CH2M Hill, 2009).

6. HAZARDOUS WASTE MANAGEMENT

Hazardous materials expected to be handled during the decommissioning process are listed in the table below. These materials included lead acid batteries, sulfur hexafluoride, diesel, hydraulic oil, lubricating oil, and mineral oil. Any other operational chemicals listed as hazardous in the AFC will be removed as part of the terminal shutdown of the plant prior to decommissioning activities.

Material	Site Use	Location	D&R Project Strategy
Lead Acid Batteries (Sulfuric Acid and Lead) size of batteries approx 10cm x 5cm x 7cm	Electrical power	Heliostats 214,000 batteries	Remove prior to heliostat stanchion processing or demolition
Sulfur hexafluoride	Switchyard/switchgear devices	Contained within equipment (approx. 200 lbs.)	Remove prior to switchgear removal
Diesel No 2	Fuel for pump engine/generators	Near fire pump; max quantity 9,000 gallons.	Drain liquid from equipment prior to removal. Triple-rinse tanks and piping prior to processing and recycling. Rinsate fluid will be disposed offsite.
Hydraulic Oil	Used in turbine starter system, turbine control valve actuators.	Contained within equipment; max quantity onsite 500 gallons.	
Lubricating Oil	Used to lubricate rotating equipment.	Contained within equipment; max quantity onsite 30,000 gallons.	
Mineral Oil	Used in transformers	Contained within transformers; max quantity onsite 105,000 gallons	

Fuel, hydraulic fluids and oils will be transferred directly to a tanker truck from the respective tanks and vessels. Storage tanks/vessels will be rinsed and rinsate will also be transferred to tanker trucks. Other items that are not feasible to remove at the point of generation, such as smaller containers lubricants, paints, thinners, solvents, cleaners, batteries and sealants will be kept in a locked utility building with integral secondary containment and meets CUPA and RCRA requirements for hazardous waste storage until removal for proper disposal. It is anticipated that all oils and batteries will be recycled at an appropriate facility. Site personnel involved in handling these materials will be trained to properly handle them. Containers utilized to store hazardous materials will be inspected regularly for any signs of failure or leakage. Additional procedures will be specified in the HMBP closure plan submitted to the CUPA.

Transportation of the removed hazardous materials will comply with regulations for transporting hazardous materials, including those set by the Department of Transportation (DOT), EPA, California Department of Toxic

**CONCEPTUAL DECOMMISSIONING AND RECLAMATION PLAN, IVANPAH SEGS
IVANPAH BASIN, CALIFORNIA**

Substances Control (DTSC), California Highway Patrol (CHP), and California State Fire Marshal. The following table lists the properties and toxicity of hazardous waste materials that will be removed.

Material	Physical Description	Health Hazard	Flammability
Sulfuric Acid	Oily, colorless liquid	Corrosive to skin, eyes, and digestive tract. Respiratory tract irritant.	Non-flammable
Sulfur hexafluoride	Colorless gas, odorless	Hazardous when inhaled	Non-flammable
Diesel No 2	Oily, light liquid	Skin irritant, aspiration hazard	Flammable
Hydraulic Oil	Oily, dark liquid	Hazardous if ingested	Combustible
Lubricating Oil	Oily, dark liquid	Hazardous if ingested	Flammable
Mineral Oil	Oily, clear liquid	Minor health hazard	Combustible

The SPCC plan for the site will be updated to cover spill prevention and countermeasures for handling of these materials during decommissioning. As previously discussed, a Site-specific Health and Safety Plan (HASP) will document health and safety requirements for establishing and maintaining a safe working environment during the implementation of the planned Site activities. Additional procedures to decrease the potential release of contaminants to the environment and contact with storm water will be specified in the SWPPP.

7. SALVAGE VALUES

Worley Parsons was commissioned to estimate quantities and anticipated values for scrap commodities.

This is a re-print of the Worley Parsons memorandum "Scrap Value Evaluation 23-Jan-09"

Scrap Value Evaluation

Provided herein is an evaluation of the recycle market and transportation costs for recyclable materials included in the draft cost estimate developed using scrap values and transportation costs as of November/December 2008.

The results of this evaluation indicate that, based on current scrap value and transportation cost data, considerable scrap value may be derived from recycling copper, aluminum, carbon steel, glass and batteries at a Las Vegas or southern California recycle center. For perspective, a positive revenue stream between \$9M and \$12M would be expected using current values, with aluminum and copper being the primary contributors and glass resulting in a net cost. This represents a reduction of the estimated decommissioning and reclamation cost by approximately one third. While mirror and plate glass recycling alone is generally a negative revenue stream regardless of the recycling center location, other scrap recycling will provide positive revenue with transport to centers within 700 to 1500 miles from the Ivanpah site if the parameters comparable to those used for this analysis are applicable when the decommissioning occurs. Adjustment of the estimated decommissioning and reclamation cost using the above scrap value leads to an improved understanding of anticipated costs, and should be incorporated into the cost estimate.

SCRAP VALUE ANALYSIS APPROACH AND RESULTS

Definitions

Mix Scrap Iron & Steel- Assorted iron & steel scrap up to any maximum size, must be free of white goods & light gauge materials under 1/8" in thickness.

White Goods- Major household appliances including stoves, fridges freezers, clothes washers, dryer & dish washers

No. 2 HMS- No. 2 Steel shall consist of clean iron & steel with a minimum thickness of 1/8", and a maximum size of 60"x18", material handling compatible to feed a furnace charge box.

No. 1 HMS (2 foot) - No. 1 HMS (2 foot) shall consist of clean iron & steel with a minimum thickness of 1/4", and a maximum size of 24"x18", material handling compatible to feed a furnace charge box. This grade may include ISRI code 201.

ISRI Code 201- Heavy melting steel 3 feet x 18 inches. Wrought iron and/or steel scrap 1/4 inch and over in thickness. Individual pieces not over 36 x 18 inches (charging box size) prepared in a manner to insure compact charging.

Aluminum Extrusions- Clean aluminum extrusions including window & door frames. Must be free of iron inserts, screws and plastic, rubber or other foreign materials.

**CONCEPTUAL DECOMMISSIONING AND RECLAMATION PLAN, IVANPAH SEGS
IVANPAH BASIN, CALIFORNIA**

Soldered Copper Pipe Scrap- Used to represent wiring recycle values and best represents the air cooled condenser materials that make up a very large percentage of the copper. Soldered Copper Pipe shall consist of assorted copper pipe (of any length) with soldered joints or ends, free of brass or bronze or non-copper fittings.

Whole Prepared Car Bodies- Used to represent galvanized steel materials. Unflattened car bodies, with tires, radiator and battery removed gas tanks acceptable but must be removed and punctured, (no propane tanks allowed). Engine and transmission may or may not be included.

LTL- The Less than Truck Load (LTL) prices shown on the website refer to the over the scale value of miscellaneous quantities of materials. LTL quantity refers to weights of less than 40,000 lbs. unless otherwise stipulated. This is the value used for comparison for the Ivanpah recycle materials.

TL- Truck Load (TL) Prices refer to sorted and prepared materials, packaged and ready for shipment in typical TL quantity weights of 40,000 lbs. unless otherwise stipulated. This is the value used for comparison for the Ivanpah recycle materials.

Mirror Scrap Glass- Mirror Scrap Glass shall contain clean whole or broken mirrors, free frames or foreign backing materials.

3/8 inch Plate Glass- 3/8" Plate Glass shall contain un-laminated plate glass scrap processed and sized to minus 3/8" (inch). This is equivalent to Andela #6.

1/8 inch Plate Glass- 1/8" Plate Glass shall contain un-laminated plate glass scrap processed and sized to minus 1/8" (inch). This is equivalent to Andela #3.

Approach to Development of 2008 Scrap Value Data and Transportation Costs

The spot price of recyclable materials used for this analysis was obtained from the websites listed below, with copies of the site information on 11/25/08 and 1/7/09.

Site use for the scrap aluminum (1/7/09) - <http://www.recycle.net/Metal-N/Aluminum/index.html>

Site used for scrap copper (1/7/09) - <http://www.recycle.net/Metal-N/Copper/index.html>

Site used for scrap steel (11/25/08) - <http://www.scrapspot.com/03-0115.html>

Site used for glass (11/25/09) - <http://www.universalwrecking.com/Sections-read-47.html>

Site used for batteries (11/25/09) - http://www.rex-change.com/cgi-bin/exchsvieview.cgi?ex=REX%3A000028&acc=IN000941&gid=01-020120-001&p=0&affilid=&sender_email=&Contact+Listing.x=14&Contact+Listing.y=9

The estimate for transportation cost was as follows. A reference for round trip trucks shipments was found in *NUREG/CR-5884 Revised Analyses of Decommissioning for the Reference Pressurized Water Reactor, Appendix C* for non-nuclear recycle and waste disposal transportation. While a directly applicable source, the data was from 1993 and was converted to 2008 presents value using the annual Consumer Price Index inflation rates from the website shown below.

http://inflationdata.com/inflation/Inflation_Rate/HistoricalInflation.aspx

Based on this adjustment, the transportation cost for a fully loaded truck was calculated to be \$36.84/ton for a dealer located in Las Vegas NV, or \$89.91/ton if the recycle materials had to be transported to Long Beach CA. The

**CONCEPTUAL DECOMMISSIONING AND RECLAMATION PLAN, IVANPAH SEGS
IVANPAH BASIN, CALIFORNIA**

Port of Long Beach was included in the analysis since it is both big enough that finding a dealer for handling the volume of scrap from the project would be very reasonable, and Long Beach has good port facilities if ocean transport to Asia was needed. Mesa, AZ was also included as a possible destination (at \$134.13 per ton) for the battery recycling since that is the location of the processor that was used for this comparison.

The inflation escalation used may be seen in Table 1, and the recycle transportation cost calculation is presented in Table 2.

Table 1 – 1993 to 2008 Escalation Due to Inflation

Year	CPI Inflation Rate	Cumulative Inflation Rate
1993	1.0296	1
1994	1.0261	1.0261
1995	1.0281	1.054933
1996	1.0293	1.085843
1997	1.0234	1.111252
1998	1.0155	1.128476
1999	1.0219	1.15319
2000	1.0338	1.192168
2001	1.0283	1.225906
2002	1.0159	1.245398
2003	1.0227	1.273668
2004	1.0268	1.307803
2005	1.0339	1.352137
2006	1.0324	1.395946
2007	1.0285	1.435731
2008	1.045	1.500339

Note that the 2008 value is the Jan to Oct average

Table 2 – Transportation Cost Calculation

Reference trip costs	RT (1993) =	\$1,212	
Reference trip distance	Dt =	257	
Inflation to 2008 from CPI	RT (2008) =	\$1,818	
d1 and d2 =Ivanpah to scrap dealer			
d1	Las Vegas =	45	
d2	Long Beach =	240	
d3	Mesa, Az =	365	
Permit costs per trip	P =	\$100	
Round trip costs = [RT*{d1 or d2}/dt] +P from the NUREG/CR-5884 Appendix C			
		\$ per round	
		trip with 20	\$/ton
		Tons	transport
Round trip cost for Las Vegas dealer		\$737	\$36.84
Round trip cost for Long Beach dealer		\$1,798	\$89.91
Round trip cost for Mesa, AZ dealer		\$2683	\$134.13

Quantities for Recycling

Estimated quantities of recyclable materials were taken from the total quantities and construction information used in the project estimate for all three units performed earlier. The following quantities were estimated:

Steel (4,383 tons) – Includes structural steel, piping, equipment and rebar.

Aluminum (6,528 tons) – Includes heliostat grounding rods, air-cooled condensers, pipe racks/cable trays, 30-foot utility poles and HVAC refrigeration systems.

Copper (1,229 tons) – Includes power supply cabling, air compressors/inst air, turbine generators, 115 kV wire, air cooled condensers, and HVAC refrigeration systems.

Mirror glass(37,684 tons) – 214,000 mirrors (3 to 4 per heliostat for a total surface of 7’ to 10’ per heliostat) at 352 pounds each.

Batteries (2,158 tons) – Includes 214,000 heliostat batteries at 20lbs each and 360 station batteries at 120lbs each.

Methodology

Revenue streams from recycling were estimated from combined analysis of current market price (which can decrease or increase frequently dependent upon market demand), estimated scrap quantities and weights, and transportation costs to derive **Reasonable Maximum, Most Likely, and Reasonable Minimum** scrap value estimates. While bronze, brass and other metals would be expected to be utilized, the steel, aluminum and copper items are most identifiable at this point in the project, which dictated the application of the per ton scrap spot prices obtained from the sources cited above as the cost basis. In addition, spot values for glass and battery recycling were utilized based on assumed mirror and battery weights. All quantities and weights are assumptions derived from the conceptual design information available, modeled from existing facilities, and/or taken from industry standards.

Results

The ranges of scrap values estimated based on current spot prices and transportation costs are presented below. Based on this analysis, the market value of aluminum and copper will have the largest effect on the overall revenue stream. Steel and batteries will generate much less revenue. Under current conditions, glass will result in net negative revenue, with significantly greater cost with increased transport distance. Other than for glass, the location of the recycling facility (Las Vegas vs. ong beach) does not make an appreciable difference in the overall expected scrap revenue.

Table 3 – Estimated Recycling Value

IVANPAH SEGS ESTIMATED 25 YEAR SALVAGE VALUES			
Material	ESTIMATED VALUE ^[1]		
	LOW	HIGH	MOST LIKELY
Steel	\$657,831.00	\$1,284,862.00	\$1,021,894.00
Aluminum	\$7,899,310.00	\$8,486,205.00	\$8,245,720.00
Copper ^[2]	\$341,009.25	\$357,580.80	\$350,790.45
Glass/Mirrors	(\$3,218,457.00)	(\$427,332.00)	(\$1,218,698.00)
Batteries	\$314,791.00	\$524,740.00	\$410,222.00
Major Equipment ^[3]	\$3,625,400.00	\$22,019,000.00	\$12,822,200.00
Totals	\$9,619,884.25	\$32,245,055.80	\$21,632,128.45

NOTES:

1. Estimated material values were taken from WorleyParsons report dated January 23, 2009, “Scrap Value Evaluation.”
2. Estimated values for copper were reduced to 15% of the WorleyParsons values to reflect the removal of turbine generators from the list of items to be recycled.
3. Major Equipment values were obtained from the totals found in Section 8.5 on Table 1: Major Equipment.

8. USED EQUIPMENT STUDY

The purpose of this study was to look at pieces of equipment that might have significantly higher value on the used equipment market as opposed to scrap value. Equipment that was considered includes steam turbine generators with air cooled condensers, boiler feed pumps, major transformers and load centers.

8.1 Used Equipment Market

A substantial market exists for used power plant equipment. Used equipment dealers/brokers locate equipment and agree to purchase or agree to market the equipment. For large items, such as the steam turbine generators, the usual practice is to have the item remain in place until a sale to an end buyer is made. The dealer (or sometimes the end buyer) will then go in and dismantle and remove the equipment from the owner’s site. For a site like Ivanpah SEGS, this is an added benefit in that the site owner will avoid the substantial cost of demolition and removal for all equipment sold on the used market.

**CONCEPTUAL DECOMMISSIONING AND RECLAMATION PLAN, IVANPAH SEGS
IVANPAH BASIN, CALIFORNIA**

The user market exists both domestically and off-shore. By far, the most significant driving forces that feed this market are reduced pricing and significantly reduced delivery times when compared to purchase and manufacture of similar new equipment. Smaller, generic items tend to sell rather quickly while large, custom items require significant time to match to the needs of perspective end purchasers. It is not uncommon to require a year or more to find an end buyer for a large steam turbine-generator.

8.2 Marketing Strategy

The used equipment will typically bring best prices if it is operational at the time of sale agreement. Strategy is to solicit proposals from used equipment dealers/brokers approximately fifteen months in advance of the actual cease of plant operation. Two to three months should be allowed to reach agreements with equipment dealers. The dealers/brokers would, in turn, initiate efforts to advertise the equipment on the market. This would allow about twelve months for perspective end purchasers to visit the facility while equipment is operational and view the O&M records, manufacturer's documentation and equipment installation documentation. The end goal is to have end user sales agreements for each item before plant shutdown. The agreements should include clear definition of terminal points and a schedule for dismantling availability and duration.

8.3 Dismantling Strategy

Once the plant is shut down, all power feeds should be physically disconnected from all equipment to be sold. All fluids and operational chemicals would be removed as per Section 5.2.3:Pre-Decommissioning Activities. The exception would be if a buyer has prearranged for power to turning gear and lube oil pumps and motors to remain until the purchased equipment is actually dismantled and removed from the site.

The equipment dismantling contractor (buyer's contractor) would then move on site and methodically prepare the equipment for breakdown and shipping. For safety reasons, it is recommended that general demolition (5.2.4 Demolition of Above-Ground Structures) be delayed in affected areas until used equipment dismantling is completed.

8.4 Effects of Equipment Sales on Closure Costs

The sale of used equipment will have a significant effect on the closure cost of Ivanpah SEGS. This study focused on steam turbine generators with air cooled condensers, boiler feed pumps, standby diesel generators, major transformers and load centers. The estimate of "most likely" estimated values falls into a Class 5 category as defined by Recommended Practice No. 18R-97 of AACE International.

**CONCEPTUAL DECOMMISSIONING AND RECLAMATION PLAN, IVANPAH SEGS
IVANPAH BASIN, CALIFORNIA**

8.5 Used Equipment Value Analysis

Processes Unlimited International, Inc. estimated future salvage values for several pieces of major equipment associated with the proposed Ivanpah Solar Electric Generating System (SEGS) after a 25 year service life. (For a full copy of study refer to Appendix1) Equipment to be estimated is shown in the following table: Equipment List.

EQUIPMENT LIST		
EQUIPMENT DESCRIPTION	QUANTITY	ADDITIONAL NOTES
100 MW Steam Turbine Generator with A/C Condenser (After study was commissioned, ISEGS elected to have all STG's be the same class units.)	2 4	Main Steam Temperature: 1004°F
		Main Steam Pressure: 2400 psig
		Reheat at 900°F
		Steam Rate: 845,238 lb/hr
		Generators to be 3600 RPM, 2 poles
200 MW Steam Turbine Generator with A/C Condenser (After study was commissioned, ISEGS elected to have all STG's be the same class units.)	4 0	Main Steam Temperature: 1004°F
		Main Steam Pressure: 2400 psig
		Reheat at 900°F
		Steam Rate: 1,680,000 lb/hr
		Generators to be 3600 RPM, 2 poles
Emergency/Standby GenSet(s) with Diesel Driver	4	Capacity: 2,000KW/4.16KV
13.8 KV Unit Transformers	3	
13.8KV to 115KV Step-up Transformers	3	
4000A 480VAC Load Centers	3	
1000A 4160VAC Load Center	1	
FW Pumps	9	3@60% per plant

The study consisted of interviews with used or surplus equipment dealers. Their responses were then pooled to arrive at predicted ranges of costs for the equipment. It should also be noted that the prices solicited were what an owner might realize from sale to the used equipment dealers, as this pricing may be substantially less than what the dealer might ask on re-sale. Contact with the vendors quickly revealed that they were not willing to give dollar values based on the brief descriptions furnished.

Vendor input was analyzed to arrive at general probable residual value ranges (generally 0 to 33% of new cost). These ranges were considered and applied to new equipment cost estimates to arrive at probable ranges. The results are shown in the following table: Major Equipment. Footnotes on Table 1 indicate varying sources for new equipment pricing and also show that the ranges were adjusted for the various types of equipment based on past experience. A "most likely" column was added that shows an average of the high and low numbers. With varying market conditions and the vast uncertainty of equipment condition after 25 years, it is suggested that the "most likely" column be used as a guide for values. The "most likely" value of selling used equipment in today's dollar is \$12,822,200.00.

**CONCEPTUAL DECOMMISSIONING AND RECLAMATION PLAN, IVANPAH SEGS
IVANPAH BASIN, CALIFORNIA**

TABLE 1: Major Equipment

IVANPAH SEGS ESTIMATED 25 YEAR SALVAGE VALUES							
EQUIPMENT DESCRIPTION	ESTIMATED VALUE RANGE (EACH) ^[1]			QUANTITY AVAILABLE	TOTAL ESTIMATED VALUE RANGE		
	LOW	HIGH	MOST LIKELY		LOW	HIGH	MOST LIKELY
100 MW Steam Turbine Generator with A/C Condenser ^[2]	\$640,000.00	\$4,800,000.00	\$2,720,000.00	4	\$2,560,000.00	\$19,200,000.00	\$10,880,000.00
200 MW Steam Turbine Generator with A/C Condenser ^[2]	\$1,200,000.00	\$9,000,000.00	\$5,100,000.00	0	\$0.00	\$0.00	\$0.00
2,000 KW Emergency/Standby GenSet(s) with Diesel Driver ^[3]	\$75,000.00	\$175,000.00	\$125,000.00	4	\$300,000.00	\$700,000.00	\$500,000.00
Boiler Feed Pump 1100 GPM @ 3500 PSI ^[4]	\$4,500.00	\$112,500.00	\$58,500.00	6	\$27,000.00	\$675,000.00	\$351,000.00
Boiler Feed Pump 2200 GPM @ 3500 PSI ^[4]	\$7,800.00	\$195,000.00	\$101,400.00	3	\$23,400.00	\$585,000.00	\$304,200.00
13.8 KV Unit Transformers 2500KVA ^[5]	\$13,000.00	\$15,000.00	\$14,000.00	3	\$39,000.00	\$45,000.00	\$42,000.00
13.8 KV Unit Transformers 7500KVA ^[5]	\$26,000.00	\$30,000.00	\$28,000.00	2	\$52,000.00	\$60,000.00	\$56,000.00
13.8KV to 115KV Step-up Transformers 200 MW ^[5]	\$160,000.00	\$200,000.00	\$180,000.00	2	\$320,000.00	\$400,000.00	\$360,000.00
13.8KV to 115KV Step-up Transformers 100 MW ^[5]	\$260,000.00	\$300,000.00	\$280,000.00	1	\$260,000.00	\$300,000.00	\$280,000.00
4000A 480VAC Load Centers ^[6]	\$8,000.00	\$10,000.00	\$9,000.00	3	\$24,000.00	\$30,000.00	\$27,000.00
1000A 4160VAC Load Center ^[6]	\$10,000.00	\$12,000.00	\$11,000.00	2	\$20,000.00	\$24,000.00	\$22,000.00
TOTALS					\$3,625,400.00	\$22,019,000.00	\$12,822,200.00

NOTES:

- Methodology for determination of future salvage values is generally a function of the present value of new equipment (see Attachment B for explanation). With the vague specifics given for equipment design (see Attachment A), present cost is somewhat speculative. Most ranges were derived from equipment vendor interviews, with adjustments based on type of equipment
- STG value based on approximate range of 4% to 30% of present value of new equipment. New prices were estimated from experience based on performance parameters and steam conditions.
- Diesel GenSet values based on approximate range of 15% to 35% of present value of new equipment. New prices were based on factoring other sized GenSet costs and further confirmed by comparing to nearly new, low hour sets found on the internet.
- BFP value based on approximate range of 1% to 20% of present value of new equipment. New prices are estimated.
- Transformer value based on approximate range of 25% (plus or minus) of present value of new equipment. New prices were estimated using Icarus estimating software.
- Load center values are based on value near estimated scrap prices. Experience has shown that equipment of this type is typically obsolete by the end of a 25 year service life due to lack of replacement parts availability.

9. COST ESTIMATE

9.1 Purpose

The purpose of this section is to describe the costs associated with the decommissioning of the three-unit Ivanpah Solar Electric Generating System, and restoration of Bureau of Land Management right of way lands to near original conditions following the decommissioning.

9.2 Project Scope and Sequencing Description

The decommissioning/restoration scope included in this estimate covers the three solar station units as well as the administrative area. The assumption is made that the plant was built and operated as currently proposed. Furthermore, the plant is assumed to have operated without major spills, mishaps or casualty and was shutdown, and that systems drained and bulk chemicals were removed by the operating staff. The project is then initiated at the Site. Mobilization activities by the project professional staff are in place for approximately six months. These activities include planning, permitting and procurement activities. Early in this phase, all equipment that is to be sold will be dismantled and removed from the facility. A large recycling center will be established in a central location to support project field work startup near the end of the planning phase. The decommissioning and restoration project is envisioned to last approximately 36 months during which all solar collection and power generation equipment will be removed and the land restored to near original condition.

As discussed in Section 5, decommissioning of the facility would occur in a phased sequential manner, with work starting at Ivanpah 1, followed by similar work at Ivanpah 2 and 3. In this method decommissioning work will be initiated at Ivanpah 3 while later stage demolition / restoration work is finished at Ivanpah 1 and Ivanpah 2.

9.3 Methodology

The tools used for this estimate followed a “bottom up” approach; work units were used that covered major work items on a lineal foot, cubic yard, pound or ton basis. However, conceptual design information for the power plants is available for Unit 1 only, and was used in preparing this estimate. The Unit 1 information was then replicated for major equipment at Ivanpah 2 and scaled up or down using engineering judgment to arrive at the quantities piping at Ivanpah 2 and all elements of Ivanpah 3. Adjustments to the estimates were made to indicate reductions due to the sale of equipment.

9.4 Summary and Approach

The estimated valuations used to generate this cost estimate were derived utilizing RS Means and historically accurate cost data and production rates used for the demolition industry at current capture rates. As a comparison to this cost estimate, unit labor and equipment rates from the Nevada Standardized Reclamation Cost Estimator (SRCE) database (<http://www.nvbond.orq1>) were incorporated into the original cost estimate to generate a revised estimate for comparison. The SRCE software was developed as a cooperative effort between the Nevada Division of Environmental Protection, Bureau of Mining Regulation and Reclamation (NDEP), the U.S. Department of Interior, Bureau of Land Management (BLM) and the Nevada Mining Association (NvMA) to facilitate accuracy,

**CONCEPTUAL DECOMMISSIONING AND RECLAMATION PLAN, IVANPAH SEGS
IVANPAH BASIN, CALIFORNIA**

completeness and consistency in the calculation of costs for mine site reclamation. While this tool is not developed for preparation of solar power plant decommissioning and reclamation cost estimates, it nevertheless represents a potential benchmark with which BLM is familiar. Both estimates also included an adjustment to the work units to more accurately capture anticipated costs associated with the removal of large storage tanks at the site.

9.5 Estimate Classification

The waste volume forecast and other commodities were used from current conceptual designs / commodities estimates from Unit 1 and scaled for Unit 2 and Unit 3. The quantities, design parameters and assumptions for both estimates are consistent and classified as order of magnitude estimates as discussed in this Decommissioning and Reclamation Plan. The method of this evaluation resulted in changed labor rates to match SRCE labor rates for craft labor where craft titles matched, including fringe benefit values. Other craft labor rates (not listed in the SRCE tables) were changed to approximately correspond to values for similar labor categories. Non-manual labor rates were changed, except no fringe benefit values were added since none were listed in the SRCE table. Rates for all demolition, recycling and earthmoving equipment were changed to correspond with or approximate SRCE monthly rates, and include operating costs (preventive maintenance and fuel) within the monthly value used.

To achieve a comparable cost estimate, the work units from the SRCE database were manipulated as necessary to correlate to the design parameters and assumptions contained in the original Decommissioning and Reclamation Plan (August 2008) cost estimate. Because the SRCE approach to work units and estimate building differs from the original approach in some respects, slight variations in the quantities, hours or other values of measurements resulted as these work units were used to generate the SRCE based estimate. For purposes of this comparison, however, the individual work units directly correspond from one estimate to the other.

9.6 Design Basis

The designs for this decommissioning and restoration project includes operation of a glass and steel recycling center, mirror and stanchion removal of each heliostat using low environmental impact equipment, explosive demolition of collector and reheat towers, and conventional demolition of all remaining equipment, structures, pavements and fencing. Clean closure of the retention ponds is included in this planning. Re-contouring of land in the in three solar fields of the units and central administration area to approximate the surrounding terrain is also included.

Glass, steel (structural, equipment and re-bar) and asphalt materials resulting from the decommissioning will be recycled. Clean concrete debris (i.e., crushed to about 2-inch minus and no rebar) and foundations that will be greater than 3 feet below final grade will be left on site. The concrete debris will be used as fill materials and in all cases be greater than 3 feet below final grade and place as to not interfere with planned revegetation of the area.

9.7 Planning Basis

This estimate is based on a six-month planning window and 36-month performance period. Extensions of this plan due to limited resources or other restrictions will add to the Project Management / hotel costs and the equipment lease elements of the estimate.

9.8 Assumptions

The following assumptions are incorporated into the estimate.

- All three units are decommissioned in a phased sequential manner as discussed previously, and within one project management structure.
- The value of the steel, glass, and asphalt recycle material was based on values per Section 7 of this report.
- The changes that occur during the definitive design, construction, and operation of the plants do not change the overall quantities used in this estimate appreciably.
- All steam turbine generators with air cooled condensers, boiler feed pumps, major transformers and load centers are assumed to be sold on the used equipment market as outlined in Section 8.
- Approximately 40% of the mass of the poured concrete at the Site will be left in situ, i.e., not broken up, since it will ultimately be covered by greater than three feet of native soils in the recontouring process to place the land in its near-original condition.

9.9 Exclusions and Exceptions

Re-vegetation, habitat restoration and post-implementation monitoring is excluded from this cost estimate. No other exclusions and/or exceptions are present at this time.

9.10 Risks and Opportunities

No “time value of money” adjustments were made to this estimate. Only present value costs are included. As with any work conducted after 25 years of operation, the misapplication or misunderstanding of any escalation or inflation adjustments can far outweigh any precision thought to be included with the estimate.

By leaving foundations at greater than 3 feet below final grade, approximately 40% of the concrete used in the demolition effort is saved. Otherwise an appreciable increase in demolition and concrete processing costs will be incurred. Likewise, if the option to leave clean concrete rubble buried on site (at greater than 3 feet deep and not interfering with revegetation) is not permitted, transport and disposal of this low value/high mass waste stream will increase the cost of the project.

9.11 Contingencies

Contingency costs are not included in this project estimate.

9.12 Management Reserve

No management reserve was included in this project estimate.

9.13 Reconciliation

This is the first published decommissioning and restoration estimate to be developed for this project and as such, no reconciliation was completed with this effort.

9.14 Benchmarking

No benchmarking was performed; however, estimates are based on past activities in the U.S. and internationally, particularly in the use of steam power plants.

9.15 Estimated Quality Assurance

The estimate was peer reviewed and reviewed for consistency by WorleyParsons project management. The estimate was adjusted to account for the sale of equipment data provided by Processes Unlimited International, Inc.

9.16 Cost Tables

Tables 1, 2, 3 and 4 of this Section present a side-by-side comparison of the cost estimates for Units 1,2 and 3, and the Administration Area/Overall Project Management/Equipment segments of the total cost estimate, respectively. Table 5 summarizes the total cost estimate. In these tables, the updated original cost estimate is referred to as the August 2008 Cost Estimate; whereas, the new cost estimate based on Nevada SRCE labor and equipment rates is referred to as the January 2009 Estimate. The evaluation indicates that an increase in the total estimate of approximately \$5,000,000 occurs when using the labor and equipment rates from the Nevada SRCE. Most labor rates were higher for the SRCE, but the estimate increase was offset slightly by a small decrease in equipment costs.

Note to readers: Due to the confidential nature of these cost tables, they will be furnished only to BLM staff under a request for confidentiality.

10. REFERENCES

California Department of Water Resources (DWR). 1964. *Bulletin No. 106-1, Ground Water Occurrence and Quality Lahontan Region*. 439 p.

CH2M Hill. 2008 and 2009. *Closure, Revegetation, and Rehabilitation Plan*. September 2008 and May 2009.

Jennings, C.W., 1961. *Geologic Map of California: Kingman Sheet. Olaf P. Jenkins Edition. California Department of Conservation, Division of Mines and Geology. Scale 1:250,000*.

Waring, G.A., 1920. *Ground water in Pahrump, Mesquite, and Ivanpah Valleys Nevada and California. Water-Supply Paper 450-C. pp. 51-85*.

Conceptual Decommissioning and Reclamation Plan, Ivanpah SEGS, Rev. A 5-Sept-08 by Worley Parsons

Memorandum – “Scrap Value Evaluation” for Ivanpah SEGS, 23-Jan-09 by Worley Parsons

Memorandum – “Nevada Reclamation Cost Estimator Comparison” for Ivanpah SEGS, 26-Jan-09 by Worley Parsons

Report – “BrightSource Ivanpah SEGS Closure Costs, 30-Mar-09 by Processes Unlimited International, Inc.

Report – “Addendum to Conceptual Decommissioning and Reclamation Plan, 1-May-2009 by Processes Unlimited International, Inc.

Figures

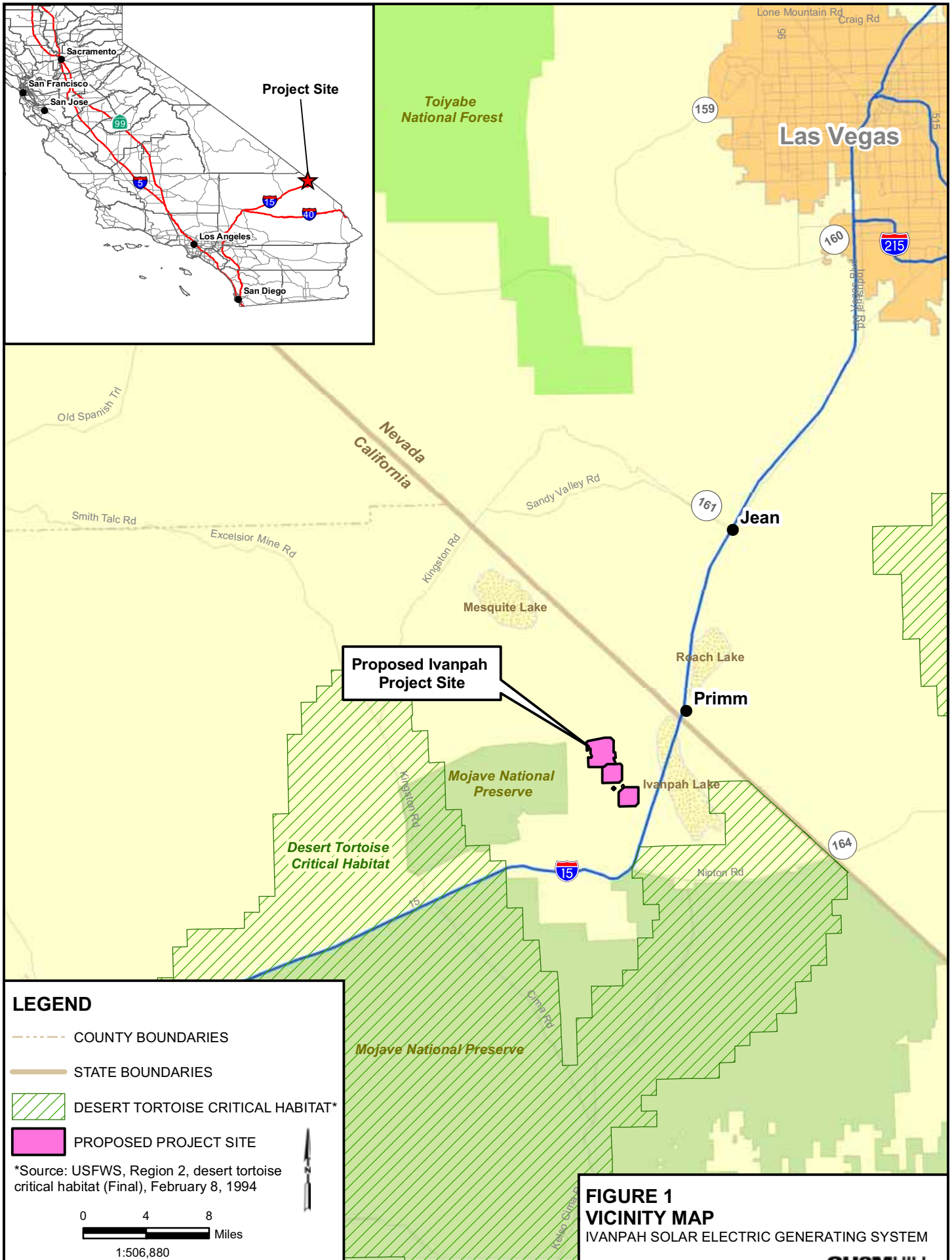

FIGURE 1
VICINITY MAP
 IVANPAH SOLAR ELECTRIC GENERATING SYSTEM

CH2MHILL

LEGEND

- COUNTY BOUNDARIES
- STATE BOUNDARIES
- DESERT TORTOISE CRITICAL HABITAT*
- PROPOSED PROJECT SITE

*Source: USFWS, Region 2, desert tortoise critical habitat (Final), February 8, 1994

0 4 8

Miles

1:506,880

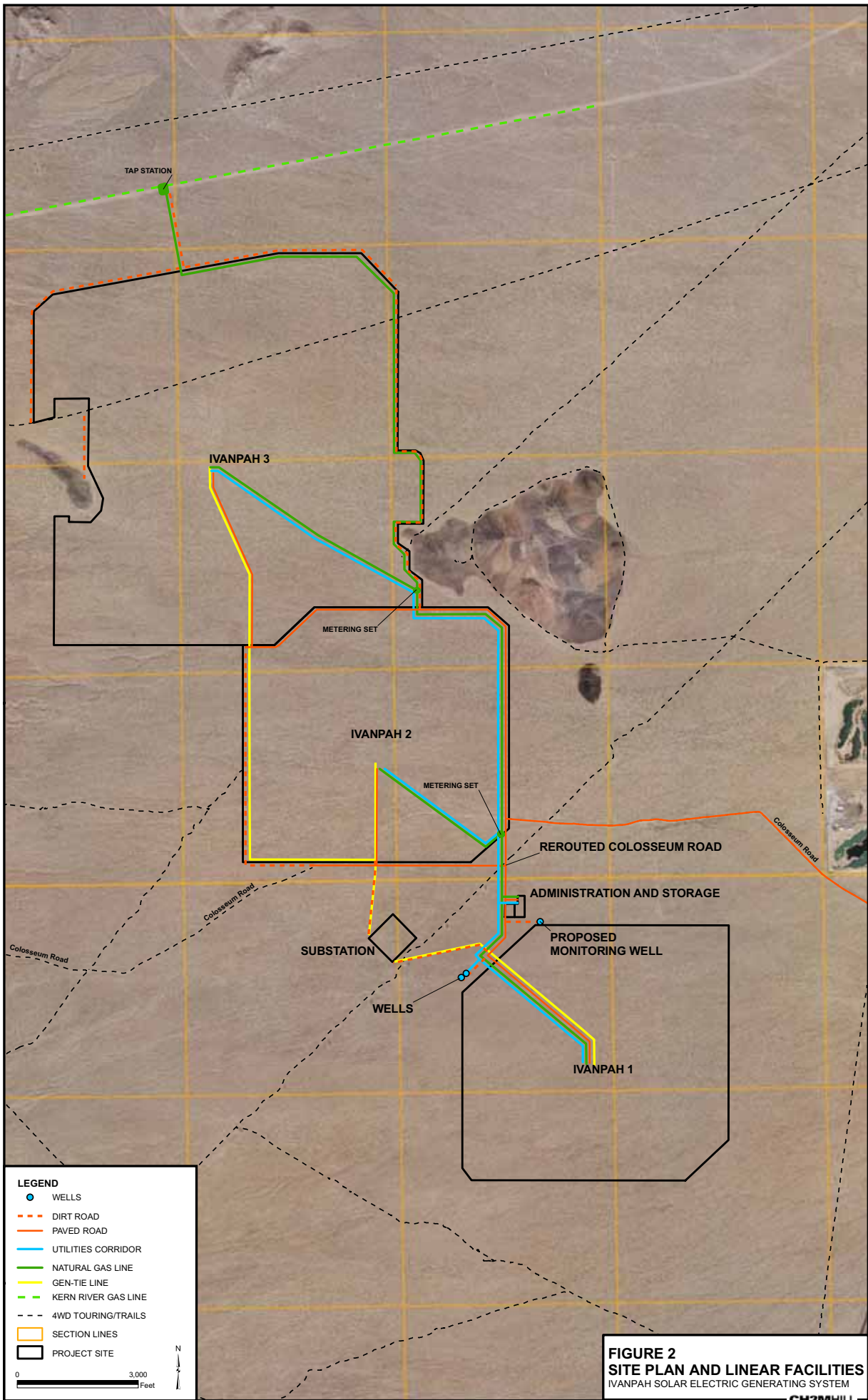

LEGEND

- WELLS
- - - DIRT ROAD
- PAVED ROAD
- UTILITIES CORRIDOR
- NATURAL GAS LINE
- GEN-TIE LINE
- KERN RIVER GAS LINE
- - - 4WD TOURING/TRAILS
- SECTION LINES
- ▭ PROJECT SITE

0 3,000 Feet

N

FIGURE 2
SITE PLAN AND LINEAR FACILITIES
 IVANPAH SOLAR ELECTRIC GENERATING SYSTEM
 CH2MHILL

Response to Comments Received on the Closure, Revegetation and Rehabilitation Plan

CEC Comments: Ivanpah SEGS Restoration and Closure Plan

Comment CEC-1

Overview: The draft *Closure, Revegetation and Rehabilitation Plan for the Ivanpah Solar Electric Generating System Eastern Mojave Desert San Bernardino County, California* (Plan) provides useful background information on and summaries of various materials and methods for revegetating native plant communities in the Eastern Mojave Desert but falls short of providing the specific details needed for post-construction revegetation efforts in temporarily disturbed areas (e.g., along the gas and water pipelines, construction logistics areas), and offers only value guidance on final decommissioning, revegetation, and closure. It is difficult for the reader to discern the specific, proposed activities on the ISEGS site from general revegetation principles. The Plan cites lessons learned in the Technical Basis Document and other references, including highly relevant research findings from the recent Castle Mountain Mine revegetation work, but does not take the next step of applying this information to detailed, site-specific recommendations. Suggestions for revisions to address this deficiency are provided as follows:

Response

Sections 2 and 7 of the revised Closure, Revegetation and Rehabilitation Plan for the Ivanpah Solar Electric Generating System Eastern Mojave Desert San Bernardino County, California (R&R Plan) were rewritten to provide the specific details needed to successfully accomplish revegetation in temporary disturbed areas.

Comment CEC-2

Success Criteria Need to be Specified: The Plan states (p 1-13) that criteria for revegetation success need to be established on the basis of successional plant associations rather than mature climax vegetation. The Plan needs to further develop this concept into concrete goals and provide specific, quantitative success criteria for parameters such as native plant density and diversity, percent cover for weeds (at least for those weeds that would interfere with successful establishment), and survival rates of transplants. For example, Bamberg (2005) established permit requirements and bond release specifications for Castle Mountain Mine at reestablishing 15% of native plant diversity and 21% of native plant density ten years following mine closure. While these targets may be inappropriate for the ISEGS site, the applicant must provide specific goals and success criteria like these for revegetation at

ISEGS. It is insufficient to plan for only comparisons with study plots rather than concrete success criteria particularly when the location and other details, such as land owner permission, are not specified.

Response

Section 7.8 describes the background and Section 7.9 the criteria for revegetation progress. No plans for study plots are proposed because the Applicant does not believe they are necessary to achieve the goals of the R&R Plan.

Comment CEC-3

Thresholds for Management or Remedial Actions: The Plan should identify a quantitative threshold that will trigger management or remedial actions if the criteria described above are not met at the specified milestone. For example, a native plant density at some percentage (e.g., 20%?) below target at year 3 might be an appropriate threshold that would prompt re-seeding, re-transplanting, weed control, or herbivore control.

Response

Section 7.9 describes the criteria for revegetation progress, and Section 7.10 describes the steps to be taken should these criteria not be met at the specified time intervals (2, 5, and 10 years after site rehabilitation is completed).

Comment CEC-4

Weed Management: The Weed Management Plan for the Ivanpah Solar Electric Generating System (Attachment DRI3-1A, Data Response Set 1F) prescribes management actions that may be taken to monitor for and eradicate specified species but is not tailored to a specific revegetation plan. The Plan cannot simply reference the weed management plan but needs to be specific about which species and densities of weed cover might require management because they could interfere with the revegetation goals. For example, on page 1-15, it would be useful to include the weed management/herbicide usage guidelines directly in this plan (e.g., include the herbicides proposed for use and the weed avoidance measures) so the reader does not have to cross reference various documents, which may not be on hand.

Response

To avoid a document that would be of truly unwieldy size, the Weed Management Plan (WMP) will continue to be referenced as a separate document, but is now attached as an appendix (Appendix B) to the RnR Plan. The WMP already specifies which species of weed would trigger management actions and also specifies those actions. The requirements of the WMP have been fully incorporated into the revised R&R Plan (see, for example, Section 7.7).

Comment CEC-5a¹

Seed Collection/Propagation Program: The Plan discusses in a general fashion the requirements of seed collection and propagation but does not offer specific details on how this major undertaking will be accomplished or discuss the infrastructure needed to support it. Quantities of seed that are likely needed are not specified.

Response

Section 7 has been expanded to address these concerns and provide more detail to guide revegetation efforts. Quantities of seed needed are estimated in Table 7-4.

Comment CEC-5b

The foundation of a successful revegetation program is quality, locally harvested, native seed, which requires careful collection, processing, and storage, but how and where will this occur on the ISEGS project site? Page 7-8 of the Plan notes that *“advanced planning of seed collection would be required to ensure early and continuous seed collection, as needed, up to the time of planting. A seed collection program will be initiated within 2 years of potential site disturbance, and continue through until revegetation seed broadcast is complete. This would allow for some variation in annual seed production while still ensuring a robust collection.”* If construction will begin by 2011, seed collection should be occurring as early as this fall 2009. Are there contractors and facilities sufficiently close to the site to provide these services? If not, the applicant would need to develop plans for a storage area/greenhouse that can provide controlled conditions and protect the seeds from pests and disease. The Plan needs to provide some information on the logistics (e.g., issues with land access/permission to collect seeds) and feasibility of having a contractor provide all the services needed to make the reseedling/transplantation effort a success or have specific information about how these services can be provided on site.

Response

As noted in section 7.3.2, the Applicant will initiate a seed collection program as soon as the CEC license and BLM grant are received. The financial support for such an endeavor is not available prior to that project milestone.

Comment CEC-5c

We suggest making on-site seed collection a priority if seed quality is acceptable and providing details on the process and timeline. Specify when a seed vendor would be used in addition to or instead of on-site seed collection. The Plan states *“Bulk seed can be collected by direct harvest from plants, underneath shrubs, and from windblown debris caught in depressions and washes...”* Which method(s) would be used?

¹ This single numbered comment contains multiple topics or issues, and these are broken out and numbered with lower case letters.

Response

Please refer to section 7.3.2, Seed and Native Stock Collection and Storage. Native seed vendors who are familiar with native, wild, seed collection will be contracted to collect, process, and store seed for the Ivanpah SEGS revegetation project.

Comment CEC-5d

The Plan acknowledges the variability of seed viability/production from year to year. Therefore, seed quality should be evaluated in advance through non-destructive X-ray analysis, dissection, or germination tests before launching a large scale collection effort, which may not be worthwhile. The Plan mentions these methods later, but does not commit to doing them as part of the advance seed collection planning. In addition, there are typos in several places where “sowing” of seeds (or “sown” seed etc.) is mentioned.

Response

BSE anticipates that a certain proportion of seed will be sterile, and is willing to entertain testing prior to utilization (Section 7.3.2.3) if a clear advantage can be obtained by such testing. At this time, the utility of such an approach is not immediately evident.

Comment CEC-6

Site-Specific Plans for Revegetation/Rehabilitation Areas: The Plan provides only general conceptual guidance for revegetating gas and water pipelines, gen-tie lines, and construction logistics area (for example, page 2-2 states “revegetation with native species will be implemented as described in Section 7,” but Section 7 provides general guidelines rather than site-specific details). Section 7 contains mostly summaries of revegetation principles, which are informative, but the Plan’s specific intentions are difficult to discern from the more general information. We suggest clearly specifying and separating the elements to be used in the ISEGS Plan. The applicant has all the information they need about existing soil conditions and adjacent plant communities to prepare detailed revegetation plans for each of these sites, including the species and approximate number of transplanted succulents that will be planted, the species, volume, application rates and techniques to be used for re-seeding, the anticipated success and proposed management to deal with anticipated setbacks to revegetation. Each of these areas needs their own specific revegetation plan rather than a general statement of principles and lists of existing species that could be used. The revegetation plans for the linear alignments and staging/laydown areas should be sufficiently detailed so that bid specifications could be prepared from the information in the plan.

Response

Please see Section 2 on Rehabilitation Logistics and the details now provided in Section 7, Site Rehabilitation Plan. Section 1 has been updated as well to more thoroughly describe the components of the project.

Comment CEC-7

Stockpiles of Topsoil, Vegetation, Mulch: The Plan needs to incorporate information about the location of topsoil and vegetation stockpiles that is described in Date Response 2C from

Data Request 145 (Data Response 145), which indicated that 4 inches of soils would be removed and stockpiled per acre, and that 30 percent of the total soil removed would be stored in the stockpile area. For the purposes of sizing the vegetative stockpile area, it was assumed that 60 percent of the vegetation onsite will be removed with 25 percent of the total volume used onsite for soil stabilization and erosion control and 75 percent transported offsite for other uses or disposal. Approximately 2.5 acres of vegetation is assumed to be removed per day, producing approximately 370 cubic yards of mulch. All of these estimates may need to be re-evaluated once the revised grading/stormwater plans have been finalized.

Response

The updated R&R Plan provides a description of the essential components of Ivanpah SEGS Low Impact Design (LID) approach to construction (see Sections 1 and 2), which includes minimizing grading and clearing, and therefore substantially reducing the amount of soil that will be stockpiled for the rehabilitation of temporary disturbed areas. In essence the heliostat fields will not be cleared, and stockpiles from temporary cleared areas will be located immediately adjacent to those areas for use in rehabilitation, and excess (if any) will be used on other rehabilitation areas. No long-term stockpile of soils is anticipated at this time because the primary benefit of soil stockpile (the seed bank and the biotic inoculum) would be degraded over the course of 3 to 5 decades.

Comment CEC-8

Salvage Techniques, Storage, Transplanting: Section 4.4 discusses salvage of succulents, and provides information on handling, storage, and transplanting techniques, but omits some crucial information. How many succulents of each species will need to be salvaged and stored to supply the revegetation efforts? What is the schedule for the salvage relative to construction and revegetation efforts, and the public sale of salvaged material? How many succulents will be made available for sale vs. transplanted along with the seeded species? Why does the Plan state that succulents will not be used in long-term revegetation? The Plan does not specify when succulent stockpiling will occur and states that plants will be allowed to air dry between 3 weeks to 6 months. What measures will be taken to ensure that rain events do not increase fungal growth in stockpiled succulents? There is no impediment to creating sufficiently detailed planting plans so that this information can be disclosed now. The Plan states on page 1-13 that *"an open-air nursery facility would be employed for succulent salvage, but no more elaborate facility is otherwise needed to support the revegetation effort"* The Plan should provide details on the location and size of this open-air nursery, and the period of time for which this nursery would need to be maintained.

Response

The Applicant agrees that succulents should be used for long-term revegetation. As described in Section 1 and shown in Figure 1-3, the Succulent Storage and Stockpiling Area (SSSA) is a 40-acre area to be located in the Construction Logistics Area (CLA). It will be used first for temporary treatment and storage of salvaged succulents, and eventually for their long-term stockpiling through plantation (in the general fashion of a mesquite (agave) plantation in the semi-arid parts of Mexico). The SSSA will be maintained for the planned life of the facility, and succulents from its plantation will be used in revegetation after

demolition of the long-term facilities (i.e., decommissioning). The details of the strategies to be used are found in Sections 4, 7, and 8.

Comment CEC-9

Erosion Control: Section 5, Surface Management Plan and Erosion Control, will need to be revised based on the results of ongoing stormwater analyses.

Response

This section has been retitled "Surface Management Plan," and Appendix F, containing the Drainage, Erosion, and Sediment Control Plan (DESCP) has been incorporated into the RnR Plan.

Comment CEC-10

Wildlife and Habitat Management: Section 5.4 states "...the functioning elements of an ecosystem would be part and parcel of the operational phase..." and refers to the site as "seminatural." Delete these references because the site will be highly impacted and lack an intact ecosystem.

Response

Section 5, the Surface Management Plan, now describes in more detail the biotic aspects of the operational phase of Ivanpah SEGS, while Sections 1 and 2 describe the LID construction measures that will leave a less impacted biota than that normally seen resulting large construction projects.

Comment CEC-11

Rehabilitation Methods: There are inconsistencies in the discussion of site preparation for revegetation efforts. Page 1-13 states: "*deep ripping (to 48 inches) and scarification (to a shallower depth) are often employed to provide decompaction after construction activities, and to provide a rough surface for seed catchment*". In Section 7.1.2.6 the Plan states: "*If needed, deep ripping should be performed to a depth of approximately 18 inches.*" Please clarify.

Response

These inconsistencies have been addressed and, for surface preparation/physical rehabilitation, please refer to the prescriptions provided in the updated Section 7.

Comment CEC-12

Revegetation Monitoring: Section 7 includes a general description of how monitoring will occur, and lists many useful parameters for monitoring such as plant density, diversity, richness, cover, and seedling establishment. However there are no quantitative success thresholds to be monitoring, and therefore no way of measuring if revegetation efforts have achieved the stated objectives, and no thresholds or triggers for remedial action if the revegetation effort is failing. The field monitoring techniques and reporting described in this section all sound good at the conceptual level, but specifics are needed (for example, number and dimensions of line transects and quadrats, identification of parties who will

receive monitoring reports) for each of the proposed revegetation sites on linear facilities and in the construction logistics area.

Response

The thresholds or criteria for progress, and for taking remedial action if revegetation appears to be retarded, are introduced in Section 7.8 and specified values are presented in Section 7.9. Field monitoring measures are described in Section 7.8.2. Section 7.11 identifies the parties to be notified.

Comment CEC-13

Closure Plan Unresponsive: Section 8, the closure plan, is unresponsive to the Energy Commission's Data Requests from December 2007:

30. Please describe the likely components of a closure plan (e.g., decommissioning methods, timing of any proposed habitat restoration, restoration performance criteria), and discuss each relative to biological resources and specifically to desert tortoise and its habitat.

31. Describe the potential funding (e.g., a performance bond) and/or legal mechanisms for decommissioning and restoration of the project site that could be used:

a. at the end of operations; and

b. in the event of bankruptcy or the untimely project closure for financial reasons.

The planning process can acknowledge the uncertainty in planning for 50 years in the future, and can include an assessment and affirmation of goals in the final closure planning. However, response to these specific questions above cannot be deferred until that time. Although the future development patterns are unknown, the default goal based on the current, predominantly undeveloped nature of the area should be to return the landscape to desert scrub. The Plan could specify that if the immediate, surrounding area is heavily urbanized, the original goal would be modified slightly, but due to the large size of the project area, a restored desert scrub could have value to wildlife even if urbanization increases in Ivanpah Valley. It would be unreasonable to assume the whole valley would be urbanized due to the proximity to the Mojave National Preserve.

Response

BSE accepts the default for long-term rehabilitation and revegetation goal as being Mojave Desert scrub similar to that of the present, as described in the revised R&R Plan. Sections 7 and 8 in particular describe the components of the closure plan as well as provide descriptions of rehabilitation measures and the prescriptions for restoration of desert scrub habitat within the project area.

On the advice of its legal counsel, the Applicant will provide to the appropriate officers of the concerned agencies, under separate cover, business-confidential information on project bonding and funding as well as information regarding revegetation cost estimates,

contracting and the project schedule. This information will not be included in the R&R Plan since it is proprietary and confidential.

Comment CEC-14

General: The Lahontan RWQCB closure requirements, if any, should be incorporated into the Closure and Restoration plan.

Response

The Applicant is in the process of working with the Lahontan RWQCB and is preparing a Section 401 permit for submission to them. A copy of the permit application will be submitted to the parties when filed. Any closure requirements the Applicant receives from the Lahontan RWQCB will be provided to CEC and BLM.

Comment CEC-15

Section 1.2.1 Project Phasing, the use of the word “phasing” does not match up with PSA General Comment # 3 where the applicant requests modification of the PSA to change the use of the word “phasing” to a word that creates less of a nexus between Ivanpah 1, 2, and 3. The applicant request each “phase” to be called “Ivanpah 1”, “Ivanpah 2”, and “Ivanpah 3” respectively.

Response

The PSA comment was based on the concern that actual construction may not occur in the order that the units are numbered. The three solar plants will be constructed in phases. However, “Phase 2” may not equate to “Ivanpah 2.” We have attempted to make appropriate edits in the extended project description (Section 1); descriptions in Section 2, Rehabilitation Logistics, are have also been updated for consistency.

Comment CEC-16

Page 1-5: The document states that the entire site would be “mowed” leaving the vegetation less than one foot tall. The next sentence states that in between every other heliostat array the ground would remain desert scrub. The implication is that the vehicle roads between every other heliostat array would be graded and devoid of vegetation, is this correct?

Response

The revised and detailed project description in Sections 1 and 2 clarify this. The access tracks between heliostat rows will be mowed, but they will not be graded.

Comment CEC-17

Page 1-8: states that additional water would be used for mirror washing during construction of Ivanpah 2 and 3. How much additional water would be required during this time (up to 5 months for Ivanpah 3)?

Response

The potential additional mirror-wash water required during the construction of Ivanpah 3 is estimated not to exceed 4.6 acre feet (Section 1.3.1.1).

Comment CEC-18

Page 1-9: discusses “deep ripping,” up to 48 inches. Would this be employed and where would this occur specifically?

Response

Section 7 has been expanded to provide a more complete description of the circumstances under which deep ripping would be required (where compaction of soils has been substantial).

Comment CEC-19

Page 7-3: states that the roads in between the heliostats would be graveled to reduce dust generation. Is this correct and that soil binders would not be used on these roads?

Response

Consistent with the descriptions provided in Sections 1 and 2, service tracks between the heliostat rows will be mowed and not graded. Overland service traffic tracking over an intact soil surface is not expected to create dust sufficient to warrant mitigation.

Comment CEC-20

Page 7-4: states that for soil decompaction a “garden fork or auger” might be used as an alternative if compaction is not severe. This does not seem realistic given the size of the project.

Response

In the rewriting and expansion of Section 7 references to technology that may not be appropriate, given the scale of the project, were deleted.

Comment CEC-21

Page 7-14: states that plant germination, growth, and survival must come from precipitation which may be supplemented by irrigation. Where would this irrigation water supply come from, how much water would be needed, and how long would this water supply be used?

Response

As described in Section 7.5, natural precipitation is the only source of water currently planned for revegetation efforts. This is consistent with studies described in Section 3, and at greater length in Appendix E, of plots that were disturbed in the past in the area and that currently support a robust successional community in the absence of any irrigation. Section 4 notes that some watering using a watering truck may be needed over the long-term to support the succulent stockpile plantation.

BLM Comments: Ivanpah SEGS Technical Basis Document

Comment BLM1-1 [BSE-22]2

Section 2, General: A substantial portion of Section 2 is dedicated to a discussion of natural succession. The source of information about succession in this text appears to be from Ricklefs (1982). BLM has access to more recent and up-to-date information on succession that should be considered in this technical approach. Succession in its pure form, most studies of which took place during the first half of the twentieth century, is no longer considered clearly predictable. Arrested succession occurs when a species “invades a community and resists its own replacement by competitive ...means” (Walker and Del Moral (2009). Cheat grass, which has been found on part of the site, often causes arrested succession by increasing fire frequency (Pellant 1996). Other invaders may behave in a similar manner. These possibilities suggest that natural succession, rather than taking a long time, may never happen at all.

Succession is extremely slow because the conditions at the site are no longer the conditions tolerated by the native. Soil compaction, modified fire regime, lack of native seeds, lack of mycorrhizal fungi, and overload of soluble forms of nitrogen are all conditions that can halt succession entirely; and all can be corrected to allow a successful restoration job.

This analysis would benefit greatly from an examination of current thinking and, in particular, from a look at the literature concerning the most likely exotics. The list of literature cited for this review, at the end of these comments, is a preliminary list which could lead to many more cited for this review, at the end of these comments, is a preliminary list which could lead to many more sources of information.

Response

This discussion is left largely to the Technical Basis Document (Appendix D), and summaries provided as needed in the R&R Plan (e.g., Sections 1.3.5.1 and 7.3.1.1). Neither the Applicant nor its contractors consider succession to be predictable, although the process itself does indeed occur. Vegetation surveys undertaken in response to these comments show that exotics such as *Bromus madritensis* (cheat grass, *B. tectorum* of some authors, does not occur in the immediate vicinity) does not occur in the density necessary to lead to arrested succession.

The rate of succession is subject to interpretation. Studies undertaken in support of this RnR Plan show that sites denuded in the mid-20th Century support a relatively diverse and dense desertscrub community today (Appendix E).

The *Weed Management Plan* (Appendix B) considers the exotics anticipated to occur and occurring in the project area. Additional references have been consulted and are referenced in this document.

² BSE provides sequential numbering of the comments to assist in tracking.

Comment BLM1-2 [BSE-23]

Page 2-2, Section 2.2, Footnote 2: The definition of “pedon” in this text is imprecise. Soil scientists use the term for a column of soil that contains all the recognized soil layers. This text has labeled it as “changes with depth,” suggesting that a pedon is a process rather than a material.

Response

This definition has been corrected and expanded in Section 3.3.1.

Comment BLM1-3 [BSE-24]

Section 2.4, General: This text implies that a mature plant community cannot be created more quickly than is done through succession. BLM’s experience is different – we believe that restoration may be accomplished by changing site conditions and bypassing succession. While desert is the most difficult habitat in which to accomplish this, it is nevertheless quite possible to modify artificially the site characteristics that may require centuries when natural succession is the only agent of change.

Response

The Applicant appreciates this observation. The revised text in (currently) Section 3 provides a more comprehensive explanation of the approach to revegetation at Ivanpah SEGS.

Comment BLM1-4 [BSE-25]

Page 3-2, Section 3.1.2, 1st Paragraph: The text states that “Truck irrigation was applied to portions of the Ivanpah SEGS site.” Since this text is a discussion of results from the Castle Mountain Mine (CMM), the reference to Ivanpah SEGS is incorrect.

Response

The reference has been corrected.

Comment BLM1-5 [BSE-26]

Page 3-2, Section 3.1.2, 2nd Paragraph: The text states that the transplanting program at CMM had poor results, but does not provide reference information for the statement. The text specifically states that data on survivorship of transplants was not provided in the Bamberg Ecological (2005) report, and does not provide any other source for this conclusion of poor transplant results. This statement should be referenced.

Response

The updated Section 3 provides a more thorough description of the results of the Castle Mountain Mine revegetation efforts, as well as referencing other revegetation efforts and studies that help guide the formulation of this RnR Plan.

Draft BLM Comments: Ivanpah SEGS Restoration and Closure Plan

Comment BLM2-1 [BSE-27]

Section 1.2 and Section 3 should be incorporated into a single updated, comprehensive Project Description within the updated Plan of Development (POD). The Project Description in the POD should then be referenced into Closure and Restoration Plan and other site-specific plans that will eventually all become part of the finalized POD. Currently, each individual plan has a separate Project Description, and these tend to become outdated and contradictory as the project develops. By developing, maintaining, and referencing a single Project Description within a living POD, the potential for the individual Project Descriptions becoming outdated or being contradicted becomes reduced.

Response

The Applicant and its contractors are well positioned to appreciate the frustration that evolving project descriptions create and a more comprehensive project description to be used for the Plan of Development was submitted as Attachment DR130-2B. Nevertheless, the most practical approach available is to provide a comprehensive project description in the revised Section 1, since a comprehensive project description must accompany the RnR Plan, since it is intended to be a stand-alone document. Also, in preparing the RnR Plan, the project engineers provided a detailed breakdown of the project components in Table 1-1 that was not contained in the POD Project Description.

Comment BLM2-2 [BSE-28]

In general, the purpose of this document should be to describe the actions that are proposed at the cessation of operations. Instead, the largest volume of the document appears to be primarily a discussion of potential closure and restoration options and methodologies, with very few actual commitments to perform specific actions. The ability of the reader to understand what actions are actually proposed is complicated by two factors:

- The frequent use of terms such as “if,” “should,” “could,” and “where appropriate,” rather than words that convey a clear commitment to an action (such as “will”); and
- The intermixing of descriptive text and text that describes proposed actions.

Where actual proposals for action are made, they are scattered throughout the document, so that no clear Plan exists. The proposed actions with respect to infrastructure removal are presented in Section 1.2.4, which is within the Introduction.

Response

The revised Sections 4, 5, 7 and 8 provide explicit measures that will be taken for the rehabilitation of both short-term and long-term disturbed areas. Sentences have been edited where identified to be declarative rather than conditional. Descriptive text is retained to provide the basis for many of the RnR Plan actions, but there has been an attempt made to deconvolve these from planned measures. Infrastructure removal is now addressed in Section 8.

Comment BLM2-3 [BSE-29]

The proposed action with respect to succulents (which is apparently to do nothing with them) is presented within Section 4, although more details on the methodology for transplanting succulents is presented in Sections 7.1.3.5 and 7.1.5. The plans for topsoil salvage and seed collection in Section 7 are similarly vague – descriptions of methods are provided, but no clear commitment is made to a proposed action.

More specific comments on these problems are provided in the Specific Comments below. However, re-organization of the document, and re-wording of the text, may be warranted to more clearly communicate the commitments being made with respect to site closure.

Response

The revised and updated succulent management plan is presented in Section 4. As described in that section, as well as Sections 7 and 8, cacti will be used in both short-term and long-term revegetation efforts and detailed action plans are laid out to this end.

The RnR Plan has been extensively reorganized and reworded.

Comment BLM2-4 [BSE-30]

The Plan specifically states it does not address interim restoration or temporary closures (see Section 1.2.4, and 1st Paragraph on Page 8-1). This is a material weakness in the plan. BLM is very concerned about the possibility of the project being halted during the construction phase with extensive disturbed areas that need to be stabilized and restored. BLM is also concerned about extended periods of non-use that may occur over the life of the facility. The current Plan does not address either situation.

Response

The revised Plan focuses on revegetation and restoration of construction impacts and on decommissioning and restoration upon permanent closure. Since temporary closure is only temporary, no revegetation or restoration is associated with that state. However, Section 8 has been revised (see Subsection 8.1) to clarify that, after a period of temporary closure, if the project owner is not able to present reasonable evidence of its plan to resume operations BLM can assume permanent closure and ask the project owner to begin the decommissioning and restoration process, or access the performance bond funds and begin the process itself.

The RnR Plan as currently rewritten is specifically designed to provide prescriptions (chiefly in Section 7) that may be used if needed.

Comment BLM2-5 [BSE-31]

This plan is quite generalized and most specific methods, acreages, and locations are left for later resolution. Although this may be taken as a conceptual plan, the ultimate Plan must provide detailed information, including a set of specifications with explicit instructions for implementation of the plan, written in specification or bid package language. Those specifications will provide direction should it become necessary for BLM to hire an outside contractor to restore the site. The specifications will provide the basis for the contractor's bid

and will become part of the contract of the successful bidder. This Plan will be part of a legally-binding contract and must be complete before it will be possible to issue the desired permits.

Response

A major objective of revising the Ivanpah SEGS RnR Plan is to provide the specifics with respect to the measures to be taken for the revegetation of short-term and long-term disturbed areas; and commitments within each Section may be taken to form the appropriate bid specifications for the actual work to be accomplished.

Comment BLM2-6 [BSE-32]

The Plan should include a discussion providing a cost estimate for site closure, decommissioning, and restoration, and a discussion of how these actions will be funded or financed. This discussion should address not only availability of funding for the site operator to perform site closure at the termination of the ROW, but the availability of funding for BLM to perform site closure, if necessary, due to abandonment by the site operator during the duration of the ROW. If the Plan does not address funding, BLM would be required to calculate a suitable amount for a performance bond to be held for the life of the project. The performance bond would be added as a stipulation to any ROW that is granted for the project. BLM prefers to have applicant prepare and include a cost estimate for said site closure, decommissioning and restoration including an estimate for interim closure/abandonment.

Response

The Applicant understands the BLM's concerns. Please see the response to Comment CEC-13. A cost estimate for revegetation has been prepared and will be provided to the appropriate officers of the concerned agencies as a business-confidential document. On the advice of counsel and senior management, neither cost estimate nor performance bond specifications will be incorporated into the R&R Plan.

Comment BLM2-7 [BSE-33]

The entire Plan with respect to the management of succulents must be revised. The issue of succulents is an example of the problem raised in General Comment #2 above -there is substantial discussion of the procedures to be used for successful succulent harvesting, stockpiling, and transplanting, but it is not clear what is actually proposed. The last sentence of Section 4 states that succulent salvage will actually not be done, while Section 7.1.5 says that "limited transplanting is proposed," but does not define what is meant by "limited." The text appears to discuss succulent salvage as a potentially successful activity, so it is not clear why Section 4 concludes by eliminating it.

As acknowledged in the introduction to Section 4, and within Section 7, succulent salvage can have a high success rate. The only rationale provided in Section 4 to support elimination of succulent maintenance is a statement that "there would be large areas occupied by Ivanpah SEGS that would not be available for revegetation until after decommissioning." It is not clear how this statement supports a conclusion that no long-term stockpiling of succulents is proposed.

The Plan must be modified to commit to the salvage, long-term storage, and eventual transplanting of succulents following decommissioning. Some of the succulents, perhaps all, must be used in the restoration program. While some of the succulents are no doubt long-lived, it may not be realistic to expect all salvaged plants to survive in a nursery for the entire lifetime of the project. A large fraction of the plants in early or prematurity should be preserved, while large and old plants may be offered for public salvage.

The sizes of the succulents to be preserved will have to be defined for each species. Please indicate in a table the sizes of each species that will be stockpiled for future use, and above which the plants will be offered for public salvage. Include in the same table the locations and counts of the plants included in each category.

The storage area should be specified, but may include trenches along the edges of work areas, near the outer boundary, or the 300+ acre construction staging area. The text should define that succulents transplanted into the nursery area will be placed in their same compass orientation as they were in their original location. The salvaged plants could also be kept in the long-term soil stockpiles, along with natives grown on the stockpiles, to keep the soil biota fresh.

Response

The R&R Plan has been revised to commit to the salvage, long-term storage, and eventual transplanting of succulents following decommissioning. Sections 4, 7, and 8 now describe these measures in some detail. A 40-acre succulent storage (for short-term) and stockpile (long-term plantation) will be located inside the Construction Logistics Area between Ivanpah 1 and 2. Section 4 also provides transplanting and replanting guidelines based on size and morphology, and the size criteria for succulents to be transplanted, versus those to be left in place under LID technology, have been specified in Section 4.5.1.

Although counts of barrel cacti (*Ferocactus*, *Echinocactus*) and hedgehog cacti (*Echinocereus*) were made during the initial biological survey, the other cactus species were not counted. Quantitative vegetation surveys made for this RnR Plan, and barrel cactus counts, provide the basis for estimating the number of cacti to be recovered. Detailed size classing will not be possible until salvage is well underway, but the area set aside for the SSSA will be sufficient to meet temporary storage needs for all cacti, be they schedule for public disposal, or subsequent revegetation.

Comment BLM2-8 [BSE-34]

All discussions of initial site preparation, grading, and vegetation removal within this Plan, especially those in Section 5, will need to be revised once the final Site Grading Plan has been developed. The final Site Grading Plan is still under development, and the amount of site disturbance that will occur is currently a topic of debate in our work on the stormwater management analysis. In general, both the text in this document and information provided verbally during our stormwater management discussions seems to imply a minimal amount of site disruption being required during site construction. The current information suggests that little or no vegetation removal is planned, only minimal site grading will be done where absolutely necessary, and vehicle traffic required for construction and operations will be so limited as to have almost no impact on soils and vegetation.

While BLM looks forward to reviewing and considering additional information that supports these assumptions of limited impact, our current information from work on similar development projects suggests that the extent and impact of grading, vegetation removal, and construction and operations traffic will be much more extensive than implied in this Plan. We are concerned that using an assumption of minimal impact at this stage of the process will lead to very serious complications during construction, when the “minimal impact” plans are found to be unrealistic or unworkable.

Response

The updated RnR Plan describes more fully the measures planned for site preparation that incorporate the goals of Low Impact Design (LID). An overarching goal is indeed to achieve a minimal amount of site disruption during site construction relative to most industrial projects. Similar development often takes the approach that subsequent site management will be simplified if the project area is bladed and cleared. While that may be the case, the Applicant is committed to a “greener” approach to site development and is willing to accommodate the consequences as well (e.g., Section 4.5).

Comment BLM2-9 [BSE-35]

The text is vague in discussing the scope of pre-construction and during-operations data collection that will be done. Section 7-1 says that baseline soil conditions should be established, but does not make a proposal to do so. Section 7.5.1 discusses the need for reference sites, but implies that they will be developed only during the post-operations monitoring program. At a minimum there must be a firm commitment to the collection of baseline data, and establishment and maintenance of a representative series of reference sites, established prior to construction, and including their preservation over the lifetime of the project. Once reference plots have been identified, they will have to be protected, making these plots an integral part of the land use and its later restoration. Those areas will become unavailable for future development. They should be considered part of the land area to be incorporated into the permits for this project.

Information on methods for establishing reference plots and collecting baseline data are available. The transect methods set forth by California Native Plant Society (CNPS) are often considered the standard; they may be reviewed in an appendix to Sawyer and Keeler-Wolfe (1995). The CNPS web site offers protocols and forms for much more rapid methods based on ocular estimates and overall evaluation of polygons of uniform vegetation:

<http://www.cnps.org/cnps/vegetation/rotocol.php#instructions>

Numerous additional methods for determining plant cover by species were offered by Bonham (1989). Point intercept methods beginning on page 109 are particularly efficient in terms of labor requirements and may provide more reliable information than the much more laborious transect and quadrat methods used by CNPS. A step-point method described on page 121 of Bonham (1989) allows the recording of hundreds of points in a short time when used by a single observer who is thoroughly familiar with the vegetation. Note that the points must be spread throughout the area to be sampled, and the underlying assumptions of the method must be rigorously respected.

Response

Section 3 and Appendix E provide the information on baseline conditions of both previously disturbed as well as pristine plant associations in the area, gathered as part of the effort to revise and update this RnR Plan. Section 7.2.5.1 provides the measures to be employed in the gathering of baseline information on soil conditions.

It is unclear, however, what advantage would be conferred to the rehabilitation and revegetation effort by maintaining offsite study plots (see the discussion in Section 7.8.1). Should there be retarded progress in revegetation, a check of the precipitation records for Las Vegas would reveal whether low precipitation might be the cause, and visual inspection of the surrounding vegetation can easily determine whether local plant associations are stressed, or not.

Sections 3 and 7 provide the methodologies used in gathering quantitative vegetation data, and the methods and goals of vegetation sampling are spelled out for the rehabilitation and revegetation of the Ivanpah SEGS.

Comment BLM2-10 [BSE-36]

Page 1-1, Section 1.1, 2nd Paragraph: This text provides some reasons why this Plan should be considered to be preliminary, and will need to be flexible based upon actual conditions at the time of decommissioning. The reasons include “unanticipated operational exigencies” and “external factors.” Section 8.1 provides much more detail regarding these reasons.

BLM agrees that conditions may change, the existing Plan must be re-evaluated at the time of implementation, and that it is appropriate to discuss this concept within the Plan. The current organization of the discussion of this issue is confusing, and should be revised. There is some brief introduction in Section 1.1, which seems to be a logical place to discuss the concept—it should be contained within the Plan introduction. However, the bulk of the discussion is within Section 8.1. It is not clear why this issue is discussed in detail in Section 8, but not Section 7 (where it is just as applicable) or in Section 1.

We recommend the entirety of Section 8.1 should be placed into Section I, to present the entire discussion of the need for flexibility in one location. That text should make clear that the flexibility needs to apply to both the revegetation plan (Section 7) and the closure plan (Section 8).

In addition to moving the discussion to the introduction, BLM has specific comments on the content of this text. These comments are provided below, on the text that is currently located in Section 8.1.

Response

The revised RnR Plan has been reorganized as recommended above. The step to re-evaluate this Plan and develop a *Final Closure, Revegetation and Rehabilitation Plan* in light of conditions approximately 5 years prior to decommissioning has been retained (Section 8.1.3). The text has been clarified to reduce the possibility of confusion.

Comment BLM2-11 [BSE-37]

Page 1-5, Section 1.2.2.3, 1st Paragraph: The text states that “ground surface between every other row of heliostat array would remain desert scrub.” While this ground surface may appear to be non-impacted in the short-term because no vegetation is actively cut down or run over, these areas will be impacted in the long-term for a variety of reasons. This strip will remain inaccessible to desert tortoise and other herbivores, and will be impacted by shading, plant maintenance, and modified hydrology. These areas must be considered to be part of the area requiring restoration.

The text also refers to cut vegetation being mulched and stored in windrows for later revegetation. The text should specify whether this is intended for revegetation of the temporary construction areas, or ultimate site closure. It is unlikely that these materials could be stored for the 50-year ROW period.

Response

The Applicant agrees that even areas that will not be mowed may be affected by project development, and further notes that there are large areas planned for mowing that will be distinctly affected. These long-term disturbed area will be subject to restoration although the actual measures will await the *Final Closure, Revegetation and Rehabilitation Plan*.

The Applicant agrees that soil and mulch storage for a 50-year period is impractical, and storage/stockpiling of these materials is for short-term disturbed area rehabilitation only as described in Section 7.

Comment BLM2-12 [BSE-38]

Page 1-5, Section 1.2.2.3, 2nd Paragraph: The text describing the characteristics of the heliostats does not provide a description of the power and communications mechanisms that will be used to make them track the sun. It is assumed that each individual heliostat has a motor that must be powered, and that some central communications mechanism must be used to direct its movement. Unless these are somehow powered and directed remotely, they must be connected to some central source by wires. If so, then this is a very substantial length of wires that will be present throughout the facility that require installation, maintenance, and eventual decommissioning. Revise this section to describe any associated wiring, including its length, installation methods, maintenance requirements, and decommissioning methods. Other sections of the Plan should be revised accordingly, to address the impact of this wiring on initial site preparation and eventual decommissioning.

Response

The updated project description in Section 1 now describes the command and control wiring and stipulates that it will be strung above ground level (Section 1.3.1.1). The Applicant respectfully requests that the more detailed information on the length of wire, impacts and maintenance requirements be deferred to the ROW documents or the NEPA review documents, and not included in this RnR Plan, since the relevance to rehabilitation is not immediately evident. Upon decommissioning, the recycling of this wire is included in Appendix G.

Comment BLM2-13 [BSE-39]

Page 1-6, Section 1.2.3.2: In the discussion of the BMPs for the use of wash water, the amount of water required for this purpose is dismissed as insignificant with respect to erosion or runoff. However, there is a clear potential for weed growth which might spread to nearby native areas. Although daytime evaporation is high in the summer, washing will be done year-round and only at night. The drip will be on a small area of soil directly below the heliostats and will penetrate the soil as a wetting front that moves downward with each addition of water. Evaporation of soil moisture takes place only at the surface; water that penetrates more than a few centimeters remains in the soil until removed by growing plants. It is likely that the wash water will promote weed growth. This concept should be discussed in the Plan, along with its impact on eventual site restoration.

Response

The Applicant's analysis of the potential amount of mirror wash water that may percolate into the soil is presented in Section 1.3.1.1. It is not considered sufficient to support weed growth, although monitoring for weed growth is nevertheless planned (Section 7.7). On alluvial fans of the Mojave Desert any given site, such as the Ivanpah SEGS, is normally underlain by a thickness of unsaturated alluvium hundreds if not thousands of feet thick. Water normally percolates a few inches to a few feet depending on the amount of rainfall, and then that water that is not lost to plant evapotranspiration enters the vapor phase and is no longer available for plant uptake. Free water does not reside in these soils, nor is it cumulative.

Comment BLM2-14 [BSE-40]

Page 1-9, Section 1.2.2.3: This section discusses fire protection, but the text does not discuss the potential fire hazards associated with this type of installation. Cheat grass, one of the exotic grasses reported for the site, is particularly noted for encouraging large and fast-spreading fires (Pellant 1996). The interactions that might exist between weed growth promoted by water use and the potential fire hazards at the installation should be discussed. Also, the text should specify whether the fire protection systems are subject to leakage.

Response

Fire protection systems will be well-maintained in part to prevent leakage. As described in Section 3, this part of the Mojave Desert does not appear to support the density of exotic weeds (especially red brome) that would be required to constitute a fire hazard. Nevertheless post-construction monitoring is planned and fire hazard action-level are currently identified as triggering weed management measures (see Section 7.7 and Appendix B).

Comment BLM2-15 [BSE-41]

Section 1.2.4, General: This entire discussion is repeated in Section 8, the Closure Plan. Because it discusses the Plan for removal of facilities following decommissioning, it belongs in Section 8, and not in the document introduction. This text should be deleted.

Response

The text has been substantially modified to avoid redundancies to the extent practicable with a document the size of the RnR Plan.

Comment BLM2-16 [BSE-42]

Section 1.3.2, General: Many of the potential activities discussed in the Technical Basis Document (TBD) are not actually proposed for implementation in the Plan itself. As discussed in General Comment #2, the reader frequently becomes confused regarding what items are discussed as potential options, versus what items are being committed to as part of the Plan. For instance, Page 1-19, 2nd Paragraph, states that “an open-air nursery would be employed for succulent salvage.” However, the final sentence in Section 4.6 clearly demonstrates that no such nursery is proposed as part of the Plan. The introductory text, and the phrasing used (“would” and “will” versus “could” and “may”) should be revised to show that this section is presenting results from the TBD, that these results are presented as possible options that are considered in the development of the Plan, but that this discussion is not the Plan itself.

Response

The RnR Plan has been rewritten in part to eliminate inconsistencies such as those described above. The summary of findings of the TBD has been abbreviated and, instead, the TBD itself is included as Appendix D.

Comment BLM2-17 [BSE-43]

Page 1-14, Section 1.3.2.2: The text dismisses some exotic species as beyond eradication. This is true only if soil function is never restored. While complete exclusion may not be possible, healthy soils often have considerable resistance to weeds and can be rebuilt with proper restoration methods. The site must not be abandoned to exotics with such reasoning. Belnap et al. (2001) gave an excellent overview of soil crusts, which are believed to have some protective effect against exotic annual grasses.

Response

As stated in Section 7.7 of the updated R&R Plan:

Special consultations with respect to ubiquitous exotic species (e.g., *Bromus madritensis* ssp. *rubens*, *Erodium cicutarium*, *Schismus* spp.) are anticipated because control of these may be impractical. These species are present throughout the Ivanpah Valley region in both disturbed and undisturbed habitats. In general in this portion of the Mojave Desert, they do not exert excessive influence on the perennial shrub plant community structure either through dominance or potential fire hazard. However, they are a common component of the herbaceous strata in low to moderate density.

Vegetation surveys completed in support of this RnR Plan demonstrate the ubiquity of these weed species even in habitats with low levels of disturbance (bioturbation) (Section 3.4.5.2; Appendix E).

Comment BLM2-18 [BSE-44]

Page 2-1, Section 2.1.1, 1st Paragraph: There is typically no need for a 75-foot wide ROW to construct a small diameter pipeline – 50 feet is normally adequate. There is also no need for an access road associated with gas pipelines. If BrightSource needs a perimeter access road around the plant sites, that would be acceptable, but do not tie it into the gas pipeline needs.

Response

The facilities associated with the gas pipeline, and the temporary ROW for its construction, follow what was requested by Southwest Gas. Their requirements included an access road. As can be seen in the plans included in Appendix A, for part of its length the access road for the gas pipeline will be the same as what is used to access to other parts of the project and used to reroute existing trails. We concur with the width of the construction ROW and have unilaterally reduced it to 50 feet. The perimeter access around the plant sites is located inside the solar plant's security fencing; whereas, the gas line will be located outside the perimeter fencing.

Comment BLM2-19 [BSE-45]

Page 2-2, Section 2.1.1: The text should specify standards to be used to define the needed amount of decompaction. Unless there are specifications and a means of measuring the performance, effective decompaction is unlikely to happen. The best means might have to do with specifying properties of the finished soil.

Response

These specifications are now presented in Section 7.2.5.2.

Comment BLM2-20 [BSE-46]

Page 2-2, Section 2.1.2: Provide the diameter of the water pipelines. The 50-foot ROW association with a water line can overlap the ROW for the gas pipeline. Provide the relationship between the locations of the water and gas pipelines, and analyze the opportunity to place the gas pipeline and water pipeline in the same trench or in adjoining trenches. Shared trenches are common in many O&G development fields.

Response

Please see the revised Section 1.3.5.1 and Appendix A. While a shared trench may be used in the future, this is not the present plan. If a shared trench is utilized, water and gas pipelines will be separated as required by state and local codes.

Comment BLM2-21 [BSE-47]

Section 2.1.3, General: Re-assess and discuss the need for an access road under the gen-tie lines. Many times roads end up under transmission lines by default, but usually not because the holder needs to clean insulators.

Response

Currently Section 1.3.1.6 maintains that there will be access roads associated with the gen-tie lines. The Applicant is, however, amenable to discussing this need further with the BLM, but at the moment considers these access roads to be prudent. Again, these roads will not be bladed, but will be mowed for initial construction and if not needed, the vegetation will be allowed to regrow.

Comment BLM2-22 [BSE-48]

Page 2-4, Section 2.2: The text states that rehabilitation areas identified during the operations phase are most likely to consist of those areas that have been affected by sheet flow or scour during flood events. First, it is not clear what is meant by rehabilitation areas “identified” during the operations phase. It is assumed that this is meant to read “areas affected by operations, and that will require rehabilitation following cessation of project operations.” Review and revise the text to clarify the areas under discussion.

Response

The text has been revised to clarify the requirements and measures to be taken (see Section 2.2).

Comment BLM2-23 [BSE-49]

Second, if the purpose of this text is to define the areas that will be affected by operations, and which will then require rehabilitation after the cessation of facility operations, then the focus on flooded areas is not appropriate, and needs to be revised. The areas that will require rehabilitation will include all areas where heliostats, heliostat wiring, roads, stormwater management structures, power blocks, pipelines, and administrative facilities were present. It will also include all areas that are disturbed as part of the decommissioning process – this may include areas which were disturbed during construction, revegetated after construction, but then re-disturbed during decommissioning.

Response

No requirement or request is stipulated in this comment. However, please see the revised text in Sections 1, 2, 7 and 8 of the RnR Plan, which addresses these project components and action items.

Comment BLM2-24 [BSE-50]

Page 2-4, Section 2.3: The purpose of Section 2 in general appears to be to define the areas that will be disturbed during the various project phases, and that will eventually require rehabilitation. This subsection actually describes proposed decommissioning procedures, but does not accomplish the purpose of defining the areas that will be disturbed during the decommissioning process. Instead of describing the process (which is repetitive of Sections 7 and 8), the text should be revised to discuss that the decommissioning process will result in the use of trucks and heavy equipment to remove site infrastructure, where these areas will be, and should specify that closure and revegetation procedures described in Sections 7 and 8 will be required for these newly disturbed areas.

Response

The revised RnR Plan has been reorganized to better explicate the various project components (Sections 1, 2), short-term disturbed areas (Section 7), and the decommissioning process (Section 8).

Comment BLM2-25 [BSE-51]

Page 3-3, Section 3.3.1, 1st Paragraph: The text states that “management and restoration decisions should be made only after a field investigation is performed to describe onsite soils and their physical and chemical properties.” BLM agrees with this statement. However, it is not clear if this is an actual commitment by the applicant, as part of the Plan. No further discussion of such a field investigation is provided. Since the objective of the restoration will be to restore pre-construction conditions, this investigation must be conducted prior to site disturbance, so its performance cannot be delayed until the expiration of the ROW.

Response

Section 3.4.4 of the revised RnR Plan now provides a summary of the field investigations to establish a baseline for vegetation conditions and objectives for revegetation. Section 7.2.5 provides the direction for the collection of baseline data on soil conditions, which will be accomplished prior to the initiation of construction but after the granting of the BLM ROW.

Comment BLM2-26 [BSE-52]

Page 3-3, Section 3.4.3.1: A reference should be provided for the source of information for this list of disturbance-adapted plants. BLM believes that some of these species are not disturbance-adapted, but would like to understand the source of the information before accepting or rejecting these species.

Response

The text has been updated to provide references for these findings. These findings are based ultimately on field observations in the project area by Dr. W.G. Spaulding who has more than 30 years' experience in the plant ecology of the Mojave Desert.

Comment BLM2-27 [BSE-53]

Page 3-4, Section 3.4.3.2: BLM disagrees with the characterization of these annual weeds as functioning essentially as native plants. Those species, wherever they have been found, have all of the fundamental characteristics of ruderals. The weed species currently designated as part of the acceptable pioneer flora included red brome, Mediterranean grass, and Russian thistle. Red brome and cheat grass help promote fires and certainly should not be considered acceptable. These species are not only not components of a functional ecosystem; they are symptoms of failure to rebuild a functional ecosystem.

Response

Comment noted. Please refer to the *Weed Management Plan* (Appendix B) as well as the revised text in Section 3.4.3.

Comment BLM2-28 [BSE-54]

Section 4, General: It is difficult to provide technical comment on the procedures discussed within this section, when the final sentence of the section implies that none of these procedures are actually proposed. A general discussion of this issue is presented in General Comment #6. Some specific comments are provided on this section, but they should be considered in light of the fact that the entire proposal needs to be reconsidered.

Response

Comment noted. Section 4 has been rewritten to reflect the commitments of the Applicant to long-term revegetation efforts.

Comment BLM2-29 [BSE-55]

Page 4-1, Section 4: BLM agrees that there's probably not too much point in salvaging shrubs. However, the large blocks of soil that come with transplanted shrubs are in themselves valuable, even when the shrubs do not survive. The text should consider using these materials within the revegetation program.

Response

While the respreading of stockpiled soil is adopted as a rehabilitation measure for the RnR Plan, after consideration, transplanting shrubs in order to transfer blocks of soil was rejected as a practical option.

Comment BLM2-30 [BSE-56]

Page 4-6, Section 4.5.3: The text proposes a single pass with a watering truck every three months to permit most plants to survive. A better idea would be to give a thorough watering when the plants first begin to show signs of stress. A single pass of a water truck is unlikely to wet the soil to more than an inch or two, especially if that water is spread over a wide area. Artificial watering should take place only when the succulents show signs of dehydrating and shrinking. The amount of water should be enough to wet the root system to its full depth at each of the infrequent watering events.

Response

Comment noted. Ultimately, for the succulent stockpile plantation the adaptive management approach will be taken.

Comment BLM2-31 [BSE-57]

Page 5-1, Section 5.1, Bullet #1, and Page 5-2, Section 5.1, 1st Paragraph: This proposal to mow vegetation may need to be revised once the actual grading plan has been finalized. In general, leaving root systems will not be a feasible option to minimize wind and water erosion, or to filter water and wind-carried sediment. This is feasible in the short-term. However, a substantial portion of the vegetation on the site will die in the longer term due to shading, soil disturbance during construction, modification of the hydrologic system, weed management, dust suppression, and maintenance activities. While site preparation activities intended to minimize disturbance to vegetation are generally favored, they must

be considered in their long-term context. If construction activities and long-term site operations are likely to kill off most or all vegetation anyway, then short-term efforts (such as mowing) to protect vegetation may not be warranted. Also, development of long-term wind and water erosion plans cannot count on root systems which may continue to be present for a few years, but will eventually decay and wash away.

Response

Comment noted. The Applicant believes that the LID approach is preferable to wholesale grading and clearing of the site and understands that there will be certain management challenges as a consequence (e.g., Sections 5.2 and 5.4).

Comment BLM2-32 [BSE-58]

Page 5-1, Section 5.1, Bullet #3: The references to detention ponds and diversion channels are examples of items that may change in the final grading plan, and that would need to be changed accordingly in this Plan.

Response

The Project no longer contains any detention ponds and the text has been revised accordingly. There are some minor diversion channels to prevent flooding of the power blocks and the substation.

Comment BLM2-33 [BSE-59]

Page 5-1, Section 5.1, Bullet #6: The text here refers to stormwater management requirements during construction. Similarly, Section 5.2 refers to the need for a General Permit for Stormwater Discharges Associated with Construction Activities.

The text should be revised to also consider the stormwater management requirements during decommissioning. It is likely that the removal of hundreds of thousands of heliostats, associated wiring, foundations, roads, and stormwater management structures will require substantial traffic and earthmoving activities. It will also last for a substantial duration of time. Therefore, the requirements for stormwater management during decommissioning will be much the same as that required for initial construction. This comment also applies to Section 8.2.7.

Response

At this time the Applicant believes that it is inappropriate to detail stormwater management requirements for three to five decades into the future. Section 8 states that the SWPPP will be updated prior to start of decommissioning activities.

Comment BLM2-34 [BSE-60]

Page 5-2, Section 5.1, 1st Paragraph: The text states that the increase in sediment yield is not expected to be substantially different from the pre-project condition.

Bullet #5 on the previous page (5-1) states that calculations will be performed to calculate required cleanout frequencies. From our ongoing work on the stormwater management systems, BLM is aware that calculations of sediment yield have not yet been performed, and

cannot be performed until upstream basin stormwater modeling has been completed. Therefore, this statement that sediment yield is not expected to be significant has not yet been substantiated by quantitative estimates. Although BLM has not done independent calculations at this time, based on our knowledge of the hydrologic system involved, we do expect that the ISEGS detention/retention ponds will generate substantial sediment yield. Therefore, this statement should either be changed, or the question of sediment yield be left open pending final calculations.

Response

As stated earlier, detention ponds are no longer expected to be part of the stormwater management.

Comment BLM2-35 [BSE-61]

Page 5-2, Section 5.3: The text states that the pH of wash water is not substantially different from the existing soil. However, the process of application and evaporation of wash water could potentially build up elements that will change the soil. The text should discuss the potential for mineral buildup in soil, and the effect it may have.

Response

The text has been updated to address this question. Please see Section 5.3. The estimated accumulation of solids resulting from this process is less than a pound/acre/century.

Comment BLM2-36 [BSE-62]

Page 5-4, Section 5.4, 2nd Paragraph: The text refers to the landscape inside the heliostat field as a "semi-natural ecosystem." See General Comment #7 and Specific Comment #16. Even if efforts are taken during construction to minimize impacts to soil and vegetation, later activities such as vegetation shading, modification of the hydrologic system, weed management, dust suppression, and maintenance traffic will have significant impacts. While the area may still attract fauna as described in this section, the reference to the area being a semi-natural ecosystem should be deleted.

Response

The reference to the area being semi-natural has been removed. Please see the revised text of Section 5.4. The Applicant believes that it is prudent to anticipate conditions resulting from LID implementation.

Comment BLM2-37 [BSE-63]

Section 7, General: The organization used in Section 7 is very confusing, especially from Section 7.1.3 through Section 7.4. Currently, the section flows as follows:

- Sections 7.1.3.1 through 7.1.3.4 discuss seeding issues.
- Section 7.1.3.5 discusses succulent transplant methods.
- Sections 7.1.3.6 through 7.1.3.10, and Section 7.1.4 discuss seeds again.
- Section 7.1.5 again discusses succulent transplant methods.
- Section 7.2 discusses seeds again, specifically planting techniques.

- Section 7.3 discusses water availability
- Section 7.4 discusses seeding techniques again.

It is recommended that these sections be re-organized to make a coherent discussion. All sections which discuss seeding, including plant types, seed sources, storage techniques, and plating techniques, would be easier to comprehend in a single section, without being interrupted by un-related items. A Plan to salvage, provide for long-term storage, and transplant of succulents following decommissioning should be provided in a separate subsection. The text on water availability can be a stand-alone section, and also should not be inserted in between two sections that both discuss seeding techniques.

Response

Sections have been partially re-organized. The organization of Section 7 is as follows: Under the Revegetation Materials and Handling section, subsections include Plant Species Selection, Seed and Native Stock Collection and Storage, Protocol for Collection and Storage, and Propagation. This is followed by the Applicable Planting Techniques section, with subsections to include Seeding, Mulch, Container-grown Plants, Natural Colonization, and Planting Protocol. Subsequent sections include Irrigation and Natural Precipitation, Herbivory and Granivory, Weed Management, and Revegetation Monitoring and Management. All references to succulent salvage selection, storage, or transplanting have been reserved to Section 4 and, where appropriate to specify revegetation measures, Sections 7 and 8.

Comment BLM2-38 [BSE-64]

Page 7-1, Section 7.1.1: The definition of where topsoil salvage would be needed is too vague, and should be revised. This section states that areas with extensive earth movement “should” have topsoil salvaged – revise the terminology to “will.” Also, the text generically discusses broad areas where topsoil salvage will be done, and areas where it will not be done. The differentiation is made based solely on whether a site has undergone intrusive excavation and grading. Areas which are subject to vehicle and foot traffic are not proposed for topsoil salvage.

Response

Wherever possible the conditional has been replaced with the declarative. The commentor is correct in that the updated RnR Plan does not anticipate topsoil salvage in areas subject to vehicle or foot travel. To do so would be to create more disturbance, which cannot be justified by the benefit gained by collecting extra topsoil.

Comment BLM2-39 [BSE-65]

At this stage of our knowledge, it seems unlikely that hundreds of thousands of heliostats, associated wiring, and stormwater management structures can be delivered to the site and installed without widespread site disturbance, even in areas where active excavation is not proposed. BLM is aware that a Technical Memorandum describing construction vehicles, heavy equipment, travel routes, expected numbers of trips and personnel, and grading needs is pending, and that the details in this document will contribute to our knowledge of the level of disturbance expected from these activities. However, based on current

information, it is BLM's expectation that there is likely to be enough disturbance from these activities that topsoil salvage will be needed.

Response

Topsoil salvage is planned where grading excavation and permanent facility placement is anticipated.

Comment BLM2-40 [BSE-66]

Section 7.1.2, General: BLM believes that topsoil is one of the most valuable assets in restoration. However, topsoil collected in 2010 will not be viable in 2061. The text should provide a specific plan for preservation and continuing enhancement of topsoil for the duration of the project. The Plan should specify the year, season, locations, and methodology of collection of topsoil from the donor sites. Specify the vertical and horizontal dimensions of the stockpiles and their locations within the facility. Describe how the topsoil will be kept viable during storage, which native species will be rotated through any intended plantings, how often plantings will be changed, and how they will be maintained. Describe how the stockpiles will be kept free of weeds. Indicate the season, locations, and method of distribution of the topsoil at the time of replacement. The top soil storage area could provide additional benefits by doubling as a seed propagation and succulent storage area. The correct choice of plants to grow would produce a seed crop above ground and a crop of mycorrhizal fungi, pathogen antagonist, plant growth-promoting rhizobacteria, and other vital soil creatures below around. On the surface the stockpile might be producing soil algae and other cryptogamic crust organisms.

Response

The Applicant concurs with the BLM that topsoil collected in 2010 will not be viable in 2061. For this reason, and in the absence of proven and economical means to maintain soil stockpiles, the Applicant is not planning for the long-term storage of soil stockpiles. Please refer to Sections 7 and 8 for rehabilitation and revegetation plans.

Comment BLM2-41 [BSE-67]

Page 7-1, Section 7.1.2.1: This section states that initial characterization of the baseline soil conditions "should" be done. However, there is no clear statement in the Plan whether such a characterization activity will actually occur.

BLM agrees that such characterization must be done, and must be done before site disturbance occurs. With respect to the specific items listed, BLM agrees that the profile description, soil texture, bulk density, and other soil properties are important items to capture. Organic matter content and CIN ratio are probably not informative in this case. Documentation of soil biota is important, but mycorrhizal fungi and soil micro-arthropods are far more central to functioning of the soil than ants and termites. The text mentions cryptogamic crust, which is difficult to measure if soil algae are considered. The text should describe what properties would actually be measured.

Response

See Section 7.2.5.1 for measures to be taken to gather soil baseline conditions, and the properties that would be measured.

Comment BLM2-42 [BSE-68]

Page 7-2, Section 7.1.2.3: The text should describe that different soil types exist on the project area, each of which typically has different soil texture and different soil microbial features. The text should describe how the designations of what is or is not topsoil will be made, and how field monitoring will be done to verify whether the plan is followed. The 2-inch depth for topsoil discussed in the text is not necessarily the best plan – it would be better to define topsoil by the presence of fine roots during the moist season. Each type of soil should be stockpiled separately, and measures to maintain soil microbial activity should be implemented separately.

Response

As previously noted, the updated section 3.3.1 describes the soils of the project area, and Section 7.2 describes soil rehabilitation measures including the placement of soil stockpiles.

Comment BLM2-43 [BSE-69]

Page 7-2, Section 7.1.2.4: The text calculates that a 75-foot wide corridor 4.6 miles in length will comprise 36.3 acres. The actual value is 41.8 acres. The text should be corrected.

Response

The text has been revised and reorganized. As stated earlier, the Applicant concurs with only allowing a 50-foot-wide ROW for gas line construction. See Table 1-1 for a breakdown of the various corridor lengths and associated acreages.

Comment BLM2-44 [BSE-70]

Page 7-3, Section 7.1.2.5, 1st Paragraph: The text states that the heliostat areas will be bladed to a depth of 1 to 3 inches. The text should define the extent of the area to be bladed – is it a small area of a few square feet at the base of every support? Is it a swath along the row, and if so, how wide and long? Is it a broader area?

Response

The text of Section 1 (and elsewhere) has been updated to note that no blading is planned for the installation of the heliostat arrays.

Comment BLM2-45 [BSE-71]

Also, the text states that topsoil would be stockpiled for later respreading, but does not provide any details. The timing and manner of collection have a large effect on the survival of the soil biota. The text should describe how much land can be salvaged under this plan. Under topsoil placement, the text should define the time of year that topsoil will be spread on the temporary disturbances, and how deep the top soil layer will be made.

Response

The Applicant has attempted to be as explicit as practicable in the revised Section 7.2, and regrets that at this time it is impossible to be as specific as is desired by the BLM.

Comment BLM2-46 [BSE-72]

Page 7-3, Section 7.1.2.5, 1st Paragraph: The text states that the roads between every other heliostat row will be graveled. See General Comment #7 – the plan for roads appears to be evolving, it is not clear if this is the current plan, based on other verbal discussions. If this is the Plan, then the width of the roads should be defined. In general, BLM believes that the proposal to grade and gravel these roads is far more realistic than recent verbal discussions of lightly traveled I-foot wide tracks. Whatever the actual proposal is, it should match the information being used in the infiltration analysis.

Response

The revised project description in Section 1 matches that planned for the infiltration analysis. The plan for the heliostat maintenance tracks has been finalized, and no grading is planned except where terrain may necessitate limited cut and fill to permit equipment travel.

Comment BLM2-47 [BSE-73]

Page 7-3, Section 7.1.2.6: See General Comment #7. The plan for soil decompaction cannot be evaluated without an understanding of the extent of the compaction. The proposal to use hand tools for decompaction implies that the areas are expected to be very limited in extent – only a few square feet at each location. As discussed in General Comment #7, BLM expects that the extent of disturbance will be more widespread, making the use of hand tools for decompaction impractical. Once the actual extent of disturbance, this proposal for the use of handtools should be re-evaluated to verify that it can be implemented.

Response

The text has been revised accordingly and may be found in Section 7.2.

Comment BLM2-48 [BSE-74]

Section 7.1.3, General: The organization and terminology used in Section 7.1.3 is very confusing.

First, the title is not really descriptive of the section's content and purpose. Section 7.1, overall, is "Rehabilitation Methods." Section 7.1.2 is titled "Soil Rehabilitation," and describes the proposed rehabilitation methods for soil, which makes sense. Section 7.1.3 appears to mostly describe the proposed rehabilitation methods for vegetation. However, the title of Section 7.1.3 ("Appropriate Plant Species") does not make this obvious. To continue with the theme of the section and logically follow Section 7.1.2, it is recommended that the section be titled "Vegetation Rehabilitation."

Then, the section contains several subsections of descriptive text regarding seeding methods. But the text does not actually state that seed collection will be done until the bottom of Page 7-6, where the text reads "Seed collection will be performed...". It is

recommended that this sentence be moved to the very beginning of Section 7.1.3 – it should be an introduction to this entire section, so the reader knows right off that the described activities are actually going to be performed. The organization of Section 7 in general, and Section 7.1.3 specifically, make it unclear to the reader whether the discussed methods are actually proposed, or are just being discussed for informational purposes. A clear introductory paragraph is needed.

The confusing insertion of text on succulents (subsection 7.1.3.5) has already been discussed above.

Response

Sections have been re-organized for clarity. See response to BLM2-37/BSE-63. Specifics proposed for seeding methods have been stated clearly in Section 7.3.3, and the numbering has been corrected.

Comment BLM2-49 [BSE-75]

Then, there is a different Section 7.1.3 heading, which appears to be a typographical error, since the subsection numbering of the previous section is continued. This error should be corrected.

Response

The error has been corrected.

Comment BLM2-50 [BSE-76]

Page 7-4, Section 7.1.3: Notes on page 1-12 state that sufficient information on the ecological dynamics of revegetation exists; therefore, a research program is unnecessary. A similar assertion is made on page 1-13, referring to the research at CMM. Research might be unnecessary if the current plan made full use of the existing information on desert restoration. However, the text in this section, and in other locations in the Plan, states that early successional species are most appropriate for revegetation and should be used here. This statement essentially abandons previous restoration research and suggests leaving site recovery to invasion by weedy plants. Information on soil compaction and soil microbiology done at CMM and elsewhere, reported in part by Bainbridge (2007), indicates that the applicant should propose to make use of plants from later successional stages.

Response

The Applicant disagrees with the assertion that use of disturbance adapted species in some fashion disregards previous research. Our reading of Bainbridge (2007), as well as other works, also fails to support the notion that late-successional species are the best to use in revegetation. Additional references have been provided to show that, in fact, attempts to revegetate disturbed landscapes with species that are not disturbance adapted have increased the probability of failure (see Section 7.3.1; Appendix D).

Comment BLM2-51 [BSE-77]

Page 7-5, Section 7.1.3.3: The text states that seed collection should occur within the local 25-mile radius area. It is not clear whether this is actually proposed – revise the text to state that seed collection will occur. The text should provide the methodology of seed collection (including that there would be no cross-country vehicle travel and vehicles would travel “open” routes), collection intensity per acre, frequency of collection in each area, storage and the feasibility of obtaining sufficient quantities of seed to facilitate meeting the success criteria on 4,000 acres.

If all solar plants currently proposed within this area are built, and all perform seed collection in this area, then there may be cumulative impacts on seed availability to be considered in the EIS.

Response

Comment noted. Wherever possible, the conditional has been changed to the declarative.

Comment BLM2-52 [BSE-78]

Page 7-8, Section 7.1.3.7, 2nd Paragraph: The text states that seed collection will be initiated within 2 years of potential site disturbance. We assume this means 2 years before site disturbance – please clarify the text.

Response

The text has been clarified. However, seed collection will not begin until the CEC license and BLM ROW grant have been issued.

Comment BLM2-53 [BSE-79]

Page 7-8, Section 7.1.3.8, 1st Paragraph: The text states that seed will be collected directly from the project area “where feasible.” The text should define the conditions in which this is or is not feasible.

Seeds of local origin are generally available only by arrangement with professional seed collectors, as discussed in Section 7.1.3.9. Although this text states that professional seed collectors “may” be used, it does not clearly define the source of the seeds -the text should define the source. An additional option is that topsoil stockpiles may be to some extent preserved for the lifetime of the project by planting with appropriate native plant species, which would also assure a seed supply. Those species should be mycorrhizal host plants; if only non- hosts such as *Atriplex* species are grown, the most vital components of soil biology will be lost with time. Appropriate plants for maintaining the soil stockpile will be found among perennial grasses and composites, as well as a range of other plant families. It is important to avoid a single-species stand of non-hosts or exotic species. Non-host families include some of the most prominent species among the early-successional plants. Chenopods, amaranths, and mustards are almost entirely non-hosts and should be avoided except when there is a specific need for their seeds.

Response

The text has been updated and revised to be more explicit where possible. There are some aspects of this plan that, unfortunately, cannot be fully planned ahead of time. Regarding the general absence of mycorrhizal host plants from those species that are early successional taxa, such as *Atriplex*, the Applicant's informed opinion is that there is a reason for that, and it would be counterproductive to attempt to revegetate with late successional plants simply because they are mycorrhizal host species.

Comment BLM2-54 [BSE-80]

Page 7-8, Section 7.1.3.8, 3rd Paragraph: The text describes seed collection from under shrubs and from depressions in the ground. That is a good method if done correctly, but it does not always supply soil microorganisms. Further, it is difficult or impossible to count seeds by species with this collection method, so the later references to seed numbers do not apply. The text should clarify these issues.

Response

Comment noted. The text has been modified and clarified where appropriate.

Comment BLM2-55 [BSE-81]

Page 7-9, Section 7.1.3.10: The text needs to specify whether storage of seeds for more than 50 years is viable, including defining the physical locations where seed storage is planned. The 4th bullet states "If seed storage is required for more than 1 year..." Given the 50 year term of the ROW, it is hard to imagine how seed storage of less than 1 year is contemplated, unless the text is referring only to seeding of temporary construction areas. The text should clarify whether seed collection is proposed to support closure at the expiration of the ROW, or is only proposed from temporary construction areas.

Response

Section 7.3.2 has been rewritten in part to clarify some of these issues. The Applicant has no plans to store seed for more than 5 to 10 years.

Comment BLM2-56 [BSE-82]

Page 7-11, Section 7.1.5: As stated above, the purpose of this section is not clear. The text refers to "limited transplanting," although Section 4.6 states that these onsite long-term stockpiling will not be done. Define what is meant by "limited."

Response

The text of Sections 4 and 7 have been updated to remove inconsistencies and to clarify what measures will be taken.

Comment BLM2-57 [BSE-83]

Section 7.2, General: This section discusses a lot of different planting techniques, but never directly states what is actually proposed. It is not clear if the purpose of the text is to discuss potential methods or to make a solid proposal, but this Plan should make a clear proposed

action. In general, the text appears to imply that broadcast seeding is the preferred method of seed application. There are several other potential ways to apply seeds, all of which are more likely to succeed than broadcasting. Drill seeding and broadcasting followed by incorporation are acceptable and both are discussed. Pitting gets little or no consideration, and imprinting is dismissed as not being suitable for sand. Imprinting has been used successfully on sandier soil than that found at the BEGS site, and this method is generally superior to broadcasting and drill seeding.

Response

The text of Section 7 has been intensively rewritten and reorganized to be more explicit regarding the measures planned and prescriptions specified for rehabilitation and revegetation.

Comment BLM2-58 [BSE-84]

Page 7-13, Section 7.2.1.4, Item #3: The distribution rate of seeds is stated as 150 Per Sq. meter. Is this total or per species? If total, this is a low number. The collection method proposed does not allow counts of seeds per species.

Response

Comment noted. Please see the revised text of Section 7.3.2.7.

Comment BLM2-59 [BSE-85]

Page 7-1 3, Section 7.2.1.4, Item #6: Mulch rates of 2.0 tons/acre are likely to be too high. Mulch in this environment does not decompose rapidly.

Response

Comment noted. The Applicant is aware of the slow decomposition rates inherent to arid climates.

Comment BLM2-60 [BSE-86]

Page 7-14, Section 7.2.3: This section is a good example of the difficulty presented in this Plan. If container grown plants are not going to be used, why have a section discussing them? By discussing them, the Plan becomes more of a list of potential actions, rather than a solid proposal describing the actions that are committed to.

Response

The Applicant agrees, and the text of Section 7 has been updated accordingly to delete reference to the use of containerized material other than to note that it will not be used.

Comment BLM2-61 [BSE-87]

Section 7.4, General: The text should specify whether continued fencing of the site will be required to keep herbivores such as tortoises and mammals off the site during the recovery period.

Response

Please refer to Section 4.5. It is anticipated that tortoise fencing will not prevent the free movement of rodents on and off the site, and LID implementation will leave substantial rodent populations onsite.

Comment BLM2-62 [BSE-88]

Section 7.5, General: Page 7-1, Section 7.1.2.1 states that collection of baseline information on soil conditions “should be” done. This section defines a variety of field monitoring, survey, and photography techniques that will be done after the cessation of operations. The text should specify that collection of similar baseline vegetation data will also be collected before site disturbance begins. It is understood that climate and other factors may result in the preferred vegetation conditions at the end of the project life being different from that currently present. The text may state that the purpose of the pre-disturbance data and photos is not to require 100% restoration of a similar community, especially if climate or other conditions have changed substantially. But the data may provide useful information that will help to evaluate the success of revegetation efforts, and will be lost forever if not collected in pre-disturbance surveys.

Response

The collection of soil baseline conditions before the initiation of construction operations is planned and explained in Section 7.2.

Comment BLM2-63 [BSE-89]

Page 7-17, Section 7.5.2: The number of quadrats proposed (3 per plot) is a very small number of quadrats. A large number of less intensive transects or other measures would give better data. Whatever method is proposed, the text should state that it will be used consistently on both the restoration and reference sites

Response

Section 7.8 described monitoring protocol and methods. Monitoring of “reference sites” is not planned, because as described more thoroughly in Section 7.8.1 and mentioned previously, there is no clear advantage in doing so.

Comment BLM2-64 [BSE-90]

Page 7-17, Section 7.5.2.1: The text states that monitoring will be performed for 9 years following the date of revegetation. The text should specify that this monitoring term applies to both revegetation following cessation of operations, and interim revegetation of the temporary construction areas. It is likely that performance of the monitoring program on the temporary construction areas will useful information that will facilitate the long-term revegetation following cessation of operations.

Response

The text of section 7.8.2.1 has been updated to note that monitoring will be conducted independently in all areas that have been subject to revegetation measures.

Comment BLM2-65 [BSE-91]

Page 7-18, Section 7.5.2.2: This text discusses the calculation of diversity using a measure of richness weighted by evenness. However, the text does not specify how the weighting is to be done, and there are several potential methods. In addition, the Plan does not describe methods to be used for increasing diversity. The proposal to use early successional species, especially the exotics suggested in Section 1.3.2.2, will lead to low diversity.

Response

As instructed by the BLM and the CEC, the Applicant assumes that current conditions typifying the landscape surrounding Ivanpah SEGS will continue even unto the late 21st Century. In addition, the Applicant notes that successional processes do not revert to a condition of stasis in the absence of active manipulation. It is assumed in the RnR Plan (and explained more fully in the TBD [Appendix D]) that over time diversity will increase as succession progresses and microhabitat (including soil) conditions become more favorable for late successional species. These late successional species occur in the landscape surrounding Ivanpah SEGS, and would be the source of propagules seeding into revegetated areas. Further, because of LID construction techniques, there is reason to expect that some late successional species will remain on site. The Applicant does not agree with the assertion that the measures proposed in the RnR Plan will lead to low diversity. That conclusion lacks supporting evidence.

Comment BLM2-66 [BSE-92]

Page 7-18, Section 7.5.2.3: The text describes the monitoring data to be collected, but does not describe what will be done with the data. For example, how will these measurements be compared to the reference sites and baseline data? What are the performance standards? What threshold will trigger remedial actions, and what will those actions be? For example, the text states that percent cover will be measured. Is the measurement of cover absolute or relative cover? And what will be done with the information?

Response

Sections 7.8 through 7.10 have been updated to address these concerns.

Comment BLM2-67 [BSE-93]

Section 7.5.2.4, General: The text should define which agencies the annual reports will be submitted to.

Response

Please see Section 7.11.

Comment BLM2-68 [BSE-94]

Page 8-1, 5th Paragraph: In several locations (Section 1.2.4, Section 2.3, Page 8-1, and Section 8.2.4) the Plan discusses which materials will be removed during final decommissioning, and which will remain in place or be buried. The text states that all

pipelines and concrete foundation materials greater than 3 feet deep will be left in place, and that concrete materials will be crushed and buried onsite.

Page 3-2, Section 3.2, 1st Paragraph describes the entire project area as an unstable, erosional surface. BLM agrees with this description. Site observations indicate that many erosional channels onsite exceed three feet in depth. This will result in any buried pipelines, wastes, or foundations becoming exposed through erosion. Therefore, each of these sections of the Plan must be modified to commit to the removal of all materials, with no onsite burial resulting in final decommissioning.

Response

The Applicant has committed to the removal of all pipelines (rather than abandoning them in place), but would still prefer to leave in place foundations at depths greater than 3 feet. Foundation concrete is physically and chemically indistinct from the lithified caliche (pedogenic calcium carbonate) strata that typically occur at depth in the soils here. Should scour expose these features at some uncertain time in the far future, they would increase microhabitat heterogeneity and provide additional habitat for small vertebrates and arthropods.

Comment BLM2-69 [BSE-95]

Page 8.1, 5th Paragraph: The text refers to recontouring of the land surface to restore the topographic gradient. The text should specify the means to accomplish this with respect to stormwater management or retention basins. These features, if implemented, will involve removal of large amount of sediment for construction. Restoring these features will likely not be as simple as re-grading, but will likely require importation of sediment from other areas of the site. The text should describe how this will be accomplished.

Response

Use of large retention basins is no longer planned. Section 8 has been updated to discuss how these plans will be developed in the *Final Closure Plan*.

Comment BLM2-70 [BSE-96]

Section 8.1, General: While BLM agrees that the current Plan should be flexible to allow modification based on future conditions, the Goals for rehabilitation of public lands are not all that uncertain and need to be spelled out in the Plan. For example, it must be assumed that the site will need to be returned to a natural state, free of noxious weeds, and with stabilized soils. BLM believes it is very realistic to assume that closure in 2061 or before involves wholesale decommissioning and dismantling of the facility. Returning the area to a desert scrub landscape will be required. BLM can accept a plan that states it may need to be adaptive to conditions in place at the time of plant closure, but the Plan still must be developed and considered as the operable Plan for two main reasons:

- Although the exact nature of the closure requirements may change, many support activities for site closure need to be accomplished before the site is disturbed, including collection of seeds, salvage of succulents, and performance of baseline soil and vegetation monitoring. It is possible that future site changes may make these activities

moot, but they are based upon the current best information regarding future closure requirements.

- The Plan must be in place, funds available; and preliminary support activities performed to allow BLM to implement the Plan in case early closure forces restoration during operational life of the plant.

While BLM agrees that there may be changes in local land use in 50 years, the Plan still must be made on the land uses that are expected and approved under BLM's management plans. Under these plans, urbanization of the Ivanpah valley in the next 50 years is not appropriate or likely on public lands, does not meet current LORS, and should not be mentioned in this Plan.

Response

The Applicant accepts the sense and the vast majority of the details in these comments (e.g., returning the project area to a desertscrub landscape; removal of installations on decommissioning), and the RnR Plan has been rewritten accordingly. Nevertheless, it can not commit to revegetation or rehabilitation goals that are not realistically attainable. In this case, the observations and analyses of the area (see Section 3 and Appendix E of the RnR Plan) make clear that the natural state of the vegetation in the Ivanpah Valley includes the presence of introduced Eurasian weeds (albeit not those formally designated "noxious"). Although we state that a *Final Closure Plan* will be prepared and updated from the methods used in revegetation and restoration of the areas impacted by the construction of the solar plants, we also state that absent other requirements, those set forth in Section 7 will be used for revegetation and restoration.



**BEFORE THE ENERGY RESOURCES CONSERVATION AND DEVELOPMENT
COMMISSION OF THE STATE OF CALIFORNIA
1516 NINTH STREET, SACRAMENTO, CA 95814
1-800-822-6228 – WWW.ENERGY.CA.GOV**

APPLICATION FOR CERTIFICATION
FOR THE *IVANPAH SOLAR ELECTRIC
GENERATING SYSTEM*

DOCKET No. 07-AFC-5

PROOF OF SERVICE
(Revised 6/24/09)

APPLICANT

Solar Partners, LLC
John Woolard,
Chief Executive Officer
1999 Harrison Street, Suite #500
Oakland, CA 94612

Steve De Young, Project Manager
*Todd A. Stewart, Project
Manager

E-MAIL PREFERRED

Ivanpah SEGS.
1999 Harrison Street, Ste. 2150
Oakland, CA 94612
sdeyoung@brightsourceenergy.com
tstewart@brightsourceenergy.com

APPLICANT'S CONSULTANTS

John L. Carrier, J. D.
2485 Natomas Park Dr. #600
Sacramento, CA 95833-2937
jcarrier@ch2m.com

COUNSEL FOR APPLICANT

Jeffery D. Harris
Ellison, Schneider
& Harris L.L.P.
2600 Capitol Avenue, Ste. 400
Sacramento, CA 95816-5905
jdh@eslawfirm.com

INTERESTED AGENCIES

California ISO
e-recipient@caiso.com

Tom Hurshman,
Project Manager
Bureau of Land Management
2465 South Townsend Ave.
Montrose, CO 81401
tom_hurshman@blm.gov

Raymond C. Lee, Field Manager
Bureau of Land Management
1303 South Highway 95
Needles, CA 92363
Raymond_Lee@blm.gov

Becky Jones
California Department of
Fish & Game
36431 41st Street East
Palmdale, CA 93552
dfgpalm@adelphia.net

INTERVENORS

California Unions for Reliable
Energy ("CURE")
Tanya A. Gulesserian
Marc D. Joseph
Adams Broadwell Joseph &
Cardozo
601 Gateway Boulevard, Ste 1000
South San Francisco, CA 94080
tgulesserian@adamsbroadwell.com

Gloria Smith, Joanne Spalding
Sidney Silliman, Sierra Club
85 Second Street, 2nd Fl.
San Francisco, CA 94105
gloria.smith@sierraclub.org
joanne.spalding@sierraclub.org
gssilliman@csupomona.edu
E-mail Preferred

Joshua Basofin, CA Rep.
Defenders of Wildlife
1303 J Street, Ste. 270
Sacramento, CA 95814
jbasofin@defenders.org
E-MAILED PREFERRED

Michael J. Connor, Ph.D.
Western Watersheds Project
P.O. Box 2364
Reseda, California 91337-2364
mjconnor@westernwatersheds.org

ENERGY COMMISSION

JEFFREY D. BYRON
Commissioner and Presiding
Member
jbyron@energy.state.ca.us

JAMES D. BOYD
Vice Chairman and
Associate Member
jboyd@energy.state.ca.us

Paul Kramer
Hearing Officer
pkramer@energy.state.ca.us

John Kessler
Project Manager
jkessler@energy.state.ca.us

Dick Ratliff
Staff Counsel
dratliff@energy.state.ca.us

Elena Miller
Public Adviser
publicadviser@energy.state.ca.us

DECLARATION OF SERVICE

I, John L. Carrier, declare that on July 2, 2009, I served and filed copies of the attached Data Response, Set 2K, revised cover page for Attachment DR125-3B. The original document, filed with the Docket Unit, is accompanied by a copy of the most recent Proof of Service list, located on the web page for this project at: [www.energy.ca.gov/sitingcases/ivanpah]. The document has been sent to both the other parties in this proceeding (as shown on the Proof of Service list) and to the Commission's Docket Unit, in the following manner:

(Check all that Apply)

FOR SERVICE TO ALL OTHER PARTIES:

sent electronically to all email addresses on the Proof of Service list;

by personal delivery or by depositing in the United States mail* at _____ with first-class postage thereon fully prepaid and addressed as provided on the Proof of Service list above to those addresses NOT marked "email preferred."

AND

FOR FILING WITH THE ENERGY COMMISSION:

sending an original paper copy and one electronic copy, mailed and emailed respectively, to the address below (*preferred method*);

OR

depositing in the mail an original and 12 paper copies, as follows:

CALIFORNIA ENERGY COMMISSION

Attn: Docket No. _____
1516 Ninth Street, MS-4
Sacramento, CA 95814-5512
docket@energy.state.ca.us

I declare under penalty of perjury that the foregoing is true and correct.



John L. Carrier, J.D.

*or by other delivery service: e.g., Fed Ex, UPS, courier, etc.