Report

Ivanpah Solar Electric Generating System Plan of Development

DOCKET 07-AFC-5

DATE	<u>08 01 2007</u>
------	-------------------

RECD.	<u>06 02 2008</u>
-------	-------------------

Prepared for
Bureau of Land Management

August 2007

CH2MHILL

2485 Natomas Park Drive
Suite 600
Sacramento, CA 95833

Report

Ivanpah Solar Electric Generating System Plan of Development

Submitted to
Bureau of Land Management

August 2007

Copyright 2007 by CH2M HILL, Inc.

Reproduction and distribution in whole or in part beyond the intended scope of the contract without the written consent of CH2M HILL, Inc. is prohibited.

Contents

Section	Page
1.0 Introduction	1
2.0 Generating Facility Description, Design, and Operation	2
2.1 Project Location and Jurisdiction	2
2.2 Process Description	3
2.3 Power Cycle.....	4
2.4 Solar Field, Solar Receiver Boiler, Steam Turbine Generator and Condenser	4
2.4.1 Solar Field	4
2.4.2 Steam Turbine Generator	5
2.5 Major Electrical Equipment and Systems	5
2.5.1 AC Power – Transmission.....	6
2.5.2 AC Power – Distribution to Auxiliaries	6
2.5.3 125-Volt DC Power Supply System	7
2.5.4 Uninterruptible Power Supply System	7
2.6 Fuel System	8
2.7 Water Supply and Use	8
2.7.1 Water Requirements.....	9
2.7.2 Water Supply	9
2.7.3 Water Quality	10
2.7.4 Water Treatment.....	10
2.8 Plant Cooling Systems	11
2.9 Waste Management.....	11
2.9.1 Wastewater Collection, Treatment, and Disposal.....	11
2.10 Management of Hazardous Materials	13
2.11 Emission Control and Monitoring	13
2.11.1 NO _x Emission Control	13
2.11.2 Particulate Emission Control	13
2.11.3 Continuous Emission Monitoring.....	13
2.12 Fire Protection.....	14
2.13 Plant Auxiliaries	14
2.13.1 Lighting.....	14
2.13.2 Grounding	14
2.13.3 Cathodic Protection.....	15
2.13.4 Service Air	15
2.13.5 Instrument Air	15
2.14 Interconnect to Electrical Grid	15
2.15 Project Construction.....	16
2.15.1 Construction Methods	17
2.15.2 Mitigation Measures	18
2.15.3 Temporary Erosion Control Measures	18

2.15.4 Permanent Erosion Control Measures..... 19

2.16 Generating Facility Operation 19

3.0 Engineering.....20

3.1 Facility Design.....20

3.1.1 Facility Safety Design.....21

3.2 Facility Reliability22

3.2.1 Facility Availability22

3.2.2 Redundancy of Critical Components23

3.2.3 Fuel Availability25

3.2.4 Water Availability25

3.2.5 Project Quality Control.....25

4.0 Facility Closure27

4.1 Temporary Closure27

4.2 Permanent Closure.....28

Tables

1 Primary Project Parameters2

2 Average Daily Water Requirements with All 3 Plants in Operation9

3 Project Schedule Major Milestones16

4 Average and Peak Construction Traffic17

5 Major Equipment Redundancy23

Figures

1 Vicinity Map

2 Site Plan and Linear Facilities

3a Ivanpah 1 Solar Field Layout

3b Ivanpah 1 Power Block Layout

3c Ivanpah 1 Power Block Elevation Views

4a Ivanpah 2 Solar Field Layout

4b Ivanpah 2 Power Block Layout

5a Ivanpah 3 Solar Field Layout

5b Ivanpah 3 Power Block Layout

5c Ivanpah 3 Power Block Elevation

6 Ivanpah 1 Solar Field Single-line Diagram

7 100 MW Heat Balance 100% Solar

8 100 mw Water Balance Diagram

Plan of Development

1.0 Introduction

Solar Partners I, LLC, Solar Partners II, LLC and Solar Partners VIII, LLC propose to develop three solar thermal plants in close proximity in the Ivanpah basin. The three plants, collectively referred to as the Ivanpah Solar Electric Generating System (SEGS) would be located in southern California's Mojave Desert, near the Nevada border, to the west of Ivanpah Dry Lake (see Figure 1, all figures are at the end of this section). The project would be located in San Bernardino County, California, on federal land managed by the Bureau of Land Management (BLM). It would be constructed in three phases: two 100-megawatt (MW) phases (known as Ivanpah 1 and 2) and a 200-MW phase (Ivanpah 3) (see Figure 2). The phasing would be planned so that Ivanpah 1 (the southern-most site owned by Solar Partners II, LLC.) would be constructed first, followed by Ivanpah 2 (the middle site, owned by Solar Partners I, LLC.), then Ivanpah 3 (the 200-MW plant on the north owned by Solar Partners VIII, LLC.), though the order of construction may change. Given that the three plants would be developed in concert, share a few facilities and are all reasonably foreseeable, this Plan of Development (POD) describes the three phases in total. Each 100-MW site requires about 850 acres (or 1.3 square miles); the 200-MW site would be about 1,660 acres (or about 2.6 square miles). The total area required for all three phases, including the Administration Building/Operations and Maintenance building and substation, would be approximately 3,400 acres.

Solar Partners I, LLC, Solar Partners II, LLC, and Solar Partners VIII, LLC (jointly, the Applicant) have applied for right-of-way (ROW) grants for the land from BLM. In California, a permit to construct and operate a solar thermal plant over 50 MW must also be obtained from the California Energy Commission (CEC), which must conduct a CEQA review of the project. The BLM and CEC have executed a Memorandum of Understanding concerning their intended joint environmental review and have indicated their intent to review all three plants in a single NEPA/CEQA process. Therefore, in this Plan of Development and in the Application for Certification to the CEC which will supplement this Plan of Development, Ivanpah 1, Ivanpah 2, and Ivanpah 3 are referred to individually as "plants" or "phases" of the whole, and they are collectively referred to as the Ivanpah Solar Electric Generating System (ISEG); the ISEG is referred to as the Project. Throughout this POD, references are provided to the AFC sections that provide more detailed material to supplement the POD by topic. Each plant includes a small package natural gas-fired start-up boiler to provide heat for plant start-up and during temporary cloud cover. The project's natural gas system would be connected to the Kern River Gas Transmission Line, which passes less than half a mile to the north of the project site. Raw water would be drawn daily from one of two onsite wells, located east of Ivanpah 2. Each well would have sufficient capacity to supply water for all three phases. Groundwater would go through a treatment system for use as boiler make-up water and to wash the heliostats. To save water in the site's desert environment, each plant would use an air cooled condenser. Water consumption, therefore, would be minimal (estimated at no more than 100 acre-feet/year (ac-ft/yr) for all three phases). Each phase

includes a small onsite wastewater plant located in the power block that treats wastewater from domestic waste streams such as showers and toilets. A larger sewage package treatment plant would also be located at the Administration/Operations and Maintenance Building, located between Ivanpah 1 and 2. Sewage sludge would be removed from the site by a sanitary service provider. No wastewater would be generated by the system, except for a small stream that would be treated and used for landscape irrigation. If necessary, a small filter/purification system would be used to provide potable water at the Administration Building.

Section 2.0 describes the Generating Facility Description, Design, Construction and Operation. The Project Engineering follows in Section 3.0. Section 4.0 then discusses Facility Closure.

The proposed project site includes three solar concentrating thermal power plants, based on distributed power tower and heliostat mirror technology, in which heliostat (mirror) fields focus solar energy on power tower receivers near the center of the heliostat array. In each plant, one Rankine cycle reheat steam turbine receives live steam from three or four solar boilers, and reheat steam from one solar reheater, at the top of its own distributed power tower adjacent to the turbine. The reflecting area of an individual heliostat is about 7.04 square meters. The solar field and power generation equipment would be started up each morning after sunrise and insolation build-up, and shut down in the evening when insolation drops below the level required to keep the turbine on line. Main project plant parameters are presented in Table 1.

TABLE 1
Primary Project Parameters

Plant	Capacity, Net MW	No. of Heliostats (approx.)	Annual Production, MWH	Utility Interconnection
Ivanpah 1	100 MW	68,000	240,000	SCE 115 kV
Ivanpah 2	100 MW	68,000	240,000	SCE 115 kV
Ivanpah 3	200 MW	136,000	480,000	SCE 115 kV

The plants would be operated and maintained by common crews of operators, working out of an administration and maintenance complex located between Ivanpah 1 and 2.

2.0 Generating Facility Description, Design, and Operation

This section describes the facility's proposed design and operation.

2.1 Project Location and Jurisdiction

The proposed site is located in San Bernardino County 4.5 miles southwest of Primm, Nevada, 3.1 miles west of the California-Nevada border (see Figure 1). The site is located in Township 17N, Range 14E, and Township 16N, Range 14E on land administered by BLM. The

Applicant filed a Form 299 right-of-way grant application for use of the land with the BLM Needles Field Office.

Based on the CEC's exclusive jurisdiction for the licensing of thermal power plants of 50 MW or more and given that the project will be on BLM lands and considered a major federal action under NEPA, the Applicant anticipates that the BLM and Commission's processes would be conducted jointly as outlined in the joint agency Memorandum of Understanding. The BLM application covers about 7,040 acres (the "Property Boundary"); the fenced area for the three plants within the project area (including substation and central administration area) would be about 3,400 acres. Access to the site would be via the Yates Well Road interchange on I-15 and Colosseum Road (spelling in accordance with Bureau of Land Management map) to the west of the Primm Golf Club.

2.2 Process Description

The heliostat (or mirror) fields focus solar energy on the power tower receivers near the center of each of the heliostat arrays. (There would be 3 arrays in the 100-MW plants and 4 arrays in the 200-MW plant). In each plant, one Rankine-cycle reheat steam turbine receives live steam from the solar boilers and reheat steam from one solar reheater – located in the power block at the top of its own tower (see Figures 3a through 3c, 4a, 4 b, and 5a through 5c). The reheat tower would be located adjacent to the turbine. Additional heliostats would be located outside the power block perimeter road, focusing on the reheat tower. Their locations are not shown on the drawings, because they would be finalized only after power block equipment outlines and elevations are finalized. The solar field and power generation equipment would be started each morning after sunrise and insolation build-up, and shut down in the evening when insolation drops below the level required to keep the turbine online.

Each plant also includes a partial-load steam boiler, which would be used for thermal input to the turbine during the morning start-up cycle to assist the plant in coming up to operating temperature more quickly. The boiler would also be operated during transient cloudy conditions, in order to maintain the turbine on-line and ready to resume production from solar thermal input, after the clouds pass. After the clouds pass and solar thermal input resumes, the turbine would be returned to full solar production.

Each plant uses an air-cooled condenser or "dry cooling," to minimize water usage in the site's desert environment. Water consumption would, therefore, be minimal – mainly to provide water for washing heliostats. Auxiliary equipment at each plant includes feed water heaters, a deaerator, an emergency diesel generator, and a diesel fire pump.

Ivanpah 1, 2 and 3 would be interconnected to the Southern California Edison (SCE) grid through upgrades to SCE's 115-kV line passing through the site on a northeast-southwest right-of-way. These upgrades would include the construction by SCE of a new 220/115-kV breaker-and-a-half substation between the Ivanpah 1 and 2 project sites. This new substation and the 220-kV upgrades would be for the benefit of Ivanpah and other interconnection customers in the region. The existing 115-kV transmission line from the El Dorado substation would be replaced with a double-circuit 220-kV overhead line that would be interconnected to the new substation. Power from Ivanpah 1, 2 and 3 would be transmitted at 115-kV to the new substation. SCE may add three new 115-kV lines to increase capacity to

the existing El Dorado-Baker-Cool Water-Dunn Siding-Mountain Pass 115-kV line heading southwest. The timing of this upgrade depends upon the development of wind projects ahead in the queue, and would not be affected by the Ivanpah SEGS project. Figure 6 is a single line diagram of the plant transmission system.

2.3 Power Cycle

The plant's power cycle would be based on a Rankine cycle turbine with three pressure stage casings. A preliminary heat balance diagram for the 100-MW plant is included in Figure 7, 100 MW Heat Balance 100% Solar. Primary thermal input would be via solar receiver boilers, superheater and reheaters at the top of distributed power towers. The 100-MW plant design uses three distributed power towers while the 200-MW plant design uses four. Live superheated steam enters a high pressure turbine casing at 160 bar and 1,004° F (540° C). It leaves the HP casing via extractions to high pressure preheaters and exhausted to the reheat circuit.

The reheat steam would be heated in a solar reheater (similar to the solar boiler), at the top of a power tower located in the power block adjacent to the turbogenerator. The reheated steam enters the intermediate pressure turbine casing at 35 bar and 896° F (480° C). It leaves the IP casing via an extraction to the deaerator and exhausts to the LP casing.

The IP exhaust enters the low pressure casing at 4.5 bar and 432° F (222° C). LP casing exhausts steam at 0.13 bar which would be condensed in an air-cooled condenser.

Condensate would be sent from the condenser well through three low pressure preheaters, to the deaerator, which also serves as feedwater reserve storage and would be the point of feedwater make-up injection. From the deaerator, high pressure feedwater pumps send feedwater through two high pressure preheaters out to the solar field boilers.

2.4 Solar Field, Solar Receiver Boiler, Steam Turbine Generator and Condenser

Electricity would be produced by each plant's Solar Receiver Boiler and the STG. The following sections describe the major components of the generating facility.

2.4.1 Solar Field

The heliostat mirrors would be arranged around each solar receiver boiler. Each mirror tracks the sun throughout the day and reflects the solar energy to the receiver boiler. The heliostats would be 7.2 feet high by 10.5 feet wide (2.20 m by 3.20m) yielding a reflecting surface of 75.6 square feet (7.04 m²). They would be arranged in arcs around the solar boiler towers asymmetrically, as described below.

100-MW Plant

1. Tower structure height would be 262 feet (80m)
2. Boiler/superheater panel height would be 39 feet (12m), with another 10 feet (3m) of added height for upper steam drum and protective ceramic insulation panels; overall tower boiler height would be therefore 312 feet (95m).
3. The first row arc of heliostats has a radius of 164 feet (50m).

4. The longest arc radius – 1,970 feet (600m) – would be in the northern section of the heliostat array. This would be due to the greater collection efficiency of heliostats in the northern section in the northern hemisphere. With the sun predominantly in the southern sky, the cosine effect of incidence and reflection angles would be less in the northern heliostats than in the southern ones. The converse – lower collection efficiency in the southern section – would also be true, and therefore the maximum southern arc radius would be the shortest – 984 feet (300m), and the southern heliostat field is the smallest.
5. The eastern sector heliostat energy collection would be more valuable than the western sector collection, because afternoon energy collection, during on-peak utility hours, would be more valuable than morning energy collection, during part-peak or off-peak hours. The maximum eastern row arc radius (1,640 feet or 500m) would, therefore, be greater than the maximum western row arc radius (1,312 feet or 400m).

200-MW Plant

1. Tower structure height would be 371 feet (113m).
2. Boiler/superheater panel height would be 56 feet (17m), with another 15 feet (4.5m) of added height for upper steam drum and protective ceramic insulation panels; overall tower boiler height would, therefore, be 459 feet (140m).
3. The first row arc radius would be 164 feet (50m) on all sides.
4. Maximum northern sector arc radius would be 2,782 feet (848m).
5. Maximum southern sector arc radius would be 1,391 feet (424m).
6. Maximum eastern sector arc radius would be 2,320 feet (707m).
7. Maximum western sector arc radius would be 1,857 feet (566m).
8. Reasons for arc radius distribution per sectors would be identical to those of the 100-MW plant

Solar boilers would be similar to those for the 100-MW plant, with appropriate scaling.

2.4.2 Steam Turbine Generator

The steam turbine system consists of a condensing steam turbine generator (STG) with reheat, gland steam system, lubricating oil system, hydraulic control system, and steam admission/induction valving. HP and IP steam from the superheater receiver enters the associated steam turbine sections through the inlet steam system. The steam expands through multiple stages of the turbine, driving the generator. On exiting the LP turbine, the steam would be directed into the air-cooled condenser.

2.5 Major Electrical Equipment and Systems

The bulk of the electric power produced by the facility would be transmitted to the grid. A small amount of electric power would be used onsite to power auxiliaries such as pumps and fans, control systems, and general facility loads including lighting, heating, and air conditioning. Some power would also be converted from alternating current (AC) to direct current (DC), which would be used as backup power for control systems, heliostat mirror

movement and other uses. Transmission and auxiliary uses are discussed in the following subsections. A proposed single line diagram illustrating the major electrical equipment and systems is included in Figure 6, Single-line diagram.

2.5.1 AC Power—Transmission

Power would be generated by the STG at 19 kV (water-air cooled) and then stepped up by transformers for transmission to the grid. The plants would connect to the utility at 115 kV. Surge arresters would be provided at the high-voltage bushings to protect the transformers from surges on the system caused by lightning strikes or other system disturbances. The transformers would be set on concrete pads within containments designed to contain the transformer oil in the event of a leak or spill. Fire protection systems would be provided for the transformers. The high-voltage side of the step-up transformers would be connected to each plant's switchyard. From the switchyard, power would be transmitted via a 115-kV transmission line to the new SCE substation.

A detailed discussion of the transmission system is provided in Section 3 of the AFC.

2.5.2 AC Power—Distribution to Auxiliaries

Auxiliary power to the steam turbine power block would be supplied at 4,160 volts AC by a double-ended 4,160-volt switchgear lineup via the oil-filled, 19-to-4.16kV station service transformer. The high-voltage side (19kV) of the station service transformer would be connected to the output of the STG as would be the primary power supply. Power can also be supplied by back-feeding power from the switchyard through the Generator Step Up transformer.

A low-voltage side (19kV) generator circuit breaker would be provided for the STG. The circuit breaker would be used to isolate and synchronize the generator, and would be located between the generator and the connection to the transformer.

The 4,160-volt switchgear lineup supplies power to the various 4,160-volt motors, and to the load center (LC) transformers, rated 4,160 to 480 volts, for 480-volt power distribution. The switchgear would have vacuum interrupter circuit breakers for the main incoming feeds and for power distribution.

The LC transformers would be oil-filled, each supplying 480-volt, 3-phase power to the double-ended load centers.

The load centers would provide power through feeder breakers to the various 480-volt motor control centers (MCCs). The MCCs would distribute power to 480-volt motors, to 480-volt power distribution panels, and lower voltage lighting and distribution panel transformers. Power for the AC power supply (120-volt/208-volt) system would be provided by the 480-volt MCCs and 480-volt power panels. 480-120/208-volt dry-type transformers would provide transformation of 480-volt power to 120/208-volt power. In addition 480-volt power would be converted to 24V DC motors to position the heliostats.

2.5.3 125-Volt DC Power Supply System

One common 125-volt DC power supply system consisting of one 100 percent capacity battery bank, two 100 percent static battery chargers, a switchboard, and two or more distribution panels would be supplied for balance-of-plant and STG equipment.

Under normal operating conditions, the battery chargers supply DC power to the DC loads. The battery chargers receive 480-volt, three-phase AC power from the AC power supply (480-volt) system and continuously charge the battery banks while supplying power to the DC loads.

Under abnormal or emergency conditions, when power from the AC power supply (480-volt) system would be unavailable, the batteries supply DC power to the DC system loads. Recharging of a discharged battery occurs whenever 480-volt power becomes available from the AC power supply (480-volt) system. The rate of charge depends on the characteristics of the battery, battery charger, and the connected DC load during charging. The anticipated maximum recharge time would be 12 hours.

The 125-volt DC system would also be used to provide control power to the 115 kV generator breaker, 4,160-volt switchgear, to the 480-volt LCs, to critical control circuits, and to the emergency DC motors.

2.5.4 Uninterruptible Power Supply System

The steam turbine power block would also have an essential service 120-volt AC, single-phase, 60-hertz (Hz) uninterruptible power supply (UPS) to supply AC power to essential instrumentation to critical equipment loads and to unit protection and safety systems that require uninterruptible AC power. A UPS system in the power block would also back up critical 4,160-volt AC loads in MMC's feeding solar boiler tower equipment.

Redundant UPS inverters would supply 120-volt AC single-phase power to the UPS panel boards that supply critical AC loads. The UPS inverters would be fed from the station 125-volt DC power supply system. Each UPS system would consist of one full-capacity inverter, a static transfer switch, a manual bypass switch, an alternate source transformer, and two or more panel boards.

The normal source of power to the system would be from the 125-volt DC power supply system through the inverter to the panel board. A solid-state static transfer switch would continuously monitor both the inverter output and the alternate AC source. The transfer switch would automatically transfer essential AC loads without interruption from the inverter output to the alternate source upon loss of the inverter output.

A manual bypass switch would also be included to enable isolation of the inverter for testing and maintenance without interruption to the essential service AC loads.

The distributed control system (DCS) operator stations would be supplied from the UPS. The continuous emission monitoring (CEM) equipment, DCS controllers, and input/output (I/O) modules would be fed using either UPS or 125-volt DC power directly.

2.6 Fuel System

Natural gas supply for Ivanpah SEGS would connect to the Kern River Gas Transmission Company (KRGT) pipeline about 0.5 mile north of the Ivanpah 3 site. However, KRGT is not a natural gas retailer. Current plans are for gas supply to be obtained from Southwest Gas Company ("Southwest"), which has completed a preliminary estimate for the required facilities. It would be possible that the applicant could seek gas supply directly from KRGT shippers currently holding transmission capacity on KRGT. Were this option pursued, the required ROW and physical facilities would be the same.

For each plant, the physical facilities of the natural gas line, starting at the tie-in point on the main KRGT transmission pipeline would be: a 2-mile, 6-inch pipeline to a fenced metering set at Ivanpah 3; from there a 3.5-mile, 4-inch pipeline that would pass through Ivanpah 2 ending at Ivanpah 1. There would be fenced metering sets at Ivanpah 1 and 2. The new 4- to 6-inch gas pipeline would extend south from the KRGT pipeline tap point through the Ivanpah 3 and Ivanpah 2 sites to the power block of the Ivanpah 1 site. The total distance from the tap point to the Ivanpah 1 power block would be about 5.3 miles

Facilities would be installed at the KRGT tie-in point to regulate the gas pressure and to remove any liquids or solid particles. The three plant metering sets would require a fenced enclosure of approximately 10 feet by 30 feet.

Construction activities related to the metering sets would include grading a pad and installing above- and belowground gas piping, metering equipment, gas conditioning, pressure regulation, and possibly pigging facilities.

2.7 Water Supply and Use

This subsection describes the quantity of water required, the sources of the water supply, and water treatment requirements. A water balance diagram for the 100-MW plant is included as Figure 8 (the 200-MW plant would have the same process with twice the volumes). AFC Section 5.15 provides a list of all permits required for construction and operation of the project.

Raw water would be drawn from one of two wells, located east of Ivanpah 2 (refer to Figure 2). The wells would provide water to all three plants. The complete 400-MW Ivanpah SEGS would require up to 46 gallons per minute (gpm) raw water make-up which would be drawn from the wells and distributed to the plants via underground HDPE or PVC pipe.

Each plant would have a raw water tank with a capacity of 250,000 gallons. A portion of the raw water (100,000 gallons) would be for plant use while the majority would be reserved for fire water.

The Ivanpah SEGS would operate an average of about 10 hours a day, 7 days a week throughout the year, with the exception of a scheduled shutdown in late December for maintenance. However, the water treatment plant would operate continuously, in order to minimize water treatment system size and capital cost, and to use off-peak energy at night. A more detailed description of the water supply system, treatment, and permits is provided in AFC Section 5.15, Water Resources. In addition, please see a study of the Ivanpah basin in AFC Appendix 5.15C.

2.7.1 Water Requirements

A breakdown of the estimated average daily quantity of water required for operation of Ivanpah 1, 2 and 3, is presented in Table 2. The daily water requirements shown are estimated quantities based on the plant operating at full load. Actual water use could be somewhat higher based upon final water quality, but would not exceed 100 ac-ft/yr for all three plants.

Water used for the heliostat washing process will be of high quality, with traces of phosphate used for pH control in concentrations of about 0.1 parts per million.

TABLE 2
Average Daily Water Requirements with All 3 Plants in Operation

Water Use	Average Daily Use (gpm)	Annual Use (ac-ft/yr)
Process and heliostat wash	46	75 *
Potable water service	1.8	3

* Based on an annual operation of 3,650 hours/year at full plant output.

2.7.2 Water Supply

The project includes the installation of two groundwater wells located east of Ivanpah 2 (see AFC Figure 5.15-2). Each well will have sufficient capacity to supply water for all three phases. Water consumption for all three phases is estimated at less than 100 ac-ft/yr. This level of pumping is expected to continue for the 50-year life of the project. All pumped water will be consumptively used and no groundwater return flows would be expected.

The project's groundwater pumping will result in minor groundwater level declines over time. The expected declines at distances of 0.5, 1, and 2 miles from the production well over the 50-year life of the project are shown in AFC Figure 5.15-7. The declines after 50 years would be expected to be 2.1 feet at 0.5 mile from the well, 1.4 feet at 1 mile, and 0.8 feet at 2 miles. The Primm golf course Colosseum Well No. 1 and No. 2 are the closest wells to the project site. These wells are located approximately 0.25 miles from the nearest project well (see AFC Figure 5.15-2).

The pumping also will alter the groundwater budget. AFC Table 5.15-5 lists the future inflows, outflows, and storage changes with the project. Because the project life is short with respect to the response time for the groundwater system, the groundwater underflow from Ivanpah Valley to Las Vegas Valley will not be impacted by the project. A 200-year simulation made by ENSR Corporation (2007) indicates that the long-term continuation of the current pumping will have only minimal impact on the underflow. Correspondingly, the underflow listed in AFC Table 5.15-5 is the same as for current conditions.

Groundwater is available within the Ivanpah Basin to supply the proposed project. Within the Ivanpah South Basin, the precipitation recharge and water-use returns exceed the current and expected future pumping (including the project and resumed operations at the Molycorp Mine). Within the Ivanpah South Basin, the recharge is 4,000 ac-ft/yr and the current water-use returns are 800 ac-ft/yr, for a total inflow to the basin of 4,800 ac-ft/yr. Current pumping in the Ivanpah South Basin is 2,300 ac-ft/yr and future pumping is estimated to be 2,800 ac-ft/yr with the project and resumed operations at the Molycorp

Mine. Overall inflows to the Ivanpah South Basin are expected to exceed future pumping by 2,000 ac-ft/yr. The project would not substantially deplete groundwater supplies such that there would be a net deficit in aquifer volume or a lowering of the local groundwater table level.

Within Ivanpah North Basin, the precipitation recharge and water-use returns also exceed the current and expected future pumping. The recharge is 2,200 ac-ft/yr, and the current water-use returns are 1,100 ac-ft/yr, for a total inflow to the basin of 3,300 ac-ft/yr. Current pumping in the Ivanpah North Basin is 2,000 ac-ft/yr, and the recharge is 2,200 ac-ft/yr. Overall inflows to the Ivanpah North Basin exceed pumping by 1,300 ac-ft/yr. Although inflows exceed pumping in the Ivanpah North Basin, underflow to the Las Vegas Valley results in an overall net groundwater loss in the Ivanpah North Basin. As described above, a 200-year simulation made by ENSR Corporation (2007) indicates that the long-term continuation of the current pumping will have only minimal impact on the underflow. Because the project life is short with respect to the response time for the groundwater system and because of the small amount of water used by the project, the groundwater underflow from Ivanpah Valley to Las Vegas Valley will not be impacted by the project. Please see the lengthy discussion of recharge estimates in the document *Groundwater Availability Ivanpah Valley, California* by Tim Durbin. This document can be found in AFC Appendix 5.15.C and is further discussed in AFC Section 5.15.

As described above, groundwater recharge to the Ivanpah Groundwater Basin occurs from precipitation on the mountains surrounding Ivanpah and Jean Lake valleys and return flows from water uses. Once developed, the project would result in 38.2 acres of impervious surfaces, which comprises 1.14 percent of the project site. Solar field development will maintain unobstructed sheet flow, with water exiting the site in existing natural contours and flows. Therefore, the project would not interfere substantially with groundwater recharge and impacts would be less than significant.

The plant uses an air-cooled condenser to conserve water in the site's desert environment. Water consumption would be, therefore, minimal—mainly to replace boiler feedwater blowdown and provide water for washing heliostats. The latter would be required in a washing cycle of 2 weeks, during which all heliostats would be washed, to maintain them at full performance. Because of dust created during site grading, this washing cycle may be more frequent (but not likely more than double) when one plant would be operating and another is being graded. Thus, for the first few months of construction of the second plant, the first plant could use up to 50 ac-ft/yr of water. Similar water use would occur for the first two plants during construction of the third plant.

2.7.3 Water Quality

Section 5.15 of the Application for Certification (AFC), Water Resources, includes a projection of the water quality based on data from the wells that serve Primm Golf Club. The project wells would be farther west, away from the dry lake, and therefore, expected to have equal or better quality water than the golf club wells.

2.7.4 Water Treatment

The main water treatment subsystems would be supplied by a water treatment specialty company, and would include:

Granular Activated Carbon Filters

The granular activated carbon (GAC) filters would be periodically replaced by the treatment company and backwashed offsite. Alum injection would be included before the GAC inlet.

De-Ionization Trailer

A company would supply a trailer containing de-ionization media and vessels to make de-ionized (DI) water. When the media have been exhausted, the water treatment company would replace the trailer and re-charge the DI media offsite. After filtration and deionization, the water would be stored in the DI water tank.

Mixed Bed

In the mixed bed, DI water would be polished to boiler feedwater quality and stored in the boiler make-up storage tank, from which it would be withdrawn and injected into the Deaerator tank, as required to maintain feedwater volume. The mixed bed would also be periodically replaced and regenerated offsite by the water treatment system vendor.

Drying Beds

No reject streams from water treatment are planned to be generated onsite under the planned treatment scheme. However, for current planning purposes, two concrete-lined drying beds of about 40 feet by 60 feet would be included in the power block. They can be used on a temporary basis for boiler commissioning and emergency outfalls from any of the processes.

2.8 Plant Cooling Systems

The cycle heat rejection system would consist of an air-cooled steam condenser system. The heat rejection system would receive exhaust steam from the low-pressure section of the steam turbine and feed water heaters and condense it back to water for reuse. The condenser would be designed to normally operate at a pressure of about 0.126 bar (3.7 inches of mercury). The condenser would remove heat from the condensing steam up to a maximum of 1,193 MMBtu/hr (1259×10^3 MJ/hr), depending on ambient temperature and plant load.

2.9 Waste Management

Waste management would be the process whereby all wastes produced at Ivanpah SEGS would be properly collected, treated (if necessary), and disposed of. Wastes include process and sanitary wastewater, nonhazardous waste and hazardous waste, both liquid and solid. Waste management is discussed in more detail in AFC Subsection 5.14.

2.9.1 Wastewater Collection, Treatment, and Disposal

The primary wastewater collection system would collect process wastewater from all of the plant equipment, including the boilers and water treatment equipment. To the extent practical, process wastewater would be recycled and reused. The water balance diagram, Figure 8, shows the expected wastewater streams and flow rates for one 100-MW plant. (The amounts would be double for the 200-MW plant). Each plant includes a small package sewage system for potable water streams, including showers and toilet. When needed, sewage sludge would be removed from site by a sanitary service. Treated wastewater from the package sewage treatment plant would be analyzed per CEC and BLM requirements

and then used to maintain local landscaping if the water is of acceptable quality. Landscaping at the project is expected to be very minimal and will likely only be installed near the administration building. A landscaping plan will be developed and submitted to BLM and the CEC for review and approval prior to the start of construction.

Plant Drains and Oil/Water Separator

General plant drains would collect containment area washdown, sample drains, and drainage from facility equipment drains. Water from these areas would be collected in a system of floor drains, hub drains, sumps, and piping and routed to the wastewater collection system. Drains that potentially could contain oil or grease would first be routed through an oil/water separator. Water from the plant wastewater collection system would be returned back into the raw water storage tank.

Power Cycle Makeup Water Treatment Wastes

Distillate from the mixed bed system would be used as the feed water for the power cycle makeup treatment system. The mixed bed unit would be a self-contained skid mounted unit. Drains from the water treatment equipment would be routed to the raw water storage tank.

Boiler Blowdown

Boiler blowdown would consist of boiler water discharged from each receiver boiler to control the concentration of dissolved solids and silica within acceptable ranges. Boiler blowdown would be discharged to flash tanks. Steam would be condensed and the condensate cooled. During the day, when the power plant operates, boiler feedwater would be made-up and blown down at receiver-boiler towers at a rate of 30 gpm. Blowdown would be flashed, condensed, and used for mirror washing. Well pumps would operate continuously pumping 11 gpm into the raw water tank until the tank is full and the pumps automatically shut down.

Solid Wastes

Ivanpah SEGS would produce maintenance and plant wastes typical of power generation operations. Generation plant wastes include oily rags, broken and rusted metal and machine parts, defective or broken electrical materials, empty containers, and other solid wastes, including the typical refuse generated by workers. Solid wastes would be trucked offsite for recycling or disposal (see AFC Subsection 5.14, Waste Management).

Hazardous Wastes

Several methods would be used to properly manage and dispose of hazardous wastes generated by Ivanpah SEGS. Waste lubricating oil would be recovered and recycled by a waste oil recycling contractor. Spent lubrication oil filters would be disposed of in a Class I landfill. Workers would be trained to handle hazardous wastes generated at the site.

Chemical cleaning wastes would consist of alkaline and acid cleaning solutions used during pre-operational chemical cleaning of the boilers, and acid cleaning solutions used for chemical cleaning of the boilers after the units are put into service. These wastes, which would be subject to high metal concentrations, would be temporarily stored onsite in portable tanks or sumps, and disposed of offsite by the chemical cleaning contractor in accordance with applicable regulatory requirements.

2.10 Management of Hazardous Materials

There would be a variety of chemicals stored and used during construction and operation of Ivanpah SEGS. The storage, handling, and use of all chemicals would be conducted in accordance with applicable LORS. Chemicals would be stored in appropriate chemical storage facilities. Bulk chemicals would be stored in storage tanks, and most other chemicals would be stored in returnable delivery containers. Chemical storage and chemical feed areas would be designed to contain leaks and spills. Concrete containment pits and drain piping design would allow a full-tank capacity spill without overflowing the containment. For multiple tanks located within the same containment area, the capacity of the largest single tank would determine the volume of the containment area and drain piping. Drain piping for reactive chemicals would be trapped and isolated from other drains to eliminate noxious or toxic vapors.

Safety showers and eyewashes would be provided adjacent to, or in the vicinity of, chemical storage and use areas. Plant personnel would use approved personal protective equipment during chemical spill containment and cleanup activities. Personnel would be properly trained in the handling of these chemicals and instructed in the procedures to follow in case of a chemical spill or accidental release. Adequate supplies of absorbent material would be stored onsite for spill cleanup.

A list of the chemicals anticipated to be used at Ivanpah SEGS and their storage locations is provided in AFC Subsection 5.5, Hazardous Materials Handling. This list identifies each chemical by type, intended use, and estimated quantity to be stored onsite.

2.11 Emission Control and Monitoring

The project uses relatively little natural gas and electricity production from natural gas will be limited to less than 5 percent of plant output. Air emissions from the combustion of natural gas in the start-up boiler would be controlled using state-of-the-art systems. To ensure that the systems perform correctly, continuous emissions monitoring for NO_x and CO would be performed. AFC Subsection 5.1, Air Quality, includes additional information on emission control and monitoring.

2.11.1 NO_x Emission Control

The boiler would be provided with a dry low-NO_x burner and 20 percent flue gas recirculation, to guarantee maximum NO_x emissions of 9 ppm (0.012 lb/MMBtu), which complies with the Mojave Desert Air Quality Management District new source performance standards (NSPS) NO_x standard of 0.2 lb/MMBtu.

2.11.2 Particulate Emission Control

Particulate emissions would be controlled by the use of best combustion practices, the use of natural gas, which would be low in sulfur, as the sole fuel for the boilers, and high efficiency air inlet filtration.

2.11.3 Continuous Emission Monitoring

For each gas-fired boiler, a separate continuous emission monitoring system (CEMS) would sample, analyze, and record fuel gas flow rate, NO_x and CO concentration levels, and

percentage of O₂ in the exhaust gas from the boiler stacks. The CEMS would transmit data to a data acquisition system (DAS) that would store the data and generate emission reports in accordance with permit requirements. The DAS would also include alarm features that would send signals to the plant DCS when the emissions approach or exceed pre-selected limits.

2.12 Fire Protection

The fire protection system would be designed to protect personnel and limit property loss and plant downtime in the event of a fire. The primary source of fire protection water would be the combined fire water/raw water storage tank.

An electric jockey pump and electric-motor-driven main fire pump would be provided to maintain the water pressure in the plant fire main to the level required to serve all fire fighting systems. In addition, a back-up diesel engine-driven fire pump would be provided to pressurize the fire loop if the power supply to the electric-motor-driven main fire pump fails. A fire pump controller would be provided for each fire pump.

The fire pump would discharge to a dedicated underground firewater loop piping system. Normally, the jockey pump would maintain pressure in the firewater loop. Both the fire hydrants and the fixed suppression systems would be supplied from the firewater loop. Fixed fire suppression systems would be installed at determined fire risk areas such as the transformers and turbine lube oil equipment. Sprinkler systems would also be installed in the Administration/Control/Warehouse/Maintenance Building and Fire Pump enclosure as required by National Fire Protection Association (NFPA) and local code requirements. Handheld fire extinguishers of the appropriate size and rating would be located in accordance with NFPA 10 throughout the facility.

Subsection 5.5, Hazardous Materials Handling, includes additional information for fire and explosion risk, and Subsection 5.10, Socioeconomics, provides information on local fire protection capability.

2.13 Plant Auxiliaries

The following systems would support, protect, and control the generating facility.

2.13.1 Lighting

The lighting system provides personnel with illumination for operation under normal conditions and for egress under emergency conditions, and includes emergency lighting to perform manual operations during an outage of the normal power source. The system also provides 120-volt AC convenience outlets for portable lamps and tools.

2.13.2 Grounding

The electrical system would be susceptible to ground faults, lightning, and switching surges that result in high voltage that constitute a hazard to site personnel and electrical equipment. The station grounding system provides an adequate path to permit the dissipation of current created by these events.

The station grounding grid would be designed for adequate capacity to dissipate the ground fault current from the ground grid under the most severe conditions in areas of high ground fault current concentration. The grid spacing would maintain safe voltage gradients.

Bare conductors would be installed below-grade in a grid pattern. Each junction of the grid would be bonded together by an exothermic weld.

Ground resistivity readings would be used to determine the necessary numbers of ground rods and grid spacing to ensure safe step and touch potentials under severe fault conditions.

Grounding conductors would be brought from the ground grid to connect to building steel and non-energized metallic parts of electrical equipment.

2.13.3 Cathodic Protection

The cathodic protection system would be designed to control the electrochemical corrosion of designated metal piping buried in the soil. Depending upon the corrosion potential and the site soils, either passive or impressed current cathodic protection would be provided.

2.13.4 Service Air

The service air system would supply compressed air to hose connections for general plant use. Service air headers would be routed to hose connections located at various points throughout the facility.

2.13.5 Instrument Air

The instrument air system would provide dry air to pneumatic operators and devices. An instrument air header would be routed to locations within the facility equipment areas and within the water treatment facility where pneumatic operators and devices would be located.

2.14 Interconnect to Electrical Grid

Ivanpah 1, Ivanpah 2, and Ivanpah 3 will be interconnected to the Southern California Edison (SCE) grid through an upgraded SCE 115-kilovolt (kV) line passing through the site on a northeast-southwest right-of-way (see AFC Figure 3.1-1). SCE has developed a service plan to interconnect six projects and allow for future growth. SCE's service plan will include: (1) the construction by SCE of a new 220-kV/115-kV breaker-and-a-half substation between the Ivanpah 1 and Ivanpah 2 project sites (called the Ivanpah Substation); (2) the replacement of the existing 115-kV transmission line from the El Dorado Substation with a double-circuit 220-kV overhead line that will be interconnected to the new substation; (3) the potential construction of a double-circuit 115-kV line and the addition of a circuit to the existing pole line to increase the capacity of the existing El Dorado-Baker-Cool Water-Dunn Siding-Mountain Pass 115-kV line heading southwest; and (4) A new Wheaton Substation for the interconnection of a proposed wind powered generation plant. This new Ivanpah Substation and system upgrades will be for the benefit of Ivanpah and other interconnecting customers in the region, as well as future growth. The Ivanpah Substation and 220-kV upgrade will be completed before the Ivanpah SEGS comes on line; the timing of the 115-kV upgrade between Ivanpah Substation and the Mountain Pass Substation will depend on the development of other generation projects ahead in the queue. Power from

each Ivanpah plant will be interconnected to the California Independent System Operator (CAISO) grid via 115-kV generator tie lines (gen-tie lines) to the new Ivanpah Substation. The design of the Ivanpah Substation and associated line upgrades will be performed by SCE and is analyzed conceptually from input provided by SCE based on the requirements of Ivanpah and other generation projects in the queue, as well as future load growth requirements.

2.15 Project Construction

Construction of the generating facility, from site preparation and grading to commercial operation, would be expected to take place from the First Quarter of 2009 to the Fourth Quarter of 2012 (48 months total). Major milestones are listed in Table 3; however, the construction order may change.

TABLE 3
Project Schedule Major Milestones

Activity	Date
Phase 1 (Ivanpah 1)	
Begin Construction	First Quarter 2009
Startup and Test	Fourth Quarter 2010
Commercial Operation	Fourth Quarter 2010
Phase 2 (Ivanpah 2)	
Begin Construction	First Quarter 2010
Startup and Test	Fourth Quarter 2011
Commercial Operation	Fourth Quarter 2011
Phase 3 (Ivanpah 3)	
Begin Construction	First Quarter 2011
Startup and Test	Fourth Quarter 2012
Commercial Operation	Fourth Quarter 2012

There would be an average and peak workforce of approximately 474 and 959, respectively, of construction craft people, supervisory, support, and construction management personnel onsite during construction. The peak construction site workforce level would be expected to occur in Month 32.

Typically, construction would be scheduled to occur between 5 a.m. and 7 p.m. on weekdays and Saturdays. Additional hours may be necessary to make up schedule deficiencies, or to complete critical construction activities (e.g., pouring concrete at night during hot weather, working around time-critical shutdowns and constraints). During some construction periods and during the startup phase of the project, some activities would continue 24 hours per day, 7 days per week.

Table 4 provides an estimate of the average and peak construction traffic during the 48-month construction period for the plant and associated linear facilities.

TABLE 4
Average and Peak Construction Traffic

Vehicle Type	Average Daily Trips	Peak Daily Trips
Construction Workers	19 buses + 95 personal vehicles	39 buses + 192 personal vehicles
Deliveries	62	145
Total	176	376

The construction laydown and parking area would occupy those areas of the plant sites that would be outside the edges of the heliostat fields. Construction access would generally be from Colosseum Road to the plant entrance road. Materials and equipment would be delivered by truck.

2.15.1 Construction Methods

Construction plans are to clear the existing site of vegetation through the use of mulching machines then to grind the remaining vegetation into mulch for use in erosion control. Civil design drawings IVAN-0-DW-112-735-001, -002, -003, -004 and -005 can be found at the end of this document. Disking and light grading may be used prior to compaction by rolling. Grading would not be intended to level the site, but rather to prepare the site for installation and future maintenance of the heliostats. Extensive site grading consisting of cuts and fills would be limited to the power block areas, receiving towers and the major access roads (asphalt roads between power blocks and gravel roads servicing the receiving towers). Within the heliostat array fields grading would be performed only between every other row of the heliostat arrays that radiate outward in concentric arcs from their associated receiving towers. Other heliostat field areas may be only cleared, disked and lightly compacted. The power block areas and receiving tower locations would then be leveled (cut and filled) and compacted using onsite soils. To reduce erosion, project construction would minimize land disturbance by limiting construction activities only to areas that would be essential to the installation and operation of the project. In addition, disturbed soils would be lightly compacted to reduce the rainfall absorptive capacity and vegetative productivity of the soils that would be permanently covered by project facilities.

Within the heliostat array fields, heliostat foundations are to be installed consisting of steel posts with concrete foundations or driven concrete filled steel pipes (exact method to be determined at a later date). Electrical connections to each heliostat would be placed underground by means of open cut trench, or (if code and operational considerations allow), placed on grade between adjacent heliostats.

Preliminary cut and fill volume calculations required for the project have been calculated to be approximately 156,875 cubic yards of cut material (Bank Measurement) to fill approximately 156,875 cubic yards (site is to be balanced) assuming a shrinkage factor of 25%. Due to the large amount of soil and vegetation that would potentially be disturbed (approximately 2,560 acres), substantial water erosion and dust control measures would be required to prevent an increased dust load and sediment load to ephemeral washes around

the construction site. The volume of vegetation to be removed from the site is estimated to be approximately 0.37 cubic yards per 100 square yards. This would result in an estimated 412,600 cubic yards of mulch available for erosion control on the project site. All cleared vegetation would not leave the site but would be mulched or composted on site to assist in erosion control and limit waste disposal. In areas of substantial grading (power block areas, the receiving towers and the major access roads), native vegetation may be harvested for possible reuse to obtain long term soil stabilization.

Because of the compaction of the soil materials during construction (where clearing and grubbing occur) and use of Best Management Practices (BMPs) to control subsequent soil erosion, it would be expected that soil erosion from water and wind during the project operation would actually be less than that which currently occurs in the proposed project area. All excavated soils would be reused during construction at the site to prevent subsequent erosion and sedimentation issues.

Once constructed, the linear facilities would have no significant effect on surficial soil onsite or offsite. The overhead transmission lines would result in the permanent loss of a limited soil area that would be equivalent to the sum of the footprint areas for all the pole footings. It is currently estimated that 38 towers would be used with approximately 16 square feet (i.e., 4 feet x 4 feet) per tower footing for a total permanent impact area of 608 square feet (0.014 acre). During construction, standard erosion and dust control methods would be implemented to avoid sedimentation into surface waterways. It is expected that full implementation of construction BMPs would reduce losses of soil to wind and water erosion to a less-than-significant level.

Any areas not required for project operations would be restored to pre-construction conditions. Construction of linears would require excavated topsoil to be stockpiled separately from the underlying excavated soils. The stockpiled topsoil would then be placed and compacted over the backfilled trench. Because these areas would be returned to their original use, these impacts would be considered temporary.

2.15.2 Mitigation Measures

Erosion control measures would be required during construction to help maintain water quality, to protect the property from erosion damage, and to prevent accelerated soil erosion or dust generation that destroys soil productivity and soil capacity. Temporary erosion control measures would be implemented before construction begins and would be maintained and evaluated during construction. These temporary measures would be removed from the site after the completion of construction and, where needed, replaced by permanent control measures.

2.15.3 Temporary Erosion Control Measures

Temporary erosion control measures typically include revegetation, mulching, physical stabilization, dust suppression, berms, ditches, and sediment barriers. Vegetation would be the most efficient form of erosion control because it keeps the soil in place and maintains the landscape over the long-term. Vegetation reduces erosion by absorbing raindrop impact energy and holding soil in place with fibrous roots. It also reduces runoff volume by decreasing erosive velocities and increasing infiltration into the soil. Due to the dry and sandy conditions of the soil, drought-tolerant species and establishment procedures that would be suited to this environment would be required for revegetation of the linears.

During construction of the project and the related linear facilities, dust erosion control measures would be implemented to minimize the wind-blown erosion of soil from the site. Local well water would be sprayed on the soil in construction areas to control dust and during re-vegetation. Assuming 0.05 ft of water would be required to control dust during the duration of construction then approximately 41.7 million gallons of water would be required.

Sediment barriers, such as straw bales, sand bags, or silt fences, slow runoff and trap sediment. Sediment barriers would generally be placed below disturbed areas, at the base of exposed slopes. Sediment barriers would most often be placed around sensitive areas, such as wetlands or washes, to prevent contamination by sediment-laden water.

Some barriers would be placed in locations where offsite drainage could occur to prevent sediment from leaving the site. If used, straw bales would be properly installed (staked and keyed), then removed or used as mulch after construction. Runoff infiltration/evaporation areas, drainage diversions, and other large-scale sediment traps would be considered due to the level of grading and excavation that would occur at the power block areas. Any soil stockpiles would be stabilized and covered if left onsite for long periods of time, including placement of sediment barriers around the base of the stockpile. These methods can be employed during trenching operations for the gas and transmission lines.

2.15.4 Permanent Erosion Control Measures

Permanent erosion control measures onsite could include drainage, and infiltration/evaporation systems, slope stabilization, check dams, stone filter rings and long-term revegetation. If soil conditions permit, revegetation would follow from planting for short-term erosion control. Revegetation of the area disturbed by construction would be accomplished using locally prevalent, non-invasive, fast-growing plant species compatible with adjacent existing plant species.

A mitigation monitoring plan would be developed in conjunction with CEC staff to set performance standards and monitor the effectiveness of mitigation measures. This plan would address the monitoring, reporting, and response requirements.

2.16 Generating Facility Operation

Management, engineering, administrative staff, skilled workers, and operators would serve multiple plants. Ivanpah SEGS would be expected to employ up to 90 full-time employees: 35 with Ivanpah 1, 20 additional with Ivanpah 2, and 35 more with Ivanpah 3. The facility would be operated 7 days a week, 10 hours per day.

Long-term maintenance schedules are currently unavailable in detail, but would include periodic maintenance and overhauls in accordance with manufacturer recommendations. Solar field component replacement rates are anticipated to be 0.5 percent per year, on average. Most unskilled labor demand includes 12 hours of nightly mirror washing, covering the entire solar field over a period of 2 weeks, to maintain heliostat performance degradation below 3 percent.

Ivanpah SEGS would be expected to have an annual plant availability of 92 to 98 percent (daylight hours). It would be possible for plant availability to exceed 98 percent for a given 12-month period.

The facility may be operated in one of the following modes:

- The facility would be operated at its maximum output as dictated by the available solar insolation, for as many hours per year as possible.
- The facility would be placed in standby mode every night when the solar insolation drops to a point which results in the STG dropping below its minimum load.
- A full shutdown would occur if forced by equipment malfunction, transmission line disconnect, or scheduled maintenance.

3.0 Engineering

This section presents information concerning the design and engineering of the Ivanpah SEGS.

3.1 Facility Design

A detailed description of the Ivanpah SEGS project is provided in AFC Subsection 2.2, Generating Facility Description, Design, and Operation. Design for safety is provided in AFC Subsection 2.3.1.1, Facility Safety Design. AFC Appendix 5.4A contains a Geotechnical Report for the Ivanpah SEGS site based on borings taken at the project site.

Descriptions of the design criteria are included in the following AFC appendices:

- Appendix 2A, Civil Engineering Design Criteria
- Appendix 2B, Structural Engineering Design Criteria
- Appendix 2C, Mechanical Engineering Design Criteria
- Appendix 2D, Electrical Engineering Design Criteria
- Appendix 2E, Control Engineering Design Criteria
- Appendix 2F, Chemical Engineering Design Criteria
- Appendix 2G, Geologic and Foundation Design Criteria

Design and engineering information and data for the following systems are found in the following Subsections of the AFC:

- **Power Generation** – See Subsection 2.2.4, Steam Turbine Generators (STGs), Boilers, and Condenser. Also see Appendix 2C and Subsection 2.2.5 through 2.2.13, which describe the various plant auxiliaries.
- **Heat Dissipation** – See Subsection 2.2.8, Plant Cooling Systems, and Appendix 2C.
- **Air Emission Control System** – See Subsection 2.2.11, Emission Control and Monitoring, and Subsection 5.1, Air Quality.
- **Waste Disposal System** – See Subsection 2.2.9 and Subsection 5.14, Waste Management.

- **Noise Abatement System** – See Subsection 5.7, Noise.
- **Switchyards/Transformer Systems** – See Subsection 2.2.5, Major Electrical Equipment and Systems; Subsection 2.2.13.2, Grounding; Subsection 2.2.5.1, AC Power-Transmission; Subsection 2.2.14, Interconnect to Electrical Grid; Section 3.0, Electric Transmission; and Appendix 2D.

3.1.1 Facility Safety Design

Ivanpah SEGS would be designed to maximize safe operation. Potential hazards that could affect the facility include earthquake, flood, and fire. Facility operators would be trained in safe operation, maintenance, and emergency response procedures to minimize the risk of personal injury and damage to the plant.

Natural Hazards

The principal natural hazard associated with the project site is earthquakes. The site would be located in UBC Seismic Risk Zone 3. Structures would be designed to meet the seismic requirements of CCR Title 24 and the 2001 California Building Code (CBC). Subsection 5.4, Geologic Hazards and Resources, includes a review of potential geologic hazards, seismic ground motion, and potential for soil liquefaction due to ground-shaking. Potential seismic hazards would be mitigated by implementing the 2001 CBC construction guidelines. Appendix 2B, Structural Engineering, includes the structural seismic design criteria for the buildings and equipment.

Flooding would not be a hazard of concern at the Ivanpah SEGS site. According to the Federal Emergency Management Agency (FEMA), the site would not be within either the 100- or 500-year flood plain. AFC Subsection 5.15, Water Resources, includes additional information on the potential for flooding.

Emergency Systems and Safety Precautions

This subsection discusses the fire protection systems, emergency medical services, and safety precautions to be used by project personnel. AFC Subsection 5.10, Socioeconomics, includes additional information on area medical services, and Subsection 5.16, Worker Safety, includes additional information on safety for workers. Appendices 2A through 2G contain the design practices and codes applicable to safety design for the project. Compliance with these requirements would minimize project effects on public and employee safety.

Fire Protection Systems

The project would rely on both onsite fire protection systems and local fire protection services.

Onsite Fire Protection Systems

The fire protection systems would be designed to protect personnel and limit property loss and plant downtime from fire or explosion. The project would have the following fire protection systems.

Steam Turbine Lube Oil Areas Water Spray System

This system provides suppression for the steam turbine area lube oil piping and lube oil storage.

Fire Hydrants/Hose Stations

This system would supplement the plant's fixed fire suppression systems. Water would be supplied from the plant fire water system.

Fire Extinguisher

The plant administrative/control/warehouse/maintenance building, water treatment building, and other structures would be equipped with fixed fire suppression systems and portable fire extinguishers as required by the local fire department.

Local Fire Protection Services

Ivanpah SEGS would be within the jurisdiction of San Bernardino County Station #53 in Baker, California, which provides fire services in the area to the State border. Their approximate response time would be 45 minutes. Station #53 has a Type 1 engine and a brush patrol vehicle. They have 3 staff on duty at all times (1 captain, 1 engineer, and 1 firefighter). San Bernardino County Fire Department also has a Mutual Aid Agreement with Clark County (Nevada) Fire Department for responses requiring more assistance.

The Hazardous Materials Risk Management Plan (see Subsection 5.5, Hazardous Materials Handling) for the plant would include all information necessary to allow fire-fighting and other emergency response agencies to plan and implement safe responses to fires, spills, and other emergencies.

Personnel Safety Program

The Ivanpah SEGS project would operate in compliance with federal and state occupational safety and health program requirements. Compliance with these programs would minimize project effects on employee safety. These programs are described in Subsection 5.16, Worker Safety.

3.2 Facility Reliability

This subsection discusses the expected facility availability, equipment redundancy, fuel availability, water availability, and project quality control measures.

3.2.1 Facility Availability

Because of the Ivanpah SEGS system needs, it would be anticipated that the facility would normally operate at high average annual capacity factors during periods of sunlight.

Ivanpah SEGS would be designed for an operating life of 50 years. Reliability and availability projections are based on this operating life. Operation and maintenance procedures would be consistent with industry standard practices to maintain the useful life status of plant components.

The percent of time that the power plants are projected to be operated would be defined as the "service factor." The service factor considers the amount of time that a unit would be operating and generating power, whether at full or partial load. The projected service factor for the power block, which considers projected percent of time of operation, differs from the

equivalent availability factor (EAF), which considers the projected percent of energy production capacity achievable. For solar plant purposes, nighttime hours are not included in the calculations.

The EAF may be defined as a weighted average of the percent of full energy production capacity achievable. The projected equivalent availability factor for the Ivanpah SEGS would be estimated to be approximately 92 to 98 percent (for daylight hours).

The EAF, which would be a weighted average of the percent of energy production capacity achievable, differs from the “availability of a unit,” which would be the percent of time that a unit would be available for operation, whether at full load, partial load, or standby.

3.2.2 Redundancy of Critical Components

The following subsection identifies equipment redundancy as it applies to project availability. A summary of equipment redundancy is shown in Table 5. Final design could differ.

TABLE 5
Major Equipment Redundancy

Description	Number	Note
Solar Receiver Boilers	Three trains—Ivanpah 1 & 2 Four trains—Ivanpah 3	Steam turbine bypass system allows all boiler trains to operate at base load with the steam turbine out of service for 30 seconds until heliostat defocusing.
Solar boiler Superheater	Three—One per plant	See note above pertaining to Solar Receiver Boilers.
STG	Three—One per plant	See note above pertaining to Solar Receiver Boilers.
Boiler feedwater pumps	One—100 percent per boiler	One spare for all Solar Receiver Boilers.
Condensate pumps	Three—50 percent capacity per plant	
Condenser	One per plant	Condenser must be in operation for plant operation or operation of boilers in steam turbine bypass mode. The condenser would be provided with split water boxes to allow online tube cleaning and repair.
Demineralizer system	One—100 percent capacity per plant	

Power Block

Ivanpah 1 and 2 would have three separate boiler steam generation trains and Ivanpah 3 would have four separate trains that would operate in parallel. Thermal energy from the steam generation system would be converted to mechanical energy, and then electrical energy in the STG. The expanded steam from the STG would be condensed and recycled to the feedwater system.

The major components of the combined-cycle power block are described below. The power block is served by the balance-of-plant systems described in AFC Subsection 2.3.2.2.2.

Steam Generation Subsystems

The steam generation subsystems consist of the receiver boiler and blowdown systems. The receiver boilers collect solar energy from the heliostat mirrors and transfer it to feedwater for steam production. This heat transfer produces steam at the pressures and temperatures required by the steam turbine. The blowdown system maintains feedwater quality. The system includes safety and auto relief valves and processing of continuous and intermittent blowdown streams.

Steam Turbine Generator Subsystems

The steam turbine converts the thermal energy in the steam to mechanical energy to drive the STG. The basic subsystems include the steam turbine and auxiliary systems, turbine lube oil system, and generator/exciter system. The generator would be water-air cooled.

Distributed Control System

The DCS would be a redundant microprocessor-based system that would provide the following functions:

- Control the Heliostat mirrors, STG, and other systems in response to unit load demands (coordinated control)
- Provide control room operator interface
- Monitor plant equipment and process parameters and provide this information to the plant operators in a meaningful format
- Provide visual and audible alarms for abnormal events based on field signals or software-generated signals from plant systems, processes, or equipment

The DCS would have functionally distributed architecture comprising a group of similar redundant processing units linked to a group of operator consoles and an engineer workstation by redundant data highways. Each processor would be programmed to perform specific dedicated tasks for control information, data acquisition, annunciation, and historical purposes.

Plant operation would be controlled from the operator panel located in the control room. The operator panel would consist of two individual video/keyboard consoles and one engineering workstation. Each video/keyboard console would be an independent electronic package so that failure of a single package does not disable more than one video/keyboard. The engineering workstation would allow the control system operator interface to be revised by authorized personnel.

Boiler Feedwater System

The boiler feedwater system transfers feedwater from the deaerator to the solar receiver boilers. The system would consist of two pumps, each pump sized for 100 percent capacity for supplying all boilers. The pump would be multistage, horizontal, motor-driven and would include regulating control valves, minimum flow recirculation control, and other associated piping and valves. One 100 percent capacity spare pump would be available for all boilers.

Condensate System

The condensate system would provide a flow path from the condenser hotwell to the deaerator. The condensate system would include three 50-percent capacity multistage, vertical, motor-driven condensate pumps.

Demineralized Water System

The demineralized water system would consist of a filter and demineralizer train from an onsite water treatment system consisting of activated carbon filters, deionization vessels. The unit would be a self-contained trailer-mounted unit. Demineralized water would be stored in a 25,000-gallon demineralized water storage tank; boiler feedwater make-up water would be stored in another 25,000-gallon tank.

Power Cycle Makeup and Storage

The power cycle (boiler) makeup and storage subsystem provides polished demineralized water for system cycle makeup and chemical cleaning operations. Major components of the system would be a mixed bed polisher for the boiler makeup water storage tank, and two 100-percent capacity, horizontal, centrifugal, cycle makeup water pumps.

Compressed Air

The compressed air system provides instrument air and service air to points of use throughout the facility. The compressed air system would include two 100-percent capacity motor-driven air compressors, two air dryers with prefilters and after filters, an air receiver, instrument air header, and service air header. All instrument air would be dried. A control valve would be provided in the service air header to prevent high consumption of service air from reducing the instrument air header pressure below critical levels.

3.2.3 Fuel Availability

Natural gas would be delivered via pipeline as described above and in AFC Section 4.0, Gas Supply.

3.2.4 Water Availability

The project would use up to 100 ac-ft/yr of well water for general process use. The boiler blowdown would be flashed into steam and condensate and the remaining water would be used to wash mirrors.

Potable water for drinking, safety showers, fire protection water, service water, and sanitary uses would be served from the onsite wells and treated appropriately.

The availability of water to meet the needs of Ivanpah SEGS is discussed in more detail in AFC Subsection 5.15, Water Resources.

3.2.5 Project Quality Control

The Quality Control Program that would be applied to Ivanpah SEGS is summarized in this section. The objective of the Quality Control Program would be to ensure that all systems and components have the appropriate quality measures applied; whether it be during design, procurement, fabrication, construction, or operation. The goal of the Quality Control Program would be to achieve the desired levels of safety, reliability, availability, operability, constructability, and maintainability for the generation of electricity.

The required quality assurance for a system would be obtained by applying controls to various activities, according to the activity being performed. For example, the appropriate controls for design work are checking and review, and the appropriate controls for manufacturing and construction are inspection and testing. Appropriate controls would be applied to each of the various activities for the project.

Project Stages

For quality assurance planning purposes, the project activities have been divided into the following nine stages that apply to specific periods of time during the project:

- **Conceptual Design Criteria.** Activities such as definition of requirements and engineering analyses.
- **Detail Design.** Activities such as the preparation of calculations, drawings, and lists needed to describe, illustrate, or define systems, structures, or components.
- **Procurement Specification Preparation.** Activities necessary to compile and document the contractual, technical and quality provisions for procurement specifications for plant systems, components, or services.
- **Manufacturer's Control and Surveillance.** Activities necessary to ensure that the manufacturers conform to the provisions of the procurement specifications.
- **Manufacturer Data Review.** Activities required to review manufacturers' drawings, data, instructions, procedures, plans, and other documents to ensure coordination of plant systems and components, and conformance to procurement specifications.
- **Receipt Inspection.** Inspection and review of product at the time of delivery to the construction site.
- **Construction/Installation.** Inspection and review of storage, installation, cleaning, and initial testing of systems or components at the facility.
- **System/Component Testing.** Actual operation of generating facility components in a system in a controlled manner to ensure that the performance of systems and components conform to specified requirements.
- **Plant Operation.** As the project progresses, the design, procurement, fabrication, erection, and checkout of each generating facility system would progress through the nine stages defined above.

Quality Control Records

The following quality control records would be maintained for review and reference:

- Project instruction manual
- Design calculations
- Project design manual
- Quality assurance audit reports
- Conformance to construction records drawings
- Procurement specifications (contract issue and change orders)
- Purchase orders and change orders
- Project correspondence

For procured component purchase orders, a list of qualified suppliers and subcontractors would be developed. Before contracts are awarded, the subcontractors' capabilities would be evaluated. The evaluation would consider suppliers' and subcontractors' personnel, production capability, past performance, and quality assurance program.

During construction, field activities would be accomplished during the last four stages of the project: receipt inspection, construction/installation, system/component testing, and plant operations. The construction contractor would be contractually responsible for performing the work in accordance with the quality requirements specified by contract.

The subcontractors' quality compliance would be surveyed through inspections, audits, and administration of independent testing contracts.

A plant operation and maintenance program, typical of a project this size, would be implemented by the applicant to control operation and maintenance quality. A specific program for this project would be defined and implemented during initial plant startup.

4.0 Facility Closure

Facility closure can be temporary or permanent. Temporary closure is defined as a shutdown for a period exceeding the time required for normal maintenance, including closure for overhaul or replacement of the steam turbine. Causes for temporary closure include a disruption in the supply of natural gas or damage to the plant from earthquake, fire, storm, or other natural acts. Permanent closure is defined as a cessation in operations with no intent to restart operations owing to plant age, damage to the plant beyond repair, economic conditions, or other reasons. AFC Subsection 2.4.1 discusses temporary facility closure; AFC Subsection 2.4.2 discusses permanent facility closure.

4.1 Temporary Closure

For a temporary facility closure, where there would be no release of hazardous materials, security of the facilities would be maintained on a 24-hour basis. The CEC and BLM would be notified. Other responsible agencies would also be notified as necessary and appropriate. Depending on the length of shutdown necessary, a contingency plan for the temporary cessation of operations would be implemented. The contingency plan would be conducted to ensure conformance with all applicable LORS and the protection of public health, safety, and the environment. The plan, depending on the expected duration of the shutdown, may include the draining of all chemicals from storage tanks and other equipment and the safe shutdown of all equipment. All wastes would be disposed of according to applicable LORS, as discussed in AFC Subsection 5.14, Waste Management.

Where the temporary closure includes damage to the facility, and there would be a release or threatened release of regulated substances or other hazardous materials into the environment, procedures would be followed as set forth in a Risk Management Plan (RMP) and a Hazardous Materials Business Plan to be developed as described in AFC Subsection 5.5, Hazardous Materials. Procedures would include methods to control releases, notification of applicable authorities and the public, emergency response, and training for plant personnel in responding to and controlling releases of hazardous materials. Once the immediate problem is solved, and the regulated substance/hazardous material release

would be contained and cleaned up, temporary closure would proceed as described above for a closure where there would be no release of hazardous materials.

4.2 Permanent Closure

When the facility is permanently closed, the closure procedure would follow a plan that would be developed as described below.

The removal of the facility from service, or decommissioning, may range from “mothballing” to the removal of all equipment and appurtenant facilities, depending on conditions at the time. Because the conditions that would affect the decommissioning decision are largely unknown at this time, these conditions would be presented to the CEC and BLM when more information would be available and the timing for decommissioning would be more imminent.

To ensure that public health and safety and the environment are protected during decommissioning, a decommissioning plan would be submitted to the BM and CEC for approval prior to decommissioning. The plan would discuss the following:

- Proposed decommissioning activities for the facility and all appurtenant facilities constructed as part of the facility
- Conformance of the proposed decommissioning activities to all applicable LORS and local/regional plans
- Activities necessary to restore the site if the plan requires removal of all equipment and appurtenant facilities
- Decommissioning alternatives other than complete restoration
- Associated costs of the proposed decommissioning and the source of funds to pay for the decommissioning

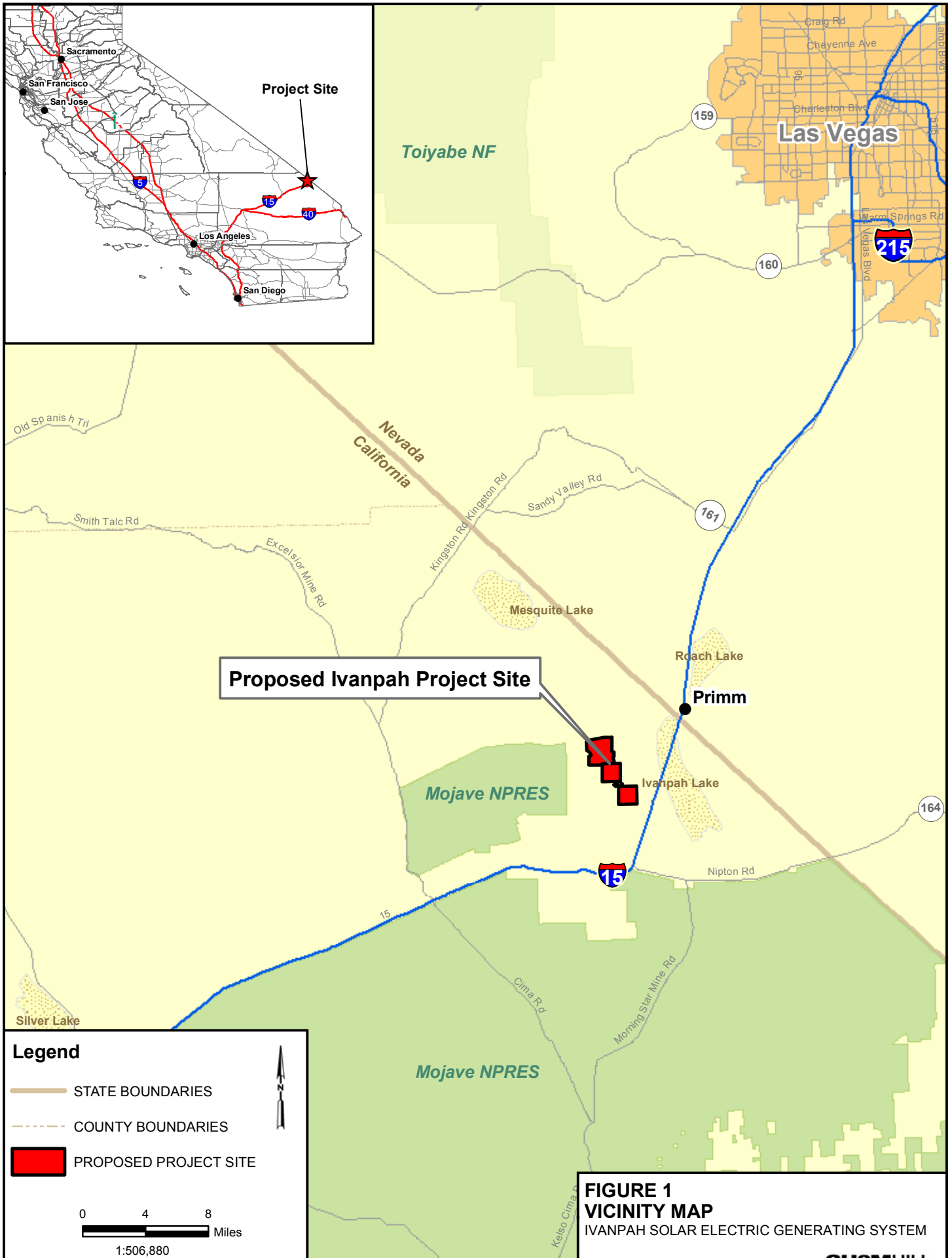

In general, the decommissioning plan for the facility would attempt to maximize the recycling of all facility components. The Applicant would attempt to sell unused chemicals back to the suppliers or other purchasers or users. All equipment containing chemicals would be drained and shut down to ensure public health and safety and to protect the environment. All nonhazardous wastes would be collected and disposed of in appropriate landfills or waste collection facilities. All hazardous wastes would be disposed of according to all applicable LORS. The site would be secured 24 hours per day during the decommissioning activities.

Figures



Proposed Ivanpah Project Site

Legend

-  STATE BOUNDARIES
-  COUNTY BOUNDARIES
-  PROPOSED PROJECT SITE

0 4 8
Miles

1:506,880

FIGURE 1
VICINITY MAP
 IVANPAH SOLAR ELECTRIC GENERATING SYSTEM

KERN RIVER GAS TRANSMISSION LINE

INTERCONNECT PT.

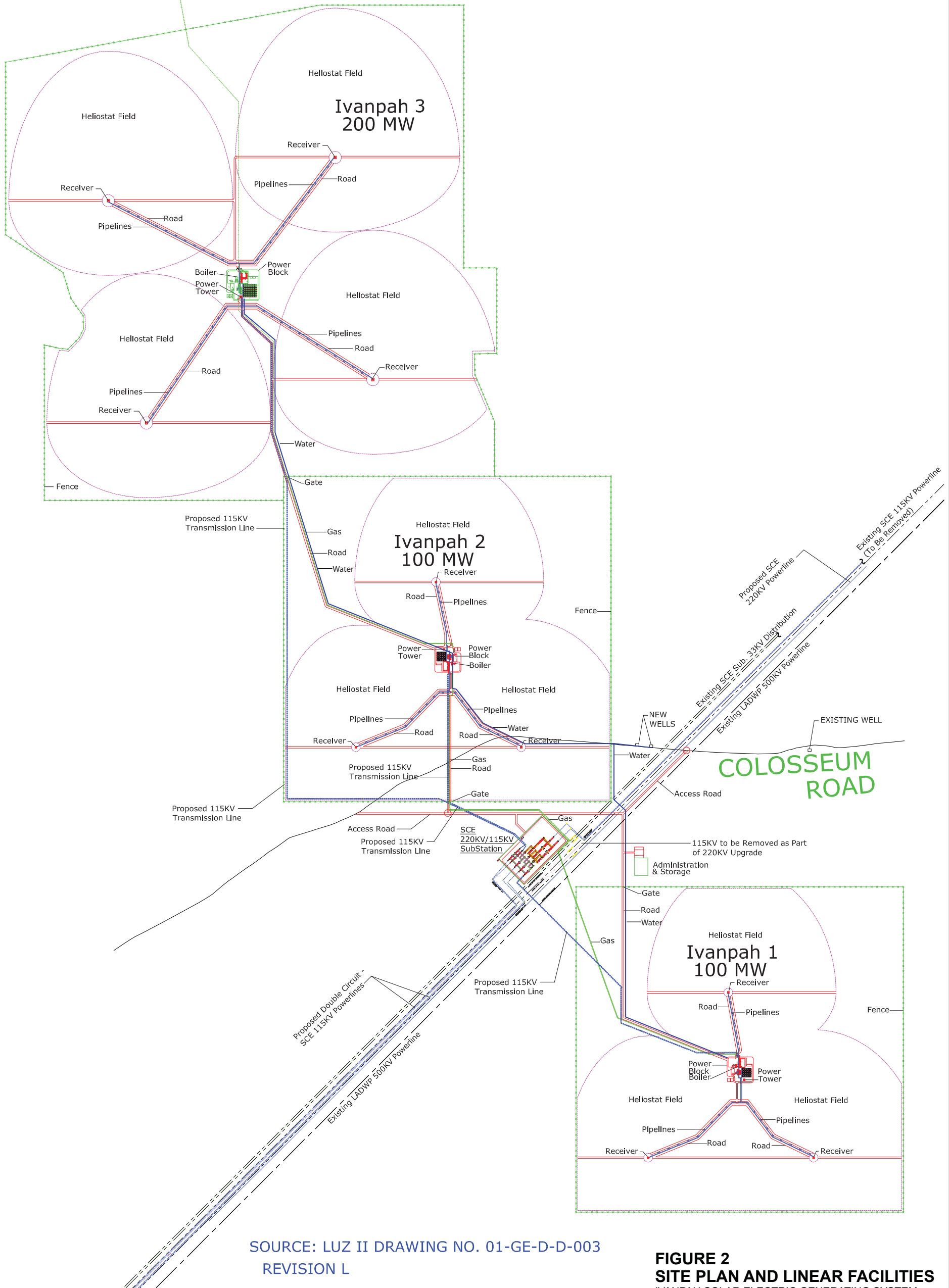

SOURCE: LUZ II DRAWING NO. 01-GE-D-D-003
REVISION L

FIGURE 2
SITE PLAN AND LINEAR FACILITIES
IVANPAH SOLAR ELECTRIC GENERATING SYSTEM

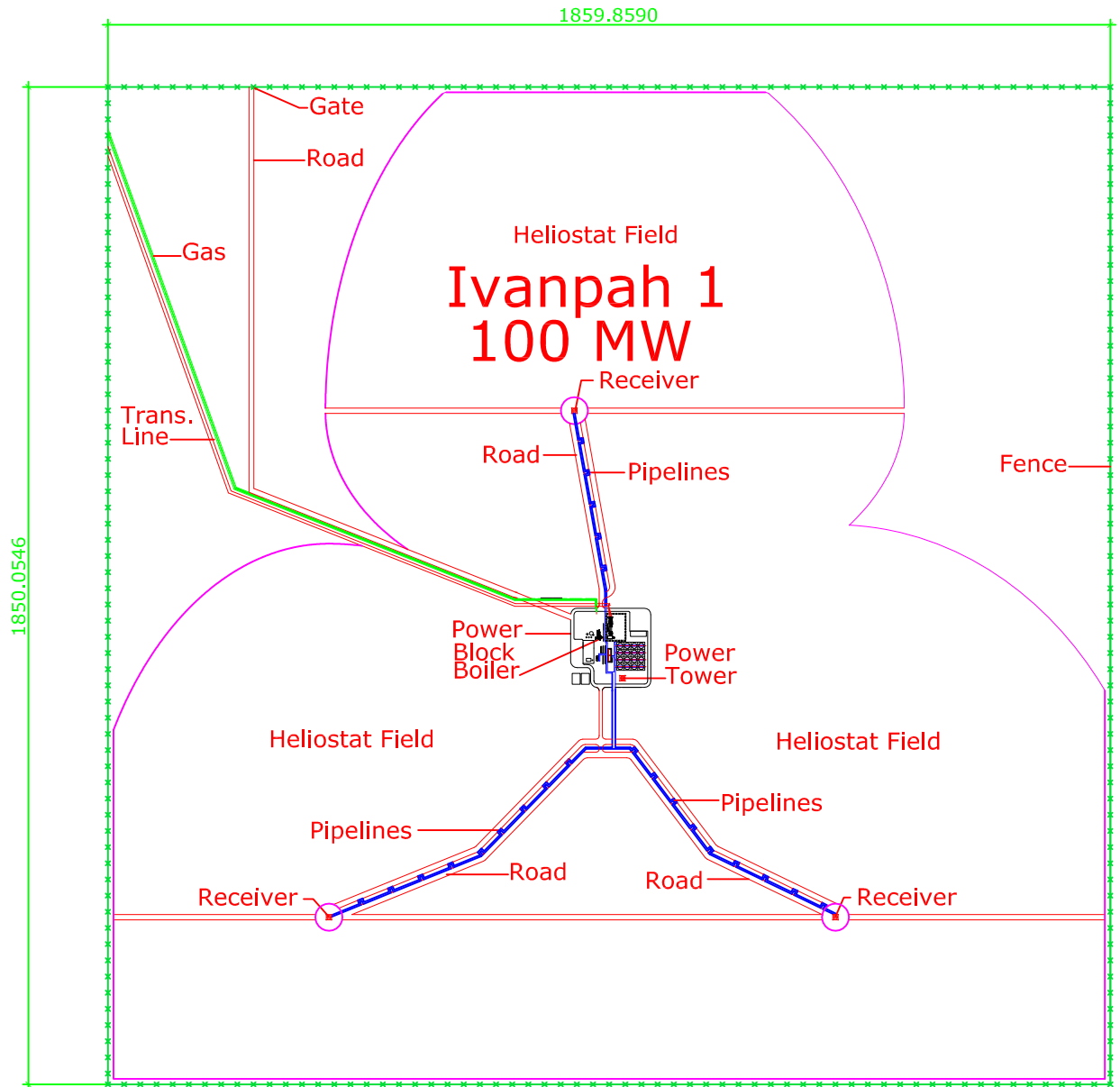
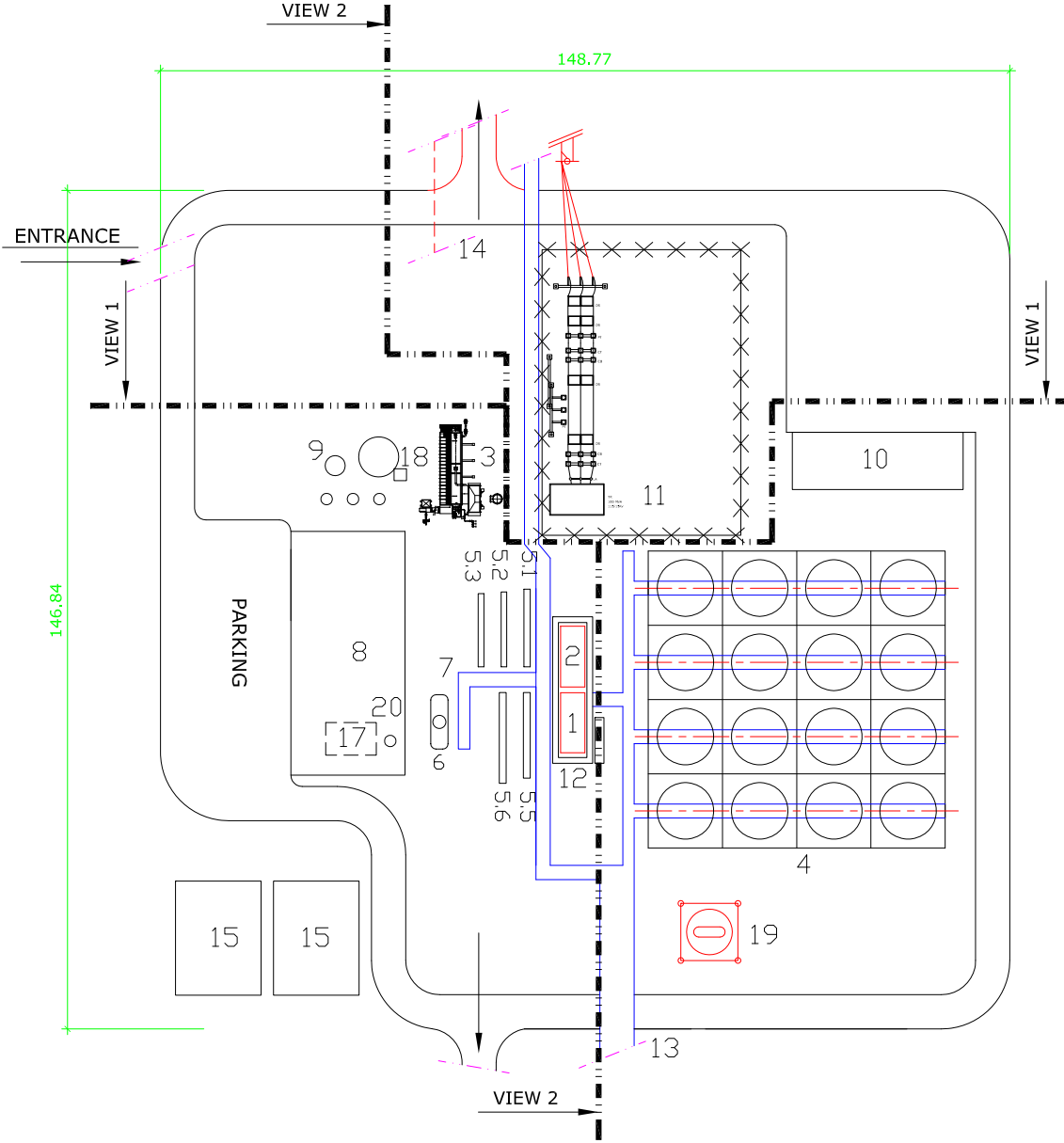

FIGURE 3a
IVANPAH 1 SOLAR FIELD LAYOUT
 IVANPAH SOLAR ELECTRIC GENERATING SYSTEM

Source: DWG 12-SF-M-D-002 Rev A



- LEGEND:**
- 1- TURBINE
 - 2- GENERATOR
 - 3- BOILER
 - 4- AIR COOLED CONDENSER
 - 5- FEED WATER PREHEATER
 - 6- DEAERATOR
 - 7- STEAM DISTRIBUTOR
 - 8- WATER TREATMENT PLANT ,ADMINISTRATION & ELECTRICAL BUILDING
 - 9- WATER STORAGE TANKS
 - 10- MAINTENANCE WING
 - 11-SWITCH YARD
 - 12-TURBINE LUBRICATION SYSTEM
 - 13-PIPE BRIDGE
 - 14-GAS PIPE
 - 15-EVAPORATION PITS
 - 16-(RESERVED)
 - 17-EMERGENCY GENERATOR
 - 18-DIESEL FIRE PUMP
 - 19- REHEATER TOWER
 - 20- EMERGENCY GENERATOR EXHAUST

FIGURE 3b
IVANPAH 1 POWER
BLOCK LAYOUT
 IVANPAH SOLAR ELECTRIC GENERATING SYSTEM

Source: DWG 012-PB-L-D-001

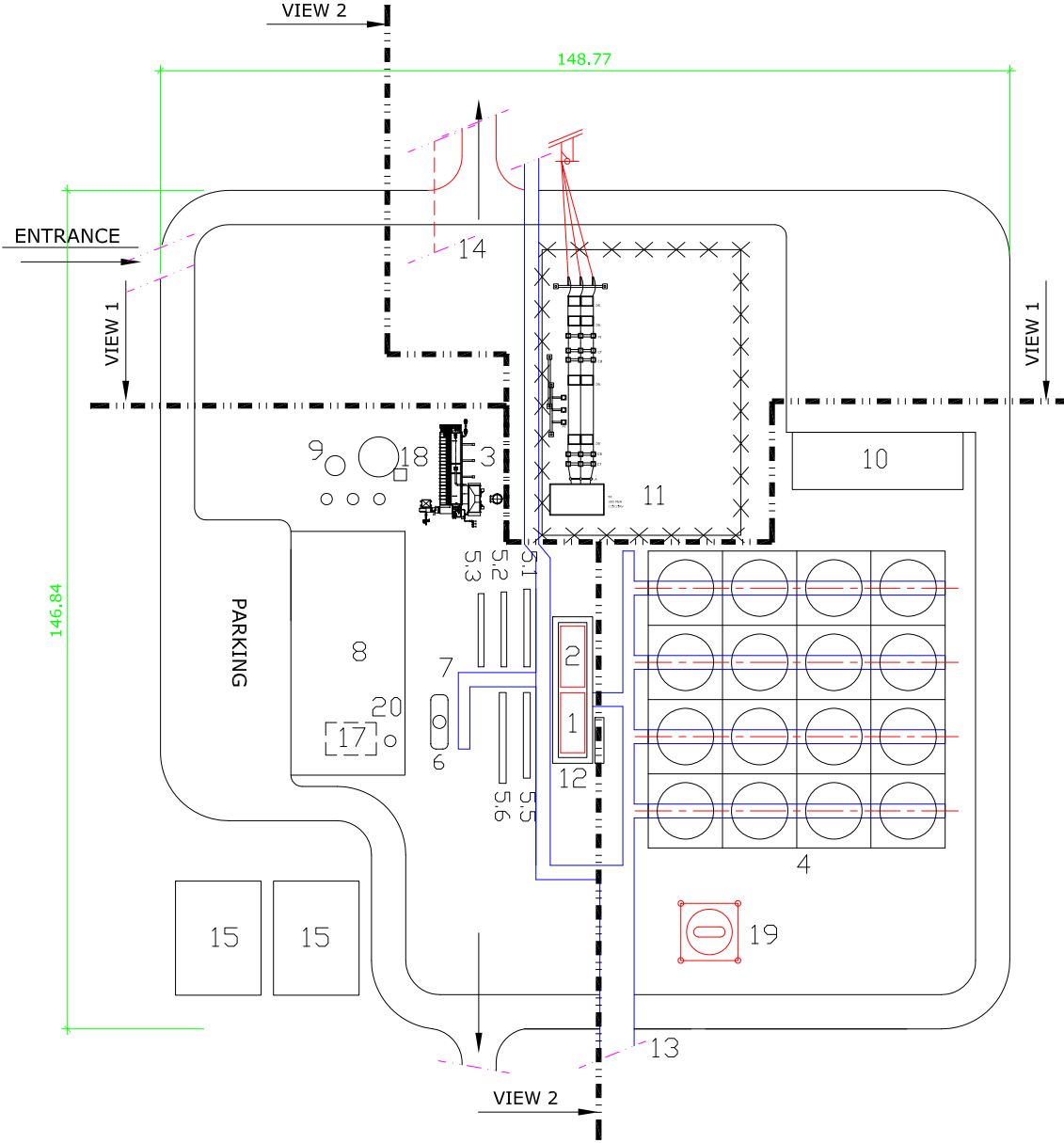

- LEGEND:**
- 1- TURBINE
 - 2- GENERATOR
 - 3- BOILER
 - 4- AIR COOLED CONDENSER
 - 5- FEED WATER PREHEATER
 - 6- DEAERATOR
 - 7- STEAM DISTRIBUTOR
 - 8- WATER TREATMENT PLANT ,ADMINISTRATION & ELECTRICAL BUILDING
 - 9- WATER STORAGE TANKS
 - 10- MAINTENANCE WING
 - 11-SWITCH YARD
 - 12-TURBINE LUBRICATION SYSTEM
 - 13-PIPE BRIDGE
 - 14-GAS PIPE
 - 15-EVAPORATION PITS
 - 16-(RESERVED)
 - 17-EMERGENCY GENERATOR
 - 18-DIESEL FIRE PUMP
 - 19- REHEATER TOWER
 - 20- EMERGENCY GENERATOR EXHAUST

FIGURE 3c
IVANPAH 1 POWER
BLOCK LAYOUT
 IVANPAH SOLAR ELECTRIC GENERATING SYSTEM

Source: DWG 012-PB-L-D-001

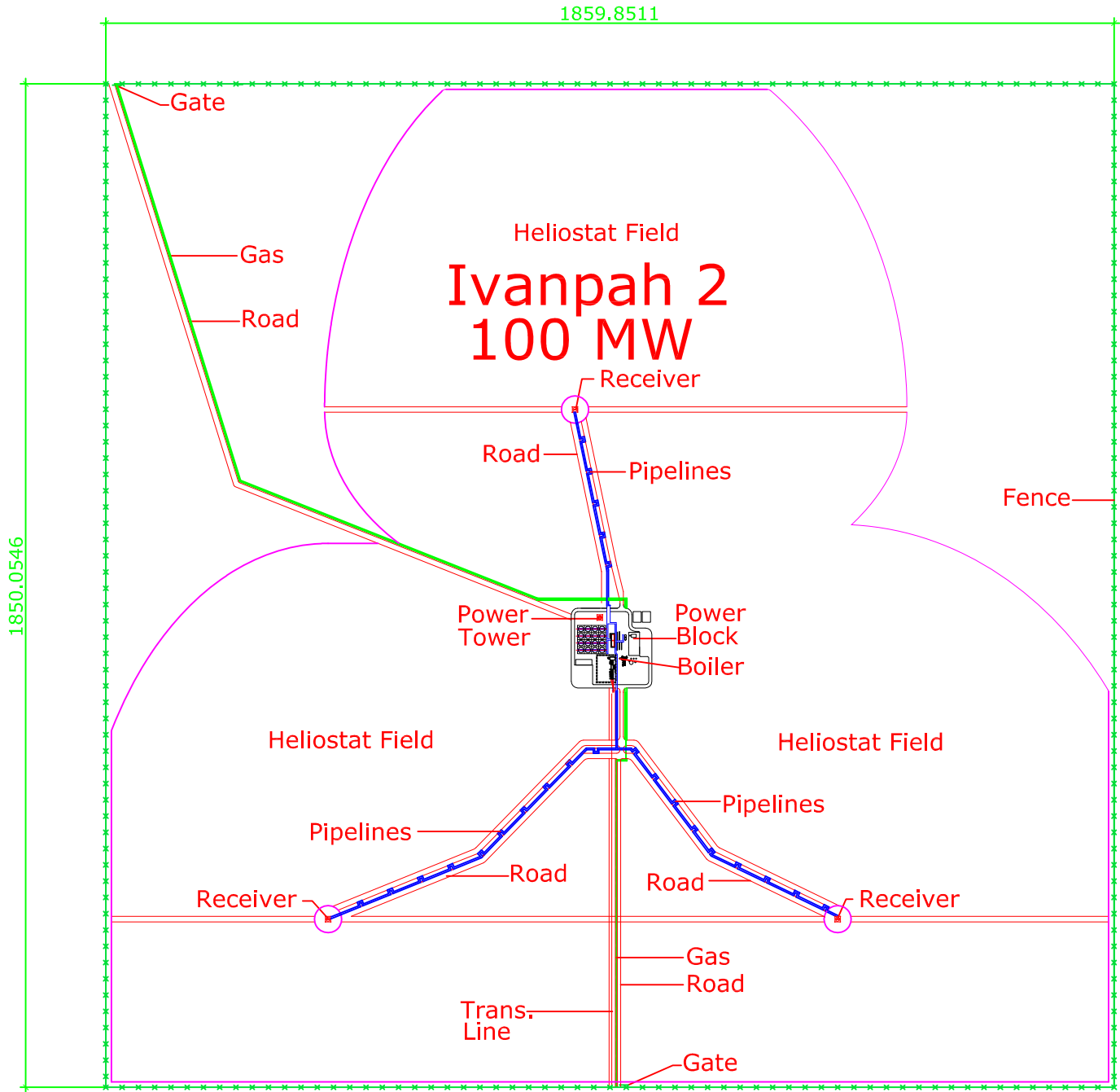

Ivanpah 2
100 MW

FIGURE 4a
IVANPAH 2 SOLAR FIELD LAYOUT
IVANPAH SOLAR ELECTRIC GENERATING SYSTEM

Source: DWG 07-SF-M-D-100 Rev D

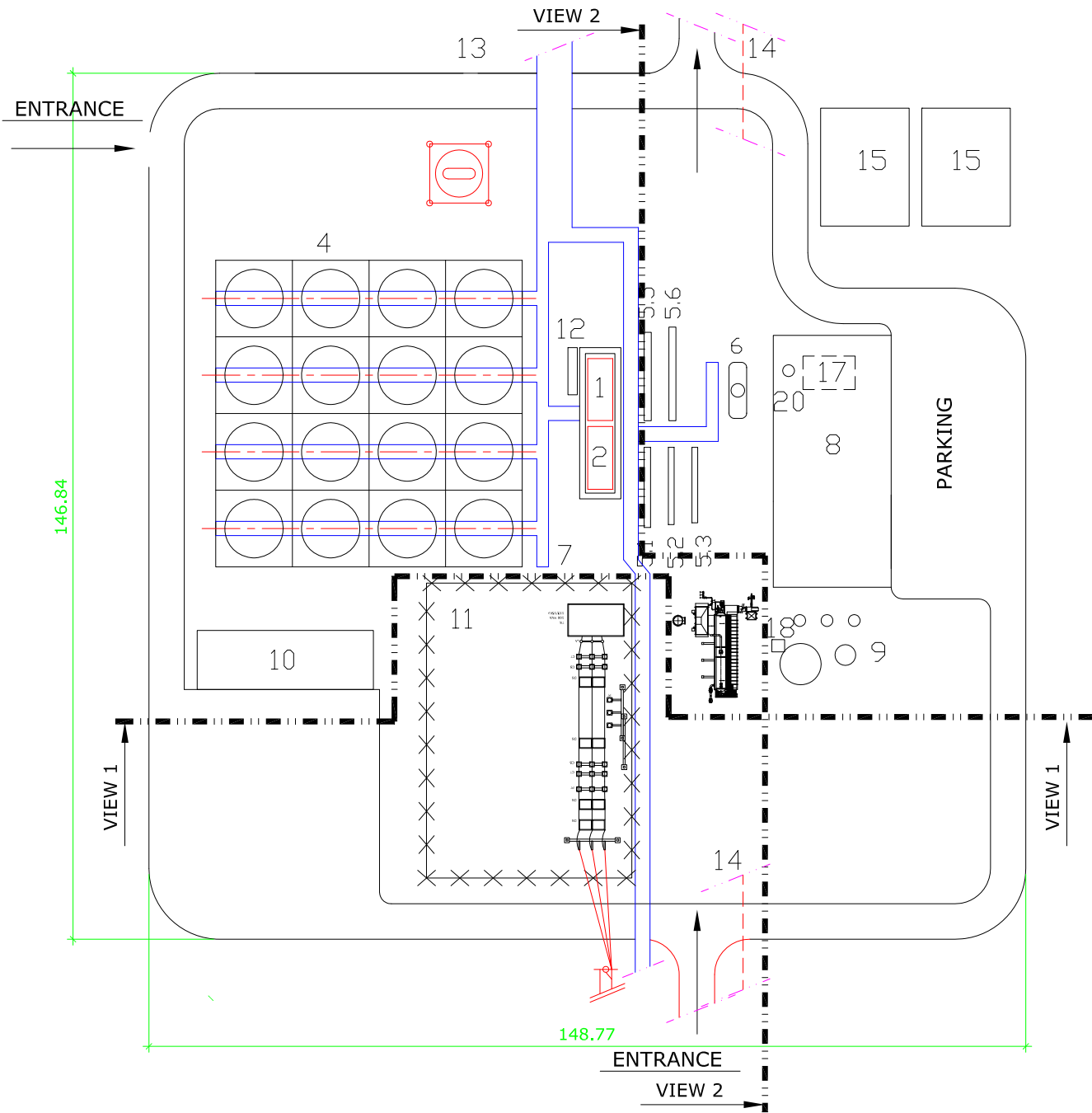

- LEGEND:**
- 1- TURBINE
 - 2- GENERATOR
 - 3- BOILER
 - 4- AIR COOLED CONDENSER
 - 5- FEED WATER PREHEATER
 - 6- DEAERATOR
 - 7- STEAM DISTRIBUTOR
 - 8- WATER TREATMENT PLANT ,ADMINISTRATION & ELECTRICAL BUILDING
 - 9- WATER STORAGE TANKS
 - 10- MAINTENANCE WING
 - 11-SWITCH YARD
 - 12-TURBINE LUBRICATION SYSTEM
 - 13-PIPE BRIDGE
 - 14-GAS PIPE
 - 15-EVAPORATION PITS
 - 16-[RESERVED]
 - 17-EMERGENCY GENERATOR
 - 18-DIESEL FIRE PUMP
 - 19-REHEAT TOWER
 - 20-EMERGENCY GENERATOR EXHAUST

FIGURE 4b
IVANPAH 2 POWER
BLOCK LAYOUT
 IVANPAH SOLAR ELECTRIC GENERATING SYSTEM

Source: DWG 012-PB-L-D-001 Rev D

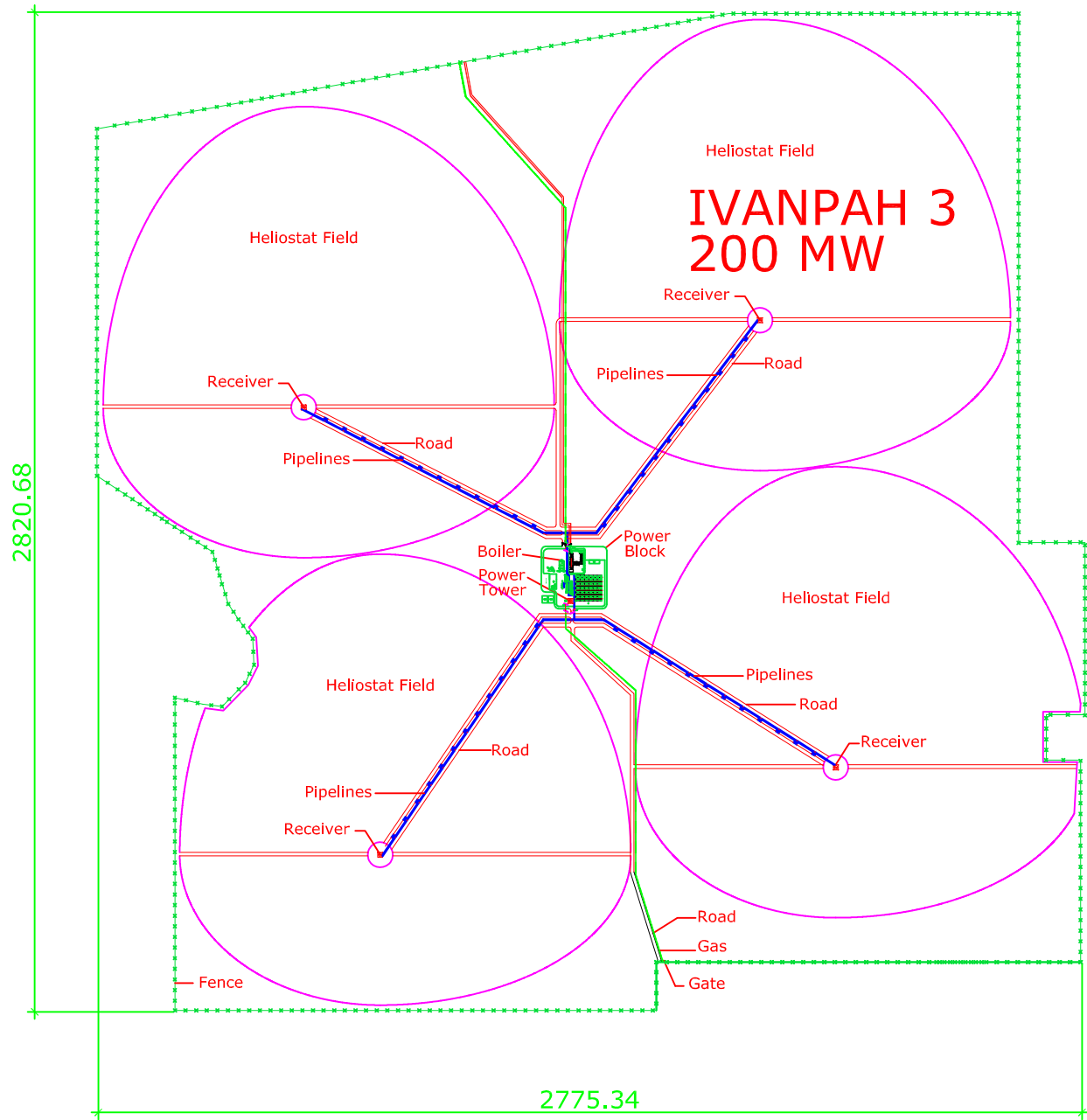
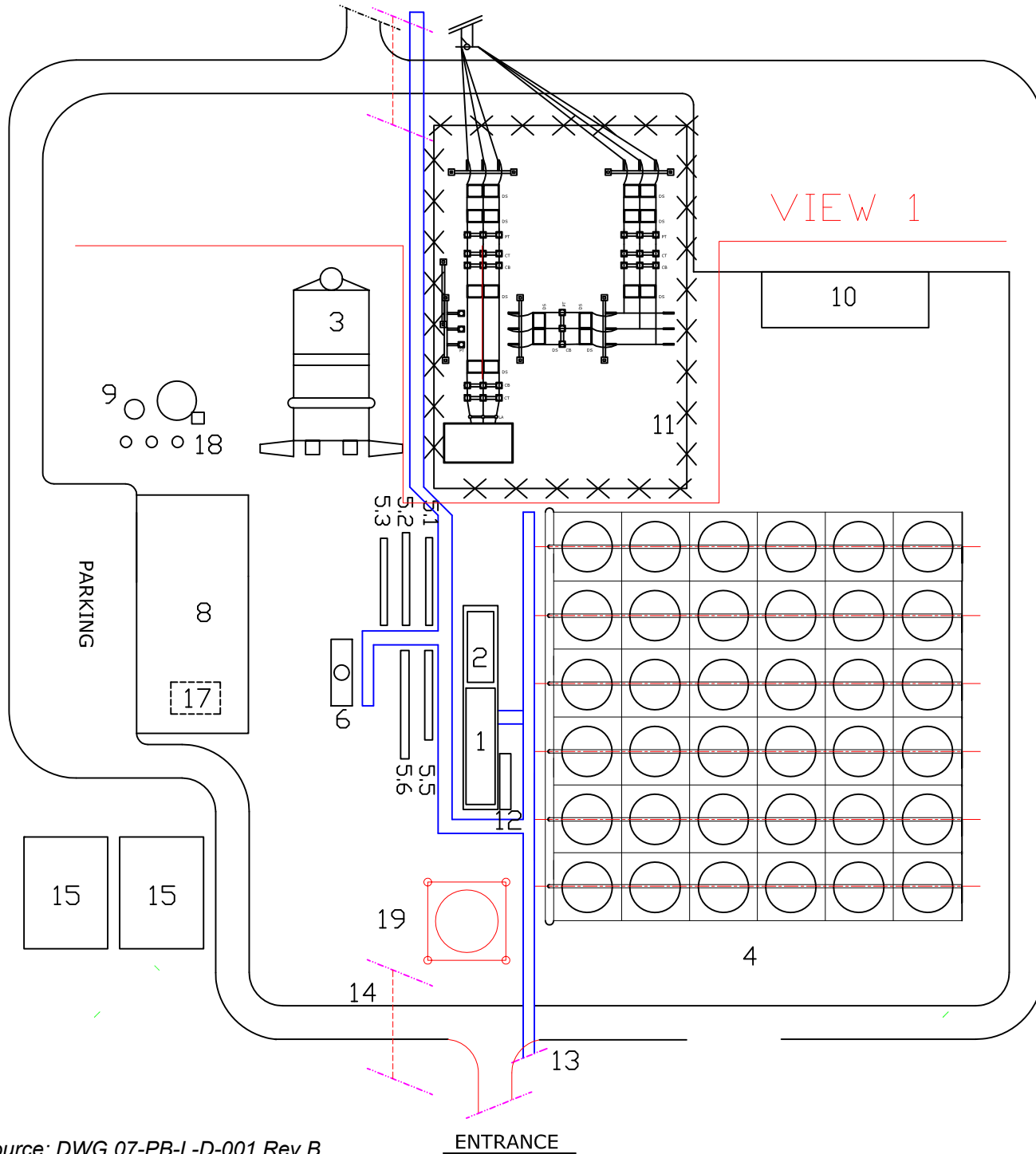

FIGURE 5a
IVANPAH 3 SOLAR FIELD LAYOUT
 IVANPAH SOLAR ELECTRIC GENERATING SYSTEM

Source: DWG 07-SF-M-D-100 Rev D



- LEGEND:**
- 1- TURBINE
 - 2- GENERATOR
 - 3- BOILER
 - 4- AIR COOLED CONDENSER
 - 5- FEED WATER PREHEATER
 - 6- DEAERATOR
 - 7- STEAM DISTRIBUTOR
 - 8- WATER TREATMENT PLANT ,ADMINISTRATION & ELECTRICAL BUILDING
 - 9- WATER STORAGE TANKS
 - 10- MAINTENANCE WING
 - 11-SWITCH YARD
 - 12-TURBINE LUBRICATION SYSTEM
 - 13-PIPE BRIDGE
 - 14-GAS PIPE
 - 15-EVAPORATION PITS
 - 16-[RESERVED]
 - 17-EMERGEY GENERATOR
 - 18-DIESEL FIRE PUMP
 - 19-SOLAR REHEAT TOWER

FIGURE 5b
IVANPAH 3 POWER
BLOCK LAYOUT
 IVANPAH SOLAR ELECTRIC GENERATING SYSTEM

Source: DWG 07-PB-L-D-001 Rev B

ENTRANCE

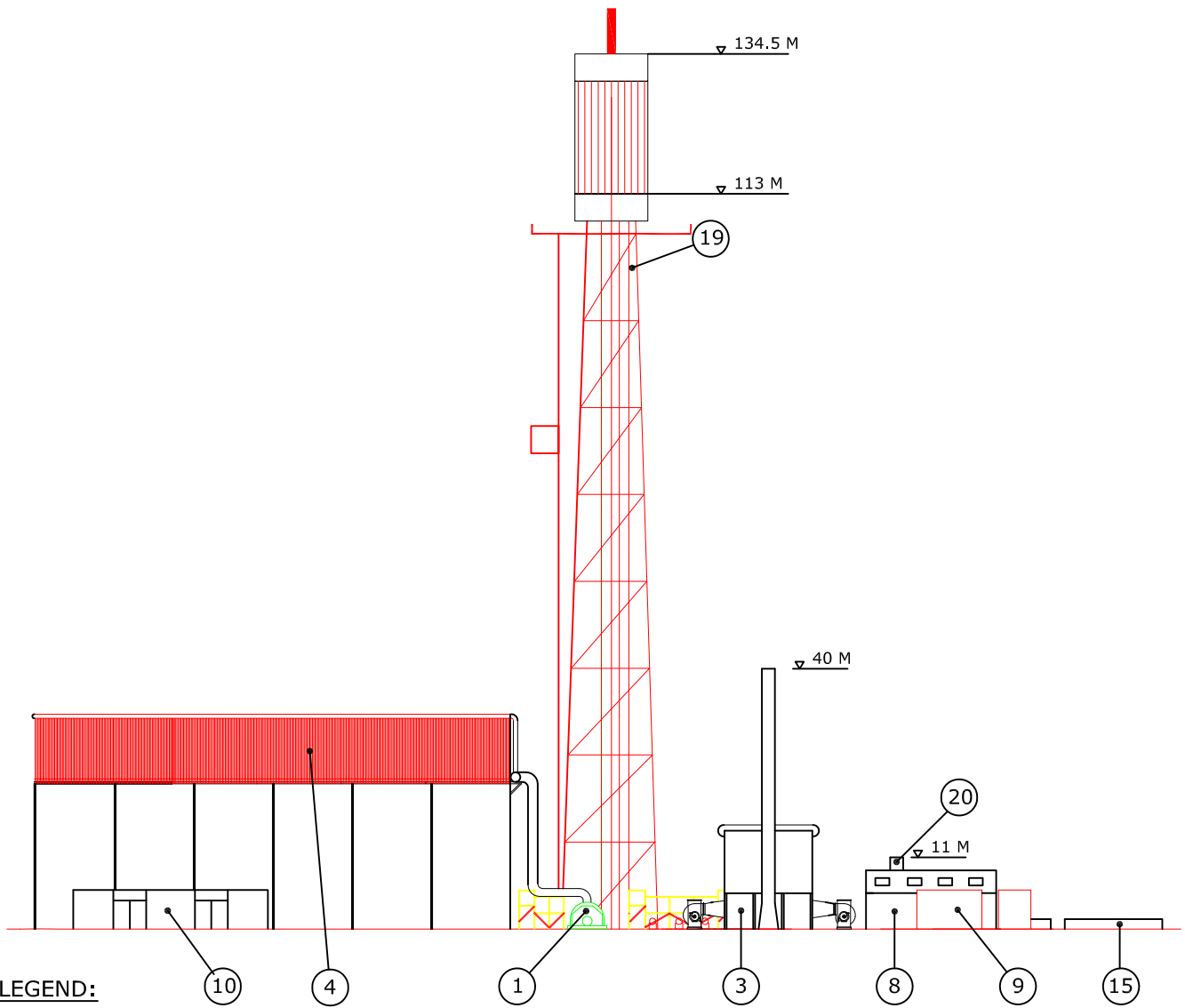

LEGEND:

- 1- TURBINE
- 2- GENERATOR
- 3- BOILER
- 4- AIR COOLED CONDENSER
- 5- FEED WATER PREHEATER
- 6- DEAERATOR
- 7- STEAM DISTRIBUTOR
- 8- WATER TREATMENT PLANT ,ADMINISTRATION & ELECTRICAL BUILDING
- 9- WATER STORAGE TANKS
- 10- MAINTENANCE WING
- 11-SWITCH YARD
- 12-TURBINE LUBRICATION SYSTEM
- 13-PIPE BRIDGE
- 14-GAS PIPE
- 15-EVAPORATION PITS
- 16-[RESERVED]
- 17-EMERGENCY GENERATOR
- 18-DIESEL FIRE PUMP
- 19- REHEATER TOWER
- 20- EMERGENCY GENERATOR EXHAUST

FIGURE 5c
IVANPAH 3 POWER BLOCK
ELEVATION

IVANPAH SOLAR ELECTRIC GENERATING SYSTEM

Source: DWG 07-PB-L-D-100 Rev D

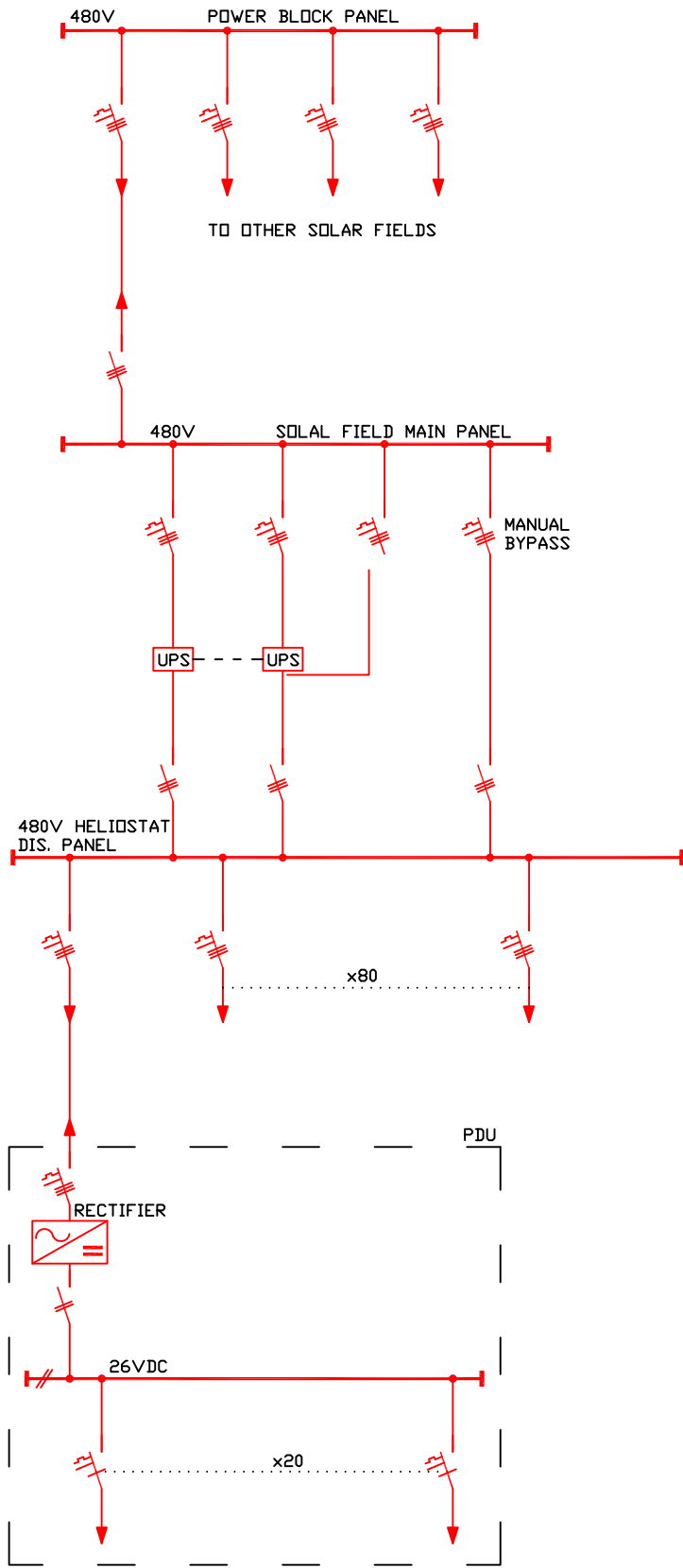

Source: DWG 01-SF-ED-001 Rev A

FIGURE 6
IVANPAH 1 SOLAR FIELD
SINGLE-LINE DESIGN

IVANPAH SOLAR ELECTRIC GENERATING SYSTEM
 BRIGHT SOURCE ENERGY

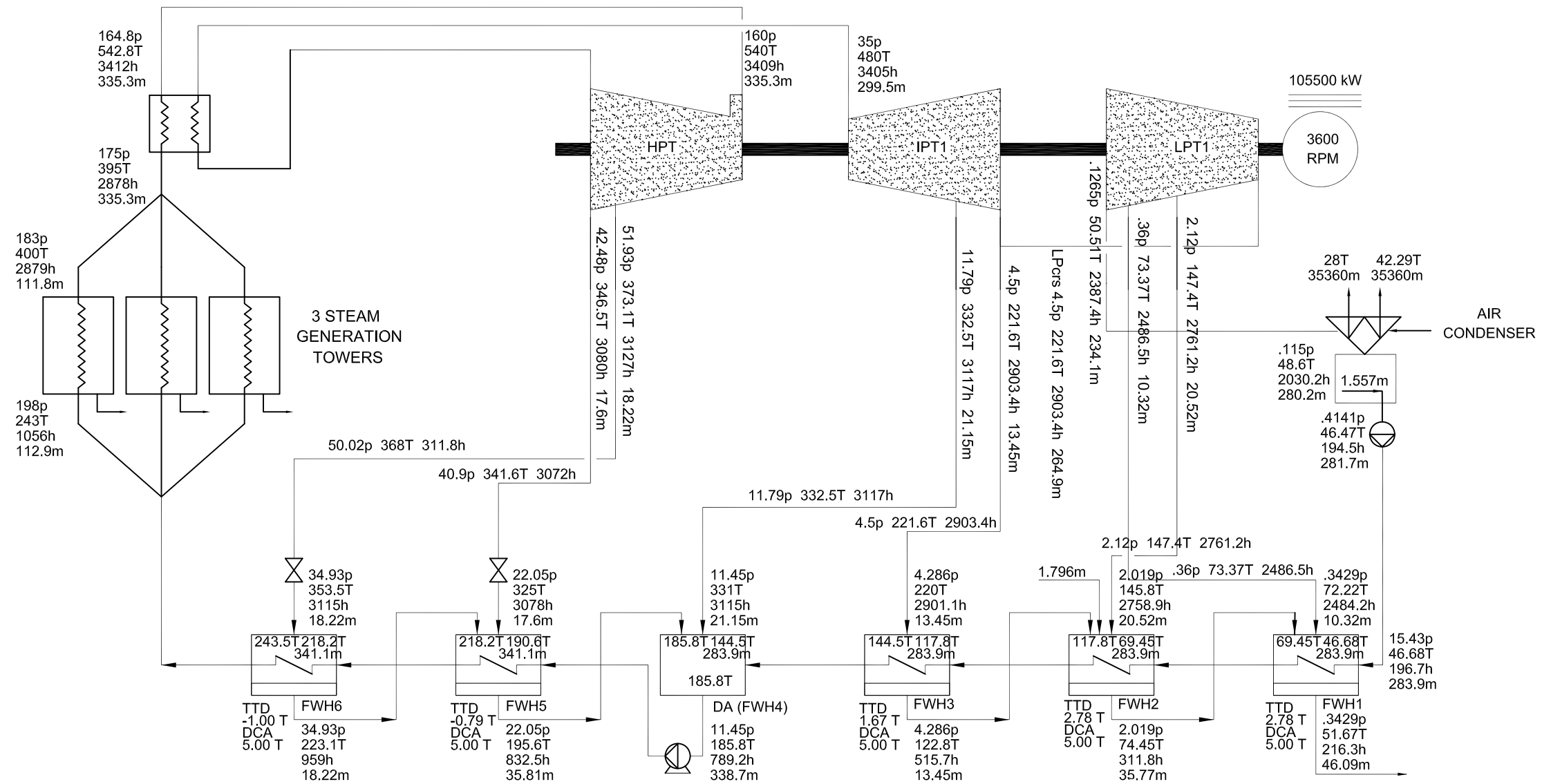

LEGEND:
 p - PRESSURE (bar)
 T - Temperature (°C)
 h - Enthalpy (Kj/Kg)
 m - Mass (Tons /hr)

Q_{in}=247.7 MWth
NET POWER 100 MW
GROSS / NET PLANT HR 8452 / 8917 kJ/kWh (42.59% / 40.37%).

FIGURE 7
100 MW HEAT BALANCE
100% SOLAR
 IVANPAH SOLAR ELECTRIC GENERATING SYSTEM

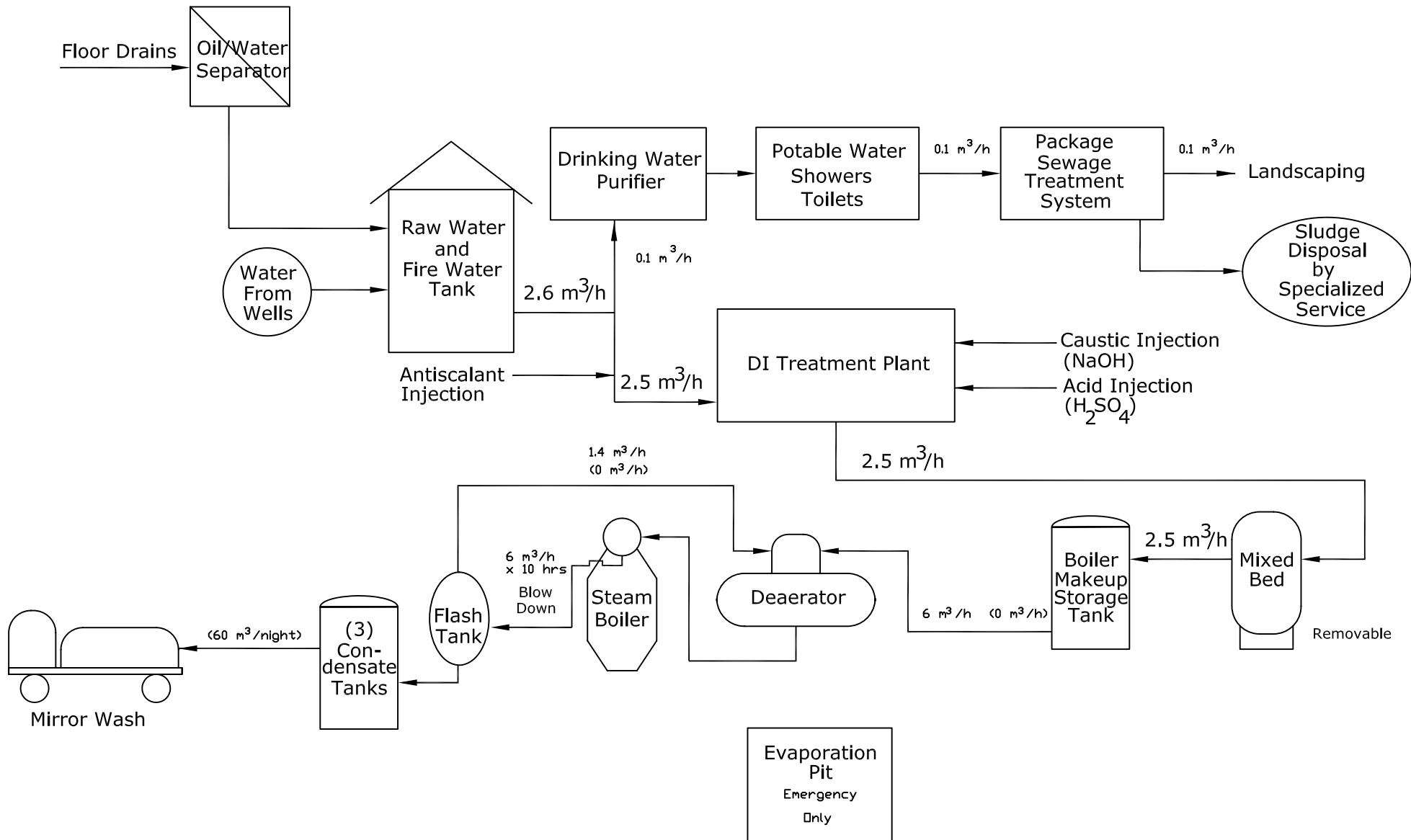
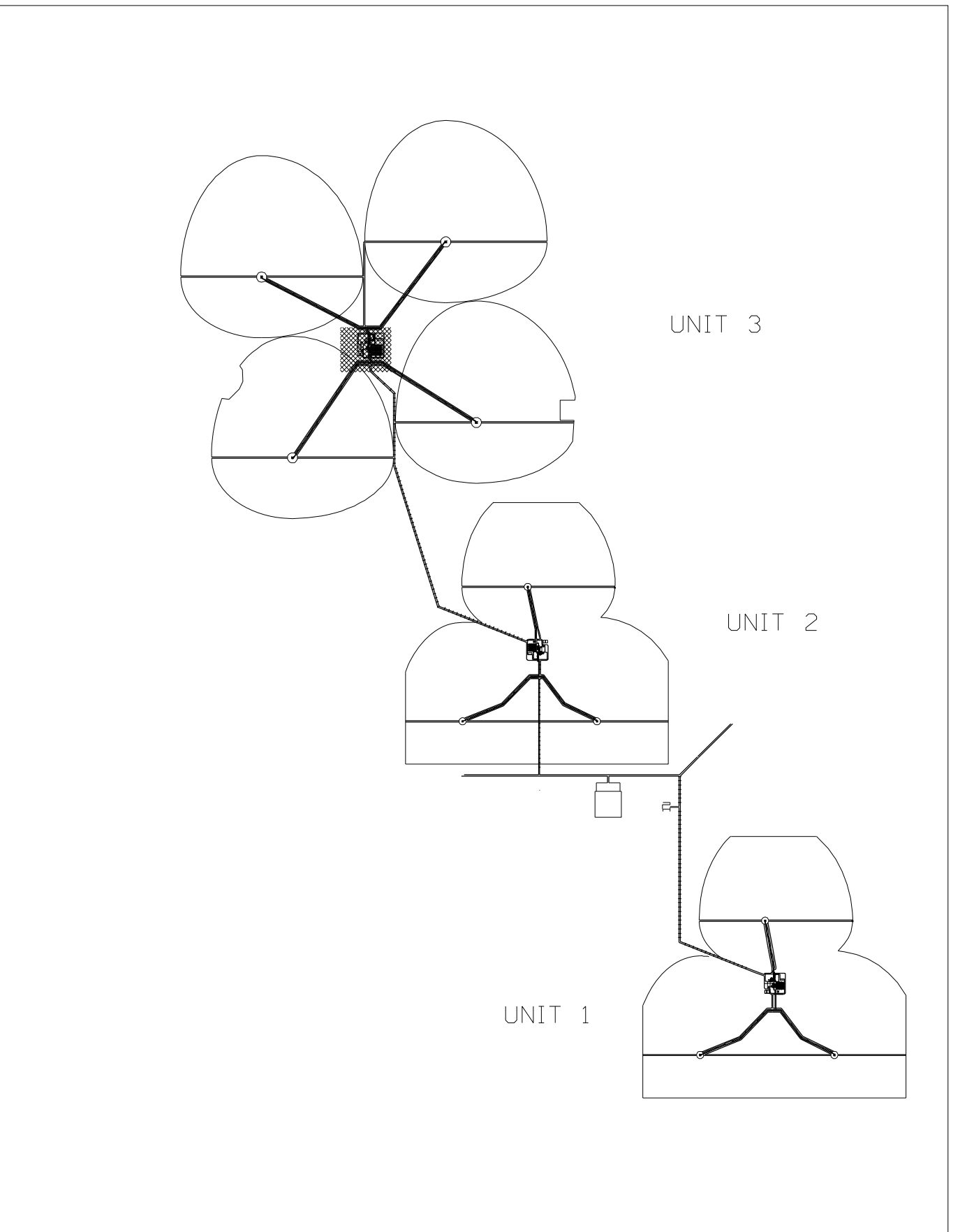
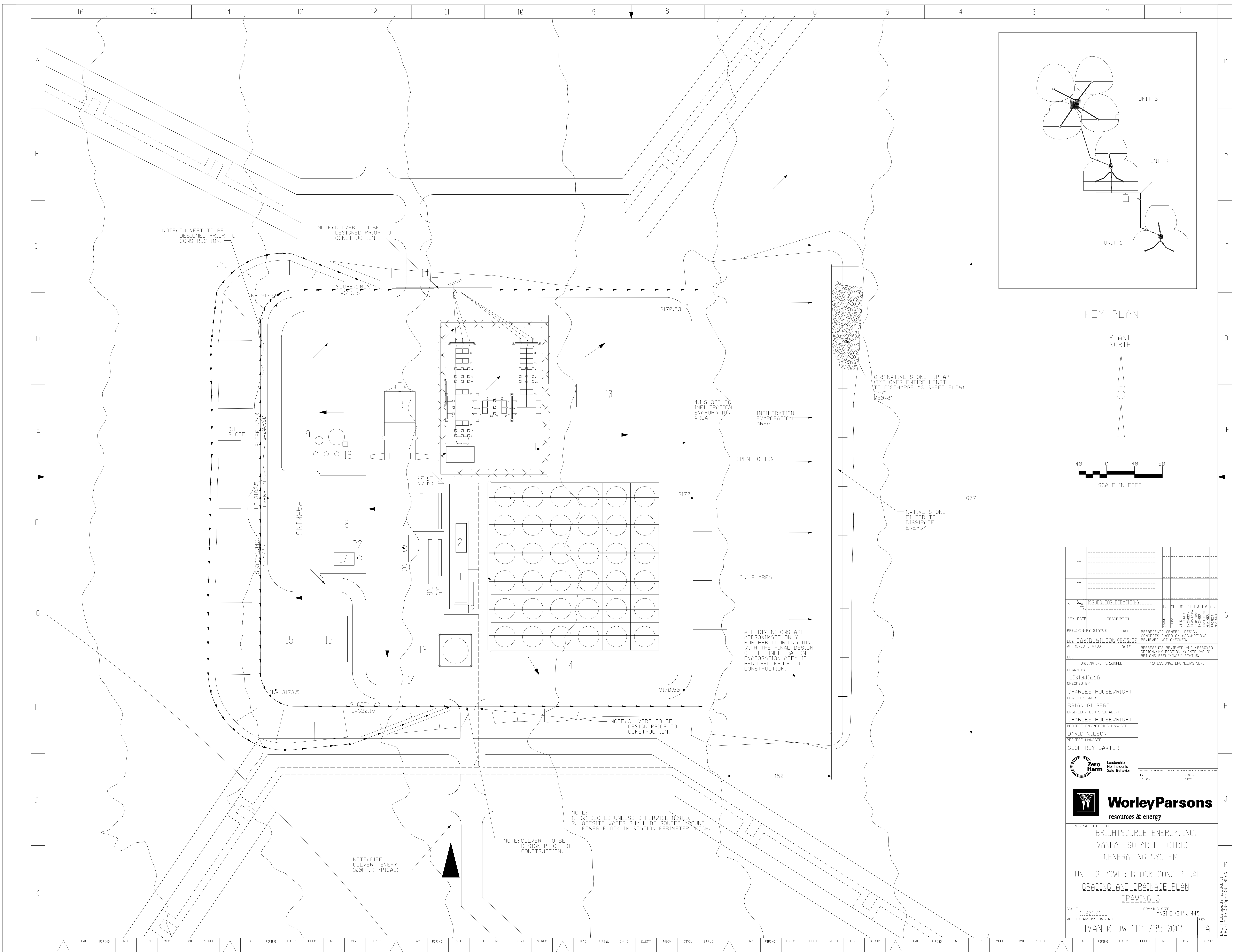

FIGURE 8
100 MW WATER BALANCE
DIAGRAM

IVANPAH SOLAR ELECTRIC GENERATING SYSTEM

Source: DWG 01-PB-F-D-100 Rev A

Drawings



KEY PLAN

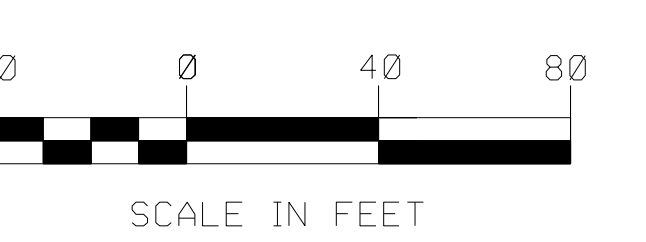
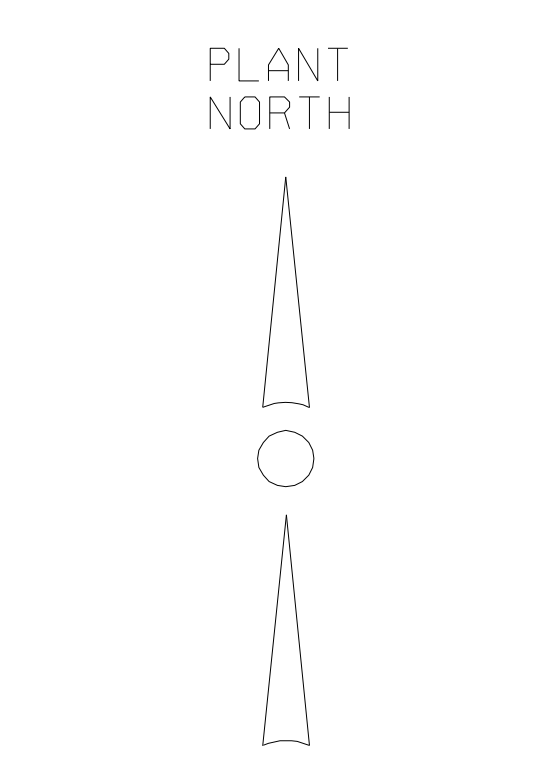

REV	DATE	DESCRIPTION	BY	CHKD	APP'D
A	08/15/07	ISSUED FOR PERMITTING	LJ	CH	DW

PHILIMINARY STATUS DATE REPRESENTS GENERAL DESIGN CONCEPTS BASED ON ASSUMPTIONS. REVIEWED NOT CHECKED.
 LE DAVID WILSON 08/15/07
 APPROVED STATUS DATE REPRESENTS REVIEWED AND APPROVED DESIGN ANY PORTION MARKED "HOLD" RETAINS PRELIMINARY STATUS.
 LE

ORIGINATING PERSONNEL	PROFESSIONAL ENGINEER'S SEAL
DRAWN BY LIXINJIANG	
CHECKED BY CHARLES HOUSEWRIGHT	
LEAD DESIGNER DAVID WILSON	
ENGINEERING SPECIALIST CHARLES HOUSEWRIGHT	
PROJECT ENGINEERING MANAGER DAVID WILSON	
PROJECT MANAGER GEOFFREY BAXTER	

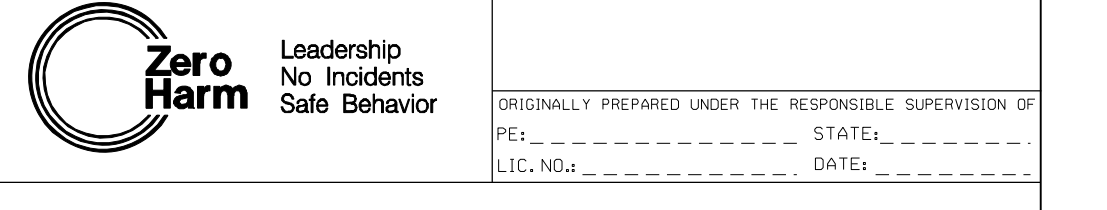

CLIENT/PROJECT TITLE
 BRIGHTSOURCE ENERGY, INC...
 IVANPAH SOLAR ELECTRIC
 GENERATING SYSTEM
 UNIT 3 POWER BLOCK CONCEPTUAL
 GRADING AND DRAINAGE PLAN
 DRAWING 3

SCALE 1"=40'-0" DRAWING SIZE ANSI E (34" x 44")
 WORLEYPARSONS DMC NO. REV
 IVAN-0-DW-112-735-003 A

△	FAC	PIPING	I & C	ELECT	MECH	CIVIL	STRUC	△	FAC	PIPING	I & C	ELECT	MECH	CIVIL	STRUC	△	FAC	PIPING	I & C	ELECT	MECH	CIVIL	STRUC	△	FAC	PIPING	I & C	ELECT	MECH	CIVIL	STRUC	△	FAC	PIPING	I & C	ELECT	MECH	CIVIL	STRUC	△
---	-----	--------	-------	-------	------	-------	-------	---	-----	--------	-------	-------	------	-------	-------	---	-----	--------	-------	-------	------	-------	-------	---	-----	--------	-------	-------	------	-------	-------	---	-----	--------	-------	-------	------	-------	-------	---

