



October 30, 2011

California Energy Commission
Dockets Office, MS-4
Re: Docket No 10-BTSTD-01
1516 Ninth Street
Sacramento, CA, 95814-5512

DOCKET	
10-BSTD-01	
DATE	OCT 30 2011
RECD.	NOV 14 2011

Dear CEC Staff:

Carrier Corporation, a division of United Technologies has review the proposed language posted on the CEC web page as of Oct 24, 2011 and would like to file the following comments and proposed changes.

In section 100.1 – Definitions and Rules of Construction the following changes should be made. There may be some other reference changes that we would recommend that the CEC double check all references and requirements to see if all references have been included.

- For AHRI 210/240 standard there have been some revisions that should be included in the Title 24 Standard. Addendum 1 has already been published and is posted on the AHRInet.org website. Addendum 1 removed the IPLV which is no longer supported by the industry as a part load metric. Addendum 2 which will be released by the end of the years adds the new IEER efficiency part load metric. The changes are shown in green in the modified text below.

AHRI ARI 210/240 is the Air-conditioning, **Heating**, and Refrigeration Institute document entitled “Unitary Air- Conditioning and Air-Source Heat Pump Equipment,” 2003 (ARI 210/240-2003, including Addendum 1 and 2)

- AHRI 340/360 has been updated from the referenced 2000 standard. The referenced standard should be AHRI 210/240-2007 with addendum 1 and 2.

AHRI ARI 340/360 is the Air-**e**Conditioning, **Heating**, and Refrigeration Institute document entitled “Commercial and Industrial Unitary Air-Conditioning and Heat Pump Equipment,” ~~2000~~ 2007 (ARI 340/360-~~2000, 2007, including addendum 1 and 2~~).

- AHRI 365 has been updated and the current version is 2009. The reference should be revised as follows.

AHRI ARI 365 is the Air-**C**eonditioning, **Heating**, and Refrigeration Institute document entitled, "Commercial and Industrial Unitary Air-Conditioning Condensing Units," ~~2002~~ 2009 (ARI 365-~~2002, 2009~~).

- AHRI 550/590 has just been updated to the 2011 version and Title 24 should reference this version of the standard.

AHRI ARI 550/590 is the Air-**c**Conditioning, **Heating**, and Refrigeration Institute document entitled “Standard for Water Chilling Packages Using the Vapor Compression Cycle,” ~~4998~~ 2011 (ARI 550/590-~~98~~2011).

- AHRI 1230-2010 with addendum 1 should be added as a reference using the following text.

[AHRI 1230-2010 with addendum 1 is the Air-Conditioning, Heating, and Refrigeration Institute document entitled Performance Rating of Variable Refrigerant Flow \(VRF\) Multi-Split Air-Conditioning and Heat Pump Equipment](#)

- The reference to ASHRAE 55-2004 is out of date and should be revised as noted.

ASHRAE STANDARD 55 is the American Society of Heating, Refrigerating and Air-Conditioning Engineers document entitled " Thermal Environmental Conditions for Human Occupancy," ~~2004~~ 2010(ASHRAE Standard 55-~~2004~~2010).

In section 110.2 (a) the following exception has been added;

EXCEPTION 2 to Section 110.2(a): Positive displacement (air- and water-cooled) chillers with a leaving evaporator fluid temperature higher than 32°F, shall show compliance with Table 110.2D when tested or certified with water at standard rating conditions, per the referenced test procedure.

This requirement appears to have been copied from the ASHRAE 90.1-2010. This is really not an exception to the ratings and should be shown as a requirement which defines the scope of the efficiency table 110.2D

In section 110.2 (c) 2 the following statement does not seem to make sense. Should the requirement be “shall include” instead of “shall not include”

2. Upgradeable Capabilities. USTs shall ~~not~~ include onboard communication devices and shall have at least one expansion port which will allow for the installation of a removable module to enable standards based communications (included but not limited to ZigBee, WiFi) and standards based messaging protocols (SmartEnergy Profile (SEP),.....

There are several issues with the proposed modifications to table 110.2-A which are listed below;

- There are no listed efficiencies for air cooled products less than 65K. They should be added to the table
- Efficiency increases have been added for 65K to 135K and 135K to 240K in 1/1/2015. These products are under federal control and this will violate federal preemption.
- Table is still showing IPLV's which are not longer supported by the AHRI 340/360 standard and the certification programs. The table needs to be revised to include the new IEER metric. The values can be obtained from the ASHRAE 90.1-2010 table. The latest version of this table has been modified by the ASHRAE 90.1 addendum j. We have included a copy of the approved addendum j.
- Several products are missing from the table and the requirements for water and evaporatively cooled and air cooled and water cooled condensing units have changed. Refer to the ASHRAE 90.1 addendum j.
- Note b is out of date and should be changed to IEER. We would recommend the ASHRAE 90.1 table format be used where the heating products are covered directly in the table and not in a footnote.

There are several issues with the proposed modifications to table 110.2-B

- There are no listed efficiencies for air cooled products less than 65K. They should be added to the table
- Requirements are shown for 2015 but they are the same as before 2015. If they were to be higher in 2015 this would be a violation of federal standards so the column should be removed.
- Table is still showing IPLV's which are not longer supported by the AHRI 340/360 standard and the certification programs. The table needs to be revised to include the new IEER metric. The values can be obtained from the ASHRAE 90.1-2010 table. The latest version of this table has been modified by the ASHRAE 90.1 addendum j. We have included a copy of the approved addendum h.

- Several product categories are missing from the table and we recommend you adopt the ASHRAE 90.1 table as shown in addendum h to the ASHRAE 90.1-2010 standard.

There are also some errors in table 110.D. The issues are listed below.

- Only the IPLV is listed for the air cooled with condenser >150 tons and it is not correct at 3.05 IPLV. Need to add the full load efficiency at 9.562 as well as correct the IPLV to 12.750 Refer to the ASHRAE 90.1 2010 standard for details.
- The footnotes have several errors. It shows the requirements for centrifugals apply only to products with a fluid temperature less than 36 F. Should be greater than 36 F.
- It shows the requirements for positive displacement to be less than 32 F. Should be greater than 32 F
- Recommend you take the footnotes directly from ASHRAE 90.1-2010 table 6.8.1D

There are issues with 110.E. The issues are listed below.

- There are some corrections to wording and notes in the ASHRAE 90.1-2010 addendum i that should be corrected in table 110.E as these products are federally controlled and the requirements should be the same.
- The requirements for SPVAC product will increase on 1/1/2012 and these values should be used in the table as they are federally controlled.

In section 110.2 several tables are missing for new product efficiency requirements that have been defined by ASHRAE 90.1 and federal requirements.

- Requirements for VRF equipment are missing which are federally controlled for full load efficiency. Refrigerant ASHRAE 90.1-2010 table 6.8.1H and table 6.8.1J
- ASHRAE 90.1 has added a new requirement for air conditioners and condensing units serving computer rooms. Should add the table to Title 24. Refer to ASHRAE 90.1-2010 table 6.8.1K
- ASHRAE 90.1 has added requirements for refrigeration equipment which is defined in table 6.8.1M and table 6.8.1 L. These are documented in the ASHRAE addendum g to the ASHRAE 90.1-2010 standard.

In section 120.3 for pipe insulation the proposal has picked up the new requirements for pipe insulation but many of the footnotes have not been included. Suggest you review the footnotes in ASHRAE 90.1-2010 and add them to Title 24

In section 120.5 (a), 4 there is an exception that allows for manufacturer certified economizers to be exempt from field testing. The issue is that the industry does not understand how to get an economizer certified as there are no defined requirements for the certification. Some requirements need to be added.

In section 140.4 (c), 2B the requirements for VAV fans with motors greater than 10HP has been eliminated. We believe you intended to lower the threshold for motors but there is no language replacing the text so you are exempting VAV fans from meeting the requirements which does not make sense.

In section 140.4 (c) 4 a requirement for HVAC motors and fans to be electronically commutated does not make sense the way it is worded. The wording is confusing Suggest you change as noted below. Suggest you also remove the requirement for remote control in the field or that you add some exceptions for packaged equipment. Overriding the control in an HVAC units can void the warranty and cause operation problems.

Fractional HVAC Motors for Pumps and Fans. Fan motors of series fan-powered terminal units. HVAC motors for pumps or fans that are ~~Fan motors of series fan-powered terminal units 1 hp or less and 1/12 hp or greater~~ **greater than 1/12 HP and less than 1 HP** shall be electronically-commutated motors or shall have a minimum motor efficiency of 70 percent when rated in accordance with NEMA Standard MG 1-2006 at full load rating conditions. ~~These motors shall also have the means to adjust motor speed for either balancing or remote control in the field.~~

In section 140.4 (e) 1 there are new requirements extending the economizer to lower capacities. We don't see the need for the additional 1800 cfm as it will result in units larger than 54,000 Btu/h to be exempted when they run cfm/ton flow rates less than 400 cfm/ton which is common in the applications today. In fact the average unit is more like 350 cfm/ton which would raise the capacity to 61,714 Btu/h and at 300 cfm/ton which is also used would raise the limit to 72,000 Btu/h. We recommend you make the following modifications.

Each individual cooling fan system that has a design ~~supply capacity over 2,500~~1,800 cfm and a total mechanical cooling capacity over ~~7554,000~~54,000 Btu/hr shall include either:

In section 140.4 (e) 2 ii The requirements in this section are not economically justified and far exceed the payback periods. The justification for the change was lumped into the change to expand the 2 speed fan down to 65,000 Btu/h which is justified, but the analysis was not show separately for the modulating capacity requirement. The requirement was proposed because of some field problems with integrated economizers which was due to control logic issues. The industry tried to explain this to the proposer of the comment, but there was very little dialog with the manufacturers of the equipment. The issue of the integrated economizers can be solved with control logic which is already in production on some commercial available equipment in the market. The proposer of the change recommended variable capacity down to 20% which will require the use of very expensive variable capacity equipment that will impact the full load performance and possibly federal preemption as well as decrease the part load efficiency if the digital scroll is used which was the basis of the costs supplied by AHRI. The proposer also claimed that equipment is already available and listed several products below 65K capacity, but the proposal is for 65K and above. There are some compressor available but only the Copeland digital will unload to 20% but will decrease part load efficiency. Also the noise can increase as much as 10 dba. We would propose the following alternate wording which results in much lower cost and equal or better efficiency and much better payback. Carrier has conducted a detail analysis of the proposed change that was also submitted to ASHRAE 90.1. Attached you will find a copy of the analysis with some additional comments related to the Title 24 proposal. We found many assumption errors in the analysis that was done for Title 24

~~ii. Effective January 1, 2015, direct expansion systems with a cooling capacity \geq 65,000 Btu/hr^a shall be capable of staging or modulating capacity in increments of no more than 20% of total cooling capacity. Controls shall not false load the mechanical cooling system by limiting or disabling the economizer or any other means, such as hot gas bypass, except at the lowest stage of cooling capacity.~~

Effective January 1, 2015, direct expansion systems with a cooling capacity \geq 54,000 Btu/hr^a shall have mechanical capacity control that is interlocked with the economizer control such that the economizer does not begin to close until the unit leaving air temperature is less than 45 F. All constant volume units with a capacity \geq 75,000 Btu/hr including 2 speed fan systems must have a minimum of 2 stages of mechanical cooling. All variable air volume units must have a minimum of 4 stages or variable capacity with a minimum capacity of 25%

In section 140.4 (e) 4 There are new requirements for air economizers that require prescriptive requirements for capacities greater than 45,000 Btu/hr and 1,500 cfm. This appears to require economizers to lower capacities than 140.4 (e) 1. The requirements should be modified to reflect the requirements of 140.4 (e) 1. We recommend the following changes;

~~Air economizers and return air dampers on an individual cooling fan system that has a design supply capacity over 1,500 cfm and a total mechanical cooling capacity over 45,000~~ 54,000 Btu/hr shall have the following features:

In section 140.4 (e) 4 A Are the requirements for warranty parts and labor or just parts which is the typical industry warranty. Don't recall seeing the economic justification for this. There are issues with economizers but many are due to commissioning and routine maintenance.

In section 140.4 (e) 4 B- Many of the dampers in units today are direct drive, but there are many air handlers that it is not practical to have direct drive. The requirements should be performance and not prescriptive. For example the warranty requirements cover this requirement.

In section 140.4 (e) 4 G – Good idea to add sensor accuracy, but it is not clear if the requirements are +/- tolerances which are typical methods used to define accuracy. Also would be good to define the range of conditions where the accuracy is required. For example accuracy of +/-1 F is not critical at temperatures greater than 80 F or at low temperatures.

In section 140.4 (e) 4 H – Field calibration of sensors is not a great idea to do in the field as it requires accurate instrumentation to calibrate the sensors which are not typically available in most service trucks.

In section 140.4 (e) 4 J – Relief air systems typically do not have to supply 100% relief as there is always some building leakage and local exhaust. Typically the industry uses 90%. Suggest you change the requirement to 90%

Table 140.4(e)-A defines new requirements for economizer tradeoff for unitary air conditions. It is not clear if the requirements are EER or IEER. It makes no sense to use EER as a means to determine if an economizer can be eliminated. Economizers only work at part load and therefore the IEER is a better metric to use. We recommend that you remove the proposed table and replace with the ASHRAE 90.1-2010 tradeoff table that was developed based on energy analysis using the IEER and IPLV. The ASHRAE 90.1 method would have to be adopted for the California climate zones, but we would be glad to help with this. The other benefit is that the ASHRAE 90.1-2010 method also allows for the tradeoff to be used for water economizers, and other than just unitary products. Refer to ASHRAE 90.1-2010 table 6.3.2 which is shown below.

TABLE 6.3.2 Eliminate Required Economizer for Comfort Cooling by Increasing Cooling Efficiency

Climate Zone	Efficiency Improvement ^a
2a	17%
2b	21%
3a	27%
3b	32%
3c	65%
4a	42%
4b	49%
4c	64%
5a	49%
5b	59%
5c	74%
6a	56%
6b	65%
7	72%
8	77%

^a If a unit is rated with an IPLV, IEER or SEER then to eliminate the required air or water economizer, the minimum cooling efficiency of the HVAC unit must be increased by the percentage shown. If the HVAC unit is only rated with a full load metric like EER or COP cooling then these must be increased by the percentage shown.

In table 140.4 (e)-C there use of fixed enthalpy, electronic enthalpy and differential enthalpy have been eliminated based on the Taylor paper presented to ASHRAE, but in section 140.4 (e) 4 G accuracy requirements have been

added for enthalpy and humidity. Requirements seem to have been based on old accuracy and not the new accuracy requirements. Also for fixed enthalpy +fixed drybulb the requirements are >28 Btu/lb or TOA>75 F. In effect the air temperature will override the enthalpy and essential make the enthalpy non function. This could result in high interior moisture levels in humid climate zones for constant volume, variable temperature systems and exceed ASHRAE 62.1 recommendations for interior moisture levels to prevent the growth of mold. Requirements should be modified to state that the lower of the two requirements assuming that the outdoor humidity with 75 F is 100%.

In section 140.4 (h) 2 ASHRAE 90.1-2010 has recently revised the requirements for 2 speed fans for cooling towers as very few companies are using this method and have gone to variable speed fan control. Shown is the ASHRAE 90.1 requirements as defined in a new addendum. It also includes requirements for tower turndown control that should be included in Title 24.

Fan Speed Control. Each fan powered by a motor of 7.5 hp (5.6 kW) or larger shall have the capability to operate that fan at 2/3 of full speed or less, and shall have controls that automatically change the fan speed to control the leaving fluid temperature or condensing temperature/pressure of the heat rejection device.

6.5.5.2 Fan Speed Control.

6.5.5.2.1 Each fan powered by a motor of 7.5 hp or larger shall have the capability to operate that fan at two-thirds of full speed or less and shall have controls that automatically change the fan speed to control the leaving fluid temperature or condensing temperature/pressure of the heat rejection device.

Exceptions:

- a. Condenser fans serving multiple refrigerant circuits.
- b. Condenser fans serving flooded condensers.
- c. Installations located in climate zones 1 and 2.
- d. ~~Up to one third of the fans on a condenser or tower with multiple fans, where the lead fans comply with the speed control requirement.~~

6.5.5.2.2 Multiple cell heat rejection equipment with variable speed fan drives shall:

- a. Operate the maximum number of fans allowed that comply with the manufacturer's requirements for all system components and
- b. Control all fans to the same fan speed required for the instantaneous cooling duty as opposed to staged (on/off) operation. Minimum fan speed shall comply with the minimum allowable speed of the fan drive system per the manufacturer's recommendations.

In section 140.4 (m) The requirements for single zone systems and variable volume systems have some issues and we propose the following modifications. We have done a study of a similar proposal for ASHRAE 90.1 and you will find the study that was done for ASHRAE 90.1 with some additional slides to relate it to the study done for Title 24. The following is a proposal that likely will get support from the industry and actual will result in equal or more savings than the current proposal.

Current Proposal

Fan Control. Each multiple zone system and single zone system listed in Table 140.4-D shall be designed to vary the airflow rate as a function of actual load. Single zone systems shall have controls and/or devices (such as two-speed or variable speed control) that will result in fan motor demand of no more than 50 percent of design wattage at 66 percent of design fan speed. Multiple zone systems shall include controls that limit the fan motor demand to no more than 30 percent of the total design wattage at 50 percent of design air volume when static pressure set point equals 1/3 of the total design static pressure. ~~Variable air volume control for single zone systems. Effective January 1, 2012 all unitary air conditioning equipment and air handling units with mechanical cooling capacity at ARI conditions greater than or equal to 110,000 Btu/hr that serve single zones shall be designed for variable supply air volume with their supply fans controlled by~~

~~two-speed motors, variable speed drives, or equipment that has been demonstrated to the Executive Director to use no more energy. The supply fan controls shall modulate down to a minimum of 2/3 of the full fan speed or lower at low cooling demand.~~

Alternate Proposal.

Each multiple zone system listed in table 140.4-D shall be designed to vary the airflow rate as a function of the load such that the fan motor demand is less than 20% at 50 percent of the design air volume when static pressure set point equals 1/3 of the total design static pressure. Variable air volume units shall have a minimum of 4 stages with a minimum stage of 25% or less.

For single zone systems with air-handling and fan-coil units with chilled-water cooling coils and supply fans with motors greater than or equal to 1 hp shall have their supply fans controlled by two-speed motors or variable-speed drives. At cooling demands less than or equal to 50% for proportionally controlled units and for 2 stage control units operating on the first stage, the supply fan controls shall be able to reduce the airflow to no greater than the larger of the following:

One half of the full fan speed, or

The volume of outdoor air required to meet the venti-lation requirements of Standard 62.1.

When operating at 50% airflow the fan motor demand shall be less than 25% of the full demand.

All single zone air-conditioning equipment and air-handling units with direct expansion cooling and a cooling capacity at AHRI conditions greater than or equal to 75,000 Btu/h shall have their supply fans controlled by two-speed motors or variable-speed drives. Constant volume units at cooling demands less than or equal to 50% for proportionally controlled units and for 2 staged controlled units operating on first stage, the supply fan controls shall be able to reduce the airflow to no greater than the larger of the following:

Two-thirds of the full fan speed, or

The volume of outdoor air required to meet the venti-lation requirements of Standard 62.1.

When operating at 66% airflow the fan motor demand shall be less than 35% of the full demand.

Both the chilled water and DX units shall also have a minimum of 2 stages of capacity and shall be capable of operating the economizer, if required, with 2 stage fan speed control with operation at low speed when the economizer capacity is less than 50%.

Table 140.4(m)-A also needs to be modified. The ¼ HP is probably not economically justified as the justification document did not include controls and modulating or 2 stage water valves so as noted above we limited the proposal for chilled water coils to 1 HP until additional studies can be validated by the industry. Also it is impossible for the industry to react to some of dates that are effective 1/1/2012 that were not previously defined. We propose that the table be revised as shown below

TABLE 140.4(m)-A – EFFECTIVE DATE FOR VARIABLE AIRFLOW CONTROL OF FAN SYSTEMS

<u>Cooling System Type</u>	<u>Fan Motor Size</u>	<u>Cooling Capacity</u>	<u>Effective Date</u>
<u>Direct Expansion</u>	<u>any</u>	<u>≥ 110,000 Btu/hr</u>	<u>1/1/2012</u>
<u>Direct Expansion</u>	<u>any</u>	<u>≥65,000 Btu/hr</u>	<u>1/1/2015</u>
<u>Chilled Water</u>	<u>≥5 HP</u>	<u>any</u>	<u>1/1/2012</u>
<u>Chilled Water</u>	<u>≥1 HP</u>	<u>Any</u>	<u>1/1/2015</u>
<u>Evaporative Cooling</u>	<u>≥5 HP</u>	<u>any</u>	<u>1/1/2012</u>
<u>Evaporative Cooling</u>	<u>≥1 HP</u>	<u>Any</u>	<u>1/1/2015</u>

In section 140.9 there are new requirements for computer rooms. In 140.9 (a) 5 there are requirements for unitary fan control. The requirements should just reference the requirements of 140.4 (m) as modified by this document.

If you have any questions or would like to discuss some of the requirements please let me know. We would be willing to have a conference call or even a face to face meeting. Others manufacturers in the industry would also be more than willing to do the same. We do have serious concerns about some of the requirements especially associated with the modulating capacity for unitary products down to 65,000 Btu/hr

Richard Lord

A handwritten signature in black ink that reads "Richard Lord". The signature is written in a cursive style with a large, looping initial "R".

Carrier Fellow
Carrier Corporation

**FAN CONTROL AND INTEGRATED
ECONOMIZER TITLE 24 PROPOSAL
CARRIER COMMENTS**

10-30-2011

Richard Lord

Carrier Corporation

Introduction

- The following presentation is a summary of the analysis work that Carrier Corporation has done regarding the Fan Control and Integrated Economizer Proposed changes to Title 24
- The analysis was done to validate a similar proposal that has been proposed to ASHRAE 90.1 at the Oct 2011 interim meeting.
- The proposals are very similar and therefore the analysis should be applicable to the changes being proposed to Title 24
- Carrier has filled official comments on the proposal to Title 24 and this document provides backup details.
- We have updated the presentation to reflect additional comments regarding the latest Title 24 justification document dated

Executive Summary

- Overall the Carrier and industry do not support the proposal as currently written and this has been communicated thru AHRI as well as Carrier comments
- The proposal should have been separated into two separate proposal so 2 speed fan and integrated economizer could be evaluated on it's own merit.
- It is likely that the industry will support the fan speed proposal, but will not support the variable capacity as it is not economically justified.
- It is claimed that products are available but they are very high tier products and are only available in small sizes less than the capacity range of the proposal. This proposal is essentially specifies products that current do not exist and are not planned for production.
- The economizer integrated issues can be solved in a much more cost effective manner using control logic and does not require modulating capacity control on constant volume and 2 speed units.
- We do agree that at a minimum 4 stages of capacity control should be required on VAV units, but that alone will not fix integrated economizer issues and controls changes are also need.
- There has been very little discussion with the industry and AHRI, but the industry would be very willing to entering into discussion to arrive at a more practical proposal.
- This document includes an alternate proposal which we believe an industry consensus as well as a national implementation could be developed.

Integrated Economizer Analysis

Economizer Cycling

- In the Title 24 justification document dated September 2011 and the ASHRAE 90.1 October 2011 justification for the integrated economizer proposal a plot of cycling problems with an economizer was documented and this is driving the proposal for capacity modulation down to 20% actual capacity
- The unit in question was a VAV unit and already had capacity control down to 25%
- Extending capacity control down to 20% as proposed will not solve the problem.
- The problem with this unit is that the economizer and capacity control are controlling to the same temperature sensor, but appear not to be link in software which results in one overriding the other and causing the cycling
- What would solve the problem is linking the economizer and compressor control such that the dampers are locked open during integrated compressor operation. In fact the manufacturer of this unit agrees a change is needed and they are working on new logic.
- There are many products on the market today that do this and do not have the problem as mentioned.

Economizer Cycling

- For constant volume units and even the new 2 speed fan units the airflow will be at full cfm when in economizer mode and integrated compression is required so the amount of capacity control is not as critical as the VAV units where the cfm is reduced during the economizer cycle.
- There are many control routines in use that limit the cycling and in fact these were simulated in the economizer proposal that we approved for the 2010 ASHRAE 90.1 Standard and which is now be considered for Title 24.
- Some of these are;
 - Lock the dampers open and only cycle the economizer when the leaving air temperature drops below 40-45 F
 - Lock the dampers open and then modulate them closed proportionally between 55 F and 45 F
 - Set the economizer set point low, 50-53 F and then when Y2 comes on it will not override the economizer
- It is beneficial to have two stages of compression control, which many of the larger units have.

Equipment Configurations

- It is important to understand the types of equipment that are involved
- In the next few slides we have included some system diagrams of typical chilled water and DX systems as well as constant volume and VAV systems
- There should be different requirements for VAV (variable air volume constant temperature) and CV (constant volume, variable temperature)
- Most of the units in the <240K capacity range are current constant volume and above 240K they begin to transition to VAV and are mostly VAV in the 760K and larger units.
- Also there should be different requirements for chilled water and DX systems due to the way the mechanical cooling is provided.

Background – Equipment Configurations

Typical Large VAV Chilled Water System

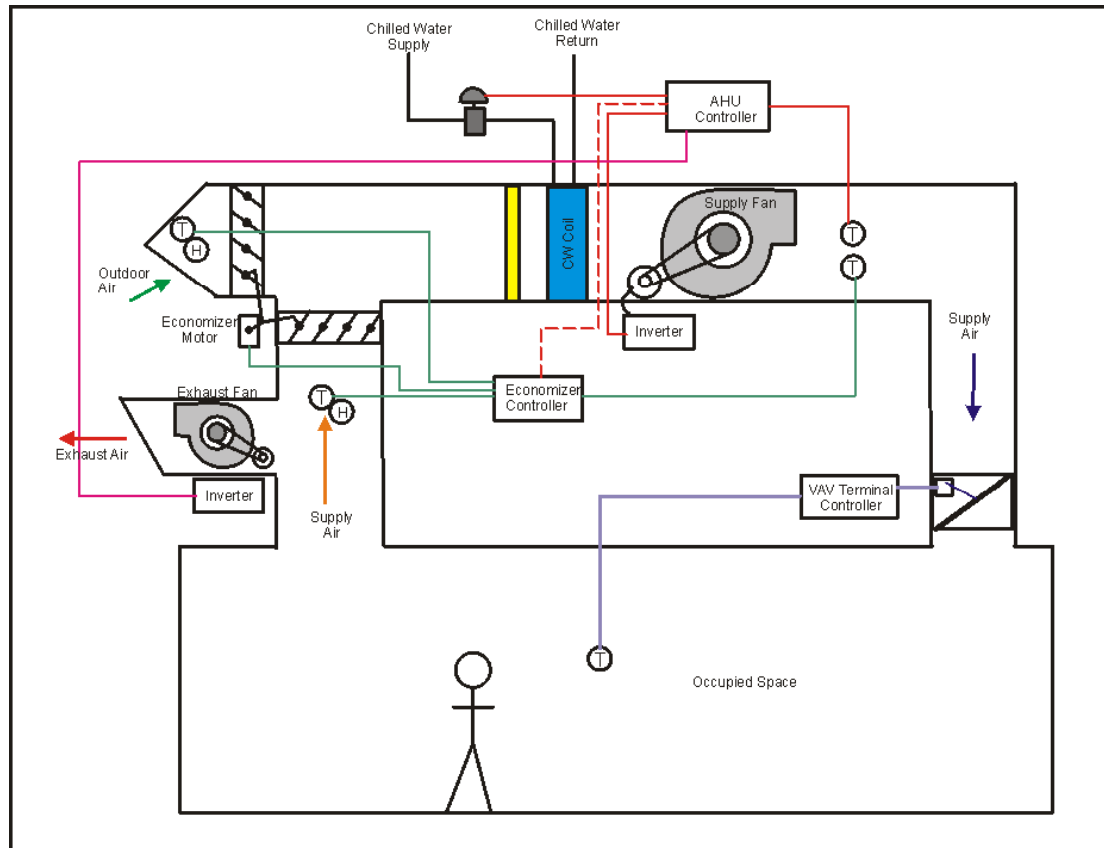

Typically supply air set point is 55 F and is used for both the economizer and chilled water coil

ASHRAE 90.1 Supply Reset

6.5.3.4 Supply-air temperature reset controls. Multiple zone HVAC systems must include controls that automatically reset the supply-air temperature in response to representative building loads, or to outdoor air temperature. The controls shall reset the supply air temperature at least 25 percent of the difference between the design supply-air temperature and the design room air temperature. Controls that adjust the reset based on zone humidity are allowed. *Zones* which are expected to experience relatively constant loads, such as electronic equipment rooms, shall be designed for the fully reset supply temperature.

Typical Reset

Supply air set point = 55 F

Space set point = 75 F

Max Reset = $.25 \times (75-55) = 5$ F

Max Reset Temperature = 60 F

Because the VAV system cfm is a function of the building load, I found that for the benchmark buildings the average maximum cfm during economizer operation is around 50% so the full benefit of economizers is not obtained. Reset which is required up to around 60 F helps.

Background – Medium Packaged Rooftop

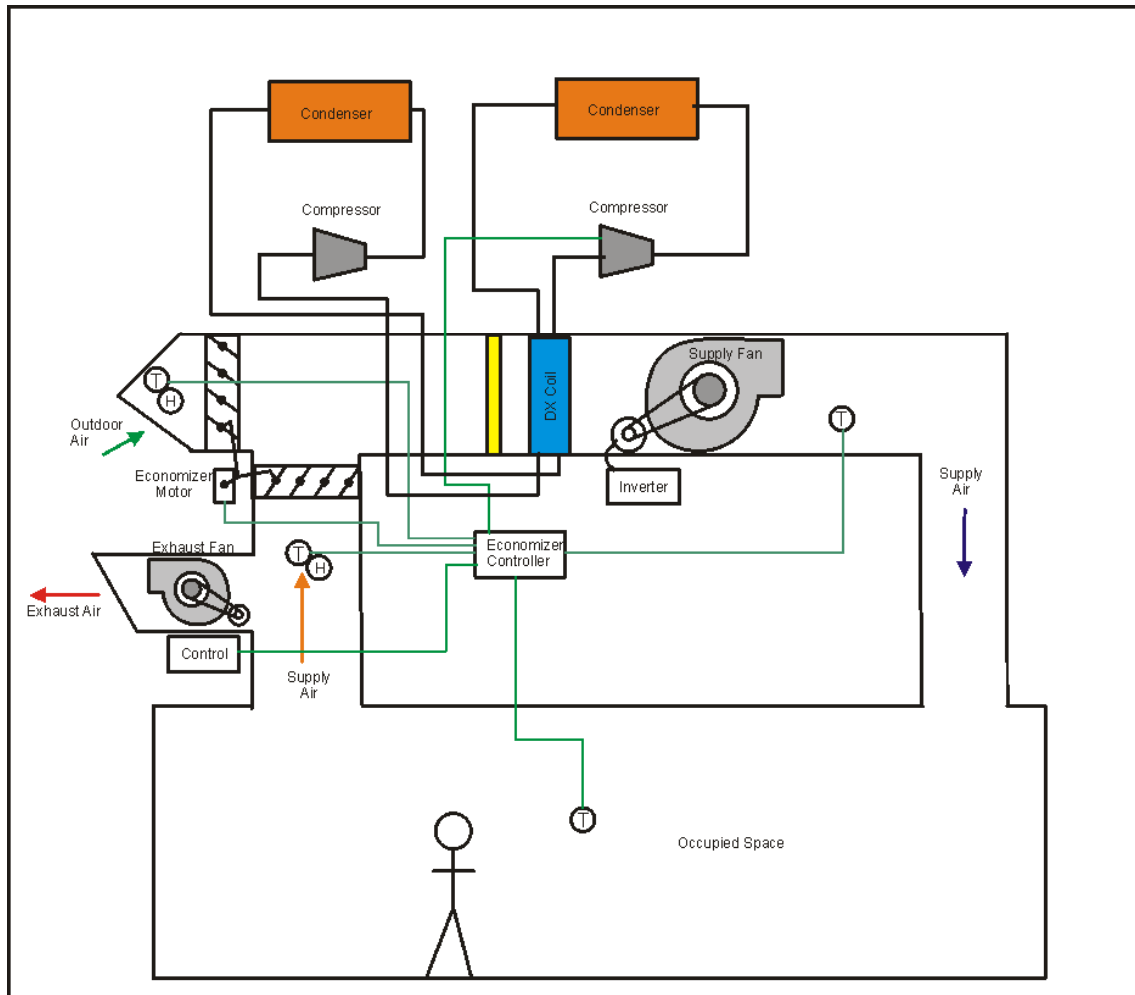

For the large units many units use a 2 compressor design, but each compressor is in a separate circuit with a face split coil

Again they are mostly constant volume and are controlled directly by a thermostat.

Most of the units in the 65K to 110K capacity range are constant volume units. In fact most units up to around 240K are constant volume.

Reference Problem Equipment Data

This is a referenced justification temperature trace from a VAV units that had a minimum capacity step of 25% where the dampers and compressor were fighting each other

Figure 2 – AC Unit Control – M5 AC-2.2C

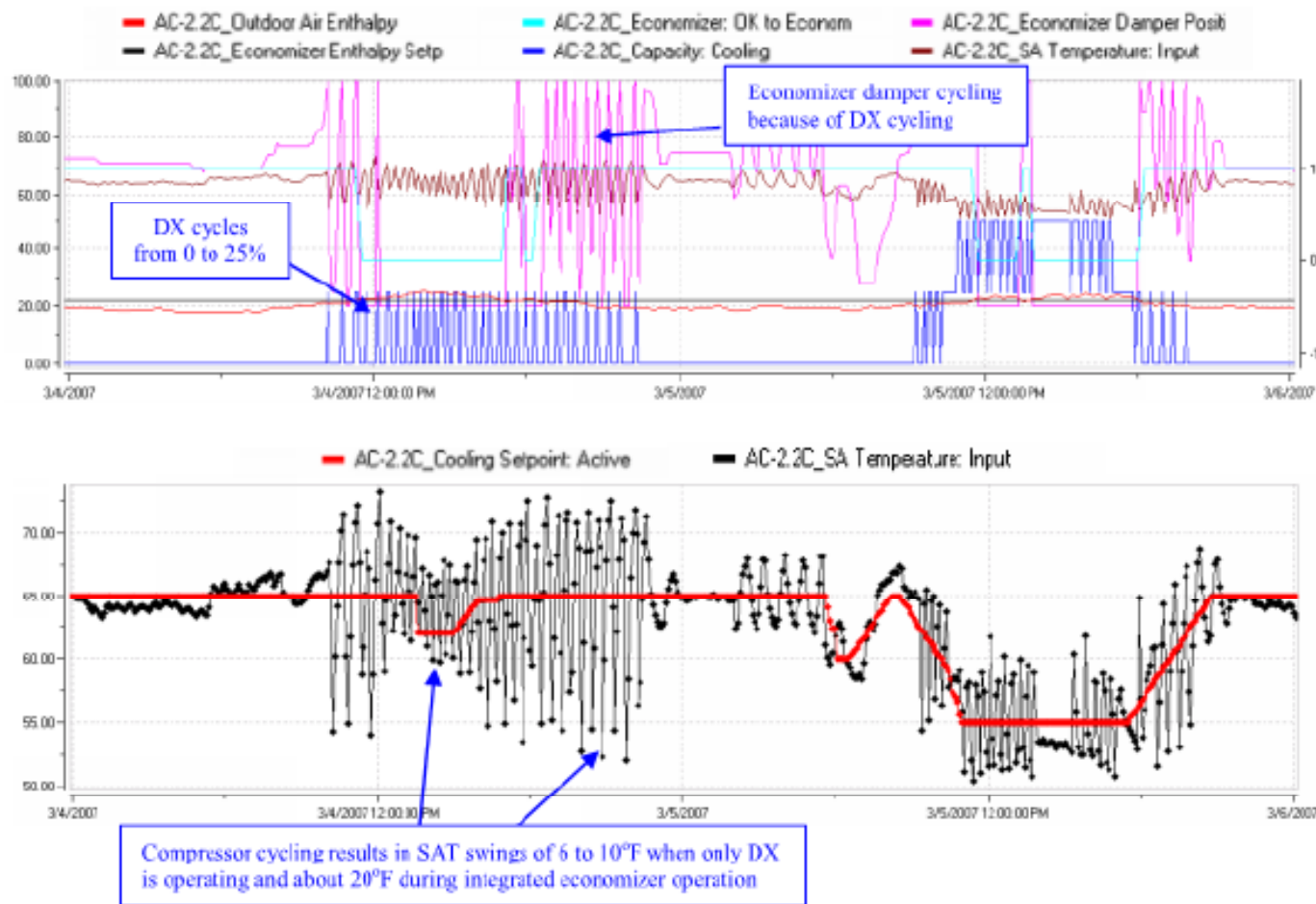

This is a VAV units that already has 4 stages of capacity and just dropping the capacity control to 20% from 25% will not solve the problem. It require controls changes

Typical 5 Ton Single Stage Rooftop

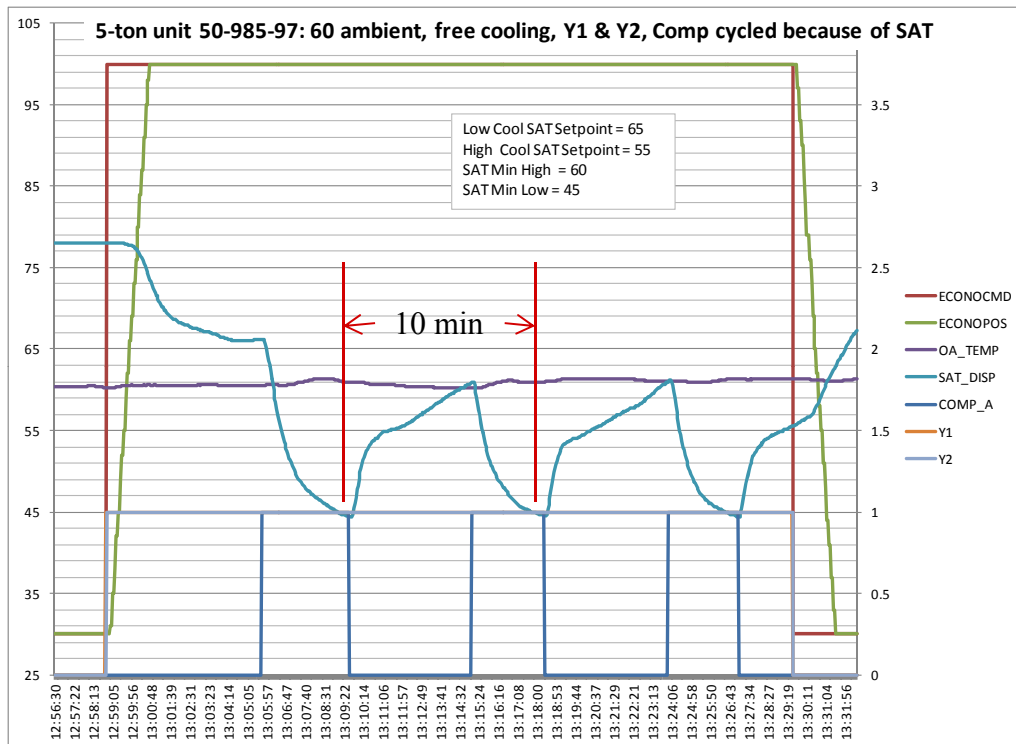

This is a trace from an actual Carrier 5 ton unit with a single compressor where the dampers are locked open and the compressor cycles on and off at duty cycle of around 10 minutes. There is degradation in performance due to the lower suctions and cycling but this was reflected in the original ASHRAE 90.1 economizer analysis and is significantly less than the assume used for the Title 24 and ASHRAE justification which assume a 25% loss in all economizer operation

Addition of two stages of capacity will further improve this and many of the units already have two mechanical stages

This the worst case with a single compressor but it shows with proper controls that the full benefit of the economizer is obtained

Integrated Economizer Example

The following shows the building load profile for the 5,400 ft² office building in San Francisco which is a high economizer use climate zone. Highlighted are the operating hours where economizer only can satisfy the load, economizer plus compressors are used (integration) and compressor only are used (mechanical cooling).

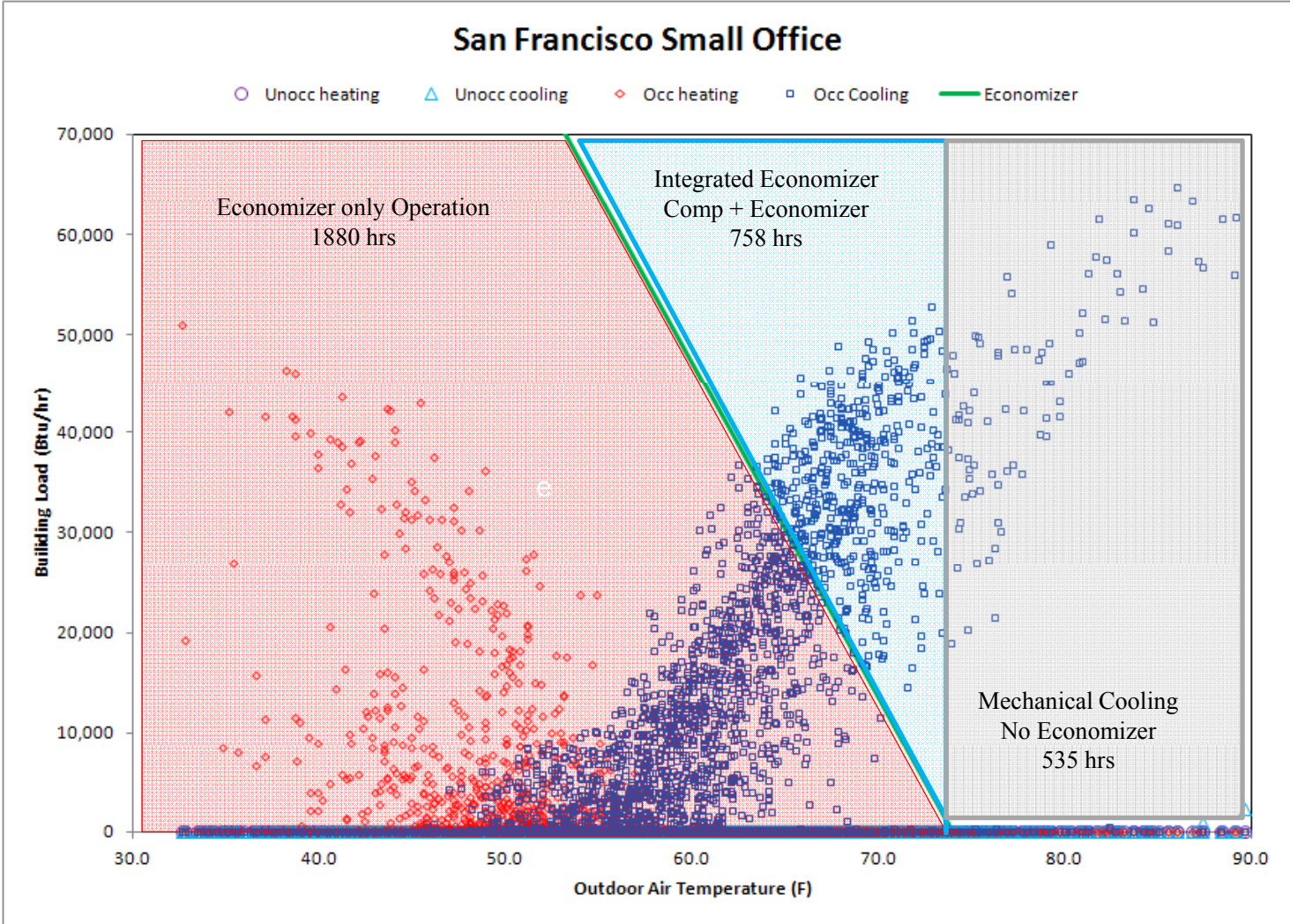

Integrated Economizer

- In the title 24 analysis the cycling economizer was estimated used 75% of the economizer energy savings determine by comparing energy with a full integrated economizer and no economizer. A different approach was used for the ASHRAE 90.1 justification.
- In the prior building load plot this results in only taking credit for 1978 hrs of economizer and essential giving no energy savings at all to integrated operation and actual de-rates some of the economizer only operation.
- It actual is more of a derate as the power savings at low ambient are more and the 25% de-rate was done on power so essential the analysis taken too much credit for integrated economizer issues
- In addition we have found that the modeling tools used do not really model DX equipment used today very accurately especial during integrated economizer operation
- You will find in the following pages a detailed analysis with actual hour by hour simulation of the Carrier integrated economizer with cycling compressors which shows a 425 kW-h power increase over an ideal economizer.
- Using the Title 24 electric rate of \$.16/kW-hr this amounts to \$68/yr savings which is a 24 year payback
- Using ASHRAE 90.1 electric rate of \$0.093/kW-hr this amounts to 41 year payback.
- This is the best zone for economizers and demonstrates that the incremental cost of the variable capacity can not be justified when compared to an accurate model of properly controlled integrated economizer

Study Proposal Assumptions & Claims

Integrated Economizers

- The proposal justifications claims that the addendum CY economizer proposal assumed full integrated economizers.
- This is not correct and the economizers were de-rated when the supply air temperature went below 55 F which is a conservative estimate.
- For the CMP analysis it was assumed that the integrated cycle would result in the loss of all integrated economizer energy savings which is grossly overstated

Conclusions for Integrated Economizers

- Using modulating compressors on constant volume is not necessary and will be a very expensive option compared to controls based solutions that are essentially very low to no cost options.
- Modulating capacity down to 25% or even lower on VAV units is important and in fact should be lower, but controls requirements are still needed to interlock the compressors and economizers
- We believe that a single compressor with an economizer is not ideal and would recommend to improve economizer integration that 2 compressor stages are used along with requirements on controls similar to what is required in ASHRAE 189.1
- The proposal also poor approach and should not define how equipment is design, but should define performance requirements.

MODULATING COMPRESSOR CAPACITY CONTROL

Modulating Compressor Capacity

- Many claims were made throughout the Title 24 justification and ASHRAE 90.1 justification that are not correct.
- Modulating compressors are starting to be used and they have some advantages for temperature control, especially on VAV systems, but they are expensive, are often noisy at part load and do not get to the 20% capacities required by the proposal.
- Equal benefits can be obtained with multiple compressors and advanced controls which are being used on many products in the market today with much lower applied costs.
- In the following pages you will find some of the issues we found with the claims made in the justification

Compressor Efficiency

- In one of the referenced papers a plot was shown that indicated variable speed compressors are significantly better at reduced load. **This curve is totally wrong.**

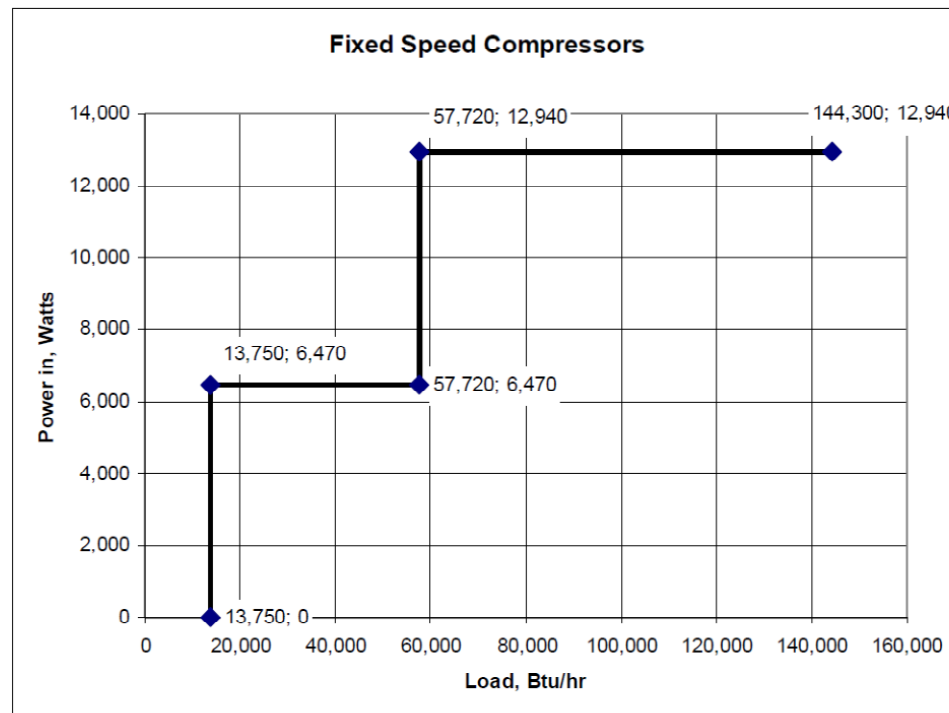

This curve is saying that at part loads the compressor power is constant which is wrong. A single compressor will cycle and the power will be the integrated sum of the on-off power plus a degradation factor for startup

The degradation coefficients are well defined and are test derived for residential systems. There is a conservative default that can be used and is defined in AHRI 210/240 and AHRI 340/360 and is used in SEER and IEER ratings.

Real Compressor Efficiency Curve

This is a correct plot of the % full load compressor power vs the full load % capacity at a constant saturated suction and saturated discharge

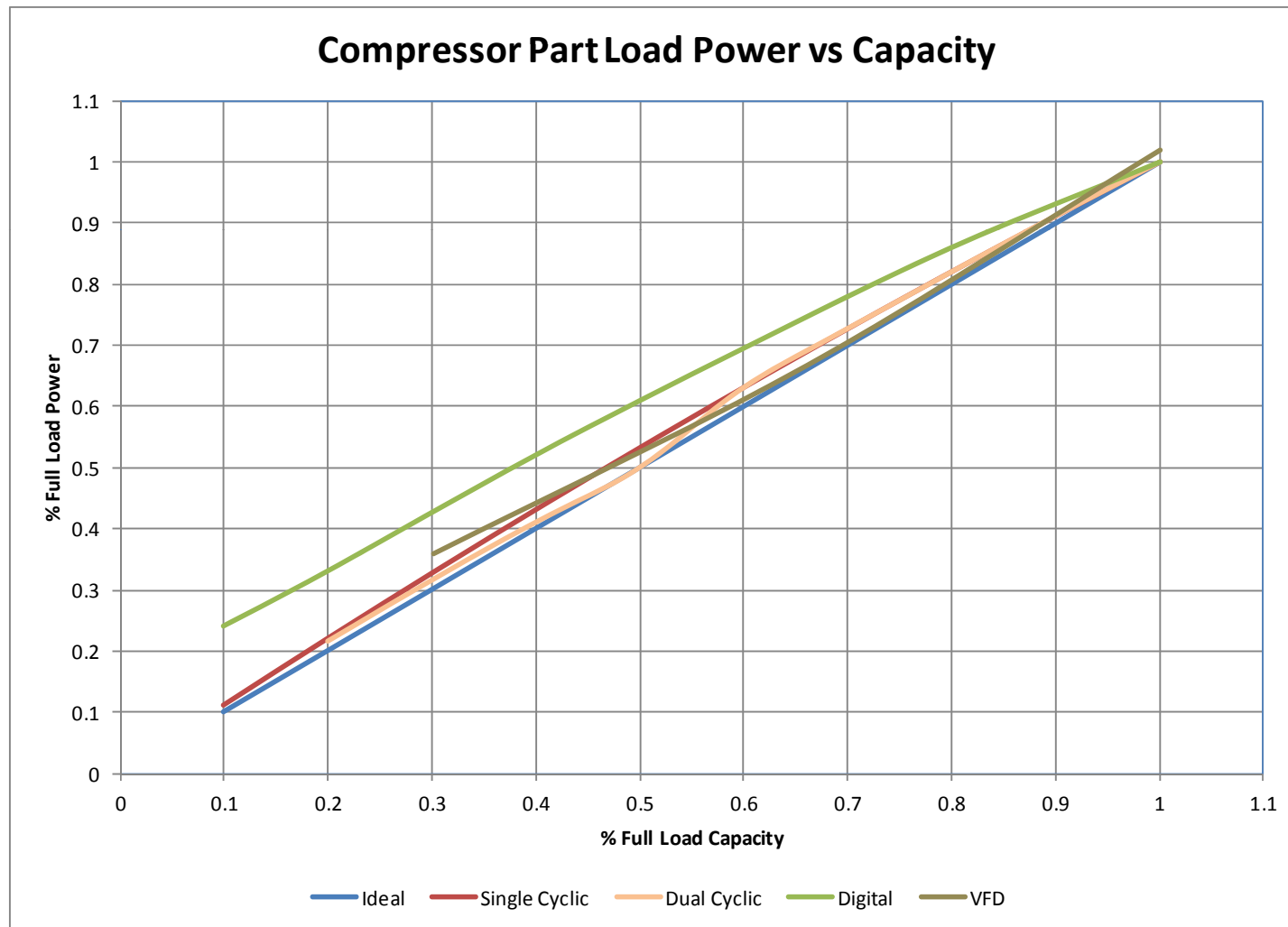

Alternate Compressor Plot

- The prior plot is misleading as it is only a compressor plot and does not factor in the rebalance of the heat exchangers as they unload in a real system.
- I created a plot of various compressor options to show what a real system impact would be.
- This is a plot of compressor and condenser fan power at a fixed ambient and return air condition

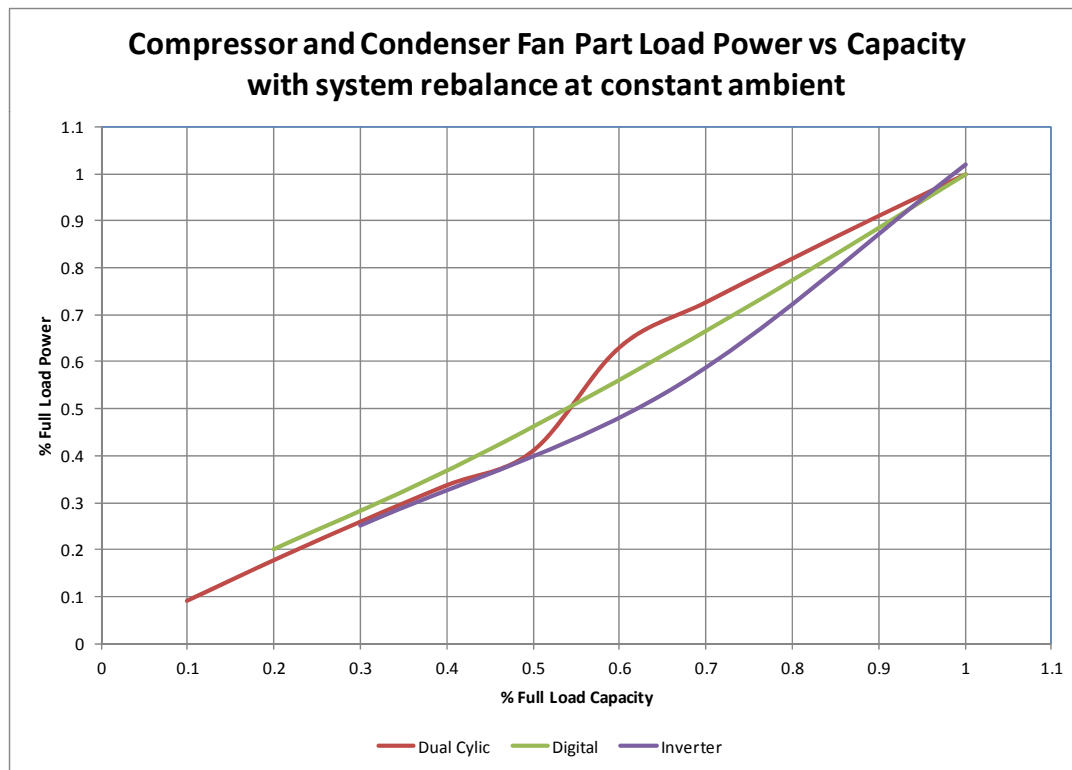

The huge performance improvement is not there and dual compressors on a single circuit perform better than a digital and close to that of a full variable speed with much lower complexity

This is actual confirmed in that most who use the digital have to limit the capacity unloading to get a good SEER

Also note that the variable speed can only get done to 30% and the requirements is 20% which is more like 15% displacement which would require dual compressors.

Costs provide to Title 24 analysis were based on single compressor digital

Study Proposal Assumptions & Claims

Variable Capacity Compressors

- In the justification report it indicates that several manufacturers have products below 65K Btu/h capacity that are variable capacity and this is correct, but they are very high tier units with many high end features and are very expensive
- But the proposal is for 65K and above and currently there is only 1 manufacturer who has a high tier products that was just introduced this month.
- Study claims that compressors are available but this is not totally correct
 - Copeland has the digital compressor thru 10 tons which as you saw is not very efficient at part load, and they only have variable speed compressors less than 5 tons
 - Danfoss has new variable speed compressors, but in this capacity range only have a minimum capacity of 33% and lose some efficiency at full load due to the inverter and over speeding of the compressor to insure oil pressure at low speed.
 - Combinations of variable and fixed capacity compressors could be used similar to VRF systems, but the cost estimates providing by AHRI and the industry were based on the use of a digital so the estimated costs would increase
- Only the digital compressor can get to 20% capacity which due to rebalance is more like 15% displacement. The current variable speed compressors are limited to around 40% actual capacity at economizer conditions unless multiple compressors are used
- There are also issues with noise which can be as much as 10 dba higher at low loads and likely there will be issues with oil return which could impact full load performance.
- Variable compressor technology is limited and likely could not support a full insertion in all products plus would take several years to develop and integrate into products
- Multiple compressors can accomplish the same and along with controls solve integrated economizer problems for some units.

Study Proposal Assumptions & Claims

Humidity Control

- Study claims that better humidity control will be obtained with the variable capacity and variable speed fans.
- Variable speed fans will help part load humidity control during non-integrated low load operation, but during economizer operation the fan is at high speed to get full benefit of the economizer
- The variable capacity compressor will actual decrease humidity control for contant volume variable temperature systems as shown in the plot of operation at economizer integrated conditions

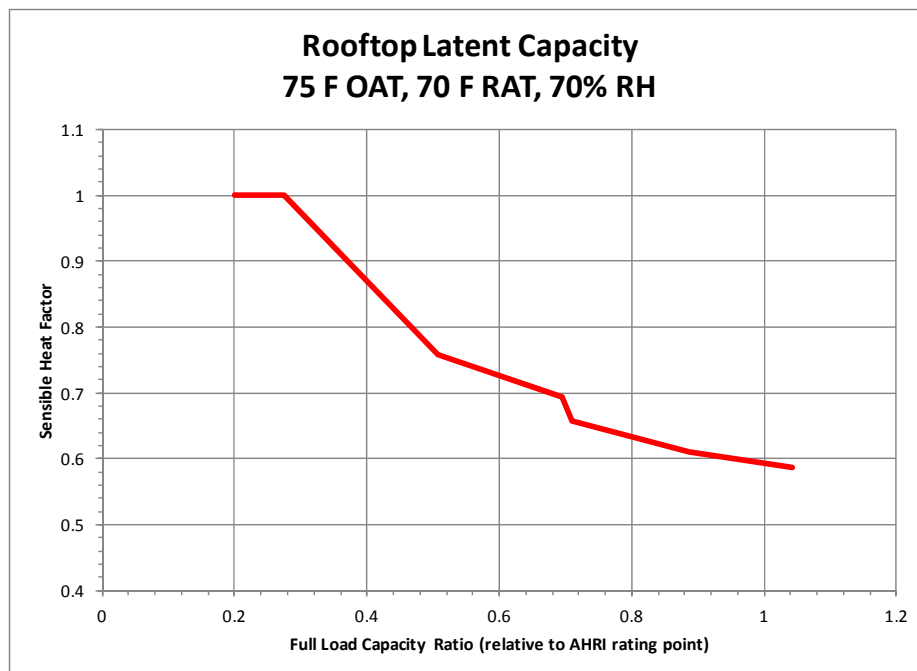

Due to the rebalance of the heat exchangers the saturated suction rises and the latent capability of the DX coils at a constant CFM decreases and below about 30% capacity the coils is only providing sensible cooling

2 Speed Fan Control

2 Speed Fan Control

- This was the original objective of the change proposal as discussed with the AHRI ULE Section.
- It is an extension of the change proposal that goes into effect on 1/1/2012 for Title 24 and ASHRAE 90.1 that requires 2 speed fans on DX units greater than 110K Btu/h and chilled water systems with a fan HP greater than 5 HP
- In general this is a very good energy savings idea and is supported by Carrier and the industry
- We do have some issues with some of the analysis for ASHRAE 90.1 and Title 24, but in the end we found our analysis actual shows more savings.

Study Proposal Assumptions & Claims

Fan Speed Control – ASHRAE 90.1

- The proposal requires for DX products a fan speed of 66% below a load of 50%
- For ASHRAE 901. The justification document assumed Variable speed fans starting at 100% load down to a speed of 50% at 50% load
- This would indicate the savings might be overstated, but the proposal also assumed very high fan and motor efficiencies and reduced the savings. In our analysis we actual found the savings are greater

Figure 5. Combined Measures: Fan Control and Integrated Economizer – Single Zone DX:
% design fan speed versus % design cooling load for a representative zone

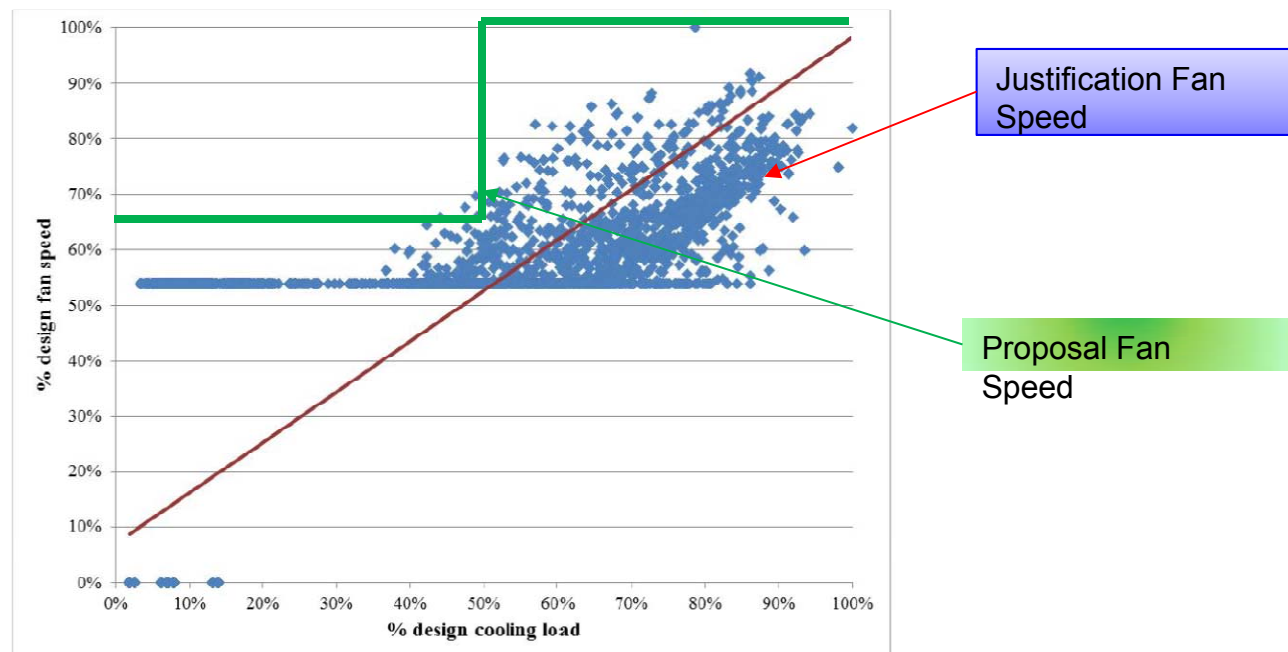

Study Proposal Assumptions & Claims

Fan Speed Control – Title 24

- For Title 24 a different approach was taken and as best we can tell modeled the intended fan speed control for DX systems, but we could not find a copy of the post processed spreadsheet analysis that was done because Equest can not model 2 speed fans
- We do know that EQuest does not do a very good job modeling the impact of reduced cfm on the equipment and something we corrected in our modeling.
- There is a problem with the proposed language which is very conservative on the fan power savings;

Fan Control. Each multiple zone system and single zone system listed in Table 140.4-D shall be designed to vary the airflow rate as a function of actual load. Single zone systems shall have controls and/or devices (such as two-speed or variable speed control) that will result in fan motor demand of no more than 50 percent of design wattage at 66 percent of design fan speed. Multiple zone systems shall include controls that limit the fan motor demand to no more than 30 percent of the total design wattage at 50 percent of design air volume when static pressure set point equals 1/3 of the total design static pressure

- The fan power savings due to the 2 speed fan will be closer to 30% and should be changed in the final proposal.

ENERGY ANALYSIS

Study Proposal Assumptions & Claims

- **Energy Analysis**

- The ASHRAE 90.1 study only looked at zones 2a, 2b, 3a, 4a, 5a, 5b and did not always use the ASHRAE standard work benchmark cities
- For the ASHRAE 90.1 analysis it assumed a complete loss of all integrated economizer benefits by using 60 F dry bulb changeover as the base and differential drybulb for the proposal
- For Title 24 it assumed a 25% de-rate in all economizer benefits
- Differential drybulb was used in a zones but is not allowed in current 90.1 high limits and in the proposal Taylor CMP
- Study used a product with a 9.7 SEER which is far below the current 90.1 requirement of 13 SEER.
- Also the SEER rated model likely was for a single stage product below 65 KBtu/hr capacity and the proposal is for products >65K
- It was likely the default model for the DX product was used which is a residential single stage products and it does not properly model variable capacity or even 2 stage capacity
- We have also found that DOE2 models do not really model performance at low return air temperatures seen during integrated economizer operation.
- ASHRAE 90.1 unit was modeled as a VAV that throttles down to 50% fan speed which is not the proposal, but is a limit of Equest, DOE2 and EnergyPlus
- Model was based on 2.5 inch total static which is about 1.3 inch external which is the high end of the application range for these products. Some units are applied down at more like .5 inches for concentric ducts. AHRI rating static is 0.35 to 0.40 inch external static. This makes the benefits of variable speed higher. A sensitive study would have been a good idea.

Study Proposal Assumptions & Claims

Cost Assumptions

- AHRI did provide data on costs as shown in the chart but some of the claims are not correct.
- These are not current product costs, and are projections based around the likely use of a digital scroll for variable capacity and assuming high volume national based volumes
- We did state that they are based on current material costs and due not reflect the likely increases in materials that will occur by 2015.
- The costs provided by AHRI for variable speed were based on digital compressors, and not variable speed which will be higher.
- It was claimed that likely these products will drop, which is not likely to happen due to the price of copper, steel and rare earth magnets used in variable speed motors
- It claims that ECM motors can be used but the HP limits of these motors are around 1 to 2 HP and can not be used on the larger products
- Study claims that the AHRI cost include installation, but they were only the incremental product price from a distributor.

ASHRAE 90.1 65K to 110K Evaluation Consumer Price Information

Option	Description	Incremental Cost			
		6 ton	7 ton	8 ton	10 ton
1	Single Stage Compression with 2 speed fan	\$ 263.50	\$ 214.00	\$ 276.50	\$ 270.67
2	2 Stage Compression with 2 speed fan	\$ 496.00	\$ 556.00	\$ 655.67	\$ 722.00
3	Variable capacity compressor, 2 speed fan	\$ 1,190.33	\$ 1,306.00	\$ 1,484.33	\$ 1,663.33
4	Variable capacity compressor, variable speed fan	\$ 2,133.00	\$ 2,374.00	\$ 2,708.00	\$ 3,148.00

Note 1 2 speed fans will have a lower speed of 2/3 or lower

Note 2 Cost data should be the incremental price to a customer for the feature

Note 3 Although we have provided cost for option 1, it is not a viable option and will cause operational problems

Energy Analysis

- There are many issues with trying to model this in DOE2, EQuest or EnergyPlus as noted in the justification report
- We have also found that the current modeling methods used in the building simulation programs do not properly model variable capacity and variable cfm products and are primarily based on full load single stage DX units that cycle at part load (Old Style Residential Equipment)
- To analysis this we created an expanded model of a typical 6 ton unit that meets the 2010 Efficiency requirements for EER and IEER. The product has an 11.0 EER and 11.2 IEER at AHRI rating conditions
- We used the building model output from the EnergyPlus models for the 5,400 ft² small office for the 2004 ASHRAE code and then normalized it allow for analysis of the 6 ton unit. This is the same model used for the Title 24 and ASHRAE 90.1 studies.
- This was then post processed thru a large spreadsheet tool with Visual Basic models of the compressors, economizers and models of the psychometric properties
- This allows us to look at the details of the operation at each hour of operation
- We including models to simulation lower leaving air temperatures during integrated economizer operation which correctly analyzed integrated economizer operation.
- Cyclic performance was degraded using the default cyclic coefficients from the AHRI340/360 standard which we know are conservative. When we test for them they are typically better

Industry Modeling Results

- The model was run for all 17 ASHRAE 90.1 climate zones using the 5,400 ft² office normalized hourly data and the benchmark cities
- Title 24 has different climate zones, but they can be mapped to the ASHRAE climate zones as shown in the table

California Climate Zone	City	HDD	CDD	ASHRAE Climate Zone
1	Arcata	5297	5	7
2	Santa Rosa	4001	712	6B
3	Oakland	3383	276	3C
4	Sunnyvale	2676	558	4C
5	Santa Maria	3541	323	5C
6	Los Angeles	1699	963	3B
7	San Diego	1220	617	3B
8	El Toro	1512	879	3B
9	Burbank	1699	963	3B
10	Riverside	3165	1711	3B
11	Red Bluff	3104	1974	3B
12	Sacramento	3285	1345	3B
13	Fresno	2682	2258	3B
14	China Lake	3135	2816	3B
15	El Centro	1392	4476	3B
16	Mt Shasta	6455	699	7

- We also ran the indoor fan as defined in the proposal where the fan is at high at loads above 50% and 2/3 speed at loads below 50%.
- We also assumed the fan would be on high speed during economizer operation (**we will recommend to change this as part of the proposal**)
- Because we can get into the details for each hour of operation we were able to separate the 2 speed fan benefits from the variable capacity and integrated economizer benefits

Integrated Economizer Analysis

- In the CMP proposal the variable capacity and variable fan change benefits were lumped together and the full derate of the economizer was taken between integrated and non integrated
- Using the model that Carrier developed, we separated out the integrated economizer savings result from the variable capacity compressor
- The justification document simulated the integrated economizer benefits by comparing full integrated savings vs non integrated savings which overstates the semi-integrated operation.

Zone	CITY	60 F Drybulb Changeover			Taylor Drybulb Changeover								
		Economizer	Integrated	hrs<55 F LAT	Economizer	Integrated	hrs<55 F LAT	Non-Ideal Incremental Power	Non-Ideal Incremental Power Cost	Incremental First Cost	Payback	Scalar Limit	Justified
		hrs	hrs	hrs	hrs	hrs	hrs	kW-h	\$	\$	yrs	yrs	
1A	Miami	92	0	0	332	53	53	4	0.36	1637	4491.5	8.86	No
1B	Riyadh	356	0	0	1039	307	86	6	0.58	1637	2801.6	8.86	No
2A	Houston	390	0	0	774	56	56	2	0.21	1637	7918.6	8.86	No
2B	Phoenix	495	0	0	1212	290	64	3	0.31	1637	5294.1	8.86	No
3A	Memphis	651	0	0	1134	106	106	8	0.76	1637	2146.8	8.86	No
3B	El Paso	907	0	0	1660	345	108	26	2.41	1637	680.4	8.86	No
3C	San Francisco	1413	0	0	2638	758	591	425	39.94	1637	41.0	8.86	No
4A	Baltimore	760	0	0	1194	131	131	18	1.66	1637	983.4	8.86	No
4B	Albuquerque	1259	0	0	1943	362	155	47	4.43	1637	369.5	8.86	No
4C	Salem	959	0	0	1652	404	273	102	9.55	1637	171.3	8.86	No
5A	Chicago	627	0	0	1001	109	109	20	1.92	1637	853.4	8.86	No
5B	Boise	1087	0	0	1622	345	192	42	3.97	1637	411.8	8.86	No
5C	Vancouver	1123	20	20	1811	525	491	1052	98.82	1637	16.6	8.86	No
6A	Burlington	693	0	0	1273	331	329	132	12.37	1637	132.4	8.86	No
6B	Helena	1060	0	0	1683	417	198	86	8.06	1637	203.0	8.86	No
7	Duluth	1006	0	0	1460	252	210	112	10.56	1637	155.0	8.86	No
8	Fairbanks	953	18	18	1390	379	272	314	29.46	1637	55.6	8.86	No

Non-Integrated Base Case

Semi-Integrated Results

As you can see the Variable capacity change by itself does not meet the Scalar limit for a 15 year design life. For Title 24 the payback period will be 58% of the ASHRAE 90.1 numbers due to the higher electric rate but even in San Francisco the payback is still 23 years which is not cost effective.

2 Speed Fan Benefit Analysis

- In the following two charts I show the metrics for a single speed, 2 stage cooling unit using the Taylor ASHRAE 90.1 CMP dry bulb changeover temperatures

Taylor Drybulb Single Speed

Zone	CITY	Operating hours			Building Load	Energy Use				Economizer					
		Cooling	Mechanical	Economizer		Total Power	Cost	Indoor Fan	Exh Fan	Ton-hrs	Non Integrated hrs>28 Btu/lb	Integrated	hrs<55 F LAT	hrs<50 LAT	hrs <45 LAT
		hrs	hrs	hrs		ton-hrs	kw-h	\$	kw-h	kw-h	Ton-hrs	hrs	hrs	hrs	hrs
1A	Miami	3226	2911	332	8675	14734	1383.49	6991	86	298	36	53	53	13	0
1B	Riyadh	3434	2543	1039	7850	20300	1906.16	9845	476	1157	2	307	86	0	0
2A	Houston	2834	2074	774	6028	11670	1095.84	6142	122	609	117	56	56	21	0
2B	Phoenix	3134	2053	1212	6046	16394	1539.36	8985	479	1219	2	291	65	0	0
3A	Memphis	2654	1556	1134	4853	10170	954.92	5752	171	938	60	106	106	40	0
3B	El Paso	3031	1549	1660	5409	14548	1366.07	8690	550	1763	22	345	108	1	0
3C	San Francisco	2711	535	2638	3144	10354	972.27	7773	1113	3225	0	762	595	179	0
4A	Baltimore	2278	1136	1194	3693	8178	767.87	4937	181	1008	39	131	131	66	1
4B	Albuquerque	2881	1138	1943	4456	12739	1196.21	8260	547	2142	2	362	155	14	0
4C	Salem	2023	604	1652	2665	8197	769.66	5800	609	1904	2	405	274	89	0
5A	Chicago	1980	1028	1001	3260	7127	669.22	4291	160	852	27	109	109	44	1
5B	Boise	2235	794	1622	3180	9565	898.20	6408	484	1791	0	345	192	25	0
5C	Vancouver	1881	345	1811	2574	7224	678.30	5393	747	2477	6	525	491	229	12
6A	Burlington	1834	737	1273	2604	6181	580.41	3975	351	1139	32	331	329	136	3
6B	Helena	2008	575	1683	2717	8328	782.00	5757	596	1879	0	417	198	46	0
7	Duluth	1737	412	1460	2117	6629	622.47	4980	419	1803	15	252	210	62	0
8	Fairbanks	1444	296	1390	1973	5631	528.79	4140	531	1785	0	379	272	113	7

Taylor Drybulb 2 speed

Zone	CITY	Operating hours			Building Load	Energy Use				Economizer					
		Cooling	Mechanical	Economizer		Total Power	Cost	Indoor Fan	Exh Fan	Ton-hrs	Non Integrated hrs>28 Btu/lb	Integrated	hrs<55 F LAT	hrs<50 LAT	hrs <45 LAT
		hrs	hrs	hrs		ton-hrs	kw-h	\$	kw-h	kw-h	Ton-hrs	hrs	hrs	hrs	hrs
1A	Miami	3226	2911	332	8675	9374	880.22	2538	86	298	36	53	53	13	0
1B	Riyadh	3434	2543	1039	7850	13984	1313.11	4970	476	1157	2	307	86	0	0
2A	Houston	2834	2074	774	6028	7849	737.00	2972	122	609	117	56	56	21	0
2B	Phoenix	3134	2053	1212	6046	11454	1075.48	5073	479	1219	2	291	65	0	0
3A	Memphis	2654	1540	1134	4853	5425	509.38	1668	29	480	70	69	69	25	0
3B	El Paso	3031	1549	1660	5409	11065	1039.02	5899	550	1763	22	345	108	1	0
3C	San Francisco	2711	535	2638	3144	10173	955.23	7624	1113	3225	0	762	595	179	0
4A	Baltimore	2278	1136	1194	3693	6163	578.72	3269	181	1008	39	131	131	66	1
4B	Albuquerque	2881	1138	1943	4456	10363	973.06	6351	547	2142	2	362	155	14	0
4C	Salem	2023	604	1652	2665	7276	683.26	5045	609	1904	2	405	274	89	0
5A	Chicago	1980	1028	1001	3260	5309	498.55	2785	160	852	27	109	109	44	1
5B	Boise	2235	794	1622	3180	8015	752.58	5160	484	1791	0	345	192	25	0
5C	Vancouver	1881	345	1811	2574	7053	662.32	5250	747	2477	6	525	491	229	12
6A	Burlington	1834	737	1273	2604	5141	482.78	3111	351	1139	32	331	329	136	3
6B	Helena	2008	575	1683	2717	7508	705.02	5095	596	1879	0	417	198	46	0
7	Duluth	1737	412	1460	2117	5949	558.61	4416	419	1803	15	252	210	62	0
8	Fairbanks	1444	296	1390	1973	5498	516.23	4030	531	1785	0	379	272	113	7

2 Speed Energy Savings		
Total Power	Total Cost	Indoor Fan Power
%	%	%
-36.4	-36.4	-63.7
-31.1	-31.1	-49.5
-32.7	-32.7	-51.6
-30.1	-30.1	-43.5
-46.7	-46.7	-71.0
-23.9	-23.9	-32.1
-1.8	-1.8	-1.9
-24.6	-24.6	-33.8
-18.7	-18.7	-23.1
-11.2	-11.2	-13.0
-25.5	-25.5	-35.1
-16.2	-16.2	-19.5
-2.4	-2.4	-2.6
-16.8	-16.8	-21.7
-9.8	-9.8	-11.5
-10.3	-10.3	-11.3
-2.4	-2.4	-2.7

As you can see the 2 speed 66% low speed fan option offers significant energy savings and cost reductions. This will decrease with operation at lower statics with we plan to do a sensitivity study on. This does exceed the savings in the Title 24 and ASHRAE 90.1 studies

2 Speed Economic Analysis

- Assuming a 2 speed fan with a lower speed of 66% for compression operation below 50% and 100% during economizer and a 2 stage compression system you get the following economics

Zone	CITY	1 speed	2 speed						
		Total Power	Total Power	Power Savings	Cost Savings	First Cost Increase	Payback	Scalar	Justified
		kw-h	kw-h	kw-h	\$	\$	yrs	yrs	
1A	Miami	14734	9374	5360	503.27	496	0.99	8.86	Yes
1B	Riyadh	20300	13984	6316	593.05	496	0.84	8.86	Yes
2A	Houston	11670	7849	3822	358.84	496	1.38	8.86	Yes
2B	Phoenix	16394	11454	4940	463.88	496	1.07	8.86	Yes
3A	Memphis	10170	5425	4745	445.54	496	1.11	8.86	Yes
3B	El Paso	14548	11065	3483	327.05	496	1.52	8.86	Yes
3C	San Francisco	10354	10173	181	17.04	496	29.11	8.86	No
4A	Baltimore	8178	6163	2014	189.15	496	2.62	8.86	Yes
4B	Albuquerque	12739	10363	2376	223.15	496	2.22	8.86	Yes
4C	Salem	8197	7276	920	86.40	496	5.74	8.86	Yes
5A	Chicago	7127	5309	1818	170.67	496	2.91	8.86	Yes
5B	Boise	9565	8015	1551	145.61	496	3.41	8.86	Yes
5C	Vancouver	7224	7053	170	15.98	496	31.03	8.86	No
6A	Burlington	6181	5141	1040	97.63	496	5.08	8.86	Yes
6B	Helena	8328	7508	820	76.98	496	6.44	8.86	Yes
7	Duluth	6629	5949	680	63.86	496	7.77	8.86	Yes
8	Fairbanks	5631	5498	134	12.56	496	39.49	8.86	No

- Results show that in many zones it can be easily justified, but in Zones 3C, 5C, and 8 it does not meet the scalar limit.
- The reason is that these are very high economizer operating zones and my model assumes the economizer is on high speed during all operation.
- This can be significantly improved by also operating with 2 speed fan operation in economizer mode when the economizer is less than 50-60% and this will be part of our alternate proposal

DX Evaluation Conclusions

- Study shows that a variable capacity can not be economically justified.
- Although the technology of variable speed and capacity are advancing it is not a common production option in the 65K and larger capacities
- For constant volume the integrated economizer can be improved with good control logic and the use of **a minimum of 2 stages of capacity**
- The two speed fan can be justified in all zones assuming that **we also require 2 speed fan operation in economizer mode**, but this will require some controls development work.
- Products that can meet these requirements are **not available** and redesign to the units to have two stages as well as economizer controls will be required, which will take 2-3 years to develop at a minimum so an **effective date of more 1/1/2015** would likely be something the industry might be able to support

Chilled Water Coil Proposal

- For the chilled water coils the CMP proposal is requiring 2 speed fans down to ¼ HP with a lower speed of 50%
- This will save energy and the first cost increase are not high assuming the units have modulating chilled water coils
- But the small fan coils, typically use 2 way on-off valves and only operation at 0 and 100% so they will not have to meet the proposed requirement as written.
- If we elect to go forward with this then an additional requirement for a minimum of 2 stages of chilled water capacity control would be required
- I have not looked into the availability of 2 stage water valves or the cost premium for modulating, but I suspect the modulating will be very expensive relative to these small fan coil costs
- We also need to check with the manufacturers of these products and get their feedback on the options for at a minimum 2 stage water control valves.
- The economic analysis done for ASHRAE and Title 24 did include the cost of modulating valves and controls, but the estimate are somewhat optimistic.
- At the stated assumptions the payback period 7.3 to 7.8 years in high cooling zones and will be longer in cold zones.
- We have not yet tried to duplicate the savings, but we would recommend for this round of changes that we limit the change to 1 HP for Chilled Water Systems which will extend the 2 speed requirements from 5 HP to 1 HP. The ¼ savings look marginal at best..

Alternate Title 24 Proposal

Alternate Title 24 Proposal

- The following show the proposed changes to Title 24. The **red text** is the original changes and the **green text** are the proposed Carrier changes.

- In section 140.4 (3) 1

Each individual cooling fan system that has a design ~~supply capacity over 2,500~~**1,800** cfm and a total mechanical cooling capacity over ~~755~~**4**,000 Btu/hr shall include either:

- In section 140.4 (e) 2 ii

~~Effective January 1, 2015, direct expansion systems with a cooling capacity \geq 65,000 Btu/hra shall be capable of staging or modulating capacity in increments of no more than 20% of total cooling capacity. Controls shall not false load the mechanical cooling system by limiting or disabling the economizer or any other means, such as hot gas bypass, except at the lowest stage of cooling capacity.~~

Effective January 1, 2015, direct expansion systems with a cooling capacity \geq 54,000 Btu/hr shall have mechanical capacity control that is interlocked with the economizer control such that the economizer does not begin to close until the unit leaving air temperature is less than 45 F. All constant volume units with a capacity \geq 75,000 Btu/hr including 2 speed fan systems must have a minimum of 2 stages of mechanical cooling. All variable air volume units must have a minimum of 4 stages or variable capacity with a minimum capacity of 25%

Alternate Title 24 Proposal

- In section 140.4 (e) 4
 - Air economizers and return air dampers on an individual cooling fan system that has ~~a design supply capacity over 1,500 cfm and~~ a total ~~mechanical cooling capacity over 45,000~~ 54,000 Btu/hr shall have the following features:
- In section 140.4 (m)
- **Current Proposal**

Fan Control. Each multiple zone system and single zone system listed in Table 140.4-D shall be designed to vary the airflow rate as a function of actual load. Single zone systems shall have controls and/or devices (such as two-speed or variable speed control) that will result in fan motor demand of no more than 50 percent of design wattage at 66 percent of design fan speed. Multiple zone systems shall include controls that limit the fan motor demand to no more than 30 percent of the total design wattage at 50 percent of design air volume when static pressure set point equals 1/3 of the total design static pressure. ~~Variable air volume control for single zone systems. Effective January 1, 2012 all unitary air conditioning equipment and air handling units with mechanical cooling capacity at ARI conditions greater than or equal to 110,000 Btu/hr that serve single zones shall be designed for variable supply air volume with their supply fans controlled by two-speed motors, variable speed drives, or equipment that has been demonstrated to the Executive Director to use no more energy. The supply fan controls shall modulate down to a minimum of 2/3 of the full fan speed or lower at low cooling demand.~~
-

Alternate Title 24 Proposal

- Alternate Proposal.

Each multiple zone system listed in table 140.4-D shall be designed to vary the airflow rate as a function of the load such that the fan motor demand is less than 20% at 50 percent of the design air volume when static pressure set point equals 1/3 of the total design static pressure. Variable air volume units shall have a minimum of 4 stages with a minimum stage of 25% or less.

For single zone systems with air-handling and fan-coil units with chilled-water cooling coils and supply fans with motors greater than or equal to 1 hp shall have their supply fans controlled by two-speed motors or variable-speed drives. At cooling demands less than or equal to 50% for proportionally controlled units and for 2 stage control units operating on the first stage, the supply fan controls shall be able to reduce the airflow to no greater than the larger of the following:

One half of the full fan speed, or

The volume of outdoor air required to meet the ventilation requirements of Standard 62.1.

When operating at 50% airflow the fan motor demand shall be less than 25% of the full demand.

All single zone air-conditioning equipment and air-handling units with direct expansion cooling and a cooling capacity at AHRI conditions greater than or equal to 75,000 Btu/h shall have their supply fans controlled by two-speed motors or variable-speed drives. Constant volume units at cooling demands less than or equal to 50% for proportionally controlled units and for 2 staged controlled units operating on first stage, the supply fan controls shall be able to reduce the airflow to no greater than the larger of the following:

Two-thirds of the full fan speed, or

The volume of outdoor air required to meet the ventilation requirements of Standard 62.1.

When operating at 66% airflow the fan motor demand shall be less than 35% of the full demand.

Both the chilled water and DX units shall also have a minimum of 2 stages of capacity and shall be capable of operating the economizer, if required, with 2 stage fan speed control with operation at low speed when the economizer capacity is less than 50%.

Alternate ASHRAE 90.1 Proposal

Proposal ASHRAE 90.1 Changes

6.4.3.10 ~~Single-Zone Variable-Air-Volume Fan~~ Controls. HVAC systems shall have variable airflow controls as follows:

- a. Air-handling and fan-coil units with chilled-water cooling coils and supply fans with motors greater than or equal to ~~5-1/4~~ hp shall have their supply fans controlled by two-speed motors or variable-speed drives. At cooling demands less than or equal to 50%, the supply fan controls shall be able to reduce the airflow to no greater than the larger of the following:

One half of the full fan speed, or

The volume of outdoor air required to meet the ventilation requirements of Standard 62.1.

- b. ~~Effective January 1, 2012, all~~ air-conditioning equipment and air-handling units with direct expansion cooling and a cooling capacity at AHRI conditions greater than or equal to ~~110,000~~ 65,000 Btu/h ~~that serve single-zones~~ shall have their supply fans controlled by two-speed motors or variable-speed drives. At cooling demands less than or equal to 50%, the supply fan controls shall be able to reduce the airflow to no greater than the larger of the following:

Two-thirds of the full fan speed, or

The volume of outdoor air required to meet the ventilation requirements of Standard 62.1.

6.5.1.3 Integrated Economizer Control. Economizer systems shall be integrated with the mechanical cooling system and be capable of providing partial cooling even when additional mechanical cooling is required to meet the remainder of the cooling load. Effective January 1, 2015, direct expansion systems with a cooling capacity at AHRI conditions $\geq 65,000$ Btu/hr shall be capable of staging or modulating capacity in increments of no more than 20% of total cooling capacity. Controls shall not false load the mechanical cooling system by limiting or disabling the economizer or any other means, such as hot gas bypass, except at the lowest stage of cooling capacity.

Alternate ASHRAE 90.1 Proposal

6.4.3.10 ~~Single Zone Variable Air Volume~~ Indoor Fan Controls. HVAC systems shall have variable airflow controls as follows:

a. Air-handling and fan-coil units with chilled-water cooling coils and supply fans with motors greater than or equal to ~~5~~1 hp shall have their supply fans controlled by two-speed motors or variable-speed drives. At cooling demands less than or equal to 50% for proportionally controlled units and for 2 stage control units operating on the first stage, the supply fan controls shall be able to reduce the airflow to no greater than the larger of the following:

One half of the full fan speed, or

The volume of outdoor air required to meet the ventilation requirements of Standard 62.1.

At 50% fan speed the power drawing of the fan system shall be not greater than 25% of the power at full fan speed.

Constant volume units shall also have a minimum of 2 stages of capacity or modulating capacity and shall be capable of operating the economizer, if required, with 2 stage fan speed control with operation at low speed when the economizer capacity is less than 50%. Variable air volume units shall have a minimum of 4 stages with a minimum stage of 25% or less.

The requirements for 1 to 5 HP will be effective 1/1/2015 and the requirements for greater than 5 HP will be effective immediately

Alternate ASHRAE 90.1 Proposal

b. ~~Effective January 1, 2012~~, all air-conditioning equipment and air-handling units with direct expansion cooling and a cooling capacity at AHRI conditions greater than or equal to ~~110,000~~ 75,000 Btu/h ~~that serve single zones~~ shall have their supply fans controlled by two-speed motors or variable-speed drives. At cooling demands less than or equal to 50% for proportionally controlled units and for 2 staged controlled units operating on first stage, the supply fan controls shall be able to reduce the airflow to no greater than the larger of the following:

Two-thirds of the full fan speed, or

The volume of outdoor air required to meet the ventilation requirements of Standard 62.1.

When operating at 2/3 speed the fan motor system shall use no more than 35% of the power at full speed.

Constant Volume units shall also have a minimum of 2 stages of capacity and shall be capable of operating the economizer if required with 2 stage fan speed control with operation at low speed when the economizer capacity is less than 60%. Variable air volume units shall have a minimum of 4 stages of capacity with a minimum stage of 25% or less or variable capacity.

The requirements for 75,000 to 110,000 Btu/hr capacity are effective 1/1/2015 and greater than 110,000 Btu/hr are effective immediately

6.5.1.3 Integrated Economizer Control. Economizer systems shall be integrated with the mechanical cooling system and be capable of providing partial cooling even when additional mechanical cooling is required to meet the remainder of the cooling load. The mechanical capacity control shall be interlocked with the economizer control such that the economizer does not begin to close until the unit leaving air temperature is less than 45 F. All units with an economizer must have a minimum of 2 stages of mechanical cooling for constant volume units and minimum of 4 stages with a minimum of 25% for variable air volume effective 1/1/2015.