

DOCKETED

| | |
|-------------------------|--|
| Docket Number: | 17-BSTD-03 |
| Project Title: | 2019 Title 24, Part 11, CALGreen Rulemaking |
| TN #: | 222230 |
| Document Title: | CASE Report ASHRAE 90.1-2016 |
| Description: | Codes and Standards Enhancement (CASE) Initiative Report for the 2019 California Building Energy Efficiency Standards. |
| Filer: | Adrian Ownby |
| Organization: | California Energy Commission |
| Submitter Role: | Commission Staff |
| Submission Date: | 1/18/2018 4:54:12 PM |
| Docketed Date: | 1/18/2018 |



Codes and Standards Enhancement (CASE) Initiative 2019 California Building Energy Efficiency Standards

Proposals Based on ASHRAE 90.1-2016 – Final Report

Measure Number: 2019-NR-ASHRAE90.1-F
Nonresidential Mechanical

August 2017



This report was prepared by the California Statewide Codes and Standards Enhancement (CASE) Program that is funded, in part, by California utility customers under the auspices of the California Public Utilities Commission.

Copyright 2017 Pacific Gas and Electric Company, Southern California Edison, Southern California Gas Company, San Diego Gas & Electric Company, Los Angeles Department of Water and Power, and Sacramento Municipal Utility District.

All rights reserved, except that this document may be used, copied, and distributed without modification.

Neither Pacific Gas and Electric Company, Southern California Edison, Southern California Gas Company, San Diego Gas & Electric Company, Los Angeles Department of Water and Power, Sacramento Municipal Utility District, or any of its employees makes any warranty, express or implied; or assumes any legal liability or responsibility for the accuracy, completeness or usefulness of any data, information, method, product, policy or process disclosed in this document; or represents that its use will not infringe any privately -owned rights including, but not limited to, patents, trademarks or copyrights.

Document Information

| | |
|----------------------------|--|
| Category: | Codes and Standards |
| Keywords: | Statewide Codes and Standards Enhancement (CASE) Initiative, Statewide Utility Codes and Standards Team, Codes and Standards Enhancements, 2019 Title 24 Part 6, efficiency, ASHRAE 90.1, cooling tower, waterside economizer, air-to-air heat recovery, equipment efficiency, fan system power, demand control ventilation (DCV). |
| Authors: | Anna Brannon, Matt Deghani, Stefan Gracik, Jared Landsman, and Ken Takahashi (Integral Group); Jeff Stein (Taylor Engineering) |
| Project Management: | California Utilities Statewide Codes and Standards Team: Pacific Gas and Electric Company, Southern California Edison, SoCalGas®, San Diego Gas & Electric Company, Los Angeles Department of Water and Power, and Sacramento Municipal Utility District |

Table of Contents

| | |
|---|-------------|
| Executive Summary | viii |
| 1. Introduction | 1 |
| 1.1 Relationship Between ASHRAE 90.1 and Title 24, Part 6..... | 2 |
| 1.2 Market Impacts and Economic Assessment for All Submeasures..... | 3 |
| 1.3 Economic Impacts of All Submeasures | 4 |
| 1.4 Methodology for Energy Savings, Lifecycle Cost-Effectiveness, and Statewide Impacts Analyses | 7 |
| 2. Fan System Power | 10 |
| 2.1 Measure Description..... | 10 |
| 2.2 Market Analysis..... | 13 |
| 2.3 Energy Savings | 14 |
| 2.4 Lifecycle Cost and Cost-Effectiveness | 18 |
| 2.5 First-Year Statewide Impacts | 21 |
| 2.6 Proposed Revisions to Code Language | 22 |
| 3. Exhaust Air Heat Recovery | 25 |
| 3.1 Measure Description..... | 25 |
| 3.2 Market Analysis..... | 27 |
| 3.3 Energy Savings | 29 |
| 3.4 Lifecycle Cost and Cost-Effectiveness | 32 |
| 3.5 First-Year Statewide Impacts | 38 |
| 3.6 Proposed Revisions to Code Language | 39 |
| 4. Equipment Efficiency | 42 |
| 4.1 Measure Description..... | 42 |
| 4.2 Market Analysis..... | 46 |
| 4.3 Energy Savings | 47 |
| 4.4 Lifecycle Cost and Cost-Effectiveness | 51 |
| 4.5 First-Year Statewide Impacts | 52 |
| 4.6 Proposed Revisions to Code Language | 54 |
| 5. Waterside Economizers | 64 |
| 5.1 Measure Description..... | 64 |
| 5.2 Market Analysis..... | 69 |
| 5.3 Energy Savings | 70 |
| 5.4 Lifecycle Cost and Cost-Effectiveness | 73 |
| 5.5 First-Year Statewide Impacts | 75 |
| 5.6 Proposed Revisions to Code Language | 77 |
| 6. Transfer Air for Exhaust Air Makeup | 80 |
| 6.1 Measure Description..... | 80 |
| 6.2 Market Analysis..... | 82 |
| 6.3 Energy Savings | 82 |

| | | |
|-----------|---|------------|
| 6.4 | Lifecycle Cost and Cost-Effectiveness | 84 |
| 6.5 | First-Year Statewide Impacts | 86 |
| 6.6 | Proposed Revisions to Code Language | 87 |
| 7. | Demand Controlled Ventilation for Classrooms | 90 |
| 7.1 | Measure Description | 90 |
| 7.2 | Market Analysis..... | 92 |
| 7.3 | Energy Savings | 93 |
| 7.4 | Lifecycle Cost and Cost-Effectiveness | 95 |
| 7.5 | First-Year Statewide Impacts | 98 |
| 7.6 | Proposed Revisions to Code Language | 100 |
| 8. | Occupant Sensor Ventilation Control Requirements | 103 |
| 8.1 | Measure Description..... | 103 |
| 8.2 | Market Analysis..... | 109 |
| 8.3 | Energy Savings | 110 |
| 8.4 | Lifecycle Cost and Cost-Effectiveness | 112 |
| 8.5 | First-Year Statewide Impacts | 115 |
| 8.6 | Proposed Revisions to Code Language | 115 |
| 9. | Bibliography..... | 125 |
| | Appendix A : Statewide Savings Methodology | 127 |
| | Appendix B : Embedded Electricity in Water Methodology..... | 148 |
| | Appendix C : Discussion of Impacts of Compliance Process on Market Actors | 150 |
| | Appendix D : Allowed Total Static Pressure Breakdown by Component | 152 |
| | Appendix E : Reference Total Static Pressure for Fan System Power Analysis | 153 |
| | Appendix F : Transfer Air Examples | 154 |
| | Appendix G : Compliance Manual Content for Occupant Sensor Ventilation Control Acceptance Test | 158 |
| | Appendix H : Marked-up Compliance Document for Air Economizer Controls Acceptance Test (For Exhaust Air Heat Recovery) | 164 |

List of Tables

| | |
|---|-----|
| Table 1: Scope of Code Change Proposal..... | xi |
| Table 2: Estimated Statewide First-Year ^a Energy and Water Savings..... | xii |
| Table 3: Industries Receiving Energy Efficiency Related Investment, by North American Industry Classification System (NAICS) Code..... | 6 |
| Table 4: Allowed Total Static Pressure under Each Standard | 10 |
| Table 5: Total Static Pressure for Each Motor Size in Order to Achieve 1.25 W/cfm | 16 |
| Table 6: Prototype Buildings Used for Energy, Demand, Cost, and Environmental Impacts Analysis – Fan System Power | 16 |

| | |
|--|----|
| Table 7: Fan System Power First-Year Energy Impacts per Square Foot – Large Office (498,589 ft ²)..... | 17 |
| Table 8: Fan System Power First-Year Energy Impacts per Square Foot – Medium Retail (24,563 ft ²) ... | 18 |
| Table 9: TDV Energy Cost Savings Over 15-Year Period per Square Foot – Large Office | 19 |
| Table 10: TDV Energy Cost Savings Over 15-Year Period per Square Foot – Medium Retail..... | 19 |
| Table 11: Fan System Power Lifecycle Cost-Effectiveness Summary per Square Foot – Large Office.... | 20 |
| Table 12: Fan System Power Lifecycle Cost-Effectiveness Summary per Square Foot – Medium Retail | 21 |
| Table 13: Statewide Energy and Energy Cost Impacts – Fan System Power..... | 22 |
| Table 14: Percentage of Products Compliant at Each Energy Recovery Ratio Thresholds..... | 28 |
| Table 15: Prototype Buildings used for Energy, Demand, Cost, and Environmental Impacts Analysis | 30 |
| Table 16: Exhaust Air Heat Recovery First-Year Energy Impacts per Square Foot – Small Office (5,502 ft ²) Prototype 2..... | 30 |
| Table 17: Exhaust Air Heat Recovery First-Year Energy Impacts per Square Foot – Medium Office (53,628 ft ²) Prototype 3 | 31 |
| Table 18: Exhaust Air Heat Recovery First-Year Energy Impacts per Square Foot – Medium Office/Lab Prototype 15 (New Construction)..... | 32 |
| Table 19: Exhaust Air Heat Recovery TDV Energy Cost Savings Over 15-Year Period per Square Foot – Small Office –Prototype 2 | 33 |
| Table 20: Exhaust Air Heat Recovery TDV Energy Cost Savings Over 15-Year Period per Square Foot – Medium Office – Prototype 3 | 33 |
| Table 21: Exhaust Air Heat Recovery TDV Energy Cost Savings Over 15-Year Period per Square Foot – Medium Office/Lab –Prototype 15..... | 34 |
| Table 22: Capital Cost for Heat Recovery Ventilators | 34 |
| Table 23: Reduced Equipment Costs Due to Peak Load Reductions | 35 |
| Table 24: Exhaust Air Heat Recovery Lifecycle Cost-Effectiveness Summary per Square Foot – Small Office | 36 |
| Table 25: Exhaust Air Heat Recovery Lifecycle Cost-Effectiveness Summary per Square Foot – Medium Office | 37 |
| Table 26: Exhaust Air Heat Recovery Lifecycle Cost-Effectiveness Summary per Square Foot – Medium Office/Lab..... | 38 |
| Table 27: Statewide Energy and Energy Cost Impacts – Exhaust Air Heat Recovery | 39 |
| Table 28: Summary of Changes to Equipment Efficiency Requirements | 43 |
| Table 29: Principal Manufacturers of HVAC Equipment Impacted by Efficiency Updates | 46 |
| Table 30: Prototype Buildings Used for Energy, Demand, Cost, and Environmental Impacts Analysis ... | 48 |
| Table 31: First-Year Energy Impacts per Square Foot for Single Package Vertical Air Conditioners – New Construction and Alterations | 49 |
| Table 32: First-Year Energy Impacts per Square Foot for Single Package Vertical Heat Pumps – New Construction and Alterations | 50 |

| | |
|--|-----|
| Table 33: First-Year Energy Impacts per Square Foot for Closed-Circuit Cooling Towers – New Construction and Alterations | 50 |
| Table 34: TDV Energy Cost Savings Over 15-Year Period of Analysis for Single Package Vertical Air Conditioners per Square Foot | 51 |
| Table 35: Statewide Energy and Energy Cost Impacts – New Construction..... | 53 |
| Table 36: Statewide Energy and Energy Cost Impacts – Alterations | 53 |
| Table 37: Prototype Buildings used for Energy, Demand, Cost, and Environmental Impacts Analysis | 72 |
| Table 38: Equipment Efficiency First-Year Energy Impacts per Square Foot –Large Office..... | 73 |
| Table 39: TDV Energy Cost Savings Over 15-Year Period of Analysis per Square Foot – Large Office . | 74 |
| Table 40: Lifecycle Cost-Effectiveness Summary per Square Foot – Large Office..... | 75 |
| Table 41: Statewide Energy and Energy Cost Impacts..... | 76 |
| Table 42: Impacts on Water Use..... | 77 |
| Table 43: Impacts of Material Use..... | 77 |
| Table 44: Prototype Buildings Used for Energy, Demand, Cost, and Environmental Impacts Analysis ... | 83 |
| Table 45: First-Year Energy Impacts per Square Foot – New Construction | 84 |
| Table 46: TDV Energy Cost Savings Over 15-Year Period of Analysis per Square Foot..... | 85 |
| Table 47: Lifecycle Cost-effectiveness Summary per Square Foot – Medium Office/Lab..... | 86 |
| Table 48: Statewide Energy and Energy Cost Impacts – New Construction..... | 87 |
| Table 49: Prototype Buildings Used for Energy, Demand, Cost, and Environmental Impacts Analysis ... | 93 |
| Table 50: First-Year Energy Impacts per Square Foot – New Construction | 94 |
| Table 51: First-Year Energy Impacts per Square Foot – New Construction | 95 |
| Table 52: TDV Energy Cost Savings Over 15-Year Period of Analysis per Square Foot..... | 96 |
| Table 53: TDV Energy Cost Savings Over 15-Year Period of Analysis per Square Foot..... | 96 |
| Table 54: Lifecycle Cost-Effectiveness Summary per Square Foot – Small Schools New Construction .. | 97 |
| Table 55: Lifecycle Cost-Effectiveness Summary per Square Foot – Large Schools New Construction .. | 98 |
| Table 56: Statewide Energy and Energy Cost Impacts – New Construction..... | 99 |
| Table 57: Statewide Energy and Energy Cost Impacts – Large Schools New Construction..... | 100 |
| Table 58: Summary of Existing and Proposed Space Types under Requirements | 104 |
| Table 59: Prototype Buildings Used for Energy, Demand, Cost, and Environmental Impacts Analysis . | 111 |
| Table 60: Small Office Prototype Space Type Adjustments | 111 |
| Table 61: First-Year Energy Impacts per Square Foot – New Construction | 112 |
| Table 62: TDV Energy Cost Savings Over 15-Year Period of Analysis per Square Foot..... | 113 |
| Table 63: Lifecycle Cost-Effectiveness Summary per Square Foot – Small Office New Construction... | 114 |
| Table 64: Statewide Energy and Energy Cost Impacts – New Construction..... | 115 |
| Table 65: Estimated New Nonresidential Construction Impacted by Proposed Code Change in 2020, by Climate Zone and Building Type (Million Square Feet)..... | 129 |

| | |
|--|-----|
| Table 66: Estimated Existing Nonresidential Floor Space Impacted by Proposed Code Change in 2020 (Alterations), by Climate Zone and Building Type (Million Square Feet)..... | 130 |
| Table 67: Translation from Forecast Climate Zone (FCZ) to Building Standards Climate Zone (BSCZ) | 131 |
| Table 68: Description of Building Types and Subtypes (Prototypes) in Statewide Construction Forecast | 132 |
| Table 69: Converting from Forecast Climate Zone (FCZ) to Building Standards Climate Zone (BSCZ) – Example Calculation..... | 133 |
| Table 70: Example of Redistribution of Miscellaneous Category - 2020 New Construction in Climate Zone 1 | 133 |
| Table 71: Percent of Floor Space Impacted by Proposed Measure, by Building Type | 134 |
| Table 72: Percent of Floor Space Impacted by Proposed Measure, by Climate Zone..... | 135 |
| Table 73: Percent of Floor Space Impacted by Proposed Measure, by Building Type | 136 |
| Table 74: Percent of Floor Space Impacted by Proposed Measure, by Climate Zone..... | 137 |
| Table 75: Percent of Floor Space Impacted by Proposed Measure, by Building Type | 138 |
| Table 76: Percent of Floor Space Impacted by Proposed Measure, by Climate Zone..... | 139 |
| Table 77: Percent of Floor Space Impacted by Proposed Measure, by Building Type | 140 |
| Table 78: Percent of Floor Space Impacted by Proposed Measure, by Climate Zone..... | 141 |
| Table 79: Percent of Floor Space Impacted by Proposed Measure, by Building Type | 142 |
| Table 80: Percent of Floor Space Impacted by Proposed Measure, by Climate Zone..... | 143 |
| Table 81: Percent of Floor Space Impacted by Proposed Measure, by Building Type | 144 |
| Table 82: Percent of Floor Space Impacted by Proposed Measure, by Climate Zone..... | 145 |
| Table 83: Percent of Floor Space Impacted by Proposed Measure, by Building Type | 146 |
| Table 84: Percent of Floor Space Impacted by Proposed Measure, by Climate Zone..... | 147 |
| Table 85: Embedded Electricity in Water by California Department of Water Resources Hydrologic Region (kWh per Acre Foot) | 148 |
| Table 86: Statewide Population-Weighted Average Embedded Electricity in Water..... | 149 |
| Table 87: Roles of Market Actors in the Proposed Compliance Process..... | 151 |
| Table 88: ASHRAE 90.1-2016 - Good Practice Air System Design..... | 152 |
| Table 89: Title 24 Nonresidential Alternative Calculation Method Reference Manual 2016 - Proposed changes to ASHRAE | 152 |

List of Figures

| | |
|---|-----|
| Figure 1: Proposed case: fan input in CBECC-Com with nonresidential ACM default total static pressure | 15 |
| Figure 2: Baseline case: fan inputs in CBECC-Com with adjusted total static pressure | 15 |
| Figure 3: Number of certified products at different heat recovery ratio thresholds (plate type) | 28 |
| Figure 4: Number of certified products at different energy recovery ratio thresholds (wheel type) | 28 |
| Figure 5. First Co. manufacturer SPVAC unit..... | 47 |
| Figure 6: Nonintegrated waterside economizer schematic | 64 |
| Figure 7: Integrated waterside economizer schematic | 65 |
| Figure 8: Number of waterside economizer hours in a typical year for current and proposed regulations | 66 |
| Figure 9: Baseline HVAC configuration in OpenStudio | 71 |
| Figure 10: Proposed HVAC configuration in OpenStudio | 72 |
| Figure 11: Temperature cooling setup and recovery time per zone type | 106 |
| Figure 12: ASHRAE summer and winter comfort zones with sample setpoints and 2°F setup and setback | 107 |
| Figure 13: Proposed realistic schedules – office occupancy..... | 120 |
| Figure 14: Proposed realistic schedules – assembly occupancy | 121 |
| Figure 15: Proposed realistic schedules – school occupancy..... | 122 |
| Figure 16: Plot of realistic schedules – office occupancy | 123 |
| Figure 17: Example of transfer air for toilet exhaust makeup | 154 |
| Figure 18: Toilet exhaust without transfer air..... | 154 |
| Figure 19: Toilet exhaust with transfer air..... | 155 |
| Figure 20: Example lab with transfer air for fume hood makeup | 156 |

EXECUTIVE SUMMARY

Introduction

The Codes and Standards Enhancement (CASE) initiative presents recommendations to support the California Energy Commission's (Energy Commission) efforts to update California's Building Energy Efficiency Standards (Title 24, Part 6) to include new requirements or to upgrade existing requirements for various technologies. The four California Investor Owned Utilities (IOUs) – Pacific Gas and Electric Company, San Diego Gas and Electric, Southern California Edison, and SoCalGas® – and two Publicly Owned Utilities (POUs) – Los Angeles Department of Water and Power and Sacramento Municipal Utility District – sponsored this effort. The program goal is to prepare and submit proposals that will result in cost-effective enhancements to improve energy efficiency and energy performance in California buildings. This report and the code change proposals presented herein are part of the effort to develop technical and cost-effectiveness information for proposed requirements on building energy-efficient design practices and technologies.

The Statewide CASE Team submits code change proposals to the Energy Commission, the state agency that has authority to adopt revisions to Title 24, Part 6. The Energy Commission will evaluate proposals submitted by the Statewide CASE Team and other stakeholders. The Energy Commission may revise or reject proposals. See the Energy Commission's 2019 Title 24 website for information about the rulemaking schedule and how to participate in the process:

<http://www.energy.ca.gov/title24/2019standards/>.

Measure Description

This report includes the Statewide CASE Team's recommendations to adopt requirements included in American National Standards Institute (ANSI)/American Society of Heating, Refrigerating and Air-Conditioning Engineers (ASHRAE)/Illuminating Engineering Society (IES) Standard 90.1-2016 – Energy Standard for Buildings Except Low-Rise Residential Buildings (ASHRAE 90.1-2016)¹. The Statewide CASE Team recommends that the seven measures described below be adopted into Title 24, Part 6.

Fan System Power (1 of 7)

The proposed fan system power fan system power measure will change the prescriptive requirements of Section 140.4(c) to harmonize with the calculation methodology used in ASHRAE 90.1-2016 Section 6.5.3.1 determine the allowed fan power. The ASHRAE 90.1-2016 calculation methodology was used as starting point for the California proposal, but adjustments were made to match the fan power allowance documented in the 2016 Title 24, Part 6 Nonresidential Alternative Calculation Method (ACM) Reference Manual. ASHRAE 90.1-2016 includes fan adjustment factors to allow for variability in allowed fan power for certain applications. The fan adjustment factors for process equipment will be incorporated into Title 24, Part 6.

Exhaust Air Heat Recovery (2 of 7)

The proposed air-to-air heat recovery measure will incorporate a new prescriptive requirement for exhaust air heat recovery. The proposed requirements for Title 24, Part 6 are based on the requirements

¹ ASHRAE 90.1 is not a publicly available document. The standard is available for purchase here:

<https://www.ashrae.org/resources--publications/bookstore/standard-90-1>

in ASHRAE 90.1-2016 Section 6.5.6.1, but the minimum energy recovery ratio requirements in ASHRAE 90.1-2016 were adjusted to establish more appropriate requirements for California's climate.

Equipment Efficiency (3 of 7)

The equipment efficiency measure will update the mandatory efficiency requirements for space conditioning equipment that appear in Tables 110.2-A through K of Title 24, Part 6. The revisions will harmonize the minimum requirements in Title 24, Part 6 with the minimum requirements that were revised for the 2016 release of ASHRAE 90.1. Tables 110.2-A through K include efficiency requirements for a wide variety of space conditioning equipment and contain hundreds of unique efficiency values. The Statewide CASE Team is proposing that 18 values in these tables be updated. Most of these changes will update the minimum efficiency values for equipment that is already covered by Title 24, Part 6.

As discussed in Section 4.1 of this report, federal law directs the United States (U.S.) Department of Energy (DOE) to review the federal minimum efficiency requirements for certain commercial and industrial equipment whenever ASHRAE 90.1 amends its standards for such equipment (42 USC 6313(a)(6)(A)). As a result of the "ASHRAE Trigger" requirements, ASHRAE has taken the lead on updating equipment efficiency requirements for space conditioning equipment, and the DOE typically adopts ASHRAE's equipment efficiency levels. States have a unique opportunity to adopt the equipment efficiency values that appear in ASHRAE 90.1 using a simplified process. The Energy Commission is not obligated to adopt ASHRAE 90.1 equipment efficiency values into Title 24, Part 6, but if the Energy Commission chooses to do so, it can adopt the equipment efficiency values without conducting a cost-effectiveness analysis. The Energy Commission can adopt the efficiency values before the DOE completes its cost-effectiveness analysis and before the DOE adopts the standards. Given that the DOE rulemaking process is typically slower than the Energy Commission's rulemaking process, this essentially means that California can adopt the equipment efficiency regulations several years earlier than the federal requirements will take effect.

The Energy Commission has requested that the Statewide CASE Team submit a CASE Report that identifies changes to Tables 110.2-A through 110.2-K based on ASHRAE 90.1-2016. Energy Commission staff indicated that the CASE Report does not need to include a lifecycle cost-effectiveness analysis, but it should include an assessment of market impacts and an economic assessment. This CASE Report includes information that will help inform the Energy Commission's determination that the proposed equipment efficiency levels can be adopted into Title 24, Part 6.

Waterside Economizers (4 of 7)

Title 24, Part 6 requirements for waterside economizers have remained unchanged since 1998. The standards for waterside economizers are lacking in clarity/detail, and the economizer hours are lower than they should be for efficient operation. The proposed code changes are based on requirements in ASHRAE 90.1-2016, although some of the requirements in ASHRAE 90.1-2016 have been tailored so they are better suited for California's climate. The proposed code changes will provide more explicit requirements for waterside economizers, including:

- Requiring integrated waterside economizers;
- Establishing limitations on pressure drop of heat exchangers used for waterside economizing;
- Adding a requirement that cooling towers must return to standard operation when not running the economizer; and
- Adding economizer requirement for chilled water systems that do not use large air handling units (affects passive "without fan" systems above a certain capacity).

The proposed requirements for Title 24, Part 6 will require more waterside economizer hours relative to ASHRAE 90.1-2016, a change intended to ensure economizers are utilized appropriately in California's relatively dry summer climate. A maximum system approach of 5°F for waterside economizers is

proposed, as well as a requirement that the system runs in full economizer mode at 49°F wet-bulb, compared to the previous requirement of 45°F wet-bulb.

Transfer Air for Exhaust Air Makeup (5 of 7)

This prescriptive measure will expand the existing Title 24, Part 6 requirement for kitchen exhaust transfer air to other types of exhaust systems, such as restroom and lab exhaust. This measure exactly matches the same requirement that was added to ASHRAE 90.1 in 2013. It is a prescriptive measure that applies to most spaces that have a process exhaust airflow rate that exceeds the airflow required for heating or cooling and that are adjacent to spaces that do not have high exhaust requirements. This will eliminate the wasteful practice of providing 100 percent outside air or 100 percent supply air to spaces with high exhaust rates while at the same time relieving air from other spaces in the same building, when the relieved air could have been transferred to the high exhaust space to reduce the total heating/cooling load.

The payback for this measure is immediate because it reduces both first cost and energy cost compared to 100 percent supply air to spaces with high exhaust rates.

Demand Controlled Ventilation for Classrooms (6 of 7)

The proposed measure consists of several modifications to the existing mandatory requirement for demand control ventilation (DCV) for high-density spaces. It applies to high-density spaces in most building types covered by Title 24, Part 6, such as offices, schools, universities, assembly spaces, churches, and retail spaces. Some spaces not previously covered by DCV, notably classrooms, would now be covered. The code change will modify the existing language in Section 120.1(c)3.

Occupant Sensor Ventilation Requirements (7 of 7)

The proposed measure modifies the existing mandatory occupant sensor ventilation control requirements in Title 24, Part 6. One of the main changes is that the existing requirements call for maintaining one quarter of the occupied minimum ventilation rate when the zone is unoccupied. The proposed requirement is to completely shut off ventilation if the space is unoccupied and the heating/cooling setpoints are satisfied. This change is facilitated by the fact that ANSI/ASHRAE Standard 62.1-2016 Ventilation for Acceptable Indoor Air Quality (ASHRAE 62.1) and the California Mechanical Code (Title 24, Part 4) now both allow “occupied standby mode” for selected spaces, meaning that zero ventilation is allowed when the space is unoccupied. The proposed measure also modifies the zones to which occupant sensor ventilation control requirements apply.

Scope of Code Change Proposal

Table 1 summarizes the scope of the proposed changes and which sections of the Standards, Reference Appendices, Alternative Calculation Manual (ACM) Reference Manual, and compliance documents will be modified as a result of the proposed change.

Table 1: Scope of Code Change Proposal

| Measure Name | Type of Requirement | Modified Section(s) of Title 24, Part 6 | Modified Title 24, Part 6 Reference Appendices | Will Compliance Software Be Modified | Modified Compliance Document(s) |
|--|---------------------|---|--|--------------------------------------|---|
| Fan System Power | Prescriptive | 140.4(c) | NR ACM 5.7.3 | Yes | NRCC-MCH-07-E |
| Air-to-Air Heat Recovery | Prescriptive | New sections in Section 140.4 | NR ACM 5.7.6.6 | Yes | NRCC-MCH-02-E |
| Equipment Efficiency | Mandatory | Tables 110.2-A through K | N/A | Yes | N/A |
| Waterside Economizers | Prescriptive | 140.4(e) | N/A | Yes | NRCC-MCH-02-E |
| Transfer Air for Exhaust Air Makeup | Prescriptive | 140.4(o) | N/A | Yes | N/A |
| Demand Controlled Ventilation for Classrooms | Mandatory | 120.1(c)3 | N/A | Yes | 2016-NRCA-MCH-06-A-Demand Control Ventilation |
| Occupant Sensor Ventilation Requirements | Mandatory | 120.1(c)5 and 120.2(e)3 | N/A | Yes | New document needed |

Market Analysis and Regulatory Impact Assessment

The market for the proposed code changes is well established and products are widely available. The Energy Commission only adopts cost-effective energy efficiency measures and has developed a specific lifecycle cost methodology that must be followed to demonstrate a measure’s cost-effectiveness.

All proposed code changes are cost-effective over the period of analysis. Overall, these proposals increase the wealth of the state of California. California consumers and businesses save more money on energy than they do for financing the efficiency measure.

The proposed changes to Title 24, Part 6 have a negligible impact on the complexity of the standards or the cost of enforcement. When developing this code change proposal, the Statewide CASE Team interviewed building officials, Title 24, Part 6 energy analysts, and others involved in the code compliance process to simplify and streamline the compliance and enforcement of this proposal.

Cost-Effectiveness

The proposed code changes were found to be cost-effective for all climate zones where they are proposed to be required. The benefit-to-cost (B/C) ratio compares the lifecycle benefits (cost savings) to the lifecycle costs. Measures that have a B/C ratio of 1.0 or greater are cost-effective. The larger the B/C ratio, the faster the measure pays for itself from energy savings. The B/C ratio for these measures range from 1.05 to 15 depending on climate zone. See Sections x.4 of Sections 2 through 8 for a detailed description of the cost-effectiveness analysis.

As explained in Section 4.1.2 of this report, the Energy Commission can adopt the equipment efficiency values that appear in ASHRAE 90.1-2016 without performing a cost-effectiveness analysis. The Statewide CASE Team did not conduct a cost-effectiveness analysis for this measure.

Statewide Energy Impacts

Table 2 shows the estimated energy savings over the first 12 months of implementation of the proposed code changes. See Sections 2 through 8 (sections x.5) for more details.

Table 2: Estimated Statewide First-Year^a Energy and Water Savings

| | First-Year Electricity Savings (GWh/yr) | First-Year Peak Electrical Demand Reduction (MW) | First-Year Water Savings (million gallons/yr) | First-Year Natural Gas Savings (million therms/yr) |
|---|--|---|--|---|
| Fan System Power (new construction) | 11.73 | 2.34 | N/A | -0.07 ^b |
| Exhaust Air Heat Recovery (new construction) | 0.20 | 1.32 | N/A | 0.01 |
| Equipment Efficiency (new construction) | 2.15 | 1.40 | N/A | N/A |
| Equipment Efficiency (alteration) | 6.74 | 4.43 | N/A | N/A |
| Waterside Economizers (new construction) | 0.25 | N/A | 4.12 | N/A |
| Transfer Air for Exhaust Air Makeup (new construction) | 0.40 | 0.85 | N/A | 0.03 |
| Demand Controlled Ventilation for Classrooms (new construction) | 3.38 | 2.17 | N/A | 0.38 |
| Occupant Sensor Ventilation Requirements (new construction) | 5.031 | 1.151 | N/A | 0.09 |
| Total | 29.79 | 13.66 | 0.16 | 0.51 |

a. First-year savings from all buildings completed statewide in 2020.

b. More efficient fan operation lowers the amount of heat going into the airstream.

Compliance and Enforcement

The Statewide CASE Team worked with stakeholders to develop a recommended compliance and enforcement process and to identify the impacts this process will have on various market actors. The compliance process for each of the seven measures is described in Sections 2 through 8 (Sections x.1.5). The impacts the proposed measures will have on various market actors are described in Section 1.2 and Appendix B. The key issues related to compliance and enforcement are summarized below:

- Education of designers on code changes; and
- Education of plan checkers and inspectors to verify code changes are followed.

Although a needs analysis has been conducted with the affected market actors while developing the code change proposals, the code requirements may change between the time the final CASE Report is submitted and the time the 2019 Standards are adopted. The recommended compliance process and compliance documentation may also evolve with the code language. To effectively implement the adopted code requirements, a plan should be developed that identifies potential barriers to compliance when rolling out the code change and approaches that should be deployed to minimize the barriers.

1. INTRODUCTION

The Codes and Standards Enhancement (CASE) initiative presents recommendations to support the California Energy Commission's (Energy Commission) efforts to update California's Building Energy Efficiency Standards (Title 24, Part 6) to include new requirements or to upgrade existing requirements for various technologies. The four California Investor Owned Utilities (IOUs) – Pacific Gas and Electric Company, San Diego Gas and Electric, Southern California Edison and SoCalGas® – and two Publicly Owned Utilities (POUs) – Los Angeles Department of Water and Power and Sacramento Municipal Utility District – sponsored this effort. The program goal is to prepare and submit proposals that will result in cost-effective enhancements to energy efficiency and energy performance in California buildings. This report and the code change proposals presented herein are part of the effort to develop technical and cost-effectiveness information for proposed requirements on building energy-efficient design practices and technologies.

The Statewide CASE Team submits code change proposals to the Energy Commission, the state agency that has authority to adopt revisions to Title 24, Part 6. The Energy Commission will evaluate proposals submitted by the Statewide CASE Team and other stakeholders. The Energy Commission may revise or reject proposals. See the Energy Commission's 2019 Title 24 website for information about the rulemaking schedule and how to participate in the process:

<http://www.energy.ca.gov/title24/2019standards/>.

The overall goal of this CASE Report is to present code change proposals for measures based on ASHRAE 90.1-2016. The report contains pertinent information supporting the code changes.

When developing the code change proposals and associated technical information presented in this report, the Statewide CASE Team worked with a number of industry stakeholders including building officials, manufacturers, builders, utility incentive program managers, Title 24, Part 6 energy analysts, and others involved in the code compliance process. The proposal incorporates feedback received during public stakeholder workshops that the Statewide CASE Team held on September 26, 2016, March 15, 2017, and March 29, 2017.

This CASE Report includes seven discrete submeasures, all of which are based on ASHRAE 90.1-2016. Section 1.1 discusses the relationship between ASHRAE 90.1 and Title 24, Part 6 and why the ASHRAE 90.1 requirements were used as a basis for the code change proposals presented in this report. Sections 1.2 and 1.3 present the market and economic impacts of all proposals on a macro level. Each of the seven code change proposals are discussed in more detail in Sections 2 through 8 of this report. The type of content presented in each subsection of Sections 2 through 8 is summarized below.

Section x.1 of each section describes the measure and its background, as well as a detailed description of how each change is accomplished in the various sections and documents that make up Title 24, Part 6. For each measure, Section x.4 describes whether the proposed measure overlaps or conflicts with other portions of the building standards including fire, seismic, and other safety standards and whether there are technical, compliance, or enforceability challenges.

The Statewide CASE Team collected input during the stakeholder outreach process on what compliance and enforcement issues may be associated with these measures. For each measure, Section x.1.5 summarizes how the proposed code change modifies the code compliance process. Appendix B presents a detailed description of how the proposed code changes could impact various market actors. When developing this proposal, the Statewide CASE Team considered methods to streamline the compliance and enforcement process and how negative impacts on market actors who are involved in the process could be mitigated or reduced. If the code change proposals are adopted, the Statewide CASE Team recommends that information presented in this section, Section x.1.5, and Appendix B be used to

develop a plan that identifies a process to develop compliance documentation and how to minimize barriers to compliance.

Section x.2 of each section presents the market analysis, including a review of the current market structure and the feasibility of the proposed code changes.

Section x.3 presents the per unit energy, demand, and energy cost savings associated with each proposed code change, as well as the methodology that the Statewide CASE Team used to estimate these factors.

Section x.4 presents the lifecycle cost and cost-effectiveness analysis for each proposed code change. This includes a discussion of additional materials and labor required to implement the measure and a quantification of the incremental cost. It also includes estimates of incremental maintenance costs—i.e., equipment lifetime and various periodic costs associated with replacement and maintenance during the period of analysis.

Section x.5 presents estimates of the statewide energy savings and environmental impacts of the proposed code change for the first year after the 2019 standards take effect. This includes the amount of energy that will be saved by California building owners and tenants, and impacts (increases or reductions) on materials with emphasis placed on any materials that are considered toxic. Statewide water consumption impacts are also considered.

Section x.6 presents specific recommendations with ~~strikeout~~ (deletions) and underlined (additions) language for the Standards, Reference Appendices, Alternative Calculation Manual (ACM) Reference Manual, Compliance Manual, and compliance documents.

1.1 Relationship Between ASHRAE 90.1 and Title 24, Part 6

Current United States (U.S.) federal law does not require states to adopt building energy efficiency codes for nonresidential buildings. However, if a state decides to adopt building efficiency codes for nonresidential buildings, the state code must result in energy performance that is equal to or better than the energy performance achieved through the current version of ASHRAE 90.1. Energy performance is evaluated on the code as a whole – not on a measure-by-measure basis. This means that the Energy Commission does not have to adopt any one measure in ASHRAE 90.1 as long as the aggregate of all measures in Title 24, Part 6 result in the same or better energy performance as the aggregate of all measures in ASHRAE 90.1 (42 USC 6832-6836).

Although California is not required to adopt every measure in ASHRAE 90.1, some of the measures adopted into ASHRAE 90.1 are well suited for California's building code. California typically reviews revisions to ASHRAE 90.1 on a measure-by-measure basis to identify potential revisions to Title 24, Part 6. It should be noted that ASHRAE 90.1 is designed to be applicable for all states. Therefore, some of the measures in ASHRAE 90.1 are not ideally suited for California. Often the ASHRAE 90.1 requirements that are not well suited for California can be modified so they are more appropriate for each California climate zone.

It is important to note that ASHRAE 90.1 and Title 24, Part 6 are structured differently. In most cases ASHRAE 90.1 code language cannot be adopted verbatim into Title 24, Part 6 because there are discrepancies in the existing code structures and terminologies. For example, ASHRAE 90.1 and Title 24, Part 6 use different climate zones, so requirements that are unique for each climate zone need to be evaluated carefully to ensure that the proposed Title 24, Part 6 Standards are cost-effective in all Title 24, Part 6 climate zones.

Typically, measures that have been vetted through the ASHRAE 90.1 public review process do not receive significant stakeholder opposition when proposed for Title 24, Part 6. This is, in part, because stakeholders have already participated in ASHRAE's consensus-building process to develop the code language that is adopted into ASHRAE 90.1. However, even if a measure has been vetted through the

ASHRAE process and adopted into ASHRAE 90.1, California must complete an independent analysis of all proposed changes to Title 24, Part 6 that are based on ASHRAE 90.1 to ensure the measure is cost-effective and feasible in the California market.² Proposed changes to Title 24, Part 6 that are based on ASHRAE 90.1-2016 must also be presented at the Energy Commission's public workshops. The information provided in this CASE Report will help inform the Energy Commission's determination that the proposed code changes are indeed cost-effective and feasible in California.

1.2 Market Impacts and Economic Assessment for All Submeasures

1.2.1 Impact on Builders

It is expected that builders will not be impacted significantly by any of the proposed code changes to Title 24, Part 6. Builders could be impacted by change in demand for new buildings and by construction costs. Demand for new buildings is driven more by factors such as the overall health of the economy and population growth than the cost of construction. The cost of complying with Title 24, Part 6 requirements represents a very small portion of the total building value. Increasing the building cost by a fraction of a percent is not expected to have a significant impact on demand for new buildings or the builders' profits.

Market actors will need to invest in training and education to ensure the workforce, including designers and those working in construction trades, know how to comply with the proposed requirements. Workforce training is not unique to the building industry, and is common in many fields associated with the production of goods and services. Costs associated with workforce training are typically accounted for in long-term financial planning and spread out across the unit price of many units so as to avoid price spikes when changes in designs and/or processes are implemented.

1.2.2 Impact on Building Designers and Energy Consultants

Adjusting design practices to comply with changing building codes practices is within the normal practice of building designers. Building codes (including Title 24, Part 6 and model national building codes published by the International Code Council, the International Association of Plumbing and Mechanical Officials, and ASHRAE 90.1) are typically updated on three-year revision cycles. As discussed in Section 1.2.1, all market actors should (and do) plan for training and education that may be required to adjust design practices to accommodate compliance with new building codes. As a whole, the measures the Statewide CASE Team is proposing for the 2019 code cycle aim to provide designers and energy consultants with opportunities to comply with code requirements in multiple ways, thereby providing flexibility in requirements can be met.

The systems addressed in the seven (7) code changes proposed in this report are already common practice. This includes cooling towers, waterside economizers, and heat recovery systems. No significant impacts to designers or energy consultants are anticipated. Any changes in workflow are outlined in Appendix B.

1.2.3 Impact on Occupational Safety and Health

The proposed code changes do not alter any existing federal, state, or local regulations pertaining to safety and health, including rules enforced by the California Division of Occupational Safety and Health. All existing health and safety rules will remain in place. Complying with the proposed code changes is not anticipated to have adverse impacts on the safety or health of occupants, or those involved with the construction, commissioning, and maintenance of the building.

² California can adopt proposed changes to equipment that appear in Table 110.2 of Title 24, Part 6 without performing a cost-effectiveness analysis if the revised equipment efficiency levels also appear in the most recent version of ASHRAE 90.1.

However, many building occupants (e.g., classroom occupants) will experience improved ventilation because the addition of carbon dioxide (CO₂) sensors and demand controlled ventilation to classrooms monitors the actual quantity of outside air being delivered to the occupied space and will alert the operators and the occupants when inadequate ventilation is being provided. Airside economizers sometimes fail, and can fail in the closed position, thus not supplying enough outside air. Without CO₂ sensors and demand controlled ventilation, this condition could persist undetected.

1.2.4 Impact on Building Owners and Occupants

Building owners and occupants will benefit from lower energy bills. As discussed in Section 1.3.1, when building occupants save on energy bills, they tend to spend it elsewhere in the economy, thereby creating jobs and economic growth for the California economy.

Some additional maintenance would be required on heat recovery systems, so building owners will need to take these costs into account during the design process.

1.2.5 Impact on Building Component Suppliers (Including Manufacturers and Distributors)

The proposed measures have little to no impact on the building component retailers. In most cases, they will increase the amount of products manufactured or distributed. In the case of the equipment efficiency measure, equipment that does not meet the mandatory requirement is eliminated, but since this is a federal requirement, all retailers are equally affected.

1.2.6 Impact on Building Inspectors

Building inspectors are minimally affected. No changes are anticipated for field verification or acceptance test requirements.

1.2.7 Impact on Statewide Employment

Section 1.3.1 discusses statewide job creation from the energy efficiency sector in general, including updates to Title 24, Part 6.

1.3 Economic Impacts of All Submeasures

1.3.1 Creation or Elimination of Jobs

In 2015, California's building energy efficiency industry employed more than 321,000 workers who worked at least part time or a fraction of their time on activities related to building efficiency. Employment in the building energy efficiency industry grew six percent between 2014 and 2015 while the overall statewide employment grew three percent (BW Research Partnership 2016). Lawrence Berkeley National Laboratory's report titled *Energy Efficiency Services Sector: Workforce Size and Expectations for Growth* (2010) provides details on the types of jobs in the energy efficiency sector that are likely to be supported by revisions to building codes.

Building codes that reduce energy consumption provide jobs through direct employment, indirect employment, and induced employment.³ Title 24, Part 6 creates jobs in all three categories with a significant amount from induced employment, which accounts for the expenditure-induced effects in the general economy due to the economic activity and spending of direct and indirect employees (e.g., nonindustry jobs created such as teachers, grocery store clerks, and postal workers). A large portion of the induced jobs from energy efficiency are the jobs created by the energy cost savings due to the energy efficiency measures. Wei, Patadia, and Kammen (2010) estimate that energy efficiency creates 0.17 to 0.59 net job-years⁴ per gigawatt hours (GWh) saved. By comparison, they estimate that the coal and natural gas industries create 0.11 net job-years per GWh produced. Using the mid-point for the energy efficiency range (0.38 net job-years per GWh saved) and estimates that this proposed code changes will result in a statewide first-year savings of 27.4 GWh, this measure will result in approximately 10.4 jobs created in the first year. See Sections 2 through 8 (Sections x.5) for statewide savings estimates.

1.3.2 Creation or Elimination of Businesses in California

There are approximately 43,000 businesses that play a role in California's advanced energy economy (BW Research Partnership 2016). California's clean economy grew ten times more than the total state economy between 2002 and 2012 (20 percent compared to two percent). The energy efficiency industry, which is driven in part by recurrent updates to the building code, is the largest component of the core clean economy (Ettenson and Heavey 2015). Adopting cost-effective code changes for the 2019 Title 24, Part 6 code cycle will help maintain the energy efficiency industry.

Table 3 lists industries that will likely benefit from the proposed code changes, classified by their North American Industry Classification System (NAICS) Code.

Specific California businesses that might be impacted by the proposed code changes include manufacturers of exhaust air heat recovery devices and waterside economizers. The proposed code changes would result in an increase in the use of these products, though it is unknown if these products are or would be manufactured directly in California. However, both requirements are prescriptive, and thus only buildings that pursue the prescriptive requirements will be required to implement these standards. Therefore, no manufacturers are required to produce these products and their business should not be negatively impacted if they are unable to meet the proposed changes.

³ The definitions of direct, indirect, and induced jobs vary widely by study. Wei, Patadia, and Kammen (2010) describe the definitions and usage of these categories as follows: "Direct employment includes those jobs created in the design, manufacturing, delivery, construction/installation, project management and operation and maintenance of the different components of the technology, or power plant, under consideration. Indirect employment refers to the 'supplier effect' of upstream and downstream suppliers. For example, the task of installing wind turbines is a direct job, whereas manufacturing the steel that is used to build the wind turbine is an indirect job. Induced employment accounts for the expenditure-induced effects in the general economy due to the economic activity and spending of direct and indirect employees, e.g., nonindustry jobs created such as teachers, grocery store clerks, and postal workers."

⁴ One job-year, or "full-time equivalent" (FTE) job, is full-time employment for one person for a duration of one year.

Table 3: Industries Receiving Energy Efficiency Related Investment, by North American Industry Classification System (NAICS) Code

| Industry | NAICS Code |
|--|-------------------|
| Residential Building Construction | 2361 |
| Nonresidential Building Construction | 2362 |
| Electrical Contractors | 23821 |
| Plumbing, Heating, and Air-Conditioning Contractors | 23822 |
| Insulation Contractors | 23831 |
| Manufacturing | 32412 |
| Other Nonmetallic Mineral Product Manufacturing | 3279 |
| Industrial Machinery Manufacturing | 3332 |
| Ventilation, Heating, Air-Conditioning, & Commercial Refrigeration Equip. Manf. | 3334 |
| Computer and Peripheral Equipment Manufacturing | 3341 |
| Communications Equipment Manufacturing | 3342 |
| Engineering Services | 541330 |
| Building Inspection Services | 541350 |
| Environmental Consulting Services | 541620 |
| Other Scientific and Technical Consulting Services | 541690 |
| Advertising and Related Services | 5418 |
| Corporate, Subsidiary, and Regional Managing Offices | 551114 |
| Office Administrative Services | 5611 |
| Commercial & Industrial Machinery & Equip. (exc. Auto. & Electronic) Repair & Maint. | 811310 |

1.3.3 Competitive Advantages or Disadvantages for Businesses in California

In 2014, California’s electricity statewide costs were 1.7 percent of the state’s gross domestic product (GPD) while electricity costs in the rest of the United States were 2.4 percent of GDP (Thornberg, Chong and Fowler 2016). As a result of spending a smaller portion of overall GDP on electricity relative to other states, Californians and California businesses save billions of dollars in energy costs per year relative to businesses located elsewhere. Money saved on energy costs can be otherwise invested, which provides California businesses with an advantage that will only be strengthened by the adoption of the proposed code changes that impact nonresidential buildings.

1.3.4 Increase or Decrease of Investments in the State of California

The proposed changes to the building code are not expected to impact investments in California on a macroeconomic scale, nor are they expected to affect investments by individual firms. The allocation of resources for the production of goods in California is not expected to change as a result of these code change proposals.

1.3.5 Effects on the State General Fund, State Special Funds and Local Governments

The proposed code changes are not expected to have a significant impact on the California’s General Fund, any state special funds, or local government funds. Revenue to these funds comes from taxes levied. The most relevant taxes to consider for these proposed code changes are: personal income taxes, corporation taxes, sales and use taxes, and property taxes. The proposed changes for the 2019 Title 24, Part 6 Standards are not expected to result in noteworthy changes to personal or corporate income, so the revenue from personal income taxes or corporate taxes is not expected to change. As discussed, reductions in energy expenditures are expected to increase discretionary income. State and local sales tax revenues may increase if building occupants spend their additional discretionary income on taxable items. Although logic indicates there may be changes to sales tax revenue, the impacts that are directly related to revisions to Title 24, Part 6 have not been quantified. Finally, revenue generated from property taxes is directly linked to the value of the property, which is usually linked to the purchase price of the property. The proposed changes will increase construction costs. As discussed in Section

1.2.1, however, there is no statistical evidence that Title 24, Part 6 drives construction costs or that construction costs have a significant impact on building price. Since compliance with Title 24, Part 6 does not have a clear impact on purchase price, it can follow that Title 24, Part 6 cannot be shown to impact revenues from property taxes.

1.3.5.1 Cost of Enforcement

Cost to the State

State government already has budget for code development, education, and compliance enforcement. While state government will be allocating resources to update the Title 24, Part 6 Standards, including updating education and compliance materials and responding to questions about the revised requirements, these activities are already covered by existing state budgets. The costs to state government are small when compared to the overall costs savings and policy benefits associated with the code change proposals. The proposed measures will affect the design of state buildings, but because they are found to be cost-effective, these measures will contribute to energy and cost savings in these buildings.

Cost to Local Governments

All revisions to Title 24, Part 6 will result in changes to compliance determinations. Local governments will need to train building department staff on the revised Title 2, Part 6 Standards. While this re-training is an expense to local governments, it is not a new cost associated with the 2019 code change cycle. The building code is updated on a triennial basis, and local governments plan and budget for retraining every time the code is updated. There are numerous resources available to local governments to support compliance training that can help mitigate the cost of retraining, including tools, training and resources provided by the IOU codes and standards program (such as Energy Code Ace). As noted throughout this report, the Statewide CASE Team considered how the proposed code change might impact various market actors involved in the compliance and enforcement process and aimed to minimize negative impacts on local governments.

1.3.6 Impacts on Specific Persons

The proposed changes to Title 24, Part 6 are not expected to have a differential impact on any groups relative to the state population as a whole, including migrant workers, commuters, or persons by age, race, or religion.

1.4 Methodology for Energy Savings, Lifecycle Cost-Effectiveness, and Statewide Impacts Analyses

1.4.1 Energy Savings Methodology

To assess the energy, demand, and energy cost impacts, the Statewide CASE Team compared current design practices to design practices that would comply with the proposed requirements. Where there is an existing Title 24, Part 6 standard that covers the building system in question, the existing conditions assume the prototype building complies with the 2016 Title 24, Part 6 Standards with the minimal allowable efficiency. Where there is no existing Title 24, Part 6 requirement that covers the building system in question, the Statewide CASE Team used current design practices as the existing condition.

The following tools were used to quantify energy savings and peak electricity demand reductions:

- **Fan System Power:** California Building Energy Code Compliance for Commercial/Nonresidential Buildings Software (CBECC-Com)
- **Exhaust Air Heat Recovery:** CBECC-Com & OpenStudio
- **Equipment Efficiency:** CBECC-Com

- **Waterside Economizer:** OpenStudio
- **Transfer Air for Exhaust Air Makeup:** OpenStudio
- **Demand Controlled Ventilation for Classrooms:** OpenStudio
- **Occupant Sensor Ventilation Requirements:** OpenStudio

1.4.2 Energy Cost Savings Methodology

Time Dependent Valuation (TDV) energy is a normalized format for comparing electricity and natural gas costs that takes into account the cost of electricity and natural gas consumed during each hour of the year. The TDV values are based on long-term discounted costs (30 years for all residential measures and nonresidential envelope measures and 15 years for all other nonresidential measures). The period of analysis used for all seven submeasures is 15 years. The TDV cost impacts are presented in 2020 present value (PV) dollars. The TDV energy estimates are based on present-valued cost savings but are normalized in terms of “TDV kBtu” (one thousand British thermal units). The Energy Commission derived the 2019 TDV values that were used in the analyses for this report (Energy + Environmental Economics 2016).

1.4.3 Incremental First Cost Methodology

The Statewide CASE Team estimated the current incremental construction costs, which represents the incremental cost of the measure if a building meeting the proposed standard were built today.

Per the Energy Commission’s guidance, design costs are not included in the incremental first cost.

1.4.4 Lifetime Incremental Maintenance Costs Methodology

Incremental maintenance cost is the incremental cost of replacing the equipment or parts of the equipment, as well as periodic maintenance required to keep the equipment operating relative to current practices over the period of analysis. The present value of equipment and maintenance costs (savings) was calculated using a three percent discount rate (d), which is consistent with the discount rate used when developing the 2019 TDV. The present value of maintenance costs that occurs in the n^{th} year is calculated as follows (where d is the discount rate of three percent):

$$\text{Present Value of Maintenance Cost} = \text{Maintenance Cost} \times \left[\frac{1}{1 + d} \right]^n$$

1.4.5 Lifecycle Cost-Effectiveness Methodology

This CASE Report proposes both mandatory and prescriptive requirements. As such, a lifecycle cost analysis is required to demonstrate that the measure is cost-effective over the 15-year period of analysis.

The Energy Commission establishes the procedures for calculating lifecycle cost-effectiveness. The Statewide CASE Team collaborated with Energy Commission staff to confirm that the methodology in this report is consistent with their guidelines, including which costs were included in the analysis. In this case, incremental first cost and incremental maintenance costs over the 15-year period of analysis were included. The TDV energy cost savings from electricity and natural gas savings were also included in the evaluation.

Design costs were not included nor was the incremental cost of code compliance verification.

According to the Energy Commission’s definitions, a measure is cost-effective if the benefit-to-cost (B/C) ratio is greater than 1.0. The B/C ratio is calculated by dividing the total present lifecycle cost benefits by the present value of the total incremental costs.

1.4.6 Statewide First-Year Energy Savings and Lifecycle Energy Cost Savings Methodology

The Statewide CASE Team calculated the first-year statewide savings by multiplying the per unit savings by the statewide new construction forecast for 2020 or expected alterations in 2020, which is

presented in more detail in Appendix A. The first-year energy impacts represent the first-year annual savings from all buildings that were completed in 2020. The lifecycle energy cost savings represent the energy cost savings over the entire 15-year analysis period. The statewide savings estimates do not take naturally occurring market adoption or compliance rates into account.

2. FAN SYSTEM POWER

2.1 Measure Description

2.1.1 Measure Overview

The proposed fan system power measure will align the prescriptive requirements of the Section 140.4(c) calculation methodology for allowed fan power with ASHRAE 90.1-2016 Section 6.5.3.1. The measure will affect all new buildings or alterations replacing existing HVAC and ductwork that has supply and return fans; exhaust fans at the system level; fan-powered variable air volume (VAV) boxes; and zonal exhaust fans greater than five horsepower (hp). This measure includes two parts: (1) updating the base fan system power allowance, and (2) including more robust fan power adjustment factors.

The measure will update the baseline fan power allowance and change the metric from limiting the allowed Watts per cubic feet per minute (W/cfm) of the fan to limiting the allowed motor nameplate horsepower or fan brake horsepower of the fan system required to handle the total static pressure generated by the duct system. This measure will align the fan power allowance with Section 5.7.3 of the 2016 Nonresidential Alternative Calculation Method (ACM) Reference Manual (also referred to as Nonresidential ACM), which is more stringent than the existing Title 24, Part 6 prescriptive requirements and the ASHRAE 90.1-2016 requirements. This should not be an issue in California as all compliant buildings using the performance pathway have been compared to the Nonresidential ACM levels since the standards were introduced in 2013. The measure will modify the ASHRAE 90.1-2016 Section 6.5.3.1 fan power requirements by changing the allowed total static pressure to match Nonresidential ACM levels as shown in Table 4. The detailed breakdown of the allowed total static pressure can be seen in Appendix D.

Table 4: Allowed Total Static Pressure under Each Standard

| | Constant Volume | Variable Volume |
|-------------------|-----------------|-----------------|
| Title 24 Part 6 | 3.96" | 6.18" |
| ASHRAE 90.1 | 3.85" | 5.35" |
| Proposed (NR ACM) | 3.50" | 4.50" |

This measure will also adopt the adjustment factors from Table 6.5.3.1-2 from ASHRAE 90.1-2016. The pressure drop adjustments will incorporate the relevant credits from ASHRAE that occur from process specific requirements. Credits to be eliminated include devices not tied to process-specific requirements:

- Energy recovery device (when not required by code)
- Coil run around loop
- Evaporative humidifier/cooler
- Sound attenuators

The intent of this measure is to align the prescriptive and performance requirements for fan power and make fan power calculations more transparent to let designers know what their maximum static pressure should be for common components. This allows designers to calculate fan power based on what is actually designed and allows California to limit pressure drops through various other devices, including future devices that may affect static pressure.

The fan efficiency requirements in ASHRAE 90.1-2016 Section 6.5.3.1.3 Fan Efficiency will not be included in the proposed measure. The fan industry is moving away from using the Fan Efficiency Grade as this metric does not consider the design conditions or the part load conditions of the fan. The

Department of Energy (DOE)⁵ is creating a new fan efficiency rating system which will eventually become a federal standard. It is the understanding of the case author this change will replace the current ASHRAE 90.1-2016 Fan Efficiency section and is being developed to better represent a fans true efficiency at both testing and design conditions. The changes proposed here focus only on fan system static pressure. Future code cycles in CA should consider adoption and or development of the fan efficiency from the DOE.

2.1.2 Measure History

The measure is being proposed because the current fan power requirements are out of date with standard practice and not aligned with national standards. Wording and exceptions of Section 140.4(c) have been modified in recent code cycles, but the fan power allowances (W/cfm) requirements are unchanged since its introduction in 1992. The code has been unchanged for several updates to the DOE standard for motor efficiency in 1997, 2010, and 2016. The fan power allowance has not changed to match the more efficient motors. The proposed measure limits the fan brake horsepower or the motor nameplate horsepower, and separates the motor efficiency, since this is a part of the developing federal standard (DOE 10 CFR 431 Subpart B). Finally, the cost-effectiveness of designing and installing heating, ventilation, and air-conditioning (HVAC) systems with lower static pressures and lower of fan power demand has improved over the past several decades.

The fan power adjustment factor of the baseline fan energy was introduced in 1998 to allow filters and other air treatment devices over one inch in water gauge (WG) pressure drop to be used without the penalty of added static pressure. In 2005, the adjustment factor equation was changed to reflect the one inch WG pressure drop, but was otherwise unchanged. The current fan power adjustment factor does not limit the added static pressure to the fan system, and the pressure drop through filters is unregulated.

Prior to the 2013 Title 24, Part 6 Standards, the baseline fan power allowance in the Nonresidential ACM Reference Manual was based on the fan power index as described in Title 24, Part 6 Section 140.4(c). The user input the brake horsepower, fan efficiency, and airflow along with the HVAC system type for the proposed design to determine the allowed W/cfm of the baseline fan. In the 2013 Standards, the fan power calculation in the Nonresidential ACM Reference Manual changed fan power to be based on airflow rate, static pressure, fan efficiency, motor efficiency, and part load curve determined by building type, HVAC system type, and fan type. This change was necessary because of the shift from the DOE-2 building energy simulation engine to a more powerful EnergyPlus engine.

2.1.3 Summary of Proposed Changes to Code Documents

2.1.3.1 Standards Change Summary

The proposed code change will replace the existing fan power allowance requirements, which are based on W/cfm, with requirements based on either design horsepower or brake horsepower. The proposed changes will align with the approach used in ASHRAE 90.1-2016 (Section 6.5.3.1.). The proposed allowances are not identical to the allowances in ASHRAE 90.1-2016, since they have been modified for California climate conditions. The fan power allowances from ASHRAE 90.1 will be modified to match the 2016 Nonresidential ACM Section 5.7.3 levels. Fan power adjustment factors from ASHRAE 90.1 Table 6.5.3.1-2 will also be included, but modified to exclude fans associated with process loads. All relevant tables and exceptions are incorporated with the above changes.

2.1.3.2 Reference Appendices Change Summary

The proposed measure will not recommend changes to the Reference Appendices.

⁵ The U.S. DOE website includes additional information about the fan efficiency rulemaking: <https://www.regulations.gov/docket?D=EERE-2013-BT-STD-0006>.

2.1.3.3 Alternative Calculation Method (ACM) Reference Manual Change Summary

This proposal will modify Section 5.7.3 of the Nonresidential ACM Reference Manual under the Process and Filtration Pressure Drop subsection. The language for this subsection will match the new adjustment factor calculation based on ASHRAE 90.1 Table 6.5.3.1-2, and a new input for adjustment factors should be included into CBECC-Com.

See Section 2.6.3 of this report for the detailed proposed revisions to the text of the Nonresidential ACM.

2.1.3.4 Compliance Manual Change Summary

The measure changes Section 4.6.2.3 Fan Power Consumption to match the new calculation method. It includes an explanation and sample calculations of the new method based on the ASHRAE 90.1 User's Manual.

2.1.3.5 Compliance Documents Change Summary

The proposed measure makes changes to NRCC-MCH-07-E Fan Power Consumption compliance document to match new calculation method. The compliance document can be an electronic compliance document like the Washington State Code MECH-FANSYS⁶ or a step-by-step form like the current California document.

Examples of the revised documents are presented in Section 2.6.4.

2.1.4 Regulatory Context

2.1.4.1 Existing Title 24, Part 6 Standards

The current prescriptive requirement in Title 24, Part 6 Section 140.4(c) establishes the maximum fan power of 0.8 W/cfm for constant volume fans and 1.25 W/cfm for variable volume fans.

2.1.4.2 Relationship to Other Title 24, Part 6 Requirements

This measure will be related to sections about filters, heat recovery, or other fan power adjustments factor devices in the code. The proposed change allows Title 24, Part 6 to cover pressure drops through these air treatment devices. There is no impact from this measure change to other parts of Title 24 beyond Part 6.

2.1.4.3 Relationship to State or Federal Laws

The proposed change will not be affected by the DOE metric, since the calculation is based on the static pressure of the fan system and not the fan itself.⁷ Future Title 24, Part 6 code cycles should consider adoption and or development of the fan efficiency from the DOE.

2.1.4.4 Relationship to Industry Standards

The measure incorporates ASHRAE 90.1-2016 Section 6.5.3.1 with improvements to meet California standards. Because it is included in ASHRAE 90.1, this measure is included already in many state

⁶ The mechanical compliance documents for the Washington State building code are available here: http://neec.net/sites/default/files/neec_codes/forms15/MECH15-v2.xlsm.

⁷ A fan efficiency metric is currently being developed by the DOE as a federal preemption for all fans that fan manufacturers will have to comply with. The Fan Efficiency Grade metric under ASHRAE 90.1 was met with criticism because it did not correlate the fan efficiency with its design operating point. The new metric, the Fan-Energy Index, will be based on design fan performance. To learn more about the decision-making process, visit the Energy Conservation Standards for Commercial and Industrial Fans and Blowers docket at <https://www.regulations.gov/docket?D=EERE-2013-BT-STD-0006>.

energy codes, including the International Energy Conservation Code 2015 Section 403.2.12, Air System Design and Control.

2.1.5 Compliance and Enforcement

This code change proposal primarily affects buildings that use the mandatory and prescriptive approaches to compliance. The key steps and changes to the compliance process are summarized below.

- **Design Phase:** Small changes are anticipated to the existing design phase process. Design teams must be aware of the code requirements and properly size their duct work to apply the lower static pressure requirements. More coordination between the mechanical designer and the structural engineer may happen to avoid ductwork and structural members being in conflict. There is a modification to an existing fan power compliance document that should be simple, yet more transparent than the previous form.
- **Permit Application Phase:** The changes to the compliance document NRCC-MCH-07-E or NRCC-PRF-01-E reflect the code change requirements. Permit reviewers will need to be briefed on the changes in requirements and how to quickly determine if the requirements are being met in the building plans.
- **Construction Phase:** No changes to the existing permit construction phase process are anticipated. The proposed measure only affects the design and permit application phase.
- **Inspection Phase:** No changes to the existing permit inspection phase process are anticipated. The proposed measure only affects the design and permit application phase.

2.2 Market Analysis

The Statewide CASE Team performed a market analysis with the goals of identifying current technology availability, current product availability, and market trends. The Statewide CASE Team considered how the proposed standard may impact the market in general and individual market actors. The Statewide CASE Team gathered information about the incremental cost of complying with the proposed measure. Estimates of market size and measure applicability were identified through research and outreach with stakeholders including utility program staff, Energy Commission staff, and a wide range of industry players who were invited to participate in utility-sponsored stakeholder meetings held on September 26, 2016, and March 29, 2017.

2.2.1 Market Structure

Principal manufacturers of fans include Energy Labs, Huntair, Greenheck Fan, Twin City Fan & Blower, and Loren Cook Company. These fans are specified by mechanical engineers for air distribution and exhaust. Fans are also manufactured by air handler units and package unit manufacturers. Package unit manufacturers include Carrier, Trane, York, Bard, AAON, and Reznor. These products are specified by mechanical engineers based on space conditioning needs for the building.

The products are distributed through manufacturer representatives or directly from the manufacturers. Fans and package units are a well-established technology and readily available from multiple manufacturers.

2.2.2 Technical Feasibility, Market Availability, and Current Practices

Fan systems are available from many different manufacturers and as a national standard, and all manufacturers are familiar with the proposed code change.

A survey on packaged air handling units was conducted to test which fan systems are not allowed due to the proposed change. A study of package units sold by Trane, AAON, Bard, and Reznor showed that most equipment under 60k BTUh capacity are not affected by the proposed change as the fan motor

nameplate power is under five hp. For unitary package HVAC units with fan motors above five hp, most fan systems are allowed except in extreme cases of systems with low airflow (<1000 cfm) and high static pressure (>5.5 inches). The current code does not regulate fan systems under 25 hp. Most packaged units less than 90 tons have less than 25 hp, therefore exempt from regulation. Of the fans that are regulated under the current code, all the package unit options are code compliant.

With the proposed change, most fan systems will comply, excluding rare cases with low airflow and high static pressure. For fan systems in these conditions, if the high static pressure is due to filters or other process equipment, then the fan adjustment factor should allow the system to comply. Otherwise, compliance can be easily met by low pressure duct work design with shorter lengths, reduced turns, and larger ductwork helps reduce the static pressure.

2.3 Energy Savings

2.3.1 Key Assumptions for Energy Savings Analysis

The energy savings analysis for the measure uses energy modeling following the guidance of the 2016 Nonresidential ACM. Energy models are sourced from CBECC-Com prototypical models and are only modified to include the proposed changes to the energy standards and Nonresidential ACM.

This measure will update the fan system power in the prescriptive requirement to Nonresidential ACM levels, generating energy savings compared to the current prescriptive baseline of 1.25 W/cfm for variable air volume systems to the current Nonresidential ACM baseline.

All other components of the existing conditions are assumed to minimally comply with the 2016 Title 24, Part 6 Standards.

2.3.2 Energy Savings Methodology

For calculating prescriptive requirement savings, the Standard Design under CBECC-Com will be assumed as the “proposed conditions” as it follows the Nonresidential ACM rulesets at 4.5 inches of total static pressure. For the baseline case, the total static pressure inputs for the proposed case will be modified so that the calculated W/cfm of the fan system is at 1.25 W/cfm.

Figure 1 shows the fan inputs in CBECC-Com prototype building for large office at 4.5 inches (based on the ACM static pressure allowance for VAV systems in Title 24, Part 6 2016) of total static pressure resulting in 0.911 W/cfm fan power index. Figure 2 shows the same fan inputs but with the total static pressure of the fan system changed to 6.231 IWC so that 1.25 W/cfm is achieved. The fan efficiency will be unchanged at 62 percent for both cases.

| | | |
|--|--------------------|------------------|
| Name: | BaseSys6 Fan | |
| Control Method: | VariableSpeedDrive | |
| Classification: | Centrifugal | |
| Status: | New | Component Qty: 1 |
| Centrifugal Type: | AirFoil | |
| Capacity and Power (For single system/terminal if Component Qty > 1) | | |
| Flow Capacity: | 25,801 | cfm |
| Flow Minimum: | 5,753 | cfm |
| Position: | DrawThrough | |
| Modeling Method: | StaticPressure | |
| Total Static Pressure: | 4.500 | inches H2O |
| Fan Efficiency: | 0.620 | |
| Motor Brake HP: | 29.512 | hp |
| Total Power (Ref): | 23.509 | kW |
| Power Per Flow (Ref): | 0.911 | W/cfm |
| Motor Information | | |
| Position: | InAirStream | |
| Nameplate HP: | 30.000 | hp |
| Type: | Open | |
| Pole Count: | 4 | |
| Motor Efficiency: | 0.936 | |

Figure 1: Proposed case: fan input in CBECC-Com with nonresidential ACM default total static pressure

| | | |
|--|--------------------|------------------|
| Name: | BaseSys6 Fan | |
| Control Method: | VariableSpeedDrive | |
| Classification: | Centrifugal | |
| Status: | New | Component Qty: 1 |
| Centrifugal Type: | AirFoil | |
| Capacity and Power (For single system/terminal if Component Qty > 1) | | |
| Flow Capacity: | 25,801 | cfm |
| Flow Minimum: | 5,753 | cfm |
| Position: | DrawThrough | |
| Modeling Method: | StaticPressure | |
| Total Static Pressure: | 6.231 | inches H2O |
| Fan Efficiency: | 0.620 | |
| Motor Brake HP: | 40.864 | hp |
| Total Power (Ref): | 32.242 | kW |
| Power Per Flow (Ref): | 1.250 | W/cfm |
| Motor Information | | |
| Position: | InAirStream | |
| Nameplate HP: | 50.000 | hp |
| Type: | Open | |
| Pole Count: | 4 | |
| Motor Efficiency: | 0.945 | |

Figure 2: Baseline case: fan inputs in CBECC-Com with adjusted total static pressure

The edited static pressure will differ based on the motor efficiency, therefore the motor size. The motor efficiencies for each motor size comes from Table NA3-2 of the 2016 Title 24 Part 6 Reference Appendices for enclosed 4 pole motors. The adjusted static pressures used in the analysis are as follows:

Table 5: Total Static Pressure for Each Motor Size in Order to Achieve 1.25 W/cfm

| Motor Horsepower (HP) | Motor Efficiency (%) | Total Static Pressure (in. WG) |
|-----------------------|----------------------|--------------------------------|
| 5 | 89.5 | 5.901 |
| 7.5 | 91.7 | 6.046 |
| 10 | 91.7 | 6.046 |
| 15 | 92.4 | 6.093 |
| 20 | 93.0 | 6.132 |
| 25 | 93.6 | 6.172 |
| 30 | 93.6 | 6.172 |
| 40 | 94.1 | 6.205 |
| 50 | 94.5 | 6.231 |
| 60 | 95.0 | 6.264 |
| 75 | 95.4 | 6.290 |
| 100 | 95.4 | 6.290 |
| 125 | 95.4 | 6.290 |
| 150 | 95.8 | 6.317 |
| 200 | 96.2 | 6.343 |

Steps to solve for the maximum total static pressure are shown in Appendix E. All other components of the prototype model will remain consistent with the Nonresidential ACM Reference Manual.

The Energy Commission provided guidance on the type of prototype buildings that must be modeled. The proposed measure affects all buildings, but the large office and medium retail prototypes were chosen for the analysis because they affect the most building square footage based on the projections for new construction in 2020.

Table 6 presents the details of the prototype buildings used in the analysis.

Table 6: Prototype Buildings Used for Energy, Demand, Cost, and Environmental Impacts Analysis – Fan System Power

| Prototype ID | Occupancy Type | Area (ft ²) | Number of Stories | Statewide Area (million ft ²) |
|--------------|----------------|-------------------------|-------------------|---|
| Prototype 1 | Large Office | 498,589 | 13 | 42.358 |
| Prototype 2 | Medium Retail | 24,563 | 1 | 35.881 |

The energy savings calculations were completed for all 16 climate zones. Savings were calculated from the current prescriptive fan power allowance reduced to the new design total static defined in the ACM Reference Manual. Energy savings were conservatively calculated in assuming only 25 percent of new construction and major renovations follow a prescriptive compliance pathway. All performance compliant permits do not have energy savings since the base static pressure is not changing in the ACM Reference Manual. The standard design is not changing, therefore performance compliance path buildings will not see any energy reductions due to this measure.

2.3.3 Per Unit Energy Impacts Results

2.3.3.1 Large Office

Energy savings and peak demand reductions per unit for large office are presented in Table 7. Per square foot electricity savings for the first year are expected to range from a high of 0.28 kilowatt-hours per square foot per year (kWh/ft²-yr) to a low of 0.19 kWh/ft²-yr depending upon climate zone. From a whole building perspective, the savings for the first year range from 139,605 kWh to 94,732 kWh depending on climate zone. Per square foot gas increases for the first year are expected to range from a

high of negative 2.71×10^{-3} therms per square foot per year (therms/ft²-yr) to a low of negative 0.28×10^{-3} therms/ft²-yr depending upon climate zone. Demand reductions are expected to range between 3.88×10^{-5} kilowatts per square foot (kW/ft²) and 2.48×10^{-5} kW/ft² depending on climate zone. With less fan motor heat going into the airstream, there is a small increase in natural gas use.

Table 7: Fan System Power First-Year Energy Impacts per Square Foot – Large Office (498,589 ft²)

| Climate Zone | Electricity Savings (kWh/ft ² -yr) | Peak Electricity Demand Reductions (kW/ft ²) | Natural Gas Savings (therms/ft ² -yr) | TDV Energy Savings (TDV kBtu/ft ² -yr) |
|--------------|---|--|--|---|
| 1 | 0.19 | 2.48×10^{-5} | -2.71×10^{-3} | 4.66 |
| 2 | 0.22 | 3.35×10^{-5} | -1.91×10^{-3} | 6.25 |
| 3 | 0.21 | 2.93×10^{-5} | -1.58×10^{-3} | 5.49 |
| 4 | 0.23 | 3.36×10^{-5} | -1.32×10^{-3} | 6.37 |
| 5 | 0.22 | 2.82×10^{-5} | -1.90×10^{-3} | 5.67 |
| 6 | 0.24 | 3.13×10^{-5} | -0.74×10^{-3} | 7.22 |
| 7 | 0.24 | 3.13×10^{-5} | -0.28×10^{-3} | 7.23 |
| 8 | 0.24 | 3.20×10^{-5} | -0.63×10^{-3} | 7.58 |
| 9 | 0.25 | 3.54×10^{-5} | -0.74×10^{-3} | 7.84 |
| 10 | 0.24 | 3.51×10^{-5} | -0.84×10^{-3} | 7.54 |
| 11 | 0.24 | 3.78×10^{-5} | -1.50×10^{-3} | 6.89 |
| 12 | 0.23 | 3.63×10^{-5} | -1.47×10^{-3} | 6.48 |
| 13 | 0.24 | 3.58×10^{-5} | -1.40×10^{-3} | 6.56 |
| 14 | 0.27 | 3.81×10^{-5} | -1.34×10^{-3} | 7.99 |
| 15 | 0.28 | 3.88×10^{-5} | -0.30×10^{-3} | 8.43 |
| 16 | 0.25 | 3.69×10^{-5} | -2.61×10^{-3} | 6.44 |

The per unit TDV energy cost savings over the 15-year period of analysis are presented in Table 9. These are presented as the discounted present value of the energy cost savings over the analysis period.

2.3.3.2 Medium Retail

Energy savings and peak demand reductions per unit for medium retail are presented in Table 8. Per square foot electricity savings for the first year are expected to range from a high of 0.43 kWh/ft²-yr to a low of 0.25 kWh/ft²-yr depending upon climate zone. From a whole building perspective, the savings for the first year range from 10,562 kWh to 6141 kWh, depending on climate zone. Per square foot gas increases for the first year are expected to range from a high of negative 10.66×10^{-3} therms/ft²-yr to a low of negative 0.49×10^{-3} therms/ft²-yr depending upon climate zone. Demand reductions are expected to range between 11.03×10^{-5} kW/ft² and 5.24×10^{-5} kW/ft² depending on climate zone.

Table 8: Fan System Power First-Year Energy Impacts per Square Foot – Medium Retail (24,563 ft²)

| Climate Zone | Electricity Savings (kWh/ft ² -yr) | Peak Electricity Demand Reductions (kW/ft ²) | Natural Gas Savings (therms/ft ² -yr) | TDV Energy Savings (TDV kBtu/ft ² -yr) |
|--------------|---|--|--|---|
| 1 | 0.25 | 5.31 x 10 ⁻⁵ | -10.66 x 10 ⁻³ | 5.47 |
| 2 | 0.26 | 6.39 x 10 ⁻⁵ | -3.05 x 10 ⁻³ | 7.80 |
| 3 | 0.25 | 5.63 x 10 ⁻⁵ | -2.61 x 10 ⁻³ | 6.95 |
| 4 | 0.26 | 5.24 x 10 ⁻⁵ | -1.95 x 10 ⁻³ | 7.95 |
| 5 | 0.25 | 5.42 x 10 ⁻⁵ | -2.72 x 10 ⁻³ | 6.91 |
| 6 | 0.30 | 6.53 x 10 ⁻⁵ | -0.96 x 10 ⁻³ | 8.98 |
| 7 | 0.30 | 6.53 x 10 ⁻⁵ | -0.49 x 10 ⁻³ | 9.12 |
| 8 | 0.31 | 7.02 x 10 ⁻⁵ | -1.01 x 10 ⁻³ | 9.79 |
| 9 | 0.31 | 7.78 x 10 ⁻⁵ | -1.41 x 10 ⁻³ | 9.89 |
| 10 | 0.33 | 8.08 x 10 ⁻⁵ | -1.32 x 10 ⁻³ | 10.54 |
| 11 | 0.32 | 9.44 x 10 ⁻⁵ | -2.35 x 10 ⁻³ | 10.66 |
| 12 | 0.29 | 8.07 x 10 ⁻⁵ | -2.64 x 10 ⁻³ | 9.09 |
| 13 | 0.33 | 9.32 x 10 ⁻⁵ | -2.57 x 10 ⁻³ | 10.43 |
| 14 | 0.35 | 9.63 x 10 ⁻⁵ | -2.35 x 10 ⁻³ | 11.38 |
| 15 | 0.43 | 11.03 x 10 ⁻⁵ | -0.68 x 10 ⁻³ | 13.99 |
| 16 | 0.30 | 7.46 x 10 ⁻⁵ | -4.82 x 10 ⁻³ | 8.02 |

The per unit TDV energy cost savings over the 15-year period of analysis are presented in Table 10. These are presented as the discounted present value of the energy cost savings over the analysis period.

2.4 Lifecycle Cost and Cost-Effectiveness

2.4.1 Energy Cost Savings Methodology

CBECC-Com was used to process the energy saving and peak electricity demand reductions resulting from the proposed measure. These benefits can be quantified using the standards reference methods.

The software currently does not have the input for adjustment factors due to filters and other air treatment devices. The software will need to be updated to include these factors. The proposed adjustment factors have been studied and documented by ASHRAE as part of the 90.1 process. Other than the items listed to be eliminated in the proposed measure, these values will remain consistent with ASHRAE 90.1-2016.

2.4.2 Energy Cost Savings Results

Per unit energy cost savings over the 15-year period of analysis are presented in Table 9 and Table 10. It is estimated that the first-year TDV energy savings ranges from 4.66 to 13.99 TDV kBtu (see Table 7 and Table 8) depending on the climate zone. The TDV methodology allows peak electricity savings to be valued more than electricity savings during non-peak periods. For both the large office and medium retail prototype buildings, the annual fan energy decreased due to the low static pressure of the proposed system. However, the heating energy increased slightly due to the reduced fan heat. Overall, the proposed measure saves energy costs over the 15-year period.

Table 9: TDV Energy Cost Savings Over 15-Year Period per Square Foot – Large Office

| Climate Zone | 15-Year TDV Electricity Cost Savings (2020 Present Value \$) | 15-Year TDV Natural Gas Cost Savings (2020 Present Value \$) | Total 15-Year TDV Energy Cost Savings (2020 Present Value \$) |
|--------------|--|--|---|
| 1 | \$0.46 | -\$0.04 | \$0.41 |
| 2 | \$0.59 | -\$0.03 | \$0.56 |
| 3 | \$0.52 | -\$0.03 | \$0.49 |
| 4 | \$0.59 | -\$0.02 | \$0.57 |
| 5 | \$0.54 | -\$0.03 | \$0.50 |
| 6 | \$0.66 | -\$0.01 | \$0.64 |
| 7 | \$0.65 | -\$0.01 | \$0.64 |
| 8 | \$0.69 | -\$0.01 | \$0.67 |
| 9 | \$0.71 | -\$0.01 | \$0.70 |
| 10 | \$0.69 | -\$0.02 | \$0.67 |
| 11 | \$0.64 | -\$0.03 | \$0.61 |
| 12 | \$0.60 | -\$0.03 | \$0.58 |
| 13 | \$0.61 | -\$0.03 | \$0.58 |
| 14 | \$0.73 | -\$0.02 | \$0.71 |
| 15 | \$0.76 | -\$0.01 | \$0.75 |
| 16 | \$0.62 | -\$0.05 | \$0.57 |

Table 10: TDV Energy Cost Savings Over 15-Year Period per Square Foot – Medium Retail

| Climate Zone | 15-Year TDV Electricity Cost Savings (2020 Present Value \$) | 15-Year TDV Natural Gas Cost Savings (2020 Present Value \$) | Total 15-Year TDV Energy Cost Savings (2020 Present Value \$) |
|--------------|--|--|---|
| 1 | \$0.67 | -\$0.18 | \$0.49 |
| 2 | \$0.75 | -\$0.05 | \$0.69 |
| 3 | \$0.67 | -\$0.05 | \$0.62 |
| 4 | \$0.74 | -\$0.03 | \$0.71 |
| 5 | \$0.66 | -\$0.05 | \$0.61 |
| 6 | \$0.82 | -\$0.02 | \$0.80 |
| 7 | \$0.82 | -\$0.01 | \$0.81 |
| 8 | \$0.89 | -\$0.02 | \$0.87 |
| 9 | \$0.91 | -\$0.03 | \$0.88 |
| 10 | \$0.96 | -\$0.02 | \$0.94 |
| 11 | \$0.99 | -\$0.04 | \$0.95 |
| 12 | \$0.86 | -\$0.05 | \$0.81 |
| 13 | \$0.98 | -\$0.05 | \$0.93 |
| 14 | \$1.06 | -\$0.04 | \$1.01 |
| 15 | \$1.26 | -\$0.01 | \$1.25 |
| 16 | \$0.79 | -\$0.08 | \$0.71 |

2.4.3 Incremental First Cost

The Statewide CASE Team estimated the current incremental construction costs and post-adoption incremental construction costs. The current incremental construction cost represents the incremental cost of the measure if a building meeting the proposed standard were built today. The post-adoption incremental construction cost represents the anticipated cost, assuming full market penetration of the measure as a result of the new standards, resulting in possible reduction in unit costs as manufacturing practices improve over time and with increased production volume of qualifying products the year the standard becomes effective.

Per the Energy Commission’s guidance, design costs are not included in the incremental first cost.

Incremental first cost for fan power was determined using a combination of existing projects, manufacturer’s selection tools, and RSMeans. Existing projects and RSMeans were used to calculate the increased cost due to larger ductwork for a lower static pressure design. Manufacturer’s selection tool and RSMeans were used to determine the decreased cost due to smaller motor size for the fans. The result was a cost increase anywhere from \$0.29/ft² to \$0.49/ft² based on airflow rate and building size.

2.4.4 Lifetime Incremental Maintenance Costs

The proposed measure was assumed to have no incremental maintenance or repair costs from standard design, since no additional equipment or controls are necessary compared to existing conditions.

2.4.5 Lifecycle Cost-Effectiveness

Results per unit lifecycle cost-effectiveness analyses are presented in Table 11 (large office) and Table 12 (medium retail). The proposed measure saves money over the 15-year period of analysis relative to the existing conditions. The proposed code change was found to be cost-effective in every climate zone.

Table 11: Fan System Power Lifecycle Cost-Effectiveness Summary per Square Foot – Large Office

| Climate Zone | Benefits TDV Energy Cost Savings + Other PV Savings ^a (2020 Present Value \$) | Costs Total Incremental PV Costs ^b (2020 Present Value \$) | Benefit-to- Cost Ratio |
|--------------|---|---|---------------------------|
| 1 | \$0.41 | \$0.36 | 1.15 |
| 2 | \$0.56 | \$0.38 | 1.45 |
| 3 | \$0.49 | \$0.38 | 1.29 |
| 4 | \$0.57 | \$0.39 | 1.45 |
| 5 | \$0.50 | \$0.38 | 1.33 |
| 6 | \$0.64 | \$0.39 | 1.66 |
| 7 | \$0.64 | \$0.38 | 1.68 |
| 8 | \$0.67 | \$0.39 | 1.72 |
| 9 | \$0.70 | \$0.40 | 1.76 |
| 10 | \$0.67 | \$0.43 | 1.55 |
| 11 | \$0.61 | \$0.40 | 1.53 |
| 12 | \$0.58 | \$0.39 | 1.50 |
| 13 | \$0.58 | \$0.40 | 1.46 |
| 14 | \$0.71 | \$0.42 | 1.69 |
| 15 | \$0.75 | \$0.42 | 1.81 |
| 16 | \$0.57 | \$0.48 | 1.18 |

- a. **Benefits – TDV Energy Cost Savings + Other PV Savings:** Benefits include TDV energy cost savings over the period of analysis (Energy + Environmental Economics 2016, 51-53). Other savings are discounted at a real (nominal – inflation) three percent rate. Other present valued savings include incremental first cost savings if proposed first cost is less than current first cost. Includes present value maintenance cost savings if present value of proposed maintenance costs is less than the present value of current maintenance costs.
- b. **Costs – Total Incremental PV Costs:** Costs include incremental equipment, replacement, and maintenance costs over the period of analysis. Costs are discounted at a real (inflation adjusted) three percent rate. Includes incremental first cost if proposed first cost is greater than current first cost. Includes present value of maintenance incremental cost if present value of proposed maintenance costs is greater than the present value of current maintenance costs. If incremental maintenance cost is negative, it is treated as a positive benefit. If there are no total incremental present valued costs, the B/C ratio is infinite.

Table 12: Fan System Power Lifecycle Cost-Effectiveness Summary per Square Foot – Medium Retail

| Climate Zone | Benefits TDV Energy Cost Savings + Other PV Savings ^a (2020 Present Value \$) | Costs Total Incremental PV Costs ^b (2020 Present Value \$) | Benefit-to- Cost Ratio |
|--------------|---|---|---------------------------|
| 1 | \$0.49 | \$0.30 | 1.22 |
| 2 | \$0.69 | \$0.32 | 1.64 |
| 3 | \$0.62 | \$0.31 | 1.49 |
| 4 | \$0.71 | \$0.33 | 1.59 |
| 5 | \$0.61 | \$0.30 | 1.56 |
| 6 | \$0.80 | \$0.32 | 1.85 |
| 7 | \$0.81 | \$0.31 | 1.93 |
| 8 | \$0.87 | \$0.34 | 1.94 |
| 9 | \$0.88 | \$0.33 | 1.98 |
| 10 | \$0.94 | \$0.36 | 1.93 |
| 11 | \$0.95 | \$0.35 | 2.03 |
| 12 | \$0.81 | \$0.33 | 1.84 |
| 13 | \$0.93 | \$0.35 | 1.99 |
| 14 | \$1.01 | \$0.35 | 2.15 |
| 15 | \$1.25 | \$0.36 | 2.60 |
| 16 | \$0.71 | \$0.36 | 1.47 |

- a. **Benefits – TDV Energy Cost Savings + Other PV Savings:** Benefits include TDV energy cost savings over the period of analysis (Energy + Environmental Economics 2016, 51-53). Other savings are discounted at a real (nominal – inflation) three percent rate. Other present valued savings include incremental first cost savings if proposed first cost is less than current first cost. Includes present value maintenance cost savings if present value of proposed maintenance costs is less than the present value of current maintenance costs.
- b. **Costs – Total Incremental PV Costs:** Costs include incremental equipment, replacement, and maintenance costs over the period of analysis. Costs are discounted at a real (inflation adjusted) three percent rate. Includes incremental first cost if proposed first cost is greater than current first cost. Includes present value of maintenance incremental cost if present value of proposed maintenance costs is greater than the present value of current maintenance costs. If incremental maintenance cost is negative, it is treated as a positive benefit. If there are no total incremental present valued costs, the B/C ratio is infinite.

2.5 First-Year Statewide Impacts

2.5.1 Statewide Energy Savings and Lifecycle Energy Cost Savings

Given data regarding the new construction forecast for 2020, the Statewide CASE Team estimates that the proposed code change will reduce annual statewide electricity use by 11.728 GWh with an associated demand reduction of 2.34 MW. Natural gas use is expected to be increased by 0.065 million therms. The energy savings for buildings constructed in 2020 are associated with a present-valued energy cost savings of approximately \$31 million in (discounted) energy costs over the 15-year period of analysis. The statewide energy savings used a 75 percent discount, based on the conservative assumption that only 25 percent of compliance follows the prescriptive compliance pathway. Results are presented in Table 13.

Table 13: Statewide Energy and Energy Cost Impacts – Fan System Power

| Climate Zone | Statewide Construction in 2020 (million ft ²) | First-Year Electricity Savings (GWh) ^a | First-Year Peak Electrical Demand Reduction (MW) | First-Year Natural Gas Savings (million therms) | Lifecycle ^b Present Valued Energy Cost Savings (PV\$ million) |
|--------------|---|---|--|---|--|
| 1 | 0.1336 | 0.029 | 0.005 | -1.0 x 10 ⁻³ | \$0.060 |
| 2 | 1.092 | 0.263 | 0.053 | -3.0 x 10 ⁻³ | \$0.683 |
| 3 | 5.5209 | 1.254 | 0.236 | -0.012 | \$3.056 |
| 4 | 2.5118 | 0.616 | 0.108 | -4.0 x 10 ⁻³ | \$1.601 |
| 5 | 0.4877 | 0.113 | 0.020 | -1.0 x 10 ⁻³ | \$0.273 |
| 6 | 3.9203 | 1.050 | 0.189 | -3.0 x 10 ⁻³ | \$2.826 |
| 7 | 2.5713 | 0.690 | 0.124 | -1.0 x 10 ⁻³ | \$1.871 |
| 8 | 5.6605 | 1.555 | 0.289 | -5.0 x 10 ⁻³ | \$4.375 |
| 9 | 6.5567 | 1.821 | 0.371 | -7.0 x 10 ⁻³ | \$5.173 |
| 10 | 4.1947 | 1.202 | 0.243 | -5.0 x 10 ⁻³ | \$3.375 |
| 11 | 0.9991 | 0.279 | 0.066 | -2.0 x 10 ⁻³ | \$0.780 |
| 12 | 5.4712 | 1.402 | 0.320 | -0.011 | \$3.791 |
| 13 | 2.1175 | 0.606 | 0.137 | -4.0 x 10 ⁻³ | \$1.601 |
| 14 | 0.8302 | 0.254 | 0.056 | -2.0 x 10 ⁻³ | \$0.716 |
| 15 | 0.7574 | 0.270 | 0.056 | N/A | \$0.756 |
| 16 | 1.1653 | 0.325 | 0.065 | -4.0 x 10 ⁻³ | \$0.750 |
| TOTAL | 43.9899 | 11.728 | 2.340 | -0.065 | \$31.686 |

a. First-year savings from all buildings completed statewide in 2020.

b. Energy cost savings from all buildings completed statewide in 2020 accrued during 15-year period of analysis.

2.5.2 Statewide Water Use Impacts

The proposed revisions to requirements for fan system power will not result in water savings.

2.5.3 Statewide Material Impacts

The proposed revisions to requirements for fan system power will not result in changes to material use.

2.5.4 Other Non-Energy Impacts

The proposed code change will not result in any other non-energy impacts.

2.6 Proposed Revisions to Code Language

The proposed changes to the Standards, Reference Appendices, and the Nonresidential ACM Reference Manual are below. Changes to the 2016 documents are marked with underlining (new language) and ~~strikethroughs~~ (deletions).

2.6.1 Standards

SECTION 140.4 – PRESCRIPTIVE REQUIREMENTS FOR SPACE CONDITIONING SYSTEMS

Subsection 140.4(C) Power Consumption of Fans. Each fan system having a total fan system motor nameplate horsepower exceeding 5 hp used for space conditioning shall meet the requirements of Items 1, 2, 3 and 4 below. Total fan system power demand equals the sum of the power demand of all fans in the system that are required to operate at design conditions in order to supply air from the heating or cooling source to the conditioned space, and to return it back to the source or to exhaust it to the outdoors.; ~~however, total fan system power demand need not include (i) the additional power demand caused solely by air treatment or filtering systems with final pressure drops more than 245 pascals or~~

one inch water column (only the energy accounted for by the amount of pressure drop that is over 1 inch may be excluded), or (ii) fan system power caused solely by exempt process loads.

1. Fan power limitations. Each HVAC system at fan system design conditions shall not exceed the allowable fan system as listed in Table 140.4-A-1 by either the
 - a. Total motor nameplate hp (Option 1) or
 - b. Total fan system bhp (Option 2)

Table 140.4-A-1 Fan Power Limitation¹

| | <u>Limit</u> | <u>Constant Volume</u> | <u>Variable Volume</u> |
|--|-------------------------------------|----------------------------------|---------------------------------|
| <u>Option 1: Fan system motor nameplate hp</u> | <u>Allowable motor nameplate hp</u> | $hp = cfm_s \times 0.00095$ | $hp = cfm_s \times 0.0013$ |
| <u>Option 2: Fan system bhp</u> | <u>Allowable fan system bhp</u> | $bhp = cfm_s \times 0.00082 + A$ | $bhp = cfm_s \times 0.0011 + A$ |

¹where

cfm_s = maximum design supply airflow rate to conditioned spaces served by the *system* in cubic feet per minute

hp = maximum combined motor nameplate horsepower for all fans in the HVAC system

bhp = maximum combined fan-brake horsepower for all fans in the HVAC system

A = sum of $(PD \times cfm_D / 4131)$

where

PD = each applicable pressure drop adjustment from Table 140.4-A-2 in inches of water

cfm_D = the design airflow through each applicable device from Table 140.4-A-2 in cubic feet per minute

Table 140.4-A-2 Fan Power Limitation Pressure Drop Adjustment

| <u>Device</u> | <u>Adjustment</u> |
|--|--|
| <u>Credits</u> | |
| <u>Return or exhaust systems required by code or accreditation standards to be fully ducted, or systems required to maintain air pressure differentials between adjacent rooms</u> | <u>0.5 in. of water</u> |
| <u>Return and/or exhaust airflow control devices</u> | <u>0.5 in. of water</u> |
| <u>Exhaust filters, scrubbers, or other exhaust treatment</u> | <u>The pressure drop of device calculated at fan system design condition</u> |
| <u>Particulate Filtration Credit: MERV 9 through 12</u> | <u>0.5 in. of water</u> |
| <u>Particulate Filtration Credit: MERV 13 through 15</u> | <u>0.9 in. of water</u> |
| <u>Particulate Filtration Credit: MERV 16 and greater and electronically enhanced filters</u> | <u>Pressure drop calculated at clean filter pressure drop at fan system design condition</u> |
| <u>Carbon and other gas-phase air cleaners</u> | <u>Clean filter pressure drop at fan system design condition</u> |
| <u>Biosafety cabinet</u> | <u>Pressure drop of device at fan system design condition</u> |
| <u>Energy recovery device, other than coil runaround loop²</u> | <u>For each airstream [(2.2 x Enthalpy Recovery Ratio) – 0.5] in. of water</u> |
| <u>Coil runaround loop²</u> | <u>0.6 in. of water for each airstream</u> |
| <u>Exhaust system serving fume hoods</u> | <u>0.35 in. of water</u> |

²Credit to be taken only when required by code

1. Constant volume fan systems. The total fan power index at design conditions of each fan system with total horsepower over 25 hp shall not exceed 0.8 watts per cfm of supply air.

EXCEPTION 1 to Section 140.4(c)1: Individual exhaust fans with motor nameplate horsepower of 1 hp or less.

EXCEPTION 2 to Section 140.4(c)1: Fan system power caused solely by exempt process loads.

2. Variable air volume (VAV) systems.
 - A. ~~The total fan power index at design conditions of each fan system with total horsepower over 25 hp shall not exceed 1.25 watts per cfm of supply air;~~

2.6.2 Reference Appendices

There will be no proposed changes to the Reference Appendices.

2.6.3 ACM Reference Manual

Section 5.7.3.2: Process and Filtration Pressure Drop will be revised to include the new adjustment factor calculation.

2.6.4 Compliance Manuals

Chapter 4.6.2.3 of the Nonresidential Compliance Manual will be revised.

2.6.5 Compliance Documents

Compliance document NRCC-MCH-07-E: Fan Power Consumption will be revised.

3. EXHAUST AIR HEAT RECOVERY

3.1 Measure Description

3.1.1 Measure Overview

Title 24, Part 6 does not currently require heat recovery ventilators in the exhaust airstream. Some buildings in some climate zones can benefit from recovering heat to precondition the outdoor air. This measure will incorporate a new prescriptive requirement for exhaust air heat recovery based on ASHRAE 90.1-2016 Section 6.5.6.1. Under the current ASHRAE requirements, most California climate zones require few or no heat recovery devices. The proposed measure adds a new Title 24, Part 6 requirement based on the ASHRAE 90.1 requirements for outdoor air fraction, climate, and airflow based on a cost-effectiveness analysis to assess the energy savings benefits of heat recovery ventilators. The requirements will be based upon Title 24, Part 6 climate zones, instead of ASHRAE climate zones. This measure also considers updating the heat recovery ratio in ASHRAE to a heat recovery value higher than 50 percent.

There are two main types of exhaust air heat recovery ventilators: sensible heat recovery and total energy recovery. Sensible heat recovery is measured by the dry-bulb air temperature is recovered while total energy recovery also includes moisture recovery also known as latent heat recovery. Due to California's dry climates, only sensible heat recovery is needed. In contrast, in humid climates, the moisture in the air measured by wet-bulb is important to pre-dehumidify the incoming ventilation air with the drier exhaust air. The proposed measure affects new buildings or alterations replacing HVAC systems in climate zones and building types determined to be cost-effective. This measure maintains the ASHRAE requirement for bypass when the economizer is in operation, so the free cooling from the economizer is not diminished.

3.1.2 Measure History

The current Title 24, Part 6 Standards do not have requirements for heat recovery ventilators. The measure has not been considered in previous Title 24, Part 6 rulemakings. There are no concerns for federal preemptions. The measure includes changes to the modeling rules and algorithms.

3.1.3 Summary of Proposed Changes to Code Documents

The sections below summarize how each Title 24, Part 6 document will be modified by the proposed change. See Section 3.6 of this report for detailed proposed revisions to code language.

3.1.3.1 Standards Change Summary

This proposal adds the following section to the Building Energy Efficiency Standards as shown below. The language will be based on the same language from ASHRAE 90.1-2016.

SECTION 140.4 – PRESCRIPTIVE REQUIREMENTS FOR SPACE CONDITIONING SYSTEMS

Subsection 140.4(o) Exhaust Air Heat Recovery. Heat recovery requirements based on ASHRAE 90.1 Section 6.5.6.1, adapted for California climate zones, will be modified. This includes updates to increase energy recovery ratio and for sensible heat energy-only type devices.

3.1.3.2 Reference Appendices Change Summary

The Nonresidential Reference Appendix will be updated to revise the acceptance test procedure.

3.1.3.3 Alternative Calculation Method (ACM) Reference Manual Change Summary

This proposal modifies the following section of the Nonresidential ACM Reference Manual as shown below.

Section 5.7.6.6 Heat Recovery: The Statewide CASE Team proposes updates to the existing section of the Nonresidential ACM Reference Manual to outline the modeling algorithm for exhaust air heat recovery systems. Since heat recovery is not a prescriptive requirement in the standard, there are no requirements for standard design. The current ruleset allows heat recovery devices to be added only when the system is a 100 percent dedicated outdoor air system. The proposed measure adds the new baseline requirements for heat recovery devices, and will require CBECC-Com to be updated to allow heat recovery for systems with less than 100 percent outside air.

3.1.3.4 Compliance Manual Change Summary

The proposed measure will add a new section to the Compliance Manual under Section 4.6.2 Prescriptive Requirements. It includes an explanation of the new requirement based on the ASHRAE 90.1 User's Manual.

3.1.3.5 Compliance Documents Change Summary

The proposed measure modifies NRCC-MCH-02-E, NRCC-MCH-05-E, NRCC-PRF-01-E, and NRCA-MCH-05-A to include provisions for heat recovery ventilators and economizer bypass controls. See Appendix H for the marked-up acceptance test compliance document.

3.1.4 Regulatory Context

3.1.4.1 Existing Title 24, Part 6 Standards

There are no existing standards for heat recovery in Title 24, Part 6 Standards.

3.1.4.2 Relationship to Other Title 24, Part 6 Requirements

The proposed measure will require a bypass for the air-side economizer, so it does not interfere with economizer operations. The heat recovery ventilator operations should be linked to the economizer's fault detection diagnostics to make sure the device is not interfering with economizer operations. There is no impact from this measure change to other parts of Title 24 beyond Part 6.

3.1.4.3 Relationship to State or Federal Laws

There are no other state or federal laws that address the proposed change.

3.1.4.4 Relationship to Industry Standards

The measure will be incorporating ASHRAE 90.1-2016 Section 6.5.6.1. The standard regulates the requirements for heat recovery ventilators by climate, outdoor airflow fraction, and supply airflow. Because it is included in ASHRAE 90.1, this measure is included in many state energy codes, such as the Washington State energy code adapted to the Washington climates.

AHRI Standard 1060/1061 is a certification standard for factory-made exhaust air heat recovery devices. This certification standard publishes the rated energy recovery ratio for heating and cooling recovery for sensible and latent energy at 100 percent airflow and 75 percent airflow. For enforcement purposes, the AHRI certificate will be used to show prescriptive compliance using the smaller value of the net sensible recovery at 100 percent airflow for heating or cooling.

3.1.5 Compliance and Enforcement

This code change proposal primarily affects buildings that use the mandatory and prescriptive approaches to compliance, since those using the performance compliance path may achieve the savings using other measures. The key steps and changes to the compliance process are summarized below.

- **Design Phase:** Changes to the existing design phase are anticipated for buildings and climates that will newly require heat recovery ventilators. The design team must be aware of the new code changes and properly size, design, and control the systems. This will increase the size of the air handling units, so coordination with the architects for mechanical room space and structural engineers for loads is anticipated.
- **Permit Application Phase:** The changes to the compliance document NRCC-MCH-02-E reflect the code change requirements. The permit reviewer will need to know in what situations heat recovery ventilators are required and check if the building is designing the air system properly. Performance compliance applications that choose to use heat recovery will also need to have the system design checked.
- **Construction Phase:** The proposed changes require mechanical subcontractors to be able to properly install heat recovery ventilators and operate as required by code.
- **Inspection Phase:** The inspector must check if the heat recovery ventilator is certified by AHRI and passes the minimum allowed energy recovery ratio for the net sensible recovery. During the acceptance testing, the inspector needs to make sure the heat recovery ventilator is working properly. The inspector must also make sure the heat recovery ventilator is not interfering with the economizer controls that will increase heating or cooling energy.

3.2 Market Analysis

The Statewide CASE Team performed a market analysis with the goals of identifying current technology availability, current product availability, and market trends. The Statewide CASE Team considered how the proposed standard may impact the market in general and individual market actors. The Statewide CASE Team gathered information about the incremental cost of complying with the proposed measure. Estimates of market size and measure applicability were identified through research and outreach with stakeholders including utility program staff, Energy Commission staff, and a wide range of industry players who were invited to participate in utility-sponsored stakeholder meetings held on September 26, 2016 and March 29, 2017.

3.2.1 Market Structure

Principal manufacturers of heat recovery ventilators include RenewAire and Venmar or as an option on packaged systems by Trane, AAON, and Carrier. The products are distributed through manufacturer representatives or directly from the manufacturers. The products are a well-established technology and readily available from multiple manufacturers.

3.2.2 Technical Feasibility, Market Availability, and Current Practices

Exhaust air heat recovery units are available from many different manufacturers and as a national standard, all manufacturers are familiar with the proposed change.

The AHRI Directory of Certified Product Performance lists tested ratings for all certified heat recovery ventilators available in the market made by AHRI participating manufacturers. The energy recovery ratio for 1,254 plate type heat recovery ventilators and 2,894 wheel type energy recovery ventilators were analyzed to determine the current availability of the market, as shown in Figure 3 and Figure 4. Table 14 shows the percentage of products that will not be compliant at each energy recovery ratio threshold. The results show that at 60 percent energy recovery ratio, 48 percent of the plate type heat recovery ventilators and 93 percent of the wheel type energy recovery ventilators are still available for prescriptive compliance.

Table 14: Percentage of Products Compliant at Each Energy Recovery Ratio Thresholds

| Minimum Recovery Requirement (Prescriptive) | Percentage of Products That Would Comply | |
|---|--|---------------------|
| | Plate Type Products | Wheel Type Products |
| 50% recovery | 86% | 95% |
| 60% recovery | 48% | 93% |
| 70% recovery | 9% | 24% |

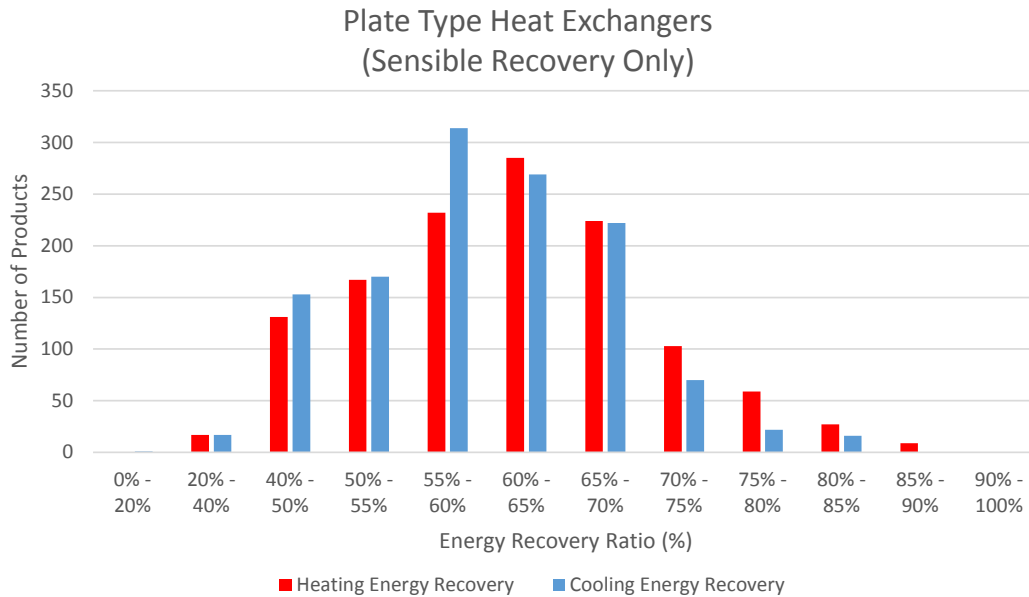

Figure 3: Number of certified products at different heat recovery ratio thresholds (plate type)

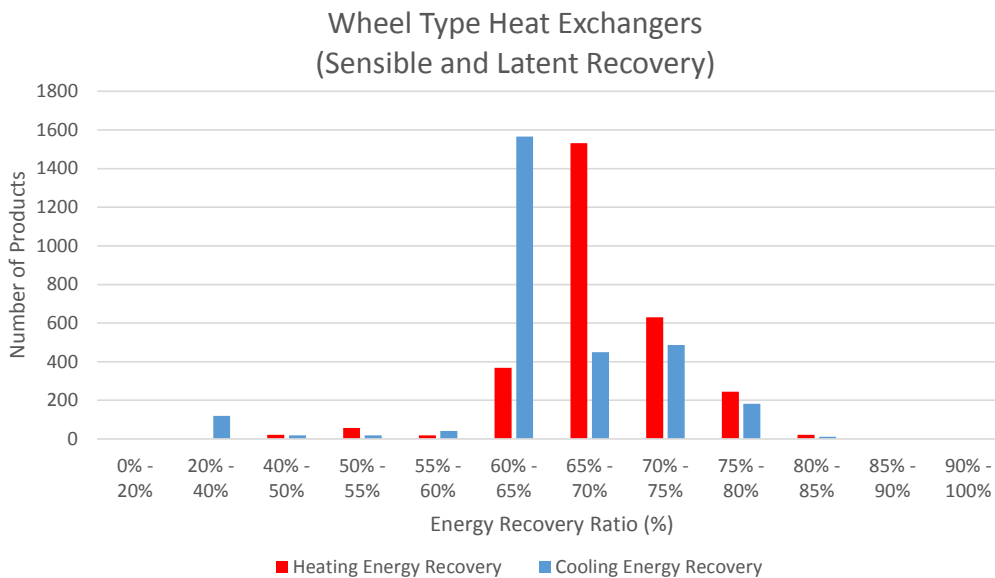

Figure 4: Number of certified products at different energy recovery ratio thresholds (wheel type)

Aside from the actual heat recovery device, technical feasibility for implementation of the heat recovery device must also be considered, such as economizer bypass, increased fan size, and co-locating the intake and exhaust. The ASHRAE 90.1 standard addresses each of these issues: Section 6.5.6.1 addresses economizer bypass, Section 6.5.3.1 addresses fan power increase, and Exception 6 to Section 6.5.6.1 addresses the feasibility of co-locating the intake and exhaust airstreams. For projects with heat recovery devices, these criteria are all current practices. Heat recovery ventilators used in package units with heat recovery devices will need to include an economizer bypass, but most package units will size the bypass opening to match the pressure drop through the heat recovery ventilator. This is to maintain consistent fan operation.

3.3 Energy Savings

3.3.1 Key Assumptions for Energy Savings Analysis

The energy savings analysis for the measure uses energy modeling following the guidance of the 2016 Nonresidential ACM. Energy models use CBECC-Com prototypical models and are only modified to include the proposed changes to the energy standards and Nonresidential ACM.

The following are the key assumptions used in the energy savings analysis:

The added static pressure to airstream will be based on ASHRAE 90.1 Section 6.5.3.1 under the fan pressure drop adjustment table for the energy recovery device.

$$2.2 \text{ IWC} * \text{Energy Recovery Ratio} - 0.5 \text{ IWC per airstream}$$

Three energy recovery ratios were analyzed: 50, 60, and 70 percent energy recovery ratio. These levels are representative of units in the AHRI database, which determines market availability. Based on an initial cost-effectiveness analysis, 70 percent energy recovery ratio was the most cost-effective threshold; however, based on market availability, 60 percent energy recovery ratio was determined to be the most feasible.

To maintain economizer energy savings, the outdoor air intake will bypass the heat recovery ventilator when the outdoor conditions are more suitable for economizer operation. It is assumed there is no fan energy savings during bypass mode and the analysis will maintain the same fan total static pressure for all operating hours. This will result in increased fan power, even during economizer bypass; however, this is consistent with typical design practice, and is also a limitation of the compliance software. The compliance software currently does not support fan energy savings during bypass and will use the same static pressure regardless of economizer bypass.

3.3.2 Energy Savings Methodology

The proposed conditions are defined as the design conditions that will comply with the proposed code change. Specifically, the proposed code change adds a heat recovery ventilator to each of the air systems for 60 percent energy recovery ratio for sensible only recovery (plate type). Due to California's dry climates, using a total energy recovery (wheel type) ventilator will not make a large difference in energy savings.

The Energy Commission provided guidance on the type of prototype buildings that must be modeled. The small office prototype building was chosen to represent buildings with packaged single zone systems. The medium office prototype building was chosen to represent typical variable air volume systems. The medium office/lab prototype building was chosen due to the high ventilation fraction (90 percent to 100 percent outdoor air fraction) that operates 24 hours a day.

Table 15 presents the details of the prototype buildings used in the analysis.

Table 15: Prototype Buildings used for Energy, Demand, Cost, and Environmental Impacts Analysis

| Prototype ID | Occupancy Type | Area (ft ²) | Number of Stories | Statewide Area (million ft ²) |
|--------------|-------------------|-------------------------|-------------------|---|
| Prototype 2 | Small Office | 5,502 | 1 | 15.288 |
| Prototype 3 | Medium Office | 53,628 | 3 | 42.358 |
| Prototype 15 | Medium Office/Lab | 53,628 | 3 | 1.742 |

The impacts of the proposed measure are climate sensitive as heating and cooling demands, airflow rates, and outdoor air fractions change for each of the 16 climate zones.

3.3.3 Per Unit Energy Impacts Results

Proposed cases were tested for this analysis at 60 percent energy recovery ratio for sensible only (plate type) heat recovery ventilators per square foot of conditioned floor area. The analysis showed that the 70 percent energy recovery ratio was the most cost-effective case; however, due to market availability, 60 percent energy recovery ratio was determined to be the most feasible.

3.3.3.1 Small Office

Energy savings and peak demand reductions per unit for small office are presented in Table 16. Per unit savings for the first year are expected to range from a high of negative 0.99 kWh/ft²-yr and 0.09 therms/ft²-yr to a low of negative 1.37 kWh/ft²-yr and 0.00 therms/ft²-yr. From a whole building perspective, the savings for the first year range from negative 5,447 kWh and 495 therms to negative 7,538 kWh and 0 therms, depending on climate zone. Demand reductions/increases are expected to range between 1.34×10^{-4} kW/ft² and negative 1.49×10^{-4} kW/ft² depending on climate zone.

Table 16: Exhaust Air Heat Recovery First-Year Energy Impacts per Square Foot – Small Office (5,502 ft²) Prototype 2

| Climate Zone | Electricity Savings (kWh/ft ² -yr) | Peak Electricity Demand Reductions (kW/ft ²) | Natural Gas Savings (therms/ft ² -yr) | TDV Energy Savings (TDV kBtu/ft ² -yr) |
|--------------|---|--|--|---|
| 1 | -1.25 | -1.49×10^{-4} | 0.07 | -22.20 |
| 2 | -1.27 | -8.05×10^{-7} | 0.04 | -25.08 |
| 3 | -1.30 | -7.69×10^{-5} | 0.03 | -30.31 |
| 4 | -1.27 | -4.22×10^{-5} | 0.02 | -28.19 |
| 5 | -1.30 | -1.18×10^{-4} | 0.03 | -31.22 |
| 6 | -1.28 | 2.10×10^{-5} | 0.01 | -32.44 |
| 7 | -1.30 | -1.01×10^{-4} | 0.00 | -35.21 |
| 8 | -1.27 | 6.00×10^{-6} | 0.01 | -31.64 |
| 9 | -1.26 | 1.24×10^{-5} | 0.01 | -29.86 |
| 10 | -1.29 | 3.57×10^{-5} | 0.01 | -29.78 |
| 11 | -1.18 | 1.34×10^{-4} | 0.04 | -19.39 |
| 12 | -1.21 | 4.86×10^{-5} | 0.04 | -21.42 |
| 13 | -1.16 | -2.60×10^{-5} | 0.04 | -21.06 |
| 14 | -1.22 | -5.46×10^{-6} | 0.04 | -23.31 |
| 15 | -0.99 | -1.08×10^{-5} | 0.00 | -21.97 |
| 16 | -1.37 | -1.31×10^{-4} | 0.09 | -17.79 |

The per square foot of conditioned floor area TDV energy cost savings over the 15-year period of analysis are presented in Table 19. These are presented as the discounted present value of the energy cost savings over the analysis period.

3.3.3.2 Medium Office

Energy savings and peak demand reductions per unit for medium office are presented in Table 17. Per unit savings for the first year are expected to range from a high of 0.20 kWh/ft²-yr and 1.16 x 10⁻³ therms/ft²-yr to a low of negative 0.23 kWh/ft²-yr and 1.47 x 10⁻⁴ therms/ft²-yr depending upon climate zone. From a whole building perspective, the savings for the first year range from 10,726 kWh and 62 therms to negative 12,334 kWh and 8 therms, depending on climate zone. Demand reductions/increases are expected to range between 3.13 x 10⁻⁴ kW/ft² and -9.09 x 10⁻⁵ kW/ft² depending on climate zone.

Table 17: Exhaust Air Heat Recovery First-Year Energy Impacts per Square Foot – Medium Office (53,628 ft²) Prototype 3

| Climate Zone | Electricity Savings (kWh/ft ² -yr) | Peak Electricity Demand Reductions (kW/ft ²) | Natural Gas Savings (therms/ft ² -yr) | TDV Energy Savings (TDV kBtu/ft ² -yr) |
|--------------|---|--|--|---|
| 1 | -0.17 | -4.84 x 10 ⁻⁵ | 1.16 x 10 ⁻³ | -4.38 |
| 2 | -0.14 | 9.67 x 10 ⁻⁵ | 8.13 x 10 ⁻⁴ | -0.82 |
| 3 | -0.19 | 2.16 x 10 ⁻⁵ | 7.21 x 10 ⁻⁴ | -4.60 |
| 4 | -0.16 | 9.48 x 10 ⁻⁵ | 5.55 x 10 ⁻⁴ | -0.76 |
| 5 | -0.20 | 4.10 x 10 ⁻⁵ | 7.96 x 10 ⁻⁴ | -4.91 |
| 6 | -0.21 | 1.78 x 10 ⁻⁴ | 3.61 x 10 ⁻⁴ | -4.22 |
| 7 | -0.23 | -9.09 x 10 ⁻⁵ | 2.32 x 10 ⁻⁴ | -5.72 |
| 8 | -0.18 | 1.79 x 10 ⁻⁴ | 3.08 x 10 ⁻⁴ | -2.16 |
| 9 | -0.14 | 1.57 x 10 ⁻⁴ | 3.69 x 10 ⁻⁴ | -0.13 |
| 10 | -0.09 | 2.26 x 10 ⁻⁴ | 3.71 x 10 ⁻⁴ | 2.68 |
| 11 | -0.03 | 3.13 x 10 ⁻⁴ | 6.13 x 10 ⁻⁴ | 4.90 |
| 12 | -0.09 | 2.38 x 10 ⁻⁴ | 7.67 x 10 ⁻⁴ | 2.25 |
| 13 | -0.03 | 2.20 x 10 ⁻⁴ | 5.82 x 10 ⁻⁴ | 3.88 |
| 14 | -0.05 | 9.81 x 10 ⁻⁵ | 5.62 x 10 ⁻⁴ | 2.25 |
| 15 | 0.20 | 2.87 x 10 ⁻⁴ | 1.47 x 10 ⁻⁴ | 10.90 |
| 16 | -0.21 | 1.39 x 10 ⁻⁵ | 1.07 x 10 ⁻³ | -5.49 |

The per square foot of conditioned floor area TDV energy cost savings over the 15-year period of analysis are presented in

Table 20. These are presented as the discounted present value of the energy cost savings over the analysis period.

3.3.3.3 Medium Office/Lab

Energy savings and peak demand reductions per unit for medium office/lab are presented in Table 18. Per unit savings for the first year are expected to range from a high of 4.32 kWh/ft²-yr and 0.04 therms/ft²-yr to a low of negative 2.27 kWh/ft²-yr and 0.00 therms/ft²-yr depending upon climate zone. From a whole building perspective, the savings for the first year range from 231,673 kWh and 2,145 therms to negative 121,735 kWh and 0 therms, depending on climate zone. Demand reductions/increases are expected to range between 3.34 x 10⁻³ kW/ft² and negative 1.21 x 10⁻⁴ kW/ft² depending on climate zone.

Table 18: Exhaust Air Heat Recovery First-Year Energy Impacts per Square Foot – Medium Office/Lab Prototype 15 (New Construction)

| Climate Zone | Electricity Savings (kWh/ft ² -yr) | Peak Electricity Demand Reductions (kW/ft ²) | Natural Gas Savings (therms/ft ² -yr) | TDV Energy Savings (TDV kBtu/ft ² -yr) |
|--------------|---|--|--|---|
| 1 | -1.91 | 5.01 x 10 ⁻⁵ | 0.04 | -46.13 |
| 2 | -0.88 | 3.81 x 10 ⁻⁴ | 0.02 | 16.77 |
| 3 | -1.99 | 7.89 x 10 ⁻⁴ | 0.02 | -44.39 |
| 4 | -1.36 | 6.14 x 10 ⁻⁴ | 0.02 | 11.21 |
| 5 | -1.91 | 3.46 x 10 ⁻⁴ | 0.02 | -46.49 |
| 6 | -1.92 | 1.11 x 10 ⁻⁴ | 0.01 | -30.35 |
| 7 | -2.27 | -8.26 x 10 ⁻⁵ | 0.01 | -53.60 |
| 8 | -1.16 | 1.30 x 10 ⁻³ | 0.01 | 6.46 |
| 9 | -0.34 | 1.20 x 10 ⁻³ | 0.01 | 38.20 |
| 10 | 0.23 | 2.72 x 10 ⁻³ | 0.01 | 66.84 |
| 11 | 1.25 | 3.34 x 10 ⁻³ | 0.01 | 121.24 |
| 12 | 0.02 | 2.20 x 10 ⁻³ | 0.01 | 69.95 |
| 13 | 0.95 | 1.52 x 10 ⁻³ | 0.01 | 89.43 |
| 14 | 1.20 | 1.32 x 10 ⁻³ | 0.01 | 82.84 |
| 15 | 4.32 | 4.63 x 10 ⁻⁴ | 0.00 | 189.69 |
| 16 | -1.71 | -1.21 x 10 ⁻⁴ | 0.03 | -38.45 |

The per square foot of conditioned floor area TDV energy cost savings over the 15-year period of analysis are presented in Table 21. These are presented as the discounted present value of the energy cost savings over the analysis period.

3.4 Lifecycle Cost and Cost-Effectiveness

3.4.1 Energy Cost Savings Methodology

CBECC-Com 2016 allows users to install heat recovery devices, but an error message will interrupt the analysis if it is not connected to a 100 percent outdoor air system. Therefore, the baseline OpenStudio models from each of the prototype buildings were instead pulled out and used to process the energy saving and peak electricity demand reduction resulting from the proposed measure.

The Nonresidential ACM must allow users to install heat recovery ventilators in air systems that do not provide 100 percent outdoor air in order to replicate the savings.

3.4.2 Energy Cost Savings Results

The per square foot of conditioned floor area energy cost savings over the 15-year period of analysis are presented in Table 19, Table 20, and Table 21. It is estimated that the first-year TDV energy savings ranges from negative 4.77 and 16.88 TDV kBtu/sf-year. The TDV methodology allows peak electricity savings to be valued more than electricity savings during non-peak periods.

Table 19: Exhaust Air Heat Recovery TDV Energy Cost Savings Over 15-Year Period per Square Foot – Small Office –Prototype 2

| Climate Zone | 15-Year TDV Electricity Cost Savings (2020 Present Value \$) | 15-Year TDV Natural Gas Cost Savings (2020 Present Value \$) | Total 15-Year TDV Energy Cost Savings (2020 Present Value \$) |
|--------------|--|--|---|
| 1 | -\$3.16 | \$1.18 | -\$1.98 |
| 2 | -\$2.90 | \$0.67 | -\$2.23 |
| 3 | -\$3.20 | \$0.50 | -\$2.70 |
| 4 | -\$2.91 | \$0.41 | -\$2.51 |
| 5 | -\$3.30 | \$0.52 | -\$2.78 |
| 6 | -\$3.08 | \$0.19 | -\$2.89 |
| 7 | -\$3.21 | \$0.08 | -\$3.13 |
| 8 | -\$2.97 | \$0.15 | -\$2.82 |
| 9 | -\$2.83 | \$0.17 | -\$2.66 |
| 10 | -\$2.85 | \$0.20 | -\$2.65 |
| 11 | -\$2.41 | \$0.69 | -\$1.73 |
| 12 | -\$2.59 | \$0.69 | -\$1.91 |
| 13 | -\$2.53 | \$0.65 | -\$1.87 |
| 14 | -\$2.73 | \$0.66 | -\$2.07 |
| 15 | -\$2.02 | \$0.07 | -\$1.96 |
| 16 | -\$3.20 | \$1.62 | -\$1.58 |

Table 20: Exhaust Air Heat Recovery TDV Energy Cost Savings Over 15-Year Period per Square Foot – Medium Office – Prototype 3

| Climate Zone | 15-Year TDV Electricity Cost Savings (2020 Present Value \$) | 15-Year TDV Natural Gas Cost Savings (2020 Present Value \$) | Total 15-Year TDV Energy Cost Savings (2020 Present Value \$) |
|--------------|--|--|---|
| 1 | -\$0.41 | \$0.02 | -\$0.39 |
| 2 | -\$0.09 | \$0.01 | -\$0.07 |
| 3 | -\$0.42 | \$0.01 | -\$0.41 |
| 4 | -\$0.08 | \$0.01 | -\$0.07 |
| 5 | -\$0.45 | \$0.01 | -\$0.44 |
| 6 | -\$0.38 | \$0.01 | -\$0.38 |
| 7 | -\$0.51 | \$0.00 | -\$0.51 |
| 8 | -\$0.20 | \$0.01 | -\$0.19 |
| 9 | -\$0.02 | \$0.01 | -\$0.01 |
| 10 | \$0.23 | \$0.01 | \$0.24 |
| 11 | \$0.42 | \$0.01 | \$0.44 |
| 12 | \$0.19 | \$0.01 | \$0.20 |
| 13 | \$0.33 | \$0.01 | \$0.35 |
| 14 | \$0.19 | \$0.01 | \$0.20 |
| 15 | \$0.97 | \$0.00 | \$0.97 |
| 16 | -\$0.51 | \$0.02 | -\$0.49 |

Table 21: Exhaust Air Heat Recovery TDV Energy Cost Savings Over 15-Year Period per Square Foot – Medium Office/Lab –Prototype 15

| Climate Zone | 15-Year TDV Electricity Cost Savings (2020 Present Value \$) | 15-Year TDV Natural Gas Cost Savings (2020 Present Value \$) | Total 15-Year TDV Energy Cost Savings (2020 Present Value \$) |
|--------------|--|--|---|
| 1 | -\$4.71 | \$0.61 | -\$4.11 |
| 2 | \$1.19 | \$0.30 | \$1.49 |
| 3 | -\$4.31 | \$0.36 | -\$3.95 |
| 4 | \$0.72 | \$0.28 | \$1.00 |
| 5 | -\$4.49 | \$0.35 | -\$4.14 |
| 6 | -\$2.87 | \$0.17 | -\$2.70 |
| 7 | -\$4.88 | \$0.11 | -\$4.77 |
| 8 | \$0.43 | \$0.15 | \$0.57 |
| 9 | \$3.26 | \$0.14 | \$3.40 |
| 10 | \$5.80 | \$0.15 | \$5.95 |
| 11 | \$10.60 | \$0.19 | \$10.79 |
| 12 | \$5.98 | \$0.25 | \$6.23 |
| 13 | \$7.73 | \$0.23 | \$7.96 |
| 14 | \$7.20 | \$0.18 | \$7.37 |
| 15 | \$16.84 | \$0.04 | \$16.88 |
| 16 | -\$3.91 | \$0.48 | -\$3.42 |

3.4.3 Incremental First Cost

Incremental first cost for the proposed measure was determined from manufacturer data and RSMMeans. This included the additional cost of including a heat recovery ventilator with bypass dampers and controls to the labor cost.

Table 22: Capital Cost for Heat Recovery Ventilators

| Size (cfm) | Base Cost (Material, Labor, Controls) | Base Cost (Material, Labor, Controls) (\$/cfm) |
|------------|---------------------------------------|--|
| 1,000 | \$6,775 | \$6.78 |
| 2,000 | \$7,925 | \$3.96 |
| 4,000 | \$9,175 | \$2.29 |
| 6,000 | \$10,700 | \$1.78 |
| 8,000 | \$11,800 | \$1.48 |
| 10,000 | \$14,200 | \$1.42 |
| 20,000 | \$25,700 | \$1.29 |
| 25,000 | \$31,400 | \$1.26 |
| 30,000 | \$34,800 | \$1.16 |
| 40,000 | \$48,000 | \$1.20 |
| 50,000 | \$56,000 | \$1.12 |

The reduced cost due to decreased peak loads by applying a heat recovery ventilator was also included in the first cost analysis. The incremental costs of heating and cooling equipment were determined using RSMMeans, and the peak load reduction was determined from each climate’s design condition as well as each building’s outdoor air percentage and supply air temperature. Boilers were estimated to cost \$237 per ton; air-cooled chillers were estimated to cost \$728 per ton; and water-cooled chiller systems were estimated to cost \$715 per ton. The total cost includes the material and labor cost of installing each piece of equipment.

Table 23: Reduced Equipment Costs Due to Peak Load Reductions

| Climate Zone | Cooling Design Condition (0.4%) [°F] | Heating Design Condition (99.6%) [°F] | Small Office (\$/ft ²) | Medium Office (\$/ft ²) | Medium Office/Lab (\$/ft ²) |
|--------------|--------------------------------------|---------------------------------------|------------------------------------|-------------------------------------|---|
| 1 | 70.4 | 30.4 | \$0.15 | \$0.00 | \$1.14 |
| 2 | 95.3 | 29.6 | \$0.23 | \$0.08 | \$1.75 |
| 3 | 82.3 | 36.7 | \$0.16 | \$0.03 | \$0.21 |
| 4 | 88.4 | 36.2 | \$0.18 | \$0.05 | \$0.39 |
| 5 | 83.8 | 32.6 | \$0.18 | \$0.03 | \$0.25 |
| 6 | 83.7 | 44.5 | \$0.13 | \$0.03 | \$0.25 |
| 7 | 83.1 | 44.8 | \$0.13 | \$0.03 | \$0.23 |
| 8 | 93.4 | 39.2 | \$0.19 | \$0.07 | \$0.53 |
| 9 | 97.7 | 38.6 | \$0.21 | \$0.09 | \$0.65 |
| 10 | 100.0 | 36.1 | \$0.23 | \$0.10 | \$0.72 |
| 11 | 105.4 | 29.9 | \$0.27 | \$0.12 | \$2.03 |
| 12 | 100.5 | 30.4 | \$0.25 | \$0.10 | \$1.88 |
| 13 | 103.5 | 31.4 | \$0.26 | \$0.11 | \$1.93 |
| 14 | 101.9 | 25.1 | \$0.28 | \$0.10 | \$2.07 |
| 15 | 111.2 | 41.4 | \$0.25 | \$0.14 | \$1.04 |
| 16 | 83.7 | 20.8 | \$0.22 | \$0.03 | \$1.67 |

3.4.4 Lifetime Incremental Maintenance Costs

The lifetime incremental maintenance cost includes the costs anticipated from cleaning the unit and testing to make sure the heat recovery ventilator is not interfering with economizer operations.

3.4.5 Lifecycle Cost-Effectiveness

Results per unit lifecycle cost-effectiveness analyses are presented in Table 24 for small office and Table 25 for medium offices, and Table 26 for medium office/labs. For small office, the measure was not found to be cost-effective in all climate zones. For medium offices, the measure was only found to be cost-effective in Climate Zone 15. For medium office/labs, the measure was found to be cost-effective in all climate zones except for 1, 3, 5, 6, 7, 8, and 16. This does not mean that cost effectiveness cannot be achieved in projects and climate zones since the prototype buildings do not represent what is possible for innovative design teams to achieve for a particular building. The primary cause of the increased electricity consumption is increased static pressure assumed in the application of exhaust air sensible heat recovery which results in significant increases in kWh consumption by the fans. Implementing expanded capabilities in the simulation software will allow performance compliance to more fully utilize the benefits of heat recovery.

Table 24: Exhaust Air Heat Recovery Lifecycle Cost-Effectiveness Summary per Square Foot – Small Office

| Climate Zone | Benefits TDV Energy Cost Savings + Other PV Savings ^a (2020 Present Value \$) | Costs Total Incremental PV Costs ^b (2020 Present Value \$) | Benefit-to- Cost Ratio |
|--------------|---|---|---------------------------|
| 1 | \$0.15 | \$3.38 | 0.04 |
| 2 | \$0.23 | \$3.68 | 0.06 |
| 3 | \$0.16 | \$4.08 | 0.04 |
| 4 | \$0.18 | \$3.96 | 0.05 |
| 5 | \$0.18 | \$4.17 | 0.04 |
| 6 | \$0.13 | \$4.34 | 0.03 |
| 7 | \$0.13 | \$4.57 | 0.03 |
| 8 | \$0.19 | \$4.32 | 0.04 |
| 9 | \$0.21 | \$4.17 | 0.05 |
| 10 | \$0.23 | \$4.26 | 0.05 |
| 11 | \$0.27 | \$3.30 | 0.08 |
| 12 | \$0.25 | \$3.39 | 0.07 |
| 13 | \$0.26 | \$3.42 | 0.08 |
| 14 | \$0.28 | \$3.71 | 0.07 |
| 15 | \$0.25 | \$3.60 | 0.07 |
| 16 | \$0.22 | \$3.31 | 0.07 |

- a. **Benefits – TDV Energy Cost Savings + Other PV Savings:** Benefits include TDV energy cost savings over the period of analysis (Energy + Environmental Economics 2016, 51-53). Other savings are discounted at a real (nominal – inflation) three percent rate. Other present valued savings include incremental first cost savings if proposed first cost is less than current first cost. Includes present value maintenance cost savings if present value of proposed maintenance costs is less than the present value of current maintenance costs.
- b. **Costs – Total Incremental PV Costs:** Costs include incremental equipment, replacement, and maintenance costs over the period of analysis. Costs are discounted at a real (inflation adjusted) three percent rate. Includes incremental first cost if proposed first cost is greater than current first cost. Includes present value of maintenance incremental cost if present value of proposed maintenance costs is greater than the present value of current maintenance costs. If incremental maintenance cost is negative, it is treated as a positive benefit. If there are no total incremental present valued costs, the B/C ratio is infinite.

Table 25: Exhaust Air Heat Recovery Lifecycle Cost-Effectiveness Summary per Square Foot – Medium Office

| Climate Zone | Benefits TDV Energy Cost Savings + Other PV Savings ^a (2020 Present Value \$) | Costs Total Incremental PV Costs ^b (2020 Present Value \$) | Benefit-to- Cost Ratio |
|--------------|---|---|---------------------------|
| 1 | \$0.00 | \$1.25 | 0.00 |
| 2 | \$0.08 | \$0.98 | 0.08 |
| 3 | \$0.03 | \$1.29 | 0.02 |
| 4 | \$0.05 | \$1.01 | 0.05 |
| 5 | \$0.03 | \$1.31 | 0.03 |
| 6 | \$0.03 | \$1.31 | 0.03 |
| 7 | \$0.03 | \$1.43 | 0.02 |
| 8 | \$0.07 | \$1.12 | 0.06 |
| 9 | \$0.09 | \$0.96 | 0.09 |
| 10 | \$0.33 | \$1.09 | 0.31 |
| 11 | \$0.55 | \$0.99 | 0.56 |
| 12 | \$0.30 | \$0.94 | 0.32 |
| 13 | \$0.45 | \$0.99 | 0.46 |
| 14 | \$0.30 | \$1.05 | 0.29 |
| 15 | \$1.11 | \$1.06 | 1.04 |
| 16 | \$0.03 | \$1.67 | 0.02 |

- a. **Benefits – TDV Energy Cost Savings + Other PV Savings:** Benefits include TDV energy cost savings over the period of analysis (Energy + Environmental Economics 2016, 51-53). Other savings are discounted at a real (nominal – inflation) three percent rate. Other present valued savings include incremental first cost savings if proposed first cost is less than current first cost. Includes present value maintenance cost savings if present value of proposed maintenance costs is less than the present value of current maintenance costs.
- b. **Costs – Total Incremental PV Costs:** Costs include incremental equipment, replacement, and maintenance costs over the period of analysis. Costs are discounted at a real (inflation adjusted) three percent rate. Includes incremental first cost if proposed first cost is greater than current first cost. Includes present value of maintenance incremental cost if present value of proposed maintenance costs is greater than the present value of current maintenance costs. If incremental maintenance cost is negative, it is treated as a positive benefit. If there are no total incremental present valued costs, the B/C ratio is infinite.

Table 26: Exhaust Air Heat Recovery Lifecycle Cost-Effectiveness Summary per Square Foot – Medium Office/Lab

| Climate Zone | Benefits TDV Energy Cost Savings + Other PV Savings ^a (2020 Present Value \$) | Costs Total Incremental PV Costs ^b (2020 Present Value \$) | Benefit-to- Cost Ratio |
|--------------|---|---|---------------------------|
| 1 | \$1.14 | \$6.20 | 0.18 |
| 2 | \$3.24 | \$2.41 | 1.34 |
| 3 | \$0.21 | \$6.07 | 0.03 |
| 4 | \$1.38 | \$2.13 | 0.65 |
| 5 | \$0.25 | \$6.26 | 0.04 |
| 6 | \$0.25 | \$4.86 | 0.05 |
| 7 | \$0.23 | \$6.89 | 0.03 |
| 8 | \$1.11 | \$2.19 | 0.51 |
| 9 | \$4.05 | \$2.65 | 1.53 |
| 10 | \$6.67 | \$2.66 | 2.51 |
| 11 | \$12.82 | \$2.89 | 4.43 |
| 12 | \$8.10 | \$2.53 | 3.20 |
| 13 | \$9.89 | \$2.46 | 4.03 |
| 14 | \$9.44 | \$3.11 | 3.03 |
| 15 | \$17.93 | \$3.07 | 5.84 |
| 16 | \$1.67 | \$5.60 | 0.30 |

- a. **Benefits – TDV Energy Cost Savings + Other PV Savings:** Benefits include TDV energy cost savings over the period of analysis (Energy + Environmental Economics 2016, 51-53). Other savings are discounted at a real (nominal – inflation) three percent rate. Other present valued savings include incremental first cost savings if proposed first cost is less than current first cost. Includes present value maintenance cost savings if present value of proposed maintenance costs is less than the present value of current maintenance costs.
- b. **Costs – Total Incremental PV Costs:** Costs include incremental equipment, replacement, and maintenance costs over the period of analysis. Costs are discounted at a real (inflation adjusted) three percent rate. Includes incremental first cost if proposed first cost is greater than current first cost. Includes present value of maintenance incremental cost if present value of proposed maintenance costs is greater than the present value of current maintenance costs. If incremental maintenance cost is negative, it is treated as a positive benefit. If there are no total incremental present valued costs, the B/C ratio is infinite.

3.5 First-Year Statewide Impacts

3.5.1 Statewide Energy Savings and Lifecycle Energy Cost Savings

Savings are calculated for the cost-effective climate zone for the Medium Office/Lab prototype as shown in Table 26. Using the new construction forecast for 2020, the Statewide CASE Team estimates that the proposed code change will decrease annual statewide electricity use by 0.20 GWh with an associated demand reduction of 1.32 MW. Natural gas use is expected to be decreased by 0.007 million therms. The energy savings for buildings constructed in 2020 are associated with a present-valued energy cost savings of approximately \$4.22 million in (discounted) energy costs over the 15-year period of analysis. Results are presented in Table 27.

Table 27: Statewide Energy and Energy Cost Impacts – Exhaust Air Heat Recovery

| Climate Zone | Statewide Construction in 2020 (million ft ²) | First-Year Electricity Savings (GWh) ^a | First-Year Peak Electrical Demand Reduction (MW) | First-Year Natural Gas Savings (million therms) | Lifecycle ^b Present Valued Energy Cost Savings (Present Value \$ million) |
|--------------|---|---|--|---|--|
| 1 | 0.0000 | 0.00 | 0.00 | 0.000 | \$0.00 |
| 2 | 0.0410 | -0.04 | 0.02 | 0.001 | \$0.06 |
| 3 | 0.0000 | 0.00 | 0.00 | 0.000 | \$0.00 |
| 4 | 0.0000 | 0.00 | 0.00 | 0.000 | \$0.00 |
| 5 | 0.0000 | 0.00 | 0.00 | 0.000 | \$0.00 |
| 6 | 0.0000 | 0.00 | 0.00 | 0.000 | \$0.00 |
| 7 | 0.0000 | 0.00 | 0.00 | 0.000 | \$0.00 |
| 8 | 0.0000 | 0.00 | 0.00 | 0.000 | \$0.00 |
| 9 | 0.1886 | -0.06 | 0.23 | 0.002 | \$0.64 |
| 10 | 0.1379 | 0.03 | 0.38 | 0.001 | \$0.82 |
| 11 | 0.0347 | 0.04 | 0.12 | 0.000 | \$0.37 |
| 12 | 0.1689 | 0.00 | 0.37 | 0.002 | \$1.05 |
| 13 | 0.0691 | 0.07 | 0.11 | 0.001 | \$0.55 |
| 14 | 0.0244 | 0.03 | 0.03 | 0.000 | \$0.18 |
| 15 | 0.2612 | 0.13 | 0.08 | 0.000 | \$0.55 |
| 16 | 0.0000 | 0.00 | 0.00 | 0.000 | \$0.00 |
| TOTAL | 0.9258 | 0.20 | 1.32 | 0.007 | \$4.22 |

- a. First-year savings from all buildings completed statewide in 2020.
- b. Energy cost savings from all buildings completed statewide in 2020 accrued during 15-year period of analysis.

3.5.2 Statewide Water Use Impacts

The proposed exhaust air heat recovery requirements will not result in water savings.

3.5.3 Statewide Material Impacts

The proposed exhaust air heat recovery requirements will not result in changes to material use.

3.5.4 Other Non-Energy Impacts

The proposed code change will not result in any other non-energy impacts.

3.6 Proposed Revisions to Code Language

The proposed changes to the Standards, Reference Appendices, and the ACM Reference Manual are below. Changes to the 2016 documents are marked with underlining (new language) and ~~strikethroughs~~ (deletions).

3.6.1 Standards

SECTION 140.4 – PRESCRIPTIVE REQUIREMENTS FOR SPACE CONDITIONING SYSTEMS

(o) – Exhaust Air Heat Recovery.

1. Systems with minimum design outdoor air fraction of 80% or greater and supply air flow of 200 cfm or greater in climate zones 2, 9, 10, 11, 12, 13, 14, 15 shall have a heat recovery system.
2. Heat recovery systems required by this section shall result in a net sensible energy recovery ratio of at least 60 percent for both heating and cooling as tested using AHRI 1060-2014 or

1061-2014 and certified by AHRI. A 60 percent sensible energy recovery ratio shall mean a change in the dry-bulb of the outdoor air supply equal to 60 percent of the difference between the outdoor air and exhaust air dry-bulb at design conditions. Provisions shall be made to bypass or control the energy recovery system to permit air economizer operation as required by Section 140.4(e): Economizers.

EXCEPTION 1 to Section 140.4(o): Systems serving spaces that are not cooled and that are heated to less than 60°F.

EXCEPTION 2 to Section 140.4(o): Where more than 60 percent of the outdoor air heating energy is provided from site-recovered energy.

EXCEPTION 3 to Section 140.4(o): Where the sum of the airflow rates exhausted and relieved within 20 feet of each other is less than 75 percent of the design outdoor airflow rate, excluding exhaust air that is either:

1. used for another energy recovery system,
2. not allowed by ASHRAE Standard 170 for use in energy recovery systems with leakage potential, or
3. of Class 4 as defined in ASHRAE Standard 62.1.

EXCEPTION 4 to Section 140.4(o): Systems expected to operate less than 20 hours per week.

3.6.2 Reference Appendices

NA7.5.4 Air Economizer Controls

NA7.5.4.1 Construction Inspection

Prior to Functional Testing, verify and document the following:

- (a) Economizer high limit shutoff control complies with Table 140.4-B of Section 140.4(e)3.
- (b) If the high-limit control is fixed dry-bulb or fixed enthalpy + fixed dry-bulb, it shall have an adjustable setpoint.
- (c) Economizer lockout control sensor is located to prevent false readings.
- (d) Sensor performance curve is provided by factory with economizer instruction material.
- (e) Sensor output value measured during sensor calibration is plotted on the performance curve.
- (f) Economizer damper moves freely without binding.
- (g) Economizer has control systems, including two-stage or electronic thermostats, that cycle compressors off when economizers can provide partial cooling
- (h) Economizer reliability features are present as specified by Standards Section 140.4(e)4.
- (i) Economizer inlet damper is designed to modulate up to 100 percent open, and return air damper to 100 percent closed, without over-pressurizing the building.
- (j) For systems with DDC controls lockout sensor(s) are either factory calibrated or field calibrated.
- (k) For systems with non-DDC controls, manufacturer's startup and testing procedures have been applied.
- (l) The economizer has been certified to the Energy Commission as specified by Section 140.4(e)4C.

(m) For systems with exhaust air heat recovery ventilators, sensor used for economizer bypass has been factory or field calibrated and manufacturer's startup and testing procedures have been applied.

NA7.5.4.2 Functional Testing

Step 1: Disable demand control ventilation systems (if applicable).

Step 2: Enable the economizer and simulate a cooling demand large enough to drive the economizer fully open. Verify and document the following:

- (a) Economizer damper is 100 percent open and return air damper is 100 percent closed.
- (b) For systems with plate type exhaust air heat recovery ventilators, verify that the bypass damper modulates 100% open, outdoor air intake modulates 100% closed, and return air damper modulates 100% closed.
- (c) For system with wheel type exhaust air heat recovery ventilators, verify that the wheel motor is turned off.
- (d) ~~(b)~~ All applicable fans and dampers operate as intended to maintain building pressure.
- (e) ~~(c)~~ The unit heating is disabled (if unit has heating capability).

Step 3: Disable the economizer and simulate a cooling demand. Verify and document the following:

- ~~(f)~~ ~~(d)~~ Economizer damper closes to its minimum position.
- ~~(g)~~ ~~(e)~~ All applicable fans and dampers operate as intended to maintain building pressure.
- ~~(h)~~ ~~(f)~~ The unit heating is disabled (if unit has heating capability).

Step 4: If unit has heating capability, simulate a heating demand and set the economizer so that it is capable of operating (i.e. actual outdoor air conditions are below lockout setpoint). Verify the following:

- ~~(i)~~ ~~(g)~~ The economizer is at minimum position
- ~~(j)~~ ~~(h)~~ Return air damper opens

Step 5: Turn off the unit. Verify and document the following:

- ~~(k)~~ ~~(i)~~ Economizer damper closes completely.

Step 6: Restore demand control ventilation systems (if applicable) and remove all system overrides initiated during the test.

3.6.3 ACM Reference Manual

Changes to Section 5.7.6.6 to the Nonresidential ACM made to add baseline heat recovery requirements and to allow air systems with less than 100 percent outdoor air to take credit for including heat recovery ventilators.

3.6.4 Compliance Manuals

Chapter 4.6.2 of the Nonresidential Compliance Manual will need to be revised with a new section pertaining to heat recovery ventilators. The manual should also include best practices for installing heat recovery ventilators.

3.6.5 Compliance Documents

Compliance document NRCC-MCH-02-E HVAC Dry System Requirements will need to be revised to include heat recovery ventilators.

4. EQUIPMENT EFFICIENCY

4.1 Measure Description

4.1.1 Measure Overview

The purpose of this measure is to update mandatory efficiency requirements for space conditioning equipment that appear in Tables 110.2-A through K, so that the minimum equipment efficiency values are as stringent as the minimum efficiency requirements in ASHRAE 90.1-2016. Not every efficiency value listed in these tables needs to be updated; the Statewide CASE Team is proposing to update only 18 values. These changes update the minimum efficiency values for equipment that is already covered by Title 24, Part 6, including the addition of subrequirements for additional capacities.

The proposed changes impact all nonresidential building types and apply to new construction and retrofits. The equipment types subject to the proposed measure are typically used in nonresidential buildings. However, variable refrigerant flow (VRF) units are also often used in high-rise residential buildings, motels, and hotels.

The changes to equipment efficiency requirements are presented in Table 28.

Table 28: Summary of Changes to Equipment Efficiency Requirements

| Equipment | Equipment Category | Proposed Change to Efficiency |
|---|--|---|
| Air conditioners | Air cooled and water cooled | No change |
| Air conditioners | Evaporatively cooled and condensing units | No change |
| Heat pumps - cooling & heating mode | Air cooled and others | No change |
| Heat pumps - cooling & heating mode | Water, groundwater and ground source | No change |
| Heat pumps - cooling & heating mode | Air-cooled gas engine | No change |
| Water chillers | Air cooled and water cooled | No change |
| Water chillers | Air- and water-cooled absorption | No change |
| Package terminal air conditioners (PTAC) | For new construction or newly conditioned buildings | No change |
| Package terminal heat pumps (PTHP) - cooling & heating mode | For new construction or newly conditioned buildings and replacements | No change |
| Single package vertical air conditioners (SPVAC) | Both weatherized and non-weatherized space constrained | Update EER and COP for weatherized units <65,000 Btu/h (EER = energy efficiency ratio; COP = coefficient of performance) |
| Single package vertical heat pumps (SPVHP) - cooling & heating mode | Both weatherized and non-weatherized space constrained | Update EER and COP for weatherized units <65,000 Btu/h |
| Heat exchangers | Liquid-to-liquid plate type | No change |
| Cooling towers | Propeller or axial fan closed circuit | Update gpm/hp to efficiency levels in ASHRAE 90.1-2016 (gpm = gallons per minute) |
| Cooling towers | All other open and closed circuit | No change |
| Condensers | Air cooled and evaporative | No change |
| VRF air conditioners | Air cooled | Update IEER to efficiency levels in ASHRAE 90.1-2016 being adopted after 1/1/2017 |
| VRF heat pumps- cooling mode | Air cooled | Update IEER to efficiency levels in ASHRAE 90.1-2016 being adopted after 1/1/2017 |
| VRF heat pumps- cooling mode | Water source | Update IEER to efficiency levels in ASHRAE 90.1-2016 being adopted after 1/1/2018 and insert requirements for EER and IEER for $\geq 240,000$ Btu/h size category |
| VRF heat pumps- heating mode | Water source | Update COP to efficiency levels in ASHRAE 90.1-2016 being adopted after 1/1/2018 and insert requirements for COP for <65,000 Btu/h and $\geq 240,000$ Btu/h size category |
| VRF heat pumps - cooling & heating mode | All other air cooled, water, ground and groundwater source | No change |
| Furnaces | Gas- and oil- fired | No change |
| Furnaces | Unit heater, oil-fired | No change |
| Boilers | Hot water and steam-, gas- and oil-fired | No change |
| Boilers | Steam (300,000 Btu/h) | No change |

4.1.2 Measure History

Federal law directs the DOE to review the federal minimum efficiency requirements for certain commercial and industrial equipment whenever ASHRAE 90.1 amends its standards for such equipment (42 USC 6313(a)(6)(A)). The following equipment is subject to this requirement:

- Small, large, and very large commercial package air conditioning and heating equipment
- Single package vertical air conditioners and heat pumps
- Packaged terminal air conditioners and heat pumps
- Warm-air furnaces
- Commercial packaged boilers
- Storage water heaters, instantaneous water heaters, and unfired hot water storage tanks

Thus, ASHRAE has taken the lead on establishing more stringent standards for the equipment in question, and DOE typically adopts ASHRAE's equipment efficiency levels. Generally speaking, ASHRAE does not complete a comprehensive market and cost analysis on measures it adopts into ASHRAE 90.1. However, ASHRAE does complete a market and cost-effectiveness analysis for the equipment efficiency values. This analysis informs the DOE's analysis of the ASHRAE equipment efficiency values and streamlines the adoption of ASHRAE equipment efficiency levels into the federal appliance standards. The DOE analysis is more robust and done to a higher technical criteria as necessary for efficiency standards that prohibit the sale of equipment that does not meet the minimum efficiency level.

Since the equipment efficiency values that are adopted into ASHRAE 90.1 will likely become the federal minimum efficiency standards, states have a unique opportunity to adopt the equipment efficiency values that appear in ASHRAE 90.1 using a simplified process. The Energy Commission is not obligated to adopt ASHRAE 90.1 equipment efficiency values into Table 110.2, but if the Energy Commission chooses to do so, the equipment efficiency values can be adopted without conducting a cost-effectiveness analysis. The Energy Commission can adopt the efficiency values in the Title 24, Part 6 Building Energy Efficiency Standards before DOE completes its cost-effectiveness analysis and before DOE adopts the standards.

The Energy Commission has requested that the Statewide CASE Team submit a CASE Report that identifies changes to Tables 110.2-A through 110.2-K based on ASHRAE 90.1. The Energy Commission staff indicated that this CASE Report does not need to include Section 8.4, Lifecycle Cost and Cost-Effectiveness. This CASE Report should include Section 1.2, "Market Impacts and Economic Assessments for All Submeasures", and Section 1.3, "Economic Impacts of All Submeasures"; however, these sections do not need to include information about cost-effectiveness. This CASE Report includes information that will help inform the Energy Commission's determination that the proposed equipment efficiency levels can be adopted into Title 24, Part 6.

Historically, Table 110.2 includes equipment efficiency values that are adopted into the most recent version of ASHRAE 90.1, but are more stringent than, or have an earlier effective date than, the currently adopted California Appliance Efficiency Regulations (Title 20) or the federal appliance efficiency standards. Although Table 110.2 historically included efficiency values that differed from current state or federal regulations, the 2016 Title 24, Part 6 Standards present a list of all relevant minimum efficiency requirements for space conditioning equipment, including equipment efficiency values that are the same as the current state or federal requirements.

4.1.3 Summary of Proposed Changes to Code Documents

The sections below summarize how each Title 24, Part 6 document will be modified by the proposed change. See Section 4.6 of this report for detailed proposed revisions to code language.

4.1.3.1 Standards Change Summary

This proposal modifies the following sections of the Building Energy Efficiency Standards as shown below. See Section 4.6.1 of this report for the detailed proposed revisions to the standards language. The language will be based on the same language from ASHRAE 90.1-2016.

SECTION 110.2 – MANDATORY REQUIREMENTS FOR SPACE CONDITIONING EQUIPMENT

Subsection 110.2(a): The proposed requirements update some of the equipment efficiency values in Tables 110.2-A through 110.2-K.

4.1.3.2 Reference Appendices Change Summary

The proposed code change does not modify the Reference Appendices.

4.1.3.3 Alternative Calculation Method (ACM) Reference Manual Change Summary

The proposed code change does not modify the Nonresidential ACM Reference Manual.

4.1.3.4 Compliance Manual Change Summary

The proposed code change does not modify the Compliance Manual.

4.1.3.5 Compliance Documents Change Summary

The proposed code change does not modify the compliance documents.

4.1.4 Regulatory Context

4.1.4.1 Existing Title 24, Part 6 Standards

Most of the proposed changes update the minimum efficiency values for equipment that is already covered by Title 24, Part 6. Some changes add size categories above and below current size categories. This does not regulate equipment that was previously unregulated; it adds subcategories to these requirements.

4.1.4.2 Relationship to Other Title 24, Part 6 Requirements

This measure does not impact any other Title 24, Part 6 requirements nor does it overlap with other Title 24, Part 6 code change proposals for the 2019 cycle.

4.1.4.3 Relationship to State or Federal Laws

The proposed code change proposal will reaffirm that the equipment efficiency values in Section 110.2 of Title 24, Part 6 will meet energy efficiency levels that are already established by other recognized standards or codes. The following standards were reviewed to establish the highest potential efficiency levels:

- California Appliance Efficiency Regulations (Title 20)
- Federal Appliance Efficiency Standards

4.1.4.4 Relationship to Industry Standards

ASHRAE 90.1-2016 was reviewed to establish the recommended efficiency levels in Section 110.2 Title 24, Part 6. The requirements pulled in all came from ASHRAE 90.1.

4.1.5 Compliance and Enforcement

This code change proposal primarily affects buildings that use the mandatory and prescriptive approaches to compliance. The key steps and changes to the compliance process are summarized below.

- **Design Phase:** There is no change from the current requirements. Design teams will still need to ensure that the equipment they are specifying meets the mandatory equipment efficiency requirements.
- **Permit Application Phase:** There is no change from the current requirements.
- **Construction Phase:** There is no change from the current requirements.
- **Inspection Phase:** There is no change from the current requirements. Inspectors will still need to verify that installed equipment meets mandatory minimum equipment efficiency.

4.2 Market Analysis

The Statewide CASE Team performed a market analysis with the goals of identifying current technology availability, current product availability, and market trends. The Statewide CASE Team considered how the proposed standard may impact the market in general and individual market actors. Estimates of market size and measure applicability were identified through research and outreach with stakeholders including utility program staff, Energy Commission staff, and a wide range of industry players who were invited to participate in utility-sponsored stakeholder meetings held on September 26, 2016, and March 29, 2017.

4.2.1 Market Structure

The proposed measure makes changes for several types of HVAC equipment. Table 29 lists the principal manufacturers of the impacted equipment types. Each manufacturer has readily available products capable of fulfilling the requirements of this measure. Each manufacturer has multiple distribution branches in California or actively sells its product in California. Manufacturers typically follow ASHRAE 90.1 guidelines, so the intention is to align Title 24, Part 6 with ASHRAE 90.1 to give manufacturers one set of standards to follow for equipment efficiency.

Table 29: Principal Manufacturers of HVAC Equipment Impacted by Efficiency Updates

| Equipment Type | Principal Manufacturers |
|--|-----------------------------------|
| VRF Air Conditioners and Heat Pumps | Mitsubishi, Daikin, LG |
| Propeller or Axial Fan Closed-Circuit Cooling Towers | BAC, Evapco, SPX |
| Single Package Vertical Air Conditioners/Heat Pumps (SPVAC/HP) | Trane, Carrier, Daikin, First Co. |

The VRF market has been growing rapidly in California in the last few years. The technology has recently become widely adopted by mechanical designers, especially in office design.

The closed-circuit cooling tower market in California is not very large. It is predominantly specified in design for high-rise residential. However, it has the potential to grow in California, as water reduction has become a significant topic in the state, and closed-circuit cooling towers require less potable water than open-circuit cooling towers.

Single package vertical air conditioners (SPVAC) are air-cooled units that are factory-assembled as a single package, in which all major components are arranged vertically. These units are intended for mounting on, adjacent interior to, or through an outside wall. They typically condition a single zone, but can also condition multiple zones. Single package vertical heat pumps (SPVHP) are a specific type of SPVAC, in which reverse cycle refrigeration is its primary heat source. SPVAC and SPVHP are often installed in closets or other hidden areas, and are most commonly used in modular classrooms. A diagram of a SPVAC is shown in Figure 5. The market for SPVAC and SPVHP is not very large in the state of California, but is fairly popular amongst design for schools and is used in some apartment projects.

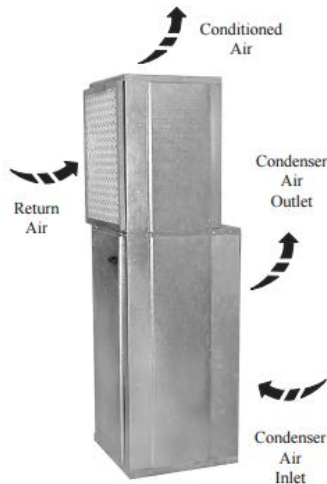

Figure 5. First Co. manufacturer SPVAC unit

4.2.2 Technical Feasibility, Market Availability, and Current Practices

The manufacturers of the HVAC equipment impacted by the proposed measure already produce equipment that meets proposed efficiency standards. The current practice for building designers and contractors is to build to be minimally compliant with Title 24, Part 6 Standards. The proposed measure will not affect the system configuration of HVAC equipment used in building construction, but it will require such HVAC equipment to meet certain efficiency levels.

ASHRAE 90.1 standards are established through public consensus process. The equipment efficiency standards in ASHRAE 90.1 undergo more evaluation than other measures in ASHRAE 90.1, because, as described above, the efficiency standards that are adopted into ASHRAE 90.1-2016 are very likely to become the national minimum efficiency standards. The key manufacturers and other stakeholders impacted by equipment efficiency standards participate in ASHRAE’s code development process. The standards are established only after confirming that compliant products are widely available from a variety of manufacturers, and the equipment that meets the proposed standards is reasonably cost-effective. This code change proposal recommends adopting the efficiency standards that were adopted by ASHRAE 90.1 without any changes. In doing so, it is reasonable to assume that the proposed standards have been vetted through ASHRAE’s code development process, and products that meet the proposed standards are readily available in the United States.

4.3 Energy Savings

4.3.1 Key Assumptions for Energy Savings Analysis

The energy savings analysis for the measure uses energy modeling following the guidance of the 2016 Nonresidential ACM. Energy models are sourced from CBECC-Com prototypical models and are only modified to include the proposed changes to the energy standards and Nonresidential ACM.

The proposed conditions are defined as the design conditions that will comply with the proposed code change. Specifically, the proposed code change will update the minimum equipment efficiency requirements in Tables 110.2A through 110.2K.

4.3.2 Energy Savings Methodology

The equipment efficiency requirements apply to both new construction and alterations to existing buildings.

The proposed code change will update the mandatory minimums for equipment efficiency in Tables 110.2A through 110.2K. The Energy Commission provided guidance on the type of prototype buildings that must be modeled. Table 30 presents the details of the prototype buildings used in the analysis. All modeling was done using OpenStudio.

Table 30: Prototype Buildings Used for Energy, Demand, Cost, and Environmental Impacts Analysis

| Prototype ID | Occupancy Type (Residential, Retail, Office, etc.) | Area (ft ²) | Number of Stories | Statewide New Construction Area (million ft ²) |
|--------------|--|-------------------------|-------------------|--|
| Prototype 1 | High-Rise Res (cooling tower) | 93,632 | 10 | 0.9 |
| Prototype 2 | Small Schools (SPVAC/SPVHP) | 24,413 | 1 | 3.1/7.6 |

Prototype 1 was used to determine energy savings for the change in efficiency of propeller or axial fan closed-circuit cooling towers. The high-rise residential prototype model was used for this analysis because closed-circuit cooling towers are predominantly used for this building type. The system in this model consisted of two water boilers, one water-cooled chiller, one cooling tower, and zonal VAV terminal units with reheat. The baseline cooling tower had an efficiency of 14.0 gpm/hp, the minimum efficiency in 2016 Title 24, Part 6 (Table 110.2-G, requirements for propeller or axial fan closed-circuit cooling towers). The proposed cooling tower had an efficiency of 16.1 gpm/hp, the minimum efficiency in ASHRAE 90.1-2016.

Prototype 2 was used to determine energy savings for the change in efficiency of SPVAC and SPVHP. The small school prototype model was used for this analysis because SPVAC/SPVHP are predominantly used for this building type. The system in this model consisted of zonal package terminal heat pumps. The baseline SPVHP had a cooling efficiency of 10.0 EER and a heating efficiency of 3.0 COP, the minimum efficiencies in 2016 Title 24, Part 6. The proposed SPVHP had a cooling efficiency of 11.0 EER and a heating efficiency of 3.3 COP, the minimum efficiencies in ASHRAE 90.1-2016. To calculate energy savings for the change in SPVAC minimum efficiency, only cooling energy savings were examined. To calculate energy savings for the change in SPVHP minimum efficiency, both cooling and heating energy savings were examined.

The proposed measure is climate sensitive since the HVAC equipment impacted by the measure are directly affected by ambient conditions, both temperature and humidity. The types of HVAC systems include both heating and cooling units; therefore, climates with extreme summer and winter temperatures will draw more energy. As HVAC equipment becomes more efficient, savings will be greater in the extreme temperature zones. Energy savings were calculated for all 16 climate zones in California. Energy savings, energy cost savings, and peak demand reductions were calculated using a TDV methodology.

Currently, California has not approved a modeling methodology for VRF. ASHRAE 90.1 does not have modeling results to support its code change. From a discussion with the co-chair of ASHRAE 90.1, VRF manufacturers researched the available market of VRF products to come up with efficiencies that they could endorse.

4.3.3 Per Unit Energy Impacts Results

The equipment efficiency measures analyzed do not have impacts on natural gas energy use. Thus, only electric values are shown.

Energy savings and peak demand reductions per square foot for new construction and alterations for SPVAC are presented in Table 31. Annual per square foot savings for the first year are expected to range from a high of 0.44 kWh/ft²-yr to a low of 0.0059 kWh/ft²-yr depending upon climate zone. From

a whole building perspective, the savings for the first year range from 10,740 kWh to 144 kWh. Demand reductions are expected to range between 3.2×10^{-4} kW/ft² and 0 kW/ft² depending on climate zone. It should be noted that there are not substantial energy savings due to the fact that the change in minimum efficiency for the modeled equipment is fairly small.

Table 31: First-Year Energy Impacts per Square Foot for Single Package Vertical Air Conditioners – New Construction and Alterations

| Climate Zone | Electricity Savings (kWh/ft ² -yr) | Peak Electricity Demand Reductions (kW/ft ²) | TDV Energy Savings (TDV kBtu/ft ² -yr) |
|--------------|---|--|---|
| 1 | 5.9×10^{-3} | 0 | 0.15 |
| 2 | 0.097 | 0 | 5.01 |
| 3 | 0.047 | 0 | 1.85 |
| 4 | 0.11 | 0 | 5.28 |
| 5 | 0.047 | 0 | 1.48 |
| 6 | 0.12 | 0 | 4.89 |
| 7 | 0.10 | 1.5×10^{-4} | 4.02 |
| 8 | 0.16 | 0 | 7.05 |
| 9 | 0.18 | 0 | 8.99 |
| 10 | 0.21 | 0 | 9.68 |
| 11 | 0.21 | 0 | 10.07 |
| 12 | 0.16 | 0 | 7.97 |
| 13 | 0.22 | 0 | 8.79 |
| 14 | 0.21 | 0 | 9.32 |
| 15 | 0.44 | 3.2×10^{-4} | 16.78 |
| 16 | 0.074 | 0 | 2.44 |

Energy savings and peak demand reductions per square foot for new construction and alterations for SPVHP are presented in Table 32. Per unit savings for the first year are expected to range from a high of 0.45 kWh/ft²-yr to a low of 0.12 kWh/ft²-yr depending upon climate zone. From a whole building perspective, the savings for the first year range from 10,986 kWh to 2,930 kWh. Demand reductions/increases are expected to range between 3.2×10^{-4} kW/ft² and 1.5×10^{-4} kW/ft² depending on climate zone.

Table 32: First-Year Energy Impacts per Square Foot for Single Package Vertical Heat Pumps – New Construction and Alterations

| Climate Zone | Electricity Savings (kWh/ft ² -yr) | Peak Electricity Demand Reductions (kW/ft ²) | TDV Energy Savings (TDV kBtu/ft ² -yr) |
|--------------|---|--|---|
| 1 | 0.16 | 1.6 x 10 ⁻⁴ | 5.13 |
| 2 | 0.19 | 1.7 x 10 ⁻⁴ | 7.35 |
| 3 | 0.12 | 1.6 x 10 ⁻⁴ | 3.89 |
| 4 | 0.17 | 1.6 x 10 ⁻⁴ | 6.77 |
| 5 | 0.12 | 1.7 x 10 ⁻⁴ | 3.67 |
| 6 | 0.15 | 1.7 x 10 ⁻⁴ | 5.71 |
| 7 | 0.12 | 1.5 x 10 ⁻⁴ | 4.51 |
| 8 | 0.19 | 1.6 x 10 ⁻⁴ | 7.78 |
| 9 | 0.21 | 1.5 x 10 ⁻⁴ | 9.84 |
| 10 | 0.25 | 2.1 x 10 ⁻⁴ | 10.62 |
| 11 | 0.30 | 1.8 x 10 ⁻⁴ | 12.28 |
| 12 | 0.25 | 1.7 x 10 ⁻⁴ | 10.14 |
| 13 | 0.31 | 1.7 x 10 ⁻⁴ | 10.89 |
| 14 | 0.30 | 1.8 x 10 ⁻⁴ | 11.40 |
| 15 | 0.45 | 3.2 x 10 ⁻⁴ | 17.19 |
| 16 | 0.28 | 1.9 x 10 ⁻⁴ | 8.44 |

Energy savings and peak demand reductions per square foot for new construction and alterations for closed-circuit cooling towers are presented in Table 33. Per unit savings for the first year are expected to range from a high of 8.5 x 10⁻² kWh/ft²-yr to a low of 8.0 x 10⁻⁴ kWh/ft²-yr depending upon climate zone. From a whole building perspective, the savings for the first year range from 7,960 kWh to 75 kWh. Demand reductions/increases are expected to range between 2.0 x 10⁻⁵ kW/ft² and 1.4 x 10⁻⁵ kW/ft² depending on climate zone.

Table 33: First-Year Energy Impacts per Square Foot for Closed-Circuit Cooling Towers – New Construction and Alterations

| Climate Zone | Electricity Savings (kWh/ft ² -yr) | Peak Electricity Demand Reductions (kW/ft ²) | TDV Energy Savings (TDV kBtu/ft ² -yr) |
|--------------|---|--|---|
| 1 | 8.0 x 10 ⁻⁴ | 1.4 x 10 ⁻⁵ | 0.03 |
| 2 | 2.2 x 10 ⁻² | 1.7 x 10 ⁻⁵ | 1.04 |
| 3 | 8.8 x 10 ⁻³ | 1.5 x 10 ⁻⁵ | 0.52 |
| 4 | 2.7 x 10 ⁻² | 1.8 x 10 ⁻⁵ | 1.20 |
| 5 | 6.8 x 10 ⁻³ | 1.6 x 10 ⁻⁵ | 0.35 |
| 6 | 3.5 x 10 ⁻² | 1.6 x 10 ⁻⁵ | 1.33 |
| 7 | 2.9 x 10 ⁻² | 1.8 x 10 ⁻⁵ | 1.21 |
| 8 | 3.8 x 10 ⁻² | 1.8 x 10 ⁻⁵ | 1.46 |
| 9 | 4.3 x 10 ⁻² | 1.8 x 10 ⁻⁵ | 1.60 |
| 10 | 4.3 x 10 ⁻² | 1.9 x 10 ⁻⁵ | 1.59 |
| 11 | 4.6 x 10 ⁻² | 1.9 x 10 ⁻⁵ | 1.69 |
| 12 | 3.5 x 10 ⁻² | 1.8 x 10 ⁻⁵ | 1.41 |
| 13 | 4.9 x 10 ⁻² | 1.9 x 10 ⁻⁵ | 1.76 |
| 14 | 4.0 x 10 ⁻² | 1.8 x 10 ⁻⁵ | 1.52 |
| 15 | 8.5 x 10 ⁻² | 2.0 x 10 ⁻⁵ | 2.64 |
| 16 | 1.3 x 10 ⁻² | 1.5 x 10 ⁻⁵ | 0.47 |

4.4 Lifecycle Cost and Cost-Effectiveness

4.4.1 Energy Cost Savings Methodology

TDV energy is a normalized format for comparing electricity and natural gas cost savings that takes into account the cost of electricity and natural gas consumed during each hour of the year. The TDV values are based on long-term discounted costs (30 years for all residential measures and nonresidential envelope measures and 15 years for all other nonresidential measures). In this case, the period of analysis used is 15 years. The TDV cost impacts are presented in 2020 present valued dollars. The TDV energy estimates are based on present-valued cost savings but are normalized in terms of TDV kBtu. Peak demand reductions are presented in peak power reductions (kW). The Energy Commission derived the 2020 TDV values that were used in the analyses for this report (Energy + Environmental Economics 2016).

4.4.2 Energy Cost Savings Results

It is estimated that the fifteen-year TDV energy cost savings for the cooling-only SPVAC range from 0.01 to 1.49 PV\$/sf. It is estimated that the first-year TDV energy cost savings for the cooling-only SPVHP range from 0.33 to 1.53 Present Value \$/ft². It is estimated that the first-year TDV energy cost savings for closed-circuit cooling towers range from 0.003 to 0.24 Present Value \$/ft². The TDV energy cost savings presented in Table 34 are given per square foot in the given climate zone.

Table 34: TDV Energy Cost Savings Over 15-Year Period of Analysis for Single Package Vertical Air Conditioners per Square Foot

| Climate Zone | 15-Year TDV Electricity Cost Savings for SPVAC (2020 Present Value \$/ft ²) | Total 15-Year TDV Energy Cost Savings for SPVAC (2020 Present Value \$/ft ²) | 15-Year TDV Electricity Cost Savings for SPVHP (2020 Present Value \$/ft ²) | Total 15-Year TDV Energy Cost Savings for SPVHP (2020 Present Value \$/ft ²) | 15-Year TDV Electricity Cost Savings for CCCT (2020 Present Value \$/ft ²) | Total 15-Year TDV Energy Cost Savings for CCCT (2020 Present Value \$/ft ²) |
|--------------|---|--|---|--|--|---|
| 1 | \$0.01 | \$0.01 | \$0.46 | \$0.46 | \$0.003 | \$0.003 |
| 2 | \$0.45 | \$0.45 | \$0.65 | \$0.65 | \$0.09 | \$0.09 |
| 3 | \$0.16 | \$0.16 | \$0.35 | \$0.35 | \$0.05 | \$0.05 |
| 4 | \$0.47 | \$0.47 | \$0.60 | \$0.60 | \$0.11 | \$0.11 |
| 5 | \$0.13 | \$0.13 | \$0.33 | \$0.33 | \$0.03 | \$0.03 |
| 6 | \$0.43 | \$0.43 | \$0.51 | \$0.51 | \$0.12 | \$0.12 |
| 7 | \$0.36 | \$0.36 | \$0.40 | \$0.40 | \$0.11 | \$0.11 |
| 8 | \$0.63 | \$0.63 | \$0.69 | \$0.69 | \$0.13 | \$0.13 |
| 9 | \$0.80 | \$0.80 | \$0.88 | \$0.88 | \$0.14 | \$0.14 |
| 10 | \$0.86 | \$0.86 | \$0.95 | \$0.95 | \$0.14 | \$0.14 |
| 11 | \$0.90 | \$0.90 | \$1.09 | \$1.09 | \$0.15 | \$0.15 |
| 12 | \$0.71 | \$0.71 | \$0.90 | \$0.90 | \$0.13 | \$0.13 |
| 13 | \$0.78 | \$0.78 | \$0.97 | \$0.97 | \$0.16 | \$0.16 |
| 14 | \$0.83 | \$0.83 | \$1.01 | \$1.01 | \$0.14 | \$0.14 |
| 15 | \$1.49 | \$1.49 | \$1.53 | \$1.53 | \$0.24 | \$0.24 |
| 16 | \$0.22 | \$0.22 | \$0.75 | \$0.75 | \$0.04 | \$0.04 |

4.4.3 Incremental First Cost

As outlined in Section 1.1, California can adopt proposed changes to equipment that appear in Table 110.2 of Title 24, Part 6 without performing a cost-effectiveness analysis, so no cost-effectiveness analysis is included.

4.4.4 Lifetime Incremental Maintenance Costs

As outlined in Section 1.1, California can adopt proposed changes to equipment that appear in Table 110.2 of Title 24, Part 6 without performing a cost-effectiveness analysis, so no cost-effectiveness analysis is included.

4.4.5 Lifecycle Cost-Effectiveness

As outlined in Section 1.1, California can adopt proposed changes to equipment that appear in Table 110.2 of Title 24, Part 6 without performing a cost-effectiveness analysis, so no cost-effectiveness analysis is included.

4.5 First-Year Statewide Impacts

4.5.1 Statewide Energy Savings and Lifecycle Energy Cost Savings

Given data regarding the new construction forecast for 2020, the Statewide CASE Team estimates that the proposed code change will reduce annual statewide electricity use by 8.89 GWh with a demand reduction of 5.83 MW and no associated natural gas reduction. The energy savings for buildings constructed in 2020 are associated with a present valued energy cost savings of approximately \$32.4 million in (discounted) energy costs over the 15-year period of analysis.

Based on information collected from mechanical designers in the state of California, approximately 50 percent of high-rise apartments contain propeller or axial fan closed-circuit cooling towers. In addition, these mechanical designers estimated the life of a closed-circuit cooling tower to be approximately 20 years. It was therefore assumed that 50 percent of new high-rise apartment construction will be affected by the code change and 2.5 percent (1/20th of 50 percent) of existing high-rise apartment alterations will be affected by the code change.

Based on information collected from mechanical designers in the state of California, approximately 20 percent of small and large schools contain SPVAC. In addition, these mechanical designers estimated the life of a SPVAC to be approximately 15 years. It was therefore assumed that 20 percent of new small and large school construction will be affected by the code change and 1.33 percent (1/15th of 20 percent) of existing small and large school alterations will be affected by the code change.

Based on information collected from mechanical designers in the state of California, approximately 50 percent of small and large schools contain SPVHP. In addition, these mechanical designers estimated the life of a SPVHP to be approximately 15 years. It was therefore assumed that 50 percent of new small and large school construction will be affected by the code change and 3.33 percent (1/15th of 50 percent) of existing small and large school alterations will be affected by the code change.

Table 35: Statewide Energy and Energy Cost Impacts – New Construction

| Climate Zone | Statewide Construction in 2020 (million ft ²) | First-Year ^a Electricity Savings (GWh) | First-Year ^a Peak Electrical Demand Reduction (MW) | Lifecycle ^b Present Valued Energy Cost Savings (Present Value \$ million) |
|--------------|---|---|---|--|
| 1 | 0.06 | 0.01 | 6.84 x 10 ⁻³ | \$0.02 |
| 2 | 0.31 | 0.05 | 3.52 x 10 ⁻² | \$0.17 |
| 3 | 1.17 | 0.11 | 1.21 x 10 ⁻¹ | \$0.32 |
| 4 | 0.71 | 0.10 | 7.77 x 10 ⁻² | \$0.37 |
| 5 | 0.14 | 0.01 | 1.53 x 10 ⁻² | \$0.03 |
| 6 | 0.77 | 0.10 | 8.46 x 10 ⁻² | \$0.35 |
| 7 | 0.81 | 0.09 | 1.11 x 10 ⁻¹ | \$0.30 |
| 8 | 1.12 | 0.18 | 1.20 x 10 ⁻¹ | \$0.70 |
| 9 | 1.15 | 0.22 | 1.14 x 10 ⁻¹ | \$0.90 |
| 10 | 1.53 | 0.34 | 2.16 x 10 ⁻¹ | \$1.35 |
| 11 | 0.40 | 0.11 | 4.89 x 10 ⁻² | \$0.39 |
| 12 | 1.64 | 0.34 | 1.88 x 10 ⁻¹ | \$1.32 |
| 13 | 0.88 | 0.24 | 1.02 x 10 ⁻¹ | \$0.77 |
| 14 | 0.28 | 0.07 | 3.47 x 10 ⁻² | \$0.26 |
| 15 | 0.28 | 0.12 | 8.66 x 10 ⁻² | \$0.41 |
| 16 | 0.31 | 0.06 | 3.88 x 10 ⁻² | \$0.17 |
| TOTAL | 11.57 | 2.15 | 1.40 | \$7.83 |

- a. First-year savings from all buildings completed statewide in 2020.
- b. Energy cost savings from all buildings completed statewide in 2020 accrued during 15-year period of analysis.

Table 36: Statewide Energy and Energy Cost Impacts – Alterations

| Climate Zone | Statewide Construction in 2020 (million ft ²) | First-Year ^a Electricity Savings (GWh) | First-Year ^a Peak Electrical Demand Reduction (MW) | Lifecycle ^b Present Valued Energy Cost Savings (Present Value \$ million) |
|--------------|---|---|---|--|
| 1 | 0.18 | 0.02 | 1.94 x 10 ⁻² | \$0.05 |
| 2 | 0.99 | 0.15 | 1.12 x 10 ⁻¹ | \$0.55 |
| 3 | 3.87 | 0.36 | 4.07 x 10 ⁻¹ | \$1.07 |
| 4 | 2.27 | 0.33 | 2.51 x 10 ⁻¹ | \$1.21 |
| 5 | 0.44 | 0.04 | 4.95 x 10 ⁻² | \$0.11 |
| 6 | 3.36 | 0.46 | 3.77 x 10 ⁻¹ | \$1.55 |
| 7 | 2.20 | 0.25 | 3.04 x 10 ⁻¹ | \$0.82 |
| 8 | 4.73 | 0.79 | 5.15 x 10 ⁻¹ | \$3.01 |
| 9 | 4.25 | 0.81 | 4.27 x 10 ⁻¹ | \$3.39 |
| 10 | 4.26 | 0.96 | 6.04 x 10 ⁻¹ | \$3.75 |
| 11 | 1.07 | 0.28 | 1.31 x 10 ⁻¹ | \$1.06 |
| 12 | 4.58 | 0.96 | 5.26 x 10 ⁻¹ | \$3.69 |
| 13 | 2.40 | 0.65 | 2.81 x 10 ⁻¹ | \$2.12 |
| 14 | 0.80 | 0.21 | 1.00 x 10 ⁻¹ | \$0.74 |
| 15 | 0.67 | 0.29 | 2.10 x 10 ⁻¹ | \$0.99 |
| 16 | 0.90 | 0.18 | 1.13 x 10 ⁻¹ | \$0.50 |
| TOTAL | 36.97 | 6.74 | 4.43 | \$24.60 |

- a. First-year savings from all buildings completed statewide in 2020.
- b. Energy cost savings from all buildings completed statewide in 2020 accrued during 15-year period of analysis.

4.5.2 Statewide Water Use Impacts

The proposed equipment efficiency requirements will not result in water savings.

4.5.3 Statewide Material Impacts

The proposed equipment efficiency requirements will not result in changes to material use.

4.5.4 Other Non-Energy Impacts

The proposed code change will not result in any other non-energy impacts.

4.6 Proposed Revisions to Code Language

The proposed changes to the Standards, Reference Appendices, and the Nonresidential ACM Reference Manual are provided below. Changes to the 2016 documents are marked with underlining (new language) and ~~striketroughs~~ (deletions). The following efficiency tables are not currently part of the proposed code language, but are currently under consideration:

- Air Conditioners and Condensing Units Serving Computer Rooms – Minimum Efficiency Requirements
- Vapor Compression Based Indoor Pool Dehumidifiers – Minimum Efficiency Requirements
- Electrically Operated DX-DOAS Units, Single Package and Remote Condenser, with Energy Recovery – Minimum Efficiency Requirements
- Electrically Operated DX-DOAS Units, Single Package and Remote Condenser, without Energy Recovery – Minimum Efficiency Requirements

4.6.1 Standards

SECTION 110.2- MANDATORY REQUIREMENTS FOR SPACE CONDITIONING EQUIPMENT

TABLE 110.2-A ELECTRICALLY OPERATED UNITARY AIR CONDITIONERS AND CONDENSING UNITS – MINIMUM EFFICIENCY REQUIREMENTS

| Equipment Type | Size Category | Efficiency ^{a, b} | | Test Procedure ^c |
|---|-------------------------------------|---|-----------------------|-----------------------------|
| | | Before 1/1/2016 | After 1/1/2016 | |
| Air conditioners, air cooled both split system and single package | ≥ 65,000 Btu/h and < 135,000 Btu/h | 11.2 EER 11.4 IEER | 11.2 EER 12.9 IEER | ANSI/AHRI 340/360 |
| | ≥ 135,000 Btu/h and < 240,000 Btu/h | 11.0 EER 11.2 IEER | 11.0 EER 12.4 IEER | |
| | ≥ 240,000 Btu/h and < 760,000 Btu/h | 10.1 EER 10.2 IEER | 10.0 EER 11.6 IEER | |
| | ≥ 760,000 Btu/h | 9.7 EER 9.8 IEER | 9.7 EER 11.2 IEER | |
| Air conditioners, water cooled | ≥ 65,000 Btu/h and < 135,000 Btu/h | 12.1 EER 12.3 IEER | 12.1 EER 13.9 IEER | ANSI/AHRI 340/360 |
| | ≥ 135,000 Btu/h and < 240,000 Btu/h | 12.5 EER 12.5 IEER | 12.5 EER 13.9 IEER | |
| | ≥ 240,000 Btu/h and < 760,000 Btu/h | 12.4 EER 12.6 IEER | 12.4 EER 13.6 IEER | |
| | ≥ 760,000 Btu/h | 12.2 EER 12.4 IEER | 12.2 EER 13.5 IEER | |
| Air conditioners, evaporatively cooled | ≥ 65,000 Btu/h and < 135,000 Btu/h | 12.1 EER ^b 12.3 IEER ^b | | ANSI/AHRI 340/360 |
| | ≥ 135,000 Btu/h and < 240,000 Btu/h | 12.0 EER ^b 12.2 IEER ^b | | |
| | ≥ 240,000 Btu/h and < 760,000 Btu/h | 11.9 EER ^b 12.1 IEER ^b | | |
| | ≥ 760,000 Btu/h | 11.7 EER ^b 11.9 IEER ^b | | |
| Condensing units, air cooled | ≥ 135,000 Btu/h | 10.5 EER 11.8 IEER | | ANSI/AHRI 365 |
| Condensing units, water cooled | ≥ 135,000 Btu/h | 13.5 EER 14.0 IEER | | |
| Condensing units, evaporatively cooled | ≥ 135,000 Btu/h | 13.5 EER 14.0 IEER | | |
| ^a IEERs are only applicable to equipment with capacity control as specified by ANSI/AHRI 340/360 test procedures. ^b Deduct 0.2 from the required EERs and IEERs for units with a heating section other than electric resistance heat. ^c Applicable test procedure and reference year are provided under the definitions. | | | | |

TABLE 110.2-B UNITARY AND APPLIED HEAT PUMPS, MINIMUM EFFICIENCY REQUIREMENTS

| Equipment Type | Size Category | Rating Condition | Efficiency ^{a,b} | Test Procedure ^c |
|---|---|--|---------------------------|-----------------------------|
| | | Before 1/1/2016 | After 1/1/2016 | |
| Air Cooled (cooling mode), both split system and single package | ≥ 65,000 Btu/h and < 135,000 Btu/h | 11.0 EER 11.2 IEER - | 11.0 EER 12.2 IEER | ANSI/AHRI 340/360 |
| | ≥ 135,000 Btu/h and < 240,000 Btu/h | 10.6 EER 10.7 IEER - | 10.6 EER 11.6 IEER | |
| | ≥ 240,000 Btu/h | 9.5 EER 9.6 IEER - | 9.5 EER 10.6 IEER | |
| Water source (cooling mode) | ≥ 65,000 Btu/h and < 135,000 Btu/h | 86°F entering water | 13.0 EER | ISO-13256-1 |
| Groundwater source (cooling mode) | < 135,000 Btu/h | 59°F entering water | 18.0 EER | ISO-13256-1 |
| Ground source (cooling mode) | < 135,000 Btu/h | 77°F entering water | 14.1 EER | ISO-13256-1 |
| Water source water-to-water (cooling) | < 135,000 Btu/h | 86°F entering water | 10.6 EER | ISO-13256-2 |
| Groundwater source water-to-water (cooling mode) | < 135,000 Btu/h | 59°F entering water | 16.3 EER | ISO-13256-1 |
| Ground source brine-to-water (cooling mode) | < 135,000 Btu/h | 77°F entering water | 12.1 EER | ISO-13256-2 |
| Air Cooled (Heating Mode) Split system and single package | ≥ 65,000 Btu/h and < 135,000 Btu/h (cooling capacity) | 47° F db/43° F wb outdoor air | 3.3 COP | ANSI/AHRI 340/360 |
| | | 17° F db/15° F wb outdoor air | 2.25 COP | |
| | ≥ 135,000 Btu/h (cooling capacity) | 47° F db/43° F wb outdoor air | 3.2 COP | |
| | | 17° F db/15° F wb outdoor air | 2.05 COP | |

CONTINUED: TABLE 110.2-B UNITARY AND APPLIED HEAT PUMPS, MINIMUM EFFICIENCY REQUIREMENTS

| Equipment Type | Size Category | Rating Condition | Efficiency^a | Test Procedure^c |
|---|--|-------------------------|-------------------------------|-----------------------------------|
| Water source (heating mode) | < 135,000 Btu/h (cooling capacity) | 68°F entering water | 4.3 COP | ISO-13256-1 |
| | ≥ 135,000 Btu/h and < 240,000 Btu/h | 68°F entering water | 2.90 COP | |
| Groundwater source (heating mode) | < 135,000 Btu/h (cooling capacity) | 50°F entering water | 3.7 COP | ISO-13256-1 |
| Ground source (heating mode) | < 135,000 Btu/h (cooling capacity) | 32°F entering water | 3.2 COP | ISO-13256-1 |
| Water source water- to- water (heating mode) | < 135,000 Btu/h (cooling capacity) | 68°F entering water | 3.7 COP | ISO-13256-2 |
| Groundwater source water-to-water (heating mode) | < 135,000 Btu/h (cooling capacity) | 50°F entering water | 3.1 COP | ISO-13256-2 |
| Ground source brine- to-water (heating mode) | < 135,000 Btu/h (cooling capacity) | 32°F entering water | 2.5 COP | ISO-13256-2 |
| ^a IEERs are only applicable to equipment with capacity control as specified by ANSI/AHRI 340/360 test procedures. ^b Deduct 0.2 from the required EERs and IEERs for units with a heating section other than electric resistance heat. ^c Applicable test procedure and reference year are provided under the definitions. | | | | |

... { no proposed changes to Table 110.2-C or Table 110.2-D} ...

TABLE 110.2-E PACKAGED TERMINAL AIR CONDITIONERS AND PACKAGED TERMINAL HEAT PUMPS – MINIMUM EFFICIENCY REQUIREMENTS

| Equipment Type | Size Category (Input) | Subcategory or Rating Condition | Efficiency | Test Procedure ^c |
|--|-----------------------------------|------------------------------------|---|-----------------------------|
| PTAC (Cooling mode) Newly constructed or newly conditioned buildings or additions | All Capacities | 95°F db Outdoor Air | 14.0 - (0.300 x Cap/1000) ^a EER | NSI/AHRI/CSA 310/380 |
| PTAC (Cooling mode) Replacements ^b | All Capacities | 95°F db Outdoor Air | 10.9 - (0.213 x Cap/1000) ^a EER | |
| PTHP (Cooling mode) Newly constructed or newly conditioned buildings or additions | All Capacities | 95°F db Outdoor Air | 14.0 - (0.300 x Cap/1000) ^a EER | |
| PTHP (Cooling mode) Replacements ^b | All Capacities | 95°F db Outdoor Air | 10.8 - (0.213 x Cap/1000) ^a EER | |
| PTHP (Heating Mode) Newly constructed or newly conditioned buildings or additions | All Capacities | - | 3.7 - (0.052 x Cap/1000) ^a COP | |
| PTHP (Heating mode) Replacements ^b | All Capacities | - | 2.9 - (0.026 x Cap/1000) ^a COP | |
| SPVAC (Cooling Mode) | <65,000 Btu/h | 95°F db / 75°F wb Outdoor Air | 10.0 EER 11.0 EER | |
| | ≥65,000 Btu/h and <135,000 Btu/h | 95°F db / 75°F wb Outdoor Air | 10.0 EER | |
| | ≥135,000 Btu/h and <240,000 Btu/h | 95°F db / 75°F wb Outdoor Air | 10.0 EER | |
| SPVAC (Cooling Mode) non-weatherized space constrained | ≤ 30,000 Btu/h | "95°F db / 75°F wb outdoor air" | 9.20 EER | |
| | > 30,000 Btu/h and ≤ 36,000 Btu/h | "95°F db / 75°F wb outdoor air" | 9.00 EER | |
| SPVHP (Cooling Mode) | <65,000 Btu/h | 95°F db / 75°F wb Outdoor Air | 10.0 EER 11.0 EER | |
| | ≥65,000 Btu/h and <135,000 Btu/h | 95°F db / 75°F wb Outdoor Air | 10.0 EER | |
| | ≥135,000 Btu/h and <240,000 Btu/h | 95°F db / 75°F wb Outdoor Air | 10.0 EER | |
| SPVHP (Cooling Mode) non-weatherized space constrained | ≤ 30,000 Btu/h | 95°F db / 75°F wb Outdoor Air | 9.20 EER | |
| | > 30,000 Btu/h and ≤ 36,000 Btu/h | 95°F db / 75°F wb Outdoor Air | 9.00 EER | |
| SPVHP (Heating Mode) | <65,000 Btu/h | 47°F db / 43°F wb Outdoor Air | 3.0 COP 3.3 COP | |
| | ≥65,000 Btu/h and <135,000 Btu/h | 47°F db / 43°F wb Outdoor Air | 3.0 COP | |
| | ≥135,000 Btu/h and <240,000 Btu/h | 47°F db / 43°F wb Outdoor Air | 3.0 COP | |
| SPVHP (Heating Mode) non-weatherized space constrained | ≤ 30,000 Btu/h | 47°F db / 43°F wb Outdoor Air | 3.00 COP | |
| | > 30,000 Btu/h and ≤ 36,000 Btu/h | 47°F db / 43°F wb Outdoor Air | 3.00 COP | |

^a Cap means the rated cooling capacity of the product in Btu/h. If the unit's capacity is less than 7000 Btu/h, use 7000 Btu/h in the calculation. If the unit's capacity is greater than 15,000 Btu/h, use 15,000 Btu/h in the calculation.

^b Replacement units must be factory labeled as follows: "MANUFACTURED FOR REPLACEMENT APPLICATIONS ONLY; NOT TO BE INSTALLED IN NEWLY CONSTRUCTED BUILDINGS." Replacement efficiencies apply only to units with existing sleeves less than 16 inches high or less than 42 inches wide and having a cross-sectional area less than 670 square inches.

^c Applicable test procedure and reference year are provided under the definitions.

... {Section of code omitted; no proposed changes to Table 110.2-F} ...

TABLE 110.2-G PERFORMANCE REQUIREMENTS FOR HEAT REJECTION EQUIPMENT

| Equipment Type | Total System Heat Rejection Capacity at Rated Conditions | Subcategory or Rating Condition | Performance Required ^{a, b, c, d} | Test Procedure ^e |
|---|--|---|--|---------------------------------------|
| Propeller or axial fan Open-circuit cooling towers | All | 95°F entering water 85°F leaving water 75°F entering air wb | ≥ 42.1 gpm/hp | CTI ATC-105 and CTI STD-201 <u>RS</u> |
| Centrifugal fan Open-circuit cooling towers | All | 95°F entering water 85°F leaving water 75°F entering air wb | ≥ 20.0 gpm/hp | |
| Propeller or axial fan closed-circuit cooling towers | All | 102°F entering water 90°F leaving water 75°F entering air wb | ≥ 14.0 gpm/hp ≥ 16.1 gpm/hp | |
| Centrifugal fan closed-circuit cooling towers | All | 102°F entering water 90°F leaving water 75°F entering air wb | ≥ 7.0 gpm/hp | |
| Propeller or axial fan evaporative condensers | All | R-507A test fluid 165°F entering gas temp 105°F condensing temp 75°F entering air wb" | ≥ 157,000 Btu/h • hp | CTI ATC-106 |
| | All | Ammonia test fluid 140°F entering gas temp 96.3°F condensing temp 75°F entering air wb" | ≥ 134,000 Btu/h • hp | |
| Centrifugal fan evaporative condensers | All | R-507A test fluid 165°F entering gas temp 105°F condensing temp 75°F entering air wb" | ≥ 135,000 Btu/h • hp | |
| | All | Ammonia test fluid 140°F entering gas temp 96.3°F condensing temp 75°F entering air wb" | ≥ 110,000 Btu/h • hp | |
| Air cooled condensers | All | 125°F condensing temperature R22 test fluid 190°F entering gas temperature 15°F subcooling 95°F entering dry bulb | ≥ 176,000 Btu/h • hp | ANSI/AH RI 460 |

^a For purposes of this table, open-circuit cooling tower performance is defined as the water flow rating of the tower at the given rated conditions divided by the fan motor nameplate power.

^b For purposes of this table, closed-circuit cooling tower performance is defined as the process water flow rating of the tower at the given rated conditions divided by the sum of the fan motor nameplate rated power and the integral spray pump motor nameplate power.

^c For purposes of this table, air-cooled condenser performance is defined as the heat rejected from the refrigerant divided by the fan motor nameplate power.

^d Open cooling towers shall be tested using the test procedures in CTI ATC-105. Performance of factory assembled open cooling towers shall be either certified as base models as specified in CTI STD-201 or verified by testing in the field by a CTI approved testing agency. Open factory assembled cooling towers with custom options added to a CTI certified base model for the purpose of safe maintenance or to reduce environmental or noise impact shall be rated at 90 percent of the CTI certified performance of the associated base model or at the manufacturer's stated performance, whichever is less. Base models of open factory assembled cooling towers are open cooling towers configured in exact accordance with the Data of Record submitted to CTI as specified by CTI STD-201. There are no certification requirements for field erected cooling towers.

^e Applicable test procedure and reference year are provided under the definitions.

For refrigerated warehouses or commercial refrigeration applications, condensers shall comply with requirements specified by Section 120.6(a) or Section 120.6(b).

TABLE 110.2-H ELECTRICALLY OPERATED VARIABLE REFRIGERANT FLOW (VRF) AIR CONDITIONERS MINIMUM EFFICIENCY REQUIREMENTS

| Equipment Type | Size Category | Heating Section Type | Sub-Category or Rating Condition | Minimum Efficiency | Test Procedure ^a |
|--|-----------------------------------|-------------------------------|----------------------------------|--|-----------------------------|
| VRF Air Conditioners, Air Cooled | <65,000 Btu/h | All | VRF Multi-split System | 13.0 SEER | ANSI/AHRI 1230 |
| | ≥65,000 Btu/h and <135,000 Btu/h | Electric Resistance (or none) | VRF Multi-split System | 11.2 EER 13.1 IEER^b 15.5 IEER^b | |
| | ≥135,000 Btu/h and <240,000 Btu/h | Electric Resistance (or none) | VRF Multi-split System | 11.0 EER 12.9 IEER^b 14.9 IEER^b | |
| | ≥240,000 Btu/h | Electric Resistance (or none) | VRF Multi-split System | 10.0 EER 11.6 IEER^b 13.9 IEER^b | |
| ^a Applicable test procedure and reference year are provided under the definitions. ^b IEERs are only applicable to equipment with capacity control as specified by ANSI/AHRI 1230 test procedures. | | | | | |

TABLE 110.2-1 ELECTRICALLY OPERATED VARIABLE REFRIGERANT FLOW AIR-TO-AIR AND APPLIED HEAT PUMPS - MINIMUM EFFICIENCY REQUIREMENTS

| Equipment Type | Size Category | Heating Section Type | Sub-Category or Rating Condition | Minimum Efficiency | Test Procedure ^b |
|---------------------------------------|-----------------------------------|-------------------------------|---|--|-----------------------------|
| VRF Air Cooled, (cooling mode) | <65,000 Btu/h | All | VRF Multi-split System | 13.0 SEER | AHRI 1230 |
| | ≥65,000 Btu/h and <135,000 Btu/h | Electric Resistance (or none) | VRF Multi-split System ^a | 11.0 EER 12.9 IEER^e <u>14.6 IEER^c</u> | |
| | ≥135,000 Btu/h and <240,000 Btu/h | Electric Resistance (or none) | VRF Multi-split System ^a | 10.6 EER 12.3 IEER^e <u>13.9 IEER^c</u> | |
| | ≥240,000 Btu/h | Electric Resistance (or none) | VRF Multi-split System ^a | 9.5 EER 11.0 IEER^e <u>12.7 IEER^c</u> | |
| VRF Water source (cooling mode) | <65,000 Btu/h | All | VRF Multi-split systems ^a 86°F entering water | 12.0 EER <u>15.8 IEER^c</u> | AHRI 1230 |
| | ≥65,000 Btu/h and <135,000 Btu/h | All | VRF Multi-split System ^a 86°F entering water | 12.0 EER <u>15.8 IEER^c</u> | |
| | ≥135,000 Btu/h | All | VRF Multi-split System ^a 86°F entering water | 10.0 EER <u>13.8 IEER^c</u> | |
| | <u>≥240,000 Btu/h</u> | <u>All</u> | <u>VRF Multi-split System^a 86°F entering water</u> | <u>10.0 EER 12.0 IEER</u> | |
| VRF Groundwater source (cooling mode) | <135,000 Btu/h | All | VRF Multi-split System ^a 59°F entering water | 16.2 EER | AHRI 1230 |
| | ≥135,000 Btu/h | All | VRF Multi-split System ^a 59°F entering water | 13.8 EER | |
| VRF Ground source (cooling mode) | <135,000 Btu/h | All | VRF Multi-split System ^a 77°F entering water | 13.4 EER | AHRI 1230 |
| | ≥135,000 Btu/h | All | VRF Multi-split System ^a 77°F entering water | 11.0 EER | |

CONTINUED: TABLE 110.2-1 ELECTRICALLY OPERATED VARIABLE REFRIGERANT FLOW AIR-TO-AIR AND APPLIED HEAT PUMPS - MINIMUM EFFICIENCY REQUIREMENTS

| Equipment Type | Size Category | Heating Section Type | Sub-Category or Rating Condition | Minimum Efficiency | Test Procedure ^b |
|--|---|----------------------|---|----------------------------------|-----------------------------|
| VRF Air Cooled (heating mode) | <65,000 Btu/h (cooling capacity) | --- | VRF Multi-split System | 7.7 HSPF | AHRI 1230 |
| | ≥65,000 Btu/h and <135,000 Btu/h (cooling capacity) | --- | VRF Multi-split system 47°F db/ 43°F wb outdoor air | 3.3 COP | |
| | | | VRF Multi-split system 17°F db/15°F wb outdoor air | 2.25 COP | |
| | ≥135,000 Btu/h (cooling capacity) ≥135,000 Btu/h and <240,000 Btu/h | --- | VRF Multi-split system 47°F db/ 43°F wb outdoor air | 3.2 COP | |
| | | | VRF Multi-split system 17°F db/15°F wb outdoor air | 2.05 COP | |
| VRF Water source (heating mode) | <u><65,000 Btu/h (cooling capacity)</u> | --- | <u>VRF Multi-split System 68°F entering water</u> | <u>4.3 COP</u> | AHRI 1230 |
| | <u>≥65,000 Btu/h and <135,000 Btu/h (cooling capacity)</u> | --- | VRF Multi-split System 68°F entering water | <u>4.2 COP</u> <u>4.3 COP</u> | |
| | <u>≥135,000 Btu/h and <240,000 Btu/h (cooling capacity)</u> | --- | VRF Multi-split System 68°F entering water | <u>3.9 COP</u> <u>4.0 COP</u> | |
| | <u>≥240,000 Btu/h (cooling capacity)</u> | --- | <u>VRF Multi-split System 68°F entering water</u> | <u>3.9 COP</u> | |
| VRF Groundwater source (heating mode) | <135,000 Btu/h (cooling capacity) | --- | VRF Multi-split System 50°F entering water | 3.6 COP | AHRI 1230 |
| | ≥135,000 Btu/h (cooling capacity) | --- | VRF Multi-split System 50°F entering water | 3.3 COP | |
| VRF Ground source (heating mode) | <135,000 Btu/h (cooling capacity) | --- | VRF Multi-split System 32°F entering water | 3.1 COP | AHRI 1230 |
| | ≥135,000 Btu/h (cooling capacity) | --- | VRF Multi-split System 32°F entering water | 2.8 COP | |
| ^a Deduct 0.2 from the required EERs and IEERs for Variable Refrigerant Flow (VRF) Multi-split system units with a heating recovery section. ^b Applicable test procedure and reference year are provided under the definitions. ^c IEERs are only applicable to equipment with capacity control as specified by ANSI/AHRI 1230 test procedures. | | | | | |

TABLE 110.2-J WARM-AIR FURNACES AND COMBINATION WARM-AIR FURNACES/AIR-CONDITIONING UNITS, WARM-AIR DUCT FURNACES, AND UNIT HEATERS

| Equipment Type | Size Category (Input) | Subcategory or Rating Condition ^b | Minimum Efficiency ^{d,e} | Test Procedure ^a |
|-----------------------------------|-----------------------|--|-----------------------------------|--|
| Warm-Air Furnace, Gas-Fired | < 225,000 Btu/h | Maximum Capacity ^b | 78% AFUE or 80% E _t | DOE 10 CFR Part 430 or Section 2.39, Thermal Efficiency, ANSI Z21.47 |
| | ≥ 225,000 Btu/h | Maximum Capacity ^b | 80% E _t | Section 2.39, Thermal Efficiency, ANSI Z21.47 |
| Warm-Air Furnace, oil-Fired | < 225,000 Btu/h | Maximum Capacity ^b | 78% AFUE or 80% E _t | DOE 10 CFR Part 430 or Section 42, Combustion, |
| | ≥ 225,000 Btu/h | Maximum Capacity ^b | 81% E _t | Section 42, Combustion, UL 727 |
| Warm-Air Duct Furnaces, Gas-Fired | All Capacities | Maximum Capacity ^b | 80% E _c | Section 2.10, Efficiency, ANSI Z83.8 |
| Warm-Air Unit Heaters, Gas-Fired | All Capacities | Maximum Capacity ^b | 80% E _c | Section 2.10, Efficiency, ANSI Z83.8 |
| Warm-Air Unit Heaters, Oil-Fired | All Capacities | Maximum Capacity ^b | 81% E _c | Section 40, Combustion, UL 731 |

^a Applicable test procedure and reference year are provided under the definitions.
^b Compliance of multiple firing rate units shall be at maximum firing rate.
^c Combustion units not covered by [NAECA the U.S. Department of Energy 10 CFR 430](#) (3-phase power or cooling capacity greater than or equal to 19 kW) may comply with either rating.
^d E_t = thermal efficiency. Units must also include an interrupted or intermittent ignition device (IID), have jacket losses not exceeding 0.75% of the input rating, and have either power venting or a flue damper. A vent damper is an acceptable alternative to a flue damper for those furnaces where combustion air is drawn from the conditioned space.
^e E_c = combustion efficiency (100% less flue losses). See test procedure for detailed discussion.
^f Units must also include interrupted or intermittent ignition device (IID) and have either power venting or an automatic flue damper.

... {Section of code omitted; no proposed changes to Table 110.2-K} ...

4.6.2 Reference Appendices

There are no proposed changes to the Reference Appendices, unless otherwise indicated below.

4.6.3 ACM Reference Manual

There are no proposed changes to the Nonresidential ACM Reference Manual.

4.6.4 Compliance Manuals

There are no proposed changes to the Residential or Nonresidential Compliance Manuals.

4.6.5 Compliance Documents

There are no revisions to compliance documents.

5. WATERSIDE ECONOMIZERS

5.1 Measure Description

5.1.1 Measure Overview

A waterside economizer is a method of using a chilled water plant's cooling towers to directly provide cooling for the chilled water system, bypassing or working in series with the chiller. When outdoor wet-bulb temperatures are sufficiently low, cooling towers are able to provide water at temperatures below the chilled-water setpoint. When these conditions exist, the chiller is shut off, and the cooling tower setpoint is reset to provide the sufficient chilled water temperature to supply the building chilled water demand. This operation is known as a nonintegrated waterside economizer.

An integrated waterside economizer allows additional savings compared to nonintegrated. When outdoor wet-bulb temperatures are sufficiently lower than the chilled water return temperature, the cooling towers can be used to precool the return chilled water prior to it entering the chiller. This reduces the load on the chiller, and expands the number of hours the chilled water plant can run in economizer mode.

Waterside economizers consist of a heat exchanger between the condenser water loop and the chilled water loop. The placement of this heat exchanger, aside from some controls implementation, determines if the waterside economizer is integrated or nonintegrated. A nonintegrated economizer places the heat exchanger in parallel or in front of the chiller, so either the chiller or the heat exchanger is meeting all of the load. An example of a nonintegrated waterside economizer is shown in Figure 6.

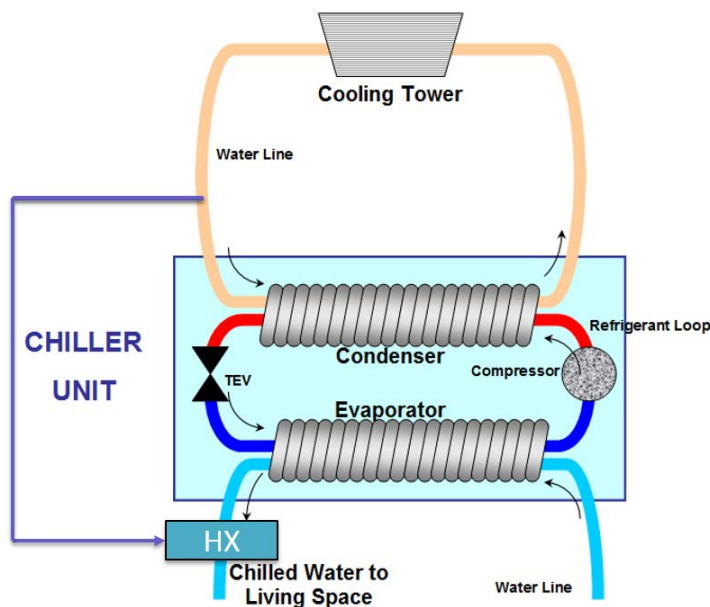

Figure 6: Nonintegrated waterside economizer schematic

The integrated waterside economizer places the heat exchanger before the chiller, so that the heat exchanger can act as a precooling coil to the chiller. When the heat exchanger can provide water that meets the chilled water setpoint, the chiller will turn off. An example of an integrated waterside economizer is shown in Figure 7.

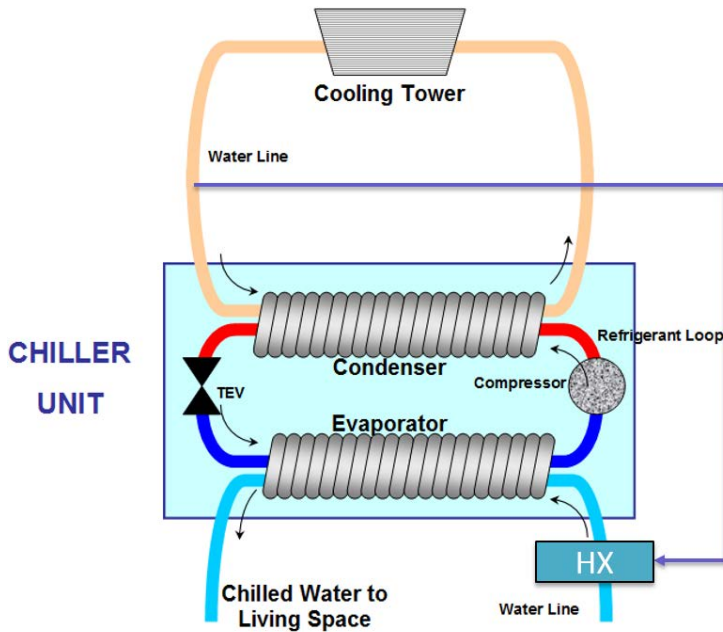

Figure 7: Integrated waterside economizer schematic

Waterside economizer systems are rated by their approach temperature, which is a measure of how many degrees the water leaving the heat exchanger is above site wet-bulb temperature. The approach determines what wet-bulb temperatures are required for the economizer to completely bypass the chiller. The approach temperature achieved is determined by the cooling tower and heat exchanger equipment. Cooling towers have a minimum temperature they can cool water to, related to surface area and fan power. Typical cooling towers have approaches of about 5°F from the wet-bulb temperature. The wet-bulb temperature is the theoretical minimum that a cooling tower can cool to. Heat exchangers have a minimum water temperature they can cool to as well, typically 4°F difference from the source temperature. The 5°F cooling tower approach and 4°F heat exchanger approach result in waterside economizers that can provide full cooling when the wet-bulb temperatures are 9°F below the chilled water supply temperature setpoint. Lowering this approach will result in many more hours available for full cooling from waterside economizers, and this CASE Report will make the case that mandating more stringent approaches is cost-effective. The Statewide CASE Team will not suggest changing the approaches at this time, since significant feedback was received regarding the difficulty for current designs to meet even the current wet-bulb temperatures. To access the savings associated with smaller system approaches for waterside economizer, designers must rethink how chilled water systems are designed, and size coils and systems for use with higher chilled water temperatures. The Statewide CASE Team urges future code change proposals to pay attention to trends in chilled water system design, and to increase this requirement as higher temperature systems become more prevalent. Figure 8 below illustrates the potential hours of economizing that can be unlocked if future proposals push the economizer approaches.

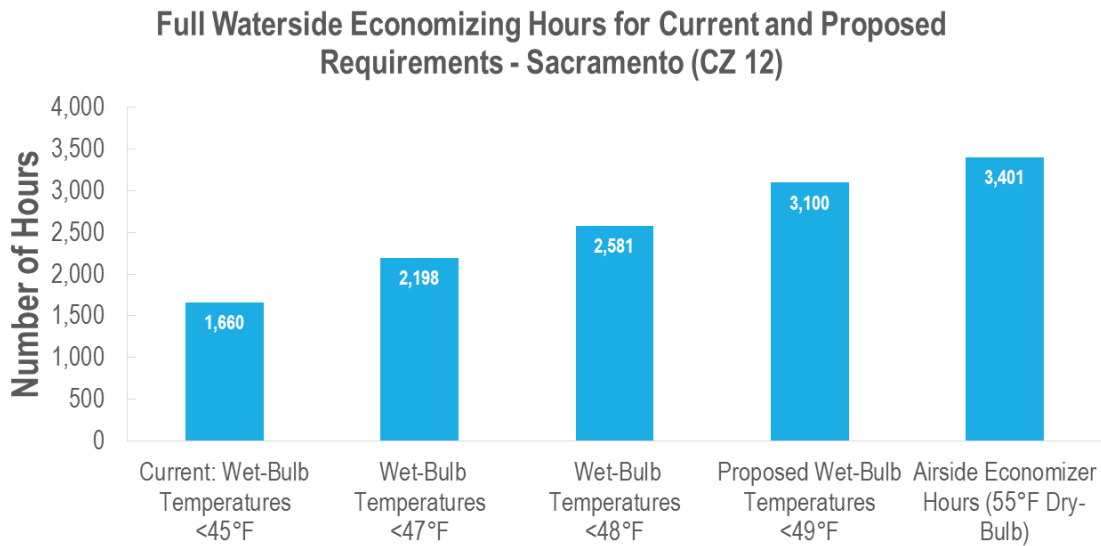

Figure 8: Number of waterside economizer hours in a typical year for current and proposed regulations

Source: Sacramento Executive Airport; CBECC-Com 2016 Weather Data

This measure proposes adding clarifying language and establishing more stringent prescriptive requirements for waterside economizers by incorporating recent changes made to ASHRAE 90.1-2013 and 2016. The proposed code changes impact any building that uses a waterside economizer to meet the requirements of Title 24, Part 6 Section 140.4(e). The proposed changes include requirements for integrated/partial waterside economizers (ASHRAE 90.1 6.5.1), maximum pressure drops for waterside economizer heat exchanger precooling coils (ASHRAE 90.1-2013 Addendum du), and waterside economizer requirements for passive/hydronic systems (ASHRAE 90.1-2013 Addendum du), which previously were not required to have an economizer.

No systems described in the ACM Reference Manual will be modified by the code change proposal, since waterside economizer will not appear in any of the baseline systems. CBECC-Com has waterside economizing capability currently, so no new features are required to comply with the proposed ACM changes.

5.1.2 Measure History

Title 24, Part 6’s regulation of waterside economizers is currently limited in application and lacking in specific details. The current language has remained unchanged since the 1998 code cycle. This measure is being proposed in order to align Title 24, Part 6 to ASHRAE 90.1-2016, specifically from the Addendum du passed between 2013 and 2016.

Addendum du was first introduced late in the ASHRAE 90.1-2010 code cycle. It underwent resubmissions with debate over minor details in the language. The addendum was finally approved by the 90.1 Standing Standards Project Committee at the 2016 winter meeting in Orlando, Florida.

Waterside economizing will save energy in California’s dry-summer Mediterranean climates. The new requirement proposed in this measure reduces energy use in hydronic systems by:

- Requiring integrated/partial waterside economizer operation, which allow the condenser system to directly provide cooling during moderate wet-bulb temperatures, reducing the load on the chiller;
- Setting a maximum pressure drop for waterside economizer heat exchanger precooling coils, which promotes good design and reduces pumping energy;

- Requiring waterside economizers for radiant and chilled beam systems (with chilled water plants above a certain threshold), which previously did not have requirements for economizing

In addition to these measures from ASHRAE 90.1, a separate code change proposal seeks to increase cooling tower efficiencies. That proposal will have a large impact on waterside economizer systems, since waterside economizer will run the cooling tower fan at high speed year-round to reach the required condenser water setpoint for economizing. Waterside economizer combined with more efficient cooling towers will result in much more efficient economizer performance.

This measure does not have any federal preemption concerns, and is the first time it has been considered for Title 24, Part 6 rulemaking.

5.1.3 Summary of Proposed Changes to Code Documents

The sections below summarize how each Title 24, Part 6 document will be modified by the proposed change. See Section 5.6 of this report for detailed proposed revisions to code language.

5.1.3.1 Standards Change Summary

This proposal modifies the following sections of the Building Energy Efficiency Standards as shown below. The language will be based on the same language from ASHRAE 90.1-2016.

The proposed measure adds a requirement for chilled water systems to have economizers if over a climate zone specific capacity listed in Section 5.6.1, in addition to the existing air handling unit requirement. It adds requirements for the 15 feet of water pressure drop limitation or bypass on the water loop to minimize energy penalty when the economizer is not in use. The measure includes a requirement that heat rejection fan energy cannot increase when the economizer is not in operation, and adds clarifying language specifying that waterside economizers must be capable of integrated partial economizing. Finally, it adds a table of chilled water capacities that specifies in which climate zones an economizer is required and what the capacity is to activate the requirement.

5.1.3.2 Reference Appendices Change Summary

The proposed code change does not modify the Reference Appendices.

5.1.3.3 Alternative Calculation Method (ACM) Reference Manual Change Summary

5.1.3.4 This proposal does not modify the ACM Reference Manual. Compliance Manual Change Summary

The compliance manual already has a good description on integrated waterside economizing, so this section will not require changes. To ensure that integrated waterside economizer is being installed, an acceptance test should be added similar to how air economizers have acceptance tests.

5.1.3.5 Compliance Documents Change Summary

The proposed code change modifies the compliance documents listed below.

NRCC-MCH-02-E: Currently, economizer is only listed under dry-side equipment. It should be added to wet-side equipment so that it is clearer to reviewers if the project is using airside or waterside economizers in order to satisfy Section 140.4(e).

5.1.4 Regulatory Context

5.1.4.1 Existing Title 24, Part 6 Standards

Waterside economizers are currently regulated by Title 24, Part 6 Section 140.4(e). The requirement states that waterside economizers must be sized to meet the full building load at 45°F wet-bulb and 50°F dry-bulb. Language exists regarding the capability requirement of partial economizing, but lacks detail. The code mandates the capability of partial cooling during conditions when mechanical cooling is still

required, but does not require its actual operation. Most of the requirements in Section 140.4(e) are written for airside economizers.

5.1.4.2 Relationship to Other Title 24, Part 6 Requirements

This measure is closely tied to the 2019 Title 24, Part 6 CASE Report on Cooling Tower Minimum Efficiency, which proposes increases to the prescriptive cooling tower efficiency requirements from 42.1 to 80 gpm/hp. Since waterside economizing results in cooling tower fans running at high power during a large portion of the year to achieve a close wet-bulb approach, it is important for this measure to benefit from the higher cooling tower efficiency required in that measure. Therefore, the analysis in this CASE Report assumes the waterside economizers will be connected to higher efficiency cooling towers proposed in the Cooling Tower Minimum Efficiency CASE Report.

5.1.4.3 Relationship to State or Federal Laws

There are no other state or federal laws that address the proposed change.

5.1.4.4 Relationship to Industry Standards

The proposed code changes are being sourced from recent changes to ASHRAE 90.1-2013 via Addendum cx. Addendum cx added the proposed waterside economizer language to ASHRAE 90.1-2013 Section 6.5.1.2. The proposal for the code change measure included analysis by the Pacific Northwest National Laboratory staff (Hart, Boldt and Rosenberg 2014) that showed that requiring waterside economizing on chilled water systems was cost-effective in all climate zones except 1A. Following a few rejected proposals with minor edits, the final version was accepted at the ASHRAE 90.1 Standing Standards Project Committee meeting during the 2016 ASHRAE Winter Conference in Orlando, Florida. The language has been published in the ASHRAE 90.1-2016 standard.

5.1.5 Compliance and Enforcement

This code change proposal primarily affects buildings that use the mandatory and prescriptive approaches to compliance. The key steps and changes to the compliance process are summarized below.

- **Design Phase:** The proposed code changes require certain buildings to specify certain equipment that they may not have otherwise had on the project, such as fluid-fluid heat exchangers. As long as designers are aware of code requirements, the normal coordination between design teams will be sufficient to ensure the building is designed to meet code. The addition of economizing equipment and larger fluid-fluid heat exchangers may make the coordination process slightly more difficult to fit all required equipment. Integrated waterside economizer requirement could create issues with chillers that cannot operate under low-lift conditions, so designers will need to understand and specify chillers that do not have these issues. Low lift describes the small temperature increase between chilled water inlet and outlet at the chiller. This temperature difference shrinks since partial cooling of the chilled water is done by the water economizer heat exchanger. Taylor Engineers has published guides to assist in the proper design of integrated waterside economizer systems.⁸
- **Permit Application Phase:** The prescriptive forms should be slightly updated so that it is clear if projects are using dry (airside) or wet (waterside) economizers to comply with the new requirements. Permit reviewers will need to be briefed on the changes in requirements and how to quickly determine if the requirements are being met in the building plans.
- **Construction Phase:** Minimal changes to the construction phase of the project are expected, as long as the responsible teams are aware of the new efficiency standards for cooling towers, so

⁸ For more information, see <http://www.taylor-engineering.com/articles>.

that they don't accept towers that do not meet this requirement. New target values for acceptance testing will be used, but nothing about the test will be fundamentally altered.

- **Inspection Phase:** The inspection phase will stay largely unchanged. The forms for cooling tower testing will be slightly modified to reflect the new efficiency requirements, but nothing in the proposed code changes will require any additional forms or change in protocol.

5.2 Market Analysis

The Statewide CASE Team performed a market analysis with the goals of identifying current technology availability, current product availability, and market trends. The Statewide CASE Team considered how the proposed standard may impact the market in general and individual market actors. The Statewide CASE Team gathered information about the incremental cost of complying with the proposed measure. Estimates of market size and measure applicability were identified through research and outreach with stakeholders including utility program staff, Energy Commission staff, and a wide range of industry players who were invited to participate in utility-sponsored stakeholder meetings held on September 26, 2016, and March 15, 2017.

5.2.1 Market Structure

Heat exchangers for waterside economizers are manufactured products, with the majority of rated products coming from companies such as Kelvion, Trane, STULZ, and Bell & Gossett. These manufacturers design the products, develop technology advancements, and publish software to aid in product selection. The actual sales and selection process is handled by independent sales representative companies. The selection is done by both the project engineer and sales representative. Currently, the major heat exchanger manufacturers provide low-approach heat exchangers, which can meet the proposed requirements.

Liquid-liquid heat exchanger ratings are covered by AHRI Standard 400. The standard establishes definitions, test requirements, rating requirements, minimum data requirements for published ratings, marking and nameplate data, and conformance conditions. Manufacturers which publish ratings for heat exchangers follow this standard for testing as well as the development of their sizing software calculations.

5.2.2 Technical Feasibility, Market Availability, and Current Practices

While the measure is expected to increase demand for high-performance, low-approach heat exchangers, interviews with design engineers show that the market is already demanding these low-approach heat exchangers to maximize hours of waterside economizing, with many product lines currently meeting the proposed standards.

The Statewide CASE Team does not anticipate issues with constructability or inspection. Based on interviews with engineers from Integral Group, Taylor Engineers, etc., many projects are selecting lower-approach heat exchangers due to the good financial payback. No inherent issue with larger and higher performance heat exchangers has been reported.

Larger heat exchangers will take up more space, which will constrain the design of rooftop-mounted cooling equipment; they may also potentially take more effort to conceal, resulting in aesthetic issues. Since the measure is prescriptive, space-constrained buildings can take the performance approach and use lower performance equipment in exchange for higher energy savings elsewhere. Besides the potential for coordination issues, the design process will remain relatively similar.

5.3 Energy Savings

5.3.1 Key Assumptions for Energy Savings Analysis

The energy savings analysis for the measure uses energy modeling following the guidance of the 2016 Nonresidential ACM. Energy models are sourced from CBECC-Com prototypical models and are only modified to include the proposed changes to the energy standards and Nonresidential ACM.

The key inputs, which affect the analysis for waterside economizers, are:

- Integrated/nonintegrated operation heat exchanger
- System approach temperature
- Cooling tower fan power

Integrated/nonintegrated operation represents the placement of the heat exchanger. Nonintegrated operation means that the heat exchanger is placed in parallel with the chiller. The chiller is shut off when wet-bulb temperatures are low enough and the heat exchanger provides the cooling load for the building. The parallel placement means that the heat exchanger cannot provide partial cooling. Integrated operation means that the heat exchanger is placed in series with the chiller, allowing it to provide partial cooling at higher wet-bulb temperatures. Since nonintegrated operation is easier to design and control, it is used for the baseline system.

Integrated operation places the chiller in series with the waterside economizer, allowing the waterside economizer heat exchanger to precool the chilled water before it reaches the chiller. This allows the economizer to operate when wet-bulb temperatures are not low enough to provide full economizing; some partial economizing can still be provided as long as the heat exchanger can provide colder water than the chilled water return temperature. An integrated waterside economizer is used for the proposed system.

Note that the modeling software is not able to account for the increased pressure drop that occurs whenever the waterside economizer is running the heat exchanger and chiller in series. The extra set of coils inserted into the flow stream results in more back pressure, which requires additional pumping energy. EnergyPlus uses a fixed pump pressure at design conditions and cannot adjust based on economizer operation. It is estimated that additional pumping pressure will be a small part of the energy use, so this is not expected to be problematic.

The system approach temperature is the lowest temperature water that the cooling tower or fluid cooler can provide given a wet-bulb temperature. It is not realistic to assume that a cooling tower or heat exchanger performs ideally, so an offset temperature is modeled. Currently Title 24, Part 6 requires a 9°F approach temperature so that waterside economizing occurs at 45°F wet-bulb for 54°F supply chilled water. This is the input for baseline and proposed models.

Waterside economizers cause cooling towers to run more often and at higher power to reach closer to the wet-bulb temperature. This causes cooling towers to use a larger proportion of energy use than normal. Currently this analysis assumes a baseline and proposed cooling tower with 80 gpm/hp efficiency to represent the higher efficiency cooling tower requirements proposed for the 2019 Title 24, Part 6 Standards. For reference, the 2016 Title 24, Part 6 cooling tower efficiency is 42.1 gpm/hp, and the ACM Reference Manual specifies an increase to 60 gpm/hp cooling towers in the standard design.

5.3.2 Energy Savings Methodology

While the vast majority of systems provide airside economizing for this system type, certain projects opt for waterside economizing, perhaps due to site-specific constraints that limit the quantity of the outdoor air intake. This measure takes the prototypical large office building with airside economizing and performs the following steps:

- Removes the airside economizer.
- The second chiller in the base case is removed and the remaining chiller sizing is set to auto size (A single chiller is easier to control for waterside economizer mode, CBECC-Com will need to address waterside economizer control in the next iteration); performance curves are unchanged from the prototype model.
- Defaults the prototype models to providing each chiller with their own pump; but to allow flow through the waterside economizer, a single pump providing flow to the entire condenser loop replaces these chiller pumps.
- Resets all chilled water and condenser water pumps and loops to auto size to allow optimized waterside economizing.
- Adds waterside economizer (water-water heat exchanger) in parallel to chiller to represent code minimum non-integrated waterside economizer system.
- Sets waterside economizer to override the chiller when full load can be met using condenser water.
- Sets the temperature difference to activate the heat exchanger to 4°F to represent the baseline approach temperature.
- Sets the condenser water loop to follow the wet-bulb with 5°F offset to represent the approach of the cooling towers:
 - The combined approaches of heat exchanger and cooling tower equal 9°F system approach.
- Sets the cooling tower fan energy to equal an efficiency of 80 gpm/hp, which is the proposed 2019 Title 24, Part 6 code minimum.

Baseline HVAC system setup in OpenStudio is shown in Figure 9.

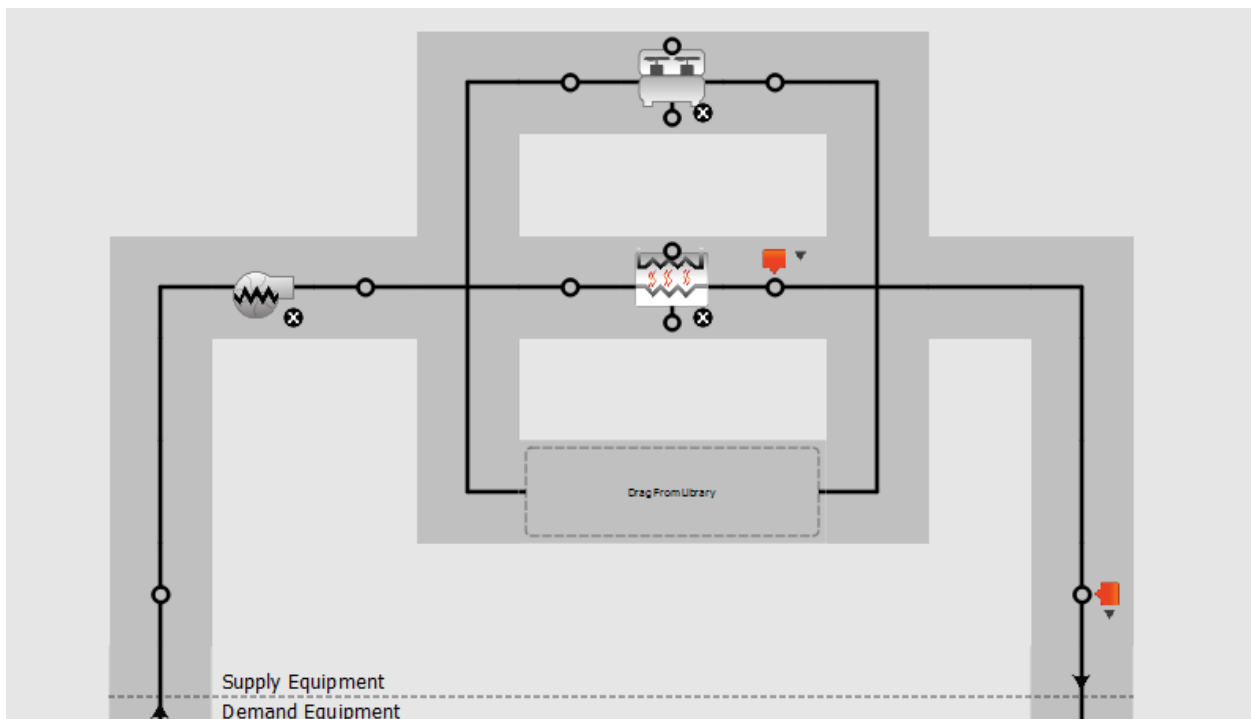

Figure 9: Baseline HVAC configuration in OpenStudio

The proposed conditions are defined as the design conditions that comply with the proposed code change. Specifically, the proposed code change:

- Moves the heat exchanger to the integrated position upstream from the chiller.

- Sets the heat exchanger to “CoolingSetpointOnOff” when condenser water temperatures are below 72°F, which shuts off waterside economizing when the increased condenser pump energy and cooling tower fan energy begin to surpass the decreased cooling energy.

Proposed HVAC configuration in OpenStudio is shown in Figure 10.

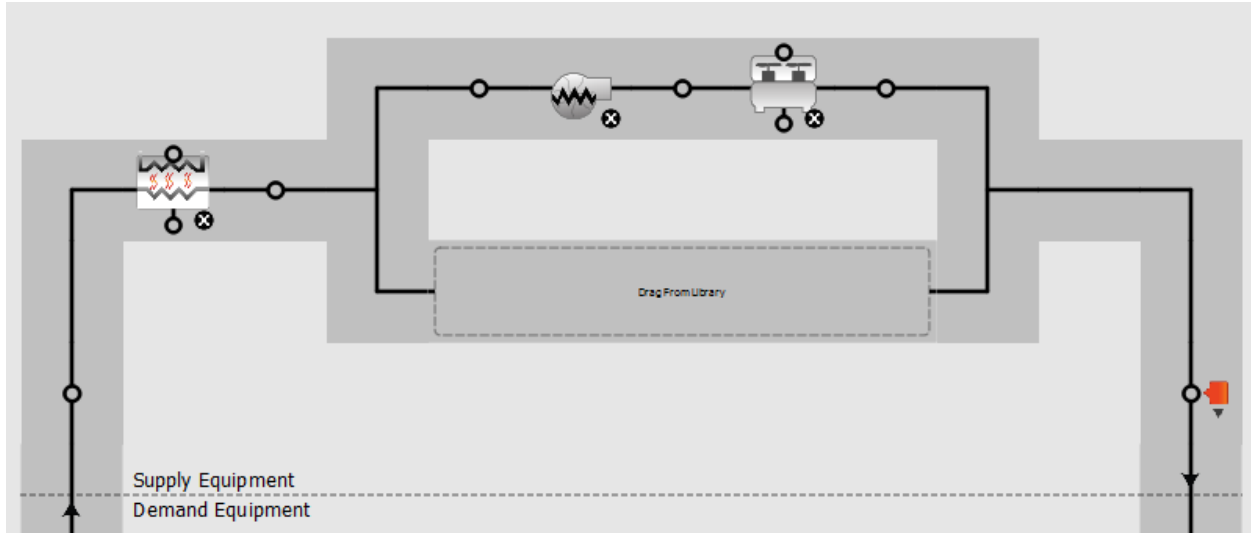

Figure 10: Proposed HVAC configuration in OpenStudio

The Energy Commission provided guidance on the type of prototype buildings that must be modeled. The prototype used in this analysis is the large office. This measure concerns buildings with large cooling plants that have condenser water loops and economizer requirements.

Table 37 presents the details of the prototype building used in the analysis.

Table 37: Prototype Buildings used for Energy, Demand, Cost, and Environmental Impacts Analysis

| Prototype ID | Occupancy Type (Residential, Retail, Office, etc.) | Area (ft ²) | Number of Stories | Statewide Area (million ft ²) |
|--------------|--|-------------------------|-------------------|---|
| Prototype 1 | Office (large) | 498,589 | 13 | 1.27 |

The impacts of this measure are climate-specific, as cooling energy decreases dramatically when there are many hours within the economizer range. In climates that have many hours between 45°F wet-bulb and 70°F wet-bulb, the savings are greatest, as the baseline case cannot do any economizing during these hours due to lack of integrated economizer. Climates that have short warm seasons, such as Climate Zone 16, see the least amount of savings, as most of the year can be in economizer mode for both baseline and proposed.

Energy savings, energy cost savings, and peak demand reductions were calculated using a TDV methodology.

5.3.3 Per Unit Energy Impacts Results

Energy savings and peak demand reductions per unit are presented in Table 38. Per unit savings for the first year are expected to range from a high of 0.28 kilowatt-hours per year (kWh/yr) to a low of 0.08 kWh/yr depending upon climate zone. The whole building savings range from 139,605 kWh/yr to 39,887 kWh/yr, depending on climate zone. Since waterside economizers save energy at milder temperature conditions, there is not expected to be demand savings from this measure. The results do

not show demand reductions. Since this measure only affects chilled water, there are no natural gas savings. Thus, the tables only show kWh/yr.

Table 38: Equipment Efficiency First-Year Energy Impacts per Square Foot –Large Office

| Climate Zone | Electricity Savings (kWh/ft ² -yr) | TDV Energy Savings (TDV kBtu/yr) |
|--------------|---|----------------------------------|
| 1 | 0.12 | 2.93 |
| 2 | 0.12 | 2.80 |
| 3 | 0.11 | 2.78 |
| 4 | 0.14 | 3.33 |
| 5 | 0.13 | 8.86 |
| 6 | 0.08 | 2.07 |
| 7 | 0.09 | 2.13 |
| 8 | 0.10 | 2.29 |
| 9 | 0.15 | 3.41 |
| 10 | 0.15 | 3.50 |
| 11 | 0.17 | 5.81 |
| 12 | 0.11 | 2.68 |
| 13 | 0.15 | 1.46 |
| 14 | 0.20 | 9.18 |
| 15 | 0.21 | 5.05 |
| 16 | 0.28 | 8.27 |

The per unit TDV energy cost savings over the 15-year period of analysis are presented in Table 39. These are presented as the discounted present value of the energy cost savings over the analysis period.

5.4 Lifecycle Cost and Cost-Effectiveness

5.4.1 Energy Cost Savings Methodology

The analysis used to quantify energy and demand savings is based on energy models from CBECC-Com. Analysis for the proposed model can be easily reproduced using the existing CBECC-Com software packages. However, the baseline model has controls functionality that is currently lacking in CBECC-Com. Nonintegrated waterside economizers should be controlled to shut off the chiller when conditions allow. This is accomplished in the heat exchanger object in OpenStudio and EnergyPlus. The control option is called “Cooling Setpoint On Off with Component Override.” To reproduce the results of the baseline minimum-compliant Title 24, Part 6 model, this functionality will need to be added to CBECC-Com. Note that it is not currently clear how to deactivate multiple chillers when using the component override function.

5.4.2 Energy Cost Savings Results

The TDV methodology allows peak electricity savings to be valued more than electricity savings during non-peak periods. The majority of savings are not during peak periods as the economizer does not operate at peak temperatures.

Table 39: TDV Energy Cost Savings Over 15-Year Period of Analysis per Square Foot – Large Office

| Climate Zone | 15-Year TDV Electricity Cost Savings (2020 Present Value \$) |
|--------------|--|
| 1 | \$0.26 |
| 2 | \$0.25 |
| 3 | \$0.25 |
| 4 | \$0.30 |
| 5 | \$0.77 |
| 6 | \$0.18 |
| 7 | \$0.19 |
| 8 | \$0.20 |
| 9 | \$0.30 |
| 10 | \$0.31 |
| 11 | \$0.52 |
| 12 | \$0.24 |
| 13 | \$0.14 |
| 14 | \$0.80 |
| 15 | \$0.45 |
| 16 | \$0.73 |

5.4.3 Incremental First Cost

The cost of integrated waterside economizers compared to nonintegrated waterside economizers is negligible according to a number of sources, most recently an ASHRAE article (Taylor 2014). The design and control of the integrated system may be thought to be more challenging to engineers without experience, but Taylor Engineering’s article demonstrates how it can actually be easier to control. There are numerous waterside economizer design guides available to assist. Overall, this measure does not contain additional first costs for waterside economizers, but merely promotes good design practices.

5.4.4 Lifetime Incremental Maintenance Costs

Fluid-fluid heat exchangers will have issues with scaling since the condenser water side is exposed to the open loop fluid. Part of regular maintenance is to take apart and clean out heat exchangers to reduce scaling. While increasing the number of hours per year that a heat exchanger is in use will cause it to scale faster, the difference is not enough to make a noticeable difference in maintenance costs.

ASHRAE lists the expected useful life of fluid-fluid heat exchangers as 24 years.

5.4.5 Lifecycle Cost-Effectiveness

This measure proposes a prescriptive requirement.

Results per unit lifecycle cost-effectiveness analyses are presented in Table 40. The proposed measure saves money over the 15-year period of analysis relative to the existing conditions. The proposed code change was found to be cost-effective in every climate zone.

There is significant variation in B/C ratios with this measure, since milder climates have much more opportunity for economizer use. The most cost-effective regions have many hours with wet-bulbs above 45°F but below 70°F where the proposed model has savings that are not captured in the baseline prototype. For example, Climate Zones 11 and 13 are hot climates and have wet-bulb temperatures that are too high to generate a better B/C ratio, while Climate Zone 7 is a mild coastal region.

Table 40: Lifecycle Cost-Effectiveness Summary per Square Foot – Large Office

| Climate Zone | Benefits TDV Energy Cost Savings + Other PV Savings ^a (2020 Present Value \$) | Costs Total Incremental PV Costs ^b (2020 Present Value \$) | Benefit-to- Cost Ratio |
|--------------|---|---|---------------------------|
| 1 | \$0.26 | \$0 | infinite |
| 2 | \$0.25 | \$0 | infinite |
| 3 | \$0.25 | \$0 | infinite |
| 4 | \$0.30 | \$0 | infinite |
| 5 | \$0.77 | \$0 | infinite |
| 6 | \$0.18 | \$0 | infinite |
| 7 | \$0.19 | \$0 | infinite |
| 8 | \$0.20 | \$0 | infinite |
| 9 | \$0.30 | \$0 | infinite |
| 10 | \$0.31 | \$0 | infinite |
| 11 | \$0.52 | \$0 | infinite |
| 12 | \$0.24 | \$0 | infinite |
| 13 | \$0.14 | \$0 | infinite |
| 14 | \$0.80 | \$0 | infinite |
| 15 | \$0.45 | \$0 | infinite |
| 16 | \$0.73 | \$0 | infinite |

- a. **Benefits – TDV Energy Cost Savings + Other PV Savings:** Benefits include TDV energy cost savings over the period of analysis (Energy + Environmental Economics 2016, 51-53). Other savings are discounted at a real (nominal – inflation) three percent rate. Other present valued savings include incremental first cost savings if proposed first cost is less than current first cost. Includes present value maintenance cost savings if present value of proposed maintenance costs is less than the present value of current maintenance costs.
- b. **Costs – Total Incremental PV Costs:** Costs include incremental equipment, replacement and maintenance costs over the period of analysis. Costs are discounted at a real (inflation adjusted) three percent rate. Includes incremental first cost if proposed first cost is greater than current first cost. Includes present value of maintenance incremental cost if present value of proposed maintenance costs is greater than the present value of current maintenance costs. If incremental maintenance cost is negative, it is treated as a positive benefit. If there are no total incremental present valued costs, the B/C ratio is infinite.

5.5 First-Year Statewide Impacts

5.5.1 Statewide Energy Savings and Lifecycle Energy Cost Savings

Given data regarding the new construction forecast for 2020, the Statewide CASE Team estimates that the proposed code change will reduce annual statewide electricity use by 0.16 GWh. The energy savings for buildings constructed in 2020 are associated with a present-valued energy cost savings of approximately \$0.35 million in (discounted) energy costs over the 15-year period of analysis. Results are presented in Table 41.

Table 41: Statewide Energy and Energy Cost Impacts

| Climate Zone | Statewide Construction in 2020 (million ft ²) ^{a, b} | First-Year Electricity Savings (GWh) ^c | Lifecycle ^d Present Valued Energy Cost Savings (PV\$ million) |
|--------------|---|---|--|
| 1 | 0.00 | 0.000 | \$0.001 |
| 2 | 0.03 | 0.004 | \$0.008 |
| 3 | 0.21 | 0.024 | \$0.051 |
| 4 | 0.07 | 0.010 | \$0.021 |
| 5 | 0.01 | 0.002 | \$0.011 |
| 6 | 0.13 | 0.010 | \$0.024 |
| 7 | 0.07 | 0.006 | \$0.013 |
| 8 | 0.19 | 0.019 | \$0.039 |
| 9 | 0.26 | 0.038 | \$0.079 |
| 10 | 0.07 | 0.010 | \$0.020 |
| 11 | 0.01 | 0.002 | \$0.006 |
| 12 | 0.14 | 0.015 | \$0.032 |
| 13 | 0.02 | 0.003 | \$0.003 |
| 14 | 0.02 | 0.003 | \$0.013 |
| 15 | 0.01 | 0.002 | \$0.004 |
| 16 | 0.04 | 0.010 | \$0.027 |
| TOTAL | 1.27 | 0.16 | \$0.35 |

- a. Currently, the savings for waterside economizer measure only incorporates large office; final analysis will include large schools and high-rise residential.
- b. Assumes three percent of large office statewide construction uses waterside economizers.
- c. First-year savings from all buildings completed statewide in 2020.
- d. Energy cost savings from all buildings completed statewide in 2020 accrued during 15-year period of analysis.

5.5.2 Statewide Water Use Impacts

Impacts on water use are presented in Table 42. It is assumed that all water savings occurred outdoors, and the embedded electricity value is 3,565 kWh/million gallons of water (for outdoor water use explicitly). The embedded electricity estimate was derived from a 2015 California Public Utilities Commission (CPUC) study that quantified the embedded electricity savings from IOU programs that save both water and energy (California Public Utilities Commission 2015a). See Appendix A for additional information on the embedded electricity savings estimates.

Water savings stem from the waterside economizer measure. Cooling towers evaporate water to reject heat from the building. Part of the heat rejection load is the waste heat due to the operating efficiency of the chiller. Waterside economizers allow the chiller to turn down or off during milder temperatures. Since this measure expands the amount of waterside economizer hours, the chiller runs less, and less heat will need to be rejected. Due to the lower heat rejection, less water has to be evaporated; therefore, the measure saves a significant amount of water due to heat rejection, on the order of 25 percent of heat rejection water use.

Table 42: Impacts on Water Use

| | On-site Indoor Water Savings (gal/yr) | On-site Outdoor Water Savings (gal/yr) | Embedded Electricity Savings ^b (kWh/yr) |
|---|---------------------------------------|--|--|
| Per Square Foot Impacts | N/A | 0.16 | negligible |
| First-year ^a Statewide Impacts | N/A | 39,796 | 141 |

- a. First-year savings from all buildings completed statewide in 2020.
- b. Assumes embedded energy factor of 3,565 kWh per million gallons of water (California Public Utilities Commission 2015b).

5.5.3 Statewide Material Impacts

The proposed code changes will increase the amount of steel used as the steel heat exchangers in buildings will be larger.

Table 43: Impacts of Material Use

| | Impact on Material Use (lb/yr) | | | | | |
|---|--------------------------------|------|--------|-------|---------|-------------------|
| | Mercury | Lead | Copper | Steel | Plastic | Others (Identify) |
| Impact (I, D, or NC) ^a | NC | NC | NC | NC | NC | NC |
| Per Unit Impacts | N/A | N/A | N/A | N/A | N/A | N/A |
| First-year ^b Statewide Impacts | N/A | N/A | N/A | N/A | N/A | N/A |

- a. Material Increase (I), Decrease (D), or No Change (NC) compared to base case (lb/yr).
- b. First-year savings from all buildings completed statewide in 2020.

5.5.4 Other Non-Energy Impacts

The proposed code change will not result in any other non-energy impacts.

5.6 Proposed Revisions to Code Language

The proposed changes to the Standards, Reference Appendices, and the ACM Reference Manual are provided below. Changes to the 2016 documents are marked with underlining (new language) and ~~strikethroughs~~ (deletions).

5.6.1 Standards

SECTION 140.4 – PRESCRIPTIVE REQUIREMENTS FOR SPACE CONDITIONING SYSTEMS

(e) Economizers.

1. Each cooling air handler that has a design total mechanical cooling capacity over 54,000 Btu/hr, or Chilled-water cooling systems without a fan or that use induced airflow, where the total capacity of these systems is greater than that listed in Table 140.4-D, shall include either:
 - A. An air economizer capable of modulating outside-air and return-air dampers to supply 100 percent of the design supply air quantity as outside; or
 - B. A water economizer capable of providing 100 percent of the expected system cooling load as calculated in accordance with a method approved by the Commission, at outside air temperatures of 50°F dry-bulb and 45°F wet-bulb and below.

EXCEPTION 1 to Section 140.4(e)1: Where special outside air filtration and treatment, for

the reduction and treatment of unusual outdoor contaminants, makes compliance infeasible.

EXCEPTION 2 to Section 140.4(e)1: Where the use of outdoor air for cooling will affect other systems, such as humidification, dehumidification, or supermarket refrigeration systems, so as to increase overall building TDV energy use.

EXCEPTION 3 to Section 140.4(e)1: Systems serving high-rise residential living quarters and hotel/motel guest rooms.

EXCEPTION 4 to Section 140.4(e)1: Where comfort cooling systems have the cooling efficiency that meets or exceeds the cooling efficiency improvement requirements in TABLE 140.4-A.

EXCEPTION 5 to Section 140.4(e)1: Fan systems primarily serving computer rooms. See Section 140.9(a) for computer room economizer requirements.

TABLE 140.4-A ECONOMIZER TRADE-OFF TABLE FOR COOLING SYSTEMS

| Climate Zone | Efficiency Improvement ^a |
|--------------|-------------------------------------|
| 1 | 70% |
| 2 | 65% |
| 3 | 65% |
| 4 | 65% |
| 5 | 70% |
| 6 | 30% |
| 7 | 30% |
| 8 | 30% |
| 9 | 30% |
| 10 | 30% |
| 11 | 30% |
| 12 | 30% |
| 13 | 30% |
| 14 | 30% |
| 15 | 30% |
| 16 | 70% |

^a If a unit is rated with an IPLV, IEER or SEER, then to eliminate the required air or water economizer, the applicable minimum cooling efficiency of the HVAC unit must be increased by the percentage shown. If the HVAC unit is only rated with a full load metric, such as EER or COP cooling, then that metric must be increased by the percentage shown.

2. If an economizer is required by Section 140.4(e)1 it shall be:
 - A. Designed and equipped with controls so that economizer operation does not increase the building heating energy use during normal operation; and

EXCEPTION to Section 140.4(e)32A: Systems that provide 75 percent of the annual energy used for mechanical heating from site-recovered energy or a site-solar energy source.
 - B. Capable of providing partial cooling even when additional mechanical cooling is required to meet the remainder of the cooling load.
3. *[omitted – change numbering to accommodate Section 140.4(e)2 added above]*
4. *[omitted – change numbering to accommodate Section 140.4(e)2 added above]*

5. l omitted – change numbering to accommodate Section 140.4(e)2 added above
6. Systems that include a water economizer to meet Section 140.4(e)1 shall include the following:
 - A. Maximum pressure drop. Precooling coils and water-to-water heat exchangers used as part of a water economizer system shall either have a waterside pressure drop of less than 15 feet of water, or a secondary loop shall be installed so that the coil or heat exchanger pressure drop is not contributing to pressure drop when the system is in the normal cooling (non-economizer) mode.
 - B. Economizer systems shall be integrated with the mechanical cooling system so that they are capable of providing partial cooling even when additional mechanical cooling is required to meet the remainder of the cooling load. Controls shall not false load the mechanical cooling system by limiting or disabling the economizer or by any other means, such as hot gas bypass, except at the lowest stage of mechanical cooling.

TABLE 140.4-D CHILLED WATER SYSTEM COOLING CAPACITY FOR WHICH AN ECONOMIZER IS REQUIRED

| <u>Climate Zones</u> | <u>Total Building Chilled Water System Capacity, Minus Capacity of Cooling units with Air Economizers</u> | |
|---|---|---|
| | <u>Building Water-Cooled Chilled Water Systems</u> | <u>Air-Cooled Chilled Water Systems or District Chilled Water Systems</u> |
| <u>15</u> | <u>≥ 960,000 Btu/h (280 kW)</u> | <u>≥ 1,250,000 Btu/h (365 kW)</u> |
| <u>1,2,3,4,5,6,7,8,9 10,11,12,13,14</u> | <u>≥ 720,000 Btu/h (210 kW)</u> | <u>≥ 940,000 Btu/h (275 kW)</u> |
| <u>16</u> | <u>≥ 1,320,000 Btu/h (385 kW)</u> | <u>≥ 1,720,000 Btu/h (505 kW)</u> |

5.6.2 Reference Appendices

There are no proposed changes to the Reference Appendices, unless otherwise indicated below.

5.6.3 ACM Reference Manual

Currently the proposed changes do not affect the Nonresidential ACM Reference Manual, but the code change team is exploring modifications to Section 5.8.4 Water-side economizers to establish adding waterside economizers to System Type 2: Four-Pipe Fan Coil.

5.6.4 Compliance Manuals

There are no proposed changes to the Residential or Nonresidential Compliance Manuals.

5.6.5 Compliance Documents

Compliance document NRCC-MCH-02-E will need to be revised to identify if projects are using airside or waterside economizers to satisfy Section 140.2(e).

6. TRANSFER AIR FOR EXHAUST AIR MAKEUP

6.1 Measure Description

6.1.1 Measure Overview

This measure expands the existing Title 24, Part 6 requirement for kitchen exhaust transfer air to other types of exhaust systems, such as toilet exhaust and lab exhaust. This measure matches the same requirement that was added to ASHRAE 90.1 in 2013. It is a prescriptive measure and applies to most spaces that have a process exhaust airflow rate exceeding the airflow required for heating or cooling and that are adjacent to spaces that do not have high exhaust requirements. This eliminates the wasteful practice of providing 100 percent outside air or 100 percent supply air to spaces with high exhaust rates, and at the same time relieves air from other spaces in the same building, when the relieved air could have been transferred to the high exhaust space to reduce the total heating/cooling load. It is common practice, for example, to serve a toilet room with a VAV box sized to match the toilet exhaust requirement when the cfm required to meet the toilet room heating/cooling load or ventilation requirement is much smaller than the exhaust requirement. A more efficient design is to only provide enough supply air to the toilet room to meet the cooling/ventilation loads and use transfer air to make up the difference of the required makeup air.

The payback for this measure is immediate because it reduces both first cost and energy cost compared to 100 percent supply air to spaces with high exhaust rates.

As a result of this proposed change, the standards will provide requirements for systems that were not previously regulated, because previously there were no limitations on the amount of conditioned air that could be used to replace air being exhausted. As a prescriptive measure it will lower the standard budget in the situations where it is applicable but the designer can still have the inefficient 100% outside air so long as other efficiency measure offset the increased energy usage.

While this code change is an expansion of the existing kitchen transfer air requirement in Section 140.9, a new section of the code is proposed under Section 140.4. The kitchen transfer air requirement is in the process section and this expansion applies to process exhaust as well as exhaust systems that are not typically thought of as process exhaust, such as toilet exhaust.

Examples of current practice and the proposed change are presented in Appendix F.

6.1.2 Measure History

This measure is being proposed because it will save energy and is cost-effective. It additionally reduces first cost. There are no preemption concerns. Transfer air for exhaust makeup for toilets, labs, etc. has been commonly used in many designs for many years. This proposal is the same as the transfer air requirement that is now in ASHRAE Standard 90.1. See Section 6.6.3 for recommended modeling rules.

6.1.3 Summary of Proposed Changes to Code Documents

The sections below summarize how each Title 24, Part 6 document will be modified by the proposed change. See Section 6.6 of this report for detailed proposed revisions to code language.

6.1.3.1 Standards Change Summary

This proposal modifies the following sections of the Building Energy Efficiency Standards as shown below. The language will be based on the same language from ASHRAE 90.1-2016.

SECTION 140.4 – PRESCRIPTIVE REQUIREMENTS FOR SPACE CONDITIONING SYSTEMS

Subsection 140.4(o) Exhaust System Transfer Air. The proposed measure adds a requirement for exhaust system transfer air. The conditioned supply air delivered to the space shall not be larger than the supply flow required to meet the space heating or cooling load, the ventilation rate required, or the mechanical exhaust flow minus the available transfer air from conditioned spaces or return air plenums. Exceptions include class 3 laboratories, vivarium spaces, spaces required to be positively pressurized, or spaces where there is a negative pressure relationship requirement with surrounding spaces.

6.1.3.2 Reference Appendices Change Summary

The proposed code change does not modify the Reference Appendices.

6.1.3.3 Alternative Calculation Method (ACM) Reference Manual Change Summary

The method of transfer air in the Nonresidential ACM model will need to be updated to ensure the baseline properly captures the procedure.

6.1.3.4 Compliance Manual Change Summary

A new section should be added to the Compliance Manual to provide guidance on this measure, similar to Section 10.3.3.2.A on page 10-6 of the 2016 Compliance Manual, which provides guidance on transfer air for kitchen exhaust air makeup. Appendix F of this report can serve as the new compliance manual section.

6.1.3.5 Compliance Documents Change Summary

No changes to the compliance documents are required. However, the Energy Commission may wish to add another document similar to “2016-NRCC-PRC-03-E Commercial Kitchens.”

6.1.4 Regulatory Context

6.1.4.1 Existing Title 24, Part 6 Standards

Transfer air for kitchens is currently regulated by Title 24, Part 6 Section 140.9. This measure will expand the requirements in this section.

6.1.4.2 Relationship to Other Title 24, Part 6 Requirements

This measure does not impact any other Title 24, Part 6 requirements nor does it overlap with other Title 24, Part 6 code change proposals for the 2019 cycle.

6.1.4.3 Relationship to State or Federal Laws

There are no other state or federal laws that address the proposed change.

6.1.4.4 Relationship to Industry Standards

This measure is based on Addendum u to ASHRAE 90.1-2013 and will be aligning with language included in the current ASHRAE 90.1-2016.

6.1.5 Compliance and Enforcement

This code change proposal primarily affects buildings that use the mandatory and prescriptive approaches to compliance. The key steps and changes to the compliance process are summarized below.

- **Design Phase:** Designers will have to be aware of code changes and apply them correctly to their designs. Designers who are intent on avoiding the changes will likely be able to do so by claiming higher than actual heating/cooling loads or claiming that transfer air is simply not available. In many cases, designs may not properly comply with the requirements because neither the designer nor the code enforcement people are aware of the requirement. Enforcement of the more complicated applications, like lab exhaust, will likely be self-enforcement by designers who have been trained to understand the new requirement. Changes

to the compliance documents are not required. Code outreach to make designers aware of these requirements is necessary to ensure savings are realized.

- **Permit Application Phase:** Enforcement of the transfer air requirement will be challenging but the energy savings potential is significant and worth the effort. Some instances, like toilet exhaust makeup, are simpler and will be easier to enforce, particularly once code enforcers are trained in the new requirements. Other instances, like lab exhaust makeup, will require a fairly well-trained enforcer to determine if inadequate transfer air is being used.
- **Construction Phase:** No changes are anticipated to the existing permit construction phase process.
- **Inspection Phase:** No changes are required to the inspection application phase process.

6.2 Market Analysis

The Statewide CASE Team performed a market analysis with the goals of identifying current technology availability, current product availability, and market trends. The Statewide CASE Team considered how the proposed standard may impact the market in general and individual market actors. The Statewide CASE Team gathered information about the incremental cost of complying with the proposed measure. Estimates of market size and measure applicability were identified through research and outreach with stakeholders including utility program staff, the Energy Commission staff, and a wide range of industry players who were invited to participate in utility-sponsored stakeholder meetings held on September 26, 2016, and March 29, 2017.

6.2.1 Market Structure

Transfer air for exhaust makeup does not require any particular technology or devices for implementation. It simply requires installing smaller, fewer, or no makeup air heating/cooling devices, e.g., smaller rooftop packaged units.

6.2.2 Technical Feasibility, Market Availability, and Current Practices

The transfer air requirement will require some engineers to change their standard design for exhaust makeup, but there are no technical feasibility or market availability issues. There are also no constructability or inspection challenges and no impacts or potential challenges on building/system longevity, occupant comfort, aesthetic, or other tradeoffs.

6.3 Energy Savings

6.3.1 Key Assumptions for Energy Savings Analysis

The energy savings analysis for the measure uses energy modeling following the guidance of the 2016 Nonresidential ACM. Energy models are sourced from CBECC-Com prototypical models and are only modified to include the proposed changes to the energy standards and Nonresidential ACM.

This measure assumes that makeup air for a space in the building, which has exhaust requirements that are higher than the ventilation cfm or the cfm required to meet the heating or cooling load, is made up with transfer air instead of 100 percent outside air or 100 percent supply air.

This is the only change to the prototype models used, and all other inputs, including schedules and internal gains, stay the same.

6.3.2 Energy Savings Methodology

The proposed conditions are defined as the design conditions that will comply with the proposed code change. Specifically, the proposed code change will require that spaces with exhaust requirements that

are higher than the ventilation cfm or the cfm required to meet the heating or cooling load is made up with transfer air instead of 100 percent outside air or 100 percent supply air.

The Energy Commission provided guidance on the type of prototype buildings that must be modeled. Nonresidential energy saving estimates are calculated using ASHRAE 90.1 prototypes for nonresidential buildings available in CBECC-Com. The medium office/laboratory prototype building was used, since this measure will directly affect laboratory buildings.

Table 44 presents the details of the prototype buildings used in the analysis.

Table 44: Prototype Buildings Used for Energy, Demand, Cost, and Environmental Impacts Analysis

| Prototype ID | Occupancy Type (Residential, Retail, Office, etc.) | Area (ft ²) | Number of Stories | Statewide Area (million ft ²) |
|--------------|--|-------------------------|-------------------|---|
| Prototype 1 | Medium Office/Lab | 53,628 | 3 | 1.39 |

The baseline medium office/laboratory prototype building is exhaust-driven in the lab spaces. The baseline prototype models for each climate zone were adjusted to balance the exhaust airflow with outdoor air, as the prototype models had exhaust air greatly in excess of what was being supplied by the air system. The baseline models were changed using OpenStudio to modify the EnergyPlus objects. Specifically, the changes included:

- Removed the plenum spaces from inclusion in floor area since they are unconditioned/unoccupied.
- In the "AirTerminal:SingleDuct:VAV:Reheat" object for each zone, set to "Control for Outdoor Air," set the "Zone Minimum Air Flow Input Method" to Constant, and removed the "Minimum Air Flow Fraction Schedule."
- The lab zones are thermal dominated by the exhaust flow rate requirements. In the lab air systems "Controller:OutdoorAir" objects, set the "Maximum Outdoor Air Flow Rate" field to 90 percent of the "Maximum Flow Rate" of the "Fan:ZoneExhaust" (this will be the sum of exhaust fans in zones served by the lab air system, accounting for the flow schedule for these fans, which has a 90 percent max), removed the "Maximum Fraction of Outdoor Air Schedule," and set "Minimum Fraction of Outdoor Air Schedule" to "Always On."

The proposed model further modified the baseline model, taking advantage of the ZoneMixing object in EnergyPlus to model transfer air coming from a source zone to a receiving zone. The outdoor air requirement is reduced for the lab systems while the office air system is active. The proposed models were also generated using OpenStudio , specifically:

- Added "ZoneMixing" objects to each office zone transferring air to the lab zone on the same floor. In the office/lab prototype building, these are the bottom and top floors. A dummy exhaust fan with no pressure rise or fan power is added to each office zone to reduce the return air from these zones going back to the office air handler.
- The "Fan:ZoneExhaust" objects in each lab zone are modified to account for which portion of the exhaust flow rate is met with transfer air. This is done by setting the "Balanced Exhaust Fraction Schedule" to Fraction Balanced. To calculate Fraction Balanced, multiply the Office HVAC Avail Schedule and Lab Exhaust Hood VAV Schedule together.
- In the "DesignSpecification:OutdoorAir" objects for the lab zones served by transfer air, set the "Outdoor Air Flow Rate Fraction Schedule" to Lab Exhaust Hood VAV Transfer Air schedule, which is the Lab Exhaust Hood VAV schedule adjusted for transfer air.

The energy savings from this measure depend on the benefit of reducing outdoor air intake, which varies by climate zone. As a result, the energy impacts and cost-effectiveness were evaluated by climate

zone. Energy savings, energy cost savings, and peak demand reductions were calculated using a TDV methodology.

6.3.3 Per Unit Energy Impacts Results

Energy savings and peak demand reductions per unit for new construction are presented in Table 45. This measure does not have savings from alterations. Annual per square foot savings for the first year are expected to range from a high of 0.412 kWh/ft²-yr and 0.0293 therms/ft²-yr to a low of 0.169 kWh/ft²-yr and negative 0.00363 therms/ft²-yr depending upon climate zone. Demand reductions/increases are expected to range between 5.20 x 10⁻⁶ kW/ft² and 8.52 x 10⁻⁴ kW/ft² depending on climate zone. The gas and demand impacts are extremely small but listed for completeness; for example, Climate Zone 16 is slightly negative but this should be interpreted as near-zero impact.

Table 45: First-Year Energy Impacts per Square Foot – New Construction

| Climate Zone | Electricity Savings (kWh/ft ² -yr) | Peak Electricity Demand Reduction (kW/ft ²) | Natural Gas Savings (therms/ft ² -yr) | TDV Energy Savings (TDV kBtu/ft ² -yr) |
|--------------|---|---|--|---|
| 1 | 0.176 | 5.65 x 10 ⁻⁴ | 0.029 | 9.86 |
| 2 | 0.251 | 7.21 x 10 ⁻⁴ | 0.029 | 13.08 |
| 3 | 0.213 | 6.29 x 10 ⁻⁴ | 0.025 | 10.73 |
| 4 | 0.268 | 6.39 x 10 ⁻⁴ | 0.025 | 12.75 |
| 5 | 0.218 | 5.99 x 10 ⁻⁴ | 0.029 | 11.14 |
| 6 | 0.300 | 6.50 x 10 ⁻⁴ | 0.022 | 13.34 |
| 7 | 0.303 | 6.68 x 10 ⁻⁴ | 0.020 | 12.81 |
| 8 | 0.324 | 7.37 x 10 ⁻⁴ | 0.022 | 14.58 |
| 9 | 0.323 | 1.26 x 10 ⁻⁴ | 0.021 | 14.01 |
| 10 | 0.324 | 7.95 x 10 ⁻⁴ | 0.022 | 13.36 |
| 11 | 0.321 | 6.00 x 10 ⁻⁴ | 0.027 | 14.03 |
| 12 | 0.289 | 8.52 x 10 ⁻⁴ | 0.027 | 13.59 |
| 13 | 0.325 | 7.78 x 10 ⁻⁴ | 0.026 | 14.93 |
| 14 | 0.267 | 1.10 x 10 ⁻⁴ | 0.019 | 11.79 |
| 15 | 0.412 | 5.20 x 10 ⁻⁶ | 0.020 | 15.11 |
| 16 | 0.169 | 6.14 x 10 ⁻⁴ | -0.004 | 3.51 |

The per unit TDV energy cost savings over the 15-year period of analysis are presented in Table 46. These are presented as the discounted present value of the energy cost savings over the analysis period.

6.4 Lifecycle Cost and Cost-Effectiveness

6.4.1 Energy Cost Savings Methodology

Energy cost savings are calculated using the TDV energy results from the EnergyPlus simulations using the conversion of 0.089 \$/TDV kBtu. The energy costs calculated are 15-year present value savings.

6.4.2 Energy Cost Savings Results

Table 46: TDV Energy Cost Savings Over 15-Year Period of Analysis per Square Foot

| Climate Zone | 15-Year TDV Electricity Cost Savings (2020 Present Value \$) | 15-Year TDV Natural Gas Cost Savings (2020 Present Value \$) | Total 15-Year TDV Energy Cost Savings (2020 Present Value \$) |
|---------------------|---|---|--|
| 1 | \$0.40 | \$0.48 | \$0.88 |
| 2 | \$0.69 | \$0.48 | \$1.16 |
| 3 | \$0.55 | \$0.40 | \$0.96 |
| 4 | \$0.73 | \$0.41 | \$1.13 |
| 5 | \$0.52 | \$0.47 | \$0.99 |
| 6 | \$0.82 | \$0.37 | \$1.19 |
| 7 | \$0.82 | \$0.32 | \$1.14 |
| 8 | \$0.95 | \$0.35 | \$1.30 |
| 9 | \$0.90 | \$0.35 | \$1.25 |
| 10 | \$0.82 | \$0.37 | \$1.19 |
| 11 | \$0.80 | \$0.45 | \$1.25 |
| 12 | \$0.76 | \$0.45 | \$1.21 |
| 13 | \$0.90 | \$0.43 | \$1.33 |
| 14 | \$0.73 | \$0.32 | \$1.05 |
| 15 | \$1.03 | \$0.32 | \$1.34 |
| 16 | \$0.38 | \$0.07 | \$0.31 |

6.4.3 Incremental First Cost

This measure is considered cost-neutral. It does not require any additional equipment and has no increased first cost.

6.4.4 Lifetime Incremental Maintenance Costs

The proposed measure was assumed to have no incremental maintenance or repair costs from standard design, since no additional equipment or controls are necessary compared to existing conditions.

6.4.5 Lifecycle Cost-Effectiveness

This measure proposes both mandatory and prescriptive requirements. As such, a lifecycle cost analysis is required to demonstrate that the measure is cost-effective over the 15-year period of analysis. Since there are savings at no increase in cost, the B/C ratio is infinite and the simple payback is immediate.

Table 47: Lifecycle Cost-effectiveness Summary per Square Foot – Medium Office/Lab

| Climate Zone | Benefits TDV Energy Cost Savings + Other PV Savings ^a (2020 Present Value \$) | Costs Total Incremental PV Costs ^b (2020 Present Value \$) | Benefit-to- Cost Ratio |
|--------------|---|---|---------------------------|
| 1 | \$0.88 | \$0 | infinite |
| 2 | \$1.16 | \$0 | infinite |
| 3 | \$0.96 | \$0 | infinite |
| 4 | \$1.13 | \$0 | infinite |
| 5 | \$0.99 | \$0 | infinite |
| 6 | \$1.19 | \$0 | infinite |
| 7 | \$1.14 | \$0 | infinite |
| 8 | \$1.30 | \$0 | infinite |
| 9 | \$1.25 | \$0 | infinite |
| 10 | \$1.19 | \$0 | infinite |
| 11 | \$1.25 | \$0 | infinite |
| 12 | \$1.21 | \$0 | infinite |
| 13 | \$1.33 | \$0 | infinite |
| 14 | \$1.05 | \$0 | infinite |
| 15 | \$1.34 | \$0 | infinite |
| 16 | \$0.31 | \$0 | infinite |

- a. **Benefits – TDV Energy Cost Savings + Other PV Savings:** Benefits include TDV energy cost savings over the period of analysis (Energy + Environmental Economics 2016, 51-53). Other savings are discounted at a real (nominal – inflation) three percent rate. Other present valued savings include incremental first cost savings if proposed first cost is less than current first cost. Includes present value maintenance cost savings if present value of proposed maintenance costs is less than the present value of current maintenance costs.
- b. **Costs – Total Incremental Present Valued Costs:** Costs include incremental equipment, replacement and maintenance costs over the period of analysis. Costs are discounted at a real (inflation adjusted) three percent rate. Includes incremental first cost if proposed first cost is greater than current first cost. Includes present value of maintenance incremental cost if present value of proposed maintenance costs is greater than the present value of current maintenance costs. If incremental maintenance cost is negative, it is treated as a positive benefit. If there are no total incremental present valued costs, the B/C ratio is infinite.

6.5 First-Year Statewide Impacts

6.5.1 Statewide Energy Savings and Lifecycle Energy Cost Savings

Given data regarding the new construction forecast for 2020, the Statewide CASE Team estimates that the proposed code change will reduce annual statewide electricity use by 0.403 GWh with an associated demand reduction of 0.854 MW. Natural gas use is expected to be decreased by 0.032 million therms. The energy savings for buildings constructed in 2020 are associated with a present-valued energy cost savings of approximately \$1.6 million in (discounted) energy costs over the 15-year period of analysis. Results are presented in Table 48.

Table 48: Statewide Energy and Energy Cost Impacts – New Construction

| Climate Zone | Statewide Construction in 2020 (million ft ²) | First-Year Electricity Savings (GWh) ^a | First-Year Peak Electrical Demand Reduction (MW) | First-Year Natural Gas Savings (million therms) | Lifecycle ^b Present Valued Energy Cost Savings (Present Value \$ million) |
|--------------|---|---|--|---|--|
| 1 | 7.10 x 10 ⁻³ | 1.00 x 10 ⁻³ | 4.00 x 10 ⁻³ | 0 | \$0.01 |
| 2 | 4.10 x 10 ⁻² | 1.00 x 10 ⁻² | 3.00 x 10 ⁻² | 1.00 x 10 ⁻³ | \$0.05 |
| 3 | 1.83 x 10 ⁻¹ | 3.90 x 10 ⁻² | 1.15 x 10 ⁻¹ | 5.00 x 10 ⁻³ | \$0.17 |
| 4 | 9.22 x 10 ⁻² | 2.50 x 10 ⁻² | 5.90 x 10 ⁻² | 2.00 x 10 ⁻³ | \$0.10 |
| 5 | 1.79 x 10 ⁻² | 4.00 x 10 ⁻³ | 1.10 x 10 ⁻² | 1.00 x 10 ⁻³ | \$0.02 |
| 6 | 1.14 x 10 ⁻¹ | 3.40 x 10 ⁻² | 7.40 x 10 ⁻² | 3.00 x 10 ⁻³ | \$0.14 |
| 7 | 9.42 x 10 ⁻² | 2.90 x 10 ⁻² | 6.30 x 10 ⁻² | 2.00 x 10 ⁻³ | \$0.11 |
| 8 | 1.61 x 10 ⁻¹ | 5.20 x 10 ⁻² | 1.18 x 10 ⁻¹ | 3.00 x 10 ⁻³ | \$0.21 |
| 9 | 1.89 x 10 ⁻¹ | 6.10 x 10 ⁻² | 2.40 x 10 ⁻² | 4.00 x 10 ⁻³ | \$0.24 |
| 10 | 1.38 x 10 ⁻¹ | 4.50 x 10 ⁻² | 1.10 x 10 ⁻¹ | 3.00 x 10 ⁻³ | \$0.16 |
| 11 | 3.47 x 10 ⁻² | 1.10 x 10 ⁻² | 2.10 x 10 ⁻² | 1.00 x 10 ⁻³ | \$0.04 |
| 12 | 1.69 x 10 ⁻¹ | 4.90 x 10 ⁻² | 1.44 x 10 ⁻¹ | 5.00 x 10 ⁻³ | \$0.20 |
| 13 | 6.91 x 10 ⁻² | 2.20 x 10 ⁻² | 5.40 x 10 ⁻² | 2.00 x 10 ⁻³ | \$0.09 |
| 14 | 2.44 x 10 ⁻² | 7.00 x 10 ⁻² | 3.00 x 10 ⁻³ | 0 | \$0.03 |
| 15 | 1.84 x 10 ⁻² | 8.00 x 10 ⁻³ | 0 | 0 | \$0.02 |
| 16 | 4.17 x 10 ⁻² | 7.00 x 10 ⁻³ | 2.60 x 10 ⁻² | 0 | \$0.01 |
| TOTAL | 1.39 x 10⁰ | 4.03 x 10⁻¹ | 8.54 x 10⁻¹ | 3.20 x 10⁻² | \$1.60 |

a. First-year savings from all buildings completed statewide in 2020.

b. Energy cost savings from all buildings completed statewide in 2020 accrued during 15-year period of analysis.

6.5.2 Statewide Water Use Impacts

The proposed transfer air for exhaust air makeup requirements will not result in water savings.

6.5.3 Statewide Material Impacts

The proposed air for exhaust air makeup requirements will not result in changes to material use.

6.5.4 Other Non-Energy Impacts

The proposed code change will not result in any other non-energy impacts.

6.6 Proposed Revisions to Code Language

The proposed changes to the Standards, Reference Appendices, and the ACM Reference Manual are provided below. Changes to the 2016 documents are marked with underlining (new language) and ~~strikethroughs~~ (deletions).

6.6.1 Standards

SECTION 140.4 – PRESCRIPTIVE REQUIREMENTS FOR SPACE CONDITIONING SYSTEMS

- (p) Exhaust System Transfer Air. Conditioned supply air delivered to any space with mechanical exhaust shall not exceed the greater of:
- the supply flow required to meet the space heating or cooling load
 - the ventilation rate required by the authority having jurisdiction, the facility Environmental Health and Safety department, or by Section 120.1

- c. the mechanical exhaust flow minus the available transfer air from conditioned spaces or return air plenums on the same floor, not in different smoke or fire compartments, and that at their closest point are within 15 feet of each other. Available transfer air is that portion of total outdoor ventilation air that
 - i. is not required to satisfy other exhaust needs,
 - ii. is not required to maintain pressurization of other spaces, and
 - iii. is transferable according to applicable codes and standards and to the class of air recirculation limitations in the California Mechanical Code.

EXCEPTION 1 to Section 140.4(p): Biosafety level-classified laboratories 3 or higher.

EXCEPTION 2 to Section 140.4(p): Vivarium spaces.

EXCEPTION 3 to Section 140.4(p): Spaces that are required by applicable codes and standards to be maintained at positive pressure relative to adjacent spaces.

EXCEPTION 4 to Section 140.4(p): Spaces where the highest amount of transfer air that could be used for exhaust makeup may exceed the available transfer airflow rate and where the spaces have a required negative pressure relationship.

SECTION 140.9 – PRESCRIPTIVE REQUIREMENTS FOR COVERED PROCESSES

- (d) **Exhaust System Transfer Air.** The exhaust system transfer air requirements in Section 140.4(p) also apply to covered processes.

6.6.2 Reference Appendices

There are no proposed changes to the Reference Appendices, unless otherwise indicated below.

6.6.3 ACM Reference Manual

All exhaust systems and associated makeup air systems shall be explicitly modeled in the proposed case. For example, toilet rooms must be modeled. If a toilet room has a 100 percent makeup from a constant volume VAV box, then that box must be included in the proposed model.

In the baseline model, the same exhaust systems are modeled. Most exhaust rates will track the proposed case exhaust rates, but some exhaust rates are limited in Title 24, Part 6 (e.g., see current Nonresidential ACM for baseline kitchen exhaust sizing). Transfer air for exhaust makeup is modeled in the baseline as follows:

1. The design air handling unit supply flow shall be the larger of (a) sizing based on the coincident peak cooling flow for all zones, or (b) total exhaust rate of all zones served.
2. The hourly minimum outside air for the air handling system shall equal the larger of: (a) total ventilation rate of all zones served by that system, or (b) the total exhaust rate that hour. Note that if the total exhaust flow in a given hour exceeds the total zone supply flow rates, then all zone minimum flow rates are increased proportionally until total zone supply flow rate = total exhaust flow.
3. The design supply airflow to zones with exhaust systems shall be the larger of (a) peak cooling/heating/ventilation flow for that zone, or (b) zone exhaust flow minus sum of all zone ventilation rates plus sum of all other zone exhaust rates.
4. The hourly supply flow to zones with exhaust systems shall be the larger of (a) current cooling/heating/ventilation flow for that zone, or (b) zone exhaust flow minus current air handler outside airflow plus sum of all other zone exhaust rates.

6.6.4 Compliance Manuals

A new section should be added to the Compliance Manual to provide guidance on this measure, similar to Section 10.3.3.2.A on page 10-6 of the 2016 Compliance Manual, which provides guidance on transfer air for kitchen exhaust air makeup. Appendix F of this report can serve as the new Compliance Manual Section F.

The acceptance chapter of the Compliance Manual will not need to be revised.

6.6.5 Compliance Documents

No changes to the compliance documents are required. However, the Energy Commission may wish to add another form similar to “2016-NRCC-PRC-03-E Commercial Kitchens.”

7. DEMAND CONTROLLED VENTILATION FOR CLASSROOMS

7.1 Measure Description

7.1.1 Measure Overview

The proposal is to make a number of modifications to the existing mandatory requirement for demand control ventilation (DCV) for high-density spaces. See Section 7.6 for the proposed language. This measure applies to high-density spaces in most building types covered by Title 24, Part 6 such as offices, schools, universities, assembly spaces, churches, and retail spaces.

Since DCV is a mandatory requirement, no changes to the Nonresidential ACM are required. Some spaces that were not previously covered by DCV, notably classrooms, would now be covered. The code change is modifying the existing language in Section 120.1(c)3 as discussed below.

- **“Modulating outside air control”** is added to Section 120.1(c)3.A to align with ASHRAE 90.1 because this is the feature of the air economizer required for DCV. When DCV was first added to 2005 Title 24, Part 6, the authors did not envision systems with modulating outside air control and envisioned systems without an economizer. Now that systems exist that have both modulation and no economizing they should meet the DCV requirement, because the cost and savings are the same as a system with a nonmodulating air economizer.
- **“Design outdoor airflow rate > 3000 cfm”** is also added to Section 120.1(c)3.A to align with ASHRAE 90.1, because even if the system did not have an airside economizer or modulating outside air control, one or both can be cost-effectively added for a system of this size.

Exception 1 is revised to align Title 24, Part 6 with ASHRAE 90.1. The primary benefit is that classrooms would now be required to use DCV instead of a simple occupancy sensor ventilation control.

7.1.2 Measure History

This measure is being proposed because it will save energy and is cost-effective. It is a modification of the existing DCV requirement, and there are no preemption concerns. The proposal is to modify Title 24, Part 6 DCV language so that it aligns more closely the ASHRAE 90.1 DCV requirement. Since DCV is a mandatory requirement, no changes to the Nonresidential ACM are required.

CO₂ DCV controls have been in use for over 30 years and were added to Title 24, Part 6 twenty-five (25) years ago in the 1992 version as an acceptable means to reduce ventilation in high-density spaces. The 2001 version of Title 24, Part 6 mandated DCV for most high-density spaces, including classrooms. In the 2005 version of Title 24, Part 6 classrooms were removed from the DCV requirement.

ASHRAE 90.1 has included mandatory DCV for classrooms since at least 1999. In the 1999 version of ASHRAE 90.1, DCV was required for densities over 100 people per 1,000 ft². In 2007 DCV was expanded to densities over 40 people/1,000 ft². And with Addendum u to ASHRAE 90.1-2010, it was further expanded to densities over 25 people/1,000 ft².

In the 25 years that CO₂-based DCV has been widely used in nonresidential buildings, there have been numerous improvements in both cost and reliability of CO₂ sensors. A key driver of these improvements are the detailed requirements for accuracy, factory calibration, and failsafe controls for CO₂ sensors that were added to Title 24, Part 6 in 2005 and expanded in 2008.

CO₂-based DCV provide the technology to improve indoor air quality because the DCV system monitors the actual quantity of outside air being delivered to the occupied space and with communications technology can alert the operators and occupants when inadequate ventilation is being

provided. Airside economizers sometimes fail and can fail in the position of not supplying adequate outside air. Without DCV controls, this condition could persist undetected for months or years.

7.1.3 Summary of Proposed Changes to Code Documents

The sections below summarize how each Title 24, Part 6 document will be modified by the proposed change. See Section 7.6 of this report for detailed proposed revisions to code language.

7.1.3.1 Standards Change Summary

This proposal modifies the following sections of the Building Energy Efficiency Standards as shown below. The language will be based on the same language from ASHRAE 90.1-2016.

SECTION 120.1- REQUIREMENTS FOR VENTILATION

Subsection 120.1(e)3 Required Demand Control Ventilation. This section will be modified to not allow exceptions for classrooms and other high-density spaces. In addition, it will not allow spaces below 1,500 ft² to be exempted. Exceptions will be added to include where space exhaust is greater than the design ventilation rate or spaces that have processes that generate dust, fumes, mists, vapors, or gases.

7.1.3.2 Reference Appendices Change Summary

The proposed code change does not modify the Reference Appendices.

7.1.3.3 Alternative Calculation Method (ACM) Reference Manual Change Summary

The baseline model will need to be updated to make sure that classrooms are a mandatory requirement, and that an error is flagged if the proposed model does not include it.

7.1.3.4 Compliance Manual Change Summary

Section 4.3.7 of the Nonresidential ACM Compliance Manual will need to be revised.

The acceptance chapter of the Compliance Manual will not need to be revised.

7.1.3.5 Compliance Documents Change Summary

No changes to the compliance documents are required. The existing document “2016-NRCA-MCH-06-A-DemandControlVentilation” is still valid for the modified DCV requirement.

7.1.4 Regulatory Context

7.1.4.1 Existing Title 24, Part 6 Standards

This measure will expand upon the existing DCV requirements in Section 120.1(c)3 by removing exceptions and altering some existing language.

7.1.4.2 Relationship to Other Title 24, Part 6 Requirements

This measure does not impact any other Title 24, Part 6 requirements nor does it overlap with other Title 24, Part 6 code change proposals for the 2019 cycle.

7.1.4.3 Relationship to State or Federal Laws

No other state or federal laws address the proposed change.

7.1.4.4 Relationship to Industry Standards

This measure is based on Addendum bs to ASHRAE 90.1-2016 and will be aligning with language included in the current ASHRAE 90.1-2016.

7.1.5 Compliance and Enforcement

This code change proposal primarily affects buildings that use the mandatory and prescriptive approaches to compliance. The key steps and changes to the compliance process are summarized below.

- **Design Phase:** Designers will have to be aware of code changes and apply them correctly to their designs. Changes to the compliance documents are not required.
- **Permit Application Phase:** No changes are anticipated to the existing permit application phase process. The requirement is anticipated to be straightforward and just as simple, if not simpler, to enforce than existing DCV requirements.
- **Construction Phase:** No changes are anticipated to the existing permit construction phase process.
- **Inspection Phase:** No changes are required to the inspection process, except for the list of required rooms for DCV.

7.2 Market Analysis

The Statewide CASE Team performed a market analysis with the goals of identifying current technology availability, current product availability, and market trends. The Statewide CASE Team considered how the proposed standard may impact the market in general and individual market actors. The Statewide CASE Team gathered information about the incremental cost of complying with the proposed measure. Estimates of market size and measure applicability were identified through research and outreach with stakeholders including utility program staff, Energy Commission staff, and a wide range of industry players who were invited to participate in utility-sponsored stakeholder meetings held on September 26, 2016, and March 29, 2017.

7.2.1 Market Structure

DCV requires CO₂ sensors. DCV has been used for ventilation controls for over 30 years and has been required in Title 24, Part 6 and ASHRAE 90.1 for over 16 years. Thousands of CO₂ sensors are installed in commercial buildings in California every year.

There are many manufacturers of CO₂ sensors, including AirTest, Telaire, BAPI, Vaisala, and Dwyer. Most of the major building automation system (BAS) manufacturers, such as Automated Logic, Siemens, and Johnson Controls, offer room thermostats that include CO₂ sensors.

The most common types of CO₂ sensors are:

- Non-dispersive infrared sensor with single beam and automatic background calibration (ABC). The ABC periodically self-calibrates using the lowest reading over a period of time, assumed to be ~400 parts per million. ABC is not recommended for buildings that are occupied 24/7, such as airports or emergency response call centers.
- Non-dispersive infrared sensor with single beam with dual wavelength and dual detector technology where a reference channel is used to maintain sensor calibration. With dual detectors, one detector tracks the unfiltered light and the other detects just the band for CO₂. As the infrared light source dims over time, the CO₂ reading is offset by a corresponding value. This type of sensor is recommended for 24/7 occupancies, such as airports and emergency response call centers.
- Non-dispersive infrared sensor with dual beam and single wavelength technology. One of the light sources, or beams, is the primary source and can dim over time. The second light source is pulsed infrequently to slow its aging and is used to calibrate the primary sensor. This type of CO₂ sensor is also appropriate for 24/7 occupancies, such as airports and emergency response call centers.

7.2.2 *Technical Feasibility, Market Availability, and Current Practices*

This measure represents a minor change to the existing DCV requirement. It will increase the number of zones to which DCV will be applied, but not significantly. There are no technical feasibility or market availability issues. There are also no constructability or inspection challenges and no impacts or potential challenges on building/system longevity, occupant comfort, aesthetics, or other tradeoffs.

7.3 Energy Savings

7.3.1 *Key Assumptions for Energy Savings Analysis*

The energy savings analysis for the measure uses energy modeling following the guidance of the 2016 Nonresidential ACM. Energy models are sourced from CBECC-Com prototypical models and are only modified to include the proposed changes to the energy standards and Nonresidential ACM.

This measure incorporates DCV in classrooms, which were previously exempted from this requirement. The only change from the prototype models used was to include DCV in classroom spaces. All other inputs, including schedules and internal gains, stay the same.

7.3.2 *Energy Savings Methodology*

The proposed conditions are defined as the design conditions that comply with the proposed code change. Specifically, the proposed code change includes DCV requirements for classrooms.

The Energy Commission provided guidance on the type of prototype buildings that must be modeled. Nonresidential energy saving estimates are calculated using ASHRAE 90.1 prototypes for nonresidential buildings available in CBECC-Com. The large and small school prototype buildings were used, as these are the only prototype buildings that contain spaces that are affected by the proposed language. No alterations were made to these models beyond adding DCV requirements.

Table 49 presents the details of the prototype buildings used in the analysis.

Table 49: Prototype Buildings Used for Energy, Demand, Cost, and Environmental Impacts Analysis

| Prototype ID | Occupancy Type | Area (ft ²) | Number of Stories | Statewide Area (million ft ²) |
|--------------|----------------|-------------------------|-------------------|---|
| Prototype 1 | Small Schools | 24,413 | 1 | 9.17 |
| Prototype 2 | Large Schools | 210,886 | 2 | 6.12 |

To model savings, the following steps were taken:

- The baseline model enables air terminals serving classroom zones to be controlled for outdoor air. This ensures enough outdoor air is being supplied to the classrooms, as it was not in the prototype.
- In the proposed model, change the space design outdoor airflow rate in classroom spaces from 0.375 cfm/ft² to 0.15 cfm/ft² and 15 cfm/person.
- Enable DCV control on the air systems.

This measure is applied to the small school and large school prototype models across all California climate zones (32 models). The energy savings from this measure varies by climate zone. Energy savings, energy cost savings, and peak demand reductions were calculated using a TDV methodology.

7.3.3 *Per Unit Energy Impacts Results*

7.3.3.1 *Small Schools*

Energy savings and peak demand reductions per unit for new construction and alterations are presented in Table 50. Per square foot savings for the first year are expected to range from 0.05 to 0.73 kWh/ft²-yr

and 0.01 to 0.06 therms/ft²-yr depending upon climate zone. Demand reductions/increases are expected to range between 2.34 x 10⁻⁵ kW/ft² and 2.85 x 10⁻⁴ kW/ft² depending on climate zone. The prototype building saw energy decreases from 1,220 kWh/yr to 17,821 kWh/yr and peak demand reductions of 0.57 kW to 6.95 kW, depending on climate zone.

Table 50: First-Year Energy Impacts per Square Foot – New Construction

| Climate Zone | Electricity Savings (kWh/ft ² -yr) | Peak Electricity Demand Reductions (kW) | Natural Gas Savings (therms/yr) | TDV Energy Savings (TDV kBtu/yr) |
|--------------|---|---|---------------------------------|----------------------------------|
| 1 | 0.08 | 2.34 x 10 ⁻⁵ | 0.06 | 13.20 |
| 2 | 0.23 | 2.89 x 10 ⁻⁴ | 0.04 | 22.35 |
| 3 | 0.08 | 6.64 x 10 ⁻⁵ | 0.03 | 10.13 |
| 4 | 0.22 | 1.39 x 10 ⁻⁴ | 0.03 | 19.90 |
| 5 | 0.08 | 2.88 x 10 ⁻⁵ | 0.04 | 10.01 |
| 6 | 0.12 | 1.20 x 10 ⁻⁴ | 0.01 | 11.07 |
| 7 | 0.05 | 1.72 x 10 ⁻⁴ | 0.01 | 6.53 |
| 8 | 0.23 | 2.70 x 10 ⁻⁴ | 0.01 | 17.22 |
| 9 | 0.33 | 2.08 x 10 ⁻⁴ | 0.02 | 25.52 |
| 10 | 0.36 | 2.77 x 10 ⁻⁴ | 0.02 | 25.97 |
| 11 | 0.43 | 2.04 x 10 ⁻⁴ | 0.03 | 33.04 |
| 12 | 0.35 | 2.32 x 10 ⁻⁴ | 0.03 | 28.19 |
| 13 | 0.44 | 1.50 x 10 ⁻⁴ | 0.03 | 27.67 |
| 14 | 0.44 | 2.85 x 10 ⁻⁴ | 0.03 | 29.60 |
| 15 | 0.73 | 2.43 x 10 ⁻⁴ | 0.01 | 36.30 |
| 16 | 0.16 | 8.03 x 10 ⁻⁵ | 0.06 | 17.43 |

The per unit TDV energy cost savings over the 15-year period of analysis are presented in Table 54. These are presented as the discounted present value of the energy cost savings over the analysis period.

7.3.3.2 Large Schools

Energy savings and peak demand reductions per unit for new construction and alterations are presented in Table 51. Per square foot savings for the first year are expected to range from a high of 0.34 kWh/ft²-yr and 0.06 therms/ft²-yr to a low of negative 0.03 kWh/ft²-yr and 0.01 therms/ft²-yr depending upon climate zone. Demand reductions are expected to range between 1.19 x 10⁻⁴ kW/ft² and 2.52 x 10⁻⁵ kW/ft² depending on climate zone. The prototype building saw 71,701 kWh/yr to 6,326 kWh/yr energy savings and 25 kW to 5 kW peak demand reduction, depending on climate zone.

Table 51: First-Year Energy Impacts per Square Foot – New Construction

| Climate Zone | Electricity Savings (kWh/ft ² -yr) | Peak Electricity Demand Reductions (kW) | Natural Gas Savings (therms/yr) | TDV Energy Savings (TDV kBtu/yr) |
|--------------|---|---|---------------------------------|----------------------------------|
| 1 | 0.07 | 2.85 x 10 ⁻⁵ | 0.06 | 12.95 |
| 2 | 0.13 | 6.33 x 10 ⁻⁵ | 0.04 | 15.24 |
| 3 | 0.06 | 4.52 x 10 ⁻⁵ | 0.03 | 8.46 |
| 4 | 0.12 | 5.53 x 10 ⁻⁵ | 0.03 | 13.07 |
| 5 | 0.06 | 5.42 x 10 ⁻⁵ | 0.04 | 9.55 |
| 6 | 0.07 | 9.38 x 10 ⁻⁵ | 0.02 | 7.43 |
| 7 | 0.03 | 7.35 x 10 ⁻⁵ | 0.01 | 4.16 |
| 8 | 0.12 | 5.38 x 10 ⁻⁵ | 0.01 | 9.14 |
| 9 | 0.16 | 1.19 x 10 ⁻⁴ | 0.02 | 13.01 |
| 10 | 0.16 | 2.78 x 10 ⁻⁵ | 0.02 | 13.34 |
| 11 | 0.22 | 9.24 x 10 ⁻⁵ | 0.03 | 19.58 |
| 12 | 0.18 | 7.44 x 10 ⁻⁵ | 0.03 | 17.31 |
| 13 | 0.23 | 5.48 x 10 ⁻⁵ | 0.03 | 17.57 |
| 14 | 0.23 | 2.52 x 10 ⁻⁵ | 0.03 | 17.39 |
| 15 | 0.34 | 4.99 x 10 ⁻⁵ | 0.01 | 17.43 |
| 16 | 0.10 | 6.08 x 10 ⁻⁵ | 0.05 | 13.94 |

The per unit TDV energy cost savings over the 15-year period of analysis are presented in Table 55. These are presented as the discounted present value of the energy cost savings over the analysis period.

7.4 Lifecycle Cost and Cost-Effectiveness

7.4.1 Energy Cost Savings Methodology

Energy cost savings are calculated using the TDV energy results from the EnergyPlus simulations using the conversion of 0.089 \$/TDV kBtu. The energy costs calculated are 15-year present value savings.

7.4.2 Energy Cost Savings Results

7.4.2.1 Small Schools

Table 52: TDV Energy Cost Savings Over 15-Year Period of Analysis per Square Foot

| Climate Zone | 15-Year TDV Electricity Cost Savings (2020 Present Value \$) | 15-Year TDV Natural Gas Cost Savings (2020 Present Value \$) | Total 15-Year TDV Energy Cost Savings (2020 Present Value \$) |
|--------------|--|--|---|
| 1 | \$0.20 | \$0.97 | \$1.17 |
| 2 | \$1.30 | \$0.68 | \$1.99 |
| 3 | \$0.39 | \$0.51 | \$0.90 |
| 4 | \$1.30 | \$0.47 | \$1.77 |
| 5 | \$0.29 | \$0.60 | \$0.89 |
| 6 | \$0.73 | \$0.25 | \$0.98 |
| 7 | \$0.45 | \$0.13 | \$0.58 |
| 8 | \$1.30 | \$0.23 | \$1.53 |
| 9 | \$1.98 | \$0.29 | \$2.27 |
| 10 | \$1.96 | \$0.35 | \$2.31 |
| 11 | \$2.35 | \$0.59 | \$2.94 |
| 12 | \$1.91 | \$0.60 | \$2.51 |
| 13 | \$1.89 | \$0.57 | \$2.46 |
| 14 | \$2.04 | \$0.59 | \$2.63 |
| 15 | \$3.05 | \$0.18 | \$3.23 |
| 16 | \$0.56 | \$0.99 | \$1.55 |

7.4.2.2 Large Schools

Table 53: TDV Energy Cost Savings Over 15-Year Period of Analysis per Square Foot

| Climate Zone | 15-Year TDV Electricity Cost Savings (2020 Present Value \$) | 15-Year TDV Natural Gas Cost Savings (2020 Present Value \$) | Total 15-Year TDV Energy Cost Savings (2020 Present Value \$) |
|--------------|--|--|---|
| 1 | \$0.18 | \$0.97 | \$1.15 |
| 2 | \$0.64 | \$0.71 | \$1.36 |
| 3 | \$0.22 | \$0.53 | \$0.75 |
| 4 | \$0.66 | \$0.50 | \$1.16 |
| 5 | \$0.19 | \$0.66 | \$0.85 |
| 6 | \$0.37 | \$0.29 | \$0.66 |
| 7 | \$0.21 | \$0.16 | \$0.37 |
| 8 | \$0.56 | \$0.26 | \$0.81 |
| 9 | \$0.83 | \$0.33 | \$1.16 |
| 10 | \$0.81 | \$0.38 | \$1.19 |
| 11 | \$1.14 | \$0.60 | \$1.74 |
| 12 | \$0.93 | \$0.61 | \$1.54 |
| 13 | \$0.98 | \$0.58 | \$1.56 |
| 14 | \$0.95 | \$0.60 | \$1.55 |
| 15 | \$1.35 | \$0.20 | \$1.55 |
| 16 | \$0.33 | \$0.91 | \$1.24 |

7.4.3 Incremental First Cost

Incremental first cost for the proposed measure was determined from manufacturer data and RSMeans. This includes the contractor cost of adding DCV via CO₂ sensors to rooms. The cost increases were based on an average of four contractor quotes. The contractors indicated an incremental cost average of \$260 per room to add CO₂ sensors, or \$0.26/ ft² for a typical 1,000 ft² classroom.

7.4.4 Lifetime Incremental Maintenance Costs

The proposed measure will have no maintenance costs, and replacement rates for CO₂ sensors are typically longer than 15 years. If the sensors must be replaced once during the 15-year period, the measure is still cost-effective in all climate zones.

7.4.5 Lifecycle Cost-Effectiveness

Results per unit lifecycle cost-effectiveness analyses are presented in Table 54 and Table 55 for the small school and large school prototypes, respectively. The proposed measure saves money over the 15-year period of analysis relative to the existing conditions. The proposed code change was found to be cost-effective in every climate zone.

7.4.5.1 Small Schools

Table 54: Lifecycle Cost-Effectiveness Summary per Square Foot – Small Schools New Construction

| Climate Zone | Benefits | Costs | Benefit-to-Cost Ratio |
|--------------|---|---|-----------------------|
| | TDV Energy Cost Savings + Other Present Value Savings ^a (2020 Present Value \$) | Total Incremental Present Value Costs ^b (2020 Present Value \$) | |
| 1 | \$1.17 | \$0.21 | 5.6 |
| 2 | \$1.99 | \$0.21 | 9.5 |
| 3 | \$0.90 | \$0.21 | 4.3 |
| 4 | \$1.77 | \$0.21 | 8.4 |
| 5 | \$0.89 | \$0.21 | 4.2 |
| 6 | \$0.98 | \$0.21 | 4.7 |
| 7 | \$0.58 | \$0.21 | 2.8 |
| 8 | \$1.53 | \$0.21 | 7.3 |
| 9 | \$2.27 | \$0.21 | 10.8 |
| 10 | \$2.31 | \$0.21 | 11.0 |
| 11 | \$2.94 | \$0.21 | 14.0 |
| 12 | \$2.51 | \$0.21 | 11.9 |
| 13 | \$2.46 | \$0.21 | 11.7 |
| 14 | \$2.63 | \$0.21 | 12.5 |
| 15 | \$3.23 | \$0.21 | 15.4 |
| 16 | \$1.55 | \$0.21 | 7.4 |

- a. **Benefits TDV Energy Cost Savings + Other PV Savings:** Benefits include TDV energy cost savings over the period of analysis (Energy + Environmental Economics 2016, 51-53). Other savings are discounted at a real (nominal – inflation) three percent rate. Other present valued savings include incremental first cost savings if proposed first cost is less than current first cost. Includes present value maintenance cost savings if present value of proposed maintenance costs is less than the present value of current maintenance costs.
- b. **Costs Total Incremental Present Valued Costs:** Costs include incremental equipment, replacement and maintenance costs over the period of analysis. Costs are discounted at a real (inflation adjusted) three percent rate. Includes incremental first cost if proposed first cost is greater than current first cost. Includes present value of maintenance incremental cost if present value of proposed maintenance costs is greater than the present value of current maintenance costs. If incremental maintenance cost is negative, it is treated as a positive benefit. If there are no total incremental present valued costs, the B/C ratio is infinite.

7.4.5.2 Large Schools

Table 55: Lifecycle Cost-Effectiveness Summary per Square Foot – Large Schools New Construction

| Climate Zone | Benefits TDV Energy Cost Savings + Other PV Savings ^a (2020 Present Value \$) | Costs Total Incremental PV Costs ^b (2020 Present Value \$) | Benefit-to- Cost Ratio |
|--------------|---|---|---------------------------|
| 1 | \$1.15 | \$0.21 | 5.5 |
| 2 | \$1.36 | \$0.21 | 6.5 |
| 3 | \$0.75 | \$0.21 | 3.6 |
| 4 | \$1.16 | \$0.21 | 5.5 |
| 5 | \$0.85 | \$0.21 | 4.0 |
| 6 | \$0.66 | \$0.21 | 3.1 |
| 7 | \$0.37 | \$0.21 | 1.8 |
| 8 | \$0.81 | \$0.21 | 3.9 |
| 9 | \$1.16 | \$0.21 | 5.5 |
| 10 | \$1.19 | \$0.21 | 5.7 |
| 11 | \$1.74 | \$0.21 | 8.3 |
| 12 | \$1.54 | \$0.21 | 7.3 |
| 13 | \$1.56 | \$0.21 | 7.4 |
| 14 | \$1.55 | \$0.21 | 7.4 |
| 15 | \$1.55 | \$0.21 | 7.4 |
| 16 | \$1.24 | \$0.21 | 5.9 |

- a. **Benefits – TDV Energy Cost Savings + Other PV Savings:** Benefits include TDV energy cost savings over the period of analysis (Energy + Environmental Economics 2016, 51-53). Other savings are discounted at a real (nominal – inflation) three percent rate. Other present valued savings include incremental first cost savings if proposed first cost is less than current first cost. Includes present value maintenance cost savings if present value of proposed maintenance costs is less than the present value of current maintenance costs.
- b. **Costs – Total Incremental Present Valued Costs:** Costs include incremental equipment, replacement and maintenance costs over the period of analysis. Costs are discounted at a real (inflation adjusted) three percent rate. Includes incremental first cost if proposed first cost is greater than current first cost. Includes present value of maintenance incremental cost if present value of proposed maintenance costs is greater than the present value of current maintenance costs. If incremental maintenance cost is negative, it is treated as a positive benefit. If there are no total incremental present valued costs, the B/C ratio is infinite.

7.5 First-Year Statewide Impacts

7.5.1 Statewide Energy Savings and Lifecycle Energy Cost Savings

Given data regarding the new construction forecast for 2020, the Statewide CASE Team estimates that the proposed code change will reduce annual statewide electricity use by 3.38 GWh with an associated demand reduction of 2.17 MW. Natural gas use is expected to be decreased by 0.384 million therms. The energy savings for buildings constructed in 2020 are associated with a present-valued energy cost savings of approximately \$17.4 million in (discounted) energy costs over the 15-year period of analysis. Results are presented in Table 56 and Table 57.

7.5.1.1 Small Schools

Table 56: Statewide Energy and Energy Cost Impacts – New Construction

| Climate Zone | Statewide Construction in 2020 (million ft ²) | First-Year Electricity Savings (GWh) ^a | First-Year Peak Electrical Demand Reduction (MW) | First-Year Natural Gas Savings (million therms) | Lifecycle ^b Present Valued Energy Cost Savings (Present Value \$ million) |
|--------------|---|---|--|---|--|
| 1 | 0.0498 | 0.004 | 0.001 | 0.003 | \$0.06 |
| 2 | 0.2474 | 0.056 | 0.071 | 0.010 | \$0.49 |
| 3 | 0.9078 | 0.073 | 0.060 | 0.027 | \$0.82 |
| 4 | 0.5588 | 0.125 | 0.078 | 0.015 | \$0.99 |
| 5 | 0.1085 | 0.008 | 0.003 | 0.004 | \$0.10 |
| 6 | 0.5999 | 0.069 | 0.072 | 0.009 | \$0.59 |
| 7 | 0.6454 | 0.032 | 0.111 | 0.005 | \$0.38 |
| 8 | 0.8754 | 0.199 | 0.236 | 0.011 | \$1.34 |
| 9 | 0.8878 | 0.293 | 0.185 | 0.015 | \$2.02 |
| 10 | 1.2399 | 0.447 | 0.343 | 0.025 | \$2.87 |
| 11 | 0.3230 | 0.139 | 0.066 | 0.011 | \$0.95 |
| 12 | 1.3180 | 0.459 | 0.306 | 0.045 | \$3.31 |
| 13 | 0.7148 | 0.314 | 0.107 | 0.023 | \$1.76 |
| 14 | 0.2255 | 0.100 | 0.064 | 0.007 | \$0.59 |
| 15 | 0.2278 | 0.166 | 0.055 | 0.002 | \$0.74 |
| 16 | 0.2433 | 0.039 | 0.020 | 0.014 | \$0.38 |
| TOTAL | 9.1729 | 2.525 | 1.779 | 0.226 | \$17.37 |

a. First-year savings from all buildings completed statewide in 2020.

b. Energy cost savings from all buildings completed statewide in 2020 accrued during 15-year period of analysis.

7.5.1.2 Large Schools

Table 57: Statewide Energy and Energy Cost Impacts – Large Schools New Construction

| Climate Zone | Statewide Construction in 2020 (million ft ²) | First-Year Electricity Savings ^a (GWh) | First-Year Peak Electrical Demand Reduction (MW) | First-Year Natural Gas Savings (million therms) | Lifecycle ^b Present Valued Energy Cost Savings (Present Value \$ million) |
|--------------|---|---|--|---|--|
| 1 | 0.0332 | 0.002 | 0.001 | 0.002 | \$0.04 |
| 2 | 0.1649 | 0.021 | 0.010 | 0.007 | \$0.22 |
| 3 | 0.6052 | 0.034 | 0.027 | 0.019 | \$0.46 |
| 4 | 0.3725 | 0.043 | 0.021 | 0.011 | \$0.43 |
| 5 | 0.0723 | 0.004 | 0.004 | 0.003 | \$0.06 |
| 6 | 0.3999 | 0.029 | 0.037 | 0.007 | \$0.26 |
| 7 | 0.4302 | 0.014 | 0.032 | 0.004 | \$0.16 |
| 8 | 0.5836 | 0.068 | 0.031 | 0.009 | \$0.47 |
| 9 | 0.5918 | 0.096 | 0.070 | 0.011 | \$0.69 |
| 10 | 0.8266 | 0.135 | 0.023 | 0.018 | \$0.98 |
| 11 | 0.2153 | 0.048 | 0.020 | 0.007 | \$0.38 |
| 12 | 0.8786 | 0.154 | 0.065 | 0.031 | \$1.35 |
| 13 | 0.4765 | 0.108 | 0.026 | 0.016 | \$0.74 |
| 14 | 0.1504 | 0.034 | 0.004 | 0.005 | \$0.23 |
| 15 | 0.1519 | 0.051 | 0.008 | 0.002 | \$0.24 |
| 16 | 0.1622 | 0.017 | 0.010 | 0.009 | \$0.20 |
| TOTAL | 6.1153 | 0.859 | 0.390 | 0.158 | \$6.92 |

a. First-year savings from all buildings completed statewide in 2020.

b. Energy cost savings from all buildings completed statewide in 2020 accrued during 15-year period of analysis.

7.5.2 Statewide Water Use Impacts

The proposed DCV requirements will not result in water savings.

7.5.3 Statewide Material Impacts

The proposed DCV requirements will not result in changes to material use.

7.5.4 Other Non-Energy Impacts

The proposed code change will not result in any other non-energy impacts.

7.6 Proposed Revisions to Code Language

The proposed changes to the Standards, Reference Appendices, and the ACM Reference Manual are provided below. Changes to the 2016 documents are marked with underlining (new language) and ~~strikethroughs~~ (deletions).

7.6.1 Standards

SECTION 120.1- REQUIREMENTS FOR VENTILATION 120.1(c)3

~~3. Required Demand Control Ventilation. HVAC systems with the following characteristics shall have demand ventilation controls complying with 120.1(c)4:~~

~~A. They have an air economizer; and~~

~~B. They serve a space with a design occupant density, or a maximum occupant load factor for egress purposes in the CBC, greater than or equal to 25 people per 1000 square feet (40~~

square feet or less per person); and

C. They are either:

i. Single zone systems with any controls; or

ii. Multiple zone systems with Direct Digital Controls (DDC) to the zone level.

3. **Required Demand Control Ventilation.** Demand ventilation controls complying with 120.1(c)4 are required for a space with a design occupant density, or a maximum occupant load factor for egress purposes in the CBC, greater than or equal to 25 people per 1000 square feet (40 square feet or less per person) if the system serving the space has one or more of the following:

A. an air economizer

B. modulating outside air control

design outdoor airflow rate > 3000 cfm

EXCEPTION 1 to Section 120.1(c)3: ~~Classrooms, call centers, office spaces served by multiple zone systems that are continuously occupied during normal business hours with occupant density greater than 25 people per 1000 ft² as specified by Section 120.1(b)2B, Healthcare facilities and medical buildings, and public areas of social services buildings are not required to have demand control ventilation.~~

EXCEPTION 2 to Section 120.1(c)3: Spaces with one of the following occupancy categories as defined in the California Mechanical Code: correctional cells, daycare sickrooms, science labs, barber shops, beauty and nail salons, and bowling alley seating shall not install demand control ventilation.

EXCEPTION 2-3 to Section 120.1(c)3: Where space exhaust is greater than the design ventilation rate specified in Section 120.1(b)2B minus 0.2 cfm per ft² of conditioned area.

EXCEPTION 3 4 to Section 120.1(c)3: Spaces that have processes or operations that generate dusts, fumes, mists, vapors, or gases and are not provided with local exhaust ventilation, such as indoor operation of internal combustion engines or areas designated for unvented food service preparation, or beauty salons shall not install demand control ventilation.

EXCEPTION 4 5 to Section 120.1(c)3: Spaces with an area of less than 150 square feet, or a design occupancy of less than 10 people as specified by Section 120.1(b)2B.

EXCEPTION 5 to Section 120.1(c)3: ~~Spaces with an area of less than 1,500 square feet complying with Section 120.1(e)5.~~

7.6.2 Reference Appendices

There are no proposed changes to the Reference Appendices, unless otherwise indicated below.

7.6.3 ACM Reference Manual

The Nonresidential ACM must be updated to ensure that the baseline model includes DCV for classrooms, and that the ruleset indicates this is a mandatory requirement. An error should be flagged if the proposed model does not also include it.

7.6.4 Compliance Manuals

Section 4.3.7 of the Nonresidential Compliance Manual will need to be revised.

The acceptance chapter of the Compliance Manual will not need to be revised.

7.6.5 Compliance Documents

No changes to the compliance documents are required. The existing document “2016-NRCA-MCH-06-A-DemandControlVentilation” is still valid for the modified DCV requirement.

8. OCCUPANT SENSOR VENTILATION CONTROL REQUIREMENTS

8.1 Measure Description

8.1.1 Measure Overview

The proposed measure is a modification of the existing mandatory occupant sensor ventilation control requirements in Title 24, Part 6. Existing requirements call for maintaining 25 percent of the occupied minimum ventilation rate when the zones are unoccupied. The proposal is to completely shut off ventilation if the covered space is unoccupied and the heating/cooling setpoints are satisfied, except for the required one-hour purge cycle prior to regularly scheduled occupancy.

The proposed measure also modifies the zones to which occupant sensor ventilation control requirements apply. The existing requirement applies to multipurpose rooms less than 1,000 square feet; classrooms greater than 750 square feet; and conference, convention, auditorium, and meeting center rooms greater than 750 square feet. Specifically, the proposed measure will apply to:

- enclosed offices less than or equal to 250 square feet
- conference rooms
- multipurpose/assembly rooms less than or equal to 1,000 square feet
- corridors
- classrooms of all sizes
- hotel guestrooms

The proposed measure does not apply to:

- enclosed offices greater than 250 square feet
- open plan offices
- office copy/print rooms
- break rooms
- multipurpose/assembly rooms greater than 1,000 square feet
- computer rooms
- penitentiary
- laboratories
- food and beverage (kitchens, dining rooms, etc.)
- gambling
- sports arenas
- healthcare
- museums
- courtrooms
- religious worship
- auditorium

Table 58: Summary of Existing and Proposed Space Types under Requirements

| Existing Spaces Covered by Requirement | Proposed Spaces Covered by Requirement |
|--|---|
| Multipurpose < 1,000 ft ² | Multipurpose/assembly < 1,000 ft ² |
| Classrooms > 750 ft ² | Classrooms of any size |
| Convention/auditorium/meeting > 750 ft ² | Conference |
| Hotel Guest rooms (card key control or occupancy sensor) | Corridor |
| | Enclosed offices < 250 ft ² |
| | Hotel guestrooms |

Though ASHRAE 62.1 does not allow occupied standby for K-12 classrooms, this proposal would continue to allow ventilation air to be shut-off during occupied standby for the following reasons:

- Occupancy sensor shut-off controls have been allowed since the 2013 version of the Title 24, Part 6 building efficiency standards without reports of widespread problems
- Classrooms are often designed with hard surfaces, and without carpeting having less potential for outgassing than other space types
- For classrooms where space generated pollutants are anticipated such as laboratory classrooms, "Spaces containing processes or operations that generate dusts, fumes, vapors or gasses" are exempted from occupied standby.

While the proposed change is a mandatory requirement, the Nonresidential ACM should be modified to allow occupied standby in the proposed model in spaces where it is allowed by ASHRAE 62.1, but not mandated by Title 24, Part 6. These spaces include:

- enclosed offices greater than 250 square feet
- open plan offices
- multipurpose/assembly rooms greater than 1,000 square feet
- museums
- courtrooms
- religious worship
- auditorium
- supermarkets
- sports arena spectator areas

To model occupied standby, the occupancy profile must have at least 10 percent of the occupied hours with zero occupancy. If the proposed model includes occupied standby ventilation controls in any of these optional spaces, then setpoints are set back and ventilation is shut off in the proposed model when they are unoccupied. In the baseline model, setpoints and ventilation remain unchanged when unoccupied.

This proposal only modifies an existing requirement and does not propose brand new requirements or provide requirements for systems or equipment that were not previously regulated.

The code change is modifying the existing language in Sections 120.1(c)5 and 120.2(e)3. These changes are listed in Section 8.6.1. Rationale for each of these changes is discussed below.

- **120.1(c)5.** Most of these requirements are incorporated into the revised 120.2(e)3.
- **Exception to 120.1(c)5** is deleted because occupied standby control saves energy and is cost-effective when DCV is used. If a conference room is unoccupied, for example, DCV does not reduce the ventilation rate below the area based minimum (e.g., 0.15 cfm/ft²); however, if this conference room also has occupied standby controls, then ventilation can be set to zero when

the room is unoccupied and energy is saved. The cost to add occupied standby to a zone with DCV is low because the zone already has an occupancy sensor and the ability to modulate the ventilation. Thus, occupied standby is highly cost-effective in DCV zones even if the zone is only unoccupied ten percent of the time.

- **EXCEPTION 1 to Sections 120.2(e)3** is deleted because it is unnecessary. The authority having jurisdiction (AHJ) already has this authority, and the spaces in question have already been determined by ASHRAE 62.1 to not require continuous ventilation when unoccupied.
- **EXCEPTION 2 to Sections 120.2(e)3**, which provides exceptions for situations when setback doesn't decrease energy, is deleted because occupant setback cannot increase energy use and should always decrease energy use for the spaces in question.
- **EXCEPTION 3 to Sections 120.2(e)3** is deleted because automatic control will have greater savings and provide better air quality because it automatically provides ventilation when occupied.
- **EXCEPTION 5 to Sections 120.2(e)3** is deleted because occupied standby control still saves energy and is cost-effective when DCV is also used, as described above.

Other exceptions that were added to 2008 Title 24, Part 6 Standards and that are removed by this measure include:

- **“Office spaces served by multiple zone systems that are continuously occupied during normal business hours with occupant density greater than 25 people per 1000 sf as specified by Section 120.1(b)2B”** – This exception is removed because high-density office spaces are rarely if ever continuously occupied at the design occupant density. A conference room, for example, will not be packed every day from 6 a.m. until 7 p.m., on every day of the year, for the life of the building. This exception also makes the standard much more difficult to enforce. An AHJ cannot be expected to determine if a particular high-density office space meets this exception.
- **New exceptions** – New exceptions are added for correctional cells, daycare sickrooms, science labs, barber shops, beauty and nail salons, and bowling alley seating. These exceptions are added for consistency with ASHRAE 90.1; because these occupancies are well defined, relatively rare, and most of them have relatively high area-based ventilation requirements, relatively high ventilation rates are still needed even if few occupants are present, which makes DCV of marginal benefit.
- **Exception 5** is deleted because CO₂ controls are still cost-effective even if the room also has occupancy sensor ventilation controls. If the room only has an occupancy sensor, then maximum ventilation is provided any time the room is occupied, even if there are only a couple people in a large room. High-density spaces are often partially occupied. The cost of CO₂ controls has come down dramatically in the last 20 years, so even if the average occupancy is 80 percent, DCV is still cost-effective.

8.1.2 Measure History

This measure is being proposed because it will save energy and is cost-effective. It is a modification of the existing occupant sensor ventilation control requirement in Title 24, Part 6 that was added in 2013, and there are no preemption concerns.

The current occupant sensor ventilation control requirement was originally intended to require full shutoff when certain zones are unoccupied. At the time, the ASHRAE Standard 62.1 committee was working on an addendum to allow certain spaces to go to zero ventilation. Unfortunately, the 62.1 change did not get passed before 2013 Title 24, Part 6 had to be completed, so the 2013 Title 24, Part 6 requirement had to be scaled back to require the area-based ventilation component to be provided even when a space was unoccupied. This change made it expensive and more difficult to implement. ASHRAE Standard 62.1-2016 now allows “occupied standby mode” for selected spaces, i.e., going to

zero ventilation when unoccupied is now explicitly allowed by the ventilation codes. This proposal takes advantage of the new 62.1 language to allow zero ventilation, thereby simplifying and reducing the cost of the Title 24, Part 6 occupant sensor ventilation control requirement.

This proposal retains the same 2°F setback and setup changes in setback during the occupied standby mode period as has been the case in Section 120.2(e)3 since the 2013 Title 24, Part 6 Standards. The primary energy impact of the setback in vacant spaces during normally occupied periods is to assure that the space is "floating" in the deadband zone between heating and cooling so airflow to the space is shut off, which reduces both ventilation loads and fan energy. To fully realize these savings in buildings with multi-zone ventilation systems, the outside air damper must reduce outside air flow rates in response to a zone entering occupied-standby mode. The reduction in space temperature by several degrees has a some impact on conduction and infiltration losses and is accounted for in the simulation.

The use of the existing 2°F setup and setback temperatures is to assure that the space can "float" as long as possible in the deadband between heating and cooling setpoints where no air is supplied to the room. When the space is vacant and there is a call for heating or cooling, air is delivered to the room with associated ventilation loads and fan energy. The 2°F setup and setback was selected during the 2013 Title 24 code revisions as a balance between energy savings and comfort. The rationale is detailed in Light Commercial Unitary HVAC CASE Report from the 2013 code cycle and is summarized below. (Statewide Utility Codes and Standards Team 2011)

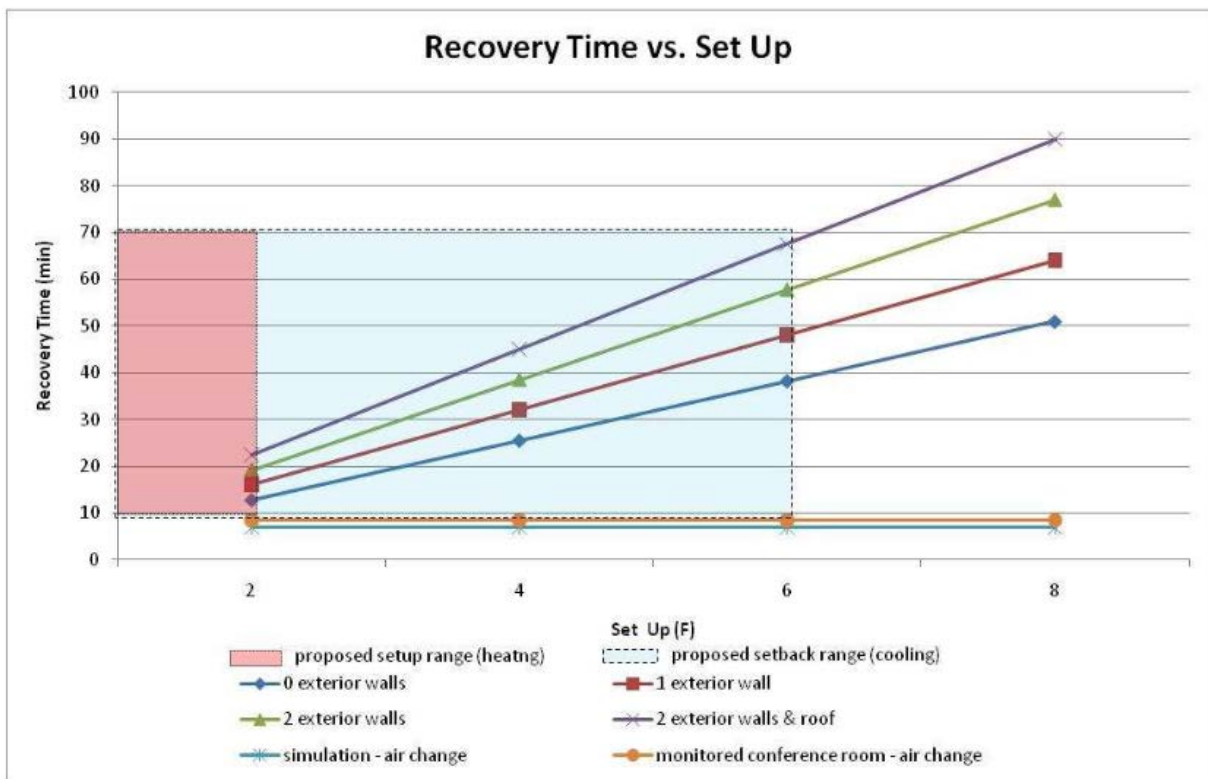

Figure 11: Temperature cooling setup and recovery time per zone type

Measurements were taken for two spaces: an interior zone and an exterior zone. A calibrated calculation was conducted to evaluate the recovery times for various set up and setback temperatures. The recovery times ranged from 13 to 23 minutes for a 2°F setup temperature. Figure 11 presents a plot from the CASE Report of recovery times versus temperature setup for various room configurations. The highest graph line is the worst-case scenario, a room with two exterior walls and a roof, with full recovery

taking 23 minutes. The lowest line represents the best-case scenario, an interior zone, and the recovery time is about 10 minutes.

This CASE Report from the 2013 code cycle also found that a 2°F set up and setback were well within comfort guidelines. The figure below illustrates the comfort conditions for systems with a 70°F heating setpoint and a 74°F cooling setpoint with 2 degree offsets for setup and setback. One can see that if one developed setpoints for the center of the comfort trapezoids, the 2°F setpoint would not result in one exceeding the comfort criteria during setup of setback. In this example one can wear winter clothes and still be comfortable during the cooling season. Operative temperature includes radiant temperature effects and setpoints would likely be adjusted slightly to account for this. The key take-away from Figure 12 is that a 2°F offset is not a huge swing in temperature or comfort.

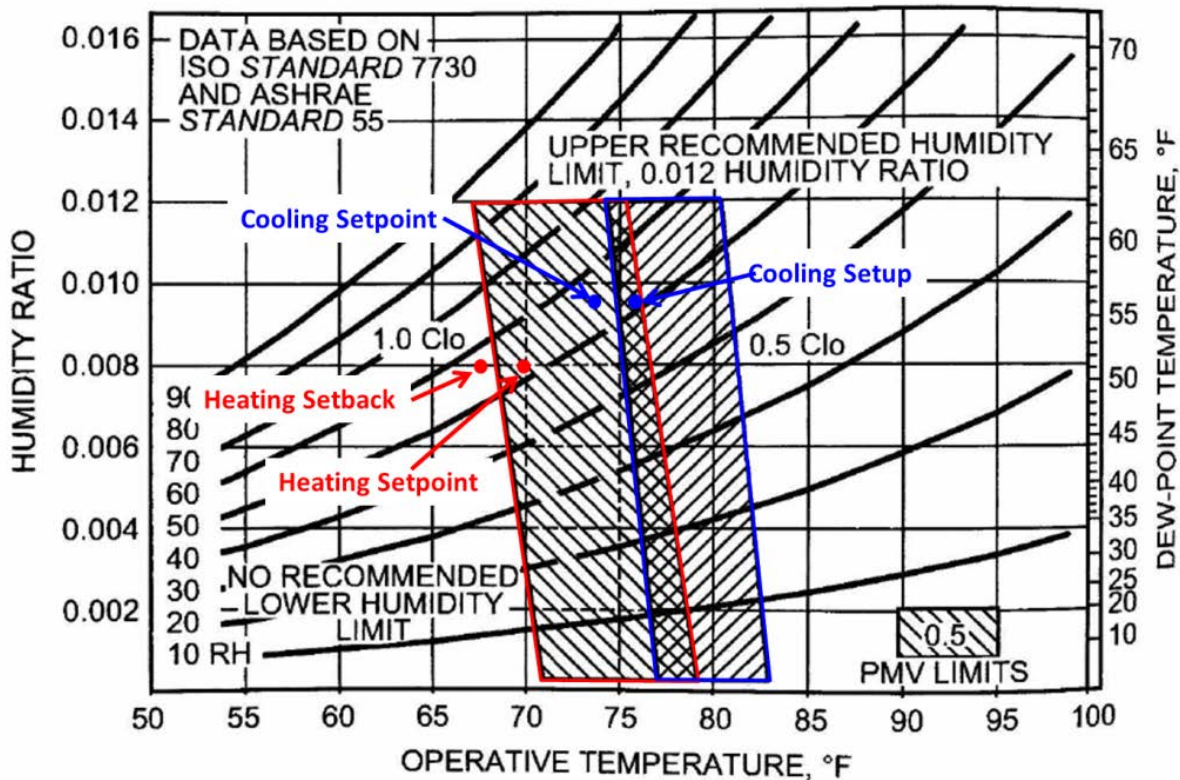

Figure 12: ASHRAE summer and winter comfort zones⁹ with sample setpoints and 2°F setup and setback

Proportional–integral–derivative (PID) controls for VAV or water based systems can define very tight setpoints for control as they essentially have infinite steps of capacity. However, for Direct Expansion (DX) systems with one or two stages, the throttling range is wider as there is an interaction between temperature control and number of minutes between compressor starts. In addition, for those few times that the controlled zone is in heating mode, turning lights off and vacating the zone of occupants could result in dropping zone temperatures. In these situations, the 2°F setback allows some time for the space temperatures to drop but the system remains in floating in the deadband between calls for heating or

⁹ Superimposed on Figure 5 "ASHRAE Summer and Winter Comfort Zones." p. 9.12. 2013 ASHRAE Handbook of Fundamentals.

cooling. During this period with no calls for heating and cooling, ventilation is shut off to the zone and fan energy is reduced or shut-off.

Multi-zone VAV systems are controlled differently than single zone systems, and larger setbacks can create problems that will waste energy. The reason VAV systems do not work as well with the larger setbacks is the supply air temperature and duct pressure setpoint can be altered whenever an unoccupied zone becomes occupied. If that zone has floated into its setback, but suddenly becomes occupied, it is now near 2°F from setpoint. The main system may reduce the supply air temperature setpoint to provide full cooling until the zone reaches the thermostat setpoint again, which reduces economizing hours for the duration, and increases fan power. For this reason, along with typically tighter setpoint control common in VAV systems, this code change proposal allows multi-zone VAV systems to have smaller setbacks, down to 0.5°F.

The proposal is similar to a proposal that ASHRAE 90.1 approved for publication and public review at the January 2017 ASHRAE meeting in Las Vegas, Nevada.

8.1.3 Summary of Proposed Changes to Code Documents

The sections below summarize how each Title 24, Part 6 document will be modified by the proposed change. See Section 8.6 of this report for detailed proposed revisions to code language.

8.1.3.1 Standards Change Summary

This proposal modifies the following sections of the Building Energy Efficiency Standards as shown below. The language will be based on the same language from ASHRAE 90.1-2016.

SECTION 120.2 – REQUIRED CONTROLS FOR SPACE-CONDITIONING SYSTEMS

Subsection 120.2(e)3 Occupancy Sensing HVAC Zone Controls. This section will be modified to require that ventilation air be reduced to zero when the space is in occupied standby mode. Also, the list of spaces where this is required will be expanded, including spaces where rooms are required to have occupant sensing lighting controls and the ASHRAE 62.1 occupancy category permits the air to be reduced to zero.

8.1.3.2 Reference Appendices Change Summary

The Nonresidential Reference Appendices will be updated to add a new acceptance test procedure.

8.1.3.3 Alternative Calculation Method (ACM) Reference Manual Change Summary

The Nonresidential ACM will need to be updated to ensure the modeling requirements of this measure are captured in the baseline model and that simulation rule sets are developed for allowing other ASHRAE qualified spaces to install occupancy sensing HVAC controls in the proposed building model and claim energy savings compliance credit for controlling these spaces when they are vacant during times that are scheduled as normally occupied.

8.1.3.4 Compliance Manual Change Summary

Section 4.3.8 of the Nonresidential Compliance Manual will need to be revised to account for the changes in coverage and for the fact that ventilation is now required to be shut off rather than set to 25 percent of the occupied ventilation rate.

8.1.3.5 Compliance Documents Change Summary

The Statewide CASE Team is not aware of an existing compliance document for the existing occupant sensor ventilation controls requirement. The Energy Commission will need to add another acceptance test similar to “2016-NRCA-LTI-02-A-LightingControl” and “2016-NRCA-MCH-06-A-DemandControlVentilation” for occupant sensor ventilation controls. An example is shown in section 8.6.5.

8.1.4 Regulatory Context

8.1.4.1 Existing Title 24, Part 6 Standards

Occupant sensor ventilation is currently regulated by Title 24, Part 6 Sections 120.1(c)5 and 120.2(e)3. This measure would expand on those requirements.

8.1.4.2 Relationship to Other Title 24, Part 6 Requirements

This measure does not impact any other Title 24, Part 6 requirements nor does it overlap with other Title 24, Part 6 code change proposals for the 2019 cycle.

8.1.4.3 Relationship to State or Federal Laws

There are no other state or federal laws that address the proposed change.

8.1.4.4 Relationship to Industry Standards

This measure is based on a recently voted addendum to ASHRAE 90.1-2016, which was approved for publication and public review at the January 2017 ASHRAE Winter Conference meeting in Las Vegas, Nevada.

8.1.5 Compliance and Enforcement

This code change proposal primarily affects buildings that use the mandatory and prescriptive approaches to compliance. The key steps and changes to the compliance process are summarized below.

- **Design Phase:** Designers will have to be aware of code changes and apply them correctly to their designs. Changes to the compliance documents are not required.
- **Permit Application Phase:** No changes are anticipated to the existing permit application phase process. The requirement is anticipated to be straightforward and just as simple, if not simpler, to enforce than existing occupant sensor ventilation requirements.
- **Construction Phase:** No changes are anticipated to the existing permit construction phase process.
- **Inspection Phase:** No changes are required to the inspection application phase process. However, the Energy Commission will need to add an acceptance test for occupied standby controls, as described in Section 8.6.5, and included in Appendix G.

8.2 Market Analysis

The Statewide CASE Team performed a market analysis with the goals of identifying current technology availability, current product availability, and market trends. The Statewide CASE Team considered how the proposed standard may impact the market in general and individual market actors. The Statewide CASE Team gathered information about the incremental cost of complying with the proposed measure. Estimates of market size and measure applicability were identified through research and outreach with stakeholders including utility program staff, Energy Commission staff, and a wide range of industry players who were invited to participate in utility-sponsored stakeholder meetings held on September 26, 2016, and March 29, 2017.

8.2.1 Market Structure

Occupied standby controls require an occupancy sensor that can communicate with the thermostat or BAS. Using the existing occupancy sensor(s) required for lighting control is less expensive than adding additional sensors, but there can still be some cost for communicating the occupancy status from the occupancy sensors to the HVAC controls. Many lighting control systems are addressable smart systems.

These systems have BACnet¹⁰ interfaces, so communicating the occupancy status to the BAS controls is practically free. According to a couple occupancy sensor manufacturers on the ASHRAE 90.1 Lighting Subcommittee, many of the basic occupancy sensors (nonaddressable smart systems) already have dry contacts that the HVAC can connect to. If the dry contacts are not standard, the cost to add them is only about \$10. These dry contacts can then be wired as inputs to the BAS zone controller (for multiple zone direct digital control systems) or to the thermostat (for single zone and non-direct digital control systems).

The CASE Report for Light Commercial Unitary HVAC from the 2013 code cycle, which included the occupancy sensor ventilation controls measure, identified at least four major thermostat manufacturers that offer a multistage thermostats with occupancy sensor input; they include Honeywell, Virconics, Jenesys, and Venstar. Other manufacturers of single-zone thermostats with occupancy sensor input now include Robertshaw, Siemens, Kele, and RCI Automation.

8.2.2 *Technical Feasibility, Market Availability, and Current Practices*

The occupied standby measure is a minor change to the existing occupant sensor ventilation controls requirement. It will increase the number of zones to which occupant sensor ventilation controls will be applied. There are no technical feasibility or market availability issues. There are also no constructability or inspection challenges and no impacts or potential challenges on building/system longevity, occupant comfort, aesthetics, or other tradeoffs.

8.3 Energy Savings

8.3.1 *Key Assumptions for Energy Savings Analysis*

The energy savings analysis for the measure uses energy modeling following the guidance of the 2016 Nonresidential ACM. Energy models are sourced from CBECC-Com prototypical models and are modified to include the proposed changes to the energy standards and Nonresidential ACM.

Because this measure is entirely dependent on operation schedules, there is a large deviation in what the results will be in different settings. This measure reduces ventilation air to zero when a space that is covered is unoccupied during regularly occupied hours. Space types affected include:

- enclosed offices less than 250 square feet – 75 percent unoccupied
- conference rooms – 75 percent unoccupied
- multipurpose/assembly rooms less than 1,000 square feet – 70 percent unoccupied
- corridors – 50 percent unoccupied
- lobbies – 75 percent unoccupied
- lecture classrooms – 70 percent unoccupied
- hotel guestrooms – unoccupied during 50 percent of rented hours

8.3.2 *Energy Savings Methodology*

The proposed code change increases the number of spaces that are required to have occupant sensor ventilation controls. To properly estimate the savings for this measure, the schedules in the prototype models were altered to estimate the amount of time that certain rooms are unoccupied, and therefore, when the ventilation air can be shut off (to zero). See the schedules in Figure 13 and Figure 16.

The Energy Commission provided guidance on the type of prototype buildings that must be modeled. Nonresidential energy saving estimates are calculated using ASHRAE 90.1 prototypes for

¹⁰ For more information, see <https://en.wikipedia.org/wiki/BACnet>.

nonresidential buildings available in CBECC-Com. The small office prototype model was used to model savings for this measure.

Table 59 presents the details of the prototype building used in the analysis.

Table 59: Prototype Buildings Used for Energy, Demand, Cost, and Environmental Impacts Analysis

| Prototype ID | Occupancy Type | Area (ft ²) | Number of Stories | Statewide Area (million ft ²) |
|--------------|----------------|-------------------------|-------------------|---|
| Prototype 1 | Small Office | 5,502 | 1 | 0.384 |

The default small office prototype model consisted of five open office zones, so the prototype was adjusted to include closed office and conference spaces as shown in Table 60.

Table 60: Small Office Prototype Space Type Adjustments

| Space | Space Type | Thermal Zone | Percent of Floor Area | Floor Area (ft ²) |
|----------------|---------------|-----------------------------|-----------------------|-------------------------------|
| Attic | no space type | Attic Thermal Zone | | 6,114 |
| Core_ZN | OpenOffice | Core_ZN Thermal Zone | 29% | 1,611 |
| Perimeter_ZN_1 | Conference | Perimeter_ZN_1 Thermal Zone | 5% | 275 |
| Perimeter_ZN_2 | ClosedOffice | Perimeter_ZN_2 Thermal Zone | 18% | 994 |
| Perimeter_ZN_3 | ClosedOffice | Perimeter_ZN_3 Thermal Zone | 17% | 952 |
| Perimeter_ZN_4 | ClosedOffice | Perimeter_ZN_4 Thermal Zone | 18% | 994 |
| Perimeter_ZN_5 | ClosedOffice | Perimeter_ZN_5 Thermal Zone | 7% | 362 |
| Perimeter_ZN_6 | OpenOffice | Perimeter_ZN_6 Thermal Zone | 6% | 315 |

To model the expected savings from this measure, new occupancy schedules were included in the model as shown in Figure 13. This required software script modifications of the simulation schedules in the prototype models to approximate savings. The baseline prototype for this measure during occupied standby mode sets back ventilation rates to 25 percent of normal operation, modeled as turning on the HVAC system serving the zone for 15 minutes out of every occupied-standby hour during HVAC operational hours. The proposed model turned completely off ventilation for the full hour. Note that in both baseline and proposed cases, the total outside air rates in the building were reduced based on the zones entering occupied standby mode.

The energy savings from this measure varies by climate zone. As a result, the energy impacts and cost-effectiveness were evaluated by climate zone. Energy savings, energy cost savings, and peak demand reductions were calculated using a TDV methodology.

8.3.3 Per Unit Energy Impacts Results

Energy savings and peak demand reductions per unit for new construction are presented in Table 61. There are now savings from alterations. Per square foot savings for the first year are expected to range from a high of 0.27 kWh/ft²-yr and 9.1 x 10⁻³ therms/ft²-yr to a low of 0.15 kWh/ft²-yr and 1.1 x 10⁻³ therms/ft²-yr depending upon climate zone. Demand reductions/increases are expected to range between 2.05 x 10⁻⁴ kW/ft² and negative 1.88 x 10⁻⁵ kW/ft² depending on climate zone. These are minor but included for completeness.

Table 61: First-Year Energy Impacts per Square Foot – New Construction

| Climate Zone | Electricity Savings (kWh/ft ² -yr) | Peak Electricity Demand Reductions (kW) | Natural Gas Savings (therms/ft ² -yr) | TDV Energy Savings (TDV kBtu/yr) |
|--------------|---|---|--|----------------------------------|
| 1 | 0.15 | 1.09 x 10 ⁻⁴ | 7.91 x 10 ⁻³ | 5.68 |
| 2 | 0.18 | 3.88 x 10 ⁻⁵ | 5.50 x 10 ⁻³ | 6.77 |
| 3 | 0.17 | 7.12 x 10 ⁻⁵ | 4.34 x 10 ⁻³ | 5.48 |
| 4 | 0.18 | 6.35 x 10 ⁻⁵ | 4.00 x 10 ⁻³ | 6.27 |
| 5 | 0.17 | 1.39 x 10 ⁻⁴ | 4.76 x 10 ⁻³ | 5.50 |
| 6 | 0.18 | 2.05 x 10 ⁻⁴ | 2.03 x 10 ⁻³ | 5.37 |
| 7 | 0.18 | 2.84 x 10 ⁻⁷ | 1.15 x 10 ⁻³ | 5.08 |
| 8 | 0.19 | -1.88 x 10 ⁻⁵ | 1.81 x 10 ⁻³ | 5.56 |
| 9 | 0.20 | -1.28 x 10 ⁻⁵ | 2.31 x 10 ⁻³ | 5.63 |
| 10 | 0.20 | -2.13 x 10 ⁻⁶ | 2.60 x 10 ⁻³ | 5.80 |
| 11 | 0.21 | 1.64 x 10 ⁻⁵ | 5.01 x 10 ⁻³ | 9.13 |
| 12 | 0.19 | 7.23 x 10 ⁻⁵ | 4.81 x 10 ⁻³ | 8.57 |
| 13 | 0.21 | 5.94 x 10 ⁻⁵ | 4.39 x 10 ⁻³ | 9.31 |
| 14 | 0.21 | 2.34 x 10 ⁻⁵ | 5.00 x 10 ⁻³ | 7.84 |
| 15 | 0.27 | 2.26 x 10 ⁻⁵ | 1.10 x 10 ⁻³ | 8.85 |
| 16 | 0.18 | 4.02 x 10 ⁻⁵ | 9.10 x 10 ⁻³ | 7.33 |

The per unit TDV energy cost savings over the 15-year period of analysis are presented in Table 62. These are presented as the discounted present value of the energy cost savings over the analysis period.

8.4 Lifecycle Cost and Cost-Effectiveness

8.4.1 Energy Cost Savings Methodology

Energy cost savings are calculated using the TDV energy results from the EnergyPlus simulations using the conversion of 0.089 \$/TDV kBtu. The energy costs calculated are 15-year present value savings.

8.4.2 Energy Cost Savings Results

Table 62: TDV Energy Cost Savings Over 15-Year Period of Analysis per Square Foot

| Climate Zone | 15-Year TDV Electricity Cost Savings (2020 Present Value \$) | 15-Year TDV Natural Gas Cost Savings (2020 Present Value \$) | Total 15-Year TDV Energy Cost Savings (2020 Present Value \$) |
|--------------|--|--|---|
| 1 | \$0.37 | \$0.13 | \$0.51 |
| 2 | \$0.51 | \$0.10 | \$0.60 |
| 3 | \$0.41 | \$0.08 | \$0.49 |
| 4 | \$0.49 | \$0.07 | \$0.56 |
| 5 | \$0.41 | \$0.08 | \$0.49 |
| 6 | \$0.44 | \$0.04 | \$0.48 |
| 7 | \$0.43 | \$0.02 | \$0.45 |
| 8 | \$0.46 | \$0.03 | \$0.49 |
| 9 | \$0.46 | \$0.04 | \$0.50 |
| 10 | \$0.47 | \$0.05 | \$0.52 |
| 11 | \$0.72 | \$0.09 | \$0.81 |
| 12 | \$0.68 | \$0.09 | \$0.76 |
| 13 | \$0.75 | \$0.08 | \$0.83 |
| 14 | \$0.61 | \$0.09 | \$0.70 |
| 15 | \$0.77 | \$0.02 | \$0.79 |
| 16 | \$0.49 | \$0.16 | \$0.65 |

8.4.3 Incremental First Cost

Incremental first cost for the proposed measure was determined from actual contractor quotes. This includes the cost of an additional occupancy sensor and added controls for the building monitoring system. The contractor quotes averaged to \$100 per room, for the 5,500-square-foot prototype model with seven rooms, resulting in a \$0.13 per square foot incremental cost.

8.4.4 Lifetime Incremental Maintenance Costs

The proposed measure will have no maintenance costs, but will include replacement costs for sensors. It is assumed controls and sensors will need to be replaced one time during the 15 years, based on their expected lifetimes. For this analysis, \$0.13 per square foot incremental replacement cost is used.

8.4.5 Lifecycle Cost-Effectiveness

Results per unit lifecycle cost-effectiveness analyses are presented in Table 63. The proposed measure saves money over the 15-year period of analysis relative to the existing conditions. The proposed code change was found to be cost-effective in every climate zone. The incremental and maintenance costs presented above were rounded. The total incremental per unit cost value of \$0.25 presented in Table 63 was calculated without rounding the components of the cost.

Table 63: Lifecycle Cost-Effectiveness Summary per Square Foot – Small Office New Construction

| Climate Zone | Benefits TDV Energy Cost Savings + Other Present Value Savings ^a (2020 Present Value \$) | Costs Total Incremental Present Value Costs ^b (2020 Present Value \$) | Benefit-to- Cost Ratio |
|--------------|--|---|---------------------------|
| 1 | \$0.51 | \$0.25 | 2.0 |
| 2 | \$0.60 | \$0.25 | 2.4 |
| 3 | \$0.49 | \$0.25 | 1.9 |
| 4 | \$0.56 | \$0.25 | 2.2 |
| 5 | \$0.49 | \$0.25 | 1.9 |
| 6 | \$0.48 | \$0.25 | 1.9 |
| 7 | \$0.45 | \$0.25 | 1.8 |
| 8 | \$0.49 | \$0.25 | 1.9 |
| 9 | \$0.50 | \$0.25 | 2.0 |
| 10 | \$0.52 | \$0.25 | 2.0 |
| 11 | \$0.81 | \$0.25 | 3.2 |
| 12 | \$0.76 | \$0.25 | 3.0 |
| 13 | \$0.83 | \$0.25 | 3.3 |
| 14 | \$0.70 | \$0.25 | 2.7 |
| 15 | \$0.79 | \$0.25 | 3.1 |
| 16 | \$0.65 | \$0.25 | 2.6 |

- a. **Benefits TDV Energy Cost Savings + Other PV Savings:** Benefits include TDV energy cost savings over the period of analysis (Energy + Environmental Economics 2016, 51-53). Other savings are discounted at a real (nominal – inflation) three percent rate. Other present valued savings include incremental first cost savings if proposed first cost is less than current first cost. Includes present value maintenance cost savings if present value of proposed maintenance costs is less than the present value of current maintenance costs.
- b. **Costs Total Incremental Present Valued Costs:** Costs include incremental equipment, replacement and maintenance costs over the period of analysis. Costs are discounted at a real (inflation adjusted) three percent rate. Includes incremental first cost if proposed first cost is greater than current first cost. Includes present value of maintenance incremental cost if present value of proposed maintenance costs is greater than the present value of current maintenance costs. If incremental maintenance cost is negative, it is treated as a positive benefit. If there are no total incremental present valued costs, the B/C ratio is infinite.

8.5 First-Year Statewide Impacts

8.5.1 Statewide Energy Savings and Lifecycle Energy Cost Savings

Table 64: Statewide Energy and Energy Cost Impacts – New Construction

| Climate Zone | Statewide Construction in 2020 (million ft ²) | First-Year Electricity Savings (GWh) ^a | First-Year Peak Electrical Demand Reduction (MW) | First-Year Natural Gas Savings (million therms) | Lifecycle ^b Present Value Energy Cost Savings (Present Value \$ million) |
|--------------|---|---|--|---|---|
| 1 | 0.098 | 0.015 | 0.011 | 0.001 | \$0.05 |
| 2 | 0.678 | 0.120 | 0.026 | 0.004 | \$0.41 |
| 3 | 3.383 | 0.560 | 0.241 | 0.015 | \$1.65 |
| 4 | 1.522 | 0.273 | 0.097 | 0.006 | \$0.85 |
| 5 | 0.295 | 0.050 | 0.041 | 0.001 | \$0.14 |
| 6 | 2.278 | 0.419 | 0.466 | 0.005 | \$1.09 |
| 7 | 1.787 | 0.320 | 0.001 | 0.002 | \$0.81 |
| 8 | 3.300 | 0.628 | -0.062 | 0.006 | \$1.63 |
| 9 | 3.987 | 0.779 | -0.051 | 0.009 | \$2.00 |
| 10 | 2.390 | 0.479 | -0.005 | 0.006 | \$1.23 |
| 11 | 0.590 | 0.121 | 0.010 | 0.003 | \$0.48 |
| 12 | 3.495 | 0.660 | 0.253 | 0.017 | \$2.66 |
| 13 | 1.256 | 0.260 | 0.075 | 0.006 | \$1.04 |
| 14 | 0.467 | 0.099 | 0.011 | 0.002 | \$0.33 |
| 15 | 0.419 | 0.113 | 0.009 | 0.000 | \$0.33 |
| 16 | 0.743 | 0.134 | 0.030 | 0.007 | \$0.48 |
| TOTAL | 26.688 | 5.031 | 1.151 | 0.090 | \$15.19 |

a. First-year savings from all nonresidential buildings with space types falling under this requirement completed statewide in 2020.

b. Energy cost savings from all buildings completed statewide in 2020 accrued during 15-year period of analysis.

8.5.2 Statewide Water Use Impacts

The proposed occupant sensor ventilation requirements will not result in water savings.

8.5.3 Statewide Material Impacts

The proposed occupant sensor ventilation requirements will not result in changes to material use.

8.5.4 Other Non-Energy Impacts

The proposed code change will not result in any other non-energy impacts.

8.6 Proposed Revisions to Code Language

The proposed changes to the Standards, Reference Appendices, and the ACM Reference Manual are provided below. Changes to the 2016 documents are marked with underlining (new language) and ~~strikethroughs~~ (deletions).

8.6.1 Standards

~~SECTION 120.1 – REQUIREMENTS FOR VENTILATION 120.1(e)5~~

5. ~~Occupant Sensor Ventilation Control Devices.~~ When occupancy sensor ventilation devices are required ~~by Section 120.2(e)3, or when meeting EXCEPTION 5 to Section 120.1(e)3,~~ occupant sensors shall be used to reduce the rate of outdoor air flow when occupants are not

present in accordance with the following:

- A. ~~Occupant sensors shall meet the requirements in Section 110.9(b)4 and shall have suitable coverage and placement to detect occupants in the entire space ventilated. Occupant sensors controlling lighting may be used for ventilation as long as the ventilation signal is independent of daylighting, manual lighting overrides or manual control of lighting. When a single zone damper or a single zone system serves multiple rooms, there shall be an occupancy sensor in each room and the zone is not considered vacant until all rooms in the zone are vacant.~~
- B. ~~One hour prior to normal scheduled occupancy, the occupancy sensor ventilation control shall allow pre-occupancy purge as described in Section 120.1(c)2.~~
- C. ~~Within 30 minutes after being vacant for all rooms served by a zone damper on a multiple zone system, and the space temperature is between the heating and cooling setpoints, then no outside air is required and supply air shall be zero.~~
- D. ~~Within 30 minutes after being vacant for all rooms served by a single zone system, the single zone system shall cycle off the supply fan when the space temperature is between the heating and cooling setpoints.~~
- E. ~~In spaces equipped with an occupant sensor, when vacant during hours of expected occupancy and the occupied ventilation rate required by Section 120.1(b)2 is not provided, then the system or zone controls shall cycle or operate to maintain the average outdoor air rate over an averaging period of 120 minutes equal to 25 percent of the rate listed in TABLE 120.1 A.~~

Exception to 120.1(c)5: ~~If Demand Control Ventilation is implemented as required by Section 120.1(4).~~

SECTION 120.2- REQUIRED CONTROLS FOR SPACE-CONDITIONING SYSTEMS 120.2(e)3

- e. **Shut-off and Reset Controls for Space-conditioning Systems.** Each space-conditioning system shall be installed with controls that comply with the following:
 - 1. *[omitted]*
 - 2. *[omitted]*
 - 3. ~~Multipurpose room less than 1000 square feet, classrooms greater than 750 square feet and conference, convention, auditorium and meeting center rooms greater than 750 square feet that do not have processes or operations that generate dusts, fumes, vapors or gasses shall be equipped with occupant sensor(s) to accomplish the following during unoccupied periods:~~
 - 1. **Occupancy Sensing HVAC Zone Controls.** HVAC zones serving only the following spaces: offices 250 square feet or less, multipurpose rooms 1,000 square feet or less, classrooms, conference rooms, enclosed corridors and hotel guest rooms, shall be controlled by occupancy sensing HVAC control systems that control ventilation and space conditioning in accordance with the following additional requirements:
 - A. Each room served by the HVAC zone shall have an occupancy sensor that communicates the room occupancy status to the occupancy sensing HVAC control system; and
 - B. Occupant sensors controlling lighting may be used for sensing the room occupancy status for the occupancy sensing HVAC control system as long as the room occupancy signal is independent of daylighting, manual lighting overrides or manual control of lighting; and

- C. The HVAC zone shall be placed in occupied-standby mode when the space conditioning zone is scheduled to be occupied and occupant sensors in all rooms served by the zone indicate that all rooms served by the zone are vacant; and
- D. During occupied-standby mode, automatically ~~Automatically~~ setup the operating cooling temperature setpoint by 2°F or more and setback the operating heating temperature setpoint by 2°F or more; and
- E. During occupied-standby mode, all airflow to the zone shall be shut off whenever the space temperature is between the active heating and cooling setpoints. Outside air dampers should modulate accordingly so that the outside airflow rate to occupied spaces does not increase due to a zone entering occupied-standby mode; and
- F. In multizone systems, when airflow is shut off to zones in accordance with item E, the system minimum outside air as calculated in Section PLACEHOLDER, shall be reduced by the outside air requirements for the zones which are shut off. and
- G. One hour prior to normal scheduled occupancy, occupancy sensing HVAC control systems shall allow pre-occupancy purge required by Section 120.1(c)2.
- ~~H. Automatically reset the minimum required ventilation rate with an occupant sensor ventilation control device according to Section 120.1(e)5.~~

EXCEPTION 1 to Sections 120.2(e)3: Spaces containing processes or operations that generate dusts, fumes, vapors or gasses

EXCEPTION 2 to Section 120.2(e)3: Elementary school classrooms or other classrooms where it is expected that art or other activities will generate dusts, fumes vapors or gasses.

EXCEPTION 4 3 to Sections 120.2(e)1 and 2, and 3: Where it can be demonstrated to the satisfaction of the enforcing agency that the system serves an area that must operate continuously.

~~**EXCEPTION 2 to Sections 120.2(e)1, 2, and 3:** Where it can be demonstrated to the satisfaction of the enforcing agency that shutdown, setback, and setup will not result in a decrease in overall building source energy use.~~

EXCEPTION 34 to Sections 120.2(e)1 and 2, and 3: Systems with full load demands of 2 kW or less, if they have a readily accessible manual shut-off switch.

EXCEPTION 45 to Sections 120.2(e)1 and 2: Systems serving hotel/motel guest rooms, if they have a readily accessible manual shut-off switch.

~~**EXCEPTION 5 to Sections 120.2(e)3:** If Demand-Control Ventilation is implemented as required by Section 120.1(e)3 and 120.1(e)(4).~~

EXCEPTION 6 to Section 120.2(e)3xx(D): Multiple zone systems with Direct Digital Controls (DDC) to the zone level which setup the operating cooling temperature setpoint by 0.5°F or more and setback the operating heating temperature setpoint by 0.5°F or more during occupied-standby mode.

~~Multiple zone systems with Direct Digital Controls (DDC) to the zone level which setup the operating cooling temperature setpoint by 0.5°F or more and setback the operating heating temperature setpoint by 0.5°F or more during occupied-standby mode.~~

8.6.2 Reference Appendices

NA7.5.1.X Occupancy Sensor Ventilation Control Acceptance Testing

For buildings with up to seven (7) occupancy sensors, all occupancy sensors shall be tested. For buildings with more than seven (7) occupancy sensors, sampling may be done on spaces with similar sensors and space geometries; sampling shall include a minimum of 1 occupancy sensor for each group of up to 7 additional photocontrols. If the first occupancy sensor in the sample group passes the acceptance test, the remaining building spaces in the sample group also pass. If the first occupancy sensor in the sample group fails the acceptance test the rest of the occupancy sensors in that group must be tested. If any tested occupancy sensor fails it shall be repaired, replaced or adjusted until it passes the test.

For each sensor to be tested do the following:

- (a) For a representative sample of building spaces, simulate an unoccupied condition. Verify and document the following:
 1. Occupancy schedule is in occupied mode
 2. The occupant sensor will activate the HVAC system for the controlled zone.
- (b) Adjust thermostat such that zone is in deadband between heating and cooling. Verify and document the following:
 1. Airflow is at ventilation minimum.
- (c) Adjust heating setpoint to slightly above current space temperature. Verify and document the following:
 1. Zone enters heating mode
- (d) Simulate an unoccupied condition. Verify and document the following within five minutes of entering occupied-standby mode:
 1. The heating setpoint is set back at least 2°F
 2. The cooling setpoint is set up at least 2°F
 3. The zone is now in deadband between heating and cooling
 4. All airflow to the zone is shut off
- (e) Repeat steps (a) through (d) but adjust cooling setpoint instead of heating setpoint:
- (f) Return system back to normal operating condition

8.6.3 ACM Reference Manual

While the proposed change is a mandatory requirement, the Nonresidential ACM Reference Manual should be modified to allow occupied standby in the proposed model in spaces where it is allowed by 62.1, but not mandated by Title 24, Part 6. These spaces include:

- enclosed offices greater than 250 square feet
- open plan offices
- multipurpose/assembly rooms greater than 1,000 square feet
- museums
- courtrooms
- religious worship
- auditorium
- supermarkets
- sports arena spectator areas

Realistic occupancy profiles are critically important not only for occupant sensor ventilation controls, but also for capturing the realistic energy performance of all HVAC systems and controls, including dual maximum zone controls and time averaged ventilation.

Figure 13, Figure 14, and Figure 15 show proposed realistic schedules for office, assembly, and school occupancies. Similar schedules are required for other occupancies. These schedules include four separate weekday schedules that would be randomly assigned to zones in the building on a daily basis. On the first weekday, the first zone is assigned weekday (WD)-1, the second is assigned WD-2, the third is assigned WD-3, the fourth is assigned WD-4, the fifth is assigned WD-5, etc. Each weekday, each zone moves to the next schedule: on the second weekday, the first zone is assigned WD-2, the second zone is assigned WD-3, etc. Similarly, there are two Saturday and Sunday schedules that are randomly assigned and cycled through the zones. The Statewide CASE Team recommends these schedules be added to the Nonresidential ACM Reference Manual.

| | | | | | | | | | | | | | | | | | | | | | | | | | |
|-----------------------|--|-------------|-----|-----|-----|-----|-----|-----|-----|-----|-----|-----|-----|-----|-----|-----|-----|-----|-----|-----|-----|-----|-----|-----|-----|
| Office Occupancy | On the first weekday the first zone is WD-1, second zone is WD-2, third is WD-3, fourth is WD-4, fifth is WD-1, etc. | | | | | | | | | | | | | | | | | | | | | | | | |
| | On the second weekday the first zone is WD-2, second zone is WD-3, etc | | | | | | | | | | | | | | | | | | | | | | | | |
| | On the third weekday the first zone is WD-3, second is WD-4, etc | | | | | | | | | | | | | | | | | | | | | | | | |
| | | Hour of Day | | | | | | | | | | | | | | | | | | | | | | | |
| Description | Daily Sch | 1 | 2 | 3 | 4 | 5 | 6 | 7 | 8 | 9 | 10 | 11 | 12 | 13 | 14 | 15 | 16 | 17 | 18 | 19 | 20 | 21 | 22 | 23 | 24 |
| Occupancy (%) | WD-1 | 0 | 0 | 0 | 0 | 0 | 0 | 10 | 20 | 90 | 95 | 95 | 95 | 95 | 95 | 95 | 95 | 95 | 70 | 50 | 30 | 10 | 0 | 0 | 0 |
| | WD-2 | 0 | 0 | 0 | 0 | 0 | 0 | 10 | 20 | 70 | 80 | 90 | 70 | 50 | 20 | 0 | 0 | 0 | 0 | 0 | 0 | 0 | 0 | 0 | 0 |
| | WD-3 | 0 | 0 | 0 | 0 | 0 | 0 | 0 | 0 | 0 | 0 | 10 | 20 | 50 | 90 | 90 | 80 | 70 | 30 | 10 | 0 | 0 | 0 | 0 | 0 |
| | WD-4 | 0 | 0 | 0 | 0 | 0 | 0 | 0 | 0 | 0 | 0 | 0 | 0 | 0 | 0 | 0 | 0 | 0 | 0 | 0 | 0 | 0 | 0 | 0 | 0 |
| | WD-AVG | 0 | 0 | 0 | 0 | 0 | 0 | 5 | 10 | 40 | 44 | 49 | 46 | 49 | 51 | 46 | 44 | 41 | 25 | 15 | 8 | 3 | 0 | 0 | 0 |
| | Sat-1 | 0 | 0 | 0 | 0 | 0 | 0 | 10 | 10 | 30 | 50 | 50 | 30 | 10 | 10 | 10 | 10 | 10 | 10 | 5 | 5 | 0 | 0 | 0 | 0 |
| | Sat-2 | 0 | 0 | 0 | 0 | 0 | 0 | 10 | 10 | 10 | 10 | 10 | 10 | 10 | 10 | 10 | 10 | 10 | 10 | 0 | 0 | 0 | 0 | 0 | 0 |
| | Sun-1 | 0 | 0 | 0 | 0 | 0 | 0 | 10 | 10 | 30 | 30 | 30 | 30 | 10 | 10 | 10 | 10 | 10 | 10 | 5 | 5 | 0 | 0 | 0 | 0 |
| Sun-2 | 0 | 0 | 0 | 0 | 0 | 0 | 0 | 0 | 0 | 0 | 0 | 0 | 0 | 0 | 0 | 0 | 0 | 0 | 0 | 0 | 0 | 0 | 0 | 0 | |
| Lighting (%) | WD-1 | 5 | 5 | 5 | 5 | 5 | 5 | 10 | 20 | 100 | 100 | 100 | 100 | 100 | 100 | 100 | 100 | 100 | 100 | 100 | 30 | 10 | 5 | 5 | 5 |
| | WD-2 | 5 | 5 | 5 | 5 | 5 | 5 | 10 | 20 | 100 | 100 | 100 | 100 | 100 | 20 | 5 | 5 | 5 | 5 | 5 | 5 | 5 | 5 | 5 | 5 |
| | WD-3 | 5 | 5 | 5 | 5 | 5 | 5 | 5 | 5 | 5 | 5 | 10 | 20 | 100 | 100 | 100 | 100 | 100 | 30 | 10 | 5 | 5 | 5 | 5 | 5 |
| | WD-4 | 5 | 5 | 5 | 5 | 5 | 5 | 5 | 5 | 5 | 5 | 5 | 5 | 5 | 5 | 5 | 5 | 5 | 5 | 5 | 5 | 5 | 5 | 5 | 5 |
| | WD-AVG | 5 | 5 | 5 | 5 | 5 | 5 | 8 | 13 | 53 | 53 | 54 | 56 | 76 | 56 | 53 | 53 | 53 | 35 | 30 | 11 | 6 | 5 | 5 | 5 |
| | Sat-1 | 5 | 5 | 5 | 5 | 5 | 5 | 10 | 10 | 30 | 100 | 100 | 30 | 10 | 10 | 10 | 10 | 10 | 10 | 5 | 5 | 5 | 5 | 5 | 5 |
| | Sat-2 | 5 | 5 | 5 | 5 | 5 | 5 | 10 | 10 | 10 | 10 | 10 | 10 | 10 | 10 | 10 | 10 | 10 | 10 | 5 | 5 | 5 | 5 | 5 | 5 |
| | Sun-1 | 5 | 5 | 5 | 5 | 5 | 5 | 10 | 10 | 30 | 30 | 30 | 30 | 10 | 10 | 10 | 10 | 10 | 10 | 5 | 5 | 5 | 5 | 5 | 5 |
| Sun-2 | 5 | 5 | 5 | 5 | 5 | 5 | 5 | 5 | 5 | 5 | 5 | 5 | 5 | 5 | 5 | 5 | 5 | 5 | 5 | 5 | 5 | 5 | 5 | 5 | |
| Receptacle (%) | WD-1 | 5 | 5 | 5 | 5 | 5 | 5 | 10 | 20 | 90 | 95 | 95 | 95 | 95 | 95 | 95 | 95 | 95 | 70 | 50 | 30 | 10 | 5 | 5 | 5 |
| Service Hot Water (%) | WD-2 | 5 | 5 | 5 | 5 | 5 | 5 | 10 | 20 | 70 | 80 | 90 | 70 | 50 | 20 | 5 | 5 | 5 | 5 | 5 | 5 | 5 | 5 | 5 | 5 |
| Elevator (%) | WD-3 | 5 | 5 | 5 | 5 | 5 | 5 | 5 | 5 | 5 | 5 | 10 | 20 | 50 | 90 | 90 | 80 | 70 | 30 | 10 | 5 | 5 | 5 | 5 | 5 |
| | WD-4 | 5 | 5 | 5 | 5 | 5 | 5 | 5 | 5 | 5 | 5 | 5 | 5 | 5 | 5 | 5 | 5 | 5 | 5 | 5 | 5 | 5 | 5 | 5 | 5 |
| | WD-AVG | 5 | 5 | 5 | 5 | 5 | 5 | 8 | 13 | 43 | 46 | 50 | 48 | 50 | 53 | 49 | 46 | 44 | 28 | 18 | 11 | 6 | 5 | 5 | 5 |
| | Sat-1 | 5 | 5 | 5 | 5 | 5 | 5 | 10 | 10 | 30 | 50 | 50 | 30 | 10 | 10 | 10 | 10 | 10 | 10 | 5 | 5 | 5 | 5 | 5 | 5 |
| | Sat-2 | 5 | 5 | 5 | 5 | 5 | 5 | 10 | 10 | 10 | 10 | 10 | 10 | 10 | 10 | 10 | 10 | 10 | 10 | 5 | 5 | 5 | 5 | 5 | 5 |
| | Sun-1 | 5 | 5 | 5 | 5 | 5 | 5 | 10 | 10 | 30 | 30 | 30 | 30 | 10 | 10 | 10 | 10 | 10 | 10 | 5 | 5 | 5 | 5 | 5 | 5 |
| | Sun-2 | 5 | 5 | 5 | 5 | 5 | 5 | 5 | 5 | 5 | 5 | 5 | 5 | 5 | 5 | 5 | 5 | 5 | 5 | 5 | 5 | 5 | 5 | 5 | 5 |
| | HVAC System | WD | Off | Off | Off | Off | Off | On | On | On | On | On | On | On | On | On | On | On | On | On | On | On | Off | Off | Off |
| Sat | | Off | Off | Off | Off | Off | Off | On | On | On | On | On | On | On | On | On | On | On | On | Off | Off | Off | Off | Off | Off |
| Sun | | Off | Off | Off | Off | Off | Off | Off | Off | Off | Off | Off | Off | Off | Off | Off | Off | Off | Off | Off | Off | Off | Off | Off | Off |
| Heating | WD | 60 | 60 | 60 | 63 | 66 | 68 | 70 | 70 | 70 | 70 | 70 | 70 | 70 | 70 | 70 | 70 | 70 | 70 | 70 | 70 | 60 | 60 | 60 | 60 |
| | Sat | 60 | 60 | 60 | 60 | 63 | 66 | 68 | 70 | 70 | 70 | 70 | 70 | 70 | 70 | 70 | 70 | 70 | 70 | 70 | 60 | 60 | 60 | 60 | 60 |
| | Sun | 60 | 60 | 60 | 60 | 60 | 60 | 60 | 60 | 60 | 60 | 60 | 60 | 60 | 60 | 60 | 60 | 60 | 60 | 60 | 60 | 60 | 60 | 60 | 60 |
| Cooling | WD | 85 | 85 | 85 | 82 | 78 | 75 | 75 | 75 | 75 | 75 | 75 | 75 | 75 | 75 | 75 | 75 | 75 | 75 | 75 | 75 | 75 | 85 | 85 | 85 |
| | Sat | 85 | 85 | 85 | 85 | 82 | 78 | 75 | 75 | 75 | 75 | 75 | 75 | 75 | 75 | 75 | 75 | 75 | 75 | 85 | 85 | 85 | 85 | 85 | 85 |
| | Sun | 85 | 85 | 85 | 85 | 85 | 85 | 85 | 85 | 85 | 85 | 85 | 85 | 85 | 85 | 85 | 85 | 85 | 85 | 85 | 85 | 85 | 85 | 85 | 85 |

Figure 13: Proposed realistic schedules – office occupancy

| | | | | | | | | | | | | | | | | | | | | | | | | | |
|-----------------------|--|-------------|-----|-----|-----|-----|-----|-----|-----|-----|-----|-----|-----|-----|-----|-----|-----|-----|-----|-----|-----|-----|-----|-----|-----|
| Assembly Occupancy | On the first weekday the first zone is WD-1, second zone is WD-2, third is WD-3, fourth is WD-4, fifth is WD-1, etc. | | | | | | | | | | | | | | | | | | | | | | | | |
| | On the second weekday the first zone is WD-2, second zone is WD-3, etc | | | | | | | | | | | | | | | | | | | | | | | | |
| | On the third weekday the first zone is WD-3, second is WD-4, etc | | | | | | | | | | | | | | | | | | | | | | | | |
| | | Hour of Day | | | | | | | | | | | | | | | | | | | | | | | |
| Description | Daily Sch | 1 | 2 | 3 | 4 | 5 | 6 | 7 | 8 | 9 | 10 | 11 | 12 | 13 | 14 | 15 | 16 | 17 | 18 | 19 | 20 | 21 | 22 | 23 | 24 |
| Occupancy (%) | WD-1 | 0 | 0 | 0 | 0 | 0 | 0 | 10 | 20 | 80 | 90 | 95 | 95 | 95 | 95 | 95 | 95 | 95 | 30 | 10 | 10 | 10 | 10 | 0 | 0 |
| | WD-2 | 0 | 0 | 0 | 0 | 0 | 0 | 10 | 20 | 70 | 90 | 100 | 70 | 50 | 20 | 0 | 0 | 0 | 0 | 0 | 0 | 0 | 0 | 0 | 0 |
| | WD-3 | 0 | 0 | 0 | 0 | 0 | 0 | 0 | 0 | 0 | 0 | 0 | 0 | 0 | 0 | 20 | 40 | 50 | 70 | 90 | 100 | 100 | 70 | 20 | 5 |
| | WD-4 | 0 | 0 | 0 | 0 | 0 | 0 | 0 | 0 | 0 | 0 | 0 | 0 | 0 | 0 | 0 | 0 | 0 | 0 | 0 | 0 | 0 | 0 | 0 | 0 |
| | WD-AVG | 0 | 0 | 0 | 0 | 0 | 0 | 5 | 10 | 38 | 45 | 49 | 41 | 36 | 29 | 29 | 34 | 36 | 25 | 25 | 28 | 28 | 20 | 5 | 1 |
| | Sat-1 | 0 | 0 | 0 | 0 | 0 | 0 | 10 | 10 | 30 | 40 | 60 | 60 | 50 | 40 | 30 | 10 | 10 | 5 | 5 | 0 | 0 | 0 | 0 | 0 |
| | Sat-2 | 0 | 0 | 0 | 0 | 0 | 0 | 10 | 10 | 10 | 10 | 10 | 10 | 10 | 10 | 10 | 10 | 10 | 5 | 0 | 0 | 0 | 0 | 0 | 0 |
| | Sun-1 | 0 | 0 | 0 | 0 | 0 | 0 | 10 | 10 | 30 | 40 | 40 | 30 | 20 | 10 | 10 | 10 | 10 | 5 | 0 | 0 | 0 | 0 | 0 | 0 |
| | Sun-2 | 0 | 0 | 0 | 0 | 0 | 0 | 0 | 0 | 0 | 0 | 0 | 0 | 0 | 0 | 0 | 0 | 0 | 0 | 0 | 0 | 0 | 0 | 0 | 0 |
| Lighting (%) | WD-1 | 5 | 5 | 5 | 5 | 5 | 10 | 100 | 100 | 100 | 100 | 100 | 100 | 100 | 100 | 100 | 100 | 100 | 10 | 10 | 10 | 10 | 5 | 5 | |
| | WD-2 | 5 | 5 | 5 | 5 | 5 | 10 | 100 | 100 | 100 | 100 | 100 | 100 | 100 | 100 | 5 | 5 | 5 | 5 | 5 | 5 | 5 | 5 | 5 | 5 |
| | WD-3 | 5 | 5 | 5 | 5 | 5 | 5 | 5 | 5 | 5 | 5 | 5 | 5 | 5 | 5 | 100 | 100 | 100 | 100 | 100 | 100 | 100 | 100 | 5 | 5 |
| | WD-4 | 5 | 5 | 5 | 5 | 5 | 5 | 5 | 5 | 5 | 5 | 5 | 5 | 5 | 5 | 5 | 5 | 5 | 5 | 5 | 5 | 5 | 5 | 5 | 5 |
| | WD-AVG | 5 | 5 | 5 | 5 | 5 | 8 | 53 | 53 | 53 | 53 | 53 | 53 | 53 | 53 | 53 | 53 | 53 | 30 | 30 | 30 | 30 | 29 | 5 | 5 |
| | Sat-1 | 5 | 5 | 5 | 5 | 5 | 10 | 10 | 100 | 100 | 100 | 100 | 100 | 100 | 100 | 100 | 10 | 10 | 5 | 5 | 5 | 5 | 5 | 5 | 5 |
| | Sat-2 | 5 | 5 | 5 | 5 | 5 | 10 | 10 | 10 | 10 | 10 | 10 | 10 | 10 | 10 | 10 | 10 | 10 | 5 | 5 | 5 | 5 | 5 | 5 | 5 |
| | Sun-1 | 5 | 5 | 5 | 5 | 5 | 10 | 10 | 100 | 100 | 100 | 100 | 100 | 100 | 10 | 10 | 10 | 10 | 5 | 5 | 5 | 5 | 5 | 5 | 5 |
| | Sun-2 | 5 | 5 | 5 | 5 | 5 | 5 | 5 | 5 | 5 | 5 | 5 | 5 | 5 | 5 | 5 | 5 | 5 | 5 | 5 | 5 | 5 | 5 | 5 | 5 |
| Receptacle (%) | WD-1 | 5 | 5 | 5 | 5 | 5 | 10 | 20 | 80 | 90 | 95 | 95 | 95 | 95 | 95 | 95 | 95 | 30 | 10 | 10 | 10 | 10 | 5 | 5 | |
| Service Hot Water (%) | WD-2 | 5 | 5 | 5 | 5 | 5 | 10 | 20 | 70 | 90 | 100 | 70 | 50 | 20 | 5 | 5 | 5 | 5 | 5 | 5 | 5 | 5 | 5 | 5 | |
| Elevator (%) | WD-3 | 5 | 5 | 5 | 5 | 5 | 5 | 5 | 5 | 5 | 5 | 5 | 5 | 5 | 5 | 20 | 40 | 50 | 70 | 90 | 100 | 100 | 70 | 20 | 5 |
| | WD-4 | 5 | 5 | 5 | 5 | 5 | 5 | 5 | 5 | 5 | 5 | 5 | 5 | 5 | 5 | 5 | 5 | 5 | 5 | 5 | 5 | 5 | 5 | 5 | 5 |
| | WD-AVG | 5 | 5 | 5 | 5 | 5 | 8 | 13 | 40 | 48 | 51 | 44 | 39 | 31 | 31 | 36 | 39 | 28 | 28 | 30 | 30 | 23 | 9 | 5 | |
| | Sat-1 | 5 | 5 | 5 | 5 | 5 | 10 | 10 | 30 | 40 | 60 | 60 | 50 | 40 | 30 | 10 | 10 | 5 | 5 | 5 | 5 | 5 | 5 | 5 | 5 |
| | Sat-2 | 5 | 5 | 5 | 5 | 5 | 10 | 10 | 10 | 10 | 10 | 10 | 10 | 10 | 10 | 10 | 10 | 5 | 5 | 5 | 5 | 5 | 5 | 5 | 5 |
| | Sun-1 | 5 | 5 | 5 | 5 | 5 | 10 | 10 | 30 | 40 | 40 | 30 | 20 | 10 | 10 | 10 | 10 | 5 | 5 | 5 | 5 | 5 | 5 | 5 | 5 |
| | Sun-2 | 5 | 5 | 5 | 5 | 5 | 5 | 5 | 5 | 5 | 5 | 5 | 5 | 5 | 5 | 5 | 5 | 5 | 5 | 5 | 5 | 5 | 5 | 5 | 5 |
| | HVAC System | WD | Off | Off | Off | Off | Off | On | On | On | On | On | On | On | On | On | On | On | On | On | On | On | On | On | Off |
| | | Sat | Off | Off | Off | Off | Off | Off | On | On | On | On | On | On | On | On | On | On | On | On | On | On | On | On | Off |
| Sun | | Off | Off | Off | Off | Off | Off | On | On | On | On | On | On | On | On | On | On | On | On | On | On | On | On | Off | |
| Heating | WD | 60 | 60 | 63 | 66 | 70 | 70 | 70 | 70 | 70 | 70 | 70 | 70 | 70 | 70 | 70 | 70 | 70 | 70 | 70 | 70 | 70 | 70 | 60 | |
| | Sat | 60 | 60 | 60 | 60 | 63 | 66 | 70 | 70 | 70 | 70 | 70 | 70 | 70 | 70 | 70 | 70 | 70 | 70 | 70 | 70 | 70 | 70 | 60 | |
| | Sun | 60 | 60 | 60 | 60 | 60 | 63 | 66 | 70 | 70 | 70 | 70 | 70 | 70 | 70 | 70 | 70 | 70 | 70 | 70 | 70 | 70 | 70 | 60 | |
| Cooling | WD | 85 | 85 | 85 | 82 | 78 | 75 | 75 | 75 | 75 | 75 | 75 | 75 | 75 | 75 | 75 | 75 | 75 | 75 | 75 | 75 | 75 | 75 | 85 | |
| | Sat | 85 | 85 | 85 | 85 | 82 | 78 | 75 | 75 | 75 | 75 | 75 | 75 | 75 | 75 | 75 | 75 | 75 | 75 | 75 | 75 | 75 | 75 | 85 | |
| | Sun | 85 | 85 | 85 | 85 | 82 | 78 | 75 | 75 | 75 | 75 | 75 | 75 | 75 | 75 | 75 | 75 | 75 | 75 | 75 | 75 | 75 | 75 | 85 | |

Figure 14: Proposed realistic schedules – assembly occupancy

| | | | | | | | | | | | | | | | | | | | | | | | | | | |
|-----------------------|--|-------------|-----|-----|-----|-----|-----|-----|-----|-----|-----|-----|-----|-----|-----|-----|-----|-----|-----|-----|-----|-----|-----|-----|-----|-----|
| School Occupancy | On the first weekday the first zone is WD-1, second zone is WD-2, third is WD-3, fourth is WD-4, fifth is WD-1, etc. | | | | | | | | | | | | | | | | | | | | | | | | | |
| | On the second weekday the first zone is WD-2, second zone is WD-3, etc | | | | | | | | | | | | | | | | | | | | | | | | | |
| | On the third weekday the first zone is WD-3, second is WD-4, etc | | | | | | | | | | | | | | | | | | | | | | | | | |
| | | Hour of Day | | | | | | | | | | | | | | | | | | | | | | | | |
| Description | Daily Sch | 1 | 2 | 3 | 4 | 5 | 6 | 7 | 8 | 9 | 10 | 11 | 12 | 13 | 14 | 15 | 16 | 17 | 18 | 19 | 20 | 21 | 22 | 23 | 24 | |
| Occupancy (%) | WD-1 | 0 | 0 | 0 | 0 | 0 | 0 | 0 | 5 | 75 | 90 | 95 | 95 | 90 | 80 | 80 | 45 | 15 | 5 | 5 | 5 | 5 | 5 | 0 | 0 | |
| | WD-2 | 0 | 0 | 0 | 0 | 0 | 0 | 0 | 5 | 75 | 90 | 90 | 80 | 80 | 80 | 80 | 45 | 15 | 5 | 5 | 5 | 5 | 0 | 0 | 0 | |
| | WD-3 | 0 | 0 | 0 | 0 | 0 | 0 | 0 | 5 | 50 | 70 | 70 | 50 | 50 | 50 | 45 | 45 | 15 | 45 | 75 | 75 | 50 | 20 | 0 | 0 | |
| | WD-4 | 0 | 0 | 0 | 0 | 0 | 0 | 0 | 0 | 0 | 0 | 0 | 0 | 0 | 0 | 0 | 0 | 10 | 10 | 15 | 20 | 20 | 10 | 0 | 0 | |
| | WD-AVG | # | # | # | # | # | # | # | 4 | 50 | 63 | 64 | 56 | 55 | 53 | 51 | 34 | 14 | 16 | 25 | 26 | 20 | 9 | # | # | |
| | Sat-1 | 0 | 0 | 0 | 0 | 0 | 0 | 0 | 10 | 30 | 50 | 50 | 30 | 10 | 0 | 0 | 0 | 0 | 0 | 0 | 0 | 0 | 0 | 0 | 0 | 0 |
| | Sat-2 | 0 | 0 | 0 | 0 | 0 | 0 | 0 | 0 | 0 | 0 | 0 | 0 | 0 | 0 | 0 | 0 | 0 | 0 | 0 | 0 | 0 | 0 | 0 | 0 | 0 |
| | Sun-1 | 0 | 0 | 0 | 0 | 0 | 0 | 0 | 0 | 0 | 30 | 30 | 30 | 30 | 10 | 10 | 10 | 10 | 5 | 5 | 0 | 0 | 0 | 0 | 0 | 0 |
| | Sun-2 | 0 | 0 | 0 | 0 | 0 | 0 | 0 | 0 | 0 | 0 | 0 | 0 | 0 | 0 | 0 | 0 | 0 | 0 | 0 | 0 | 0 | 0 | 0 | 0 | 0 |
| Lighting (%) | WD-1 | 5 | 5 | 5 | 5 | 5 | 5 | 5 | 5 | 100 | 100 | 100 | 100 | 100 | 100 | 100 | 100 | 15 | 5 | 5 | 5 | 5 | 5 | 5 | 5 | |
| | WD-2 | 5 | 5 | 5 | 5 | 5 | 5 | 5 | 5 | 100 | 100 | 100 | 100 | 100 | 100 | 100 | 100 | 15 | 5 | 5 | 5 | 5 | 5 | 5 | 5 | |
| | WD-3 | 5 | 5 | 5 | 5 | 5 | 5 | 5 | 5 | 100 | 100 | 100 | 100 | 100 | 100 | 100 | 100 | 15 | 100 | 100 | 100 | 100 | 20 | 5 | 5 | |
| | WD-4 | 5 | 5 | 5 | 5 | 5 | 5 | 5 | 5 | 5 | 5 | 5 | 5 | 5 | 5 | 5 | 5 | 10 | 10 | 15 | 20 | 20 | 10 | 5 | 5 | |
| | WD-AVG | 5 | 5 | 5 | 5 | 5 | 5 | 5 | 5 | 76 | 76 | 76 | 76 | 76 | 76 | 76 | 76 | 14 | 30 | 31 | 33 | 33 | 10 | 5 | 5 | |
| | Sat-1 | 5 | 5 | 5 | 5 | 5 | 5 | 5 | 10 | 30 | 100 | 100 | 30 | 10 | 5 | 5 | 5 | 5 | 5 | 5 | 5 | 5 | 5 | 5 | 5 | 5 |
| | Sat-2 | 5 | 5 | 5 | 5 | 5 | 5 | 5 | 5 | 5 | 5 | 5 | 5 | 5 | 5 | 5 | 5 | 5 | 5 | 5 | 5 | 5 | 5 | 5 | 5 | 5 |
| | Sun-1 | 5 | 5 | 5 | 5 | 5 | 5 | 5 | 5 | 30 | 30 | 30 | 30 | 10 | 10 | 10 | 10 | 10 | 5 | 5 | 5 | 5 | 5 | 5 | 5 | 5 |
| | Sun-2 | 5 | 5 | 5 | 5 | 5 | 5 | 5 | 5 | 5 | 5 | 5 | 5 | 5 | 5 | 5 | 5 | 5 | 5 | 5 | 5 | 5 | 5 | 5 | 5 | 5 |
| Receptacle (%) | WD-1 | 5 | 5 | 5 | 5 | 5 | 5 | 5 | 5 | 75 | 90 | 95 | 95 | 90 | 80 | 80 | 45 | 15 | 5 | 5 | 5 | 5 | 5 | 5 | 5 | |
| Service Hot Water (%) | WD-2 | 5 | 5 | 5 | 5 | 5 | 5 | 5 | 5 | 75 | 90 | 90 | 80 | 80 | 80 | 80 | 45 | 15 | 5 | 5 | 5 | 5 | 5 | 5 | 5 | |
| Elevator (%) | WD-3 | 5 | 5 | 5 | 5 | 5 | 5 | 5 | 5 | 50 | 70 | 70 | 50 | 50 | 50 | 45 | 45 | 15 | 45 | 75 | 75 | 50 | 20 | 5 | 5 | |
| | WD-4 | 5 | 5 | 5 | 5 | 5 | 5 | 5 | 5 | 5 | 5 | 5 | 5 | 5 | 5 | 5 | 5 | 10 | 10 | 15 | 20 | 20 | 10 | 5 | 5 | |
| | WD-AVG | 5 | 5 | 5 | 5 | 5 | 5 | 5 | 5 | 51 | 64 | 65 | 58 | 56 | 54 | 53 | 35 | 14 | 16 | 25 | 26 | 20 | 10 | 5 | 5 | |
| | Sat-1 | 5 | 5 | 5 | 5 | 5 | 5 | 5 | 10 | 30 | 50 | 50 | 30 | 10 | 5 | 5 | 5 | 5 | 5 | 5 | 5 | 5 | 5 | 5 | 5 | 5 |
| | Sat-2 | 5 | 5 | 5 | 5 | 5 | 5 | 5 | 5 | 5 | 5 | 5 | 5 | 5 | 5 | 5 | 5 | 5 | 5 | 5 | 5 | 5 | 5 | 5 | 5 | 5 |
| HVAC System | WD | Off | Off | Off | Off | Off | Off | Off | On | On | On | On | On | On | On | On | On | On | On | On | On | On | Off | Off | Off | |
| | Sat | Off | Off | Off | Off | Off | Off | Off | Off | On | On | On | On | On | Off | Off | Off | Off | Off | Off | Off | Off | Off | Off | Off | Off |
| Heating | Sun | Off | Off | Off | Off | Off | Off | Off | Off | Off | Off | Off | Off | Off | Off | Off | Off | Off | Off | Off | Off | Off | Off | Off | Off | Off |
| | WD | 60 | 60 | 60 | 60 | 60 | 63 | 66 | 70 | 70 | 70 | 70 | 70 | 70 | 70 | 70 | 70 | 70 | 70 | 70 | 70 | 70 | 70 | 60 | 60 | 60 |
| | Sat | 60 | 60 | 60 | 60 | 60 | 60 | 63 | 66 | 70 | 70 | 70 | 70 | 70 | 70 | 60 | 60 | 60 | 60 | 60 | 60 | 60 | 60 | 60 | 60 | 60 |
| Cooling | Sun | 60 | 60 | 60 | 60 | 60 | 60 | 60 | 60 | 60 | 60 | 60 | 60 | 60 | 60 | 60 | 60 | 60 | 60 | 60 | 60 | 60 | 60 | 60 | 60 | 60 |
| | WD | 85 | 85 | 85 | 85 | 85 | 82 | 78 | 75 | 75 | 75 | 75 | 75 | 75 | 75 | 75 | 75 | 75 | 75 | 75 | 75 | 75 | 75 | 85 | 85 | 85 |
| | Sat | 85 | 85 | 85 | 85 | 85 | 85 | 82 | 78 | 75 | 75 | 75 | 75 | 75 | 85 | 85 | 85 | 85 | 85 | 85 | 85 | 85 | 85 | 85 | 85 | 85 |
| Sun | 85 | 85 | 85 | 85 | 85 | 85 | 85 | 85 | 85 | 85 | 85 | 85 | 85 | 85 | 85 | 85 | 85 | 85 | 85 | 85 | 85 | 85 | 85 | 85 | 85 | |

Figure 15: Proposed realistic schedules – school occupancy

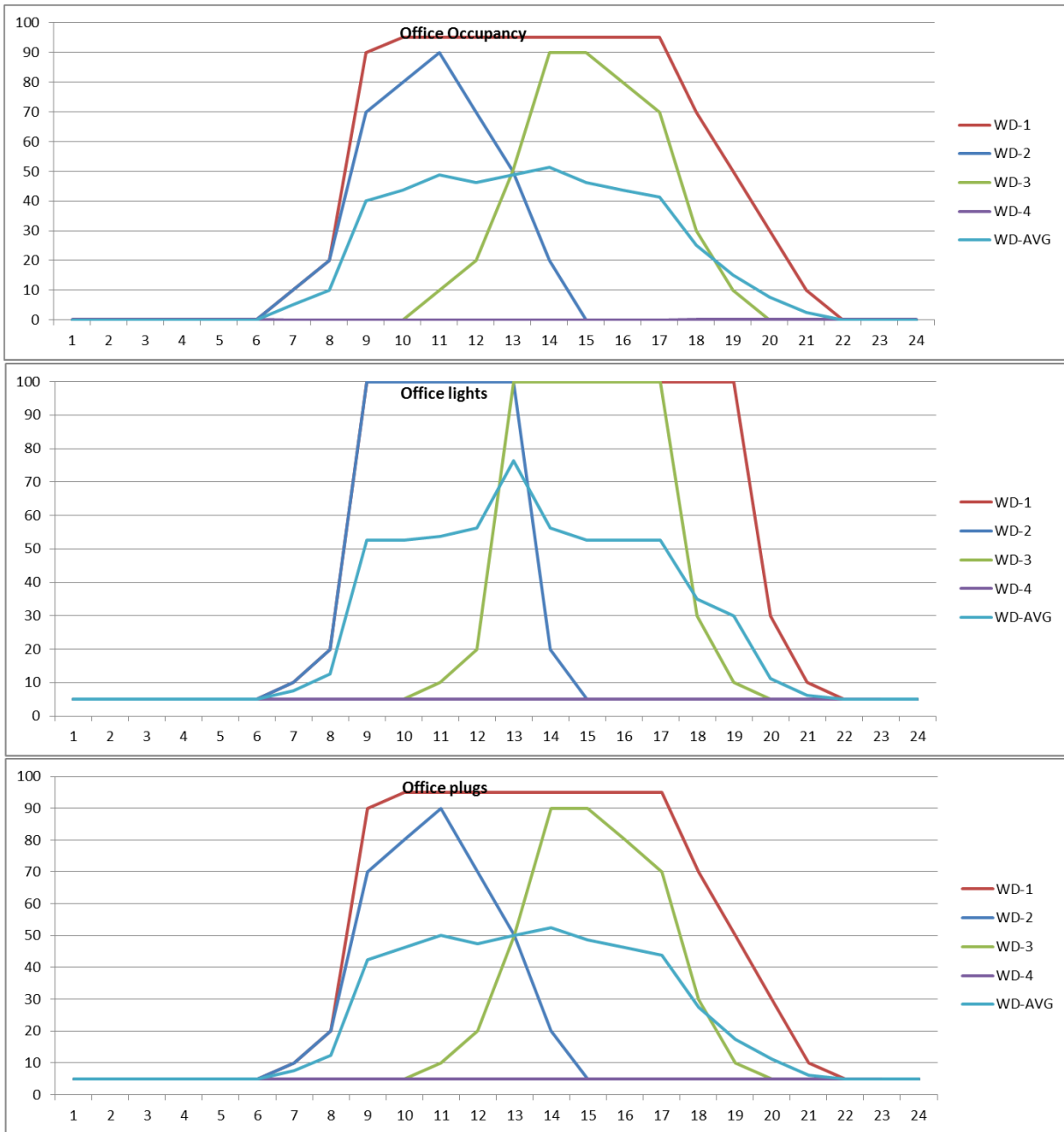

Figure 16: Plot of realistic schedules – office occupancy

8.6.4 Compliance Manuals

Section 4.3.8 of the Nonresidential Compliance Manual will need to be revised to account for the changes in coverage and for the fact that ventilation is now required to be shut off rather than set to 25 percent of the occupied ventilation rate.

The Statewide CASE Team also recommends the following additional guidance be added to this section:

“If a zone is served by a dedicated outdoor air system (DOAS) and a separate cooling system (e.g., VRF), then the DOAS flow to that zone must shut off and stay shut off when the zone is vacant and within deadband. If it drifts outside deadband while still unoccupied, then the DOAS flow is allowed

to come back on, but should not come on if doing so uses more energy, i.e., the separate cooling system can cycle on/off to meet the setup temperature setpoint in occupied standby mode without bringing on the ventilation.

Occupied standby control is allowed by Title 24, Part 6 wherever it is allowed by ASHRAE 62.1-2016 in spaces where Title 24, Part 6 does not mandate occupied standby control. These spaces include:

- enclosed offices greater than 250 square feet
- open plan offices
- multipurpose/assembly rooms greater than 1,000 square feet
- museums
- courtrooms
- religious worship
- auditorium
- supermarkets
- sports arena spectator areas

Credit is given in the ACM for voluntary use of occupied standby controls. If occupied standby controls are installed in a space that is not required to have occupied standby controls, then the proposed model will include occupied standby for that space, but the baseline model will not.”

The acceptance chapter of the Compliance Manual (Chapter 13) will not need to be revised. See Appendix G for recommended content for the Compliance Manual.

8.6.5 Compliance Documents

The Statewide CASE Team is not aware of an existing compliance document for the existing occupant sensor ventilation controls requirement. The Energy Commission will need to add another acceptance test similar to “2016-NRCA-LTI-02-A-LightingControl” and “2016-NRCA-MCH-06-A-DemandControlVentilation” for occupant sensor ventilation controls. This new acceptance test could have the following functional test:

1. Put zone in occupied mode (i.e., adjust occupancy schedule).
2. Physically occupy the zone such that the occupancy sensor detects a person.
3. Adjust thermostat such that zone is in deadband between heating and cooling.
4. Observe that minimum ventilation is supplied.
5. Adjust heating setpoint to slightly above current space temperature so the zone is in heating mode (e.g., hot water reheat valve is open or furnace has cycled on).
6. Vacate the zone such that occupancy sensor does not detect a person, but zone is still scheduled to be occupied.
7. Observe that, within five minutes of entering occupied standby mode, the heating setpoint is set back at least 2°F, the cooling setpoint is set up at least 2°F, the zone is now in deadband between heating and cooling, and all airflow to the zone is shut off. Note that the occupancy sensor itself may have a delay of up to 20 minutes per Standard Section 110.9(b), so the total delay for the HVAC controls to respond can be up to 20 minutes.
8. As similar test is conducted in cooling mode and the system sets up and shuts off airflow to the zone within 20 minutes of the zone being vacated.

9. BIBLIOGRAPHY

- AHRI. 2013. *2013 Standard for Performance Rating of Air to-Air Exchangers for Energy Recovery Ventilation Equipment*. Air-Conditioning, Heating, and Refrigeration Institute.
- AHRI. 2014. *2014 Standard for Performance Rating of Air to-Air Exchangers for Energy Recovery Ventilation Equipment*. Air-Conditioning, Heating and Refrigeration Institute.
- AHRI. 2015. *2015 Standard for Performance Rating of Liquid to Liquid Heat Exchangers*. Air-Conditioning, Heating, and Refrigeration Institute.
- ASHRAE. 2016. *ANSI/ASHRAE Standard 62.1-2016. Ventilation for acceptable indoor air quality*. Atlanta: American Society of Heating, Refrigerating, and Air-Conditioning Engineers, Inc.
- ASHRAE. 2016. *ANSI/ASHRAE/IES Standard 90.1-2016 - Energy Standard for Buildings Except Low-Rise Residential Buildings*. Atlanta: American Society of Heating, Refrigerating, and Air-Conditioning Engineers, Inc.
- BW Research Partnership. 2016. *Advanced Energy Jobs in California: Results of the 2016 California Advanced Energy*. Advanced Energy Economy Institute.
- California Department of Water Resources. 2016. "California Counties by Hydrologic Regions." Accessed April 3, 2016. <http://www.water.ca.gov/landwateruse/images/maps/California-County.pdf>.
- California Energy Commission. 2015. "2016 Building Energy Efficiency Standards: Frequently Asked Questions." Accessed February 2, 2017. http://www.energy.ca.gov/title24/2016standards/rulemaking/documents/2016_Building_Energy_Efficiency_Standards_FAQ.pdf.
- California Public Utilities Commission. 2015a. "Water/Energy Cost-Effectiveness Analysis: Errata to the Revised Final Report." Prepared by Navigant Consulting, Inc. <http://www.cpuc.ca.gov/WorkArea/DownloadAsset.aspx?id=5350>.
- . 2015b. "Water/Energy Cost-Effectiveness Analysis: Revised Final Report." Prepared by Navigant Consulting, Inc. <http://www.cpuc.ca.gov/WorkArea/DownloadAsset.aspx?id=5360>.
2016. *CBECC-COM 2016 Weather Data*. Sacramento.
- Energy + Environmental Economics. 2016. "Time Dependent Valuation of Energy for Developing Building Efficiency Standards: 2019 Time Dependent Valuation (TDV) Data Sources and Inputs." Prepared for the California Energy Commission. July. http://docketpublic.energy.ca.gov/PublicDocuments/16-BSTD-06/TN212524_20160801T120224_2019_TDV_Methodology_Report_7222016.pdf.
- Ettenson, Lara, and Christa Heavey. 2015. *California's Golden Energy Efficiency Opportunity: Ramping Up Success to Save Billions and Meet Climate Goals*. Natural Resources Defense Council & Environmental Entrepreneurs (E2).
- Goldman, Charles, Merrian C. Fuller, Elizabeth Stuart, Jane S Peters, Marjorie McRay, Nathaniel Albers, Susan Lutzenhiser, and Mersiha Spahic. 2010. *Energy Efficiency Services Sector: Workforce Size and Expectations for Growth*. Lawrence Berkeley National Laboratory.
- Hart, Reid, Jeff Boldt, and Michael Rosenberg. 2014. "Pre-cooling Chilled Water Return – Replacing Yesterday's Strainer Cycle." *ASHRAE 2014 Winter Conference*. 1-8.

- National Energy Assistance Directors Association. 2011. "2011 National Energy Assistance Survey Final Report." Accessed February 2, 2017.
<http://www.appriseinc.org/reports/Final%20NEADA%202011%20Report.pdf>.
- Sacramento Executive Airport. 2016.
- Shrestha, Som Sagar. 2009. *Performance evaluation of carbon-dioxide sensors used in building HVAC applications*. PhD thesis. Iowa State University.
- Statewide Utility Codes and Standards Team. 2011. "Codes and Standards Enhancement (CASE) Report: Light Commercial Unitary HVAC."
http://www.energy.ca.gov/title24/2013standards/prerulemaking/documents/current/Reports/Nonresidential/HVAC/2013_CASE_NR_Light_Commercial_Unitary_UPDATED_Nov_2011.pdf.
- Taylor, Steve. 2014. "How to Design & Control Waterside Economizers." *ASHRAE Journal* 30.
- Thornberg, Christopher, Hoyu Chong, and Adam Fowler. 2016. *California Green Innovation Index - 8th Edition*. Next 10.
- Touchstone Energy Cooperatives. 2016. "Nonrefrigerative Cooling Systems."
<http://bea.touchstoneenergy.com/resourcelibrary/article/1852>.
- U.S. Census Bureau, Population Division. 2014. "Annual Estimates of the Resident Population: April 1, 2010 to July 1, 2014."
<http://factfinder2.census.gov/bkmk/table/1.0/en/PEP/2014/PEPANNRES/0400000US06.05000>.
- U.S. EPA (United States Environmental Protection Agency). 2011. "Emission Factors for Greenhouse Gas Inventories." Accessed December 2, 2013.
<http://www.epa.gov/climateleadership/documents/emission-factors.pdf>.
- Wei, Max, Shana Patadia, and Daniel M. Kammen. 2010. "Putting renewables and energy efficiency to work: How many jobs can the clean energy industry generate in the US?" *Energy Policy* 38: 919-931.
- Zabin, Carol, and Karen Chapple. 2011. *California Workforce Education & Training Needs Assessment: For Energy Efficiency, Distributed Generation, and Demand Response*. University of California, Berkeley Donald Vial Center on Employment in the Green Economy. Accessed February 3, 2017.
http://laborcenter.berkeley.edu/pdf/2011/WET_Appendices_ALL.pdf.

Appendix A: STATEWIDE SAVINGS

METHODOLOGY

The projected total statewide nonresidential new construction forecast in 2020 is presented in Table 65. The projected total statewide nonresidential existing statewide building stock in 2020 is presented in Table 66.

To calculate first-year statewide savings, the Statewide CASE Team multiplied the per-unit savings by statewide new construction estimates for the first year the standards will be in effect (2020). The Energy Commission Demand Analysis Office provided the Statewide CASE Team with the nonresidential new construction forecast. The raw data presented annual total building stock and new construction estimates for twelve building types by forecast climate zones (FCZ). The Statewide CASE Team completed the following steps to refine the data and develop estimates of statewide floor space that will be impacted by the proposed code changes:

1. Translated data from FCZ data into building climate zones (BCZ). This was completed using the FCZ to BCZ conversion factors provided by the Energy Commission (see). Translated data from FCZ data into building standards climate zones (BSCZ). Since Title 24, Part 6 uses BSCZ, the Statewide CASE Team converted the construction forecast from FCZ to BSCZ using conversion factors supplied by the Energy Commission. The conversion factors, which are presented in Table 67 represent the percentage of building square footage in FCZ that is also in BSCZ. For example, looking at the first column of conversion factors in Table 67, 22.5 percent of the building square footage in FCZ 1 is also in BSCZ 1 and 0.1 percent of building square footage in FCZ 4 is in BSCZ 1. To convert from FCZ to BSCZ, the total forecasted construction for a specific building type in each FCZ was multiplied by the conversion factors for BSCZ 1, then all square footage from all FCZs that are found to be in BSCZ 1 are summed to arrive at the total construction for that building type in BSCZ 1. This process was repeated for every climate zone and every building type. See Table 69 for an example calculation to convert from FCZ to BSCZ. In this example, construction BSCZ 1 is made up of building floorspace from FCZs 1, 4, and 14.
2. Redistributed square footage allocated to the “Miscellaneous” building type. The building types included in the Energy Commissions’ forecast are summarized in Table 68. The Energy Commission’s forecast allocated 18.5 percent of the total square footage from nonresidential new construction in 2020 and the nonresidential existing building stock in 2020 to the miscellaneous building type, which is a category for all space types that do not fit well into another building category. It is likely that Title 24, Part 6 requirements will apply to the miscellaneous building types, and savings will be realized from this floor space. The new construction forecast does not provide sufficient information to distribute the miscellaneous square footage into the most likely building type, so the Statewide CASE Team redistributed the miscellaneous square footage into the remaining building types in such a way that the percentage of building floor space in each climate zone, net of the miscellaneous square footage, will remain constant. See for an example calculation.
3. Made assumptions about the percentage of nonresidential new construction in 2020 that will be impacted by the proposed code changes by building type and climate zone. The Statewide CASE Team’s assumptions are presented in Table 71 and Table 72 and discussed further below.
4. Made assumptions about the percentage of the total nonresidential building stock in 2020 that will be impacted by the proposed code changes (additions and alterations) by building type and climate zone. The Statewide CASE Team’s assumptions are presented in Table 71 and Table 72 and discussed further below.

5. Calculated nonresidential floor space that will be impacted by the proposed code changes in 2020 by building type and climate zone for both new construction and alterations.

Table 65: Estimated New Nonresidential Construction Impacted by Proposed Code Change in 2020, by Climate Zone and Building Type (Million Square Feet)

| Climate Zone | New Construction in 2020 (Million ft ²) | | | | | | | | | | | |
|--------------|---|------|--------|------|-------|-------|--------|---------|------|-------|---------|--------|
| | OFF-SMALL | REST | RETAIL | FOOD | NWHSE | RWHSE | SCHOOL | COLLEGE | HOSP | HOTEL | OFF-LRG | TOTAL |
| 1 | 0.06 | 0.02 | 0.11 | 0.04 | 0.05 | 0.00 | 0.08 | 0.04 | 0.04 | 0.03 | 0.07 | 0.53 |
| 2 | 0.26 | 0.12 | 0.89 | 0.23 | 0.60 | 0.05 | 0.41 | 0.20 | 0.26 | 0.30 | 1.04 | 4.37 |
| 3 | 0.86 | 0.49 | 3.95 | 0.92 | 3.57 | 0.23 | 1.51 | 0.91 | 1.05 | 1.66 | 6.93 | 22.08 |
| 4 | 0.59 | 0.26 | 2.14 | 0.56 | 1.35 | 0.12 | 0.93 | 0.46 | 0.64 | 0.66 | 2.34 | 10.05 |
| 5 | 0.11 | 0.05 | 0.42 | 0.11 | 0.26 | 0.02 | 0.18 | 0.09 | 0.12 | 0.13 | 0.45 | 1.95 |
| 6 | 0.79 | 0.58 | 3.31 | 0.83 | 2.72 | 0.12 | 1.00 | 0.57 | 0.63 | 0.77 | 4.37 | 15.68 |
| 7 | 1.06 | 0.32 | 2.04 | 0.63 | 1.14 | 0.01 | 1.08 | 0.47 | 0.67 | 0.67 | 2.20 | 10.29 |
| 8 | 1.10 | 0.83 | 4.78 | 1.19 | 3.86 | 0.16 | 1.46 | 0.80 | 0.96 | 1.11 | 6.39 | 22.64 |
| 9 | 1.08 | 0.92 | 5.05 | 1.23 | 4.13 | 0.14 | 1.48 | 0.94 | 1.37 | 1.28 | 8.62 | 26.23 |
| 10 | 1.23 | 0.80 | 3.83 | 1.08 | 3.28 | 0.07 | 2.07 | 0.69 | 0.81 | 0.74 | 2.17 | 16.78 |
| 11 | 0.35 | 0.11 | 0.81 | 0.28 | 0.80 | 0.09 | 0.54 | 0.17 | 0.26 | 0.18 | 0.41 | 4.00 |
| 12 | 1.87 | 0.54 | 4.39 | 1.16 | 3.76 | 0.28 | 2.20 | 0.84 | 1.24 | 1.10 | 4.50 | 21.88 |
| 13 | 0.76 | 0.25 | 1.79 | 0.60 | 1.53 | 0.25 | 1.19 | 0.35 | 0.56 | 0.40 | 0.79 | 8.47 |
| 14 | 0.20 | 0.15 | 0.76 | 0.20 | 0.64 | 0.02 | 0.38 | 0.12 | 0.16 | 0.14 | 0.54 | 3.32 |
| 15 | 0.27 | 0.11 | 0.66 | 0.23 | 0.72 | 0.02 | 0.38 | 0.09 | 0.11 | 0.17 | 0.27 | 3.03 |
| 16 | 0.28 | 0.17 | 0.96 | 0.26 | 0.67 | 0.04 | 0.41 | 0.21 | 0.24 | 0.19 | 1.25 | 4.66 |
| TOTAL | 10.86 | 5.71 | 35.88 | 9.52 | 29.09 | 1.63 | 15.29 | 6.97 | 9.13 | 9.53 | 42.36 | 175.96 |

Table 66: Estimated Existing Nonresidential Floor Space Impacted by Proposed Code Change in 2020 (Alterations), by Climate Zone and Building Type (Million Square Feet)

| Climate Zone | Alterations in 2020 (Million ft ²) | | | | | | | | | | | |
|--------------|--|---------------|----------------|---------------|----------------|--------------|---------------|---------------|---------------|---------------|-----------------|-----------------|
| | OFF-SMALL | REST | RETAIL | FOOD | NWHSE | RWHSE | SCHOOL | COLLEGE | HOSP | HOTEL | OFF-LRG | TOTAL |
| 1 | 2.73 | 0.88 | 4.78 | 1.62 | 2.38 | 0.13 | 3.53 | 1.82 | 2.07 | 1.67 | 2.84 | 24.44 |
| 2 | 12.17 | 4.54 | 36.30 | 9.60 | 25.39 | 2.01 | 19.78 | 10.78 | 13.49 | 12.78 | 42.20 | 189.02 |
| 3 | 38.63 | 18.17 | 151.04 | 35.13 | 131.95 | 9.12 | 76.78 | 45.17 | 53.16 | 60.60 | 253.74 | 873.49 |
| 4 | 27.68 | 10.22 | 87.74 | 22.82 | 59.86 | 5.08 | 45.31 | 24.79 | 32.05 | 29.44 | 98.68 | 443.67 |
| 5 | 5.38 | 1.98 | 17.04 | 4.43 | 11.62 | 0.99 | 8.80 | 4.81 | 6.22 | 5.72 | 19.16 | 86.14 |
| 6 | 38.56 | 25.66 | 151.51 | 37.93 | 141.00 | 5.72 | 67.06 | 37.58 | 39.97 | 42.09 | 185.70 | 772.79 |
| 7 | 45.42 | 13.19 | 91.67 | 27.80 | 61.31 | 0.56 | 44.03 | 23.99 | 32.87 | 39.02 | 100.79 | 480.66 |
| 8 | 53.32 | 36.68 | 216.43 | 53.96 | 198.41 | 7.91 | 94.33 | 51.73 | 58.95 | 59.71 | 269.76 | 1101.22 |
| 9 | 48.16 | 38.63 | 208.86 | 51.10 | 187.63 | 6.38 | 83.68 | 55.09 | 71.12 | 58.70 | 325.38 | 1134.72 |
| 10 | 57.16 | 36.87 | 181.33 | 50.35 | 193.92 | 3.72 | 86.58 | 35.65 | 42.41 | 41.29 | 97.29 | 826.56 |
| 11 | 14.71 | 4.26 | 32.27 | 11.02 | 35.01 | 4.07 | 21.73 | 8.91 | 12.96 | 7.24 | 15.55 | 167.75 |
| 12 | 74.91 | 21.41 | 178.69 | 47.18 | 159.80 | 12.34 | 92.47 | 42.13 | 62.74 | 46.57 | 175.87 | 914.10 |
| 13 | 31.99 | 9.62 | 69.46 | 23.37 | 59.41 | 10.14 | 49.08 | 18.18 | 27.37 | 15.15 | 27.86 | 341.64 |
| 14 | 9.42 | 6.98 | 34.78 | 9.34 | 36.18 | 1.10 | 16.30 | 6.38 | 8.44 | 7.24 | 22.63 | 158.79 |
| 15 | 11.93 | 4.65 | 28.37 | 9.43 | 34.97 | 0.91 | 13.82 | 4.06 | 5.63 | 7.11 | 10.82 | 131.71 |
| 16 | 12.29 | 7.16 | 41.58 | 11.18 | 32.67 | 1.81 | 17.73 | 10.87 | 12.33 | 8.82 | 46.72 | 203.16 |
| TOTAL | 484.47 | 240.90 | 1531.85 | 406.27 | 1371.51 | 71.99 | 741.00 | 381.94 | 481.79 | 443.15 | 1,694.99 | 7,849.86 |

Table 67: Translation from Forecast Climate Zone (FCZ) to Building Standards Climate Zone (BSCZ)

| | | Building Standards Climate Zone (BSCZ) | | | | | | | | | | | | | | | | |
|-----------------------------|----|--|-------|-------|-------|------|-------|-------|-------|--------|-------|-------|--------|-------|-------|-------|-------|-------|
| | | 1 | 2 | 3 | 4 | 5 | 6 | 7 | 8 | 9 | 10 | 11 | 12 | 13 | 14 | 15 | 16 | Total |
| Forecast Climate Zone (FCZ) | 1 | 22.5% | 20.6% | 0.0% | 0.0% | 0.0% | 0.0% | 0.0% | 0.0% | 0.0% | 0.0% | 9.8% | 33.1% | 0.2% | 0.0% | 0.0% | 13.8% | 100% |
| | 2 | 0.0% | 0.0% | 0.0% | 0.0% | 0.0% | 0.0% | 0.0% | 0.0% | 0.0% | 0.0% | 22.0% | 75.7% | 0.0% | 0.0% | 0.0% | 2.3% | 100% |
| | 3 | 0.0% | 0.0% | 0.0% | 0.0% | 0.0% | 0.0% | 0.0% | 0.0% | 0.0% | 0.0% | 20.9% | 22.8% | 54.5% | 0.0% | 0.0% | 1.8% | 100% |
| | 4 | 0.1% | 13.7% | 8.4% | 46.0% | 8.9% | 0.0% | 0.0% | 0.0% | 0.0% | 0.0% | 0.0% | 22.8% | 0.0% | 0.0% | 0.0% | 0.0% | 100% |
| | 5 | 0.0% | 4.2% | 89.1% | 0.0% | 0.0% | 0.0% | 0.0% | 0.0% | 0.0% | 0.0% | 0.0% | 6.6% | 0.0% | 0.0% | 0.0% | 0.0% | 100% |
| | 6 | 0.0% | 0.0% | 0.0% | 0.0% | 0.0% | 0.0% | 0.0% | 0.0% | 0.0% | 0.0% | 0.0% | 100.0% | 0.0% | 0.0% | 0.0% | 0.0% | 100% |
| | 7 | 0.0% | 0.0% | 0.0% | 0.0% | 0.0% | 0.0% | 0.0% | 0.0% | 0.0% | 0.0% | 0.0% | 0.0% | 75.8% | 7.1% | 0.0% | 17.1% | 100% |
| | 8 | 0.0% | 0.0% | 0.0% | 0.0% | 0.0% | 40.1% | 0.0% | 50.8% | 8.7% | 0.0% | 0.0% | 0.0% | 0.0% | 0.0% | 0.0% | 0.5% | 100% |
| | 9 | 0.0% | 0.0% | 0.0% | 0.0% | 0.0% | 6.4% | 0.0% | 26.9% | 54.8% | 0.0% | 0.0% | 0.0% | 0.0% | 6.1% | 0.0% | 5.8% | 100% |
| | 10 | 0.0% | 0.0% | 0.0% | 0.0% | 0.0% | 0.0% | 0.0% | 0.0% | 0.0% | 74.9% | 0.0% | 0.0% | 0.0% | 12.3% | 7.9% | 4.9% | 100% |
| | 11 | 0.0% | 0.0% | 0.0% | 0.0% | 0.0% | 27.0% | 0.0% | 30.6% | 42.4% | 0.0% | 0.0% | 0.0% | 0.0% | 0.0% | 0.0% | 0.0% | 100% |
| | 12 | 0.0% | 0.0% | 0.0% | 0.0% | 0.0% | 0.1% | 0.0% | 4.2% | 95.6% | 0.0% | 0.0% | 0.0% | 0.0% | 0.0% | 0.0% | 0.1% | 100% |
| | 13 | 0.0% | 0.0% | 0.0% | 0.0% | 0.0% | 0.0% | 69.6% | 0.0% | 0.0% | 28.8% | 0.0% | 0.0% | 0.0% | 1.6% | 0.1% | 0.0% | 100% |
| | 14 | 2.9% | 0.0% | 0.0% | 0.0% | 0.0% | 0.0% | 0.0% | 0.0% | 0.0% | 0.0% | 0.0% | 0.0% | 0.0% | 0.0% | 0.0% | 97.1% | 100% |
| | 15 | 0.0% | 0.0% | 0.0% | 0.0% | 0.0% | 0.0% | 0.0% | 0.0% | 0.0% | 0.0% | 0.0% | 0.0% | 0.0% | 0.1% | 99.9% | 0.0% | 100% |
| | 16 | 0.0% | 0.0% | 0.0% | 0.0% | 0.0% | 0.0% | 0.0% | 0.0% | 100.0% | 0.0% | 0.0% | 0.0% | 0.0% | 0.0% | 0.0% | 0.0% | 100% |

Table 68: Description of Building Types and Subtypes (Prototypes) in Statewide Construction Forecast

| Energy Commission Building Type ID | Energy Commission Description | Prototype Description | | | |
|------------------------------------|--|-----------------------|-------------------------------|---------|---|
| | | Prototype ID | Floor Area (ft ²) | Stories | Notes |
| OFF-SMALL | Offices less than 30,000 square feet | Small Office | 5,502 | 1 | Five-zone office model with unconditioned attic and pitched roof. |
| REST | Any facility that serves food | Small Restaurant | 2,501 | 1 | Similar to a fast food joint with a small kitchen and dining areas. |
| RETAIL | Retail stores and shopping centers | Stand-Alone Retail | 24,563 | 1 | Stand-alone store similar to Walgreens or Banana Republic. |
| | | Large Retail | 240,000 | 1 | Big box retail building, similar to a Target or Best Buy store. |
| | | Strip Mall | 9,375 | 1 | Four-unit strip mall retail building. West end unit is twice as large as other three. |
| | | Mixed-Use Retail | 9,375 | 1 | Four-unit retail representing the ground floor units in a mixed-use building. Same as the strip mall with adiabatic ceilings. |
| FOOD | Any service facility that sells food and or liquor | N/A | N/A | N/A | N/A |
| NWHSE | Non-refrigerated warehouses | Warehouse | 49,495 | 1 | High ceiling warehouse space with small office area. |
| RWHSE | Refrigerated warehouses | N/A | N/A | N/A | N/A |
| SCHOOL | Schools K-12, not including colleges | Small School | 24,413 | 1 | Similar to an elementary school with classrooms, support spaces and small dining area. |
| | | Large School | 210,886 | 2 | Similar to high school with classrooms, commercial kitchen, auditorium, gymnasium and support spaces. |
| COLLEGE | Colleges, universities, community colleges | Small Office | 5,502 | 1 | Five-zone office model with unconditioned attic and pitched roof. |
| | | Medium Office | 53,628 | 3 | Five zones per floor office building with plenums on each floor. |
| | | Medium Office/Lab | 53,628 | 3 | Five zones per floor building with a combination of office and lab spaces. |
| | | Public Assembly | | 2 | TBD |
| | | Large School | 210,886 | 2 | Similar to high school with classrooms, commercial kitchen, auditorium, gymnasium and support spaces. |
| | | High Rise Apartment | 93,632 | 10 | 75 residential units along with common spaces and a penthouse. Multipliers are used to represent typical floors. |
| HOSP | Hospitals and other health-related facilities | N/A | N/A | N/A | N/A |
| HOTEL | Hotels and motels | Hotel | 42,554 | 4 | Hotel building with common spaces and 77 guest rooms. |
| MISC | All other space types that do not fit another category | N/A | N/A | N/A | N/A |
| OFF-LRG | Offices larger than 30,000 square feet | Medium Office | 53,628 | 3 | Five zones per floor office building with plenums on each floor. |
| | | Large Office | 498,589 | 12 | Five zones per floor office building with plenums on each floor. Middle floors represented using multipliers. |

Table 69: Converting from Forecast Climate Zone (FCZ) to Building Standards Climate Zone (BSCZ) – Example Calculation

| Climate Zone | Total Statewide Small Office Square Footage in 2020 by FCZ (Million Square Feet) [A] | Conversion Factor FCZ to BSCZ 1 [B] | Small Office Square Footage in BSCZ 1 (Million Square Feet) [C] = A x B |
|--------------|---|-------------------------------------|--|
| 1 | 0.204 | 22.5% | 0.046 |
| 2 | 0.379 | 0.0% | 0.000 |
| 3 | 0.857 | 0.0% | 0.000 |
| 4 | 1.009 | 0.1% | 0.001 |
| 5 | 0.682 | 0.0% | 0.000 |
| 6 | 0.707 | 0.0% | 0.000 |
| 7 | 0.179 | 0.0% | 0.000 |
| 8 | 1.276 | 0.0% | 0.000 |
| 9 | 0.421 | 0.0% | 0.000 |
| 10 | 0.827 | 0.0% | 0.000 |
| 11 | 0.437 | 0.0% | 0.000 |
| 12 | 0.347 | 0.0% | 0.000 |
| 13 | 1.264 | 0.0% | 0.000 |
| 14 | 0.070 | 2.9% | 0.002 |
| 15 | 0.151 | 0.0% | 0.000 |
| 16 | 0.035 | 0.0% | 0.000 |
| Total | 8.844 | | 0.049 |

Table 70: Example of Redistribution of Miscellaneous Category - 2020 New Construction in Climate Zone 1

| Building Type | 2020 Forecast (Million ft ²) [A] | Distribution Excluding Miscellaneous Category [B] | Redistribution of Miscellaneous Category (Million ft ²) [C] = B x 0.11 | Revised 2020 Forecast (Million ft ²) [D] = A + C |
|----------------------------|---|---|---|---|
| Small office | 0.049 | 12% | 0.013 | 0.062 |
| Restaurant | 0.016 | 4% | 0.004 | 0.021 |
| Retail | 0.085 | 20% | 0.022 | 0.108 |
| Food | 0.029 | 7% | 0.008 | 0.036 |
| Non-refrigerated warehouse | 0.037 | 9% | 0.010 | 0.046 |
| Refrigerated warehouse | 0.002 | 1% | 0.001 | 0.003 |
| Schools | 0.066 | 16% | 0.017 | 0.083 |
| College | 0.028 | 7% | 0.007 | 0.035 |
| Hospital | 0.031 | 7% | 0.008 | 0.039 |
| Hotel/motel | 0.025 | 6% | 0.007 | 0.032 |
| Miscellaneous | 0.111 | --- | - | --- |
| Large offices | 0.055 | 13% | 0.014 | 0.069 |
| Total | 0.534 | 100% | 0.111 | 0.534 |

Fan System Power

Table 71: Percent of Floor Space Impacted by Proposed Measure, by Building Type

| Building Type <i>Building subtype</i> | Composition of Building Type by Subtypes ^a | Percent of Square Footage Impacted ^b | |
|--|---|---|---|
| | | New Construction | Existing Building Stock (Alterations) ^c |
| Small office | | 25 | 0 |
| Restaurant | | 25 | 0 |
| Retail | | 25 | 0 |
| <i>Stand-Alone Retail</i> | 10% | 25 | 0 |
| <i>Large Retail</i> | 75% | 25 | 0 |
| <i>Strip Mall</i> | 5% | 25 | 0 |
| <i>Mixed-Use Retail</i> | 10% | 25 | 0 |
| Food | | 25 | 0 |
| Non-refrigerated warehouse | | 25 | 0 |
| Refrigerated warehouse | | 25 | 0 |
| Schools | | 25 | 0 |
| <i>Small School</i> | 60% | 25 | 0 |
| <i>Large School</i> | 40% | 25 | 0 |
| College | | 25 | 0 |
| <i>Small Office</i> | 5% | 25 | 0 |
| <i>Medium Office</i> | 15% | 25 | 0 |
| <i>Medium Office/Lab</i> | 20% | 25 | 0 |
| <i>Public Assembly</i> | 5% | 25 | 0 |
| <i>Large School</i> | 30% | 25 | 0 |
| <i>High Rise Apartment</i> | 25% | 25 | 0 |
| Hospital | | 25 | 0 |
| Hotel/motel | | 25 | 0 |
| Large offices | | 25 | 0 |
| <i>Medium Office</i> | 50% | 25 | 0 |
| <i>Large Office</i> | 50% | 25 | 0 |

- Presents the assumed composition of the main building type category by the building subtypes. All 2019 CASE Reports assumed the same percentages of building subtypes.
- When the building type is composed of multiple subtypes, the overall percentage for the main building category was calculated by weighing the contribution of each subtype.
- Percent of existing floor space that will be altered during the first year the 2019 Standards are in effect.

Table 72: Percent of Floor Space Impacted by Proposed Measure, by Climate Zone

| Climate Zone | Percent of Square Footage Impacted | |
|--------------|------------------------------------|--|
| | New Construction | Existing Building Stock (Alterations) ^a |
| 1 | 100 | 0 |
| 2 | 100 | 0 |
| 3 | 100 | 0 |
| 4 | 100 | 0 |
| 5 | 100 | 0 |
| 6 | 100 | 0 |
| 7 | 100 | 0 |
| 8 | 100 | 0 |
| 9 | 100 | 0 |
| 10 | 100 | 0 |
| 11 | 100 | 0 |
| 12 | 100 | 0 |
| 13 | 100 | 0 |
| 14 | 100 | 0 |
| 15 | 100 | 0 |
| 16 | 100 | 0 |

a. Percent of existing floor space that will be altered during the first year the 2019 Standards are in effect.

Exhaust Air Heat Recovery

Table 73: Percent of Floor Space Impacted by Proposed Measure, by Building Type

| Building Type <i>Building subtype</i> | Composition of Building Type by Subtypes ^a | Percent of Square Footage Impacted ^b | |
|--|---|---|-------------------------------|
| | | New Construction- HRV < 8000 | New Construction- HRV Labs |
| Small office | | 0 | 0 |
| Restaurant | | 0 | 0 |
| Retail | | 13 | 0 |
| <i>Stand-Alone Retail</i> | 10% | 0 | 0 |
| <i>Large Retail</i> | 75% | 15 | 0 |
| <i>Strip Mall</i> | 5% | 15 | 0 |
| <i>Mixed-Use Retail</i> | 10% | 10 | 0 |
| Food | | 0 | 0 |
| Non-refrigerated warehouse | | 0 | 0 |
| Refrigerated warehouse | | 0 | 0 |
| Schools | | 12 | 0 |
| <i>Small School</i> | 60% | 10 | 0 |
| <i>Large School</i> | 40% | 15 | 0 |
| College | | 8 | 20 |
| <i>Small Office</i> | 5% | 0 | 0 |
| <i>Medium Office</i> | 15% | 15 | 0 |
| <i>Medium Office/Lab</i> | 20% | 0 | 100 |
| <i>Public Assembly</i> | 5% | 15 | 0 |
| <i>Large School</i> | 30% | 15 | 0 |
| <i>High Rise Apartment</i> | 25% | 0 | 0 |
| Hospital | | 50 | 0 |
| Hotel/motel | | 0 | 0 |
| Large offices | | 18 | 0 |
| <i>Medium Office</i> | 50% | 15 | 0 |
| <i>Large Office</i> | 50% | 20 | 0 |

- Presents the assumed composition of the main building type category by the building subtypes. All 2019 CASE Reports assumed the same percentages of building subtypes.
- When the building type is composed of multiple subtypes, the overall percentage for the main building category was calculated by weighing the contribution of each subtype.
- Percent of existing floor space that will be altered during the first year the 2019 standards are in effect.

Table 74: Percent of Floor Space Impacted by Proposed Measure, by Climate Zone

| Climate Zone | Percent of Square Footage Impacted | |
|--------------|------------------------------------|--|
| | New Construction- HRV < 8000 | New Construction- HRV Labs ^a |
| 1 | 0 | 0 |
| 2 | 0 | 100 |
| 3 | 0 | 0 |
| 4 | 0 | 0 |
| 5 | 0 | 0 |
| 6 | 0 | 0 |
| 7 | 0 | 0 |
| 8 | 0 | 0 |
| 9 | 0 | 100 |
| 10 | 0 | 100 |
| 11 | 0 | 100 |
| 12 | 0 | 100 |
| 13 | 0 | 100 |
| 14 | 0 | 100 |
| 15 | 100 | 100 |
| 16 | 0 | 0 |

a. Percent of existing floor space that will be altered during the first year the 2019 Standards are in effect.

Equipment Efficiency

Table 75: Percent of Floor Space Impacted by Proposed Measure, by Building Type

| Building Type <i>Building subtype</i> | Composition of Building Type by Subtypes ^a | Percent of Square Footage Impacted ^b | |
|--|---|---|---|
| | | New Construction | Existing Building Stock (Alterations) ^c |
| Small office | | 0% | 0% |
| Restaurant | | 0% | 0% |
| Retail | | 0% | 0% |
| <i>Stand-Alone Retail</i> | 10% | 0% | 0% |
| <i>Large Retail</i> | 75% | 0% | 0% |
| <i>Strip Mall</i> | 5% | 0% | 0% |
| <i>Mixed-Use Retail</i> | 10% | 0% | 0% |
| Food | | 0% | 0% |
| Non-refrigerated warehouse | | 0% | 0% |
| Refrigerated warehouse | | 0% | 0% |
| Schools | | 70% | 5% |
| <i>Small School</i> | 60% | 70% | 5% |
| <i>Large School</i> | 40% | 70% | 5% |
| College | | 13% | 1% |
| <i>Small Office</i> | 5% | 0% | 0% |
| <i>Medium Office</i> | 15% | 0% | 0% |
| <i>Medium Office/Lab</i> | 20% | 0% | 0% |
| <i>Public Assembly</i> | 5% | 0% | 0% |
| <i>Large School</i> | 30% | 0% | 0% |
| <i>High Rise Apartment</i> | 25% | 50% | 3% |
| Hospital | | 0% | 0% |
| Hotel/motel | | 0% | 0% |
| Large offices | | 0% | 0% |
| <i>Medium Office</i> | 50% | 0% | 0% |
| <i>Large Office</i> | 50% | 0% | 0% |

- Presents the assumed composition of the main building type category by the building subtypes. All 2019 CASE Reports assumed the same percentages of building subtypes.
- When the building type is composed of multiple subtypes, the overall percentage for the main building category was calculated by weighing the contribution of each subtype.
- Percent of existing floor space that will be altered during the first year the 2019 Standards are in effect.

Table 76: Percent of Floor Space Impacted by Proposed Measure, by Climate Zone

| Climate Zone | Percent of Square Footage Impacted | |
|--------------|------------------------------------|--|
| | New Construction | Existing Building Stock (Alterations) ^a |
| 1 | 100 | 100 |
| 2 | 100 | 100 |
| 3 | 100 | 100 |
| 4 | 100 | 100 |
| 5 | 100 | 100 |
| 6 | 100 | 100 |
| 7 | 100 | 100 |
| 8 | 100 | 100 |
| 9 | 100 | 100 |
| 10 | 100 | 100 |
| 11 | 100 | 100 |
| 12 | 100 | 100 |
| 13 | 100 | 100 |
| 14 | 100 | 100 |
| 15 | 100 | 100 |
| 16 | 100 | 100 |

a. Percent of existing floor space that will be altered during the first year the 2019 standards are in effect.

Waterside Economizer

Table 77: Percent of Floor Space Impacted by Proposed Measure, by Building Type

| Building Type <i>Building subtype</i> | Composition of Building Type by Subtypes ^a | Percent of Square Footage Impacted ^b | |
|--|---|---|---|
| | | New Construction | Existing Building Stock (Alterations) ^c |
| Small office | | 0 | 0 |
| Restaurant | | 0 | 0 |
| Retail | | 0 | 0 |
| <i>Stand-Alone Retail</i> | 10% | 0 | 0 |
| <i>Large Retail</i> | 75% | 0 | 0 |
| <i>Strip Mall</i> | 5% | 0 | 0 |
| <i>Mixed-Use Retail</i> | 10% | 0 | 0 |
| Food | | 0 | 0 |
| Non-refrigerated warehouse | | 0 | 0 |
| Refrigerated warehouse | | 0 | 0 |
| Schools | | 0 | 0 |
| <i>Small School</i> | 60% | 0 | 0 |
| <i>Large School</i> | 40% | 0 | 0 |
| College | | 0 | 0 |
| <i>Small Office</i> | 5% | 0 | 0 |
| <i>Medium Office</i> | 15% | 0 | 0 |
| <i>Medium Office/Lab</i> | 20% | 0 | 0 |
| <i>Public Assembly</i> | 5% | 0 | 0 |
| <i>Large School</i> | 30% | 0 | 0 |
| <i>High Rise Apartment</i> | 25% | 0 | 0 |
| Hospital | | 0 | 0 |
| Hotel/motel | | 0 | 0 |
| Large offices | | 3 | 0 |
| <i>Medium Office</i> | 50% | 3 | 0 |
| <i>Large Office</i> | 50% | 3 | 0 |

- Presents the assumed composition of the main building type category by the building subtypes. All 2019 CASE Reports assumed the same percentages of building subtypes.
- When the building type is composed of multiple subtypes, the overall percentage for the main building category was calculated by weighing the contribution of each subtype.
- Percent of existing floor space that will be altered during the first year the 2019 standards are in effect.

Table 78: Percent of Floor Space Impacted by Proposed Measure, by Climate Zone

| Climate Zone | Percent of Square Footage Impacted | |
|--------------|------------------------------------|--|
| | New Construction | Existing Building Stock (Alterations) ^a |
| 1 | 100 | 0 |
| 2 | 100 | 0 |
| 3 | 100 | 0 |
| 4 | 100 | 0 |
| 5 | 100 | 0 |
| 6 | 100 | 0 |
| 7 | 100 | 0 |
| 8 | 100 | 0 |
| 9 | 100 | 0 |
| 10 | 100 | 0 |
| 11 | 100 | 0 |
| 12 | 100 | 0 |
| 13 | 100 | 0 |
| 14 | 100 | 0 |
| 15 | 100 | 0 |
| 16 | 100 | 0 |

a. Percent of existing floor space that will be altered during the first year the 2019 standards are in effect.

Transfer Air for Exhaust Air Makeup

Table 79: Percent of Floor Space Impacted by Proposed Measure, by Building Type

| Building Type <i>Building subtype</i> | Composition of Building Type by Subtypes ^a | Percent of Square Footage Impacted ^b | |
|--|---|---|--|
| | | New Construction | Existing Building Stock (Alterations) ^c |
| Small office | | 0% | 0 |
| Restaurant | | 0% | 0 |
| Retail | | 0% | 0 |
| <i>Stand-Alone Retail</i> | 10% | 0% | 0 |
| <i>Large Retail</i> | 75% | 0% | 0 |
| <i>Strip Mall</i> | 5% | 0% | 0 |
| <i>Mixed-Use Retail</i> | 10% | 0% | 0 |
| Food | | 0% | 0 |
| Non-refrigerated warehouse | | 0% | 0 |
| Refrigerated warehouse | | 0% | 0 |
| Schools | | 0% | 0 |
| <i>Small School</i> | 60% | 0% | 0 |
| <i>Large School</i> | 40% | 0% | 0 |
| College | | 20% | 0 |
| <i>Small Office</i> | 5% | 0% | 0 |
| <i>Medium Office</i> | 15% | 0% | 0 |
| <i>Medium Office/Lab</i> | 20% | 100% | 0 |
| <i>Public Assembly</i> | 5% | 0% | 0 |
| <i>Large School</i> | 30% | 0% | 0 |
| <i>High Rise Apartment</i> | 25% | 0% | 0 |
| Hospital | | 0% | 0 |
| Hotel/motel | | 0% | 0 |
| Large offices | | 0% | 0 |
| <i>Medium Office</i> | 50% | 0% | 0 |
| <i>Large Office</i> | 50% | 0% | 0 |

- Presents the assumed composition of the main building type category by the building subtypes. All 2019 CASE Reports assumed the same percentages of building subtypes.
- When the building type is composed of multiple subtypes, the overall percentage for the main building category was calculated by weighing the contribution of each subtype.
- Percent of existing floor space that will be altered during the first year the 2019 standards are in effect.

Table 80: Percent of Floor Space Impacted by Proposed Measure, by Climate Zone

| Climate Zone | Percent of Square Footage Impacted | |
|--------------|------------------------------------|--|
| | New Construction | Existing Building Stock (Alterations) ^a |
| 1 | 100 | 0 |
| 2 | 100 | 0 |
| 3 | 100 | 0 |
| 4 | 100 | 0 |
| 5 | 100 | 0 |
| 6 | 100 | 0 |
| 7 | 100 | 0 |
| 8 | 100 | 0 |
| 9 | 100 | 0 |
| 10 | 100 | 0 |
| 11 | 100 | 0 |
| 12 | 100 | 0 |
| 13 | 100 | 0 |
| 14 | 100 | 0 |
| 15 | 100 | 0 |
| 16 | 100 | 0 |

a. Percent of existing floor space that will be altered during the first year the 2019 standards are in effect.

Demand Control Ventilation for Classrooms

Table 81: Percent of Floor Space Impacted by Proposed Measure, by Building Type

| Building Type <i>Building sub-type</i> | Composition of Building Type by Sub-types ^a | Percent of Square Footage Impacted ^b | |
|---|--|---|---|
| | | New Construction | Existing Building Stock (Alterations) ^c |
| Small office | | 0 | 0 |
| Restaurant | | 0 | 0 |
| Retail | | 0 | 0 |
| <i>Stand-Alone Retail</i> | 10% | 0 | 0 |
| <i>Large Retail</i> | 75% | 0 | 0 |
| <i>Strip Mall</i> | 5% | 0 | 0 |
| <i>Mixed-Use Retail</i> | 10% | 0 | 0 |
| Food | | 0 | 0 |
| Non-refrigerated warehouse | | 0 | 0 |
| Refrigerated warehouse | | 0 | 0 |
| Schools | | 100% | 0 |
| <i>Small School</i> | 60% | 100% | 0 |
| <i>Large School</i> | 40% | 100% | 0 |
| College | | 0 | 0 |
| <i>Small Office</i> | 5% | 0 | 0 |
| <i>Medium Office</i> | 15% | 0 | 0 |
| <i>Medium Office/Lab</i> | 20% | 0 | 0 |
| <i>Public Assembly</i> | 5% | 0 | 0 |
| <i>Large School</i> | 30% | 0 | 0 |
| <i>High Rise Apartment</i> | 25% | 0 | 0 |
| Hospital | | 0 | 0 |
| Hotel/motel | | 0 | 0 |
| Large offices | | 3 | 0 |
| <i>Medium Office</i> | 50% | 3 | 0 |
| <i>Large Office</i> | 50% | 3 | 0 |

- Presents the assumed composition of the main building type category by the building subtypes. All 2019 CASE Reports assumed the same percentages of building subtypes.
- When the building type is composed of multiple subtypes, the overall percentage for the main building category was calculated by weighing the contribution of each subtype.
- Percent of existing floor space that will be altered during the first year the 2019 Standards are in effect.

Table 82: Percent of Floor Space Impacted by Proposed Measure, by Climate Zone

| Climate Zone | Percent of Square Footage Impacted | |
|--------------|------------------------------------|--|
| | New Construction | Existing Building Stock (Alterations) ^a |
| 1 | 100 | 0 |
| 2 | 100 | 0 |
| 3 | 100 | 0 |
| 4 | 100 | 0 |
| 5 | 100 | 0 |
| 6 | 100 | 0 |
| 7 | 100 | 0 |
| 8 | 100 | 0 |
| 9 | 100 | 0 |
| 10 | 100 | 0 |
| 11 | 100 | 0 |
| 12 | 100 | 0 |
| 13 | 100 | 0 |
| 14 | 100 | 0 |
| 15 | 100 | 0 |
| 16 | 100 | 0 |

a. Percent of existing floor space that will be altered during the first year the 2019 standards are in effect.

Occupant Sensor Ventilation Requirements

Table 83: Percent of Floor Space Impacted by Proposed Measure, by Building Type

| Building Type <i>Building subtype</i> | Composition of Building Type by Subtypes ^a | Percent of Square Footage Impacted ^b | |
|--|---|---|---|
| | | New Construction | Existing Building Stock (Alterations) ^c |
| Small Office | | 50% | 0 |
| Restaurant | | 0% | 0 |
| Retail | | 0% | 0 |
| <i>Stand-Alone Retail</i> | 10% | 0% | 0 |
| <i>Large Retail</i> | 75% | 0% | 0 |
| <i>Strip Mall</i> | 5% | 0% | 0 |
| <i>Mixed-Use Retail</i> | 10% | 0% | 0 |
| Food | | 0% | 0 |
| Non-refrigerated warehouse | | 0% | 0 |
| Refrigerated warehouse | | 0% | 0 |
| Schools^d | | 0% | 0 |
| <i>Small School</i> | 60% | 50% | 0 |
| <i>Large School</i> | 40% | 50% | 0 |
| College | | 13% | 0 |
| <i>Small Office</i> | 5% | 50% | 0 |
| <i>Medium Office</i> | 15% | 30% | 0 |
| <i>Medium Office/Lab</i> | 20% | 30% | 0 |
| <i>Public Assembly</i> | 5% | 0% | 0 |
| <i>Large School</i> | 30% | 0% | 0 |
| <i>High Rise Apartment</i> | 25% | 0% | 0 |
| Hospital | | 0% | 0 |
| Hotel/motel | | 0% | 0 |
| Large offices | | 30% | 0 |
| <i>Medium Office</i> | 50% | 30% | 0 |
| <i>Large Office</i> | 50% | 30% | 0 |

- Presents the assumed composition of the main building type category by the building subtypes. All 2019 CASE Reports assumed the same percentages of building subtypes.
- When the building type is composed of multiple subtypes, the overall percentage for the main building category was calculated by weighing the contribution of each subtype.
- Percent of existing floor space that will be altered during the first year the 2019 standards are in effect.
- Occupancy sensing control of ventilation has applied to classroom since 2013, so added coverage is 0%.

Table 84: Percent of Floor Space Impacted by Proposed Measure, by Climate Zone

| Climate Zone | Percent of Square Footage Impacted | |
|--------------|------------------------------------|--|
| | New Construction | Existing Building Stock (Alterations) ^a |
| 1 | 100 | 0 |
| 2 | 100 | 0 |
| 3 | 100 | 0 |
| 4 | 100 | 0 |
| 5 | 100 | 0 |
| 6 | 100 | 0 |
| 7 | 100 | 0 |
| 8 | 100 | 0 |
| 9 | 100 | 0 |
| 10 | 100 | 0 |
| 11 | 100 | 0 |
| 12 | 100 | 0 |
| 13 | 100 | 0 |
| 14 | 100 | 0 |
| 15 | 100 | 0 |
| 16 | 100 | 0 |

a. Percent of existing floor space that will be altered during the first year the 2019 standards are in effect.

Appendix B: EMBEDDED ELECTRICITY IN WATER METHODOLOGY

The Statewide CASE Team assumed the following embedded electricity in water values: 4,848 kWh/million gallons of water (MG) for indoor water use and 3,565 kWh/MG for outdoor water use. Embedded electricity use for indoor water use includes electricity used for water extraction, conveyance, treatment to potable quality, water distribution, wastewater collection, and wastewater treatment. Embedded electricity for outdoor water use includes all energy uses upstream of the customer; it does not include wastewater collection or wastewater treatment. The embedded electricity values do not include on-site energy uses for water, such as water heating and on-site pumping. On-site energy impacts are accounted for in the energy savings estimates presented in this report.

These embedded electricity values were derived from research conducted for CPUC Rulemaking 13-12-011. The CPUC study aimed to quantify the embedded electricity savings associated with IOU incentive programs that result in water savings, and the findings represent the most up-to-date research by the CPUC on embedded energy in water throughout California (California Public Utilities Commission 2015a, 2015b). The CPUC analysis was limited to evaluating the embedded electricity in water and do not include embedded natural gas in water. Since accurate estimates of the embedded natural gas in water were not available at the time of writing, this CASE Report does not include estimates of embedded natural gas savings associated with water reductions.

The CPUC embedded electricity values used in the CASE Report analysis are shown in Table 85. These values represent the average energy intensity by hydrologic region, which are based on the historical supply mix for each region regardless of who supplied the electricity (IOU supplied and non-IOU supplied). The CPUC calculated the energy intensity of marginal supply, but recommended using the average IOU and non-IOU energy intensity to estimate total statewide average embedded electricity of water use in California.

Table 85: Embedded Electricity in Water by California Department of Water Resources Hydrologic Region (kWh per Acre Foot)

| Region | Extraction, Conveyance, and Treatment | Distribution | Wastewater Collection + Treatment | Outdoor (Upstream of Customer) | Indoor (All Components) |
|--------|---------------------------------------|--------------|-----------------------------------|--------------------------------|-------------------------|
| NC | 235 | 163 | 418 | 398 | 816 |
| SF | 375 | 318 | 418 | 693 | 1,111 |
| CC | 513 | 163 | 418 | 677 | 1,095 |
| SC | 1,774 | 163 | 418 | 1,937 | 2,355 |
| SR | 238 | 18 | 418 | 255 | 674 |
| SJ | 279 | 18 | 418 | 297 | 715 |
| TL | 381 | 18 | 418 | 399 | 817 |
| NL | 285 | 18 | 418 | 303 | 721 |
| SL | 837 | 163 | 418 | 1,000 | 1,418 |
| CR | 278 | 18 | 418 | 296 | 714 |

Hydrologic Region Abbreviations:

NC = North Coast, SF = San Francisco Bay, CC = Central Coast, SC = South Coast, SR = Sacramento River, SJ = San Joaquin River, TL = Tulare Lake, NL = North Lahontan, SL = South Lahontan, CR = Colorado River

Source: Navigant team analysis

Source: California Public Utilities Commission 2015b

The Statewide CASE Team used the CPUC’s indoor and outdoor embedded electricity estimates by hydrologic region (presented in Table 85) and population data by hydrologic region from the U.S. Census Bureau to calculate the statewide population-weighted average indoor and outdoor embedded electricity values that were used in the CASE Report analysis (see Table 86). The energy intensity values presented in Table 85 were converted from kWh per acre foot to kWh per million gallons to harmonize with the units used in the CASE Report analysis. There are 3.07 acre feet per million gallons.

Table 86: Statewide Population-Weighted Average Embedded Electricity in Water

| Hydrologic Region | Indoor Water Use (kWh/ million gallon) | Outdoor Water Use (kWh/ million gallon) | Percent of California Population |
|---|---|--|---|
| North Coast | 2,504 | 1,221 | 2.1% |
| San Francisco | 3,410 | 2,127 | 18.2% |
| Central Coast | 3,360 | 2,078 | 3.8% |
| South Coast | 7,227 | 5,944 | 44.8% |
| Sacramento River | 2,068 | 783 | 8.1% |
| San Joaquin River | 2,194 | 911 | 4.7% |
| Tulare Lake | 2,507 | 1,224 | 6.3% |
| North Lahontan | 2,213 | 930 | 0.1% |
| South Lahontan | 4,352 | 3,069 | 5.5% |
| Colorado River | 2,191 | 908 | 6.5% |
| Statewide Population- weighted Average | 4,848 | 3,565 | |

Sources: U.S. Census Bureau 2014; California Department of Water Resources 2016

Appendix C: DISCUSSION OF IMPACTS OF COMPLIANCE PROCESS ON MARKET ACTORS

This section discusses how the recommended compliance process could impact various market actors. The Statewide CASE Team asked stakeholders for feedback on how the measure would impact various market actors during public stakeholder meetings that were held on September 26, 2016, March 15, 2017, and March 29, 2017 (Statewide CASE Team 2019 Utility-Sponsored Stakeholder Meeting for Nonresidential HVAC). The stakeholder meeting did not include transfer air for exhaust air makeup, demand controlled ventilation for classrooms, and occupant sensor ventilation requirements, so a separate outreach effort was conducted on these measures' impacts. The key results from feedback received during stakeholder meetings and other target outreach efforts are detailed below.

Table 87 identifies the market actors who will play a role in complying with the proposed change, the tasks for which they will be responsible, their objectives in completing the tasks, how the proposed code change could impact their existing work flow, and ways to mitigate negative impacts.

The proposed compliance process will fit within the current workflow of the market actors involved since it will not create new tasks or remove existing tasks. The proposed process will not require coordination between market actors other than currently existing coordination or collaborations. No new specialized training or additional resources will be involved from the proposed process other than what is described in the CASE Report. The proposed compliance process will alter existing compliance documents to reflect the code change that market actors will need to identify and incorporate into their workflow.

Table 87: Roles of Market Actors in the Proposed Compliance Process

| Market Actor | Task(s) In Compliance Process | Objective(s) in Completing Compliance Tasks | How Proposed Code Change Could Impact Work Flow | Opportunities to Minimize Negative Impacts of Compliance Requirement |
|--------------------------------|--|---|--|---|
| Building Owner | <ul style="list-style-type: none"> • Provide funding for building • Provide owner project requirements (OPR) | <ul style="list-style-type: none"> • Building completed according to OPR • Building passes inspection | <ul style="list-style-type: none"> • Higher first costs | <ul style="list-style-type: none"> • Be aware of equipment costs so can budget ahead of time |
| Architects | <ul style="list-style-type: none"> • Develop building details and sections • Coordinate equipment sizes with mechanical designer | <ul style="list-style-type: none"> • Satisfy owner desires • Minimal clarifications • Meet project budget | <ul style="list-style-type: none"> • Additional coordination and space required for mechanical equipment | <ul style="list-style-type: none"> • None anticipated |
| Energy Consultant | <ul style="list-style-type: none"> • Determine necessary compliance documents • Complete compliance documents | <ul style="list-style-type: none"> • Project energy goals and code requirements are met • Compliance document passes plan examination | <ul style="list-style-type: none"> • More stringent requirements to meet | <ul style="list-style-type: none"> • Automated verification of compliance on form • Compliance software improvements to identify standard design requirements |
| Mechanical Designer | <ul style="list-style-type: none"> • Design mechanical system and details • Select equipment | <ul style="list-style-type: none"> • Design to meet Title 24, Part 6 code • Do this cost-effectively | <ul style="list-style-type: none"> • Mechanical equipment must be more efficient | <ul style="list-style-type: none"> • Automated verification of compliance on form |
| HVAC Subcontractor / Installer | <ul style="list-style-type: none"> • Install HVAC system • Select correct equipment | <ul style="list-style-type: none"> • Meet schedule • Complete within budget • Passes inspection | <ul style="list-style-type: none"> • Heavier/larger equipment to install • New required items which may be unfamiliar with | <ul style="list-style-type: none"> • Clear and concise requirements |
| Plans Examiner | <ul style="list-style-type: none"> • Ensures building is designed to code | <ul style="list-style-type: none"> • Forms are completed correctly • Do this with minimal training | <ul style="list-style-type: none"> • New code changes and requirements to identify | <ul style="list-style-type: none"> • Automate compliance documents to verify if equipment meets code |
| Building Inspector | <ul style="list-style-type: none"> • Verify equipment is registered with Title 24, Part 6 • Ensures building is designed to code • Issue Certificate of Occupancy | <ul style="list-style-type: none"> • Do this quickly • Get things right the first time • Do this with minimal training | <ul style="list-style-type: none"> • New code changes and requirements to identify | <ul style="list-style-type: none"> • Require equipment to display Title 24, Part 6 information on equipment and submittals |
| Manufacturer | <ul style="list-style-type: none"> • Sell products to engineers which meet code | <ul style="list-style-type: none"> • Get things right the first time • Satisfy design team requests | <ul style="list-style-type: none"> • Some products may not meet new requirements | <ul style="list-style-type: none"> • Simplify requirements and language so it's clear what products comply |

Appendix D: ALLOWED TOTAL STATIC PRESSURE BREAKDOWN BY COMPONENT

The following is the detailed breakdown of the static pressure drop through each component of the air system used as a basis for the fan system power analysis. ASHRAE static pressures are based on good design practices from research done in 2005. The fan system power measure will match the Nonresidential ACM Reference Manual by modifying the ASHRAE standards as shown in the following tables.

Table 88: ASHRAE 90.1-2016 - Good Practice Air System Design

| Basic Components | VAV System Press Drop Good Practice Dirty Filters " w.g. | Constant Volume System Press Drop Good Practice Dirty Filters " w.g. |
|--------------------|--|--|
| Return/Exhaust ESP | 1.0 | 0.5 |
| Air Blender | 0.2 | 0.2 |
| Inlet/MA Sect | 0.5 | 0.5 |
| Pre-Filter | 0.5 | 0.5 |
| Heat Coil | 0.3 | 0.3 |
| Cooling Coil | 0.6 | 0.6 |
| Outlet Trans | 0.25 | 0.25 |
| Supply ESP | 2.0 | 1.0 |
| Total | 5.35 | 3.85 |

Table 89: Title 24 Nonresidential Alternative Calculation Method Reference Manual 2016 - Proposed changes to ASHRAE

| Basic Components | VAV System Press Drop Good Practice Dirty Filters " w.g. | Constant Volume System Press Drop Good Practice Dirty Filters " w.g. |
|--------------------|--|--|
| Return/Exhaust ESP | 1.0 | 0.75 |
| Inlet/MA Sect | 0.5 | 0.5 |
| Pre-Filter | 0.3 | 0.3 |
| Heating Coil | 0.3 | 0.3 |
| Cooling Coil | 0.3 | 0.3 |
| Outlet Trans | 0.25 | 0.25 |
| Supply ESP | 1.85 | 1.0 |
| Total | 4.5 | 3.40 |

Appendix E: REFERENCE TOTAL STATIC PRESSURE FOR FAN SYSTEM POWER ANALYSIS

To find the necessary total static pressure of the fan system need to reach 1.25 W/cfm in the CBECC-Com model, the following calculation was used.

First, the maximum allowed airflow rate was solved for each motor size at the reference fan power index of 1.25 W/cfm. The motor power equation from ASHRAE 90.1-2016 Appendix G Section G3.1.2.9 was used to find the necessary power of the fan:

$$P_{fan} = \frac{bhp \times 746}{\mu_{motor}}$$

Where P_{fan} is the maximum power of the fan system (in watts), bhp is the brake horsepower of the fan, and μ_{motor} is the motor efficiency at the motor size.

By dividing both sides with the airflow rate (cfm), the W/cfm can be isolated from the equation.

$$\frac{W}{cfm} = \frac{bhp \times 746}{\mu_{motor}} \times \frac{1}{cfm}$$

Since the needed brake horsepower and motor efficiency is known for each motor, and the reference W/cfm is 1.25, maximum allowed airflow rate can be solved for each motor:

$$cfm = \frac{bhp \times 746}{\mu_{motor} \times 1.25}$$

Now that the maximum allowed airflow rate is known, this can be plugged into the fan power equation:

$$bhp = \frac{cfm \times TSP}{6356 \times \mu_{fan}}$$

Where TSP is the total static pressure of the fan system and μ_{fan} is the fan efficiency.

The brake horsepower and cfm are known from the previous equation and the fan efficiency is dictated by the Nonresidential ACM Reference Manual at 62 percent for systems greater than 10,000 cfm. By solving for the total static pressure at each motor horsepower, values as shown in Table 5 can be derived.

Appendix F: TRANSFER AIR EXAMPLES

Toilet Rooms

Figure 17 shows two toilet rooms, each with 300 cfm of exhaust, 60 cfm of supply air, and 240 cfm of transfer air from the adjacent ceiling return air plenum.

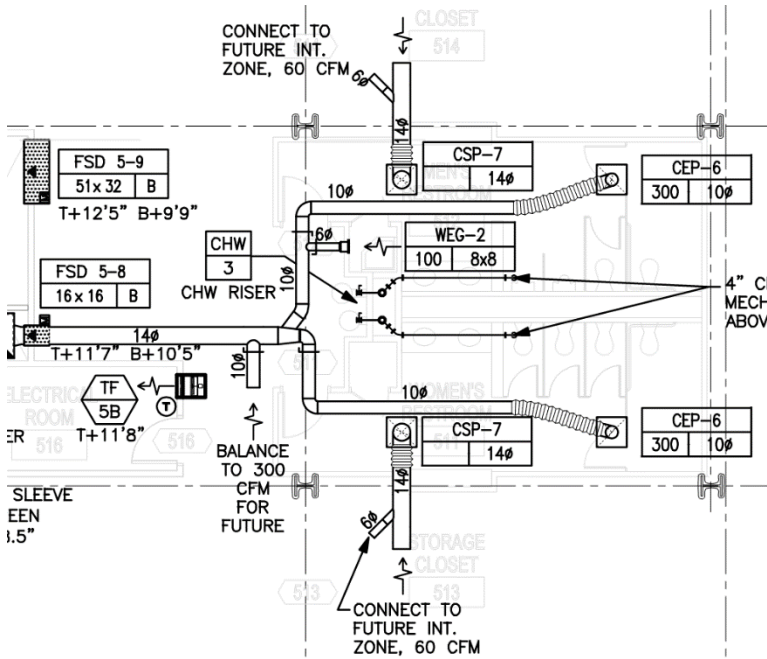

Figure 17: Example of transfer air for toilet exhaust makeup

Figure 18 is another toilet room, but this one uses a constant volume VAV box to provide 100 percent supply air makeup for the exhaust. The exhaust rate is much higher than the cooling load in the space, so a reheat coil is required to prevent the space from being overcooled. This is an expensive and inefficient design. The building's water heating system would also have to operate even in warm weather to prevent overcooling.

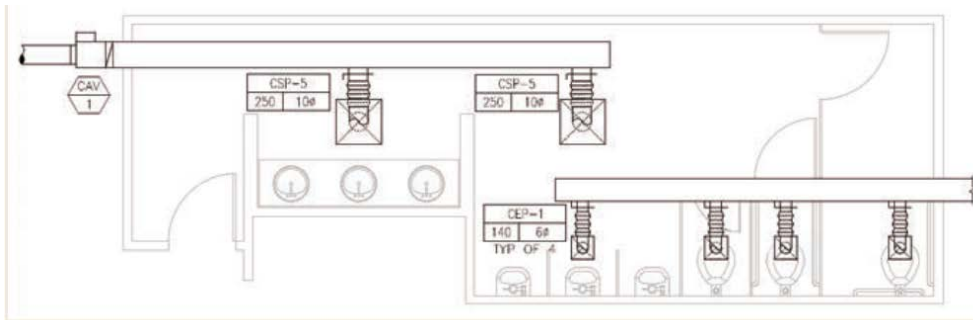

Figure 18: Toilet exhaust without transfer air

Figure 19 is the same toilet room as Figure 18, but with a much less expensive and more efficient design that uses only transfer air from the adjacent space for toilet makeup using an undercut (U.C.) under the door to the toilet room. The heating/cooling loads in interior toilet rooms are very low, thanks largely to

modern efficient lighting, so using 100 percent transfer air will keep most toilet rooms within 1°F of the adjacent space, which is generally acceptable for transient spaces such as toilet rooms.

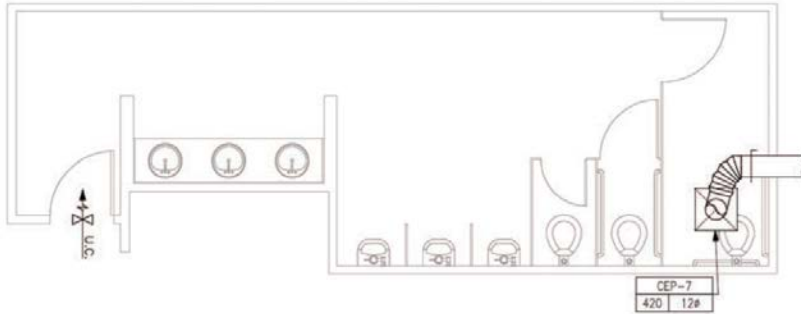

Figure 19: Toilet exhaust with transfer air

Laboratories

The University of California, Santa Cruz Coastal Biology Building is a lab building with fume hoods in most of the lab spaces. The labs are served by variable volume fume hoods, variable volume general exhaust (to maintain the required minimum air change rates), and supply air VAV boxes to meet the heating/cooling loads and provide minimum ventilation. When the fume and general exhaust rates exceed the supply VAV box flow, the fume and general exhaust valves simply pull the remaining makeup through the sound boots from the return plenum which serves the entire building (offices, classrooms, computer rooms, etc.). See Figure 18.

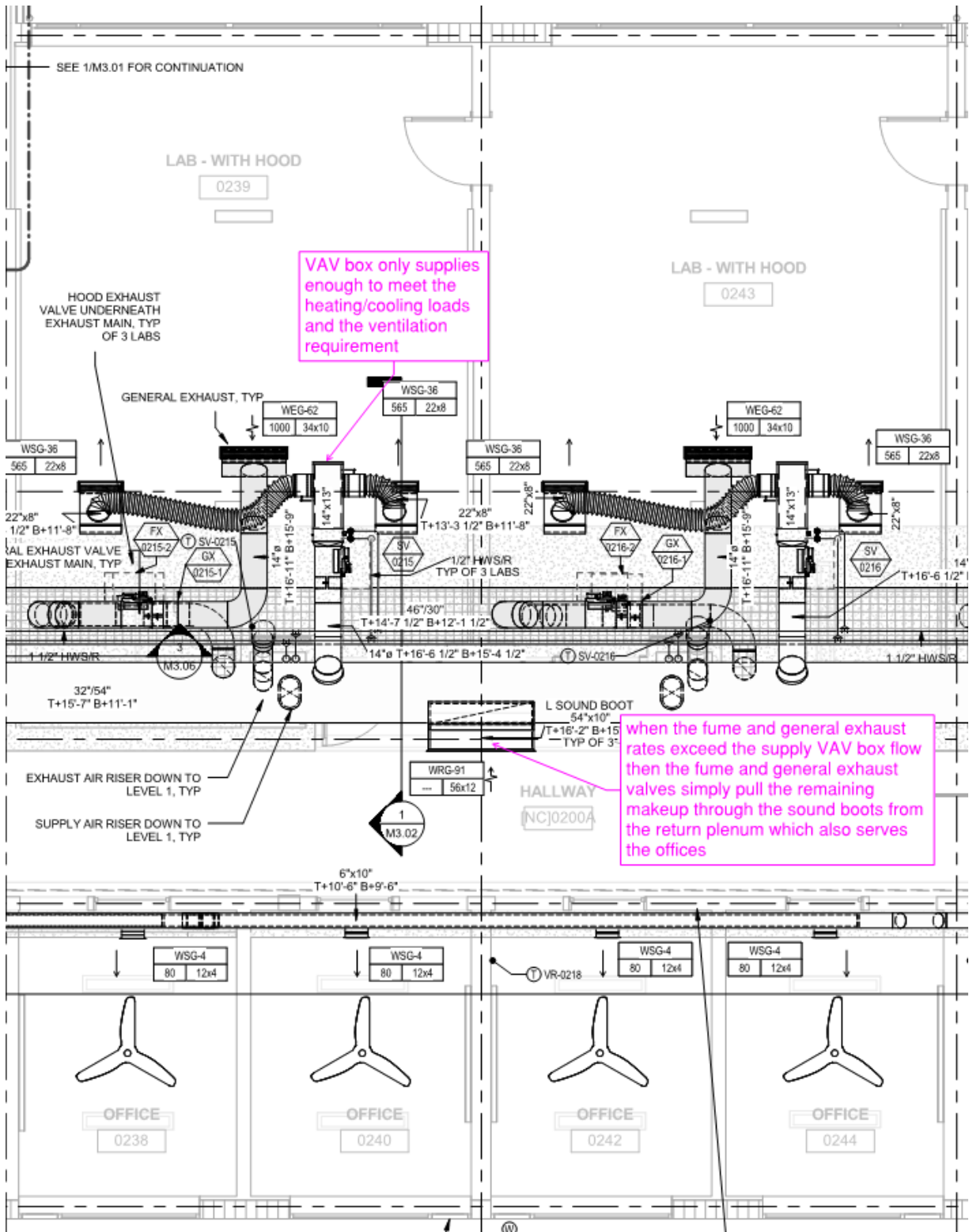

Figure 20: Example lab with transfer air for fume hood makeup

The air handler serving the labs also serves the offices. The minimum outside airflow rate at the air handler is equal to the larger of (a) the total ventilation rate to all zones and (b) the total exhaust rate from all zones. If the Coastal Biology Building did not use transfer air for makeup, then the minimum

outside airflow at the air handler would have to increase to equal the total exhaust rate from all zones plus the total ventilation rate of zones without high exhaust rates (e.g., all the offices, classrooms). Not only would this increase fan energy, cooling energy, and heating energy, but it would also increase the capacity and first cost of the air handlers, chillers, boilers, pumps, etc.

Exceptions

It is important to understand that there are several exceptions to this requirement. The most important is the “class of air” limitation in the California Mechanical Code (based on ASHRAE 62.1-2016). Class 2 air, for example, cannot be transferred to Class 1 spaces. Toilet rooms and labs are typically Class 2. Office spaces are typically Class 1, so it is acceptable to transfer from an office to a toilet or lab, but not vice versa.

Other exceptions include spaces with dangerous biological agents and vivarium spaces.

There are also two partial exceptions: lab spaces that require positive pressurization, and negatively pressurized spaces that can use more transfer air than is potentially available. In these cases, direct transfer of available transfer air from the return plenum is not required, but the available transfer air must be transported back to the air handler serving the exhausted space. This is so that the air handler can recirculate this air back to all spaces served if doing so is more efficient than bringing in more outside air.

These exceptions were developed based on public review comments to the ASHRAE 90.1 committee from stakeholders around the country.

Appendix G: COMPLIANCE MANUAL CONTENT FOR OCCUPANT SENSOR VENTILATION CONTROL ACCEPTANCE TEST

13.4.1 Occupancy Sensor Ventilation Control Acceptance

| NA7.5.X Occupancy Sensor Ventilation Control Acceptance | |
|---|--|
| Use Compliance Document NRCA-MCH-XX-X | |
| Purpose of the Test | |
| | The purpose of the test is to verify that systems required to employ occupant sensor controlled ventilation (refer to §120.2(e)3) can shut off airflow to applicable zones which are reported to be unoccupied by an occupancy sensor. Occupancy Sensor Ventilation Control refers to an HVAC system's ability to shut off air flow when the space served is reported by the occupancy sensor to be unoccupied, and the space is not requesting heating or cooling. |
| Who Can Perform the Test | |
| | Mechanical Acceptance Technicians |
| Instrumentation | |
| | To perform the test, it may be necessary to measure the airflow entering the zone. If airflow shutoff cannot be verified via inspection, instrumentation required may include: <ul style="list-style-type: none"> • Air Velocity Meter and/or Flow Hood |
| Test Conditions | |
| | Equipment installation is complete (including HVAC unit, duct work, sensors, and control system). HVAC system must be ready for system operation, including completion of all start-up procedures per manufacturer's recommendations. Building automation system (BAS) programming (if applicable) for the air handler and demand Controlled ventilation strategy must be complete. To perform the test, it may be necessary to use BAS to override or temporarily modify the occupancy sensor reading. Document the initial conditions before overrides or manipulation of the settings. All systems must be returned to normal at the end of the test. |
| Estimated Time to Complete | |

| |
|--|
| <p>Visual inspection: 0.25 to 0.5 hours</p> <p>Functional testing: 0.5 to 1 hours (depending on necessity to adjust time delay or mask sensor to prevent false triggers)</p> |
| <p>Acceptance Criteria</p> |
| <p>Standard occupant sensor responds to “typical” occupant movement to turn the HVAC ON immediately.</p> <p>A minimum OSA setting is provided whenever the system is in Occupied mode per §120.1(c)4E.</p> <p>HVAC controlled by the occupant sensor turn OFF at the pre-set time delay.</p> <p>The programmed maximum time delay is not greater than 20 minutes.</p> <p>The room temperature setpoint deadband increases by a minimum of 0.5°F for multi-zone systems and 2°F for single-zone systems.</p> <p>Occupant sensor does not trigger a false ON or OFF.</p> <p>Status indicator or annunciator operates correctly.</p> |
| <p>Potential Issues and Cautions</p> |
| <p>It is imperative that the test be performed during a time when the tester can have full control over the occupancy of the space.</p> <p>The time delay can be adjusted to minimize test time, but the time delay setting must be reset upon completion of the test (not to exceed 20 minutes).</p> <p>To avoid detection of significant air movement from an HVAC diffuser or other source, which can cause the sensor to turn the HVAC ON (this is most critical with ultrasonic sensors).</p> <p>If motion in an adjacent area is causing an unwanted trigger, the technician may adjust the coverage pattern intensity or mask the sensor with an opaque material.</p> |
| <p>Test Application</p> |
| <p>Newly Constructed and Additions/Alterations: All new Occupancy Sensor Ventilation controls installed on new or existing HVAC systems must be tested.</p> |

Occupancy Sensor Ventilation Control Requirements. The intent was to limit the Occupancy Sensor Ventilation Control requirement to systems that primarily serve spaces with intermittent occupancy. However, it is possible that a facility may have a majority of spaces with fixed occupancy and only a few intermittent occupancy zones that meet the requirement, but still must implement Occupancy Sensor Ventilation Control for those intermittent occupancy zones. Single-zone HVAC systems can include, but are not limited to: 1) constant volume packaged units with stand-alone economizer controllers (e.g., Honeywell W7220 JADE Economizer Module); or 2) constant volume systems with individual dampers/actuators and either stand-alone or centralized DDC control.

The Energy Standards require that only HVAC systems with the following characteristics must employ Occupant Sensor Control Ventilation:

- Spaces served with specific use types or have the following occupancy densities, as described in the California Building Code (CBC) Chapter 10, must utilize DCV control:
 - Office 250 square feet or less
 - Multipurpose Rooms 1,000 square feet or less
 - Classrooms
 - Conference Rooms
 - Enclosed Corridors
 - Hotel Guest Rooms

The purpose of the test is to ensure that an occupant sensor functioning properly to achieve the desired HVAC control. Occupant sensors are used to automatically turn HVAC on and keep them on when a space is occupied, and turn them off automatically and setback the thermostat when the space is unoccupied after a reasonable time delay. The time delay, typically adjustable, will prevent HVAC from rapid cycling through ON and OFF when spaces are occupied frequently but temporarily. It also helps avoid false OFF triggering when there is little apparent occupant movement.

Visual Inspection Items

Prior to functional testing, verify and document the following.

| Visual Inspection Items Checklist | |
|--|---|
| <input type="checkbox"/> | Occupant sensors are located to minimize false signals. |
| <input type="checkbox"/> | Sensors are no closer than four feet from a HVAC diffuser. |
| <input type="checkbox"/> | Passive infrared sensor pattern does not enter into adjacent zones. |
| <input type="checkbox"/> | Passive infrared sensor pattern does not enter into adjacent zones. |
| <input type="checkbox"/> | Ultrasonic occupant sensors do not emit audible sound 5 feet from source. |
| <input type="checkbox"/> | Occupant sensors have been certified to the Energy Commission in accordance with the applicable provision in §110.9 . Verify that model numbers of all occupant sensors are listed on the Energy Commission database as “Certified Appliances & Control Devices” (http://www.energy.ca.gov/appliances/database/). |
| <input type="checkbox"/> | For buildings with up to seven (7) occupancy sensors, all occupancy sensors must be tested and sampling may not be used. |
| <input type="checkbox"/> | For buildings with more than seven (7) occupancy sensors, sampling may be done on spaces with similar sensors and space geometries. |
| <input type="checkbox"/> | Sampling shall include a minimum of 1 occupancy sensor for each group of up to 7 additional photocontrols. |
| <input type="checkbox"/> | If the first occupancy sensor in the sample group passes the acceptance test, the remaining building spaces in the sample group also pass. |
| <input type="checkbox"/> | If the first occupancy sensor in the sample group fails the acceptance test the rest of the occupancy sensors in that group must be tested. |
| <input type="checkbox"/> | If any tested occupancy sensor fails it shall be repaired, replaced or adjusted until it passes the test within the limits of the technician’s authority to do so. |

A. Functional Performance Testing

| Functional Performance Testing Checklist | |
|--|---|
| □ | <p>Step 1: Simulate an occupied condition</p> <p>Simulate a situation where an occupant enters a space with an occupancy sensor</p> <p><i>Verify and Document</i></p> <ul style="list-style-type: none"> • Occupancy schedule is in occupied mode • The occupant sensor will activate the HVAC system for the controlled zone. |
| □ | <p>Step 2: Adjust thermostat such that zone is in deadband between heating and cooling</p> <p>Test that the system responds as expected when the system does need heating or cooling.</p> <p>Verify and Document</p> <p>Ensure airflow is at ventilation minimum</p> |
| □ | <p>Step 3: Adjust heating setpoint to slightly above current space temperature</p> <p>The purpose of this step is to ensure that the automatic thermostat setback requirement is functioning correctly. If the thermostat is supposed to set back 2°F when unoccupied, the zone setpoint should be set to be about 1°F above the occupied thermostat setpoint, so that when the setpoint is setback by 2°F once the zone is unoccupied in Step 4, the room will be within the deadband and should no longer request heating or cooling.</p> <p><i>Verify and Document</i></p> <p>Ensure that the zone enters heating mode</p> |
| □ | <p>Step 4: Simulate an unoccupied condition</p> <p>Vacate the zone such that occupancy sensor does not detect a person, but the zone is still scheduled to be occupied. Once unoccupied the zone thermostat setpoint should be setback, so that the zone is operating within the thermostat deadband, and no longer requires heating or cooling.</p> <p>Verify and Document</p> <p>Within five minutes of entering occupied standby mode</p> <ul style="list-style-type: none"> • The heating setpoint is set back at least 2°F • The cooling setpoint is set up at least 2°F • The zone is now in deadband between heating and cooling • All airflow to the zone is shut off <p>Note that the occupancy sensor itself may have a delay of up to 20 minutes per Standard Section 110.9(b), so the total delay for the HVAC controls to respond can be up to 20 minutes.</p> |

| | |
|--------------------------|---|
| <input type="checkbox"/> | Step 5: Repeat steps 1 through 5 but adjust cooling setpoint. <ul style="list-style-type: none">• For step 3, adjust the setpoint slightly below cooling setpoint to ensure zone enters cooling mode |
| <input type="checkbox"/> | Step 6: Return system back to normal operating condition. <p>Ensure all schedules, setpoints, operating conditions, and control parameters are placed back at their initial conditions.</p> |

Appendix H: MARKED-UP COMPLIANCE DOCUMENT FOR AIR ECONOMIZER CONTROLS ACCEPTANCE TEST (FOR EXHAUST AIR HEAT RECOVERY)

| | | |
|------------------------------------|---------------------------------|----------------|
| CERTIFICATE OF ACCEPTANCE | | NRCA-MCH-05-A |
| Air Economizer Controls Acceptance | | (Page 1 of 3) |
| Project Name: | Enforcement Agency: | Permit Number: |
| Project Address: | City: | Zip Code: |
| System Name or Identification/Tag: | System Location or Area Served: | |

| | |
|---|---|
| <i>Note: Submit one Certificate of Acceptance for each system that must demonstrate compliance.</i> | Enforcement Agency Use: Checked by/Date |
|---|---|

| |
|--|
| A. Construction Inspection |
| <ol style="list-style-type: none"> 1. Supporting documentation needed to perform test includes: <ol style="list-style-type: none"> a. 2016 Building Energy Efficiency Standards Nonresidential Compliance Manual (<i>NA7.5.4 Air Economizer Controls Acceptance At-A- Glance</i>). b. 2016 Building Energy Efficiency Standards. |
| <ol style="list-style-type: none"> 2. Instrumentation to perform test includes: <ol style="list-style-type: none"> a. Hand-held temperature probe Calibration Date: _____ (must be within last year) b. Device capable of calculating enthalpy (i.e. psychrometer) Calibration Date: _____ (must be within last year) c. 1.2 k Ohm Resistor (when specified by the manufacturer) |
| <ol style="list-style-type: none"> 3. Installation: (all of the following boxes should be checked) <div style="margin-left: 40px;"> <input type="checkbox"/> Economizer high limit shutoff control complies with Table 140.4-B found in the 2016 Building Energy Efficiency Standards </div> |

Section 140.4(e)3.

- a. 5-year manufacturer warranty of economizer assembly
 - b. Provide a product specification sheet proving capability of at least 60,000 actuations
 - c. Provide a product specification sheet proving compliance with AMCA Standard 500-D damper leakage at 10 cfm/ft² at 250 Pascals (1.0 in w.g). A product specification sheet showing the manufacturer's results after following the testing procedures of AMCA Standard 500-D. A product specification sheet showing the economizer outside air and return air damper leakage rates have been certified to the Energy Commission in accordance with Section 110.
 - d. If the high limit setpoint is fixed dry-bulb or fixed enthalpy + fixed dry-bulb then the control shall have an adjustable setpoint.
 - e. Outdoor air, return air, mixed air, and supply air sensors shall be calibrated as follows:
 - i. Dry-bulb and wet-bulb temperatures accurate to ±2°F over the range of 40°F to 80°F
 - ii. Enthalpy accurate to ±3 Btu/lb over the range of 20 Btu/lb to 36 Btu/lb
 - iii. Relative humidity (RH) accurate to ±5% over the range of 20% to 80% RH
 - f. Check that the sensor performance curve(s) is provided by the factory and sensor output values measured during sensor calibration are plotted on the performance curve(s).
 - g. Sensors used for high limit control shall be located to prevent false readings, including but not limited to being
 - Unitary systems with an economizer have control systems, including two-stage or electronic thermostats, that cycle compressors off when economizers can provide partial cooling.
 - System has return fan speed control, relief dampers, or dedicated relief fans to prevent building over pressurization in full economizer mode.
 - For systems with DDC controls, sensor used for economizer lockout has been factory or field calibrated.
 - For systems with non-DDC controls, manufacturer's startup and testing procedures have been applied.
 - For systems with exhaust air heat recovery ventilators, sensor used for economizer bypass has been factory or field calibrated and manufacturer's startup and testing procedures have been applied.

| B. Functional Testing | Results | | |
|---|----------------|----|----|
| Is the economizer listed in the CEC equipment certification directory? (if yes, proceed to Section D.) | Yes | No | |
| Step 1: Disable demand control ventilation systems (if applicable) | | | |
| Step 2: Enable the economizer and simulate a cooling demand large enough to drive the economizer fully open. Verify the following: | | | |
| a. Economizer damper modulates 100% open. | Yes | No | |
| b. Return air damper modulates 100% closed. | Yes | No | |
| c. <u>For systems with plate type exhaust air heat recovery ventilators, verify that the bypass damper modulates 100% open, outdoor air intake modulates 100% closed, and return air damper modulates 100% closed.</u> <u>For system with wheel type exhaust air heat recovery ventilators, verify that the wheel motor is turned off.</u> | Yes | No | NA |
| d. For systems that meet the criteria of 2016 Building Energy Efficiency Standards Section 140.4(e)1, verify that the economizer remains 100% open with the use of mechanical cooling. This occurs when the cooling demand can no longer be met by the economizer alone. | Yes | No | |
| e. All applicable fans and dampers operate as intended to maintain building pressure. | Yes | No | |
| f. The unit heating is disabled (if applicable). | Yes | No | NA |
| Step 3: Disable the economizer and simulate a cooling demand. Verify the following: | | | |
| a. Economizer damper closes to its minimum position. | Yes | No | |
| b. All applicable fans and dampers operate as intended to maintain building pressure. | Yes | No | |
| c. The unit heating is disabled (if applicable). | Yes | No | NA |
| Step 4: If the unit is equipped with heating, simulate a heating demand and enable the economizer. Verify the following: | | | |
| a. Economizer damper closes to its minimum position. | Yes | No | NA |

| | | | |
|--|-----|----|----|
| b. Return air damper opens. | Yes | No | NA |
| Step 5: Turn off the unit and verify the following: | | | |
| a. Economizer damper closes completely. | Yes | No | |
| Step 6: System returned to initial operating conditions | Yes | No | |

| C. Testing Results | PASS / FAIL | |
|--|--------------------|--|
| Step 2: Simulate cooling load and enable the economizer (all answers are Y and/or NA). | | |
| Step 3: Simulate cooling load and disable the economizer (all answers are Y and/or NA). | | |
| Step 4: Simulate heating demand and enable the economizer (all answers are Y and/or NA). | | |
| Step 5: Turn off the unit (all answers are Y). | | |

| D. Evaluation |
|---|
| <input type="checkbox"/> PASS: All Construction Inspection responses are complete and all Testing Results responses are "Pass" or the economizer is listed in the CEC equipment certification directory. |
| Notes: |
| |