

## DOCKETED

<b>Docket Number:</b>	15-WATER-01
<b>Project Title:</b>	Water Energy Technology (WET) Program
<b>TN #:</b>	205044
<b>Document Title:</b>	Baltimore Aircoil Company Comments: Water and Energy Savings with Adiabatic Fluid Coolers and Condensers
<b>Description:</b>	N/A
<b>Filer:</b>	System
<b>Organization:</b>	Baltimore Aircoil Company/Preston Blay
<b>Submitter Role:</b>	Public
<b>Submission Date:</b>	6/16/2015 1:59:04 PM
<b>Docketed Date:</b>	6/16/2015

*Comment Received From: Preston Blay*

*Submitted On: 6/16/2015*

*Docket Number: 15-WATER-01*

## **Water and Energy Savings with Adiabatic Fluid Coolers and Condensers**

See attached document.

*Additional submitted attachment is included below.*

# Water and Energy Savings with Adiabatic Fluid Coolers and Condensers

**Docket: 15-WATER-01**

**Project Title: Water Energy Technology (WET) Program**

Baltimore Aircoil Company is pleased to offer the TrilliumSeries of fluid coolers and condensers for consideration under California's Water Energy Technology (WET) Program.

Evaporative condensers and closed circuit cooling towers are often used in highly energy efficient HVAC&R systems, including comfort cooling, industrial processes, and supermarket applications. The high system efficiency is enabled by the lower operating temperature levels and lower heat rejection fan energy of evaporative heat rejection. However, water is consumed in this process, which can present challenges in regions experiencing severe drought conditions such as California.

While air cooled equipment does not use water, it is substantially less energy efficient. Because air cooled systems are forced to operate at high temperatures and more heat rejection fan energy is required than with evaporative heat rejection, the water savings is more than offset by the additional energy consumption even in water challenged regions. As water is also consumed in the production of electrical energy, the higher energy consumption of air cooled systems leads to additional water consumption at the typical power plant. Studies have estimated that the net water usage of air cooled systems can approach the net use of water by water cooled systems when the water used at the power plant is included<sup>1</sup>.

Hybrid adiabatic fluid coolers and condensers offer a compromise between these two alternatives which can benefit many projects where there is a desire to achieve a different balance point between the consumption of energy and water. Adiabatic units consume only a fraction of the water of evaporative heat rejection while offering much lower energy consumption than air cooled alternatives. Baltimore Aircoil Company offers such a line of adiabatic fluid coolers and condensers known as the TrilliumSeries™:

<http://www.baltimoreaircoil.com/english/products/hybrid/trilliumseries/brochures-manuals>

A recent installation in California demonstrated the advantages of this technology. At the Nugget Food 4 Less store in Woodland, California, an evaporative condenser was at the end of its useful life and needed to be replaced. Rather than use another evaporative unit, a TrilliumSeries™ condenser was selected. Annual water use was reduced by 75% compared to the conventional unit with essentially the same energy consumption. As an added benefit, the system refrigerant charge was reduced by 86%. The savings from the lower water and water treatment costs, along with the reduced refrigerant charge, produced a simple payback of 4.1 years for the added investment on this project. A trade publication article on this installation is attached for reference.

---

<sup>1</sup> Seminar 48: A Comprehensive Comparison of Air- and Water-Cooled Chillers Over a Range of Climates, Mark Hydeman PE, Salt Lake City ASHRAE Conference, June 2008

# Water and Energy Savings with Adiabatic Fluid Coolers and Condensers

Another recent project in Oklahoma was quoted versus air cooled condensers. The design condensing temperature was reduced from 120°F to 95°F, reducing compressor size requirements. In addition, condenser fan horsepower was lowered, peak demand charges were reduced, and system refrigerant charge was reduced by over 90%. System energy use declined by 12.5% with a minimal use of water for the adiabatic cooling mode. The total savings produced a 1.95 year simple payback for the investment in the TrilliumSeries™ versus conventional air cooled condensers.

These two examples illustrate the versatility of the concept which can be applied to reduce water and / or energy use. Besides condensing duties, these units can also handle fluid cooling duties as shown in the installation photo in Figure 1 below.



**Figure 1 Trillium Fluid Cooler, H Mart, Los Angeles CA**

Further information on all of the benefits of this technology along with a trade publication article on the "Food 4 Less" installation is included with this submission. Note also that hybrid condensers are also mentioned in the 50% Advanced Energy Design Guide for Supermarkets published by ASHRAE earlier this year (page 53 of the AEDG). This AEDG is available as a free download at:

<https://www.ashrae.org/standards-research--technology/advanced-energy-design-guides/50-percent-aedg-free-download>

Contact: Preston Blay, Director of Refrigeration  
Baltimore Aircoil Company  
[pblay@baltimoreaircoil.com](mailto:pblay@baltimoreaircoil.com)  
Office: 40-799-6458

# INDOOR COMFORT

SEPTEMBER 2012

THE VOICE OF THE INDUSTRY  
**NEWS**

www.indoorcomfortnews.com

THE WEST'S LEADING MONTHLY NEWSMAGAZINE FOR THE AIR CONDITIONING, HEATING, REFRIGERATION, SHEET METAL AND VENTILATING INDUSTRIES



## Case Study

Advanced plastic cooling towers help ensure reliability of expanding hospital's HVAC system.

Page 16



## Editorial Focus

What's new? What's been upgraded? Find out here as ICN takes a look at the latest releases in Heating Products.

Page 18

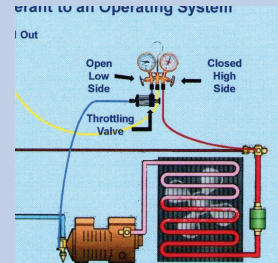

## Technical Training

In Part 35 of his "Growing Green Technicians" series, contributing editor Jim Johnson takes a look at R-410A refrigeration systems

Page 27

## CEC Adopts Nonresidential Building Energy Use Disclosure Program

Goal is to encourage energy conservation and upgrades.

By Ted Rieger,  
Northern California Correspondent

The California Energy Commission (CEC) adopted regulations July 11 to implement a Nonresidential Building Energy Use Disclosure program as required under

legislation passed in 2007 (AB 1103, Saldana.) The regulations require an owner of a nonresidential building in California, in advance of the sale, lease, or financing of the building, to benchmark the building's energy use with the U.S. Environmental Protection Agency's (EPA) ENERGY STAR Portfolio Manager system and to disclose statements



of the building's energy usage to potential buyers, lessees, and lenders. The long-term goal is to encourage energy conservation and upgrades in nonresidential buildings, by disclosing energy use data and features in order to add value to these buildings for prospective buyers and tenants.

In a presentation at the adoption hearing,

CEC staff project manager Justin Regnier explained, "Energy represents up to 30% of the total cost of operation of an office building. These are controllable costs that can be managed through efficiency improvements, unlike most other operational costs, such as mortgage or lease payments and taxes that tend to be fixed." Regnier noted that most

Continued on Page 14

## New HVAC/R Training Courses Offered in PG&E Territory

The Institute of Heating and Air Conditioning Industries, Inc. (IHACI) and Pacific Gas and Electric (PG&E) will offer a series of free training courses beginning October 2012.

Training classes include the popular North American Technician Excellence (NATE) training series, which consists of eight evening classes. In addition, System Performance and Air Distribution modules will

also be offered. Each module consists of four evening classes.

Currently, IHACI cosponsors training with Southern California Gas Company, Southern California Edison and San Diego Gas and Electric.

For details about IHACI and PG&E training, see the advertisement on **Page 21**. Registration will be handled by IHACI. Seating is limited to 50 students and is on a first-come, first-served basis.

For additional information, please contact IHACI at (818) 551-1555.

## Case Study



These Carrier open-drive reciprocating compressors were part of the Food 4 Less supermarket's refrigeration system that was converted from R-22 to R-407F by RSI of West Sacramento. (Photo by Ted Rieger)

## With Broken Condenser Unit, Supermarket Sees Opportunity

By Ted Rieger, Northern California Correspondent

Following the unexpected and sudden failure of a condenser for the refrigeration system at a Food 4 Less supermarket in Woodland, Calif., Refrigeration Solutions, Inc. (RSI) provided a temporary replacement condenser and recharged and converted the system from R-22 to R-407F refrigerant, resulting in minimal downtime for the store's operation.

The refrigeration system served the store's entire cooling load for all refrigerated display cases, its backroom meat and produce cold storage units for inventory, and the store's HVAC system. The condenser went down at 2:30 am on a Thursday morning, and RSI was able to have the refrigeration system running and the store open for business again

Continued on Page 26

## Daikin Engineer Named New ASHRAE President

Page 14

## Inside

DEPARTMENTS

Industry News 4

CARSES 22

Indoor People 29

Classifieds 30

FEATURES

COLUMNS



**Case Study 15**  
At the University of California, Berkeley, a portable cooling solution provided by Atlas Sales & Rentals offers the ideal solution to cooling a vintage slide projector built in 1940.

**Legal Lines 26**  
It is important to not only comply with all of the terms and conditions of a contract, but also any statutory laws in place.

**Industry Education 28**  
Be aware of the safety and liability issues when using flammable refrigerants.

SAVE THE DATE!

**IHACI 33rd  
HVAC/R/SM  
Trade Show**

Wednesday,  
November 14, 2012  
Pasadena  
Convention Center

PRSRST STD  
U.S. POSTAGE  
PAID  
LITTLE ROCK, AR  
PERMIT NO. 1884

INDOOR COMFORT NEWS  
454 W. Broadway  
Glendale, CA 91204  
CHANGE SERVICE REQUESTED



## The Importance of Knowing Statutory Laws on Public Works Projects

By Sam K. Abdulaziz & Kenneth S. Grossbart  
Abdulaziz, Grossbart & Rudman

It is very important to not only comply with all of the terms and conditions of a contract, but also any statutory laws in place that may govern the project as well. This is particularly true on public works projects.

In the case of *G. Voskian Construction, Inc. v. Alhambra Unified School District*, the issue of change orders is once again at question. This particular project involved two separate contracts. The first contract was for improvements on a relocation project and the second contract was for a fire alarm contract on the same jobsite. Voskian was the general contractor on both

projects. Time was of the essence on these contracts because the District wanted the projects done before school resumed in the fall.

Both contracts indicated that modifications or changes could only be made if they were agreed to in writing between the contractor and the Assistant Superintendent or her designee. Because of the rush that the District was in to get the projects completed, the Assistant Superintendent indicated that Voskian should deal with the construction manager to finalize change orders. Rather than wait for the District to approve all of the change orders and hold up the job, the District would “bunch” the change orders together and process them at a later time.

Voskian discovered that the plans and specifications for the relocation project contained errors which required changes as well as a second contract to cover the work for the fire alarm system. New plans were prepared for the fire alarm system portion of the project and bids were received based on the plans. Voskian was the lowest bidder and entered into the second contract with the District.

After Voskian was awarded the bid for the fire alarm system, he realized that the plans were incorrect. The project actually needed more alarm devices, conduit and wiring than the plans had shown. Voskian submitted change orders for both of the contracts and proceeded to do the work based on oral assent from the construction manager.

The District refused to pay Voskian and he then filed a claim with the District per Government Code section 910 et seq. The District rejected the claim and litigation ensued. The trial court found in favor of Voskian. The District appealed and the Appellate Court

affirmed the trial court’s decision.

The Appellate Court indicated that although it was accurate that change orders for extra work must be in writing, the District did eventually approve the change orders on the first contract long after the work was completed so that was no longer at issue. The change orders were approved and therefore the District needed to pay Voskian for those change orders in the first contract.

As to the second contract, since Voskian’s initial bid was based on incorrect plans and specifications as supplied by the District, the Appellate Court found that Voskian was entitled to payment for the extra work. This decision was based on many prior court decisions wherein a rule regarding public works contracts have been set. The rule is that if a public works contractor is misled by incorrect plans and specifications that are issued by the public authority then that contractor is entitled to recover

for the extra work and/or expenses because of the extra work necessary for the misrepresentation in the plans and specifications.

We had previously written about another case, *Greg Opinski Construction, Inc. v. City of Oakdale*, wherein Opinski did not follow the contract with respect to change order procedures. Opinski ended up owing \$65,000 in liquidated damages because of delays even though he did the work on the change orders (which were not accepted). Voskian was lucky that the District eventually accepted the change orders on the first contract and had incorrect plans on the second contract or Voskian could have been in the same boat as Opinski.

We cannot reiterate enough how very important it is for all contractors to completely understand what the contract says, to know the statutory laws that affect projects, and to make sure that all change orders are in writing. In the same situation, you may not be as lucky as Voskian!

**Distinguished Design**  
ARCHITECTURAL GRILLS & REGISTERS

*Classic Grills brings you our new line of proprietary thermal composite grills and registers*

- Lightweight
- Affordable Pricing
- Available With Dampers
- Shorter Lead Times



Please call us at (760) 213-0427  
Or view our website at:  
[www.distinguisheddesigngrills.com](http://www.distinguisheddesigngrills.com)

### Food4Less R-22 Changeover

Continued from Page 1

by Friday afternoon.

RSI president, owner and founder Sam Wilson noted that the store had been planning a refrigerant changeover for the system from R-22, given its price increase, reduced availability, and the planned production phase-out of R-22 by 2020. Wilson was able to access and connect a used Hussmann condenser unit, and noted, “With the failure of the evaporative condenser, the system lost its whole charge, so it was a good time to switch to a new, environmentally-friendly refrigerant, as there was no reason to go back to R-22.”

Wilson worked with Refrigeration Supplies Distributor (RSD) and its three nearby branches in Rancho Cordova, Roseville and Sacramento that supplied the refrigerant and the parts to convert the system. RSD helped select a replacement refrigerant suitable for the system. Tom Hardy of RSD said, “We looked at the refrigerant conversion charts and specifications, and R-407F provided similar performance capacities and efficiencies to R-22 across the range of low, medium and high temperature applications for which the store’s refrigeration system operates.”

R-407F is an HFC class of

refrigerant manufactured by Honeywell under the label of Genetron Performax LT as an R-22 replacement that is a blend of 30% R-32, 30% R-125, and 40% R-134a. It is a non-ozone depleting refrigerant and has a lower global warming potential (GWP) than R-22. The recommended lubricant to use with R-407F in the compressors and system is polyolester oil (POE), a synthetic oil.

Food 4 Less has a two-stage refrigeration system with six Carrier 5H line open-drive reciprocating compressors with a total system capacity of about 210 tons. Conversion required replacing all rubber/elastomer seals and O-rings in the refrigeration system’s valves using kits, such as Wolverine reseal kits, supplied by RSD. Rubber seals can shrink and leak if used with R-407F and POE oil. “Converting the compressors’ shaft seals was a big deal, and we had to replace and rebuild any valve section with an O-ring using a reseal kit, which is one of the major aspects of a refrigerant conversion,” Wilson said. Seal replacements are recommended for shaft seals on open drive compressors, older solenoid valves, heat reclaim valves, Schrader fittings, and sight glass gaskets.

RSI will install a new, more efficient Baltimore Air Coil (BAC) Trillium Series air/water con-

denser with a Dry-Coil Adiabatic Design that saves energy, reduces refrigerant charge and reduces operating costs. An on-demand adiabatic pre-cooler uses water only on the hottest days to maintain condensing temperatures better than typical air-cooled condensers. The BAC Trillium also uses high-efficiency electronically commutated (EC) motors and variable fan speed control. In addition to energy and cost savings, this high-efficiency condenser is expected to save the store an estimated 1 million gallons of water/year. “I think we will start seeing more of these condensers being installed in areas where water conservation is a big issue,” Wilson said.

RSI, based in West Sacramento, specializes in commercial and industrial refrigeration system installation and service and is the factory authorized distributor of Hussmann Refrigerated Display Cases and systems for Northern California. Wilson, who has 35 years of experience in the refrigeration industry, started RSI in 2005 and holds a C-38 refrigeration contractor’s license. The company’s clients include supermarket and grocery stores, food processing and packing facilities, and refrigerated warehousing operations. RSI is planning R-22 refrigerant conversions at other supermarkets in the region, including a change-out to R-407F at a store in Davis before the end of 2012.

**Need Portable Cooling?**  
*Call the Specialists*



- Rentals and Sales
- Locations Nationwide
- Primary, Supplemental, or Emergency Cooling
- On Call 24/7



**Atlas Sales & Rentals, Inc.**  
THE PORTABLE COOLING & HEATING SPECIALISTS  
[www.AtlasSales.com](http://www.AtlasSales.com)

**Toll Free 800-972-6600**

**MOVINCOOL**  
PREFERRED DISTRIBUTOR

MovinCool, SpotCool & Office Pro are registered trademarks of DENSO Corporation.



# TrilliumSeries™ Condenser

## TABLE OF CONTENTS

1	TrilliumSeries™ Condenser	10	ECOFLEX CONTROLS
3	BENEFITS	11	SELECTION AND PAYBACK ANALYSIS SOFTWARE
8	MODES OF OPERATION	12	CO <sub>2</sub> APPLICATIONS
9	ENGINEERING DATA	14	ENGINEERING DATA FOR CO <sub>2</sub> APPLICATIONS



# The TrilliumSeries™ Condenser

The TrilliumSeries™ Condenser uses a patented Dry-Coil Adiabatic™ Design that saves energy, reduces refrigerant charge, and lowers operating costs. With the use of proprietary logic and EcoFlex controls, the On-Demand Adiabatic™ Pre-Cooler uses water only on the hottest days to maintain condensing temperatures that typical air cooled technology cannot achieve. **Because of this, the TrilliumSeries™ Condenser is the lowest total cost of ownership product for supermarket refrigeration systems.**

## > The TrilliumSeries™ Condenser

### ▶ REDUCES SYSTEM ENERGY

- Up to 37.2% annual system energy reduction
- Up to 43.5% peak energy reduction
- Direct drive VSEC motor minimize fan energy required

### ▶ REDUCES WATER CONSUMPTION

- Water is used only when the ambient temperature requires it
- Water from the unit can be used for irrigation
- Water monitoring package minimizes water use

### ▶ REDUCES INSTALLATION COST

- 60% lower refrigerant charge help meet EPA's Greenchill certification
- Reduces overall system size by operating at lower condensing temperatures

### ▶ NEEDS MINIMAL MAINTENANCE

- Takes same time as air cooled
- No water treatment required
- On-Demand Adiabatic™ Pre-Cooler Media can be replaced in ½ hour
- Easily spray off coated coils

### ▶ PROVIDES LONG TERM RELIABILITY

- UL Approved Unit
- Coated Microchannel coils tested per ASTM G85-A4 for 3000+ hours
- Industrial grade Type 304 Stainless Steel and an exclusive Thermosetting Hybrid Polymer coating on all structural panels







The following chart compares the TrilliumSeries™ Condenser to air cooled and evaporative equipment for both new construction and replacement projects. The TrilliumSeries™ Condenser has an advantage in many categories versus either the air cooled and evaporative equipment. For more detailed information on each topic, please go to the page listed.

Benefits of the TrilliumSeries™ Condenser		Page	New Construction		Replacement	
			TrilliumSeries™ Condenser	Air Cooled	TrilliumSeries™ Condenser	Air Cooled
Energy Savings	Reduces monthly energy bill	3-4	✓		✓	
	Reduces peak demand	4	✓		✓	
	Qualifies for energy rebates	5	✓	✓ <sup>[1]</sup>	✓	✓ <sup>[1]</sup>
	Built in energy tracking	5	✓	✓	✓	✓
Water Savings	Reduces water use	6	✓		✓	
	Water use monitoring	6	✓		✓	
	Reduces monthly water bill	6	✓		✓	
Installation Savings	Significantly reduces refrigerant charge	7	✓		✓	
	Saves space	3	✓		✓	
	Reduces weight	3	✓		✓	
Other Benefits	Maintenance	7	✓	✓	✓	✓
	Long term reliability	7	✓	✓	✓	✓
	Shrinks size of the rack	3	✓			
	Increases system capacity	3			✓	
	California Title 24	3	✓		✓	
	Transcritical CO <sub>2</sub> systems	12-14	✓	✓ <sup>[2]</sup>	✓	✓ <sup>[2]</sup>



**NOTES:**

1. Air cooled condensers with EC motors may qualify for energy rebates.
2. Air cooled gas coolers can be used for transcritical CO<sub>2</sub> applications in only certain climates (see **Page 12**).

**The TrilliumSeries™ Condenser has the advantage!**

# Benefits

## > Ownership Benefits

In a variety of climate conditions, the TrilliumSeries™ Condenser provides the lowest total cost of ownership compared to air cooled units.

### ▶ INSTALLATION ADVANTAGES

- 60% lower refrigerant charge may help meet EPA's Greenchill Certification
- Compact and lighter in weight
- Single point electrical connection
- Direct drive VSEC motors and Whisper Quiet Fans are standard
- For new stores, reduces overall system size by operating at lower condensing temperatures
- Exempt from Title 24 legislation
- For refrigeration upgrades, increases system capacity without changing out expensive racks

### ▶ ECONOMIC ADVANTAGES

- Attractive payback time frames
- Lower total cost of ownership

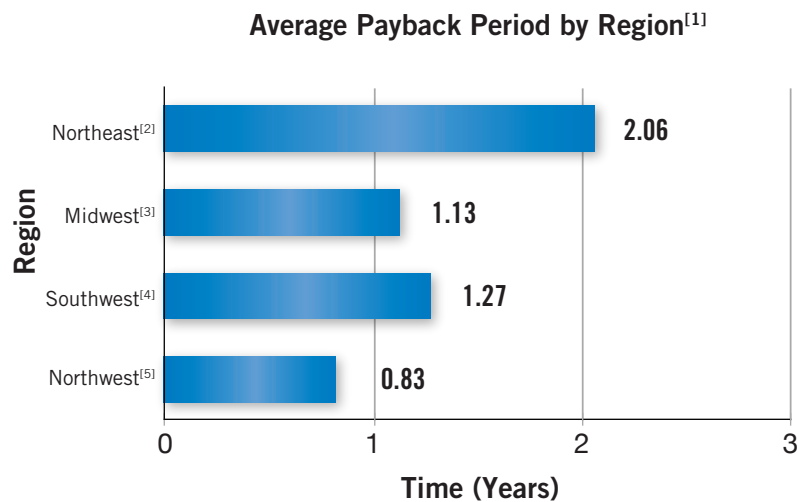

#### NOTES:

1. Average payback periods based on current analyses performed. Specific payback periods vary. Utility prices (electricity, water, etc) vary by state and system details vary by job.
2. Northeast region includes MA, MD, CT, DC, NJ, NY, PA, and RI.
3. Midwest region includes MN and MO.
4. Southwest region includes LA, TX, and Southern CA.
5. Northwest region includes Northern CA, OR, and UT.



## > System Energy Savings Reduce Monthly Energy Bills

- ▶ Reduced condensing temperatures
- ▶ Less compressor work
- ▶ Direct drive VSEC motors minimize fan energy required

**Annual 37.2% System Energy Reduction for El Paso, Texas**

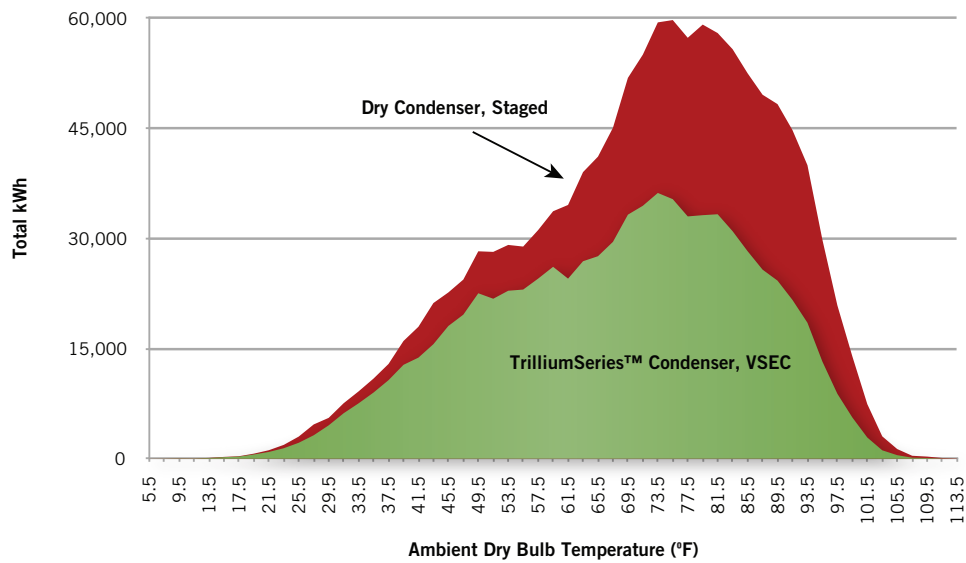

**Average Peak Energy Reduction in %kW by State**

## > Peak Energy Savings

- ▶ Up to 43.5% peak energy reduction compared to air cooled units by operating compressors at significantly lower condensing temperatures
  - Peak energy is more expensive than off peak energy
  - Reduces peak demand charges
  - Potential for substantial state and local energy rebates

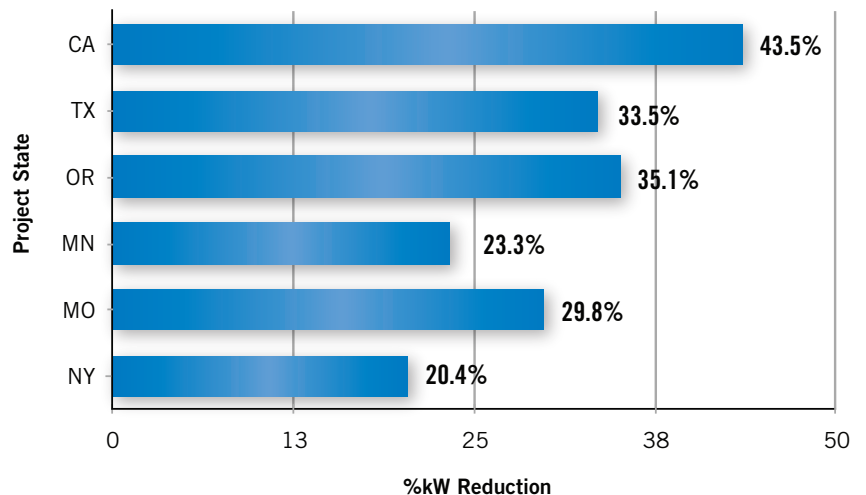



# Benefits

## > Rebates

Most states offer utility incentives and rebates which further decrease the initial investment of the TrilliumSeries™ Condenser.

Type of Rebate	Example based on <a href="http://www.dsireusa.org">www.dsireusa.org</a>
<b>Custom</b>	Custom Measures and Retro-commissioning: \$0.11/kWh saved up to 75% of incremental cost
<b>Refrigeration</b>	<ul style="list-style-type: none"><li>• Refrigeration Equipment: \$35-\$1000/unit</li><li>• Air Conditioning and Refrigeration: \$0.09 - \$0.15/kWh saved</li></ul>
<b>VFDs on Fan Motors or Other Controls</b>	<ul style="list-style-type: none"><li>• Variable Frequency Drives: \$80/HP</li><li>• Refrigeration Controls: \$75-\$100/Controller</li></ul>

Dsireusa.org is a website with information on state, local, utility, and federal incentives and policies that promote renewable energy and energy efficiency. Established in 1995 and funded by the U.S. Department of Energy, DSIRE is an ongoing project of the N.C. Solar Center and the Interstate Renewable Energy Council.

For custom rebates, an analysis of the overall system energy savings from air cooled to the TrilliumSeries™ Condenser may be necessary and is available from Baltimore Aircoil Company.

## > Optional Built-in Energy Tracking / Alarms

- ▶ Optional alarms for the fans, pumps and valves reduce high head pressure instances
- ▶ Optional energy monitoring maintains efficient operation over the life of the product



## > On-Demand Adiabatic™ Pre-Cooler



- ▶ Water is used ONLY when the ambient temperature requires it
  - Water spray saturates and cleans the On-Demand Adiabatic™ Pre-Cooler media of any dust and debris
- ▶ No water treatment is required
- ▶ Free draining prevents stagnant water
- ▶ LEED® Points available for water efficient landscaping (WE credit 1) based on 2009 LEED for Retail and Commercial Interior rating system
  - Water from the drain and overflow can be used for irrigation or other non-potable uses
- ▶ **CONTROLS OPTIONS**
  - **WATER QUALITY SENSOR (OPTION)** – Flushes the sump based on a factory preset conductivity level to minimize water use.
  - **WATER MONITORING (OPTION)** – This option monitors the amount of purged water and maintains efficient operation over the life of the product.

Average Annual Water Use Compared to Evaporative Condensers

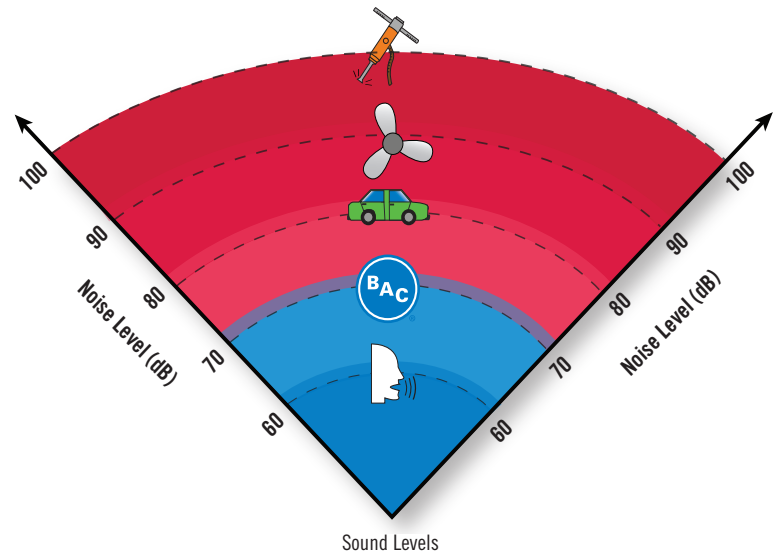
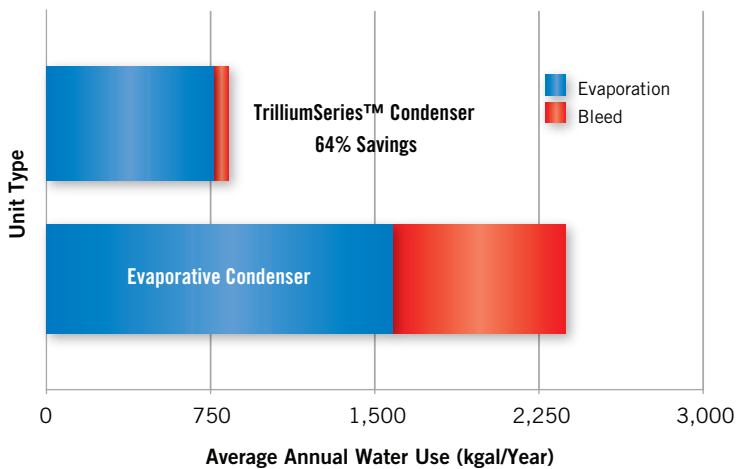

## > Low Sound

- ▶ Whisper Quiet Fans are standard
- ▶ Direct drive VSEC fan motors vary the fan speed eliminating sudden starts and stops

# Benefits

## > Easy Maintenance

- ▶ Requires the same time to maintain as an air cooled condenser
- ▶ Water treatment is not required
  - Water is turned on only when ambient temperature requires it
  - Water spray saturates and cleans the On-Demand Adiabatic™ Pre-Cooler media of any dust and debris
- ▶ On-Demand Adiabatic™ Pre-Cooler media acts as a filter to prevent debris from reaching the microchannel
  - Can be removed without tools for easy coil inspection
- ▶ Clean-out ports on both ends of water distribution header facilitate easy cleaning
- ▶ The EcoFlex Controls maintain a clean sump
- ▶ Pump and strainer are easily accessible from the access hatch

## > Charge Reduction

- ▶ 60% less charge than comparable air cooled condensers
- ▶ Reduced charge could help meet EPA's Greenchill commitments
- ▶ Lowers greenhouse gas emissions of the supermarket refrigeration system

## > Peace of Mind

- ▶ All units are equipped with state of the art EcoFlex controls, On-Demand Adiabatic™ Pre-Cooler, and daily automatic sump clean out
- ▶ Critical components are stocked and ship within 24-hours
- ▶ Manual discrete spray system (water bypass) standard
- ▶ Durable materials of construction extend the life of the unit
- ▶ Sump and drain pans drain freely
- ▶ Ability to switch fans from automatic to manual fan override in case of control signal loss
- ▶ Access hatch sensor shuts off the fan when the hatch is opened
- ▶ UL Approved unit
- ▶ Coated microchannel independently tested per G85-A4 for 3,000+ hours

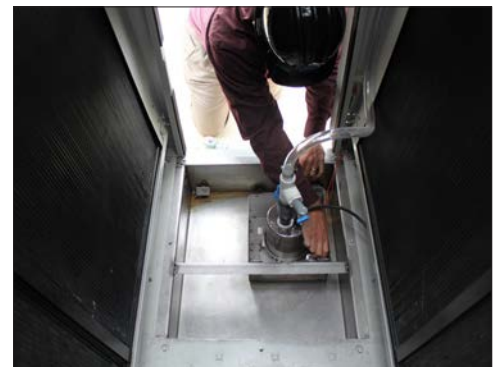

Easy Access to Pump and Strainer

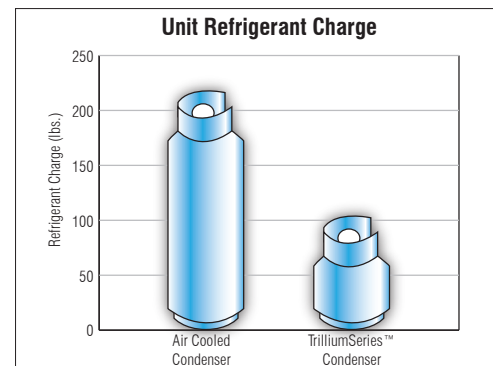

Charge Reduction

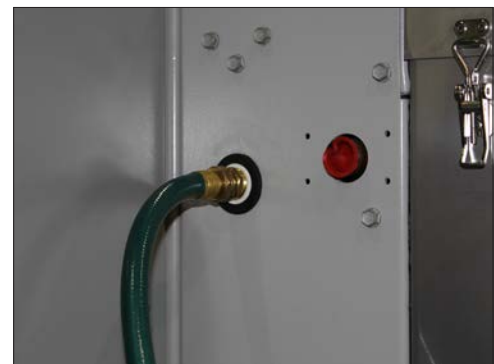

Discrete Spray System



# Modes of Operation

## ➤ Dry Mode

When the ambient air is below the set point, the unit runs as a dry cooler to save water and energy. The ambient air condenses the refrigerant in the microchannel coils which is then returned to the system.

## ➤ On-Demand Adiabatic™ Pre-Cooler Mode

When the unit is in On-Demand Adiabatic™ Pre-Cooler mode, water is evenly sprayed over the highly efficient media. The air is humidified as it passes through the media, cooling temperatures down to 2-3°F above wet-bulb temperature. Such substantial depression of the dry bulb temperature results in a major increase in dry cooling capacity.

The cooler air passes over the microchannel and condenses the refrigerant in the microchannel which is then returned to the system. In the sump there is an industrial duty pump that recirculates the water. Part of the distributed water is evaporated, while the excess water assists in rinsing the On-Demand Adiabatic™ Pre-Cooler media. The EcoFlex Controls determine when the water is purged from the sump.

### ▶ ON-DEMAND ADIABATIC™ PRE-COOLER OPERATION MODES

There are three different ways to optimize unit operation.

- **Standard Logic (Default):** The controller will start the Pre-Cooler Mode at a preset outside air temperature to increase the unit's capacity and efficiency.
- **Water Saver Logic:** The controller will optimize the unit's dry efficiency and only use water when the conditions require the extra cooling capacity. Pre-Cooler Mode will be initiated only when the outside air temperature is above the switch point and the fans are running at 90% or above for over 60 seconds. This mode will recheck conditions every two hours.
- **Energy Saver Logic:** The controller will optimize its sequence so that the least amount of energy is consumed to meet the present load of the unit. Pre-Cooler Mode will be initiated at 10 degrees below the switch point and if the fan speed is above 35%.

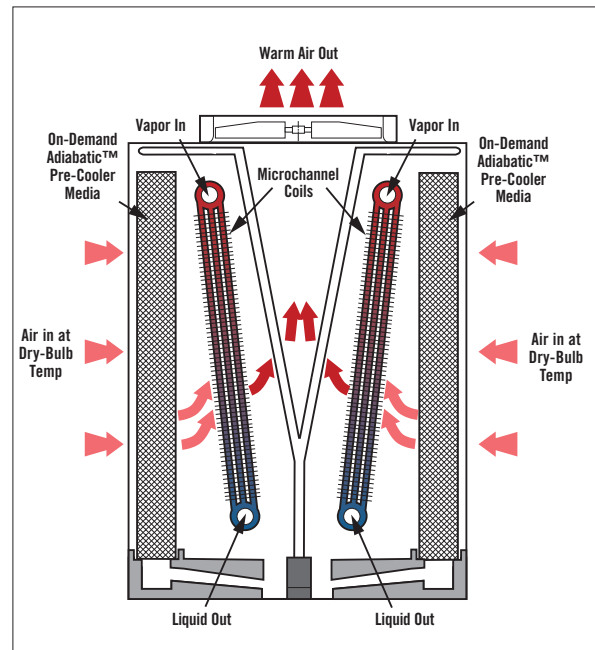

Dry Mode Operation

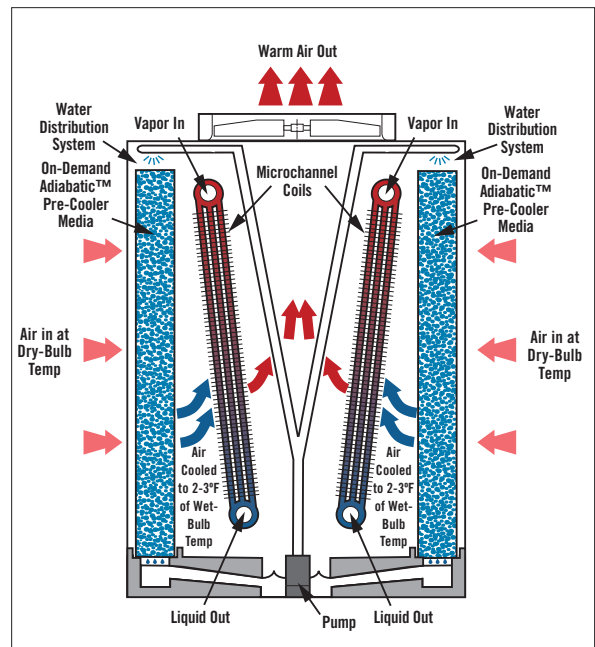

On-Demand Adiabatic™ Pre-Cooler Mode

# Engineering Data

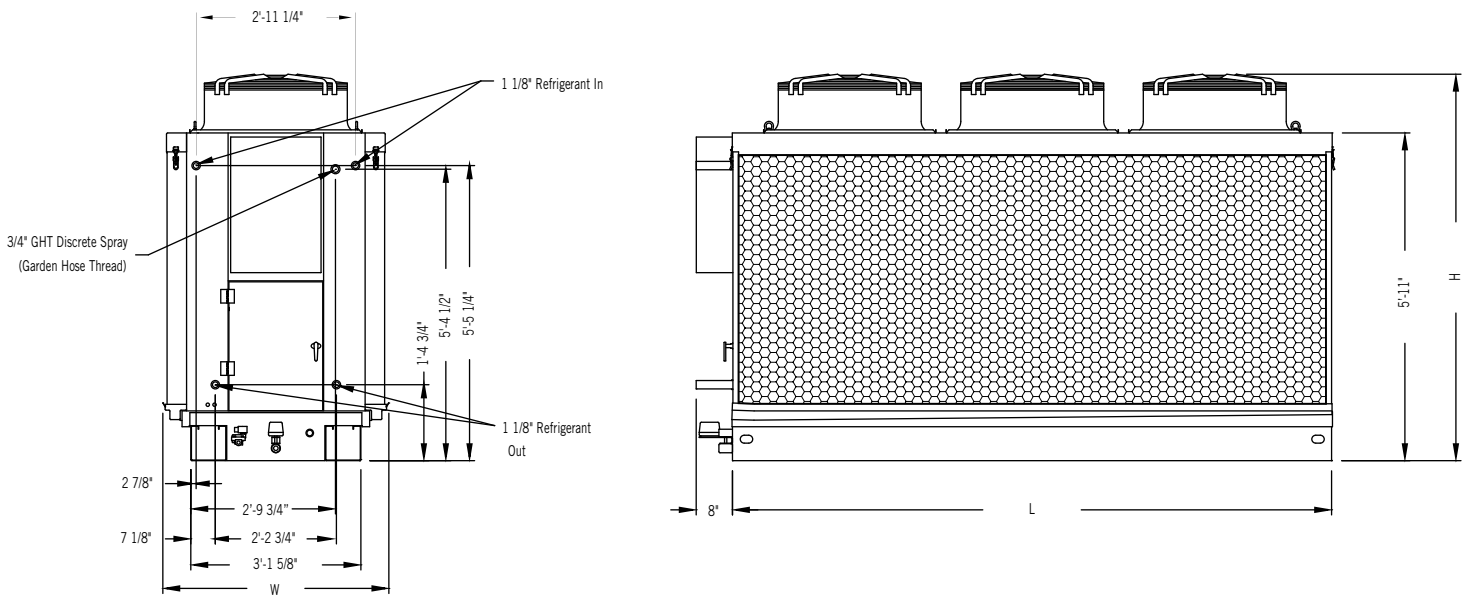

Model	Fan Qty	Base Heat Rejection (MBH) <sup>1)</sup>	Base Tons	Motor HP	Pump HP	Airflow (CFM)	Total Unit FLA at 460V	Unit Length (L)	Unit Width (W)	Unit Height (H)	Shipping Weight (lbs)	Operating Weight (lbs)
TSDC-033-3	1	391	33	3.0	0.25	14,890	4.4	5'-11"	4'-2"	7'-0"	1,280	1,450
TSDC-059-6.2	2	702	59	6.2	0.25	28,000	8.9	8'-7"	4'-2"	7'-0"	1,740	1,950
TSDC-086-9.6	3	1,026	86	9.6	0.25	41,400	13.0	11'-9"	4'-2"	7'-0"	2,300	2,550
TSDC-116-12.4	4	1,405	117	12.4	0.25	56,000	20.6	16'-3"	4'-4"	7'-1/2"	3,200	3,550



## NOTES:

1. Base Heat Rejection (MBH) is based on R-134a 95°F dry-bulb/76°F wet-bulb and 105°F condensing temperature.
2. The water make-up connection is 3/4". The water drain connection is 1 1/4". The water overflow connection is 1 1/2".

**Do not use for construction.** Refer to factory certified dimensions. This catalog includes data current at the time of publication, which should be reconfirmed at the time of purchase. Up-to-date engineering data, free product selection software, and more can be found at [www.BaltimoreAircoil.com](http://www.BaltimoreAircoil.com).

# EcoFlex Controls



The TrilliumSeries™ Condenser is furnished standard with state of the art EcoFlex Controls that provide efficient year round performance. Each unit is shipped with custom controls logic that reduces energy consumption and optimizes water usage. The system is pre-programmed and ready to operate upon arrival from the factory.

## Controls Logic

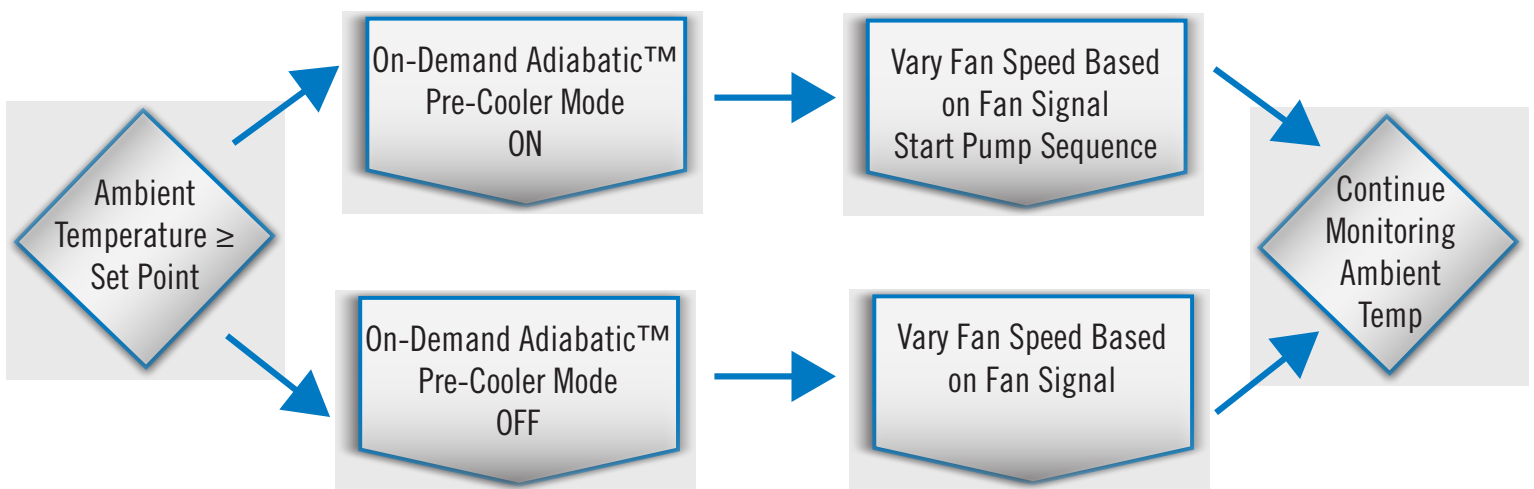

## > EcoFlex Controls Logic Features

- ▶ **ENERGY MONITORING** – Measures the energy use of the TrilliumSeries™ Condenser and verifies efficient operation over the life of the equipment.
- ▶ **WATER MONITORING** – Measures the water use and maintains efficient operation of the unit.
- ▶ **ALARMS** – Signals provided for fans, pumps, or valves to reduce instances of high system head pressure.
- ▶ **COMMUNICATIONS CARDS** – Allows for seamless integration over Modbus and BACnet to monitor all system components in a single location.



# Selection and Payback Analysis Software

The TrilliumSeries™ Condenser program allows you to select the optimum unit based on ASHRAE design conditions and weather profile by bin data that are pre-populated by city and state.

**TrilliumSeries™ Condenser Selection Program**

Home Options Contact Us Help

Heat Rejection Method (Recommended): Adiabatic Operation

**Design Conditions**

Country: United States  
 State: Alabama (AL)  
 City: BIRMINGHAM MUNICIPAL AP, AL, USA  
 Refrigerant: R-134a  
 Total Heat Rejection: 1000.00 MBH  
 Condensing Temperature: 95.00 °F  
 Wet Bulb Temperature: 75.10 °F  
 Dry Bulb Temperature: 95.00 °F  
 Elevation: 0.0 ft

**Selection Requirements**

Number of Units: Min Units: 1, Max Units: 12  
 Multiples of Same Unit Only:   
 Reserve Capability: Min Reserve: -5%, Max Reserve: 50%  
 Specify Maximum:   
 Number of Fans per Unit: Min Fans: 1, Max Fans: 4  
 Maximum Dimensions (ft): Max. Length (for all units): 999, Max. Width: 999, Max. Height: 999

**Selection Ranking**

- Price Ranking
- Estimated Annual Energy Use
- Total Cost of Ownership

Buttons: Load Selection Parameters, Go To Model Information Screen, Go To Payback Analysis Screen, Select Models, Reset

## > Selection

You can select the product based on estimated annual energy use, total cost of ownership over 15 years of operation, and first cost.

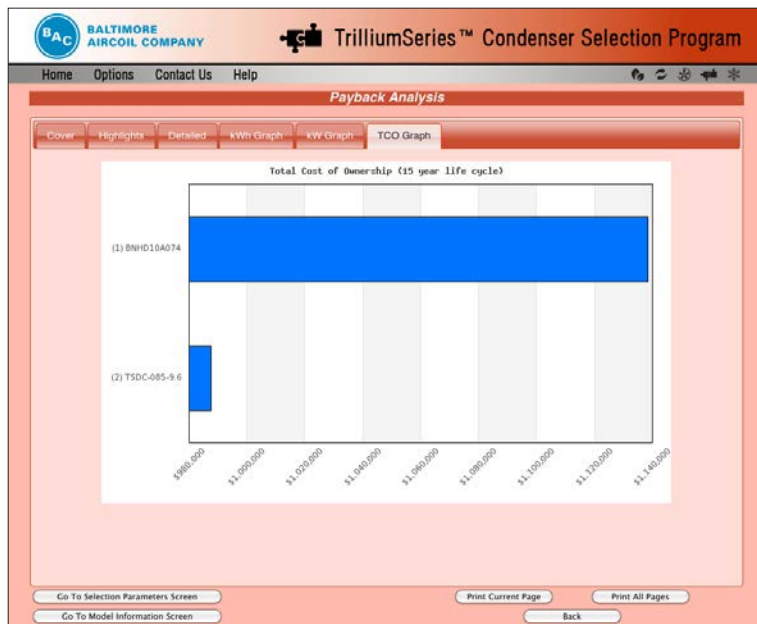

## > Comparison

Example of total cost of ownership compared to an equally sized air cooled condenser with staged fans based on energy, water, refrigerant use, and other annual operating costs such as maintenance.

The total cost of ownership of the TrilliumSeries™ Condenser is substantially less than an air cooled condenser with staged fans.

# TrilliumSeries™ Condenser for Transcritical CO<sub>2</sub> Applications

The TrilliumSeries™ Condenser empowers transcritical CO<sub>2</sub> applications throughout the United States.

## > There are many benefits of CO<sub>2</sub> refrigeration systems including:

- ▶ **NO REGULATORY LIABILITY OR RESTRICTIONS**
- ▶ **NO EXPENSIVE FUTURE RETROFITS DUE TO REFRIGERANT PHASE OUT**
- ▶ **REDUCED SYSTEM CARBON FOOTPRINT WITH GLOBAL WARMING POTENTIAL OF “1” AND OZONE DEPLETING POTENTIAL OF “0”**
- ▶ **LOW INSTALLED COST DUE TO LOWER REFRIGERANT PRICES AND NO REFRIGERANT TAX**

With an estimated 2,885 European food retail stores using CO<sub>2</sub> transcritical refrigeration systems, their application is constantly expanding to other countries including Canada and the Northern part of the United States. Energy efficient, economical refrigeration systems are normally limited to colder climates due to the limitations of air cooled gas coolers.

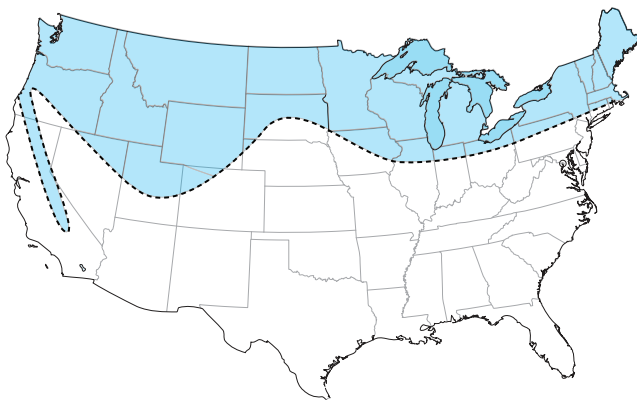

Climate Limitation of CO<sub>2</sub> Systems with Air Cooled Condensers

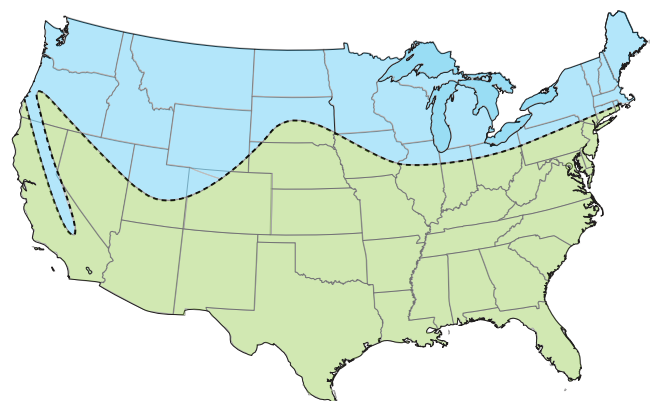

TrilliumSeries™ Condenser Expands CO<sub>2</sub> Applications

However, by using the TrilliumSeries™ Condenser's unique adiabatic design, it is possible to eliminate their restrictions due to warmer climates and save additional energy in cooler ones.

## > TrilliumSeries™ Condenser Transcritical CO<sub>2</sub> Benefits:

- ▶ LOWER TOTAL COST OF OWNERSHIP
- ▶ REDUCED COMPRESSOR WORK
- ▶ HIGH EFFICIENCY VSEC MOTORS
- ▶ NO WATER TREATMENT
- ▶ INTELLIGENT CONTROLS
- ▶ LOWER OPERATING PRESSURE

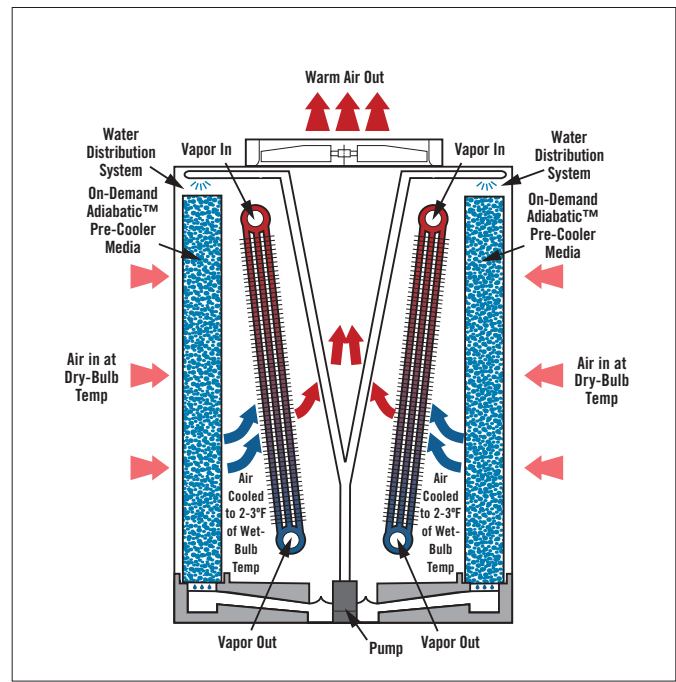

On-Demand Adiabatic™ Pre-Cooler Mode

## > Example

The critical point of CO<sub>2</sub> is 85°F which means that the system is a condenser in subcritical mode when the high side is below 85°F and is a gas cooler in transcritical mode above 85°F.

Condenser Type	Air Cooled	TrilliumSeries™ Condenser
Summer Conditions	95°F Dry Bulb	95°F Dry Bulb/75°F Wet Bulb
Air Temp to the Condenser	95°F	78°F to 80°F
Gas Temperature	230°F in, 105°F out	176°F in, 87°F out
Gas Pressure	1,500 psi	1,100 psi

The TrilliumSeries™ Condenser allows energy efficient operation of CO<sub>2</sub> transcritical systems throughout the U.S. by reducing the refrigerant temperature from 105°F to 87°F.

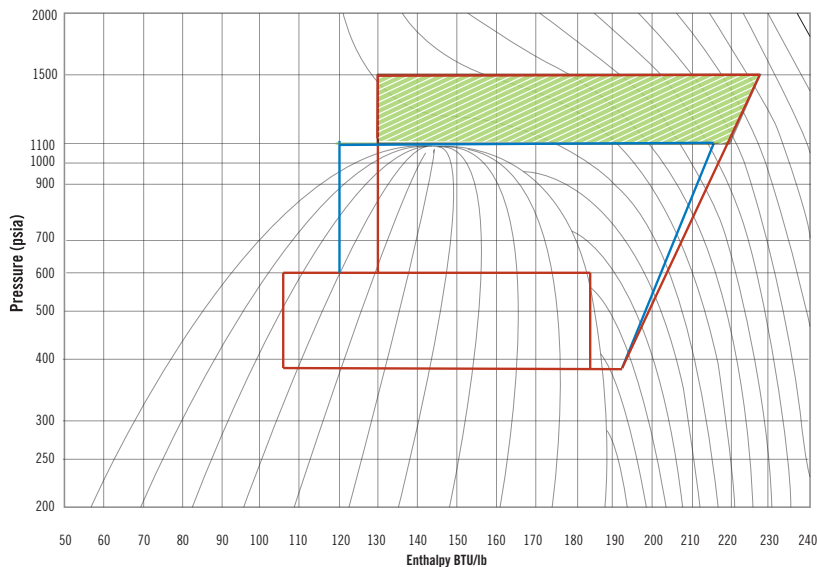

- Thermodynamic Process with Air Cooled Condenser
- Thermodynamic Process with TrilliumSeries™ Condenser
- Energy Savings using TrilliumSeries™ Condenser in CO<sub>2</sub> Application

**Using the TrilliumSeries™ Condenser drastically reduces your direct and indirect carbon emissions while making energy efficient designs possible in any climate!**

# Engineering Data for CO<sub>2</sub> Applications

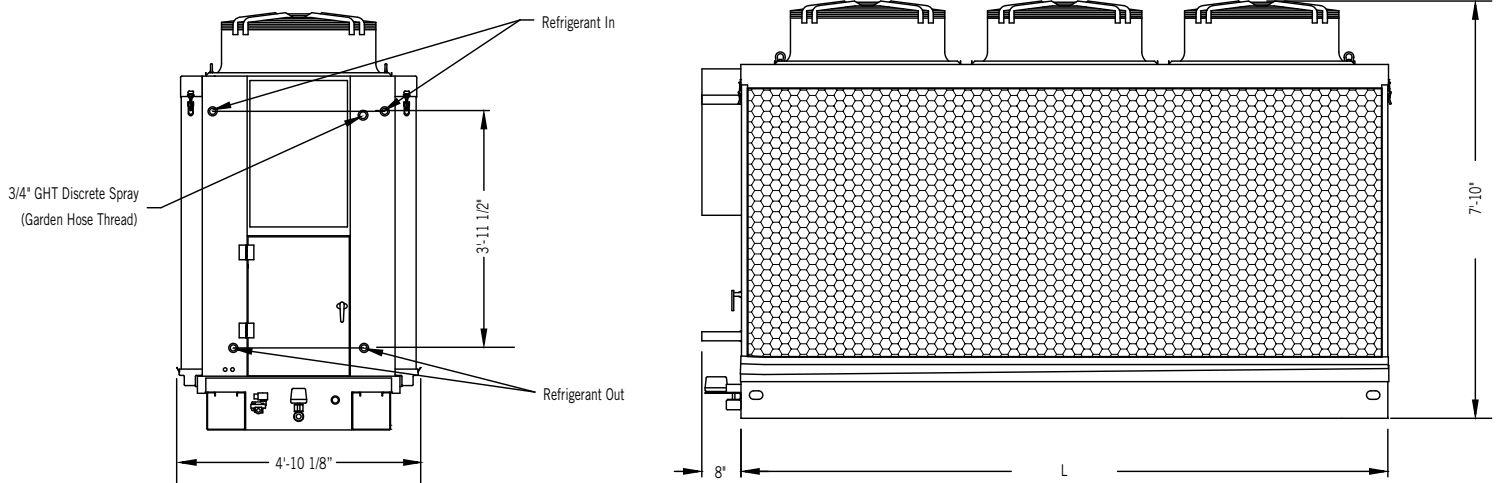

Model	Fan Qty	Base Heat Rejection (MBH) <sup>(1)</sup>	Base Tons	Motor BHP	Airflow (CFM)	Pump HP	Unit FLA at 460V	Unit Length (L)	Shipping Weight (lbs)	Operating Weight (lbs)
TSDC-C02-044-3	1	530	44	3	15,200	0.25	4.4	5'-3"	1,650	1,840
TSDC-C02-077-6.2	2	828	77	6	28,800	0.25	8.2	7'-11"	2,300	2,530
TSDC-C02-112-9.6	3	1,344	112	9.6	42,600	0.25	13	11'-1"	2,970	3,250
TSDC-C02-152-12.4	4	1,848	152	12	57,500	0.25	16.2	15'-7"	3,940	4,290



**NOTE:**

1. Base Heat Rejection (MBH) is based on R-744 200°F CO<sub>2</sub> gas cooling with 90°F dry-bulb/76°F wet-bulb ambient.

**Do not use for construction.** Refer to factory certified dimensions. This catalog includes data current at the time of publication, which should be reconfirmed at the time of purchase. Up-to-date engineering data, free product selection software, and more can be found at [www.BaltimoreAircoil.com](http://www.BaltimoreAircoil.com).



**BALTIMORE  
AIRCOIL COMPANY**

COOLING TOWERS

---

CLOSED CIRCUIT COOLING TOWERS

---

ICE THERMAL STORAGE

---

EVAPORATIVE CONDENSERS

---

**HYBRID PRODUCTS**

---

PARTS & SERVICES



[www.BaltimoreAircoil.com](http://www.BaltimoreAircoil.com)

7600 Dorsey Run Road, Jessup, MD 20794 > Telephone: (410) 799-6200 > Fax: (410) 799-6416

© 2014 Baltimore Aircoil Company > S410/2-A