

## DOCKETED

<b>Docket Number:</b>	15-IEPR-04
<b>Project Title:</b>	AB1257 Natural Gas Act Report
<b>TN #:</b>	206470
<b>Document Title:</b>	AB 1251 Natural Gas Act Report: Strategies to Maximize the Benefits Obtained from Natural Gas as an Energy Source
<b>Description:</b>	Final Staff Report
<b>Filer:</b>	Rachel MacDonald
<b>Organization:</b>	California Energy Commission
<b>Submitter Role:</b>	Commission Staff
<b>Submission Date:</b>	10/30/2015 4:02:33 PM
<b>Docketed Date:</b>	10/30/2015

**California Energy Commission**  
**FINAL STAFF REPORT**

**AB 1257 NATURAL GAS ACT REPORT:  
STRATEGIES TO MAXIMIZE THE BENEFITS  
OBTAINED FROM NATURAL GAS AS AN  
ENERGY SOURCE**

Prepared Pursuant to Assembly Bill 1257 (Chapter 759, Statutes of 2014)



CALIFORNIA  
ENERGY COMMISSION

Edmund G. Brown Jr., Governor

NOVEMBER 2015

CEC-200-2015-006 SF

# CALIFORNIA ENERGY COMMISSION

Silas Bauer  
Andre Freeman  
Rey Gonzalez  
Jason Harville  
Melissa Jones  
Rachel MacDonald  
Chris Marxen  
Brad Meister  
Garry O'Neill  
Bill Pennington  
Charles Smith  
David Vidaver  
***Primary Authors***

Rachel MacDonald  
***Project Manager***

Ivin Rhyne  
***Office Manager***  
**SUPPLY ANALYSIS OFFICE**

Sylvia Bender  
***Deputy Director***  
**ENERGY ASSESSMENTS DIVISION**

Robert P. Oglesby  
***Executive Director***

## DISCLAIMER

Staff members of the California Energy Commission prepared this report. As such, it does not necessarily represent the views of the Energy Commission, its employees, or the State of California. The Energy Commission, the State of California, its employees, contractors and subcontractors make no warrant, express or implied, and assume no legal liability for the information in this report; nor does any party represent that the uses of this information will not infringe upon privately owned rights. This report has not been approved or disapproved by the Energy Commission nor has the Commission passed upon the accuracy or adequacy of the information in this report.

## **ACKNOWLEDGEMENTS**

The authors would like to acknowledge the following individuals for their valuable contributions to this report:

Catherine M. Elder for valuable input.

Kristen Driskell for guidance and editing an early draft of the report.

Jana Romero and Patrick Saxton for guidance and editing.

## ABSTRACT

Assembly Bill 1257 (Bocanegra, Chapter 749, Statutes of 2013) requires the California Energy Commission, beginning November 1, 2015, and every four years thereafter, to identify strategies to maximize the benefits of natural gas as an energy source. The Energy Commission developed this report to explore the strategies and options for using natural gas, including biogas, to realize environmental and societal benefits.

The report explores strategies and recommendations regarding natural gas, including:

- Natural gas pipeline infrastructure, storage, and reliability.
- Natural gas for electric generation.
- Combined heat and power using natural gas.
- Natural gas as a transportation fuel.
- End-use efficiency applications using natural gas for heating and cooling, water heating, and appliances.
- Natural gas and zero-net-energy buildings.
- Other natural gas low-emission resources, biogas, and biomethane.
- Greenhouse gas emissions associated with the natural gas system.

The amount of electricity generated using natural gas in California has increased in the past two decades. California consistently ranks as the second highest gas-consuming state in the nation, further indicating that natural gas is an integral part of the state electricity and fuel portfolio. The report findings indicate that several improvements could be made to natural gas infrastructure. In addition, research is necessary to balance state and federal greenhouse gas reduction and renewable generation policy, while providing grid stability.

**Keywords:** Natural gas, biomethane, transportation, fuel, generation, resource portfolio, combined heat and power, low emission, biogas, efficiency, heating, cooling, appliances, pipeline, infrastructure, reliability, zero net energy, greenhouse gas, benefits, Assembly Bill 1257

MacDonald, Rachel, Silas Bauer, Andre Freeman, Rey Gonzalez, Jason Harville, Melissa Jones, Chris Marxen, Brad Meister, Garry O'Neill, Bill Pennington, Charles Smith, David Vidaver. 2015. *Strategies to Maximize the Benefits Obtained From Natural Gas as an Energy Source*. California Energy Commission. CEC-200-2015-006.

# TABLE OF CONTENTS

<b>ACKNOWLEDGEMENTS</b> .....	<b>I</b>
<b>ABSTRACT</b> .....	<b>II</b>
<b>EXECUTIVE SUMMARY</b> .....	<b>1</b>
Natural Gas Infrastructure and Pipeline Safety .....	1
Natural Gas for Electric Generation.....	2
Combined Heat and Power Systems and Natural Gas .....	2
Natural Gas as a Transportation Fuel.....	3
End-Use Efficiency Applications and Natural Gas, Including Zero-Net-Energy Buildings.....	4
Low-Emission Resources and Biogas .....	5
Greenhouse Gas Emissions Associated With the Natural Gas System .....	6
Conclusions .....	9
<b>CHAPTER 1: Introduction</b> .....	<b>11</b>
<b>CHAPTER 2: Pipeline Safety and Natural Gas Infrastructure Improvements</b> .....	<b>13</b>
Introduction.....	13
California Pipeline Safety .....	13
Pipeline Safety Improvements.....	15
Other Safety Efforts.....	18
The Southern System Minimum Flow Requirement.....	20
Gaps in Knowledge and Research .....	26
<b>CHAPTER 3: Natural Gas for Electric Generation</b> .....	<b>28</b>
Introduction.....	28
Federal Regulations.....	28
Gas-Electric Coordination .....	29
Renewables Integration .....	31

<b>CHAPTER 4: The Role of Natural Gas as a Fuel for Combined Heat and Power Systems</b>	<b>34</b>
Introduction.....	34
Opportunities.....	34
Existing Policies and Programs .....	35
Cost-Benefit Analyses .....	37
Challenges .....	38
Gaps in Knowledge and Research .....	39
<b>CHAPTER 5: Natural Gas as a Transportation Fuel .....</b>	<b>41</b>
Introduction.....	41
Transportation Fuel in California.....	41
Natural Gas Vehicles and Fuel .....	43
Natural Gas Fueling Infrastructure.....	45
Biomethane Production Opportunities .....	46
Sustainable Freight and Transport Sector Opportunities.....	49
Alternative and Renewable Fuel and Vehicle Technology Program .....	49
Public Interest Energy Research Natural Gas Program .....	51
Areas for Further Research .....	52
<b>CHAPTER 6: Natural Gas and End-Use Efficiency Applications.....</b>	<b>55</b>
Introduction.....	55
Building Sector.....	55
Water Heating and Hot Water Delivery .....	56
Space Heating and Cooling.....	56
Cooking.....	57
Industrial Sector.....	58
Existing Policies and Programs .....	59
Cost-Benefit and Effectiveness Analysis .....	60
Challenges in California .....	61
Technology Considerations.....	61

Environmental Considerations.....	62
Gaps in Knowledge and Research .....	63
<b>CHAPTER 7: Natural Gas Use for Zero-Net-Energy Buildings.....</b>	<b>66</b>
Introduction.....	66
California and ZNE Buildings .....	66
Existing Policies and Programs .....	67
Residential .....	69
Nonresidential.....	69
Cost-Benefit Analyses .....	69
Challenges in California .....	70
Gaps in Knowledge and Research .....	73
<b>CHAPTER 8: Natural Gas and Biogas as Low-Emissions Resources .....</b>	<b>74</b>
Introduction.....	74
Biogas and Biomethane Production.....	74
Landfill Waste Disposal.....	75
Diverting Organic Solid Waste .....	75
Collection of Landfill Gas.....	76
Manure Management.....	77
Wastewater Treatment.....	77
Other Feedstock Opportunities .....	78
Opportunities for Biomethane Use in California .....	79
Challenges in California .....	79
Regulatory Issues.....	79
Costs .....	80
Gaps in Knowledge and Research .....	81
<b>CHAPTER 9: Greenhouse Gas Emissions and the Natural Gas System.....</b>	<b>82</b>
Introduction.....	82
Natural Gas System Emissions.....	82



Methane Emissions and the Natural Gas System .....	83
The Natural Gas System .....	85
Methods for Quantifying Methane Emissions .....	87
Methane Emission Estimates From State and Federal Inventories .....	88
Findings From Recent Assessments of Methane Emissions.....	91
Uncertainties in Estimating Methane Emissions.....	94
Setting Boundaries of the Natural Gas System .....	95
Problems With Measurement and Sample Bias .....	96
Methane Emissions From Out-of-State Oil and Gas Production.....	99
State and Federal Efforts to Address Methane Leakage .....	100
State Efforts to Address Methane Emissions.....	100
ARB Activities.....	101
CPUC Activities.....	102
Energy Commission Activities .....	102
Natural Gas Utility Activities .....	103
EDF Comprehensive Study.....	105
Federal Efforts to Address Methane Emissions .....	106
Areas for Further Research .....	108
<b>Acronyms .....</b>	<b>109</b>
<b>Appendix A.....</b>	<b>1</b>

## LIST OF FIGURES

	Page
Figure 1: So Cal Gas and SDG&E Pipeline System.....	21
Figure 2: Net Generation of U.S. Electricity by Coal and Natural Gas (2001 to 2014).....	29
Figure 3: Alternative Fuel Prices .....	43
Figure 4: California Natural Gas Vehicle Registrations for 2013.....	44

Figure 5: California’s 2013 Greenhouse Gas Inventory Using 100-Year (Left Pie Chart) and 20-Year (Right Pie Chart) Global Warming Potential Values ..... 84

Figure 6: California 2013 Methane Emission Sources ..... 85

Figure 7: Schematic Representation of the Natural Gas System..... 86

Figure 8: 2008 Natural Gas System Methane Emissions for Five Consecutive Inventories.... 89

Figure 9: U.S. Methane Emissions From the U.S. Natural Gas System..... 90

**LIST OF TABLES**

	Page
Table 1: Proposed Pipeline Projects to Address the SoSysMin Issue.....	26
Table 2: Low-Carbon Fuel Standard Carbon Intensity Values .....	48
Table 3: Previous ARFVTP Awards as of March 9, 2015 .....	50
Table 4: Energy Commission’s R&D Program Funding .....	53
Table A-1: Interstate Natural Gas Pipelines Interconnecting to California as of April 2, 2015	1



## EXECUTIVE SUMMARY

The California Energy Commission developed this report to explore the strategies and options for using natural gas, including biogas, pursuant to Assembly Bill 1257 (Bocanegra, Chapter 749, Statutes of 2013).

Energy Commission staff has addressed natural gas issues in the following areas:

- Natural gas pipeline infrastructure, storage, and reliability
- Natural gas for electric generation
- Combined heat and power using natural gas
- Natural gas as a transportation fuel
- End-use efficiency applications using natural gas for heating and cooling, water heating, and appliances
- Natural gas and zero-net-energy buildings
- Other natural gas low-emission resources, biogas, and biomethane
- Greenhouse gas emissions associated with the natural gas system

In developing the report, the Energy Commission held public workshops seeking input from experts, industry stakeholders, the public, and various state agencies, including the California Air Resources Board (ARB), California Public Utilities Commission, State Water Resources Control Board, and the Department of Conservation, Division of Oil, Gas, and Geothermal Resources.

### Natural Gas Infrastructure and Pipeline Safety

California continues to rank as the second highest natural gas consuming state in the United States, with daily natural gas demand ranging from a little over 6 billion cubic feet per day to as high as 11 billion cubic feet per day, depending on the time of year. Increased demand and the opening of new production areas in recent years have provided California with access to diverse natural gas sources. The immediate gas infrastructure challenges California faces relate to pipeline safety, infrastructure enhancements, gas-electric system coordination concerns, and renewables integration.

As a result of the pipeline explosion in San Bruno on September 9, 2010, the California Public Utilities Commission (CPUC) formed an independent review panel of experts to gather and review facts and make recommendations to the CPUC. The panel developed recommendations that provided the cornerstone of a comprehensive effort launched by the CPUC to create a culture where safety permeates all of its regulatory activity.

California is improving its pipeline safety with research and analysis. The Energy Commission has funded research to help address natural gas safety after the San Bruno

explosion. In addition, the Energy Commission awards research funds for natural gas system projects on an ongoing basis. Current research is focused on developing new technologies, such as sensors and ultrasonic transducers, to monitor the integrity of gas pipelines. These projects are intended to reduce the cost and size of leak detection sensors and diagnostic tools and improve accuracy of leak and defect detection. The Energy Commission will continue to support research that improves natural gas infrastructure and safety.

## Natural Gas for Electric Generation

Several proposed or adopted federal air and water quality regulations are expected to reduce U.S. reliance on coal for generating electricity. These rules include the air toxics rule, the Clean Power Plan to reduce power plant emissions, the greenhouse gas new source performance standard, changes to water effluent rules, and others. Together, they may increase demand for natural gas-fired generation, depending on what choices utilities make when replacing electricity formerly generated by coal.

In California, roughly 40 percent of the natural gas is used to generate electricity. For the United States, the amount of natural gas used for electric generation is 31 percent. As California electric utilities convert electricity generation portfolios away from carbon-intensive resources, the way natural gas is used will change. These changes will affect not only the quantity of natural gas used to generate electricity, but how and when natural gas-fired resources need to operate. These new operational profiles will require a higher degree of coordination between the gas and electric industries.

Keeping the gas system in balance could potentially become more challenging as the state further increases the portion of its electricity generated from renewable resources. On October 7, 2015, Governor Edmund G. Brown signed Senate Bill 350 (De León, Chapter 547, Statutes of 2015). Known as the Clean Energy and Pollution Reduction Act of 2015, SB 350 increases the state's Renewables Portfolio Standard goals to 50 percent renewable generation by 2030. In 2013, renewables in California produced about 21 percent of retail electricity sales. The electricity produced from renewables such as wind and solar—the largest source of renewable electricity generation among California's Renewables Portfolio Standard-eligible technologies—varies depending on conditions each hour (or even minute to minute). Some of that variation in renewables generation output is predictable (for example: solar generates only during daylight hours); some of it is not as predictable (for example: cloud cover reducing solar output or wind variations affecting wind generation).

## Combined Heat and Power Systems and Natural Gas

Combined heat and power, also known as cogeneration, has the potential to provide many benefits and opportunities to California. Historically, the most important feature of combined heat and power has been fuel efficiency. A properly sized and operated combined

heat and power facility can produce thermal, mechanical, and electrical energy using less fuel than would otherwise be used to acquire the same energy via a more traditional system of boilers and central-station grid electricity.

Despite the many advantages, the growth in combined heat and power development in California has been relatively flat in recent years. Many regulatory and economic barriers exist for a combined heat and power developer, and often these barriers result in a combination of cost and risk that is too high to justify the project. Economically, projects often face three major cost barriers, including nonbypassable charges, grid interconnection, and contracting difficulties. Estimating the benefits of combined heat and power systems is a challenging and sometimes contentious issue.

The Energy Commission recognizes that the challenges facing combined heat and power today could be lessened by new regulatory and market frameworks. The Energy Commission should continue to develop and support new frameworks that will better value the true costs and benefits of combined heat and power generation and align utility incentives with those costs and benefits.

### Natural Gas as a Transportation Fuel

Transportation accounts for nearly 40 percent of California's total energy consumption and roughly 36 percent of state greenhouse gas emissions. While petroleum accounts for more than 90 percent of California's transportation energy sources, there could be significant changes in the fuel mix by 2020 as a result of technological advances, market trends, consumer behavior, and government policies.

The range of alternatives to petroleum-based fuels is diverse, including biofuels, electricity, hydrogen, and natural gas. California has established programs and regulatory initiatives to ensure that the future transportation fuel supply reduces carbon intensity, tailpipe emissions, and adverse economic impacts, and uses a secure domestic fuel source when possible.

Natural gas is also playing an important role in developing the emerging hydrogen vehicle industry. There are several options available for producing low-carbon intensity hydrogen fuel for transportation. The majority of the existing hydrogen fueling stations use hydrogen made by steam reformation that converts natural gas or biomethane to hydrogen. This process and other technologies could allow hydrogen fueling stations and centralized fuel producers to use the existing natural gas infrastructure as a secure source of fuel for hydrogen production.

The Energy Commission Fuels and Transportation Division implements the Alternative and Renewable Fuel and Vehicle Technology Program that provides up to \$100 million per year for projects that will transform California's fuel and vehicle types to help attain state climate change policies. To support natural gas-related activities in California's transportation sector, funding is targeted at the major areas where public investment can help remove

barriers to the adoption of alternative fuels. In addition, the *2014 Integrated Energy Policy Report* indicates that one key area showing improvement is transportation research. The Energy Commission Energy Research and Development Division transportation research program focuses on developing and advancing state-of-the-art electricity and natural gas-fueled transportation solutions that reduce fossil fuel consumption, greenhouse gas emissions, and air pollutants in the state.

This research program has accelerated the development of zero- and near-zero-emission technologies. In September 2015, Cummins Westport Innovations certified its first near-zero engines for buses, waste haulers, and medium-duty trucks. This engine will reduce oxides of nitrogen (NO<sub>x</sub>) emissions by more than 90 percent from the current standard and will play an important role in improving air quality for Californians.

Many fleets in California have already converted petroleum-consumption vehicle fleets to operate on natural gas. At this time, however, the relative price advantage of natural gas vehicles has diminished, as natural gas vehicles have a greater incremental cost compared to similar gasoline and diesel vehicles. California fleets must weigh the benefits of the lower-cost fuel prices against the increased purchase price of these vehicles. The Energy Commission should support research to help better understand the cost and societal benefits of natural gas as a transportation fuel.

### End-Use Efficiency Applications and Natural Gas, Including Zero-Net-Energy Buildings

California households and businesses consume about one-third of the total state natural gas demand or about 7 billion therms of natural gas annually. Residential natural gas consumption is driven mostly by space and water heating, followed distantly by cooking and miscellaneous home uses, such as clothes dryers and pools. Similarly, commercial natural gas consumption is primarily from space and water heating, with cooking being a significant end use as well. Other uses in commercial buildings include process loads, such as commercial laundry or heated pools, and paint dryers in auto shops.

Residential and commercial natural gas consumption has remained relatively flat for the past two decades despite increases in population, jobs, and gross state product. During this period, the *California Building Energy Efficiency Standards* have increased stringency, and investments in statewide utility energy efficiency programs have grown. This is contributing to the relative flattening of natural gas consumption. Maintaining this flat natural gas consumption trend over the next decade may be more challenging. Senate Bill 350 seeks to double statewide energy efficiency savings in electricity and natural gas retail end use by 2030. The Energy Commission will coordinate with the CPUC and the ARB, as well as utilities and the public to ensure these goals are achieved.

The industrial sector is a major energy consumer and one of the largest users of natural gas in the state, accounting for about 25 percent of total use in 2012. The largest users include

petroleum and coal products manufacturing, oil and natural gas extraction, food processing, printing, and manufacture of electronics, transportation equipment, fabricated metals, furniture, chemicals, plastics, and machinery. These sectors represent prime areas of opportunity for reducing industrial natural gas use. Consequently, the industrial sector represents an important target for improving the efficiency of natural gas use through the adoption of new technologies and improved energy management practices.

There does not appear to be a clear-cut path for natural gas policy in end-use applications when considering zero-net-energy buildings. The Energy Commission adopted the following key recommendations in the *2011 Integrated Energy Policy Report* for achieving high levels of energy efficiency in the *Building Energy Efficiency Standards* updates between now and the 2020 zero-net-energy effective date:

- The Energy Commission, CPUC, local governments, utilities, and builders should collaborate to encourage the building industry to reach these advanced energy efficiency levels.
- The Energy Commission, CPUC, builders, and other stakeholders should collaborate to accomplish workforce development programs to impart the skills necessary to change building practices to accomplish zero net energy in newly constructed buildings.

The Energy Commission can use its regulatory authority in both building energy efficiency and appliance efficiency standards to require buildings and the equipment used in buildings to be more energy-efficient. The timing between the Energy Commission's adoption of the zero-net-energy goal in 2007 and the 2020 effective date for newly constructed homes is short. The Energy Commission made significant energy efficiency upgrades to the 2010 and 2013 California Energy Code, and the Commission expects to adopt the *2016 Building Energy Efficiency Standards* in 2015.

Zero-net-energy buildings will need to have extensive energy efficiency measures, lowering the onsite electricity and natural gas use as much as possible. One way to address this situation would be to identify strategies to offset residual natural gas usage, such as through uses of waste heat, including combined heat and power, or potentially through the use of renewable gas resources at the building site or on a community basis.

### Low-Emission Resources and Biogas

Biogas is typically derived from organic fuel sources, such as biomass, digester gas, or landfill gas. Biogas is principally composed of methane and carbon dioxide. Biomethane is the treated product of biogas where carbon dioxide and other contaminants are removed. Biomethane can supplement or directly replace the use of natural gas. In most cases, the potential for biomethane production is limited by immutable factors, such as "waste-in-place" at a landfill or the volumetric flow of water into a wastewater treatment plant. Production can be increased if there are opportunities to process additional biomass



feedstocks within normal agricultural or industrial operations, such as dairy digesters accepting food waste or wastewater treatment plants codigesting fats, oils, and grease. Manure management, landfills, and wastewater treatment are three of California's largest anthropogenic methane-producing sources, and the capture and subsequent reduction of these methane emissions are arguably one of the greatest benefits for using biomethane.

The *2014 Integrated Energy Policy Report* indicated that biofuel data are needed to better understand the potential of biofuel as a low-carbon resource. The Energy Commission should continue to provide information to the U.S. Environmental Protection Agency so that low-carbon biofuels are appropriately recognized and categorized in the annual Renewable Fuel Standard volumetric targets. The Energy Commission should work with the CPUC and the ARB to overcome potential barriers impeding commercial biogas projects and explore the availability of potential funding or incentive programs to help bring additional low-carbon biogas projects on-line.

Some biomass-rich locations are relatively close to population centers and therefore utility pipelines, but interconnection to utility pipelines can still be difficult. The Energy Commission should continue to coordinate with the CPUC on its interconnection rulemaking, which includes biofuel interconnection. California should encourage increases in biomethane production and use to reduce methane emissions and decarbonize natural gas used in California.

### **Greenhouse Gas Emissions Associated With the Natural Gas System**

Natural gas is composed of multiple chemical compounds, but methane is the main component, comprising about 90 percent or more of the natural gas. Natural gas has the potential to reduce greenhouse gas emissions by shifting away from higher carbon dioxide-emitting fuels like coal, gasoline, or diesel. Methane, however, is a highly potent, short-lived greenhouse gas that can reduce or potentially eliminate the climate change benefits of switching to natural gas. Methane emissions originate from the intentional operations of the natural gas system (venting of natural gas, pneumatic devices using natural gas, and so forth), as well as from leakage throughout the natural gas supply chain from the production, processing, transportation, storage, distribution, and use of natural gas.

Estimating methane emissions from the natural gas system has proven challenging, with divergence in estimates of methane emissions from recent research studies. Additional research activities are underway at both the national and state level to reduce the uncertainty surrounding current estimates. These efforts will help provide California policy makers with accurate and comprehensive assessments of the emissions from natural gas to develop effective greenhouse gas reduction approaches.

A fundamental question regarding the climate benefits of using natural gas is how much methane is escaping from the natural gas system. Researchers estimate emissions from the natural gas supply chain using bottom-up, top-down, and hybrid methods. The "bottom-

up” method is a straightforward summing up of emissions using emissions factors for the various components of the natural gas system. “Top-down” estimates use ambient measurements of methane and other compounds in the atmosphere to estimate emissions. Hybrid methods try to take advantage of both methods by reconciling the estimates from the top-down and bottom-up methods.

Methane emission estimates for California are uncertain. Recent bottom-up work estimating methane emissions from California’s natural gas system suggested emissions less than 1 percent of total throughput. Some top-down studies indicate these may be underestimated. A comparison of the various study results is complicated by the use of different methods, data, device counts, as well as differences in the various components of the natural gas system that are either excluded or included. This research is ongoing.

The uncertainties and gaps in estimating methane emissions in California include the following:

- Most studies to date are not comprehensive life-cycle studies in that they typically do not capture all the components of the natural gas system, such as emissions downstream of the distribution system (for example, end use in homes) or from out-of-state natural gas production areas.
- Problems with measurement and sample bias may occur in the various studies because sample sizes are not large enough due to cost and practicality to be statistically representative of the population of various components of the natural gas system being measured and extrapolated.
- The presence of superemitters that emit at significantly greater rates and volumes than other similar types of emitters may be missed in sampling, and, as a result, emissions may be underestimated. Several studies suggest that methane emissions are dominated by a small fraction of the emitters.
- Bottom-up and top-down estimates from oil and gas production in other states vary widely and are complicated by the lack of widely accepted methods to allocate the emissions between the natural gas and oil sectors, since many wells produce both oil and natural gas.

Despite the uncertainty in the emission estimates, there is adequate evidence that California needs to move forward aggressively to reduce methane emissions both inside and outside the state. Research is underway to better understand emissions from the natural gas system and identify actions to immediately reduce methane emissions. In addition, natural gas utilities are already taking steps to reduce emissions. The following examples highlight some of these activities:

- The Energy Commission is funding ongoing research to assess methane emissions and support natural gas pipeline infrastructure and safety. This research includes surveying the main sources of emissions such as production and processing, transmission and

distribution, underground storage units, abandoned wells, liquefied natural gas fueling stations, and end uses in homes.

- The Energy Commission is also supporting studies on safety issues to be able to detect leaks that may endanger public health and safety. For example, several ongoing projects focus on developing and testing cost-effective leak detection and pipeline integrity monitoring sensors and tools, as well as demonstrating them in the lab, under simulated field conditions, and at a few actual field sites.
- The California natural gas utilities are already taking actions to reduce methane emissions on their distribution system, many of which are being driven primarily by safety concerns following the San Bruno explosion. The investor-owned utilities have replaced old cast iron pipelines, which are notorious sources of emissions, and have plans to accelerate replacement of other pipes in their systems.
- The gas utilities are also engaged in research and development involving the leak detection technologies and real-time notification of leaks. For example, Pacific Gas and Electric is using a mobile platform to detect leaks in the distribution system and to immediately implement measures to eliminate these emissions. In another example, Southern California Gas and San Diego Gas & Electric are installing “smart gas meters” to help with detecting leaks.
- The ARB is developing a strategy to further reduce short-lived climate pollutants, including methane in accordance with Senate Bill 605 (Lara, Chapter 523, Statutes of 2014). In addition, the ARB has already developed regulations for methane from municipal solid waste landfills and is developing regulations to reduce methane from oil and gas production, processing, and storage operations.
- The ARB is also sponsoring several research efforts on methane, including a study, to be completed by the end of the year, to develop California-specific emission factors for distribution pipelines. Moreover, the ARB continues to fund research taking measurements of greenhouse gases at towers located throughout the state.
- The CPUC, working in partnership with the ARB, opened a rulemaking to reduce emissions from natural gas transportation and distribution pipeline leaks under Senate Bill 1371 (Leno, Chapter 525, Statutes of 2014). It requires the CPUC to establish and requires the use of best practices for leak surveys, patrols, leaks survey technology, leak prevention, and leak detection.
- The Environmental Defense Fund is coordinating a comprehensive study of methane leakage with more than 100 academics, natural gas utilities, research institutions, and others. The 16 projects include studies to measure and estimate methane emissions at natural gas production sites, utility distribution systems, and other components of the natural gas system. Ten of the studies have been completed, several others will be completed in the summer of 2015, and the synthesis project is expected by the end of 2015.

- At the federal level, the Federal Energy Regulatory Commission has adopted a policy to allow pipeline owners to recover major capital investment costs that address pipeline safety or reduce greenhouse gas emissions. The U.S. Environmental Protection Agency has issued proposed regulations to reduce methane emissions from compressors, well completions and fracturing, and pneumatic devices.
- A number of federal agencies including the National Oceanic and Atmospheric Administration, the U.S. Department of Energy, the National Aeronautics and Space Administration, and others are engaged in research primarily focused on development of methane sensors and establishing better ways to characterize methane emissions.

The results of the research that is underway, including the Environmental Defense Fund research, will be important in determining the role that natural gas should play in California climate change strategies. In addition, new research and development is likely to be initiated in the coming months to address the gaps and uncertainties identified above.

## Conclusions

The Energy Commission prepared this report to address the comprehensive array of natural gas topic areas identified within Assembly Bill 1257. The report provides an overview of natural gas issues in the state and the current status of the natural gas system, and identifies opportunities for additional research and information gathering. The report is designed to be a beneficial tool to lawmakers and regulators as they face decisions on energy policy in California.

Making recommendations for the implementation strategies for all the areas identified is premature at this time. Many ongoing regulatory initiatives are being undertaken by various agencies in the state (mostly relating to air pollution, greenhouse gases, and the increased use of renewable energy sources). Furthermore, there is research underway that could provide additional information on several uncertainties, including the impacts of methane emissions from the natural gas sector and the best use of biomethane. Because of current uncertainties, recommendations in this report are generally limited to monitoring and participating in regulatory initiatives and additional research in several key areas. There is, however, enough knowledge to continue to move forward with emission reduction strategies at the state level and encourage action at the federal level. Lastly, without implementation strategies, it is also premature to measure private sector job development.

While this report was being developed, new legislation was passed that affects the future of natural gas in California. Newly passed Senate Bill 350 increases the state's Renewables Portfolio Standard goals to 50 percent renewable generation by 2030. In addition, SB 350 seeks to double statewide energy efficiency savings in electricity and natural gas retail customers by 2030. The bill also seeks to further electrify California's transportation sector. The role natural gas will have in achieving these goals needs additional study. The Energy

Commission will coordinate with the CPUC and the ARB, as well as utilities and the public to implement the bill.

# CHAPTER 1:

## Introduction

The California Energy Commission prepared this report to address the comprehensive array of natural gas topic areas identified within Assembly Bill 1257 (Bocanegra, Chapter 749, Statutes of 2013). Natural gas is an important fuel source in California, especially in the industrial and electric power sectors. Recent changes in California's regulatory policies, mostly related to renewable energy and greenhouse gas emissions, mean that the natural gas market will be evolving with the changing regulatory environment. The report provides an overview of natural gas issues in the state and the current status of the natural gas system, and identifies opportunities for additional research and information gathering. The report is designed to be a beneficial tool to lawmakers and regulators as they face decisions on energy policy in California.

Under Assembly Bill 1257, Energy Commission staff has addressed the following natural gas issues:

- Natural gas pipeline infrastructure, storage, and reliability
- Natural gas for electric generation
- Combined heat and power using natural gas
- Natural gas as a transportation fuel
- End-use efficiency applications using natural gas for heating and cooling, water heating, and appliances
- Natural gas and zero-net-energy buildings
- Other natural gas low emission resources, biogas, and biomethane
- Greenhouse gas emissions associated with the natural gas system

In developing the report, the Energy Commission held public workshops seeking input from experts, industry stakeholders, the public, and various state agencies, including the California Air Resources Board, the California Public Utilities Commission, the State Water Resources Control Board, the Department of Conservation, and the Division of Oil, Gas, and Geothermal Resources.

AB 1257 seeks to identify strategies for job development in the private sector, particularly distressed areas, as well as evaluating economic cost and environmental impacts of greenhouse gas emissions from production, transportation, and use of natural gas. At this time there are not sufficient data to adequately address these requirements. Further, making recommendations for implementation strategies for all of the areas identified is premature as many ongoing regulatory initiatives are being undertaken by various agencies in the state (mostly relating to air pollution, greenhouse gases, and the increased use of renewable

energy sources), and data regarding the impacts of methane emissions from the natural gas sector are lacking.

Due to these uncertainties, recommendations in this report are generally limited to monitoring and participating in regulatory initiatives and additional research in several key areas. The Energy Commission may pursue these issues in *2016 Integrated Energy Policy Report Update*.

# CHAPTER 2: Pipeline Safety and Natural Gas Infrastructure Improvements

## Introduction

Adequate infrastructure consisting of transmission pipelines, storage, distribution mains, and related equipment must be maintained and operated safely to maximize the benefits of natural gas and meet California's future demand. This chapter reviews the safety and infrastructure-related steps that could be taken to meet California's future demand for natural gas. This chapter also covers the immediate gas infrastructure challenges of pipeline safety, delivering sufficient gas into Southern California Gas Company's (So Cal Gas) southern system, potential exports to Mexico along the pipelines east of California that would reduce supply available for the state, gas-electric system coordination, and renewables integration.

## California Pipeline Safety

The explosion of a Pacific Gas and Electric Company (PG&E) high-pressure transmission pipeline in a residential neighborhood on September 9, 2010, killing eight people, injuring 58, and destroying or damaging more than 100 homes, has changed how citizens, energy regulators, and other public officials view natural gas pipeline safety. Lapses in pipeline safety led to that explosion.<sup>1</sup> A natural gas system that does not protect the health and safety of Californians, by definition, does not satisfy the requirements of the Public Utilities Code and cannot meet California's future need for natural gas.

To accomplish this greater vigilance, the maintenance of infrastructure records and the continuous and rigorous enforcement of safety standards are essential. The passage of Senate Bill 705 (Leno, Chapter 522, Statutes of 2011), reinforces this by establishing that "[i]t is the policy of the state that the [California Public Utilities] Commission and each gas corporation place safety of the public and gas corporation employees as the top priority," and by requiring utilities to submit safety plans.

Within days of the pipeline explosion at San Bruno and with the National Transportation Safety Board (NTSB) investigation still underway, the California Public Utilities

---

<sup>1</sup> April 9, 2015 CPUC Commissioners voted to adopt the *Final Decision Different* that penalizes PG&E \$1.6 billion for operations violations.

<http://docs.cpuc.ca.gov/PublishedDocs/Published/G000/M150/K539/150539121.PDF>.



Commission (CPUC) directed the formation of an independent review panel of experts to gather and review facts and make recommendations to the CPUC.<sup>2</sup> In June 2011, the panel delivered eight recommendations for PG&E. Key among the recommendations was that PG&E review its integrity management threat assessment method, ensure capture of all relevant pipeline design data, improve and apply risk management including at the management level, improve its Supervisory Control and Data Acquisition (SCADA) systems, and modify its corporate culture so that safety is emphasized over financial performance.

The panel also made 15 recommendations for the CPUC. These recommendations provide the cornerstone of a comprehensive effort launched by the CPUC to create a culture in which safety permeates all of its regulatory activity. Two major actions taken by the CPUC that exemplify this safety culture are the adoption of a safety policy statement on July 10, 2014, and the imposition of a \$1.6 billion penalty on PG&E in April 2015.<sup>3</sup> CPUC President Michael Picker noted this penalty was the largest ever imposed on a California utility and one of the largest in the United States.<sup>4</sup>

While the panel's work was still underway, the CPUC responded to San Bruno with a series of direct and sometimes pointed orders to California's gas utilities.<sup>5</sup> PG&E was ordered, on September 13, 2010, to lower the operating pressure of line 132 and voluntarily reduced the pressure in several related lines that serve the San Francisco peninsula.<sup>6</sup> In December 2010, the CPUC Executive Director ordered PG&E to reduce operating pressures to 20 percent below maximum allowable operating pressure (MAOP) for various additional pipelines until assessments of the integrity of those lines were complete.<sup>7</sup> Roughly six weeks later, the Executive Director ordered further pressure reductions on PG&E pipelines that had experienced pressure excursions of greater than 10 percent of MAOP.<sup>8</sup>

---

2 CPUC Resolution No. L-403.

3 The safety policy statement was adopted as the report of CPUC Commissioner Michael Picker and does not have a unique resolution number. The fine was imposed under D. 15-04-024.

4 Opening remarks at April 9, 2015, CPUC voting meeting.  
<http://www.cpuc.ca.gov/NR/rdonlyres/11A401C1-505A-4DF1-891D-688309FF478D/0/PresidentPickerCommentsonSanBrunoModifiedPresidingOfficerDecisionsandPresidentPickerDec.pdf>.

5 The CPUC has a detailed timeline of events related to natural gas pipeline safety posted on its website. <http://www.cpuc.ca.gov/PUC/events/timeline.htm>.

6 CPUC Executive Director letter and Resolution L-403, dated September 13, 2010.

7 CPUC Executive Director order dated December 16, 2010.

8 CPUC D. 11-09-006 describes the pressure reductions and approved steps for restoring pressure upon finding adequate documentation of appropriate MAOP.

## Pipeline Safety Improvements

In early January 2011, the CPUC's Executive Director acted on recommendations from the NTSB and ordered not only PG&E, but all four of California's investor-owned natural gas utilities to produce "traceable, verifiable, and complete records" to validate the MAOP on transmission pipelines located in Class 3 or 4 locations or in Class 1 or 2 locations in high consequence areas (HCA).<sup>9</sup> It further directed that segments without acceptable records either be subject to hydrostatic or other strength testing or be replaced.

The initial responses from the utilities to the pipeline records search order revealed that only Southwest Gas (a Lake Tahoe area utility) believed it was in possession of records for all of the pipeline segments pertinent to the NTSB recommendation.<sup>10</sup> Subsequently, on June 9, 2011, the CPUC ordered all the gas utilities to file by August 26, 2011, detailed plans to complete pressure testing on the segments for which inadequate records were found.<sup>11</sup> Those plans are generally known as the Pipeline Safety Enhancement Plans (PSEPs). In later summarizing why it had ordered submission of the PSEPs, the CPUC stated:

*"(t)hat the historic exemption and the utilities' record-keeping deficiencies had resulted in circumstances inconsistent with the safety, health, comfort, and convenience of utility patrons, employees, and the public. The Commission ordered all natural gas transmission pipelines in service in California to be brought into compliance with modern standards for safety, and all California natural gas system operators to file and serve a proposed Implementation Plan to comply with the requirement that all in-service natural gas transmission pipeline in California has been pressure tested in accord with 49 CFR 192.619, excluding subsection 49 CFR 192.619(c)."*<sup>12</sup>

In December 2012, the CPUC approved PG&E's 2012 – 2014 PSEP, which outlined criteria and a timetable for PG&E to test or replace segments for which it had inadequate records or which had vintage seam welds not meeting modern standards. PG&E also had to add remote or automatic valves, retrofit some segments to allow the use of in-line inspection

---

9 The NTSB letter. <http://www.nts.gov/safety/safety-recs/reletters/P-10-002-004.pdf> and the CPUC's Executive Director's order were ratified by the Commission by resolution on January 13, 2011. HCAs are generally defined as an area within a specified distance of a pipeline that has 20 or more buildings intended for human occupancy or identified sites, such as beaches, playgrounds, and recreational facilities.

10 January 21, 2011, Letter of Southwest Gas Corporation's James F. Winderlin to CPUC Executive Director Paul Clanon. Southwest Gas serves a small area in Southern California.

11 CPUC, D. 11-06-017.

12 CPUC, D. 13-10-024, page 4.

(ILI) techniques, and transition to a fully electronic asset management system.<sup>13</sup> Phase I of the plan, which went through 2014 alone, involved replacing 186 miles of pipe, strength testing more than 780 miles, retrofitting and then performing ILI on 200 miles, and then replacing some 228 gas shut-off valves along its pipelines.<sup>14</sup> PG&E estimated a cost of \$2.2 billion for these changes, of which PG&E proposed shareholders bear slightly more than \$0.5 billion.<sup>15</sup>

Sempra's (parent company of So Cal Gas and SDG&E) plan outlined a somewhat similar multiyear effort to replace 192 miles of transmission pipeline, but it would have to strength test only 407 miles of pipeline. It also proposed upgrading, replacing, or adding 487 valves on the So Cal Gas system and 74 on the San Diego Gas & Electric Company (SDG&E) system to provide remote control capability.<sup>16</sup> Sempra estimated Phase 1 of the plan to cost \$1.5 billion for So Cal Gas and \$236 million for SDG&E, with cost recovery extended over 10 years.<sup>17</sup> The CPUC moved consideration of the Sempra plan to its Triennial Cost Allocation Proceeding.<sup>18</sup>

Southwest Gas filed a plan to conduct pressure testing and found that about 7 of its 15 miles of transmission pipeline did not have pressure test records. It also proposed replacing some pipeline to accommodate ILI tools as well as a remote control valve at one location. Southwest Gas estimated the work would cost \$7.4 million, which the CPUC approved.<sup>19,20</sup>

---

13 ILI provides pipeline condition data relating to "indentations, wall loss, pipe strain, metallurgical variations, and certain types of cracks." Finding of Fact 26, D. 12-12-030.

14 PG&E, "Natural Gas Transmission The Energy Commission projects the state's demand for natural gas for electric generation to remain flat over the early 2020's as growth in demand for electricity (for example, due to population growth) is likely to be met with distributed renewable resources." Within the *Pipeline Replacement or Testing Implementation Plan*, submitted August 26, 2011, in keeping with D. 11-06-017 in R. 11-02-019, page 3.

15 PG&E's *Natural Gas Transmission Pipeline Replacement or Testing Implementation Plan*, page 5.

16 The safety discussions post-San Bruno focus significantly on the benefits to be attained by greater use of automated and/or remotely-controlled valves given the frustration over it taking PG&E 90 minutes to close off gas to the San Bruno blast and the heroic efforts by two PG&E employees to close them manually. See the *Report of the Independent Review Panel San Bruno Explosion*, June 24, 2011, page 75. Also, see the *Consumer Protection and Safety Division's Incident Investigation Report, September 9, 2010, PG&E Pipeline Rupture in San Bruno, California*, pages 119 to 121 and 152.

17 *Pipeline Safety Enhancement Plan of Southern California Gas Company and San Diego Gas and Electric Company*, submitted August 26, 2011, pursuant to D. 11-06-017 in R. 11-02-019, pages 48 – 52.

18 CPUC, A. 11-11-002.

19 Southwest Gas Corporation, *Natural Gas Transmission Pipeline Comprehensive Pressure Testing Implementation Plan*. Submitted in response to CPUC D. 11-06-07 in R. 11-02-019, August 26, 2011.

In approving PG&E's PESP the CPUC emphasized "why we must make the safety journey":

*"Among all the public utility facilities, natural gas transmission and distribution pipelines present the greatest public safety challenges. ... gas pipelines carry flammable gas under pressure in transmission lines, often at high pressure – and these pipelines are typically located in public right-of-ways, at times in densely populated areas. The dimensions of the threat to public safety from natural gas pipeline systems, including the pace at which death and life-altering injuries can occur, are far more extreme than other public utility systems. This unique feature requires that natural gas system operators and this Commission assume a different perspective when considering natural gas system operations. This perspective must include a planning horizon commensurate with that of the pipelines; that is, in perpetuity, as well as an immediate awareness of the extreme public safety consequences of neglecting safe system construction and operation."*<sup>21</sup>

While the CPUC approved PG&E's PSEP, it approved rate recovery of significantly less at only \$1.3 billion of the total cost of \$2.2 billion, disallowing portions of the costs such as a contingency reserve and increasing the amount borne by shareholders.<sup>22</sup> It also reemphasized the continuing need for PG&E to develop a "safety culture."

Similarly, in approving the So Cal Gas/SDG&E PESP, the CPUC ruled that there was "an identified need to enhance the safety and reliability of the natural gas pipeline transmission systems operated by SDG&E and So Cal Gas."<sup>23</sup> It also ruled that shareholders should "absorb the portion of the Safety Enhancement costs that were caused by any prior imprudent management," the costs of pressure testing where the company cannot produce records, and for pipelines it chooses to replace rather than test.<sup>24</sup>

Implementation of the PSEPs continues. As of August 2014, PG&E completed MAOP validation of its 6,750-mile transmission pipeline system and hydrostatically tested more than 565 miles of pipeline. It also replaced nearly 90 miles of pipeline and expects its PESP to be complete in 2017.<sup>25</sup> So Cal Gas has reported that it was able to find records for about

---

20 CPUC, D. 13-10-024.

21 CPUC, D. 12-12-030, page 43 and see Finding of Fact 4.

22 CPUC, D. 12-12-030, Table E-4.

23 CPUC, D. 14-06-007, Finding of Fact 4.

24 CPUC, D. 14-06-007, Findings of Fact 13 and 14. There apparently remains some dispute about whether the cut-off date for ratepayers versus shareholders bearing pressure test costs is 1961 or 1956. See D. 15-03-049.

25 August 14, 2014, letter from Paul Clanon, Executive Director CPUC, to NTSB Acting Chairman Christopher A. Hart.

245 miles of the 385 miles of pipeline it initially thought it would have to strength test or replace.<sup>26</sup> The PSEP work for So Cal Gas and SDG&E is scheduled to be completed by the end of 2018. PSEP work to address the mainline going into San Diego (Line 1600) will be delayed until the CPUC acts on the September 30, 2015, application to loop that line so that the existing line can be taken out of service without creating reliability problems.<sup>27</sup>

In issuing its more general April 9, 2015, rulings and decision on penalties for the San Bruno explosion and fire, the CPUC documented 2,425 violations of federal and state codes, standards, and orders, noting “some of the violations lasted for nearly 60 years.”<sup>28</sup> The violations include failure to keep adequate records, various incorrect operating procedures relating to changing pressures, and failure to update pipeline class location designations (which can then affect MAOPs) as local populations grew. No other utilities have been assessed penalties relating to pipeline safety violations, though the CPUC has required shareholder funding of some of the records finding, strength testing, and replacement costs for the Sempra utilities and for Southwest Gas.<sup>29</sup> In addition to fining PG&E for its San Bruno-related violations, the CPUC ordered PG&E to also correct all the deficiencies found by the NTSB. In his remarks, CPUC President Picker also emphasized the need to see action translate into seeing a safety culture fully take hold.

In the ensuing years, the energy agencies, including the Energy Commission and the California Independent System Operator (California ISO) have worked together with the utilities to manage pipeline outages required for safety testing or replacement to minimize impacts to power plants and electric reliability.

### Other Safety Efforts

In addition to the policies and procedures at the CPUC, California can also enhance its pipeline safety with research and analysis. The Energy Commission offered research program funds to help address natural gas safety soon after the San Bruno explosion. In addition, the Energy Commission carefully examined whether natural gas capacity to serve all customers would be sufficient during the winter of 2011, when a portion of the PG&E system was limited to operate at lower pressures, and the Energy Commission stood prepared to help approve contingency plans and assist other policy makers.

---

26 A. 14-12-015, “Chapter III Description of PSRMA Costs Prepared Direct Testimony of Richard D. Phillips,” page 3 and page 11.

27 December 5, 2014, Letter of Sempra’s Tamara Rasberry in Docket No. 15-IEPR-04 – “AB1257 Natural Gas Act Report.”

28 CPUC D. 15-04-024, page 2.

29 In approving the Sempra utilities’ PSEP, the CPUC noted there is a difference between disallowing shareholder recovery versus imposing a penalty. D. 15-04-025, pages 31 – 36.

Meeting California's future natural gas needs will require continuing research, development, and deployment funding for projects that explore new technologies to monitor and address pipeline safety and integrity assessment. The goals are to conduct research in natural gas infrastructure not adequately addressed by the regulatory and competitive markets and provide research that will result in tangible benefits to utility customers. The focus is on projects that have the potential to monitor pipeline integrity, improve damage prevention and detection, better detect defects and leaks, increase safety, and enhance the transmission and distribution capabilities of the natural gas system. Research projects focused on safety, which will also help minimize methane leakage from the natural gas system, are discussed in Chapter 9.

Current demonstration and deployment support of precommercial pipeline integrity management and inspection technologies will provide additional field operational data and increase operator confidence. These technologies have not been adequately addressed by competitive and regulatory markets and will provide significant benefits to pipeline operators. Research is also focused on developing new technologies, such as microelectro-mechanical sensors, piezoelectric sensors, and ultrasonic transducers to monitor the integrity of gas pipelines and inspect girth welds and other defects in gas pipelines.<sup>30</sup> Funded projects are developing and demonstrating low-cost, long-life reliable sensors for both inspection and continuous monitoring of pipelines.

The objectives of the current research projects are to reduce the cost and size of leak detection sensors and diagnostic tools, improve the accuracy of leak and defect detection, design and develop prototypes integrated with hardware and software for prototype systems, and test the prototypes in the lab under simulated field conditions.

One of the most common causes of pipeline failure is third-party excavation damage. Prevention can be accomplished through improved right-of-way (ROW) monitoring technologies and programs to promote public knowledge regarding pipeline safety. By providing operators with early notification of potential external threats and educating the public on its role in pipeline safety, the occurrence of failures in California's pipeline network can be reduced. For dig-in prevention programs to work, (1) excavators have to call 8-1-1 in advance of their activities and have the work site marked before they start work, and (2) the information in the utility database about the location of the lines must be accurate. Preserving the health and safety of Californians means these programs require more outreach and more attention to compliance.

The other area that must command greater attention is the distribution system. PG&E, for example, has 42,000 miles of distribution pipe and 3.3 million gas service connections and

---

<sup>30</sup> Piezoelectric sensors measure changes in pressure, acceleration, temperature, strain, or force by converting them to an electrical charge.

related assets.<sup>31</sup> In its 2014 General Rate Case, PG&E proposed a distribution pipeline replacement program to replace aging assets based on a risk determination that includes the probability of a leak on each section of pipe. This will be augmented by the Gas Distribution Asset Management Project known as “Pathfinder,” which will enhance and convert PG&E’s gas distribution asset data into an integrated geographic information system, using software from the German multinational firm SAP SE (GIS/SAP system), and provide analytical and visualization tools to enhance gas distribution management.<sup>32</sup> The CPUC approved funding for Pathfinder, noting its “integral importance” to robust integrity management.<sup>33</sup> Leak detection and repair also become higher priorities both in terms of maintaining safety and to eliminate methane leaks. PG&E is deploying use of the Picarro Surveyor leak detection technology, which is a vehicle mounted leak sensor system. In addition, the CPUC Safety and Enforcement Division, in March 2015, released its “Survey of Natural Gas Leakage Abatement Best Practices,” and a separate rulemaking is underway to consider ways to address leakage.<sup>34</sup>

Senate Bill 1371 (Leno, Chapter 525, Statutes of 2014) requires the CPUC to adopt rules and procedures that focus on minimizing and addressing pipeline leaks as a hazard, while giving priority to the safety, reliability, and affordability of service relevant to the operation, maintenance, repair, and replacement of commission-regulated gas pipeline infrastructure. SB 1371 also requires that due consideration be given to reducing GHG emissions to the maximum extent feasible in accordance with the state’s greenhouse gas reductions goals. The ARB is working in partnership with the CPUC on this effort.

## **The Southern System Minimum Flow Requirement**

The Southern System Minimum (SoSysMin) flow requirement refers to the requirement that enough gas is delivered through the El Paso Natural Gas (EPNG) South Mainline at the Ehrenberg receipt point at the California border to meet the load in the So Cal Gas southern system, or zone. The Southern California natural gas pipeline system is shown in **Figure 1**. The southern zone includes the SDG&E gas service area and territory east to the California/Arizona border.

---

31 CPUC, A. 12-11-009, Exhibit (PG&E-3) “Gas Distribution,” pages 1-22.

32 PG&E launched Pathfinder to improve the quality of and access to information in PG&E’s distribution records.

33 CPUC, D. 14-08-032, page 112.

34 CPUC, OIR 15-01-008.

Figure 1: So Cal Gas and SDG&E Pipeline System

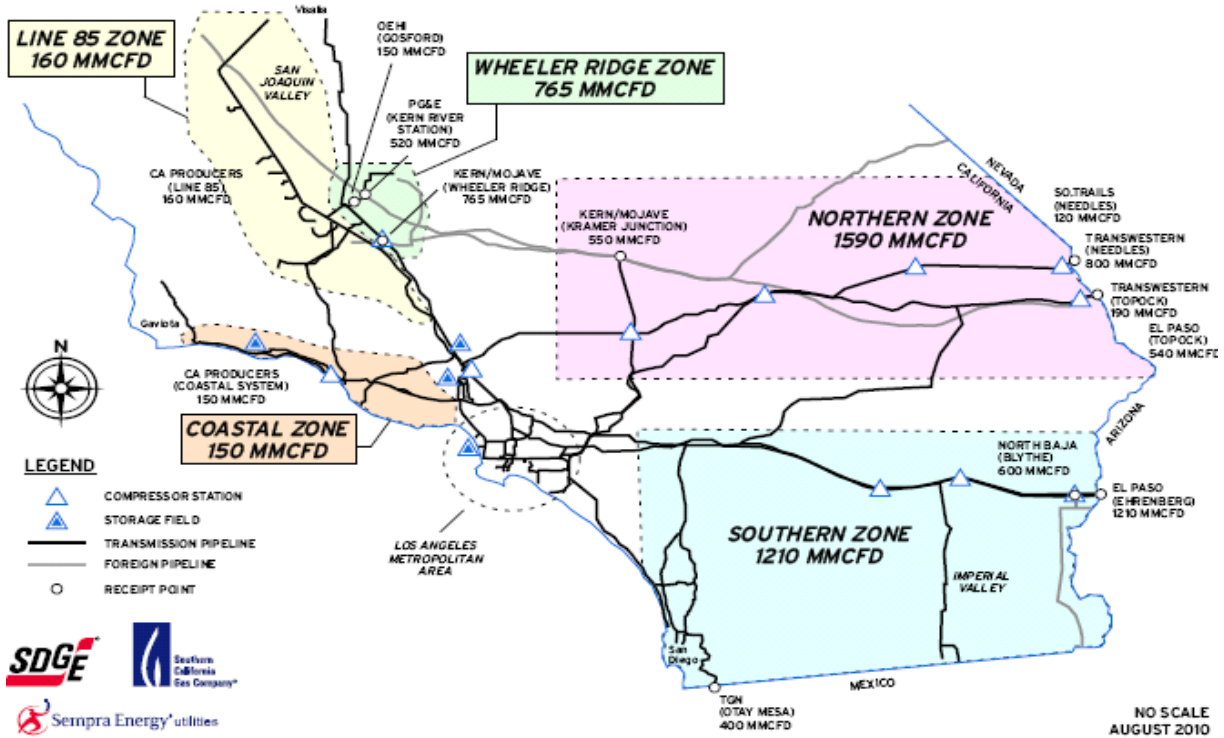

Source: Sempra.

The flow requirements are necessary because the southern zone is relatively isolated, with limited interconnection to other gas receipt points in California. No gas storage is located within the southern zone, and gas from So Cal Gas’ storage facilities cannot reach it. Even when there is excess capacity on the EPNG South Mainline, it is not always in the economic interests of shippers along the pipeline to deliver supplies into the southern system when there are higher priced markets elsewhere. Nor is it in the interests of end users to purchase out-of-state gas on the southern mainline when that gas is priced higher than supplies that are connected to pipelines delivering into So Cal Gas at receipt points other than the Ehrenberg hub.

The CPUC has granted So Cal Gas permission to enter the market and purchase “make-up” gas to serve load. This short-term solution was meant to be for infrequent small amounts of gas to meet total demand in the southern system that is delivered at Ehrenberg.<sup>35</sup> Instead, So

<sup>35</sup> So Cal Gas has also used other tools, such as discounting access to the Ehrenberg receipt point, to try to make it more economically attractive, entering into agreements by which other suppliers deliver additional gas at Ehrenberg on a baseload basis, and buying the California portion of Questar’s Southern Trails line and upgrading its interconnection to allow it to deliver a little more gas into the southern mainline.



Cal Gas purchased make-up gas on about 80 days in the 12-month period from August 2013 to August 2014. In some cases, So Cal Gas' effort to purchase additional gas has occurred well after the "timely" or first nomination cycle of the gas day. This may push prices higher as liquidity drops off, with fewer sellers having less gas available to sell than earlier in the gas day.

With the state's increasing interdependency between natural gas and electricity, concerns about possible curtailments have been raised by stakeholders. Until the recent event in the summer of 2015, winters were generally identified as the periods in which possible curtailments may occur. However, the possibility of curtailment of electric generators in summer raises additional concerns. For example, on June 30 and July 1, 2015, So Cal Gas issued a general curtailment watch to noncore customers in the Los Angeles Basin. The aforementioned watch transformed into an actual curtailment of natural gas service to certain power plants in the Los Angeles Basin, causing the California Independent System Operator (California ISO) to issue a "Flex Alert" calling for electricity conservation.<sup>36</sup> The curtailments lasted from five to six hours on each of the two days. This curtailment episode resulted from the combination of several factors including:

- Low hydroelectric availability.
- Low ability to import electricity from out of state.
- Unusually high temperatures, resulting in very high electricity demand and, in turn, unusually high natural gas demand.
- A reduction in natural gas pipeline receipt capability caused by a pipeline being taken out of service to conduct important pipeline safety integrity work.

A review of So Cal Gas's maintenance schedule showed a storage inventory of 108 billion cubic feet (Bcf) and withdrawals on those two days of as much as 1.3 Bcf/d. This is much lower than the 2.7 Bcf/d it withdrew during the winter of 2013 – 2014 curtailments discussed below. While So Cal Gas did not cite a limitation on storage withdrawals as a factor contributing to the curtailment, the gas utilities would not expect to pull such high volumes from storage in the summer. In fact, the maintenance schedule showed various summer maintenance activities occurring at So Cal Gas' gas storage facilities, which would have precluded such large withdrawals.

The combination of conditions that led to curtailments were high gas demand when gas infrastructure was down for planned maintenance, coupled with high temperatures causing

---

<sup>36</sup> Information on curtailments is posted in the "Critical Notices" section of So Cal Gas' Envoy System.

<https://scgenvoy.sempra.com/#nav=/Public/ViewExternalEbb.getMessageLedger%3FfolderId%3D1%26rand%3D19>.

high electricity demand when electricity supplies were limited by the lack of hydroelectricity and constraints on imports.

Before the summer curtailment event occurred on June 26, 2015, So Cal Gas filed an application at the CPUC to modify the gas curtailment rules and asked the CPUC to approve the new rules by August 2016. In A. 15-05-020, So Cal Gas and SDG&E seek to designate 10 local service zones.<sup>37</sup> Curtailment within each zone would occur after directing all electric generators to hold the respective gas burns at the dispatched level throughout the duration of the curtailment episode, combined with a \$50 per million British thermal units (MMBtu) penalty for taking gas above the hourly burn allowed during the curtailment. The sequence of curtailment to different customers would proceed as follows:

- Step 1: Dispatchable electric generation not currently operating
- Step 2: Up to 60 percent of currently dispatched operating electric generation load
- Step 3: Up to 100 percent, pro-rata cogeneration and nonelectric generation noncore usage
- Step 4: Remaining dispatched and operating electric generation load
- Step 5: Large core (Priority 2A)
- Step 6: Small core nonresidential (Priority 1)
- Step 7: Residential (Priority 1)

To the extent operationally feasible, So Cal Gas and SDG&E further propose working with affected grid operators to reallocate the combined maximum allowed usage for the remaining dispatched electric generation load within the affected zones. The changes reflect formal recognition that the gas and electric utilities and California ISO need greater clarity and flexibility to work together to preserve electricity reliability when gas reliability is threatened.

In addition to recent summer 2015 events, the winter of 2013 – 2014 resulted in localized curtailments or near-curtailments in which So Cal Gas did not receive sufficient gas supply at Ehrenberg.<sup>38</sup> The first occurred in early December 2013, when a winter storm caused very high natural gas demand on the West Coast that spread eastward to cause gas prices to not only rise in general, but to rise to relatively higher levels as areas east of California experienced even colder temperatures. Those prices exceeded the So Cal Gas Citygate price and not only reduced the incentive to sell gas for delivery at Ehrenburg, but caused customers to prefer gas purchases at locations connected to receipt points other than

---

<sup>37</sup> CPUC, A-15-05-020.

<sup>38</sup> Another event, in February 2011, saw cold weather to the east of California cause curtailments throughout the Southwest.

Ehrenburg. On December 6, 2013, So Cal Gas and SDG&E curtailed standby service due to the reduced flows of gas into the So Cal Gas system.<sup>39</sup> On the following Monday, it issued a curtailment watch to customers in the Rainbow Corridor and SDG&E service area.<sup>40</sup> It also curtailed off-system service and later issued a curtailment watch for the area from El Segundo south to Huntington Beach.<sup>41</sup>

On February 6, 2014, a similar set of circumstances occurred. So Cal Gas and SDG&E first curtailed standby service and then moved to emergency curtailment of electricity generation.<sup>42</sup> This curtailment initially affected only the southern zone but was later extended to cover its entire system, citing continued low system receipts and high electric generation demand. All generators were “instructed to hold their current load,” meaning they could not increase their gas consumption.<sup>43</sup>

Curtailments in the SDG&E gas service area are of particular concern for two reasons. First, there is virtually no industrial load in San Diego County, so there is little to curtail other than electric generation.<sup>44</sup> Second, much of the local area electricity generation was operating at higher levels to make up for power generation lost with the closure of the San Onofre Nuclear Generating Station (San Onofre). So Cal Gas has calculated that the annual average SoSysMin requirement has increased by 100 Mdt/day (converts to 97.3 million

---

39 CPUC, A.14-06-021, Prepared Direct Testimony of Beth Musich, So Cal Gas, and SDG&E, June 27, 2014, page 3.

[https://scgenvoy.sempira.com/#nav=/Public/ViewExternalEbb.getMessageLedger%3FledgerType%3Dmessage%26Page%3Dfilter%26datePosted\\_from%3D12%252F05%252F2013%26datePosted\\_to%3D12%252F10%252F2013%26keyword%3D%26folderId%3D1%26rand%3D167](https://scgenvoy.sempira.com/#nav=/Public/ViewExternalEbb.getMessageLedger%3FledgerType%3Dmessage%26Page%3Dfilter%26datePosted_from%3D12%252F05%252F2013%26datePosted_to%3D12%252F10%252F2013%26keyword%3D%26folderId%3D1%26rand%3D167).

40 Curtailment information.

[https://scgenvoy.sempira.com/ebb/attachments/1386602045690\\_Curtailment\\_Watch\\_120913.pdf](https://scgenvoy.sempira.com/ebb/attachments/1386602045690_Curtailment_Watch_120913.pdf).

41 Curtailment information.

[https://scgenvoy.sempira.com/#nav=/Public/ViewExternalEbb.getMessageLedger%3FledgerType%3Dmessage%26Page%3Dfilter%26datePosted\\_from%3D12%252F05%252F2013%26datePosted\\_to%3D12%252F10%252F2013%26keyword%3D%26folderId%3D1%26rand%3D167](https://scgenvoy.sempira.com/#nav=/Public/ViewExternalEbb.getMessageLedger%3FledgerType%3Dmessage%26Page%3Dfilter%26datePosted_from%3D12%252F05%252F2013%26datePosted_to%3D12%252F10%252F2013%26keyword%3D%26folderId%3D1%26rand%3D167).

42 CPUC, A.14-06-021, Prepared Direct Testimony of Beth Musich, So Cal Gas, and SDG&E, June 27, 2014, page 3.

43 Curtailment information.

[https://scgenvoy.sempira.com/#nav=/Public/ViewExternalEbb.getMessageLedger%3FledgerType%3Dmessage%26Page%3Dfilter%26datePosted\\_from%3D02%252F05%252F2014%26datePosted\\_to%3D02%252F07%252F2014%26keyword%3D%26folderId%3D1%26rand%3D109](https://scgenvoy.sempira.com/#nav=/Public/ViewExternalEbb.getMessageLedger%3FledgerType%3Dmessage%26Page%3Dfilter%26datePosted_from%3D02%252F05%252F2014%26datePosted_to%3D02%252F07%252F2014%26keyword%3D%26folderId%3D1%26rand%3D109).

44 Curtailments of small core customers are avoided at all costs because of the public safety danger of pilot lights going out and the very high cost to restore service, requiring high numbers of personnel going door-to-door. For an example of such an incident, see *FERC/NERC Staff Report on the 2011 Southwest Cold Weather Event: Causes and Recommendations*, August 2011, page 132.

cubic feet per day [MMcf/d]) and stated: “(T)he San Onofre outage has been a major contributor to this increase.”<sup>45</sup> Meanwhile, deliveries into the southern zone have decreased from 2010 to 2012 by more than that amount.<sup>46</sup>

With the problem occurring much more frequently than anticipated, So Cal Gas developed a more comprehensive, physical solution to the SoSysMin issue by filing an application to build what is known as their North-South Pipeline.<sup>47</sup> The project would allow gas received at northern receipt points to flow into the southern zone by adding a new 60-mile, 36-inch diameter pipeline with a capacity of 800 MMcf/d from the Adelanto Compressor Station to the Moreno Pressure Limiting Station and rebuilding the Adelanto Compressor Station to 30,000 horsepower of compression.

So Cal Gas estimates that the total cost of the project will be \$621.3 million. Several stakeholders have intervened in the case, which remains pending before the CPUC. Transwestern Pipeline Company, LLC and TransCanada Pipelines Limited, and Kinder Morgan, owner of the EPNG line, proposed alternatives. Each argues that their project is the best value. They also contend that their individual projects can be permitted and constructed more quickly than So Cal Gas can build the North-South Pipeline. Key elements of the So Cal Gas proposal and the three alternative proposals are summarized in **Table 1**. Evidentiary hearings on the proposals took place in July and August 2015, which should allow CPUC action by year’s end.

---

45 CPUC, A.14-06-021, Prepared Direct Testimony of Beth Musich, So Cal Gas, and SDG&E, June 27, 2014, page 3.

46 Supplemental Direct Testimony of Beth Musich Regarding the Transfer of SoSysMin Flow Responsibility. SDG&E & So Cal Gas. September 10, 2012, Page 13, Figure 1.  
<http://socalgas.com/regulatory/documents/a-11-11-002/2010-1023/Musich%20TCAP%20Supplemental%20Testimony%20091012.pdf>.

47 CPUC, A.13-12-013, Application for Authority to Recover North-South Project Revenue Requirement in Customer Rates and for Approval of Related Cost Allocation and Rate Design Proposals.

**Table 1: Proposed Pipeline Projects to Address the SoSysMin Issue**

Options	Location	Estimated Cost	Cost to Ratepayers	Capacity	Est. Time Frame
So Cal Gas SDG&E	Adelanto, CA, to Moreno Pressure Limiting Station	\$621.3 Million	Yes	800 MMcf/d	6 Years
Transwestern	Arizona side of border, Needles to Ehrenberg	\$418 Million	No – Transwestern; indirect costs to ratepayers	800 MMcf/d	24-36 Months
TransCanada	Western Edge of the Rice Valley Wilderness, Needles to Blythe	\$585.4 Million	No – TransCanada; indirect costs to ratepayers	775 MMcf/d	3 Years
Kinder Morgan <sup>48</sup>	Arizona side of border, Needles to Ehrenberg	Estimated 30% - 50% less than So Cal Gas’ proposed project	No – Kinder Morgan; indirect costs to ratepayers	Scalable - 300 MMcf/d to 800 MMcf/d	3 Years

Source: Compilation by Energy Commission staff from information in CPUC Proceeding A13-12-013.

## Gaps in Knowledge and Research

To achieve the public safety goals articulated in Public Utilities Code and recently amplified in Senate Bill 705, California needs to know the locations and condition of the pipelines. The gas utilities are making progress in this area, but as CPUC President Picker noted in his April 8, 2015, comments explaining the San Bruno penalty decision, incidents continue to occur.<sup>49</sup>

In addition, ways to prevent unauthorized excavation need further attention. This includes exploring how to achieve better compliance with existing “Call Before You Dig” programs,

---

48 Energy Commission, direct testimony of Mr. Anthony Sanabria, Kinder Morgan, during the November 18, 2014, AB 1257 Staff Workshop on California’s Natural Gas Infrastructure, Storage, and Supply. Workshop Transcript pages. 61-63. Docket 15-IEPR-04. [http://docketpublic.energy.ca.gov/PublicDocuments/15-IEPR-04/TN203454\\_20141216T135019\\_Transcript.pdf](http://docketpublic.energy.ca.gov/PublicDocuments/15-IEPR-04/TN203454_20141216T135019_Transcript.pdf).

49 Written copies of comments. <http://www.cpuc.ca.gov/NR/rdonlyres/D8E5C7F1-A0A1-48C3-A80B-7FEDC84F9529/0/PresidentPickerCommentsonPGESafetyCultureandEnforcementTheory.pdf>.

as well as development and demonstration of technologies for right-of-way monitoring and prevention of damage due to unauthorized excavation.

Leak detection is also very important. PG&E's field-testing and deployment of the Picarro surveyor leak detection technology are a key step in demonstrating the accuracy and efficacy, as well as cost-effectiveness, for wide-scale acceptance, deployment, and use by gas pipeline operators and regulators. Even more robust, reliable, accurate, and large area capacity tools such as mobile and aerial (drones) could also be researched and developed.

Funding for pipeline safety research has been in the range of \$1 million to \$2 million per year. The kinds of programs described above require additional funds in the order of \$10 million per year. The other infrastructure challenges certainly require regulatory and policy planning vigilance. Some further study could be conducted on whether it could be worthwhile to invest in additional line-packing capability near certain power plants and potentially comparing the cost of doing so to the other solutions identified above.<sup>50</sup>

In addition, since studies conducted in the Western Region focused on short-term deliverability in the context of peak winter demand, it would be prudent to explore line pack conditions and document the velocity at which gas can be delivered to the rapid-fire gas units during the afternoon ramp-up.<sup>51</sup> It would also be important to look at other seasons like summer peak electric generation in light of the curtailment earlier this summer.

An issue is that the necessary detailed data are not available to the Energy Commission and other public agencies to conduct this kind of analysis.<sup>52</sup> The same issue arises in understanding the system impacts of the proposed North-South pipeline or taking segments of lines out of service for hydrostatic testing or replacement. Only the gas utilities have the detailed data needed to perform hydraulic modeling that is specific enough to be accurate and reach conclusions. Notably, electricity system flow modeling is routinely performed by parties who sign nondisclosure agreements with FERC or the California ISO to get analogous data sets. Greater vigilance on public safety and the need for the gas system to operate more flexibly point to the need to develop an open planning process on the gas side, then explore how the state might go about building that capability.

---

<sup>50</sup> *Line-packing* is the introduction of new gas at a receipt point and "packs" or adds pressure to the line.

<sup>51</sup> Schlag, Nick. *Natural Gas Infrastructure Adequacy in the Western Interconnection: An Electric System Perspective; Phase 1 and Phase 2 Reports*. Energy and Environmental Economics, Inc., March 2014 (Phase 1), July 2014 (Phase 2), prepared for the Western Interstate Energy Board and the State and Provincial Steering Committee.

<sup>52</sup> The data set for the Western Interstate Energy Board work was purchased from a proprietary third-party vendor and did not have all the detail needed. So Cal Gas was very helpful in performing additional detailed hydraulic modeling, but the team could only watch and review So Cal Gas' results.

# CHAPTER 3:

## Natural Gas for Electric Generation

### Introduction

This chapter reviews California’s coordination efforts with federal regulations, the natural gas and the electric industry, and renewables integration. California will need to continue broad coordination efforts to (1) achieve increasingly stringent federal air and water quality regulations, (2) improve natural gas and electricity market scheduling, and (3) adapt and support the system with the growing deployment of renewable generation resources.

### Federal Regulations

Several proposed or adopted federal air and water quality regulations are expected to reduce U.S. reliance on coal for generating electricity. These rules include the Mercury and Air Toxics Standards (MATS) for power plants; the Clean Power Plan (111d) to reduce carbon pollution from existing power plants; the New Source Performance Standards addressing carbon dioxide for new, modified, and reconstructed power plants; changes to water effluent rules; and others. Together, they may increase demand for natural gas-fired generation, depending on what choices utilities make about how to replace the electricity formerly generated by coal.

As other states “decarbonize,” they may use more natural gas. At some point, that higher natural gas demand may translate into the need for new pipeline and storage capacity. The lower natural gas prices in recent years have already resulted in some replacement of coal with natural gas, although gas use for electricity generation grew reasonably since 2001, as shown in **Figure 2**. The United States Environmental Protection Agency’s (U.S. EPA) analysis of how states could meet its Clean Power Plan also shows only 1.2 trillion cubic feet (Tcf) of additional increase in natural gas use by 2020, then declining into the future.<sup>53</sup>

---

<sup>53</sup> EPA Clean Power Plan *Regulatory Impact Analysis*, page ES-24.  
<http://www2.epa.gov/sites/production/files/2014-06/documents/20140602ria-clean-power-plan.pdf>.

**Figure 2: Net Generation of U.S. Electricity by Coal and Natural Gas (2001 to 2014)**

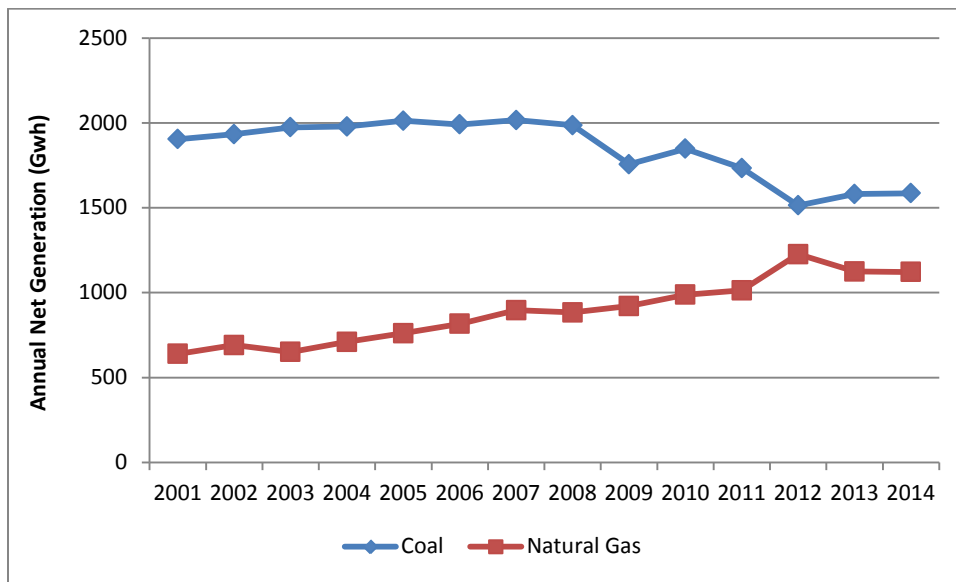

Source: Energy Commission staff analysis of EIA net electricity generation data found at <http://www.eia.gov/electricity/data/browser/#/topic/0?agg=2,0,1&fuel=91q&geo=g&sec=g&linechart=ELEC.GEN.COW-US-99.A&columnchart=ELEC.GEN.COW-US-99.A~ELEC.GEN.NG-US-99.A&map=ELEC.GEN.COW-US-99.A&freq=A&start=2001&end=2014&ctype=columnchart&ltype=pin&rtype=s&pin=&rse=0&maptype=0>.

Other states located “upstream” of California, on the pipelines that interconnect to California gas utilities, use more natural gas to generate electricity. In the future, those pipelines may need to be expanded. Historically, building pipeline capacity has been a years-long but relatively straightforward exercise characterized by a “let the market decide” policy at the Federal Energy Regulatory Commission. As long as shippers commit to a project in sufficient numbers for a pipeline sponsor to justify taking the remaining risk of undersubscription, pipelines have been approved and built once construction-related environmental impacts were assessed.

## Gas-Electric Coordination

In California, roughly 40 percent of the natural gas is used to generate electricity.<sup>54</sup> The thermal efficiency of natural gas-fired generation is typically described by measuring the heat rate. The heat rate of a power plant expresses how much fuel is necessary (measured in British thermal unit [Btu]) to produce one unit of energy (measured in kilowatt-hour [kWh]). The heat rate of California natural gas-fired generation is obtained by dividing the

<sup>54</sup> 2014 California Gas Report. California Gas and Electric Utilities, page 15. <http://www.socalgas.com/regulatory/documents/cgr/2014-cgr.pdf>.



total fuel used by the total energy produced. A lower heat rate indicates a more efficient system. A recent Energy Commission paper noted that the thermal efficiency of natural gas-fired generation in California from 2001 through 2013 has improved more than 17 percent.<sup>55</sup>

For the United States the amount of natural gas used for electric generation is 31 percent.<sup>56</sup> As California electric utilities convert electricity generation portfolios away from carbon-intensive resources, the way natural gas is used will change. These changes will affect not only the quantity of natural gas used to generate electricity, but how and when natural gas-fired resources need to operate. These new operational profiles will require a higher degree of coordination between the gas and electric industries.

In light of this increased reliance on natural gas for electric generation, the need for more effective coordination between the natural gas and electric industry has been a topic of discussions and studies. Several events served to cement these concerns, including:

- The September 9, 2010, natural gas pipeline explosion at San Bruno and realization by the Energy Commission, California ISO, and CPUC of the need to coordinate continued service to generating facilities while pressure reductions, hydrostatic testing, and pipeline replacement activities were underway.
- The February 2011 cold event that caused curtailment of gas service to customers, including electric generators in Texas, New Mexico, Arizona, and Southern California.
- The January 2012 closure of San Onofre and the resulting need to generate from gas-fired facilities to meet demand and provide grid support in southern Orange and San Diego Counties.
- The winter 2013 – 2014 polar vortex events that caused natural gas curtailments in Northern and Southern California on December 9-10, 2013, and February 6, 2014.
- The summer 2015 gas curtailments incident on the So Cal Gas system.

Partially in response to some of the above-mentioned events, on April 16, 2015, FERC issued a final rule to improve coordination of wholesale natural gas and electricity market scheduling.<sup>57</sup> The final rule adopted two proposals submitted by the North American Energy Standards Board (NAESB) to revise the interstate natural gas nomination timeline and make conforming changes to their standards by moving the Timely Nomination Cycle

---

<sup>55</sup> *Thermal Efficiency of Gas-Fired Generation in California: 2014 Update*.

<http://www.energy.ca.gov/2014publications/CEC-200-2014-005/CEC-200-2014-005.pdf>.

<sup>56</sup> In 2013 based on EIA *U.S. Natural Gas Consumption by End Use*.

[http://www.eia.gov/dnav/ng/ng\\_cons\\_sum\\_dcunus\\_a.htm](http://www.eia.gov/dnav/ng/ng_cons_sum_dcunus_a.htm).

<sup>57</sup> FERC Docket RM14-2-000; Order No. 809. <http://www.ferc.gov/whats-new/comm-meet/2015/041615/M-1.pdf>.

deadline for scheduling gas transportation from 11:30 a.m. Central Clock Time (CCT) to 1 p.m. CCT. The rule also added a third intraday nomination cycle during the gas operating day to help shippers adjust their scheduling to reflect changes in demand.

## Renewables Integration

Keeping the gas system in balance could potentially become more challenging as the state further increases the portion of electricity generated from renewables as part of its strategy to reduce greenhouse gas emissions.<sup>58,59</sup> In 2013, California served about 21 percent of retail electricity sales from renewables.<sup>60,61</sup> Senate Bill 350 increases California's Renewables Portfolio Standard (RPS) goals to 50 percent renewable generation by 2030. This, along with Governor Brown's executive order seeking to reduce GHG emissions 80 percent below 1990 levels by 2050, will result in further challenges for system operators dependent on dispatchable natural gas generation and for grid reliability.

The electricity produced from renewables such as wind and solar—the largest source of renewable electricity generation among RPS-eligible technologies—varies depending on conditions each hour (or even minute to minute). Some of that variation in renewables generation output is predictable (for example, solar generates only during daylight hours); some of it is not as predictable (for example, cloud cover reducing solar output or wind variations affecting wind generation).

When generation from renewables declines but load does not, other generation sources must be called on to operate to maintain the grid. Certain natural gas-fired power plants are used to meet local reliability needs, to provide emergency system support, and to provide the range of ancillary services that are needed by the California ISO to keep the integrated

---

58 The California Global Warming Solutions Act of 2006, Assembly Bill 32.  
[http://www.leginfo.ca.gov/pub/05-06/bill/asm/ab\\_0001-0050/ab\\_32\\_bill\\_20060927\\_chaptered.html](http://www.leginfo.ca.gov/pub/05-06/bill/asm/ab_0001-0050/ab_32_bill_20060927_chaptered.html).

59 Governor Edmund G. Brown's Executive Order B-30-15. <http://gov.ca.gov/news.php?id=18938>.

60 CPUC, *RPS Quarterly Report, 3rd Quarter 2014*, Page 3.  
<http://www.cpuc.ca.gov/NR/rdonlyres/CA15A2A8-234D-4FB4-BE41-05409E8F6316/0/2014Q3RPSReportFinal.pdf>.

61 Renewable energy sources that are eligible for utility procurement under California's RPS program include solar thermal electric, solar photovoltaics, landfill gas, wind, biomass, geothermal electric, municipal solid waste, energy storage, anaerobic digestion, small hydroelectric, tidal energy, wave energy, ocean thermal, biodiesel, and fuel cells using renewable fuels. Database of State Incentives for Renewables and Efficiency (DSIRE).  
[http://www.dsireusa.org/incentives/incentive.cfm?Incentive\\_Code=CA25R&re=0&ee=0](http://www.dsireusa.org/incentives/incentive.cfm?Incentive_Code=CA25R&re=0&ee=0).

electric system running reliably.<sup>62</sup> California ISO is the entity that gives operating instructions to the various generation units to ensure enough electricity is produced to meet demand for most of the state. Studies performed by the California ISO show that the predicted variation in renewables production mean that large numbers of remaining resources, namely those fired by natural gas, will need to ramp up production quickly, as the renewables generation falls off, and be turned down quickly as the renewables production increases.<sup>63</sup> The result is greater variation in gas load, as well as large draws on the gas system, sometimes very quickly.

The timing, magnitude, and speed of these start-ups may create several potential issues. Any start-up risks using gas not properly scheduled for delivery on the gas system, which then becomes a source of a potential gas system imbalance. More imbalances are likely to cause more operational flow orders (OFO) to be called and/or more OFO penalties issued to gas-fired generators. Other potential consequences include the possibility that an electric generator might also incur an additional cost by having to sell unused natural gas back to the market at a loss after the California ISO decommits the facility from generating, or it might incur higher costs from needing gas storage service more frequently to help manage more frequent changes in load.

Another issue with relying on natural gas to backup renewables is magnitude: even when schedulers know the ramp-up is coming, it is possible for the associated draws on the gas system to be so large that over a short period there is not enough gas available in the pipeline when the generator fires. The gas line capacity is generally not an issue because that is studied by the gas utility when the generator signs up for gas service; the line is sized adequately at that time to meet projected gas load. Rather, the question is whether the gas will be there, especially if it was not scheduled in advance.

Gas system operators can prepare for this potential variable natural gas demand to some degree by packing gas into transmission pipelines during periods of low load, which are typically at night, with another low usually in early afternoon. "Line packing," as this is called, is the degree to which a gas line holds more gas than is being used at a given moment. In essence, an operator can use pressure to pack the gas molecules more closely together: one might imagine adding more people into an elevator car, for example, and how they squeeze closer together to allow more people on board. Line packing is ultimately limited by the maximum allowable operating pressure (MAOP) of the pipelines. "Drafting" is the opposite of line packing and occurs when the rate of gas deliveries to end users

---

62 *Framework for Evaluating Greenhouse Gas Implications of Natural Gas-Fired Power Plants in California.* <http://www.energy.ca.gov/2009publications/CEC-700-2009-009/CEC-700-2009-009.PDF>.

63 The California ISO, however, continues to monitor changes in the gas industry for any potential effect to its policies allowing market participants to recover additional start-up and minimum load costs.

exceeds the rate of gas receipts into the pipeline.<sup>64</sup> Too much drafting can lead to loss of pressure in the pipeline and difficulty delivering gas to end users, such as gas-fired flexible generation. Gas system operators routinely pack their systems at night and then draft a bit for the morning load as people warm their homes as they get up in the morning.

*Line pack* is a form of very short-term storage. Using gas from California's underground natural gas storage facilities may not always be able to quickly supply gas-fired generation. With a couple of exceptions, those storage facilities are simply not located close enough to most of the gas-fired power plants that will be called on to start up quickly.<sup>65</sup> Some amount of gas storage is reserved to provide balancing service, but it is too limited today to prevent the system getting out of balance and the consequent need for OFOs. It could be that reserving more gas storage for balancing service would reduce the number of OFOs. It could also be useful to increase the line-packing capability near key gas-fired plants.<sup>66</sup> There is also the potential that the new California ISO energy imbalance market will help reduce the need to rapidly fire up gas resources. This, in addition to energy storage or even time of use rates, will modify the anticipated steepness of afternoon ramping and address this operational concern. However, the California ISO continues to monitor changes in the gas industry for any potential impact to its policies, allowing market participants to recover additional start-up and minimum load costs.

---

64 Spectra Energy description of line packing and drafting. <http://www.spectraenergy.com/Natural-Gas-101/Glossary-of-Energy-Terms/L/>.

65 Those exceptions are the large gas-fired units located near PG&E's Los Medanos gas storage facility, but even those have not been independently verified.

66 For a description of how this could work, see ICF International, *Firming Renewable Electric Power Generators: Opportunities and Challenges for Natural Gas Pipeline*." Submitted to the INGAA Foundation, March 2011, page 77. <http://www.ingaa.org/File.aspx?id=12761>. This study also describes the general use of gas to back up variable renewable generation and the ability of the gas system to meet that rapid ramp-up.

# **CHAPTER 4:**

## **The Role of Natural Gas as a Fuel for Combined Heat and Power Systems**

### **Introduction**

This chapter discusses the benefits that California may receive from combined heat and power (CHP) systems using natural gas. This includes an overview of CHP policies and programs, as well as addresses the challenges and barriers to CHP deployment.

### **Opportunities**

CHP has the potential to provide many benefits and opportunities to California. Historically, the most important feature of CHP has been fuel efficiency. A properly sized and operated CHP facility can produce thermal, mechanical, and electrical energy using less fuel than would otherwise be used to acquire the same energy via a more traditional system of boilers and central-station grid electricity. Moreover, some CHP systems are designed to collect waste heat from thermally intensive operations, such as manufacturing and industry, which is then used to generate electricity. While the efficiency of CHP facilities varies greatly depending on technologies used and the use of thermal energy, all forms of CHP are ultimately designed to decrease costs via increased fuel efficiency. Secondarily, they can also provide energy consumers with greater price certainty, energy security, and control over their business processes. On-site power, heating, and cooling can help shield a business from the costs associated with grid outages.

Today, the state recognizes the potential for CHP to provide benefits beyond the needs of those employing it. Greater fuel efficiency can directly result in a reduction of the greenhouse gas (GHG) emissions and criteria pollutants associated with the saved fuel, resulting in environmental benefits for the state. The distributed, local nature of most CHP systems results in many benefits to the electrical grid as a whole, including contribution to regional resource adequacy requirements, greater grid stability via reduced risk of major outages, reduction in net demand, and reduction in costs associated with power transmission and distribution infrastructure. When CHP is used at critical facilities (for example, hospitals, prisons, wastewater treatment plants, and data centers), the increased energy security enjoyed by these facilities also benefits members of the public who rely on their services. Broadly speaking, the cost savings a business can achieve through CHP also affects the larger economy. Lower costs offer incentives for that business to operate in California and to operate more efficiently, thereby contributing to benefits associated with greater economic activity (for example, increased jobs and tax revenue).

While the majority of CHP facilities use fossil fuels, predominately natural gas, many CHP technologies are capable of using reduced- or zero-carbon fuels, such as biomethane or blends of natural gas and biomethane. For any fuel, however, CHP facilities are ultimately designed to reduce the costs (both monetary and environmental) of deriving useful energy from that fuel by using it as efficiently as possible.

## Existing Policies and Programs

California has many policies, programs, and incentives in place for CHP procurement. In 2001, the Self Generation Incentive Program was created in response to energy shortages during the California energy crisis of 2000 – 2001.<sup>67</sup> The program provides rebates for the first 3 megawatts (MW) of capacity for qualifying distributed energy resources. The program, however, has changed many times since 2001. The program initially emphasized wind, solar, and fuel cells but included a much smaller incentive for CHP. On January 1, 2008, solar, microturbines, internal combustion engines, and small gas turbines were removed from the program, which effectively removed CHP from the program (with the possible exception of fuel-cell CHP), conforming to Assembly Bill 2778 (Lieber, Chapter 617, Statutes of 2006).<sup>68</sup> In 2011, CHP technologies were restored, and incentive rates were restructured by technology category, with the most emphasis on energy storage, biogas, and fuel cells.<sup>69</sup> Nonrenewable CHP is still included but at a relatively low incentive rate compared to renewable CHP and other technologies. Today's Self Generation Incentive Program focuses more on offering incentives for emerging distributed energy resources (DER) technologies than on CHP.

In December 2008, the ARB approved the *Climate Change Scoping Plan*, under Assembly Bill 32 (Núñez, Chapter 488, Statutes of 2006), in which it set a target of an additional 4,000 megawatts (MW) of installed capacity from efficient CHP by 2020. This increase corresponded to a target reduction of 6.7 million metric tons carbon dioxide equivalent (MMTCO<sub>2e</sub>) of GHG emissions. In its May 2014 *First Update to the Climate Change Scoping Plan*, the ARB maintained these goals.<sup>70</sup>

---

67 Assembly Bill 970 (Ducheny, Chapter 239, Statutes of 2000). [http://www.leginfo.ca.gov/pub/99-00/bill/asm/ab\\_0951-1000/ab\\_970\\_bill\\_20000907\\_chaptered.html](http://www.leginfo.ca.gov/pub/99-00/bill/asm/ab_0951-1000/ab_970_bill_20000907_chaptered.html).

68 Assembly Bill 2778 (Lieber, Chapter 617, Statutes of 2006). [http://www.leginfo.ca.gov/pub/05-06/bill/asm/ab\\_2751-2800/ab\\_2778\\_bill\\_20060929\\_chaptered.html](http://www.leginfo.ca.gov/pub/05-06/bill/asm/ab_2751-2800/ab_2778_bill_20060929_chaptered.html).

69 CPUC, (D.11-09-015), September 8, 2011. <http://www.energy.ca.gov/2012publications/CEC-200-2012-002/CEC-200-2012-002.pdf>.

70 ARB, *First Update to the Climate Change Scoping Plan*, May 2014, page 41. [http://www.arb.ca.gov/cc/scopingplan/2013\\_update/first\\_update\\_climate\\_change\\_scoping\\_plan.pdf](http://www.arb.ca.gov/cc/scopingplan/2013_update/first_update_climate_change_scoping_plan.pdf).

In early 2010, the Energy Commission adopted guidelines for certification under a CHP feed-in tariff established by Assembly Bill 1613 (Blakeslee, Chapter 713, Statutes of 2007), the Waste Heat and Carbon Emissions Reduction Act.<sup>71</sup> Eligible projects are CHP installations of no more than 20 MW that meet specified fuel efficiency and nitrogen oxides (NO<sub>x</sub>) emission standards, in addition to meeting performance criteria. To date, the program has received little participation. Only six projects are certified under Assembly Bill 1613, and of these, only two are fully interconnected with permanent utility contracts. Many developers claim that the exported electricity price of the tariff is too low to make a project economical, and the lack of participation seems to support this assertion.

In June 2010, Governor Edmund G. Brown Jr's *Clean Energy Jobs Plan* called for an additional 6,500 MW of new CHP capacity by 2030.<sup>72</sup> At the time, California had nearly 8,500 MW of installed CHP capacity.<sup>73</sup>

Later in 2010, the CPUC adopted the qualifying facilities (QF) and CHP Program Settlement Agreement (D.10-12-035).<sup>74</sup> The QF and CHP Program Settlement Agreement ended numerous legal disputes between investor-owned utilities (IOUs), QF representatives, and ratepayer advocacy groups and mandated that California's three largest IOUs procure 3,000 MW of CHP and achieve 4.8 million metric tons of carbon dioxide (MMTCO<sub>2e</sub>) of the 2008 *Climate Change Scoping Plan* GHG reduction target—proportional to the amount of electricity sales by the IOUs.

On June 11, 2015, the CPUC issued Decision 15-06-028, establishing procurement targets for the CHP's Second Program Period.<sup>75</sup> The decision also revised the greenhouse gas emissions reduction targets to collectively achieve 2.72 MMTCO<sub>2e</sub> of emissions reductions from CHP facilities by 2020 and established a schedule of four competitive solicitations for CHP facilities between 2015 and 2020.

CHP also receives policy and financial support from the federal government, including President Barack Obama's August 30, 2012, executive order calling for an additional 40

---

71 Assembly Bill 1613 (Blakeslee, Chapter 713, Statutes of 2007).

[http://www.energy.ca.gov/wasteheat/documents/ab\\_1613\\_bill\\_20071014\\_chaptered.pdf](http://www.energy.ca.gov/wasteheat/documents/ab_1613_bill_20071014_chaptered.pdf).

72 Office of the Governor, *Clean Energy Jobs Plan*, 2011, page 6.

[http://gov.ca.gov/docs/Clean\\_Energy\\_Plan.pdf](http://gov.ca.gov/docs/Clean_Energy_Plan.pdf).

73 Hedman, Bruce, Ken Darrow, Eric Wong, Anne Hampson. ICF International, Inc., *Combined Heat and Power: 2015 – 2030 Market Assessment*, 2012, page 1. <http://energy.ca.gov/2012publications/CEC-200-2012-002/CEC-200-2012-002-REV.pdf>.

74 CPUC, *CHP Program Settlement Agreement (D.10-12-035)*, 2010, page 2.

[http://docs.cpuc.ca.gov/word\\_pdf/FINAL\\_DECISION/128624.pdf](http://docs.cpuc.ca.gov/word_pdf/FINAL_DECISION/128624.pdf).

75 CPUC, *CHP Power Procurement Matters (D.15-06-028)*, June 11, 2015.

<http://docs.cpuc.ca.gov/PublishedDocs/Published/G000/M152/K559/152559026.PDF>.



gigawatts (GW) of CHP capacity nationwide.<sup>76</sup> Financially, CHP is supported primarily through the business energy investment tax credit, which provides a tax credit based on a percentage of the total expenditures of a CHP system. Additional federal support can be found through U.S. Department of Energy CHP Policies and Incentives Database.<sup>77</sup>

Despite these many ambitious goals and policies, California's total installed CHP capacity has changed very little since the ARB published its *Climate Change Scoping Plan*, maintaining a level of roughly 8,500 – 9,000 MW.<sup>78</sup>

## Cost-Benefit Analyses

Proper valuation of CHP systems is a challenging and sometimes contentious issue. Much of the existing body of analysis comes from, or is funded by, CHP stakeholders (primarily utilities and CHP organizations), and this work often focuses on specific costs or benefits. There is little analysis of the net benefits of CHP funded by neutral parties—a fact that has confused the issue.

Two frequently cited reports are from ICF International, commissioned by the Energy Commission in 2009 and 2011.<sup>79, 80</sup> While these reports do not attempt to fully quantify the net benefits of CHP, they do include detailed discussions of the market impacts of state policies on CHP and the effect of CHP on California's GHG goals.

Analysis and monetization of CHP costs and benefits are an ongoing area of research and debate.

---

76 President of the United States, *Executive Order – Accelerating Investment in Industrial Energy Efficiency*, August 30, 2012.. <https://www.whitehouse.gov/the-press-office/2012/08/30/executive-order-accelerating-investment-industrial-energy-efficiency>.

77 U.S. EPA, CHP Policies and incentives database, accessed May 5, 2015. <http://www.epa.gov/chp/policies/database.html>.

78 *Combined Heat and Power Policy Analysis and 2011-2013 Market Assessment*, ICF International, prepared for the California Energy Commission, CEC-200-2012-002, February 2012.

79 Darrow, Ken, Bruce Hedman, Anne Hampson. *2009 CHP Market Assessment*. Energy Commission, PIER Program. CEC-500-2009-094-F, April 2010.

80 *Combined Heat and Power Policy Analysis and 2011-2013 Market Assessment*, ICF International, prepared for the California Energy Commission, CEC-200-2012-002., February 2012.



## Challenges

Despite the many benefits of CHP, the growth and development of CHP in California has been relatively flat in recent years. Many regulatory and economic barriers exist for a CHP developer, and often these barriers result in a combination of cost and risk that is too high to justify the project. Many of these challenges were recently discussed in greater detail in stakeholder comments to the Energy Commissions July 2014 CHP Workshop.<sup>81</sup>

Economically, projects often face three major cost barriers: nonbypassable charges, grid interconnection, and contract difficulties. *Nonbypassable charges*, a collection of energy surcharges that a consumer must pay for self-generated electricity that displaces the previous demand for grid electricity, can erode a large portion of the energy cost savings that a consumer would otherwise realize by installing a CHP system. While grid interconnection processes are frequently being revised, many CHP developers still claim that the interconnection process is unnecessarily complex, long, and costly. Furthermore, the full cost of interconnection is often not known until after significant costs have already been incurred in the process. Uncertainty in interconnection time and cost can lead to much higher perceived risk for project developers.

Finally, many existing and potential CHP systems have difficulty obtaining adequate contract lengths and/or prices if they currently, or plan to, export power. Utilities have little incentive to contract with most CHP facilities, and the current regulatory system of tariffs and CHP procurement rarely results in contracts with terms greater than 12 years. These short contract lengths require that a CHP facility receive a much higher price for energy than would otherwise be required to obtain an acceptable payback period, which in turn reduces the ability to compete in procurement processes.

CHP development also faces many regulatory challenges. While California has a variety of ambitious CHP procurement goals, regulatory efforts to achieve these results have so far been unsuccessful in developing new CHP and have left the future of the existing fleet in doubt. Economic incentives, such as feed-in tariffs and grants, have had little effect and appear to be too small or inconsistent to encourage developers. Procurement targets have also fallen short. In the case of the qualifying facilities (QFs), the CHP Program Settlement Agreement has failed to procure the kind of traditional, baseload CHP that was intended.

Fundamentally, the challenges to CHP development in California can be viewed as the by-product of misaligned incentives. A business using CHP is driven by its business process and usually cannot adjust its energy output without either affecting business operations or wasting thermal energy (and thereby losing the efficiency gains of the CHP system). Thus, such a business desires a contract where exported power is purchased on a must-take basis. On the other hand, an electric utility has little incentive to procure a nondispatchable

---

81 Stakeholder comments. [http://energy.ca.gov/chp/documents/2014-07-14\\_workshop/comments/](http://energy.ca.gov/chp/documents/2014-07-14_workshop/comments/).

resource and can cite several potential costs associated with accommodating that resource. Moreover, a CHP system decreases the electric utility rate base and so, in a sense, can be seen as a competitor. Economically, the costs and, in particular, the benefits of CHP are not fully monetized. For example, nonbypassable charges and demand/standby charges exist to compensate a utility for the costs that were incurred on behalf of the departing customer and to support customer load when its own generation is not operational. Many of the benefits, however, that arise from that departed load (for example, reduction in peak demand, reduced strain and outage risk for grid infrastructure, energy security for critical facilities) are not monetized and, therefore, are essentially obtained for free by utilities and ratepayers. In short, many of the challenges facing CHP development today could be lessened, or at least made much clearer, by regulatory and market frameworks that better value the true costs and benefits of CHP generation and align utility incentives with those costs and benefits.

## **Gaps in Knowledge and Research**

As discussed in the previous section, analysis and monetization of the costs and benefits of CHP need much more research. As many CHP technologies are mature technologies, the challenges that additional research could address are as much economic and regulatory as they are engineering.

Within the broader subject of CHP costs and benefits, three areas stand out: displacement, GHG reductions, and the net impacts of departed load and distributed generation. When calculating what CHP and other forms of distributed generation displace when operated by a customer to meet load, the impacts of that distributed generation are determined in large part by comparing the characteristics of the distributed generation to those of the traditional utility central generation it displaces. However, determining exactly what generation is displaced can be difficult. In an ideal situation, CHP is displacing the marginal generator—possibly an inefficient, fossil-fueled peaking plant. On the other hand, it is possible (although currently rare) that a must-take CHP resource could force renewable curtailment and effectively displace carbon-free generation. Determining an appropriate method to use in estimating the net or average characteristics of displaced generation is a key step toward answering many of the other questions regarding the net benefits of CHP, including GHG reductions.

While large industrial CHP facilities are a mature technology, these facilities can still benefit from cheaper and more effective emission control technologies. As California transitions to a lower-carbon energy system, such improvements may be necessary for facilities to compete with cleaner sources of energy in the future. Furthermore, previous research indicates that a large amount of California's CHP technical potential resides in smaller, nontraditional

commercial and residential applications.<sup>82</sup> Research into increasing the cost-effectiveness of small CHP units, or allowing them to function as enabling technologies to complement intermittent renewables, could help California tap into this technical potential.

Another key area of research is the effects of distributed generation, including CHP, on infrastructure cost and operations. Infrastructure investments, grid stability, and power quality all have serious implications for California's ratepayers, businesses, and economy. Determining the way that CHP affects these issues, and how it may be used to improve them, is critical toward understanding the role that CHP has to play in California's energy future.

---

<sup>82</sup> *Combined Heat and Power Policy Analysis and 2011-2013 Market Assessment*, ICF International, prepared for the California Energy Commission, CEC-200-2012-002, February 2012.

# CHAPTER 5:

## Natural Gas as a Transportation Fuel

### Introduction

This chapter reviews current uses of natural gas as a vehicle fuel and the state of the fueling infrastructure in California. A discussion of upgrades to the state's infrastructure, specifically addressing fueling needs, potential new fleet use, and the use of biomethane as an alternative to conventional natural gas, follows. The chapter concludes with an overview of the efforts of the Energy Commission's Alternative and Renewable Fuel and Vehicle Technology Program and related support of natural gas-related activities in California's transportation sector.

### Transportation Fuel in California

Transportation accounts for nearly 40 percent of total California energy consumption and roughly 36 percent of state GHG emissions.<sup>83</sup> While petroleum accounts for more than 90 percent of California transportation energy sources, there could be significant changes in the fuel mix by 2020 as a result of technology advances, market trends, consumer behavior, and government policies.<sup>84</sup>

When looking at the viable alternatives to conventional fuels, many options have been considered as California works to develop cleaner and reliable fuel sources and reduce dependency on petroleum. The range of alternatives to petroleum-based fuels is diverse, including biofuels, electricity, hydrogen, and natural gas. California has established programs and regulations to ensure that the future transportation fuel supply lowers carbon intensity, lowers tailpipe emissions, reduces adverse economic impacts, and uses a secure domestic fuel source where possible. For example, natural gas has been used successfully in urban transit buses and is the fuel of choice for more than 5,800 buses or 59 percent of California's urban transit bus population.<sup>85</sup>

---

83 Energy Commission, *2014 IEPR Update*, 2015, pages 10-11.

<http://energy.ca.gov/2014publications/CEC-100-2014-001/CEC-100-2014-001-CMF.pdf>.

84 Energy Commission, *2013 IEPR*, 2013, page 5. <http://www.energy.ca.gov/2013publications/CEC-100-2013-001/CEC-100-2013-001-CMF.pdf>.

85 ARB, *Advanced Clean Transit*, slide deck dated May 2015, page 15.

<http://www.arb.ca.gov/msprog/bus/workshoppresentation.pdf>.

Natural gas vehicles (NGVs) may also offer the opportunity for lower criteria pollutant emissions. Historically, natural gas engines were cleaner than diesel engines and provided emissions benefits. Diesel and natural gas engines must meet the same 0.20 grams of NO<sub>x</sub> per brake horsepower-hour emission standard. In December 2013, the ARB adopted an optional reduced NO<sub>x</sub> emission standard for heavy-duty vehicles, which can encourage engine manufacturers to demonstrate their emission reductions. Such standards include NO<sub>x</sub> levels that are 50, 75, and 90 percent lower than the current 0.2 gram NO<sub>x</sub> standard. The initial statement of reasons for the voluntary standard suggests that heavy-duty natural gas engines may be the primary initial technology for meeting the more aggressive 75 and 90 percent NO<sub>x</sub> reduction targets. Depending on the ability of natural gas engine manufacturers to demonstrate such reductions, this could further support the market deployment of heavy-duty natural gas trucks.<sup>86</sup>

On September 10, 2015, the ARB certified a Cummins Westport 8.9 liter natural gas engine at the 0.01 gram NO<sub>x</sub> standard or 95 percent lower than the prevailing standard of 0.86.<sup>87</sup> No other heavy-duty engine has been certified to such a low level. This engine is expected to be available in 2016, with a similar 12 liter version market-ready in 2017.

The usage of natural gas and biomethane in the transportation sector offers significant opportunities to assist California in meeting its goals for reducing the environmental impact of fuels, reducing petroleum usage, and providing cost savings to fleets. When installed with low-NO<sub>x</sub> engines, NGVs have benefits in reducing NO<sub>x</sub> emissions, which are a precursor for both ground-level ozone and particulate matters. GHG benefit is provided by NGVs with the use of renewable natural gas. With the wide variety of viable operational locations for NGVs, the tailpipe emissions reductions from use of these vehicles can be realized in many areas that are severely impacted by vehicle air pollution. The development of advanced low-emission natural gas engines, production of low-carbon-intensity biomethane, and expansion of the natural gas fueling infrastructure have been identified as other avenues to further expand the benefits of natural gas in the transportation sector over time.

The *2014 Integrated Energy Policy Report (IEPR) Update* provided support and recommendations for the use of natural gas in the transportation sector. One of the key areas showing improvement is transportation research. The Energy Commission Energy Research and Development Division transportation research program is focused on developing and advancing state-of-the-art electricity and natural gas-fueled transportation

---

<sup>86</sup> ARB, *Staff Report: Initial Statement of Reasons for Proposed Rulemaking*, October 23, 2013, page 60. <http://www.arb.ca.gov/regact/2013/hdghg2013/hdghg2013isor.pdf>.

<sup>87</sup> ARB Executive Order A-021-0630. [http://www.arb.ca.gov/msprog/onroad/cert/mdehdehdv/2016/cummins\\_mhdd\\_a0210630\\_8d9\\_0d20-0d01\\_ng.pdf](http://www.arb.ca.gov/msprog/onroad/cert/mdehdehdv/2016/cummins_mhdd_a0210630_8d9_0d20-0d01_ng.pdf).

solutions that reduce fossil fuel consumption, greenhouse gas emissions, and air pollutants in the state. Many of California’s fleets have already converted their petroleum-consumption vehicle fleets to operate on natural gas. California fleets must weigh the benefits of the lower cost fuel prices against the increased purchase price of these vehicles. The Energy Commission should support research to help understand the cost and societal benefits of natural gas as a transportation fuel.

## Natural Gas Vehicles and Fuel

The primary driver for converting petroleum-consumption vehicle fleets over to operate on natural gas originally was the cost savings that can be realized by purchasing natural gas, which historically has been cheaper than gasoline and diesel as shown in **Figure 3**. Recently, however, the relative price advantage has diminished significantly. As NGVs have a greater incremental cost compared to similar gasoline and diesel vehicles, fleets must weigh the benefits of the lower cost fuel prices against the increased purchase price of these vehicles. When the spread between natural gas and diesel or gasoline is high, NGVs can provide a strong return on investment, with many high fuel-consumption vehicles in the heavy-duty sector paying back the incremental cost difference in as little as two years.

**Figure 3: Alternative Fuel Prices<sup>88</sup>**

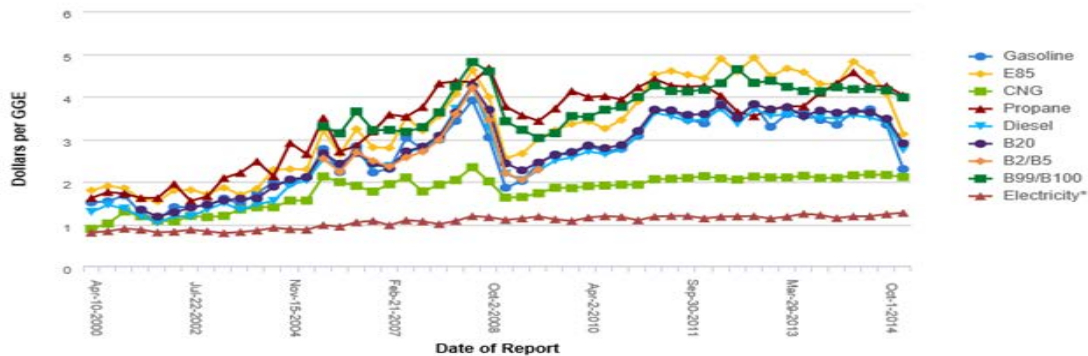

Source: U.S. DOE Alternative Fuels Data Center.

When petroleum prices are low, natural gas prices are high (as is often the case for renewable natural gas), or the incremental cost of a natural gas vehicle is high, there is,

<sup>88</sup> U.S. DOE Alternative Fuels Data Center, (accessed on March 1, 2015).

<http://www.afdc.energy.gov/fuels/prices.html>. Electricity prices are reduced by a factor of 3.4 because electric motors are, on average, 3.4 times more efficient than internal combustion engines.

however, less of a business case for fleet managers to convert to natural gas. To promote alternative fuel vehicles like NGVs, government entities have offered incentives to help reduce the incremental cost of these vehicles.

There are only a few light-duty vehicles that can use natural gas available directly from original equipment manufacturers, and Honda recently announced the discontinuance of its natural gas Civic for the 2016 model year.<sup>89</sup> There are more models available with dual-fuel options.<sup>90</sup> Vehicles may also be retrofitted with a kit to use natural gas. There are, however, many options available in the medium- and heavy-duty vehicle (MHDV) sector. There are also many options for vehicle upfit/retrofit available from ARB-certified engine manufacturers.

Since vehicles in the MHDV sector have significantly greater fuel costs than light-duty vehicles, there is a significant continuing interest in these vehicles from companies severely impacted by the rising costs of petroleum fuels. Some of the fleets making the transition to NGVs include municipal, transit bus, freight transport (for example, UPS or FedEx), waste disposal, and taxi fleets, as reflected in **Figure 4**. Opportunities in the marine and rail sectors are being investigated as alternatives for the off-road vehicle sector but will require additional research and development to be more widely adopted.

**Figure 4: California Natural Gas Vehicle Registrations for 2013**

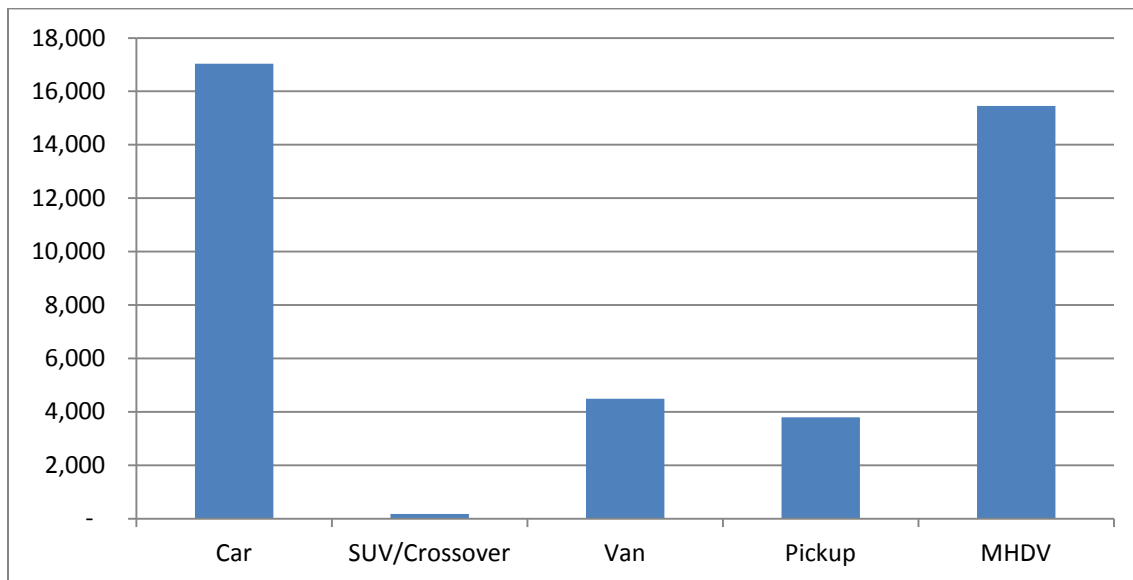

Source: Energy Commission staff analysis of 2013 Department of Motor Vehicles vehicle registration database.

<sup>89</sup> U.S. DOE, *Hybrids, Diesels, and Alternative Fuel Vehicles*, (Accessed on April 1, 2015). <http://www.fueleconomy.gov/feg/alternatives.shtml>.

<sup>90</sup> See <http://www.ngvamerica.org/vehicles/vehicle-availability/>.

## Natural Gas Fueling Infrastructure

To support NGV deployments, fleets and major fuel providers have established an early network of more than 45 liquid natural gas (LNG) and 500 compressed natural gas (CNG) fueling locations throughout the state.<sup>91</sup> The facilities are primarily located close to existing centralized fueling points for large vehicle fleets. These locations allow fueling stations to serve an established set of customers, while being available as a fueling option for local fleets that are considering the adoption of NGVs.

The expansion of the California natural gas fueling infrastructure will be closely tied to the increase in the number of vehicles operating in the state. To be economically viable, a fuel provider must have a reliable stream of customers to warrant the significant investment to construct a fueling station. To enable fleets to purchase NGVs, there must be sufficient fueling infrastructure available locally to support deployment of NGVs. Fuel providers will often work with fleets and provide the infrastructure if fleets will commit to a certain amount of fuel purchases per year. This coordination allows fleets to have fueling infrastructure provided to them where it may otherwise be cost-prohibitive for them to build it.

In addition to the large public and private fueling facilities, there are also fueling options available for home use. Several units are sold that can be installed at a home and connected to the local natural gas line. These options provide a fueling option for owners of NGVs that may not be close to a major NGV fleet. So Cal Gas also offers a special tariff for nonresidential customers, which allows the utility to “plan, design, procure, construct, own, operate, and maintain compression equipment on customer premises.”<sup>92</sup>

Additional opportunities for expanding the NGV infrastructure lie in the long-haul truck sector. The duty cycle of these vehicles requires them to travel along the major transportation corridors in California and connected regions. To enable the deployment of these vehicles, a system of strategically located natural gas fueling stations must be developed. Development of such a system will require significant interest and investment from large fleets and fuel providers. Also, there are opportunities with smaller fleets, such as school districts and municipal fleets. These entities are tethered primarily to a single point and transition to alternative fuels based on an economic or environmental analysis of

---

91 Energy Commission, *2015-2016 Investment Plan Update for the Alternative and Renewable Fuel and Vehicle Technology Program*, 2015, page 49. <http://energy.ca.gov/2014publications/CEC-600-2014-009/CEC-600-2014-009-CMF.pdf>.

92 So Cal Gas, *Compression Services Tariff*. <http://www.SoCalGas.com/innovation/natural-gas-vehicles/refueling/compression-services-tariff.shtml>.



available options and often require outside funding supporting the transition to alternative fuels such as natural gas.

Natural gas is also playing an important role in the development of the emerging hydrogen vehicle industry. There are several options available for producing hydrogen fuel for transportation. A majority of the existing hydrogen fueling stations use steam reformation that converts methane or natural gas to hydrogen. This process allows hydrogen fueling stations and centralized fuel producers to use the existing natural gas infrastructure as a secure source of fuel for hydrogen production. Based on the latest automaker survey by ARB, roughly 18,500 fuel cell electric vehicles using hydrogen are expected by 2020.<sup>93</sup>

To date, the Energy Commission Alternative and Renewable Fuel and Vehicle Technology Program (ARFVTP) has provided funding for 48 new or upgraded hydrogen refueling stations throughout the state.<sup>94</sup> Of these, 43 are expected to dispense hydrogen derived primarily or significantly from natural gas or renewable natural gas. The Energy Commission should continue to support natural gas fueling infrastructure research and development.

## **Biomethane Production Opportunities**

As California works to increase its alternative fuel consumption, biomethane production has been identified as a source of transportation fuel that can help lower the overall carbon intensity of the fuel supply. When compared on a well-to-wheels basis, biomethane used in NGVs can provide significant GHG reductions when compared to gasoline and diesel. Certain types of biomethane production use organic waste stream feedstocks that would otherwise be disposed of in landfills or treated in anaerobic lagoons, resulting in significant emissions of methane and causing negative impacts to local air and water. Diversion of organic materials to anaerobic digestion plants provides reduced land use, decreases methane emissions from material decomposition, and produces both biomethane and secondary goods such as fertilizer.

The ARB has worked with the Argonne National Laboratory to refine the California-modified Greenhouse Gases, Regulated Emissions, and Energy Use in Transportation (CA-GREET) model, which measures life-cycle GHG emissions on a well-to-wheel basis. The

---

93 ARB, *Annual Evaluation of Fuel Cell Electric Vehicle Deployment and Hydrogen Fuel Station Network Development*, June 2014, page 18.

[http://www.arb.ca.gov/msprog/zevprog/ab8/ab8\\_report\\_final\\_june2014.pdf](http://www.arb.ca.gov/msprog/zevprog/ab8/ab8_report_final_june2014.pdf).

94 Energy Commission, *2015-2016 Investment Plan Update for the Alternative and Renewable Fuel and Vehicle Technology Program*, 2015, page 45. <http://energy.ca.gov/2014publications/CEC-600-2014-009/CEC-600-2014-009-CMF.pdf>.

recently proposed carbon intensity values under the new preliminary model, CA-GREET 2.0, include updating the carbon intensity values for gasoline, diesel, and alternative fuels. The resulting values show a neutral to modest GHG benefit comparing conventional natural gas to gasoline and diesel, and a significant GHG benefit comparing biomethane and renewable natural gas to gasoline and diesel. Indeed, some of the biomethane and renewable natural gas pathways represent the lowest carbon pathways available under the Low-Carbon Fuel Standard (LCFS) as shown in **Table 2**. For instance, under the existing LCFS regulation, CNG from generic landfill gas offers carbon intensity roughly 80 percent lower than diesel, while CNG from biomethane derived from high-solids anaerobic digestion is 125 percent lower than diesel.

The Energy Commission expects additional research that is underway to help refine this assessment. The Energy Commission should continue to coordinate with and support the ARB's research, as well as develop research and development that expands biomethane integration and fueling infrastructure.

**Table 2: Low-Carbon Fuel Standard Carbon Intensity Values<sup>95</sup>**

<b>Fuel Source</b>	<b>CA-GREET 1.8b<sup>96</sup></b> (Grams CO <sub>2</sub> -equivalent per megajoule, adjusted to baseline-fuel equivalent using EER)	<b>CA-GREET 2.0</b> (Grams CO <sub>2</sub> -equivalent per megajoule, adjusted to baseline-fuel equivalent using EER)
<b>Ultra-Low-Sulfur Diesel</b>	98	102 <sup>97</sup>
<b>California Reformulated Gasoline</b>	99	98 <sup>98</sup>
<b>North American Natural Gas (CNG)</b>	76	87 <sup>99</sup>
<b>North American Natural Gas (LNG)</b>	80	94 <sup>93</sup>
<b>Landfill Gas (CNG)</b>	13	20 <sup>93</sup>
<b>WWTP Sludge (CNG)</b>	15	9 or 34 <sup>100</sup>
<b>Biomethane Derived From High-Solids Anaerobic Digestion of Food and Green Wastes (CNG)</b>	-14	-25 <sup>101</sup>

Source: ARB. Units in table are adjusted to megajoule (MJ) of baseline fuel, by dividing the alternative fuel CI by its EER. The energy economy ratio (EER) for diesel and gasoline is 1. The EER for CNG and LNG used in a spark ignition engine is 0.9.

95 ARB: Table is intended to illustrate the expected ordinal ranking of various fuel CIs. Under the adopted LCFS regulation (adopted September 25, 2015, and pending approval), alternative fuel providers will submit data specific to each operation and supply chain to determine their actual CI.

96 ARB, CA-GREET 1.8b versus 2.0 CI Comparison Table, accessed on April 1, 2015, pages 2-10. [http://www.arb.ca.gov/fuels/lcfs/lcfs\\_meetings/040115\\_pathway\\_ci\\_comparison.pdf](http://www.arb.ca.gov/fuels/lcfs/lcfs_meetings/040115_pathway_ci_comparison.pdf).

97 2015 LCFS Third 15-Day Modified Regulation Order, Table 6. <http://www.arb.ca.gov/regact/2015/lcfs2015/lcfs3rd15daymodregorder.pdf>.

98 2015 LCFS Third 15-Day Modified Regulation Order, Table 1 (footnote). <http://www.arb.ca.gov/regact/2015/lcfs2015/lcfs3rd15daymodregorder.pdf>.

99 The LCFS regulation (adopted September 25, 2015, and pending OAL approval), alternative fuel providers will submit data specific to each operation and supply chain to determine their actual CI. The value given here should not be understood or used as an average CI result, but rather as a typical result intended to illustrate the expected ordinal ranking of various fuel CIs.

100 2015 LCFS Third 15-Day Modified Regulation Order, Table 6. The CI of 34 applies to a small capacity wastewater treatment plant (WWTP) with no surplus power production; the CI of 9 is for a large WWTP with power export to grid.

101 2015 LCFS Third 15-Day Modified Regulation Order, Table 6. and adjusted by EER=0.9. <http://www.arb.ca.gov/regact/2015/lcfs2015/lcfs3rd15daymodregorder.pdf>.

## **Sustainable Freight and Transport Sector Opportunities**

To achieve California's public health, GHG reduction, energy security, and air quality improvement goals, the California freight transport sector has been identified as an area where significant near-term opportunities exist. Through ARB's *Sustainable Freight: Pathways to Zero and Near-Zero Emissions Discussion Document*,<sup>102</sup> California has identified several areas of promise to integrate greater quantities of natural gas technology into the freight transportation sector, to help achieve these goals. These opportunities are especially important to address the significant public health and air quality issues faced by California's most vulnerable populations in disadvantaged communities.

For medium- and heavy-duty trucks operating in the freight transport sector, the adoption of low-NO<sub>x</sub> engines that are expected to be commercially available between 2015 – 2016, mixed with the use of low-carbon renewable natural gas, can be used to address the significant greenhouse gas and air quality issues that existing vehicles create.

In the off-road and marine sectors, the use of LNG in conjunction with advanced low-emissions engines powered by low-carbon renewable natural gas shows significant opportunities to reduce diesel particulate matter, NO<sub>x</sub>, and GHG emissions. With these vehicles operating in ports and freight hubs in high pollution areas, the introduction of these systems can assist California regions in meeting state and federal protective air quality standards.

## **Alternative and Renewable Fuel and Vehicle Technology Program**

The Energy Commission Fuels and Transportation Division implements the Alternative and Renewable Fuel and Vehicle Technology Program (ARFVTP). With funds collected from vehicle registration and smog fees, the ARFVTP provides up to \$100 million per year for projects that will transform California fuel and vehicle types to help attain the state climate change policies. This includes projects that:

- Reduce Californian's use and dependence on petroleum transportation fuels and increase the use of alternative and renewable fuels and advanced vehicle technologies.
- Produce sustainable alternative and renewable low-carbon fuels in California.
- Expand alternative fueling infrastructure, and fueling stations.
- Improve the efficiency, performance, and market viability of alternative light-, medium-, and heavy-duty vehicle technologies.

---

102 ARB, *Sustainable Freight: Pathways to Zero and Near-Zero Emissions Discussion Document*, April 2015, pages 4-5. <http://www.arb.ca.gov/gmp/sfti/sustainable-freight-pathways-to-zero-and-near-zero-emissions-discussiondocument.pdf>.

- Retrofit medium- and heavy-duty on-road and off-road vehicle fleets to alternative technologies or fuel use.
- Expand the alternative fueling infrastructure available to existing fleets, public transit, and transportation corridors.
- Establish workforce training programs and conduct public outreach on the benefits of alternative transportation fuels and vehicle technologies.

To support natural gas-related activities in California’s transportation sector, the ARFVTP has targeted the major areas where public investment can help remove barriers to the adoption of this alternative fuel.

With the limited number of natural gas fueling stations being built currently, the equipment necessary for construction is often custom-fabricated. Due to the lack of economies of scale, the costs for these facilities sometimes prevent interested fleets from switching over their aging diesel fleets to cleaner natural gas options. To help remove this barrier, the Energy Commission has provided funding for natural gas fueling infrastructure construction to entities that may not have access to the necessary capital for such long-term investments.

Similar to natural gas fueling infrastructure, the upfront capital necessary to purchase NGVs is sometimes cost-prohibitive for interested parties. To reduce this upfront incremental cost, ARFVTP funds have been used to offer incentives for the purchase of NGVs throughout the state, as shown in **Table 3**. Vehicles purchased with these incentives have ranged from light-duty passenger vehicles used for personal transportation to heavy-duty applications such as waste disposal trucks and large freight transport vehicles.

To advance the MHDV sector beyond the existing vehicles options, the ARFVTP has funded the development of advanced natural gas vehicles, including natural gas hybrid-electric drivetrains and low-NO<sub>x</sub> engine development. These technologies will help improve the overall emissions profiles for natural gas usage in this sector while providing similar economic benefits as existing natural gas vehicles provide.

**Table 3: Previous ARFVTP Awards as of March 9, 2015**

Funded Activity	Cumulative Awards to Date (in millions)	# of Projects or Units
Biomethane Production	\$51.0	15 Projects
Natural Gas Fueling Infrastructure	\$16.1	59 Fueling Stations
Natural Gas Vehicle Deployment	\$64.6	4,470 Cars and Trucks**
Natural Gas Engine Research, Development and Demonstration	\$16.40	18 Projects

Source: Energy Commission. \*Includes both completed and pending vehicle incentives, as well as encumbered funds for future incentives. \*\*Does not yet include any vehicles funded under agreement with UC Irvine to administer future NGV incentives.

## Public Interest Energy Research Natural Gas Program

The Energy Commission Energy Research and Development Division administers the Natural Gas Research Program. Transportation has the largest carbon footprint of any sector in California, making it a critical area for innovation. Energy Commission research and development (R&D) focuses on developing and advancing state-of-the-art electricity and natural gas-fueled transportation solutions that reduce fossil fuel consumption, GHG emissions, and air pollutants in the state transportation sector.

The Energy Commission research and development activities include:

- Accelerating the commercial viability of NGVs.
- Improving energy efficiency of NGVs.
- Advancing the clean and cost-effective production of renewable natural gas for transportation use.

With these goals in mind, the Energy Commission has identified major areas that can be affected by R&D funding activities.

The market demand for natural gas-powered commercial vehicles has increased significantly in recent years. Natural gas market penetration, however, has been constrained by the unavailability of certain engine sizes and performance ratings. The range of medium- and heavy-duty natural gas engines available to the North American commercial vehicle market is not as comprehensive as the range of diesel engines, for which there is a product line of medium- and heavy-duty diesel engines over a broad range of engine displacement, power, and torque. Specifically, there is no natural gas engine available that is ideally suited for Classes 3 through 6 commercial vehicle markets, including pickup and delivery trucks, utility trucks, school buses, shuttle buses, yard tractors, and specialized municipal works vehicles such as street sweepers. These market segments typically use 6- to 8-liter diesel engines, with a typical rating range from 200 to 300 horsepower and 500 to 750 lb-ft peak torque. In certain cases such as yard tractors and rear-engine, transit-bus style, Type D school buses, original equipment manufacturers and end users have elected to use larger engines such as Cummins Westport Inc.'s 8.9-liter ISL G engine to enable partial natural gas engine penetration. These engines, however, are typically larger and more expensive (and require heavier transmissions and driveline components) than those installed in the vehicle models typically used in Class 3 through Class 6 target markets. A smaller engine will be more cost-effective and will provide a better option for the majority of customers in the target markets. In many cases, installing larger engines is simply not an option due to physical constraints in the engine bays of the vehicles typically used in these applications.

Following development of 6- to 8-liter natural gas engines, the next phase in R&D is to perform integration and demonstration efforts to validate the functionality of the engine technology in an appropriate vehicle while evaluating the performance of this newly

configured vehicle. The integration and demonstration effort will also help identify any performance or emissions issues that should be addressed prior to commercialization. This final phase will provide engine manufacturers additional insight into opportunities to optimize the performance of the engines and determine the needs of the Class 3 through Class 6 markets before commercialization. Without these additional steps, the newly developed engines could face technical and market barriers that hinder market deployment. Integration and demonstration are critical to the successful deployment of newly developed natural gas engines in the Class 3 through Class 6 markets.

Fuel efficiency is critical in determining engine performance, and operating efficiency can be a key enabler for the market transformation to natural gas engine technology in heavy-duty trucks. Natural gas engine fuel efficiency relative to diesel engine efficiency determines cost savings for prospective fleet customers, as well as criteria, toxic, and GHG emission benefits. The fuel efficiency of heavy-duty natural gas-fueled trucks, however, varies widely among engine types and vehicle operations. While new engines, such as the unthrottled Westport Innovations high-pressure direct injection natural gas engines, offer efficiency comparable to diesel engines, the more common throttled and spark-ignited natural gas engines experience losses in fuel efficiency that vary widely between steady-speed highway operation and urban stop-and-go operation. Actual measurements of relative fuel efficiency between candidate heavy-duty natural gas engines and various diesel engines in representative fleet operations are needed to help prospective fleet customers evaluate potential fuel cost savings, to document public benefits, and to provide the appropriate incentives that will support market advancement and expansion.

Fuel efficiency can be monitored in actual day-to-day fleet operation, and emissions of pollutants and GHGs can be measured, both in the laboratory over driving cycles selected using data generated from actual day-to-day operation, as well as with an emission-instrumented trailer towed over actual daily routes. Such testing can also identify and measure any deterioration of performance. It is important to select and enlist representative fleets including those using ARFVTP incentives.

## **Areas for Further Research**

Over the past five years, the Energy Commission R&D program has funded and partnered on significant R&D efforts related to advanced natural gas vehicles. **Table 4** provides an overview of the awarded R&D projects.

**Table 4: Energy Commission’s R&D Program Funding**

<b>Funding Topic</b>	<b>Cumulative Funding</b>	<b>No. of Projects</b>
Natural Gas Engine Development *	\$10.35M	8
Natural Gas Vehicle On-Board Storage	\$2.20M	2
Fueling Infrastructure	\$400K	1
Natural Gas Vehicle Systems (Hybridization)	\$2.7M	3

Source: Energy Commission. \* Three engines have been successfully commercialized.

One of the highest priorities, as identified in the *Natural Gas Vehicle Research Roadmap* (CEC-500-2008-044-FN) is the R&D of advanced natural gas engines for a broader range of engine sizes for more applications.<sup>103</sup> The results of the research investments for this priority have yielded natural gas engines on the market that compete well with diesel engines by offering comparable performance benefits. This is especially significant in the heavy-duty transportation sector, where vehicles consume significant fuel, log high miles, and are the largest contributors to on-road emissions on a per vehicle basis. While the market for natural gas vehicles has expanded, and has been enabled by the R&D funds provided by the Energy Commission, funding limits force a narrow selection of engine sizes and vehicle applications, resulting in a slow market transformation.

One of the final phases in engine development is vehicle demonstration. Feedback from vehicle fleets indicates that the demonstration phase is one of the key factors to demonstrate functionality of developed vehicles and give fleets the opportunity to operate and gain confidence with the conversion to the new technology. To expand the vehicle demonstration effort, developed advanced natural gas engines must be integrated into a variety of vehicle applications. A focused and aggressive effort to target key markets in the medium- to heavy-duty truck sector can accelerate adoption of the developed technologies.

Additional opportunities that exist but have not had adequate funding include the development and demonstration of large natural gas engines with advanced technology for railroad locomotives (starting with switch engines servicing the ports) that can also be used for large off-road vehicles such as earthmovers and mine trucks. These large engines constitute a major opportunity for significant NO<sub>x</sub> and particulate matter emission reductions, as well as reducing dependence on petroleum and potentially reducing GHG emissions. Such engines will likely be LNG-fueled, with an opportunity for CNG for local switch operation. There is also a related need for development of standards for LNG rail tenders to fuel railroad locomotives. A coordinated agency effort among ARB and South

---

103 See <http://www.energy.ca.gov/2008publications/CEC-500-2008-044/CEC-500-2008-044-F.PDF>.



Coast Air Quality Management District, engine manufacturers General Electric and Caterpillar/EMD, Class 1 railroads, as well as marine engine and vessel manufacturers may lower emissions for these large engines, vehicles, and vessels.

The *2014 Integrated Energy Policy Report Update* indicates that NGVs can have a positive impact on California's transportation sector. These benefits will be enhanced by the further development of the biomethane production facilities and research, development, and deployment of natural gas engines. Continued efforts will be made by the Energy Commission, ARB, and other interested stakeholders to better quantify the impacts of natural gas vehicles on the environment.

- **Low-NO<sub>x</sub> Engines:** California faces challenging requirements for reducing criteria air pollutants by 2023 and 2032. Further development of low-NO<sub>x</sub> engines, both for NGVs and conventional vehicles, is needed to help achieve these goals for vehicle applications where introducing zero-emission technologies is not feasible.
- **Expanding Engine Availability:** The MHDV sector consists of many vehicle types with unique service applications. R&D can help build a broader suite of natural gas engines, enabling NGVs to displace a greater number of gasoline and diesel trucks in the future.
- **NGV Investment:** Additional research may be needed into the factors that inform fleet owner decisions on when to invest in NGVs and how state policies can better influence that decision.
- **Biomethane Production:** Further research, development, and demonstration into biomethane production technologies and opportunities can contribute to lower carbon intensity for natural gas as a transportation fuel.
- **Biomethane Distribution Needs:** Integrating biomethane into the California natural gas distribution grid will expand the availability of biomethane producers to market their fuel. Further research may be needed into how to ease this process.

# CHAPTER 6: Natural Gas and End-Use Efficiency Applications

## Introduction

This chapter addresses natural gas and end-use applications in California in both the residential and commercial building sectors. It covers a range of applications, as well as existing policies and programs.

## Building Sector

California households and businesses consume about one-third of the total state natural gas usage or about 7 billion therms of natural gas annually.<sup>104</sup> Residential natural gas consumption is driven mostly by space and water heating, followed distantly by cooking and miscellaneous home uses such as clothes dryers and pools. Similarly, commercial natural gas consumption is primarily from space heating and water heating, with cooking being a significant end use as well. Other end uses in commercial buildings include process loads, such as commercial laundry, heated pools, and other loads, such as paint dryers in auto shops.

Residential and commercial natural gas consumption has remained relatively flat for the past two decades despite increases in population, jobs, and gross state product.<sup>105</sup> During this period, the stringency of the *California Building Energy Efficiency Standards* (Title 24, Part 6 California Code of Regulation) has increased, as has investment in statewide utility energy efficiency programs. This has contributed to the flattening of natural gas consumption. Maintaining this flat natural gas consumption trend over the next decade, however, may be more challenging. Though natural gas burns relatively cleanly compared to other fossil fuels, opportunities for major improvements in natural gas energy efficiency and technology innovation are sparse. Research on new technologies and reducing costs of proven high-efficiency technologies is necessary to help reduce natural gas consumption in the face of forecasted increases in population and economic growth.

---

104 Rosales, Jesselyn, Doris Yamamoto. March 2012. *The Natural Gas Research, Development and Demonstration Program: Proposed Program Plan and Funding Request for Fiscal Year 2012-13*. Energy Commission. Publication Number: CEC-500-2012-084, page 17.  
<http://www.energy.ca.gov/2013publications/CEC-500-2013-014/CEC-500-2013-014.pdf> .

105 *Gross state product* is a measurement of the economic output of a state or province. It is the sum of value added by all industries within the state and is the state counterpart to national gross domestic product.

## Water Heating and Hot Water Delivery

About 49 percent of the natural gas used by residents and 32 percent of the natural gas used by commercial facilities (for example, restaurants) is for water heating.<sup>106</sup>

Natural gas water heating is used in more than 70 percent of California homes, and of this amount, more than 95 percent use storage (tank) water heaters.<sup>107</sup> Innovations over the past decade have resulted in advances in tankless systems, high-efficiency condensing units, hot water distribution systems, reduced-flow showerheads and faucets, and solar water heating systems. Implementation of these energy-efficient technologies and practices will result in reduced natural gas use. Furthermore, training and design guides, better modeling tools, and building energy efficiency standards will further reduce natural gas use in buildings.<sup>108</sup>

For commercial buildings, the largest user of natural gas for water heating is in restaurants, lodging, and healthcare facilities. There are opportunities to address the large use in these occupancy types through higher-efficiency equipment, such as condensing water heaters, and through heat recovery (and in some cases combined heat and power [CHP]), and solar water-heating applications.

## Space Heating and Cooling

Natural gas is the main space-heating fuel for homes and businesses. More than 90 percent of households with gas service have gas heating.<sup>109</sup> Across all commercial building types, space heating remains the most dominant natural gas end use. Some commercial buildings also use natural gas for cooling through absorption chillers or gas-driven engines. Absorption chillers or gas-driven engine chillers tend to have lower efficiencies than the

---

106 Seto, Betty, Jarred Metoyer, Rachel Schiff, Jon Taffel (DNV KEMA Energy & Sustainability). March 2014. *Natural Gas Energy Efficiency in Buildings: Roadmap for Future Research*. California Energy Commission. Publication number: CEC-500-2014-036-D. <http://www.energy.ca.gov/2014publications/CEC-500-2014-036/CEC-500-2014-036-D.pdf>.

107 Ibid., page 19.

108 The 2008 and 2013 Title 24 Building Energy Efficiency Standards now require pipe insulation in all new home construction.

109 Energy Commission informational Web page. <http://energyalmanac.ca.gov/naturalgas/overview.html>.

electric counterparts; therefore, the gas systems are often used primarily for load shifting and or reduction applications.<sup>110,111,112</sup>

Innovations over the past decade have resulted in increased energy efficiency of gas furnaces and new innovations in condensing gas units. These technological improvements have also been complemented with improvements to the building envelope and air delivery systems—primarily aimed at keeping buildings airtight and reducing heat loss. In addition, low NO<sub>x</sub> residential central furnaces have been deployed and should enter the market in 2015.

## Cooking

About 23 percent of the natural gas used in the commercial sector in California, or approximately 580 million therms, is for commercial cooking.<sup>113</sup> There are 560,000 commercial cooking appliances installed and operating in California and about roughly 70 percent are powered by natural gas. The typical, full-load peak efficiency is the theoretical maximum efficiency for the cooking equipment. It ranges from 20 to 30 percent. Actual in-kitchen utilization efficiencies, which represent the total energy actually attributed to the food product over the cooking day, are in the 5 to 10 percent range.<sup>114</sup> As a result of recent research funded by the Energy Commission, new higher-efficiency equipment can reduce

---

110 Lizardos, Evans J. October 2011. American Society of Heating, Refrigerating and Air-Conditioning Engineers, Inc. *Absorption vs. Electric Chiller Technologies*, page 13.

<http://www.ashraebistate.org/sites/all/files/events/Chill%20Technologies-101211.pdf>.

111 American DG Energy Inc. *Natural Gas Chiller Cooling Systems*. <http://www.americandg.com/on-site-utility/cooling-1>.

112 Arnold, Roger L. Jr, William P. Bahnfleth. September 1998. *Peak Shaving Using Natural Gas Engine-Driven Chillers*, pages 56-59. *Heating/Piping/Air-Conditioning*, Vol. 70, Issue No. 9.

[http://www.engr.psu.edu/ae/faculty/bahnfleth/peak\\_shaving.pdf](http://www.engr.psu.edu/ae/faculty/bahnfleth/peak_shaving.pdf).

113 Seto, Betty, Jarred Metoyer, Rachel Schiff, Jon Taffel (DNV KEMA Energy & Sustainability). March 2014. *Natural Gas Energy Efficiency in Buildings: Roadmap for Future Research*. California Energy Commission. Publication number: CEC-500-2014-036-D.

<http://www.energy.ca.gov/2014publications/CEC-500-2014-036/CEC-500-2014-036-D.pdf>.

114 Johnson, Frank, Don Fisher, Larry Brand, Eddie Huestis (Gas Technology Institute). July 2013. *Advanced Foodservice Appliances for California Restaurants*. California Energy Commission. Publication number: CEC-500-2014-021, page 1. <http://www.energy.ca.gov/2014publications/CEC-500-2014-021/CEC-500-2014-021.pdf>.

natural gas consumption by about 23 million therms annually, assuming a 30 to 50 percent penetration in the marketplace.<sup>115</sup>

## Industrial Sector

The industrial sector is a major energy consumer and one of the largest users of natural gas in the state, accounting for about 25 percent of total use in 2012.<sup>116</sup> Nearly every industrial subsector in California relies in some way on natural gas. The bulk of natural gas consumption in California industry, however, is dominated by a relatively small set of industrial subsectors. The largest users include petroleum and coal products manufacturing, oil and natural gas extraction, food processing, printing, and the manufacturing of electronics, transportation equipment, fabricated metals, furniture, chemicals, plastics, and machinery. These sectors represent prime areas of opportunity for reducing industrial natural gas use. Consequently, industry represents an important target for improving the efficiency of natural gas use through the adoption of new technologies and improved energy management practices.

Specific operations and product segments within industries can also be identified as major natural gas users. Within food processing, for example, canned and dehydrated fruits and vegetables account for a significant share of natural gas use, due to drying and steam processing. Paper and paperboard mills account for a large share of natural gas use in the forest products industry, primarily due to heat used for drying and water evaporation.

Understanding how natural gas is used in California industry makes it possible to focus on opportunities and take advantage of ways to expand the potential benefits. While allocations differ across industrial sectors, process heating and steam generation represent the primary uses of natural gas in California industry. Together, these two uses account for about 85 percent of industrial natural gas use and represent a significant opportunity for realizing efficiency gains. Boilers (steam generation) account for about half of the natural gas used for process heating. The other half is used in a wide range of process heaters that serve a multitude of functions, from melting to forming to drying.<sup>117</sup>

---

115 Seto, Betty, Jarred Metoyer, Rachel Schiff, Jon Taffel (DNV KEMA Energy & Sustainability). March 2014. *Natural Gas Energy Efficiency in Buildings: Roadmap for Future Research*. California Energy Commission. Publication number: CEC-500-2014-036-D.  
<http://www.energy.ca.gov/2014publications/CEC-500-2014-036/CEC-500-2014-036-D.pdf>.

116 Energy Commission informational website.  
<http://energyalmanac.ca.gov/naturalgas/overview.html>.

117 XENERGY, Inc., for PG&E, December 2001. *California Industrial Energy Efficiency Market Characterization Study*.  
<http://www.calmac.org/publications/California%20Ind%20EE%20Mkt%20Characterization.pdf>.

## Existing Policies and Programs

In the past four decades, the state adopted several important new laws and policies that include aggressive goals for energy efficiency and environmental protection. These laws and policies established the appliance and building efficiency standards and called for increased energy efficiency to meet carbon reduction goals in agreement with Assembly Bill 32, the California Global Warming Solutions Act of 2006 (Nuñez/Pavley, Chapter 488, Statutes of 2006).<sup>118</sup> While these laws support and advocate for energy efficiency generally, including efficiency in the end use of natural gas, this section summarizes programs that will have ongoing specific effects on natural gas as an end use.

**Natural Gas Research and Development Program:** This program is funded by a ratepayer surcharge on all natural gas consumed in California.<sup>119</sup> The Energy Commission administers the program for the CPUC.<sup>120</sup> The purpose is to fund R&D projects in energy efficiency, renewable energy and advanced generation, transportation, natural gas-related environmental research, and natural gas infrastructure that advance science and technology and that benefit California natural gas ratepayers.<sup>121</sup>

**Assembly Bill 758 (Skinner, Chapter 470, Statutes of 2009):** Assembly Bill 758 requires the Energy Commission to collaborate with the CPUC and stakeholders to develop a comprehensive program to achieve greater energy efficiency in existing residential and nonresidential buildings. The Energy Commission developed the *Comprehensive Energy Efficiency Program for Existing Buildings Scoping Report* in 2012, and released its final draft *California's Existing Buildings Energy Efficiency Action Plan* in March 2015.<sup>122</sup> These plans prioritize strategies and approaches to achieve Governor Brown's recent goal and executive order direction to double the rate of efficiency savings in buildings in California through

---

118 The state appliance standards are preempted by the federal appliance standards for nearly all gas-fired appliances; thus the state is prohibited from setting more stringent efficiency requirements for these products.

119 Public Utilities Code, Section 890.

120 California Public Utilities Commission. August 2004. Decision 04-08-010.  
[http://docs.cpuc.ca.gov/PublishedDocs/WORD\\_PDF/FINAL\\_DECISION/39314.PDF](http://docs.cpuc.ca.gov/PublishedDocs/WORD_PDF/FINAL_DECISION/39314.PDF).

121 Seto, Betty, Jarred Metoyer, Rachel Schiff, Jon Taffel (DNV KEMA Energy & Sustainability). March 2014. *Natural Gas Energy Efficiency in Buildings: Roadmap for Future Research*. California Energy Commission. Publication number: CEC-500-2014-036-D.  
<http://www.energy.ca.gov/2014publications/CEC-500-2014-036/CEC-500-2014-036-D.pdf>.

122 The *California's Existing Buildings Energy Efficiency Action Plan*.  
[http://docketpublic.energy.ca.gov/PublicDocuments/15-IEPR-05/TN205919\\_20150828T153953\\_Existing\\_Buildings\\_Energy\\_Efficiency\\_Action\\_Plan.pdf](http://docketpublic.energy.ca.gov/PublicDocuments/15-IEPR-05/TN205919_20150828T153953_Existing_Buildings_Energy_Efficiency_Action_Plan.pdf).

2030.<sup>123</sup> The final draft *California's Existing Buildings Energy Efficiency Action Plan* recognizes the importance of saving natural gas energy through both past California efforts, as well as the massive energy efficiency improvement called for by the Governor's direction.

**Senate Bill 350 (De León, Chapter 547, Statutes of 2015):** In addition to increased renewable generation goals, SB 350 seeks to double statewide energy efficiency savings in electricity and natural gas for retail customers by 2030. The Energy Commission, in collaboration with the CPUC, will develop and establish energy efficiency savings and demand reduction targets for existing residential and nonresidential buildings by 2017.

**Assembly Bill 802 (Williams, Chapter 604, Statutes of 2015):** AB 802 requires the CPUC to authorize electric and gas utilities to provide incentives to customers for energy efficiency measures associated with a project that brings an existing building up to building code and standards.<sup>124</sup> AB 802 also enhances the Energy Commission's existing authority to collect certain types of data for forecasting, planning, and program design. The intent of the bill is to increase energy savings through energy efficiency measures.

## Cost-Benefit and Effectiveness Analysis

The Energy Commission sponsored cost-effectiveness/cost-benefit analysis related to natural gas efficiency measures during development of the *California Building Energy Efficiency Standards*.

Research showed that it was cost-effective to mandate hot water pipe insulation, resulting in an estimated present value to cost ratio of 1.2 to 2.0. The *2008 and 2013 Building Energy Efficiency Standards* included insulated kitchen pipes, insulated underground pipes, and pipe insulation for all hot water pipes greater than  $\frac{3}{4}$  inch in diameter.<sup>125</sup>

The 2005 Flex Your Power Award recipient, Winesecrets, has created a low-energy tartrate removal system that was demonstrated in wineries in 2002 using a \$300,000 grant from the Energy Commission.<sup>126</sup> The process, known as Selective Tartrate Removal System (STARS),

---

123 January 5, 2015, Governor Brown's inaugural address. <http://gov.ca.gov/news.php?id=18828>.

124 Assembly Bill 802.

[http://leginfo.legislature.ca.gov/faces/billNavClient.xhtml?bill\\_id=201520160AB802](http://leginfo.legislature.ca.gov/faces/billNavClient.xhtml?bill_id=201520160AB802).

125 Davis Energy Group, Inc. April 2006. *Measure Information Template: PEX Parallel Piping Hot Water Distribution Systems*. California Energy Commission, page 6.

[http://www.energy.ca.gov/title24/2008standards/prerulemaking/documents/2006-05-18\\_workshop/2006-05-11\\_PEX.PDF](http://www.energy.ca.gov/title24/2008standards/prerulemaking/documents/2006-05-18_workshop/2006-05-11_PEX.PDF).

126 Mirviss, Lillian. March 2014. *Public Interest Energy Research 2013 Annual Report*. California Energy Commission. Publication Number: CEC-500-2014-035-CMF, page 51.

<http://www.energy.ca.gov/2014publications/CEC-500-2014-035/CEC-500-2014-035-CMF.pdf>.



applies electro dialysis to remove tartrates from wine more efficiently. With the support of the Energy Commission, the technology continues to advance. STARS units process 5 million gallons of wine a year in California, saving 4 million kilowatt hours (kWh) of electricity and 1 million gallons of water, as well as reducing waste sodium hydroxide, sulfuric acid, and salt in the effluent water. In addition, this process prevents 38,000 gallons of wine from being lost due to tartrate removal, and more than 12,000 therms of natural gas are saved because there is no need to warm the wine back up for bottle labeling.<sup>127</sup> If sales stopped today, the present value of operating existing STARS machines in California through 2020 is \$8.7 million, 28 times the Energy Commission's investment. California jobs have been created in sales, rental, installation services, and the increased competitiveness of the California wine industry. Currently, 20 Californians are directly employed as a result of Winesecrets dissemination of STARS.

## Challenges in California

This section discusses some of the major challenges with adopting new technologies and the regulatory constraints associated with natural gas use in buildings and industries.

### Technology Considerations

#### *Cost-Effectiveness*

High-efficiency natural gas equipment is often more expensive than standard efficiency equipment. Combining the higher cost of equipment with the relatively low cost of natural gas as the fuel source may result in a longer payback period. This makes it difficult to justify purchase based on energy savings alone. For instance, a solar water-heating system installed as a residential retrofit can cost upward of \$9,000, including collectors and storage tank, compared to the approximate cost of \$1,000 for a standard tank water heater.<sup>128</sup> The payback based on energy cost savings, however, can be more than 20 years, which exceeds the life of the solar water-heating components. The key to making energy-efficient equipment more affordable and attractive to California consumers is to reduce the equipment and installation cost while providing the same level of service as the standard equipment.

---

<sup>127</sup> When wine undergoes cold stabilization, condensation from the cold temperatures builds up on the bottle, creating a challenge when adhering labels. After cold stabilization, many wineries have to warm wine bottles back up to near room temperature for labels to adhere properly.

<sup>128</sup> Solar Water Heater pricing based on *June 2015 California Solar Initiative Annual Report*. [http://www.cpuc.ca.gov/NR/rdonlyres/8E158382-9114-4756-B0C7-AA6CA1A110A4/0/CSI\\_2015AnnualReport\\_FINAL.pdf](http://www.cpuc.ca.gov/NR/rdonlyres/8E158382-9114-4756-B0C7-AA6CA1A110A4/0/CSI_2015AnnualReport_FINAL.pdf). Standard water tank pricing for natural gas based on: [http://www.energy.ca.gov/title24/2016standards/rulemaking/documents/15-day\\_language/additional\\_documents\\_relied\\_upon/Codes\\_and\\_Standards\\_Enhancement\\_Initiative\\_\(CASE\)\\_Residential\\_Instantaneous\\_Water\\_Heaters\\_Updated\\_Version\\_2015-02-20\\_TN-74627.pdf](http://www.energy.ca.gov/title24/2016standards/rulemaking/documents/15-day_language/additional_documents_relied_upon/Codes_and_Standards_Enhancement_Initiative_(CASE)_Residential_Instantaneous_Water_Heaters_Updated_Version_2015-02-20_TN-74627.pdf).



### *Proven/Unproven Track Record of the Technology*

To create demand for high-efficiency equipment, Californians must be assured that the promised energy savings and other benefits will be realized to justify the higher-cost equipment. Demonstrations of advanced technologies in actual residential and commercial buildings, along with independent measured data that show actual savings, benefits, and reliable performance, are needed to provide confidence that the savings are realistic. For example, research on new energy-efficient cooking equipment showed that it could reduce food service energy use by 23 to 40 percent, depending on the technology. Demonstrations of this equipment will happen in 2015 in several food service establishments in California to monitor energy savings and cooking performance.

### *Trained Workforce*

In some cases, there is a shortfall of adequately trained contractors who can install high-efficiency equipment correctly to maximize its efficiency. According to a study by Lawrence Berkeley National Laboratory (LBNL), it is important to educate and support the building and construction industries to make sure they are able to provide a trained workforce to support the growth in energy efficiency and to integrate building and industrial process system efficiency into existing building and construction, through apprenticeship and trades curricula.<sup>129</sup> This could be a cost-effective way to train large numbers of electricians; heating, ventilation, and air-conditioning (HVAC) contractors; mechanical insulators; and homebuilders.

## Environmental Considerations

### *Nitrogen Oxides (NO<sub>x</sub>)*

One of the challenges facing natural gas use is air emissions. To meet the Federal Clean Air Act, specifically the 2023 and 2032 Ozone Standards for Extreme Non-Attainment Areas in California, natural gas-burning equipment will be required to reduce NO<sub>x</sub> emissions by 75 to 80 percent.<sup>130</sup> This requirement greatly impacts natural gas use in the South Coast Air Quality Management District and the San Joaquin Valley Air Pollution Control District. More efficient burners may have about 10 to 15 percent higher NO<sub>x</sub> levels based on some limited testing done by the Gas Technology Institute (GTI) for food

---

129 Goldman, Charles A., et. al. March 2010. *Energy Efficiency Services Sector: Workforce Education and Training Needs*. Lawrence Berkeley National Laboratory. LBNL-3163E, page xvi.  
<http://emp.lbl.gov/sites/all/files/REPORT%20lbl-3163e.pdf>.

130 Oral comments from So Cal Gas during *Proposed Natural Gas Research Initiatives Stakeholder Workshop for FY 2015/16*, January 2015.

service equipment. Research by GTI, however, indicates that the level of NO<sub>x</sub> emissions in commercial food service appliances varies significantly based on the design and burner type.

Additional research is needed to better understand the relationship of equipment design and burner type, the impact on energy efficiency and NO<sub>x</sub> emissions, and the opportunities for further cost-effective improvements to gas technologies. In certain geographical areas there may be measurable impact by end-use electrification of space conditioning and cooking equipment.

#### *Indoor Air Quality and Methane Leaks*

As buildings are better sealed against air leakage to improve energy efficiency, research is needed to correlate indoor air quality and potential health impacts associated with combustion of natural gas-fired appliances. Recently completed research indicates that combustion of natural gas in household ranges and cooktops results in emissions of NO<sub>x</sub> and carbon monoxide (CO). Recent research is also evaluating the potential of methane leaks in homes. Potential health hazards could result if these combustion products are inadequately exhausted from the building.<sup>131</sup> Research is needed to demonstrate new, energy-efficient technologies that minimize or eliminate impacts to indoor air quality.

## **Gaps in Knowledge and Research**

This section will describe the knowledge gaps that require additional future research.<sup>132 133</sup>

The Energy Commission does not have sufficient funding to support adequate scale-up of the successful technologies within the efficiency area of research. More funding to directly support the scale-up of a wide variety of successful technologies is needed. A properly crafted scale-up plan for new technologies would ultimately lead to increased adoption among new users.

Success and uptake of a new efficient product are not just tied to the availability, production, and distribution of the new equipment from the manufacturer. Coordinated

---

131 Mullen, Nasim A., Jina Li, Brett C. Singer. December 2012. *Impact of Natural Gas Appliances on Pollutant Levels in California Homes*. Lawrence Berkeley National Laboratory. LBNL-5970E, page 3. See [http://eetd.lbl.gov/sites/all/files/impact\\_of\\_natural\\_gas\\_appliances.pdf](http://eetd.lbl.gov/sites/all/files/impact_of_natural_gas_appliances.pdf).

132 Seto, Betty, Jarred Metoyer, Rachel Schiff, Jon Taffel (DNV KEMA Energy & Sustainability). March 2014. *Natural Gas Energy Efficiency in Buildings: Roadmap for Future Research*. California Energy Commission. Publication number: CEC-500-2014-036-D. <http://www.energy.ca.gov/2014publications/CEC-500-2014-036/CEC-500-2014-036-D.pdf>.

133 California Energy Commission. Presentation slides from January 12, 2015. [http://www.energy.ca.gov/research/notices/2015-01-13\\_workshop/presentations/FY2015-2016\\_Natural\\_Gas\\_Research\\_Initiatives\\_Presentation.pdf](http://www.energy.ca.gov/research/notices/2015-01-13_workshop/presentations/FY2015-2016_Natural_Gas_Research_Initiatives_Presentation.pdf).

scale-up aimed at real penetration, integration, and long-term success requires interactions among a variety of groups, including utilities, trade organizations, manufacturers, and a host of other stakeholders. It also requires an understanding of each major customer's future equipment needs, the customer's environment, and demonstrations of how the new, efficient products can meet all his or her needs without compromising customer satisfaction and quality, while saving energy, water, and money.

A recent example is the use of new, more efficient lines of cooking equipment to include conveyor ovens, convection ovens, ranges, foodservice woks, underfired broilers, and overfired broilers. While the new equipment is very efficient and is accepted among initial users, the reach of the new cook lines has been rather limited to a relatively small group of users. Expanding a scale-up component for these types of products could lead to much wider adoption across the industry, resulting in significant future savings.

Research is needed to demonstrate cost-effective technologies and strategies for reducing natural gas use and cost for water heating and hot water delivery, such as designing and field testing new, efficient low-NO<sub>x</sub> burner technology and characterization of natural gas use across different building types.

Use of natural gas as a heating fuel may face challenges meeting state and local air quality requirements for NO<sub>x</sub> and particulate matter, especially in Southern California. Research is needed to improve space heating/cooling technology and delivery of efficiency to address technology cost and meeting local environmental air quality requirements.

Research is needed to develop "smart" appliances to improve technology efficiency while reducing equipment cost and air emissions. Further, in reviewing indoor air quality, the requirement of some programs to perform Natural Gas Appliance Testing (NGAT) to address safety considerations should be included.<sup>134</sup> Research is needed to develop next-generation approaches for advanced hybrid systems, including micro CHP products, which integrate multiple technologies and account for interactive effects of natural gas appliances for ZNE buildings.

A knowledge gap exists on the interaction between natural gas appliances and chemical constituents found in commercial and residential buildings and the need for improved, energy-efficient filtration systems. Research is needed to address data gaps on the interaction between natural gas appliances and indoor air pollution sources (such as moisture, combustion devices, plastics, fire retardants, products for cleaning or finishing surfaces) and improving air filter performance. Research is needed to evaluate the

---

<sup>134</sup> The NGAT program requires contractors to perform combustion testing that includes carbon monoxide measurement at each appliance and in ambient air, draft pressure measurement and spillage evaluation for atmospherically vented appliances, and worst-case negative pressure measurement for each combustion appliance zone.

performance of mechanical ventilation systems in newly constructed California buildings to improve indoor air quality.

To advance energy-efficient emerging and underused technologies in this risk-averse sector, demonstrations of technologies are needed to justify cost-effectiveness. Moreover, research is needed to identify cost-effective opportunities for heat recovery from combustion systems and natural gas burners in the industrial sector.

Lastly, research is needed to address the high cost for condensing appliances. Technical approaches should include the development of protective coatings or the use of less expensive alternative materials as a substitute for expensive stainless steel typically used in condensing appliance design.

# CHAPTER 7:

## Natural Gas Use for Zero-Net-Energy Buildings

### Introduction

The development of new energy production, energy efficiency, and construction technologies has made zero-net-energy consumption possible in many buildings. This chapter addresses natural gas use in zero-net-energy (ZNE) buildings, as well as opportunities for ZNE, existing ZNE policy and programs, and the challenges that ZNE faces in California.

### California and ZNE Buildings

The simplest explanation of a ZNE building is that it uses only as much energy as it produces. The benefits of a ZNE building are that the consumer will have lower energy costs and the energy can be obtained from renewable resources. The California Energy Commission adopted the following ZNE goal in the *2007 Integrated Energy Policy Report*:

Increase the efficiency levels of the building standards and combine them with on-site generation so that newly constructed buildings are ZNE by 2020 for residences and 2030 for commercial buildings.

In the *2013 Integrated Energy Policy Report*, the Energy Commission adopted the following definition for ZNE Code Building, developed in collaboration with the CPUC:

A ZNE code building is one where the net amount of energy produced by on-site renewable energy resources is equal to the value of the energy consumed annually by the building, at the level of a single “project” seeking development entitlements and building code permits, measured using the Energy Commission time-dependent valuation metric. A ZNE code building meets an energy use intensity value designated in the building energy efficiency standards by building type and climate zone that reflects best practices for highly efficient buildings.<sup>135</sup>

---

<sup>135</sup> The *2016 Integrated Energy Policy Report* will propose a minor edit in the 2013 definition of ZNE: “A ZNE code building is one where the *value of the* net amount of energy produced by on-site renewable energy resources is equal to the value of the energy consumed annually by the building, at the level of a single “project” seeking development entitlements and building code permits, measured using the Energy Commission time-dependent valuation metric...”

The result could be accomplished through reducing the energy use (both electricity and natural gas) for the building to low levels through energy efficiency, improved energy use practices, and the greater use of renewable energy sources. The implementation of ZNE building concepts in California can have a tremendous impact on the state meeting its energy and environmental goals.

California utilities have offered many new construction programs, incentives, and project pilots to advance the state ZNE building goals. Thousands of homes have been built with increased building energy efficiency standards. The Energy Commission anticipates the *2019 Building Energy Efficiency Standards* development to fully achieve the building efficiency measures necessary to realize ZNE.

## **Existing Policies and Programs**

The Energy Commission ZNE goal has long been supported by the CPUC in the *Long-Term Energy Efficiency Strategic Plan*, through the development of action plans for both nonresidential and residential buildings, and through studies to assess technical feasibility and to plan for implementation. Likewise, the ZNE goal has been supported by ARB in its *Climate Change Scoping Plans*. Governor Edmund G. Brown Jr. also has actively supported ZNE for newly constructed buildings through his original *Clean Energy Jobs Plan*, and in his Executive Order B-18-12, which calls for all newly constructed state buildings to be ZNE by 2025.

The Energy Commission is pursuing development of the *2016 Building Energy Efficiency Standards* to make important energy efficiency upgrades to newly constructed residences in California. The Energy Commission, with support from the California utilities, developed and proposed the following upgrades to prescriptive standards, improving the performance standards by lowering the energy budget: high-performance attics with emphasis on insulation at the roof deck, high performance walls with emphasis on advanced insulation methods, instantaneous water heating, and high-efficacy lighting, emphasizing light emitting diodes (LEDs). The first three measures will result in considerable natural gas savings.

In the *2011 Integrated Energy Policy Report*, the Energy Commission adopted the following key recommendations for achieving high levels of energy efficiency in the building energy efficiency standards updates between now and the 2020 ZNE effective date:

- The Energy Commission, CPUC, local governments, and builders should collaborate to encourage the building industry to reach these advanced energy efficiency levels in a substantial segment of the market through industry-specific training and financial incentives.
- The Energy Commission and CPUC should coordinate future investor-owned utilities (IOUs) “new construction-related” programs with the Energy Commission’s efforts to

meet the ZNE goals through triennial updates of mandatory energy efficiency standards and reach codes.<sup>136</sup> By offering incentives for achieving reach standards, providing technology demonstration and development, and conducting pilot programs for demonstrating ZNE solutions, new technologies and building practices can be integrated into upcoming triennial updates of the building standards quicker and with more success.

- The Energy Commission, CPUC, builders, and other stakeholders should collaborate to accomplish workforce development programs to impart the skills necessary to change building practice to accomplish ZNE in newly constructed buildings.
- Starting in 2013, the California IOUs, in response to CPUC direction, have worked to focus attention of key programs—Codes and Standards Program, California Advanced Home Program (CAHP), Emerging Technology Program, and Workforce, Education and Training Program—on collaboration to deliver on the ZNE goals. The CAHP has redesigned its new construction incentive program to develop and put into place a revamped incentive structure that bases its incentives on target energy use intensity values, as anticipated by the *2013 Integrated Energy Policy Report*.

In the second half of 2014, the Energy Commission worked with the CPUC, California IOUs, Sacramento Municipal Utilities District, and the California Building Industry Association to establish the “High Performance Attics and High Performance Walls Code Readiness Initiative.”

On June 10, 2015, the Energy Commission unanimously approved building energy efficiency standards to reduce energy costs, save consumers money, and increase comfort in new and upgraded homes and other buildings.

Single-family homes built with the Energy Commission *2016 Building Energy Efficiency Standards* are expected to use about 28 percent less energy for lighting, heating, cooling, ventilation, and water heating than those built under the 2013 standards. The new standards, which take effect on January 1, 2017, focus on three key areas: updating residential requirements to move closer to California ZNE goals, updating nonresidential and high-rise residential requirements, and improving the clarity and consistency of existing regulations. Based on a 30-year mortgage, the Energy Commission estimates that standards will add about \$11 per month for the average home but save consumers \$31/month on monthly heating, cooling, and lighting bills.

---

136 Referred to as “reach codes,” Public Resources Code Section 25402.1(h)2 and Section 10-106 of the Building Energy Efficiency Standards (Standards) establish a process which allows local adoption of energy standards that are more stringent than the statewide Standards.

## Residential

Other major improvements in the *2016 Building Energy Efficiency Standards* include:

- High-performance attics: extra insulation at the roof deck in addition to ceiling insulation will reduce the attic temperature by 35 degrees or more during hot summer days.
- High-performance walls: builders can choose from many different assemblages to reduce heating and cooling needs in the home year round.
- Lighting: installation of high-quality lighting with controls that nearly halve the energy required for lights in new homes.
- Water heating: installation of tankless water heaters that reduce use by about 35 percent.

## Nonresidential

- Envelope: revision of outer building, or envelope, requirements for all nonresidential and high-rise residential buildings.
- Lighting: update power allowances for lights to align with the American Society of Heating, Refrigerating, and Air-Conditioning Engineers standards.
- Elevators: require lights and fans to shut off when an elevator is empty.
- Escalators and moving walkways: require escalators and moving walkways in transit areas to run at a lower, less energy-consuming speed when not in use.
- Windows and doors: require lockout sensors that turn off cooling and heating systems if a door or window is left open for more than five minutes.

## Cost-Benefit Analyses

Estimates of the energy and GHG reductions, as well as cost-effectiveness and other economic valuations of the role of ZNE in accomplishing California climate change goals, can be found in the ARB's *Climate Change Scoping Plan* (December 2008) and the *First Update to the Climate Change Scoping Plan* (May 2014).<sup>137</sup> It lays out a plan that will continue to further decrease GHG emissions and meet federal air quality requirements. But, to accomplish this, every major economic sector must play a role in the effort.

The Warren-Alquist Act, which created the Energy Commission in 1974, obligates the Energy Commission to meet specific cost-effectiveness requirements in the course of adopting energy efficiency standards for buildings and appliances. The Energy

---

<sup>137</sup> *Climate Change Scoping Plans*.

[http://www.arb.ca.gov/cc/scopingplan/document/adopted\\_scoping\\_plan.pdf](http://www.arb.ca.gov/cc/scopingplan/document/adopted_scoping_plan.pdf) and <http://www.arb.ca.gov/cc/scopingplan/document/updatedscopingplan2013.htm>.



Commission, in collaboration with the CPUC, has made multiple updates of its building and appliance standards on the road to ZNE. For the latest round of standards, estimates of the energy savings and cost-effectiveness, as well as GHG reductions of natural gas measures in contributing to further accomplishment of ZNE goals, can be found within Energy Commission rulemaking documents.<sup>138</sup>

Under the oversight of the CPUC, research has been conducted to support the development of specific action plans to meet the *Long-Term Energy Efficiency Strategic Plans* for ZNE. Estimates of energy savings and carbon reductions of ZNE buildings in California can be found in *The Technical Feasibility of ZNE Buildings in California*.<sup>139</sup> This study is a forward-looking stress test of the ZNE construction goals set forth by the CPUC and the Energy Commission. The goals establish both a 2020 and a 2030 goal. The 2020 goal sets a target for all low-rise residential new construction to reach ZNE, and the 2030 goal sets a target for all commercial new construction to reach ZNE. This study assesses the different possibilities for accomplishing these goals and sets forth a list of recommendations. These recommendations include load reductions, use of passive systems such as natural ventilation, use of active systems for heat recovery, and further research to increase the efficiency of PV panels.

## Challenges in California

The ZNE goals address the total energy that the building and related energy-using equipment and systems consume. ZNE buildings must have high levels of energy efficiency of both the structure and energy-using appliances, combined with the addition of clean, renewable power generation, typically solar photovoltaic (PV).

ZNE could not be achieved without carefully addressing the natural gas energy use that is prominent in today's buildings. This is particularly true in homes, where approximately 18.5 percent of the natural gas delivered to consumers in California is typically used for space or water heating, or cooking.<sup>140</sup> The Energy Commission can use its regulatory authority, both building energy efficiency standards (Title 24, Part 6 [California Energy Code] and Part 11 [California Green Building Standards Code]) and appliance efficiency

---

138 2016 *California Building Energy Efficiency Standards*.  
<http://www.energy.ca.gov/title24/2016standards/rulemaking/>.

139 CALMAC Study ID—PGE0326.01. <http://www.cpuc.ca.gov/NR/rdonlyres/8DC39CB6-A29C-4789-B888-A9556F500BE5/0/CaliforniaZNETechnicalFeasibilityReport.pdf>.

140 U.S. EIA, Natural Gas Consumption by End Use Database, accessed on June 1, 2015.

standards (Title 20, Chapter 4, Article 4) to require buildings and the equipment used in buildings to be energy-efficient, and it has done so for both<sup>141</sup>.

The time window between the Energy Commission adoption of the ZNE goal in 2007 and the 2020 effective date of the goal for newly constructed residential buildings is short. The Energy Commission made significant energy efficiency upgrades to the *2010 and 2013 California Building Energy Efficiency Standards* and expects even more stringent standards in the 2016 and 2019 updates.

The Energy Commission is pursuing critical energy efficiency measures, which will require significant changes in traditional building practices for residential building envelopes, upgrading the efficiency of water heating and residential lighting. Consistent with the ZNE goal, these measures will save both electricity and natural gas. Finally, the Energy Commission is engaged in a multiphase proceeding to upgrade appliance efficiency standards, which are expected to contribute to meeting the ZNE goals by saving electricity consumption from lighting and plug loads, and natural gas consumption for water heating resulting from the reduced water flow of plumbing fittings.

The residual electricity and natural gas consumption after these energy efficiency measures are implemented must be offset by rooftop solar photovoltaics (PV) or other renewable resources. Under current net energy metering rules, building owners are compensated at retail rates for onsite PV generation up to but not exceeding their annual energy usage. Any annual surplus generation is compensated at relatively low rates.<sup>142</sup> One way to address this situation would be to identify means of otherwise offsetting the residual natural gas usage, such as through uses of waste heat, including CHP, or potentially through the use of renewable gas resources at the building site or on a community basis.

One potential way to reduce emissions from end-use applications is to replace natural gas appliances, such as gas stoves, water heaters, and space-conditioning units, with electric appliances. This fuel-switching is called “electrification,” and at this time the greenhouse gas emission reduction benefits are not clear since a significant amount of electricity in the grid comes from natural gas combustion. Other things to consider are that end-use natural gas appliances typically have higher efficiencies than power plants, and they avoid losses in the electricity system. To the extent that California’s generation mix and policy continues to advance more renewables versus natural gas generation, electrification would realize additional emission benefits. It is also not clear from a customer perspective how cost-effective end-use electrification applications are. Further research is necessary to better

---

141 The state appliance standards are preempted by the federal appliance standards for nearly all gas fired appliances; thus the state is prohibited from setting more stringent efficiency requirements for these products.

142 Example of surplus generation rates. <https://www.sce.com/wps/portal/home/regulatory/tariff-books/rates-pricing-choices/net-surplus-compensation>.

understand the trade-offs for electrification. For example, a recent July 2015 City of Palo Alto Utilities Advisory Commission memo indicated that it may be cost-effective for residential customers to switch from natural gas to electric heat pump technologies for water heating, and that space heating is close to being cost-effective.<sup>143</sup> The same memo indicated that the overall lifetime cost and operation of electric stoves and clothes dryers was more expensive versus natural gas.

A recent study conducted by So Cal Gas and Navigant Consulting concluded that mixed-fuel homes have cost and consumer preference advantages over electric-only ZNE homes when compared to a baseline electric-only home.<sup>144</sup> The South Coast Air Quality Management District (SCAQMD) indicated in its draft 2016 management plan that while it has adopted the most stringent NO<sub>x</sub> emission regulations for new residential and commercial natural gas-fired water heaters and space heaters in the nation, residential natural gas combustion-related NO<sub>x</sub> emissions remain a significant source of emissions, ranked second highest among stationary NO<sub>x</sub> emission sources.<sup>145</sup> It recommends energy efficiency as an effective means to augment SCAQMD existing regulations to bring about further NO<sub>x</sub> reductions. The SCAQMD further recommends promoting energy-efficient technologies in future SCAQMD regulatory or incentive programs.

The *2013 Integrated Energy Policy Report* recognized that as a practical matter, there will be a need to allow for meaningful flexibility as a significant number of buildings may be unable to meet the on-site renewable energy resources component of the ZNE code building definition. For example, a home may not meet ZNE building code due to rooftop shading. The ZNE building code definition anticipates the need for “development entitlements” for off-site renewables, such as community-based renewable resources, to be a viable option for builders and developers. Any option for achieving compliance with ZNE requirements that relies on off-site renewable resources must provide a clear method for building department verification that ensures that the resources exist when that the building is being permitted. In addition, there should be no ambiguity regarding whether the building is properly offset by the community resource and that information concerning the development entitlement is reliably available without delay or significant additional work effort on the part of the building department at the point in time that compliance decisions are required.

---

143 July 2014 Utility Advisory Board Memo.

<https://www.cityofpaloalto.org/civica/x/filebank/documents/47998>.

144 Navigant Consulting, *Strategy and Impact Evaluation of ZNE Regulations on Gas-Fired Appliances and Phase 1 Technology Report*, March 2015

145 South Coast AQMD Draft 2016 Management Plan White Paper, *Residential and Commercial Energy White Paper - Draft*. <http://www.aqmd.gov/docs/default-source/Agendas/aqmp/white-paper-working-groups/preliminary-draft-residential-and-commercial-energy-white-paper.pdf?sfvrsn=2>.

It is possible that community-based, renewable natural gas resources could be considered for these “development entitlements” if they could meet these building department reliability, verifiability, and enforceability needs.

## Gaps in Knowledge and Research

An important area where additional knowledge and research are needed is on the costs of ZNE impacts to the electricity grid. A discussion of grid impacts can be found in the CPUC report *The Road to ZNE*.<sup>146</sup> This study identifies pathways to achieving ZNE for new construction low-rise homes by 2020 and commercial buildings by 2030. It has three main objectives: (1) establish framework for ZNE research, (2) perform market assessment that identifies market intervention strategies, and (3) identify pathways to ZNE for residential and commercial new construction.

The study found that ZNE goals will help achieve California GHG reduction goals, and while they are not legally mandated, it would benefit the economy to meet them. The study also found that the ZNE market is still early in development, and there remain significant uncertainties, such as the potential impacts of the ZNE goals on the electrical grid and whether the goals are cost-effective. It found that reducing the costs of renewables is necessary and identified the need for greater coordination among the regulatory agencies.

The Energy Commission should continue to explore the connection between end-use natural gas applications and the increased electrification of buildings and electric appliances. The joint CPUC and Energy Commission June 2015 *New Residential Zero Net Energy Action Plan 2015-2020* indicates that there is still uncertainty and lack of a clear path to achieving the vision of ZNE.<sup>147</sup> Further, the report doesn’t address natural gas applications with ZNE.

---

146 See page 104 <http://www.cpuc.ca.gov/NR/rdonlyres/0474B6C9-2288-4EA0-B3B1-83ECBD4C70A4/0/TheRoadtoZNEReport.pdf>.

147 See [http://www.cpuc.ca.gov/NR/rdonlyres/92F3497D-DC5C-4CCA-B4CB-05C58870E8B1/0/ZNERESACTIONPLAN\\_FINAL\\_060815.pdf](http://www.cpuc.ca.gov/NR/rdonlyres/92F3497D-DC5C-4CCA-B4CB-05C58870E8B1/0/ZNERESACTIONPLAN_FINAL_060815.pdf).

# CHAPTER 8:

## Natural Gas and Biogas as Low-Emissions Resources

### Introduction

This chapter provides an overview of California biogas and biomethane production opportunities, as well as the challenges they face.

### Biogas and Biomethane Production

*Biogas* is typically derived from organic fuel sources, such as biomass, digester gas, or landfill gas. Biogas is principally composed of methane and carbon dioxide. Biomethane is the treated product of biogas where CO<sub>2</sub> and other contaminants are removed. Biogas is a by-product of normal operations at many landfills (operating and closed), dairies, and wastewater treatment facilities. Biogas can also be produced by stand-alone facilities either directly through biochemical conversion processes (anaerobic digestion) or indirectly through gas reformation of producer gas from thermochemical conversion processes. End-use opportunities include electricity production, temperature control, and transportation fuel production. In each of these cases, biogas (or biomethane) can supplement or directly replace the use of natural gas. Biomethane can also be injected into utility pipelines if quality standards are met. At this time, there is not industry consensus on the best use of biomethane.

Generally, facilities such as dairies, landfills, and wastewater treatment plants produce biogas as a by-product of normal operation. In most cases, the potential for methane production is limited by immutable factors, such as the “waste-in-place” at a landfill or volumetric flow of water into a wastewater treatment plant. In some cases, production can be increased if there are opportunities to process additional biomass feedstocks within normal operations. Examples include dairy digesters accepting food waste and wastewater treatment plants codigesting fats, oils, and grease.

Arguably, one of the greatest benefits of using biomethane is the reduction of anthropogenic methane emissions. Manure management, landfills, and wastewater treatment are three of the largest anthropogenic methane-producing sources in California.

## Landfill Waste Disposal

There are two distinct methods for collecting methane that would reduce the overall emissions of landfill waste disposal: the diversion of organics from landfill disposal and collection of landfill gas at existing landfills.

### Diverting Organic Solid Waste

Diversion of organic waste from landfills represents opportunities for methane collection and avoidance of anthropogenic methane emissions. In 2012, methane emissions from landfills were more than 8 million metric tons of carbon dioxide (MMTCO<sub>2e</sub>).<sup>148 149</sup> Although most operating landfills are required to install gas collection systems, these systems cannot capture all of the gas produced, and collection efficiency is a function of time, decay rate, moisture content, and management practices. During the first 10 years of gas collection in a landfill, the calculated gas collection efficiency can range from 25 to 75 percent of gas production.<sup>150</sup>

Assembly Bill 341 (Chesbro, Chapter 476, Statutes of 2011) requires that at least 75 percent of all solid waste generated in California be source reduced, recycled, or composted by 2020.<sup>151</sup> California Department of Resources, Recycling, and Recovery (CalRecycle) estimates that diverting 75 percent of compostable materials to compost and anaerobic digestion can reduce landfill methane emissions by 4.5 to 5.6 MMTCO<sub>2e</sub> per year and reduce the annual landfill disposal by 7.5 million tons annually.<sup>152</sup> Its analysis assumes that half (3.75 million tons) of the material will be available for energy production, while the remaining material will be composted. In some applications, biomass sent to anaerobic digesters could reduce

---

148 ARB, 2000 – 2012 Greenhouse Gas Inventory. <http://www.arb.ca.gov/cc/inventory/data/data.htm>.

149 Calculation based upon the Intergovernmental Panel on Climate Change Fourth Assessment Report's Global Warming Potentials, Chapter 3, which accounts for methane collected by landfill gas collection systems. 2006 IPCC Guidelines for National Greenhouse Gas Inventories Volume 5, Chapter 3: Solid Waste Disposal. <http://www.ipcc-nggip.iges.or.jp/public/2006gl/vol5.html>.

150 Morton A. Barlaz, Jeff P. Chanton & Roger B. Green, (2009). "Controls on Landfill Gas Collection Efficiency: Instantaneous and Lifetime Performance." *Journal of the Air & Waste Management Association*, pages 1399-1404.

151 See [http://www.leginfo.ca.gov/pub/11-12/bill/asm/ab\\_0301-0350/ab\\_341\\_bill\\_20111006\\_chaptered.html](http://www.leginfo.ca.gov/pub/11-12/bill/asm/ab_0301-0350/ab_341_bill_20111006_chaptered.html).

152 California Department of Resources Recycling and Recovery, AB 32 Scoping Plan Technical Paper *Composting and Anaerobic Digestion*, 2013. Page 5, Table 2. <http://www.calrecycle.ca.gov/Actions/Documents/77/20132013/935/Composting%20and%20Anaerobic%20Digestion%20FINAL.pdf>.

methane emissions by an estimated 2 MMTCO<sub>2</sub>e per year and could produce more than 8 billion standard cubic feet (Bcf) of biomethane annually.<sup>153</sup>

### Collection of Landfill Gas

Assembly Bill 341 has established the goal of 75 percent reduction in landfilled waste through recycling, composting, and other waste reduction efforts by 2020. The remaining 25 percent of collected waste is expected to become landfilled. Reducing the amount of landfill waste by 75 percent will decrease or eliminate the potential atmospheric emissions from those wastes. However, the remaining 25 percent of collected and landfilled waste, as well as existing waste-in-place, will result in atmospheric methane emissions from those wastes.

The biomass decay rate in landfills is relatively inefficient compared to controlled processes such as anaerobic digestion, requiring decades of operation and maintenance of gas collection systems after landfills are closed. According to the latest waste characterization study from the CalRecycle, organic material (biomass) comprises more than 60 percent of solid waste disposed in landfills.<sup>154</sup> Nearly half of this material, or 30 percent of all solid waste, is compostable; that is, it is a suitable feedstock for anaerobic digestion. More than 10 million tons of compostable material is disposed in landfills each year.<sup>155</sup> The California biomass collaborative estimates that diverting 5.8 million tons per year of food, leaves, and grass to anaerobic digester systems can produce 13 Bcf of biomethane per year.<sup>156</sup>

---

153 This is a staff estimate assuming 25 percent volatile solids, methane production of about 5 standard cubic feet per pound of organic solid waste, and 50 percent methane production efficiency. Actual production will depend several real-world factors, such as technology, feedstock type, and so forth.

154 CalRecycle California 2008 Statewide Waste Characterization Study, November, 2009, Table ES-3 (paper, lumber, organics). <http://www.calrecycle.ca.gov/Publications/Detail.aspx?PublicationID=1346>.

155 California Department of Resources Recycling and Recovery, *Composting and Anaerobic Digestion*, September, 2013. Page 2. <http://www.calrecycle.ca.gov/Actions/Documents/77/20132013/935/Composting%20and%20Anaerobic%20Digestion%20FINAL.pdf>.

156 California Biomass Collaborative, University of California, Davis. *An Assessment of Biomass Resources in California, 2013 – Draft*. Contractor Report to the California Energy Commission. PIER Contract 500-11-020, Table 3.2.4.1. [http://biomass.ucdavis.edu/files/2015/04/CA\\_Biomass\\_Resource\\_2013Data\\_CBC\\_Task3\\_DRAFT.pdf](http://biomass.ucdavis.edu/files/2015/04/CA_Biomass_Resource_2013Data_CBC_Task3_DRAFT.pdf).



## Manure Management

Manure management represents the second largest source of methane emissions in California, accounting for more than 10.6 MMTCO<sub>2</sub>e per year. Manure management at dairies account for more than 10.2 MMTCO<sub>2</sub>e per year.<sup>157</sup> Dairies generate significant amounts of methane, primarily from manure storage lagoons. In certain application, these emissions can be collected using existing anaerobic digester technologies to enclose lagoons or by replacing lagoons with enclosed tanks.<sup>158</sup>

The California Biomass Collaborative estimates that dairies generate 6 million dry tons of manure each year and that this manure, combined with other cattle manure, has the technical maximum potential to produce 17 Bcf (33 Bcf gross) of biomethane per year.<sup>159,160</sup> In certain applications, anaerobic digestion of dairy manure can provide non-energy benefits such as improving nutrient management, reducing dairy odors, and possibly improving groundwater quality. The process can also be designed to produce solids that are rich in ammonia and useful as a stable fertilizer or fiber for animal bedding.<sup>161</sup>

## Wastewater Treatment

As of 2013, California's wastewater treatment facilities account for 1.65 MMTCO<sub>2</sub>e of methane emissions per year. According to data collected by the California Association of Sanitation Agencies, there are 242 active water, wastewater, and sewage treatment plants in California with a combined flow of more than 3,000 million gallons per day. There are nearly 140 wastewater treatment plants with average daily flow rates above 1 million

---

157 California's Greenhouse Gas Inventory by Intergovernment Panel on Climate Change Category (filter for methane emissions from manure management).

158 ARB, *First Update to the Climate Change Scoping Plan. Appendix C - Focus Group Working Papers Agriculture Working Paper*. May 2014, page 9.  
[http://www.arb.ca.gov/cc/scopingplan/2013\\_update/agriculture.pdf](http://www.arb.ca.gov/cc/scopingplan/2013_update/agriculture.pdf).

159 California Biomass Collaborative, University of California, Davis, *An Assessment of Biomass Resources in California, 2013 – Draft*. Table 2.1.5.5.  
[http://biomass.ucdavis.edu/files/2015/04/CA\\_Biomass\\_Resource\\_2013Data\\_CBC\\_Task3\\_DRAFT.pdf](http://biomass.ucdavis.edu/files/2015/04/CA_Biomass_Resource_2013Data_CBC_Task3_DRAFT.pdf).

160 California Biomass Collaborative, University of California, Davis. *An Assessment of Biomass Resources in California, 2013 – Draft*. Contractor Report to the California Energy Commission. PIER Contract 500-11-020. Staff calculation using Table 3.2.3.1 and Table 2.5.2.  
[http://biomass.ucdavis.edu/files/2015/04/CA\\_Biomass\\_Resource\\_2013Data\\_CBC\\_Task3\\_DRAFT.pdf](http://biomass.ucdavis.edu/files/2015/04/CA_Biomass_Resource_2013Data_CBC_Task3_DRAFT.pdf).

161 ARB, *First Update to the Climate Change Scoping Plan. Appendix C - Focus Group Working Papers Agriculture Working Paper*. May 2014, pages 9-10.  
[http://www.arb.ca.gov/cc/scopingplan/2013\\_update/agriculture.pdf](http://www.arb.ca.gov/cc/scopingplan/2013_update/agriculture.pdf).



gallons per day and using anaerobic digesters in their treatment process with an combined flow rate of 2,800 million gallons per day.<sup>162,163</sup> These facilities are capable of producing about 7 Bcf of methane per year.<sup>164</sup> Electricity generated using biogas from wastewater treatment used 3.8 million MMBtu of biogas, or 4 Bcf of biomethane, in 2013.<sup>165</sup> Thus, the net available resource is 3 Bcf of methane per year.

## Other Feedstock Opportunities

Other waste feedstock opportunities do exist to produce biomethane through anaerobic conversion of organic waste, such as cattle manure, and thermochemical conversion of lignocellulosic organic wastes, such as wood waste. More research is needed to develop technologies and feedstock collection systems to make them a viable option for California. These opportunities include thermochemical conversion under different temperatures, pressures, and using various thermal media—such a gasification, hydro-plasma gasification, plasma-arc gasification, pyrolysis, and so forth. Syngas, or other product gases from these processes, are rich in hydrogen, hydrocarbons, and/or carbon oxides. Chemical reformation can be applied to produce methane or other hydrocarbons. Chemical reformation, while possible, requires additional fuel processing, equipment, and on-site energy use.

The aforementioned factors, however, increase the overall production cost of biomethane from these feedstocks. Therefore, generation projects using biomethane generated from these feedstocks are limited to research and demonstration serving on-site energy uses. These projects typically experience similar interconnection challenges as combined heat and power projects as many are not eligible for incentive programs. Further research should be conducted to quantify the long-term benefits of enabling biomethane production from these feedstocks, and to determine whether incentive programs should be considered to enable these technologies.

---

162 In general, it is assumed that flow rates below 1 million gallons per day would not lead to biogas yields high enough to make an energy project economically feasible.

163 California Biomass Collaborative, California Biomass Facilities, May 2013.  
<http://biomass.ucdavis.edu/tools/california-biomass-facilities-reporting-system/>.

164 Assuming 100 gallons of wastewater can produce 1.15 CF of biogas (65 percent methane content, 90 percent recoverable). California Biomass Collaborative, University of California, Davis. *An Assessment of Biomass Resources in California, 2013 – Draft*. Contractor Report to the California Energy Commission. PIER Contract 500-11-020, page 43.  
[http://biomass.ucdavis.edu/files/2015/04/CA\\_Biomass\\_Resource\\_2013Data\\_CBC\\_Task3\\_DRAFT.pdf](http://biomass.ucdavis.edu/files/2015/04/CA_Biomass_Resource_2013Data_CBC_Task3_DRAFT.pdf).

165 QFER CEC-1304 Power Plant Owner Reporting Database. Data accessed 11/25/2014.  
[http://energyalmanac.ca.gov/electricity/web\\_qfer/source\\_files](http://energyalmanac.ca.gov/electricity/web_qfer/source_files).

## Opportunities for Biomethane Use in California

Biomethane can be used on-site to offset conventional natural gas or propane use, generate electricity, and/or fuel vehicles. Biomethane can also be transported offsite and used as a direct replacement for natural gas in many applications. Capturing and using biomethane from feedstock and waste sources are an additional greenhouse gas reduction strategy because it creates value and opportunity for a natural by-product of these processes.

Assembly Bill 1900 (Gatto, Chapter 602, Statutes of 2012) requires the CPUC to adopt pipeline access rules to ensure gas corporations provide nondiscriminatory open access to the pipeline system for biomethane, regardless of the type or source of the biogas. The issue being that biogas typically contains levels of contaminants or constituents such as ammonia, biologicals, hydrogen, mercury, and siloxanes that exceed allowable levels for health and safety. A CPUC rulemaking proceeding, R.13-02-008, was opened on February 13, 2013, to implement the tasks in AB 1900. On January 16, 2014, the CPUC issued Decision 14-01-034 adopting concentration standards for the 17 Constituents of Concern and the monitoring, testing, reporting, and recordkeeping protocols for biomethane to be injected into the gas utilities' pipelines.<sup>166</sup>

On April 9, 2014, the second phase of this proceeding was opened to consider who should bear the costs of meeting the standards and requirements that the CPUC adopted in D.14-01-034.<sup>167</sup>

On June 11, 2015, the CPUC issued Decision 15-06-029 adopting a monetary incentive program to encourage the in-state production and distribution of biomethane. This incentive provides 50 percent of qualified interconnection costs up to \$1.5 million for biomethane projects that successfully interconnect with utilities' pipeline system and remain in operation for at least 30 days.<sup>168</sup>

## Challenges in California

### Regulatory Issues

A common concern that many project developers, utilities, and gas providers have cited is the effect of regulatory uncertainty and the effect of regulation changes on long-term contracts. Uncertainty creates development risk, which increases debt-financing costs. This

---

<sup>166</sup> See <http://docs.cpuc.ca.gov/PublishedDocs/Published/G000/M086/K466/86466318.PDF>.

<sup>167</sup> See <http://docs.cpuc.ca.gov/PublishedDocs/Efile/G000/M089/K642/89642428.PDF>.

<sup>168</sup> CPUC Decision 15-06-029 from Rulemaking 13-02-008, dated June 11, 2015.

uncertainty can jeopardize the viability of a project. Recent changes in the regulation of biomethane pipeline injection will need to be tested by real development and demonstration of upgrading equipment that can produce biomethane gas of consistent quality before this uncertainty can be overcome.

## Costs

A key challenge to biomethane distribution is the location of feedstock. In most cases, the highest concentrations of biomass feedstock are generally not located near natural gas pipelines. For locations that do not have feasible natural gas pipeline access, the gas must be used for onsite generation or for transportation biofuels. Feedstock for biomethane production is generally in rural regions. Building the infrastructure necessary to access remote biomethane sources will be cost-prohibitive, as developers are required to pay for pipeline extensions and upgrades.

Some biomass-rich locations are relatively close to population centers and, therefore, more likely to have better access to utility pipelines, but utility pipeline interconnection can still be costly. According to a recent CPUC report, interconnection costs can range from \$858,000 to \$2.6 million and depend on specifications unique to each project. Lengthy interconnection processes can further increase costs for project developers.<sup>169</sup>

Excess costs are not easily absorbed because bioenergy projects are limited in size by the resources available. Generally, the production of biogas is a by-product of other processes, such as waste disposal. This limits the potential for methane production by unchangeable factors, such as the volume of a landfill or wastewater treatment plant. Increased production can be possible if the plant can process alternative feedstock within normal operation. Examples can include dairy digesters accepting food waste and wastewater treatment plants codigesting fats, oils, and grease. Compared to natural gas, however, these projects will be relatively small and will have difficulty absorbing infrastructure capital costs.

Biomethane can be used as a direct replacement for natural gas in many applications. Because the heating value of biomethane is generally lower than fossil natural gas, blending with propane may be required to achieve heating values of greater than 990 British thermal unit (Btu) per standard cubic foot. Natural gas prices have been much lower than the production cost of biomethane. For example, the Point Loma Wastewater Plant produces biomethane at roughly \$8.50 per MMBtu compared to an average cost of \$4.00 per MMBtu

---

169 CPUC: *Small-Scale Bioenergy Resource Potential, Costs, and Feed-in-Tariff Implementation Assessment*, April 2013. [http://www.cpuc.ca.gov/NR/rdonlyres/9ABE17A5-3633-4562-A6DA-A090EB3F6D07/0/SmallScaleBioenergy\\_DRAFT\\_04092013.pdf](http://www.cpuc.ca.gov/NR/rdonlyres/9ABE17A5-3633-4562-A6DA-A090EB3F6D07/0/SmallScaleBioenergy_DRAFT_04092013.pdf).

for natural gas.<sup>170</sup> As a result, biomethane production is more expensive than natural gas extraction.

### Gaps in Knowledge and Research

Given that biomethane is feedstock-restricted, more research is needed to understand the highest environmental and societal value applications for renewable natural gas, and how this value may be affected over time by regulatory, environmental, economic, and other conditions. This understanding will inform effective strategies and policies.

Another research area to explore is *power-to-gas* (P2G) for utility-scale storage applications. P2G produces hydrogen from electrical energy by electrolysis and is used as a storage medium directly, or can be further converted to methane. P2G is being used commercially in Europe with more projects underway.

---

170 Transcript of Staff Workshop Challenges to Procuring Biomethane in California, May 31, 2013, comments by Frank Mazanec (BioFuels Energy, LLC), page 108.

[http://www.energy.ca.gov/2013\\_energypolicy/documents/2013-05-31\\_workshop/2013-05-31\\_transcript.pdf](http://www.energy.ca.gov/2013_energypolicy/documents/2013-05-31_workshop/2013-05-31_transcript.pdf).

# **CHAPTER 9: Greenhouse Gas Emissions and the Natural Gas System**

## **Introduction**

Natural gas is a significant component of the California energy system and is both a potential fuel to reduce greenhouse gas (GHG) emissions and a source of GHG emissions itself.

The primary focus of this chapter is on methane emissions associated with the natural gas system. This chapter starts with a discussion of the importance of methane emissions, a description of the natural gas system, and the associated sources of GHG emissions from that system. It then discusses the methods used to quantify methane emissions, estimates of methane from emission inventories, and findings from recent studies on life-cycle methane emissions.<sup>171</sup> The chapter identifies the uncertainties and gaps in estimating methane emissions and some areas where research is needed to guide California policy makers in determining the future role of natural gas in the state. Finally, it outlines what state and federal agencies, along with natural gas utilities and stakeholders, are doing to address methane emissions.

## **Natural Gas System Emissions**

The primary source of carbon dioxide (CO<sub>2</sub>) emissions is combustion of natural gas in power plants, appliances, industrial processes, and vehicles. Natural gas has the potential to reduce CO<sub>2</sub> emissions by shifting away from higher GHG-emitting fuels like coal (in power plants) and gasoline or diesel (in vehicles). California has developed policy to reduce emissions of CO<sub>2</sub>, which is the most abundant greenhouse gas and drives long-term climate change.

To the extent that unburned methane escapes or leaks anywhere along the natural gas supply chain, however, the GHG impact of using natural gas is higher compared to the

---

<sup>171</sup> Although many studies on methane emissions are characterized as life-cycle assessments the majority tend to focus on particular components of the natural gas system, such as production or processing, or on particular uses of natural gas, such as in power plants or as a transportation fuel, without providing the coherent and comprehensive view of life-cycle emissions that is needed.

GHG impacts of combustion. The fundamental question regarding the climate benefits of using natural gas is how much methane is escaping from the natural gas system. Estimates of methane emissions to date are highly variable. Some studies estimate methane emission levels that are high enough to offset the benefits of burning natural gas in place of more carbon-intensive fuels. For this reason, it is critical that California policy makers have a clear understanding, as well as an accurate and comprehensive assessment, of the GHG emissions associated with the natural gas system to develop effective GHG reduction strategies.

## Methane Emissions and the Natural Gas System

Natural gas is primarily composed of methane and heavier alkanes (chains of multiple carbon and hydrogen atoms), with methane comprising about 90 percent or more of the total composition. Methane, a highly potent, short-lived GHG, is the second most prevalent GHG emitted in California, with CO<sub>2</sub> being the most dominant. The lifetime of methane in the atmosphere is much shorter than CO<sub>2</sub>; however, it is more efficient at trapping radiation than CO<sub>2</sub>. Atmospheric methane breaks down over time, so the global warming potential is highest when first emitted then declines.<sup>172</sup> As a result, 1 ton of methane is equal to 72 tons of CO<sub>2</sub> over a 20-year time frame and 25 tons over a 100-year time frame.<sup>173</sup> The ARB estimates that methane makes up about 17 percent of GHG emissions in the state on a 20-year basis and 8 percent on a 100-year basis, using the Intergovernmental Panel on Climate Change assessment on global warming potential, as shown in **Figure 5**.

---

172 LaCont, R., *Methane Emissions in the Natural Gas Life Cycle*, April 2015, page 3. <http://westernenergyboard.org/2015/05/final-report-released-by-mj-bradley/>.

173 Forster, P. (2007). "Changes in Atmospheric Constituents and in Radiative Forcing." *In: Climate Change 2007: The Physical Science Basis. Contribution of Working Group I to the Fourth Assessment Report of the Intergovernmental Panel on Climate Change* (Solomon, S., D. Qin, M. Manning, Z. Chen, M. Marquis, K.B. Averyt, M. Tignor and H.L. Miller [eds.]). Cambridge University Press, Cambridge, United Kingdom and New York, NY, USA. Page 212. <https://www.ipcc-wg1.unibe.ch/publications/wg1-ar4/ar4-wg1-chapter2.pdf>

**Figure 5: California’s 2013 Greenhouse Gas Inventory Using 100-Year (Left Pie Chart) and 20-Year (Right Pie Chart) Global Warming Potential Values**

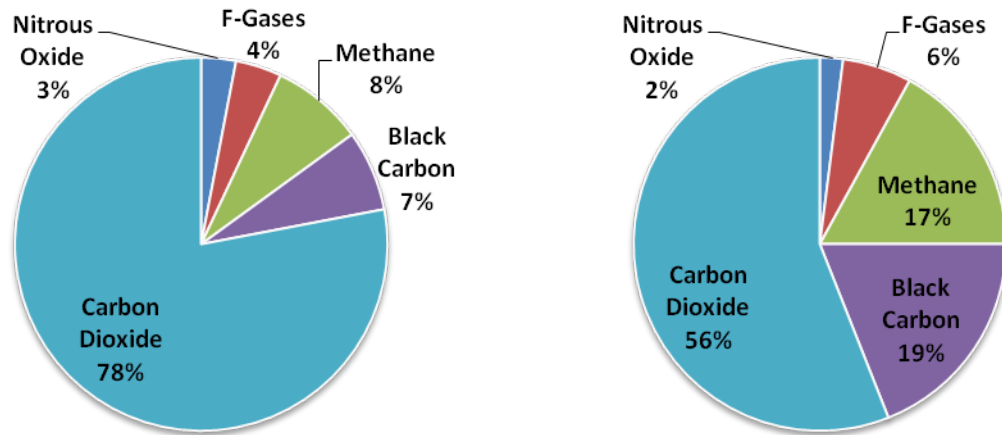

Source: ARB, Short-Lived Climate Pollutant Reduction Strategy: Concept Paper, May, 2015, p. 11. <http://www.arb.ca.gov/cc/shortlived/shortlived.htm>.

In-state estimates of methane emissions from the oil and gas system, including pipelines, account for about 13 percent of the total methane emitted in the state. Methane is also produced biologically in ruminant animals (such as dairy cattle), landfills and waste handling, from agricultural production, and other sources. Methane emissions from the major sources are difficult to measure due to the number of sources and areawide nature of many sources, which often include complex biological processes, as shown in **Figure 6**.

**Figure 6: California 2013 Methane Emission Sources**

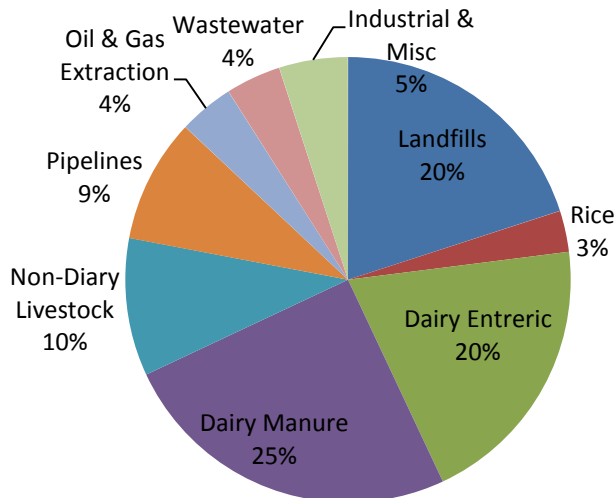

Source: ARB, *Draft Short-Lived Climate Pollutant Reduction Strategy*: September, 2015, p. 26 See <http://www.arb.ca.gov/cc/shortlived/2015draft.pdf.htm>.

ARB 2015 Edition GHG Inventory: <http://www.arb.ca.gov/cc/inventory/data/data.htm>.

Methane emissions come from both intentional and unintentional releases of natural gas. Unintentional releases of methane, or fugitive emissions, can come from multiple sources and phases of the natural gas system, such as from leaking pipelines, abandoned wells, or inefficient combustion. Intentional releases are purposeful and known emissions that occur in the normal operations of the natural gas system. For example, safety dictates the venting of natural gas when pressures reach levels where there could be a safety risk. Estimates of methane emissions from the natural gas system need to include both intentional releases and fugitive emissions across all phases of the natural gas system.

## The Natural Gas System

The natural gas system includes several components or phases from production at wells through processing, transportation, storage, and distribution to final end user, as shown in **Figure 7**. Natural gas is produced from underground reservoirs by two types of wells: those that produce only natural gas, commonly referred to as *dry wells*, and wells that produce gas along with crude oil, commonly referred to as *associated gas*.



**Figure 7: Schematic Representation of the Natural Gas System**

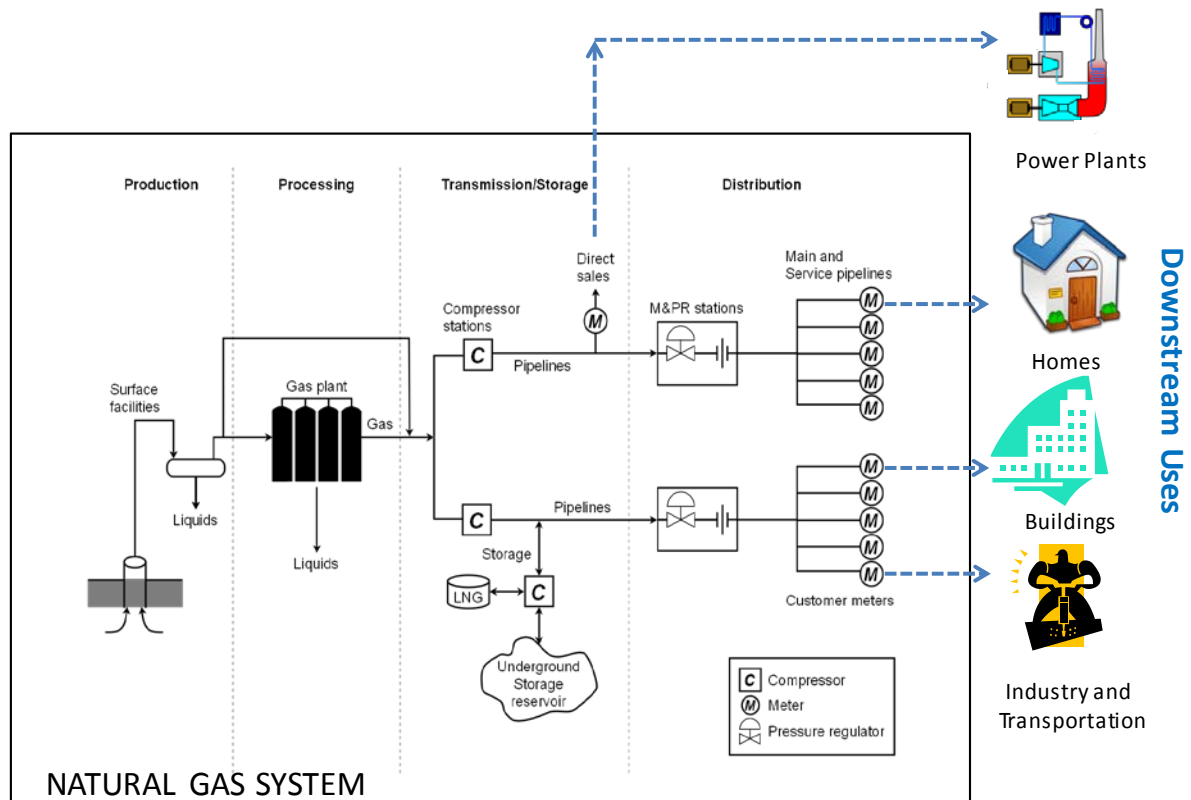

Source: Modified from U.S. EPA Presentation<sup>174</sup>.

Natural gas produced from wells is collected in gathering systems and then processed to remove impurities and segregate the other alkane by-products like propane or butane. The natural gas is then transported through a transmission pipeline system where compressors move gas through the pipe. Some, but not all, transmission pipeline systems include underground storage where there is favorable geology nearby, as shown in **Figure 7**.

The natural gas is delivered via a distribution system, where different lines or sections operate at various pressures controlled by regulating valves. In general, the closer the natural gas is to a customer, the smaller the pipe diameter and the lower the pressure. In California, underground storage is a major feature of the gas distribution system, allowing

174 See <http://epa.gov/climatechange/Downloads/ghgemissions/2013Workshop/ghgrp-draft-summary.pdf>.

gas utilities or large customers such as power plant owners to store gas during low-demand periods for withdrawal to supplement supplies during peak-demand periods.

From the distribution system, natural gas is then delivered to a customer's gas meter for use by residential, commercial, or industrial customers, and power plants. Once the natural gas is delivered to the customer meter, it is then used in appliances and equipment in homes, businesses, and industrial processes. These are shown as "downstream uses" in **Figure 7**.

## Methods for Quantifying Methane Emissions

Estimates of methane emissions are developed using bottom-up, top-down, and hybrid methods. Each of these methods has limitations, which can cause uncertainty and variance in methane emission estimates. The major uncertainties associated with both bottom-up and top-down studies are discussed in more detail in a later section.

The "bottom-up" method applies emission factors (for example, grams of methane emitted per mile of transmission line), which are typically averages based on measured emissions from a device or facility that is part of the gas system. These emission factors are then multiplied by activity factors for different components of the natural gas system (for example, miles of pipeline). Estimating emissions is then a straightforward summing up of emissions from all components of the natural gas system. Both the ARB and U.S. EPA use bottom-up studies for their methane emission inventories.

One of the shortcomings of bottom-up studies is that emission factors involve key assumptions that may not be representative of the population being measured and extrapolated. For example, the samples may not accurately represent current technologies and practices. In addition, because measurements for use in developing emission factors are expensive, the sample sizes are typically small; as a result, the estimates provide less certainty than would those produced by a larger sample size.<sup>175</sup>

"Top-down" studies use measurements of methane and other compounds in the atmosphere to estimate emissions. For example, emissions can be estimated by taking measurements with a research airplane upstream and downstream of a potential source or basin, while accounting for information such as wind velocity and the enhanced concentration of methane downwind of the source.

It appears that one of the greatest challenges for top-down studies is attributing observed methane concentrations among multiple sources, including both anthropogenic and natural sources.<sup>176</sup> There are other challenges to using ambient measurements for statewide

---

175 Brandt, A.R. (2014). "Methane Leaks From North American Natural Gas Systems." *Science Magazine*, 343(6172) pages 733-735. <http://www.novim.org/images/pdf/ScienceMethane.02.14.14.pdf>.

176 Ibid., pages 733-735.

emissions. For example, LBNL researchers used an aircraft to measure methane emissions around refineries and a mobile platform for measuring around wells where the only potential sources of methane were those individual facilities.<sup>177</sup> This technique is robust for measuring a snapshot of emissions from the entire facility and is especially good for an area source like underground natural gas storage facility. However, for a more complex facility, measurement of emissions over a short period of a few days cannot be assumed to be representative of all facilities across the state on an annual basis.

Unless tracers, or fingerprint compounds, can be identified and measured, top-down studies do not reveal which of the many sources of methane can be attributed to the natural gas system.<sup>178</sup> Not all top-down studies, however, suffer from the problem of disentangling the emissions that are attributed to the natural gas system from other sources of methane. However, there are other challenges, such as the representativeness of the sample.

Regardless of the method employed, studies on methane emissions rely on numerous assumptions to estimate vented and fugitive emissions based on limited test data.<sup>179</sup> Complicating all three of the methods is the presence of “superemitters” that emit methane at significantly greater rates and volumes than other similar types of emitters. The presence or absence of superemitters means that the odds of missing that superemitter when selecting a sample design is higher. If only a few sources are actually emitting large amounts and they are missed when selecting a random sample, the emissions will be underestimated. Several studies, in fact, suggest that emissions are dominated by a small fraction of these superemitters at well sites, gas-processing plants, coproduced liquids storage, compressors on transmission pipelines, and distribution systems.<sup>180</sup>

## Methane Emission Estimates From State and Federal Inventories

U.S. EPA has seen wide variation in methane estimates presented in its GHG inventories over the last few years. **Figure 8** shows U.S. EPA emission estimates for the same year (2008) across five consecutive inventories (2010 to 2014), illustrating the effect that method changes

---

177 Fischer, Marc L., “Preliminary Measurement From the Natural Gas System in California: From Well to Downstream of the Meters,” Presentation from June 1, 2015, Energy Commission Workshop.

178 Allen, D.T. (2014). “Methane Emissions From Natural Gas Production and Use: Reconciling Bottom-Up and Top-Down Measurements.” *Current Opinion in Chemical Engineering*, 5(0):78-83. <http://www.sciencedirect.com/science/article/pii/S2211339814000525>.

179 LaCont, R., *Methane Emissions in the Natural Gas Life Cycle*. April 2015, page 6. <http://westernenergyboard.org/2015/05/final-report-released-by-mj-bradley/>.

180 Brandt, A.R. (2014). “Methane Leaks From North American Natural Gas Systems.” *Science Magazine*, 343(6172) pages 733-735. <http://www.novim.org/images/pdf/ScienceMethane.02.14.14.pdf>.

and new information can have on emissions estimates from a single year.<sup>181</sup> The largest changes in the U.S. EPA estimates are primarily associated with natural gas production. After the large jump in methane emissions related to the change in method for estimating emissions from production in the 2011 U.S. EPA GHG Inventory, a concerted effort by U.S. EPA, the natural gas industry, government and research organizations, environmental groups, and other stakeholders led to substantial changes in how emission estimates from certain activities were developed.

**Figure 8: 2008 Natural Gas System Methane Emissions for Five Consecutive Inventories**

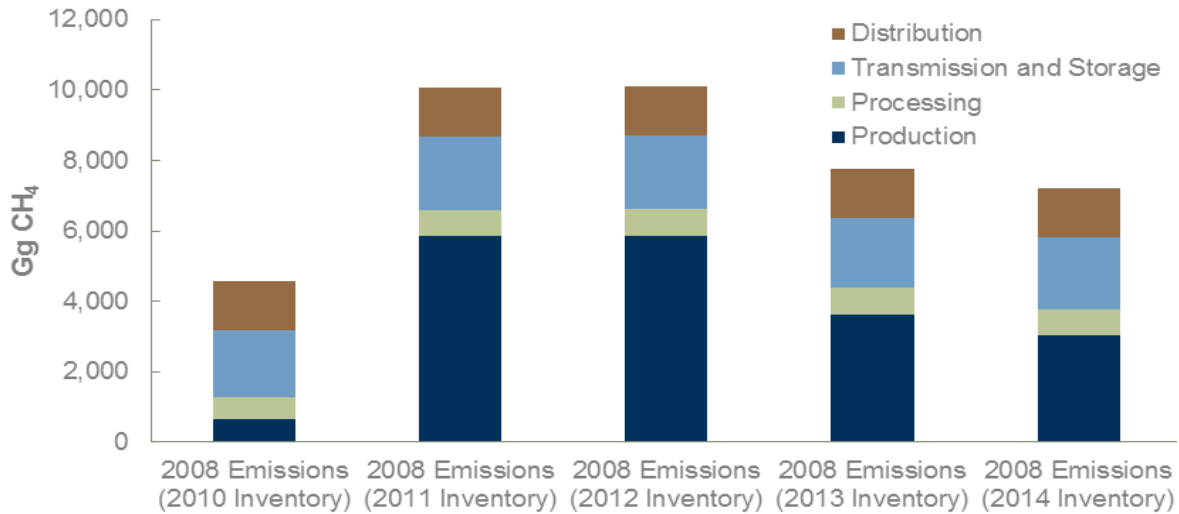

Source: M.J. Bradley & Associates, *Methane Emissions in the Natural Gas Life-Cycle*, April 2015.

The U.S. EPA has undertaken updates of its methods to improve the accuracy of methane emissions estimates, especially for production of natural gas, and has made significant changes in approach over the last several years.<sup>182</sup>

**Figure 9** shows the U.S. EPA inventory of total methane emissions associated with the natural gas system from 2008 to 2012, with methane emissions decreasing over the last few years, with a slight uptick in 2013.

ARB estimates that methane emissions in California have increased slightly, only about 5 percent, between 2009 and 2013.<sup>183</sup>

181 LaCont, R., *Draft Report of Methane Emissions in the Natural Gas Life Cycle*, October 2014, page 8. <http://westernenergyboard.org/?s=Draft+Report+on+Methane+Emissions&submit.x=1&submit.y=12>.

182 Ibid., pages.6-9.

183 ARB's emission inventory includes methane associated with in-state oil and gas production and natural gas pipeline fugitive emissions. ARB, 2015 Edition of GHG Emission Inventory: 2000 – 2013.

**Figure 9: U.S. Methane Emissions From the U.S. Natural Gas System**

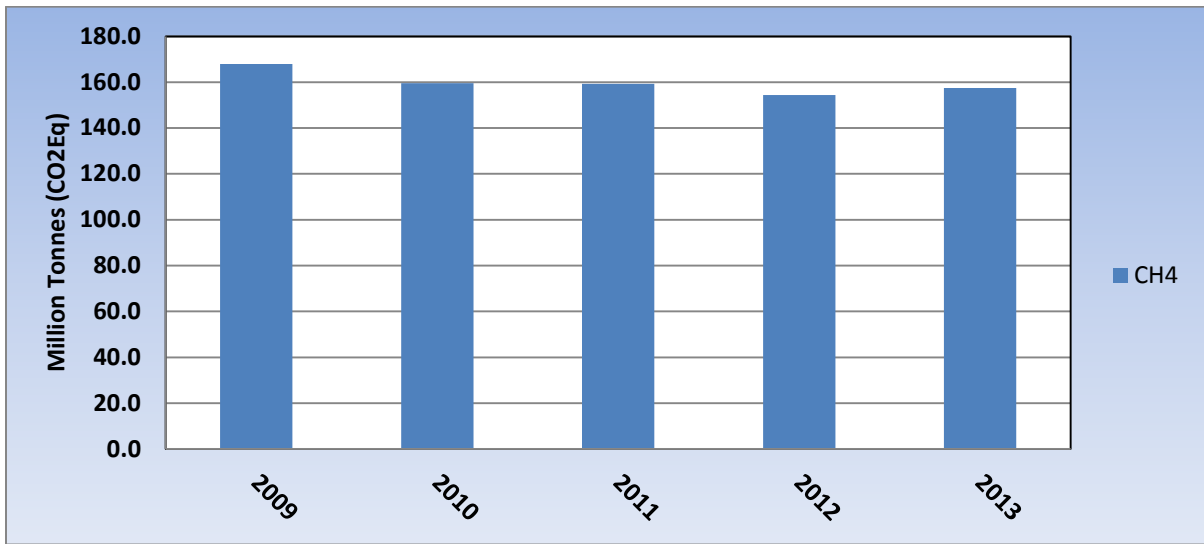

Source: U.S. EPA, *U.S. Greenhouse Gas Inventory Report: 1990-2013*.

---

<http://www.arb.ca.gov/cc/inventory/data/data.htm> and  
[http://www.arb.ca.gov/cc/inventory/data/tables/ghg\\_inventory\\_by\\_sector\\_00-13\\_20150424.xlsx](http://www.arb.ca.gov/cc/inventory/data/tables/ghg_inventory_by_sector_00-13_20150424.xlsx).

## Findings From Recent Assessments of Methane Emissions

Over the last few years, several studies have been conducted to estimate the climate impacts of switching to natural gas from high-emitting fossil fuels such as coal for electricity generation and gasoline and diesel for transportation. For electricity production, it is fairly well understood that on a unit-by-unit basis, natural gas produces lower levels of CO<sub>2</sub> emissions than coal when combusted, due to the lower carbon content and because it burns relatively cleanly. Estimating methane emissions associated with natural gas electricity production, as well as for transportation, is a fairly recent and still emerging area of study. As a result, there is a significant controversy over the amount of methane that is emitted from the natural gas system and what this means for climate change reduction policies.

Recent work estimating methane emissions from California's natural gas system suggested emissions were less than 1 percent of throughput.<sup>184</sup> Some peer-reviewed studies suggest, however, that these emissions may be underestimated, as discussed below. There is a large degree of uncertainty associated with methane emission estimates because the studies may use different methods, data, and device counts, as well as difference in the components of the natural gas system that are either included or excluded. This makes direct comparison of the various studies difficult. When these differences are combined with the other challenges discussed above, such as the presence of superemitters and problems with attribution, there is variation among the studies that have attempted to quantify methane emissions from natural gas. This is an area of ongoing research.

An important assessment of methane emissions published in the *Proceedings of the National Academy of Science* in 2012 and updated by the Environmental Defense Fund in 2014 concluded that to realize an immediate net climate benefit from the use of natural gas, the percentage of methane emitted from the natural gas system should be lower than 2.7 percent for coal-burning power plants, 1.4 percent for gasoline cars, and 0.8 percent for heavy-duty vehicles.<sup>185</sup> Also in 2012, another prominent study was conducted that compared a number of academic assessments of national upstream methane leakage,

---

184 ARB, Transportation Fuels: "ARB Technology Assessment, 2014." Presentation at the ARB Technology Assessment Workshop. <http://www.arb.ca.gov/msprog/tech/presentation/fuels.pdf>.

185 O'Connor, T., Environmental Defense Fund. "Panel 2: Natural Gas Market Assessment and Methane Leakage," June 23, 2014, California Energy Commission Workshop, Slide 3. [http://www.energy.ca.gov/2014\\_energy\\_policy/documents/2014-06-23\\_workshop/presentations/13\\_O\\_Connor\\_EDF\\_IEPR-Presentation.pdf](http://www.energy.ca.gov/2014_energy_policy/documents/2014-06-23_workshop/presentations/13_O_Connor_EDF_IEPR-Presentation.pdf). EDF updated these estimates to account for new data. The original source: Alvarez, R. (April 24, 2014). "Greater Focus Needed on Methane Leakage From Natural Gas Infrastructure." *Proceedings of the National Academy of Science*, Vol. 109, no.17, pages 6435-6440. <http://www.pnas.org/content/109/17/6435>.

excluding the distribution system, ranging from 0.7 – 2.7 percent of withdrawal for conventional natural gas, to 1.0 to 4.5 percent for shale gas.<sup>186</sup>

A 2014 meta-analysis compared the methane emissions estimates of 20 recent academic studies and concluded that the national normalized leakage rate for methane ranged from 1.87 to 2.62 and were 1.25 to 1.75 times the estimates in the U.S. EPA GHG inventory.<sup>187</sup> The study concluded that official inventories consistently underestimate actual emissions, with the natural gas and oil sectors as important contributors. The study notes, however, that excess leakage above the U.S. EPA inventory was not attributed entirely to natural gas sources and infrastructure. Some methane leakage from other sources like landfills and livestock could be underestimated, and the leakage could include other sources not estimated, such as seepage and abandoned wells.<sup>188</sup> The study concluded that the very high leakage rates in some of the recent atmospheric studies are unlikely to be representative of typical natural gas system leakage rates and that hydraulic fracturing was unlikely to be a dominant contributor to total methane emissions.<sup>189</sup>

The 2014 meta-analysis study also notes that many independent experiments suggest that a small number of “superemitters” could be responsible for a large percentage of leakage. The presence of superemitters is noted in several studies. While it may prove difficult and possibly expensive to identify these superemitters, the 2014 study notes that these emitters present an opportunity for large methane mitigation benefits.

California imports around 95 percent of its natural gas from production areas outside the state. Several studies have attempted to quantify methane emissions associated with U.S. production areas. One study estimates methane emissions from the Haynesville production region in Texas on the order of 1 to 2.1 percent of the total natural gas production.<sup>190</sup> The same study estimates methane emission of 1.0 to 2.8 percent for the Fayetteville region in Arkansas and 0.18 to 0.41 percent for the Marcellus region in Pennsylvania. Another study

---

186 Weber, C. (2012) “Life Cycle Carbon Footprint of Shale Gas: Review of Evidence and Implications,” *Environmental Science & Implications*, (46) pages 5688-5695.

<http://pubs.acs.org/doi/abs/10.1021/es300375n>. Also, as presented by ARB, Transportation Fuels: ARB Technology Assessment Presented at the Technology Assessment Workshop, September 3, 2014, page 54. <http://www.arb.ca.gov/msprog/tech/presentation/fuels.pdf>.

187 Brandt, A.R. (2014). “Methane Leaks from North American Natural Gas Systems.” *Science Magazine*, 343(6172) pages 733-735. <http://www.novim.org/images/pdf/ScienceMethane.02.14.14.pdf>.

188 Ibid., pages 733-735.

189 Ibid., pages 733-735.

190 Peischl, J. (March 2015). “Quantifying Atmospheric Methane Emissions From the Haynesville, Fayetteville, and Northeastern Marcellus Shale Gas Production Regions.” *Journal of Geophysical Science Research*, Page 1. <http://onlinelibrary.wiley.com/doi/10.1002/2014JD022697/abstract>.



estimates leakage rates (in terms of energy content) of 10.1 for the Bakken production region in North Dakota and 9.1 percent for the Eagle Ford production area in South Texas.<sup>191</sup>

A series of studies in the Barnett Shale Region in Texas suggest that methane emissions numbers are as much as 50 percent higher than estimates from U.S. EPA's emission inventory.<sup>192</sup>

There are no similar reports for the San Juan Basin, but a study using satellite data suggests that this area may be a "hot spot" for methane emissions in the United States.<sup>193</sup> No information is available from the natural gas production region in Canada, but a related study seems to suggest that emissions may be higher than previously thought.<sup>194</sup> New top-down studies are underway to identify the main source of methane emissions in the San Juan region and other oil- and gas-producing basins.

Even if better estimates are developed for the different producing areas, estimates will also need to account for emissions from the pipelines that bring the natural gas to California, as well as gathering and processing plants. A recent study on methane emissions from the natural gas transmission and storage system in the United States suggests that methane emissions are significantly higher than estimated emissions in the U.S. EPA inventory.<sup>195</sup> The study notes that some of the difference can be attributed to inclusion of emission sources that are not covered by U.S. EPA reporting rules, updated emission factors, and superemitter emissions.

A recent study of methane emissions from natural gas gathering and processing suggests that estimated emissions from processing plants are significantly lower than U.S. EPA inventory estimates, while emission estimates for gathering are substantially higher than

---

191 Schneising, O. (2014). "Remote Sensing of Fugitive Methane Emissions From Oil and Gas Production in North American Tight Geologic Formations." *Earth's Future*, 2(10).  
<http://onlinelibrary.wiley.com/doi/10.1002/2014EF000265/full>.

192 Harriss, R. (2015). "Using Multi-Scale Measurements to Improve Methane Emission Estimates From Oil and Gas Operations in the Barnett Shale Region, Texas." *Environmental Science & Technology*.

193 Kort EA. (2014). Four Corners: The Largest U.S. Methane Anomaly Viewed From Space." *Geophysical Research Letters*, (19):6898-6903.  
<http://onlinelibrary.wiley.com/doi/10.1002/2014GL061503/abstract>.

194 Tyner DR. (2014). Emission Factors for Hydraulically Fractured Gas Wells Derived Using Well- and Battery-level Reported Data for Alberta, Canada. *Environmental Science & Technology*. 48(24) pages 14772-14781. <http://pubs.acs.org/doi/abs/10.1021/es502815b>.

195 Zimmerle, DI. (2015). "Methane Emissions From Natural Gas Transmission and Storage System in the United States." *Environmental Science & Technology*.



U.S. EPA inventory estimates.<sup>196</sup> Another recent study of natural gas gathering facilities and processing plants suggests that methane emissions measured at several gathering facilities were less than 1 percent of throughput, with a smaller number of gathering facilities less than 0.1 percent.<sup>197</sup> The same study suggests methane emissions of less than 1 percent of throughput for all processing plants that were measured.

A recent study of methane emissions from local gas distribution systems in the United States suggests that methane emissions are substantially less than U.S. EPA inventories, reflecting significant upgrades in metering and regulating stations, improvements in leak detection and maintenance, as well as differences in methods.<sup>198</sup>

## Uncertainties in Estimating Methane Emissions

Recent estimates of methane emissions from the natural gas system have varied due in part to the large population of sources throughout the natural gas system, differing measurements and estimation approaches, and the presence of superemitters.<sup>199</sup> Researchers note that reconciling differences between top-down and bottom-up measurements of methane emissions will be critical to fully understanding methane emissions from the natural gas supply chain and, as a result, recommend a combination of approaches for future studies. Several uncertainties inherent in these approaches will need to be addressed. These include:

- The need to be inclusive and comprehensive when establishing the boundaries of the natural gas system.
- Understanding and addressing problems with measurement and sample bias.
- The complexity in estimating emissions from oil and gas production.

After the reconciliation of the estimation methods and the reduction of uncertainties, improved recommendations for approaches to be used in future studies can be developed.

---

196 Marchese, AI (2015). "Methane Emissions From United States Natural Gas Gathering and Processing," *Environmental Science & Technology*, pages 10718–10727.

197 Ibid., pages 10718–10727.

198 Lamb, B.K. (2015). "Direct Measurements Show Decreasing Methane Emissions From Natural Gas Local Distribution Systems in the United States," *Environmental Science & Technology*.

199 Allen, D.T. (2014). "Methane Emissions From Natural Gas Production and Use: Reconciling Bottom-Up and Top-Down Measurements," *Current Opinion in Chemical Engineering*. Volume 5, pages 78-83. <http://www.sciencedirect.com/science/article/pii/S2211339814000525>.

## Setting Boundaries of the Natural Gas System

There are several issues to consider when estimating methane emissions related to the components that are included in the natural gas system. Leaving out emissions from certain aspects of the gas system can lead to uncertainties and gaps in quantifying them. Typically, the natural gas system has been characterized to include production, processing, transmission/storage, and distribution. Several additional elements related to natural gas have more recently been recognized as important to include in methane emissions estimates, and it has been suggested that the boundaries of the system should be more broadly established.

Potential emissions downstream of the meters in homes, buildings, and industrial facilities are traditionally excluded from the boundaries of the natural gas system but are an additional source of methane emissions that must be considered to produce full life-cycle emission estimates. For example, research underway by Lawrence Berkeley National Laboratory looking at methane emissions indicates that tankless water heaters may be a significant contributor of methane emissions behind the meter in homes.<sup>200</sup>

Since California imports the majority of its natural gas supplies from regions outside the state, it is important that these upstream methane emissions are included when assessing emissions. Quantifying methane emissions associated with oil and gas production has proven challenging and is an area with significant variance among studies and ongoing research.

Another emerging issue related to methane emissions from natural gas is the need to include infrastructure that is no longer in use but nonetheless may be emitting methane, such as abandoned wells. Researchers have concluded that abandoned oil and gas wells provide a potential pathway for methane leakage.<sup>201</sup> Abandoned wells within the state, as well as those located in regions from which California imports gas supplies, need to be considered. In California alone, the extensive history of oil development beginning in the 1930s and peaking in the mid-1980s has resulted in tens of thousands to hundreds of thousands of abandoned wells.

---

200 Presentation by Marc L. Fischer, LBNL, Preliminary measurements from the natural gas system in California: from well to downstream of the meters, June 1, 2015. See also Transcript of June 1, 2015 Commissioner Workshop on Fugitive Methane Emissions. Page 158.

<https://efiling.energy.ca.gov/Lists/DocketLog.aspx?docketnumber=15-IEPR-04>.

201 Bohlen, S., California Division of Oil, Gas and Geothermal Resources, *Fugitive Methane Emissions: Natural Gas in CA and the Role of Hydraulic Fracturing*, June 1, 2015.

<https://efiling.energy.ca.gov/Lists/DocketLog.aspx?docketnumber=15-IEPR-04>.

At this point, only preliminary results from limited measurements of methane emissions at abandoned wells in North American production basins show significant emissions levels.<sup>202</sup> For example, measurements of methane emissions taken at 19 abandoned wells in Pennsylvania were scaled, assuming they were representative of all abandoned wells in the state, to arrive at an estimate that abandoned wells constitute 4-7 percent of estimated total anthropogenic methane emissions in Pennsylvania.<sup>203</sup> The study notes that some wells were disproportionately high; three of the measured wells and flows rates were three orders of magnitude larger than median flows from the other wells. Other top-down research of North American so-called “tight” geologic formations using remote sensing suggests that emissions from oil and gas production are higher than estimates from bottom-up studies and inventories.<sup>204 205</sup>

One difficulty in assessing emissions from abandoned oil and gas wells is that the number of these wells in the United States is highly uncertain and is complicated by the fact that many of the abandoned wells are “lost” with no evidence of existence at the surface and/or via public records.<sup>206</sup> Because methane content and drilling and production practices vary across different production basins, little is known about methane emissions from the millions of abandoned wells in the United States. It is the subject of ongoing research, and more definitive studies on emissions from abandoned wells may be available over the next several years. The authors of this and other preliminary studies suggest that additional research is needed to accurately describe and include methane emissions in inventories.

## Problems With Measurement and Sample Bias

Differences in sampling methods create complications in achieving legitimate and comparable estimates of methane leakage. Because constant measurement of all emissions is

---

202 Kang, M. (2014). “Direct Measurement of Methane Emissions From Abandoned Oil and Gas Wells in Pennsylvania,” *Proceedings of the National Academy of Science*, 111(51) pages 18173-18177. <http://www.pnas.org/content/111/51/18173.abstract>.

203 Ibid., page 18173.

204 Weber, C. (2012). “Life Cycle Carbon Footprint of Shale Gas: Review of Evidence and Implications.” *Environmental Science & Implications*, 46, pages 5688-5695. <http://pubs.acs.org/doi/abs/10.1021/es300375n>.

205 Tight formations are those in which the pore spacing between molecules is very small; enhanced techniques often need to be used to produce gas from tight formations.

206 Kang, M. (2014). “Direct Measurement of Methane Emissions From Abandoned Oil and Gas Wells in Pennsylvania,” *Proceedings of the National Academy of Science*, 111(51) page 18176. <http://www.pnas.org/content/111/51/18173.abstract>.

resource-intensive, methods are needed to sample emissions and then use those samples as representative of the whole population of components or processes. Top-down and bottom-up methods use different types of sampling at different points in the natural gas supply chain, which leads to discrepancies between the results produced by the different methods.<sup>207</sup>

In bottom-up studies, there need to be sufficient sample sizes for the very different components in the natural gas system to develop representative emission factors. The goal of this approach is to measure emissions from a statistically representative sample of sources, so they can be extrapolated to large populations.<sup>208</sup> There is also the potential of sampling bias at self-selected facilities.<sup>209</sup> Researchers for one study point out that activity and device counts for bottom-up estimates "...are contradictory, incomplete, and of unknown representativeness."<sup>210</sup> The EPA's inspector general notes that many of U.S. EPA emission factors for the oil and natural gas production sector are of questionable quality because they are based on limited and/or low-quality data.<sup>211</sup> Much more data and research are needed to develop more accurate and representative estimates for the different sources.

As mentioned, it appears that total emissions are dominated by a small number of "superemitters," and it may be difficult and costly to identify them.<sup>212</sup> <sup>213</sup> Bottom-up inventories rely on testing done on a small sample of components that most likely do not capture a representative sample of superemitters. For example, in one study of natural gas infrastructure, 58 percent of emissions came from 0.06 percent of possible sources.<sup>214</sup> Since

---

207 Allen, D.T. (2014). "Methane Emissions From Natural Gas Production and Use: Reconciling Bottom-Up and Top-Down Measurements." *Current Opinion in Chemical Engineering*, 5(0) pages 78-83. <http://www.sciencedirect.com/science/article/pii/S2211339814000525>.

208 Ibid., pages 78-83.

209 Ibid., pages 78-83.

210 Brandt, A.R. (2014). "Methane Leaks From North American Natural Gas Systems," *Science Magazine*, 343(6172) pages 733-735. [http://nature.berkeley.edu/er100/readings/Brandt\\_2014.pdf](http://nature.berkeley.edu/er100/readings/Brandt_2014.pdf).

211 Office of the Inspector General, EPA, *EPA Needs to Improve Air Emission Data for the Oil and Natural Gas Production Sector*, 2013, page 15. <http://www.epa.gov/oig/reports/2013/20130220-13-P-0161.pdf>.

212 Brandt, A.R. (2014). "Methane Leaks From North American Natural Gas Systems," *Science Magazine*, 343(6172) pages 733-735. [http://nature.berkeley.edu/er100/readings/Brandt\\_2014.pdf](http://nature.berkeley.edu/er100/readings/Brandt_2014.pdf).

213 T Kuo, J., *Estimation of Methane Emissions From the California Natural Gas System*, California Energy Commissions, 2012, CEC-500-2014-072. <http://www.energy.ca.gov/2014publications/CEC-500-2014-072/CEC-500-2014-072.pdf>.

214 Brandt, A.R. (2014). "Methane Leaks From North American Natural Gas Systems," *Science Magazine*, 343(6172) pages 733-735. [http://nature.berkeley.edu/er100/readings/Brandt\\_2014.pdf](http://nature.berkeley.edu/er100/readings/Brandt_2014.pdf).

only a small fraction of leaks likely represents a high percentage of total emissions, this creates big challenges for bottom-up inventories because it requires testing of all components in the natural gas system to ensure that all superemitters are identified and captured within the analysis.<sup>215</sup> Also, there are no standardized methods and protocols among the different studies for taking measurements at different sources.

Sample bias based on geography can introduce uncertainties in methane estimates. Emissions can vary between regions for several reasons. Potential causes for regional variation include societal differences, such as local policies or regulations, and differences in infrastructure, such as well types or well-completion procedures. In addition, the methane content of natural gas at wells varies depending on which production basin it comes from, for example, Colorado versus Texas. Natural gas coming into California from different regions has significantly different emissions profiles. When mixed with other gas flowing through the pipeline system, the calculation of emissions is further complicated. In addition, the composition of natural gas can vary significantly depending on where it is in the natural gas system. For example, methane leaks at the well head in the production phase typically have lower methane content (and higher propane and butane content) than from leaks in the transportation portions of the system.<sup>216</sup>

Top-down emission estimates also have data and sampling issues. For example, it can be difficult to attribute ambient measurements of emissions to a variety of sources of methane, such as landfills, dairies, natural seeps, and wetlands in a region. Chemical fingerprints (for example, ethane is associated mostly with methane from petroleum-based sources such as well and natural seeps) can be used to help differentiate emissions sources, but some uncertainty in source attribution will still remain.<sup>217</sup> Ambient measurements can also rely on complex computations of weather conditions to link measured ambient concentrations to potential sources. These computations often have relatively high levels of uncertainty.<sup>218</sup>

An issue for both bottom-up and top-down methods is that emissions can be sporadic, and testing done at discrete times may or may not capture episodes that can dominate annual emissions. For example, before a well enters into full operation, some high emissions may

---

215 Allen, D.T. (2014). "Methane Emissions From Natural Gas Production and Use: Reconciling Bottom-Up and Top-Down Measurements." *Current Opinion in Chemical Engineering*, 5(0) pages 78-83. <http://www.sciencedirect.com/science/article/pii/S2211339814000525>.

216 LaCont, R., *Methane Emissions in the Natural Gas Life Cycle*, April 2015, page 15. <http://westernenergyboard.org/2015/05/final-report-released-by-mj-bradley/>.

217 Methane is CH<sub>4</sub>, ethane is C<sub>2</sub>H<sub>6</sub>, butane is C<sub>4</sub>H<sub>10</sub>, and propane is C<sub>3</sub>H<sub>8</sub>. More carbon atoms means higher carbon and GHG content.

218 Allen, D.T. (2014). "Methane Emissions From Natural Gas Production and Use: Reconciling Bottom-Up and Top-Down Measurements." *Current Opinion in Chemical Engineering*, 5(0) pages 78-83. <http://www.sciencedirect.com/science/article/pii/S2211339814000525>.

take place during “well completion,” when drilling finishes and a well is prepared for production.<sup>219</sup> Once it is connected to a gas gathering system and enters normal production, emissions from the well should decrease. These could be factors contributing to the different emissions levels from aerial testing performed at associated oil fields and underground natural gas storage facilities in California, which shows widely divergent emissions levels for testing done on different days. It is also difficult to estimate emissions per unit of natural gas produced or consumed.

## **Methane Emissions From Out-of-State Oil and Gas Production**

Since California imports most of its natural gas from production basins located outside the state, it is important that methane emissions associated with these sources are accounted for in methane emissions estimates. Despite several recent research efforts to address methane emissions from the oil and gas sector, this is a nascent area of study, and as a result, there is variability in the different estimates from these studies. As discussed, major revisions to U.S. EPA inventory of methane emissions from oil and gas production have been made over the last few years and indicate a large amount of uncertainty in this area. Several studies based on measurements of ambient methane at different production basins suggest that methane emissions from oil and gas production could be considerably higher than emission inventories and other bottom up studies.<sup>220</sup>

A complicating factor in assessing methane emissions from oil and gas production is accurately allocating the emissions between the natural gas and petroleum systems since only a fraction of the methane emissions that occur during joint production are attributed to natural gas.<sup>221</sup> For example, the production of natural gas and liquid products in combination with oil is common in most of the rapidly growing shale areas, such as the Eagle Ford region in Texas.<sup>222</sup> Because the hydrocarbon products and the emissions associated with extracting them from different reservoir types can differ, when estimating

---

219 The kinds of activities conducted to place a well into production include perforating the well lining in the production zone so that gas can flow into and up the well. It could also include hydraulic fracturing, and then generally includes hooking the well up to small-diameter gas-gathering pipelines that will move the gas from the well to processing facilities.

220 Schneising O. (2014). “Remote Sensing of Fugitive Methane Emissions From Oil and Gas Production in North American Tight Geologic Formations.” *Earth’s Future*, 2(10). <http://onlinelibrary.wiley.com/doi/10.1002/2014EF000265/full>.

221 EPA uses a method for allocating GHG emissions between the oil and gas sector in its inventory, but several studies suggest that there could be improvements in the allocation method.

222 Zavala-Araiza, D., Allen D.T., Harrison, M., George, F.C., Jersey, G.R. (2015). “Allocating Methane Emissions to Natural Gas and Oil Production from Shale Formations,” *ACS Sustainable Chemistry & Technology*, 49(8) pages 492-498. <http://pubs.acs.org/doi/pdf/10.1021/sc500730x>.



emissions from the natural gas supply chain, it is important to accurately allocate emissions to particular hydrocarbon products and reservoir types.<sup>223</sup> There is an ongoing effort to continue to improve estimates of emissions at both the national and state levels. There is not yet, however, a widely accepted method for allocating emissions between natural gas and petroleum sectors.

Some studies use the same data, while in others the sources were from different production basins, making comparisons and efforts to come to convergence difficult.<sup>224</sup> Also, to estimate emissions per unit of natural gas extracted from a well, it is necessary to know beforehand the amount of gas that will be extracted from the well during the lifetime of the well, which is at best an uncertain estimation.<sup>225</sup>

Efforts to better understand methane leakage from the oil and gas sector, including methods for allocating methane emissions to natural gas, are being developed. Uncertainty about methods for allocating emissions between the oil production and the natural gas production sectors is a challenge for both top-down and bottom-up studies. Wide variance between bottom-up and top-down estimates from the oil and natural gas sectors have not been resolved but may be partially explained by inaccuracy in equipment and device counts, outdated EPA emission factors, uncertainties in modeled calculations, and sampling issues.

Research in this area would help to narrow the divergence among the studies and lead to more accurate estimates of methane from out-of-state natural gas production.

## **State and Federal Efforts to Address Methane Leakage**

Despite the uncertainty in quantifying methane emissions, there is, nonetheless, adequate evidence that California should move forward aggressively to reduce methane emissions, both within and outside the state. Several state and federal efforts have or will be undertaken to address methane emissions and are discussed below.

### **State Efforts to Address Methane Emissions**

California has taken significant steps in reducing short-lived climate pollutant (SLCP) emissions, especially black carbon from transportation, methane from oil and gas operations

---

223 Ibid., page 492.

224 Weber, C. (2012). "Life Cycle Carbon Footprint of Shale Gas: Review of Evidence and Implications." *Environmental Science & Implications*, 46, pages 5688-5695. <http://pubs.acs.org/doi/abs/10.1021/es300375n>.

225 Heath, G. A. (2014). "Harmonization of Initial Estimates of Shale Gas Life Cycle Greenhouse Gas Emissions for Electric Power Generation." *Proceedings of the National Academy of Sciences*, 111(31): E3167-E3176. <http://www.pnas.org/content/111/31/E3167.full.pdf>.

and landfill emissions, and fluorinated-gas emissions from refrigerants, insulating foams, and aerosol propellants. Still, more remains to be done to reduce emissions from these and other sources.<sup>226</sup> Various efforts by state agencies will help in this regard.

### ARB Activities

The ARB has taken a leadership role in working with other state agencies and stakeholders to develop strong planning and decisive action on the release of methane and other SLCPs, which they believe will deliver reduction in the short-term and will play an important role in achieving the goal of reducing California's GHG emissions by 40 percent below 1990 levels by 2030, and 80 percent below 1990 levels by 2050. Assembly Bill 1496 (Thurmond, Chapter 604, Statutes of 2015) requires the ARB to monitor and measure methane emissions and collect information to conduct life-cycle GHG analysis of gas produced or imported into the state.

The Legislature recognized the critical role that SLCPs must play in the state climate efforts with the passage of Senate Bill 605 (Lara, Chapter 523, Statutes of 2014). SB 605 requires the ARB to develop a strategy by the end of 2015 to further reduce SLCP emissions.<sup>227</sup> In May 2015, the ARB released a concept paper presenting initial ideas that were considered and evaluated by ARB, in coordination with other agencies, as it developed the SLCP Strategy. ARB released a draft strategy document in September 2015 that identifies scientific targets, which align with levels of GHG emission reduction needed worldwide to stabilize climate, including reducing methane emission by at least 40 percent. A major focus of this effort is developing strategies that put organic waste streams to beneficial use by reducing market barriers. In addition, the strategy calls for minimizing methane emissions from all infrastructure and equipment in the natural gas sector. ARB has already established regulations for methane from municipal solid waste landfills. In addition, ARB is developing a regulation to reduce methane emissions from oil and gas production, processing, and storage operations.

ARB has also supported research over the last several years to address methane and other SLCPs, including:<sup>228</sup>

- Improving emissions estimates through the collection of atmospheric and ground-based measurements of GHG emissions.

---

<sup>226</sup> ARB, *Short-Lived Climate Pollutant Reduction Strategy: Concept Paper*, May, 2015, page 19. [http://www.arb.ca.gov/cc/shortlived/concept\\_paper.pdf](http://www.arb.ca.gov/cc/shortlived/concept_paper.pdf).

<sup>227</sup> Senate Bill 605. [http://leginfo.legislature.ca.gov/faces/billNavClient.xhtml?bill\\_id=201320140SB605](http://leginfo.legislature.ca.gov/faces/billNavClient.xhtml?bill_id=201320140SB605).

<sup>228</sup> Methane Research Projects. <http://www.arb.ca.gov/cc/shortlived/shortlived.htm>.



- Determining spatial distribution of ozone precursors and GHG concentrations for the Los Angeles Basin.
- Calibrating, validating, and implementing process models for agricultural GHG emissions.
- Inverse modeling to verify California's GHG inventory.

## CPUC Activities

Under Senate Bill 1371 (Leno, Chapter 525, Statutes of 2014) and in consultation with the ARB, the CPUC is developing rules to reduce emissions from gas transmission and distribution pipeline leaks throughout the state. Together, these rules should create a comprehensive approach to limit methane leaks from oil and gas operations. As discussed, however, the primary source of natural gas is from out-of-state suppliers, so the state should continue to advocate for strong national methane standards to ensure potential climate benefits from use of natural gas in the state.

Senate Bill 1371 (Leno, Chapter 525, Statutes of 2014) requires the CPUC to minimize leaks as a hazard to be addressed and to reduce emissions of natural gas "to the maximum extent possible" to advance goals of GHG emissions. It directs the CPUC to "establish and require the use of best practices for leak surveys, patrols, leak survey technology, leak prevention, and leak detection." SB 1371 also requires gas corporations to file reports about natural gas leaks, leak management practices, and "estimates of gas lost due to leaks" annually.

SB 1371 also requires the CPUC to confer with the ARB and open a proceeding to adopt rules. A rulemaking (R. 15-01-008) was launched on January 15, 2015. On March 17, 2015, the CPUC released a report on best practices for surveys of natural gas leakage abatement. The CPUC proposed that for SB 1371 GHG reductions all leaks should be considered hazardous to people, property, or the environment.<sup>229</sup> The report also recommends that "the best practice would be to repair all leaks immediately as they are found" but recognized that might not be practical and could be costly.

## Energy Commission Activities

The Energy Commission has funded research related to the natural gas system focused on assessing methane emissions and supporting natural gas pipeline infrastructure and safety.<sup>230</sup> The Energy Commission is supporting research to identify the main sources of

---

229 CPUC Safety and Enforcement Division Staff Report, *Survey of Natural Gas Leakage Abatement Best Practices*, March 17, 2015. <http://www.cpuc.ca.gov/NR/rdonlyres/78171FC7-C5D9-44E5-A922-F49BF9C9D7F9/0/SEDSB1371LenoNaturalGasLeakageAbatementBestPracticesFinal.pdf>.

230 Energy Commission, Presentation at 2015 IEPR Workshop on Fugitive Methane Emissions: Energy Commission Natural Gas Research Activities, June 1, 2015. <https://efiling.energy.ca.gov/Lists/DocketLog.aspx?docketnumber=15-IEPR-04>.

emissions (for example, wells, distribution system) and to improve the calculation of how much methane is emitted from the natural gas system in California. Several research projects are already completed, including measuring and modeling long-lived GHG emissions at two tall towers for methane emission estimates and developing California-specific methane emission factors.

In one of the ongoing Energy Commission projects, LBNL researchers are surveying methane emissions from key subsectors of the natural gas system, including production and processing, transmission and distribution, underground storage units, abandoned wells, LNG fueling stations, and end uses in homes. It is expected that this work will identify the main sources of emissions from the natural gas system, but further work will be required to fully quantify total annual emissions. A complementary ongoing project will improve capabilities of air-based identification of methane leaks from transmission pipelines.

The Energy Commission is also supporting studies on safety issues to be able to detect potential failure modes that may endanger public health and safety. For example, several ongoing projects focus on developing and testing cost-effective leak detection and pipeline integrity monitoring sensors and tools, as well as demonstrating them in the lab under simulated field conditions and at a few actual field sites. This also includes real-time monitoring of the pipeline defects and damage due to corrosion and improper girth welds, as well as damage to pipelines from encroachments and unauthorized right-of-way activities. These sensors and tools can be effective in monitoring the health and integrity of the pipelines, helping the pipeline operators to develop proper pipeline monitoring and maintenance practices, while properly operating and maintaining the pipelines. This is expected to improve pipeline safety and reduce danger to public health, as well as reduce chances of catastrophic events, such as the 2010 San Bruno pipeline explosion. Projects in this area of research include:

- Developing a mechanical pressure sensor and flow sensor for inspecting and monitoring natural gas pipelines.
- Demonstrating a multichannel electromagnetic acoustic transducer sensor module for inline detection.<sup>231</sup>
- Developing a real-time corrosion monitoring system for pipeline integrity detection.

### Natural Gas Utility Activities

Natural gas utilities are already taking steps to reduce emissions. For example, the California natural gas utilities have replaced old, cast iron pipelines and some unprotected

---

<sup>231</sup> Electromagnetic acoustic transducer sensor modules use an ultrasonic nondestructive testing method which does not require contact with the material. This is especially useful for automated inspection purposes.

steel pipes, which typically have more leaks per mile than protected steel and plastic.<sup>232</sup> PG&E, So Cal Gas, and SDG&E note that their primary focus in reducing methane leakage is addressing distribution system leaks, which they also note have been heavily driven by safety concerns following the San Bruno explosion. PG&E along with a number of partners, including the National Aeronautics and Space Administration (NASA), the University of California, Jet Propulsion Lab (JPL), the Energy Commission, and others, are funding several research, development, and deployment projects. For example, one project demonstrated a stationary methane laser sensor that continuously monitors the line of sight above pipelines and provides rapid warning. PG&E tested a handheld methane detector that uses laser-based technology and has superior sensitivity than other commercial handheld detectors. PG&E is also involved in using a Schlieren gas imaging technique that can observe leak flow remotely. In addition, PG&E is using a Picarro mobile platform system to detect leaks in the distribution system and immediately implementing measures to eliminate these emissions.<sup>233</sup> PG&E are also collaborating on a number of other research efforts. There is a concern that the effects of these measures may not be adequately documented in open literature to support further research, development, and demonstration (RD&D).

So Cal Gas and SDG&E are also active in RD&D to reduce methane emissions on their gas systems, including many of the same technologies and programs being implemented by PG&E. Their Going Forward Plan to reduce methane emissions includes collaborating with the CPUC to cost-effectively enhance infrastructure safety, while yielding environmental benefits.<sup>234</sup> They are funding RD&D for new technologies and greater efficiencies. They are also partnering with academia, regulators, and industry on studies and programs.

All of So Cal Gas and SDG&E RD&D efforts are summarized in their Technology Plan, which is designed to provide near-term, real-time field data on large pipeline rights-of-way to prevent, address, and manage pipeline incidents.<sup>235</sup> So Cal Gas and SDG&E are developing methane detectors that provide real-time notification of major leaks. For

---

232 Lamb, B.K. (2015). "Direct Measurements Show Decreasing Methane Emissions From Natural Gas Local Distribution Systems in the United States." *Environmental Science & Technology*, 49(8):5161-5169. <http://pubs.acs.org/doi/full/10.1021/es505116p>.

233 One of the reasons for the immediacy of fixing leaks is that the repair crew is deployed along with the platform, integrating the fixing into the leak detection.

234 So Cal Gas/SDG&E, Presentation: *IEPR Staff Workshop, Fugitive Methane Emissions in California's Natural Gas System*, June 1, 2015, page 5. [http://docketpublic.energy.ca.gov/PublicDocuments/15-IEPR-04/TN204783\\_20150529T154031\\_Intergrated\\_Energy\\_Policy\\_Report\\_IEPR\\_Staff\\_Workshop\\_Fugitive\\_M.pdf](http://docketpublic.energy.ca.gov/PublicDocuments/15-IEPR-04/TN204783_20150529T154031_Intergrated_Energy_Policy_Report_IEPR_Staff_Workshop_Fugitive_M.pdf).

235 *Ibid.*, pages 8-9.

example, new mobile detection vehicles and unmanned aerial vehicles are being used to investigate possible events on the system. They are also looking at using fiber optic cabling along pipelines to provide early warning for events of digging, movement, and impact. In addition, So Cal Gas and SDG&E are installing smart gas meters that will help detect leaks by identifying excessive consumption and inefficient equipment, which will, in turn, reduce methane emissions. They are also hoping to use smart meters to connect carbon monoxide monitoring, smoke alarms, or other sensors.

In addition to reducing methane emissions, So Cal Gas is preparing for the deep carbon reductions that will be required in California after 2020.<sup>236</sup> They are investigating ways to decarbonize natural gas with the use of hydrogen that would be generated from excess power produced by solar and wind, and by the use of biomethane from the sustainable harvesting of biomass.<sup>237</sup>

### EDF Comprehensive Study

The Environmental Defense Fund (EDF) commissioned an economic analysis of methane emission reduction opportunities for the oil and gas industries.<sup>238</sup> The study estimated that a 40 percent reduction in onshore methane emissions was possible with existing technologies at a net total cost of \$0.66 per thousand cubic feet (Mcf) of methane reduced, or less than \$0.01/Mcf of methane produced. This analysis accounts for savings for companies implementing methane reduction; however, it assumes that there are easy ways to identify superemitters, and it is unclear how realistic this assumption may be.

About 100 participants, including academics, natural gas utilities, research institutions, and others, are funding research coordinated by the EDF. The EDF program is the most comprehensive set of studies trying to improve the characterization of emissions from the natural gas system. It includes 16 studies covering all the parts of the natural gas system.<sup>239</sup> Five common principles underlie this research effort: (1) Led by academic scientists; (2) Employ multiple methods, where possible; (3) Input from independent scientific experts; (4)

---

236 George Minter, So Cal Gas, *Natural Gas Pathways: Natural Gas Vehicles in California*, presentation at the June 23, 2014, IEPR workshop.

[http://www.energy.ca.gov/2014\\_energypolicy/documents/#06232014](http://www.energy.ca.gov/2014_energypolicy/documents/#06232014).

237 Biomethane is methane obtained from biogas after cleaning impurities and other processing to make it suitable quality for the natural gas system.

238 ICF International, *Economic Analysis of Methane Emissions Reduction Opportunities in the U.S. Onshore Oil and Natural Gas Industries*, Prepared for EDF, March, 2014.

[https://www.edf.org/sites/default/files/methane\\_cost\\_curve\\_report.pdf](https://www.edf.org/sites/default/files/methane_cost_curve_report.pdf).

239 EDF, *Methane Research: The 16 Studies Series, An Unprecedented Look At Methane from the Natural Gas System*. [https://www.edf.org/sites/default/files/methane\\_studies\\_fact\\_sheet.pdf](https://www.edf.org/sites/default/files/methane_studies_fact_sheet.pdf).

Make all data public to ensure transparency; and (5) Publish results in a peer-reviewed journal.

The studies include measuring and estimating methane emissions at natural gas production sites, including liquids loading and pneumatic controllers, gathering and processing facilities, and transmission and storage in interstate pipelines. On the distribution side, research projects include better characterizing of methane emissions in utility distribution systems in various regions of the United States, tower-based quantitative techniques for measuring methane in urban environments, and mapping methane leaks from local distribution systems. Other research includes fly-over studies on oil and gas production basins, investigating superemitters, and various pilot projects. The final product is the project synthesis to gain an integrated understanding of what can be learned from the various research efforts. Ten of the studies have been completed, several others will be completed in late summer of 2015, and the synthesis project is expected in 2016.

## **Federal Efforts to Address Methane Emissions**

At the national level, several federal agencies are addressing and supporting research on methane emissions from the natural gas system. The U.S. DOE as well as natural gas utilities and the GTI are conducting further research to better identify methane emissions. For example, a branch of U.S. DOE recently awarded nearly \$30 million for research developing accurate low-cost methane sensors. Once these sensors are developed, the goal is to deploy them in multiple locations to identify methane emissions and to be able to implement the necessary corrective actions.

The National Oceanic and Atmospheric Administration is also heavily involved in research using aircrafts and tall towers to characterize emissions from important basins, including some work done in California, mostly in the Los Angeles region and the southern part of the San Joaquin Valley. The National Aeronautic and Space Administration (NASA) has made satellite information available to researchers that can be used to infer atmospheric concentrations. In addition, NASA is working very closely with the ARB and the Energy Commission using research-grade infrared cameras installed in aircraft that can detect methane leaks. This work promises to deliver very useful information in the near future.

The U.S. EPA recently released a proposed rule that would amend the new source performance standards (NSPS) for the oil and natural gas source category by setting standards for both methane and volatile organic compounds for several emission sources not currently covered by NPSP and proposing methane standards for certain emissions sources that are currently regulated for volatile organic compounds.<sup>240</sup> As a result, GHG

---

240 Oil and Natural Gas Sector: Emission Standards for new and Modified Sources, Federal Register, September 18, 2015. <http://www3.epa.gov/airquality/oilandgas/actions.html>.

emission standards would include hydraulically fractured oil and gas well completions or green completions and fugitive emissions at well sites, compressor stations, pneumatic pumps and natural gas processing plants. The new standards are in response to President Obama's *Climate Action Plan: Strategy to Reduce Methane Emissions*.<sup>241</sup> The strategy summarizes the sources of methane emissions, commits to new steps to cut emissions of this potent GHG, and outlines the Obama Administration efforts to improve the measurement of these emissions. The strategy builds on progress to date and takes steps to further cut methane emissions from several sectors, including the oil and natural gas sector.

The Federal Energy Regulatory Commission (FERC) does not have any explicit GHG regulations in place or proposed for natural gas infrastructure. FERC, however, adopted a new policy statement in early 2015 that will be applied in upcoming gas infrastructure rate cases that would allow recovery of major capital investment costs when the investment addresses pipeline safety or reduces GHG emissions.<sup>242</sup> The primary driver of the policy statement is the set of directives issued by the NTSB and the United States Department of Transportation Pipeline and Hazardous Materials Safety Administration, along with the 2011 Pipeline Safety Act to expand integrity management, reconfirm MAOP, replace cast iron pipeline, and a number of other activities to improve safety. The policy statement also refers to the U.S. EPA rule for mandatory reporting of GHG emissions including those from production, processing, transportation, and distribution of natural gas as another driver of the policy.

The policy statement adopts five thresholds that must be met to allow cost recovery under a "modernization cost surcharge," including:

- Recent review of existing rates.<sup>243</sup>
- Costs that must be one-time capital costs incurred to comply with safety or environmental regulations and each must be specifically identified.
- Cannot shift costs to captive customers.
- Must provide period review of the surcharge and base rates.
- Must work collaboratively to seek shipper support.

---

241 See

[https://www.whitehouse.gov/sites/default/files/strategy\\_to\\_reduce\\_methane\\_emissions\\_2014-03-28\\_final.pdf](https://www.whitehouse.gov/sites/default/files/strategy_to_reduce_methane_emissions_2014-03-28_final.pdf).

242 The April 15, 2015 *Policy Statement: Cost Recovery for Modernization of Natural Gas Facilities*, goes into effect in October, 2015. <http://www.ferc.gov/whats-new/comm-meet/2015/041615/G-1.pdf>.

243 A review of existing rates must be done in either an NGA Section 4 rate proceeding or a collaborative effort between the pipeline and its customers.

For the first time, FERC recently allowed, in a contested settlement for Columbia Gas Transmission, a tracking mechanism on “substantial pipeline modernization costs” of \$300 million annually for five years.<sup>244</sup> The mechanism included a reduction in Columbia Gas Transmission base rates, and Columbia Gas Transmission also agreed to spend \$100 million each year and not recover it through the tracking mechanism. Additional efforts to pursue recovery of safety or environmental costs for interstate pipelines are anticipated in the next few years.

## Areas for Further Research

There are a number of areas where additional research could help to reduce the uncertainty in the current estimates of methane emissions. A few of these are listed below, including the following:<sup>245</sup>

- Continue efforts to bring convergence between bottom-up and top-down methods for estimating methane emissions.
- Continue to develop allocation methods to attribute emissions between the oil and gas systems.
- Collect additional data to develop better methane emission factors or other methods for use in inventories.
- Develop technologies for the early detection of gross methane emissions and for the identification of the source.
- Develop cost-effective methane mitigation/recovery technologies to address known emission sources during pipeline operation and maintenance.
- Develop system and regional specific emission factors for pipeline facilities from actual system performance data.
- Develop a continuous integrity monitoring system (in-situ) that can continuously monitor the integrity of pipelines.
- Evaluate how the use of existing natural gas infrastructure can reduce methane emissions from biological sources.

---

244 FERC Order Approving Settlement. <http://www.ferc.gov/EventCalendar/Files/20130124163733-RP12-1021-000.pdf>

245 Many of the recommendations for additional research were identified in: Comments of So Cal Gas on the June 1, 2015 *IEPR* Workshop, in Support of the Assembly Bill 1257 *Strategies to Maximize Benefits Obtained From Natural Gas as an Energy Source Draft Staff Report*, on Fugitive Methane Emissions in California's Natural Gas System Docket No. 15-IEPR-04, June 15, pages 4-5. <https://efiling.energy.ca.gov/Lists/DocketLog.aspx?docketnumber=15-IEPR-04>.

## Acronyms

Acronym	Definition
ARFVTP	Alternative and Renewable Fuel and Vehicle Technology Program
Bcf (/d)	Billion cubic feet (per day)
Btu	British thermal unit
ARB	California Air Resources Board
CalRecycle	California Department of Resources, Recycling, and Recovery
California ISO	California Independent System Operator
CC	Combined cycle
CHP	Combined heat and power
CPUC	California Public Utilities Commission
CPUC SED	CPUC Safety and Enforcement Division
CO <sub>2</sub>	Carbon dioxide
CO	Carbon monoxide
CHP	Combined heat and power
CNG	Compressed natural gas
EPNG	El Paso Natural Gas
EDF	Environmental Defense Fund
FERC	Federal Energy Regulatory Commission
GTI	Gas Technology Institute
GWh	Gigawatt hours
GW	Gigawatts
GHG	Greenhouse gas
HVAC	Heating, ventilation, and air conditioning
ILI	In-line inspection
<i>IEPR</i>	<i>Integrated Energy Policy Report</i>
IOUs	Investor owned utilities
kWh	Kilowatt hour
LADWP	Las Angeles Department of Water and Power
LBNL	Lawrence Berkeley National Laboratory
LCFS	Least carbon fuel standards
LNG	Liquefied natural gas
LCA	Local Capacity Areas
LTPP	Long-Term Procurement Planning
MAOP	Maximum allowable operating pressure
MHDV	Medium and heavy duty vehicle
MW	Megawatts
MMBtu	Million British thermal units
MMcf(/d)	Million cubic feet (per day)
MMT	Million metric tons
MMTCO <sub>2</sub> e	Million metric tons of carbon dioxide equivalent
NTSB	National Transportation Safety Board



Acronym	Definition
NGV	Natural gas vehicle
NO <sub>x</sub>	Nitrogen oxides
OFOs	Operational flow orders
PG&E	Pacific Gas and Electric Company
PV	Photovoltaic
PSEP	Pipeline safety enhancement plans
QF	Qualifying facility
QFER	<i>Quarterly Fuels and Energy Report</i>
RPS	Renewables Portfolio Standard
R&D	Research and development
SED GSRB	SED Gas Safety and Reliability Branch
SDG&E	San Diego Gas and Electric Company
San Onofre	San Onofre Nuclear Generation Station
STARS	Selective Tartrate Removal System
SLCP	Short-lived climate pollutant
So Cal Gas	Southern California Gas Company
SoSysMin	Southern system minimum
SWRCB	State Water Resources Control Board
SCADA	Supervisory Control and Data Acquisition
Mcf	Thousand cubic feet
Tcf	Trillion cubic feet
the panel	CPUC Independent Review Panel
U.S. DOE (/FE)	United States Department of Energy (Office of Fossil Energy)
U.S. EPA	United States Environmental Protection Agency
U.S. EIA	United States Energy Information Administration
WIEB	Western Interstate Energy Board
ZNE	Zero net energy

# Appendix A

**Table A-1: Interstate Natural Gas Pipelines Interconnecting to California as of April 2, 2015**

Pipeline	Supply Source	Maximum Delivery Capacity	California Border Receipt Point/Receiving Utility System
Gas Transmission Northwest (GTN)	Western Canadian Sedimentary Basin	2.272 Bcf/d	Malin, OR/PG&E Redwood Path
Ruby Pipeline	Rocky Mountains	1.684 Bcf/d	Malin, OR/PG&E Redwood Path
Tuscarora Gas Transmission Company	Western Canadian Sedimentary Basin, Rocky Mountains	300 MMcf/d	Malin, OR/City of Susanville Natural Gas Department
Paiute Pipeline	Western Canadian Sedimentary Basin, Rocky Mountains	44 MMcf/d	North and South Lake Tahoe, CA/Southwest Gas
Kern River Gas Transmission Company	Rocky Mountains	1.900 Bcf/d	Daggett, CA/PG&E Baja Path
El Paso Natural Gas (EPNG) North Mainline	Anadarko, Permian, San Juan	2.145 Bcf/d	Topock, AZ: PG&E Baja Path, So Cal Gas, Mojave Pipeline
El Paso Natural Gas (EPNG) South Mainline	Permian	1.410 Bcf/d	Ehrenberg, AZ/So Cal Gas
Transwestern Pipeline Company	Anadarko, Permian, San Juan	1.210 Bcf/d	Topock, AZ; Needles, CA/ PG&E Baja Path, So Cal Gas, Mojave Pipeline
Questar Southern Trails Pipeline	San Juan	240 MMcf/d	Mohave Valley, AZ/ So Cal Gas, PG&E Baja Path
Mojave Pipeline Company	Anadarko, Permian, Rocky Mountains, San Juan	798 MMcf/d	Topock, AZ; Daggett, CA/So Ca IGas
Transportadora de Gas Natural (TGN)	Costa Azul LNG Import Facility	413 MMcf/d	Otay Mesa, CA/SDG&E
North Baja Pipeline System	Permian	513 MMcf/d	Ehrenberg, AZ/ So Cal Gas
<b>Maximum California Delivery Capacity</b>		<b>13.33 Bcf/d</b>	

Source: California Energy Commission with data from Regional Pipeline Flow Report #201, provided by PointLogic Energy LLC, an OPIS Company. Not all of these pipelines can deliver these maximum volumes into California concurrently due either to take-away constraints on the California side of the interconnection or the fact that North Baja, for example, is not designed to "serve" California but rather transports gas from Ehrenberg into Mexico's Baja Norte system that parallels the International Boundary to Costa Azul.