

DOCKETED

Docket Number:	15-AFC-02
Project Title:	Mission Rock Energy Center
TN #:	221866
Document Title:	Mission Rock Preliminary Staff Assessment Project Description & Cultural Figures
Description:	Figures Project Description and Cultural
Filer:	Raquel Rodriguez
Organization:	California Energy Commission
Submitter Role:	Commission Staff
Submission Date:	11/28/2017 9:44:27 AM
Docketed Date:	11/28/2017

MISSION ROCK ENERGY CENTER

Preliminary Staff Assessment Environmental Assessment Part 2 Project Description and Cultural Figures



CALIFORNIA
ENERGY COMMISSION
Edmund G. Brown, Jr, Governor

November 2017
CEC-700-2017-001-PSA

DOCKET NUMBER 15-AFC-02

**PROJECT
DESCRIPTION
FIGURES**

PROJECT DESCRIPTION - FIGURE 1
Mission Rock Energy Center - Regional Location



CALIFORNIA ENERGY COMMISSION - SITING, TRANSMISSION AND ENVIRONMENTAL PROTECTION DIVISION
 SOURCE: AFC Figure 1.2-1

PROJECT DESCRIPTION - FIGURE 2
Mission Rock Energy Center - Architectural Rendering of Power Plant and Battery Array



PROJECT DESCRIPTION

Aerial Image © Google Earth 5/1/2015 Annotation © CH2M 2015

PROJECT DESCRIPTION - FIGURE 3
Mission Rock Energy Center - Site Location Map

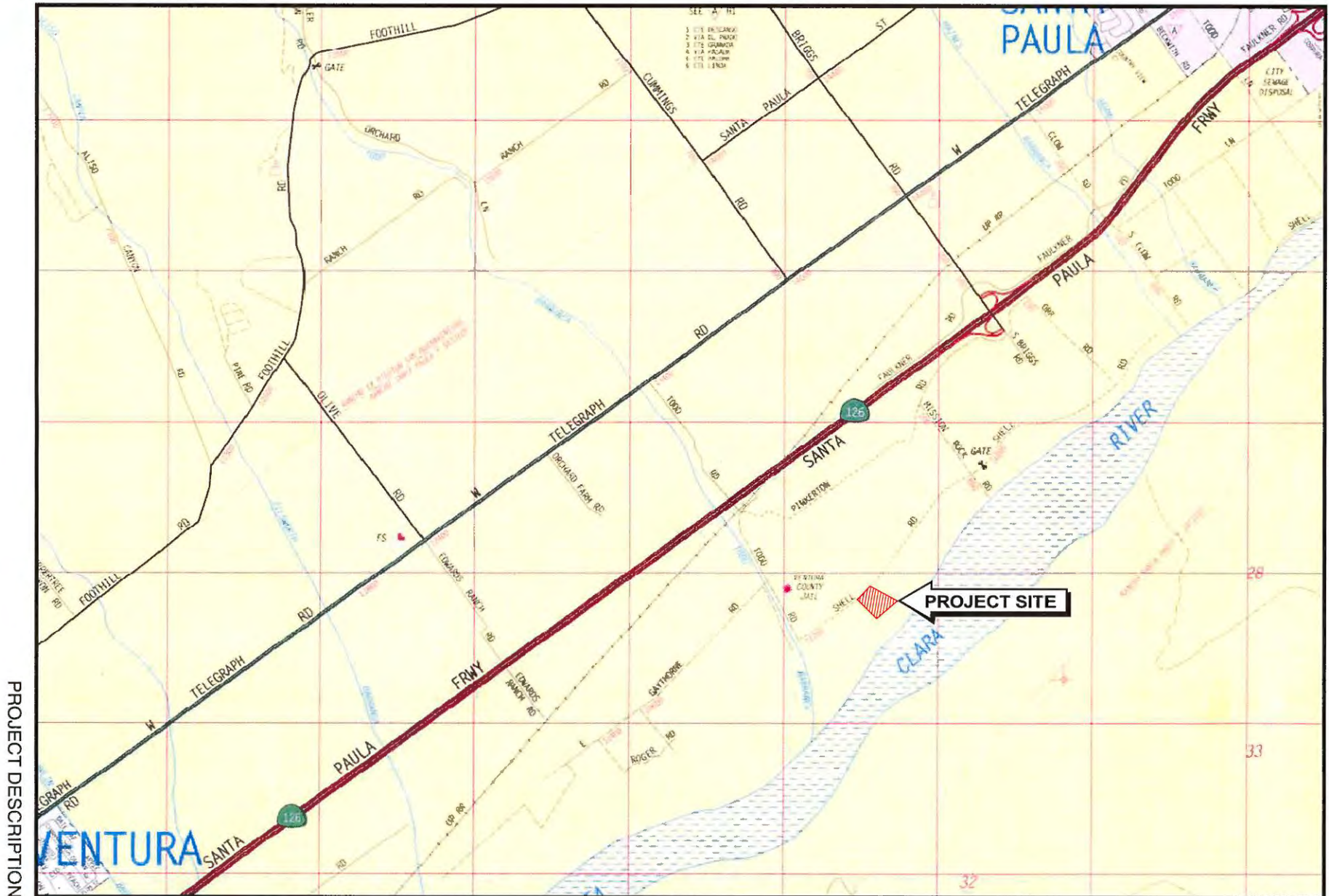

PROJECT DESCRIPTION

PROJECT DESCRIPTION - FIGURE 4
Mission Rock Energy Center - Project Site Overview



INQUIRY #: 3702321.5

YEAR: 2012

| = 500'



CALIFORNIA ENERGY COMMISSION - SITING, TRANSMISSION AND ENVIRONMENTAL PROTECTION DIVISION
SOURCE: 15-AFC-02/TN207160-31_20151231T114509_Appendix_514A_Phase_I_ESA

PROJECT DESCRIPTION

PROJECT DESCRIPTION - FIGURE 5
Mission Rock Energy Center - Project Site - Close up



PROJECT DESCRIPTION

PROJECT DESCRIPTION - FIGURE 6

Mission Rock Energy Center - General Arrangement

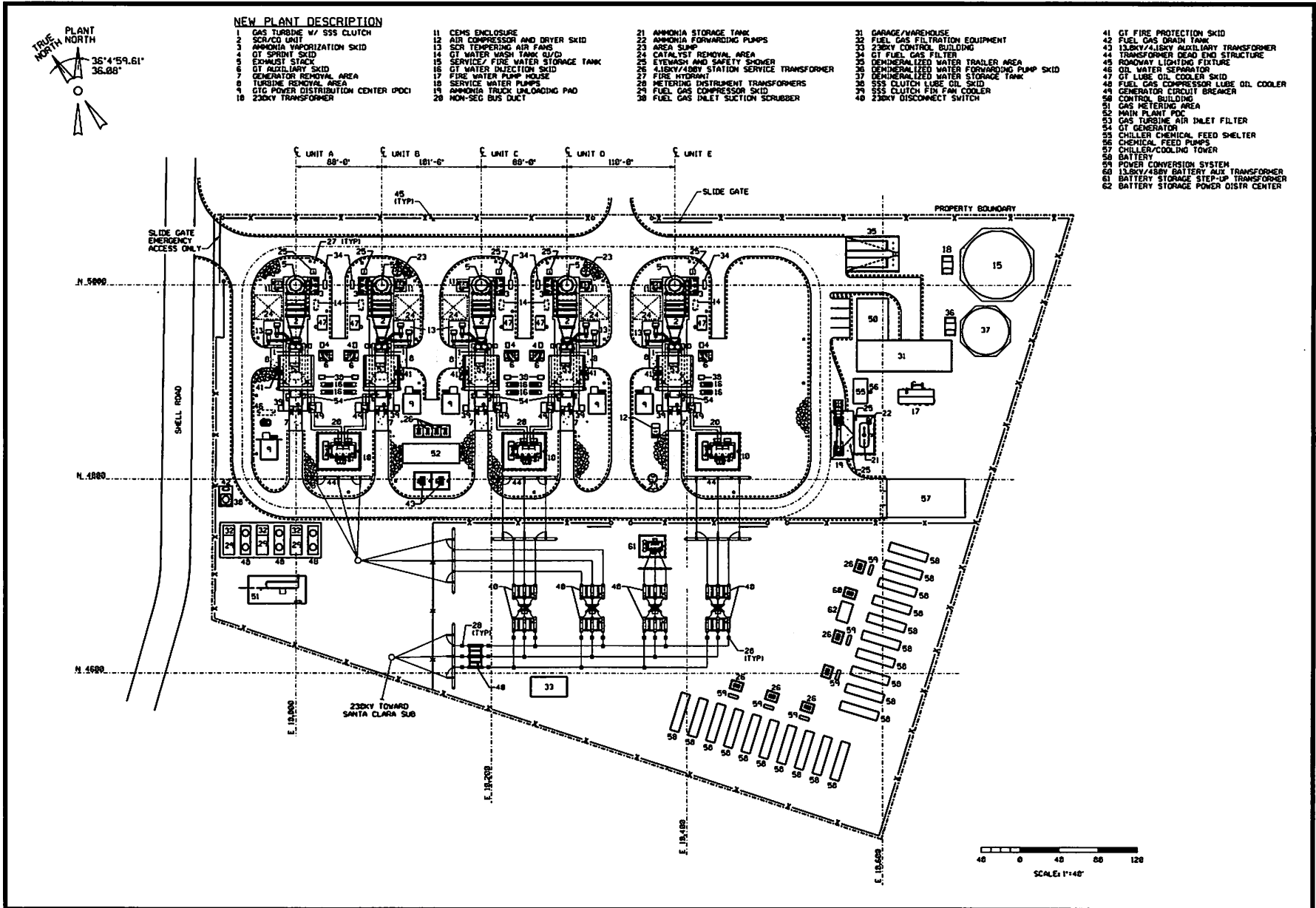

PROJECT DESCRIPTION

PROJECT DESCRIPTION - FIGURE 7
Mission Rock Energy Center - Elevations

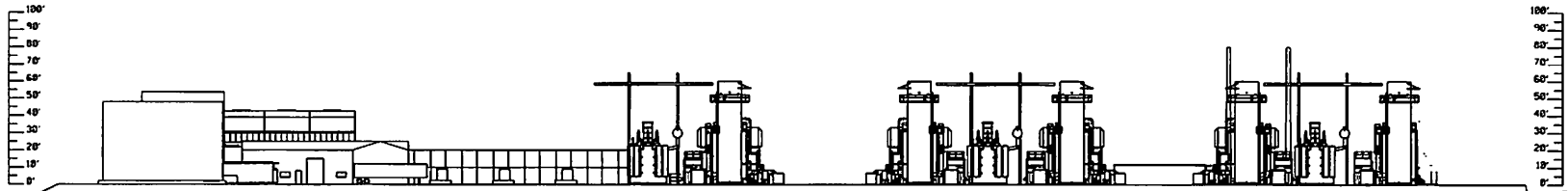

ELEVATION VIEW LOOKING SOUTH

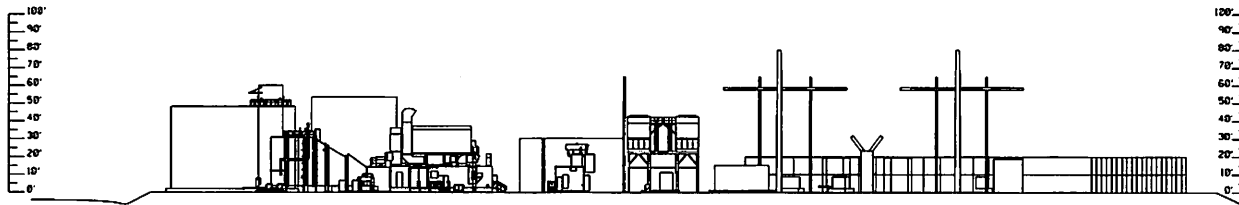

ELEVATION VIEW LOOKING EAST

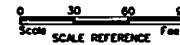

PROJECT DESCRIPTION

PROJECT DESCRIPTION - FIGURE 8
 Mission Rock Energy Center - Project Including Transmission Line and Linear

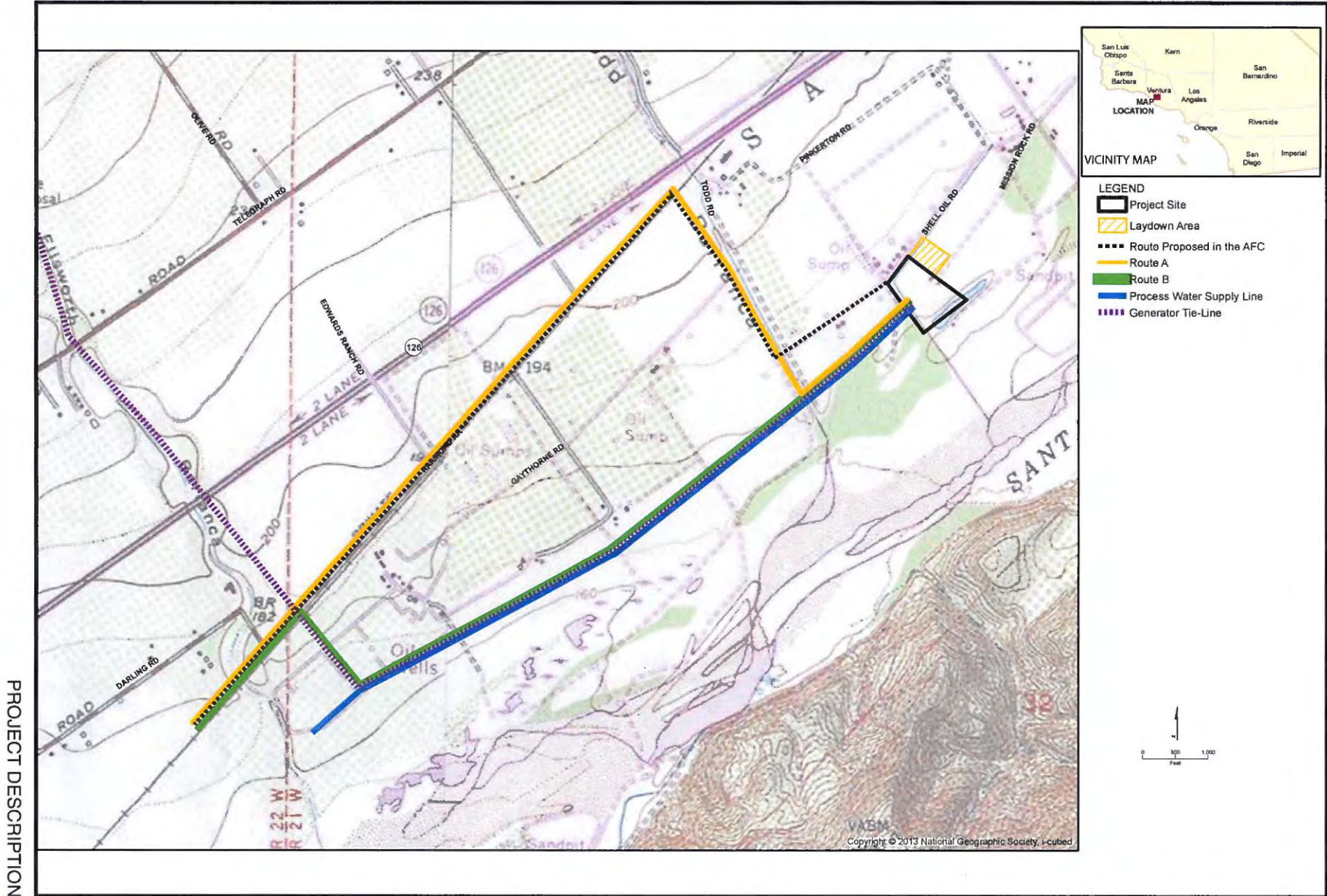

PROJECT DESCRIPTION - FIGURE 9
Mission Rock Energy Center - Typical Monopole Design

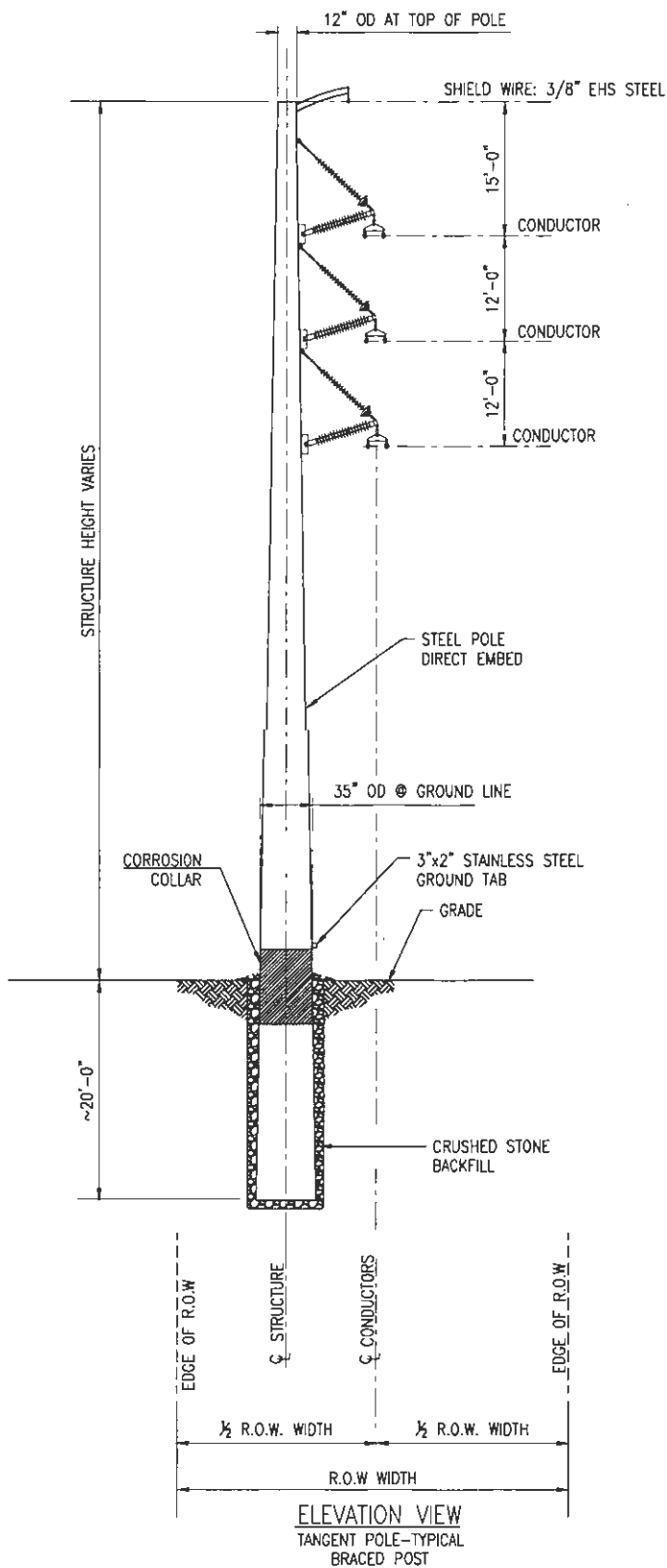

PROJECT DESCRIPTION - FIGURE 10
Mission Rock Energy Center - Water Balance - Annual Average

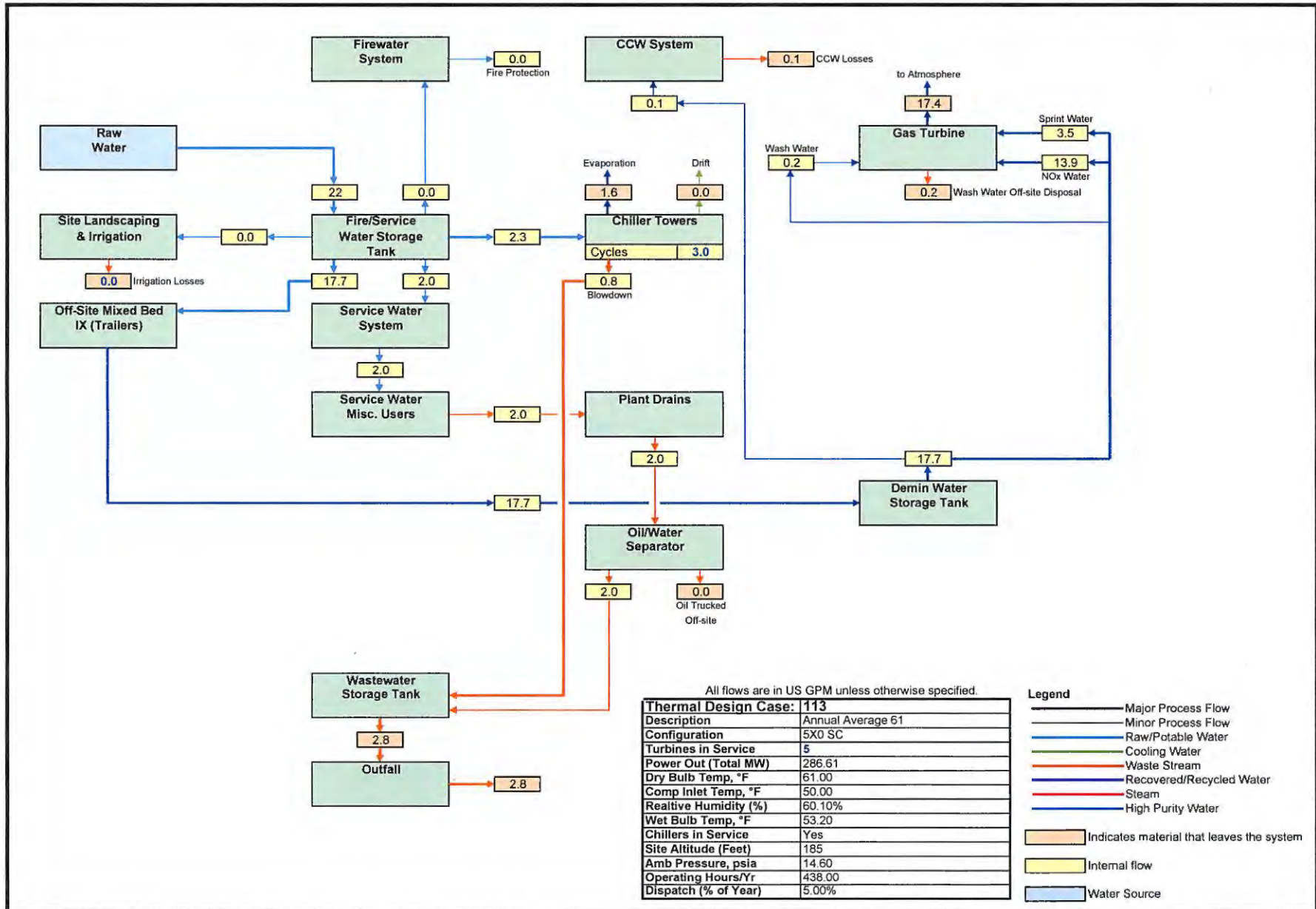

PROJECT DESCRIPTION

PROJECT DESCRIPTION - FIGURE 11
Mission Rock Energy Center - Water Balance - Annual Maximum

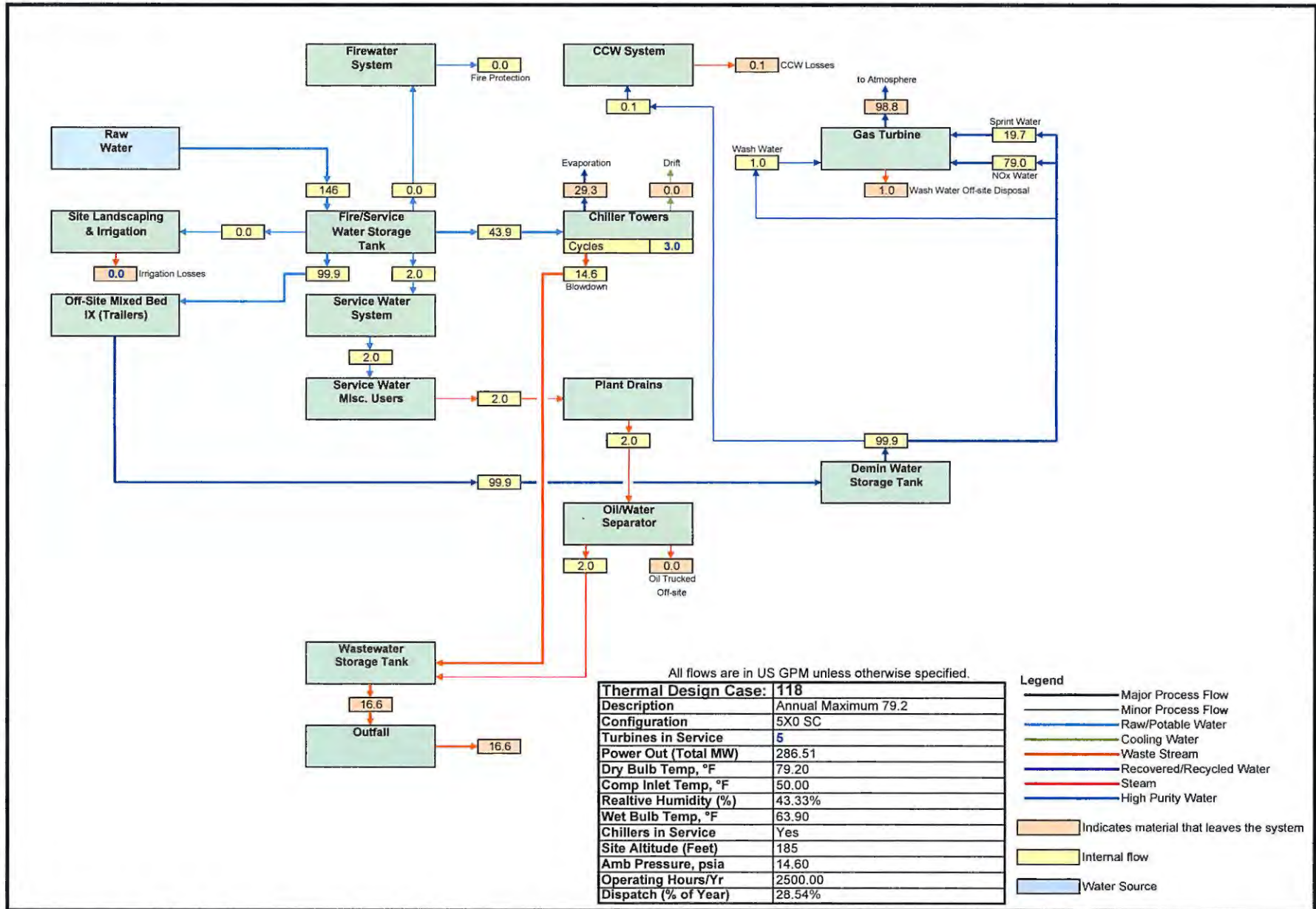

PROJECT DESCRIPTION

PROJECT DESCRIPTION - FIGURE 12
Mission Rock Energy Center - FEMA Floodplain

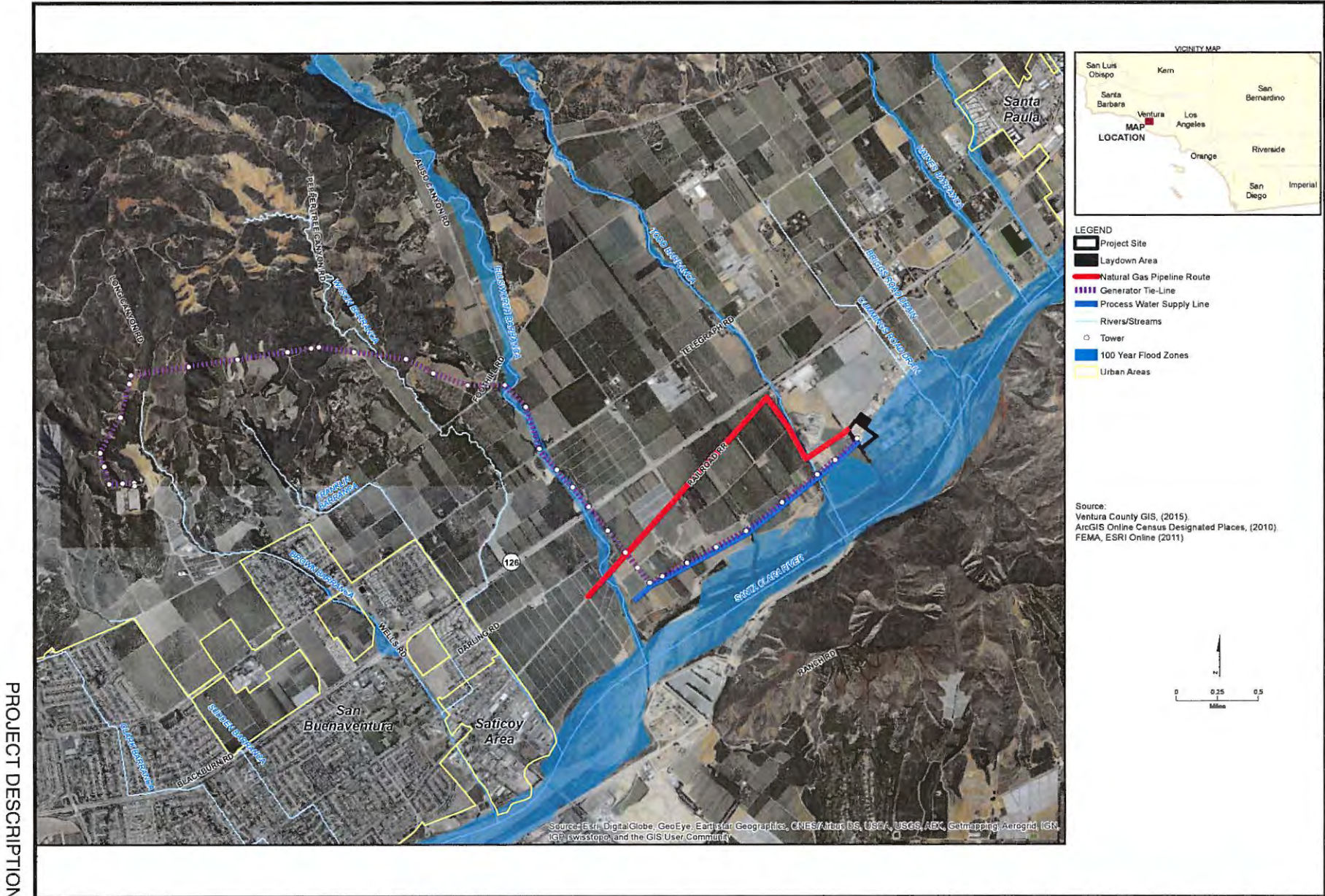

PROJECT DESCRIPTION

PROJECT DESCRIPTION - FIGURE 13
Mission Rock Energy Center - Grading Plan Exhibit

NOTES

1. SITE IS TO BE RAISED TO THE 100 YEAR FLOOD PLAIN ELEVATION OF 191.3 AND 3:1 SLOPES TO EXISTING GRADE AROUND ALL THE SIDES, EXCEPT THE NORTH-WEST SIDE WILL HAVE A SMALL RETAINING WALL AROUND 4 FEET TALL. RAMPS FROM EXISTING GRADE WILL BE INSTALLED AT THE MAIN ENTRANCE AND EMERGENCY ACCESS AT THE NORTH-WEST CORNER TO GAIN ACCESS TO THE SITE. ALL TOP OF EQUIPMENT FOUNDATION FOOTINGS WILL CONSTRUCTED AT ELEVATION 192.3 ONE FOOT OR HIGHER ABOVE THE 100 YEAR FLOOD PLAIN ELEVATION OF 191.3.
2. APPROXIMATE EXCAVATION QUANTITIES:
 CUT= 0 CUBIC YARDS
 FILL= 110,000 CUBIC YARDS
2. SEE PROFILE SHEET FOR RAMPS INTO SITE FROM EXISTING GRADES.

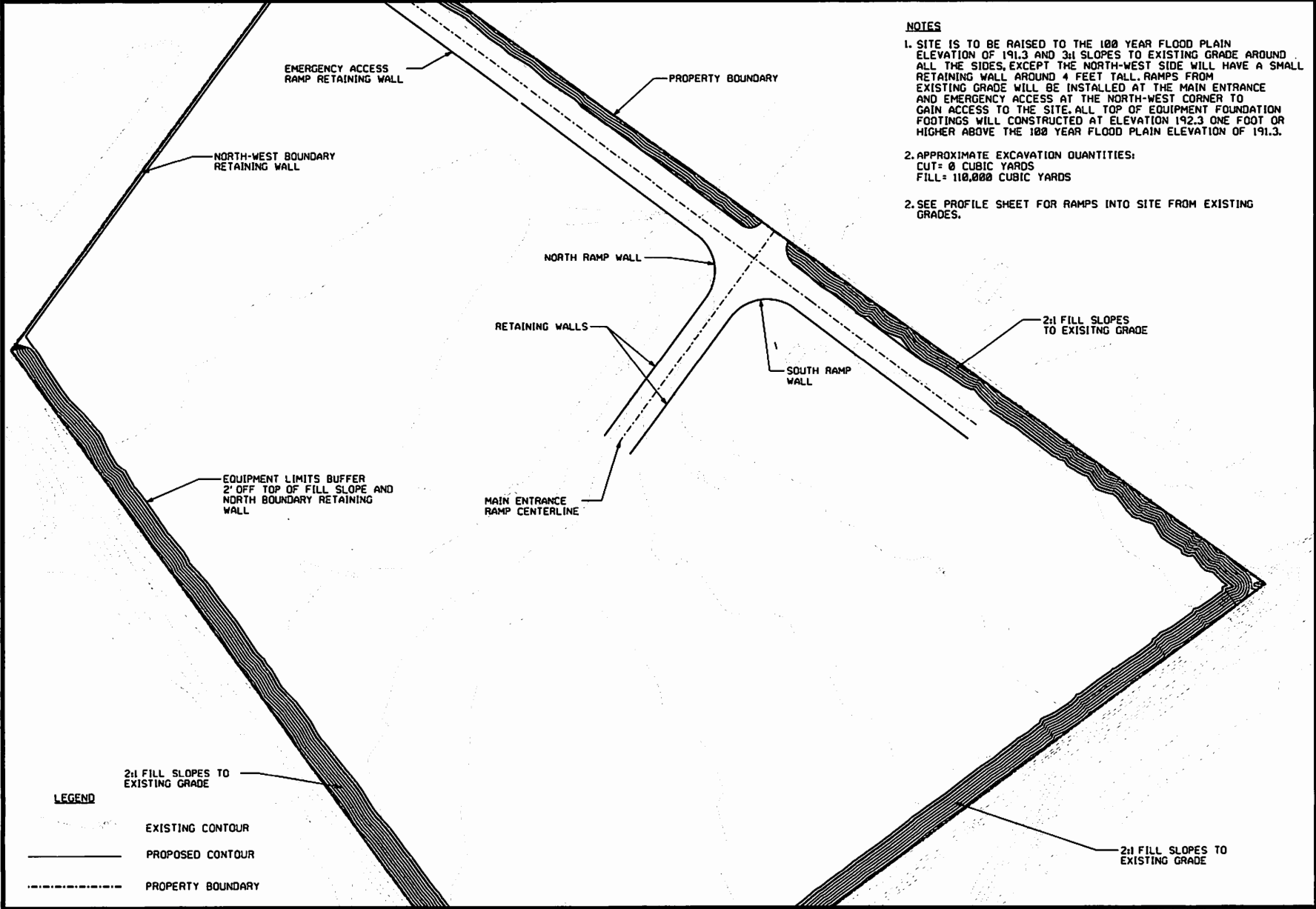

PROJECT DESCRIPTION

CULTURAL FIGURES

CULTURAL RESOURCES - FIGURE 1
 Mission Rock Energy Center - Chumash Locations

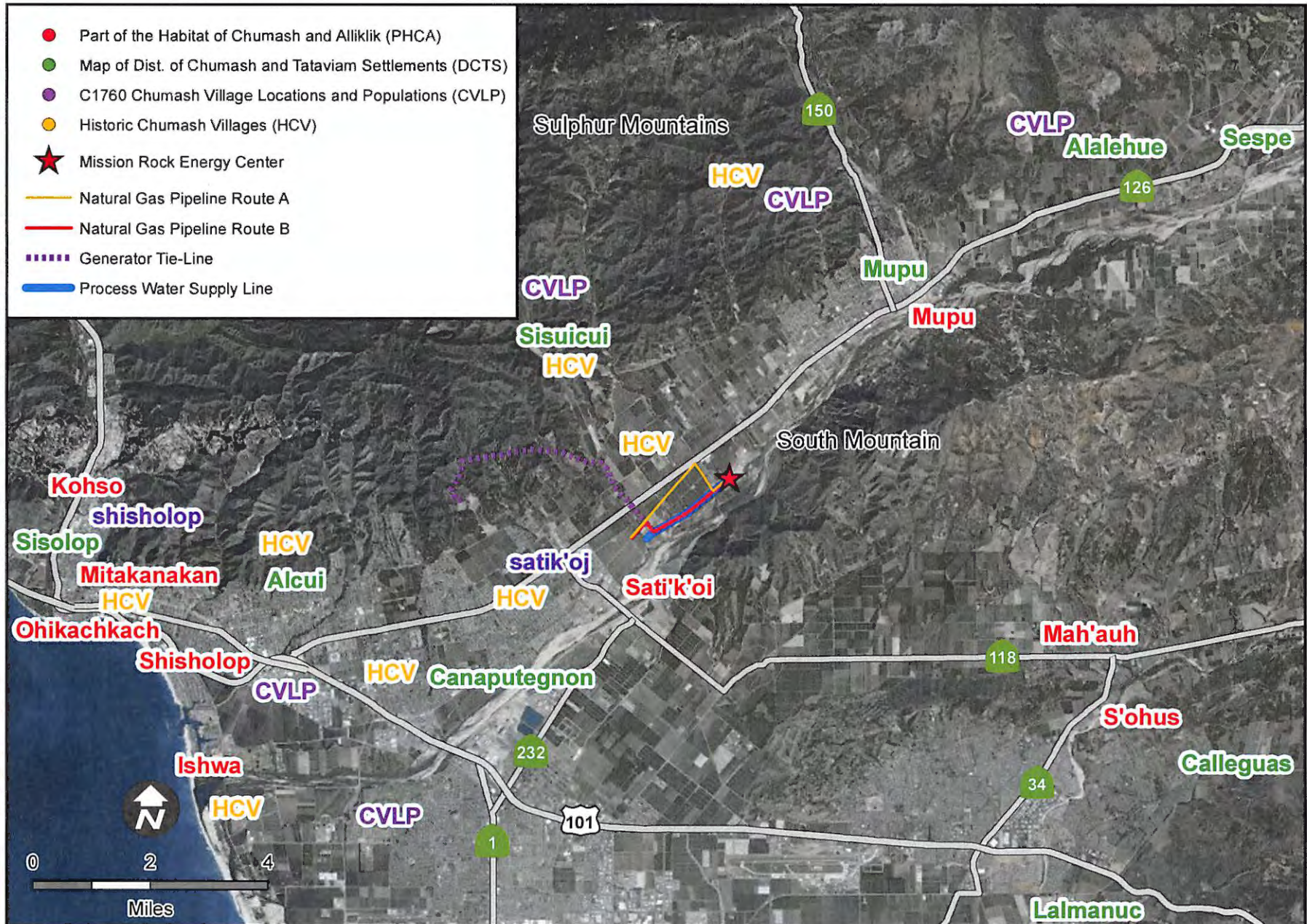

CALIFORNIA ENERGY COMMISSION - SITING, TRANSMISSION AND ENVIRONMENTAL PROTECTION DIVISION

SOURCE: King 1971:30; King 1975: 175; Kroeber 1976:526; McLendon and Johnson 1999:31; Northwest Economic Associates et al. 2014:Figure 44, 219; CH2M; California Energy Commission; TIGER, ESRI Imagery

CULTURAL RESOURCES - FIGURE 2

Mission Rock Energy Center - Archaeological Project Area of Analysis



CULTURAL RESOURCES - FIGURE 3
 Mission Rock Energy Center - Built Environment Project Area of Analysis



CULTURAL RESOURCES - FIGURE 4
Mission Rock Energy Center - Ethnographic Project Area of Analysis



CULTURAL RESOURCES - FIGURE 5
 Mission Rock Energy Center - Historic Built Environment Survey

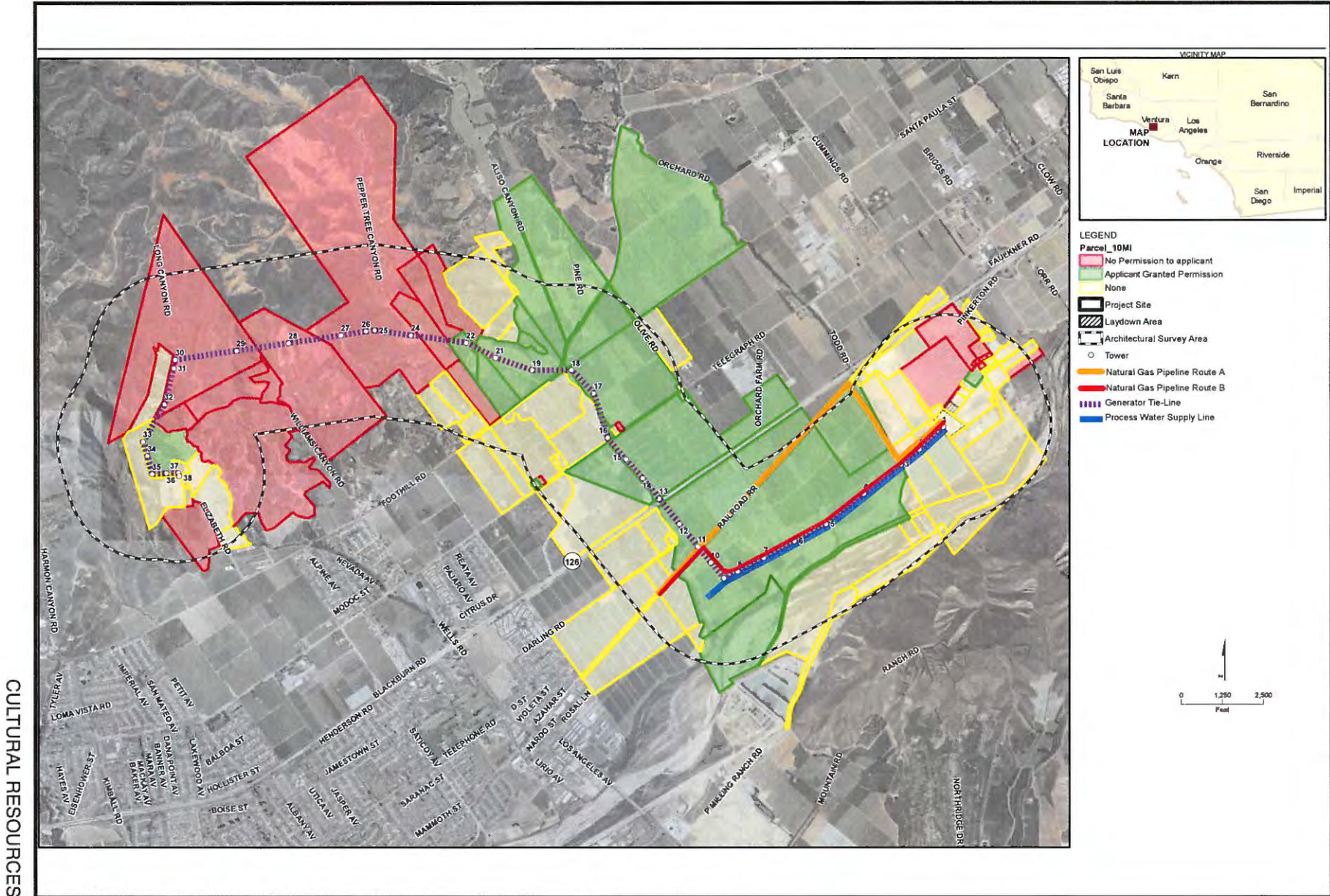

CULTURAL RESOURCES - FIGURE 6
Mission Rock Energy Center - Historic Landscape Features



CULTURAL RESOURCES - FIGURE 7

Mission Rock Energy Center - Past Incursions to the Santa Clara Valley Rural Historic Landscape

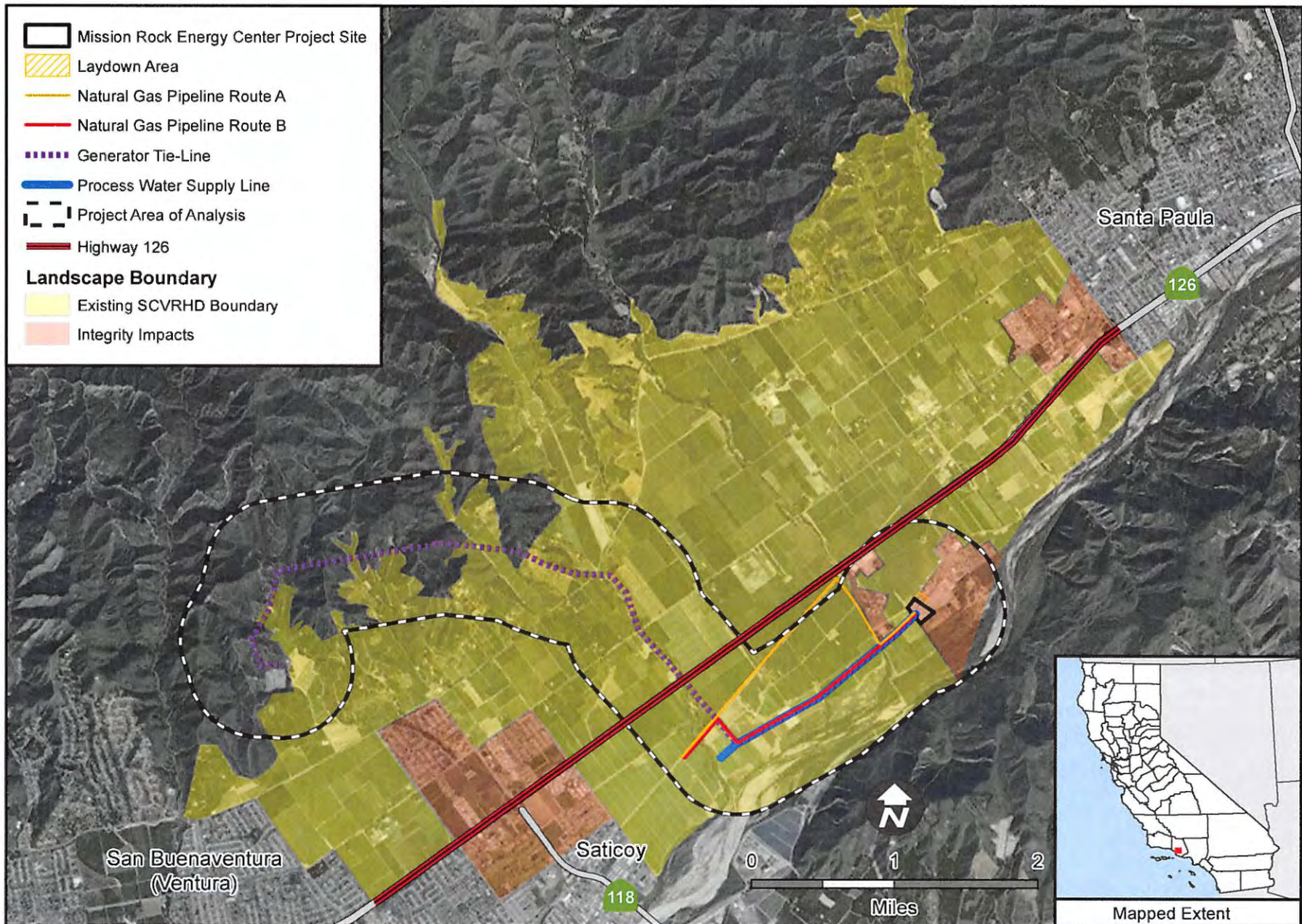

CALIFORNIA ENERGY COMMISSION - SITING, TRANSMISSION AND ENVIRONMENTAL PROTECTION DIVISION

SOURCE: CH2M, California Energy Commission, TIGER, ESRI Imagery

CULTURAL RESOURCES - FIGURE 8

Mission Rock Energy Center - Santa Clara Valley Rural Historic Landscape Sub-districts in the Mission Rock PAA

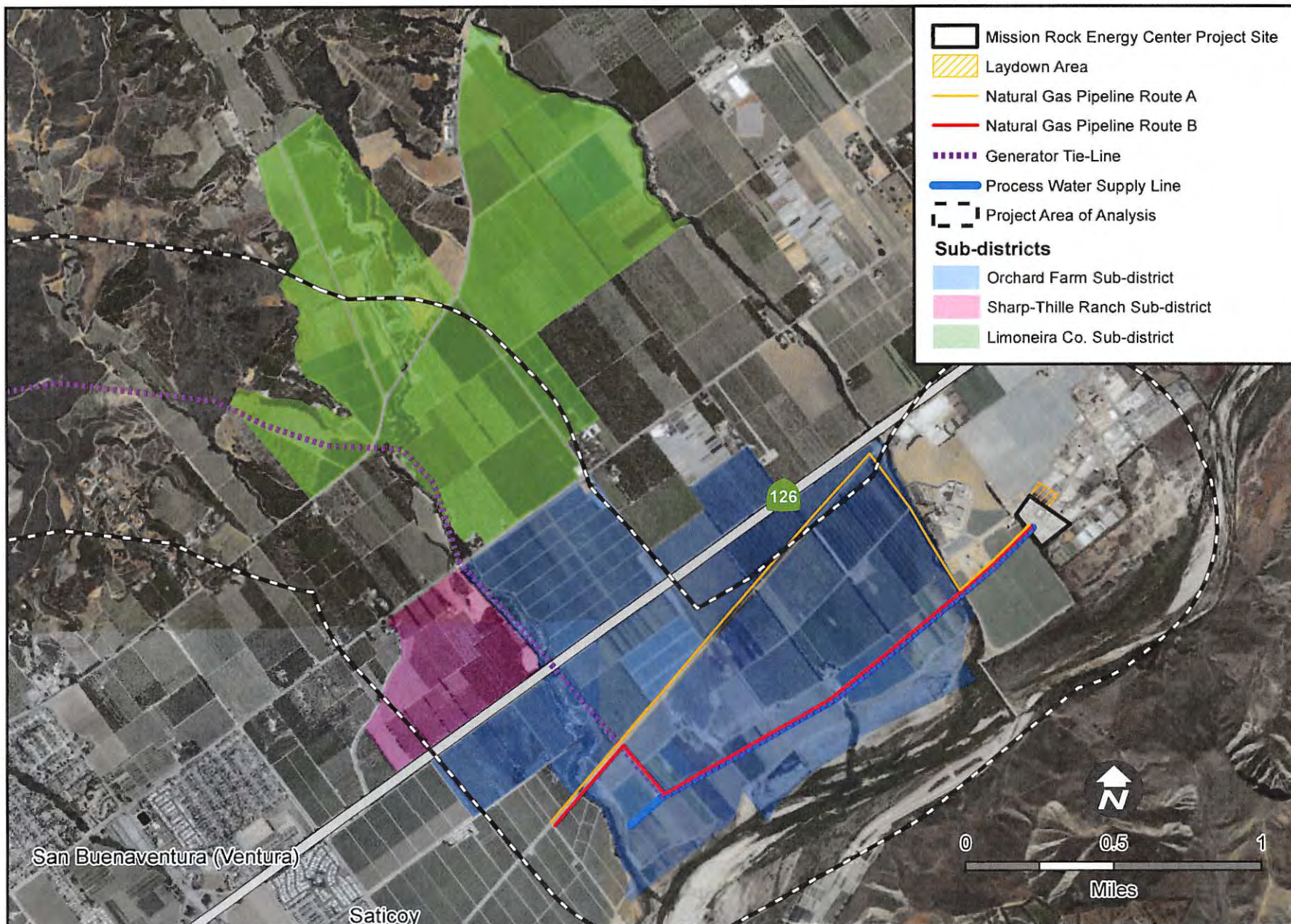

CULTURAL RESOURCES - FIGURE 9
Mission Rock Energy Center - Project Area 1938



CALIFORNIA ENERGY COMMISSION - SITING, TRANSMISSION AND ENVIRONMENTAL PROTECTION DIVISION
SOURCE: University of CA Regents, University of Santa Barbara Map Room Aerial Photograph - 1938

CULTURAL RESOURCES

CULTURAL RESOURCES - FIGURE 10
Mission Rock Energy Center - Project Area 2016



CALIFORNIA ENERGY COMMISSION - SITING, TRANSMISSION AND ENVIRONMENTAL PROTECTION DIVISION
SOURCE: ESRI Imagery, OSM Roads

CULTURAL RESOURCES - FIGURE 11

Mission Rock Energy Center - Cultural Resources Eligible/Ineligible for Listing on the CRHR

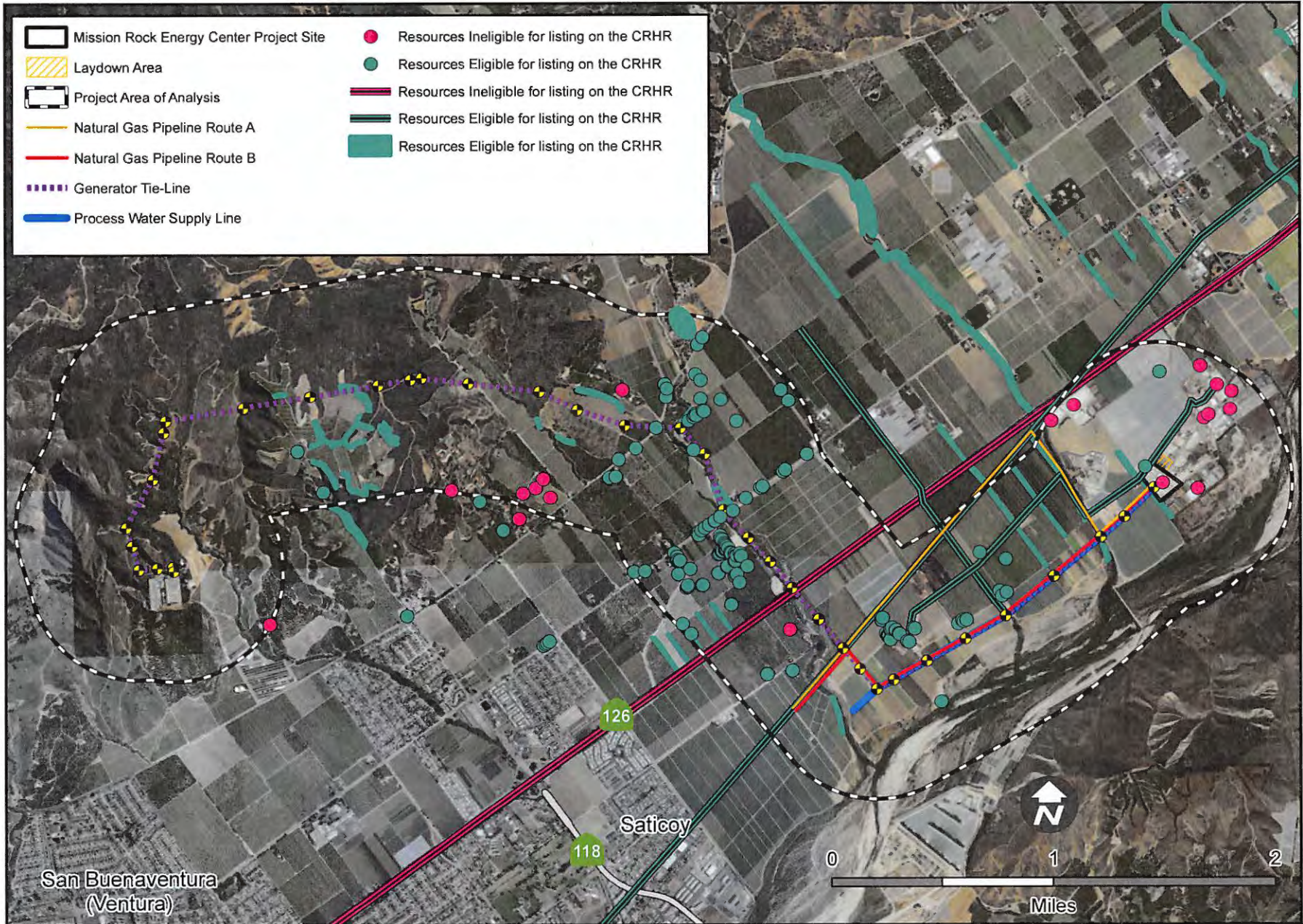

CALIFORNIA ENERGY COMMISSION - SITING, TRANSMISSION AND ENVIRONMENTAL PROTECTION DIVISION

SOURCE: CH2M, California Energy Commission, TIGER, ESRI Imagery

CULTURAL RESOURCES - FIGURE 12

Mission Rock Energy Center - Location and Direction of Heritage Observation Points (HOPs)

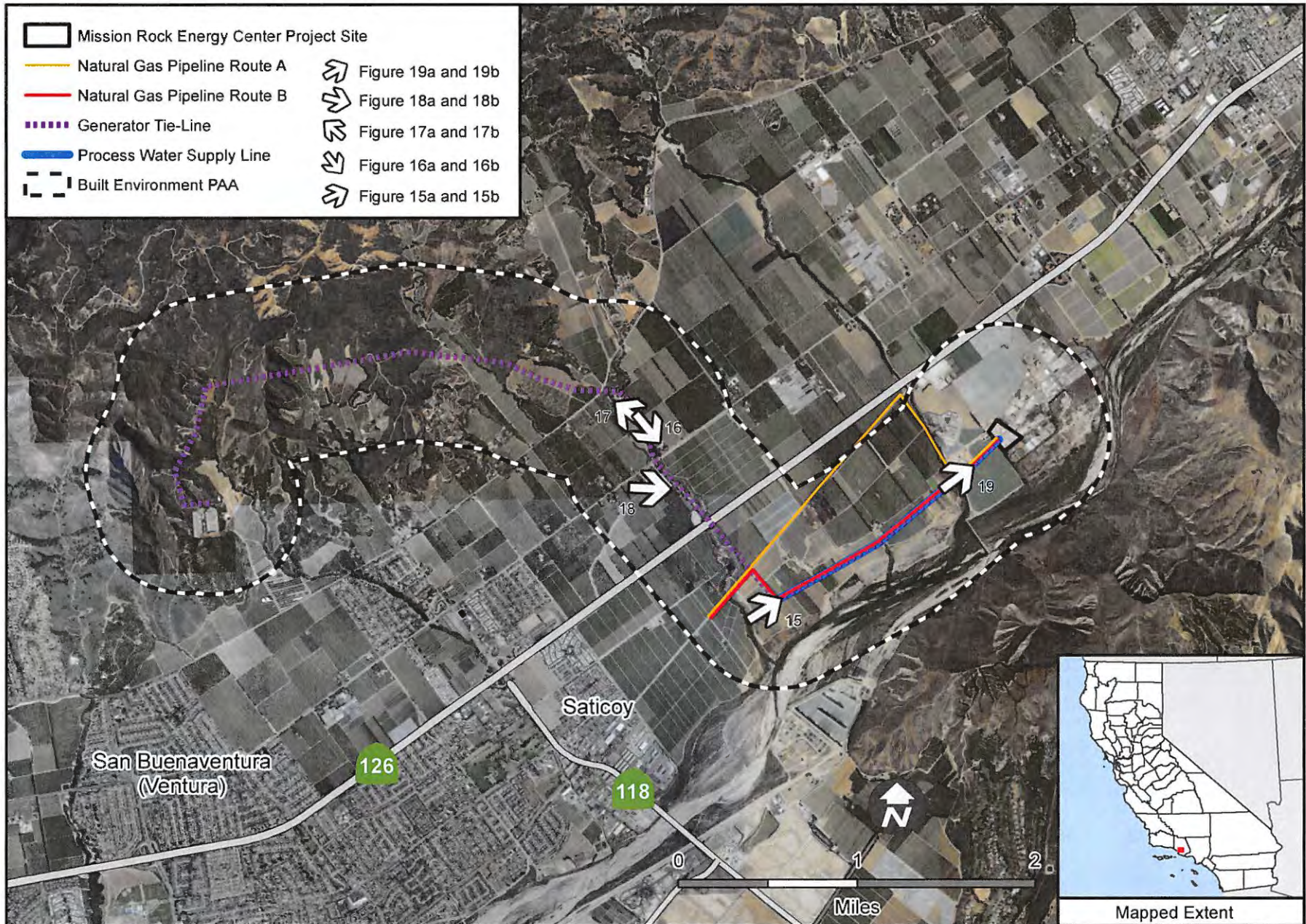

CALIFORNIA ENERGY COMMISSION - SITING, TRANSMISSION AND ENVIRONMENTAL PROTECTION DIVISION

SOURCE: CH2M, California Energy Commission, TIGER, ESRI Imagery

CULTURAL RESOURCES - FIGURE 13A

Mission Rock Energy Center - Orchard Farm Subdistrict Baseline Condition



CULTURAL RESOURCES

CULTURAL RESOURCES - FIGURE 13B

Mission Rock Energy Center - Orchard Farm Subdistrict with Proposed Project



CULTURAL RESOURCES

CULTURAL RESOURCES - FIGURE 14A

Mission Rock Energy Center - View from Ellsworth Barranca - North of Telegraph Road - Facing South - Baseline Condition



CULTURAL RESOURCES

CULTURAL RESOURCES - FIGURE 14B

Mission Rock Energy Center - View from Ellsworth Barranca - North of Telegraph Road - Facing South - With Proposed Project



CULTURAL RESOURCES

CULTURAL RESOURCES - FIGURE 15A

Mission Rock Energy Center - View from Ellsworth Barranca - North of Telegraph Road - Facing North - Baseline Condition



CULTURAL RESOURCES

CALIFORNIA ENERGY COMMISSION - SITING, TRANSMISSION AND ENVIRONMENTAL PROTECTION DIVISION

SOURCE: William Kanemoto & Associates, 2016

CULTURAL RESOURCES - FIGURE 15B

Mission Rock Energy Center - View from Ellsworth Barranca - North of Telegraph Road - Facing North - Proposed Project



CULTURAL RESOURCES

CULTURAL RESOURCES - FIGURE 16A

Mission Rock Energy Center - View from Sharp-Thille Historic Tower - Facing East - South East - Baseline Condition

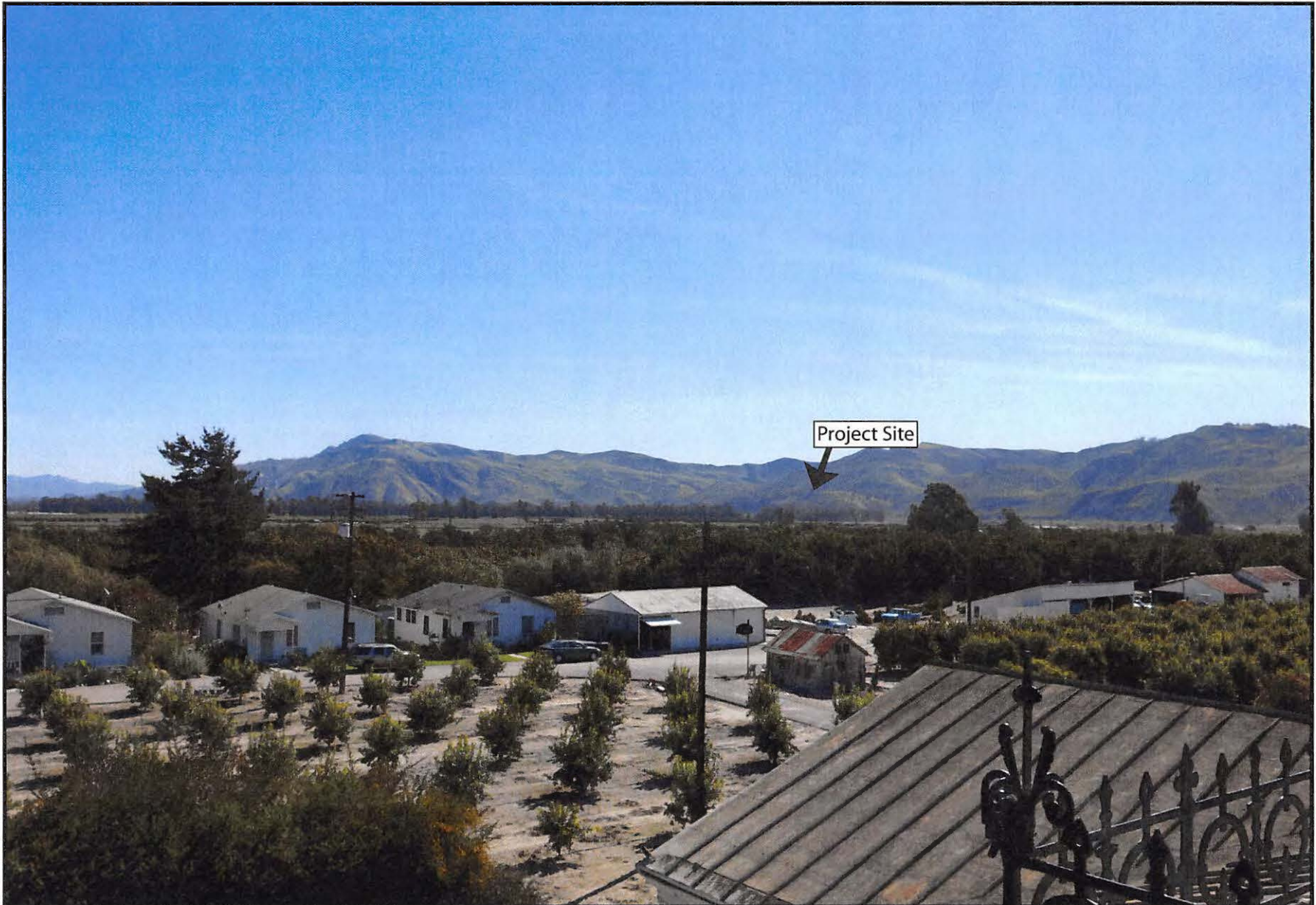

CULTURAL RESOURCES

CALIFORNIA ENERGY COMMISSION - SITING, TRANSMISSION AND ENVIRONMENTAL PROTECTION DIVISION

SOURCE: Photo Taken by CEC Cultural Staff March 29, 2017

CULTURAL RESOURCES - FIGURE 16B

Mission Rock Energy Center - View from Sharp-Thille Historic Tower - Facing East - South East



CULTURAL RESOURCES

CULTURAL RESOURCES - FIGURE 17A

Mission Rock Energy Center - View of Historic Tree Row West of Project Site - Facing East Baseline Condition

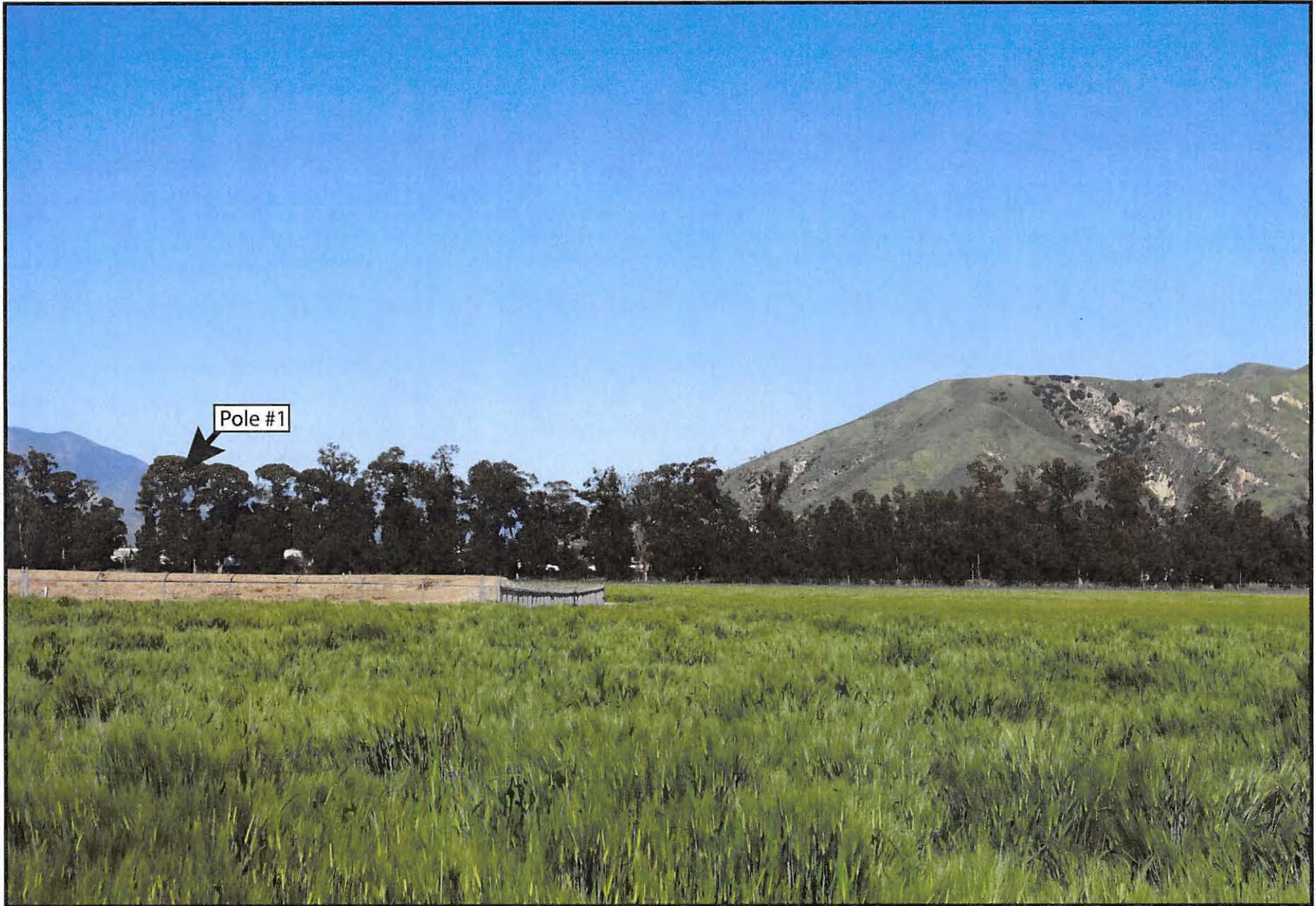

CULTURAL RESOURCES

CULTURAL RESOURCES - FIGURE 17B

Mission Rock Energy Center - View of Historic Tree Row West of Project Site - Facing East - Proposed Project

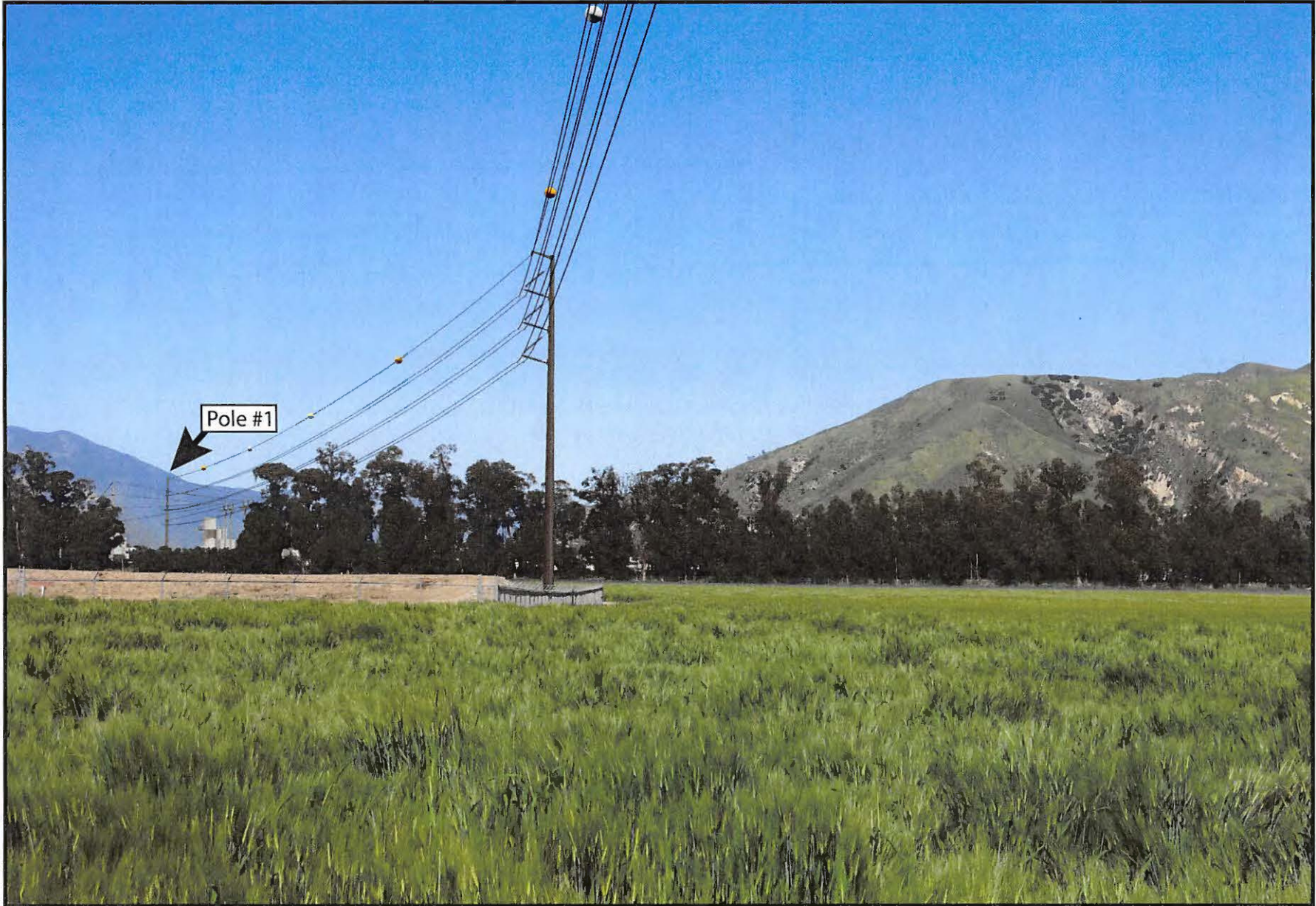

CULTURAL RESOURCES

CALIFORNIA ENERGY COMMISSION - SITING, TRANSMISSION AND ENVIRONMENTAL PROTECTION DIVISION

SOURCE: Photo Taken by CEC Cultural Staff March 30, 2017, William Kanemoto & Associates, 2017

CULTURAL RESOURCES - FIGURE 18

Mission Rock Energy Center - Santa Clara Valley Rural Historic Landscape Significant Viewsheds Within Mission Rock PAA

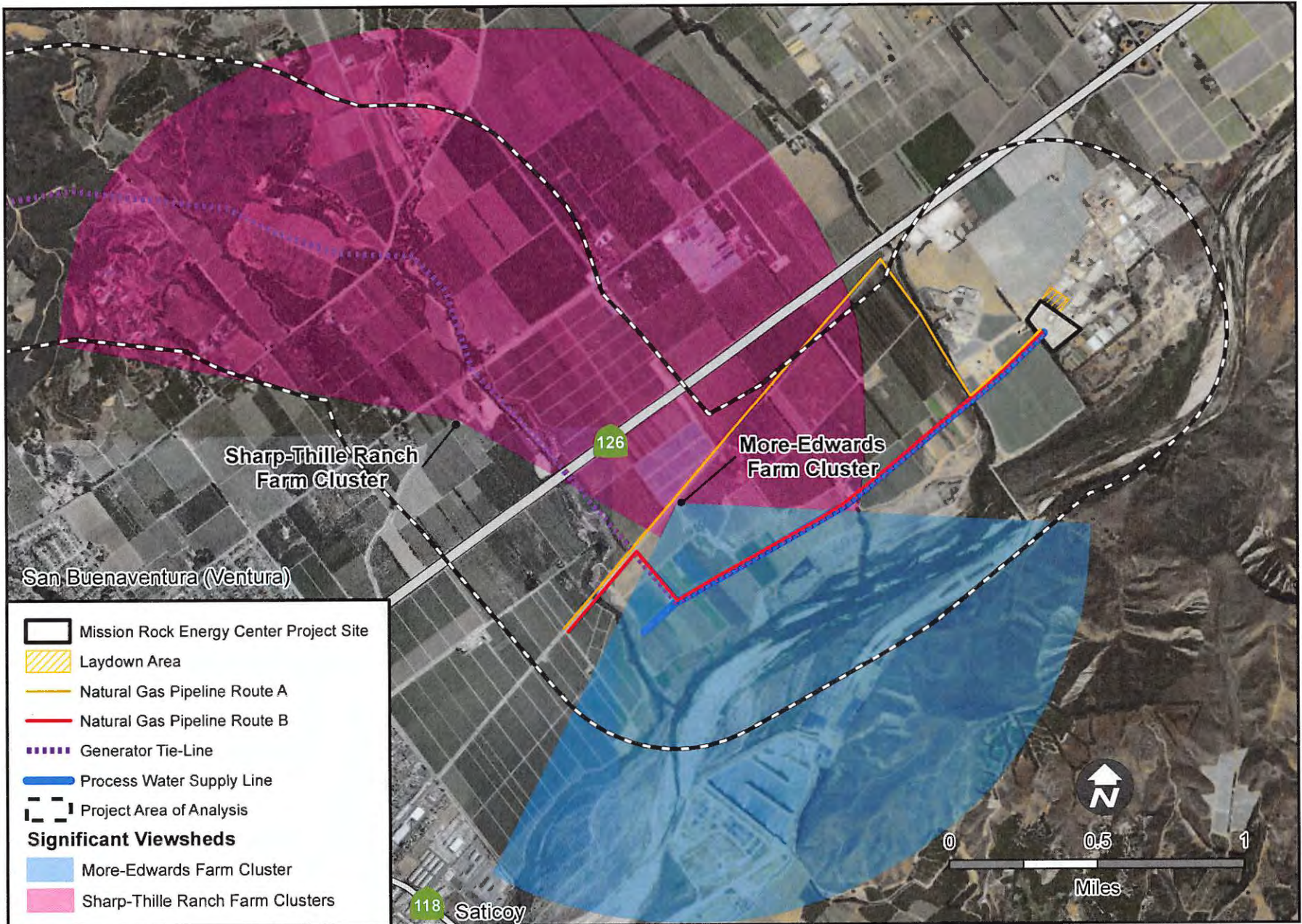

CULTURAL RESOURCES - FIGURE 19

Mission Rock Energy Center - Cumulative Projects With Significant Impacts to Historical Res.

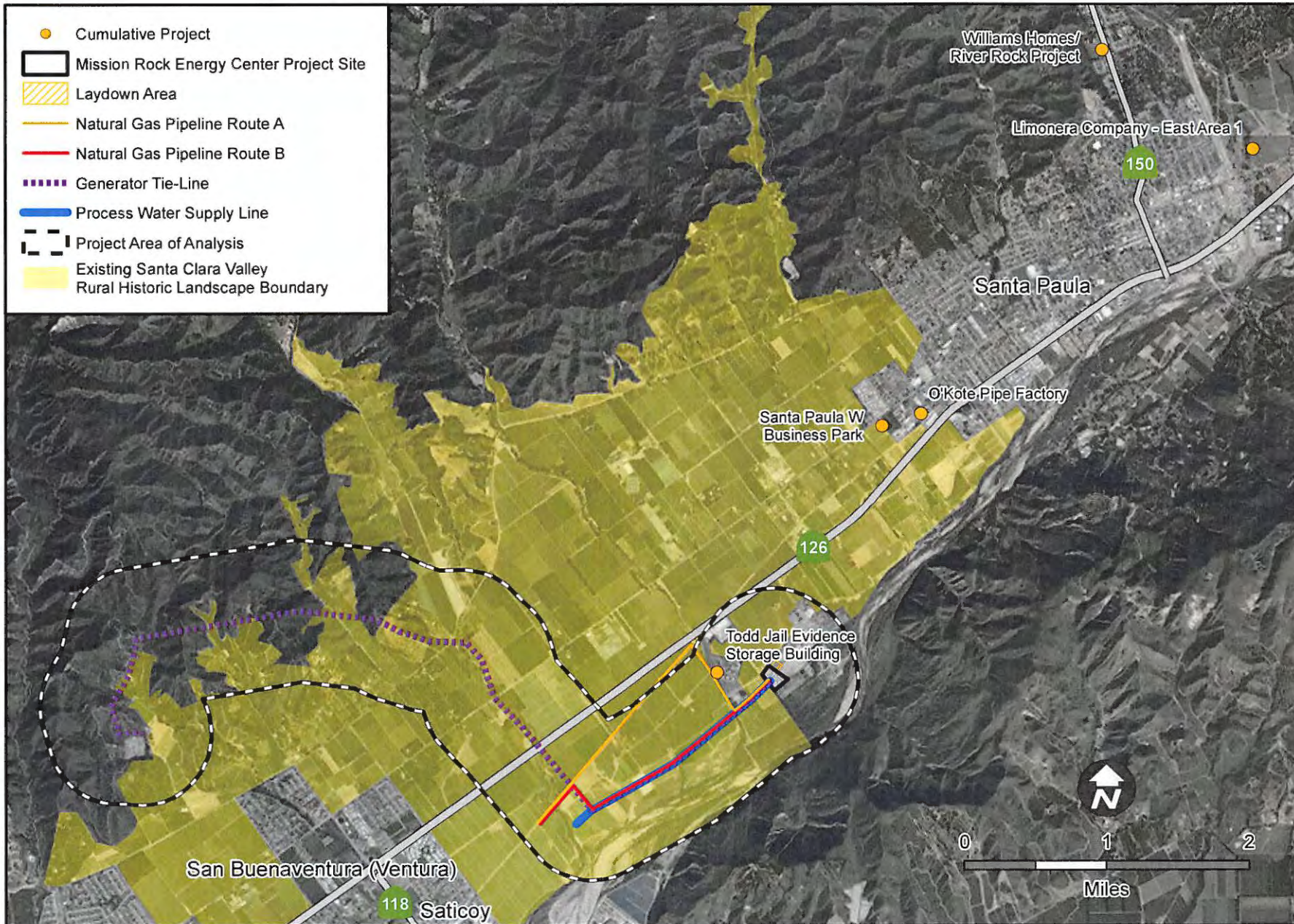

CALIFORNIA ENERGY COMMISSION - SITING, TRANSMISSION AND ENVIRONMENTAL PROTECTION DIVISION

SOURCE: CH2M, California Energy Commission, TIGER, ESRI Imagery

CULTURAL RESOURCES - FIGURE 20
Mission Rock Energy Center - Historical Resource Impact Score

■ Cumulative Impact ■ Landscape as a Whole ■ Historic Trees and Treerows ■ Sharp-Thille Subdistrict ■ Orchard Farm

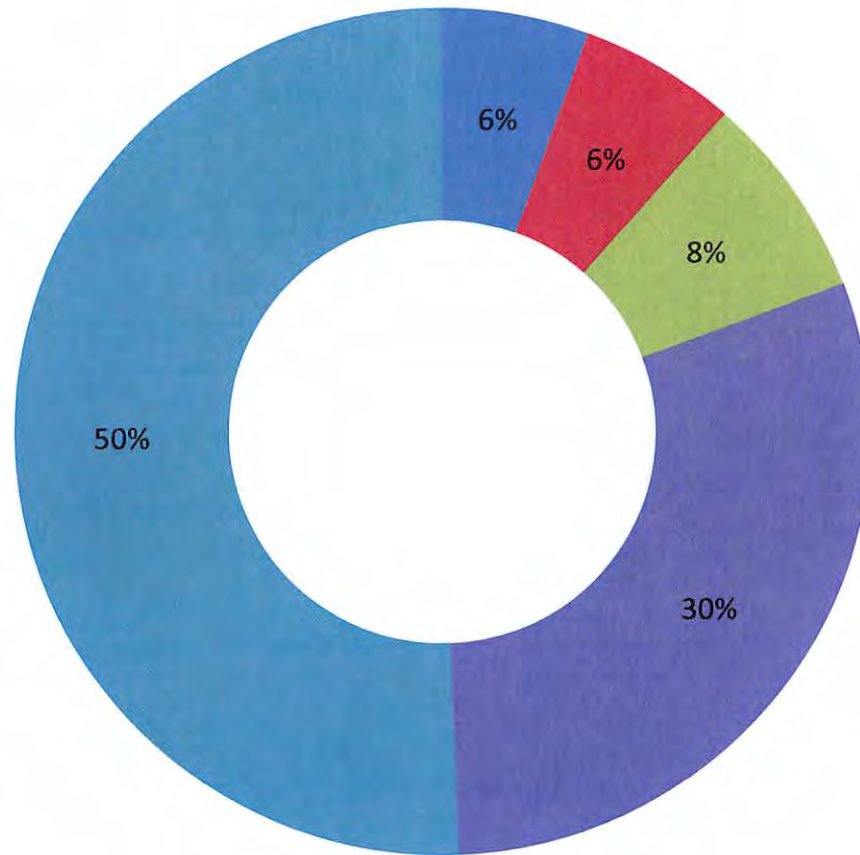

CULTURAL RESOURCES

CULTURAL RESOURCES - FIGURE 21

Mission Rock Energy Center - Santa Clara Valley Rural Historic District Mitigation Estimate

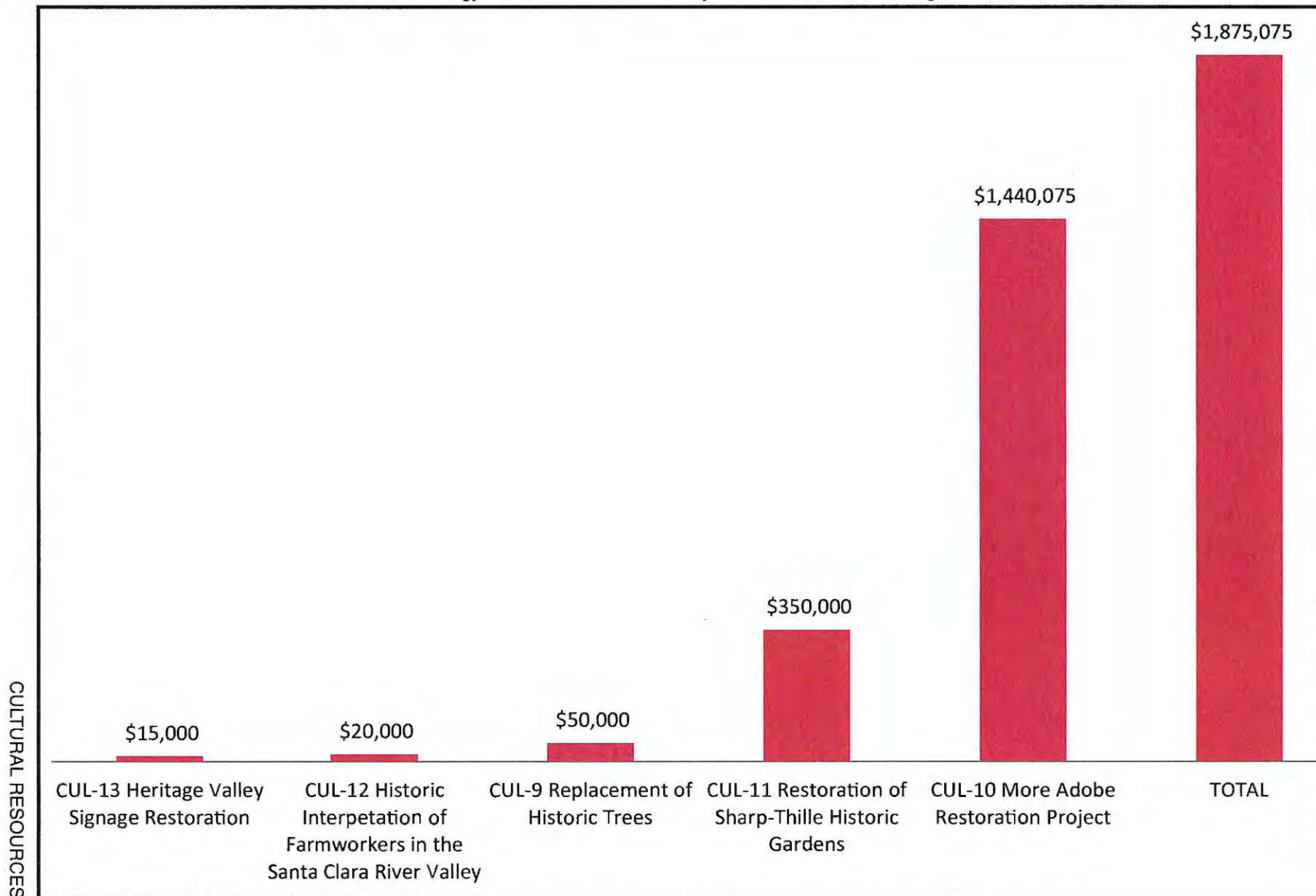

CULTURAL RESOURCES - FIGURE 22
Mission Rock Energy Center - Heritage Valley Tourism Bureau Signage



CULTURAL RESOURCES