

DOCKETED

Docket Number:	15-AFC-01
Project Title:	Puente Power Project
TN #:	221150
Document Title:	Draft Commission Report Senate Bill 350 Doubling Energy Efficiency Savings by 2030
Description:	TN 220927 is a draft report from the Energy Commission regarding the Requirements of SB 350 to double energy efficiency by 2030. The City may refer to this document during questioning at the evidentiary hearing on September 14.
Filer:	PATRICIA LARKIN
Organization:	SHUTE, MIHALY & WEINBERGER LLP
Submitter Role:	Intervenor Representative
Submission Date:	9/13/2017 12:33:16 PM
Docketed Date:	9/13/2017

DOCKETED

Docket Number:	17-IEPR-06
Project Title:	Doubling Energy Efficiency Savings
TN #:	220927
Document Title:	Senate Bill 350 Doubling Energy Efficiency Savings by 2030
Description:	DRAFT COMMISSION REPORT: Senate Bill 350: Doubling Energy Efficiency Savings by 2030
Filer:	Raquel Kravitz
Organization:	California Energy Commission
Submitter Role:	Commission Staff
Submission Date:	8/28/2017 2:43:24 PM
Docketed Date:	8/28/2017

California Energy Commission

DRAFT COMMISSION REPORT

Senate Bill 350: Doubling Energy Efficiency Savings by 2030

California Energy Commission

Edmund G. Brown Jr., Governor

August 2017 | CEC-400-2017-010-CMD



California Energy Commission

Robert B. Weisenmiller, Ph.D.

Chair

Commissioners

Karen Douglas, J.D.

J. Andrew McAllister, Ph.D.

David Hochschild

Janea A. Scott

Melissa Jones

Michael Jaske

Michael Kenney

Brian Samuelson

Cynthia Rogers

Manjit Ahuja

Elena Giyenko

Primary Authors

Michael Sokol

Project Manager

Sylvia Bender

Deputy Director

ENERGY ASSESSMENTS DIVISION

Dave Ashuckian

Deputy Director

EFFICIENCY DIVISION

Robert P. Oglesby

Executive Director

DISCLAIMER

This draft report was prepared by the California Energy Commission – docket # 17-IEPR-06. A final report will be released in October 2017 and considered for adoption by the full Energy Commission at its Business Meeting on November 8, 2017. The views and recommendations contained in this document are not official policy of the Energy Commission until the report is adopted.

ACKNOWLEDGEMENTS

California Energy Commission

Martha Brook, Bryan Early, Linda Schrupp, Andrea Gough, Christine Collopy, William Dietrich, Eric Knops, Laith Younis, Erik Jensen, Angela Wuerth, Esq., Caryn Holmes, Esq., Harinder Kaur, Barbara Crume

Contributing Agencies

California Public Utilities Commission

Paula Gruending, Simon Baker, Robert Strauss, Pete Skala, Katie Wu

California Department of Water Resources

Rachel Ballanti

California Department of Community Services and Development

Charles Belk, Glen Baird

California Department of General Services

Valerie Keisler

Northern California Power Agency

Jonathan Changus

Contractors

NORESKO - Contractor to Efficiency Division

Dimitri Contoyannis, Skye Lei, Matt Leach, John Arent, Roger Hedrick, Nikhil Kapur, Chitra Nambiar, Benjamin Park, Silas Taylor

TRC Energy Services - Subcontractor to NORESKO

Catherine Chappell, Abhijeet Pande, Michael Mutmansky, Megan Dawe, Avani Goyal

Center for Sustainable Energy - Subcontractor to NORESKO

Lindsey Hawes, Laura Parsons, Christina Machak, Alissa Burger, Angela Barich, Timothy Treadwell, Rebecca Sappenfield

Navigant – Contractor to California Public Utilities Commission

Amul Sathe, Greg Wikler

ABSTRACT

Senate Bill 350, the Clean Energy and Pollution Reduction Act of 2015 (De León, Chapter 547, Statutes of 2015), requires the California Energy Commission to establish annual targets that will achieve a cumulative doubling of statewide energy efficiency savings and demand reductions in electricity and natural gas final end uses. This report establishes the proposed statewide doubling targets for electricity and natural gas end uses that must be achieved by 2030. It proposes sub-targets for the portion of projected energy efficiency savings that can be achieved through programs funded by the state's investor-owned and publicly owned electric and natural gas utilities. The report also proposes sub-targets for programs funded through sources other than utility rates. In addition, the report identifies projected non-utility efficiency savings from the industrial and agricultural sectors. The report outlines recommendations to ensure that California meets SB 350 energy efficiency doubling targets.

Keywords: Energy efficiency, SB 350, publicly owned, investor-owned, utility, codes and standards, financing, fuel substitution, non-utility, programs

Please use the following citation for this report:

Jones, Melissa, Michael Jaske, Michael Kenney, Brian Samuelson, Cynthia Rogers, Elena Giyenko, and Manjit Ahuja. 2017. *Senate Bill 350: Doubling Energy Efficiency Savings by 2030*. California Energy Commission. Publication Number: CEC-400-2017-010-CMD.

TABLE OF CONTENTS

	Page
Acknowledgements	i
Abstract	ii
Table of Contents	iii
List of Figures	v
List of Tables	vii
Executive Summary	1
Overview.....	1
SB 350 Energy Efficiency Doubling Targets.....	1
Utility Programs Savings Projections.....	3
Non-utility Program Savings Projections	4
Recommendations	4
Establish Aggregate Electricity and Natural Gas Targets	6
CHAPTER 1: Introduction	7
Outline of Chapters.....	7
Definitions	8
Targets and Sub-targets.....	8
Cost-Effectiveness.....	8
Feasible.....	9
Adversely Impact Public Health and Safety.....	10
Additional Achievable Energy Efficiency.....	10
Net Versus Gross Energy Savings	10
CHAPTER 2: Doubling Energy Efficiency Savings	12
SB 350 Energy Efficiency Doubling Targets	12
SB 350 Doubling Target for Electricity	13
SB 350 Doubling Target for Natural Gas	13
Public Process for SB 350 Target Setting.....	15
CHAPTER 3: Investor-Owned Utility Energy Efficiency Programs	17
Historical Energy Efficiency Savings	17
IOU Energy Efficiency Target Setting.....	18
Energy Efficiency Potential and Goals.....	19
Net and Cumulative Savings Goals	19
Cost-Effectiveness	20
IOU Market Potential.....	21
CPUC-Adopted IOU Energy Efficiency Goals.....	21
Adjustments to CPUC Savings Projections	23
CHAPTER 4: Publicly Owned Utility Energy Efficiency	25

Historical Energy Efficiency Savings 25

POU Energy Efficiency Potential and Goals Studies 27

POU Energy Efficiency Goals 28

Adjusted POU Energy Efficiency Projections 29

POU Comments on Proposed SB 350 Doubling Sub-targets 32

CHAPTER 5: Potential Energy Efficiency Programs Needing Additional Analysis 34

Fuel Substitution Programs 34

 Determining Energy Savings and GHG Emission Reductions 35

 Cost Considerations 35

 Comments on Fuel Substitution..... 36

Conservation Voltage Reduction..... 37

 Comments on Conservation Voltage Reduction..... 37

Agricultural and Industrial Sector Energy Efficiency..... 38

CHAPTER 6: Non-utility Energy Efficiency Programs 40

Energy Savings From Codes and Standards 40

 Title 24 State Building Energy Efficiency Standards 42

 Federal Appliance Standards 43

 Title 20 State Appliance Regulations..... 43

Energy Savings From Financing Programs 44

 Property Assessed Clean Energy 45

 Local Government Challenge 46

 Proposition 39: Clean Energy Jobs Act..... 46

 Energy Conservation Assistance Act..... 46

 Greenhouse Gas Reduction Fund..... 46

 Energy Savings Program 47

 Air Quality Management District Programs..... 47

Energy Savings From Behavioral and Market Transformation 48

 Benchmarking..... 49

 Energy Asset Rating..... 50

 Behavioral, Retrocommissioning, and Operational Savings..... 50

 Smart Meters and Controls 50

 Fuel Substitution..... 51

CHAPTER 7: Recommendations 52

Fund and Improve Energy Efficiency Programs..... 52

Develop Additional Energy Efficiency Programs..... 52

Enhance Reporting and Estimating Energy Efficiency Savings..... 53

 Standardized Historical Savings Estimates 53

 Reporting on Disadvantaged Communities..... 54

 Reporting Hourly and Seasonal Impacts..... 55

 Evaluation, Measurement, and Verification..... 55

ACRONYMS/Abbreviations 58

APPENDIX A: Utility Savings Technical Issues and Assessment A-1

- Investor-Owned Utilities’ Potential and Goals Study A-3
 - Technical, Economic, and Market Potential A-3
 - Incremental Market Potential A-5
 - Potential and Goals Study Draft Scenarios A-6
- Proposed California Public Utilities Commission –Jurisdictional Savings Targets A-9
 - Investor-Owned Utilities Statewide Codes and Standards Program A-9
- Proposed Adjustments to the Potential Study A-11
- Energy Efficiency Savings in Historical Years A-11
- Proposed CPUC-Jurisdictional SB 350 Savings Projections A-11
- Publicly Owned Utility Potential and Goals Study A-13
 - Economic Potential A-14
 - Market Potential A-16
 - Natural Gas Savings Potential A-16
- 10-Year Electricity Savings Projections A-16
- Adjustments to POU-Proposed Projections A-18
- Fuel Substitution Programs A-23
 - Site Energy and Source Greenhouse Gas Emissions A-23
- Interutility Departing Load/Gaining Load Considerations A-24
- Conservation Voltage Reduction A-25
 - Background and Historical Conservation Voltage Reduction Efforts A-25
- Modern CVR Capabilities A-26
- Recent Utility Efforts A-28

APPENDIX B: Standards Non-utility Technical Assessment, Benchmarking, and Industrial and Agricultural B-1

- Standards Savings Included in the *2016 IEPR Update* Managed Demand Forecast B-1
 - Methods B-1
- Navigant and Whole-Building Data Access, Benchmarking, and Public Disclosure (AB 802) B-2
 - Methods B-2
 - Analysis B-3
 - Savings Projections B-3
- Agricultural and Industrial Sectors B-3
 - Methods B-5
 - Savings Projections B-5

LIST OF FIGURES

	Page
Figure 1: Proposed SB 350 Doubling Target for Electricity (GWh)	2
Figure 2: Proposed SB 350 Doubling Target and Sub-targets for Natural Gas (Therms)	2

Figure 3: Combined Electricity and Natural Gas Savings Projections (Quad BTUs)	3
Figure 4: Proposed SB 350 Doubling Target for Electricity (GWh).....	13
Figure 5: Proposed SB 350 Doubling Target for Natural Gas (Therms)	14
Figure 6: Projected Combined Electricity and Natural Gas Savings (Quad BTUs)	15
Figure 7: IOU Reported Electricity Savings (GWh).....	17
Figure 8: Combined (2006-2016) IOU Reported Electricity Savings by End Use	18
Figure 9: Annual Electricity Savings—mTRC (GHG Adder #1) Reference Scenario (GWh).....	22
Figure 10: Annual Natural Gas Savings – mTCR (GHG Adder #1) Reference Scenario (MMTherms) ..	22
Figure 11: Electricity Savings – mTRC (GHG Adder #1) Reference Scenario by Program Type (Excluding Codes and Standards) (GWh)	23
Figure 12: Natural Gas Savings – mTRC (GHG Adder #1) Reference Scenario by Program Type (Excluding Codes and Standards) (MM Therms).....	24
Figure 13: POU Reported Electricity Savings (GWh)	26
Figure 14: Combined (2006-2016) POU Reported Electricity Savings by End Use (GWh).....	26
Figure 15: POU Ten-Year Cumulative Savings Potential	28
Figure 16: Ten-Year Cumulative Savings Goals by POU Group.....	29
Figure 17: POU Annual Incremental Electricity Savings Goals	30
Figure 18: POU Annual Goals With Adjustments	30
Figure 19: Effect of Adjustments to POU Cumulative Savings.....	31
Figure 20: Proposed POU Adjusted Cumulative Sub-targets	32
Figure 21: Projected Electricity Savings Estimates for Agricultural and Industrial Programs (GWh) ...	39
Figure 22: Projected Natural Gas Savings Estimates for Agricultural and Industrial Programs (MM Therms)	39
Figure 23: Projected Electricity Savings Estimates for Future Codes and Standards (GWh).....	41
Figure 24: Projected Natural Gas Savings Estimates for Future Codes and Standards (MM Therms) .	42
Figure 25: Projected Electricity Savings Estimates for Financing Programs (GWh)	44
Figure 26: Projected Natural Gas Savings Estimates for Financing Programs (MM Therms)	45
Figure 27: Projected Electricity Savings Estimates for Behavioral and Market Transformation Programs (GWh)	48
Figure 28: Projected Natural Gas Savings Estimates for Behavioral and Market Transformation Programs (MM Therms)	49
Figure A-1: Electricity Technical, Economic, and Market Potential for IOUs Using TRC Reference Scenario (GWh).....	A-4

Figure A-2: Natural Gas Technical, Economic, and Market Potential for IOUs Using TRC Reference Scenario (MM Therms)A-5

Figure A-3: Electricity Savings—Five Scenarios (Including Codes and Standards) (GWh) A-8

Figure A-4: Natural Gas Savings - Five Scenarios (Including Codes and Standards) (MM Therms)A-9

Figure A-5: Electricity Savings – TRC Reference Scenario With Four Program Types (GWh)A-10

Figure A-6: Natural Gas Savings – TRC Reference Scenario With Four Program Types (MM Therms) 11

Figure A-7: Electricity Savings – TRC Reference Scenario by Program Type (Excluding Codes and Standards) (GWh) A-12

Figure A-8: Natural Gas Savings – TRC Reference Scenario by Program Type (Excluding Codes and Standards) (MM Therms) A-12

Figure A-9: POU Ten-Year ELRAM Projections (GWh) A-17

Figure A-10: Ten-Year Cumulative Targets by POU Group (GWh) A-18

Figure A-11: POU Annual Incremental Electricity Savings Targets (GWh) A-20

Figure A-12: POU Annual Incremental Targets With Adjustments (GWh)..... A-20

Figure A-13: Effect of Adjustments to POU Cumulative Savings..... A-21

Figure A-14: Early Distribution Voltage Control Configuration A-26

Figure A-15: Modern CVR/VVO Equipment ConfigurationA-27

LIST OF TABLES

	Page
Table 1: Scenarios for Energy Efficiency Potential.....	21
Table A-1: Comparison of POU and IOU Characteristics in California	A-1
Table A-2: Variables Affecting Energy Efficiency Potential.....	A-6
Table A-3: Draft Scenarios for Energy Efficiency Potential – Summary	A-7
Table A-4: Comparison of POU 10-Year Forward Potentials in GWh	A-13
Table A-5: POU Technical Potential Groups of Measures.....	A-13
Table A-6: Economic Screening of Measures	A-15
Table A-7: Adjustments to POU-Submitted Targets	A-19
Table A-8: POU Energy Efficiency Targets (GWh)	A-22
Table B-1: Electricity (GWh) and Natural Gas (MM Therms) Savings Projected From 2015 Onwards for Recently Adopted State and Federal Appliance Standards.....	B-2
Table B-2: Electricity (GWh) and Natural Gas (MM therms) Savings Projected From 2015 Through 2029 for Benchmarking and Disclosure	B-3

Table B-3 Industrial Sector Incremental Savings: A- Electricity (GWh), B- Natural Gas (MM Therm)B-5

Table B-4 Agriculture Sector Incremental Savings: A- Electricity (GWh), B- Natural Gas (MM Therm)
.....B-6

EXECUTIVE SUMMARY

Overview

Senate Bill 350, the Clean Energy and Pollution Reduction Act (De León, Chapter 547, Statutes of 2015) requires the California Energy Commission to set ambitious annual targets for increasing energy efficiency savings and demand reductions to achieve a statewide cumulative doubling of energy efficiency savings in electricity and natural gas final end uses by January 1, 2030. The Energy Commission also must report biennially to the Legislature on progress achieved toward meeting the statewide SB 350 energy efficiency doubling targets and the impacts on disadvantaged communities.

The targets for doubling energy efficiency savings are ambitious. These bold targets will help focus the necessary attention and creativity on harnessing emerging technologies, progressive program designs, and innovative market solutions that together can move the savings trajectory upward. Meeting the targets will require the collective effort of many entities, including state and local governments, utilities, program deliverers, market participants, and end-use customers. But with proper tracking of energy efficiency savings, midcourse corrections in both utility and non-utility programs, and ongoing support from California's leading elected officials, the state is well-positioned to meet the doubling targets by 2030.

Much of the untapped energy efficiency potential to meet the doubling targets can be achieved by improving the energy efficiency of existing buildings, as well as the appliances, and other devices used in them. The Energy Commission developed the *Existing Buildings Energy Efficiency Action Plan* to improve the energy efficiency of existing residential, commercial, and government buildings. The plan relies on measures and programs to increase energy efficiency markets, create more effective targeting and delivery of energy efficiency upgrade services, improve the decision making of occupants and investors, and advance improvements to the performance of California's buildings.

This draft Commission report proposes separate targets for electricity and natural gas to achieve a cumulative doubling of statewide energy efficiency savings by January 1, 2030 as called for in SB 350. Both utility energy efficiency programs and programs funded through sources other than utility ratepayers, also referred to as non-utility programs, will be necessary to achieve the doubling targets. The report proposes sub-targets for individual utilities and non-utility energy efficiency programs. Finally, it presents recommendations and next steps to ensure that California achieves the SB 350 doubling targets.

SB 350 Energy Efficiency Doubling Targets

SB 350 directs the Energy Commission to base the SB 350 energy efficiency targets on a doubling of the additional achievable energy efficiency contained in the *California Energy Demand Updated Forecast, 2015-2025* extrapolated to 2030. For the publicly owned utilities, the target is based on their most recent adopted energy efficiency targets, also extrapolated to 2030. **Figure 1** and **Figure 2** show the proposed SB 350 doubling targets for savings of electricity and natural gas with the projected contributions of the different programs including utility and non-utility programs to achieve the targets. Because the SB 350 deadline is January 1, 2030, the last full year of the Energy Commission's analysis is 2029. The Energy Commission established sub-targets for utility savings from investor-owned and publicly owned utilities based on projected energy efficiency savings from utility programs.

For the non-utility programs, the Energy Commission established sub-targets based on the savings estimates for codes and standards, financing programs and behavioral and market transformation. New opportunities for non-utility energy efficiency financing are expected to encourage additional participation in utility incentive programs. These incremental savings projections are delineated as *additional program participation* in **Figure 1** and **Figure 2**. In addition, preliminary assessments of possible energy savings from the agricultural and industrial sectors are included in the non-utility savings sub-targets.

Figure 1: Proposed SB 350 Doubling Target for Electricity (GWh)

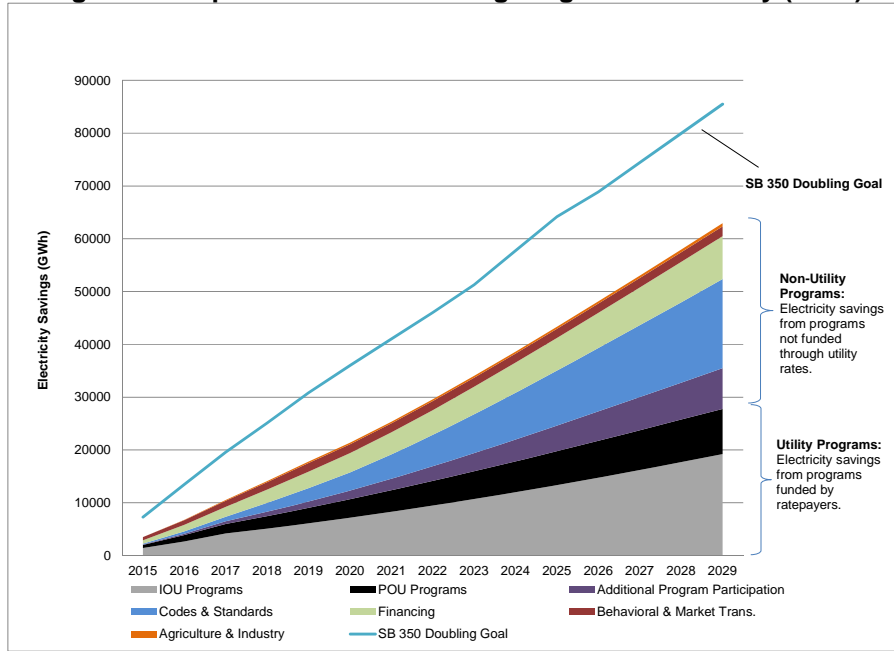

Source: California Energy Commission staff, Efficiency Division. Based on work in Attachment A by NORESKO. August 2017.

Figure 2: Proposed SB 350 Doubling Target and Sub-targets for Natural Gas (Therms)

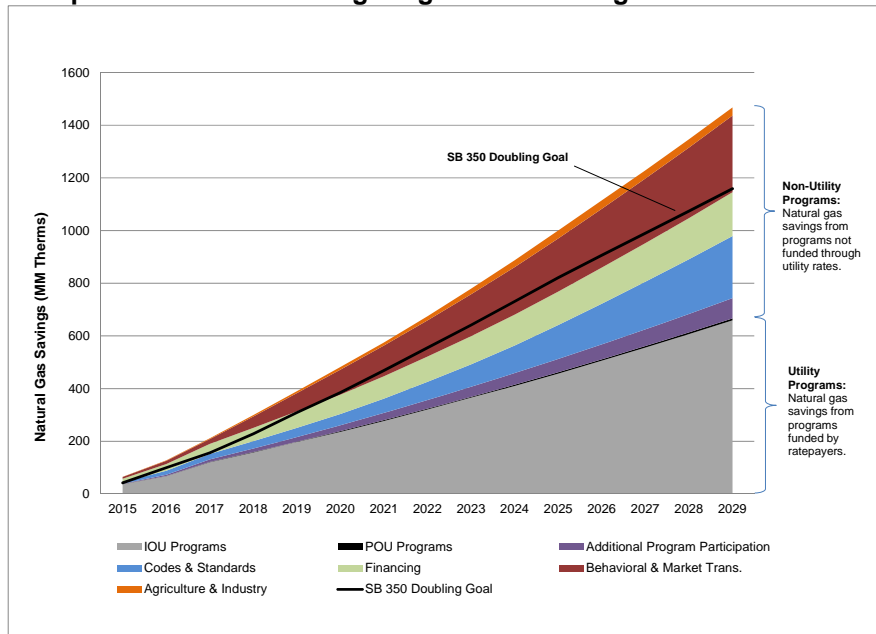

Source: California Energy Commission staff, Efficiency Division. Based on work in Attachment A by NORESKO. August 2017.

Figure 3 shows the combined site-level electricity and natural gas projected savings from utility and non-utility programs (in Quad BTUs). The top line represents the combination of the doubling targets for electricity and natural gas, not the aggregate target provided for in SB 350.

Figure 3: Combined Electricity and Natural Gas Savings Projections (Quad BTUs)

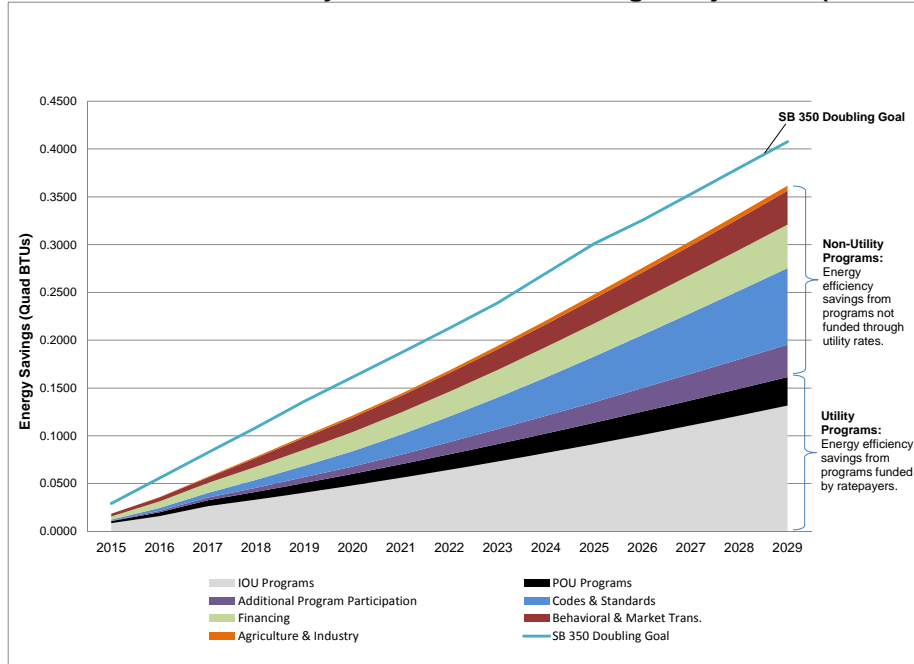

Source: California Energy Commission staff, Efficiency Division Based on work in Attachment A by NORESO. August 2017.

Utility Programs Savings Projections

SB 350 directs the Energy Commission, when assessing the feasibility and cost-effectiveness of utility energy efficiency programs, to consider the results of the energy efficiency potential studies. Two important studies of energy efficiency savings potential were conducted by the California Public Utilities Commission for its jurisdictional entities, primarily investor-owned utilities, and by the California Municipal Utilities Association on behalf of the publicly owned utilities. Since the studies were underway when SB 350 implementation was just beginning, neither study identifies specifically how utilities might accomplish a large increase in savings associated with the SB 350 doubling targets. Each study is designed to determine a market-based savings potential for voluntary utility-incentive retrofit and new construction programs, along with codes and standards, under a given a set of assumptions. These studies are detailed in Chapters 3 and 4 and Appendix A.

In developing projections of energy efficiency savings for utility programs, the Energy Commission analyzed the electricity and natural gas efficiency savings projections for 2018 and beyond from the two potential studies. The studies lacked a uniform set of assumptions applicable to all utilities, resulting in inconsistent reporting of expected energy efficiency savings. The Energy Commission adjusted the savings projections to address this issue. The reported savings for some publicly owned utilities were adjusted from gross to net, since many utilities use net savings in assessing energy efficiency potential. The 2027 projections of efficiency savings for publicly owned utilities were extrapolated to 2030. For both investor-owned and publicly owned utilities; the years 2015-2017 were added to the 2018-2030 savings projections. The final adjustment was to remove codes and standards savings from investor-

owned and publicly owned utility projections and count them as part of the non-utility sub-targets. The savings projection for investor-owned and publicly owned utilities for electricity and natural gas end uses are shown in **Figure 1** and **Figure 2**. In addition, Chapters 3 and 4 and Appendix A of this report detail how the investor-owned and publicly owned utility sub-targets were established.

Non-utility Program Savings Projections

The non-utility sub-targets include projected savings from programs at the Energy Commission, other state agencies, local governments, and other local entities. The Energy Commission is responsible for a portion of the non-utility savings, including the *Building Energy Efficiency Standards*, the *Appliance Efficiency Regulations*, multiple financing programs (such as Proposition 39 and Energy Conservation Assistance Act programs), and programs to transform markets. The *Existing Buildings Energy Efficiency Action Plan* outlines many of the Energy Commission's energy savings strategies. Several other financing programs offered by other state agencies and private entities are major contributors to non-utility energy savings. The additional utility incentive program participation anticipated from expanded access to capital increases the savings possible from these other financing programs. The largest contributor to natural gas market transformation energy savings is expected to come from fuel substitution programs. The programs and the associated contributions to projected savings to meet the SB 350 doubling targets are shown in **Figure 1** and **Figure 2** and detailed in Chapter 6, Appendix B, and Attachment A.

The Energy Commission developed preliminary projections of non-utility programs that are incremental to the energy savings identified in the utility potential studies to minimize possible overlap in savings projections. The preliminary estimates in this draft Commission report are being further analyzed and revised projections of energy savings will be included in the final version of this report. Programs that are cost-effective and feasible and did not adversely affect public health and safety were included in the projected savings estimates. Many of the programs have a cost-effectiveness metric that was evaluated in developing the savings estimates. The detailed methods for developing non-utility savings sub-targets are described in Appendix B and Attachment A.

Recommendations

Fund and Improve Energy Efficiency Programs

Efficiency programs, especially financing programs, are assumed to be funded through 2029, yet many of them do not have an ongoing funding source or are expected to end before then. The following recommendations will help ensure adequate funding for energy efficiency programs to achieve SB 350 savings targets.

- Maintain or expand current levels of funding for finance programs, including the Water Energy Grant, Low-Income Weatherization Program, Proposition 39, and others. Coordinate with state and local agencies that deliver energy efficiency programs, along with stakeholders.
- Develop and reward programs that most effectively attract and leverage private capital; simplify and reduce the cost of program participation; and offer incentives measured and sustained performance.
- Increase the funding of the Energy Conservation Assistance Act program to allow more access to schools, cities, counties, and special districts for energy efficiency projects.

- Improve code compliance by increasing interagency collaboration, stakeholder engagement, and funding for outreach and education at the local level, especially for local building permit offices and the contractor communities.

Develop Additional Energy Efficiency Programs

To meet the SB 350 electricity and natural gas doubling targets, it will be necessary to develop new programs or expand existing ones. The following recommendations will help deliver additional energy efficiency savings.

- Create new energy efficiency programs that capture additional savings in collaboration with utilities, state and local governments, and stakeholders.
- Expand the workforce training available to improve the quality of energy efficiency equipment installation, consistent with recommendations from the *Low-Income Barriers Report* and the *Existing Building Energy Efficiency Action Plan*.
- Develop an appropriate approach to implement fuel substitution programs that maximizes cost-effective greenhouse gas emission reductions in collaboration with California Public Utilities Commission, California Air Resources Board, utilities, and stakeholders.

Improve Reporting and Estimating of Efficiency Savings

SB 350 requires the Energy Commission to report to the Legislature every two years on progress toward achieving the energy efficiency doubling targets for energy efficiency. It also requires an assessment of the impact of such savings on hourly and seasonal electricity demand patterns in local utility service territories and on disadvantaged communities. To carry out these responsibilities and determine that progress is being achieved in meeting SB 350 targets, the Energy Commission will need to collect additional data, develop better estimation methods, and expand evaluation, measurement, and verification efforts. The following recommendations will need to be implemented.

Standardized Historical Savings Estimates

- Ensure that sufficient disaggregated, or broken-down, data, including hourly and seasonal, is available on historical energy consumption and efficiency savings estimates in coordination with the California Public Utilities Commission, investor-owned utilities, and publicly owned utilities.
- Ensure access to additional energy savings data from non-utility programs in coordination with energy efficiency program deliverers, including other government agencies and private program implementers including Property Assessed Clean Energy providers.

Reporting on Disadvantaged Communities

- Determine and apply the best methods to ensure adequate reporting of energy efficiency impacts in disadvantaged communities, including whether simplified methods should be used initially while more definitive methods are developed and implemented.

Reporting Hourly and Seasonal Impacts

- Improve estimation of hourly impacts of energy efficiency savings for each utility in cooperation with the California Public Utilities Commission, investor-owned utilities, and publicly owned utilities.

Improve Evaluation, Measurement, and Verification

- Establish robust evaluation, measurement, and verification to estimate savings projections for target setting for Energy Commission Title 24 and Title 20 standards and use the results to improve and expand compliance and enforcement.
- Place a high priority on understanding energy efficiency savings decay to obtain a better understanding of this topic for use in improving projections of cumulative savings.

Projecting Future Energy Efficiency Savings

- Ensure that the next round of potential and goals studies support SB 350 implementation by using consistent reporting conventions and assumptions in target setting and tracking in collaboration with the California Public Utilities Commission and publicly owned utilities.
- Develop improved methods to estimate additional savings potential beyond existing programs from the agricultural and industrial sectors and their contribution to the SB 350 doubling target in collaboration with utilities, agricultural, and industrial stakeholders.

Establish Aggregate Electricity and Natural Gas Targets

The Energy Commission has the authority to base targets on aggregate, or collective, electricity and natural gas projected savings. Before establishing aggregate targets, the Commission must adopt an aggregation methodology in a public process that allows input from stakeholders. The following recommendation will allow for aggregation of targets.

- Develop a specific aggregation methodology for consideration in the next cycle of target setting in the *2019 Integrated Energy Policy Report* process in collaboration with the California Public Utilities Commission, investor-owned and publicly owned utilities, and other stakeholders.

CHAPTER 1:

Introduction

On October 7, 2015, Governor Edmund G. Brown Jr. signed into law Senate Bill 350, which sets ambitious annual targets for energy efficiency and renewable electricity aimed at reducing greenhouse gas (GHG) emissions. SB 350 directs the Energy Commission to establish annual targets that will achieve a statewide cumulative doubling of energy efficiency savings and demand reductions in electricity and natural gas final end uses by January 1, 2030. This mandate is one of the primary measures to help the state achieve its long-term climate goal of reducing GHG emissions to 40 percent below 1990 levels by 2030.

This chapter outlines the organization and content of the remaining chapters of the report and defines several important terms and topics related to energy efficiency programs and savings projections used in the report.

Outline of Chapters

Chapter 2 presents the proposed statewide cumulative energy efficiency doubling targets for electricity and natural gas as called for in SB 350, as well as the associated combined energy savings. It also summarizes the energy efficiency savings projections developed for utility and non-utility programs to meet the doubling targets.

Chapter 3 discusses investor-owned utility (IOU) programs that are expected to contribute to meeting the SB 350 energy efficiency doubling targets. It discusses the energy efficiency potential and goals study conducted by the California Public Utilities Commission (CPUC) that was relied on to estimate projected savings and set sub-targets for the electric and gas IOUs.

Chapter 4 presents the projected energy efficiency savings from publicly owned utilities' (POU) programs. Like the IOUs, the savings for POU programs were based on a potential and goals study conducted for California Municipal Utilities Association (CMUA) on behalf of the POU. The chapter outlines the sub-targets proposed for the different POU.

Chapter 5 discusses additional energy efficiency programs that can contribute to meeting the SB 350 doubling targets. The chapter discusses issues relating to fuel switching, such as changing from natural gas to electricity and conservation voltage reduction, which involves optimizing voltage on the distribution system to reduce losses. In addition, preliminary estimates of projected non-utility agricultural and industrial energy efficiency savings are presented.

Chapter 6 describes the projected energy savings from non-utility energy efficiency programs and establishes sub-targets for the different programs. Non-utility programs are grouped into the following categories: codes and standards, financing programs, behavioral and market transformation programs, and agricultural and industrial. Utility programs also include behavioral and market transformation programs that are discussed in Chapters 3 and 4.

Chapter 7 outlines proposed recommendations and next steps that will be necessary to achieve the SB 350 doubling targets.

Definitions

Several terms related to the SB 350 energy efficiency targets and the savings projections presented in this report have specific meanings that require explanation. SB 350 requires that the Energy Commission establish the energy efficiency doubling targets “to the extent doing so is cost-effective, feasible, and will not adversely impact public health and safety.”¹ These terms are explained below. In addition, several other terms related to the energy efficiency and doubling targets are discussed below.

Targets and Sub-targets

As used in this report, the term *target* is used to refer to the separate targets for electricity and natural gas end-use savings called for under SB 350. The term *sub-target* is used in two ways. For utility programs, sub-targets are set for each IOU and POU. For non-utility programs, sub-targets are set for each program. The program sub-targets are grouped into categories of like programs as outlined in Chapter 6, but no targets or sub-targets are proposed for the categories.

Cost-Effectiveness

In determining cost-effectiveness of the different energy efficiency programs and measures for inclusion in the SB 350 doubling targets, different cost-effectiveness metrics are used, many of which are established by statute or regulation. An overview of the definitions of cost-effectiveness for utility and non-utility programs is presented below.

Utility Programs

In evaluating cost-effectiveness of IOU programs, the CPUC uses several avoided cost tests from a *California Standard Practices Manual*, the most common of which are the total resource cost (TRC) and the program administrator cost (PAC) tests.² The “total costs” differ in each of these tests. The TRC test compares the benefits, which are the avoided cost of generating electricity and supplying natural gas, with the total costs, which include program administration and participant costs, but not the incentive costs. The PAC test compares the same avoided cost benefits with the total costs, which include program administration and incentive costs, but not the out-of-pocket costs paid by customers. The POUs use similar cost-effectiveness tests and in the latest study of projected energy efficiency program savings used the TRC test based on 2016 avoided cost estimates.

Codes and Standards

The building standards must be cost-effective when taken in entirety and when amortized over the economic life of the structure compared with historical practice.³ The Energy Commission considers the value of the energy saved, whether there is any effect on product efficacy for the consumer, and the life-cycle cost of complying with the standards. In addition to cost-effectiveness, the Energy Commission considers the effect on housing costs, total statewide costs and benefits over the lifetime of the standard, economic impacts on business, and alternative approaches and the associated costs. The current building standards use a time-dependent valuation (TDV) metric to calculate the energy

1 Public Resources Code Section 25310(c)(1).

2 *Energy Efficiency Policy Manual Version 5*. July 2013.
[http://www.cpuc.ca.gov/uploadedFiles/CPUC_Public_Website/Content/Utilities_and_Industries/Energy -
Electricity_and_Natural_Gas/EEPPolicyManualV5forPDF.pdf](http://www.cpuc.ca.gov/uploadedFiles/CPUC_Public_Website/Content/Utilities_and_Industries/Energy_-_Electricity_and_Natural_Gas/EEPPolicyManualV5forPDF.pdf).

3 Public Resources Code Section 25402(b)(3).

benefits of building efficiency measures (space heating, space cooling, indoor air quality and ventilation, and water heating).⁴ To comply with the standards, a proposed building design must not exceed a given energy budget for energy use related to space heating, space cooling, indoor air ventilation, and water heating.

The appliance standards must not result in added costs to consumers over the life of the appliance.⁵ In determining cost-effectiveness, the Energy Commission must consider the value of the energy (or water) saved, whether there is any effect on product efficacy for the consumer, and the life-cycle cost to the consumer of complying with an adopted standard. To meet this requirement, the Energy Commission uses one of two cost-effectiveness metrics: simple payback and life-cycle benefit. If the payback period (in years) is less than the design life of the appliance, then it is cost-effective.⁶ The second type of cost-effectiveness is life-cycle benefit (in dollars), which has to be positive for the standard to be cost-effective.⁷

Other Efficiency Programs

In evaluating the cost-effectiveness of the remaining non-utility programs, the Energy Commission relied on a general definition in calculating cost-effectiveness of energy resources, including conservation and load management programs. Cost-effectiveness means that project benefits must outweigh the project costs, including a value for any costs and benefits to the environment.⁸ For Proposition 39 projects however, the total benefits must be greater than project costs over time.⁹ In selecting projects, the Energy Commission may consider non-energy benefits, such as health and safety, in addition to energy benefits.¹⁰ Where specific cost-effectiveness tests were used to evaluate projected savings from non-utility energy efficiency programs, they are addressed in the various sections of the report, including Appendix B and Attachment A.

Feasible

A common sense definition of *feasible* is contained in the California Environmental Quality Act: “Feasible means capable of being accomplished in a successful manner within a reasonable period of time, taking into account economic, environmental, social, and technological factors.”¹¹ For SB 350, feasibility includes how technically feasible the energy efficiency program is, how likely participation is in an energy efficiency program, and how realistic savings projections are given economic, social, technological, and environmental constraints.

4 For electricity, a TDV factor is assigned to each hour of the year in each of the 16 climate zones, based on hourly marginal electricity costs, including energy, losses, transmission and distribution, capacity, ancillary services, and a Renewables Portfolio Standard (“RPS”) adder, then scaled up to match average retail rate. For natural gas and propane, monthly TDV factors are used.

5 Public Resources Code Section 25402(c)(1).

6 *Simple payback* is the incremental cost to improve an appliance divided by the average annual present value savings.

7 *Life-cycle benefit* is the difference between the annual average present value savings multiplied by the design life and the incremental cost of improvement.

8 Public Resources Code Section 25001(c).

9 Public Resources Code Section 26206(c).

10 *Energy Commission Proposition 39: California Clean Energy Jobs Act, 2016 Program Implementation Guidelines*. July 2016. p. 22. An eligible energy project must achieve a minimum savings-to-investment ratio (SIR) of 1.01; for every dollar invested in the eligible energy project, the local educational agency will accrue \$1.01 in savings. The SIR is based on the cumulative present value of the savings benefits realized over the life of the eligible energy project. <http://www.energy.ca.gov/2016publications/CEC-400-2016-005/CEC-400-2016-005-CME.pdf>.

11 Public Resources Code Section 21061.1.

In assessing the feasibility of energy efficiency savings, SB 350 requires the Energy Commission and the CPUC to “consider the results of energy efficiency potential studies that are unrestricted by previous levels of utility energy efficiency savings.”¹² From the utility perspective, some considerations could include expected consumer behavior in response to programs. A high-level examination of feasibility was done for the different programs.

Adversely Impact Public Health and Safety

The Energy Commission interprets the clause “will not adversely impact public health and safety” to mean primarily ensuring reliability of electricity supply.¹³ Energy efficiency savings are relied upon in the generation, transmission, and distribution system planning of utilities and state entities. If energy efficiency program savings do not materialize as expected, reliability could be adversely impacted. A high-level assessment on the potential impact of the different program types on grid reliability was performed.

In addition, the phrase is broad enough to allow the Energy Commission to assess the effect of targets on GHG and other air pollutant emissions. Energy efficiency programs should reduce the need for power generation and result in fewer emissions of harmful air pollutants. However, if expected energy efficiency fails to occur, there could be a negative impact on the environment and public health.

Additional Achievable Energy Efficiency

For setting SB 350 targets, *cumulative doubling* of energy efficiency savings means the savings realized in 2030, not the sum of the cumulative energy efficiency savings realized in every year from 2015 through 2030. Under SB 350, the baseline for this doubling is the sum of midcase estimate of *additional achievable energy efficiency* (AAEE) savings, as contained in the *California Energy Demand Update Forecast, 2015-2025* and the targets set by local publicly owned electric utilities pursuant to Section 9505 of the Public Resources Code.¹⁴ AAEE savings are in addition to the *committed* energy efficiency savings already embedded in the forecast. AAEE is the incremental energy savings from the future market potential identified in utility potential studies not included in the baseline demand forecast, but reasonably expected to occur, including future updates of building codes, appliance regulations, and new or expanded IOU or POU energy efficiency programs.¹⁵

Net Versus Gross Energy Savings

The energy efficiency evaluation community introduced the concept of *net* and *gross* savings to address program *free ridership*.¹⁶ Generally, gross savings are the observed savings among program participants. They include savings from consumers who would have implemented measures even if they were not participants in a program (free riders), savings when the same measures in a program are installed without incentives, or savings that extend beyond the specific measures incentivized in a

12 Public Resources Code Section 25310(c)(4).

13 Public Resources Code Section 25300 asserts that “reliable supply of energy [be] consistent with protection of public health and safety.”

14 Public Resources Code Section 25310(c)(1) and 2531(c)(2).

15 California Energy Commission. 2015. *2015 Integrated Energy Policy Report*. pp 138-139. Publication Number: CEC-100-2015-001-CMF.

16 *Free ridership* refers to someone who would install an energy efficiency measure without any program incentives because of the return on investment for the measure but receives a financial incentive or rebate anyway.

program, also referred to as *spillover*.¹⁷ Net savings adjust for these two components of savings. There is no single analytic method for computing net savings from gross savings, and at the national level, there are numerous approaches for estimating net-to-gross ratios.

¹⁷ *Spillover* refers to additional reductions in energy consumption or demand that is due to program influences beyond those directly associated with program participation. As a result, these savings may not be recorded in the program tracking system and credited to the program.

CHAPTER 2:

Doubling Energy Efficiency Savings

The proposed SB 350 doubling targets for electricity and natural gas consist of projected energy efficiency savings from programs and measures funded by utility ratepayers and from non-utility programs. Utility programs include programs funded by the state's IOUs, community choice aggregators (CCA) and regional energy networks (REN)¹⁸ under the CPUC's jurisdiction, as well as the state's POUs that are governed by local boards. Utility programs use a variety of mechanisms to encourage energy efficiency such as rebates and energy audits. The funding for non-utility efficiency programs comes primarily from government sources. These state agency and local government programs can increase energy efficiency at the customer end-use level through financing, directly installing energy efficiency measures, and increasing public awareness of energy efficiency best practices.

SB 350 Energy Efficiency Doubling Targets

SB 350 directs the Energy Commission to use the additional achievable energy efficiency (AAEE) contained in the *California Energy Demand Updated Forecast, 2015-2025* and the 2013 energy efficiency projections adopted by POUs and extend them both to 2030.¹⁹ It then directs the Energy Commission to double those savings projections to arrive at the SB 350 targets for electricity and natural gas, to the extent doing so is cost-effective, feasible, and will not adversely impact public health and safety. AAEE is credible, incremental energy savings not yet considered committed or firm, but deemed reasonably likely to occur, including savings from future updates of building codes, appliance standards, and new or expanded utility programs.²⁰

Projected energy efficiency savings for utility ratepayer-funded programs are categorized by IOU and POU, with proposed sub-targets for each utility. Projected efficiency savings from non-utility energy efficiency efforts were separated into categories representing similar types of programs including codes and standards, financing programs, behavioral and market transformation measures, and agricultural and industrial programs.²¹ Sub-targets have been proposed for programs within the non-utility savings categories.

Projected energy efficiency savings are calculated for electricity in gigawatt hours (GWh) and for natural gas in millions of therms (MM therms or 1 million therms). The combined energy savings

18 Community choice aggregators (CCAs) and regional energy networks (RENs) are local government entities that offer energy efficiency programs to residents and businesses.

19 Kavalec, Chris, 2015. *California Energy Demand Updated Forecast, 2015-2025*. California Energy Commission, Electricity Supply Analysis Division. Publication Number: CEC-200-2014-009-CMF. At <http://www.energy.ca.gov/2014publications/CEC-200-2014-009/CEC-200-2014-009-CMF.pdf>.

20 AAEE are the incremental energy efficiency savings beyond the committed energy efficiency included in the Energy Commission's baseline demand forecast. The AAEE is subtracted from the baseline forecast to create a "managed" forecast for use in the state's energy planning.

21 Behavioral and market transformation measures as used in this report includes measures and programs that in the industry are referred to as behavioral, retrocommissioning, and operational, or BROs. These include home energy reports, residential real-time feedback, residential competitions or challenges, energy management systems, building certification, and numerous others.

projections from electricity and natural gas are also presented using a common unit, British thermal units (BTUs).

SB 350 Doubling Target for Electricity

The statewide cumulative energy efficiency savings target for electricity, along with projected savings for utility and non-utility programs, is presented in **Figure 4**. The top line is the arithmetic doubling of projected AEE savings from 2015 to 2025, with the 2026 to 2030 projected savings extrapolated using a trend line.

Utility electricity programs, as shown in **Figure 4**, account for just over 50 percent of total projected savings, while non-utility programs contribute the remaining savings. The IOUs account for about 37 percent of total projected savings, while POUs account for about 13 percent. About 20 percent of total projected savings is contributed by codes and standards, while financing programs make up 13 percent, and behavioral and market transformation comprise 3 percent. Non-utility agricultural and industrial sector savings make up less than 1 percent of total projected savings. Non-utility financing activities that spur additional participation in utility incentive programs make up about 12 percent of total projected savings.

Figure 4: Proposed SB 350 Doubling Target for Electricity (GWh)

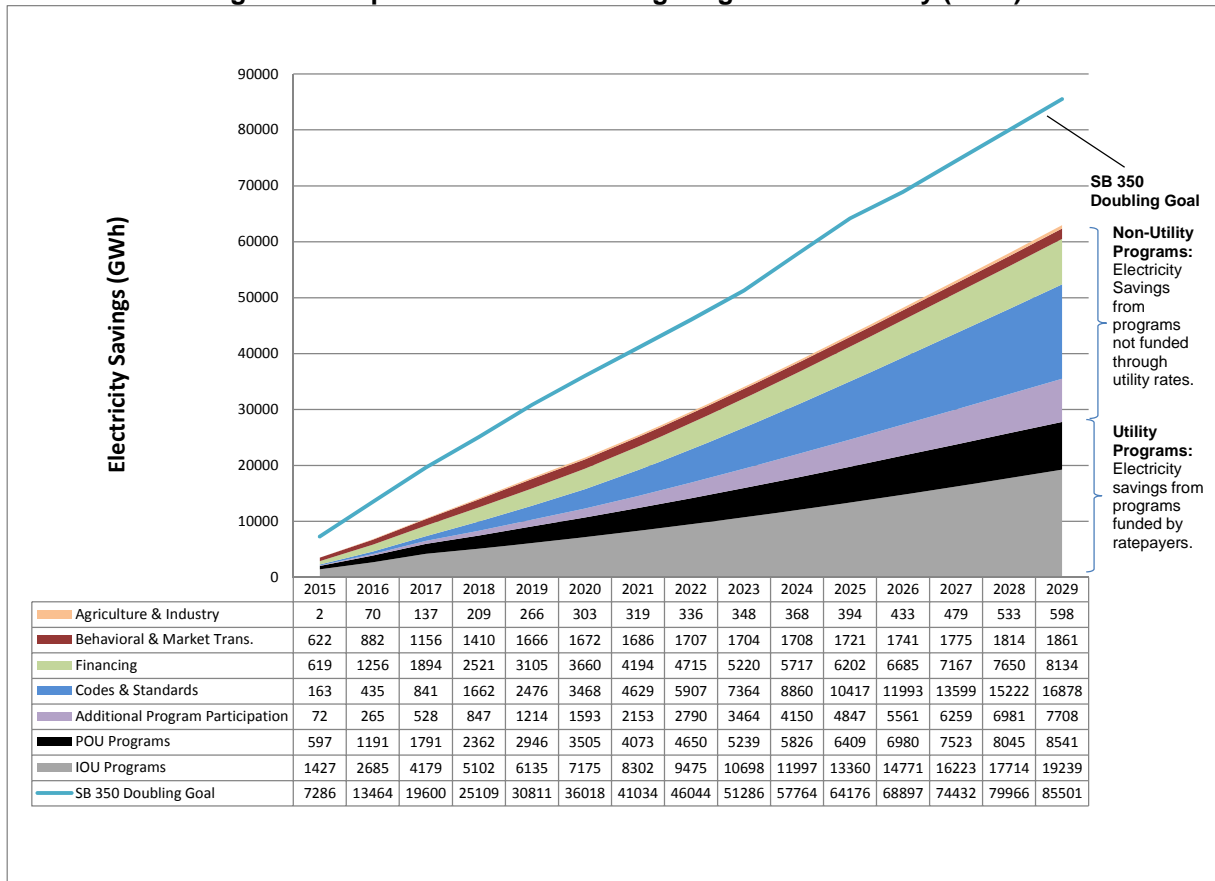

Source: California Energy Commission staff, Efficiency Division. Based on work in Attachment A by NORESKO. August 2017.

SB 350 Doubling Target for Natural Gas

The energy efficiency doubling target for natural gas (in MM therms), along with projected savings for utility and non-utility programs, is presented in **Figure 5**. For natural gas utility programs, as show in

Figure 5, utility programs account for just fewer than 50 percent of total projected savings, while non-utility programs contribute the remaining savings. Of the savings from non-utility programs, about 12 percent is contributed by codes and standards, while financing programs make up roughly 11 percent and behavioral, and market transformation comprises about 20 percent. Projected savings from the non-utility agricultural and industrial sector make up about 2 percent of total savings. Non-utility financing that spurs additional participation in utility incentive programs make up about 5 percent.

Figure 5: Proposed SB 350 Doubling Target for Natural Gas (Therms)

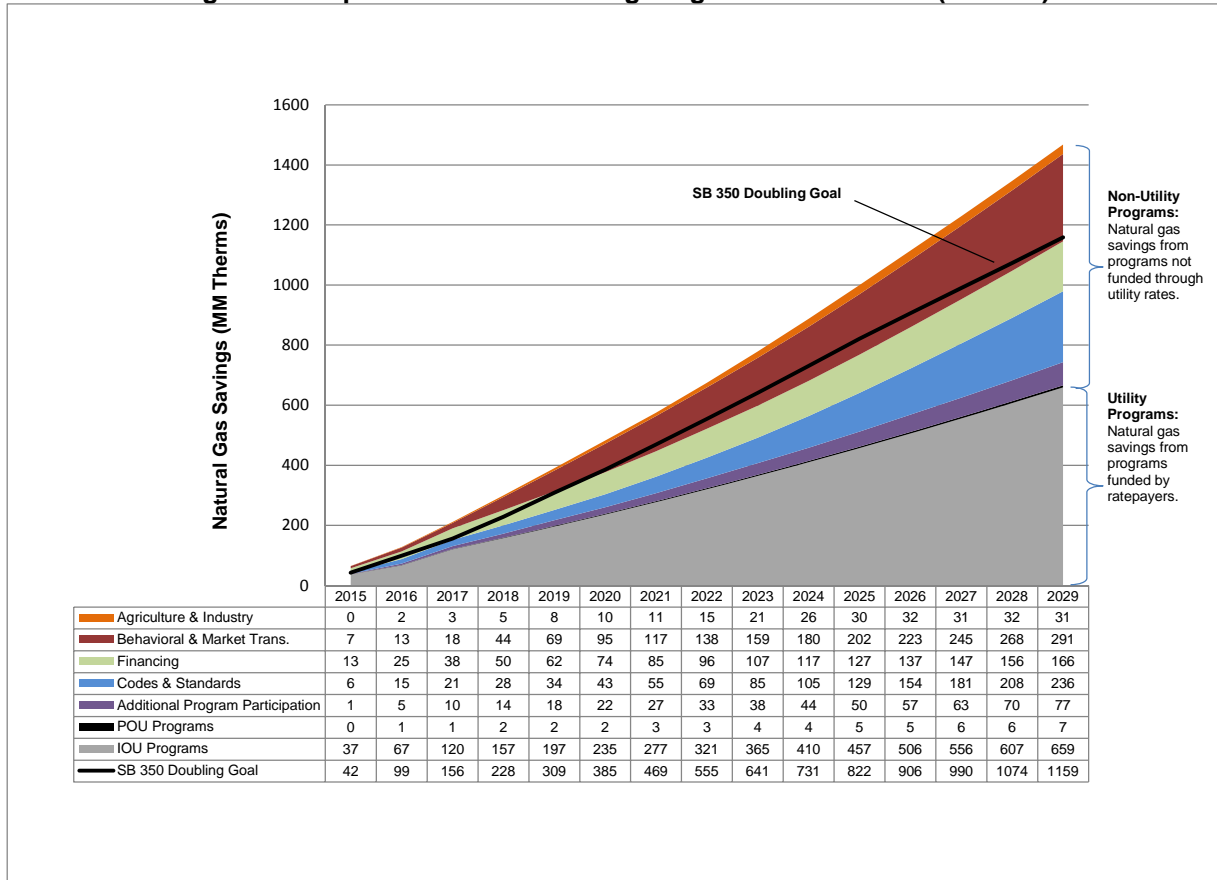

Source: California Energy Commission staff, Efficiency Division. Based on work in Attachment A by NORESKO. August 2017.

The combined projected energy efficiency savings for electricity and natural gas, along with the projections of savings for each program in the utility and non-utility categories, are presented in **Figure 6**, which shows the combined site-level projected savings from electricity and natural gas programs.²² The top line is the combination of the cumulative doubling target for electricity and natural gas that was developed through an arithmetic doubling of projected AAEE savings from 2015 to 2025, with the 2026 to 2030 projected savings extrapolated using a trend line.²³

²² **Figure 5** combines electricity and natural gas savings into site level Quads (1015 BTUs) using fuel specific unit conversions. There are 3.413x10⁻⁶ Quads per GWh and 10⁻⁴ Quads per MM Therms.

²³ Under Public Resources Code Section 25310(c)(2), the Energy Commission can establish a target that aggregates projected electricity and natural gas savings, which implies considering relative cost-effectiveness of electricity versus natural gas savings potential, relative contribution of electricity versus natural gas in reducing GHG emissions, and other issues. The Energy Commission has not exercised this authority for this report but will examine aggregated targets in future target-setting cycles.

Figure 6: Projected Combined Electricity and Natural Gas Savings (Quad BTUs)

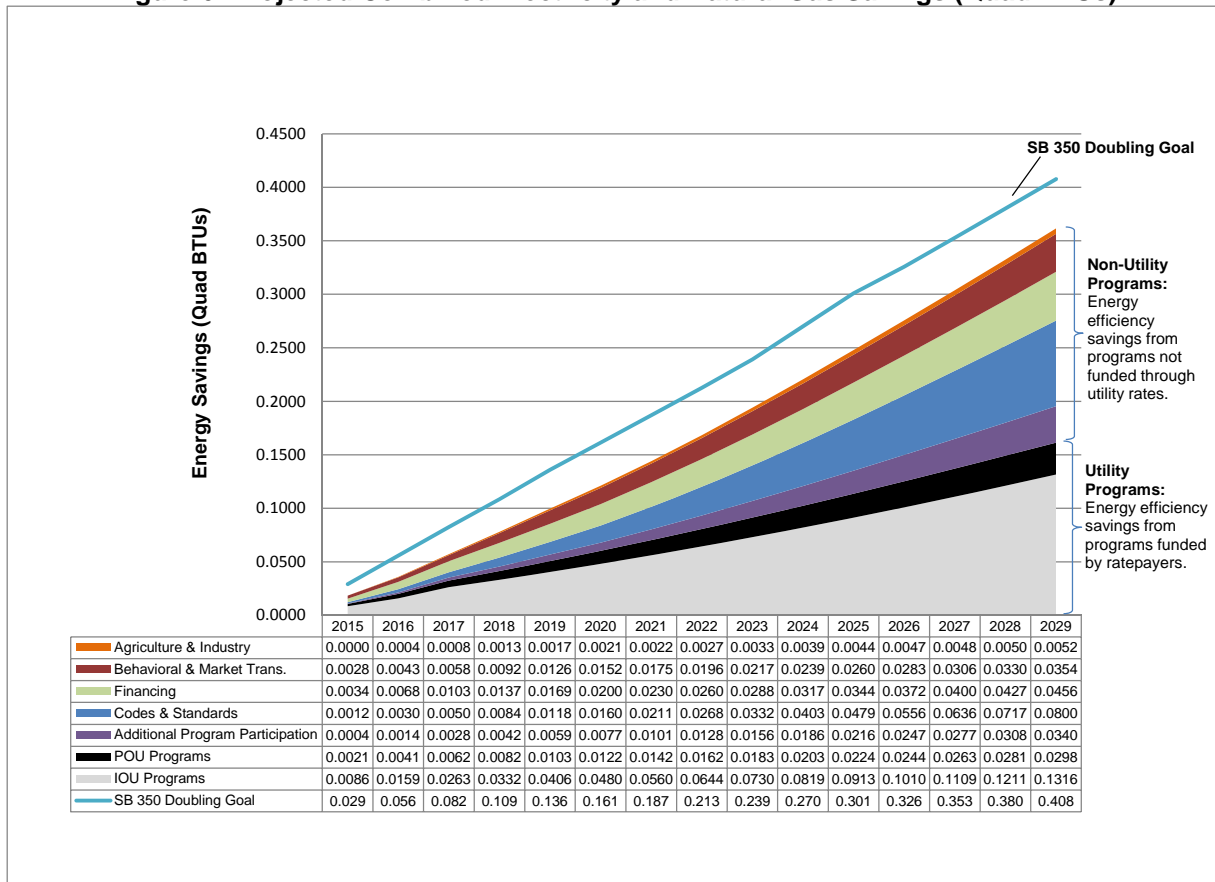

Source: California Energy Commission staff, Efficiency Division. Based on work in Attachment A by NORESKO. August 2017.

Public Process for SB 350 Target Setting

The doubling targets proposed in this report were developed in collaboration with the CPUC, IOUs, POUs, and other stakeholders in a public process. Working closely with the CPUC, the Energy Commission held a series of workshops to solicit stakeholder feedback and discuss issues related to the SB 350 doubling energy efficiency savings targets. The first workshop, held on July 11, 2016, was a joint workshop with the CPUC to address data and analytical needs for the doubling of energy efficiency.

In January 2017, the Energy Commission published the *Framework for Establishing the Senate Bill 350 Energy Efficiency Savings Doubling Targets* (Framework Paper), which provided a process and policy framework for establishing the energy efficiency targets that SB 350 requires. A draft of the *SB 350 2030 Energy Efficiency Savings Goal* was also published by the Energy Commission staff for stakeholder comment. On January 23, 2017, the Energy Commission held a workshop on SB 350 energy efficiency doubling to solicit input on the proposed doubling target and questions raised in the Framework Paper.

On June 19, 2017, the Energy Commission held a workshop on methodologies for SB 350 energy efficiency target setting. Building upon the Framework Paper and input from stakeholders, two staff papers were released in July 2017 for public comment that presented analyses of the energy efficiency savings that can be achieved for utility programs and other energy efficiency savings efforts.

One paper laid out the staff's projections of the energy efficiency savings that can be achieved by electric and gas utilities toward the doubling targets. Energy Commission staff analyzed two studies commissioned by the CPUC and POUs that identified energy efficiency savings potential that could be achieved by utilities.

A companion staff paper focused on savings from sources other than utility programs, also referred to as "non-utility" programs. Energy Commission staff, with the help of its contractor NORESKO (and subcontractors), estimated energy savings potential from non-utility programs in three program areas: codes and standards, financing, and behavioral and market transformation programs.

The Energy Commission will hold an additional workshop on this draft Commission report on September 7, 2017. The Energy Commission anticipates consideration of the report for adoption at the November 8, 2017, business meeting.

CHAPTER 3: Investor-Owned Utility Energy Efficiency Programs

Since the 1970s, California utilities have been offering energy efficiency programs to their customers in both the residential and nonresidential sectors, including the agriculture and industrial segments. A variety of ratepayer-funded programs, from financial assistance to workforce education and public outreach, are helping businesses and homes reduce energy costs and carbon emissions. These energy efficiency programs are important as they reduce GHG emissions, represent the lowest-cost energy resource option and the cleanest form of energy available, and play significant roles in meeting California’s energy and climate policy objectives. This chapter discusses utility ratepayer-funded programs that are an important part of the state’s strategy to achieve the SB 350 energy efficiency savings doubling target.

Historical Energy Efficiency Savings

The IOU electricity savings accomplishments are shown in **Figure 7**. IOU gross electricity savings from first-year efficiency measure installations totaled around 3,239 GWh in 2016, a slight decrease of less than 1 percent from 2015. Cumulatively, for the past 10 years IOUs reported almost 38,000 GWh in gross electricity savings. IOUs’ electricity savings have varied significantly from year to year since 2012.

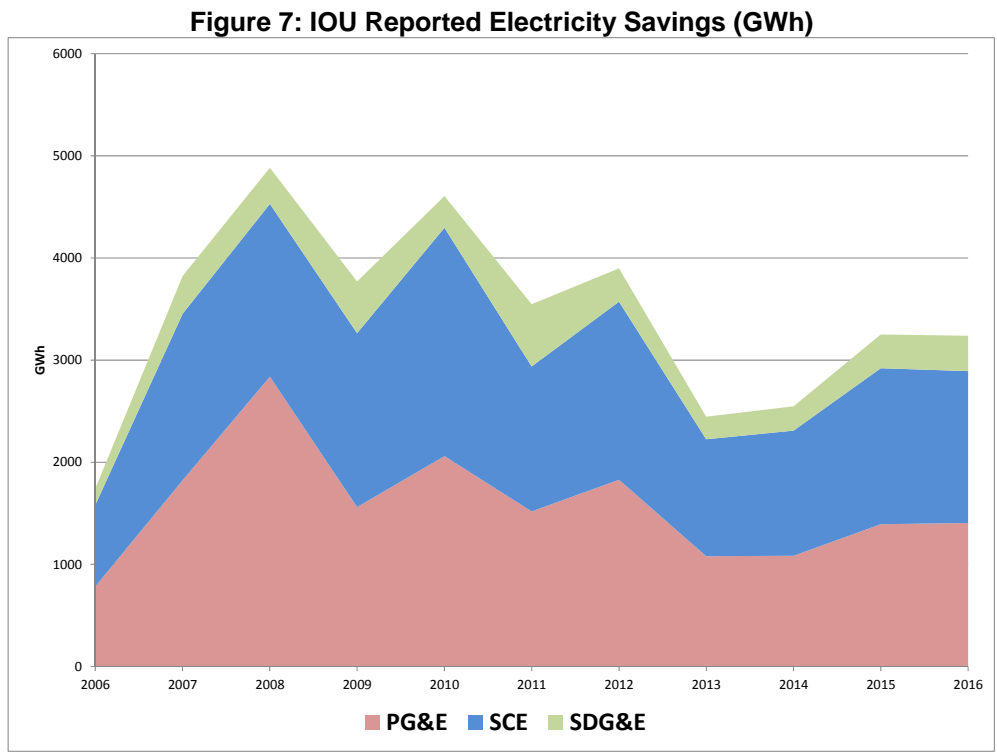

Source: California Energy Commission staff, Energy Assessments Division, July 2017, based on the IOUs’ Annual Energy Efficiency Reports. These savings numbers are reported savings and not evaluated savings.

The IOU electricity savings by end use in both residential and nonresidential sectors are shown in **Figure 8**. Three of the largest end uses – lighting, process, and heating, ventilation, and air-conditioning (HVAC) equipment – account for the majority of savings.

Figure 8: Combined (2006-2016) IOU Reported Electricity Savings by End Use

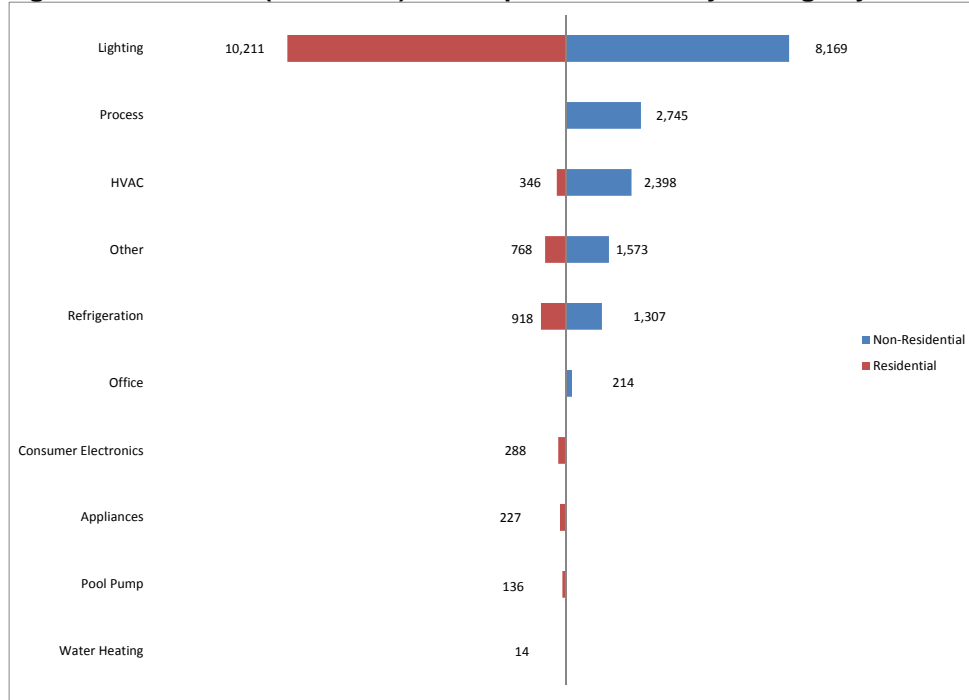

Source: California Energy Commission staff, Energy Assessments Division, July 2017.

In past years, the CPUC approved three-year energy efficiency program cycles, which often were followed by a one- or two-year bridge period. This starting and stopping of efficiency funding are not well-suited to bring about long-term energy efficiency savings, as shown in **Figure 7**. In 2014, the CPUC authorized 10-year funding referred to as a “rolling portfolio cycle” that established firm future funding commitments. Additional rules are being established by the CPUC to identify a clear timeline for coordinating various activities in its regulatory process that have until now been difficult to align appropriately. These activities include technical updates, program design and portfolio planning, program operations, and program reporting and evaluation. These rules will also allow different types of measurement, evaluation, measurement and verification (EM&V) studies to have faster turn-around times and to be incorporated into portfolios on a more frequent and timely basis.

IOU Energy Efficiency Target Setting

The following sections discuss and quantify projected savings from IOU energy efficiency programs that can contribute to meeting the SB 350 doubling targets. Chapter 5 discusses additional opportunities for utility energy savings from fuel switching and conservation voltage reduction (CVR). In addition, estimated savings from the non-utility agricultural and industrial sectors are presented in Chapter 5. Chapter 6 identifies the potential savings from non-utility fuel substitution.

Energy Efficiency Potential and Goals

Starting in 2006 with the passage of Senate Bill 1037 (Kehoe, Chapter 366, Statutes of 2005), the CPUC, in consultation with the Energy Commission, has been required to identify all potentially achievable cost-effective energy efficiency savings and establish energy efficiency goals every other year for investor-owned electrical and gas corporations. The energy efficiency savings goals are based on findings of the potential and goals studies, which are also done every other year. These studies estimate all the potential energy savings available through different technologies, program measures, codes and standards and behavioral and market transformation programs that the IOUs can use in their energy efficiency portfolios. Potential and goals studies typically identify energy efficiency savings based on technical, economic, and market potential.

The CPUC is setting energy efficiency goals for the IOUs.²⁴ The most recent *2018 IOU Potential and Goals Study* is designed to determine a version of market-based savings potential under a given set of assumptions.²⁵ The most recent study, which was already underway when SB 350 was first being implemented, was not specifically designed to identify how utility programs might contribute to the large increase in energy efficiency savings necessary to achieve the SB 350 doubling goals. Additional efforts will be necessary to identify utility program savings beyond the current goal setting.

For the current goal setting, *technical potential* is defined as the amount of energy savings that would be possible if the highest level of efficiency for all technically applicable opportunities to improve energy efficiency were taken, including retrofit measures, replace-on-burnout measures, and new construction measures. The technical potential represents the projected total energy savings available each year that is above the baseline of the Title 20 and Title 24 codes and federal appliance standards.

Using the results of the technical potential analysis, the economic potential is calculated as the total energy efficiency potential available when limited to only cost-effective measures, as determined by the cost-effectiveness metrics described in the section on cost-effectiveness below. All components of economic potential are a subset of technical potential. Finally, a market potential analysis is conducted that calculates the energy efficiency savings that could be expected in response to specific levels of incentives and assumptions about market influences and barriers.

All components of market potential are a subset of economic potential.²⁶ Assumptions about stock turnover rates are not applied annually to these categories of efficiency potential. Instead, efficiency improvements are assumed to be applied to all applicable equipment and systems in the first year that those improvements are available.

Net and Cumulative Savings Goals

After seven years of gross savings goals, the CPUC is returning to setting net savings goals for the IOU energy efficiency portfolios beginning in 2018 because net savings numbers are used in many

²⁴ Due to data limitations, the CPUC can develop goals only by IOU service territories rather than by program administrator, which means there are no separate goals for CCAs and RENs. CCAs report energy savings independently; however, CCAs savings projections are incorporated into the CPUC/Navigant potential study as part of IOU planning areas.

²⁵ CPUC R.13-11-005, Appendix A. Prepared by Navigant for the CPUC, *Energy Efficiency Potential and Goals Study for 2018 and Beyond*. June 2017. <http://docs.cpuc.ca.gov/PublishedDocs/Efile/G000/M190/K624/190624112.PDF>

²⁶ Some studies also refer to this as maximum achievable potential. Market potential is used to establish the utilities' energy efficiency goals, as determined by the CPUC.

proceedings, including the CPUC's long-term procurement planning proceeding²⁷ and in calculating AAE for the Energy Commission's energy demand forecast.²⁸ Also, by using net savings numbers, potential double counting with savings in the forecast due to AB 802 to-code savings mandate can be reduced.

In 2016, the CPUC ordered staff to collaborate with the Energy Commission and other stakeholders through the Joint Agency Steering Committee and the Demand Analysis Working Group, to update the methodology used to develop cumulative goals and potentially support cumulative goals for the update of the *2018 IOU Potential and Goals Study*. This process is on-going. As a reliable method for developing cumulative goals has not yet been developed, the proposed decision adopting energy efficiency goals for 2018 through 2030 does not set cumulative goals. Instead the proposed decision instructs CPUC staff to assess the viability of using a method for calculating persistence decay, to be considered by the Energy Commission for SB 350 target setting.²⁹ Resolving this issue requires distinguishing between physical decay in performance of a measure versus the customer behavioral issues of replacing that measure. Although this will likely require intensive research studies taking years to implement, narrowing the uncertainty about savings decay is fundamental to reliance upon projections of cumulative energy efficiency savings that are used to displace other resource additions in pursuing the overall goal of GHG emission reductions.

Cost-Effectiveness

The *2018 IOU Potential and Goals Study* constructed scenarios to examine the market potential using a range of cost-effectiveness tests. As discussed in Chapter 1, the two most commonly used methods for determining cost-effectiveness of IOU programs are the TRC and the PAC. Because the primary emphasis of SB 350 is on GHG emission reductions, determining cost-effectiveness accounting for these reductions is important in setting energy efficiency targets.

In April 2017, the CPUC released a staff proposal for an interim GHG adder to be used as an input into different cost-effectiveness tests for evaluating distributed energy resources.³⁰ The CPUC staff proposed adopting an annualized straight line escalation from \$0 per tonne carbon dioxide (CO₂) in 2017 to \$250 in 2030, which is the marginal abatement cost for that year based on preliminary integrated resource planning (IRP) modeling results. The IOUs proposed an alternate GHG adder curve based on the Allowance Price Containment Reserve used in the Cap-and-Trade Program.³¹ This curve is an extrapolation of the preliminary values used by California Air Resources Board in the *2030 Scoping Plan Update*.³²

²⁷ <http://docs.cpuc.ca.gov/PublishedDocs/Published/G000/M158/K663/158663325.PDF>.

²⁸ <http://www.energy.ca.gov/publications/displayOneReport.php?pubNum=CEC-200-2016-016-CMF>.

²⁹ <http://docs.cpuc.ca.gov/PublishedDocs/Efile/G000/M194/K656/194656346.PDF>.

³⁰ Rulemaking 14-10-003, Administrative Law Judge Ruling Requesting Comment on an Interim Greenhouse Gas Adder, Energy Division Staff Proposal Addendum: Interim GHG Adder, April, 3, 2017. https://apps.cpuc.ca.gov/apex/?p=401:58:0::NO:RP.59.RIR:P5_PROCEEDING_SELECT:R1410003.

³¹ Joint IOUs Opening GHG Adder Comments, page 6 <http://docs.cpuc.ca.gov/PublishedDocs/Efile/G000/M185/K576/185576217.PDF>.

³² The curve is an extrapolation of the prices in California Air Resources Board Staff Report, "Initial Statement of Reasons," Appendix C, August 2, 2016, Table 5. Available at <https://www.arb.ca.gov/regact/2016/capandtrade16/appc.pdf>.

IOU Market Potential

The two GHG adders discussed in the previous section were used in constructing the scenarios for consideration in the IOU goal setting. To keep the number of scenarios manageable but still provide a range of alternatives to bound market potential, five scenarios were proposed and are listed in **Table 1**. The TRC | Reference scenario represents “business as usual” and continues current policies. Three alternate scenarios continue to assume similar program design but apply different cost-effectiveness tests and avoided costs. The final scenario (PAC | Aggressive) is meant to show an upper bound for the combination of program participation and cost-effectiveness screens relying on existing and enhanced and/or expanded programs.

Table 1: Scenarios for Energy Efficiency Potential

Scenario	Cost Effectiveness Screen	Program Engagement
TRC Reference	TRC test using 2016 Avoided Costs	Reference
mTRC (GHG Adder #1) Reference	TRC test using 2016 Avoided Costs + IOU proposed GHG Adder	Reference
mTRC (GHG Adder #2) Reference	TRC test using 2016 Avoided Costs + CPUC staff proposed GHG Adder	Reference
PAC Reference	PAC test using 2016 Avoided Costs	Reference
PAC Aggressive	PAC test using 2016 Avoided Costs	Aggressive

Source: CPUC, *2018 IOU Potential and Goals Study*, June 2017.
<http://docs.cpuc.ca.gov/PublishedDocs/Efile/G000/M190/K624/190624112.PDF>

CPUC-Adopted IOU Energy Efficiency Goals

The CPUC released a proposed decision on August 25, 2017, with the draft IOU energy efficiency goals.³³ The goals are proposed for adoption by the CPUC commissioners at the end of September 2017. To set IOU goals for SB 350, the Energy Commission is proposing to use the individual IOU targets established by the CPUC, minus the savings from codes and standards for this first iteration of SB 350 savings assessment. Further analysis will be necessary in upcoming IEPRs to adjust the SB 350 targets to reflect changing market conditions or other external factors and to report on IOU progress in achieving doubling targets.

Figure 9 and **Figure 10** reflect the annual electricity and natural gas savings for the IOUs using the mTRC (GHG Adder #1) scenario, which is the scenario relied on for setting the IOU goals in the CPUC’s proposed decision. For 2018, the IOUs’ electricity goals are proposed to be about 3 percent higher than the electricity goals adopted from the 2015 Potential and Goals Study and in 2024 the goals will be about 70 percent higher for electricity. The 2018 gas goals are proposed to be 48 percent higher than the 2015 Potential and Goals Study and 103 percent higher in 2024. Much of the increase in savings is due to behavior, retrocommissioning, and operational savings (BROs) reflecting greater market adoption as incentives increase and consumers become more aware of such programs leading to higher levels of customer uptake.

³³ CPUC Proposed Decision Adopting Energy Efficiency Goals for 2018 – 2030. August 25, 2017.
<http://docs.cpuc.ca.gov/PublishedDocs/Efile/G000/M194/K656/194656346.PDF>

Figure 9: Annual Electricity Savings—mTRC (GHG Adder #1) Reference Scenario (GWh)

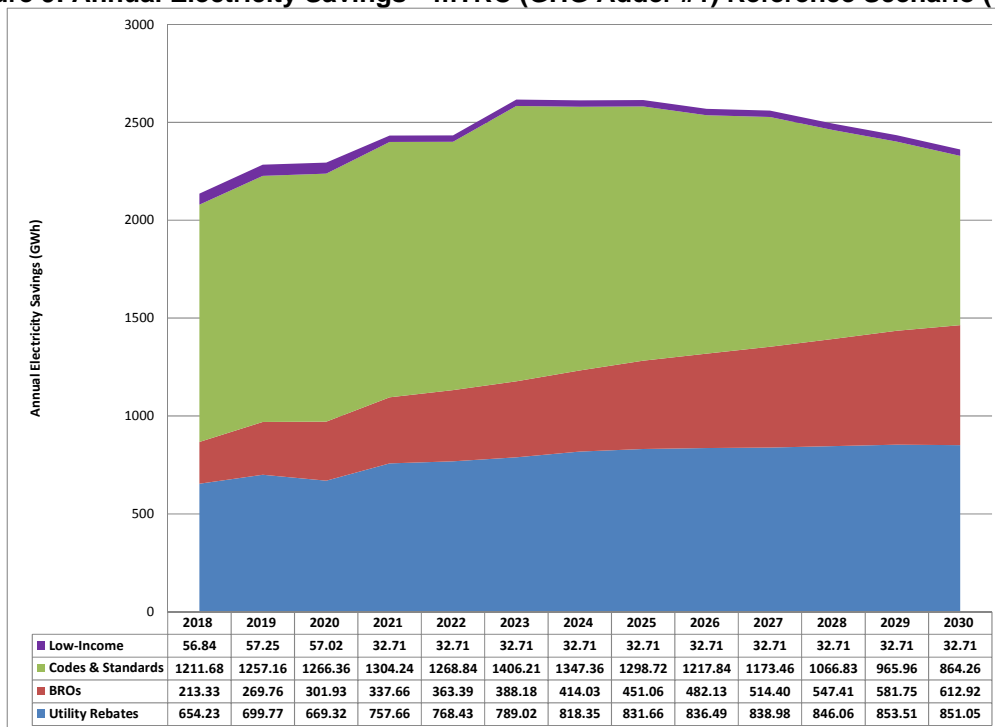

Source: CPUC/Navigant. *Energy Efficiency Potential and Goals Study for 2018 and Beyond - Final Public Report*. August 2017. <http://docs.cpuc.ca.gov/PublishedDocs/Efile/G000/M194/K614/194614840.PDF>.

Figure 10: Annual Natural Gas Savings – mTRC (GHG Adder #1) Reference Scenario (MMTherms)

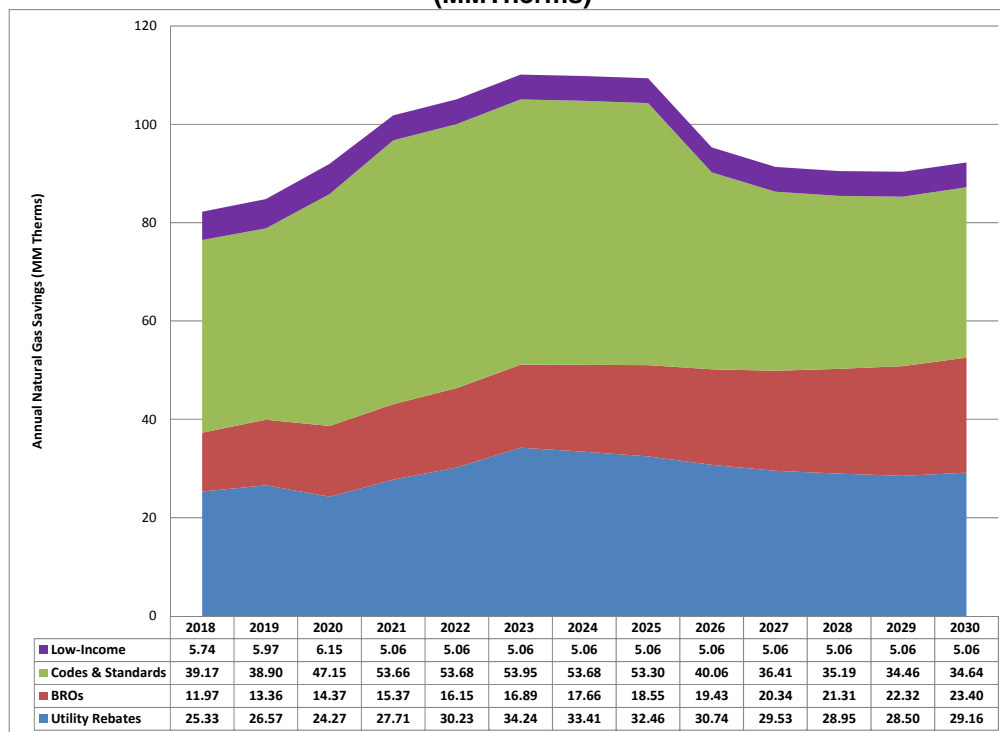

Source: CPUC/Navigant. *Energy Efficiency Potential and Goals Study for 2018 and Beyond - Final Public Report*. August 2017. <http://docs.cpuc.ca.gov/PublishedDocs/Efile/G000/M194/K614/194614840.PDF>.

Adjustments to CPUC Savings Projections

For setting IOU targets under SB 350, the Energy Commission proposes specific adjustments to the savings projections presented in the mTRC – GHG Adder #1 scenario of the *2018 IOU Potential and Goals Study* that will help streamline accounting and tracking of savings. These are:

- The savings projections for codes and standards were excluded from the utility projected savings and accounted for under non-utility programs.
- For consistency with SB 350, historical savings for 2015-2017 were added to reflect 2015 base year.³⁴
- Cumulative savings projections are selected in conformance with the requirement of SB 350 that the statewide doubling goal be cumulative

Error! Not a valid bookmark self-reference. shows cumulative electricity savings projections and **Figure 12** shows cumulative natural gas savings projections using the mTRC – GHG Adder #1 scenario.

Figure 11: Electricity Savings – mTRC (GHG Adder #1) Reference Scenario by Program Type (Excluding Codes and Standards) (GWh)

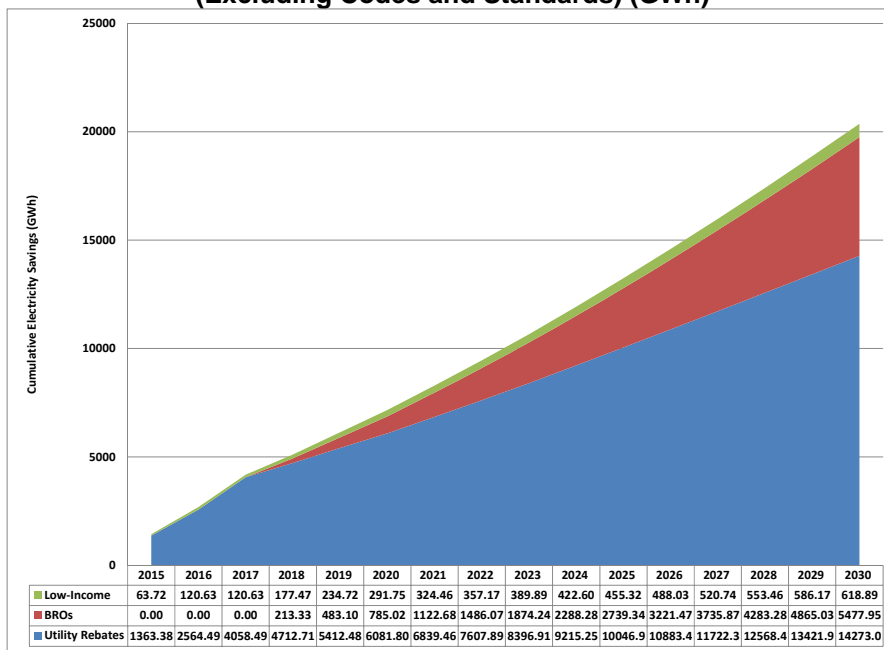

Source: CPUC/Navigant. *Energy Efficiency Potential and Goals Study for 2018 and Beyond - Final Public Report*. August 2017. <http://docs.cpuc.ca.gov/PublishedDocs/Efile/G000/M194/K614/194614840.PDF>.

³⁴ The *2018 IOU P potential and Goals Study* only reported from the years 2018 through 2030. Energy Efficiency savings for 2015-2016 may be subject to change pending final evaluations by the CPUC.

Figure 12: Natural Gas Savings – mTRC (GHG Adder #1) Reference Scenario by Program Type (Excluding Codes and Standards) (MM Therms)

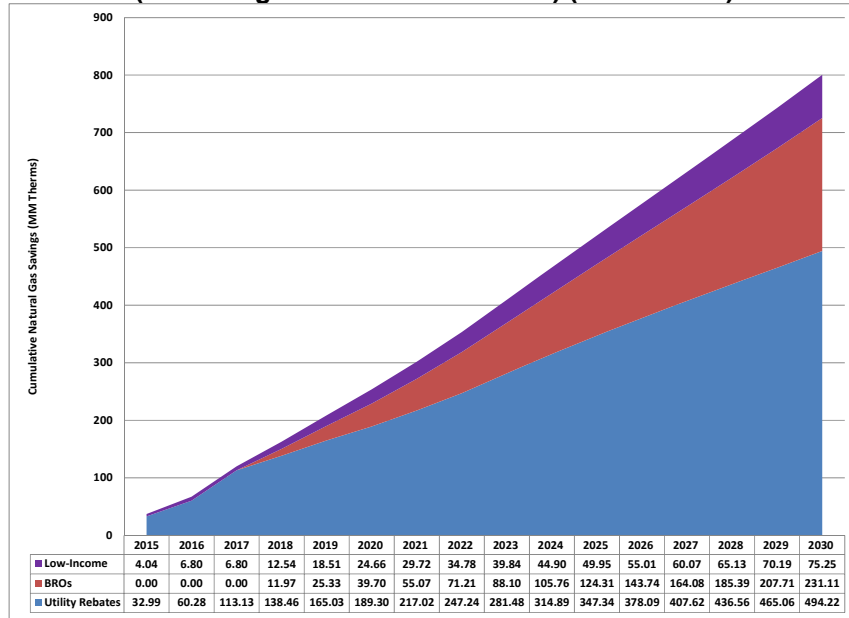

Source: CPUC/Navigant. *Energy Efficiency Potential and Goals Study for 2018 and Beyond - Final Public Report*. August 2017. <http://docs.cpuc.ca.gov/PublishedDocs/Efile/G000/M194/K614/194614840.PDF>.

CHAPTER 4:

Publicly Owned Utility Energy Efficiency

California's POU are vertically integrated utilities regulated by local governing boards and that vary by size, customer base, and resource portfolios. POU electricity savings programs provide subsidies and incentives for energy efficiency to the final end users. POU incentive programs range from cash rebates for the purchase of higher-efficiency products and home energy upgrades to customized financial incentives and awareness and education campaigns that improve customer energy use behavior. Only a few small POUs provide natural gas service to end-use customers, which is a small fraction of the scale of natural gas service provided by IOUs to end users across the state.³⁵ Thus, natural gas savings from energy efficiency measures presented in Chapter 3 are largely a result of CPUC-supervised IOU activities. Additional POU natural gas savings have not been included in the SB 350 targets.

POU incentives for electricity savings can be designed for customers or can be directed further upstream in larger consumer market supply chains to encourage manufacturers, retailers, contractors, and builders to influence how consumers pick building designs, choose operating methods, or buy home appliances. POUs also administer load management programs that provide technical assistance and customer incentives to install automated demand response equipment, undertake voluntarily scheduled load reduction, and manage peak-day and time-of-use consumption patterns.

Historical Energy Efficiency Savings

The POU electricity savings accomplishments are shown in **Figure 13**. POU net electricity savings from first-year efficiency measure installations totaled around 575 GWh in 2016, a slight increase of 2 percent over 2015. In March of each year, CMUA submits an annual report on energy efficiency savings.³⁶ Cumulatively, POUs reported more than 5,000 GWh in net electricity savings for the past 10 years. POUs' electricity savings have been steadily increasing since 2012.

The POU electricity savings by end use in both residential and nonresidential sectors are shown in **Figure 14**. Two of the largest end uses – lighting and heating, ventilation, and air-conditioning (HVAC) equipment – account for the majority of savings.

³⁵ The City of Palo Alto provides both electricity and natural gas service to end-use customers and offers energy efficiency programs. Only very limited data and program descriptions of these programs were available for the *POU Potential and Goals Study*.

³⁶ CMUA, *Energy Efficiency in California's Public Power Sector Status Reports*, Appendix B <http://www.ncpa.com/policy/reports/energy-efficiency/>.

Figure 13: POU Reported Electricity Savings (GWh)

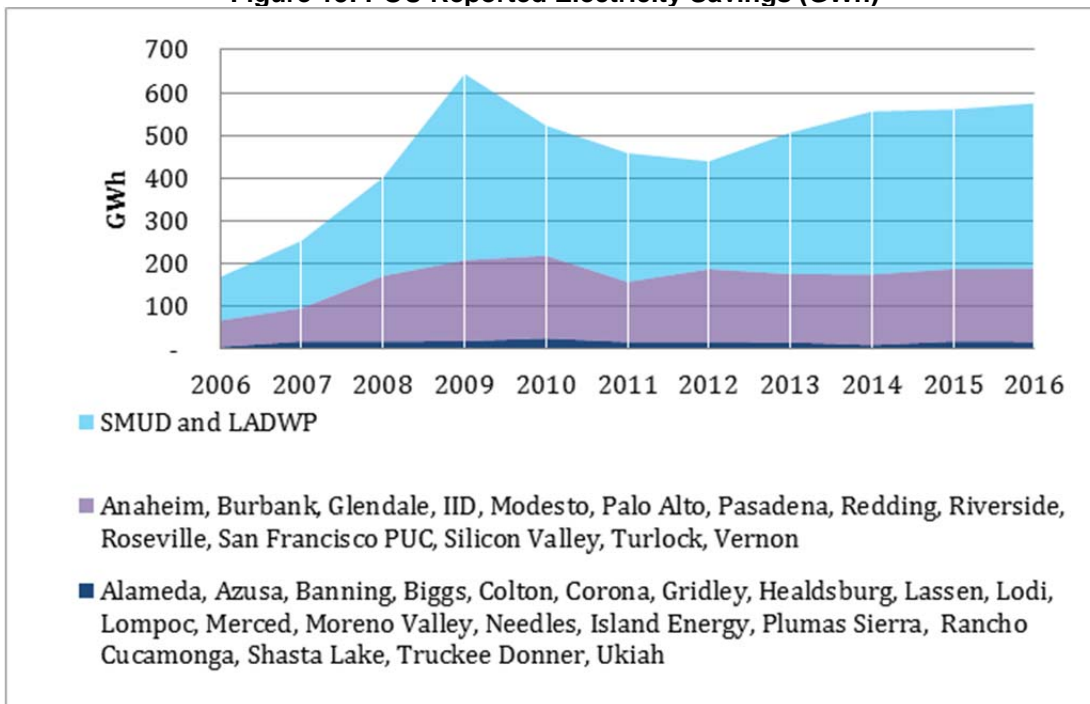

Source: California Energy Commission staff, July 2017, based on *Energy Efficiency in California's Public Power Sector Status Reports*, Appendix B <http://www.ncpa.com/policy/reports/energy-efficiency/>.

Figure 14: Combined (2006-2016) POU Reported Electricity Savings by End Use (GWh)

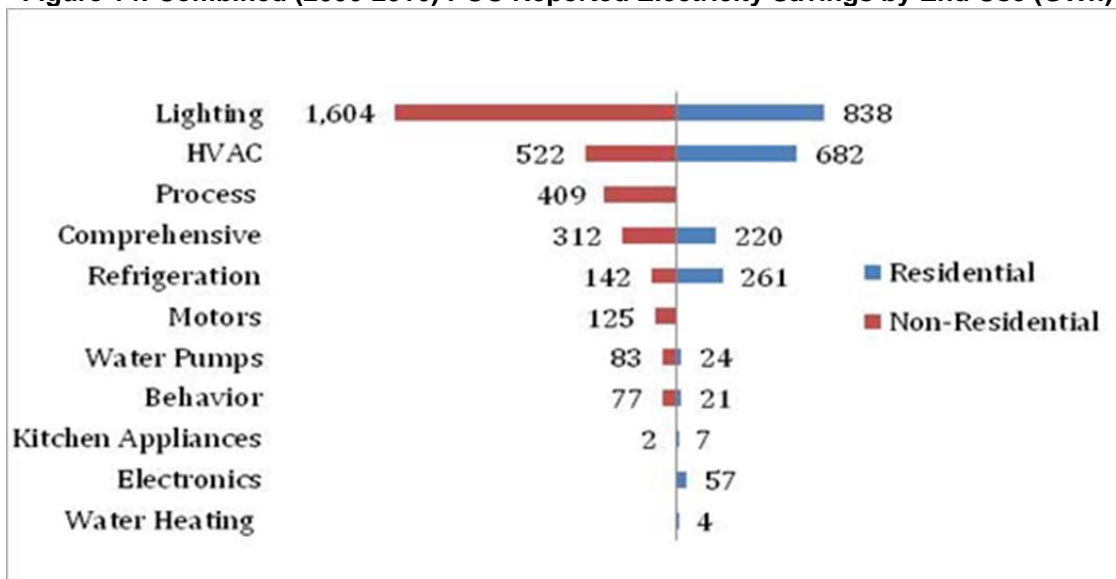

Source: California Energy Commission staff, July 2017, based on *Energy Efficiency in California's Public Power Sector Status Reports*, Appendix B <http://www.ncpa.com/policy/reports/energy-efficiency/>.

POU Energy Efficiency Potential and Goals Studies

POUs are required to identify on a four-year cycle all feasible and cost-effective energy efficiency savings and establish 10-year annual goals.³⁷ In addition, they are required to provide to their customers and the Energy Commission the results of evaluation studies that measure and verify claimed demand reduction and energy savings. The CMUA, in partnership with the Northern California Power Agency (NCPA) and the Southern California Public Power Authority (SCPPA), collaborated on developing individual POU 10-year electricity savings projections to establish electricity savings goals. CMUA used the contractor Navigant to perform the technical assessment used by the POUs in establishing the 10-year targets.³⁸

The POUs' 2017 report on energy efficiency potential and goals (*POU Potential and Goals Study*) was submitted in March 2017. The study uses the Navigant's Electricity Resource Assessment Model (ELRAM) to calculate technical, economic, market-maximum, and market-adjusted electricity savings projections. ELRAM is substantially similar to the Navigant model used by the CPUC to establish energy efficiency goals for the IOUs. The *POU Potential and Goals Study* presents a base set of projections of electricity savings and demand reduction as a function of projected electricity sales. Each POU then directed CMUA/Navigant to modify estimates using alternative assumptions, or other changes, for its own portion of the overall POU savings projection. The *POU Potential and Goals Study* contains the results of the adjustments to the base analysis identified by each POU, so there is no uniform set of assumptions common to all POUs, nor have any alternative scenarios been prepared.

The POUs generally use the levelized cost of energy efficiency measures as the most useful metric for evaluating cost-effectiveness and for making comparisons to generation resources.³⁹ ELRAM estimates economic potential as the amount of technical potential that is cost-effective, as defined in this case by the results of the TRC test.⁴⁰ POUs use the TRC test as a cost-benefit analysis of relevant energy efficiency measures, excluding market barriers such as lack of consumer knowledge. Benefits include the avoided costs of generation, transmission and distribution investments, avoided fuel costs, and other benefits that may accrue to participants and/or to the utility. Costs vary by economic test but may include incremental technology cost, incentives, administrative costs, and/or lost revenue.

For the *POU Potential and Goals Study*, *technical potential* is defined as the complete penetration of all available energy efficiency measures. It is a product of the electricity savings per unit of a measure, the quantity of applicable efficiency units in each facility, and the number of facilities in a utility service territory. The quantity of applicable units per year is determined by the effective useful life of the measure. Economic potential represents a portion of the technical potential if a utility installs measures that meet the cost-effectiveness screening, which uses both the TRC and PAC tests. POU market potential is estimated in response to specific levels of incentives, program design, the magnitude of utility rebates, and assumptions about policies, market influences, and market barriers. Gross and net

37 Assembly Bill 2021 (Levine, Chapter 734, Statutes of 2006) AB 2021 required 10-year efficiency targets to be set every three years. Assembly Bill 2227 (Bradford, Chapter 606, Statutes of 2012) changed the frequency of target setting to every four years.

38 CMUA, *Energy Efficiency in California's Public Power Sector: 11th Edition* – 2017, March 15, 2017. http://www.ncpa.com/wp-content/uploads/2015/02/2017_POU_EE_Reportv2.pdf.

39 CMUA, *Energy Efficiency in California's Public Power Sector: 11th Edition*. 2017. p. 18.

40 *Energy Efficiency Potential Forecasting for California's Publicly Owned Utilities*. Prepared by Navigant for CMUA. February 22, 2017. p. 12.

market potentials are estimated incrementally and cumulatively. Some of the POU-specific methods differ in whether the estimates are considered net of naturally occurring efficiency or free riders.

Figure 15 provides savings potential using the ELRAM projections for the composite of all POUs. Technical and economic potentials are relatively constant through time reflecting the definition of these concepts described above. Market potential and net program savings projections grow through time as year-by-year savings accumulate. However, by the end of the 10-year period, only limited amounts of economic potential have been achieved.

Figure 15: POU Ten-Year Cumulative Savings Potential

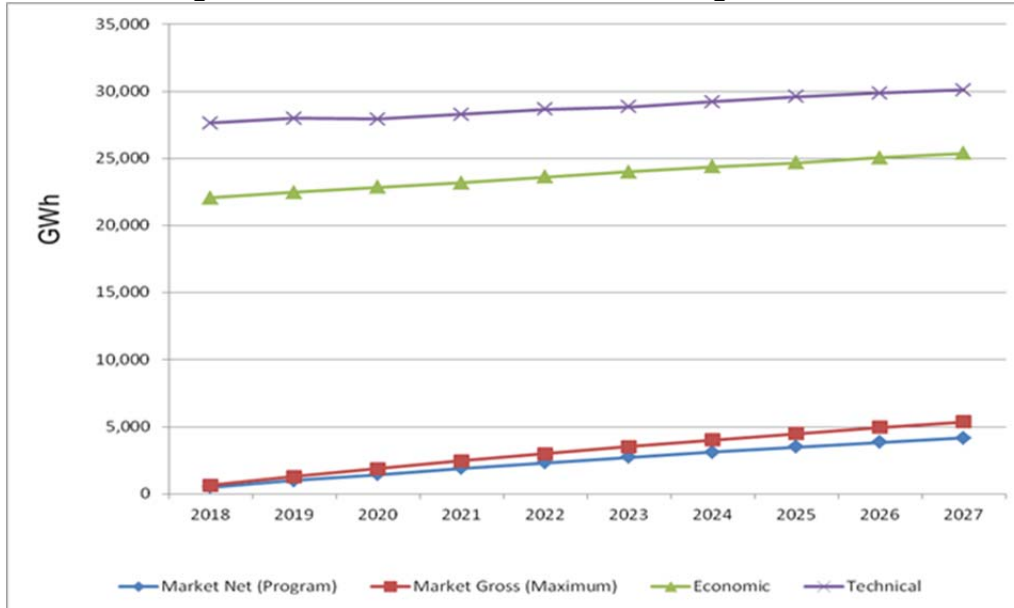

Source: CMUA, *POU Potential and Goals Study*, March 2017. http://docketpublic.energy.ca.gov/PublicDocuments/17-IEPR-06/TN217680_20170522T124015_Energy_Efficiency_in_California's_Public_Power_Sector_11th_Edit.pdf.

POU Energy Efficiency Goals

As described above, POUs used different assumptions to arrive at their individual goals. **Figure 16** provides a view of cumulative 10-year savings for all POUs combined into three size groups. The Los Angeles Department of Water and Power (LADWP) and the Sacramento Municipal Utility District (SMUD) alone account for much more than half of total cumulative savings. The 14 medium-sized POUs account for about a quarter of the cumulative savings.⁴¹ The remaining POUs collectively account for a very small share of composite POU savings.

⁴¹ The large and medium-sized POUs are the 16 utilities for which the integrated resource planning requirements of SB 350 are applicable. These are the 16 POUs for which historical energy sales are 700 GWh per year or larger.

Figure 16: Ten-Year Cumulative Savings Goals by POU Group

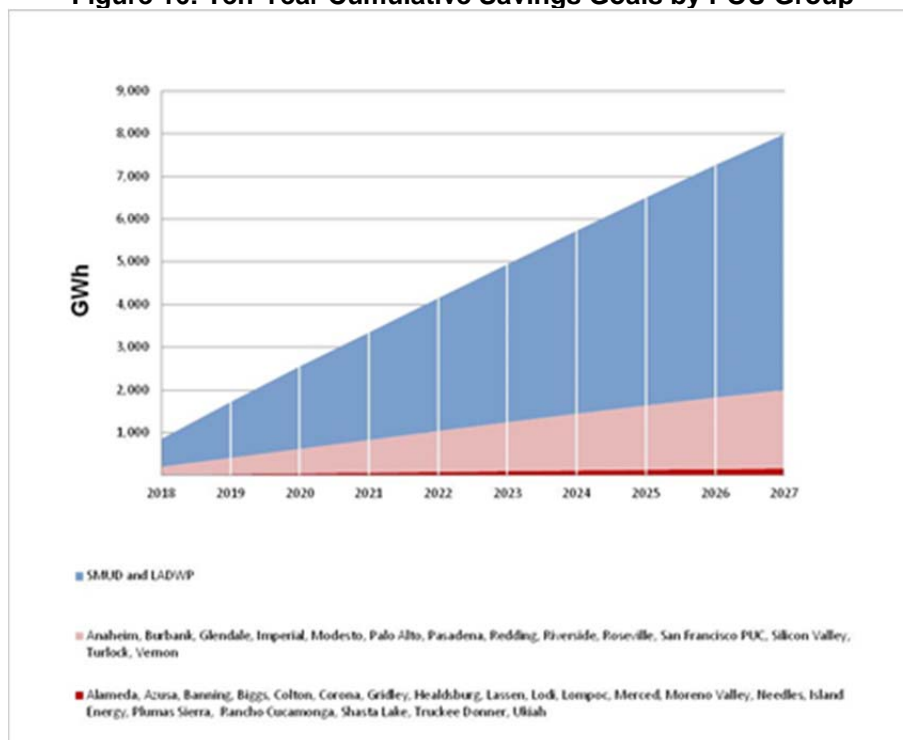

Source: California Municipal Utilities Association, *POU Potential and Goals Study*, March 2017.
http://docketpublic.energy.ca.gov/PublicDocuments/17-IEPR-06/TN217680_20170522T124015_Energy_Efficiency_in_California's_Public_Power_Sector_11th_Edit.pdf.

Adjusted POU Energy Efficiency Projections

Since each POU customizes the final projections of goals that were submitted to the Energy Commission, the composite projections shown above do not use a uniform basis for developing future savings projections. To partially address this problem for SB 350 and the energy demand forecast, Energy Commission has adjusted the savings estimates presented in the *POU Potential and Goals Study*.

The first adjustment was to shift from gross to net savings for POUs. As discussed in Chapter 1, energy efficiency savings can be reported as either net or gross. The *POU Potential and Goals Study* used net savings estimates rather than gross savings. However, several POUs directed CMUA/Navigant to use gross savings for setting goals in the *POU Potential and Goals Study*. The second adjustment was to exclude savings from codes and standards, as was done for the IOUs. Those savings have been accounted for in non-utility program savings projections. The third adjustment was to add historical savings from 2015-2017 and extrapolate savings from 2027 through 2029 for consistency with SB 350.

The effect of these adjustments on the three aggregate groups of POUs can be seen by comparing **Figure 17** and **Figure 18**. Both figures report annual incremental savings and generally report reductions in annual savings going forward in time. The most important difference between the two figures is that **Figure 17** begins in 2018, while **Figure 18** begins in 2015. This difference reflects the requirement of SB 350 to use 2015 as the base year. The second important difference is that all the annual incremental values in **Figure 18** are scaled down about 200 GWh per year compared to the

corresponding values in **Figure 17**. This difference reflects the exclusion of codes and standards savings and the replacement of gross savings by net savings.

Figure 17: POU Annual Incremental Electricity Savings Goals

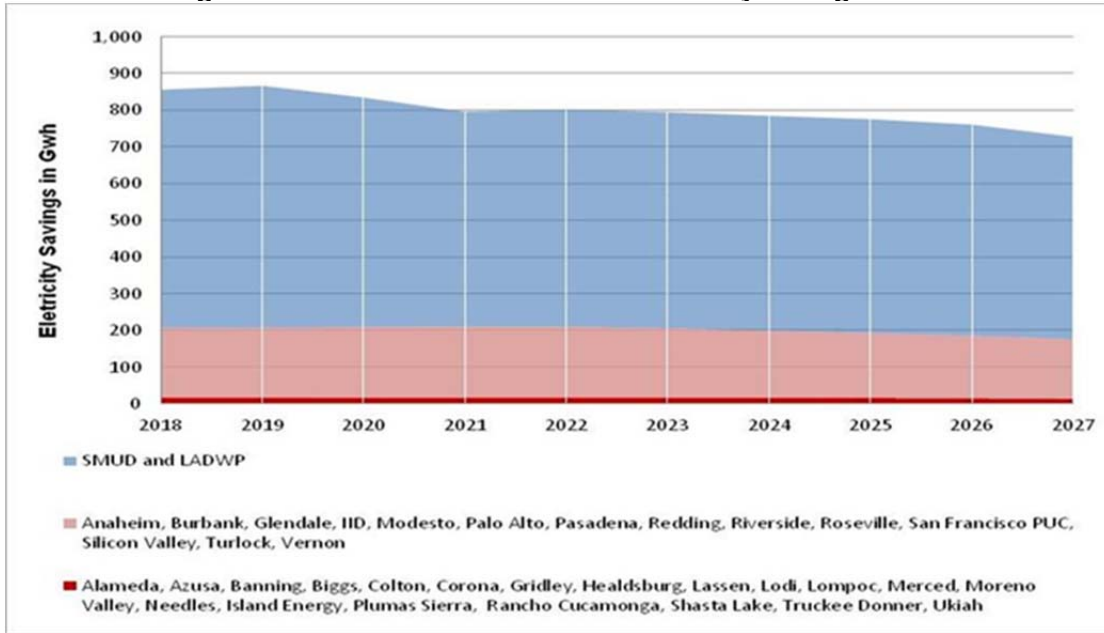

Source: California Municipal Utilities Association, *POU Potential and Goals Study*, March 2017. http://docketpublic.energy.ca.gov/PublicDocuments/17-IEPR-06/TN217680_20170522T124015_Energy_Efficiency_in_California's_Public_Power_Sector_11th_Edit.pdf.

Figure 18: POU Annual Goals With Adjustments

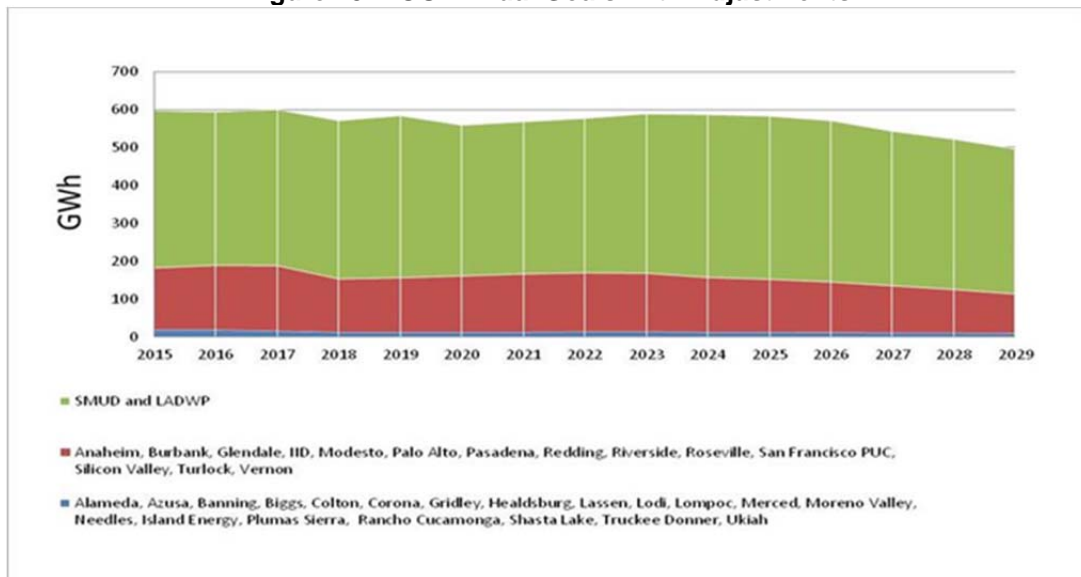

Source: Energy Commission Staff, Energy Assessments Division, July 2017. Based on CMUA, *POU Potential and Goals Study*, March 2017. http://docketpublic.energy.ca.gov/PublicDocuments/17-IEPR-06/TN217680_20170522T124015_Energy_Efficiency_in_California's_Public_Power_Sector_11th_Edit.pdf.

Figure 19 depicts the cumulative effect of these proposed adjustments on the original POU projections as submitted in March 2017. The blue line represents the cumulative savings for all POU for the period submitted within the CMUA report – 2018 to 2027. The red line indicates the adjustment to remove codes and standards savings – all annual values on the red line are lower in each year than those for the

blue line. The green line represents the effect of replacing gross savings with net savings. As with the first adjustment, all green line values are lower in each year than the corresponding red line values. Finally, the purple line represents the results of adding savings in the historical years of 2015 and 2016 (and estimated savings for current year 2017), so the value for each year is always higher in 2018 to 2027 reflecting adding a constant value to the original POU projections.

Figure 19: Effect of Adjustments to POU Cumulative Savings

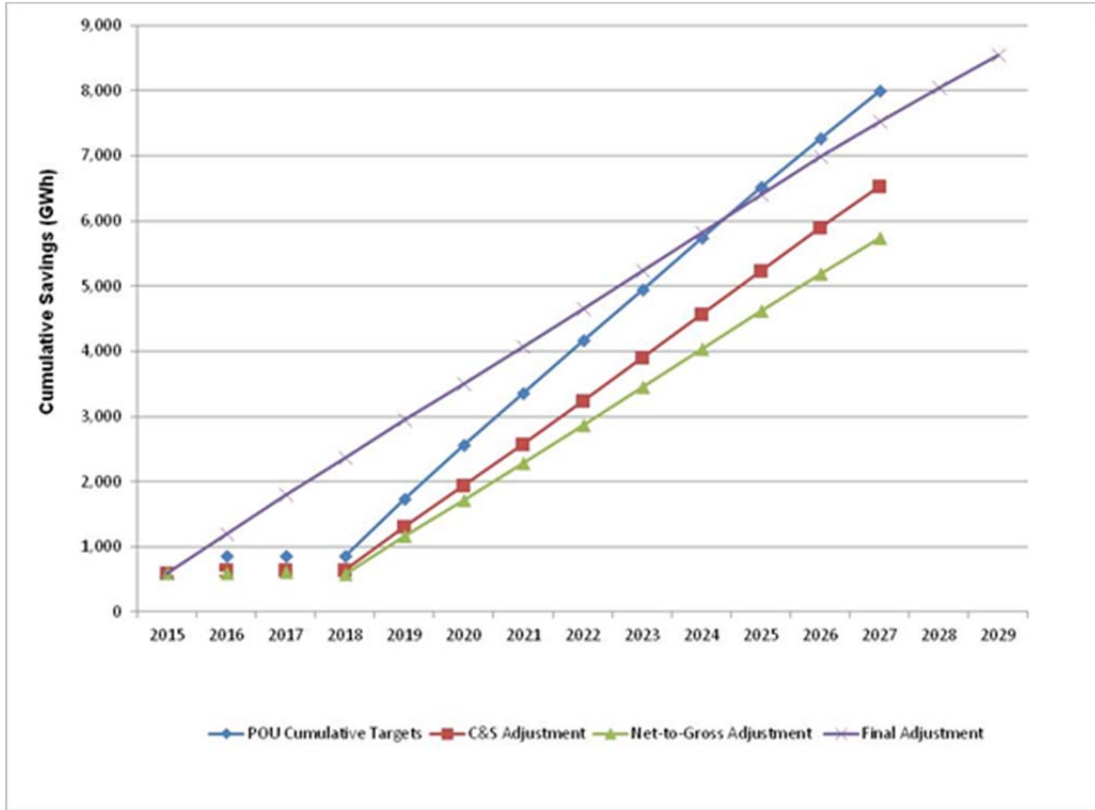

Source: California Energy Commission Staff, Energy Assessments Division, July 2017. Based on CMUA, *POU Potential and Goals Study*, March 2017. http://docketpublic.energy.ca.gov/PublicDocuments/17-IEPR-06/TN217680_20170522T124015_Energy_Efficiency_in_California's_Public_Power_Sector_11th_Edit.pdf.

Figure 20, using the same format as **Figure 16**, represent the adjusted cumulative savings by the three POU size groups. Targets by POU are presented in Appendix A.

Figure 20: Proposed POU Adjusted Cumulative Sub-targets

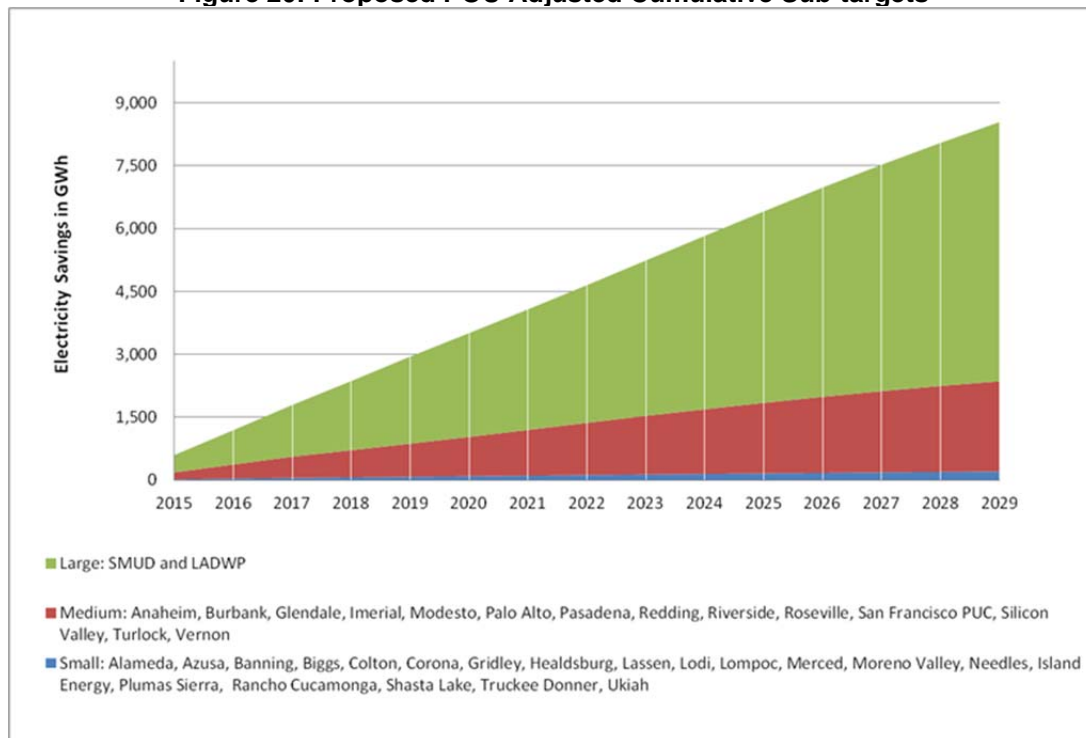

Source: California Energy Commission staff, Energy Assessments Division, July 2017.

POU Comments on Proposed SB 350 Doubling Sub-targets

Both SMUD and the joint POU's filed comments expressing concern about the proposed target-setting process for publicly owned utilities (POUs).⁴² For example, the joint POU's state that "the reference to establishing targets for IRP utilities should be reframed as it implies that the CEC staff targets preempt the POU targets adopted by local governing boards, and that POU's subject to the IRP will be expected to incorporate the Energy Commission targets instead of their own adopted targets into their IRP filings; neither of which is within the scope of the CEC's authority to direct."⁴³ Similarly, SMUD states: "The exclusive authority to establish POU-specific energy efficiency targets rests with the POU's governing boards."⁴⁴ SMUD also states: "SB 350 continues the previous Commission authority to establish statewide efficiency targets that were established via SB 1037 in 2005, while providing direction to the Commission that the new statewide targets established this year be aimed at a cumulative doubling of energy efficiency by 2030."⁴⁵ SB 350 also continues the longstanding policy in Public Utilities Code Section 9505(b) that it is POU's governing boards that must adopt energy

⁴² *Joint Publicly Owned Utilities Comments on Draft Staff Papers on SB 350 Energy Efficiency Savings Doubling Targets*, Docket No. 17-IEPR-06, August 3, 2017. [http://docketpublic.energy.ca.gov/PublicDocuments/17-IEPR-06/TN220545_20170803T165754_Jonathan Changus Comments CMUA NCPA and SCPPA Joint Comments on.pdf](http://docketpublic.energy.ca.gov/PublicDocuments/17-IEPR-06/TN220545_20170803T165754_Jonathan%20Changus%20Comments%20CMUA%20NCPA%20and%20SCPPA%20Joint%20Comments%20on.pdf)

⁴³ *Ibid.* p. 9.

⁴⁴ *Comments of the Sacramento Municipal Utility District on Senate Bill 350 Energy Efficiency Target Setting for Utility Programs*, Docket No. 17-IEPR-06, p.2. [http://docketpublic.energy.ca.gov/PublicDocuments/17-IEPR-06/TN220539_20170803T145417 Lourdes JimenezPrice Comments Comments of the Sacramento Municipi.pdf](http://docketpublic.energy.ca.gov/PublicDocuments/17-IEPR-06/TN220539_20170803T145417_Lourdes%20JimenezPrice%20Comments%20of%20the%20Sacramento%20Municipi.pdf)

⁴⁵ *Ibid.* p.2.

efficiency targets, continuing to indicate that these targets should be 'consistent with' the statewide targets established by the Commission."⁴⁶

SMUD and the joint POU's misconstrue the Energy Commission's role in this proceeding. The Energy Commission has never stated that the POU targets that it identifies as part of the SB 350 process should supplant the POU's own targets or that the POU's would be obligated to incorporate these targets as their own. Rather, the Energy Commission targets reflect the POU-adopted targets with adjustments that are necessary to ensure a uniform basis for developing savings projections. In fact, the Energy Commission agrees that POU's can continue to set their own targets, even if those targets are developed using different methods than those adopted by the Energy Commission.

However, the Energy Commission has an affirmative obligation to recommend improvements that "can be made in either the level of a local publicly owned electric utility's annual targets to achieve all cost-effective, reliable, and feasible energy savings and demand reductions and enable local publicly owned electric utilities, in the aggregate, to achieve statewide targets established pursuant to Section 25310."⁴⁷ The Energy Commission also has an affirmative obligation to assess "the effect of energy efficiency savings on electricity demand statewide, in local service territories, and on an hourly and seasonal basis" ⁴⁸

In meeting these legislative mandates, the Energy Commission has determined that using inconsistent methods of accounting for savings is confusing at best and misleading at worst. In fact, the Energy Commission can neither establish targets that will achieve the cumulative doubling target through energy efficiency savings and demand reduction resulting from a variety of programs nor track savings from these programs without accounting for program savings consistently across programs. While POU's may use their own approach in developing their targets, the Energy Commission's responsibility is broader – it must ensure that the targets it establishes are both "based on" the POU's targets and consistent with the legislative targets for a statewide doubling of energy efficiency savings.

46 Ibid. p. 1-2.

47 Public Resources Code Section 25305.2.

48 Public Resources Code Section 25310(e)(1).

CHAPTER 5:

Potential Energy Efficiency Programs Needing Additional Analysis

Several other programs have the potential to deliver significant energy savings toward meeting the SB 350 goals. Issues related to utility fuel substitution and conservation voltage reduction (CVR) programs are discussed in this chapter. Estimates of savings from non-utility fuel substitution are presented in Chapter 6 and Attachment A. Estimates of non-utility agricultural and industrial energy efficiency savings potential are presented in this chapter. The Energy Commission will need additional data and analysis to fully understand the potential savings that might be counted toward the SB 350 doubling target. The Energy Commission intends to reexamine these programs and measures in future update cycles. These programs are discussed below.

Fuel Substitution Programs

SB 350 allows programs that save energy in final end uses by using cleaner fuels to reduce GHG emissions from the provision of energy services.⁴⁹ The Energy Commission defines *fuel substitution* as a measure involving the substitution of one utility-supplied or interconnected energy source for another, such as electricity and natural gas.⁵⁰ For example, advances in heat pump technology have made substituting electricity for natural gas for heating systems more viable and offer increased efficiency compared to traditional resistance heating devices such as electric clothes dryers.⁵¹ The vast majority of buildings in California use natural gas for water and space heating. Substituting natural gas with heat pumps for space and water heating could reduce both energy consumption and GHG emissions.⁵²

Estimated potential savings from this type of electrification were included with other non-utility programs since no utility submitted fuel substitution program savings projections and these measures were not evaluated as part of the utility potential and goals studies. The savings from non-utility fuel substitution are presented in **Figure 27** and **Figure 28** in Chapter 6 and discussed in detail in Attachment A.

The following discusses issues related to fuel substitution savings that might be pursued by utilities.

49 Public Resources Code Section 25310(d).

50 *Fuel switching* involves shifting from an energy source that is not utility-supplied or interconnected, for example petroleum, to a utility-supplied or interconnected energy source. These measures are not allowed under SB 350.

51 "Heat Pump Systems," U.S. Department of Energy, accessed June 12, 2017, <https://energy.gov/energysaver/heat-pump-systems>.

52 "Heat Pump Water Heaters," U.S. Department of Energy, accessed June 12, 2017 <https://energy.gov/energysaver/heat-pump-water-heaters>.

Determining Energy Savings and GHG Emission Reductions

SB 350 requires that fuel switching result in both energy savings and associated GHG emission reductions.⁵³ Previous efforts to assess the impacts of fuel substitution programs have introduced two key terms – *site* and *source*.⁵⁴ *Site* refers to the location of the end user consuming energy to obtain an energy service. *Source* refers to the location(s) of the production or generation of the fuel consumed at the end user's site. In most applications, site energy consumption for specific program participants is unambiguous. However, the complexities of electric generation mean that source energy and accompanying emissions that provide electric energy to the end user introduce numerous analytic uncertainties.

To satisfy the site requirement for energy savings, the end-use energy consumed at a given site must be lower while maintaining the same level of service. For example, the end-use site energy consumed by an electric appliance must be lower than the energy consumed by a natural gas appliance that performs the same level of service.⁵⁵ An analysis that relied upon a decrease in source energy as the basis for determining if there is an energy reduction, given the large-scale shift to renewable generation through time, could mistakenly infer a site energy reduction when only energy consumed in the generation, transmission, and distribution processes was reduced.⁵⁶

Satisfying the source requirements for emission reductions will involve comparing, for example, GHG emissions from natural gas combustion at the site with the average GHG emissions of the electricity resource mix serving the end use. Natural gas end-use source GHG emissions are only slightly higher than natural gas site GHG emissions and change only with the efficiency of the end-user combustion process.⁵⁷ However, as previously noted, for electric end uses, the source GHG emissions will change through time as the resource mix shifts toward renewable generation and away from generating technologies that produce GHG emissions.

Cost Considerations

It appears that the majority of fuel substitution may occur within the four IOU service areas. Therefore, it is logical to consider the CPUC cost-effectiveness requirements for fuel substitution, and then consider additional or different criteria needed to meet the requirements of SB 350. One or more fully developed fuel substitution programs are needed to evaluate whether the SB 350 requirement for energy savings and GHG reductions are sufficient to satisfy the CPUC's three-prong test and to determine where there are differences in outcome.

The interactions between different types of utilities and other energy providers raise complexities that involve financial interests that may be difficult to sort. The CPUC has historically addressed fuel substitution in cases of competing interests between Southern California Edison (SCE) and Southern

53 Public Resources Code Section 25310(d).

54 For example, CPUC D.05-04-051, pp. 16-17. See http://docs.cpuc.ca.gov/PublishedDocs/WORD_PDF/FINAL_DECISION/45783.PDF.

55 Reducing energy usage at the site generally refers to electric heat pump technologies replacing technologies that directly combust natural gas.

56 Converting energy consumption for electric and natural gas appliances to BTUs will allow for the comparison of technologies to determine whether end use consumption at the site is reduced.

57 The difference between site and source GHG emissions from end-user consumption is distribution losses. This has historically been estimated at about 2 percent of annual usage.

California Gas Company (SoCalGas) through the three-prong test. More widespread fuel substitution could cause load shifting within and between CPUC jurisdictional entities. There is also the potential for load to shift from a gas company to a POU. These complexities will need to be addressed if it appears that more widespread fuel substitution is being pursued. Some parties have raised concerns about barriers to fuel substitution presented by the cost-effectiveness method based on using a TDV metric.

Comments on Fuel Substitution

Several parties provided comments on fuel substitution issues. SCE and Pacific Gas and Electric (PG&E) recommend further development of rules, guidelines, or clarifications to the proposed treatment of fuel substitution to remove current policy impediments.^{58, 59} SCE and SoCalGas encourage use of the CPUC's established rules for fuel substitution (the three-prong test) and caution against modifying the test in a way that would compromise the associated screening role to ensure technologies are energy-efficient, provide net resource value to ratepayers, and maintain customer choice.⁶⁰ SMUD generally supports the need for demonstrable savings from fuel substitution but argues against use of the CPUC's test since it is under review and may be modified.⁶¹ SMUD believes the utility responsible for implementing the fuel substitution measure should receive the savings credit. It supports a simulation dispatch for assessing marginal natural gas values but believes that rather than using the statewide energy mix utilities, it should be allowed to use its own resource mix.

The Natural Resources Defense Council (NRDC) suggests that methane emissions associated with the production, transmission, distribution, and on-site use of natural gas should be included in any method to determine fuel substitution savings since methane has a high global warming potential.⁶² SoCalGas cautions that including electrification of final end uses as a strategy to reduce energy consumption may preclude adoption other lower carbon energy sources and decelerate achievement of the state's climate goals.⁶³ It notes that the use of renewable gas to reduce methane emissions is a strategy relied upon by the California Air Resources Board's *Short-Lived Climate Pollutant Reduction Plan and Scoping Plan*.⁶⁴

58 Southern California Edison Company's Comments on Draft Staff Papers on Senate Bill (SB) 350 Energy Efficiency Savings Doubling Targets, Docket No. 17-IEPR-06, August 3, 2017, http://docketpublic.energy.ca.gov/PublicDocuments/17-IEPR-06/TN220538_20170803T140140_Catherine_Hackney_Comments_SCE_Comments_on_Draft_Staff_Papers_o.pdf.

59 Docket 17-IEPR-06: Pacific Gas and Electric Comments on Draft Staff Papers Regarding 2030 Energy Efficiency Doubling Targets, http://docketpublic.energy.ca.gov/PublicDocuments/17-IEPR-06/TN220541_20170803T155809_Pacific_Gas_and_Electric_Comments_Pacific_Gas_and_Electric_Comp.pdf.

60 Southern California Gas Company, Comments on CEC Staff's Two Draft Papers on SB 350 Energy Efficiency Savings Doubling Targets, Docket #17-IEPR-06, p. 3. http://docketpublic.energy.ca.gov/PublicDocuments/17-IEPR-06/TN220542_20170803T162655_Jennifer_Morris_Comments_SoCalGas_Comments_on_SB_350_Energy_Eff.pdf.

61 Comments of the Sacramento Municipal Utility District on Senate Bill 350 Energy Efficiency Target Setting for Utility Programs, Docket No. 17-IEPR-06, pp.3-5. http://docketpublic.energy.ca.gov/PublicDocuments/17-IEPR-06/TN220539_20170803T145417_Lourdes_JimenezPrice_Comments_Comments_of_the_Sacramento_Munici.pdf.

62 Comments of Natural Resources Defense Council (NRDC) on the 2017 Integrated Energy Policy Report (IEPR) Draft Staff Papers on SB 350 Energy Efficiency Savings Doubling Targets. Docket No. 17-IEPR-06, August 3, 2017, pp 2-4. http://docketpublic.energy.ca.gov/PublicDocuments/17-IEPR-06/TN220546_20170803T170248_Natural_Resources_Defense_Council_Comments_NRDC_CommentsDraft_S.pdf.

63 Southern California Gas Company, Comments on CEC Staff's Two Draft Papers on SB 350 Energy Efficiency Savings Doubling Targets, Docket #17-IEPR-06, pp. 2-3. http://docketpublic.energy.ca.gov/PublicDocuments/17-IEPR-06/TN220542_20170803T162655_Jennifer_Morris_Comments_SoCalGas_Comments_on_SB_350_Energy_Eff.pdf.

64 Ibid. p. 2.

The Energy Commission has identified a recommendation and next steps to address outstanding issues related to fuel substitution in Chapter 7.

Conservation Voltage Reduction

Conservation voltage reduction (CVR) is a proven technology for reducing energy use and peak demand. CVR improves the efficiency of the distribution system by optimizing voltage. The key principle of CVR operation is that the standard voltage band between 114 and 126 volts can be compressed using regulation to the lower half (114–120 volts) instead of the upper half (120–126 volts),⁶⁵ producing considerable energy savings at low cost and without harm to consumer appliances.⁶⁶ Sensors detect distribution voltages, and when voltages exceed preset limits, voltage regulation equipment is triggered. The benefits from reduced energy consumption (metered end-user usage and distribution losses) and avoided equipment damage through time must exceed the investment and operating costs for CVR to make sense from an economic perspective.

Distribution utilities implement these activities, not the end user, so there are no programs that either attract or provide incentives for end users. It is expected that energy procurement will be reduced because of such activities, with a portion of the savings occurring as metered energy usage reductions by end users and another portion as reductions in distribution losses by the distribution utility.

The fundamental question of both IOU distribution utilities and POU is whether investments in more sophisticated distribution equipment are less expensive than the present value of the reduction in energy consumption. If a distribution utility is not also providing generation services to some or all of the end users receiving distribution services, then the distribution utility will be less able to recover CVR investments through charges for energy consumed. Given the evolving role of non-utility energy entities under the CPUC's jurisdiction, determining the cost-effectiveness of such activities is growing more complex. POU do not face this challenge because they are vertically integrated and have not unbundled the services they offer to customers.

Several research/demonstration projects in California utility service areas were funded by U.S. Department of Energy through the American Recovery and Reinvestment Act of 2009 (ARRA) program in the late 2000s. Among them were CVR projects at Glendale Water and Power and SMUD that were part of distribution system improvement efforts. Palo Alto undertook a self-funded project more specifically oriented to using CVR as an end-user energy savings project. These efforts will help identify opportunities for utilities to use CVR.

Additional details on CVR are provided in Appendix A.

Comments on Conservation Voltage Reduction

The California Efficiency and Demand Management Council (CEDMC) supports the inclusion of CVR as an energy-saving measure under SB 350.⁶⁷ However, it disagrees with the characterization that CVR

⁶⁵ In the United States, regulations require that voltage be made available to consumers at 120 volts (V) plus or minus 5 percent, yielding a range of 126V to 114V.

⁶⁶ Electrical equipment including air conditioning, refrigeration, appliances and lighting is designed to operate most efficiently at 114V. Power delivered at higher voltage wastes energy as heat.

⁶⁷ Docket 17-IEPR-06: *California Efficiency + Demand Management Council Comments on the Draft Staff Papers on Senate Bill 350 Energy Efficiency Targets*, August 3, 2017, pp. 3-6. http://docketpublic.energy.ca.gov/PublicDocuments/17-IEPR-06/TN220498_20170802T075328_Senate_Bill_350_Energy_Efficiency_Target_Setting_for_UTILITY_Pr.pdf.

is an emerging technology. CEDMC notes that CVR has been demonstrated to be cost-effective in saving energy by regulatory agencies and utilities around the country. It believes that CVR and advanced voltage technologies deserve increased attention, including potential studies by IOUs and POUs, consideration of incentives to support deployment of technologies and addressing lost revenue and inclusion in IOU energy efficiency business plans. Honeywell also provided comments indicating interest in participating in studying the merits of CVR as a CVR technology provider.⁶⁸ Future efforts will be necessary to identify ways to implement societally cost-effective CVR.

Agricultural and Industrial Sector Energy Efficiency

California is home to the nation's largest and most diversified agricultural and food processing sector. California's agricultural abundance includes more than 400 commodities, which are grown on 77,500 farms and ranches and were collectively valued at about \$47 billion in 2015. The state's largest irrigated crops by acreage are nuts (almonds, pistachios, and walnuts), grapes, tomatoes, broccoli, and lettuce. Although food processing occurs throughout the state, these industries are concentrated in the Central Valley. The valley is home to more than 3,000 factory sites, including the world's largest facility for processing milk, milk powder, and butter (California Dairies, Inc.); cheese (Hilmar Cheese Company); wine (E & J Gallo); and poultry (Foster Farms). There are common loads that are likely to lend themselves to efficiency improvements, such as refrigeration. Statewide, the agricultural sector (including water pumping) uses slightly less than 7 percent of electricity and about 1 percent of natural gas.

In 2016, California became the sixth largest economy in the world. Manufacturing and other industrial production play a major part in maintaining California's economic success, contributing nearly 10 percent of the state's gross domestic product. California leads the nation in such market segments as electronics and computer manufacturing.⁶⁹ The industrial sector has diverse customer types, sizes, and operations. Industries in this sector include oil refineries; oil and gas extraction industries; printing plants; plastic injection molding facilities; component fabrication plants; lumber and paper mills; cement plants and quarries; metal processing plants; chemical industries; assembly plants; water and wastewater treatment plants; and food processing, among others.

Over the past two decades, the composition of industry in California has been changing with a decrease in *heavy* manufacturing and energy-consuming industries, and the rise of light manufacturing and less energy-intensive industries.⁷⁰ In spite of the decrease in heavy industry, the industrial sector still consumes a significant amount of energy in the state. Statewide, the industrial sector uses about 15 percent of electricity and 28 percent of natural gas.⁷¹ This sector has significant untapped potential for energy savings. A central challenge in tapping those savings is that each industry has unique situations and proprietary information.

68 RE: *Senate Bill 350 Energy Efficiency Target Setting for Utility Programs*, Honeywell, August 2, 2017. http://docketpublic.energy.ca.gov/PublicDocuments/17-IEPR-06/TN220498_20170802T075328_Senate_Bill_350_Energy_Efficiency_Target_Setting_for_Utility_Pr.pdf.

69 *Energy Efficiency Business Plan 2018-2025*. January 2017. Pacific Gas and Electric Company.

70 De la Rue du Can, Stephane, Ali Hasanbeigi, and Jayant Sathaye. Lawrence Berkeley National. *2011 ACEEE Summer Study on Energy Efficiency in Industry*. <http://aceee.org/files/proceedings/2011/data/papers/0085-000057.pdf>.

71 Energy Consumption Data Management System. 2017. California Energy Commission. Staff communication.

Projections for agricultural and industrial sector energy savings for electricity and natural gas are shown in **Figure 21** and **Figure 22**, respectively. The methodology and analyses for estimating these savings are detailed in Appendix B. These preliminary estimates will be revisited through collaboration with agricultural groups to develop better estimates of energy savings potential in future update cycles.

Figure 21: Projected Electricity Savings Estimates for Agricultural and Industrial Programs (GWh)

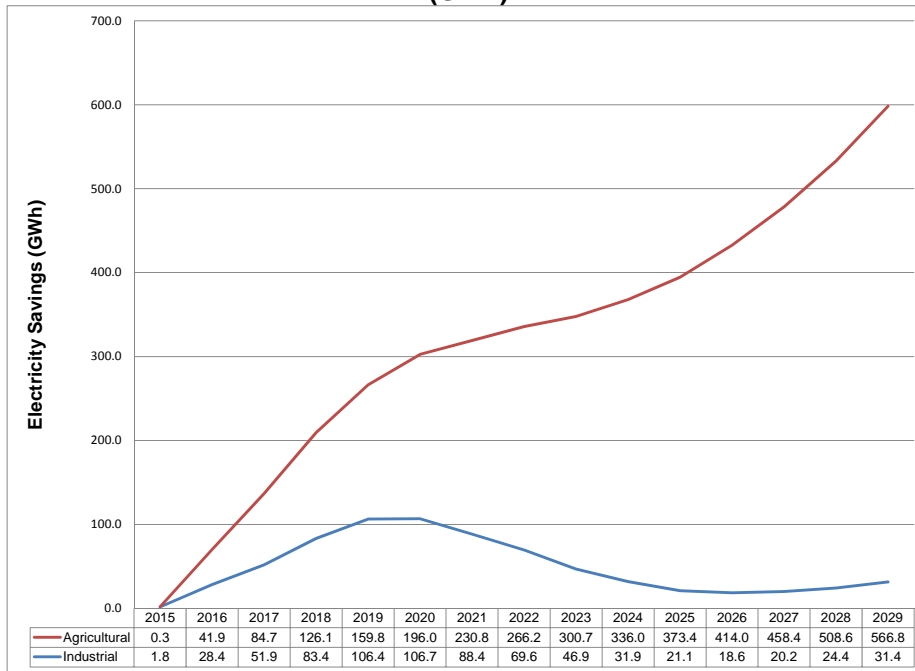

Source: California Energy Commission staff, Efficiency Division, August 2017.

Figure 22: Projected Natural Gas Savings Estimates for Agricultural and Industrial Programs (MM Therms)

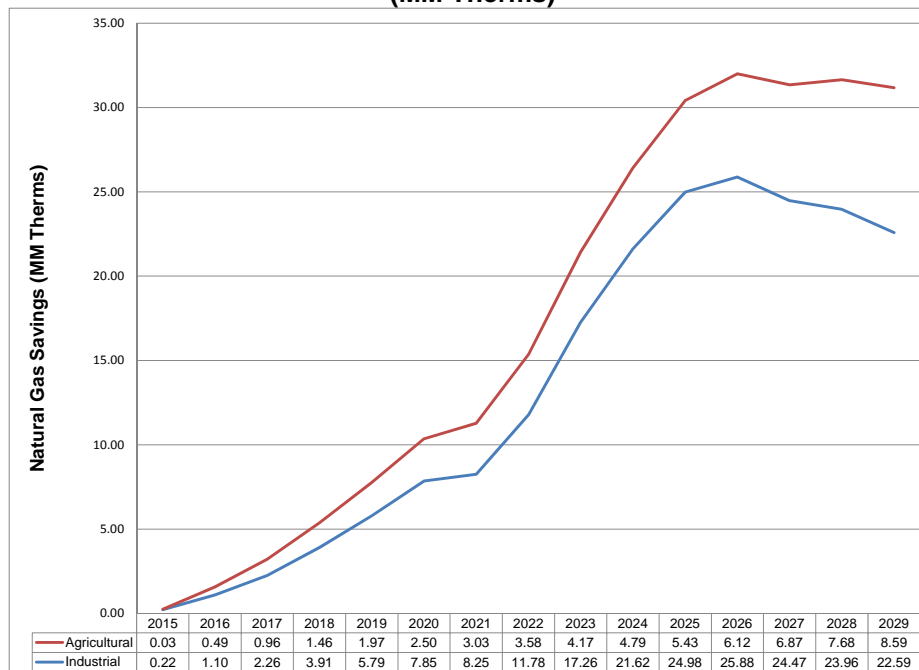

Source: California Energy Commission staff, Efficiency Division, August 2017.

CHAPTER 6:

Non-utility Energy Efficiency Programs

There are a variety of energy efficiency programs that are not funded by utility ratepayers that will contribute to meeting the state’s doubling target, which are grouped into the following categories: codes and standards; financing programs that are behavioral; and market transformation programs. This chapter identifies the potential source for non-utility program savings, including programs at the Energy Commission, other state agencies, local governments, and other local entities. The following sections discuss projected electricity savings and natural gas savings from the programs not funded through utility rates and proposed targets for the programs. In each category sub-targets have been proposed for the programs based on these savings estimates. Specific methods for estimating of projected savings for non-utility programs are detailed in Appendix B and Attachment A.

Energy Savings From Codes and Standards

Since the 1970s, the Energy Commission has been responsible for establishing standards for buildings and appliances that conserve electricity and natural gas. Specific programs within the codes and standards category that contribute future energy savings to meet the SB 350 doubling target include Title 24 *Building Energy Efficiency Standards* (building standards), the *California Green Building Standards Code* (CALGreen),⁷² Title 20 state *Appliance Efficiency Regulations* (appliance regulations), and federal appliance standards.

Figure 23 shows projected electricity savings, and **Figure 24** shows the projected natural gas savings from codes and standards discussed in the following sections. Projected savings from the building standards up to the 2019 cycle for new construction only and the appliance regulations up to 2019 (with a few adopted in 2023 and 2024) are included in the *2018 IOU Potential and Goals Study*, discussed in Chapter 3. Discussions with CPUC staff indicate that any potential overlap from codes and standards identified in non-utility programs addressed below and IOU rebate programs included in the utility programs (discussed in Chapter 3) is likely to be small and difficult to separate in the short run before evaluation of IOU programs generates updated information. To account for this, a blanket 10 percent reduction was applied to programs determined to be at risk.⁷³ For POU programs, discussions with POUs and CMUA indicated that only savings from the 2016 building standards were included in the *POU Potential and Goals Study*; therefore, no overlap was identified.

72 CALGreen provides a set of voluntary specifications that can be used as model ordinances that allow a city and/or county to easily establish more stringent building efficiency standards based on local climatic, geological, or topographical conditions.

73 This 10 percent overlap is shown as additional program participation and may be removed in future update cycles if it is determined they should be counted as utility savings.

Figure 23: Projected Electricity Savings Estimates for Future Codes and Standards (GWh)

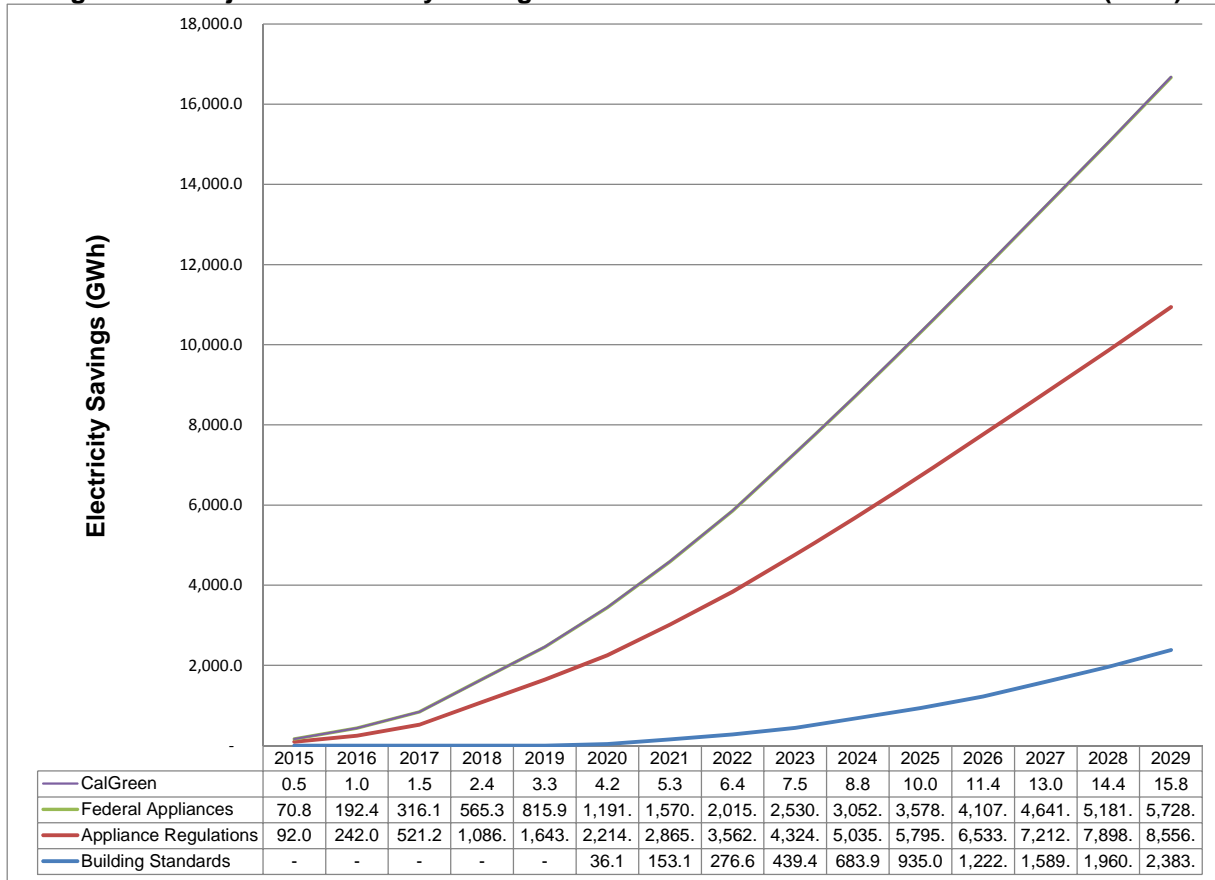

Source: California Energy Commission staff, Efficiency Division. Based on work in Attachment A by NORESKO August 2017.

Figure 24: Projected Natural Gas Savings Estimates for Future Codes and Standards (MM Therms)

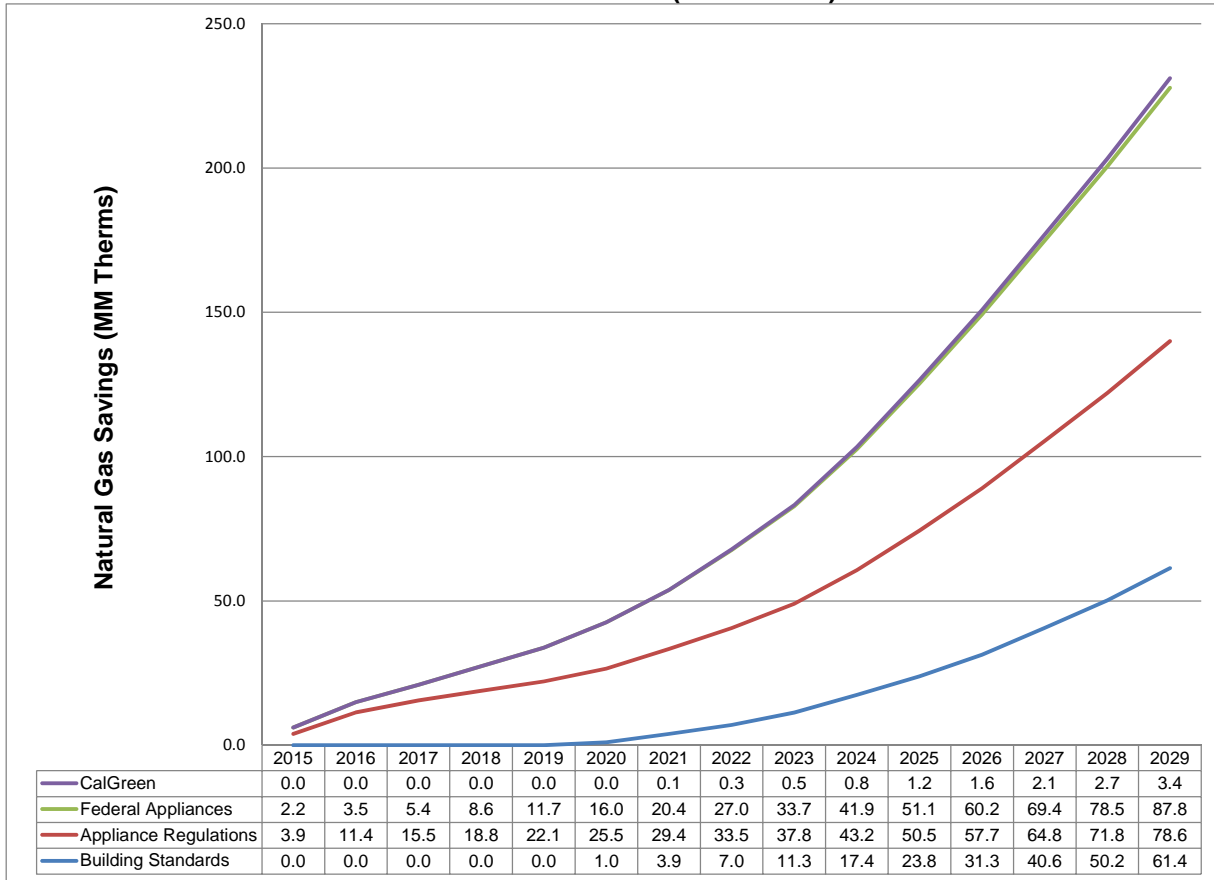

Source: California Energy Commission staff, Efficiency Division. Based on work in Attachment A by NORESKO. August 2017.

Title 24 State Building Energy Efficiency Standards

The Energy Commission’s building standards set energy and water design standards for residential and nonresidential buildings. The building standards include cost-effective energy efficiency requirements for newly constructed buildings, additions to existing buildings, and alterations to existing buildings. These standards are part of the California Building Codes, which are updated triennially, expected to occur in 2019, 2022, 2025, and 2028.⁷⁴ For each update of the building standards, proposed new efficiency measures and improvements to existing measures are evaluated.⁷⁵

Projected savings from the 2019 building standards for new construction are already included in the baseline forecast. Projected savings from the 2019 building standards for additions and alterations are included in the estimates for non-utility programs and begin delivering savings in 2020, once they have gone into effect. Older vintages of the building standards are included in the baseline forecast but will be captured as non-utility program savings in future updates, since final estimates are not available at this time. Energy savings projections presented in this section include the 2022, 2025, and 2028

⁷⁴ The California Building Code (Title 24, California Code of Regulations) is a collection of codes covering various elements such as electrical, mechanical, plumbing, fire, historic buildings, and so forth. They also include the Energy Commission’s *Building Energy Efficiency Standards* (California Energy Code, Title 24, Part 6) and the California Green Building Standards (Title 24, Part 11).

⁷⁵ Public Resources Code Section 25402(b)(1).

building standards. In accordance with Governor Brown’s 2020 and 2030 zero-net-energy goals, the 2019 and 2028 standards will include consideration of new zero-net-energy requirements for residential and nonresidential buildings. The 2022 standards will examine low-rise and high-rise multifamily buildings and the potential for establishing efficiency measures specific to multi-family buildings, distinct from other residential and nonresidential buildings. As discussed in Chapter 3, projected energy savings for codes and standards advocacy by the IOUs are included in the non-utility programs.

The *California Green Building Standards Code*, also known as *CALGreen*, provides a set of voluntary specifications that can be used as model ordinances that allow a city and/or county to easily establish more stringent building efficiency standards based on local climatic, geological, or topographical conditions. These local ordinances complement the statewide standards and ensure California consumers fully realize the benefits of advancements in energy efficiency.⁷⁶

Federal Appliance Standards

The federal appliance standards are implemented at the manufacturing stage and affect any market sector where the products are installed or used. Federal appliance standards, based on mandatory deadlines in the federal appliance law, have a preemptive effect on state standards, with some exceptions.⁷⁷ As a result, California cannot set standards for products already covered under the federal appliance standards.⁷⁸ California typically participates in federal rulemakings to ensure that stringent standards that save Californians money on the utility bill are adopted. Savings estimates for appliance regulations from the 2015 AAEE and for new measures from 2017 through 2029, as well as any measures that can be updated to provide additional incremental savings, were included.

Future savings from new federal standards focused on high-energy-consumption appliances with the greatest potential for energy savings have been included in the energy savings projections include heating, HVAC, domestic hot water systems, battery chargers, commercial clothes washers, and lighting.⁷⁹

Title 20 State Appliance Regulations

The Energy Commission has responsibility for establishing and enforcing *Appliance Efficiency Regulations* (appliance regulations) that set minimum efficiency standards and test procedure, marking, and disclosure requirements for both federally and nonfederally regulated appliances.⁸⁰ The appliance regulations include the requirement that a regulated appliance may not be sold or offered for sale in California unless it is certified to comply with the standards. Well-designed mandatory energy

76 Findings of the local condition(s) and the adopted local building standard(s) must be filed with the California Building Standards Commission to become effective, and cost-effectiveness must be demonstrated to the Energy Commission before they can be enforced.

77 The federal Energy Policy and Conservation Act of 1975, as amended by the Energy Policy Act of 2005 and the Energy Independence and Security Act of 2007.

78 Under the general rules of federal preemption, states that had set standards prior to federal enactment may enforce their state standards up until the federal standards become effective. States that have not set standards for a product category that is now enforced by the federal government are subject to the federal standard immediately.

79 The analysis of California and federal appliance standards was coordinated to eliminate potential overlap especially for emerging technologies and appliances not federally regulated.

80 Title 24, Sections 1601-1609, California Code of Regulations.

efficiency standards transform markets by removing inefficient products with the intent of increasing the overall economic welfare of most consumers without seriously limiting their choice of products.

Energy Savings From Financing Programs

Several financing mechanisms for energy efficiency investments have emerged in recent years. These programs not funded through utility rates are major contributors to projected energy savings.

Financing programs include the Property

Assessed Clean Energy (PACE) program, the Local Government Challenge, Proposition 39, the Energy Conservation Assistance Act (ECAA), the Low-Income Weatherization Program, the Water-Energy Grant Program; and California Department of General Services -operated Energy Savings Program (DGS-Energy Savings). In addition, some IOUs have indicated that they intend to shift their programs from rebates toward more financing programs in the future.⁸¹ Savings projections from these programs are shown in **Figure 25** for electricity and **Figure 26** for natural gas. It is unclear at this time whether this could create double-counting with the analysis prepared for these programs by NORESKO and other contractors to the Energy Commission, or whether this is an issue for the future.

Figure 25: Projected Electricity Savings Estimates for Financing Programs (GWh)

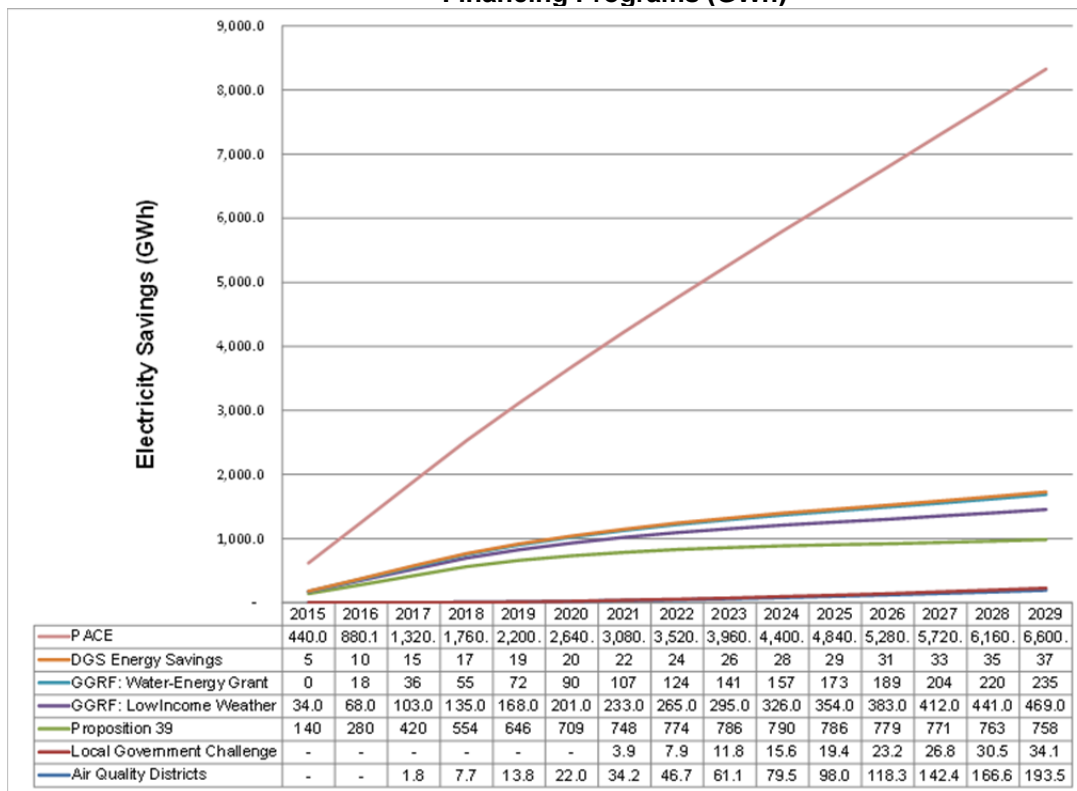

Source: California Energy Commission staff, Efficiency Division. Based on work in Attachment A by NORESKO. August 2017.

⁸¹ PG&E, Application of Pacific Gas and Electric Company (U 39 M) for Approval of 2018-2025 Rolling Portfolio Energy Efficiency Business Plan and Budget, January 17, 2017, p. 10.

Figure 26: Projected Natural Gas Savings Estimates for Financing Programs (MM Therms)

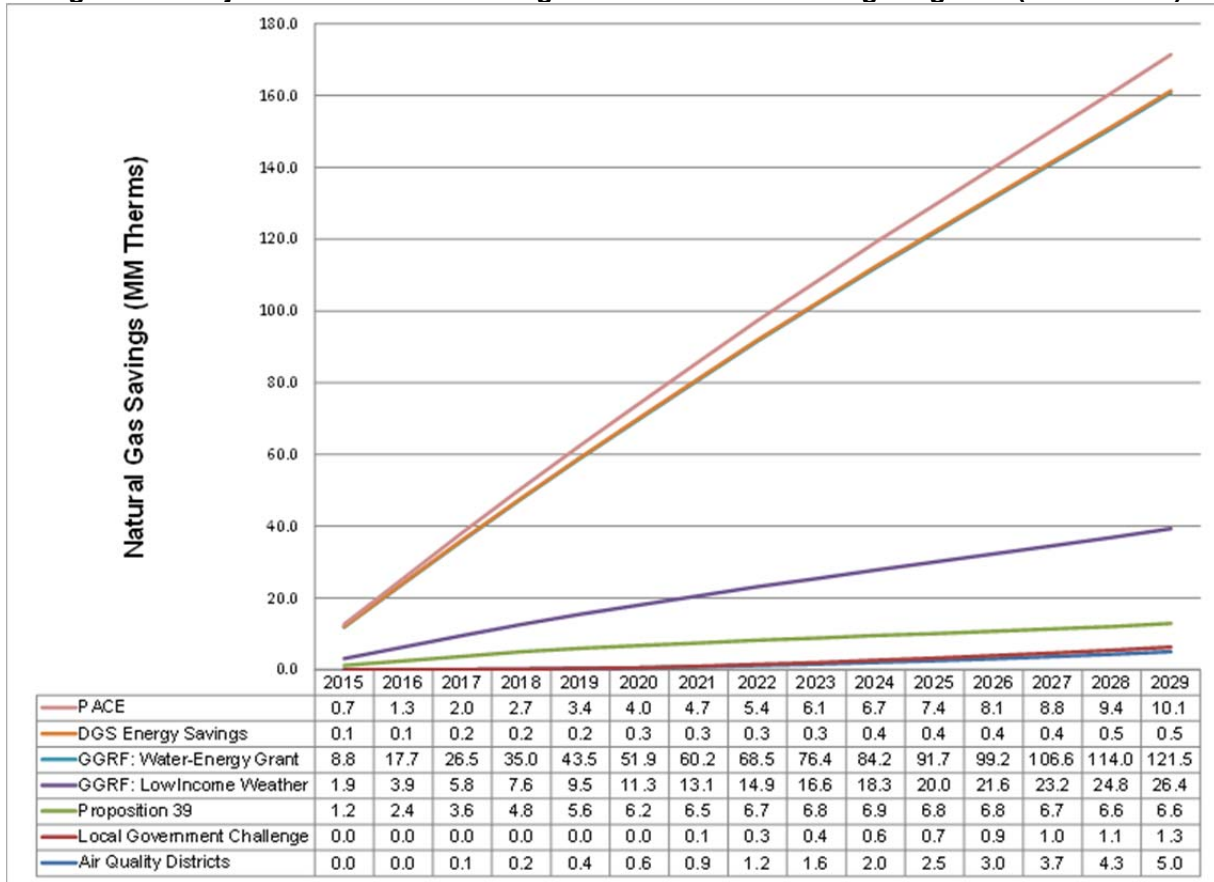

California Energy Commission staff, Efficiency Division. Based On Work in Attachment A by NORESO. August 2017.

Property Assessed Clean Energy

Since 2007, PACE programs, offered by private lenders, have been allowed in California.⁸² Property owners of residential and commercial buildings can fund energy efficiency, water efficiency, or renewable energy projects with limited upfront capital using PACE loans. PACE financing is offered primarily to residential building owners, largely due to the simplicity in ownership for residential buildings.⁸³ PACE loans rely on the existing framework of residential property taxes by allowing property owners to repay the entire loan for a project through a special tax assessment made on the property.⁸⁴ Loan payments can be amortized for a period of up to 20 years, with an option to extend the payback period as necessary.⁸⁵ Some common measures include building envelope, attic insulation, HVAC equipment and controls, lighting equipment and controls, and cool roofs.

⁸² Assembly Bill 811 (Levine, Chapter 159, Statutes of 2008).

⁸³ The complexity of commercial buildings that may arise from the variation in owners, investors, lease holders, lease terms, and other factors can inhibit the adoption of PACE financing for improvement projects.

⁸⁴ PACE programs are limited to participating districts where the private lenders have legal agreements with cities and counties that allow repayment of the loans through property taxes.

⁸⁵ According to several PACE providers, the following features represent the key benefits of the program: long-term, fixed-rate financing; no down payment; financing terms independent of credit history; nonrecourse, no financial covenants; easy credit approval; fully transferable and assignable upon sale; treated as an operating expense and available for pass-through to tenant.

Local Government Challenge

The Local Government Challenge (LGC) is grant program designed to help the state meet the targets set by SB 350 and Assembly Bill 802 (Williams, Chapter 590, Statutes of 2015). The LGC uses funds remaining from ARRA to encourage local jurisdictions to implement new energy efficiency projects, update climate action plans, and address other energy/climate issues. The projects funded by LGC are proposed to reduce statewide electricity consumption, increase self-generation capacity, and improve the conditions of facilities and equipment. The program is divided into two parts: the Small Government Leadership Challenge and the Energy Innovation Challenge. Depending on the awardee of the grant, various building sectors will be affected.

Proposition 39: Clean Energy Jobs Act

The Clean Energy Jobs Act, also known as Proposition 39, provides funding for planning and installing energy efficiency upgrades and clean energy generation at schools. The initiative changed California's corporate income tax code and allocates projected revenue to the general fund and the Clean Energy Job Creation Fund for five fiscal years (2013-2014 to 2017-2018).⁸⁶ The funds are awarded to local educational agencies, including K-12 school districts, county offices of education, charter schools, and state special schools, and California community colleges to upgrade existing facilities. The types of energy efficiency upgrades that can be done to a building vary greatly. Some examples of the measures include building envelope, insulation, HVAC, and cool roofs.

Energy Conservation Assistance Act

The Energy Conservation Assistance Act (ECAA) loan program administered by the Energy Commission delivers revolving loans to schools, cities, counties, and special districts to finance projects with proven energy demand and/or cost savings. Funds for ECAA loans come from repayment of previous funds with additional infusions from allocations by the Legislature and ARRA funds.⁸⁷ The ECAA financing program is designed to ease the adoption of energy projects through a simple process that does not involve credit approval, collateral, or fees. There are two types of loans offered through this program. Education facilities, except universities, qualify for a 0 percent interest loan, whereas cities, counties, and colleges and universities qualify for a 1 percent interest loan. Loans are often used to upgrade the building envelope, electrical systems, HVAC, and/or lighting.

Greenhouse Gas Reduction Fund

The Greenhouse Gas Reduction Fund (GGRF) was set up by three statutes that direct the proceeds from the California Cap-and-Trade Program into the GGRF.⁸⁸ A portion of the GGRF budget is used to fund programs that save energy through installation of more energy-efficient appliances and weatherization of low-income homeowners' properties. Two elements of the GGRF are expected to

⁸⁶ SB 110 (Committee on Budget and Fiscal Review, Chapter 55, Statutes of 2017) has modified the Proposition 39 program and extended it. This bill also allocated an additional \$100 million of unspent Prop. 39 monies to ECAA-Ed. The bill also made ECAA-Ed competitive.

⁸⁷ The 1 percent loan was developed separately as ECAA-Ed funds. Proposition 39: *California Clean Energy Jobs Act, K-12 Program and Energy Conservation Assistance Act 2015-2016 Progress Report*, California Energy Commission, 2016.

⁸⁸ Assembly Bill 1532 (Pérez, Chapter 807, Statutes of 2012), Senate Bill 535 (De León, Chapter 830, Statutes of 2012), and Senate Bill 1018 (Budget and Fiscal Review Committee, Chapter 39, Statutes of 2012).

result in energy savings: the Low-Income Weatherization Program (LIWP) and the Water-Energy Grant Program.

In addition to GGRF funds, the LIWP is funded by the federal weatherization program. The program, administered by the Department of Community Services and Development, is targeted at different subsets of low-income households in disadvantaged communities.⁸⁹ The Single Family/Small Multi-Family EE and Solar Water Heating subprogram provides single-family and small multifamily low-income homes with weatherization and energy efficiency measures.⁹⁰ The Large Multi-Family EE and Renewables subprogram provides multifamily, low-income properties with technical assistance and incentives for weatherization and energy efficiency measures. Program participants receive a home energy assessment to generate a list of recommended measures to improve the energy efficiency of the home. Energy savings from lighting, ceiling fans, appliances, insulation, and microwaves installed because of this program are expected to deliver energy savings that will contribute to meeting SB 350 targets.

Water-energy grants administered by the Department of Water Resources are used to improve the water and energy efficiency and reduce GHG emissions of residential and commercial buildings through measures such as clothes washers, dryers, and dishwashers. Energy savings are captured primarily by installing measures to reduce hot water use, which then decreases the energy needed to heat water.

Energy Savings Program

The Energy Savings Program operated by the Department of General Services (DGS) uses energy service companies to implement energy upgrades in state buildings. Projects are funded by loans taken out by the state agency that are paid back by the realized savings from the retrofit. The common types of measures funded by the loan include upgrading lighting, installing energy-efficient HVAC systems, and retrocommissioning. An initial \$25 million payment from the Energy Commission provided the seed money to begin the EE Retrofit Revolving loan program.

Air Quality Management District Programs

California air quality management districts (AQMDs) may require or encourage lead agencies under the California Environmental Quality Act (CEQA) to address environmental impacts of air pollution from building projects. Energy efficiency measures that reduce energy consumption at the building level that are being considered by AQMDs and air pollution control districts (APCDs) include exceeding the building standards by installing programmable thermostat timers, upgrading lighting, and installing energy-efficient appliances.⁹¹ Other mitigation could include the use energy efficiency measures, such as HVAC retrofits, retrocommissioning, envelope upgrades, and other whole-building measures on existing buildings. Although there are no current programs, these types of programs have the potential to capture energy savings and GHG reductions by 2030.

⁸⁹ The three programs include (1) Single Family/Small Multi-Family EE and Solar Water Heating; (2) Single-Family Solar Photovoltaics; and (3) Large Multi-Family EE and Renewables.

⁹⁰ The Department of Community Services and Development's Low-Income Weatherization Program serves low-income homes. Specifically, it seeks to help households in disadvantaged communities as identified by CalEnviroScreen 2.0, which calculates if someone qualifies as disadvantaged or low-income in the state.

⁹¹ *Quantifying Greenhouse Gas Mitigation Measures: A Resource for Local Government to Assess Emission Reductions From Greenhouse Gas Mitigation Measures*, California Air Pollution Control Officers Association, August 2010.

Energy Savings From Behavioral and Market Transformation

There are additional energy efficiency savings that can result from behavioral and market transformation changes as opposed to installing a physical measure like new lighting or HVAC. These include behavioral, retrocommissioning, and operational (BROs) changes that are initiated by informing the customer or building owner of energy usage. Other programs include fuel substitution, benchmarking, energy asset ratings, and computer applications using smart meter data (smart meter and controls), among others. Energy savings can also be realized through market transformation efforts for measures that are on the cusp of widespread adoption but need additional public education or funding. An example of market transformation is the automation of appliances through the *Internet of Things*, which is the communication between devices using the Internet, connected to a customer's smart meter. Electricity and natural gas savings from these programs are shown **Figure 27** and **Figure 28**, respectively.

Figure 27: Projected Electricity Savings Estimates for Behavioral and Market Transformation Programs (GWh)

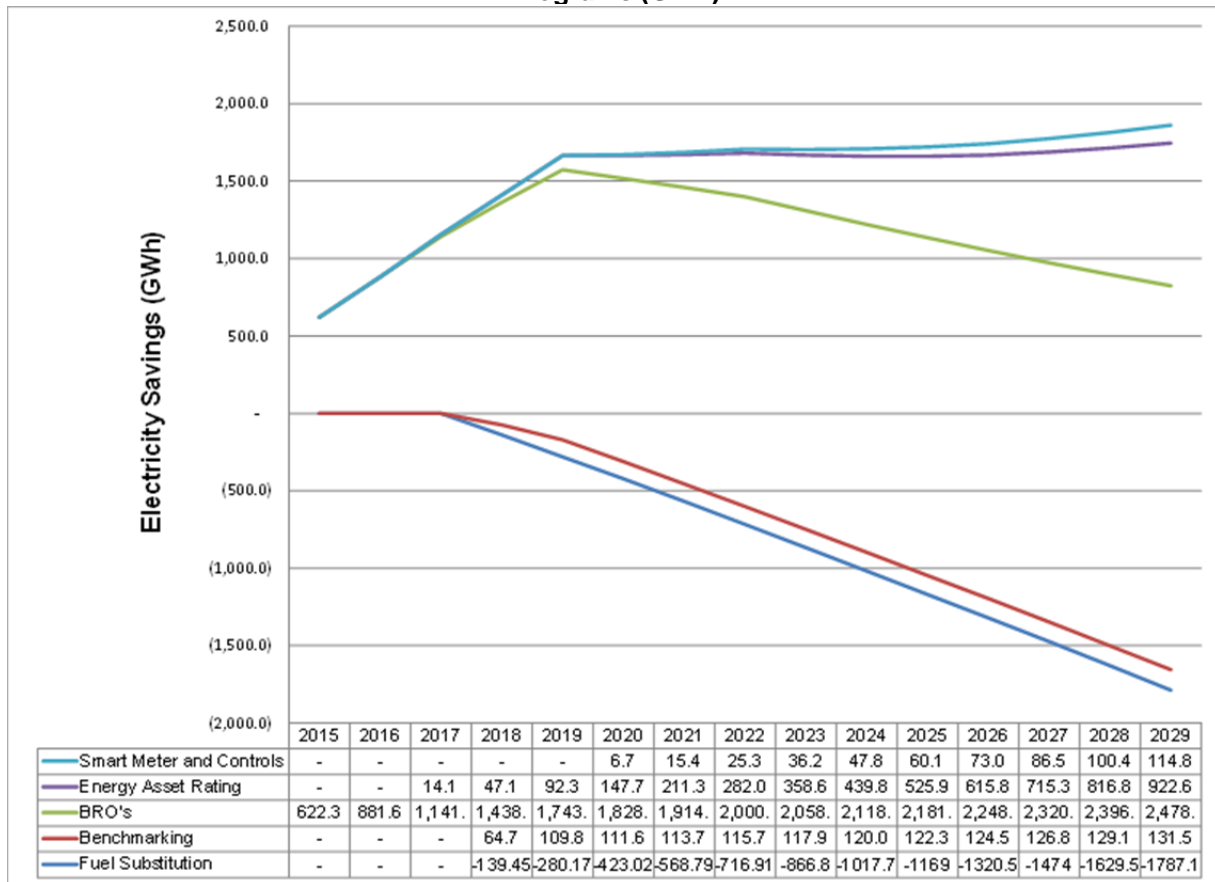

California Energy Commission staff, Efficiency Division. Based On Work in Attachment A by NORESO. August 2017.

Figure 28: Projected Natural Gas Savings Estimates for Behavioral and Market Transformation Programs (MM Therms)

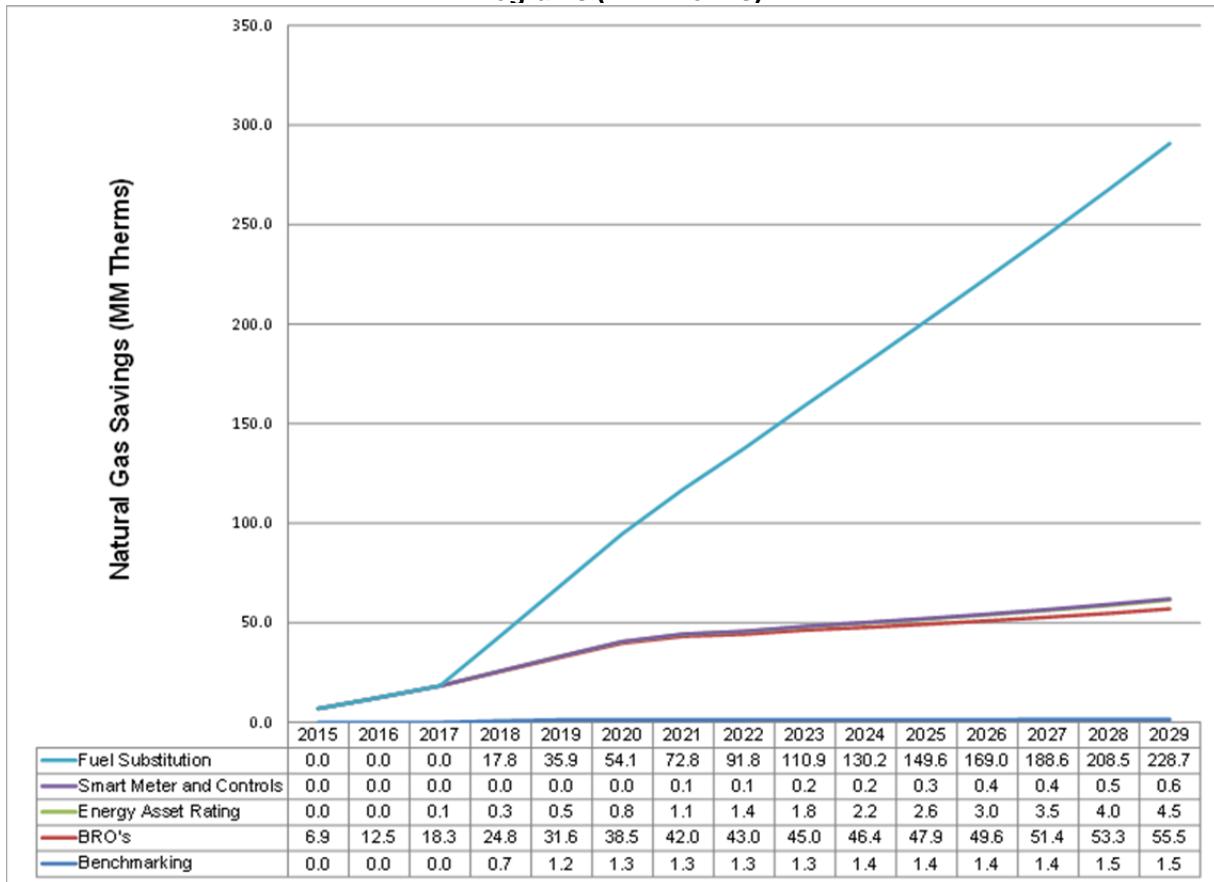

California Energy Commission staff, Efficiency Division. Based on work in Attachment A by NORESKO. August 2017.

Benchmarking

AB 802 directs the Energy Commission to create a mandatory benchmarking and public disclosure program for certain commercial and multifamily residential buildings, as well as making certain building-level energy-use information available to building owners, agents, and operators upon request.⁹² The Energy Commission has proposed regulations that would implement the benchmarking and public disclosure provisions of AB 802. Specifically, the regulations would require the owners of most commercial and residential buildings larger than 50,000 square feet to report building-level energy performance information to the Energy Commission annually, with commercial buildings beginning in 2018 and residential buildings beginning in 2019. The Energy Commission will publish this information on a public website. The program will assist in achieving energy savings by providing better information about buildings to prospective buyers or lessees, allowing policy makers and planners to be better informed and helping energy service companies target their services. As local ordinances with requirements exceeding the statewide requirements (for example, by requiring audits

⁹² An earlier benchmarking program established under of Assembly Bill 1103 (Saldaña, Chapter 533, Statutes of 2007) required the owner or operator of a nonresidential building to disclose the benchmarking information of that building to a prospective buyer, lessee, or lender.

or retrocommissioning, or by including smaller buildings) become more common, energy efficiency savings can continue to increase.⁹³

Energy Asset Rating

The Energy Commission *EBEE Action Plan* calls for standardized energy asset ratings for both residential and nonresidential buildings.⁹⁴ An *asset rating* is a method of quantifying the efficiency potential of a building itself, independent of the number of occupants and their behavioral choices. By including an asset rating as part of real estate listings or information for a building owner, one can factor the behavior-independent energy costs of a building into their decision making and amend their behavior to achieve the full potential energy efficiency. The factors affecting underlying efficiency potential include the envelope, heating, cooling, ventilation, and hot water systems of the building, along with the installed lighting and major appliances, as well as any offsetting electrical power produced by on-site renewable systems. Energy savings that can be directly attributed to an energy asset rating are behavioral, whereas any measures implemented due to knowing and acting on the rating is attributable to that specific program.

Behavioral, Retrocommissioning, and Operational Savings

The idea behind BROs savings is to give energy customers greater accessibility to their energy data for a greater understanding of their energy usage to influence them to become more energy-efficient. Energy customers can accomplish this through energy efficiency improvements, such as purchasing more efficient technologies or by changing behavior that affects building energy usage, including shifting appliance and equipment use to off-peak hours and turning off energy measures when not needed. Changes in behavior have been shown to provide quantifiable effects on energy consumption.

Retrocommissioning is checking that equipment was installed correctly, like the ducts of an HVAC system. It helps discover ways to capture energy savings in existing buildings. Operational savings improve the operation of the equipment of a building by offering certifications and training. Effective building operations have significantly affected energy use for multifamily and commercial buildings

Smart Meters and Controls

Utilities have begun deploying advanced metering infrastructure (AMI) to enable two-way communications with their customers. There are numerous aspects of AMI that can contribute to energy savings, including what are referred to as *smart meters*. The smart meter may be able to communicate through the Internet with devices in the building that are connected as part of IOU. For example, the air conditioner can be sent a signal to operate minimally when the electricity rates are above a threshold, or the clothes dryer can be set to run as soon as the electricity rate drops below a desired level. This communication would result in both load shifting and energy savings. Although smart meters have been widely installed across California, they have not been the focus of specific

⁹³ At this time, the cities of San Francisco, Berkeley, and Los Angeles have local ordinances requiring benchmarking, reporting, and audits. The increased access to building-level energy use information provided by AB 802 will make it easier for more jurisdictions to create local ordinances.

⁹⁴ California Energy Commission. *2016 Existing Buildings Energy Efficiency Action Plan Update - Final*. Strategy 1.4, "Adopt Uniform Asset Ratings to Compare Building Properties." December 2016. http://docketpublic.energy.ca.gov/PublicDocuments/16-EBP-01/TN214801_20161214T155117_Existing_Building_Energy_Efficiency_Plan_Update_Deceber_2016_Thi.pdf.

energy efficiency programs, and much of the potential of these devices remains unrealized.⁹⁵ Most of the energy savings from using smart meter data are captured in the previous category of behavioral and market transformation programs. The focus of this section is the automation of appliances and other loads in a building by communicating with a smart meter.

Fuel Substitution

In Chapter 5, issues surrounding fuel substitution were addressed. As noted, there are very few utility fuel substitution programs, but this could apply to a wide range of residential and nonresidential buildings. Fuel substitution can include measures for space heating, water heating, clothes dryers, and possibly additional nonresidential measures. The requirements of SB 350 allow measures such as *appliance electrification*, which is substituting a natural gas appliance with an electric appliance. Advances in heat pump technology have made substituting natural gas with electricity for heating systems more viable and offer increased efficiency compared to traditional resistance heating devices such as electric clothes dryers. The vast majority of buildings in California use natural gas for water and space heating. Substituting natural gas with heat pumps for space and water heating could reduce both energy consumption and GHG emissions.

⁹⁵ Mooney, Chris, "Why 50 Million Smart Meters Still Haven't Fixed America's Energy Habits," *The Washington Post*, 2015. Accessed June 12, 2017, https://www.washingtonpost.com/news/energy-environment/wp/2015/01/29/americans-are-this-close-to-finally-understanding-their-electricity-bills/?utm_term=.18f33f7d09e2.

CHAPTER 7:

Recommendations

Several actions must be taken to meet the SB 350 doubling targets. Efficiency programs, especially financing programs, are assumed to be funded through 2029, yet many of them do not have an ongoing funding source or are expected to end before then. Ensuring adequate funding for energy efficiency programs will be important in meeting the SB 350 targets. As California moves forward, it is essential to closely examine how programs are performing and make adjustments that will maximize the savings achieved. Sufficient data must be collected from numerous parties to adequately track progress in meeting the SB 350 doubling targets. There must be an ongoing effort to look for innovative ways to create new program designs. The following discusses proposed recommendations and next steps to address these issues.

Fund and Improve Energy Efficiency Programs

Since the energy efficiency projections for many of the non-utility programs assume that the funding remains constant through 2029, any loss of funding will increase the energy savings gap that exists between current sub-targets and the SB 350 doubling targets. In addition, to maximize the full potential of energy efficiency equipment and appliances, they must be installed correctly, consistent with the *Low-Income Barriers Report* and the *EBEE Action Plan*. The projection of energy savings for the building standards and appliance regulations assumes that there is 100 percent compliance to show the full potential impact. For this assumption to be realized, there needs to be increased compliance across the state. The following recommendations will need to be implemented.

- Maintain or expand current levels of funding of financing programs, including the Water Energy Grant, LIWP, and Proposition 39, and others. Coordinate with state and local agencies that deliver energy efficiency programs and stakeholders.
- Develop and reward programs that most effectively attract and leverage private capital, simplify and reduce the cost of program participation, and provide incentives for real-world performance.
- Increase the funding of the ECAA program to allow more access to schools, cities, counties, and special districts for energy efficiency projects.
- Improve code compliance by increasing interagency collaboration, stakeholder engagement, and funding for outreach and education at the local level, especially for local building permit offices and the contractor communities.

Develop Additional Energy Efficiency Programs

To meet the SB 350 electricity doubling target, it will be necessary to develop new programs or expand existing ones. As utilities have noted, expansion of utility programs may be difficult to do in a manner that honors the requirement that utility programs be cost-effective, feasible and not adversely impact

health and safety.⁹⁶ However, any changes in IOU programs requirements must be done through a CPUC proceeding. The following recommendations and next steps must be undertaken:

- Create new energy efficiency programs that capture additional savings in collaboration with utilities, state and local governments, and stakeholders.
- Expand the workforce training available to improve the quality of energy efficiency equipment installation, consistent with recommendations from the *Low-Income Barriers Report* and the *EBEE Action Plan*.
- Develop an appropriate approach to implement of fuel substitution programs that maximizes GHG emission reductions in collaboration with CPUC, California Air Resources Board (CARB), utilities, and stakeholders. Next steps include the following:
 - Convene a working group to review SB 1383 and CARB's *Short-Lived Climate Reduction Pollutant Reduction Strategy* and provide recommendations about complementary or competing roles of substituting electricity for natural gas and replacing natural gas with renewable gas as strategies for reducing GHG emissions.
 - Establish a joint effort between Energy Commission and CPUC to coordinate SB 350 fuel substitution requirements.

Enhance Reporting and Estimating Energy Efficiency Savings

As discussed, SB 350 requires the Energy Commission to report to the Legislature every two years on progress toward achieving the energy efficiency savings doubling targets. It also requires an assessment of the impact of such savings on hourly and seasonal electricity demand patterns in local utility service territories and on disadvantaged communities. Neither of these two legislatively mandated evaluation criteria is supported by existing reporting requirements. To determine that progress is being achieved, the Energy Commission will need to collect additional data from utilities and other responsible entities. Through such information, the Energy Commission will be able to determine how programs are performing and whether further legislative action may be needed to authorize new energy efficiency implementation authority to achieve the SB 350 doubling target.

Standardized Historical Savings Estimates

All utilities provide energy efficiency program savings reports, both the expenditure level for activities and estimated savings, to the Energy Commission, the CPUC, or both. IOUs report level of activity to the CPUC at least quarterly, with nominal savings estimates including hourly data that use approved *ex ante* savings values. The CPUC staff then conducts extent EM&V using contractors.⁹⁷ The nature of the current EM&V process is that final *ex post* savings estimates have lagged 2-3 years behind reported energy efficiency activity. POUs provide annual reports to the Energy Commission in March of each year for the previous year but do not have hourly data for energy efficiency saving estimates in most

⁹⁶ Joint Publicly Owned Utilities' Comments on Draft Staff Papers on *SB 350 Energy Efficiency Savings Doubling Targets*, August 3, 2017, p. 7.

⁹⁷ The EM&V process to determine final *ex post* savings means estimates lag 2-3 years behind reported energy efficiency activity. Incomplete and/or preliminary versions of many variables are available earlier but will ultimately be revised once *ex post* values are complete.

cases.⁹⁸ The Energy Commission is revising data collection regulations and is proposing to collect hourly data from the IOUs and the two large POUs, LADWP and SMUD.⁹⁹ The following recommendations will need to be implemented.

- Ensure that sufficient disaggregated data, including hourly and seasonal, is available on historical energy consumption and efficiency savings estimates in coordination with the CPUC, IOUs, and POUs. Next steps include the following:
 - The Energy Commission and CPUC should collaborate to reduce the time currently required to produce analytically rigorous savings estimates.
 - The Energy Commission and POUs should coordinate to ensure that each POU provides appropriately documented estimates of net and gross savings and of savings from codes and standards.
- Ensure access to additional energy savings data from non-utility programs in coordination with energy efficiency program deliverers, including other state, regional, and local agencies. Next steps include the following:
 - Incorporate appropriate regulatory requirements in the Energy Commission's update of data collection regulations (Phase II of Title 20 Data Collection Regulations).
 - Work with non-utility program deliverers, including PACE program administrators, to voluntarily report energy savings while data collection regulations are being developed.
 - Work with new responsible entities not now implementing formal EM&V to help establish a credible basis for estimating historical and projected energy efficiency savings for the energy efficiency activities of each.

Reporting on Disadvantaged Communities

Some utility service areas include many disadvantaged communities, while others may have few or none. Disaggregated energy savings estimates will be necessary to identify impacts in disadvantaged communities from those of the utility's other participating customers. This will require utilities to geocode their customers, or at least those customers participating in energy efficiency programs, and begin reporting historical savings for each of these two subsets separately. The following recommendation will need to be implemented.

- Work with utilities to determine and apply the best methods to ensure adequate reporting of energy efficiency impacts in disadvantaged communities, including whether simplified methods should be used initially while more definitive methods are developed and implemented.

⁹⁸ The EE Reporting Tool used by POUs has been simplified to eliminate some of the information that is now needed by the Energy Commission to develop the impacts the Legislature mandated. The simplification from 8,760 hourly measure savings profiles down to just six TOU periods, while making reporting easier for POUs, is now a barrier to developing 8,760 hourly projections of impacts.

⁹⁹ Energy Commission Order Instituting Rulemaking (Docket No. 16-OIR-03, In the Matter of Developing Regulations, Guidelines and Policies for Implementing SB 350 and AB 802, Title 20 Data Collection Regulations to Support New Analytical Needs.

Reporting Hourly and Seasonal Impacts

Historically hourly impact data have not been provided on a measured basis. Instead, synthetic estimates have been developed and applied generically across utilities for those applications requiring hourly impacts.¹⁰⁰ Operational issues are pushing utilities and system operators to better understand hourly impacts of high penetrations of renewable generation, behind-the-meter PV systems, and energy efficiency savings. The Legislature, in establishing mandates for higher reliance upon energy efficiency, recognized the importance of measured hourly impacts of energy efficiency to improve demand forecasting and support system planning and operations.

- Determine and apply the best methods to improve estimation of hourly impacts of energy efficiency savings for each utility in cooperation with the California Public Utilities Commission, investor-owned utilities, and publicly owned utilities. Next steps include the following:
 - The Energy Commission should form a working group to determine appropriate source for measure savings hourly profiles and for satisfying SB 350 hourly demand impacts for the *2019 IEPR* cycle.
 - The Energy Commission should incorporate appropriate regulatory requirements in its update of data collection regulations (Phase II of Title 20 Data Collection Regulations).

Evaluation, Measurement, and Verification

Although there will be continuing uncertainty in savings projections that are the basis for SB 350 targets and sub-targets, the State must focus improvements to EM&V in two specific areas. This focus would ensure that there is a full understanding of savings achieved from each year's energy efficiency programs and market activities and how these savings accumulate through time toward the 2030 targets. Establishing cumulative targets places the focus on actual savings persisting over time, whereas incremental targets place the emphasis on accomplishing near-term targets. Additional research and analysis are needed to better understand persistence of savings through time and emphasize measures and customer education that increase expected savings over time. Savings from codes and standards and the related attribution to utility programs or to the agency promulgating the standards are an area requiring additional work. The following recommendations will need to be implemented.

- Establish formal EM&V activities at the Energy Commission to measure savings projections for target setting for Energy Commission Title 24 and Title 20 standards, and to use as the basis for improvement in compliance and enforcement activities. Next steps include the following:
 - Work with CPUC and POU representatives to fully understand existing codes and standards programs and develop a mutually agreeable methods and tools to determine the impact of codes and standards.
 - The Demand Analysis Working Group and the Demand Forecast Expert Panel should review the Energy Commission's forecasting models for treatment of codes and standards,

¹⁰⁰ The CPUC-administered DEER process periodically develops updated generic hourly load shapes for energy efficiency measures.

as well as the CPUC's evaluation methods and tools for codes and standards, and offer recommendations for changes that would reduce discrepancies.

- Place a high priority on understanding energy efficiency savings decay to obtain a better understanding of this topic for use in improving projections of cumulative savings. Next steps include the following:
 - The Energy Commission, CPUC, and CPUC's EM&V team should review methods used to determine savings decay and replacement and develop a program to coordinate assumptions between energy efficiency savings potential models and Energy Commission demand forecasting models.
 - The CPUC should develop a methodology for calculating cumulative energy efficiency goals at the earliest date compatible with its use of energy efficiency savings projections in various proceedings.

Future Energy Efficiency Savings Projections

The Energy Commission will implement the SB 350 energy efficiency doubling targets based on periodic revisions of the sub-targets established for each responsible entity while establishing the doubling target only once. This means that utilities and other responsible entities will need to periodically provide projections of program savings that will flow through the target-setting process multiple times before January 1, 2030 is reached. As noted earlier, the potential and goals studies done by the CPUC and POU's have inconsistent accounting conventions and assumptions.

- Ensure that the next round of potential and goals studies support SB 350 implementation by using consistent reporting conventions and assumptions for the target-setting and tracking process in collaboration with the CPUC and POU's. Next steps include the following:
 - Work with the CPUC and POU's to undertake behavioral studies appropriate to each major customer sector to improve potential studies that are assuming existing nonparticipants will behave like recent program participants.
 - The Energy Commission's Energy Research and Development Division, the CPUC, and major utilities should initiate experiments to determine whether behavioral barriers can be overcome by new program designs.
 - Based upon behavioral research results, the Energy Commission, CPUC, and POU's should work to adapt potential models to more fully include behavioral barriers to high-energy efficiency adoption.
 - The Energy Commission will work with the POU's to establish uniform saving projection conventions for use in the next cycle of POU potential studies.¹⁰¹
 - Work with the CPUC and POU's to establish improved methods for measuring energy efficiency program savings in recent and current years to improve projections of cumulative savings to 2030.
- Develop improved methods of estimating additional savings potential beyond existing programs from the agricultural and industrial sectors and their contribution to the SB 350 doubling targets in

¹⁰¹ For example, whether projected savings are estimated using an AB 802 "existing" baseline or a "to code" baseline.

collaboration with utilities and agricultural and industrial stakeholders. Next steps include the following:

- Review utility agricultural and industrial programs and methods for projecting savings in the 2018 – 2028 CPUC potential study.
- Collaborate with agriculture stakeholders to better understand opportunities for energy savings and develop program designs and funding mechanisms to ensure their contribution to achieving the SB 350 doubling targets.
- Collaborate with industry stakeholders to better understand opportunities for energy savings and develop program designs to ensure their contribution to achieving the SB 350 doubling targets.

Establish Aggregate Electricity and Natural Gas Targets

SB 350 provides the authority for the Energy Commission to aggregate, or combine, electricity and natural gas savings projections when establishing targets. To aggregate target the Energy Commission must, “in a public process that allows input from other stakeholders, adopt a methodology for aggregating electricity and natural gas final end-use energy efficiency savings in a consistent manner based on source of energy reduction and other relevant factors.”¹⁰² The Energy Commission has not yet exercised this authority as doing so implies considering relative cost-effectiveness of electricity versus natural gas savings potential, relative contribution of electricity versus natural gas in reducing GHG emissions, and the relationship of this authority to potential fuel substitution programs allowed by SB 350. However, stakeholders have asserted that an aggregated target is the best method to guide decisions about fuel substitution of natural gas to electricity versus natural gas efficiency programs.¹⁰³

To address this:

- Develop one or more proposed specific aggregation methods for consideration in the next cycle of target setting during the *2019 Integrated Energy Policy Report* procures in collaboration with the CPUC, IOUs, POUs, and other stakeholders.

¹⁰² Public Resources Code Section 25310(c)(2).

¹⁰³ SCE, *Sothorn California Edison Company's Comments on Draft Staff Papers on Senate Bill (SB) 350 Energy Efficiency Savings Doubling Targets*, page 3.

ACRONYMS/ABBREVIATIONS

Acronyms/Abbreviations	Original Term
AAEE	Additional Achievable Energy Efficiency
AB 802	Assembly Bill 802 (Williams, Chapter 590, Statutes of 2015)
AB 2021	Assembly Bill 2021 (Levine, Chapter 734, Statutes of 2006)
AMI	Advanced metering infrastructure
APCDs	Air pollution control districts
APCR	Allowance price containment reserve
AQMDs	Air quality management districts
ARRA	American Recovery and Reinvestment Act
BROs	Behavioral, Retrocommissioning, and Operational Programs
BTU	British thermal unit
C&S	Codes and standards
CAISO	California Independent System Operator
CARB	California Air Resources Board
CCA	Community choice aggregators
C-E	Cost-effectiveness
CMUA	California Municipal Utilities Association
CMUA/Navigant	Publicly Owned Utility <i>Energy Efficiency Potential and Goals Study</i>
CPUC	California Public Utilities Commission
CPUC/Navigant	Investor-Owned Utility <i>Energy Efficiency Potential and Goals Study for 2018 and Beyond</i>
CVR	Conservation voltage reduction
DEER	Database of Energy Efficiency Resources
DER	Distributed energy resource
DGS	Department of General Services
DOE	U.S. Department of Energy
<i>EBEE Action Plan</i>	<i>Existing Buildings Energy Efficiency Action Plan</i>

ECAA	Energy Conservation Assistance Act
ELRAM	Electric Resource Assessment Model
EM&V	Evaluation, measurement, and verification
Energy Commission	California Energy Commission
<i>Framework Paper</i>	<i>Framework for Establishing the Senate Bill 350 Energy Efficiency Savings Doubling Targets</i>
GGRF	Greenhouse Gas Reduction Fund
GHG	Greenhouse gas
GWh	Gigawatt-hour
GWP	Glendale Water and Power
HVAC	Heating, ventilation, and air conditioning
<i>IEPR</i>	<i>Integrated Energy Policy Report</i>
IOU	Investor-owned utility
IRP	Integrated resource planning
kWh	Kilowatt-hour
LADWP	Los Angeles Department of Water and Power
LEA	Local education agency
LGC	Local Government Challenge
LIWP	Low-Income Weatherization Program
MM Therms	Million therms
mTRC	Modified total resource cost
Navigant	Navigant Consulting
NCPA	Northern California Power Agency
NRDC	Natural Resources Defense Council
P&G	Potential and goal
PA	Program administrator
PAC	Program administrator cost
PACE	Property Assessed Clean Energy
PCT	Participant Cost Test

PG&E	Pacific Gas and Electric Company
POU	Publicly owned utility
PRC	Public Resources Code
PUC	Public Utilities Code
Quad BTU	Quadrillion British thermal units
RIM	Ratepayer Impact Measure Test
SB 1037	Senate Bill 1037 (Kehoe, Chapter 366, Statutes of 2005)
SB 350	Clean Energy and Pollution Reduction Act (Senate Bill 350) De León, Chapter 547, Statutes of 2015)
SCE	Southern California Edison Company
SoCal Gas	Southern California Gas Company
SCPPA	Southern California Public Power Authority
SCT	Societal Cost Test
SDG&E	San Diego Gas & Electric Company
SMUD	Sacramento Municipal Utility District
TRC	Total Resource Cost

APPENDIX A: Utility Savings Technical Issues and Assessment

Two important studies of energy efficiency savings potential are relied upon for establishing sub-targets for utility programs.¹⁰⁴ The California Public Utilities Commission (CPUC) worked with Navigant Consulting (Navigant) to prepare *Energy Efficiency Potential and Goals Study for 2018 and Beyond*¹⁰⁵ (2018 IOU Potential and Goals Study), adhering to the method established in previous work. The study objective was to adapt the 2015 potential and goals to the requirements of AB 802 and SB 350, resulting in IOU programs using an “existing conditions” baseline as opposed to a “code baseline.” Even though the 2018 IOU Potential and Goals Study did not attempt to double IOU savings, SB 350 directed that goals not be set based on past studies. Consequently, 2018 IOU Potential and Goals Study used a combination of different calibration and scenario.

The POUs, through the California Municipal Utilities Association (CMUA), also contracted with Navigant, producing *Energy Efficiency Potential Forecasting for California’s Publicly Owned Utilities*¹⁰⁶ (*POU Potential and Goals Study*.) Using an approach similar to the CPUC study, the *POU Potential and Goals Study* identified 10-year energy efficiency savings projections for each POU. These projections were submitted to the Energy Commission in March 2017 as required by the Public Resources Code (PRC) 25310(b).

Table A-1 summarizes the differences between POU and IOU characteristics that influence energy efficiency planning.

Table A-1: Comparison of POU and IOU Characteristics in California

	POU	IOU
Ownership	Locally owned by municipal government body, an independent district, or customers/members of the rural cooperative utility residing within the local service area.	Privately owned by shareholders or stockholders. Not limited to the service area.

104 The information presented in this appendix related to IOUs is based on the draft 2018 IOU Potential and Goals Study. The appendix will be updated to reflect the final report released on August 25, 2017.

105 California Public Utilities Commission. *Energy Efficiency Potential and Goals Study for 2018 and Beyond*. June 15, 2017, http://ftp.cpuc.ca.gov/gopher-data/energy_division/EnergyEfficiency/DAWG/2018andBeyondPotentialandGoals%20StudyDRAFT.pdf.

106 *Energy Efficiency Potential Forecasting for California’s Publicly Owned Utilities* http://docketpublic.energy.ca.gov/PublicDocuments/17-IEPR-06/TN217680_20170522T124015_Energy_Efficiency_in_California's_Public_Power_Sector_11th_Edit.pdf

Structure/ Management	Nonprofit public entity managed by locally elected officials/ public employees.	Shareholder-elected board appoints management team of private sector employees.
Rate Setting	Customer rates are set by each utility's governing body or city council in a local public forum.	For profit means investors receive rate of return adding a cost element different from POUs. Customer rates are set and regulated by California Public Utilities Commission (CPUC) through a general rate case proceeding that includes some customer participation, especially through customer advocacy groups.
Mission/Goals	Optimize benefits for local customers, usually in the form of lower energy rates.	Optimize return on investment for shareholders, subject to policy goals set by the Legislature and/or CPUC.
Financing	Public utilities have access to tax-free bonds and co-ops have access to low-interest loans usually at the local level.	Shareholders (investors), the sale of bonds and bank borrowing help finance the utility's operations. Allows recovery through rate structure.
Profit/Net Revenue	Rates are set to recover costs and earn additional return to maintain bond ratings and invest in new facilities.	Utility rates are set to recover costs and earn a reasonable return as profits for shareholders in return for the risk they bear for investing in new facilities.
Size/Heterogeneity	Although POUs dramatically differ in geographical size and number of customers, most are small or mid-sized with the exception of LADWP and SMUD.	Very large in size and number of customers. Complex, heterogeneous customer mix.
Planning and Procurement of Power Generation Resources	POUs develop plans to meet resource requirements and then either develop or contract for new supplies. Operate their own generation facilities or purchase power through contracts.	A combination of CPUC-centric and IOU planning. A biennial LTPP proceeding to evaluate the utilities' need for new generation resources and establish rules for rate recovery of procurement transactions. Under SB 350, an integrated resource planning process will replace the long-term program plan approach.

Transmission	Some larger POU, like LADWP, SMUD, Imperial, and Turlock Irrigation District own, control, and manage their own transmission grid are balancing authorities. Smaller POU are part of IOU planning areas.	IOUs own transmission lines, but Independent System Operator controls and manages the IOUs' transmission lines as a single open-access grid system. IOU generation has no more access to the system than competing generators and marketers.
Retail Service	Some POU, such as Silicon Valley Power, cities of Corona, Lompoc, Colton, and Plumas-Sierra Rural Electric provide direct access ¹⁰⁷ load within city limits.	All IOUs provide direct access and bundled service, which includes all aspects of service—electricity generation, sales, administration, and deliveries.

Source: California Energy Commission staff, Energy Assessments Division, July 2017.

Investor-Owned Utilities' Potential and Goals Study

Decision 15-10-028 ordered CPUC staff to conduct a potential and goals study that assesses all the technologies and measures that the utilities could use to make up their energy efficiency portfolios.

Technical, Economic, and Market Potential

Technical potential is defined as the amount of energy savings that would be possible if the highest level of efficiency for all technically applicable opportunities to improve energy efficiency were taken, including retrofit measures, replace-on-burnout measures, and new construction measures. The technical potential represents the total energy savings available each year that is above the baseline established by Title 20 and Title 24 codes and federal appliance standards.

As shown in **Figure A-1** and **Figure A-2**, using the results of the technical potential analysis, the economic potential is calculated as the total energy efficiency potential available when limited to only cost-effective measures. All components of economic potential are a subset of technical potential. Both technical and economic potential, as presented in the CPUC studies, are “instantaneous,” not “annualized.” Assumptions about stock turnover rates are not applied annually to these categories of efficiency potential. Instead, efficiency improvements are assumed to be applied to all applicable equipment and systems in the first year that those improvements are available.

The final output of the *2018 IOU Potential and Goals Study* is a market potential analysis, which calculates the energy efficiency savings that could be expected in response to specific levels of incentives and assumptions about market influences and barriers. All components of market potential are a subset of economic potential. Some studies also refer to this as “maximum

¹⁰⁷ *Direct access* means the ability of a retail customer to purchase electricity or other energy sources directly from an energy supplier other than utility.

achievable potential.” One significant difference between market potential and both technical and economic potential is that the former is annualized, whereas the latter two are instantaneous. The CPUC uses market potential to establish the IOUs’ energy efficiency goals.¹⁰⁸

Figure A-1: Electricity Technical, Economic, and Market Potential for IOUs Using TRC Reference Scenario (GWh)

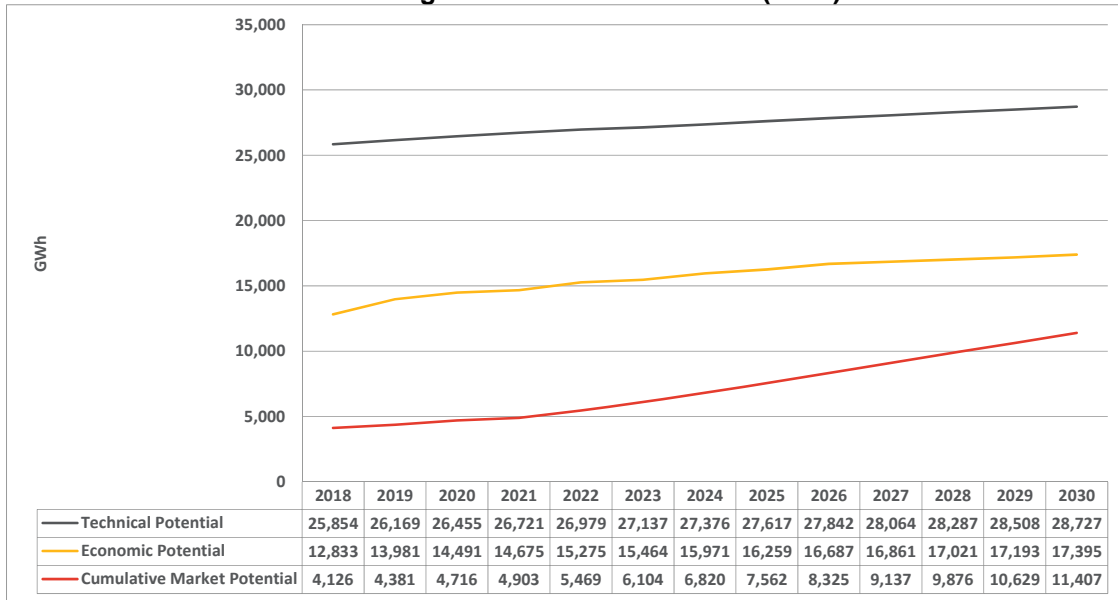

Source: California Energy Commission staff, Energy Assessments Division, July 2017. Based on *2018 IOU Potential and Goals Study*, June 2017, TRC1 Reference Scenario.

108 California Public Utilities Commission. *2018 IOU Potential and Goals Study*. June 2017.

Figure A-2: Natural Gas Technical, Economic, and Market Potential for IOUs Using TRC Reference Scenario (MM Therms)

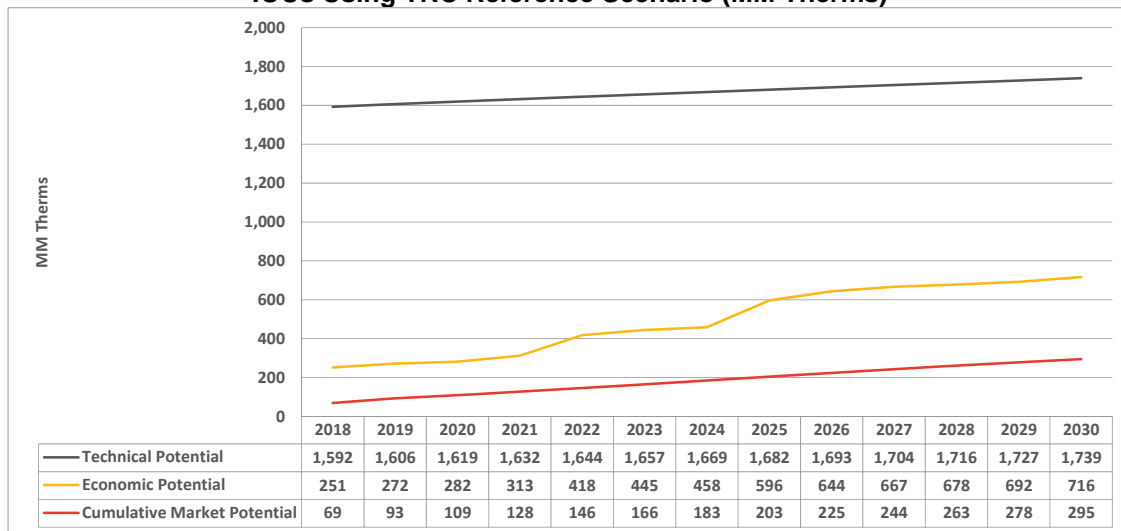

Source: California Energy Commission staff, Energy Assessments Division, July 2017. Based on *2018 IOU Potential and Goals Study*, June 2017, TRC1 Reference Scenario.

Incremental Market Potential

Incremental savings represent the annual energy and demand savings achieved by the set of programs and measures in the first year that the measure is implemented. Assumptions do not include the additional savings that the measure will produce over the life of the equipment. A view of incremental savings is necessary to understand what additional savings a year of energy efficiency programs will produce. This has been the basis for IOU program goals.¹⁰⁹

In the 2011, 2013, and 2015 potential and goals studies, a single forecast of energy efficiency potential was produced for informing IOU goals. This forecast was calibrated to historical program activity. In these past studies, alternate scenarios were considered only in the AAEE forecast used by the Energy Commission. The AAEE scenarios were developed after the CPUC had established goals and were primarily driven by the needs of the Energy Commission. The 2018 potential and goals study considers multiple scenarios to inform goal setting.

SB 350 directed the CPUC to adopt goals based on energy efficiency potential studies that are not restricted by previous levels of utility energy efficiency savings. CPUC staff proposed to meet this direction by exploring scenarios reflecting alternative future outcomes based on variables that can be controlled by policy decisions or program influence. The *2018 IOU Potential and Goals Study* considers scenarios primarily built around policies and program decisions that are under the control of the CPUC and IOUs collectively; these scenarios are referred to as “internally influenced” variables. On the other hand, “externally influenced” variables were not considered in scenarios that inform the goals. External variables are those over which CPUC and IOUs

¹⁰⁹ California Public Utilities Commission, *2018 IOU Potential and Goals Study for 2018 and Beyond*. June 2017.

collectively have no control. A list of example internally and externally influenced variables can be found in **Table A-2**.

Table A-2: Variables Affecting Energy Efficiency Potential

Internally Influenced	Externally Influenced
<ul style="list-style-type: none"> • Cost-effectiveness (C-E) test • C-E measure screening threshold • Incentive levels • Marketing & Outreach • Behavior, Retro commissioning & Operational (BROs) customer enrollment over time • IOU financing programs 	<ul style="list-style-type: none"> • Building stock forecast • Retail energy price forecast • Measure-level input uncertainties (unit energy savings, unit costs, densities) • Non-IOU financing programs

Source: 2018 IOU Potential and Goals Study, June 2017.

Potential and Goals Study Draft Scenarios

CPUC staff worked with Navigant to develop draft scenarios for consideration in the goal-setting process. Each of the internally influenced variables in **Table A-2** is expected to have an impact on the forecast of energy efficiency potential. The combined impact of these variables represents a scenario.

CPUC staff considered the following when advising Navigant on the draft scenarios:

- CPUC staff followed closely the developments in the integrated distributed energy resources (IDER) proceeding. These developments informed the alternative cost-effective tests to consider.
- On February 2017, CPUC staff released a Societal Cost Test (SCT) white paper with recommendations for parameters to support a SCT, as well as potential modifications to the currently used TRC and PAC tests.¹¹⁰
- On April 2017, CPUC staff proposed a GHG adder curve as an interim value that could inform goal setting. The interim GHG adder proposal followed the methods proposed in the SCT staff white paper. The GHG adder curve was developed based on draft runs of the RESOLVE model in the IRP.¹¹¹
- In the comments to the proposed interim GHG adder, the joint IOUs proposed an alternative GHG adder curve based on the Allowance Price Containment Reserve (APCR).¹¹² This curve is an extrapolation of preliminary values released by the California Air Resources Board (CARB) during development of the CARB *AB 32 Scoping Plan Update*. Although the proposed allowance prices are not final and are subject to change, CPUC staff believes they are a reasonable alternative to the staff proposal and will

¹¹⁰ <http://docs.cpuc.ca.gov/PublishedDocs/Efile/G000/M175/K295/175295886.PDF>.

¹¹¹ <http://docs.cpuc.ca.gov/PublishedDocs/Efile/G000/M182/K363/182363230.PDF>.

¹¹² Joint Opening GHG Adder Comments, page 6 <http://docs.cpuc.ca.gov/PublishedDocs/Efile/G000/M185/K576/185576217.PDF>. The curve is an extrapolation of the prices on ARB Staff Report *Initial Statement of Reasons*, Appendix C, August 2, 2016, Table 5. Available at <https://www.arb.ca.gov/regact/2016/capandtrade16/appc.pdf>.

give stakeholders the chance to see how market potential changes when using alternative GHG adder values.

CPUC staff’s intent was to keep the number of scenarios manageable but still provide a range of alternatives to bound market potential. Therefore, five scenarios were proposed and are listed in **Table A-3**.

Table A-3: Draft Scenarios for Energy Efficiency Potential – Summary

Scenario	Cost Effectiveness Screen	Program Engagement
TRC Reference	TRC test using 2016 Avoided Costs	Reference
metric (GHG Adder #1) Reference	TRC test using 2016 Avoided Costs + IOU proposed GHG Adder	Reference
mTRC (GHG Adder #2) Reference	TRC test using 2016 Avoided Costs + CPUC staff proposed GHG Adder	Reference
PAC Reference	PAC test using 2016 Avoided Costs	Reference
PAC Aggressive	PAC test using 2016 Avoided Costs	Aggressive

Source: 2018 IOU Potential and Goals Study, June 2017.

The “TRC | Reference” scenario represents “business as usual” and is a continuation of current policies. Three of the alternate scenarios continue to assume similar program design but apply different cost-effectiveness tests and avoided costs. The final scenario (PAC | Aggressive) is meant to show an upper bound of the combination of program engagement and cost-effectiveness screens. **Figure A-3** and **Figure A-4** show the five scenarios.

The following tests were used to help develop the scenarios:

Total Resource Cost Test (TRC)—The California Standard Practice Manual defines the *TRC test* as the measurement of the net benefits and costs that accrue to society (the program administrator and all its customers). It compares the benefits, which are the avoided cost of generating electricity and supplying natural gas, with the total costs, which include program administration and customer costs. The TRC does not include the costs of incentives.

Modified TRC Test (mTRC)—The mTRC test builds upon the TRC test by including a GHG adder along with the avoided cost of electricity and natural gas.

- GHG Adder #1—IOU Proposal for GHG Adder (CARB APCR price)
- GHG Adder #2—CPUC Staff Proposal for GHG Adder (based on preliminary RESOLVE model runs in the IRP proceeding)

Program Administrator Cost Test (PAC)—The California Standard Practice Manual defines the PAC test as the measurement of the net benefits and costs that accrue to program administrator. It compares the benefits, which are the avoided cost of generating electricity and supplying natural gas, with the total costs, which include program administration and incentive costs. The PAC does not include the out-of-pocket costs paid by customers.

- Reference—Existing Programs
- Aggressive—Existing Programs + Enhanced/Expanded Programs

California Public Utilities Commission Goals Adoption Process

The *2018 IOU Potential and Goals Study* was released on June 15, 2017, and a workshop was held on June 20, 2017. Comments were due July 7, 2017, and reply comments were due July 14, 2017. The CPUC may be adjusting the final projections based on party comments on the proceeding record.

The CPUC expects to release a proposed decision at the end of August 2017 with the proposed IOU energy efficiency goals. The proposed decision will undergo another round of comments. The CPUC commissioners should adopt the final goals at the end of September.

Although this year’s potential and goals study included more measures than before, the IOUs’ goals may ultimately be as much as 15 percent lower than the goals adopted from the 2015 study.

Figure A-3: Electricity Savings—Five Scenarios (Including Codes and Standards) (GWh)

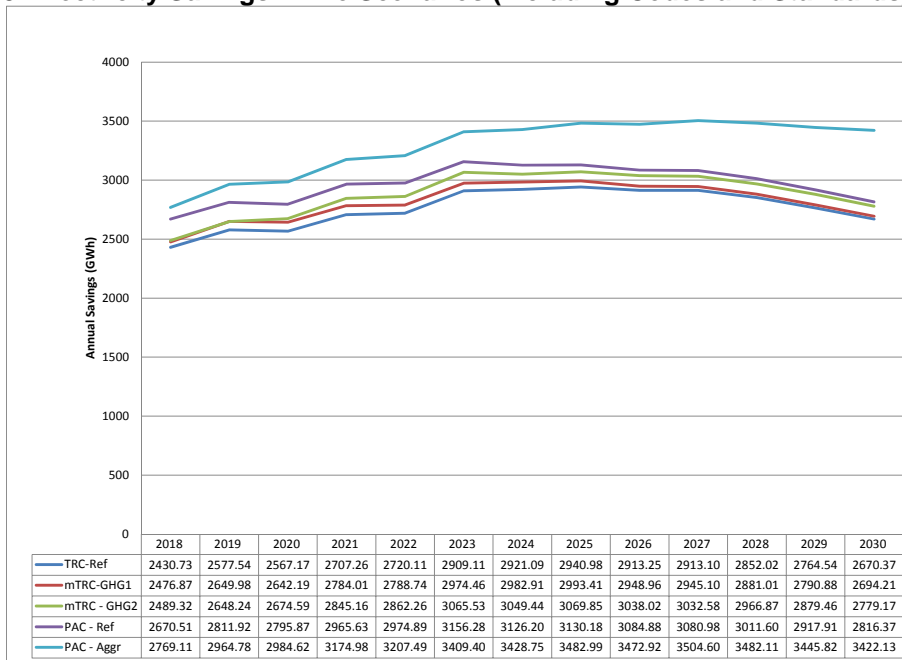

Source: California Energy Commission, Energy Assessments Division, July 2017. Based on *2018 IOU Potential and Goals Study*, June 2017, TRC1 Reference Scenario.

Figure A-4: Natural Gas Savings - Five Scenarios (Including Codes and Standards) (MM Therms)

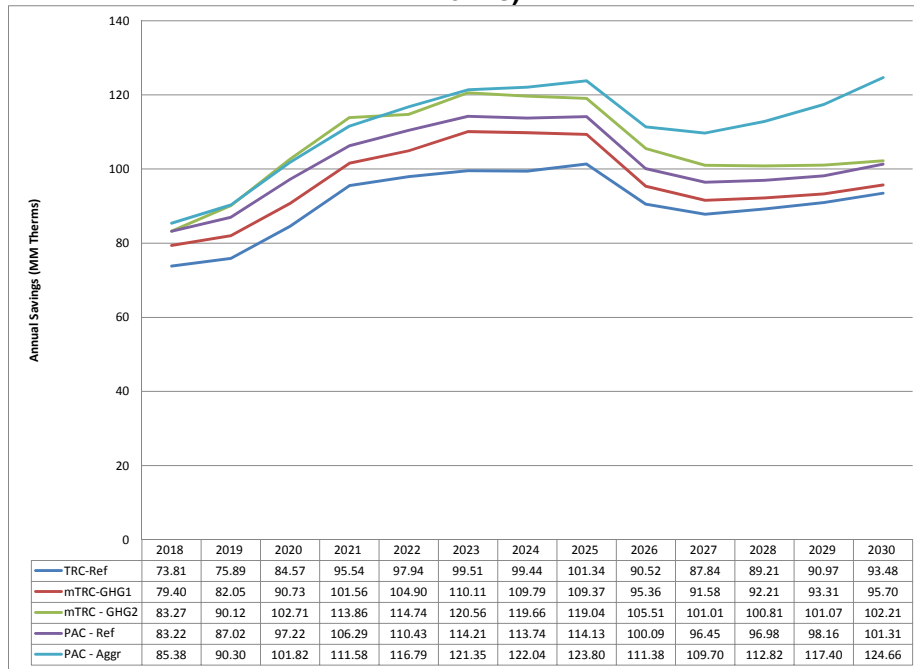

Source: California Energy Commission, Energy Assessments Division, July 2017. Based on *2018 IOU Potential and Goals Study*, June 2017, TRC1 Reference Scenario.

Proposed California Public Utilities Commission – Jurisdictional Savings Targets

This section identifies two adjustments to the projections of the *2018 IOU Potential and Goals Study* that Energy Assessments Division proposes in identifying IOU SB 350 savings targets. This section concludes with graphs of cumulative electricity and natural gas savings, using the TRC-Ref scenario as an example pending final CPUC decision, for the total savings from CPUC-jurisdictional entities.¹¹³

Investor-Owned Utilities Statewide Codes and Standards Program

The CPUC adopted a Statewide Codes and Standards Program as part of the original energy efficiency strategic plan in 2008. This program includes several elements – building and appliance standard advocacy for more stringent requirements, compliance improvement, reach codes, and planning and coordination. A substantial budget has been allocated to these efforts, but the benefits are great, since adopting and realizing more stringent standards affect all customers, and there is no direct measure implementation cost to the utility. In D.16-08-019, numerous parties proposed reforms for this program in light of the AB 802 requirements to shift toward use of existing baselines. However, the CPUC decided it was premature to revise these

¹¹³ All analyses reported here use the IOU distribution utility service area as the basis for analysis. To the extent that the CPUC decides to allow CCAs to undertake an expanded scope of energy efficiency activities through time, then partitioning savings projections appropriate to multiple entities may be appropriate for SB 350.

programs and instead worked with the Energy Commission in various forums to devise improved methods for code savings quantification.¹¹⁴

As shown in **Figure A-5** and **Figure A-6**, using the TRC-Ref scenario as an example, projections of attributable savings from various codes and standards activities are the largest of the four categories of savings in the draft *2018 IOU Potential and Goals Study*. Now that the Energy Commission is producing its own estimates of savings from future tightening of codes and standards, there is concern that there is increased potential for double-counting between the *2018 IOU Potential and Goals Study* projections and Energy Commission projections documented in the separate Energy Commission staff paper.¹¹⁵ Therefore, as an interim accounting mechanism, the Energy Commission is excluding *2018 IOU Potential and Goals Study* attributable codes and standards savings from proposed IOU savings for SB 350. It is expected that this issue will receive explicit attention in later phases of this proceeding and in interagency efforts to prepare for the next cycle of target setting.

Figure A-5: Electricity Savings – TRC Reference Scenario With Four Program Types (GWh)

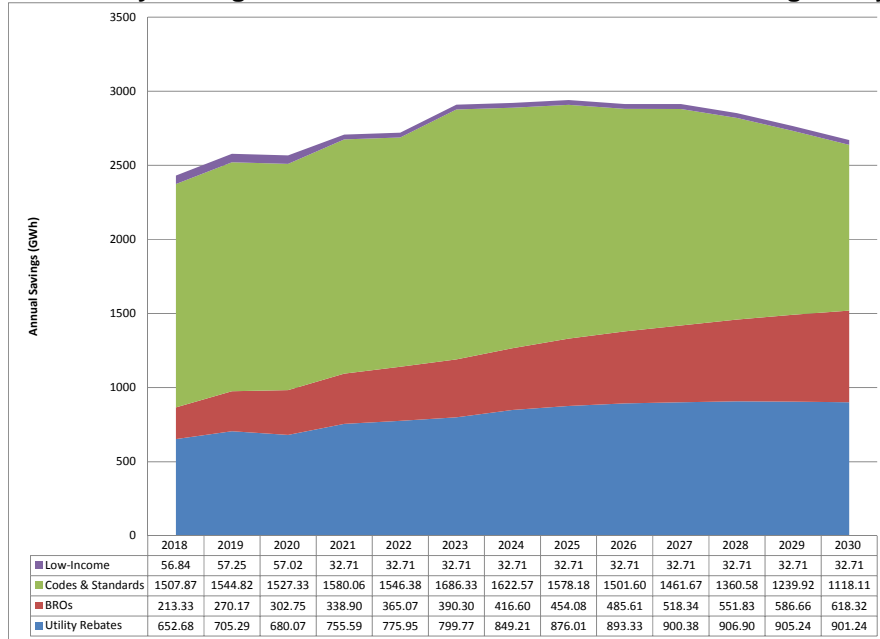

Source: California Energy Commission, Energy Assessments Division, July 2017, based on *2018 IOU Potential and Goals Study*, TRC 1 Reference Scenario.

114 CPUC, D.16-08-019, page 31. See <http://docs.cpuc.ca.gov/PublishedDocs/Published/G000/M166/K232/166232537.PDF>.

115 Kenney, Michael, Brian Samuelson, Manjit Ahuja. 2017. *Senate Bill 350 Energy Efficiency Targets for Programs Not Funded through Utility Rates*. California Energy Commission. Publication Number: CEC-400-2017-009-SD.

Figure A-6: Natural Gas Savings – TRC Reference Scenario With Four Program Types (MM Therms)

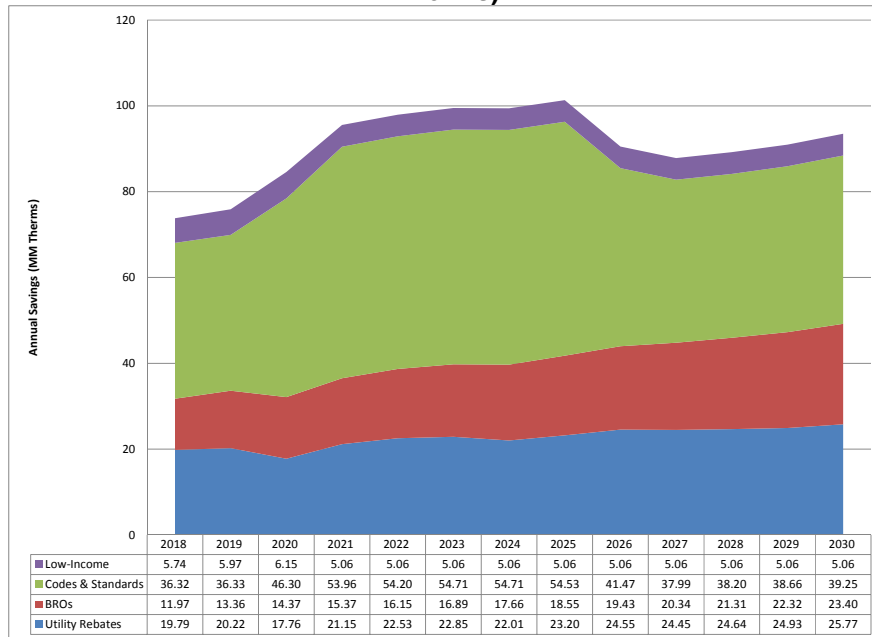

Source: California Energy Commission, Energy Assessments Division, July 2017, based on *2018 IOU Potential and Goals Study*, TRC1 Reference Scenario.

Proposed Adjustments to the Potential Study

The Energy Commission is making two nonsubstantive adjustments to the final CPUC savings projections for the IOUs. Because SB 350 uses 2015 as the base year, the Energy Commission will be adding 2015, 2016, and 2017 to the 2018-2029 projections to the cumulative savings. Energy Commission will also exclude savings from most codes and standards effective after 2019 to avoid double-counting with independent estimates by the Efficiency Division for future standard impacts.

Energy Efficiency Savings in Historical Years

The Energy Commission understands that SB 350 establishes 2015 as the base year for cumulative projections. The *2018 IOU Potential and Goals Study* only reported 2018 to 2030. This means that energy efficiency savings from 2015-2017 must be added to the *2018 IOU Potential and Goals Study* analyses that covered 2028 through 2030. The CPUC has not released final evaluations of program savings for 2015-2016, and 2017 is still unfolding. The Energy Commission developed its own estimates of historical savings for the four program categories as an interim measure. Those values are reported in **Figure A-7** and **Figure A-8**. The Energy Commission understands that CPUC will endeavor to provide improved estimates as part of preparing values for consideration by the CPUC when it adopts final energy efficiency program savings in September 2017.

Proposed CPUC-Jurisdictional SB 350 Savings Projections

Figure A-7 and **Figure A-8** report proposed combined CPUC-jurisdictional energy efficiency savings from 2015 through 2029 for electricity and natural gas, respectively, using the TRC-Ref

scenario for illustration. In contrast to **Figure A-3** and **Figure A-4**, the exclusion of attributable codes and standards savings reduces the aggregate amounts and shifts the emphasis to utility rebate programs as the dominant source of savings.

Figure A-7: Electricity Savings – TRC Reference Scenario by Program Type (Excluding Codes and Standards) (GWh)

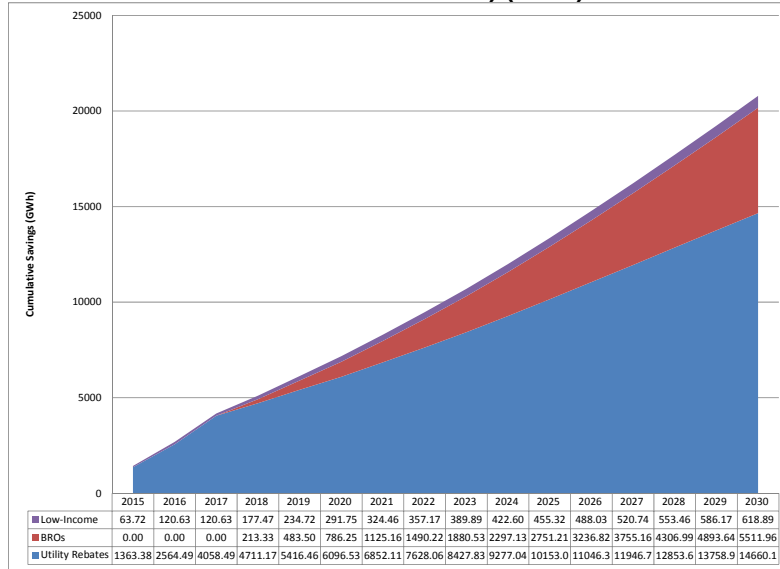

Source: California Energy Commission, Energy Assessments Division, July 2017. Based on 2018 IOU Potential and Goals Study, June 2017, TRC1 Reference Scenario.

Figure A-8: Natural Gas Savings – TRC Reference Scenario by Program Type (Excluding Codes and Standards) (MM Therms)

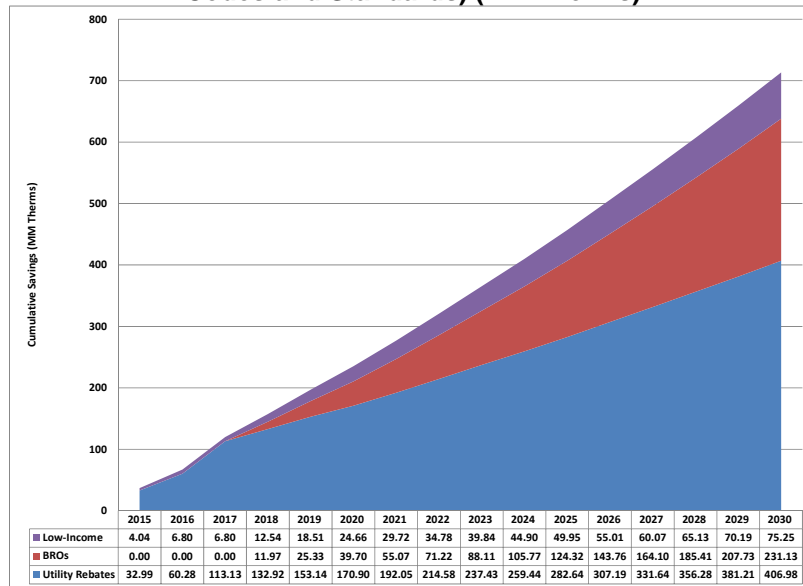

Source: California Energy Commission, Energy Assessments Division, July 2017. Based on 2018 IOU Potential and Goals Study, June 2017 TRC1 Reference Scenario.

Publicly Owned Utility Potential and Goals Study

The POUs, through CMUA, submitted 10-year energy efficiency savings projections, based on an approach similar to the CPUC's, for each POU in the *POU Potential and Goals Study* in March 2017. The POUs used a tool developed by Navigant Consulting called the *Electricity Resource Assessment Model (ELRAM)*. ELRAM is an Excel spreadsheet model designed to estimate technical, economic, and market potentials. ELRAM estimates electricity savings and demand reduction as a function of projected electricity sales. Each POU provided its total baseline system electricity sales projections, and the model compared results after energy efficiency programs implementation assumptions are applied. Adjustments to the model to accommodate each POU's unique set of inputs are common. Since the initial development in 2007, the model has been used by CMUA, its members, and more than 50 electric utilities nationwide.

Table A-4 below provides the savings projection summed for all POUs from their potential studies for the past four cycles. Although the studies resulting from these four versions of ELRAM show increasingly large technical and economic potential, the market gross potential and proposed savings targets have been more stable.

Technical Potential

ELRAM technical potential conceptually is similar to that of the IOU model. As described in Chapter 3, technical potential provides a starting point for determining achievable levels of cost-effective market potential. It is calculated as a product of the electricity savings per unit of a measure, the quantity of applicable efficiency units in each facility, and the number of facilities in a utility service territory. The quantity of applicable units per year is determined by measuring effective useful life. **Table A-4** shows the difference in POU technical potential levels among 10-year periods analyzed in 2007 (2007–2016), in 2010 (2011–2020) in 2013 (2014–2023), and 2017 (2018–2027). The estimate of all 38 POUs technical energy savings potential is 30,117 GWh in 2027. This estimate is 44 percent higher than the 2013 estimate. The list of ELRAM-recognized measure types is provided in below in **Table A-5**.

Table A-4: Comparison of POU 10-Year Forward Potentials in GWh

	2007	2010	2013	2017
Technical	13,687	10,693	20,950	30,115
Economic	10,553	9,525	15,999	25,374
Market Gross	5,907	6,206	10,952	5,371
Electricity Savings Target	6,630	7,403	7,366	7,969

Source: California Energy Commission, Energy Assessments Division, July 2017, based on *Energy Efficiency in California's Public Power Sector Status Reports*, <http://www.ncpa.com/policy/reports/energy-efficiency/>.

Table A-5: POU Technical Potential Groups of Measures

Measure Group	Description
Replacement on burnout (ROB)	Implementation of an energy-efficient measure after the existing equipment fails.
Retrofit (RET)	Immediate installation of an energy-efficient measure that improves the efficiency of an existing technology. The lifetime of the base technology is not a factor as retrofit measures generally do not replace existing technologies. The energy impact is therefore only the amount of improvement to the existing technology.
Dual Baseline (DUB)	The dual-baseline measure type is an early replacement that replaces an existing technology before the end of useful life; however, savings are calculated using a less efficient “as-found condition” baseline for the first part of the remaining useful life (RUL) and a “code condition” for the second portion of the RUL. These result in higher initial energy savings under the first baseline and lower savings under the second baseline once the measure would have reached the end of the effective useful life (EUL). Measure costs are also adjusted to reflect the change in baselines.
Behavioral Programs (BEH)	Programs designed to influence consumer behavior through the provision of training and/or information. As with emerging technologies, achievable potential is calculated using a Bass diffusion model rather than the traditional measure payback.
Low-Income	Measures that are implemented as part of utility administered low-income program.
New Construction	Installation of a measure or package of measures at the time of construction.
Demand Response	Strategies specifically designed to reduce peak demand. There are generally very little energy savings associated with these strategies.

Source: Navigant and California Energy Commission, Energy Assessments Division, July 2017.

Economic Potential

Similar to the IOU model, POU economic potential represents a portion of the technical potential if a utility installs measures selected by the results of the cost-effectiveness screening. As described in Chapters 2 and 4, cost-effective measures are those with a test result of 1 or greater of the Total Resource Cost (TRC) and the Program Administrator Cost (PAC). POU provide TRC

and PAC test results, using a benefit/cost ratio, derived from the E3 Reporting Tool. Descriptions of the ELRAM cost/benefit screening are provided in below in **Table A-6**. Historically, economic potential is around 80 percent of technical potential. The economic potential estimated for the POUs in the 2017-2028 study is 60 percent higher than the 2013 estimate.

Table A-6: Economic Screening of Measures

Test	Description
Total Resource Cost (TRC)	This test includes all quantifiable costs and benefits of an energy efficiency measure that may accrue to participants or the utility. For example, a measure passing the TRC test is cost-effective if the sum of the avoided costs and other benefits accruing to participants or the utility are greater than the sum of the measure costs and the utility's administrative costs.
Program Administrator Cost Test (PAC)	This test measures the costs of an energy efficiency program based on the costs incurred by the utility (including incentive costs) and excluding any net costs incurred by the participant. For example, a measure passing the PAC test is cost-effective if the sum of the avoided costs (costs avoided by energy and demand savings of the measure) and other utility benefits are greater than the utility's costs to promote the measure, including incentives provided to customers.
Ratepayer Impact Measure Test (RIM)	This test measures what happens to a dwelling or business' electric bills or rates due to changes in utility revenue and operating costs caused by the program. For example, a measure passing the RIM test is cost-effective if the avoided costs are greater than the sum of the utility's costs and the "lost revenues" caused by the measure.
Participant Cost Test (PCT)	This test measures the quantifiable benefits and costs to the customer due to participation in the program. For example, a measure passing the PCT test is cost-effective if the reduced electric costs to the participating customer from the measure exceed the after-incentive cost of the measure to the customer.
Customer Payback	This measurement calculates the incremental technology cost divided by the incentive and the reduction in the electric bill. If multi-life benefits and costs are considered, it also includes the PV of future technology costs and future incentives and bill reductions.
Levelized Measure Cost/kWh	This metric multiplies the energy efficiency measure costs by the Capital Recovery Factor and divides by the first-year kWh savings.

Source: California Energy Commission, Energy Assessments Division, July 2017

Market Potential

CMUA, in its annual report, formulated a foundational principle for POU energy efficiency efforts that the customer is central to realizing energy savings, implying that a final end user is ultimately responsible for the decision to comply, invest, or otherwise implement an energy efficiency measure. “Customers are ultimately responsible for achieving savings from energy efficiency. To fully realize potential energy savings, policies and programs must aim to remove barriers and encourage voluntary action by customers to reduce energy usage.”¹¹⁶

Market potential is further limited by such factors as program design, the magnitude of utility incentives, and rebates. Efficiency savings are estimated in response to specific levels of incentives and assumptions about policies, market influences, and market barriers. When the cost-effectiveness screening value at the measure level is less than 1.0, it is common to assess for market feasibility. POU market potential varies significantly based on local policy and program assumptions. Some of the POU-specific methods differ in whether the estimates are considered net of naturally occurring efficiency or free riders. In addition to gross and net estimates, market potentials are estimated on incrementally and cumulatively. The gross market potential estimated for the POUs in the 2017-2028 study is 60 percent lower than 2013 estimate.

Natural Gas Savings Potential

Only two POUs, both small, provide natural gas service to end-use customers.¹¹⁷ The ELRAM tool does not address natural gas savings; thus, savings projections for natural gas are not reported in the main CMUA report submitted in March 2017. The CMUA report, provided to the Energy Commission because of a data request, provides a limited description of natural gas savings projections for the City of Palo Alto. Natural gas service by the two POUs is a small fraction of the scale of natural gas service provided by IOUs to end users across the state; thus, natural gas savings from energy efficiency measures are due to of CPUC-supervised IOU activities. Natural gas savings projections for IOUs are discussed in Chapter 3.

10-Year Electricity Savings Projections

Figure A-9 provides results of the ELRAM projections for the composite of all POUs. Technical and economic potentials are relatively constant through time, reflecting the definition of these concepts described above. Market potential and net program savings projections grow through time as year-by-year savings accumulate. However, by the end of the 10-year period, only limited amounts of economic potential have been achieved.

¹¹⁶ *Energy Efficiency in California's Public Power Sector: A 2016 Status Update* p.25.

¹¹⁷ The City of Palo Alto provides both electricity and natural gas service to end-use customers. The City of Long Beach provides natural gas service to end users.

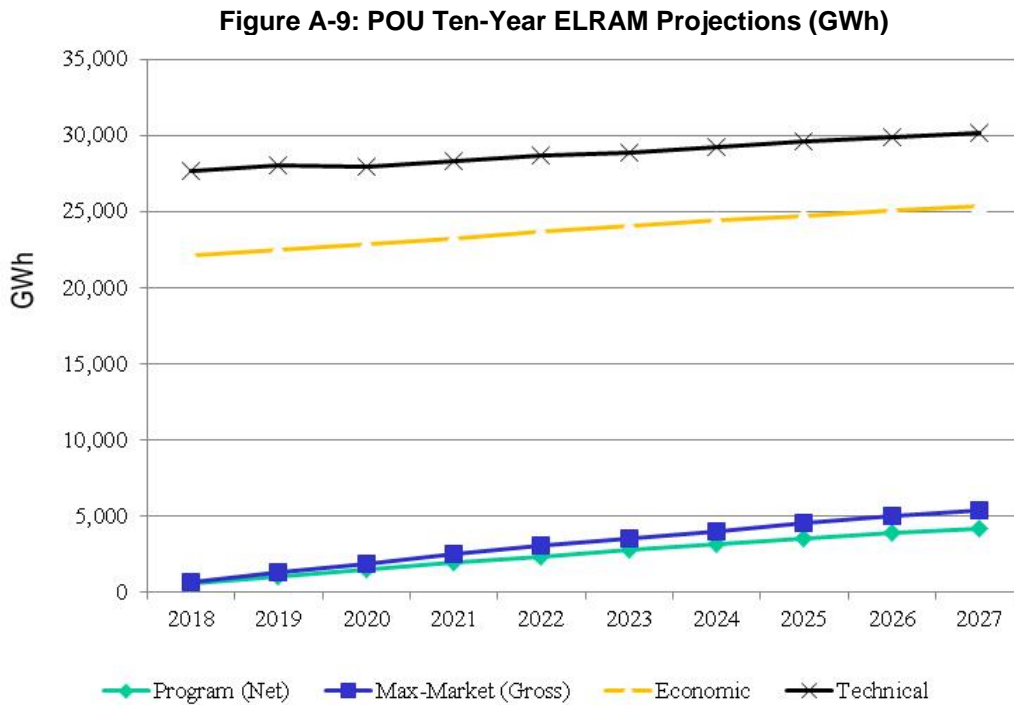

Source: California Energy Commission, Energy Assessments Division, July 2017, based on *Energy Efficiency in California's Public Power Sector Status Reports*, Appendix C <http://www.ncpa.com/policy/reports/energy-efficiency/>.

Figure A-10 provides a view of projected cumulative 10-year savings for all POUs combined into three size groups. LADWP and SMUD alone account for more than half of total cumulative savings. The 14 medium-sized POUs account for about a quarter of the cumulative savings.¹¹⁸ The remaining 20 POUs collectively account for a very small share of composite POU savings.

¹¹⁸ The large and medium-sized POUs are the 16 utilities for which the integrated resource planning requirements of SB 350 apply. These are the 16 POUs for which historical energy sales are 700 GWh per year or larger.

Figure A-10: Ten-Year Cumulative Targets by POU Group (GWh)

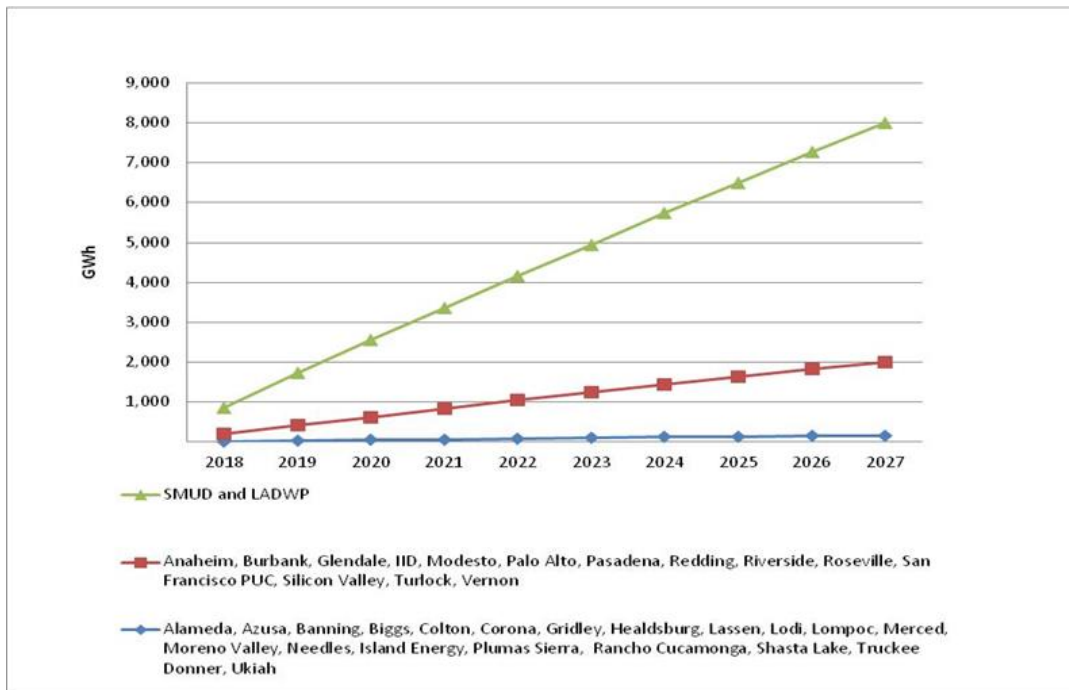

Source: California Energy Commission, Energy Assessments Division, July 2017, based on *Energy Efficiency in California's Public Power Sector Status Reports*, Appendix C <http://www.ncpa.com/policy/reports/energy-efficiency/>.

Adjustments to POU-Proposed Projections

The Energy Commission proposes to adjust the energy efficiency targets submitted by the POUs in March 2017. As described earlier, the CMUA process that engaged Navigant Consulting to develop an energy efficiency potential study allowed each POU to customize the final targets projections. Many POUs took advantage of this opportunity, and the composite projections described earlier do not use a uniform basis for developing future savings projections. As described in Chapter 4, the Energy Commission does not believe that such customized definitions can be the basis for SB 350 energy efficiency targets, although the decisions that POUs have made can continue to be used for each POUs' own internal planning.

Three types of changes to POU projections as submitted are proposed:

- Exclude code and standard savings from utility targets and include such savings in the non-utility program savings group.
- Shift from gross to net basis for calculating historical and future savings.
- For SB 350, add historical savings for 2015-2017 and extrapolate savings from 2027 through December 31, 2029.

Table A-7 provides an overview of how these adjustments apply to each of the 16 large and medium-sized POUs. Clearly all POUs' projections are adjusted to add historical years and to extend projections to 2029. This reflects a mismatch in the portions of the law establishing

requirements for POUs to submit projections to the Energy Commission and the SB 350 mandates for the Energy Commission to adopt targets from 2015 to January 1, 2030. Eight of 16 POUs need to have savings adjusted from a gross to net basis. Six POUs need to have savings projections adjusted to exclude savings from codes and standards. The effect of the combined adjustments for all POUs is generally larger than is the case for most utilities because LADWP and SMUD – the two largest POUs in California - are projected to receive all adjustments.

Table A-7: Adjustments to POU-Submitted Targets

	Description of POU Submitted Target	Adjust for Net	Adjust for C&S	Added Years
LADWP	Market Gross + C&S	✓	✓	✓
SMUD	Market Gross + C&S	✓	✓	✓
Imperial	Market Net + C&S		✓	✓
Anaheim	Market Gross + C&S	✓	✓	✓
Riverside	Market Gross: 1% Avg. Annual	✓		✓
Pasadena	Market Gross: 1.25% Avg. Annual	✓		✓
Turlock	Market Net + C&S		✓	✓
Santa Clara	Market Net			✓
Glendale	Market Net + C&S		✓	✓
Burbank	Market Gross	✓		✓
Modesto	Market Net			✓
Roseville	Market Gross	✓		✓
Palo Alto	Market Net			✓
Vernon	Market Net + C&S		✓	✓
Redding	Market Gross	✓		✓
San Francisco PUC	Market Net			✓

Source: California Energy Commission, Demand Analysis Office, July 2017.

The effect of these adjustments on the three aggregate groups of POUs can be seen by comparing **Figure A-11** and **Figure A-12**. Both figures report annual and incremental savings, and generally both figures report reductions in annual savings going forward. The most important difference between the two figures is that **Figure A-11** begins in 2018, while **Figure A-12** begins in 2015. This difference reflects the requirement of SB 350 to use 2015 as the base year. The second most important difference is that all the annual incremental values in **Figure A-12** are scaled down about 200 GWh per year compared to the corresponding values in **Figure A-11**. This reflects the exclusion of C&S savings and the replacement of gross by net savings.

Figure A-11: POU Annual Incremental Electricity Savings Targets (GWh)

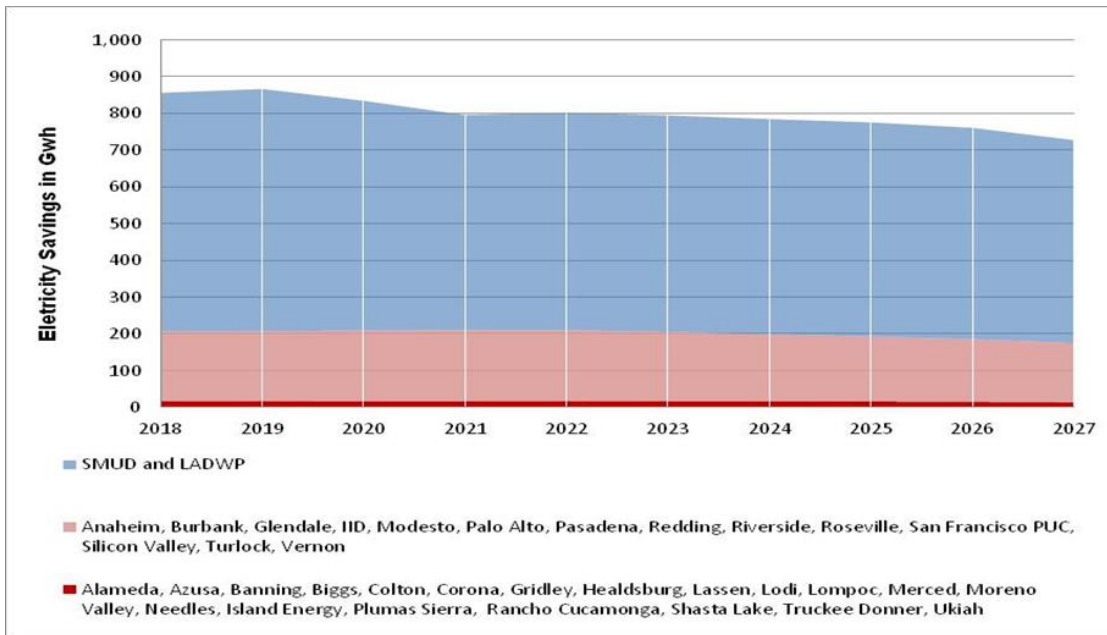

Source: California Energy Commission, Demand Analysis Office, July 2017. Based on *Energy Efficiency in California's Public Power Sector Status Reports*, Appendix C <http://www.ncpa.com/policy/reports/energy-efficiency/>.

Figure A-12: POU Annual Incremental Targets With Adjustments (GWh)

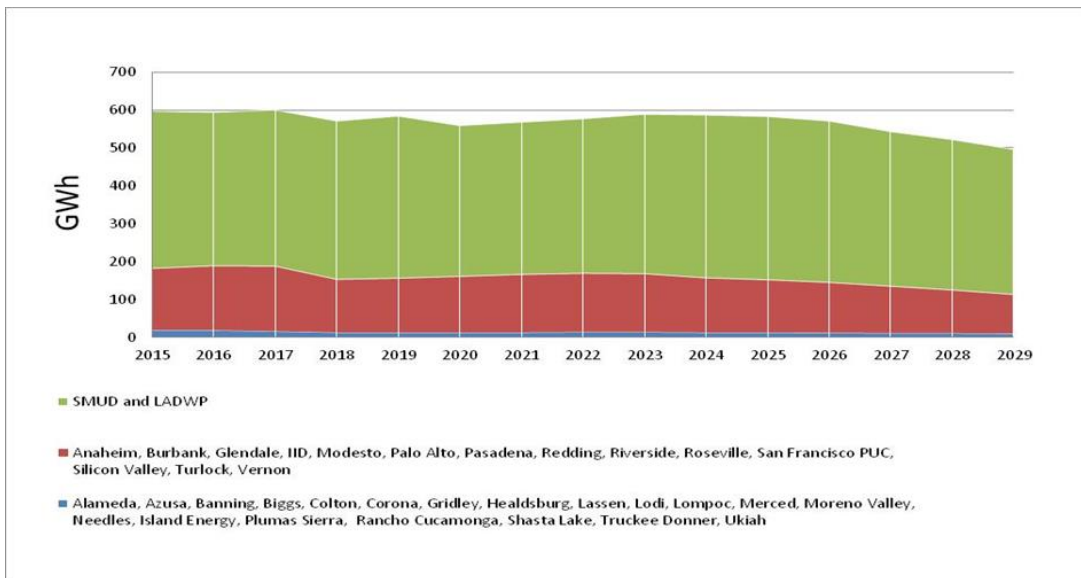

Source: California Energy Commission, Demand Analysis Office, July 2017 Based on *Energy Efficiency in California's Public Power Sector Status Reports*, Appendix C <http://www.ncpa.com/policy/reports/energy-efficiency/>.

Figure A-13 depicts the cumulative effect of these proposed adjustments on the original POU projections as submitted in March 2017. The blue line represents the cumulative savings for all POU for the period submitted within the CMUA report – 2018 to 2027. Since the annual savings decrease through time (as shown in **Figure A-11** and **Figure A-12**), the cumulative line adds less to the cumulative total in each successive year, so the slope of the blue line diminishes. The red

line indicates the adjustment to remove C&S savings – all annual values on the red line are lower in each year than for the blue line. The green line represents the effect of eliminating gross savings and replacing them with net savings. As with the first adjustment, all green line values are lower in each year than the corresponding red line values. Finally, the purple line represents the results of adding savings in the historical years of 2015 and 2016 (and estimated savings for current year 2017), so the value for each year is always higher in 2018 to 2027 reflecting adding a constant value to the original POU projections.

Figure A-13: Effect of Adjustments to POU Cumulative Savings

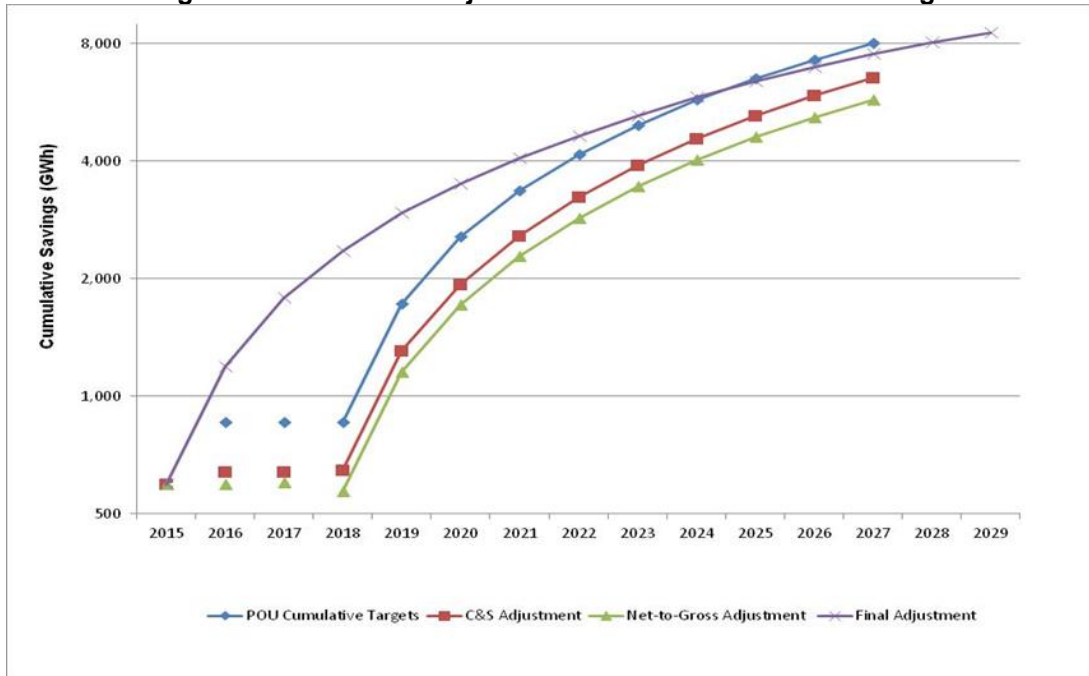

Source: California Energy Commission Staff, Energy Assessments Division, July 2017.

Table A-8: POU Energy Efficiency Targets (GWh)

POU	2018	2019	2020	2021	2022	2023	2024	2025	2026	2027	Total
IRP Group											
LADWP	499	504	461	410	408	402	404	414	417	406	4,324
SMUD	150	155	164	175	184	187	181	169	158	146	1,669
Imperial	33	34	34	32	31	29	28	27	25	22	295
Anaheim	28	28	27	26	26	25	24	23	22	20	249
Riverside	23	23	23	23	23	23	23	23	23	24	233
Pasadena	14	14	14	14	14	14	14	14	14	14	137
Turlock	16	15	15	15	14	14	13	12	11	10	134
Santa Clara	13	13	14	15	15	15	13	12	12	11	132
Glendale	15	15	15	14	14	14	12	12	11	10	131
Burbank	11	11	11	12	13	13	14	14	13	13	124
Modesto	9	10	11	12	13	13	14	14	13	12	121
Roseville	8	9	9	10	10	10	9	9	8	8	89
Palo Alto	7	7	8	8	8	8	9	9	9	9	82
Vernon	5	5	6	6	6	5	5	4	4	4	48
Redding	4	4	4	4	4	4	4	4	4	3	40
San Francisco	4	4	4	4	4	4	4	3	3	3	38
Non-IRP Group											
Small POU ¹¹⁹	13	13	12	13	12	12	13	12	12	11	123
Combined POU ^s	852	864	832	793	798	792	782	773	758	725	7,969

Source: CMCEA *Energy Efficiency in California's Public Power Sector Status Reports*, Appendix C. Electricity savings is rounded to the nearest GWh.

¹¹⁹ Small POU^s group include Colton, Lodi, Merced, Moreno Valley, Alameda, Truckee Donner, Shasta Lake, Banning, Healdsburg, Rancho Cucamonga, Lassen, Lompoc, Corona, Pittsburg, Ukiah, Victorville, Plumas-Sierra, Gridley, Needles, Biggs, Trinity, Azusa.

Fuel Substitution Programs

Site Energy and Source Greenhouse Gas Emissions

Previous efforts to assess the impacts of fuel substitution programs have introduced two key terms – site and source.¹²⁰ *Site* refers to the location of the end user consuming energy to obtain an energy service. *Source* refers to the location(s) of the production or generation of the fuel consumed at the end user’s site. In most applications, *site* energy consumption for specific program participants is unambiguous; however, the complexities of electric generation mean that source energy and emissions to provide electric energy to the end user introduce numerous analytic uncertainties. To satisfy the energy savings requirements of PRC 25310(d) (10), the end-use *site* energy consumed for equal energy service delivered must be lower with an electric appliance versus a natural gas appliance. To satisfy the GHG emissions requirement, the site natural gas GHG emissions must exceed the expected electric generation *source* production emissions.¹²¹ Reducing *site* GHG generally implies electric heat pump technologies replacing direct combustion natural gas technologies. Converting energy consumption for electric and natural gas appliances to British thermal units (BTUs) will enable this energy consumption comparison. Reducing *source* GHG emissions means comparing GHG emissions from site natural gas combustion with the GHG emissions characteristics of the electricity resource mix serving the end-use customer. Natural gas end-use *source* GHG emissions are only slightly higher than natural gas *site* GHG emissions and change only with the efficiency of the end-user combustion process.¹²² Electric *source* GHG emissions will change through time as the resource mix shifts toward renewable generation and away from generating technologies that produce GHG emissions. Chapter 5 discusses estimated energy savings in electricity and natural gas from fuel substitution programs for 2015 through 2029.

Use of *site* energy as the basis for energy reduction is critical to meet the energy restriction of PRC 25310(d) (10) to require end-user energy savings. An analysis that relied upon a source energy reduction requirement, in the face of a massive shift to renewable generation through time, could mistakenly infer a site energy reduction when only energy consumed in the generation, transmission, and distribution was reduced.

A production simulation model will capture electricity changes in generation, transmission, and distribution losses in the analysis of GHG emission impacts. So, the difference between site and source energy would be captured in this portion of the analysis. Further, a production simulation model explicitly models each hour chronologically so that the projection of electric system emissions will inherently address the specific hours that load would be increased by fuel-substitution impacts and the mix of renewables and GHG-emitting resources that is the least-cost

120 For example, CPUC D.05-04-051, pp. 16-17. See http://docs.cpuc.ca.gov/PublishedDocs/WORD_PDF/FINAL_DECISION/45783.PDF.

121 Natural Resources Defense Council’s (NRDC) Comments submitted following the January 23, 2017, workshop appear to misunderstand the Framework paper – both energy savings and projected GHG emission reductions are required by the language of PRC 25310(d)(10).

122 The difference between site and source GHG emissions from end-user consumption is distribution losses. This has historically been estimated at about 2 percent of annual usage.

dispatch to satisfy that load increase given an assumed resource mix. The following steps would be needed to estimate net GHG emission reduction requirements:

- a) An analysis of the hourly shifts in load from penetration of electricity fuel substitution measures.
- b) A production simulation model with proper inputs for performance of renewable generation.
- c) A resource mix that accurately matches the end-use customers expected to participate in the fuel substitution program.

Properly constructed, such an analysis would identify how efficient electric heat pump technologies would satisfy the two requirements of PRC 25310(d) (10) in two use cases: (1) replacing existing natural gas appliances and (2) installing electric appliances in new construction.

Interutility Departing Load/Gaining Load Considerations

Historically, the CPUC has been addressing fuel substitution programs where the issues focused on competing interests of SCE and SCG and ultimately resolved them by creating the three-prong test for fuel substitution.¹²³ The CPUC will continue to have a strong interest in this issue within (PG&E and SDG&E) and between (SCE and SCG, or PG&E versus CCAs) its jurisdictional entities. However, the language of SB 350 as embodied in PRC 25310(d)(10) appears to limit the extent to which fuel substitution programs can be used to satisfy the doubling goal. Further, it is clear that at least some electric-only POUs are interested in fuel-substitution programs in ways they were not two or three decades ago. Since there are five natural gas distribution utilities and more than 50 electric distribution utilities, fuel substitution raises the issue of an IOU natural gas utility losing sales and a wholly separate, financially independent POU electric utility gaining electric sales. Of course, the natural gas utility is expected to lose load through natural gas energy efficiency programs, but unlike traditional energy efficiency programs, fuel substitution causes electric load to increase. When the financial and regulatory issues are confined to a single entity (PG&E, SDG&E, or Palo Alto), a clear-cut assessment is feasible. When two independent organizations are involved – a natural gas utility regulated by the CPUC and an electric utility regulated by its own governing board - then a variety of financial and regulatory complications arise.

¹²³ California Public Utilities Commission, *Energy Efficiency Policy Manual* – Version 5, 2013, pp. 24-25. See [http://www.cpuc.ca.gov/uploadedFiles/CPUC_Public_Website/Content/Utilities_and_Industries/Energy/Energy_Programs/Demand_Side_Management/EE_and_Energy_Savings_Assist/EEPPolicyManualV5forPDF%20\(1\).pdf](http://www.cpuc.ca.gov/uploadedFiles/CPUC_Public_Website/Content/Utilities_and_Industries/Energy/Energy_Programs/Demand_Side_Management/EE_and_Energy_Savings_Assist/EEPPolicyManualV5forPDF%20(1).pdf).

Conservation Voltage Reduction

Background and Historical Conservation Voltage Reduction Efforts

Conservation voltage reduction (CVR) technology has been around since the 1970s. Since reducing energy consumption and equipment protection are both enhanced by maintaining distribution voltage in narrow limits, utilities install equipment that seeks to keep voltage in the bottom end of the acceptable range to reduce energy consumption and to avoid high voltage spikes that damage equipment. Sensors detect distribution voltages, and voltage regulation equipment is triggered when voltages exceed preset limits. The benefits from reduced energy consumption (metered end-user usage and distribution losses) and avoided equipment damage through time must exceed the investment and operating costs for CVR to make sense from an economic perspective. CVR is explicitly included within the possible programmatic activities listed in PRC 25310(d) that may be used to satisfy the SB 350 doubling goal.

CVR reduces energy consumption resulting by a reduction in feeder voltage. A variety of techniques accomplish this feeder voltage reduction, including tap-changing transformers, line drop compensators, generator excitation controls, voltage regulators, line-switchable capacitor banks, static VAR compensators, circuit reconfiguration, and load control. CVR is a technique for improving the efficiency of the electrical grid by reducing average voltage on the feeder lines that run from secondary distribution equipment to homes and businesses, saving energy at the point of consumption. By controlling voltage on a distribution circuit to the lower end of the tolerance bands, efficiency benefits can be realized by consumers and the distribution utility. End-user electricity consumption is reduced when certain end-use loads draw less power at lower voltages, and distribution system losses are reduced by the combination of less electricity consumption incurring losses and lower losses per unit of consumption when voltage is regulated in a tighter range.

In the United States, regulations require that voltage be made available to consumers at 120 volts (V) plus or minus 5 percent, yielding a range of 126V to 114V. The key principle of CVR operation is that the standard voltage band between 114 and 126 volts can be compressed via voltage regulation equipment to the lower half (114–120) instead of the upper half (120–126), producing considerable energy savings at low cost and without harm to consumer appliances. Electrical equipment including air conditioning, refrigeration, appliances, and lighting is designed to operate most efficiently at 114V. Power delivered at higher voltage wastes energy. On feeder lines, voltage on the line gradually decreases as the number of customers (cumulative load) on the line increases, also known as *line drop*. Power is often transmitted at higher voltages to ensure that the voltage at the last house is at least 114V.

CVR was initially popular in the late 1970s and early 1980s as the benefits of this class of distribution equipment were realized. **Figure A-14** (taken from an EPRI Power Point presentation)¹²⁴ provides a simple schematic of a distribution line segment and the two types of

¹²⁴ Electric Power Research Institute, Robert Uluski Power Point presentation, "Volt/VAR Control and Optimization Concepts and Issues," 2011.

equipment (voltage regulator and capacitor bank) that would respond through preset controllers responding to measured line voltage and current.

Figure A-14: Early Distribution Voltage Control Configuration

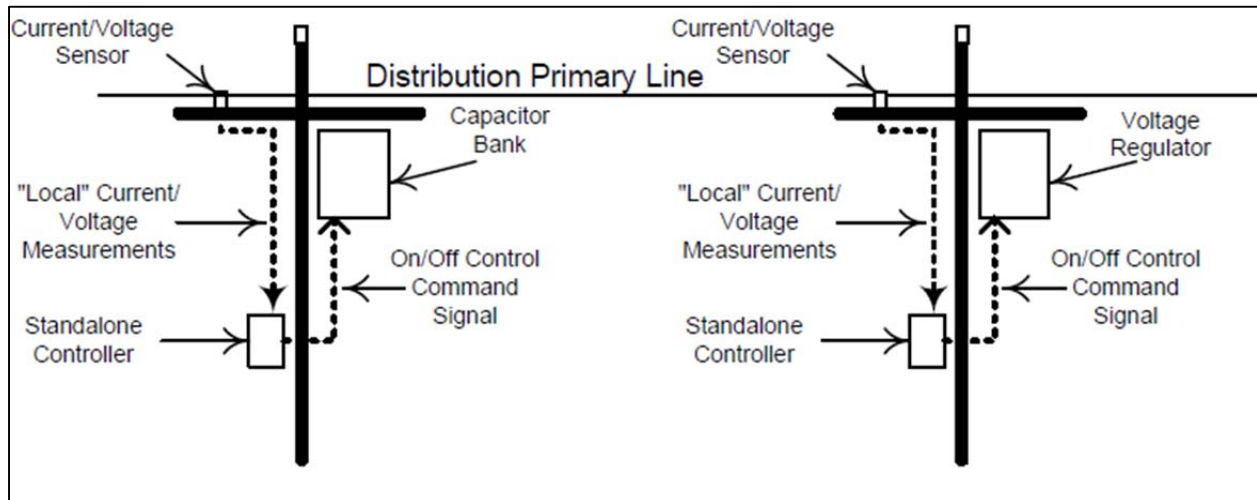

Source: EPRI, Uluski Power Point, 2011, page 13.

Unfortunately, the limitations of existing equipment at the time were encountered, and only limited penetration took place. The inability to monitor distribution line voltages in real time and to install and operate equipment that responded to dynamic conditions meant that simulations using stylized conditions were used to determine whether net benefits were expected. Of course, this resulted in performance that did not actually match expectations.

Modern CVR Capabilities

Advances in data acquisition capabilities, computer processing, and general sophistication about dynamic, real-time control have fundamentally changed the CVR picture of the 1970s. **Figure A-15** portrays a modern approach to CVR.

Figure A-15: Modern CVR/VVO Equipment Configuration

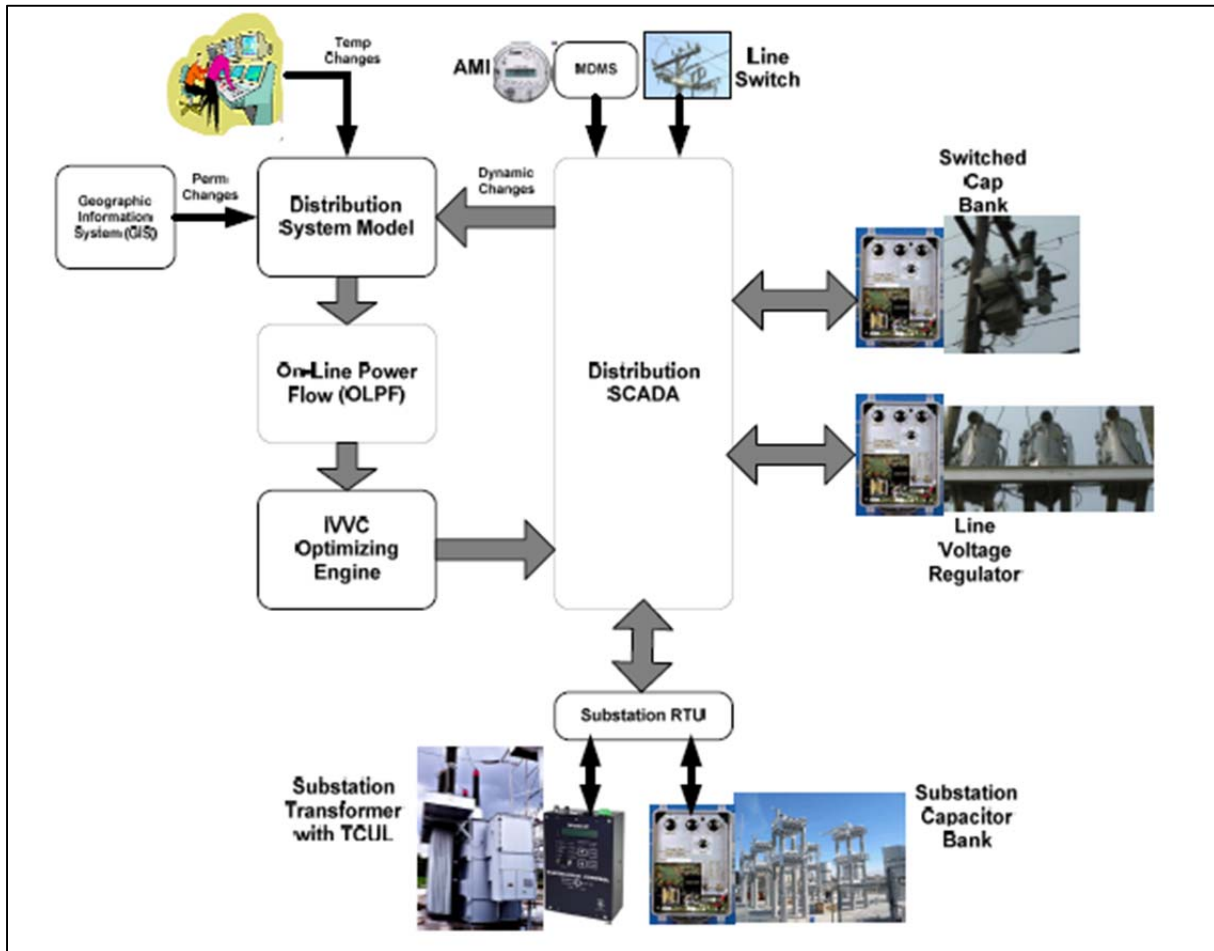

Source: EPRI, Uluski Power Point, 2011, page 33.

Several important changes from **Figure A-15** should be noted. First, a distribution supervisory control and data acquisition (SCADA) system collects real-time, short-interval data about the distribution system and forwards them to a distribution control center for use.¹²⁵ This means that control systems can be designed to address near-real-time conditions rather than stylized assumptions. Second, line voltage regulators and switched capacitor banks can respond to signals sent from the distribution control center rather than preset responses to readings from sensors wired to the controller. Third, distribution system models can be developed that integrate readings from many sensors and respond to trends in readings through time (and perhaps anticipated conditions for the near future) to generate signals to send to specific voltage regulators and capacitor banks. In effect, the condition of a large segment of the distribution system can be understood and signals sent in near-real time to optimize overall response to these conditions.

¹²⁵ *Supervisory control and data acquisition* is a control system architecture that uses computers, networked data communications, and graphical user interfaces for high-level process supervisory management. Typically used at the transmission level, it is being implemented for distribution systems.

Another issue of growing importance is the need to understand and control reactive power. In recent years, the types of equipment in customer premises have shifted toward items that consume or generate reactive power. Reactive power versus real power imbalances create power quality problems that were less important, and certainly less appreciated, in the historical period. Tighter control over reactive power can expand distribution system capacity to provide real power to end users, thus allowing greater use of existing distribution system capacity and thereby reducing or delaying equipment upgrades. Generally, CVR nomenclature has been replaced by volt-VAR optimization or sometimes CVR/VVO to reflect this interest in reactive power control.

Recent Utility Efforts

Several research/demonstration projects in California utility service areas were funded by DOE through the American Recovery and Reinvestment Act of 2009. Among them are CVR projects at Glendale Water and Power (GWP) and the Sacramento Municipal Utility District (SMUD) that were part of distribution system improvements. Palo Alto undertook a self-funded project specifically oriented to using CVR as an end-user energy savings project.

GWP undertook a pilot project in 2014-15 testing a software product patented by Dominion Voltage, Inc. The software uses AMI data to understand short-time-interval reductions in energy consumption by end users along with distribution line equipment measurements to determine total energy consumption reductions when various control strategies are implemented.¹²⁶ GWP was sufficiently convinced of the merits of CVR/VVO to undertake a full-scale implementation of these technologies on its system. GWP expects to deploy these technologies on 12 kilovolt (kV) feeders serving about one-third of its end-use customers by the end of 2017. Whether CVR/VVO is cost-effective for lower voltage feeders is still being assessed.¹²⁷

SMUD undertook a multifaceted distribution system research project as part of its DOE-funded Smart Sacramento® project. A volt/VAR optimization was part of this effort. In 2011, SMUD assessed how six feeders would respond to triggering of capacitor banks or one of several voltage settings. While SMUD obtained favorable results, there was some diversity among the circuits. SMUD intended to pursue a larger demonstration to refine the control strategy of the initial demonstration.¹²⁸

Palo Alto's CVR project was designed to examine the impacts of CVR on end-user energy consumption and to determine whether energy savings on the Palo Alto system matched those found on other utility distribution systems.¹²⁹ Given some differences of the Palo Alto system from those examined in previous studies, the expected impact of CVR was unclear. A simple engineering study manually assessed impacts on several feeders and confirmed that further reductions of distribution feeder voltage would induce end-user energy savings. According the

¹²⁶ City of Glendale, City Council Agenda, Agreement with Dominion Voltage, Inc., January 28, 2014.

¹²⁷ GWP representative, personal email, June 1, 2017.

¹²⁸ Energy Commission, *Sacramento Municipal Utility District SCADA Retrofit*, CEC-500-2014-078, September 2014, Appendix A.

¹²⁹ Plaxico, *Final Report: Evaluation of Conservation Voltage Reduction (CVR) Potential on City of Palo Alto Distribution System – Early Experimental Results*, 2013.

consultant study, Palo Alto's implementation of CVR on its system may depend partly upon whether there are any energy efficiency mandates for which CVR savings could contribute. Now that SB 350 energy efficiency targets can use CVR as a compliance mechanism, Palo Alto may be interested in pursuing CVR implementation.

PG&E¹³⁰ and SCE¹³¹ have pursued similar efforts under various smart grid initiatives that are heavily motivated by distributed energy resource (DER) issues. A principal issue for these IOUs has been development of improved abilities to predict where the existing distribution system can accept DER exports back into the distribution grid. Such exports create voltage and power quality issues affecting other end users on nearby segments of the distribution system, so direction from the CPUC to improve abilities to guide DER development has accelerated interest in modern CVR/VVO systems. Both SCE and PG&E pursued expansion of deployment efforts in recent general rate cases. A settlement agreement scaled back the expansion initially proposed by PG&E for at least the near term,¹³² and SCE's general rate case is under review.

130 PG&E, *2017 General Rate Case Prepared Testimony On Electric Distribution*, Exhibit (PG&E-4), pages 13-2, and 13-35 through 13-42, September 2015. See <http://pgera.azurewebsites.net/Regulation/ValidateDocAccess?docID=346362>.

131 SCE, 2018 *General Rate Case Testimony, Transmission & Distribution (T&D) Volume 11 – Grid Technology*, Exhibit SCE-02, Vol. 11, September 2016, pages 43-49. See [http://www3.sce.com/sscc/law/dis/dbattach5e.nsf/0/EE6E8ADC1D78B5CF882580210068F916/\\$FILE/SCE02V11.pdf](http://www3.sce.com/sscc/law/dis/dbattach5e.nsf/0/EE6E8ADC1D78B5CF882580210068F916/$FILE/SCE02V11.pdf).

132 Personal communication via email, Simon Baker, February 09, 2017.

APPENDIX B: Standards Non-utility Technical Assessment, Benchmarking, and Industrial and Agricultural

Standards Savings Included in the 2016 IEPR Update Managed Demand Forecast

The analyses described in the previous sections for Energy Commission and federal standards do not include savings for the impacts of standards adopted in 2015 and future standards up to 2019 that are already embedded in the Energy Commission's managed demand forecast last adopted in the *2016 IEPR Update* proceeding.

Methods

Staff reviewed the baseline demand forecast and the corresponding AEE projections (subtracting AEE from the baseline makes the managed demand forecast) from the *2016 IEPR Update* proceeding to determine the size of these impacts. The *2016 IEPR Update* cycle did not include new AEE analyses; rather, the AEE analyses developed in the *2015 IEPR* proceeding were simply scaled down by the first year of savings (added into the 2016 baseline forecast) and extrapolated one additional year into the future.¹³³ Table 12 of the *2015 California Energy Demand Update* report summarizes the vintages of Title 24, Title 20, and federal appliance efficiency standards that were assessed in that proceeding.¹³⁴ As the five AEE cases are defined to include some of the same vintages of prospective Title 24 building standards that have been reassessed and described earlier in this report, staff selected the mid baseline-mid low AEE case to obtain savings projections for just 2016 updates to Title 24 Building Standards, Title 20 Appliance Standards, and federal appliance standards enacted, but not yet effective. Further, since the CPUC is implementing revised programs to address AB 802 requirements to use existing baseline in most instances, staff believes that some portion of the Title 24 Building Standards savings reported in the *2016 IEPR Update* duplicates behavior, retrocommissioning, and operational efficiency (BROs) savings projections included in the staff companion paper describing utility target setting. Thus, of the selected AEE case, only appliance standards have clearly incremental savings that do not duplicate other assessments in the two utility potential studies¹³⁵ or the estimates of future standards described above in this paper.

133 California Energy Commission, *California Energy Demand Updated Forecast, 2017-2027*. Publication Number: CEC-200-2016-016-CMF, p. 47. See http://docketpublic.energy.ca.gov/PublicDocuments/16-IEPR-05/TN215745_20170202T125433_FINAL_California_Energy_Demand_Updated_Forecast_20172027.pdf.

134 California Energy Commission, *California Energy Demand 2016-2026, Revised Electricity Forecast*. Publication Number: CEC-200-2016-001-V1., p. 58. See http://docketpublic.energy.ca.gov/PublicDocuments/15-IEPR-03/TN207439_20160115T152221_California_Energy_Demand_20162026_Revised_Electricity_Forecast.pdf.

135 Giyenko, Elena, Cynthia Rogers, Michael Jaske, and Linda Schrupp. 2017. *Senate Bill 350 Energy Efficiency Target Setting for Utility Programs*. California Energy Commission. Publication Number: CEC-200-2017-005-SD.

Table B-1 reports the electricity and natural gas savings for recently adopted Title 20 and federal appliance standards affecting appliances purchased in 2015 and future years. In staff’s judgment, these are incremental savings to those reported earlier in the draft Commission report.

Table B-1: Electricity (GWh) and Natural Gas (MM Therms) Savings Projected From 2015 Onwards for Recently Adopted State and Federal Appliance Standards

Energy Unit	2015	2016	2017	2018	2019	2020	2021	2022	2023	2024	2025	2026	2027	2028	2029
Elec (GWh)	92	242	502	851	1200	1541	1864	2185	2505	2769	3029	3287	3506	3752	3990
NG (MM Therms)	3.9	11.4	15.5	18.8	22.1	25.5	29.1	32.6	36.2	40.4	44.7	49.0	53.3	57.6	61.8

Source: California Energy Commission staff, Efficiency Division.

Navigant and Whole-Building Data Access, Benchmarking, and Public Disclosure (AB 802)

Program Description: AB 802 provides data access to owners of buildings with no residential utility accounts and buildings with five or more utility accounts. Moreover, buildings with more than 50,000 square feet of gross floor area and no residential utility accounts, as well as buildings with more than 50,000 square feet of gross floor area and 17 or more residential utility accounts will be included in the benchmarking and public disclosure program.

Methods

It is not straightforward to estimate the savings attributable to the benchmarking program, as the proposed regulations do not require building owners to take any action to reduce energy use; the regulations would only require building owners to report energy performance information to the Energy Commission. However, the increased visibility of building energy performance the program provides may drive building owners and tenants to reduce energy use, either through making behavioral and operational changes or through making building improvements.

Staff used IOU electricity sales as a portion of statewide electricity sales¹³⁶ to estimate the portion of statewide energy consumption in commercial and residential buildings¹³⁷ that is in investor-owned utility territories, and then divided energy savings from investor-owned utility efficiency programs¹³⁸ by consumption to estimate percentage savings from current participation in efficiency programs.

Staff conjectured that participation in the benchmarking program might cause a doubling of the savings from current participation in investor-owned utility energy efficiency programs in those buildings subject to the statewide benchmarking and public disclosure program that are not

¹³⁶ *California Electric Utility Service Areas*, http://www.energy.ca.gov/maps/serviceareas/electric_service_areas.html, July 18, 2017

¹³⁷ <https://www.eia.gov/state/?sid=CA#tabs-2>, July 18, 2017

¹³⁸ <http://eestats.cpuc.ca.gov/Views/EEDataPortal.aspx>, July 18, 2017.

already subject to a local mandatory benchmarking and public disclosure ordinance (which have more stringent requirements than the proposed statewide program).¹³⁹

Staff therefore multiplied the estimated savings rate by the estimated consumption in buildings subject to the program but not to local programs, to calculate consumption expected to be avoided due to the statewide program.

Analysis

Overlap with the baseline demand forecast is unlikely, but overlap with ratepayer programs is possible. Because the Energy Commission’s draft regulations have not yet been adopted, energy savings from them are not incorporated into the baseline forecast. However, three cities in the state have local benchmarking programs, which might result in some savings being incorporated into the baseline. Ratepayer program savings may overlap with benchmarking energy savings because they are included in the measure list developed by Navigant as part of its IOU potential and goals study.¹⁴⁰ Incremental energy savings will need to account for these overlaps.

Savings Projections

Table B-2: Electricity (GWh) and Natural Gas (MM therms) Savings Projected From 2015 Through 2029 for Benchmarking and Disclosure

Energy Unit	2015	2016	2017	2018	2019	2020	2021	2022	2023	2024	2025	2026	2027	2028	2029
Elec (GWh)	0	0	0	64.7	109.8	111.6	113.7	115.7	117.9	120.0	122.3	124.5	126.8	129.1	131.5
NG (MM therms)	0.0	0.0	0.0	0.7	1.2	1.3	1.3	1.3	1.3	1.4	1.4	1.4	1.4	1.5	1.5

Source: California Energy Commission staff, Efficiency Division.

Agricultural and Industrial Sectors

The same methods are used to estimate potential energy savings from both industry and agriculture sectors. This approximates the potential energy savings that can be captured by programs not funded through utility rates. For this estimation, staff used the recently published Total Resource Cost-Reference (TRC-Ref) and Program Administrator Cost test-Aggressive (PAC-Aggressive) scenarios from the Navigant/CPUC 2018 Potential and Goals Study.¹⁴¹ The TRC test measures the net costs of a demand-side management program as a resource option based on the total costs of the program, including both the participants’ and the utility’s costs.¹⁴² The reference scenario uses business-as-usual incentive levels. Whereas the PAC is a test measures the net costs

¹⁴⁰ Navigant. *Energy Efficiency Potential and Goals Study for 2018 and Beyond*. June 2017.

¹⁴¹ Navigant, *Energy Efficiency Potential and Goals Study for 2018 and Beyond*, Prepared for the California Public Utilities Commission, June 2017.

¹⁴² California Public Utilities Commission, California Standard Practice Manual, page 18. 2001. Available at <http://www.cpuc.ca.gov/egyefficiency/>.

of a demand-side management program as a resource option based on the costs incurred by the program administrator, including incentive costs but excluding any net costs incurred by the participant.¹⁴³ In the aggressive scenario, the PAC has more incentives available and a greater marketing strength beyond what is modeled in the reference case.

¹⁴³ Ibid., page 23. 2001.

Methods

These tests represent a business-as-usual and the most aggressive energy efficiency market potential scenario, respectively. The energy savings estimated for the programs not funded through utility rates are the difference between the PAC-Aggressive and TRC-Ref cost-effectiveness test scenarios. Staff has chosen this increment of savings because it has already been determined to be cost-effective and, since it is an aggressive scenario reliant upon additional funding for incentives, it is possible that the funding and additional savings could come from programs not funded through utility rates. To estimate these energy savings, staff summed the measures from the Navigant industrial and agricultural market potential results viewer to get electricity and natural gas savings. The PAC-Aggressive electricity totals for both sectors are subtracted from the TRC-Ref electricity totals. The same process is done for natural gas totals for both sectors. The differences that result from this subtraction are the incremental energy savings. Table 1 shows the expected electricity and natural gas savings potential up to 2029 for the industrial sector, and Table 2 shows these savings for the agricultural sector. Staff may update this approach by replacing the TRC-Ref should it be different from the scenario CPUC adopts in September 2017. The TRC-Ref is used only because it projects the energy savings that staff assumes the CPUC will adopt as the investor-owned utility goals. If a substitution is necessary, then the potential energy savings will decrease because TRC-Ref has the lowest expected energy savings of the scenarios presented by the Navigant/CPUC study. To capture the incremental energy savings, the Energy Commission will need to collaborate with stakeholders in the industrial and agricultural sectors to determine which measures have the greatest potential for energy savings and the best means through which a program not funded through utility rates can implement those measures.

Savings Projections

Table B-3 Industrial Sector Incremental Savings: A- Electricity (GWh), B- Natural Gas (MM Therm)

1A

Industrial Sector Incremental Electricity (GWh) Savings	2015	2016	2017	2018	2019	2020	2021	2022	2023	2024	2025	2026	2027	2028	2029
TRC-Ref	136.26	285.98	398.53	509.56	590.55	594.17	589.13	554.66	503.19	457.88	429.15	412.03	405.93	411.60	427.82
PAC-Aggr	138.05	314.35	450.47	592.93	696.99	700.89	677.57	624.22	550.12	489.76	450.22	430.63	426.08	436.00	459.26
Incremental Savings (Differential)	1.79	28.37	51.94	83.37	106.43	106.73	88.44	69.57	46.94	31.88	21.07	18.60	20.15	24.40	31.44

Source: Navigant and California Energy Commission staff.

1B

Industrial Sector Incremental Natural Gas (MM Therm) Savings	2015	2016	2017	2018	2019	2020	2021	2022	2023	2024	2025	2026	2027	2028	2029
TRC-Ref	4.84	13.46	22.50	31.87	41.43	48.02	57.00	67.12	76.76	85.77	94.09	103.70	110.86	117.79	125.11
PAC-Aggr	5.06	14.56	24.75	35.78	47.22	55.88	65.25	78.90	94.02	107.39	119.08	129.57	135.34	141.76	147.69
Incremental Savings (Differential)	0.22	1.10	2.26	3.91	5.79	7.85	8.25	11.78	17.26	21.62	24.98	25.88	24.47	23.96	22.59

Source: Navigant and California Energy Commission staff.

Table B-4 Agriculture Sector Incremental Savings: A- Electricity (GWh), B- Natural Gas (MM Therm)

2A

Agricultural Sector Incremental Electricity (GWh) Savings	2015	2016	2017	2018	2019	2020	2021	2022	2023	2024	2025	2026	2027	2028	2029
TRC-Ref	27.69	68.03	109.61	148.75	196.93	238.22	274.36	303.28	325.48	341.48	353.16	362.43	371.37	382.03	395.28
PAC-Aggr	27.97	109.88	194.31	274.86	356.69	434.21	505.17	569.49	626.19	677.45	726.58	776.41	829.72	890.58	962.05
Incremental Savings (Differential)	0.27	41.85	84.71	126.11	159.76	195.99	230.82	266.21	300.72	335.97	373.42	413.98	458.35	508.55	566.77

Source: Navigant and California Energy Commission staff.

2B

Agricultural Sector Incremental Natural Gas (MM Therm) Savings	2015	2016	2017	2018	2019	2020	2021	2022	2023	2024	2025	2026	2027	2028	2029
TRC-Ref	0.26	1.13	1.91	2.91	3.93	4.97	6.04	7.10	8.29	9.52	10.78	12.07	13.40	14.77	16.19
PAC-Aggr	0.29	1.61	2.87	4.37	5.90	7.47	9.07	10.68	12.47	14.31	16.22	18.20	20.27	22.45	24.78
Incremental Savings (Differential)	0.03	0.49	0.96	1.46	1.97	2.50	3.03	3.58	4.17	4.79	5.43	6.12	6.87	7.68	8.59

Source: Navigant and California Energy Commission staff, Efficiency Division.



SB 350 ENERGY SAVINGS POTENTIAL DEVELOPMENT PLAN

DRAFT

Prepared for:
California Energy Commission

Prepared by:
NORESCO

Supported by:
TRC Energy Services
Center for Sustainable Energy

Prepared on:
July 18, 2017

Contract Reference:
CEC 400-15-012
Work Authorization 2

ATTACHMENT A: NON-UTILITY PROGRAM TECHNICAL ASSESSMENT

BUILDING STANDARDS – TITLE 24 FROM 2019¹⁴⁴ THROUGH 2029

Program Description: Title 24 Part 6 (Title 24) is the California Building Energy Efficiency Standards, and covers regulated energy uses in buildings. Title 24 contains the regulations that govern the construction of buildings in California. The code is on a three year cycle, with the most recent implemented version being 2016, effective January 1, 2017. Future versions relevant to this analysis will be 2019, 2022, 2025, 2028, and possibly 2031 (as it relates to early adoption, for example).

Buildings Affected:

- Residential and nonresidential buildings, excluding certain building types and end uses (hospitals, industrial buildings, and non-covered processes, including refrigerated warehouse loads and data center uninterruptible power supply (UPS) power).
- Applies to all cases in which an application for a building permit or renewal of existing permit is filed (new construction, additions, or alterations). Requirements are different for new construction than for additions or alterations to existing buildings.

Methods

Relevant Measures:

- The code covers a wide range of building systems, including: envelope, space conditioning systems, water heating systems, lighting, and certain covered processes.
- Requirements are different for new construction than for additions, alteration or repairs to existing buildings; measure packages will be altered accordingly.
- For their Potential and Goals Study analyses, Navigant has analyzed a number of measures associated with versions of Title 24 spanning 2005 to 2019 (new construction). Measures have been analyzed both individually and as bundles.
- In general, Title 24 measures can be categorized as follows:
 - *Mandatory measures:* always required by code for applicable permit scope (e.g., new construction, alteration, and addition)
 - *Prescriptive measures:* required when using a prescriptive compliance approach, but may be “traded off” for other specified efficiency features through alternative prescriptive pathways. The prescriptive package is the basis for the standard design, which establishes the reference baseline that a proposed building is compared against. Prescriptive measures are used to define performance for savings projections
 - *Compliance options:* building components or technologies which can be used in a performance compliance model, but are not required. This list established the range of viable design options for projects utilizing the alternative compliance method (ACM). Because these measures are not required, they do not factor into savings projections.
 - *Acceptance tests:* may improve compliance rates, and their application may be considered an efficiency measure.

¹⁴⁴ The starting year of the analysis depends on Navigant’s 2018 Potential and Goals study. Currently, Navigant results are only available through Title 24 2016. However, Navigant is analyzing proposed Title 24 2019 for new construction as part of the 2018 Potential and Goals study.

Data Sources:

Projected IOU savings for 2016 Title 24 will be extracted from the Results Viewer¹⁴⁵ for Navigant's 2015 Potential and Goals Study.

Projected IOU savings for 2019 Title 24 for new construction will be included in Navigant's 2018 Potential and Goals Study.¹⁴⁶ Navigant will not include estimates of 2022 Title 24 in the 2018 Potential and Goals Study, although preliminary estimates were considered.

Updated POU targets for 2018-2023 and new POU targets for 2024-2027 will be extracted from the 2017 POU Energy Efficiency Report.¹⁴⁷

Some recent technical feasibility studies could shed light on the long-term limit for C&S savings, including Arup's 'The Technical Feasibility of Zero Net Energy in California' from 2012¹⁴⁸, and ASHRAE's 'Final Report ASHRAE 1651-RP Development of Maximum Technically Achievable Energy Targets for Commercial Buildings Ultra-Low Energy Use Building Set' from 2015.¹⁴⁹

The 2016 Impact Analysis Report¹⁵⁰ will be used as a reference point for comparison with Navigant's 2018 PG results (as they become available).

The 2015 AAEE analysis¹⁵¹ provides a reference for the scale of POU Building Standards savings compared to that for IOUs.

Methodology:

The NORESKO Team will leverage available data and methodology to the extent possible, most specifically from Navigant's Potential and Goals Studies. As it becomes available, Navigant's most recent data, which is expected to include updated estimates for savings associated with 2016 Title 24, as well as new construction estimates for 2019 Title 24, will be collected and incorporated. Accordingly, the NORESKO Team will be responsible for estimating savings associated with additions and alterations for version 2019 and for new construction, additions, and alterations for version 2022 and beyond. From a methodology standpoint, the research team will work with Navigant to ensure the analysis approach is consistent with that which Navigant has applied and refined through numerous Potential and Goals efforts. Details of Navigant's analysis as they may relate to this study include:

- For their Potential and Goals analysis, Navigant has used the Integrated Standards Savings Model (ISSM) developed by CADMUS and DNV GL to estimate net C&S savings attributable to the IOU C&S Program efforts.¹⁵²
- The 2015 Potential and Goals Study include savings estimates for 2016 Title 24; estimates were derived via bundled measures (single family new construction, multi-family new construction, non-residential new construction, and other).

¹⁴⁵ <http://www.cpuc.ca.gov/General.aspx?id=6442452620>

¹⁴⁶ <http://www.cpuc.ca.gov/General.aspx?id=6442452619>

¹⁴⁷ "Energy Efficiency in California's Public Power Sector: 11th Edition," 2017.

¹⁴⁸ Arup. "The Technical Feasibility of Zero Net Energy Buildings in California," 2012.

¹⁴⁹ Glazer, Jason. "Final Report ASHRAE 1651-RP Development of Maximum Technically Achievable Energy Targets for Commercial Buildings Ultra-Low Energy Use Building Set," 2015.

¹⁵⁰ NORESKO; Nittler, Ken. "Impact Analysis: 2016 Update to the California Energy Efficiency Standards for Residential and Nonresidential Buildings," 2015.

¹⁵¹ http://www.energy.ca.gov/2015_energy_policy/documents/2015-12-17_additional_aee.php

¹⁵² Cadmus, Energy Services Division and DNV GL. Integrated Standards Savings Model (ISSM).

- For the 2018 Potential and Goals Study, Navigant’s codes and standards measure list indicates that discrete measures were analyzed for versions of Title 24 through 2016 (although only a handful of discrete non-residential addition and alteration measures were analyzed for 2016, whereas a much more comprehensive set of discrete measures was analyzed for 2013), but that 2019 Title 24 for new construction was analyzed exclusively using bundled measures based on program-level savings estimates.

For building additions and alterations, as opposed to new construction, any measure-based savings projections will need to be based on existing condition estimates by building type and climate region. Savings estimates for additions and alterations will need to consider which building type(s) are affected, what triggers to-code updates and what frequency of to-code updates is expected. This is consistent with Navigant’s Potential and Goals analysis methodology as it relates to existing building additions and alterations.

It is anticipated that the overall program scope of Title 24 will change over time; to be successful, any approach to projecting savings potential of future program iterations will have to capture this expected progression. For example, expansions or anticipated expansions to Title 24 that have been incorporated or considered in recent years include:

- New covered processes have been added (commercial kitchens, laboratory exhausts, parking garage exhaust, data centers)
- Increased acceptance testing and fault detection and diagnostics have been employed as steps along a path to verify as-designed savings
- Hospitals have been considered for inclusion

Approach:

The research team extracted 2016 Title 24 electricity and natural gas savings projections for California new construction from the Results Viewer for Navigant’s 2015 Potential and Goals Study. The Potential and Goals study only captures net attributable savings to IOU C&S Program efforts.

According to the 2016 Impact Analysis Report, 2016 Title 24 is on the order of 10 percent more stringent than 2013 Title 24. Assuming that Navigant’s new construction savings estimates correspond to roughly a 10 percent improvement in the Standard, the research team made the following assumptions to project new construction savings for future code iterations:

2019 Title 24 will be 10 percent more stringent than 2016 Title 24, resulting in equivalent year-over-year savings starting in year 2020

Improvements to Title 24 will slow starting with 2022 Title 24, due to diminishing returns and reduction in available energy reductions associated with increasing the stringency of requirements for currently regulated loads. As Title 24 continues to improve, the gap between best-in-class performance and the minimum requirements of Title 24 is shrinking. The assumption is that Title 24 progression for new construction improved efficiency will slow to 5 percent for 2022 Title 24 and 2025 Title 24, resulting in year-over-year savings that are 50 percent less than what Navigant is projecting for 2016 Title 24

As savings opportunities shrink for currently regulated loads, the research team expects the scope of Title 24 to expand to include previously unregulated loads (for example, hospital loads and plug loads). With an expanded scope, the expectation is that Title 24 progression will increase back to 10 percent improvement for the 2028 iteration, increasing year-over-year savings projections back to what Navigant is projecting for 2016 Title 24

For each iteration of Title 24, the effective date is the calendar year following the adoption year (for example, 2019 (additions and alterations) Title 24 savings begin to be realized in 2020).

The 2016 Impact Analysis Report indicates that the magnitude of savings expected due to additions and alterations is roughly equivalent to that which is expected for new construction. Accordingly, the research team made the following assumptions to project addition and alteration savings:

2016 Title 24 year-over-year alteration savings are equivalent to what Navigant is projecting for new construction

Whereas new construction savings are expected to decrease for future iterations due to diminishing returns associated with currently regulated loads, addition and alteration savings are expected to increase. The NORESO team anticipates that future Title 24 will increase emphasis on realizing addition and alteration savings because the opportunity is so great due to the size of the current building stock compared to the small percentage of new construction that occurs each year. Accordingly, year-over-year savings due to additions and alterations are expected to remain steady through 2019 Title 24, increase by 50 percent through 2025 Title 24, and increase by an additional 50 percent for 2028 Title 24 (such that the year-over-year addition and alteration savings realized by 2028 Title 24 will be double those realized by 2016 Title 24).

POU-claimed Title 24 savings were estimated by scaling estimates for IOU-claimed savings according to the ratio of POU to IOU Building Standards savings projected by the 2015 AAEE¹⁵³

Savings Projections:

Table 1: Electricity (GWh) and Natural Gas (MM therms) Savings Projected From 2015 Through 2029 for Building Energy Efficiency Standards

Energy Unit	2015	2016	2017	2018	2019	2020	2021	2022	2023	2024	2025	2026	2027	2028	2029
Elec (GWh)	0	0	0	0	0	36	153	277	439	684	935	1223	1590	1961	2384
NG (MM therms)	0	0	0	0	0	1.0	3.9	7.0	11.3	17.4	23.8	31.3	40.6	50.2	61.4

Source: California Energy Commission staff.

¹⁵³ Note that the 2015 AAEE contains savings projections only for SMUD and LADWP amongst the POU. To scale up to total POU savings from SMUD and LADWP savings, the research team applied the assumption that SMUD and LADWP make up 74.2% of POU savings, which aligns with the assumption made by the Energy Commission as part of the Framework analysis.

APPLIANCE REGULATIONS – TITLE 20 FROM 2018¹⁵⁴ THROUGH 2029

Program Description: Title 20, known as the California Appliance Efficiency Regulations, contains the performance standard that establishes the minimum performance for listed appliances to be sold and installed in California. The code includes performance requirements for electric and natural gas appliances, and covers water usage. The California Energy Commission, which regulates Title 20, is not required to update the code on any specific interval; individual standards are updated upon receiving sufficient data to support new or amended efficiency standards or test procedures for individual appliances. The scope of Title 20 is limited by the U.S. Department of Energy (DOE) Federal Appliance Standards under the National Appliance Energy Conservation Act (NAECA) of 1987, which states that no individual state can adopt appliance standards for products regulated at the national level, except where the federal appliance law makes exceptions due to unique state or local interests. Therefore, Title 20 can generally only regulate appliances outside the scope of DOE appliance standards.

Buildings Affected: This affects all building types and extends beyond the building into personal electronics and other devices that are not hard wired into a structure. These standards are implemented at the manufacturing stage and impact any market sector where the products are installed or used. Building markets affected include:

- Residential and nonresidential
- New construction and additions, alterations, and repairs. New equipment in an addition, alteration or repair will be affected.
- Private and public buildings

Methods

Relevant Measures:

Title 20 standards apply to individual measures for most appliances, equipment, luminaires, and miscellaneous load products, such as televisions, used in all types of buildings. The code covers a wide range of consumer and commercial products, from battery chargers to industrial appliances. This study will analyze and estimate impacts for future Title 20 measures based on available data, limitations imposed by federal preemption, and accounting for overlap with measures included in the 2015 and 2018 Potential and Goals Studies.

The analysis will investigate possible new measures which have not been previously regulated, as well as updates to existing standards where technological advancements, reduced costs, or improved test standards make it feasible to increase the stringency of a standard. For example, there are potential opportunities for indoor luminaire standards for products that are not currently regulated under Title 20 or federal standards. Additionally, technological advancements in computers and computer systems may allow for an update between now and 2029 to the standards regulating these products, which the Energy Commission recently adopted in 2016.

Additionally, there are measures worth evaluating for standard development that are either emerging technologies or do not have a clear measure path at this time. These include phantom load sources in commercial construction (light switches, BAS control devices, monitoring panels for building systems, etc.). The large scale adoption of Internet of Things (IoT) and computerized building systems and controls has a significant downside; there are many devices in the building that are providing status or monitoring information and enabling wired or wireless communication in the building systems that often have a continuous load on the electrical system, regardless of equipment operation status.

Data Sources:

¹⁵⁴ The starting year of the analysis depends on Navigant's 2018 Potential and Goals study. The starting year is 2015, but no savings is anticipated in the middle wedge until 2017 and increasing as the Navigant PG model tapers off to 2024.

This study will use projected savings from individual measures that Navigant has not currently included in the 2018 Potential and Goals calculations. For measures that are not currently in Title 20 planning (and in the future measures list) the impact of various measures may be difficult to collect. Data sources to identify potential measures and energy saving estimates include:

- The Appliance Standards Awareness Project (ASAP) report “Next Generation Standards: How the National Energy Efficiency Standards Program Can Continue to Drive Energy, Economic, and Environmental Benefits.”¹⁵⁵
- ENERGY STAR® and other voluntary standard and specification product databases.
- California Investor Owned Utility (IOU) and other utility-sponsored incentive programs for specific appliance installations.
- Additional information for measures not covered in the bottom wedge may be available from Navigant or through simplified market review of the possible measures.
- Discussions with IOU Codes and Standards program staff and their consultants working on Title 20 efforts.
- Shipment or installation data from manufacturing industry representatives, such as NEMA, or U.S. imports data.
- U.S. DOE Test Standards, which provide the opportunity to establish an appliance performance standard.

Methodology:

The NORESKO Team will use available research to the extent it is available to provide reasonable energy savings estimates for future Title 20 measures. Research will be based on the data sources listed above, and applicable data from 2018 Potential and Goals documents.

- This analysis establishes a high-level, top-down savings estimate for future Title 20 updates. The NORESKO team assumed that annual incremental savings decrease over time as appliance standards become increasingly more stringent, reducing available energy performance improvements, and opportunities for new standards decrease. The analysis used the following assumptions:
 - Savings returns for currently regulated appliances decrease as standards become more efficient.
 - Navigant 2018 PG Title 20 incremental savings end in 2024 (no new standards considered beyond 2024, although savings due to standards implemented through 2024 persist into later years). Accordingly, savings attributed to standards projected to be implemented after 2024 would fall into the middle wedge.
 - Navigant’s 2018 PG analysis considers interactive effects for electricity and natural gas due to adopted measures. In their analysis, natural gas savings are negative in some years due to an increase in heating load as certain electrical loads in a building decrease due to Title 20 standards in those years. A reduction in cooling is also included in the interactive effects for these measures, when applicable. The natural gas losses are partially mitigated in the future as the Title 20 measures which cause the increased heating load depreciate in efficiency over time. There is a stabilization of natural gas savings moving forward due to a combination of electrical and natural gas savings opportunities in Title 20 appliances, and the general move toward electrification in the future.
 - New Title 20 savings opportunities will occur at the same rate as historical trends, but with reduced savings opportunities due to diminishing returns¹⁵⁶.

¹⁵⁵ deLaski, Andrew, et. al., “Next Generation Standards: How the National Energy Efficiency Standards Program Can Continue to Drive Energy, Economic, and Environmental Benefits”, ASAP, Washington DC, 2016. Available online.

¹⁵⁶ There is no statutorily required schedule or review of Title 20 standards; therefore, the NORESKO team used historical trends to estimate the rate of adopted standards.

Savings Projections

Table 2: Electricity (GWh) and Natural Gas (MM therms) Savings Projected From 2015 Through 2029 for Appliance Efficiency Regulations

Energy Unit	2015	2016	2017	2018	2019	2020	2021	2022	2023	2024	2025	2026	2027	2028	2029
Elec (GWh)	0	0	19	236	443	674	1002	1377	1820	2267	2767	3247	3707	4147	4567
NG (MM therms)	0.0	0.0	0.0	0.0	0.0	0.0	0.3	0.9	1.6	2.8	5.8	8.7	11.5	14.2	16.8

Source: California Energy Commission staff.

FEDERAL APPLIANCE STANDARDS FROM 2019¹⁵⁷ THROUGH 2029

Program Description: Under U.S. legislation, starting with the Energy Policy and Conservation Act (EPCA) in 1975 for consumer products and the National Appliance Energy Conservation Act of 1987 (NAECA) for residential appliances, the Department of Energy (DOE) is directed to develop and update energy efficiency standards and test procedures for certain appliances, equipment, lighting, and consumer products. The federal standards set the minimum requirement for products. The DOE is required by Congressional legislation to review each standard at least once every six years for potential revisions, and to set appliance efficiency standards at levels that achieve the maximum improvement in energy efficiency that is technologically feasible and economically justified¹⁵⁸. DOE updates the standards on a rolling basis, as individual measures are proposed for adoption. The national standards program currently covers the energy requirements of 60 categories of products.

Buildings Affected: Federal appliance standards are not unique or specific to any particular building type. These standards are implemented at the manufacturing stage and impact any market sector where the products are installed or used. Building markets affected include:

- Residential and nonresidential
- New construction and additions, alterations, and repairs. New equipment in an addition, alteration or repair will be affected.
- Private and public buildings

Methods

Relevant Measures:

Federal appliance standards apply to individual measures for most appliances, equipment, and lighting products used in most building types, and some consumer products not designated to any particular building sector, such as external power supplies and battery chargers. Potential appliances and products for this analysis fall into the following two categories:

Those that currently have a federal appliance standard in place. These appliance standards could be updated during DOE's mandatory review process if there are technology improvements, cost reductions, or other updates that allow a more stringent standard to be adopted.

¹⁵⁷ The starting year of the analysis depends on Navigant's 2018 Potential and Goals study.

¹⁵⁸ <https://energy.gov/savings/federal-appliance-standards>

Those that are not currently regulated under DOE appliance standards either because they are outside the scope of current standards or are new technologies.

Current federal standards cover, but are not limited to, the following technology categories:

Residential, nonresidential, and industrial heating and air conditioning systems

Residential and nonresidential water heating

Consumer Electronics, including:

Battery chargers

Microwave ovens

- Residential and/or nonresidential appliances, including:

Clothes washer and dryer

Dishwasher

Ceiling fans

Refrigerators and freezers

Lamps and ballasts used in residential and nonresidential installations (to a limited scope)

Additional measures that will be investigated for energy savings potential include:

- Establishing or improving test standards that will allow for adoption or improvement of an appliance standard.
- Lighting products and other appliances not currently covered in federal standards, such as set-top boxes and commercial dryers.
- Emerging technologies.
- Voluntary standards, specifications, and test procedures that can inform mandatory standards, such as ENERGY STAR, WaterSense, NEMA, and AHRI.
- Connected products through the Internet of Things and building networks.
- Improved compliance and enforcement of standards.

Federal appliance standards also cover water conservation measures, including those for faucets, showerheads, and water closets. Water conservation measures that also produce energy savings will be considered and, due to DOE's final rule in 2010, local governments can set more stringent standards for certain water-consuming appliances if a standard has not been amended after five years¹⁵⁹.

For each expected new or updated standard, the baseline will be the energy performance of the previous appliance standard or, for new appliance standards, the market standard performance. The DOE is required to review appliance standards at least once every six years from the prior adoption date, but each standard is on its own unique schedule; that is, standards are not all updated simultaneously.

Data Sources:

This analysis will rely on several data sources to identify future updates to current standards and potential new standards. A primary data source to identify known and adopted standards will be the 2018 Navigant Potential and Goals (PG) study.

Additionally, the following data sources will be used to identify current standards, potential future updates to current standards, and potential new standards for appliances not yet regulated by DOE:

Data Source	Expected Use	
U.S. DOE Building Technology Office (BTO) Multi-Year Program Plan: Fiscal Years 2016-2020	High level savings goals due to federal appliance standards. The BTO set a goal of 20% reduction in energy consumption by 2025 due to appliance standards.	
2003 and 2012 Commercial	To estimate nonresidential building energy use	

¹⁵⁹ 10 C.F.R § 430 (2010)

Building Energy Consumption Survey (CBECS) from U.S. Energy Information Administration ¹⁶⁰	intensity (EUI) in kWh/ft ² and therms/ft ² . This will be used to identify the trends in energy use from 2003 to 2012 to estimate 2010 EUIs. The actual EUIs from CBECS will not be used because California building energy use is likely different than the national average; the trend data will be used.	
2006 California Commercial End Use Survey (CEUS) ¹⁶¹	To estimate California nonresidential building energy use intensity (EUI) in kWh/ft ² and therms/ft ² . This will be used to estimate the 2010 EUIs in California, adjusted from 2006 using the trends in consumption determined from the national CBECS data.	
2009 California Residential Appliance Saturation Survey (RASS)	To estimate residential building energy use intensity (EUI) in kWh/ft ² and therms/ft ² . This will be used to estimate the savings associated with the goals set in the BTO Multi-Year Plan to reduce energy consumption per square foot by 20%.	
CEC Demand Forecast office residential and nonresidential building stock and new construction forecast	Estimate the future square footage affected by appliance standards.	

Methodology:

To estimate energy savings potential for future federal appliance standards, both new standards and updates to current standards, the NORESO team will make high level estimates based on DOE Building Technology Office (BTO) goals, and then refine savings estimates based on measure-by-measure data or estimates based on available sources. The analysis will use the following information, or make estimates based on professional judgment and available data:

- DOE energy reduction goals
- List of measures or groups of measures expected to be adopted
- Building sector, as applicable, for each expected measure
- Timeline of expected measure adoption/effective date and updates (six year cycle per standard)
- Unit energy savings estimates
- California sales estimates (or scaled by population)
- Compliance rate for each standard
- Normal market adoption (NOMAD) at time standard goes into effect

¹⁶⁰ <https://www.eia.gov/consumption/commercial/>

¹⁶¹ <http://www.energy.ca.gov/ceus/>

- This analysis establishes a high-level savings estimate for future updates to current federal appliance standards and future new appliance standards. The NORESKO team based estimates on goals set by the Department of Energy’s (DOE) Building Technology Office (BTO) to reduce building energy consumption by 30 percent compared to 2010 energy consumption through 2029¹⁶². To support this, the BTO set a goal to reduce energy use per square foot in buildings by 20 percent by 2025 through appliance and equipment standards. The NORESKO team estimated California-specific savings by establishing 2010 building energy use intensities and reducing energy consumption per building by 20 percent by 2025. The analysis applied the savings to new construction and expected alteration and retrofit square footage in California through 2029. The resulting savings impact both electric and natural gas usage. The following approach established the estimates:
 - Estimated 2010 California building energy use intensity (EUI) for nonresidential and residential buildings in California using CBECS, CEUS, and RASS data. 2010 EUIs are needed to align with the BTO reduction goals. The NORESKO team used the 2003 and 2012 national CBECS data to identify trends in nonresidential building consumption. The team then used the trending to adjust 2006 California CEUS data to estimate nonresidential building kWh and therms consumption per square foot in 2010. The CBECS and CEUS data do not include identical building types; therefore, the most relevant CBECS building type was applied to the CEUS data. For example, CBECS does not differentiate between small and large office buildings like CEUS does, so the office building trend data was used for both. 2009 RASS data was collected in 2009 through early 2010; therefore, the 2009 RASS data was used for residential kWh and therms use per square foot¹⁶³.
 - Estimated energy reduction from 2010 to 2025 based on the BTO goal of 20 percent reduction by 2025. 20 percent is achieved by estimating that appliance standards will reduce energy consumption by two to four percent every two years until 2024¹⁶⁴.
 - Identified affected square footage using Energy Commission Demand Forecast Office new construction and building stock estimates. All new construction will be impacted by appliance standards. Existing buildings will be impacted if replacing equipment or performing a retrofit. The affected existing building square footage was estimated assuming an effective useful life (EUL) of 15 years; meaning a replacement or retrofit will occur every 15 years. The analysis team divided existing building square footage for each year by 15 to estimate impacted square footage.
 - Estimated energy savings by applying the reduced EUI per year to the affected new construction and existing building square footage per year. The analysis reduced the 2010 EUIs by two to four percent every two years and the savings are applied to the applicable square footage from 2015 through 2029. For the analysis, the team assumed that savings to meet the goal will begin to be realized at year 2011 and must commence by 2024 to achieve 20 percent by 2025; however, the NORESKO team only includes savings starting in 2015 under the assumption that prior savings are captured in previous PG and AAEE studies. This requires 1.5 percent savings per year, or 3 percent every two years. The analysis assumes annual savings will increase in 2016 due to activity from the Obama administration, then ramp up again in the years preceding the 2025 goal. The analysis does not estimate additional energy reduction from appliance standards beyond 2025; therefore, the energy savings per year estimated for 2024 are projected to continue each year through 2029.
- There are considerations and limitations for the estimates, including:
 - The savings estimates are based on BTO goals without identifying appliances and equipment standards that will contribute to the savings.

¹⁶² U.S. DOE Building Technology Office Multi-Year Program Plan: Fiscal Years 2016-2020.
<https://energy.gov/eere/buildings/downloads/multi-year-program-plan>

¹⁶³ The CEC funded the study and began administering the survey in 2009; therefore it is called the 2009 RASS study.

¹⁶⁴ Reductions only occur through 2024 because the BTO goal is to achieve 20 percent reduction by 2025.

- The 2010 EUIs are best estimates based on available survey data from years before and after 2010.

Savings Projections

Table 3: Electricity (GWh) and Natural Gas (MM therms) Savings Projected From 2015 Through 2029 for Federal Appliance Standards

Energy Unit	2015	2016	2017	2018	2019	2020	2021	2022	2023	2024	2025	2026	2027	2028	2029
Elec (GWh)	71	192	316	565	816	1192	1571	2015	2531	3052	3578	4107	4641	5182	5729
NG (MM therms)	2.2	3.5	5.4	8.6	11.7	16.0	20.4	27.0	33.7	41.9	51.1	60.2	69.4	78.5	87.8

Source: California Energy Commission staff.

LOCAL GOVERNMENT ORDINANCES FROM 2016¹⁶⁵ THROUGH 2029

Program Description: Jurisdictions within California develop and adopt local ordinances requiring that select or all new construction and/or additions, alterations, and repairs projects improve energy efficiency beyond Title 24, Part 6. Jurisdictions often adopt these ordinances when a new version of Title 24 Building Energy Efficiency Standards goes into effect. The main drivers for these ordinances are for cities or counties to achieve goals set in their Climate Action Plans, such as greenhouse gas emissions targets, carbon neutrality, and reduced energy consumption.

Buildings Affected: The following building types, construction, and market sectors may be included under a local ordinance. Each jurisdiction can determine which are appropriate and feasible to include for their goals. Local ordinances may include:

- Residential and nonresidential, excluding certain building types if exempt in the ordinance (e.g. hospitals, industrial, etc.).
- New construction and additions, alterations, and repairs. Requirements for new construction may differ from those for additions, alterations, or repairs to existing buildings.
- Private and public buildings

Methods

Relevant Measures:

Local government ordinances can either require specific measure installation, such as a cool roof, or whole building performance, such as a percent improvement over Title 24 baseline. The baseline for energy savings is the current Title 24 code at the time the ordinance goes into effect. As California has progressively moved towards zero net energy (ZNE) for all new construction, jurisdictions have adopted whole building performance requirements more often than individual measure requirements.

¹⁶⁵ Navigant's 2018 Potential and Goals study does not include this program.

Jurisdictions can develop their own local ordinance, or can conduct an analysis to adopt Title 24, Part 11 California Green Building Standards Code (CALGreen), which includes voluntary green building standards that become mandatory where adopted.¹⁶⁶ Whether adopting a CALGreen tier or developing a specific local ordinance, jurisdictions must submit an analysis to the Energy Commission showing the ordinance is cost effective and will not result in more energy use than the Title 24, Part 6 baseline. Within 2016 CALGreen, there are residential and nonresidential energy efficiency in Appendices A4 and A5 that list the tiers of whole building performance for residential and nonresidential new construction. The whole building tiers include:

- Residential:
 - Prerequisite: Quality Insulation Installation (QII)
 - Tier 1: 15 percent compliance margin or Energy Budget that is no more than 85 percent of the Standard Design Energy Budget.
 - Tier 2: 30 percent compliance margin or Energy Budget that is no more than 70 percent of Standard Design Energy Budget.
 - Zero Net Energy design: Tier 1 (CZ 6 and 7 for single family, CZ 3, 5, 6, and 7 low-rise multifamily) or Tier 2 (CZ 1-5, 9-16 for single family, CZ 1, 2, 4, and 8-16 low-rise multifamily) + on-site renewable energy generation to achieve an Energy Design Rating (EDR) zero as calculated by compliance software.
- Nonresidential:
 - Prerequisite:
 - Outdoor lighting 90 percent or less of allowed outdoor lighting power,
 - Restaurants 8,000 square feet or greater must install solar thermal with a solar savings fraction of 0.15
 - Tier 1: 5 percent (projects with either lighting or mechanical) or 10 percent (projects with lighting and mechanical) reduction in Energy Budget compared to Standard Design Energy Budget.
 - Tier 2: 10 percent (projects with either lighting or mechanical) or 15 percent (projects with lighting and mechanical) reduction in Energy Budget compared to Standard Design Energy Budget.
 - On-site Renewable Energy:
 - Includes solar, wind, geothermal, low-impact hydro, biomass, and bio-gas
 - 1 percent of electric power or 1 kW, in addition to the electrical demand required to meet 1 percent of natural gas and propane, OR
 - Green power that provides a minimum of 50 percent electric from renewable sources

To conduct the cost effectiveness study, jurisdictions follow the California Energy Commission time dependent valuation (TDV)-based Life Cycle Cost Analysis methodology and only include measures that are regulated under Title 24 to achieve whole building performance (i.e. excluding equipment regulated by federal or Title 20 appliance standards). However, under the whole building performance approach, projects are not limited to installing measures that are regulated under Title 24 to meet the ordinance. It is expected that many projects will meet the requirements through the following improvements:

- Quality Insulation Installation
- Efficient heating, ventilation, and air-conditioning equipment and distribution system
- Efficient domestic hot water systems
- Home Energy Rating System (HERS) verifications
- Daylighting, high efficacy lighting, and controls in nonresidential buildings

Data Sources:

The following data sources are known and will be used in this analysis:

¹⁶⁶ <http://www.bsc.ca.gov/Home/CALGreen.aspx>

Data Source	Expected Use	
Energy Commission website list of adopted and pending local energy ordinances by jurisdiction ¹⁶⁷	Identify jurisdictions that will or intend to adopt ordinances, and identify the required efficiency level	
Energy Commission forecasted new construction square footage	Determine portion of total new construction that will be impacted by local ordinances	
Energy Commission existing building stock data	Determine portion of existing building stock that will be impacted by local ordinances	
Permits issued in local jurisdictions that have adopted or intend to adopt a local ordinance	Determine portion of total new construction, additions, and alterations that will be impacted by local ordinances	

Methodology:

To estimate potential electricity and natural gas savings for local government ordinances, the analysis team will estimate the portion of California new construction that will be impacted by a Local Government Ordinance and the estimated energy savings for a Local Government Ordinance in each jurisdiction. For the analysis, the team assumes that each Local Government Ordinance will adopt performance requirements in line with the expected improvement for the next version of Title 24. That is, a local ordinance adopted for 2019 Title 24 will be in line with the expected efficiency improvements for 2022 Title 24. The savings from the Local Government Ordinance are achieved until the next version of Title 24 goes into effect. At that point, it is assumed that each jurisdiction would adopt a new reach code in line with the next version of Title 24; therefore, no overlap occurs between Local Government Ordinances and Title 24.

The NORESO team will use the same projected Title 24 efficiency improvements as those used for the Title 24 program analysis for each future cycle of Title 24 from 2019 through 2029. The team will gather data on the jurisdictions that will likely adopt a Local Government Ordinance requiring energy efficiency improvement over Title 24 baselines; this will be based on historical data from the Energy Commission.¹⁶⁸ For local ordinances requiring efficiency above 2016 Title 24, data is currently available on the Energy Commission website and will be used to determine unit energy savings, that is, savings per square foot. Square footage impacted will be determined based on publicly available permit data from jurisdictions that have adopted, intend to adopt, or are expected to adopt a local ordinance.

Local government ordinances have not previously been included in PG studies and will not be captured in the 2018 PG study.

- For this program, the analysis team assumed that jurisdictions that adopted a Local Government Ordinance above 2016 Title 24 will continue to adopt Local Government Ordinances for future versions of Title 24. The analysis estimated the square footage that will likely be impacted by future Local Government Ordinances in each of these jurisdictions and applied the expected statewide efficiency level and energy savings for the next Title 24 code update through 2029. The following steps were used to estimate potential energy savings:
 - Established baseline: in coordination with the Title 24 program energy savings estimates, the team used expected energy efficiency improvements for 2019, 2022, 2025, and 2028 Title 24 as the baseline for future Local Government Ordinances.
 - Determined the portion of affected California construction: based on Energy Commission data of previously adopted local ordinances, the analysis team assumes the same jurisdictions will continue to Local Government Ordinances. The estimated square footage is based on available issued permit data in these jurisdictions and Energy Commission forecast construction data. The eligible square footage in each jurisdiction will be reduced to the affected square footage based on historical participation rates for IOU/POU above-code

¹⁶⁷ <http://www.energy.ca.gov/title24/2016standards/ordinances/>

¹⁶⁸ <http://www.energy.ca.gov/title24/2016standards/ordinances/>

incentive programs, such as Savings by Design, to account for overlap. IOU program participation rates will be applied to the granularity available; the rates may not be available by city or county, but instead, by IOU territory. POU program participation will be more specific to the cities and counties where a Local Government Ordinance is adopted.

Estimated energy savings: The analysis team assumed that jurisdictions will adopt local ordinances that require whole building performance in line with the expected efficiency improvement for the next version of Title 24. For example, local ordinances adopted for 2016 Title 24 will require performance equivalent to the expected efficiency improvements for 2019 Title 24. Although Local Government Ordinances are localized requirements, TRC applied the statewide energy savings estimates from the Title 24 program analysis, which the NORESO team is also conducting.

Determined total potential energy savings: using the affected square footage and the expected future Title 24 energy efficiency levels, the analysis team estimated the total potential energy savings for Local Government Ordinances through 2029.

Savings Projections

Table 4: Electricity (GWh) and Natural Gas (MM therms) Savings Projected From 2015 Through 2029 for Local Government Ordinances (CALGreen)

Energy Unit	2015	2016	2017	2018	2019	2020	2021	2022	2023	2024	2025	2026	2027	2028	2029
Elec (GWh)	0.5	1.0	1.5	2.4	3.3	4.2	5.3	6.4	7.5	8.8	10.0	11.4	13.0	14.4	15.8
NG (MM therms)	0.0	0.0	0.0	0.0	0.0	0.0	0.1	0.3	0.5	0.8	1.2	1.6	2.1	2.7	3.4

Source: California Energy Commission staff.

AIR QUALITY MANAGEMENT DISTRICTS POLLUTANT MITIGATION

Program Description: The California Environmental Quality Act (CEQA) requires state and local agencies within California to follow a protocol of analysis and public disclosure of environmental impacts of proposed projects and adopt all feasible measures to mitigate those impacts. In California, there are 35 different air quality districts tasked with enforcing the requirements of CEQA: 23 Air Pollution Control Districts (APCDs) and 12 Air Quality Management Districts (AQMDs).

Where any project under CEQA’s jurisdiction is identified as having potentially significant environmental impacts, the relevant APCD or AQMD is tasked with identifying mitigation measures and alternatives by preparing an Environmental Impact Report. Environmental impact is assessed according to a variety of different environmental resource factors: (1) agricultural resources, (2) air quality, (3) biological resources, (4) cultural resources, (5) geology and soils, (6) greenhouse gases (GHGs), (7) hazards and hazardous materials, (8) hydrology and water quality, (9) land use and planning, (10) mineral resources, (11) noise, (12) population and housing, (13) public services, (14) recreation, (15) transportation and traffic, and (16) utilities and service systems.

Guidelines published by individual air quality districts identify energy efficiency measures that can be applied to reduce GHGs and other Criteria Air Pollutants (CAP) to below the threshold values established by CEQA, or the discretion of the District.

Buildings Affected: CEQA applies to nearly all projects in California. All public agencies are required to mitigate or avoid significant effects on the environment of projects that they carry out or approve whenever it is feasible to do so. Additionally, CEQA applies to all private projects for which a government permit or other entitlement for use is required. While specific guidance regarding ensuring CEQA compliance varies from district to district, all districts are tasked with enforcing the same set of CEQA requirements.

Methods

Relevant Measures:

Specific efficiency-based environmental impact mitigation measures include:

- Envelope/Site
- Shade trees
- Cool roof membranes
- Green roof construction
- Increase roof insulation
- HVAC
- Smart meters and programmable thermostats
- Duct sealing
- Domestic hot water heaters
- Solar water heaters
- Tank-less water heaters
- Low water use appliances and fixtures
- Lighting
- Daylighting
- Whole building measures
- New construction compliance with CA GBC standards
- Existing buildings retrofit to meet CA GBC standards

Data Sources:

- *California Environmental Quality Act (CEQA) and State CEQA Guidelines*¹⁶⁹. This document contains all of the specific requirements that each air quality district is tasked with enforcing. It includes detailed descriptions of the environmental resource factors and thresholds of significance as they relate to pollutants and other impact metrics.
- *California Air Pollution Control Officer's Association*. Association website¹⁷⁰ provides information on relevant energy efficiency efforts.
- *Air Pollution Control District San Luis Obispo County*. Website¹⁷¹ provides information on relevant energy efficiency efforts.

Data have not been found to indicate the specific impact of CEQA on commercial and residential building efficiency via the enforcement of the air quality districts. Presumably, complying with applicable codes and standards (i.e. Title 24, Title 20, and Federal Appliance Standards) would go a long way towards bettering environmental impact thresholds.

¹⁶⁹ Association of Environmental Professionals. CEQA Statute and Guidelines. 2016.
http://resources.ca.gov/ceqa/docs/2016_CEQA_Statutes_and_Guidelines.pdf

¹⁷⁰ <http://www.capcoa.org/>

¹⁷¹ <http://www.slocleanair.org/>

Methodology:

With respect to estimating program impact, Air Quality District Criteria Pollutant Mitigation aligns more closely with Codes and Standards than with financing or rebate programs; CEQA establishes requirements and the air quality districts are tasked with enforcing those requirements. Accordingly, it is anticipated that the approach through which the savings potential of Air Quality District Criteria Pollutant Mitigation will be estimated will approximate that which will be developed for relevant codes and standards (i.e. Title 24, Title 20, and Federal Appliance Standards). However, while the expectation is that much of the data for codes and standards analysis will be provided by Navigant, there is no current expectation that Navigant has considered the savings potential associated with regional air quality districts.

While it is expected that compliance with applicable Building and Appliance Standards will contribute significantly to meeting CEQA requirements, the NORESO Team's literature review clearly indicates that meeting code minimum requirements for a new construction or alteration project is not expected in general to fully satisfy CEQA requirements. In particular, a memo published by the law firm Shute, Mihaly & Weinberger, LLP¹⁷² clearly indicates that Title 24 "does not extend beyond the buildings themselves" and therefore "does not address many of the considerations required under Appendix F of the CEQA Guideline." Indeed, CEQA Appendix F highlights a number of potentially significant energy implications of a project that extend beyond the scope of Title 24, including: (1) energy consuming equipment and processes which will be used during construction, operation, and/or removal of the project; (2) total estimated daily vehicle trips to be generated by the project and the additional energy consumed per trip by mode; and (3) the effects of the project on peak and base demand periods for electricity and other forms of energy.

Where a project is anticipated to exceed environmental impact thresholds established by CEQA, mitigation is required. While a wide range of action can contribute to mitigation, energy efficiency interventions factor prominently into recommended strategies. In particular, BAAQMD Air Quality Guidelines specifically identify exceeding the energy efficiency requirements of Title 24 as a potential approach to mitigation. AQMD requirements are currently assumed to result in an additional 5 percent of electricity and gas savings currently projected for iterations of Title 24 starting in 2016 and continuing through 2028.

Savings Projections

Table 5: Electricity (GWh) and Natural Gas (MM therms) Savings Projected From 2015 Through 2029 for Air Quality Management District Programs

Energy Unit	2015	2016	2017	2018	2019	2020	2021	2022	2023	2024	2025	2026	2027	2028	2029
Elec (GWh)	0	0	2	8	14	22	34	47	61	80	98	118	142	167	194
NG (MM therms)	0.0	0.0	0.1	0.2	0.4	0.6	0.9	1.2	1.6	2.0	2.5	3.0	3.7	4.3	5.0

Source: California Energy Commission staff.

¹⁷² Shute, Mihaly & Weinberger, LLP. "Don't Forget the Energy Implications of New Projects – CEQA Guidelines Appendix F". http://www.smwlaw.com/files/CEQA_Guidelines_Appendix_F.pdf

LOCAL GOVERNMENT CHALLENGE (LGC)

Program Description: This program consists of four awarded energy innovation grants to local governments, and a number of small government grants, primarily directed towards climate action plans, in response to Energy Commission solicitation GFO-16-404. The individual projects were recently awarded under funding stemming from the American Recovery and Reinvestment Act (ARRA).

The energy innovation grants were (Awardee-Project):

- 1) Marin Clean Energy – Building Efficiency Optimization Project
- 2) City of San Diego – Smart City Open Urban Platform (SCOUP)
- 3) City of San Leandro – Innovative Energy Efficiency and Renewable Energy Deployment Project
- 4) Stop Waste Energy Council – Accelerating Multifamily Building Upgrades

The small government leadership challenge awards were:

- 1) City of Del Mar - Civic Center Energy Efficiency Enhancements
- 2) Gateway Cities Council of Governments - Climate Action Planning (CAP) Framework
- 3) San Bernardino Council of Governments - Sub-Regional Greenhouse Gas Reduction Plan Update
- 4) County of San Luis Obispo - EnergyWise Plan Energy Section Update including Zero Net Energy Neighborhood Feasibility, Design, and Implementation Study
- 5) City of Santa Cruz - Deep Energy Efficiency at Municipal Facilities through Advanced Building Controls
- 6) Ventura County Regional Alliance - Central Coast Energy Plan
- 7) Marin General Services Authority - Marin Climate and Energy Partnership/Resilient Neighborhoods Grassroots Climate Action
- 8) City of Galt - City of Galt Climate Action Plan, Corridor Plan, and Master Plan
- 9) City of Santa Barbara - City of Santa Barbara, ZNE Roadmap and Implementation Plan

Due to the funding source, the energy savings estimate will be limited to the projects listed above.

Buildings Affected: Residential and non-residential. The affected building type varies by project. The approach taken is to evaluate the energy innovation grants in detail, and evaluate a small subset of the climate action plans.

Methods:

Relevant Measures:

The savings measures for this program vary by project, from multifamily building upgrades, to a detailed energy upgrade to a wastewater treatment plant, to outdoor lighting and street lighting energy savings. Where measures may not fall into a standard building end use category, they may need to be evaluated separately.

Data Sources:

A list of data sources is provided below.

- Energy Commission Award Notice¹⁷³
- Brief Summary of awarded projects scope and project narratives¹⁷⁴
- Program request for proposal guidelines¹⁷⁵
- Interviews with project proposal authors (city governments and other organizations)
- Published literature on similar climate action plans
- Methodology for converting GHG emissions to energy savings
- Interviews with subject matter experts (Energy and Environmental Economics, and others)
- Information on Climate Action Plan(s) from other, similar cities and jurisdictions in California
- Proposal submittals for the awarded projects¹⁷⁶

Methodology:

Generate top-down estimates of the savings potential for the program. For this phase, the NORESO team performed the following calculations and employed a set of assumptions to project the energy savings potential from 2015 through 2029.

- Data Gaps
 - Some projects only included greenhouse reduction goals (GHG) reduction goals as the metric of performance, with no energy savings data available.
- Calculations
 - First, the analysis categorized the Energy Innovation Grant projects and Local Government Challenge programs into projects (1) with specific energy efficiency measures or targets, and (2) with general GHG reduction goals.
 - For programs with specific performance targets, the NORESO team extracted electricity and gas savings from relevant project narratives or conversion of GHG reduction goals.
 - The programs with specific targets as a direct result of photovoltaics systems or other renewable or storage technologies will not be considered in the Phase 1 savings estimate.
 - For climate action plans at the city or county level, the Phase 1 savings approach is the following:
 - Developed estimates of greenhouse gas (GHG) reduction per capita, either from program data or from a representative city. NORESO determined that the City of Pleasanton Climate Action Plan¹⁷⁷ was an exemplary model¹⁷⁸, with detailed projections of energy savings and greenhouse gas reductions by sector. Estimates of existing energy consumption or GHG production for the awarded cities were not available for the Phase 1 analysis.

¹⁷³ California Energy Commission. Notice of Proposed Award. Local Government Challenge. Grant Solicitation, GFO-16-404. April 11, 2017.

¹⁷⁴ Confidential. Local Government Challenge one-pagers of awarded projects from the Energy Commission.

¹⁷⁵ California Energy Commission. Request for Proposals - Local Government Challenge. GFO-16-404. February 2017.

¹⁷⁶ Confidential. Local Government Challenge proposal submittal packages from the Energy Commission.

¹⁷⁷ City Of Pleasanton 2011. City of Pleasanton Climate Action Plan, December 2011. Available online at: <http://www.cityofpleasantonca.gov/civicax/filebank/blobdload.aspx?BlobID=24757>

¹⁷⁸ Note that the City of Pleasanton was not awarded LGC funding.

- Used a conversion from GHG reduction targets to energy savings targets from the City of Pleasanton Plan, and used the City of Pleasanton’s breakdown of energy consumption among the buildings, transportation, waste treatment and industrial sectors. While this will vary among local jurisdictions, NORESO considers this a fair starting point for an estimate. The fraction of planned GHG savings that are due to building energy efficiency is approximately 50% of the total GHG planned reductions.
 - Applied conversions between electricity and gas use and avoided CO₂ emissions from the Statewide IOU Codes and Standards Program.
 - Applied an estimate (assumed for Phase 1 at 25%) of the fraction of the energy savings target that can be attributed to the Climate Action Plan itself.
- Assumptions
 - For GHG to energy savings conversion, the split between electricity and gas was assumed to be 80 % electricity and 20% gas for small municipalities. Although this was an assumption, data on non-residential buildings shows a similar split for non-residential and residential buildings.

The following approach was used:

Identify Baseline energy consumption for the affected area. This was collected from either the Proposal and project narrative, information from local government officials, or where neither of those methods was feasible, through city census estimates and comparison of energy use with similar local governments.

Projects for Del Mar and Marin Clean Energy were deemed as not relevant to this savings estimate, since they deal with PV generation and supply side distributed energy resource (DER) management.

For San Luis Obispo County, since neither baseline energy usage nor energy savings targets were available, NORESO first estimated the residential population that live in low-income areas as 20 percent of the county. An approximate EUI estimate and home size was applied to determine a baseline energy use. It was also assumed that 25 percent of single-family homes in this category could potentially receive efficiency upgrades through 2029.

Each of the projects was evaluated through an attribution matrix that considered the following mitigating factors:

- PV: where programs included PV among broad goals, the contribution of PV towards savings was set to 25 percent. Where PV was the only identified measure, it was set to 100 percent. Where targeted measures were identified with specific savings targets without any use of PV, the contribution was set to 0 percent.
- IOU/POU Overlap: to align with other program methodologies, the overlap from any IOU and POU programs was fixed at 10 percent. For these programs, aggressive goals with building-level energy target reductions exceed many focused IOU and POU programs, so the anticipated overlap is limited.
- Non-Building Fraction: many climate action plans addressing GHG reduction identify measures well outside of building energy efficiency programs (streetlights, transportation, city planning, etc.). NORESO estimated the fraction of planned savings attributed to measures outside of buildings based on the project narratives and review of program data.
- Attribution Factor: the percentage of the potential targeted building stock that would likely be directly affected by the program. For programs that are targeting specific buildings, the attribution factor is 100 percent. For others, it is assumed to be 25 percent.

A combination of each of these factors yields a “Potential Rate”, which is the fraction of potential target savings that can be directly attributed to the program.

Table 6. Summary of Program Potential against Targeted Savings

	PV Fraction	Non-Building Fraction	IOU/POU Overlap	Attribution	Potential Rate
StopWaste	25%	0	10%	100%	65%
Santa Barbara	25%	0%	10%	25%	16%
Galt	25%	40%	10%	25%	6%
Gateway Cities	25%	10%	10%	25%	14%
San Bernardino COG	25%	25%	10%	25%	10%
Del Mar	100%	0%	10%	25%	0%
Marin Clean Energy	100%	0%	10%	25%	0%
San Leandro	75%	0%	10%	100%	15%
San Luis Obispo	25%	0%	10%	25%	16%
Santa Cruz	0%	0%	10%	25%	23%
Ventura County	25%	0%	10%	25%	16%

Programs with specific building targets provided specific savings targets, so those targets were assumed for the savings estimate. From the potential rate of savings, a savings multiplier of 33 percent across all programs without a specific target was applied.

Finally, savings calculations were divided into annual incremental savings. For broader projects that affect a large number of buildings, it is assumed that the projects will ramp up in scope and savings steadily from 10 percent of targeted savings in 2021 to 100 percent through 2029.

The following considerations were also factored into the analysis:

Accounting for Codes & Standards Overlap. Because this program targets public buildings, the NORESO teams assumes little-to-no natural construction turnover in the absence of additional financing. As such, zero percent of program savings were assumed to overlap with Navigant’s 2018 Potential and Goals¹⁷⁹ (2018 PG) codes and standards estimates.

Accounting for Measure Savings Decay. Weighting factors by measure category, which were based on detailed measure data collected through the program, were assigned as follows: 21.5 percent HVAC equipment, 3.2 percent HVAC control equipment, 8.6 percent HVAC operation, 53.9 percent lighting equipment, 4.8 percent lighting control equipment, and 8 percent other.

Correcting for Market Saturation. The 2105 Existing Buildings Energy Efficiency Action Plan¹⁸⁰ indicates that: (1) the DGS reports about 125 million square feet of state-leased or –owned floor space; (2) nationwide, approximately 64 percent of government-owned buildings or municipality-owned, while 22 percent are state-owned. Additionally, the DGS reports¹⁸¹ about 20 million square feet of state-leased floor space. Combining that information with

¹⁷⁹ <http://www.cpuc.ca.gov/General.aspx?id=6442452619>

¹⁸⁰ CEC. *California’s Existing Buildings Energy Efficiency Action Plan*. September 2015.

¹⁸¹ <http://www.dgs.ca.gov/resd/Programs/LeasingandPlanning.aspx>

project data that indicates an approximate 90/10 split between local government buildings and public schools, and an assumption of average per project electricity savings of 15 percent, the NORESO team estimates the total market for this program at around 320 million square feet. Accordingly, the analysis team predicts that the calculated savings projection through 2029 would result in less than 10 percent of all applicable buildings being improved through 2029. As this seems reasonable, no correction was made to account for market saturation.

Savings Projections

Table 7: Electricity (GWh) and Natural Gas (MM therms) Savings Projected From 2015 Through 2029 for the Local Government Challenge

Energy Unit	2015	2016	2017	2018	2019	2020	2021	2022	2023	2024	2025	2026	2027	2028	2029
Elec (GWh)	-	-	-	-	-	-	3.9	7.9	11.8	15.6	19.4	23.2	26.8	30.5	34.1
NG (MM therms)	0.0	0.0	0.0	0.0	0.0	0.0	0.1	0.3	0.4	0.6	0.7	0.9	1.0	1.1	1.3

Source: California Energy Commission staff.

PROPOSITION 39 (CALIFORNIA CLEAN ENERGY JOBS ACT)

Program Description: Proposition 39 (Prop 39), the California Clean Energy Jobs Act, provides up to \$550 million annually for the purpose of funding projects that create jobs while improving energy efficiency and expanding clean energy generation throughout five fiscal years beginning with 2013-2014 and ending with 2017-2018. Annual appropriations for the five-year cycle are based on actual tax revenue generated from the corporate income tax code that funds Prop 39. As a result, funding for each fiscal year varies based on the State budget. The State of California requires that a large portion of Prop 39 funds be allocated to eligible Local Educational Agencies ¹⁸²(LEA) and California Community Colleges (CCC) for energy efficiency and self-generation projects. A small percentage of the Prop 39 funds is appropriated for other components of the program, including financing, technical assistance, workforce development, and energy planning services. Currently, the first four years of funding (2013-2017) have been committed to eligible LEAs and CCCs. The fifth year of funding (2017-2018) has been estimated and is pending approval in June 2017. In the K-12 system, funds are allocated to specific LEAs according to average daily attendance (85 percent weighting) and number of students eligible for free and reduced-price meals (FRPM) (15 percent weighting) applicable to a funding year. In the CCC system, funds are allocated according to number of Full Time Equivalent Students (FTES).

¹⁸² LEAs include K-12 school districts, county offices of education, charter schools, and state special schools.

Prop 39 funds can be applied to energy efficiency retrofits and clean energy installations, as well as related facility improvements and repairs that contribute to reduced operating costs and enhanced health and safety conditions. Additionally, funds can be appropriated to hire energy managers and provide relevant staff training. The use of funds must comply with two factors: loading order and cost effectiveness. Projects applying for Prop 39 funding shall be sequenced in accordance to California's "loading order" of energy resources. Energy efficiency and demand response projects are first priorities, followed by renewable energy generation, distributed generation, combined heat and power applications, and clean and efficient fossil-fired generation, in the order stated. Projects are also evaluated by the cost effectiveness criteria, calculated in terms of Savings to Investment Ratio (SIR), based on the total energy savings and net project costs over the project life-cycle. Additionally, Prop 39 funds can be combined with other project financing and funding mechanisms such as utility incentives (mandatory), utility On-Bill Financing (OBF) programs, and the Energy Conservation Assistance Act (ECAA) loan programs. The Energy Commission published a Progress Report ¹⁸³ in August 2016 that indicates the appropriation of Prop 39 funds from 2013 to 2017.

Buildings Affected:

Non-residential only

- Existing K-12 school facilities
- Existing County offices of education facilities
- Existing Charter school facilities
- Existing State special school facilities
- Existing Community College facilities

Note: New construction is excluded from Prop 39.

Methods

Relevant Measures:

Data collected for Prop 39-funded projects indicates a clear list of commonly implemented measures, while there may be additional measures not yet reported and captured. Final reporting for project completion is due June 30, 2021, after which more data will be made available. For all cases, savings are measured against the existing building conditions. The currently available list of measures¹⁸⁴ that relate to energy efficiency is as follows:

- Building Envelope
 - Cool Roofs
 - Insulation
 - Shading Devices/Window Film
 - Windows/Skylights
- Domestic Hot Water (DHW)
 - DHW Heater
 - Waste Heat Recovery
 - Water Tank/Pipe Insulation
- Electrical
 - High Efficiency Transformer
- HVAC
 - Chiller/Boiler Replacement

¹⁸³ California Energy Commission. The California Clean Energy Jobs Act: Proposition 39. Sacramento, California. August, 2016. Page 3.

¹⁸⁴ List of measures are based on various data sources, including the Energy Commission's K-12 Postsecondary Education Participants System (PEPS) Data Workbook and the Chancellor's Office Prop 39 Data Workbook.

- Condensing Furnace
- Door Switch/Occupancy Sensors
- Energy Management System
- Programmable/Smart Thermostats
- Cooling Towers
- Demand Controlled Ventilation
- Duct Sealing
- Evaporative Coolers
- HVAC and Air Handler Repairs
- New Economizer
- Packaged/Split System AC/Heat Pump/VRF
- Room/Window AC
- VAV System
- Retrocommissioning (Continuous)
- Irrigation
 - High Efficiency Sprinkler
 - Irrigation Pump Control
- Kitchen
 - High-Efficiency Appliances
 - Strip Curtain/Auto Closer
- Lighting
 - CFL Lamp Retrofit
 - Lighting Controls
 - Exterior Fixture Retrofit
 - Interior Fixture Retrofit
 - LED Exit Signs
 - Retrofit Interior Lamps to LED
- Plug Loads
 - Power Management
 - Vending Machine Misers
- Pool
 - Swimming Pool Cover
- Pumps, Motors, and Drives
 - Energy Efficient Pumps
 - Premium Efficiency Motors
 - Variable Frequency Drives

Note the following about the above list: (i) energy storage was removed from the list for not being an efficiency measure (while energy storage reduces peak demand, it is not a net energy saver); (ii) solar water heating is classified as renewable generation; and (iii) while irrigation measures primarily reduce water usage, they are included due to potential for at least some corresponding electrical savings.

Data Sources: The process of data collection and analysis relies on available reports and workbooks published by the Energy Commission¹⁸⁵ and the Chancellor's Office¹⁸⁶. An overview of relevant data sources used for this analysis is summarized below.

- *K-12 Postsecondary Education Participants System (PEPS) Data Workbook*. This workbook provides detailed information for each individual K-12 Prop 39 project. It is updated on a regular basis by the Energy Commission as more applications are approved; the latest version covers information through 2017. The NORESKO team extracted information from the following available data parameters to support SB 350 analysis:

¹⁸⁵ California Energy Commission. Proposition 39 K-12 Program. 2017. <http://www.energy.ca.gov/efficiency/proposition39/>

¹⁸⁶ California Community Colleges Chancellor's Office. Proposition 39. 2017. <http://extranet.cccco.edu/Divisions/FinanceFacilities/Proposition39.aspx>

- Detail of Prop 39 funding appropriations
 - Total annual grant amount requested by LEA's (2013-2017)
 - Total annual grant amount requested for Energy Manager
 - Total annual grant amount requested for Training per year
 - Total annual grant amount requested for Energy Efficiency Measures
- Detail of energy efficiency measures funded by Prop 39
 - Energy efficiency measure title
 - Fiscal year in which the measure is funded
 - Estimated completion date
 - Average time gap between funding year to completion year
 - Estimated square footage affected by measure
 - Estimated annual electric savings
 - Estimated annual gas savings
 - Estimated measure cost
 - Estimated utility rebate
- Detail of self-generation projects funded by Prop 39
 - Estimated measure cost
 - Estimated project rebate
- Cost effectiveness
 - Savings-to-investment ratio at the measure level
 - Savings-to-investment ratio at the Energy Expenditure Plan level
- *K-12 Proposition 39 Program: Energy Expenditure Plan Handbook*. This handbook provides detail regarding project and measure eligibility, as well as the process through which an LEA can submit, execute, and track a Proposition 39 project. For projects that wish to bypass the need for a professional energy audit, 28 separate energy calculators are available to estimate the performance of specific measures (12 lighting measures, 9 HVAC measures, 2 plug load measures, 3 envelope measures, the electrical transformer measure, and a PV measure). Excluding the solar photovoltaic (PV) measure calculator, the details embedded in these calculators will be useful to specifying energy modeling inputs for relevant measures.
- *K-12 Prop 39 Progress Report to the Citizens Oversight Board*. This report is published annually to summarize program outcomes to date for all active projects implemented by the LEAs. The latest version of the Progress Report covers information through the end of the 2015-2016 fiscal year (June 30, 2016). Summaries provided in the Progress Report will inform overall program performance, cost effectiveness, and limitations.
- *CCC Chancellor's Office Project Data Workbook*. This workbook provides detailed information for each individual CCC Prop 39 project. It is updated on a regular basis as more applications are approved; the latest version captures information through 2016. The NORESO team extracted information from the following available data parameters to support SB 350 analysis:
 - Detail of Prop 39 funding appropriations
 - Total annual grant amount requested by CCC (2013-2016)
 - Detail of energy efficiency measures funded by Prop 39
 - Energy efficiency measure title
 - Fiscal year in which the measure is funded
 - Estimated annual electric savings
 - Estimated annual gas savings
 - Estimated measure cost
 - Estimated utility rebate
 - Detail of self-generation projects funded by Prop 39
 - Estimated measure cost
 - Estimated project rebate
 - Cost effectiveness
 - Savings-to-investment ratio at the measure level

- CCC Prop 39 Implementation Guidelines and Addenda. This program guideline provides detail regarding project and measure eligibility, as well as the process through which a CCC can submit, execute, and track a Prop 39 project. Qualification criteria and cost effectiveness thresholds are provided along with calculation methodology and code compliance requirements.
- CCC Prop 39 Progress Report to the Citizens Oversight Board. This report is published annually to summarize program outcomes to date for all active projects implemented by community colleges. The latest version of the Progress Report covers information through the end of the 2014-2015 fiscal year (October 2015). Summaries provided in the Progress Report will inform overall program performance, cost effectiveness, and limitations.

Methodology:

While Prop 39 funding is expected to end in the 2017-2018 fiscal year with project close-out expected by June 2021, the SB 350 analysis will assume that Prop 39 (or a similar program able to generate comparable savings) will be extended through 2029 for purposes of developing incremental savings projections that can be applied to SB 350. The analysis of this program will be conducted through a phased approach as follows:

- Generate top-down estimates of the savings potential for the program. For this phase, the NORESO team performed the following calculations and employed a set of assumptions to project the energy savings potential from 2015 through 2029.

Data Gaps

- For K-12, it appears that the first-year project data for 2013-2014 and the current-year project data for 2016-2017 are incomplete, as the reported funding amounts fall significantly below the expected funding amount.
- For CCC, the data covers only up to 2016 with partial project data available for 2015-2016. There is no information for 2016-2017 published in the workbook.

Calculations

- Since the Prop 39 data sets include both energy efficiency and self-generation projects, this analysis extracted the energy efficiency-only data to serve as basis of the savings projections.
- For the purpose of savings projections, the annual energy savings data were normalized by the associated funding amount. This method produced two normalized energy savings estimates for kWh savings and therm savings per dollar of funding.
- Using the normalized energy savings estimates along with the known funding amounts for 2013-2017 and the estimated funding amount for 2017-2018, the analysis extrapolated the available project data to generate annual funding and energy savings data for all five years of the current program cycle (2013-2018).
- The estimated five-year data were plotted to evaluate trends. However, the results did not reveal any clear patterns of energy savings or funding levels. Data seems to primarily vary by the approved funding amount which is dependent on the State budget approval. It appears that energy savings potential may fluctuate based on budget variance for each year.
- For the purpose of Phase 1, the analysis calculated an average annual funding level based on the five-year estimates and assumed that the funding level will remain constant from 2015 through 2029. The projected funding level was then applied to extrapolate average annual electric and gas savings projected through 2029.

Assumptions

- Funding level to remain constant through 2029 for the purpose of Phase 1 estimates.
- Publicly available data is limited to the information from K-12 and CCC workbooks.
- More project savings will be reported until 2021 when final close-out is required.
- The actual funding and energy savings data will better correspond to the approved budget as more data becomes reported.
- Average of funding and energy savings data by normalization can serve as a preliminary method of savings projections in Phase 1, despite many variables yet to be considered.

- The following considerations were also factored into the analysis:
 - Correcting for Renewable Generation. Solar PV savings had already been removed during. The NORESO team also removed solar thermal savings (only 0.2 percent of total savings).
 - Accounting for Codes & Standards Overlap. Because this program targets public buildings, the NORESO teams assumes little-to-no natural construction turnover in the absence of additional financing. As such, zero percent of program savings were assumed to overlap with Navigant’s 2018 Potential and Goals¹⁸⁷ (2018 PG) codes and standards estimates.
 - Accounting for Measure Savings Decay. Weighting factors by measure category, which were based on detailed measure data collected through the program, were assigned as follows: 21.5 percent HVAC equipment, 3.2 percent HVAC control equipment, 8.6 percent HVAC operation, 53.9 percent lighting equipment, 4.8 percent lighting control equipment, and 8 percent other.
 - Correcting for Market Saturation. Assuming that 90 percent of K-12 schools in California are public¹⁸⁸, 44 percent of college buildings are at community colleges¹⁸⁹, and that each project achieves 15 percent electricity savings on average, the NORESO team estimates that the calculated savings projection through 2029 would result in approximately 260 percent of public school and community college buildings being improved through 2029. While it is possible that some schools would execute multiple projects through the program through 2029, this seems like a clear indication of market saturation. To correct for market saturation, the NORESO assumed program funding (and subsequent savings) would start to decrease by 30 percent each year starting in 2019. This correction lowers the market saturation rate to approximately 100 percent, which assumes that the number of repeat customers would be roughly equivalent to the number of schools that don’t participate.

Savings Projections

Table 8: Electricity (GWh) and Natural Gas (MM therms) Savings Projected From 2015 Through 2029 for Proposition 39

Energy Unit	2015	2016	2017	2018	2019	2020	2021	2022	2023	2024	2025	2026	2027	2028	2029
Elec (GWh)	140	280	420	554	646	709	748	774	786	790	786	779	771	763	758
NG (MM therms)	1.2	2.4	3.6	4.8	5.6	6.2	6.5	6.7	6.8	6.9	6.8	6.8	6.7	6.6	6.6

Source: California Energy Commission staff.

GREENHOUSE GAS REDUCTION FUND – LOW INCOME WEATHERIZATION PROGRAM

¹⁸⁷ <http://www.cpuc.ca.gov/General.aspx?id=6442452619>

¹⁸⁸ <https://articles.niche.com/private-school-vs-public-school-breakdown/>

¹⁸⁹ http://www.ppic.org/content/pubs/report/R_0416HEBKR.pdf

Program Description: Low Income Weatherization (LIW) is a statewide program funded by the Greenhouse Gas Reduction Fund (GGRF) through California Cap-and-Trade auction proceeds. The program aims to implement energy efficient measures in low-income single family and multi-family complexes in disadvantaged communities, including PV installations, solar hot water heaters, and other energy reducing projects.

The overarching goals of the LIW program are as follows:

- Reduce Greenhouse Gas emissions in disadvantaged communities.
- Create jobs and provide training for members of disadvantaged communities.
- Reduce the energy bills of the low-income households served.

The LIW program received \$75 million in funding through the 2014-15 budget approved by the State legislation in order to implement these goals. It is estimated that 17,700 households will benefit from this program.

Buildings Affected:

Residential only – This program specifically targets 100 percent of the households located in disadvantaged communities as identified by CalEnviroScreen 2.0. The building stock of these households include:

- Single-family buildings
- Small multi-family buildings
- Large multi-family buildings.

Methods

Relevant Measures:

Health and safety assessments and measures
Weatherization and renewable energy measures
Energy efficient light bulbs
Ceiling fans and appliances
Insulation (ceiling, wall, floor)
Microwaves, solar water heating and solar photovoltaics

Data Sources:

Low Income Weatherization Program Fact Sheet¹⁹⁰: This resource supplies general program information:

Details on program overview, as well as building types affected.
Funding information
Low Income Weatherization Program Overview:
Details on how funding was allocated for 2015

Data LIWP_SF_SMF_EE_Only_04_03_2017 data workbook¹⁹¹: This resource provides measure data, limited to the 2015 program year for energy efficiency projects:

Counties and agencies
Total project costs
GGRF funding amount granted
Project life/equipment life
GHG reductions in MT CO₂-equivalent
Estimated cost savings
Estimated energy savings (kWh and therms)
MISSING: Project/measure name

Methodology:

The analysis of this program is as follows:

- Generate top-down estimates of the savings potential for the program. For this phase, the NORESO team performed the following calculations and employed a set of assumptions to project the energy savings potential from 2015 through 2029.
 - Data Gaps
 - The historical data set provides one full year of savings data for 2015. The lack of data for additional years prohibited the application of data trends or average values.
 - The historical data set provides funding data for 2015.
 - The Energy Commission provided feedback to indicate that additional data may be available to derive savings claims for past LIW program participants.
 - Calculations
 - 2015 project savings data were leveraged to determine total electricity and natural gas savings for the entire program year. The total savings from 2015 was then applied as the savings projections for 2015-2029.
 - Assumptions
 - Annual growth of savings and funding level remain the same as the 2015 values.

¹⁹⁰ California Department of Community Services & Development. Low Income Weatherization Program Fact Sheet. March 22, 2016.

¹⁹¹ Data_LIWP_SF_SMF_EE_Only_04_03_2017 data workbook provided by Community Services and Development (CSD).

- 10% of program savings are claimed by IOU/POU programs for rebates and incentives provided
- The following considerations were also factored into the analysis:
 - Correcting for Renewable Generation. Approximately 36 percent of all program savings result from solar PV projects; another 15 percent result from solar thermal projects for domestic hot water¹⁹². In total 51 percent of program savings are achieved through the implementation of renewable generation measures. Total program savings were reduced by 51 percent to account only for savings generated through efficiency improvements.
 - Accounting for Codes & Standards Overlap. Because this program targets low-income housing in disadvantaged communities, the NORESKO teams assumes little-to-no natural construction turnover in the absence of additional financing. As such, zero percent of program savings were assumed to overlap with Navigant’s 2018 Potential and Goals¹⁹³ (2018 PG) codes and standards estimates.
 - Accounting for Measure Savings Decay. Weighting factors by measure category, which were based on detailed measure data collected through the Proposition 39 program, were assigned as follows: 21.5 percent HVAC equipment, 3.2 percent HVAC control equipment, 8.6 percent HVAC operation, 53.9 percent lighting equipment, 4.8 percent lighting control equipment, and 8 percent other.
 - Correcting for Market Saturation. Assuming 2.2 million¹⁹⁴ of 12.3 million¹⁹⁵ households qualify as “low-income,” at that each project achieves 15 percent electricity savings on average, the NORESKO team estimates that the calculated savings projection through 2029 would result in approximately one third of low-income households being improved through 2029. As this seems reasonable, no correction was made to account for market saturation.

Savings Projections

Table 9: Electricity (GWh) and Natural Gas (MM therms) Savings Projected From 2015 Through 2029 for the Low Income Weatherization Program

Energy Unit	2015	2016	2017	2018	2019	2020	2021	2022	2023	2024	2025	2026	2027	2028	2029
Elec (GWh)	34	68	103	135	168	201	233	265	295	326	354	383	412	441	469
NG (MM therms)	1.9	3.9	5.8	7.6	9.5	11.3	13.1	14.9	16.6	18.3	20.0	21.6	23.2	24.8	26.4

Source: California Energy Commission staff.

¹⁹² <http://www.csd.ca.gov/Portals/0/Documents/LIWP%20Public%20Hearing%20Presentation%20Final.pdf>

¹⁹³ <http://www.cpuc.ca.gov/General.aspx?id=6442452619>

¹⁹⁴ <http://www.csd.ca.gov/Portals/0/Documents/LIWP%20Public%20Hearing%20Presentation%20Final.pdf>

¹⁹⁵ IEPR Building Stock Data

GREENHOUSE GAS REDUCTION FUND – DEPARTMENT OF WATER RESOURCES WATER-ENERGY GRANT PROGRAM

Program Description: The Water-Energy Grant Program (WEG), funded by the Greenhouse Gas Reduction Fund (GGRF) and operated by the Department of Water Resources (DWR) is a statewide program to promote reduction of greenhouse gas emissions primarily in the residential and non-residential sectors and particularly in disadvantaged communities. Proceeds from the California Cap-and-Trade Program are allocated each year to the WEG program to fund projects that reduce greenhouse gas emissions in California, while also delivering economic, environmental, and public health benefits for Californians, particularly including benefits to disadvantaged communities. Another key objective of the WEG program is to establish an incentive structure for making climate investments through clean technologies and innovative solutions. Water reduction or conservation is the main criterion for program eligibility, but energy use and greenhouse gas reduction are also prioritized.

Buildings Affected:

The following building types, construction, and market sectors may be included under a local ordinance. Each jurisdiction can determine which are appropriate for their goals. Local ordinances may include:

- Residential and nonresidential, excluding certain building types if exempt in the ordinance (e.g. hospitals, industrial, etc.).
- New construction and additions, alterations, and repairs. Requirements for new construction may differ from those for additions, alterations, or repairs to existing buildings.
- Private and public buildings

Methods

Relevant Measures:

- Replace high-water-use and high-energy-use fixtures with WaterSense labeled efficient.
- Implementation of an Automated Metering Infrastructure (AMI) system
- Retrofit residential turf and expand water-energy programs by installing water-saving devices
- Augment local gas company programs with water saving devices and development of marketing materials
- Design and installation of smart irrigation control systems
- Installation of low-flow irrigation units and timers.
- Increase large landscape irrigation efficiency at commercial, industrial and institutional sites (CII)
- Direct installation of clothes washers and dryers in disadvantaged communities.
- Replace turf grass with Central Valley-appropriate drought tolerant landscapes.
- Retrofit faucet aerators and low-flow showerheads
- Install water meters and upgrading 10,100 existing water meter transponders to the advanced metering infrastructure/automatic meter reading (AMI/AMR) system transponders.
- Increase the total number of rebates distributed by including rebates for water and energy-efficient dishwashers.

Data Sources:

- *Cap and Trade Annual Report*¹⁹⁶. This report is published annually to summarize program outcomes to date for all active projects. The latest version of the Progress Report covers information through the end of the 2016. Summaries provided in the Progress Report will inform overall program performance, cost effectiveness, and limitations.
- *Fixed_DWR_WUE Excel workbook*¹⁹⁷: This workbook provides detailed information for each individual WUE project including:
 - Detailed list of measures to be applied
 - Estimated total cost for each measure

Methodology:

The analysis of this program will be conducted as follows:

- Generate top-down estimates of the savings potential for the program. For this phase, the NORESKO team performed the following calculations and employed a set of assumptions to project the energy savings potential from 2015 through 2029.
 - Data Gaps
 - The historical data set provides a full-year of savings data for 2014 and a partial-year savings data for 2016.
 - The historical data set provides only one year of funding data for 2015. The funding amount for 2016 and 2017 were based on research of publicly available data.
 - Calculations
 - An estimate of the projected savings for this program was made by taking the average of electricity and gas savings from 2014 and 2016 historical savings data. The average savings from 2014 and 2016 was then applied as the savings projections for 2015-2029 due to a lack of more granular historical data.
 - Assumptions
 - Annual growth of savings and funding level remain the same as the average of 2014 and 2016 values.
 - 10% of program savings are claimed by IOU/POU programs for rebates and incentives provided
- The following considerations were also factored into the analysis:
 - Correcting for Renewable Generation. There is no indication from the program data set that solar thermal projects are included. As such, the NORESKO team made no correction to correct for savings due to renewable generation.
 - Accounting for Codes & Standards Overlap. Because this program targets disadvantaged communities, the NORESKO teams assumes little-to-no natural construction turnover in the absence of additional financing. As such, zero percent of program savings were assumed to overlap with Navigant's 2018 Potential and Goals¹⁹⁸ (2018 PG) codes and standards estimates.
 - Accounting for Measure Savings Decay. Weighting factors by measure category, which were based on detailed measure data collected through the Proposition 39 program, were assigned as follows: 21.5 percent HVAC equipment, 3.2 percent HVAC control equipment, 8.6 percent HVAC operation, 53.9 percent lighting equipment, 4.8 percent lighting control equipment, and 8 percent other.

¹⁹⁶ California Air Resources Board. Cap and Trade Annual Report. March 2017.
https://arb.ca.gov/cc/capandtrade/auctionproceeds/cci_annual_report_2017.pdf

¹⁹⁷ Fixed_DWR_WUE Excel workbook was sourced by the Energy Commission.

¹⁹⁸ <http://www.cpuc.ca.gov/General.aspx?id=6442452619>

- **Correcting for Market Saturation.** For the GGRF Low Income Weatherization Program (LIWP), the NORESKO team estimated that 2.2 million of 12.3 million households, approximately 18 percent, qualify as “low-income.” By extending this ratio to disadvantaged communities as a whole, biasing towards building types that consume the most water (restaurants, schools, hospitals, and dwellings), and assuming that each project achieves 10 percent¹⁹⁹ electricity savings on average, the NORESKO team estimates that the calculated savings projection through 2029 would result in approximately 40 percent of low-income households being improved through 2029. As this seems reasonable, no correction was made to account for market saturation.

Savings Projections

Table 10: Electricity (GWh) and Natural Gas (MM therms) Savings Projected From 2015 Through 2029 for the Water-Energy Grant

Energy Unit	2015	2016	2017	2018	2019	2020	2021	2022	2023	2024	2025	2026	2027	2028	2029
Elec (GWh)	0	18	36	55	72	90	107	124	141	157	173	189	204	220	235
NG (MM therms)	8.8	17.7	26.5	35.0	43.5	51.9	60.2	68.5	76.4	84.2	91.7	99.2	106.6	114.0	121.5

Source: California Energy Commission staff.

DEPARTMENT OF GENERAL SERVICES STATEWIDE ENERGY RETROFIT PROGRAM

Program Description: This program, administered by the Department of General Services (DGS), provides funding to State agencies to fund energy efficiency (EE) retrofits in their buildings through the Energy Efficient Property Revolving Fund. The funds for this program were supplied by the American Recovery and Reinvestment Act of 2009 (ARRA). The funding is expected to be paid back from the energy savings that result from the energy retrofit projects, at which point, the funds will be replenished and become available for subsequent projects.

There are several EE projects remaining in the current funding cycle, but most have completed. A new funding cycle has been approved for 2017-18. DGS improved the process by streamlining program implementation.

Buildings Affected:

Public buildings owned or operated by State agencies.

Methods

Relevant Measures:

¹⁹⁹ Note that this is less than the 15% estimate applied to other retrofit programs because only domestic hot water generation is impacted.

The list of current and past projects provided by DGS presents a set of applicable measures that could be employed in this program. The following are the most prevalent energy efficiency measures funded by this program:

- Lighting retrofit
- Lighting controls
- Energy management system upgrade
- HVAC equipment replacement
- HVAC retro-commissioning and optimization
- Variable Air Volume (VAV) conversion
- Variable speed drive installation

Data Sources:

- *DGS Annual Legislative Report (ALR)*²⁰⁰. This report provides information regarding loans to state departments and agencies for energy projects on state owned buildings.
- *DGS ESCO EE data current workbook*²⁰¹. This data, which were provided by DGS, provide information on the amount of funding that has been paid back to the fund, the simple payback of the measures, and the annual savings in kWh, therms, and project implementation costs.

Methodology:

There are a number of variables that may impact how this program will continue into the future. Assuming the current funding will remain available and the program will continue to replenish the funds from energy savings, it is possible to calculate the weighted average simple payback for the projects to determine the rate at which funds are recycled into new projects. Combining this with a calculation of the annual kWh or therm savings for the projects that have occurred will provide a reasonable estimate for future efficiency savings through this program.

Additionally, it will be necessary to apply adjustment factors to the energy savings projections in order to account for opportunities that may be front-loaded in the priority list and newer technologies and techniques that will be adopted in the future. An evaluation of this program will be conducted to chart the savings opportunities available in the future.

The approach for analysis is as follows:

- ALR and other DGS-supplied information will be used to estimate the savings and annual growth of savings assuming the program parameters and funding levels remain the same. At this time, the future energy savings for this program will be based on DGS estimates for future annual savings from the program rather than based on historical trends.

Assumptions employed as part of the analysis:

- Approximately 50% of the savings in this program are claimed initially through other utility incentive programs for equipment replacement. Utility incentive claims will decrease in the future as the oldest buildings are retrofitted and less attractive projects are available for future retrofits, but may increase (as a percentage) as the building approach ZNE and incentives to push buildings over emerge.

²⁰⁰ Department of General Services. Energy Efficient State Property Revolving Fund Annual Legislative Report. 2016.

²⁰¹ DGS ESCO_EE_data_current workbook, sourced by the Energy Commission.

- The feedback from Energy Commission Staff indicates that there is an anticipated reduction in the investment levels as the revolving fund is paid back and becomes available for new projects. This is reflected in the savings rates. Based on input from the Energy Commission, the NORESO team assumed 2 GWh annual savings beginning in 2018.
- Beyond the initial reduction guidance, the funding rate will be maintained as the fund is assumed to be managed sustainably into the future.
- The savings of natural gas will track comparably with electricity, and there is no adjustments made for electrification.
- For cumulative savings, the NORESO team assumed all projects have an effective useful life (EUL) equal to 15 years so assumed no decay of savings. This is because the most recent program reporting document²⁰² shows the program measures as interior and exterior lighting upgrades, HVAC upgrades, and envelope measures – all of which have an EUL of at least 15 years. This analysis also assumed no savings from renewable energy, since no renewable energy measures (e.g., solar PV) were shown in the program reporting document.

In general, the NORESO team was not able to find publicly available information beyond the sources used. NORESO team adjusted the assumption of savings claimed by utility incentive programs – i.e., adjust the assumption listed in the first bullet under the Phase 1 approach. The NORESO team assumed that this varied by year but average approximately 50 percent. The NORESO team assumed that utility incentive programs claimed 10 percent of savings each year. This is based on the NORESO team’s default assumption for state financing programs; the default assumption stems from the average fraction of project costs covered by utility programs for Proposition 39 projects.

The NORESO team conducted an initial outreach to the DGS EE revolving loan fund program manager to request additional program information including future funding, projected savings, expected overlap with utility incentive programs, and other factors that would affect program savings.

Because this program targets public buildings, the NORESO teams assumes little-to-no natural construction turnover in the absence of additional financing. As such, zero percent of program savings were assumed to overlap with Navigant’s 2018 Potential and Goals²⁰³ (2018 PG) codes and standards estimates.

The 2015 Existing Buildings Energy Efficiency Action Plan²⁰⁴ indicates that the DGS reports about 125 million square feet of state-leased or –owned floor space. Additionally, the DGS reports²⁰⁵ about 20 million square feet of state-leased floor space. Given the size of the potential market, by assuming that program projects achieved 15 percent electricity savings on average the NORESO team estimates that the calculated savings projection through 2029 would result in less than 10 percent of state-owned buildings being improved through 2029. As this seems reasonable, no correction was made to account for market saturation.

Savings Projections

²⁰² DGS ESCO_EE_data_current workbook

²⁰³ <http://www.cpuc.ca.gov/General.aspx?id=6442452619>

²⁰⁴ CEC. *California’s Existing Buildings Energy Efficiency Action Plan*. September 2015.

²⁰⁵ <http://www.dgs.ca.gov/resd/Programs/LeasingandPlanning.aspx>

Table 11: Electricity (GWh) and Natural Gas (MM therms) Savings Projected From 2015 Through 2029 for the Energy Savings Program

Energy Unit	2015	2016	2017	2018	2019	2020	2021	2022	2023	2024	2025	2026	2027	2028	2029
Elec (GWh)	5	10	15	17	19	20	22	24	26	28	29	31	33	35	37
NG (MM therms)	0.1	0.1	0.2	0.2	0.2	0.3	0.3	0.3	0.3	0.4	0.4	0.4	0.4	0.5	0.5

Source: California Energy Commission staff.

ENERGY CONSERVATION ASSISTANCE ACT (ECAA)

Program Description: The Energy Conservation Assistance Act (ECAA), is a revolving loan program provided by the Energy Commission to support energy efficiency and energy generation projects pursued by public institutions. ECAA operates on a fixed interest rate basis and provides loans of up to \$3 million per application on a first come first serve basis. The ECAA financing program is designed to facilitate the adoption of energy projects, through a simple process that does not involve credit approval, collateral or fees. In order to be eligible for a loan, project applications must demonstrate energy savings. ECAA loans must be repaid in energy cost savings within 20 years, including principal and interest, which is equivalent to approximately 20 years of simple payback for 0 percent loans and 17 years for 1 percent loans. Project guidelines require that energy projects must be cost-effective and technically feasible in order to qualify for ECAA financing.

Buildings Affected:

Public facilities are eligible to receive ECAA funds; the bulleted list below indicates which types of public facilities are eligible for 0 percent loans and which are eligible for 1 percent interest rate loans. Residential, commercial, and/or private non-profit institutions are **not** eligible for these funds.

- Eligible for 0 percent Interest Rate Loans:
 - School district
 - Charter School
 - County office of education
 - State special school
 - Community College district
- Eligible for 1 percent Interest Rate Loans:
 - Cities
 - Counties
 - Special Districts
 - Public College or University (Except Community Colleges)
 - Public Care Institutions/Public Hospitals
 - University of California and
 - California State University

Methods

Relevant Measures:

The following measures are common examples of energy efficiency measures implemented in past projects:

- Building Envelope
 - Cool Roofs

- Cogeneration
 - Digester gas cogeneration system
- Electrical
 - High Efficiency Transformers
- HVAC
 - Install kitchen exhaust hood controls
 - Install package heating, ventilating and air conditioning units
 - Chiller replacement
 - Direct digital control system
 - Heater replacements
 - Programmable thermostats
 - Equipment replacement
 - Ventilation and air conditioning improvements
 - High efficiency motors
 - Pool control
- Lighting
 - Interior fixture retrofit
 - Interior re-lamping
 - LED exit signs
 - Exterior fixture retrofit
 - Lighting Controls
 - Bike and pedestrian path lights
 - Street lighting retrofit

Note that renewable generation measures have been removed because they do not contribute to reducing electricity and natural gas consumption.

Data Sources:

- *2015-2016 Project Data Workbook*²⁰⁶. The Energy Commission has provided both high-level and measure-level product data for the past two years. Key data captured include:
 - Detailed list of measures to be applied
 - Estimated electricity and gas savings for each measure
 - Estimated useful life
 - Estimated total cost by project
 - Cost effectiveness, in the form of simple payback, for each measure
 - Rollup summaries at the project level
- *Energy Efficiency Financing Website*²⁰⁷. This resource outlines the eligible buildings that the loan funds may be used on, as well as the process by which the applicant may submit their project proposal.
- *California's Local Government Energy Efficiency Portal*²⁰⁸. This resource provides a high level overview of the ECAA program as well as what is required to submit an application.
- *ECAA Program Loans Website*²⁰⁹. This resource provides a little background information on the ECAA program, as well as county by county data concerning loan information. Data are also available at the project level for loan amount, cost savings, electricity savings and natural gas savings at the project level, dating back to the year 2000.

Methodology:

The analysis of this program is as follows:

- Generate top-down estimates of the savings potential for the program. For this phase, the NORESO team performed the following calculations and employed a set of assumptions to project the energy savings potential from 2015 through 2029.
 - Data Gaps
 - There is no annual budget limit; however, the budget limit per project is \$3M.
 - There is no data on utility rebates applied to the measures in the data set.
 - Calculations
 - Since the ECAA data sets include both energy efficiency and self-generation projects, this analysis extracted the energy efficiency-only data to serve as basis of the savings projections.
 - Historical data was gathered and organized based on project year. Where available, electrical and gas savings data were then utilized to project trends for future savings assumptions. There was no clear trend in the data, so instead an average value was used to project out through 2029.
 - Assumptions
 - For Phase 1, the NORESO team assumed that no ECAA savings can be assigned to the middle wedge because the current savings projections have been captured by the Demand Forecast.

²⁰⁶ ECAA Project Data Workbook was sourced by the Energy Commission.

²⁰⁷ California Energy Commission. Energy Efficiency Financing. State of California. 2017. <http://www.energy.ca.gov/efficiency/financing/>

²⁰⁸ California's Local Government Energy Efficiency Portal. <http://eecoordinator.info/cec-offers-1-loans-for-efficiency-generation-projects/>

²⁰⁹ California Energy Commission. ECAA Program Loans. State of California. 2017. <http://www.energy.ca.gov/efficiency/financing/calmap/county/>.

- The following considerations were also factored into the analysis:
 - Accounting for Codes & Standards Overlap. Because this program targets public buildings, the NORESKO teams assumes little-to-no natural construction turnover in the absence of additional financing. As such, zero percent of program savings were assumed to overlap with Navigant's 2018 Potential and Goals²¹⁰ (2018 PG) codes and standards estimates.
 - Accounting for Measure Savings Decay. Weighting factors by measure category, which were based on detailed measure data collected through the Proposition 39 program, were assigned as follows: 21.5 percent HVAC equipment, 3.2 percent HVAC control equipment, 8.6 percent HVAC operation, 53.9 percent lighting equipment, 4.8 percent lighting control equipment, and 8 percent other.
 - Correcting for Market Saturation. The 2015 Existing Buildings Energy Efficiency Action Plan²¹¹ indicates that: (1) the DGS reports about 125 million square feet of state-leased or –owned floor space; (2) nationwide, approximately 64 percent of government-owned buildings or municipality-owned, while 22 percent are state-owned. Additionally, the DGS reports²¹² about 20 million square feet of state-leased floor space. Combining that information with project data that indicates an approximate 80/20 split between state or local government buildings and public schools, and an assumption of average per project electricity savings of 15 percent, the NORESKO team estimates the total market for this program at around 550 million square feet. Accordingly, the analysis team predicts that the calculated savings projection through 2029 would result in approximately 16 percent of all applicable buildings being improved through 2029. As this seems reasonable, no correction was made to account for market saturation.

Savings Projections

No incremental savings could be estimated at this time. All energy savings are captured by the baseline demand forecast. Staff will update estimates in the draft commission report using new information from the recently passed SB 110 (2017).²¹³

²¹⁰ <http://www.cpuc.ca.gov/General.aspx?id=6442452619>

²¹¹ CEC. *California's Existing Buildings Energy Efficiency Action Plan*. September 2015.

²¹² <http://www.dgs.ca.gov/resd/Programs/LeasingandPlanning.aspx>

²¹³ Public Resources Code § 26205.5(a)

PROPERTY ASSESSED CLEAN ENERGY (PACE)

Program Description: Property assessed clean energy (PACE) is a financing program that provides property owners with alternative financing options to fund energy efficiency, renewable energy, and water conservation upgrades on existing and new residential and commercial buildings. In California, the first commercial and residential PACE programs were created in 2008²¹⁴. This financing program is offered by private lenders; hereafter referred to as PACE providers, and does not rely on public funding. PACE is designed to provide viable financing options to increase adoption of energy efficiency, renewable energy, and water conservation measures throughout California. Property owners of residential and commercial buildings can finance up to 100 percent of the project costs for qualifying projects through PACE. The fundamental mechanism of PACE relies on the existing framework of building property taxes whereby the entire loan, including principal and interest, can be repaid through a special tax assessment made on the property where energy projects are implemented. Loan payments can be amortized for a period of up to 20 years, with an option to extend payback period as necessary. By leveraging property taxes, the property improvements funded through PACE will be associated with the physical properties rather than the borrowers. In addition, the loan can be transferred between property owners at the time of sale or ownership transfer. Furthermore, the interest may be tax deductible. According to several PACE providers, the following features are representative of the key benefits of PACE:

- Long-term, fixed-rate financing
- No down payment required
- Financing terms independent of credit history
- Non-recourse, no financial covenants
- Easy credit approval
- Fully transferable and assignable upon sale
- Repaid through property taxes
- Treated as an operating expense and available for pass-through to tenant
- Available in active PACE participating districts in California

PACE financing is only available in participating districts where the private lenders have established legal agreements with cities and counties to channel the loan repayment through property taxes. This may be one of the limitations in the statewide adoption rate of PACE, although the number of PACE providers is on the rise. There are currently 19 PACE providers in California available to both residential and commercial property owners²¹⁵. The number of projects funded by PACE is higher for residential than for commercial, primarily due to the simplicity in ownership for residential buildings. The complexity of commercial buildings may arise from the variance in owners, investors, lease holders, lease terms, and other factors that inhibit the adoption of PACE financing for improvement projects.

Buildings Affected:

The PACE financing program is primarily available to residential and commercial property owners. It may also be available to public or municipal properties depending on local jurisdiction. As such, the following building types will be considered, as primary and secondary, for the purpose of this analysis:

- Residential (primary)
- Commercial (primary)
- Municipal (secondary)

²¹⁴ Kaat, Joe, *et al.* Residential and Commercial PACE Financing in California Rooftop Solar Challenge Areas. October 2014.

²¹⁵ Center for Sustainable Energy®. PACE Searchable Database. California. State of California. 2016.

<http://energycenter.org/policy/property-assessed-clean-energy-pace>

However, currently not all buildings in California in the residential, commercial and public sectors are affected by PACE due to the limited number of participating cities and counties. It may be reasonable to assume that PACE will become available statewide in all regions, since the program has expanded rapidly in the past few years and is continuing to expand. Many districts are in the process of offering PACE in their areas. Amongst the building sectors affected by PACE, those with the following circumstances may be ideal candidates for this financing program:

- Routine building improvements
- Recent property acquisitions
- Large tenant improvement projects
- New construction and redevelopment

Methods

Relevant Measures:

Eligible measures that can be financed with PACE may vary by PACE providers. In many jurisdictions, energy audits are recommended though not required for residential applications, whereas ASHRAE-level energy audits are often required for commercial buildings. Since the basis of PACE is on property valuation, the qualification of energy measures prioritizes building improvements that are permanently affixed to a property and can reduce on-site electric, gas or water consumption. As measures are approved by local PACE providers and may vary across districts, there is not a comprehensive list of measures available that applies to all districts. Below is a list of common measures:

- Building Envelope
- Attic insulation
- Building insulation
- Air Sealing and Ventilation
- HVAC equipment and controls
- Building control systems
- Lighting equipment and controls
- Daylighting
- Water heating
- Refrigeration
- Compressed air
- EV charging stations
- Elevator modernization
- Cool Roofs
- Cogeneration

Note that renewable generation measures are not included because they do not contribute to reducing electricity and natural gas consumption. The list of relevant measures may also include water conservation measures that reduce pumping load which in turn achieves energy savings. Further analysis will be necessary to understand the scope of water conservation measures.

Data Sources:

The process of data collection and analysis relies on the program insight provided by the Energy Commission, Center for Sustainable Energy®, and other publicly available information. The lack of statewide reporting mandates enforced on PACE has limited the availability of project data with energy savings reported by measure. Further outreach and data collection efforts will be necessary to expand the breadth and depth of the data sources used for this analysis. An overview of relevant data sources used for this study is summarized below.

- *Residential PACE in California: Feasibility of Studying Impacts on Mortgage Performance and Energy Savings*²¹⁶: This feasibility study is published by Lawrence Berkeley National Laboratory (LBNL) to assess the overall performance of the residential PACE activity statewide. The study states a list of objectives including (1) categorize residential PACE activity in California, (2) establish research questions relevant to PACE, and (3) identify data sources required to address the research questions, (4) identify existing data available, and (5) make recommendations on future PACE studies. However, the study does not provide concrete project or savings data that can be leveraged for this analysis. The NORESKO Team may apply findings of this study to establish outreach efforts and scenarios development in later analysis.
- *California State Treasurer PACE Loss Reserve Program*²¹⁷: This is a residential program that reports on residential projects enrolled into the PACE Loss Reserve Program, administered by the California Alternative Energy and Advanced Transportation Financing Authority (CAEATFA). Under this program, the PACE providers are required to report on the size and status of their portfolios on a semi-annual basis for all participating residential projects. Although this data source only represents a subset of all residential projects within the PACE framework and does not include commercial, the data available present a reference point for annual enrollment, funding and energy savings for the residential sector. The NORESKO team extracted information from the following available data parameters to support SB 350 analysis:
 - Annual kWh savings by PACE provider (2014-2016)
 - Annual therm savings by PACE provider (2014-2016)
 - Annual MT CO₂ savings by PACE provider (2014-2016)
 - Annual self-generation in kWh by PACE provider (2014-2016)
 - Annual total enrollment applications (2014-2016)
 - Annual total PACE financing amount (2014-2016)
- *PACENation Market Data*²¹⁸: This data source aggregates commercial and residential statistics for PACE programs implemented throughout the United States. Most data points are reported on a national level, while a few select parameters are reported at the state level. The NORESKO team extracted information from the following available data parameters to the refinement of savings estimates of this analysis:
 - Commercial:
 - Total financing approved nationwide
 - Total financing approved in California
 - Number of projects financed through PACE
 - Percent by project type (energy efficiency, renewable energy, mix)
 - Percent by building type (office, retail, etc.)
 - Annual funding amount (2010-2016)
 - Residential:
 - Total financing approved nationwide
 - Total financing approved in California
 - Number of projects financed through PACE

²¹⁶ Fadrhonc, Emily Martin, *et al.* Lawrence Berkeley National Laboratory. Residential PACE in California: *Feasibility of Studying Impacts on Mortgage Performance and Energy Savings*. January 2016.

²¹⁷ California State Treasurer John Chiang. PACE Loss Reserve Program. State of California. 2016. <http://treasurer.ca.gov/caeatfa/pace/activity.asp>

²¹⁸ PACENation. <http://pacenation.us/pace-market-data/>

- Percent by project type (energy efficiency, renewable energy, mix)
 - Annual funding amount (2010-2016)
- *Residential and Commercial PACE Financing in California*²¹⁹. This paper provides a high-level overview of the PACE program, enabling policies and case studies. From the case studies that analyzed five PACE districts, the following data may be extracted to a varying extent:
 - Total funded amount in a defined period
 - Total bill savings in a defined period
 - Total energy savings in a defined period
 - Types of measures, if specified
 - Percent of loans for energy efficiency vs. renewable energy, if specified
- *PACE districts searchable database*²¹⁵. There is a public web database available that can search for PACE district by address and shows a comprehensive list of active PACE districts in California.
- *California HERO Public Stats*²²⁰. Through Center for Sustainable Energy, there may be public statistical data available for specific PACE providers. Data that can be extracted may include:
 - Total funded amount in a defined period
 - Total bill savings in a defined period
 - Total energy savings in a defined period
 - Quantity of applications submitted and approved in a defined period
 - Percentage of improvements associated with energy efficiency versus other categories

Methodology:

The analysis of PACE will focus on the energy efficiency component that can be used to establish energy savings potential through 2029. There appears to be significant potential for PACE to continue to penetrate the residential market while increasing saturation in the commercial sector.

The data sources identified will be leveraged to produce initial savings estimates and refined savings estimates as described below. The analysis of this program will be conducted as follows:

- Generate top-down estimates of the savings potential for the program. The NORESO team performed the following calculations and employed a set of assumptions to project the energy savings potential from 2015 through 2029.

Data Gaps

- The lack of statewide reporting mandates enforced on PACE limited the availability of project data with energy savings reported by measure. Further outreach and data collection efforts will be necessary to expand the breadth and depth of the data sources used for this analysis.
- The Energy Commission and the NORESO team identified some high-level statistics published by various PACE programs that can be used to generate initial savings estimates. However, the high-level statistics only represent a subset of the current PACE market. More data will need to be collected and analyzed to consider the entire market potential.

²¹⁹ Kaat, Joe, *et al.* Residential and Commercial PACE Financing in California Rooftop Solar Challenge Areas. October 2014.

²²⁰ CaliforniaHERO PACE Program. PACE Statistics on Improvements and Lifetime Impact. 04/19/2017.

<http://www.herogov.com/faq>

Calculations

- Since the PACE data sets include both energy efficiency and self-generation projects, this analysis extracted the energy efficiency-only data to serve as basis of the savings projections.
- Due to limited project data, the SB 350 savings projections were assumed to continue at a constant level based on the annual energy savings data reported by the CAEATFA PACE Loss Reserve Program for residential projects. This method took a conservative approach in leveraging existing data that only represents a subset of the residential market and a subset of the PACE programs.

Assumptions

There is no comprehensive PACE data set available to indicate energy savings by building sector at the project level.

The CAEATFA data consists of a subset of residential projects and does not cover the entire residential portfolio of PACE projects in California.

Savings projections are conservative and will be refined in later work with more scenarios and funding trends.

Savings Projections

Table 12: Electricity (GWh) and Natural Gas (MM therms) Savings Projected From 2015 Through 2029 for PACE

Energy Unit	2015	2016	2017	2018	2019	2020	2021	2022	2023	2024	2025	2026	2027	2028	2029
Elec (GWh)	440	880	1320	1760	2200	2640	3080	3520	3960	4400	4841	5281	5721	6161	6601
NG (MM therms)	0.7	1.3	2.0	2.7	3.4	4.0	4.7	5.4	6.1	6.7	7.4	8.1	8.8	9.4	10.1

Source: California Energy Commission staff.

BEHAVIORAL, RETROCOMMISSIONING AND OPERATIONAL SAVINGS (BROS) FROM 2016²²¹ THROUGH 2029.

Program Description: Under AB 802 and SB 350, CPUC worked with the Energy Commission to include programs that achieve energy efficiency through behavioral, retrocommissioning, and operational savings with at least two- or three-year expected useful life into the 2018 Potential and Goals study (2018 PG).²²² BROS programs target improvements that either result in accomplishing the same work (e.g. space cooling) more efficiently or reducing/eliminating energy use without relying on installation of new energy efficient technologies.

²²¹ Start year of analysis depends on Navigant’s analysis period.

²²² <http://www.cpuc.ca.gov/General.aspx?id=6442452619>

Buildings Affected:

BROS affect all market sectors, depending on the specific program target. Existing buildings are targeted more than new construction, where operational changes can result in energy savings without requiring expensive retrofits or equipment upgrades. The following building markets are impacted:

- Residential and non-residential
- New construction and additional, alterations, and repairs; however alterations and repairs are likely targeted by more programs
- Public and private buildings

Methods

Relevant Measures:

To identify relevant measures, this study will look at those that Navigant has identified for the 2018 PG as well as additional program offerings from IOUs, POU, and third-parties. There may be significant overlap with the 2018 PG, which is estimating program participation through 2029 for some of the following measures. Most measures are whole building, but some may target specific systems, such as HVAC or lighting operation.

*Indicates measures that Navigant is including in the 2018 PG. Navigant is projecting out participation in these energy saving programs through 2029 based on an estimated rate of market uptake. There may be additional savings potential for these programs beyond Navigant's estimate.

Potential residential measures:

- Mailed feedback: Home Energy Reports*
- Challenge/Competitions*
- Real-Time Feedback: Online Portal*
- Real-Time Feedback: In Home Display*
- Audits
- Prepay (for example, mPower)
- Smart Thermostat
- Community Based Social Marketing
- Social Media

Potential commercial measures:

- Building Operator Certification (BOC)*
- Strategic Energy Management (SEM)*
- Building Energy Management and Information Systems (BEIMS)*
- Business Energy Reports (BERs)*
- Benchmarking*
- Retrocommissioning (operations and controls solutions)*
- Challenge/Competitions*
- Audits
- CBSM - Community Based Social Marketing
- Green leases
- Tenant-Operator Engagement (COMFY)
- ISO 50001:2011 support for Energy Management Systems

Additional measures will be identified through data collection. Most of the measures Navigant has identified are based on IOU offerings; the NORESO team will investigate potential measures from POU and third-parties.

Data Sources:

The current IOU offerings for BROS programs are minimal, and most are considered non-resource based. Therefore, the NORESKO team will investigate BROS programs currently or previously being implemented outside of California for potential savings impacts. The savings estimates will rely heavily on evaluations of these programs and their applicability to the California market. Potential data sources include, but are not limited to:

- Navigant 2018 Potential and Goals (2018 PG) analysis, including supporting BROS documentation and studies
- BROS program data from outside California, such as Envision Charlotte²²³
- ACEEE reports, including:
 - Advanced metering initiatives and residential feedback programs: a meta-review for household electricity-saving opportunities²²⁴
- Additional studies and evaluation reports, including:
 - CIEE: Behavioral assumptions underlying energy efficiency programs for businesses²²⁵
 - CIEE: Behavioral assumptions underlying California residential sector energy efficiency programs²²⁶
 - See Change Institute: From Categorizing to Characterizing: A Landscape Analysis of Behavior-Based Energy Programs²²⁷
- IOU and OPower HER impact evaluation reports
- IOU Behavioral program:
 - PG&E Residential pay-for-performance
 - PG&E Step-up, Power-down
 - PG&E Smart Choice

The NORESKO team needs to determine the applicability of selected BROS measures in the California market, based on any regulatory or infrastructure barriers. This study will also require feedback from CPUC and program implementers on the feasibility of offering and claiming savings for the selected BROS measures by the IOUs, POUs, or a third-party implementer.

Methodology:

The analysis method for estimating BROS potential energy savings will be to identify potential measures that can be offered in California, estimate savings potential, then determine feasibility and applicability to California participants. The NORESKO team will use representative measures with the best available data. The NORESKO team will refine those estimates, as well as include additional measures not assessed in this analysis.

To identify relevant programs, the NORESKO team considered programs that Navigant identified for the 2018 PG as well as additional program offerings from IOUs, POUs, and third-parties.

²²³ <http://envisioncharlotte.com/>

²²⁴ <http://www.energycollection.us/Energy-Metering/Advanced-Metering-Initiatives.pdf>

²²⁵ http://www.calmac.org/publications/Behavioral_Assumptions_in_EE_Programs_for_Businesses_White_Paper.pdf

²²⁶ https://energy.gov/sites/prod/files/2013/12/f6/ba_ee_res_wp.pdf

²²⁷

https://static1.squarespace.com/static/57895997e4fcb5b7319778e9/t/58e2ca4c9de4bbc0654661d1/1491257934368/et14pge7791_behavioral_landscape_analysis.pdf

The NORESO team included ten BROS programs from the 2018 PG study. These programs were not included in the Navigant 2015 AAEE workbook²²⁸, so the team considered them to be incremental to savings included in the baseline wedge. Table 294 provides a list of the BRO programs included in this study's BROS analysis. The NORESO team used the 2018 PG to develop assumptions for electricity and natural gas savings, and participation in these programs.

Table 293. 2018 PGT BROS Programs included in the Analysis

Bldg Type (Res or Nonres)	Program Name (Abbreviation)	Program Summary
Res	Home Energy Report (HER)	Provides periodic mailings with feedback on home's energy use, normative comparisons to neighbors, and tips for improving energy efficiency
Res	Real-time Feedback: In home display (RT In home)	Uses advanced metering data to provide real-time electricity usage via an in-home display (IHD)
Res	Real-time feedback: online portal (RT online)	Uses advanced metering data to provide real-time electricity usage via an online portal, such as a website or a smart phone application
Res	Small competitions (<10,000 people) (Small Comp.)	A small number of participants compete in energy-related challenges, events, or contests to reduce energy consumption either directly or through education;
Res	Large competitions (>10,000 people) (Large Comp.)	A large number of participants compete in energy-related challenges, events, or contests to reduce energy consumption either directly or through education
Res	Strategic Energy Management (SEM)	A continuous improvement approach that focuses on changing business practices to enable commercial and industrial companies to save money by reducing energy consumption and waste.
Nonres	Building Operator Certification (BOC)	Offers energy efficiency training and certification courses to commercial building operators
Nonres	Building Energy Management and Information Systems (BEMIS)	Provides IT-based monitoring and control systems that provide information on the performance of components of a building's infrastructure
Nonres	Business Energy Reports (BERs)	Provides small and medium businesses with mailings with feedback on energy use, normative comparisons to similar businesses, and energy saving tips (the commercial equivalent to HERs). 2018 PG assumes savings only for retail, lodging, restaurants, and "other".
Nonres	Retrocommissioning (RCx)	Commissioning to optimize performance of systems (primarily HVAC)

This study included three programs that were outside of the 2018 PG: (1) Smart Thermostat; (2) PG&E Pay for Performance (P4P), and (3) Advanced Metering Initiatives: Real-time Feedback.

²²⁸ The "AAEE CS Prog by Measure CED2015" workbook

Smart thermostat programs include initiatives that provide or incentivize smart thermostats – as in, devices that allow users to adjust the temperature remotely, use occupancy-based temperature management, automate settings, and provide other features to control and optimize thermostat settings. The NORESO team used an ACEEE conference paper that described savings from an Energy Trust of Oregon program for smart thermostats to estimate savings (Lieb, 2016). Because the ACEEE paper only documented natural gas savings, the research team included only natural gas savings for this analysis. In additional analysis the research team will look for savings estimates for electricity savings, taking into account possible double-counting with other programs.

PG&E launched the P4P program as one of its High Opportunity Program and Projects (HOPPs). The P4P program works with Aggregators -- parties responsible for managing a portfolio consisting of numerous residential homes that receive energy efficiency interventions – to maximize energy savings from those sites. The Aggregators work directly with residential customers and contractors to achieve energy savings through retrofits in addition to operational and/or behavioral interventions. Aggregator payments are determined based on gross energy savings through a PG&E facilitated weather normalized pre/post analysis of each participating customer's metered energy consumption. PG&E pays each aggregator a set rate per therm and kWh. The NORESO team took information on program savings and participation from the California Energy Data and Reporting System (CEDARS) (CPUC, 2017) and the HOPPs program filing (PG&E, 2016).

The NORESO team used a meta-analysis conducted by the American Council for an Energy Efficient Economy (ACEEE) to estimate savings from advanced metering initiatives that provide real-time feedback, either through an on-line portal or in-home display (ACEEE, 2010). The savings documented in the ACEEE study from real-time feedback programs (4-6 percent) were higher than the savings estimated for the real-time programs in the 2018 PG (approximately 1-2 percent). As described in the Methodology section, the NORESO team only counted incremental savings for the real-time feedback programs beyond the savings estimated in the 2018 PG for the real-time in-home display and real-time only programs.

The NORESO team used the assumptions shown in Table for savings, participation, and effective useful life (EUL) for BROS programs identified in the 2018 PG. The source for each assumption is indicated with a superscript letter (a, b, c, or d) described below the figure. As shown, this study primarily used the 2018 PG for savings and participation assumptions.

Table 14. Savings Assumptions for BROS Programs Identified in the 2018 PGT

Program	% kWh Savings per participant (Range)	% Therm Savings per participant (Range)	Participation Assumption	EUL (years)
HER	1.5% (1-2.3%) ^a	0.6% (0.6-1.9%) ^a	1.6M in 2015 ^a ; participation increases according to population growth ^b	1 ^b
RT In-home	2.3% ^b	0.0% ^b	4%, with additional 8% growth annually ^b	1 ^b
RT Online	1.3% ^b	1.3% ^b	10%, with additional 8% growth annually ^b	1 ^b
Small Comp.	8.1% ^b	5.2% ^b	0.02% ^b	1 ^b
Large Comp.	4.1% ^b	5.2% ^b	115,000 in 2015 ^c	1 ^b
SEM	3.0% ^b	3.5% ^b	1.0% ^b	5 ^b
BOC	63 per 1000 sf (18-151 per 1000 sf) ^d	6 per 1000 sf (0.8-14.2 per 1000 sf) ^d	1.18%, with additional 12.5% growth annually ^b	6.5 ^b
BEMIS	3% (0-4.2%) ^d	3.5% (0-7.4%) ^d	5.60% ^b	5 ^b
BERs	1.9% (1.6%-2.2%) ^d	0.9% restaurants ^b	1%, 1% increase each year ^b	2 ^b
RCx	4.7% (0-12.7%) ^d	4.7% (0-12.7%) ^d	1.28% ^b	5 ^b

- Savings vary for each IOU from 1-2.3 percent for kWh and 0.6-1.9 percent for therms. This study assumed the savings percentages for the PG&E HER program (1.5 percent kWh, 0.6 percent therms, based on the PG&E HER 2014 Impact Evaluation), because the PG&E HER program had significantly more participants than the SCE and SDG&E HER programs. This study will calculate savings specific to each IOU, and will use the 2015 PG&E HER Impact Evaluation²²⁹. For the participation assumption, this study followed the 2018 PG and assumed that the number of participants in the 2015 HER programs would grow according to California population growth.
- Based on 2018 PG assumptions, as described in 2.PG Appendix - BROS Methodology_2017-04-13.
- Based on 2014 San Diego Gas & Electric Manage Act Save (MAS) participation numbers
- Based on 2018 PG assumptions. To identify an estimate with the range, this study averaged the values across all building types and Program Administrators (PAs). In additional analysis this study will calculate savings for each building type for each PA, and multiply these by the estimated square footage of each building type in each PA territory.

The NORESO team used the assumptions shown in Table 1 for savings and participation for BROS programs identified outside of the 2018 PG. Because the research team did not identify estimates of savings persistence for these programs, this study used the conservative assumption of 1 year as the EUL for these programs.

- Smart Thermostat: The Energy Trust of Oregon study (Lieb, 2016) found 4.9 percent-6 percent natural gas savings. Given that California has a milder climate than Oregon, the NORESO team assumed half of the higher end savings: 6 percent / 2 = 3 percent. For participation, this study assumed 1 percent of households would participate based on industry judgment.

²²⁹ Published on May 22, 2017, after development of this study's preliminary analysis.

- **AMI Real-time feedback:** To estimate kWh savings per participant, the NORESKO team started with the ACEEE study findings, which found approximately 4 percent savings nationally. Because California is a mild climate compared with the rest of the U.S. (including a lower cooling load), the NORESKO team assumed 3 percent savings total from AMI real-time feedback. Because the 2018 PG assumed 1-2 percent savings from real-time feedback programs, the NORESKO team assumed an incremental savings of 1 percent. For participation assumptions, the team used the 2018 PG assumption for in-home display programs of 4 percent, since this is more conservative than the assumption of 10 percent for on-line portals
- **Res P4P:** To estimate savings per participant, the NORESKO team used projections from the program HOPPs filing (PG&E, 2016). For the participation assumptions, the team assumed the number of participants from the HOPPs filing, and used our industry experience to assume that participation increases by 5 percent annually.

Table 15. Savings Assumptions for BROS Programs Outside the 2018 PGT

Program	% kWh Savings per participant	% Therm Savings per participant	Participation Assumption	EUL (years)
Smart Thermostat	0%	3%	1%, with growth according to population growth	1
AMI Real-time Feedback	1%	0%	4%	1
Res P4P	6%	16%	2,000 households initially, with participation increasing by 5% annually	1

Savings Projections

Table 16: Electricity (GWh) and Natural Gas (MM therms) Savings Projected From 2015 Through 2029 for Behavioral, Retrocommissioning, and Operational Programs

Energy Unit	2015	2016	2017	2018	2019	2020	2021	2022	2023	2024	2025	2026	2027	2028	2029
Elec (GWh)	622.3	881.6	1141	1438	1743	1828	1914	2000	2058	2118	2181	2248	2320	2396	2478
NG (MM therms)	6.9	12.5	18.3	24.8	31.6	38.5	42.0	43.0	45.0	46.4	47.9	49.6	51.4	53.3	55.5

Source: California Energy Commission staff.

ENERGY ASSET RATINGS

Program Description: This program consists of two similar but separately funded programs, the California Home Energy Rating System (HERS) Whole House program, and Nonresidential Energy Asset Rating Program (a potential program that is not currently established). Both programs are designed to determine an asset rating of new and existing buildings that are measures of building performance, decoupled from operational details such as operating hours and building controls. Energy asset ratings characterize the major energy uses of the building through surveying and energy modeling. The program also provides some level of information on recommended efficiency measures to improve building performance. While the residential HERS Whole House program has been active for a number of years, the Nonresidential Energy Asset Rating program completed a pilot phase but was not fully rolled out to the marketplace.

Other national programs, such as ASHRAE's Building Energy Quotient (eQ) program, and international programs present in Ireland, Portugal and other countries have developed and implemented programs to develop asset ratings for commercial buildings.

Nonresidential Energy Asset Rating:

As part of a comprehensive program (AB 758 – 2009) to achieve greater energy savings in existing residential and nonresidential buildings, the Energy Commission developed and implemented a pilot program in 2012 to develop a protocol for asset ratings. The goals of the program were:

- Rate the inherent energy efficiency of the commercial building's envelope, lighting and HVAC systems relative to code and existing commercial building stock;
- Provide a metric relating to the financial implications of a building's energy efficiency;
- Communicate the importance of zero net energy buildings as a reference point for California's energy policy;
- Communicate a building's potential for an improved energy efficiency infrastructure, by comparing performance to other buildings of similar type and location;
- Be a reasonably priced rating for building owners to obtain.

The program complements an operational rating, such as EnergyStar. EnergyStar bases ratings on actual energy performance (bills), but the Nonresidential Energy Asset Rating is intended to normalize for operational effects and provide insights to relative building performance and potential energy efficiency capital improvement projects.

At an individual building level, the rating process required the following steps:

Data collection: an auditor collected high-level information about existing HVAC equipment, lighting, and building envelope performance from available information onsite (actual nameplate information and model information, for example). Where information was not available, defaults would be specified based on building vintage.

Data analysis: the collected data would be fed into a streamlined building performance model, applying intelligent defaults and applying fixed operational data. The building's performance is compared against a fixed benchmark for a given building type and climate. The benchmark can be based on either historical data (CEUS or CBECS, for instance), or based on a code-vintage basis (a building that minimally complies with 2005 Title 24 code, for example).

Rating Calculation: a performance rating on a 0-100 scale is provided, and can be paired with a letter grade (A-F).

Rating Communication: A certificate is generated, explaining the rating. The certificate can also include some possible insights into energy efficiency upgrades. While the Nonresidential Energy Asset Rating is not intended to take the place of an audit, it can provide some good guidance on energy end uses and relative efficiency of different building systems and features.

A key distinction between energy asset ratings and other efficiency programs is that onsite photovoltaics and cogeneration systems could potentially be considered an asset, as they provide persistent savings. The program was suspended after the pilot due to funding availability, but shows promise and is well-aligned with other programs and with Energy Commission goals.

Buildings Affected:

The Nonresidential Energy Asset Rating Program would affect most commercial building types, with the exception of some buildings with process loads, including labs, data centers and possibly refrigerated warehouses, and hospitals. Mixed use buildings could fall into the scope, but would require additional research to adequately define the reference point and the required building inputs. The table below shows the planned scope of the Nonresidential Energy Asset Rating Program.

Table 17. Proposed Nonresidential Energy Asset Rating Building Type Classification

Proposed Building Types	Use Existing DOE Reference Building	Use Modified DOE Reference Building	New Modeling Prototype Required
Large Office	X		
Medium Office	X		
Small Office	X		
Data Processing/Computer Center		X	
Lab/R&D Facility			X
Quick Service Restaurant	X		
Full Service Restaurant	X		
Bar/Tavern/Nightclub/Similar		X	
Supermarket	X		
Convenience Store		X	
Stand-alone Retail	X		
Strip Mall	X		
Refrigerated Warehouse		X	
Unconditioned Warehouse		X	
Conditioned Warehouse		X	
Small Hotel	X		
Large Hotel	X		
Primary School	X		
Secondary School	X		
College or University		X	
Religious Assembly			X
Health/Fitness Center			X
Theater/Performing Arts			X
Library/Museum			X
Conference/Convention Center			X
Other Recreational/Public Assembly			X
Service			X
Assembly/Light Mfg.			X
Police/Fire Stations			X

Source: Crowe, Elliot, et. al. 2012. California’s Commercial Building Energy Asset Rating System (BEARS): Technical Approach and Design Considerations, ACEEE 2012 Summer Study Proceedings.

Some buildings would be excluded due to the lack of available protocols necessary to establish the “100” reference point on the scale. The precise scope of the program would depend on the willingness of the different building sectors to embrace the rating program.

Methods

Relevant Measures:

While a building energy asset rating does not replace an energy audit of the building, a secondary benefit of this program is to identify potential energy upgrade projects. Efficiency improvements that would result in savings beyond normal end-of-life replacement projects could include:

- Equipment upgrade replacement (chiller, boiler, packaged rooftop units)
- Lighting upgrades

Control upgrades – upgrade to DDC controls
Envelope Upgrades
Plug-load controls

The granularity of recommendations depends upon the detail of energy audits performed as a part of the rating process. This program assessment requires an estimate of the net increase in probability that rated buildings would undergo efficiency improvement projects sooner than buildings not rated by the program. A possible benefit as well is a richer source of data for portfolio management, for companies that have a number of similar facilities in California.

Data Sources:

The team will leverage a number of data sources for the Nonresidential Energy Asset Rating program estimates. Where possible, interviews and other correspondence with various actors in the programs (administrative staff, raters, and energy efficiency upgrade providers) will yield supporting information for the savings estimates.

Data sources include:

- NORESO and Energy Commission Data on Nonresidential Energy Asset Rating Pilot Project
- Other Asset Rating Programs (DOE, ASHRAE Building eQ, Massachusetts DOER)
- CEUS²³⁰ and CBECS²³¹ Databases for historical energy performance of existing buildings by type
- Correspondence with Real Estate Industry Professionals on interaction between asset ratings and property valuation
- Estimates of site energy use intensity (EUI) by building type and building vintage, from the Urban Footprint project

²³⁰ <http://capabilities.itron.com/CeusWeb/Default.aspx>

²³¹ <https://www.eia.gov/consumption/commercial/data/2012>

Methodology:

The analysis of this program is as follows:

Because HERS Whole House is an established program, the NORESO team assumed that associated savings would already be captured in the state demand forecast, and therefore not contribute to SB 350 savings goals.

- Identify affected building types and building stock. The estimate includes office, retail, restaurant, warehouse, school and hotel buildings. High-rise residential, grocery, hospital buildings and other buildings with significant process loads (labs, data centers) are excluded.
- Floor area data by building type were extracted from the IEPR building stock data.
- Distribution of non-residential floor area by building type and size was collected from 2012 CBECS. Data were collected to determine what fraction of floor area by building type is expected to be contained within buildings larger than 50,000 ft².
- Nonresidential building energy use intensities (for electricity and gas, separately) were extracted from the California Commercial End-Use Survey (CEUS). To account for the age of CEUS data, values were updated according to the ratio of energy use data captured by 2012 CBECS and 2003 CBECS²³² (ratios were calculated for each combination of fuel and building type).
- Annual benchmark savings are derived from ENERGY STAR data collected from 2008 to 2011 for buildings in Portfolio Manager. While ENERGY STAR reports results of 2.4 percent annual savings, the data seem to indicate diminishing year-after-year returns²³³; accordingly, the NORESO team's savings estimates are based on a logarithmic data fit that assumes savings decrease in out years once the low-hanging fruit have been harvested. Based on a 60/40 distribution between electricity and gas across the non-residential and multifamily building stock, the NORESO team assumes that the majority of savings due to benchmarking would be electricity savings. Based on a 60/40 distribution between electricity and gas across the non-residential and multifamily building stock, assuming first-year benchmarking savings of 3.9 percent for electricity and 1.3 percent for gas results in an 80/20 split between electricity and natural gas savings and total savings that align with the logarithmic fit to the ENERGY STAR data.
- For buildings larger than 50,000 ft², for which benchmarking and data disclosure will be required by AB 802, the NORESO team assumed that Nonresidential Energy Asset Rating would increase ENERGY STAR-predicted savings by 50 percent (assumption is that savings would increase but at a diminishing rate due to benchmarking data already being available).
- For buildings between 25,000 ft² and 50,000 ft², the NORESO team assumed that Nonresidential Energy Asset Rating would be the only form of benchmarking and estimated savings equivalent to ENERGY STAR-predicted savings.
- Amongst the selected building types, the NORESO team assumes that an additional 2 percent of the existing building stock would get Nonresidential Energy Asset Rating each year and begin to realize energy savings.

²³² <https://www.eia.gov/consumption/commercial/data/2003/>

²³³ The most significant opportunities for savings will be addressed first, leaving lesser opportunities for additional savings in future years.

- The research team assumes that 90 percent of Energy Asset Rating savings would ultimately be realized through a financing or incentive program (the other 10 percent are assumed to occur naturally according to the initiative of the building owner or operator). For this phase, to make a clear distinction between savings expected to be claimed by utilities and those expected to be attributed to programs run by the state, the NORESO team assigned a portion of the 90 percent of Energy Asset Rating savings expected to be realized through financing and incentive programs to expected enhanced IOU and POU programs according to the ratio of projected cumulative IOU and POU savings (both known and expected) to the total projected cumulative savings across all programs. The remainder of Energy Asset Rating savings is currently attributed to Energy Asset Rating itself; however, it may be appropriate for later phases to assign a portion of that savings to other state-run programs.

Savings Projections

Table 18: Electricity (GWh) and Natural Gas (MM therms) Savings Projected From 2015 Through 2029 for Energy Asset Rating

Energy Unit	2015	2016	2017	2018	2019	2020	2021	2022	2023	2024	2025	2026	2027	2028	2029	2030
Elec (GWh)	0	0	14	47	92	148	211	282	359	440	526	616	715	817	923	1,033
NG (MM therms)	0	0	0.1	0.3	0.5	0.8	1.1	1.4	1.8	2.2	2.6	3.0	3.5	4.0	4.5	5.0

Source: California Energy Commission staff.

SMART METER AND CONTROLS

Program Description: This program is intended to leverage the smart meters that have been installed in California to encourage reduction in energy consumption by providing consumers with real-time information on the costs associated with energy consumption at that time. As energy is reduced during peak load periods, some of the load may be shed to lower periods, saving the consumer money, and also saving energy consumption via the employment of a direct, Internet of Things (IoT) or otherwise-connected device. Smart meters can be installed on electric, gas, and water meters.

While not a currently established program, there is support to suggest that implementation of a smart meter and controls program can result in energy savings. As of 2015, over 80 percent of meters in California are listed as Advanced Metering Infrastructure (AMI) electricity meters. These meters enable the variable rate structures, demand response, and improved customer feedback and control.²³⁴

As the smart meter market develops, there is potential for feedback to include historical baseline information, and enable the control of energy consumption in a manner that reflects the Time Dependent Valuation (TDV) of the energy consumed.

²³⁴ <http://www.utilitydive.com/news/how-smart-meters-are-changing-energy-efficiency-in-california/410489/>

Further, the smart meter may be able to communicate through the internet with devices in the building that are connected as part of the IoT. For example, the air conditioner can be sent a signal to only operate minimally when the electricity rates are above a threshold, or the clothes dryer can be set to run as soon as the electricity rate drops below a desired level. This communication will be automatic, but the decision-making will initially be made by the consumer, rather than the utility. Utilities, however, have chosen to incentivize this through programs to encourage reduced demand peaks, lower overall energy consumption, and lower overall TDV for the consumption profile in some circumstances. For example, PG&E uses this to encourage peak reduction through their SmartRate rate plan, with an incentive of lower overall rates predicated on the consumer reducing electricity usage on certain days of peak demand; which is limited to 15 per year.²³⁵

Note that smart meters are effectively the enabling technology needed to create behavioral programs, which results in a potential for substantial overlap with the Behavioral, Retrocommissioning, and Operational Savings (BROS) program. For this reason, the NORESKO team has adopted a narrow interpretation of smart metering; that is, the employment of a direct, IoT or otherwise-connected device. Energy efficiency opportunities that involve semi-active or ongoing participant decision-making fall outside the scope of this definition (such opportunities are included in the BROS program). Additionally, as part of this study, the NORESKO team will only consider smart meter-based interventions that reduce energy consumption (interventions that only shift demand will not be analyzed).

Buildings Affected:

Residential buildings are candidates for smart meter savings because they generate a relatively high level of discretionary energy consumption. There is opportunity for smart meter savings in nonresidential buildings as well. For example, a facility manager may choose to reduce light levels when the energy cost crosses a threshold, even if there isn't a demand response event occurring. In some cases, BAS controls may facilitate action that enables automated smart meter savings; in other cases, BAS capabilities may be able to determine the necessary efficiency intervention without the need for smart meter input at all.

Methods

Relevant Measures:

The NORESKO team will focus analysis efforts on smart meter measures capable of reducing site energy use via IoT or otherwise-connected devices. The measures to be analyzed for this program may include:

- Differences in flat vs. tiered rates that encourage energy or TDV savings
- Rate structures with feedback-based incentives
- Automatic or IoT interface connection incentives or benefits

²³⁵ https://www.pge.com/en_US/residential/rate-plans/rate-plan-options/smart-rate-add-on/discover-smart-rate/discover-smart-rate.page

Data Sources:

Current research on smart meters indicates that the savings potential of smart metering is not being fully realized.²³⁶ Rate structure analysis from utility filings may be employed to inform time of use energy consumption models. The NORESKO team will evaluate applicability of selected measures in the California market, based on any regulatory or infrastructure barriers. This study will also require feedback from CPUC and program implementers regarding feasibility of offering and claiming savings for the selected measures.

Methodology:

The NORESKO team will identify potential measures that can be offered in California, estimate savings potential, and determine feasibility and applicability to California participants. The analysis will use generalized energy efficiency savings concepts to predict savings. The NORESKO team will refine those estimates, as well as include measures not assessed herein if any specific information is available.

The analysis of this program is as follows:

The research team evaluated smart meter and controls potential for buildings of all types and sizes, including all non-residential buildings and all multifamily and single-family homes. The source of expected energy savings is reduction in consumption associated with automatic response of IoT or otherwise connected devices to smart meter feedback.

Floor area data by building type were extracted from the IEPR building stock data. For multifamily buildings, IEPR data capture number of households. To convert number of multifamily households, the research team followed the same assumptions leveraged by the 2016 Impact Analysis Report²³⁷: 26 percent of multifamily households are high rise units with a floor area of 1,248 ft²; the remaining households are contained within 6,960 ft², two-story, 8 dwelling buildings (870 ft² per unit). For single family homes, 45 percent of homes are assumed to be 2,100 ft² and 55 percent are assumed to be 2,700 ft².

Commercial building energy use intensities (for electricity and gas, separately) were extracted from the California Commercial End-Use Survey (CEUS).²³⁸ To account for the age of CEUS data, values were updated according to the ratio of energy use data captured by 2012 CBECS²³⁹ and 2003 CBECS²⁴⁰ (ratios were calculated for each combination of fuel and building type).

Residential building energy use intensities (for electricity and gas, separately) were extracted from the California Statewide Residential Appliance Saturation Study (RASS) for 2009.²⁴¹

Due to the lack of data availability related to the potential for smart meter and controls, as well as the general indication that demand and time-of-use response interventions are the area of focus for the technology, the NORESKO team made the following conservative assumptions regarding the energy efficiency potential of smart meter and controls:

- Energy savings from smart meter and controls will not begin to be realized until 2020.

²³⁶ https://www.washingtonpost.com/news/energy-environment/wp/2015/01/29/americans-are-this-close-to-finally-understanding-their-electricity-bills/?utm_term=.f050c02532b1

²³⁷ NORESKO; Nittler, Ken. "Impact Analysis: 2016 Update to the California Energy Efficiency Standards for Residential and Nonresidential Buildings," 2015.

²³⁸ <http://capabilities.itron.com/CeusWeb/Default.aspx>

²³⁹ <https://www.eia.gov/consumption/commercial/data/2012>

²⁴⁰ <https://www.eia.gov/consumption/commercial/data/2003/>

²⁴¹ <https://webtools.dnvgl.com/rass2009/>

- Approximate savings will increase to approximately 0.5 percent for electricity and 0.25 percent for natural gas by year five and then flatten out after that. A logarithmic fit is applied to determine savings by year.
- Starting in 2020, an additional 2 percent of buildings will begin to realize savings via smart meter and controls each year.

Savings Projections

Table 19: Electricity (GWh) and Natural Gas (MM therms) Savings Projected From 2015 Through 2029 for the Smart Meters and Controls

Energy Unit	2015	2016	2017	2018	2019	2020	2021	2022	2023	2024	2025	2026	2027	2028	2029
Elec (GWh)	0	0	0	0	0	7	15	25	36	48	60	73	86	100	115
NG (MM therms)	0.0	0.0	0.0	0.0	0.0	0.0	0.1	0.1	0.2	0.2	0.3	0.4	0.4	0.5	0.6

Source: California Energy Commission staff.

FUEL SUBSTITUTION (ELECTRIFICATION)

Program Description: While not a program per se; the Fuel Substitution category captures energy savings that can be achieved at the site level by substituting one utility-supplied fuel for another. By definition, that means substituting electricity for natural gas, or vice versa. Because it is not anticipated that substituting natural gas for electricity would result in net site energy savings, electrification will be the main area of focus for this category of savings.

Buildings Affected:

Any commercial or residential new construction or retrofit project for which site energy usage can be reduced by replacing existing natural gas-powered equipment with electrical equivalents. Because there is no specific program in place, the current approach is to not limit the potential savings to any particular building sector. Additionally, as it relates to projecting savings potential, different funding mechanisms (grants, standard loans, no interest loans, on-bill financing, etc.) will be considered.

Methods

Relevant Measures:

Anticipated energy efficiency measures include replacing natural gas-powered equivalents with the following electrical alternatives:

- Standard efficiency electrical equipment
 - Electric resistance heating
 - Electric resistance clothes dryers
 - Electric resistance domestic hot water heaters
- High efficiency electrical equipment
 - Heat pump heating and cooling systems, including min-split systems
 - Heat pump domestic hot water heaters

- Combined space and water heating heat pumps
- Heat pump clothes dryers

Data Sources:

- *Electrification Technology White Papers.*²⁴² White papers detailing anticipated energy performance are available for a number of relevant high efficiency technologies, including: (1) variable capacity heat pumps, (2) ducted and space-decoupled heat pump water heaters, (3) combined space and water heating using CO₂ refrigerant air-to-water heat pumps, (4) ductless mini-split heat pump systems, and (5) heat pump clothes dryers. Such papers will facilitate the specification of energy efficiency measure energy modeling inputs.
- *City of Palo Alto Electrification Work Plan.*²⁴³ This report recommends 10 tasks to reduce Palo Alto's use of natural gas and gasoline and to electrify its buildings and vehicles over a 5 year period. The subset of the 10 recommended tasks that relate to building energy consumption are as follows: (1) promote heat pump water and space heating in existing homes; (2) provide resources to homeowners to convert existing homes to all-electric homes; (3) explore the development of retail electric rate schedule for homes that electrify; (4) explore additional residential and commercial building code changes to expedite electrification; (5) evaluate utility connection fees and permitting fees associated with electrification projects; (6) explore opportunities to electrify existing and new city buildings; (7) explore new financing sources to expedite electrification; and (8) analyze options for district heating to reduce natural gas in commercial buildings. Additional relevant tasks recommended to be deferred include: (1) facilitate electrification of space heating in existing large commercial buildings, and (2) study electrification as a potential element in any future residential or commercial energy efficiency ordinance.
- *Space and Water Heating Electrification in Palo Alto: Code Feasibility and Cost Effectiveness Analysis.*²⁴⁴ Palo Alto engaged TRC Energy Services to provide analysis for electrification of new and existing buildings within the city. The scope of the analysis includes: (1) consideration of potential ramifications on electrical service at the building level, (2) evaluation of the cost effectiveness of a number of different electrification strategies by building type (single family residential, low-rise multifamily, small office, and medium office); and (3) evaluation of potential code, technical and operational barriers to electrification in both the residential and commercial building sectors.
- *Urban Footprint Energy Modeling Analysis.*²⁴⁵ NORESO recently executed a large scale analysis that evaluated the potential impacts of a number of perspective policy changes; electrification was amongst the policy changes analyzed. The analysis spanned a number of different building types and climate zones.
- *Sacramento Municipal Utilities District (SMUD).*²⁴⁶ SMUD offers heat pump water heater rebates, indicating that the adoption of measures that enable fuel substitution is incentivized in certain cases.

Methodology:

Because there are few existing programs built around fuel substitution (i.e. electrification), there are limited historical data available from which to project future potential savings. Accordingly, a bottom-up energy modeling approach will likely be necessary to realistically estimate potential natural gas savings associated with electrification. That being said, existing electrification analyses will be utilized to the extent possible to alleviate the overall burden of analysis, particularly early in the analysis.

242 Southern California Edison. Electrification Technology White Papers.

243 City of Palo Alto. City Council Staff Report. "Fuel Switching/aka Electrification." August 17, 2015.

244 City of Palo Alto. TRC Energy Services. "Palo Alto Electrification Final Report." November 16, 2016.

245 California Energy Commission. Urban Footprint Energy Modeling Analysis. 2015-2016.

246 <https://www.smud.org/en/index.htm>

The analysis of this program is as follows:

- Leverage previous electrification studies by both NORESO and TRC to provide a rough estimate for the overall natural gas savings potential associated with statewide electrification of buildings. Based on those analyses and other known studies associated with electrification (some additional literature view will be required to determine if the currently noted data sources are sufficient to capturing relevant electrification technologies), finalize a list of electrification measures to be included in a more thorough electrification analysis. Note that the electrification measures analyzed result in a net energy reduction (in terms of both site and source energy).

Savings Projections

Table 20: Electricity (GWh) and Natural Gas (MM therms) Savings Projected From 2015 Through 2029 for Fuel Substitution

Energy Unit	2015	2016	2017	2018	2019	2020	2021	2022	2023	2024	2025	2026	2027	2028	2029
Elec (GWh)	0	0	0	-139	-280	-423	-569	-717	-867	-1018	-1169	-1321	-1474	-1629	-1787
NG (MM therms)	0	0	0	17.8	35.9	54.1	72.8	91.8	110.9	130.2	149.6	169.0	188.6	208.5	228.7

Source: California Energy Commission staff.

Additional Program Participation:

The NORESKO team assumes that 10 percent²⁴⁷ of all savings realized through state financing programs will ultimately be claimed by IOUs or POUs through their respective rebate programs. Accordingly, savings for state financing programs have been reduced by 10 percent, which the research team has redistributed to IOU and POU programs according to the relative magnitudes of their expected savings in a given year (for example, if IOU savings are projected to double POU savings for a given year, one third of the state financing overlap will be assigned to POU programs, and two thirds will be assigned to IOU programs). Because the NORESKO team anticipates that these savings are additional savings not currently captured by bottom wedge IOU and POU estimates, they are categorized in the updated wedge diagrams as additional program participation.

²⁴⁷ This is a placeholder number. There is evidence that state financing program projects take advantage of utility rebate programs. In general, the percentage of project costs offset by rebates is small, but it is unclear what portion of the overall savings is claimed by the utilities and how that amount relates to offset costs.