

DOCKETED

Docket Number:	15-AFC-01
Project Title:	Puente Power Project
TN #:	218882
Document Title:	Supplemental Testimony of Dr. Revell Exhibit Final Draft Guidelines for Coastal Flood Hazard Analysis and Mapping
Description:	N/A
Filer:	PATRICIA LARKIN
Organization:	SHUTE, MIHALY & WEINBERGER LLP
Submitter Role:	Intervenor Representative
Submission Date:	6/15/2017 3:00:55 PM
Docketed Date:	6/15/2017

Final Draft Guidelines for
Coastal Flood Hazard
Analysis and Mapping
for the

Pacific Coast of the United States

Prepared for



FEMA

A Joint Project by
FEMA Region IX, FEMA Region X, FEMA Headquarters

Contact

Les Sakumoto
Project Officer
FEMA Region IX
1111 Broadway
Oakland, CA 94607

Study Contractor

nhc

northwest hydraulic consultants
3950 Industrial Boulevard
West Sacramento, CA 95819

Contacts

Edward Wallace
Robert MacArthur
Shyamal Chowdhury

Final Draft Guidelines for
**Coastal Flood Hazard
Analysis and Mapping**
for the
Pacific Coast of the United States

Prepared for:



FEMA

A Joint Project by
FEMA Region IX, FEMA Region X, FEMA Headquarters

FEMA Study Contractor:

northwest hydraulic consultants, inc.

Final Draft Prepared November 2004, Section D.4.5 Revised January 2005

All policy and standards in this document have been superseded by the FEMA Policy for Flood Risk Analysis and Mapping.
However, the document contains useful guidance to support implementation of the new standards.

PROJECT SUMMARY

PS.1 PURPOSE OF STUDY

The Federal Emergency Management Agency (FEMA) is responsible for preparing Federal Insurance Rate Maps (FIRMs) that delineate hazard zones and Base Flood Elevations in coastal areas of the United States. These areas are among the most densely populated and economically important areas in the nation. Coastal areas are subject to a variety of natural processes that result in significant hazards to public safety and property along the nation's coastlines, including extreme conditions of storm surge flooding, waves, erosion, rainfall, and wind. The purpose of this study is to evaluate existing FEMA procedures for delineating coastal flood hazard areas in three major coastal regions of the United States (Atlantic, Gulf, and Pacific) and to develop recommended new guidelines and procedures in one of these areas (Pacific).

This project was authorized cooperatively by FEMA Headquarters, FEMA Region IX, and FEMA Region X in October 2003. The project is managed by Les Sakumoto, Project Officer for FEMA Region IX. Northwest Hydraulic Consultants, Inc. is the lead consultant and manager of the Technical Working Group. The primary work products for the study are the Final Draft Guidelines attached to this Project Summary, and a Phase 1 Summary Report (May 2004). The Final Draft Guidelines (generally referred to below as "Guidelines") provide guidance for coastal flood hazard analyses and mapping, specific to the Pacific Coast of the United States. The Phase 1 Summary Report provides background on the project approach; describes the process used for evaluating existing guidelines; and summarizes the recommendations for the Pacific, Atlantic, and Gulf Coasts. Appendices to the Phase 1 Report include information on the Technical Working Group, key references, and Focused Studies conducted on 11 categories of technical topics.

PS.2 PROJECT CONTEXT AND GOAL

Approximately 50 percent of the population of the United States resides on or near the coast (less than 50 miles from the coastline). More than 3,000 communities are located in this 12,000-mile-long coastal zone, which is covered by approximately 7,400 existing FIRM panels. Much of this inventory of coastal FIRMs is more than 20 years old. Faced with maintenance of the present inventory and creation of new FIRM panels, FEMA began an ambitious plan for Map Modernization in 1997. Congress approved a FY 2003 budget that included a significant increase for funding the Map Modernization Plan, and FEMA has placed a high priority on coastal flood hazard mapping.

While considering the needs of Map Modernization in coastal areas, FEMA recognized the need for a comprehensive review of procedures that will be used to identify coastal flood hazards. This review was needed to consider recent advances in coastal flood hazard assessment and mapping, and potential modifications to existing FEMA procedures based on state-of-the-art scientific understanding of coastal processes, new technology and numerical modeling techniques, improved and expanded data, and modern mapping techniques.

The overall goal of this project is to incorporate recent advances in the sciences and in coastal engineering into a recommended approach for improved coastal flood hazard mapping for the Pacific Coast of the United States, based on an understanding of local and regional coastal processes.

PS.3 DESCRIPTION OF NEEDS BY GEOGRAPHIC REGION

Guidelines for the Atlantic Coast, Gulf Coast, and Great Lakes have been assembled from elements developed over the course of many years; however, no comprehensive assessment has been done to evaluate their effectiveness in hazard mapping for the Atlantic and Gulf Coasts. During this time, the Pacific Coast was recognized as a special case because of differences in coastal processes (e.g., tsunamis, El Niño, swell) and geomorphic characteristics, but no FEMA guidance was established specifically for this coast.

PS.3.1 Pacific Coast

In general, the FIRMs for the Pacific Coast of the United States are more than 20 years old. These maps require comprehensive updating to adequately define hazard zones in some of the most densely populated and fastest growing areas of the United States. FEMA's existing coastal flooding guidelines focus on storm types (especially hurricanes) and coastal processes that are relevant to the open coast settings of the Atlantic and Gulf Coasts. The Pacific Coast is subject to storm types, wave conditions, and coastal processes that differ from those in other coastal regions of the country. Therefore, much of the existing guidance is not directly transferable to the analysis of Pacific Coast coastal flood hazards. An assessment of the existing guidance was needed to determine which portions may be transferred or modified for use on the Pacific Coast and what new procedures are needed.

PS.3.2 Atlantic and Gulf Coasts

A comprehensive review of the existing guidelines was needed in light of more recent experience and new technology. Modified or new procedures are needed to incorporate experience from previous studies and appeals, information on actual damages, and post-storm verification data. In addition, a review of the basis of existing procedures was needed in light of an improved understanding of ocean and coastal processes from recent research and new data. The existing procedures include little guidance on analysis of storm meteorology, storm surge, or wave setup. In addition, there is a need to evaluate expansion of the guidelines to address flood hazards in coastal areas not directly exposed to ocean swell and waves generated by distant weather conditions (e.g., bays and estuaries, referred to as Sheltered Waters in this document).

PS.3.3 Other Areas

The review and update of the guidelines are intended to facilitate consistent and accurate mapping of coastal flood hazards in the Map Modernization Plan. Because of the unique coastal processes in Alaska, Hawaii, the Great Lakes, Caribbean islands, and Pacific islands, the project focuses on guidelines for the oceanic coastlines of the conterminous United States. It is anticipated that many of the identified procedures will be transferable to these other areas, but that additional

work will be required to address unique physical characteristics and processes in each of these regions.

PS.4 PROJECT APPROACH AND SCHEDULE

The project approach included two key elements to ensure that the project was completed rapidly and effectively: (1) a team of technical experts (Technical Working Group, or TWG) was assembled with experience in various coastal processes and their effects in different geographic regions of the country, and (2) the project was conducted in two phases—Phase 1 to evaluate the existing guidelines for all three coasts and Phase 2 to develop proposed new draft guidelines for the Pacific Coast.

The TWG is comprised of coastal experts from private industry, academic and research institutions, federal agencies (National Oceanic and Atmospheric Administration, U.S. Army Corps of Engineers, and U.S. Geological Survey), flood insurance study contractors, map coordination contractors, and FEMA Headquarters and regional engineers. The TWG includes members from all three coastal regions of the United States and from Europe. An alphabetical listing of the Technical Working Group is provided after the Executive Summary. This group was organized to implement a collaborative approach to identify the needs and priorities for improved coastal flood hazard mapping procedures, consider potential alternatives, and develop recommendations based on consensus among coastal experts.

The project schedule was established based on FEMA's targets for the Map Modernization Plan. The project approach recognized that improvements to the Guidelines would need to be prioritized to maintain the adopted schedule. Phase 1 was initiated in October 2003, and a final draft Phase 1 Summary Report was delivered to FEMA in June 2004.

Phase 2 of the project was initiated in May 2004, and Final Draft Guidelines were delivered to FEMA in electronic format in November 2004. The Final Draft Guidelines are appended to this Project Summary in hard copy. Additional Technical Support information will be submitted to FEMA in January 2005.

Completion of the project on this schedule allows coastal flood insurance studies to proceed with new draft guidance in fiscal year (FY) 2004/2005. The schedule has required an intensive work effort to complete a comprehensive review of existing procedures, to recommend modifications to existing procedures, develop new methods, and prepare the Final Draft Guidelines. This effort involved approximately 30 organizations and active participation of more than 60 individuals.

PS.5 PHASE 1 TASKS

The approach for the assessment phase of the project (Phase 1) was to examine all technical areas of the coastal flood hazard mapping process. Initial tasks focused on a review of the existing guidelines and the needs and priorities for their improvement. Under these tasks, coastal experts from the TWG reviewed existing guideline methodologies for the ocean and coastal processes analyzed in flood insurance studies (e.g., storm meteorology, storm surge, wave setup, wave transformation, wave runup, and overtopping) and evaluated their applicability for each coastline.

Case studies were prepared to demonstrate application of guideline methodologies in previous coastal flood insurance studies on each coast, and representative studies were prepared to demonstrate application of guideline procedures to particular coastal processes.

An international literature search was conducted to identify sources of information on existing and evolving coastal engineering practices and to identify pertinent scientific research that may be useful in developing new guidelines. The international experience of several TWG members was used during this task to provide the project with information, techniques, and practices from around the world.

The initial tasks described above served as the basis for reporting and discussion at Workshop 1, held in Sacramento, California, on December 2–4, 2003. The workshop was attended by 38 members of the TWG from across the country. The workshop agenda included:

- ④ review of existing guidelines and practices;
- ④ technical presentations on the state of the science in coastal processes;
- ④ workshop sessions to identify needs, priorities, and potential guideline improvements by coastal geographic areas and coastal processes; and
- ④ Summary sessions to list and prioritize needed guideline improvements.

The primary result of Workshop 1 was a list of 53 technical topics for consideration in updating the guidelines. Each item also included an initial assessment of the time and data required to develop improved procedures. This assessment resulted in categorizing each topic as “Critical,” “Important,” “Available,” or “Helpful.” “Critical” and “Important” topics were considered the highest priorities for development of new or improved procedures, and were subdivided into topics that could likely be addressed in the 6-month time frame of the project (“Critical”) and those that would require longer term development by FEMA (“Important”). “Available” topics were considered areas where existing data or methodologies were readily available for updating or creating guidelines. “Helpful” topics were considered valuable but lower priority. These priority classes were assigned by the TWG for each topic on the Atlantic and Gulf Coasts, Pacific Coast, and in Sheltered Waters (Non-Open Coast).

The results from Workshop 1 were used to formulate focused studies that organized the 53 technical topics into 11 categories according to coastal processes and coastal flood hazard mapping procedures. Each of these 11 categories became the subject of a focused study: (1) Storm Meteorology, (2) Stillwater Elevations, (3) Wave Characteristics, (4) Wave Transformation, (5) Wave Setup, (6) Event-Based Erosion, (7) Wave Runup and Overtopping, (8) Coastal Structures, (9) Sheltered Waters, (10) Tsunamis, and (11) Hazard Zones. These focused studies are included in the Appendices to the Phase 1 Report.

The focused studies were conducted by groups of individuals from the TWG, each coordinated by a focused study leader. This organization allowed the 11 focused studies to be completed simultaneously and rapidly. Preliminary drafts of the focused studies were presented at Workshop 2 on February 23–26, 2004, and subsequently were refined by the study groups.

The focused studies contain recommendations on the approach for updating the guidelines on three coasts (Pacific, Atlantic, and Gulf). These recommendations include further studies and guideline development work that vary in complexity, level of effort, and time requirements. The level of effort required to complete the recommendations for “Critical” and “Available” items identified in Workshop 2 significantly exceeded the available time and budget for Phase 2 (development of Pacific Coast guidelines). Therefore, in March 2004 the project team engaged in a significant effort to develop options for limiting the scope and cost of Phase 2 work while retaining the most important topics and a balance among the 11 technical categories. The selected option deferred some recommendations for future development in the National Flood Insurance Program (NFIP) but maintained the target of producing reliable guidelines for coastal studies on the Pacific Coast in FY 2004/2005.

PS.6 SUMMARY OF PHASE 1 FINDINGS

A complete list of topics and recommendations developed by the TWG during Workshops 1 and 2 is provided in Table 2 of the Phase 1 Summary Report. Following are a few of the key findings from the Phase 1 activities:

- ④ Procedures are needed to compute the 1% annual chance flood elevation where 1% stillwater levels do not necessarily coincide with 1% wave conditions (e.g., Pacific Coast and sheltered waters along all three coasts).
- ④ Procedures to better represent wave setup are needed on all coasts.
- ④ Procedures should be developed to use regional databases and wave transformation models to develop wave spectra at the surf zone.
- ④ Methods are needed to evaluate the amount of wave dissipation due to propagation over muddy or flat nearshore areas.
- ④ Procedures to quantify the effects of wave setup and event-based erosion in a variety of geomorphic settings are needed.
- ④ On the Atlantic Coast, a review of the 540 square-foot erosion criterion is needed in light of new data; on the Pacific Coast, a similar geometric method is needed based on Pacific Coast data.
- ④ A probabilistic method for tsunami hazard assessment and methods for combining tsunami hazards with other coastal hazards are needed.
- ④ Updates and amplification of existing guidelines for wave runup and overtopping and associated hazard zones are needed. Improved methodology for wave overwash is needed.
- ④ Some coastal processes, such as surge, wave transformation, and tsunamis, are best analyzed at a regional scale rather than in flood studies of individual communities.
- ④ Sheltered waters (non-open coast areas) require specialized guidance because of their unique hydrodynamic and geomorphic characteristics compared to the open coast. For example,

new methods for calculating fetch-limited wind waves should be evaluated and incorporated in guidelines, to the extent appropriate.

Recommended approaches to address these and other needs are included in Sections 4 and 5 of the June 2004 Phase 1 Summary Report.

PS.7 PHASE 2 – PREPARATION OF DRAFT GUIDELINES

As noted above, priorities were established by the TWG to implement a portion of the Phase 1 recommendations to prepare new guidelines for the Pacific Coast during Phase 2. The Guidelines developed in Phase 2 are designed to address the following general requirements:

- ④ Consideration of geomorphic settings and their relationship to required analysis, including clear distinction between the open coast and sheltered water settings;
- ④ Development of procedures for defining the 1% percent annual chance flood elevation as a combination of wave and water level characteristics where a single dominant storm mechanism (e.g., hurricane) can not be defined; and
- ④ Identification of analyses that may best be accomplished at a regional scale (e.g., wave transformation, tsunamis), and the appropriate input to local analyses and hazard mapping.

Phase 2 included limited case studies to develop and test new procedures and to develop simple models designed specifically for use in FEMA flood insurance studies. The following technical areas were identified for case studies and testing:

- ④ Storm Meteorology – testing to develop procedures for 1% flood elevation determination based on wave and water level combinations in open coast and sheltered waters settings
- ④ Stillwater Elevations – testing for procedures to extract surge data from tide gage data; development of a simplified surge model for the Pacific Coast
- ④ Wave Characteristics – case study to develop wind field and other input data specifications and methods for application of spectral models
- ④ Wave Transformation – assess wave transformation models
- ④ Wave Setup – testing of Boussinesq models; development and testing of a new setup model
- ④ Runup and Overtopping – runup model testing combined with 1% flood elevation testing in Storm Meteorology; develop an analytical model for waver overtopping; and test numerical wave overtopping model
- ④ Event-Based Erosion – testing of geometric models and procedures
- ④ Flood Hazard Zones – development of new criteria for VE Zone mapping based on depth and velocity of flow

A separate case study was also recommended by the TWG to develop a probabilistic methodology that considers both near-field and far-field sources of tsunamis. This case study is being accomplished outside the scope of the current project because of the highly specialized nature of the required analyses. This case study is expected to be accomplished through interagency cooperation among FEMA, the National Oceanic and Atmospheric Administration, and the U.S. Geological Survey, with assistance from private consultants and research institutions, such as the University of Southern California. This case study is scheduled for completion early in 2005.

The Final Draft Guidelines developed in Phase 2 provide guidance for selecting and combining specific methods to evaluate coastal flood hazards for a wide range of coastal settings and storm conditions found along the Pacific Coast of the United States. Within these Guidelines, “methods” means the individual techniques used to make specific computations. “Study methodology” is the combination of appropriate methods and data necessary to develop flood hazard zones for depiction on a Flood Insurance Rate Map (FIRM).

The Guidelines are numbered to fit into FEMA’s existing guidance document for coastal flooding, Appendix D of the Guidelines and Specifications for Flood Hazard Mapping Partners (April 2003).

Section D.4.1 provides an overview of the Guidelines for the Pacific Coast, and Section D.4.2 provides guidance on study methodology. Specific methods for analysis of flood frequencies; waves and water levels; wave setup, runup, and overtopping; coastal erosion; and coastal structures are presented in Sections D.4.3 through D.4.7. Section D.4.8 provides a placeholder for future guidance on analysis of flood hazards due to tsunamis. In most cases, several methods may be applicable to a specific coastal setting. The objective of these guidelines is to provide guidance for developing an appropriate methodology based on the coastal setting and available data for a given project location. Section D.4.9 provides guidance on mapping of flood hazard zones and Base Flood Elevations, and Section D.4.10 provides guidance on study documentation. Sections D.4.11 through D.4.13 provide references, notations, and acronyms.

The following are key components of the new Pacific Coast Final Draft Guidelines:

- ④ Guideline procedures summarize the basic steps in selecting analysis methods according to coastal setting and availability of data.
- ④ Clear distinctions are made between “open coast” and “sheltered water” areas and how hazard assessments shall proceed in each setting.
- ④ An approach is presented for evaluating the 1% annual chance flood, based on the concept of “system response analyses” rather than traditional “event analyses.” The response approach uses measured or predicted wave conditions along with simultaneously measured or predicted water-levels to determine site specific storm response parameters, such as runup and maximum water levels at points of interest. Storm event responses in the surf zone and backshore are computed for a variety of storms, and statistically evaluated to define the 1% annual chance flood

characteristics. This method of assessing system responses in the surf zone and backshore avoids the need to consider joint probability analysis of waves and water levels.

- ④ A statistical method is recommended for determining the 1% still water level for a tidal location subject to flooding by both coastal and riverine mechanisms.
- ④ A section on “flood frequency analysis methods” is provided in the guidelines. For studies where long periods (greater than 30 years) of measured or hindcast data are available, the Generalized Extreme Value Distribution Method with parameters estimated by the Method of Maximum Likelihood is recommended for estimating extreme values, such as 1% annual chance total water level and stillwater level. For flood studies where long periods of measured or hindcast data are NOT available then statistical simulation methods such as the Monte Carlo Method are recommended.
- ④ Several available wave hindcast databases are compared. The Global Reanalysis of Ocean Waves (GROW) is recommended for use in “open coast” FIS studies for the Pacific.
- ④ A modified version of WHAFIS is described that allows for variation of wind speed and its application to the non-hurricane wind climate found along the Pacific Coast.
- ④ Regional wave transformation modeling is recommended for areas such as the Southern California Bight where offshore islands, deep canyons and headlands require complex wave transformations.
- ④ New procedures for computing wave setup and runup using parametric, simple numerical models, and advanced “Boussinesq” modeling procedures are provided, with guidance explaining where and when such procedures are required.
- ④ Wave runup is recommended to be evaluated at the 2% exceedance level rather than the 50% (mean) exceedance level presently recommended in Appendix D.
- ④ A new numerical model using the Direct Integration Method (DIM) is recommended for calculating static and dynamic (infragravity) components of wave setup for the Pacific Coast setting. Simple parameterized models are also developed based on DIM.
- ④ The Atlantic and Gulf Coast “540 Rule” for beach and dune erosion is not recommended for the Pacific Coast. Simple “geometric models” are recommended for estimating event-based erosion of sand beaches and dunes for the Pacific Coast. The concept of the “most likely winter profile” for various coastal beach settings is introduced and procedures for estimating eroded winter profiles during 1% annual flood conditions are presented for six coastal beach settings.

- ④ New runup and overtopping methods are recommended. A simple analytical trajectory model is developed for wave overtopping by splash. (Please note that the TWG recommends that these new methods be thoroughly tested for several settings, prior to their general application.)
- ④ The guidelines propose to define the VE splash zone as the landward extent of the overtopping splash trajectory.
- ④ A new criterion for VE Zone delineation referred to as the *high velocity flow zone* is proposed. This criterion is applicable to areas landward of *the wave overtopping splash zone*, where the product of flow depth times the flow velocity squared (hv^2) is greater than or equal to 200 ft³/sec². This new criterion may also be applicable to hazard delineation of tsunami runup in the future.
- ④ Guidance is presented for delineating coastal flood hazard zones and Base Flood Elevations (BFEs) based on these new methods.

PS.8 Summary

These Guidelines offer insight and recommended methods to analyze complex Pacific Coast flood processes in a reasonable way. However, they require technical judgment and experience in their application, and are not a prescriptive technique that can be applied uniformly in all study areas. The Guidelines are intended to apply to a range of settings, but they cannot address all settings and conditions due to the broad variability of the Pacific Coast. They include new methods that were developed over a one-year period by the TWG assembled by FEMA. Methods were selected and developed through collaboration and consensus to be robust and reproducible, but at the release date of this document (November 2004), many of these methods have not been fully tested in FISs. Therefore, the TWG recommends that these new methods and Guidelines be thoroughly tested for a variety of settings, prior to general distribution and application throughout FEMA.

Experience and judgment in coastal engineering is required in order to apply the procedures provided in the Final Draft Guidelines. The Mapping Partner may determine that minor modifications or deviations from the Guidelines are necessary to adequately define the coastal flooding conditions and map flood hazard zones in specific areas. In these cases, documentation of these differences is required as part of the intermediate and final study submittals.

Some “Critical” and “Important” topics identified in Phase 1 for the Pacific Coast were not addressed in Phase 2 because of limited time and resources. Section 4 of the Phase 1 Summary Report provides a brief summary that can be used for planning of future guidance development by FEMA, and the Focused Studies appended to the report provide background on these topics.

No additional work on guideline development for the Atlantic and Gulf Coasts was conducted in Phase 2. Section 5 of the Phase 1 Summary Report provides a brief summary of recommendations

that can be used for planning future guidance development by FEMA. In addition, some Pacific Coast guidelines developed during Phase 2 may be applicable to analyses on the Atlantic and Gulf Coasts with little or no modification. The potential applicability of Pacific Coast guidelines in specific technical categories is identified in Section 5 of the Phase 1 Summary Report. The Focused Studies appended to the report also provide reference information that may be useful to study contractors as a supplement to the existing guidelines.

The project approach relied heavily on the collaboration of Technical Working Group members to meet a compressed schedule. It is envisioned that the next phase of guideline development for coastal flood hazards will be guided by TWG recommendations for testing, extending, and refining the procedures defined in the Final Draft Guidelines. Specialized FEMA Study Contractors and other Mapping Partners will likely be engaged in preparing test cases and examples, and in providing feedback on application to specific settings. FEMA recognizes that the Guideline is an evolving document, and will encourage refinement through various mechanisms.

PS.9 Acknowledgements

FEMA gratefully acknowledges the significant effort, collaboration, and interaction of the members of the TWG to produce this highly technical work product. Study Leaders and members of the TWG are listed below in alphabetical order.

FEMA Project Coordinator

Les Sakumoto

FEMA, Region IX

Oakland, CA

Study Leaders

The following individuals (listed alphabetically) participated as Phase 2 Study Leaders. They guided technical development of methods and application methodologies for assessing coastal flood hazards on the Pacific Coast and participated in the preparation of the Final Draft Guidelines.

Robert Battalio
Philip William & Associates, Ltd.
San Francisco, CA

Robert Dean
University of Florida
Gainesville, FL

Shyamal Chowdhury
nhc
West Sacramento, CA

Darryl Hatheway
Michael Baker Jr., Inc.
Alexandria, VA

Kevin Coulton
HDR
Portland, OR

Christopher Jones
C. Jones & Associates
Durham, NC

David Divoky
Watershed Concepts
Atlanta, GA

Robert MacArthur
nhc
West Sacramento, CA

William McDougal
Independent Consultant
Corvallis, OR

Edward Wallace
nhc
West Sacramento, CA

Group Meeting Facilitator

Roy Wright
Coray Gurnitz Consulting
Arlington, VA

Technical Working Group

The following individuals (listed alphabetically) participated in the Technical Working Groups to prepare Focused Studies, attend workshops, prepare reporting for the Phase One Summary Report and may also have participated in the preparation of Draft Guidelines.

Robert Battalio
Philip Williams & Associates, Ltd.
San Francisco, CA

Doug Bellomo
FEMA Headquarters
Washington, DC

Ida Brøker
Danish Hydraulic Institute
Hørsholm, Denmark

David Carlton
FEMA Region X
Bothell, WA

Shyamal Chowdhury
nhc
West Sacramento, CA

Michael Craghan
FEMA Region III
Philadelphia, PA

Ian Collins
Independent Consultant
Vista, CA

Kevin Coulton
HDR
Portland, OR

Robert Dean
University of Florida
Gainesville, FL

Michael DelCharco
Taylor Engineering
Jacksonville, FL

David Divoky
Watershed Concepts
Atlanta, Georgia

Claudio Fassardi
BMT Scientific Marin Services, Inc.
Escondido, CA

Eric Geist
USGS
Menlo Park, CA

Mike Goetz
FEMA Region I
Boston, MA

Frank Gonzalez
NOAA/PMEL
Seattle, WA

Robert Guza
SIO
La Jolla, CA

Darryl Hatheway
Michael Baker Jr., Inc
Alexandria, VA

Emily Hirsch
FEMA Headquarters
Washington, DC

Maria Honeycutt
PBS&J
Beltsville, MD

Terry Hull
Taylor Engineering
Jacksonville, FL

Jeff Johnson
nhc
Seattle, WA

Christopher Jones
C. Jones & Associates
Durham NC

Dale Kerper
Danish Hydraulic Institute
Cardiff, CA

Paul Komar
Oregon State University
Corvallis, OR

Technical Working Group

Ray Lenaburg
FEMA Region IX
Oakland, CA

Jeremy Lowe
Philip Williams & Associates, Ltd
San Francisco, CA

Chia-Chi Lu
Noble Consultants, Inc
New Port Beach, CA

Robert MacArthur
nhc
West Sacramento, CA

William McDougal
Independent Consultant
Corvallis, OR

Ronald Noble
Noble Consultants, Inc
Novato, CA

Don Resio
Corps of Engineers
Vicksburg, MS

Trey Ruthven
Applied Coastal
Mashpee MA

Les Sakumoto
FEMA Region IX
Oakland, CA

Dick Seymour
CDIP/SIO
La Jolla, CA

Norm Scheffner
CHT
Edwards, MS

Costas Synolakis
University of Southern California
Los Angeles, CA

Will Thomas
Michael Baker Jr., Inc
Alexandria VA

Alicia Urban
nhc
West Sacramento, CA

Zach Usher
FEMA Region II
New York, NY

Mark Vieira
FEMA Region IV
Atlanta, GA

Ed Wallace
nhc
West Sacramento, CA

Jon Walters
Nolte
San Diego, CA

Joy Woo
EDAW
Sacramento, CA

Roy Wright
Coray Gurnitz Consulting
Arlington, VA

Max Yuan
FEMA Headquarters
Washington, DC

Gary Zimmerer
FEMA Region VI
Denton, TX

Table of Contents

Section	Page
D.4 Coastal Flooding Analyses and Mapping: Pacific Coast.....	D.4.1-1
D.4.1 Pacific Coast Guidelines Overview	D.4.1-2
D.4.1.1 Pacific Coast Setting and Characteristics	D.4.1-4
D.4.1.2 Pacific Coast Flood Insurance Studies.....	D.4.1-7
D.4.1.2.1 Study Scoping	D.4.1-7
D.4.1.2.2 Regional vs. Local Studies.....	D.4.1-9
D.4.1.2.3 Sheltered Waters	D.4.1-10
D.4.1.2.4 Tsunami Hazards	D.4.1-12
D.4.1.2.5 Debris.....	D.4.1-12
D.4.1.2.6 Beach Nourishment and Constructed Dunes	D.4.1-13
D.4.1.2.7 Hazard Zone Definitions and Use by FEMA.....	D.4.1-13
D.4.1.2.8 Reporting Requirements	D.4.1-15
D.4.2 Study Methodology.....	D.4.2-1
D.4.2.1 Overview.....	D.4.2-1
D.4.2.2 Setting	D.4.2-2
D.4.2.2.1 Open Coast and Sheltered Water	D.4.2-3
D.4.2.2.2 Shoreline Profile Settings	D.4.2-3
D.4.2.3 Coastal Zones.....	D.4.2-5
D.4.2.4 Event and Response Analysis Considerations	D.4.2-8
D.4.2.5 Selection of Events	D.4.2-10
D.4.2.5.1 Open Coast.....	D.4.2-10
D.4.2.5.2 Sheltered Waters	D.4.2-10
D.4.2.5.3 1% Annual Chance Conditions.....	D.4.2-10
D.4.2.5.4 0.2% Annual Chance Conditions.....	D.4.2-16
D.4.2.6 Summary of Methods.....	D.4.2-16
D.4.2.7 Examples.....	D.4.2-18
D.4.2.7.1 Open Coast, Dune Backed Beach Scenario Using <i>Parametric</i> DIM Model for Setup/Runup	D.4.2-20
D.4.2.7.2 Open Coast, Dune Backed Beach Scenario Using <i>Numerical</i> DIM Model for Setup/Runup	D.4.2-24
D.4.2.7.3 Sheltered Water, Seawall Backed Beach Scenario Using <i>Parametric</i> DIM for Setup/Runup	D.4.2-27
D.4.3 Flood Frequency Analysis Methods	D.4.3-1
D.4.3.1 The 1% Annual Chance Flood.....	D.4.3-1
D.4.3.2 Event vs. Response Statistics.....	D.4.3-2
D.4.3.2.1 Event-Selection Method.....	D.4.3-2
D.4.3.2.2 Response-based Approach	D.4.3-3
D.4.3.2.3 Hybrid Method.....	D.4.3-4
D.4.3.3 General Statistical Methods	D.4.3-4
D.4.3.3.1 Overview.....	D.4.3-4
D.4.3.3.2 Elementary Probability Theory.....	D.4.3-5

Table of Contents (cont.)

Section	Page
D.4.3.3.3	Distributions of Continuous Random Variables D.4.3-6
D.4.3.3.4	Stationarity D.4.3-8
D.4.3.3.5	Correlation Between Series..... D.4.3-9
D.4.3.3.6	Convolution of Two Distributions D.4.3-9
D.4.3.3.7	Important Distributions D.4.3-9
D.4.3.4	Data Sample and Estimation of Parameters..... D.4.3-12
D.4.3.4.1	Plotting Positions D.4.3-13
D.4.3.4.2	Method of Moments: Conventional Moments D.4.3-14
D.4.3.4.3	Method of Moments: Probability-weighted Moments and Linear Moments D.4.3-14
D.4.3.4.4	Maximum Likelihood Method..... D.4.3-14
D.4.3.5	Extreme Value Analysis in an FIS..... D.4.3-15
D.4.3.6	Simulation Methods D.4.3-17
D.4.3.6.1	JPM D.4.3-17
D.4.3.6.2	EST D.4.3-18
D.4.3.6.3	Monte Carlo Method..... D.4.3-18
D.4.3.7	Additional Resources D.4.3-19
D.4.4	Waves and Water Levels D.4.4-1
D.4.4.1	Waves..... D.4.4-1
D.4.4.1.1	Wave Spectra D.4.4-2
D.4.4.1.2	Measured Deepwater Wave Data..... D.4.4-4
D.4.4.1.3	Hindcast Wave Data D.4.4-6
D.4.4.1.4	Wave Transformations..... D.4.4-11
D.4.4.1.5	Waves in Sheltered Waters D.4.4-22
D.4.4.1.6	Data Requirements..... D.4.4-25
D.4.4.1.7	Documentation D.4.4-25
D.4.4.2	Water Levels D.4.4-26
D.4.4.2.1	Overview..... D.4.4-26
D.4.4.2.2	Astronomic Tide D.4.4-26
D.4.4.2.3	Surge D.4.4-31
D.4.4.2.4	Water Levels in Sheltered Waters..... D.4.4-34
D.4.4.2.5	Water Levels During El Niños..... D.4.4-38
D.4.4.2.6	1% Annual Chance Still Water Levels D.4.4-39
D.4.4.2.7	Non-Stationary Processes D.4.4-44
D.4.5	Wave Setup, Runup, and Overtopping D.4.5-1
D.4.5.1	Wave Setup and Runup..... D.4.5-1
D.4.5.1.1	Introduction..... D.4.5-1
D.4.5.1.2	Background, Definitions, and Approaches D.4.5-1
D.4.5.1.3	General Input Requirements D.4.5-6
D.4.5.1.4	Setup and Runup on Beaches: Descriptions and Recommendations..... D.4.5-7
D.4.5.1.5	Runup on Barriers D.4.5-10

Table of Contents (cont.)

Section	Page
D.4.5.1.6	Example Computations of Total Runup D.4.5-18
D.4.5.1.7	Documentation..... D.4.5-20
D.4.5.2	Overtopping D.4.5-20
D.4.5.2.1	Overview..... D.4.5-20
D.4.5.2.2	Background..... D.4.5-23
D.4.5.2.3	Data Requirements..... D.4.5-27
D.4.5.2.4	Mean Overtopping Rate at the Crest..... D.4.5-27
D.4.5.2.5	Limits of Overtopping and Hazard Zones Landward of the Barrier Crest D.4.5-28
D.4.5.2.6	Documentation..... D.4.5-32
D.4.5.3	Wave Dissipation and Overland Wave Propagation..... D.4.5-32
D.4.5.3.1	Assessment of Enhanced Wave Dissipation..... D.4.5-33
D.4.5.3.2	Wave Attenuation by Bottom and Vegetation Interactions..... D.4.5-34
D.4.5.3.3	Overland Wave Propagation (WHAFIS)..... D.4.5-38
D.4.5.3.4	Documentation..... D.4.5-39
D.4.6	Coastal Erosion D.4.6-1
D.4.6.1	Overview..... D.4.6-1
D.4.6.2	Pacific Coast Characteristics Related to Storm-induced Erosion D.4.6-1
D.4.6.3	Background and Definitions D.4.6-2
D.4.6.3.1	Coastal Exposure D.4.6-2
D.4.6.3.2	Beach Setting D.4.6-3
D.4.6.3.3	Data Sources D.4.6-9
D.4.6.4	Estimating Eroded Beach Profiles D.4.6-12
D.4.6.4.1	The Concept of the Most Likely Winter Profile D.4.6-12
D.4.6.4.2	General Approach for Estimating Eroded Beach Profiles from Single Storms..... D.4.6-12
D.4.6.5	Estimating Profile Changes for Sand Beaches Backed by Low Sand Berms or High Dunes (Beach Setting No. 1) D.4.6-14
D.4.6.5.1	General K&D and MK&A Model Characteristics and Applicability..... D.4.6-16
D.4.6.5.2	MK&A and Its Application to Beach Setting No. 1..... D.4.6-17
D.4.6.5.3	Time Dependency of Profile Response (Within the MK&A and K&D Models) D.4.6-23
D.4.6.5.4	Summary of the MK&A Geometric Modeling Approach for Sand Beaches Backed by Sand Berms and Dunes (Beach Setting No. 1) D.4.6-26
D.4.6.5.5	K&D Geometric Modeling Approach for Sand Beaches Backed by Sand Berms and Dunes (Beach Setting No. 1)..... D.4.6-28
D.4.6.5.6	Potential Future Use of Process-based Models..... D.4.6-33

Table of Contents (cont.)

Section	Page
D.4.6.6	Estimating Profile Changes for Sandy Beaches Backed by Protective Structures (Beach Setting No. 2) D.4.6-34
D.4.6.7	Estimating Profile Changes for Gravel and Cobble Beaches (Beach Setting No. 3)..... D.4.6-36
D.4.6.8	Estimating Profiles for Beaches Backed by Erodeable Bluffs or Cliffs (Beach Setting No. 4) D.4.6-40
	D.4.6.8.1 General Approach for Beach Setting No. 4 D.4.6-42
	D.4.6.8.2 Detailed Bluff Erosion Analyses D.4.6-44
D.4.6.9	Estimating Beach Profiles for Beaches Backed by Erosion-Resistant Bluffs or Cliffs (Beach Setting No. 5)..... D.4.6-48
D.4.6.10	Profiles in Tidal Flats and Wetlands (Beach Setting No. 6)..... D.4.6-48
D.4.7	Coastal Structures D.4.7-1
D.4.7.1	Purpose and Overview D.4.7-1
D.4.7.2	Evaluation Criteria..... D.4.7-2
	D.4.7.2.1 Detailed Engineering Evaluation of Coastal Armoring Structures..... D.4.7-2
	D.4.7.2.2 Coastal Armoring Structure Evaluation Based on Limited Data and Engineering Judgment D.4.7-3
	D.4.7.2.3 Evaluation of Beach Stabilization Structures D.4.7-3
D.4.7.3	FIS Treatment of Coastal Armoring Structures D.4.7-4
	D.4.7.3.1 Failure and Removal of Coastal Armoring Structures D.4.7-4
	D.4.7.3.2 Partial Failure of Coastal Armoring Structures D.4.7-4
	D.4.7.3.3 Buried Coastal Structures D.4.7-9
	D.4.7.3.4 Coastal Levees D.4.7-9
	D.4.7.3.5 Operation and Maintenance D.4.7-16
D.4.7.4	FIS Treatment of Beach Stabilization Structures..... D.4.7-16
D.4.7.5	FIS Treatment of Miscellaneous Structures..... D.4.7-17
	D.4.7.5.1 Piers, Navigation Structures, and Port Facilities D.4.7-17
	D.4.7.5.2 Bridges, Culverts, and Tide Gates D.4.7-18
D.4.7.6	Data Requirements..... D.4.7-18
D.4.7.7	Study Documentation..... D.4.7-19
D.4.8	Tsunamis (Future Section)..... D.4.8-1
D.4.9	Mapping of Flood Hazard Zones and Base Flood Elevations D.4.9-1
D.4.9.1	Review and Evaluation of Basic Results D.4.9-1
D.4.9.2	Identification of Flood Insurance Risk Zones..... D.4.9-2
	D.4.9.2.1 VE Zone D.4.9-2
	D.4.9.2.2 AE Zone D.4.9-5
	D.4.9.2.3 AH Zone..... D.4.9-5
	D.4.9.2.4 AO Zone..... D.4.9-5
	D.4.9.2.5 X Zone D.4.9-5

Table of Contents (cont.)

Section	Page
D.4.9.3 Wave Envelope	D.4.9-5
D.4.9.4 Criteria for Flood Boundary and Hazard Zone Mapping.....	D.4.9-6
D.4.9.5 Transect Examples	D.4.9-8
D.4.9.6 Mapping Procedures	D.4.9-18
D.4.10 Study Documentation.....	D.4.10-1
D.4.10.1 General Documentation	D.4.10-1
D.4.10.2 Engineering Analyses	D.4.10-1
D.4.11 References.....	D.4.11-1
D.4.12 Notation.....	D.4.12-1
D.4.13 Acronyms.....	D.4.13-1
D.4.14 Glossary	D.4.14-1

Table of Contents (cont.)

Figure		Page
D.4.1-1	Applicable Area – Pacific Coast Guidelines.....	D.4.1-1
D.4.1-2	Pacific Coast Guidelines Overview	D.4.1-3
D.4.2-1	Study Methodology Development Considerations	D.4.2-2
D.4.2-2a	Shoreline Profile Setting Nos. 1 to 3	D.4.2-4
D.4.2-2b	Shoreline Profile Setting Nos. 4 to 6	D.4.2-4
D.4.2-3	Coastal Zones.....	D.4.2-6
D.4.2-4	Coastal Zones and Processes	D.4.2-7
D.4.2-5	Transition from Multiple to Single Events	D.4.2-9
D.4.2-6	Determination of 1% Conditions	D.4.2-13
D.4.2-7	Methodology Examples	D.4.2-18
D.4.3-1	Cumulative and Density Distributions for the La Jolla Tide Residual	D.4.3-16
D.4.4-1a	Example of a One-Dimensional Continuous Spectrum.....	D.4.4-2
D.4.4-1b	Example of a Two-Dimensional Continuous Energy Spectrum.....	D.4.4-2
D.4.4-2a	Example of a One-Dimensional Discrete Spectrum	D.4.4-3
D.4.4-2b	Example of a Two-Dimensional Discrete Spectrum	D.4.4-3
D.4.4-3	NDBC Buoy Locations near Southern California	D.4.4-5
D.4.4-4	NDBC Buoy Locations in the North Pacific.....	D.4.4-5
D.4.4-5	WIS Stations in Central California	D.4.4-8
D.4.4-6	WIS Stations in Southern California.....	D.4.4-9
D.4.4-7	Example of GROW Station Locations Along the Pacific Coast.....	D.4.4-10
D.4.4-8	Flow Chart for Wave Transformation Analysis.....	D.4.4-14
D.4.4-9	Example Placement of Nearshore Point and Location of Cross-Shore Transects	D.4.4-15
D.4.4-10	Conceptual Diagram of Spectral Transformation	D.4.4-15
D.4.4-11	Flow Chart of Tasks to Derive Nearshore Wave Hindcast Information for a FEMA Study Area	D.4.4-21
D.4.4-12	Predicted and Observed Tides at Crescent City, California	D.4.4-30
D.4.4-13	Definition Sketch for the BST Formulation.....	D.4.4-32
D.4.4-14	El Niño Fluctuations since 1970	D.4.4-39
D.4.4-15	Schematic Illustration of Riverine and Surge Rate Combination.....	D.4.4-43
D.4.5-1	Schematic of Energy and Momentum Transfer from Winds to Waves within the Wave-generating Area, and to the Surf Zone and Related Processes.....	D.4.5-2
D.4.5-2	Wave Setup Due to Transfer of Momentum.....	D.4.5-3
D.4.5-3	Static Wave Setup Definitions at Still Water Level and Maximum Setup.....	D.4.5-3
D.4.5-4	Definitions of Static and Dynamic Wave Setup and Incident Wave Runup	D.4.5-4
D.4.5-5	Spectral Width Parameter Versus <i>Gamma</i> for JONSWAP Spectra	D.4.5-7
D.4.5-6	Runup on Coastal Structures, Definition Sketch	D.4.5-11
D.4.5-7	Non-dimensional Total Runup vs. Iribarren Number	D.4.5-12
D.4.5-8	Berm Parameters for Wave Runup Calculations	D.4.5-14
D.4.5-9	Structure Porosity Definition	D.4.5-14

Table of Contents (cont.)

Figure	Page
D.4.5-10	Example Plot Showing the Variation of Surf Zone Parameters D.4.5-17
D.4.5-11	Offshore Profile for Example Problem D.4.5-19
D.4.5-12	Definition Sketch for Two Types of Overtopping D.4.5-22
D.4.5-13	Parameters Available for Mapping BFEs and Flood Hazard Zones D.4.5-23
D.4.5-14	Definition Sketch for Wave Overtopping by Splash D.4.5-29
D.4.5-15	Solution of Trajectory Equations for Splashdown Distances D.4.5-30
D.4.5-16	Overtopping Resulting in Bore Propagation D.4.5-31
D.4.5-17	Schematic of Wave Attenuation Processes D.4.5-33
D.4.5-18	Native Pacific Cordgrass Meadow at Blackie’s Pasture, Marin County D.4.5-37
D.4.5-19	Tall Stand of Atlantic Smooth Cordgrass Hybrids Invading a Native Patch of Pacific Cordgrass Meadow near Tiburon, California D.4.5-37
D.4.6-1	Typical Pacific Coast Summer and Winter Beach Profiles D.4.6-2
D.4.6-2a	Sand Beach Backed by High Sand Dune (Beach Setting No. 1) D.4.6-4
D.4.6-2b	Sand Beach Backed by Low Sand Berm (Beach Setting No. 1) D.4.6-4
D.4.6-3	Sand Beach Backed by Shore Protection Structures (Beach Setting No. 2) D.4.6-5
D.4.6-4	Cobble, Gravel, Shingle, or Mixed Grain Sized Beach and Berms (Beach Setting No. 3) D.4.6-5
D.4.6-5	Erodible Coastal Bluffs (Beach Setting No. 4) D.4.6-6
D.4.6-6	Non-Erodible Coastal Bluffs and Cliffs (Beach Setting No. 5) D.4.6-6
D.4.6-7	Tidal Flats and Wetlands (Beach Setting No. 6) D.4.6-7
D.4.6-8	Evolution of the Initial Beach Profile Before Occurrence of Large Storm Event D.4.6-13
D.4.6-9	Definition Sketch of MLWP for Sand Beach Backed by Sand Dunes (Beach Setting No. 1) D.4.6-14
D.4.6-10	Sandy Beach Backed by Low Berm, Newport Beach, CA D.4.6-15
D.4.6-11	Sandy Beach Backed by Low Berm, Huntington Beach, CA D.4.6-15
D.4.6-12	Photograph of Netarts Bay, Oregon D.4.6-17
D.4.6-13	Definition Sketches for Terms and Dimensions Required by the Modified Komar & Allan Geometric Model D.4.6-19
D.4.6-14	Relationships Between Beach Slope and Median Diameter of Beach Sands D.4.6-20
D.4.6-15	Schematics of Dune Overtopping with the MK&A Model D.4.6-22
D.4.6-16	Storm Duration Recession Reduction Factor D.4.6-26
D.4.6-17	Key Activities to Determine Beach Profile Changes for Beach Setting No. 1. D.4.6-26
D.4.6-18	Definition Sketch for K&D Geometric Model D.4.6-29
D.4.6-19	Sketch for K&D Geometric Model for Case Where Historical Beach Profile Data Are Available to Prepare the MLWP D.4.6-29
D.4.6-20	Sand Beach Backed by Shore Protection Structures, Crystal Cove, California D.4.6-35
D.4.6-21	Key Activities to Determine Beach Profile Changes for Beach Setting No. 2 D.4.6-35
D.4.6-22	Sand Beach Backed by Cobble Berm and Bluffs, South Carlsbad, California D.4.6-37
D.4.6-23	Sand Beach Backed by Cobble and Shingle Berm and Sandy Terrace, Batiqutos Lagoon, California D.4.6-37

Table of Contents (cont.)

Figure	Page
D.4.6-24 Measured Beach Profile Change Due to January 1988 Storm, Baticuitos Lagoon, California.....	D.4.6-38
D.4.6-25 Measured Beach Profile Change Before and After January 1988 Storm, Baticuitos Lagoon, California.....	D.4.6-38
D.4.6-26 Key Activities to Determine Beach Profile Changes for Beach Setting No. 3.	D.4.6-39
D.4.6-27 Wave Cut Coastal Bluff, Encinitas, California.....	D.4.6-41
D.4.6-28 Bluff Failure and Retreat During 1998 El Niño Storms, Pacifica, California	D.4.6-41
D.4.6-29 Bluff Failure and Retreat, Encinitas, California	D.4.6-42
D.4.6-30 Key Activities to Determine Beach Profile Changes for Bluffs Beach Setting No. 4	D.4.6-43
D.4.6-31 Typical Erodible Bluff Profile Fronted by Narrow Sand-capped Beach.....	D.4.6-46
D.4.6-32 Photo of Erosion-resistant Cliff	D.4.6-48
D.4.6-33 Key Activities to Determine Beach Profile Changes for Beach Setting No. 5	D.4.6-49
D.4.6-34 Photograph of Tidal Flats and Wetlands Complex	D.4.6-50
D.4.6-35 Key Activities to Determine Beach Profile Changes for Beach Setting No. 6.	D.4.6-50
D.4.7-1a General Classification of Coastal Armoring Structures.....	D.4.7-5
D.4.7-1b General Classification of Coastal Armoring Structures.....	D.4.7-6
D.4.7-2 Partial Failure of Vertical Coastal Structure.....	D.4.7-7
D.4.7-3 Partial Failure of a Sloping Revetment.....	D.4.7-8
D.4.7-4 Example of a Buried Coastal Structure that Could Affect Flood Hazard Zones and BFEs.....	D.4.7-10
D.4.7-5 Methodology for Evaluating Buried Coastal Structures.....	D.4.7-11
D.4.7-6 Buried Structure Remains Buried During 1% Annual Chance Flood	D.4.7-12
D.4.7-7 Buried Structure Exposed During 1% Annual Chance Flood	D.4.7-13
D.4.7-8 Levee Removal, Multiple Levee Situation	D.4.7-15
D.4.9-1 Example Designation of High-velocity Flow VE Zones Based on Flood Depth and Velocity	D.4.9-3
D.4.9-2 Simplified Mapping Procedure for Overtopped Barrier	D.4.9-4
D.4.9-3 Seaward Portion of Wave Envelope based on Total Water Level and Wave Crest Elevation.....	D.4.9-6
D.4.9-4a Non-erodible High Coastal Bluff with VE Zone Controlled by Wave Runup (No Overtopping).....	D.4.9-9
D.4.9-4b Plan View of Flood Hazard Zones and BFEs, Non-erodible High Coastal Bluff with VE Zone Controlled by Wave Runup (No Overtopping).....	D.4.9-9
D.4.9-5a Erodible Low Coastal Bluff with VE Zone Controlled by Wave Runup, Overtopping Splash, and High-velocity Flow	D.4.9-10
D.4.9-5b Erodible Low Coastal Bluff with VE Zone Controlled by Wave Runup, Overtopping Splash, and High-velocity Flow	D.4.9-10
D.4.9-6a Sandy Beach Backed by High Sand Dune with PFD Controlling the VE Zone	D.4.9-11

Table of Contents (cont.)

Figure		Page
D.4.9-6b	Sandy Beach Backed by High Sand Dune with PFD Controlling the VE Zone	D.4.9-12
D.4.9-7a	Sandy Beach Backed by Low Sand Dune with Overtopping Splash Controlling VE Zone.....	D.4.9-13
D.4.9-7b	Sandy Beach Backed by Low Sand Dune with Overtopping Splash Controlling VE Zone	D.4.9-13
D.4.9-8a	Sandy Beach Backed by Shore Protection Structure with VE Zone Controlled by the Splash Zone and High-velocity Flow from Wave Overtopping	D.4.9-14
D.4.9-8b	Sandy Beach Backed by Shore Protection Structure with VE Zone Controlled by the Splash Zone and High-velocity Flow from Wave Overtopping	D.4.9-15
D.4.9-9a	Cobble, Gravel, Shingle, or Mixed Grain Sized Beach with VE Zone Controlled by Wave Runup, Overtopping, and High-velocity Flow	D.4.9-16
D.4.9-9b	Cobble, Gravel, Shingle or Mixed Grain Sized Beach with VE Zone Controlled By Wave Runup, Overtopping and High Velocity Flow	D.4.9-17

Table of Contents (cont.)

Table		Page
D.4.2-1	Summary of Methods Presented in Section D.4	D.4.2-16
D.4.2-2	Open Coast, Dune Backed Beach Example using Parametric DIM Model for Setup/Runup.....	D.4.2-22
D.4.2-3	Open Coast, Dune Backed Beach using Numerical DIM Model for Setup/Runup.....	D.4.2-25
D.4.2-4	Sheltered Water, Seawall Backed Beach using Parametric DIM Model for Setup/Runup.....	D.4.2-28
D.4.5-1	Summary of Factors to Be Applied with DIM.....	D.4.5-9
D.4.5-2	Recommended Procedure to Avoid Double Inclusion of Wave Setup Components	D.4.5-10
D.4.5-3	Summary of γ Runup Reduction Factors	D.4.5-13
D.4.5-4	Example Characteristics.....	D.4.5-18
D.4.5-5	Comparison of Results from Various Methods of Calculating 2% Total Runup for Examples	D.4.5-19
D.4.5-6	Overtopping Parameters Used in Hazard Zone Mapping	D.4.5-23
D.4.5-7	Equations for Wave Overtopping	D.4.5-26
D.4.5-8	Summary of Equations for Overland Propagation (Over Uniform Depth).....	D.4.5-35
D.4.5-9	Common Vegetation Types on Atlantic, Gulf, and Pacific Coasts.....	D.4.5-39
D.4.6-1	Common Beach Settings Found Along the California, Oregon, and Washington Coastlines.....	D.4.6-7
D.4.6-2	Equilibrium Beach Profile Coefficients.....	D.4.6-24
D.4.6-3	Estimates of the Beach Profile Time Response	D.4.6-24

D.4 Coastal Flooding Analyses and Mapping: Pacific Coast

This section of Appendix D provides guidance for coastal flood hazard analyses and mapping that are specific to the Pacific Coast of the United States, generally referred to as “guidelines”. The procedures described in this section were developed by a Technical Working Group (TWG) assembled by the Federal Emergency Management Agency (FEMA) in October 2003. They are intended to provide guidance that is generally independent of other Appendix D sections, and that is based on the specific physical processes that influence coastal flooding on the Pacific Coast.

This section focuses on the Pacific Coast from California’s border with Mexico to the State of Washington’s border with Canada, as shown in Figure D.4.1-1. The coastline of the States of Alaska and Hawaii, and other islands in the Pacific Ocean are subject to unique meteorological conditions and physical processes that are important to coastal flooding, but are not specifically addressed in this version of Section D.4. However, much of this section is considered applicable in these geographic areas if engineering methods and judgment that address geographically unique processes or settings are applied to supplement the procedures described. In addition, some procedures may be applicable to specific settings in other geographic areas of the United States.

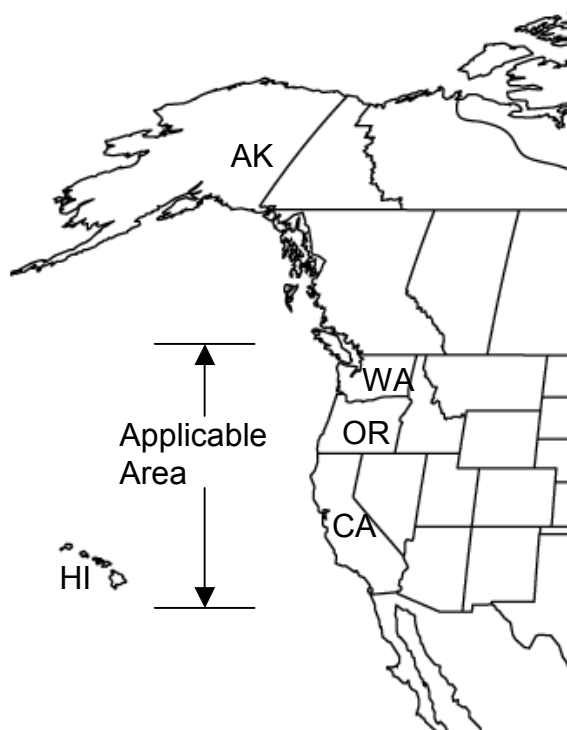

Figure D.4.1-1. Applicable Area – Pacific Coast Guidelines

D.4.1 Pacific Coast Guidelines Overview

Section D.4 is organized to:

- Present background information (Section D.4.1);
- Provide guidance on selecting study methodologies (Section D.4.2);
- Provide a set of technical methods as potential tools to be used in various study settings (Sections D.4.3 to D.4.8);
- Provide guidance on flood hazard mapping (Section D.4.9);
- Provide guidance on study documentation (Section D.4.10); and
- Provide reference information (Sections D.4.11 to D.4.14).

Figure D.4.1-2 shows the general layout of the document. Because it is anticipated that few readers will use the guidance by reading sequentially from beginning to end, Section D.4.2 provides a framework for overall study methodologies that Mapping Partners can use to refer to more detailed analysis methods in subsequent subsections. In many cases, multiple methods are presented for analysis of a single coastal process, and several coastal processes must be analyzed from offshore to onshore to produce hazard zone designations for a coastal Flood Insurance Study (FIS). Section D.4.2 provides guidance on selecting analysis methods that are applicable to particular coastal settings and on linking the analysis of individual coastal processes together in a study methodology. In this sense, the document is organized with a set of general instructions in Section D.4.2, and a toolbox for selection of specific methods in Sections D.4.3 to D.4.8. The appropriate tools must be selected based on study objectives, coastal exposure, geomorphic setting, and available data.

Coastal flooding on the Pacific Coast is a product of combined offshore, nearshore, and shoreline processes. The interrelationships of these processes are complex, and their relative effects vary significantly with coastal setting. These complexities present challenges in the determination of the 1% annual chance flood for FEMA hazard mapping purposes. The fundamental philosophy of this section is to provide a set of technical tools that can be selected and applied as needed to match specific site conditions and physical processes relevant to coastal flood hazards.

These guidelines offer insight and recommended methods to analyze complex Pacific coast flood processes in a reasonable way. However, they require technical judgment and experience in their application, and are not a prescriptive technique that can be applied uniformly in all study areas. The guidelines are intended to apply to a range of settings, but they cannot address all settings and conditions due to the broad variability of the Pacific Coast. They include new methods that

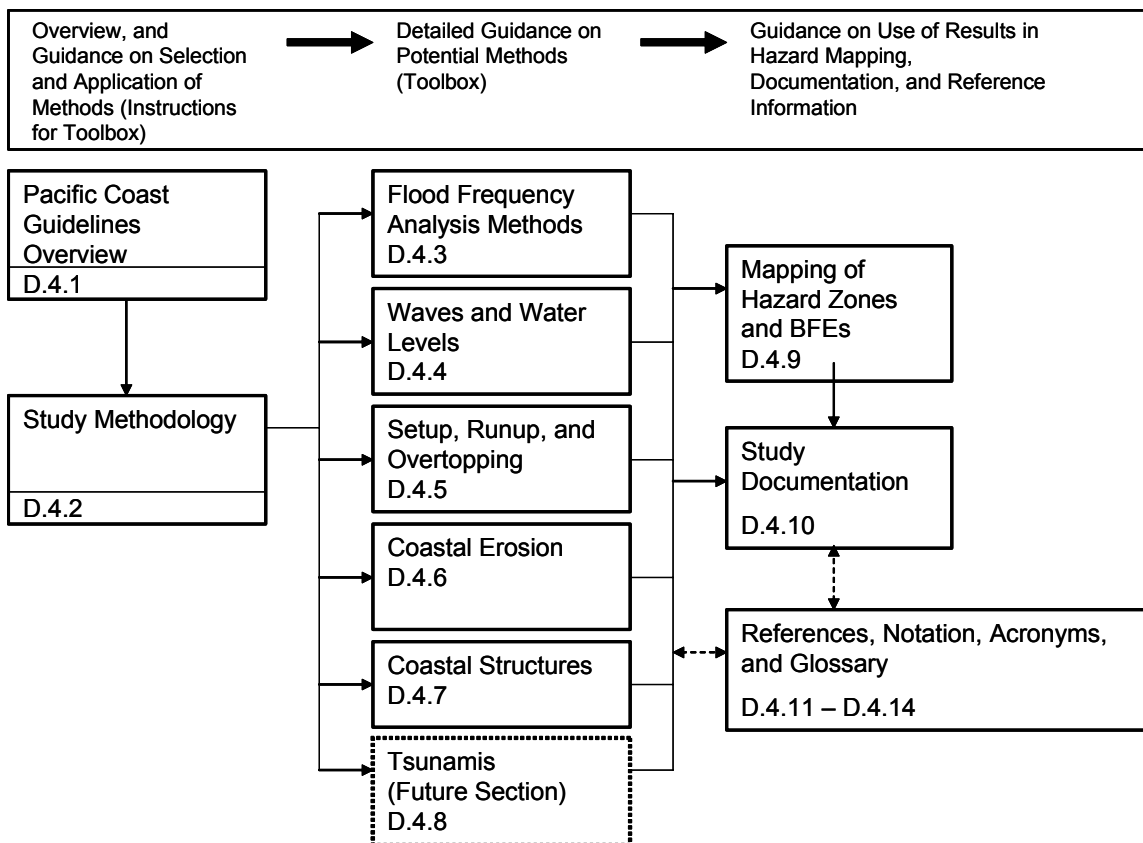

Figure D.4.1-2. Pacific Coast Guidelines Overview

were developed over a one-year period by the TWG assembled by FEMA. Methods were selected and developed to be robust and reproducible, but at the release date of this document (November 2004), many of these methods have not been fully tested in FISs. Application of experience and judgment in coastal engineering is necessary to apply the procedures described. The Mapping Partner may determine that minor modifications or deviations from these guidelines are necessary to adequately define the coastal flooding conditions and map flood hazard zones in specific areas. In these cases, documentation of these differences is required as part of intermediate and final study submittals.

Other appendices provide specific information on subjects such as study scoping (Appendix I), aerial mapping and surveying (Appendix A), treatment of levee systems (Appendix H), formats for FIS reports and rate maps (Appendices J and K), formats for draft digital data and Digital Flood Insurance Rate Map (DFIRM) databases (Appendix L), guidance for technical and administrative support data (Appendix M), and draft data capture standards and guidelines (draft Appendix N). The guidance provided here is intended only to supplement these sections with information specific to coastal flooding on the Pacific Coast. The Mapping Partner shall refer to other appendices where specific guidance is required on technical elements common to most FISs.

Subsections D.4.1.1 and D.4.1.2 provide an overview of the Pacific Coast setting relevant to flood hazards and an introduction to FISs for the Pacific Coast, respectively.

D.4.1.1 Pacific Coast Setting and Characteristics

The Pacific Coast of the contiguous United States is approximately 1,000 miles in overflight length, but significantly longer when inlets, bays, headlands, and islands are considered. It encompasses a broad spectrum of geological and biological provinces.

The overall geology is determined by the existence of tectonic activity throughout, in sharp contrast to the Atlantic and Gulf coasts (Inman and Nordstrom, 1971). On the Pacific Coast, active faults marking tectonic plate boundaries cross the coastline in a number of locations. Subduction zones (continental plate riding over downward-plunging oceanic plates) are found in the northern half. The leading edge of the Pacific Coast is marked by very narrow and steep continental shelves with oceanic depths often found within a few miles of the shoreline. Southern California, a fragment of continental crust attached to the largely oceanic Pacific Plate, has widely varying coastal geology caused by the collection of plate fragments during tectonic collisions in the distant past. Although it has the characteristic narrow continental shelf, the Southern California Bight is marked by a large number of offshore islands and banks rising sharply out of deep water more than 60 miles offshore. This results in partial to nearly complete sheltering of some sections of this 200-mile-long coast from wave energy arriving from certain directions, and produces one of the most complex wave environments in the world.

A string of near-coast mountain ranges is almost continuous along the Pacific Coast. The subduction of the oceanic Pacific Plate under the North American Plate in Washington and Oregon results in volcanic activity well inland from the coast and its influence on the coastal setting is a slow uplift of the land, tending to partially offset the worldwide increase in sea level. Coastal mountain ranges have a profound effect on the geology of the shoreline. The majority of the Pacific Coast's length is comprised of rocky headlands and steep slopes dropping directly to the shore.

The Pacific Coast is ice-free in spite of the high latitude of its northern boundary because of the moderating effects of the south-flowing current, which originates as the warm Kuroshio Current, that cools as it traverses the Northern Pacific. It is broad and slow near the end of its path compared to the relatively narrow and fast-flowing character near its origin. As a result, the North Pacific current (it carries a variety of local names) has negligible effect on the intensity or direction of storm waves reaching the Pacific Coast.

Pacific Coast tides are semidiurnal (two highs per day) and have a range of about 6 feet in the south increasing to about 9 feet in the north.

The Pacific Coast, on the eastern rim of a very long wave-generating fetch, is in the path of the westerly winds that dominate the weather in the Northern Temperate Zone. This results in swell and storm waves with very long periods, greater than 20 seconds in major storms. Antarctic-generated swell, with a number of potential great circle paths, results in low southern swell on the Pacific Coast throughout the year, most obvious during the summer when northern hemisphere waves are at a minimum.

The dominant storm waves result from winter storms initiated south of the Aleutian chain. The fetch is often more than 600 miles, such that wave height and period are controlled by wind speed and duration. Because these storm paths are at a low angle to the general coastline trend, the wave energy impacting a particular location is highly variable. In general, these winter storms produce the highest waves in the northwest and the lowest in the Southern California Bight, which is protected by the abrupt coastal direction change at Point Conception and the offshore islands. Thus, the typical La Niña conditions (intervals between El Niños) provide low southern swell in summer with occasional local storms and a series of major wave events with long peak periods during the winter months (December through March or April.)

The El Niño of 1982-83, the strongest such global climate oscillation in recorded history, resulted in several record-breaking storm wave events, extensive structural damage, and severe erosion (Seymour et al., 1984). During El Niño episodes, for intervals of a year or two, the trade winds normally blowing towards the west near the equator weaken or reverse. This causes a slow sloshing of the Pacific Ocean towards the east and an increase in local sea level that can be as great as 1.5 feet. More significantly, a series of winter storms are spawned north of the Hawaiian Islands with paths directed towards the Pacific Coast. The 1982-83 storms approached the Southern California Bight from almost exactly west, resulting in extreme flooding and wave impact damage on this coast and slightly lower waves impacting the Northwest. The El Niño of 1997-98, steered on a more northerly track by continental high pressure areas, resulted in larger waves in the Northwest than in Southern California (Komar, 1998). The largest waves recorded off Southern California occurred in a La Niña year resulting from a very tight and intense storm initiated close to the coast in January 1988, which moved rapidly onshore (Shore and Beach, 1989). The largest waves recorded off the North Pacific Coast in the last century also occurred in a La Niña interval (Allen and Komar, 2000). Major storms along the Pacific Coast, regardless of the wave generation area, typically persist for 3 to 4 days.

Exposure to long waves generated anywhere in the Pacific Ocean yields the potential for tsunami impacts anywhere on the Pacific Coast; however, much of the seacoast is protected from extensive tsunami flooding by cliffs, steep coastal slopes, or deep water very close to shore. The magnitude of the amplification at the shoreline of the modest deep water tsunami wave heights is dictated by local bathymetry. Flooding risk from tsunamis is highly variable along the coast. One such susceptible location, Crescent City, in Northern California, suffered substantial damage in 1964 from a tsunami initiated by an earthquake in Alaska (Kanamori, 1970).

The Pacific Coast can be divided into two rainfall regimes. North of Monterey Bay, precipitation is greater and snow accumulation is heavy and reliable on inland mountain peaks, such that rivers flow year-round and spring floods are common. South of this point, rainfall is restricted to the winter months and declines in magnitude with reduced latitude. Rivers flow only in the winter and flooding is highly episodic. Except at San Francisco Bay, all of the Pacific Coast rivers discharge directly into the Pacific Ocean. Because the sediment load-carrying capacity is strongly related to both rainfall in the watershed and flooding intensity in the river system (Inman and Jenkins, 1999), the supply of sand to the coastline grades from a maximum in the north to a minimum in the south. The combination of this sand supply condition, the varying coastal geology, and the north-south gradient in wave energy levels results in very different beach configurations in the two rainfall provinces.

North of Monterey, beaches are found in the lowered valleys at the mouths of streams or rivers that flow year-round. The sizes of the accompanying spits are related to the sediment capacity of the streams. South of Monterey Bay and extending to Point Conception, a series of beaches and accompanying dune fields exist as large (10-15 miles long) crescentic bays anchored on the north by large rocky headlands. Beginning at Point Conception and continuing south and east to the border with Mexico are a series of more or less continuous beaches, broken into littoral cells by rocky headlands (such as Palos Verdes, Fermin, Dana and La Jolla points), most in the order of 60 miles in length (Inman and Frautschy, 1966). Thus, the vast majority of the sandy beaches on the Pacific Coast are found in a region that is slightly more than 20% of the total coastline. Their existence in the area with the lowest potential for delivering sand to the coastline owes entirely to the reduced incident wave energy related to latitude and to the substantial wave barriers provided by Point Conception and the offshore islands.

Relevant to FEMA FISs, the dominant coastal flood-related hazards differ substantially for the Pacific Coast from those on the Atlantic and Gulf coasts. Whereas the dominant source of coastal hazards on the Atlantic and Gulf coasts is associated with large storm surge (up to 20+ feet) caused by high wind stresses over broad and shallow continental shelves, the narrow continental shelves of the Pacific Coast preclude surges greater than a few feet. Here, however, large waves with long periods can cause both static and oscillating elevation of the water levels at the shore. The combination is referred to as “wave runup”. The oscillating component of wave runup can have periods from tens of seconds to several minutes. Wave runup and the energy of large breaking waves contribute to coastal hazards and can cause significant beach erosion and structural damage. Because Pacific storms often result in large rainfalls, coastal and riverine flooding can combine to increase flood hazards near river mouths.

Characteristics of sheltered waters along the Pacific Coast differ from the Atlantic and Gulf coasts. For example, much of the Atlantic and Gulf coasts are characterized by barrier islands, while few barrier islands exist on the Pacific Coast. Also, while 80 to 90% of the Atlantic and Gulf coast shorelines are marshes fringing sheltered waters, less than 20% of the Pacific Coast consists of marsh lands and these are concentrated in lagoons and bays (CEM, 2003). More specific characteristics also differ between the coasts. For example, the inner bars of Pacific Coast inlets are less pronounced than those at Atlantic and Gulf coast inlets (O’Brien, 1976).

Sheltered waters in the State of Washington are predominantly associated with the straits, passages, channels, and islands of Puget Sound. Farther south along the open coast, the large river estuaries of Grays Harbor and Willapa Bay provide sheltered water conditions with jettied and natural inlets. At the Washington and Oregon state border, the Columbia River forms the largest river estuary along the Pacific Coast. Sheltered waters along the coast of Oregon are limited to isolated bays and estuaries associated with rivers flowing out of the Coast Range.

The coastline of Northern California presents more isolated sheltered water areas than the Oregon Coast, with Humboldt Bay as the most significant sheltered water body in this area. The largest sheltered water body in California is the San Francisco Bay. This bay is actually a series of bays, with San Francisco Bay oriented to the south and east of San Francisco, and San Pablo, Suisun, Grizzly, and Honker bays to the north and east and confluent with the Sacramento and San Joaquin rivers. A series of open embayments characterize the Southern California Coast, the largest of these include Monterey and Santa Monica bays. In the vicinity of Santa Barbara

and Los Angeles, a series of large offshore islands provide sheltering effects within the Santa Barbara Channel and Passage, the San Pedro Channel, and the Gulf of Santa Catalina. At the Mexican border, Mission and San Diego bays represent the last major sheltered water bodies along the Pacific Coast.

Although this version of guidance for the Pacific Coast does not specifically address Alaska and the Pacific Islands, the physical setting and coastal flooding processes in sheltered water areas are generally similar, with Alaskan waters further characterized by deep fjords, passages, and inland waterways, and Pacific Island waters by offshore reefs and islands.

D.4.1.2 Pacific Coast Flood Insurance Studies

This subsection briefly introduces Pacific Coast FISs through a discussion of general study considerations, including special considerations for sheltered waters and unique study conditions. Descriptions of typical study scoping activities, hazard zone definitions, and study reporting requirements are also provided. Additional information on flood hazard zone mapping and study documentation is provided in Sections D.4.9 and D.4.10, respectively.

D.4.1.2.1 Study Scoping

Study scoping is defined as the process of determining the extent of a particular coastal FIS and defining the fundamental methodologies to be used in completing the study. As used in this subsection, this process includes two major tasks.

The first task is designed to assess the need for flood hazard mapping for communities and to assign priorities. FEMA has implemented the use of an automated study scoping tool as a module in the Watershed Information SystEm (WISE[®]) software package to assist Mapping Partners in conducting study scoping. This system provides a consistent methodology for producing a database of information and associated shapefiles that can be used to assess mapping needs. The module can be used to produce reports and maps for community scoping meetings, and to interactively revise and prioritize study reaches during the meetings. The module's ranking tools can be used to assign ranking and funds to community requests and to geographically display the results. The Mapping Partner shall consult with the FEMA study representative to define the appropriate use of the WISE scoping module for a particular study area, including review of previous scoping efforts.

The second task involves determining of general study methodologies based on study area setting, morphology, and coastal processes. This step also includes practical considerations of data availability and data collection needs, as well as study time and budget requirements. Sections D.4.2 and D.4.3 on study methodology and analysis methods shall be consulted by Mapping Partners to determine which methods are appropriate for a particular coastal study setting and their general requirements for data and flooding analysis. In some complex study areas, a scoping phase of the coastal FIS may be needed to determine the availability of data and define a study methodology that combines a number of analysis methods and mapping procedures.

The following general procedures shall be followed for scoping the study methodology:

1. Define the objectives of the study using the scoping module of WISE, information from the communities, and information from the FEMA study representative.
2. Review prior flood studies at the site or in the vicinity.
3. Review the study area setting exposure and shoreline morphology.
4. Make an initial assessment of the probable types and extent of hazard zones in the study area.
5. Identify subregions and reaches based on onshore conditions (e.g., shore geometry, structures), nearshore conditions (e.g., local exposure, profile morphology), and offshore conditions (e.g., depth contours, geometry of sheltered waters).
6. Define potentially applicable study methodologies using Sections D.4.2 and D.4.3 as guidance.
7. Determine data requirements and data availability to support various analysis methods.
8. Assess the probable study methods in terms of level of complexity and probable accuracy of results – in general, the simplest methodology that provides reliable results shall be chosen. Incremental benefits of more sophisticated or detailed analysis may be assessed in this step.
9. Refine selection of analysis methods based on data requirements and reliability to synthesize an overall study methodology that effectively combines multiple analysis methods. For some studies, alternatives to the methods described in this section may be required to address specific situations.
10. Confirm that the study methodology is adequate to support development of anticipated flood hazard zones and produce required mapping.
11. Estimate time and budget requirements.
12. Adjust study extent, data collection, analysis methods, or overall methodology, if necessary, to meet study time and budget constraints.

Some flexibility is desirable in selecting study methodologies with respect to the procedures defined in these guidelines. Overarching considerations in selecting study methodologies shall include a basis in physical processes and quality-assured data, use of technically reliable and current analysis methods, reproducibility using standard engineering methods, verification of results using sensitivity tests and simple checks, and consistency with this appendix and other FEMA guidance.

D.4.1.2.2 Regional vs. Local Studies

Flood insurance studies have usually been performed for a single political jurisdiction, most commonly a county, with the FISs and Flood Insurance Rate Maps (FIRMs) being specifically developed for that community. Adjacent communities have been addressed only insofar as necessary to ensure that Base Flood Elevations (BFEs) match at the study community boundaries. The hydrologic and hydraulic efforts have also typically stopped at the community boundaries, or have extended only so far beyond them as to encompass complete hydrologic units, such as drainage basins, which are necessary to determine conditions within the study community.

This *local study* approach has been followed, in part, due to the demanding computational effort necessary to encompass large regions within the analysis. For example, storm surge calculations require large computational grids, which in turn require large computer capacity and long execution time. To model more than a limited coastal region was difficult or impossible with the computer capabilities of only a few years ago. Similarly, ocean wave simulations have been restricted to limited zones in past studies. Although this community-by-community approach proved tractable, it also introduces some compromise into the studies. For example, a long length of coast that is simulated by breaking it into small sections means that boundary conditions must be specified for each segment, with some probable loss in both efficiency and accuracy.

A second compromise in local studies is that different Mapping Partners may make different assumptions that lead to differences between adjacent studies. Furthermore, not all Mapping Partners have the necessary tools and experience to perform some types of coastal flooding analyses.

The idea of *regional studies* is to perform large-scale regional analyses for certain portions of the engineering tasks needed in a community study and to make these analyses available as input to the local studies. For example, Section D.4.4 of these guidelines describes large regional databases (such as the Global Reanalysis of Ocean Waves [GROW] data) of wave hindcast data. These data can be transformed to the nearshore area, just outside the surf zone, as part of a regional study effort covering a very large portion of the Pacific Coast, using a single, consistent, state-of-the-art methodology. The advent of modern computational abilities makes these regional efforts feasible and more cost-effective than community-by-community repetition of a similar effort.

Regional studies can be implemented to varying degrees. Regional studies need not be as large as an entire coastline or a statewide analysis, but instead might cover a small number of counties. This would be the case if there is a physical characteristic of a region that makes it logical to treat it as a unit, instead of breaking it up into smaller areas. For example, wave studies might be accomplished regionally according to directional exposure, island sheltering, breadth of shelf, or other physical factors. Similarly, tsunami analysis might be done by region according to large-scale tectonic considerations. In a general way, processes that originate in the far field – such as incident waves and tsunamis – are candidates for regional analysis because a single coherent source might affect a large coastal reach. In an event-selection analysis, the selected event might be adopted regionally, controlling behavior within a multi-community basin such as a large sound.

The extent to which regional studies, perhaps focused on particular coastal processes, are available and can be used in local FISs depends on planning and implementation of these studies by FEMA. The Mapping Partner shall consult with FEMA study representatives during the study scoping to determine if relevant regional information or analysis is available and should be incorporated into the study methodology.

D.4.1.2.3 Sheltered Waters

Generally accepted definition for “sheltered waters”, which are taken here to include inland waters, enclosed basins, fetch-limited waters, and low-energy beaches, does not exist (Jackson et al., 2002). For the purposes of these guidelines, “sheltered” is assumed to imply a significant sheltering effect on the inland propagation of storm surge, waves, and wind by land masses and vegetation. “Sheltered waters” are water bodies or regions that experience diminished forces from wind and/or wave action relative to the open coast due to the presence of physical barriers, both natural and human, either on land or under water.

Sheltered water areas are exposed to the same flood-causing processes as are open coastlines (high winds, wave setup, runup, and overtopping), but sheltering effects reduce the wave energy and flood potential. The Mapping Partner shall evaluate these potential sheltering effects at both a regional scale and at a local site scale.

At a regional scale, wind-generated waves in sheltered water areas are highly dependent on the shape and orientation of the surrounding terrain to prevailing wind directions. Wave generation and transformation in sheltered waters are usually limited by the open water fetch distance, complex bathymetry, and often the presence of in-water and shoreline coastal structures. Other processes, such as the effects of flood discharges from rivers, can modify local tidal and storm surge elevations, and relatively strong tidal and/or fluvial currents can combine to create tidal and hydrodynamic conditions only found in sheltered water areas.

Bays and estuaries often display significant spatial variability in tidal still water elevations. For example, South San Francisco Bay often exhibits a standing wave with nearly twice the tide range of the central bay and an elevated mean tide and high water elevation compared to the open coast. San Pablo and Suisun bays, to the north and extending into the Sacramento-San Joaquin Delta area, display a progressively muted tidal range and lower elevated mean tide. These effects are the result of the combined effects of complex tidal hydraulics, residual currents, local winds, and river runoff. Oceanic storm surge can also be modified in estuaries, with surge heights sometimes uniformly additive to local tidal datums throughout an estuary, or amplified or muted within a given region of a large estuary.

The Mapping Partner shall review bathymetric and topographic maps and aerial photographs, and make field observations to determine if a coastal flood study site is located within sheltered waters and to assess the degree of sheltering from swell, waves, and wind. The Mapping Partner shall investigate local site scale features contributing to sheltering from wind and waves and affecting flooding at a study site. It is important to note that sheltered water characteristics and processes viewed at a regional scale may be different at a local scale due to site-specific controls (Jackson and Nordstrom, 1992). In general, more detailed examination of local conditions will be required in sheltered waters than on the open coast.

Based on map observations of bathymetry and terrain, the extent of sheltered water areas can be approximately delineated. A rule of thumb for estimating a wind sheltering effect is to assume wind speeds can be blocked if the ratio U/h_m is less than 0.1, where U is wind speed and h_m is the height of the land barrier, in consistent units (CEM, 2003). For example, wind speeds up to 80 mph may be blocked by a land mass 800 feet high. This disruption of the wind creates a boundary layer effect, which can be roughly estimated to extend in the downwind direction a distance approximately 30 times the height of the land mass (CEM, 2003), or for this example, about 4 miles. Mapping Partners shall evaluate the terrain surrounding a flood study site, together with the seasonal direction of local storm winds.

General wave transformation conditions within a sheltered water body may be inferred from wave patterns observed on vertical aerial photographs. During field reconnaissance, the Mapping Partner shall make field observations to identify conditions that affect selection of a study approach. Jackson et al. (2002) have identified characteristics of sheltered water shorelines that may be useful as a guide for field reconnaissance.

The Mapping Partner shall define a general approach to a sheltered water study at the scoping phase of the project. Because sheltered water areas experience the same flood-causing processes as open coast areas, guidance for performing coastal flood studies in sheltered waters is integrated throughout the remainder of these guidelines. Where procedures apply specifically to sheltered waters, they are identified in the individual subsections.

Beyond the initial effort to determine if a study site is located within a sheltered water area, as described above, a general approach to sheltered water studies shall address the following topics:

- **Topography/Bathymetry:** The Mapping Partner shall obtain backshore topography to define hazard zones, obtain nearshore bathymetry to define beach profiles, and define the geometry (size and volume) of the sheltered water body to evaluate hydrodynamic conditions. Detailed bathymetric data will likely be required in tidal inlets to assess their hydrodynamic characteristics, which may control the magnitude and timing of flood components, such as tidal still water levels (SWLs) and wave propagation.
- **Wind:** The climate in sheltered waters is dependent on localized wind conditions, and wave data are typically unavailable at suitable resolution. The study approach will typically focus more on the identification of appropriate wind data sources rather than wave data (as may be relied upon for open coast studies). Accordingly, the Mapping Partner shall identify, obtain, and review available wind data from the nearest appropriate sources; augment long-term data from established weather stations with available short-term data from local governments, industries, or private landowners to verify local wind conditions; and define characteristics related to fundamental wind parameters, such as wind source, seasonal direction, duration, magnitude, and vertical velocity distribution.
- **Tide and Currents:** The Mapping Partner shall identify, obtain, and review available tide gage data to define fundamental tide characteristics, such as astronomical tide, storm surge, tidal amplification, wind setup, and tidal and fluvial currents. Long-term data from established tide stations with observed tides may need to be augmented with data from other sources. In some cases, estimates of natural tidal datums from landscape features,

such as mud and vegetation lines, may provide verification of estimated extremal tide elevations.

- **Waves:** The Mapping Partner shall obtain available data on observed wave height, wave length, and wave period, and shall assess probable extreme wave conditions given potential bathymetric and vegetative effects on wave energy.

These general topics can define the forcing functions, boundary conditions, and constraints necessary for analytical and/or numerical modeling approaches to flood determination. Sheltered water physical processes can be complex and may require detailed numerical modeling to define adequately the flood hazards. Given the availability and relative ease of use of modern numerical models, the Mapping Partner shall consider a numerical modeling approach to a sheltered water study where simpler methods do not appear reliable. Model selection shall be made with consideration of the level of complexity of physical processes, data available for calibration, flood risk, and available study budget. If the physical scale of the sheltered water coastal flood study is small and the geographic setting and physical processes are relatively well understood and simple, the Mapping Partner shall confer with the FEMA study representative about the feasibility of using simplified analytical approaches instead of numerical models. A limited analytical approach may also be appropriate to obtain a quick assessment of physical conditions and/or to provide a check of the results from a numerical modeling approach.

D.4.1.2.4 Tsunami Hazards

Much of the Pacific Coast and the sheltered waters along the Pacific Coast are subject to tsunami hazards. The most recent major tsunami to affect the Pacific Coast was the 1964 Great Alaskan Tsunami that affected California, Oregon, and Alaska. Tsunamis are very long waves of small steepness generated by impulsive geophysical events such as earthquakes and landslides. This version of the Pacific Coast guidelines includes a placeholder (Section D.4.8) for future FEMA guidance on tsunami hazards. The Mapping Partner shall confer with the FEMA study representative to discuss treatment of tsunami hazards in a particular study area.

D.4.1.2.5 Debris

Debris entrained in tidal floodwaters and cast inland by wave runup and overtopping is a common phenomenon on parts of the Pacific Coast. Natural debris consists of floating woody debris, such as drift logs, branches, cut firewood, and other natural floatable materials. Masses of drift logs covering large portions of open water have been observed during flood events along the Oregon Coast. Wave-cast beach sediments, such as cobbles and gravel, also constitute natural debris. Debris from human sources may originate from flood damage. This debris may include broken pieces of shore revetment cast inland by extreme wave runup, or floatable materials, such as construction materials, building materials, and home furnishings.

Debris hazards depend on the beach type and configuration, debris sources, the inland extent of wave overtopping, the proximity of insured structures to the shoreline, and the height of the structures above the BFE. At the present time, debris hazards are not explicitly included in FEMA flood hazard zones. However, the Mapping Partner shall note significant debris hazards in a study area and confer with the FEMA study representative, so relevant information may be shared with community floodplain managers.

D.4.1.2.6 Beach Nourishment and Constructed Dunes

Current FEMA policy is not to consider the effects of beach nourishment projects in flood hazard mapping. Beach nourishment, in effect, is treated as a temporary shoreline disturbance, or an “uncertified” coastal structure (a structure not capable of withstanding the base flood event and/or a structure without an approved maintenance plan).

However, given that beach nourishment is being used by more and more communities in response to coastal erosion, it is becoming increasingly difficult to obtain recent topographic data that do not reflect prior beach nourishment. In many communities, beach nourishment has been ongoing for a decade or more (predating the NFIP in some cases).

Mapping Partners should be aware that flood hazard mapping of coastal areas could potentially be affected by various types of beach nourishment, and that current topographic data may reflect beach nourishment efforts.

The Mapping Partner shall determine whether beach nourishment affects a study area, research any beach nourishment projects identified, identify any available data that would allow the performance of the beach nourishment project(s) to be assessed, and determine whether the beach nourishment is likely to persist and to have an effect on flood hazard mapping. If the beach nourishment is determined likely to have an effect on flood hazard zones or BFEs, the Mapping Partner shall contact the FEMA study representative to determine whether an exception to current FEMA policy should be considered.

The presence of constructed dunes in the study area may raise similar questions. For all practical purposes, the Mapping Partner shall treat constructed or reconstructed dunes (referred to as “artificial” dunes by FEMA) as natural dunes would be treated during the FIS. Note, however, the condition of the artificial dune may alter this procedure; NFIP regulations [44 CFR 65.11(a)] do not allow an artificial dune to be considered an effective barrier to coastal flooding unless it has well-established, longstanding vegetative cover, regardless of its size and cross-section.

D.4.1.2.7 Hazard Zone Definitions and Use by FEMA

Coastal flood hazard zones shown on the FIRM are generally divided into three categories: 1) VE zone (the coastal high hazard area); 2) AE zone (and other A zones, where flood hazards are not as severe as in VE zones); and 3) X zone (which is only subject to flooding by floods more severe than the 1% annual chance flood). AH zone and AO zone designations are used in special situations.

Delineation of flood hazard zones involves a set of analyses (waves, water levels, wave effects, and shoreline response) combined into a methodology for a particular study area. The criteria for establishing flood hazard zones are briefly described below. The reader should refer to subsequent sections for a detailed description of the mapping parameters and their derivation.

D.4.1.2.7.1 VE Zone

VE Zones are coastal high hazard areas where wave action and/or high-velocity water can cause structural damage during the 1% annual chance flood. VE Zones are identified using one or more of the following criteria for the 1% flood conditions:

1. The **wave runup zone** occurs where the (eroded) ground profile is 3.0 feet or more below the TWL.
2. The **wave overtopping splash zone** is the area landward of the crest of an overtopped barrier, in cases where the potential wave runup exceeds the barrier crest elevation by 3.0 feet or more ($\Delta R > 3.0$ feet). The landward extent is defined by $y_{G,outer}$ (Section D.4.5.2)
3. The **high-velocity flow zone** is landward of the overtopping splash zone (or area on a sloping beach or other shore type), where the product of depth of flow times the flood velocity squared (hv^2) is greater than or equal to $200 \text{ ft}^3/\text{sec}^2$.
4. The **breaking wave height zone** occurs where 3-foot or greater wave heights could occur (this is the area where the wave crest profile is 2.1 feet or more above the static water elevation).
5. The **primary frontal dune zone**, as defined in 44 CFR Section 59.1 of the National Flood Insurance Program (NFIP) regulations.

D.4.1.2.7.2 AE Zone

AE Zones are areas of inundation by the 1% annual chance flood, including areas with TWL less than 3.0 feet above the ground, or areas with wave heights less than 3.0 feet. These areas are also subdivided into elevation zones with BFEs assigned. The AE Zone generally will extend inland to the limit of the 1% annual chance flood still water elevation or TWL, whichever dominates.

D.4.1.2.7.3 AH Zone

AH Zones are areas of shallow flooding or ponding with water depths generally limited to 1.0 to 3.0 feet. These areas are usually not subdivided, and a BFE is assigned.

D.4.1.2.7.4 AO Zone

AO Zones are areas of sheet-flow shallow flooding where the product of hv^2 is less than $200 \text{ ft}^3/\text{sec}^2$, or where the potential runup is less than 3.0 feet above an overtopped barrier crest ($\Delta R < 3.0$ feet). Sheet flow in these areas will either flow into another flooding source (AE Zone), result in ponding (AH Zone), or deteriorate because of ground friction and energy losses to merge into the X Zone. AO areas are designated with 1-, 2-, or 3-foot depths of flooding.

D.4.1.2.7.5 X Zone

X Zones are areas above the 1% annual chance flood level. On the FIRM, a shaded X Zone area is inundated by the 0.2% annual chance flood, and an unshaded X Zone area is above the 0.2% annual chance flood.

Detailed guidance on hazard zone mapping is provided in Section D.4.9.

D.4.1.2.8 Reporting Requirements

Reporting requirements for coastal FISs shall follow guidance provided in Appendix M for the preparation of a Technical Support Data Notebook (TSDN). The TSDN shall consist of the following four major sections, which are more specifically described in Appendix M:

- General documentation;
- Engineering analyses;
- Mapping information; and
- Miscellaneous reference materials.

In general, the material compiled for these sections of a coastal FIS TSDN will be similar to a riverine study, with the exception of the engineering analyses section. The engineering analyses section of a TSDN for a coastal study shall be formatted to reflect the required intermediate data submissions, together with the subsequent correspondence from FEMA and any other subsequent documentation related to a particular intermediate data submission. The purpose and content of individual intermediate data submissions are briefly described below.

Due to the differences between coastal and riverine flood studies and the complexity of coastal studies, intermediate data submissions are required from the Mapping Partner. Intermediate data submissions provide defined milestones in the coastal flood study process where independent reviews are conducted to confirm that the methods and findings are acceptable to FEMA. The primary purpose of this submission and review process is to minimize revisions to analysis methods late in the study.

Coastal analyses involving hydrodynamic modeling for development of water levels and wave processes (transformation, refraction, and diffraction) are highly specialized and complex. Changes or corrections to water-level and wave analyses after they have been used in analysis of shoreline processes and in flood hazard zone mapping are expensive and time consuming. Therefore, FEMA has established intermediate data submission requirements to facilitate review of analysis methods and results at appropriate milestones. The Mapping Partner shall submit the data for FEMA review in accordance with the sequence discussed below.

D.4.1.2.8.1 Intermediate Submission No. 1 – Scoping and Data Review

In this phase of reporting, the Mapping Partner provides the background information on the study setting and available data relevant to the study area. Any new data needed for the detailed coastal analyses in the following phases (offshore waves and water levels and nearshore hydraulics) should be identified in this phase. The study should not proceed until all of the information is available and incorporated in the scoping document for approval.

- **Data Review:** If available at this stage, data may include survey control data, topographic data from aerial photography, Light Detection and Ranging (LIDAR), and field surveys, and bathymetric survey data. Data shall include available tidal elevation, wind speed, and tidal current data; evaluation of local and regional tide gage records; selection of wind stations in the vicinity of the study area that can provide reasonable

length of record, hourly values, and peak gusts to help estimate extreme wind statistics; available tidal current data where currents have a significant influence on coastal flooding potential, including effects on wave refraction and wind wave development; and available historical data (measured and anecdotal) on past coastal flood events.

- **Site Reconnaissance:** The results of the site reconnaissance shall be documented to characterize exposure and coastal morphology; inventory existing coastal structures and levees (including buried coastal structures); identify shorelines where beach nourishment has occurred and could influence coastal flooding analyses and mapping; characterize coastal vegetation where it may influence coastal flooding analyses and mapping; locate analysis transects for subsequent field survey and ultimate use in wave calculations; and identify representative reaches with similar exposure, morphology, and features.
- **Technical Approach:** The submission shall describe the technical approach to analysis of coastal processes and mapping flood hazards in the various settings and shoreline morphologies present in the study area.

D.4.1.2.8.2 Intermediate Submission No. 2 – Offshore Water Levels and Waves

This submission shall be completed before operational modeling runs or computations are performed to transform waves in the shoaling zone and compute wave runup, setup, and overtopping. This submission shall document the selection of offshore water level and wave storm events from data and hindcasts; summarize offshore wave characteristics and statistics; present extremal assessments of wind and wave data; and define input data for restricted fetch analyses.

D.4.1.2.8.3 Intermediate Submission No. 3 – Nearshore Hydraulics

This submission shall be completed before flood hazard mapping is conducted and document the analyses related to: water level and wave analyses to develop base (1% annual chance) flood conditions at the shoreline, including wave modeling for transformation, refraction, diffraction, and shoaling; wave runup, setup, and overtopping assessments in the surf zone; coastal structure and erosion analyses; and inland and overland water level and wave analyses. This submission should include data on control, field, aerial, and bathymetric surveys. It should also include validation of results with available historical flood data, and discussion of modeling results by transect (as needed for interpretation of flood hazards). Where riverine sources influence coastal flood hazard zones in the study area, this submission shall include analysis of riverine flood stages and frequencies.

D.4.1.2.8.4 Intermediate Submission No.4 – Hazard Mapping

This submission will be prepared at the completion of draft delineations of flood hazard zones. The following information shall be submitted to describe the use of analysis results to identify and delineate flood hazard zones:

- **Flood Hazard Zone Limit Identification:** Discuss the determination of hazard zone limits and BFEs resulting from the wave runup analyses and wave overtopping rates determined during the coastal hydraulics phase. Describe the results of coastal flood

mapping at shoreline reaches protected by coastal structures (credited or failed). Provide discussion of the values used to define thresholds for the horizontal and vertical limits of the VE zone for wave runup, wave overtopping, and splash zones (at structures). Provide a table of results as a summary by transect of the still water elevation, wave setup, maximum wave crest elevation, wave runup elevations, overtopping rates, maximum shoreward VE zone elevations, and landward VE zone elevations.

- **Flood Hazard Zone Map Boundary Delineation:** Draft work maps for the study area showing all flood hazard zone limits identified along the transects resulting from the detailed analyses and transferred to the topographic work maps. Describe any engineering judgment used to interpolate and delineate hazard zones in between transects including land features that might affect flood hazards, changes in contours, the lateral extent of coastal structures. Provide detailed documentation and technical justification of any adjustments in the hazard zone mapping due to observed historical flood data and/or damages in the study area.

The Mapping Partner will receive review comments within 30 days of the receipt of each data submission. The Mapping Partner shall include the interim review in the project schedule and shall plan the study work to minimize the effect of the reviews on the overall schedule for FIS and DFIRM production. Additional information on reporting requirements is provided in Section D.4.10.

D.4.2 Study Methodology

This section provides guidance for selecting and combining specific technical methods and data into a study methodology. The selection of methods depends upon the coastal setting and available data.

D.4.2.1 Overview

In this appendix, “methods” means the individual techniques used to make specific computations. “Study methodology” is the combination of appropriate methods and data necessary to develop flood hazard zones for depiction on a Flood Insurance Rate Map (FIRM). A variety of technical methods are presented in Sections D.4.3 through D.4.7 of this appendix. In most cases, several methods may be applicable to a specific coastal setting. The objective of this section is to provide guidance for developing an appropriate methodology based on the coastal setting and available data.

A significant portion of Appendix D is devoted to the presentation of technical methods. It is important to remember that the objective of this document is to provide guidance necessary to develop flood hazard zones and maps. The level of technical analysis should remain consistent with this objective. It is only necessary to obtain data and conduct analyses that are required to accomplish this objective. Because there are often several methods available to conduct similar analyses, the Mapping Partner must choose methods that are technically consistent, are applicable for the study setting, use available data, and are appropriate for project resources.

The recommended generalized study methodology is summarized below. To consider what data and technical methods are appropriate, begin onshore by identifying information that is required to develop the flood hazard zones and mapping. This involves identifying the physical processes that likely contribute to flood hazards in the study area, and their interaction with particular geomorphic settings. In some cases, this initial review will not resolve all of the questions related to coastal processes and hazard zones. However, the review should identify the data requirements for one or more methods that can be applied to make these determinations. For example, it may not be clear at the beginning of a study whether a particular coastal structure or levee will meet Federal Emergency Management Agency (FEMA) criteria. In this case, the data and methods needed to determine whether the structure will fail or not, and the data and methods needed to analyze the failed and in-place conditions, should be identified.

After a review of probable hazards at the shoreline, progress offshore considering what data and analyses are then required at each level and for each setting within the study area to accomplish the previous onshore analysis step. This will establish the offshore limit of the data and computations necessary to conduct the analyses. In most cases, this limit will correspond to offshore conditions. Once the offshore data requirements for the study are established, bring the waves and other information back onshore to determine information to develop the hazard zones. In other words, the mapping needs are established by progressing from the hazard map to the offshore, but the analysis proceeds in the direction of the physics – from offshore to onshore.

Different data requirements are associated with different analysis methods. For example, if methods are based on the deep water unrefracted significant wave height and peak wave period, it is not necessary to examine the details of the spectrum. If it is not necessary to transform the waves across the surf zone, the surf zone bathymetry is not required for this method. More advanced methods generally require additional data.

Figure D.4.2-1 summarizes the basic steps in selecting analysis methods. This logic may be applied to both the overall study (study methodology) and to selection of methods for each major coastal process to be analyzed in developing flood hazard zones. The basic logic begins with the definition of objectives, which should focus on development of flood hazard zones at an appropriate resolution and level of accuracy considering potential damages, inherent uncertainty in the analyses, schedule, and budget. The geomorphic setting is a key factor in identifying dominant physical processes that must be analyzed and the appropriate methods for analysis. Potential methods applicable to a given setting may have different data requirements, and the availability of data may influence the selection of methods. Once a methodology has been defined (combination of methods and data), the Mapping Partner must confirm that the methodology satisfies the study objectives, including time and budget constraints.

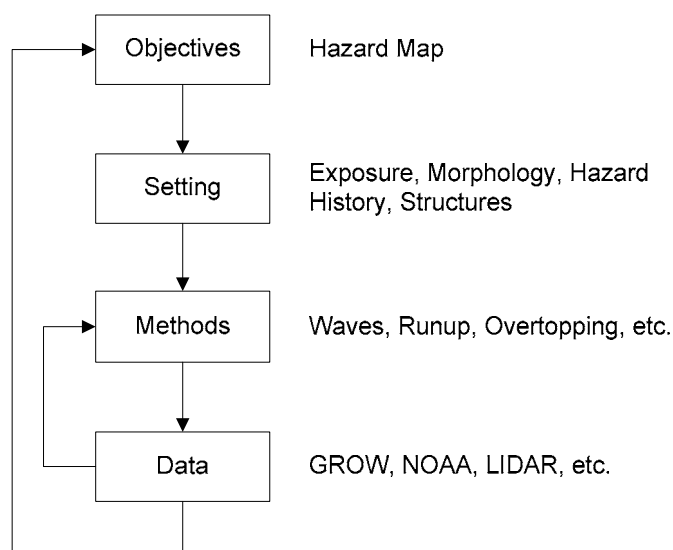

Figure D.4.2-1. Study Methodology Development Considerations

D.4.2.2 Setting

The study area setting and hazard history will determine which methods and data are necessary and/or appropriate. Important considerations include the coastal exposure (open water or sheltered water), the shoreline morphology (e.g., dunes, bluffs, cliffs, etc.), and the shore conditions (topography, development, etc.). Consideration of each of these conditions frames the data requirements and the appropriate analysis methods.

D.4.2.2.1 Open Coast and Sheltered Water

A primary consideration is the exposure of the shoreline; either open coast or sheltered water. Open coast settings are exposed to the full influence of the Pacific Ocean and include processes such as sea, swell, astronomical tides, and El Niño. In sheltered water, the waves are primarily due to local processes, while on the open coast, waves may be generated by both local and distant weather conditions. On the open coast, the interrelationships among waves and water-level processes may be quite complex. As a result, simultaneous measurements and/or hindcasts of these processes are recommended to avoid reconstructing the complex interrelationships. This is a key point for the Pacific Coast. Methodologies prescribed in Appendix D.4 recognize the complexity of describing the interactions between waves and water levels, and as such these processes are analyzed simultaneously in time as they naturally occur in nature.

In sheltered water, the waves are typically generated by local weather, which simplifies the interrelationships. As a result, it may be possible to employ statistical or simulation techniques to analyze these processes. However, additional considerations in sheltered water such as tidal amplification, currents, and the effects of river inflows must be considered. While most methods for open coasts are also applicable for sheltered water, a number of special considerations for sheltered water exist.

D.4.2.2.2 Shoreline Profile Settings

The shoreline morphology determines which analysis tools are appropriate for estimating shoreline responses. The general shoreline settings on the Pacific Coast include: 1) sandy beach backed by low sand berm or high sand dune formations; 2) sandy beach backed by coastal development or shore protection structures; 3) cobble, gravel, shingle beach or mixed grain sized beach; 4) erodible coastal bluffs; 5) non-erodible coastal bluffs and cliffs; and 6) tidal flats and wetlands. Details of the specific methods for each setting are given in Section D.4.6.

Figures D.4.2-2a, b summarize key considerations for each of these six settings. In all settings, the existing shoreline conditions must be determined. These are required to determine the present location of the shoreline, condition of structures, etc. For settings in which beach profile changes are computed (beach/dune and structures), the initial winter profile from which storm-induced changes are calculated must be determined. This initial profile is referred to as the most likely winter profile (MLWP). Profile changes are estimated with the appropriate model to yield an eroded profile. If the eroded profile results in dune breaching, structure failure, or bluff recession, then an adjusted final profile must be determined. Wave setup, runup, overtopping, and overland propagation are then determined for the final profile. These result are then used for mapping the flooding hazards.

1. For a sandy beach backed by a low sand berm or high sand dune, the MLWP is the expected winter condition of the beach profile at the time when a large storm might occur. This is the initial profile condition from which beach changes associated with large storms are calculated. This is an important step because there are significant differences

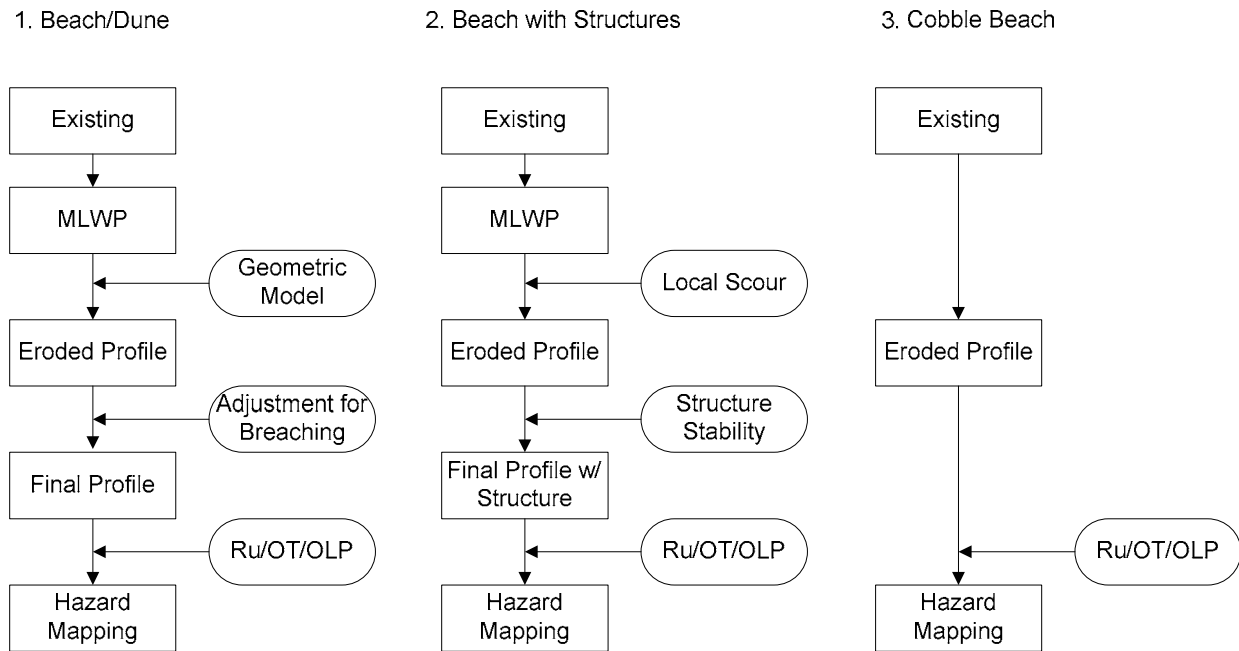

Figure D.4.2-2a. Shoreline Profile Setting Nos. 1 to 3

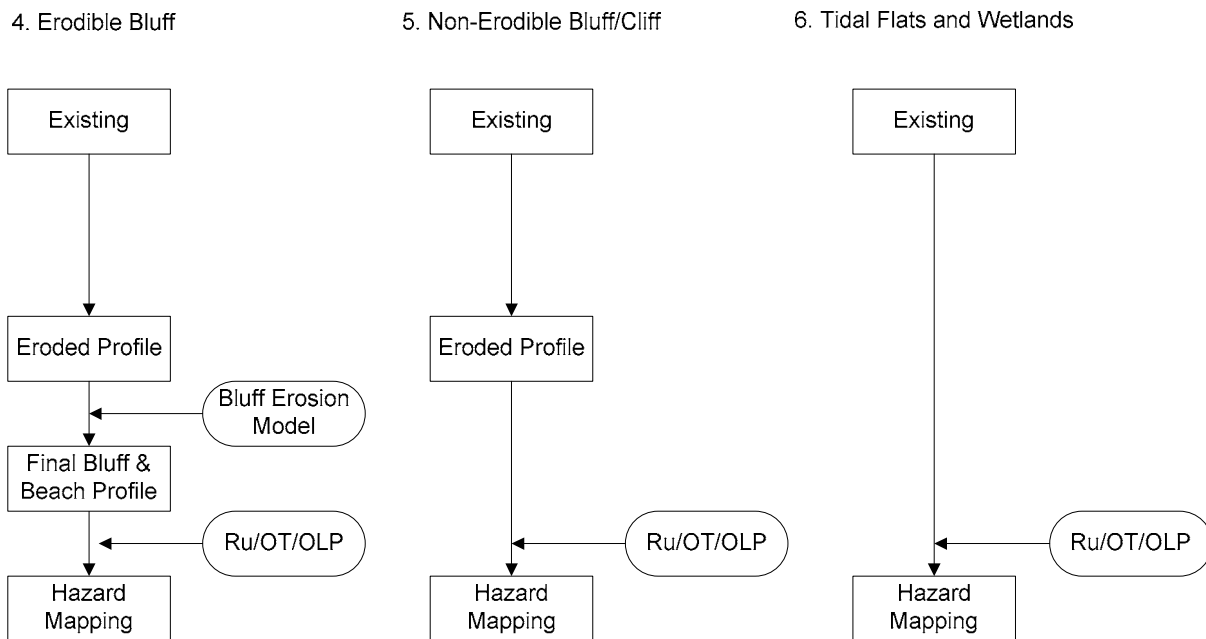

Figure D.4.2-2b. Shoreline Profile Setting Nos. 4 to 6

between the summer and winter profile conditions. The changes are estimated using geometric profile response models to determine the eroded profile. Process-based models are an alternative means of estimating the profile changes. At present, process-based models have not been adequately calibrated for Pacific Coast conditions, and are not recommended without site-specific calibration. If the dune is overtopped or breached, then the profile is adjusted by removing a portion of the dune. The runup (*Ru*), overtopping (*OT*), overland wave propagation (*OLP*), and possibly ponding are then calculated using this final profile.

2. For a sandy beach backed by shore protection structures, the eroded profile is determined from data rather than a shoreline change model. The structure may cause local scour and the structure may fail. The final profile based on these processes is then examined for *Ru/OT/OLP* and possibly ponding.
3. For a cobble beach, little analytical guidance is available because many of the cobble beaches on the Pacific Coast are mixed grain sizes and are difficult to model. As a result, observed profiles during large events are used as the basis for determining *Ru/OT/OLP* and possibly ponding.
4. For erodible bluffs, the eroded winter beach profile is determined from measurements. The bluff recession is estimated with a bluff erosion model. The resulting profile is then used to determine the *Ru/OT/OLP* and possibly ponding.
5. For non-erodible bluffs, the eroded winter beach profile is determined from measurements. This profile is then used to determine the *Ru/OT/OLP* and possibly ponding.
6. For tidal flats and wetlands, it is assumed that there is no erosion over the timescale of a single storm. Therefore, *Ru/OT/OLP* are determined on the existing profile for high water level and storm conditions.

D.4.2.3 Coastal Zones

Figure D.4.2-3 shows the cross-shore divided into four zones. The offshore zone is the area influenced by waves and water levels that are not substantially influenced by bathymetry or topography. Dominant processes in this zone include swell, seas, astronomical tides, storm surge, and large-scale climatic perturbations such as El Niño. The shoaling zone is the area outside the surf zone where offshore conditions are transformed by interaction with bathymetry or topography. This includes refraction, diffraction, dissipation, and generation of waves. The surf zone is where waves break as they interact with the bottom. Dominant processes include wave setup, runup, overtopping, erosion, and interaction with structures. The backshore zone is the area that is outside the normal surf zone, but may be subject to inundation during coastal flooding events. This area is subject to development and is the critical area for determination of flood hazards.

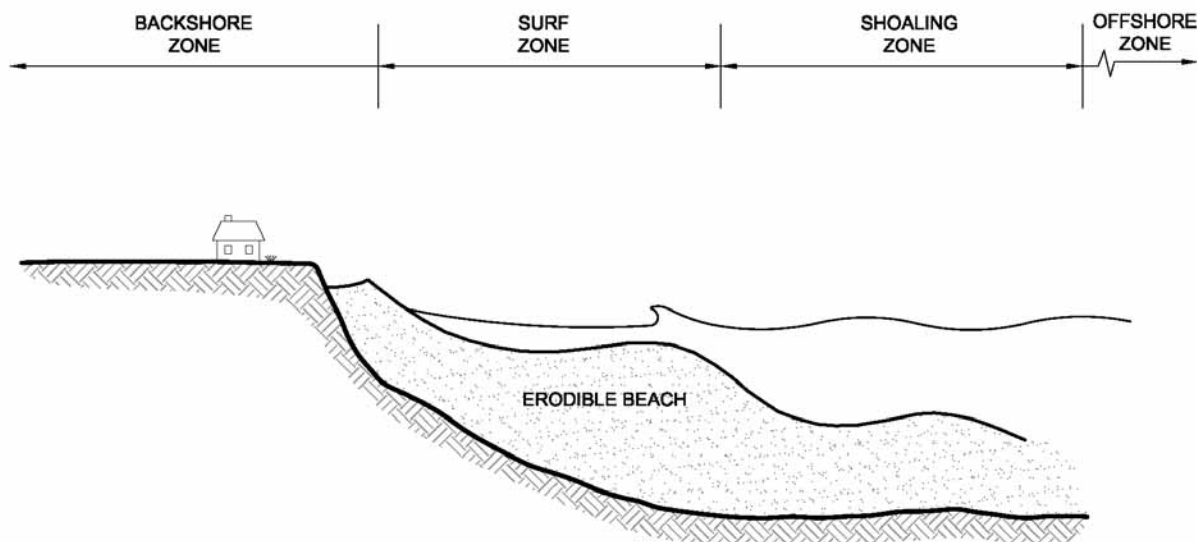

Figure D.4.2-3. Coastal Zones

Typical computations for a coastal Flood Insurance Study (FIS) progress from offshore through the shoaling and surf zones. The transformation of waves and the interaction of waves and corresponding water levels with the backshore zone are used to define hazard zones. The general parameters used for hazard zone mapping are water level (elevation and depth), water velocity, and the product of water depth and velocity squared. This last parameter is used as a threshold indicator for damage potential in areas of sheet flow overtopping.

Figure D.4.2-4 shows the coastal processes as they are referenced to in the analysis methods given in Sections D.4.3 through D.4.7. Note that offshore does not necessarily mean deep water conditions. Offshore simply means outside the surf zone. If the offshore is not in deep water, then the offshore and shoaling zones are combined. Also, the determination of hazards is not restricted to the backshore. Depending on the type and magnitude of event, the flood hazard may also occur in the surf or other zones.

Computations made in each zone use data from the preceding zone and pass the results to the next zone. Computations generally start in the offshore zone. Wave information is determined from measurements or hindcasts. Water levels are determined primarily from measurements. The resulting estimates for waves and water levels are then passed to the shoaling zone where wave transformations are determined. The offshore wave conditions are input to wave transformations, but the wave transformations do not influence the offshore wave conditions. Therefore, offshore wave conditions may be determined independently from the transformations.

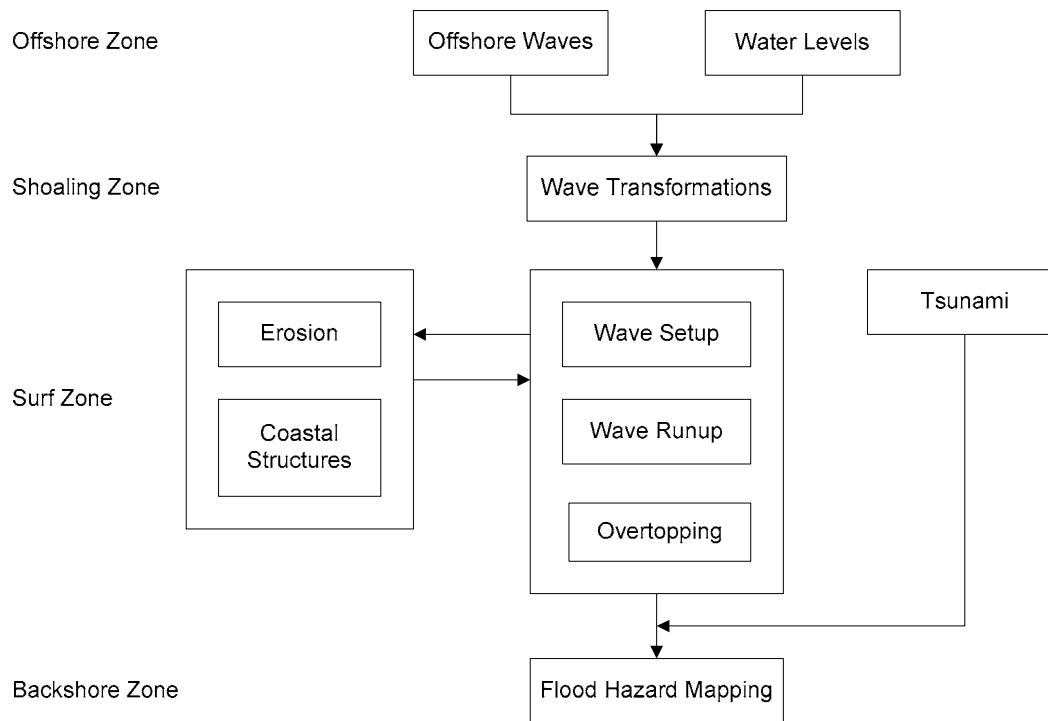

Figure D.4.2-4. Coastal Zones and Processes

In the shoaling zone, the offshore waves are transformed onshore to a water depth outside the breaker line. This requires information for the bathymetry and possibly other factors, such as dissipation over kelp beds, mud flats, or wetlands. Several of the surf zone analysis methods require unrefracted deep water wave conditions. After the waves have been transformed across the shoaling zone, the corresponding unrefracted deep water conditions may also be determined. These results are then passed on to the surf zone. Again, the surf zone results do not influence the wave transformations, so wave transformations may be determined independently of the surf zone. The structure of this appendix reflects this independence. Section D.4.4, Waves and Water Levels, includes processes that occur in the offshore and shoaling zones; these are offshore waves, water levels, and wave transformations.

Surf zone computations use nearshore bathymetry and either the wave conditions determined outside the breaker line or the unrefracted deep water conditions. Setup, runup, overtopping, and erosion are estimated at the shoreline depending upon the specific shoreline conditions. These results are then passed to the backshore zone to determine flood hazards.

In the backshore, information from the surf zone is combined with topography and land use type to calculate hazards and develop a hazard map. For most cases, the backshore does not influence the surf zone and the surf zone is independent of the backshore. However, it is possible that processes in the surf zone are not completely independent of processes in the backshore zone. For example, surface runoff during a storm can increase backshore flooding, but may also develop an ephemeral stream across the beach face that will impact surf zone processes. Unless site-specific conditions that violate this assumption exist, it is recommended that independence

be used in the analysis. This key assumption is invoked below to define the transition from analyses based on multiple events to an analysis based on a single event.

D.4.2.4 Event and Response Analysis Considerations

On the Atlantic and Gulf coasts, the 1% annual chance flood has typically been associated with a 1% storm event condition defined offshore and transformed to the surf zone. Because increased wave heights and water levels are both associated with the same forcing event, typically a hurricane, this association is reasonable. However, on the Pacific Coast, waves may be associated with both local and distant storms; water levels are influenced by El Niño, setup, and tides; and low frequency oscillations in the surf zone significantly influence runup. As a result, no single mechanism is responsible for the 1% annual chance flood. Rather, a number of processes are occurring and the statistical interrelationships among these processes are not well defined. Therefore, statistical tools such as joint probability, Monte Carlo, and empirical simulation methods are difficult to apply. An alternative is to use measured or predicted wave conditions along with simultaneous measured or predicted water-level conditions. Bundling the physical processes together as they actually occur in nature eliminates the need to determine the statistical relationships among the various processes. The response in the surf zone and backshore to these simultaneous physical processes may then be determined, and the 1% annual chance flood characteristics are determined from the response statistics rather than the event statistics.

An event corresponds to a set of time-dependent wave and water-level conditions taken as a paired data set with a specific duration. This differs from the concept of independently analyzing a 1% wave or 1% water level. When treated together, no statistical probability is assigned to either the waves or the water levels. Rather, a number of observed large events (i.e., high waves and water levels) are analyzed to determine a number of responses in the backshore zone each year. The largest response from each year is noted and then the annual maxima for the entire period of record are analyzed to determine the 1% annual chance flood response. This general methodology differs substantially from that typically used on the Atlantic and Gulf coasts.

As noted above, the wave and water-level analysis for the offshore and shoaling zones in sheltered water may be treated differently than open water due to a smaller number of independent variables and/or lack of reliable wave data or hindcasts. However, the concept of using a set of conditions to define responses and performing statistical analysis on the responses may also be applied in sheltered water.

The 1% response may be determined at the boundary of any one of the zones shown in Figure D.4.2-3. For example, a 1% annual chance combination of waves and water levels might be statistically determined in the offshore zone by examining the joint occurrence of waves and water levels. This condition could be transformed onshore, setup and runup estimated, and the flood hazard zone mapped. However, it is unlikely that this single combination of waves and water levels with a 1% annual chance in the offshore zone corresponds to the 1% annual chance flood hazard in the backshore zone. Other combinations of waves and water levels that have a lower probability of occurrence may result in higher levels of the flood hazard due to differing responses in the form of runup, setup, erosion, or coastal structure interaction in the backshore zone. These responses are dependent on variables such as wave period and event duration. The

1% annual chance flood is defined as the basis for hazard zone mapping by FEMA; thus, the response at the backshore is the condition of interest. Again, the mapping of the hazard is not restricted to the backshore, and under some circumstances may also occur in the surf zone or other zones.

Although the response-based approach is reasonable theoretically, it may not be practical to include all coastal processes in the computations before statistical analysis in the backshore. This would require a very large set of computations with potentially significant spatial variation in controlling conditions and results. However, the further the response-based approach can practically be carried onshore, the better the estimate of the 1% annual chance flood hazard in the backshore zone. As a standard methodology, it is recommended that the 1% annual chance determination be made on total water level (TWL) elevations. If overtopping occurs, then the determination of the overtopping rate and overtopping volume should be made using the 1% runup and the associated storm. These are the most significant hydrodynamic parameters influencing flood hazards. This standard methodology may require modification where processes in the backshore (ponding, riverine flows, etc.) influence the flood hazards.

Figure D.4.2-5 shows a cross-shore diagram of the transition from multiple storms to a single condition for the case of a dune-backed sand beach. Waves and simultaneous water levels are determined for multiple storms each year. Each of these storms is then transformed to the nearshore. Then, setup, runup, and dune recession are determined for each of the storms. The largest TWL elevation is selected from each year, and then an extreme value statistical analysis is conducted on the annual maxima from all years of the record to determine the 1% annual chance runup event. This single event is then used to determine the corresponding 1% overtopping rate and volume. These terms are then used to determine hazards. Hazard indicators include the water depth, velocity, and product of depth times velocity squared.

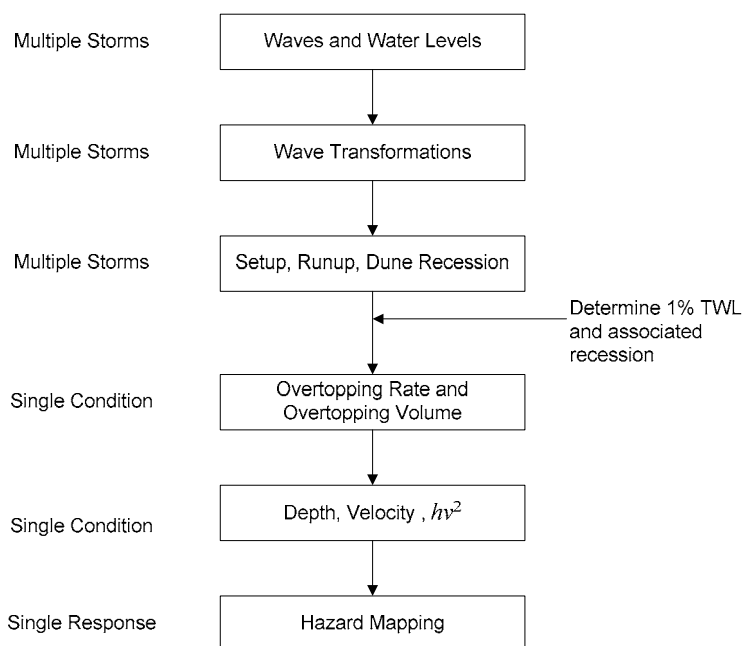

Figure D.4.2-5. Transition from Multiple to Single Events

D.4.2.5 Selection of Events

D.4.2.5.1 Open Coast

Offshore wave conditions, as either measured data or hindcasts, are available for most of the open coast shorelines of the Pacific. It is recommended that these data be used for offshore wave conditions. Each storm year, the largest 10 to 20 storms from these data are selected for analysis. The water levels occurring at the time of each of the storms are determined from measurements or calculations. By examining the 10 to 20 largest storms each year, it is very probable that one of these, along with the associated water levels, captures the largest actual response for the year. The largest storms should be based on largest wave height and the largest resulting runoff. The largest response for each year of the simulations (annual maximum) is used in an extreme value statistical analysis to determine the 1% annual chance flood response. Concerns about capturing the relevant storm each year may be addressed by analyzing more storms each year.

D.4.2.5.2 Sheltered Waters

For open coasts, wave conditions can be determined from existing data, either wave measurements or wave hindcasts. In sheltered waters, if these data are available, then analysis methods similar to open water coastlines are recommended. If these data are not available, wave information must be estimated through hindcasts. These hindcasts should be based on two-dimensional (2-D) numerical models or using the parametric methods prescribed in the Coastal Engineering Manual (CEM) (USACE, 2003). Winds used in the hindcast model should correspond to the largest storms each year. The resulting waves are combined with water levels occurring at the same time to estimate the responses. The largest response for each year is selected and analyzed to determine the 1% annual chance flood response similar to the methods used in open waters.

Conducting this type of analysis for a number of storms each year for a number of years requires substantial amounts of data and a significant computational effort to combine actual water levels with hindcast waves. It may not be practical or possible to conduct this number of computations. For these cases, joint probability methods may be used. In this approach, a limited set of wave and water-level conditions are used to estimate joint probabilities. A number of responses are then calculated based on the data from these distributions. The results are then analyzed to determine the 1% annual chance flood response.

Sheltered waters are the only exposure setting in which joint probability methods are applicable. They are only to be used where data are not available or sufficient hindcasts cannot be conducted to capture the annual maximum response.

D.4.2.5.3 1% Annual Chance Conditions

The determination of the 1% annual chance flood hazards based on a 1% annual chance response at the shoreline (as opposed to estimation of 1% annual chance storm conditions offshore) provides a more direct connection between the actual causal events and the flooding response. However, as soon as the 1% annual chance response is statistically estimated through external analysis, the resulting flood parameters (e.g., elevation, velocity, depth, volume) are no longer coupled to the forcing physics.

The still water level (SWL) is the elevation of the free surface in the absence of waves and wave effects. The primary components are the astronomical tide, El Niño, and surge. The TWL is the SWL plus the wave effects. The primary wave effects are static setup, dynamic setup, and runup. The TWL is an important parameter for identifying coastal flood hazards because it is the primary term that identifies if overtopping will occur. Therefore, the TWL is the variable upon which the selection of the 1% conditions is based. However, the TWL is not the only important variable for determining flood hazards. Other variables include the profile change, the overtopping rate (q), and the overtopping volume (V). The determination of the 1% q and V somewhat complicates the analysis.

The 1% TWL does not correspond to any single physical event. Rather, it is an extrapolation of the TWL conditions from the largest events because of the limited duration of the available data. If the TWL exceeds the backshore elevation, the overtopping rate and overtopping volume are also calculated. The TWL primarily depends on the water level, wave conditions, and the beach face or structure slope. The overtopping rate depends on these variables and the height of the dune or structure. The overtopping volume depends upon these variables and the duration of the overtopping event. In the 1% annual chance determinations, the 1% overtopping rate and overtopping volume are all assumed to be associated with the 1% TWL events. This may not always be the case. Mapping Partners may propose an alternative statistical approach for defining the 1% annual chance flood if this assumption is not appropriate for specific conditions.

A similar concern may exist if multiple transects are considered for a ponding calculation. The 1% annual chance overtopping volume would correctly be addressed by considering all transects that contribute to the ponding simultaneously in the overtopping analysis. However, this may be computationally intensive and not justified by the accuracy of other steps in the analysis. Unless there are unique site-specific reasons to do otherwise, it is recommended that the 1% values of TWL, overtopping rate, and overtopping volume calculated for each transect be used.

The following discussion outlines the procedure for determining the 1% overtopping rate and volume using the TWL as the basis for selecting the most significant conditions. For this discussion, it is assumed that the wave data have 20 storms per year for each year of 30 years of wave data. For each storm, the following terms are computed: the maximum TWL; the maximum wave height (H) and the associated wave period (T); peak enhancement factor of the spectrum (γ); the storm duration (D); the storm duration recession reduction factor (α); the maximum overtopping (q) (if overtopping occurs); and overtopping volume (V) (integral $q dt$). H corresponds to the appropriate wave height for the analysis. For a beach, it is the offshore wave height, but for a structure, it is the wave height at the toe of the structure.

The values for the computed terms that correspond to the largest TWL each year are saved for the extreme value analysis. Again, the TWL is the indicator for selecting the most significant conditions. In addition, the largest storm in the wave data is noted and the time series of both the waves and the water levels are recorded.

For all storms, the TWL is computed and therefore it is straightforward to make a 1% estimate of TWL based on the annual maxima. The determination of the 1% overtopping rate and volume are more complicated and fall into three categories.

- **Case 1:** If the 30 years of wave data do not result in overtopping and the extrapolation to the 1% conditions does not result in overtopping, then it is not necessary to consider overtopping. The results correspond to the adjusted profile and the 1% TWL conditions.
- **Case 2:** If at least one storm in each year of the 30 years of waves results in overtopping, then an extreme value analysis may be directly conducted using the TWL, overtopping rate, and overtopping volume. The profile corresponds to the adjusted profile with overtopping.
- **Case 3:** If there is not an overtopping event for each year of data, it is more difficult to determine the 1% overtopping rate and volume. For this case, the 1% q is calculated from the appropriate overtopping equation using the 1% estimates for H and T (and other variables if required). The profile corresponds to the adjusted profile with overtopping. The 1% V is more difficult to estimate because it depends on the variation of wave conditions and water levels during a storm. A 1% storm is approximated by linearly scaling up the largest storm time series in the record by the 1% H , T , and D . Overtopping is then computed using the 1% storm, the water-level changes associated with the 1% storm, and the data for SWL. The overtopping is integrated over the storm duration to yield the 1% V . Note that this 1% storm is only used in Case 3 and only then for estimating V . It is not a 1% design storm condition as is commonly used on the Atlantic and Gulf coasts.

To summarize the three cases:

- **Case 1:** There is no overtopping.
- **Case 2:** The annual maxima provide sufficient data to make a direct statistical determination of the 1% Q and V .
- **Case 3:** The annual data are not sufficient to make a direct statistical determination, so the variables needed to compute q and V are determined (by scaling) at the 1% level and then these are used to calculate the 1% q and V .

In general, the application of these procedures to shoreline settings that may experience profile changes (berms/dunes, erodible bluffs, and structures) are more difficult than settings that do not have profile changes (cobble beaches, non-erodible bluffs/cliffs, and tidal flats/wetlands). Figure D.4.2-6 shows a general flow diagram for all shoreline settings. For settings that do not have profile changes, the profile change boxes do not apply. For cases with changes, then the appropriate type of profile change for the setting shall be used.

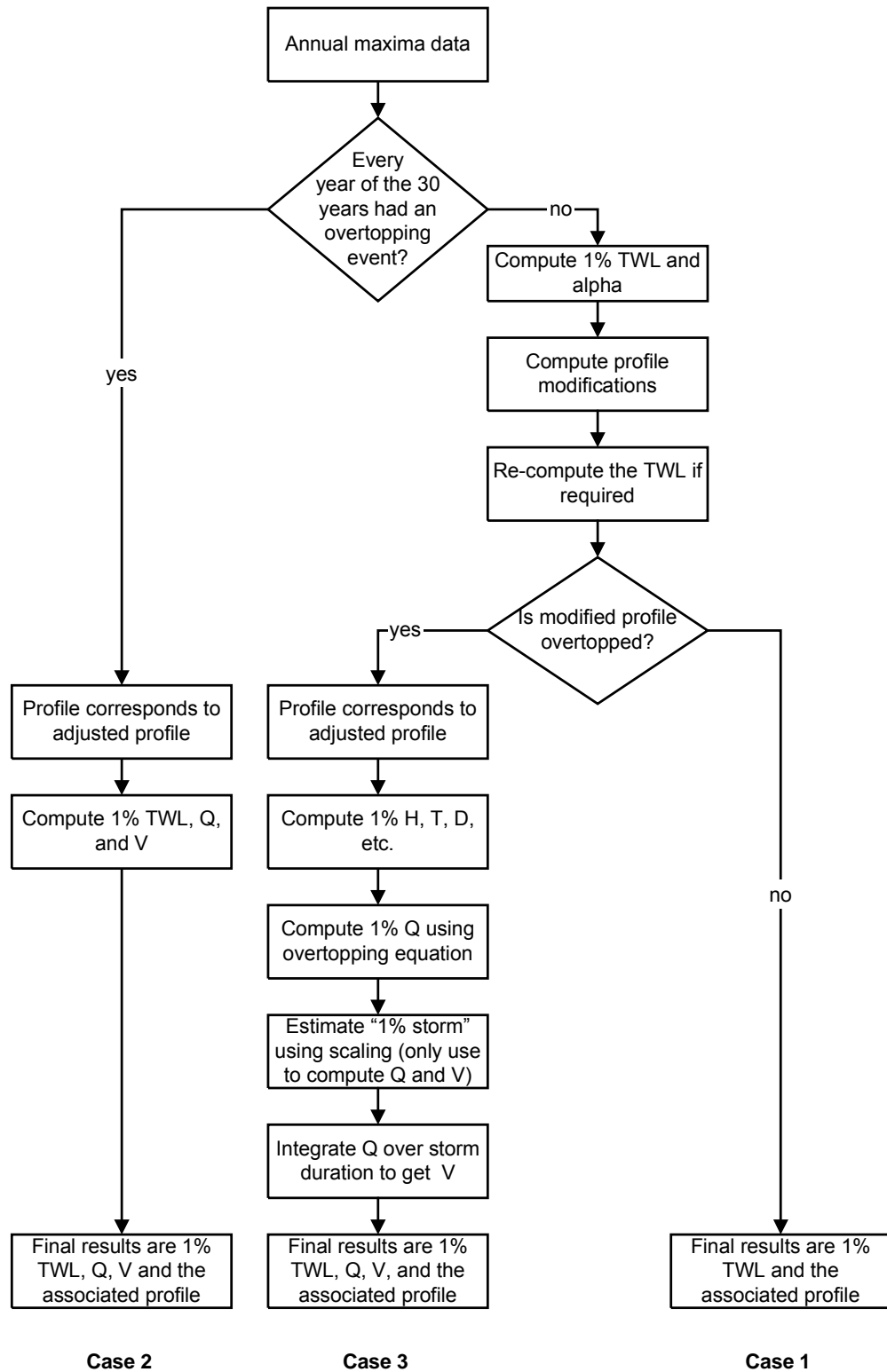

Figure D.4.2-6. Determination of 1% Conditions

Example: Sandy Beach Backed by Berm or Dune (Setting No. 1)

For each of the 20 annual storms:

1. Determine static setup and/or TWL as required by geometric recession model to calculate the potential recession for the storm, $R_{\infty storm}$.
2. Determine storm duration recession reduction factor for the storm, α .
3. Determine duration limited recession for storm, R_{storm} , and if the berm/dune is breached.
4. If runup is different on modified profile, re-compute runup.
5. If runup results in overtopping, then compute overtopping. Save the maximum overtopping value. Compute the overtopping volume as $V = \text{integral } q \text{ dt}$ over duration of storm.
6. For each year, save conditions corresponding to the largest annual TWL conditions: TWL, q , V , α , H , T , D , γ , etc.

Determine 1% conditions:

If every year of the 30 years has overtopping (Case 2):

- The profile corresponds to the adjusted profile.
- Directly compute 1% estimates of TWL, q , and V (Generalized Extreme Value [GEV] and maximum likelihood).

If there are any years with no overtopping:

- Determine the 1% setup and/or TWL α , and R_{storm} .

If there is no overtopping at the 1% level (Case 1):

- If runup is different on modified profile, re-compute TWL.

If there is overtopping at the 1% level (Case 3):

- The profile corresponds to the adjusted profile.
- Compute the 1% H , T , D , etc.
- Calculate the 1% q from overtopping equations.
- Select the largest storm, and scale it up by the 1% H , T , and D to define 1% storm to obtain q and V .
- Using the 1% storm, water-level changes due to the 1% storm, and the measured SWL, determine the 1% V by integrating q over the duration of the storm.

Example: Beach Backed by Structure (Setting No. 2)

For each of the 20 annual storms:

1. Determine the TWL and wave height at structure.
2. Compute scour and adjust profile as required.
3. Determine structure stability. If structure fails, completely or partially remove structure.
4. If runup is different on modified profile, re-compute runup. (Note: Runup requires wave height at the toe of the structure.)
5. If runup results in overtopping, then compute overtopping. Save the maximum overtopping value. Compute the overtopping volume as $V = \text{integral } q \, dt$ over duration of storm.
6. For each year, save conditions corresponding to the largest annual TWL conditions: TWL, q , V , α , H , T , D , γ , etc.

Determine 1% conditions:

If every year of the 30 years has overtopping (Case 2):

- The profile corresponds to the adjusted profile (structure removed or partially failed).
- Directly compute 1% estimates of TWL, q , and V (GEV and maximum likelihood).

If there are any years with no overtopping:

- Determine the 1% TWL and local H .

If there is no overtopping at the 1% level (Case 1):

- If runup is different on modified profile, re-compute TWL.

If there is overtopping at the 1% level (Case 3):

- The profile corresponds to the adjusted profile.
- Compute the 1% H , T , D , etc.
- Calculate the 1% q from overtopping equations.
- Select the largest storm, and scale it up by the 1% H , T , D .
- Using the 1% storm, water-level changes because of the 1% storm, and the measured SWL, determine the 1% V by integrating q over the duration of the storm.

The methodology for determining the 1% overtopping rate and volume is similar for the other settings, cobble beach, erodible bluff, non-erodible bluff or cliff, and tidal flats/wetlands.

D.4.2.5.4 0.2% Annual Chance Conditions

The 0.2% annual chance conditions (500-year conditions) are used to map the X zones. The determination of the 0.2% conditions and the associated flood hazards is completely analogous to the methods used to determine the 1% conditions. The 0.2% conditions are determined using the same GEV results as the 1% conditions (but evaluating at the 0.2% level) and all of the same physical processes are addressed in a similar way.

D.4.2.6 Summary of Methods

Table D.4.2-1 is a summary of methods presented in Section D.4. This table provides an overview of available methods and reference to the appropriate section of the document.

Table D.4.2-1. Summary of Methods Presented in Section D.4

Zone/Process	Method	Comments
All Zones	<p>Statistics (D.4.3) 1% condition - GEV and maximum likelihood fit Peak over threshold with Pareto distribution Joint Probability Methods (JPM), Monte Carlo, Empirical Simulation Technique (EST)</p>	<p>Annual maxima are used to determine the 1% condition. JPM, Monte Carlo, or EST are only used in sheltered waters</p>
Offshore Zone	<p>Waves (D.4.4) Measured NDBC, CDIP Hindcast GROW, WIS, WAVEWATCH III Wave Generation 2-D models CEM parametric model</p>	<p>The use of significant wave conditions (height, period, direction, storm duration) or directional spectra depends upon the choice of the methods selected for determining setup, runup, and overtopping. The wave record must be long enough (30 years or longer) to reasonably estimate the 1% annual chance condition. Wave generation methods are only applicable in sheltered waters or a regional-scale offshore model.</p>
Offshore Zone	<p>Water Level (D.4.4) Measured Water Level astronomical tide, surge, El Niño Sheltered Waters Seich, tidal amplification, rivers</p>	<p>In most cases, the measured TWL, corrected to local conditions, is used in the analyses. A number of other factors can influence the water level in sheltered waters.</p>

**Table D.4.2-1. Summary of Methods Presented in Section D.4
(cont.)**

Zone/Process	Method	Comments
Shoaling Zone	Wave Transformations (D.4.4) Straight and parallel contours shoaling and Snell’s Law Spectral methods transformation coefficients, CDIP Nearshore transformations 2-D spectral and time domain models Sheltered waters seiching, inlets	Numerical models are typically only required for complex bathymetry
Surf Zone	Wave Setup and Runup (D.4.5) Beaches DIM parametric DIM numerical Advanced Models - Boussinesq Structures van der Meer, CEM	Methods combine setup and runup. Parametric method only requires significant wave height. Advanced models are only necessary for complex conditions.
Surf Zone and Backshore Zone	Erosion (D.4.6) Beaches Geometric Models Process-Based Models Shore Protection Structures CEM scour equations Cobble Beaches Observed storm profiles Erodible Bluffs Nobel bluff erosion model Non-Erodible Bluffs and Cliffs No erosion Tidal Flats and Wetlands No erosion	Process-based models are not recommended for the Pacific Coast at this time. The Atlantic and Gulf Coast “540 Rule” is not recommended for the Pacific Coast.
Backshore Zone	Overtopping (D.4.5) Beaches CEM Structures CEM, Besley	
Backshore Zone	Overland Flow (D.4.5) Cox and Machemehl, WHAFIS	

Table D.4.2-1. Summary of Methods Presented in Section D.4 (cont.)

Zone/Process	Method	Comments
Backshore	Hazard Indicators (D.4.8) Runup depth Overtopping splash distance Depth times velocity squared Wave height Primary frontal dune	

D.4.2.7 Examples

There are many methods and data sources presented in this appendix. The development of the details for a specific study methodology depends on the coastal setting, available data, and project resources. However, the overall methodology for most studies is likely to be similar. Consider the three cases shown in Figure D.4.2-7.

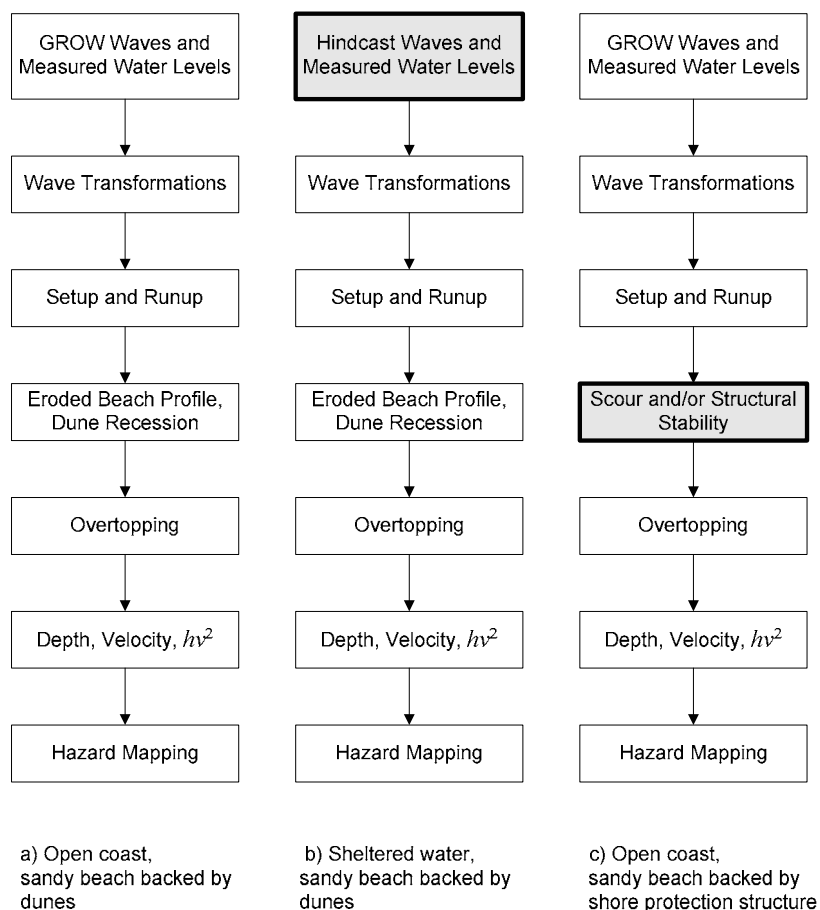

Figure D.4.2-7. Methodology Examples

Case (a) is for an open coast exposure, with a sand beach backed by dunes. The principal steps are:

1. In the offshore zone, determine the wave and water-level conditions.
2. In the shoaling zone, transform the waves to the nearshore.
3. In the surf zone, determine the setup, runup, dune recession, eroded beach profile, and overtopping.
4. In the backshore zone, determine the hazard indicators: depth, velocity, depth times velocity squared (hv^2), overtopping, etc.
5. Map the hazards.

Now consider the setting for Case (b). The only difference between Cases (a) and (b) is that the setting for Case (b) is in sheltered water. The most significant difference in the methodologies is that in sheltered water, wave information is generally not available and must be hindcast or statistically estimated. The waves and water levels are then combined and transformed onshore to the study area. There are differences in the magnitude of specific components in wave transformations between open coasts and shelter waters (i.e., dissipation over shoals), but the overall processes are similar. The same comment is also true for the surf zone and backshore processes.

Case (c) is similar to Case (a), except that rather than a dune, there is a coastal shore protection structure. The only significant difference in the analysis is the method to estimate dune recession is replaced by a method to estimate structure responses. All of the other principal steps in the two methodologies are similar.

The principal steps in the methodology are similar for most study cases. However, there are differences in the specific methods that may be employed at a given step. The following examples demonstrate the selection of specific methods. These examples are for demonstration purposes and may not correspond to an actual study site.

D.4.2.7.1 Open Coast, Dune Backed Beach Scenario Using *Parametric* DIM Model for Setup/Runup

Setting: Open coast, bottom contours that are nearly straight and parallel, and a sand beach backed by dunes.

Data: Offshore GROW hindcast data and measured water levels. Winter season beach and dune profiles. Sand grain size.

For this example, the parametric DIM model is selected to estimate setup and runup, and overtopping is estimated with empirical equations.

The hazards are determined primarily from the 1% annual chance TWL. The 1% TWL is determined at the corresponding eroded beach profile location. This final TWL may be based on the results from the DIM parametric runup model or re-evaluated on the eroded profile using the more complex DIM numerical runup model. If there is overtopping, this may cause additional erosion of the dune. This is addressed in a very simplistic manner. For the modified Komar and Allan method, the MLWP slope is extended until it daylight out the back side of the dune. For the Kriebel and Dean method, the profile is recessed until it daylight out the back of the dune. For this breached condition, the 1% overtopping rate and volume are determined using the wave and water-level conditions corresponding to the 1% TWL.

The DIM model (both the parametric and numerical versions) provides estimates of the total runup. The total runup is the sum of the static setup plus the dynamic setup plus the wave runup. For random waves, the runup corresponds to the value exceeded by 2% of the runup events. This is a short-term statistic associated with a group of waves or associated with a particular storm. It is a standard definition of runup and is commonly denoted as $R_{2\%}$. This 2% is different from the 1% annual condition that is associated with long-term extreme value statistics. The 1% condition has an annual probability of occurrence of 1%, which approximately corresponds to the 100-year condition, while the runup corresponds to the 2% exceedance in several hours of waves. To avoid confusion, the 2% runup is referred to as the *total runup* or just the runup and is denoted as R . Unless otherwise indicated, the runup in all sections of D.4 is defined as the 2% runup.

The GROW waves are analyzed for each storm year to determine the 10 storms that have the largest wave height and the 10 storms that have the largest runup, yielding up to 20 storms per year. The parametric DIM model is used to estimate the setup/runup that depends upon the product of the wave height and wave length. Therefore, the 10 storms that have the largest wave height-length product are selected. Many of the storms selected by the height and by the height-length criteria may be the same. The parametric DIM model is based on the unrefracted deep water significant wave height. The dune recession model is based on the peak runup that occurs during the storm and the duration of the storm. Therefore, the required wave conditions for each storm are the peak unrefracted deep water wave height, the wave period, and the storm duration. No computations regarding the spectral or time series details of the waves are required, nor are details of the waves in the surf zone.

The dune recession model requires the determination of the MLWP. This is the expected condition of the beach profile during the winter season when a large storm might occur. The MLWP may be determined from winter beach profile data, average winter wave conditions, or historical information. For this example, winter profile data are available.

Next, each storm in each storm year is examined with the dune recession model. The model can start each storm from the MLWP or sum the recession from multiple storms over a season. Unless there are data or other information available to suggest that multiple storms be considered, a single storm-by-storm analysis is used. For the present example, this would yield 10 to 20 TWL estimates per year. The conditions corresponding to the largest TWL each year are saved. These annual maxima for each storm year of wave data are then analyzed using a GEV and maximum likelihood. The methods discussed in Subsection D.4.2.5.3 are used to determine the 1% overtopping rate and volume. Using these values and an overland flow model, the depth, depth times velocity squared, and wave height are estimated in the backshore. The hazards are identified based on these results.

Specific methods for each of these steps are identified in Table D.4.2-2. In Table D.4.2-2, H_s is the significant wave height, T_p is the peak wave period, D is the storm duration, $H_{s\ max}$ is the maximum significant wave height during the storm, L_0 is the deep water wave length, h is the water depth, q is the overtopping rate, and v is the water velocity.

If the 0.2% annual chance flood conditions are to be determined, the steps starting from the statistical analysis are repeated at the 0.2% level. It is not necessary to repeat any of the analyses before this step. The results from the GEV are used to determine the 0.2% values. These are then used in the remaining steps following the same procedures as for the 1% conditions.

Table D.4.2-2. Open Coast, Dune Backed Beach Example using Parametric DIM Model for Setup/Runup



Zone	Processes	Recommended Methods	Comments
Offshore		<p>GROW hindcasts for H_s, T_p, and direction every 3 hours</p> <p>Measured Water Levels</p>	<p>Empirical runup equations use H_s and T_p, so spectra are not required for waves.</p> <p>Not required to separate components (i.e., El Niño, astronomical tide, surge, etc.). Correct water levels to same times as waves.</p>
Shoaling		<p>For straight and parallel contours, use shoaling and Snell's Law refraction. For complex bathymetry, use numerical models.</p> <p>Select 10 largest wave height storms per year and 10 largest $H_s L_o$ storms per year</p>	<p>Determine unrefracted deep water wave conditions. Only transform H_s and T_p</p> <p>At the peak of each storm, determine $H_{s,max}$ and T_p, and determine D. Note annual storms along with waves and water levels.</p>
Surf		<p>Parametric DIM model</p> <p>Geometric methods: MK&A or K&D</p> <p>If dune breaching, daylight specified profile on back side of dune.</p> <p>DIM parametric or numerical model to estimate TWL on modified profile.</p> <p>GEV and maximum likelihood to estimate 1% TWL and other variables as required.</p>	<p>DIM is for total runup, which includes static setup, dynamic setup, and wave runup.</p> <p>Determine MLWP from survey data or waves and local conditions. Determine maximum SWL and/or TWL each year for the appropriate geometric method, compute eroded beach profile and dune recession.</p> <p>For MK&A, extend MLWP slope to back side of dune. For K&D, translate profile shoreward.</p> <p>If profile adjustments influence TWL, recompute TWL.</p> <p>Using the largest TWL event from each year, determine the 1% conditions.</p>

Table D.4.2-2. Open Coast, Dune Backed Beach Example using Parametric DIM Model for Setup/Runup (cont.)

Surf		Geometric Method: MK&A or K&D	Determine eroded beach profile and dune recession for 1% TWL and if overtopping, include profile adjustment for dune breaching.
		Empirical equations	Determine the maximum overtopping rate and estimate the overtopping volume.
Backshore		Cox and Machemehl	Determine the depth, velocity, and flow.
Hazard		Determine quantities necessary to map VE, VO, AH, AO, BFE, etc.	Map the hazard zones.

D.4.2.7.2 Open Coast, Dune Backed Beach Scenario Using *Numerical* DIM Model for Setup/Runup

Setting: Open coast, bottom contours that are nearly straight and parallel, and a sand beach backed by dunes.

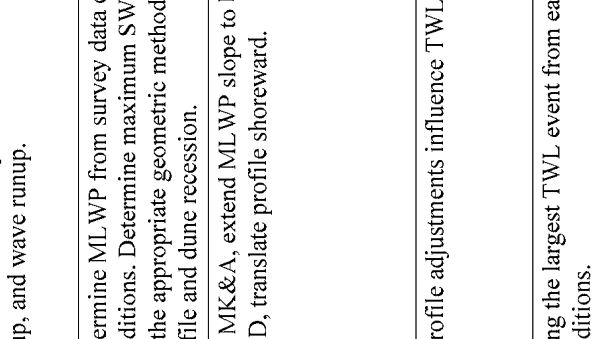
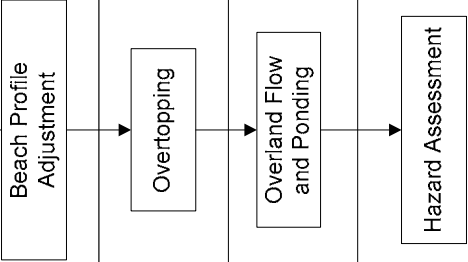
Data: Offshore GROW hindcast data and measured water levels. Winter season beach and dune profiles. Sand grain size.

For this example, the DIM numerical model is selected to estimate setup. Runup is determined by the methods described in Subsection D.4.5.1. All other conditions and methods are the same as in the preceding example. This example shows that the data requirements are dependent upon the choice of analysis methods. An advantage of the DIM numerical model over the parametric version is that the effects of surf zone bathymetry and detailed spectral wave statistics may be included. The DIM model integrates a 1-D wave spectrum across a transect to yield the setup. The dynamic wave setup and the incident wave runup are combined statistically.

A wave time series is developed assuming a JONSWAP spectrum. The magnitude of the dynamic setup is sensitive to the bandwidth of the spectrum that is characterized by the JONSWAP peak enhancement factor, γ . GROW wave data sets provide information to estimate γ . Time series are developed assuming random phases. The DIM model uses the unrefracted deep water wave conditions. The shoaling/refraction may be estimated for the spectrum using the spectral wave transformation methods. Waves on the Pacific Coast, and especially in Southern California, tend to have three energy components; southern swells, northern storms, and local seas. The DIM model can treat each of these as a JONSWAP spectrum and develop a combined time series. Unless there are unusual conditions, this computational effort is not warranted and a single JONSWAP spectrum may be used. The DIM numerical model is 1-D in the cross-shore direction, and a directional spectrum is not required. However, the influence of wave direction on the energy must be considered in the wave transformations.

The DIM numerical model integrates the momentum equations across the surf zone and requires the beach profile as input data. Steps in implementing the numerical DIM model are summarized in Table D.4.2-3. The spectral wave information, wave transformations, and estimates for runup/setup differ from the preceding example. All other steps are similar.

Table D.4.2-3. Open Coast, Dune Backed Beach using Numerical DIM Model for Setup/Runup



Zone	Processes	Recommended Methods	Comments
Offshore		<p>GROW hindcasts for H_s, T_p direction, and gamma every 3 hours</p> <p>Measured Water Levels</p>	<p>DIM uses a parameterized JONSWAP spectrum (or multiple simultaneous spectra).</p> <p>Not required to separate components (i.e., El Niño, astronomical tide, surge, etc.). Correct water levels to same times as waves.</p>
Shoaling		<p>For straight and parallel contours, use shoaling and Snell's Law. For complex bathymetry, use transformation coefficients.</p> <p>Select 10 largest wave height storms per year and 10 largest $C_g E$ storms per year</p>	<p>Determine unrefracted deep water spectral wave conditions (1-D spectrum).</p> <p>At the peak of each storm, determine $H_{s,max}$ and T_p, and determine D. Note annual storms along with waves and water levels.</p>
Surf		<p>DIM numerical model</p> <p>Geometric methods: MK&A or K&D</p> <p>If breaching, daylight specified profile on back side of dune.</p> <p>DIM parametric or numerical model to estimate TWL on modified profile.</p> <p>GEV and maximum likelihood to estimate 1% TWL.</p>	<p>From spectra for each 3 hour interval of data, develop time series assuming random phases.</p> <p>Determine MLWP from survey data or waves and local conditions. Determine maximum SWL and/or TWL each year for the appropriate geometric method, compute eroded beach profile and dune recession.</p> <p>For MK&A, extend MLWP slope to back side of dune. For K&D, translate profile shoreward.</p> <p>If profile adjustments influence TWL, recompute TWL.</p> <p>Using the largest TWL event from each year, determine the 1% conditions.</p>

Table D.4.2-3. Open Coast, Dune Backed Beach Using Numerical DIM Model for Setup/Runup (cont.)

Surf	<pre> graph TD A[Beach Profile Adjustment] --> B[Overtopping] B --> C[Overland Flow and Ponding] C --> D[Hazard Assessment] </pre>	Geometric Method: MK&A or K&D	Determine eroded beach profile and dune recession for 1% TWL and if overtopping, include profile adjustment for dune breaching.
Backshore		Empirical equations	Determine the maximum overtopping rate and estimate the overtopping volume.
Hazard		Cox and Machemehl	Determine the depth, velocity, and flow.
		Determine quantities necessary to map VE, VO, AH, AO, BFE, etc	Map the hazard zones.

D.4.2.7.3 Sheltered Water, Seawall Backed Beach Scenario Using Parametric DIM for Setup/Runup

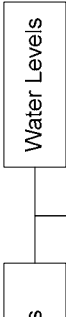
Setting: Sheltered water, bottom contours that are nearly straight and parallel, and a sand beach backed by seawall.

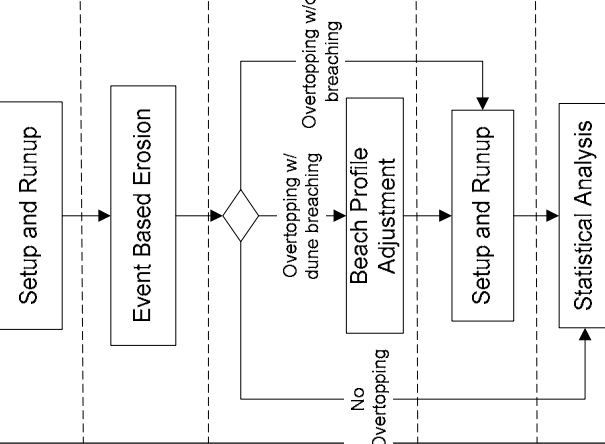
Data: Historical meteorological information and measured water levels. Winter season beach profile. Structure configuration. Sand grain size.

In this example, wave data are not available and must be estimated. There are two methods for estimating waves: 1) 2-D wave generation models and 2) parametric models. The 2-D models are generally superior, but are data-, labor-, and computationally intensive. For this example, the CEM parametric approach is used. The objective is to determine the largest TWL that occurs each year, which is then used in the GEV to determine the 1% conditions. The computational effort may be significantly reduced by carefully selecting which storms to analyze. The wind speed, duration, and fetch length (wave direction) determine the magnitude of the waves. The waves, along with water level (which may include the effects of both tidal and riverine processes), determine the TWL. Different transects in a sheltered water area will have different storms for the 1% TWL because of the wind direction. For many sheltered water areas, the waves will be fetch limited.

Once the waves have been hindcast, they are transformed to the site. The beach profile fronting the structure should be determined from data corresponding to winter conditions. For these conditions, local scour at the structure is determined using the methods from the CEM. Next, the stability of the structure is examined. If the structure fails, or is not a FEMA-recognized structure, it should be fully or partially removed. Details of this procedure are given in Section D.4.8.

Determination of runup on structures differs from beaches in that the wave conditions are evaluated at the toe of the structure rather than in deep water. Simple estimates of the wave height at the toe may be made assuming a breaker index times the total static water depth (SWL plus the static wave setup). Other alternatives are to use the DIM numerical model or Boussinesq models. The specific wave runup equation depends on the structure configuration.

Once the largest TWL for each year has been determined, the rest of the analysis is similar to the previous two examples. Table D.4.2-4 summarizes considerations for a structure in sheltered water.

Table D.4.2-4. Sheltered Water, Seawall Backed Beach using Parametric DIM Model for Setup/Runup



Zone	Processes	Recommended Methods	Comments
Offshore	 <pre> graph TD Waves[Waves] --> Transformations[Transformations] WaterLevels[Water Levels] --> Transformations </pre>	<p>Hindcast waves using CEM parametric method</p> <p>Measured Water Levels</p>	<p>Careful selection of storms can reduce the number of storms analyzed each year.</p> <p>Not required to separate components (i.e., El Niño, astronomical tide, surge, etc.). Correct water levels to same times as waves.</p>
Shoaling	 <pre> graph TD Transformations[Transformations] --> LocalScour[Local Scour] LocalScour --> StructureStability[Structure Stability] </pre>	<p>For straight and parallel contours, use shoaling and Snell's Law refraction. For complex bathymetry, use numerical models.</p> <p>Select the 2 or 3 largest TWL storms per year.</p> <p>CEM method</p>	<p>If the bathymetry is complex, parametric models may not be adequate.</p> <p>Determine H_{smax} and T_p and estimate D. Note annual storms along with waves and water levels.</p> <p>Compute scour and modify beach profile.</p>
Surf	 <pre> graph TD StructureStability[Structure Stability] --> Decision{ } Decision -- No Failure --> BeachProfile[Beach Profile Adjustment] Decision -- Failure --> BeachProfile BeachProfile --> SetupRunup[Setup and Runup] SetupRunup --> StatisticalAnalysis[Statistical Analysis] </pre>	<p>CEM methods</p> <p>If structure fails, adjust configuration.</p> <p>DIM model</p> <p>Use GEV and maximum likelihood to estimate 1% TWL.</p>	<p>Compute (broken) wave height at structure and determine stability.</p> <p>Completely or partially remove structure.</p> <p>If profile is complex, use DIM numerical. Need H at toe to calculate R.</p> <p>Using the largest TWL event from each year, determine the 1% conditions.</p>

Table D.4.2-4. Sheltered Water, Seawall Backed Beach Using Parametric DIM Model for Setup/Runup (cont.)

<pre> graph TD A[Beach Profile Adjustment] --> B[Overtopping] B --> C[Overland Flow and Ponding] C --> D[Hazard Assessment] </pre>	CEM method	Determine eroded beach profile and dune recession for 1% TWL and if overtopping, include profile adjustment for dune breaching.
Suif	CEM equations	Determine the maximum overtopping rate and estimate the overtopping volume.
Backshore	Cox and Machemehl	Determine the depth, velocity, and flow.
Hazard	Determine quantities necessary to map VE, VO, AH, AO, BFE, etc	Map the hazard zones.

D.4.3 Flood Frequency Analysis Methods

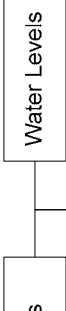
This section outlines general features of statistical methods used in a flood insurance study, including providing basic statistical tools that are frequently needed. It is recommended that extremal analysis of annual maxima be performed using the Generalized Extreme Value (GEV) Distribution with parameters estimated by the Method of Maximum Likelihood. The discussion in this section is illustrative only; guidelines for application of these tools in specific instances are provided in other sections of this appendix.

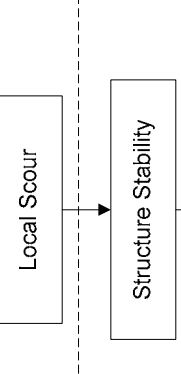
D.4.3.1 The 1% Annual Chance Flood

The primary goal of a coastal Flood Insurance Study (FIS) is to determine the flood levels throughout the study area that have a 1% chance of being exceeded in any given year. The level that is exceeded at this rate at a given point is called the 1% annual chance flood level at that point, and has a probability of 0.01 to be equaled or exceeded in any year; on the average, this level is exceeded once in 100 years and is commonly called the 100-year flood.

The 1% annual chance flood might result from a single flood process or from a combination of processes. For example, astronomic tide and storm waves combine to produce the total high water runup level. There is no one-to-one correspondence between the 1% annual chance flood elevation and any particular storm or other flood-producing mechanism. The level may be produced by any number of mechanisms, or by the same mechanism in different instances. For example, an incoming wave with a particular height and period may produce the 1% annual chance runup, as might a quite different wave with a different combination of height and period.

Furthermore, the flood hazard maps produced as part of an FIS do not necessarily display, even locally, the spatial variation of any realistic physical hydrologic event. For example, the 1% annual chance levels just outside and just inside an inlet will not generally show the same relation to one another as they would during the course of any real physical event because the inner waterway may respond most critically to storms of an entirely different character from those that affect the outer coast. Where a flood hazard arises from more than one source, the mapped level is not the direct result of any single process, but is a construct derived from the statistics of all sources. Note then that the 1% annual chance flood level is an abstract concept based as much on the statistics of floods as on the physics of floods.

Because the 1% annual chance flood level cannot be rigorously associated with any particular storm, it is a mistake to think of some observed event as having been the 1% annual chance event. A more intense storm located at a greater distance might produce the same flood level, or the same flood level might be produced by an entirely different mechanism, such as by a tsunami from a distant landslide or earthquake. Furthermore, if a particular storm were, in fact, the so-called 100-year event, it could not be so everywhere, but only in its effect at a particular point.

The 1% annual chance flood level is a consequence solely of the areawide flooding mechanisms recognized for a particular location. That is, there may be mechanisms that are not taken into account, but that could also produce water levels comparable to the 1% level or that could

contribute to the 1% level. For example, tsunamis occur in all oceans, so even the Atlantic Coast is vulnerable to tsunami attack at some frequency. The Great Lisbon earthquake of 1755 (with magnitude approaching 9) produced a large Atlantic tsunami that was felt in the New World; however, tsunamis are not recognized as areawide flood sources for the Atlantic Coast. Similarly, advances in science may from time to time reveal new flood mechanisms that had not previously been recognized; for example, only in recent years has the physics of El Niños been clarified and their contribution to coastal flood levels recognized.

D.4.3.2 Event vs. Response Statistics

The flood level experienced at any coastal site is the complicated result of a large number of interrelated and interdependent factors. For example, coastal flooding by wave runup depends upon both the local waves and the level of the underlying still water upon which they ride. That still water level (SWL), in turn, depends upon the varying astronomic tide and the possible contribution of a transient storm surge. The wave characteristics that control runup include amplitude, period, and direction, all of which depend upon the meteorological characteristics of the generating storm including its location and its time-varying wind and pressure fields. Furthermore, the resulting wave characteristics are affected by variations of water depth over their entire propagation path, and thus depend also on the varying local tide and surge. Still further, the beach profile, changing in response to wave-induced erosion, is variable, causing variation in the wave transformation and runup behavior. All of these interrelated factors may be significant in determining the coastal flood level with a 1% annual chance of occurrence.

Whatever methods are used, simplifying assumptions are inevitable, even in the most ambitious response-based study, which attempts to simulate the full range of important processes over time. Some of these assumptions may be obvious and would introduce little error. For example, a major tsunami could occur during a major storm, and it might alter the storm waves and runup behavior and dominate the total runup. However, the likelihood of this occurrence is so small that the error incurred by ignoring the combined occurrence would be negligible. On the other hand, the conclusion might not be so clear if the confounding event were to be storm surge rather than a tsunami because extreme waves and surge are expected to be correlated, with high waves being probable during a period of high surge.

These guidelines offer insight and methods to address the complexity of the coastal flood process in a reasonable way. However, the inevitable limitations of the guidance must be kept in mind. No fixed set of rules or cookbook procedures can be appropriate in all cases, and the Mapping Partner must be alert to special circumstances that violate the assumptions of the methodology.

D.4.3.2.1 Event-Selection Method

A great simplification is made if one can identify a single event (or a small number of events) that produces a flood thought to approximate the 1% flood. This might be possible if, for example, a single event parameter (such as deep-water wave height) is believed to dominate the final runup, so the 1% value of that particular item might suffice to determine the 1% flood. In its simplest form, one might identify a significant wave height thought to be exceeded with only 1% chance, and then to follow this single wave as it would be transformed in propagation and as it would run up the beach. This is the *event-selection method*. Used with caution, this method may

allow reasonable estimates to be made with minimal cost. It is akin to the concept of a design storm, or to constructs such as the standard project or probable maximum storms.

The inevitable difficulty with the event-selection method is that multiple parameters are always important, and it may not be possible to assign a frequency to the result with any confidence because other unconsidered factors always introduce uncertainty. Smaller waves with longer periods, for example, might produce greater runup than the largest waves selected for study. A slight generalization of the event-selection method, often used in practice, is to consider a small number of parameters – say wave height, period, and direction – and attempt to establish a set of alternative, “100-year” combinations of these parameters. Alternatives might be, say, pairs of height and period from each of three directions, with each pair thought to represent the 1% annual chance threat from that direction, and with each direction thought to be associated with independent storm events. Each such combination would then be simulated as a selected “event”, with the largest flood determined at a particular site being chosen as the 100-year flood. The probable result of this procedure would be to seriously underestimate the true 1% annual chance level by an unknown amount. This can be seen easily in the hypothetical case that all three directional wave height and period pairs resulted in about the same flood level. Rather than providing reassurance that the computed level were a good approximation of the 100-year level, such a result would show the opposite – the computed flood would not be at the 100-year level, but would instead approximate the 33-year level, having been found to result once in 100 years from each of three independent sources, for a total of three times in 100 years. It is not possible to salvage this general scheme in any rigorous way – say by choosing three, 300-year height and period combinations, or any other finite set based on the relative magnitudes of their associated floods – because there always remain other combinations of the multiple parameters that will contribute to the total rate of occurrence of a given flood level at a given point, by an unknown amount.

D.4.3.2.2 Response-based Approach

With the advent of powerful and economical computers, a preferred approach that considers all (or most) of the contributing processes has become practical; this is the *response-based approach*. In the response-based approach, one attempts to simulate the full complexity of the physical processes controlling flooding, and to derive flood statistics from the results (the local response) of that complex simulation. For example, given a time history of offshore waves in terms of height, period, and direction, one might compute the runup response of the entire time series, using all of the data and not pre-judging which waves in the record might be most important. With knowledge of the astronomic tide, this entire process could be repeated with different assumptions regarding tidal amplitude and phase. Further, with knowledge of the erosion process, storm-by-storm erosion of the beach profile might also be considered, so its feedback effect on wave behavior could be taken into account.

At the end of this process, one would have a long-term simulated record of runup at the site, which could then be analyzed to determine the 1% level. Clearly, successful application of such a response-based approach requires a tremendous effort to characterize the individual component processes and their interrelationships, and a great deal of computational power to carry out the intensive calculations.

The response-based approach is preferred for all Pacific Coast FISs.

D.4.3.2.3 Hybrid Method

Circumstances may arise for which the Mapping Partner can adopt a *hybrid* method between the event-selection and response-based extremes; this hybrid method may substantially reduce the time required for repeated calculations. The Mapping Partner must use careful judgment in applying this method to accurately estimate the flood response (e.g., runup); detailed guidance and examples of the method can be found in PWA (2004).

The hybrid method uses the results of a response-based analysis to guide the selection of a limited number of forcing parameters (e.g., water level and wave parameter combinations) likely to approximate the 1% annual chance flood response (e.g., runup). A set of baseline response-based analyses are performed for transects that are representative of typical geometries found at the study site (e.g., beach transects with similar slopes; coastal structures with similar toe and crest elevations, structure slopes, and foreshore slopes). The results obtained for these representative transects are then used to guide selection of parameters for other similar transects within the near vicinity. The Mapping Partner may need to consider a range of forcing parameters to account for variations in the response caused by differences in transect geometry; a greater range of forcing parameters will need to be considered for greater differences between transect geometries.

The hybrid method simply postulates that if a set of wave properties can be found that reproduces the 1% annual chance flood established by a response-based analysis at a certain transect, then the same set of parameters should give a reasonable estimate at other transects that are both similar and nearby.

D.4.3.3 General Statistical Methods

D.4.3.3.1 Overview

This section summarizes the statistical methods that will be most commonly needed in the course of an FIS to establish the 1% annual chance flood elevation. Two general approaches can be taken depending upon the availability of observed flood data for the site. The first, preferred, approach is used when a reasonably long observational record is available, say 30 years or more of flood or other data. In this *extreme value analysis* approach, the data are used to establish a *probability distribution* that is assumed to describe the flooding process, and that can be evaluated using the data to determine the flood elevation at any frequency. This approach can be used for the analysis of wind and tide gage data, for example, or for a sufficiently long record of a computed parameter such as wave runup.

The second approach is used when an adequate observational record of flood levels does not exist. In this case, it may be possible to simulate the flood process using hydrodynamic models driven by meteorological or other processes for which adequate data exist. That is, the hydrodynamic model (perhaps describing waves, tsunamis, or surge) provides the link between the known statistics of the generating forces, and the desired statistics of flood levels. These *simulation* methods are relatively complex and will be used only when no acceptable, more economical alternative exists. Only a general description of these methods is provided here; full

documentation of the methods can be found in the user's manuals provided with the individual simulation models. The manner in which the 1% annual chance level is derived from a simulation will depend upon the manner in which the input forcing disturbance is defined. If the input is a long time series, then the 1% level might be obtained using an extreme value analysis of the simulated process. If the input is a set of empirical storm parameter distributions, then the 1% level might be obtained by a method such as joint probability or Monte Carlo, as discussed later in this section.

The present discussion begins with basic ideas of probability theory and introduces the concept of a continuous probability distribution. Distributions important in practice are summarized, including, especially, the extreme value family. Methods to fit a distribution to an observed data sample are discussed, with specific recommendations for FIS applications. A list of suggested additional information resources is included at the end of the section.

D.4.3.3.2 Elementary Probability Theory

Probability theory deals with the characterization of random events and, in particular, with the likelihood of occurrence of particular outcomes. The word "probability" has many meanings, and there are conceptual difficulties with all of them in practical applications such as flood studies. The common frequency notion is assumed here: the probability of an event is equal to the fraction of times it would occur during the repetition of a large number of identical *trials*. For example, if one considers an annual storm season to represent a trial, and if the event under consideration is occurrence of a flood's exceeding a given elevation, then the annual probability of that event is the fraction of years in which it occurs, in the limit of an infinite period of observation. Clearly, this notion is entirely conceptual, and cannot truly be the source of a probability estimate.

An alternate measure of the likelihood of an event is its expected *rate of occurrence*, which differs from its probability in an important way. Whereas probability is a pure number and must lie between zero and one, rate of occurrence is a measure with physical dimensions (reciprocal of time) that can take on any value, including values greater than one. In many cases, when one speaks of the probability of a particular flood level, one actually means its rate of occurrence; thinking in terms of physical rate can help clarify an analysis.

To begin, a number of elementary probability rules are recalled. If an event occurs with probability P in some trial, then it fails to occur with probability $Q = 1 - P$. This is a consequence of the fact that the sum of the probabilities of all possible results must equal unity, by the definition of total probability:

$$\sum_i P(A_i) \equiv 1 \quad (\text{D.4.3-1})$$

in which the summation is over all possible outcomes of the trial.

If A and B are two events, the probability that either A or B occurs is given by:

$$P(A \text{ or } B) = P(A) + P(B) - P(A \text{ and } B) \quad (\text{D.4.3-2})$$

If A and B are mutually exclusive, then the third term on the right-hand side is zero and the probability of obtaining either outcome is the sum of the two individual probabilities.

If the probability of A is contingent on the prior occurrence of B , then the *conditional probability* of A given the occurrence of B is defined to be:

$$P(A | B) \equiv \frac{P(AB)}{P(B)} \quad (\text{D.4.3-3})$$

in which $P(AB)$ denotes the probability of both A and B occurring.

If A and B are *stochastically independent*, $P(A/B)$ must equal $P(A)$, then the definition of conditional probability just stated gives the probability of occurrence of both A and B as:

$$P(AB) = P(A)P(B) \quad (\text{D.4.3-4})$$

This expression generalizes for the joint probability of any number of independent events, as:

$$P(ABC\dots) = P(A)P(B)P(C)\dots \quad (\text{D.4.3-5})$$

As a simple application of this rule, consider the chance of experiencing at least one 1% annual chance flood ($P = 0.01$) in 100 years. This is 1 minus the chance of experiencing no such flood in 100 years. The chance of experiencing no such flood in 1 year is 0.99, and if it is granted that floods from different years are independent, then the chance of not experiencing such a flood in 100 years is 0.99^{100} according Equation D.4.3-5 or 0.366. Consequently, the chance of experiencing at least one 100-year flood in 100 years is $1 - 0.366 = 0.634$, or only about 63%.

D.4.3.3.3 Distributions of Continuous Random Variables

A continuous random variable can take on any value from a continuous range, not just a discrete set of values. The instantaneous ocean surface elevation at a point is an example of a continuous random variable; so, too, is the annual maximum water level at a point. If such a variable is observed a number of times, a set of differing values *distributed* in some manner over a range is found; this fact suggests the idea of a *probability distribution*. The observed values are a *data sample*.

We define the *probability density function*, PDF, of x to be $f(x)$, such that the probability of observing the continuous random variable x to fall between x and $x + dx$ is $f(x) dx$. Then, in accordance with the definition of total probability stated above:

$$\int_{-\infty}^{\infty} f(x) dx = 1 \quad (\text{D.4.3-6})$$

If we take the upper limit of integration to be the level L , then we have the definition of the *cumulative distribution function*, CDF, denoted by $F(x)$, which specifies the probability of obtaining a value of L or less:

$$F(x \leq L) \equiv \int_{-\infty}^L f(x) dx \quad (\text{D.4.3-7})$$

It is assumed that the observed set of values, the sample, is derived by random sampling from a *parent distribution*. That is, there exists some unknown function, $f(x)$, from which the observed sample is obtained by random selection. No two samples taken from the same distribution will be exactly the same. Furthermore, random variables of interest in engineering cannot assume values over an unbounded range as suggested by the integration limits in the expressions shown above. In particular, the lower bound for flood elevation at a point can be no less than ground level, wind speed cannot be less than zero, and so forth. Upper bounds also exist, but cannot be precisely specified; whatever occurs can be exceeded, if only slightly. Consequently, the usual approximation is that the upper bound of a distribution is taken to be infinity, while a lower bound might be specified.

If the nature of the parent distribution can be inferred from the properties of a sample, then the distribution provides the complete statistics of the variable. If, for example, one has 30 years of annual peak flood data, and if these data can be used to specify the underlying distribution, then one could easily obtain the 10-, 50-, 100-, and 500-year flood levels by computing x such that F is 0.90, 0.98, 0.99, and 0.998, respectively.

The entirety of the information contained in the PDF can be represented by its moments. The *mean*, μ , specifies the *location* of the distribution, and is the first moment about the origin:

$$\mu = \int_{-\infty}^{\infty} x f(x) dx \quad (\text{D.4.3-8})$$

Two other common measures of the location of the distribution are the mode, which is the value of x for which f is maximum, and the median, which is the value of x for which F is 0.5.

The spread of the distribution is measured by its variance, σ^2 , which is the second moment about the mean:

$$\sigma^2 = \int_{-\infty}^{\infty} (x - \mu)^2 f(x) dx \quad (\text{D.4.3-9})$$

The *standard deviation*, σ , is the square root of the variance.

The third and fourth moments are called the skew and the kurtosis, respectively; still higher moments fill in more details of the distribution shape, but are seldom encountered in practice. If the variable is measured about the mean and is normalized by the standard deviation, then the *coefficient of skewness*, measuring the asymmetry of the distribution about the mean, is:

$$\eta_3 = \int_{-\infty}^{\infty} \left(\frac{x - \mu}{\sigma}\right)^3 f(x) dx \quad (\text{D.4.3-10})$$

and the *coefficient of kurtosis*, measuring the peakedness of the distribution, is:

$$\eta_4 = \int_{-\infty}^{\infty} \left(\frac{x - \mu}{\sigma}\right)^4 f(x) dx \quad (\text{D.4.3-11})$$

These four parameters are properties of the unknown distribution, not of the data sample. However, the sample has its own set of corresponding parameters. For example, the *sample mean* is:

$$\bar{x} = \frac{1}{n} \sum_i x_i \quad (\text{D.4.3-12})$$

which is the average of the sample values. The *sample variance* is:

$$s^2 = \frac{1}{n-1} \sum_i (x_i - \bar{x})^2 \quad (\text{D.4.3-13})$$

while the sample skew and kurtosis are:

$$C_s = \frac{n}{(n-1)(n-2)s^3} \sum_i (x_i - \bar{x})^3 \quad (\text{D.4.3-14})$$

$$C_K = \frac{n(n+1)}{(n-1)(n-2)(n-3)s^4} \sum_i (x_i - \bar{x})^4 \quad (\text{D.4.3-15})$$

Note that in some literature the kurtosis is reduced by 3, so the kurtosis of the normal distribution becomes zero; it is then called the *excess kurtosis*.

D.4.3.3.4 Stationarity

Roughly speaking, a random process is said to be stationary if it is not changing over time, or if its statistical measures remain constant. Many statistical tests can be performed to help determine whether a record displays a significant trend that might indicate non-stationarity. A simple test that is very easily performed is the Spearman Rank Order Test. This is a non-parametric test operating on the ranks of the individual values sorted in both magnitude and time. The Spearman *R* statistic is defined as:

$$R = 1 - \frac{6 \sum_i (d_i)^2}{n(n^2 - 1)} \quad (\text{D.4.3-16})$$

in which *d* is the difference between the magnitude rank and the sequence rank of a given value. The statistical significance of *R* computed from Equation D.4.3-16 can be found in published tables of Spearman's *R* for *n* - 2 degrees of freedom.

D.4.3.3.5 Correlation Between Series

Two random variables may be statistically independent of one another, or some degree of interdependence may exist. Dependence means that knowing the value of one of the variables permits a degree of inference regarding the value of the other. Whether paired data (x,y) , such as simultaneous measurements of wave height and period, are interdependent or correlated is usually measured by their *linear correlation coefficient*:

$$r = \frac{\sum_i (x_i - \bar{x})(y_i - \bar{y})}{\sqrt{\sum_i (x_i - \bar{x})^2} \sqrt{\sum_i (y_i - \bar{y})^2}} \quad (\text{D.4.3-17})$$

This correlation coefficient indicates the strength of the correlation. An r value of +1 or -1 indicates perfect correlation, so a cross-plot of y versus x would lie on a straight line with positive or negative slope, respectively. If the correlation coefficient is near zero, then such a plot would show random scatter with no apparent trend.

D.4.3.3.6 Convolution of Two Distributions

If a random variable, z , is the simple direct sum of the two random variables x and y , then the distribution of z is given by the convolution integral:

$$f_z(z) = \int_{-\infty}^{\infty} f_x(T) f_y(z-T) dT \quad (\text{D.4.3-18})$$

in which subscripts specify the appropriate distribution function. This equation can be used, for example, to determine the distribution of the sum of wind surge and tide under the assumptions that surge and tide are independent and they add linearly without any nonlinear hydrodynamic interaction.

D.4.3.3.7 Important Distributions

Many statistical distributions are used in engineering practice. Perhaps the most familiar is the *normal* or *Gaussian* distribution. We discuss only a small number of distributions, selected according to probable utility in an FIS. Although the normal distribution is the most familiar, the most fundamental is the uniform distribution.

D.4.3.3.7.1 Uniform Distribution

The uniform distribution is defined as constant over a range, and zero outside that range. If the range is from a to b , then the PDF is:

$$f(x) = \frac{1}{b-a}, \quad a \leq x < b, \quad 0 \text{ otherwise} \quad (\text{D.4.3-19})$$

which, within its range, is a constant independent of x ; this is also called a *top-hat* distribution.

The uniform distribution is especially important because it is used in drawing random samples from all other distributions. A random sample drawn from a given distribution can be obtained by first drawing a random sample from the uniform distribution defined over the range from 0 to 1. Set $F(x)$ equal to this value, where F is the cumulative distribution to be sampled. The desired value of x is then obtained by inverting the expression for F .

Sampling from the uniform distribution is generally done with a random number generator returning values on the interval from 0 to 1. Most programming languages have such a function built in, as do many calculators. However, not all such standard routines are satisfactory. While adequate for drawing a small number of samples, many widely used standard routines fail statistical tests of uniformity. If an application requires a large number of samples, as might be the case when performing a large Monte Carlo simulation (see Subsection D.4.3.6.3), these simple standard routines may be inadequate. A good discussion of this matter, including lists of high-quality routines, can be found in the book *Numerical Recipes*, included in Subsection D.4.3.7, Additional Resources.

D.4.3.3.7.2 Normal or Gaussian Distribution

The normal or Gaussian distribution, sometimes called the bell-curve, has a special place among probability distributions. Consider a large number of large samples drawn from some unknown distribution. For each large sample, compute the sample mean. Then, the distribution of those means tends to follow the normal distribution, a consequence of the *central limit theorem*. Despite this, the normal distribution does not play a central role in hydrologic frequency analysis. The standard form of the normal distribution is:

$$f(x) = \frac{1}{\sigma(2\pi)^{1/2}} e^{-\frac{(x-\mu)^2}{2\sigma^2}}$$

$$F(x) = \frac{1}{2} + \frac{1}{2} \operatorname{erf}\left(\frac{x-\mu}{\sqrt{2}\sigma}\right)$$

(D.4.3-20)

D.4.3.3.7.3 Rayleigh Distribution

The Rayleigh distribution is important in the theory of random wind waves. Unlike many distributions, it has some basis in theory; Longuet-Higgins (1952) showed that with reasonable assumptions for a narrow banded wave spectrum, the distribution of wave height will be Rayleigh. The standard form of the distribution is:

$$f(x) = \frac{x}{b^2} e^{-\frac{x^2}{2b^2}}$$

$$F(x) = 1 - e^{-\frac{x^2}{2b^2}}$$

(D.4.3-21)

The range of x is positive, and the scale parameter $b > 0$. In water wave applications, $2b^2$ equals the mean square wave height. The mean and variance of the distribution are given by:

$$\mu = b\sqrt{\frac{\pi}{2}}$$

(D.4.3-22)

$$\sigma^2 = b^2\left(2 - \frac{\pi}{2}\right)$$

The skew and kurtosis of the Rayleigh distribution are constants (approximately 0.63 and 3.25, respectively) but are of little interest in applications here.

D.4.3.3.7.4 Extreme Value Distributions

Many distributions are in common use in engineering applications. For example, the log-Pearson Type III distribution is widely used in hydrology to describe the statistics of precipitation and stream flow. For many such distributions, there is no underlying justification for use other than flexibility in mimicking the shapes of empirical distributions. However, there is a particular family of distributions that are recognized as most appropriate for extreme value analyses, and that have some theoretical justification. These are the so-called *extreme value distributions*.

Among the well-known extreme value distributions are the *Gumbel* distribution and the *Weibull* distribution. Both of these are candidates for FIS applications, and have been widely used with success in similar applications. Significantly, these distributions are subsumed under a more general distribution, the GEV distribution, given by:

$$f(x) = \frac{1}{b} \left\{ 1 + c \left(\frac{x-a}{b} \right) \right\}^{\frac{1}{c}-1} e^{-(1+c(x-a)/b)^{-1/c}}$$

for $-\infty < x \leq a - \frac{b}{c}$ with $c < 0$ and $a - \frac{b}{c} \leq x < \infty$ with $c > 0$

$$f(x) = \frac{1}{b} e^{-e^{-(x-a)/b}} e^{-e^{-(x-a)/b}} \quad \text{for } -\infty \leq x < \infty \quad \text{with } c = 0$$

(D.4.3-23)

The cumulative distribution is given by the expressions:

$$F(x) = e^{-(1+c(x-a)/b)^{-1/c}}$$

for $-\infty < x \leq a - \frac{b}{c}$ with $c < 0$ and $a - \frac{b}{c} \leq x < \infty$ with $c > 0$

$$F(x) = e^{-e^{-(x-a)/b}} \quad -\infty \leq x < \infty \quad \text{with } c = 0$$

(D.4.3-24)

In these expressions, a , b , and c are the *location*, *scale*, and *shape* factors, respectively. This distribution includes the *Frechet* (Type 2) distribution for $c > 0$ and the *Weibull* (Type 3)

distribution for $c < 0$. If the limit of the exponent of the exponential in the first forms of these distributions is taken as c goes to 0, then the simpler second forms are obtained, corresponding to the Gumbel (Type 1) distribution. Note that the Rayleigh distribution is a special case of the Weibull distribution, and so is also encompassed by the GEV distribution.

The special significance of the members of the extreme value family is that they describe the distributions of the extremes drawn from other distributions. That is, given a large number of samples drawn from an unknown distribution, the extremes of those samples tend to follow one of the three types of extreme value distributions, all incorporated in the GEV distribution. This is analogous to the important property of the normal distribution that the means of samples drawn from other distributions tend to follow the normal distribution. If a year of water levels is considered to be a sample, then the annual maximum, as the largest value in the sample, may tend to be distributed according to the statistics of extremes.

D.4.3.3.7.5 Pareto Distribution

If for some unknown distribution the sample extremes are distributed according to the GEV distribution, then the set of sample values exceeding some high threshold tends to follow the Pareto distribution. Consequently, the GEV and Pareto distributions are closely related in a dual manner. The Pareto distribution is given by:

$$F(y) = 1 - \left(1 + \frac{cy}{\hat{b}}\right)^{-1/c} \quad \text{for } y = x - u$$

$$\text{with } \hat{b} = b + (u - a) \quad \text{(D.4.3-25)}$$

where u is the selected threshold. In the limit as c goes to zero, this reduces to the simple expression:

$$F(y) = 1 - e^{-y/\hat{b}} \quad \text{for } y > 0 \quad \text{(D.4.3-26)}$$

D.4.3.4 Data Sample and Estimation of Parameters

Knowing the distribution that describes the random process, one can directly evaluate its inverse to give an estimate of the variable at any recurrence rate; that is, at any value of $1-F$. If the sample consists of annual maxima (see the discussion in Subsection D.4.3.5), then the 1% annual chance value of the variable is that value for which F equals 0.99, and similarly for other recurrence intervals. To specify the distribution, two things are needed. First, an appropriate form of the distribution must be selected from among the large number of candidate forms found in wide use. Second, each such distribution contains a number of free parameters (generally from one to five, with most common distributions having two or three parameters) that must be determined.

It is recommended that the Mapping Partner adopt the GEV distribution for FIS applications for reasons outlined earlier: extremes drawn from other distributions (including the unknown parent distributions of flood processes) may be best represented by one member of the extreme value

distribution family or another. The remaining problem, then, is determination of the three free parameters of the GEV distribution, a , b , and c .

Several methods of estimating the best values of these parameters have been widely used, including, most frequently, the methods of plotting positions, moments, and maximum likelihood. The methods discussed here are limited to point-site estimates. If statistically similar data are available from other sites, then it may be possible to improve the parameter estimate through the method of *regional frequency analysis*; see Hosking and Wallis (1997) for information on this method. Note that this sense of the word *regional* is unrelated to what is meant by *regional studies* discussed elsewhere in these guidelines.

D.4.3.4.1 Plotting Positions

Widely used in older hydrologic applications, the method of plotting positions is based on first creating a visualization of the sample distribution and then performing a curve-fit between the chosen distribution and the sample. However, the sample consists only of the process variable; there are no associated quantiles, and so it is not clear how a plot of the sample distribution is to be constructed. The simplest approach is to rank order the sample values from smallest to largest, and to assume that the value of F appropriate to a value is equal to its fractional position in this ranked list, R/N where R is the value's rank from 1 to N . Then, the smallest observation is assigned *plotting position* $1/N$ and the largest is assigned $N/N=1$. This is clearly unsatisfactory at the upper end because instances larger than the largest observed in the sample can occur. A more satisfactory, and widely used, plotting position expression is $R/(N+1)$, which leaves some room above the largest observation for still larger elevations. A number of such plotting position formulas are encountered in practice, most involving the addition of constants to the numerator and denominator, $(R+a)/(N+b)$, in an effort to produce improved estimates at the tails of the distributions.

Given a plot produced in this way, one might simply draw a smooth curve through the points, and usually extend it to the recurrence intervals of interest. This constitutes an entirely empirical approach and is sometimes made easier by constructing the plot using a transformed scale for the cumulative frequency. The simplest such transformation is to plot the logarithm of the cumulative frequency, which flattens the curve and makes extrapolation easier.

A second approach would be to choose a distribution type, and adjust its free parameters, so a plot of the distribution matches the plot of the sample. This is commonly done by least squares fitting. Fitting by eye is also possible if an appropriate *probability paper* is adopted, on which the transformed axis is not logarithmic, but is transformed in such a way that the corresponding distribution plots as a straight line; however, this cannot be done for all distributions.

These simple methods based on plotting positions, although widely used, are not recommended. Two fundamental problems with the methods are seldom addressed. First, it is inherent in the methods that each of N quantile bins of the distribution is occupied by one and only one sample point, an extremely unlikely outcome. Second, when a least squares fit is made for an analytical distribution form, the error being minimized is taken as the difference between the sample value and the distribution value, whereas the true error is not in the value but in its frequency position.

D.4.3.4.2 Method of Moments: Conventional Moments

An alternate method that does not rely upon visualization of the empirical distribution is the method of moments, of which there are several forms. This is an extremely simple method that generally performs well. The methodology is to equate the sample moments and the distribution moments, and to solve the resulting equations for the distribution parameters. That is, the sample moments are simple functions of the sample points, as defined earlier. Similarly, it may be possible to express the corresponding moments of an analytical distribution as functions of the several parameters of the distribution. If this can be done, then those parameters can be obtained by equating the expressions to the sample values.

D.4.3.4.3 Method of Moments: Probability-weighted Moments and Linear Moments

Ramified versions of the method of moments overcome certain difficulties inherent in conventional methods of moments. For example, simple moments may not exist for a given distribution form or may not exist for all values of the parameters. Higher sample moments cannot adopt the full range of possible values; for example, the sample kurtosis is constrained algebraically by the sample size.

Alternate moment-based approaches have been developed including probability-weighted moments and the newer method of linear moments, or L-moments. L-moments consist of simple linear combinations of the sample values that convey the same information as true moments: location, scale, shape, and so forth. However, being linear combinations rather than powers, they have certain desirable properties that make them preferable to normal moments. The theory of L-moments and their application to frequency analysis has been developed by Hosking; see, for example, Hosking and Wallis (1997).

D.4.3.4.4 Maximum Likelihood Method

A method based on an entirely different idea is the method of maximum likelihood. Consider an observation, x , obtained from the density distribution $f(x)$. The probability of obtaining a value close to x , say within the small range dx around x , is $f(x) dx$, which is proportional to $f(x)$. Then, the *posterior* probability of having obtained the entire sample of N points is assumed to be proportional to the product of the individual probabilities estimated in this way, in consequence of Equation D.4.3-5. This product is called the *likelihood* of the sample, given the assumed distribution:

$$L = \prod_1^N f(x_i) \tag{D.4.3-27}$$

It is more common to work with the logarithm of this equation, which is the *log-likelihood*, LL , given by:

$$LL = \sum_1^N \log f(x_i) \tag{D.4.3-28}$$

The simple idea of the maximum likelihood method is to determine the distribution parameters that maximize the likelihood of the given sample. Because the logarithm is a monotonic function, this is equivalent to maximizing the log-likelihood. Note that because $f(x)$ is always less than one, all terms of the sum for LL are negative; consequently, larger log-likelihoods are associated with smaller numerical values.

Because maximum likelihood estimates generally show less bias than other methods, they are preferred. However, they usually require iterative calculations to locate the optimum parameters, and a maximum likelihood estimate may not exist for all distributions or for all values of the parameters. If the Mapping Partner considers alternate distributions or fitting methods, the likelihood of each fit can still be computed using the equations given above even if the fit was not determined using the maximum likelihood method. The distribution with the greatest likelihood of having produced the sample should be chosen.

D.4.3.5 Extreme Value Analysis in an FIS

For FIS extreme value analysis, the Mapping Partner may adopt the annual maxima of the data series (runup, SWL, and so forth) as the appropriate data sample, and then fit the GEV distribution to the data sample using the method of maximum likelihood. Also acceptable is the peak-over-threshold (POT) approach, fitting all observations that exceed an appropriately high threshold to the generalized Pareto distribution. The POT approach is generally more complex than the annual maxima approach, and need only be considered if the Mapping Partner believes that the annual series does not adequately characterize the process statistics. Further discussion of the POT approach can be found in references such as Coles (2001). The Mapping Partner can also consider distributions other than the GEV for use with the annual series. However, the final distribution selected to estimate the 1% annual chance flood level should be based on the total estimated likelihood of the sample. In the event that methods involve different numbers of points (e.g., POT vs. annual maxima), the comparison should be made on the basis of average likelihood per sample point because larger samples will always have lower likelihood function values.

As an example of this process, consider extraction of a surge estimate from tide data. As discussed in Section D.4.4, the tide record includes both the astronomic component and a number of other components such as storm surge. For this example, all available hourly tide observations for the tide gage at La Jolla, California, were obtained from the National Oceanic and Atmospheric Administration (NOAA) tide data website. These observations cover the years from 1924 to the present. To work with full-year data sets, the period from 1924 to 2003 was chosen for analysis.

The corresponding hourly tide predictions were also obtained. These predictions represent only the astronomic component of the observations based on summation of the 37 local tidal constituents, so departure of the observations from the predictions represents the anomaly or residual. A simple utility program was written to determine the difference between corresponding high waters (observed minus predicted) and to extract the maximum such difference found in each year. Only levels at corresponding peaks should be considered in the analysis because small-phase displacements between the predicted and observed data will cause spurious apparent amplitude differences.

The resulting data array consisted of 80 annual maxima. Inspection of this file showed that the values were generally consistent except for the 1924 entry, which had a peak anomaly of over 12 feet. Inspection of the file of observed data showed that a large portion of the file was incorrect, with reported observations consistently above 15 feet for long periods. Although the NOAA file structure includes flags intended to indicate data outside the expected range, these points were not flagged. Nevertheless they were clearly incorrect, and so were eliminated from consideration. The abridged file for 1924 was judged to be too short to be reliable, and so the entire year was eliminated from further consideration.

Data inspection is critical for any such frequency analysis. Data are often corrupted in subtle ways, and missing values are common. Years with missing data may be acceptable if the fraction of missing data is not excessive, say not greater than one quarter of the record, and if there is no reason to believe that the missing data are missing precisely because of the occurrence of an extreme event, which is not an uncommon situation. Gages may fail during extreme conditions and the remaining data may not be representative and so should be discarded, truncating the total period.

The remaining 79 data points in the La Jolla sample were used to fit the parameters of a GEV distribution using the maximum likelihood method. The results of the fit are shown in Figure D.4.3-1 for the cumulative and the density distributions. Also shown are the empirical sample CDF, displayed according to a plotting position formula, and the sample density histogram. Neither of these empirical curves was used in the analysis; they are shown only to provide a qualitative idea of the goodness-of-fit.

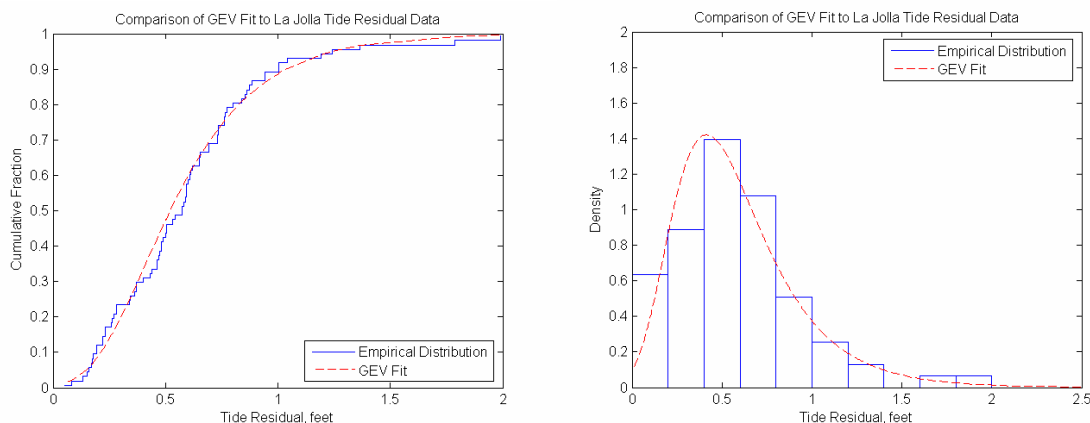

Figure D.4.3-1. Cumulative and Density Distributions for the La Jolla Tide Residual

The GEV estimate of the 1% annual chance residual for this example was 1.74 feet with a log-likelihood of -19.7. The estimate includes the contributions from all non-astronomic processes, including wind and barometric surge, El Niño superelevation, and wave setup to the degree that it might be incorporated in the record at the gage location. Owing to the open ocean location of the gage, rainfall runoff is not a contributor in this case. *Note that this example is shown for descriptive purposes only, and is not to be interpreted as a definitive estimate of the tide residual statistics for this location for use in any application.* In particular, the predictions were

obtained from the NOAA website and so were made using the currently-adopted values of the tidal constituents. While this may be acceptable for an open ocean site such as La Jolla where dredging, silting, construction, and such are not likely to have caused the local tide behavior to change significantly over time, this may not be the case for other sites; the residual data should be estimated using the best estimates of the past astronomic components. *Nevertheless, this example illustrates the recommended general procedure for performing an extremal analysis using annual maximum observations, the GEV distribution, and the method of maximum likelihood.*

D.4.3.6 Simulation Methods

In some cases, flood levels must be determined by numerical modeling of the physical processes, simulating a number of storms or a long period of record, and then deriving flood statistics from that simulation. Flood statistics have been derived using simulation methods in FIS using four methods. Three of these methods involve storm parameterization and random selection: the Joint Probability Method (JPM), the Empirical Simulation Technique (EST), and the Monte Carlo method. These methods are described briefly below. In addition, a direct simulation method may be used in some cases. This method requires the availability of a long, continuous record describing the forcing functions needed by the model (such as wind speed and direction in the case of surge simulation using the one-dimensional [1-D] BATHYS model). The model is used to simulate the entire record, and flood statistics are derived in the manner described previously.

D.4.3.6.1 JPM

JPM has been applied to flood studies in two distinct forms. First, as discussed in a supporting case study document (PWA, 2004), joint probability has been used in the context of an event selection approach to flood analysis. In this form, JPM refers to the joint probability of the parameters that define a particular event, for example, the joint probability of wave height and water level. In this approach, one seeks to select a small number of such events thought to produce flooding approximating the 1% annual chance level. This method usually requires a great deal of engineering judgment, and should only be used with permission of the Federal Emergency Management Agency (FEMA) study representative.

FEMA has adopted a second sort of JPM approach for hurricane surge modeling on the Atlantic and Gulf coasts, which is generally acceptable for any site or process for which the forcing function can be parameterized by a small number of variables (such as storm size, intensity, and kinematics). If this can be done, one estimates cumulative probability distribution functions for each of the several parameters using storm data obtained from a sample region surrounding the study site. Each of these distributions is approximated by a small number of discrete values, and all combinations of these discrete parameter values representing all possible storms are simulated with the chosen model. The rate of occurrence of each storm simulated in this way is the total rate of storm occurrence at the site, estimated from the record, multiplied by each of the discrete parameter probabilities. If the parameters are not independent, then a suitable computational adjustment must be made to account for this dependence.

The peak flood elevations for each storm are saved for subsequent determination of the flood statistics. This is done by establishing a histogram for each point at which data have been saved,

using a small bin size of, say, about 0.1 foot. The rate contribution of each storm, determined as described above, is summed into the appropriate elevation bin at each site. When this is done for all storms, the result is that the histograms approximate the density function of flood elevation at that site. The cumulative distribution is obtained by summing across the histogram from top down; the 1% elevation is found at the point where this sum equals 0.01. Full details of this procedure are provided in the user's manual accompanying the FEMA storm surge model (FEMA, 1987).

D.4.3.6.2 EST

The U.S. Army Corps of Engineers has developed a newer technique, EST, that FEMA approved for FIS; a full discussion can be found in Scheffner et al. (1999). The technique is based on bootstrap resampling-with-replacement, random-neighbor walk, and subsequent smoothing techniques in which a random sampling of a finite length historical-event database is used to generate a larger long-period database. The only assumption is that future events will be statistically similar in magnitude and frequency to past events.

The EST begins with an analysis of historical storms that have affected the study area. The selected events are then parameterized to define relevant input parameters that are used to define the dynamics of the storms (the components of the so-called input vectors) and factors that may contribute to the total response of the storm such as tidal amplitude and phase. Associated with the storms are the response vectors that define the storm-generated effects. Input vectors are sets of selected parameters that define the total storm; response vectors are sets of values that summarize the effects. Basic response vectors are determined numerically by simulating the historical storms using the selected hydrodynamic model.

These sets of input and response vectors are used subsequently as the basis for the long-term surge history estimations. These are made by repeatedly sampling the space spanned by the input vectors in a random fashion and estimating the corresponding response vectors. By repeating this step many thousands of times, an extremely long period of simulated record is obtained. The final step of the procedure is to extract statistics from the simulated long record by performing an extremal analysis on the simulated record as though it were a physical record.

D.4.3.6.3 Monte Carlo Method

As discussed above for the JPM approach, the Monte Carlo method is based on probability distributions established for the parameters needed to characterize a storm. Unlike JPM, however, these probability distributions are not discretized. Instead, storms are constructed by randomly choosing a value for each parameter by generating a random value uniformly distributed between 0 and 1, and then entering the cumulative distribution at this value and selecting the corresponding parameter value. Each storm selected by this Monte Carlo procedure is simulated with the hydrodynamic model, and shoreline elevations are recorded. Simulating a large number of storms in this way is equivalent to simulating a long period of history, with the frequency connection established through the rate of storm occurrence estimated from a local storm sample. The Monte Carlo method has been used extensively in concert with a 1D surge model by the State of Florida to determine coastal flood levels; see the 1D surge discussion in Section D.4.4 for additional information. An example of a Monte Carlo approach to the statistics of

wave runup in sheltered waters is shown in a supporting case study document (PWA, 2004). In that example, distributions were first developed for the forcing functions (winds, waves, water levels), and from them a long simulated time series was derived by Monte Carlo random sampling. Another example of a Monte Carlo analysis is shown in the context of event-based erosion in Section D.4.6; in that example, a Monte Carlo approach was used to relate bluff failure to bluff toe erosion.

D.4.3.7 Additional Resources

The foregoing discussion has been necessarily brief; however, the Mapping Partner may consult a large amount of literature on probability, statistics, and statistical hydrology. Most elementary hydrology textbooks provide a good introduction. For additional guidance, the following works might also be consulted:

Probability Theory:

An Introduction to Probability Theory and Its Applications, Third Edition, William Feller, 1968 (two volumes). This is a classic reference for probability theory, with a large number of examples drawn from science and engineering.

The Art of Probability for Scientists and Engineers, Richard Hamming, 1991. Less comprehensive than Feller, but provides clear insight into the conceptual basis of probability theory.

Statistical Distributions:

Statistics of Extremes, E.J. Gumbel, 1958. A cornerstone reference for the theory of extreme value distributions.

Extreme Value Distributions, Theory and Applications, Samuel Kotz and Saralees Nadarajah, 2000. A more modern and exhaustive exposition.

Statistical Distributions, Second Edition, Merran Evans, Nicholas Hastings, and Brian Peacock, 1993. A useful compendium of distributions, but lacking discussion of applications; a formulary.

An Introduction to Statistical Modeling of Extreme Values, Stuart Coles, 2001. A practical exposition of the art of modeling extremes, including numerous examples. Provides a good discussion of POT methods that can be consulted to supplement the annual maxima method.

Statistical Hydrology:

Applied Hydrology, Ven Te Chow, David Maidment, and Larry Hays, 1988. One of several standard texts with excellent chapters on hydrologic statistics and frequency analysis.

Probability and Statistics in Hydrology, Vujica Yevjevich, 1972. A specialized text with a lot of pertinent information for hydrologic applications.

General:

Numerical Recipes, Second Edition, William Press, Saul Teukolsky, William Vetterling, and Brian Flannery, 1992. A valuable and wide ranging survey of numerical methods and the ideas behind them. Excellent discussions of random numbers, the statistical description of data, and

modeling of data, among much else. Includes well-crafted program subroutines; the book is available in separate editions presenting routines in FORTRAN and C/C++.

Software:

Several open-source and commercial software packages provide tools to assist in the sorts of analyses discussed in this section. In particular, the S, S-PLUS, and R programming languages (commercial and open-source versions of a high-level statistical programming language) include comprehensive statistical tools. The R language package is available for free from the web site <http://www.r-project.org/>; several books discussing the use of R and S are available. Other well-known software packages include *Mathematica*, *Matlab*, *SPSS*, and *SYSTAT*.

D.4.4 Waves and Water Levels

This section provides guidance for two study components: the definition of offshore waves and their transformation to the surf zone; and the determination of water levels, including tide and wind setup. Guidance on special considerations in sheltered waters is provided for both of these components. This section also includes guidance on water level during El Niños, 1% still water levels (SWLs), combined effects of surge and riverine runoff, and consideration of non-stationary processes.

D.4.4.1 Waves

Section D.4.2 defines the analysis steps of a typical Flood Insurance Study (FIS) in terms of zones moving from the offshore zone to the shoaling zone to the surf zone to the backshore. The characteristics of waves at the surf zone must be defined to estimate runup, setup, and overtopping (see Section D.4.5), erosion (see Section D.4.6), and effects on coastal structures (see Section D.4.7) at the shore. Wave characteristics at the surf zone are seldom available directly from measurements. Therefore, typical steps in the wave analysis for a FIS include defining wave characteristics in the offshore zone, transforming the waves to the surf zone, and then creating equivalent deepwater water characteristics (back-transforming), so the transformed characteristics can be easily used in subsequent analyses.

The primary source of offshore wave information consists of predictions from wave hindcasting models, supported by limited measurements. The hindcast databases have been extended to cover relatively long periods (30 years or more), while measurements are generally available for only a few years and are sparsely spaced. Hindcasts and observations commonly represent conditions at a point offshore, usually in deep water. Because waves in the surf zone are strongly influenced by local bathymetry and shoreline configuration, hindcast or measured wave data must be modified to account for wave transformations between the reference station and the study area.

The guidance provided below on wave analysis includes the following:

- Definition of wave spectra (D.4.4.1.1), which represent the distribution of wave energy over frequencies and directions, and are used in some wave transformations;
- Discussion of deepwater wave data (D.4.4.1.2), which may be used where available to define offshore wave characteristics;
- Discussion of hindcast offshore wave data (D.4.4.1.3), which are considered the most likely sources of wave characteristics for FISs on the open coast;
- Description of wave transformations (D.4.4.1.4), with emphasis on spectral transformation methods and a discussion of potential regional approaches to spectral transformations; and
- Description of special considerations in sheltered waters (D.4.4.1.5), where wave generation is dependent on local winds, and offshore waves are typically determined using wave hindcasts, which are often fetch-limited.

Because it typically occurs in the backshore zone, wave overland propagation and dissipation is treated in Section D.4.5, Wave Setup, Runup, and Overtopping.

Several general methods of defining offshore waves and transforming them to the surf zone with varying complexity are described here; the methods selected in a particular study area will depend on the availability of information and the complexity of shoaling zone and surf zone characteristics. It is difficult to define a single method for a given setting – judgment is required by the Mapping Partner to select the type and level of analysis appropriate to the setting and study needs. A general consideration is that the level of wave analysis should be appropriate to support the methods to be used in subsequent analysis of wave effects at the shoreline.

D.4.4.1.1 Wave Spectra

The characterization of random waves by *spectra* is summarized here. Wave spectra represent the distribution of wave energy over frequency and direction. Wave spectra can be either continuous or discrete and can be expressed either one-dimensionally or two-dimensionally.

A one-dimensional (1-D) continuous spectrum, $S(f)$, specifies the distribution of the wave energy over frequency, f , as shown schematically in Figure D.4.4-1a.

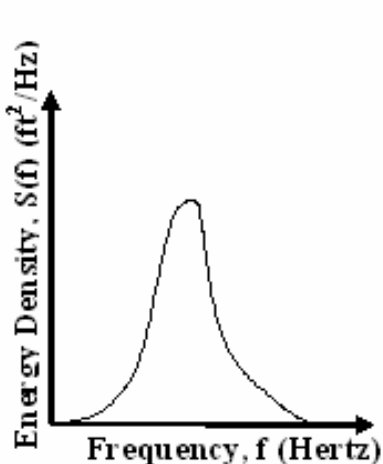

Figure D.4.4-1a) Example of a One-Dimensional Continuous Spectrum

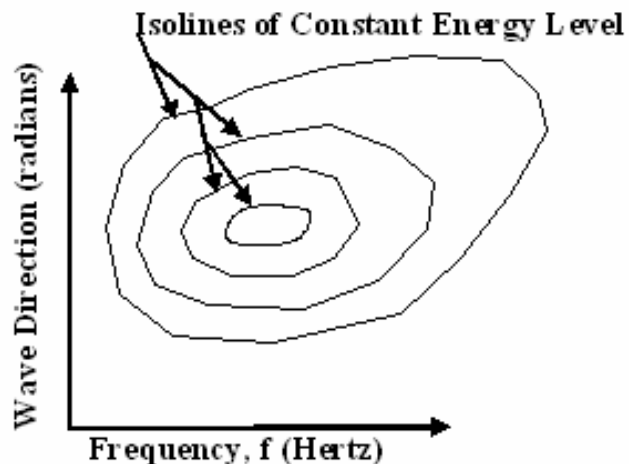

Figure D.4.4-1b) Example of a Two-Dimensional Continuous Energy Spectrum

The energy density contained in a small frequency interval, Δf , is approximately $S(f)\Delta f$; the integral over all frequencies is the total energy density of the waves, E , where:

$$E = \overline{\eta^2} = \int_0^{\infty} S(f)df \quad (\text{D.4.4-1})$$

is the mean square of the fluctuations of the water surface η about the mean level. The spectrum can also be two-dimensional (2-D), with the wave energy distributed over both wave direction and frequency as shown in Figure D.4.4-1b. A 2-D (or directional) wave energy spectrum is denoted as $S(f, \theta)$ in which θ is the direction from which the waves are arriving; that is, according to the usual convention, a north wind generates north waves. In this case, the energy density is the double integral over both direction and frequency:

$$E = \int_0^{\infty} \int_0^{2\pi} S(f, \theta) d\theta df \quad (\text{D.4.4-2})$$

such that the total energy at any frequency is the integral of the energy spectral density over direction at that frequency.

Wave spectra can also be discrete, and analogues exist between the expressions for discrete and continuous spectra. Figure D.4.4-2a shows an example of a 1-D discrete spectrum in which the total energy density is now given by a summation over a set of N discrete frequency components:

$$E = \sum_{n=1}^N S(f_n) \quad (\text{D.4.4-3})$$

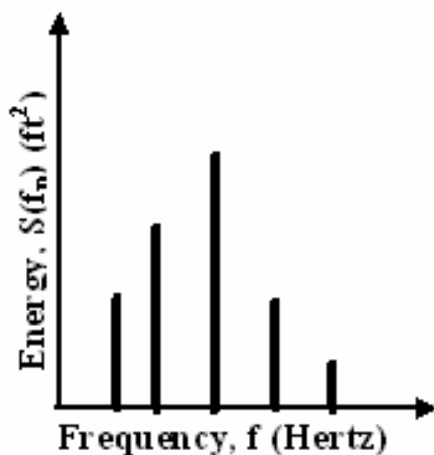

Figure D.4.4-2a) Example of One-Dimensional Discrete Spectrum

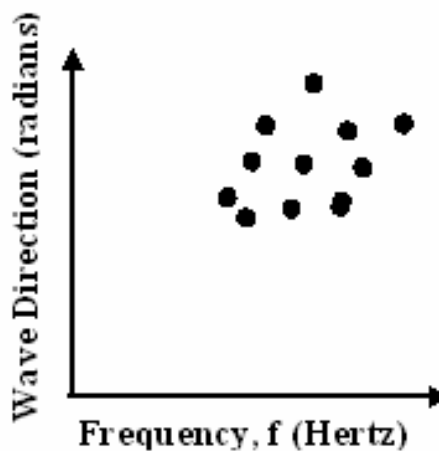

Figure 4.4-2b) Example of Two-Dimensional Discrete Spectrum

Similarly, the 2-D discrete spectrum, Figure D.4.4-2b, is denoted as $S(f_n, \theta_m)$, such that the total energy density, E , is given by the double summation over N frequencies and $M(n)$ directions:

$$E = \sum_{n=1}^N \sum_{m=1}^{M(n)} S(f_n, \theta_{n,m}) \quad (\text{D.4.4-4})$$

As can be seen from these equations, the essential difference between continuous and discrete spectra is that, for continuous spectra, energy is contributed by all frequencies and directions (for 2-D continuous spectra), whereas for discrete spectra, the wave energy contribution is non-zero only at particular frequencies (and at particular directions for 2-D discrete spectra). In the guidance below, discrete spectra are assumed to be used unless otherwise stated.

D.4.4.1.2 Measured Deepwater Wave Data

Ideally, long-term wave data measurement programs could replace the use of deepwater wave hindcasts and transformation modeling to shallow water. However, wave gages are expensive to install and maintain, and are often temporarily out of service for maintenance or repair. Nevertheless, wave measurements are extremely important for confirmation and verification of the results of hindcast modeling. For the Pacific Coast, the principal sources of wave measurements are the National Data Buoy Center (NDBC) and the Coastal Data Information Program (CDIP), which is supported by the State of California and the U.S. Army Corps of Engineers (USACE). There are also “records of opportunity” that may be obtained from oil company platforms, local agencies, and numerous engineering studies performed along the coast.

D.4.4.1.2.1 National Data Buoy Center

The NDBC (<http://www.ndbc.noaa.gov/>) is a branch of the National Oceanic and Atmospheric Administration (NOAA). NDBC has installed and maintained offshore meteorological and oceanographic buoys since the late 1960s. Many of these buoys have been in place at specific locations for a sufficiently long period such that reasonably accurate wave height statistics can be derived. (Federal Emergency Management Agency [FEMA] studies typically require a minimum of 30 years of data to achieve acceptable predictions.) Many other buoy locations are available with limited record periods and are not suitable for direct statistical prediction of extremes. However, the data from any wave sensor might still be very useful to check wave hindcast models.

Figure D.4.4-3 shows locations of the NDBC Met-Ocean buoys in the Southern California area; Figure D.4.4-4 shows locations in the North Pacific. Not all of the buoys that are shown on the maps are always present, and often those shown are temporarily removed for maintenance and may be replaced in slightly different locations. Data inventories (locations, dates of installation, and records) are available at the website noted above. Most wave data are in the form of 1-D spectra with summaries of wave height and periods (spectral peak and average); very few have wave directional information.

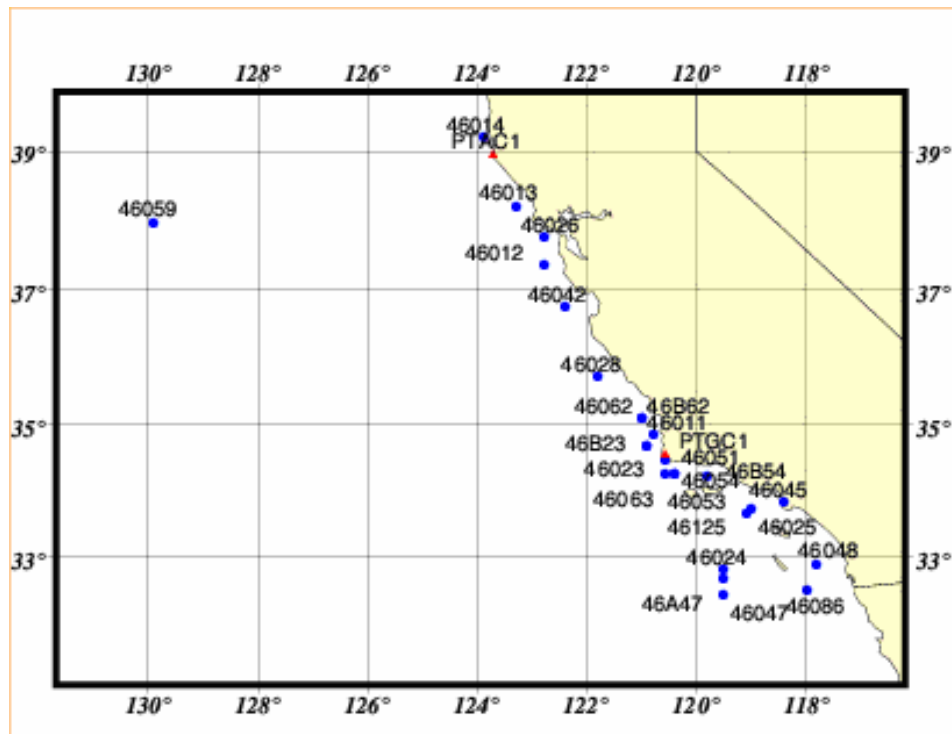

Figure D.4.4-3. NDBC Buoy Locations near Southern California

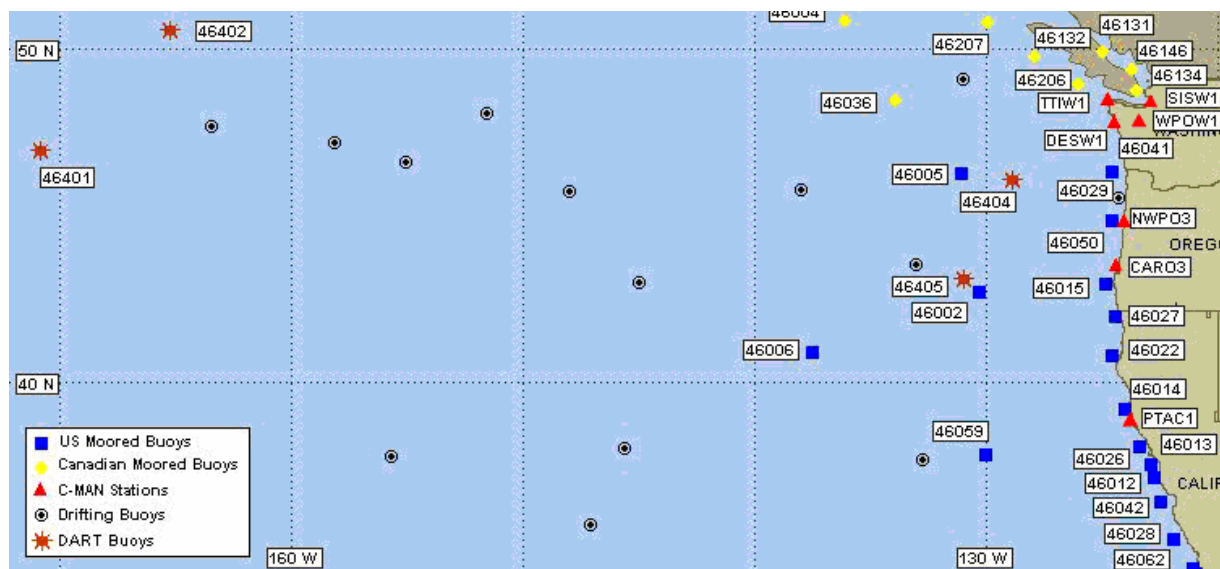

Figure D.4.4-4. NDBC Buoy Locations in the North Pacific

The NDBC buoys record wave amplitudes by sensing the vertical heave acceleration. To obtain wave direction estimates, the sensors include two horizontal accelerometers. The moorings are designed to minimize the restraints on the buoy motions, but it should be recognized that this is not a perfect decoupling; in particular, the response to longer waves (periods greater than 20 seconds) may be affected. In the most recent buoy configuration, wave data are recorded for 20 minutes each hour. For directional spectra buoys, the outputs from the horizontal accelerometer

sensors are used to derive a mean wave direction and an angular spreading. The estimates of angular spreading are inherently poor, as only two coefficients can be determined to represent what should commonly be a narrow directional distributional function associated with swells.

D.4.4.1.2.2 Coastal Data Information Program

The CDIP employs a number of nearshore buoys that record directional wave spectra. They are installed and maintained by Scripps Institution of Oceanography under the sponsorship of USACE, Office of Naval Research, the State of California, and others. The program has been expanded recently to include installations on the Atlantic Coast, the Great Lakes, Hawaii, and other areas of the Pacific Ocean (http://cdip.ucsd.edu/dbase/web_stations/public_station_directory.shtml). Some older data include measurements by pressure sensors rather than buoys.

Data from the CDIP buoys are analyzed to give wave heights and estimates of wave directions. The basic sensors are accelerometers that sense vertical acceleration and two orthogonal horizontal accelerations. These exhibit limitations similar to those discussed above for NDBC directional wave buoys. The “apparent” horizontal accelerations may be contaminated by the buoy responses in “tilting” (pitch and roll). The relative magnitudes of the two components provide a good approximation to mean wave direction at each frequency band within the spectrum, but directional spread estimates are inherently limited because only two components are available to define what might be a relatively narrow directional distribution in shallow waters.

D.4.4.1.3 Hindcast Wave Data

Hindcast wave data consist of estimates of wave parameters derived from weather data, rather than actual wave observations, through application of wave generation models. Some earlier flood studies used hindcast wave data developed by the Navy’s Fleet Numerical Weather Central, which was analyzed and published by Meteorology International Inc. (MII, 1977). The Wave Information Studies (WIS) developed by the USACE Waterways Experiment Station at Vicksburg have also been used. The WIS data include statistical summaries of wave conditions and time series for the period from 1956 to 1975 for the Pacific Coast (WIS Report 17 by Jensen et al., 1989), with a separate report (WIS Report 20 by Jensen et al., 1992) for Southern California. An important limitation of these older studies is that they did not include swells from the Southern hemisphere or from Northeast Pacific tropical storms. The WIS period also corresponded to a time when satellite meteorological measurements were not available or were very limited, and the number of data buoys was much smaller than it is now.

Significant improvements in the analysis of historical meteorology have been made in recent years. Wind fields have been re-analyzed and have been used with so-called third- and fourth-generation wave hindcast models to yield improvements in wave hindcasts over periods of 20-30 years. The advent of very economical high speed computing capabilities has enabled directional wave spectral modeling to be performed on the entire Pacific Ocean, and even globally. These newer models have been calibrated and verified by comparison with measured data at offshore buoys and with satellite scatterometer measurements.

Wave hindcast databases that can be considered for use in an FIS include:

- WAVEWATCH III by Fleet Numerical Meteorology and Oceanography Center (FNMOC);
- WIS by the USACE; and
- Global Reanalysis of Ocean Waves (GROW) by Ocean Weather Inc.

D.4.4.1.3.1 WAVEWATCH III

The U.S. Navy FNMOC prepares weather and wave forecasting for all oceans of the world (<<https://www.fnmoc.navy.mil/PUBLIC/>>). The basic model, known as WAVEWATCH III, computes directional wave spectra using 25 frequency and 24 direction bins. Products include sea wave heights, periods, and directions; swell wave heights, periods, and directions; and several other meteorological parameters. The emphasis of the available data is forecasting. There is an historical database dating back to July 1997 that can be downloaded (with permission) from the FNMOC site. This database is too short for estimating extreme waves. However, given that the model is readily available and can be downloaded from the WAVEWATCH site, the hindcasting model could conceivably be extended by a user as long as the analyzed wind fields for earlier years are prepared or available. WAVEWATCH III is a third-generation deepwater wave prediction model (WAMDIG, 1933; Komen et al., 1994).

D.4.4.1.3.2 Wave Information System

The WIS was developed by the Waterways Experiment Station of the USACE (<<ftp://wisftp.wes.army.mil/pub/outgoing/wisftp/>>). WIS reports cover both the U.S. coasts and the Great Lakes. Wave hindcast data include separate values for sea and swell wave heights, periods, and directions. Many stations are located close to shore and include some portion of the shallow water transformations. For the Pacific Coast, the period of hindcasting is 1956 through 1975. Figures D.4.4-5 and D.4.4-6 illustrate examples of locations for which WIS data can be downloaded from the referenced website.

WIS is currently being updated to add coverage for a more recent time period. It has been suggested that WIS may overestimate wave heights along the Pacific Coast. Consequently, if WIS data are to be used in a study, the Mapping Partner must review them to assess their accuracy by comparison with other data available for the area.

D.4.4.1.3.3 Global Reanalysis of Ocean Waves

GROW data are available from Ocean Weather Inc. at <www.oceanweather.com/metocean/grow/index.html>. These data include the results of a hindcast modeling system that covers the entire Pacific Ocean. The data are continually updated after comparisons with buoy measurements and scatterometer satellite observations. The data include a total of 23 parameters including heights, periods and directions for seas and swells. Also included are wind speed and direction, directional spreading of wave energy, and spectral moments (first and second). The hindcasts are based on directional spectral modeling using 23 frequency bands by 24 direction

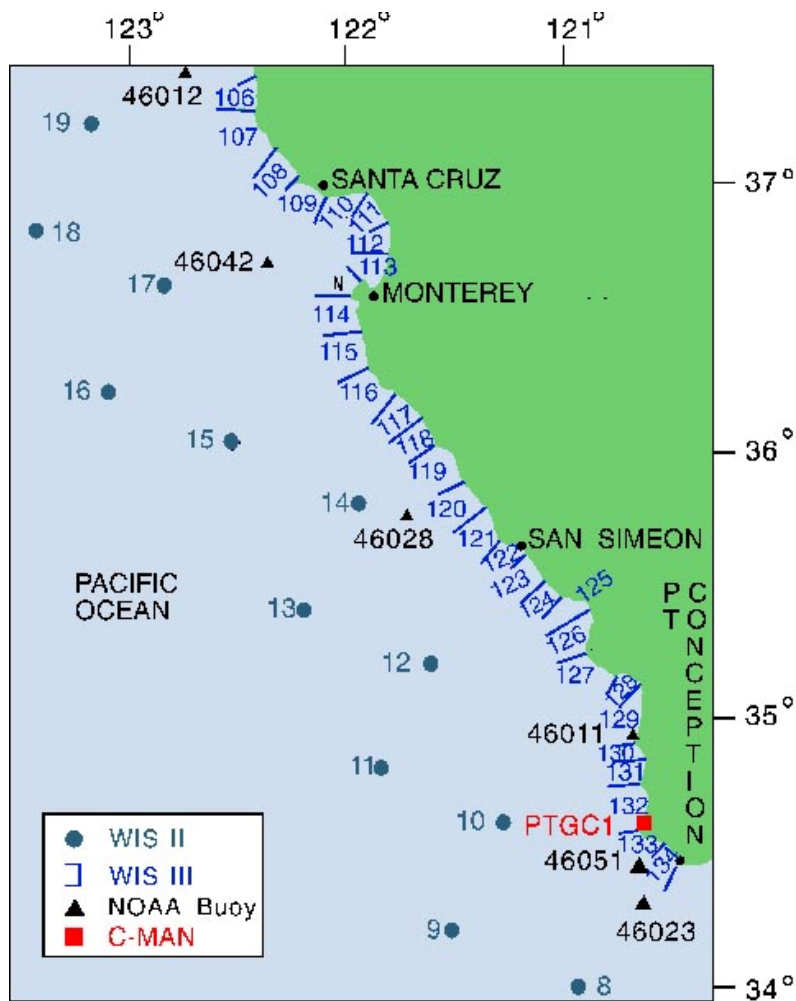

Figure D.4.4-5. WIS Stations in Central California

bands. GROW data are available at 3-hour intervals beginning January 1, 1970 through present, on grid points at every 0.625 degrees latitude and 1.25 degrees longitude. Figure D.4.4-7 shows some of the grid points that are available along the Pacific Coast.

The wave data files can be purchased in ASCII format. Standard output includes 23 parameters (19 meteorological and wave parameters) every 3 hours for the period of the hindcast (1970 to the present). The data include:

- Sea heights (energy), periods, and directions
- Swell heights (energy), periods, and directions
- Significant wave height, dominant period, and dominant direction (from sea or swell)
- Spectral moments (m_1 and m_2)
- Angular spreading parameter (related to the exponent n in $\cos^n(\theta - \theta_0)$).

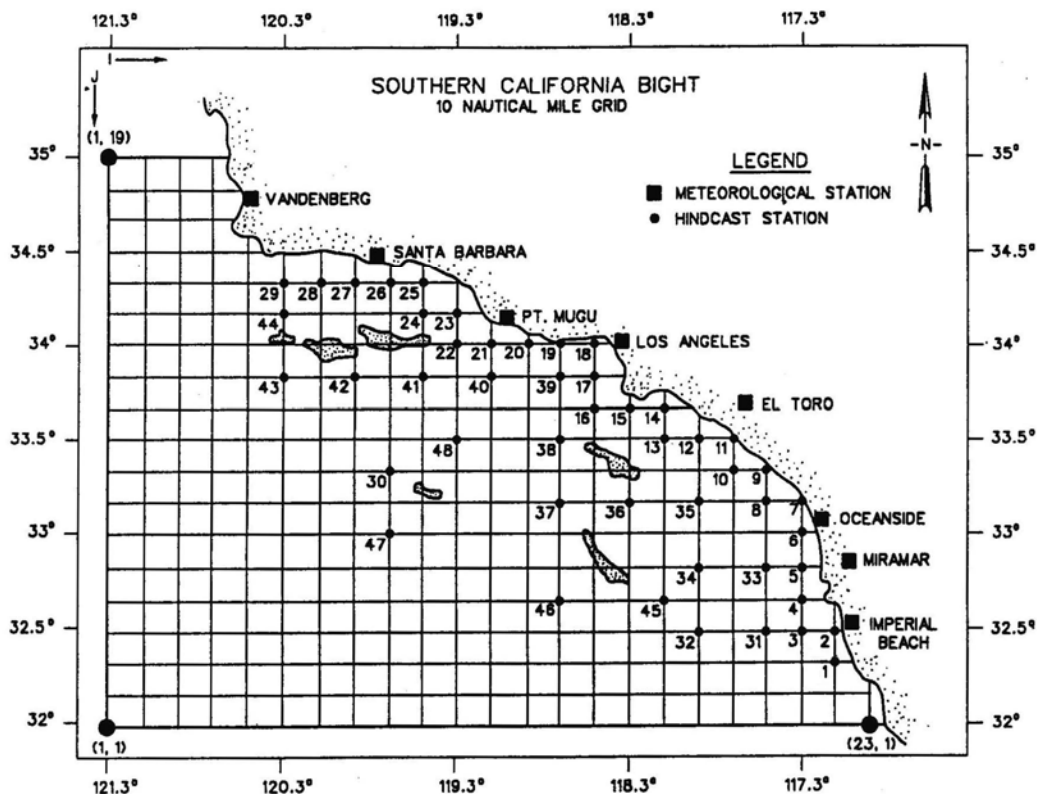

Figure D.4.4-6. WIS Stations in Southern California

From this data, directional spectral inputs for application to shallow water wave transformations can be specified. The directional spreading is available, but it is necessary to adopt a spectral peakedness factor in a Joint North Sea Wave Project (JONSWAP) type spectral formulation. The spectral form should be taken (after Goda, 1985) as:

$$S(f, \theta) = S(f)G(\theta) \tag{D.4.4-5}$$

$$S(f) = \alpha H_s^2 T_p^{-4} f^{-5} \exp[-1.25(T_p f)^{-4}] \gamma^{\exp[-(T_p f - 1)^2 / 2\sigma^2]} \tag{D.4.4-6}$$

$$\alpha \cong \frac{0.0624}{0.230 + 0.0336\gamma - 0.185(1.9 + \gamma)^{-1}}$$

$$\sigma = \sigma_a : f \leq f_p$$

$$\sigma = \sigma_b : f \geq f_p$$

in which the directional spectrum is assumed to be separable into frequency and direction terms. Directional information is contained in the function G ; subscript p denotes peak; α , γ , and σ are parameters with $\gamma = 1$ for sea and 9 for swell; $\sigma_a = 0.07$; and $\sigma_b = 0.09$.

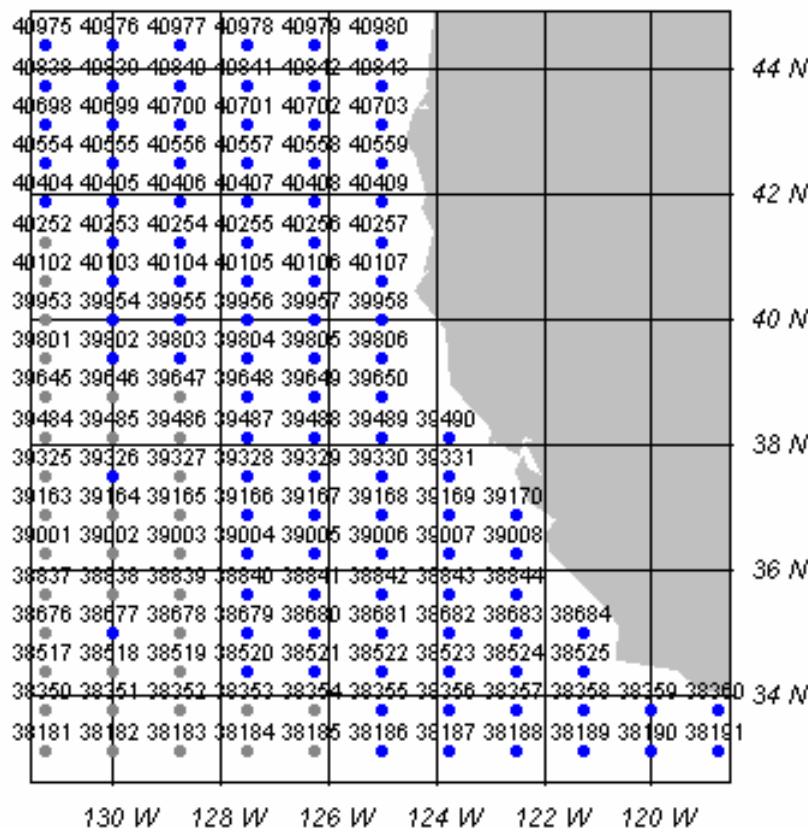

Figure D.4.4-7. Example of GROW Station Locations Along the Pacific Coast

Directional spreading is modeled using the following cosine power function:

$$G(\theta) = G_0 \cos^n (\theta - \theta_{main}) \quad (D.4.4-7)$$

in which θ_{main} is the main wave direction (MWD) and n is the directional spreading index. The relationship between the angular spreading parameter in the GROW hindcast (ANGSPR) and n is as follows:

$$n = \frac{2 \times ANGSPR}{1 - ANGSPR} \quad (D.4.4-8)$$

and

$$G_0 = \frac{1}{\pi} 2^{n-1} \frac{\Gamma^2(n/2 + 1)}{\Gamma(n + 1)} \quad (D.4.4-9)$$

where Γ is the gamma function. Goda suggests that G_0 should be treated as a function of frequency relative to the peak frequency. This refinement may not be essential; sensitivity tests

have shown that the practical difference in results after wave transformation routing to shallow water is negligible.

GROW assumes deepwater (depth > 3,200 feet) at the hindcast point. The reference GROW point should be taken offshore of this depth and clear of all headlands, islands, and shoals that may cause wave directions to be modified. Wherever possible, wave data should be evaluated by comparison with measurements that may be available in the study area.

D.4.4.1.3.4 Hindcast Wave Data Comparisons

In the future, alternative sources of wave data such as longer records of direct measurements from offshore buoys, improved wave modeling from WIS or WAVEWATCH III may be available and may be advantageous for use. The principal restriction of these alternative sources at present is that the WAVEWATCH III data cover a limited period, and the WIS data for the Pacific Coast are thought to give wave heights that are somewhat too large. It has also been noted that the wave periods reported by offshore buoys may be too low. Comparisons between data sources can be made where they overlap. Specifically, the GROW data overlap with the WIS data between 1970 and 1975, and with buoy data where available. There are generally no overlaps between the NOAA buoy data and the currently available WIS data ending in 1975.

Normally, GROW data are provided at 3-hour intervals, which should be adequate for any FIS. This yields 2,920 records per year (2,928 in a leap year). The GROW data include 23 parameters (19 meteorological and oceanographic parameters) at each time step, so a complete 30-year file would contain about 90,000 data lines. This may exceed the capacity of some common software, although many specialized packages are available for manipulation of data sets of this magnitude. The NOAA data are stored in annual blocks on the NOAA website. The WIS data are stored at 3-hour time steps with 15 parameters that include the separation of sea and swell. WIS II (Pacific Coast) provides a record from 1956 through 1975 in text format, in addition to statistical summaries.

At the present time, the GROW hindcasts may provide the most comprehensive and current data set for FIS use in most open coast locations.

D.4.4.1.4 Wave Transformations

D.4.4.1.4.1 Overview

The primary wave data used in a Pacific Coast FIS are obtained from offshore deepwater hindcasts and observations as described above. However, the deepwater wave characteristics cannot be used directly to describe flood processes onshore. During propagation from deep water to the shallow water at the study site, the waves undergo major transformations in amplitude and direction, which depend upon the bathymetry over which they travel. To determine the ultimate onshore wave effects and flood levels (erosion, runoff, setup, overtopping, and so forth) the Mapping Partner must account for these changes in the wave characteristics by determining the *wave transformations*, for a particular study area and coastal setting.

The major transformation processes are refraction, diffraction, and shoaling, all of which alter the waves' heights, while refraction and diffraction also affect their paths. For more information

on these fundamental wave processes, the Mapping Partner should consult either the Shore Protection Manual (USACE, 1984) or the Coastal Engineering Manual (CEM) (USACE, 2003). Other processes that may be important include local wave growth because of winds, wave-wave interactions, wave-current interactions, and reflection. The Mapping Partner shall consider and document these processes when appropriate.

The level of complexity of the Mapping Partner's wave transformation effort depends upon two major considerations. First is the complexity of the bathymetry in the site vicinity. If the site lies in an area that can be adequately characterized by straight and parallel depth contours, relatively simple wave transformation procedures may be entirely acceptable. If, however, the site is fronted by rapidly varying bathymetry, such as a steep, narrow canyon, or by islands or shoals, then the wave propagation behavior is correspondingly complex, and complex procedures are required.

The second consideration is the manner in which the transformed wave parameters will be used in subsequent surf zone and shoreline computations. Section D.4.5 includes three potential methods for wave setup computations that may be used depending on complexity of the surf zone, setting, and overall study methodology. These are: 1) a parameterized version of the Direct Integration Method (DIM); 2) a DIM numerical model; and 3) Boussinesq modeling. The parameterized DIM approach requires only the deepwater equivalent significant wave height, peak period, and peak enhancement parameter. The numerical DIM approach requires an equivalent deepwater wave frequency spectrum, and the Boussinesq approach requires a full directional spectrum or wave time series. The selection of transformation methods must therefore consider the input required in this subsequent analysis step.

The complexity of the analysis depends on the complexity of the site characteristics and dominant transformation processes that must be represented. In some study areas, both the shoaling zone and surf zone bathymetry may be relatively simple, and the offshore waves relatively uniform. In this case, complex transformation methods may not be required. For the case of simple bathymetry with straight and parallel contours, this may be accomplished with shoaling and Snell's Law for refraction. This approach may be applied to a single wave or to a wave spectrum. For more complex bathymetries and to account for other transformation processes (e.g., diffraction), transformation determinations based on 2-D hydrodynamic modeling, such as Boussinesq models, are needed. These models may be used to develop spectral transformations, or if the wave transformations are nonlinear, to transform the time series of the wave surface elevations. In sheltered waters or other areas where significant wave generation occurs in the shoaling zone, a 2-D spectral wave model that also accounts for wave generation may be desirable. The guidance below provides background primarily on the spectral transformation methods.

As shown in the accompanying flow chart (Figure D.4.4-8), the determination of wave transformations for a typical Pacific Coast FIS includes four major steps:

1. Review site conditions and available wave information.
2. Develop a transformation approach.
3. Perform the transformation from deepwater to nearshore.
4. Convert nearshore results to equivalent deepwater conditions.

If the study site lies in an area of extremely complex bathymetry, a high resolution transformation model might be required to resolve local refraction and diffraction behavior. Rather than perform the entire analysis using a highly detailed model in offshore areas where conditions do not require it, the Mapping Partner can establish the wave transformations using a two-step process, first bringing the waves close to shore with a model of normal resolution, and then performing a second nearshore transformation of those waves using a fine grid in the more local area of complex bathymetry.

The spectral method of wave transformation relates shallow water spectra with offshore spectra through multiplication by an array of wave transformation coefficients. The transformation array is developed by application of a 2-D hydrodynamic wave transformation model applied over the bathymetry between the site and the deepwater data source points. It is recognized that there may be situations where alternative methods may be more appropriate. For example, wave transformations in sheltered waters may be better determined using a spectral wave model that also considers wind wave generation (see Subsection D.4.4.1.5).

The Mapping Partner must perform a thorough and detailed review of site conditions as part of this wave transformation analysis. A comprehensive summary of the site should include the following items:

- Bathymetry sets for the offshore and nearshore regions.
- Locations for several cross-shore transects in the nearshore region that encapsulate the local character of the coastline and the seabed steepness.
- Locations and types of coastal structures.
- Identification of special processes (such as diffraction, reflection, or the presence of strong currents or local winds) that might influence wave transformation.
- A specific definition of the site boundary for the analysis.
- The location of the source offshore spectral wave data.
- Appropriate tide level. In most cases a single tide level on the order of mean higher high water (MHHW) is sufficient for flood studies. However, higher water levels or a range of levels may be considered as appropriate.

The Mapping Partner shall select nearshore points that act as output locations for the transformation of the offshore wave spectra. It is recommended that the Mapping Partner shall select nearshore points just outside the surf zone as defined by the large waves breaking during extreme events. Engineering judgment shall be used to determine transect spacing. It is recommended that transects extend far enough in the seaward direction, so the most seaward point is outside of the surf zone. An example approach to selecting a nearshore point and a series of cross-shore transects is shown in Figure D.4.4-9. The shore transects are located to represent reaches of shoreline with similar wave exposure and beach characteristics including man-made features such as coastal structures.

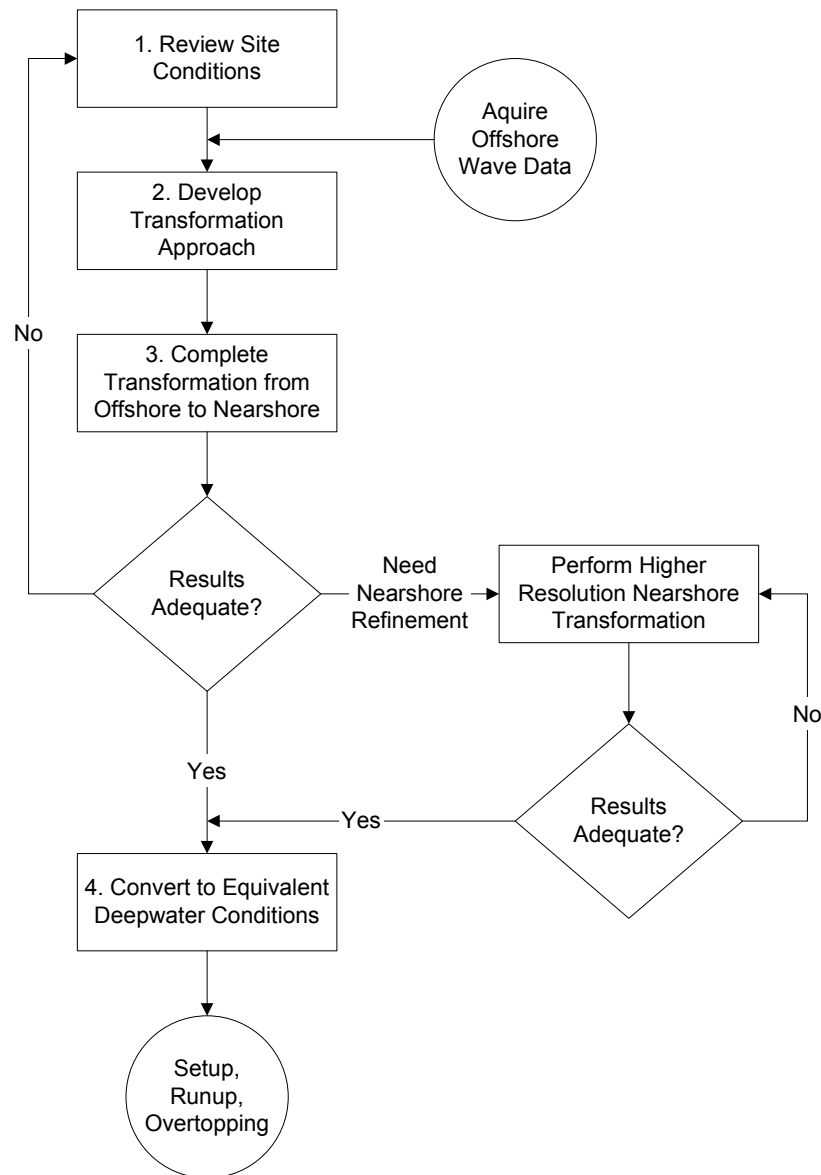

Figure D.4.4-8. Flow Chart for Wave Transformation Analysis

As a necessary part of quality control, the Mapping Partner is responsible for ensuring that numerical transformation results adequately represent site behavior. If numerical methods that have not been validated are used, the Mapping Partner shall consider the need to obtain field data measurements to validate the wave transformation procedures.

D.4.4.1.4.2 Spectral Transformation Methods

In the spectral method, the offshore wave spectrum is converted to a nearshore wave spectrum using an array (or arrays) of wave transformation coefficients for discrete wave frequency and offshore direction intervals. A conceptual diagram of the spectral method using an array of transformation coefficients is shown in Figure D.4.4-10.

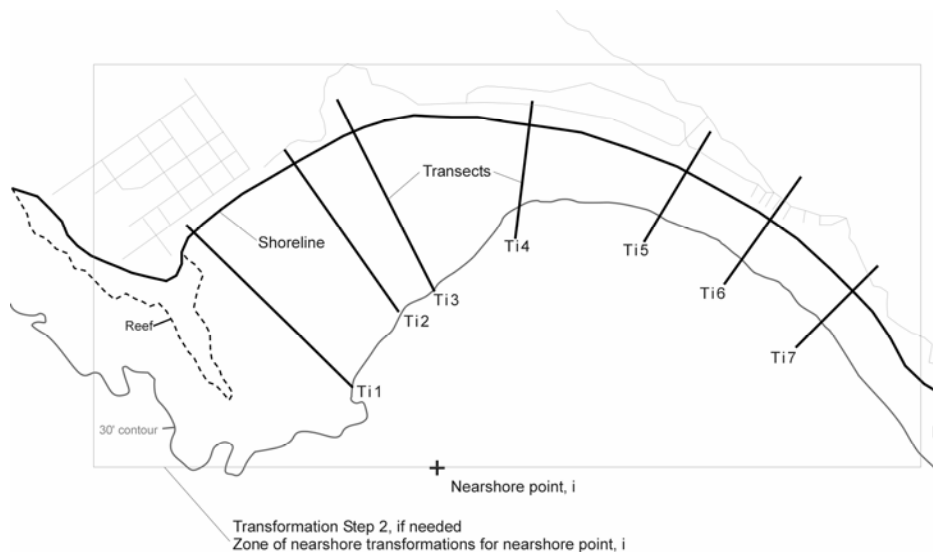

Figure D.4.4-9. Example Placement of Nearshore Point and Location of Cross-Shore Transects

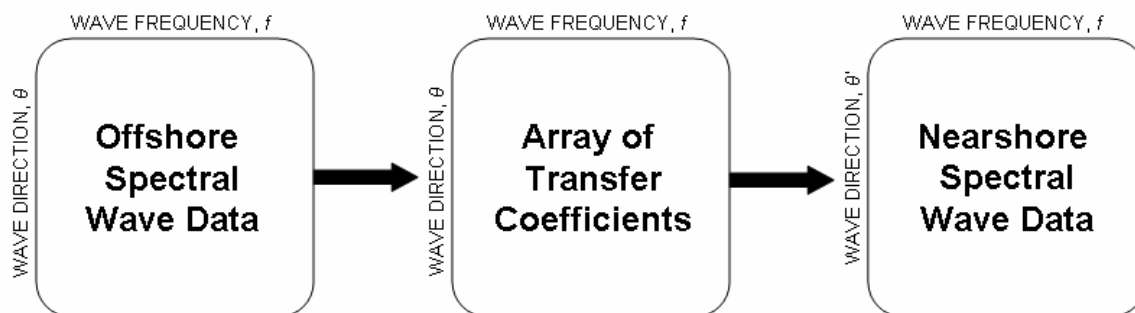

Figure D.4.4-10. Conceptual Diagram of Spectral Transformation

This transformation process should incorporate all important transformation processes in the study area, including shoaling, refraction, sheltering, diffraction, island blocking, and so forth. In this process, the discrete frequencies remain the same as they were in deepwater; however, the discrete directions change owing to wave refraction. At the nearshore location, the spectrum is consolidated to a single direction per frequency, and stored for later use. This consolidated spectrum is also transformed back to deepwater for a different set of applications. The back-transformation allows the Mapping Partner to work with equivalent deepwater conditions; the back-transformed deepwater spectrum is characterized by one direction per frequency.

Spectral transformations are often based on application of a 2-D hydrodynamic model to develop the array of transformation coefficients, and this level of analysis will be appropriate in most situations on the Pacific Coast.

Transformation of the Deepwater Spectrum to a Nearshore Location

The array of transformation coefficients can take several forms depending on the methods used to calculate them; more complex site conditions require more complex calculations to achieve adequate accuracy. A representative conceptual form of the transformation relationship is:

$$S_{ns}(f_n, \theta'_{n,m}) = S_o(f_n, \theta_{o,n,m}) K_s^2(f_n) \{K_r^2(f_n, \theta_{o,n,m}) G_\theta(f_n, \theta_{o,n,m})\} \quad (D.4.4-10)$$

in which subscripts *o* and *ns* denote offshore and nearshore conditions, and *m* and *n* denote the discrete direction and frequency components, respectively; the prime denotes the transformed nearshore direction. K_s is the shoaling coefficient, K_r is the refraction coefficient, and $G_\theta(f_n, \theta_{o,n,m})$ accounts for the change of direction between offshore and nearshore (not modifying the energy level of the spectral element); taken together, K_r and G represent the effects of refraction.

In studies where the DIM approach will be used for setup and runup, calculation of the full nearshore directional spectrum is unnecessary because the subsequent setup and runup calculations require only the frequency spectrum (no direction information is required after the wave transformation calculations). Then the spectral transformation becomes:

$$S_{ns}(f_n) = K_s^2(f_n) \sum_{m=1}^{M(n)} K_r^2(f_n, \theta_{o,n,m}) S_o(f_n, \theta_{o,n,m}) \quad (D.4.4-11)$$

where $M(n)$ is the number of direction components for the n^{th} frequency component.

If the nearshore directional spectrum is desired, the direction transformations must be determined. For straight and parallel depth contours, Snell's Law gives a simple relationship based on offshore angle of wave approach, nearshore depth, and wave frequency. Otherwise, the directional transformation can be complex owing to converging and diverging zones of wave energy; the Mapping Partner shall develop the directional transformation with care. One approach is to develop smoothed directional distributions at the shallow water location for each frequency. This approach lends itself to the application of discrete back-refraction models and is used by CDIP. An alternative method is to establish an array of mean wave directions at the shallow water location based on transformation of directional distributions from each offshore direction and selected frequency; this approach lends itself to application of contemporary 2-D spectral wave transformation models.

In areas where the bottom contours are reasonably straight and parallel, the Mapping Partner may choose instead to carry out the transformation using simplified methods for straight and parallel contours. In this case, the necessary linear wave transformation coefficients are given by:

$$K_r^2 = \cos \theta_o / \cos \theta \quad (D.4.4-12)$$

$$K_s^2 = C_{Go} / C_G \quad (D.4.4-13)$$

where C_G is the group velocity and the subscript o denotes the deepwater location; the unsubscripted variables are at the nearshore site. The refracted wave directions are given by

$$\sin \theta = \frac{C}{C_o} \sin \theta_o \quad (\text{D.4.4-14})$$

and

$$C_G = \frac{C}{2} \left[1 + \frac{2kh}{\sinh 2kh} \right] \quad (\text{D.4.4-15})$$

The wave celerity, or phase velocity, is given by $C = L/T$ where T is the wave period and L is the wave length, related by the implicit dispersion equation:

$$L = \frac{gT^2}{2\pi} \tanh \left(\frac{2\pi h}{L} \right) \quad (\text{D.4.4-16})$$

The water depth is denoted by h and the gravitational acceleration by g .

Consolidation of the Nearshore Spectrum

After the nearshore spectrum $S_{ns}(f_n, \theta'_{n,m})$ is established, it is consolidated into a discrete spectrum with a single direction for each frequency. The requirements for the consolidated nearshore spectrum are: (1) that total energy be preserved, and (2) that the longshore component of momentum be preserved.

The total energy of the nearshore spectrum for each frequency, f_n :

$$S_{ns}(f_n) = \sum_{m=1}^M S_{ns}(f_n, \theta'_{n,m}) \quad (\text{D.4.4-17})$$

The effective direction, $\theta'_{eff,n}$, for each frequency is determined from

$$\theta'_{eff,n} = \frac{1}{2} \sin^{-1} \left(\frac{1}{S_{ns}(f_n)} \sum_{m=1}^M S_{ns}(f_n, \theta'_m) \frac{C_G}{C} \sin 2\theta'_m \right) \quad (\text{D.4.4-18})$$

in which C_G and C are the group and phase velocities, respectively.

Transformation of the Consolidated Nearshore Spectrum to Deepwater Equivalent

After the equivalent nearshore spectrum has been determined, it can be back-transformed to deepwater by applying the shoaling or refraction coefficients previously found. The equivalent deepwater spectrum is the nearshore spectrum de-shoaled to deepwater, but retaining the influence of refraction. Therefore, the equivalent deepwater spectrum is the spectral version of the equivalent deepwater wave height, H_0' ; traditionally used for coastal analyses. The

equivalent deepwater spectrum, $S'_o(f_n)$; can be calculated from either the nearshore spectrum or the incident deepwater spectrum. In the first case, the nearshore spectral elements are divided by the appropriate shoaling coefficients:

$$S'_o(f_n) = \frac{S_{ns}(f_n)}{K_s^2(f_n)} \quad (\text{D.4.4-19})$$

In the second case, the deepwater equivalent spectrum is calculated directly from the incident deepwater spectrum by incorporating the effect of refraction:

$$S'_o(f_n) = \sum_{m=1}^{M(n)} K_r^2(f_n, \theta_{o,n,m}) S_o(f_n, \theta_{o,n,m}) \quad (\text{D.4.4-20})$$

Spectral Transformation Output

Output from the spectral transformation approach should consist of the following items:

- A wave frequency spectrum outside the breaker line at one or more nearshore point(s);
- An equivalent deepwater wave spectrum;
- An equivalent deepwater significant wave and a peak period;
- Three spectral moments (m_0 , m_1 , and m_2) for the equivalent deepwater wave spectrum; and
- Directional information, if required, for the equivalent offshore spectrum.

Wave spectra for each transect in the nearshore are converted to deepwater conditions and equivalent deepwater wave parameters are calculated from the spectra. The necessary spectral moments can be calculated from the following equation:

$$m_i = \sum_{a \leq f_n \leq b} f_n^i S(f_n) \quad (\text{D.4.4-21})$$

where m_i is the i^{th} spectral moment and (a,b) are suitable cutoff frequencies. The spectral moments are used to calculate the spectral width (or narrowness of the peak of the frequency spectrum), which is important for the setup calculations discussed in Section D.4.5. The spectral moments should be calculated by summing the spectral terms from the low frequency cutoff, a , to the high frequency cutoff, b . The low frequency cutoff is typically assumed to be 0.0 Hz, but it is often as high as 0.03 Hz, depending on the analysis methods employed to generate the offshore spectrum. For the purposes of calculating the spectral width only, the high frequency cutoff should be limited to about $1.8 f_p$, where f_p is the peak frequency (Goda, 1983). This cutoff is recommended so that the higher frequency wind waves do not dilute the calculated “peakedness” of the spectrum.

4.4.1.4.3 Regional Transformation and CDIP

Accurate prediction of waves in the nearshore region requires modeling the evolution of the deepwater wave spectrum across the continental shelf. In some regions such as Southern

California, offshore islands must also be taken into account. As a result, predicting waves at a single nearshore location generally requires setting up a relative large bathymetry grid, or a series of nested grids, to adequately address the sheltering and shallow water transformation of the incident waves.

Given the relatively large time and computational investment required to set up such a model for a single coastal site or short reach of coast, government agencies (NOAA, USACE, U.S. Geological Survey [USGS], U.S. Navy) are frequently adopting a broad regional wave modeling approach. There are several commercial and public domain spectral wave models that can be used for regional shallow water wave problems, and relatively large-scale regional wave modeling has become computationally and economically tractable with present computer technology. Wave model domains are prepared to provide predictions for relatively long sections of coastline (e.g., the entire Southern California Bight), and sheltering and shallow water effects are pre-computed to the extent permitted by the model resolution. Where such data are already available, Mapping Partners should adopt them if possible, and focus study resources more efficiently on specific localized environment factors (e.g., an ebb shoal at an inlet, or nearby reflective coastal structures) that may influence flood levels. As noted before, a second high-resolution nearshore transformation step may be needed.

Should a Mapping Partner be required to undertake development of a regional numerical transformation model, significant considerations include not only which of the available spectral wave models should be used, but especially the choice and implementation of the model's various tools and variables (such as grid characteristics, boundary conditions, and parameterized wave physics) to achieve sufficiently accurate results. Perhaps the most important of these model factors is whether any nonlinear aspects of the wave spectrum evolution from the shelf break to a location outside the surf zone need to be included. In most cases, these nonlinear effects can be neglected, and the Mapping Partner can use a fully linear approach in which the regional modeling only has to be performed once. Linear wave transformation coefficients are produced by the model in this instance, and can be used repeatedly to transform any deepwater wave spectrum to the coastline.

An independent regional transformation modeling effort is only undertaken by the Mapping Partner with concurrence of the FEMA study representative. In many instances, the Mapping Partner will adopt transformation data developed by others, such as the CDIP program described in the subsections below.

CDIP Coastal Wave Transformation Database

The CDIP at Scripps Institution of Oceanography has implemented a spectral refraction modeling method to derive regional coastline wave predictions just seaward of the surfzone (O'Reilly and Guza, 1991). The model accounts for island blocking, wave refraction, and wave shoaling. Spectral refraction back-refracts wave rays from the site of interest to unsheltered deepwater over the entire range of possible wave frequencies and wave directions. The retained starting and ending ray angles are then used to map a deepwater directional spectrum to a sheltered or shallow water spectrum at the back-refraction site. The resulting solutions are more realistic than those obtained using an assumption of unidirectional monochromatic deepwater

waves. The Mapping Partner should consult technical documents from CDIP (2004a and 2004b) for a complete description of model validation and user's documentation.

When available, the Mapping Partner shall adopt CDIP transformation data to carry out the deepwater to nearshore wave transformation. An overview of the general steps to be followed by the Mapping Partner in cooperation and coordination with CDIP for the development of nearshore wave information is shown in Figure D.4.4-11. The primary steps to be taken include:

1. Ensure that local bathymetry data are accurate and up-to-date; if needed, update the bathymetric grid and the CDIP transformation coefficient database for the study area.
2. Validate coefficients with local wave data if available, and assess the need for additional validation measurements.
3. Transform selected deepwater (unsheltered) wave hindcast spectra to the nearshore model sites using the reviewed transformation coefficients.

These steps are discussed below.

Local Bathymetry Assessment

CDIP maintains regional wave model bathymetric grids, and software to create and modify them, for the coast of California. The water depths in the grids extend from approximately 15-foot depth out to the continental shelf break. The grids are derived primarily from digital hydrographic survey data collected by the National Ocean Survey (NOS) and distributed by the National Geophysical Data Center (NGDC). The coastal coverage of the NOS is particularly dense in Southern California and generally adequate for the remaining portions of the West Coast with either sizable population or frequently navigated coastal waters.

Each regional grid is produced from a very large number of NOS survey points. The data are screened for outliers and the resulting grids are plotted and visually inspected for errors.

Nevertheless, the local bathymetry at a study area remains a potential source of modeling error. Bathymetric errors may be the result of old or sparse surveys that fail to resolve a shallow water feature, or from changes in the local bathymetry owing to nearshore processes or dredging. As an initial task in the wave hindcast process, the Mapping Partner shall obtain and review local bathymetric information. This may include review of available survey maps for the area, a datasearch for bathymetric surveys performed by agencies other than NOS, and discussions with local authorities and local mariners. The Mapping Partner should then meet with CDIP and FEMA representatives to review this information and assess whether changes to the existing regional model grid and the model transformation coefficient database are needed. In addition, the need for new field measurements for model validation should be determined at this time.

Transformation Coefficient Validation

CDIP has validated the spectral refraction wave model predictions at numerous locations throughout Southern California over the past 15 years. This has provided some assurance that

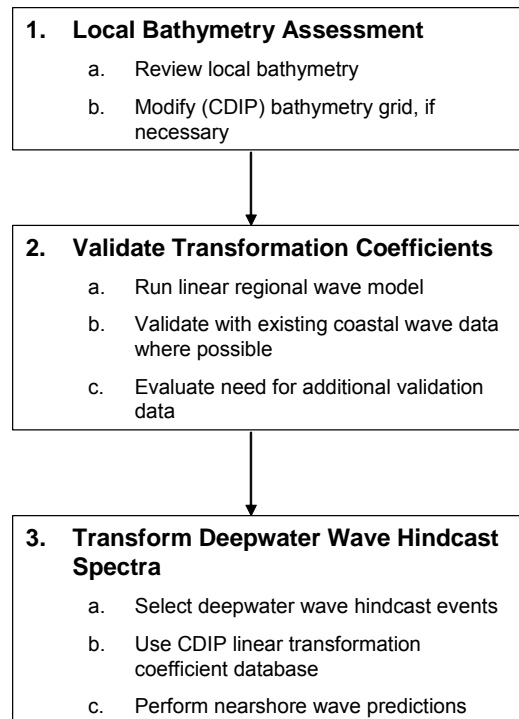

Figure D.4.4-11. Flow Chart of Tasks to Derive Nearshore Wave Hindcast Information for a FEMA Study Area

refraction and shoaling are the dominant transformation processes on narrow continental shelves such as those found on the West Coast. The various validation studies have also shown that significant model prediction errors can occur owing to model boundary condition errors (errors in the deepwater directional wave spectra and/or local bathymetry) or a neglected physical process such as wave reflection from a cliff-lined coastline.

Therefore, the second task in developing wave hindcasts for a FEMA study area is to assess the need for additional wave model validation. Mapping Partners will meet with FEMA and CDIP representatives to discuss the local geographic setting and determine if there are specific bathymetric or topographic features that might require modeling of additional physical processes. CDIP can also provide information on existing wave measurements in or near the study region that could be used for validation purposes.

The collection of wave measurements for model validation is an expensive and time-consuming task because both deepwater directional data and nearshore wave data are required, and data must be collected for a long enough period of time to observe a variety of wave events. The decision on whether to attempt additional model validation should be based in part on overall FEMA regional wave model information needs, and must be approved by the FEMA study representative.

The final task is to transform deepwater wave hindcast spectra to the nearshore using the reviewed, and possibly updated, spectral transformation coefficients from the CDIP database.

D.4.4.1.4.4 Local Seas

Local winds can affect waves during propagation; the regional transformation method described above does not include consideration of the effects of local winds. If local seas are considered important to the events being modeled, it is recommended that they be superimposed as a separate wave train, and integrated into the nearshore spectra. This can be accomplished by taking the estimated directional sea state, in spectral form, and applying the transformation coefficient array, as if it were generated offshore at the same or similar directions. If islands or shoals offshore of the wind field affect the transformation coefficients such that the site is artificially sheltered, an additional transformation is needed to refract the seas to the site.

D.4.4.1.4.5 High-resolution Nearshore Transformation

Once the primary transformation of waves to the nearshore point(s) is complete, it may be necessary to perform a secondary transformation to account for the effects of local complex bathymetry. For this, the Mapping Partner may use a spectral wave model with the ability to propagate the wave components from the nearshore point(s) to the local transects.

A number of such models are in wide use; the Mapping Partner should review FEMA's list of approved models for candidates. Should a model that is not on the approved list be deemed advantageous for the study, the Mapping Partner should coordinate with the FEMA study representative.

Specific model user's manuals and documentation must be relied upon for guidance in modeling considerations. In any case, model grids should be constructed with appropriate resolution to simulate irregular bottom contours and any special bathymetric features. The grids should also be constructed, so the transect locations are not close to the grid boundaries. The Mapping Partner shall locate output points on the model grids corresponding to the locations of the local transects. A sufficient number of modeling runs shall be performed so that a 2-dimensional (frequency and direction) energy transfer coefficient array can be constructed for each local transect. These coefficients are similar to those developed for the primary deepwater to nearshore transformation. Once the transfer coefficients have been determined, the Mapping Partner shall convert the wave spectra at the nearshore point(s) to wave spectra at the location of each transect using methods discussed earlier.

D.4.4.1.5 Waves in Sheltered Waters

D.4.4.1.5.1 Storm Wind Fields

The ocean wave data discussed above may not be available for sheltered waters. In this case, local wave generation modeling may need to be undertaken. A first step in this effort is the acquisition of necessary wind data. In sheltered waters, transitions between land topography and open water areas affect the characteristics of the wind field. The wind *fetch* is the open water area over which wind waves are generated, and storm seas in sheltered waters are limited by the size and shape of the water body ("fetch-limited" seas). Wind speed, wind duration, fetch length, and water depth are the main parameters that determine the heights and periods of locally generated wind waves. (See USACE, 2003 and 1984 for details.)

Time series of 2-D (surface) wind fields are the most realistic representations of storm conditions. Several numerical wave models have the capability to incorporate 2-D time-varying wind fields, but adequate wind field data are not typically available. Instead, point wind data are most commonly measured by anemometers or wind gages operated by government agencies or airports. To use such point data, the Mapping Partner may follow a procedure in which:

- Extreme wind speeds are estimated from wind gage measurements at a point (extremal analysis is discussed in Section D.4.3);
- The wind speed duration is adjusted to optimize for the fetch-limited wave condition; and
- The fetch-limited wind condition is applied as a steady-state boundary forcing function in a 2-D numerical model.

A wind gage might not be located at the study site, but several gages may be located within the vicinity of the site. The selection of wind data from a particular gage should be based on data availability, proximity of the gage to the site, the length of the data record, and the type of data recorded. The goal is to obtain the longest record of quality data that is representative of wind conditions at the study site.

Anemometer measurements of wind data are recorded in various ways. Average wind speed and direction over a given interval (i.e., 2 minutes or 1 second) are typically recorded at regular intervals (i.e., every hour). Peak gust wind speed and direction of the “fastest mile” wind speed may also be reported. Wind roses that show the percent occurrence of wind speeds for compass directions may also be available, and are useful for understanding wind conditions but may not be suitable for estimating extreme wind conditions associated with the 1% annual chance flood.

Various adjustments to wind data recorded by wind gages may be necessary. The USACE CEM (2003) and *SPM* (1984) contain detailed procedures for adjusting wind data. It may be necessary to adjust wind data for the following:

- *Level*, if the wind speed is observed at a level other than the standard anemometer height of 10 meters;
- *Duration*, to obtain the appropriate fetch-limited wind speed for wave hindcasts corresponding to the averaging interval;
- *Overwater*, if winds measured over land are used to hindcast waves over water; and
- *Stability* of the atmospheric boundary layer for fetches longer than 16 km.

See the CEM (USACE, 2003) or the *SPM* (USACE, 1984) for a detailed discussion of these adjustments.

The statistical methods described in Section D.4.3 should be used to estimate extreme wind speeds associated with the 1% annual chance flood. The Mapping Partner shall consider wind direction when estimating extreme wind speeds to include only winds that generate waves affecting the site. That is, the wind data should first be segregated into directional sectors

corresponding to distinct meteorological events (i.e., storms occurring during different seasons that arrive from different directions).

Storm duration is also an important parameter for the characterization of the 1% annual chance flood and for use in estimating event-based-erosion (Subsection D.4.6.1). As discussed in Subsection D.4.2.4, the preferred approach is to consider storm episodes as they have occurred in nature, so duration is effectively bundled with intensity and direction information. If this cannot be done owing to lack of data, duration may be estimated by analyzing the persistence of high winds above a threshold.

D.4.4.1.5.2 Wave Generation Modeling in Sheltered Waters

Two-Dimensional Models

Subject to FEMA approval, spectral wave models can be used to calculate 2-D wind-wave generation. Such models are based on an energy balance equation that accounts for wave propagation processes and processes that add or remove energy from individual frequency and direction bands. The wind input to the models can be steady and uniform, spatially variable, or non-steady. The model depth grid shall encompass the entire fetch area of interest. Wind setup (surge) within the basin can be calculated by linking the models to 1- or 2-D surge models; the depth change caused by wind setup can significantly affect wind-wave generation in shallow waters.

Two-dimensional wind-wave generation models can be found on the FEMA-approved models list. A Mapping Partner shall review 2-D models available at the time of the study. Although steady-state modeling (time-constant wind, wave, and water level conditions) with a uniform wind field is common and is adequate for most flood studies, 2-D models may allow consideration of a spatially variable wind speed, possibly resulting in more accurate results. Similarly, a time-dependent approach can be considered if the time-variation of the winds is known, or if tidal excursions are important to either the wind-wave generation process itself, or to depth dependent wave transformations occurring in the generation area. Application of models in a time-dependant mode entails additional effort to determine appropriate parameters and to document the more complex calculations, but may provide more accurate results. Specific guidance for use of any model shall be obtained from the corresponding user's manual; model results shall be verified against observed data, whenever possible, to confirm validity of the model implementation.

Two-dimensional wave model output shall include nearshore frequency and direction spectra at specific locations, as well as wave height, period, and depth for model grid points. Wave spectral output shall be determined at a nearshore point and/or several transect points; the output directional and frequency spectra for most spectral models can be selected for specific grid points. Some models provide parameterized spectra rather than 2-D spectra. In such a case, the parameterized spectra can be converted to complete spectra by fitting a JONSWAP spectrum to the parameters as explained in the CEM (2003).

Parametric Methods

In some situations, such as when studying a small embayment, simplified parametric methods are appropriate. When using parametric methods, the Mapping Partner shall consult the latest version of the CEM (2003) for specific guidance. Depending on the site conditions and other study factors, straight-line, composite, or representative fetch methods may be used (CEM, 2003; PWA, 2004).

Selection of Wind Input

In sheltered waters, the small area of the water body often results in the hindcast waves being fetch limited. For these conditions, the averaging time used for the wind speed determination may have to be adjusted to correspond to the fetch-limited duration. For example, if the minimum wind duration corresponding to the fetch conditions is 30 minutes and the wind speed data are given as 10-minute averages, then the 10-minute averaged wind speed should be adjusted to a 30-minute averaged wind speed for use in the wave generation model; this adjustment may be done using methods described in the CEM. The computation is iterative because the minimum duration depends on the wind speed.

Such an adjustment is recommended when waves are determined by parametric methods. If 2-D numerical methods are used, then the appropriate user's manual for the numerical model should be consulted for specific guidance; an adjustment may not be needed in all cases.

D.4.4.1.6 Data Requirements

The Mapping Partner shall carefully choose the source and the location of the reference hindcast/observation point for the basic input wave data. This must be near the study site but far enough removed, so there is no interference from offshore islands and shoals. It is recommended that GROW data be given primary consideration, but alternative sources such as WIS data and measurements should always be considered and compared. Additional sources of offshore wave hindcast data continue to become available. The Mapping Partner should attempt to identify such newer data, which, if available, shall be approved by the FEMA study representative before use in a study.

D.4.4.1.7 Documentation

Documentation shall include details of the sources of wave and wind data. It should also include comparisons between alternate sources (where several may be available) and with any local measurements. Documentation of the incident deepwater waves used for routing to shallow water should include periods, directions, and directional spreading. The selection of coefficients for angular spreading and spectral peakedness parameters shall be clearly stated and justified.

Methods of extrapolation of hindcast and/or measured data to 1% annual chance values should be documented, including comparisons between alternate procedures if appropriate.

The Mapping Partner shall document all wave generation assumptions used in modeling and parametric approaches, including the nature of data used to define winds (speeds, directions, duration) and bathymetry (including the 100-year water-level determination). The documentation

shall include any approximations or assumptions used in the analysis. When observational data, such as wave buoy data, are available, the wave height, period, and spectral parameters should be compared to the model output.

The Mapping Partner shall document the assumptions, methods, and results of all analyses of wave transformation conducted for the FIS. This documentation should include selection of offshore and nearshore points, source of transformation coefficients, any special assumptions regarding local transformation processes such as sheltering and reflection, and so forth. If a spectral wave model is applied for nearshore transformation determination, all modeling factors should be sufficiently documented, so the modeling effort could be reproduced if necessary. If a field effort is undertaken to validate transformation models, the field work shall be summarized in detail, including times and locations of all observations, general conditions at the time of the work, a full description of all equipment and procedures, and a summary of all data in archival form. All study output should be documented and summarized in a format suitable for subsequent flooding analyses including setup, runup, overtopping, and erosion.

D.4.4.2 Water Levels

D.4.4.2.1 Overview

The two fundamental components of the Base Flood Elevation (BFE) are *water levels*, discussed in this subsection, and waves, discussed in the previous subsection. The still water level (SWL) is the base elevation upon which the waves ride. It consists of several parts including mean sea level (MSL), the astronomic tide that fluctuates around MSL, the El Niño fluctuation, and storm surge. All storm wave contributions are excluded; static wave setup (Section D.4.5) contributes to the *mean water level* (MWL), somewhat higher than the SWL.

The following subsections discuss each of the still water components in turn, including an outline of methods to determine water-level statistics. Also included is a discussion of non-stationarity in the processes that control water levels.

D.4.4.2.2 Astronomic Tide

D.4.4.2.2.1 Tides and Tidal Datums

The astronomic tide is the regular rise and fall of the ocean surface in response to the gravitational influence of the moon, the sun, and the Earth. Because the astronomic processes are entirely regular, the tides, too, behave in an entirely regular, though complex, manner. A useful overview of tidal physics is presented in a small booklet published by NOAA's NOS, *Our Restless Tides*, now out of print, but available in electronic form from the NOAA website (<<http://www.co-ops.nos.noaa.gov/pub.html>>) where many other documents of related interest can be found.

The tides along the Pacific Coast are mixed and semi-diurnal, meaning that there are two highs and two lows each day; conventionally, mixed tides are semi-diurnal tides for which the magnitudes of successive highs or successive lows have large variation. The average of all the highs is denoted as mean high water, MHW, while the average of all the lows is *mean low water* (MLW). Averages are taken over the entire tidal datum *epoch*, which is a particular 19-year

period explicitly specified for the definition of the datums; a full astronomic tidal cycle covers a period of 18.6 years. The average of all hourly tides over the epoch is the MSL.

The daily highs are generally unequal, as are the lows, so one speaks of the higher-high water, lower-high, higher-low, and lower-low. At a given coastal location, each of these has a mean value denoted by mean higher high water (MHHW), mean lower high water (MLHW), mean higher low water (MHLW), and mean lower low water (MLLW) respectively, with an obvious convention. In addition to these, one speaks of the mean tide level, MTL, which is the average of MHW and MLW, and is also called the half-tide level.

These several levels are important because they constitute the datums to which tide data have traditionally been referred. Local charts and recorded tide gage data are generally referenced to local MLLW. This introduces some ambiguity because MLLW varies from place to place and from epoch to epoch. For use in FISs, then, these tidal datums are insufficient in themselves, and must be related to a standard vertical datum, North American Vertical Datum (NAVD) or National Geodetic Vertical Datum (NGVD); it is not always straightforward to make this connection. However, NOAA maintains tidal benchmarks for many stations that are now tied to a standard vertical datum. Benchmark sheets are available at NOAA's site, <<http://co-ops.nos.noaa.gov/bench.html>>. The following example is extracted directly from the Los Angeles benchmark sheet:

Tidal datums at LOS ANGELES, OUTER HARBOR based on:		
LENGTH OF SERIES:	19 Years	
TIME PERIOD:	January 1983 - December 2001	
TIDAL EPOCH:	1983-2001	
CONTROL TIDE STATION:		
Elevations of tidal datums referred to Mean Lower Low Water (MLLW), in METERS:		
HIGHEST OBSERVED WATER LEVEL (01/27/1983)	=	2.384
MEAN HIGHER HIGH WATER (MHHW)	=	1.674
MEAN HIGH WATER (MHW)	=	1.449
MEAN TIDE LEVEL (MTL)	=	0.868
MEAN SEA LEVEL (MSL)	=	0.861
MEAN LOW WATER (MLW)	=	0.287
NORTH AMERICAN VERTICAL DATUM-1988 (NAVD)	=	0.062
MEAN LOWER LOW WATER (MLLW)	=	0.000
LOWEST OBSERVED WATER LEVEL (12/17/1933)	=	-0.832
Bench Mark Elevation Information		
	In METERS above:	
Stamping or Designation	MLLW	MHW
8-14 FT ABOVE MLLW	4.194	2.746
WILMINGTON D9A 1954	2.967	1.518
WILMINGTON D10B 1954	2.832	1.383
11 1935 RESET 1967	4.711	3.263
NO 13 1971	4.147	2.698
A 1296 1977	3.167	1.718
0660 N 1977	3.553	2.104
10 1930 RESET 1985	3.101	1.653
NO 14 1971	4.068	2.619
0660 P 2000	4.252	2.803

In this example, NAVD is shown to be at 0.062 meters above MLLW for the specified 1983-2001 epoch, fixing the tidal datums. Not all benchmark sheets include NAVD (or NGVD) as this example does, but most include surveyor's benchmark information as shown above, through which the tidal datums can usually be tied to a standard vertical datum as needed in FISs; these benchmark sheets include full descriptions of the benchmarks and exact locations.

D.4.4.2.2 Tide Observations

The tide is recorded at a large number of gages maintained by NOAA, with records dating back over 100 years in some cases. Much of these data are available at NOAA's website, <http://www.co-ops.nos.noaa.gov/data_res.html>, as either six-minute or hourly time series over the particular site's entire period of record. Additional data may be available from NOAA, USACE, or others.

The tide observations record the total water level at the gage, suitably filtered to suppress high frequency wave components, leaving the long period components associated not only with astronomic tide, but also with sea-level fluctuations caused by atmospheric pressure fluctuations (sea level can change by about 1 foot for each 1 inch of change in barometric pressure), El Niño variations, wind setup (storm surge), riverine rainfall runoff into a relatively confined tide gage site, low frequency tsunami elevation, and wave setup to the degree that it exists at the gage site. In general, little wave setup is reflected in tide gage data because gages may be located in protected areas not subject to much setup, or in open areas outside the surf zone, and so seaward of the largest setup values (see Subsection D.4.5.1 for discussion of the physics of setup).

The fact that the tide gage record includes all of these non-astronomic low frequency components makes it possible to extract total still water statistics from gage data, subject to the setup proviso noted. A general method to extract still water statistics from gage data is discussed below.

D.4.4.2.3 Tide Predictions

The astronomic component of the observed tide gage record is considered to be well-known in principle, consisting of the summation of 37 tidal constituents that are simply sinusoidal components with established periods, and with site-dependent amplitudes and phases. These constituents are available for most gage locations from the NOAA site, <http://www.co-ops.nos.noaa.gov/data_res.html>.

The NOAA website also provides tide predictions for any date in the past or future, limited however to one year of predictions at a time. Note that these predictions are computed using the currently adopted values of the 37 tidal constituents for the site.

The Mapping Partner should obtain NOAA's tide prediction computer program, NTP4, and generate tide predictions as needed. The advantages include not only convenience, but more importantly, the ability to use other constituent values than those currently adopted. This is important because the local tide depends not only on the astronomic forcing, but also on the response of the local basins. The response can, and does, change with time owing to siltation and dredging, construction of coastal structures such as breakwaters, changes in inlet geometry, and so forth. Consequently, the astronomic tide observed at a fixed location may not be stationary,

but may have changed over the period of record. NOAA can provide previous estimates of the tidal constituents for a site, and these should be used with the NOAA computer program to produce more realistic predictions than would be achieved using only the current data for a prior period.

NOAA's tide prediction program, NTP4, is not available online, but can be purchased from NOAA at nominal cost, including both source code, an executable file (a DOS console program), and two manuals that thoroughly document the theory and practice of tide prediction: U.S. Department of Commerce Special Publication 98, *Manual of Harmonic Analysis and Prediction of Tides (1940, 1958)*, and a 1982 supplement updating certain numerical factors to 21st century values.

Finally, there may be some ambiguity or uncertainty in tide prediction associated with El Niño fluctuations. As discussed elsewhere, the El Niño effect causes periodic rise and fall of coastal sea levels, and these are inevitably incorporated in the data from which the tidal constituents are determined. The same is true for sea-level fluctuations associated with barometric fluctuations, although El Niño effects are more persistent. It is expected, then, that to some degree the determination of tidal constituents has been confounded by El Niños. The affected constituents would be those with periods comparable to characteristic El Niño fluctuation periods. The phasing of the El Niño fluctuation and the selected tidal epoch would influence the manner and extent to which these processes would then appear intermingled; estimates of tidal constituents obtained from short duration observations might be especially vulnerable in this regard because a long period of observation may effectively smooth the El Niño contribution toward a null average. Nevertheless, for FIS applications, the Mapping Partner shall assume that the tidal constituents do not include non-astronomic components.

D.4.4.2.2.4 Extraction of Non-astronomic Still Water from Gage Records

As discussed above, both observed data and a method to predict the purely astronomic component of those observations are available. By subtracting the predictions from the observations, one arrives at a time series of the non-astronomic contribution to the measured still water, including surge and meteorological effects, El Niño levels, rainfall runoff, and tsunamis – in fact, all non-astronomic components termed *still water*. As a practical matter, the static setup will not usually be present in the record to a significant degree, for reasons already mentioned. Figure D.4.4-12 shows measured and predicted tides at Crescent City for a five-day period in 1983. As shown, superimposed on the fluctuating astronomic tide is a slowly varying residual component approximately 2 feet in amplitude.

The recommended procedure to extract still water statistics from the difference between the observed and predicted data is extremely simple in concept, assuming that the period of record is significant (30 years or more) and that the older predictions were made using the appropriate set of tidal constituents, *not* necessarily those in current use. One first determines the differences between the observed and predicted elevations of the highs and lows, and then scans these to locate the annual peaks. These annual peaks are used to fit an extreme value distribution, from which the 1% annual chance elevation can be found.

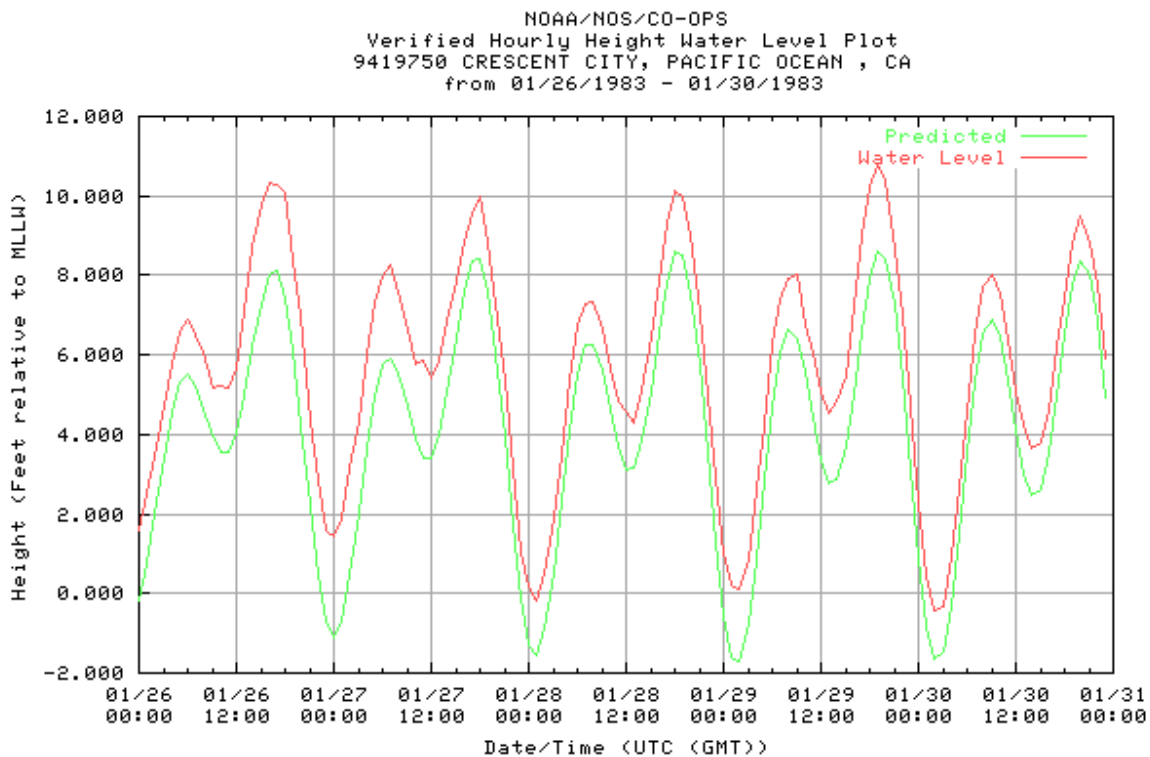

Figure D.4.4-12. Predicted and Observed Tides at Crescent City, California

As discussed in Subsection D.4.3.3, an acceptable approach is to adopt the Generalized Extreme Value (GEV) Distribution, and to determine the distribution parameters by the method of maximum likelihood. An example is shown in Section D.4.3. The Mapping Partner may consider other distributions and other fitting techniques although the particular result with the greatest likelihood value among all of the considered distribution types should be adopted, unless otherwise approved by the FEMA study representative.

This recommended procedure is based upon the annual maxima of the residual rather than the annual maxima of the raw data because the underlying astronomic tide is not a random variable, but is deterministic and is limited to a known maximum (less than or equal to the sum of the 37 tidal constituent amplitudes). For these reasons, it is not appropriate to extrapolate the bounded and deterministic portion of the record out to the upper tail of an unbounded distribution. Subsequent consideration of the combined effects of the separated tide and the residual still water can be made as discussed elsewhere.

Finally, it is emphasized that although this procedure is straightforward in concept, it can be complicated in practice. One complicating factor – changes in the tidal constituents over time – has already been mentioned. Another is the fact that tidal predictions are made with respect to tidal datums, and these may have changed over time, even when referenced to a fixed standard such as NAVD. Changes in the constituents are one source of datum shift, while changes in relative sea level (including sea-level rise and land subsidence) are another. The Mapping Partner

should carefully review the history of the tide gage, the history of the tidal datums, the history of the published constituents, and the local history of relative sea level to ensure that at each step, the residual is properly defined.

D.4.4.2.3 Surge

D.4.4.2.3.1 General Considerations

Storm surge is the rise of the ocean surface that occurs in response to barometric pressure variations (the inverse barometer effect) and to the stress of the wind acting over the water surface (the wind setup component). Wave setup is excluded by this definition. Setup is not incorporated in the established procedures for storm surge modeling, nor is it present to a significant degree in tide gage data owing to the typical configuration of gages with respect to the zone of large setup; consequently, it must be taken into account separately as discussed in Subsection D.4.5.1.

Storm simulation models must be capable of adequately prescribing and implementing wind, pressure, and tidal boundary conditions into the physics of the model if the model-generated spatial and temporal distribution of surge and circulation are to be physically realistic. Models of differing complexity are in wide use, including 1-D and 2-D models. The Mapping Partner should consult FEMA's list of approved models to select an appropriate model for a given study. Should a model that is not on the list appear advantageous, the Mapping Partner shall discuss the possibility of its use with the FEMA study representative.

Guidance for complex 2-D modeling is best obtained from the user's manual for a particular model. However, to aid the Mapping Partner in model selection, a supporting document (*Surge Modeling Overview*) has been prepared as a supplement to these guidelines. It briefly addresses storm surge modeling from a numerical hydrodynamic perspective, so a Mapping Partner can evaluate the adequacy of candidate storm surge models. The discussion can help the Mapping Partner assess strengths and weaknesses of programs and assist in the selection of an appropriate model by identifying important model features and capabilities.

It is recognized, however, that surge on the Pacific Coast is relatively small compared to wave effects and to surge on the Atlantic and Gulf coasts. Consequently, a complex and expensive 2-D modeling effort should seldom be necessary, and should be considered only after discussion with the FEMA study representative. The simpler 1-D surge modeling method discussed in the following section is usually adequate for the Pacific Coast.

D.4.4.2.3.2 Simplified 1-D Surge Modeling

The generally narrow continental shelf and the lower winds that prevail on the Pacific Coast result in a lesser wind-induced surge than on the Atlantic and Gulf of Mexico coastlines, which are attacked by hurricanes. Consequently, satisfactory estimates of open coast surge on the Pacific can usually be obtained using methods far simpler than the full 2-D approach. There are several reasons a Mapping Partner might wish to make such estimates: the Mapping Partner may wish to determine SWL in regions where an absence of tide gage data makes it impractical to extract still water data from the tide residual; the Mapping Partner might wish to compare the surge level from a wind of a certain magnitude with the 1% annual chance wave event; or the 1%

annual chance wave event might be accompanied by strong onshore winds and the Mapping Partner might wish to include this contribution or to evaluate the significance of neglecting it.

For such purposes, a computer program (BATHYS) has been developed based on the so-called Bathystrophic Storm Tide (BST) theory formulated originally by Freeman, Baer, and Jung (1954). The BST theory accounts for the onshore component of wind stress and the Coriolis force associated with the Earth's rotation. The assumptions of the model are that the onshore forces are in static balance; however, the longshore component includes inertia and requires some time to achieve a balance. A user's manual describing the program and its use in much greater detail is available separately.

The System of Interest and Governing Equations

The system of interest is shown in Figure D.4.4-13. A wind with speed W is directed at an angle, θ , to the x -axis that is parallel to the shoreline. The surge distribution is $\eta(y)$, where y is the cross-shore direction. The wind obliquity induces a mean current, $U(y,t)$, which varies with time, t .

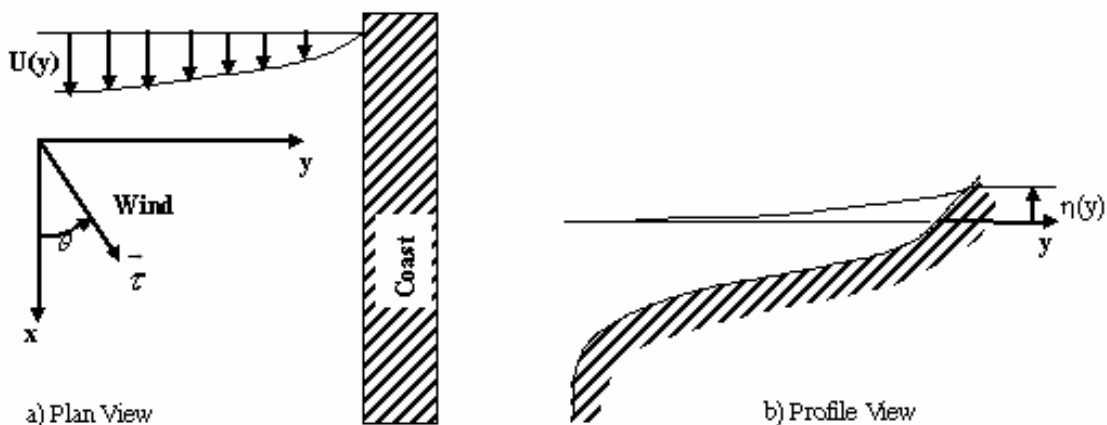

Figure D.4.4-13. Definition Sketch for the BST Formulation

The governing equations are:

y Direction

$$\frac{\partial \eta}{\partial y} = \frac{1}{g} \left(\frac{n\tau_y}{\rho(h+\eta)} - f_c U \right) \quad (\text{D.4.4-22})$$

x Direction

$$\frac{\partial U}{\partial t} = \frac{1}{h+\eta} \left(\frac{\tau_x}{\rho} - \frac{fU^2}{8} \right) \quad (\text{D.4.4-23})$$

In these equations, n (≈ 1.05 to 1.1) is a factor that augments the onshore component of the wind stress, τ_y , to account for the bottom frictional effect because of return flow; τ_x is the longshore component of wind stress; ρ is the mass density of water (≈ 1.99 slugs/ft³); and f_c is the Coriolis coefficient ($= 2\Omega \sin\phi$) where Ω and ϕ are the rotational speed of the Earth in radians per second and latitude, respectively. The quantity f is the Weisbach Darcy friction factor (≈ 0.08 to 0.16).

The longshore and onshore components of the wind stress are specified in terms of a wind stress coefficient, k , and the wind direction, θ , relative to a shore normal

$$\begin{cases} \tau_x \\ \tau_y \end{cases} = \begin{cases} \cos \theta \\ \sin \theta \end{cases} k |W| W \quad (\text{D.4.4-24})$$

where the wind stress coefficient, k , is that developed by Van Dorn (1953):

$$k = \begin{cases} 1.2 \times 10^{-6}, & |W| \leq W_c \\ 1.2 \times 10^{-6} + 2.25 \times 10^{-6} \left(1 - \frac{W_c}{|W|}\right)^2, & |W| > W_c \end{cases} \quad (\text{D.4.4-25})$$

Program Input and Output

The input quantities to the program are the bathymetry along the shore normal transect, $h(y)$, and the wind speed and direction, $W(t)$ and $\theta(t)$, which can be specified so as to vary linearly with time between specified pairs of wind speeds and directions at selected times. The output of the program is the wind surge at the shore, η_s , as a function of time. To incorporate the effects of astronomic tide, the program permits specification of a time-dependent condition at the seaward boundary of the transect.

Because the longshore current varies as a function of time, the surge, η_s , also varies with time. This reflects the contribution of the Coriolis force; for fixed wind conditions, the surge approaches a constant value as the longshore current approaches its constant equilibrium value for a given wind speed and direction.

The program is extremely efficient and easy to use, with minimal input requirements. The necessary bathymetric data can be obtained from available charts, and wind data can usually be extracted from the GROW database, which includes wind speed and direction over a GROW cell at 3-hour intervals for the duration of the record. The wind values are representative of the entire cell; if finer resolution is thought to be needed (for example, to account for sheltering), then the Mapping Partner should attempt to obtain supplementary wind data from the National Weather Service (NWS), local airports and agencies, and so forth. Tide boundary condition data can be obtained from tide tables, from the NOAA website, or using the NOAA prediction program, NTP4.

A second simplified tool, the DIM program discussed in Section D.4.5, is also available. It was developed especially for the computation of setup over a shore normal transect similar to that used here by BATHYS. DIM requires additional input, however, because its primary purpose is wave setup simulation. The user's manuals for these programs should be consulted for additional details and examples of use.

D.4.4.2.3.3 Surge Estimation from Tide Data

A procedure was outlined in Subsection D.4.4.2.2.4, to extract the total still water, exclusive of astronomic tide, from a tide gage record. It is in general difficult or impossible to distinguish among the several components of the residual, including surge, and there is usually no need to do so. Consequently, the tide residual methodology can be considered equivalent to the estimation of surge from tide data, for all practical purposes. What one generally wants is the 1% annual chance level of the total flood, irrespective of mechanism.

D.4.4.2.4 Water Levels in Sheltered Waters

D.4.4.2.4.1 Overview

Water levels and wave propagation in sheltered waters may be influenced by a variety of factors that can alter coastal flood characteristics. Incoming storm surge and the resulting extreme still water elevations along the shorelines of sheltered waters may achieve higher elevations than at adjacent open coast locations owing to channelization and tidal amplification controlled by the orientation, geometry, and bathymetry of the basin; lower elevations may occur if restrictive tidal inlets impede the incoming tide. Small basins may also experience higher water levels from the contributions of direct precipitation and runoff, or from resonant basin oscillations called *seiche*.

Recorded tide elevations may require transposition from the tide gage to a flood study site within sheltered waters, to better represent the local still water elevation during the 1% annual chance flood event. Guidance for evaluating and applying tide gage data to ungaged locations is provided in this subsection.

As waves propagate into sheltered water from the open coast, additional wave transformations may occur. Tidal inlets are a significant feature that controls the entry and propagation of waves into inland waters; guidance is provided on inlet characteristics and effects. Other characteristics of sheltered waters that may lead to additional wave transformations include, but are not limited to, the presence of tidal and fluvial currents, channel shoaling, navigation structures, and vegetation.

In general, detailed numerical modeling may be the most appropriate method for estimating water levels and wave transformations in these complex coastal settings. However, simpler techniques may be used if small-scale localized effects do not lend themselves to large-scale modeling, or if the Mapping Partner wishes to make preliminary estimates of the relative importance of processes before proceeding to more detailed evaluations.

D.4.4.2.4.2 Variability of Tide and Surge in Sheltered Waters

As a very long wave such as surge or tide propagates through a varying geometry, its amplitude changes in response to reflection, frictional damping, variations in depth causing shoaling, and variations in channel width causing convergence or divergence of the wave energy. In general, these changes are best investigated through application of 2-D long wave models. However, it may be possible to adopt simpler procedures that can provide sufficient accuracy for much less time and cost.

In some cases, tide data may have to be transposed from a gaged site to an ungaged site. If a sheltered water study site is located in the immediate vicinity of a tide gage, the Mapping Partner can use data from the gage without adjustments, but if the study site is distant from the tide gage, the tide data may need to be adjusted so as to reasonably represent the site. It is emphasized that “Considerable care must be exercised in transposing the adjusted observed [tide] data to a nearby site since large discrepancies may result” (USACE, 1986). Although transposition of historic tide data from a nearshore tide gage out to an open coast location is much simpler and so preferable to its transposition farther inland, there remains a need for reasonable methods to estimate the variation of inland tidal elevations in ungaged regions of sheltered waters.

Some simple empirical evidence may permit an approximate evaluation of these variations:

- Established tidal datums from multiple gages in the sheltered area reflect the natural variation of tide elevations; interpolation between gages gives a first-order estimate of spatial variation.
- The normal vegetation line may provide additional information between gages, insofar as it mirrors the general variation of the normal tidal elevation.
- Similarly, observed debris lines and highwater marks from historical storms may illustrate the variation of storm surge within the sheltered geometry, outside the surge generation zone.

Tides and storm surges propagating into sheltered water areas undergo changes controlled by frictional effects and basin geometry. The Mapping Partner must evaluate the differences between the physical settings of the nearest tide gage(s) and the study site, and the distance and hydraulic characteristics of the intervening waterways between these locations to establish a qualitative understanding of the potential differences in tidal elevations between the gaged and ungaged locations. If flood high water marks are available in the vicinity of the ungaged sheltered water study site, these elevations shall be compared to recorded tide elevations to correlate surge components of the tidal still water between locations. In general, surge data are of more limited availability than tide data. It may sometimes be reasonable to assume similarity between surge and tide, and so infer surge variation from known tide variation. The validity of such inference is limited, however, by differences in amplitude and duration of high water from the two processes, and by the fact that tide is cyclic and so may not vary in the same manner as a single surge wave.

Both empirical equations and numerical models can be used to describe the variation of tides and surges propagating into sheltered water areas. The Mapping Partner shall select the most

appropriate approach for the study, with consideration for the location of the study site within the sheltered water body, the complexity of the physical processes, and the cost of a particular approach. Appropriate numerical models can range from simple 1-D models to complex 2-D models. The Mapping Partner shall thoroughly evaluate the limitations and capabilities of appropriate models in view of the site-specific issues that need to be resolved to obtain reliable estimates of tidal flood elevations.

For simple tidal inlet settings, or as a first approximation before detailed numerical modeling, Mapping Partners may use analytical methods provided in the CEM (Chapter II-6-2(b)) to estimate bay tide amplitudes. Guidance for estimating the associated inlet parameters is also provided in the CEM. Examples provided in the CEM are limited to estimating the predicted astronomical tide amplitude in a small bay based on an adjacent open coast tide range obtained from tide tables. These CEM methods may also be applied in a two-step process to transpose recorded tide gage data (still water elevations) from one bay to another nearby unged sheltered water body as follows:

1. Apply the CEM methods and nomograms in reverse to estimate the adjacent open coast annual maximum still water elevations (astronomical tide elevation plus storm surge height) based on recorded still water elevations from a primary tide gage in the sheltered water body closest to the flood study site. The physical setting of a primary tide gage may be such that recorded tide elevations are representative of open coast tide elevations; however, this condition should not be assumed.
2. Using the estimated open coast tide elevation, reapply the CEM methods and nomograms (in forward mode) to estimate the associated annual maximum still water elevations in the unged sheltered water body where the study site is located. Use of the same open coast still water elevation between the gaged and unged sheltered water areas is acceptable if it can be assumed that the annual extreme still water elevations are generated from regional storm systems large enough in spatial extent to encompass the two locations.

When tidal elevations are to be established in an unged sheltered water body, it is recommended that a limited tidal monitoring program be undertaken to estimate tidal datums near the study site. NOAA (2003) provides guidance on methods and computational techniques for establishing tidal datums from a short series of record. The accuracy of the resulting datums on the West Coast can range from 0.13 foot for a one-month series of data to 0.06 foot for a 12-month series (NOAA, 2003); a short-term effort will usually be entirely adequate for use in a FEMA FIS.

The complex shorelines and bathymetry of sheltered waters may lead to significant changes in tide characteristics. The objective of short-term monitoring should be to provide observed data from which tidal datums may be estimated to check the accuracy of subsequent higher elevation estimates of extremal still water elevations in unged sheltered water areas and, in turn, to increase the level of confidence in the resulting flood hazard elevations.

Irrespective of the approach taken, the Mapping Partner shall evaluate the physical setting of the tide gage(s) from which data are used. Observation of the gage setting may provide insight to the

relative degree of sheltering or other characteristics of a given tide gage. Information on NOAA tide gages can be obtained from the Internet at <http://www.co-ops.nos.noaa.gov/usmap.html>. Mapping Partners shall also determine if a tidal benchmark has been established near the flood study site (<http://www.co-ops.nos.noaa.gov/bench.html>). Tidal benchmarks are elevation reference points near a tide gage to which tidal datums are referenced. Some tidal benchmarks are now tied to the NAVD88, or to the earlier NGVD29, providing an appropriate vertical elevation reference. Benchmark elevations may become invalid over time if changes occur in local tide conditions because of dredging, erosion, or other factors (NOAA, 2000a); the Mapping Partner shall review the publication date of the data together with information concerning any recent changes in the vicinity of the tide gage setting to ensure the data are accurate.

If the physical setting and tidal processes of a coastal flood study site are particularly complex and the application of the simple methods described in the CEM are questionable, the Mapping Partner is encouraged to consult with the NOAA NOS <http://co-ops.nos.noaa.gov/index.html> for further guidance on estimating tidal and surge elevations at ungaged sites (USACE, 1986).

Tidal Inlets

Tidal inlets control the movement of water between the open coast and adjacent sheltered waters. Inlets may be broadly classified as unimproved (natural) or improved (maintained). The physical opening of a tidal inlet, whether natural or maintained, has a direct and often significant effect on the propagation of tides, surge, and waves into sheltered waters and on subsequent coastal flood conditions. The Mapping Partner shall review the CEM Section II-6-2 on inlet hydrodynamics for comprehensive guidance on data, methods, and example problems related to the behavior of tidal inlets.

Seiching

Seiche is a standing wave oscillation occurring in enclosed or semi-enclosed basins, which may be generated by low frequency incident waves or atmospheric pressure fluctuations; seiching may also be called harbor oscillation, harbor resonance, surging, sloshing, and resonant oscillation. It is usually characterized by wave periods ranging from 30 seconds to 10 minutes, determined by the characteristic dimensions and depth of the basin (CEM, 2003).

The amplitude of seiche is usually small; the primary concern is often with the associated currents that can cause large excursions and damage to moored vessels if resonance occurs. However, surface elevations and boundary flooding in an enclosed basin may become pronounced if the incoming wave excitation contains significant energy at the basin's natural seiche periods. The Mapping Partner shall investigate the likelihood of seiche under extreme water-level and wave conditions. Bathymetry, basin dimensions, and incoming wave characteristics should be reviewed to determine the potential for seiching; the CEM (Section II-5-6) provides background and guidance for estimating the natural periods of open and closed basins. Numerical models are most appropriate for evaluating the effects of long waves in enclosed basins and shall be considered for use in a sheltered water study if seiching is believed to have the potential to contribute significantly to boundary flooding during the 1% annual chance flood condition.

D.4.4.2.4.3 Documentation

The Mapping Partner shall document the characteristics of all gages located within or near the study area. Methods adopted to infer the variation of tidal datums between gages shall be documented, as shall procedures used to transpose data from one site to another. If a brief field effort is undertaken to determine the variation of tidal datums within ungaged regions, the Mapping Partner shall fully document that effort, including: locations of observations; observation methods and instrumentation; dates and times of all observations; meteorological and oceanographic conditions during and preceding the period of observation; and other factors that may have had an influence on water levels, or may affect interpretation of the results. If surge variation is inferred from tide variation, the Mapping Partner shall document the basis for similarity assumptions, and the manner in which the inferences were made. Inlet analyses should be documented including all procedures, methodological assumptions, field surveys (dates, times, procedures, instrumentation, and findings), and all inlet data adopted from other sources.

D.4.4.2.5 Water Levels During El Niños

The El Niño/La Niña process produces substantial variation in SWLs along the Pacific Coast, with anomalies persisting for long periods. These variations are the result of large-scale oceanographic changes associated with changes in the equatorial trade wind patterns. The result of interest here is the creation of very large-scale non-tidal sea-level fluctuations extending over oceanic distances.

As summarized in a supporting document for these guidelines prepared by Komar and Allen (2004), El Niño conditions begin with the periodic cessation of the Pacific trade winds, allowing the sea surface slope to change, and producing an eastward flow of warm water along the equator. Upon reaching the South American coast, this flow splits into components traveling both north and south, affecting the entire Pacific Coast as far north as Alaska. Eventually, tradewind conditions reestablish in the Pacific and conditions reverse, initiating the La Niña phase.

The time scale of these processes is indicated in Figure D.4.4-14 in which the Multivariate ENSO Index (MEI) is a derived unit incorporating multiple meteorological parameters related to El Niño variation; the shaded band represents the threshold for event identification.

The significant El Niños of 1982 and 1997 are evident; these events raised water levels along the Pacific Coast by 1 to 2 feet in some areas, persisted for long periods, and contributed to extreme erosion at many sites (see Komar and Allen, 2004, for a survey of those effects).

The contribution of the El Niño process to the statistics of still water is thought to be fully reflected in tide gage data, and so forms a portion of the tide residual discussed earlier. Still water estimates derived from tide gage data can be assumed to properly reflect this process, although it has been pointed out that tide predictions may contain a portion of El Niño effect because the tidal constituents are determined empirically. Nevertheless, the Mapping Partner shall consider how specific El Niño/La Niña episodes might affect interpretation of the historical record, and how particular data observed during the El Niño/La Niña extremes should be interpreted.

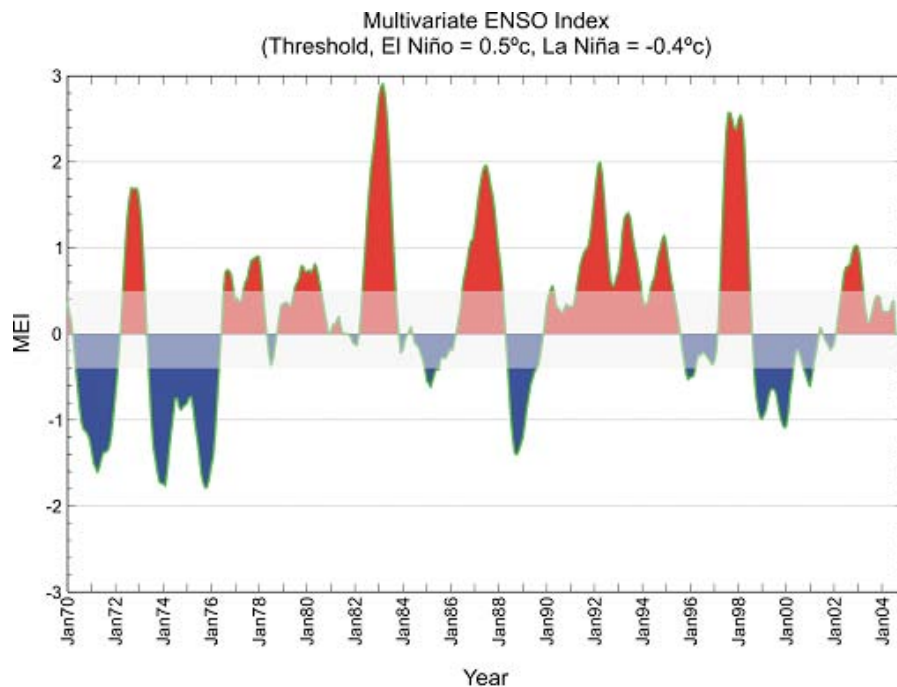

Figure D.4.4-14. El Niño Fluctuations since 1970 (Komar and Allen, 2004)

D.4.4.2.6 1% Annual Chance Still Water Levels

The 1% annual chance flood on the Pacific Coast is seldom the result of still water alone; other processes such as wave runup or tsunamis ride atop the still water, which serves as a base. The exception might be well-sheltered areas, protected from waves and affected only by the high SWLs associated with tide, surge, and El Niño fluctuations; even in such areas, however, the total 1% flood level may include a physically independent contribution from rainfall runoff.

Consequently, there are two aspects of still water statistics for a Mapping Partner to consider: What is the 1% annual chance SWL at a site? How does still water contribute to the total 1% level? Even if it is known that the BFE at the study site is determined by wave runup, for example, the former question may not be irrelevant, and the Mapping Partner may need to estimate the 1% SWL separately from the higher BFE.

Three distinct still water components can be identified: astronomic tide, El Niño fluctuations, and storm surge (wind and pressure setup). A fourth still water component is important, but is not the result of coastal processes as are the others. This is the superelevation of tidal waters associated with rainfall runoff. The riverine 1% flood profile along a tidal river typically begins near MHW or MHHW at the mouth, and rises as one proceeds upstream. Although the riverine flood level along the lower reaches of the tidal river is considered to be physically unrelated to coastal flood processes, the final flood mapping must represent the contributions of both mechanisms. Consequently, the rainfall runoff excess elevation may be considered a fourth type of coastal still water elevation.

The following subsections address methods by which the statistics of each still water type may be determined, and also give an overview of the ways in which the statistics of combined processes can be addressed.

D.4.4.2.6.1 Tide Statistics

The astronomic tide is a deterministic process. Consequently, tide statistics can be generated directly from the local tidal constituents. One simple way to do this is to sample the predicted tide at random times throughout the tidal epoch. Alternatively, predictions can be used to obtain highs and lows, from which corresponding statistics can be derived. It is noted that the maximum possible tide is given simply by the sum of the amplitudes of the 37 tidal constituents.

D.4.4.2.6.2 Surge Statistics

The development of surge statistics can be approached in two general ways. First, if sufficient data are available from tide gage records, then an extremal analysis of the residual after subtraction of the astronomic tide can be performed. As noted above, this requires determination of the annual peak residuals for the period of record, and a fit to a GEV distribution using the method of maximum likelihood (or an alternate method if appropriate). The Mapping Partner should keep in mind that the 1% level determined in this way will include the contributions of all mean water components affecting the gage, including the El Niño fluctuation, static wave setup to the degree it exists at the gage site, and riverine rainfall runoff.

The second way in which surge 1% levels are determined is through numerical modeling of surge elevation using 1-D or 2-D models, as discussed above, combined with a statistical model relating the surge simulations to storm frequency and storm parameter distributions. Three ways of doing this have been used: the Joint Probability Method (JPM), which has been used in many FISs on the Atlantic and Gulf coasts in combination with the FEMA Storm Surge Model; the more recent Empirical Simulation Technique (EST), which has been used in combination with the ADCIRC model for recent studies; and a Monte Carlo approach, which has been used for coastal setback determinations in the State of Florida, and which is particularly suited for use with the 1-D surge model, BATHYS, described previously. Because the surge levels on the Pacific Coast are generally small compared to the Atlantic and Gulf coasts, it is not expected that JPM and EST studies with large 2-D surge models are often necessary. The 1-D BATHYS model with Monte Carlo simulation, or – more directly – with direct simulation of the wind record using, say, GROW data, should be adequate in most cases. Brief descriptions of the JPM, EST, and Monte Carlo methods are given in Section D.4.3.

For Pacific Coast applications, an alternate method of 1% surge estimation may be considered; it is the most straightforward and simplest method of all. This is to perform a direct simulation of the local wind record using available wind data, such as the GROW data, for example, which specifies wind speed and direction at 3-hour intervals over the entire record of more than 30 years. This is a feasible task owing to the efficiency of the 1-D BATHYS model (or the alternative DIM model discussed in Section D.4.5).

Tide can be very simply accounted for by adopting the predicted tide as the offshore boundary condition. For each year of simulation, the peak surge should be stored; an extremal analysis using these annual peaks then gives the required surge statistics.

Use of this approach should be first approved by the FEMA study representative. Some small revision of the 1-D model could be made to read both wind and tide (for arbitrarily long durations) from separate input data files, and to automatically store annual peaks for the

frequency analysis. As with the storm-by-storm simulation, the Mapping Partner shall make a critical assessment of the wind data before considering this approach. GROW data are representative of a relatively large cell and may not reflect important local factors such as sheltering by islands; other, more local, data may be required.

D.4.4.2.6.3 El Niño Statistics

No separate account of El Niño statistics is suggested. The pertinent El Niño effects are embedded in available data, such as tide gage still water data (incorporating the effect of El Niños on ocean level) and GROW wave data (incorporating the meteorological effects), and so will be automatically taken into account for in any analyses made using those data resources. For most purposes, the El Niño contribution may be assumed to be part of the surge estimate obtained from the tide gage residuals.

D.4.4.2.6.4 Combined Effects: Surge Plus Tide

The simulation of storm surge is usually performed over water depths representing mean conditions, or some other fixed level. The 1-D Monte Carlo approach in which tide is incorporated as a time-dependent boundary condition is an exception.

Because tide is ubiquitous, the flood level associated with storm surge must be based on the combined surge-plus-tide levels. Four approaches of differing complexity are mentioned here.

First, if the surge and tide can be assumed to combine linearly (that is, neither is physically altered by the presence of the other), then the simplest method is to simply add them in some manner. If a surge episode is relatively long compared with a tidal cycle, then high tide will be certain to occur at some time for which the surge is near its peak, and a simple sum of amplitudes may be sufficiently accurate.

However, if the surge duration is short, this approximation is inadequate. The next simplest assumption, still assuming linear superposition, is based on the fact that the probability density function for a sinusoid is largest at its extrema – tide is generally near a local high water, or near a local low water, and spends more time near those values than in between. It may be reasonable, then, to assume that the peak surge occurs with equal probability near a high tide or near a low tide, taking mean high and mean low as representative values. Each of the corresponding elevation sums would be assigned 50% of the rate associated with the particular storm (as if each storm were to occur twice, once at high tide and once at low tide), and the frequency analysis would proceed with these divided rates.

A third, slightly more accurate approach but still assuming physical independence, is based on the convolution method mentioned in Section D.4.3. In this method, the probability density functions for both tide and surge without tide are used. Previous discussion has shown how both of these may be established. If the probability density of the tide level Z is denoted by $p_T(Z)$ and the probability density of the surge level is $p_S(Z)$, then the probability density of the sum of the two is given by:

$$p(Z) = \int_{-\infty}^{\infty} p_T(T)p_S(Z-T) dT = \int_{-\infty}^{\infty} p_T(Z-S)p_S(S) dS \quad (D.4.4-26)$$

where the indicated integrations are over all tide and surge levels.

In some cases, however, the essential assumption that the tide and surge can be linearly added is not satisfied. In shallow water areas extending a large distance inland, the enhanced depth associated with tide (or surge) affects the propagation and transformation of the surge (or tide). That is, there is a nonlinear hydrodynamic interaction between the two. In such a case, more complex methods are required because the nonlinear interaction can only be taken into account by hydrodynamic considerations, not by any amount of purely statistical effort. Two approaches to this issue have been adopted in study methods already identified. The FEMA storm surge methodology adopts a procedure in which a small number of storms are simulated around a set of tide assumptions with differing amplitudes and phases. These additional simulations are used to provide guidance for simple adjustments that are made to the large set of computations performed on MSL. The EST approach treats astronomic tide (amplitude and phase) as additional input vector components, which are incorporated into the hydrodynamic model as part of the boundary conditions. The 1-D Monte Carlo approach includes tide as part of the surge simulation and so does not require a separate step to combine the two.

Should the Mapping Partner be required to perform 2-D surge modeling (for example, in sheltered waters), it will be necessary to consult the user's manuals or other documentation of the adopted models to obtain additional guidance on this topic.

D.4.4.2.6.5 Combined Effects: Surge Plus Riverine Runoff

The final instance of combined still water frequency to be described concerns the determination of the 1% SWL in a tidal location subject to flooding by both coastal and riverine mechanisms. This is the case in the lower reaches of all tidal rivers.

The simplest assumption is that the extreme levels from coastal and riverine processes are independent, or at least widely separated in time. This assumption is generally acceptable because the storms that produce extreme rainfall and runoff may not be from the same set as the storms that produce the greatest storm surge. Furthermore, if a single storm produces both large surge and large runoff, the runoff may be significantly delayed by the time required by overland flow, causing the runoff elevation to peak after the storm surge. Clearly, there may be particular storms and locations for which these assumptions are not true, but even so they are not expected to be so common as to strongly influence the final statistics. If, for a steep terrain area of the Pacific Coast, it is thought that peak runoff and peak surge may commonly coincide owing to local conditions, then the Mapping Partner must consider the likely correlation between the two, and discuss with the FEMA study representative whether a departure from the method given here should be used.

The procedure is straightforward, beginning with development of curves or tables for rate of occurrence vs. flood level for each flood source (riverine and coastal). Rate of occurrence can be assumed equal to the reciprocal of the recurrence interval, so the 100-year flood has a rate of occurrence of 0.01 times per year. This is numerically equal to what is more loosely called the

flood elevation probability. Then one proceeds as follows at each point of interest, P, within the mixed surge/runoff tidal reach.

1. Select a flood level Z within the elevation range of interest at point P.
2. Determine the rates of occurrence $R_{P,R}(Z)$ and $R_{P,S}(Z)$ of rainfall runoff and storm surge exceeding Z at site P (number of events per year).
3. Find the total rate $R_{P,T}(Z) = R_{P,R}(Z) + R_{P,S}(Z)$ at which Z is exceeded at point P, irrespective of flood source.
4. Repeat steps (1) through (3) for the necessary range of flood elevations.
5. Plot the combined rates $R_{P,T}(Z)$ vs Z and find $Z_{P,100}$ by interpolation at $R_{P,T} \approx 0.01$.
6. Repeat steps (1) through (5) for a range of sites covering the mixed tidal reach.
7. Construct the 100 year composite profile passing through the several combined 100-year elevation points, and blending smoothly into the pure-riverine and pure-surge 100-year profiles at the ends of the mixed reach.

The procedure is shown schematically in Figure D.4.4-15, in which the combined curve has been constructed by addition of the rates at elevations of 6, 8, 10, and 12 feet. The entire procedure can be implemented in a simple calculator program, with the input at point P being the 10-, 50-, 100-, and 500-year levels for both runoff and surge, as obtained from standard FIS tables.

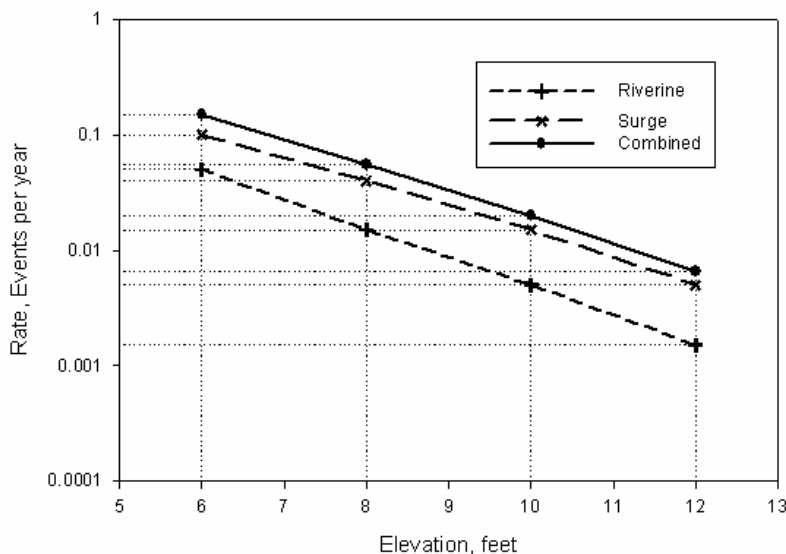

Figure D.4.4-15. Schematic Illustration of Riverine and Surge Rate Combination

D.4.4.2.7 Non-Stationary Processes

Conceptually, a *stationary process* may be thought of as one that does not change in its essential characteristics over time; its descriptors are fixed or stationary. For example, a stationary random process would be one for which its mean, standard deviation, and other moments are unchanging over time. A non-stationary process is one for which these measures do change. Whether a fluctuating process is thought to be, or appears to be, non-stationary can depend upon the time window through which it is viewed. Processes that appear to display definite non-stationary trends when viewed at a short scale, may be seen to fluctuate around an unchanging mean when viewed from a more distant perspective. For example, the tide appears non-stationary when viewed over a period of one hour, but appears entirely stationary when viewed over an entire tidal epoch.

The appropriate time window for FISs is established by the period of record covered by the available hydrologic data on the one hand, and the probable lifetime of a particular study, on the other. Consider El Niños, discussed above. Viewed for a period of a small number of months or years, the El Niño phenomenon appears to be a decidedly unsteady process during which ocean levels rise, and other environmental changes occur. However, when seen at a scale of about 15 years or more, the El Niño variations appear to be more or less steady fluctuations, mirrored by the opposite La Niña phases, and showing no evident non-stationary trends. Examining observations over a short interval, say 5 years or less, may require recognition of a temporary lack of stationarity, whereas a record covering multiple cycles of El Niño, such as long-term tide gage data and the GROW wave data, may properly reflect the effects of the fluctuation, without requiring any special consideration of non-stationarity. This is characteristic of time series: it is difficult or impossible to discern whether an observed change is the result of a trend or is merely a temporary fluctuation.

For practical FIS considerations, two sorts of non-stationarity seem significant. The first is the apparent change of sea level, which has been observed on all coasts. Because it is sea level relative to land that is most significant, an apparent change of sea level can be the result of either sea-level rise, or land subsidence.

The second type of non-stationarity that is important for coastal studies is the long-term change in tidal datums, which may occur as basins evolve through silting, dredging, migration and evolution of inlets, human construction including harbor improvements and breakwaters, and so forth. Both types are discussed below.

D.4.4.2.7.1 Relative Sea Level – Sea-level Rise

Sea level rise appears to be a real, long-term effect observed all along the U.S. coastline. For the majority of the Pacific Coast, the rate of rise is between 0 and 3 millimeters per year, or up to about 1 foot per century; see, for example, data available from NOAA at its website <<http://tidesandcurrents.noaa.gov/sltrends/sltrends.shtml>>. The Philadelphia District of the USACE maintains a useful collection of sea-level rise links at their website <http://www.nap.usace.army.mil/cenap-en/slr_links.htm>. There is also a very large set of sea-level trend data for individual stations along the Pacific Coast, which can be obtained from the referenced NOAA site.

The significance of such data is two-fold. First, the Mapping Partner must be aware of these changes to properly interpret historical data upon which new studies might be partly based. This has been discussed, for example, in a prior section on tides. Second, the likely continuation of these trends into the future will have some impact, although usually small, on the interpretation of today's Flood Insurance Rate Maps (FIRMs) at a future date. In particular, the Mapping Partner should consider the likely impact of sea-level rise on flood delineation, and document any unusual changes that might be anticipated.

D.4.4.2.7.2 Relative Sea Level – Land Subsidence

Land subsidence produces the same sort of effect as sea-level change – a rise in the apparent sea level – but subsidence might be much the more significant factor in a local area. For example, portions of the Sacramento-San Joaquin Delta have subsided by more than 15 feet since reclamation for agriculture began in the 19th century. Many areas in Southern California have subsided by several feet as a result of gas, oil, or water extraction over the past few decades.

Such large displacements make it imperative that historical data be interpreted with caution. The Mapping Partner must ensure that gage datums have been properly adjusted over time so that water-level records, benchmarks, observed highwater marks, and all similar data are properly interpreted.

The USGS is a primary repository of land subsidence data for the United States, and should be consulted to obtain local site information covering the entire period of study data that might be compromised by unrecognized subsidence. The USGS web pages may be searched for local subsidence information at <http://search.usgs.gov/>.

Other data sources may be more helpful in some cases. The Mapping Partner should consult with local city and county engineering departments, and with the local professional surveying community, which may be aware of isolated subsidence issues not reflected in national programs.

D.4.4.2.7.3 Astronomic Tide Variation

Tide datums and tidal constituents may change over time owing to changes in the geometry of a tidal basin, so tide may also constitute a non-stationary process. This makes it imperative that tide predictions for prior years be made using tidal constituents appropriate to that time, and that tidal data be adjusted as necessary for shifts in tidal datums with respect to a fixed datum such as NAVD or NGVD. The NOAA website can provide predictions for past times, but all such predictions are made using the current default set of constituents, and so may inaccurately portray past tide levels and datums. Archived copies of tidal constituents can be obtained from NOAA by special request. Flexibility in applications such as these makes it wise to use a tide prediction program such as NOAA's own program, NTP4.

D.4.5 Wave Setup, Runup, and Overtopping

This section provides methodology for establishing the static and fluctuating water-level characteristics in the nearshore including wave setup, runup, and overtopping of sandy beaches and natural or constructed barriers. Additionally, procedures for calculating attenuation of waves propagating over flooded areas, including dissipative bottoms and through vegetation, are presented.

D.4.5.1 Wave Setup and Runup

D.4.5.1.1 Introduction

The wave, meteorological, and bathymetric characteristics for the Pacific Coast are quite different from those on the Atlantic and Gulf coasts for which methodology to quantify the 1% chance water levels has been developed previously. The wave differences are due to the longer period waves and generally distant generation locations for the Pacific Coast whereas the meteorological differences are fewer hurricanes and thus lower winds. The major bathymetric differences are due to the relatively narrow Pacific Coast continental shelf widths. There are two major consequences of these differences for the 1% annual chance Pacific Coast hazards: (1) the wind surge component is relatively small due to the lower wind velocities coupled with the narrow shelf widths, and (2) the narrow spectra result in a substantial oscillating component of the wave setup with periods of tens to hundreds of seconds. Thus, the oscillating wave setup is a significant component of the total wave runup and a major contributor to coastal hazards on the Pacific Coast.

Wave setup and runup recommendations presented are based on a literature review, new developments, and comparison of available methods for quantifying these processes. Where possible, the most physics-based approaches have been identified and recommended.

D.4.5.1.2 Background, Definitions, and Approaches

Wave setup and runup contribute significantly to the damage potential of severe waves along the Pacific Coast. The total runup, R , includes three components: (1) static wave setup, $\bar{\eta}$, (2) dynamic wave setup, $\hat{\eta}$, and (3) incident wave runup, R_{inc} , i.e., conceptually:

$$R = \bar{\eta} + \hat{\eta} + R_{inc} \quad (D.4.5-1)$$

in which $\bar{\eta}$ and $\hat{\eta}$ are the magnitudes of the mean and oscillating wave setup components and R_{inc} the runup component due to the incident waves. In application, the two oscillating components ($\hat{\eta}$ and R_{inc}) are combined statistically to determine exceedance levels. Unless stated differently in this document, R refers to 2% runup conditions. The oscillating component of wave setup is a type of infragravity wave and is referred to here as *dynamic wave setup*. Each of the three components of total runup is defined and discussed below.

Wave setup is the additional elevation of the water level due to the effects of transferring wave-related momentum to the surf zone. Momentum is transferred from winds to waves in the wave-generating area (usually in deep water for the Pacific Coast) and then is conveyed to shore by the waves similar to the manner that waves transport energy from the generating area to shore; see Figure D.4.5-1. A main difference between energy and momentum is that energy is dissipated in the surf zone whereas momentum is transferred to the water column. This transfer is equivalent to a shoreward-directed “push” on the water column that causes a *tilt* of the water surface; see Figure D.4.5-2. The wave setup is small and negative seaward of the surf zone (*setdown*) and begins to rise in the surf zone due to the transfer of momentum; see Figure D.4.5-3. If only one wave of a constant height and period were present, the wave setup would be steady.

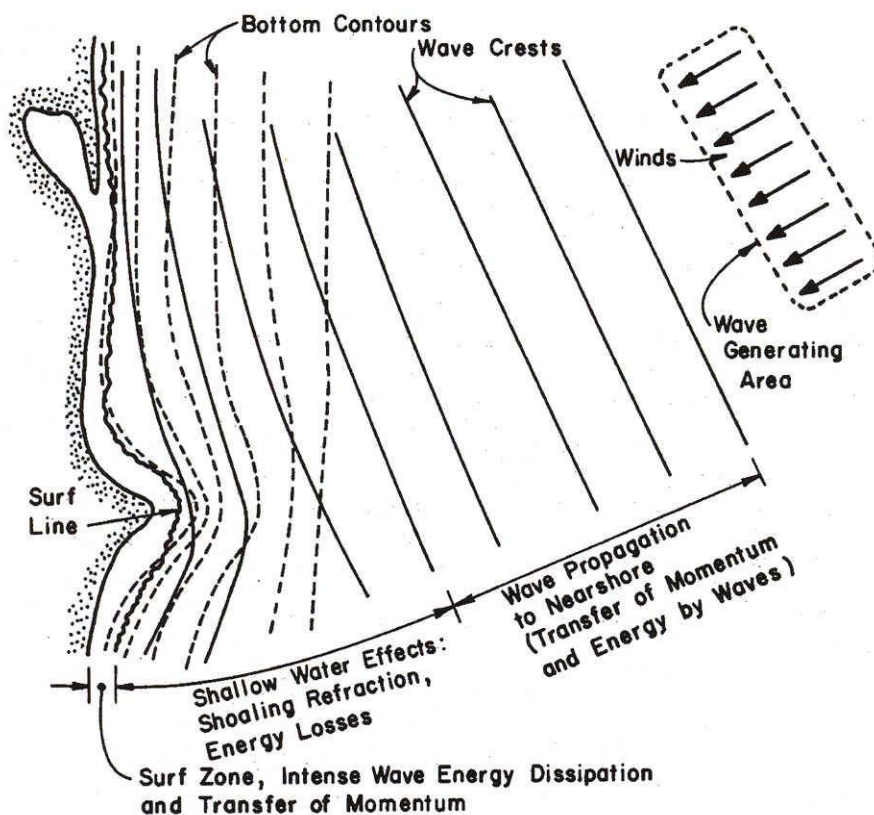

Figure D.4.5-1. Schematic of Energy and Momentum Transfer from Winds to Waves within the Wave-generating Area, and to the Surf Zone and Related Processes

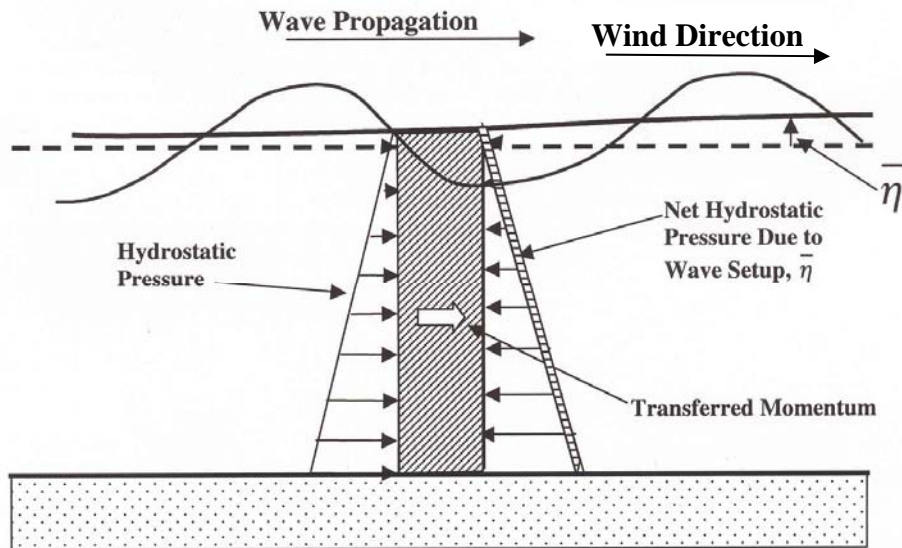

Figure D.4.5-2. Wave Setup Due to Transfer of Momentum

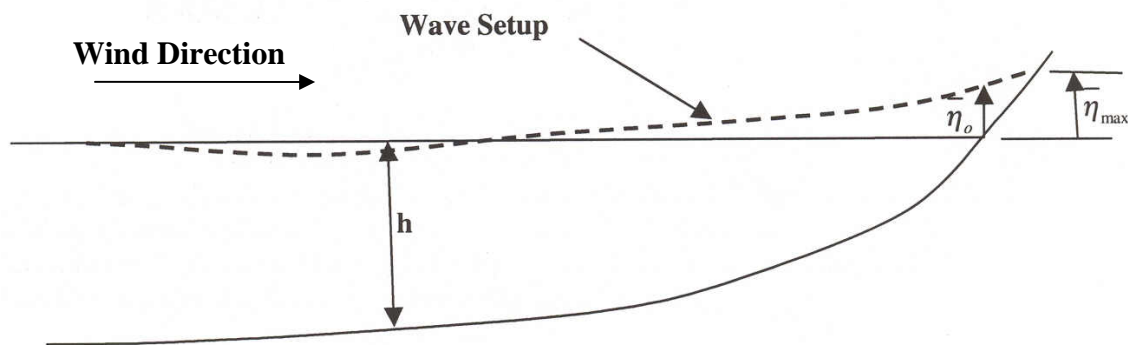

Figure D.4.5-3. Static Wave Setup Definitions at Still Water Level, $\bar{\eta}_o$, and Maximum Setup, $\bar{\eta}_{max}$

For a single wave component, the static setup, $\bar{\eta}(h)$, at any water depth, h , can be expressed as:

$$\bar{\eta}(h) = \left(-\frac{\kappa}{16} + \frac{(3/8)\kappa}{1+(3/8)\kappa^2} \right) H_b - \frac{(3/8)\kappa^2}{1+(3/8)\kappa^2} h \quad (D.4.5-2)$$

where κ is the ratio (assumed a constant) of the breaking wave height to water depth within the surf zone and h is the still water depth, i.e., the depth in the absence of waves or wave effects. The wave setup at the still water line, $\bar{\eta}_o$, and the maximum wave setup, $\bar{\eta}_{max}$, can be expressed from Equation D.4.5-2 in terms of the breaking wave height, H_b :

$$\bar{\eta}_o = \left(-\frac{\kappa}{16} + \frac{(3/8)\kappa}{1+(3/8)\kappa^2} \right) H_b \quad (D.4.5-3)$$

The equivalent expression for the maximum wave setup, $\bar{\eta}_{\max}$, is:

$$\bar{\eta}_{\max} = \left\{ \frac{\left(-\frac{\kappa}{16} + \frac{(3/8)\kappa}{1+(3/8)\kappa^2} \right)}{\left(1 - \frac{(3/8)\kappa^2}{1+(3/8)\kappa^2} \right)} \right\} H_b \quad (D.4.5-4)$$

For the usual value of $\kappa = 0.78$, the following relations result:

$$\bar{\eta}(h) = 0.189H_b - 0.186h \quad (D.4.5-5)$$

$$\bar{\eta}_o = 0.189H_b \quad (D.4.5-6)$$

$$\bar{\eta}_{\max} = 0.232H_b \quad (D.4.5-7)$$

More realistic wave-breaking models that account for the actual profile will usually reduce the wave setup for the relatively mild profile slopes of the Pacific Coast. For a wave system consisting of more than one wave component (i.e., a wave spectrum), the breaking wave height in the above expressions is replaced by the root mean square breaking wave height, $(H_b)_{rms}$. Of significance on the Pacific Coast is that for wave systems consisting of more than one wave component, the setup is oscillating consisting of a steady and a so-called *dynamic component*; see Figure D.4.5-4. The dynamic wave setup component is larger for narrower wave spectra and is substantial on the Pacific Coast during extreme storms and thus will require quantification for

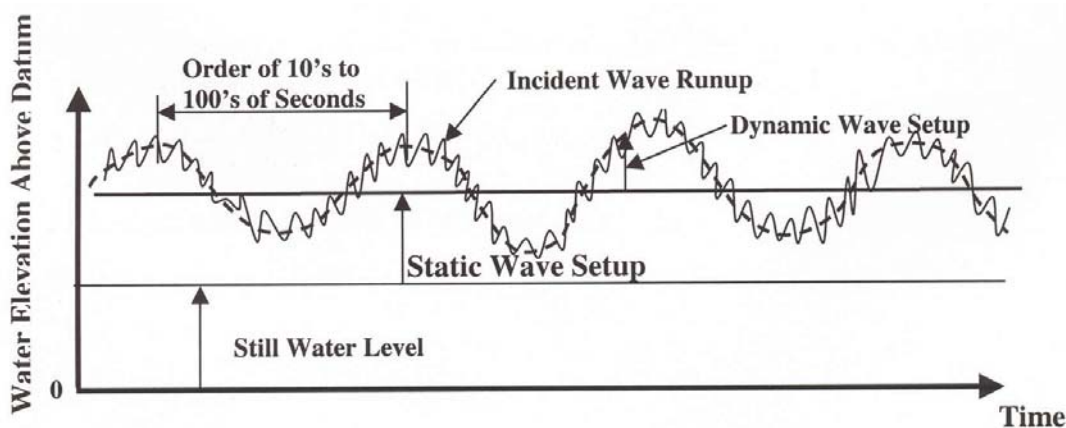

Figure D.4.5-4. Definitions of Static and Dynamic Wave Setup and Incident Wave Runup

flood mapping purposes. In addition to contributing to the total wave runup and thus the shoreward reach of the waves, dynamic wave setup can carry floating debris such as logs at high velocities and thus increase the hazards and damage potential in coastal areas. Figure D.4.5-4 illustrates the three components that define the upper limit of wave effects.

Incident wave runup on natural beaches or barriers is usually expressed in a form originally due to Hunt (1959) in terms of the so-called *Iribarren number*, ξ , as follows:

$$\xi = \frac{m}{\sqrt{H/L}} \quad (\text{D.4.5-8})$$

in which m is a representative profile slope and is defined, depending on the application, as the beach slope or the slope of a barrier that could be either a dune or constructed element such as a breakwater or revetment. H and L are wave height and length, respectively. The wave characteristics in the Iribarren number can be expressed in terms of breaking or deep water characteristics. For purposes here, two wave characteristics in the Iribarren number are used including that based on the significant deep water wave height, H_o , and peak or other wave period, T , of the deep water spectrum, and that based on the significant wave height at the toe of a barrier. The first definition for a sandy beach is as follows:

$$\xi_o = \frac{m}{\sqrt{H_o/L_o}} \quad (\text{D.4.5-9})$$

where L_o is the deep water wave length:

$$L_o = \frac{g}{2\pi} T^2 \quad (\text{D.4.5-10})$$

and g is the gravitational constant. The beach profile slope is the average slope out to the breaking depth associated with the significant wave height. Other definitions of the Iribarren number are defined later in this section as needed.

The 2% incident wave runup on natural beaches, R_{inc} , is expressed in terms of the Iribarren number as:

$$R_{inc} = 0.6 \frac{m}{\sqrt{H_o/L_o}} H_o \quad (\text{D.4.5-11})$$

Several definitions are relevant to the determination of runup and overtopping considered later in this section. The term *still water level* (SWL) has an accepted definition in coastal engineering as the water level in the absence of wind waves and their effects and thus would include the astronomical tide, El Niño, and surge due to wind effects, but would not include either of the wave setup components. However, the wave setup components are included in the base water level for calculating wave runup and overtopping. Thus, the term *static water level* (STWL) is

defined here as the sum of the SWL and the static wave setup, $\bar{\eta}$. Terminology is also useful to describe the sum of the static water level and a X% dynamic wave setup component. For purposes here, this will be defined as the *dynamic water level X%* (DWLX%). For example, the elevation corresponding to a 2% Dynamic Water Level would be the sum of the SWL (including astronomical tide, El Niño, and wind surge if present), the static wave setup, and the 2% dynamic wave setup. The term *reference water level* (RWL) is used as general terminology to refer to the water level that is appropriate for the particular application being discussed. As defined in Section D.4.2, the total water level (TWL) is the sum of the SWL, the wave setup, and wave runup.

D.4.5.1.3 General Input Requirements

The wave transformation element of the *Guidelines and Specifications* (Section D.4.4) produces a nearshore shallow water wave spectrum outside the breaking zone and an equivalent deep water wave spectrum. The approaches detailed in the following subsections base the total wave runup on the equivalent deep water wave spectrum for the case of natural beaches or for the case of runup on a barrier, the significant wave height at the toe of the barrier. To apply some of these methods, a parameterized (Joint North Sea Wave Project [JONSWAP]) spectrum is developed. The following wave characteristics are quantified: (1) equivalent deep water significant wave height, (2) peak wave period, and (3) spectral width (here spelled out as *Gamma* to avoid confusion with the Greek letter γ used to denote other parameters in this subsection). Large values of *Gamma* are associated with narrow spectra. Additionally, in some of the methods, an approximate uniform nearshore slope of the profile, m , must be established.

The deep water significant wave height and the peak period can be determined using the information provided from the wave transformation output. The recommended basis for determination of the spectral peakedness parameter (*Gamma*) is described below.

A parameter defined by Longuet-Higgins to quantify the spectrum narrowness (or peakedness) is based on the moments of the frequency spectrum, m_i , defined previously as Equation D.4.4-21 in Section D.4.4 and refined below as Equation D.4.5-12:

$$m_i = \sum_{n=1}^N f_n^i S(f_n) \quad (D.4.5-12)$$

where $S(f_n)$ is the wave energy at the discrete frequency, f_n . The Longuet-Higgins definition of the spectral narrowness, ν , is expressed in terms of the spectral moments:

$$\nu = \left[\frac{m_0 m_2}{m_1^2} - 1 \right]^{1/2} \quad (D.4.5-13)$$

such that for an infinitely narrow spectrum, $\nu = 0$. For purposes here, the two spectral peakedness parameters, ν and *Gamma*, have been plotted for JONSWAP spectra and the results are presented in Figure D.4.5-5. The spectral moments, m_0 , m_1 , and m_2 , for the actual equivalent deep water spectrum are provided from the wave transformation analysis effort (Section D.4.4),

and ν is determined from Equation D.4.5-13 and then Γ determined from Figure D.4.5-5 as input into the total wave runup methodology for the case of natural beaches.

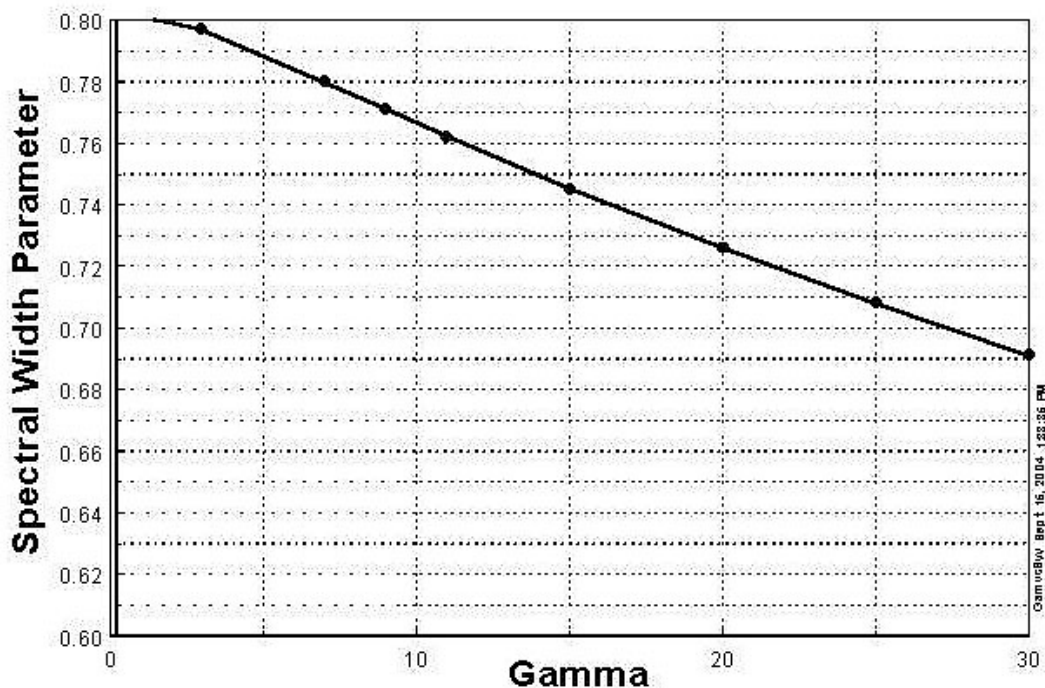

Figure D.4.5-5. Spectral Width Parameter Versus Γ for JONSWAP Spectra

D.4.5.1.4 Setup and Runup on Beaches: Descriptions and Recommendations

A basic difficulty exists in applying the usual total runup equations to Pacific Coast conditions. The total runup shall include wave setup; however, when these equations are applied to approximate 1% annual chance Pacific Coast wave conditions, the total wave runup can be less than predicted for static and dynamic wave setup alone. This apparent paradox stems from the fact that most laboratory experiments on which these equations are based were conducted under conditions much different than those of concern on the Pacific Coast and the equations governing wave setup and incident wave runup have different dependencies on the variables (beach slope and wave characteristics) and thus the methods based on available experimental data cannot be extended outside the range of variables for which the experiments were conducted. Thus, it is necessary to account for this limitation of the usual equations for total wave runup in developing recommendations for the Pacific Coast.

The Direct Integration Method (DIM) was developed for calculating static and dynamic (infragravity) components of wave setup accounting for as much of the physics as possible. This one-dimensional method accounts for the spectral shape, the detailed bathymetry, and is based on integration of the governing equations from deep to shallow water. DIM can be applied by a simple set of empirical equations and by full implementation of the numerical model.

Three general approaches to address the wave setup components of the total wave runup on natural beaches are available: (1) empirical methods, (2) DIM developed in conjunction with this effort, and (3) advanced wave models, primarily the Boussinesq type. Because the dynamic wave

setup is considered to be very significant on Pacific Coast shorelines and depends on the spectral width and DIM is the only method (other than the Boussinesq models) that can account for variable spectral width, DIM is the preferred method for application.

D.4.5.1.4.1 Direct Integration Method

Because the DIM approach does not include the effects of incident wave runup, it is recommended that the 2% incident runup be incorporated and added statistically as discussed in more detail later. The recommended formulation is:

$$R_{inc} = F_R \xi_o H_o \quad (D.4.5-14)$$

The coefficient F_R in the above equation will differ for sandy beaches and barriers as discussed in the following subsections. The DIM approach allows the wave and bathymetric characteristics to be taken into consideration. Specifically, the spectral shape and actual bathymetry can be represented. A detailed discussion of the DIM program is presented in a User's Manual in the supporting documentation to these *Guidelines and Specifications*. Two applications of DIM are available to the Mapping Partner: the computer program and a set of equations. The equations available are based on parameterized spectra (the JONSWAP spectrum that allows various spectral widths to be considered) and uniform profile slopes. The program DIM calculates the total wave setup and provides as output the static (average) wave setup, $\bar{\eta}$, and the root mean square (rms), η_{rms} , of the fluctuating wave setup around the average. Static and dynamic wave setup increase with wave period and the rms of the fluctuating setup component has been found to increase with the narrower spectra. The static setup component, $\bar{\eta}$, and rms of the dynamic setup component, η_{rms} , can be determined using the DIM program or the following equations:

$$\bar{\eta} = 4.0 F_H F_T F_{Gamma} F_{Slope} \quad (D.4.5-15)$$

and

$$\eta_{rms} = 2.7 G_H G_T G_{Gamma} G_{Slope} \quad (D.4.5-16)$$

where the units of $\bar{\eta}$ and η_{rms} are in feet and the factors are for wave height (F_H and G_H), wave period, (F_T and G_T), JONSWAP spectrum narrowness factor (F_{Gamma} and G_{Gamma}), and nearshore slope (F_{Slope} and G_{Slope}). These factors are defined in Table D.4.5-1. With the exception of the spectral narrowness factors, the F and G factors are the same. The nearshore slope is the average slope between the runup limit and twice the break point of the significant wave height with the depth, h_b , at this point defined as $h_b = H_b / \kappa$. For purposes here, κ can be taken as 0.78. Because the wave setup components vary with the 0.2 power of this effective slope, these values are not overly sensitive to the value of effective slope.

Table D.4.5-1. Summary of Factors to Be Applied with DIM

Variable	Factor for			
	Wave Height	Wave Period	Spectral	Nearshore Profile
$\bar{\eta}$	$(H_o/26.2)^{0.8}$	$(T/20.0)^{0.4}$	1.0	$(m/0.01)^{0.2}$
η_{rms}	$(H_o/26.2)^{0.8}$	$(T/20.0)^{0.4}$	$(Gamma)^{0.16}$	$(m/0.01)^{0.2}$

In applying the DIM method (whether from the program DIM or from the equations and Table D.4.5-1), it is necessary to develop the statistics of the oscillating wave setup and incident wave runup. This combination is based on the rms values (or standard deviations, σ) of each component. The standard deviation of setup fluctuations, $\sigma_1(\equiv \eta_{rms})$, is determined from the program or from the guidance provided in Table D.4.5-1. The recommended standard deviation for the incident wave oscillations, σ_2 , on natural beaches is given by:

$$\sigma_2 = 0.3 \xi_o H_o \quad (D.4.5-17)$$

and the standard deviation associated with the relatively steep barriers is addressed later. With the two standard deviations (σ_1 and σ_2) available, the total oscillating contribution to the 2% total wave runup, $\hat{\eta}_T$, is determined as the combination of the two standard deviations of the fluctuating components, σ_1 and σ_2 :

$$\hat{\eta}_T = 2.0 \sqrt{\sigma_1^2 + \sigma_2^2} \quad (D.4.5-18)$$

The results of the computations using DIM suggest that the fluctuating component of the wave setup is normally distributed and that the maxima of the fluctuating component of wave setup are Rayleigh-distributed, similar to the general behavior found by Hedges and Mase (2004) in laboratory experiments of wave setup and wave runup.

D.4.5.1.4.2 Advanced Wave Models

Wave models are becoming more sophisticated and able to account for the complexities of water waves. A rapidly developing class of these is the so-called *Boussinesq models*, which are both commercially and publicly available with the commercial models generally being the more user friendly. In addition to wave setup, *Boussinesq models* can calculate wave runup. In conjunction with the development of these *Guidelines and Specifications*, one-dimensional Boussinesq models have been applied to calculate total wave runup and the average and oscillating components were calculated separately. The comments below are based on an assessment of these Boussinesq results.

Based on comparison with other methods, Boussinesq models yield generally realistic results. The main concern with Boussinesq modeling is the “learning curve” required to carry out these types of computations with confidence. Additionally, it was difficult to carry out calculations for

deep water waves with a small directional dependency. The reason for this difficulty lies in the associated substantial longshore wave lengths and the need for them to be represented by a two-dimensional model. One possible Federal Emergency Management Agency (FEMA) application that would avoid the repeated learning curve requirement would be to carry out computations on a regional basis using Boussinesq models. The rate of improvement/development of Boussinesq models is moderate at present; however, it is likely that this type of model will be much more capable in 10 to 20 years than at present. Thus, at this stage, a Mapping Partner may elect to apply Boussinesq models; however, for application on a regional basis, it is preferable to wait for further developments and improvements. If a Boussinesq model is applied, the Mapping Partner shall obtain FEMA approval and it is suggested that calculations also be carried out using the DIM methodology for comparison of results.

D.4.5.1.5 Runup on Barriers

D.4.5.1.5.1 Special Considerations Due to Dynamic Wave Setup

Previous discussions have emphasized that a large wave runup event on the Pacific Coast is anticipated to have a more substantial dynamic wave setup than is present in the database on which available runup methods are based. Thus, special consideration is required in the calculation of wave runup and wave overtopping, which is the subject of a later subsection. The issues are to include the dynamic wave setup appropriately without double inclusion of the static and dynamic wave setup components that are inherent in the empirical database from which the runup and overtopping methodology were based. Table D.4.5-2 describes the recommended methodology for both open coast and sheltered water settings. This methodology is illustrated through example calculations and separate supporting documentation.

Table D.4.5-2. Recommended Procedure to Avoid Double Inclusion of Wave Setup Components

Case	Procedure
Open Coast, Sandy Beach	Apply DIM for wave setup with statistically combined incident runup, Equations D.4.5-17 and D.4.5-18
Open Coast, Coastal Barrier Present	Apply DIM for wave setup and reduce dynamic wave setup by amount considered to be most likely present in laboratory tests on which runup equations are based
Sheltered Waters, Sandy Beach	Same as open coast, sandy beach
Sheltered Waters, Coastal Barrier Present	Same as open coast, coastal barrier present

D.4.5.1.5.2 Methodology for Calculating Wave Runup on Barriers

In this subsection, *barriers* include steep dune features and coastal armoring structures such as revetments. Runup elevations on barriers depend not only on the height and steepness of the incident wave (and its interaction with the preceding wave), but also on the geometry (and construction) of the structure. Runup on structures can also be affected by antecedent conditions resulting from the previous waves and structure composition. Due to these complexities, runup on structures is best calculated using equations developed with tests on similar structures with

similar wave characteristics. Runup equations generally take the form of Equation D.4.5-14, with coefficients developed from laboratory or field experiments. Following Equation D.4.5-1, the incident wave runup (R_{inc}) for structures is added to the wave setup values ($\bar{\eta}$ and $\hat{\eta}$) statistically based on application of DIM. Also, DIM is applied to estimate the setup water surface at the toe of the structure, as appropriate, in most cases where the structure toe will be within the surf zone.

The recommended approach to calculating wave runup on structures is based on the Iribarren number (ξ) and reduction factors developed by Battjes (1974), van der Meer (1988), de Waal & van der Meer (1992), and described in the *Coastal Engineering Manual* (CEM) (USACE, 2003). The approach is referred to as the *TAW* (Technical Advisory Committee for Water Retaining Structures) method and is clearly articulated in van der Meer (2002) and includes reduction factors for surface roughness, the influence of a berm, structure porosity, and oblique wave incidence. The TAW method is useful as it covers a wide range of wave conditions for calculating wave runup on both smooth and rough slopes. In addition to being well documented, the TAW method agrees well with both small- and large-scale experiments.

It is important to note that other runup methods and equations for structures of similar form may provide more accurate results for a particular structure. The Mapping Partner shall carefully evaluate the applicability of any runup method to verify its appropriateness. Figure D.4.5-6 shows a general cross-section of a coastal structure, a conceptual diagram of wave runup on a structure, and definitions of parameters.

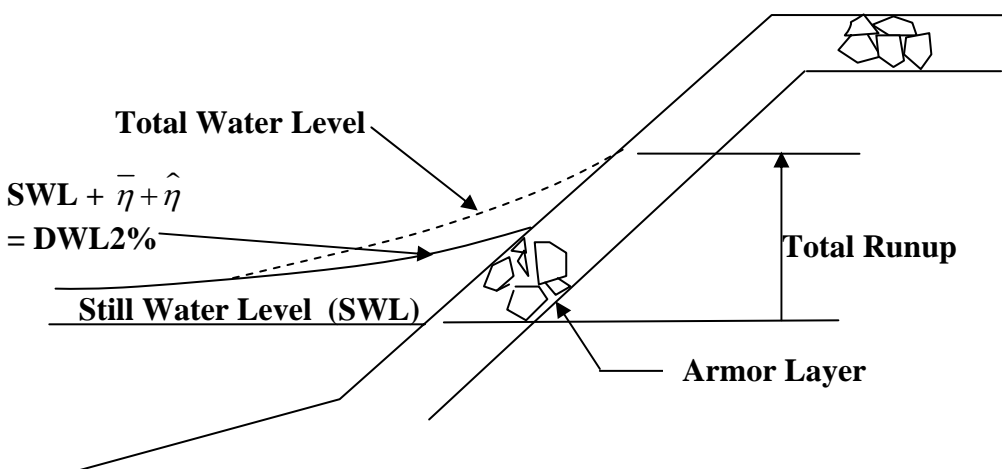

Figure D.4.5-6. Runup on Coastal Structures, Definition Sketch

Most of the wave runup research and literature shows a clear relationship between the vertical runup elevation and the Iribarren number. Figure D.4.5-7 shows the relative runup (R/H_{mo}) plotted against the Iribarren number for two different methods: (1) van der Meer (2002), and (2) Hedges & Mase (2004). In Figure D.4.5-7, both runup equations are derived from laboratory experimental data and are plotted within their respective domains of applicability for the Iribarren number. Each equation shows a consistent linear relationship between the relative

runup and ξ_{om} for values of ξ_{om} below approximately 2. For values of ξ_{om} above approximately 2, only the van der Meer method is applicable. Moreover, due to its long period of availability and wide international acceptance, the van der Meer relationship (also referred to as the TAW runup methodology) is recommended here. The Mapping Partner shall characterize the wave conditions in terms of ξ_{om} and be aware of the runup predictions provided by the various methods available in the general literature.

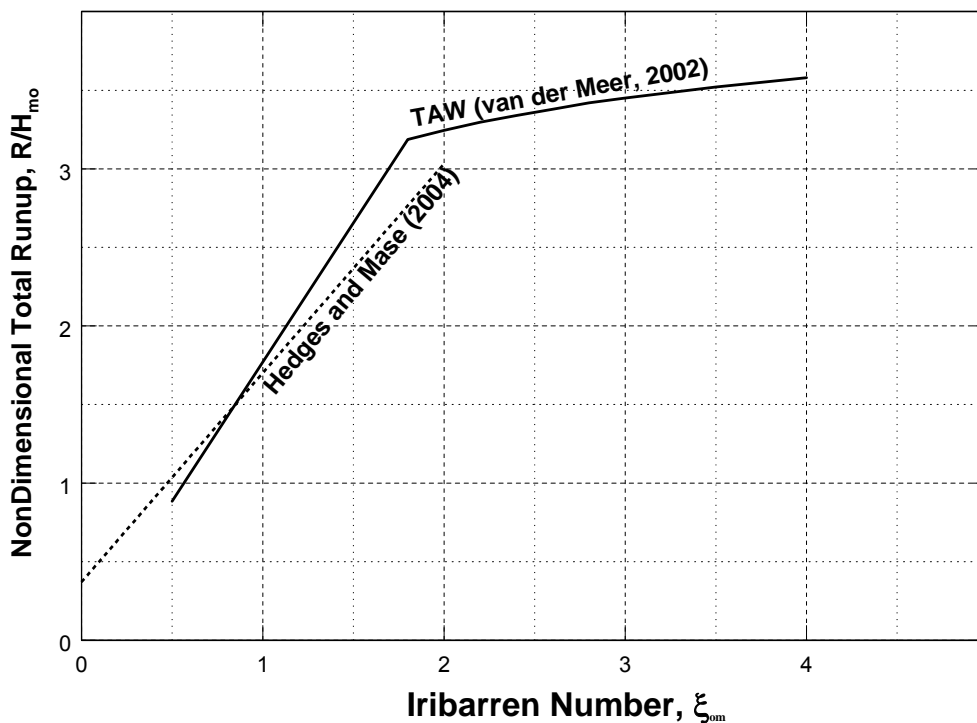

Figure D.4.5-7. Non-dimensional Total Runup vs. Iribarren Number

The general form of the wave runup equation recommended for use is (modified from van der Meer, 2002):

$$R = H_{mo} \left\{ \begin{array}{ll} 1.77\gamma_r\gamma_b\gamma_\beta\gamma_P\xi_{om} & 0.5 \leq \gamma_b\xi_{om} < 1.8 \\ \gamma_r\gamma_b\gamma_\beta\gamma_P \left(4.3 - \frac{1.6}{\sqrt{\xi_{om}}} \right) & 1.8 \leq \gamma_b\xi_{om} \end{array} \right\} \quad (D.4.5-19)$$

where:

R is the 2% runup = $2\sigma_2$

H_{mo} = spectral significant wave height at the structure toe

γ_r = reduction factor for influence of surface roughness

γ_b = reduction factor for influence of berm

γ_β = reduction factor for influence of angled wave attack

γ_P = reduction factor for influence of structure permeability

Equations for quantifying the γ parameters are presented in Table D.4.5-3. The reference water level at the toe of the barrier for runup calculations is DWL2%. Additionally, because some wave setup influence is present in the laboratory tests that led to Equation D.4.5-19, the following adjustments are made to the calculation procedure for cases of runup on barriers.

Table D.4.5-3. Summary of γ Runup Reduction Factors

Runup Reduction	Characteristic/Condition	Value of γ for Runup
Roughness Reduction Factor, γ_r	Smooth Concrete, Asphalt and Smooth Block Revetment	$\gamma_r = 1.0$
	1 Layer of Rock With Diameter, D . $H_s / D = 1$ to 3.	$\gamma_r = 0.55$ to 0.60
	2 or More Layers of Rock. $H_s / D = 1.5$ to 6.	$\gamma_r = 0.5$ to 0.55
	Quadratic Blocks	$\gamma_r = 0.70$ to 0.95. See Table V-5-3 in CEM for greater detail
Berm Section in Breakwater, γ_b , B = Berm Width, $\left(\frac{\pi d_h}{x}\right)$ in radians	Berm Present in Structure Cross-section. See Figure D.4.5-8 for Definitions of B , L_{berm} , and Other Parameters	$\gamma_b = 1 - \frac{B}{2L_{berm}} \left[1 + \cos\left(\frac{\pi d_h}{x}\right) \right], 0.6 < \gamma_b < 1.0$ $x = \begin{cases} R & \text{if } \frac{-R}{H_{mo}} \leq \frac{d_h}{H_{mo}} \leq 0 \\ 2H_{mo} & \text{if } 0 \leq \frac{d_h}{H_{mo}} \leq 2 \end{cases}$ (D.4.5-21) Minimum and maximum values of $\gamma_b = 0.6$ and 1.0, respectively
Wave Direction Factor, γ_β , β is in degrees and = 0° for normally incident waves	Long-Crested Waves	$\gamma_\beta = \begin{cases} 1.0, & 0 < \beta < 10^\circ \\ \cos(\beta - 10^\circ), & 10^\circ < \beta < 63^\circ \\ 0.63, & \beta > 63^\circ \end{cases}$ (D.4.5-22)
	Short-Crested Waves	$1 - 0.0022 \beta , \beta \leq 80^\circ$ $1 - 0.0022 80 , \beta \geq 80^\circ$ (D.4.5-23)
Porosity Factor, γ_P	Permeable Structure Core	$\gamma_P = 1.0, \xi_{om} < 3.3; \gamma_P = \frac{2.0}{1.17(\xi_{om})^{0.46}}, \xi_{om} > 3.3$ and porosity = 0.5. for smaller porosities, proportion γ_P according to porosity . See Figure D.4.5-9 for definition of porosity (D.4.5-24)

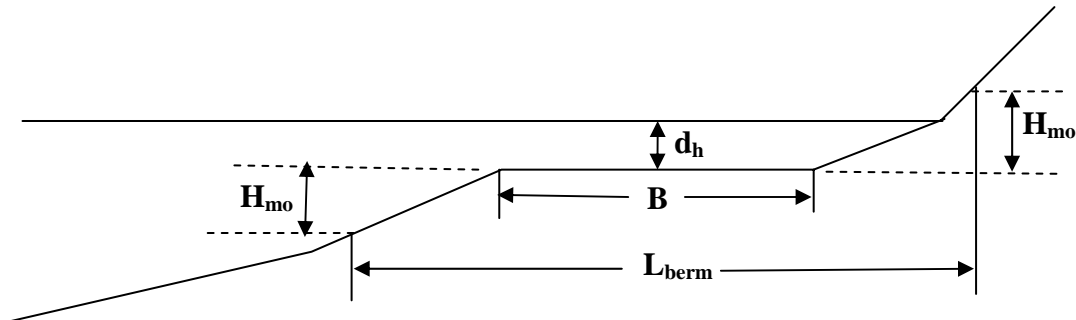

Figure D.4.5-8. Berm Parameters for Wave Runup Calculations

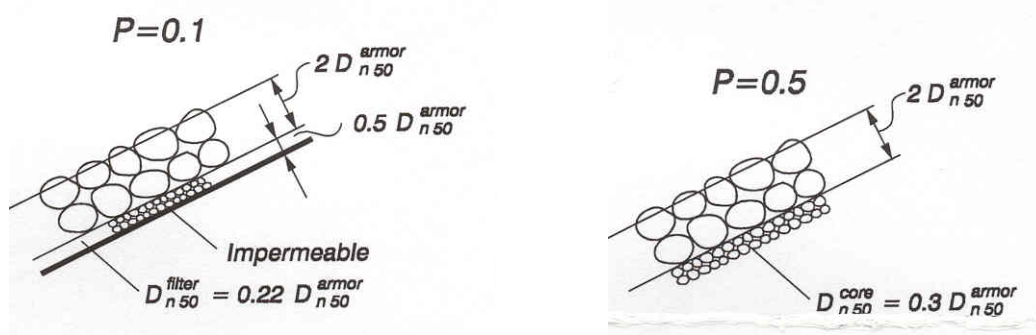

Figure D.4.5-9. Structure Porosity Definition

The steps below are based on the consideration of laboratory tests conducted with a JONSWAP *Gamma* equal to 3.3, which is the average of the spectra entering into the development of the JONSWAP spectrum. Also, see Table D.4.5-2.

1. Calculate, using DIM methodology, $\hat{\eta}_{rms}$ ($= \sigma_1$) for: (1) *Gamma* equal to 3.3, and (2) the *Gamma* value of interest for the 1% percent chance conditions.
2. Reduce the dynamic wave setup at the toe of the structure by the difference between the 2% dynamic wave setup values associated with the *Gamma* of interest and *Gamma* = 3.3, i.e., $\sigma_1(\text{Gamma} > 3.3) = \sigma_1(\text{Gamma of interest}) - \sigma_1(\text{Gamma} = 3.3)$. For cases in which the *Gamma* of interest is less than 3.3, set the value of $\sigma_1 = 0$ (Equations D.4.5-17 and D.4.5-18).

For a smooth impermeable structure of uniform slope with normally incident waves, each of the γ runup reduction factors is 1.0.

In calculating the Iribarren number to apply in Equation D.4.5-19, the Mapping Partner shall use Equation D.4.5-9 and replace H_o with H_{mo} and replace T with $T_{m-1.0}$ (the spectral wave period) in Equation D.4.5-10. H_{mo} and $T_{m-1.0}$ are calculated as:

$$H_{mo} = 4.0\sqrt{m_o} \quad (\text{D.4.5-25})$$

$$T_{m-1.0} = \frac{T_p}{1.1} \quad (\text{D.4.5-26})$$

where H_{mo} is the spectral significant wave height at the toe of the structure and T_p is the peak wave period. In deep water, H_{mo} is approximately the same as H_s , but in shallow water, H_{mo} is 10-15% smaller than the H_s obtained by zero up crossings (van der Meer, 2002). In many cases, waves are depth-limited at the toe of the structure and H_b can be substituted for H_{mo} , with H_b calculated using a breaker index of 0.78 unless the Mapping Partner can justify a different value. The breaker index can be calculated based on the bottom slope and wave steepness by several methods, as discussed in the CEM (USACE, 2003). As noted, the water depth at the toe of the structure shall include the static wave setup and the 2% dynamic wave setup, calculated with DIM. In terms of the Iribarren number, the TAW method is valid in the range of $0.5 < \xi_{om} < 8-10$, and in terms of structure slope, the TAW method is valid between values of 1:8 to 1:1. The Iribarren number as described above is denoted ξ_{om} as indicated in Equation D.4.5-19.

Runup on structures is very dependent on the characteristics of the nearshore and structure geometries. Hence, better runup estimates may be possible with other runup equations for particular conditions. The Mapping Partner may use other runup methods based on an assessment that the selected equations are derived from data that better represent the actual profile geometry or wave conditions. See CEM (USACE, 2003) for a list of presently available methods and their ranges of applicability.

D.4.5.1.5.3 Special Cases—Runup from Smaller Waves

In some special cases, neither of the previously described methods (Subsection D.4.5.1.4, Setup and Runup Beaches: Description and Recommendations, or Subsection D.4.5.1.5 Runup on Barriers) is applicable. These special cases include steep slopes in the nearshore with large Iribarren numbers or conditions otherwise outside the range of data used to develop the total runup for natural beach methods. Also, use of the TAW method is questionable where the toe of a structure, or naturally steep profile such as a rocky bluff, is high relative to the water levels, limiting the local wave height and calculated runups to small values. In these cases, it is necessary to calculate runup with equations of the form of Equation D.4.5.1-19 and to avoid double inclusion of the setup as discussed in Subsections D.4.5.1.5.1 and D.4.5.1.5.2 and Table D.4.5-2 and to carry out the calculations at several locations across the surf zone using the average slope in the Iribarren number. With this approach, it is possible that calculations with the largest waves in a given sea condition may not produce the highest runup, but that the highest runup will be the result of waves breaking at an intermediate location within the breaking zone.

The recommended procedure is to consider a range of (smaller) wave heights inside the surf zone in runup calculations. For this approach, for all depths considered, the dynamic setup is reduced if the *Gamma* of interest exceeds 3.3 as described in Subsections D.4.5.1.5.1 and D.4.5.1.5.2 and Table D.4.5-2. For each depth considered, the static setup is calculated with Equation D.4.5-5 with the water level including the 2% dynamic wave setup replacing the depth, h , in that equation. With the 2% dynamic water level available, methods of calculating wave runup on barriers is applied and are described in greater detail below.

The concept of a range of calculated runup values is depicted schematically in Figure D.4.5-10 where an example transect and setup water surface profile are shown. Figure D.4.5-10 also shows the corresponding range of depth-limited breaking wave heights calculated based on a breaker index and plotted by breaker location on the shore transect. The Iribarren number was also calculated and plotted by breaker location in Figure D.4.5-10. The calculation of ξ at each location uses the deshoaled deepwater wave height corresponding to the breaker height, the deepwater wave length and the average slope calculated from the breaker point to the approximate runup limit. Note that this average slope (also called composite slope, as defined in the CEM [USACE, 2003] and SPM [USACE, 1984] increases with smaller waves because the breaker location approaches the steeper part of the transect near the shoreline. This increases the numerator in the ξ equation. Also, the wave height decreases with shallower depths, reducing the wave steepness in the denominator of the ξ equation. Hence, as plotted in Figure D.4.5-10, ξ increases as smaller waves closer to shore are examined, increasing the relative runup (R/H). However, because the wave height decreases, the runup value, R , reaches a maximum and then decreases.

The following specific steps are used to determine the highest wave runup caused by a range of wave heights in the surf zone:

1. Calculate, using DIM, the reduced 2% dynamic wave setup based on the *Gamma* of interest and Subsections D.4.5.1.5.1 and D.4.5.1.5.2 and Table D.4.5-2. Calculate the static wave setup based on Equation D.4.5-5 for the cross-shore location considered. Replace h in that equation with the sum of the still water depth at the location and the 2% dynamic wave setup.
2. Calculate the runup using the methods described earlier for runup on a barrier. This requires iteration for this location to determine the average slope based on the differences between the runup elevation and the profile elevation at the location and the associated cross-shore locations. Iterate until the runup converges for this location.
3. Repeat the runup calculations at different cross-shore locations until a maximum runup is determined.

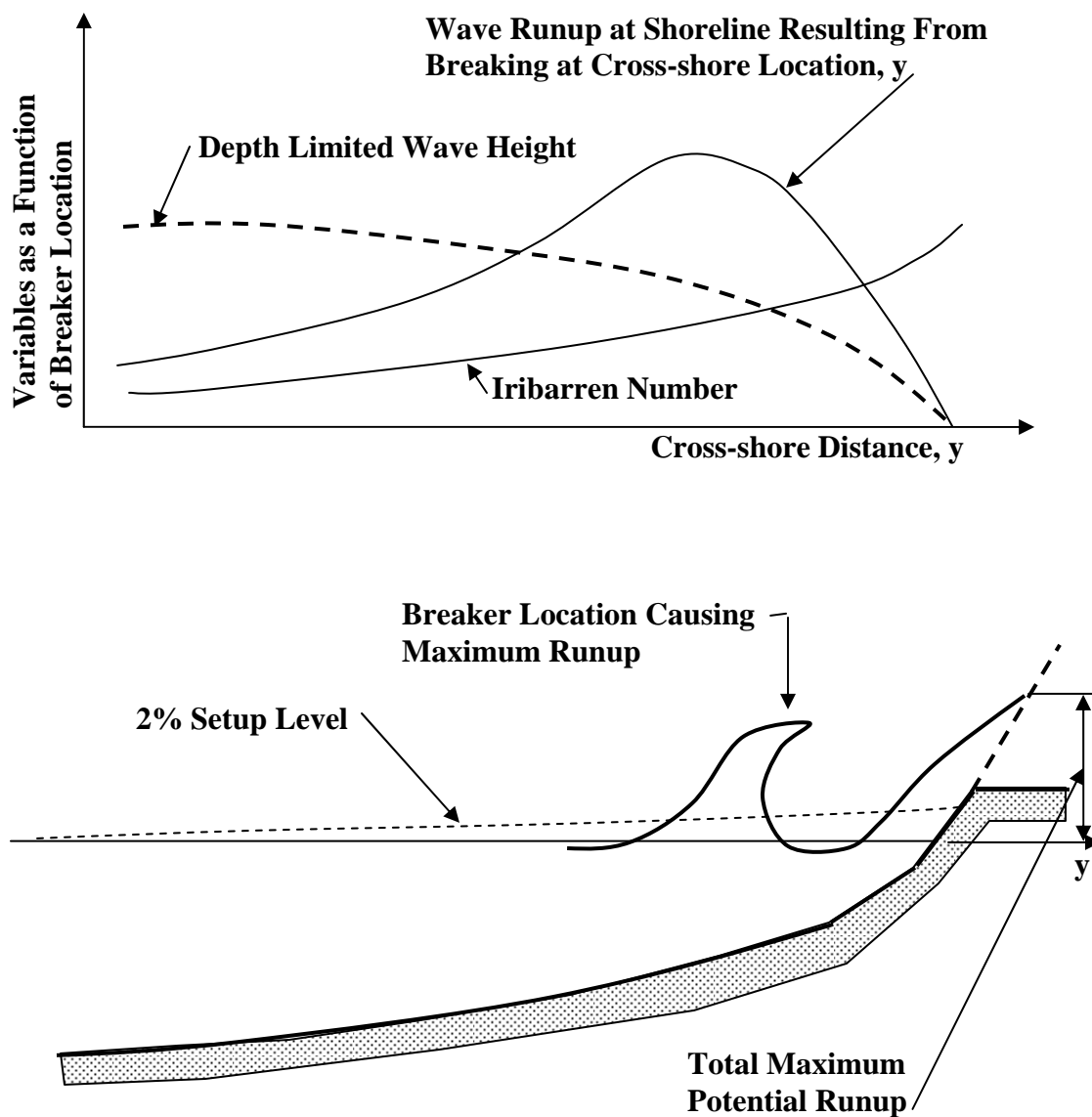

Figure D.4.5-10. Example Plot Showing the Variation of Surf Zone Parameters

D.4.5.1.6 Example Computations of Total Runup

Four examples corresponding to the four settings in Table D.4.5-2 are examined and total runup values presented. The conditions for the four examples are presented in Table D.4.5-4. These examples have been selected to illustrate application of the methodology for several settings. The supporting documents provide a detailed step-by-step presentation of the calculations associated with these four examples and seven additional examples..

Table D.4.5-4. Example Characteristics

Example	Water Level and Wave Conditions	Profile Conditions	Barrier Characteristics
1. Open Coast, Sandy Beach	Astronomical tide = 3 feet above NAVD* and wind surge = 2 feet. $H_{mo} = 26.2$ feet; $T = 20$ sec; $\Gamma = 30$ in JONSWAP spectrum	Slope = 1:60	No barrier
2. Open Coast With Structure Present	Same as Example 1	Slope = 1:60	Slope = 1:1.5, 1 layer rock of 3 feet diameter, toe depth = 2 feet below NAVD. porosity considered to be 0.2
3. Sheltered Water, Sandy Beach	Astronomical tide = 3 feet, above NAVD and wind surge = 1 foot. $H_{mo} = 6.0$ feet; $T = 5$ sec; $\Gamma = 1$ in JONSWAP spectrum	Slope = 1:60	No barrier
4. Sheltered Water With Structure Present	Same as Example 3	Slope = 1:60	Same as Example 2

*NAVD = North American Vertical Datum

Example 1: Open Coast, Sandy Beach

The actual bathymetry for this example is presented in Figure D.4.5-11 and is approximated here as a uniformly sloping profile with slope of 1:60 out to twice the approximate significant wave height breaking point. The deep water Iribarren number, ξ_o , for this case is calculated to be 0.147.

Table D.4.5-5 presents the 2% exceedance results based on the DIM program and coefficients in Table D.4.5-1 with a nearshore slope of 1:60 as well as the results from the Boussinesq model calculations. To illustrate the role of the spectral width, the results for a Γ of unity based on the equations have been presented as a footnote to Table D.4.5-5.

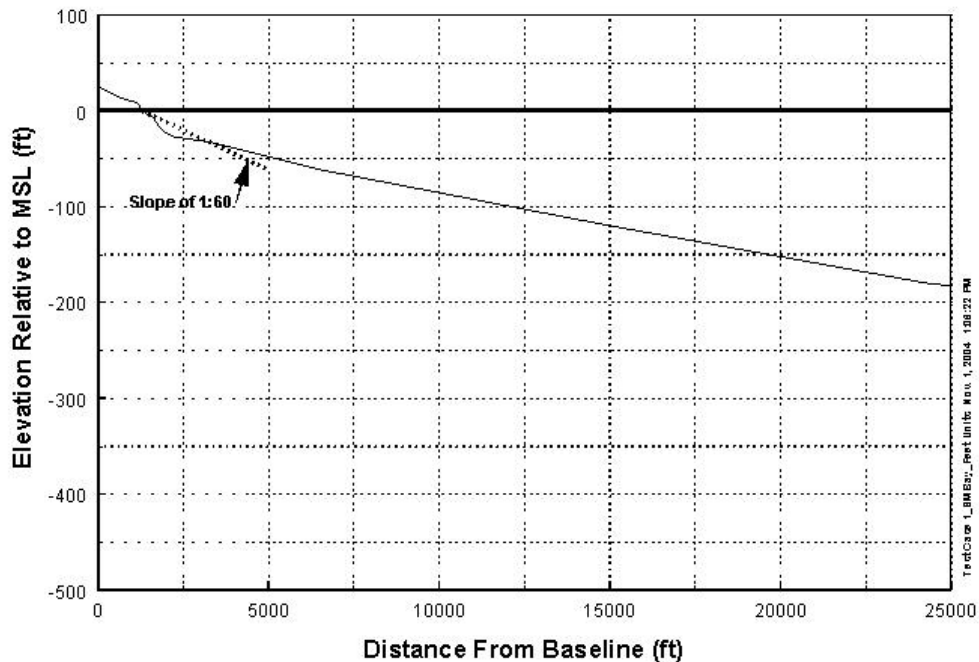

Figure D.4.5-11. Offshore Profile for Example Problem

Table D.4.5-5. Comparison of Results from Various Methods of Calculating 2% Total Runup for Examples

Example	Method	2% Total Runup (ft)		
		Static Setup (ft)	Combined Dynamic Setup and Incident Wave Runup (ft)	Total Runup (ft)
1	Boussinesq Equations	5.33	8.71	14.04
1	DIM Program	4.89	10.11	15.53*
1	Equations (Table D.4.5-1) Based on DIM	4.43	10.58	15.01
2	Equations (Table D.4.5-1) Based on DIM and Equation D.4.5-19	4.43	23.44	27.87
3	Equations (Table D.4.5-1) (Based on DIM)	0.78	1.10	1.88
4	Equations (Table D.4.5-1) Based on DIM and Equation D.4.5-19	0.78	9.20 (Incident Wave Runup) (Dynamic Setup = 0.0)	9.98

* Note: For a Γ (JONSWAP spectral peakedness) value of 1.0, the 2% total runup by the DIM method is 10.85 feet. The total runup for all examples is above SWL.

Example 2: Open Coast with Structure Present

The runup reduction factors determined for this example from Table D.4.5-3 are: $\gamma_r = 0.6$, $\gamma_b = 1.0$, $\gamma_\beta = 1.0$, and $\gamma_p = 0.86$. Values of the runup were based on the DIM methodology and Equation D.4.5-19 with adjustment for the dynamic setup considered to occur in the model tests that led to Equation D.4.5-19. The total 2% dynamic water depth at the toe of the structure was found to be 14.49 feet, which yielded an approximate significant wave height at the structure toe of 11.30 feet for use in Equation D-4.5-19. The value of ξ_{om} is 8.16. The total runup above SWL was determined to be 27.87 feet.

Example 3: Sheltered Waters, Natural Beach

The deep water Iribarren number based on the conditions in this example is: $\xi_o = 0.077$. The total 2% runup above SWL was determined to be 1.88 feet.

Example 4: Sheltered Waters with Structure Present

The runup reduction factors determined for this example were obtained from Table D.4.5-3 and are the same as for Example 2: $\gamma_r = 0.6$, $\gamma_b = 1.0$, $\gamma_\beta = 1.0$, and $\gamma_p = 0.86$. The total runup value was based on the DIM methodology and Equation D.4.5-19 with adjustment for the dynamic setup considered to occur in the model tests that led to Equation D.4.5-19. This resulted in a dynamic setup, $\eta_{rms} = 0$. The total 2% dynamic water depth at the toe of the structure was found to be 6.78 feet resulting in $H_{mo} = 5.29$ feet. The relevant Iribarren number at the breakwater toe is: $\xi_{om} = 2.95$. The total runup elevation above SWL was determined to be 9.98 feet.

D.4.5.1.7 Documentation

The Mapping Partner shall document the procedures and values of parameters employed to establish the 1% chance total wave runup on the various transects on natural beaches and barriers that could include steep dunes and structures. In particular, the basis for establishing the runup reduction factors and their values shall be documented. The documentation shall be especially detailed in case the methodology deviates from that described herein and/or in the recommendations in the supporting documentation. Any measurements and/or observations shall be recorded as well as documented or anecdotal information regarding previous major storm-induced runup. Any notable difficulties encountered and the approaches to addressing them shall be described clearly.

D.4.5.2 Overtopping

D.4.5.2.1 Overview

Wave overtopping occurs when the barrier crest height is lower than the potential runup level; waves running up the face of a barrier reach and pass over the barrier crest. If the total runup elevation (calculated in Subsection D.4.5.1) exceeds the crest elevation, z_c , then the overtopping of the structure is potentially significant and requires evaluation to define hazard zones.

There are three physical forms of overtopping:

1. *Green water overtopping* occurs when waves break onto or over the barrier and the overtopping volume is relatively continuous.
2. *Splash overtopping* occurs when waves break seaward of the face of the structure, or where the barrier is high in relation to the wave height, and overtopping is a stream of droplets. Splash overtopping can be carried over the barrier under its own momentum or may be driven by onshore wind.
3. *Spray overtopping* is generated by the action of wind on the wave crests immediately offshore of the barrier. Without the influence of a strong onshore wind, this spray does not contribute to significant overtopping volume.

Mapping hazard zones due to green water and splash overtopping requires an estimate of the velocity or discharge of the water that is propelled over the crest, and the envelope of the water surface, defined by the water depth, landward of the crest. Ideally:

- Base Flood Elevations (BFEs) are determined based on the water surface envelope landward of the barrier crest.
- Hazard zones are determined based on the inland extent of greenwater and splash overtopping, and on the depth and force of flow in any sheet flow areas.

The calculation methods for the hazard zones landward of the barrier crest differ for green water overtopping and splash overtopping and depend on the ratio R'/z_c' as illustrated in Figure D.4.5-12. For $1 < R'/z_c' < 2$, splash overtopping dominates and for $R'/z_c' > 2$, bore propagation dominates. Each of these types results in the occurrence of a hazard zone, although the calculations quantifying the hazard zones differ as described later in this subsection. Note that R' and z_c' are relative to the DWL2%.

Figure D.4.5-13 shows the parameters that may be available for use in mapping BFEs and flood hazard zones and are listed in Table D.4.5-6 (availability depends on the runoff and overtopping methods employed). Again, the reference water level for overtopping calculations is the DWL2%. The remainder of this subsection is organized as follows. First the methodology for calculating overtopping rates is reviewed. Secondly, methods are presented for calculating the hazard zones landward of the crest of the barrier for the two types of overtopping discussed above and illustrated in Figure D.4.5-12.

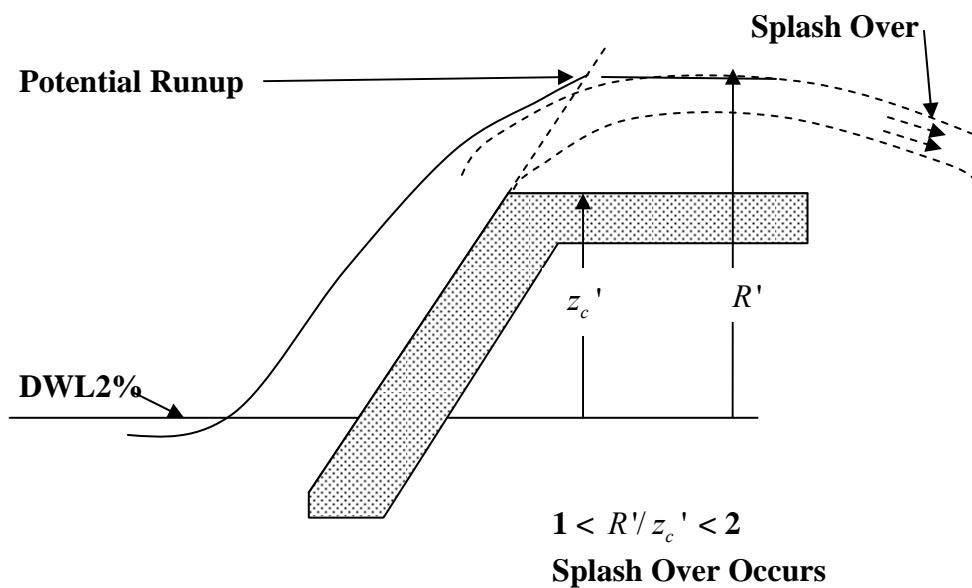

a) Conditions for Splash Overtopping

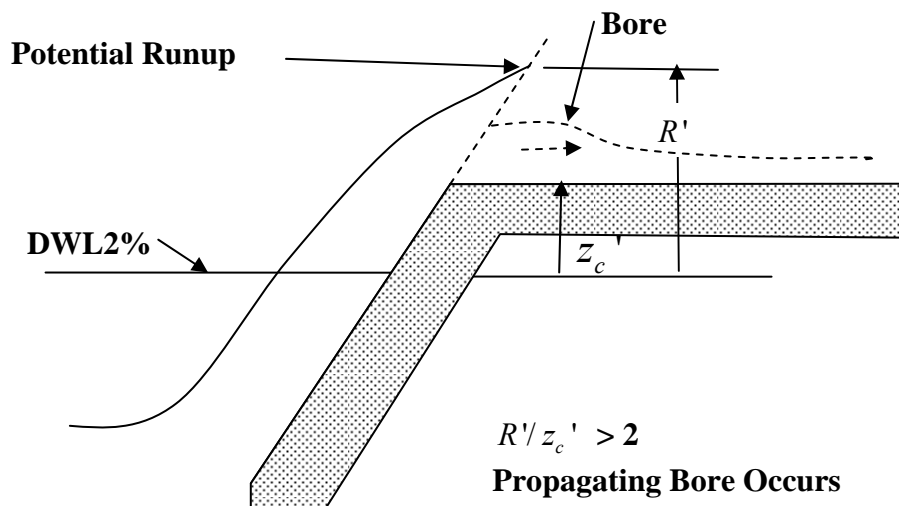

b) Conditions for Bore Propagation Overtopping

Figure D.4.5-12. Definition Sketch for Two Types of Overtopping

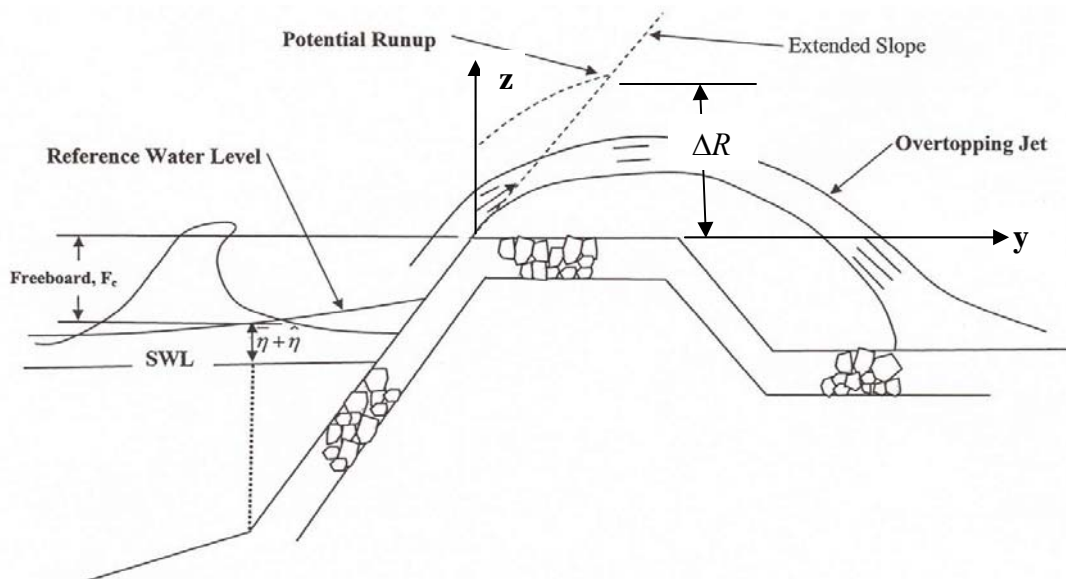

Figure D.4.5-13. Parameters Available for Mapping BFEs and Flood Hazard Zones

Table D.4.5-6. Overtopping Parameters Used in Hazard Zone Mapping

Parameter	Variable	Units
Total potential runup elevation	R	ft
Mean overtopping rate	q	cfs/ft
Landward extent of green water and splash overtopping	$y_{G,Outer}$	ft
Depth of overtopping water at a distance y landward of crest	$h(y)$	ft

Due to the complexity of overtopping processes and the wide variety of structures over which overtopping can occur, wave overtopping is highly empirical and generally based on laboratory experimental results and on relatively few field investigations.

D.4.5.2.2 Background

Overtopping calculations are subject to more uncertainty than runup calculations. While runup models may replicate observed runup values with errors of about 20%, predicted overtopping rates are often in error by a factor of 2 or more (Kobayashi, 1999). Some overtopping predictions may be even less accurate, given the fact that subtle changes in wave conditions, water level, structure geometry and characteristics can have a very large effect on overtopping rates.

D.4.5.2.2.1 Empirical Equations

Wave overtopping may be predicted by a number of different methods, but chiefly by semi-empirical equations that have been fitted to hydraulic model tests using irregular waves for specific structure geometries. These empirical equations have the general form:

$$Q = a e^{-(bF')} \text{ or } Q = a (F')^{-b} \quad (\text{D.4.5-27})$$

where Q is a dimensionless average discharge per unit length of structure and F' is a dimensionless freeboard. It is noted that these two dimensionless quantities are defined differently depending on the researcher and the structure characteristics. Overtopping rates predicted by these formulae generally include green water and splash overtopping because both parameters are recorded during the model tests.

Section VI-5-2b of the CEM (USACE, 2003) describes several different methods that have been developed for particular geometries. The choice of method depends upon the form of wave behavior at or on the structure, and the nature of the structure.

D.4.5.2.2.2 Types of Wave Behavior

Any discussion on wave-structure interaction requires that the key wave processes be categorized, so these different processes may be separated. Four key terms, non-breaking or breaking on normally sloped structures and reflecting or impacting on steeper structures, are defined below to describe breaking and overtopping processes.

For beaches and normally sloping structures, the simplest division is to separate *breaking* conditions where waves break on the structure from non-breaking waves. These conditions can be identified using the surf similarity parameter (or Iribarren number) defined in terms of beach or structure slope ($\tan \alpha$), and wave steepness (H_{mo}/L_o):

$$\xi_{op} = \frac{\tan \alpha}{\sqrt{\frac{H_{mo}}{L_o}}} = \frac{\tan \alpha}{\sqrt{S_{op}}} \quad (D.4.5-28)$$

where S_{op} is wave steepness as defined above. *Breaking* on normally sloped (1:1.5 to 1:20) surfaces generally occurs where $\xi_{op} \leq 1.8$, and *non-breaking* conditions when $\xi_{op} > 1.8$.

On very steep slopes or vertical walls, *reflecting* overtopping occurs when waves are relatively small in relation to the local water depth and of lower wave steepness. The structure toe or approach slope does not critically influence these waves. Waves run up and down the wall, giving rise to relatively smoothly varying loads. In contrast, *impacting* breaking on steep slopes occurs when waves are larger in relation to local water depths, perhaps shoaling up over the approach bathymetry or structure toe itself.

For simple vertical walls, the division between *reflecting* and *impacting* conditions is made using the parameter h_* .

$$h_* = \frac{h}{H_{mo}} \left(\frac{2\pi h}{gT_m^2} \right) \quad (D.4.5-29)$$

Reflecting conditions can generally be said to occur where $h_* \geq 0.3$, and *impacting* conditions when $h_* < 0.3$.

D.4.5.2.2.3 Nature of the Structure

The relative freeboard, F_c/H_s , is a very important parameter for predicting overtopping. Increasing wave height or period increases overtopping discharges as does reducing the crest freeboard, either by lowering the crest or raising the water level.

For structures with small relative freeboards, various prediction methods of overtopping discharge converge, indicating that the slope of the structure no longer has much influence in controlling overtopping. Over the normal range of freeboards, the characteristics for slope of 1:1 to 1:2 are similar, but overtopping reduces significantly for slopes flatter than 1:2. Empirical methods for sloping structures are applicable over specific slope ranges – structures tested usually lie between 1:1 and 1:8 with occasional tests at 1:15 or lower. Vertical and very steep walls (1:1 or steeper) have different prediction tools due to their distinct physical overtopping regimes as noted in the preceding section.

Most empirical methods were developed initially for smooth slopes and have been subsequently extended and modified for rough slopes. This is often accomplished by the inclusion of a reduction factor for surface roughness, γ_r , and other features as discussed previously in Subsection D.4.5.1.5.2 and summarized in Table D.4.5-3.

Increasing permeability of the structure decreases runup and overtopping as a larger proportion of the flow takes place inside the structure. Increasing porosity also reduces runup and overtopping because a larger volume of water can be stored in the voids. These differences in response characteristics make it convenient to distinguish between impermeable and permeable structures through a porosity reduction factor, γ_p .

Berms can also have a considerable impact on the runup and overtopping. van der Meer (2002) defines a reduction factor for berms, γ_b , that takes into account both the depth of water over the berm and its width. Berms are most effective in reducing runup and overtopping if the horizontal surface is close to SWL. Their effectiveness decreases with depth and can be neglected when the depth of water over the berm is greater than $2H_{mo}$.

D.4.5.2.2.4 Selection of Empirical Methods

The Mapping Partner is responsible for selecting and applying a suitable method to predict overtopping. Because the methods available for predicting overtopping are empirically based, the choice of method is substantially influenced by the characteristics of the transect that is being analyzed. Section VI-5-2b of the CEM (USACE, 2003) shall be reviewed to determine if a similar structure geometry has been tested. Care shall be taken to determine whether the transect being analyzed falls within the range of conditions for the model tests. Table D.4.5-7 presents overtopping relationships for various types of structures and conditions. The conditions associated with these different situations are discussed below.

If the structure to be analyzed has not been tested, generalized methods for predicting wave overtopping on sloping and vertical structures are available and can be applied.

- *Normally sloping structures* (slopes milder than 1:1.5 vertical to horizontal): For the majority of structures with impermeable smooth or rough slopes and with straight or bermed slopes, the formulation developed progressively by de Waal and van der Meer (1992), van der Meer and Janssen (1995), and van der Meer et al. (1998) is suitable. This is shown in Table VI-5-11 of the CEM (USACE, 2003) and the method is fully articulated in van der Meer (2002).
- *Steep and vertical walls*: For this case, the formulation developed by Besley et al. (1998), Besley (1999), Besley and Allsop (2000), as extended by Allsop et al. (2004) is suitable.

These general methods are described in more detail in the following subsections and the recommended equations are summarized in Table D.4.5-7.

Table D.4.5-7. Equations for Wave Overtopping

Quantity and General Conditions	Characteristic/Condition	Relationships
Non-Dimensional (Q) and Dimensional (q) Mean Overtopping Rates <hr/> <i>Normally Sloping Structures</i> $1:15 < \tan \alpha < 1:1.5$	Breaking Waves $\xi_{op} \leq 1.8$	$q = Q \sqrt{\frac{gH_{mo}^3 \tan \alpha}{S_{op}}}, \quad Q = 0.06e^{-4.7F'}$ $F' = \frac{F_c}{H_{mo}} \frac{\sqrt{S_{op}}}{\tan \alpha} \frac{1}{\gamma_r \gamma_B \gamma_\beta \gamma_P} \quad (D.4.5-30)$ <p>Note: If the overtopping rate (q) from this equation exceeds that for non-breaking waves below, use the result for non-breaking waves below</p>
	Non-Breaking Waves $\xi_{op} > 1.8$	$q = Q \sqrt{gH_{mo}^3}, \quad Q = 0.2e^{-2.3F'}$ $F' = \frac{F_c}{H_{mo}} \frac{1}{\gamma_r \gamma_\beta} \quad (D.4.5-31)$
Non-Dimensional (Q) and Dimensional (q) Mean Overtopping Rates <hr/> <i>Steeply Sloping or Vertical Structures (at or steeper than 1:1.5). Some Approaching Waves Not Broken</i>	Non-Breaking Waves (Reflecting) $h_* \geq 0.3$	$q = Q \sqrt{gH_{mo}^3}$ $Q = 0.05e^{-2.78F_c/H_{mo}} \quad (D.4.5-32)$ $h_* = \left(\frac{h}{H_{mo}} \frac{h}{L_{om}} \right)$
	Breaking Waves (Impacting) $h_* < 0.3$	$q = Q \sqrt{gh^3 h_*^2}$ $Q = 1.37 \times 10^{-4} (F')^{-3.24}$ $F' = \frac{F_c}{H_{mo}} h_* \quad (D.4.5-33)$

Table D.4.5-7. Equations for Wave Overtopping (cont.)

Quantity and General Conditions	Characteristic/Condition	Relationships
Non-Dimensional (Q) and Dimensional (q) Mean Overtopping Rates Steeply Sloping or Vertical Structures (at or steeper than 1:1.5). All Approaching Waves Broken	Structure Toe Below DWL2% Water Level	$q = Q\sqrt{gh^3}h_*^2$ $Q = 0.27 \times 10^{-4} e^{-3.24(F_c/H_{mo})h_*}$ valid for $(F_c/H_{mo})h_* \leq 0.03$ (D.4.5-34)
	Structure Toe Above DWL2% Water Level	$q = Q\sqrt{gh^3}h_*^2$ $Q = 0.06e^{-4.7F_c S_{op}^{-0.17}}$ (D.4.5-35)
Shallow Foreshore Slopes	Foreshore Slope < 1:2.5 $\xi_{op} > 7$	$q = Q\sqrt{gh^3}h_*^2$ $Q = 0.21\sqrt{gH_{mo}^3}e^{-F'}$ $F' = \frac{F_c}{\gamma_r \gamma_\beta H_{mo} (0.33 + 0.022\xi_{op})}$ (D.4.5-36)

Note: H_{mo} is the spectral significant wave height at the toe of the structure.

D.4.5.2.3 Data Requirements

Overtopping is a function of both hydraulic and structure parameters:

$$q = f(H_{mo}, T_p, \beta, F_c, h_s, \text{geometry}) \quad (D.4.5-37)$$

where H_{mo} is the significant wave height at the toe of the structure, T_p is the peak period, β is the angle of wave attack, F_c is the freeboard as shown in Figure D.4.5-13, and h_s is the 2% depth of water at the toe of the structure. The Mapping Partner shall take care to follow the specification for the hydraulic parameters as described in the chosen method. In most methods, the wave conditions is specified at the toe of the structure.

In addition to a description of the waves and water levels, a description of the structure geometry is required. Depending on the method used, the geometry of the structure, especially complex geometries such as berms, may be specified in particular ways. The Mapping Partner shall ensure that the specification for the structure geometry are followed as described in the chosen method.

D.4.5.2.4 Mean Overtopping Rate at the Crest

D.4.5.2.4.1 Sloping Structures (van der Meer, 2002)

The prediction method for simple smooth and armored slopes, as described in van der Meer (2002), distinguishes between breaking and non-breaking waves on the basis of ξ_{op} and use different definitions of dimensionless discharge and dimensionless freeboard. Influence factors, $\gamma_b, \gamma_p, \gamma_f, \gamma_\beta$, have been described previously in Subsection D.4.5.1.5.2. There is one difference in

the definitions of the runup reduction factors (γ parameters), which is for the direction of wave approach β . For this case,

$$\gamma_{\beta} = \begin{cases} 1.0 - 0.0033|\beta|, & (0 \leq |\beta| \leq 80^{\circ}) \\ 1.0 - 0.0033|80|, & (|\beta| \geq 80^{\circ}) \end{cases} \quad (\text{D.4.5-38})$$

For breaking waves $\xi_{op} \leq 1.8$, the overtopping rate, is calculated as defined in Table D.4.5-7, Equation D.4.5-30 in which Q is a dimensionless overtopping discharge for plunging breaking waves and F' is the dimensionless freeboard for breaking waves (see Figure D.4.5-13).

Similar relationships are available for non-breaking waves when $\xi_{op} > 1.8$, using different dimensionless parameters as defined in Table D.4.5-7, Equation D.4.5-31.

D.4.5.2.4.2 Steep and Vertical Walls (Besley and Allsop, 2000)

The calculation procedure for steep and vertical walls described by Besley and Allsop (2000) distinguishes between plunging and surging waves on the basis of h_* (see Equations D.4.5-32 and D.4.5-33) and use different definitions of dimensionless discharge and dimensionless freeboard.

For $h_* \geq 0.3$, reflecting waves predominate and a dimensionless discharge can be calculated with Equation D.4.5-32 in Table D.4.5-7.

For impacting conditions, $h_* < 0.3$, mean overtopping is given by Equation D.4.5-33 in Table D.4.5-7.

For conditions under which waves reaching the wall are all broken, two formulae are suggested depending upon whether the toe of the structure is above or below the DWL2% level.

For structures with the toe below the DWL2% level, refer to Equation D.4.5-34 in Table D.4.5-7.

For structures with the toe above the DWL2%, refer to Equation D.4.5-35 in Table D.4.5-7.

D.4.5.2.4.3 Shallow Foreshore Slope

For a shallow foreshore slope ($m < 1:2.5$), apply Equation D.4.5-36 in Table D.4.5-7.

D.4.5.2.5 Limits of Overtopping and Hazard Zones Landward of the Barrier Crest

As discussed previously and illustrated in Figure D.4.5-12, hazard zones landward of the barrier crest can be a result of splash overtopping, which occurs for $1 < R'/z_c' < 2$, or for bore overtopping, which occurs for $R'/z_c' > 2$. The methodologies to calculate the limits of the hazard zones for each of these cases is described below. These methodologies are approximate and both consider the Froude number to be 1.8 as found by Ramsden and Raichlen (1990).

D.4.5.2.5.1 Overtopping by Splash

Figure D.4.5-14 presents a detailed view of the associated variables for this type of overtopping.

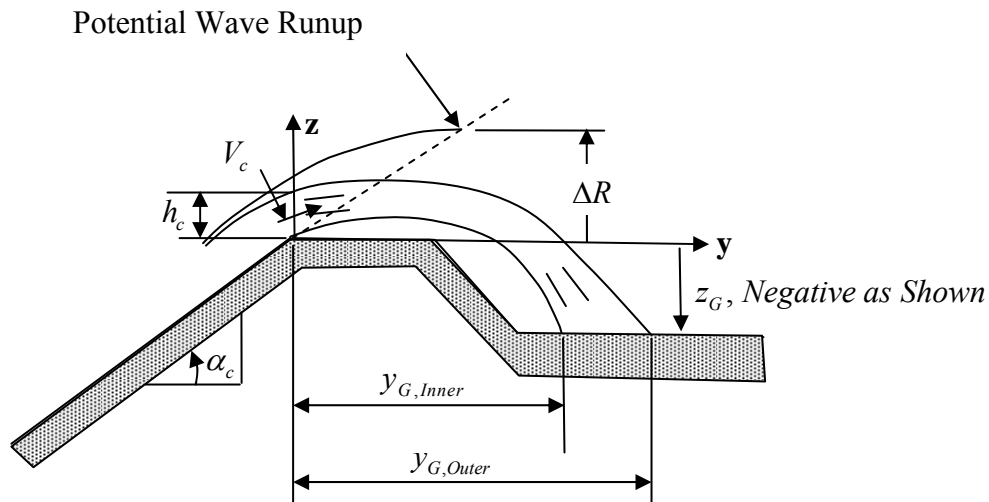

Figure D.4.5-14. Definition Sketch for Wave Overtopping by Splash

First, the calculation steps are presented and then the associated calculations discussed in greater detail. The following steps define the approach to establishing the splashdown distance for the 1% annual event and the landward limit of the hazard zone defined as: $hV^2 = 200 \text{ ft}^3/\text{sec}^2$.

1. Calculate the excess potential runup, $\Delta R = R - z_c$, $V_c \cos \alpha$ and h_c . $V_c = 1.1\sqrt{g\Delta R}$ and $h_c = 0.38\Delta R$. In the case of a vertical seawall, apply Equations D.4.5-9 and D.4.5-19 replacing the numerator: $\tan \alpha$ by 1.0 for calculation of the excess runup, ΔR .
2. Estimate, based on data, the associated onshore wind component, W_y . Use $W_y = 44 \text{ ft/sec}$ as a minimum.
3. Calculate an enhanced onshore water velocity component (denoted by prime): $(V_c \cos \alpha)' = V_c \cos \alpha + 0.3(W_y - V_c \cos \alpha)$. In the case of a vertical seawall, this simplifies to $(V_c \cos \alpha)' = 0.3W_y$.
4. Determine an effective angle, α_{eff} , where $\tan \alpha_{eff} = V_c \sin \alpha / (V_c \cos \alpha)'$.
5. Apply Figure D.4.5-15 for the particular geometry to quantify the outer limit of the splash region, $y_{G,Outer}$, where $V_c = \sqrt{[(V_c \cos \alpha)']^2 + [V_c \sin \alpha]^2}$.

6. Calculate the total energy, E , of the splashdown: $E = \Delta R - z_G$, where both variables are relative to the barrier crest elevation.
7. Calculate the initial splashdown V_o and h_o according to: $V_o = 1.1\sqrt{gE}$ and $h_o = 0.19E$
8. Calculate the landward limit of $hV^2 = 200 \text{ ft}^3/\text{sec}^2$, where h is the water depth given by the Cox-Machemehl method (discussed below) and V is considered to be uniform, i.e., $V = V_o$.

Splashdown Limits

The landward splashdown limit is based on consideration of the trajectory of the splash as shown schematically in Figure D.4.5-14. This landward splashdown limit is determined by use of Figure D.4.5-15 where the horizontal axis is $(z_G - z_c)/[V_c^2 \sin^2 \alpha_{eff}/2g]$, where V_c includes the wind effect (Steps 3 and 4 above) and the vertical axis is the non-dimensional distance, $y_{G,Outer}$. Note that in most cases, the horizontal axis is negative.

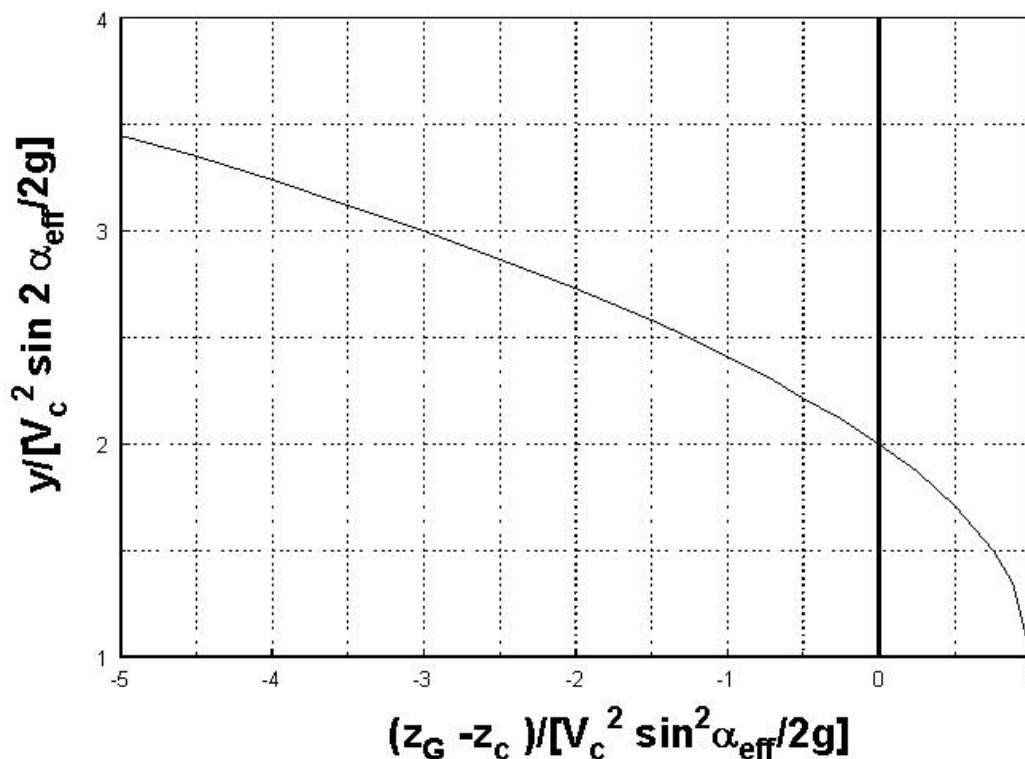

Figure D.4.5-15. Solution of Trajectory Equations for Splashdown Distances

The Cox-Machemehl Method

The Cox-Machemehl (C-M) method is applied to both the splash case and the bore propagation case of wave overtopping. The form recommended here is modified slightly from that developed by C-M. Given the initial depth, h_o , the depth decays with distance as:

$$h(y) = \left[\sqrt{h_o} - \frac{5(y - y_o)}{A\sqrt{gT^2}} \right]^2 \quad (\text{D.4.5-39})$$

where h_o is determined from Step 6 and for an initial approximation, the non-dimensional parameter A may be taken as unity. For non-zero slopes landward of the barrier, m_{LW} , the A value in the denominator of the above equation shall be modified by $A_m = A(1 - 2.0m_{LW})$, where A_m includes the effect of the landward slope and the value in the parentheses is limited to the range 0.5 to 2.0. Note that m_{LW} is positive sloping upwards in the landward direction. If the maximum distance of bore propagation does not appear reasonable or match observations, the Mapping Partner shall carefully examine the results to determine if a factor A different than described above is warranted to increase or decrease inland wave transmission distance as appropriate.

D.4.5.2.5.2 Bore Propagation

For this case, the Mapping Partner shall apply the C-M method considering a Froude number = 1.8 as for the case shown in Figure D.4.5-12 and refined below as Figure D.4.5-16.

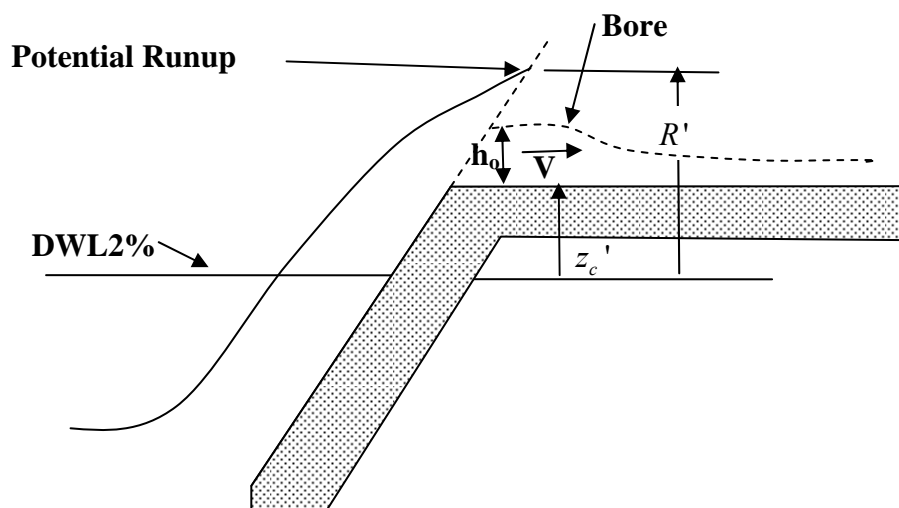

Figure D.4.5-16. Overtopping Resulting in Bore Propagation

The steps required to calculate the distance to $hV^2 = 200 \text{ ft}^3/\text{sec}^2$ are described below.

1. Calculate the initial velocity, V_o , and initial depth, h_o , as: $V_o = 1.1\sqrt{g\Delta R}$ and $h_o = 0.38\Delta R$.
2. Calculate the landward limit of $hV^2 = 200 \text{ ft}^3/\text{sec}^2$, where h is the water depth given by the C-M method, including the effect of landward slope, m_{LW} , as appropriate and V is considered to be uniform, i.e., $V = V_o$.

D.4.5.2.6 Documentation

The methods and results obtained in quantifying the 1% annual chance overtopping values shall be described in detail. The following shall be provided for the overtopped transects: (1) profiles, (2) assumptions and considerations including runup reduction factors, (3) overtopping values associated with the 1% chance event, and (4) basis for establishing the 1% splash zones landward of the barrier including any assumptions made. Any measurements and/or observations and documented or anecdotal information from previous major storm-induced overtopping and damage shall be recorded. Any notable difficulties encountered and the approaches to addressing them shall be described clearly.

D.4.5.3 Wave Dissipation and Overland Wave Propagation

This subsection provides guidance for estimating wave dissipation over broad, shallow areas, and quantifying wave height decrease during overland propagation. Due to the relatively steep nearshore on most of the Pacific Coast, coastal flooding is typically governed by total runup and overtopping. Therefore, consideration of wave dissipation and overland propagation is usually not required. In the paragraphs below, *enhanced wave dissipation* refers to dissipation by the mechanisms discussed in this subsection.

Wave energy is dissipated when propagating over relatively broad, shallow areas due to increased bottom friction, percolation in sandy seabeds, movement of cohesive seabeds, and drag induced by vegetation; see Figure D.4.5-17 for a conceptual definition sketch. Dissipation mechanisms can result in smaller wave heights than predicted by typical shoaling and depth-induced breaking relationships. Available analysis methods rely on parameters that have a wide range of values that can be difficult to quantify reliably. Therefore, the overall approach required to quantify dissipation may entail use of empirical data, possibly collected by the Mapping Partner at the study site or available from a similar site. In most situations, the amount of dissipation is small when compared to the effort required to analyze the dissipation processes. In addition, the risk of overestimating wave dissipation with available tools, resulting in an underestimation of flood risk, can be significant.

On the Pacific Coast, enhanced wave dissipation in excess of depth-induced breaking is most likely to occur when high tidal waters cause overland wave propagation in low-lying coastal areas. The Wave Height Analysis for Flood Insurance Studies (WHAFIS) computer program has

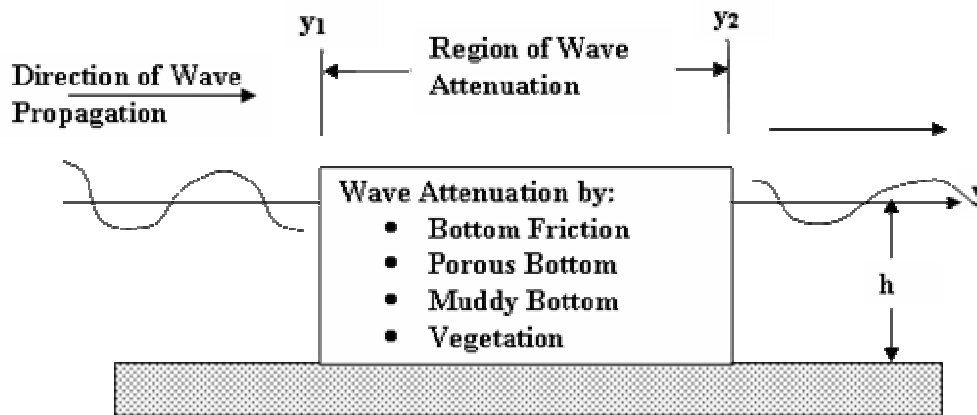

Figure D.4.5-17. Schematic of Wave Attenuation Processes

been developed to address overland wave propagation and is recommended for use on the Pacific Coast. Because WHAFIS was developed for the Atlantic and Gulf coasts, minor modifications are required for use on the Pacific Coast, hence the Mapping Partner shall obtain approval from FEMA.

D.4.5.3.1 Assessment of Enhanced Wave Dissipation

Damping of waves occurs due to the effects of bottom friction, percolation in sandy seabeds, viscous damping by cohesive bed movements, and drag imparted on the wave motions by vegetation. These processes are influenced by water depth, the distance waves travel over a sandflat, mudflat or through vegetation. Other important factors include vegetation type and whether wave regeneration occurs due to winds.

The Mapping Partner shall consider the attenuation of wave height and energy. Initial considerations shall be based on whether the wave attenuation is of sufficient magnitude to warrant including in a Flood Insurance Study (FIS). In general, enhanced wave dissipation shall not be considered unless calculations indicate wave heights are attenuated by more than 20% and/or the reduction in wave heights has a significant effect on total runup or the wave input to the overland propagation analysis.

If waves are propagating in the presence of an onshore wind field, enhanced dissipation shall be considered only within a scheme that allows additional wind-wave generation. This can be accomplished with wind-wave generation and transformation models (see Section D.4.4) and WHAFIS (Subsection D.4.5.3.3). However, if the site is sheltered and wave height regeneration is unlikely, wave attenuation by sandflats, mudflats, or vegetation can be considered in an independent calculation. Initial considerations for the Mapping Partner are:

- What are the physical site characteristics?
- Is the area within the prevailing wind field?
- Are there sheltered areas where wind regeneration does not occur?
- Will the effect of the sandflat, mudflat, or vegetation be significant?

At this time, available information on the Pacific Coast is insufficient to provide site-specific data and results for the Mapping Partner. Therefore, calculations involving a range of relevant parameters are required. If the attenuation is deemed to be potentially significant, site-specific data, calibration, and verification may be necessary for FIS applications.

D.4.5.3.2 Wave Attenuation by Bottom and Vegetation Interactions

If attenuation is significant, the following methodology can be employed to perform an initial assessment to determine if more detailed calculations are necessary. Bottom dissipation mechanisms can be mathematically expressed as a negative forcing term in the conservation of wave energy equation for steady-state, longshore uniform conditions as follows:

$$\frac{dEC_G}{dy} = -\varepsilon \quad (\text{D.4.5-40})$$

where E is the wave energy density, C_G is the wave group velocity, ε is the energy dissipation rate per unit bottom area, and y is the direction of wave propagation. Dissipation can occur at the surface, the bottom of the water column, and within the water column due to wave breaking. One may consider ε as the sum of energy dissipations due to wave breaking and bottom and internal effects. Dissipation due to bottom and internal effects dominates in areas of non-breaking waves whereas dissipation due to breaking dominates within the breaking zone. Equations discussed in Subsections D.4.5.3.2.1 and D.4.5.3.2.2 and summarized in Table D.4.5-8 can be used to develop an initial assessment of the magnitude of enhanced wave dissipation due to bottom effects and vegetation. If this dissipation is considered significant, the Mapping Partner may elect to use equations within these subsections to calibrate a method. Calibration could be based on pairs of measured wave heights and distances over approximately uniform depth conditions, and collected at a location similar to the study site, i.e., similar site geometry and similar wave conditions. Data used to calibrate the method shall be collected along the direction of wave propagation showing changes in wave height and period across the site. The following subsections present methodology for calculating wave dissipation resulting from various mechanisms. Table D.4.5-8 summarizes the equations governing wave attenuation by various processes and recommends ranges of required parameters to calculate attenuation.

D.4.5.3.2.1 Wave Attenuation by Bottom Interactions

Wave Attenuation Due to Bottom Friction

For a rough bottom, Dean and Dalrymple (1991) express energy dissipation due to bottom friction as shown in Table D.4.5-8, Equation D.4.5-41. In addition to the equation for ε , this table presents the approximate range of the unknown friction factor, f , the equation governing attenuation, and the expression for the unknown friction factor if the wave heights at two locations are known. The variables appearing in the expressions are defined as a table footnote.

Wave Attenuation Due to Percolation

For a porous bottom, Dean and Dalrymple (1991) express energy dissipation due to bottom percolation as shown in Table D.4.5-8, Equation D.4.5-42.

Table D.4.5-8. Summary of Equations for Overland Propagation (Over Uniform Depth)

Wave Damping By	ε	Unknowns and Approximate Ranges	Solution for Wave Heights, H_1 and H_2 , for Waves Propagating Over Distance $y_2 - y_1$	Value of Unknown For Measured Wave Heights, H_1 and H_2 Over Distance $y_2 - y_1$
Bottom Friction	$\frac{\rho f H^3 \sigma^3}{48\pi \sinh^3 kh}$	$0.04 < f < 0.16$	$\frac{H_2}{H_1} = \frac{1}{1 + \frac{f \sigma^3 H_1 (y_2 - y_1)}{12 C_G \pi \sinh^3 kh}}$	$f = \frac{(H_1 - H_2) 12 C_G g \pi \sinh^3 kh}{H_2 H_1 (y_2 - y_1) \sigma^3}$ (D.4.5-41)
Percolation	$\frac{\rho g^2 K k H^2}{8\nu \cosh^2 kh}$	$K = 3.3 D_{10\%} \pm 30\%$, $D_{10\%}$ = Diameter for Which 10% is Smaller in cm	$H_2 = H_1 e^{-A_2 (y_2 - y_1)}$, $A_2 = \frac{g K k}{2 C_G \nu \cosh^2 kh}$	$K = \frac{C_G \nu \cosh^2 kh}{(y_2 - y_1) g k} \ln \left(\frac{H_1}{H_2} \right)$ (D.4.5-42)
Muddy Bottom	$\frac{\rho_2 H^2 \sqrt{\sigma \nu_2}}{16 \sigma^2} e^{2kh} (\sigma^2 - gk)^2$	$3 < \rho_2 < 4.5 \text{ slugs / ft}^3$ $0.1 < \nu_2 < 1 \text{ ft}^2 / \text{sec}$	$H_2 = H_1 e^{-A_3 (y_2 - y_1)}$, $A_3 = \frac{\rho_2 \sqrt{\sigma \nu_2} g K k}{4 C_G \rho g \sigma^2} e^{2kh} (\sigma^2 - gk)^2$	$\rho_2 \sqrt{\nu_2} = \frac{2 C_G \sigma^{3/2} \rho g}{(y_2 - y_1) e^{2kh} (\sigma^2 - gk)^2} \ln \left(\frac{H_1}{H_2} \right)$ (D.4.5-43)
Vegetation	$\frac{\rho g^{3/2} C_D C_p D H^3}{12 S^2 \pi h^{1/2}}$	$2 < C_D C_p < 6$	$\frac{H_2}{H_1} = \frac{1}{1 + \frac{C_D C_p D H_1 (y_2 - y_1)}{3 \pi S^2 h}}$	$C_p C_D = \frac{3 \pi (H_1 - H_2) S^2 h}{H_2 H_1 D (y_2 - y_1)}$ (D.4.5-44)

Definitions: f = Bottom friction coefficient; σ and k = Wave angular frequency and wave number, respectively; ν and ν_2 = Water and mud kinematic viscosity, respectively; ρ and ρ_2 = Water and mud mass density, respectively; C_D and C_p = Stem and plant drag coefficients, respectively; S is plant stem spacing.

D.4.5-35

Section D.4.5

Wave Attenuation Due to a Viscous Bottom

Mudflats are common Pacific Coast features within lagoons and bays. Waves are damped when traveling across mudflats, due to the movement of sediment-rich water column and bed. The viscous, plastic nature of mud-rich sediments allows the soft bottom to deform in response to wave forces, resulting in the absorption of some of the wave energy. There are several methods for developing a preliminary estimate of wave dissipation due to viscous damping.

Dean and Dalrymple (1991) and Lee (1995) express energy dissipation due to a viscous bottom as shown in Table D.4.5-8, Equation D.4.5-43. If the Mapping Partner determines that wave attenuation over mudflats is important, additional methods are provided in Massel (1996); however, any method to determine wave attenuation by mudflats shall be used with care. Ranges of values of ρ_2 are 3 to 4.5 slugs/ft³ and ν_2 ranges from 0.1 to 1.0 ft²/s.

D.4.5.3.2.2 Wave Attenuation by Vegetation

Investigators have shown that vegetation damps wave energy, e.g., Dean (1978, 1979), Knutson (1982, 1988), Moeller et al. (1996, 1999, 2002), and Hansen (2002). Vegetation reduces incoming wave heights by imparting resistance (drag) on incoming waves, thereby causing a reduction in wave height and steepness, which results in a decrease in wave height and energy.

Mapping Partners working in areas where extensive marsh vegetation exists shall determine if the reduction in wave height by vegetation is significant. Applying Equation D.4.5-44 in Table D.4.5-8 by Knutson (1988) provides a method to determine whether further quantification of wave attenuation by vegetation is required.

Methods for calculating wave damping by vegetation that are included within the *Guidelines and Specifications* Appendix D (2003) may be employed in the Pacific Coast region. Important variables include drag coefficient, plant drag coefficient, stem diameter, spacing, water depth, stand width, and bottom slope.

It shall be noted that marsh vegetation differs from region to region and with salinity levels. Cordgrass (shown in Figures D.4.5-18 and D.4.5-19), although present on both coasts, varies in stature, with Pacific cordgrass (*Spartina foliosa*) being less substantial than Atlantic cordgrass (*Spartina alterniflora*).

However, the effects of these differing vegetation types on attenuating incoming wave energy for site-specific cases requires verification.

To account for wave attenuation by vegetation, the following is required:

- Determine the initial wave height seaward of vegetation;
- Determine the distance waves will travel through marsh vegetation;
- Quantify plant characteristics, i.e., stem diameter and spacing;



Figure D.4.5-18. Native Pacific Cordgrass Meadow at Blackie's Pasture, Marin County



Figure D.4.5-19. Tall Stand of Atlantic Smooth Cordgrass Hybrids Invading a Native Patch of Pacific Cordgrass Meadow near Tiburon, California

- Apply plant drag coefficients (C_D = original drag coefficient approximately 1.0, C_P = plant drag coefficient approximately 5.0); and
- Calculate wave attenuation for the site in question (Equation D.4.5-44).

The Mapping Partner may choose to perform a field study to determine the amount of wave attenuation by vegetation. Relatively simple survey and data acquisition techniques can be performed to measure wave attenuation by vegetation. Using pressure sensors and/or current meters, wave characteristics in the study area can be determined. Surveying instruments can be

used to characterize the site. The procedures include: installing instrumentation to measure wave heights offshore of the area with vegetation, using survey techniques to measure the distance that the waves will travel through the vegetation and site characteristics (i.e., water depth, bed slope, etc.), and measurement of plant characteristics (i.e., stem diameter, height, spacing, density). Application of field results obtained to Equation D.4.5-44 will provide guidance on the significance of wave dissipation for a particular site.

If calculations predict greater than 20% reduction, the Mapping Partner shall include the effects in the FIS. If results are not significant, the Mapping Partner may ignore attenuation by vegetation.

D.4.5.3.3 Overland Wave Propagation (WHAFIS)

The *Guidelines and Specifications*, Appendix D (2003) consider water wave transformations by marsh vegetation (pages D-67 to D-87). The fundamental analysis of wave effects for a flood map project is conducted with the WHAFIS computer program, which estimates the changes in wave height due to interactions with vegetation. WHAFIS simulates the vegetation effects on wave height and energy dissipation by both rigid and flexible vegetation. Consistent with other coastal analyses, the WHAFIS model considers the study area by representative transects. For WHAFIS, transects are selected with consideration given to major topographic, vegetative, and cultural features. The ground profile is defined by elevations referenced to an appropriate vertical datum (typically National Geodetic Vertical Datum [NGVD] or NAVD). The profile usually begins at elevation 0.0 and proceeds landward until either the wave crest elevation remains less than 0.5 feet above the mean water elevation for the 1% annual chance flood or another flooding source is encountered. Currently, WHAFIS in its entirety is only approved for use on the Atlantic and Gulf coasts.

Use of the model is explained in detail in the *Guidelines and Specifications* Appendix D. Mapping Partners wishing to use the WHAFIS model to estimate wave attenuation by Pacific Coast marshes must use care with preparation and input of required site data.

Several factors must be addressed before application of the WHAFIS model to the Pacific Coast. First, local marsh vegetation must be characterized. Default values within the model are coded for Atlantic and Gulf coast vegetations only. To use the model with Pacific Coast vegetation, vegetation parameters must be input manually into the model. Second, wind velocity parameters within the currently approved model are based on Atlantic and Gulf coast storms associated with hurricane conditions. These wind speeds are too high for most Pacific Coast conditions.

D.4.5.3.3.1 Characterization of Pacific Coast Vegetation

Application of WHAFIS to Pacific Coast vegetation has been partially confirmed. Certain types of vegetation are common to the Atlantic Coast, Gulf Coast, and Pacific Coast regions and described in more detail in Table D.4.5-9. WHAFIS can be used for limited Pacific Coast vegetation types that are the same or similar to those already represented in WHAFIS, but test cases are needed to verify the validity of the model for use with most Pacific Coast vegetation types.

Table D.4.5-9. Common Vegetation Types on Atlantic, Gulf, and Pacific Coasts

Species	Common Name	New England	Southeast	Gulf Coast	Southern California	Northern California	Pacific Northwest
<i>Batis maritima</i>	Saltwort			x	x		
<i>Distichlis spicata</i>	Salt Grass	x			x	x	x
<i>Scirpus americanus</i>	Olney's Bulrush		x				x
<i>Scirpus olneyi</i>	Olney Three square			x		x	
<i>Scirpus robustus</i>	Salt Marsh Bulrush	x		x		x	
<i>Scirpus validus</i>	Soft Stemmed Bulrush		x	x			x
<i>Spartina alterniflora</i>	Smooth Cord Grass	x	x	x		x	

D.4.5.3.3.2 Use of WHAFIS for Dissipation Only

Although WHAFIS is not approved for use in Pacific Coast regions, certain features are appropriate. The program can be used to determine whether a vegetation type in a specific area will attenuate wave heights regardless of wind speed. This is taken into account in the model by using the Vegetation Elevation card (using equivalent rigid vertical cylinders) only. For this case, there is only damping; no energy input from wind is included even though the wind might be strong and the vegetation might be sparse. The Mapping Partner shall choose vegetation values for stem diameter, height, spacing, and a drag coefficient. The wind speed, implicitly, will be zero.

D.4.5.3.3.3 Use of WHAFIS for Dissipation and Wind Wave Generation

The Marsh Grass card provides more flexibility with the vegetation parameters. This is the only WHAFIS card type that considers both energy input and energy dissipation. This card accounts for energy input by wind over the free surface, which is especially important if the vegetation is fully submerged and damping by the vegetation occurs; however, this card will impose a wind speed of 60 mph. Care must be taken with use of the Marsh Grass card because wind speeds are based on Atlantic and Gulf Coast (hurricane) conditions.

A modified version, P-WHAFIS, has been written that allows for variation of wind speed and therefore can be used in a generation wind field. This recently modified version has been tested but has not been approved by FEMA for unrestricted use. If the Mapping Partner chooses to use P-WHAFIS, prior approval from FEMA is required.

D.4.5.3.4 Documentation

Areas where wave attenuation was examined and the results obtained shall be described. The characteristics of these areas that led to the consideration of wave attenuation and the values of the attenuation parameters used in the analysis shall be quantified. Results of interest include the potential effect of wave attenuation on the hazard zones and the decisions reached as to whether to further include wave attenuation in the analysis leading to hazard zone delineation. Any field measurements and/or observations shall be recorded as well as documented or anecdotal information regarding previous overland damping during major storms, perhaps by runup events less than expected in the lee of attenuation features as discussed in this subsection. Any notable difficulties encountered and the approaches to addressing them shall be clearly described.

D.4.6 Coastal Erosion

This section provides methods for Mapping Partners to define the shape and location of eroded beach profiles, upon which the 1% flood conditions (waves and water levels) will act and from which flood hazard zones and Base Flood Elevations (BFEs) will be mapped.

D.4.6.1 Overview

Erosion processes and consequences of erosion can either be “episodic” or “chronic.” These two descriptors assign a very important temporal component to erosion processes and their results. *Episodic erosion* is the shore and backshore adjustment that results from short duration, high intensity meteorologic and oceanic storm events. This type of event response results in shore adjustment and occurs during a single storm or during a series of closely spaced storm events within a storm season. Shore and backshore profile changes during intense storms and hurricanes can result in dramatic beach and dune erosion, retreat, breaching, or removal of backshore dunes; cause retreat and collapse of bluff and cliff formations; and culminate in greater landward encroachment of waves and flooding from the ocean. *Chronic erosion* is associated with slow, long-term processes such as gradual shoreline adjustment associated with: (1) sea level rise, (2) land subsidence, (3) changes in sediment supply due to watershed modifications or dam building, and (4) decadal adjustments in rainfall, runoff, and wave climate associated with global warming.

Current Federal Emergency Management Agency (FEMA) regulations are limited to risks and losses occurring as the direct result of a storm event. The National Flood Insurance Program (NFIP) does not address long-term gradual chronic erosion but focuses on flood-related erosion, episodic erosion, due to storm events¹. FEMA does not currently map long-term erosion hazard areas as some local or state agencies do. FEMA Flood Insurance Rate Maps (FIRMs) do not inform property owners of erosion risks. FIRMs only indicate risks from flooding hazards in the form of BFEs and flood hazard zones. Therefore, flood assessment guidelines in this section only include methods for estimating eroded shore and backshore profiles during single large storm events, so runup and overtopping computations can be made to determine flood risks associated with those events. Section D.4.9 discusses how results from event-based erosion assessments are to be used by Mapping Partners to determine flood risks and delineate hazard zones.

D.4.6.2 Pacific Coast Characteristics Related to Storm-induced Erosion

Pacific storms track from the Pacific Ocean toward the coasts of California, Oregon, and Washington. Unlike hurricanes that occur along the Atlantic and Gulf coasts, Pacific Coast storms are frontal storms. These storms have smaller peak force wind speeds and surges than hurricanes, but have much longer durations (often on the order of several days). Intense Pacific storms are capable of generating 40- to 60-foot waves, and Pacific storms often “line up” in a series of back-to-back events that track thousands of miles across the Pacific Ocean to attack the West Coast of the United States for weeks with elevated tides and high surf. A series of storms

¹ Discussions of long-term erosion and the potential consequences of chronic erosion are found in materials listed in the reference section of this document and in many of the support documents referenced herein.

with only short periods of time between their peaks are capable of causing significant beach profile recession. One, two, or more storms may occur in a winter season before a severe storm event occurs. The periodic occurrence of El Niño oceanic conditions significantly amplifies the effects of Pacific storms with increased sea level and wave heights. This change in oceanic temperature, weather, and wave climate during El Niño periods is unique to the Pacific and usually represents meteorological and oceanic conditions when wind, waves, total water levels, and coastal erosion are the greatest.

Pacific Coast beaches undergo typical seasonal changes in profile and location from summer to winter conditions. During winter months, increased total water levels along with high-energy, steep waves tend to move sand offshore, adjusting the beach profile and its cross shore location. By the end of the summer or early fall after months of calm seas, the beach has recovered and the berms and back beach dunes may be well developed again. Figure D.4.6-1 provides a sketch of generalized seasonal profile changes that occur on sand beaches of the Pacific Coast.

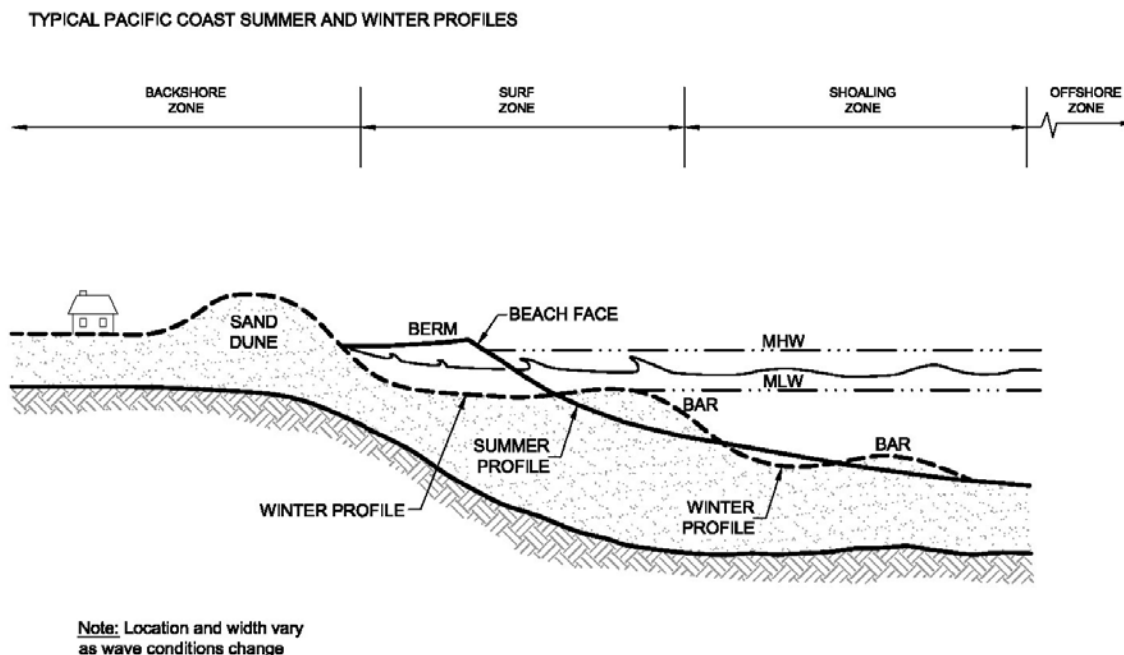

Figure D.4.6-1. Typical Pacific Coast Summer and Winter Beach Profiles (after Bascom, 1964)

D.4.6.3 Background and Definitions

By their nature, coastlines are extremely complex and dynamic environments. The type and magnitude of coastal erosion are closely related to general coastal exposure and beach setting.

D.4.6.3.1 Coastal Exposure

Coastal exposure refers to: (1) whether the coastline and beach are situated on the open coast, e.g., exposed to the undiminished waves, water levels, tides, winds, and currents associated with the open coast, or (2) whether the coastline is located within a sheltered area that is fully or partially protected from the direct action of ocean waves, winds, tides, water levels, and currents.

The latter condition is referred to as a *sheltered water area*. Beach erosion processes resulting from changes in total water level and wave action are similar along the open coast and within sheltered water areas; however, the magnitude, rate, and ultimate beach response may be quite different for sheltered water areas due to dramatic differences in total water-level changes and wave energy during large storms. Sheltered water areas typically have reduced wave energy and smaller runup. Some sheltered water areas found in confined embayments or estuaries may, however, experience higher still water elevations resulting from the combined effects of astronomical tides and fresh water runoff from streams and rivers and modified tidal and surge conditions.

The primary differences in estimating coastal erosion for these two types of beach exposures relate to how waves and water levels are determined for the 1% response storm condition. Refer to Section D.4.2 for guidance on how the 1% annual chance storm is determined and to Sections D.4.4 and D.4.5 for guidance on how waves and water levels are estimated for these two coastal exposures.

D.4.6.3.2 Beach Setting

Beach setting refers to localized geomorphic characteristics of the shore and backshore zone related to site-specific geology, profile shape, material composition, and material erodibility; proximity to other dominant features such as coastal inlets, storm outfalls, streams, and creeks; harbors and coastal structures; littoral sediment supply; and pocket beaches; and seasonal changes in beach width due to changes in wave direction. Six common beach settings representative of those along the California, Oregon, and Washington coastlines are addressed in these guidelines:

1. Sandy beach backed by a low sand berm or high sand dune formation
2. Sandy beach backed by shore protection structures
3. Cobble, gravel, shingle, or mixed grain sized beach and berms
4. Erodeable coastal bluffs
5. Non-erodeable coastal bluffs or cliffs
6. Tidal flats and wetlands

Figures D.4.6-2 through D.4.6-7 provide sketches and define terms for these six common beach settings found along the Pacific Coast. Table D.4.6-1 describes these settings, and lists recommended methods and data necessary for estimating beach profiles for use during runup computations. For the most part, these six settings are found in both open coast and sheltered water areas. However, the magnitude and net effects of tides, waves, currents, and erosion often differ between open coasts and sheltered areas. Policy and criteria for evaluating the stability and performance of coastal beach nourishment projects are not yet developed, and only basic guidance is provided in Section D.4.1, Pacific Coast Guidelines Overview.

Beach settings (1) and (2) are likely to be the most important coastal settings from a hazards mapping perspective. These two settings tend to experience the most erosion and flooding during large storm events. The following sections describe procedures for estimating storm-induced erosion for all six Pacific Coast beach settings listed in Table D.4.6-1. Two different

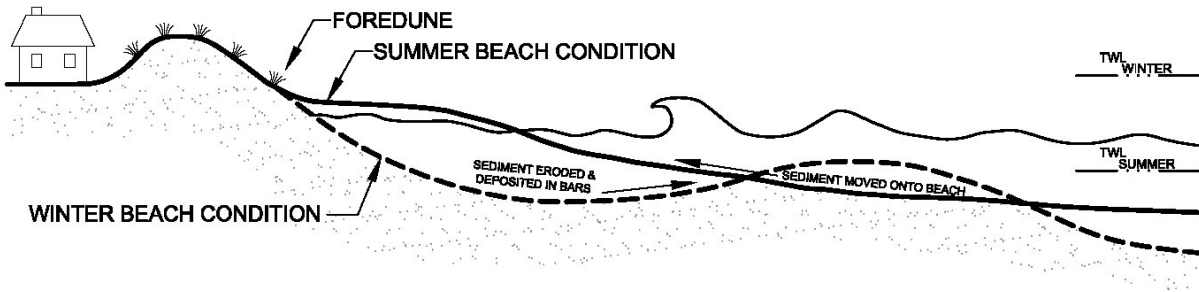

Figure D.4.6-2a. Sand Beach Backed by High Sand Dune (Beach Setting No. 1) (after Griggs, 1985)

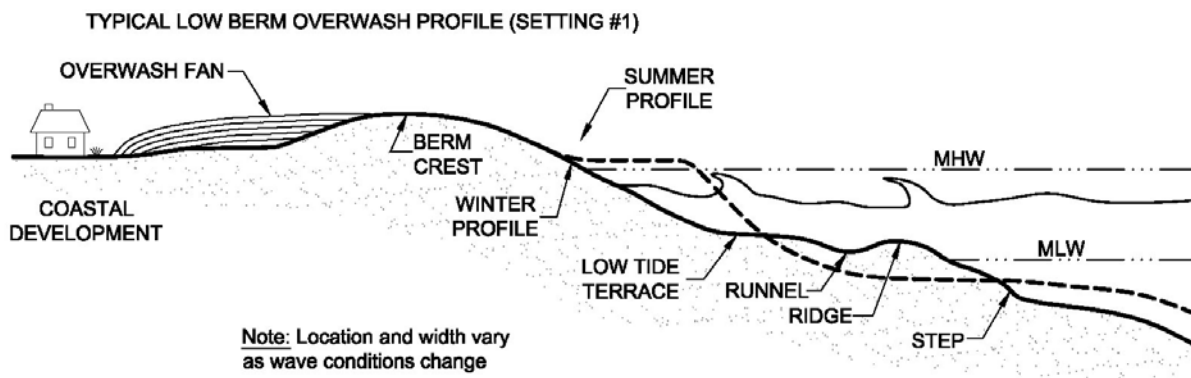

Figure D.4.6-2b. Sand Beach Backed by Low Sand Berm (Beach Setting No. 1) (after Bascom, 1964)

SANDY BEACH BACKED BY SHORE PROTECTION STRUCTURES (SETTING #2)

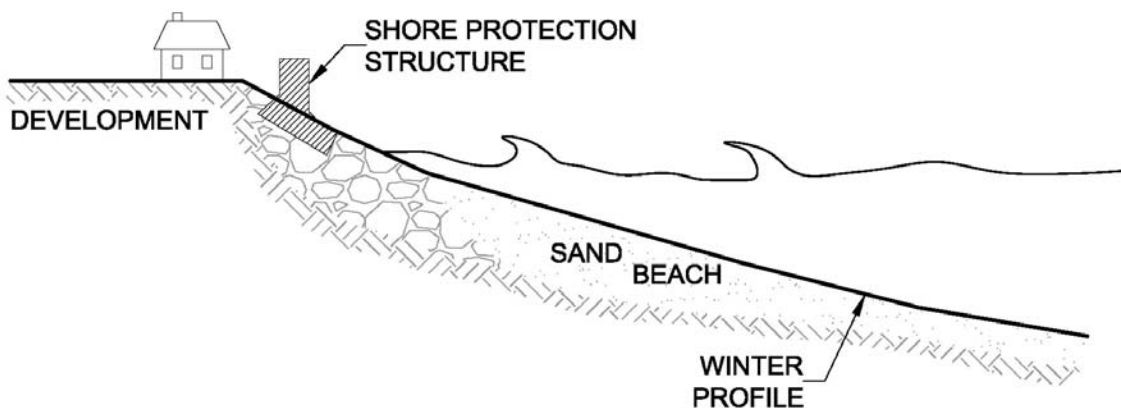

Figure D.4.6-3. Sand Beach Backed by Shore Protection Structures (Beach Setting No. 2)

COBBLE, GRAVEL, SHINGLE OR MIXED GRAIN SIZE BEACH (SETTING #3)

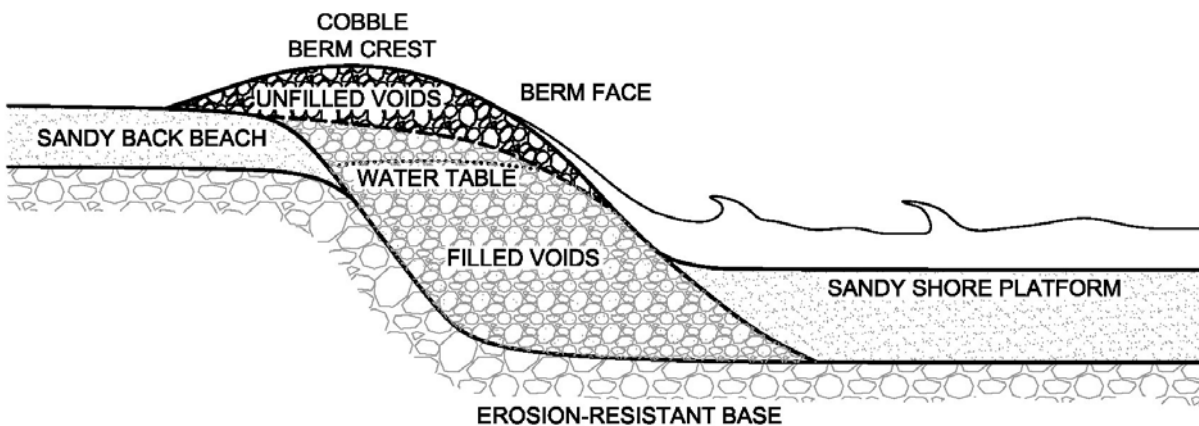
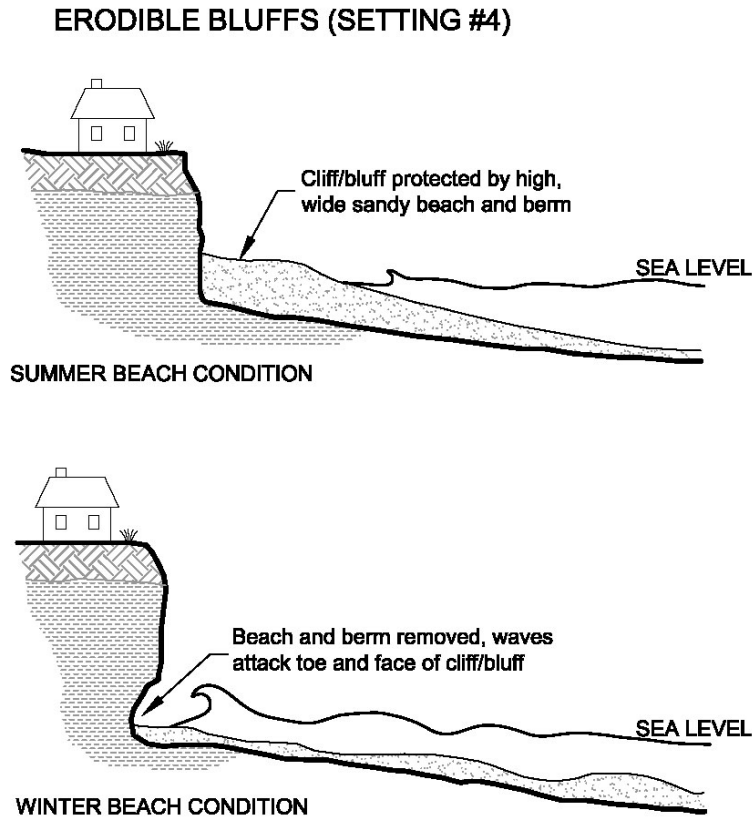
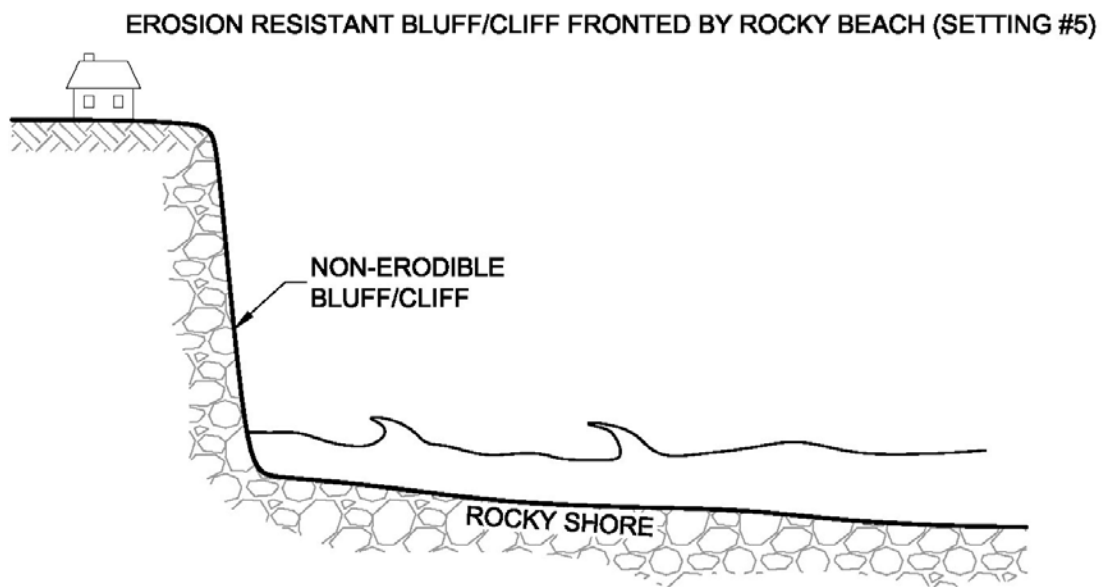

Figure D.4.6-4. Cobble, Gravel, Shingle, or Mixed Grain Sized Beach and Berms (Beach Setting No. 3)



**Figure D.4.6-5. Erodible Coastal Bluffs
(Beach Setting No. 4) (after Griggs, 1985)**



**Figure D.4.6-6. Non-Erodible Coastal Bluffs and Cliffs
(Beach Setting No. 5)**

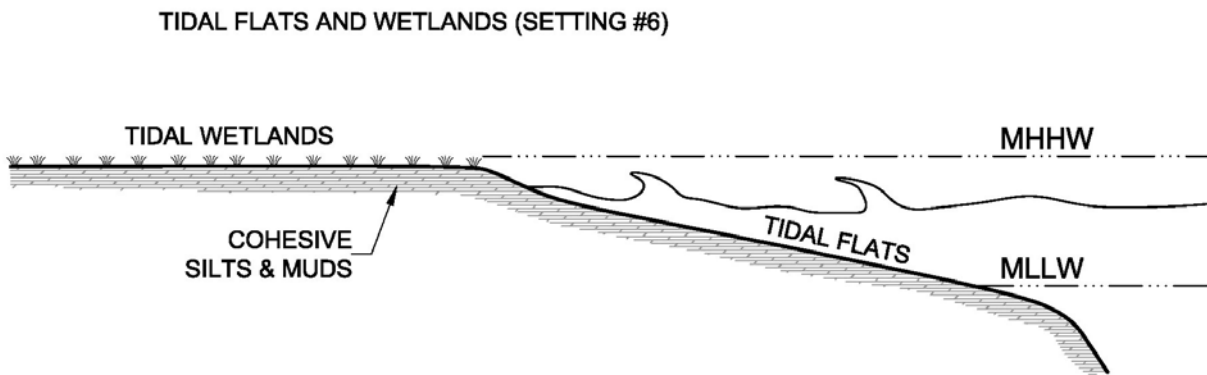

Figure D.4.6-7. Tidal Flats and Wetlands (Beach Setting No. 6)

Table D.4.6-1. Common Beach Settings Found Along the California, Oregon, and Washington Coastlines

Beach Setting	Reference to Sketch or Photo of Beach Setting	Materials	Recommended MLWP Methods	Recommended Eroded Profile Methods	Data Requirements
1. Sandy beach backed by low sand berm or high sand dune formation	Figures D.4.6-1, D.4.6-2a, D.4.6-2b, D.4.6-8, D.4.6-9, D.4.6-10, D.4.6-11, D.4.6-12, D.4.6-13, D.4.6-14, D.4.6-15, D.4.6-16, D.4.6-17, D.4.6-18, D.4.6-19	Fine to coarse beach and dune sands	<p>See Subsection D.4.6.4</p> <ol style="list-style-type: none"> 1. Begin with (surveyed) existing beach profiles. 2. Develop MLWP and overlay on existing beach profile: <ol style="list-style-type: none"> 2.a. <i>If have good post-large storm eroded beach profile data:</i> Use those data as initial winter beach profile, e.g., the MLWP. 2.b. <i>If not:</i> Use MLWP methods listed in Subsections D.4.6.5 and D.4.6.5.2 if using MK&A geometric erosion model, or use methods listed in Subsections D.4.6.5 and D.4.6.5.5 if using the K&D geometric erosion model. 	<p>See Subsection D.4.6.5</p> <ol style="list-style-type: none"> 1. Begin with the MLWP. 2. Select the MK&A or K&D method for computing beach erosion/recession that occurs to the MLWP during the 1% storm. 3. Apply the (a) MK&A model (Subsection D.4.6.5) primarily for open coast OR and WA beaches backed by high dunes, and (b) the K&D model (Subsection D.4.6.5) for CA Open Coasts or Sheltered Waters. 	<ul style="list-style-type: none"> - Local wave and water-level information - Local geology and beach and dune material characteristics - Historical beach profile data. - Recent data for project study area - LIDAR or surveyed profile data
2. Sandy beach backed by shore protection structures	Figures D.4.6-3, D.4.6-20, D.4.6-21	-Fine to coarse beach sands -Need characteristics of other fill or revetment materials	<p>See Subsections D.4.6.4 and D.4.6.6</p> <ol style="list-style-type: none"> 1. Estimate beach slope m from beach profile measurements immediately following winter storms, or 2. Estimate m from median grain size and beach exposure relationships (see Fig. D.4.6-9). 	<p>See Subsections D.4.6.6 and D.4.7</p> <ol style="list-style-type: none"> 1. Use post large-storm beach profile data. 2. Compute local scour depths at toe in front of structures, (see CEM). 3. Determine whether structure fails or is overtopped (D.4.7). 4. Adjust profile from step 1 to account for effects computed in steps 2 and 3. 	<ul style="list-style-type: none"> - Local wave and water-level information - Local geology and beach and dune material characteristics - Historical beach profile data - Recent data for project study area - LIDAR or surveyed profile data - Characteristics and dimensions of foundations and structures

Table D.4.6-1. Common Beach Settings Found Along the California, Oregon, and Washington Coastlines (cont.)

Beach Setting	Reference to Sketch or Photo of Beach Setting	Materials	Recommended MLWP Methods	Recommended Eroded Profile Methods	Data Requirements
3. Cobble, gravel, shingle or mixed grain size beach and berms	Figures D.4.6-4, D.4.6-22, D.4.6-23, D.4.6-24, D.4.6-25, D.4.6-26	Medium gravel to large cobble and small boulders	<p>See Subsection D.4.6.7</p> <p>Assume cobble beach and berm profile is stable; however, fronting beach sands may erode during winter storms (see Figs. D.4.6-15 and 16) Therefore, assume MLWP is same as eroded winter storm profile.</p>	<p>See Subsection D.4.6.7</p> <p>Determine eroded winter storm profile from measured historical beach profiles, supplemented by probing or trenching to cobble bottom</p>	<ul style="list-style-type: none"> -Local wave and water-level information -Local geology and beach and cobble berm material characteristics -Historical beach profile data -Recent data for project study area - LIDAR or surveyed profile data
4. Erodible coastal bluff fronted by narrow sandy beach	Figures D.4.6-5, D.4.6-27, D.4.6-28, D.4.6-29, D.4.6-30, D.4.6-31	<p><i>Bluff materials:</i> Loosely cemented sands and gravels</p> <p><i>Beach materials:</i> Fine to coarse sands, some small gravels, cobbles</p>	<p>See Subsection D.4.6.8</p> <ul style="list-style-type: none"> -Develop MLWP from measured historical beach profiles following large storm events; seek historical profiles during El Niño years if possible. -Supplement profile data with probing or trenching to confirm seasonal depth of scour. - If available, use historic eroded winter profile measured right after large storm. 	<p>See Subsection D.4.6.8</p> <ul style="list-style-type: none"> -Develop eroded beach profile from measured historical beach profiles following large storm events during El Niño years if possible. -Supplement profile data with probing or trenching to confirm seasonal depth of scour. -If bluff is erodible, apply Noble Engineers Bluff Erosion Method for bluffs (USACE, 2003) using estimate beach slope and elevations from eroded beach profile, above. 	<ul style="list-style-type: none"> -Local wave and water-level information -Beach and bluff material characteristics and erodibility information -Perform field inspections and sampling to determine geotechnical bluff erosion parameters -Historical beach profile and bluff retreat data -Recent data for project study area
5. Non-erodible coastal bluffs or cliffs (Note: This setting is often fronted by a rocky beach or rock platform capped with a thin layer of sand)	Figures D.4.6-6, D.4.6-32, D.4.6-33	<p><i>Bluff materials:</i> Erosion-resistant rock or cemented sands and gravels</p> <p><i>Beach materials:</i> Thin layer of fine to coarse sands with some small gravels, over rocky bottom or rock platform</p>	<p>See Subsection D.4.6.9</p> <p>Assume the winter beach profile is stable and is estimated from measured historical beach profiles, supplemented by probing to rocky bottom</p>	<p>See Subsection D.4.6.9</p> <ul style="list-style-type: none"> -Verify that bluff or cliff setting is non-erodible. -Determine winter beach profile from measured profile information and probing in March-April. 	<ul style="list-style-type: none"> -Local wave and water-level information -Geologic information for study area -Historical beach, bluff and cliff profile data -Recent data for project study area

Table D.4.6-1. Common Beach Settings Found Along the California, Oregon, and Washington Coastlines (cont.)

Beach Setting	Reference to Sketch or Photo of Beach Setting	Materials	Recommended MLWP Methods	Recommended Eroded Profile Methods	Data Requirements
6. Tidal flats and wetlands	Figures D.4.6-7, D.4.6-34, D.4.6-35	<p><i>Tidal Flats:</i> Cohesive sediment and organic materials; cohesive clays and silts;</p> <p><i>Wetlands:</i> cohesive clays, silts and organic materials often capped with marsh vegetation</p>	<p>See Subsection D.4.6.10</p> <p>-Assume tidal flats and wetland profiles are stable during single storm events. -Examine historical site information to determine whether profiles are stable, receding or accreting. -Determine winter profiles from LIDAR and/or other measured historical profiles.</p>	<p>See Subsection D.4.6.10</p> <p>Tidal flats and wetland surfaces typically do not erode during storm events; check local history of site; use LIDAR surveys or measured profiles to develop final winter profiles.</p>	<p>-Local wave and water-level information -Sediment & geologic information for study area -Historical profile data -Recent data for project study area -RU, OT and wave propagation computations will require estimates of vegetation density and roughness</p>

methods are proposed for Beach Setting No. 1, depending on whether the backshore is a berm or dune and if there is overtopping during the 1% storm event.

D.4.6.3.3 Data Sources

Estimation of coastal erosion during storm events typically requires the following types of site-specific beach information and data:

1. Summaries and photos of historical coastal erosion
2. Aerial photos of study area
3. Local geology and shore and backshore material characteristics
4. Previous Flood Insurance Study (FIS) mapping and reporting
5. Historic and recent beach survey data: Light Detection and Ranging (LIDAR) topography and profile data

The following list provides references and websites where pertinent data may be obtained for use in event-based erosion analyses:

- Allan, J. C. and P. D. Komar. August 2004. Morphologies of Beaches and Dunes on the Oregon Coast, with Tests of the Geometric Dune-Erosion Model. Technical Memo. August 2004, 43 pp.
- Barton, C. C. 2004. U.S. National Coastal Assessment, USGS, Geologic Division, St. Petersburg, FL, website: <http://coastal.er.usgs.gov/national_assessment/>.
- Beach Morphology Monitoring Program Beach Profiles, 2004: <http://www.ecy.wa.gov/programs/sea/swces/research/change/monitoring/beach_profiles.htm>.

- California Coastal Zone Conservation Commission. 1975. *California Coastal Plan*. Prepared by the California Coastal Zone Conservation Commission, State of California, San Francisco, CA. 443 pp.
- Carr, E. E. 2002. Database of Federal Inlets and Entrances. U.S. Army Corps of Engineers, Coastal Inlets Research Program. <<http://cirp.wes.army.mil/cirp/inletsdb/inletsdbinfo.html>>. June 19.
- Coastal Natural Hazards Policy Working Group. 1994. *Improving Natural Hazards Management on the Oregon Coast*, Oregon Sea Grant, Oregon State University, Publication No. ORESU-T-94-002, 128 pp.
- Department of Navigation and Oceanic Development. 1977. *Assessment and Atlas of Shoreline Erosion Along the California Coast*, State of California Resources Agency, Department of Navigation and Ocean Development, Sacramento, CA, 305 pp.
- Elliott, D. L., C. G. Holladay, W. R. Barchet, H. P. Foote, and W. F. Sandusky. 1986. Wind Energy Resource Atlas of the United States, DOE/CH 10093-4, DE86004442. Prepared by Pacific Northwest Laboratory, Richland, WA. Prepared for the U.S. Department of Energy, Assistant Secretary, Conservation and Renewable Energy, Office of Solar Electric Technologies, Wind/Ocean Technologies Division. Published by the Solar Technical Information Program, Solar Energy Research Institute [now the National Renewable Energy Laboratory], Golden, CO. October. <http://tredec.nrel.gov/wind/pubs/atlas/atlas_index.html>.
- Flick, R. E. (ed.). 1994. *Shoreline Erosion Assessment and Atlas of the San Diego Region, Volume II*. California Department of Boating and Waterways, Sacramento, CA.
- Gerstel, W. J., M. J. Brunengo, W. S. Lingley, Jr., R. L. Logan, H. Shipman, and T. L. Walsh. 1997. Puget Sound Bluffs: The Where, Why, and When of Landslides Following the Holiday 1996/97 Storms. *Washington Geology*, vol. 25, no. 1. March. <<http://www.dnr.wa.gov/geology/pugetls.htm>>.
- Good, J. W. (ed.). 1992. *Coastal Natural Hazards, Science, Engineering and Public Policy*. Oregon Sea Grant, Oregon State University, Publication No. ORESU-B-92-001, 162 pages.
- Gornitz, V., Beaty, T., and R. Daniels. 1997. A Coastal Hazards Data Base for the U.S. West Coast. ORNL/CDIAC-81, NDP-043C, Oak Ridge National Laboratory, Oak Ridge, Tennessee. <<http://cdiac.ornl.gov/epubs/ndp/ndp043c/43c.htm>>.
- Komar, P.D. 1997. *The Pacific Northwest Coast: Living with the Shores of Oregon and Washington*. Duke University Press.
- Nichols, M. D., 2003. *Draft Review of California Coastal Erosion Planning and Response: A Strategy for Action*. California Resources Agency, Ocean Resources Management Program, Sacramento, CA.

- NOAA. 2000a. Tidal Datums and Their Applications. NOAA Special Publication NOS CO-OPS 1, Silver Spring, MD. June. <http://www.co-ops.nos.noaa.gov/publications/tidal_datums_and_their_applications.pdf>.
- NOAA. 2000b. Nautical Chart Symbols, Abbreviations and Terms, Chart No. 1, Eleventh Edition. Lighthouse Press, Annapolis, MD. 99 pp. NOAA Nautical Chart Users Manual. <<http://chartmaker.ncd.noaa.gov/staff/ncum/ncum.htm>>.
- NOAA. 2003. Computational Techniques for Tidal Datums Handbook, NOAA Special Publication NOS CO-OPS 2, Silver Spring, MD. September. <http://www.co-ops.nos.noaa.gov/publications/Computational_Techniques_for_Tidal_Datums_handbook.pdf>.
- Peterson, C. D, M. E. Darienzo, D. Hamilton, D. J. Pettit, R. K. Yeager, P. L. Jackson, C. L. Rosenfeld, and T. A. Terich. 1994. *Cascadia Beach-Shoreline Database, Pacific Northwest Region, USA*. State of Oregon, Department of Geology and Mineral Industries, Open File Report 0-94-2, Portland, OR.
- Southwest Washington Coastal Erosion Study, 1996: <<http://www.ecy.wa.gov/programs/sea/swces/overview.htm>>.
- U.S. Army Corps of Engineers (USACE-LAD). 2003. *Encinitas and Solana Beach Shoreline Feasibility Study, San Diego County, California - Coastal Engineering Appendix Without Project Conditions*, Los Angeles District Corps of Engineers. August 2003.
- ———. 1998. *Coastal Erosion Along the U.S. West Coast During the 1997-98 El Nino: Expectations and Observations*. USGS, Center of Coastal Geology. <http://coastal.er.usgs.gov/lidar/AGU_fall98/>.
- Important Links to Other Information Sites Regarding California Coastal Zone Management Topics: <<http://www.coastal.ca.gov/web/sites.html>>.
- <http://coastal.er.usgs.gov/lidar/AGU_fall98/>: Coastal Erosion (NOAA).
- <<http://geodesy.noaa.gov/RSD/coastal/cscap.shtml>>: Remote Sensing (NOAA).
- <<http://gis.ca.gov/catalog/BrowseRecord.epl?id=1468>>: Assessment and Atlas of Shoreline Erosion along the California Coast (Calif. Dept. of Boating & Waterways).
- <<http://gis.sfsu.edu/data.htm>>: Listing of GIS Data Bases for Various Types of Data.
- <<http://www.californiacoastline.org/>>: California Coastal Records Project-Aerial Photographic Survey of the California Coastline.
- <<http://www.csc.noaa.gov/shoreline/>>: Shoreline Data (NOAA).

- <<http://www.csc.noaa.gov/crs/tcm/missions.html>>: Topographic Data (NOAA).

D.4.6.4 Estimating Eroded Beach Profiles

D.4.6.4.1 The Concept of the Most Likely Winter Profile

To estimate beach erosion and profile changes for a specific coastal setting that occurs during a particular winter storm event, it is important to first estimate the initial beach profile conditions that exist just before the occurrence of the storm (see Figure D.4.6-8). This initial beach profile represents the likely winter profile conditions for a particular coastal setting, defined as the *Most Likely Winter Profile* (MLWP). These initial conditions must be estimated before determining beach profile changes for a particular storm event. Once determined by the Mapping Partner, the MLWP is then modified according to the amount of erosion that occurs during a specified storm event as a result of increased water levels and wave action. Figure D.4.6-9 provides a generalized definition sketch of the MLWP for a typical sand beach backed by high sand dunes.

D.4.6.4.2 General Approach for Estimating Eroded Beach Profiles from Single Storms

The first step is to locate the site on a large-scale map. Next, determine the coastal exposure, open coast, or sheltered water area. Next, obtain and review mapping and published information regarding the site and its geologic, morphologic, seasonal water levels and wave climate, coastal processes, and erosional characteristics (e.g., refer to Subsection D.4.6.3.3 for references to sources for these types of information). Next, review historic summer and winter beach profile data if available, then determine the type of coastal setting(s) and the seasonal erosion characteristics that best represent the study area. Select from the six common beach settings applicable to coastlines of California, Oregon, and Washington that are described in Subsection D.4.6.3 and listed in Table D.4.6-1. Several different setting types may exist within the same study area depending on the aerial size and complexity of the study area. Therefore, a large project area with more than one type of beach setting, a variety of coastal exposures, and spatially varying material composition may require different data and the application of different procedures to estimate the MLWP or eroded profile for each representative setting. Mapping Partners should always establish subreaches within the larger study area that typify representative shore and backshore conditions within a particular subreach. If a series of cross-shore profiles is used to represent the shore and backshore for the study area, profiles must be carefully located to best capture the morphologic and potential erosional, runup, and overtopping aspects of each subreach.

After the study area is divided into representative subreaches, Mapping Partners must estimate the initial pre-storm event beach profile (MLWP) for each cross-shore profile in the subreaches. Methods for establishing the MLWP for each of the six primary settings defined above are presented in Subsections D.4.6.5 through D.4.6.10. Once determined by the Mapping Partner, the MLWP is then modified according to the amount of erosion that may occur for a particular setting and profile location during a specified storm event. Beach Setting No. 1 will always

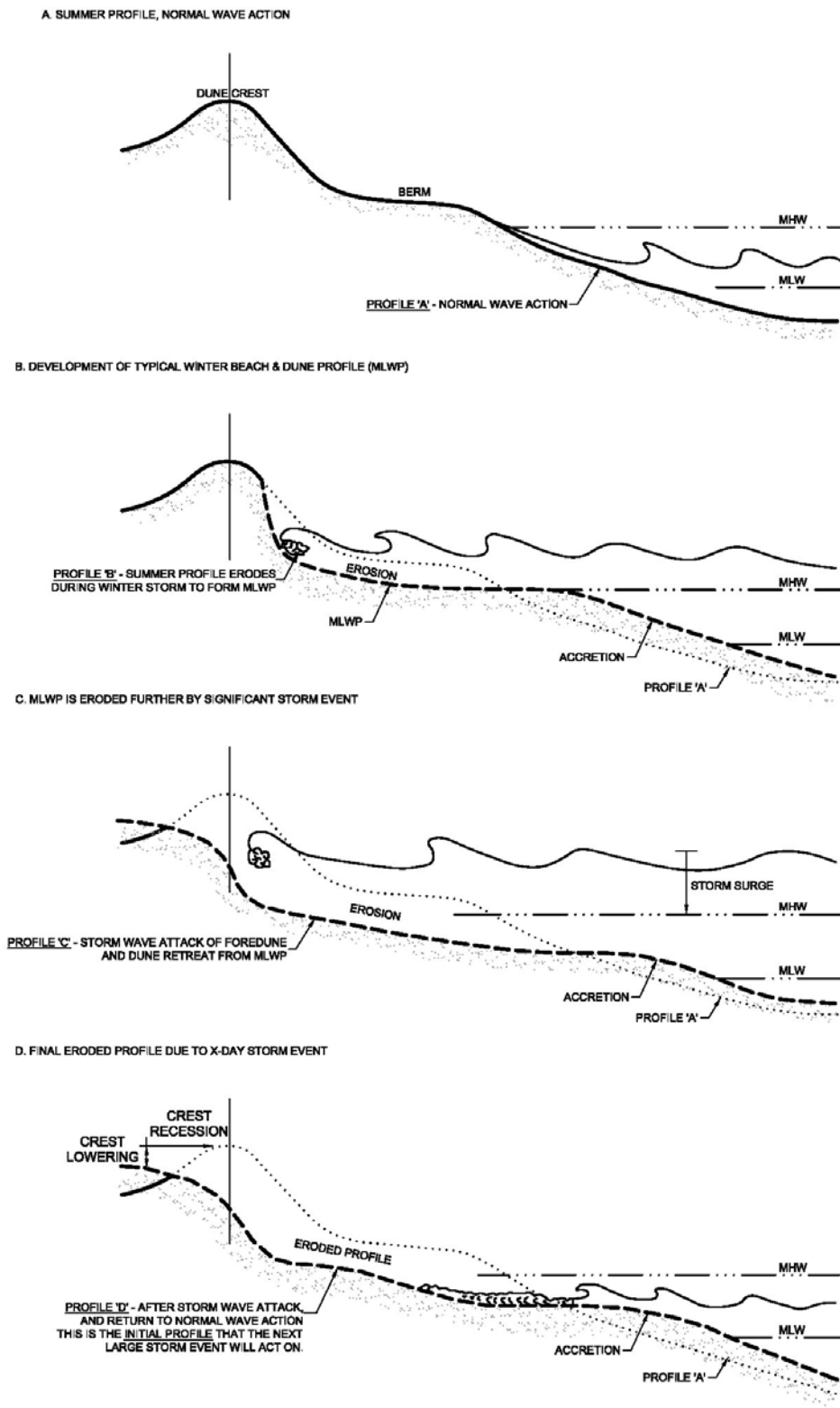

Figure D.4.6-8. Evolution of the Initial Beach Profile Before Occurrence of Large Storm Event (after SPM, 1984)

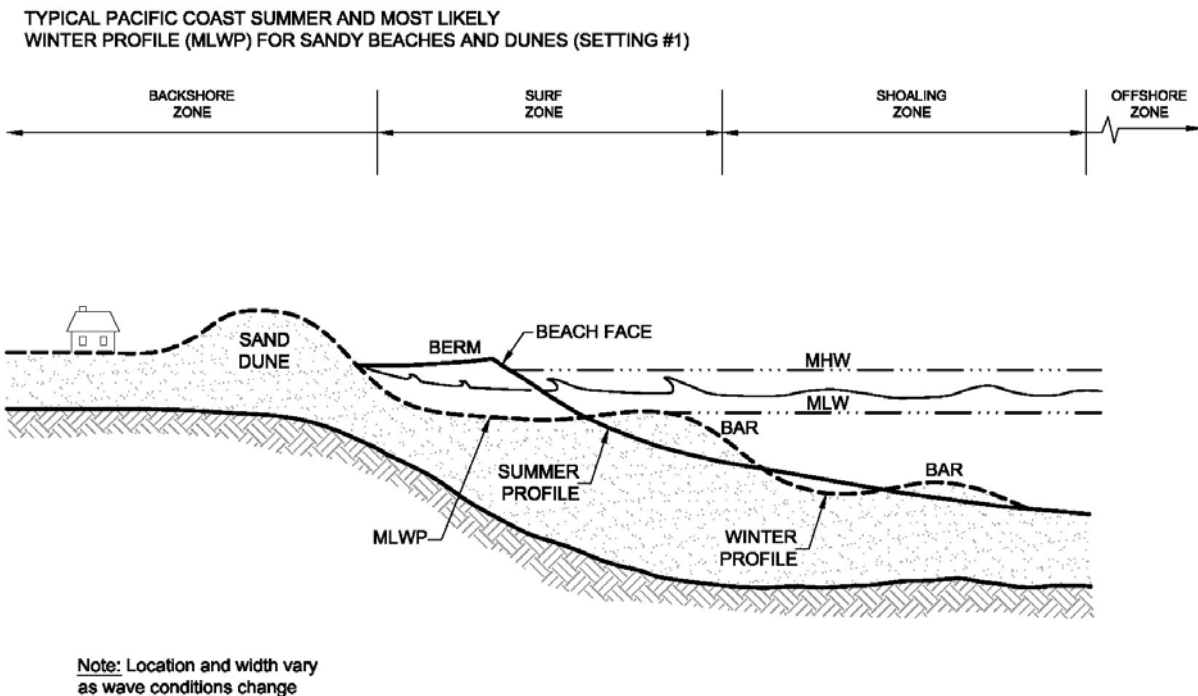

Figure D.4.6-9. Definition Sketch of MLWP for Sand Beach Backed by Sand Dunes (Beach Setting No. 1) (after Bascom, 1964)

require development of the MLWP, followed by computation of the amount of additional profile adjustment (erosion) that may occur to the MLWP during any specified storm event. Depending on beach material properties and width of the beach, Beach Setting No. 2 may require a similar two-step process to determine the eroded beach profile in front of shore protection structures. Beach Setting Nos. 3 and 4 should be checked for erosion potential, but they are less likely to experience significant erosion beyond what one would estimate as the MLWP for those settings. Beach Setting Nos. 5 and 6 are typically stable and erosion-resistant, so once the Mapping Partner establishes the winter profiles, analyses of further erosion is not required. The amount of erosion and profile adjustment that occurs for Beach Setting Nos. 1 and 2 depends on the magnitude and duration of the event and is related to the total water level and wave characteristics. Methods and procedures for estimating beach profile changes for each of the six primary settings are presented next.

D.4.6.5 Estimating Profile Changes for Sand Beaches Backed by Low Sand Berms or High Dunes (Beach Setting No. 1)

The main erosion-related factors affecting beach profiles during storms are: (1) antecedent conditions of the beach and back beach (profiles and beach-dune juncture elevation) before the occurrence of the specified storm event (this issue of initial beach conditions is addressed by the MLWP); (2) forcing processes that include the duration and time histories of the wave characteristics, water levels, and runup; and (3) response elements that include the beach setting and the dune/bluff characteristics, including material erodibility. Mapping Partners need methods that account for the general effects of these processes for estimating the change in profile that the

beach and back beach dunes will experience during the event in order to compute runup and overtopping and set BFEs, and establish depth and velocity hazard zones.

For Beach Setting No.1, a sandy beach backed by a low sand berm provides some buffer against storm wave attack. These beaches typically exhibit a very significant change in beach profile due to seasonal changes. The range of the seasonal change in berm width can vary from 50 to 250 feet as an extreme. Figures D.4.6-10 and D.4.6-11 show broad sandy beaches backed by low sand berms. Figure D.4.6-2b provides a sketch of a typical beach profile for broad sandy beaches backed by low sand berms (Beach Setting No. 1).



**Figure D.4.6-10. Sandy Beach Backed by Low Berm, Newport Beach, CA
(Source: Noble Consultants, Inc.)**



**Figure D.4.6-11. Sandy Beach Backed by Low Berm, Huntington Beach, CA
(Source: Noble Consultants, Inc.)**

Several event-based erosion assessment models are available, including simplified geometric models, simple process-based numerical simulation models, and more complex process-based simulation models. At the present time, process-based models have not been refined or calibrated for general application to Pacific Coast conditions. Therefore, use of process-based models is not recommended unless Mapping Partners have site-specific model calibration and validation data. Otherwise, Mapping Partners shall use the simplified geometric models discussed below.

The long-standing 540 ft³/ft criterion previously adopted by FEMA for estimating Atlantic and Gulf coast dune erosion should not be used on the Pacific Coast. The Technical Working Group (2004) determined that general application of the 540 criterion is not applicable for the Pacific Coast and found that there are simple geometric models that are more reliable and applicable for assessing dune and berm erosion on the Pacific Coast. Two geometric models are recommended: the K&D model developed by Kriebel and Dean (1993) and the MK&A model that was developed by Komar et al. (2002) and further modified by McDougal and MacArthur (2004). The MK&A model was developed and tested for the Oregon and Washington coast, so it is most applicable to Type 1 beach settings found in Oregon and Washington. The K&D model is more generalized and has been regularly applied to Type 1 beach settings in California, with successful test applications in Oregon and Washington.

D.4.6.5.1 General K&D and MK&A Model Characteristics and Applicability

Regardless of the simplicity of these geometric models, both the K&D and the MK&A models produce reasonable estimations of sand beach and dune recession during single storm events. Both models were tested using measured beach profile and wave data in southern California and in Oregon. Model results agreed well with observed conditions. However, the determination of reliable input parameters is crucial to the accuracy of model results.

The erosion potential in the MK&A model is determined entirely by the change in the total water level and the beach slope, and is very sensitive to the slope. For the K&D model, the wave setup, event duration, D_{50} of the beach material, and profile characteristics (beach face slope and surf zone profile) determine the maximum beach erosion potential. The K&D model considers the conservation of sand volume between the erosion from the upper portion of the beach and its deposition offshore. For both models, the storm duration directly affects the maximum beach erosion and must be determined carefully.

The K&D model (Kriebel and Dean, 1993) was developed for four different beach profiles: (1) a square berm, (2) a sloping backshore, (3) a sand beach backed by high dunes (15 to 50 feet high), and (4) a sand beach backed by a low berm with a wide backshore. Therefore, the K&D model is applicable to a wider variety of beach conditions and settings. For the purposes of these guidelines, we only consider one of the typical equilibrium beach conditions (Beach Setting No. 1) available with the K&D model.

Southern California has many broad sand beaches backed by relatively low sand berms and broad back beach terraces. Beaches backed by high sand dunes are more common in northern California, Oregon, and Washington. The crest elevations of the low sand berms generally range between +5 to +15 feet high. If wave runup is included in the total water level, as is done in the MK&A model, the water level can easily exceed the low berm crest during moderate to large

storms. The MK&A geometric model was developed primarily for applications along the Oregon and Washington coasts and is most appropriate for application to high dunes that are unlikely to be overtopped during a storm event. The K&D model is recommended for either case, where low berms can be easily overtopped during the storm event, or for high dunes that are unlikely to be overtopped. Figure D.4.6-12 shows a typical section of open Oregon coastline fronted by a long broad sand beach backed by high dunes where the MK&A model was successfully applied. All model results should be checked against observed post-storm data for reasonableness.



**Figure D.4.6-12. Photograph of Netarts Bay, Oregon
(Photo Provided by Jonathan Allan)**

D.4.6.5.2 MK&A and Its Application to Beach Setting No. 1

A geometric model for foredune erosion has been employed by Komar et al., (2002) on the Oregon and Washington coast to establish coastal setback distances for sandy beaches backed by dunes. This model was modified by McDougal and MacArthur (2004) to provide estimates of beach profile recession due to large storm events. The model is based on the underlying assumptions of an MLWP and the characteristic shape of shoreline recession that will result during a large wave and water-level event. The shoreline recession profile is characterized by the beach face slope, m , the beach-dune juncture elevation, E_j , and cross-shore location of the beach-dune juncture, y_j . These are shown in Figure D.4.6-13A. The juncture elevation is taken to occur at the maximum extent of the total runup plus the measured tide. The measured tide includes all processes that influence the water surface elevation such as surge and El Niño. The total runup is defined to include static and dynamic wave setup. The sum of the total runup plus the tide (including surge and El Niño) is referred to as the total water level (TWL). The sum of the astronomical tide, El Niño, and surge is the still water level (SWL) and is typically obtained from measurements. The setup and runup are calculated using methods described in Section D.4.5.

D.4.6.5.2.1 MK&A Methods for Estimating the MLWP

The first step for determining eroded beach profiles is to estimate the MLWP for each cross-shore profile. When using the MK&A method, the upper profile is specified by the beach face slope in the swash zone, m and the beach-dune juncture elevation and cross-shore location, E_j $_{MLWP}$ and y_j $_{MLWP}$ as shown in Figure D.4.6-13A. Because both the elevation and location of the juncture may be associated with different magnitudes of TWL events, the notation $()_{MLWP}$ is used to denote the MLWP case. The juncture elevation in the MK&A model is taken to occur at the maximum extent of the still water plus the total runup. The measured tide includes all processes that influence the water surface elevation such as the astronomical tide, surge, and El Niño. The runup is defined to include wave setup. The beach face slope is determined in the swash zone at high water levels. For the MLWP, m and E_j $_{MLWP}$ are determined from beach profile measurements following a significant storm or at the end of the winter season, or they may be determined from typical winter wave and water-level conditions (as explained below).

The MLWP should be determined from profile data immediately following a significant storm or series of winter storms. The greater the time between the end of the storm conditions and the measurement of the profile, the less reliable the estimates of the MLWP. During this time, aeolian transport, sloughing of the dune face scarp, and re-construction of the upper profile all tend to mask the MLWP beach face (swash zone) slope and in particular, the beach-dune juncture. As these processes proceed, the elevation of the beach-dune juncture actually increases. Profiles taken during the summer and fall should not be used. Profiles measured later in the winter season are preferred as they should represent the maximum beach response due to the seasonal cycle.

D.4.6.5.2.2 Estimating E_j $_{MLWP}$ and m from Profile Data

Komar and Allan (2004) suggest that E_j $_{MLWP}$ can be determined from LIDAR data and field verification. Unfortunately, this requires data collected immediately following significant storm events in order to capture the most likely eroded profile before other processes occur that may mask E_j $_{MLWP}$ or adjust its location. This procedure is also best supported by detailed site inspections immediately following storm events in order to survey and photo document beach profile conditions. McDougal and MacArthur (2004) discuss sensitivities and difficulties estimating the MLWP based solely on survey data.

D.4.6.5.2.3 Estimating m from Median Diameter of Beach Sands

Bascom (1964), Wiegel (1964), and others have shown that there are strong correlations between the beach face slope and the median diameter of the beach sands as shown in Figure D.4.6-14. These types of relationships can be used to estimate the beach face slope. The user must select the curve that best matches the coastal exposure, beach material characteristics, and settings represented by the curves prepared by the original authors. Open coasts along Oregon and Washington experience beach slopes approximately two times as steep as one would estimate using Wiegel's regional relationship as shown in Figure D.4.6-14, or approximately 1:25-30 (v:h). Therefore, Mapping Partners shall check estimated slope values from Figure D.4.6-14 with observed data. It is recommend that regional relationships similar to these be developed and tested for the different coastal exposures and settings found in California, Oregon, and Washington for estimating winter beach face slope.

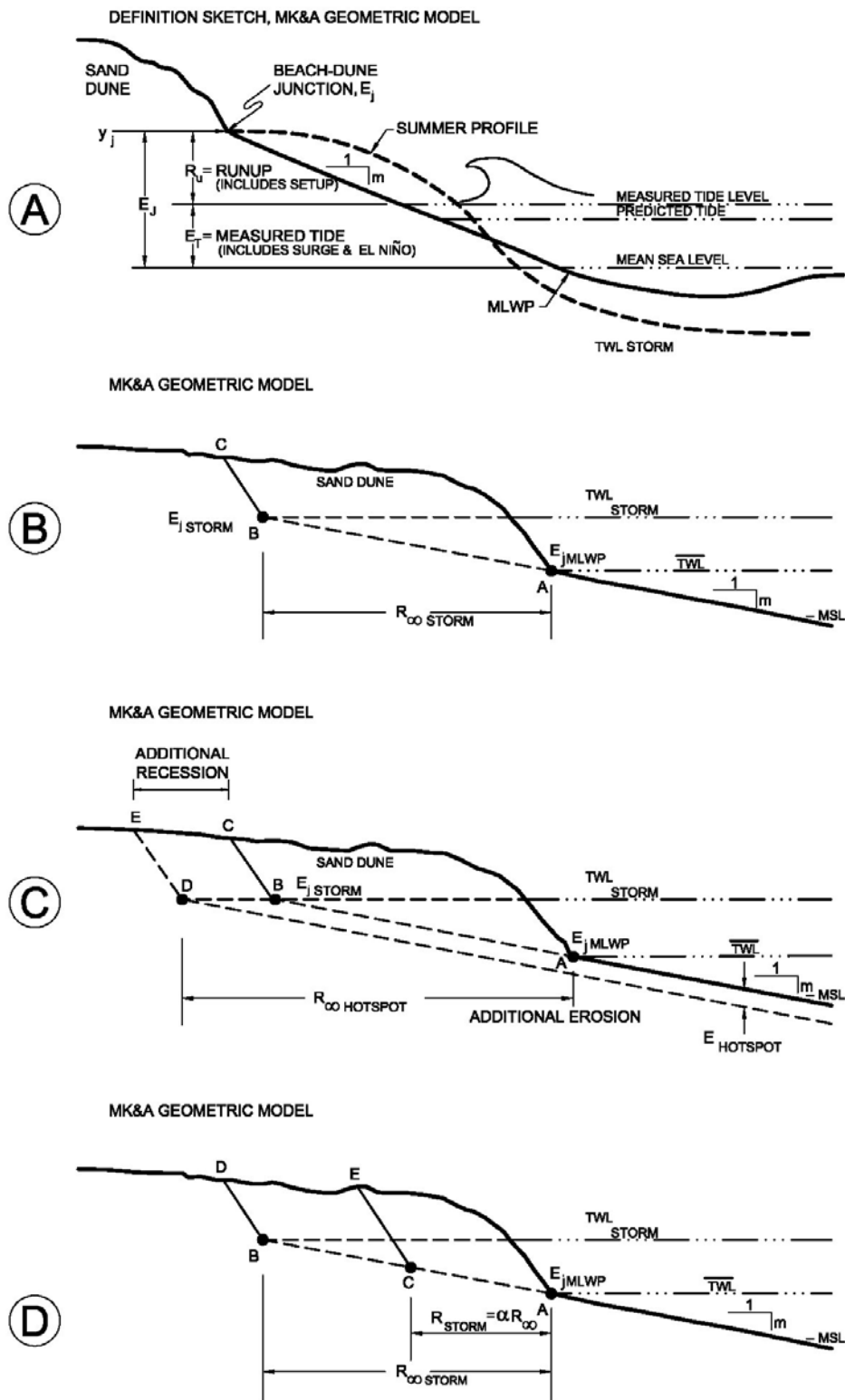

Figure D.4.6-13. Definition Sketches for Terms and Dimensions Required by the Modified Komar & Allan Geometric Model (after Komar et al., 2002, and McDougal and MacArthur, 2004)

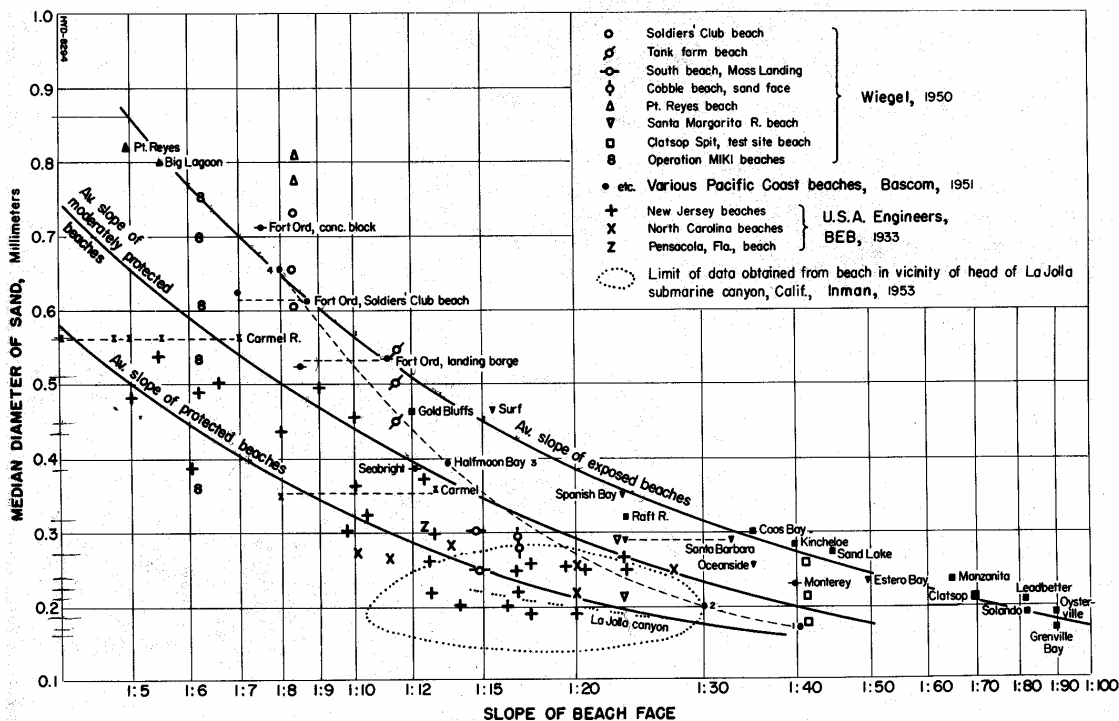

Figure D.4.6-14. Relationships Between Beach Slope and Median Diameter of Beach Sands (from Wiegels, 1964)

D.4.6.5.2.4 $E_{j,MLWP}$ from Wave and Water Levels

Given the difficulty in identifying a single value to select for $E_{j,MLWP}$ based on beach profile data alone, it may be possible to supplement the estimate with information about the waves and water levels that are typically responsible for producing the dune-beach juncture elevation, E_j . The juncture elevation can be estimated for the typical winter wave conditions as:

$$E_j = (R + E_T)_{winter\ storm\ average} \tag{D.4.6-1}$$

where the runup includes the setup and the tide includes surge and El Niño (see Figure D.4.6-13A). In Equation D.4.6-1, E_j represents the average of the sum of R and E_T from 10 to 20 largest storms per year, averaged over the storm duration for the entire wave data record.

The following subsection provides detailed procedures for estimating beach profile changes for sandy beaches backed by berms and sand dunes (Beach Setting No. 1, Table 4.6-1) using the MK&A model.

D.4.6.5.2.5 MK&A Model for Estimating Beach Profile Changes

The key assumption in the MK&A model is that when a large storm event occurs, the upper beach face slope remains constant but the beach-dune juncture adjusts in response to the higher level of waves and tides. This is shown in Figure D.4.6-13B. A typical winter pre-storm (MLWP) condition is shown as the solid line. This is taken as the initial condition (the MLWP)

to establish m and E_{jMLWP} . If a storm event elevates the TWL, then the shoreline erodes and retreats. The beach-dune juncture location associated with this retreat (point B in Figure D.4.6-13B) is estimated as the projection along the beach face slope onshore to the elevation of the storm's TWL. Above this elevation, the sand is assumed to remain at the angle of repose (approximately 30°) up to the surface elevation of the dune. The recession in the MK&A model due to $E_{j\text{ Storm}}$ is calculated as the recession in excess of the MLWP. The maximum potential recession is given by:

$$R_{\infty\text{ Storm}} = \frac{E_{j\text{ Storm}} - E_{jMLWP}}{m} \quad (\text{D.4.6-2})$$

where $E_{j\text{ Storm}}$ and E_{jMLWP} correspond to Equation D.4.6-1 beach-dune juncture elevations evaluated at the storm conditions and for the MLWP. The MK&A method gives the maximum potential equilibrium cross-shore change in shoreline position landward from the MLWP resulting from a storm event. However, the actual amount of beach erosion and dune recession depends on wave conditions, TWL, and storm duration. Therefore, the amount of beach erosion and dune recession for a particular storm event is less than the maximum potential cross-shore change represented by $R_{\infty\text{ Storm}}$ by a factor referred to as the storm duration recession reduction factor, α , as discussed in Subsection D.4.6.5.3. Figure D.4.6-13D shows a sketch of this where the profile ACBD represents the maximum potential equilibrium cross-shore change in shoreline position, $R_{\infty\text{ Storm}}$ and ACE is the actual eroded profile for the storm related to its duration. This is discussed further in Subsection D.4.6.5.3.

The cross-shore location of the juncture point, y_j is the initial location for the MLWP and may change with time (Figure D.4.6-13A). This can be in response to chronic erosion, sea-level changes, or other long-term effects. It may be necessary to adjust y_j for the MLWP if the time between the MLWP determination and the analysis of the recession is significant or if chronic shoreline position changes are significant.

If a beach consists of a thin layer of sand capping a wave-cut terrace or other erosion-resistant materials, then the MLWP occurs at the location and profile of the erosion-resistant layer.

Figure D.4.6-13C shows a second beach-dune juncture at point D. This additional recession is associated with other processes such as chronic erosion or local hot spots. Hot spots may develop when the profile is located in a rip current embayment or in the lee of a littoral barrier. Following Komar et al. (2002), where an adjustment was allowed for hot spots, the recession may be written as:

$$R_{\infty\text{ HotSpot}} = \frac{E_{j\text{ Storm}} - E_{jMLWP} + E_{\text{HotSpot}}}{m} \quad (\text{D.4.6-3})$$

where E_{HotSpot} is the localized lowering of the profile due to shoreline recession during a significant storm event due to local hot spots. Effects of site-specific hot spots and the amount of local beach lowering at that location is estimated from seasonal monitoring data from past large storm events.

D.4.6.5.2.6 Dune Overtopping with the MK&A Model

If E_j Storm exceeds the dune crest elevation, then the dune will be overtopped. This occurs independently of the storm duration or profile recession. The overtopping volumes may be estimated using the excess runup, which is the height that the predicted runup exceeds the dune elevation. If E_j Storm is less than the dune crest elevation, the dune crest may still be removed as shown by profile ACD in Figure D.4.6-15.

Note that the MK&A method is best applied to sand beaches with high dunes where overtopping is not expected to occur. The K&D method (discussed in Subsection D.4.6.5.5) will accommodate some overtopping, and therefore is more suitable for sand beaches with dunes and lower berms. However, neither model addresses the changes in the berm nor dune shape when overtopping occurs. Breaching typically results in a significant lowering of the dune profile and development of an overwash fan. The present methodologies do not provide a direct mechanism to address this breaching process. When overtopping occurs, the dune profile is adjusted by extending the MLWP slope m to the backside of the dune. Figure D.4.6-15B shows this scenario as profile ACE continuing seaward from the heel of the dune. Relationships like those shown in Figure D.4.6-14 by Wiegel (1964) can be used to estimate the ultimate beach face slope following significant dune breaching. If this approach is used, Mapping Partners should check the reliability of their results with observed information and data.

The following subsection describes how the effects of storm duration and seasonal responses are considered by the two recommended geometric models (MK&A and K&D).

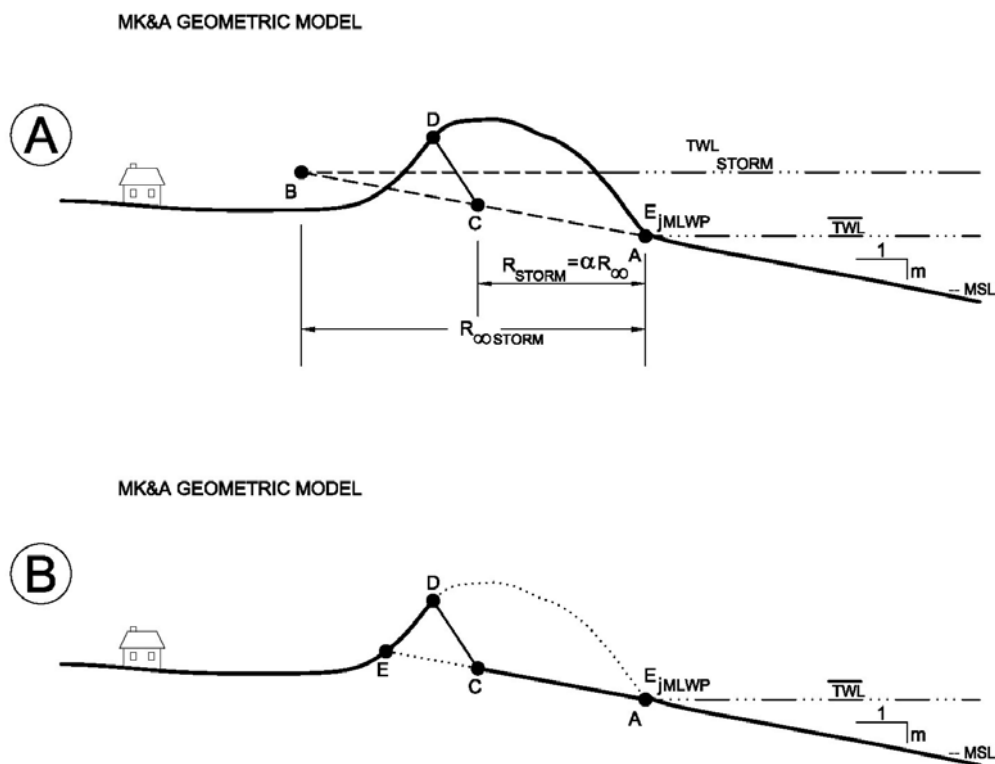

Figure D.4.6-15. Schematics of Dune Overtopping with the MK&A Model

D.4.6.5.3 Time Dependency of Profile Response (Within the MK&A and K&D Models)

The geometric models (MK&A and K&D) provide an estimate of the maximum potential cross-shore displacement of the profile. The wave and water levels must persist long enough to achieve this maximum. This is often not the case because a single storm event may have a shorter duration than is required to achieve the maximum potential cross-shore recession. Kriebel and Dean (1993) proposed a method to include the duration effects of a storm with respect to the response time scale of a beach profile.

The time scale for the beach profile was estimated from numerical model results to be:

$$T_s = C_1 \frac{H_b^{3/2}}{g^{1/2} A^3} \left(1 + \frac{h_b}{B} + \frac{m W_b}{h_b} \right)^{-1} \quad (\text{D.4.6-4})$$

in which T_s is the time scale, C_1 is an empirical constant (=320), H_b is the breaker height, h_b is the breaker depth, g is the acceleration due to gravity, B is the berm elevation, m is the beach face slope, W_b is the surf zone width, and A is the beach profile parameter that defines an equilibrium profile according to Equation D.4.6-5.

$$h = A y^{2/3} \quad (\text{D.4.6-5})$$

The beach profile parameter, A , depends primarily upon sediment grain size, D_{50} . Table D.4.6-2 summarizes A over a range of sediment sizes. The values in Table D.4.6-2 are well approximated by the equations:

$$A = \begin{cases} 0.06551 \ln(D_{50}) + 0.208 & (\text{m}^{1/3}) \\ 0.099731 \ln(D_{50}) + 0.309 & (\text{ft}^{1/3}) \end{cases} \quad (\text{D.4.6-6})$$

in which D_{50} is the sand diameter in mm and A is in $\text{m}^{1/3}$ or $\text{ft}^{1/3}$. Table D.4.6-3 gives estimates of the time scale for several representative conditions. It is seen that typical times are on the order of 10 to 100 hours. As the surf zone width increases, the response time also increases. Properties that increase the surf zone width include larger wave height, smaller sand size, and a milder slope. The response time also increases as the berm height increases. The longer profile response time associated with larger wave heights has the interesting result that the largest wave height may not yield the largest recession because it takes longer for the larger waves to achieve the maximum potential recession. Consider the first two waves in Table D.4.6-3, which only differ in wave height and the associated breaker depths. Assuming the period in both cases is 13 s and the storm duration is 24 hours and employing methods discussed below, the 10-foot wave height has a recession of 70 feet and the 20-foot wave has a recession of 55 feet.

**Table D.4.6-2. Equilibrium Beach Profile Coefficients
(Dean and Dalrymple, 2002)**

D_{50} (mm)	A (m ^{1/3})	A (ft ^{1/3})
0.1	0.063	0.0936
0.2	0.100	0.1486
0.3	0.125	0.1857
0.4	0.145	0.2155
0.5	0.161	0.2392
0.6	0.173	0.2571
0.7	0.185	0.2749
0.8	0.194	0.2883
0.9	0.202	0.2987
1.0	0.210	0.3120

Table D.4.6-3. Estimates of the Beach Profile Time Response

H_b (ft)	h_b (ft)	D_{50} (mm)	A (ft ^{1/3})	m	B (ft)	W_b (ft)	T_s (hrs)
10	13	0.2	0.1486	0.05	10	801	28
20	25	0.2	0.1486	0.05	10	2267	53
30	38	0.2	0.1486	0.05	10	4164	77
20	25	0.2	0.1486	0.05	1	2267	14
20	25	0.2	0.1486	0.05	10	2267	53
20	25	0.2	0.1486	0.05	20	2267	64
20	25	0.2	0.1486	0.01	10	2267	96
20	25	0.2	0.1486	0.02	10	2267	80
20	25	0.2	0.1486	0.10	10	2267	34
20	25	0.1	0.0936	0.05	10	4533	138
20	25	0.2	0.1486	0.05	10	2267	53
20	25	0.5	0.2392	0.05	10	1110	18

The beach profile response is determined by a convolution integral. It is assumed that the time dependency of the storm hydrograph may be approximated as:

$$f(t) = \sin^2 \left(\pi \frac{t}{T_D} \right) \quad \text{for } 0 < t < T_D \quad (\text{D.4.6-7})$$

where t is time from the start of the storm and T_D is the storm duration. The convolution integral is:

$$R(t) = \frac{R_{\infty}}{T_S} \int_0^t f(\tau) e^{-(t-\tau)/T_S} d\tau \quad (\text{D.4.6-8})$$

which integrates to:

$$\frac{R(t)}{R_{\infty}} = \frac{1}{2} \left\{ 1 - \frac{\beta^2}{1 + \beta^2} \exp(-t/T_S) - \frac{1}{1 + \beta^2} [\cos(2\pi t/T_D) + \beta \sin(2\pi t/T_D)] \right\} \quad (\text{D.4.6-9})$$

where $\beta = 2\pi T_S / T_D$ and R_{∞} is the maximum potential recession that would occur if the storm duration was infinite as yielded by Equations D.4.6-2 and D.4.6-3 (Figure D.4.6-13D) for the MK&A method. If the storm duration is long with respect to the profile time scale, then a significant portion of the maximum potential shoreline response will occur. As the ratio of T_S / T_D decreases, less of the maximum shoreline change will be realized. The time of the maximum recession is determined by setting the derivative of Equation D.4.6-9 equal to zero and solving for the time. This yields:

$$\exp\left(-\frac{t_m}{T_D}\right) = \cos\left(\frac{2\pi t_m}{T_S}\right) - \frac{T_D}{2\pi T_S} \sin\left(\frac{2\pi t_m}{T_S}\right) \quad (\text{D.4.6-10})$$

in which t_m is the time that the maximum occurs with respect to the start of the storm. Unfortunately, this is a transcendental equation and must be solved by approximation or numerical methods. The maximum recession that occurs as the result of a single storm or duration limited response is:

$$\alpha = \frac{R_m}{R_{\infty}} = \frac{1}{2} \left[1 - \cos\left(2\pi \frac{t_m}{T_D}\right) \right] \quad (\text{D.4.6-11})$$

where α is the storm duration recession reduction factor, R_m is the maximum recession that occurs for the given storm duration that occurs at time t_m . Figure D.4.6-16 gives the solution to Equation D.4.6-11 in graphical form. Therefore, duration limited recession is:

$$R_m = \alpha R_{\infty} \quad (\text{D.4.6-12})$$

Multiple Storm Responses

The maximum recession observed on the Pacific Coast often results from the occurrence of several storms in succession. Unless there is site-specific information or guidance for using multiple storms, it is recommended that a single storm analysis be used. If multiple storms are to be considered, then the cumulative recession may be estimated by summing the contribution of each storm to the recession beyond the previous profile. McDougal and MacArthur (2004b) discuss methods for conducting cumulative recession analyses in their report entitled *EBE MLWP Discussion*. Before initiating a seasonal response investigation, Mapping Partners should check with the FEMA study representative to confirm that this level of analysis is necessary and that there are sufficient historical data to confirm the results.

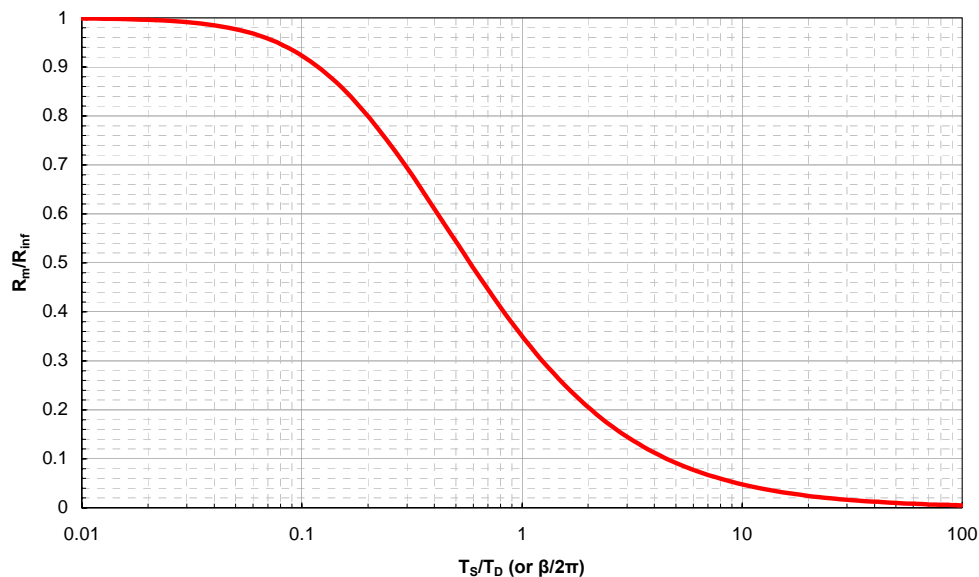

Figure D.4.6-16. Storm Duration Recession Reduction Factor

D.4.6.5.4 Summary of the MK&A Geometric Modeling Approach for Sand Beaches Backed by Sand Berms and Dunes (Beach Setting No. 1)

Mapping Partners evaluating sand beaches backed by sand berms and dunes (Beach Setting No. 1) using the MK&A model approach shall complete the following steps to estimate the beach erosion and recession associated with storm events. Figure D.4.6-17 shows the sequence of key activities and computational considerations required to determine storm-induced beach profile changes for Beach Setting No. 1.

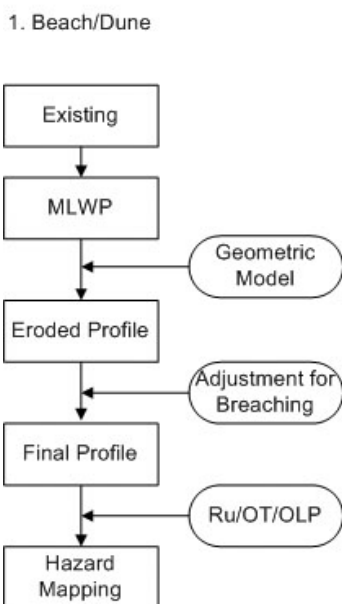

Figure D.4.6-17. Key Activities to Determine Beach Profile Changes for Beach Setting No. 1

Develop Data:

1. Obtain wave and water-level data necessary to define the waves and water levels for the 10-20 largest storms each year.
2. Determine existing shoreline location and conditions.
3. Define reaches alongshore in which wave, beach, and backshore conditions are nearly uniform. Data and calculations must be conducted for at least each subreach.
4. Obtain beach profile data required to establish the MLWP or the annual winter wave and water-level conditions to develop an MLWP for each subreach.
5. Determine median sand diameter, D_{50} , on the beach face for each subreach.
6. Obtain historical beach profile data required to estimate the magnitude of local hot spot erosion and site-specific beach lowering with each subreach being evaluated within the study area.
7. Seek historical data for use in validating results from the application of the simple geometric models.

Determine MLWP:

1. Estimate beach slope m from measured post-storm winter profile data as discussed in Subsection D.4.6.5.2 or use a relationship such as Wiegels' (1964) (Figure D.4.6-14) to relate median beach sand diameter to beach slope, m .
2. Estimate E_j $_{MLWP}$ based on measured winter profile data following the occurrence of large storms or make estimates using winter wave and water-level conditions as outlined in Subsection D.4.6.5.2.
3. Estimate the cross-shore location for the MLWP, y_j , related to existing beach profile conditions.

Determine Beach Recession for Each Storm Event:

1. Determine static setup and/or TWL as required for the geometric recession model to calculate the potential recession for the storm, $R_{\infty storm}$.
2. Determine storm duration recession reduction factor for the storm, α (Figure D.4.6-16).
3. Determine duration limited recession for storm, R_{storm} , and if the berm/dune is breached, modify beach and berm/dune profile to account for breaching or local hot spot erosion if necessary according to Subsection D.4.6.5.3.
4. If runup is different on the modified profile, re-compute runup.

5. If runup results in overtopping, then compute overtopping. Save the maximum overtopping value. Also compute the overtopping volume as $V = \text{integral } Q \, dt$ over duration of storm.
6. For each year, save conditions corresponding to the largest annual TWL storm event: TWL, Q , V , α , H , T , D , γ , R_{storm} , etc.

Use Measured Profiles to Validate Results:

Mapping Partners shall always locate the best and most reliable measured data for their project site. They should also use measured beach profile data wherever possible: (1) to aid in estimating the MLWP, and (2) to determine, calibrate, and validate the eroded beach profile for a specified storm event. The eroded beach profile estimated for a particular storm event is the profile required for computing runup and overtopping associated for that event.

Determine the 1% Storm Event:

Mapping Partners shall follow procedures outlined in Section D.4.2 for determining the 1% percent storm conditions for use in determining flood hazards.

D.4.6.5.5 K&D Geometric Modeling Approach for Sand Beaches Backed by Sand Berms and Dunes (Beach Setting No. 1)

Kriebel and Dean developed an analytical solution to approximate the temporal beach-profile response to a single storm (Kriebel and Dean, 1993). The maximum potential recession of a sand beach profile, R_{∞} , was established based on the equilibrium principle proposed by Bruun (1962) for erosion due to long-term, sea-level rise. Kriebel and Dean assumed an equilibrium beach profile with respect to the prevailing water level and wave climate. Typically, the prevailing water level is referred to the mean sea level (MSL). The eroded profile is then shifted upwards by an elevation equal to the water-level rise caused by storm surge and wave setup, and landward by an amount of beach recession potential (R_{∞}) until a volume balance is achieved between sand eroded from the upper portion of the beach and sand deposited offshore. Based on this conservation of sand volume, the maximum erosion potential (R_{∞}) can be defined as a function of the water-level rise (S) during a storm, breaking wave depth (h_b), surf zone width (W_b), berm or dune height (B or D), and the slope (m) of the upper foreshore beach face. Along the Pacific Coast, the water-level rise during a storm event is mostly influence by wave setup, as the storm-induced surge tends to have a minor effect.

Kriebel and Dean presented analytical solutions to estimate the maximum erosion potential R_{∞} for four different beach settings. The solution for one of the four settings that is typically observed on the Pacific Coast, as shown in Figures D.4.6-18 and D.4.6-19, is presented as follows:

- Maximum erosion potential for a beach backed by a low sand berm:

$$R_{\infty} = \frac{S(W_b - h_b / m)}{B + h_b - S / 2} \quad (\text{D.4.6-13})$$

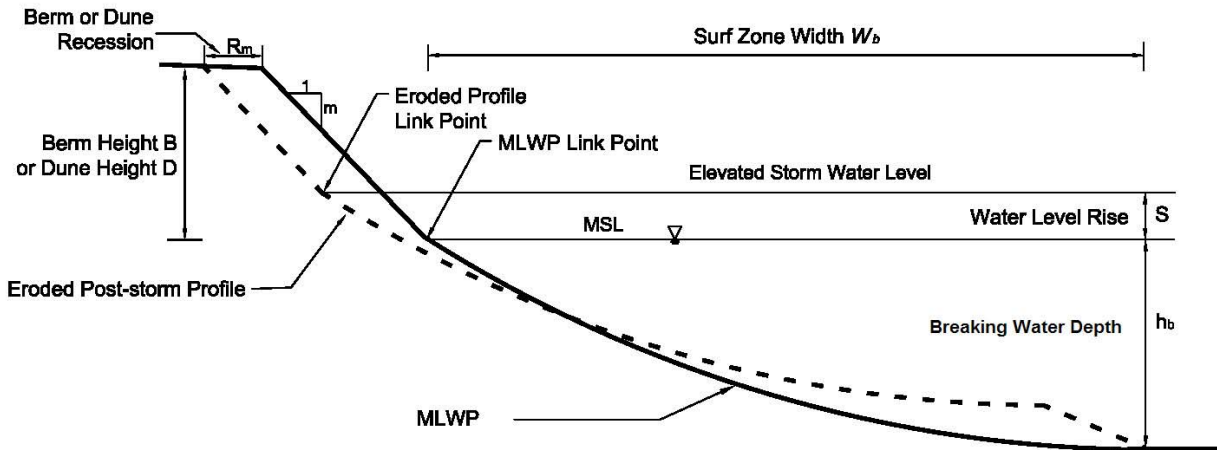

Figure D.4.6-18. Definition Sketch for K&D Geometric Model

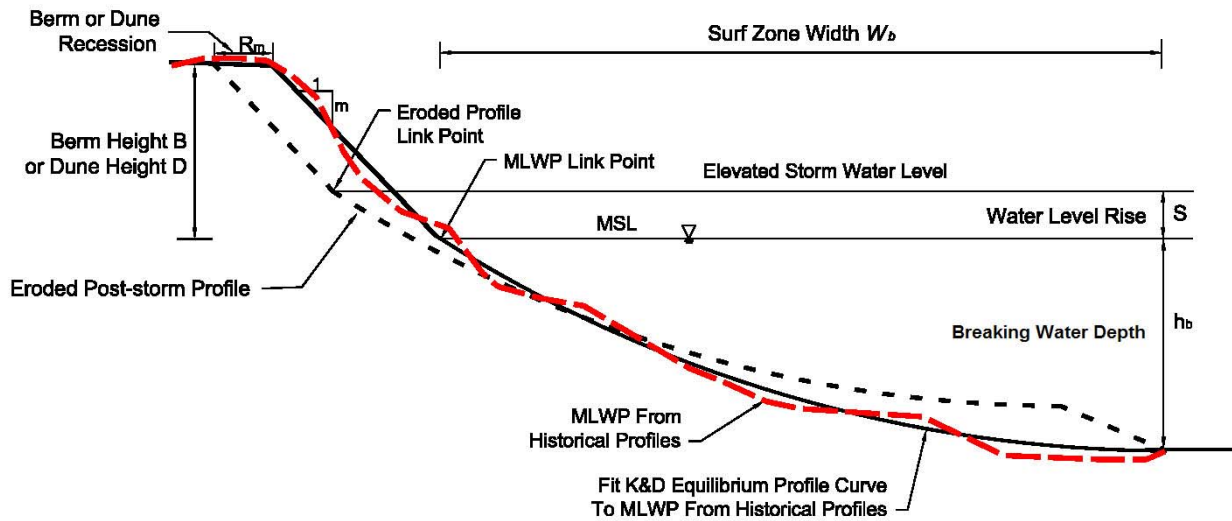

Figure D.4.6-19. Sketch for K&D Geometric Model for Case Where Historical Beach Profile Data Are Available to Prepare the MLWP

- Maximum erosion potential for a beach backed by a high sand dune:

$$R_{\infty} = \frac{S(W_b - h_b / m)}{D + h_b - S / 2} \quad (\text{D.4.6-14})$$

where S is the water-level rise representing the sum of the peak storm surge (wind effects and barometric pressure effects) and the wave setup, h_b is the breaking water depth, W_b is the surf zone width, m is the slope of the foreshore fronting face, and B and D are the berm and dune heights above the prevailing water level, respectively. Equations D.4.6-13 and D.4.6-14 estimate the maximum recession potential, assuming that the storm event lasts indefinitely. The actual storm-induced recession (R_m), which depends strongly on the duration of each storm event, must be multiplied by a storm duration recession reduction factor, α , as stated in Subsection D.4.6.5.3. For backshore profiles that are not well approximated by the analytical solutions given in Kriebel and Dean (1993), a conservation of sand volume equation (i.e., a simple balance of cuts and fills) may be solved numerically. Further discussion of this computational procedure is provided in the following guidelines.

Because the elevated storm water level is based on the magnitude of wave setup and storm surge only to a small extent on the Pacific Coast, it is likely that the storm water level is below the berm or dune height. In the event that the elevated storm water level is higher than the crest of the berm or dune, the K&D model may no longer be applied and the profile must be adjusted for overtopping. When the K&D model is applied to estimate the storm-induced erosion, various model input parameters are required. The calculation of storm-induced erosion, using the K&D convolution method, is delineated as follows:

Acquire Wave and Water-level Data:

1. Obtain hindcasted wave data (e.g., Global Reanalysis of Ocean Waves [GROW] data) and measured historical water levels necessary to define the oceanographic conditions including waves and water levels for 10-20 largest storm events for every hindcasted year.
2. Acquire historical beach profiles to establish the MLWP (i.e., pre-storm beach profile conditions).
3. Seek historical pre- and post-storm profiles to validate the application of the simple K&D geometric models.

Determine MLWP for K&D Method:

First, determine existing shoreline location and conditions. Then, establish representative reaches within the shoreline area being analyzed that are similar in coastal morphology (average offshore/nearshore bathymetry, wave exposure, onshore beach slope, beach materials, etc.). This may consist of only one typical reach or several different typical reaches for the shoreline area being analyzed. Following are procedures for establishing the MLWP for a sandy beach backed by either a low sand berm or a high sand dune for application with the K&D geometric model.

1. Procedure for a Study Site Without Previously Surveyed Historical Profiles

- a. Determine existing shoreline location and conditions.
- b. Always use measured historical post-storm winter beach profile data when available to establish the MLWP. However, if there are no historical post-storm winter beach profile data, conduct a basic wading survey from the crest of the berm or dune to the approximate mean low low water (MLLW) line (see National Oceanic and Atmospheric Administration [NOAA] tidal datum) following a series of winter storms in March or April to prepare a surveyed beach profile from the berm crest to approximately MLLW.
- c. Collect sediment samples, preferably in late March or early April to determine the median sand diameter (D_{50}) for use in Equations D.4.6-5 and D.4.6-6.
- d. Determine the MSL from NOAA's tidal datum, and identify the MSL location across the beach profile. This location divides the beach profile into an upper foreshore berm/dune section and the surf zone section.
- e. Plot the measured upper foreshore profile section above the MSL line based on the basic wading survey, site photographs, and available historical information (see Figure D.4.6-18).
- f. Determine the berm or dune height (B or D) above the MSL line and foreshore slope (m) from the estimated upper foreshore section (see Figure D.4.6-18).
- g. Approximate the surf zone section of the MLWP from Kriebel and Dean's equilibrium beach profile, based on the measured D_{50} and the application of Table D.4.6-2 and Eqs. D.4.6-5 and D.4.6-6.
- h. Assemble the entire MLWP based on the surveyed upper foreshore and surf zone sections linked at the MSL, as illustrated in Figure D.4.6-18.
- i. Document data sources, assumptions, and conversions.

2. Procedure for a Study Site With Previously Surveyed Historical Profiles:

- a. Determine existing shoreline location and conditions.
- b. Select a representative surveyed winter profile (see Figure D.4.6-19) from historical post-storm beach profile data, which was surveyed during the end of the winter season (March-April) and represents the typical winter beach profile conditions.
- c. Determine the MSL from NOAA's tidal datum, and identify the MSL location across the beach profile. This location divides the beach profile into an upper foreshore berm/dune section and the surf zone section.

- d. Determine the berm or dune height (B or D) above the MSL line and compute the foreshore slope (m) through linear curve fitting to the upper foreshore section.
- e. Determine the surf zone section of the MLWP by curve-fitting Kriebel and Dean's equilibrium profile from Eqs. D.4.6-5 and D.4.6-6 to the surf zone section of the surveyed beach profile below the MSL line (see Figure D.4.6-19).
- f. Assemble the entire MLWP based on the approximated upper foreshore and surf zone sections linked at the MSL, as illustrated in Figure D.4.6-19.
- g. After the MLWP is defined, determine the K&D model input parameters including the berm or dune height (B or D) and the foreshore slope (m) (see Figures D.4.6-18 and D.4.6-19).

Quantify Peak Storm Conditions of a Selected Storm Event:

The peak storm conditions for a selected storm event shall be used to determine the storm surge including the wave setup, wave breaking, and storm duration. Storm surge resulting from the fluctuations in the wind speed and atmospheric pressure is usually small in the Pacific Coast, and thus the wave setup is the primary parameter to determine the water-level rise. The increase in water level induced by El Niño events should also be included, if applicable (see Section D.4.4, Waves and Water Levels). The peak storm conditions include wave height, period, and incoming direction at the peak of the storm, as well as the storm duration that is characterized in Section D.4.4. These wave conditions are used to determine the wave setup (S), water depth of breaking wave (h_b), and the surf zone width (W_b) needed by the K&D geometric model. The MSL water depth can be used as a representative water depth to calculate wave transformation. The procedures are listed as follows:

1. Determine the breaking water depth (h_b) and the surf zone width (W_b), based on the MLWP and the selected wave event.
2. Estimate the wave setup using the formula presented in Subsection D.4.5.1.
3. Based on the procedures described in Section D.4.4, calculate the storm surge induced by wind effects and barometric pressure effects, if applicable.
4. Estimate the increase in water level induced by the El Niño Southern Oscillation (ENSO) events in accordance with the procedures stated in Section D.4.4, if applicable.
5. Determine the total increase in water level (S) induced by the storm (see Figures D.4.6-18 and D.4.6-19).

Calculate Storm-induced Beach Erosion:

1. Calculate the maximum beach erosion potential R_∞ using Equation D.4.6-13, if the subject beach is backed by sand berms with height B .

2. Calculate the maximum beach erosion potential R_{∞} using Equation D.4.6-14, if the subject beach is backed by sand dunes with height D .
3. Calculate the time scale (T_S) from Equation D.4.6-4.
4. Determine the storm duration (T_D) from Subsection D.4.4.1, and compute the storm duration recession reduction factor, α , from Figure D.4.6-16 for the given value of T_D/T_S .
5. Multiply the maximum recession potential (R_{∞}) by the storm duration recession reduction factor to estimate the storm-induced beach erosion and recession distance (R_m).

Prepare Eroded Post-Storm Beach Profile:

1. Set back the upper foreshore profile above the elevated storm wave level (see Figures D.4.6-18 and D.4.6-19) landward by the calculated berm or dune recession distance R_m with the same fronting-face slope (m).
2. Place the new link point between the upper foreshore section and the surf zone section at the elevated storm water level (see Figures D.4.6-18 and D.4.6-19).
3. Shift the surf zone section of the MLWP below the MSL landwards and upwards to the link point (see dashed curve below the MSL line in Figures D.4.6-18 and D.4.6-19).
4. The adjusted profile from Steps 1 to 3 produces the “eroded storm profile” for a specified location and beach profile. Mapping Partners shall perform these steps for all beach profiles needed to describe the spatial adjustments to the beach and dune system being evaluated.
5. Document results and assumptions.

D.4.6.5.6 Potential Future Use of Process-based Models

Process-based models are typically more complex and have greater data input requirements than simplified geometric models, but are formulated to include the effects of more of the physical processes affecting beach erosion and coastal sediment transport. While conserving sand volumes, as done by the K&D geometric model, process-based models also compute the cross-shore transport of beach sand induced by nearshore storm waves, and determine the change in beach profile based on material grain size, wave energy, and the variation in sand transport rate. Two simple process-based models, SBEACH (Larson and Kraus, 1989, 1998; Larson et al., 1990) and EBEACH (Kriebel, 1984a, 1984b; Kriebel and Dean, 1985), have been widely used in the eastern United States to calculate storm-induced beach erosion. Other, more complex process-based models, such as the COSMOS model (Southgate and Nairn, 1993) developed in England, have also been used to calculate storm-induced beach erosion. More complex models can be data-intensive, time-consuming, and costly to use. However, for certain settings, application of simple or complex process-based models presents a significant opportunity to improve how beach profile changes are depicted over simplified geometric-based models.

Both SBEACH and EBEACH have been calibrated to the large-scale laboratory wave-tank experiments and field data on the Atlantic and Gulf coasts. They have been applied to numerous field case studies on the Atlantic and Gulf coasts, and to a lesser degree in the Great Lakes, environments that more closely fit the conditions for which they were developed and calibrated. However, several less-successful experiences using SBEACH, EBEACH, and COSMOS have occurred on the coasts of California (Noble Consultants, 1994) and Oregon (Komar et al., 1999; Komar, 2004). Documentation of these attempted applications indicates that these process-based models may underpredict the erosion during storms on the Pacific Coast, where the beach morphology and storm characteristics differ from the beach settings that were used in developing these models.

In August 2004, the U.S. Army Corps of Engineers (USACE) officially recognized the limitation of SBEACH to predict erosion on Pacific Coast beaches and funded a research program to explore the causes of the model's underprediction of erosion on the Pacific Coast so as to improve its applicability for the Pacific Coast region. The Coastal and Hydraulics Laboratory (CHL) is currently modifying the SBEACH model, so it can be applied to the specific site characteristics and wave climate of the Pacific Coast region. Noble Consultants has provided the identical database to CHL for the four southern California shoreline locations that were used for field verification of the K&D (Kriebel and Dean, 1993) and MK&A (McDougal and MacArthur, 2004) simplified geometric models discussed above.

Eventually, simple and complex process-based models will become more reliable and will ultimately provide additional means for estimating event-based erosion along the Pacific Coast. However, further reformulation and validation are required before they can be used in FEMA coastal flood hazard assessments. At this time, without accurate calibration to local conditions, process-based models are not recommended for general use.

D.4.6.6 Estimating Profile Changes for Sandy Beaches Backed by Protective Structures (Beach Setting No. 2)

Figure D.4.6-20 shows a photograph of a typical sand beach backed by coastal development and protective structures in Southern California. This setting is often subject to dramatic beach erosion and profile adjustment during single events. Figure D.4.6-3 shows a typical beach profile for this setting, while Figure D.4.6-21 shows the sequence of key activities and computational considerations required to determine storm-induced beach profile changes for Beach Setting No. 2.

The Mapping Partner shall perform the following steps to develop the MLWP for this type of setting:

1. Review the references listed in the support documents and literature on assessing performance and erosion at coastal structures; review Section D.4.7.
2. Determine existing shoreline location and condition of structures.
3. Examine photos and historical pre- and post-storm event LIDAR and beach profile data for the study area and develop a MLWP for the beach by examining the envelope of seasonal post-storm event beach profile data.



Figure D.4.6-20. Sand Beach Backed by Shore Protection Structures, Crystal Cove, California (Source: Noble Consultants)

2. Beach with Structures

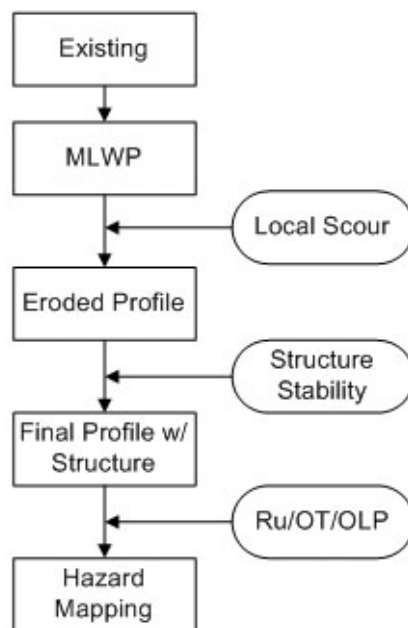

Figure D.4.6-21. Key Activities to Determine Beach Profile Changes for Beach Setting No. 2

4. The toe of a structure often becomes buried beneath sand deposits during calm sea conditions. Try to determine whether the MLWP profile is formed by the structure at its toe by probing through the sand along the toe of the structure to measure the depth of sand at the toe. Inspection trenches can also be dug and *profiled* by an experienced

coastal geologist (here *profiling* means identifying and mapping the vertical location and thickness of distinct sediment lenses along the cut face of an inspection trench). Results from this activity should provide information on the historical depth of scour that has occurred in front of the structure.

5. If a relatively broad sandy beach is located in front of the coastal structure, the MLWP for the sand beach portion must be estimated from historical winter beach profile data, supplemented with probing or inspection trench data down to an elevation of approximately MLLW.
6. Survey the elevation of the top of structures and back-beach profile. Depending on available data, some types of LIDAR data may be suitable for this purpose.
7. Next, splice the structural profile, average winter sand beach profile, and back beach profiles together to create a continuous beach profile that represents the complete MLWP for the beach, structure profile, and back beach areas.
8. Next, determine if the MLWP can experience additional erosion during a selected storm event.
9. If further erosion is possible during a large storm, determine likely depth of local scour in front of structures and compare to the scour depths determined from probing or trenching and smooth MLWP to reflect this local change; refer to Section D.4.7 and to the CEM (USACE, 2003).
10. Use this continuous beach profile for subsequent runoff computations.
11. Determine whether the structures are overtopped, damaged, or removed during the storm event being evaluated according to methods prescribed in Section D.4.7.
12. Try to validate assumptions and results using observed data from previous large storm events.
13. Document assumptions, data that were used, and results.

D.4.6.7 Estimating Profile Changes for Gravel and Cobble Beaches (Beach Setting No. 3)

Explicit procedures for determining beach and back beach profile changes on gravel and cobble beaches are not as well developed or documented as for sand beaches. Figures D.4.6-22 and D.4.6-23 show typical Pacific Coast cobble berm-backed beaches. Figure D.4.6-4 provides a sketch of a typical cobble beach profile (Beach Setting No. 3) and shows the different material layering and composition present for these settings. Cobble beaches and berms are often quite stable features as indicated by the measured cross-beach profiles shown in Figures D.4.6-24 and D.4.6-25. The Mapping Partner shall assume that the cobble beach and cobble berms are stable features during storms and act like natural shoreline protection features, but that the toe and apron become partially covered with sands during summer months and mild winter seasons.



Figure D.4.6-22. Sand Beach Backed by Cobble Berm and Bluffs, South Carlsbad, California (Photo by Noble Consultants)



Figure D.4.6-23. Sand Beach Backed by Cobble and Shingle Berm and Sandy Terrace, Batiquitos Lagoon, California (Photo by Noble Consultants)

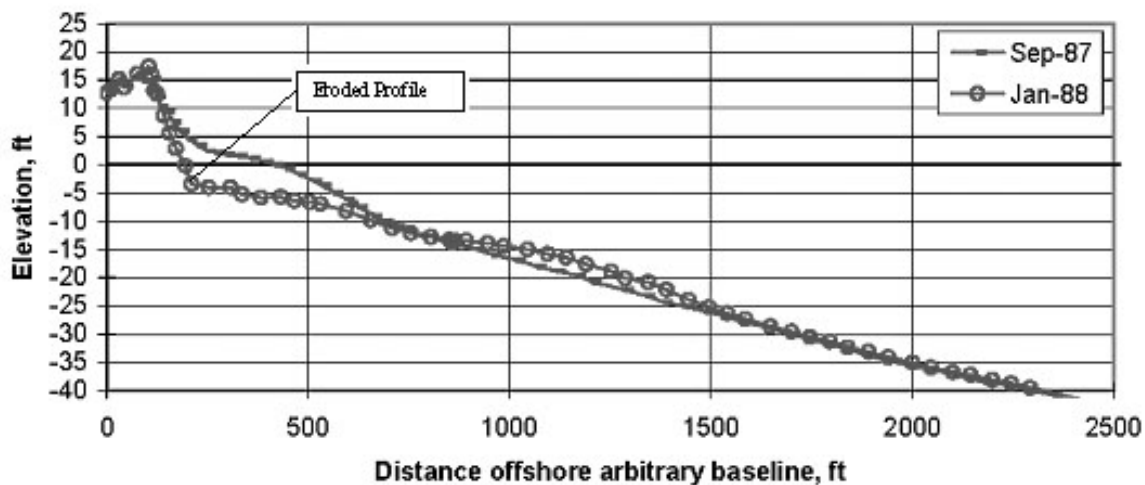

Figure D.4.6-24. Measured Beach Profile Change Due to January 1988 Storm, Batiquitos Lagoon, California

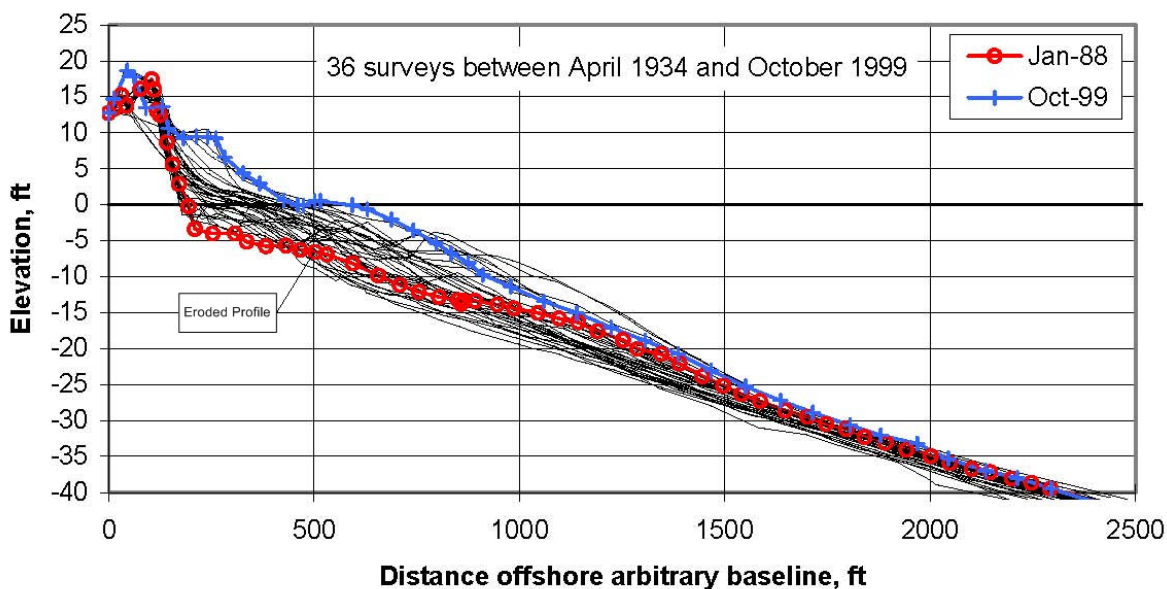

Figure D.4.6-25. Measured Beach Profile Change Before and After January 1988 Storm, Batiquitos Lagoon, California

Perform local probing and inspection trenching from the berm face out onto the beach to validate this assumption and to determine the typical eroded winter profile. If it is determined from other measured data from past storm events that the eroded winter profile underestimates the amount of cobble beach retreat during large storm events, then use the observed data for the eroded beach profile for runup and overtopping. Otherwise, use the eroded winter profile for subsequent runup and overtopping computations.

Figure D.4.6-26 shows the sequence of key activities and computational considerations required to determine storm-induced beach profile changes for Beach Setting No. 3.

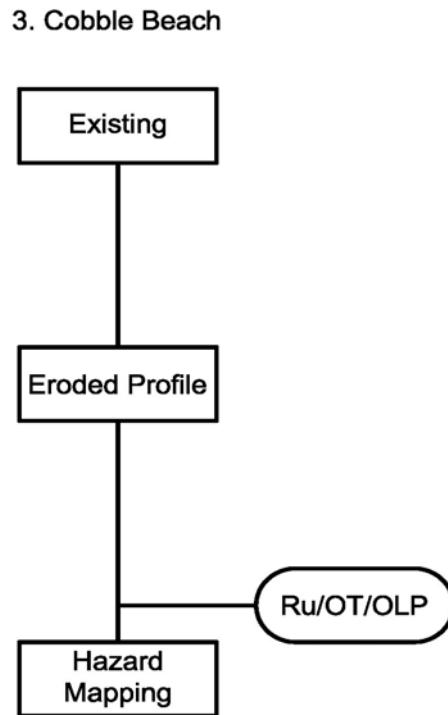

Figure D.4.6-26. Key Activities to Determine Beach Profile Changes for Beach Setting No. 3

Mapping Partners shall use the following procedure to establish the typical eroded winter profile for Beach Setting No. 3, Cobble, gravel or shingle beaches and berms:

1. Review the references listed in the support documents and literature on the design of and construction of dynamic revetments and cobble berms.
2. Examine photos and historical pre- and post-storm event LIDAR and beach profile data for the study area and develop a typical winter profile from observed data (refer to Figure D.4.6-25 for an example of historical profiles).
3. Verify this profile by probing or trenching through the sand along the toe of a cobble berm to measure the profile of the cobble berm left by the previous period of high wave conditions. (See Figures D.4.6-4 and D.4.6-25 that show how the toe of a cobble berm often becomes buried beneath sand deposits during calm sea conditions.) The eroded profile (circles) was surveyed only a few days following a major storm event in January 1988.
4. If a relatively broad sandy beach is located in front of the cobble berm, determine whether there is a history of significant erosion of the sand beach portion and include that information in the beach profile data.
5. Survey the top of berm and back-beach profile.

6. Splice the cobble berm profile, winter sand beach profile, and top-of-berm and back beach profiles together to create a continuous beach profile that represents the complete profile for the beach, cobble berm, and back beach areas.
7. Use this eroded beach profile for subsequent runup computations during the selected storm event, unless other information indicates the profile may need further adjustment during large storm events.
8. Check results and try to validate them with observed information.
9. Document assumptions and results.

D.4.6.8 Estimating Profiles for Beaches Backed by Erodible Bluffs or Cliffs (Beach Setting No. 4)

Significant portions of the California coast have narrow to nonexistent beaches backed by high, steep, erodible coastal bluffs and cliffs, as shown in Figures D.4.6-27, D.4.6-28, and D.4.6-29 and illustrated in Figure D.4.6-5. The evolution of this bluff-type shoreline is significantly different from that of the sandy beaches backed by either dunes or low-lying berms. A thin sand lens often overlays a rocky beach or bedrock platform fronting the bluff. These thin deposits of sand are removed each winter storm season. If storm water levels reach sufficient elevations to intersect the toe of the bluffs, storm waves can directly impinge upon the bluff face causing bluff toe erosion. If enough material is eroded from the toe during a storm, the upper portion of the bluff can fail, resulting in bluff retreat (Figures D.4.6-28 and D.4.6-29). This type of bluff failure and retreat is common along the Pacific Coast, and is particularly important in the highly developed coastal communities of central and southern California. It should be noted that significant bluff failure may not occur during all storm events. However, if the bluff materials are erodible, toe erosion and bluff failure is possible during single storm events. The rate and extent of bluff erosion and failure depends on the site-specific bluff profile conditions at the time of the event (toe elevation and setback distance from the surf zone) and on the erodibility of the bluff materials. In some locations, it may take several storms to cause sufficient toe erosion to lead to bluff failure, or only one significant event with sufficient TWL, duration, and wave orientation to result in significant storm erosion.

Previous estimates for coastal bluff retreat have typically resorted to temporally averaged rates over a long period. Though the average annual rate of coastal cliff erosion is a reasonable indicator of the gradual retreat of the bluff top, it does not adequately predict the episodic nature of bluff failure that can result in 3 to 50 feet of retreat during a single storm event. The average annual retreat rate provides a misleading indication of the hazards of coastal bluff or cliff erosion because the occurrence of storms of sufficient magnitude and duration to cause significant bluff retreat are episodic. At some locations, coastal bluffs have fairly low elevations and may be overtopped by large wave events. Therefore, assessment of coastal flood and erosion hazards in coastal settings (Beach Setting No. 4) with erodible bluffs requires special methods and data.



**Figure D.4.6-27. Wave Cut Coastal Bluff, Encinitas, California
(Source: USACE, Los Angeles District)**



**Figure D.4.6-28. Bluff Failure and Retreat During 1998 El Niño Storms, Pacifica, California
(Photo by Kevin Coulton)**



**Figure D.4.6-29. Bluff Failure and Retreat, Encinitas, California
(Photo by Noble Consultants, Inc.)**

During the reconnaissance phase of a coastal flood assessment, Mapping Partners shall determine whether the study area includes erodible coastal bluffs and cliffs (Beach Setting No. 4) and whether the bluff elevations are low enough for overtopping.

D.4.6.8.1 General Approach for Beach Setting No. 4

Figure D.4.6-30 shows the sequence of key activities and computational considerations required to determine storm-induced beach profile changes for Beach Setting No. 4.

Determine the coastal setting and history of episodic and chronic bluff erosion for the study area; then:

1. Obtain reliable beach and bluff profile data (surveyed cross-shore profiles or LIDAR) for existing conditions. Try to obtain these data near the end of the winter season in March or April.
2. Determine whether bluff erosion and failure monitoring data are available for the study area. Obtain and examine that information to determine the magnitude of episodic toe erosion and bluff retreat.
3. Estimate top-of-bluff elevations and compare to potential significant storm TWL and whether the bluff is subject to overtopping or frequent wave attack or toe erosion.

4. Erodible Bluff

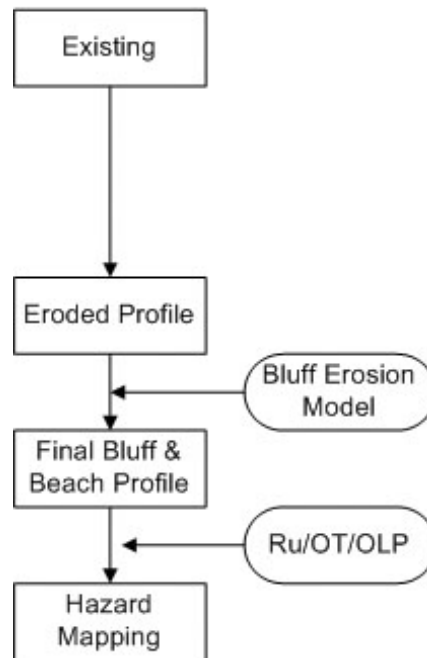

Figure D.4.6-30. Key Activities to Determine Beach Profile Changes for Beach Setting No. 4

4. Perform a site inspection to confirm general historical information related to episodic erosion or overtopping hazards associated with the site. Determine relative erodibility of the bluff materials using standard geologic/geotechnical field procedures (Sunamura 1983; USACE-LAD, 2003; and Williams et al., 2004).
5. If potential damage to structures or public safety are determined not to be significant, the Mapping Partner shall document those results and whether further analyses are recommended.
6. If further analysis of bluff erosion or overtopping is not recommended, or the site is determined to be non-eroding, assume the bluff or cliff is classified as Beach Setting No. 5 (and document why) and that the bluff or cliff is non-eroding during large events. Then apply methods listed in Subsection D.4.6.9 for analyses of non-erodible bluffs.
7. Perform all further runup and overtopping analyses on the surveyed existing winter conditions beach and bluff profiles for the site.
8. Document results, and summarize the data, methods used, and assumptions associated with the analyses.

If it is determined that the study site experiences significant erosion and retreat during large storm events, then the Mapping Partner shall document those findings and discuss with the

FEMA study representative whether there are sufficient data, time, and budget to perform a more detailed bluff erosion analysis. Depending on the site-specific characteristics of the setting and bluff materials, a detailed bluff erosion analysis is likely to require detailed geologic sampling, bluff erosion monitoring data, and bluff erosion simulation analyses. Data requirements and procedures for conducting detailed bluff erosion analyses are presented in the next subsection.

D.4.6.8.2 Detailed Bluff Erosion Analyses

As part of the effort for the USACE feasibility study along the Encinitas/Solana Beach shoreline, Noble Consultants, Inc., developed a statistical modeling procedure to characterize the bluff failure induced by storm wave attacks (USACE-LAD, 2003). The approach and statistical model have been certified by the USACE, Coastal Engineering Research Center as the preferred method to statistically quantify the random bluff failure for shoreline studies that include a bluff failure component. Information on this approach is available from USACE Los Angeles District and has been published in the *Journal of the American Shore & Beach Preservation Association* (Williams, Lu, and Qin, 2004).

Given wave and TWL characteristics and the erodibility of buff materials, the statistical bluff failure model estimates bluff toe erosion induced by impinging waves and predicts random episodic bluff failures for varying storm conditions. A semi-empirical formulation developed by Sunamura (1982, 1983) is used to quantify the short-term bluff toe erosion rate as a function of the intensity of impinging waves and the site-specific erosion resistance of bluff materials:

$$X = \sum_{i=j}^N X_i = \sum_{i=j}^N k \left(C + \ln \frac{\rho g H_i}{S_c} \right) \Delta t_i \quad (\text{D.4.6-15})$$

where X is the accumulated bluff toe erosion depth from N waves acting on the bluff toe, X_i is the individual erosion by the i -th wave with height of H_i and duration of Δt_i , S_c is the compressive strength of the bluff material, ρ is the density of water, g is the gravitational acceleration, C is a non-dimensional constant, k is a constant with dimensions of length over time $[L/T]$, and subscript j is the group number of the critical wave height H_j to initiate the toe erosion, which is given by $H_j = S_c e^{-c} / \rho g$.

This procedure requires regional and site-specific data. A statistical Monte Carlo simulation approach is used to characterize the correlation between bluff toe erosion and bluff failure for temporally varying wave conditions. If the cumulative depth of the bluff toe notch induced by storm waves exceeds a locally determined threshold value for triggering a bluff failure, the individual upper bluff retreat is determined by a randomly selected retreat value from an historic database for the site. The threshold value is empirically determined from historical bluff failure events. It may vary from one coastal bluff region to another. In the Encinitas/Solana Beach region, the threshold value of the cumulative toe erosion at which a bluff failure is likely to occur is approximately 8 feet.

The methodology may be applied in any situation where undermining of the bluff toe triggers upper bluff block failure; however, substantial field data are required to determine several of the required parameters and for proper calibration of the bluff failure model. Therefore, if the

Mapping Partner determines that a detailed bluff erosion study is necessary, he/she must provide the following field data, at a minimum:

1. The type of rock formation and/or bluff soil materials from which stability and the erosion-resistant force of the bluff material can be quantified.
2. Field measurements of bluff toe erosion in response to cumulative wave energy associated with past storm events for determining and calibrating empirical coefficients required by the Sunamura formula used by the model.
3. Historical data of upper bluff failures, indicating approximate horizontal length and transverse width of bluff top land loss during past storm events for formulating the probability distribution of the severity of bluff failure.

Two sets of field data are required to establish and calibrate the wave-induced toe erosion and to establish the statistical representation of bluff failure events. To calibrate the toe erosion produced by the statistical model, the depth of the toe erosion shall be measured before and after significant storm events and correlated to the cumulative wave energy during those events at the bluff toe. At least two full years of data are required to capture seasonal variability of toe erosion, and up to five years of data may be needed to calibrate the correlation between the impinging waves and the resultant toe erosion. Longer monitoring periods are desirable and will include more storm events and more cumulative wave energy statistics, and thus result in higher accuracy in model calibration.

To assemble the representative statistics of random occurrences, adequate observations of upper bluff failures are required. At least two to five years of monitoring data are required to provide a reasonable representation of the size distribution of the failures. The larger the database, the less uncertainty there is in the predicting toe failure. There are no known analytical methods for forecasting bluff toe erosion and failure; therefore, a statistical approach is the only means of forecasting bluff failure and retreat due to the random temporal wave action during large storms. To capture any seasonal variability, at least 5 years of data are required, and to ensure a statistically valid database, up to 10 years of data may be needed if failures are uncommon. This is likely to limit the applicability of this approach for traditional FEMA coastal flood studies, unless these data are readily available at the beginning of the project. If it is determined that data are available and that the application of the statistical bluff failure model is necessary, use the following procedures:

Characterize Fronting Beach Conditions

The Mapping Partner shall perform Steps 1 through 6 under general approach, above. Assess whether the potential damage to the bluff-top developments resulting from bluff failure is highly probable. If a subject bluff is fronted by either a sand berm or dune with a sufficient width to separate the bluff from direct wave impingement during the winter months, the storm-induced erosion to the berm and dune, as stated in Subsection D.4.6.4, should be applied. If the protective sand berm or dune is removed during the winter months, use this eroded condition as the winter beach profile and apply the bluff failure model for that beach condition. If eroded winter profile data are not available, then the profile should be developed by probing down to erosion-resistant materials along beach transects to establish the bedrock profile. A typical eroded winter profile

should be developed from surveyed and probing data of the underlying bedrock layer for each typical reach of shoreline area being analyzed. A sketch of a typical erodible bluff fronted by a rock platform capped with a thin sand layer is shown in Figure D.4.6-31. If the fronting beach is a broad sandy beach with berms or dunes, apply beach erosion methods prescribed in Subsection D.4.6.5.

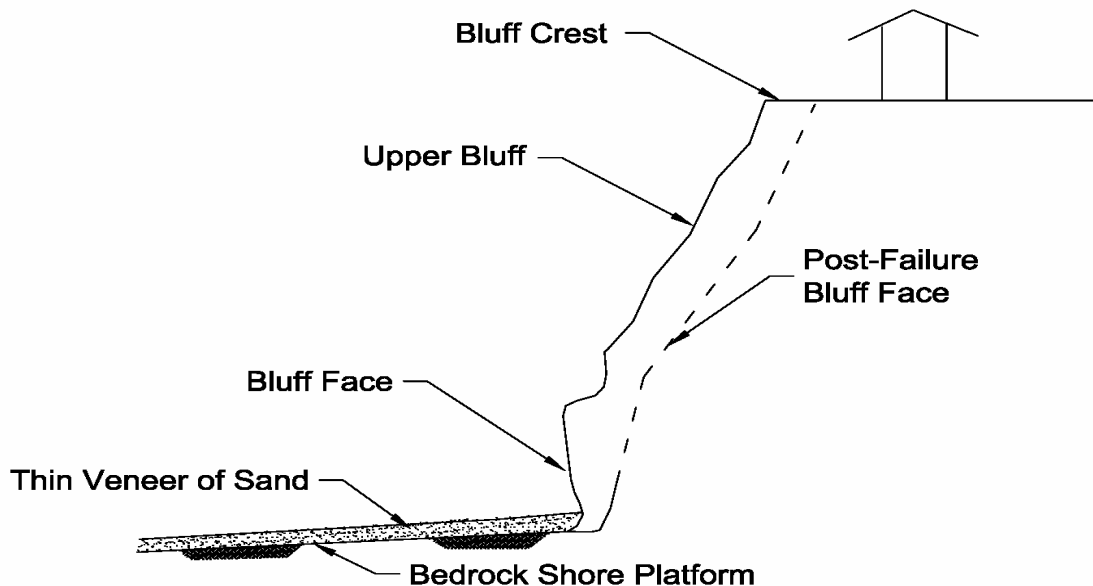

Figure D.4.6-31. Typical Erodible Bluff Profile Fronted by Narrow Sand-capped Beach

Apply Bluff Failure Model

Following are procedures for applying the statistical bluff failure model:

1. Collect field data for each setting and subreach along the study area.
 - a. Measure bluff toe erosion during at least two separate periods.
 - b. Conduct field probing to determine the bedrock layer across the beach area.
 - c. Determine the elevation of the bluff toe and bedrock layer intercept and cross-shore slope.
2. Assemble historical bluff failure events.
 - a. Determine bluff failure characteristics in terms of the length along the bluff crest-line and the transverse recession dimensions.
 - b. Formulate probability distribution of the magnitude of various bluff failure events.
 - c. Determine the threshold value of toe notch depth when the upper bluff failure occurs (see USACE, 2003; Williams et al., 2004).

3. Calibrate Sunamura's empirical equation.
 - a. Determine the wave histogram including storm events within the two separate historical wave and erosion periods.
 - b. Estimate the temporal histogram of wave heights at the bluff base for each of the selected periods with synchronized tide levels.
 - c. Determine the bluff resistance force for the type of bluff material at the site.
 - d. Calibrate Sunamura's empirical equation (i.e., Equation D.4.6-15) from the cumulative toe erosion measured in these two separate periods and quantify the total impinging wave energy during each period from hindcast data.
4. Calibrate bluff retreat model by simulating past bluff failure events.
 - a. Assemble historical wave characteristics at the bluff base and synchronize with measured tide levels.
 - b. Determine the probability distribution of wave characteristics at the bluff base.
 - c. Apply the Monte Carlo sampling technique to randomly select the histogram of wave characteristics at the bluff base.
 - d. Estimate the cumulative notch depth at the bluff toe using the calibrated toe erosion equation (Equation D.4.6-15).
 - e. Apply the same Monte Carlo sampling technique to randomly select a bluff failure event if the accumulative notch depth is deeper than the prescribed threshold value deduced from Step 2. Assemble historical bluff failure events.
 - f. Perform multiple simulations for a required long-term duration (e.g., 10 years) until a statistical representation regarding the occurrence of bluff failure is achieved.
 - g. Derive the statistical mean and other pertinent properties, such as the exceeding probability of a cumulative bluff retreat distance at the end the modeled duration.
 - h. Compare results with observed data from the site and adjust coefficients as necessary.
5. Apply calibrated model for 1% annual storm event.
 - a. Determine winter profiles for fronting beach conditions and elevation of bluff-beach intercept.
 - b. Apply calibrated model for entire 1% annual storm.
 - c. Determine amount of toe erosion and bluff crest line recession for the 1% storm.

- d. Use this adjusted profile for all further runup and overtopping analyses associated with the 1% annual storm.

6. Document results, data, and assumptions.

D.4.6.9 Estimating Beach Profiles for Beaches Backed by Erosion-Resistant Bluffs or Cliffs (Beach Setting No. 5)

Erosion-resistant bluffs and cliffs are often fronted by rock terraces, rocky beaches, or narrow rock platforms capped with thin layers of sand or gravel. Once the thin sand cap is eroded from the rocky beach, this beach setting is stable; see Figure D.4.6-6 and Figure D.4.6-32. Therefore, Mapping Partners shall assume the sand cap is removed from the beach profile before a significant storm event and use the adjusted rocky beach profile along with measured profiles for the non-erodible bluffs or cliffs for all subsequent runup and overtopping computations. Document assumptions, methods, data resources, and results. Figure D.4.6-33 shows the sequence of key activities and computational considerations required to determine storm-induced beach profile changes for Beach Setting No. 5.

D.4.6.10 Profiles in Tidal Flats and Wetlands (Beach Setting No. 6)

Tidal flats and wetlands are low-gradient coastal features, usually found in sheltered water areas and comprised of fine cohesive silts and clays; see Figures D.4.6-7 and D.4.6-34. Figure D.4.6-35 shows the sequence of key activities and computational considerations required to determine storm-induced beach profile changes for Beach Setting No. 6.



Figure D.4.6-32. Photo of Erosion-resistant Cliff

5. Non-Erodible Bluff/Cliff

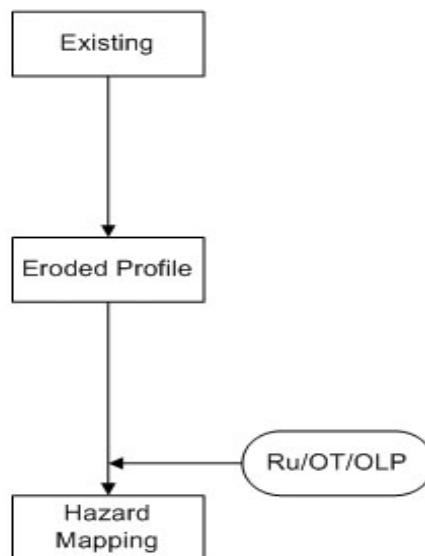

Figure D.4.6-33. Key Activities to Determine Beach Profile Changes for Beach Setting No. 5

Sedimentation processes in this beach setting are typically depositional. Over time, these coastal landforms may become capped with wetland vegetation and detrital deposits and debris from overland wave propagation during storm events. Therefore, Mapping Partners may assume that tidal mudflats and wetland profiles do not erode over the time-scale of single storm event. Mapping Partners should compare existing tidal flat and wetland profiles with recent post-storm profiles to verify this assumption. If it is determined that no measurable erosion occurs during single storm events, then the Mapping Partner shall use the existing profile information to determine runup, overtopping, and overland propagation. However, if it is found that measurable changes can occur during a single storm, the Mapping Partner should document the observed changes experienced at the site and propose to the FEMA study representative a procedure for using that information to adjust the existing profiles before determining runup, overtopping, and overland propagation. The Mapping Partner shall document assumptions, data used, and methods implemented to prepare the final profiles, and summarize the results.



**Figure D.4.6-34. Photograph of Tidal Flats and Wetlands Complex
(Photo by Northwest Hydraulic Consultants, Inc.)**

6. Tidal Flats and Wetlands

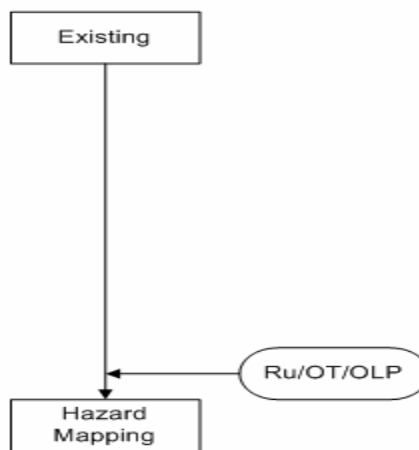

**Figure D.4.6-35. Key Activities to Determine Beach Profile Changes for
Beach Setting No. 6**

D.4.7 Coastal Structures

D.4.7.1 Purpose and Overview

This section outlines methods for analyzing the stability and effects of coastal structures during 1% annual chance flood conditions.

Coastal structures can significantly affect local topography and flood hazards, and the evaluation of coastal structures is a necessary part of any flood hazard study. The evaluation should, where possible, determine whether a coastal structure will survive (and provide protection to upland areas from) the 1% annual chance flood.

- If a particular structure is expected to remain intact through the 1% annual chance flood, the structure geometry shall be used in all ensuing Flood Insurance Study (FIS) analyses that accompany the flood event (e.g., event-based erosion, wave runup and overtopping, and determination of wave crest elevations).
- If a particular structure is expected to fail during the 1% annual chance flood, the coastal structure shall either be removed entirely before ensuing analyses, or be replaced by an appropriate failed configuration before ensuing analyses.
- If the performance of a particular structure is uncertain, both intact and failed configurations should be analyzed, and the most hazardous flood conditions should be mapped.

For the purposes of these guidelines and specifications, coastal structures are classified as follows:

- **Coastal Armoring Structures:** Generally shore-parallel structures constructed to prevent erosion of uplands and mitigate coastal flood effects (e.g., seawalls, revetments, bulkheads, and levees). Note that coastal levees are classified as armoring structures here, but are often referred to as flood control structures.
- **Beach Stabilization Structures:** Structures intended to stabilize or reduce erosion of the beach, and by so doing, to afford some protection to upland areas (e.g., groins, breakwaters, sills, and reefs).
- **Miscellaneous Structures:** Structures not included above that can affect flood hazards, especially in sheltered waters (e.g., piers, port and navigation structures, bridges, culverts, and tide gates).

Criteria for evaluating the stability and performance of coastal armoring structures for FIS purposes are well-developed, and are discussed in detail. Criteria for evaluating beach stabilization structures are not yet developed, and only basic guidance is provided. Criteria for evaluating miscellaneous structures are not standardized, and only basic guidance is provided.

D.4.7.2 Evaluation Criteria

Mapping Partners are not required to perform detailed engineering evaluations of all coastal structures within the study area, and in fact, rarely do so. However, when such an evaluation is performed, there are specific evaluation criteria that must be applied.

D.4.7.2.1 Detailed Engineering Evaluation of Coastal Armoring Structures

Specific criteria for evaluating coastal armoring structures are contained in an April 23, 1990 Federal Emergency Management Agency (FEMA) memorandum (FEMA, 1990), “Criteria for Evaluating Coastal Flood Protection Structures for National Flood Insurance Program Purposes.”¹

The evaluation criteria applicable to coastal armoring structures include the following:

- Design Criteria
 - Water levels and wave (height and period) conditions
 - Minimum freeboard
 - Toe protection
 - Backfill protection
 - Structure alignment and terminations

- Structural Stability
 - Flood-induced erosion and toe scour analyses
 - Geotechnical analysis
 - Structure sliding, rotation, and overturning
 - Stability of riprap, armor stone, and filters
 - Breaking wave forces
 - Material adequacy (suitability and durability)
 - Ice and impact forces

- Adverse Impact Evaluation

¹ The criteria discussed in this memorandum are based in large part on Technical Report 89-15 prepared by the U.S. Army Corps of Engineers, Coastal Engineering Research Center (USACE CERC) for FEMA, Criteria for Evaluating Coastal Flood-Protection Structures (Walton et al., 1989). The criteria in the memorandum have been adopted as the basis for NFIP accreditation of new or proposed coastal structures to reduce the flood hazard areas and elevations designated on NFIP maps, but can be applied to existing coastal structures.

Where a Mapping Partner chooses to perform a detailed engineering evaluation of an existing coastal armoring structure during an FIS, FEMA requires the evaluation to be based upon the criteria outlined in the April 23, 1990 FEMA memorandum, and upon as-built documentation. When as-built documents are not available, the evaluation should be based upon best available data, standard design and engineering assumptions, and conservative estimates of material properties. The evaluation should be confirmed and documented by past performance during severe storm events. The underlying requirement is that the evaluation must yield an accurate assessment of coastal structure performance during the 1% annual chance flood, based upon available evidence.

It should be noted, however, that the state of the art of coastal structure evaluation is constantly evolving. Thus, the Mapping Partner may choose to propose evaluation criteria that differ from those contained in the April 23, 1990 FEMA memorandum (e.g., from the Coastal Engineering Manual [CEM] [USACE, 2003], or from other authoritative and accepted references). However, alternate evaluation procedures and criteria should not be used in an FIS without permission from the FEMA study representative.

- Community and/or State Review
- Maintenance Plan
- Certification

D.4.7.2.2 Coastal Armoring Structure Evaluation Based on Limited Data and Engineering Judgment

For the purposes of an FIS, the Mapping Partner may not have sufficient resources and time to conduct a detailed evaluation of each coastal armoring structure within the study area. In such cases, the Mapping Partner can apply engineering judgment (albeit, guided by the FEMA memorandum and *Technical Report 89-15* criteria) to determine likely stability of each structure during the 1% annual chance flood. These conclusions may largely be based upon available archive information and local observations. Note that any data and procedures used in the evaluations shall be documented (see Subsections D.4.7.6 and D.4.7.7), and communities and property owners shall be made aware that these evaluations are for mapping purposes only.

If the available information does not clearly point to survival or failure of a coastal structure, the Mapping Partner may either:

- a) Conduct a detailed evaluation based on the FEMA criteria (April 23, 1990), or
- b) Perform the erosion and wave analyses for both the intact and failed structure cases, and map the flood hazards associated with the more hazardous case.

If option b) is selected, the Mapping Partner shall clearly document the results of all cases investigated and specify which case is used for mapping purposes. It should be noted that a failed coastal structure may or may not yield the greatest flood hazards. Therefore, coastal flood analyses for the intact and failed conditions should be performed, with the greatest resulting flood hazard being mapped. Maintaining results of all analyses may be useful in the event map revisions are requested by property owners based upon certified structures².

D.4.7.2.3 Evaluation of Beach Stabilization Structures

Guidance on how to predict the survival or failure of groins, which usually fail by loss of profile (through settlement, displacement, or deterioration) and/or by becoming detached at their landward ends, is not readily available. Likewise, guidance on how to predict the failure of breakwaters, sills, and reefs (usually through loss of profile) is not readily available. Some information on failure modes may be available in technical or historical literature, and should be consulted by the Mapping Partner.

² Often, property owners request revisions to the Flood Insurance Rate Map (FIRM) based upon existing, new, or proposed coastal structures. Map revisions based upon coastal structures require a detailed evaluation and certification by a professional engineer registered in the subject state. FEMA has distributed the *Coastal Structure Form* (MT-2, Form 5, available at <http://www.fema.gov/pdf/fhm/mt2_f5.pdf>) to evaluate coastal structures as the basis for map revisions.

If a Mapping Partner chooses to evaluate beach stabilization structures during an FIS, the proposed evaluation methods and procedures should be discussed with the FEMA study representative, in advance, and approval by FEMA must be obtained before the evaluations can be carried out.

D.4.7.3 FIS Treatment of Coastal Armoring Structures

Technical Report 89-15 identifies four primary functional types of coastal flood protection structures: gravity seawalls, pile-supported seawalls, anchored bulkheads, and dikes or levees. A fifth type, revetment, is added here (see Figure D.4.7-1).

Technical Report 89-15 recommends as a general policy that “FEMA not consider anchored bulkheads [as providing flood protection] during large storms”. Thus, the default assessment for open coast anchored bulkheads should be that they are assumed to fail during the 1% annual chance flood. Mapping Partners may choose to treat some anchored bulkheads as surviving the flood and/or providing some degree of flood protection, but those instances may be limited (e.g., in sheltered waters, when the bulkhead is stable during the 1% annual chance flood conditions).

Many seawalls, revetments, and (some) bulkheads may be recognized on flood hazard maps if they remain intact during the 1% annual chance storm (in some cases, even if overtopped). These structures may provide total or limited protection against flooding, erosion, and waves, depending upon their location, strength, and dimensions.

D.4.7.3.1 Failure and Removal of Coastal Armoring Structures

In the event that a coastal structure is determined to fail, the Mapping Partner shall remove the structure entirely from the analysis transect, or estimate the partial collapse of the structures where appropriate (see Subsection D.4.7.3.2). If the failed structure is removed entirely, the remaining soil profile should be altered to achieve its likely slope immediately after structure failure. Information on slopes behind failed structures is limited. These slopes may vary from 1 on 100 (v:h) for unconsolidated sands to 1:1 or steeper for consolidated material landward of the failed structure.

This post-failure slope for this analysis should be in the range of 1:1 to 1:1.5 (v:h). Note that the post-failure slope may not necessarily match the long-term stable slope, but will serve as the basis for subsequent site-specific, event-based erosion wave height, wave runup, and wave overtopping analyses.

D.4.7.3.2 Partial Failure of Coastal Armoring Structures

Frequently, coastal structures are constructed of either concrete or large individual armor units. Consequently, it is improbable that the structural components will be completely destroyed or removed from the vicinity during the 1% annual chance flood. It may be appropriate to assume partial failure of such structures and to model accordingly.

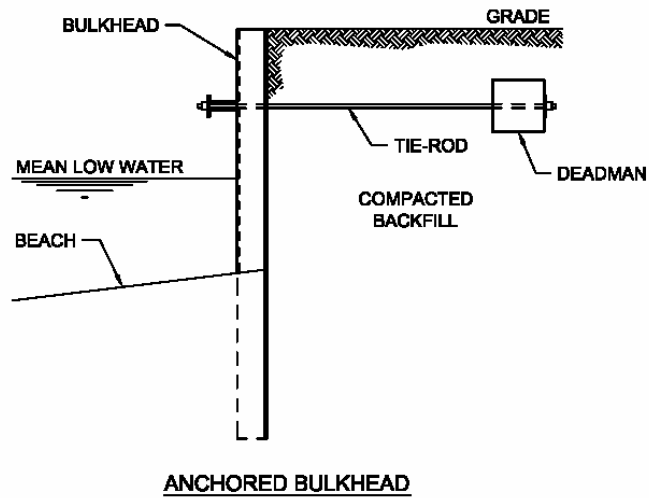
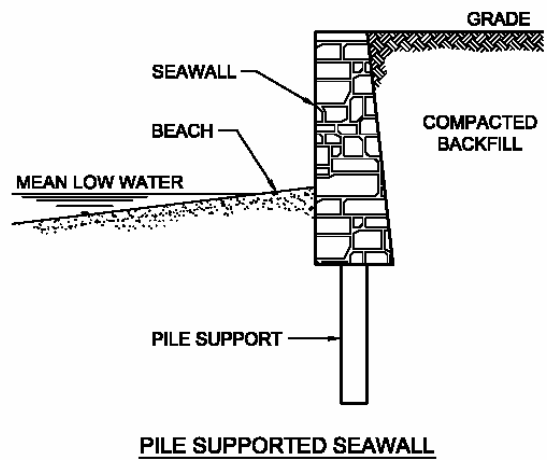
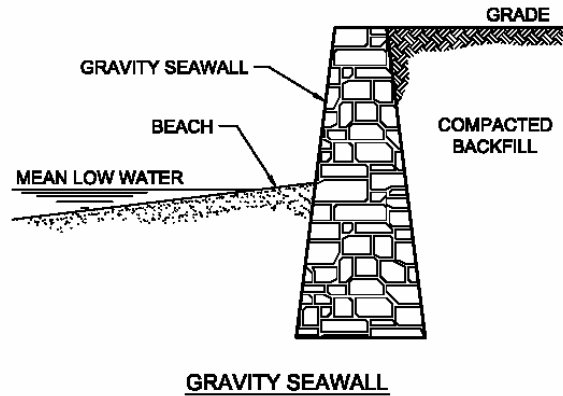

PRIMARY FUNCTIONAL TYPE OF COASTAL ARMORING STRUCTURES

Figure D.4.7-1a. General Classification of Coastal Armoring Structures

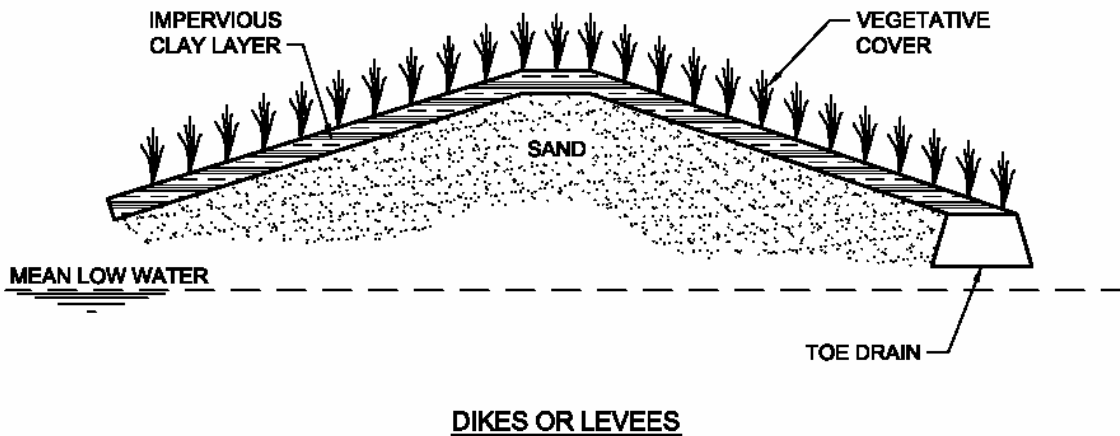
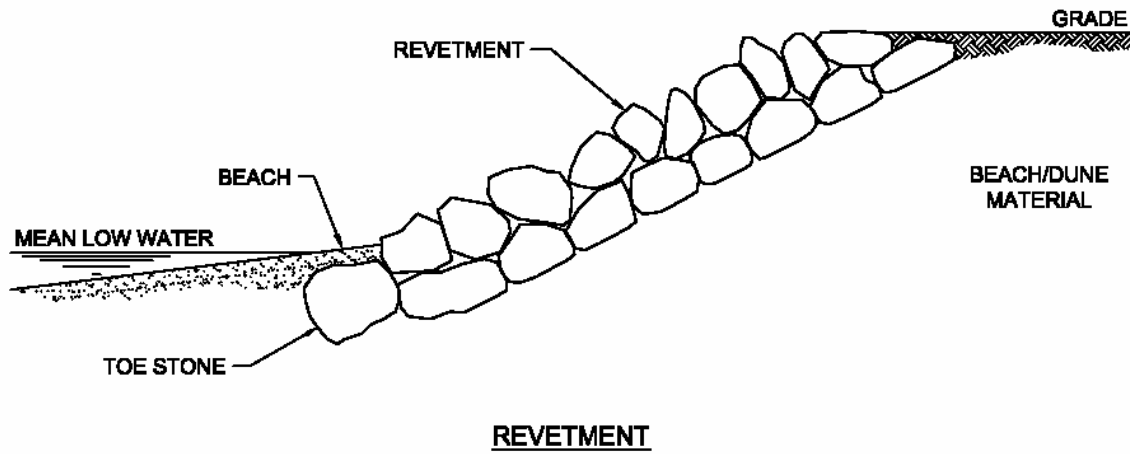

PRIMARY FUNCTIONAL TYPE OF COASTAL ARMORING STRUCTURES

Figure D.4.7-1b. General Classification of Coastal Armoring Structures

A recommended simple geometric approach for approximating partial failure of a vertical or near-vertical coastal armoring structure is as follows (see Figure D.4.7-2):

1. Estimate toe scour at the subject structure based upon the methods described in the CEM (USACE, 2003).
2. Assume the structure fails and falls into a rough, porous slope at 1:1.5 (v:h).
3. Extend the 1:1.5 failure slope from the depth of scour at the structure toe landward to the point where it intersects the existing grade.

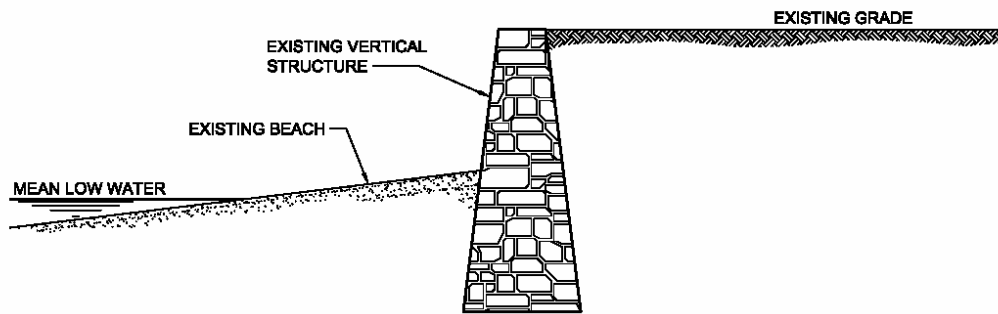

VERTICAL STRUCTURE GEOMETRY PRIOR TO FAILURE

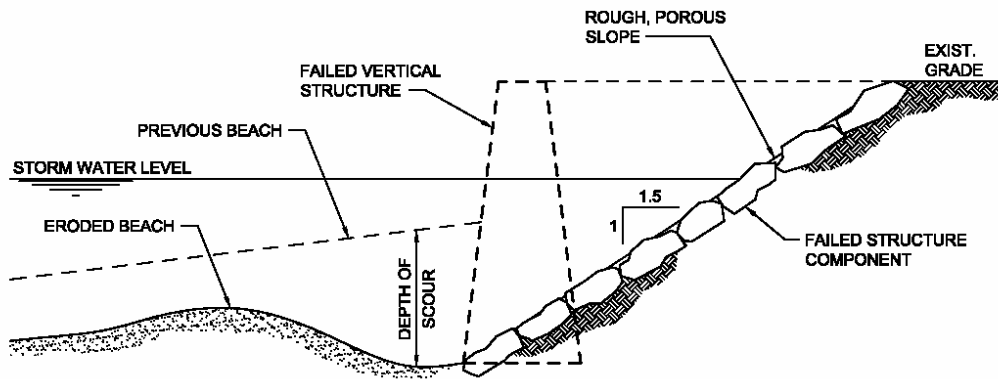

VERTICAL STRUCTURE FAILURE GEOMETRY

PARTIAL FAILURE OF VERTICAL COASTAL STRUCTURE

Figure D.4.7-2. Partial Failure of Vertical Coastal Structure

A recommended approach for approximating partial failure of a sloping revetment (due to undermining at the toe, or to collapse at the top due to erosion behind the structure) is as follows (see Figure D.4.7-3):

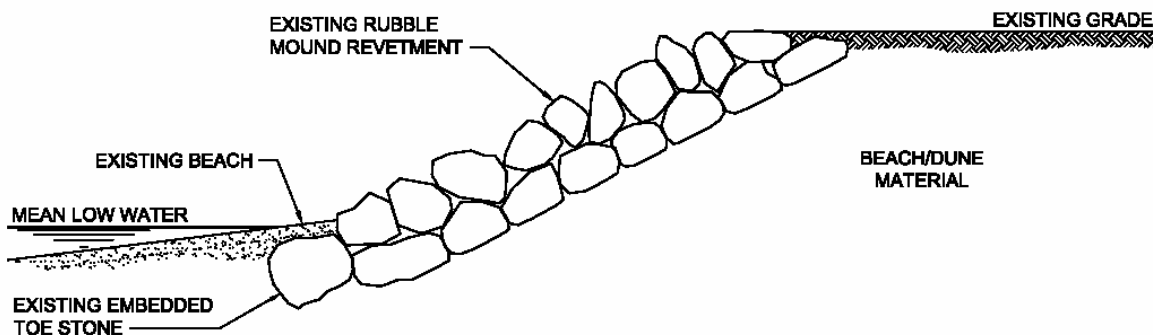

REVETMENT GEOMETRY PRIOR TO FAILURE

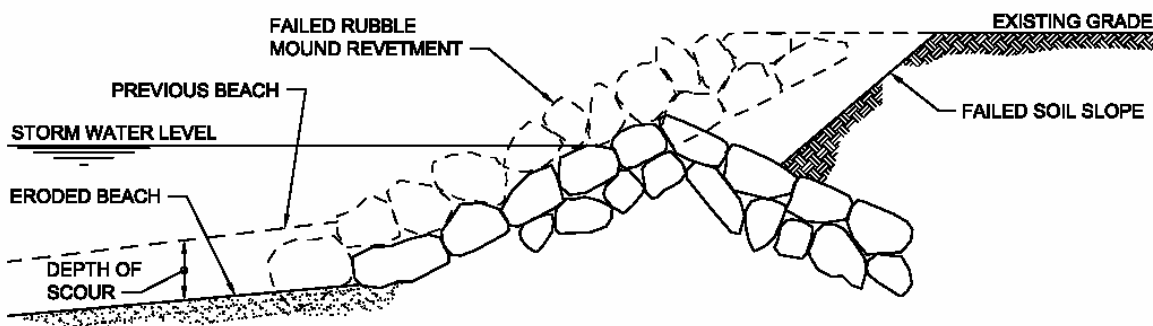

REVETMENT FAILURE GEOMETRY

PARTIAL FAILURE OF A SLOPING REVETMENT

Figure D.4.7-3. Partial Failure of a Sloping Revetment

1. Assume the structure will collapse in place into a triangular section throughout the structure footprint, with side slopes equal to the original structure slope.
2. Assume the landward side of the failed configuration will be half exposed and half buried. Approximate the soil slope landward from the failed structure at a slope in the range of 1:1 to 1:1.5 (v:h).

After determining an appropriate failure configuration, the Mapping Partner shall conduct wave height and wave runup analyses upon the failed structure, as discussed in preceding sections. The Mapping Partner shall select an appropriate roughness factor when conducting runup and overtopping analyses on the failed structure.

In some cases, the assumed failed slope may result in the undermining of buildings located landward of the coastal structure. If this occurs, the building shall be removed from the analysis transect and not considered during subsequent wave effects modeling.

D.4.7.3.3 Buried Coastal Structures

In some instances, coastal structures may be covered or buried by sediments, and not readily observable during FIS site reconnaissance. For example, Figure D.4.7-4 shows two photographs in the Pacific City, Oregon, area taken approximately 10 years apart (courtesy of Paul Komar). The top photo was taken in 1978, and shows a revetment that was constructed to protect development from El Niño-related erosion. The bottom photo, taken in 1988, shows the same site once the El Niño had subsided and large quantities of sediment had moved back onto the beach. This is one example where a buried structure is of a size and construction to possibly affect coastal flood hazards, and should—like exposed structures—be considered during the FIS.

The Mapping Partner is responsible for inquiring as to whether buried coastal structures exist within the study area during the preliminary investigation phase of the FIS, and should include input from the community. The Mapping Partner should also carefully review aerial photographs of the study area to locate buried structures.

Once the Mapping Partner has determined that a coastal structure is likely buried at a site, the next steps are to collect information about the structure and follow the study process outlined in Figure D.4.7-5. Conducting the erosion analysis outlined in Section D.4.6 is part of the process, and may result in two outcomes: 1) the buried structure will remain buried during the 1% annual chance flood (see Figure D.4.7-6), or 2) the buried structure will be exposed by the 1% annual chance flood (see Figure D.4.7-7).

Note that the buried structure study process need not be followed unless the presence of buried structures is known or is highly likely, and that the *Guidelines and Specifications* do not require field investigations to identify buried coastal structures. There may be some instances where limited field work (such as soil probes to locate the structure) might be useful, but this should be limited to cases where large buried structures are known to exist.

D.4.7.3.4 Coastal Levees

Levees are man-made structures (usually earthen embankments that may or may not have their slopes and crest armored) that prevent flooding of low-lying areas. A *levee system* consists of a levee, or levees, and associated structures, such as closure and drainage devices, that are constructed and operated to prevent flooding of interior areas.

For any protective effects of coastal levees or levee systems to be recognized by the National Flood Insurance Program (NFIP) and incorporated into flood hazard maps, they must be designed, constructed, operated, and maintained to resist erosion and prevent any flooding or



Figure D.4.7-4. Example of a Buried Coastal Structure that Could Affect Flood Hazard Zones and BFEs (top photo taken in 1978, bottom photo taken in 1988 – courtesy of Paul Komar)

Methodology for Evaluation of Buried Coastal Flood Protection Structures

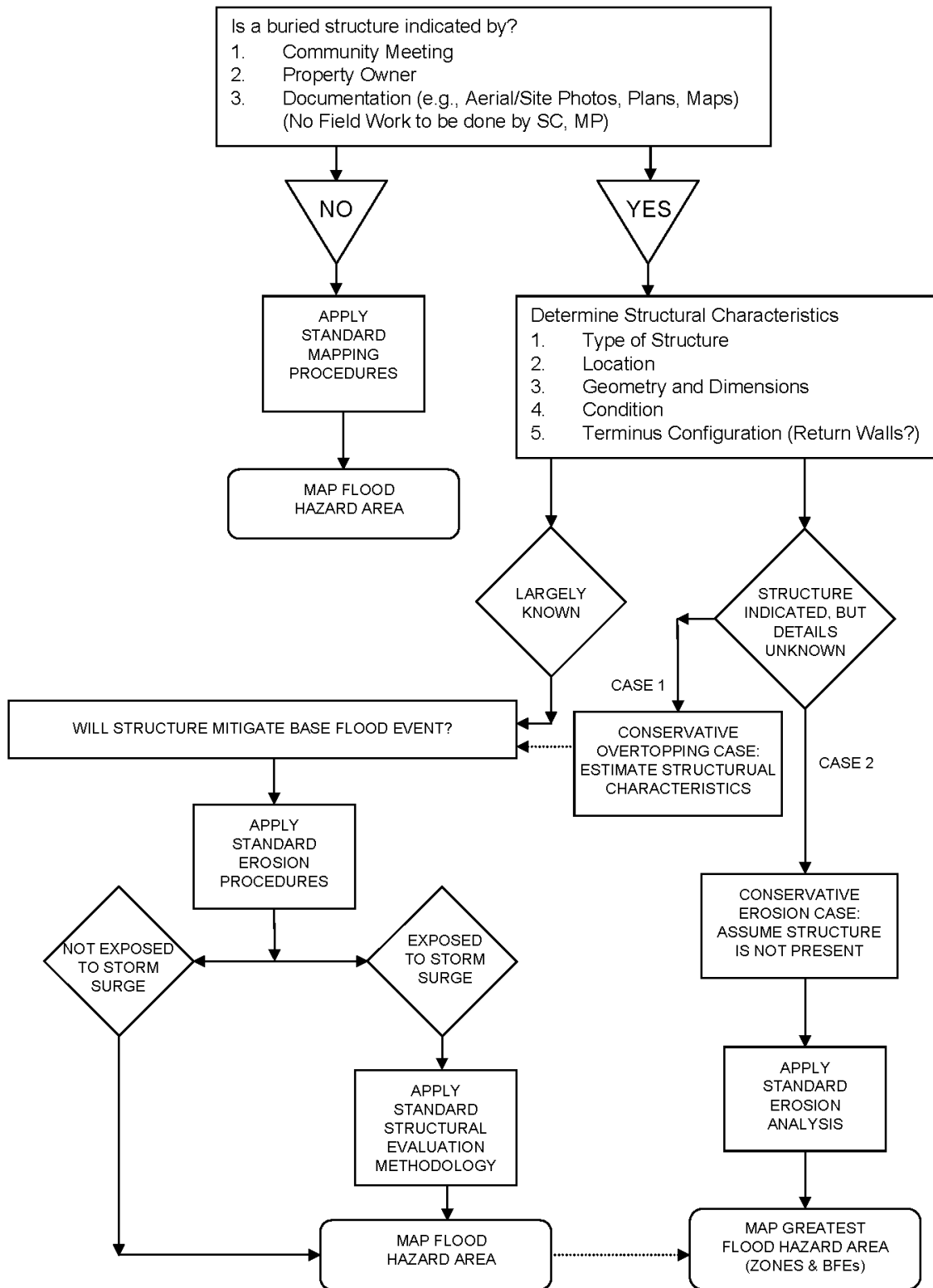
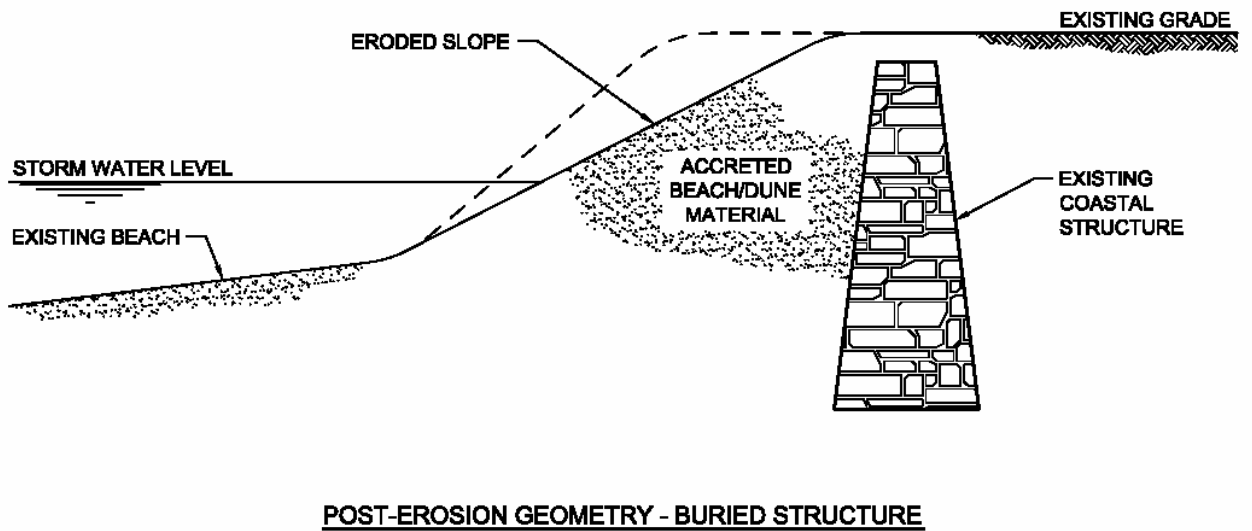
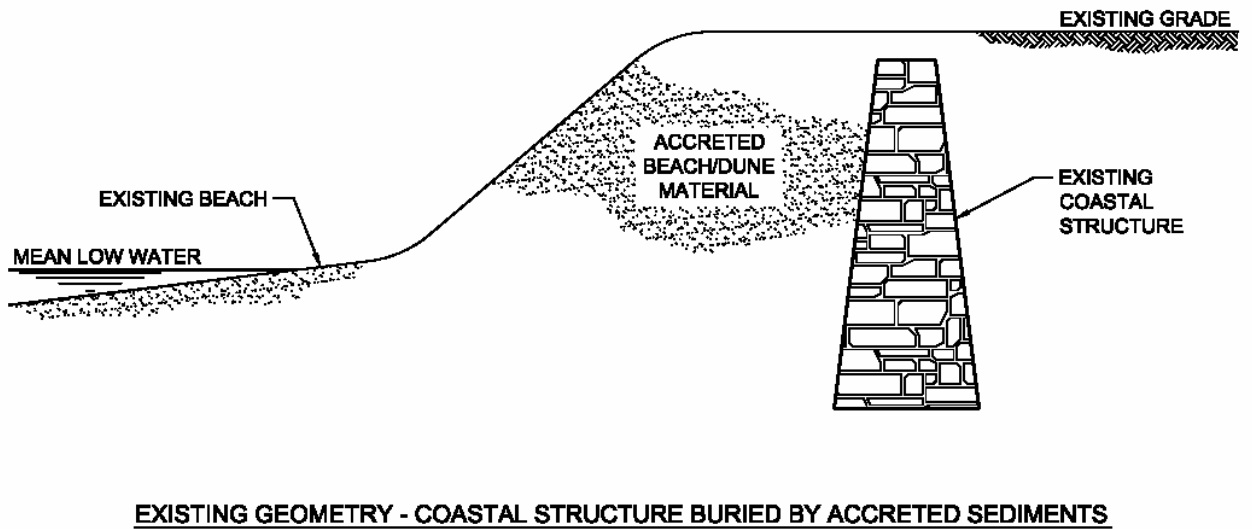
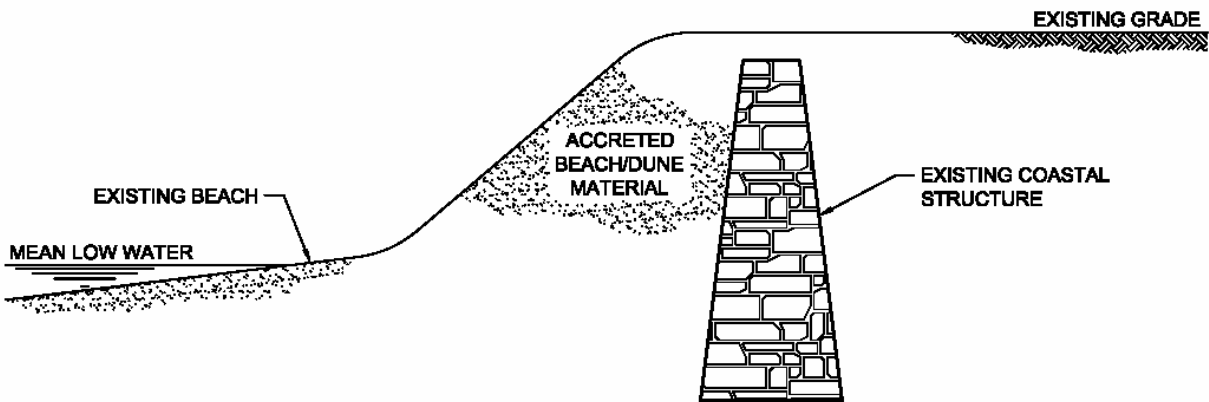

Figure D.4.7-5. Methodology for Evaluating Buried Coastal Structures



NON-EXPOSURE OF BURIED STRUCTURE DURING 1% ANNUAL CHANCE FLOOD

Figure D.4.7-6. Buried Structure Remains Buried During 1% Annual Chance Flood



EXISTING GEOMETRY - COASTAL STRUCTURE BURIED BY ACCRETED SEDIMENTS

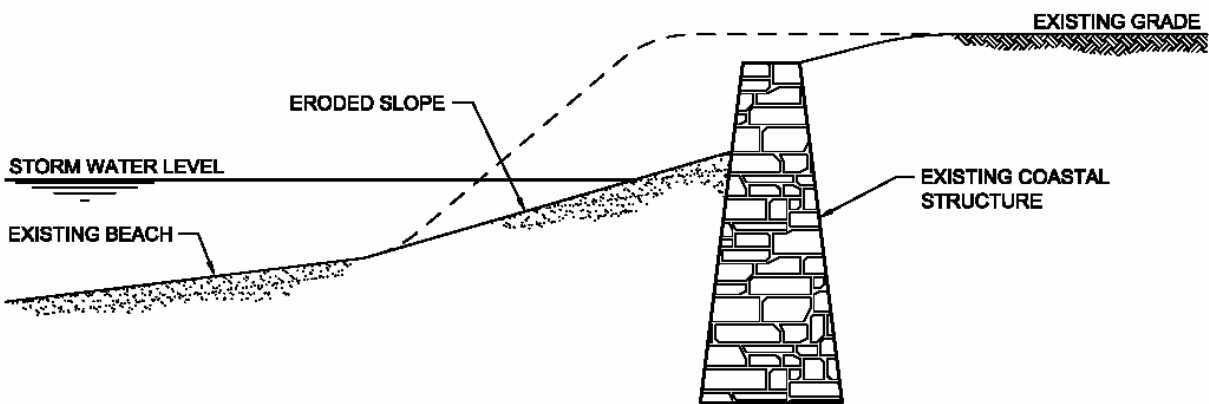

POST-EROSION GEOMETRY - BURIED STRUCTURE

EXPOSURE OF BURIED STRUCTURE DURING 1% ANNUAL CHANCE FLOOD

Figure D.4.7-7. Buried Structure Exposed During 1% Annual Chance Flood

wave overtopping landward of the levee crest during 1% annual chance flood conditions; also, the levee or levee system must be certified as providing that level of protection. NFIP regulations (44 CFR Part 65.10) detail the requirements for a levee to be recognized as providing protection from flooding, including a freeboard requirement specific to coastal levees — the crest elevation of the levee must be elevated at least 2 feet above the 1% annual chance still water elevation, and 1 foot above the 1% annual chance wave height or the maximum wave runup elevation (whichever is greater)³. Additional guidance for evaluating levees can be found in Appendix H of the *Guidelines and Specifications*.

For consideration of a coastal levee as the basis of a map revision, the “Riverine Structure Form” (MT-2, Form 3, available at <http://www.fema.gov/pdf/fhm/mt2_f3.pdf>) must be completed in addition to the “Coastal Structure Form”.

For consideration of levees that are subject to both coastal and riverine conditions, the Mapping Partner shall determine freeboard requirements using water levels determined using the methods contained in Section D.4.4 and Section D.4.5. Because Base Flood Elevations (BFEs) are required to be mapped to within a 0.5-foot tolerance (*Guidelines and Specifications* Appendix C.6.3), the combined still water and riverine flood profile shall be adjusted to an inland extent where the effects of waves and/or runup diminish to 0.5 foot or less. The resulting flood profile shall be compared to the crest elevations of flood protection along the combined tidal-river reach to determine if interior areas are sufficiently protected.

D.4.7.3.4.1 Levee Failure and Removal

Current FEMA policy states that in instances where levees cannot meet the requirements for recognition by the NFIP, the levees shall be “removed” from the analysis. Two scenarios are considered here: 1) a single levee on an analysis transect, and 2) multiple levees along an analysis transect.

Single Levee Case: If a community cannot provide the Mapping Partner with evidence that a levee is certified as meeting FEMA’s requirements in 44 CFR 65.10, then the Mapping Partner shall remove the levee from subsequent analyses. In such a case, the Mapping Partner shall:

1. Modify the topography along the transect by erasing the levee cross-section and joining the ground elevations on each side of the levee with a straight line.
2. If the Mapping Partner determines that the failed levee provides substantial (but not complete) protection against incident wave action during 1% annual flood conditions, the Mapping Partner shall assume no wave action penetrates beyond the failed levee, and that only still water flooding (tide + wind setup) and locally generated waves (i.e., waves generated in the region behind the levee) shall affect the flooded area behind the levee.

³ To be recognized by the NFIP, riverine levees require a minimum of 3 feet of freeboard above the 1% annual chance flood elevation and a minimum of 4 feet of freeboard within 100 feet of locations where the flow is constricted (e.g., a bridge); in addition, the upstream end of the levee must provide an additional 0.5 foot of freeboard added to the minimum.

3. If the Mapping Partner determines that the failed levee provides minimal protection against incident wave action during 1% annual flood conditions, the Mapping Partner shall consult with the FEMA study representative to determine whether subsequent analyses should assume incident wave action penetrates beyond the failed levee.

Multiple Levee Case: If a community cannot provide the Mapping Partner with evidence that the outer levee is certified as meeting FEMA’s requirements in 44 CFR 65.10, then the Mapping Partner shall remove the outer levee from subsequent analyses. In such a case, the Mapping Partner shall:

1. Modify the topography along the transect by erasing the outer levee cross-section and joining the ground elevations on each side of the levee with a straight line.
2. If the Mapping Partner determines that the failed outer levee provides substantial (but not complete) protection against incident wave action during 1% annual flood conditions, the Mapping Partner shall assume no wave action penetrates beyond the outer levee, and that only still water flooding (tide + wind setup) and locally generated waves (i.e., waves generated in the region behind the levee) shall affect the next landward levee (see Figure D.4.7-8).

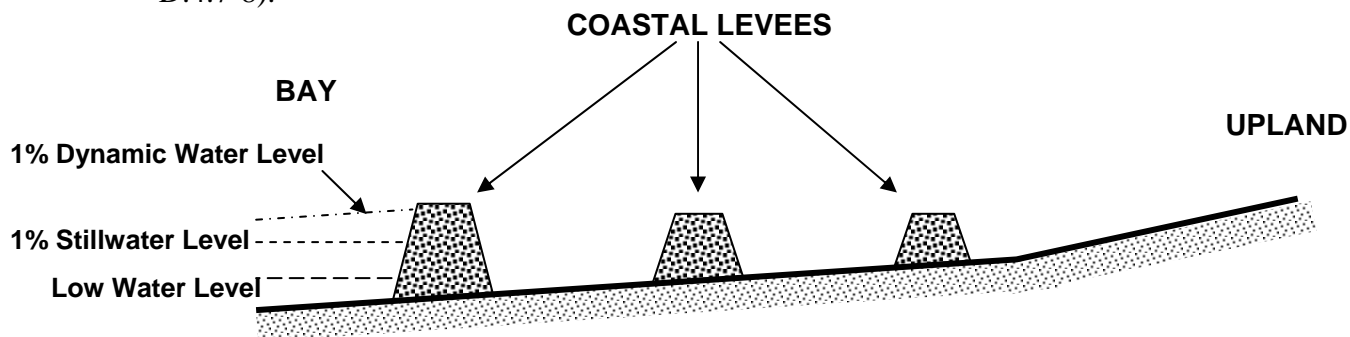

Multiple Levee Scenario, Prior to Levee Evaluation and Removal

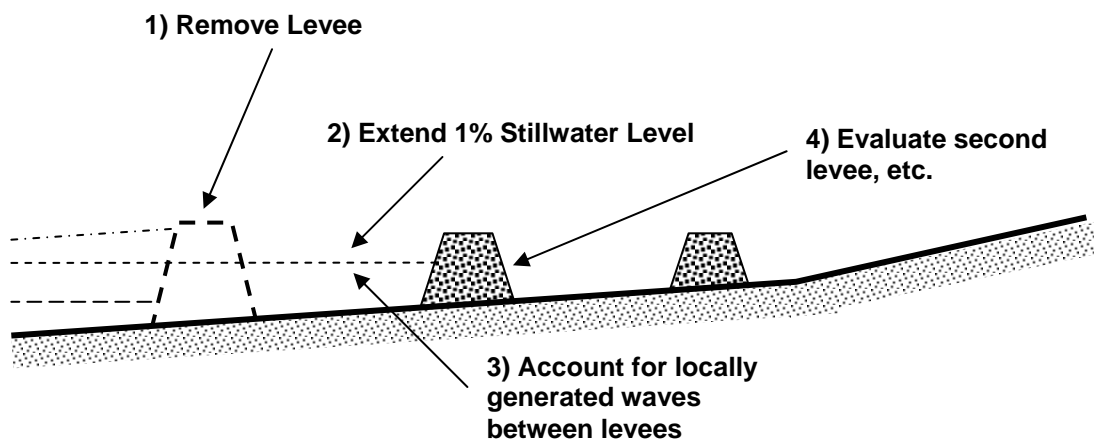

Multiple Levee Scenario, Outer Levee Removal (prior to inner levee evaluations)

Figure D.4.7-8. Levee Removal, Multiple Levee Situation

3. If the Mapping Partner determines that the failed outer levee provides minimal protection against incident wave action during 1% annual flood conditions, the Mapping Partner shall consult with the FEMA study representative to determine whether subsequent analyses should assume incident wave action penetrates beyond the failed outer levee.
4. The Mapping Partner shall repeat steps 1 through 3 for each additional levee along the transect, for which certification cannot be supplied by the community.

D.4.7.3.5 Operation and Maintenance

Both the FEMA memorandum (April 23, 1990) and the NFIP regulations indicate that an operation and maintenance plan is required as part of certification that a coastal structure will withstand the 1% annual chance flood. At a minimum, the plan must document the formal procedure to maintain the stability, height, and overall integrity of the structure and its associated structures and systems.

NFIP regulations, 44 CFR Part 65.10, require that all maintenance activities must be under the jurisdiction of a federal or state agency, an agency created by federal or state law, or an agency of the community participating in the NFIP that must assume ultimate responsibility for maintenance. Often, the aforementioned government entities are unable to take responsibility for maintenance of private structures. However, a government agency can recognize private property owners as the responsible party for maintenance of an existing structure.

For the purposes of an FIS, the Mapping Partner shall ascertain (through discussions with the community and property owners) whether operation and maintenance plans exist for coastal structures that are expected to remain intact during 1% annual chance flood conditions. Mapping Partners may not have sufficient resources and time to conduct detailed evaluations of the operation and maintenance of each coastal structure within the study area. In such cases, the Mapping Partner shall make an engineering judgment about the adequacy of structure operation and maintenance. The Mapping Partner must document data, materials and assumptions associated with the flood hazard determinations related to structure operation and maintenance. Communities and property owners should be made aware that these evaluations are for mapping purposes only.

D.4.7.4 FIS Treatment of Beach Stabilization Structures

If a Mapping Partner chooses to evaluate beach stabilization structures (e.g., groins, jetties, sills, or similar structures) during an FIS, the following approach is recommended:

- Identify any beach stabilization structures during the FIS reconnaissance phase.
- Use historical evidence and engineering judgment to determine whether the structures (or similar structures nearby) have been damaged or detached (during prior storms or gradually over time).
- Document prior damage to the stabilization structures and any resulting shoreline recession attributable to the structural damage.

- Notify the FEMA study representative if the Mapping Partner intends to remove beach stabilization structures or reduce their effects during the FIS analyses. Obtain FEMA concurrence before proceeding with the following steps.
- Use historical evidence and engineering judgment to predict the likely shoreline configuration (in plan view and elevation) if the structures fail during 1% annual chance flood conditions.
- Subject the modified shoreline and profile to typical FIS analyses (e.g., event-based erosion analysis, wave runup and overtopping analysis, and wave height analysis).
- Note that in the case of some stabilization structures, it is unlikely that their failure will require “removal” from analysis transects; the effects of the structure failure on the shoreline configuration, however, should be considered by the analyses.

D.4.7.5 FIS Treatment of Miscellaneous Structures

Current FEMA guidance does not address the effects of miscellaneous structures (e.g., piers, port and navigation structures, bridges, culverts, tide gates, etc.) on coastal flood hazard analysis and mapping. This section provides general guidance for identifying and analyzing the effects of miscellaneous structures on flooding in sheltered water areas as follows:

- The Mapping Partner shall identify structures – in addition to the coastal armoring and beach stabilization structures addressed above – that could exert a significant influence on nearshore waves and currents, coastal sediment transport, or ponding in backshore areas, during 1% annual flood conditions, particularly in sheltered waters. This should be done during the FIS reconnaissance phase.
- Once identified, the Mapping Partner shall use historical evidence, other readily available data, and engineering judgment to determine whether the miscellaneous structures are likely to survive the 1% annual flood conditions. If the structures are likely to fail, then they (and their effects on the shoreline and flooding) should be removed from subsequent analyses.
- The Mapping Partner shall notify the FEMA study representative as to how he/she intends to address miscellaneous structures and their effects during the FIS analyses, and obtain FEMA concurrence before proceeding.

D.4.7.5.1 Piers, Navigation Structures, and Port Facilities

The Mapping Partner shall review navigation charts, aerial photographs, and other information relative to piers, navigation structures, and port facilities (including dredged channels) that may affect the propagation and transformation or dissipation of waves within a sheltered water body, or that may affect littoral sediment transport. The Mapping Partner shall consider the range of possible effects of these structures and facilities during 1% annual flood conditions, using readily available data and site characteristics as a guide.

The Mapping Partner shall verify basic structure and facility information with local agencies and communities to determine the location, extent, and influence of these features. If there is any uncertainty concerning major features and their potential effects on upland flood hazards, limited field surveys or additional data collection shall be considered to augment existing data.

D.4.7.5.2 Bridges, Culverts, and Tide Gates

The shorelines of sheltered waters are often paralleled by roads and railroads in backshore areas. The effect of these structures on coastal flooding can be most pronounced where they intersect tidally influenced creeks, river channels, and floodplains. The Mapping Partner shall consider the presence and influence of roadways, railways, embankments and abutment fill, and bridge piers on flood hazards during 1% annual flood conditions.

The Mapping Partner shall identify the location and condition of culverts, tide gates, and other flow control structures in the vicinity of the study site and evaluate their potential to affect interior flood elevations. Design calculations and reports for individual culverts and tide gates, and storm drainage master plans for larger drainage systems shall be obtained and reviewed by the Mapping Partner to understand design criteria and provide data for hydraulic calculations and hazard zone delineation.

D.4.7.6 Data Requirements

The Mapping Partner shall obtain documentation for each coastal structure that could provide protection during 1% annual chance flood conditions, or significantly affect flood hazards in the study area. That documentation should include, but not be limited to, the following:

- Type, location, layout, dimensions, and crest elevation of structure;
- Dominant site particulars (e.g., local water depth, tide, surge and wave conditions, erosion rate, sediment characteristics and geotechnical conditions, debris hazards, and ice climate);
- Construction materials and present integrity;
- Historical record for structure, including construction date, plans, and specifications; recent inspection reports and photographs; maintenance plan and responsible party; and dates and descriptions of damage, repairs, and modifications; and
- Clear indications of effectiveness or ineffectiveness.

The Mapping Partner shall develop much of this information through office activity, including a careful review of aerial and site photographs, reports and information provided by the community and property owners, and other readily available information. In the case of some major coastal structures, site inspection would be advisable to confirm preliminary judgments.

Note that the level and detail of the structure and site data collected should be consistent with the level of analysis undertaken by the Mapping Partner. An analysis based on engineering judgment, or multiple analyses assuming different structure responses during 1% annual chance

flood conditions (e.g., structure survives intact, partial failure, complete failure), will require less detailed and precise information than a structural engineering and geotechnical evaluation of a coastal structure.

D.4.7.7 Study Documentation

If coastal structures are present in the study area, the Mapping Partner shall document the data (see Subsection D.4.7.2.1), methods, and procedures used to evaluate the adequacy of the structures to survive 1% annual chance flood conditions. This documentation shall include any assumptions or approximations used in the analyses. The same documentation shall be required in the event that coastal structures are indicated by information collected during the FIS, but are apparently buried and not visible during the study.

The Mapping Partner shall document the results of all analyses of coastal structures conducted for the FIS. In cases where the study contractor could not determine whether a given structure would survive the 1% annual chance flood intact, and where multiple analyses were conducted for the structure (i.e., intact condition, failed condition, and removed from the analysis transect), the Mapping Partner shall document each analysis and record the structure condition that was used to map flood hazard zones and BFEs. This information will be useful in the event a map revision is requested based upon a structure condition different from that used as the basis for the FIRM.

D.4.8 Tsunamis

This page intentionally left blank.

D.4.9 Mapping of Flood Hazard Zones and Base Flood Elevations

This section provides guidance to Mapping Partners on the delineation of coastal flood hazard zones and Base Flood Elevations (BFEs).

D.4.9.1 Review and Evaluation of Basic Results

Before mapping the flood elevations and flood hazard zones, the Mapping Partner shall review results from the models and assessments from a common-sense viewpoint and compare them to available observed historical flood data. When using models, there is the potential to forget that the transects represent real shorelines being subjected to high water, waves, and winds. Familiarity and experience with the coastal area being modeled or similar areas should provide an idea of what is a “reasonable” result.

The main point to be emphasized is that the results should not be blindly accepted. There are many uncertainties and variables in coastal processes during an extreme flood and many possible adjustments to methodologies for treating such an event. The validity of any model is demonstrated by its success in reproducing recorded events. Therefore, the model results must be in basic agreement with past flooding patterns, and historical data must be used to evaluate these results.

It would be very convenient if data from a storm closely approximating the 1% annual chance flood were available, but this is seldom the case. Although most historical flood data are for storms less intense than a 1% annual chance flood, these data will still indicate, at a minimum, the areas that should be within the flood zones. For instance, if a storm that produced a flood below the 1% annual chance flood elevation generally caused structural damage to houses 100 feet from the shoreline, a “reasonable” VE Zone width must be at least 100 feet. Similarly, houses that collected flood insurance claims for the same storm (without building foundation or structural damages) should be at least be located in an AE, AH, or AO Zone. If the analyses of the 1% annual chance flood produce flood zones and elevations indicating lesser hazards than those recorded for a more common storm, the analyses should be reevaluated. One possible explanation for change in flood patterns since the historical flood event, might be a new coastal structure acting to reduce flood hazards in the local area.

If there are indications that a reevaluation is needed, the Mapping Partner shall determine whether the results of the assessment are appropriate. The Mapping Partner shall attempt to compare all aspects of the coastal hazard assessment to past effects, whether in the form of data, profiles, photographs, or anecdotal descriptions. The Mapping Partner shall examine other data input to the assessments for wave effects (wave setup, wave height, wave runup, and wave overtopping). This includes checking that the still water levels (SWLs) and dynamic water levels are correct and that the results of wave analyses are consistent with the historical data. The Mapping Partner shall use judgment and experience to project previous storm effects to the 1% annual chance conditions and to ensure that the coastal assessment results are consistent with previous observed events.

D.4.9.2 Identification of Flood Insurance Risk Zones

The Mapping Partner shall identify the flood insurance risk zones and BFEs, including the wave effects to be identified on each transect plot, before delineating the flood insurance risk zones on the work maps. The existing topography, eroded topography, coastal structure effects, combined wave analyses (wave runup, overtopping and overland propagation) are all important to the proper identification of flood insurance risk zones, and coastal study technical documentation. The total water level (TWL) is the sum of SWL, wave setup, and wave runup. Hazard zones that are generally mapped in coastal areas include: VE, AE, AH, AO and X.¹

D.4.9.2.1 VE Zone

VE Zones are coastal high hazard areas where wave action and/or high-velocity water can cause structural damage during the 1% annual chance flood. VE Zones are identified using one or more of the following criteria for the 1% flood conditions:

1. The **wave runup zone** occurs where the (eroded) ground profile is 3.0 feet or more below the TWL.
2. The **wave overtopping splash zone** is the area landward of the crest of an overtopped barrier, in cases where the potential wave runup exceeds the barrier crest elevation by 3.0 feet or more ($\Delta R > 3.0$ feet). The landward extent is defined by $y_{G,outer}$ (Section D.4.5.2)
3. The **high-velocity flow zone** is landward of the overtopping splash zone (or area on a sloping beach or other shore type), where the product of depth of flow times the flow velocity squared (hv^2) is greater than or equal to 200 ft³/sec².
4. The **breaking wave height zone** occurs where 3-foot or greater wave heights could occur (this is the area where the wave crest profile is 2.1 feet or more above the static water elevation).
5. The **primary frontal dune zone**, as defined in 44 CFR Section 59.1 of the National Flood Insurance Program (NFIP) regulations.

The actual VE Zone boundary shown on the Flood Insurance Rate Map (FIRM) is defined as the furthest inland extent of the five criteria. VE Zones are subdivided into elevation zones, and whole-foot BFEs shall be assigned. Four of the VE Zone mapping criteria (all except the high-velocity zone) were previously incorporated into the Atlantic and Gulf of Mexico sections of Appendix D, and can also be applied in Pacific coastal areas. In one case – wave overtopping splash zone – the applicability of the VE criterion has been expanded to include sloping barriers (the Atlantic and Gulf of Mexico sections of Appendix D presently limit use of the overtopping splash VE Zone to vertical walls).

The high-velocity flow zone mapping criterion was developed for these Pacific Coast *Guidelines and Specifications*, based on new knowledge of high-velocity flows caused by wave overtopping

¹ For a complete list of flood insurance risk zones, refer to Volume 1, Subsection 1.4.2.7 of the *Guidelines and Specifications*.

and overland flow in coastal areas, and can also be applied to Atlantic and Gulf of Mexico areas. This criterion can be applied on beaches, and on the seaward and landward sides of coastal dunes, structures, and barriers (see Figure D.4.9-1). Landward transitions from this VE Zone will normally be to the AO Zone, but this may vary depending upon the site and the conditions being mapped.

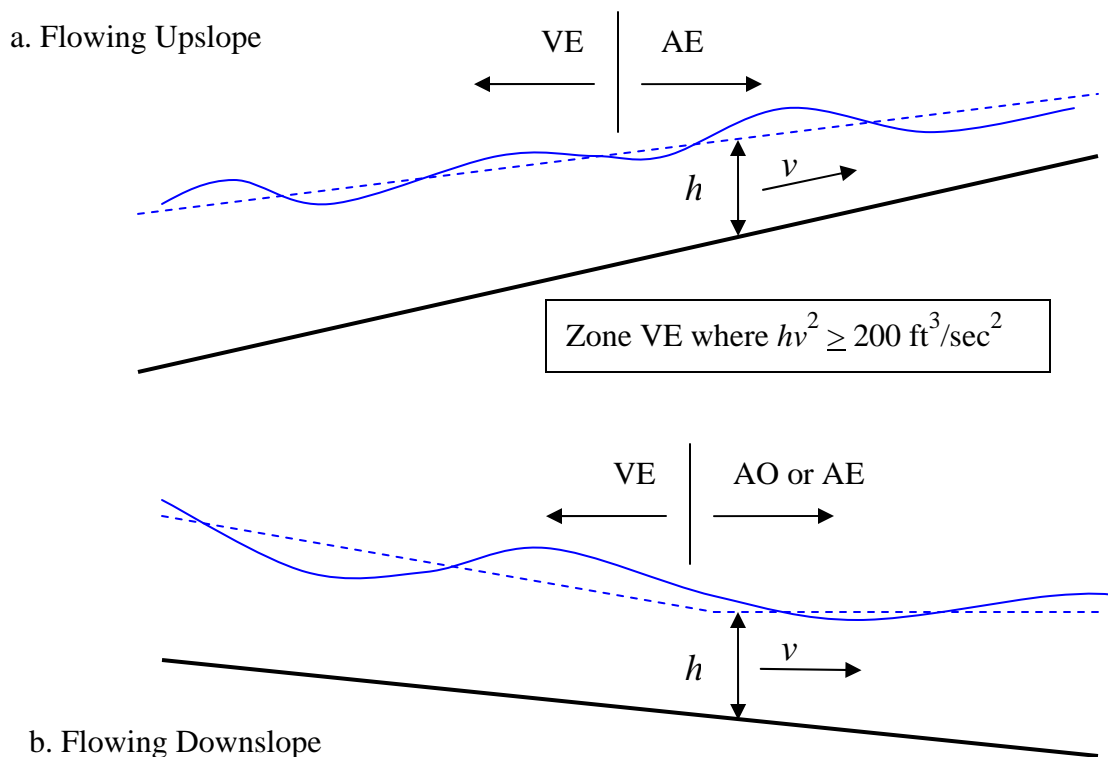

Figure D.4.9-1. Example Designation of High-velocity Flow VE Zones Based on Flood Depth and Velocity

It should be noted that other mapping differences exist between these guidelines and the Atlantic and Gulf of Mexico sections of Appendix D. In these guidelines, the VE runup elevation is not limited to 3.0 feet above the barrier crest, and the Atlantic and Gulf of Mexico sections of Appendix D simplified runup procedure (AO Zone) shown in Figure D-15 of Appendix D has been modified to delineate a VE Zone landward of the barrier when the potential runup is at least 3.0 feet above the barrier crest, as shown in Figure D.4.9-2.

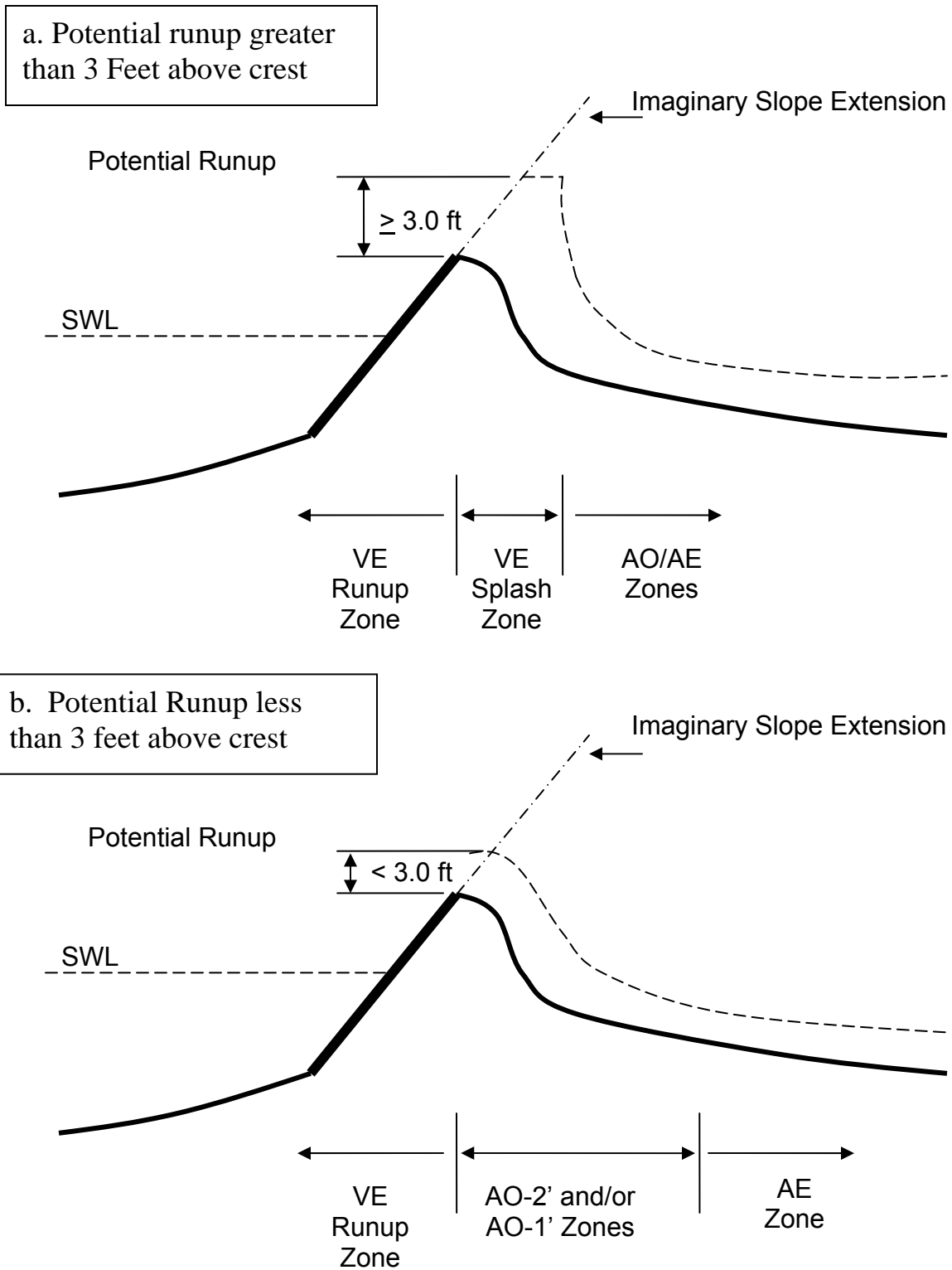

Figure D.4.9-2. Simplified Mapping Procedure for Overtopped Barrier

D.4.9.2.2 AE Zone

AE Zones are areas of inundation by the 1% annual chance flood, including areas with TWL less than 3.0 feet above the ground, or areas with wave heights less than 3.0 feet. These areas are also subdivided into elevation zones with BFEs assigned. The AE Zone generally will extend inland to the limit of the 1% annual chance flood still water elevation or TWL, whichever dominates.

D.4.9.2.3 AH Zone

AH Zones are areas of shallow flooding or ponding with water depths generally limited to 1.0 to 3.0 feet. These areas are usually not subdivided, and a BFE is assigned.

D.4.9.2.4 AO Zone

AO Zones are areas of sheet-flow shallow flooding where the product of hv^2 is less than 200 ft^3/sec^2 , or where the potential runup is less than 3.0 feet above an overtopped barrier crest ($\Delta R < 3.0$ feet). Sheet flow in these areas will either flow into another flooding source (AE Zone), result in ponding (AH Zone), or deteriorate because of ground friction and energy losses to merge into the X Zone. AO areas are designated with 1-, 2-, or 3-foot depths of flooding.

D.4.9.2.5 X Zone

X Zones are areas above the 1% annual chance flood level. On the FIRM, a shaded X Zone area is inundated by the 0.2% annual chance flood, and an unshaded X Zone area is above the 0.2% annual chance flood.

D.4.9.3 Wave Envelope

The seaward portion of the wave envelope is a combination of the potential wave runup elevation with the controlling wave crest elevation profile. The wave crest elevation profile is plotted along a transect (from the 0.0 map datum elevation landward) based on results of the Wave Height Analysis for Flood Insurance Studies (WHAFIS) model or other methodology output. A horizontal line is extended seaward from the potential wave runup elevation to its intersection with the wave crest profile to obtain the wave envelope, as shown in Figure D.4.9-3. If the runup elevation is greater than the maximum wave crest elevation, the wave envelope will be represented as a horizontal line (extending to the elevation 0.0 location on the transect) at the runup elevation, and the BFE for mapping purposes will be based on that elevation. Conversely, if the wave runup is negligible, the wave crest elevation profile becomes the wave envelope.

The landward portion of the wave envelope (landward of the bluff edge, crest of eroded dune, or seaward edge of a coastal structure) will be a combination of an overtopping bore or splash area and sheet flow.

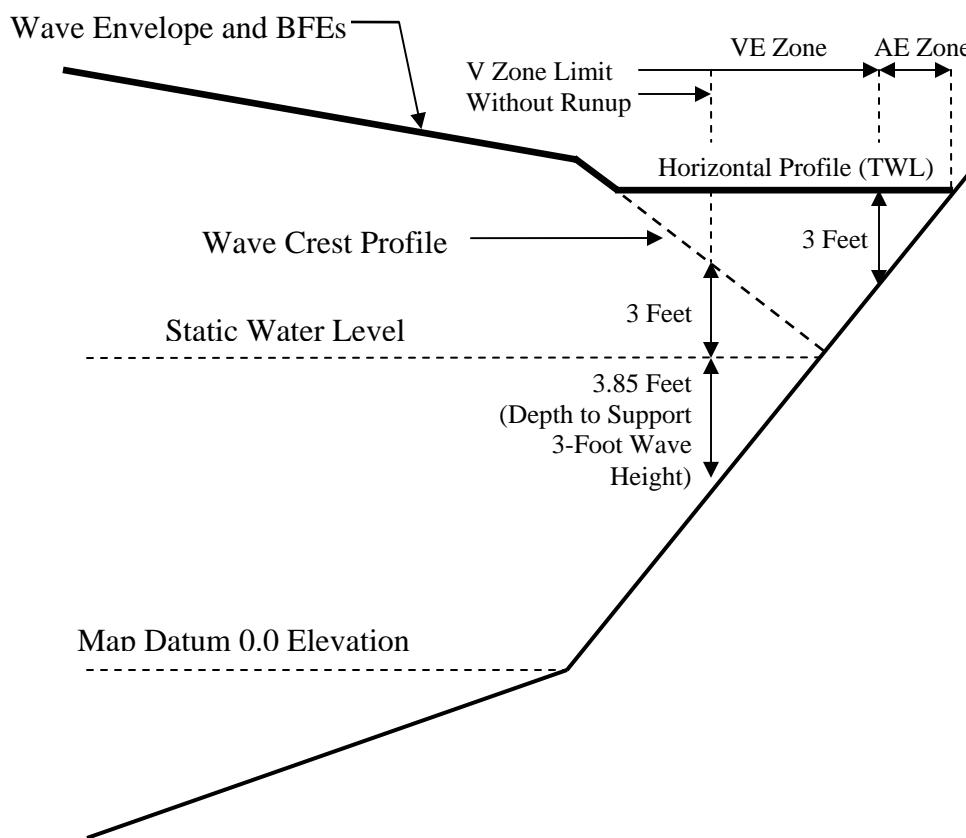

Figure D.4.9-3. Seaward Portion of Wave Envelope based on Total Water Level and Wave Crest Elevation

D.4.9.4 Criteria for Flood Boundary and Hazard Zone Mapping

The first step in identifying the flood insurance risk zones along a transect is locating the inland extent of the VE Zone, also known as the VE/AE boundary. The mapped VE/AE Zone boundary is based on the most landward limit of the five criteria outlined in Subsection D.4.9.2.1. The Mapping Partner shall extend the AE Zone from the VE/AE boundary to the inland limit of the 1% annual chance inundation, which is a ground elevation equal to the potential runup elevation, or the 1% annual chance SWL or static water level (still water plus static wave setup) if runup is negligible. The Mapping Partner may designate additional areas of 1% annual chance flooding because of wave overtopping sheet flow and shallow flooding or ponding as the AH Zone or the AO Zone. The Mapping Partner shall label all areas above the 1% annual chance inundation as the X Zone (shaded for the 0.2% annual chance flood or unshaded for areas outside of all flooding effects).

The Mapping Partner shall then subdivide the VE and AE Zone areas into elevation zones with whole-foot BFEs assigned according to the wave envelope. Generally, the VE Zone is subdivided first. Initially, the Mapping Partner shall mark the location of all elevation zone

boundaries on a transect. Because whole-foot BFEs are being used, these should always be mapped at the location of the half-foot elevation on the wave envelope. However, the Mapping Partner shall not subdivide the horizontal runup portion of the seaward wave envelope (see Figure D.4.9-3), if any; the BFE shall be the runup elevation, rounded to the nearest whole foot.

Ideally, the Mapping Partner would establish an elevation zone for every BFE in the wave envelope; however, because these zones are mapped on the FIRM, so buildings or property can be located in a flood insurance risk zone, the Mapping Partner shall use a minimum width for the mapped zone to provide a usable FIRM. For coastal areas, the general guidance is to have a minimum zone width of 0.2 inch on the FIRM. The mapping criteria and ability to map all coastal BFEs and hazard zones changes is dependent upon the map scale of the FIRM. Because digital FIRM data can be easily enlarged, the map scale limitations should be reviewed by the Mapping Partner with the FEMA study representative and community officials.

The Mapping Partner shall combine elevation zones that do not meet the minimum width with an adjacent zone or zones to yield an elevation zone equal to or wider than the minimum width. The BFE for this combined zone is a weighted average of the combined zones. When combining VE Zones, the Mapping Partner shall not reduce the maximum BFE at the shoreline, by averaging.

The AE Zone, if wide enough, shall be subdivided in the same manner. If the total AE Zone width is less than the minimum width, the lowest elevation VE Zone is usually assigned to that area. This situation typically occurs for steep or rapidly rising ground profiles, and it is not unreasonable to designate the entire inundated area as a VE Zone. In some cases, however, it may be appropriate for the Mapping Partner to extend the AE Zone slightly into the next zone seaward to satisfy the minimum width requirement.

Relatively low areas landward of zones subject to wave effects may be subject to shallow flooding or ponding of flood water; the Mapping Partner shall designate these areas as AH or AO Zones. Such designations can be relatively common landward of coastal structures, bluffs, ridges, and dunes, where wave overtopping occurs.

Identifying appropriate zones and elevations may require particular care for dunes, given that the entire primary frontal dune is defined as coastal high hazard area. Although the analyses may have determined a dune will not completely erode and wave action should stop at the retreated duneface with only overtopping possibly propagating inland, the Mapping Partner shall designate the entire dune as a VE Zone as defined in the NFIP regulations. The Mapping Partner shall assign the last calculated BFE at the open coast duneface (whether VE or AE Zone) to be the dominant VE Zone BFE for the entire primary frontal dune and extended to the landward limit of the primary frontal dune. It may seem unusual to use a BFE that is lower than the ground elevation, although this is fairly common. Most of the BFEs for areas where the dune was assumed to be eroded are also below existing ground elevations. In these cases, it is the VE Zone designation that is most important to the NFIP where, under current regulations, structures in VE Zones must be built on pilings and alterations to the dunes are prohibited.

D.4.9.5 Transect Examples

Settings occurring along the open coastlines and sheltered waters of California, Oregon, and Washington include the following:

1. Sandy beach backed by a low sand berm or high sand dune formation.
2. Sandy beach backed by shore protection structures.
3. Cobble, gravel, shingle, or mixed grain sized beach and berms.
4. Erodeable coastal bluffs.
5. Non-erodeable coastal bluffs or cliffs.
6. Tidal flats and wetlands.

The examples discussed below depict idealized transects for these beach settings, where erosion, wave runup, and overtopping are the dominant coastal processes, to illustrate common flood hazard zonations in a quantitative way. BFEs shown are arbitrary and included for illustrative purposes only.

- Example 1.** Figures D.4.9-4a and D.4.9-4b illustrate flood hazard mapping for a non-erodible coastal bluff which is high enough to prevent overtopping during 1% flood conditions. The area seaward of the bluff will be mapped as the VE Zone, with a BFE set at the potential runup elevation. The area landward of the bluff face will be mapped as X Zone (unshaded).

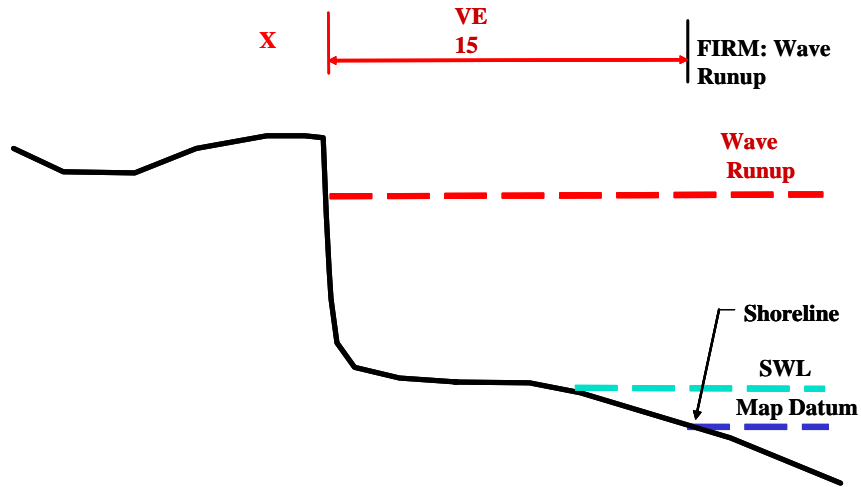

Figure D.4.9-4a. Non-erodible High Coastal Bluff with VE Zone Controlled by Wave Runup (No Overtopping)

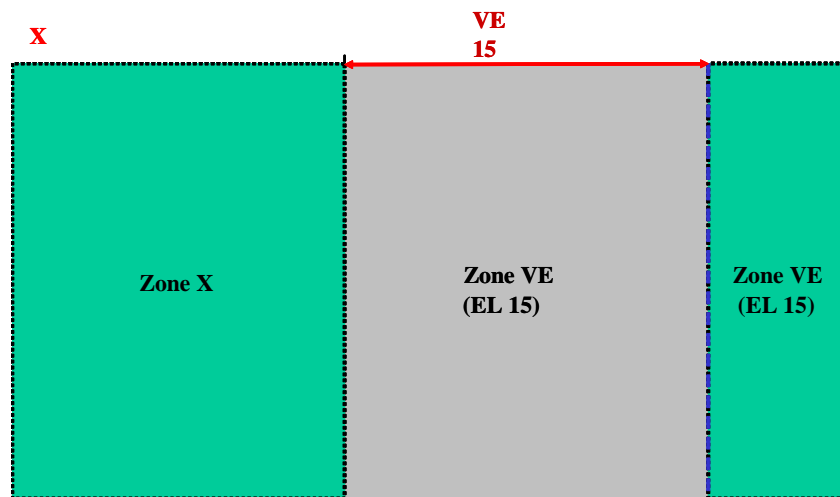

Figure D.4.9-4b. Plan View of Flood Hazard Zones and BFEs, Non-erodible High Coastal Bluff with VE Zone Controlled by Wave Runup (No Overtopping)

- Example 2.** Figures D.4.9-5a and D.4.9-5b illustrate flood hazard mapping for an erodible coastal bluff that is not high enough to prevent overtopping and where the potential runup reaches higher than 3.0 feet above the crest. In the example shown, the eroded profile is calculated first using procedures described in Section D.4.6, then wave runup and overtopping are mapped against the eroded profile. The area seaward of the bluff will be mapped as the VE Zone, with a BFE set at the potential runup elevation. The area immediately landward of the eroded bluff face will be mapped as VE Zone based on the calculated splash zone width. The area landward of the splash zone will be mapped as a high-velocity flow VE Zone where $hv^2 \geq 200 \text{ ft}^3/\text{sec}^2$ and as AO Zone where $hv^2 < 200 \text{ ft}^3/\text{sec}^2$. BFEs in the VE splash zone and VE high-velocity flow zone will be based on the calculated water surface profile decay (see Subsection D.4.5.2.5).

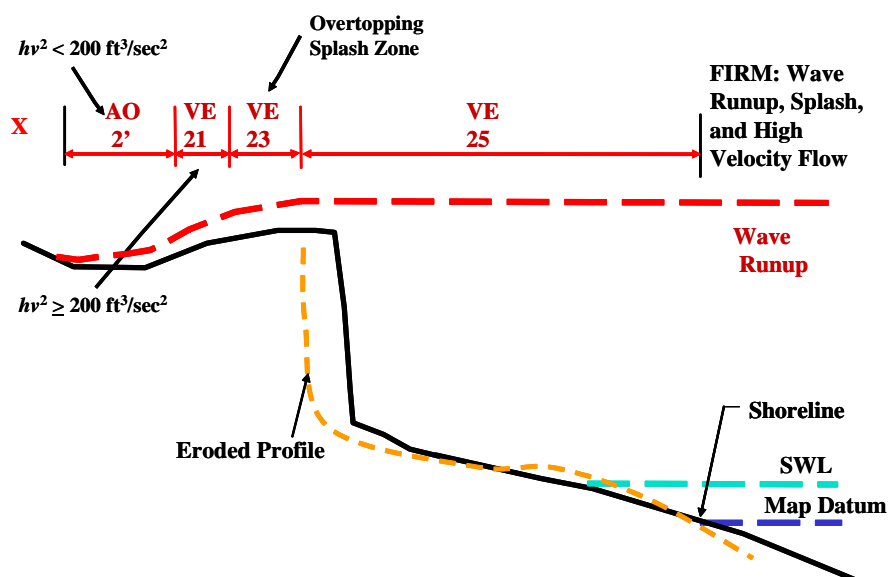

Figure D.4.9-5a. Erodible Low Coastal Bluff with VE Zone Controlled by Wave Runup, Overtopping Splash, and High-velocity Flow

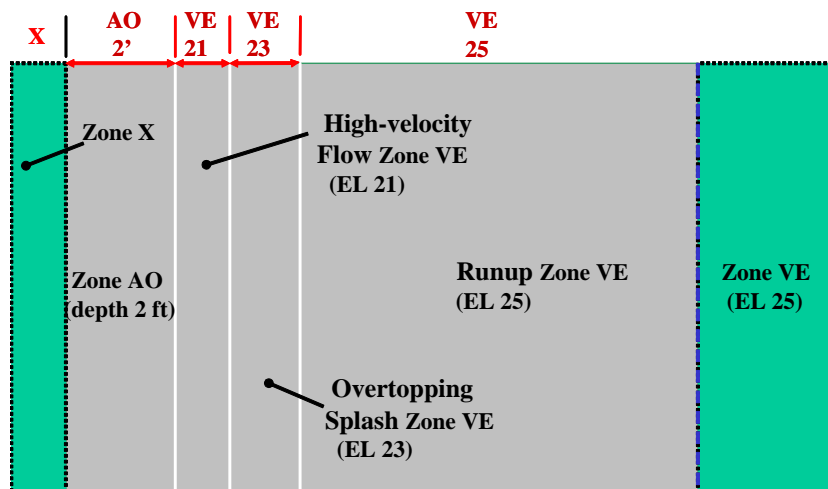

Figure D.4.9-5b. Erodible Low Coastal Bluff with VE Zone Controlled by Wave Runup, Overtopping Splash, and High-velocity Flow

- Example 3.** Figures D.4.9-6a and D.4.9-6b illustrate flood hazard mapping for a primary frontal dune (PFD) that is large enough (in cross-section) to prevent removal and high enough to prevent overtopping during 1% flood conditions. In the example shown, the eroded profile is calculated first (see Section D.4.6), then wave runup is mapped against the eroded profile. The area seaward of the eroded dune face would, except for the PFD designation, be mapped as the AE Zone (where the runup depth < 3.0 feet) and the VE Zone (where the runup depth ≥ 3.0 feet). The area landward of the eroded dune face would, except for the PFD designation, be mapped as X Zone. However, given the PFD designation, the area between the shoreline and the landward heel of the dune will be mapped as VE Zone; the BFE at the dune face (EL 13) will be continued landward to the PFD landward limit. Note that this is the only mapping scenario where the hazard zone (landward of the dune face) is based on coastal morphology, not on actual flood hazards during the 1% flood. Likewise, the BFE landward of the dune face is an extension of the BFE at the dune face, not representative of the actual flood profile.

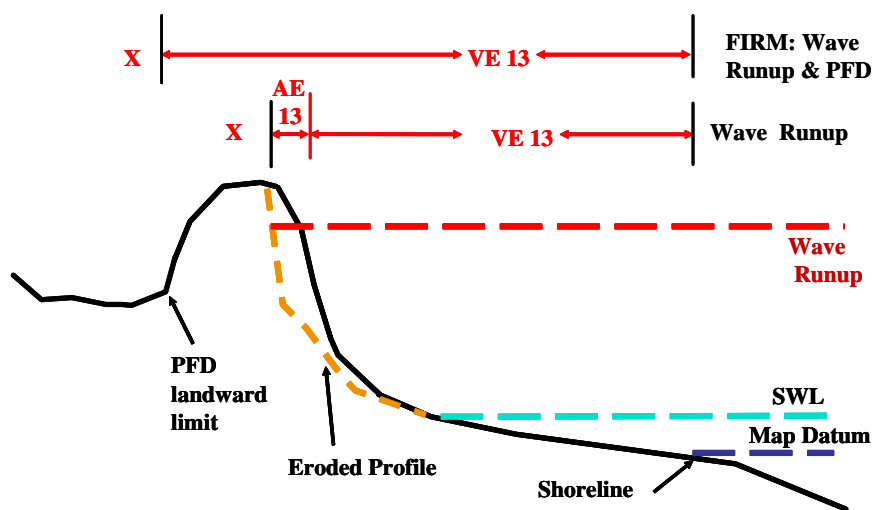

Figure D.4.9-6a. Sandy Beach Backed by High Sand Dune with PFD Controlling the VE Zone

If the dune in Figure D.4.9-6.a was not high enough to prevent overtopping and the potential runup extended more than 3.0 feet above the crest, an overtopping splash VE Zone would be indicated on the landward side of the eroded crest, and a high-velocity flow VE Zone would lie farther landward (if $hv^2 \geq 200 \text{ ft}^3/\text{sec}^2$). If the high-velocity flow VE Zone terminates seaward of the PFD limit, the PFD designation would determine the VE/AE boundary. If the high-velocity flow zone extends landward of the PFD limit, the high-velocity flow VE Zone would determine the VE/AO boundary. If no high-velocity flow VE Zone exists in the example (if $hv^2 \leq 200 \text{ ft}^3/\text{sec}^2$), then the VE/AO boundary would be set at the PFD limit or the overtopping splash limit, whichever is farther landward. In all cases, the BFEs landward of the eroded dune crest would be mapped at the higher of the PFD BFE, the splash zone BFE, and the high-velocity flow BFE at any given point along the transect.

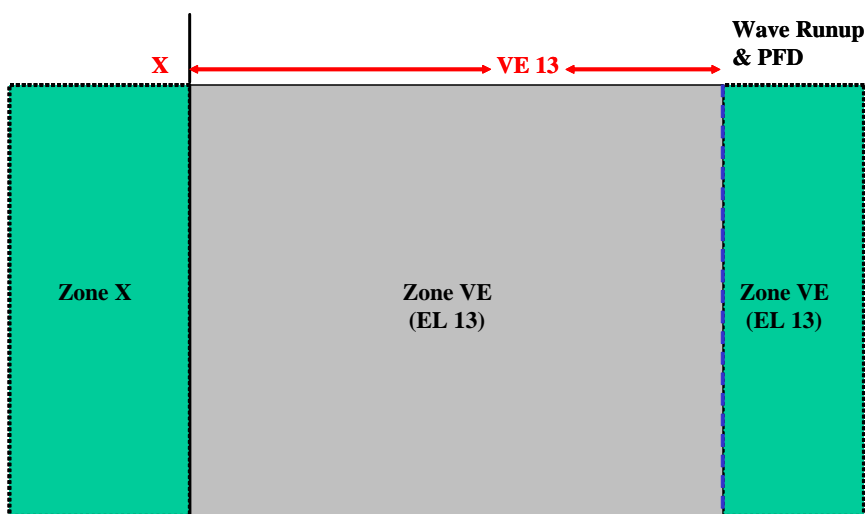

Figure D.4.9-6b. Sandy Beach Backed by High Sand Dune with PFD Controlling the VE Zone

- Example 4.** Figures D.4.9-7a and D.4.9-7b illustrate flood hazard mapping for a low coastal dune where the dune cross-section is insufficient to prevent removal by the 1% flood. The eroded profile is calculated and adjusted (see Section D.4.6), then the resulting profile is checked for inundation, overland wave propagation, wave runup, and overtopping. In the example shown, the remnant dune crest is not inundated, so overland wave propagation is not mapped. Instead, hazard zones are mapped based on the combined effects of wave runup, overtopping splash (runup extends more than 3.0 feet above the crest in this example), high-velocity flow and PFD. The width of and BFE for the VE splash zone are calculated using the procedures described in Subsection D.4.5.2.5. In this example, the overtopping splash zone extends farther landward than the PFD, and determines the VE/AO boundary.

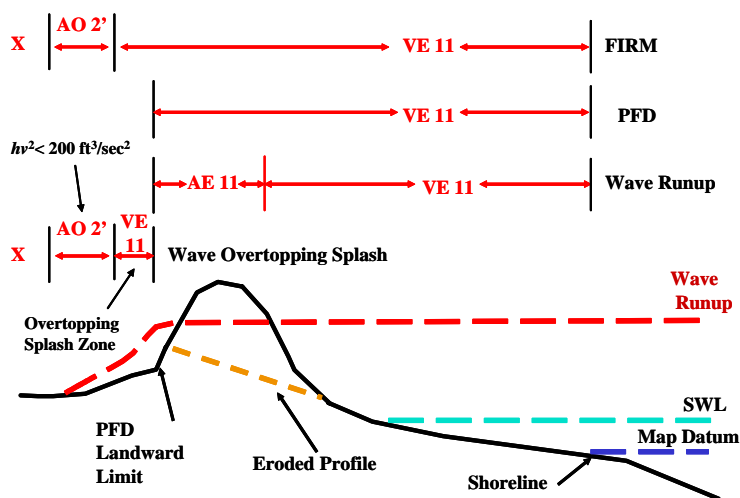

Figure D.4.9-7a. Sandy Beach Backed by Low Sand Dune with Overtopping Splash Controlling VE Zone

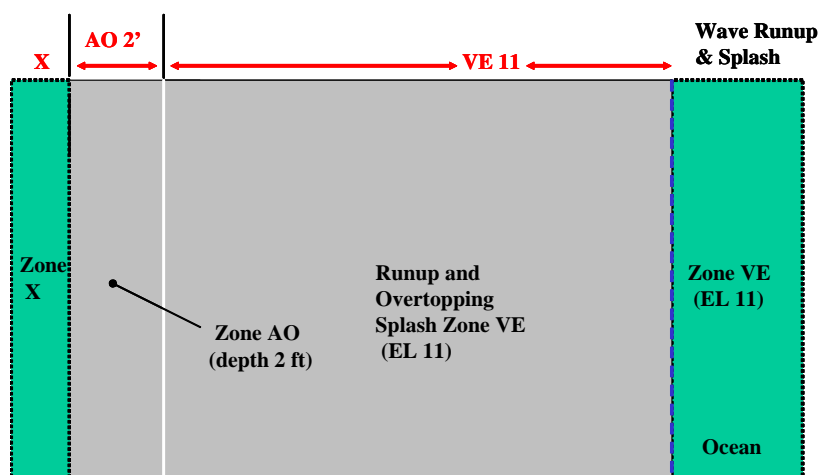

Figure D.4.9-7b. Sandy Beach Backed by Low Sand Dune with Overtopping Splash Controlling VE Zone

- Example 5.** Figures D.4.9-8a and D.4.9-8b illustrate flood hazard mapping for an overtopped coastal structure that remains intact during the 1% flood (see Section D.4.7 for a discussion of structure failure and local scour considerations). In this example, the potential runup reaches an elevation greater than 3.0 feet above the crest of the structure therefore, an overtopping splash VE Zone is mapped landward of the structure; crest. (Note: If the potential runup was less than 3.0 feet above the crest, no VE overtopping splash zone would be mapped, and an AO sheet flow zone would be mapped instead.) The width of and BFE for the VE splash zone are calculated using the procedures described in Subsection D.4.5.2.5. The flow velocity and water surface profile landward of the structure are used to calculate hv^2 values landward of the crest, and a high-velocity flow VE Zone is mapped where $hv^2 \geq 200 \text{ ft}^3/\text{sec}^2$, while AO Zone is mapped where $hv^2 < 200 \text{ ft}^3/\text{sec}^2$. Note that the same basic procedure is used for vertical and sloping structures, the principal difference being the equations used to calculate wave runup and splash distances. Thus, if this particular structure was assumed to sustain total or partial failure during the 1% flood, a similar procedure would be applied, but with sloping structure equations rather than vertical structure equations.

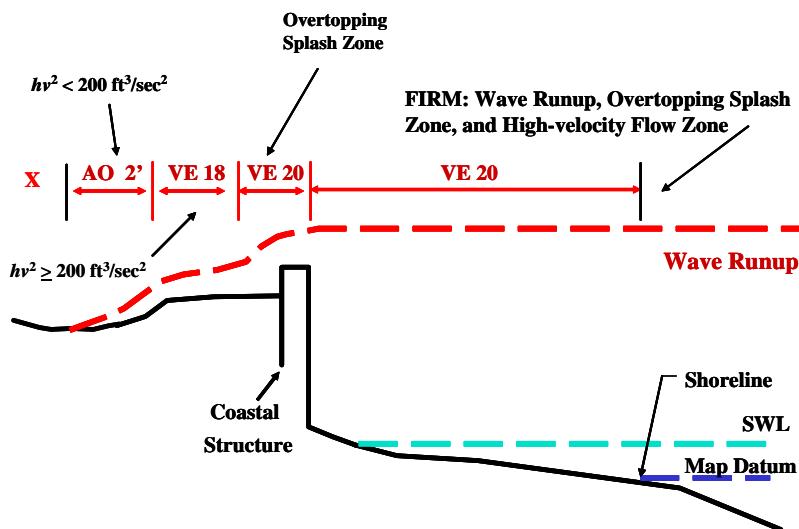

Figure D.4.9-8a. Sandy Beach Backed by Shore Protection Structure with VE Zone Controlled by the Splash Zone and High-velocity Flow from Wave Overtopping

With shore structures having steep slopes, runup elevations are relatively high and a wide range of wave hazards can occur, including erosion or scour near the structure. These circumstances may result in a variety of distinct and compact situations, where appreciable engineering judgment can be required for appropriate assessment of flood hazards.

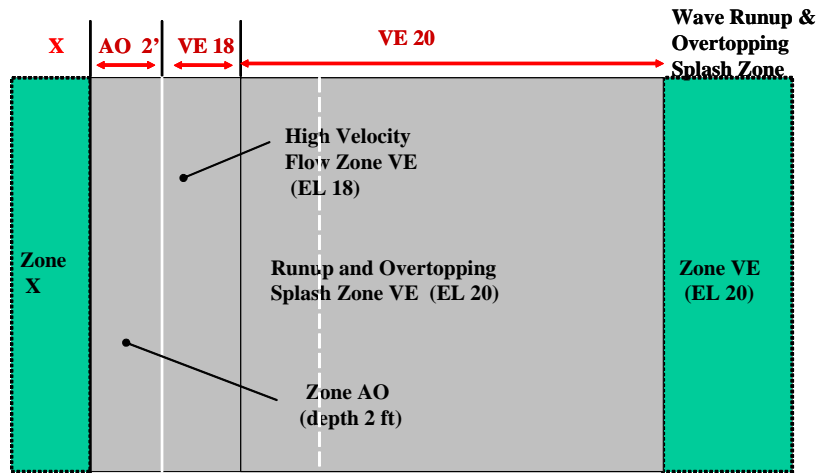

Figure D.4.9-8b. Sandy Beach Backed by Shore Protection Structure with VE Zone Controlled by the Splash Zone and High-velocity Flow from Wave Overtopping

- Example 6.** Figures D.4.9-9a and D.4.9-9b illustrate flood hazard mapping for a beach profile composed of gravel, cobble, or mixed grain sizes. In this example, the Most Likely Winter Profile (MLWP) configuration should be determined in accordance with Section D.4.6, and the wave hazards should be modeled using the eroded profile. There will be no PFD designation for a gravel, cobble, or mixed grain size profile, so the mapped hazard zones and BFEs will reflect calculated flood hazards only.

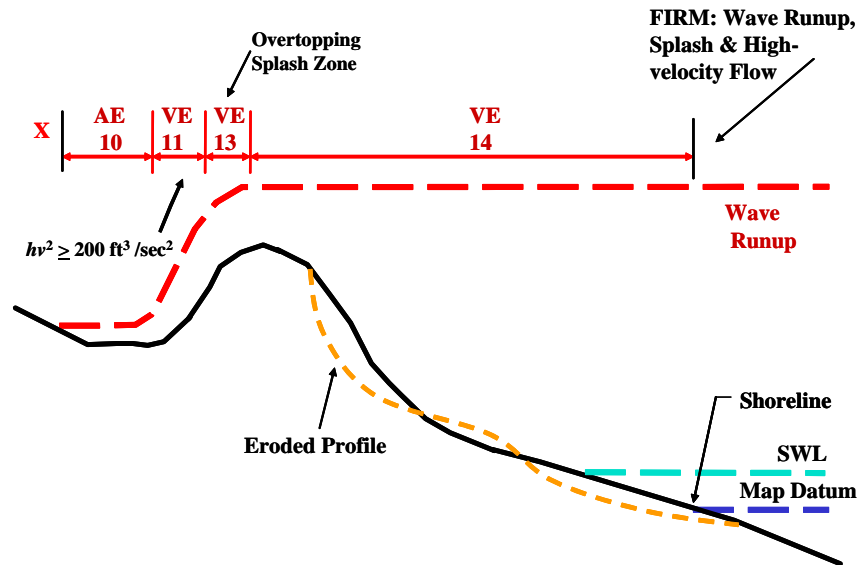

Figure D.4.9-9a. Cobble, Gravel, Shingle, or Mixed Grain Sized Beach with VE Zone Controlled by Wave Runup, Overtopping, and High-velocity Flow

In this example, the potential runup is assumed to reach more than 3.0 feet above the crest, so an overtopping splash zone is mapped landward of the profile crest, with a high-velocity flow VE Zone and AE Zone to the rear. The AE Zone is mapped instead of the AO Zones shown in Examples 2, 4, and 5 because the overtopping ponds in the area behind the crest in this case. The mean overtopping rate calculations (see Section D.4.5.2) shall be used to determine the volume of water overtopping the barrier during the 1% flood conditions, and the BFE in AE Zone shall be determined based on the overtopping volume and the local topography.

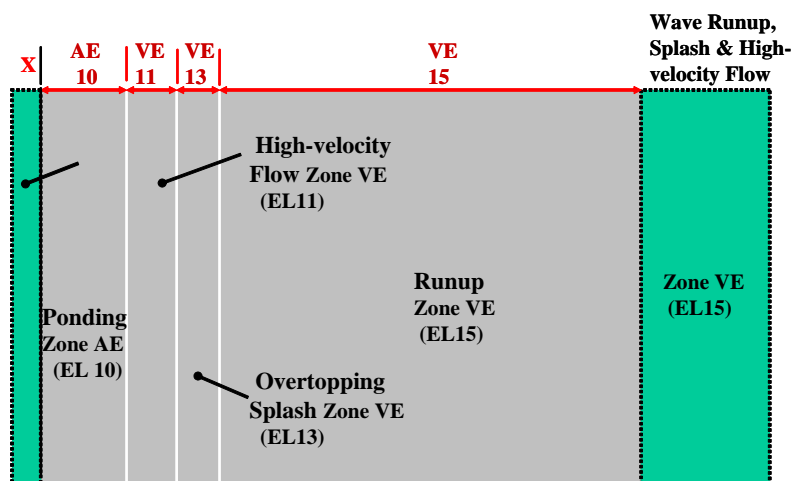

Figure D.4.9-9b. Cobble, Gravel, Shingle or Mixed Grain Sized Beach with VE Zone Controlled By Wave Runup, Overtopping and High Velocity Flow

- Example 7 (no figure).** For the case where a profile is inundated by the static water level during the 1% flood – such as a tidal wetland, low sand beach or other flooded low-lying area – wave runup and overtopping need not be calculated and mapped. Instead, the hazard zones and BFEs shall be mapped based on the results of the WHAFIS model, as modified for use on the Pacific coast (see Section D.4.5.3), or other similar analysis, or similar analysis. The VE Zone shall be mapped where the vertical difference between the wave crest elevation and the static water level is equal to or greater than 2.1 feet; the AE Zone shall be mapped where the difference is less than 2.1 feet. BFEs shall be mapped at even-foot increments, in a stair-step fashion, following the wave crest profile.

D.4.9.6 Mapping Procedures

Properly integrated delineation of the results of flooding analyses involves judgment and skill in reading topographic and land cover maps. The time and effort put forth to determine the flood elevations and extents will be negated if the results of these analyses are not properly delineated on the FIRM. The FIRM is usually produced from the work maps. Therefore, the Mapping Partner shall transfer the flood zones and elevations identified on the transects to the work maps and interpolate boundaries between transects. The Mapping Partner shall set up the work maps with contour lines, buildings, structures, vegetation, and transect lines clearly located. Because roads are often the only fixed physical features shown on the FIRM, the Mapping Partner shall ensure that other features and the flood zone boundaries are properly located on the work maps in relation to the centerline of the roads as they will appear on the FIRM. The starting point (0 Station) for each transect should be clearly annotated on the work maps.

For each transect, the Mapping Partner shall transfer the identified elevation zones from the transect to the work maps, marking the location of the boundaries along the transect line, so boundary lines can be interpolated between transects. The Mapping Partner shall ensure that boundaries are marked at the correct location. Because of erosion assumptions, the location of the 0.0 foot elevation at the shoreline can change on the transect but the 0 Station will not change on the work map.

Using the transect profile, the Mapping Partner shall determine the location of the zone change in relation to a physical feature (e.g., ground contour, back side of a row of houses, 50 feet into a vegetated area) and delineate the boundary line for the area represented by that transect along this feature. The Mapping Partner shall measure the widths of the zones carefully; zones that narrow to less than 0.2 inch must be tapered to an end. Likewise, if the zone becomes much wider, it may be possible to break an averaged elevation zone into two mapped elevation zones.

One of the more difficult steps in delineating coastal flood zones and elevations is the transition between transect areas. Good judgment and an understanding of typical flooding patterns are the best tools for this job. Initially, the Mapping Partner shall locate the area of transition (an area not exactly represented by either transect) on the work maps. The Mapping Partner shall then delineate the floodplain boundaries for each transect up to this area. The Mapping Partner shall examine how a transition can be made across this area to connect matching zones and still have the boundaries follow logical physical features. Other transects similar to this area could give an indication of flooding. Sometimes the elevation zones for the two contiguous transects are not the same; in such cases, the Mapping Partner may have to taper the zones to an end or enlarge the zones and subdivide them in the transition area.

Transition zones may be necessary between areas with high runup elevations to avoid large differences in BFEs and to smooth the change in flood boundaries. These zones are to be fairly short and cover the shore segment with a slope not exactly typical of either area. The Mapping Partner shall determine the transition elevation using judgment in examining runup transects with similar slopes. The Mapping Partner shall not use transition zones if there is a very abrupt change in topography, such as the end of a structure.

Lastly, the Mapping Partner shall map the X Zone areas. The Mapping Partner shall show areas below the 0.2% annual chance TWL that are not covered by any other flood zone as the X Zone (shaded) on the FIRM. Often, the maximum runup elevation is higher than the 0.2% annual chance TWL; in such cases, the X Zone (shaded) designation will not be used in that area. All other areas are designated X Zone without shading.

Because flood elevations are rounded to the nearest whole foot, the Mapping Partner does not need to spend hours resolving a minor elevation difference. Also, because coastal structures must be located on the FIRM, the Mapping Partner shall attempt whenever possible to smooth the boundary lines and to follow a fixed feature such as a road. In preparing the FIRM, the Mapping Partner shall ensure that the mapped results are technically correct and that the FIRM is easy for the community official, engineer or surveyor, and insurance agent to use.

D.4.10 Study Documentation

This section summarizes the reporting requirements for coastal Flood Insurance Studies (FISs) on the Pacific Coast, with emphasis on the intermediate data submissions that document the basis and results of coastal flooding analyses during the course of the FIS.

Reporting requirements for coastal FISs shall follow guidance provided in Appendix M for the preparation of a Technical Support Data Notebook (TSDN). The TSDN shall consist of the following four major sections, which are more specifically described in Appendix M:

- General Documentation;
- Engineering Analyses;
- Mapping Information; and
- Miscellaneous Reference Materials.

The material compiled for these sections of a coastal FIS TSDN will be similar to a riverine study, with the exception of the Engineering Analyses section. The Engineering Analyses section of a TSDN for a coastal study shall be formatted to reflect the intermediate data submissions required for a coastal study.

D.4.10.1 General Documentation

This portion of the TSDN incorporates background information compiled by the Mapping Partner related to changes in scope; special problem reports (SPRs); minutes of meetings held with the Federal Emergency Management Agency (FEMA), communities, and other Mapping Partners; and all correspondence for the study effort (email and hard copy). A complete list of TSDN reporting requirements for General Documentation is provided in Appendix M.

D.4.10.2 Engineering Analyses

Due to the complexity of coastal studies, intermediate data submissions are required from the Mapping Partner. Intermediate data submissions provide defined milestones in the coastal flood study process for review of study approach and results. The Mapping Partner shall submit the data to FEMA in accordance with the sequence discussed below.

The following intermediate data submissions are required from Mapping Partners, who perform coastal FISs unless otherwise specified by FEMA:

- Intermediate Submission No. 1 – Scoping and Data Review
- Intermediate Submission No. 2 – Offshore Water Levels and Waves
- Intermediate Submission No. 3 – Nearshore Hydraulics
- Intermediate Submission No. 4 – Draft Flood Hazard Mapping

The Mapping Partner shall receive review comments within 30 days of the receipt of each data submission. The Mapping Partner performing the study shall establish a work plan, so the

interim review does not cause any delay in the submission of the draft FIS report and Flood Insurance Route Map (FIRM) reflecting the results of the coastal study.

D.4.10.2.1 Intermediate Submission No. 1 – Scoping and Data Review

In this phase of reporting, the Mapping Partner provides the background information on the study setting and available data relevant to the study area. Any new data needed for the detailed coastal analyses in the following phases (i.e., Offshore Waves and Water Levels; Nearshore Hydraulics) shall be identified in this phase. Unless otherwise agreed upon with FEMA, the study shall not proceed until all of the information is available and incorporated in the scoping document for approval.

- **Topographic and Bathymetric Data:** If available at this stage, this submission shall include survey control data, topographic data from aerial photography, Light Detection and Ranging (LIDAR), field surveys, and bathymetric survey data. If survey work is still in progress, the submission shall include available data at the time of submission and a detailed description of the planned survey data collection. Information shall be submitted on the extent of topographic and bathymetric mapping, key mapping parameters (e.g., contour intervals and accuracy standards), horizontal and vertical datums, location and extent of transects, and other pertinent information describing the extent and quality of survey information to be used in the study. If existing community mapping data will be used to supplement survey efforts for the study, the Mapping Partner shall submit information on the date, accuracy standards, datums, extent, and any limitations of the mapping.
- **Tide, Wind, Wave, Current, and Flooding Data:** This submission shall include a description of available tidal elevation, wind speed, and wave data that relate to study analysis requirements. The submission shall include an evaluation of local and regional tide gage records recognizing that these include astronomical tide, surge, El Niño, and possibly other influences (e.g., river flows, wave setup); residuals based on astronomical tide predictions shall be included where relevant to the study analysis. The submission shall include review and selection of wind stations in the vicinity of the study area that can provide reasonable length of record, hourly values, and peak gusts to help estimate extreme wind statistics; evaluation of available wave or wave hindcast data; evaluation of available current data and evaluation of the influence of currents on coastal flooding, if any; and evaluation of available historical data (measured and anecdotal) on past coastal flood events.
- **Site Reconnaissance:** Results of the site reconnaissance shall be summarized to characterize exposure and coastal morphology by shoreline segment or reach; provide an inventory of existing coastal structures and levees; characterize coastal vegetation where it may influence coastal flooding analyses and mapping; identify transect locations to be field surveyed; describe the rationale for selection of transects to represent shoreline segments and reaches in subsequent water-level and wave calculations; and describe any unusual study area characteristics (e.g., floodborne debris, tsunamis, beach nourishment, multiple levees, etc.) that may require special consideration in the study or further guidance from FEMA.

- **Technical Approach:** The submission shall describe the technical approach to analysis of coastal processes and mapping flood hazards in the various settings and shoreline morphologies present in the study area.

D.4.10.2.2 Intermediate Submission No. 2 – Offshore Water Levels and Waves

Documentation of this phase shall describe the primary analyses of water-level and wave conditions to be applied during the detailed analyses in the nearshore hydraulics phase. Where applicable, the submission shall include:

- **Wave Data and Hindcasts:** The submission shall describe data and analyses used to select and define storm events for use in response-based analysis of nearshore processes and subsequent statistical analysis of 1% and 0.2% annual chance flood conditions. Documentation shall include details of the sources of wave and wind data. It shall also include comparisons between alternate sources (where more than one is available and feasible for use in the FIS) and comparison with local measurements. Documentation of incident deepwater waves should include period, direction, and directional spreading parameters. The selection of coefficients for angular spreading and spectral peakedness parameters shall be clearly stated and justified.
- **Estimation of the 1% and 0.2% Annual Chance Flood:** Documentation shall be provided on the methods to be used to estimate the 1% and 0.2% annual chance coastal flooding conditions. These may include response-based and joint probability methods, depending on study setting. Methods of extrapolation of hindcast and/or measured data to 1% and 0.2% annual chance values should be documented, including comparisons between alternate procedures if appropriate. Where extremal analyses of wave, wind, water level, and residual tides are used, the submission shall include documentation of the analyses to develop frequency relationships, including a description of the data sets and analysis assumptions.
- **Sheltered Waters – Hindcast Waves:** Documentation shall be provided on fetch length determination and corresponding wind speeds, directions, and durations for use in hindcast analyses. This shall include documentation of wind speed adjustments and wind field hindcast methods.
- **Sheltered Waters – Water Levels:** The Mapping Partner shall document the characteristics of tide gages located within or near the study area that will potentially be used in study analyses or validation. Methods adopted to infer the variation of tidal datums between gages shall be documented, as shall procedures used to transpose data from one site to another. If a field effort is undertaken to determine the variation of tidal datums within ungaged regions, the Mapping Partner shall fully document that effort, including: locations of observations; observation methods and instrumentation; dates and times of all observations; meteorological and oceanographic conditions during and preceding the period of observation; and other factors that may have influenced water levels, or that may affect interpretation of the results. If surge variation is inferred from tide variation, the Mapping Partner shall document the basis for similarity assumptions, and the manner in which the inferences were made. Inlet analyses shall be documented,

including all procedures, methodological assumptions, field surveys (dates, times, procedures, instrumentation, and findings), and all inlet data adopted from other sources.

D.4.10.2.3 Intermediate Submission No. 3 – Nearshore Hydraulics

The nearshore hydraulics phase provides documentation of methods applied and detailed analyses conducted before the hazard zone mapping phase.

Wave Information: The Mapping Partner shall document all assumptions used to define waves. In sheltered waters, this shall include a summary of fetch determination, winds (speeds, directions, duration), and bathymetry used in hindcasts. The documentation shall include the approximations or assumptions used in the analysis. When observational data, such as wave buoy data, are available, the wave height, period, and spectral parameters should be compared to the predicted waves.

- **Wave Transformation:** The Mapping Partner shall document the assumptions, methods, and results of all analyses of wave transformations conducted for the FIS. This documentation shall include selection of offshore and nearshore points, source of transformation coefficients, and any special assumptions regarding local transformation processes such as sheltering and reflection. If a spectral wave model is applied for nearshore transformation, all modeling factors shall be sufficiently documented, so the modeling effort can be reproduced if necessary. If a field effort is undertaken to validate transformation models, the field work shall be summarized in detail, including times and locations of all observations, general conditions at the time of the work, a full description of all equipment and procedures, and a summary of all data in archival form. A description of the bathymetric data used in the transformation calculations shall be provided.
- **Runup, Setup, and Overtopping Analyses:** The Mapping Partner shall document the runup, setup, and overtopping analysis assumptions, methods, input data, and results. This shall include a description of overtopping cases for the annual maxima data, determination of total water level (TWL), and determination of flood hazard zone parameters (1% and 0.2% flood depths, overtopping splash penetration and overtopping rate, and overland flow velocity) at each transect. This shall include a description of profiles used, runup reduction factors, and basis for splash zones to be used in hazard mapping. The documentation shall include a description of any observations or measurements used to validate or adjust analysis results, any deviations from recommended procedures in Section D.4.5, any difficulties encountered in the analyses, and the technical decisions or approaches taken in their resolution.
- **Wave Dissipation and Overland Propagation:** The Mapping Partner shall describe the areas where wave attenuation was investigated, and document the analysis assumptions, methods, input data, and results. This shall include documentation of any field observations or measurements, as well as available historical or anecdotal information regarding wave attenuation during flooding events.
- **Coastal Armoring Structures:** The Mapping Partner shall describe assumptions and investigations of the various coastal armoring structures (e.g., seawalls, revetments,

bulkheads, levees, etc.) in the study area relevant to stability and capability to withstand 1% annual chance water-level and wave conditions. This documentation shall include any assumptions or approximations used in the analyses. The same documentation shall be required in the event that coastal structures are apparently buried and not visible, but are indicated by information collected during the FIS. In cases where the Mapping Partner could not determine whether a given structure would survive the 1% annual chance flood intact, and where multiple analyses were conducted for the structure (i.e., intact condition, failed condition/removed from the analysis transect), the Mapping Partner shall document each analysis and record the structure condition that was used to map flood hazard zones and Base Flood Elevations (BFEs). This information will be useful in the event a map revision is requested based upon a structure condition different from that used as the basis for the FIRM. The Mapping Partner shall consult with the FEMA study representative regarding the treatment of levees (single levees or multiple levee systems) during the FIS.

- **Beach Stabilization Structures:** The Mapping Partner shall document the treatment of beach stabilization structures (e.g., groins, offshore breakwaters, sills, etc.) during the FIS. If the Mapping Partner proposes removal or modification of beach stabilization structures (or their shoreline effects) during the 1% annual chance flood, the Mapping Partner shall document the existence, history of, and shoreline response to beach stabilization structures, and consult with the FEMA study representative.

Miscellaneous Structures: If miscellaneous structures (e.g., piers, port and navigation structures, bridges, culverts, tide gates, etc.) are present in the study area and could exert a significant influence on nearshore waves, currents, sediment transport, or backshore ponding, the Mapping Partner shall document the data, methods, and procedures used to evaluate the stability of these structures during the 1% annual chance flood and their effects on coastal flooding. This documentation shall include any assumptions or approximations used in the analyses.

Erosion Analyses: The Mapping Partner shall document the erosion analysis assumptions, methods, input data, and results. A description shall be provided of the data used to determine Most Likely Winter Profile (MLWP) and Eroded Profile conditions, and the methods used to estimate profile adjustments as a function of annual maxima data and 1% TWL conditions. Where applicable, the potential recession and recession reduction factor shall be reported at each transect.

- **Verification to an Observed Coastal Flood Event:** Where available, background information shall be provided for measured and anecdotal historical coastal flood data at or near the study area that are used in verification of the FIS analyses. This shall include a description of the method used (if any) to reconstruct wind and water-level data during the flood event, observed flood conditions, elevations, and areas of inundation. Where possible, the recurrence interval of the observed event should be estimated.
- **Special Study Considerations:** The Mapping Partner shall document any unusual conditions in the study area and the methods proposed to map hazard zones based on these conditions. These may include tsunami-related hazards, effects of beach nourishment, effects of floodborne debris, special hydrodynamic considerations in tidal

inlets and passages, effects of riverine inflows, unusual erosion or other sedimentation characteristics, unusual structure effects, effects of multiple levees, and any other factors that the Mapping Partner considers relevant to mapping flood hazards accurately.

D.4.10.2.4 Intermediate Submission No. 4 – Draft Flood Hazard Mapping

The draft flood hazard mapping phase provides documentation of the methods used to convert the results of the detailed hydraulic analyses to flood hazard zones.

- **Flood Hazard Zone Limit Identification:** The Mapping Partner shall document the analysis results used in the determination of hazard zone limits and BFEs. This shall include a summary table by transect of results for 1% TWL, 1% SWL, and determination of flood hazard zone parameters (1% and 0.2% flood depths, overtopping splash penetration and overtopping rate, overland flow velocity, overland wave propagation, and primary frontal dune location), as appropriate. In addition, the summary shall include a description of the basis for erosion and coastal structure conditions (e.g., overtopping cases, method of profile determination, failed and buried coastal structure cases, etc.) used in the determination of the hazard zones.
- **Flood Hazard Zone Map Boundary Delineation:** The Mapping Partner shall provide draft work maps for the study area showing all flood hazard zone limits identified along the transects resulting from the detailed analyses and transferred to the topographic work maps. This submission shall describe the engineering judgment used to interpolate and delineate hazard zones in between transects, including land features that might affect flood hazards, changes in contours, and the lateral extent of coastal structures. It shall also provide detailed documentation and technical justification of adjustments in the hazard zone mapping that were made due to observed historical flood data and/or damages in the study area.

The Mapping Partner shall incorporate all intermediate submissions and modifications based on review comments in each phase into the Engineering Analyses section of the TSDN.

D.4.10	Study Documentation.....	1
D.4.10.1	General Documentation	1
D.4.10.2	Engineering Analyses	1

D.4.11 References

- Ahrens, J.P. 1981. Irregular Wave Runup on Smooth Slopes. *Technical Aid No. 81-17*, U.S. Army Engineer Waterways Experiment Station, Coastal Engineering Research Center, Vicksburg, MS.
- Ahrens, J.P. 1990. Dynamic Revetments. In *Proceedings of the 22nd International Conference on coastal Engineering* held July 2-6, 1990 in Delft, The Netherlands. American Society of Civil Engineers, pages 1837-1850.
- Allan, Jonathan C. and Paul D. Komar. 2004. Morphologies of Beaches and Dunes on the Oregon Coast, with Tests of the Geometric Dune-Erosion Model, *Technical Memo*, August 2004, 43 pp.
- Allsop, W. 2004. Note on Technical Guidance for Overtopping Studies, HR Wallingford, *Technical Note CBR3663 TN 01 Rev 01*, Wallingford, England, August 25.
- Bascom, Willard. 1964. *Waves and Beaches - The Dynamics of the Ocean Surface*, Anchor Books, Doubleday & Company, Garden City, New York, 267 pp.
- Battjes, J.A. 1974. *Computation of Set-Up, Longshore Currents, Runup and Overtopping Due to Wind Generated Waves*. PhD Dissertation, Technische Hogeschool, Delft, Netherlands.
- Besley, P. 1999. Overtopping of seawalls – design and assessment manual, *R & D Technical Report W 178, ISBN 1 85705 069 X*, Environment Agency, Bristol, UK.
- Besley, P. and Allsop N.W.H. 2000. Wave overtopping of seawalls, breakwaters and related structures. Chapter 6 In *Handbook of Coastal Engineering*, pages 6.1-6.21, Editor J. Herbich, ISBN 0-07-134402-0, McGraw-Hill, New York.
- Besley, P., Stewart, T. & Allsop, N.W.H. 1998. Overtopping of vertical structures: new prediction methods to account for shallow water conditions, *Proc. ICE Conf. Coastlines, Structures and Breakwaters*, Thomas Telford, London.
- Bruun, P. 1962. Sea Level Rise As A Cause of Shore Erosion, *Journal of Waterway, Division, ASCE*, 88 (1); 117-130.
- Chappell, G. 1978. Coastal Flooding Study Methodology for Northern Puget Sound, *Interagency Memorandum to Frank Tsai*, FEMA Engineering/Hydraulics, March 10.
- Cox, J. C. and Machemehl, J. 1986. Overland Bore Propagation Due to an Overtopping Wave. *Journal of Waterway, Port, Coastal and Ocean Engineering*, Vol. 112, pp. 161-163.
- Darras, M., Daemrich, K.F., Funke, E.R., Goda, Y., Huntington, S.W., Mynett, A.E., Sand, S.E., Stansberg, C.T., Thompson, E.F. 1986. List of Sea State Parameters, *Permanent International Association of Navigation Congresses Supplement to Bulletin No 52*, General Secretariat of PIANC: Résidence Palace, Quartier, Jordaens, rue de la Loi, 155, 1040 Brussels, Belgium.

Dean, R.G. 1978. Effects of Vegetation on Shoreline Erosional Processes, *Proceedings, National Symposium on Wetlands*, November, pp. 415-426.

Dean, R.G. 1979. Evaluation of Possible Bias in the Storm Surge Data Due to Wave Effects, *Research Report CE-82-29*, University of Delaware, civil Engineering Department, Newark, DE.

Dean, R.G. 1987. Recommended Interim Methodology for Calculation of Wave Action and Wave Set-up Effects, *Research Report CE-82-32*, University of Delaware, Civil Engineering Department, Newark, DE.

Dean, R.G. 1987. Recommended Procedure for Calculating Wave Damping Due to Vegetation Effects and Wave Instability, *Research Report CE-78-302*, University of Delaware, Civil Engineering Department, Newark, DE.

Dean, R. G. and R. A. Dalrymple .1991. *Water Wave Mechanics for Engineers and Scientists*, World Scientific Press, Singapore, 353 pages.

Dean, R.G., and Dalrymple, R.A. 2002. *Coastal Processes with Engineering Application*, Pg. 174, Cambridge University Press, 475pp.

de Waal, J.P., and van der Meer, J.W. 1992. Wave run-up and overtopping on coastal structures. *Proceedings of 23rd International Conference on Coastal Engineering*: pp1758-1771, ASCE, New York.

Downing, J. 1983. *The Coast of Puget Sound: Its Processes and Development*, Puget Sound Books, Seattle Washington, 126 p.

Federal Emergency Management Agency (FEMA). 1990. *Criteria for Evaluating Coastal Flood Protection Structures for National Flood Insurance Program (NFIP) Purposes*, Memorandum from Harold Duryee, FIA Administrator to FEMA Regional Directors. April 23, 1990. 7 pp.

Federal Emergency Management Agency (FEMA). 2003. *Guidelines and Specifications for Flood Hazard Mapping Partners, Appendix D: Guidance for Coastal Flooding Analyses and Mapping*. Washington, D.C.

Franco, L, de Gerloni, M and van der Meer, J W. 1994. Wave overtopping at vertical and composite breakwaters. *Proc. Coastal Engineering Conference*, Kobe, Japan.

Goda, Y. 1983. *Analysis of Wave Grouping and Spectra of Long Traveled Swells*. In Report of the Port and Harbour Research Institute, Japan, 22(1): 3-41.

Goda, Y. 1985. *Random Seas and Design of Maritime Structures*, University of Tokyo Press, Japan.

Griggs, Gary and Lauret Savoy, editors. 1985. *Living with the California Coast*, Sponsored by the National Audubon Society, Duke University Press, Duham, North Carolina.393 pp.

Hedges, T. S. and H. Mase 2004. Modified Hunt's Equation Incorporating Wave Setup, *Journal of Waterway, Port, Coastal and Ocean Engineering*, Vol. 130, No. 3, ASCE, pp. 109 – 113.

Herbich, J.B. 1991. *Handbook of Coastal and Ocean Engineering*, Gulf Publishing Company, Houston, Texas.

Hunt, I. A. 1959. Design of Seawalls and Breakwaters, *Journal of Waterways and Harbors Division, ASCE*, Vol. 85, No. 3, pp. 123 – 152.

Inman, D.L. and J.D. Frautschy. 1966. Littoral processes and the development of shorelines. *Proc. Specialty Conf. on Coastal Engineering*, ASCE, Santa Barbara, CA, 511-536

Inman, D.L. and C.E. Nordstrom. 1971. On the tectonic and morphologic classification of coasts, *Journal of Geology*, 79, 1-21.

Inman, D.L. and Jenkins, S.A. 1999. Climate change and the episodicity of sediment flux of small California rivers. *Journal of Geology*, 107: 251-270.

Jackson, N.L., K.F. Nordstrom. 1992. Site Specific Controls on Wind and Wave Processes and Beach Mobility on Estuarine Beaches in New Jersey, U.S.A., *Journal of Coastal Research*, Vol. 8, No. 1, pp. 88-98.

Jackson, N.L., K.F. Nordstrom, I. Eliot, and G. Masselink. 2002. "Low Energy" Sandy Beaches in Marine and Estuarine Environments: A Review, *Geomorphology* 48, pp 147-162.

Jensen, O.J. & Sorensen, T. 1979. Overspilling / overtopping of rubble mound breakwaters. Results of studies, useful in design procedures. *Coastal Engineering* Vol. 3 pp. 51-65

Johnson, J.W. 1972. Tidal Inlets on the California, Oregon and Washington Coasts, University of California Hydraulic Engineering Laboratory, *HEL-24-12*, Berkeley, CA, February.

Kanamori, H. 1970. The Alaska earthquake of 1964: Radiation of long-period surface waves and source mechanism, *Journal of Geophysical Research*. 75, 5029-5040.

Kirby, J. T. and Ozkan, H. T. 1992. Combined Refraction/Diffraction Model for Spectral Wave Conditions REF/DIF S, Version 1.0. Documentation and User's Manual, *Research Report No. CACR-92-06*, Center for Applied Coastal Research, Department of Civil Engineering, University of Delaware, Newark.

Knutson, P.L., W.N. Seelig, and M.R. Innskeep. 1982. Wave Damping in *Spartina Alterniflora* Marshes, *Wetlands, Journal the Society of Wetland Scientists*, Vol. 2, pp 87-105.

Knutson, P.L. and J.C. Steele. 1988. Siting Marsh Development Projects on Dredged Material in the Chesapeake Bay, *Proceedings, Beneficial Uses of Dredged Material Workshop*, Baltimore, MD, U.S. Army Engineer Waterways Experiment Station, Vicksburg, MS.

- Kobayashi, N. 1999. Wave Runup and Overtopping on Beaches and Coastal Structures. Page 95-154 in P. L-F. Liu (ed), *Advances in Coastal and Ocean Engineering – Vol. 5*. World Scientific.
- Komar, P.D. 1998. *Beach Processes and Sedimentation*: 2nd edition, Prentice Hall.
- Komar, P.D. 1998. The 1997-98 El Nino and erosion of the Oregon coast. *Shore & Beach*, 66:3
- Komar, P.D. 2004. Memorandum #3 to NHC, *Process-based numerical models of dune erosion*.
- Komar, P.D. and Jonathan C. Allan. 2004. El Nino Processes and Erosion of the U.S. West Coast, *Technical Memo*, August 9, 2004.
- Komar, P.D. and Jonathan C. Allan. 2002. Assessments of nearshore-process climates related to their potential for producing beach and property erosion, *Shore and Beach*, Vol. 70(3): 31-40.
- Komar, P.D., McDougal, W.G., Marra, J.J. and P. Ruggiero. 1999. The Rational Analysis of setback Distance: Applications to Oregon Coast, *Shore and Beach*, 67 (1), 41-49.
- Komar, P.D., W.G., Marra, J.J. and Allan, C.J. 2002. Coastal Erosion Processes and Assessments of Setback Distances, in Proceedings of Solutions to Coastal Disasters '02, Feb 24-27, 2002, San Diego, California, pp 808-822.
- Kriebel, D.L., and R.G. Dean. 1985. Numerical Simulation of Time-Dependent Beach and Dune Erosion. *Coastal Engineering*. Volume 9. Pages 221-245.
- Kriebel, D.L. and Dean R. G. 1993. Convolution method for time-dependent beach profile response, *Journal of Waterway, Port, Coastal, and Ocean Engineering*, ASCE, 119: 204-226.
- Kriebel, D. L. 1984a. Beach Erosion Model (EBEACH) Users Manual, Volume I: Description of Computer Model, *Beach and Shores Technical and Design Memorandum No. 84-5-I*, Division of Beaches and Shores, Florida Department of Natural Resources, Tallahassee, FL.
- Kriebel, D. L. 1984b. Beach Erosion Model (EBEACH) Users Manual, Volume II: Theory and Background, *Beach and Shores Technical and Design Memorandum No. 84-5-II*, Division of Beaches and Shores, Florida Department of Natural Resources, Tallahassee, FL.
- Kuik, A. J., G. Ph. van Vledder, and L.H. Holthuijsen. 1988. A Method for Routine Analysis of Pitch-and-Roll Buoy Data. *Journal of Physical Oceanography*, 18: 1020-1034.
- Larson, M., and Kraus, N. C. 1989. SBEACH: Numerical model for simulating storm-induced beach change; Report 1, Empirical foundation and model development, *Technical Report CERC-89-9*, U.S. Army Engineer Waterways Experiment Station, Vicksburg, MS.
- Larson, M. and Kraus, N. 1998. SBEACH: Numerical model for simulating storm-induced beach change; Report 5, Representation of non-erodible (hard) bottoms, *Technical Report CERC-89-9*, U.S. Army Engineer Waterways Experiment Station, Vicksburg, MS.

- Larson, M., Kraus, N. C., and Byrnes, M. R. 1990. SBEACH: Numerical model for simulating storm-induced beach change; Report 2, Numerical formulation and model tests, *Technical Report CERC-89-9*, U.S. Army Engineer Waterways Experiment Station, Vicksburg, MS.
- Lee, S. C. 1995. *Response of Mud Shore Profiles to Waves*, Ph.D. Dissertation, Coastal and Oceanographic Engineering Department, University of Florida, Gainesville, Florida, 214 pages.
- Massel, S. R. 1995, *Ocean Surface Waves: Their Physics and Prediction*, World Scientific Press, Singapore, 491 pages.
- McDougal, W. G. and R. C. MacArthur. 2004-a. Geometric Model for Foredune Erosion, *Technical Memo/ Support Document for FEMA Guidelines*, August 2, 2004, 28 pp.
- McDougal, W. G. and R. C. MacArthur. 2004-b. EBE MLWP Discussion, *Internal Support Document*, August 22, 2004, 4 pp.
- Miller, C.D. 1984. Problems and Approaches in Mapping Velocity along the U.S. Coastline, in: Managing High Risk Flood Areas: 1985 and Beyond, *Proceedings of the Eight Annual Conference of the Association of State Floodplain Managers*, editors: J. Monday and D.L. Butler, Portland ME, June 11-14.
- NOAA. 2000. Nautical Chart Symbols, Abbreviations and Terms, Chart No. 1, Eleventh Edition, Lighthouse Press, Annapolis MD.99 p. NOAA Nautical Chart Users Manual <<http://chartmaker.ncd.noaa.gov/staff/ncum/ncum.htm>>.
- NOAA, 2000a. Tidal Datums and Their Applications, *NOAA Special Publication NOS CO-OPS-1*, Silver Springs MD, June. <http://www.co-ops.nos.noaa.gov/publications/tidal_datums_and_their_applications.pdf>
- NOAA. 2003. Computational Techniques for Tidal Datums Handbook, *NOAA Special Publication NOS CO-OPS-2*, Silver Springs MD, September. <http://www.co-ops.nos.noaa.gov/publications/Computational_Techniques_for_Tidal_Datums_handbook.pdf>.
- Noble Consultants, Inc. 1994. “*Reconnaissance Report: Malibu/Los Angeles County Coastline, California*”, prepared for the U.S. Corps of Engineers, Los Angeles District, April 1994.
- Noble Consultants, Inc. 2004. “*Test Case Studies for Geometric Models*”, Draft report prepared for NHC & FEMA, August 2004.
- Nordstrom, K.F. and N.L. Jackson. 1992. Two dimensional change on sandy beaches in estuaries, *Zeitschrift fur Geomorphologie*, 36 (4), pp. 465-478.
- O’Brien, M.P. 1976. Notes on Tidal Inlets on Sandy Shores, *GITI Report 5*, DACW72-71-C-0005, February, 28 p.
- Pugh, D.T. 1987. *Tides, Surges and Mean-Sea Level*, John Wiley & Sons, Ltd., New York, New York.

Pullen T., Allsop N.W.H, Pearson, J. and Bruce, T. 2004. Violent wave overtopping discharges and the safe use of seawalls, *Proc. DEFRA Conference of River and Coastal Engineers*, York, June 2004.

Pullen T., Allsop N.W.H, Pearson, J. and Geeraerts, J. 2004. Violent Wave Overtopping at Samphire Hoe: Field and Laboratory Measurements, to appear in *Proceedings of the 29th International Conference on Coastal Engineering*, ASCE, Lisbon, Portugal.

PWA. 2004. *Technical Report on Wave Transformations and Storm Wave Characteristics*, Report prepared for NHC & FEMA.

Ramsden, J.D. and F. Raichlen. 1990. Forces on Vertical Wall Caused by Incident Bores, *Journal of Waterway, Port, Coastal and Ocean Engineering*, American Society of Civil Engineers, Vol. 116, No. 5, pp. 592-613.

Raudkivi, A.J. 1996. Permeable Pile Groins, *Journal of Waterway, Port, Coastal, and Ocean Engineering*, ASCE, Vol. 122, No. 6, pp. 267-272.

Richardson, E.V. and S.R. Davis. 1995. Evaluating Scour at Bridges, Federal Highway Administration Publication No. FHWA-IP-90-017, *Hydraulic Engineering Circular No. 18*, November.

Ruggerio, P. P. D. Komar, W. G. McDougal, J. J. Marra and R. A Beach. 2001. Wave Runup, Extreme Water Levels and the Erosion of Properties Backing Beaches, *Journal of Coastal Research*, Vol. 17, No. 2, pp. 407 – 419.

Sakai, S. and N. Kobayashi. 1990. Breaking Condition of Shoaling Waves on Opposing Current, *Journal of Waterway, Port, Coastal, and Ocean Engineering*, ASCE, Vol. 116, No. 2, pp. 302-306.

Seymour, R.J., R.R. Strange III, D.R. Cayan, and R.A. Nathan. 1984. Influence of El Ninos on California's wave climate. *Proc. 19th Int. Conf. on Coastal Engineering*, ASCE, Houston, TX, 1, 577-592.

Southgate, H.N., and R.B. Nairn. 1993. Deterministic Profile Modeling of Nearshore Processes I: Waves and Currents. *Coastal Engineering*. Volume 19. Pages 27-56.

Stockdon, H. F., R. A. Holman, P. A. Howd and A. H. Sallenger, Jr. 2004. Empirical Parameterization of Setup, Swash, and Runup, *Manuscript Submitted to Journal of Geophysical Research for Publication Consideration*.

Sunamura, Tsuguo. 1982. A Predictive Model for Wave-Induced Cliff Erosion, With Application to Pacific Coasts of Japan, *Journal of Geology*, 1982, Vol. 90.

Sunamura, Tsuguo, 1983. *CRC Hand Book of Coastal Processes and Erosion, Chapter 12: Processes of Sea Cliff and Platform Erosion*, CRC Press, Inc.

Technical Working Group. 2004. *Draft Phase 1 Summary Report*, prepared for FEMA Region XI, June 2004.

U.S. Army Corps of Engineers (USACE). 1984. *Shore Protection Manual*, Dept of the Army, Waterways Experiment Station; U.S. Army Corps of Engineers, Vicksburg, MS.

U.S. Army Corps of Engineers (USACE) .2003. *Coastal Engineering Manual*. Engineer Manual 1110-2-1100, U.S. Army Corps of Engineers, Washington, D.C. (in 6 volumes).

U.S. Army Corps of Engineers (USACE-LAD). 1991. *State of California Report San Diego Region, Coast of California Storm and Tidal Waves Study, Main Report and Appendices*, Los Angeles District Corps of Engineers, September 1991.

U.S. Army Corps of Engineers (USACE-LAD). 2003. *Encinitas and Solana Beach Shoreline Feasibility Study, San Diego County, California - Coastal Engineering Appendix Without Project Conditions*, Los Angeles District Corps of Engineers, August 2003.

U.S. Army Corps of Engineers (USACE) .1981. *Low Cost Shore Protection...A Guide for Local Government Officials*, US Government Printing Office, Washington DC.

U.S. Army Corps of Engineers (USACE) .1986. *Storm Surge Analysis and Design Water Level Determinations*, EM 1110-2-1412, DAEN-CWH-W, Washington, D.C., April 15.

van der Meer, J.W. 2002. *Wave Run-up and Overtopping at Dikes*. Technical Report, Technical Advisory Committee for Water Retaining Structures (TAW), Delft, The Netherlands.

van der Meer, J.W. and Janssen J.P.F.M. 1995. Wave run-up and wave overtopping at dikes. In *Wave Forces on Inclined and Vertical Wall Structures*, pp 1-26, ed. Kobayashi N. and Demirbilek Z., ISBN 0-7844-0080-6, ASCE, New York.

van der Meer J.W., Tonjes P. and de Waal J.P. 1998. A code for dike height design and examination. *Proc. Conf. Coastlines, Structures & Breakwaters '98*, at ICE, March 1998, pp 5-21, Thomas Telford, London

van Gent, M.R.A. 2002. *Low-exceedance wave overtopping events: Measurements of velocities and the thickness of water-layers on the crest and inner slope of dikes*. Delft Cluster.

Van Oorschot, J.H., and d'Angremond, K. 1968. The Effect of Wave Energy Spectra on Wave Run-Up. *Proceedings of the 11th International Coastal Engineering Conference*, American Society of Civil Engineers, Vol 2, pp 886-900.

Wade, J. E. and E. W. Hewson. 1980. *A Guide to Biological Wind Prospecting*. DOE/ET/20316-80-2. Available from National Technical Information Service, Springfield, Virginia.

Walton, T.L., J.P. Ahrens, C.L. Truitt and R.G. Dean. 1989. *Criteria for Evaluating Coastal Flood-Protection Structures. Technical Report CERC 89-15*. USACE Waterways Experiment Station. Vicksburg, MS.

Weberg, P. and D. Hatheway. 2002. Post-Storm Flood Hazard Verification for Hurricane Lenny in St. Croix, in: *Solutions to Coastal Disasters*, American Society of Civil Engineers, San Diego, February 24-27.

Weigel, R. 1961. *Closely Spaced Piles as a Breakwater*, Dock and Harbor Authority, London, U.K., 42(491), 150.

Wiegel, R.L. 1964 *Oceaographical Engineering*, Prentice-Hall, Englewood Cliffs, NJ.

Williams, B.M., Lu, C.C. & Qin, W.K. 2004. Numerical Model Using Monte Carlo Simulation Technique and Sunamura's Equation, *Journal of The American Shore & Beach Preservation Association*, Vol. 72 , No.3, Summer 2004.

_____ *various authors* .1989. *Shore & Beach*, Vol. 57:4, See entire volume that is devoted to January 1988 storm.

D.4.12 Notation

Symbol	Description	Units	Typical Units	
			English	SI
A	Equilibrium beach profile coefficient	$L^{1/3}$	$ft^{1/3}$	$m^{1/3}$
B	Berm height	L	ft	m
C	Wave phase velocity or celerity	L/T	ft/s	m/s
C_G	Wave group velocity	L/T	ft/s	m/s
C_k	Sample kurtosis	--	--	--
C_p	Plant drag coefficient	--	--	--
C_s	Sample skewness	--	--	--
C_0	Deepwater wave celerity, $gT / 2\pi$	L/T	ft/s	m/s
D	Quarrystone diameter	L	ft	m
	Dune height	L	ft	m
D_{50}	Size of 50 th percentile of sediment	L	mm	mm
d_h	Depth over berm	L	ft	m
E	Wave energy	LF/L	ft-lb/ft	N-m/m
	Crest elevation of structure	L	ft	m
$E_{HotSpot}$	Extra profile lowering at a hot spot	L	ft	m
E_j	Beach-dune juncture elevation	L	ft	m
E_{jMLWP}	Beach-dune juncture elevation for the MLWP	L	ft	m
E_{jStorm}	Beach dune juncture elevation during a storm	L	ft	m
E_T	Total still water elevation	L	ft	m
e	Base of natural logarithms (=2.718)	--	--	--
F	Cumulative probability function	--	--	--
F_c	Freeboard	L	ft	m
F'	Dimensionless freeboard	--	--	--
F_H, F_T, F_{gamma}	Static setup coefficients in DIM model	--	--	--
F_{slope}				
F_n	Discrete spectral frequency	1/T	hz	hz
F_R	Wind wave runup coefficient	--	--	--
f	Wave frequency	1/T	hz	hz
	Darcy-Weisbach resistance coefficient	--	--	--
	Probability density function	--	--	--
f_e	Coriolis coefficient	1/T	1/S	1/S
f_p	Spectral peak frequency, $1/T_p$	1/T	hz	hz
G_H, G_T, G_{gamma}	Dynamic setup coefficients in DIM model	--	--	--
G_{slope}				
G_0	Normalizing function for directional spectrum spreading function	--	--	--

Symbol	Description	Units	Typical Units	
			English	SI
$G(\theta)$	Directional spectrum spreading function	--	--	--
$G(f,\theta)$	Directional spreading function	--	--	--
g	Gravitational acceleration	L/T ²	ft/s ²	m/s ²
H	Wave height	L	ft	m
H'_o	Unrefracted deep water wave height	L	ft	m
H_b	Breaking wave height	L	ft	m
H_{m0}	Spectral significant wave height	L	ft	m
H_o	Deep water wave height	L	ft	m
H_s	Significant wave height	L	Ft	m
H_x	Wave height at x location in surf zone	L	ft	m
h^*	Wave structure parameter	--	--	--
h	Water depth	L	ft	m
h_b	Breaker depth	L	ft	m
h_c	Depth over crest	L	ft	m
h_m	Height of the land barrier	L	ft	m
h_o	Depth over crest	L	ft	m
K_s	Shoaling coefficient	--	--	--
$K_s(f_n)$	Spectral shoaling coefficient	--	--	--
$K_r(f_n, \theta_{o,n,m})$	Spectral refraction coefficient	--	--	--
k	Wave number, $2\pi / L$	rad/T	rad/ft	rad/m
	Bluff erosion parameter	--	--	--
L	Likelihood	--	--	--
LL	Log-likelihood	--	--	--
L_{berm}	Berm width	L	ft	m
L_{om}	Spectral deep water wave length	L	ft	m
L_0	Deep water wave length, $gT^2 / 2\pi$	L	ft	m
$M(n)$	Number of direction components in spectrum at f_n	--	--	--
m	Beach slope (rise/run)	L/L	--	--
m_n	n^{th} moment of spectral density, $\int_{f_1}^{f_2} f^n S(f) df$	L ² /T ⁿ	ft ² /s ⁿ	m ² /s ⁿ
N	Degrees of freedom of a chi-squared distribution	--	--	--
	Number of waves	--	--	--

Symbol	Description	Units	Typical Units	
			English	SI
P	Average porosity of rubble structure cover layer	--	--	--
	Precipitation rate	L/T	in./hr	mm/hr
	Probability	--	--	--
Q	Dimensionless overtopping	--	--	--
q	Mean overtopping rate per unit length	L^2/T	ft^2/s	m^2/s
R	Total wave runup	L	ft	m
	Spearman statistic	--	--	--
R_{iuc}	Incident wind wave runup	L	ft	m
R_m	Reduced recession due to storm duration	L	ft	m
R_{Total}	Total runup (static setup plus dynamic setup plus incident wave runup.)	--	--	--
$R_{2\%}$	Runup exceeded by 2% of the runup crest	L	ft	m
R_{∞}	Maximum potential profile recession	L	ft	m
$R_{\infty HotSpot}$	Potential recession at a hot spot	L	ft	m
$R_{\infty storm}$	Potential recession for storm	L	ft	m
r	Linear correlation coefficient			
S	Water level change	L	ft	m
S_c	Compressive strength of bluff material	F/L^2	lb/ft^2	N/m^2
$S(f)$	Spectral density	L^2-T^2	ft^2/hz	m^2/hz
$S(f, \theta)$	Directional spectral density	L^2T/deg	$(ft^2/hz)/deg$	$(m^2/hz)/deg$
$S_0(f_n, \theta_{o,n,m})$	Discrete directional spectrum in deep water	L^2-T^2	ft^2/hz	m^2/hz
$S_{ns}(f_n, \theta_{o,n,m})$	Discrete directional spectrum in nearshore	L^2-T^2	ft^2/hz	m^2/hz
s	Sample standard deviation	--	--	--
$S(f)$	Continuous spectrum	L^2T	ft^2/hz	m^2/hz
T	Wave period	T	s	s
T_D	Storm duration	T	hr	hr
T_p	Spectral peak period, $1/f_p$	T	s	s
T_s	Significant wave period	T	S	S
	Time scale for beach profile response	--	--	--
t	Time	T	s	s
V_c	Velocity at crest	L/T	ft/s	m/s
V_f	Fall velocity	L/T	ft/s	m/s

Symbol	Description	Typical Units		
		Units	English	SI
V_{max}	Maximum overtopping volume per wave per unit length	L ² /wave	ft ² /wave	m ² /wave
v	Horizontal (v) component of local fluid velocity (water particle velocity)	L/T	ft/s	m/s
W	Wind speed	L/T	mi/hr	m/s
W_b	Surf zone width to breaker line	L	ft	m
W_c	Wind stress coefficient term	L/T	mph	kph
W_x	x component of wind speed	L/T	mi/hr	m/s
W_y	y component of wind speed	L/T	mi/hr	m/s
X	Accumulated bluff to erosion	L	ft	m
\bar{x}	Sample mean	--	--	--
x,y,z	Right-handed Cartesian coordinates	L	ft	m
$y_{G,inner}$	Seaward extent of overtopping	L	ft	m
$y_{G,outer}$	Landward extent of overtopping	L	ft	m
y_0	Cross-shore location of structure crest	L	ft	m
z_c	Structure crest elevation	L	ft	m
z_G	Elevation behind crest	L	ft	m
$()_b$	Term evaluated at the breaker line	--	--	--
$()_o$	Term evaluated in deep water	--	--	--
$\tan \alpha$	Structure slope	--	--	--
α	Storm duration recession reduction factor	--	--	--
	JONSWAP Spectrum term	L ² T	ft ² /hz	m ² /hz
α_c	Structure crest slope	--	--	--
β	Storm profile response coefficient	--	--	--
	Wave angle at structure	deg	deg	deg
γ	Specific gravity of a fluid	F/L ³	lb/ft ³	N/m ³
	Peak enhancement factor used in the JONSWAP spectrum	--	--	--
γ_b	Breaker depth index	--	--	--
	Runup berm coefficient	--	--	--
$\gamma_r \gamma_p \gamma_b \gamma_f \gamma_\beta$	Runup reduction coefficients	--	--	--
Δf	Frequency increment	1/T	hz	hz
ΔR	Potential excess runup	L	ft	m
ε	Energy dissipation rate	F/LT	lb/s-ft	n/m-s
$\hat{\eta}$	Dynamic or oscillating setup	L	ft	m
$\bar{\eta}$	Mean or static wave setup	L	ft	m
$\bar{\eta}_b$	Static setback at the breaker point	L	ft	m

Symbol	Description	Units	Typical Units	
			English	SI
$\bar{\eta}_{max}$	Maximum static wave setup	L	ft	m
$\bar{\eta}_{min}$	Minimum static wave setup	L	ft	m
$\bar{\eta}_o$	Static setup at the shoreline	L	ft	m
$\eta(x,t)$	Displacement of water surface relative to SWL	L	ft	m
$\overline{\eta^2}$	Mean square of water surface fluctuations	L ²	ft ²	m ²
η_3	Coefficient of skewness	--	--	--
η_4	Coefficient of kurtosis	--	--	--
η_i	Water surface displacement by incident wave	L	ft	m
η_{rms}	rms value of free surface elevation	L	ft	m
$\bar{\theta}$	Overall mean wave direction	deg	deg	deg
θ	Direction of wave propagation	deg	deg	deg
θ_{main}	Main wave direction in a directional spectrum	deg	deg	deg
θ_m	Discrete wave direction	deg	deg	deg
$\theta_m(f)$	Mean wave direction as a function of frequency.	deg	deg	deg
κ	Breaker index	--	--	--
	Wind stress factor	--	--	--
μ	Population Mean	--	--	--
ν	Spectral narrowness parameter	--	--	--
ζ	Surf similarity parameter or Iribarren number	--	--	--
ζ_{om}	Spectral deep water ζ	--	--	--
ζ_0	Deep water ζ	--	--	--
π	Constant = 3.14159	--	--	--
ρ	Mass density of water	M/L ³	slug/ft ³	kg/m ³
ρ_a	Mass density of air	M/L ³	slug/ft ³	kg/m ³
ρ_{fw}	Mass density of fresh water	M/L ³	slug/ft ³	kg/m ³
ρ_s	Mass density of sediment	M/L ³	slug/ft ³	kg/m ³
Ω	Rotational speed of the earth	rad/T	rad/S	rad/S
φ	Latitude	deg	deg	deg
τ_x, τ_y	Wind stress	F/L ²	lb/ft ²	N/m ²
σ	Population standard deviation	L	ft	m

D.4.13 Acronyms

The Federal Emergency Management Agency (FEMA) has an extensive list of acronyms posted on the FEMA website at <http://www.fema.gov/fhm/dl_cgs.shtm>, *Acronyms and Abbreviations*. The acronyms below are specific to this document and include some of the acronyms given in the FEMA list.

1-D	One-Dimensional
2-D	Two-Dimensional
BFE	Base Flood Elevation
BST	Bathystrophic Storm Tide
CDF	Cumulative Distribution Function
CDIP	Coastal Data Information Program
CEM	Coastal Engineering Manual
CERC	Coastal Engineering Research Center
CFR	Code of Federal Regulations
CHL	Coastal and Hydraulics Laboratory
DFIRM	Digital Flood Insurance Rate Map
DIM	Direct Integration Method
DWLX%	Dynamic water levelX%
ENSO	El Niño, Southern Oscillation
EST	Empirical Simulation Technique
FEMA	Federal Emergency Management Agency
FIRM	Flood Insurance Rate Map
FIS	Flood Insurance Study
FNMOCC	Fleet Numerical Meteorology and Oceanography Center
<i>G&S</i>	<i>FEMA Guidelines and Specifications</i>
GEV	Generalized extreme value
GIS	Geographic Information Systems
GROW	Global Reanalysis of Ocean Waves
JONSWAP	Joint North Sea Wave Project
JPM	Joint Probability Method
LIDAR	Light Detection and Ranging (System)
MHHW	Mean higher high water
MHLW	Mean higher low water
MHW	Mean high water
MII	Meteorology International Inc.
MLHW	Mean lower high water

MLLW	Mean lower low water
MLW	Mean low water
MLWP	Most Likely Winter Profile
MSL	Mean Sea Level
MTL	Mean tide level
MWD	Main wave direction
MWL	Mean water level
NAVD	North American Vertical Datum
NDBC	National Data Buoy Center
NFIP	National Flood Insurance Program
NGDC	National Geophysical Data Center
NGVD	National Geodetic Vertical Datum
NOAA	National Oceanic and Atmospheric Administration
NOS	National Ocean Survey
NWS	National Weather Service
PDF	Probability Density Function
PFD	Primary Frontal Dune
POT	Peak-over-threshold
rms	Root mean square
RWL	Reference water level
SOEN	Southern Oscillation El Niño
SPM	Shore Protection Manual
SPR	Special problem report
STWL	Static water level
SWL	Still water level
TAW	Technical Advisory Committee for Water Retaining Structures
TSDN	Technical Support Data Notebook
TWG	Technical Working Group
TWL	Total water level
USACE	U.S. Army Corps of Engineers
USGS	U.S. Geological Survey
WHAFIS	Wave Height Analysis for Flood Insurance Studies
WIS	Wave Information Studies
WISE®	Watershed Information SystEm, a registered trademark of Watershed Solutions, Inc.

D.4.14 Glossary

Most of the coastal engineering terms in this glossary are from the *Shore Protection Manual* (USACE, 1984) and *Coastal Engineering Manual* (USACE, 2002) and are supplemented with additional terms relevant to hazard mapping. FEMA has an extensive glossary posted on the FEMA website at <http://www.fema.gov/fhm/dl_cgs.shtm> *Glossary*.

----- A -----

ACCRETION May be either natural or artificial. Natural accretion is the buildup of land, solely by the action of the forces of nature, on a beach by deposition of water- or airborne material. Artificial accretion is a similar buildup of land by reason of an act of man, such as the accretion formed by a GROIN, BREAKWATER, or beach fill deposited by mechanical means. Also AGGRADATION.

ADJUSTABLE GROIN A GROIN whose permeability can be changed, usually with gates or removable sections.

ADVANCE (of a beach) (1) A continuing seaward movement of the shoreline. (2) A net seaward movement of the shoreline over a specified time. Also PROGRESSION.

AEOLIAN See EOLIAN.

ALIGNMENT The course along which the center line of a channel, canal or drain is located.

ALLUVIAL DEPOSITS Detrital material which is transported by a river and deposited usually temporarily at points along the flood plain of a river. Commonly composed of sands and gravels.

ALLUVIAL PLANE A plain bordering a river, formed by the deposition of material eroded from areas of higher elevation.

ALLUVIUM Soil (sand, mud, or similar detrital material) deposited by streams, or the deposits formed.

ALONGSHORE Parallel to and near the shoreline; LONGSHORE.

AMPLITUDE, WAVE (1) The magnitude of the displacement of a wave from a mean value. An ocean wave has an amplitude equal to the vertical distance from still-water level to wave crest. For a sinusoidal wave, the amplitude is one-half the wave height. (2) The semirange of a constituent tide.

ANGLE OF REPOSE The maximum slope (measured from the horizontal) at which soils and loose materials on the banks of canals, rivers or embankments will stay stable.

ANISOTROPIC Having properties that change with changing directions.

ANOXIC Refers to an environment that contains little or no dissolved oxygen and hence little or no benthic marine life. These conditions arise in some basins or fjords where physical circulation of seawater is limited.

ANTIDUNES BED FORMS that occur in trains and are in phase with, and strongly interact with, gravity water-surface waves.

APRON Layer of stone, concrete or other material to protect the toe of a structure.

AQUIFER A geologic formation that is water-bearing, and which transmits water from one point in the formation to another.

- ARCHIPELAGO** A sea that contains numerous islands; also the island group itself.
- ARMOR LAYER** Protective layer on a **BREAKWATER** or **SEAWALL** composed of armor units.
- ARMOR UNIT** A relatively large quarrystone or concrete shape that is selected to fit specified geometric characteristics and density. It is usually of nearly uniform size and usually large enough to require individual placement. In normal cases it is used as primary wave protection and is placed in thicknesses of at least two units.
- ARTIFICIAL NOURISHMENT** The process of replenishing a beach with material (usually sand) obtained from another location.
- ASTRONOMICAL TIDE** The tidal levels and character which would result from gravitational effects, e.g. of the Earth, Sun and Moon, without any atmospheric influences.
- ATTENUATION** (1) A lessening of the amplitude of a wave with distance from the origin. (2) The decrease of water-particle motion with increasing depth. Particle motion resulting from surface oscillatory waves attenuates rapidly with depth, and practically disappears at a depth equal to a surface wavelength.

----- **B** -----

- BACKRUSH** The seaward return of the water following the uprush of the waves. For any given tide stage the point of farthest return seaward of the backrush is known as the Limit of backrush or limit backwash.
- BACKSHORE** That zone of the shore or beach lying behind the upper swash zone.
- BACKWASH RIPPLES** Low amplitude ripple marks formed on fine sand beaches by the Backwash of the waves.
- BANK** (1) The rising ground bordering a lake, river, or sea; or of a river or channel, for which it is designated as right or left as the observer is facing downstream. (2) An elevation of the sea floor or large area, located on a continental (or island) shelf and over which the depth is relatively shallow but sufficient for safe surface navigation (e.g., Georges Bank); a group of shoals. (3) In its secondary sense, used only with a qualifying word such as "sand bank" or "gravel bank," a shallow area consisting of shifting forms of silt, sand, mud, and gravel.
- BAR** A submerged or emerged embankment of sand, gravel, or other unconsolidated material built on the sea floor in shallow water by waves and currents.
- BARRIER SPIT** Similar to a barrier island, but connected to the mainland.
- BASIN** A depressed area with no surface outlet, such as a lake basin or an enclosed sea.
- BASIN, BOAT** A naturally or artificially enclosed or nearly enclosed harbor area for small craft.
- BATHMETRIC CHART** A topographic map of the bed of the ocean, with depths indicated by contours (isobaths) drawn at regular intervals.
- BATHYMETRY** The measurement of depths of water in oceans, seas, and lakes; also information derived from such measurements.
- BAY** A recess in the shore or an inlet of a sea between two capes or headlands, not as large as a gulf but larger than a cove.
- BAYMOUTH BAR** A bar extending partly or entirely across the mouth of a bay.

- BEACH** The zone of unconsolidated material that extends landward from the low water line to the place where there is marked change in material or physiographic form, or to the line of permanent vegetation (usually the effective limit of storm waves). The seaward limit of a beach--unless otherwise specified--is the mean low water line. A beach includes foreshore and backshore. See also **SHORE, SUSTAINABLE BEACH, AND SELF-SUSTAINING BEACH**.
- BEACH BERM** A nearly horizontal part of the beach or backshore formed by the deposit of material by wave action. Some beaches have no berms, others have one or several.
- BEACH CREST** The point representing the limit of normal high tide wave run-up (see **BERM CREST**).
- BEACH EROSION** The carrying away of beach materials by wave action, tidal currents, littoral currents, or wind.
- BEACH FACE** The section of the beach normally exposed to the action of the wave uprush. The **FORESHORE** of a **BEACH**. (Not synonymous with **SHOREFACE**.)
- BEACH FILL** Material placed on a beach to renourish eroding shores.
- BEACH HEAD** The cliff, dune or sea wall looming above the land ward limit of the active beach.
- BEACH MATERIAL** Granular sediments, usually sand or shingle moved by the sea.
- BEACH PLAN SHAPE** The shape of the beach in plan; usually shown as a contour line, combination of contour lines or recognizable features such as beach crest and/or the still water line.
- BEACH PROFILE** A cross-section taken perpendicular to a given beach contour; the profile may include the face of a dune or sea wall, extend over the backshore, across the foreshore, and seaward underwater into the nearshore zone.
- BEACH RIDGE** See **RIDGE, BEACH**.
- BEACH SCARP** See **SCARP, BEACH**.
- BEACH WIDTH** The horizontal dimension of the beach measured normal to the shoreline and landward of the higher-high tide line (on oceanic coasts) or from the still water level (on lake coasts).
- BED** The bottom of a watercourse, or any body of water.
- BED FORMS** Any deviation from a flat bed that is readily detectable by eye and higher than the largest sediment size present in the parent bed material; generated on the bed of an alluvial channel by the flow.
- BED LOAD** Sediment transport mode in which individual particles either roll or slide along the bed as a shallow, mobile layer a few particle diameters deep, the part of the load that is not continuously in suspension.
- BED PROTECTION** A (rock) structure on the bed in order to protect the underlying bed against erosion due to current and/or wave action.
- BED SHEAR STRESS** The way in which waves (or currents) transfer energy to the sea bed.
- BEDDING PLANE** A surface parallel to the surface of deposition, which may or may not have a physical expression. The original attitude of a bedding plane should not be assumed to have been horizontal.
- BEDROCK** The solid rock that underlies gravel, soil, and other superficial material. Bedrock may be exposed at the surface (an outcrop) or it may be buried under a few centimeters to thousands of meters of unconsolidated material.

- BENCH** (1) A level or gently sloping erosion plane inclined seaward. (2) A nearly horizontal area at about the level of maximum high water on the sea side of a dike.
- BENCH MARK, TIDAL** A bench mark whose elevation has been determined with respect to mean sea level at a nearby tide gauge; the tidal bench mark is used as reference for that tide gauge.
- BENCH MARK** A permanently fixed point of known elevation. A primary bench mark is one close to a tide station to which the tide staff and tidal datum originally are referenced.
- BENEFITS** The asset value of a scheme, usually measured in terms of the cost of damages avoided by the scheme, or the valuation of perceived amenity or environmental improvements
- BENTHIC** Pertaining to the sub-aquatic bottom.
- BENTHOS** Those animals who live on the sediments of the sea floor, including both mobile and non-mobile forms.
- BERM** (1) On a beach: a nearly horizontal plateau on the beach face or backshore, formed by the deposition of beach material by wave action or by means of a mechanical plant as part of a beach renourishment scheme. Some natural beaches have no berm, others have several. (2) On a structure: a nearly horizontal area, often built to support or key-in an armor layer.
- BERM, BEACH** See **BEACH BERM**.
- BERM BREAKWATER** Rubble mound structure with horizontal berm of armor stones at about sea level, which is allowed to be (re)shaped by the waves.
- BERM CREST** The seaward limit of a **BERM**. Also called **BERM EDGE**.
- BIFURCATION** Location where a river separates in two or more reaches or branches (the opposite of a confluence).
- BIGHT** A bend in a coastline forming an open bay. A bay formed by such a bend.
- BIOTURBATION** The disturbance of sediment bedding by the activities of burrowing organisms.
- BIRDFOOT DELTA** A river delta formed by many levee-bordered distributaries extending seaward and resembling in plan the outstretched claws of a bird. Example: Mississippi River delta.
- BLANKET (FOUNDATION or BEDDING)** A layer or layers of graded fine stones underlying a **BREAKWATER**, **GROIN** or rock embankment to prevent the natural bed material from being washed away.
- BLOWOUT** A depression on the land surface caused by wind erosion.
- BLUFF** A high, steep bank or cliff.
- BOG** A wet, spongy, poorly drained area which is usually rich in very specialized plants, contains a high percentage of organic remnants and residues and frequently is associated with a spring, seepage area, or other subsurface water source. A bog sometimes represents the final stage of the natural processes of eutrophication by which lakes and other bodies of water are very slowly transformed into land areas.
- BOIL** An upward flow of water in a sandy formation due to an unbalanced hydrostatic pressure resulting from a rise in a nearby stream, or from removing the overburden in making excavations.
- BOLD COAST** A prominent landmass that rises steeply from the sea.
- BORE** A very rapid rise of the tide in which the advancing water presents an abrupt front of considerable height. In shallow estuaries where the range of tide is large, the high water

- is propagated inward faster than the low water because of the greater depth at high water. If the high water overtakes the low water, an abrupt front is presented, with the high-water crest finally falling forward as the tide continues to advance. Also EAGER.
- BOTTOM** (nature of) The composition or character of the bed of an ocean or other body of water (e.g., clay, coral, gravel, mud, ooze, pebbles, rock, shell, shingle, hard, or soft).
- BOTTOM BOUNDARY LAYER** The lower portion of the water flow that experiences frictional retardation based on its proximity to the bed.
- BOTTOMSET** One of the horizontal or gently inclined sediment layers deposited in front of the advancing forest beds of a delta.
- BOULDER** A rounded rock more than 256 mm (10 inch) in diameter; larger than a cobblestone. See **SOIL CLASSIFICATION**.
- BOUNDARY CONDITIONS** Environmental conditions, e.g. waves, currents, drifts, etc. used as boundary input to physical or numerical models.
- BRAIDED RIVER** A river type with multiple channels separated by shoals, bars and islands.
- BREACHING** Failure of the beach head or a dike allowing flooding by tidal action.
- BREAKER** A wave breaking on a shore, over a REEF, etc. Breakers may be classified into four types: **COLLAPSING**--breaking occurs over lower half of wave, with minimal air pocket and usually no splash-up. Bubbles and foam present. **PLUNGING**--crest curls over air pocket; breaking is usually with a crash. Smooth splash-up usually follows. **SPILLING**--bubbles and turbulent water spill down front face of wave. The upper 25 percent of the front face may become vertical before breaking. Breaking generally occurs over quite a distance. **SURGING**--wave peaks up, but bottom rushes forward from under wave, and wave slides up beach face with little or no bubble production. Water surface remains almost plane except where ripples may be produced on the beachface during runback.
- BREAKER DEPTH** The still-water depth at the point where a wave breaks. Also called **BREAKING DEPTH**.
- BREAKER INDEX** Ratio of breaking wave height to deepwater wave height.
- BREAKER ZONE** The zone within which waves approaching the coastline commence breaking, typically in water depths of between 5 and 10 meters.
- BREAKING** Reduction in wave energy and height in the surf zone due to limited water depth.
- BREAKWATER** A structure protecting a shore area, harbor, anchorage, or basin from waves.
- BUFFER AREA** A parcel or strip of land that is designed and designated to permanently remain vegetated in an undisturbed and natural condition to protect an adjacent aquatic or wetland site from upland impacts, to provide habitat for wildlife and to afford limited public access.
- BULKHEAD** A structure or partition to retain or prevent sliding of the land. A secondary purpose is to protect the upland against damage from wave action.
- BUOY** A float; especially a floating object moored to the bottom, to mark a channel, anchor, shoal rock, etc. Some common types include: a nun or nut buoy is conical in shape; a can buoy is squat and cylindrical above water and conical below water; a spar buoy is a vertical, slender spar anchored at one end; a bell buoy, bearing a bell, runs mechanically or by the action of waves, usually marks shoals or rocks; a whistling buoy, similarly operated, marks shoals or channel entrances; a dan buoy carries a pole with a flag or light on it.

BUOYANCY The resultant of upward forces, exerted by the water on a submerged or floating body, equal to the weight of the water displaced by this body.

BYPASSING, SAND Hydraulic or mechanical movement of sand from the accreting updrift side to the eroding downdrift side of an inlet or harbor entrance. The hydraulic movement may include natural movement as well as movement caused by man.

----- C -----

CAISSON Concrete box-type structure.

CALIFORNIA CURRENT A deep-ocean boundary current that flows south-southeasterly along the U.S. west coast. The current is shallow, broad and slow moving carrying cold, nutrient poor waters toward the equator.

CALCAREOUS Containing calcium carbonate (CaCO_3), chiefly as the minerals calcite and aragonite. When applied to rock, it implies that as much as 50 percent of the rock is carbonate (e.g., calcareous sand).

CALM The condition of the water surface when there is no wind waves or swell.

CANAL An artificial watercourse cut through a land area for such uses as navigation and irrigation.

CANYON A relatively narrow, deep depression with steep slopes, the bottom of which grades continuously downward. May be underwater (submarine) or on land (SUBAERIAL).

CAPE A land area jutting seaward from a continent or large island which prominently marks a change in, or interrupts notably, the coastal trend; a prominent feature. Examples: Cape Cod, Massachusetts; Cape Hatteras, North Carolina.

CAPILLARY WAVE A wave whose velocity of propagation is controlled primarily by the surface tension of the liquid in which the wave is traveling. Water waves of length less than about 1 inch are considered capillary waves. Waves longer than 1 inch and shorter than 2 inches are in an indeterminate zone between capillary and gravity waves.

CARTOGRAPHY The science and art of making maps.

CATCHMENT AREA The area which drains naturally to a particular point on a river, thus contributing to its natural discharge.

CAUSEWAY A raised road across wet or marshy ground, or across water.

CAUSTIC In refraction of waves, the name given to the curve to which adjacent orthogonals of waves refracted by a bottom whose contour lines are curved, are tangents. The occurrence of a caustic always marks a region of crossed orthogonals and high wave convergence.

CELERITY Wave speed.

CHANNEL (1) A natural or artificial waterway of perceptible extent which either periodically or continuously contains moving water, or which forms a connecting link between two bodies of water. (2) The part of a body of water deep enough to be used for navigation through an area otherwise too shallow for navigation. (3) A large strait, as the English Channel. (4) The deepest part of a stream, bay, or strait through which the main volume or current of water flows.

- CHANNEL CAPACITY** The maximum flow which a channel is capable of transmitting without its banks being overtopped.
- CHANNEL-MOUTH BAR** A bar built where a stream enters a body of standing water, resulting from decreased flow velocity.
- CHART A** special-purpose map, esp. one designed for navigation such as a bathymetric chart.
- CHART DATUM** The plane or level to which soundings (or elevations) or tide heights are referenced (usually LOW WATER DATUM). The surface is called a tidal datum when referred to a certain phase of tide. To provide a safety factor for navigation, some level lower than MEAN SEA LEVEL is generally selected for hydrographic charts, such as MEAN LOW WATER or MEAN LOWER LOW WATER. See DATUM PLANE.
- CHEMICAL WEATHERING** Disintegration of rocks and sediments by chemical alteration of the constituent minerals or of the cementing matrix. It is caused by exposure, oxidation, temperature changes, and biological processes.
- CHOP** The short-crested waves that may spring up quickly in a moderate breeze, and which break easily at the crest. Also WIND CHOP.
- CHOPPY SEA** Short, rough waves tumbling with a short and quick motion. Short-crested waves that may spring up quickly in a moderate breeze, and break easily at the crest.
- CLAPOTIS** The French equivalent for a type of STANDING WAVE. In American usage it is usually associated with the standing wave phenomenon caused by the reflection of a nonbreaking wave train from a structure with a face that is vertical or nearly vertical. Full clapotis is one with 100 percent reflection of the incident wave; partial clapotis is one with less than 100 percent reflection.
- CLASTIC ROCKS** Rocks built up of fragments which have been produced by weathering and erosion of pre-existing rocks and minerals and, typically, transported mechanically to their point of deposition.
- CLAY** A fine grained, plastic, sediment with a typical grain size less than 0.004 mm. Possesses electromagnetic properties which bind the grains together to give a bulk strength or cohesion. See SOIL CLASSIFICATION.
- CLIFF** A high, steep face of rock; a precipice. See also SEA CLIFF.
- CLIMATE** The characteristic weather of a region, particularly regarding temperature and precipitation, averaged over some significant interval of time (years).
- CLOSURE DEPTH** The water depth beyond which repetitive profile surveys (collected over several years) do not detect vertical sea bed changes, generally considered the seaward limit of littoral transport. The depth can be determined from repeated cross-shore profile surveys or estimated using formulas based on wave statistics. Note that this does not imply the lack of sediment motion beyond this depth.
- CNOIDAL WAVE** A type of wave in shallow water (i.e., where the depth of water is less than 1/8 to 1/10 the wavelength). The surface profile is expressed in terms of the Jacobian elliptic function $cn u$; hence the term cnoidal.
- CO-TIDAL LINES** Lines which link all the points where the tide is at the same stage (or phase) of its cycle.
- COAST** (1) A strip of land of indefinite width (may be several kilometers) that extends from the shoreline inland to the first major change in terrain features. (2) The part of a country regarded as near the coast.
- COASTAL AREA** The land and sea area bordering the shoreline.

- COASTAL CURRENTS** (1) Those currents which flow roughly parallel to the shore and constitute a relatively uniform drift in the deeper water adjacent to the surf zone. These currents may be tidal currents, transient, wind-driven currents, or currents associated with the distribution of mass in local waters. (2) For navigational purposes, the term is used to designate a current in coastwise shipping lanes where the tidal current is frequently rotary.
- COASTAL DEFENSE** General term used to encompass both coast protection against erosion and sea defense against flooding.
- COASTAL FORCING** The natural processes which drive coastal hydro- and morphodynamics (e.g. winds, waves, tides, etc).
- COASTAL PLAIN** The plain composed of horizontal or gently sloping strata of clastic materials, generally representing a strip of sea bottom that has emerged from the sea in recent geologic time.
- COASTAL PROCESSES** Collective term covering the action of natural forces on the shoreline, and near shore seabed.
- COASTAL STRIP** A zone directly adjacent to the waterline, where only coast related activities take place. Usually this is a strip of some 100 m wide. In this strip the coastal defense activities take place. In this strip often there are restrictions to land use.
- COASTAL ZONE** The transition zone where the land meets water, the region that is directly influenced by marine and lacustrine hydrodynamic processes. Extends offshore to the continental shelf break and onshore to the first major change in topography above the reach of major storm waves. On barrier coasts, includes the bays and lagoons between the barrier and the mainland.
- COASTAL ZONE MANAGEMENT** The integrated and general development of the coastal zone. Coastal Zone Management is not restricted to coastal defense works, but includes also a development in economical, ecological and social terms. Coastline Management is a part of Coastal Zone Management.
- COASTLINE** (1) Technically, the line that forms the boundary between the coast and the shore. (2) Commonly, the line that forms the boundary between the land and the water, esp. the water of a sea or ocean.
- COBBLE** A rock fragment between 64 and 256 mm in diameter, usually rounded. See **SOIL CLASSIFICATION**.
- COFFERDAM** A temporary watertight structure enclosing all or part of the construction area so that construction can proceed in the dry.
- COHESIVE SEDIMENT** Sediment containing significant proportion of clays, the electromagnetic properties of which cause the sediment to bind together.
- COLLOID** As a size term refers to particles smaller than 0.00024 mm, smaller than clay size.
- COMBER** (1) A deepwater wave whose crest is pushed forward by a strong wind; much larger than a whitecap. (2) A long-period breaker.
- COMPETENCE** The ability of a wind or water current to transport detritus, in terms of particle size rather than amount, measured as the diameter of the largest particles.
- COMPLEX SPIT** A large **RECURVED SPIT** with secondary spits developed at its end.
Example: Sandy Hook, New Jersey.
- CONFLUENCE** The junction of two or more river reaches or branches (the opposite of a bifurcation).

- CONSOLIDATION** The gradual, slow compression of a cohesive soil due to weight acting on it, which occurs as water is driven out of the voids in the soil. Consolidation only occurs in clays or other soils of low permeability.
- CONTINENTAL SHELF** (1) The zone bordering a continent extending from the line of permanent immersion to the depth, usually about 100 m to 200 m, where there is a marked or rather steep descent toward the great depths of the ocean. (2) The area under active littoral processes during the HOLOCENE period. (3) The region of the oceanic bottom that extends outward from the shoreline with an average slope of less than 1:100, to a line where the gradient begins to exceed 1:40 (the CONTINENTAL SLOPE).
- CONTINENTAL SLOPE** The declivity from the offshore border of the CONTINENTAL SHELF to oceanic depths. It is characterized by a marked increase in slope.
- CONTOUR** A line on a map or chart representing points of equal elevation with relation to a DATUM. It is called an ISOBATH when connecting points of equal depth below a datum. Also called DEPTH CONTOUR.
- CONTROLLING DEPTH** The least depth in the navigable parts of a waterway, governing the maximum draft of vessels that can enter.
- CONVERGENCE** (1) In refraction phenomena, the decreasing of the distance between orthogonals in the direction of wave travel. Denotes an area of increasing wave height and energy concentration. (2) In wind-setup phenomena, the increase in setup observed over that which would occur in an equivalent rectangular basin of uniform depth, caused by changes in planform or depth; also the decrease in basin width or depth causing such increase in setup.
- CORE** (1) A cylindrical sample extracted from a beach or seabed to investigate the types and depths of sediment layers. (2) An inner, often much less permeable portion of a BREAKWATER or BARRIER BEACH.
- CORIOLIS EFFECT** Force due to the Earth's rotation, capable of generating currents. It causes moving bodies to be deflected to the right in the Northern Hemisphere and to the left in the Southern Hemisphere. The "force" is proportional to the speed and latitude of the moving object. It is zero at the equator and maximum at the poles.
- COVE** A small, sheltered recess in a coast, often inside a larger embayment.
- COVER LAYER** The outer layer used in a rubble system as protection against external hydraulic loads.
- CREEK** (1) A stream, less predominant than a river, and generally tributary to a river. (2) A small tidal Channel through a coastal MARSH.
- CREEP** Very slow, continuous downslope movement of soil or debris.
- CRENULATE** An indented or wavy shoreline beach form, with the regular seaward- pointing parts rounded rather than sharp, as in the cusped type.
- CREST** Highest point on a beach face, BREAKWATER, or sea wall.
- CREST LENGTH, WAVE** The length of a wave along its crest. Sometimes called CREST WIDTH.
- CREST OF WAVE** (1) the highest part of a wave. (2) That part of the wave above still-water level.
- CREST OF BERM** The seaward limit of a berm. Also called BERM EDGE.
- CROSS-BEDDING** An arrangement of relatively thin layers of rock inclined at an angle to the more nearly horizontal BEDDING PLANES of the larger rock unit. Also referred to as cross-stratification.

CROSS-SHORE Perpendicular to the shoreline.

CROWN WALL Concrete superstructure on a rubble mound.

CURRENT (1) The flowing of water, or other liquid or gas. (2) That portion of a stream of water which is moving with a velocity much greater than the average or in which the progress of the water is principally concentrated. (3) Ocean currents can be classified in a number of different ways. Some important types include the following: (1) Periodic - due to the effect of the tides; such Currents may be rotating rather than having a simple back and forth motion. The currents accompanying tides are known as tidal currents; (2) Temporary - due to seasonal winds; (3) Permanent or ocean - constitute a part of the general ocean circulation. The term **DRIFT CURRENT** is often applied to a slow broad movement of the oceanic water; (4) Nearshore - caused principally by waves breaking along a shore.

CURRENT, COASTAL One of the offshore currents flowing generally parallel to the shoreline in the deeper water beyond and near the surf zone; these are not related genetically to waves and resulting surf, but may be related to tides, winds, or distribution of mass.

CURRENT, DRIFT A broad, shallow, slow-moving ocean or lake current. Opposite of **CURRENT, STREAM**.

CURRENT, EBB The tidal current away from shore or down a tidal stream. Usually associated with the decrease in the height of the tide.

CURRENT, EDDY See **EDDY**.

CURRENT, FEEDER Any of the parts of the nearshore current system that flow parallel to shore before converging and forming the neck of the **RIP CURRENT**.

CURRENT, FLOOD The tidal current toward shore or up a tidal stream. Usually associated with the increase in the height of the tide.

CURRENT, INSHORE See **INSHORE CURRENT**.

CURRENT, LITTORAL Any current in the littoral zone caused primarily by wave action; e.g., **LONGSHORE CURRENT, RIP CURRENT**. See also **CURRENT, NEARSHORE**.

CURRENT, LONGSHORE The littoral current in the breaker zone moving essentially parallel to the shore, usually generated by waves breaking at an angle to the shoreline.

CURRENT METER An instrument for measuring the velocity of a current.

CURRENT, NEARSHORE A current in the **NEARSHORE ZONE**.

CURRENT, OFFSHORE See **OFFSHORE CURRENT**.

CURRENT, PERIODIC See **CURRENT, TIDAL**.

CURRENT, PERMANENT See **PERMANENT CURRENT**.

CURRENT, RIP See **RIP CURRENT**.

CURRENT, STREAM A narrow, deep, and swift ocean current, as the Gulf Stream.
CURRENT, DRIFT.

CURRENT SYSTEM, NEARSHORE See **NEARSHORE CURRENT SYSTEM**.

CURRENT, TIDAL The alternating horizontal movement of water associated with the rise and fall of the tide caused by the astronomical tide-producing forces. Also **CURRENT, PERIODIC**. See also **CURRENT, FLOOD** and **CURRENT, EBB**.

CURRENT-REFRACTION Process by which wave velocity, height, and direction are affected by a current.

CUSP One of a series of short ridges on the **FORESHORE** separated by crescent-shaped troughs spaced at more or less regular intervals. Between these cusps are hollows. The

- cusps are spaced at somewhat uniform distances along beaches. They represent a combination of constructive and destructive processes. Also BEACH CUSP.
- CUSPATE BAR A crescent-shaped bar uniting with the shore at each end. It may be formed by a single spit growing from shore and then turning back to again meet the shore, or by two spits growing from the shore and uniting to form a bar of sharply cusped form.
- CUSPATE SPIT The spit that forms in the lee of a shoal or offshore feature (BREAKWATER, island, rock outcrop) by waves that are refracted and/or diffracted around the offshore feature. It may eventually grow into a TOMBOLO linking the feature to the mainland.
- CYCLOIDAL WAVE A steep, symmetrical wave whose crest forms an angle of 120 degrees and whose form is that of a cycloid. A trochoidal wave of maximum steepness. See also TROCHOIDAL WAVE.
- CYCLONE A system of winds that rotates about a center of low atmospheric pressure. Rotation is clockwise in the Southern Hemisphere and anti-clockwise in the Northern Hemisphere. In the Indian Ocean, the term refers to the powerful storms called HURRICANES in the Atlantic.

----- **D** -----

- DAM Structure built in rivers or estuaries, basically to separate water at both sides and/or to retain water at one side.
- DATUM Any permanent line, plane or surface used as a reference datum to which elevations are referred.
- DATUM, CHART See CHART DATUM.
- DATUM, PLANE The horizontal plane to which soundings, ground elevations, or water surface elevations are referred. Also REFERENCE PLANE. The plane is called a TIDAL DATUM when defined by a certain phase of the tide. The following datums are ordinarily used on hydrographic charts: MEAN LOW WATER--Atlantic coast (U. S.), Argentina, Sweden, and Norway. MEAN LOWER LOW WATER--Pacific coast (U. S.). LOW WATER DATUM--Great Lakes (U. S. and Canada). A common datum used on United States topographic maps is MEAN SEA LEVEL. See also BENCH MARK.
- DAVIDSON CURRENT Deep-ocean boundary current off the west coast of the U.S. which brings warmer, saltier, low oxygen, high phosphate equatorial type water from low to high latitudes.
- DEBRIS LINE A line near the limit of storm wave uprush marking the landward limit of debris deposits.
- DECAY AREA Area of relative CALM through which waves travel after emerging from the generating area.
- DECAY DISTANCE The distance waves travel after leaving the generating area (FETCH).
- DECAY OF WAVES The change waves undergo after they leave a generating area (FETCH) and pass through a calm, or region of lighter winds. In the process of decay, the significant wave height decreases and the significant wavelength increases.
- DEEP WATER Water so deep that surface waves are little affected by the ocean bottom. Generally, water deeper than one-half the surface wavelength is considered deep water. Compare SHALLOW WATER.

- DEEP WATER WAVES** A wave in water the depth of which is greater than one-half the **WAVE LENGTH**.
- DEFLATION** The removal of loose material from a beach or other land surface by wind action.
- DEGRADATION** The geologic process by means of which various parts of the surface of the earth are worn away and their general level lowered, by the action of wind and water.
- DELTA** (1) An **ALLUVIAL DEPOSIT**, usually triangular or semi-circular, at the mouth of a river or stream. The delta is normally built up only where there is no tidal or current action capable of removing the sediment at the same rate as it is deposited, and hence the delta builds forward from the coastline. (2) A **TIDAL DELTA** is a similar deposit at the mouth of a tidal **INLET**, put there by **TIDAL CURRENTS**.
- DELTA PLAIN** The nearly-level surface composing the landward portion of a large **DELTA**.
- DENSITY** Mass (in kg) per unit of volume of a substance; kg/m³. For pure water, the density is 1,000 kg/m³, for seawater the density is usually more. Density increases with increasing salinity, and decreases with increasing temperature. More information can be found in "properties of seawater". For stone and sand, usually a density of 2,600 kg/m³ is assumed. Concrete is less dense, in the order of 2,400 kg/m³. Some types of basalt may reach 2,800 kg/m³. For sand, including the voids, one may use 1,600 kg/m³, while mud often has a density of 1,100 – 1,200 kg/m³.
- DENSITY CURRENT** Phenomenon of relative flow within water due to difference in density. For example, the salt-water wedge is a density current, as is a volcanic nuée ardente.
- DENSITY STRATIFICATION** The lateral expansion of a sediment plume as it moves out of the distributary mouth, where salt and fresh water mix. This is most likely to occur where the speed of the river flow is moderate to low and the distributary mouth is relatively deep.
- DENSITY-DRIVEN CIRCULATION** Variations in salinity create variations in density in estuaries. These variations in density create horizontal pressure gradients, which drive estuarine circulation.
- DEPRESSION** A general term signifying any depressed or lower area in the ocean floor.
- DEPTH** The vertical distance from a specified datum to the sea floor.
- DEPTH CONTOUR** See **CONTOUR**., also isobath.
- DEPTH, CONTROLLING** See **CONTROLLING DEPTH**.
- DEPTH FACTOR** See **SHOALING COEFFICIENT**.
- DEPTH OF BREAKING** The still-water depth at the point where the wave breaks. Also **BREAKER DEPTH**.
- DERRICK STONE** See **STONE, DERRICK**.
- DESIGN HURRICANE** See **HYPOTHETICAL HURRICANE**.
- DESIGN STORM** A hypothetical extreme storm whose waves coastal protection structures will often be designed to withstand. The severity of the storm (i.e. return period) is chosen in view of the acceptable level of risk of damage or failure. A **DESIGN STORM** consists of a **DESIGN WAVE** condition, a design water level and a duration.
- DESIGN WAVE** In the design of **HARBORS**, harbor works, etc., the type or types of waves selected as having the characteristics against which protection is desired.
- DESIGN WAVE CONDITION** Usually an extreme wave condition with a specified return period used in the design of coastal works.
- DETACHED BREAKWATER** A **BREAKWATER** without any **SUBAERIAL** connection to the shore.

- DETRITUS** Small fragments of rock which have been worn or broken away from a mass by the action of water or waves.
- DIFFERENTIAL EROSION / WEATHERING** These features develop in rocks which have varying resistance to the agencies of erosion and/or weathering so that parts of the rock are removed at greater rates than others. A typical example is the removal of soft beds from between harder beds in a series of sedimentary rocks. The term may be applied to any size of feature, from small-scale etching to the regional development of hills and valleys controlled by hard and soft rocks.
- DIFFRACTION (of water waves)** The phenomenon by which energy is transmitted laterally along a wave crest. When a part of a train of waves is interrupted by a barrier, such as a **BREAKWATER**, the effect of diffraction is manifested by propagation of waves into the sheltered region within the barrier's geometric shadow.
- DIFFRACTION COEFFICIENT** Ratio of diffracted wave height to deep water wave height.
- DIKE** Earth structure along sea or river in order to protect low lands from flooding by high water; dikes along rivers are sometimes called levees. Sometimes written as **DYKE**.
- DISCHARGE** The volume of water per unit of time flowing along a pipe or channel.
- DITCH** A channel to convey water for irrigation or drainage.
- DIURNAL** Having a period or cycle of approximately one **TIDAL DAY**.
- DIURNAL CURRENT** The type of tidal current having only one flood and one ebb period in the tidal day. A **ROTARY CURRENT** is diurnal if it changes its direction through all points of the compass once each tidal day.
- DIURNAL INEQUALITY** The difference in height of the two high waters or of the two low waters of each day. Also, the difference in velocity between the two daily flood or **EBB CURRENTS** of each day.
- DIURNAL TIDE** A tide with one high water and one low water in a tidal day.
- DIVERGENCE** (1) In refraction phenomena, the increasing of distance between orthogonals in the direction of wave travel. Denotes an area of decreasing wave height and energy concentration. (2) In wind-setup phenomena, the decrease in setup observed under that which would occur in an equivalent rectangular basin of uniform depth, caused by changes in planform or depth. Also the increase in basin width or depth causing such decrease in setup.
- DIVERGING WAVE** Waves that move obliquely out from a vessel's sailing line.
- DIVERSION CHANNEL** A waterway used to divert water from its natural course. The term is generally applied to a temporary arrangement e.g. to by-pass water around a dam site during construction.
- DOCK** The slip or waterway between two piers, or cut into the land, for the reception of ships.
- DOLPHIN** A cluster of piles.
- DOWNDRIFT** The direction of predominant movement of littoral materials.
- DOWNSTREAM** Along coasts with obliquely approaching waves there is a longshore (wave-driven) current. For this current, one can define an upstream and a **DOWNSTREAM** direction. For example, on a beach with an orientation west-east, the sea is to the north. Suppose the waves come from NW, then the current flows from West to East. Here, **UPSTREAM** is west of the observer, and east is downstream of the observer.
- DOWNWELLING** A downward movement (sinking) of surface water caused by onshore Ekman transport, converging **CURRENTS**, or when a water mass becomes more dense than the surrounding water.

- DRAINAGE BASIN** Total area drained by a stream and its tributaries.
- DREDGING** Excavation or displacement of the bottom or shoreline of a water body. Dredging can be accomplished with mechanical or hydraulic machines. Most is done to maintain channel depths or berths for navigational purposes; other dredging is for shellfish harvesting, for cleanup of polluted sediments, and for placement of sand on beaches.
- DRIFT** (noun) (1) Sometimes used as a short form for LITTORAL DRIFT. (2) The speed at which a current runs. (3) Floating material deposited on a beach (driftwood). (4) A deposit of a continental ice sheet; e.g., a DRUMLIN.
- DRIFT CURRENT** A broad, shallow, slow-moving ocean or lake current.
- DRIFT SECTOR** A particular reach of marine shore in which LITTORAL DRIFT may occur without significant interruption, and which contain any and all natural sources of such drift, and also any accretion shore forms accreted by such drift.
- DROMOND** A large medieval fast-sailing galley or cutter.
- DROWNED COAST** A shore with long, narrow channels, implying that subsidence of the coast has transformed the lower portions of river valleys into tidal estuaries.
- DRUMLIN** A low, smoothly-rounded, elongate hill of compact glacial till built under the margin of the ice and shaped by its flow.
- DRYING BEACH** That part of the beach which is uncovered by water (e.g. at low tide). Sometimes referred to as 'SUBAERIAL' beach.
- DUNES** (1) Ridges or mounds of loose, wind-blown material, usually sand. (2) Bed forms smaller than bars but larger than ripples that are out of phase with any water-surface gravity waves associated with them.
- DURABILITY** The ability of a rock to retain its physical and mechanical properties (i.e. resist degradation) in engineering service.
- DURATION** In wave forecasting, the length of time the wind blows in nearly the same direction over the FETCH (generating area).
- DURATION, MINIMUM** The time necessary for steady-state wave conditions to develop for a given wind velocity over a given fetch length.
- DURATION OF EBB** The interval of time in which a tidal current is ebbing, determined from the middle of the slack waters.
- DURATION OF FALL** The interval from high water to low water.
- DURATION OF FLOOD** The interval of time in which a tidal current is flooding, determined from the middle of slack waters.
- DURATION OF RISE** The interval from low water to high water.
- DYNAMIC EQUILIBRIUM** Short term morphological changes that do not affect the morphology over a long period.
- DYNAMIC VISCOSITY** In fluid dynamics, the ratio between the shear stress acting along any plane between neighboring fluid elements and the rate of deformation of the velocity gradient perpendicular to this plane.

----- **E** -----

EAGER See BORE.

- EBB** Period when tide level is falling; often taken to mean the ebb current which occurs during this period.
- EBB CURRENT** The movement of a tidal current away from shore or down a tidal stream. In the semidiurnal type of reversing current, the terms greater ebb and lesser ebb are applied respectively to the ebb currents of greater and lesser velocity of each day. The terms of maximum ebb and minimum ebb are applied to the maximum and minimum velocities of a continuously running ebb current, the velocity alternately increasing and decreasing without coming to a slack or reversing. The expression maximum ebb is also applicable to any ebb current at the time of greatest velocity.
- EBB INTERVAL** The interval between the transit of the moon over the meridian of a place and the time of the following strength of ebb.
- EBB SHIELD** High, landward margin of a flood-tidal shoal that helps divert ebb-tide currents around the shoal.
- EBB STRENGTH** The **EBB CURRENT** at the time of maximum velocity.
- EBB TIDAL DELTA** The bulge of sand formed at the seaward mouth of **TIDAL INLETS** as a result of interaction between tidal currents and waves. Also called inlet-associated bars and estuary entrance shoals.
- EBB TIDE** The period of tide between high water and the succeeding low water; a falling tide.
- ECHO SOUNDER** An electronic instrument used to determine the depth of water by measuring the time interval between the emission of a sonic or ultrasonic signal and the return of its echo from the bottom.
- ECOSYSTEM** The living organisms and the nonliving environment interacting in a given area, encompassing the relationships between biological, geochemical, and geophysical systems.
- EDDY** A circular movement of water formed on the side of a main current. Eddies may be created at points where the main stream passes projecting obstructions or where two adjacent currents flow counter to each other.
- EDDY CURRENT** See **EDDY**.
- EDGE WAVE** An ocean wave parallel to a coast, with crests normal to the shoreline. An edge wave may be **STANDING** or **PROGRESSIVE**. Its height diminishes rapidly seaward and is negligible at a distance of one wavelength offshore.
- EKMAN TRANSPORT** Resultant flow at right angles to and to the right of the wind direction (in the northern hemisphere) referred to as **UPWELLING** and **DOWNWELLING**.
- ELEVATION** The vertical distance from mean sea level or other established datum plane to a point on the earth's surface; height above sea level. Although sea floor elevation below msl should be marked as a negative value, many charts show positive numerals for water depth.
- EL NIÑO** Warm equatorial water which flows southward along the coast of Peru and Ecuador during February and March of certain years. It is caused by poleward motions of air and unusual water temperature patterns in the Pacific Ocean, which cause coastal downwelling, leading to the reversal in the normal north-flowing cold coastal currents. During many El Niño years, storms, rainfall, and other meteorological phenomena in the Western Hemisphere are measurably different than during non-El Niño years. (See La Niña).
- ELUTRIATION** The process by which a granular material can be sorted into its constituent particle sizes by means of a moving stream of fluid (usually air or water). Elutriators are

- extensively used in studies of sediments for determining Particle size distribution. Under certain circumstances wind, rivers and streams may act as elutriating agents.
- EMBANKMENT** Fill material, usually earth or rock, placed with sloping sides and with a length greater than its height. Usually an embankment is wider than a dike.
- EMBAYMENT** An indentation in the shoreline forming an open bay.
- EMERGENT COAST** A coast in which land formerly under water has recently been exposed above sea level, either by uplift of the land or by a drop in sea level.
- ENDEMIC** Native or confined to a specific geographic area.
- ENERGY COEFFICIENT** The ratio of the energy in a wave per unit crest length transmitted forward with the wave at a point in shallow water to the energy in a wave per unit crest length transmitted forward with the wave in deep water. On refraction diagrams this is equal to the ratio of the distance between a pair of orthogonals at a selected shallow-water point to the distance between the same pair of orthogonals in deep water. Also the square of the **REFRACTION COEFFICIENT**.
- ENTRANCE** The avenue of access or opening to a navigable channel or inlet.
- EOLIAN (also AEOLIAN)** Pertaining to the wind, esp. used with deposits such as loess and dune sand, and sedimentary structures like wind-formed ripple marks.
- EOLIAN SANDS** Sediments of sand size or smaller which have been transported by winds. They may be recognized in marine deposits off desert coasts by the greater angularity of the grains compared with waterborne particles.
- EQUATORIAL CURRENTS** (1) Ocean currents flowing westerly near the equator. There are two such currents in both the Atlantic and Pacific Oceans. The one to the north of the equator is called the North Equatorial Current and the one to the south is called the South Equatorial Current. Between these two currents there is an easterly flowing stream known as the Equatorial Countercurrent. (2) Tidal currents occurring semimonthly as a result of the moon being over the equator. At these times the tendency of the moon to produce **DIURNAL INEQUALITY** in the current is at a minimum.
- EQUATORIAL TIDES** Tides occurring semimonthly as the result of the moon being over the equator. At these times the tendency of the moon to produce a **DIURNAL INEQUALITY** in the tide is at a minimum.
- EROSION** The wearing away of land by the action of natural forces. On a beach, the carrying away of beach material by wave action, tidal currents, littoral currents, or by deflation.
- ESCARPMENT** A more or less continuous line of cliffs or steep slopes facing in one general direction which are caused by erosion or faulting. Also **SCARP**.
- ESTUARY** (1) The part of a river that is affected by tides. (2) The region near a river mouth in which the fresh water of the river mixes with the salt water of the sea and which received both fluvial and littoral sediment influx.
- EUSTATIC SEA LEVEL CHANGE** Change in the relative volume of the world's ocean basins and the total amount of ocean water.
- EYE** In meteorology, usually the "eye of the storm" (hurricane): the roughly circular area of comparatively light winds and fair weather found at the center of a severe tropical cyclone.

----- **F** -----

- FAIRWAY** The parts of a waterway that are open and unobstructed for navigation. The main traveled part of a waterway; a marine thoroughfare.
- FAR-INFRAGRAVITY** The frequency band (nominally 0.001 - 0.02 Hz) occupied by **SHEAR INSTABILITIES** of the longshore current. This band falls both below and in the lower part of the Infragravity band occupied by Infragravity waves.
- FATHOM** A unit of measurement used for soundings equal to 1.83 meters (6 feet).
- FATHOMETER** The copyrighted trademark for a type of **ECHO SOUNDER**.
- FAULT** A fracture in rock along which there has been an observable amount of displacement. Faults are rarely single planar units; normally they occur as parallel to sub-parallel sets of planes along which movement has taken place to a greater or lesser extent. Such sets are called fault or fracture-zones.
- FAUNA** The entire group of animals found in an area.
- FEEDER BEACH** An artificially widened beach serving to nourish downdrift beaches by natural littoral currents or forces.
- FEEDER CURRENT** The currents which flow parallel to shore before converging and forming the neck of a **RIP CURRENT**.
- FEEDER CURRENT** See **CURRENT, FEEDER**.
- FEELING BOTTOM** The initial action of a deepwater wave, in response to the bottom, upon running into shoal water.
- FETCH** The area in which **SEAS** are generated by a wind having a fairly constant direction and speed. Sometimes used synonymously with **FETCH LENGTH**. Also **GENERATING AREA**.
- FETCH LENGTH** The horizontal distance (in the direction of the wind) over which a wind generates seas or creates a **WIND SETUP**.
- FETCH-LIMITED** Situation in which wave energy (or wave height) is limited by the size of the wave generation area (fetch).
- FILTER** Intermediate layer, preventing fine materials of an underlayer from being washed through the voids of an upper layer.
- FIORD (FJORD)** A narrow, deep, steep-walled inlet of the sea, usually formed by entrance of the sea into a deep glacial trough.
- FIRTH** A narrow arm of the sea; also, the opening of a river into the sea.
- FLOOD** (1) Period when tide level is rising; often taken to mean the flood current which occurs during this period (2) A flow beyond the carrying capacity of a channel.
- FLOOD CHANNEL** Channel located on ebb-tidal shoal that carries the flood tide over the tidal flat into the back bay or lagoon.
- FLOOD CURRENT** The movement of a tidal current toward the shore or up a tidal stream. In the semidiurnal type of reversing current, the terms greater flood and lesser flood are applied respectively to the flood currents of greater and lesser velocity each day. The terms maximum flood and minimum flood are applied to the maximum and minimum velocities of a flood current the velocity of which alternately increases and decreases without coming to slack or reversing. The expression maximum flood is also applicable to any flood current at the time of greatest velocity.

- FLOOD GATE** A gravity outlet fitted with vertically-hinged doors, opening if the inner water level is higher than the outer water level, so that drainage takes place during low water.
- FLOOD INTERVAL** The interval between the transit of the moon over the meridian of a place and the time of the following flood.
- FLOOD MARK** Proof of any kind on the shoreline, or on structures like bridge abutments, used to determine the highest level attained by the water surface during the flood (note: the height of the flood mark usually includes the wave run-up).
- FLOOD PLAIN** (1) A flat tract of land bordering a river, mainly in its lower reaches, and consisting of ALLUVIUM deposited by the river. It is formed by the sweeping of the meander belts downstream, thus widening the valley, the sides of which may become some kilometers apart. In time of flood, when the river overflows its banks, sediment is deposited along the valley banks and plains. (2) Synonymous with 100-year floodplain. The land area susceptible to being inundated by stream derived waters with a 1 percent chance of being equaled or exceeded in any given year.
- FLOOD RAMP** Seaward-dipping sand platform dominated by flood-tidal currents, located on ebb-tidal shoal near the opening to the inlet.
- FLOOD ROUTING** The determination of the attenuating effect of storage on a river-flood passing through a valley by reason of a feature acting as control (e.g. a reservoir with a spillway capacity less than the flood inflow, or the widening or narrowing of a valley).
- FLOOD TIDAL DELTA** The bulge of sand formed at the landward mouth of TIDAL INLETS as a result of flow expansion.
- FLOOD TIDE** The period of tide between low water and the succeeding high water; a rising tide.
- FLOOD WALL, SPLASH WALL** Wall, retired from the seaward edge of the seawall crest, to prevent water from flowing onto the land behind.
- FLORA** The entire group of plants found in an area.
- FLUVIAL** Of or pertaining to rivers; produced by the action of a river or stream (e.g., fluvial sediment).
- FLUSHING TIME** The time required to replace all the water in an ESTUARY, HARBOR, etc., by action of current and tide.
- FOAM LINE** (1) The front of a wave as it advances shoreward, after it has broken. (2) Lines of foam such as those which move around the head of a RIP.
- FOLLOWING WIND** Generally, the same as a tailwind; in wave forecasting, wind blowing in the direction of ocean-wave advance.
- FOREDUNE** The front DUNE immediately behind the backshore.
- FORERUNNER** Low, long-period ocean SWELL which commonly precedes the main swell from a distant storm, especially a tropical cyclone.
- FORESHORE** The part of the shore, lying between the crest of the seaward berm (or upper limit of wave wash at high tide) and the ordinary low-water mark, that is ordinarily traversed by the uprush and backrush of the waves as the tides rise and fall. See BEACH FACE.
- FORE REEF** The seaward side of a REEF (usually coral); in places a steep slope covered with reef talus.
- FORWARD SPEED** (hurricane)Rate of movement (propagation) of the hurricane eye in meters per second, knots, or miles per hour.

- FREEBOARD** At a given time, the vertical distance between the water level and the top of the structure. On a ship, the distance from the waterline to main deck or gunwale.
- FRINGING REEF** A coral REEF attached directly to an insular or continental shore. There may be a shallow channel or lagoon between the reef and the adjacent mainland.
- FRONT OF THE FETCH** In wave forecasting, the end of the generating area toward which the wind is blowing.
- FROUDE NUMBER** The dimensionless ratio of the inertial force to the force of gravity for a given fluid flow. It may be given as $Fr = V/Lg$ where V is a characteristic velocity, L is a characteristic length, and g the acceleration of gravity - or as the square root of this number.
- FULLY-DEVELOPED SEA** The waves that form when wind blows for a sufficient period of time across the open ocean. The waves of a fully developed sea have the maximum height possible for a given wind speed, FETCH and duration of wind.

----- **G** -----

- GABION** (1) Steel wire-mesh basket to hold stones or crushed rock to protect a bank or bottom from erosion. (2) Structures composed of masses of rocks, rubble or masonry held tightly together usually by wire mesh so as to form blocks or walls. Sometimes used on heavy erosion areas to retard wave action or as a foundation for BREAKWATERS or JETTIES.
- GALE** A wind between a strong breeze and a storm. A continuous wind blowing in degrees of moderate, fresh, strong, or whole gale and varying in velocity from 28 to 47 nautical miles per hour (see BEAUFORT SCALE).
- GAUGE (GAGE)** Instrument for measuring the water level relative to a datum.
- GENERATING AREA** In wave forecasting, the continuous area of water surface over which the wind blows in nearly a constant direction. Sometimes used synonymously with FETCH LENGTH. Also FETCH.
- GEOGRAPHICAL INFORMATION SYSTEM (GIS)** Database of information which is geographically referenced, usually with an associated visualization system.
- GEOMETRIC MEAN DIAMETER** The diameter equivalent of the arithmetic mean of the logarithmic frequency distribution. In the analysis of beach sands, it is taken as that grain diameter determined graphically by the intersection of a straight line through selected boundary sizes, (generally points on the distribution curve where 16 and 84 percent of the sample is coarser by weight) and a vertical line through the median diameter of the sample.
- GEOMETRIC SHADOW** In wave diffraction theory, the area outlined by drawing straight lines paralleling the direction of wave approach through the extremities of a protective structure. It differs from the actual protected area to the extent that the diffraction and refraction effects modify the wave pattern.
- GEOMORPHOLOGY** (1) That branch of physical geography which deals with the form of the Earth, the general configuration of its surface, the distribution of the land, water, etc. (2) The investigation of the history of geologic changes through the interpretation of topographic forms.

- GEOPHYSICS** The study of the physical characteristics and properties of the earth, usually employing quantitative physical methods.
- GEOTEXTILE** A synthetic fabric which may be woven or non-woven used as a filter.
- GLACIER** A large body of ice moving slowly down a slope of valley or spreading outward on a land surface (e.g., Greenland, Antarctica) and surviving from year to year.
- GLACIO-ISOSTASY** The state of hydrostatic equilibrium of the earth's crust as influenced by the weight of glacier ice.
- GLOBAL POSITIONING SYSTEM (GPS)** A navigational and positioning system developed by the U.S. Department of Defense, by which the location of a position on or above the Earth can be determined by a special receiver at that point interpreting signals received simultaneously from several of a constellation of special satellites.
- GORGE** (1) The deepest portion of an inlet, the **THROAT**. (2) A narrow, deep valley with nearly vertical rock walls.
- GRADED BEDDING** An arrangement of particle sizes within a single bed, with coarse grains at the bottom of the bed and progressively finer grains toward the top of the bed.
- GRADIENT** (1) A measure of slope (soil- or water-surface) in meters of rise or fall per meter of horizontal distance. (2) More general, a change of a value per unit of distance, e.g. the gradient in longshore transport causes erosion or accretion. (3) With reference to winds or currents, the rate of increase or decrease in speed, usually in the vertical; or the curve that represents this rate.
- GRADING** Distribution with regard to size or weight, of individual stones within a bulk volume; heavy, light and fine grading are distinguished.
- GRADUAL CLOSURE METHOD** Method in which the final closure gap in a dam is closed gradually either by the vertical or horizontal closure method; this in contradiction with a sudden closure.
- GRANULAR FILTER** A layer of granular material which is incorporated in an embankment, dam, dike, or bottom protection and is graded so as to allow seepage to flow across or down the filter zone without causing the migration of the material adjacent to the filter.
- GRAVEL** Unconsolidated natural accumulation of rounded rock fragments coarser than sand but finer than pebbles (2-4 mm diameter).
- GRAVITY WAVE** A wave whose velocity of propagation is controlled primarily by gravity. Water waves more than 5 cm long are considered gravity waves. Waves longer than 2.5 cm and shorter than 5 cm are in an indeterminate zone between **CAPILLARY** and **GRAVITY WAVES**. See **RIPPLE**.
- GROIN** (British, **GROYNE**) Narrow, roughly shore-normal structure built to reduce longshore currents, and/or to trap and retain littoral material. Most groins are of timber or rock and extend from a **SEAWALL**, or the backshore, well onto the foreshore and rarely even further offshore. See **T-GROIN**, **PERMEABLE GROIN**, **IMPERMEABLE GROIN**.
- GROIN BAY** The beach compartment between two groins.
- GROIN SYSTEM** A series of groins acting together to protect a section of beach. Commonly called a **GROIN field**.
- GULF** A relatively large portion of the ocean or sea extending far into land; the largest of various forms of inlets of the sea (e.g., Gulf of Mexico, Gulf of Aqaba).
- GUT** A tidal stream connecting two larger waterways.

----- **H** -----

HALCOCLINE A zone in which salinity changes rapidly.

HALF-TIDE LEVEL A plane midway between **MEAN HIGH WATER** and **MEAN LOW WATER**, also called **MEAN TIDE LEVEL**.

HARBOR (British, **HARBOUR**) Any protected water area affording a place of safety for vessels. See also **PORT**.

HARBOR OSCILLATION (HARBOR SURGING) The nontidal vertical water movement in a harbor or bay. Usually the vertical motions are low; but when oscillations are excited by a tsunami or storm surge, they may be quite large. Variable winds, air oscillations, or surf beat also may cause oscillations. See **SEICHE**.

HARD DEFENSES General term applied to impermeable coastal defense structures of concrete, timber, steel, masonry, etc, which reflect a high proportion of incident wave energy.

HEAD OF RIP The part of a rip current that has widened out seaward of the breakers. See also **CURRENT, RIP; CURRENT, FEEDER; and NECK (RIP)**.

HEADLAND (HEAD) (1) A comparatively high promontory with either a **CLIFF** or steep face extending out into a body of water, such as a sea or lake. An unnamed **HEAD** is usually called a headland. (2) The section of **RIP CURRENT** which has widened out seaward of the **BREAKERS**, also called **HEAD OF RIP**. (3) Seaward end of **BREAKWATER** or dam.

HEADWATER LEVEL The level of water in the reservoir.

HEAVE (1) The vertical rise or fall of the waves or the sea. (2) The translational movement of a craft parallel to its vertical axis. (3) The net transport of a floating body resulting from wave action.

HIGH SEAS This term, in municipal and international law, denotes the continuous body of salt water in the world that is navigable in its character and that lies outside territorial waters and maritime belts of the various countries.

HIGH TIDE, HIGH WATER (HW) The maximum elevation reached by each rising tide. See **TIDE**.

HIGH WATER (HW) Maximum height reached by a rising tide. The height may be solely due to the periodic tidal forces or it may have superimposed upon it the effects of prevailing meteorological conditions. Nontechnically, also called the **HIGH TIDE**.

HIGH WATER LINE In strictness, the intersection of the plane of mean high water with the shore. The shoreline delineated on the nautical charts of the National Ocean Service is an approximation of the high water line. For specific occurrences, the highest elevation on the shore reached during a storm or rising tide, including meteorological effects.

HIGH WATER MARK A reference mark on a structure or natural object, indicating the maximum stage of tide or flood.

HIGH WATER OF ORDINARY SPRING TIDES (HWOST) A tidal datum appearing in some British publications, based on high water of ordinary spring tides.

HIGHER HIGH WATER (HHW) The higher of the two high waters of any tidal day. The single high water occurring daily during periods when the tide is diurnal is considered to be a higher high water.

HIGHER LOW WATER (HLW) The higher of two low waters of any tidal day.

HINDCASTING In wave prediction, the retrospective forecasting of waves using measured wind information.

HINTERLAND The region lying inland from the coast. Also the inland area served by a port.

HISTORIC EVENT ANALYSIS Extreme analysis based on hindcasting typically ten events over a period of 100 years.

HOLOCENE An epoch of the QUATERNARY period, from the end of the PLEISTOCENE, about 8,000 years ago, to the present time.

HOMOPYCNAL FLOW A condition in which the outflow jet from a river or coastal inlet and the water in the receiving basin are of the same density or are vertically mixed.

HOOK A spit or narrow cape of sand or gravel which turns landward at the outer end; a RECURVED SPIT.

HORIZONTAL CLOSURE METHOD Construction of a dam by dumping the materials from one or both banks, thus constricting the channel progressively laterally until the dam is closed. This method is also known as end dumping and point tipping.

HURRICANE An intense tropical cyclone in which winds tend to spiral inward toward a core of low pressure, with maximum surface wind velocities that equal or exceed 33.5 m/sec (75 mph or 65 knots) for several minutes or longer at some points. **TROPICAL STORM** is the term applied if maximum winds are less than 33.5 m/sec but greater than a whole gale (63 mph or 55 knots). Term is used in the Atlantic, Gulf of Mexico, and eastern Pacific.

HURRICANE PATH or TRACK Line of movement (propagation) of the eye through an area.

HURRICANE STAGE HYDROGRAPH A continuous graph representing water level stages that would be recorded in a gage well located at a specified point of interest during the passage of a particular hurricane, assuming that effects of relatively short-period waves are eliminated from the record by damping features of the gage well. Unless specifically excluded and separately accounted for, hurricane surge hydrographs are assumed to include effects of astronomical tides, barometric pressure differences, and all other factors that influence water level stages within a properly designed gage well located at a specified point.

HURRICANE WIND PATTERN or ISOVEL PATTERN An actual or graphical representation of near-surface wind velocities covering the entire area of a hurricane at a particular instant. Isovels are lines connecting points of simultaneous equal wind velocities, usually referenced 9 meters (30 feet) above the surface, in meters per second, knots, or meters per hour; wind directions at various points are indicated by arrows or deflection angles on the isovel charts. Isovel charts are usually prepared at each hour during a hurricane, but for each half hour during critical periods.

HYDRAULIC RADIUS Quotient of the wetted cross-sectional area and the wetted perimeter.

HYDRAULICALLY EQUIVALENT GRAINS Sedimentary particles that settle at the same rate under the same conditions.

HYDROGRAPHY (1) The description and study of seas, lakes, rivers and other waters. (2) The science of locating aids and dangers to navigation. (3) The description of physical properties of the waters of a region.

HYDROGRAPHIC PRESSURE The pressure exerted by water at any given point in a body of water at rest.

HYPOPYCNAL FLOW Outflow from a river or coastal inlet in which a wedge of less dense water flows over the denser sea water.

HYPOTHETICAL HURRICANE ("HYPOHURRICANE") A representation of a hurricane, with specified characteristics, that is assumed to occur in a particular study area, following a specified path and timing sequence. **TRANSPOSED**--A hypohurricane based on the storm transposition principle, assumed to have wind patterns and other characteristics basically comparable to a specified hurricane of record, but transposed to follow a new path to serve as a basis for computing a hurricane surge hydrograph that would be expected at a selected point. Moderate adjustments in timing or rate of forward movement may also be made, if these are compatible with meteorological considerations and study objectives. **HYPOHURRICANE BASED ON GENERALIZED PARAMETERS**--Hypohurricane estimates based on various logical combinations of hurricane characteristics used in estimating hurricane surge magnitudes corresponding to a range of probabilities and potentialities. The **STANDARD PROJECT HURRICANE** is most commonly used for this purpose, but estimates corresponding to more severe or less severe assumptions are important in some project investigations. **STANDARD PROJECT HURRICANE (SPH)**--A hypothetical hurricane intended to represent the most severe combination of hurricane parameters that is reasonably characteristic of a specified region, excluding extremely rare combinations. It is further assumed that the SPH would approach a given project site from such direction, and at such rate of movement, to produce the highest **HURRICANE SURGE HYDROGRAPH**, considering pertinent hydraulic characteristics of the area. Based on this concept, and on extensive meteorological studies and probability analyses, a tabulation of "Standard Project Hurricane Index Characteristics" mutually agreed upon by representatives of the U. S. Weather Service and the Corps of Engineers, is available. **PROBABLE MAXIMUM HURRICANE**--A hypohurricane that might result from the most severe combination of hurricane parameters that is considered reasonably possible in the region involved, if the hurricane should approach the point under study along a critical path and at optimum rate of movement. This estimate is substantially more severe than the SPH criteria. **DESIGN HURRICANE**--A representation of a hurricane with specified characteristics that would produce **HURRICANE SURGE HYDROGRAPHS** and coincident wave effects at various key locations along a proposed project alignment. It governs the project design after economics and other factors have been duly considered. The design hurricane may be more or less severe than the SPH, depending on economics, risk, and local considerations.

----- **I** -----

ICE AGE A loosely-used synonym of glacial epoch, or time of extensive glacial activity; specifically of the latest period of widespread continental glaciers, the **PLEISTOCENE Epoch**.

ICE FRONT The floating vertical cliff forming the seaward edge of an **ICE SHELF** or other glacier that enters the sea.

ICE SHELF A extensive sheet of ice which is attached to the land along one side but most of which is afloat and bounded on the seaward side by a steep cliff (**ICE FRONT**) rising 2 to 50+ m above sea level. Common along polar coasts (Antarctica, Greenland), and generally of great breadth and sometimes extending tens or hundreds of km seaward from the continental coastline.

IMPERMEABLE GROIN A **GROIN** constructed such that sand cannot pass through the structure (but sand may still move over or around it).

INCIDENT WAVE Wave moving landward.

INFRAGRAVITY WAVE Long waves with periods of 30 seconds to several minutes.

INLET (1) A short, narrow waterway connecting a bay, lagoon, or similar body of water with a large parent body of water. (2) An arm of the sea (or other body of water) that is long compared to its width and may extend a considerable distance inland. See also **TIDAL INLET**.

INLET GORGE Generally, the deepest region of an inlet channel.

INSHORE (ZONE) In beach terminology, the zone of variable width extending from the low water line through the breaker zone. Also **SHOREFACE**.

INSHORE CURRENT Any current in or landward of the breaker zone.

INSULAR SHELF The zone surrounding an island extending from the low water line to the depth (usually about 183 m; 100 fathoms) where there is a marked or rather steep descent toward the great depths.

INTERNAL WAVES Waves that occur within a fluid whose density changes with depth, either abruptly at a sharp surface of discontinuity (an interface), or gradually. Their amplitude is greatest at the density discontinuity or, in the case of a gradual density change, somewhere in the interior of the fluid and not at the free upper surface where the surface waves have their maximum amplitude.

INTERTIDAL The zone between the high and low water tides.

IRREGULAR WAVES Waves with random wave periods (and in practice, also heights), which are typical for natural wind-induced waves.

IRROTATIONAL WAVE A wave with fluid particles that do not revolve around an axis through their centers, although the particles themselves may travel in circular or nearly circular orbits. Irrotational waves may be **PROGRESSIVE**, **STANDING**, **OSCILLATORY**, or **TRANSLATORY**. For example, the Airy, Stokes, cnoidal, and solitary wave theories describe irrotational waves. Compare **TROCHOIDAL WAVE**.

ISOBATH A contour line connecting points of equal water depths on a chart.

ISOPACHYTE Line connecting points on the seabed with an equal depth of sediment.

ISOVEL PATTERN See **HURRICANE WIND PATTERN**.

ISTHMUS A narrow strip of land, bordered on both sides by water, that connects two larger bodies of land.

----- **J** -----

JET To place (a pile, slab, or pipe) in the ground by means of a jet of water acting at the lower end.

JETTY On open seacoasts, a structure extending into a body of water, which is designed to prevent shoaling of a channel by littoral materials and to direct and confine the stream or tidal flow. Jetties are built at the mouths of rivers or tidal inlets to help deepen and stabilize a channel.

JOINT PROBABILITY The probability of two (or more) things occurring together.

JOINT PROBABILITY DENSITY Function specifying the joint distribution of two (or more) variables.

JOINT RETURN PERIOD Average period of time between occurrences of a given joint probability event.

JONSWAP SPECTRUM Wave spectrum typical of growing deep water waves developed from field experiments and measurements of waves and wave spectra in the Joint North Sea Wave Project

----- **K** -----

KATABATIC WIND Wind caused by cold air flowing down slopes due to gravitational acceleration.

KEY A cay, esp. one of the low, insular banks of sand, coral, and limestone off the southern coast of Florida.

KINEMATIC VISCOSITY The dynamic viscosity divided by the fluid density.

KINETIC ENERGY (OF WAVES) In a progressive oscillatory wave, a summation of the energy of motion of the particles within the wave.

KNOLL A submerged elevation of rounded shape rising less than 1000 meters from the ocean floor and of limited extent across the summit. Compare SEAMOUNT.

KNOT The unit of speed used in navigation equal to 1 nautical mile (6,076.115 ft or 1,852 m) per hour.

----- **L** -----

LAGGING OF TIDE The periodic retardation in the time of occurrence of high and low water due to changes in the relative positions of the moon and sun.

LAGOON A shallow body of water, like a pond or sound, partly or completely separated from the sea by a barrier island or REEF. Sometimes connected to the sea via an INLET.

LAMINAR FLOW Slow, smooth flow, with each drop of water traveling a smooth path parallel to its neighboring drops. Laminar flow is characteristic of low velocities, and particles of sediment in the flow zones are moved by rolling or SALTATION.

LAND BREEZE A light wind blowing from the land to the sea, caused by unequal cooling of land and water masses.

LAND-SEA BREEZE The combination of a land breeze and a sea breeze as a diurnal phenomenon.

- LANDLOCKED** Enclosed, or nearly enclosed, by land--thus protected from the sea, as a bay or a harbor.
- LANDMARK** A conspicuous object, natural or artificial, located near or on land, which aids in fixing the position of an observer.
- LEAD LINE** A line, wire, or cord used in sounding (to obtain water depth). It is weighted at one end with a plummet (sounding lead). Also **SOUNDING LINE**.
- LEDGE** A rocky formation forming a ridge or **REEF**, especially one underwater or near shore.
- LEE** (1) Shelter, or the part or side sheltered or turned away from the wind or waves. (2) (Chiefly nautical) the quarter or region toward which the wind blows.
- LEEWARD** The direction toward which the wind is blowing; the direction toward which waves are traveling.
- LENGTH OF WAVE** The horizontal distance between similar points on two successive waves measured perpendicularly to the crest.
- LEVEE** (1) A ridge or **EMBANKMENT** of sand and silt, built up by a stream on its flood plain along both banks of its channel. (2) A large **DIKE** or artificial **EMBANKMENT**, often having an access road along the top, which is designed as part of a system to protect land from floods.
- LIGHT BREEZE** A wind with velocity from 4 to 6 **KNOTS**.
- LIMIT OF BACKRUSH (LIMIT OF BACKWASH)** See **BACKRUSH**, **BACKWASH**.
- LITTORAL** Of or pertaining to a shore, especially of the sea.
- LITTORAL CELL** A reach of the coast that is isolated sedimentologically from adjacent coastal reaches and that features its own sources and sinks. Isolation is typically caused by protruding headlands, submarine canyons, inlets, and some river mouths that prevent littoral sediment from one cell to pass into the next. Cells may range in size from a multi-hundred meter **POCKET BEACH** in a rocky coast to a **BARRIER ISLAND** many tens of kilometers long.
- LITTORAL CURRENT** See **CURRENT**, **LITTORAL**.
- LITTORAL DEPOSITS** Deposits of littoral drift.
- LITTORAL DRIFT, LITTORAL TRANSPORT** The movement of beach material in the littoral zone by waves and currents. Includes movement parallel (long shore drift) and sometimes also perpendicular (cross-shore transport) to the shore.
- LITTORAL TRANSPORT RATE** Rate of transport of sedimentary material parallel or perpendicular to the shore in the littoral zone. Usually expressed in cubic meters (cubic yards) per year. Commonly synonymous with **LONGSHORE TRANSPORT RATE**.
- LITTORAL ZONE** In beach terminology, an indefinite zone extending seaward from the shoreline to just beyond the breaker zone.
- LOAD** The quantity of sediment transported by a current. It includes the suspended load of small particles and the bedload of large particles that move along the bottom.
- LONG WAVES** Waves with periods above about 30 seconds; can be generated by wave groups breaking in the surf zone. See also **INFRAGRAVITY WAVES**.
- LONGSHORE** Parallel to and near the shoreline; **ALONGSHORE**.
- LONGSHORE BAR** A sand ridge or ridges, running roughly parallel to the shoreline and extending along the shore outside the trough, that may be exposed at low tide or may occur below the water level in the offshore.
- LONGSHORE CURRENT** See **CURRENT**, **LONGSHORE**.
- LONGSHORE DRIFT** Movement of (beach) sediments approximately parallel to the coastline.

- LONGSHORE TRANSPORT RATE** See **LITTORAL TRANSPORT RATE**.
- LONGSHORE TROUGH** An elongate **DEPRESSION** or series of depressions extending along the lower **BEACH** or in the offshore zone inside the **BREAKERS**.
- LOOP** That part of a **STANDING WAVE** where the vertical motion is greatest and the horizontal velocities are least. Loops (sometimes called **ANTINODES**) are associated with **CLAPOTIS** and with **SEICHE** action resulting from wave reflections. Compare **NODE**.
- LOW TIDE (LOW WATER, LW)** The minimum elevation reached by each falling tide. See **TIDE**.
- LOW TIDE TERRACE** A flat zone of the beach near the low water level.
- LOW WATER (LW)** The minimum height reached by each falling tide. Nontechnically, also called **LOW TIDE**.
- LOW WATER DATUM** An approximation to the plane of mean low water that has been adopted as a standard reference plane. See also **DATUM, PLANE** and **CHART DATUM**.
- LOW WATER LINE** The line where the established **LOW WATER DATUM** intersects the shore. The plane of reference that constitutes the **LOW WATER DATUM** differs in different regions.
- LOW WATER OF ORDINARY SPRING TIDES (LWOST)** A tidal datum appearing in some British publications, based on low water of ordinary spring tides.
- LOWER HIGH WATER (LHW)** The lower of the two high waters of any tidal day.
- LOWER LOW WATER DATUM** An approximation to the plane of **MEAN LOWER LOW WATER** that has been adopted as a standard reference plane for a limited area and is retained for an indefinite period regardless of the fact that it may differ slightly from a better determination of **MEAN LOWER LOW WATER** from a subsequent series of observations.
- LOWER LOW WATER (LLW)** The lower of the two low waters of any tidal day. The single low water occurring daily during periods when the tide is diurnal is considered to be a lower low water.
- LUNAR DAY** The time of rotation of the Earth with respect to the moon, or the interval between two successive upper transits of the moon over the meridian of a place. The mean lunar day is approximately 24.84 solar hours in length, or 1.035 times as great as the mean solar day. Also called **TIDAL DAY**.
- LUNAR TIDE** The portion of the tide that can be attributed directly to attraction to the moon.

----- **M** -----

- MACH-STEM WAVE** Higher-than-normal wave generated when waves strike a structure at an oblique angle.
- MACRO-TIDAL** Tidal range greater than 4 m.
- MANAGED RETREAT** The deliberate setting back (moving landward) of the existing line of sea defense in order to obtain engineering or environmental advantages - also referred to as managed landward realignment. Sometimes refers to moving roads and utilities landward in the face of shore retreat.

- MANGROVE** A tropical tree with interlacing prop roots, confined to low-lying brackish areas.
- MARGIN, CONTINENTAL** A zone separating a continent from the deep-sea bottom.
- MARGINAL PROBABILITY** The probability of a single variable in the context of a joint probability analysis.
- MARGINAL RETURN PERIOD** The return period of a single variable in the context of a joint probability analysis.
- MARIGRAM** A graphic record of the rise and fall of the tide. The record is in the form of a curve in which time is represented by abscissas and the height of the tide by ordinates.
- MARKER, REFERENCE** A mark of permanent character close to a survey station, to which it is related by an accurately measured distance and azimuth (or bearing).
- MARKER, SURVEY** An object placed at the site of a station to identify the surveyed location of that station.
- MARSH** (1) A tract of soft, wet land, usually vegetated by reeds, grasses and occasionally small shrubs. (2) Soft, wet area periodically or continuously flooded to a shallow depth, usually characterized by a particular subclass of grasses, cattails and other low plants.
- MARSH, DIKED** A former salt marsh which has been protected by a DIKE.
- MARSH, SALT** A marsh periodically flooded by salt water.
- MASS TRANSPORT, SHOREWARD** The movement of water due to wave motion, which carries water through the BREAKER ZONE in the direction of wave propagation. Part of the NEARSHORE CURRENT SYSTEM.
- MATTRESS** A blanket of brushwood or bamboo, poles, geotextile and reed lashed together to protect a shoreline, embankment or river/sea bed against erosion. Sometimes placed on the sea bed during JETTY construction to prevent stone from settling into soft bottom.
- MEAN DEPTH** The average DEPTH of the water area between the still water level and the SHOREFACE profile from the waterline to any chosen distance seaward.
- MEAN DIAMETER, GEOMETRIC** See GEOMETRIC MEAN DIAMETER.
- MEAN HIGH WATER SPRINGS (MHWS)** The average height of the high water occurring at the time of spring tides.
- MEAN HIGH WATER (MHW)** The average height of the high waters over a 19-year period. For shorter periods of observations, corrections are applied to eliminate known variations and reduce the results to the equivalent of a mean 19-year value. All high water heights are included in the average where the type of tide is either semidiurnal or mixed. Only the higher high water heights are included in the average where the type of tide is diurnal. So determined, mean high water in the latter case is the same as mean higher high water.
- MEAN HIGHER HIGH WATER (MHHW)** The average height of the higher high waters over a 19-year period. For shorter periods of observation, corrections are applied to eliminate known variations and reduce the result to the equivalent of a mean 19-year value.
- MEAN LOW WATER (MLW)** The average height of the low waters over a 19-year period. For shorter periods of observations, corrections are applied to eliminate known variations and reduce the results to the equivalent of a mean 19-year value. All low water heights are included in the average where the type of tide is either semidiurnal or mixed. Only lower low water heights are included in the average where the type of tide is diurnal. So determined, mean low water in the latter case is the same as mean lower low water.
- MEAN LOW WATER SPRINGS** The average height of low waters occurring at the time of the spring tides. It is usually derived by taking a plane depressed below the half-tide level by an amount equal to one-half the spring range of tide, necessary corrections being applied

to reduce the result to a mean value. This plane is used to a considerable extent for hydrographic work outside of the United States and is the plane of reference for the Pacific approaches to the Panama Canal. Frequently abbreviated to LOW WATER SPRINGS.

MEAN LOWER LOW WATER (MLLW) The average height of the lower low waters over a 19-year period. For shorter periods of observations, corrections are applied to eliminate known variations and reduce the results to the equivalent of a mean 19-year value. Frequently abbreviated to LOWER LOW WATER.

MEAN RANGE OF TIDE The difference in height between MEAN HIGH WATER and MEAN LOW WATER.

MEAN RISE OF THE TIDE The height of MEAN HIGH WATER above the plane of reference or DATUM of chart.

MEAN SEA LEVEL The average height of the surface of the sea for all stages of the tide over a 19-year period, usually determined from hourly height readings. Not necessarily equal to MEAN TIDE LEVEL.

MEAN STEEPNESS The ratio of the MEAN DEPTH to the horizontal distance over which the MEAN DEPTH was determined.

MEAN TIDE LEVEL A plane midway between MEAN HIGH WATER and MEAN LOW WATER. Not necessarily equal to MEAN SEA LEVEL. Also HALF-TIDE LEVEL.

MEAN WATER LEVEL The mean surface level as determined by averaging the heights of the water at equal intervals of time, usually at hourly intervals.

MEAN WAVE HEIGHT The mean of all individual waves in an observation interval of approximately half an hour. In case of a Rayleigh distribution 63% of the significant wave height.

MEANDERING A single channel having a pattern of successive deviations in alignment which results in a more or less sinusoidal course.

MEDIAN DIAMETER The diameter which marks the division of a given sand sample into two equal parts by weight, one part containing all grains larger than that diameter and the other part containing all grains smaller.

MEGARIPPLE See SAND WAVE.

MESO-TIDAL Tidal range between 2 m and 4 m.

METEOROLOGICAL TIDES Tidal constituents having their origin in the daily or seasonal variation in weather conditions which may occur with some degree of periodicity.

MICRO-TIDAL Tidal range less than 2 m.

MID-EXTREME TIDE A plane midway between the extreme high water and the extreme LOW WATER occurring in any locality.

MIDDLE-GROUND SHOAL A shoal formed by ebb and flood tides in the middle of the channel of the LAGOON or estuary end of an inlet.

MINERAL A naturally occurring, inorganic, crystalline solid that has a definite chemical composition and possesses characteristic physical properties.

MINIMUM DURATION See DURATION, MINIMUM.

MINIMUM FETCH The least distance in which steady-state wave conditions will develop for a wind of given speed blowing a given duration of time.

MIST Water vapor suspended in the air in very small drops finer than rain, larger than fog.

MIXED CURRENT Type of tidal current characterized by a conspicuous velocity difference between the two floods or two ebbs usually occurring each tidal day.

- MIXED TIDE** A type of tide in which the presence of a diurnal wave is conspicuous by a large inequality in either the high or low water heights, with two high waters and two low waters usually occurring each tidal day. In strictness, all tides are mixed, but the name is usually applied without definite limits to the tide intermediate to those predominantly semidiurnal and those predominantly diurnal.
- MOLE** In coastal terminology, a massive land-connected, solid-fill structure of earth (generally revetted), masonry, or large stone, which may serve as a breakwater or pier.
- MONOCHROMATIC WAVES** A series of waves generated in a laboratory, each of which has the same length and period.
- MONOLITHIC** Like a single stone or block. In coastal structures, the type of construction in which the structure's component parts are bound together to act as one.
- MORaine** An accumulation of earth, stones, etc., deposited by a glacier, usually in the form of a mound, ridge or other prominence on the terrain.
- MORPHODYNAMICS** (1) The mutual interaction and adjustment of the seafloor topography and fluid dynamics involving the motion of sediment. (2) The coupled suite of mutually interdependent hydrodynamic processes, seafloor morphologies, and sequences of change.
- MORPHOLOGICALLY AVERAGED** Single wave condition producing the same net longshore drift as a given proportion of the annual wave climate.
- MORPHOLOGY** River/estuary/lake/seabed form and its change with time.
- MUD** A fluid-to-plastic mixture of finely divided particles of solid material and water.
- MUD FLAT** A level area of fine silt and clay along a shore alternately covered or uncovered by the tide or covered by shallow water.

----- N -----

- NATIONAL TIDAL DATUM EPOCH (NTDE)** A period of 19 years adopted by the National Ocean Service as the period over which observations of tides are to be taken and reduced to average values for tidal datums.
- NATURAL TRACER** A component of a sediment deposit that is unique to a particular source and can be used to identify the source and transport routes to a place of deposition.
- NAUTICAL MILE** The length of a minute of arc, 1/21,600 of an average great circle of the Earth. Generally one minute of latitude is considered equal to one nautical mile. The accepted United States value as of 1 July 1959 is 1,852 meters (6,076.115 feet), approximately 1.15 times as long as the U.S. statute mile of 5,280 feet. Also geographical mile.
- NEAP HIGH WATER** See NEAP TIDE.
- NEAP LOW WATER** See NEAP TIDE.
- NEAP RANGE** See NEAP TIDE.
- NEAP TIDAL CURRENT** Tidal current of decreased velocity occurring semimonthly as the result of the moon being in quadrature.
- NEAP TIDE** Tide of decreased range occurring semimonthly as the result of the moon being in quadrature. The NEAP RANGE of the tide is the average semidiurnal range occurring at the time of neap tides and is most conveniently computed from the harmonic constants.

The NEAP RANGE is typically 10 to 30 percent smaller than the mean range where the type of tide is either semidiurnal or mixed and is of no practical significance where the type of tide is DIURNAL. The average height of the high waters of the neap tide is called NEAP HIGH WATER or HIGH WATER NEAPS (MHWN), and the average height of the corresponding LOW WATER is called NEAP LOW WATER or LOW WATER NEAPS (MLWN).

- NEARSHORE (1) In beach terminology an indefinite zone extending seaward from the SHORELINE well beyond the BREAKER ZONE. (2) The zone which extends from the swash zone to the position marking the start of the offshore zone, typically at water depths of the order of 20 m.
- NEARSHORE CIRCULATION The ocean circulation pattern composed of the NEARSHORE CURRENTS and the COASTAL CURRENTS.
- NEARSHORE CURRENT SYSTEM The current system caused primarily by wave action in and near the breaker zone, and which consists of four parts: the shoreward mass transport of water; longshore currents; seaward return flow, including rip currents; and the longshore movement of the expanding heads of rip currents. See also NEARSHORE CIRCULATION.
- NECK (1) The narrow strip of land which connects a peninsula with the mainland, or connects two ridges. (2) The narrow band (rip) of water flowing seaward through the surf. See also RIP CURRENT.
- NESS Roughly triangular promontory of land jutting into the sea, often consisting of mobile material, i.e. a beach form.
- NETWORK A set consisting of: (a) stations for which geometric relationships have been determined and which are so related that removal of one station from the set will affect the relationships (distances, directions, coordinates, etc.) between the other stations; and (b) lines connecting the stations to show this interdependence.
- NIP The cut made by waves in a shoreline of emergence.
- NODAL ZONE An area in which the predominant direction of the LONGSHORE TRANSPORT changes.
- NODE That part of a STANDING WAVE where the vertical motion is least and the horizontal velocities are greatest. Nodes are associated with CLAPOTIS and with SEICHE action resulting from wave reflections. Compare LOOP.
- NOURISHMENTT he process of replenishing a beach. It may occur naturally by longshore transport, or be brought about artificially by the deposition of dredged materials or of materials trucked in from upland sites.
- NUMERICAL MODELING Refers to analysis of coastal processes using computational models.

----- **O** -----

OCEANOGRAPHY The study of the sea, embracing and indicating all knowledge pertaining to the sea's physical boundaries, the chemistry and physics of seawater, marine biology, and marine geology.

- OFFSHORE** (1) In beach terminology, the comparatively flat zone of variable width, extending from the **SHOREFACE** to the edge of the **CONTINENTAL SHELF**. It is continually submerged. (2) The direction seaward from the shore. (3) The zone beyond the nearshore zone where sediment motion induced by waves alone effectively ceases and where the influence of the sea bed on wave action is small in comparison with the effect of wind. (4) The breaker zone directly seaward of the low tide line.
- OFFSHORE BARRIER** See **BARRIER BEACH**.
- OFFSHORE BREAKWATER** A **BREAKWATER** built towards the seaward limit of the littoral zone, parallel (or nearly parallel) to the shore.
- OFFSHORE CURRENT** (1) Any current in the offshore zone. (2) Any current flowing away from shore.
- OFFSHORE WIND** A wind blowing seaward from the land in the coastal area.
- ONSHORE** A direction landward from the sea.
- ONSHORE WIND** A wind blowing landward from the sea in the coastal area.
- OPPOSING WIND** In wave forecasting, a wind blowing in a direction opposite to the ocean-wave advance; generally, a headwind.
- ORBIT** In water waves, the path of a water particle affected by the wave motion. In deepwater waves the orbit is nearly circular, and in shallow-water waves the orbit is nearly elliptical. In general, the orbits are slightly open in the direction of wave motion, giving rise to **MASS TRANSPORT**.
- ORBITAL CURRENT** The flow of water accompanying the orbital movement of the water particles in a wave. Not to be confused with wave-generated **LITTORAL CURRENTS**.
- ORDINARY HIGH WATER MARK (OHWM)** That mark that will be found by examining the bed and banks and ascertaining where the presence and action of waters are so common and usual, and so long continued in all ordinary years, as to mark upon the soil a character distinct from that of the abutting upland, in respect to vegetation as that condition exists on June 1, 1971, as it may naturally change thereafter, or as it may change thereafter in accordance with permits issued by a local government. Also defined as **MEAN HIGH WATER LINE**.
- ORDINARY TIDE** This expression is not used in a technical sense by the U.S. Coast and Geodetic Survey, but the word "ordinary" when applied to tides, may be taken as the equivalent of the word "mean". Thus "ordinary **HIGH WATER LINE**" may be assumed to be the same as "mean high water line".
- ORTHOGONAL** On a wave-refraction diagram, a line drawn perpendicularly to the wave crests. Also called **WAVE RAY**.
- OSCILLATION** (1) A periodic motion backward and forward. (2) Vibration or variance above and below a mean value.
- OSCILLATORY WAVE** A wave in which each individual particle oscillates about a point with little or no permanent change in mean position. The term is commonly applied to progressive oscillatory waves in which only the form advances, the individual particles moving in closed or nearly closed orbits. Compare **WAVE OF TRANSLATION**. See also **ORBIT**.
- OUTCROP** A surface exposure of bare rock, not covered by soil or vegetation.
- OUTFALL** A structure extending into a body of water for the purpose of discharging sewage, storm runoff, or cooling water.

- OUTFLANKING EROSION** behind or around the land-based end of a **GROIN**, **JETTY**, or **BREAKWATER** or the terminus of a **BULKHEAD**, **REVETMENT**, or **SEAWALL**, usually causing failure of the structure or its function
- OVERSPLASH** The water that splashes over the top of a **BREAKWATER**, **SEAWALL**, etc.
- OVERTOPPING** Passing of water over the top of a structure as a result of wave runoff or surge action.
- OVERWASH** (1) The part of the **UPRUSH** that runs over the crest of a **BERM** or structure and does not flow directly back to the ocean or lake. (2) The effect of waves overtopping a **COASTAL DEFENSE**, often carrying sediment landwards which is then lost to the beach system.

----- **P** -----

- PARAPET** A low wall built along the edge of a structure such as a **SEAWALL** or **QUAY**.
- PARTICLE VELOCITY** The velocity induced by wave motion with which a specific water particle moves within a wave.
- PATCH REEF** A moundlike or flat-topped organic **REEF**, generally less than 1 km across, frequently forming part of a larger reef complex.
- PASS** In hydrographic usage, a navigable channel through a bar, **REEF**, or shoal, or between closely adjacent islands. On the Gulf of Mexico coast, inlets are often known as passes (e.g., Sabine Pass).
- PEAK PERIOD** The wave period determined by the inverse of the frequency at which the wave energy spectrum reaches its maximum.
- PEBBLES** Beach material usually well-rounded and between about 4 mm to 64 mm diameter. See **SOIL CLASSIFICATION**.
- PENINSULA** An elongated body of land nearly surrounded by water and connected to a larger body of land by a neck or isthmus.
- PERCHED BEACH** A beach or fillet of sand retained above the otherwise normal profile level by a submerged dike.
- PERCOLATION** The process by which water flows through the interstices of a sediment. Specifically, in wave phenomena, the process by which wave action forces water through the interstices of the bottom sediment and which tends to reduce wave heights.
- PERIGEAN RANGE** The average semidiurnal range occurring at the time of the **PERIGEAN TIDES** and most conveniently computed from the harmonic constants. It is larger than the mean range where the type of tide is either semidiurnal or mixed and is of no practical significance where the type of tide is diurnal.
- PERIGEAN TIDAL CURRENTS** Tidal currents of increased velocity occurring monthly as the result of the moon being in perigee (i.e., at the point in its orbit nearest the Earth).
- PERIGEAN TIDES** Tides of increased range occurring monthly as the result of the moon being in perigee.
- PERIODIC CURRENT** A current caused by the tide-producing forces of the moon and the sun; a part of the same general movement of the sea that is manifested in the vertical rise and fall of the tides. See also **CURRENT**, **FLOOD** and **CURRENT**, **EBB**.

- PERMANENT CURRENT** A current that runs continuously, independent of the tides and temporary causes. Permanent currents include the freshwater discharge of a river and the currents that form the general circulatory systems of the oceans.
- PERMEABILITY** The property of bulk material (sand, crushed rock, soft rock in situ) which permit movement of water through its pores.
- PERMEABLE GROIN** A GROIN with openings or voids large enough to permit passage of appreciable quantities of LITTORAL DRIFT through the structure.
- PETROGRAPHY** The systematic description and classification of rocks.
- PETROLOGY** That branch of geology which treats the scientific study of rocks.
- PHASE** In surface wave motion, a point in the period to which the wave motion has advanced with respect to a given initial reference point.
- PHASE INEQUALITY** Variations in the tides or tidal currents associated with changes in the phase of the Moon in relation to the Sun.
- PHASE VELOCITY** Propagation velocity of an individual wave as opposed to the velocity of a wave group.
- PHI GRADE SCALE** A logarithmic transformation of the Wentworth grade scale for size classifications of sediment grains based on the negative logarithm to the base 2 of the particle diameter: $= -\log_2 d$. See SOIL CLASSIFICATION.
- PHOTIC ZONE** The zone extending downward from the ocean surface within which the light is sufficient to sustain photosynthesis. The depth of this layer varies with water clarity, time of year and cloud cover, but is about 100 m in the open ocean. It may be considered the Depth to which all light is filtered out except for about one percent and may be calculated as about two and one-half times the depth of a SECCHI DISK reading.
- PHOTOGRAMMETRY** The science of deducing the physical dimensions of objects from measurements on images (usually photographs) of the objects.
- PHOTOMOSAIC** An assemblage of photographs, each of which shows part of a region, put together in such a way that each point in the region appears once and only once in the assemblage, and scale variation is minimized.
- PHREATIC LEVEL** Upper surface of an unconfined aquifer (e.g. the top sand layer in a dike) at which the pressure in the groundwater is equal to atmospheric pressure.
- PHYSICAL GEOLOGY** A large division of Geology concerned with earth materials, changes of the surface and interior of the earth, and the forces that cause those changes.
- PHYSICAL MODELING** Refers to the investigation of coastal or riverine processes using a scaled model.
- PIER** A structure, usually of open construction, extending out into the water from the shore, to serve as a landing place, recreational facility, etc., rather than to afford coastal protection. In the Great Lakes, a term sometimes improperly applied to jetties.
- PIERSON-MOSKOWITZ SPECTRUM** Wave spectrum typical of fully-developed deep water waves.
- PIEZOMETRIC SURFACE** The level at which the hydrostatic water pressure in an aquifer will stand if it is free to seek equilibrium with the atmosphere. For artesian wells, this is above the ground surface.
- PILE** A long, heavy timber or section of concrete or metal that is driven or jetted into the earth or seabed to serve as a support or protection.
- PILING** A group of piles.

- PIPING** Erosion of closed flow channels (tunnels) by the passage of water through soil; flow underneath structures, carrying away particles, may endanger the stability of the structure.
- PLACER DEPOSITS** Mineral deposits consisting of dense, resistant and often economically valuable minerals which have been weathered from TERRIGENOUS rocks, transported to the sea and concentrated in marine sediments by wave or current action.
- PLACER MINE** Surface mines in which valuable mineral grains are extracted from stream bar or beach deposits.
- PLAIN, COASTAL** See COASTAL PLAIN.
- PLANFORM** The outline or shape of a body of water as determined by the still-water line.
- PLATEAU** A land area (usually extensive) having a relatively level surface raised sharply above adjacent land on at least one side; table land. A similar undersea feature.
- PLEISTOCENE** An epoch of the Quaternary Period characterized by several glacial ages.
- PLUNGE POINT** (1) For a plunging wave, the point at which the wave curls over and falls. (2) The final breaking point of the waves just before they rush up on the beach.
- PLUNGING BREAKER** See BREAKER.
- POCKET BEACH** A beach, usually small, in a coastal reentrant or between two littoral barriers.
- POINT** (1) The extreme end of a CAPE, or the outer end of any land area protruding into the water, usually less prominent than a CAPE. (2) A low profile shoreline promontory of more or less triangular shape, the top of which extends seaward.
- POORLY-SORTED (POORLY-GRADED)** Said of a clastic sediment or rock that consists of particles of many sizes mixed together in an unsystematic manner so that no one size class predominates.
- PORE PRESSURE** The interstitial pressure of water within a mass of soil or rock.
- POROSITY** Percentage of the total volume of a soil not occupied by solid particles but by air and water.
- PORT** A place where vessels may discharge or receive cargo; it may be the entire harbor including its approaches and anchorages, or only the commercial part of a harbor where the QUAYS, WHARVES, facilities for transfer of cargo, docks, and repair shops are situated.
- POTENTIAL ENERGY OF WAVES** In a progressive oscillatory wave, the energy resulting from the elevation or depression of the water surface from the undisturbed level.
- PRISM** See TIDAL PRISM.
- PROBABILITY** The chance that a prescribed event will occur, represented by a number (p) in the range 0 - 1. It can be estimated empirically from the relative frequency (i.e. the number of times the particular event occurs, divided by the total count of all events in the class considered).
- PROBABILITY DENSITY** Function specifying the distribution of a variable.
- PROBABLE MAXIMUM WATER LEVEL** A hypothetical water level (exclusive of wave runup from normal wind-generated waves) that might result from the most severe combination of hydrometeorological, geoseismic, and other geophysical factors and that is considered reasonably possible in the region involved, with each of these factors considered as affecting the locality in a maximum manner. This level represents the physical response of a body of water to maximum applied phenomena such as hurricanes, moving squall lines, other cyclonic meteorological events, tsunamis, and astronomical

tide combined with maximum probable ambient hydrological conditions such as wave setup, rainfall, runoff, and river flow. It is a water level with virtually no risk of being exceeded.

PRODELTA The part of a DELTA that is below the effective depth of wave erosion, lying beyond the delta front and sloping down into the basin into which the delta is advancing.

PROFILE, BEACH The intersection of the ground surface with a vertical plane; may extend from the behind the DUNE line or the top of a bluff to well seaward of the breaker zone.

PROGRESSION (of a beach) See ADVANCE.

PROGRESSIVE WAVE A wave that moves relative to a fixed coordinate system in a fluid. The direction in which it moves is termed the direction of wave propagation.

PROMONTORY A high point of land projecting into a body of water; a HEADLAND.

PROPAGATION OF WAVES The transmission of waves through water.

PROTOTYPE In laboratory usage, the full-scale structure, concept, or phenomenon used as a basis for constructing a scale model or copy.

----- Q -----

QUARRY RUN Waste of generally small material, in a quarry, left after selection of larger grading.

QUARRYSTONE Any stone processed from a quarry.

QUATERNARY (1) The youngest geologic period; includes the present time. (2) The latest period of time in the stratigraphic column, 0 B 2 million years, represented by local accumulations of glacial (PLEISTOCENE) and post-glacial (HOLOCENE) deposits which continue, without change of fauna, from the top of the Pliocene (Tertiary). The quaternary appears to be an artificial division of time to separate pre-human from post-human sedimentation. As thus defined, the quaternary is increasing in duration as man's ancestry becomes better understood.

QUAY (pronounced KEY) A stretch of paved bank, or a solid artificial landing place parallel to the navigable waterway, for use in loading and unloading vessels.

QUICKSAND Loose, yielding, wet sand which offers no support to heavy objects. The upward flow of the water has a velocity that eliminates contact pressures between the sand grains and causes the sand-water mass to behave like a fluid that yields easily to pressure and tends to suck down heavy objects.

----- R -----

RADAR An instrument for determining the distance and direction to an object by measuring the time needed for radio signals to travel from the instrument to the object and back, and by measuring the angle through which the instrument's antenna has traveled.

- RADIOACTIVE DATING (RADIOMETRIC DATING)** Calculating an age in years for geologic materials by measuring the presence of a short-life radioactive element (e.g., carbon-14) or a long-life element (e.g., potassium-40/argon-40). The term applies to all methods of age determination based on nuclear decay of naturally-occurring radioactive isotopes. Carbon-14 methods are often used to determine the age of peat or wood found in BARRIER ISLANDS.
- RADIUS OF MAXIMUM WINDS** Distance from the eye of a hurricane, where surface and wind velocities are zero, to the place where surface wind speeds are maximum.
- RAISED BEACH** A wave-cut platform, with or without a covering of beach materials, which is now raised above the present sea-level.
- RANDOM WAVES** The laboratory simulation of irregular sea states that occur in nature.
- RANGE OF TIDE** The difference in height between consecutive high and low waters. The **MEAN RANGE** is the difference between **MEAN HIGH WATER** and **MEAN LOW WATER**. The **GREAT DIURNAL RANGE** or **DIURNAL RANGE** is the difference in height between **MEAN HIGHER HIGH WATER (MHHW)** and **MEAN LOWER LOW WATER (MLLW)**. Where the type of tide is diurnal, the mean range is the same as the diurnal range.
- RAY, WAVE** See **ORTHOGONAL**.
- RAYLEIGH DISTRIBUTION** A model probability distribution, commonly used in analysis of waves.
- REACH** (1) An arm of the ocean extending into the land, e.g., an **ESTUARY**. (2) A straight section of restricted waterway that is uniform with respect to discharge, slope, and cross-section.
- RECENT(Geological)** A synonym of **HOLOCENE**. See also **QUATERNARY**.
- RECESSION** (1) A continuing landward movement of the shoreline. (2) A net landward movement of the shoreline over a specified time.
- RECHARGE** The addition of new water to an **AQUIFER** or to the zone of saturation.
- RECTIFICATION** The process of producing, from a tilted or oblique photograph, a photograph from which displacement caused by tilt has been removed.
- RECURVED SPIT** A spit whose outer end is turned landward by current deflection, by the opposing action of two or more currents, or by **WAVE REFRACTION**; a **HOOK**.
- RED TIDE** Discoloration of surface waters, most frequently in **COASTAL ZONES**, caused by large concentrations of microorganisms.
- REEF** An offshore consolidated rock hazard to navigation, with a least depth of about 20 meters (10 fathoms) or less. Often refers to coral **FRINGING REEFS** in tropical waters.
- REEF, ATOLL** See **ATOLL**.
- REEF, BARRIER** See **BARRIER REEF**.
- REEF BREAKWATER** Rubble mound of single-sized stones with a crest at or below sea level which is allowed to be (re)shaped by the waves.
- REEF, FRINGING** See **FRINGING REEF**.
- REFERENCE PLANE** The plane to which sounding and tidal data are referred. See **DATUM PLANE**.
- REFERENCE POINT** (1) A specified location (in plan elevation) to which measurements are referred. (2) In beach material studies, a specified point within the **REFERENCE ZONE**.
- REFERENCE STATION** A place for which tidal constants have previously been determined and which is used as a standard for the comparison of simultaneous observations at a

- second station. Also, a station for which independent daily predictions are given in the tide or current tables from which corresponding predictions are obtained for other stations by means of differences or factors.
- REFERENCE ZONE** In regard to beach measuring procedure, the part of the FORESHORE subject to wave action (between the Limit of UPRUSH and the Limit of BACKWASH) at mid-tide stage. In areas of great tidal range a more complex definition is needed.
- REFLECTED WAVE** That part of an incident wave that is returned seaward when a wave impinges on a steep beach, barrier, or other reflecting surface.
- REFLECTION** The process by which the energy of the wave is returned seaward.
- REFRACTION (of water waves)** (1) The process by which the direction of a wave moving in shallow water at an angle to the contours is changed: the part of the wave advancing in shallower water moves more slowly than that part still advancing in deeper water, causing the wave crest to bend toward alignment with the underwater contours. (2) The bending of wave crests by currents.
- REFRACTION COEFFICIENT** The square root of the ratio of the distance between adjacent orthogonals in deep water to their distance apart in shallow water at a selected point. When multiplied by the SHOALING FACTOR and a factor for friction and percolation, this becomes the WAVE HEIGHT COEFFICIENT or the ratio of the refracted wave height at any point to the deepwater wave height. Also, the square root of the ENERGY COEFFICIENT.
- REFRACTION DIAGRAM** A drawing showing positions of wave crests and/or orthogonals in a given area for a specific deepwater wave period and direction.
- REGULAR WAVES** Waves with a single height, period, and direction.
- RESERVOIR** An artificial lake, basin or tank in which a large quantity of water can be stored.
- RESIDUAL (WATER LEVEL)** The components of water level not attributable to astronomical effects.
- RESONANCE** The phenomenon of amplification of a free wave or oscillation of a system by a forced wave or oscillation of exactly equal period. The forced wave may arise from an impressed force upon the system or from a boundary condition.
- RETARDATION** The amount of time by which corresponding tidal phases grow later day by day (about 50 minutes).
- RETROGRESSION (of a beach)** See RECESSION.
- RETURN PERIOD** Average period of time between occurrences of a given event.
- REVERSING TIDAL CURRENT** A tidal current that flows alternately in approximately opposite directions with a SLACK WATER at each reversal of direction. Currents of this type usually occur in rivers and straits where the direction of flow is more or less restricted to certain channels. When the movement is towards the shore, the current is said to be flooding, and when in the opposite direction it is said to be ebbing.
- REVTMENT** (1) A facing of stone, concrete, etc., to protect an EMBANKMENT, or shore structure, against erosion by wave action or currents. (2) A retaining wall. (3) Facing of stone, concrete, etc., built to protect a SCARP, EMBANKMENT or shore structure against erosion by waves of currents.
- REYNOLDS NUMBER** The dimensionless ratio of the inertial force to the viscous force in fluid motion, $Re = VL/\nu$ where L is a characteristic length, ν the kinematic viscosity, and V a characteristic velocity. The Reynolds number is of importance in the theory of hydrodynamic stability and the origin of turbulence.

- RIA** A long, narrow inlet, with depth gradually diminishing inward. Shorter and shallower than a FJORD.
- RIDGE AND RUNNEL** Beach topography consisting of sand bars that have welded to the shore during the recovery stage after a storm. At low tide, water ponds in the runnels and flows seaward through gaps in the ridge.
- RIDGE, BEACH** A nearly continuous mound of beach material that has been shaped by wave or other action. Ridges may occur singly or as a series of approximately parallel deposits.
- RILL MARKS** Tiny drainage channels in a beach caused by the flow seaward of water left in the sands of the upper part of the beach after the retreat of the tide or after the dying down of storm waves.
- RIP** A body of water made rough by waves meeting an opposing current, particularly a tidal current; often found where tidal currents are converging and sinking.
- RIP CHANNEL** A channel cut by seaward flow of RIP CURRENT, usually crosses a LONGSHORE BAR.
- RIP CURRENT** A strong surface current flowing seaward from the shore. It usually appears as a visible band of agitated water and is the return movement of water piled up on the shore by incoming waves and wind. With the seaward movement concentrated in a limited band its velocity is somewhat accentuated. A rip consists of three parts: the FEEDER CURRENTS flowing parallel to the shore inside the breakers; the NECK, where the feeder currents converge and flow through the breakers in a narrow band or "rip"; and the HEAD OF RIP, where the current widens and slackens outside the breaker line. A rip current is often miscalled a rip tide. Also called RIP SURF.
- RIP SURF** See RIP CURRENT.
- RIP TIDE** Incorrect term for RIP CURRENT.
- RIPARIAN** (1) Pertaining to the banks of a body of water. (2) Of, on or pertaining to the banks of a river.
- RIPPLE** (1) The ruffling of the surface of water; hence, a little curling wave or undulation. (2) A wave less than 0.05 meter (2 inches) long controlled to a significant degree by both surface tension and gravity. See CAPILLARY WAVE and GRAVITY WAVE.
- RIPPLE MARKS** Undulations produced by fluid movement over sediments. Oscillatory currents produce symmetric ripples whereas a well-defined current direction produces asymmetrical ripples. The crest line of ripples may be straight or sinuous. The characteristic features of ripples depend upon current velocity, particle size, persistence of current direction and whether the fluid is air or water. Sand DUNES may be regarded as a special kind of super-ripple.
- RIPPLES (bed forms)** Small bed forms with wavelengths less than 0.3 m (1 foot) and heights less than 0.03 m (0.1 foot).
- RIPRAP** A protective layer or facing of quarystone, usually well graded within wide size limit, randomly placed to prevent erosion, scour, or sloughing of an embankment or bluff; also the stone so used. The quarystone is placed in a layer at least twice the thickness of the 50 percent size, or 1.25 times the thickness of the largest size stone in the gradation.
- RISK ANALYSIS** Assessment of the total risk due to all possible environmental inputs and all possible mechanisms.
- ROCK WEATHERING** Physical and mineralogical decay processes in rock brought about by exposure to climatic conditions either at the present time or in the geological past.

- ROCK** (1) An aggregate of one or more minerals; or a body of undifferentiated mineral matter (e.g., obsidian). The three classes of rocks are: (a) Igneous B crystalline rocks formed from molten material. Examples are granite and basalt. (b) Sedimentary B resulting from the consolidation of loose sediment that has accumulated in layers. Examples are sandstone, shale and limestone. (c) Metamorphic B formed from preexisting rock as a result of burial, heat, and pressure. (2) A rocky mass lying at or near the surface of the water or along a jagged coastline, especially where dangerous to shipping.
- ROLLER** An indefinite term, sometimes considered to denote one of a series of long-crested, large waves which roll in on a shore, as after a storm.
- ROTARY CURRENT, TIDAL** A tidal current that flows continually with the direction of flow changing through all points of the compass during the tidal period. Rotary currents are usually found offshore where the direction of flow is not restricted by any barriers. The tendency for the rotation in direction has its origin in the deflecting force of the earth's rotation and, unless modified by local conditions, the change is clockwise in the Northern Hemisphere and counterclockwise in the Southern Hemisphere. The velocity of the current usually varies throughout the tidal cycle, passing through two maxima in approximately opposite directions and two minima with the direction of the current at approximately ninety degrees from the direction at the time of maximum velocity.
- RUBBLE** (1) Loose angular waterworn stones along a beach. (2) Rough, irregular fragments of broken rock.
- RUBBLE-MOUND STRUCTURE** A mound of random-shaped and random-placed stones protected with a cover layer of selected stones or specially shaped concrete armor units. (Armor units in a primary cover layer may be placed in an orderly manner or dumped at random.)
- RUN-UP, RUN-DOWN** The upper and lower levels reached by a wave on a beach or coastal structure, relative to still-water level.
- RUNNEL** A corrugation or trough formed in the foreshore or in the bottom just offshore by waves or tidal currents.

----- S -----

- S-SLOPE BREAKWATER** Rubble mound with gentle slope around still-water level and steeper slopes above and below.
- SALIENT** Coastal formation of beach material developed by **WAVE REFRACTION** and diffraction and long shore drift comprising of a bulge in the coastline towards an offshore island or breakwater, but not connected to it as in the case of a **TOMBOLO** - see also **Ness** and **Cusp**.
- SALINITY** Number of grams of salt per thousand grams of sea water, usually expressed in parts per thousand (ppt).
- SALINITY GRADIENT** Change in salinity with expressed in parts per thousand per foot.
- SALT MARSH** A marsh periodically flooded by salt water (also tidal marsh; sea marsh).
- SALT-WEDGE ESTUARY** In this circulation type, the density-driven component dominates and two well-mixed layers are separated by a sharp **HALOCLINE**. The seawater entering the channel appears as a tongue or wedge.

- SALTATION** That method of sand movement in a fluid in which individual particles leave the bed by bounding nearly vertically and, because the motion of the fluid is not strong or turbulent enough to retain them in suspension, return to the bed at some distance downstream. The travel path of the particles is a series of hops and bounds.
- SAND** Sediment particles, often largely composed of quartz, with a diameter of between 0.062 mm and 2 mm, generally classified as fine, medium, coarse or very coarse. Beach sand may sometimes be composed of organic sediments such as calcareous reef debris or shell fragments.
- SAND BAR** (1) See **BAR**. (2) In a river, a ridge of sand built to or near the surface by river currents.
- SAND BYPASSING** See **BYPASSING**, **SAND**.
- SAND DUNE** A **DUNE** formed of sand.
- SAND REEF** See **BAR**.
- SAND SPIT** A narrow sand **EMBANKMENT**, created by an excess of deposition at its seaward terminus, with its distal end (the end away from the point of origin) terminating in open water.
- SAND WAVES** (1) Longshore sand waves are large-scale features that maintain form while migrating along the shore with speeds on the order of kilometers per year. (2) Large-scale asymmetrical bedforms in sandy river beds having high length to height ratios and continuous crestlines.
- SCARP, BEACH** An almost vertical slope along the beach caused by erosion by wave action. It may vary in height from a few cm to a meter or so, depending on wave action and the nature and composition of the beach. See also **ESCARPMENT**.
- SCATTER DIAGRAM** A two-dimensional histogram showing the joint probability density of two variables within a data sample.
- SCOUR** Removal of underwater material by waves and currents, especially at the base or toe of a shore structure.
- SCOUR PROTECTION** Protection against erosion of the seabed in front of the toe.
- SEA** (1) A large body of salt water, second in rank to an ocean, more or less landlocked and generally part of, or connected with, an ocean or a larger sea. Examples: Mediterranean Sea; South China Sea. (2) Waves caused by wind at the place and time of observation. (3) State of the ocean or lake surface, in regard to waves.
- SEA BREEZE** A light wind blowing from the sea toward the land caused by unequal heating of land and water masses.
- SEA CHANGE** (1) A change wrought by the sea. (2) A marked transformation.
- SEA CLIFF** A cliff situated at the seaward edge of the coast.
- SEA GRASS** Members of marine seed plants that grow chiefly on sand or sand-mud bottom. They are most abundant in water less than 9 m deep. The common types are: Eel grass (*Zostera*), Turtle grass (*Thalassia*), and Manatee grass (*Syringodium*).
- SEA LEVEL** See **MEAN SEA LEVEL**.
- SEA LEVEL RISE** The long-term trend in **MEAN SEA LEVEL**.
- SEA PUSS** A dangerous longshore current; a rip current caused by return flow; loosely, the submerged channel or inlet through a bar caused by those currents.
- SEA STATE** Description of the sea surface with regard to wave action. Also called state of sea.
- SEACOAST** The coast adjacent to the sea or ocean.

SEAMOUNT An elevation rising more than 1000 meters above the ocean floor, and of limited extent across the summit. Compare **KNOLL**.

SEAS Waves caused by wind at the place and time of observation.

SEASHORE (1) (Law) All ground between the ordinary high-water and low-water mark. (2) The shore of the sea or ocean, often used in a general sense (e.g., to visit the seashore).

SEAWALL (1) A structure, often concrete or stone, built along a portion of a coast to prevent erosion and other damage by wave action. Often it retains earth against its shoreward face. (2) A structure separating land and water areas to alleviate the risk of flooding by the sea. Generally shore-parallel, although some reclamation **SEAWALLS** may include lengths that are normal or oblique to the (original) shoreline. A **SEAWALL** is typically more massive and capable of resisting greater wave forces than a **BULKHEAD**.

SECHHI DISK Visibility disk (white and black, 30 cm diameter) used to measure the transparency of the water.

SEDIMENT (1) Loose, fragments of rocks, minerals or organic material which are transported from their source for varying distances and deposited by air, wind, ice and water. Other sediments are precipitated from the overlying water or form chemically, in place. Sediment includes all the unconsolidated materials on the sea floor. (2) The fine grained material deposited by water or wind.

SEDIMENT CELL In the context of a strategic approach to coastal management, a length of coastline in which interruptions to the movement of sand or shingle along the beaches or near shore sea bed do not significantly affect beaches in the adjacent lengths of coastline.

SEDIMENT SINK Point or area at which beach material is irretrievably lost from a coastal cell, such as an estuary, or a deep channel in the seabed.

SEDIMENT SOURCE Point or area on a coast from which beach material is supplied, such as an eroding cliff, or river mouth.

SEDIMENT TRANSPORT The main agencies by which sedimentary materials are moved are: gravity (gravity transport); running water (rivers and streams); ice (glaciers); wind; the sea (currents and **LONGSHORE DRIFT**). Running water and wind are the most widespread transporting agents. In both cases, three mechanisms operate, although the particle size of the transported material involved is very different, owing to the differences in density and viscosity of air and water. The three processes are: rolling or traction, in which the particle moves along the bed but is too heavy to be lifted from it; **SALTATION**; and suspension, in which particles remain permanently above the bed, sustained there by the turbulent flow of the air or water.

SEDIMENT TRANSPORT PATHS The routes along which net sediment movement occurs.

SEEPAGE The movement of water through small cracks, pores, interstices, out of a body of surface or subsurface water. The loss of water by infiltration from a canal, reservoir or other body of water or from a field. It is generally expressed as flow volume per unit of time.

SEICHE (1) A standing wave oscillation of an enclosed waterbody that continues, pendulum fashion, after the cessation of the originating force, which may have been either seismic or atmospheric. (2) An oscillation of a fluid body in response to a disturbing force having the same frequency as the natural frequency of the fluid system. Tides are now considered to be seiches induced primarily by the periodic forces caused by the Sun and Moon. (3) In the Great Lakes area, any sudden rise in the water of a harbor or a lake

whether or not it is oscillatory (although inaccurate in a strict sense, this usage is well established in the Great Lakes area).

SEISMIC REFLECTION The return of part of the energy of seismic waves to the earth=s surface after the waves bounce off an acoustic boundary (typically rock or material of different density).

SEISMIC REFRACTION The bending of seismic waves as they pass from one material to another.

SEISMIC SEA WAVE See TSUNAMI.

SELECTIVE SORTING A process occurring during sediment transport that tends to separate particles according to their size, density, and shape. A well-sorted distribution contains a limited range of grain sizes and usually indicates that the depositional environment contains a narrow range of sediment sizes or a narrow band of depositional energy. A poorly-sorted distribution contains a wide range of grain sizes indicating multiple sources of sediment or a wide range of deposition energies.

SELF-SUSTAINING BEACH A BEACH that has either natural or engineered sand retention and that can be stable through the continued supply of natural sediment sources, without any mechanical nourishment over a long period. Subsets include: Natural or Geomorphically Self-sustaining Beaches: self-sustaining naturally without the construction of retaining structures and with no continued mechanical sand nourishment. Anthropogenically Self-sustaining Beaches: self-sustaining by the construction of retaining structure(s) with or without initial beach fill but with no continued mechanical sand nourishment.

SEMIDIURNAL Having a period or cycle of approximately one-half of a tidal day (12.4 hours). The predominating type of tide throughout the world is semidiurnal, with two high waters and two low waters each tidal day. The tidal current is said to be semidiurnal when there are two flood and two ebb periods each day.

SENSING, REMOTE The response of an instrument or organism to stimuli from a distant source.

SETBACK A required open space, specified in shoreline master programs, measured horizontally upland from an perpendicular to the ordinary high water mark.

SETUP, WAVE Superelevation of the water surface over normal surge elevation due to onshore mass transport of the water by wave action alone.

SETUP, WIND See WIND SETUP.

SHALLOW WATER (1) Commonly, water of such a depth that surface waves are noticeably affected by bottom topography. It is customary to consider water of depths less than one-half the surface wavelength as shallow water. See TRANSITIONAL ZONE and DEEP WATER. (2) More strictly, in hydrodynamics with regard to progressive gravity waves, water in which the depth is less than 1/25 the wavelength.

SHALLOW WATER WAVE A PROGRESSIVE WAVE which is in water less than 1/25 the wave length in depth.

SHEAR INSTABILITIES Instabilities of the surf zone longshore current commonly found on beaches with barred depth profiles. These instabilities are vertical motions with little surface elevation expression. Conservation of vorticity is the restoring mechanism.

SHEAR WAVES See SHEAR INSTABILITIES

SHEET EROSION The removal of a thin layer of surface material, usually topsoil, by a flowing sheet of water.

SHEET FLOW Sediment grains under high shear stress moving as a layer that extends from the bed surface to some distance below (on the order of a few cm). Grains are transported in the direction of fluid flow.

SHEET PILE See **PILE**, **SHEET**.

SHEET, SMOOTH A sheet on which field control and hydrographic data such as soundings, depth curves, and regions surveyed with a wire drag are finally plotted before being used in making a final chart.

SHELF, CONTINENTAL See **CONTINENTAL SHELF**.

SHELF, INSULAR See **INSULAR SHELF**.

SHINGLE (1) Loosely and commonly, any beach material coarser than ordinary gravel, especially any having flat or flattish pebbles. (2) Strictly and accurately, beach material of smooth, well-rounded pebbles that are roughly the same size. The spaces between pebbles are not filled with finer materials. Shingle often gives out a musical sound when stepped on. The term is more widely used in Great Britain than in the U.S.

SHOAL (1) (noun) A detached area of any material except rock or coral. The depths over it are a danger to surface navigation. Similar continental or insular shelf features of greater depths are usually termed **BANKS**. (2) (verb) To become shallow gradually. (3) To cause to become shallow. (4) To proceed from a greater to a lesser depth of water.

SHOALING Decrease in water depth. The transformation of wave profile as they propagate inshore.

SHOALING COEFFICIENT The ratio of the height of a wave in water of any depth to its height in deep water with the effects of refraction, friction, and percolation eliminated. Sometimes **SHOALING FACTOR** or **DEPTH FACTOR**. See also **ENERGY COEFFICIENT** and **REFRACTION COEFFICIENT**.

SHOALING FACTOR See **SHOALING COEFFICIENT**.

SHORE The narrow strip of land in immediate contact with the sea, including the zone between high and low water lines. A shore of unconsolidated material is usually called a **BEACH**. Also used in a general sense to mean the coastal area (e.g., to live at the shore).

SHORE NORMAL A line at right-angles to the contours in the surf zone.

SHORE TERRACE A terrace made along a **COAST** by the action of waves and shore currents; it may become dry land by the uplifting of the shore or the lowering of the water. Also known as shore platform or wave-cut platform.

SHOREFACE The narrow zone seaward from the low tide **SHORELINE**, covered by water, over which the beach sands and gravels actively oscillate with changing wave conditions. See **INSHORE (ZONE)**.

SHORELINE The intersection of a specified plane of water with the shore or beach (e.g., the high water shoreline would be the intersection of the plane of mean high water with the shore or beach). The line delineating the shoreline on National Ocean Service nautical charts and surveys approximates the mean high water line.

SHORELINE MANAGEMENT The development of strategic, long-term and sustainable Coastal defense and land-use policy within a sediment cell.

SHORT-CRESTED WAVE A wave, the crest length of which is of the same order of magnitude as the wave length. A system of short-crested waves has the appearance of hills being separated by troughs.

SIGNIFICANT WAVE A statistical term relating to the one-third highest waves of a given wave group and defined by the average of their heights and periods. The composition of

the higher waves depends upon the extent to which the lower waves are considered. Experience indicates that a careful observer who attempts to establish the character of the higher waves will record values which approximately fit the definition of the significant wave.

SIGNIFICANT WAVE HEIGHT The average height of the one-third highest waves of a given wave group. Note that the composition of the highest waves depends upon the extent to which the lower waves are considered. In wave record analysis, the average height of the highest one-third of a selected number of waves, this number being determined by dividing the time of record by the significant period. Also **CHARACTERISTIC WAVE HEIGHT**.

SIGNIFICANT WAVE PERIOD An arbitrary period generally taken as the period of the one-third highest waves within a given group. Note that the composition of the highest waves depends upon the extent to which the lower waves are considered. In wave record analysis, this is determined as the average period of the most frequently recurring of the larger well-defined waves in the record under study.

SILL (1) A submerged structure across a river to control the water level upstream. (2) The crest of a spillway.

SILT Sediment particles with a grain size between 0.004 mm and 0.062 mm, i.e. coarser than clay particles but finer than sand. See **SOIL CLASSIFICATION**.

SINUSOIDAL WAVE An oscillatory wave having the form of a sinusoid.

SLACK TIDE (SLACK WATER) The state of a tidal current when its velocity is near zero, especially the moment when a reversing current changes direction and its velocity is zero. Sometimes considered the intermediate period between ebb and flood currents during which the velocity of the currents is less than 0.05 meter per second (0.1 knot). See **STAND OF TIDE**.

SLIDE In mass wasting, movement of a descending mass along a plane approximately parallel to the slope of the surface.

SLIP A berthing space between two piers.

SLIP FACE The steep, downwind slope of a **DUNE**; formed from loose, cascading sand that generally keeps the slope at the **ANGLE OF REPOSE** (about 34 deg.).

SLOPE The degree of inclination to the horizontal. Usually expressed as a ratio, such as 1:25, indicating one unit rise in 25 units of horizontal distance; or in a decimal fraction (0.04). Also called **GRADIENT**.

SLOUGH A small muddy marshland or tidal waterway which usually connects other tidal areas. See **BAYOU**.

SLUICE A structure containing a gate to control the flow of water from one area to another.

SLUMP In mass wasting, movement along a curved surface in which the upper part moves vertically downward while the lower part moves outward.

SOFT DEFENSES Usually refers to beaches (natural or designed) but may also relate to energy-absorbing beach-control structures, including those constructed of rock, where these are used to control or redirect coastal processes rather than opposing or preventing them.

SOIL A layer of weathered, unconsolidated material on top of bed rock; in geologic usage, usually defined as containing organic matter and being capable of supporting plant growth.

- SOIL CLASSIFICATION (size)** An arbitrary division of a continuous scale of grain sizes such that each scale unit or grade may serve as a convenient class interval for conducting the analysis or for expressing the results of an analysis. There are many classifications used.
- SOLITARY WAVE** A wave consisting of a single elevation (above the original water surface), whose height is not necessarily small compared to the depth, and neither followed nor preceded by another elevation or depression of the water surfaces.
- SORTING** Process of selection and separation of sediment grains according to their grain size (or grain shape or specific gravity).
- SORTING COEFFICIENT** A coefficient used in describing the distribution of grain sizes in a sample of unconsolidated material. It is defined as $S_o = Q_1/Q_3$, where Q_1 is the diameter (in millimeters) which has 75 percent of the cumulative size-frequency (by weight) distribution smaller than itself and 25 percent larger than itself, and Q_3 is that diameter having 25 percent smaller and 75 percent larger than itself.
- SOUND** (1) (noun) a relatively long arm of the sea or ocean forming a channel between an island and a mainland or connecting two larger bodies, as a sea and the ocean, or two parts of the same body; usually wider and more extensive than a STRAIT. Example: Long Island Sound. (2) (verb) To measure the depth of the water.
- SOUNDING** A measured depth of water. On hydrographic charts the soundings are adjusted to a specific plane of reference (SOUNDING DATUM).
- SOUNDING DATUM** The plane to which soundings are referred. See also CHART DATUM.
- SOUNDING LINE** A line, wire, or cord used in sounding, which is weighted at one end with a plummet (sounding lead). Also LEAD LINE.
- SPILLING BREAKER** See BREAKER.
- SPILLOVER LOBE** Linguoid, bar-like feature formed by ebb tidal current flow over a low area of an ebb shield.
- SPILLWAY** A structure over or through a dam for discharging flood flows.
- SPIT** A small point of land or a narrow shoal projecting into a body of water from the shore.
- SPOIL** Overburden or other waste material removed in mining, dredging, and quarrying.
- SPRING RANGE** The average SEMIDIURNAL range occurring at the time of SPRING TIDES and most conveniently computed from the harmonic constants. It is larger than the MEAN RANGE where the type of tide is either SEMIDIURNAL or MIXED, and is of no practical significance where the type of tide is DIURNAL.
- SPRING TIDAL CURRENTS** Tidal currents of increased velocity occurring semi-monthly as the result of the moon being new or full.
- SPRING TIDE** A tide that occurs at or near the time of new or full moon (SYZYGY) and which rises highest and falls lowest from the mean sea level.
- SPUR-DIKE** See GROIN.
- STACK** An isolated, pillar-like rocky island isolated from a nearby headland by wave erosion; a needle or chimney rock.
- STAND OF TIDE** A interval at high or low water when there is no sensible change in the height of the tide. The water level is stationary at high and low water for only an instant, but the change in level near these times is so slow that it is not usually perceptible. See SLACK TIDE.
- STANDARD PROJECT HURRICANE** See HYPOTHETICAL HURRICANE.
- STANDING WAVE** A type of wave in which the surface of the water oscillates vertically between fixed points, called nodes, without progression. The points of maximum vertical

- rise and fall are called antinodes or loops. At the nodes, the underlying water particles exhibit no vertical motion, but maximum horizontal motion. At the antinodes, the underlying water particles have no horizontal motion, but maximum vertical motion. They may be the result of two equal progressive wave trains traveling through each other in opposite directions. Sometimes called CLAPOTIS or STATIONARY WAVE.
- STATION, CONTROL** A point on the ground whose horizontal or vertical location is used as a basis for obtaining locations of other points.
- STATIONARY WAVE** A wave of essentially stable form which does not move with respect to a selected reference point; a fixed swelling. Sometimes called STANDING WAVE.
- STEP** The nearly horizontal section which more or less divides the BEACH from the SHOREFACE.
- STILLWATER LEVEL (SWL)** The surface of the water if all wave and wind action were to cease. In deep water this level approximates the midpoint of the wave height. In shallow water it is nearer to the trough than the crest. Also called the UNDISTURBED WATER LEVEL.
- STOCHASTIC** Having random variation in statistics.
- STOCKPILE** Sand piled on a beach foreshore to nourish downdrift beaches by natural littoral currents or forces. See FEEDER BEACH.
- STONE** Quarried or artificially-broken rock for use in construction, either as aggregate or cut into shaped blocks as dimension stone.
- STONE, DERRICK** Stone heavy enough to require handling individual pieces by mechanical means, generally weighing 900 kg (1 ton) and up.
- STORM SURGE** A rise above normal water level on the open coast due to the action of wind stress on the water surface. Storm surge resulting from a hurricane also includes that rise in level due to atmospheric pressure reduction as well as that due to wind stress. See WIND SETUP.
- STORM TIDE** See STORM SURGE.
- STRAIT** A relatively narrow waterway between two larger bodies of water (e.g., Strait of Gibraltar). See also SOUND.
- STRAND** (1) The shore or beach of the ocean or a large lake. The land bordering any large body of water, especially a sea or an arm of the ocean. (2) WHARF, QUAY, or roadway along a water body, esp. in a city.
- STRAND PLAIN** A prograded shore built seawards by waves and currents.
- STRANDFLAT** A wave-cut platform; an elevated wave-cut terrace
- STRANDING** The running aground of a ship upon a STRAND, ROCK, or bottom so that it is fast for a time.
- STRANDLINE** An accumulation of debris (e.g. seaweed, driftwood and litter) cast up onto a beach, and lying along the limit of wave up rush. A shoreline above the present water level.
- STRATIGRAPHY** (1) The study of stratified rocks (sediments and volcanics) especially their sequence in time. (2) The character of the rocks and the correlation of beds in different localities.
- STREAM** (1) A course of water flowing along a bed in the Earth. (2) A current in the sea formed by wind action, water density differences, etc.; e.g. the Gulf Stream. See also CURRENT, STREAM.

- STREAM CURRENT** A narrow, deep and swift ocean current, such as the Gulf Stream.
Opposite of **DRIFT CURRENT**.
- STRUCTURAL GEOLOGY** The branch of geology concerned with the internal structure of bed rock and the shapes, arrangement, and interrelationships of rock units.
- SUBAERIAL** Situated or occurring on or adjacent to the surface of the earth, usually meaning above the water surface.
- SUBAERIAL BEACH** That part of the beach which is uncovered by water (e.g. at low tide sometimes referred to as drying beach).
- SUBAQUEOUS** Existing, formed, or taking place under water; submerged.
- SUB-TIDAL BEACH** The part or the beach (where it exists) which extends from low water out to the approximate limit of storm erosion. The latter is typically located at a maximum water depth of 8 to 10 meters and is often identifiable on surveys by a break in the slope of the bed.
- SUBCRITICAL FLOW** Flow for which the Froude number is less than unity; surface disturbances can travel upstream.
- SUBDUCTION ZONE** Elongate region in which the sea floor slides beneath a continent or island arc.
- SUBMARINE CANYON** V-shaped valleys that run across the **CONTINENTAL SHELF** and down the **CONTINENTAL SLOPE**.
- SUBMERGENT COAST** A **COAST** in which formerly dry land has been recently drowned, either by land subsidence or a rise in seal level.
- SUBORDINATE STATION** A tide or current station at which a short series of observations has been obtained, which is to be reduced by comparison with simultaneous observations at another station having well-determined tidal or current constants.
- SUBSIDENCE** Sinking or downwarping of a part of the earth's surface.
- SUBTIDAL** Below the low-water datum; thus permanently.
- SUPER-CRITICAL FLOW** Flow for which the Froude number is greater than unity; surface disturbances will not travel upstream.
- SURF** (1) Collective term for **BREAKERS**. (2) The wave activity in the area between the shoreline and the outermost limit of breakers. (3) In literature, the term surf usually refers to the breaking waves on shore and on reefs when accompanied by a roaring noise caused by the larger waves breaking.
- SURF BEAT** Irregular oscillations of the nearshore water level with periods on the order of several minutes.
- SURF ZONE** The zone of wave action extending from the water line (which varies with tide, surge, set-up, etc.) out to the most seaward point of the zone (breaker zone) at which waves approaching the coastline commence breaking, typically in water depths of between 5 to 10 meters.
- SURFACE GRAVITY WAVE (PROGRESSIVE)** (1) this is the term which applies to the **WIND WAVES** and **SWELL** of lakes and oceans, also called **SURFACE WATER WAVE**, **SURFACE WAVE** or **DEEP WATER WAVE**, (2) a progressive **GRAVITY WAVE** in which the disturbance is confined to the upper limits of a body of water. Strictly speaking this term applies to those progressive **GRAVITY WAVES** whose celerity depends only upon the wave length.
- SURFACE WATER WAVE** See **SURFACE GRAVITY WAVE (PROGRESSIVE)**.

- SURGE** (1) The name applied to wave motion with a period intermediate between that of the ordinary wind wave and that of the tide, say from 2 to 60 min. It is low height, usually less than 0.9 m (3 ft). See also SEICHE. (2) In fluid flow, long interval variations in velocity and pressure, not necessarily periodic, perhaps even transient in nature. (3) see **STORM SURGE**.
- SURGING BREAKER** See **BREAKER**.
- SURVEY, CONTROL** A survey that provides coordinates (horizontal or vertical) of points to which supplementary surveys are adjusted.
- SURVEY, HYDROGRAPHIC** A survey that has as its principal purpose the determination of geometric and dynamic characteristics of bodies of water.
- SURVEY, PHOTOGRAMMETRIC** A survey in which monuments are placed at points that have been determined photogrammetrically.
- SURVEY, TOPOGRAPHIC** A survey which has, for its major purpose, the determination of the configuration (relief) of the surface of the land and the location of natural and artificial objects thereon.
- SUSPENDED LOAD** (1) The material moving in suspension in a fluid, kept up by the upward components of the turbulent currents or by colloidal suspension. (2) The material collected in or computed from samples collected with a **SUSPENDED LOAD SAMPLER**. Where it is necessary to distinguish between the two meanings given above, the first one may be called the "true suspended load."
- SUSPENDED LOAD SAMPLER** A sampler which attempts to secure a sample of the water with its sediment load without separating the sediment from the water.
- SUSTAINABLE BEACH** A beach area that is now and will continue to receive sufficient sediment input over a long period (years or decades) to remain stable. Such sediment input can be through either natural supplies of sediment or various forms of mechanical beach nourishment (placement by hydraulic dredge, land haul of material, nearshore deposition, etc.)
- SWALE** The depression between two beach ridges.
- SWASH** The rush of water up onto the beach face following the breaking of a wave. Also **UPRUSH, RUNUP**.
- SWASH BARS** Low broad sandy bars formed by sediment in the surf and swash zones, separated by linear depressions, or **RUNNELS**, running parallel to the shore. Sand bodies that form and migrate across ebb-tidal shoals because of currents generated by breaking waves.
- SWASH CHANNEL** (1) On the open shore, a channel cut by flowing water in its return to the present body (e.g., a rip channel). (2) A secondary channel passing through or shoreward of an inlet or river bar.
- SWASH MARK** The thin wavy line of fine sand, mica scales, bits of seaweed, etc., left by the uprush when it recedes from its upward limit of movement on the beach face.
- SWASH PLATFORM** Sand sheet located between the main ebb channel of a coastal inlet and an adjacent barrier island.
- SWASH ZONE** The zone of wave action on the beach, which moves as water levels vary, extending from the limit of run-down to the limit of run-up.
- SWELL** Wind-generated waves that have traveled out of their generating area. Swell characteristically exhibits a more regular and longer period and has flatter crests than waves within their fetch (**SEAS**).

SYNOPTIC CHART A chart showing the distribution of meteorological conditions over a given area at a given time. Popularly called a weather map.

SYZYGY The two points in the Moon's orbit when the Moon is in conjunction or opposition to the Sun relative to the Earth; time of new or full Moon in the cycle of phases.

----- **T** -----

T-GROIN A GROIN built in the shape of a letter T with the trunk section connected to land.

TECTONIC FORCES Forces generated from within the earth that result in uplift, movement, or deformation of part of the earth's crust.

TECTONICS The study of the major structural features of the Earth's crust or the broad structure of a region.

TERMINAL GROIN A GROIN, often at the end of a barrier spit, intended to prevent sediment passage into the channel beyond.

TERRACE A horizontal or nearly horizontal natural or artificial topographic feature interrupting a steeper slope, sometimes occurring in a series.

TERRIGENOUS SEDIMENTS Literally land-formed sediment that has found its way to the sea floor. The term is applied (a) to sediments formed and deposited on land (e.g., soils, sand DUNES), and (b) to material derived from the land when mixed in with purely marine material (e.g., sand or clay in a shelly limestone).

THALWEG In hydraulics, the line joining the deepest points of an inlet or stream channel.

THRESHOLD OF MOTION The point at which the forces imposed on a sediment particle overcome its inertia and it starts to move.

THRESHOLD VELOCITY The maximum orbital velocity at which the sediment on the BED begins to move as waves approach shallow water.

TIDAL CREEK A creek draining back-barrier areas with a current generated by the rise and fall of the tide.

TIDAL CURRENT See CURRENT, TIDAL.

TIDAL DATUM See CHART DATUM and DATUM PLANE.

TIDAL DAY The time of the rotation of the Earth with respect to the Moon, or the interval between two successive upper transits of the Moon over the meridian of a place, approximately 24.84 solar hours (24 hours and 50 minutes) or 1.035 times the mean solar day. Also called lunar day.

TIDAL DELTA See DELTA.

TIDAL FLATS (1) Marshy or muddy areas covered and uncovered by the rise and fall of the tide. A TIDAL MARSH. (2) Marshy or muddy areas of the seabed which are covered and uncovered by the rise and fall of tidal water.

TIDAL INLET (1) A natural inlet maintained by tidal flow. (2) Loosely, any inlet in which the tide ebbs and flows. Also TIDAL OUTLET.

TIDAL MARSH Same as TIDAL FLATS.

TIDAL PERIOD The interval of time between two consecutive, like phases of the tide.

TIDAL POOL A pool of water remaining on a beach or reef after recession of the tide.

- TIDAL PRISM** (1) The total amount of water that flows into a harbor or out again with movement of the tide, excluding any fresh water flow. (2) The volume of water present between MEAN LOW and MEAN HIGH TIDE.
- TIDAL RANGE** The difference in height between consecutive high and low (or higher high and lower low) waters.
- TIDAL RISE** The height of tide as referred to the datum of a chart.
- TIDAL RIVER** That part of a river where the water level is influenced by the tide.
- TIDAL SHOALS** Shoals that accumulate near inlets due to the transport of sediments by tidal currents associated with the inlet.
- TIDAL STAND** An interval at high or low water when there is no observable change in the height of the tide. The water level is stationary at high and Low water for only an instant, but the change in level near these times is so slow that it is not usually perceptible.
- TIDAL WAVE** (1) The wave motion of the tides. (2) In popular usage, any unusually high and destructive water level along a shore. It usually refers to STORM SURGE or TSUNAMI.
- TIDALLY DRIVEN CIRCULATION** The movement of fresh water and seawater that are mixed by the sloshing back and forth of the ESTUARY in response to ocean tides.
- TIDE** The periodic rising and falling of the water that results from gravitational attraction of the Moon and Sun and other astronomical bodies acting upon the rotating Earth. Although the accompanying horizontal movement of the water resulting from the same cause is also sometimes called the tide, it is preferable to designate the latter as TIDAL CURRENT, reserving the name TIDE for the vertical movement.
- TIDE, DAILY RETARDATION OF** The amount of time by which corresponding tides grow later day by day (about 50 minutes). Also LAGGING.
- TIDE, DIURNAL** A tide with one high water and one low water in a day.
- TIDE, EBB** See EBB TIDE.
- TIDE, FLOOD** See FLOOD TIDE.
- TIDE, MIXED** See MIXED TIDE.
- TIDE, NEAP** See NEAP TIDE.
- TIDE, SEMIDIURNAL** See SEMIDIURNAL TIDE.
- TIDE, SLACK** See SLACK TIDE.
- TIDE, SPRING** See SPRING TIDE.
- TIDE STAFF** A tide gage consisting of a vertical graduated staff from which the height of the tide can be read directly. It is called a fixed staff when it is secured in place so that it cannot be easily removed. A portable staff is designed for removal from the water when not in use.
- TIDE STATION** A place at which tide observations are being taken. It is called a primary tide station when continuous observations are to be taken over a number of years to obtain basic tidal data for the locality. A secondary tide station is one operated over a short period of time to obtain data for a specific purpose.
- TIDE, STORM** See STORM SURGE.
- TIDE TABLES** Tables which give daily predictions of the times and heights of the tide. These predictions are usually supplemented by tidal differences and constants by means of which additional predictions can be obtained for numerous other places.
- TIDE, WIND** See WIND TIDE.
- TIDES, RIP** See RIP.

TOE Lowest part of sea- and portside BREAKWATER slope, generally forming the transition to the seabed.

TOMBOLO A bar or spit that connects or "ties" an island to the mainland or to another island. See CUSPATE SPIT. Also applied to sand accumulation between land and a DETACHED BREAKWATER.

TONGUE A long narrow strip of land, projecting into a body of water.

TOPOGRAPHIC MAP A map on which elevations are shown by means of contour lines.

TOPOGRAPHY The configuration of a surface, including its relief and the positions of its streams, roads, building, etc.

TRAINING WALL A wall or jetty to direct current flow.

TRANSGRESSION, MARINE The invasion of a large area of land by the sea in a relatively short space of time (geologically speaking). Although the observable result of a marine transgression may suggest an almost instantaneous process, it is probable that the time taken is in reality is thousands or millions of years. The plane of marine transgression is a plane of UNCONFORMITY.

TRANSITIONAL ZONE (TRANSITIONAL WATER) In regard to progressive gravity waves, water whose depth is less than 2 but more than 1/25 the wavelength. Often called shallow water.

TRANSLATORY WAVE See WAVE OF TRANSLATION.

TRANSPOSED HURRICANE See HYPOTHETICAL HURRICANE.

TRANSVERSE BAR A bar which extends approximately right angles to shorelines.

TRANSVERSE WAVE Waves that propagate along a sailing line of a vessel.

TRENCH A long narrow submarine depression with relatively steep sides.

TROCHOIDAL WAVE A theoretical, progressive oscillatory wave first proposed by Gerstner in 1802 to describe the surface profile and particle orbits of finite amplitude, nonsinusoidal waves. The wave form is that of a prolate cycloid or trochoid, and the fluid particle motion is rotational as opposed to the usual irrotational particle motion for waves generated by normal forces. Compare IRROTATIONAL WAVE.

TROPICAL CYCLONE See HURRICANE.

TROPICAL STORM A tropical cyclone with maximum winds less than 34 m/sec (75 mile per hour). Compare with HURRICANE or TYPHOON (winds greater than 34 m/sec).

TROUGH A long and broad submarine DEPRESSION with gently sloping sides.

TROUGH OF WAVE The lowest part of a waveform between successive crests. Also, that part of a wave below still-water level.

TRUNCATED LANDFORM A landform cut off, especially by EROSION, and forming a steep side or CLIFF.

TSUNAMI A long-period wave caused by an underwater disturbance such as a volcanic eruption or earthquake. Also SEISMIC SEA WAVE. Commonly miscalled "tidal wave."

TURBIDITY (1) A condition of a liquid due to fine visible material in suspension, which may not be of sufficient size to be seen as individual particles by the naked eye but which prevents the passage of light through the liquid. (2) A measure of fine suspended matter in liquids.

TURBIDITY CURRENT A flowing mass of sediment-laden water that is heavier than clear water and therefore flows downslope along the bottom of the sea or a lake.

TURBULENT FLOW Any flow which is not LAMINAR, i.e., the stream lines of the fluid, instead of remaining parallel, become confused and intermingled.

TYPHOON See HURRICANE. The term typhoon is applied to tropical cyclones in the western Pacific Ocean.

----- U -----

UNCONFORMITY A surface that represents a break in the geologic record, with the rock unit immediately above it being considerably younger than the rock beneath. There are three major aspects to consider: (1) Time. An unconformity develops during a period of time in which no sediment is deposited. This concept equates deposition and time, and an unconformity represents unrecorded time. (2) Deposition. Any interruption of deposition, whether large or small in extent, is an unconformity. This aspect of unconformity pre-supposes a standard scale of deposition which is complete. Major breaks in sedimentation can usually be demonstrated easily, but minor breaks may go unrecorded until highly detailed investigations are made. (3) Structure. Structurally, unconformity may be regarded as planar structures separating older rocks below from younger rocks above, representing the break as defined in (1) and (2) above. A plane of unconformity may be a surface of weathering, Erosion or denudation, or a surface of non-deposition, or possibly some combination of these factors. It may be parallel to the upper strata, make an angle with the upper strata, or be irregular. Subsequent Earth movements may have folded or faulted it.

UNCONSOLIDATED In referring to sediment grains, loose, separate, or unattached to one another.

UNDERCUTTING Erosion of material at the foot of a Cliff or bank, e.g., a sea cliff, or river bank on the outside of a meander. Ultimately, the overhang collapses, and the process is repeated.

UNDERTOW (1) A current below water surface flowing seaward; the receding water below the surface from waves breaking on a shelving beach. (2) Actually undertow is largely mythical. As the BACKWASH of each wave flows down the BEACH, a current is formed which flows seaward. However, it is a periodic phenomenon. The most common phenomena expressed as undertow are actually RIP CURRENTS.

UNDERWATER GRADIENT The slope of the sea bottom. See SLOPE.

UNDEVELOPED COASTAL BARRIER A depositional geologic feature that is subject to wave, tidal, and wind energies, and protects landward aquatic habitats from direct wave attack, and all associated aquatic habitats, including adjacent wetlands, marshes, estuaries, inlets, and Nearshore waters, but only if there are few manmade structures and human activities do not significantly impede geomorphic and ecological processes.

UNDISTURBED WATER LEVEL Same as STILL WATER LEVEL.

UNDULATION A continuously propagated motion to and fro, in any fluid or elastic medium, with no permanent translation of the particles themselves.

UPCOAST In United States usage, the coastal direction generally trending toward the north.

UPDRIFT The direction opposite that of the predominant movement of littoral materials.

UPLAND Dry land area above and landward of the **ORDINARY HIGH WATER MARK (OHWM)**. Often used as a general term to mean high land far from the **COAST** and in the interior of the country.

UPLIFT The upward water pressure on the base of a structure or pavement.

UPRUSH The rush of water up the **FORESHORE** following the breaking of a wave, also called **SWASH** or **RUNUP**.

UPSTREAM Along coasts with obliquely approaching waves there is a longshore (wave-driven) current. For this current one can define an upstream and a **DOWNSTREAM** direction. For example, on a beach with an orientation west-east with the sea to the north, the waves come from NW. Then the current flows from West to East. Here, upstream is West of the observer, and East is **DOWNSTREAM** of the observer.

UPWELLING The process by which water rises from a deeper to a shallower depth, usually as a result of offshore surface water flow. It is most prominent where persistent wind blows parallel to a coastline so that the resultant Ekman transport moves surface water away from the coast.

----- **V** -----

VALLEY An elongated depression, usually with an outlet, between **BLUFFS** or between ranges of hills or mountains.

VALLEY, SEA A submarine depression of broad valley form without the steep side slopes which characterize a canyon.

VALLEY, SUBMARINE A prolongation of a land valley into or across a continental or insular shelf, which generally gives evidence of having been formed by stream erosion.

VELOCITY OF WAVES The speed at which an individual wave advances. See **WAVE CELERITY**.

VELOCITY PROFILE The velocity gradient within the **BOTTOM BOUNDARY LAYER**, displayed as a graph of height above the bed against the velocity of the flow.

VISCOSITY (or internal friction) That molecular property of a fluid that enables it to support tangential stresses for a finite time and thus to resist deformation. Resistance to flow.

----- **W** -----

WASH LOAD Part of the suspended load with particle sizes smaller than found in the bed; it is in near-permanent suspension and transported without deposition; the amount of wash load transported through a reach does not depend on the transport capacity of the flow; the load is expressed in mass or volume per unit of time.

WASHOVER Sediment deposited inland of a beach by overwash processes.

WATER DEPTH Distance between the seabed and the still water level.

WATER LEVEL Elevation of still water level relative to some datum.

- WATERLINE** A juncture of land and sea. This line migrates, changing with the tide or other fluctuation in the water level. Where waves are present on the beach, this line is also known as the limit of backrush (approximately, the intersection of the land with the still-water level.)
- WAVE** A ridge, deformation, or undulation of the surface of a liquid.
- WAVE AGE** The ratio of wave speed to wind speed.
- WAVE, CAPILLARY** See **CAPILLARY WAVE**.
- WAVE CELERITY** The speed of wave propagation.
- WAVE CLIMATE** The seasonal and annual distribution of wave height, period and direction.
- WAVE CLIMATE ATLAS** Series of maps showing the variability of wave conditions over a long coastline.
- WAVE CREST** See **CREST OF WAVE**.
- WAVE CREST LENGTH** See **CREST LENGTH, WAVE**.
- WAVE, CYCLOIDAL** See **CYCLOIDAL WAVE**.
- WAVE DECAY** See **DECAY OF WAVES**.
- WAVE DIRECTION** The direction from which a wave approaches.
- WAVE DIRECTIONAL SPECTRUM** Distribution of wave energy as a function of wave frequency and direction.
- WAVE FORECASTING** The theoretical determination of future wave characteristics, usually from observed or predicted meteorological phenomena.
- WAVE FREQUENCY** The inverse of wave period.
- WAVE FREQUENCY SPECTRUM** Distribution of wave energy as a function of frequency.
- WAVE, GRAVITY** See **GRAVITY WAVE**.
- WAVE GROUP** A series of waves in which the wave direction, wavelength, and wave height vary only slightly. See also **GROUP VELOCITY**.
- WAVE HEIGHT** The vertical distance between a crest and the preceding trough. See also **SIGNIFICANT WAVE HEIGHT**.
- WAVE HEIGHT COEFFICIENT** The ratio of the wave height at a selected point to the deepwater wave height. The **REFRACTION COEFFICIENT** multiplied by the shoaling factor.
- WAVE HINDCASTING** See **HINDCASTING, WAVE**.
- WAVE, INFRAGRAVITY** See **INFRAGRAVITY WAVE**.
- WAVE, IRROTATIONAL** See **IRROTATIONAL WAVE**.
- WAVE, MONOCHROMATIC** See **MONOCHROMATIC WAVES**.
- WAVE OF TRANSLATION** A wave in which the water particles are permanently displaced to a significant degree in the direction of wave travel. Distinguished from an **OSCILLATORY WAVE**.
- WAVE, OSCILLATORY** See **OSCILLATORY WAVE**.
- WAVE PEAK FREQUENCY** The inverse of wave peak period.
- WAVE PERIOD** The time for a wave crest to traverse a distance equal to one wavelength. The time for two successive wave crests to pass a fixed point. See also **SIGNIFICANT WAVE PERIOD**.
- WAVE, PROGRESSIVE** See **PROGRESSIVE WAVE**.
- WAVE PROPAGATION** The transmission of waves through water.
- WAVE RAY** See **ORTHOGONAL**.

- WAVE, REFLECTED** That part of an incident wave that is returned seaward when a wave impinges on a steep beach, barrier, or other reflecting surface.
- WAVE REFRACTION** See REFRACTION (of water waves).
- WAVE ROSE** Diagram showing the long-term distribution of wave height and direction.
- WAVE SETDOWN** Drop in water level outside of the breaker zone to conserve momentum as wave particle velocities and pressures change prior to wave breaking.
- WAVE SETUP** See SETUP, WAVE.
- WAVE, SINUSOIDAL** An oscillatory wave having the form of a sinusoid.
- WAVE, SOLITARY** See SOLITARY WAVE.
- WAVE SPECTRUM** In ocean wave studies, a graph, table, or mathematical equation showing the distribution of wave energy as a function of wave frequency. The spectrum may be based on observations or theoretical considerations. Several forms of graphical display are widely used.
- WAVE, STANDING** See STANDING WAVE.
- WAVE STEEPNESS** The ratio of wave height to wavelength also known as sea steepness.
- WAVE TRAIN** A series of waves from the same direction.
- WAVE TRANSFORMATION** Change in wave energy due to the action of physical processes.
- WAVE, TROCHOIDAL** See TROCHOIDAL WAVE.
- WAVE TROUGH** The lowest part of a wave form between successive crests. Also that part of a wave below still-water level.
- WAVE VELOCITY** The speed at which an individual wave advances.
- WAVE, WIND** See WIND WAVES.
- WAVELENGTH** The horizontal distance between similar points on two successive waves measured perpendicular to the crest.
- WAVES, INTERNAL** See INTERNAL WAVES.
- WEIBULL DISTRIBUTION** A model probability distribution, commonly used in wave analysis.
- WEIR** A low dam or wall across a stream to raise the upstream water level. Termed fixed crest weir when uncontrolled.
- WEIR JETTY** A jetty with a low section or weir over which littoral drift moves into a predredged deposition basin which is then dredged periodically.
- WETLANDS** Lands whose saturation with water is the dominant factor determining the nature of soil development and the types of plant and animal communities that live in the soil and on its surface (e.g. Mangrove forests).
- WELL-SORTED** Clastic sediment or rock that consists of particles all having approximately the same size. Example: sand dunes.
- WHARF** A structure built on the shore of a harbor, river, or canal, so that vessels may lie alongside to receive and discharge cargo and passengers.
- WHITECAP** On the crest of a wave, the white froth caused by wind.
- WICKER FAGGOT** Bundles of twigs or sticks, often willow, used in building earthworks or levees (traditional practice in Holland and China.). Alternate term: fascine
- WIND CHOP** See CHOP.
- WIND, FOLLOWING** See FOLLOWING WIND.
- WIND, KATABATIC** See KATABATIC WIND
- WIND, OFFSHORE** A wind blowing seaward from the land in a coastal area.
- WIND, ONSHORE** A wind blowing landward from the sea in a coastal area.

WIND, OPPOSING See **OPPOSING WIND**.

WIND ROSE Diagram showing the long-term distribution of wind speed and direction.

WIND SEA Wave conditions directly attributable to recent winds, as opposed to swell.

WIND SETDOWN Drop in water level below the still water level on the windward ends of enclosed bodies of water and semi- enclosed bays.

WIND SETUP On reservoirs and smaller bodies of water (1) the vertical rise in the still-water level on the leeward side of a body of water caused by wind stresses on the surface of the water; (2) the difference in still-water levels on the windward and the leeward sides of a body of water caused by wind stresses on the surface of the water. **STORM SURGE** (usually reserved for use on the ocean and large bodies of water).

WIND STRESS The way in which wind transfers energy to the sea surface.

WIND TIDE See **WIND SETUP**, **STORM SURGE**.

WIND WAVES (1) Waves being formed and built up by the wind. (2) Loosely, any wave generated by wind.

WINDWARD The direction from which the wind is blowing.

**COASTAL FLOOD HAZARD
ANALYSIS AND MAPPING
FOR THE
PACIFIC COAST OF THE UNITED
STATES**



FEMA

All policy and standards in this document have been superseded by the FEMA Policy for Flood Risk Analysis and Mapping. However, the document contains useful guidance to support implementation of the new standards.