

DOCKETED

Docket Number:	15-AFC-01
Project Title:	Puente Power Project
TN #:	215539
Document Title:	Exhibit - Proposed Final 2016 Integrated Energy Policy Report
Description:	N/A
Filer:	PATRICIA LARKIN
Organization:	SHUTE, MIHALY & WEINBERGER LLP
Submitter Role:	Intervenor Representative
Submission Date:	1/24/2017 2:19:39 PM
Docketed Date:	1/24/2017

DOCKETED

Docket Number:	16-IEPR-01
Project Title:	General/Scope
TN #:	215418
Document Title:	Proposed Final 2016 Integrated Energy Policy Report Update- Clean Version
Description:	N/A
Filer:	Stephanie Bailey
Organization:	California Energy Commission
Submitter Role:	Commission Staff
Submission Date:	1/18/2017 12:26:54 PM
Docketed Date:	1/18/2017

California Energy Commission
COMMISSION REPORT

2016 Integrated Energy Policy Report Update

California Energy Commission

Edmund G. Brown Jr., Governor

January 2017 | CEC-100-2016-003-CMF



California Energy Commission

Robert B. Weisenmiller, Ph.D.

Chair

Commissioners

Karen Douglas, J.D.

J. Andrew McAllister, Ph.D.

David Hochschild

Janea A. Scott

Stephanie Bailey

Jim Bartridge

Ryan Eggers

Guido Franco

Cary Garcia

Judy Grau

Aleecia Gutierrez

Eli Harland

Mike Jaske

Melissa Jones

Chris Kavalec

Lana Wong

Sonya Ziaja

Primary Authors

Raquel Kravitz

Project Manager

Heather Raitt

Program Manager

Robert P. Oglesby

Executive Director

DISCLAIMER

Staff members of the California Energy Commission prepared this report. As such, it does not necessarily represent the views of the Energy Commission, its employees, or the State of California. The Energy Commission, the State of California, its employees, contractors and subcontractors make no warrant, express or implied, and assume no legal liability for the information in this report; nor does any party represent that the uses of this information will not infringe upon privately owned rights. This report has not been approved or disapproved by the Energy Commission nor has the Commission passed upon the accuracy or adequacy of the information in this report.

ACKNOWLEDGEMENTS

Rizaldo Aldas	Chuck Gentry	Silvia Palma-Rojas
Al Alvarado	Mike Gravely	Jamie Patterson
Ollie Awolowo	Ashley Gutierrez	Fernando Pina
Gina Barkalow	Jon Hilliard	Scott Polaske
Kevin Barker	Jeanine Hinde	Kiel Pratt
Gerry Bemis	Yu Hou	Ramsha Qasim
Sylvia Bender	David Hungerford	Ken Rider
Matt Chalmers	Roger Johnson	Gabriel Roark
Kristy Chew	Steve Kerr	Carol Robinson
Justin Cochran	Andrea Koch	Jana Romero
Alex Coffman	Suzanne Korosec	Patrick Saxton
Denise Costa	Laura Laurent	Tim Singer
Rhetta deMesa	Ellen LeFevre	Katharina Snyder
Collin Doughty	Virginia Lew	Michael Sokol
Catherine Elder	Grant Mack	David Stoms
Scott Flint	Heather Mehta	Marylou Taylor
Jonathan Fong	Jennifer Nelson	Laurie ten Hope
Sandra Fromm	Le-Huy Nguyen	Kevin Uy
Matt Fung	Le-Quyen Nguyen	Lisa Worrall
Tom Gates	Rebecca Oliver	Susan Wilhelm

PREFACE

Senate Bill 1389 (Bowen, Chapter 568, Statutes of 2002) requires the California Energy Commission to prepare a biennial integrated energy policy report that assesses major energy trends and issues facing the state's electricity, natural gas, and transportation fuel sectors and provides policy recommendations to conserve resources; protect the environment; ensure reliable, secure, and diverse energy supplies; enhance the state's economy; and protect public health and safety (Public Resources Code § 25301[a]). The Energy Commission prepares updates to these assessments and associated policy recommendations in alternate years, (Public Resources Code § 25302[d]). Preparation of the *Integrated Energy Policy Report* involves close collaboration with federal, state, and local agencies and a wide variety of stakeholders in an extensive public process to identify critical energy issues and develop strategies to address those issues.

ABSTRACT

The *2016 Integrated Energy Policy Report Update* provides the results of the California Energy Commission's assessments of a variety of energy issues facing California. Many of these issues will require action if the state is to meet its climate, energy, air quality, and other environmental goals while maintaining reliability and controlling costs. The *2016 Integrated Energy Policy Report Update* covers a broad range of topics, including the environmental performance of the electricity generation system, landscape-scale planning, the response to the gas leak at the Aliso Canyon natural gas storage facility, transportation fuel supply reliability issues, updates on Southern California electricity reliability, methane leakage, climate adaptation activities for the energy sector, climate and sea level rise scenarios, and the *California Energy Demand Forecast*.

Keywords: California Energy Commission, electricity demand forecast, Aliso Canyon, natural gas, methane emissions, climate adaptation, climate change, Environmental Performance of the Electricity Generation System, Southern California reliability, nuclear

Please use the following citation for this report:

California Energy Commission Staff. 2016. *2016 Integrated Energy Policy Report Update*.
California Energy Commission. Publication Number: CEC-100-2016-003-CMF.

TABLE OF CONTENTS

	Page
Executive Summary	1
CHAPTER 1: Environmental Performance of the Electricity Generation System	13
Introduction	13
California’s GHG Reduction Policies and the Impact on the Electricity System.....	14
Changes in California’s Electricity System	21
Closure of Nuclear Facilities	35
The Environmental Performance of the Electricity System.....	39
Nuclear Decommissioning.....	61
Emerging and Transformative Technologies	66
Policy Development and Planning Going Forward	76
Recommendations.....	80
CHAPTER 2: Energy Reliability in Southern California	86
Aliso Canyon Natural Gas Storage Facility	86
Transportation Fuel Supply Reliability Impacts	115
Update on Southern California Electricity Reliability.....	123
Recommendations.....	142
CHAPTER 3: Climate Adaptation and Resiliency	145
U.S. and California Adaptation Policy Developments	146
Adaptation Activities in California’s Energy Sector.....	148
Development of Climate and Sea Level Rise Scenarios for the Energy Sector	157
Recommendations.....	172
CHAPTER 4: Electricity Demand Forecast Update	175
Background.....	175
2017 <i>IEPR</i> Forecast and Beyond.....	175
Future Data and Analytical Needs	181
California Energy Demand Updated Forecast, 2017-2027	182
Method.....	184
Recommendations.....	191
APPENDIX A: Methane Emissions Associated With Natural Gas Consumption in California	A-1
APPENDIX B: Offshore Renewable Energy Workshop Summary	B-1
APPENDIX C: 2016 Lead Commissioner Request for Data Related to California’s Nuclear Power Plants	C-1

LIST OF FIGURES

	Page
Figure ES-1: California's Path to Progress to Meet Climate Goals	2
Figure 1: California's GHG Emissions in 2014	17
Figure 2: Relative Contribution of Various Greenhouse Gases in California.....	18
Figure 3: California's Path to Progress to Meet Climate Goals.....	19
Figure 4: California GHG Emissions by Category (2000-2014).....	20
Figure 5: Installed In-State Electric Generation Capacity by Resource Type (2001-2015).....	22
Figure 6: Electric Generation by Resource Type (2001-2015).....	23
Figure 7: RPS Renewable Capacity Installed in California (in MW) by Resource Type	25
Figure 8: California Renewable Energy Generation From 1983 to 2014 by Resource Type (In-State and Out-of-State).....	26
Figure 9: Statewide and U.S. Baseline Electricity Annual Consumption per Capita	30
Figure 10: Decline in GHG Emissions per Capita and per GDP Over the Last 25 Years While California's Economy Grew.....	31
Figure 11: California GHG Emissions per GDP and per Capita in Comparison With Other Countries	32
Figure 12: Annual and Expected Energy From Coal Used to Serve California (1996-2026)	35
Figure 13: Cooling Process for Operating Power Plants That Have a Steam Cycle.....	44
Figure 14: Historical and Projected OTC Fleet Water Usage.....	46
Figure 15: Southern California Gas Company Natural Gas Transmission System	92
Figure 16: Electric Generation Plants Served by Aliso Canyon	94
Figure 17: Simplified Timeline Illustrating Gas and Electricity Scheduling.....	98
Figure 18: Greater Los Angeles Area Refinery Locations	116
Figure 19: West Coast Petroleum Product Supply Map	117
Figure 20: Greater Los Angeles Area Refinery Usage as a Percentage of Total SoCalGas System	119
Figure 21: Greater Los Angeles Area Refinery Natural Gas Versus Still Gas Usage	120
Figure 22: Greater Los Angeles Area Refinery Natural Gas Usage by Operation Type...	121
Figure 23: California Spot Gasoline to New York Mercantile Exchange (NYMEX) Futures Price Spread.....	122

Figure 24: Baseline LCAAT Projections Showing Local Capacity Surpluses/Deficits.....	136
.....	136
Figure 25: Scenario Projections Showing Local Capacity Surpluses/Deficits for the West Los Angeles Subarea.....	138
Figure 26: Scenario Results Showing Local Capacity Surpluses/Deficits for the San Diego Subarea.....	138
Figure 27: Global CO ₂ Emissions: Fossil Fuels and Cement Production.....	161
Figure 28: Annual Average Temperature Projections: Sacramento	163
Figure 29: Average Annual Temperature: Upper Annual Estimation From 32 Global Climate Models Using LOCA Results for a Grid Cell in Sacramento.....	165
Figure 30: Cumulative CO ₂ Emissions for RCPs and INDCs Global Emissions Scenarios	166
Figure 31: Modeling Domains for the Numerical Climate Simulations Performed by UCLA	167
Figure 32: Sea Level Rise Projections for California up to 2200: Extreme Values (95th Percentile in Inches)	171
Figure 33: Statewide Commercial Employment.....	183
Figure 34: Statewide Personal Income.....	183
Figure 35: Statewide Baseline Annual Electricity Consumption	185
Figure 36: Statewide Baseline Annual Noncoincident Peak Demand.....	185
Figure 37: Combined IOU AAEE Energy Savings	186
Figure 38: Combined IOU AAEE Peak Savings	187
Figure 39: Combined POU AAEE Energy Savings	188
Figure 40: Combined POU AAEE Peak Savings	188
Figure 41: <i>CEDU 2016</i> Managed Peak Forecast and Managed Forecast With Final Adjustment for Peak Shift, PG&E Planning Area.....	190
Figure 42: <i>CEDU 2016</i> Managed Peak Forecast and Managed Forecast with Final Adjustment for Peak Shift, SCE Planning Area.....	190
Figure 43: <i>CEDU 2016</i> Managed Peak Forecast and Managed Forecast with Final Adjustment for Peak shift, SDG&E Planning Area	191
Figure 44: Methane Emissions in California (2014).....	A-2
Figure 45: California Fossil Fuel Consumption (2014).....	A-3
Figure 46: Revised Schematic of the Natural Gas System.....	A-4

LIST OF TABLES

	Page
Table 1: Statewide Emissions From California Electricity and Cogeneration in 2013 (Tons per Day, Except Percentage of Total Emissions).....	41
Table 2: Statewide Emissions From California Electricity and Cogeneration in 2000 (Tons per Day, Except Percentage of Total Emissions).....	41
Table 3: Average Total Project Land Use per MW by Fuel Type	49
Table 4: SoCalGas Underground Gas Storage Fields Key Operating Characteristics	93
Table 5: Average Number of Days of Withdrawal from Aliso Canyon.....	94
Table 6: Forecasted 2016 Winter Peak Day Demand.....	95
Table 7: Forecasted 2016 Summer Peak Day Demand.....	96
Table 8: Historical Days Simulated	101
Table 9: Risk Scenarios	101
Table 10: Status of Mitigation Measures.....	104
Table 11: Results of Hydraulic Analysis	113
Table 12: Conventional Generation Projects in San Onofre Area.....	127
Table 13: Authorized Preferred Resources in San Onofre Area	128
Table 14: Transmission Projects in the San Onofre Area Affecting Regional Reliability.....	131
Table 15: Sea Level Rise Estimates From the National Research Council in 2012 and From Scripps in 2016 (Inches)	170
Table 16: Waste Generated by Diablo Canyon Units 1 and 2	C-3
Table 17: San Onofre Unit 1 Waste Disposal Volumes	C-4
Table 18: San Onofre Units 2 and 3 Waste Disposal Volumes.....	C-4
Table 19: Spent Fuel Assemblies and Uranium Stored at San Onofre.....	C-5
Table 20: Onsite Spent Nuclear Fuel Capacity.....	C-7

EXECUTIVE SUMMARY

California continues to be a global leader in developing energy and environmental policies to address climate change. As the sixth largest economy in the world, California has demonstrated that it can grow its economy while reducing the environmental footprint of its energy system. Californians rely on their energy system to fuel the cars that get them to work, to power hospitals and schools, to pump water to communities and crops, and to operate machinery—to name only a few examples. Energy fuels the economy, but it is also the biggest source of greenhouse gas emissions that lead to climate change. Despite California's leadership, Californians are experiencing the impacts of climate change including higher temperatures, prolonged drought, and more wildfires. There is an urgent need to reduce greenhouse gas emissions and increase the state's resiliency to climate change. As Governor Edmund G. Brown Jr. said, "It's time for courage, it's time for creativity, and it's time for boldness to tackle climate change."

The world is at a transition point. There is growing international recognition that greenhouse gas emissions are changing the climate with wide-ranging impacts, including higher temperatures that affect everything from human health to energy demand to agricultural output; more extreme weather events such as increasingly devastating hurricanes, stronger storms, and prolonged heat waves; and rising sea level that is displacing communities and stressing infrastructure. On December 14, 2016, Governor Brown stated that "The time has never been more urgent... the world is facing tremendous danger." California's unprecedented drought is resulting in the death of vast swaths of drought-stressed trees that have succumbed to bark beetle infestation—more than 102 million trees have died since 2010. About half of the 20 largest wildfires in California burned in the last decade. Climate change impacts put U.S. military installations at greater risk and could increase international conflict.

For this report, the energy system includes energy extraction, transport, conversion (such as combusting natural gas in power plants to generate electricity or producing gasoline and diesel from crude oil in refineries), and consumption for services (such as electricity for lighting, natural gas use in homes and buildings for space and water heating, and gasoline and diesel to fuel cars and trucks), as well as electricity from out-of-state plants serving California. Using this broad definition, the energy system is the source of 80 percent of the state's greenhouse gas emissions. As is necessary, California must transition its energy system to reduce greenhouse gas emissions. In his 2015 state-of-the-state address, Governor Brown laid out his vision for reducing California's greenhouse gas emissions and said that it "means that we continue to transform our electrical grid, our transportation system and even our communities." This report examines how the state is transforming its electricity sector and identifies transformations that are still needed in other sectors of the energy system to achieve the state's energy and climate policy goals.

California's Policy Initiatives to Reduce Greenhouse Gas Emissions

California took a bold new step to reduce greenhouse gas emissions on September 8, 2016—Governor Brown signed Senate Bill 32 (Pavley, Chapter 249, Statutes of 2016), putting into law a statewide goal to reduce greenhouse gas emissions 40 percent below 1990 levels by 2030. He also signed a companion bill, Assembly Bill 197 (Garcia, Chapter 250, Statutes of 2016), to assure that the state's implementation of its climate change policies is transparent and equitable, with the benefits reaching disadvantaged communities.

These bills build on the 40 percent by 2030 greenhouse gas reduction goal set in Governor Brown's Executive Order B-30-15 and comes 10 years after enactment of the California Global Warming Solutions Act of 2006 (Assembly Bill 32, Núñez, Chapter 488, Statutes of 2006) (AB 32), the landmark legislation that requires the state to reduce greenhouse gas emissions to 1990 levels by 2020. California is well on its way to meeting the 2020 target, but the new 2030 requirement is much more ambitious and requires renewed focus and creativity to meet it. Figure ES-1 show's California's greenhouse gas reduction goals against historical greenhouse gas emissions.

Figure ES-1: California's Path to Progress to Meet Climate Goals

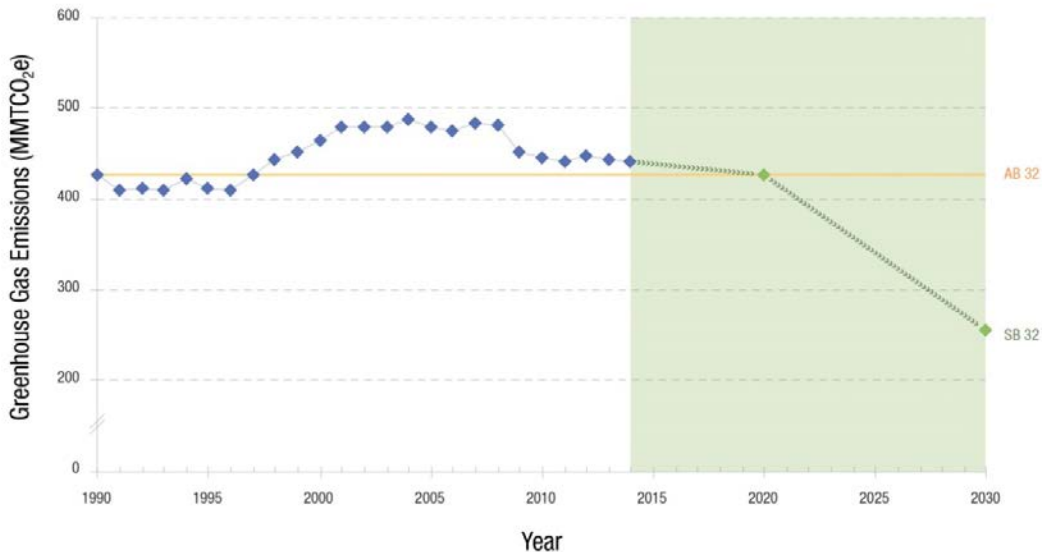

Source: California Energy Commission, Tracking Progress web page, Greenhouse Gas Emission Reductions, updated December 20, 2016.

Note: Not shown is California's 2050 goal to reduce greenhouse gas emissions 80 percent below 1990 levels by 2050 as set in Executive Order B-30-15.

Another groundbreaking effort to address climate change was Senate Bill 1383 (Lara, Chapter 395, Statutes of 2016) (SB 1383), which requires the California Air Resources Board (ARB) to develop and begin implementing a comprehensive strategy to reduce

emissions of short-lived climate pollutants. Short-lived climate pollutants cause more climate change in a shorter time frame than carbon dioxide, the primary greenhouse gas, such that emission reductions can produce faster benefits. By January 1, 2018, the ARB is required to develop a comprehensive strategy to reduce emissions of short-lived climate pollutants to reduce methane emissions by 40 percent, hydrofluorocarbon gases by 40 percent, and anthropogenic black carbon by 50 percent below 2013 levels by 2030. SB 1383 also requires, as part of the *2017 Integrated Energy Policy Report (IEPR)*, the Energy Commission to make recommendations on the development and use of renewable natural gas, including biomethane and biogas.

Through Assembly Bill 1613 (Committee on Budget, Chapter 370, Statutes of 2016), Senate Bill 859 (Committee on Budget and Fiscal Review, Chapter 368, Statutes of 2016), Assembly Bill 1550 (Gomez, Chapter 369, Statutes of 2016), and Assembly Bill 2722 (Burke, Chapter 510, Statutes of 2016) the Governor and Legislature allocated \$900 million from the Greenhouse Gas Reduction Fund to help equitably achieve the state's 2030 greenhouse gas reduction goal. The funding distributes proceeds from California's cap-and-trade program to limit greenhouse gas emissions by supporting programs that benefit disadvantaged communities, advance clean transportation, protect the natural environment, and cut short-lived climate pollutant emissions.

While California is taking bold steps to reduce its greenhouse gas emissions, the state generates only 1 percent of global emissions—reducing California's emissions will not be enough to solve climate change. Speaking in Beijing, China, in 2013, Governor Brown called for unified action to combat climate change. "We're in one world. We've got one big problem, and we all have to work on it. And what's beautiful and exciting about climate change is no one group can solve the problem—not the United States, not California, not Japan, not China—we all have to do it. This is a great unifier. This is an imperative where human beings could collaborate."

To advance global action, the Governor is spearheading the Under2Coalition, a commitment by cities, states, and countries to take action to help limit the rise in global average temperature to below 2 degrees Celsius. Signatories agree to reduce greenhouse gas emissions 80 to 95 percent below 1990 levels by 2050 or achieve a per capita annual emissions target of less than 2 metric tons by 2050; such emission reductions are considered sufficient to avoid catastrophic climate change. Collectively, 165 jurisdictions representing 33 countries, 1.08 billion people, and 35 percent of the global economy have signed or endorsed the *Subnational Global Climate Leadership Memorandum of Understanding*. (See <http://under2mou.org/> for the latest statistics on the "Under 2 MOU.") Governor Brown was also a leader at the 2015 United Nations Climate Change Conference in Paris and has signed accords with leaders from Mexico, China, Canada, Japan, Israel, and Peru to reduce greenhouse gas emissions. In December 2016, Governor Brown joined the governors from Oregon and Washington as well as leaders from Chile and France to launch a new partnership of jurisdictions worldwide to

protect coastal communities and economies from rising ocean acidity, the International Alliance to Combat Ocean Acidification.

California is also working with its partners to address climate change through regional efforts. Governor Brown joined Alaska, British Columbia, Oregon, and Washington to form the Pacific Coast Collaborative, a forum for leadership and information sharing on issues of concern to the Pacific North America. The Clean Energy and Pollution Reduction Act (De León, Chapter 547, Statutes of 2015) (Senate Bill 350) paves the way for a regional electricity grid that will provide benefits in terms of lower energy costs, lower greenhouse gas emissions, and better reliability.

In his 2015 inaugural speech, the Governor set the following goals for 2030: double efficiency of existing buildings and make heating fuels cleaner, increase from one-third to 50 percent electricity derived from renewable sources, and reduce today's petroleum use in cars and trucks by up to 50 percent. The Governor also called for the state to "reduce the relentless release of methane, black carbon, and other potent pollutants across industries. And we must manage farm and rangelands, forests, and wetlands so they can store carbon." The Governor's energy efficiency and renewable energy goals were codified in SB 350, which also requires investor-owned utilities to increase the access to electricity as a transportation fuel to support widespread transportation electrification.

Transformation of California's Electricity System Over the Last Decade

California has realized tremendous progress in the environmental performance of its electricity system over the last decade, primarily as a result of its energy and environmental policies. While AB 32 sets an economywide, rather than sector-specific, requirement to attain 1990 levels by 2020, greenhouse gas emissions from the electricity sector are already 20 percent *below* 1990 levels. With transportation accounting for about 37 percent of California's greenhouse gas emissions in 2014, transforming California's transportation system away from gasoline to zero-emission and near-zero-emission vehicles is a fundamental part of the state's efforts to meet its climate goals.

Reduced greenhouse gas emissions from the electricity sector is largely attributable to increases in renewable energy and decreases in coal-fired generation. Installed capacity of renewable energy in California has more than tripled from 6,800 megawatts (MW) in 2001 to 26,300 MW (including small, self-generation such as rooftop solar) as of October 31, 2016. Meanwhile, coal-fired electricity served about 11 percent of California's electricity demand in 2000 but has steadily declined to serve less than 6 percent by the end of 2015, and is expected to decline to zero by the middle of the next decade. Criteria pollutant emissions from the electricity sector (emissions that cause smog and harm human health) are modest, contributing just 2 percent of total emissions in 2000, and were cut by more than half by 2015.

Most of the growth in renewable energy resources has come from wind and solar. Solar in particular has realized tremendous growth in California, increasing from a little more than 400 MW in 2001 to more than 7,000 MW in 2015. The most dramatic change is the addition of utility-scale, solar photovoltaic power plants, especially between 2010 and 2015 when installed capacity rose from roughly 40 MW to 5,700 MW. Residential solar installations have also grown dramatically, with California accounting for more than 40 percent of the installed capacity nationwide. Enacted in 2006, Senate Bill 1 (Murray, Chapter 132, Statutes of 2006) set the goal to install 3,000 MW of solar energy systems on new and existing residential and commercial sites by 2017. The state has already exceeded that goal with the installation of 4,400 MW, almost 2,000 MW of which were installed just in 2014 and 2015.

California rightly treasures its natural landscapes. Its beauty is an enduring draw to visitors, and it is home to diverse wildlife and vegetation. The land and waterways are also sacred to many California Native Americans. As part of an effort to protect its natural resources while planning for needed development, California has made tremendous strides in its land-use planning for electricity generation and transmission projects. The increased development of large-scale renewable energy projects, particularly in sensitive desert landscapes, prompted federal, state, and local agencies to conduct landscape-scale planning to both protect the region's cultural resources and foster development of needed renewable generation. The *Desert Renewable Energy Conservation Plan* is a comprehensive effort to identify the most appropriate areas for large-scale renewable energy development within 22 million acres of public and private desert landscape while protecting and conserving desert ecosystems. After eight years of extensive stakeholder engagement and multiagency collaboration, on September 14, 2016, the U.S. Secretary of the Interior Sally Jewell approved Phase I of the *Desert Renewable Energy Conservation Plan* covering 10.8 million acres of public lands managed by the Bureau of Land Management in the California desert.

Building on such planning efforts, the Energy Commission, California Public Utilities Commission (CPUC), California Independent System Operator (California ISO), the California Natural Resources Agency, and the U.S. Bureau of Land Management launched the Renewable Energy Transmission Initiative (RETI 2.0) to identify the constraints and opportunities for new transmission needed to access additional renewable energy resources.

As water is an increasingly precious resource in California, the state has worked to reduce water consumption associated with electricity generation and the impacts on aquatic environments. Over the past decade, the fossil-fueled power plant fleet in California has become more water-efficient, resulting in a relatively modern fleet of thermal power plants that consume little water. Energy production uses less than 1 percent of all consumptive water use in California, but the use can impact the water supply of local communities. The total amount of freshwater used for cooling has not increased in the last decade, despite the addition of numerous thermal power plants.

The increased use of dry-cooling technologies and the use of recycled water have significantly increased the water efficiency of power plants in California. Even greater improvements can be achieved, however, by updating the 2003 *IEPR* water policy to require the use of recycled water and alternative technologies for all power plant operations. Based upon the last four to five years of drought, it is time to make California's energy system resilient to drought.

More Work is Needed to Decarbonize California's Overall Energy System

The advancements in California's electricity system demonstrate that California is capable of transforming its energy system in a relatively short time frame; however, much more work is needed to reduce greenhouse gases to 40 percent below 1990 levels by 2030. California must dramatically reduce emissions even as its population is expected to grow from about 38 million today to more than 44 million by 2030.

The rapid growth in California's renewable resources has brought new challenges for grid operators trying to maintain reliability while managing swings in wind and solar generation. In 2013, the California ISO projected that net energy demand after subtracting behind-the-meter generation (*net load*) could be as low as 12,000 MW by 2020 and that meeting peak demand may require ramping up 13,000 MW in three hours. Two days in 2016 illustrate that the grid is already experiencing unprecedented operational fluctuations that grid operators were bracing for in 2020. On May 15, 2016, the net load reached a minimum of 11,663 MW, and on February 1, 2016, the three-hour ramp was 10,892 MW, with the peak shifting to later hours in the day. Helping address such challenges, the California ISO, PacifiCorp, NV Energy, Arizona Public Service, and Puget Sound Energy participate in an Energy Imbalance Market (EIM) to balance supply and demand deviations in real time and dispatch least-cost resources every five minutes. With the EIM, excess energy in the California ISO balancing area can be transferred to other areas in real time. If not for energy transfers through the EIM, the California ISO would have curtailed 272,000 MWh of renewable energy in the first half of 2016, equivalent to 116,000 metric tons of carbon emissions.

Development of a regional, westwide electricity market is critical to help integrate renewable energy resources, maximize the use of these resources, and achieve benefits beyond those gained with the EIM. The California ISO's study found that a regional grid would save California ratepayers up to \$1.5 billion per year; create between 9,900 and 19,300 additional jobs in the state, primarily due to the reduced cost of electricity; and reduce greenhouse gas emissions by more than 7 million metric tons by 2030.

As California moves away from fossil fuels to reduce greenhouse gas emissions, it will need more resources that can be depended on to quickly and cost-effectively ramp up or down to help maintain the reliability of the electricity system. Flexibility is necessary to compensate for hourly changes in variable renewable generation and energy demand, as well as outages for power plant maintenance and seasonal variations in hydropower

generation. Natural gas-fired power plants offer the most flexibility for quickly, reliably, and cost-effectively ramping up or down to balance supply and demand. California relies on the ramping capabilities of natural gas even as it is moving away from using it—in the summer of 2016 natural gas use was down 20 percent in California compared to the previous year due to better hydroelectric conditions and more renewable energy coming on-line. The state will need to transition to other options, however, to meet its flexibility needs, including reliably and quickly ramping energy load up or down (demand response) and deploying cost-effective storage to manage excess generation and then inject it into the system when needed. Assembly Bill 33 (Quirk, Chapter 680, Statutes of 2016) requires the CPUC to analyze the potential for long-duration bulk energy storage to help integrate renewable resources. Even as the state works to increase demand response and storage capacity by orders of magnitude, it will likely depend on some natural gas-fired generation to meet its needs for flexibility.

Another change in California's energy system is the decision by hundreds of thousands of homeowners to install solar on their rooftops. However, the electricity distribution system was designed on a different model, one that was based on the use of large-scale, conventional power plants and in which electricity would flow to the end user. The growing use of small, distributed generation requires upgrades to the distribution system that will better enable California to meet its greenhouse gas reduction goals and maintain a safe and reliable system. As California electrifies its transportation system, this need will only grow.

Similarly, developing more utility-scale renewable generation to meet the state's 2030 greenhouse gas reduction goals and Renewables Portfolio Standard requirements will require new investments in the state's electric transmission system. (The Renewables Portfolio Standard was established in 2002 to require 20 percent of electricity retail sales be served with eligible renewable energy by 2017 and became increasingly more aggressive to require 50 percent by 2030 [set in 2015].) In his *Clean Energy Jobs Plan*, Governor Brown set a goal to dramatically reduce the permitting time for transmission projects needed to tap new renewable resources to no longer than three years. The permitting process, however, continues to lag, taking six to eight years. It is past time for the Energy Commission, CPUC, and California ISO to implement the Governor's vision for transmission permitting, and the agencies should do so within the next two years through a determined effort of regulatory process reform.

Energy efficiency and demand response are also key components of the state's strategy to reduce greenhouse gas emissions. Consistent deployment of efficiency through building codes, appliance standards, and ratepayer-funded programs has had a tremendous positive impact. At sufficient scale, energy efficiency reduces the need for new generation and transmission resources. The Energy Commission is implementing the *Existing Buildings Energy Efficiency Action Plan* to help meet the Governor's goal. But the state will need to do even more.

Transforming California’s transportation sector away from gasoline to zero-emission and near-zero-emission vehicles—powered predominantly with renewable electricity—is fundamental to California’s strategy for meeting its greenhouse gas reduction goals. While sales are growing and infrastructure deployment is advancing, much more growth is needed to meet the Governor’s goal of 1.5 million zero-emission vehicles on California roadways by 2025.

All Californians need to have access to, and realize the benefits from, efforts to advance energy efficiency and weatherization, renewable energy, and zero-emission and near-zero-emission vehicles. In accord with SB 350, state agencies are evaluating the barriers for low-income customers, including those living in disadvantaged communities, to access these clean energy technologies and are providing recommendations for how to address these barriers. The Energy Commission reported on energy efficiency and renewable energy, while the ARB is reporting on clean transportation, in consultation with other state agencies, by early 2017. To ensure the full economic and societal benefits of California’s clean energy transition are realized, the Energy Commission is also evaluating the barriers to contracting opportunities for local small businesses in disadvantaged communities, along with potential solutions.

Finally, innovative ideas and technologies will help spur advancements and technology breakthroughs needed in the years ahead. California leads the nation in the development of innovative technologies and must continue to support the research, development, and deployment of emerging technologies that will be critical to ultimately transform its energy system.

California Needs to Manage the Legacy of Its Aging Infrastructure

While California must take swift action to address climate change, it is also grappling with the legacy of an aging energy infrastructure. In the past few years, the state has suffered two major disruptions in its energy infrastructure that require vigilance and have tested the state’s abilities to provide reliable energy services to Southern California. Californians expect a reliable energy supply; energy supply disruptions can put public health and safety at risk and have consequences to local businesses and the economy as a whole.

The most recent disruption stems from the massive leak at the Aliso Canyon natural gas storage facility in late 2015 that severely disrupted the local community and continues to put the energy reliability of the area at risk. The ARB estimates that the leak added about 20 percent to statewide methane emissions over the duration.¹ The Energy Commission, CPUC, California ISO, and the Los Angeles Department of Water and Power worked together to assess the risks to local energy reliability and develop action plans

¹ The Southern California Gas Company has committed to address methane emissions from Aliso Canyon, including signing letters of intent with several dairies, which are the largest source of methane emissions in California.

to reduce the risk. The action plans identify measures to reduce reliance on the Aliso Canyon natural gas storage facility. The *Aliso Canyon Action Plan to Preserve Gas and Electric Reliability for the Los Angeles Basin* focused on reducing natural gas used to produce electricity and better matching gas deliveries with demand on a daily basis. In the summer, electricity demand is high as air conditioners run more in hot weather. In the winter, the demand for natural gas used in homes and business for heating goes up and the demand for electricity goes down. Thus the *Aliso Canyon Gas and Electric Reliability Winter Action Plan* focuses on reducing natural gas use for heating.

In response to the leak at Aliso Canyon, the legislature passed a suite of bills addressing the storage of natural gas. Senate Bill 380 (Pavley, Chapter 14, Statutes of 2016) continues the moratorium on injection of natural gas at the Aliso Canyon gas storage facility until specified standards are met. Senate Bill 826 (Leno, Chapter 23, Statutes of 2016) appropriates \$2.5 million to the California Council on Science and Technology to study the long-term viability of natural gas storage facilities in California in accordance with the Governor's Aliso Canyon State of Emergency Proclamation. Senate Bill 887 (Pavley, Chapter 673, Statutes of 2016) establishes a framework for reforming natural gas storage well oversight and regulation. Senate Bill 888 (Allen, Chapter 536, Statutes of 2016) assigns the Office of Emergency Services as the lead agency for large natural gas leak emergency responses and directs the CPUC to level financial penalties for gas leaks and use the funds to reduce the impacts.

Apart from the major leak at Aliso Canyon, there are concerns about ongoing leaks that occur throughout the natural gas system, including extraction, transmission, distribution, and end use. Natural gas is primarily composed of methane, a more potent greenhouse gas than the carbon dioxide created when it or other fossil fuels are burned for energy use. Ongoing research is aimed at identifying and reducing such leaks, and Assembly Bill 1496 (Thurmond, Chapter 604, Statutes of 2016) requires the ARB to monitor methane emissions and conduct a life-cycle analysis of natural gas.

The second ongoing risk to energy reliability in Southern California stems in part from the unexpected shutdown of the San Onofre Nuclear Generating Station (San Onofre) in 2012 and the permanent closure of the plant in 2013. This was compounded by the planned closure of several natural gas-fired power plants along the Southern California coast as a result of the phaseout of once-through cooling technologies. Once-through cooling was commonly used when power plants were developed in the 1950s through the 1970s, and the related phaseout is an important improvement in the environmental footprint of California's energy system. Implementation of the policy, however, must be made with careful consideration to the impacts on local electricity reliability. A multiyear, joint agency effort has been closely tracking the development of resources needed to assure reliability in the area, including preferred resources (such as energy efficiency, demand response, distributed renewable energy generation, and storage), transmission additions, and conventional generation. One of the conventional generation projects that the interagency team is tracking, the Carlsbad Energy Center,

was planned to replace the Encina plant but is facing delays from legal challenges. Although the joint agency efforts have worked diligently to maintain reliability while meeting the once-through cooling phaseout schedule, the joint agencies may need to request that the State Water Resources Control Board delay the schedule for the Encina power plant.

The last operational nuclear power plant in California, Diablo Canyon, will close by 2025 as part of an agreement among Pacific Gas and Electric Company, labor, and environmental organizations. The decommissioning of San Onofre is now underway, and the planning and preparations to shut down Diablo Canyon in 2024-2025 will occur over the next several years. For both plants, public safety, security, environmental remediation, and the management of radioactive materials will continue to be key concerns throughout the decommissioning (and for the remaining operational years of Diablo Canyon). Policy makers, local officials, and the owners of the plants must plan for the long-term management of spent nuclear fuel onsite, taking into account the unique seismic and tsunami hazards of coastal locations, the dense population surrounding San Onofre, and the maintenance and potential replacement issues related to aging systems. Citizen groups, local government, and state agencies continue to express concern over long-term onsite storage, while engaging federal agencies and congressional representatives for expedited development of both interim and permanent storage options for nuclear materials. Furthermore, the safe transport of nuclear waste over California's railways and highways must also be planned and managed for a future date when the federal government begins to accept high-level nuclear waste from decommissioning nuclear plants.

Planning for the Future

Over the last decade, regulators focused primarily on developing program-specific targets to advance California's energy system (such as separate targets for renewable energy, energy efficiency, demand response, storage, and other attributes), but the state is shifting to a more comprehensive approach aimed at improving the performance of the system and achieving the 2030 greenhouse gas reduction goals. SB 350 requires investor-owned utilities, other electricity retail sellers, and larger publicly owned utilities to develop integrated resource plans that incorporate both supply- and demand-side resources to meet greenhouse gas emission reduction goals, maintain reliability, and control costs. The integrated resource plans will be the primary tool for implementing greenhouse gas reduction measures in the electricity sector.

In planning for new transmission and generation infrastructure, the state needs to continue refining and implementing proactive strategies, like landscape-scale planning, to reduce energy infrastructure impacts. Such efforts integrate environmental information into statewide energy planning and decision making and can be used for local planning efforts. Further, the state needs to accelerate efforts to incorporate climate science and adaptation into landscape-level and infrastructure planning. The

Energy Commission, in coordination with other state and federal agencies, should update and provide guidance documents to advance best management practices in permitting renewable energy power plants.

Charting a new course to meet the 2030 greenhouse gas reduction goals will also require expanded and improved analytical capabilities. The energy demand forecast informs infrastructure planning decisions, such as the need for additional energy resources or transmission that can have long-term implications for the state's greenhouse gas emissions. To reflect changes in the evolving energy system, forecasters need access to more granular data, particularly more locational data, to track supply and demand fluctuations associated with, for example, increases in distributed energy resources, energy efficiency, and zero-emission vehicle charging. Further analysis is also needed to better understand how the peak demand is shifting to later in the day with the increased use of rooftop solar. It will also be important to understand the potential effects of new residential time-of-use rates that encourage consumers to change when they use electricity. Efforts to begin addressing these issues in this *IEPR* lay the groundwork for revisions to the Energy Commission's forecast in the *2017 IEPR* and beyond.

California will need to redouble its efforts to reduce greenhouse gases from the transportation sector. Ongoing efforts to transform California's transportation system requires among other things, advancing both zero-emission and near-zero-emission vehicle infrastructure and vehicle deployment. The Energy Commission and other California state agencies will continue to implement the actions set forth in the *Zero-Emission Vehicle Action Plan* to meet the Governor's goals for zero-emission vehicles.

Despite efforts to reduce greenhouse gas emissions, California's climate is changing, requiring action to protect lives, livelihoods, and ecosystems. Governor Brown's Executive Order B-30-15 mandates expansion of state adaptation efforts, with the goal of making the anticipation and consideration of climate change a routine part of planning. Also in 2015 and 2016, four bills became law in California that will collectively enhance the state's capacity to anticipate and remain resilient in the face of climate change at local and regional levels, across a variety of economic sectors, and in a manner that protects people, places, and resources. The bills are Senate Bill 379 (Jackson, Chapter 608, Statutes of 2015), Senate Bill 246 (Wieckowski, Chapter 606, Statutes of 2015), Assembly Bill 1482 (Gordon, Chapter 603, Statutes of 2015), and Assembly Bill 2800 (Quirk, Chapter 580, Statutes of 2016).

More research is needed to continue monitoring and to better understand how the energy system impacts the environment and how the changing climate will affect the environmental performance of the energy system. Continued climate research for the energy sector is also needed to better inform climate adaptation and mitigation strategies; for example, energy planners should use a common set of climate scenarios as selected by the Climate Action Team Research Working Group and implement updated guidance from the Ocean Protection Council.

The state needs to build on and expand the successes realized in the electricity sector over the last decade. Meeting the 2030 greenhouse gas reduction goal in the energy sector will be a considerable challenge, but California has the talent, tenacity, and resources to make the necessary transformation.

CHAPTER 1: Environmental Performance of the Electricity Generation System

Introduction

California's energy and greenhouse gas (GHG) policies over the last 10 years have dramatically changed the California electrical generation system while improving its environmental performance. The Energy Commission's *2005 Environmental Performance Report (EPR)*² concluded that the state's electricity system was relatively clean, noting improvements that could help reduce environmental impacts.³ Since then, the state has implemented laws and policies to support the overall GHG reduction goals, expand renewable development, promote energy efficiency investments, encourage distributed generation, and move away from high-GHG-emitting generating resources such as coal.

In addition, the state has established policies for power plant cooling and water conservation, including restrictions on freshwater use and elimination of once-through cooling (OTC) for power plants, as well as policies that protect and conserve natural resources.

Implementing this suite of policies has helped California achieve GHG reductions, improve air quality, increase water efficiency for power plants, and provide other environmental benefits. At the same time, the rapid expansion of renewable resources in the last few years presents a new set of land-use and environmental challenges that the state is addressing.

The *Final 2016 Environmental Performance Report of California's Electrical Generation System*⁴ (*2016 EPR*) builds off previous *EPRs* to evaluate changes in the electricity system from climate change and energy policies over the previous decade. The *2016 EPR* analyzes the environmental impacts of those changes, including impacts to GHG emissions; air quality; public health; water; land use; biological, cultural, and visual resources; environmental justice (EJ); and related issues. It discusses nuclear decommissioning issues associated with the closure of the San Onofre Nuclear

² Public Resources Code Section 25303(b).

³ McKinney, Jim. 2005. *2005 Environmental Performance Report of California's Electrical Generation System*. California Energy Commission, CEC-700-2005-016. <http://www.energy.ca.gov/2005publications/CEC-700-2005-016/CEC-700-2005-016.PDF>.

⁴ Bartridge, Jim, Melissa Jones, Eli Harland, Judy Grau. 2016. *Final 2016 Environmental Performance Report of California's Electrical Generation System*. California Energy Commission. Publication Number: CEC-700-2016-005-SF.

Generating Station (San Onofre) and the proposed closure of the Diablo Canyon Power Plant (Diablo Canyon). It also discusses transformative technologies and approaches that may support California's long-term GHG reduction goals and reduce environmental impacts from renewable energy resources. Further, this chapter discusses landscape-scale planning efforts for both generation and transmission. Finally, this chapter presents recommendations for policies and actions necessary to improve environmental performance.

California's GHG Reduction Policies and the Impact on the Electricity System

In 2006, the Legislature passed the California Global Warming Solutions Act of 2006 (Assembly Bill 32, Núñez, Chapter 488, Statutes of 2006) (AB 32), which required the state to reduce its GHG emissions to 1990 levels by 2020 and charged the California Air Resources Board (ARB) with adopting regulations to achieve the maximum technologically feasible and cost-effective GHG emission reductions. The ARB, along with the Energy Commission, California Public Utilities Commission (CPUC), and a host of other state agencies and stakeholders, developed an initial *AB 32 Scoping Plan* laying out California's approach to meeting the AB 32 GHG reduction goal.⁵ Key recommendations for achieving reductions included expanding and strengthening existing energy efficiency programs, as well as building and appliance standards; achieving a statewide renewable energy mix of 33 percent by 2020; developing a Cap-and-Trade Program; and addressing transportation related GHG emissions. The ARB completed the first update to the *AB 32 Scoping Plan* in May 2014, noting that the set of actions the state is taking to address climate change is driving down GHG emissions and moving California steadily toward a clean energy economy.⁶ ARB is updating the Scoping Plan to reflect Senate Bill 350 (De León, Chapter 547, Statutes of 2015) (SB 350) provisions expected to be complete in the spring of 2017.⁷

In his 2015 inaugural address,⁸ Governor Edmund G. Brown Jr. laid out his vision for reducing GHG emissions by setting the following goals for 2030:

- Increase from one-third to 50 percent the state's electricity derived from renewable sources.
- Reduce today's petroleum use in cars and trucks by up to 50 percent.
- Double the efficiency of existing buildings and make heating fuels cleaner.

5 <http://www.arb.ca.gov/cc/scopingplan/scopingplan.htm>.

6 California Air Resources Board, *The First Update to the Climate Change Scoping Plan: Building on the Framework*, May 2014, http://www.arb.ca.gov/cc/scopingplan/2013_update/first_update_climate_change_scoping_plan.pdf.

7 For additional information see <http://www.arb.ca.gov/cc/scopingplan/scopingplan.htm>.

8 Governor Brown's 2015 inaugural address, January 5, 2015, <https://www.gov.ca.gov/news.php?id=18828>.

Further, he stated, “We must also reduce the relentless release of methane, black carbon, and other potent pollutants across industries. And we must manage farm and rangelands, forests, and wetlands so they can store carbon.”

The Governor said that meeting these goals “means that we continue to transform our electrical grid, our transportation system, and even our communities.” On April 19, 2015, Governor Brown put forward Executive Order B-30-15 that set a GHG reduction goal of 40 percent below 1990 levels by 2030.⁹ Senate Bill 32 (Pavley, Chapter 249, Statutes of 2016) (SB 32) put the Governor’s goal into law by requiring the state to reduce GHG emissions 40 percent below 1990 levels by 2030. The companion bill, Assembly Bill 197 (Garcia, Chapter 250, Statutes of 2016) (AB 197), assures that the state’s implementation of its climate change policies is transparent and equitable, with the benefits reaching disadvantaged communities.

Senate Bill 350 codified goals for 50 percent renewable energy and doubling of energy efficiency savings in buildings and retail end uses by 2030, as called for in the Governor’s Executive Order B-30-15. SB 350 also requires the ARB to establish, in coordination with the CPUC and the Energy Commission, emission targets for the electricity sector and load-serving entities that help achieve the statewide 2030 GHG reduction goal. In addition, SB 350 requires retail energy sellers to develop integrated resource plans to allow for a more cohesive examination of how the different policies and mandates can fit together to achieve the most cost-effective and efficient GHG reductions for the state. (For more information on integrated resource plans, see Chapter 4: Electricity Forecast, “Future Data and Analytical Needs.”) SB 350 also requires the Energy Commission to study barriers to and opportunities for low-income and disadvantaged communities to increase access to energy efficiency and renewable energy investments and programs, electrical corporations to accelerate programs and investments in widespread transportation electrification, and the state to move toward the voluntary transformation of the California Independent System Operator (California ISO) into a regional organization. These additional provisions of SB 350 are also discussed in later sections of this chapter.

The Electricity System in Context of California’s Overall Greenhouse Gas Emissions

While outside the scope of the *2016 EPR* and not included in that report, for the IEPR, it is helpful to put electricity sector GHG emissions in context with other sectors of California’s energy use. For the IEPR, the *energy system* is defined as including all activities related to:

- Energy extraction (such as oil and natural gas wells).

⁹ It also set a long-term goal to reduce GHG emissions 80 percent below 1990 levels by 2050. <https://www.gov.ca.gov/news.php?id=18938>.

- Fuel and energy transport (for example, oil and natural gas pipelines).
- Conversion of energy from one form to another (such as combusting natural gas in power plants to generate electricity or producing gasoline and diesel from crude oil in refineries).
- Energy services (such as electricity for lighting, natural gas use in homes and buildings for space and water heating, and gasoline and diesel to fuel cars and trucks).
- Electricity (and associated emissions) from out-of-state power plants that produce electricity consumed in California.

Under this broad definition, the energy system was responsible for about 80 percent of the gross GHG emissions in California in 2014.¹⁰

Looking at emissions by sector as shown in Figure 1, electricity generation, including imported electricity consumed in California, accounted for about 20 percent of California's GHG emissions in 2014. The industrial sector, which includes oil refineries, accounted for roughly 24 percent, and the residential and commercial sectors accounted for roughly 11 percent. Although not shown in Figure 1, GHG emissions from the residential and commercial sectors collectively account for more than 26 percent when including electricity use in those sectors. The transportation sector is the largest contributor of GHG emissions in California, accounting for roughly 37 percent of statewide emissions in 2014. As discussed below, the state has made great strides in the electricity sector, demonstrating that California is capable of transforming its electricity system in a relatively short time frame. To achieve the 2030 GHG reduction goal, the state must make even more progress in the electricity sector and transform all sectors of its energy system.

¹⁰ This calculation was made using ARB Inventory 2014 data.

Figure 1: California's GHG Emissions in 2014

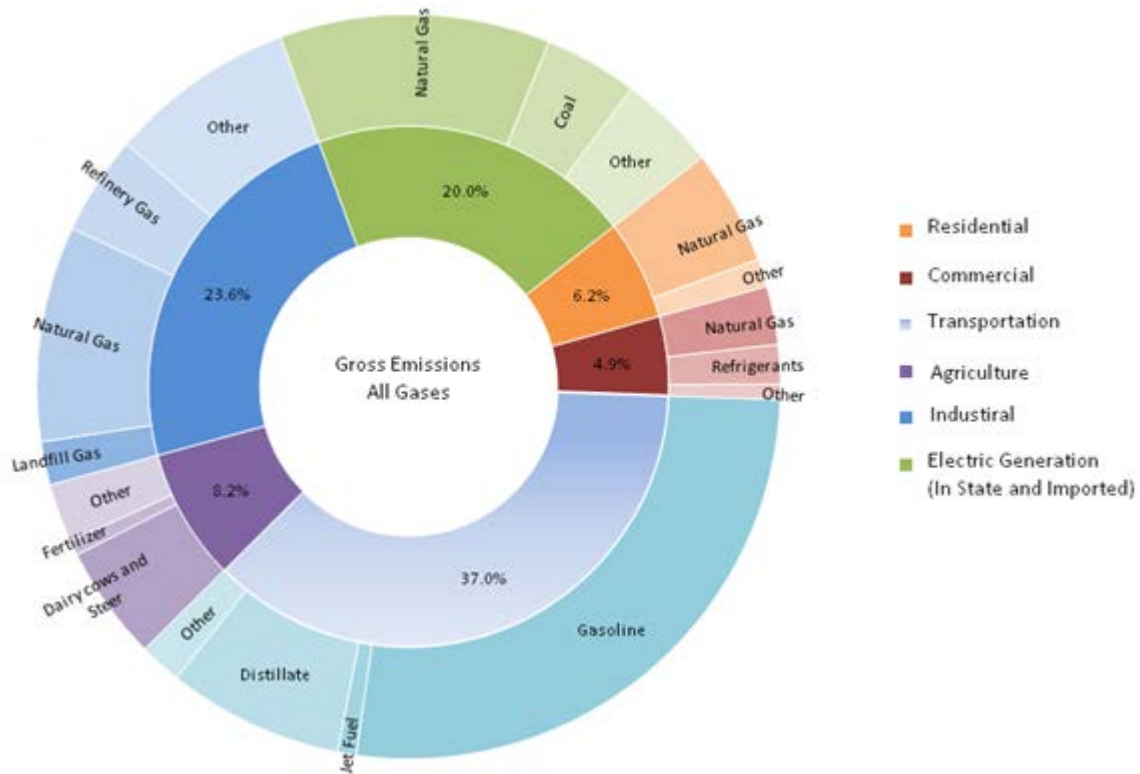

Source: Energy Commission staff based on data from the ARB's *Greenhouse Gas Emissions Inventory— 2016 Edition*. (Percentages may not total 100 percent due to rounding.)

Although California's GHG emissions are primarily (about 82 percent) carbon dioxide (CO₂), short-lived climate pollutants (SLCP) are another important component of the state's GHG emissions: they are powerful climate forcers¹¹ that remain in the atmosphere for a much shorter time than CO₂. While Figure 1 includes both CO₂ and SLCP, Figure 2 shows the relative contribution of SLCP and CO₂. SLCP include methane (primarily from agriculture and forestry), black carbon (soot, primarily from transportation), and fluorinated gases (primarily from the commercial sector), as shown in Figure 2. These climate pollutants can heat the atmosphere with tens to thousands of times greater potency than CO₂ and are estimated to account for about 40 percent of climate forcing from anthropogenic pollution (pollution associated with human activities). The ARB is working to reduce SLCP emissions for an immediate beneficial impact on climate change.¹² Further, Senate Bill 1383 (Lara, Chapter 395, Statutes of

¹¹ *Climate forcing* refers to the difference between energy that Earth receives from the sun and the amount of energy radiated back into space. *Man-made climate forcing* is the additional energy that is retained in the Earth's atmosphere, oceans, and land due to the presence of greenhouse gases and aerosols in our atmosphere, as well as changes in land surface reflectivity.

¹² California Air Resources Board, *Revised Proposed Short-Lived Climate Pollutant Reduction Strategy*, November 2016, <http://www.arb.ca.gov/cc/shortlived/shortlived.htm>.

2016) requires the ARB to develop and implement a strategy to reduce SLCP emissions below 2013 levels by 2030 as follows: cut methane emissions by 40 percent, anthropogenic black carbon by 50 percent, and hydrofluorocarbon gases by 40 percent.

Figure 2: Relative Contribution of Various Greenhouse Gases in California

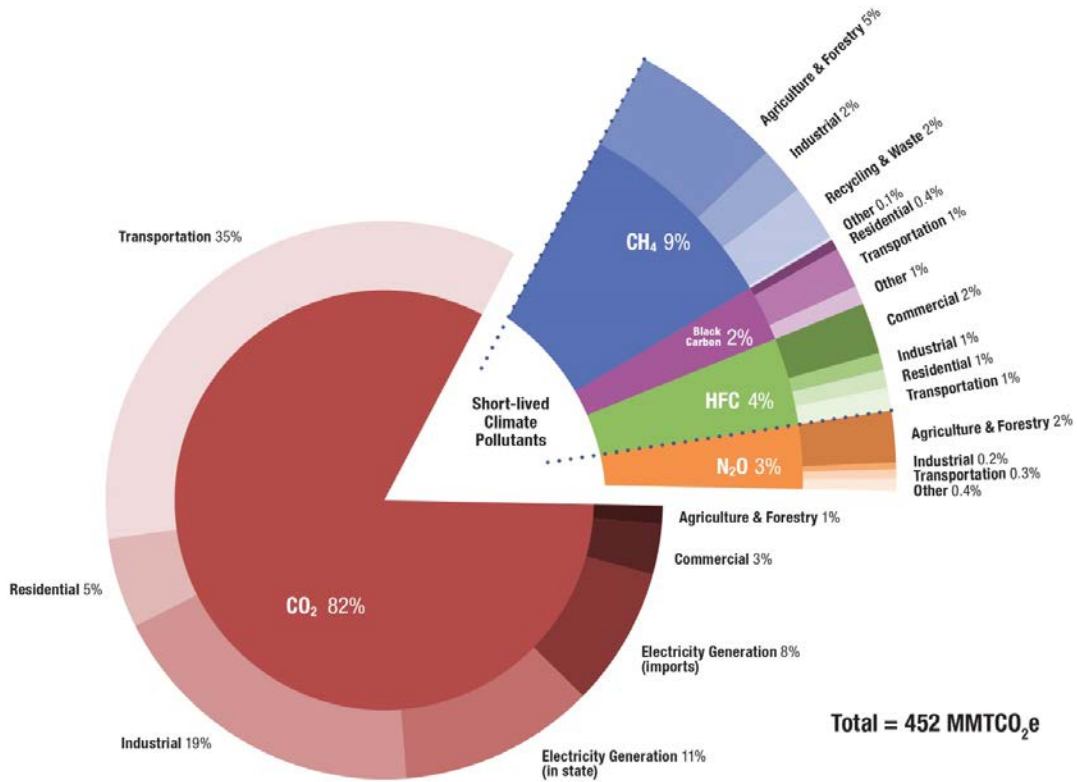

Source: California Energy Commission staff using data from the ARB's *Greenhouse Gas Emissions Inventory – 2016 Edition* (available at <https://www.arb.ca.gov/cc/inventory/data/data.htm>).

Note: 2014 data shown with the exception of black carbon for which 2013 are the most recent data available.

Meeting California's 2030 GHG reduction goal will require reducing emissions across a broad range of sources in all sectors of California. While the state is well on its way to meeting the goal to reduce GHG emissions 20 percent below 1990 levels by 2020, reducing emissions 40 percent below 1990 levels by 2030 is much more ambitious. Figure 3 shows California's greenhouse gas reduction goals against historical greenhouse gas emissions.

Figure 3: California's Path to Progress to Meet Climate Goals

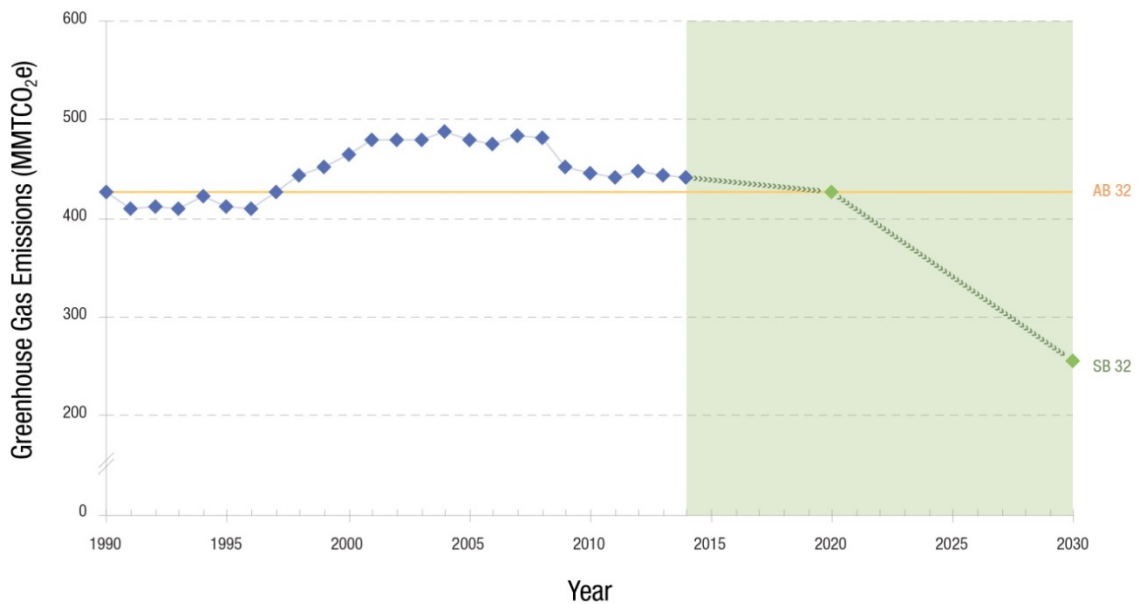

Source: California Energy Commission, Tracking Progress web page, Greenhouse Gas Emission Reductions, updated December 20, 2016.

Note: Not shown is California's 2050 goal to reduce greenhouse gas emissions 80 percent below 1990 levels by 2050 as set in Executive Order B-30-15.

Electricity System GHG Emission Reductions

California's electricity sector has made great strides to advance the state's GHG reduction goals, with emissions in 2014 about 20 percent below 1990 levels. Further illustrating California's relatively low GHG emissions, close to half of the state's electricity emissions are from out-of-state power consumed in California, although out-of-state power represents about a third of California's resource mix.¹³ There is significant year-on-year variability in GHG emissions from the electricity sector as the system compensates for swings in generation. Factors affecting the system include variation in hydropower due to California's drought, variations in imports from out-of-state resources, outages to refuel nuclear power plants, as well as the shutdown of San Onofre. For example, natural gas use was down 20 percent in California in the summer of 2016 compared to the previous year due to better hydro conditions and more renewable energy coming on-line.¹⁴ The overall trend indicates that GHG emissions from

13 California Energy Commission. 2015. *2015 Integrated Energy Policy Report*. Publication Number: CEC-100-2015-001-CMF.

14 <http://www.eia.gov/todayinenergy/detail.cfm?id=27812>.

the electricity sector are declining relative to the emissions performance of other sectors, as shown in Figure 4.

The decline in electricity sector GHG emissions is due to many factors, including the increase in renewable generation, energy efficiency, and distributed resources; modernization of the natural gas fleet; the decline in out-of-state coal-fired generation imports; as well as transmission additions and changes to electricity markets. In the future, the increasing connection between the electricity and transportation sectors could be as significant as the emergence of solar photovoltaics (PV), if not more. Increasing transportation electrification is expected to bring tremendous air quality and GHG benefits to the state in the future.

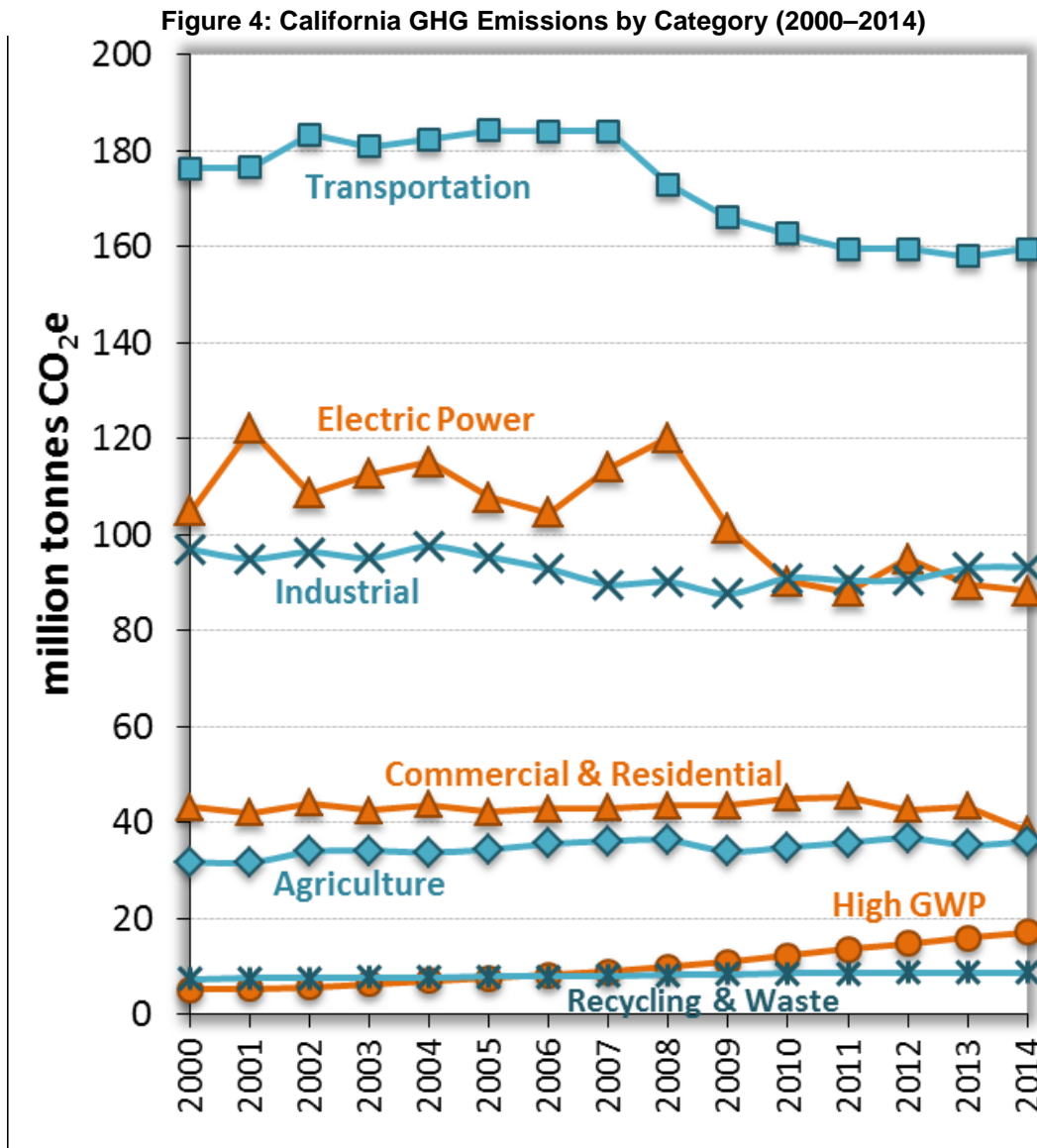

Source: ARB California GHG Emission Inventory, 2016 Edition: <http://www.arb.ca.gov/cc/inventory/data/data.htm>.

An emerging GHG issue for the electricity sector is methane, a highly potent GHG. Natural gas, which is about 90 percent methane, has the potential to reduce CO₂ emissions by shifting away from higher CO₂-emitting fuels like coal in power plants and gasoline or diesel in vehicles. A fundamental question, however, is how much methane is escaping from the natural gas system as such leakage reduces the GHG benefits of using natural gas. Estimates of methane emissions to date are highly variable and uncertain,¹⁵ and some studies estimate that emission levels are high enough to offset the benefits of burning natural gas in place of more carbon-intensive fuels. This is discussed further in Appendix A (Methane Emissions Associated with Natural Gas Consumption in California). Such leakage can occur throughout the natural gas system through normal operations, including intentional releases of gas (venting) and unintentional leaks, and is generally distinct from the major leak at the Aliso Canyon natural gas storage facility. (For more discussion, see Chapter 2: Energy Reliability in Southern California.)

Changes in California's Electricity System

State energy and GHG reduction policies adopted over the past decade including the Renewables Portfolio Standard (RPS), the Emission Performance Standard (EPS), and the Cap-and-Trade Program have altered California's resource mix, putting generation from coal resources on a steep decline. Energy and climate change policy has also affected the customer side of the meter with continued energy efficiency improvements and the emergence of distributed generation, such as rooftop solar PV systems. In addition, climate change is influencing the demand for electricity as higher temperatures increase air conditioning loads in summer and decrease heating loads in winter. Climate change also exacerbates drought conditions, which increases the risk of wildfires that can damage the electric grid and cause energy reliability problems, among other risks to human life and property. The following section discusses the connections between these major policies and electricity system changes.

California's Electricity Resource Mix

The composition of California's in-state generation capacity (in megawatts, or MW) has undergone several changes between 2001 and 2015, as shown in Figure 5. Although natural gas-fired capacity is still a dominant generation resource, in the last few years, significant amounts of renewable resources have been brought on-line. This increase in renewable resources is detailed in the next section of this chapter. The closure of San Onofre significantly reduced the amount of nuclear generation in the state. Several coal

¹⁵ California Energy Commission, *AB 1257 Natural Gas Act Report: Strategies to Maximize the Benefit Obtained from Natural Gas as an Energy Source*, 2015, Publication Number CEC-2000-2015-006, http://docketpublic.energy.ca.gov/PublicDocuments/15-IEPR-04/TN206470_20151030T160233_STAFF.pdf.

facilities also closed; these are relatively small but still major contributors to GHG emissions.¹⁶

Figure 5: Installed In-State Electric Generation Capacity by Resource Type (2001–2015)

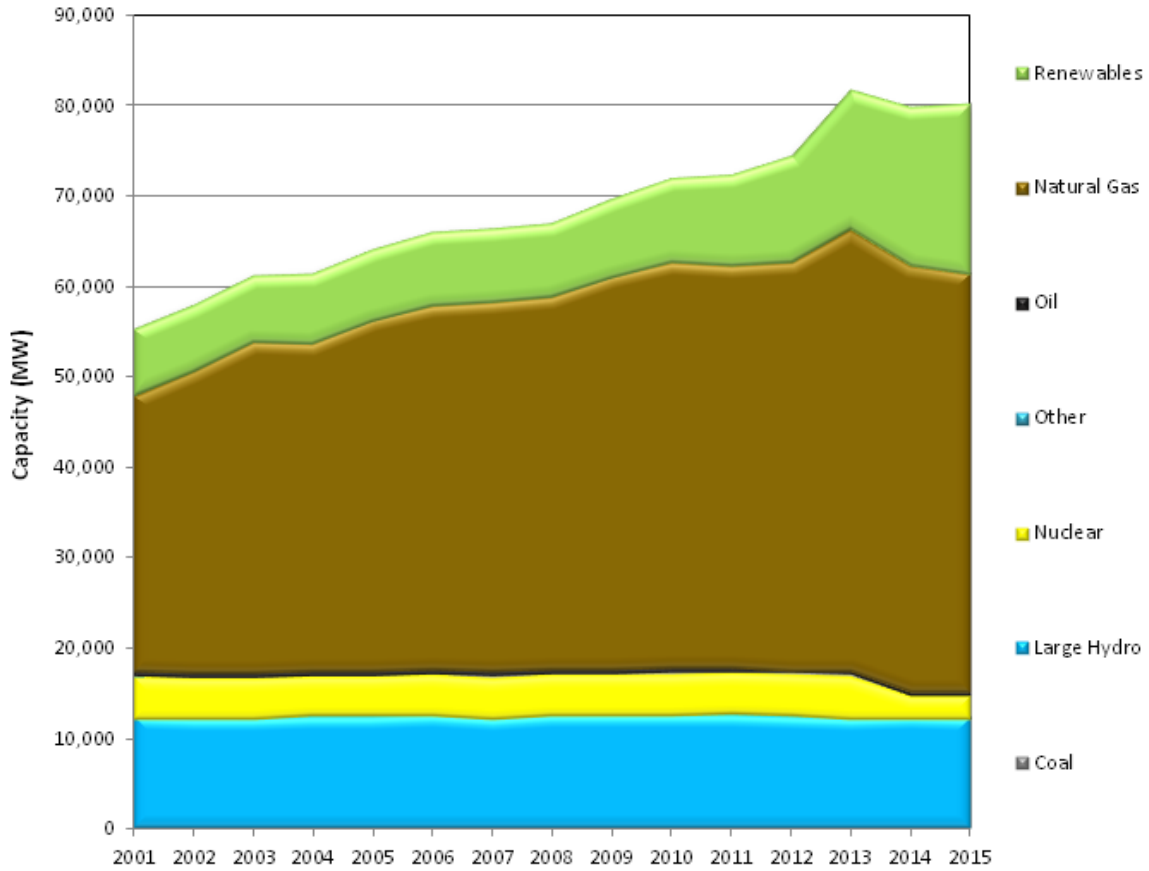

Source: California Energy Commission, 1304 Power Plant Data Reporting, Energy Assessments Division. (“Other” includes small amounts of distillate and jet fuel.)

Generation remained relatively flat over the last 14 years, increasing only slightly, consistent with slower growth in energy demand, as shown in Figure 6. As with capacity, electric generation is dominated by natural gas-fired power plants. There has also been substantial growth in renewable generation, with much of it from variable energy resources. The increase in total generation from renewable resources is not as dramatic as the growth of installed renewable capacity, mostly due to lower capacity factor renewable energy like wind and solar and newer renewable capacity that is just beginning to report generation output.¹⁷ Figure 6 also shows the sharp drop in nuclear

16 For the status of coal and petroleum coke facilities in California, see Tracking Progress for Reliance On Coal, http://www.energy.ca.gov/renewables/tracking_progress/#coal (Note: In late 2015 the Rio Bravo Poso cogeneration facility announced that it would close, which isn’t reflected in the Tracking Progress report.)

17 California’s RPS is measured in percentage of retail sales, not percentage of total generation. As a result, the data in Figure 2 and Figure 3 should not be used to measure progress in achieving the RPS.

generation from the closure of San Onofre, the dramatic effect of the drought on hydroelectric generation, and the continued decline in coal-fired generation.

Figure 6: Electric Generation by Resource Type (2001–2015)

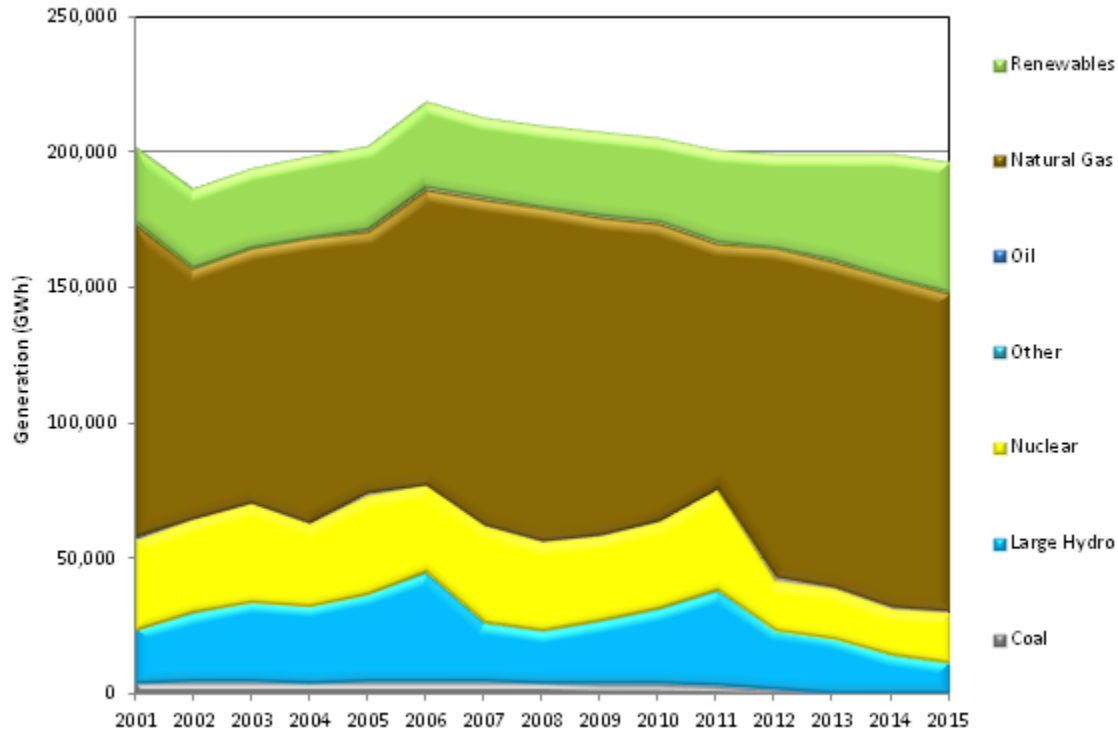

Source: California Energy Commission, 1304 Power Plant Data Reporting, Energy Assessment Division. (“Other” includes small amounts of distillate and jet fuel.)

Expansion of Renewable Resources

California’s first RPS was established in 2002 under Senate Bill 1078 (Sher, Chapter 516, Statutes of 2002) with the goal of increasing the percentage of renewable energy in the state’s electricity mix to 20 percent by 2017. The RPS was accelerated in 2006 under Senate Bill 107 (Simitian, Chapter 464, Statutes of 2006) by requiring that 20 percent of electricity sales be served by renewable energy resources by 2010. The RPS was subsequently increased to 33 percent by 2020 with the passage of Senate Bill X1-2 (Simitian, Chapter 1, Statutes of 2011). SB 350 requires all load-serving entities, including electrical corporations, community choice aggregators,¹⁸ electric service providers, investor-owned utilities (IOUs), and publicly owned utilities (POUs), to achieve

¹⁸ *Community choice aggregation* allows local governments and some special districts to pool (or aggregate) their electricity load to purchase and/or develop power on behalf of their residents, businesses, and municipal accounts.

50 percent by December 31, 2030.¹⁹ The passage and implementation of the state's 33 percent RPS statute resulted in an unprecedented deployment of renewable energy facilities in the state, as is anticipated with the 50 percent RPS mandate.

Largely under the leadership of Governor Brown, in-state renewable capacity more than tripled between 2001 and 2016. Installed capacity of renewable energy in California increased from 6,800 megawatts (MW) in 2001 to almost 21,300 MW in 2016. Including behind-the-meter capacity (such as rooftop solar) and facilities smaller than 1 MW, installed capacity reached 26,300 MW by the end of 2016. (See "The Emergence of Distributed Generation" below for more information on the dramatic growth of behind-the-meter capacity.) Figure 7 shows in-state renewable capacity by fuel type for facilities larger than 1 MW and excluding behind-the-meter generation. The most dramatic change is the addition of utility-scale solar PV, especially between 2010 and 2015 when installed, operating capacity rose from roughly 40 MW to 5,700 MW. This capacity growth includes both new facilities and capacity expansions to existing solar PV plants. Solar thermal technology was the second largest category of growth, increasing from roughly 400 MW in 2012 to nearly 1,300 MW in 2015, with no new additions in 2016. Installed wind capacity increased at a slightly slower pace from around 1,500 MW in 2001 to 4,000 MW in 2011 and then jumped to roughly 6,100 MW by 2016. Further, there are about 10,000 MW of new renewable capacity being proposed that have environmental permits and are in preconstruction or construction phases.²⁰

¹⁹ <http://www.energy.ca.gov/sb350/>.

²⁰ The data reported here are from the California Energy Commission's Tracking Progress webpage, Renewable Energy, updated December 22, 2016, and posted December 27, 2016. http://www.energy.ca.gov/renewables/tracking_progress/#renewable.. The Tracking Progress data are a proxy for RPS progress as the analysis aims to include only data from renewable energy facilities that are operating and are RPS-eligible. The *2016 EPR* uses information from 1304 Power Plant Data Reporting that includes some renewable facilities that did not operate or were not RPS-eligible. Also, 1304 Power Plant Data Reporting includes only plants that are 1 MW or larger.

Figure 7: RPS Renewable Capacity Installed in California (in MW) by Resource Type

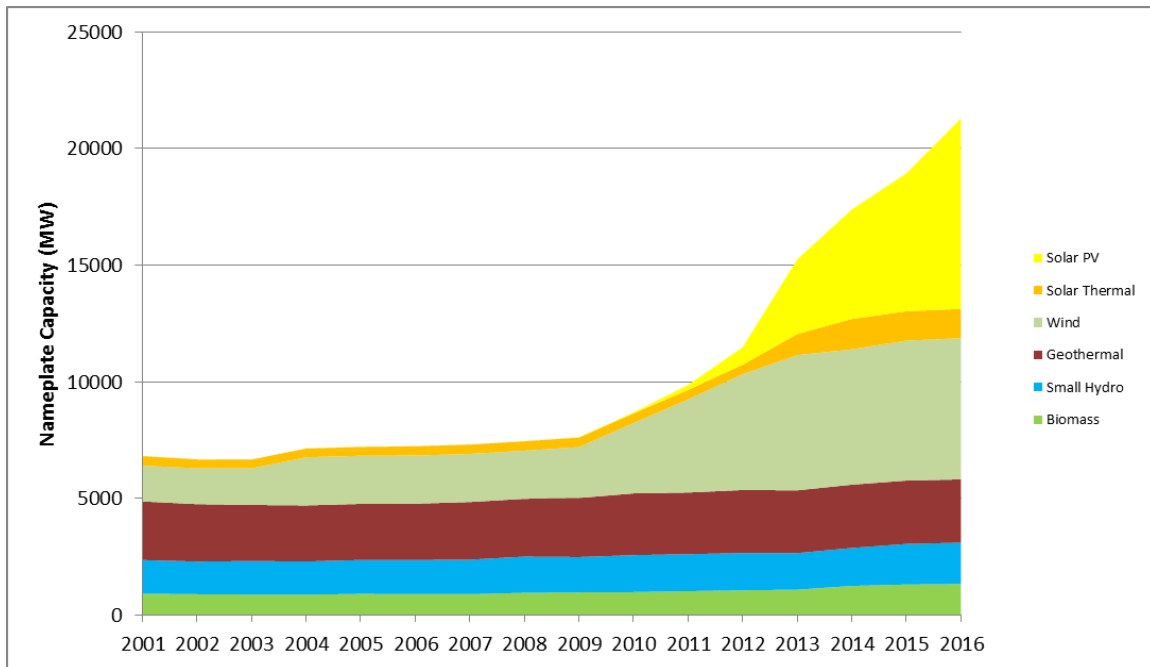

Source: California Energy Commission, prepared with data from Tracking Progress, Renewable Energy, updated December 22, 2016, and posted December 27, 2016. (This approximates RPS eligibility but it should not be used for evaluating compliance.)

The growth in renewable generation serving California by resource type from 1983–2014 is shown in Figure 8 on the next page. The data in Figure 8 are intended to be representative of RPS-eligible generation, and so it includes energy delivered into California from out-of-state facilities that are RPS-eligible.²¹ Overlaid on the graph are some of the policies, discussed above, that helped stimulate the market for renewables. Prior to the RPS, Figure 8 shows the resurgence of renewable resources in the state beginning in 1980s, resulting largely from policies established by Governor Brown under his first administration.²² The next major increase in renewable projects came roughly after 2008, when projects procured in response to the RPS began coming on-line.²³ The increase in renewable energy generation after 2008 coincides with decreases in GHG emissions in the electricity sector, as seen in Figure 4. California is well on its way to meeting the requirement for 33 percent renewables by 2020.

²¹ The data in Figure 6 are a proxy for the RPS but do not reflect the RPS accounting rules that allow for, among other things, carry-over between multi-year compliance periods. For more information, see the section on “Percentage Renewable is a Proxy for RPS Progress” at http://www.energy.ca.gov/renewables/tracking_progress/#renewable.

²² To implement the Public Utility Regulatory Policies Act of 1978, which was passed at the federal level in response to the 1973 energy crisis, California instituted standard offer contracts for renewable projects that spurred renewable development in the state.

²³ The original RPS statute was passed in 2002.

Figure 8: California Renewable Energy Generation From 1983 to 2014 by Resource Type (In-State and Out-of-State)

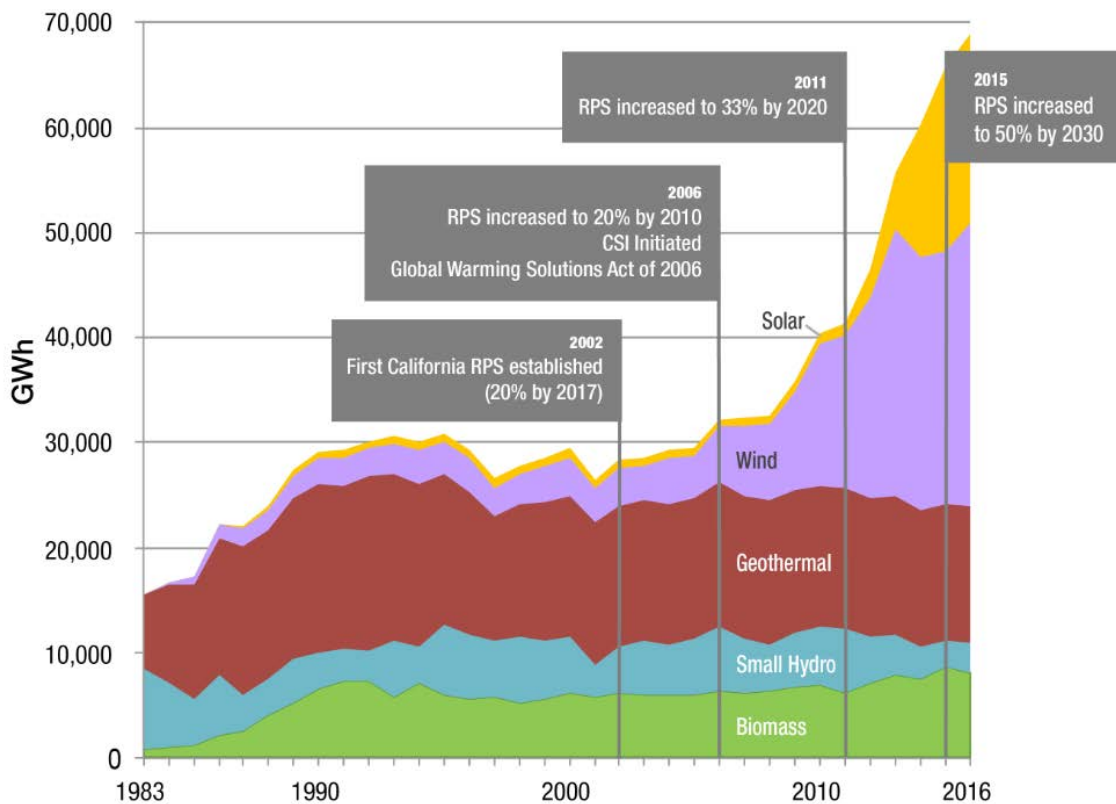

Source: California Energy Commission, Tracking Progress web page, Renewable Energy, updated December 22, 2016, and posted December 27, 2016.

The rapid deployment of renewable energy facilities over the last decade has led to a new level of biological, land-use, and cultural impacts that were different from those seen in the review of conventional generation facilities. These new large renewable resources have a larger environmental footprint when compared with traditional generation technologies such as natural gas. In addition, renewable projects are often located in more remote locations, like the desert, where there is more limited experience and understanding of renewable energy development and the associated environmental impacts.

As more variable renewable electricity generating resources, like wind and solar, are added to California's electricity resource mix, it becomes more challenging to integrate them while maintaining grid reliability, safety, and security. The flexible natural gas-fired power plants used to integrate renewables must have the ability to sit idle or at very low levels of output while renewable resources generate energy, then quickly start and rapidly ramp up as renewable resources ramp down, such as when the sun sets or the wind calms.

The California ISO has raised concerns about the large ramps up and down in generation needed to maintain reliability. In 2013 the California ISO projected that net energy demand after subtracting behind-the-meter generation (*net load*) could be as low as 12,000 MW by 2020 and that meeting peak demand may require ramping up 13,000 MW in three hours. The grid is already experiencing the large operational fluctuations that grid operators were not expecting until 2020. On May 15, 2016, the net load reached a minimum of 11,663 MW and on February 1, 2016, the three-hour ramp was 10,892 MW.²⁴ The section later in the chapter on “Energy Imbalance Market” describes one important tool that is helping to balance such fluctuations in supply and demand.

There is a growing need for flexible resources to compensate for hourly changes in variable renewable generation and energy demand, as well as outages for power plant maintenance and seasonal variations in hydropower generation. Currently, natural gas-fired power plants offer the most flexibility for quickly, reliably, and cost-effectively ramping up or down to balance supply or demand. As California moves toward reducing GHG levels to 40 percent below 1990 levels by 2030, it is important that nonfossil resources are developed to integrate renewables.²⁵ Potential options are being developed in California, including energy storage, demand response, and portfolio diversification.²⁶ On November 20, 2015, Energy Commission Chair Robert B. Weisenmiller and CPUC President Michael Picker jointly conducted a workshop to discuss bulk energy storage in California, including the challenges of planning the electric grid and developing future bulk energy storage projects, the potential for bulk energy storage to address grid challenges, and the operations of existing bulk energy storage projects in California.²⁷ Assembly Bill 33 (Quirk, Chapter 680, Statutes of 2016) requires the CPUC to analyze the potential for long-duration bulk energy storage to help integrate renewable resources. There are also potential regional solutions for integrating renewable energy resources, including taking advantage of the diversity of renewable resources and related varying generation profiles across the broader western region. (For example, see “Increasing Regionalization” below for more information.)

The Emergence of Distributed Generation

In 2006, Senate Bill 1 (Murray, Chapter 132, Statutes of 2006) established a suite of solar programs with a goal of building a self-sustaining solar market combined with high levels of energy efficiency in the state’s homes and businesses. The SB 1 programs build

24 California ISO Market Performance and Planning Forum presentation, July 21, 2016, p.56, http://www.caiso.com/Documents/Agenda-Presentation-MarketPerformance-PlanningForum-Jul21_2016.pdf.

25 The 2030 GHG reduction goal is an important step on the way to reducing GHG emissions to 80 percent below 1990 levels by 2050.

26 Portfolio diversification can be achieved by leveraging seasonal, geographical, and technological characteristics.

27 Mathias, John, Collin Doughty, and Linda Kelly. 2016. *Bulk Energy Storage in California*. California Energy Commission. Publication Number: CEC-200-2016-006.

on California's three ratepayer-funded incentive programs for solar energy systems: the Energy Commission's New Solar Homes Partnership (NSHP), the CPUC's California Solar Initiative (CSI) program, and the collective solar programs offered through the publicly owned utilities (POUs).²⁸ California has also used net energy metering (NEM) to offer incentives for customer adoption of small-scale, renewable generation, starting in 1995 with several subsequent legislative changes over the years.²⁹ The CSI had a goal of installing 3,000 MW of solar on homes and businesses in California by the end of 2016, which was surpassed in 2015.³⁰ Due to the success of the CSI program and the solar market in general, much of the program has met its goals and the funds are exhausted. Many solar systems continue to be installed, however, without CSI funding. Through SB 1 incentives, Californians installed about 2,300 MW of solar PV. A larger amount of capacity, more than 2,800 MW, has since been installed in California without SB 1 rebates. The state's NEM policy, the federal investment tax credit, and cost reductions in solar PV have helped spur continued market growth.³¹

CSI also has a goal to install 585 million therms of gas-displacing solar hot water systems by the end of 2017.³² The CSI-Thermal program offers cash rebates of up to \$4,366 on solar water heating systems for single-family residential customers. Multifamily and commercial properties qualify for rebates of up to \$800,000 on solar water heating systems and eligible solar pool heating systems qualify for rebates of up to \$500,000.³³

The Energy Commission's NSHP program provides financial incentives to encourage the installation of eligible solar energy systems on new home construction. The ongoing recovery of the market from the housing crisis (coincident with the start of the NSHP program) has resulted in growing amounts of solar installed on new homes, and as of October 31, 2016, about 192 MW was reserved or installed, demonstrating substantial progress toward the program goal of 360 MW. On June 9, 2016, the CPUC approved \$111.78 million in additional funding for continuing financial incentives for homeowners, builders, and developers to install solar energy systems on new, energy-efficient homes with the Energy Commission as the NSHP program administrator.³⁴

28 Combined, these programs encompass new and existing residential, multifamily, and commercial buildings.

29 Senate Bill 656 (Alquist, Chapter 369, Statutes of 1995), Assembly Bill 920 (Huffman, Chapter 376, Statutes of 2009), Assembly Bill 327 (Perea, Chapter 611, Statutes of 2013), and Assembly Bill 1637 (Low, Chapter 658, Statutes of 2016).

30 California Energy Commission, *Tracking Progress: Renewable Energy*, 2016, p. 14, http://www.energy.ca.gov/renewables/tracking_progress/

31 California Energy Commission's Tracking Progress webpage, Renewable Energy, updated December 22, 2016, and posted December 27, 2016, http://www.energy.ca.gov/renewables/tracking_progress/#renewable.

32 <http://www.gosolarcalifornia.ca.gov/about/index.php>.

33 <http://www.gosolarcalifornia.ca.gov/solarwater/index.php>.

34 California Energy Commission, Tracking Progress webpage, Renewable Energy, updated December 22, 2016, and posted December 27, 2016.

The emergence of behind-the-meter distributed generation or self-generation, primarily solar PV, has helped reduce demand for electricity from the grid; however, as discussed in the *2016 EPR*, the expansion of distributed generation will require further understanding of the cost and benefits of integrating it into the grid. Nearly 610,000 residential and commercial self-generation solar projects³⁵ totaling almost 5,100 MW³⁶ were installed in California, about 2,000 MW of which were installed just in 2014 and 2015. Residential installations in California represent more than 40 percent of all solar PV installed in the United States, and nonresidential installations represent 50 percent.³⁷

Energy Efficiency and Energy Demand

The Warren-Alquist Act requires the Energy Commission to reduce the wasteful, uneconomic, inefficient, or unnecessary consumption of energy by developing building standards, appliance standards, and energy efficiency programs.³⁸ These energy efficiency efforts have saved California consumers billions of dollars since the 1970s and have held per capita energy use in the state relatively constant, while the rest of the United States has increased by roughly 40 percent, as shown in Figure 9. This is also true for California's per capita GHG emissions, with both energy efficiency and the rapid increase in renewable resources contributing to this decline in consumption, as shown in Figure 10. Also shown in Figure 10, California's economy grew (as demonstrated by growth in gross domestic product, or GDP) as its GHG emissions declined over the last 25 years. Figure 11 shows California's GHG emissions per capita and per GDP in comparison with other countries. California has relatively high economic output relative to its GHG emissions and its per capita emissions are similar to those of Germany and Israel.

35 This is based on (1) Publicly Owned Utilities SB1 Solar Program Status Reports, available at http://www.energy.ca.gov/sb1/pou_reports/ (2) California Distributed Generation Statistics, *Currently Interconnected Data Set* of all solar PV (NEM) systems within Pacific Gas and Electric Company (PG&E), Southern California Edison Company (SCE), and San Diego Gas & Electric (SDG&E) service territories, available at <http://www.californiadgstats.ca.gov/downloads/>. Commercial also includes educational, industrial, military, nonprofit, other government, and school projects.

36 California Energy Commission's Tracking Progress Web page, Renewable Energy, updated December 22, 2016, and posted December 27, 2016, http://www.energy.ca.gov/renewables/tracking_progress/#renewable relies on interconnection data from the CPUC. The California Distributed Generation Statistics, *Currently Interconnected Data Set* (accessed December 15, 2016), does not include 281 MW from 310 customer sites but is included in the Energy Commission's Tracking Progress Web page on Renewable Energy.

37 Solar Energy Industries Association, Q3 2016 Press Release, September 12, 2016, <http://www.seia.org/news/us-solar-market-adds-more-2-gw-q2-2016>.

38 Warren-Alquist Act. Public Resources Code, Section 25007, http://www.energy.ca.gov/reports/Warren-Alquist_Act/.

Figure 9: Statewide and U.S. Baseline Electricity Annual Consumption per Capita

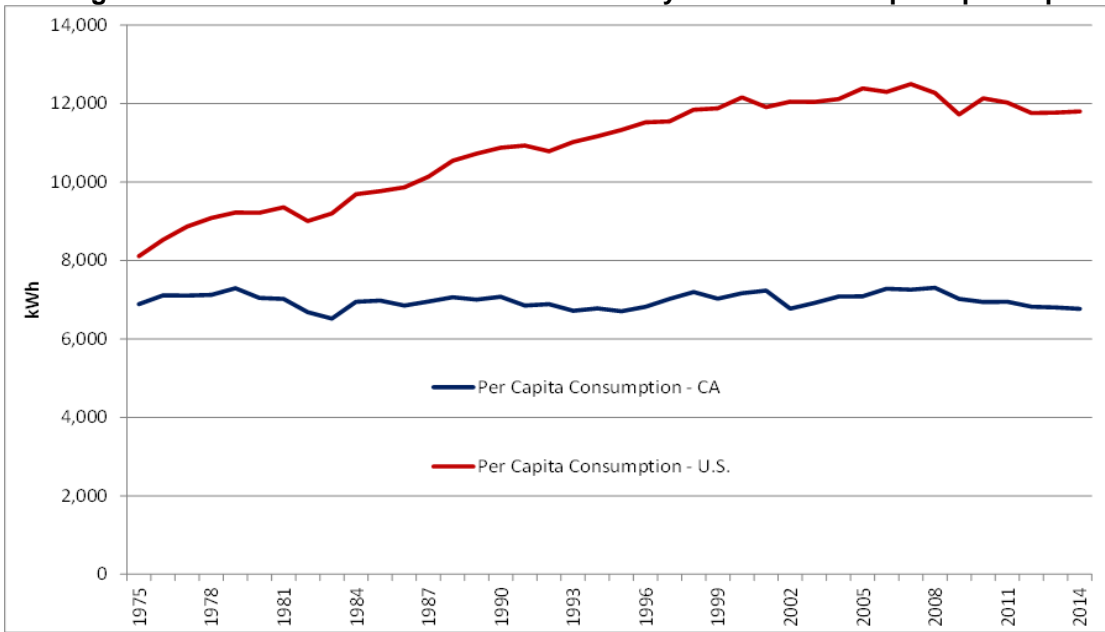

Source: California Energy Commission, 2016, *California Energy Demand 2016-2026, Revised Electricity Forecast*. California Energy Commission. Publication Number: CEC-200-2016-001-V1 Adopted 2016

Figure 10: Decline in GHG Emissions per Capita and per GDP Over the Last 25 Years While California's Economy Grew

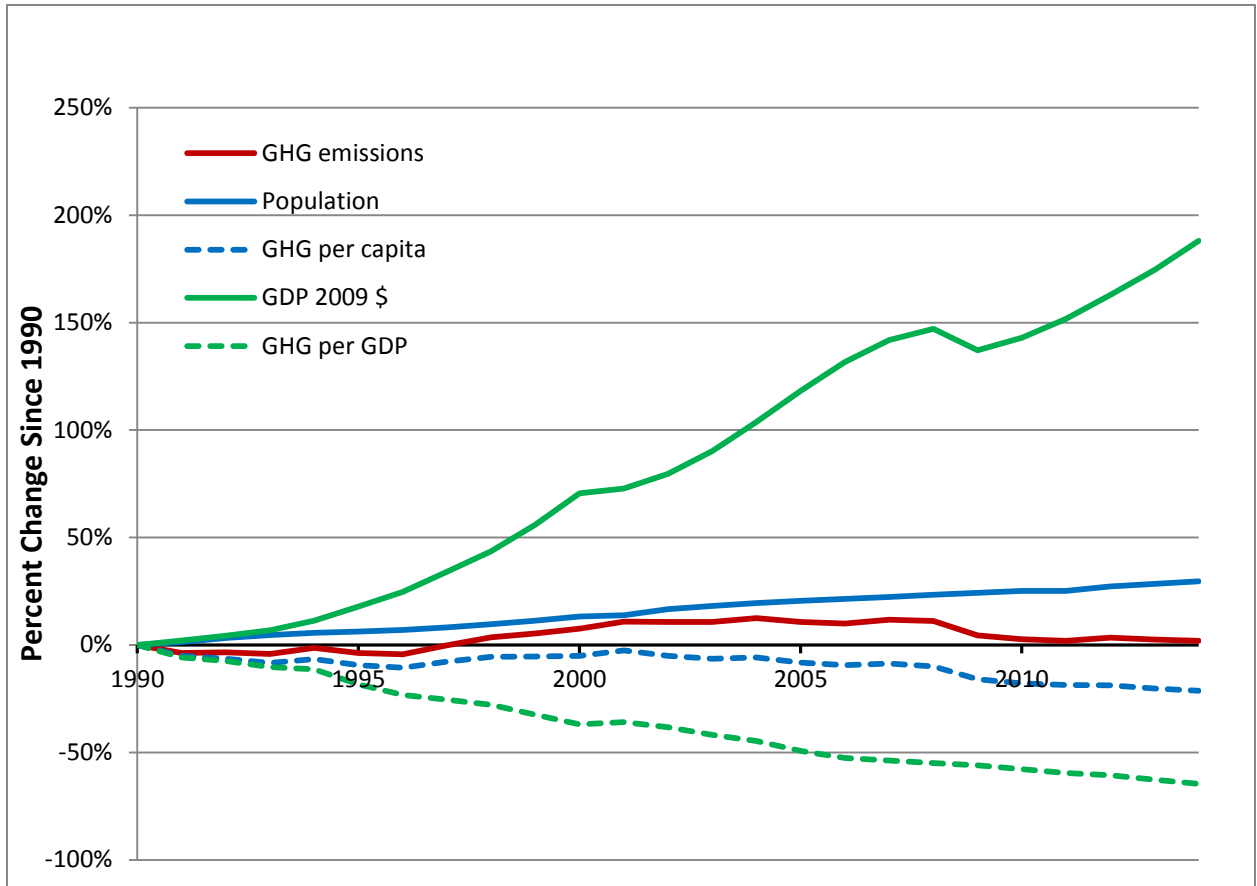

Source: California Energy Commission staff

Figure 11: California GHG Emissions per GDP and per Capita in Comparison With Other Countries

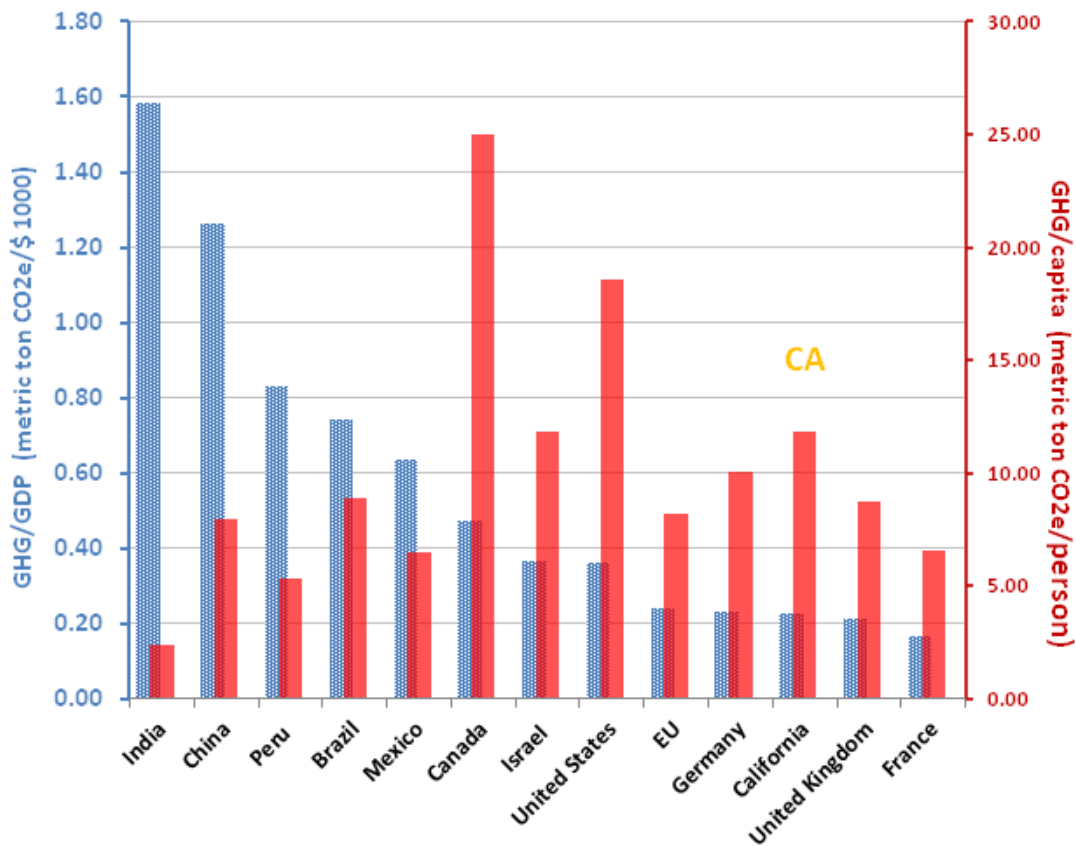

Source: California Energy Commission staff using data from ARB (GHG Inventory) and the Department of Energy's Carbon Dioxide Information Analysis Center

Energy efficiency standards help overcome well-understood barriers in markets for appliances and buildings, eliminating the least efficient products and practices from the marketplace. California utilities' energy efficiency programs since the 1970s offer some of the lowest-cost energy resource options and help meet California's energy and climate policy objectives. Still, more action is needed to reduce energy consumption in existing buildings as the energy used in them accounts for more than one-quarter of all GHG emissions in California.³⁹ In 2015, the Energy Commission adopted the *Existing Buildings Energy Efficiency Action Plan*⁴⁰ to help meet the Governor's goal to double the efficiency savings of existing buildings by 2030 and adopted the first update in December 2016. Further updates are expected every three years.

39 California Energy Commission. 2015. *2015 Integrated Energy Policy Report*. Publication Number: CEC-100-2015-001-CMF, p. 10.

40 California Energy Commission. 2015. *Existing Buildings Energy Efficiency Action Plan*. Publication Number: CEC-400-2015-013-F, p. 10, http://docketpublic.energy.ca.gov/PublicDocuments/15-IEPR-05/TN205919_20150828T153953_Existing_Buildings_Energy_Efficiency_Action_Plan.pdf.

SB 350 requires the Energy Commission to establish annual targets for statewide energy efficiency savings and demand reduction that will achieve a doubling of energy efficiency savings from buildings and retail end uses by 2030. Further, Assembly Bill 802 (Williams, Chapter 590, Statutes of 2015) gives the Energy Commission authority to acquire utility customer usage and billing data for use in studies to improve demand forecasting and technical knowledge of the role of energy efficiency in reducing customer demand. The *2015 IEPR* focused on energy efficiency and included a recommendation that the Energy Commission work with utility resource planners and stakeholders to determine what data will be needed for further forecast granularity, particularly hourly forecasts, to support statewide planning needs as well as SB 350.⁴¹ As part of the *2016 IEPR Update*, parties are collaborating to address methodological improvements in the demand forecast, including solar PV and efficiency modeling and the potential influences of other load-modifying resources as discussed in Chapter 4: Electricity Demand Forecast Update.^{42, 43}

Energy demand for electricity over the last 14 years has been relatively flat, tempered by economic and demographic conditions, as well as continued energy efficiency efforts and new distributed generation. Energy efficiency reduces electricity infrastructure needs, lowers renewable electricity procurement requirements, and allows greater electric infrastructure flexibility as the state moves toward transportation electrification. The deferral or reduction in infrastructure needs has helped minimize the environmental impacts from the electricity sector.

Future electricity demand is expected to be influenced by climate change, and the potential incremental impacts on both electricity consumption and peak demand are captured in the Energy Commission's adopted demand forecast from the *2015 Integrated Energy Policy Report*.⁴⁴ Statewide average temperatures in California have increased by 1.7 degrees Fahrenheit from 1895 to 2011, with warming the greatest in the Sierra Nevada. Higher overall temperatures cause increases in peak demand, for example, for air conditioning in the summer, as well as decreased heating needs in winter.⁴⁵ Electricity demand will also be affected by the increase of transportation

41 California Energy Commission, *2015 IEPR*, 2016, p. 145, http://www.energy.ca.gov/2015_energypolicy/index.html.

42 Notice of IEPR Commissioner Workshop on Methodological Improvements to the Energy Demand Forecast for 2017 and Beyond, 2016 IEPR Update, Thursday, June 23, 2016, and Notice of Joint Agency IEPR Workshop on Energy Demand Forecasting and Doubling of Energy Efficiency - Data and Analytical Needs, 2016 IEPR Update, July 11, 2016, <https://efiling.energy.ca.gov/Lists/DocketLog.aspx?docketnumber=16-IEPR-05>.

43 For more information on the Energy Commission's role implementing SB 350 and AB 802, see <http://www.energy.ca.gov/sb350/index.html>.

44 California Energy Commission, *California Energy Demand 2016-2026, Revised Electricity Forecast*, 2016, Publication Number: CEC-200-2016-001-V1, pp. 36-38, http://docketpublic.energy.ca.gov/PublicDocuments/15-IEPR-03/TN207439_20160115T152221_California_Energy_Demand_20162026_Revised_Electricity_Forecast.pdf.

45 Higher temperatures have a host of other associated impacts including changes in precipitation patterns and snowpack which affect hydropower resources; increased risk of extreme events such as wildfires, inland

electrification and the introduction of zero-emission vehicles in response to climate change, which are also captured in the Energy Commission's demand forecast as discussed in Chapter 4: Electricity Demand Forecast Update.⁴⁶

Declining Coal Generation and Imports

California's Emission Performance Standard (EPS), established under Senate Bill 1368 (Perata, Chapter 598, Statutes of 2006), prevents California utilities from making new long-term commitments (five years or more) to high GHG-emitting baseload power plants—plants that emit more than 1,100 pounds of CO₂ per megawatt-hour. This restriction is achieving one of the primary goals of SB 1368 to encourage California utilities' divestiture of high GHG-emitting power plants. The amount of coal-fired electricity serving California has been declining with coal-fired generation serving about 11 percent of California's electricity demand in 2000 and declining to less than 6 percent by the end of 2015.⁴⁷ These declines are expected to continue, largely in response to the EPS, as shown in Figure 12.

The state's IOUs have already divested themselves of high GHG-emitting power plants, and the POUs are making significant progress in divesting themselves of long-term ownership or contractual arrangements. Los Angeles Department of Water and Power (LADWP) has taken, and is taking, actions that resulted in divestiture of its out-of-state coal-fired Navajo Generating Station in 2015 and will allow divestiture of the Intermountain Power Project by 2025. Five POU members of the Southern California Public Power Authority (SCPPA) and the M-S-R (Modesto Irrigation District, Silicon Valley Power, and Redding, collectively) Public Power Authority are exiting ownership of the San Juan Generating Station by 2018.

flooding and severe storms; and reduced efficiency. See the *2013 IEPR* (Chapter 9) and *2015 IEPR* (Chapter 9) for further discussion of impacts related to the energy system.

46 California Energy Commission, *California Energy Demand 2016-2026, Revised Electricity Forecast*, 2016, Publication Number: CEC-200-2016-001-V1, pp. 39-41, http://docketpublic.energy.ca.gov/PublicDocuments/15-IEPR-03/TN207439_20160115T152221_California_Energy_Demand_20162026_Revised_Electricity_Forecast.pdf.

47 California Energy Commission, Tracking Progress web page Reliance on Coal, November 3, 2016.

Figure 12: Annual and Expected Energy From Coal Used to Serve California (1996–2026)

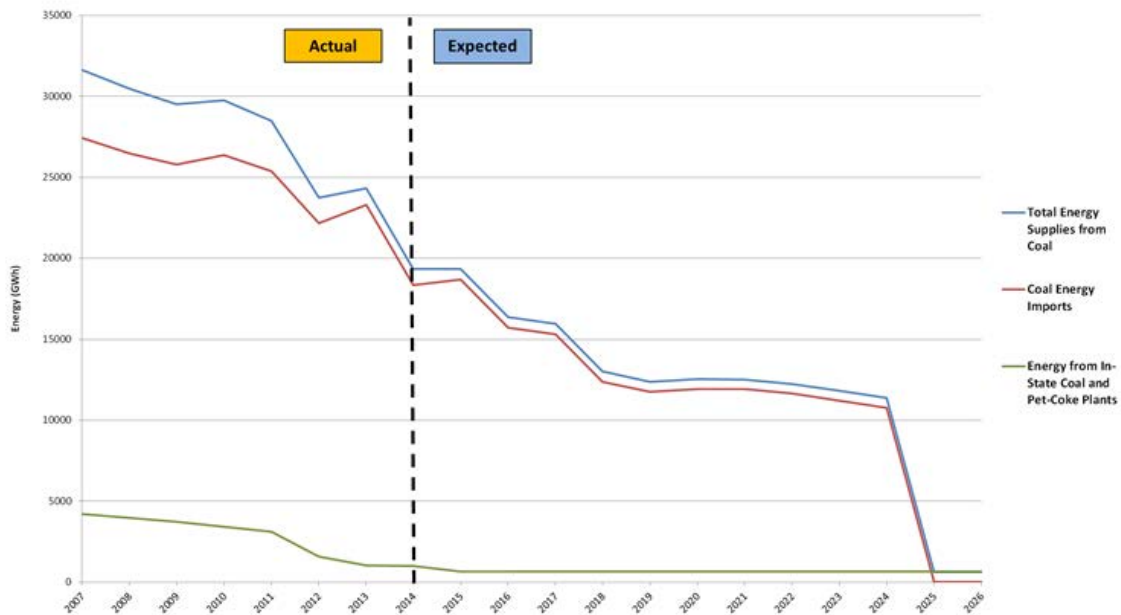

Source: California Energy Commission, CPUC, and ARB presentation at the October 1, 2015, kickoff public workshop on Scoping Plan Update to Reflect 2030 Target, http://www.arb.ca.gov/cc/scopingplan/meetings/10_1_15slides/2015slides.pdf. *Includes identified coal imports, but does not include possible imports of coal that are reported by utilities under SB 1305 Power Source Disclosure as unspecified.

Closure of Nuclear Facilities

From 2001 to 2011, nuclear energy comprised about 15 percent to 18 percent of California’s generation mix, primarily from two power plants in California—San Onofre and Diablo Canyon.⁴⁸ Southern California Edison (SCE) permanently retired the San Onofre plant in 2013 following the unplanned shutdown of Units 2 and 3 in January 2012 due to the discovery of cracks in tubing in newly installed steam generators. The closure of San Onofre cut the amount of nuclear generation in California by about half, from more than 18 percent in 2011 to about 9 percent since 2012.⁴⁹ The closure of San Onofre created electricity reliability issues in Southern California that are discussed in Chapter 2: Energy Reliability in Southern California, “Update on Southern California Electric Reliability.”

California now has one operating nuclear power plant, the Diablo Canyon power plant. The two reactors at Diablo Canyon are licensed to operate through 2024 and 2025. On June 21, 2016, Pacific Gas and Electric Company (PG&E) announced a Joint Proposal with labor and leading environmental organizations that will phase out the production of nuclear power at Diablo Canyon by 2025 and increase investment in energy efficiency,

⁴⁸ Nuclear generation was also imported from Palo Verde nuclear power plant in Arizona.

⁴⁹ California Energy Commission, *Tracking Progress, California’s Installed Electric Power Capacity and Generation*, updated August 31, 2016, calculated from Table 2: In-State Electric Generation by Fuel Type From Power Plants Larger Than 1 MW, p. 7.

renewable energy, and energy storage beyond current state mandates.⁵⁰ Despite the loss of zero-GHG-emitting generation from San Onofre and the loss of zero-GHG emitting hydroelectric generation due to the drought, GHG emissions from the electricity sector continue to decline due to an increase in wind and solar renewable generation and a decrease in reliance on coal.⁵¹ Further, California is expected to meet its climate goals despite the closure of Diablo Canyon by relying on other zero-emission sources of generation and energy conservation measures to reduce GHGs, as described in PG&E's joint proposal.

Changes in the Transmission System

The state's renewable energy and decarbonization policies spurred many transmission additions in the last decade. At the same time, the phaseout of fossil-fired OTC units and the retirement of San Onofre pose reliability challenges that necessitate additional transmission upgrades, as discussed in Chapter 2: Energy Reliability in Southern California, "Update on Southern California Electric Reliability." The need to interconnect intermittent and sometimes remote wind and solar generation creates increasing challenges for the operation of the entire interconnected Western grid system. California continues to pursue regional opportunities that provide benefits to both California and western states. These issues are discussed in the following sections.

Renewable Transmission

The Energy Commission recognized the lack of adequate transmission to deliver some of the state's promising renewable energy resources to load centers as a major barrier in implementing the RPS as early as 2004.⁵² Through concerted efforts by the Energy Commission, CPUC, California ISO, and the state's utilities, substantial progress has been achieved in removing transmission barriers to renewable development. The California ISO's *2010-2011 Transmission Plan* was the first plan to include transmission upgrades needed for renewables and placed a high priority on the interconnection and deliverability of electricity from renewable generation projects funded by the American Recovery and Reinvestment Act of 2009.

The transmission needed to access renewable generation development to achieve the state's 33 percent RPS by 2020 has largely been identified, and those projects are

50 PG&E News Release, "In Step with California's Evolving Energy Policy, PG&E, Labor and Environmental Groups Announce Proposal to Increase Energy Efficiency, Renewables and Storage While Phasing Out Nuclear Power Over the Next Decade." June 21, 2016. Retrieved from http://www.pge.com/en/about/newsroom/newsdetails/index.page?title=20160621_in_step_with_californias_evolving_energy_policy_pge_labor_and_environmental_groups_announce_proposal_to_increase_energy_efficiency_renewables_and_storage_while_phasing_out_nuclear_power_over_the_next_decade.

51 California Air Resources Board, *California GHG Emission Inventory, 2016 Edition*. http://www.arb.ca.gov/cc/inventory/pubs/reports/2000_2014/ghg_inventory_trends_00-14_20160617.pdf.

52 California Energy Commission, *2004 IEPR Update*, 2004, p.35, http://www.energy.ca.gov/2004_policy_update/.

moving forward.⁵³ The California ISO has indicated that future annual planning cycles will focus on moving beyond the 33 percent planning framework in response to SB 350.

Energy Imbalance Market

In November 2014, the California ISO and PacifiCorp⁵⁴ launched the Energy Imbalance Market (EIM). The EIM is a voluntary market for trading imbalance energy (deviations between scheduled energy and meter data) to balance supply and demand deviations in real time from 15-minute energy schedules and dispatching least-cost resources every 5 minutes in the combined network of the California ISO and EIM entities. The many benefits of the EIM include reduced costs for utility customers and California ISO market participants, reduced carbon emissions, more efficient use and integration of renewable energy, and enhanced reliability through broader system visibility. NV Energy began its participation as an EIM entity on December 1, 2015, and Puget Sound Energy and Arizona Public Service began participation on October 1, 2016.

Other utilities have also announced plans for joining the EIM, including Portland General Electric in 2017, Idaho Power Company in 2018, and Seattle City Light in 2019. On October 18, 2016, the California ISO and El Centro Nacional de Control de Energía announced that the Mexican electric system operator has agreed to explore— participation of its Baja California Norte grid in the EIM. On October 21, 2016, the California ISO announced that the Balancing Authority of Northern California (BANC) and Sacramento Municipal Utility District intend to begin negotiations with the California ISO to join the EIM. LADWP has also expressed interest in joining. As described in the *2016 EPR*, the economic and environmental performance of the EIM has continued to improve, especially with the addition of NV Energy in December 2015, with the majority of EIM transfers into the California ISO coming from non-emitting resources since that time.⁵⁵ The benefits of avoided renewables curtailment are significant according to California ISO studies, with an estimated 305,000 megawatt-hours (MWh) exported instead of curtailed, which displaced an estimated 130,000 metric tons of CO₂ in the first, second, and third quarters of 2016.⁵⁶

53 California ISO. 2016. *2015-2016 Transmission Plan*. Available at <http://www.caiso.com/Pages/documentsbygroup.aspx?GroupID=D5EE02E2-0E3A-46DF-BDA9-52EDBD09AC8E>.

54 PacifiCorp operates within two balancing authorities: Pacific Power in Oregon, Washington, and California; and Rocky Mountain Power in Utah, Wyoming, and Idaho.

55 California Energy Commission, *Final 2016 Environmental Performance Report of California's Electrical Generation System, 2016*, Publication Number: CEC-700-2016-005-SF, <https://efiling.energy.ca.gov/Lists/DocketLog.aspx?docketnumber=16-IEPR-03>.

56 California ISO, 2016, available at http://www.caiso.com/Documents/ISO-EIMBenefitsReportQ2_2016.pdf and http://www.caiso.com/Documents/ISO_EIM_BenefitsReportQ1_2016.pdf.

Increasing Regionalization

Interest in multistate transmission projects and regional markets continues to increase in light of the 50 percent RPS by 2030 and GHG emission reduction requirements, the success of California ISO's EIM, the potential addition of PacifiCorp to the California ISO's balancing authority area, and compliance with the Federal Energy Regulatory Commission's (FERC) interregional Order No. 1000.⁵⁷ The U.S. EPA's Clean Power Plan⁵⁸ has also sparked interest in regional cooperation to comply with state GHG reduction targets for existing power plants. The ARB recently released *California's Proposed Compliance Plan for the Federal Clean Power Plan*, prepared in collaboration with the Energy Commission and CPUC, for public comment.⁵⁹ California is the first state to show how CPP compliance can work and to do so in ways that demonstrate the federal mandates can support state programs, and vice versa. Planned generation associated with several multistate transmission projects could provide seasonal and geographical diversity that could complement California's renewable generation. On April 13, 2015, the California ISO and PacifiCorp signed a memorandum of understanding to explore the feasibility, costs, and benefits of PacifiCorp's full participation in the California ISO as a participating transmission owner.

As directed by SB 350, the voluntary transformation of the California ISO would occur through additional transmission owners joining the ISO with approval from their own state or local regulatory authorities. Expansion of a regional market offers several potential advantages over the EIM, including more efficient day-ahead unit commitment and dispatch of resources, reduced reserve requirements, smoother integration of renewables, and more efficient and cost-effective transmission planning. The Energy Commission, CPUC, and ARB are holding workshops to discuss related matters, including governance structure⁶⁰ and studies on the environmental and economic impacts of a regional grid operator.

In July 2016, the California ISO released final study results of the impacts of a transformation to a regional market and found that California ratepayers stand to save \$55 million per year under a limited expansion with only PacifiCorp fully participating in a regional grid in 2020. The final studies also estimate that California ratepayers would save up to \$1.5 billion per year assuming a larger regional footprint that includes

57 Order No. 1000 is a Final Rule that reforms the Commission's electric transmission planning and cost allocation requirements for public utility transmission providers. The rule builds on the reforms of Order No. 890 and corrects remaining deficiencies with respect to transmission planning processes and cost allocation methods. For more information see <https://www.ferc.gov/industries/electric/indus-act/trans-plan.asp>.

58 The Clean Power Plan, which includes customized state goals to cut carbon pollution and strong standards for power plants was announced by President Obama on August 3, 2015. For more information see <https://www.epa.gov/cleanpowerplan/clean-power-plan-existing-power-plants>.

59 <http://www.arb.ca.gov/cc/powerplants/powerplants.htm>.

60 For more information see http://www.energy.ca.gov/sb350/regional_grid/.

all the U.S. balancing authorities in the Western Interconnection⁶¹ except for the two federal power marketing administrations. While the CO₂ emissions in the Western Electricity Coordinating Council (WECC)⁶² are estimated to decrease from 331.3 million metric tons in 2020 to 307.3 million metric tons in 2030, even without a regional market, an additional reduction in 2030 to below 300 million metric tons is estimated in 2030 with a regional market. A regional market in 2030 is estimated to create between 9,900 and 19,300 additional jobs in California, primarily due to the reduced cost of electricity.

With a more efficient renewable resource expansion to meet California's RPS, implementing a regional market would result in reduced impacts on WECC-wide land use, biological resources, and water use (even with an expected shift in some land-use and biological resource impacts from California to out of state). With a more efficient generator dispatch of a regional market across the WECC, water use for thermal generators is reduced for natural gas-fired combined-cycle units in California, as well as for gas-fired and coal-fired units in the rest of the WECC. Reduced generation from gas-fired generators in California also provides benefits to disadvantaged communities by decreasing power plant emissions in the San Joaquin Valley and South Coast air basins.⁶³

On August 8, 2016, Governor Brown sent a letter to the California Legislature in which he noted that while there has been significant progress made by the California ISO on a transition proposal that meets the criteria in SB 350, there are important unresolved questions, including the governance structure, that cannot be answered before the end of the current legislative session. Governor Brown directed his staff, the Energy Commission, the CPUC, and the ARB to continue to work with the Legislature, the California ISO, interested parties, and other state and energy regulators to develop a proposal for the Legislature to consider in 2017.⁶⁴

The Environmental Performance of the Electricity System

Over the last decade, California has adopted several policies to support the environmental performance of the electricity system, including addressing fresh water

61 The Western Interconnection is an alternating current (AC) power grid that stretches from western Canada south to Baja California, Mexico, reaching eastward over the Rockies to the Great Plains.

62 The Western Electricity Coordinating Council (WECC) is a non-profit corporation that exists to assure a reliable Bulk Electric System in the geographic area known as the Western Interconnection.

63 The final SB 350 study results are available at <http://www.aiso.com/Pages/documentsbygroup.aspx?GroupID=4C17574F-73AE-40E3-942C-59C3A13BBD1>.

64 The August 8, 2016, letter from Governor Brown to the leaders of the California State Legislature is available at <http://www.aiso.com/Documents/GovernorBrownsLetterToLegislativeLeadersRegardingRegionalISOGovernance.pdf>.

shortages and more frequent droughts, eliminating OTC for power plant cooling, protecting and conserving natural resources, and increasing the focus on disadvantaged communities and tribal engagement. The influx in renewable generation has brought with it new and different environmental impacts than the conventional generation resources built in the past. The amount of development footprint acreage associated with renewable resources is much larger than for conventional natural gas plants. In addition, remote renewable resources have different impacts, such as on biological and cultural resources, particularly in desert environments. This section describes the major environmental policies and the resulting environmental performance of the electricity system.

Air Quality and Public Health

State and federal regulators have developed ambient air quality standards (AAQS),⁶⁵ or safe concentrations, for a set of air emissions known as *criteria air pollutants*.⁶⁶ These AAQS are protective to humans, crops, forests, and buildings. Moreover, industrial processes such as fossil-fueled and renewable electricity generation resources can emit trace amounts of toxic air contaminants that have cancerous and noncancerous effects on public health but are not covered by AAQS.

Ambient air quality in California continues to improve with the ongoing implementation by local, state, and federal regulators of the federal and California Clean Air Acts. However, both state and federal regulators have long recognized that progress attaining Clean Air Act ambient air quality standards requires no backsliding or easing of emissions controls and regulations. The poor, but improving ambient air quality in some regions of the state makes it difficult to obtain air permits for even the cleanest electric generation facilities.

Reductions in Criteria Pollutants

The *2016 EPR* confirms many of the findings regarding air quality and public health from the *2005* and *2007 EPRs*. Statewide criteria pollutant emissions inventory data show declining emissions for electricity production and cogeneration plants.⁶⁷ The electricity and cogeneration facilities contribute a small percentage of California's overall criteria pollutant emissions, with values ranging from 0.3 to 5.6 percent of

65 *Ambient air quality standards* (AAQS) define clean air, and are established to protect even the most sensitive individuals in California's communities. For more information, see <http://www.arb.ca.gov/research/aaqs/caaqs/caaqs.htm>.

66 *Criteria air pollutant emissions* are those pollutants that have ambient air quality standards. Criteria air pollutants common to the power sector include nitrogen dioxide (NO₂), sulfur dioxide (SO₂), carbon monoxide (CO), ozone (O₃), respirable particulate matter (PM10), and fine particulate matter (PM2.5). In addition, volatile organic compound (VOC) emissions are analyzed because they are precursors to both O₃ and particulate matter. Ammonia is not considered a criteria air pollutant.

67 *Cogeneration* or *combined heat and power* is the simultaneous generation of electrical or mechanical power and useful thermal energy from a single fuel source. For more information see <http://www.energy.ca.gov/chp/>.

statewide emissions in 2013, as shown in Table 1, compared with 0.3 to 2.5 percent of statewide emissions in 2000, as shown in Table 2.⁶⁸ The state expects the electricity generation system to continue reducing criteria pollutants and improving air quality.

**Table 1: Statewide Emissions From California Electricity and Cogeneration in 2013
(Tons per Day, Except Percentage of Total Emissions)**

Source Category	Reactive Organic Gases (ROG)	Carbon Monoxide (CO)	Oxides of Nitrogen (NOx)	Oxides of Sulfur (SOx)	Particulate Matter (PM)	
					PM10	PM2.5
Electricity Production	2.5	36.3	21.1	4.8	5.5	5.0
Cogeneration	1.9	35.7	15.6	1.1	2.4	2.3
Electricity Total	4.4	72	36.8	5.9	7.9	7.3
Other Stationary Sources	989	1,158	321	52	1,328	325
Mobile Sources	746	6,142	1,747	47	124	85
Total Emissions	1,739	7,372	2,106	105	1,460	418
Electricity and Cogeneration Percent of Total Emissions	0.3%	1.0%	1.7%	5.6%	0.5%	0.7%

Source: California Air Resources Board. Almanac Emissions Projection Data. http://www.arb.ca.gov/app/emsinv/2013/emssumcat_query.php?F_YR=2012&F_DIV=-4&F_SEASON=A&SP=2013&F_AREA=CA, accessed April 26, 2016. Note: As total sulfur oxide (SOx) emissions dropped from 2000 to 2013, the SOx mass emissions of the power plant sector (which also decreased) became a larger portion of the now much smaller total mass of SOx emissions. Sulfur emissions have been reduced from both the transportation fuels (for example, diesel sulfur limits were changed from 5,000 ppm to 15 ppm) and from power sector emissions as the last few liquid-fueled power plants are retired, and coal or petroleum coke is now used only at two small in-state power plants. Lastly, any sulfur emission from geothermal, biomass, and gas, liquid or solid fossil-fuel use in the power or industrial sectors are small, and contribute to state and local SOx levels that are well below ambient air quality standards.

**Table 2: Statewide Emissions From California Electricity and Cogeneration in 2000
(Tons per Day, Except Percentage of Total Emissions)**

Source Category	ROG	CO	NOx	SOx	PM10	PM2.5
Electricity Production	4.7	69.2	60.6	5.4	7.2	6.9
Cogeneration	3.0	48.1	28.7	1.8	3.5	3.7
Electricity Total	7.7	117.3	89.3	7.2	10.7	10.6
Other Stationary Sources	1,339	1,545	590	134	1,457	400
Mobile Sources	1,555	12,908	3,103	148	161	123
Total Emissions	2,902	14,570	3,782	289	1,629	534
Electricity and Cogeneration Percent of Total Emissions	0.3%	0.8%	2.4%	2.5%	0.7%	2.0%

Source: California Air Resources Board. Almanac Emissions Projection Data. http://www.arb.ca.gov/app/emsinv/2013/emssumcat_query.php?F_YR=2000&F_DIV=-4&F_SEASON=A&SP=2013&F_AREA=CA, accessed April 26, 2016.

Air Quality Permitting

Past EPRs have raised concerns about system reliability given potential barriers to obtaining air permits for new and replacement generation facilities in some air basins. This issue is heightened where multiple or overlapping energy system stressors occur in an area, resulting in potentially thin reserve margins and shortened planning horizons.

⁶⁸ These data represent emissions from the facility only and do not include fuel production or delivery emissions. Only in-state generation and emissions are included in the table.

In particular, because particulate matter emissions result from disparate natural and anthropomorphic activities, it is difficult to find large enough sources to generate offsets for new emissions sources like power plants.

In Southern California, several natural gas power plants are being retired in 2017 to 2020 in response to a policy to phase out the use of OTC technologies. (For more information, see “Power Plant Cooling and Water Use” below and Chapter 2: Reliability, “Update on Southern California Electricity Reliability.”) The combination of these OTC retirements and the unexpected retirement of San Onofre are challenging reliability planning for Southern California. Local air districts have recognized that their permitting processes could compound local reliability issues, whether due to uncertain permitting time frames or scarce emission offsets.⁶⁹ The South Coast Air Quality Management District (SCAQMD) crafted rules that address both air quality improvements and permitting of power plants. Like the OTC plants, the proposed in-basin replacements are natural gas-fired. But the improvement in efficiency and dispatchability should limit operations, providing for reliability while reducing gas use. SCAQMD Rule 1304(a) (2) allows existing boiler units such as the OTC plants an exemption from offsets on a MW-per-MW basis, ensuring that generation could be built to meet reliability needs within Southern California.⁷⁰

Air Quality Trends

Over the next decade, the state expects to see several trends and changes to the electricity system. California’s natural gas facilities improved thermal efficiency by 29 percent compared to 14 years ago,⁷¹ primarily due to the retirement of aging power plants and the deployment of new more flexible and efficient combustion turbine plants. The retirement and replacement of gas-fired power plants using OTC, as well as other gas-fired plants that reach the end of the useful life, will continue to improve the efficiency of California’s thermal fleet and reduce criteria (and GHG) pollutants in the state.

Increasing reliance on renewable energy facilities that typically do not have combustion emissions has and will continue to change the operating profile of the natural gas fleet. The market is also moving toward more flexible natural gas-fired power plants that are able to integrate growing levels of renewable resources, such as wind and solar. While this new operational profile may emit more CO₂ and criteria air pollutant emissions during ramping periods, the reduced operation of the facilities over the longer term is

69 For example, new rules that lower emission thresholds for PM_{2.5} may increase costs, while evolving federal, state, and local rules on GHGs have required additional time to complete air permits.

70 SCAQMD is developing two additional 1304 exemption rules that will open up some emission offsets to greenfield power plant projects. *Greenfield* refers to land not previously developed or polluted.

71 California Energy Commission, *Thermal Efficiency of Gas-Fired Generation in California: 2015 Update*, 2016 Publication Number: CEC 200-2016-002, p. 12, <http://www.energy.ca.gov/2016publications/CEC-200-2016-002/CEC-200-2016-002.pdf>.

expected to reduce air pollutant emissions and GHG emissions overall. Examples of this would be the proposed Mission Rock project in Ventura County and the Stanton Energy Reliability Center in Orange County, which include batteries that act as spinning reserves so combustion turbines need not operate overnight.

A final emerging concern is the air quality impacts of fugitive dust during construction of electric generation facilities. Coccidioidomycosis, or "valley fever," is a fungal infection encountered primarily in southwestern states, particularly in Arizona and the desert areas of Southern California.⁷² According to the California Department of Public Health, even young and healthy people can get Valley Fever, but those who live, work, or travel in areas with high rates of valley fever may be at a higher risk of infection, especially if they work in jobs where dirt and soil are disturbed.⁷³ Trenching, excavation, farm, and construction workers are often the most exposed population. In California, 28 employees working on the construction of solar facilities on ranch lands in San Luis Obispo County have contracted Valley Fever. As farmed land generally has fewer Valley Fever spores,⁷⁴ the development of solar projects in the San Joaquin Valley may reduce the potential for exposure to Valley Fever.

Power Plant Cooling Water Use and Conservation

Conserving freshwater and avoiding wasteful use have long been part of the state's water policy.⁷⁵ In the *2003 IEPR*, the Energy Commission adopted a water conservation policy for power plants to limit the use of freshwater for power plant cooling to only where alternative water supply sources and alternative cooling technologies are shown to be "environmentally undesirable" or "economically unsound."⁷⁶ The *2003 IEPR* noted that because power plants have the potential to use substantial amounts of water in evaporative cooling towers, the Energy Commission has the responsibility to apply state water policy to minimize the use of freshwater, promote alternative cooling technologies, and minimize or avoid degradation of the quality of the state's water resources.

Since then, the Energy Commission has encouraged project owners proposing to build new power plants in California to reduce water consumption with water-efficient technologies such as dry cooling and conserve freshwater by using recycled water. As

72 Since it is spread through spores in airborne fugitive emissions and not through person-to-person contact, exposure to the fungus occurs during construction, natural disasters, extreme winds, or activities such as sweeping a patio.

73 See <https://www.cdph.ca.gov/HealthInfo/discond/Documents/VFGeneral.pdf>.

74 This is probably the result of the mechanical tilling and the application of nitrogen-based fertilizers.

75 State Constitution, Article X, Section 2 and SWRCB Resolution 75-58.

76 California Energy Commission, 2003. *2003 Integrated Energy Policy Report*. Publication Number 100-03-019DF.

well as conserving water, this policy has resulted in an electricity system that is more reliable in drought conditions.

The 2005 EPR reported a trend away from the use of freshwater for power plant cooling compared to previous years, as well as increased use of recycled water, more efficient cooling technologies, dry cooling, and recycling of process wastewater through zero-liquid-discharge systems. The downward trend in water use continued as a growing number of applications for new thermal power plants proposed water conservation features upfront.

The total capacity of steam-cycle power plants in California has increased from about 13,400 MW in 2003 to about 23,800 MW in 2014. Of the 13,400 MW of installed capacity using a steam cycle in 2003, 30 percent used recycled water, 63 percent used freshwater, and 7 percent used dry cooling. Of the 23,800 MW in 2014, 47 percent used recycled water, 35 percent used freshwater, and about 18 percent used dry cooling. Over the same period, freshwater used for cooling remained roughly the same, as shown in Figure 13.

Figure 13: Cooling Process for Operating Power Plants That Have a Steam Cycle
Operating Power Plants with Steam Cycle

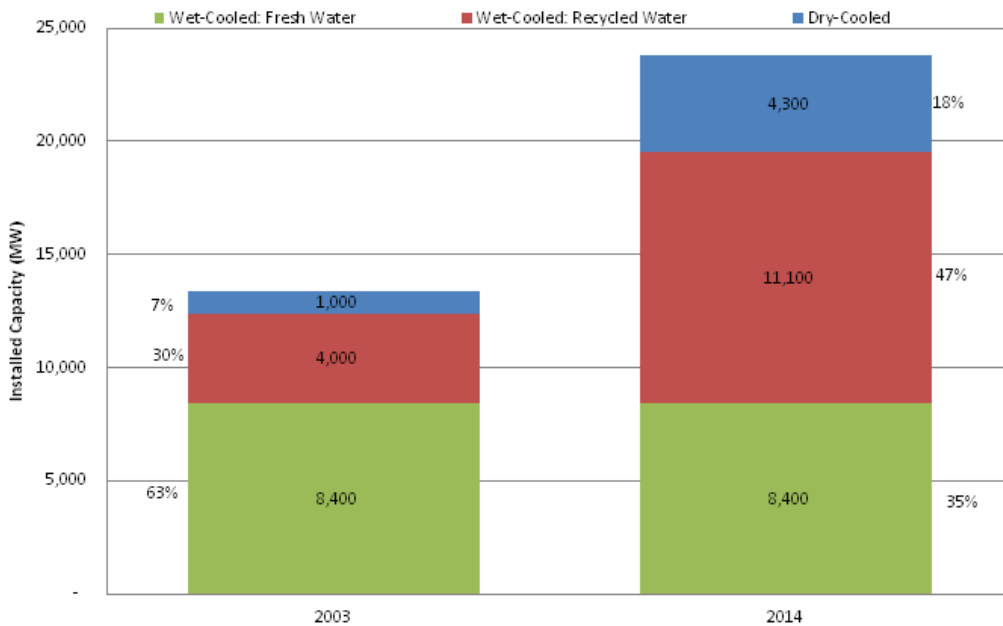

Source: California Energy Commission Staff and Quarterly Fuel and Energy Report

Improved Water Efficiency in Power Plant Cooling

Over the past decade, the California fossil-fueled power plant fleet has become more water-efficient, resulting in a relatively modern fleet of thermal power plants that consume little water. Energy production uses less than 1 percent of all consumptive

water use in California. This trend of improved water efficiency has significantly reduced overall pressure on freshwater sources for power generation in California.

While water used at power plants is a relatively small portion of total water consumption, it can be a significant local use and is frequently a contentious issue during siting discussions. Some power plants contribute funds into local community water conservation to offset their freshwater use when the use of dry cooling or recycled water is not feasible. Recent examples from Energy Commission siting decisions include a water conservation plan to advance the local water district's leak detection and repair program, a water conservation program that required the installation of irrigation controllers in a desert area, the conversion of a golf course to the use of recycled water, and the fallowing of agricultural land.

Eliminating OTC for Power Plant Cooling

The *2005 EPR* highlighted the adverse impacts of power plants using OTC systems on marine and estuarine ecosystems. In 2010, the State Water Resources Control Board (SWRCB) adopted a policy to address power plant OTC in the state without disrupting the critical needs of the state's electricity system.⁷⁷ (For more information, see Chapter 2: Reliability, "Update on Southern California Electricity Reliability.") The OTC policy addresses the discharge of heated water into marine and estuarine ecosystems and the death of multitudes of species through impingement and entrainment.⁷⁸

The SWRCB notes that California's generating plants using OTC, many of which have operated for 30 years or more, present a considerable and chronic stressor to the state's coastal aquatic ecosystems. The final rule issued by the SWRCB directs power plants using OTC to reduce their intake flow rate to the level attained by a closed-cycle wet-cooling system or reduce impacts to aquatic life by other means. Assuming that OTC units continue to repower or retire as expected, the withdrawal of water for cooling power plants would be almost eliminated by 2030, removing the source of a significant negative impact to California's marine ecosystem.

Figure 14 shows the annual reduction in the use of ocean water for cooling from 2010 to 2030.⁷⁹ A large share of the OTC withdrawals have historically been made by San Onofre and Diablo Canyon nuclear facilities, which each has design flows of close to 2.5 billion gallons per day. Because these nuclear facilities have tended to run at very high capacity factors, along with ongoing cooling requirements related to the safety of the plants, withdrawals have historically been close to the design flows on a continuous basis.

77 State Water Resources Control Board, *Statewide Policy on the Use of Coastal and Estuarine Waters for Power Plant Cooling (Attachment 1)*, 2010, http://www.waterboards.ca.gov/water_issues/programs/ocean/cwa316/docs/policy100110.pdf.

78 "Impingement" is the entrapment and death of large marine organisms on cooling system intake screens, and "entrapment" is the death of small plants and animals that pass through the intake into the plant.

79 For more information, see http://www.swrcb.ca.gov/water_issues/programs/ocean/cwa316/.

Other OTC power plants have historically used much less of the design flows since they operate at lower capacity factors compared to the nuclear plants, and when they are operating less, withdrawals are reduced.⁸⁰ Consequently, the closure of San Onofre, along with the proposed closure of Diablo Canyon, will eliminate a significant proportion of the total OTC fleet water usage.⁸¹ (For more information on nuclear energy in California, see the sections on “Changes in California’s Electricity System” and “Nuclear Decommissioning” above in this chapter.)

Figure 14: Historical and Projected OTC Fleet Water Usage

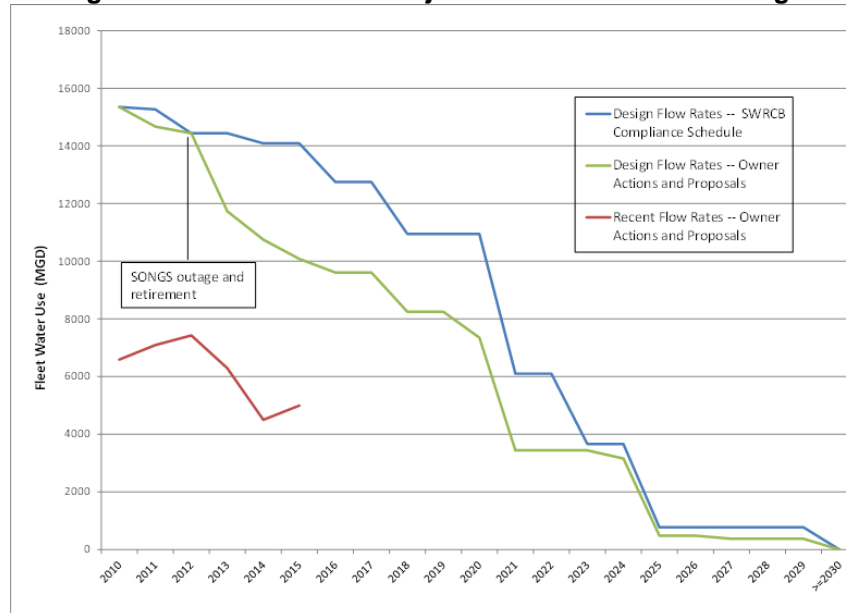

Source: California Energy Commission, *Tracking Progress: Once-Through Cooling Phase-Out*, February 9, 2016, available at http://www.energy.ca.gov/renewables/tracking_progress/documents/once_through_cooling.pdf

Water Use for Renewable Resources

Over the last 10 years, the addition of renewable energy resources contributed to a decrease in electricity system water use.

Utility-scale wind and solar PV technologies can operate with essentially no water requirements, though PV facilities typically use some water for panel washing. Because solar collectors cover thousands of acres, however, all utility-scale renewable energy facilities require large amounts of water during construction for dust control and soil grading. With sandy, dry, and windy conditions typical of the desert, the amount of

⁸⁰ State Water Resources Control Board, *Water Quality Control Policy on the Use of Coastal and Estuarine Waters for Power Plant Cooling, Final Substitute Environmental Document*, May 4, 2010, p. 33, http://www.swrcb.ca.gov/water_issues/programs/ocean/cwa316/docs/cwa316may2010/sed_final.pdf.

⁸¹ The reduction in OTC water usage does not necessarily result in a one-for-one reduction in marine and estuarine impacts. Multiple factors, including seasonality, play a role, and the relationship is site-specific as facility entrainment rates vary substantially.

water used for construction can be considerable, especially with limited water supplies in many parts of the desert.

Both solar thermal and geothermal technologies use heat to produce power, and the impacts of these technologies on water resources are similar to those of fossil-fueled thermal power plants.⁸² California power plants with the largest water consumption rates are solar thermal (38 to 1,000 gallons per MWh on average for dry-cooled and wet-cooled, respectively) and geothermal facilities (3,850 gallons per MWh on average for wet-cooled). Conventional power plant water use ranges from 13 to 250 gallons per MWh on average for dry- and wet-cooled generation, respectively.⁸³ As with conventional generation, geothermal and solar thermal facilities can be designed and built to incorporate water conservation and water efficiency.^{84, 85} Since adoption of the 2003 *IEPR* water policy, dry-cooled solar thermal generation contributes 642 MW of capacity using more than 90 percent less water per MWh than wet-cooled counterparts.⁸⁶

Geothermal power plants also impact water quality since the hot water pumped from underground reservoirs often contains high levels of sulfur, salt, and other minerals. Most geothermal facilities use closed-loop water systems, in which extracted water is pumped directly back into the geothermal reservoir to prevent contamination and land subsidence.

Drought and Power Plant Cooling

California's ongoing drought has raised concerns about the long-term sustainability of water supplies and the allocation of these supplies to multiple societal demands. In 2015, Governor Brown proclaimed a state of emergency regarding drought and issued Executive Orders B-29-15 and B-37-16. Executive Order B-29-15 gave the Energy Commission authority to accelerate processing of license amendments for several power plant projects experiencing curtailed water supplies. Executive Order B-37 continues the accelerated licensing and requires strengthening of local drought resilience by requiring water agencies to develop water shortage contingency plans. As the climate continues to change, California must prepare for the possibility that drought conditions may become

82 As noted previously, nuclear power plants such as San Onofre and Diablo Canyon withdraw large amounts of OTC, but because the water is returned to the ocean or estuary, albeit at temperatures higher than when withdrawn, the water use is not considered consumptive.

83 Nuclear power plants use large amounts of water for OTC, as discussed above in the section on "Eliminating OTC for Power Plant Cooling." However, since the water used in OTC at nuclear power plants is injected back into the marine environment after use, the water is not consumed.

84 For example, almost 1,500 MW of geothermal capacity uses recycled water, and nearly 30 MW of geothermal units are successfully dry-cooled.

85 Water consumption rates of various technologies were reported in Table 15 of the 2015 *IEPR*. California Energy Commission. 2015. *2015 Integrated Energy Policy Report*. Publication Number: CEC-100-2015-001-CMF.

86 See page 86 of the 2016 *Final Environmental Performance Report*. http://docketpublic.energy.ca.gov/PublicDocuments/16-IEPR-03/TN214098_20161018T145845_Staff_Report_Final_2016_Environmental_Performance_Report_of_Cal.pdf.

the norm rather than the exception. For more discussion on climate adaptation, see Chapter 3: Climate Adaptation and Resiliency.

As discussed in the *2015 IEPR*, the drought has also raised concerns about the availability and deliverability of water for power plant cooling.⁸⁷ Power plants that use recycled water as the primary supply are considered to have the most drought-resistant supply after dry cooling, though local water conservation requirements could reduce flows to wastewater treatment plants that produce recycled water. Power plants that depend upon surface or groundwater face more uncertainty due to curtailed water deliveries and subsidence issues. Federal and state regulators have significantly curtailed some surface water deliveries that have the potential to reduce the supply and shut down the conveyance system to power plants. So far, affected plants have been able to identify and access alternative water supplies or conveyance mechanisms, sometimes requiring license amendment approvals by the Energy Commission.⁸⁸

Revisiting the 2003 IEPR Water Policy

The current *2013 IEPR* water policy allows for consideration of the diversity of water supply in California, changes in technology, and other conditions unique to a power plant licensing case. The current water policy could be adapted to reflect drought conditions and support climate adaptation policy objectives. In addition, the water policy could be updated in light of the Sustainable Groundwater Management Act, which established a new structure for managing California's groundwater resources at a local level by local agencies.⁸⁹ Policy updates could require applicants to evaluate whether the water supply would be available in groundwater basins where groundwater sustainability plans are implemented.

Land-Use Changes from Renewable Energy Expansion

Although the estimated average efficiency in land use of each technology varies, renewable technologies require more land per megawatt than natural gas and nuclear power plants. As shown in Table 3, the average land use for renewable projects, measured as acreage per megawatt (acres/MW), is 2.5 acres/MW for biomass, 6 acres/MW for geothermal, 7 acres/MW for solar, and ranges from 24.8 to 40 acres/MW

87 California Energy Commission. 2015. *2015 Integrated Energy Policy Report*. Publication Number: CEC-100-2015-001-CMF.

88 Over the past two years, the four projects requiring licensing amendments for water supply include Tracy Combined Cycle Power Plant, Mariposa Energy Project, Colusa Generating Station, and High Desert Power Plant. Four power plants in west and south Kern County that rely on significant supplies from the State Water Project could also eventually be affected.

89 The Sustainable Groundwater Management Act is composed of three bills, Assembly Bill 1739 (Dickinson, Chapter 347, Statutes of 2014), Senate Bill 1319 (Pavley, Chapter 348, Statutes of 2014), and Senate Bill 1168 (Pavley, Chapter 346, Statutes of 2014). Senate Bill 13 (Pavley, Chapter 225, Statutes of 2015) made clarifying changes and added additional requirements to the Act.

for wind.^{90, 91} This is compared to a natural gas power plant with an average of 0.08 acres/MW. As a result, the amount of land needed for electricity generation has increased with the expansion of large-scale renewable energy technologies. The acreage assumptions in Table 3 are land-use disturbances based on total project area. These acreage effects do not account for other disturbances such as those associated with extraction of natural gas, nuclear, and biomass.

Table 3: Average Total Project Land Use per MW by Fuel Type

Fuel Type	Average Total Project Land Use per Megawatt
Natural Gas	0.08 acres/MW
Nuclear	0.832 acres/MW
Biomass	2.5 acres/MW
Geothermal	6.0 acres/MW
Solar	7.0 acres/MW
Small Hydro	7.5 acres/MW
Large Hydro	29.125 acres/MW
Wind	Ranges from 24.8 to 40 acres/MW

Sources: (1) California Energy Commission staff; (2) National Renewable Energy Laboratory (NREL) Technical Report NREL/TP-6A2-45834, available at <http://www.nrel.gov/docs/fy09osti/45834.pdf>; (3) NREL Technical Report NREL/TP-6A20-56290, available at <http://www.nrel.gov/docs/fy13osti/56290.pdf>; and (4) DRECP Acreage Calculator at http://www.drecp.org/documents/docs/DRECP_Acreage_Calculator_Documentation.pdf.

These estimates of land use per MW reflect overall project footprints but not necessarily the land-use intensity. For example, the direct land use disturbance for a wind project is a fraction of the total project area, with the rest remaining available for complementary uses such as ranching, farming, forestry, or habitat. As reported in Table 3, on average a wind energy facility may require up to 40 acres per MW of capacity to ensure that the facility has adequate clearance between wind turbine blades, as well as strategic placement and spacing of turbines to capture maximum wind energy potential. The amount of spacing between wind turbines depends on the wind resource and topography of the site where a wind energy facility is developed. In some locations with certain configurations, wind energy facilities are capable of providing 1 MW of power

90 The average acres per MW shown in Table 4 are planning assumptions that were used for planning in the *Desert Renewable Energy Conservation Plan (DRECP)* and are based on averages for each technology type. These values are used in the *2016 EPR* to better understand the scale of acreage developed for renewable energy.

91 The estimate for wind assumes all wind capacity added between 2005 and 2015 is new and not replacement or repower capacity, so the acreage assumption is likely higher than the actual incremental acres that were developed.

with roughly 24 acres, which is why there is a range in Table 3 above. While solar technologies also have minimum spacing between solar collectors to minimize shading of the collectors by equipment, solar collectors tend to be developed densely and use land more intensively.

The growth of renewable energy as a land use in California over the last decade has impacted natural lands and resources, especially (though not exclusively) in the California desert. Loss of agricultural land from the conversion to energy generation has also increased in agricultural areas such as the San Joaquin Valley and parts of Imperial and Riverside Counties. Given the amount of land needed for renewable energy, it will be increasingly important to look for opportunities to reduce conflicts with other land uses and to incorporate renewable energy technologies into the landscape in ways that minimize impacts and create multiple benefits where possible. As described at the close of this section, the state will continue to use a variety of landscape-scale planning for renewable energy.

Biological Impacts

California has 218 state- and 187 federally protected native plants,⁹² and 85 state- and 132 federally protected wildlife species, an increase since the *2005 EPR*.⁹³ This increase is mainly due to impacts and habitat loss associated with human development and climate change, though several species that have been listed as special status species since 2005 are potentially sensitive to impacts associated with energy development.⁹⁴ California has more endemic⁹⁵ and federally protected species than any other state and is the most biologically diverse state within the continental United States. This diversity is a result of the wide range of climates and habitats within California. Many rare or sensitive species in California have localized distributions, increasing their potential to be negatively impacted by energy development.

Since 2005, more than 10,000 MW of new natural gas-fired generation has been added to California's electricity mix and is estimated to have impacted roughly 600 acres. The environmental impacts are varied and relate largely to the habitats in or near the power plant. For example, vernal pools and seasonal wetlands were among the habitats impacted by natural gas-fired plants added since 2005, with mitigation typically involving purchasing land for permanent conservation and/or payment to conservation foundations. Although the number of natural gas-fired power plants in California has

92 California Department of Fish and Wildlife. 2016. "State Federally Listed Endangered, Threatened, and Rare Plants in California." April 2016. <https://nrm.dfg.ca.gov/FileHandler.ashx?DocumentID=109390&inline>.

93 Ibid.

94 Townsend's big-eared bat (http://www.fgc.ca.gov/CESA/Townsend's_Big-eared_Bat/tbebpetition.pdf) and the flat-tailed horned lizard (http://www.fgc.ca.gov/CESA/Flat-tailed_Horned_Lizard/fthl_petition_reduced.pdf) are both state candidates for special-status species listing that may be sensitive to impacts associated with energy development.

95 California has 481 endemic species. (<https://dfg.ca.gov/SWAP/2005/docs/SWAP-2005.pdf>)

increased, technological improvements have increased the related efficiency and decreased nitrogen emissions,⁹⁶ lowering the potential environmental impact of these facilities on a per-unit basis.

Renewable Energy Biological Impacts

Nearly 12,000 MW of renewable generation has been added to California's electrical generation capacity since 2001 and is estimated to have affected roughly 200,000 acres in a variety of general and technology-specific ways. The general effects associated with renewable development include habitat loss, degradation, and alteration. Due to factors such as resource availability, transmission availability, and efforts to avoid known environmental and land-use conflicts, large renewable projects of similar technology type tend to develop in clusters.⁹⁷

Numerous indirect impacts to ecosystems from the development of large-scale solar projects and associated facilities in the desert are apparent. For example, communities that depend upon sand dune habitat have been disrupted by elimination or modification of sand transport systems. Sand dune-dependent species such as Mojave fringe-toed lizards and several special-status plants were impacted through reduced sand transport, leading to deflation of the dunes, plant successional shifts,⁹⁸ and other related events that degraded habitat for these species. Furthermore, the first cases of canine distemper in desert kit fox were detected near solar development areas in 2011.⁹⁹

Energy projects can also attract species not otherwise found in the area or increase the concentration of predatory species, as demonstrated by ravens that have been attracted by water or trash at a site, which then prey on tortoise or other species. Furthermore, issues related to bird collisions with reflective solar panels are occurring.¹⁰⁰ Many renewable energy projects require large areas of land that must be graded and where

96 Nitrogen emissions can cause shifts in the species composition of ecosystems that are found in nitrogen-sensitive areas. Nitrogen is the primary limiting factor to plant growth in nitrogen-poor soils, and excess nitrogen can alter soil toxicity or encourage the growth of nonnative or invasive species.

97 For example, wind farms are built in wind resource areas such as on ridgelines, and solar plants are often built in areas with flat ground, high levels of insolation, and access to transmission.

98 *Successional shifts* occur after disturbance or a change to the physical environment of an ecosystem. They are characterized by a shift in the plants present in the ecosystem, and can have implications for both the short- and long-term makeup of the ecosystem as a whole.

99 Potential causes of the outbreak include added stress on the foxes from passive relocation efforts for development of solar facilities, as well as relocating foxes to areas where they were potentially exposed to the canine distemper virus.

100 "There is growing concern about 'polarized light pollution' as a source of mortality for wildlife, with evidence that photovoltaic panels may be particularly effective sources of polarized light. A desert environment punctuated by a large expanse of reflective, blue panels may be reminiscent of a large body of water. Birds for which the primary habitat is water, including coots, grebes, and cormorants, were over-represented in mortalities at the Desert Sunlight facility (44 percent) compared to Genesis (19 percent) and Ivanpah (10 percent)." (Kagan, R.A., T.C. Viner, P.W. Trail, and E.O. Espinoza (2014). *Avian Mortality at Solar Energy Facilities in Southern California: A Preliminary Analysis*. National Fish and Wildlife Forensics Laboratory, Ashland, OR, pp. 16-17, <http://alternativeenergy.procon.org/sourcefiles/avian-mortality-solar-energy-ivanpah-apr-2014.pdf>).

roads and supporting infrastructure are built. This landscape alteration changes drainage patterns and the flow of water to surrounding areas, further altering landscapes and affecting biological resources. For example, roads in or near habitat for desert kit fox, desert tortoise and Mojave fringe-toed lizard can increase injury or mortality. Furthermore, developments with site perimeter or wildlife exclusion fences can potentially interrupt migration routes for sensitive species.

In addition to the general impacts discussed above, the following technology-specific impacts were identified in the *2016 EPR*.

Wind Energy Impacts

The biggest biological resource issue for wind energy development has been avian mortality, for both migratory and resident birds and bats, due to collisions with wind turbine blades. There are opportunities for repowering existing wind facilities that may help reduce collision risk. Recent efforts to better understand avian mortality from wind energy development have focused on the standardization of mortality data collection to enable comparison of mortality data across wind energy generation types and locations. State and federal guidelines provide information to help guide best management practices for decreasing avian impacts.¹⁰¹ As new scientific information is created and as California learns more from current data collection, the state should consider updating its guidelines.

Solar Development Impacts

Solar PV has relatively few technology-specific effects aside from the general issues of habitat loss, degradation, and alteration. Direct mortality may result from construction or equipment, loss or modification of habitat, and stress due to relocation. Birds flying over a project may mistake the reflective surfaces of the solar panels for bodies of water and fly into those panels. Since 2005, a significant portion of new solar PV development has occurred on agricultural lands, some of which can support specific biological resources. For example, the burrowing owl relies on agricultural lands in Southern California, and the Swainson's hawk is supported by agricultural resources in Northern California.

Parabolic troughs and power towers at solar thermal facilities have been subject to increased public scrutiny over avian and insect deaths, particularly due to collision and the effects of solar flux (or concentrated sunlight). Avian deaths documented at parabolic trough facilities are the result of collisions with the troughs, and not typically solar flux. Solar power towers and parabolic troughs that use air-cooled condensers can provide roosting locations that have impacted birds and bats. Since 2005, a significant number of avian mortalities have been recorded in evaporation ponds at solar thermal

¹⁰¹ The Energy Commission, working with the California Department of Fish and Wildlife, developed the voluntary *California Guidelines for Reducing Impacts to Birds and Bats from Wind Energy Development*, and the U.S. Fish and Wildlife Service issued the *Land-Based Wind Energy Guidelines*.

plants where process water can contain toxins, salts, oils, or other substances that pose a risk to avian species.

Transmission and Interconnection Impacts

New transmission lines and related corridors with lengths typically ranging from 1 mile to well over 100 miles and widths ranging from 60 to 200 feet have led to temporary and permanent loss of habitat, with impacts similar to those associated with other terrestrial development. However, there were also several unique impacts to biological resources, such as habitat fragmentation. Avian impacts such as death through collisions or electrocution are well-understood, and best management practices to avoid these impacts are a standard part of the construction of transmission lines.

Due to the remote sites and long distances to the nearest point of interconnection for large-scale renewable projects, there is a higher likelihood of temporary and permanent loss of habitat for species such as burrowing owl, desert tortoise, and desert kit fox. Also, the slow and often difficult recovery for desert-dwelling plants means that any restoration efforts may take much longer than they would have in other ecosystems.

Mitigation for Biological Impacts

Regulatory and permitting agencies at local, state, and federal levels have instituted and followed policies that attempt to avoid and minimize impacts first, then mitigate remaining impacts to biological resources. Most, if not all, of the impacts that have occurred at power plant project sites have been offset by mitigation. Efforts were also made to minimize these impacts using deterrents, design alterations, and selection of alternative sites. Mitigation by permanently preserving habitat similar to the habitat disturbed by construction has become increasingly difficult. The amount of suitable habitat is decreasing, landowners are increasing prices in regions with high solar insolation, and finding contiguous parcels (which are preferred for mitigation) is becoming less likely. The California Advance Mitigation Act helped overcome this difficulty by authorizing the California Department of Fish and Wildlife (CDFW) to implement a program to create a mitigation bank in advance of project development by purchasing appropriate habitat within the desert that developers would then purchase as mitigation for their eligible renewable energy projects.¹⁰² Even with effective, project-specific mitigation, there are concerns about compounding stressors or cumulative impacts to species and ecosystems, as well as adding stress to natural systems from future climate change.

Landscape-scale planning, like the *Desert Renewable Energy Conservation Plan (DRECP)*, attempts to address this concern by identifying the most appropriate areas for large-scale renewable energy development within the desert landscape by designing a

¹⁰² California Advance Mitigation Act, SB X-8 34, Padilla, Chapter 9, Statutes of 2009–2010 Eighth Extraordinary Session.

conservation framework to foster and maintain species resiliency across desert ecosystems, with explicit consideration of the impacts of climate change. Furthermore, CDFW and U.S. Bureau of Land Management (U.S. BLM) signed a durability agreement in 2015 that allows BLM-managed federal lands to be used for a variety of conservation actions that will contribute to achieving the overall DRECP conservation framework goals and, in specific circumstances, for project-level mitigation.¹⁰³

To support the design and implementation of the DRECP, the Energy Commission's Research and Development Division initiated several research projects to compile or model biological data on where species exist, their habitat needs, and how and where they use the desert landscape.¹⁰⁴ Other studies investigated how renewable energy development might impact species or developed tools to predict impacts. For example, one project is quantifying desert fox movements in parts of the desert with solar energy development to better understand the impacts of solar development of desert kit fox. New data were also collected to better monitor actual impacts of projects during construction and operation, to better understand how species react to energy development.

Cultural Resources

Cultural resources at power plants sites, especially historical resources and tribal cultural resources, can be directly impacted by physical disturbance to land and related archeology, as well as indirectly impacted by visual, sound, and olfactory intrusion upon culturally imbued landscapes.¹⁰⁵ The expansion of large renewable energy generation projects in rural lands such as the California desert has resulted in the identification of vast amounts of cultural resources. There has been a significant increase in the number of cultural resources affected by utility-scale renewable energy development in desert areas compared to smaller-scale energy project development in previously disturbed urban areas.

Transmission lines and interconnections, because of the long, linear nature, have the potential to cause direct damage to cultural resources from ground disturbance, such as mowing the right-of-way, grading, installing transmission towers, building access roads, grading helicopter fly yards and staging areas, and installing pull sites for electrical cable. In addition, construction of transmission towers and lines can present visual and

103 http://www.drecp.org/documents/docs/2015_Durability_Agreement_BLM_CAFW.pdf.

104 For a summary of research supporting the *DRECP* see <http://www.energy.ca.gov/2014publications/CEC-500-2014-091/CEC-500-2014-091-BR.pdf>.

105 *Historical resources* include buildings, sites structures, objects, areas, places, cultural landscapes, tribal cultural resources, and records and manuscripts. *Cultural resources* are a type of historical resource defined as sites, features, places, cultural landscapes, sacred places, and objects with cultural value to a California Native American tribe that are either included or eligible for inclusion in the California Register of Historical Resources or a local register of historical resources or determined to be significant by the lead agency (Pub. Resources Code, § 21074[a]).

auditory intrusions to historical districts, cultural landscapes, and other types of cultural resources.

The growth of renewable energy development in the California deserts has led to a high degree of engagement on the part of California Native American tribes and communities. Numerous tribes—including Kawaiisu, Cahuilla, Kamia, Kumeyaay, Paiute, Shoshone, Chemehuevi, Mojave, Quechan, and Serrano—have called the inland desert home for millennia, continue to live there, and maintain cultural practices that served their ancestors for generations. Energy Commission siting cases such as the Blythe Solar Power Project and Genesis Solar Energy Project and the now withdrawn/terminated Rio Mesa, Palen, and Hidden Hills solar projects saw intense tribal involvement in all aspects of the proceedings. Tribes expressed concerns about cultural and landscape preservation, as well as concerns over effects on biological resources, water, air quality, and view aesthetics. This engagement has increased tribal knowledge within energy facility permitting and the state’s knowledge of tribal values, interests, and methods of engagement.

For large-scale renewable projects in the California deserts, the Energy Commission uses a set of *standard conditions* that define the minimum qualifications for project cultural resources personnel, the content requirements of an avoidance and archaeological mitigation plan (cultural resources monitoring and mitigation plan), construction monitoring procedures, Native American involvement, and reporting intervals. These are applied in cases where cultural resources are not identified within the project site, where inadvertent discoveries could occur during construction. Where there are known cultural resources on a power plant site that could be impacted, these standard conditions are modified and amplified by mitigation measures tailored to cultural resources identified during licensing. Tribal consultation is further addressed in the section below on Environmental Justice.

Visual Resources

Compared to conventional generation technologies, the area within which visual impacts may occur is typically much greater for utility-scale renewable projects, particularly for projects using solar power tower technology. These project sites cover thousands of acres that are frequently surrounded by low mountain ranges and public lands used for a variety of recreational activities. Most of the project acreage for solar thermal projects is covered by solar collector arrays that cause diffused or direct reflected glare when transitioning between the downward-facing stow position and the tracking positions. The more diffuse glare from solar PV power plants can also present a visual quality impact, a distraction to pilots, or an intrusive visual nuisance to sensitive viewer groups such as residents, recreationists, and motorists.

Glare from solar PV panels can be reduced by using textured glass, using antireflective coatings, and installing site blinds and screening to reduce potential impacts to certain observers. Glare from concentrated solar power plants with mirrors, such as solar power

tower and solar parabolic trough projects, can be reduced by altering heliostat or trough positioning and by fence construction to partially shield views. Concentrated solar power plants with mirrors can also potentially cause glare to pilots and motorists. The Energy Commission is continuing to investigate glare impact and determine the best methods for mitigation.

Wind energy projects are typically highly visible on the landscape and result in significant visual impacts. There are several siting and design strategies that can reduce visual impacts, such as integrating turbine arrays and turbine design with the surrounding landscape, inserting breaks or open zones to create distinct visual groups of turbines, using nonreflective paints and coatings to reduce reflection and glare, and designing sites to make security lights nonessential. The visual effects of wind projects are sometimes minimized when projects are in areas with lower visual sensitivity, such as large acreage ranchlands not near recreational use areas. Impacts are also reduced by avoiding installations of wind turbines along ridgelines. Even with implementation of these and other mitigation strategies, the visual impacts from wind power projects often remain significant with no feasible mitigation measures identified to reduce impacts to less than significant.

The high-voltage transmission lines associated with utility-scale power plants require installation of transmission structures and power lines that have the potential to impact visual resources in areas near the transmission line route. The overall goal is to reduce the visual intrusion and contrast with the environment in areas where a new transmission line could be highly visible. In natural settings self-weathering steel transmission structures tend to blend more with the landscape. In urban settings galvanized structures that have been dulled to reduce reflectivity might help reduce visual impacts.

Environmental Justice

With continued population growth and diversity, most locations where energy facilities are proposed are likely to include an EJ population. Attention to protecting those least able to improve their living conditions and most likely to face barriers to participating in planning or permitting processes is an important priority. Continued outreach to those communities most vulnerable to these potential burdens, such as air emissions and noise, is critical to ensure their concerns are heard and addressed. Disadvantaged, vulnerable, and EJ communities will likely bear a disproportionate burden of climate change impacts. As climate impacts become more pronounced across the state, climate adaptation efforts focused on communities most vulnerable to potential increased burdens from the effects of climate change, such as air emissions and extreme heat days, will be increasingly important.

Since 1994, federal agencies are required to make EJ a part of their missions by developing a strategy that identifies and addresses disproportionately high and adverse human health or environmental effects of federal programs, policies, or activities on

minority and low-income populations.¹⁰⁶ California passed its first environmental justice law in 1999, Senate Bill 115 (Solis, Chapter 690, Statutes of 1991), codifying a definition for environmental justice as "the fair treatment of people of all races, cultures, and incomes with respect to the development, adoption, implementation, and enforcement of environmental laws, regulations and policies."¹⁰⁷

Building on this landmark legislation, California instituted policies including tribal consultation requirements for planning agencies, publishing meeting notices in both English and Spanish, and allowing additional time for comments translated into English at state-held public meetings. Senate Bill 535 (De León, Chapter 830, Statutes of 2012) (SB 535) also established requirements to spend at least 25 percent of cap-and-trade funds on projects that benefit disadvantaged communities and at least 10 percent for projects in these communities. Assembly Bill 1532 (Pérez, Chapter 807, Statutes of 2012) allocates no less than 25 percent of available proceeds from the carbon auctions held under California's Global Warming Solutions Act of 2006 to projects that will benefit these disadvantaged communities.

SB 535 also requires the California Environmental Protection Agency (CalEPA) to identify disadvantaged communities based on geographic, socioeconomic, public health, and environmental hazard criteria. The development of the CalEnviroScreen tool was a major step in implementing CalEPA's *2004 Environmental Justice Program Update*,^{108,109} which called for developing guidance to analyze the impacts of multiple pollution sources in California communities. The CalEnviroScreen tool assesses communities at the census tract level in California to identify communities most burdened by pollution from multiple sources and most vulnerable to the effects, taking into account socioeconomic characteristics and underlying health status.¹¹⁰

In support of the 2030 GHG reduction goal, the Governor and Legislature put into place a suite of new laws to equitably achieve the state's climate goals. Assembly Bill 1613 (Chapter 370, Statutes of 2016) and the companion bill, Senate Bill 859 (Committee on Budget and Fiscal Review, Chapter 386, Statutes of 2016), allocate \$900 million from the Greenhouse Gas Reduction Fund (proceeds from California's cap-and-trade program to limit greenhouse gas emissions) to support programs that benefit disadvantaged communities, advance clean transportation, protect the natural environment, and cut short-lived climate pollutant emissions. Assembly Bill 1550 (Gomez, Chapter 369,

106 President Clinton's Executive Order 12898.

107 Government Code Section 65040.12.

108 California Environmental Protection Agency. 2014. California Communities Environmental Health Screening Tool, Version. 2.0 (CalEnviroScreen 2.0), Guidance and Screening Tool. October 2014. Available at <http://oehha.ca.gov/ej/ces2.html>.

109 California Environmental Protection Agency. 2004. *2004 Environmental Justice Program Report*. Available at <http://www.calepa.ca.gov/EnvJustice/ActionPlan/PhaseI/March2005/EJrptSept2004.pdf>.

110 For more information, see <http://oehha.ca.gov/calenviroscreen/general-info/calenviroscreen-update>.

Statutes of 2016) modifies how funding is allocated to benefit disadvantaged communities by assuring a minimum of 25 percent of the funding to projects located within, and benefitting individuals living in, disadvantaged communities and an additional 5 percent to projects that benefit low-income households. Assembly Bill 2722 (Burke, Chapter 510, Statutes of 2016) establishes the Transformative Climate Communities program to fund programs that advance multiple climate and clean energy efforts in an communitywide approach, such as integrating affordable housing near transit, energy efficiency, and clean transportation.

One of the requirements of SB 350 is for state agencies to evaluate the barriers for low-income customers, including those living in disadvantaged communities, to access clean energy technologies and provide recommendations for how to address these barriers. The study comprises two parts: the Energy Commission completed and adopted the portion discussing energy efficiency and renewable energy on December 14, 2016, (part A)¹¹¹ and the ARB is reporting on zero-emission and near-zero-emission transportation options in consultation with other state agencies (part B), by early 2017. Furthermore, to ensure the full economic and societal benefits of California's clean energy transition are realized, the Energy Commission is also evaluating the barriers to contracting opportunities for local small businesses located in disadvantaged communities, along with potential solutions.

Environmental Justice and Tribal Governments

Consultation with California Native American tribal governments is the responsibility of local, state, and federal agencies and is detailed in several sections of federal and state law and policy. Most such authorities on tribal consultation apply to general plans and specific project proposals. The *2005 EPR* observed that the law and guidance for Senate Bill 18 (Burton, Chapter 905, Statutes of 2004) implementation set a positive model for local agencies to consult with California Native American tribes. In 2011, Governor's Executive Order B-10-11 directed state agencies to afford California Native American tribes, including both federally recognized and nonrecognized, the opportunity to "provide meaningful input into the development of policy on matters that affect tribal communities." The order also directed all state agencies under the Governor's jurisdiction to adopt tribal consultation policies. The Energy Commission adopted a tribal consultation policy that implements the California Natural Resources Agency's consultation policy for Energy Commission programs and projects.¹¹² Assembly Bill 52 (Gatto, Chapter 535, Statutes of 2014) amended the California Environmental Quality Act to address:

111 Scavo, Jordan, Suzanne Korosec, Esteban Guerrero, and Bill Pennington. 2016. *A Study of Barriers and Solutions to Energy Efficiency, Renewables, and Contracting Opportunities Among Low-Income Customers and Disadvantaged Communities*. California Energy Commission. Publication Number: CEC-300-2016-009-SD.

112 California Energy Commission. 2014. California Energy Commission Tribal Consultation Policy (Executive Order B-10-11). December. Order No. 14-1210-3. Sacramento, California, available at http://www.energy.ca.gov/tribal/documents/2014-12-10_Tribal_Consultation_Policy_and_Order.pdf.

- The definition of Native American tribes.
- Lead agency responsibilities to consult with California Native American tribes.
- The definition of a tribal cultural resource (a type of historical resource, or cultural resource with regulatory significance).

The Energy Commission has integrated EJ into its environmental impact analyses under CEQA and the Commission's siting regulations since 1995.¹¹³ Among other guidance, the *Final Guidance for Incorporating Environmental Justice Concerns in EPA's Compliance Analyses*¹¹⁴ guides the EJ analyses, which may include outreach to tribal governments to identify those minority groups who use or depend upon natural and cultural resources that could be affected by the proposed action. The Energy Commission consults with tribal governments to discern whether a proposed energy facility may affect cultural resources and related Native American practices.

Historically, the Energy Commission's EJ impact assessments focused on resident minority and low-income populations in a given project vicinity across several resource categories (including cultural resources). With the advent of utility-scale solar projects in the California deserts and the landscape-scale impact potential, Energy Commission recognized that the resident EJ population was not the only appropriate analytical unit in all energy development siting cases. The Energy Commission identified cultural landscapes essential to tribal cultural practices and uses that extended far beyond the reservation (tribal lands) boundaries. In analyzing the potential EJ impacts of energy development on tribal governments, Energy Commission consults with tribal governments known to use proposed project vicinities for subsistence and traditional cultural practices, instead of treating only tribal governments residing in the project vicinity.

In addition to consulting with California Native American tribes on specific generation projects, the Energy Commission has also engaged formally and informally with tribes on a series of planning efforts, including *DRECP*, San Joaquin Least Conflict Planning for Solar PV, and the Renewable Energy Transmission Initiative (RETI) 2.0 process. These processes offer tribes an opportunity to inform government agencies, developers, and the public about potential conflicts with cultural resources at the landscape scale so that cultural resource sensitivity can be considered at the planning level.

Best Management Practices for Renewable Energy Development

In December 2010, the Renewable Energy Action Team (REAT) issued a *Best Management Practices and Guidance Manual: Desert Renewable Energy Projects*, which helps inform

¹¹³ California Energy Commission. 2016. Environmental Justice. Sacramento, California. Available at http://www.energy.ca.gov/public_adviser/environmental_justice_faq.html.

¹¹⁴ Environmental Protection Agency. 2016. *Final Guidance for Incorporating Environmental Justice Concerns in EPA's NEPA Compliance Analyses*. April. Available at <https://www.epa.gov/sites/production/files/2015-04/documents/ej-guidance-nepa-compliance-analyses.pdf>.

developers and regulatory agencies of best practices when preparing and reviewing development applications to accelerate renewable energy project permitting.¹¹⁵ REAT agencies should continue to use the best management practices and consider updating them so that they reflect the current state of technology and incorporate lessons learned from the permitting and development process. Updates to the best management practices should include strategies on how to achieve multiple environmental and land-use benefits from renewable energy development, where appropriate.

Landscape-Scale Planning

Landscape-scale planning approaches take into consideration a wide range of potential constraints and conflicts, including environmental sensitivity, conservation and other land uses, tribal cultural resources, and more when considering future renewable energy development. Previous *IEPRs* and *IEPR Updates* have discussed the benefits of using landscape-scale approaches for renewable energy and transmission planning.¹¹⁶

California has attempted to balance the need for future renewable energy development and transmission through landscape planning processes that proactively address environmental and land-use issues to promote renewable energy development, integrate that information into planning and procurement, and coordinate land-use and transmission planning. Through current and previous planning efforts, such as the first and second RETI processes,¹¹⁷ the joint REAT agency work on the *DRECP*, and the stakeholder-led San Joaquin Valley Identification of Least-Conflict Lands study, California agencies, federal agencies, local governments, tribes, and stakeholders have collaborated to identify the most appropriate areas for renewable energy development.

Moving forward, the state continues to refine its approach to planning for renewable energy by coordinating with entities from federal, state, and local governments, as well as collaborating with stakeholders from a wide range of disciplines to proactively prepare for future renewable energy development, including ongoing work in the California desert. The U.S. BLM executed a record of decision (ROD) for the *DRECP* Land Use Plan Amendment (LUPA) on September 14, 2016, that, among other things, will guide how renewable energy is developed on federal lands in the California desert.

Within the state's various planning efforts, including landscape-scale planning efforts like the *DRECP*, there are also opportunities to prepare for the transmission infrastructure that might be needed to meet long-term future needs. Consistent with the

115 <http://www.energy.ca.gov/2010publications/REAT-1000-2010-009/REAT-1000-2010-009.PDF>.

116 The Nature Conservancy studied the costs and impacts of integrating ecological information into long-term energy planning and found that a 50 percent renewable portfolio could be achieved with low impacts to natural areas. See http://www.scienceforconservation.org/downloads/ORB_report.

117 RETI 2.0 did not incorporate a land-use analysis but collected important environmental data to make it available for future decision making.

Garamendi Principles,¹¹⁸ the *2015 IEPR* recommended that the state develop a set of right-sizing policies through the *2016 IEPR Update* process, informed by energy planning processes. Right-sizing expands the analysis of large transmission facilities and looks beyond a 10-year planning time frame to determine whether a proposed transmission line or project in areas with constrained corridors should be sized larger to meet needs more than 10 years out, to reduce the future costs and environmental impacts of new transmission facilities. Application of a right-sizing policy in various planning processes should also consider a suite of transmission technologies available that can increase the efficiency of the existing and future transmission system. This could help ensure that as new transmission projects are planned, they would not have to be replaced or upgraded after construction.

Nuclear Decommissioning

As noted above in the section above on “Changes to California’s Electricity System,” San Onofre was permanently shut down in 2013, and plans are underway to shut down the last remaining operational nuclear power plant in California, Diablo Canyon. With these changes, important work remains to decommission the plants and manage the nuclear waste from each, as well as from two other facilities that are in varying stages of decommissioning, Humboldt Bay and Rancho Seco.

All four of California’s nuclear plant sites serve as interim storage facilities for high-level nuclear waste such as spent nuclear fuel. All the spent fuel at both Humboldt Bay and Rancho Seco has been moved into dry cask storage in on-site independent spent fuel storage installations (ISFSIs), while the spent fuel at Diablo Canyon and San Onofre is stored both in ISFSIs and spent fuel cooling pools. The discussion below will focus primarily on San Onofre and Diablo Canyon due to the presence of mixed storage, the age and radioactivity of spent fuel in storage, and the levels of activity on-site.

Federal Activities

NRC Decommissioning Rulemaking

In 2015 the NRC launched a new rulemaking proceeding to identify ways to improve the current decommissioning process and regulations.¹¹⁹ (The decommissioning rulemaking

118 Senate Bill 2431 (Garamendi, Chapter 1457, Statutes of 1988) recognized the value of the transmission system and the need for coordinated long-term transmission corridor planning to maximize the efficiency of transmission rights-of-way and avoid single-purpose lines. The bill established four principles, commonly referred to as the *Garamendi Principles*, for the planning and siting of new transmission facilities. The four Garamendi Principles should be pursued in the following order: 1) Encourage the use of existing rights-of-way (ROW) by upgrading existing transmission facilities where technically and economically feasible; 2) when construction of new transmission lines is required, encourage expansion of existing ROW, when technically and economically feasible; 3) provide for the creation of new ROW when justified by environmental, technical, or economic reasons defined by the appropriate licensing agency; and 4) where there is a need to construct additional transmission capacity, seek agreement among all interested utilities on the efficient use of that capacity.

119 U.S. Nuclear Regulatory Commission Proposed Rule to Improve Decommissioning Planning, <http://www.nrc.gov/waste/decommissioning/public-involve.html>.

was discussed in more detail in the 2015 IEPR.) Under the decommissioning process in place, plant owners may ask the NRC to approve exemptions and/or amendments to the operating licenses as the decommissioning moves forward. Nuclear plant owners may seek license exemptions and/or amendments based on reduced safety and security hazards. For example, once a reactor is permanently defueled, a plant owner (licensee) may seek a license amendment or exemption in operations areas such as staffing and training, security, and emergency preparedness to reflect the new defueled status of the reactor. Under the current regulations, state and local stakeholders have limited ability to voice concerns about site-specific issues arising from the decommissioning. In the case of San Onofre, state and local stakeholders have pointed to the seismic hazards of the site and proximity to densely populated areas as two significant issues that should continue to be important considerations in any decisions made regarding the decommissioning and potential license amendments.

In a recent meeting before the NRC commissioners,¹²⁰ Chair Robert B. Weisenmiller presented California's position in addition to submitting formal comments to the *Federal Register* on the decommissioning rulemaking.¹²¹ The submitted comments focused on items that maximize safety while minimizing environmental and economic impacts, increasing public engagement, and expanding roles for the states and stakeholders. Two recommendations that incorporate all these principles were formation of an expanded, independent advisory board or panel and a site-specific decommissioning process, defined by a site-specific risk profile.

California requires that the decommissioned plant site be restored to the original condition, which will entail additional activities beyond NRC requirements and that will extend the process beyond SCE's current 20-year plan. Due to the proximity to major urban areas, there are remaining concerns about the long-term safety and security at the San Onofre site, since spent fuel will be maintained on site indefinitely in the absence of final disposal at a federally owned or operated facility. Moreover, with the recent announcement of plans to retire Diablo Canyon by 2025, the Energy Commission sees engagement in the decommissioning rulemaking as an important opportunity to represent and inject California's concerns into the new regulations. The next step on the current NRC timeline is to publish the draft decommissioning regulatory basis in the first quarter of 2017 for public review and comment.

120 Power Reactor Decommissioning Rulemaking public meeting, March 15, 2016, <http://www.nrc.gov/reading-rm/doc-collections/commission/tr/2016/>.

121 Letter to Secretary of U.S. Nuclear Regulatory Commission from the California Energy Commission regarding, the "Amended Comment on the Draft Regulatory Basis: Regulatory Improvements for Power Reactors Transitioning to Decommissioning" (Docket ID: NRC-2015-0070). NRC Accession Number ML16092A238.

U.S. Department of Energy (DOE) Consent-Based Siting

The DOE has proposed a consent-based siting process to develop storage solutions for the long-term, sustainable management of the nation's high-level radioactive waste.¹²² The DOE's initial goal is to identify sites that have public support for the interim storage of nuclear waste from the nation's nuclear plants.¹²³ Chair Weisenmiller provided the keynote speech at a DOE-led public meeting held in Sacramento, California, in April 2016.

In response to the invitation for public comment, the Energy Commission submitted comments to the DOE on July 29, 2016. The comment letter focused on items that promote a transparent and inclusive public process, address transportation concerns, and support affected entities and equitable participation in the process. DOE released a draft report on September 15, 2016, that includes input from the public meetings and written comments. The DOE solicited comments on its draft report to ensure that the contents accurately reflected the input received. The DOE issued a final report, *Designing a Consent Based Siting Process: Summary of Public Input*, on December 29, 2016.¹²⁴

The Energy Commission also expressed support in the *2015 IEPR* for the legislation cosponsored by U.S. Senator Dianne Feinstein (D-Calif.) to establish a Nuclear Waste Administration, a consent-based siting process for repositories and storage facilities, and a pilot program for interim spent fuel storage as identified in the Nuclear Waste Administration Act of 2015.¹²⁵ Congressional activities in support of nuclear waste management are even more relevant due to the June 3, 2016, ruling by the U.S. Court of Appeals on the petition against the NRC's Continued Storage Rule: "*To the extent that the petitioners disagree with the NRC's current policy for the continued storage of spent nuclear fuel, their concerns should be directed to Congress. For the reasons stated herein, the Court denies the petitions for review.*"¹²⁶

122 U.S. Department of Energy Consent-Based Siting, <http://www.energy.gov/ne/consent-based-siting>.

123 These interim sites would allow the DOE to begin fulfilling its responsibility of taking spent nuclear fuel from the nation's commercial reactors and store it at one or more "consolidated" sites while a geologic repository is sited, constructed, and licensed for the final disposal of the nuclear waste.

124 <https://www.energy.gov/ne/downloads/designing-consent-based-siting-process-summary-public-input-report>.

125 Senate Coalition Introduces Comprehensive Nuclear Waste Legislation, March 24, 2015, <http://www.feinstein.senate.gov/public/index.cfm/press-releases?ID=472C5FD2-3A9A-41F2-B0DB-CF6F9C9570C4>.

126 *STATE OF NEW YORK, ET AL. v. U.S. NUCLEAR REGULATORY COMMISSION*, USCA Case #14-1210, Document #1616468 (D.C. Circuit 2016). Retrieved from http://www.lawandenvironment.com/wp-content/uploads/sites/5/2016/06/document_gw_01-2.pdf.

Status Updates for Decommissioning Plants

San Onofre

Three years after SCE permanently ceased operations at the San Onofre nuclear plant, decommissioning is well underway. Decommissioning of a nuclear generating facility involves transferring spent fuel from reactors into safe storage, followed by the removal and disposal of radioactive components and materials from the plant site. SCE has stated it intends to complete the full NRC-mandated decommissioning for San Onofre Units 2 and 3 within 20 years, even though the NRC allows up to 60 years to decommission a plant.¹²⁷ California requires the plant site to be restored to the original condition in addition to the NRC requirements. Moreover, the environmental restoration of the San Onofre site is required as part of the U.S. Navy site lease to SCE, although a final agreement between the parties for the site restoration terms has not yet been reached. Per SCE's decommissioning plan, a dry cask storage facility will remain at the plant site at least until 2051, at which time the restoration of the site will be complete.¹²⁸

As of June 2016, SCE had achieved the necessary site modifications for placing the plant in a "cold and dark" state, which means the San Onofre plant is now de-energized and in safe, nonoperating conditions. SCE also initiated the process of "islanding" the spent fuel pool. Islanding the spent fuel pools involves replacing the normal systems that support the spent fuel pools with stand-alone cooling and filtration systems. SCE indicated in a November 10, 2016, San Onofre Community Engagement Panel meeting decommissioning update presentation¹²⁹ that the islanding of the spent fuel pools had been completed and legacy systems removed from service. SCE also has undertaken activities to build a new partially underground ISFSI on the plant site to hold spent nuclear fuel from Units 2 and 3. Construction of the new ISFSI is expected to be completed in 2017.

SCE has removed all the fuel rods from the Unit 2 and 3 reactors to a spent fuel pool for cooling and expects to complete the transfer of the fuel rods from the pool to dry cask storage in the new ISFSI by 2019. The spent fuel will remain in dry storage in the ISFSI until such time that the spent fuel can be transferred to a federal storage facility or repository. SCE's current spent fuel management plans are based on the DOE beginning to take nuclear waste from facilities in 2024. The transfer off-site to a federal disposal facility of all spent nuclear fuel from San Onofre is proposed to be completed in 2049

¹²⁷ California Energy Commission, *2015 IEPR*, 2016, p. 171, http://www.energy.ca.gov/2015_energypolicy/index.html.

¹²⁸ The target date of 2051 is predicated on the assumption that the federal government will accept the stored spent nuclear fuel in the dry cask storage facility for final disposal in a federal nuclear waste facility in the period leading up to 2051.

¹²⁹ https://www.songscommunity.com/docs/111016_DecommissioningUpdate.pdf.

assuming the DOE begins accepting nuclear waste nationally in 2024 and shipments from San Onofre start in 2030.¹³⁰

Although the risks to public safety and security are lessened as the decommissioning of San Onofre progresses, they are not eliminated. The presence of spent nuclear fuel on-site for years or even decades means local emergency preparedness must be maintained and security measures must remain in place. Environmental impacts of decommissioning must also be monitored to protect the public, the surrounding water and land, and the plant site itself.

Status of Diablo Canyon

As noted above, PG&E announced plans in June 2016 to shut down Diablo Canyon at the end of the current licenses in 2024-2025 in accordance with an agreement (the joint proposal) among PG&E, labor, and environmental organizations.¹³¹ A detailed discussion of the Joint Proposal can be found in the *2016 EPR*.

The first step in implementing the Joint Proposal was to secure an extension of a State Lands Commission (CSLC) lease to allow the continued use of tidal lands for the water intake structures, breakwaters, cooling water discharge channel, and other structures associated with Diablo Canyon. The newly extended lease, approved unanimously in June 2016 by the CSLC, will expire concurrent with the existing NRC operating licenses.

The joint proposal also addressed the future decommissioning of Diablo Canyon. First, PG&E agreed to prepare a site-specific decommissioning plan no later than the date when PG&E must file the 2018 Nuclear Decommissioning Cost Triennial Proceeding with the CPUC. Second, PG&E pledged to expedite the transfer of spent nuclear fuel from the cooling pool to dry storage upon the retirement of the plant in 2025. PG&E will develop “technically feasible” transfer schedules that are based on SCE’s spent nuclear fuel transfer schedule as providing a benchmark for Diablo Canyon. PG&E will also provide the plan to the Energy Commission and collaborate with the Energy Commission on the post-shutdown transfer of spent nuclear fuel to dry cask storage.¹³²

Seismic safety will continue to be an important concern for the Diablo Canyon plant, not only for the remaining operational period, but for the decades ahead when spent fuel is

130 CPUC Decision 16-04-019, April 21, 2016. Joint Application of Southern California Edison Company (U338E) and San Diego Gas & Electric Company (U902E) to Find the 2014 SONGS Units 2 and 3 Decommissioning Cost Estimate Reasonable and Address Other Related Decommissioning Issues. Application 14-12-007, filed December 10, 2014, p. 7. Retrieved from <http://docs/cpuc.ca.gov/PublishedDocs/Published/G000/M160/K090/160090034.PDF>.

131 PG&E News Release, “In Step with California’s Evolving Energy Policy, PG&E, Labor and Environmental Groups Announce Proposal to Increase Energy Efficiency, Renewables and Storage While Phasing Out Nuclear Power Over the Next Decade.” June 21, 2016. Retrieved from http://www.pge.com/en/about/newsroom/newsdetails/index.page?title=20160621_in_step_with_californias_evolving_energy_policy_pge_labor_and_environmental_groups_announce_proposal_to_increase_energy_efficiency_renewables_and_storage_while_phasing_out_nuclear_power_over_the_next_decade.

132 PG&E Application 16-08-006, filed on August 11, 2016. Attachment A, Joint Proposal, p. 13.

stored on-site. Recent state legislation will allow the Independent Peer Review Panel to continue to provide outside review of seismic hazard assessments for the remainder of the operating license.¹³³ Although the plant will stop operating within the next decade, improving the knowledge base of the regional and site-specific seismic hazards will continue to be important.

Two additional factors that will continue to be a concern for Diablo Canyon will be maintenance of the aging facility and site security. As the facility ages, systems, structures, and components are all subject to radiation and age-related degradation, which, if unchecked, could lead to impaired safety and loss of function.¹³⁴ Aging and weathering are also concerns for the on-site ISFSI facility. PG&E maintains maintenance and monitoring programs that have been approved by the NRC to address the risks associated with aging plant systems. Further, the NRC, nuclear industry stakeholders, and the National Laboratories are developing aging management processes and programs for the nation's ISFSIs to address concerns over the safety of long-term on-site storage.¹³⁵ The reactor vessel heads and steam generators of both units at Diablo Canyon were also replaced in 2008 for Unit 2 and 2009 for Unit 1.

Emerging and Transformative Technologies

The energy sector has seen dramatic technological change over the last 10 years. Meeting GHG reduction goals and achieving 50 percent renewable energy will depend on multiple integrated technologies and revisions to existing systems. The Energy Commission anticipates further advancement of renewable energy technologies, including untapped renewable resources from the ocean, a significant increase in distributed energy resources (DER) investment, and deployment of advanced energy storage.¹³⁶ These emerging energy technologies will support the additional renewable energy that will allow California to achieve long-term energy and climate goals.

The *2016 EPR* includes an overview of the many advanced energy technologies in the research and development pipeline, and this section highlights some of the technologies that have the potential to transform California's energy system. The section summarizes the technological status and outlook of existing renewable technologies, describes the status of offshore ocean energy technologies and projects, discusses the growing role of

133 Assembly Bill 361, Achadjian, Chapter 399. Signed October 1, 2015.

134 California Energy Commission, *An Assessment of California's Nuclear Power Plants: AB 1632 Report*, 2008, p. 16, <http://www.energy.ca.gov/2008publications/CEC-100-2008-009/CEC-100-2008-009-CMF.PDF>.

135 "Division of Spent Fuel Management Regulatory Conference 2015" U.S. Nuclear Regulatory Commission, Office of Nuclear Material Safety and Safeguards, Division of Spent Fuel Management, November 2015. Presentations available at <http://www.nrc.gov/public-involve/conference-symposia/dsfm/dsfm-reg-conf-2015.html>.

136 Assembly Bill 327 (Perea, Chapter 611, Statutes of 2013) provides a definition for DER that includes distributed renewable generation resources, energy efficiency, energy storage, electric vehicles, and demand response technologies.

DER technologies, and summarizes the current and future opportunities for advanced energy storage. The state recognizes that multiple technologies will be needed to achieve its GHG reduction goals across all sectors and therefore must remain technology-neutral to ensure that all technologies have the opportunity to participate in a competitive market.

Renewable Energy

Evolving Utility-Scale Solar and Next Generation Wind Energy

As described earlier, solar energy is a major part of California's renewable resource portfolio and is enabling the state to achieve near-term RPS and climate goals. California has some of the best solar resources in the world, making it an ideal place for utility-scale solar development. Another enabling factor of rapid solar deployment is a 45 percent decline in the median installed price of utility-scale solar PV systems from 2010 to 2015,¹³⁷ with comparable declines for rooftop systems.¹³⁸ California's renewable energy goals, abundant sunshine, and cost declines for solar PV will continue to drive significant solar PV growth. While this growth will help reduce statewide GHGs, the state will need to develop strategies and conduct research that enables solar technologies to reliably and safely integrate into the electricity system. Concentrating solar power (CSP) has not seen the same level of cost declines. However, the opportunity to incorporate thermal energy storage into the design of these plants may make them more attractive and valuable as California moves to higher penetrations of renewable energy.

Like solar PV, wind energy technologies are also contributing to California's success in reducing GHGs and are becoming more cost-effective due to improvement in turbine manufacturing processes and increases in wind turbine size. DOE reported that the price of power purchase agreements for onshore wind have dropped significantly from the high of around \$70/MWh, with an average of about \$20/MWh between 2009 and 2015.¹³⁹ At a January 28, 2016, Energy Commission workshop, participants recommended new wind resource maps with a higher hub height, around 200 meters (656 feet) compared to the 100 meter height wind maps that are used today.¹⁴⁰ Workshop participants also suggested that some legacy projects might not be suitable

137 Bolinger, Mark and Joachim Seel, Lawrence Berkeley National Laboratory, Utility-Scale Solar 2015: An Empirical Analysis of Project Cost, Performance, and Pricing Trends in the United States, August 2016, https://emp.lbl.gov/sites/all/files/lbnl-1006037_report.pdf.

138 Barbose, Galen, and Naim Darghouth, Lawrence Berkeley National Laboratory, *Tracking the Sun IX: The Installed Price of Residential and Non-Residential Photovoltaic Systems in the United States*, August 2016, https://emp.lbl.gov/sites/all/files/tracking_the_sun_ix_report_0.pdf.

139 Wiser, R., M. Bolinger. *2015 Wind Technologies Market Report*. LBNL. August 2016. <http://energy.gov/eere/wind/downloads/2015-wind-technologies-market-report>. DOE reports that the average price decline in wind energy PPAs across the United States. is largely driven by significant wind energy development in the interior United States, which is generally associated with relatively low wind energy PPA prices as compared to the Western United States.

140 <http://www.energy.ca.gov/research/notices/index.html#01282016wind>.

to repower with larger and taller turbines. These wind energy facilities might increase the capacity factor and efficiency by adapting technologies that improve aerodynamic efficiency of existing turbines or by replacing older turbines with modern turbines with higher capacity factors.

Repowering existing wind energy facilities with more efficient technologies offers an opportunity for California to replace renewable wind energy with newer facilities that are designed to minimize avian impacts and reuse existing land, which is an opportunity to improve the environmental performance of wind energy generation.¹⁴¹

Bioenergy From Forest Biomass and Advanced Geothermal

Bioenergy technologies, particularly those that convert forest biomass into bioenergy, can provide benefits such as helping alleviate the growing threat of wildfires and providing dispatchable renewable energy that may help integrate intermittent renewable energy. As noted in the *2016 Draft EPR*, tree mortality contributes to wildfires.¹⁴² Forest biomass presents a large resource for renewable generation, and progress is being made by both policy makers and stakeholders in addressing financial hurdles, creating value-added opportunities for coproducts, finding ways to monetize the value of non-energy benefits, and streamlining the permitting process. For instance, the BioMAT program under Senate Bill 1122 (Rubio, Chapter 612, Statutes of 2012) aids new biomass power plants by tasking large utilities to procure 50 MW from facilities that use forest material from sustainable forest management. Passed in 2016, Senate Bill 859 (Committee on Budget and Fiscal Review, Chapter 368, Statutes of 2016) requires electrical corporations and larger local publicly owned utilities to purchase their proportionate share of 125 MW of electricity from existing bioenergy facilities that use fuel from “high hazard zones” in California.¹⁴³ Furthermore, since 2012, the Energy Commission has already funded or is proposing to fund roughly \$31.6 million in bioenergy research demonstration projects, including \$15 million for forest biomass, to help demonstrate the benefits of bioenergy.¹⁴⁴

141 In June 2016 the Energy Commission released the grant funding opportunity “Improving Performance and Cost Effectiveness of Small Hydro, Geothermal and Wind Energy Technologies (GFO-16-301),” which solicits applications to increase strategies and tools to increase the effective use of wind resources in California. <http://www.energy.ca.gov/contracts/GFO-16-301/>.

142 For an in-depth description of tree mortality see pages 115 -117 in the *2016 Draft EPR*. http://docketpublic.energy.ca.gov/PublicDocuments/16-IEPR-03/TN212338_20160718T142510_Draft_2016_Environmental_Performance_Report_of_California's_Ele.pdf.

143 Senate Bill 859 defines two tiers of high hazard zones. “Tier 1 high hazard zone” includes areas where wildlife and falling trees threaten power lines, roads, and other evacuation corridors; critical community infrastructure; or other existing structures, as designated by the Department of Forestry and Fire Protection under the Proclamation of a State of Emergency on Tree Mortality declared by the Governor on October 30, 2015. “Tier 2 high hazard zone” includes watersheds that have significant tree mortality combined with community and natural resource assets, as designated by the Department of Forestry and Fire Protection under the Proclamation of a State of Emergency on Tree Mortality declared by the Governor on October 30, 2015.

144 *The Electric Program Investment Charge: Proposed 2012-14 Triennial Investment Plan* (October 2012 Staff Final Report, available at <http://www.energy.ca.gov/2012publications/CEC-500-2012-082/CEC-500-2012-082->

Like bioenergy, emerging geothermal technologies offer multiple resource values, for example, colocating mineral extraction activities with geothermal plants. Geothermal energy is a renewable energy source that can provide ancillary services and baseload power to the energy generation system. Some geothermal power plants can be equipped with the telemetry and controls required for automatic governor control operation to provide flexible capacity. One example of this is the Puna facility in Hawaii. It has remote control capability which allows the electric company to make automatic adjustments to the plant generation in response to grid demand.¹⁴⁵ Geothermal power plants have very high capacity factors, often above 90 percent, and use land more efficiently than most other types of renewable energy. To advance the flexible capabilities of geothermal resources, the Energy Commission is supporting research to investigate how operation of the Geysers geothermal plants in Sonoma County may be modified to help integrate intermittent renewable resources.¹⁴⁶

Offshore Ocean Energy

Offshore renewable energy includes wind, wave, tidal, and ocean thermal technologies, with the first offshore wind project in the country on-line on December 12, 2016, near Block Island, Rhode Island.¹⁴⁷ The Energy Commission held a workshop on May 25, 2016, to discuss issues surrounding development of offshore renewable energy in California. The discussion is summarized in Appendix B.¹⁴⁸

In January 2016, Trident Winds, LLC submitted an unsolicited lease request to the federal Bureau of Ocean Energy Management (BOEM) for a floating wind energy project off the coast at Morro Bay in San Luis Obispo County.¹⁴⁹ This is the first formal request for a lease for wind development in federal waters off California, and BOEM has begun to determine whether there is competitive interest in the area requested.¹⁵⁰ The project would be the first U.S. commercial project to use floating wind technology rather than

SF.pdf) provided \$8.6 million for 5 projects, and *The Electric Program Investment Charge: Proposed 2015-2017 Triennial Investment Plan* (April 2014 Commission Report, available at <http://www.energy.ca.gov/2014publications/CEC-500-2014-038/>) has targeted \$23 million, including \$15 million for forest biomass.

145 Matek, Benjamin, 2015. "Flexible Opportunities With Geothermal Technology: Barriers and Opportunities." *The Electricity Journal*, Vol. 28, Issue 9, 45-51.

146 http://www.energy.ca.gov/business_meetings/2014_packets/2014-12-10/Item_13b_EPC-14-002_Geysers_Power_Company_LLC.pdf.

147 <http://dwwind.com/project/block-island-wind-farm/>.

148 http://www.energy.ca.gov/2016_energypolicy/documents/index.html#05252016.

149 http://docketpublic.energy.ca.gov/PublicDocuments/16-IEPR-03/TN211636_20160524T153307_Morro_Bay_Offshore_a_1000_floating_offshore_wind_farm.pptx.

150 <http://www.boem.gov/press03212016a/>.

fixed-bottom turbines. If approved, the project would begin construction in 2021-2022 and commercial operations in 2025.¹⁵¹

In response to a request from Governor Brown, BOEM announced on May 31, 2016, that it will work with the state to establish a Federal-California Marine Renewable Energy Task Force to collaborate on planning, permitting, and coordinating renewable energy development off the California coast.¹⁵²

Distributed Energy Resources

As described earlier, the electricity system is evolving into a more decentralized system that integrates DER, including several combinations of small-scale, clean distributed energy resources. Assembly Bill 327 (Perea, Chapter 611, Statutes of 2013) defines DER to include distributed renewable energy generation resources, energy efficiency, energy storage, electric vehicles, and demand response technologies. As required by AB 327, in August 2014, the CPUC opened a proceeding to guide IOUs in preparing and submitting distribution resource plans (DRPs) to the CPUC for review, modification, and approval and to evaluate the capability of existing IOU infrastructure and planning processes to integrate DER.¹⁵³ In July 2015, the IOUs submitted their DRP applications, and the CPUC, working with parties and the public, has been reviewing, modifying, and approving portions of the DRPs.

Before the CPUC initiated the DRP proceeding, in September 2013, Caltech's Resnick Sustainability Institute and the California Governor's Office created the More Than Smart initiative to "provide an engineering/economic framework for state regulators to consider complex changes needed to electric distribution company operations, infrastructure planning and oversight with high penetrations of DER."^{154, 155}

Also in response to AB 327, the CPUC rescoped its integrated demand-side management proceeding to focus on developing mechanisms to procure a broader set of integrated distributed energy resources (IDER). The IDER proceeding focuses on establishing the ways in which DER is competitively sourced from locations that the IOUs identify in their DRPs. The CPUC is coordinating the DRP and IDER proceedings closely together.¹⁵⁶

151 http://docketpublic.energy.ca.gov/PublicDocuments/16-IEPR-03/TN211636_20160524T153307_Morro_Bay_Offshore_a_1000_floating_offshore_wind_farm.pptx.

152 BOEM has established similar task forces in 13 other coastal states to examine how to resolve potential conflicts between renewable development and environmental concerns and other uses.

153 <http://docs.cpuc.ca.gov/PublishedDocs/Published/G000/M103/K223/103223470.pdf>.

154 <http://morethansmart.org/>

155 The report *More Than Smart: A Framework to Make the Distribution Grid More Open, Efficient and Resilient* is available at <http://morethansmart.org/wp-content/uploads/2015/06/More-Than-Smart-Report-by-GTLG-and-Caltech-08.11.14.pdf>.

156 For more on the IDER proceeding see <http://www.cpuc.ca.gov/General.aspx?id=10710>.

In general, DERs, especially renewable DERs, have less environmental impact per MW than conventional generation and utility-scale renewable energy development. DER, being typically close to load centers, is often on or located adjacent to developed sites (for example on rooftops and brownfields) rather than greenfields.^{157, 158} Some DERs, like energy efficiency or automated demand response that operates with sensors and small controllers, have very little impact on the environment. Nevertheless, some small facilities, especially smaller wholesale solar PV projects, may be developed on lands with wildlife habitat or agricultural values or may have other localized environmental impacts related to visual resources or other issues.

The Energy Commission's Electric Program Investment Charge (EPIC) Program is funding a project with engineering consultant Black and Veatch to identify environmentally preferred areas for distributed generation and demonstrate how the spatial information, factors, and analytical approach could be applied effectively for local distributed generation planning. The proposed scope of work will pilot the inclusion of DER into energy planning at the local level in parallel with ongoing planning at the state level.

An interagency team of the Energy Commission, CPUC, California ISO, and ARB, known as the Joint Agency Steering Committee (JASC), is responsible for coordinating activities that contribute toward increasing the granularity of the Energy Commission's demand forecast. One result of the improved forecasting capabilities will be better understanding the locational and time of day impacts for energy efficiency, demand response, distributed generation, and electrical storage.¹⁵⁹ (For more information, see Chapter 4: Electricity Demand Forecast Update, "2017 IEPR Forecast and Beyond.")

Integration of Distributed Energy Resources

Some DER technologies such as energy efficiency and demand response can be integrated relatively seamlessly with the grid. Though DER generation technologies tend to have fewer land-use impacts than utility-scale renewable energy, DER technologies have not been developed at a similar scale and pace because the development of these technologies depends largely on customer investment, making them more unpredictable and challenging to integrate into the grid. Nevertheless, it is technically possible for DER technologies to meet future load growth and replace utility-scale generation that must

157 In this context, *brownfields* are those places that have previously been developed, and *greenfields* are those places that have never been developed.

158 The Los Angeles City Council is considering delaying approval of ground-mount solar PV arrays to allow community input regarding open space. <http://www.latimes.com/local/lanow/la-me-ln-solar-clash-feed-in-tariff-20140618-story.html>.

159 2016 IEPR Update workshop on Energy Demand Forecast and Doubling of Energy Efficiency- Data and Analytical Needs, July 11, 2016, http://docketpublic.energy.ca.gov/PublicDocuments/16-IEPR-05/TN212626_20160804T144906_Transcript_of_the_07112016_Joint_Agency_IEPR_Workshop_on_Energy.pdf, pp. 11-12.

be connected to load centers with transmission.¹⁶⁰ However, there are many challenges with planning for and developing a highly distributed electric grid, especially those related to consumer choice and system reliability.¹⁶¹

“The growth of DERs is going to have a significant impact on the grid, which is why we have to be not only planning for this change, but starting now on getting the grid ready for this next major transformation in the utility industry”, said Ron Nichols, president of Southern California Edison. “In our recently published white paper,¹⁶² we describe the planning decisions we need to make and how they will have profound implications for how well and how quickly the grid needs to adapt to meet customer choices and environmental needs.”¹⁶³

As discussed above, the installation of distributed PV systems has grown dramatically in California. Due to the variability of solar resources at any location, these PV systems require support from the electricity grid in the form of ancillary services.¹⁶⁴ Net energy metering (NEM)¹⁶⁵ customers are able to use the electric grid as highly valuable energy storage for very little cost, which may increase the cost of maintaining and operating the electric system for electric consumers without NEM. With the passage of AB 327, the CPUC is updating rules and policies that better balance the cost of integrating distributed generation. As noted in the CPUC decision (D.16-01-044) approving a NEM successor tariff, there is additional work that must be completed to better characterize “the benefits and costs of the NEM successor tariff to all customers and the electric system” and “that a better understanding of the impact of customer-sited distributed

160 See the Energy Commission report *San Joaquin Valley Distributed Energy Resource, Regional Assessment*, which evaluates the impacts of distributed energy resources at a regional scale on SCE’s electricity system in the Southern San Joaquin Valley. <http://www.energy.ca.gov/publications/displayOneReport.php?pubNum=CEC-200-2016-004>.

161 See the Energy Commission staff paper *Customer Power, Decentralized Energy Planning and Decision-Making in the San Joaquin Valley*, which describes consumer challenges to overcoming barriers to DER deployment. <http://www.energy.ca.gov/publications/displayOneReport.php?pubNum=CEC-200-2016-005>.

162 SCE, *The Emerging Clean Energy Economy: Customer-driven. Modernized. Reliable*, September 2016, http://docketpublic.energy.ca.gov/PublicDocuments/16-IEPR-03/TN214639_20161205T160959_The_Emerging_Clean_Energy_Economy.pdf.

163 December 6, 2016, email communication between Heather Sanders (SCE) and Heather Raitt (Energy Commission).

164 Ancillary services include reactive power, voltage support, and frequency regulation. *Reactive power* is the portion of electricity that establishes and sustains the electric and magnetic fields of alternating-current equipment. Reactive power must be supplied to most types of magnetic equipment, such as motors and transformers. It also must supply the reactive losses from transmission facilities. Reactive power is provided by generators, synchronous condensers, or electrostatic equipment such as capacitors and directly influences electric system voltage. *Voltage support* is a service provided by generating units or other equipment such as shunt capacitors, static VAR compensators, or synchronous condensers that is required to maintain established grid voltage criteria. *Frequency regulation* is an ancillary service category that provides support for maintaining grid stability within a defined range above or below 60 Hertz. Source: California Public Utilities Commission, Key Definitions for Energy Storage Proceeding R.10-12-007, <http://www.cpuc.ca.gov/WorkArea/DownloadAsset.aspx?id=3155>.

165 NEM allows customers with an eligible renewable energy system to receive a bill credit for excess electricity generated from their renewable energy system and sent back to the utility grid.

resources on the electric system will be developed from work currently under way but not yet completed in other Commission proceedings, including but not limited to the distribution resources plan proceeding (Rulemaking (R.) 14-08-031), the integrated distributed energy resources proceeding (R.14-10-003), and the recently opened rulemaking to consider technical issues for future TOU [time of use] rates (R.15-12-012).”¹⁶⁶

On the other hand, some emerging strategies may help lessen the impact that widespread deployment of PV systems is expected to have on the electricity grid. For example, improved distribution system planning like that described by More Than Smart and being proposed in the IOU DRPs can help improve the locational impacts of solar PV on the grid and the environment. Also, packaging distributed PV with other DER at the building and/or community scale may help smooth short-term ramps in generation output, provide needed grid services to the local distribution grid (such as reactive power, voltage support, and frequency regulation), and shift oversupply to meet evening peak demand and effectively level the net load. These combined DER products can potentially participate in California ISO markets as bundled DER products under Phase I (now complete and approved by FERC) and Phase II (underway) of the Energy Storage and Distributed Energy Resources stakeholder initiative.¹⁶⁷

The value of combined DER portfolios and the services they may provide are just starting to be quantified or demonstrated. Current and planned research will provide better data and information that can be factored into grid modeling and integrated resource plans. For example, smart inverters¹⁶⁸ have the potential to support the grid by providing reactive power, voltage regulation, and frequency regulation. However, additional investigation is needed to determine the most effective ways to use advanced inverter capabilities to enhance system performance.¹⁶⁹ Initial studies have suggested that the operational value of distributed PV can be dramatically increased by the inclusion of energy storage,¹⁷⁰ advanced inverters,¹⁷¹ and other enabling technologies at or near the generation site. Strategic installation of distributed PV and energy storage

166 <http://docs.cpuc.ca.gov/PublishedDocs/Published/G000/M158/K181/158181678.pdf>.

167 To learn more about the California ISO initiative to open its markets to DER, see Energy Storage and Distributed Energy Resources Phase I and II stakeholder initiatives, https://www.caiso.com/informed/Pages/StakeholderProcesses/EnergyStorage_AggregatedDistributedEnergyResources.aspx.

168 For an inverter to be considered “smart,” it must have a digital architecture, bidirectional communications capability, and robust software infrastructure.

169 As described in *San Joaquin Valley Distributed Energy Resource, Regional Assessment*, the Energy Commission plans to assess the effects of smart inverters on the energy system at the distribution feeder level. <http://www.energy.ca.gov/publications/displayOneReport.php?pubNum=CEC-200-2016-004>.

170 Rocky Mountain Institute. October 2015. *The Economics of Battery Energy Storage*. <http://www.rmi.org/Content/Files/RMI-TheEconomicsOfBatteryEnergyStorage-FullReport-FINAL.pdf>.

171 National Renewable Energy Laboratory. November 2014. *Advanced Inverter Functions to Support High Levels of Distributed Solar*. <http://www.nrel.gov/docs/fy15osti/62612.pdf>.

with other DER at specific locations on the distribution grid may reduce the need for other system upgrades, which can translate to less spending for utilities and more savings for electricity customers.¹⁷²

Two of the largest challenges to unlocking locational values of DER are the difficulty of predicting or forecasting consumer DER investment decisions and limited transparency into IOU distribution planning processes. The CPUC, along with groups like More than Smart, is addressing these challenges through proceedings that will ultimately direct IOUs to increase distribution planning transparency.¹⁷³

As described above and detailed in the *2016 EPR*, California is undertaking several efforts to unlock the value of DER to the grid, including the DRP proceeding, the IDER proceeding, and updating Rule 21 requirements to implement recommendations of the Smart Inverter Working Group.¹⁷⁴ Most recently, on September 29, 2016, the CPUC released a discussion draft titled “California’s Distributed Energy Resources Action Plan: Aligning Vision and Action” to help align the CPUC’s vision and actions to advance DER.¹⁷⁵

Energy Commission staff coordinates with CPUC and IOU representatives to discuss smart grid research, implementation of the DRPs, and other CPUC proceedings on utility grid interfacing, energy storage, microgrids, and distribution system modeling. The Energy Commission monitors and provides input into relevant CPUC proceedings such as smart inverters, Rule 21, DRP, and IDER by participating in working groups (for example, the smart inverter working group and More Than Smart) and in various Energy Commission- and CPUC-led workshops.

As the state takes the next steps toward a more decentralized electric grid, it should continue to support distribution planning and research that advances DER deployment. To this end, the Energy Commission’s Energy Research and Development Division will support the development of a roadmap for enabling high-penetration renewables,

172 Tierney, Susan F. Ph.D. March 2016. *The Value of “DER” to “D”: The Role of Distributed Energy Resources in Supporting Local Electric Distribution System Reliability*.

http://www.cpuc.ca.gov/uploadedFiles/CPUC_Public_Website/Content/About_Us/Organization/Divisions/Policy_and_Planning/Thought_Leaders_Events/Tierney%20White%20Paper%20-%20Value%20of%20DER%20to%20D%20-%2030-30-2016%20FINAL.pdf.

173 <http://www.energy.ca.gov/publications/displayOneReport.php?pubNum=CEC-200-2016-005>.

174 Electric Rule 21 is a tariff that describes the interconnection, operating and metering requirements for generation facilities to be connected to a utility’s distribution system, over which the California Public Utilities Commission (CPUC) has jurisdiction, including PG&E, SCE, and SDG&E. For more information describing Rule 21 and the Smart Inverter Working Group: <http://www.cpuc.ca.gov/General.aspx?id=3962>.

175 CPUC, *California’s Distributed Energy Resources Action Plan: Aligning Vision and Action*, September 29, 2016, http://www.cpuc.ca.gov/uploadedFiles/CPUC_Public_Website/Content/About_Us/Organization/Commissioners/Michael_J._Picker/2016-09-26%20DER%20Action%20Plan%20FINAL3.pdf

including DERs. The roadmap will investigate research conducted to date, barriers, and research gaps and identify future research needs.

Advanced Energy Storage

Energy storage may play an important role in California's transition to a decarbonized grid. Expansion of energy storage capacity will help improve grid operations by integrating intermittent renewable generation, reducing peak power demand, and reducing the need for additional power plants and transmission and distribution upgrades.¹⁷⁶ To implement Assembly Bill 2514 (Skinner, Chapter 469, Statutes of 2010), the CPUC established an energy storage procurement target of 1,325 MW for IOUs by 2020, with installations required no later than the end of 2024.¹⁷⁷

In the first round of the AB 2514 energy storage procurement, the California IOUs selected more than 300 MW of energy storage systems. Among these projects are the use of a 100 MW battery storage system to replace a peaker plant, 50 MW of building and energy storage combinations that provide fast grid storage, and the assessments of new energy storage technologies like flywheels, zinc air battery technology, and a range of applications for lithium ion battery technologies. The IOUs are preparing for the second round of competitive bids for energy storage projects and will announce their selections in 2017. Furthermore, at the direction of the CPUC, SCE and SDG&E have proposed 50 MW of lithium ion energy storage projects in Southern California to prepare their systems for any impacts from the loss of natural gas supply from Aliso Canyon.¹⁷⁸ (For further discussion of Aliso Canyon energy reliability issues, see Chapter 2.) With this large increase in the application of energy storage, California is becoming a key state in evaluating and assessing the performance and value of energy storage to support the rapidly changing needs of the grid.

Historically, the only cost-effective storage has been pumped hydroelectric storage. As described during the November 20, 2015, joint Energy Commission and California Public Utilities Commission Long-Term Procurement Plan Workshop on Bulk Energy Storage there is a limited supply of pumped hydroelectric storage opportunities in California because most of the suitable geography "for pumped storage projects in California have already been developed."¹⁷⁹ Furthermore, these systems are impacted by seasonal water supplies and continue to be impacted by the California drought. As described in the *2016 EPR*, there are three operating utility-scale hydroelectric pumped storage facilities

176 <http://www.energy.ca.gov/research/energystorage/tour/>.

177 CPUC, Decision Adopting Energy Storage Procurement Framework and Design Program Decision 13-10-04, <http://www.cpuc.ca.gov/General.aspx?id=3462>.

178 <http://www.greentechmedia.com/articles/read/california-utilities-are-fast-tracking-battery-projects-to-manage-aliso-can>.

179 Joint California Energy Commission and California Public Utilities Commission Long-Term Procurement Plan Workshop on Bulk Energy Storage, November 20, 2015. <http://www.energy.ca.gov/research/notices/#11202015.p.14>.

and a fourth that has received federal approval but has not started construction. In the past few years in California, there have been proposals for other utility-scale storage options, including solar thermal storage, like the Solana parabolic trough project with six hours of thermal storage in Arizona, and electric battery storage combined with power plants, like at the proposed Mission Rock Energy project.

Also, many companies have developed distributed energy storage systems. Increasingly common are energy storage systems for homes and businesses. Electric customers use energy storage mostly as a way to use electricity more efficiently from the electric grid and reduce their electric costs. This is done either by charging energy storage when electric prices are low or by charging energy storage with onsite distributed generation, like solar PV. Most energy storage systems are designed to offer electric customers more options to reduce use of grid electricity and to manage how and when electricity is consumed. To further investment in distributed energy storage, the legislature passed Assembly Bill 2868 (Gatto, Chapter 681, Statutes of 2016), which requires the CPUC to direct PG&E, SCE, and SDG&E to develop programs to accelerate deployment of up to 500 MW of distributed energy storage systems.

Policy Development and Planning Going Forward

California leads the nation in reducing GHG emissions through the cap-and-trade program, energy efficiency innovation, and renewable energy deployment. California continues to be a leader in the technology innovation needed to meet the state's aggressive GHG reduction goals, as evidenced by patent filings and investments in clean technologies in California.¹⁸⁰ The state is also leads in climate change research and adapting its infrastructure to these changes. Continuing to advance California's GHG reduction goals will require improved planning and coordination; as well as continuing support of research, development, and deployment of emerging technologies that will ultimately transform the energy system.

Planning for Renewable Development

The rapid deployment of renewable energy projects throughout California is one of the greatest success stories and challenges of the past decade. While the dramatic growth in renewable energy is helping reduce GHG emissions and certain environmental impacts, new environmental issues have emerged. As described above and in more detail in the *2016 EPR*, renewable energy development can have impacts on a variety of resources, like visual, cultural, and biological. However, meeting the state's 2030 GHG reduction goals and RPS requirements will require additional utility-scale renewable generation and new investments in the state's electric transmission system.

180 Next10, *2016 California Green Innovation Index, 8th Edition*, <http://www.next10.org/sites/next10.org/files/2016-california-green-innovation-index-1.pdf>.

Landscape-level approaches, also known as *landscape-scale planning*, take into consideration a wide range of potential constraints and conflicts, including environmental sensitivity, conservation and other land uses, tribal cultural resources, and more when considering future renewable energy development. Previous *IEPRs* and *IEPR Updates* have discussed the benefits of using landscape-level approaches for renewable energy and transmission planning.¹⁸¹ Furthermore, in his Clean Energy Jobs Plan,¹⁸² Governor Brown set a goal to dramatically reduce the permitting time for transmission projects needed to deliver clean energy to no longer than three years.

Through previous and current efforts, such as the first and second RETI processes, the joint REAT agency work on the *DRECP*, and the stakeholder-led San Joaquin Valley Identification of Least-Conflict Lands study, federal and state agencies, local governments, tribes, and stakeholders have gained experience with planning approaches that seek to identify the best areas for renewable energy development. These approaches have also underscored the importance of including spatial land-use data in renewable energy and transmission planning. In a letter to the California ISO initiating the second RETI process, Energy Commission Chair Robert B. Weisenmiller and CPUC President Michael Picker noted that there is proven value in using science-driven findings and broad consensus planning to assess the relative potential of different locations for renewable energy, especially in the context of identifying policy-driven transmission lines.^{183,184}

This experience in planning for and permitting renewable energy generation and transmission projects, along with the strong relationship among agencies that have worked together to help achieve these goals, is important to the state in ongoing and future efforts to achieve California's renewable energy and climate goals. Unfortunately, the permitting process for major, high-priority transmission projects can take six to eight years to plan and permit.¹⁸⁵ As noted in the Energy Commission's *2012 Renewable Action Plan*,¹⁸⁶ options to help the timely development of transmission projects include a programmatic CEQA review program for transmission facilities, completing the

181 The Nature Conservancy studied the costs and impacts of integrating ecological information into long-term energy planning and found that a 50 percent renewable portfolio could be achieved with low impacts to natural areas. See http://www.scienceforconservation.org/downloads/ORB_report.

182 https://www.gov.ca.gov/docs/Clean_Energy_Plan.pdf.

183 http://www.energy.ca.gov/reti/reti2/documents/2015-07-30_Letter_to_CAISO_RE_RETI_2_Initiative_from_CEC_and_CPUC.pdf.

184 David J. Hayes, former Deputy Secretary of the U.S. Department of the Interior, suggests that landscape-scale initiatives can assist the siting of new renewable projects and offer project opportunities for project mitigation. See http://www.eli.org/sites/default/files/docs/elr-na/44.elr_.10016.pdf, pp. 10018-10020.

185 General Information on Permitting Electric Transmission Projects at the California Public Utilities Commission, Slides 8-9, June 2009, available at: <http://www.cpuc.ca.gov/CEQA/>.

186 California Energy Commission, 2012. 2012 Integrated Energy Policy Report Update. Publication Number: CEC-100-2012-001-CMF.

environmental component of a Certificate of Public Convenience and Necessity for policy-driven transmission facilities prior to the California ISO finding of need, or leveraging the Energy Commission's environmental expertise to reduce analysis time without compromising quality. The Energy Commission, CPUC, and California ISO should implement the Governor's vision for transmission permitting within the next two years through a determined effort of regulatory process reform.

California has an opportunity to learn from and build upon successful past efforts to permit renewable energy projects and related transmission. These efforts include interagency coordination mechanisms, permitting best practices, and various landscape planning initiatives that were implemented in the context of other environmental and land-use considerations.

Climate Adaptation

Adaptation to climate change has become integral to all resource sector planning. The rising temperatures of climate change can cause more severe wildfires, sea level rise, increased energy demand, decreased hydroelectric availability, and several other impacts on California's population and natural resources.¹⁸⁷ New laws and policies are empowering planning for climate impacts and adaptation to climate change, as discussed in Chapter 3: Climate Adaptation and Resiliency. Climate adaptation is becoming increasingly important, and the Energy Commission should continue working closely with all stakeholders to advance the science and understanding of the issue and strengthen the capacity of local, regional, and state governments to plan for and respond to climate impacts.

Planning for Transportation Electrification

Transportation electrification is a key element of the state's strategy to reduce GHG emissions, petroleum use, and air emissions in the transportation sector. On March 23, 2012, Governor Brown issued Executive Order B-16-2012 to encourage ZEVs in California and set a long-term goal of reaching 1.5 million ZEVs on California's roadways by 2025.¹⁸⁸ The executive order established milestones for three periods:

- By 2015, California's major metropolitan areas will be able to accommodate ZEVs through infrastructure plans.
- By 2020, California's ZEV infrastructure will be able to support up to 1 million vehicles.

By 2025, 1.5 million ZEVs will be on California's roadways with easy access to infrastructure. The *2013 ZEV Action Plan*¹⁸⁹ listed the actions to be undertaken by the

187 California Energy Commission, *Our Changing Climate 2012: Vulnerability & Adaptation to the Increasing Risks from Climate Change in California, 2012*, www.energy.ca.gov/2012publications/.../CEC-500-2012-007.pdf

188 Executive Order B-16-12, <https://www.gov.ca.gov/news.php?id=17463>.

189 [https://www.opr.ca.gov/docs/Governor's_Office_ZEV_Action_Plan_\(02-13\).pdf](https://www.opr.ca.gov/docs/Governor's_Office_ZEV_Action_Plan_(02-13).pdf).

Energy Commission and other relevant state agencies to meet the Governor's Executive Order B-20-15. The *2016 ZEV Action Plan*¹⁹⁰ outlines progress on the *2013 ZEV Action Plan* and identifies new actions state agencies will take to move forward toward the milestones in the Governor's executive order, as follows:

- Raising consumer awareness and education about ZEVs
- Ensuring ZEVs are accessible to a broad range of Californians
- Making ZEV technologies commercially viable in targeted applications the medium-duty, heavy-duty and freight sectors
- Aiding ZEV market growth beyond California

In July 2015, Governor Brown also called on state agencies to work together to develop an integrated action plan that establishes targets to improve freight efficiency, increase adoption of zero-emission technologies, and increase competitiveness of California's freight system.¹⁹¹

The state agencies answered this call by delivering the *California Sustainable Freight Action Plan*¹⁹² to Governor Brown in July 2016. The action plan includes recommendations¹⁹³ on:

- A long-term 2050 Vision and Guiding Principles for California's future freight transport system.
- Targets for 2030 to guide the state toward meeting the vision.
- Opportunities to leverage state freight transport system investments.
- Actions to initiate over the next five years to make progress towards the targets and the vision.
- Potential pilot projects to achieve on-the-ground progress in the near-term.
- Additional concepts for further exploration and development, if viable.

Achieving Governor Brown's goal to reduce petroleum use in cars and trucks by up to 50 percent by 2030 will require a transformation of the transportation sector. Changes needed include increasing the use of cleaner vehicles with zero-emission and near-zero-emission technologies in all vehicle categories, reducing the carbon content of motor vehicle fuels, reducing the use of rail and aviation fuels, reducing vehicle travel demand, and improving system efficiencies.

190 https://www.gov.ca.gov/docs/2016_ZEV_Action_Plan.pdf.

191 Executive Order B-32-15, <https://www.gov.ca.gov/news.php?id=19046>.

192 http://www.dot.ca.gov/casustainablefreight/documents/FINAL_07272016.pdf.

193 <http://www.dot.ca.gov/casustainablefreight/faq.html>.

California's electric utilities are expected to play an integral role in California's efforts to accelerate the transformation of the transportation sector by increasing access to electricity as a transportation fuel. SB 350 calls for widespread transportation electrification.¹⁹⁴ SB 350 requires the CPUC, in consultation with the ARB and Energy Commission, to direct electrical corporations to file applications for programs and investments to accelerate transportation electrification, reducing California's dependence on petroleum. As noted previously, SB 350 requires the ARB, in consultation with the Energy Commission, other state agencies, and the public, by January 1, 2017, to report on barriers and recommendations for increasing access to zero-emission and near-zero-emission transportation options to low-income customers, including those in disadvantaged communities.

Transportation electrification is likely to have a profound impact on the electricity system, maybe greater than the emergence of solar PV. Adequate interagency planning to maintain system reliability while increasing numbers of vehicles become integrated with the grid will be necessary to ensure GHG, criteria pollutants, and toxic air contamination reduction benefits for the electricity sector, as well as the transportation sector. The IRP processes for the state's load-serving entities outlined in SB 350 will be especially important in implementing transportation electrification.

Recommendations

The *2005 EPR* found that the electricity system was relatively clean, and as the *2016 EPR* describes, this trend toward improved environmental performance of the electricity system has continued over the last 10 years. Nevertheless, as summarized in this chapter, new technologies like solar and wind have large development footprints and can have adverse impacts to the environment. To ensure the state continues to make decisions that improve the environmental performance of the state's electricity system while meeting GHG reduction and renewable energy goals, the Energy Commission recommends:

Climate Adaptation

- **Continue monitoring and research to understand how the energy system impacts the environment and how the changing climate will affect the environmental performance of the energy system.** The Energy Commission should accelerate research and coordination with stakeholders to advance the science and understanding of climate change and the ways in which those changes may impact natural gas, electricity, and transportation fuels systems.

¹⁹⁴ SB 350 defines *transportation electrification* to include the use of electricity from external sources of electrical power, including the electrical grid, for all or part of vehicles, vessels, trains, boats, or other equipment that are mobile sources of air pollution and GHGs and the related programs and charging and propulsion infrastructure investments to enable and encourage this use of electricity.

- **Accelerate efforts to incorporate climate science and adaptation into landscape-level and infrastructure planning.** Building off the climate adaptation strategy developed for the conservation strategy of the *Desert Conservation Renewable Energy Plan (DRECP)*, accelerate the incorporation of climate change scenarios and improve planning tools according to the four guiding principles (discussed in Chapter 3: Climate Adaptation and Resiliency) of Executive Order B-30-15: prioritizing win-win solutions for emissions reduction and preparedness, promoting flexible and adaptive approaches, protecting the state’s most vulnerable populations, and prioritizing natural infrastructure solutions.

Greenhouse Gas Emissions

- **Continue to develop utility integrated resource plans (IRPs) that demonstrate long-term greenhouse gas (GHG) reductions that reflect the electricity sector’s percentage in achieving the economywide GHG reductions of 40 percent from 1990 levels by 2030, as set forth by SB 350.** To achieve long-term GHG reductions and improve the performance of the electricity system, integrated resource planning should examine the trade-offs among various energy-related strategies, measures, and programs, including evaluation of electrification, methane, and short-lived climate pollutant emissions. Thereafter, the state should use all available enforcement mechanisms to ensure GHG reductions are achieved.
- **Continue research to better understand and address methane leakage from the natural gas system.** Natural gas, which is composed primarily of methane, is a significant component of California’s energy system and represents roughly 43 percent of California’s total energy consumption from fossil fuels. While the use of natural gas offers a means to reduce total GHG emissions, methane emissions associated with natural gas production, transmission, distribution, and final consumption could diminish or negate the potential climate benefits of relying on natural gas. The state should continue to support efforts to develop a more comprehensive accounting of methane leakage and emissions from the natural gas system. Further, the state should continue efforts to reduce methane leakage, including the California Public Utilities Commission’s (CPUC’s) gas leak abatement rules, the California Air Resources Board’s (ARB’s) proposed *Short-Lived Climate Pollutant Reduction Strategy*, and Department of Conservation’s Division of Oil, Gas and Geothermal Resources Proposed Oil and Gas Regulations.

Statewide Energy Planning and Permitting Coordination

- **Continue to apply proactive tools and approaches like landscape-scale planning to help meet renewable energy and GHG reduction goals.** The state should continue to work with federal, state and local agencies and stakeholders to apply landscape-scale planning tools and approaches to renewable energy and needed transmission, including evaluation of transmission. This should include a central platform, such as Data Basin, that includes spatial data associated with renewable

energy planning to allow for high-level assessments of alternatives that consider potential upgrades to existing transmission facilities (including emerging and transformative technologies that improve flexibility and optimize transmission), the use of transmission corridors, and the “right sizing” of new transmission facilities to accommodate current and potential future needs.

- **The 2017 IEPR process will integrate information gathered and produced from energy planning efforts, including DRECP, San Joaquin Valley Identification of Least Conflict Lands, and the Renewable Energy Transmission Initiative (RETI) to inform energy planning.**
- **Expedite permitting of the highest priority transmission projects.** State agencies should better align processes and increase efficiencies to provide for faster permitting of the highest priority transmission projects that are sited to avoid and minimize impacts to sensitive resources (for example, projects with the ability to deliver renewable energy to market). Permitting time for these projects should not exceed three years.
- **Implement the *DRECP*.** The state should work closely with the U.S. Bureau of Land Management (U.S. BLM) to implement the *DRECP Land Use Plan Amendment* and continue to work with counties on renewable energy planning in the DRECP area. The state should work with federal agencies, tribes, counties, and other stakeholders to identify opportunities and strategies in the *DRECP* to achieve the conservation framework of the *DRECP*.
- **Continue to evaluate renewable energy development impacts and find solutions to strengthen planning, permitting, and mitigation for renewable energy development.** To support the design, development, and implementation of the *DRECP*, the Energy Commission executed several research projects to understand species habitats and activities potentially impacted by renewable energy development, develop science-based tools to predict impacts on species, and test promising new strategies to mitigate impacts. The state should continue to prioritize similar public-interest research in emerging renewable resource areas where the issues and species may be different from the *DRECP*.
- **Continue to support and promote the Energy Imbalance Market and regionalization as tools to better integrate wind and solar generation across broader markets through shorter dispatch periods.** The Energy Commission, the CPUC, and the ARB will continue to support the California Independent System Operator (California ISO) and the Legislature to develop a proposal for the California Legislature to consider in 2017.
- **As part of an Intergovernmental Renewable Energy Task Force, the state should work closely with the Bureau of Ocean Energy Management (BOEM) and other federal and state government agencies, researchers, renewable energy**

developers, and other stakeholders to discuss issues surrounding planning, permitting, and developing renewable energy off California's coast. Offshore renewable resources like wind, wave, and tidal energy offer the possibility of an abundant supply of renewable, zero-carbon energy but also raise important questions about environmental and permitting complexities. The state should work closely with BOEM and other federal and state agencies through the task force.

Water

- **Update the 2003 IEPR water policy to require the use of recycled water and alternative technologies for all power plant operations, not just wet-cooling towers.** To date, implementation of the 2003 IEPR water policy has led to significant gains in water conservation and the use of alternative water supplies. Although the California fleet of thermal power plants is making efficient use of water and is becoming more resilient to drought, more can and should be done. The current policy focuses on replacement of wet cooling with alternative water supplies or technologies where feasible. Where freshwater use has been permitted in recent cases, staff has often required water conservation offset programs. If a project proposes water conservation offsets for mitigation of freshwater use, the actual water savings should be real, surplus, and achievable.
- **The Energy Commission should continue to monitor water use at power plants, particularly those using groundwater, to evaluate the sustainability of water supplies.** During the current drought, water supplies are affected by water rights curtailment, water delivery interruptions, and overdraft and subsidence of groundwater basins. The state should identify water-use efficiencies and investigate water conservation opportunities. Alternative and backup water supply options should be identified to prevent possible supply interruptions and could negatively impact power plant reliability.

Nuclear Decommissioning

- **The Energy Commission will continue to advocate for federal action that leads to the permanent removal of spent nuclear fuel from California's nuclear plants.** Inclusion of state and local agencies and the community in the Nuclear Regulatory Commission decommissioning rulemaking is essential in building public trust and support for power reactor site decommissioning. The U.S. Department of Energy (DOE) must act expeditiously in siting voluntary storage and disposal facilities while developing a siting process that supports a transparent and inclusive public process. Furthermore, it is important that the DOE begin identifying and prioritizing sites so that an initial shipment schedule can be proposed in support of developing the transportation procedures, routes, policies, and supporting infrastructure. The safe, uneventful management and transport of spent nuclear fuel must be paramount in all federal policies.

Cultural Resources

- **Continue to Build State Agency/Tribal Government Relationships.** The Energy Commission should continue to build upon relationships with tribes in a manner that is responsive to California Environmental Quality Act tribal consultation requirements, Executive Order B-10-11, California Natural Resources Agency tribal consultation policy, and the Energy Commission's tribal consultation policy. Such efforts should include conducting due diligence on project-by-project actions, collaborating with tribes in renewable energy planning, and hosting a statewide Tribal Energy Summit in 2017.

New and Emerging Technologies

- **Continue a collaborative approach to develop emerging distributed energy resource (DER) technologies to support the development and implementation of DER deployment programs and efforts.** DER technologies including distributed renewable generation resources, targeted energy efficiency, energy storage, electric vehicles, and demand response technologies offer similar GHG benefits as larger utility-scale renewable technologies, and DER generation technologies tend to have much higher land-use efficiencies. To capture the benefits of these technologies, California should continue its work advancing DER technologies by coordinating with entities such as More Than Smart, the New York State Energy Research and Development Authority, the DOE's Advanced Research Projects Agency-Energy, and the military, as well as with other states and countries. The Energy Commission should also continue its collaboration with the CPUC and California utilities to better understand the cost and benefits of DER portfolios on utility systems.
- **Continue to develop and implement stakeholder-driven road-mapping processes that help commercialize emerging DER technologies.** The state should continue to implement and, if appropriate, update the joint agency roadmaps described in the *2016 EPR* for demand response, vehicle-grid integration, system improvements to enable high-penetration renewable generation, and energy storage. The state should also continue to build upon these successful stakeholder-driven efforts for emerging technologies by completing a joint agency roadmap to commercialize and advance microgrids and zero-net-energy buildings in California. These activities should be jointly coordinated with the Energy Commission, CPUC, the California ISO, and other agencies, as appropriate.
- **Continue taking steps to enable the integration of a high penetration of DER technologies into the electric grid while ensuring the safe, reliable, and cost-effective delivery of electricity.** As investment in DER technologies continues to grow, DER technologies are affecting how utilities plan and operate the electric grid. There is significant variability in stakeholder estimates of future DER deployment levels, which poses challenges for grid planners to forecast the location and timing of DER deployment and associated grid needs. Operating a grid with a high

penetration of DER technologies can also be challenging due to the intermittency of resources and lack of visibility to grid operators. The state should continue to address these planning and operational challenges by applying knowledge gained and tools developed from DER research and demonstrations within future research and decision-making processes. Energy Commission staff coordinates regularly with CPUC and investor-owned utility representatives to discuss smart grid research, implementation of the Distribution Resource Plans and other CPUC proceedings in the areas of utility grid interfacing, energy storage, microgrids and distribution system modelling. The Energy Commission serves in an advisory capacity on proceedings such as smart inverters, Rule 21, distribution resource planning, and integrated distributed energy resources by participating as members of working groups (for example, smart inverter working group and More Than Smart) and by participating in various Energy Commission- and CPUC-led workshops. The Energy Commission will continue to provide input to relevant CPUC proceedings that enable and deploy DER technologies including their interconnection and operation at the distribution level.

CHAPTER 2:

Energy Reliability in Southern California

One of the primary concerns of California's energy agencies is maintaining the reliability of the state's energy system. Californians expect a reliable energy supply for both electricity and gas, which supports a well-functioning economy. Potential consequences of energy supply disruptions include risk to public health and safety plus economic consequences to businesses and economic activity. California has suffered from two major disruptions to its energy infrastructure in recent years that have required rapid, sustained, and coordinated response by state and local agencies, balancing authorities, utilities, and others to maintain energy reliability. The most recent major disruption was the massive leak from the Aliso Canyon natural gas storage facility in late 2015. Previously, California's electricity system was challenged by the unexpected shutdown of the San Onofre Nuclear Generating Station (San Onofre) in 2012, which was compounded by the planned closure of several natural gas plants¹⁹⁵ in Southern California. Both situations require ongoing work to ensure reliability of California's energy system, as discussed below.

Aliso Canyon Natural Gas Storage Facility

A major natural gas leak from the Aliso Canyon natural gas storage facility was detected on October 23, 2015, and was permanently sealed on February 18, 2015. The leak has had far-reaching impacts, felt most acutely by the local community where thousands of residents left their homes during the leak due to the noxious smell and health concerns. The facility is in the northern San Fernando Valley in the Santa Susana Mountains near the Porter Ranch community. The storage facility was originally an oil field in the late 1930s, and the Southern California Gas Company (SoCalGas) began converting it into a gas reservoir after partial depletion in 1973.

Governor Edmund G. Brown Jr. issued an emergency proclamation on January 6, 2016,¹⁹⁶ directing the California Governor's Office of Emergency Services to coordinate a multiagency effort to address the leak. The proclamation was comprehensive, building on months of regulatory and oversight actions from seven state agencies mobilized to protect public health, oversee SoCalGas' actions to stop the leak, track methane

195 The Huntington Beach 3 and 4 units were retired November 1, 2012, to provide air credits for the Walnut Creek Energy Park. The absence of San Onofre created voltage problems in Southern Orange County, so Huntington Beach 3 and 4 were converted to synchronous condensers in 2013 to provide voltage support. The Huntington Beach 3 and 4 synchronous condensers are under contract through 2017 to provide voltage support.

196 "Governor Brown Issues Order on Aliso Canyon Gas Leak," <https://www.gov.ca.gov/news.php?id=19263>.

emissions, ensure worker safety, safeguard energy reliability, and address any other problems stemming from the leak. (See sidebar for more information.)

In response to the leak at Aliso Canyon, the Legislature passed a suite of bills addressing the storage of natural gas. Senate Bill 380 (Pavley, Chapter 14, Statutes of 2016) (SB 380) continues a moratorium on injection of natural gas at the Aliso Canyon gas storage facility until specified standards are met and puts into law portions of the Governor's emergency proclamation. Senate Bill 826 (Leno, Chapter 23, Statutes of 2016) appropriates \$2.5 million to the California Council on Science and Technology to study the long-term viability of natural gas storage facilities in California in accordance with the Governor's Aliso Canyon State of Emergency Proclamation. Senate Bill 887 (Pavley, Chapter 673, Statutes of 2016) establishes a framework for reforming natural gas storage well oversight and regulation. Senate Bill 888 (Allen, Chapter 536, Statutes of 2016) assigns the Office of Emergency Services as the lead agency for large natural gas leak emergency responses and directs the CPUC to level financial penalties for gas leaks and use the funds to reduce the impact of leaks.

Provisions of Emergency Proclamation

The Department of Conservation's Division of Oil, Gas and Geothermal Resources (DOGGR) has issued emergency regulations that govern all natural gas storage facilities throughout the state, including Aliso Canyon,¹ while it is developing new permanent regulations for natural gas storage facilities.² The Division of Occupational Safety and Health is protecting on-site worker safety. The Office of Environmental Health Hazard Assessment is evaluating public health concerns from the leak.

Natural gas is composed primarily of methane, a potent greenhouse gas, and the California Air Resources Board (ARB) is evaluating the greenhouse gas impacts of the leak and mitigation measures and has developed a Climate Impacts Mitigation Program.³ For more information about efforts to quantify leakage, see Appendix A.

The California Public Utilities Commission (CPUC) is investigating the cause of the gas leak, an investigation that could result in enforcement actions, and is tracking the costs associated with the leak.⁴

The Governor's emergency proclamation called on the Energy Commission, CPUC, and California Independent System Operator (California ISO) to "take all actions necessary to ensure the continued reliability of natural gas and electric supplies during the moratorium on gas injections into Aliso Canyon."

1 DOGGR issued emergency regulations on February 5, 2016, see Emergency Orders and Regulations at <http://www.conservation.ca.gov/dog/Pages/AlisoCanyon.aspx>.

2 On July 8, 2016, DOGGR publicly released pre-rulemaking draft regulations for receiving public input on the development of updates to the regulations governing the Division's Gas Storage Program, see <http://www.conservation.ca.gov/dog/Pages/UndergroundGasStorage.aspx>.

3 See ARB, Aliso Canyon Climate Impacts Mitigation Program at http://www.arb.ca.gov/research/aliso_canyon_natural_gas_leak.htm.

4 The state is also part of an ongoing enforcement action against SoCalGas that may result in penalties and mitigation measures independent of any actions the CPUC may take.

The *2016 Integrated Energy Policy Report Update (2016 IEPR Update)* discussion of Aliso Canyon focuses on the most immediate issues for maintaining energy reliability

in Southern California. In the event that natural gas injections into Aliso Canyon cannot resume, the *2016 IEPR Update* analysis is focused on:

- Electric system reliability for summer 2016.
- Both gas and electric system reliability for winter 2016–2017.

Ongoing work will continue in the *2017 IEPR* to ensure near-term reliability of the energy system in Southern California.

Background

In terms of California's energy system, the Aliso Canyon facility is critical to the natural gas transmission and distribution system in Southern California. For decades, the underground storage facility has helped meet the energy needs of the region. It provides gas to 11 million customers for home heating, hot water, and cooking. The gas system in California is not designed to meet all winter peak demand from flows on the pipeline system coming into California. Winter peak demand is met partially by storage. The storage facility has been critical to meet winter peak demand as well as help meet the summer peak electricity demand for natural gas-fired power plants, especially as the region transitioned away from oil-burning utility electric generation.

Attempts to plug, or *kill*, the leaking well (SS-25) failed in November and December 2015. Meanwhile, the facility operator, SoCalGas, withdrew natural gas from the facility with the aim of reducing gas pressure to help kill the well and reduce the amount of gas leaking. The California Department of Conservation's Division of Oil, Gas, and Geothermal Resources (DOGGR) directed SoCalGas not to inject any gas into the storage facility until completion of a safety review. Recognizing that the storage field could be out of service or available only at reduced capacity for an extended period, the Energy Commission, CPUC, DOGGR, Governor's Office of Emergency Services, and other state agencies, as well as the California ISO and the Los Angeles Department of Water and Power (LADWP), began assessing the potential impacts to natural gas and electricity reliability. On January 21, 2016, CPUC Executive Director Timothy Sullivan directed SoCalGas to withdraw natural gas from Aliso Canyon down to an actual working gas inventory of 15 billion cubic feet (Bcf). Sullivan further directed SoCalGas to hold the gas inventory at this level to meet energy reliability requirements for the remainder of the winter and summer 2016. Gas could be withdrawn from this 15 Bcf inventory level to meet energy reliability during this time based on a strict withdrawal protocol designed to preserve the amount of working gas in the field, since no injections were allowed.

In response to the Governor's emergency proclamation, the Energy Commission Chair Robert B. Weisenmiller, CPUC President Michael Picker, and California ISO Chief Executive Officer Stephen Berberich wrote a letter to Governor Brown dated February 1, 2016, addressing gas system reliability. They wrote, "The nexus between the gas and power systems in the greater Los Angeles area is a complex problem to assess given the constraints on gas deliveries, rapid changes in electricity demand that occur every day, and electric transmission constraints that limit electricity imports into the area." The

letter announced the creation of a team to perform the needed studies on reliability issues that included experts from their organizations and LADWP. The energy leaders also stated, “We are bringing the same urgency and attention to this as we did when faced with the unexpected closure of the San Onofre Nuclear Generating Station. Our organizations worked together effectively then, and we will again.”¹⁹⁷

On February 18, 2016, state officials announced that the leak was permanently plugged after 119 days.¹⁹⁸ With the leak stopped, DOGGR maintained the moratorium prohibiting SoCalGas from injecting natural gas for storage at the facility until completion of a comprehensive safety review. This safety review requires all 114 wells at the Aliso Canyon storage facility to be either thoroughly tested for safe operation or removed from operation and isolated from the underground reservoir. The *Natural Gas Storage: Moratorium 2015-2016* (SB 380)¹⁹⁹ codified this moratorium on injection until completion of the comprehensive safety review.

While the safety review is underway, the facility has not been used as it normally would be to meet the energy demands of Southern California. Gas delivery within the Los Angeles area is limited by pipeline capacity²⁰⁰ and the speed at which gas moves. Given the limitations of gas flow and other storage sites as discussed in more detail below, SoCalGas historically has relied on the Aliso Canyon storage facility to meet hourly energy demand changes, particularly the large and rapid swings in gas demand for electricity generation in the summer. The current constraints at Aliso Canyon are unprecedented, creating uncertainty about the reliability of energy system operations in the region.

Aliso Canyon Action Plan to Preserve Gas and Electric Reliability for Southern California

Consistent with their commitment in the February 1, 2016, letter to the Governor, the Energy Commission, CPUC, and California ISO worked jointly with LADWP to release the *Aliso Canyon Action Plan to Preserve Gas and Electric Reliability for the Los Angeles Basin*,²⁰¹ (action plan) which focused on maintaining reliability in summer 2016. The

197 Energy Commission Chair Robert B. Weisenmiller, CPUC President Michael Picker, California ISO CEO Stephen Berberich, letter to Governor Edmund G. Brown Jr., February 1, 2016, http://docketpublic.energy.ca.gov/PublicDocuments/16-IEPR-02/TN210801_20160322T100019_212016_Letter_from_CECISOCPUc_to_EGB.pdf.

198 See <http://www.conservation.ca.gov/dog/Pages/AlisoCanyon.aspx>. February 18, 2016, “Officials Confirm Gas Leak is Sealed.”

199 Senate Bill 380 was passed on an emergency basis and went into effect immediately on May 10, 2016.

200 Playa Del Rey storage field is located within the greater Los Angeles area and provides limited support due to its small size.

201 Prepared by the staff of the California Public Utilities Commission, California Energy Commission, the California Independent System Operator, and the Los Angeles Department of Water and Power, *Aliso Canyon Action Plan to Preserve Gas and Electric Reliability for the Los Angeles Basin*, April 5, 2016, http://www.energy.ca.gov/2016_energypolicy/documents/2016-04-

Action Plan included an assessment of energy reliability risks for summer 2016 and a list of mitigation measures to reduce those risks. As Chair Weisenmiller said, “We do not eliminate the risk, but we will reduce the risk” of energy curtailment in Southern California.²⁰² A companion document²⁰³ provided the technical assessment that helped inform development of the *Action Plan*. Since much of the needed natural gas system data and hydraulic modeling capacity were held by SoCalGas, the gas company was asked to join the Technical Assessment Group to perform and review the required reliability analysis and help explore mitigation measures.

On April 8, 2016, the Energy Commission, CPUC, California ISO, and LADWP held a joint workshop near the Porter Ranch community to present the *Action Plan*.²⁰⁴ Based on feedback from the workshop, an *Update to Aliso Canyon Action Plan to Preserve Gas and Electric Reliability for the Los Angeles Basin for Summer 2016* and a summary of the workshop comments and response to comments were published May 27, 2016.²⁰⁵ On August 26, 2016, the agencies jointly held a second workshop to discuss energy reliability risks for winter 2016-2017 and present the *Aliso Canyon Gas and Electric Reliability Winter Action Plan (Winter Action Plan)*.²⁰⁶ The *Winter Action Plan* included an assessment of energy reliability risks for winter 2016-2017 and a list of mitigation measures to reduce those risks. Similar to the summer assessment, a companion document²⁰⁷ provided the technical assessment that helped inform mitigation strategies in the *Winter Action Plan*. The winter assessment also included an independent examination of the hydraulic analysis by Los Alamos National Laboratory and Walker & Associates. The independent examination also included a review of the summer

08_joint_agency_workshop/Aliso_Canyon_Action_Plan_to_Preserve_Gas_and_Electric_Reliability_for_the_Los_Angeles_Basin.pdf.

202 Joint Agency Workshop on Aliso Canyon Action Plan for Local Energy Reliability in Summer 2016, April 8, 2016, Rothleder, M., http://docketpublic.energy.ca.gov/PublicDocuments/16-IEPR-02/TN211181_20160422T102708_Transcript_of_the_04082016_Joint_Agency_Workshop_on_Aliso_Canyo.pdf, p. 3.

203 Prepared by the Staff of the California Public Utilities Commission, California Energy Commission, the California Independent System Operator, the Los Angeles Department of Water and Power, and Southern California Gas Company, *Aliso Canyon Risk Assessment Technical Report* April 5, 2016, http://www.energy.ca.gov/2016_energypolicy/documents/2016-04-08_joint_agency_workshop/Aliso_Canyon_Risk_Assessment_Technical_Report.pdf.

204 The Energy Commission, CPUC, California ISO, LADWP jointly held the workshop. On the dais, executives joining the leadership from the energy agencies included representatives from the Governor’s Office, DOGGR, the South Coast Air Quality Management District, California Natural Resources Agency, ARB, and the Office of Emergency Services.

205 See http://www.energy.ca.gov/2016_energypolicy/documents/index.html#04082016 April 8, 2016.

206 Prepared by the Staff of the California Public Utilities Commission, California Energy Commission, the California Independent System Operator, and the Los Angeles Department of Water and Power, http://docketpublic.energy.ca.gov/PublicDocuments/16-IEPR-02/TN212903_20160822T091330_Aliso_Canyon_Gas_and_Electric_Reliability_Winter_Action_Plan.pdf.

207 Ibid.

assessment. The discussion below is based on the joint agency action plan for summer 2016 and the assessment for winter 2016–2017.

Background on Southern California Gas System

To understand the role and importance of Aliso Canyon in maintaining energy reliability, it is first useful to provide background on the natural gas system in Southern California, as well as on relevant gas tariffs and operating rules. This background provides the rationale for the subsequent mitigation measures put forward in the action plan.

Gas System Operational Characteristics in Southern California

SoCalGas owns and operates high-pressure gas pipelines, its backbone transmission system, and natural gas storage facilities in Southern California. The transmission system can accept as much as 3.875 Bcf per day of natural gas from several pipelines that connect California to gas-producing areas such as New Mexico, Texas, or the Rocky Mountains. Figure 15 presents a map of the SoCalGas system. Some of the gas flowing through the backbone transmission system flows directly to customers, and the remainder is stored in one of SoCalGas' underground storage facilities.

Winter peak demand for natural gas occurs on cold days, when buildings and homes use gas for heating; summer peaks occur on hot days, when gas-fired generators supply electricity to air conditioners. Winter demand can be as high as 5.1 Bcf per day, with several days more than 4 Bcf per day. Accessing storage supplies is essential to meeting winter gas demand when it exceeds 3.875 Bcf, the maximum rate that gas can be imported into the area.

Although 3.875 Bcf is the maximum capacity for delivering gas into the region, actual flow may be less than 3.875 Bcf if cold weather drives up demand east of California and gas is diverted to meet those needs. Extreme cold can also result in freezing gas lines limiting available supplies. Either situation can trigger the need for SoCalGas to tap stored supplies of natural gas, as can other conditions, as explained below in the section on “Gas Scheduling and Balancing.”

Figure 15: Southern California Gas Company Natural Gas Transmission System

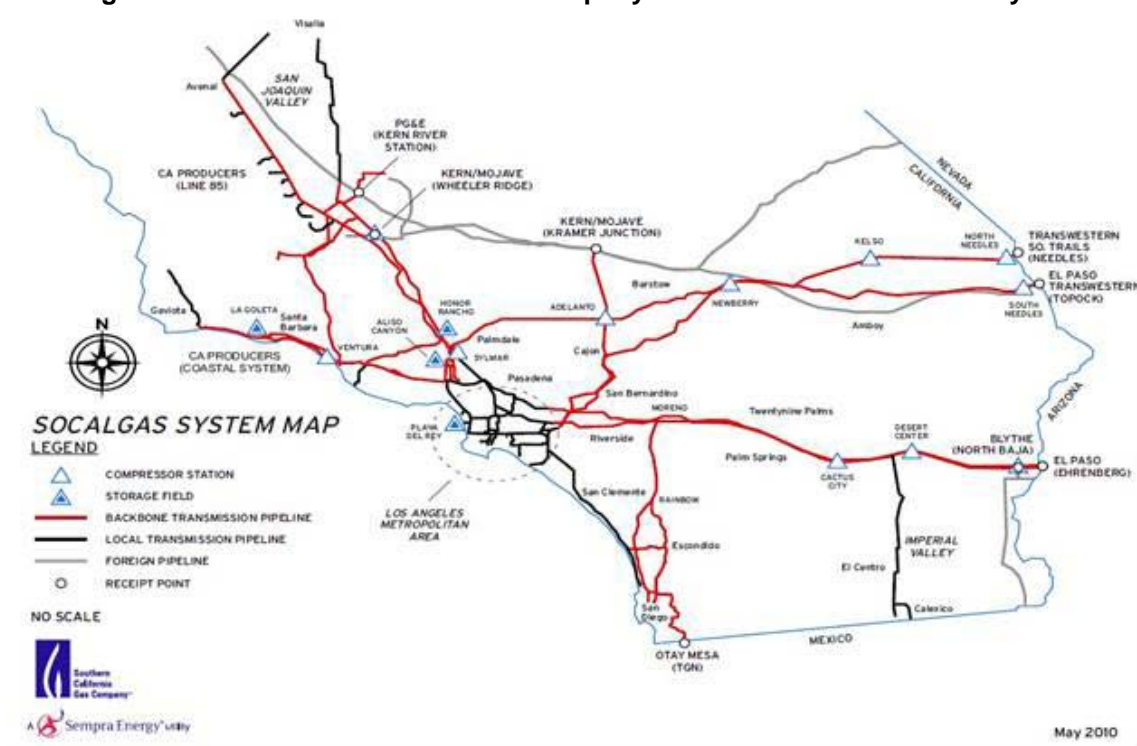

Source: Southern California Gas Company

Aliso Canyon is one of the largest natural gas storage fields in the United States, with the capacity to hold 86 Bcf of working gas,²⁰⁸ and is one of four storage fields operated by SoCalGas. Table 4 provides a list of SoCalGas' storage fields with the associated working capacity and withdrawal and injection capacity of each. Given that Playa del Rey is very small, flow from Honor Rancho takes several hours to reach areas of peak demand, and La Goleta is too far away and only marginally connected to the L.A. Loop, Aliso Canyon is the only storage field available to support substantial hourly operating changes within the greater Los Angeles area. This makes the Aliso Canyon storage facility essential to the reliability of both the gas and electrical systems (especially but not solely within the greater Los Angeles area) and uniquely critical to meet gas demand in the summer months. Summer gas demand is driven by demand for electricity and can create large and rapid swings in gas demand.

208 Gas within a storage field consists of working gas and cushion gas. *Cushion gas* is the amount of gas that is needed to pressurize the reservoir for operations and must remain in the field, while *working gas* is withdrawn and replenished on a cyclical basis.

Table 4: SoCalGas Underground Gas Storage Fields Key Operating Characteristics

Field	Location	Connects To	Working Gas Maximum Inventory (Bcf)	Withdrawal (Bcfd)	Injection (Bcfd)
Aliso Canyon	San Fernando Valley	L.A. Loop	86.2	1.9	0.4
Playa del Rey	Marina del Rey	L.A. Loop	1.8	0.4	0.07
Honor Rancho	Santa Clarita	Backbone North	27.0	1.0	0.2
La Goleta	Santa Barbara	Coastal	20.2	0.4	0.2
TOTAL			136.1	3.8	1.1

Source: *Aliso Canyon Action Plan to Preserve Gas and Electric Reliability for the Los Angeles Basin* (Bcfd is short for billion cubic feet per day)

Alternate sources of natural gas that are hundreds of miles away are not viable for meeting hourly changes in electricity demand. Natural gas moves at about 25 to 30 miles per hour through high-pressure pipelines, and about 20 miles per hour on lower-pressure pipelines. To date, gas stored inside the greater Los Angeles area is the only way to match supply with demand.²⁰⁹

SoCalGas' frequent use of the Aliso Canyon storage facility is shown in Table 5. From 2012 to 2015, SoCalGas withdrew from Aliso Canyon an average of 134 out of 151 winter days and 70 out of 214 summer days.^{210, 211} Withdrawals occurring during summer months sometimes provide support to gas-fired generation within the greater Los Angeles area. Figure 16 shows the Aliso Canyon delivery area and the 17 major power plants, totaling about 9,800 MW,²¹² served by Aliso Canyon. Of the total generating capacity, 40 percent is within the LADWP balancing authority area, and 60 percent is with the California ISO balancing authority area.

209 Playa del Rey is also located within the greater Los Angeles area. Playa del Rey is not sufficient to keep operating pressures at safe levels because of the small size and the length of time it takes to refill the facility once any gas is withdrawn. Early on, the CPUC and the Energy Commission considered whether compressed or liquefied natural gas tankers deployed near power plants would help. The agencies concluded that they would not be helpful as those vehicles introduce safety concerns and deliver too little gas relative to power plant requirements to be useful.

210 Winter is defined as November 1 through March 31, and summer is April 1 to October 31. These dates coincide with the traditional underground gas storage withdrawal and injection seasons for the natural gas industry.

211 SoCalGas' Envoy™ system reports withdrawals on a system-accumulated basis and not by storage facility; thus, these data are not available except via data request to SoCalGas. This contributes to the inability of many members of the public to immediately understand why Aliso Canyon is so important to reliable gas operations.

212 While the focus has been on the greater Los Angeles area and its associated 17 plants and 9,800 MW of generation capacity directly affected, the joint agencies have learned that Aliso Canyon limitations can have indirect effects on 48 plants generating 20,120 MW.

Table 5: Average Number of Days of Withdrawal From Aliso Canyon

	Jan	Feb	Mar	Apr	May	June	July	Aug	Sept	Oct	Nov	Dec
Average Number of Days Per Year Aliso Withdrawals	31	21	18	7	3	6	13	18	12	12	26	31

Source: CPUC Energy Division Preliminary Staff Analysis, February 16, 2016

Figure 16: Electric Generation Plants Served by Aliso Canyon



Source: California Energy Commission staff

Core and Noncore Customers

Since 1988, CPUC regulations separate gas supply, or procurement, from gas transportation service, and gas utility customers are split into two groups: core and noncore customers. Core customers include homes, small commercial operations, and small industrial customers. They typically receive their gas-related services including procurement, transmission, storage, distribution, metering, and billing in a single package from a gas utility. Noncore customers include large industrial and commercial customers, hospitals, power plants, and oil refineries. The noncore customers procure their own natural gas supplies and use SoCalGas' transmission and distribution system to transport the gas where it is needed.

In the event of insufficient supplies, noncore customers would be curtailed first, while core customers would be last.²¹³ Some of these noncore customers are oil refineries, which are also crucial to California’s economy. (For further discussion of potential impacts on oil refineries, see section on “Transportation Fuel Supply Reliability Impacts.”) Tariff changes approved by the CPUC in June 2016 provide a curtailment sequence where electric generation plants are the first to be curtailed, thereby extending protection to refineries by allowing them to establish minimum usage requirements. In more severe curtailment scenarios, however, some exposure to gas curtailment remains.

Core customers account for more than half of the gas consumed in SoCalGas’ service territory on a peak demand winter day. Table 6 presents a forecast of winter peak demand by customer type for 2016.

Table 6: Forecasted 2016 Winter Peak Day Demand

Customer	2016 Forecasted Peak Demand	Percent of Peak Demand
Core	3.050 Bcf	60
Electric Generation	1.031 Bcf	20
Noncore, not electric generation	0.996 Bcf	20
Winter Total	5.077 Bcf	100

Source: CPUC Energy Division Preliminary Staff Analysis, February 16, 2016; initially taken from 2014 California Gas Report, p. 90

The demand profile flips during the summer, and noncore customers consume more than core customers. The core customer loads that are sensitive to heating degree days decline, and electric generation increases due to increased demand for air conditioning.²¹⁴ Table 7 presents a forecast of summer peak demand by customer type for 2016.

213 Priority rules for order of service in case of curtailment still generally reflect those adopted in the 1970s gas shortages when little natural gas was used for electricity generation. For a time, the Fuel Use Act actually prohibited use of natural gas in noncogeneration baseload electric generating plants; many gas-fired generators also had the ability to burn an alternate fuel. Today, many gas appliances require electricity to ignite, meaning that many will not work if electricity service is out.

214 *Heating degree days* is a parameter that is designed to reflect the demand for energy needed to heat a home or building. Heating degree days are calculated using ambient air temperatures and a base temperature (for example, 65 degrees) below which it is assumed that space heating is needed.

Table 7: Forecasted 2016 Summer Peak Day Demand

Customer	2016 Forecasted Peak Demand	Percent of Peak Demand
Core	0.634 Bcf	20
Electric Generation	1.943 Bcf	60
Noncore, not electric generation	0.634 Bcf	20
Summer Total	3.211 Bcf	100

Source: CPUC Energy Division Preliminary Staff Analysis, February 16, 2016; initially taken from 2014 California Gas Report, p. 90

Gas Scheduling and Balancing

Each day, shippers (noncore customers) must notify the gas company regarding how much gas they plan to transport and subsequently use.²¹⁵ Historically, the market rules for noncore customers to schedule delivery of their gas supply assumed that stored natural gas would be available to correct any “imbalances,” or differences between the quantities delivered versus consumed. Scheduling gas in the greater Los Angeles area with the Aliso Canyon storage facility operating under normal conditions worked as follows.²¹⁶

Shippers have not been required to, and often do not, transport the exact amount of natural gas they use each day. Instead, SoCalGas has required noncore customers to “true-up” the amount of gas transported and consumed on a monthly basis, plus or minus 10 percent.²¹⁷ Shippers have not had to make up the difference until the following month. Thus, the daily deliveries of noncore customers have varied considerably from actual demand on a daily basis, and the required monthly true-up allowed a 10 percent variance without penalty. This flexibility has been allowed for a long time and has been beneficial to the shippers, but was possible only because large amounts of gas storage were available in Southern California.²¹⁸

The only exception to the balancing rules was when the system became so far out of balance that storage alone could not correct it. In such cases, SoCalGas makes an

215 This notification is called, variously, “scheduling” or “nominating” gas.

216 California Public Utilities Commission approved in Decision 16-06-021, Decision Approving Daily Balancing Proposal Settlement Agreement, revised rules implementing operational measures to help Southern California Gas Company and San Diego Gas & Electric Company ensure gas supply reliability during the upcoming summer and next winter heating season. The term of the settlement will conclude upon the earlier of (1) any superseding decision or order by the Commission, (2) return of Aliso Canyon to at least 450 million cubic feet per day (MMcfd) of injection capacity and 1,395 MMcfd of withdrawal capacity, or (3) November 30, 2016.

217 *True-up* means to balance the amount of gas delivered with the actual demand.

218 Electric utilities have pointed out that this flexibility is of particular comfort as California adds more renewables and needs to ramp up and down more frequently use of gas-fired generating facilities. Other noncore customers may use it to promote price arbitrage or for other reasons.

Operational Flow Order (OFO) to notify customers that they must more closely match their use with deliveries or face penalties. The penalty varies depending on the severity of the imbalance. Since they are issued late in the day, shippers have few tools available to respond. OFOs were intended to be the exception rather than the rule.

The timing of scheduling gas deliveries is another factor contributing to imbalances. Shippers, including electric generators, schedule their gas at 9:30 a.m. The generators then bid into the California ISO's day-ahead electricity market at 10:00 a.m. They find out which generators will be dispatched by the California ISO when the California ISO announces awards at 1:00 p.m.²¹⁹ Since generators must schedule gas supply before they receive their awards for generating electricity, they must guess how much gas they will use,²²⁰ leading to variances between nominations and actual consumption. If large enough, the variances can lead SoCalGas to call OFOs or, worse, curtail gas service.

Compounding these complexities is the timing of when scheduling requests are confirmed from interstate pipelines, as seen in Figure 17. Interstate pipelines deliver "confirmations" of schedule requests from SoCalGas at 2:30 p.m. The day-ahead wholesale power market is closed by the time SoCalGas receives interstate pipeline confirmations and determines whether they need to call an OFO (or a curtailment). This is especially problematic for LADWP, which has fewer options to replace any curtailment of gas-fired generation.

219 Effective April 1, 2016, the nomination times shown above changed. For example, 9:30 a.m. changed to 11:00 a.m., and 2:30 p.m. changed to 4:00 p.m. A fifth intraday window was added. Figure 3 shows the old format for simplicity.

220 Generators often guess very well owing to their experience watching weather and market conditions. Generators' use can also vary, as their efficiency changes with ambient air temperature changes. Generators can also end up being dispatched in real time differently than from the day-ahead market awards should, for example, real-time demand differs from the day-ahead forecast.

Figure 17: Simplified Timeline Illustrating Gas and Electricity Scheduling

Time	Natural Gas	Electricity
9:30 AM	Gas shippers submit Initial Scheduling Requests (for Gas Flow 7am Next Day)	
10:00 AM		Day-Ahead wholesale trading closes to LADWP
		Bids due to CAISO day-ahead market
11:00 AM		
1:00 PM	SoCalGas - ISO Mismatch	CAISO Notifies Generators of Awards to Generate Next Day
2:30 PM	Pipelines confirm shipper schedules back to SoCalGas	
4:00 PM	Gas shippers submit revised schedules (for Gas Flow 7am Next Day)	
6:00 PM	SoCalGas posts OFO if difference between forecast demand and pipeline confirmations that storage can't handle -- or curtailment	This is too late for LADWP to buy on wholesale market that closed at 10:00AM
8:00 PM		Deadline for LADWP to start pumping at Castaic*
MIDNIGHT		Electricity Day Begins
7:00 AM	Gas Day Begins	
8:00 AM	Gas shippers correct schedules in IntraDay window 3 (ID 3); change effective x pm	
3:00 PM	Gas shippers correct schedules in IntraDay window 4 (ID 4); change effective x pm	

* Castaic is a pumped storage hydro-electric facility owned by LADWP.

Source: California Energy Commission staff

Los Angeles Department of Water and Power

LADWP, which provides electricity to 1.4 million customers, is its own balancing authority and, consequently, must meet specific supply reliability metrics. These metrics require LADWP to maintain transmission line loading within limits and provide voltage support for its system. Without this voltage support, LADWP is unable to accept into its system imported generation. Gas-fired generation plays a key role in meeting these reliability metrics with specific minimum generation requirements that vary depending on system load and other conditions. LADWP owns about 40 percent of the gas-fired generation capacity in the greater Los Angeles area. This local, in-basin generation represents about 24 percent of LADWP's total electrical generation to meet its load. It imports the rest of the electricity it needs using electric transmission lines it owns.

LADWP forecasts its daily gas-fired generation requirement to meet its load and reliability requirements and schedules the gas needed to meet this generation requirement. This forecast is based on expected demand, weather, and system conditions. LADWP's gas consumption during the 2015 summer averaged 0.141 Bcf with a maximum usage of 0.336 Bcf. However, loss of a generation resource or transmission circuit, an unexpected reduction in variable generation (primarily wind and solar) and/or weather forecasting error may significantly increase the need for gas-fired generation. These events often happen with little warning.

At peak, about 72 percent of the available import capability is committed to importing LADWP, Burbank, and Glendale resources from external wind, solar, geothermal, coal, and nuclear resources owned by the balancing authority members. The remaining 28 percent of LADWP's electric transmission capacity is not used and is available to import more electricity from outside its system. This import capability can be used only if energy is available for purchase. Thus, LADWP has limited capability to shift load from gas-fired generation. It has some additional generation capacity it can access from its Castaic hydroelectric pumped storage facility. LADWP has some import capability from the California ISO that can replace a portion of its own gas-fired generation, but the quantity would depend on whether the California ISO has excess energy available and the ability to transmit it to the tie with LADWP. The shorter the notice that LADWP has before it has to reduce its gas demand, the fewer the options it has.

Risk Assessment

In December 2015, the Energy Commission, CPUC, and California ISO began discussing possible gas and electric reliability risks due to the potential loss of Aliso Canyon. As noted above, SoCalGas uses Aliso Canyon to balance its system on a daily and hourly basis, throughout the year. The location of Aliso Canyon within the greater Los Angeles area, proximity to SoCalGas' key loads, and connections to the local transmission system make it critical to the energy system. The absence of Aliso Canyon means the system has to operate differently than it has historically. When gas curtailments occur, noncore customers are the first to be curtailed, and in practice, electric generators have been the first noncore customers to be curtailed. In some cases, electric generation may be able to absorb the gas curtailments and redispatch available resources, but gas curtailments may be large enough to cause electric curtailments. Thus, the constrained operations at Aliso Canyon create reliability risks that required further analyses to better understand and to develop a plan for lessening the risk of gas and electricity curtailments.

Winter 2016 Analysis (January 22 through March 2016)

As discussed above, SoCalGas began withdrawing gas from Aliso Canyon in November 2015 after the leak was detected at well SS-25. Those withdrawals increased in December, and DOGGR directed SoCalGas not to inject any gas into the storage field until a safety review of the facility was completed. Continuing withdrawals at the late-December 2015 pace would have emptied the field by mid-February 2016, leaving no gas in the field for withdrawal in late winter and, without injections, no gas in the field for the upcoming summer.

The energy agencies recognized the threat to gas and electric reliability that could arise if gas was not available in the field for withdrawal, and on January 21, 2016, the CPUC directed SoCalGas to reduce inventory levels to 15 Bcf of actual working gas.²²¹ The CPUC's *Preliminary Staff Analysis of Los Angeles Basin's 2016 Energy Demand and the*

²²¹ Jan. 21, 2016: CPUC Letter to SoCalGas on Working Gas Level. See <http://www.cpuc.ca.gov/aliso/>.

Role of Aliso Canyon Storage, posted February 16, 2016, describes the calculations that support leaving a 15 Bcf reserve in the field.²²² The preliminary analysis behind the recommendation to hold inventory at 15 Bcf allowed SoCalGas to withdraw enough gas to support a winter core peak demand day and to support summer 2015 electricity generation demand levels. This analysis was based on a simple comparison of daily demand to daily supply. The working gas level is intended to support potential withdrawals during late winter 2016 (January 22 through March) and through summer 2016 (April through October). Three general risks are addressed by holding this level in inventory: the inability to rely solely on flowing supplies to meet peak demand, the operational uncertainty about how the field will perform at such a low inventory level, and the need to use some gas from storage during the summer.²²³ Given the mild weather during late winter 2016 and the use of low OFOs to increase volumes of pipeline supplies, none of the reserves remaining in the field were needed, preserving the 15 Bcf for summer 2016.

Summer 2016 Analysis

The technical assessment of summer 2016 energy impacts as result of constrained operations at the Aliso Canyon facility accounted for constraints on gas deliveries, operational features of the system, daily rapid changes in electricity demand, and electric transmission constraints that limit electricity imports into the area. In preparing the subsequent more detailed risk assessment for summer, the Technical Assessment Group²²⁴ looked beyond the daily balance of gas supply and demand to perform an engineering analysis simulating operating pressures on the system and communication time schedules between the gas and electric industries. The engineering analysis used the industry standard hydraulic model that simulates gas system operations, measuring flows and pressures within key pipelines, from an engineering perspective.²²⁵ The Technical Assessment Group worked collaboratively to develop the analysis assumptions, extensively review the results, and assess the impact on electricity operations for power plants within the California ISO and LADWP balancing areas.

222 Feb. 16, 2016: *Preliminary CPUC Staff Analysis of Los Angeles Basin's 2016 Energy Demand and the Role of Aliso Canyon Storage*, see <http://www.cpuc.ca.gov/aliso/>.

223 Gas is withdrawn from storage under natural pressure. The withdrawal capability from the gas field declines as inventory declines because lower volume in the field results in lower pressure. Based on SoCalGas' modeling of withdrawal capacity at Aliso Canyon, the maximum withdrawal rate of 1.8 Bcf per day begins to decline when working gas storage inventory reaches 37 Bcf, and at 15 Bcf the withdrawal rate is estimated at 0.888 Bcf per day, declining to 0.540 Bcf per day as the inventory approaches 0. SoCalGas has not operated the field at such low inventory levels that there is uncertainty about the performance of the facility.

224 As noted above, the Technical Assessment Group was composed of staff members from the Energy Commission, CPUC, LADWP, and SoCalGas.

225 The model is now owned and supported by international consultancy DNV-GL. It is used by most gas utilities and pipelines and remains known to many in the natural gas industry as the Stoner pipeline simulation model.

The hydraulic analysis assessed actual operations on four days that were expected to stress the system as presented in Table 8. SoCalGas often relied upon stored gas from Aliso Canyon to follow hourly changes in gas-fired electricity generation on the days analyzed, particularly the summer days.

Table 8: Historical Days Simulated

Date	Condition	Total Demand (Bcfd)
9/16/2014	LADWP Peak Day	3.5
7/30/2015	Large Electric Generation Ramp	3.2
9/9/2015	California ISO- Large Difference Between Day Ahead and Real Time Actual + LADWP 2015 Peak	3.5
12/15/2015	Winter Day and High Electric Generation	4

Source: *Aliso Canyon Risk Assessment Technical Report*, p. 19

The results of the hydraulic analysis show that mismatches between scheduled gas and actual demand as small as 150 million cubic feet per day (Mmcf) would result in operating pressure violations on the system that could result in gas curtailments. Staff used statistical analysis to calculate the number of days throughout the year that would present a high risk of significant system stress on SoCalGas' and San Diego Gas & Electric's (SDG&E's) pipeline systems without supplies from Aliso Canyon. The risk assessment was based on the hydraulic analysis and layered in planned and unplanned gas facility outages, including potential days of overlap (days when there is an imbalance of 150 MMcf and facility outages). Four scenarios were developed that layer in the outages, and the results of the four scenarios are shown in Table 9.

Table 9: Risk Scenarios

Scenario	Gas Quantity Curtailed
1. Mismatch between scheduled gas and actual demand	180 MMcf
2. Mismatch plus outage other storage field	480 MMcf
3. Mismatch plus pipeline outage	600 MMcf
4. Mismatch plus outages both other storage and pipeline	1,100 MMcf

Source: *Aliso Canyon Risk Assessment Technical Report*, p. 32

The results of the risk analysis were used in the electric analysis to assess the ultimate impact on electricity operations for power plants within both the California ISO and LADWP balancing areas. The California ISO and LADWP performed a complementary

joint assessment translating the gas assessment to electricity generation impacts. The studies established the minimum generation in Orange County and other areas to meet local reliability criteria while maximizing energy imports from the north and east in the greater Los Angeles area, Orange County, and San Diego to minimize the use of gas-fired generation needed throughout the remainder of the SoCalGas and SDG&E system.²²⁶ The assessment of the impact that a gas curtailment could have on the California ISO and LADWP electric system was limited to summer 2016. Curtailment on the gas system at the volumes estimated in Table 9 would significantly impact the reliability of the electric system.²²⁷ After redispatch of the electric system, the electric system is able to accommodate only about 180 MMcfd of gas curtailments, as found in Scenario 1. The increasing depths of gas curtailment in Scenarios 2, 3, and 4 are too deep for the electric system to absorb and would result in residual gas curtailments to the electric system on the order of 100 to 500 MMcf over an eight-hour period. This amount of gas curtailments translates into 1,000 to 4,000 plus MW of potential electric generation reduction.²²⁸

The following are key findings from the technical report:

- The gas system is unable to tolerate mismatches between scheduled flowing gas and actual demand as small as 150 MMcfd.
- The situation is worse if planned or unplanned outages of pipeline or other storage fields occur.
- Without gas from Aliso Canyon, the greater Los Angeles area can expect 16 summer days of gas curtailment in 2016, with electric generators being curtailed first. Shifting generation to SDG&E doesn't prevent curtailment.
- Up to 14 summer days may require electric service interruption, leaving millions of customers affected.
- Risk scenarios estimate curtailment from 150 MMcfd to 1.10 Bcfd. Only one scenario can be absorbed before electricity generation cuts occur.

226 The analysis was based on a typical summer high load day as represented by September 9, 2015, rather than a 1-in-10 year load level, and did not include the contingency reserve requirement necessary to immediately meet the greater of the loss of the Most Severe Single Contingency or roughly 6 percent of the hourly peak load.

227 More detail about the four days, the simulations, the risk scenarios, the electric analysis, and results can be found in the technical report. (*Aliso Canyon Risk Assessment Technical Report April 5, 2016*, http://www.energy.ca.gov/2016_energypolicy/documents/2016-04-08_joint_agency_workshop/Aliso_Canyon_Risk_Assessment_Technical_Report.pdf.)

228 Joint Agency Workshop on Aliso Canyon Action Plan for Local Energy Reliability in Summer 2016, April 8, 2016, Rothleder, M., http://docketpublic.energy.ca.gov/PublicDocuments/16-IEPR-02/TN211181_20160422T102708_Transcript_of_the_04082016_Joint_Agency_Workshop_on_Aliso_Canyo.pdf, p.p. 73-74.

Mitigation Measures

The action plan originally identified 18 mitigation measures to reduce the risk of gas curtailment in summer 2016, including using the current supply of 15 Bcf stored in Aliso Canyon during periods of peak demand to avoid electrical interruptions, directing all shippers to closely match scheduled gas deliveries with actual demand every day, and asking customers to use less energy. For a detailed description of each of the 18 mitigation measures, please refer to the action plan. More than forty stakeholders, including Senator Fran Pavley, subsequently commented on the action plan and the staffs of the joint agencies summarized and responded to the comments.²²⁹ In general, there was significant support for the 18 mitigation measures presented at the April 8, 2016, workshop. In response to the comments, the agencies added three new measures, which are outlined in the update to the action plan: to expand and accelerate battery energy storage, to explore dual fuel capability for LADWP units, and to protect California ratepayers.²³⁰ The last measure in part responds to one of Senator Pavley's concerns about limiting consumers' exposure to additional costs.²³¹

Table 10 presents the list of 21 summer mitigation measures and a status update for each. Ten new winter mitigation strategies are included in the table but will be discussed later in this chapter. Many mitigation measures are underway and provide a no-regrets plan to reduce gas and electric reliability risk. Nineteen of the 21 summer mitigation measures do not involve the use of Aliso Canyon. These measures can be grouped into six general categories: prudent use of Aliso Canyon, state and federal tariff changes, operational coordination, LADWP operations, reducing natural gas and electricity use, and market monitoring.

229 Staff of the California Public Utilities Commission, California Energy Commission, the California Independent System Operator, and the Los Angeles Department of Water and Power, *Aliso Canyon Public Comments and Response to Comments*, May 27, 2016, Docket 16-IEPR-02 Natural Gas, TN# 211670, http://www.energy.ca.gov/2016_energypolicy/documents/2016-04-08_joint_agency_workshop/2016-04-08_comments.php.

230 Prepared by the staff of the California Public Utilities Commission, California Energy Commission, the California Independent System Operator, and the Los Angeles Department of Water and Power, *Update to Aliso Canyon Action Plan to Preserve Gas and Electric Reliability for the Los Angeles Basin for Summer 2016*.

231 Chair Robert B. Weisenmiller letter to The Honorable Fran Pavley, California State Senate, May 20, 2016, http://docketpublic.energy.ca.gov/PublicDocuments/16-IEPR-02/TN211596_20160523T073145_52016_Response_to_Senatro_Pavley_Re_Aliso_Canyon.pdf.

Table 10: Status of Mitigation Measures

CATEGORY	MITIGATION MEASURE	Target Completion	Lead Agency	Tracking Status as of 12/11/16	Status in Winter Assessment
Prudent Aliso Canyon Use	1. Make Available 15 Bcf Stored At Aliso Canyon to Prevent Summer Electricity Interruptions	Summer 2016	CPUC	Completed 6/2/16	Done
	2. Efficiently Complete the Required Safety Review at Aliso Canyon to Allow Safe Use of the Field	TBD	DOGGR	Thirty-two wells have now passed all tests required under the safety review and have been given the green light by DOGGR. Eighty wells have been isolated and taken out of operation, and 2 are pending test results. On 11/1/16, SoCalGas requested authorization to resume injections, which begins the process on the disposition of operations at the storage field.	Underway
Tariff Changes	3. Implement Tighter Gas Balancing Rules	Summer 2016	CPUC	Completed 6/1/16	Done (see below for changes for Winter)
	4. Modify Operational Flow Order (OFO) Rule	Summer 2016	CPUC	Completed 6/1/16	Done
	5. Call Operational Flow Orders Sooner in Gas Day	TBD		On Standby List for further development if needed (after 9/1/16)	On Hold
	6. Provide Market Information to Generators Before Cycle 1 Gas Scheduling	Summer 2016	ISO	Completed first phase 6/2/16 Completed second phase 7/6/16	Done
	7. Consider ISO market changes that increase gas-electric coordination	Summer 2016	ISO	Completed first phase 6/2/16; Completed second phase 7/6/16	Continuing (On June 1, 2016, FERC accepted proposed tariff revisions for California ISO market changes to address Aliso Canyon issues to be effective on an interim basis and to expire by November 30, 2016.)

CATEGORY	MITIGATION MEASURE	Target Completion	Lead Agency	Tracking Status as of 12/11/16	Status in Winter Assessment
Operational Coordination	8. Increase Electric and Gas Operational Coordination	Summer 2016	ISO/ LADWP	Completed 5/19/16	Done
	9. Establish More Specific Gas Allocation among Electric Generators In Advance of Curtailment	Summer 2016	CPUC	Completed	Done
	10. Determine if Any Gas Maintenance Tasks Can be Safely Deferred	Summer 2016	CPUC	Completed 6/29/16	Done
LADWP Operational Flexibility	11. Curtail Physical Gas Hedging	Summer 2016	LADWP	Completed 3/3/16	Continuing
	12. Stop Economic Dispatch	Summer 2016	LADWP	Completed Feb. 2016	Continuing
	13. Curtail Block Energy and Capacity Sales	Summer 2016	LADWP	Completed Feb. 2016	Continuing
	14. Explore Dual Fuel Capability	Summer 2016 and Winter 2017	LADWP	Completed 10/11/2016	Done through 9/13/16 for summer and will continue through winter

CATEGORY	MITIGATION MEASURE	Target Completion	Lead Agency	Tracking Status as of 12/11/16	Status in Winter Assessment
Reduce Natural Gas and Electricity Use	15. Ask customers to Reduce Natural Gas and Electricity Energy Consumption	Summer 2016 (electricity) Winter 2016 (gas)	CPUC/ ISO/ LADWP	Completed 5/31/16 (Electricity Flex Alerts) Completed 6/16/16 (Conserve Energy SoCal)	Underway
	16. Expand Gas and Electric Efficiency (EE) Programs Targeted at Low-Income Customers	Start Summer 2016 and continues beyond	CPUC	Completed	Underway
	17. Expand Demand Response (DR) Programs that Target Air Conditioning and Large Commercial Use	Start summer 2016 and continues beyond	CPUC	Completed 7/6/16	Underway for Electricity
	18. Reprioritize Existing Energy Efficiency Toward Projects with Potential to Impact Usage	Summer 2016	CPUC/ LADWP	Completed	Done
	19. Reprioritize Solar Thermal Program Spending to Fund Projects for Summer and by end of 2017	Summer 2016 Winter 2017	CPUC/ LADWP	Completed 5/11/16	Underway
	20. Accelerate Electricity Storage	Summer 2016	CPUC/ LADWP	Completed	Underway

CATEGORY	MITIGATION MEASURE	Target Completion	Lead Agency	Tracking Status as of 12/11/16	Status in Winter Assessment
Market Monitoring	21. Protect California Ratepayers	Summer 2016 & beyond	ISO	Completed (Start of Monitoring 6/1/16) 2016 Second Quarter report released 8/22/16	Underway
	22. Develop and Deploy Gas Demand Response (DR) Program	Winter 2016	CPUC	Completed 11/14/2016	Done
Gas-targeted Programs to Further Reduce Usage	23. Develop and Deploy Gas Cold Weather Messaging	Winter 2016	CPUC	Completed	Done
	24. Create Advance Gas Burn Operating Ceiling for Electric Generation	Winter 2016	ISO	Impose a ceiling on the electric generation gas burn for very cold days as part of the Aliso Canyon Gas-Electric Coordination Phase 2 initiative. The California ISO submitted an amendment to FERC on 10/14/2016 and requested a ruling by the end of November.	New for Winter
Winter Operations Changes	25. Keep the Tighter Noncore Balancing Rules	Winter 2016	CPUC	Completed 12/5/2016	Done
	26. Add Core Balancing Rules	Winter 2016	CPUC	Reduce core customer imbalances that add to system stresses. SoCalGas has agreed to file an application addressing the feasibility of incorporating Advanced Metering Initiative data into the core balancing process by September 30, 2017.	New for Winter

CATEGORY	MITIGATION MEASURE	Target Completion	Lead Agency	Tracking Status as of 12/11/16	Status in Winter Assessment
Use of Gas from Aliso Canyon	27. Update the Aliso Canyon Withdrawal Protocol and Gas Allocation Process	Winter 2016	CPUC	The Aliso Canyon Withdrawal Protocol and Gas Allocation Process for winter is in place.	New for Winter
Reduce Gas Maintenance Downtime	28. Submit Reports Describing Rapid Progress on Restoring Pipeline Service	Winter 2016	CPUC	Get lines out during maintenance outages back in service as quickly as possible.	New for Winter
Increase Gas Supply	29. Identify and solicit additional gas supply sources including more CA Natural Gas Production	Winter 2016	CEC	Determine what producers can do to increase deliveries into the SoCalGas system.	New for Winter
	30. Prepare to buy LNG	Winter 2016	CEC/CPUC	Affiliate issues should not prohibit SDG&E from obtaining LNG and its delivery from the Costa Azul facility in Mexico using the Otoy Mesa receipt point. Noncore customers currently can contract for either BajaNorte capacity or LNG capacity.	Done
Refineries	31. Monitor Natural Gas Use at Refineries and Gasoline Prices	Winter 2016	CEC	Completed	Done

Source: Joint agency staff

Several mitigation measures involve tariff changes. The California ISO submitted tariff changes to the Federal Energy Regulatory Commission (FERC) to improve electricity and natural gas market coordination. SoCalGas submitted tariff changes to the CPUC requesting daily balancing. SoCalGas and settling parties submitted a proposed settlement agreement changing the OFO and emergency flow order protocols but not accepting daily balancing. FERC and the CPUC have acted quickly to approve the tariff changes put forth. The planning, preparation, and coordination of the gas and electrical operations with constrained operations at Aliso Canyon were tested early in the summer as many cities in the greater Los Angeles area experienced record mid-June temperatures. The California ISO called the first Flex Alert of the season on June 20,

2016, to get customers to conserve energy, and Aliso Canyon went into standby mode. The interagency efforts including the continued use of low OFOs and the stricter noncore balancing rules avoided withdrawals from Aliso Canyon by increasing the use of pipeline supplies, preserving the gas remaining in the field for later use. Furthermore, on July 27 and July 28, 2016, the California ISO called Flex Alerts due to high loads and temperatures in its balancing authority area and across the region, and again, there were no gas issues or withdrawals from Aliso Canyon.

Energy Commission Chair Weisenmiller called on many governmental agencies, including the California Department of Corrections and Rehabilitation, California Department of General Services, California Health and Human Services Agency, California Department of Transportation, Port of Los Angeles, Port of Long Beach, University of California, California State University, and the Metropolitan Water District of Southern California, to find ways to manage and reduce their electricity and natural gas use through operational improvements, facility equipment upgrades, and the deployment of complementary technologies. In response to the first Flex Alert, simple measures such as turning up thermostats in state buildings were enacted.

Resumption of Limited Operations at Aliso Canyon

Aliso Canyon began the summer with 15 Bcf in storage. On June 2, 2016, the CPUC issued the *2016 Aliso Canyon Summer Withdrawal Protocol* and ordered SoCalGas to make withdrawals from the 15 Bcf as necessary to ensure reliable gas supplies and avoid electric curtailments. As of January 6, 2017, 113 wells have passed Phase 1 safety tests for mechanical integrity, indicating that the wells have integrity and no leaks exist, while 34 wells have passed all safety inspections (both Phase 1 and Phase 2 tests).^{232, 233}

SoCalGas submitted a plan to state agencies on June 10, 2016, that proposes maintaining emergency gas withdrawal capacity at Aliso Canyon in summer 2016 by relying on withdrawals from a relatively small number of wells that have passed both Phase 1 and Phase 2 testing, while plugging and isolating the remaining wells from use. This approach complies with SB 380 and allows reinjection into the field through a limited number of wells. Bringing a limited number of wells back into full production quickly, however, may be insufficient to meet expected regional energy needs. On June 15, 2016, the CPUC issued an order to SoCalGas to maintain withdrawal capacity of 420 MMcfd to reduce the risk of electricity curtailments.²³⁴ The challenge was starting reinjection early enough through the limited number of fully tested wells to ensure

232 DOGGR has identified a series of tests that each well must undergo for the safety inspection. Phase 1 consists of two tests, noise and temperature logs. Abnormalities in Phase 1 testing must be addressed immediately. Phase 2 tests are a series of four additional tests: casing inspection log, cement bond test, multiarm caliper inspection test, and pressure test.

233 Test Results of Aliso Canyon Wells, <http://www.conservation.ca.gov/dog/AlisoCanyon>.

234 See June 15, 2016: CPUC Letter to SoCal Gas re Aliso Canyon Natural Gas Storage Facility comprehensive safety testing at <http://www.cpuc.ca.gov/aliso/>.

sufficient volume in the field to meet winter 2016–2017 reliability while maintaining sufficient withdrawal capacity to meet summer 2016 reliability needs.

Because the withdrawal capacity from the limited number of fully tested wells may be insufficient to provide reliability, withdrawal capacity from untested wells may be needed to meet reliability under SB 380, section 3217(i) (1). Section 3217 provides that if production capacity supplied by the tested and remediated wells is demonstrably insufficient, the State Oil and Gas supervisor may allow other gas storage wells to be used. On June 15, 2016, State Oil and Gas Supervisor Ken Harris issued a letter to conditionally authorize SoCalGas to withdraw gas from any well that has passed Phase 1 mechanical integrity testing but only for withdrawals necessary to maintain reliability, avoid curtailment, and respond to electric system reliability risks.²³⁵

As previously mentioned, 34 wells have passed all safety tests. The remaining wells have been mechanically sealed off from the storage reservoir in compliance with SB 380 and the safety review. On November 1, 2016, SoCalGas requested authorization to resume injections, which began a process for DOGGR and the CPUC to make this determination. The request initiated a review and inspection of the field, to be followed by a public meeting and ultimately a decision on whether the storage field can be operated safely. On January 17, 2017, the State Oil and Gas supervisor issued a letter to SoCalGas informing them that DOGGR and the CPUC have completed their comprehensive review of well safety at the facility and are in the process of determining whether it is safe to allow injection of natural gas to resume.²³⁶ DOGGR issued a public notice announcing two public meetings scheduled on February 1, 2017, and February 2, 2017 to be held near Porter Ranch.²³⁷

Winter 2016-2017 Assessment (November 2016 Through March 2017)

The winter action plan is part of the state’s response, along with the *Aliso Canyon Winter Assessment Technical Report*. The state’s assessment shows risk for this winter without Aliso Canyon is lower than the risk estimated for summer. Although there are uncertainties about winter weather conditions and operational performance, conservation and other mitigation measures are expected to help meet the energy needs of Southern California this winter.

The summer action plan was a forecast based primarily on natural gas used by power plants to produce electricity because air conditioners run more during hot weather and

235 See June 15, 2016: DOGGR letter on Aliso Canyon Withdrawal Authorization at <http://www.cpuc.ca.gov/aliso/>.

236 http://www.conservation.ca.gov/dog/Documents/Aliso/2017.1.17_DOGGR_Letter_of_Findings_regarding_Aliso_Canyon_Storage_Facility.pdf.

237 http://www.conservation.ca.gov/dog/Documents/Aliso/2017.1.17_Aliso_Canyon_Storage_Facility_Public_Notice.pdf.

electricity demand is higher. The *Winter Action Plan* flips the equation because more natural gas is used in the colder months by households and small businesses and less natural gas is used by power plants to generate electricity.

The assessments were prepared by the Energy Commission, CPUC, California ISO, and LADWP. They stem from three analyses:

- The Energy Commission’s independent analysis estimating the balance (or reserve margin) between supply and demand under a variety of weather conditions, combined with alternate Aliso Canyon injection and withdrawal scenarios.
- Hydraulic modeling of winter peak day demand by SoCalGas, which was reviewed by two independent experts—Los Alamos National Laboratory and the consulting firm Walker & Associates. (The SoCalGas modeling estimates how much gas load might need to be curtailed.)
- An analysis by the California ISO and LADWP using the gas curtailment estimates to determine how much gas electric generators could absorb and whether electricity service interruptions could occur on a winter peak day.

The gas balance explores periods longer than a single peak day, looking across the entire winter. The gas balance analysis found that under normal weather conditions with no gas withdrawn from Aliso Canyon and reasonable assumptions about utilization rates²³⁸ on pipeline delivering into SoCalGas, the gas system will be able to meet each month’s average daily demand for the winter season from November 1 through March 31. In certain months, it will be able to do so only by increasing withdrawals from other storage facilities. A cold winter makes that more difficult but still appears feasible within inventory margins. However, on a winter peak day, defined as the coldest day forecasted in a 1-in-10-year period for noncore customer demand (plus 1-in-35 demand for core customers), the gas balance analysis shows a need to curtail about 0.3 billion cubic feet (Bcf) of natural gas. Reducing this curtailment does not appear possible by withdrawing more gas from other storage fields.

The analyses also found Southern California residents could still face challenges. Other issues could arise—gas lines could freeze, regional demand could increase from other western states connected to California’s system, and equipment breakdowns could limit delivery capacity. If disruption of service is possible on the coldest days, that risk could

238 Utilization rates below 100% do not necessarily imply that additional capacity is available for use. A pipeline company that primarily serves a seasonal market, for instance, may have a relatively low average utilization rate especially during the summer months. But that does not mean there is unreserved capacity on a long-term basis. On the other hand, during periods of high demand for natural gas transportation services, usage on some portions of a pipeline system may exceed 100% of certificated capacity. For more information see https://www.eia.gov/pub/oil_gas/natural_gas/analysis_publications/ngpipeline/usage.html.

be reduced by using natural gas from Aliso Canyon. Those possibilities are examined next.

The gas balance analysis considered additional scenarios that assume injections at Aliso Canyon beginning in September, October, or November. These scenarios increase the inventory of gas available at Aliso Canyon and allow higher withdrawals. While none of the scenarios consider a return to the withdrawal level of the past at Aliso Canyon, the withdrawal scenarios tested are sufficient to alleviate the projected gas curtailments shown when Aliso Canyon is not part of the system. Even with higher inventories at Aliso Canyon, the analysis identifies several months in which SoCalGas will likely have to deviate from normal storage withdrawal patterns at Aliso Canyon and its other fields to avoid curtailments or preserve an operating margin. For scenarios where injections are delayed until October, the reserve margin on a winter peak day is less than 10 percent, providing little assistance to accommodate equipment failures or other weather events.

In the hydraulic modeling, which examines a snapshot of a day and examines details not discernable in the gas balance, SoCalGas found that it cannot meet the 5.2 Bcf demand on the coldest day without gas from Aliso Canyon. The hydraulic analysis assumed no Aliso Canyon and exposes a problem that receipts coming into both Wheeler Ridge Zone plus full withdrawals at Honor Rancho are infeasible. The analysis found that line 225 into the greater Los Angeles area is congested, and Honor Rancho withdrawals are reduced to 850 mmcf/d from 1,000 mmcf/d—a loss of 150 mmcf/d capacity. Table 11 shows the results of the hydraulic analysis for three levels of pipeline capacity utilization. SoCalGas found that it can provide a maximum of 4.7 Bcf per day, assuming pipeline capacity of 100 percent, that is, no transmission or storage outages. Line 3000 is on an outage, so accounting for this outage, maximum servable demand is reduced to 4.5 Bcf per day. Historically, winter supplies have mostly been within the range of 50 to 80 percent utilization, but the expectation is that supplies will be higher than historical values in part due to the new balancing rules. Assuming 85 percent pipeline utilization, the maximum servable demand is 4.2 Bcf per day.

Table 11: Results of Hydraulic Analysis

Condition: Flowing Supply at Receipt Points (Pipeline Utilization by Shippers) or Pipeline Outage	Maximum Servable Demand (Bcf per Day)
100% pipeline capacity utilization	4.7
Loss of 0.2 Bcf flowing to Line 3000 maintenance work	4.5
85% pipeline utilization/less gas at receipt points	4.2

Source: *Aliso Canyon Winter Risk Assessment Technical Report*

This confirms that SoCalGas cannot meet its 1-in-10 year design day planning criterion of 5.2 Bcf. Half a Bcf per day of gas load would need to be curtailed on a 1-in-10 year peak day, assuming pipeline capacity at 100 percent, and 1.0 Bcf per day of gas load would need to be curtailed on a 1-in-10 year peak day, assuming pipeline capacity at 85 percent. This is a larger amount than the 0.3 Bcf shown in the Energy Commission analysis for reasons uncovered in the hydraulic analysis. The higher level of curtailments found by SoCalGas is attributable to additional system constraints found in the hydraulic modeling that are unidentifiable in the gas balance analysis and assumptions about lower pipeline utilization on cold days. The hydraulic modeling was verified by independent reviewers at Los Alamos National Laboratory and the consulting firm Walker & Associates and published as another companion report: *Independent Review of Hydraulic Modeling for Aliso Canyon Risk Assessment, August 19, 2016*.²³⁹

Even with the estimated gas curtailment on a 1-in-10 year peak day, the analysis by the electric balancing authorities—the California ISO and LADWP—shows that under most conditions they can replace the lost gas-fired electricity generation from resources not served by SoCalGas. Other noncore customers that comprise critical energy infrastructure, such as petroleum refineries, may not have to be curtailed, although the exact nature of curtailments depends on further settlement discussions among the parties relating to SoCalGas’ curtailment rule and its application.

The California ISO and LADWP assessed their ability to absorb the potential gas curtailments up to 1.0 Bcf; they have more flexibility in the winter than in summer due to lower electricity demand, their ability to import power, and their ability to rely on generation sources outside the SoCalGas service area to replace lost output. Transmission capacity for the winter is significantly greater than that of the summer. Increased transmission capacity combined with lower winter system loading results in fewer direct impacts because of Aliso Canyon. Based on three assumptions, the

²³⁹ The independent review of the hydraulic modeling affirms the results of the hydraulic modeling and found the modeling consistent with industry practices. Their recommendations are consistent with the *Action Plan*. They found that the statistical analysis for summer may overstate the risk relative to unplanned outage days but underestimate the risk of high impact, low probability events. The report is at http://docketpublic.energy.ca.gov/PublicDocuments/16-IEPR-02/TN212902_20160822T091331_Independent_Review_of_Hydraulic_Modeling_for_Aliso_Canyon_Risk.pdf.

balancing authorities concluded that they can absorb most of the 1.0 Bcf-per-day curtailment SoCalGas is showing for a winter peak day's 1-in-10-year demand, assuming pipeline capacity of 85 percent. Those assumptions include that electric transmission import capability remains unimpaired, no gas-fired generation that is needed outside the SoCalGas service area is out of service, and every unit the balancing authorities seek to use has natural gas to operate.

The California ISO and LADWP found that electric reliability can be satisfied for a 1-in-10-year winter peak electric load conditions with minimum gas burn of 96 mmcf/d in response to post N-1²⁴⁰ contingency conditions and with a gas burn as low as 22 mmcf/d (with somewhat higher risk) under normal precontingency, along with the ability to import generation into the greater Los Angeles area. The electric system is expected to be able to maintain electric reliability for winter 2016–2017 without interruption to electric service as long as the total SoCalGas supportable gas delivery and supply is greater than 4.1 Bcf/d under normal precontingency conditions and 4.2 Bcf/d to support N-1 contingency conditions on the electric system. If supportable SoCalGas gas-delivered supply falls below 4.1 Bcf/d during peak winter gas demand conditions, it may be necessary to withdraw from Aliso Canyon to avoid electric load interruption.

Under the current curtailment rules, noncore customers are the first to be curtailed, while core customers are the last to be curtailed. The SoCalGas/SDG&E system has sufficient capacity to meet the 1-in-35-year peak day design standard of 3.5 Bcf per day for core service without supply from Aliso Canyon and without assuming 100 percent receipt point utilization.²⁴¹ Customers at homes and small businesses do not appear to be at risk. However, there is increased risk of localized core outages without the availability of Aliso Canyon supply that results from interstate pipeline shortfalls or storage/transmission facility outages. Withdrawals from Aliso Canyon can reduce this risk.

The *Winter Action Plan* identifies 10 new measures to reduce, but not eliminate, the possibility of gas curtailments large enough to cause electricity service interruptions this winter. The measures are in addition to measures implemented for summer. Some of the new measures are aimed at reducing the impacts to customers, including electric generators, who have experienced additional cost to absorb the operational impact caused by the loss of Aliso Canyon. These new measures include:

- Extending the tighter gas balancing rules for noncore customers into the winter, in conjunction with creating new balancing rules for SoCalGas when it schedules gas for core customers

²⁴⁰ N-1 is the loss of any generator, transmission line, transformer, shunt device without fault, or single pole block on a high-voltage direct-current (HVDC) transmission line.

²⁴¹ Natural gas is delivered to an agreed upon point on the pipeline system, also known as a receipt point. The receipt point capacity indicates the amount of gas that can be delivered at that receipt point. One hundred percent utilization means that the entire receipt point capacity is being utilized.

- Setting limits in advance on gas consumption by generators on winter peak days, essentially “precurtailing” some electric generation
- Initiating focused messaging asking consumers to reduce gas use
- Creating demand response programs to reward lower natural gas use
- Revising the withdrawal protocol at Aliso Canyon based on withdrawal and injection capacity and winter demands.

The new measures identified for winter are listed above in Table 11. Please refer to the *Winter Action Plan* for detailed descriptions of each mitigation measure.

Transportation Fuel Supply Reliability Impacts

As covered above, the inability to withdraw natural gas from Aliso Canyon put the greater Los Angeles area’s gas and electricity system reliability at risk. The risk to electric generation is lower than for summer, but even with mitigation measures in place, there remains some risk. Stakeholder comments made on the joint agency *Aliso Canyon Risk Assessment Technical Report*, released April 5, 2016, indicated that California transportation fuel production could be disrupted significantly if reliable service of natural gas and electricity was disrupted. To explore this issue, the Energy Commission held a workshop June 17, 2016, in San Pedro to examine current natural gas availability in Southern California and to determine how gas curtailments might impact refineries located there.

As Catherine Elder with Aspen Environmental Group explained during her presentation at the June 17 workshop, several risk scenarios were explored in the *Aliso Canyon Risk Assessment Technical Report*. When gas operators are facing a relatively high-demand day that occurs along with system imbalances, “the gas operators have fewer and fewer tools that they can use to fix upsets during the day or fix a change in circumstances.”²⁴² When those days happen to also occur during a period of planned or unplanned outages, the potential for gas curtailments grows large enough to affect service to customers.

Curtailments could potentially affect the eight refineries in the greater Los Angeles area, six of which produce gasoline that meets California’s regulatory requirements for sale in-state (Figure 18). These refineries could file for an electricity outage exemption under CPUC Decision 01-04-006.²⁴³ The CPUC has also adopted revisions to the order in which large natural gas customers are curtailed. Under those rules, refineries are supposed to

242 IEPR workshop on Transportation Fuel Supply Reliability Due to Reduced Natural Gas Availability in Summer 2016, June 17, 2016, http://docketpublic.energy.ca.gov/PublicDocuments/16-IEPR-02/TN212396_20160722T135015_Transcript_of_the_06172016_IEPR_Workshop.pdf, p. 13.

243 CPUC, Order Instituting Rulemaking into the operation of interruptible load programs offered by Pacific Gas and Electric Company, San Diego Gas & Electric Company, and Southern California Edison Company and the effect of these programs on energy prices, other demand responsiveness programs, and the reliability of the electric system., Decision 01-04-006, April 3, 2001, http://docs.cpuc.ca.gov/published/Final_decision/6143.htm.

share in absorbing the impact of gas curtailments, however, refineries are also allowed to negotiate minimum usage requirements, an amount of gas delivery that will not be curtailed. Because of this, the scenarios analyzed in the *Aliso Canyon Risk Assessment Technical Report* assumed curtailments would continue to be borne first by electric generators. If curtailments larger than the electric generation load were to occur, or if the new curtailment rules embody low minimum usage requirements, a large-scale gas system curtailment could impact operations at one or at all refineries.

Figure 18: Greater Los Angeles Area Refinery Locations

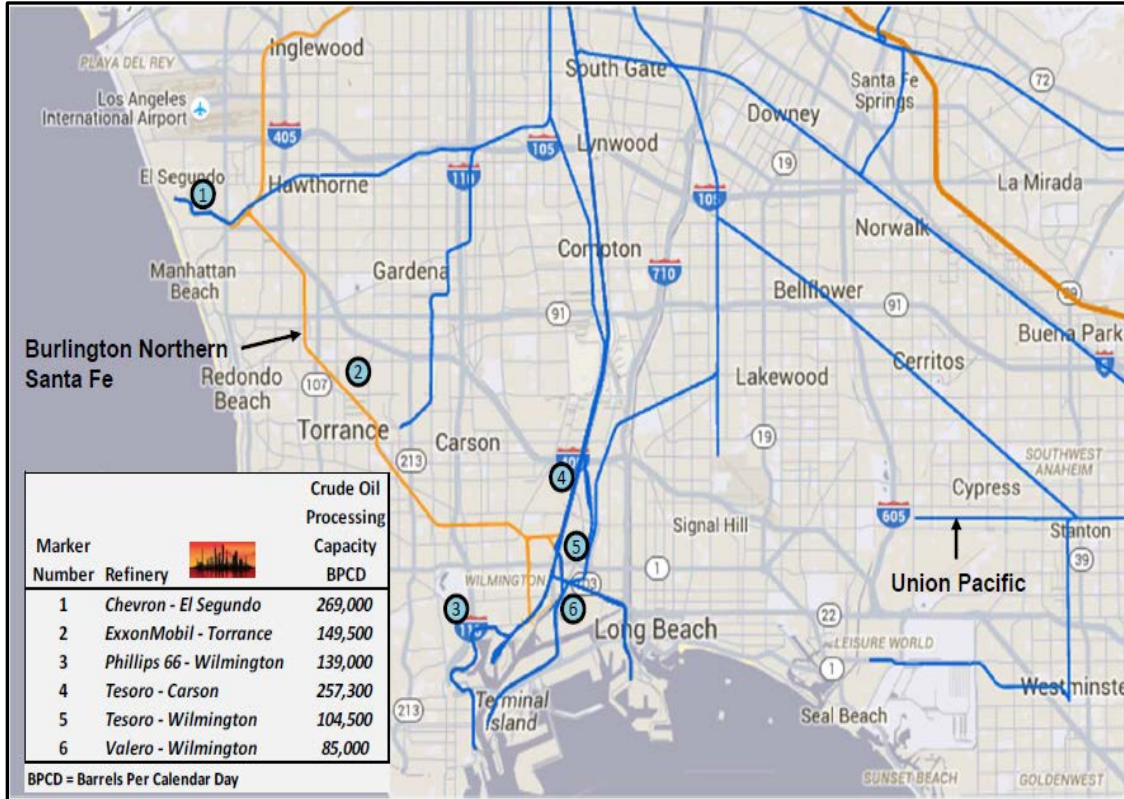

Source: Oil Change International base map, Energy Information Administration refinery data, and California Energy Commission analysis

Greater Los Angeles area refineries are part of the larger West Coast Petroleum Administration for Defense District 5 (PADD 5) system,²⁴⁴ with the major refinery hubs being highly isolated from other PADD areas. These refinery hubs are the primary points of activity for the petroleum fuel supply chain, with raw materials entering and finished products leaving. Figure 19 shows a product supply map for California. The greater Los Angeles area refinery hub is the largest in PADD 5, accounting for 55 percent of California specification gasoline production, 44 percent of California specification diesel

244 The Petroleum Administration for Defense Districts (PADDs) are geographic aggregations of the 50 States and the District of Columbia into five districts: PADD 1 is the East Coast, PADD 2 the Midwest, PADD 3 the Gulf Coast, PADD 4 the Rocky Mountain Region, and PADD 5 the West Coast. PADD 5 consists of the California, Arizona, Nevada, Oregon, Washington, Alaska, and Hawaii.

production, 62 percent of jet fuel production, and 59 percent of U.S. Environmental Protection Agency specification fuel production. Although the greater Los Angeles area hub processes about 53 percent of California’s crude oil, on average it supplies 96 percent of Southern California’s fuel demand.²⁴⁵

Figure 19: West Coast Petroleum Product Supply Map

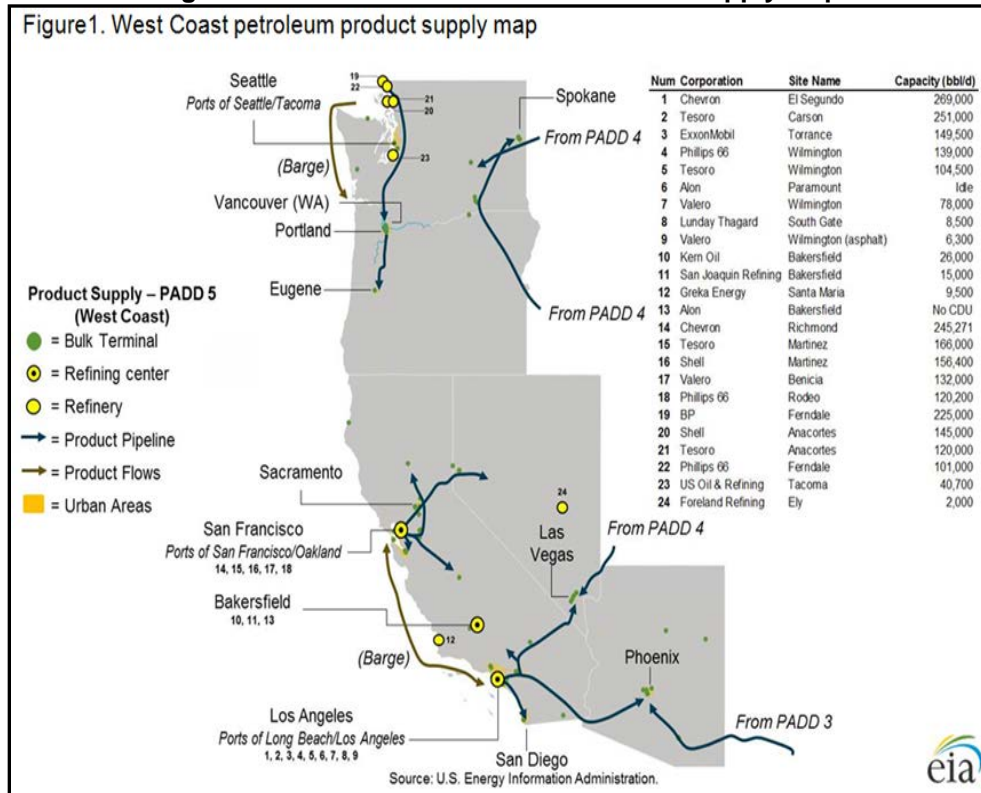

Source: U.S. Energy Information Administration

Refineries must maintain a “steady-state” balance of pressure and heat in the associated processes. To do this, refineries require consistent electrical and natural gas service. Distillation towers are the first step of the refining process and can achieve temperatures greater than 1,050 degrees Fahrenheit using natural gas burners and electrical pumps that separate the various hydrocarbon compounds out of the crude oil feedstock. The various compounds are then moved to other refinery units for further processing. High temperatures must be maintained to ensure proper flow through and separation by all refinery units. Refinery operator comments at the workshop revealed that any sudden loss of service triggers emergency shutdown procedures that shut off operations in all processing units.²⁴⁶ This hard stop in production triggers safety

245 Stillwater Associates, http://docketpublic.energy.ca.gov/PublicDocuments/16-IEPR-02/TN211849_20160617T085039_Refinery_Reliability_Issues_and_Impacts_to_California's_Petrole.pdf.

246 IEPR workshop on Transportation Fuel Supply Reliability Due to Reduced Natural Gas Availability in Summer 2016, June 17, 2016, http://docketpublic.energy.ca.gov/PublicDocuments/16-IEPR-02/TN212396_20160722T135015_Transcript_of_the_06172016_IEPR_Workshop.pdf, p. 63.

protocols that require temperature and pressure to be dropped safely, stopping product movement in piping and processing units. As product sits in pipes and units, decreasing temperature and pressure can cause product to solidify, especially in the case of heavier hydrocarbon liquids, which can form asphalt-like material that would then need to be removed to resume operations. Inspection of refinery units and piping lasts days, with material buildup potentially adding days or weeks to the restart process.

Additional comments at the workshop from industry representatives indicated that reduced natural gas consumption could be accommodated at certain levels,²⁴⁷ but it requires proper lead time to fully coordinate operations at the refinery with their natural gas providers. No specific time frame was given, with longer lead times (ideally a week) being preferred.²⁴⁸ Finally, refiners and Energy Commission staff noted that some key intermediate products needed to make California fuels are produced by ancillary service providers not on refinery premises. The most important of these products is hydrogen, the production of which uses both natural gas and electricity for steam reforming. Curtailing these ancillary services would disrupt the refinery “steady-state” production flow and have the potential to trigger emergency shutdowns. Temporary loss of any of these ancillary facilities would interrupt essential services to multiple refineries.

To measure the amount of natural gas usage by greater Los Angeles area refineries, Energy Commission staff conducted an ad hoc Petroleum Industry Information Reporting Act survey of refinery natural gas use by operational type for all greater Los Angeles area refineries. Figure 20 shows that from January 2014 to November 2015, greater Los Angeles area refineries used 9 percent to 13 percent of all natural gas provided by SoCalGas. On average, this was roughly 11 percent of all natural gas demand in the greater Los Angeles area. These values exclude any nonrefinery-owned ancillary operations that are related to refinery operations, such as plants that produce hydrogen.

247 IEPR workshop on Transportation Fuel Supply Reliability Due to Reduced Natural Gas Availability in Summer 2016, June 17, 2016, http://docketpublic.energy.ca.gov/PublicDocuments/16-IEPR-02/TN212396_20160722T135015_Transcript_of_the_06172016_IEPR_Workshop.pdf, pp. 72-73.

248 IEPR workshop on Transportation Fuel Supply Reliability Due to Reduced Natural Gas Availability in Summer 2016, June 17, 2016, http://docketpublic.energy.ca.gov/PublicDocuments/16-IEPR-02/TN212396_20160722T135015_Transcript_of_the_06172016_IEPR_Workshop.pdf, p. 72.

Figure 20: Greater Los Angeles Area Refinery Usage as a Percentage of Total SoCalGas System

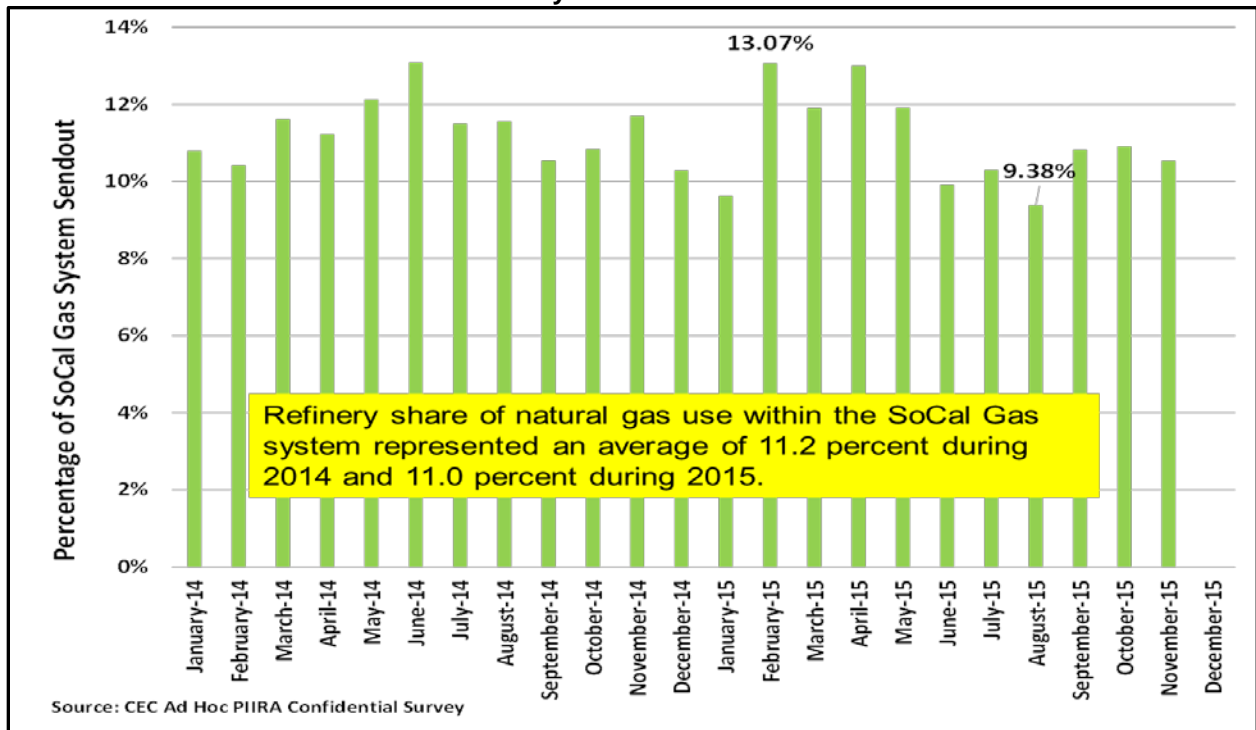

Source: California Energy Commission

Figure 21 shows greater Los Angeles area refinery use of both natural gas and refinery *still gas*, a mixture of gases produced by refinery operations, such as distillation, cracking, reforming, and other processes.²⁴⁹ Still gas is primarily methane (natural gas) and ethane but contains other gases such as hydrogen. Still gas provides a less consistent burn that diminishes heating efficiency and consistency and is, thus, less desirable than natural gas. Still gas is used for heating (in furnaces) and creation of steam (in boilers) because these applications do not require the superior fuel property characteristics necessary for hydrogen production or the operation of cogeneration units.

From January 2014 to December 2015, outside-sourced natural gas (not still gas) represented roughly 53 percent of all natural gas used in refinery operations of boilers, heaters, on-site hydrogen production, and cogeneration. The lowest usage rate was 48 percent in August 2015. It is unclear whether refineries can use more still gas in operations since both cogeneration and hydrogen production used roughly 80 percent of all natural gas used in refinery operations in 2014 and 2015, as shown in Figure 22.

²⁴⁹ Energy Information Administration, <http://www.eia.gov/tools/glossary/index.cfm?id=still%20gas>.

Figure 21: Greater Los Angeles Area Refinery Natural Gas Versus Still Gas Usage

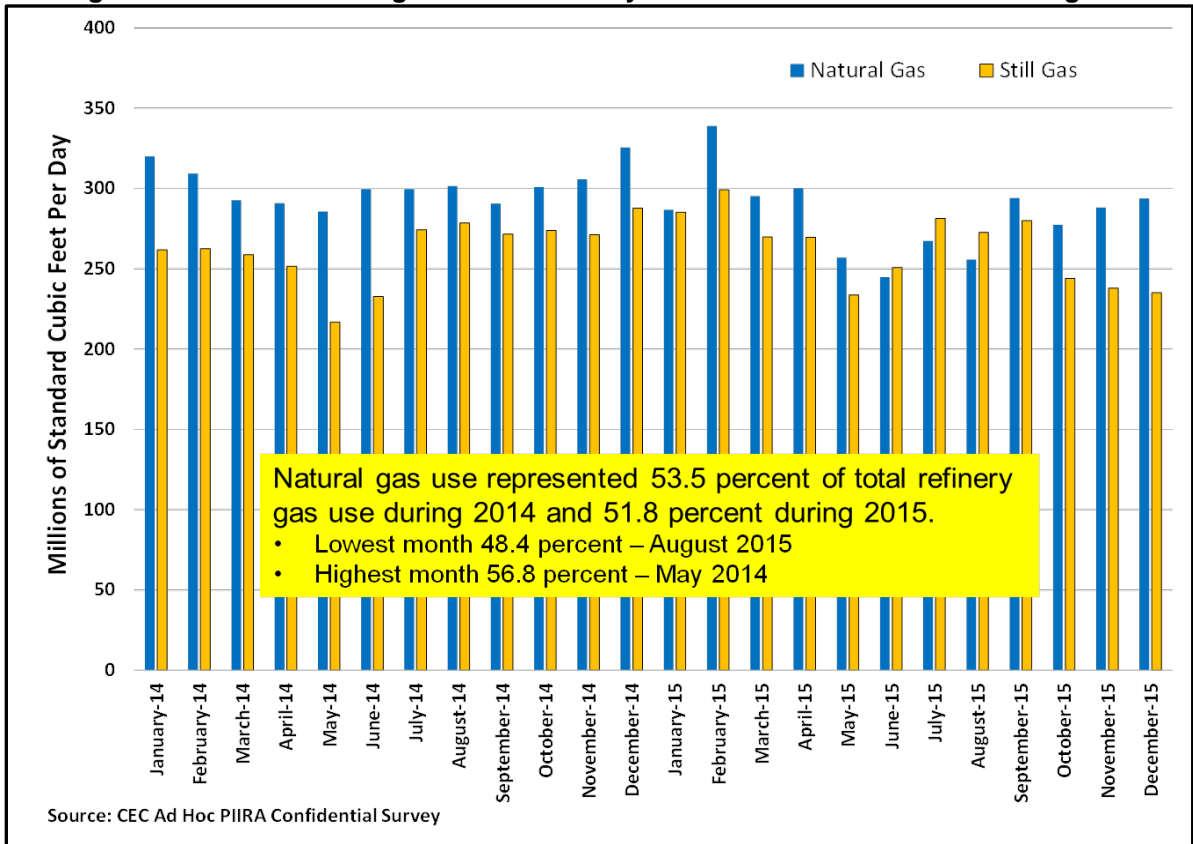

Source: California Energy Commission

Figure 22: Greater Los Angeles Area Refinery Natural Gas Usage by Operation Type

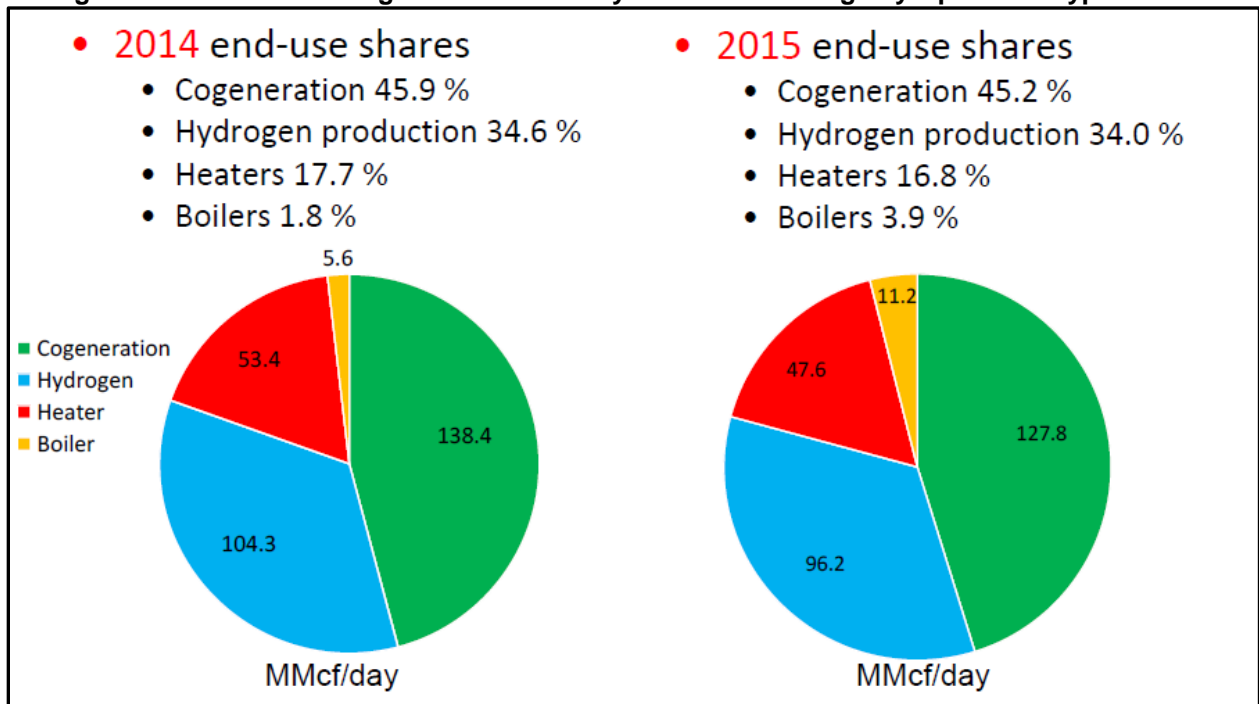

Source: California Energy Commission

During the summer of 2016, no gas or electricity curtailments attributed to Aliso Canyon occurred. In September and October 2016, however, there were widespread electricity outages in Southern California Edison’s territory, though it was unrelated to Aliso Canyon. These outages impacted the Torrance refinery and temporarily cut production.

During the workshop, CPUC representative Greg Reisinger presented a proposed rule in proceeding A. 15-06-020 and outlined seven steps that a curtailment order for natural gas would follow. Natural gas curtailment for each step would need to be fully implemented before proceeding to the next step. The steps are detailed below:

- 1) Electric generation operating or forecasted to be operating when curtailment order is in effect remains available—but curtail all other natural gas generation.
- 2) Curtail up to 40 percent in the summer and 60 percent of dispatched electric generation load.
- 3) Curtail up to 100 percent of non-electric generation, noncore, and noncore cogeneration on a pro-rata basis *except for pre-established refinery minimum usage requirements*.
- 4) Curtail of up to 100 percent of remaining refinery natural gas use not curtailed in step three, and the remainder of dispatched and operating natural gas using electric generation.

- 5) Curtail large core customers.
- 6) Curtail small core nonresidential customers.
- 7) Curtail residential customers.

SoCalGas' curtailment procedure is defined in its Tariff Rule 23 which was revised on July 14, 2016, in CPUC Decision 16-07-008. The revised rules became effective November 1, 2016, the beginning of the winter season for gas customers. SoCalGas is currently and continuously working with refiners to balance natural gas demand in curtailment situations.

Figure 23: California Spot Gasoline to New York Mercantile Exchange (NYMEX) Futures Price Spread

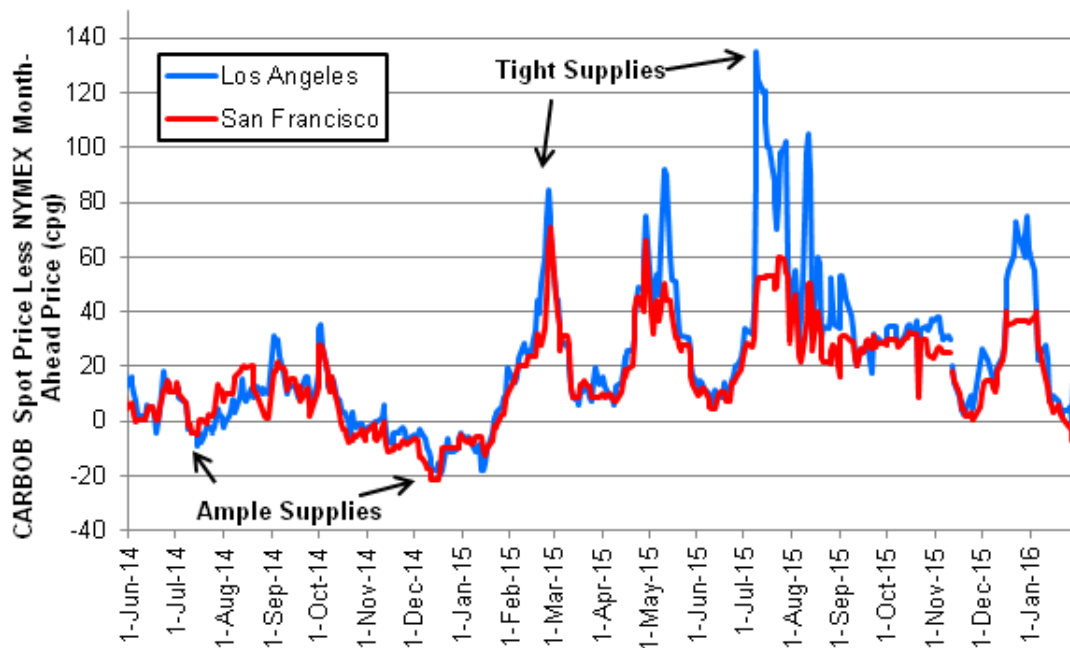

Source: U.S. Energy Information Administration and OPIS

As shown in Figure 23, Petroleum Market Advisory Committee member Dave Hackett from Stillwater Associates showed that large price increases follow significant unplanned refinery outages. When maintenance disruptions to fuel production are expected, fuel producers can plan to obtain alternative sources of supply needed to meet their contractual obligations. These actions usually minimize the likelihood of prices spikes associated with planned maintenance. Sudden, unplanned losses of fuel production in the greater Los Angeles area have historically resulted in large price spikes due to the time required to resupply the Southern California market from outside sources. Price spikes of greater magnitude and longer duration have occurred when additional alternative sources of replacement fuel supply needed to come via marine vessel from greater distances, such as Gulf Coast-based refineries or other countries.

Conclusions from the workshop focused on the need for continued dialogue between refineries and natural gas utilities to establish reasonable minimal natural gas usage requirements for refineries and to ensure utilities understand the operational flexibility of each refinery.²⁵⁰ Refinery industry representatives indicated that such conversations were already underway. Commissioners present suggested that refineries should continue to look at improving efficiency measures, both short- and long-term, to cope with the possible long-term loss of Aliso Canyon natural gas storage.²⁵¹ The Energy Commission would also continue to monitor refinery activities using its pre-existing Petroleum Industry Information Reporting Act reports and ad-hoc survey authority (as needed).

Update on Southern California Electricity Reliability

Aside from the reliability issues with respect to Aliso Canyon, a separate and continuing stress to the reliability of the electricity system in Southern California is related to the unexpected 2013 closure of San Onofre. The closure of San Onofre is more complicated than replacing the 2,200 MW of capacity it provided because San Onofre also supplied voltage support and reactive power²⁵² to maintain stability for much of the transmission system in Southern California, as well as providing capacity to balance flows and keep transmission lines from overloading. These consequences had not been fully appreciated until San Onofre closed.

Another factor affecting the reliability of the Southern California electricity system was the State Water Resources Control Board's (SWRCB's) decision in May 2010 to phase out the use of ocean water for cooling 19 gas-fired coastal power plants. Ten of these facilities are in the greater Los Angeles and San Diego areas. These power plants use once-through cooling (OTC) technology that was common in the 1950s and 1970s when the plants were developed. The use of OTC technology has been a large, long-term stressor to the state's coastal aquatic ecosystems. (For more information, see Chapter 1: Environmental Performance of the Electricity Generation System, "Power Plant Cooling Water Use and Conservation.") The SWRCB's OTC policy includes a compliance date for each power plant but also recognizes that some of these plants are critical for system and local reliability. Thus, the policy created the joint-agency Statewide Advisory Committee on Cooling Water Intake Structures²⁵³ (SACCWIS) to advise the SWRCB

250 IEPR workshop on Transportation Fuel Supply Reliability Due to Reduced Natural Gas Availability in Summer 2016, June 17, 2016, http://docketpublic.energy.ca.gov/PublicDocuments/16-IEPR-02/TN212396_20160722T135015_Transcript_of_the_06172016_IEPR_Workshop.pdf, p. 95.

251 IEPR workshop on Transportation Fuel Supply Reliability Due to Reduced Natural Gas Availability in Summer 2016, June 17, 2016, http://docketpublic.energy.ca.gov/PublicDocuments/16-IEPR-02/TN212396_20160722T135015_Transcript_of_the_06172016_IEPR_Workshop.pdf, p. 101.

252 Reactive power (vars) is required to maintain the voltage to deliver active power (watts) through transmission lines.

253 SACCWIS includes representatives from the Energy Commission, CPUC, California Coastal Commission, California State Lands Commission, ARB, the California ISO, and the State Water Resources Control Board.

annually on whether the compliance schedule would threaten reliability of California's electricity supply, including local area reliability and statewide grid reliability, and permitting constraints. This multiyear effort to assure energy reliability in Southern California in the face of power plant closures has been addressed in each *IEPR* since 2013.

Following Southern California Edison's (SCE's) announcement that it would retire rather than repair San Onofre, Governor Brown asked the energy agencies, utilities, and air districts to draft a plan for replacing the power and energy that had been provided by San Onofre. In response, technical staff of energy agencies, air districts, the ARB, and utilities prepared the *Preliminary Reliability Plan for LA Basin and San Diego* (reliability plan)²⁵⁴ in 2013. The *Reliability Plan* evaluated local capacity requirements to identify actions that state and local agencies could take to maintain electricity reliability in the Los Angeles and San Diego areas. The plan suggested that roughly 50 percent of the capacity that was shut down be replaced by preferred resources (energy efficiency, demand response, fuel cells, renewable distributed generation, combined heat and power, and so forth) and 50 percent by conventional generation. In addition, the plan included transmission projects to fill the need.

This joint agency effort by the Energy Commission, CPUC, California ISO, and the ARB continues to monitor and track projects identified in the Southern California *Reliability Plan*. By monitoring and tracking specific projects, the joint agency team is able to discern the critical path projects that are needed to maintain reliability in Southern California while keeping OTC deadlines on course. The Aliso Canyon gas storage situation discussed previously in this chapter is also being monitored for any additional impacts to Southern California reliability. The joint agency staff provides advance notice to the leadership of the respective agencies and the California Environmental Protection Agency (this group is collectively referred to as the *Energy Principals*) of any potential reliability issues or other anticipated problems and identifies necessary mitigation options and recommendations for their timing.

Local Reliability Assessment Framework

The joint agencies, along with representatives from the investor-owned utilities and local air districts in the South Coast Air Basin and San Diego, conducted a workshop August 29, 2016, on the status of overall reliability and current projects that have been initiated to maintain electrical reliability in Southern California. Details from agency tracking of project milestone progress, updates to the Local Capacity Area Accounting Tool (LCAAT) and preliminary results, and processes related to potential contingency options were discussed. Preferred resources and conventional generation are tracked by the CPUC, transmission is tracked by the California ISO, and potential contingency

²⁵⁴ *Preliminary Reliability Plan for LA Basin and San Diego*, August 30, 2013, http://www.energy.ca.gov/2013_energypolicy/documents/2013-09-09_workshop/2013-08-30_prelim_plan.pdf.

options, including LCAAT scenarios and OTC deferral, are tracked by the Energy Commission. LCAAT provides an integrated assessment of whether resources in five regions of Southern California are expected to meet or exceed capacity requirements for each local area from 2016 through 2025. Projected shortfalls indicate a looming reliability problem. If the assessment of the LCAAT is confirmed by in-depth power flow and stability studies by the California ISO, then mitigation measures would be considered. The joint agency team provides quarterly updates for the Energy Principals.

Conventional Generation Projects

In 2016, even though the permitting dimension of power plant development is becoming clearer, new uncertainties have been introduced by interveners contesting CPUC-approved power purchase agreements (PPAs) between project developers and utilities. Table 14 lists the six conventional generation projects that the joint agency team is tracking.

The joint agency team is tracking two SDG&E projects totaling 918 MW. These projects include Pio Pico, Carlsbad Energy Center (composed of five 100 MW peakers). Conventional generation projects of immediate importance for the summer of 2018 are the Pio Pico and Carlsbad Energy Center projects. The Pio Pico project entered full construction early 2015, was synchronized to the California ISO-controlled grid in June 2016 and became operational in September 2016. The project is fully participating in California ISO market operations. This project is on track for use through SDG&E's tolling agreement by June 2017.

The situation with the Carlsbad Energy Center, which is replacing the OTC Encina facility, has recently become clearer. Although CPUC approval of the power purchase agreement for the Carlsbad project was appealed in 2015, delaying the on-line date until 2018, the Court of Appeals affirmed the CPUC Decision in an unpublished opinion on November 30, 2016. Since the construction schedule for Carlsbad is estimated to be 18–24 months and Carlsbad will not be on-line until after the start of the summer season of 2018, the energy agencies have begun to implement an OTC compliance date deferral for Encina with SWRCB.²⁵⁵

Since reasonable expectations are that Carlsbad will not be available for summer 2018, focus is shifting to how much of Encina's 965 MW should be deferred and for how long. Using the assumptions of the California ISO's 2015–2016 Transmission Planning Process,²⁵⁶ the 2016 LCAAT results project an estimated 650 MW deficit in 2018 without

255 To be as precise as possible about Carlsbad's on-line date, NRG has agreed to meet with the technical staff of the SACCWIS agencies within one month of a final Court of Appeals decision to review its intended construction schedule and major contingencies that could affect this date.

256 Each year, the California ISO conducts its transmission planning process to identify potential system limitations as well as opportunities for system reinforcements that improve reliability and efficiency. For more information see <https://www.caiso.com/planning/Pages/TransmissionPlanning/2015-2016TransmissionPlanningProcess.aspx>.

Encina or Carlsbad, suggesting that most of Encina's capacity will be needed. To inform the process, the California ISO is preparing new analytic studies of local capacity requirements for 2018, using assumptions vetted by the CPUC and Energy Commission staff. The California ISO will study the local capacity requirement consequences of a Carlsbad Energy Center delay beyond the second quarter of 2018 using updated assumptions to determine how much of Encina's capacity may be needed. These studies would form the basis for a specific request to SWRCB to defer the compliance dates for some or all of Encina's units. Previous discussion with SWRCB has indicated that 12–18 months would be required to develop and process a deferral request, depending on the need for and complexity of specialized local capacity studies.²⁵⁷ Once the California ISO completes its technical studies, the interagency technical team will prepare a draft report proposing specific deferral periods for Encina units for consideration by SACCWIS. If SACCWIS decides to make a specific compliance date deferral request for Encina, then the SWRCB becomes the forum to make a change in the OTC compliance date for each of Encina's five units. Although SWRCB could process a deferral request for Encina faster than one year, this is the expected period given what is likely to be a contested decision.

Furthermore, the joint agency team is tracking three projects being pursued by SCE totaling 1,382 MW: Alamitos, Huntington Beach, and Stanton. In D. 15-11-041,²⁵⁸ the CPUC approved SCE's contracts for AES Alamitos (640 MW), AES Huntington Beach (644 MW), and Stanton Energy Reliability Center (98 MW), as well as 430 MW of preferred resources, including energy storage.²⁵⁹ Several parties submitted applications for rehearing the decision. The CPUC denied the rehearing requests in D.16-05-053²⁶⁰ but modified the decision to require SCE to procure the minimum amounts of preferred resource as authorized in previous decisions. This effectively required SCE to procure an additional 169 MW of preferred resources or file a petition to modify the underlying requirement if additional procurement is not necessary.

257 Due to interactions of San Diego and greater Los Angeles area portions of the SCE system, a full local capacity requirements assessment is needed to determine how much total capacity is needed to assure regional reliability.

258 CPUC, *Decision Approving, in Part, Results of Southern California Edison Company Local Capacity Requirements Request for Offers for the Western LA Basin Pursuant to Decisions 13-02-015 And 14-03-004*, Decision 15-11-041, November 19, 2015.
<http://docs.cpuc.ca.gov/PublishedDocs/Published/G000/M156/K064/156064924.PDF>.

259 *Preferred resources* include energy efficiency, demand response, renewable distributed generation, and energy storage.

260 CPUC, *Order Modifying Decision 15-11-041 and Denying Rehearing of the Decision as Modified*, Decision 16-05-053, May 26, 2016,
<http://docs.cpuc.ca.gov/PublishedDocs/Published/G000/M162/K888/162888503.pdf>.

Table 12: Conventional Generation Projects in San Onofre Area

	Conventional Generation Projects	PTO/Sponsor	Target in-service dates
1	Pio Pico (305 MW)	SDG&E	6/1/2017
2	Carlsbad Energy Center (500 MW)	SDG&E	No sooner than Q2 2018
3	AES Alamosa (640 MW)	SCE	6/1/2020
4	AES Huntington Beach (644 MW)	SCE	5/1/2020
5	Stanton Energy Reliability Center (98 MW)	SCE	7/1/2020

Source: Southern California Reliability Planning Team, February 10, 2016

Preferred Resources

The joint agency team is tracking both Long-Term Procurement Plan (LTPP) *authorized* preferred resources, which are designated in specific CPUC decisions, as well as *assumed* preferred resources from ongoing programs. The *authorized* preferred resources were to begin coming on-line as early as May 1, 2016, as shown in Table 13. The CPUC approved preferred resource procurement for SCE through D.13-02-015²⁶¹ and D.14-03-004²⁶² for 600–1,000 MW (as well as an additional 300 to 500 MW that could be from any resource). Subsequently, the CPUC approved SCE’s application for 500.6 MW of preferred resources in the greater Los Angeles area on November 19, 2015, with the exception of six demand response (DR) contracts totaling 70 MW, resulting in a net total of 430.6 MW.²⁶³ These DR contracts were denied on the basis of not meeting the definition for “preferred resources” and excessive costs. Two interveners requested reconsideration of the PPAs for conventional generation, which the CPUC denied in D.16-05-053; these interveners then appealed the CPUC’s decision to the court of appeals, but the court rejected the petition on September 1, 2016. The practical effect is a slowdown of the scheduled development of preferred resources relative to that shown in Table 13.

261 CPUC, Decision Authorizing Long-Term Procurement for Local Capacity Requirements, Decision 13-02-015, February 13, 2013, <http://docs.cpuc.ca.gov/PublishedDocs/Published/G000/M050/K374/50374520.PDF>.

262 CPUC, *Decision Authorizing Long-Term Procurement for Local Capacity Requirements Due to Permanent Retirement of the San Onofre Nuclear Generations Stations*, Decision 14-03-004, March 13, 2014, <http://docs.cpuc.ca.gov/PublishedDocs/Published/G000/M089/K008/89008104.PDF>.

263 CPUC Decision 15-11-041, *Decision Approving, in Part, Results of Southern California Edison Company Local Capacity Requirements Request for Offers for the Western La Basin Pursuant to Decisions 13-02-015 and 14-03-004*, November 19, 2015, <http://docs.cpuc.ca.gov/PublishedDocs/Published/G000/M156/K064/156064924.PDF>.

The CPUC authorized SDG&E to procure 300 MW of preferred resources (at least 25 MW of the 300 MW must be from energy storage) in D.15-05-051.²⁶⁴ SDG&E filed an application (A.16-03-014) for 38.5 MW of energy efficiency and storage, of which 37.5 MW of energy storage was approved by the CPUC for an early 2017 in-service date. It also launched another preferred request for offers (RFO) and expects to file an application for that in the third quarter of 2017.²⁶⁵ At the August 29, 2016, IEPR workshop on Southern California Electricity Reliability, SDG&E representatives stated the corporate strategy is to conduct a series of RFOs to obtain the benefits of cost reductions. Although SDG&E still intends to meet its obligation to acquire preferred resources by 2022, this strategy increases intermediate-term uncertainty about the timing and mix of preferred resources that SDG&E will eventually acquire.

Table 13: Authorized Preferred Resources in San Onofre Area

	Authorized Preferred Resource Projects	PTO/Sponsor	Target In-Service Dates
1	SCE Energy Storage (263.64 MW)	SCE	2016–2023
2	SCE Energy Efficiency (124.04 MW)	SCE	2016–2020
3	SCE Demand Response (5 MW)	SCE	2016–2023
4	SCE Renewable Distributed Generation (37.92 MW)	SCE	2016–2023
5	SCE Preferred Resources Pilot (181.6 MW)	SCE	2014–2020
6	SDG&E Preferred RFO I (38.5MW) (261.5 MW authority Remaining)	SDG&E	TBD
	SDG&E Preferred RFO II (140MW goal) (121.5 MW authority remaining)	SDG&E	TBD

Source: Southern California Reliability Planning Team, February 10, 2016, and California Energy Commission staff updates

SCE’s Preferred Resources Pilot, a multiyear clean energy study, is investigating if, and how, preferred resources will allow SCE to meet local needs at the distribution level and manage or offset projected electricity demand growth from 2013–2022 in the Johanna

264 CPUC Decision 15-05-051, *Decision Conditionally Approving San Diego Gas & Electric Company’s Application for Authority to Enter Into Purchase Power Tolling Agreement With Carlsbad Energy Center, LLC*, May 21, 2015, <http://docs.cpuc.ca.gov/SearchRes.aspx?DocFormat=ALL&DocID=152058431>.

265 CPUC, Application 16-03-014, *Application of San Diego Gas & Electric Company (U 902 E) for Approval of Energy Storage and Energy Efficiency Contracts Arising From the Track IV Local Capacity Requirement All Source Requests for Offers*, March 30, 2016.

and Santiago substation areas of Orange County. If successful, the pilot will allow SCE to meet demand growth with less conventional generation. The target in-service date for these resources is in the 2014–2020 time frame. As of July 2016, SCE had deployed 94 MW and expects 181.6 MW by 2020 of energy efficiency, DR, distributed generation, and energy storage. Moreover, The CPUC issued a proposed decision on June 26, 2016, approving two solar photovoltaic (PV) projects for a combined 2.2 MW. SCE is in the midst of a second Preferred Resources Pilot RFO seeking an additional 100 MW of preferred resources and submitted an application in November 2016.²⁶⁶

To address potential reliability issues associated with Aliso Canyon as discussed in the previous section, the CPUC has requested that SCE consider accelerating the on-line dates for preferred resources with approved contracts that are located in the greater Los Angeles area and solicit additional storage resources that could be brought on-line by the end of 2016. SCE is engaged in negotiations for bridge contracts to carry existing programs forward for preferred resources.

The CPUC approved a draft resolution supporting SDG&E's contract with AES Energy Storage LLC on August 18, 2016. These two lithium-ion battery storage facilities at the Escondido (30 MW/120 MWh) and El Cajon (7.5 MW/30 MWh) SDG&E substations farther south of Path 26 help address Aliso Canyon-related reliability issues.²⁶⁷ The contracts specify that the projects will be on-line on or before January 31, 2017.²⁶⁸

Assumed preferred resources from existing energy efficiency and DR programs are expected to provide 1,638 MW in 2022 and 1,031 MW in 2018.²⁶⁹ For energy efficiency, SCE achieved 305 MW, and SDG&E achieved 60.2 MW of gross verified demand reductions in 2013–2014. DR load impacts were reported and evaluated to provide 160 MW in the San Onofre affected area in 2014 and 166 MW in 2015. CPUC Decision 14-10-046 approved funding at 2015 levels for future energy efficiency programs through 2025 or until changed,²⁷⁰ and bridge year funding for current DR programs has been adopted through 2017.²⁷¹ Monitoring the performance of programs for which impacts

266 CPUC Application 16-11-002, Application Of Southern California Edison Company (U 338-E) For Approval Of The Results Of Its Second Preferred Resources Pilot , Request For Offers, [http://www3.sce.com/sscc/law/dis/dbattach5e.nsf/0/90FB3FB07AB4489A88258061007BC92A/\\$FILE/A1611XX-SCE%20Application%20for%20Approval%20of%20Second%20PRP%20RFO.pdf](http://www3.sce.com/sscc/law/dis/dbattach5e.nsf/0/90FB3FB07AB4489A88258061007BC92A/$FILE/A1611XX-SCE%20Application%20for%20Approval%20of%20Second%20PRP%20RFO.pdf).

267 *Path 26* is the name for the collection of transmission lines connecting Northern and Southern California.

268 Final resolution E-4798. San Diego Gas & Electric Company (SDG&E) approved of engineering, procurement, and construction contracts with AES Energy Storage LLC., Agenda ID 15088, August 19, 2016. <http://docs.cpuc.ca.gov/PublishedDocs/Published/G000/M166/K269/166269958.PDF>.

269 CPUC/ED staff report the following breakdown: 1,031 MW in 2018 (198MW of EE, 281 MW of DG, and 552 MW of EE) and 1,638 MW in 2022 (198 MW of DR, 457 MW of DG, and 983 MW of EE).

270 CPUC, Decision 14-10-46, *Decision Establishing Energy Efficiency Savings goals and Approving 2015 Energy Efficiency Programs and Budgets (Concludes Phase I of R.13-11-005)*, October 16, 2014, <http://docs.cpuc.ca.gov/PublishedDocs/Published/G000/M129/K228/129228024.pdf>.

271 CPUC, Decision 16-06-029, *Adopting Bridge Funding for 2017 Demand Response Programs and Activities*, June 9, 2016, <http://docs.cpuc.ca.gov/PublishedDocs/Published/G000/M163/K467/163467479.PDF>.

are assumed is difficult. The lag between reported program activity and release of final savings estimates continues to be longer than desired when such large reliance is placed on assumed savings. Slow release of the results of in-depth evaluation, monitoring, and verification of energy efficiency program savings leads to increased uncertainty for preferred resource performance. As discussed below, LCAAT examines the consequences of assumed and discounted performance of energy efficiency programs to determine how such uncertainty affects satisfaction of local reliability requirements.

Transmission Projects

The joint agency team is tracking nine active transmission projects, including two critical transmission lines, and up to 1,800 MVars²⁷² of reactive support.²⁷³ Most of the transmission projects being tracked are on schedule to be in service in summer 2018 and summer 2021. Two large transmission line projects are encountering delays, however, with each possibly leading to reliability concerns unless mitigation measures are undertaken. The transmission projects being tracked, the sponsor, and expected in-service dates are shown in Table 14, with further discussion provided below.

272 An *MVAR* is a mega unit of reactive power in electrical engineering. The basic unit is a *VAR*, or volt amperes reactive.

273 Reactive power (vars) is required to maintain the voltage to deliver active power (watts) through transmission lines. Several devices (rated in MVars) can be used to control reactive power in addition to traditional generating plants.

Table 14: Transmission Projects in the San Onofre Area Affecting Regional Reliability

	Transmission Projects	PTO/Sponsor	Target in-service dates
1	Talega Synchronous Condensers (2x225 MVAR)	SDG&E	In Service 8/7/2015
2	Extension of Huntington Beach Synchronous Condensers (280 MVAR)	SCE	Extended for 1/1/17–12/31/17
3	Imperial Valley Phase Shifting Transformers (2x400 MVAR)	SDG&E	6/1/2017
4	Sycamore Canyon–Peñasquitos 230kV Line	SDG&E	2018
5	Miguel Synchronous Condensers (450/-242 MVAR)	SDG&E	6/1/2017
6	San Luis Rey Synchronous Condensers (2x225 MVAR)	SDG&E	12/31/2017
7	San Onofre Synchronous Condensers (1x225 MVAR)	SDG&E	12/31/2017
8	Santiago Synchronous Condensers (1x225 MVAR)	SCE	12/31/2017
9	Mesa Loop-in Project and South of Mesa 230kV Line Upgrades	SCE	possible delay past 12/31/2020

Source: Southern California Reliability Planning Team, February 10, 2016, and Energy Commission staff updates

The Talega synchronous condensers were completed and placed in service in August 2015. The California ISO Board of Governors extended the reliability-must-run²⁷⁴ contract for the Huntington Beach synchronous condensers through 2017 in August 2016.

The California ISO Board of Governors approved the Imperial Valley phase shifting transformers²⁷⁵ project March 20, 2014, as part of the California ISO’s 2013–2014 TPP. SDG&E is the project sponsor. The project is within existing facility boundaries and is already permitted for this purpose and voltage. Construction started at the end of summer 2016, and the project is targeting installation and energization in the second quarter of 2017.

The California ISO Board of Governors approved the Miguel synchronous condenser project March 20, 2014, as part of the California ISO’s 2013–2014 Transmission

274 The California ISO will allow utilities to generate power that is needed to ensure system reliability. This includes generation required to meet the reliability criteria for interconnected systems operation, needed to meet demand in constrained areas, and needed to provide security support of the California ISO or of a local area.

275 A *phase-shifting transformer* is a device for controlling the power flow through specific lines in a complex power transmission network.

Planning Process (TPP). SDG&E was selected as the project sponsor on September 9, 2014. No application filing is needed since work is within an existing substation; the project is exempt under CPUC General Order 131. A certificate of public convenience and necessity/permit to construct is not required. Construction started January 20, 2016, and the target in-service date is June 2017.

The California ISO board approved the San Luis Rey synchronous condenser project March 20, 2014, as part of the California ISO's 2013-2014 TPP. The project sponsor is SDG&E. The project is within the existing facility boundary, which is already permitted for this purpose and voltage. SDG&E confirmed construction began in May 2015 with the removal of the 138 kV facilities at San Luis Rey. The project in-service date has been shifted from June 2017 to December 2017 due to the unexpected delay of grading permits from the City of Oceanside.

The California ISO board approved the San Onofre Synchronous Condenser project on March 20, 2014, as part of the California ISO's 2013-2014 TPP. The project sponsor is SDG&E. This project is within the existing facility boundary, which is already permitted for this purpose and voltage. The facility was permitted August 13, 2015, and construction started on May 2, 2016. The target in-service date is December 2017.

The CPUC's Legal Division audited the San Onofre and San Luis Rey projects as part of its ongoing review of transmission rate cases for CPUC jurisdictional entities at FERC. On March 17, 2016, a FERC order found the CPUC's arguments outside the scope of the proceeding and encouraged the CPUC to address concerns regarding whether some of SDG&E's projects should be selected in the California ISO's transmission plan in the relevant California ISO transmission planning cycle.²⁷⁶

The California ISO board approved the Santiago synchronous condenser project March 20, 2014, as part of the California ISO's 2013-2014 TPP. The project sponsor is SCE. The project is within the existing facility boundary, which is already permitted for this voltage. This project was formerly collocated with the San Onofre synchronous condenser but then became a separate project with a different sponsor and location due to challenges of constructing two of these dynamic reactive support devices on limited real estate located within the U.S. Marines' Camp Pendleton facility. Onsite construction commenced May 2, 2016, with a targeted in-service date in December 2017.

The two transmission line projects (Sycamore Canyon-Peñasquitos 230 kilovolt [kV] Line and Mesa Loop-in Project and South of Mesa 230 kV Line Upgrades) are in the CPUC permitting process. The 500 kV Mesa Loop-in project is critical for Southern California reliability before summer 2021 as scheduled retirements of OTC units proceed,

276 The California ISO transmission planning process identifies transmission projects that are needed to meet reliability, policy or economic needs. FERC is providing a suggestion to the CPUC that if the CPUC is concerned about which projects are selected in the transmission planning process, they should raise their concerns in the relevant ISO transmission planning cycle.

according to the California ISO's 2015–2016 TPP. SCE filed an application for a permit to construct the Mesa Substation Project with the CPUC on March 13, 2015. A Draft environmental impact report (EIR) was released April 29, 2016, with a 45-day comment period ending June 13.²⁷⁷ SCE is concerned that alternatives to the preferred project identified in the EIR process, if approved, would require substantial engineering redesign of the project, leading to further delays. Comments from the California ISO on June 27, 2016, indicated that two of the three environmentally superior alternatives would not meet all reliability requirements. The Final Environmental Impact Report was released on October 7, 2016. The CPUC expects an expedited proceeding with a possible decision in February 2017.²⁷⁸ The estimated construction period for this project is four and a half years. Delays in completion of the EIR or of the final CPUC decision or a CPUC decision calling for substantial redesign of the project could delay the project in-service date. If the Mesa Loop-In project in-service date is delayed beyond the beginning of summer 2021 and resources are insufficient to satisfy resource adequacy requirements, then a temporary extension of the Redondo Beach or Alamitos, if electrically feasible,²⁷⁹ beyond the December 31, 2020, OTC compliance date could be a potential mitigation option.

The California ISO Board of Governors approved the Sycamore-Peñasquitos project March 20, 2013, as part of the California ISO 2012–2013 TPP. The California ISO selected SDG&E as the project sponsor through a competitive solicitation on March 14, 2014. The project application was filed with the CPUC by SDG&E on April 7, 2014. The CPUC began the California Environmental Quality Act review in August 2014. The final EIR from the CPUC was released on March 13, 2016. A prehearing conference was set for March 28, 2016, with hearings in June 2016. The briefing period concluded June 28, 2016, which triggered a 90-day period, after which the administrative law judge issued a proposed decision. Originally, estimated schedule dates were to have the facility permitted by the end of 2016, with a construction start in January 2017 and an in-service date of March 2018. The CPUC issued a decision approving the project with additional undergrounding on October 13, 2016. It is expected to be in-service June 1, 2018, with an accelerated schedule.

SDG&E is pursuing another transmission line project in the far northern portion of its service area known as the South Orange County Reliability Enhancement (SOCRE) project. While SOCRE is important for reliability of distribution service to its growing

277 Mesa 500-kv Substation Project Home Page,
<http://www.cpuc.ca.gov/environment/info/ene/mesa/mesa.html#DEIR>.

278 CPUC Application 15-03-003, In the Matter of the Application of Southern California Edison Company (U338E) for a Permit to Construct Electrical Substation Facilities with Voltage over 50 kV: Mesa 500 kV Substation Project, Scoping Memo and Ruling of Assigned Commissioner, November 14, 2016,
<http://docs.cpuc.ca.gov/PublishedDocs/Efile/G000/M169/K668/169668697.PDF>.

279 Short circuit duty at the 230/66 kV substations within the greater Los Angeles area may result in circuit breakers stressed beyond the associated rating if both existing and new generating facilities are operated concurrently at Alamitos.

customer load in Southern Orange County, SOCRE is not considered critical to overall San Diego or combined San Diego/greater Los Angeles area regional reliability.²⁸⁰ CPUC D. 16-12-064 approved the project on December 15, 2016.

Contingency Planning

The California ISO modeled these approved transmission projects, the CPUC approved investor-owned utility (IOU) procurement contracts, and additional expected IOU procurement by SCE and SDG&E within remaining LTPP authorized amounts is in the California ISO's 2015-2016 TPP. The California ISO also used the demand forecast approved by the Energy Commission in January 2015 in its 2015-2016 TPP. With these and other study assumptions, the California ISO produced new local capacity area requirements for 2021 and 2025.²⁸¹ The California ISO now believes these requirements are necessary to assure local reliability.

The intent of CPUC D.14-03-004 was to provide sufficient procurement authorization to SCE and SDG&E to enable a combination of preferred resources and conventional generation to satisfy reliability needs in Southern California due to the retirement of San Onofre and the expected retirement during 2017-2020 of several natural gas-fired OTC power plants. As described above, development of preferred resources, conventional generation, and transmission system upgrades is not precisely matching the assumptions used in the studies that were inputs into the CPUC proceeding, nor has the electrical grid evolved in precisely the manner expected at the time of those studies. To address the consequences of these changes, the interagency team agreed that a screening tool was needed to make annual projections of the balance between resources and requirements for local capacity areas and key subareas. If projections revealed deficits, several contingency mitigation measures were needed that could be used to resolve the deficits and avoid the threats to reliability.

Projection Tool for Local Capacity Area Surplus/Deficit Assessments

In 2015, because of concern about the California ISO findings of insufficient resources in 2024, Energy Commission staff developed a Local Capacity Annual Assessment Tool (or LCAAT) to supplement the California ISO's analysis of local capacity requirements.²⁸²

280 SDG&E, oral comment of John Jontry at August 29, 2016, IEPR workshop.

281 *Local capacity areas* (LCA) exist because the topology of the bulk transmission system does not allow peak load within such an area to be fully supported from resources anywhere in the balancing authority area because transmission lines would overload or voltage would be unstable. Each LCA is established by examining the set of transmission line segments between pairs of substations and calculating the maximum combined import capacity. Each LCA must have sufficient generation located within the local area to meet peak load, less the maximum import capacity of the transmission lines connected that area, to the high-voltage transmission system. *Local capacity requirements* (LCR) describe the amount of generating capacity that must be available within the local area.

282 California Energy Commission, *Assessing Local Reliability In Southern California Using A Local Capacity Annual Assessment Tool*, CEC-200-2015-004, August 2015, <http://www.energy.ca.gov/publications/displayOneReport.php?pubNum=CEC-200-2015-004>.

In 2016, Energy Commission staff updated assumptions to match those used in the California ISO's 2015-2016 TPP for its baseline inputs and then used the local area capacity requirements developed by the California ISO.²⁸³ The analysis provides year-by-year projections of resource surpluses or deficits relative to local capacity requirements for five areas within Southern California. This tool can quickly assess the potential consequences of many combinations of input assumptions. In comparison, the California ISO's analysis uses power flow and stability methods in the California ISO's studies that are highly resource-intensive, thus limiting the number of variations that can be assessed with the staffing levels and time constraints of the annual transmission planning process. The caveat is that Energy Commission staff would analyze scenario analyses using the LCAAT tool, and then the California ISO would analyze the Southern California power system using a power flow or stability analysis tool to determine the local capacity requirements to meet applicable national (NERC), regional (WECC), and California ISO planning criteria. The LCAAT tool is a load and resource analysis tool and is intended for screening only. The power flow analysis tool examines the power system in more detail, particularly under contingency conditions where transmission elements, or generating plants, are unavailable.

For 2016, the Energy Commission staff analyses using baseline assumptions show deficits in all five of the local capacity areas or key subareas by 2025. Figure 24 shows the surplus/deficit results for each of the five local capacity areas or key subareas. Of these five areas, the West Los Angeles subarea and the larger San Diego-Imperial Valley local capacity area show deficits beginning in 2021 and extending through 2025, while the San Diego subarea shows deficits in many years throughout the projected time horizon. Although transmission system upgrades and demand-side savings reduce local capacity requirements from what they otherwise would have been, the expected decline of resources due to OTC retirements at the end of 2020 results in deficits by 2021. The pattern of near-term surplus and longer-term deficit was also found in the combined Los Angeles /San Diego subarea in 2015 assessments, but the 2016 assessment shows a deficit only at the end of the projection period.

283 California Energy Commission, *Assessing Local Reliability In Southern California Using A Local Capacity Annual Assessment Tool: 2016 Update*, CEC-200-2015-011, August 2016, <http://www.energy.ca.gov/publications/displayOneReport.php?pubNum=CEC-200-2016-011>.

Figure 24: Baseline LCAAT Projections Showing Local Capacity Surpluses/Deficits

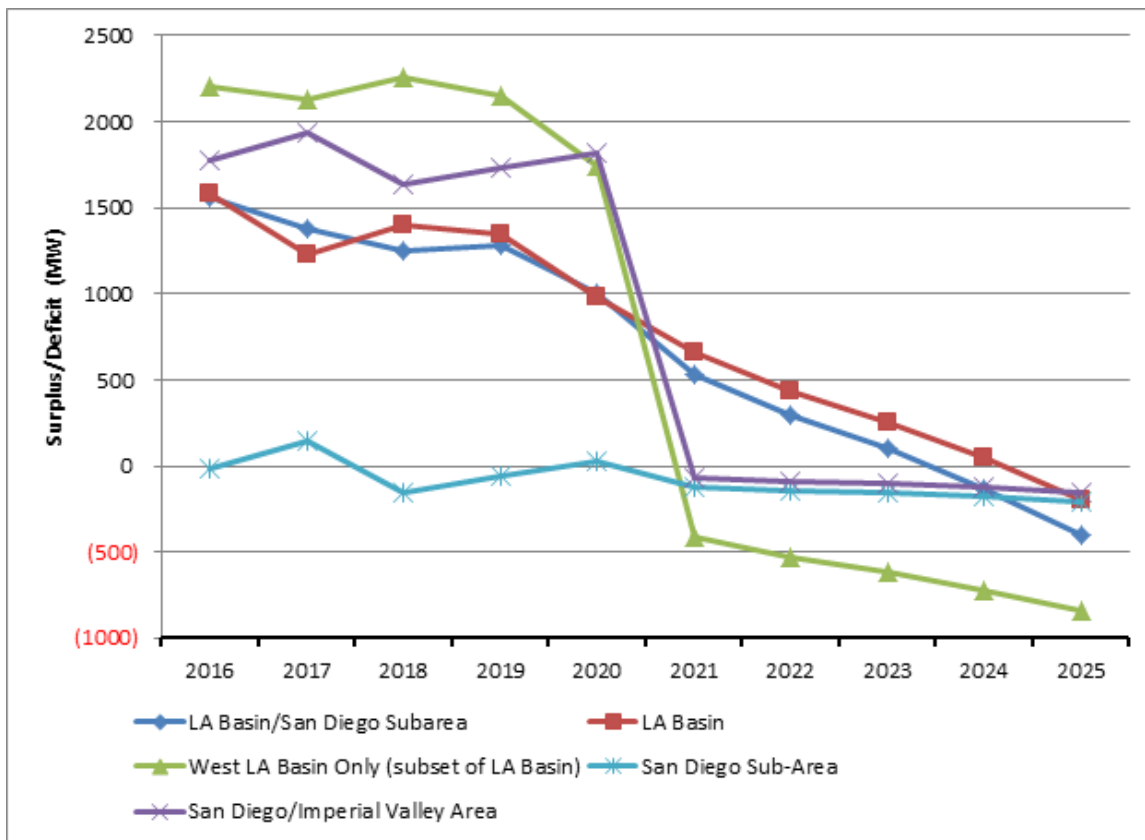

Source: California Energy Commission staff, 2015

Because there is uncertainty surrounding the assumptions used in the baseline assessment, staff conducted both a sensitivity study for the impact of each variable and a scenario study changing assumptions for multiple variables in logical groupings. Variables that were examined in the sensitivity study include peak demand forecast, projections of additional achievable energy efficiency savings, impact on peak demand of customer-side-of-the-meter rooftop photovoltaic capacity, and the amount of existing power plant capacity that retires during the study period. The amount of change tested for each variable was developed from an assessment of the specific factors causing uncertainty for that variable. The sensitivities studied were nearly the same as those for the original 2015 assessment and show a range around the baseline results—either increasing surpluses or worsening deficits. The 2016 assessment added an examination of the *peak shift* phenomenon. *Peak shift* results from high penetrations of behind-the-meter rooftop photovoltaic systems. These systems generate most output in early and midafternoon hours, but output declines rapidly in the late afternoon and early evening. On hot summer afternoons when customer load remains high into early evening hours, almost all load must be satisfied through the grid by supply-side resources; however, because supply-side solar resource production output also declines rapidly in later afternoon and evening hours, the staff analysis derated or reduced the capacity of these

resources in this sensitivity compared to the standard capacity rating convention. Only in the San Diego-Imperial Valley local capacity area are solar supply-side resources a significant share of all resources, leaving this area most affected by the peak shift phenomenon.²⁸⁴ (See Chapter 4: Electricity Demand Forecast Update, “Improvements to Forecast Methods” for more information.)

In addition to the sensitivity study, staff developed two alternative scenarios, including a *high surplus* and a *pessimistic* scenario designed to reflect multiple changes from baseline assumptions. Figure 25 plots the baseline and the two alternative scenarios for the West Los Angeles subarea. Both alternative scenarios show the same basic pattern as the baseline results—substantial local capacity surplus through 2020 and a major decline in local capacity for 2021 due to OTC retirements. The *pessimistic* scenario has a deeper deficit that steadily worsens compared to the baseline through the end of the analysis period. The *high surplus* scenario shows surpluses for all years.²⁸⁵

Figure 26 plots the baseline and two alternative scenarios for the San Diego subarea. As in the case of the West Los Angeles subarea, the pessimistic case is worse than the baseline in all years with the difference growing through time. In the high surplus case, a surplus exists in all years, but the difference between high surplus and baseline is narrowing toward the end of the projection period.

284 The electrical areas defining local capacity areas tend to accentuate dense urban areas with high loads and insufficient transmission capacity to support this load under peak conditions and worst contingencies; thus, substantial internal generation is needed. Urban settings generally do not have available land for wind or solar resource development, so vulnerability of solar supply-side resources to the peak-shift resource derate phenomenon is limited. San Diego-Imperial Valley is the exception to this rule.

285 The high surplus scenario includes the peak demand forecast of the *2015 IEPR*, which does not address the peak shift phenomenon, so a preliminary estimate of increased peak loads to fix this limitation has been added. Energy Commission staff continues to study this phenomenon, expecting to resolve it in the *2017 IEPR* proceeding.

Figure 25: Scenario Projections Showing Local Capacity Surpluses/Deficits for the West Los Angeles Subarea

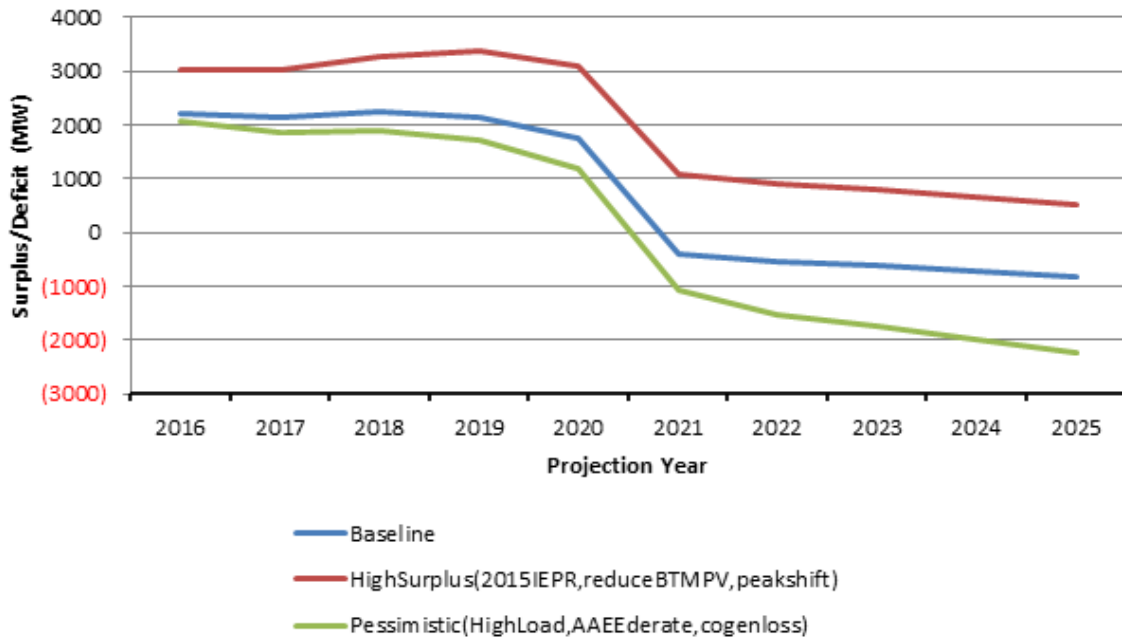

Source: California Energy Commission staff, 2016

Figure 26: Scenario Results Showing Local Capacity Surpluses/Deficits for the San Diego Subarea

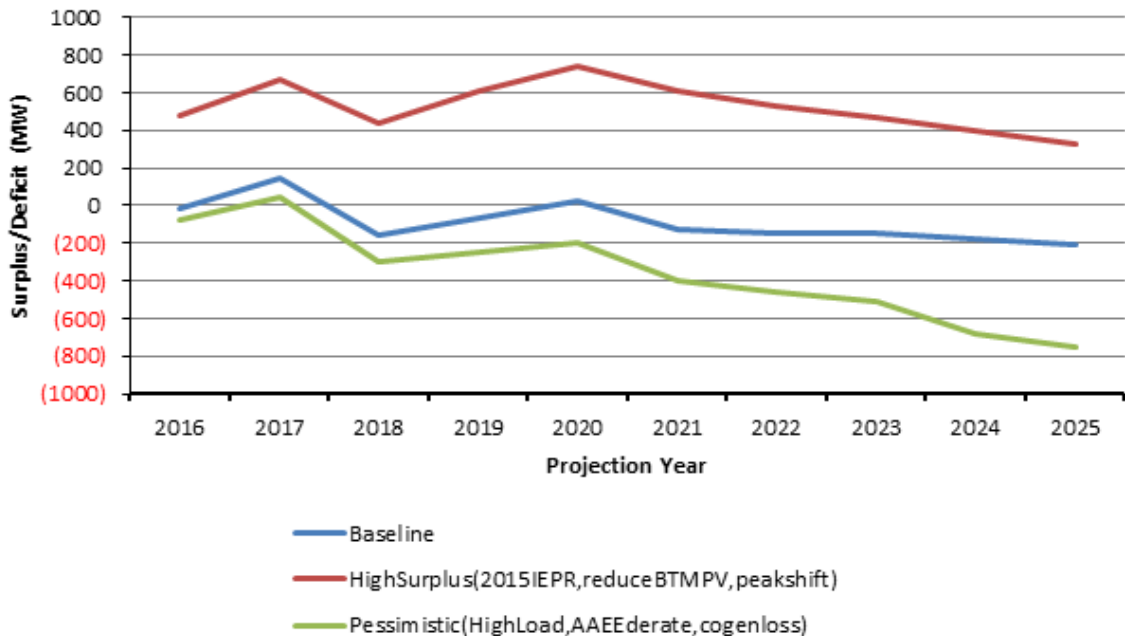

Source: California Energy Commission staff, 2016

Contingency Mitigation Measures

Over the past year, the joint agency Southern California Reliability Project (SCRIP) team has continued to develop contingency mitigation measures that can be triggered if resource expectations do not match requirements. Two concepts introduced at the *2014 IEPR Update* workshop have continued to be refined:

- Requesting SWRCB to defer compliance dates for specific OTC facilities when on-line dates are delayed for a new power plant that would allow retirement of the related OTC facility.
- Developing conventional power plant proposals as far through the permitting processes as practicable, but then holding the projects in reserve to receive final procurement approval and begin construction.

The details of these types of mitigation measures have been refined over the past year. An Energy Commission staff report documents the details for each option.²⁸⁶

OTC Compliance Date Deferral

Efforts to develop the OTC compliance date deferral measure are essentially complete. The sequence of steps has been discussed among the SCRIP team and with SWRCB staff. Five broad steps would be followed in sequence:

- Conduct analyses and prepare a draft report for SACCWIS.²⁸⁷
- Issue draft report for comments, respond to comments, conduct SACCWIS meeting, revise proposal, and submit a formal SACCWIS request to SWRCB.
- Review by the SWRCB of SACCWIS report and prepare staff recommendation.
- Issue public notice, solicit comments, respond to comments, board consideration.
- Prepare Office of Administrative Law package and review by the Office of Administrative Law.

Allowing normal periods for each of the above steps to enable a full public process would take roughly one year, though this could be accelerated if unforeseen circumstances warranted. It might take longer if the energy agencies believed new analyses were necessary in the initial step to substantiate the need for deferral.

286 California Energy Commission, *Mitigation Options for Contingencies Threatening Southern California Electric Reliability*, CEC-200-2016-010, August 2016, <http://www.energy.ca.gov/publications/displayOneReport.php?pubNum=CEC-200-2016-010>.

287 SACCWIS includes seven organizations: California ISO, Energy Commission, CPUC, California Coastal Commission, State Lands Commission, California Air Resources Board (ARB), and SWRCB.

New Gas-Fired Generation Development

At the *2015 IEPR* workshop on Southern California Electricity Reliability, Energy Commission staff, with input from technical staff of the other SCRP agencies, developed a paper outlining three options for a new generation mitigation measure. Following the workshop, the team recommended to executive management that only one option be pursued. In this option, a pool of projects that are already permitted (but do not have power purchase agreements) is identified and monitored. If a contingency is foreseen with appropriate characteristics, one project would be selected, permits would be updated as needed, and a PPA would be drafted, approved, and constructed. This approach takes advantage of an expected pool of projects that either already have or are likely to receive Energy Commission permits, which could “sit on the shelf” for a few years waiting to be triggered if contingencies warrant construction. This approach provides a mitigation measure that could actually be constructed and become operational by summer 2021, while others examined in the *2015 IEPR* proceeding could not come on-line as quickly. Since air quality agencies have made clear that over time permits will become stale and need to be updated, creating further expenses for speculative projects that one hopes will never be constructed, it is unclear how long a pool of projects will persist to make this approach viable beyond the next few years.

Triggering the Mitigation Measures

The contingency process discussed among the SCRP agencies seeks to assure reliability by anticipating any projected shortfall of energy resources needed to meet local capacity requirements. Analysis for the early detection of such shortfalls must be created to accomplish this. As described above, Energy Commission staff has developed a local capacity projection tool that builds off California ISO power flow study results for snapshot years to provide a year-by-year accounting for resource surpluses or deficits compared to local capacity requirements. A protocol would be developed to determine whether any projected shortfalls revealed by this tool justify a recommendation to trigger mitigation measures. The California ISO would be asked to conduct confirmatory power flow studies to verify the conclusions of the projection tool in some instances. The nature and expected duration of a deficit would help choose between the two mitigation options developed to date. For example, a temporary deficit induced by a delay in the on-line date of a replacement power plant would logically lead to choosing the OTC deferral option.

Alternatively, if the expected deficit is shown to persist, then something more fundamental is creating the problem. Examples resulting in this pattern include inconsistencies between current reliability study results and the assumptions used to authorize procurement, failure of preferred resources to develop at the level hoped for when planning assumptions were created, or unexpectedly large retirements due to more stringent air quality regulations than previously expected. If the energy agencies' leadership recommends triggering mitigation measures, then the applicable agencies

overseeing the approval of a specific mitigation measure would implement proposed actions, according to established approval processes.

Assessing Progress

The Energy Commission has been hosting a series of workshops with commissioners and executives of key agencies since 2013 to discuss Southern California reliability issues. As evident from workshops in previous IEPR cycles, and the most recent workshop held August 29, 2016, the Energy Commission and the collaborating agencies in the SCRP are committed to assuring electrical reliability for the region. The coordinated planning discussed at the workshop promotes this goal. All the procedural opportunities to participate in the decision-making processes of the agencies continue to exist and will allow stakeholders to provide input if specific projects are proposed. The Energy Commission anticipates a similar update from the staff of the key agencies in another workshop next summer as part of the *2017 IEPR* proceeding.

Public Comments

On August 29, 2016, the Energy Commission hosted a public workshop to review the progress since the August *2015 IEPR* workshop to implement the preliminary reliability plan and help assure electricity reliability in Southern California. The management of the Energy Commission, the California ISO, the South Coast Air Quality Management District, the SWRCB, and the CPUC participated. Staff of the agencies, utilities, and air permitting districts provided updates on their respective areas of expertise.

Substantive comments focused on two dimensions of staff's analyses: whether the energy resource tabulation was overstating resource availability and thus understating the size of deficits in key areas, and whether further options should be considered to address the reliability problems revealed by the analysis. Regarding the nature of the problem, the Independent Energy Producers Association (IEP) supported staff conclusions that resource deficits in key areas required action by the energy regulatory agencies to resolve the deficits. Cogentrix, an independent power producer, asserted that the nature of the problem was actually worse than the staff analysis indicates, because staff's modeling incorrectly assumes that generating resources currently available will continue to be available until a prescribed retirement age is reached. Cogentrix says this assumption (common to California ISO local capacity study accounting practices as well) overstates the willingness of some generator owners to remain within the California market when financial returns are insufficient. Cogentrix illustrates the consequences for the San Diego subarea if it were to relocate its two peaking facilities to other locations in the United States where longer-term contract opportunities exist. Withdrawing their 99 MW of capacity of these facilities would place San Diego subarea into a clear deficit condition in all future years.

Regarding solutions to these local capacity area deficits, both IEP and Cogentrix assert that additional mitigations should be implemented. IEP suggests that an all-source RFO be implemented that would acquire fully complete projects deliverable in the first

quarter of 2021 in the western Los Angeles area. It appears that this approach is a broadening of the staff's new construction option that would add any generating resources which could be designed, permitted, and constructed as quickly as those that are permitted or about to be permitted. Cogentrix proposes a more comprehensive change to the current market structure that would provide resource contracting opportunities to assure the financial viability of flexible facilities located in local capacity areas. In this manner Cogentrix's approach assures the continued presence of existing resources in local areas for local reliability, and assures that resources being operated in a flexible manner continue to be available to integrate supply-side renewable resources and behind-the-meter solar resources into the grid.

After carefully reviewing comments received on the *Draft 2016 IEPR Update* that echoed their comments at the workshop,²⁸⁸ Energy Commission staff is committed to studying forward contracting of flexible resources in the *2017 IEPR*. Staff will examine how much flexible capacity is available under contract, estimate the reserve margin, and identify any actions needed to better ensure reliability.

Recommendations

Aliso Canyon

- **Continue coordinated action plan monitoring and implementation to address the energy reliability risks in light of changes in the use of the Aliso Canyon storage facility.** The Energy Commission, California Public Utilities Commission (CPUC), California Independent System Operator (California ISO), and Los Angeles Department of Water and Power (LADWP) should continue to work together to analyze and assess the energy reliability impacts of constrained operations at Aliso Canyon and develop and implement action plans to address those risks. The actions plans should help reduce reliance on Aliso Canyon.
- **Monitor, evaluate, and refine as needed the tariff and market changes needed to reduce daily imbalances in gas scheduling for the greater Los Angeles area.** The Energy Commission, CPUC, California ISO, and LADWP should evaluate the effectiveness of tariff changes for tighter gas balancing rules and California ISO market changes and determine whether any further tariff changes are necessary.
- **Monitor the electricity and natural gas markets for any signs of market manipulation.** The Federal Energy Regulatory Commission and the California ISO should continue market monitoring to ensure well-functioning markets and avoid market manipulation.

288 http://docketpublic.energy.ca.gov/PublicDocuments/16-IEPR-01/TN214410_20161107T161143_Greg_Blue_Comments_Cogentrix_Comments_on_Draft_2016_IEPR_Update.pdf.

- **Continue to advance and align state programs to quantify and reduce methane emissions from the natural gas system.** Coordinated California Air Resources Board (ARB) and Energy Commission programs to research and monitor methane leakage must continue and be expanded. A continuous effort for at least five more years is reasonable. The studies must include investigation on how to cost-effectively reduce emissions due to leakage and corroborate reported emission reductions in the future.

Transportation Fuel Supply

- **Encourage regular communication between natural gas producers and refiners about curtailment flexibility.** Refining companies in Southern California should remain in continual contact with SoCalGas, Southern California Edison, and LADWP, forecasting and planning for a potential curtailment, and should construct a plan to reduce natural gas use, while maintaining transportation fuel production. In the long-term, refineries should consider possible efficiency improvements to reduce future exposure to natural gas and electricity curtailments. The Energy Commission will use its Petroleum Industry Information Reporting Act data request authority to monitor the situation as needed.

San Onofre Shutdown and Once-Through Cooling Compliance

- **Assure local reliability in San Diego.** Inter-agency staff (staff from the Energy Commission, CPUC, California ISO, and ARB) should prepare a draft report for consideration by Statewide Advisory Committee on Cooling Water Intake Structures (SACCWIS) that recommends deferral of Encina’s once-through cooling compliance dates until Carlsbad comes on-line. The interagency staff should identify specific units at Encina for which to request deferral based on studies by the California ISO, with the study results and inputs agreed upon by the joint agency team.
- **Assure that energy resources needed for local reliability remain available.** The Energy Commission will direct its staff to study forward contracting in the *2017 Integrated Energy Policy Report*, using contract data obtained from the CPUC. The study would identify the extent to which various types of energy resources may be vulnerable to premature retirement and/or relocation and will consider needed actions. The CPUC should consider revising its resource adequacy program to require that resources required for local reliability are contracted sufficiently forward to assure availability until new options can be assessed, permitted, and developed.²⁸⁹

289 In R.14-10-010, Assigned Commissioner Florio issued a revised Scoping Memo and Ruling that includes consideration of multiyear forward resource adequacy requirements. This may be a vehicle to address the general issue raised by IEP and Cogentrix or the narrower issue of assuring local requirements. See <http://docs.cpuc.ca.gov/PublishedDocs/Efile/G000/M166/K987/166987422.PDF>.

- **Develop projections for local reliability resulting from generation, preferred resources, and transmission projects.** Reduce time lags in reporting evaluated preferred resource performance as these are the basis for expected future performance. Continue to enhance and upgrade the Local Capacity Area Assessment tool. Continue support from agencies to vet and report results to the Energy Principals.
- **Continue focus on implementing the Southern California Reliability Action Plan.** The preferred resources, transmission upgrades, and conventional generation identified in this 2013 report are crucial to continuing electric reliability.
- **Continue to develop contingency planning mitigation measures and options.** Continue to refine contingency mitigation options, especially issues of longevity or air permits, and be ready to take appropriate mitigation action if substantial delays are expected.
- **Continue the Southern California Reliability Project agency team.** The multiagency team should continue the timely monitoring and information sharing activities now in place.

CHAPTER 3:

Climate Adaptation and Resiliency

California is experiencing the effects of climate change, requiring action to protect lives, livelihoods, and ecosystems while working to limit climate change in accord with national, international, and subnational policy. Impacts of climate change on California include higher temperatures; changes in precipitation patterns; increased risk of extreme events such as wildfires, inland flooding, and severe storms; and sea level rise.²⁹⁰ For example, longer and more frequent drought is anticipated with climate change. Impacts of California's current drought are far-reaching, including the death of more than 102 million trees since 2010, largely due to bark beetle infestation of drought-stressed trees.²⁹¹ The 13 largest wildfires burned in California since 2000.²⁹² Climate change impacts to U.S. military installations put its military operations at greater risk and could increase international conflict.²⁹³ These are just a few examples of the effects of climate change. A growing body of new policies—called climate adaptation, preparedness, or resilience—is intended to grapple with what is known from climate science and incorporate planning for climate change into the routine business of governance, infrastructure management, and administration. The focus of this chapter is on these policies and the related research and implementation for California's energy sector.

This chapter begins with background on the developments in climate-related policy affecting California, including federal efforts, and recent additions to California's efforts to adapt to climate change. The chapter then reviews the strategic research response underway to assist climate adaptation and vulnerability studies in the state's energy sector. It outlines lessons and themes from the June 21, 2016, Integrated Energy Policy Report (IEPR) workshop on climate adaptation and resiliency for the energy sector. A key factor in adaptation efforts is preparing for sea level rise; for the energy sector, considering sea level rise is relevant particularly with respect to siting new power plants and other energy infrastructure projects. This chapter therefore discusses the

290 Summary information available at <http://www.energy.ca.gov/publications/displayOneReport.php?pubNum=CEC-500-2012-007>. Publication # CEC-500-2012-007. July, 2012. For more complete information on the Third Assessment from the California Climate Change http://www.climatechange.ca.gov/climate_action_team/reports/third_assessment/index.html.

291 <https://www.fs.fed.us/news/releases/new-aerial-survey-identifies-more-100-million-dead-trees-california>.

292 http://www.fire.ca.gov/communications/downloads/fact_sheets/Top20_Acres.pdf.

293 <http://www.reuters.com/article/us-usa-climatechange-idUSKCN11K0BC> and Center for Climate and Security, *Military Expert Panel Report: Sea Level Rise and the U.S. Military's Mission*, September 2016, <https://climateandsecurity.org/reports/#CORRELATIONS>.

development of a set of common climate and sea level rise scenarios for use in energy infrastructure planning.²⁹⁴

Prior *IEPRs* have addressed the science of climate impacts²⁹⁵ which will not be repeated here. The Energy Commission is supporting energy sector vulnerability and adaptation studies that will enhance understanding of climate impacts and will contribute to *California's Fourth Climate Change Assessment*. These studies are ongoing and will be completed in late 2018.

U.S. and California Adaptation Policy Developments

In the past three years, California and the United States enacted a suite of climate adaptation policies with implications for California's energy sector. These include state and national executive orders and state-level legislation.

The *2009 Climate Adaptation Strategy*,²⁹⁶ developed in response to Executive Order S-13-2008, delineated general principles of adaptation that state agencies were directed to follow.

Governor Brown's Executive Order B-30-15 mandates expansion of state adaptation efforts, with the goal of making the anticipation and consideration of climate change a routine part of planning. Specifically, Executive Order B-30-15 directs state agencies to incorporate climate change impacts into the state's Five-Year Infrastructure Plan; factor climate change into state agencies' planning and investment decisions; and regularly update the state's adaptation plan, *Safeguarding California Plan*, to identify how climate change will affect California infrastructure and industry, and what actions the state can take to reduce the risks posed by climate change. The executive order provides four guiding principles:

- Prioritizing win-win solutions for emissions reduction and preparedness.
- Promoting flexible and adaptive approaches.
- Protecting the state's most vulnerable populations.
- Prioritizing natural infrastructure solutions.

Finally, Executive Order B-30-15 directs state agencies supporting climate science to maintain strong support for state-supported regional climate science.

294 Although both climate and sea level rise scenarios may also be used by other state agencies for other purposes, for example, by the Ocean Protection Council to inform guidance documents, the focus in this report is the application of scenarios to energy sector adaptation.

295 California Energy Commission. 2015. *2015 Integrated Energy Policy Report*. Publication Number: CEC-100-2015-001-CMF, http://docketpublic.energy.ca.gov/PublicDocuments/15-IEPR-01/TN212018_20160629T154356_2015_Integrated_Energy_Policy_Report_Full_File_Size.pdf.

California Energy Commission. 2015. *2014 Integrated Energy Policy Report Update*. Publication Number: CEC-100-2014-001-CMF, <http://www.energy.ca.gov/2014publications/CEC-100-2014-001/CEC-100-2014-001-CMF.pdf>.

296 See <http://www.energy.ca.gov/2009publications/CNRA-1000-2009-027/CNRA-1000-2009-027-F.PDF>.

Also in 2015, three adaptation bills became law in California, and an additional bill became law in 2016. Collectively, these bills will enhance California's capacity to anticipate and remain resilient in the face of climate change, at local and regional levels, across a variety of economic sectors, and in a manner that protects people, places, and resources.

- Senate Bill 379 (Jackson, Chapter 608, Statutes of 2015) requires local hazard mitigation plans developed by cities and counties to address climate adaptation and resilience. Senate Bill 379 explicitly names Cal-Adapt²⁹⁷ as a source of information to help cities and counties assess local vulnerabilities to climate change.
- Senate Bill 246 (Wieckowski, Chapter 606, Statutes of 2015) establishes a Climate Adaptation and Resiliency Program to be administered by the Governor's Office of Planning and Research (OPR). The bill requires the program to coordinate regional and local efforts with state adaptation strategies, perform periodic reviews of the *California Adaptation Planning Guide*, and establish a clearinghouse of information on adaptation.
- Assembly Bill 1482 (Gordon, Chapter 603, Statutes of 2015) requires the California Natural Resources Agency (CNRA) to update the state's adaptation plan triennially and requires state agencies to integrate adaptation concerns into planning, as well as consider the use of natural systems and natural infrastructure in adaptation. Assembly Bill 1482 also expands the role of the Strategic Growth Council to foster implementation of the state's adaptation strategy.
- Assembly Bill 2800 (Quirk, Chapter 580, Statutes of 2016) requires state agencies to take into account the current and future impacts of climate change when planning, designing, building, operating, maintaining, and investing in state infrastructure. The bill, by July 1, 2017, and until July 1, 2020, requires CNRA to establish a Climate-Safe Infrastructure Working Group for examining how to integrate scientific data concerning projected climate change impacts into state infrastructure engineering.

At the national level, President Obama signed Executive Order 13563 "Preparing the United States for Impacts of Climate Change" on November 1, 2013. Following Hurricane Sandy, Executive Order 13563 requires federal agencies to begin preparing the nation for the impacts of a changing climate.²⁹⁸ The U.S. Department of Energy (DOE) has implemented several actions. Notably, the agency created the Partnership for Energy

297 Cal-Adapt (<http://cal-adapt.org/>) is an interactive website initially developed under the Public Interest Energy Research (or PIER) Program to make California climate science available and accessible to the public, utilities, and decision makers.

298 See <http://resources.ca.gov/climate/safeguarding/>.

Sector Climate Resilience (DOE Partnership).²⁹⁹ This is a voluntary group of electric utilities that are developing and pursuing strategies to reduce climate and weather-related vulnerabilities. Several major utilities in California are participating in this effort, including, Pacific Gas and Electric (PG&E), Sacramento Municipal Utility District, San Diego Gas & Electric (SDG&E), and Southern California Edison (SCE). Finally, the Obama administration announced on May 10, 2016, the start of public and private sector efforts to increase community resilience through building codes and standards that would ease climate impacts.³⁰⁰

Adaptation Activities in California’s Energy Sector

In compliance with Executive Order B-30-15, the CNRA issued *Safeguarding California: Implementation Action Plans*, composed of sector-specific adaptation plans, in early 2016.³⁰¹ One of the adaptation plans—the Energy Adaptation Plan—was prepared under the leadership of the Energy Commission, the California Public Utilities Commission (CPUC), and the California Department of General Services. This plan includes commitments to:

- Establish the Energy Adaptation Working Group between the Energy Commission and the CPUC to design, implement, and monitor adaptation actions for the energy sector.
- Work with the DOE, the investor-owned utilities (IOUs), and the publicly owned utilities (POUs) on the vulnerability assessments resilience plans that they have agreed to produce as part of their membership in the DOE Climate Resilience Partnership.
- Work with other California IOUs and POUs and other energy utilities and entities that are part of natural gas (Energy Commission and CPUC) and transportation fuel systems (Energy Commission only) to implement a program similar to the DOE Climate Resilience Partnership.
- Collaborate on research needs and efforts within the Energy Commission and CPUC to ensure that research produces actionable science.
- Formalize the Energy Commission climate and sea level rise scenarios as part of an effort to foster science-driven decisions.
- Encourage cooperation and collaboration among all utilities and the various regional climate resilience collaborators.

299 Ibid.

300 Ibid.

301 Ibid.

Work to implement the commitments in the *Safeguarding California Plan* is underway. For example, the Energy Commission Chair Robert B. Weisenmiller and CPUC Commissioner Liane Randolph initiated the Energy Adaptation Working Group that includes representatives from OPR, CNRA, and the Governor’s Office of Emergency Services. The working group defines climate adaptation for the energy sector as:

*Planning and implementation to provide reliable and accessible energy in California, accounting for current and projected effects of climate change, and including iterative learning mechanisms to refine efforts as climatic conditions and scientific knowledge evolve.*³⁰²

Thus, implementing climate adaptation for the energy sector relies on science, allowing for realism about future conditions and needs, and builds in the means to revise strategies as needed to better meet changing conditions and improve system resiliency. Ongoing work is advancing climate science as it applies to California’s energy sector as discussed below.

Climate Research in Support of Energy Sector Resiliency

In February 2015, California released its *Climate Change Research Plan*,³⁰³ which articulates near- and mid-term climate change research needs to ensure that the state stays on track to meet its climate goals. Since 2006, California has produced three scientific climate change assessments that have been instrumental in guiding state policy and supporting informed responses to climate change. California’s *Fourth Climate Change Assessment*, to be released in late 2018, is the first interagency effort to implement a substantial portion of this *Climate Change Research Plan*. The effort integrates research results across sectors to develop consistent adaptation strategies that can be used by public and private stakeholders. As climate science and knowledge about local and regional vulnerabilities continue to evolve, it is critical that California continue to invest in regionally relevant climate science. Designed to complement local, federal, and international efforts, *California’s Fourth Climate Change Assessment* will advance actionable science that serves the growing needs of state- and local-level decision makers from a variety of sectors.

The Energy Commission supports research with the aim of improving the reliability and resilience of California’s natural gas, electricity, and transportation fuels (petroleum) systems to climate change while still meeting California’s climate and environmental goals. Energy sector adaptation research has been designed to promote “win-win” strategies that deliver benefits under current as well as expected future climate conditions; unify adaptation and mitigation strategies; and deliver practical results in

302 Informally adopted during the first meeting of the Energy Adaptation Working Group on January 15, 2016.

303 See http://www.climatechange.ca.gov/climate_action_team/reports/CAT_research_plan_2015.pdf.

collaboration with key stakeholders, including utilities. These guiding principles are discussed below.

Win-win strategies: California’s energy system has been tested by extreme weather and climate-related events, including wildfire, drought, and coastal and inland flooding. Well-planned responses to these extremes and hazards can provide useful information regarding how to respond to climate-linked extremes in the future. Technologies and management and planning strategies, such as determining the best locations for microgrids, designed to increase the resilience of the state’s energy sector to climate change can be used to protect against immediate hazards and extreme events. These “win-win” strategies deliver benefits today while hedging against worsening climate change tomorrow. For example, seasonal (months in advance) and decadal (10 or more years) probabilistic climate forecasts can be extremely useful to improve the management of energy systems. This practice has been shown to also be extremely useful as an adaptation tool. One example is the Integrated Forecast and Reservoir Management (INFORM) system, a decision-support tool that incorporates probabilistic forecasts into the management of state and federal reservoirs in Northern California.³⁰⁴ Studies of INFORM demonstrated that incorporation of forecasts produced better results for water management, hydropower, and environmental protection of aquatic habitat. For the climate scenarios tested in the study, researchers found INFORM consistently outperformed existing management practices in providing water deliveries during droughts, maintaining firm energy generation, and sustaining favorable environmental conditions in the San Francisco Bay Delta.³⁰⁵

Integration of mitigation and adaptation: The state’s *Climate Change Research Plan* for California identifies the integration of climate change mitigation and adaptation efforts as a priority for state-sponsored research.³⁰⁶ This integration is also consistent with Executive Order B-30-15, which requires state agencies’ planning and investment be guided by the principle of prioritizing “actions that both build climate preparedness and reduce [greenhouse gas] emissions.” Research on energy sector adaptation incorporates this imperative by considering adaptation strategies that will simultaneously achieve mitigation goals, and vice versa. For example, a trilogy of collaborative research projects exploring long-term energy scenarios for California is taking into account not only 2030 and 2050 emissions reductions goals, but also concerns about resilience to a changing climate.

304 Hydrologic Research Center and Georgia Water Resources Institute, 2013. *Integrated Forecast and Reservoir Management (INFORM): Enhancements and Demonstration Results for Northern California (2008-2012)*. California Energy Commission. Publication number: CEC-500-2014-019. <http://www.energy.ca.gov/publications/displayOneReport.php?pubNum=CEC-500-2014-019>.

305 HRC-GWRI, 2011. *Climate Change Implications for Managing Northern California Water Resources in the Latter 21st Century*. California Energy Commission, PIER Energy-Related Environmental Research. CEC-500-2010-051. <http://www.energy.ca.gov/2010publications/CEC-500-2010-051/CEC-500-2010-051.pdf>.

306 Climate Action Team, 2015, *Climate Change Research Plan for California*, http://climatechange.ca.gov/climate_action_team/reports/CAT_research_plan_2015.pdf.

Bottom-up studies to complement scenario-based analyses: Informing on-the-ground adaptation efforts requires knowledge of site-specific vulnerabilities, in addition to possible scenarios to which systems may be subjected. A recently concluded project led by Professor John Radke from the University of California, Berkeley, using a three-dimensional hydrodynamic model applied to the San Francisco Bay Area and the Sacramento-San Joaquin Delta concluded that specific portions of the PG&E transmission pipelines should be protected if sea level is higher than 1 meter. PG&E provided strong technical support for this project. PG&E concluded that immediate actions are not needed because sea level rise on the order of 1 meter is not expected until the end of this century. More importantly, protective measures could be implemented with normal upgrades of the natural gas system, decreasing the cost of adaptation.³⁰⁷

Status, Lessons Learned From Current Adaptations Activities for the Energy Sector

Past and current adaptation activities in California provide early lessons that can be used to inform future actions. This section discusses these lessons and additional complementary approaches as highlighted in presentations and discussion at the June 21, 2016, IEPR workshop on climate adaptation. The workshop included a review of recent climate adaptation policies and programs that focus on energy issues at the national, state, and regional levels. Energy Commission staff and researchers presented recent enhancements to existing tools that support climate adaptation planning for the energy sector. Representatives from state agencies, POU, IOU, and other groups participated in a panel discussion on their efforts to increase the resiliency of California's energy system to climate impacts.

Agencies Are Already Supporting Adaptation Through the Development of Tools and Guidance

As discussed at the workshop, state agencies are already working on adaptation in multiple ways. Examples of incorporating adaptation planning include, among other things, issuing guidance on how to protect natural and man-made resources from sea level rise and including climate change and climate extremes as one of the multiple hazards facing California.^{308, 309} California has supported the development of tools to

307 Radke, J., G. Biging. *Assessment of Bay Area Natural Gas Pipeline Vulnerability to Climate Change*. University of California, Berkeley. Draft Final PIER Natural Gas Report.

308 Presentation by Deborah Halberstadt, Deputy Secretary for Ocean and Coastal Matters, California Natural Resources Agency. June 21, 2016, IEPR workshop.

Ewing, L., "Sea Level Rise Policy Guidance and Support for Local and Regional Efforts," California Coastal Commission, June 21, 2016, IEPR workshop.

309 Curry, T., "Building Resiliency for All Hazards," Governor's Office of Emergency Services, June 21, 2016, IEPR workshop.

identify physical climate impacts and ways to adapt to these impacts. Many of these tools are already in use for adaptation planning.

For example, as discussed at the workshop and later in this chapter, energy utilities are relying heavily upon Cal-Adapt to develop vulnerability assessments—a precursor to adaptation plans—for the DOE Partnership. Cal-Adapt is an interactive web site that offers tools, climate data, and resources to communicate local risks related to climate change, as well as offering support with research, adaptation planning, and the development of customized applications. The Energy Commission is rolling out Cal-Adapt 2.0, which offers substantial enhancements to the original version (released in June 2011). Enhancements include improved fidelity regarding projected temperature extremes as well as spatial distribution of precipitation, an Applications Programming Interface that supports third-party development of custom tools that leverage data on Cal-Adapt, alignment with the current scenarios and Global Climate Models used by the International Panel on Climate Change, and the capability to visualize and analyze several preloaded shape files (for example, census tracts tagged with CalEnviroScreen scores, watersheds, and counties) or a user-specified shape file.

There are other tools in addition to Cal-Adapt, that have proved useful for decision makers. A version of the Climate Console tool, developed by the Conservation Biology Institute,³¹⁰ was instrumental in preparing the *Desert Renewable Energy Conservation Plan*.³¹¹ Also, the CoSMoS tool, developed to estimate how the California shoreline would evolve with sea level rise, is used in research projects³¹² supported by the Energy Commission to identify risks for energy coastal infrastructures.

At the workshop, Commissioner Karen Douglas from the Energy Commission noted that “most if not all our decisions” address issues in the natural environment that are affected by climate change. She stated, in reference to Cal-Adapt and the tools highlighted above, that “we need these kinds of tools to...meet the promise of... making climate science actionable in the adaptation realm.”³¹³

At the workshop, the CPUC reported that the agency has encouraged IOUs to expand their climate adaptation assessments.³¹⁴ For example, the CPUC encouraged IOUs to

310 <http://climateconsole.org/ca>.

311 <http://www.drecp.org/>.

312 For example, projects with the University of California at Santa Cruz and Irvine and ICF looking at the vulnerability of electricity and natural gas infrastructure to sea level rise.

313 IEPR workshop on Climate Adaptation and Resiliency for the Energy Sector, June 21, 2016, http://docketpublic.energy.ca.gov/PublicDocuments/16-IEPR-04/TN212477_20160727T135220_Transcript_of_the_06212016_Joint_IEPR_Workshop_on_Climate_Adapt.pdf, p. 113.

314 See also, Ralff-Douglas, Kristin, *Climate Adaptation in the Electricity Sector: Vulnerability and Resiliency Plans*. California Public Utilities Commission. January 6, 2016. [http://www.cpuc.ca.gov/uploadedFiles/CPUC_Public_Website/Content/About_Us/Organization/Divisions/Policy_and_Planning/PPD_Work/PPD_Work_Products_\(2014_forward\)/PPD%20-%20Climate%20Adaptation%20Plans.pdf](http://www.cpuc.ca.gov/uploadedFiles/CPUC_Public_Website/Content/About_Us/Organization/Divisions/Policy_and_Planning/PPD_Work/PPD_Work_Products_(2014_forward)/PPD%20-%20Climate%20Adaptation%20Plans.pdf).

consider in their planning current and future generation and distribution assets not owned by the utilities, the entire supply chain for fuel and critical infrastructure components, and interdependencies with the telecommunication sector and water sector, and other parts of the electricity network in the western United States. Energy Commission staff reported that it is supporting these efforts with energy research, including the creation of climate scenarios and tools that are available for energy entities such as POU's and stakeholders in the petroleum sector to use.³¹⁵

Further, as mentioned above, the Energy Commission is collaborating with Governor's Office of Planning and Research, CNRA, and the CAT Research Working Group to guide research on climate adaptation through California's Climate Assessment. Regarding the choice of climate models for research, of the ten global climate models recommended for use by the California Department of Water Resources (DWR) Climate Change Technical Advisory Group (CCTAG), the Climate Action Team Research Working Group prioritized 4 models for use in *California's Fourth Climate Change Assessment*, based on the ability of the models to capture key processes of concern for water resources. These models represent systematic selection based on metrics related to the state's climate vulnerability: HadGEM2-ES (warm/dry); CNRM-CM5 (cool/wet), CanESM2 (average), and MIROC5 (spans range of variability). The other six downscaled climate models suggested by the California Department of Water Resources CCTAG include ACCESS-1.10, CCSM4, CESM1-BGC, GFDL-CM3, HadGEM2-CC, and CMCC-CMS. All of these models combined with RCP 4.5 and RCP 8.5 and downscaled according to the LOCA methodology are available through the beta site for Cal-Adapt 2.0 (<http://beta.cal-adapt.org/>). The four priority global climate models selected, in general, cover the range of outcomes from all the global climate models that were available for the last report from the Intergovernmental Panel on Climate Change. The selection was done for practical reasons, given the fact that the vast majority of the groups participating in the Fourth Climate Assessment will not be able to handle more than four climate scenarios.

Working Across Sectors, Threats, and Geography is Imperative

The energy sector in California cannot be resilient without consideration of other sectors and resources upon which it depends. At the June 21, 2016, IEPR workshop, Peter Gleick, president of the Pacific Institute, suggested that water, in particular, is critical for safe and resilient power generation.³¹⁶ (For further discussion on water use in the electricity sector, see Chapter 1: Environmental Performance of the Electricity Generation System, "Power Plant Cooling Water Use and Conservation.") Also, discussion at the workshop illustrated how California's vulnerability to climate change extends

315 Franco, Guido, and Kristin Ralff-Douglas, "California Public Utilities Commission/California Energy Commission Adaptation Working Group," California Public Utilities Commission and California Energy Commission, June 21, 2016, IEPR workshop on Climate Adaptation and Resiliency for the Energy Sector.

316 Gleick, P., "Water, Drought, Climate Change, and Social Vulnerability," Pacific Institute, June 21, 2016, IEPR workshop on Climate Adaptation and Resiliency for the Energy Sector.

beyond its borders and immediate assets. For example, the 2011 floods in Thailand had consequences for California’s Silicon Valley because its supply chain was partially dependent on the area.³¹⁷ Further, climate impacts are not discrete events. Neil Miller, executive director of Infrastructure Development at the California Independent System Operator (California ISO), suggested at the June 21, 2016, IEPR workshop that the California ISO needs to explore more aggressively the links between factors such as heat waves and fire risks rather than planning for them as independent events that are unlikely to happen at the same time. Mr. Miller suggested turning to the “climate scenarios that are being developed to help better understand the linkages.”³¹⁸ Dr. Susanne Moser,³¹⁹ an expert on climate adaptation, suggested that utilities, agencies, and the energy sector in general need to look broadly to truly assess climate vulnerability and options for adaptation.³²⁰ Even within the same sector, preparing for climate change across geography includes—at a minimum—working across utility territories and balancing authorities.

Transdisciplinary Work Is a Vehicle for Meaningful Adaptation

At the workshop, Dr. Moser also emphasized that meaningful engagement with stakeholders at multiple levels of adaptation research and planning³²¹ is critical if the research is to inform decisions at the local or regional levels and/or spur action in the private sector.³²² This theme was echoed by Larry Greene, Vice Chair of the Alliance of Regional Collaboratives for Climate Adaptation (ARCCA).³²³ Whitney Albright, the

317 Moser, S. C., “Linking Climate Scenarios to Planning and Decision-Making,” Stanford University, June 21, 2016, IEPR workshop on Climate Adaptation and Resiliency for the Energy Sector, http://docketpublic.energy.ca.gov/PublicDocuments/16-IEPR-04/TN212477_20160727T135220_Transcript_of_the_06212016_Joint_IEPR_Workshop_on_Climate_Adapt.pdf.

See also Moser, S.C. and J.A.F. Hart, 2015, *Climatic Change*, 129: 13. doi:10.1007/s10584-015-1328-z.

318 Miller, N., “Linking Climate Scenarios to Planning and Decision Making,” California Independent System Operator, June 21, 2016, IEPR workshop on Climate Adaptation and Resiliency for the Energy Sector, http://docketpublic.energy.ca.gov/PublicDocuments/16-IEPR-04/TN212477_20160727T135220_Transcript_of_the_06212016_Joint_IEPR_Workshop_on_Climate_Adapt.pdf.

319 Dr. Moser is the Director and Principal Researcher of Susanne Moser Research & Consulting, a Social Science Research Fellow at the Woods Institute for the Environment at Stanford University and a Research Associate at the University of California, Santa Cruz, Institute for Marine Sciences.

320 Moser, S. C., “Linking Climate Scenarios to Planning and Decision-Making,” Stanford University, June 21, 2016, IEPR workshop on Climate Adaptation and Resiliency for the Energy Sector, http://docketpublic.energy.ca.gov/PublicDocuments/16-IEPR-04/TN212477_20160727T135220_Transcript_of_the_06212016_Joint_IEPR_Workshop_on_Climate_Adapt.pdf.

321 Dr. Moser suggested five elements of good transdisciplinary work: codesign, coproduction, codissemination, coimplementation, and coevaluation. This model of work depends on joint involvement with people and agencies traditionally defined as “end users,” who may include stakeholders, community members, managers, and planners, among others. In the model of transdisciplinary work, these actors need to be engaged from the outset.

322 Moser, S. C., “Linking Climate Scenarios to Planning and Decision-Making,” Stanford University, June 21, 2016, IEPR workshop on Climate Adaptation and Resiliency for the Energy Sector.

323 IEPR workshop on Climate Adaptation and Resiliency for the Energy Sector, June 21, 2016, <http://docketpublic.energy.ca.gov/PublicDocuments/16-IEPR->

Climate Science Lead at the California Department of Fish and Wildlife, described the extensive adaptation work supported by her agency. She commented on the need to consider natural ecosystems in the design of human systems, including the implementation of climate mitigation and adaptation options.³²⁴

Energy Utilities Have Benefited From State-Sponsored Research to Inform Actions Designed to Reduce Vulnerability to Climate Change

SCE reported at the workshop that it has developed a system based on Cal-Adapt to identify potential impacts to its infrastructure. SCE is ready to include the new climate scenarios that will be available via Cal-Adapt and update its analyses and report results to the DOE's Partnership. SDG&E reported that it has been working with ICF, with support from the Energy Commission, to develop and implement strategies to reduce wildfire risk—which is crucial since the frequency and severity of wildfires are projected to increase with climate change and wildfires are a threat to energy infrastructure.³²⁵

The case study demonstrates that the type of transdisciplinary engagement that Dr. Moser was advocating for is becoming a reality in California. SDG&E is fully involved in the design and implementation of the study.³²⁶

Utilities are Already Dealing With Consequences of Climate Change and Have Varying Capabilities to Plan for and Respond to Extreme Events and Hazards

POUs' present capacity to adapt is somewhat different from the larger, relatively well-funded IOUs. Two of the larger POUs, Sacramento Municipal Utility District (SMUD) and the Los Angeles Department of Water and Power (LADWP), have climate adaptation programs;³²⁷ however, this is not the case for the more than 40 smaller POUs. The small POUs conduct their climate adaptation work when their respective local agencies or

04/TN212477_20160727T135220_Transcript_of_the_06212016_Joint_IEPR_Workshop_on_Climate_Adapt.pdf, p. 197.

324 IEPR workshop on Climate Adaptation and Resiliency for the Energy Sector, June 21, 2016, http://docketpublic.energy.ca.gov/PublicDocuments/16-IEPR-04/TN212477_20160727T135220_Transcript_of_the_06212016_Joint_IEPR_Workshop_on_Climate_Adapt.pdf, pp. 174-179.

325 IEPR workshop on Climate Adaptation and Resiliency for the Energy Sector, June 21, 2016, http://docketpublic.energy.ca.gov/PublicDocuments/16-IEPR-04/TN212477_20160727T135220_Transcript_of_the_06212016_Joint_IEPR_Workshop_on_Climate_Adapt.pdf, pp. 265-273.

326 D'Agostino, B., "SDG&E Wildfire Resilience and Climate Risk Strategy Overview," American Meteorological Society's Energy Committee, June 21, 2016, IEPR workshop on Climate Adaptation and Resiliency for the Energy Sector.

327 IEPR workshop on Climate Adaptation and Resiliency for the Energy Sector, June 21, 2016, http://docketpublic.energy.ca.gov/PublicDocuments/16-IEPR-04/TN212477_20160727T135220_Transcript_of_the_06212016_Joint_IEPR_Workshop_on_Climate_Adapt.pdf, p. 223 and p. 230.

counties perform this type of analysis.³²⁸ Senate Bill 379 may potentially affect the small POU's because this bill requires local hazard mitigation plans developed by cities and counties to address climate adaptation. At the June 21, 2016, IEPR workshop, Scott Tomashefsky, regulatory affairs manager from the Northern California Power Agency (which represents 15 medium and small POU's), suggested that POU's are being affected by a changing climate, as demonstrated by the effects on their operation by the Butte and McCabe wildfires. Although not discussed at the workshop, wildfires have already damaged energy infrastructure in California. In September 2015, the Geysers Geothermal Plant in Lake and Sonoma Counties was partially destroyed by the Valley Fire and has since needed to rebuild cooling towers and communications equipment.³²⁹ LADWP provided another example at the workshop. During the drought, LADWP had no water flowing to Los Angeles in the L.A. Aqueduct for the first time in 100 years; as such, the region lost its lowest greenhouse gas (GHG) intensity electricity source.³³⁰

Funding and Planning Are Needed for Robust Responses to Climate Change

Although early vulnerability studies are being conducted by utilities,³³¹ and there are positive signs of collaboration,³³² adaptation is an iterative process. As such, processes and sufficient funding must be in place to allow for learning and change as the state and energy industry begin to implement initial changes. At the June 21, 2016, IEPR workshop, Ken Alex, director of OPR, stated that funding streams are an important consideration in adaptation planning and implementation.³³³ This insight was repeated by Mr. Greene, Vice Chair of ARCCA, who noted that while regional climate collaborators have already had great success, they are hindered by their inability to provide funding for full-time staff or reliable meeting places—two assets that are crucial to the

328 IEPR workshop on Climate Adaptation and Resiliency for the Energy Sector, June 21, 2016, http://docketpublic.energy.ca.gov/PublicDocuments/16-IEPR-04/TN212477_20160727T135220_Transcript_of_the_06212016_Joint_IEPR_Workshop_on_Climate_Adapt.pdf, p. 239.

329 See <http://www.bloomberg.com/news/articles/2015-09-15/california-wildfire-damages-five-calpine-geysers-power-plants>.

330 IEPR workshop on Climate Adaptation and Resiliency for the Energy Sector, June 21, 2016, http://docketpublic.energy.ca.gov/PublicDocuments/16-IEPR-04/TN212477_20160727T135220_Transcript_of_the_06212016_Joint_IEPR_Workshop_on_Climate_Adapt.pdf, p. 223.

331 Anderson, B., "Climate Change Resilience and Preparedness," PG&E, June 21, 2016 IEPR workshop on Climate Adaptation and Resiliency for the Energy Sector.

332 IEPR workshop on Climate Adaptation and Resiliency for the Energy Sector, June 21, 2016, http://docketpublic.energy.ca.gov/PublicDocuments/16-IEPR-04/TN212477_20160727T135220_Transcript_of_the_06212016_Joint_IEPR_Workshop_on_Climate_Adapt.pdf, p. 197.

333 IEPR workshop on Climate Adaptation and Resiliency for the Energy Sector, June 21, 2016, http://docketpublic.energy.ca.gov/PublicDocuments/16-IEPR-04/TN212477_20160727T135220_Transcript_of_the_06212016_Joint_IEPR_Workshop_on_Climate_Adapt.pdf, pp. 80-81.

structural integrity of collaborative groups.³³⁴ Likewise, Mr. Tomashefsky noted that many POU's do not have reliable, or sufficiently robust, funding streams to support adaptation and resiliency efforts, which makes embarking on the “next steps” of any plan, for example, adaptation planning jointly with forestry agencies, exceptionally difficult, if not impossible.³³⁵

Development of Climate and Sea Level Rise Scenarios for the Energy Sector

To investigate potential consequences of climate change, scientists and policy analysts depend on climate scenarios. These scenarios show plausible pathways of different aspects of potential future conditions. As the Intergovernmental Panel on Climate Change (IPCC) puts it, “The goal of working with scenarios is not to predict the future but to better understand uncertainties and alternative futures, in order to consider how robust different decisions or options may be under a wide range of possible futures.”³³⁶

Through implementation of the Climate Action Team's³³⁷ *Climate Change Research Plan for California* and participation in the Fourth Climate Change Assessment, the Energy Commission is promoting the development of climate and sea level rise scenarios to inform climate adaptation and planning. This is consistent with one of the recommendations in the *Safeguarding California Plan* discussed above.

The Energy Commission has supported the development of climate scenarios for California for more than a decade.³³⁸ These scenarios offer a robust scientific basis for understanding the implications of a changing climate to the energy system, including adaptation to sea level rise. As Commissioner Douglas pointed out at the June 21, 2016, workshop, “The question of how to assess potential sea level rise in infrastructure and especially coastal power plant licensing proceedings is something that is far from theoretical right now.”³³⁹ The discussion below focuses on downscaling global climate

334 IEPR workshop on Climate Adaptation and Resiliency for the Energy Sector, June 21, 2016, http://docketpublic.energy.ca.gov/PublicDocuments/16-IEPR-04/TN212477_20160727T135220_Transcript_of_the_06212016_Joint_IEPR_Workshop_on_Climate_Adapt.pdf, p. 166.

335 IEPR workshop on Climate Adaptation and Resiliency for the Energy Sector, June 21, 2016, http://docketpublic.energy.ca.gov/PublicDocuments/16-IEPR-04/TN212477_20160727T135220_Transcript_of_the_06212016_Joint_IEPR_Workshop_on_Climate_Adapt.pdf, p. 239.

336 Intergovernmental Panel on Climate Change, *Fifth Assessment Report (AR5)*, 2008-2009. <http://ipcc.ch/report/ar5/>.

337 The CAT, or Climate Action Team, was created by Executive Order S-03-05.

338 Climate Action Team, 2015, *Climate Change Research Plan for California*, http://climatechange.ca.gov/climate_action_team/reports/CAT_research_plan_2015.pdf.

339 IEPR workshop on Climate Adaptation and Resiliency for the Energy Sector, June 21, 2016, http://docketpublic.energy.ca.gov/PublicDocuments/16-IEPR-04/TN212477_20160727T135220_Transcript_of_the_06212016_Joint_IEPR_Workshop_on_Climate_Adapt.pdf, p. 40.

scenarios for use in California policy settings such that California's energy infrastructure planning can become more resilient to a changing climate.

Global Emissions Scenarios

Climate scenarios can be constructed in multiple ways. Since 1992, the IPCC has produced three generations of climate scenarios, which have then been used as a common foundation for modeling climate change around the world. Sharing common baseline scenarios allows researchers to compare across models that are built around the IPCC scenarios.

The most recent generation of scenarios are referred to as Representative Concentration Pathways (RCPs); these were used as the foundation for the *IPCC's Fifth Assessment Report* and are the international standard for climate scenarios. The RCPs can be directly interpreted in terms of global energy imbalances or *radiative forcing* (expressed as watts per square meter). The highest RCP (RCP8.5) constructed by the IPCC is congruent with rising emissions at 2 percent per year through 2050, plateauing around the end of the century, whereas the lowest RCP (2.6) is believed to have a two thirds chance of keeping global warming within 2 degrees Celsius above preindustrial levels.³⁴⁰

Global emission scenarios such as the RCPs are used as input to global climate models to estimate how climate will change. There are 32 global climate models created and used by research centers around the world that are run in supercomputers consuming enormous computer power. Consequently, only representative emission scenarios are used for the different visions of the future. For example, there are dozens of versions of the RCP8.5 scenario, but only one is used to run the global climate computer models. This adds another source of uncertainty that it is not well-quantified.

Projecting Global Emissions That Reflect the Paris Agreement

Modeling can illuminate the particular climatic consequences associated with various GHG emission reduction targets and, thus, provide a glimpse into what targets must be met to comply with particular climate goals. International efforts to reduce GHG emissions inform such modeling efforts.

Over the past two decades, nations worldwide have worked to refine and implement an agreement to protect the planet from the potentially catastrophic impacts of climate change. The 1992 United Nations Framework Convention on Climate Change (UNFCCC) set a goal to reduce GHG emissions to prevent dangerous interferences with the climatic system. Since then, nations worldwide convene yearly to negotiate the implementation of the framework. These meetings are referred to as *Conferences of Parties*, or *COPs*. Two especially notable COPs are the 1997 COP that produced the Kyoto Protocol and the recent 2015 COP, or "COP21." The COP21 produced the Paris Agreement, which sets a

340 For more information, see <http://www.aimes.ucar.edu/docs/IPCC.meetingreport.final.pdf> and <http://www.nature.com/nature/journal/v463/n7282/full/nature08823.html>.

target of no more than 2 degrees Celsius warming, with a goal of 1.5 degrees.³⁴¹ Although the UNFCCC COP process has not been without problems,³⁴² it has produced some notable results in regards to implementation. European GHG emissions have declined by about 19 percent since 1990, even though economic output increased by 45 percent—an accomplishment credited to the European Union’s interpretation of its member nations’ responsibilities under the Kyoto Protocol.³⁴³

The Paris Agreement, which took effect on November 4, 2016,³⁴⁴ has the potential to foster significant inroads for greater adaptation and widespread, coordinated mitigation efforts. Thus far, 163 countries have submitted voluntary pledges to reduce GHG emissions, with descriptions of how they will achieve these reductions.³⁴⁵ These nations represent about 99 percent of total global emissions and include developed and developing countries, and, importantly, the largest historical emitter and the largest current emitter of GHG emissions.³⁴⁶ The pledges are known as *Intended Nationally Determined Contributions (INDCs)*, which become “Nationally Determined Contributions” when governments formally join the Paris Agreement.³⁴⁷ The agreement allows NDCs to be changed at any time, but only to be strengthened.

The INDCs represent a new approach. They can be tied to the local interests and capacities of the nations involved, which may increase the likelihood of success. For example, China is concerned about serious air pollution problems in its urban areas, and its proposed reductions are strongly tied to its efforts to improve air quality in China, as indicated in China’s 13th Five-Year Plan.³⁴⁸ China has also expressed ambitions to be the leading supplier of clean energy technologies in the global market—an area that is

341 United Nations Framework Convention on Climate Change, Adoption of the Paris Agreement, December 12, 2015, <http://unfccc.int/resource/docs/2015/cop21/eng/l09r01.pdf>.

342 New, M., D. Liverman, H. Schroder, and K. Anderson, 2010, “Four Degrees and Beyond: The Potential for a global Temperature Increase of Four Degrees and Its Implications,” *Philosophical Transactions of the Royal Society Academy*, Vol 269, Issue 1934.

Liverman, D., and S. Billett, 2010, “Copenhagen and the Governance of Adaptation,” *Environment: Science and Policy for Sustainable Development*, Volume 52, Issue 3.

343 This trend from 1997 to 2014 is a decline of about 17 percent. European Environmental Agency. <http://www.eea.europa.eu/data-and-maps/data/data-viewers/greenhouse-gases-viewer>. Accessed on July 5, 2016.

344 http://unfccc.int/paris_agreement/items/9444.php.

345 <http://www4.unfccc.int/submissions/indc/Submission%20Pages/submissions.aspx>.

346 In 1990, the four top emitters in descending order were the United States, the European Union, China, and India. In 2014, the top four were China, the United States, the European Union, and India. (EDGAR v4.3 data base).

347 Keohane, R.O., and D.G. Victor, 2016, “Cooperation and Discord in Global Climate Policy,” *Nature Climate Change*.

348 <http://www.china-un.org/eng/zt/China123456/>. Approved in March 2016.

expected to skyrocket with the implementation of the INDCs.³⁴⁹ Finally, China's pledge has tied carbon intensity to economic development by expressing it as GHG emissions per gross domestic product. This formulation is based on the premise that, at least on a first order, higher economic development tends to increase GHG emissions. China has expressed its intention to peak GHG emissions by 2030 and lower net GHG emissions after 2030. The calculations and expectations of INDCs, however, may not always be realistic. In some cases, there may be reason to be more optimistic than INDC goals would suggest. For example, some argue that the actions and plans being implemented by China may move the peak emissions to 2025 or earlier.³⁵⁰

The INDCs and the subsequent Nationally Determined Contributions would end in 2030; however, it is expected that subsequent COP meetings would establish post-COP21 targets that would be more "ambitious" than those established in 2015.

Modeling efforts can illuminate the particular climatic consequences associated with various targets and, thus, provide a glimpse into what targets must be met to comply with particular climate goals. For example, Figure 27 shows one view of post-COP21 commitments under two potential scenarios. The first scenario (INDC+), assumes that there is no increase in ambition, such that by 2030, carbon dioxide (CO₂) emissions per gross domestic product decreases 2 percent annually, which could result in almost flat global emissions after 2030. The second scenario (INDC++) assumes increased ambition beyond the INDCs submitted for the Paris Agreement, such that countries implement a minimum of 5 percent per year decarbonization rate. This is the average decarbonization rate required by the European Union and the United States to achieve their INDCs from 2020 to 2030.³⁵¹ Figure 27 also shows the emissions associated with the RCPs that were developed to inform the preparation of the last climate assessment of the IPCC.³⁵² However, the RCPs were developed several years ago. For this reason, emissions after 2005 in RCPs can be compared with actual historical global emissions after 2005. Actual historical emissions from 2005 to present are consistent with the high-emission scenario known as RCP8.5, a fact reflected in the preparation of the INDCs.

349 Crooks, Ed, Jan. 9, 2015, "China Extends Lead Over US a Top Green Energy Backer," *Financial Times*, <http://www.ft.com/cms/s/0/8209e816-97de-11e4-b4be-00144feabdc0.html#axzz4DIUZPOjW>.

350 Tollefson, Jeff, February 2016, "Global Warming 'Hiatus' Debate Flares Up Again," *Nature*, <http://www.nature.com/news/global-warming-hiatus-debate-flares-up-again-1.19414>.

351 Fawcett, A., et al., 2015, "Can Paris Pledges Avert Severe Climate Change?" *Science*, Volume 350, Issue 6265.

352 Intergovernmental Panel on Climate Change, *Fifth Assessment Report (AR5)*, 2008-2009. <http://ipcc.ch/report/ar5/>.

Moss, Richard et al. 2010. "The Next Generation of Scenarios for Climate Change Research and Assessment" *Nature*, Vol. 463, pages 747-756. <http://www.nature.com/nature/journal/v463/n7282/full/nature08823.html>.

Figure 27: Global CO₂ Emissions: Fossil Fuels and Cement Production

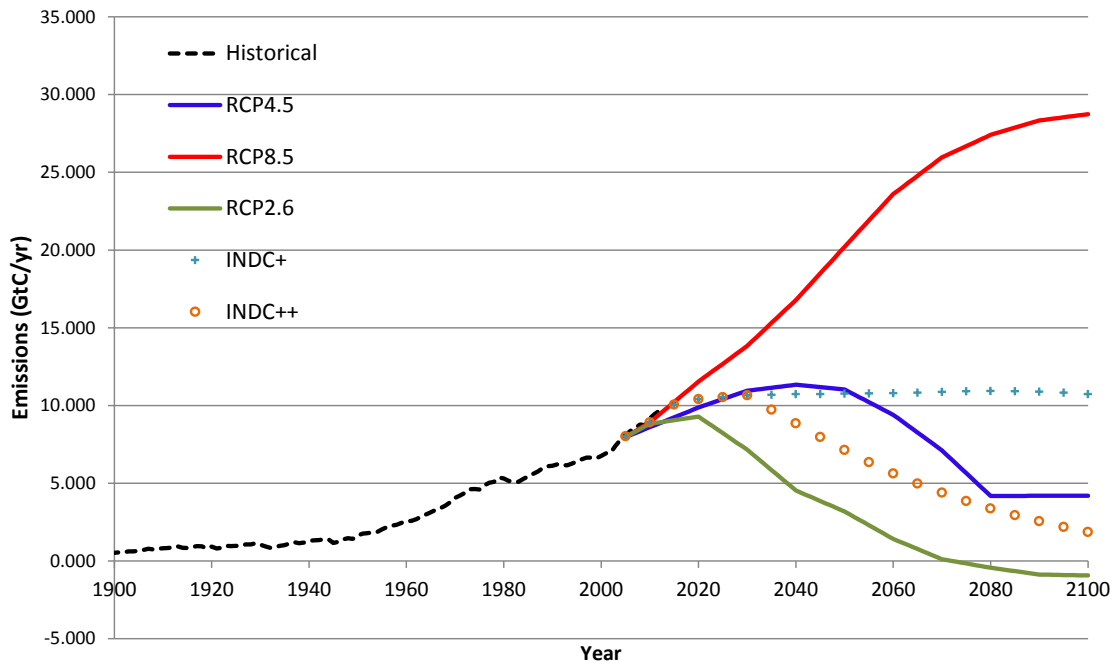

Data Source: IPCC.³⁵³ and Fawcett et al., 2015.³⁵⁴

At the subnational level, in 2014 the UNFCCC launched the Non-State Actor Zone program to track the performance of pledges made by subnational entities, including private companies. The entities included in this program represent about one-third of the global economy.³⁵⁵ California and others are taking the lead by signing a Memorandum of Understanding referred to as the “Under 2 MOU” pledging emissions reductions congruent with the goal of limiting planetary warming below 2 degrees Celsius (3.6 degrees Fahrenheit) above preindustrial levels. The Under 2 MOU signatories also adopt a target of limiting GHG emissions to 2 tons per capita or 80-95 percent below the 1990 level by 2050. As of October 6, 2016, 136 subnational entities representing 33 countries and six continents have signed or endorsed the Under 2 MOU. Together, they represent 1.08 billion people and 35 percent of the global economy.³⁵⁶

353 IPCC, 2014: Summary for policymakers. In: *Climate Change 2014: Impacts, Adaptation, and Vulnerability. Part A: Global and Sectoral Aspects. Contribution of Working Group II to the Fifth Assessment Report of the Intergovernmental Panel on Climate Change* [Field, C.B., V.R. Barros, D.J. Dokken, K.J. Mach, M.D. Mastrandrea, T.E. Bilir, M. Chatterjee, K.L. Ebi, Y.O. Estrada, R.C. Genova, B. Girma, E.S. Kissel, A.N. Levy, S. MacCracken, P.R. Mastrandrea, and L.L. White (eds.)]. Cambridge University Press, Cambridge, United Kingdom and New York, NY, USA, pp. 1-32.

354 Fawcett, A., et al., 2015, “Can Paris Pledges Avert Severe Climate Change?” *Science*, Volume 350, Issue 6265.

355 Hsu, A., et al., June 2015 “Towards a New Climate Diplomacy,” *Nature Climate Change*, pp. 501-503.

356 <http://under2mou.org/> Accessed on December 22, 2016. For current information, see <http://under2mou.org/>.

Downscaling Global Climate Modeling to California

As discussed below, the Scripps Institution of Oceanography (Scripps) at the University of California, San Diego, has developed a new technique to translate the outputs from global climate models to California. Scripps developed the downscaling technique as part of an interagency agreement in support of *California's Fourth Climate Change Assessment*. In addition, the University of California, Los Angeles, with funding from the DOE and others, has produced simulations for California using dynamic numerical models.³⁵⁷ These scenarios are also available for the Fourth Climate Change Assessment. Finally, Scripps has produced sea level rise scenarios that can inform energy infrastructure planning.

Climate Projections Using Localized Constructed Analogues (LOCA)

Scripps' new method for downscaling global climate modeling results is known as the *LOCA downscaling method*. It was designed to address some of the deficiencies of prior methods, such as difficulties in simulating heat waves and the geographical distribution of local precipitation events.³⁵⁸ Scripps has developed climate scenarios using LOCA for the 32 global climate models available from the IPCC.³⁵⁹ The scenarios are available in a grid of about 3.5-mile-by-3.5-mile resolution covering the entire state. The outputs are available on a daily basis from 1950 to 2100. An example of an output for a grid cell near the Sacramento International Airport is shown in Figure 28.

357 Hall, A.F., Sun, D.B. Walton, M. Schwartz, N. Berg, K. Reich. 2016. *Dynamically Downscaled CMIP5 Climate Projections Over California*. California Energy Commission. White paper submitted to the 2016 IEPR Update.

358 Recently the federal government decided to implement the localized constructed analogues (LOCA) model, developed for the Energy Commission, at a national scale for the RCP8.5 and RCP4.5 emission scenarios (Franco and Ralf-Douglass, 2016, presentation at the June 21, 2016, IEPR workshop, http://docketpublic.energy.ca.gov/PublicDocuments/16-IEPR-04/TN212477_20160727T135220_Transcript_of_the_06212016_Joint_IEPR_Workshop_on_Climate_Adapt.pdf). This allows for the consideration of impacts and actions outside California that have consequences in the state. For example, CPUC Commissioner Randolph, Neil Miller from the California Independent System Operator (June 21, 2016, IEPR workshop), and others have expressed concern about region-wide heatwaves that affect the entire Southwestern United States. Applying LOCA to the national scale will allow researchers, managers, and stakeholders to estimate how these events would manifest with a changing climate. This is also in agreement with the *Pacific Coast Action Plan on Climate and Energy* (see page 28) promoting collaboration on climate issues with other states/regions.

359 Pierce, D. W., D. R. Cayan, L. Dehann. 2016. *Creating Climate Scenarios for the 4th CA Climate Assessment*. California Energy Commission. White paper submitted to the 2016 IEPR Update.

Figure 28: Annual Average Temperature Projections: Sacramento

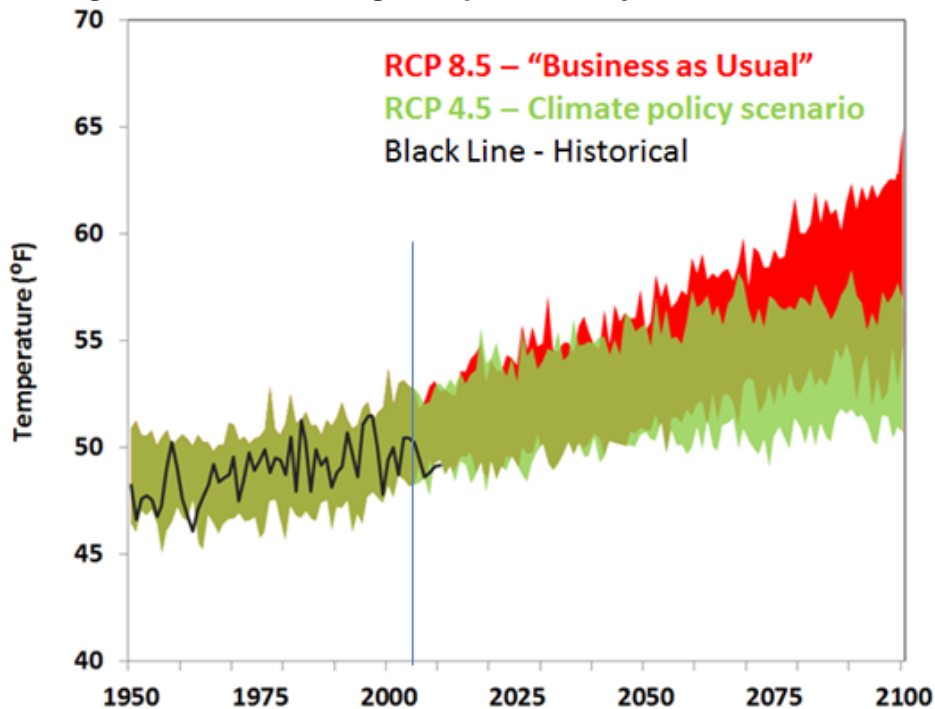

Source: California Energy Commission staff using data from Pierce, D. W., D. R. Cayan, L. Dehann, 2016, *Creating Climate Scenarios for the 4th CA Climate Assessment*, California Energy Commission, white paper submitted to the 2016 IEPR Update.

The green and red areas represent the range of outputs from all the 32 models after downscaling with LOCA, with the darker green indicating overlap. Two important features can be observed in Figure 28. First, the LOCA simulations of the historical period from 1950 to 2004 agree with the observations (black line) in a statistical sense. A perfect correspondence is not expected because the global climate models start simulations at the beginning of the industrial revolution, and actual historical conditions (black line) represent only one of the potential climate outcomes. The second main feature is that the green and red areas do not diverge much before 2050. This indicates that the *average* climate in the next 36 years is already predetermined by past emissions including emissions from 2005 to the present. The simulations show significant temperature divergence at the end of this century. The two RCPs diverge somewhat in expected extreme events in 2050,³⁶⁰ but this is not shown in the above figure.

Of the 32 global climate models, the DWR's CCTAG deemed 10 more suitable for simulations for California. The determination was based on how well the models simulated large-scale features of climate that are important to California, such as

360 Franco, G., S. Wilhelm, S. Ziaja, 2016. *Global Cumulative CO₂ Emissions and Climate Change Manifestations in California*. Draft internal staff paper. California Energy Commission.

temperatures in the Pacific in the region that is used to characterize El Niño events.³⁶¹ Though not shown in Figure 29, the 10 selected models adequately cover the range of temperatures produced by the 32 models.

Scripps linked the LOCA outputs for the 10 selected models with a land surface and hydrological model known as the Variable Infiltration Capacity model. The Variable Infiltration Capacity model provides additional outputs such as soil moisture and streamflows in California rivers. This information will be used to estimate impacts and identify adaptation options for the different parts of the energy system, such as hydropower units and the availability of cooling water for power plants.

As indicated above, RCPs are not necessarily congruent with INDC pledges related to the 2015 Paris Agreement. Since global and local modeling is available only for the RCPs, it would be important to infer the climate implications of the INDCs using climate modeling results for the RCPs. It has been shown that ambient temperatures scale almost in line with cumulative CO₂ emissions at the global³⁶² and subcontinental scales.³⁶³ Fortunately, this relationship between cumulative CO₂ emissions and ambient temperature also applies to local scales in California. Figure 29 shows how the upper range of RCP8.5 and RCP4.5 behaves as a function of global CO₂ emissions for a grid cell in Sacramento. The simple relationship is well-documented. It has been shown to work for different downscaling results from multiple climate models and even to infer the behavior of extreme temperature events.³⁶⁴ Figure 29 shows that if only model simulations from RCP8.5 were available, it would have been possible to infer temperature impacts for RCP4.5 for a given year knowing the cumulative emissions for that year.³⁶⁵

361 For more information on DWR's selection, see http://www.water.ca.gov/climatechange/docs/2015/Perspectives_Guidance_Climate_Change_Analysis.pdf.

362 IPCC, "2014: Summary for policymakers," *Climate Change 2014: Impacts, Adaptation, and Vulnerability, Part A: Global and Sectoral Aspects, Contribution of Working Group II to the Fifth Assessment Report of the Intergovernmental Panel on Climate Change* [Field, C.B., V.R. Barros, D.J. Dokken, K.J. Mach, M.D. Mastrandrea, T.E. Bilir, M. Chatterjee, K.L. Ebi, Y.O. Estrada, R.C. Genova, B. Girma, E.S. Kissel, A.N. Levy, S. MacCracken, P.R. Mastrandrea, and L.L. White eds.]. Cambridge University Press, pp. 1-32.

363 Leduc M., H.D. Matthews, R. de Elia, 2016, "Regional Estimates of the Transient Climate Response to Cumulative CO₂ Emissions," *Nat. Clim. Change*, 6 474-8.

364 Franco, G., S. Wilhelm, S. Ziaja, 2006. *Global Cumulative CO₂ Emissions and Climate Change Manifestations in California*. Draft internal staff paper. California Energy Commission.

365 For alternative global emission scenarios (for example, INDC+), it is possible to estimate temperature impacts for a given year for a specific grid using results similar to Figure 3b if the cumulative CO₂ emissions is known for the relevant year.

Figure 29: Average Annual Temperature: Upper Annual Estimation From 32 Global Climate Models Using LOCA Results for a Grid Cell in Sacramento

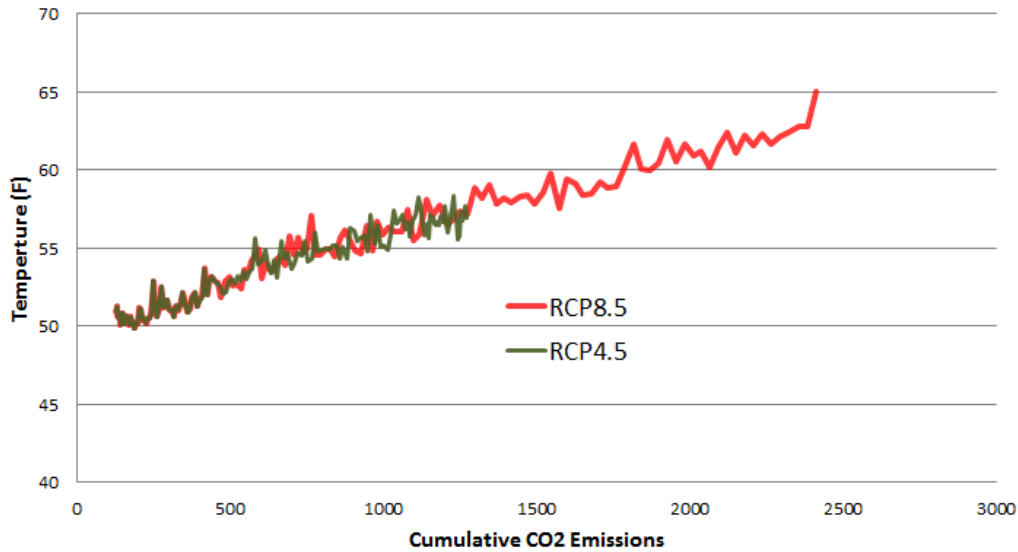

Source: California Energy Commission staff using data from Pierce, D. W., D. R. Cayan, L. Dehann, 2016, *Creating Climate Scenarios for the 4th CA Climate Assessment*, California Energy Commission, white paper submitted to the 2016 IEPR Update.

Figure 30 shows cumulative CO₂ for the global emissions scenarios discussed above. From this figure, it is possible to estimate the impacts of non-RCP scenarios. In the figure, one can compare the estimated ambient temperature of a given trajectory by drawing a horizontal line from the point on a non-RCP trajectory, for example, INDC++ at year 2100, back to an RCP. For example, the figure below shows that ambient temperature on the INDC++ scenario in 2100 would be similar to those of RCP8.5 at midcentury. Another way to put this is that following an INDC++ emissions trajectory would delay major ambient temperature increases by 50 years, assuming that RCP8.5 would otherwise be business as usual.

Figure 30: Cumulative CO₂ Emissions for RCPs and INDCs Global Emissions Scenarios

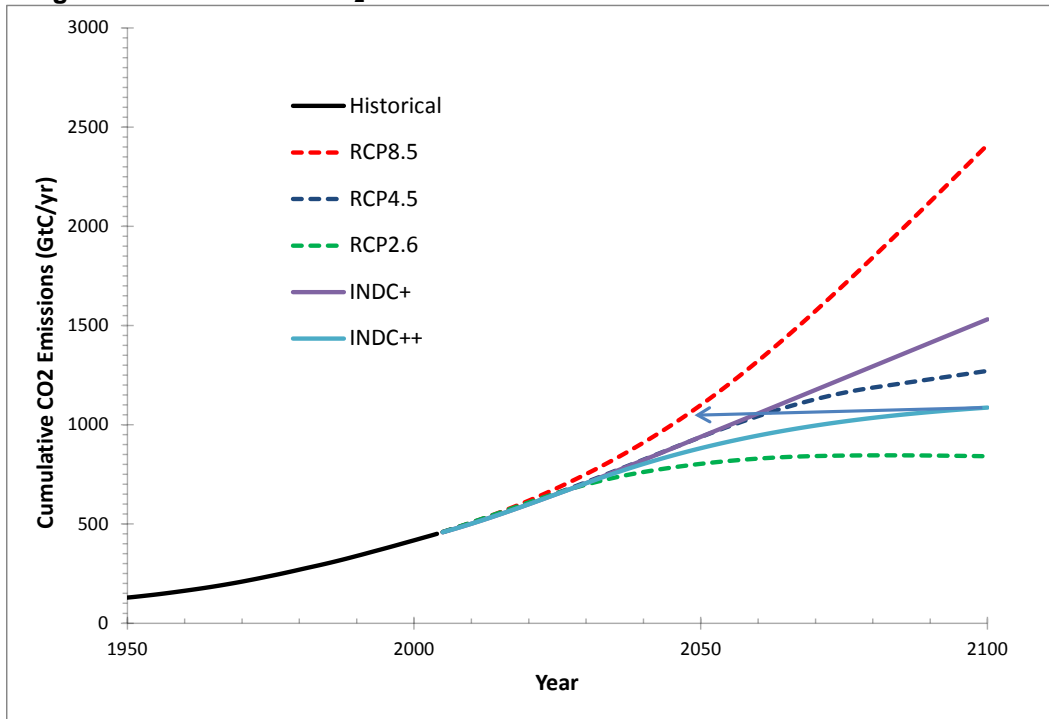

Source: California Energy Commission staff using data from IPCC and Fawcett et al., 2015

Climate Projections From University of California, Los Angeles (UCLA)

UCLA used the Weather Forecasting and Research (WRF) model to create historical (1981–2006) and future (2091–2100) scenarios. WRF is a numerical weather prediction model that uses the law of physics, such as the law of conservation of mass and energy, to produce the simulations. Figure 31 shows the modeled geographical areas, which includes a high-resolution modeling in the Sierra Nevada (1.9 miles or 3 kilometers). Because numerical models can produce significant departures from observed conditions if driven directly from the outputs from global climate models, the research group at the university used simulations of actual historical data modified as suggested by the global climate models to estimate future conditions.³⁶⁶

366 Hall, A., F. Sun, D.B. Walton, M. Schwartz, N. Berg, K. Reich. 2016. *Dynamically Downscaled CMIP5 Climate Projections Over California*. California Energy Commission. White paper submitted to the 2016 IEPR Update, http://docketpublic.energy.ca.gov/PublicDocuments/16-IEPR-04/TN211804_20160614T101822_Dynamically_Downscaled_CMIP5_Climate_Projections_Over_California.pdf.

Figure 31: Modeling Domains for the Numerical Climate Simulations Performed by UCLA

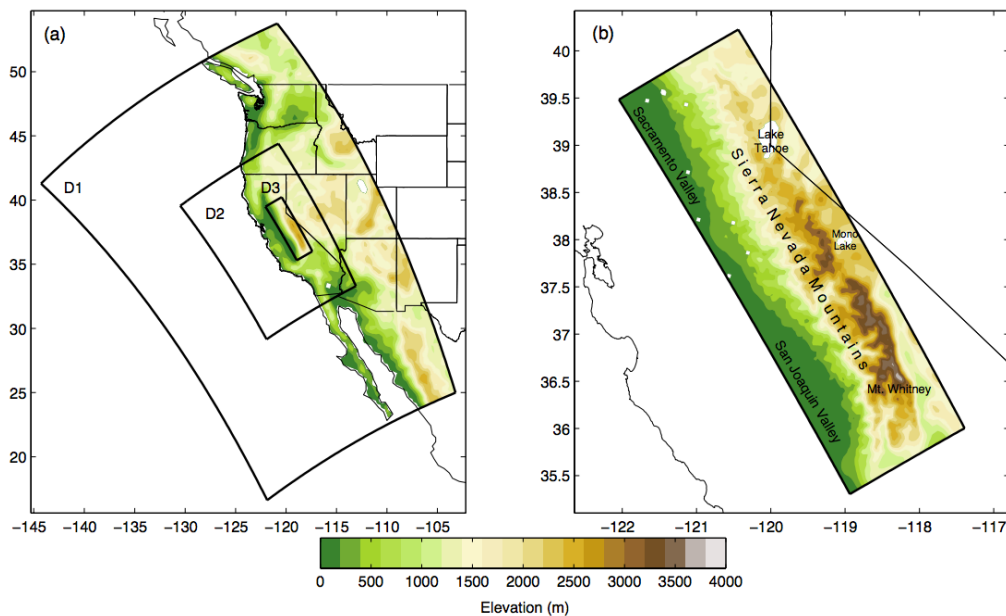

Source: Hall, A., F. Sun, D. B. Walton, M. Schwartz, N. Berg, K. Reich, 2016, *Dynamically Downscaled CMIP5 Climate Projections Over California*, California Energy Commission, white paper submitted to the 2016 IEPR Update.

The image on the left side in Figure 31 shows the topographic data in meters used for the WRF simulations. The D1, D2, and D3 domains have a resolution of 16.9, 5.6, and 1.9 miles, respectively. The image on the right in Figure 31 shows the innermost (D3) topography. The color gradient shows the topography in the selected domains. The green range shows relatively low elevations. While at the other end of the spectrum, brown to gray indicates high elevations.

The UCLA climate scenarios complement the scenarios developed by Scripps. For example, UCLA has calculated subdaily changes in climate that could be used to infer how the daily projections developed by Scripps could be translated into subdaily data. Subdaily data (for example, hourly data) can be used to create more detailed energy forecasts in the future as changes in the diurnal profile of temperature and other meteorological factors also affect the diurnal profile of energy demand and, therefore, electricity generation. Also, hourly data are needed for other adaptation planning. (For example, when designing storm drainage systems, data on maximum hourly precipitation levels are needed.)

Sea Level Rise Scenarios for California Planning

The Coastal and Ocean Working Group of the California Climate Action Team updated its sea level rise guidance document in March 2013. This document incorporated the findings from the National Research Council report *Sea Level Rise for the Coasts of California, Oregon, and Washington* released in 2012.³⁶⁷ The sea level rise document

³⁶⁷ NRC, 2012, *Sea-Level Rise for the Coasts of California, Oregon, and Washington: Past, Present, and Future*, The National Academies Press.

allows for flexibility in selecting which numbers should be used for regulatory and planning purposes. It suggests, among other things, that selection of sea level rise values be “based on agency and context-specific considerations of risk tolerance and adaptive capacity.” Entities engaged in climate adaptation planning for the energy sector should rely on the California Ocean Protection Council guidance for long-term planning.

At the same time, researchers for the Fourth Climate Change Assessment will use sea level projections prepared by Scripps.³⁶⁸ The interdependencies and distinctions between scientific development and guidance documents warrant clarification—especially in light of the Ocean Protection Council’s pending release of an update to sea level rise guidance, which may or may not be fully cohere, or be logically consistent, with the climate scenarios discussed later in this section. The Energy Commission is making every effort to make research policy-relevant and reduce the time to incorporate new scientific information into policy guidance.

Guidance documents are policy documents that depend on the best available scientific information and, in some cases, the opinion of selected experts to harmonize the treatment of a given issue (for example, assumptions about sea level rise) in regulatory and planning efforts. In this sense, they are snapshots of the best available science and the policy priorities at the time. Because guidance documents are aimed at promoting practical goals, in some cases they need to manage gaps in scientific information by including “best judgment decisions” when there is insufficient scientific information but decisions must be made.

Guidance documents and scientific research evolve at different paces, each with respective considerations. Scientific research continues during and after publication of guidance documents. The rate of change for guidance documents depends in part on the rate of useable scientific research production, because they rely on “best available science,” which is always in flux. That relationship, however, is syncopated and variable. Climate change guidance documents evolve more slowly and have lags between revisions. The slower rate allows time for regulators to review and evaluate evolving science. Also, the lag between guidance revisions provides some stability to stakeholders and long-term planners. Further, scientific findings are occasionally at odds with one another, and it requires time to develop a sufficiently strong consensus to support new policy documents. It would, therefore, not be practical (nor necessarily desirable) to revise guidance documents constantly based on every new scientific finding, especially in research characterized by the rapid generation of information, as in the case of contributions of melting ice sheets to sea level rise. The Ocean Protection

368 Cayan, D.R., J. Kalansky, S. Iacobellis, D. Pierce. 2016. *Creating Probabilistic Sea Level Rise Projections*. California Energy Commission. White paper submitted to the 2016 IEPR Update, http://docketpublic.energy.ca.gov/PublicDocuments/16-IEPR-04/TN211806_20160614T101823_Creating_Probabilistic_Sea_Leve_Rise_Projections.pdf.

Council, CNRA, and OPR are developing adaptation guidance documents to use in long-range energy planning.

The sea level rise scenarios are based upon emerging science that is not completely consolidated, but the core modeling methods and key results have undergone peer review in mainstream science literature. Furthermore, guidance provided from a panel of sea level rise experts support the approach and key inputs used by Scripps.³⁶⁹ In particular, there was agreement that contributions from Antarctica to sea level rise may increase faster than assumed in the past, especially under higher rates of global warming.³⁷⁰ Table 15 shows the sea level rise scenarios from the report from the National Research Council that was the basis for the Ocean Protection Council guidance document and the projections prepared by the study team from Scripps. Table 15 also includes projections from two INDCs-related scenarios discussed above. The good news is that emissions reductions decisions made now still allow for limiting the rate of growth of sea level rise, as shown in Figure 32. The bad news, as also shown in Figure 32, is that West Antarctic ice sheet breakup may be unleashed with plausible levels of future climate warming, even under moderate GHG emissions well beyond the end of this century. Thus, the policy implications for post-2100 sea level rise scenarios may need additional consideration.

369 Ibid.

370 DeConto, R.M., D. Pollard, 2016, "Contribution of Antarctica to Past and Future Sea Level Rise," *Nature*, 531, 591-597, doi:10.1038/nature17145.

Table 15: Sea Level Rise Estimates From the National Research Council in 2012 and From Scripps in 2016 (Inches)

Medium Values (50th percentile)

Year	National Research Council	Scripps				
		RCP8.5	RCP4.5	RCP2.6	INDC+	INDC++
2000	0	0	0	0	0	0
2050	11.0	9.0	7.7	6.9	7.7	7.4
2100	36.2	53.8	29.0	16.9	34.6	23.8

Extreme Values (95th percentile)

Year	National Research Council	Scripps				
		RCP8.5	RCP4.5	RCP2.6	INDC+	INDC++
2000	0	0	0	0	0	0
2050	23.9	15.0	12.9	11.7	12.9	12.4
2100	65.0	94.5	55.4	30.0	64.3	44.5

Source: Cayan, D.R., J. Kalansky, S. Iacobellis, D. Pierce, 2016, *Creating Probabilistic Sea Level Rise Projections*, California Energy Commission, white paper submitted to the 2016 IEPR Update.

Figure 32: Sea Level Rise Projections for California up to 2200: Extreme Values (95th Percentile in Inches)

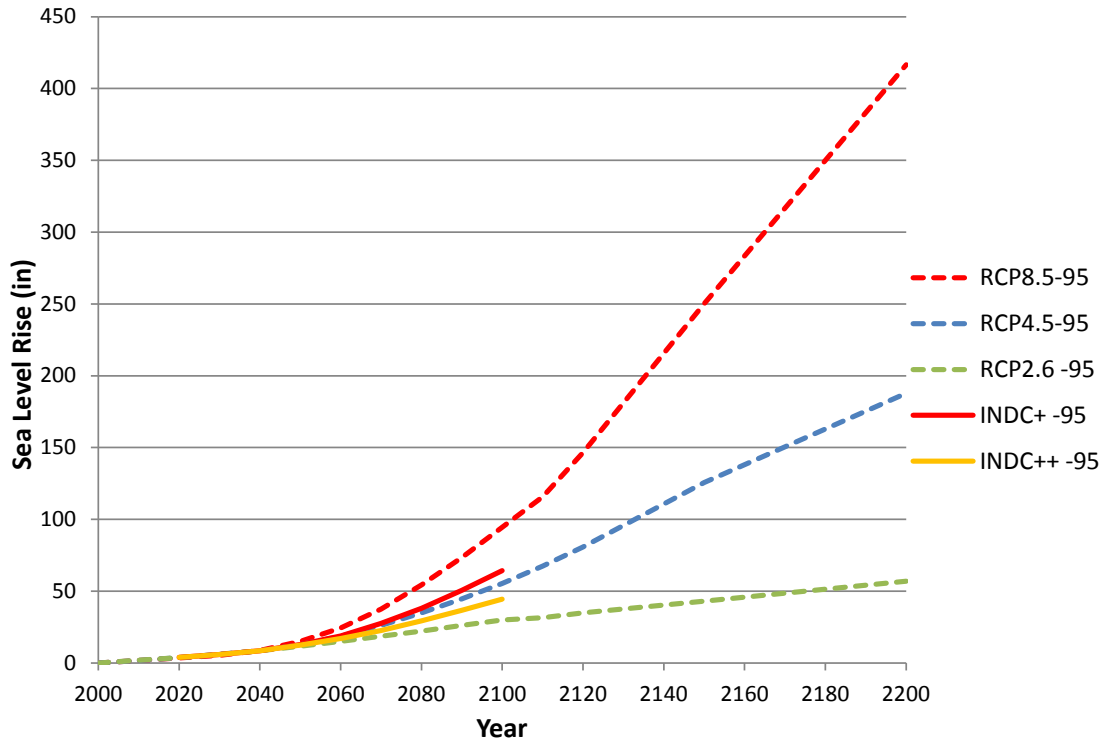

Source: Cayan, D.R., J. Kalansky, S. Iacobellis, D. Pierce, 2016, *Creating Probabilistic Sea Level Rise Projections*, California Energy Commission, white paper submitted to the 2016 IEPR Update

The values in Table 15 are presented as percentiles. Unfortunately, this presentation may give the mistaken impression that science is advanced enough to give a precise likelihood of events. The percentiles, however, were calculated using a combination of modeling runs and inferences about likelihoods based on expert opinion,³⁷¹ which is a common approach used in scientific circles to estimate the likelihood of future events when high uncertainty is involved. These estimates must be updated frequently to take into account rapidly evolving science.

To be compatible with what other state agencies will assume for sea level rise, energy agencies should implement the forthcoming guidance document, prepared by the Ocean Protection Council, for regulatory and long-term planning. However, for research, the Energy Commission and CNRA plan to use the sea level rise projections prepared by Scripps.

As part of the Fourth Climate Change Assessment, a research team has been working to help address the wide range of uncertainty in sea level rise projections by assigning

371 Cayan, D.R., J. Kalansky, S. Iacobellis, D. Pierce. 2016. *Creating Probabilistic Sea Level Rise Projections*. California Energy Commission. White paper submitted to the 2016 IEPR Update, http://docketpublic.energy.ca.gov/PublicDocuments/16-IEPR-04/TN211806_20160614T101823_Creating_Probabilistic_Sea_Leve_Rise_Projections.pdf.

quasi-probabilistic projections for RCP4.5 and RCP8.5. These projections rely on models that probabilistically account for the processes that feed into sea level rise as well as expert elicitation. Based on this work, the CAT Research Working Group recommends using the central estimate (50th percentile), high (95th percentile), and very high (99.9th percentile) in research supporting the Fourth Climate Change Assessment. These percentiles were selected to provide conservative assumptions about future sea level rise and to have research results in 2018 if the evolving science of sea level rise finds these upper limits more likely. These sea level rise projections are not to be used for regulatory and planning processes at this time. As indicated above, the Ocean Protection Council is preparing a revised guidance document on sea level rise that is designed for regulatory and planning purposes.

Recommendations

- **Continue to support climate research for the energy sector to better inform climate adaptation and mitigation strategies.** The California Public Utilities Commission (CPUC) and the Energy Commission should continue to support climate change research for the energy sector and more directly link their research with other activities such as long-term planning, permitting of new energy facilities, and the development of codes and standards. The Energy Commission should continue to be responsive to the research priorities framed by the Climate Action Team’s Research subgroup and help develop an iterative and collaborative research and planning cycle. When all agencies work together to frame research priorities, the results can be incorporated into adaptation planning, and policy issues resulting from plans can then be reflected in the next framing of research priorities.
- **Energy research and planning, respectively, should use a common set of climate scenarios as selected by the Climate Action Team Research Working Group and the Governor’s Office of Planning and Research Adaptation Technical Advisory Group. Energy planning should also implement updated guidance from the Ocean Protection Council.** The energy sector should strive to use climate and sea level scenarios that are consistent with the climate guidance document that the Governor’s Office of Planning and Research plans to release in the summer of 2017, California’s Fourth Climate Change Assessment, and planning efforts at local levels. For this reason, the energy sector should use a suite of the four global climate models regionally downscaled for California for RCP8.5 and RCP4.5 as selected by the Climate Action Team Research Working Group for California’s Fourth Climate Change Assessment.³⁷² The energy sector should implement the upcoming Ocean

³⁷² The Climate Action Team Research Working Group prioritized four models for use in *California’s Fourth Climate Change Assessment* as follows: HadGEM2-ES (warm/dry); CNRM-CM5 (cool/wet), CanESM2 (average), and MIROC5 (spans range of variability). These models are available through the beta site for Cal-Adapt 2.0 (<http://beta.cal-adapt.org/>). For more information, see section above on “Agencies Are Already Supporting Adaptation Through the Development Tools and Guidance.”

Protection Council sea level rise guidance document. For energy sector research that involves sea level rise, the research should be consistent with the California Fourth Climate Change Assessment recommendations on sea level rise and uncertainty.³⁷³

- **Continue to implement Executive Order B-30-15 by incorporating implications of climate change, where appropriate, into Energy Commission and CPUC planning and decision making.** The Energy Commission and the CPUC should continue to identify and consider implications of climate change and continue to use the Energy Sector Adaptation Working Group to ensure that the implications of climate change are a routine part of integrated energy planning.
- **The CPUC and the Energy Commission should continue to coordinate their adaptation activities via their Adaptation Working Group.** The two energy agencies have formed a working group with the California Natural Resources Agency, the Office of Emergency Management, and the Office of Planning and Research to coordinate climate adaptation activities. Activities include working collaboratively and iteratively with the investor-owned utilities and publicly owned utilities on producing robust vulnerability assessments and resilience plans that can be the cornerstone of efforts to incorporate adaptation planning and measures into utility operations, relevant CPUC proceedings, and Energy Commission research. This working group will also collaborate on research needs and efforts within the commissions to ensure that research produces actionable science, investment, and operational parameters and fosters science-driven decisions. Finally, this group will encourage cooperation and collaboration among all utilities and the various regional climate resilience collaboratives.
- **California climate adaptation planning should consider effects on California's energy system associated with impacts that occur out of state.** Energy Commission research and planning should consider climate impacts outside California that may have implications for the state. For example, California's energy sector depends heavily on hydropower generation in the Pacific Northwest. Future work should also expand knowledge of connections across sectors and geography that may influence resilience in California's energy sector.³⁷⁴ To the extent possible, Energy Commission research and adaptation efforts should coordinate and leverage

373 The CAT Research Working Group recommends using quasi-probabilistic projections for RCP4.5 and RCP8.5 as follows: the central estimate (50th percentile), high (95th percentile), and very high (99.9th percentile) in research supporting the Fourth Climate Change Assessment. For more information, see section above on "Sea Level Rise Scenarios for California Planning."

374 Considering climate impacts outside California is consistent with the *Pacific Coast Action Plan on Climate and Energy*, signed by Governor Edmund G. Brown Jr. and leaders from Oregon, Washington, and British Columbia. That action plan recognizes the interdependencies of west-coast states and provinces and the potential for regional climate and energy research to inform climate action by states in a way that better protects the entire region. See <https://www.gov.ca.gov/news.php?id=18284>.

federal research and the Pacific Coast Collaborative to expedite climate change and adaptation research and planning.

- **Support local adaptation planning efforts and increase outreach about available analytical tools.** The Energy Commission and other state agencies should support local agencies, including publicly owned utilities, in preparing adaptation plans. Greater outreach is needed to inform local agencies about the resources and tools available for adaptation work in the energy sector.
- **Investigate means to provide long-term support for Cal-Adapt advancement, maintenance, and expansion.** The need for climate adaptation will continue into the future, as will the evolution and refinement of the scientific basis for resilience efforts. Providing current scientific results to decision makers and stakeholders in a manner that can directly inform deliberation, planning, management, operations, and infrastructure-related decisions is critical. Intermediary tools, like Cal-Adapt, that provide peer-reviewed scientific data in a format that is accessible and cost-free for planners and the public are, therefore, a necessity. Current legal and resource limitations will impede the expansion of Cal-Adapt to provide adaptation support tools and services that would benefit publicly owned utilities and local agencies, especially in disadvantaged, low-income, and vulnerable communities. The Energy Commission, in collaboration with sister agencies, should therefore allocate resources for the long-term viability of Cal-Adapt.

CHAPTER 4:

Electricity Demand Forecast Update

Background

The California Energy Commission provides full forecasts for electricity and natural gas demand every two years as part of the *Integrated Energy Policy Report (IEPR)* process. The forecasts are used in various proceedings, including the California Public Utilities Commission's (CPUC's) Long-term Procurement Planning (LTPP) process and the California Independent System Operator's (California ISO's) Transmission Planning Process (TPP). In addition, the Energy Commission provides annual year-ahead peak demand forecasts for the resource adequacy process in coordination with the California ISO and the CPUC.

The Energy Commission's full demand forecast is done biennially, in odd-numbered years. Recognizing the process alignment needs and schedules of the CPUC and California ISO planning studies, the Energy Commission provides an update to the full IEPR forecast in even-numbered years. The update consists of revising economic and demographic drivers used in the previous full IEPR forecast with the most current projections. Further, the update adds one more year of historical electricity consumption and peak demand data, and self-generation technology adoptions and pending adoptions, which are used to recalibrate the forecast to the last historical year. Typically, other factors that affect the forecast, such as results of energy efficiency programs and projected electricity rates are not updated. In addition, projections for additional achievable energy efficiency (AAEE), which measures estimated savings from future efficiency initiatives, will remain unchanged until the next full forecast.

As in the full IEPR forecasts, the forecast update includes three demand cases designed to capture a reasonable range of demand outcomes over the next 10 years. The *high energy demand* case incorporates relatively high economic/demographic growth, relatively low electricity and natural gas rates, and relatively low committed efficiency program, self-generation, and climate change impacts. The *low energy demand* case includes lower economic/demographic growth, higher assumed rates, and higher committed efficiency program and self-generation impacts. The *mid* case uses input assumptions at levels between the *high* and *low* cases.

2017 IEPR Forecast and Beyond

Aside from the typical forecast update, this year's IEPR process focused on meeting the goals outlined in the Clean Energy and Pollution Reduction Act (De León, Chapter 547, Statutes of 2015) (Senate Bill 350). Among other requirements outlined in SB 350, the California Legislature set forth the goal of doubling statewide energy efficiency savings (relative to current projections) by 2030 and establishing strategies and targets to meet

that goal. This prompted the Energy Commission to evaluate future data needs and forecast improvements to build technical capability for new assessments of statewide energy demand. As part of the *2016 IEPR Update*, the Energy Commission hosted two public workshops to discuss current staff efforts to improve forecasting capabilities and future data and analytical requirements.

Improvements to Forecast Methods

The first workshop, held June 23, 2016, focused on methodological changes to be incorporated into the upcoming *2017 California Energy Demand (CED 2017)* forecast and future forecasting efforts. Topics included:

- Changes to modeling behind-the-meter photovoltaics (PV).
- Future shifts in peak demand timing and magnitude due to growth of behind-the-meter PV and other demand modifiers.
- The addition of a long-term hourly forecasting model.
- Continued refinements to geographical disaggregation, or breakdown, of the demand forecast.
- A new process to ensure timely agreement between the utilities and the Energy Commission on weather normalized peak demand estimates.

This latter element, which represents peak demand assuming “normal” weather in the last historical year, is a key step in developing long-term planning area peak forecasts.³⁷⁵ A weather-normalized peak value in the last historical year provides a starting point from which peak demand growth can be projected. Energy Commission staff works closely with utility forecasters to develop a consensus on best estimates of these values. Developing a timely consensus has proved challenging in past forecasts in part due to the various analyses and methodologies for defining “normal” weather and modeling peak loads, and because of the limited time available to develop the estimates since the peak may occur in September. Thus, Energy Commission staff developed an improved process with specific deadlines involving utilities to ensure agreement on weather-normalized peak estimates.³⁷⁶ This should help prevent delays in finalizing future IEPR forecasts.

In addition to discussing improvements to behind-the-meter PV modeling, Energy Commission staff stressed the need for accurate interconnection and generation data from utilities going forward.³⁷⁷ Moreover, staff examined potential improvements to

³⁷⁵ Peak demand is weather-normalized to provide the proper benchmark for comparison to future peak demand.

³⁷⁶ IEPR workshop on Methodological Improvements to the Energy Demand Forecast for 2017 and Beyond, June 23, 2016, http://docketpublic.energy.ca.gov/PublicDocuments/16-IEPR-05/TN212279_20160713T144327_Transcript_of_the_06232016_IEPR_Commissioner_Workshop.pdf, p. 95.

³⁷⁷ IEPR workshop on Methodological Improvements to the Energy Demand Forecast for 2017 and Beyond, June 23, 2016, http://docketpublic.energy.ca.gov/PublicDocuments/16-IEPR-05/TN212279_20160713T144327_Transcript_of_the_06232016_IEPR_Commissioner_Workshop.pdf, p. 9.

future modeling efforts that include differentiating customers by electricity usage level rather than using an “average” customer, incorporating new types of ownership structures for PV systems such as leases, and using alternative cost-effective metrics for customer adoption modeling. Energy Commission forecasting staff received input from California investor- and publicly owned utilities, the U.S. Energy Information Administration, and the National Renewable Energy Laboratory.³⁷⁸

Improvements in behind-the-meter PV modeling also feed into several other topics that will be addressed in future forecasts. Previously, demand forecast assumptions fixed the timing of annual peak demand projections. However, preliminary staff analysis shows that rapid growth in behind-the-meter PV adoption and the resulting increase in solar generation during typical peak hours may shift or delay daily peak timing by one or more hours when compared to historical peak loads. Continuing with a static assumption for peak timing would lead to overestimating behind-the-meter PV production at the peak hour and underestimating forecasted peak demand.

The California ISO and utilities staff urged the Energy Commission to incorporate the effect of a potential peak shift into future demand forecasts to ensure the most accurate estimates of planning area peak demand. Forecasting staff developed a preliminary method to account for the peak shift effect for the *California Energy Demand Updated Forecast 2017–2027 (CEDU 2016)*, but a more comprehensive analysis is required to account for changes to customer consumption patterns due to factors such as the economy, weather, and other demand modifiers. For *CEDU 2016*, forecast adjustments reflect projected changes to peak hour and magnitude because of PV, the primary driver of this shift, as well as AAEE. This adjustment will be based on historical rather than projected load patterns and is, therefore, somewhat incomplete. A more complete method will be adopted for *CED 2017*.

As recommended in the *2015 IEPR*, the Energy Commission plans to include hourly projections of electricity demand in future electricity forecasts. An initial long-term hourly forecasting model, developed with input from the Energy Commission’s Demand Analysis Independent Expert Panel, is scheduled for use in the *2017 IEPR Energy Demand Forecast*. The long-term hourly forecasting model will be capable of forecasting hourly loads over a 10-year period at the level of the three major California ISO transmission access charge areas.³⁷⁹ This hourly forecast, combined with projected hourly impacts of PV, energy efficiency, electric vehicles, demand response, and time-of-use rates, will give a more complete assessment of the peak shift and accompanying

378 IEPR workshop on Methodological Improvements to the Energy Demand Forecast for 2017 and Beyond, June 23, 2016, http://docketpublic.energy.ca.gov/PublicDocuments/16-IEPR-05/TN212279_20160713T144327_Transcript_of_the_06232016_IEPR_Commissioner_Workshop.pdf, p. 56 and p. 74.

379 The California ISO maintains four Transmissions Access Charge Areas, or TACs used for the allocation of transmission costs to entities using the state grid. The TAC areas correspond to PG&E, SCE, SDG&E, and VEA transmission territories.

changes in peak demand. Assuming the availability of more granular data, such as that flowing from customer-level advanced metering infrastructure, further disaggregation of this model would be possible. Energy Commission staff is working with utility staff to determine an optimal level of disaggregation to better serve transmission and local area planning.

Comments from stakeholders that attended the June 23, 2016, IEPR workshop highlighted the importance of a transparent public process while forecast methods continue to be refined. Stakeholders recognized the analytical and data challenges ahead and offered valuable input to support the development of new forecast methodologies. The following are examples of the stakeholder comments:

- “As regulators try to strike this balance between reliability and affordability, technical support and expertise from a wider group of stakeholders will be critical.” – Damon Franz, Solar City³⁸⁰
- “Creating a repository of load forecasting data at the state level is an excellent idea... More work invested in analysis and less in data collection intuitively would be more productive.” – Michael Cockayne, LoadForecast.net³⁸¹
- “It is critical that the 8760 AAEE forecast accurately represent hourly impacts of energy efficiency savings to effectively inform robust policy and programs...” – Kala Viswanathan, et al., Natural Resources Defense Council³⁸²

The impact of transportation electrification on future electricity demand is another area in which deeper understanding and analysis is needed. To that end, another panel of transportation modeling experts will be reviewing the current suite of transportation energy forecasting models and making recommendations for the *2017 IEPR* and beyond. Closer coordination with other relevant state agencies on transportation electrification will clarify model inputs and assumptions that reflect the state’s electrification policy, within a forecasting context.

Senate Bill 350

Another important consideration for future forecasts is how to incorporate the SB 350 requirement to double energy efficiency savings by 2030 within the forecast and what new data and analytics will be needed to establish a clear baseline and assess the state’s

380 See http://docketpublic.energy.ca.gov/PublicDocuments/16-IEPR-05/TN212183_20160707T162703_Francesca_Wahl_Comments_SCTY_Comments__Energy_Demand_Forecast_2.pdf.

381 See http://docketpublic.energy.ca.gov/PublicDocuments/16-IEPR-05/TN212139_20160706T112840_Michael_Cockayne_Comments_Comment_on_Methodological_Improvement.pdf.

382 See http://docketpublic.energy.ca.gov/PublicDocuments/16-IEPR-05/TN212165_20160707T140351_Kala_Viswanathan_Comments_NRDC_Comments_on_Demand_Forecast_Met h.pdf.

progress in achieving these savings. The Energy Commission hosted a foundational joint agency workshop to begin public discussion of this issue that included commissioners, executives, and staff from the CPUC, California ISO, and the California Air Resources Board.

The Joint Agency Steering Committee (JASC), an interagency team of senior management representatives that operates under the guidance of these agency decision makers, opened the workshop. The JASC is responsible for aligning the multiple agency processes affecting the Energy Commission's electricity demand forecast and the use of the forecast in other proceedings. Both Assembly Bill 802 (Williams, Chapter 590, Statutes of 2015) (AB 802) and SB 350 have implications for the agencies' use of an agreed-upon forecast set for procurement and transmission planning. AB 802 creates new baseline conditions for utility programs, making savings incremental to those already captured in codes and standards more technically difficult to differentiate. For SB 350, the JASC will assist with coordination on economywide greenhouse gas reduction goals and integrated resource planning objectives that include doubled energy efficiency savings, transportation electrification, and higher levels of renewables, among others.

The July 11, 2016, workshop introduced a key set of fundamental decisions for the Energy Commission to resolve in establishing the framework of the SB 350 requirement to double energy efficiency savings. These decisions include specifying energy efficiency targets, determining cost-effectiveness metrics, and defining an approach for quantifying fuel substitution/fuel switching. Additional questions to be addressed related to technical aspects of calculating energy savings. Based on written comments received from stakeholders, ongoing discussion will be necessary to address questions and issues raised at this workshop. Stakeholders emphasized a need for state agencies to coordinate efforts effectively when addressing the following fundamental objectives:³⁸³

- Developing an achievable statewide approach
- Defining and measuring cost-effectiveness and feasibility
- Developing strategies to collect, analyze and manage data, including from community choice aggregators
- Leveraging new tools for data analytics
- Having access to advanced metering infrastructure (AMI) data to conduct more comprehensive analysis and define implementable solutions³⁸⁴

383 2016 IEPR, Docket #16-IEPR-05, comments received from various parties.

384 *Advanced metering infrastructure* is an integrated system of smart meters, communications networks, and data management systems that enables two-way communication between utilities and customers.

- Engaging customer support and communicating the importance of energy savings
- Frequently updating critical studies such as end-use surveys and saturation studies

As indicated by the comments received, there is tremendous value in identifying the most diverse and robust data sets to enhance current forecasting methods, provide the fundamental information to establish energy efficiency targets, evaluate energy savings, and improve data analytics. Revision of the forecast method, and deepening the related informational underpinnings, permits—demands—the application of a variety of modern analytical tools to energy policy, planning, and programs. The following sample of stakeholder comments highlights the support for advanced data collection going forward:

- “We encourage the Commission to provide regulations and processes that will support the increased use of AMI data analysis to characterize and compare energy use in existing homes.” – Steve Schmidt, Home Energy Analytics³⁸⁵
- “We need to learn the best practices from other states and perform sophisticated analysis using AMI and real time data.” – Kala Viswanathan, Natural Resources Defense Council³⁸⁶
- “[...]Data must be updated annually to ensure that energy efficiency measures that make the greatest contribution to peak needs are appropriately credited for these contributions...” – Spencer Olinek, Pacific Gas and Electric (PG&E)³⁸⁷
- “Obtaining the 8760 hour data for energy efficiency could further enhance peak demand modeling...” – Michael Cockayne, LoadForecast.net³⁸⁸

The JASC will continue to lead the discussion across key agencies, coordinate various groups that are addressing SB 350 and AB 802 policies and the related impacts on the forecast, and develop additional information and recommendations for agency leadership to address these issues. A key goal will be to identify issues that may affect the agreed-upon use of a forecast set in the state’s planning proceedings.

385 See http://docketpublic.energy.ca.gov/PublicDocuments/16-IEPR-05/TN212371_20160720T152031_Lisa_Schmidt_Comments_HEA_Comments_on_71116_IEPR_Workshop.pdf.

386 See http://docketpublic.energy.ca.gov/PublicDocuments/16-IEPR-05/TN212462_20160725T162013_Kala_Comments_NRDC_Comments_on_the_Energy_Demand_Forecast_and_D.pdf.

387 See http://docketpublic.energy.ca.gov/PublicDocuments/16-IEPR-05/TN212428_20160722T163058_Pacific_Gas__Electric_Comments_Pacific_Gas__Electric_Comments_o.pdf.

388 See http://docketpublic.energy.ca.gov/PublicDocuments/16-IEPR-05/TN212313_20160715T085739_Michael_Cockayne_Comments_Recommendation_to_include_8760_shapes.pdf.

Energy efficiency potential and goals studies are the first step in identifying technical, economic, and market potential for energy efficiency savings that could be incremental to, and counted toward, the savings doubling called for in SB 350. At the July 11, 2016, workshop, Navigant Consultants described some initial thinking about how current potential modeling practices could be adapted to capture some of the new savings streams identified in SB 350.³⁸⁹

On July 19, 2016, the Demand Analysis Working Group held the first of several technical discussions on the next CPUC investor-owned utility (IOU) Potential and Goals Study, scheduled to be completed in April 2017. This study, designed to yield AAEE savings for *CED 2017*, will incorporate AB 802 adjustments to reflect an “existing baseline” rather than assume code compliance as the baseline for buildings and appliances. In addition, the study will include “SB 350-friendly” scenarios to help evaluate potential efficiency gains from enhancing current programs, codes, and standards to contribute toward achieving a doubling of end-use energy efficiency savings.

Future Data and Analytical Needs

In addition to the existing baseline requirements, AB 802 established the authority for the Energy Commission to acquire individual utility customer usage and billing data. On January 13, 2016, the Energy Commission opened Rulemaking 16-OIR-01³⁹⁰ to consider amending the agency’s regulations specifying data collection and disclosure for load-serving entities. These amendments will help the Energy Commission implement SB 350 and AB 802 provisions and clarify existing provisions in the regulations. Data collected under these regulations will be used for studies that will improve demand forecasting and technical knowledge of the role of energy efficiency in reducing customer demand, and provide characterizations of specific energy demands that can be met through targeted programs and/or market action. These data will also allow regional assessments of hourly and seasonal impacts of savings, disaggregation and improvement of energy demand forecasts, improved electricity peak load forecasts, and enable baselining and improved characterization of energy consumption across customer sectors and end uses. Granular data will allow the forecast to be disaggregated, or broken down, by location and specific times of day or year, making it more useful for resource and transmission planning.

At the July 11, 2016, IEPR workshop, experts in the fields of energy efficiency measurement and evaluation and data analytics presented current modeling techniques and discussed future data needs. Part of the discussion centered on access to more

389 IEPR workshop on Energy Demand Forecast and Doubling of Energy Efficiency- Data and Analytical Needs, July 11, 2016, http://docketpublic.energy.ca.gov/PublicDocuments/16-IEPR-05/TN212626_20160804T144906_Transcript_of_the_07112016_Joint_Agency_IEPR_Workshop_on_Energy.pdf, p. 54 and p. 64.

390 http://www.energy.ca.gov/business_meetings/2016_packets/2016-01-13/Item_05_OIR-SB_350/Item%205%20OIR%20SB350_final_1-4-16.pdf.

granular energy usage data, new analytical tools for metered data, and the need to learn more about customer behavior in future energy efficiency and consumption analyses. The forum included representatives from Kevala Analytics, the California Center for Sustainable Communities, Lawrence Berkeley National Laboratory, and Stanford University.

A second workshop jointly led by the Energy Commission and the CPUC is planned for January 23, 2017, to continue discussing how the doubling of energy efficiency savings might be achieved under SB 350. The 2030 energy efficiency goal will require a wide range of new delivery mechanisms and program offerings, far more than business as usual through utility efficiency programs and building and appliance standards.

SB 350 also requires the Energy Commission to establish a process for 16 publicly owned utilities to submit integrated resource plans to the Energy Commission for review by January 1, 2019, and requires the CPUC to establish a similar process for regulated load-serving entities.³⁹¹ These comprehensive electricity system planning documents are intended to ensure that investor- and publicly owned utilities meet greenhouse gas emission reduction targets and lay out the resource needs, policy goals, physical and operational constraints, and general priorities or proposed resource choices. Further, SB 350 requires that the integrated resource plans address procurement for energy efficiency, demand response, energy storage, transportation electrification, diversified procurement, and resource adequacy. The plans will provide a means for assessing how utilities intend to use their future demand and supply resources to align with the energy and other policies goals outlined in SB 350.

California Energy Demand Updated Forecast, 2017–2027

Updated Economic and Demographic Drivers

In general, current projections for economic growth in California expect modest growth similar to projections used for *CED 2015*. As shown in Figure 33, the projection for statewide commercial employment³⁹² in the *CEDU 2016* mid case is slightly lower than in *CED 2015*. By 2026, commercial employment is around 0.58 percent lower in the new mid case compared to *CED 2015*. Annual growth rates from 2015-2026 average 1.25 percent, 1.17 percent, and 1.06 percent in the *CEDU 2016* high, mid, and low scenarios, respectively, compared to 1.19 percent in the *CED 2015* mid case.

Figure 34 shows historical and projected personal income at the statewide level for the three *CEDU 2016* scenarios and the *CED 2015* mid demand case. By 2026, income is around 1.19 percent higher in the *CEDU 2016* mid case compared to *CED 2015*. Annual

391 To that end, the CPUC issued an Order Instituting Rulemaking (R.16-0-007) in February 2016. An inventory of CPUC proceedings related to SB 350 is available at <http://www.cpuc.ca.gov/sb350/>. The Energy Commission's first workshop to consider a POU process was held April 18, 2016.

392 Total employment minus employment in the industrial and agricultural sectors.

growth rates from 2015-2026 average 3.18 percent, 2.94 percent, and 2.71 percent in the *CEDU 2016* high, mid, and low scenarios, respectively, compared to 2.88 percent in the *CED 2015* mid case.

Figure 33: Statewide Commercial Employment

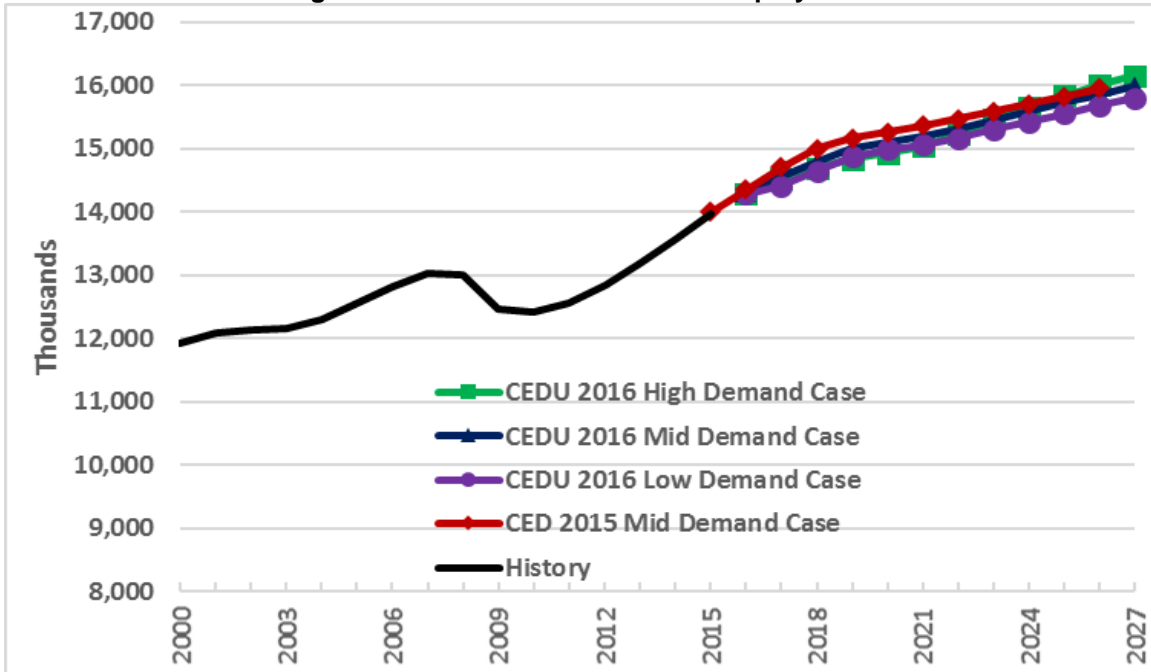

Sources: Moody's Analytics and IHS Global Insight, 2015-2016.

Figure 34: Statewide Personal Income

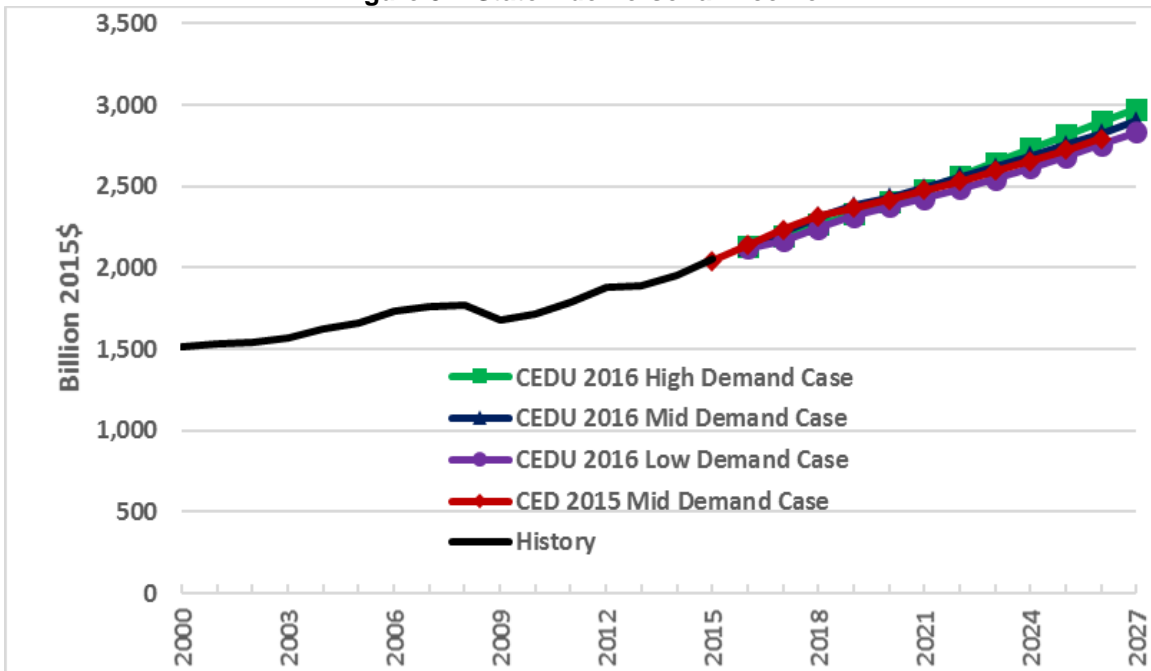

Sources: Moody's Analytics and IHS Global Insight, 2015-2016.

Method

The Energy Commission uses detailed models for each economic sector (such as residential, commercial, industrial, and transportation) to project electricity consumption and demand for the full IEPR energy demand forecast. In addition to the more complex sector models, staff also estimates single-equation econometric models by sector, which typically yields similar results at the aggregate, or collective, level. Staff relied on these econometric models, re-estimated to incorporate historical data for 2015, for *CEDU 2016*. The explanatory variables and estimation results for each econometric model are provided in the posted report for the *California Energy Demand Updated Forecast 2017-2027*.³⁹³

To ensure a proper comparison to *CED 2015*,³⁹⁴ results from the econometric models are benchmarked to the earlier energy demand forecast to isolate the effects from the revised set of economic and demographic drivers. Percentage changes in electricity demand caused by the updated drivers as estimated by the econometric models are then applied to *CED 2015* results.

California Energy Demand Forecast Results

Figure 35 shows projected *CEDU 2016* electricity consumption for the three baseline cases and the *CED 2015* mid demand forecast. By 2026, consumption in the updated mid case is projected to be 0.23 percent lower than the *CED 2015* mid case. Annual growth rates from 2015-2026 for the *CEDU 2016* cases average 1.42 percent, 1.05 percent, and 0.66 percent in the high, mid, and low cases, respectively, compared to 0.93 percent in the *CED 2015* mid case. Although the starting point (2016) in the new forecast is lower than had been projected in *CED 2015*, due to lower-than-expected economic growth, long-term growth in consumption remains comparable to *CED 2015* mid case.

Figure 36 shows projected *CEDU 2016* noncoincident peak demand for the three baseline cases and the *CED 2015* mid demand peak forecast. By 2026, statewide peak demand in the updated mid case is projected to be 1.1 percent lower than the *CED 2015* mid case. Annual growth rates from 2016-2026 for the *CEDU 2016* cases average 1.03 percent, 0.44 percent, and -0.30 percent in the high, mid, and low cases, respectively, compared to 0.45 percent in the *CED 2015* mid case. Comparable growth in personal income and residential consumption results in similar growth of noncoincident net peak demand in the updated mid demand case compared to *CED 2015*.

393 http://docketpublic.energy.ca.gov/PublicDocuments/16-IEPR-05/TN214635_20161205T142341_California_Energy_Demand_Updated_Forecast.pdf.

394 Kavalec, Chris, Nick Fugate, Cary Garcia, and Asish Gautam. 2016. *California Energy Demand 2016-2026, Revised Electricity Forecast*. California Energy Commission.

Figure 35: Statewide Baseline Annual Electricity Consumption

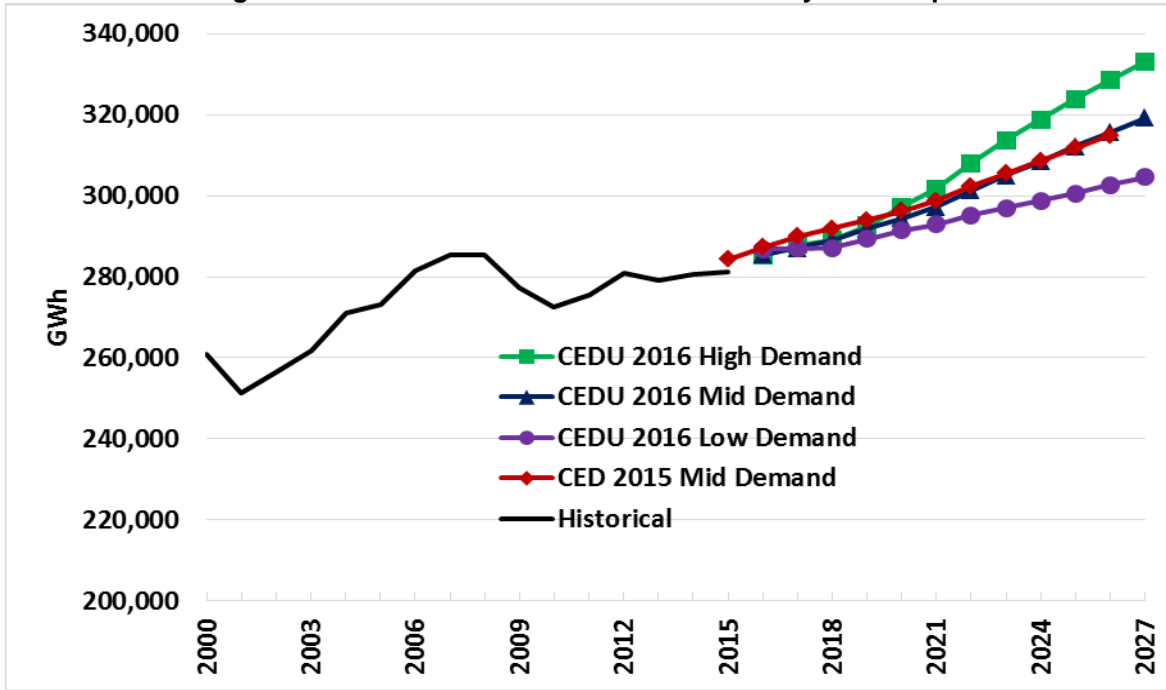

Source: California Energy Commission, Demand Analysis Office, 2016.

Figure 36: Statewide Baseline Annual Noncoincident Peak Demand

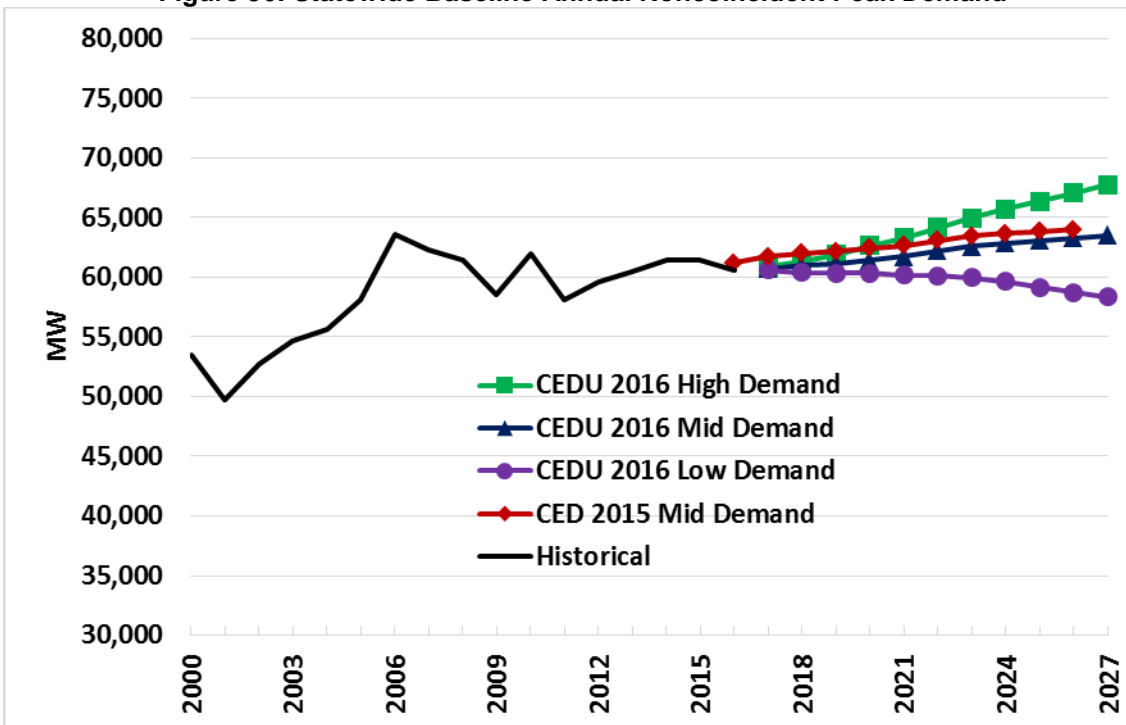

Source: California Energy Commission, Demand Analysis Office, 2016.

For *CEDU 2016*, IOU AAEE estimates remain the same as in *CED 2015*, though they now include estimated savings for 2027 developed by Navigant Consulting. However, as applied to *CEDU 2016*, estimated impacts are calculated as incremental to 2015 for energy and 2016 for peak since any AAEE savings in these two years would be embedded in the historical data. Figure 37 and Figure 38 show updated incremental projected AAEE savings for the combined investor-owned utility service territories for the five savings scenarios for energy and peak, respectively.³⁹⁵ Managed forecasts, reflecting AAEE impacts, are provided in the subregional demand forms (1.1c and 1.5) posted with the *CEDU 2016* report. By 2027, incremental mid baseline-mid AAEE energy savings are expected to be nearly 19,500 gigawatt hours (GWh), not accounting for transmission and distribution losses. The more conservative mid baseline-low AAEE case reaches around 14,600 GWh of savings by 2027. For peak, the mid-baseline-mid AAEE case yields around 4,300 MW of incremental savings by 2027, while the mid baseline-mid AAEE case provides just above 3,200 MW of savings.

Figure 37: Combined IOU AAEE Energy Savings

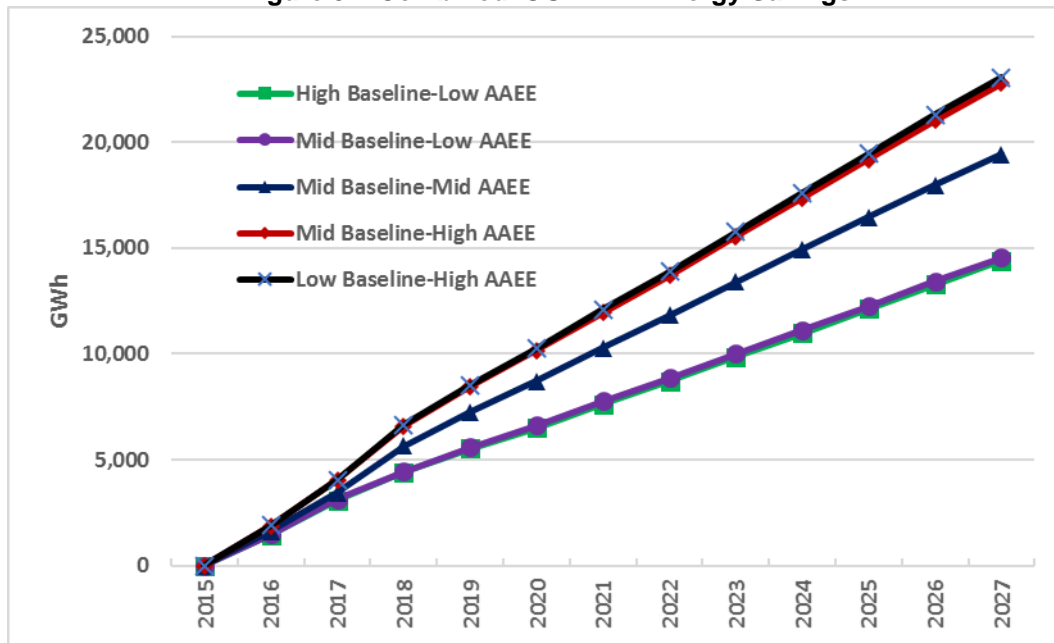

Source: California Energy Commission, Demand Analysis Office, 2016.

395 The five cases include high baseline, low AAEE; mid baseline, high AAEE; mid baseline, mid AAEE; mid baseline, low AAEE; and low baseline, high AAEE. The scenarios are defined by a combination of assumptions used in the baseline forecast (for example, building stock) and in the AAEE simulation (for example, the Total Resource Cost test threshold).

Figure 38: Combined IOU AAEE Peak Savings

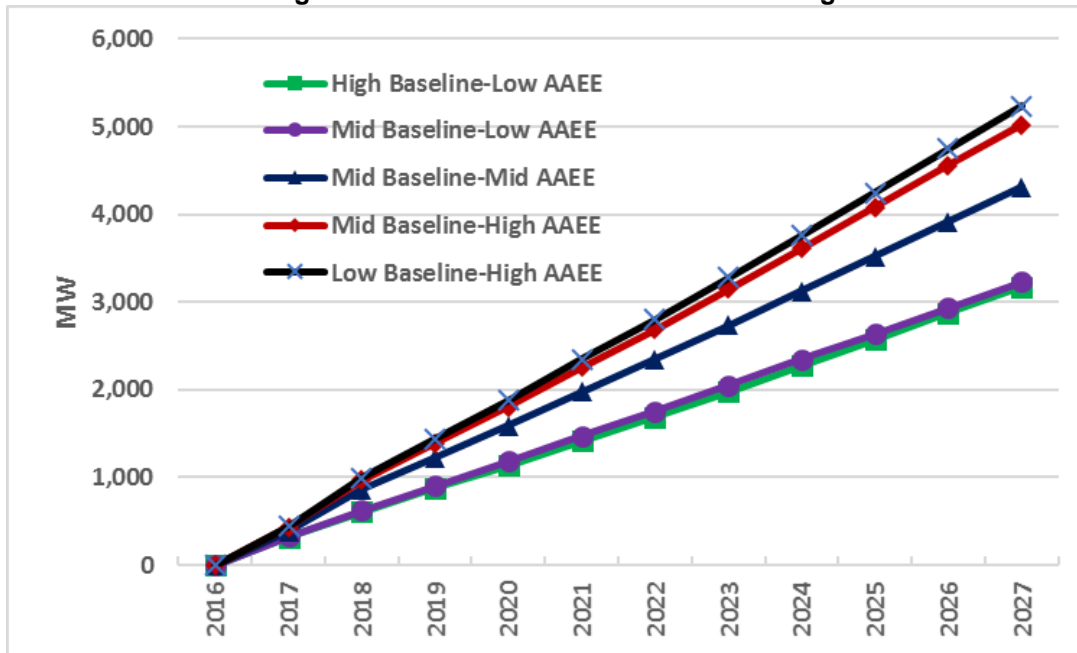

Source: California Energy Commission, Demand Analysis Office, 2016.

As in *CED 2015*, AAEE savings for the two largest California POU (Los Angeles Department of Water and Power, or LADWP, and Sacramento Municipal Utility District, or SMUD) are included in *CEDU 2016*. AAEE savings estimates for POU remain the same as in *CED 2015* except for the inclusion of savings estimates for 2027, extrapolated from 2025-2026 growth rates. As with IOU savings, energy savings is measured as incremental to 2015 and peak savings as incremental to 2016. Figure 39 and Figure 40 show updated LADWP and SMUD’s combined incremental AAEE savings for the high, mid, and low demand cases. By 2027, the mid and low demand cases for POU AAEE are just above 3,200 GWh of energy savings, while the high demand case is closer to 2,500 GWh. For peak, POU AAEE savings for the mid and low demand cases are near 800 MW of savings, while the high demand case is just about 600 MW of savings.

Figure 39: Combined POU AAEE Energy Savings

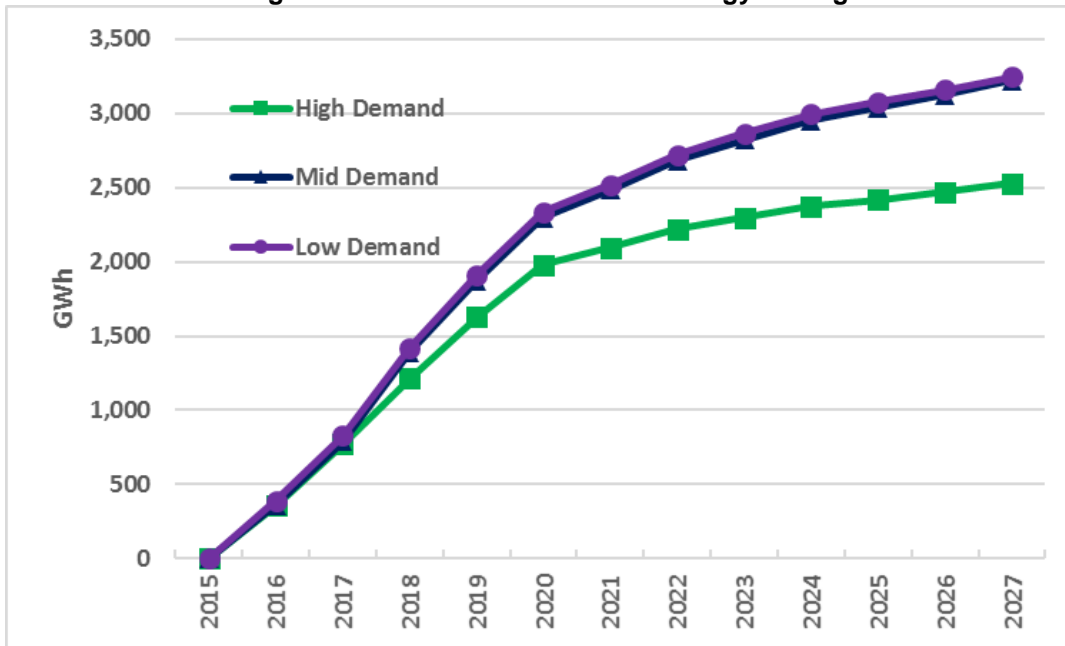

Source: California Energy Commission, Demand Analysis Office, 2016.

Figure 40: Combined POU AAEE Peak Savings

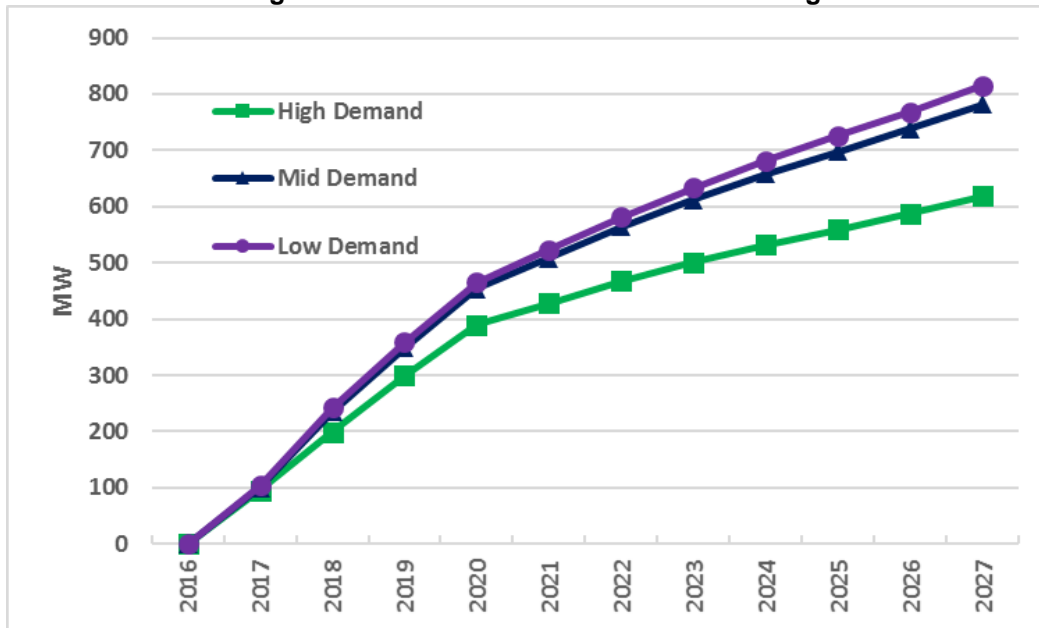

Source: California Energy Commission, Demand Analysis Office, 2016.

Preliminary Peak Shift Scenario Analysis

As demand modifiers such as PV, efficiency, time-of-use pricing, and electric vehicles affect load to a growing degree, hourly load profiles may change to the extent that peak load provided by load-serving entities may occur at a different hour of the day. In particular, PV generation may shift utility peaks to a later hour as a significant part of

load at traditional peak hours (late afternoon) is served by PV, with generation dropping off quickly as the evening hours approach.

For *CEDU 2016*, staff developed a scenario analysis of potential peak shift and the resulting impact on peak demand served by utilities for the investor-owned utility planning (transmission access charge) areas for the managed forecast (that is, the mid baseline case combined with mid AAEE). The results of the *final adjusted managed peak* scenario analysis can be used by the California ISO in transmission planning studies to review previously approved projects or procurement of existing resource adequacy resources to maintain local reliability. These results, however, should not be used in identifying new needs triggering new transmission projects given the preliminary nature of the analysis. More complete analyses will be developed for IEPR forecasts once full hourly load forecasting models are developed.

The *CEDU 2016* scenario analysis for peak shift consisted of three main components:

- Hourly load profiles for PV generation
- Hourly load profiles for AAEE savings
- Projected weather-normalized hourly end-use loads for each of 8,760 hours for each year, where end-use load is defined as utility-supplied load including line losses plus PV generation plus avoided line losses

The impacts of time-of-use and electric vehicles were not included in the scenario analysis as estimated load shapes for these modifiers are at a very preliminary stage and require more data and study.

For each year, hourly estimates of PV generation and AAEE savings (including avoided losses) were subtracted from hourly end-use load to give estimates of loads served by utilities in each investor-owned utility planning area. The annual maximum of these hourly loads represents an adjusted peak projection for a given year that incorporates peak shift brought about by PV and AAEE, peaks that now occur at a later hour. The difference between these peaks and *CEDU 2016* projected utility-served managed peaks (that is, the mid baseline case combined with mid AAEE) for each year gives a preliminary annual peak shift adjustment for 2016-2027. Since the *CEDU 2016* peak for 2016 is based on actual historical loads and therefore incorporates any peak shift that may have already occurred, the annual adjustments were recalculated to be incremental to 2016.

Staff prepared the *final adjusted managed peak* scenario based on the upward trend found in preliminary analysis of peak shift. This was calculated using a linear regression with estimated peak shift adjustments specified as a function of time. The resulting trended adjustments are shown in Figure 41 for PG&E, Figure 42 for Southern California Edison (SCE), and Figure 43 for San Diego Gas & Electric (SDG&E), referred to as *final* adjustments for this scenario.

Figure 41: CEDU 2016 Managed Peak Forecast and Managed Forecast With Final Adjustment for Peak Shift, PG&E Planning Area

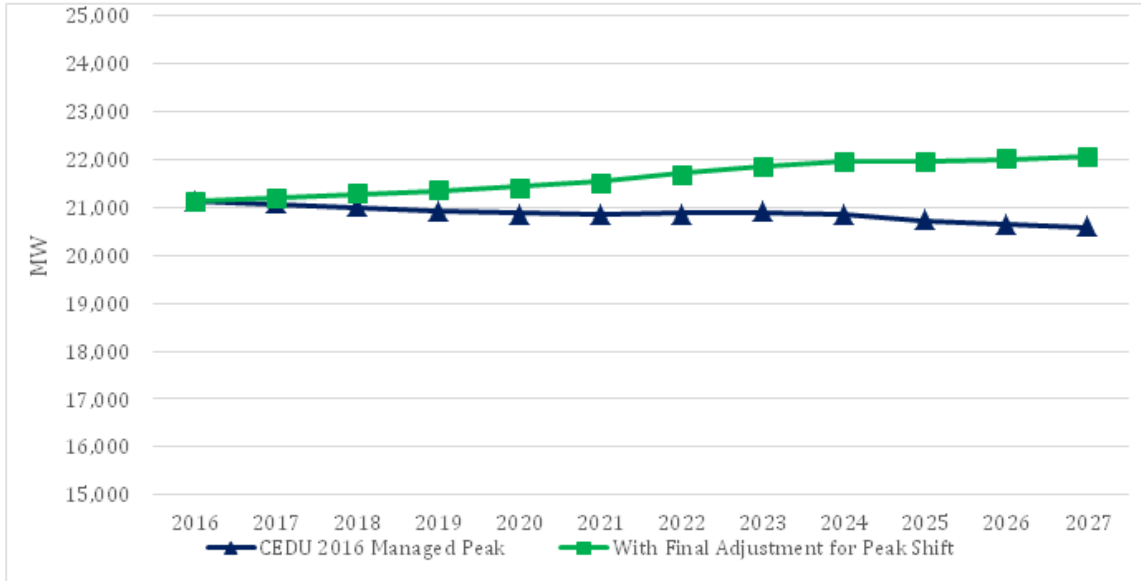

Source: Demand Analysis Office, California Energy Commission, 2016.

Figure 42: CEDU 2016 Managed Peak Forecast and Managed Forecast with Final Adjustment for Peak Shift, SCE Planning Area

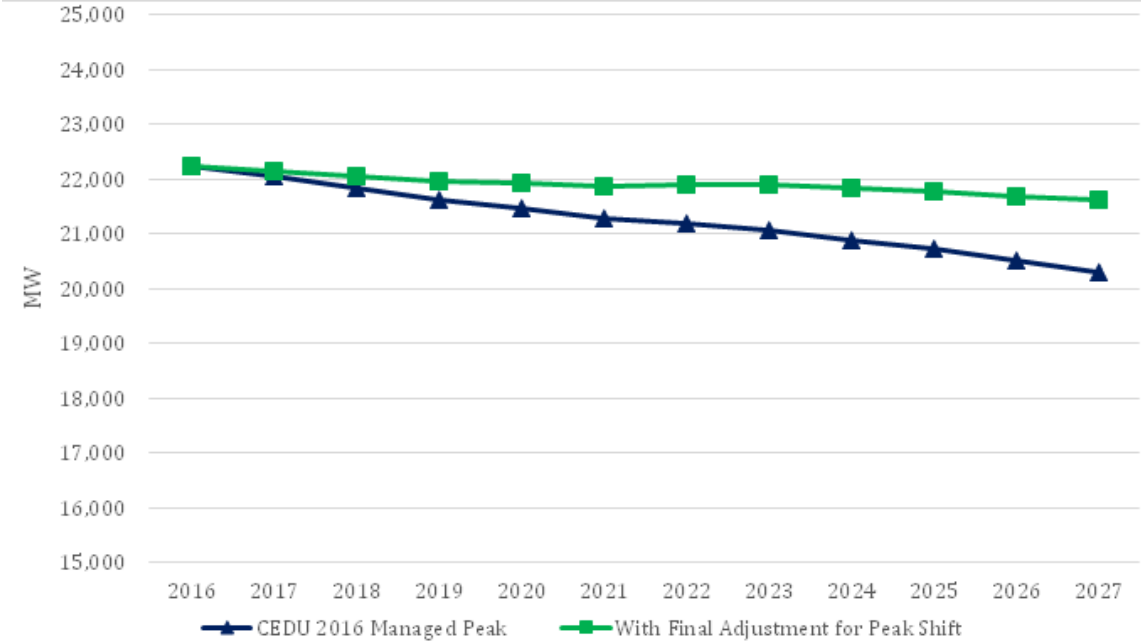

Source: Demand Analysis Office, California Energy Commission, 2016.

Figure 43: CEDU 2016 Managed Peak Forecast and Managed Forecast with Final Adjustment for Peak shift, SDG&E Planning Area

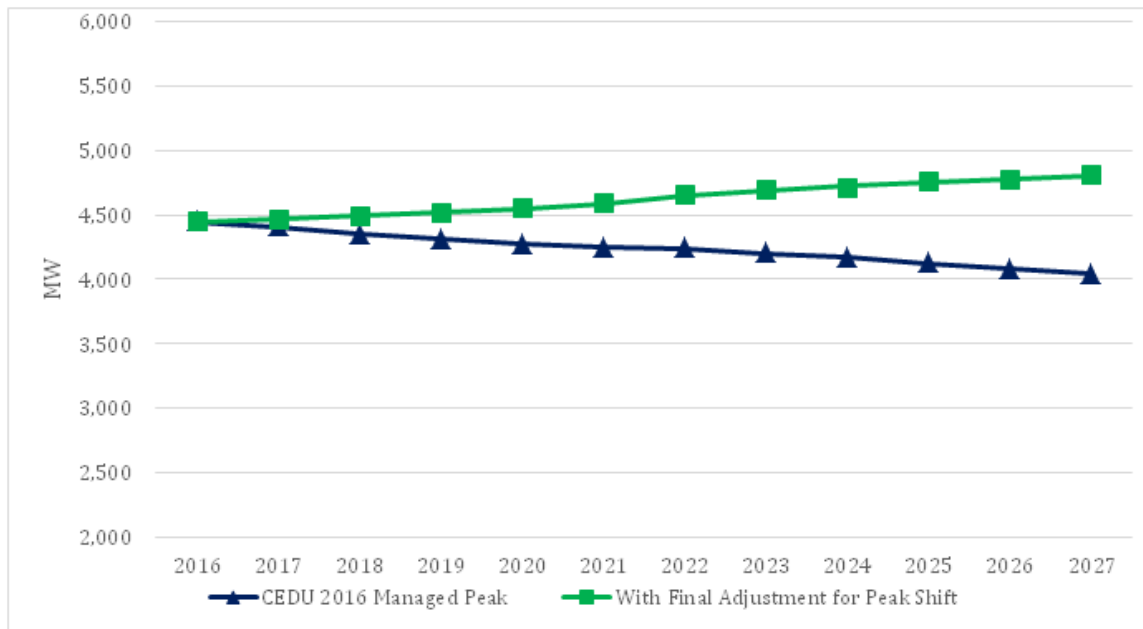

Source: Demand Analysis Office, California Energy Commission, 2016.

Recommendations

- Continue development of long-term hourly forecasting capability.** Energy Commission staff will initiate a 10-year hourly forecasting model for the 2017 *Integrated Energy Policy Report (IEPR)* forecast, including the base forecast and additional achievable energy efficiency. This model will incorporate assessments of the hourly impacts of behind-the-meter solar photovoltaic, energy storage, electric vehicles, demand response programs, and time-of-use rates. For future forecasts, staff will further disaggregate the hourly forecast, as more granular utility customer data becomes available. Further disaggregation of the hourly forecast may be informative to local area and distributed resource planning studies.
- Further refine transportation electrification forecasting capabilities.** Forecasting staff is working with Idaho National Laboratory to develop more accurate measurement of electric vehicle charging profiles for the 2017 *IEPR* energy demand forecast. These improved estimates will directly support the long-term hourly forecasting model and continued refinements to forecast disaggregation.
- Develop timely approach to weather normalization.** Working with stakeholders, Energy Commission staff will continue to develop and refine a weather normalization process to ensure that issues are resolved well prior to adoption of the energy demand forecast. Moreover, Energy Commission staff supports California Independent System Operator (California ISO) efforts to share California ISO system load data used by the Energy Commission with utility staff to further promote a timely process for evaluating weather normalized peak demand.

- **Continue to evaluate the impact of peak shift in 2017 IEPR energy demand forecast.** During the *2017 IEPR* proceeding, Energy Commission staff should continue discussions with the California ISO, the California Public Utilities Commission (CPUC), and utilities to address the impact of peak shift on demand forecasts and incorporate these shifts into future forecasts.
- **Improve behind-the-meter forecasting capabilities.** Energy Commission staff should emphasize the need for accurate behind-the-meter photovoltaic production profiles and continue to work with stakeholders to determine potential improvements to photovoltaic forecasting capabilities.
- **Continue to improve estimates of energy efficiency savings in the demand forecast in fulfillment of Senate Bill 350 requirements.** During the *2017 IEPR* process, Energy Commission staff will encourage stakeholder involvement as it determines the best methods for evaluating statewide energy efficiency savings and forecasted savings as the Energy Commission develops the tools needed to implement Senate Bill 350.
- **Initiate a public stakeholder process to address the suite of strategies to be pursued to achieve the “doubling” of statewide energy efficiency savings, and assign responsibilities for achieving the targets.** The Energy Commission and the CPUC should conduct a workshop early in the *2017 IEPR* process to consider the wide variety of programs and delivery mechanisms needed to successfully double incremental energy efficiency savings and how to account for them in the forecast.
- **Modify current data collection regulations to reflect the data authority of Assembly Bill 802 and the data needs for Senate Bill 350 implementation.** Energy Commission staff will continue to host meetings and public workshops to discuss draft versions of updated data collection regulation language. One key item will be customer-level meter data. The Energy Commission requires California utilities and community choice aggregators to provide this data for baseline assessments and detailed projections of energy efficiency resources as outlined by Assembly Bill 802 and Senate Bill 350.

Acronyms

AAEE	—	additional achievable energy efficiency
AAQS	—	ambient air quality standards
AB	—	Assembly Bill
AHSM	—	Advanced Horizontal Storage Modules
AMI	—	advanced metering infrastructure
AMP	—	aging management program
ARB	—	California Air Resources Board
ARCCA	—	Alliance of Regional Collaboratives for Climate Adaptation
Bcf	—	billion cubic feet
Bcfd	—	billion cubic feet per day
BMP Manual	—	best management practices manual
BOEM	—	Bureau of Ocean Energy Management
California ISO	—	California Independent System Operator
CAT	—	Climate Action Team
CCC	—	California Coastal Commission
CCTAG	—	Climate Change Technical Advisory Group
CDFW	—	California Department of Fish and Wildlife
CEDU	—	<i>California Energy Demand Updated Forecast</i>
CF	—	cubic feet
Climate-ADAPT	—	Climate Adaptation Platform
CNRA	—	California Natural Resources Agency
CO	—	carbon monoxide
CO₂	—	carbon dioxide
COPs	—	Conferences of the Parties
CPP	—	United States Clean Power Plan
CPUC	—	California Public Utilities Commission
CSI	—	California Solar Initiative
CSLC	—	California State Lands Commission
CSP	—	concentrating solar power
CSPA	—	California Sportfishing Protection Alliance
DER	—	distributed energy resources
Diablo Canyon	—	Diablo Canyon Power Plant
DOE	—	Department of Energy
DOGGR	—	Department of Conservation's Division of Oil, Gas, and Geothermal

	Resources
DR	— demand response
DRECP	— <i>Desert Renewable Energy Conservation Plan</i>
DRP	— distribution resource plan
EDF	— Environmental Defense Fund
EE	— energy efficiency
EIM	— energy imbalance market
EIR	— environmental impact report
EJ	— environmental justice
EPIC	— Electric Program Investment Charge
EPR	— <i>Environmental Performance Report</i>
EPS	— California’s Emission Performance Standard
FERC	— Federal Energy Regulatory Commission
GHG	— greenhouse gas
GWh	— gigawatt hours
HVDC	— high-voltage direct current
IDER	— integrated distributed energy resources
IEP	— Independent Energy Producers
IEPR	— <i>Integrated Energy Policy Report</i>
INDC	— Intended Nationally Determined Contributions
INFORM	— Integrated Forecast and Reservoir Management System
IOU	— investor-owned utility
IPCC	— Intergovernmental Panel on Climate Change
IRP	— integrated resource plan
ISFSI	— Independent Spent Fuel Storage Installations
JASC	— Joint Agency Steering Committee
kV	— Kilovolt
LADWP	— Los Angeles Department of Water and Power
LBL	— Lawrence Berkeley National Laboratory
lbs	— pounds
LCAAT	— Local Capacity Area Accounting Tool
LOCA	— localized constructed analogues
LTPP	— Long-Term Procurement Plan
LUPA	— Land Use Plan Amendment
MMcfd	— million cubic feet per day
MOU	— memorandum of understanding
MPC	— multipurpose canister

MTU	—	metric tons of uranium
MVAR	—	mega unit of reactive power
MW	—	megawatt
MWh	—	megawatt hour
NASA	—	National Aeronautics and Space Administration
NEM	—	net energy metering
NMFS	—	National Marine Fisheries Service
NOAA	—	National Oceanic and Atmospheric Administration
NO_x	—	oxides of nitrogen
NO₂	—	nitrogen dioxide
NRC	—	Nuclear Regulatory Commission
NRDC	—	Natural Resources Defense Council
NREL	—	National Renewable Energy Laboratory
NYMEX	—	New York Mercantile Exchange
O₃	—	ozone
OFO	—	operational flow order
OPC	—	California Ocean Protection Council
OPR	—	Governor's Office of Planning and Research
OTC	—	once-through cooling
PADD5	—	Petroleum Administration for Defense District Five
PCFFA	—	Pacific Coast Federation of Fishermen's Associations
PG&E	—	Pacific Gas and Electric
PIER	—	Public Interest Energy Research
PM	—	particulate matter
POU	—	publicly owned utility
PV	—	photovoltaic
RCPs	—	Representative Concentration Pathways
REAT	—	Renewable Energy Action Team
RETI	—	Renewable Energy Transmission Initiative
ROG	—	reactive organic gases
ROW	—	rights-of-way
RPS	—	Renewables Portfolio Standard
SACCWIS	—	Statewide Advisory Committee on Cooling Water Intake Structures
San Onofre	—	San Onofre Nuclear Generating Station
SB	—	Senate Bill
SCAQMD	—	South Coast Air Quality Management District
SCE	—	Southern California Edison

SCPPA	—	Southern California Public Power Authority
Scripps	—	Scripps Institution of Oceanography
SCRIP	—	Southern California Reliability Project
SDG&E	—	San Diego Gas & Electric
SoCalGas	—	Southern California Gas Company
SOCRE	—	South Orange County Reliability Enhancement
SO_v	—	oxides of sulfur
SO₂	—	sulfur dioxide
SWRCB	—	State Water Resources Control Board
TPP	—	Transmission Planning Process
UC Davis	—	University of California, Davis
UCLA	—	University of California, Los Angeles
UMAX	—	underground maximum
UNFCCC	—	United Nations Framework Convention on Climate Change
U.S. BLM	—	United States Bureau of Land Management
U.S. EPA	—	United States Environmental Protection Agency
USFWS	—	United States Fish and Wildlife Service
vars	—	reactive power
VOC	—	volatile organic compound
WECC	—	Western Electricity Coordinating Council
WRF	—	Weather Forecasting and Research
ZEV	—	zero-emission vehicle

APPENDIX A: Methane Emissions Associated With Natural Gas Consumption in California

Methane emissions contributed to about 9 percent of the total greenhouse (GHG) gas emissions in California in 2014. Methane emissions from the natural gas system comprise about 10 percent of the state's methane emissions and are the fourth largest source of methane emissions in California, as shown in Figure 44. This is in contrast with the recent U.S. Environmental Protection Agency (U.S. EPA) inventory for the United States that puts the United States' natural gas system as the main contributor to overall methane emissions in the nation.³⁹⁶ As explained in more detail below, this is mostly because California imports about 90 percent of the natural gas consumed in the state and natural gas extraction is a dominant source of methane emissions outside California. Based on the California Air Resources Board's (ARB's) GHG inventory, however, methane emissions from the natural gas system contributes about 0.9 percent³⁹⁷ to California's total GHG emissions.

396 U.S. EPA (2016). Inventory of U.S. Greenhouse Gas Emissions and Sinks: 1990–2014 (April 2016).

397 This figure does not include methane emissions from the extraction of natural gas in California. Natural gas is generated mostly in wells producing both crude oil and natural gas. The ARB inventory reports total emissions from oil and natural gas extraction as about 2 MMTCO₂e.

Figure 44: Methane Emissions in California (2014)

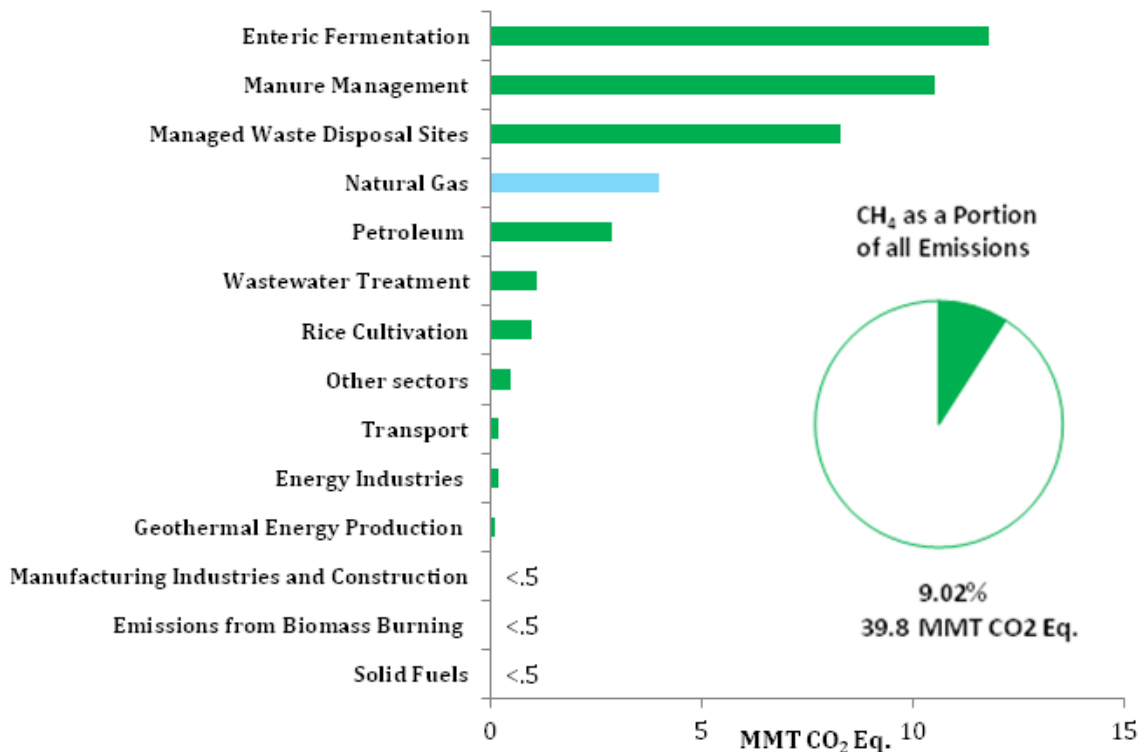

Source: California Air Resources Board, Greenhouse Gas Emissions Inventory for 2014. (2016 Update available at <https://www.arb.ca.gov/cc/inventory/data/data.htm>)

Natural gas represents about 43 percent of the total energy consumption from fossil fuels in California, larger than the contribution from gasoline, which is about 28 percent. The dominant role of natural gas in California can be seen in Figure 45, which presents the energy consumption from all fossil fuels in the state.

Figure 45: California Fossil Fuel Consumption (2014)

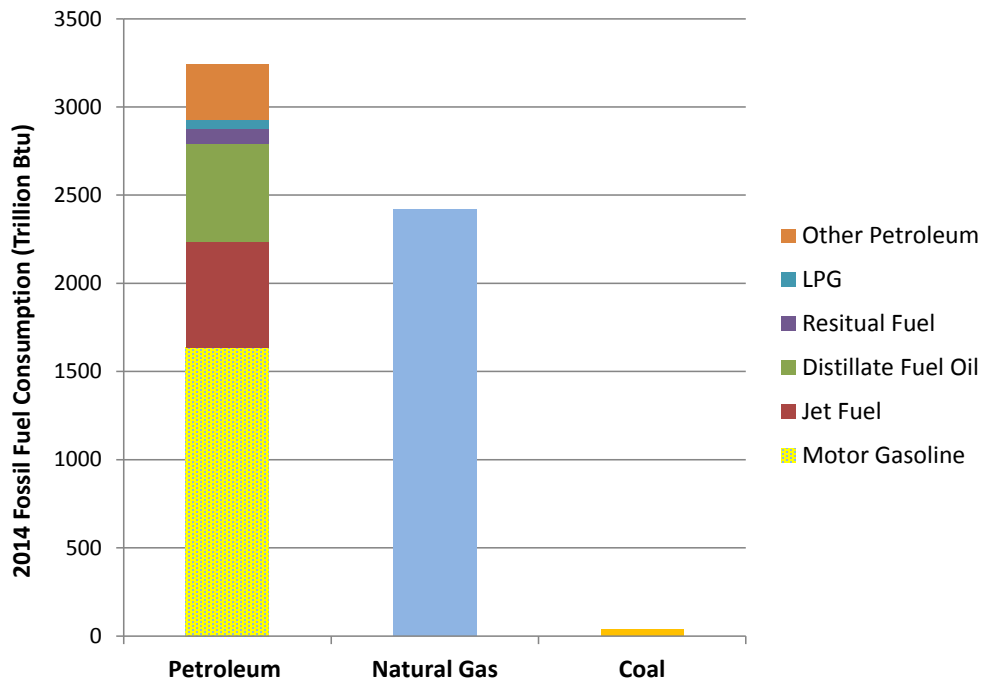

Source: U.S. Energy Information Administration, 2015, <http://www.eia.gov/state/data.cfm?sid=CA#ConsumptionExpenditures>.

Natural gas is composed primarily of methane, which comprises more than 90 percent of the total composition of the gas. There are specific thresholds for methane emissions from natural gas production, including extraction, transmission, distribution, and final consumption, which would negate the climate benefit of switching to natural gas, if exceeded. Unintentional releases of methane, or fugitive emissions, can come from multiple sources and phases of the natural gas system, such as from leaking pipelines, abandoned wells, or inefficient combustion. Intentional releases, such as venting for safety reasons, are purposeful and known emissions that occur in the normal operations of the natural gas system. According to a study published in the *Proceedings of the National Academy of Science* in 2012, to realize an immediate net climate benefit from the use of natural gas, methane emissions from the natural gas system should be lower than 0.8 percent, 1.4 percent, and 2.7 percent of production³⁹⁸ to justify a transition from heavy-duty diesel vehicles, gasoline cars, and coal-burning power plants respectively.³⁹⁹ As discussed below, some argue that the national average emission rate

398 “Percentage of production” is a standard format for quantifying methane emissions; the other format is gigagrams of methane per year. Percentage of production is measured by taking the amount of methane emitted and dividing that by the total production of natural gas (or throughput) from the relevant area. So, for example, if 1,000,000 units of gas are produced and distributed, but 1,000 units methane leak from the pipeline, then the percentage of production would be $1000/1,000,000 = 0.001$ or 0.1 percent.

399 These numbers were modified from original source of Alvarez et al. 2012 by the Environmental Defense Fund to account for new data (see http://www.energy.ca.gov/2014_energypolicy/documents/2014-06-23_workshop/presentations/13_O_Connor_EDF_IEPR-Presentation.pdf).

may be close to 2.4 percent; however, more work is needed to more accurately estimate emissions and reduce those impacts where possible. Therefore, without an accurate and comprehensive accounting of methane emissions from the natural gas sector, the climate benefits of natural gas as a transition fuel remain unclear.⁴⁰⁰ Any amount of methane emissions from the natural gas system will diminish the relative climate benefits of natural gas compared with other fuels.⁴⁰¹

Figure 46 presents an expanded and more complete view of the natural gas system. Conventional definitions include only the elements inside the rectangle; however, it is now evident that the conventional representation artificially excluded important sources of emissions from the natural gas system. Emissions from abandoned and idle wells should be taken into account, along with natural seepage; in addition, emissions from final consumption downstream of meters must also be quantified.

Figure 46: Revised Schematic of the Natural Gas System

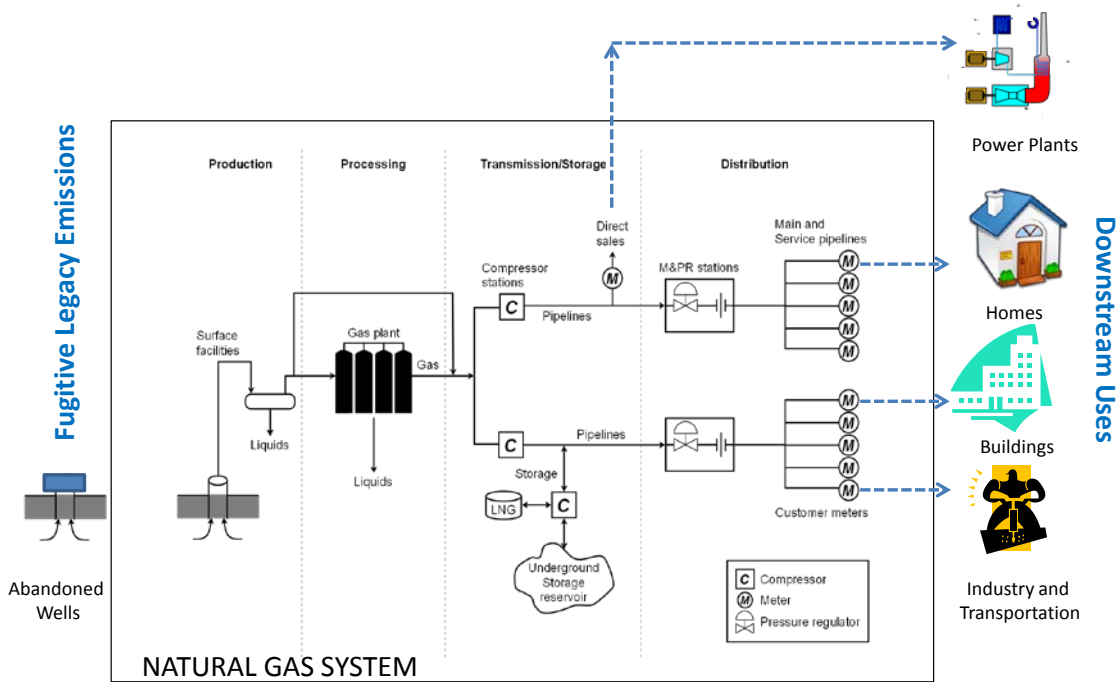

Source: Enhanced from an original graphic from a U.S. Environmental Protection Agency publication

About 90 percent of the natural gas consumed in California comes from Canada, the Southwestern United States, and the Rocky Mountains region, while the remainder originates from wells in California. Methane emissions outside California are therefore

400 Brandt A.R., G.A. Heath, et al., "Methane Leaks from North American Natural Gas Systems." *Science*, 2014, 343(6172):733-735.

401 The global warming potential of methane is 72 if impacts are only accounted for 20 years and 25 for a 100-year time horizon. *Global warming potentials* are used to compare the climate impacts of greenhouse gases in comparison with carbon dioxide.

very important to quantify the climate implications of natural gas consumed in California.

Researchers and technical staff estimate emissions using *bottom-up*, *top-down*, and hybrid methods. The *bottom-up* method applies emission factors (for example, grams of methane emitted per mile of transmission line) to each component of the natural gas system (for example, miles of pipeline). Estimating emissions is then a straightforward summing of emissions from all components of the natural gas system. *Top-down* estimates use ambient measurements of methane and other compounds to estimate emissions. For example, measurements can be taken with a research airplane upstream and downstream of a potential source or basin. Then, using information such as wind velocity and the enhanced concentration of methane downwind of the source, emissions can be estimated. Hybrid methods try to take advantage of both methods by reconciling the estimates from the top-down and bottom-up methods as much as possible. Each method has limitations, which can cause variance and uncertainty in estimates of methane emissions.

Recent Scientific Studies

The ARB, the California Public Utilities Commission (CPUC), the Governor's Office of Planning and Research, and the Energy Commission held a technical symposium on methane emissions on June 6 and 7, 2016, and discussed several new scientific findings.

A study by Lawrence Berkeley National Laboratory (LBNL) and University of California, Davis (UC Davis), shed some light on potential main sources of methane emissions in California.⁴⁰² The study was not designed to provide "final" emissions estimates, but to survey potential sources of emissions from wells to final consumption in California, and to estimate the source of expected excess emissions. Measurements strongly suggest that all parts of the natural gas system, as described in Figure 46, are leaking. Measurements of the distribution system in the San Francisco Bay Area suggest that emissions are equal to 0.3 to 0.5 percent of consumption, which is larger than what was previously estimated (0.2 percent of consumption). A similar field study for Bakersfield put this number at about 0.3 percent.⁴⁰³ These estimates are larger than industry sponsored studies coordinated by the Environmental Defense Fund (EDF) targeting only distribution lines. Field studies conducted by LBNL most likely include emissions downstream of meters from homes in addition to distribution lines, so the higher percentages are expected.

402 Joint Agency Methane Symposium, June 6, 2016, Fischer, M., http://docketpublic.energy.ca.gov/PublicDocuments/16-IEPR-02/TN212394_20160722T134457_Transcript_of_the_06062016_Joint_Agency_Symposium_and_IEPR_Work.pdf, p. 152.

403 Ibid.

LBNL also developed a method to estimate emissions from homes and home appliances (for example, water heaters) and tested the method on 10 homes and appliances. The results showed varying degrees of leakage. These research findings support additional research to characterize emissions from behind the meter and include these sources in future GHG inventories. While the statistical significance of a sample of 10 homes is extremely limited, it nonetheless demonstrates clearly that additional ongoing research is needed. A representative from ARB indicated that as soon as representative methane emission estimates are available, they will be added to the ARB inventory.⁴⁰⁴ The Energy Commission has three research projects to better characterize methane emissions from homes and buildings, including appliances. Results are expected in 2017.

The LBNL and UC Davis research team demonstrated that some capped or idle wells in the Sacramento Delta are leaking; however, the full characterization of emissions will be available only after new research projects supported by the Energy Commission and ARB generate results.⁴⁰⁵ The LBNL and UC Davis research team also tested oil refineries using a research aircraft. Measured emissions were a factor of 10 higher than what is reported to the U.S. EPA from these facilities; however, it is unclear what fraction of emissions is due to natural gas consumption and use and what fraction is from oil refining. Measurements of underground natural gas storage units suggest that emissions can vary widely from facility to facility, and median measured emissions are similar to twice the annual voluntary emission reporting.⁴⁰⁶

404 Joint Agency Methane Symposium, June 6, 2016, Huang, A., http://docketpublic.energy.ca.gov/PublicDocuments/16-IEPR-02/TN212394_20160722T134457_Transcript_of_the_06062016_Joint_Agency_Symposium_and_IEPR_Work.pdf, p. 76. (Also personal communication with Guido Franco.)

405 Stanford University is also testing abandoned wells in California.

406 Joint Agency Methane Symposium, June 6, 2016, Fischer, M., http://docketpublic.energy.ca.gov/PublicDocuments/16-IEPR-02/TN212394_20160722T134457_Transcript_of_the_06062016_Joint_Agency_Symposium_and_IEPR_Work.pdf, p. 159.

Dr. Ramón Alvarez from EDF summarized the main new findings from multiple studies conducted in the United States in collaboration with natural gas companies.⁴⁰⁷ The main finding was that top-down and bottom-up methods can produce very similar results, provided that bottom-up methods are enhanced with accurate counting of units (for example, number of pneumatic control devices) and if superemitters⁴⁰⁸ are included, using special statistical techniques. At the same time, repeated “top-down” measurements should be conducted to validate bottom-up estimates and reduce uncertainties with the bottom-up methods. EDF also reported about an extensive study for 8,220 well pads in seven producing basins in the United States, all located outside California.

Aliso Canyon

The Energy Commission, in collaboration with the California Air Resources Board, envisioned and supported a coordinated research effort to survey methane emissions from the natural gas system from wells to final consumption. In response to the Aliso Canyon natural gas leak, the Energy Commission asked Scientific Aviation, a member of the research team, to conduct several airborne flight measurements to quantify the methane leak rates at Aliso Canyon and subsequently at all the natural gas storage facilities in California. The availability of results in a manner of hours was very useful in assessing the magnitude of the leak and providing estimates of the total amount leaked to the atmosphere. The Southern California Gas Company has committed to address methane emissions from Aliso Canyon, including signing letters of intent with several dairies, which are the highest source of GHG emitting sectors. A paper featured in the scientific journal *Science* reported total methane emissions during the 112-day duration event of about 97,100 metric tons—or 5 billion standard cubic feet.¹ During days with peak emissions, Aliso Canyon doubled the methane emissions rate of the entire Los Angeles Basin. The California Air Resources Board estimates that the leak added roughly 20 percent to statewide methane emissions over the duration.

For more information see Conley, S., et al, “Methane Emissions From the 2015 Aliso Canyon Blowout in Los Angeles, California,” *Science*, March 18, 2016, Volume 351, Issue 6279, pp. 1317–1320.

¹ On October 21, 2016, the Air Resources Board released its final determination of total methane emissions from the Aliso Canyon natural gas leak. Its best estimate is 99,650 metric tons of methane, which is about 2 percent higher than was reported in *Science*.

407 Joint Agency Methane Symposium, June 6, 2016, Alvarez, M., http://docketpublic.energy.ca.gov/PublicDocuments/16-IEPR-02/TN212394_20160722T134457_Transcript_of_the_06062016_Joint_Agency_Symposium_and_IEPR_Work.pdf, p. 92.

408 *Superemitters* are sources that produce abnormally large amounts of methane emissions. While there is no agreed-upon threshold for a large source of methane emissions to be defined as a *superemitter*, Zavala-Araiza, et al., in their 2015 publication in *Environmental Science and Technology*, defines *superemitters* as “those with the highest proportional loss rates (methane emitted relative to methane produced).” For more information, see “Toward A Functional Definition of Methane Super-Emitters: Application to Natural Gas Production Sites,” <http://www.ncbi.nlm.nih.gov/pubmed/26148555>.

Surprisingly, 92 percent of the observed leaking sources were storage tanks. This represents an opportunity to focus emissions reduction efforts, but without knowing for sure which tanks will be leaking, mitigation measures become complicated. Dr. Alvarez summarized the results from multiple studies reported in the scientific literature since 2015 for gas-producing basins. He estimated production-weighted average emissions of 1.9 percent of production.⁴⁰⁹ If emissions from the rest of the natural gas system are about 0.5 percent as estimated by Dr. Alvarez, total methane emissions would be about 2.4 percent of production.

The methane symposium also featured several presentations about innovative monitoring technologies to measure methane emissions in ambient air with detectors that would cost substantially less than similar units in the marketplace. Hundreds to thousands of these instruments could be deployed in a given facility, and some form of *inversion dispersion* modeling technique would be required to localize leaks.⁴¹⁰ Other groups have developed measuring systems that could be used to scan large areas (such as laser-based measurements) and/or to “see” leaks using infrared cameras that could also be deployed in drones. The U.S. Department of Energy’s ARPA-E program is a leader in this work, and the program efforts are very encouraging.⁴¹¹ In a complementary project by Stanford University, researchers have developed a numerical toolkit that can create a virtual gas field to estimate which technologies will be most effective detecting emissions; it is unclear if in-position measurement with hundreds of sensors would be more cost-effective than remote sensing covering large areas. The virtual system could be used to test the effectiveness of the proposed U.S. EPA methane rule requiring optical gas imaging semiannually.⁴¹²

In November 2016, the ARB put forward a revised version of its proposed strategy to reduce short-lived climate pollutants, including methane. It includes a goal to reduce methane emissions from the natural gas system by 40 percent below current levels in 2025 and by a minimum of 45 percent in 2030, and to reduce all other methane sources by 40 percent in 2030.⁴¹³ This aligns with the United States Environmental Protection Agency (U.S. EPA) goal to reduce methane emissions from the natural gas system by 40

409 Another speaker from the National Oceanic and Atmospheric Administration and the University of Colorado suggested that this number is about 1.6 percent of production (Sweeny, 2016). Actual emissions may be lower than the draft reported values for several reasons (Franco et al., 2016) but drastic changes are not expected.

410 Inversion of dispersion modeling takes data from downwind observations to estimate backward location, amount and time of pollutant release.

411 Gorence, N., 2016, ARPA-E’s Monitor Program, Technology to Quantify Methane Emissions.

412 Joint Agency Methane Symposium, June 6, 2016, Brandt, A. R., Kemp, C., et al., http://docketpublic.energy.ca.gov/PublicDocuments/16-IEPR-02/TN212394_20160722T134457_Transcript_of_the_06062016_Joint_Agency_Symposium_and_IEPR_Work.pdf, p. 51.

413 California Air Resources Board, *Revised Proposed Short-Lived Climate Pollutant Reduction Strategy*, November 2016, p. 9, <http://www.arb.ca.gov/cc/shortlived/shortlived.htm>.

to 45 percent below 2012 levels by 2025. Further, Governor Brown signed Senate Bill 1383 (Lara, Chapter 395, Statutes of 2016) into law on September 19, 2016, that requires the ARB to develop and begin implementing a strategy to reduce short-lived climate pollutant emissions, including methane emissions, by 40 percent below 2013 levels by 2030. To reduce methane emissions from the natural gas system, improved emissions tracking and quantification tools are necessary. Assembly Bill 1496 (Thurmond, Chapter 604, Statutes of 2016) requires the ARB to monitor methane emissions and conduct a life-cycle analysis of natural gas produced in California and imported into the state. Both the Energy Commission and the ARB are supporting research initiatives designed to improve the quantification of methane emissions and several new projects are underway or are planned.⁴¹⁴ For example, both agencies are collaborating with the National Aeronautics and Space Administration (NASA) Jet Propulsion Laboratory to deploy advanced cameras that can detect and quantify large sources of emissions (known as superemitters). NASA and the two state agencies will invest close to \$3 million on this research project that began at the end of summer 2016. Funding from the Energy Commission's Natural Gas Research Program will support activities for the natural gas system, and the ARB research will cover the identification of superemitters from other sources of methane such as landfills and dairy farms.

The Energy Commission is also supporting studies on safety issues to detect potential failures in natural gas infrastructure that may endanger public health and safety. For example, several ongoing projects focus on developing and testing cost-effective leak detection and pipeline integrity monitoring sensors and tools and demonstrating them in the lab under simulated field conditions and at several actual field sites. This also includes real-time monitoring of pipeline defects and damage due to corrosion and improper girth welds, as well as damage to pipelines from encroachments and unauthorized right-of-way activities. These sensors and tools can monitor effectively the health and integrity of the pipelines and help pipeline operators develop proper monitoring, operation, and maintenance practices. This will lead to improved pipeline safety, a reduced potential danger to public health, and a lower chance of catastrophic events, such as the 2010 San Bruno pipeline explosion.

Recent scientific studies strongly suggest that methane emissions are underestimated in current inventories and that inclusion of superemitters in the inventories is necessary. The identification of superemitters is technically feasible, but the most cost-effective way to find them is not clear. Since emissions have been shown to be intermittent in most cases, it would be necessary to regularly or continuously monitor emissions. The symposium did not include presentations directly addressing costs to control emissions; however, an update to an ICF study suggests that control costs may be higher

414 Joint Agency Methane Symposium, June 6, 2016, Duren, R., Ydav, V., Verhulst, K., et al., http://docketpublic.energy.ca.gov/PublicDocuments/16-IEPR-02/TN212394_20160722T134457_Transcript_of_the_06062016_Joint_Agency_Symposium_and_IEPR_Work.pdf, p. 22.

than anticipated.⁴¹⁵ This updated study was sponsored by the natural gas industry, which also provided cost of control estimates for specific actions to ICF. Additional cost studies are warranted to consider the cost associated with the identification of superemitters and emission monitoring programs.

⁴¹⁵ ICF International, 2016, *Economic Analysis of Methane Emission Reduction Potential From Natural Gas Systems*.

APPENDIX B: Offshore Renewable Energy Workshop Summary

One of the goals of the *2016 Integrated Energy Policy Report Update (2016 IEPR Update)* is to explore emerging technologies that provide low-carbon electricity generation and grid support. Offshore renewable energy resources like wind, wave, and tidal energy offer the possibility of an abundant supply of renewable, zero-carbon energy, but also raise important questions about environmental and permitting complexities.

The Energy Commission held a workshop on May 25, 2016,⁴¹⁶ that included representatives of federal and state government regulatory agencies, researchers, renewable energy developers, and other stakeholders to discuss issues surrounding planning, permitting, and developing offshore renewable energy in California. The workshop included presentations on research findings, technology viability, resource potential, roles of various government agencies in the permitting process, and project developer and stakeholder perspectives. The following summary reflects the information presented at the workshop and discussions among participants and does not reflect analysis or evaluation by the Energy Commission. Updates that have occurred since the May 2016 workshop are also included.

Background

In January 2016, Trident Winds, LLC submitted a lease request to the federal Bureau of Ocean Energy Management (BOEM) for a floating wind energy project off the coast at Morro Bay, the first formal

WORKSHOP PRESENTERS AND PANELISTS

Audubon Society
California Coastal Commission
California Dept. of Fish and Wildlife
California Energy Commission
California Natural Resources Agency, Ocean Protection Council
California Sportfishing Protection Alliance
California State Lands Commission
CH2M
Institute for Advanced Technology and Public Policy CalPoly CalWave
Magellan Wind
Morgan Lewis Law Firm
National Oceanic and Atmospheric Administration
National Renewable Energy Laboratory
Natural Resources Defense Council
Pacific Coast Federation of Fishermen's Associations
Principle Power
Stanford University
Surfrider Foundation
Trident Winds
U.S. Bureau of Ocean Energy Management
U.S. Department of the Navy
U.S. Fish and Wildlife Service

⁴¹⁶ The complete workshop record is available at http://www.energy.ca.gov/2016_energy_policy/documents/index.html#05252016.

request for a lease for wind development in federal waters off California. If approved, the project would begin construction in 2021–2022 and commercial operations in 2025. Because of increasing interest in offshore renewable resources and the Trident Wind request, Governor Edmund G. Brown Jr. sent a letter May 12, 2016, to U.S. Department of Interior Secretary Sally Jewell requesting the BOEM to establish a task force to look at opportunities for offshore renewable energy development off the California coast. BOEM announced May 31, 2016, that it will work with the State of California to establish an Intergovernmental Renewable Energy Task Force similar to those created for 13 other coastal states to examine how to resolve potential conflicts among renewable development, environmental concerns, and other uses.

Workshop Summary

Offshore Wind Technologies

Resource Potential

Stanford University has researched converting California to a power mix that is 100 percent wind, water, and solar. The analysis assumed a mix of 26.5 percent large-scale solar photovoltaic (PV) plants, 25 percent onshore wind turbines, 15 percent large-scale concentrating solar plants, 10 percent offshore wind turbines, 7.5 percent residential rooftop PV, 5.5 percent commercial/government rooftop PV, 5 percent geothermal plants, 4.5 percent hydroelectric plants, and 0.5 percent each tidal turbines and wave devices.

Estimates indicate there is more than enough offshore wind potential to meet 10 percent of total California energy needs under an all-renewable regime in 2050. Stanford University estimates energy potential for monopole, multileg, and floating wind turbines ranging from 59 to 76 gigawatts (GW), while the National Renewable Energy Laboratory (NREL) identified 159 GW of technical resource potential compared to the 12.8 GW assumed in the Stanford study.

Stanford identified Cape Mendocino in Northern California as a promising site for an offshore wind park because of the combination of a good wind resource and access to existing transmission, although that transmission might need to be upgraded. Based on wind speed data at the site, it would provide relatively smooth power output, unlike onshore wind production that can have spikes and lulls, and peak production in the summer and in the afternoon, which matches California's air-conditioning demand.

According to NREL wind resource evaluations, California's coastline has strong winds out to 15 nautical miles. While California gross offshore wind resource capacity is close to 1,700 GW, the technical resource potential based on water depths and wind speeds is estimated at 159 GW.

The Stanford presentation noted that offshore wind resources have the potential to deliver power steadily throughout the day, unlike onshore wind where there the

resource is more variable. There is also the option of bundling offshore wind and wave power generation. Because wave power is less variable than wind, it can reduce the number of hours of zero power. This opinion was echoed by a representative of the CalWaveSM project, a proposed national wave energy test center that is the subject of a two-year feasibility study by Cal Poly San Luis Obispo and various partners under a grant from the U.S. Department of Energy. The representative stated that wave energy has the potential to deliver energy more consistently than terrestrial wind and solar and can be forecasted relatively accurately based on satellite and ocean buoy data.

Floating Offshore Wind

The National Renewable Energy Laboratory is working with the U.S. Department of Energy to study offshore wind resources, opportunities, and costs. In looking at fixed-bottom versus floating platform technologies, NREL believes that the latter technologies provided added benefits because they can be sited farther from shore, which means better wind resources and lower siting conflicts relative to fixed-bottom technologies. Floating technologies have higher costs in part because there has been little deployment of these technologies to date, and the prototypes that have been deployed have not been optimized. However, there is potential for cost parity since floating technologies can reduce marine operations and the need for fixed platforms.

The three configurations of floating platform technologies being developed and tested today are spar, semisubmersible, and tension-leg platform. Semisubmersible turbines are more stable before being anchored than the other turbine types, which makes them easier to tow to the installation site and therefore more attractive. However, the industry is working on ways to allow sustainable deployment of spar and tension-leg platform technologies as well, which would allow them to be more competitive.

There are several challenges with floating offshore wind technologies, including the need to reduce levelized costs; the lack of floating wind design standards; the need for more experience with electric cabling systems that are being adapted from oil and gas technologies and fixed bottom wind systems; and in California, higher sea states in the Pacific Ocean that can cause complications with operation and maintenance and increase operating costs.

Current and Projected Market Activity

There is ongoing investment in floating offshore wind technologies in North America, Europe, and Asia, including 9 demonstration projects totaling \$416 million and 19 research projects totaling \$74 million. Research areas include floating wind project design, foundation design, foundation testing and evaluation, operations and maintenance, materials, environmental studies and surveying, and simulation of floating wind projects.

According to a 2015 NREL report,⁴¹⁷ there are 248 GW of offshore wind development globally in the pipeline (projects that have entered into the regulatory process), with much of this development in Europe. Development is focused on fixed-bottom technologies. As more projects enter the construction and financial phases, turbine manufacturers will have more certainty to inform their decisions to invest in better turbines and infrastructure.

There is a trend in the offshore wind market for projects that are installed in deeper water and farther from shore, both of which add to project costs. However, the market is seeing capital expenditures over time coming down as new 6-8 MW offshore turbines are beginning to drive costs down for fixed-bottom technologies.

NREL believes market development for offshore wind projects is accelerating. There are projects on the horizon over the next 10 years that are in the planning stages, including more than 1,200 MW in Oahu, a 1,000 MW project proposed for Morro Bay (San Luis Obispo County), and several smaller projects proposed in Japan, the United Kingdom, and France. The representative from Trident Winds noted that more than 200 MW of floating wind capacity is projected by 2020 in the United Kingdom, Portugal, Japan, and France.

Future Cost and Performance

NREL is involved in research to inform the Renewables Portfolio Standard Calculator used by the California Public Utilities Commission to compare the costs of different technologies. NREL identified six hypothetical sites along the California coast and assessed cost and performance for 2015, 2020, and 2025. Criteria for site selection included annual average wind speeds higher than 7 meters per second, water shallower than 1,000 meters, lowest use conflicts, potential for grid connections, and potential proximity to operations ports. The analysis assumed generic turbines with 6, 8, and 10 MW of capacity since the industry is projecting these size turbines will be developed during this time frame. Evaluation of the potential power production from these sites showed that all six sites had similar diurnal patterns for offshore wind from the Channel Islands to the Oregon border, and that wind peak appears to correlate well with hourly and seasonal energy demand in California. The wind characteristics also complemented solar generation and could offset the risk of curtailment.

The analysis projected a trend of cost reductions and increased capacity factors at each of the six sites, with costs dropping to around 10-12 cents/kilowatt-hour (kWh) by 2030. With preliminary analysis showing that offshore wind hourly characteristics may be complementary to solar generation in California, additional research may be warranted on how offshore wind can complement solar generation in California's electricity mix.

417 National Renewable Energy Laboratory, Smith, A., T. Stehly, and W. Musial, *2014-2015 Offshore Wind Technologies Market Report*, September 2015, <http://www.nrel.gov/docs/fy15osti/64283.pdf>.

Wave Energy

The CalWaveSM representative noted that resource projections for wave energy—converting the kinetic energy in waves across the ocean to electricity—are smaller than for offshore wind at about 7,500 MW. While Northern California has better offshore wind and wave energy resources, much of California’s electric load and grid infrastructure are in the southern part of the state. In addition, gas-fired thermal power plants on California’s southern coastline are facing the decision whether to shut down rather than take on the added investment needed to comply with the state’s prohibition of once-through cooling technologies, and could leave behind large capacity substations and other infrastructure that could be repurposed for offshore renewable resources like wave energy. The CalWaveSM representative estimated that phase-out of once-through power plant cooling could provide more than 10,000 MW of coastal substations for ocean renewable projects. In addition, there is infrastructure in place to support the 27 offshore oil platforms in the southern part of the state, which could also support offshore renewables.

The CalWaveSM project would be a permanent facility, with a 25-to-30-year design life, on the open ocean to conduct testing on wave energy that could be prohibitively expensive for developers to undertake. The project has an agreement with Vandenberg Air Force Base for onshore operations and for negotiating a power purchase agreement. The project will be developed in phases starting with 1-5 MW and progressing to 40-50 MW. The test center expects to have four testing berths and, if funded by Congress, would come on-line in 2021 or 2022. Federal, state, and local agencies will be involved with the permitting and licensing the project, and initial outreach to the fishing community, environmental and recreational groups, and Native American tribes indicates preliminary support for the project.

Government Agency Roles

The morning panel at the workshop included an extensive discussion of the roles of the various government agencies that will be involved in evaluating and licensing offshore renewable energy projects. Represented agencies included the:

- **Federal Bureau of Ocean Energy Management (BOEM):** BOEM is a department under the U.S. Department of Interior, with the objective of overseeing all energy and mineral development in the outer continental shelf (3 to 200 nautical miles offshore). Traditionally, BOEM’s oversight has focused on oil and gas development and marine minerals, but offshore wind was added to its portfolio in 2005. The renewable energy leasing process at BOEM has four stages: planning and analysis, leasing, site assessment, and construction and operations. The first phase includes the establishment of an Intergovernmental Renewable Energy Task Force, issuance of a request for information and/or call for information and nominations, area identification, and environmental review. The second phase, leasing, includes publication of leasing notices and issuance of the actual

lease(s). Phase 3 site assessment includes characterization of the site and development of a Site Assessment Plan, followed by the final phase of construction and operations. Stakeholder engagement is crucial, and there are numerous opportunities throughout the process for stakeholders to become engaged, including through meetings of the Intergovernmental Renewable Energy Task Force,⁴¹⁸ as well as through future NEPA and other governmental review processes.

- **California State Lands Commission (CSLC):** The CSLC is an independent commission composed of the Lieutenant Governor, the State Controller, and the Director of the Department of Finance, with jurisdiction over state waterways, rivers, the Delta, San Francisco Bay, and out to the state/federal offshore boundary, roughly 3 miles offshore. The agency is primarily a land and resource trust manager rather than a regulatory agency and issues leases for use, occupation, and development of lands. As a landowner, the CSLC is able to simplify renewable energy development and in 2013 prepared a report on marine renewable energy and environmental impacts.⁴¹⁹ CSLC's 2016-2020 Strategic Plan also recognizes that its revenue-generating portfolio for leasing activities has depended highly on oil and gas activities, and commits to increasing renewable energy in its leasing portfolio both on- and offshore.
- **California Coastal Commission (CCC):** The CCC was established by voter initiative in 1972 and later made permanent by the Legislature through the Coastal Act of 1976. Among the issues the agency deals with that will be applicable to offshore energy projects are marine species and habitat, water quality, public access and recreation, commercial and recreational fishing, navigation and hazards, and coastal public views. The CCC has direct permit jurisdiction in state waters three miles out and authority for project review in federal waters. For project components that are on shore, the agency issues a coastal development permit for areas where it has direct jurisdiction, but there are also coastal areas of the state where local governments have authority and will issue the permit. In addition, the CCC has additional authority under the Coastal Zone Management Act to review federal projects or federally permitted projects that are outside the coastal zones. In these cases, it is the effect of the project, not location, that determines whether the CCC has authority—if there is an impact on fish, then a project could be considered to generate a spillover effect in the coastal zone.

418 The first meeting of the BOEM/California Intergovernmental Renewable Energy Task Force was held on October 13, 2016. For additional information see: <https://www.boem.gov/California/>.

419 <http://www.slc.ca.gov/Info/Reports/MRE-AdvancingCAGoals.pdf>.

- **National Oceanic and Atmospheric Administration (NOAA):** The Office of National Marine Sanctuaries and the National Marine Fisheries Service are under NOAA and each has a role in permitting offshore energy projects.
 - **Office of National Marine Sanctuaries:** There are four national marine sanctuaries in California, defined as having conservation, recreational, ecological, historical, cultural, archaeological, or esthetic qualities. Permit pathways under the National Marine Sanctuaries Act include general permits for research, education or management, authorization of another agency’s permit, a special use permit for a limited number of activities, and certification that “grandfathers” another agency’s permit for a newly designated sanctuary. For example, for an offshore wind project, a permit could be issued during the project evaluation stage for research if the research would also provide information on resources within the marine sanctuary, while an authorization permit could be issued for the transmission cable that goes through the sanctuary.
 - **National Marine Fisheries Service (NMFS):** The NMFS is responsible for stewardship of ocean resources and habitat and follows the licensing and permitting processes of a variety of agencies, including BOEM, the Federal Energy Regulatory Commission, the U.S. Army Corp of Engineers, and the U.S. Department of Energy. The service also consults under various acts such as the Endangered Species Act and the Marine Mammal Protection Act, among others. Species potentially affected by offshore renewable energy projects include fish that are born in and return to freshwater to spawn (for example, Chinook salmon); marine fish; sea turtles; and abalone; and marine mammals like seals, sea lions, dolphins, whales, and sea otters. Potential impacts on these species from offshore renewable development include entanglement, collision, behavioral and navigation impacts, noise, electromagnetic fields, habitat disturbance or destruction, and potential changes to sediment or water circulation. There are many data gaps regarding the potential impacts to species from various technologies where offshore renewable energy could be developed.
- **U.S. Fish and Wildlife Service (USFWS):** Like the National Marine Fisheries Service, USFWS covers certain species, about a dozen of which overlap with wind development in California. There are features of offshore wind development that could significantly impact seabirds. There are islands and other areas where seabird nesting and breeding areas are located, and any development near those islands will put seabirds at risk. USFWS does not have regulations on the incidental take, or capture or killing, of birds, but instead works with other agencies on mitigation and with industry to minimize impacts. USFWS has an open rulemaking for a process to regulate incidental bird take under the Migratory Bird Treaty Act and hopes to adopt the rule in 2017. Possible approaches include continuing voluntary guidance and compliance with best

practices, a process of general authorizations for industry hazards with known mitigation measures, a process for providing permits, or the ability to authorize incidental take in programmatic agreements with federal agencies.

- **California Department of Fish and Wildlife (CDFW):** CDFW is the steward of California's resources and habitats and manages fish and wildlife habitats while managing public use of those areas. The department's jurisdiction is similar to that of the CSLC, essentially the state and everything to three miles offshore. CDFW's authority comes from the Legislature, Fish and Game Code, Public Resources Code, the California Environmental Quality Act, and the Endangered Species Act, among others. The department works closely with other governmental agencies and provides expertise on state resources that will be impacted by any type of project. The department would need to be involved in any incidental take permits under the Endangered Species Act, whether the project is in state or federal waters. Specific permits might not apply to offshore renewable energy project, but CDFW would definitely need to coordinate and be involved with all permitting agencies and project proponents. CDFW has a lot of data to contribute to the process.

Agency Coordination

BOEM underscored the importance of starting now with interaction and coordination among federal, state, and local agencies, with a joint agency meeting held in June 2016 in Sacramento to begin discussions of the Intergovernmental Renewable Task Force. The discussions will likely focus on the proposed Trident Wind project, but there could also be discussion of drafting a charter for the task force itself. CSLC noted it would likely be lead agency for lands it manages directly and has a history of preparing joint documents with its federal sister agencies, BOEM, the Bureau of Reclamation, and others. While CSLC's jurisdiction goes out three miles, some submerged lands have been granted to certain local governments who do the day-to-day management, such as the Port of Los Angeles. In those cases, the local lead agency would be the CEQA lead, but CSLC would oversee the process. However, due to the siting requirements of offshore renewable projects, they have the potential to cross through multiple jurisdictions, requiring interagency coordination and the preparation of both CEQA and NEPA documents.

In response to questions regarding potential challenges in preparing joint CEQA and NEPA documents among different agencies, participants stated that building the right teams with the right experience and expertise will produce a well-written document. Others noted that joint documents have been prepared for offshore oil and gas development in Santa Barbara County and for dredging in San Francisco Bay that are examples of coordination activities that worked well. The CCC noted that in the case of the Trident Wind Project, it would likely defer to whichever agency is lead.

The question was raised as to how Memoranda of Understanding between agencies might relate to the offshore renewable energy review. Some participants felt that MOUs are useful for setting expectations for data sharing and standards and ensuring that each agency is aware of the other's statutes and criteria. They noted, however, that even without an MOU, agencies would be working with each other, sharing data, and communicating. An MOU can, however, help agencies to better coordinate things like information requests so that parties need to respond to only a single request for public input for all agencies rather than one at a time.

Several agencies at the workshop mentioned that they have representatives on the California Marine Renewable Energy Working Group, an interagency group chaired by the California Ocean Protection Council. BOEM noted that the group has been primarily a communications forum up to this point, but now that there is an actual project under consideration, it is incorporating the members of that group into its interagency efforts.

Identifying Available Data and Data Gaps

While many participants acknowledged data are available from offshore renewable development elsewhere, they also raised concerns about the applicability of those data to California or California species. These kinds of projects have not yet been tested in California, so there is no information on the impacts of these projects on local resources and species. There are likely some data available from oil and gas projects deployed off California that could provide information on anchoring, cabling, and other items, which appear to be components that California permitting agencies feel comfortable with. However, with the focus on deep-water development, habitats may be different from what have been evaluated, and more research needs to be conducted about the potential impacts of this development. In addition, permitting for oil and gas development has been done on a much smaller scale, and with larger areas being proposed for offshore renewable energy development, there are many questions about impacts and mitigation.

Participants agreed that mitigation in an ocean environment will be challenging. Agencies are used to addressing mitigation issues in coastal or estuarine areas, but it will be difficult to determine adequate mitigation under CEQA, NEPA, and other acts and regulations. It will be important to bring in marine mammal and fisheries experts from the local areas where a project is proposed to be located and to work with all stakeholders potentially impacted by the project. Several participants noted that there are elements of offshore wind development that are analogous to oil and gas offshore development, so experience managing those projects will be useful. It will be necessary to identify areas that are biologically rich and would have the most impact to avoid those areas, but more research is needed to determine what the right distance to maintain from sensitive areas. Another challenge is related to migratory birds for which the regulations allow zero take, so no mitigation is possible.

BOEM noted that it has an environmental studies program that is being realigned to focus on renewable energy and has requested input from universities and state and

local agencies. BOEM held the California Ocean Renewable Energy Conference on November 1-2, 2016⁴²⁰ to discuss renewable technologies and environmental issues.

Several participants agreed that it would be useful to prepare a preconstruction baseline for the areas under consideration to provide a clear picture of what exists in terms of species, habitats, and resources. Going forward, some of the data gaps identified by participants included:

- The types of vibration and noise that could result from these projects, and the associated impact on species and habitats.
- Site-specific data for areas far from shore.
- What technologies will be used, and the potential impacts of those technologies.
- Remote-sensing capabilities to provide information on how devices are interacting with the environment.
- Potential impacts of developing large-scale projects in huge arrays that could have different impacts than single structures, and cumulative impacts from large numbers of projects.

The question was raised on whether there is any consideration of a programmatic approach to evaluating these technologies similar to the Solar Programmatic Environmental Impact Statement or the *Desert Renewable Energy Conservation Plan (DRECP)*. Several parties noted that it would be very valuable to identify areas in the ocean and coastal environment where development would have the least impact, but agencies noted there are no plans for such an approach at this time. One of the challenges identified with such an approach was that offshore renewable energy projects are often location-specific and depend on resource availability and the existence of infrastructure to bring the energy to shore.

Another identified concern is the changing ocean environment due to climate change, and the need for offshore renewable energy planning to consider what type of ocean environment is being planned toward. Participants discussed concerns from ocean acidification and warming because of climate change and noted the challenges with balancing the analysis of environmental effects from offshore renewable development against the environmental effects of continuing to rely on fossil fuels for energy.

Interested Agencies and Tribal Engagement

The California Ocean Protection Council (OPC) was created under the California Ocean Protection Act, signed into law in 2004 by Governor Arnold Schwarzenegger, with the mission of ensuring that California maintains healthy, resilient, and productive ocean and coastal ecosystems for current and future generations. Part of OPC's role is to convene agencies to look at issues affecting the ocean and the coast. OPC chairs the

420 For more information see: https://www.boem.gov/CORE_Conference/.

California Marine Renewable Energy Working Group, created in 2010, which will likely be merged with the BOEM Intergovernmental Renewable Task Force. OPC also convenes a science advisory team to serve the science and policy needs of California in coastal issues, with representatives from various areas including the social sciences, tribal and cultural issues, legal issues, and environmental science. The working group has examined potential conflicts resulting from development of marine renewable energy.

OPC agreed with the governmental agency representatives that establishing relationships among agencies is important. The council stated it has developed very strong relationships with the scientific community and integrates what is learned into state planning. OPC also has a role in ensuring that tribal input is incorporated into its documents, and noted that planning for renewable energy development must build in enough time to address tribal concerns, particularly given the number of tribes, each with its own processes and perspectives.

The U.S. military is another interested party when it comes to developing renewable resources off the California coast. The primary services that operate off the coast are the U.S. Navy, the U.S. Marine Corp, and the U.S. Air Force. In the past, many of the military's activities were land-based, but more are now occurring offshore, either on, below, or above the water. The military has worked with state agencies to be more proactive about energy and to educate stakeholders that share areas where renewable energy development could occur. The military stated that it agrees with the task force concept, but recommended using landscape planning processes similar to the *DRECP* and the San Joaquin Valley Identification of Least-Conflict Lands study. An important lesson learned in these processes was the value of being proactive and using a forward-thinking landscape analysis process. Often, by the time a developer prepares an application for a renewable project, it has already spent significant time and money on a location that may turn out to be inappropriate. Further, the military suggested that the San Joaquin process was a better fit because it was a fairly quick, stakeholder-driven, nonregulatory process with agency technical support.

A member of the Energy Commission staff who works closely with California tribes spoke briefly about tribal issues, noting that tribal representatives were unable to attend but that in the future it will be important to get more tribes at the table to present their points of view. There are around 184 tribal entities in California, about 150 of which are federally recognized, with about a third of those entities located on the coast. While existing laws and guidelines recognize cultural landscapes as something to be protected in state planning, when moving farther offshore spiritual values may increasingly come into play, for example, the pathway to the sun when it sets over the ocean. When discussing laying cables closer to shore, much of that area was above water at some point, and marine archaeology is increasingly identifying cultural resources on the ocean floor that must be considered. It will also be important to establish relationships with the tribes in advance rather than reaching out to them only when there is a crisis and a project is being proposed.

Offshore Renewable Developer Perspectives

Developers expressed the need to change the perception of offshore wind technologies and to take advantage of the untapped wind energy resources in deeper waters. Floating semisubmersible platforms have been used for decades in the oil and gas industry and are well-understood, and developers are working on technologies to get the best performance when marrying hydrodynamic and aerodynamic forces.

Principle Power discussed its WindFloat system, which can support any conventional commercial wind turbine. WindFloat uses three columns filled with water and displaces water between columns to compensate for changes in wind speed and direction to maintain verticality of the turbine and maximize the efficiency of wind production. The system has been tested over four years in extreme conditions and, according to the developer, has performed according to specifications. Principle Power contends that floating offshore wind will be an industry game-changer because it allows installation farther from shore, in deeper waters, and in larger windfarms. This, in turn, opens the market to coastal areas with high power demand, high electricity prices, and high population density. In addition, there are opportunities to reduce cost and risk, making offshore wind more financeable. Offshore technologies have the potential for fewer environmental impacts and geotechnical requirements, and for added flexibility in terms of site location and water depth. Also, some technologies can be fully assembled on shore and towed to the installation site, which reduces the risks and costs associated with installation. Principle Power's target markets for the WindFloat system in the near term include Scotland (48 MW), France (48 MW), Portugal (25 MW), the United States (Oregon up to 24 MW), and Japan (5-6 MW). Precommercial floating projects indicate a decline in levelized cost of energy and increased competitiveness with current industry levels.

Trident Winds discussed its proposed 1 GW floating offshore wind farm in Morro Bay. The site was chosen because of access to the transmission system and the ability to reuse infrastructure remaining after closure of the Morro Bay power plant originally owned by Pacific Gas and Electric Company and now owned by Dynegy. The site was also selected to reduce impacts on fishing grounds and habitats, shipping lanes, and birds and marine mammals. There will be a single cable to bring power to shore with a floating offshore substation at the southeast corner of the project with each unit facing the wind and interconnected with cables. The project is taking advantage of 27 years' worth of data collected by a buoy near the proposed site that indicates that the wind resource closely follows electricity demand. Based on U.S. Coast Guard estimates of range visibility, the site will not be visible from the shoreline at Morro Bay, Cambria, or San Simeon. Trident Winds submitted its lease request to the BOEM on January 14, 2016, which was accepted by BOEM on March 21, 2016. BOEM published a Request for Interest in the *Federal Register* on August 18, 2016 to determine competitive interest in the site and requested comments and information from the public on the proposed area. Statoil Wind US nominated the same area of commercial interest submitted by Trident Winds.

These projects could require more than 30 permits and licenses from Federal and state agencies and require significant outreach and discussion with affected stakeholders.⁴²¹

Magellan Wind discussed lessons learned from offshore wind development in the eastern United States as well as issues developers face. Offshore wind in the eastern United States is regulated in the same way as offshore oil and gas development, and there are issues (such as oil spills) that do not apply to offshore wind. In addition, the eastern United States did not have the same cooperative relationships between federal and state agencies that appear to exist in California. Magellan Wind noted the need for consistency and ownership by state agencies when permitting offshore wind to develop the institutional memory and understanding of the complex issues associated with these technologies, given how long it will take to permit and build these facilities. Some of the major unknowns are environmental effects of these projects, and Magellan Wind has met with environmental groups to seek assistance on determining the right studies and identifying data gaps. The developer also committed to making post-construction monitoring data publicly available and working with national and regional environmental groups to identify unintended consequences and take mitigation measures as needed. The three main challenges developers must address are reducing costs, securing regulatory certainty, and avoiding litigation.

Stakeholder Perspectives

The California Sportfishing Protection Alliance (CSPA) noted that while it has been active in the permitting of hydropower projects regulated by the Federal Energy Regulatory Commission, offshore wind is new and poses challenges for stakeholder representatives. Hydropower is a mature, known technology, while ocean energy technologies are untested. In addition, the roles and jurisdictions of the various agencies involved in offshore energy permitting and licensing are unclear to stakeholders, making it difficult to participate meaningfully in the various proceedings. CSPA is very concerned about the potential impacts on recreational and commercial fishing. There is already fragmentation of accessible fishing areas due to marine sanctuaries and navigation issues, and additional development will add to that problem, particularly since there may be hundreds of sites or projects. There also appears to be more focus on the permitting process than on how to reduce the effects of the projects, which could cause irreversible damage to marine ecosystems and fishing.

The Pacific Coast Federation of Fishermen's Associations (PCFFA) echoed CSPA's concerns about fragmentation of fishing areas, referencing various closures, areas designated as protected in perpetuity, conservation areas, and so on. PCFFA noted that fishing near large offshore rigs is impossible; moreover, some fisheries operate around the clock, and it is easy to snag an offshore rig in the dark. PCFFA also noted that each fishing community has specific concerns and issues that make it difficult for one

421 For more information see: <https://www.boem.gov/California/>.

representative to represent all interests adequately. While fishermen recognize the effects of fossil fuels on ocean acidification and the need to move toward renewable, the reality is that more areas closed to fishing will affect them more immediately than long-term climate change. There are also concerns about bird mortality. The industry has worked with long-line fisheries to eliminate sea bird mortality but has been told that the whole west coast fishery would be closed if a certain number of a specific albatross were taken. It is unclear whether bird kills by wind turbines could lead to a shutdown of the fisheries.

The Surfrider Foundation agreed with concerns by the recreational and fishing industry and emphasized the need to ensure that tribal representatives, as well as other stakeholders, are part of the conversation. Surfrider noted the need to ensure adequate baseline data as well as postconstruction monitoring to ensure that impacts are identified and addressed. There should also be some attention paid to potential impacts on wave-dependent recreation from wave energy projects, particularly cumulative impact that could be larger than anticipated. Surfrider Foundation and other stakeholders suggested that public meetings be held at times when working people can attend, the decision-making process should be as transparent as possible, and agencies make every effort to convey the information in ways that laypeople can understand.

The Natural Resources Defense Council (NRDC) acknowledged that offshore wind development will help California move away from fossil fuels that damage the environment, but noted that it must be developed in a way that protects ocean habitats and species. NRDC has been involved in offshore wind development on the east coast, and advocated for mandatory lease terms that protect specific species. NRDC's specific recommendations for offshore renewable development in California include the following:

- Agencies need to base their permitting and licensing decisions on best available information on potential impacts and should conduct comprehensive environmental reviews of all projects to understand the full range of impacts of renewable energy, including acoustic disturbances, bird and bat mortality, ship strikes, cable issues, and effects on geological formations.
- Agencies need to ensure quality and consistency of environmental reviews, including an assessment of cumulative impacts and identification of a full range of alternatives.
- Agencies should adopt mitigation measures, including mandatory lease requirements.
- The permitting and licensing process should be a holistic, science-based process that includes landscape-level studies to identify areas of highest concern. Marine spatial planning can help identify areas best for offshore wind.

- Agencies must ensure early and ongoing input from stakeholders and require monitoring of projects to identify impacts and enable improvements in project design, including postconstruction monitoring and adaptive management.

The National Audubon Society discussed its Pacific Flyway Seabird Program, which includes birds that often travel through California. There are 216 new marine Important Bird Areas in the Pacific Flyway and 150 species of birds. Seabirds are one of the most threatened groups of organisms in the world, with 27 percent of bird species identified as special concern. California has two federally endangered seabirds, the short-tailed albatross and the California least tern. In addition to ocean areas, offshore rocks and islands are of critical concern as breeding areas. Areas of concern for the Audubon Society include bird collision with turbines, disruption of migratory pathways, impacts on foraging habitat and forage fish, coastal and seabed infrastructure impacts, transmission line collisions on shore, and the lack of monitoring technologies for offshore energy projects. Recommendations include taking an ecosystem approach in analyses that includes fisheries and other human uses of marine systems and assessing the Central and Southern California seas as has been done for the North.

The Nature Conservancy noted that California continues to make progress in protecting its natural resources but echoed the recommendation of other stakeholders for agencies to conduct landscape-scale, science-based spatial planning to support good siting decisions. Robust stakeholder participation is key, and stakeholders need to have complete information and understand when and in what forum they should make their concerns known.

APPENDIX C: 2016 Lead Commissioner Request for Data Related to California's Nuclear Power Plants

On May 23, 2016, as part of the California Energy Commission's *2016 Integrated Energy Policy Report Update (2016 IEPR Update)* proceeding, Commissioner Karen Douglas and Chair Robert B. Weisenmiller requested that Pacific Gas and Electric Company (PG&E) and Southern California Edison Company (SCE) provide data related to the Diablo Canyon Power Plant (Diablo Canyon) and the San Onofre Nuclear Generating Station (San Onofre).⁴²² PG&E announced plans in June 2016 to shut down Diablo Canyon at the end of its current licenses in 2024-2025 in accordance with an agreement (the Joint Proposal) among PG&E, labor, and environmental organizations.⁴²³ That announcement and the California State Lands Commission's approval of the land lease to coincide with the current Nuclear Regulatory Commission operating license caused the Energy Commission to shift focus to spent nuclear fuel management and facility decommissioning.⁴²⁴ The Energy Commission modified its data request to assist in preparing the *2016 IEPR Update*. The modified request was consistent with the shift in focus to spent nuclear fuel management and facility decommissioning.

2016 Nuclear Power Plant Data Request and Company Response: Progress in Spent Nuclear Fuel On-site Management

Nuclear Waste Accumulation—Diablo Canyon and San Onofre

As follow-up to the *2013 IEPR* and *2015 IEPR* recommendations, the Energy Commission requested information from PG&E and SCE regarding the current status of onsite storage and disposal of low-level waste and spent nuclear fuel and their plans for decommissioning. The Energy Commission asked PG&E and SCE to provide the most recent disposal plans and disposal cost assessments for low-level waste (categorized as

⁴²² 2016 Lead Commissioner Request for Data Related to California's Nuclear Power Plants. California Energy Commission. May 23, 2016. Retrieved from <https://efiling.energy.ca.gov/Lists/DocketLog.aspx?docketnumber=16-IEPR-07>.

⁴²³ PG&E News Release, "In Step with California's Evolving Energy Policy, PG&E, Labor and Environmental Groups Announce Proposal to Increase Energy Efficiency, Renewables and Storage While Phasing Out Nuclear Power Over the Next Decade." June 21, 2016. Retrieved from http://www.pge.com/en/about/newsroom/newsdetails/index.page?title=20160621_in_step_with_californias_evolving_energy_policy_pge_labor_and_environmental_groups_announce_proposal_to_increase_energy_efficiency_renewables_and_storage_while_phasing_out_nuclear_power_over_the_next_decade.

⁴²⁴ Notice of Modification: 2016 Lead Commissioner Request for Data Related to California's Nuclear Power Plants. California Energy Commission. June 30, 2016. Retrieved from <https://efiling.energy.ca.gov/Lists/DocketLog.aspx?docketnumber=16-IEPR-07>

Class A, B, C, or Greater-than Class-C—or GTCC) and spent nuclear fuel storage completed to satisfy this request. They were also asked to provide a table of waste generated, including number of spent fuel assemblies, metric tons of uranium, and volumes of low level waste (Class A-C & GTCC). The Energy Commission also asked PG&E and SCE to provide the information in a table, categorized by quantity generated through 2015, quantity expected at the end of license, and quantity expected during decommissioning.

PG&E's Response to the 2016 IEPR Data Request on the Progress in Spent Nuclear Fuel On-Site Management Concerning Nuclear Waste Accumulation

The following are excerpts from the submitted response with minor modifications to references, tables, and acronyms for consistency.

In the Joint Proposal of PG&E and parties to retire Diablo Canyon Nuclear Power Plant (Diablo Canyon) at the expiration of the current (Nuclear Regulatory Commission) operating licenses, PG&E has committed to preparing a Diablo Canyon site-specific decommissioning study for submittal to the CPUC no later than the date when the 2018 Nuclear Decommissioning Cost Triennial Proceeding will be filed.⁴²⁵ Current costs provided by existing vendors for Class A, B, C, and GTCC disposal are not suitable for estimating the ultimate disposal costs of these wastes, given PG&E does not have the waste characterization or applicable state approval to ship decommissioning waste from Diablo Canyon to these sites, nor is a Diablo Canyon decommissioning contract in place that would set the price per cubic foot. Furthermore, a proposed merger between the two possible vendors (Energy Solutions in Utah and WCS in Texas) could, if completed, result in monopoly pricing that could be significantly greater than estimates last provided in the *2013 IEPR*.

The data presented below in Table 16 updates Table 12: Waste Generated at Diablo Canyon (Units 1 and 2) from the *AB 1632 Assessment of California's Operating Nuclear Plants: Final Report*, published in October 2008 (CEC-100-2008-005-F, page 213).

⁴²⁵ The following was obtained from PG&E's Joint Proposal document, section 5.4.1 pages 12 & 13. PG&E will prepare a Diablo Canyon site-specific decommissioning study and submit it to the CPUC in an application for approval no later than the date when the 2018 NDCTP will be filed. PG&E will seek authorization from the CPUC in the Joint Proposal Application to disburse funds from the Diablo Canyon decommissioning trust to fund the site specific decommissioning study. The site-specific decommissioning study will update the 2015 NDCTP forecast and incorporate the costs of (i) the Employee Program described in Section 5.3, (ii) the Community Impacts Mitigation Program in Section 4.1, (iii) a plan for expedited post-shut-down transfer of spent fuel to Dry Cask Storage as promptly as is technically feasible using the transfer schedules implemented at the San Onofre Nuclear Generating Station as a benchmark for comparison, and provided PG&E will also provide the plan to the CEC, collaborate with the CEC, and evaluate the CEC's comments and input; and (iv) a plan to continue existing emergency planning activities, including maintenance of the public warning sirens and funding of community and state wide emergency planning functions until the termination of Diablo Canyon 's 10 CFR Part 50 license, subject to CPUC approval and funding in decommissioning rates. The Parties will support CPUC approval and funding of these elements of PG&E's revised Diablo Canyon decommissioning study.

Table 16: Waste Generated by Diablo Canyon Units 1 and 2

Diablo Canyon	Spent Fuel		Waste			
	No. of Assemblies	Metric Tons Uranium	Class A (ft ³)	Class B (ft ³)	Class C (ft ³)	GTCC (ft ³)
Total Generated through June 2016	3,190	1,371.30	15,803	1,146	1,353	*
2016 through end of license	1,192	512.56	2,592	432	0	*
Decommissioning	0	0	1,206,787	3,700	1,178	3,298
Total	4,382	1,884.26	1,225,182	5,278	2,531	3,298

Source: Data provided by PG&E. Documents can be found at <https://efiling.energy.ca.gov/Lists/DocketLog.aspx?doctetnumber=16-IEPR-07> *GTCC is not generated per se during reactor operation. Irradiated components will become GTCC upon disassembly of larger components during decommissioning.

SCE’s Response to the 2016 IEPR Data Request on the Progress in Spent Nuclear Fuel On-Site Management Concerning Nuclear Waste Accumulation

The following are excerpts from the submitted response with minor modifications to references, tables, and acronyms for consistency.

San Onofre Unit 1 permanently retired in 1992, and Units 2 and 3 permanently retired in 2013. The units are being decommissioned and are not generating any more spent nuclear fuel. Tables 17 and Table 18, as provided in the most recent decommissioning cost estimates, summarize the most recent disposal plans and disposal cost assessments for low-level waste at the San Onofre facility for all three units. All costs are shown at the 100 percent level in 2014 dollars.

SCE plans to ship the Class A waste to the Energy Solutions disposal facility at Clive, Utah, and the Class B and C waste to the Waste Control Specialists disposal facility in Andrews County, Texas. SCE plans to store the GTCC waste in canisters in the Independent Spent Fuel Storage Installation (ISFSI) at the San Onofre site until removal by the U.S. Department of Energy (DOE). For estimating costs, SCE applies a 25 percent contingency factor to the costs stated in the tables below.

There are 395 Unit 1 spent fuel assemblies stored at the San Onofre site. All of these are stored in canisters (dry storage) in the ISFSI, awaiting removal by DOE. In addition, there are 270 Unit 1 fuel assemblies stored at the General Electric-Hitachi facility in Morris, Illinois. These are stored in a wet pool, also awaiting removal by DOE. The estimated cost to store all Unit 1 fuel at the San Onofre ISFSI until removal by DOE is \$25.6 million (100 percent share, 2014 dollars).

There are 3460 Units 2 and 3 spent fuel assemblies stored at the San Onofre site. Of these spent fuel assemblies, 792 of these are stored in canisters (dry storage) in the ISFSI, and 2668 are stored in wet pools. SCE plans to transfer all fuel to dry storage in the ISFSI by 2019. The estimated cost to store all Unit 2 and 3 fuel until removal by DOE is \$1,243.1 million (100 percent share, 2014 dollars). SCE anticipates that the DOE will remove and accept the San Onofre fuel assemblies during the 2024-2049 period.

Table 17: San Onofre Unit 1 Waste Disposal Volumes

Facility and Waste Class	Waste Weight (lbs)	Waste Volume (CF)	Burial Volume (CF)	Packaging Cost	Transportation Cost	Base Burial Cost	Total Disposal Cost
Class B, C, & GTCC							
Class B & C	1,525,000	7,598	7,598	\$525,000	\$16,800,000	\$36,310,869	\$53,635,869
GTCC	27,159	55	167	\$0	\$210,000	\$3,440,770	\$3,650,770
Energy Solutions							
Class A-Debris	37,263	723	723	\$733	\$2,988	\$46,214	\$49,935
Other							
Out of State Class III Landfill	155,545,280	2,393,004	2,393,004	\$0	\$11,759,838	\$3,633,106	\$15,392,944
Scrap Metal Recycler	1,651,239	66,050	66,050	\$0	\$8,149	\$0	\$8,149
Grand Total	158,785,941	2,467,431	2,467,542	\$525,542	\$28,780,975	\$43,430,959	\$72,737,667

Source: Data provided by SCE. Documents can be found at <https://efiling.energy.ca.gov/Lists/DocketLog.aspx?docketnumber=16-IEPR-07> *Values are presented in pounds (lbs), cubic feet (CF), and U.S. dollars (\$).

Table 18: San Onofre Units 2 and 3 Waste Disposal Volumes

Facility and Waste Class	Waste Weight (lbs)	Waste Volume (CF)	Burial Volume (CF)	Packaging Cost	Transportation Cost	Base Burial Cost	Total Disposal Cost
Class B, C, & GTCC							
Class B	1,132,323	6,696	15,199	\$1,199,186	\$6,433,599	\$72,635,570	\$80,268,355
Class C	407,380	1,546	8,191	\$2,064,309	\$26,706,007	\$39,142,870	\$67,913,186
GTCC	92,861	190	1,882	\$196,288	\$1,680,000	\$38,775,980	\$40,652,268
Energy Solutions							
Class A	223,124,400	3,500,614	3,648,469	\$10,770,182	\$84,563,005	\$282,589,924	\$377,923,111
Other							
Out of State Class III Landfill	1,909,207,440	25,212,269	29,372,422	\$0	\$146,326,469	\$43,929,750	\$190,256,219
Scrap Metal Recycler	184,787,372	377,117	7,391,495	\$0	\$911,926	\$0	\$911,926
Grand Total	2,318,751,776	29,098,431	40,437,658	\$14,229,964	\$266,621,006	\$477,074,094	\$757,925,064

Source: Data provided by SCE. Documents can be found at <https://efiling.energy.ca.gov/Lists/DocketLog.aspx?docketnumber=16-IEPR-07> *Values are presented in pounds (lbs), cubic feet (CF), and U.S. dollars (\$).

Table 19 below provides the number of spent fuel assemblies and corresponding metric tons of uranium for spent fuel stored on site at San Onofre.

Table 19: Spent Fuel Assemblies and Uranium Stored at San Onofre

	Spent Fuel Assemblies	Metric Tons Uranium
Unit 1*	395	146.253
Unit 2	1726	730.003
Unit 3	1734	733.007

Source: Data provided by SCE. Documents can be found at <https://efiling.energy.ca.gov/Lists/DocketLog.aspx?doctetnumber=16-IEPR-07> *Excludes 270 assemblies stored at GE Hitachi Facility in Morris, IL.

Spent Fuel Pool and Independent Spent Fuel Storage Installation – Diablo Canyon and San Onofre

The Energy Commission requested the following information from PG&E and SCE:

1. A progress report on the transfer of spent fuel from pools into dry casks (in compliance with Nuclear Regulatory Commission (NRC) spent fuel cask and pool storage requirements).
2. An updated evaluation of the potential long-term impacts and projected costs of spent fuel storage in pools versus dry cask storage of higher burn-up fuels in densely packed pools, and the potential degradation of fuels and package integrity during long-term wet and dry storage and transportation offsite.
3. Information on the developments of facility specific aging cask management programs onsite and within the nuclear engineering community, and any related technological considerations.
4. Updated tables on the status of spent nuclear fuel and current onsite storage capacity and a table summarizing the current spent fuel conditions including radiation levels. Tables on the current ISFSI should contain information on capacity, planned expansions and timetables, planned loading configurations and associated thermal loads, and estimated thermal loads of the current ISFSI multi-purpose canisters.
5. Alternative spent fuel management schemes to expeditiously transfer spent nuclear fuel assemblies from the wet spent fuel pool to dry casks in the ISFSI. PG&E should consider isolating the spent fuel pool to eliminate the need for using Pacific Ocean seawater for cooling the spent fuel pool system. PG&E should also include information demonstrating sufficient space for all spent fuel (fuel consumed if Diablo Canyon was relicensed) to be kept on site in the ISFSI and also all assessments of the lifetime of the dry casks.

PG&E's Response to the 2016 IEPR Data Request on the Progress in Spent Nuclear Fuel On-Site Management Concerning the Spent Fuel Pool and Independent Spent Fuel Storage Installation

The following are excerpts from the submitted response with minor modifications to references, tables, and acronyms for consistency.

1. As of July 8, 2016, there are 2,006 used fuel assemblies stored in the spent fuel pools. There are 37 casks loaded with a total of 1,184 assemblies. The current plan is to load 12 additional casks in 2016 and 8 casks in each of the years 2018, 2020, and 2022.⁴²⁶
2. No stand-alone cost-benefit analysis of wet vs. dry storage has been performed. Spent fuel is stored in pools for a minimum of five years before being placed in dry cask storage. As stated previously by PG&E, the operational cost of maintaining the dry cask storage facility is about \$2.5 million annually. This cost includes security and operational support. PG&E does not have specific numbers for the cost to maintain and operate the systems that support the spent fuel pool operation.

Cost/benefit studies have not been developed for the long-term storage of spent nuclear fuel at the Diablo Canyon site. It is assumed in budget development that PG&E will store spent nuclear fuel on site until the DOE is ready to remove the spent fuel. Estimates of Direct Cost for movement of spent nuclear fuel into dry storage have been developed and planned for the near-term operating budgets. PG&E has developed a dry storage facility that is licensed and permitted to store all of the spent nuclear fuel generated during the 40-year licensed life of Diablo Canyon. It is still PG&E's position that the facility is an interim solution until the DOE assumes its responsibility and collects the fuel for reprocessing or long-term storage.

3. In June 2016, the NRC issued NUREG-1927, *Standard Review Plan for Renewal of Specific Licenses and Certificates of Compliance for Dry Storage of Spent Nuclear Fuel - Final Report*, Revision 1 (Standard Review Plan). This Standard Review Plan provides guidance and information on review of aging management programs (AMPs), including learning AMPs that consider and respond to operating experience. The guidance provides example AMPs for welded stainless steel canisters, reinforced concrete structures, and a high burnup fuel monitoring and assessment program.

⁴²⁶ The following information was obtained from presentations given by PG&E representatives at the Diablo Canyon Independent Safety Committee Public Meetings. The Diablo Canyon design capacity for the ISFSI is 138 Holtec HI-STORM casks arranged on 7 pads each with 20 mounting locations. The current dry fuel storage plan is based upon maintaining about 772 assemblies in the spent fuel pool to accommodate core offloads. Maintaining compliance with NRC regulations require that four older fuel assemblies surround each newer assembly. The final emptying of the spent fuel pool will occur about 10 years after final shutdown when the decay heat level has reached the allowable value for the cask license. The Holtec HI-STORM 100 multi-purpose canisters (MPC) are loaded using a uniform and preferential loading pattern intended to reduce radiation dose to cask loading personnel. The current MPCs hold a maximum of 32 assemblies. The 2016 loading campaign will mount 6 MPCs from Unit 1 and 2 onto the ISFSI pad from August through November. This will bring the total number of MPCs on the ISFSI pads to 49 by the end of 2016.

PG&E is evaluating this document for the development of aging management programs.

4. Table 20 provides 2016 updates to Table 14: On-Site Spent Fuel Capacity (number of assemblies) from the *AB 1632 Assessment of California's Operating Nuclear Plants: Final Report*, October 2008 (CEC-100-2008-005-F, page 217). The radiation levels and thermal loads will be maintained within the limits defined in the Diablo Canyon ISFSI Technical Specifications.

Table 20: Onsite Spent Nuclear Fuel Capacity

Diablo Canyon		
	Assemblies	MTU
ISFSI Capacity	4,416	1,898.88
Planned Expansions	0	0
Total Planned ISFS Capacity	4,416	1,898.88
Spent Fuel Pool Current Capacity	2,621	1,127.03
Total On-site Storage Capacity	7,037	3,025.91
Assemblies Generated during Current licensing Period	4,382	1,884.26
Spent Fuel Pool Original Design Capacity (Before re-racking)	540	232.2

Source: Data provided by PG&E. Documents can be found at <https://efiling.energy.ca.gov/Lists/DocketLog.aspx?docketnumber=16-IEPR-07> *Values are in metric tons of Uranium (MTU).

5. PG&E has not evaluated reducing the loading schedule at Diablo Canyon after shutdown but notes that it would require a revision to PG&E's NRC license and evaluation of cask and support equipment changes and the possibility of major facility demolitions and construction.

SCE's Response to the 2016 IEPR Data Request on the Progress in Spent Nuclear Fuel On-Site Management Concerning the Spent Fuel Pool and Independent Spent Fuel Storage Installation

The following are excerpts from the submitted response with minor modifications to references, tables, and acronyms for consistency.

1. SCE complies with all NRC requirements for nuclear spent fuel storage. SCE's spent fuel management plan provides for the safe and secure storage of spent fuel until the DOE meets its acknowledged contractual obligations to remove the spent fuel from the site. SCE will continue to adhere to its spent fuel

management plan in which spent fuel for San Onofre Units 2 and 3 is stored in the San Onofre Units 2 and 3 spent fuel pools or a dry cask storage container at the San Onofre ISFSI. SCE expects to begin the transfer of spent fuel remaining in the pools to the ISFSI in 2017 and to complete the effort by mid-2019.

2. All nuclear spent fuel generated at San Onofre is stored in accordance with the regulations and requirements of the NRC in the San Onofre Units 2 and 3 spent fuel pools or in dry cask storage canisters at the San Onofre ISFSI. Both wet and dry storage of spent nuclear fuel are safe. Fuel is not expected to degrade during long-term wet or dry storage. Dry storage is considered preferable for a permanently closed site that will undergo decommissioning. SCE plans to move all spent fuel at San Onofre Units 2 and 3 currently in wet storage into dry storage by 2019, the base case used in the *2014 Decommissioning Cost Analysis of the San Onofre Nuclear Generating Station Units 2 and 3*.⁴²⁷ SCE performed a sensitivity analysis of the cost to delay the transfer of the spent fuel to dry storage until December 2023 and determined that spent fuel storage costs would increase by \$490.4 million. Dry storage is a safe, secure, passive economical system for long-term storage of spent fuel. Dry storage enables SCE to retire active systems and components, including energized equipment and the associated maintenance, a change that enhances worker safety. Using less equipment also means SCE can reduce the size of the San Onofre “footprint” that requires security surveillance. All these changes set the stage for a more efficient decommissioning, and provide cost savings for customers.

The NRC defines high burnup fuel as having an average burnup of greater than 45 GWD/MTU (NRC Interim Staff Guidance -11 Revision 3, Issue: Cladding Considerations for the Transportation and Storage of Spent Fuel). There are 1,115 high burnup fuel assemblies in wet storage at San Onofre, and 8 high burnup fuel assemblies stored at the San Onofre ISFSI. Typically, high burnup fuel will require a longer period of wet storage prior to being transferred to a dry cask storage canister. Storage of high burnup fuel is not expected to result in any degradation. The Areva dry cask storage canisters on the San Onofre ISFSI are licensed to store and transport high burnup fuel. Based on testing in the laboratory and modeling, NRC staff has determined that high burnup fuel can be safely stored and transported. The NRC, DOE, and EPRI continue to study and evaluate high burnup fuel. The studies and tests are confirmatory. The Holtec dry cask storage canisters to be used on the San Onofre ISFSI are licensed to store high burnup fuel. The Holtec cask license application for transportation is under NRC review and includes high burnup fuel.

⁴²⁷ EnergySolutions Document No. 164001, *2014 Decommissioning Cost Analysis of the San Onofre Nuclear Generating Station Units 2 and 3*.

3. The potential for any canister or concrete degradation will be addressed as part of the Aging Management Program that will be developed by the dry cask storage system canister vendors. Aging management requirements and programs are under development through the joint efforts of the NRC, NEI, cask vendors, EPRI, and utilities, including SCE. EPRI, national labs, universities, and cask vendors have completed extensive research related to potential aging mechanisms associated with extended dry storage of spent nuclear fuel. Aging management programs will be developed for both the Areva and Holtec systems consistent with NRC requirements. The aging management programs will include engineered, programmatic, and mitigating methods for monitoring the health of the dry cask storage systems.
4. The status of all of the spent fuel located at San Onofre is provided in the response to discussion on page C-3. Only San Onofre 2 and 3 spent fuel remains in the spent fuel pools; San Onofre Units 1, 2, and 3 spent fuel is located on the San Onofre ISFSI; and additional San Onofre Unit 1 spent fuel is located at the GE spent fuel storage facility in Morris, Illinois. The San Onofre ISFSI has 50 NUHOMS Advanced Horizontal Storage Modules (AHSM) containing canisters with spent fuel, and one AHSM contains a canister with San Onofre Unit 1 GTCC waste. The ISFSI has an additional 12 NUHOMS modules available for storage of canisters. An expansion of the San Onofre ISFSI is underway and, once completed, will provide space for 75 Holtec Underground Maximum (UMAX) storage modules and Multi-Purpose Canister (MPC)-37 canisters. The expansion and storage modules provide sufficient storage for the San Onofre Units 2 and 3 spent fuel remaining in the spent fuel pools and any GTCC waste from decommissioning. Based on the schedule for completing the expansion and bringing in the UMAX storage modules, in 2017 spent fuel from the spent fuel pools will begin to be moved to the ISFSI. By mid-2019, all the spent fuel identified in Table 21 on page C-5, with the exception of the San Onofre Unit 1 spent fuel in Morris, Illinois, will be located on the San Onofre ISFSI in AHSM and UMAX storage modules.

The Holtec MPC-37 canister will be used for loading the remaining spent fuel onto the ISFSI. The MPC-37 canister can contain up to 37 spent fuel assemblies. The loading patterns for the canisters have not been finalized. Based on the spent fuel assemblies remaining in the pools it is estimated that the maximum decay heat for an MPC-37 canister will be no higher than 26 kW. The maximum design heat load for the MPC-37 canister is 35.3 kW. All the 50 NUHOMS canisters that are on the San Onofre ISFSI are maintained in accordance with the NRC approved certificate of compliance and NRC requirements. The NRC has verified the heat load and radiological condition of the modules on the ISFSI by inspection and documented the inspections in reports dated February 13, 2014, (ML14045A317) and May 5, 2016 (ML16127A580).

Progress in Completing 2013 IEPR and 2015 IEPR Recommendations

San Onofre Nuclear Generation Station Status of Decommissioning

The Energy Commission asked SCE to provide an update on the decommissioning of San Onofre. The request stated that the decommissioning update should include information on the current terms of the Navy lease, as well as any planning pertaining to the funding and maintenance of the ISFSIs if on-site storage must be continued beyond 2029.

SCE's response to the Energy Commission request on the status of San Onofre's decommissioning has been incorporated into the *Final 2016 IEPR Environmental Performance Report of California's Electrical Generation System* (EPR).⁴²⁸ The details can be reviewed in Chapters 3 and 4 of the EPR or SCE's response to the data request.⁴²⁹

428 Bartridge, Jim, Melissa Jones, Eli Harland, Judy Grau. 2016. *Final 2016 Environmental Performance Report of California's Electrical Generation System*. California Energy Commission. Publication Number: CEC-700-2016-005-SF.

429 The full responses from both PG&E and SCE can be found at <https://efiling.energy.ca.gov/Lists/DocketLog.aspx?docketnumber=16-IEPR-07>.