

DOCKETED

Docket Number:	15-AFC-01
Project Title:	Puente Power Project
TN #:	213002
Document Title:	Refinement to Transmission Interconnection
Description:	N/A
Filer:	Patty Paul
Organization:	Latham & Watkins LLP
Submitter Role:	Applicant Representative
Submission Date:	8/26/2016 4:45:14 PM
Docketed Date:	8/26/2016



Application for Certification (15-AFC-01)

Puente Power Project (P3)
Oxnard, CA

Refinement to Transmission Interconnection



August 2016

Submitted to:
The California Energy Commission



Prepared by:



TABLE OF CONTENTS

	Page
INTRODUCTION.....	1
INTERCONNECTION TO TRANSMISSION GRID	1
TRANSMISSION LINE CONFIGURATION.....	1
TRANSMISSION SYSTEM OPERATION AND MAINTENANCE.....	2

LIST OF FIGURES

Revised Figure 1-1	Visual Simulation of Puente Power Project Including Demolition of MGS Units 1 and 2
Revised Figure 2.1-1	Site Plan
Revised Figure 2.7-1	Plot Plan
Revised Figure 2.7-5b	Single-Line Diagram – P3 Unit
Revised Figure 3-1	Electrical Interconnection to the SCE Switchyard
Revised Figure 3-2	Typical High-Voltage Poles
Revised Figure 4.13-4b	Photographic Simulation without MGS Units 1 and 2 from Key Observation Point 1
Revised Figure 4.13-5b	Photographic Simulation without MGS Units 1 and 2 from Key Observation Point 2
Revised Figure 4.13-6b	Photographic Simulation without MGS Units 1 and 2 from Key Observation Point 3
Revised Figure 4.13-8b	Photographic Simulation without MGS Units 1 and 2 from Key Observation Point 5

LIST OF ACRONYMS AND ABBREVIATIONS

CTG	combustion turbine generator
GE	General Electric
GSU	generator step-up
kV	kilovolt
P3	Puente Power Project
SCE	Southern California Edison

INTRODUCTION

As a result of further engineering refinements and ongoing discussions with Southern California Edison (SCE) regarding the facilities interconnection for the Puente Power Project (P3), a minor change to the transmission interconnection has been made. The 220-kilovolt (kV) transmission interconnection for the proposed P3 will now consist of a single gen-tie connection, which will require one mono-pole structure and one take-off structure, providing a direct connection to SCE's transmission system and bypassing the existing Mandalay Switchyard. The modified components of the transmission interconnection are described below, and shown on Revised Figures 2.1-1, 2.7-1, 2.7-5b, 3-1, and 3-2. Figures 1-1, 4.13-4b, 4.13-5b, 4.13-6b, and 4.13-8b from the *Project Enhancement and Refinement, Demolition of Mandalay Generating Station Units 1 and 2* were also updated and are included herein. All other aspects of the transmission interconnection not discussed below remain as described in the Application for Certification.

INTERCONNECTION TO TRANSMISSION GRID

The new P3 unit will be connected to a single gen-tie line connecting directly to the SCE 220-kV transmission system, and bypassing the existing Mandalay Switchyard. The combustion turbine generator (CTG) unit will connect to the transmission system via a generator step-up (GSU) transformer. One auxiliary transformer will be provided, and connected on the lower side of the GSU transformer on the CTG. Single-ended 4-kV and 480-volt switchgear lineups will be provided as required to serve the General Electric (GE)-supplied electrical loads, as well as all required balance-of-plant loads. A backup diesel generator has been included to facilitate safe shutdown, and serve station loads in the event of the loss of the single line feeding the auxiliary system.

The 220-kV single circuit for the project will be a direct gen-tie line between the P3 unit and SCE's 220-kV transmission system. A conceptual diagram showing the proposed interconnection is shown on Revised Figure 3-1. The transmission line interconnection will be approximately 250 feet in total length, from the GSU to the 220-kV tie-in-point at the take-off structure. The interconnection will mostly lie within the P3 site, but will cross a small portion of the Mandalay Generating Station site. The existing transmission line from the SCE's Mandalay Switchyard to an existing transmission structure across and east of Harbor Boulevard will be rerouted/reconfigured from the new take-off structure to the transmission system, thereby bypassing the Mandalay Switchyard.

In addition, there will be an electrical enclosure installed in the southern portion of the existing Mandalay Switchyard to house the protection, control, and telecommunications equipment.

TRANSMISSION LINE CONFIGURATION

The new 220-kV circuit line from the project switchyard to the new take-off structure will use one steel pole structure. The steel pole and the take-off structure will be constructed of weathered or galvanized steel. The steel pole structure will be bolted or slip-fit design. The pole will be a single-circuit structure, and the take-off structure will be a double-circuit structure. The single-circuit structure will be approximately 80 to 90 feet tall; the double-circuit structure will be approximately 80 to 90 feet tall, with phase conductors that may be arranged horizontally, vertically, or in a delta configuration, depending on the requirements for particular structures. The vertical configuration will be the predominant configuration type (see Revised Figure 3-2).

Two ground wires will be installed on the 220-kV structures. A 0.5-inch extra-high-strength-steel ground wire will be used, unless one of the ground wires is replaced by an optical ground wire of approximately the same diameter. The optical wire will be used, as necessary, to meet any communication requirements between P3 and SCE.

TRANSMISSION SYSTEM OPERATION AND MAINTENANCE

Applicant will own, operate, and maintain the transmission lines up to the point of interconnection with SCE's transmission system at the take-off structure. SCE will own, operate, and maintain the facilities beyond the take-off structure.



08/25/16 hk \\1578sr-w2403\gis\Graphics\NRG Puente Power Project\Aug 2016\REV_ Figs_aug2016.indd

**VISUAL SIMULATION OF PUENTE POWER PROJECT
INCLUDING DEMOLITION OF MGS UNITS 1 AND 2**

NRG
Puente Power Project
Oxnard, California
August 2016

REVISED FIGURE 1-1

anfile - manurby VA Projects\GIS - Proj\MandalayEnergyCenter\deliberables\SitePlan\RevisedFigure2_1-1_SitePlan2Rev.mxd 7/18/2016 3:06:07 PM 11578r-w3102-j35graphical\NGC\PointPower Project\Map 2016\REV - Figs_aug2016.mxd

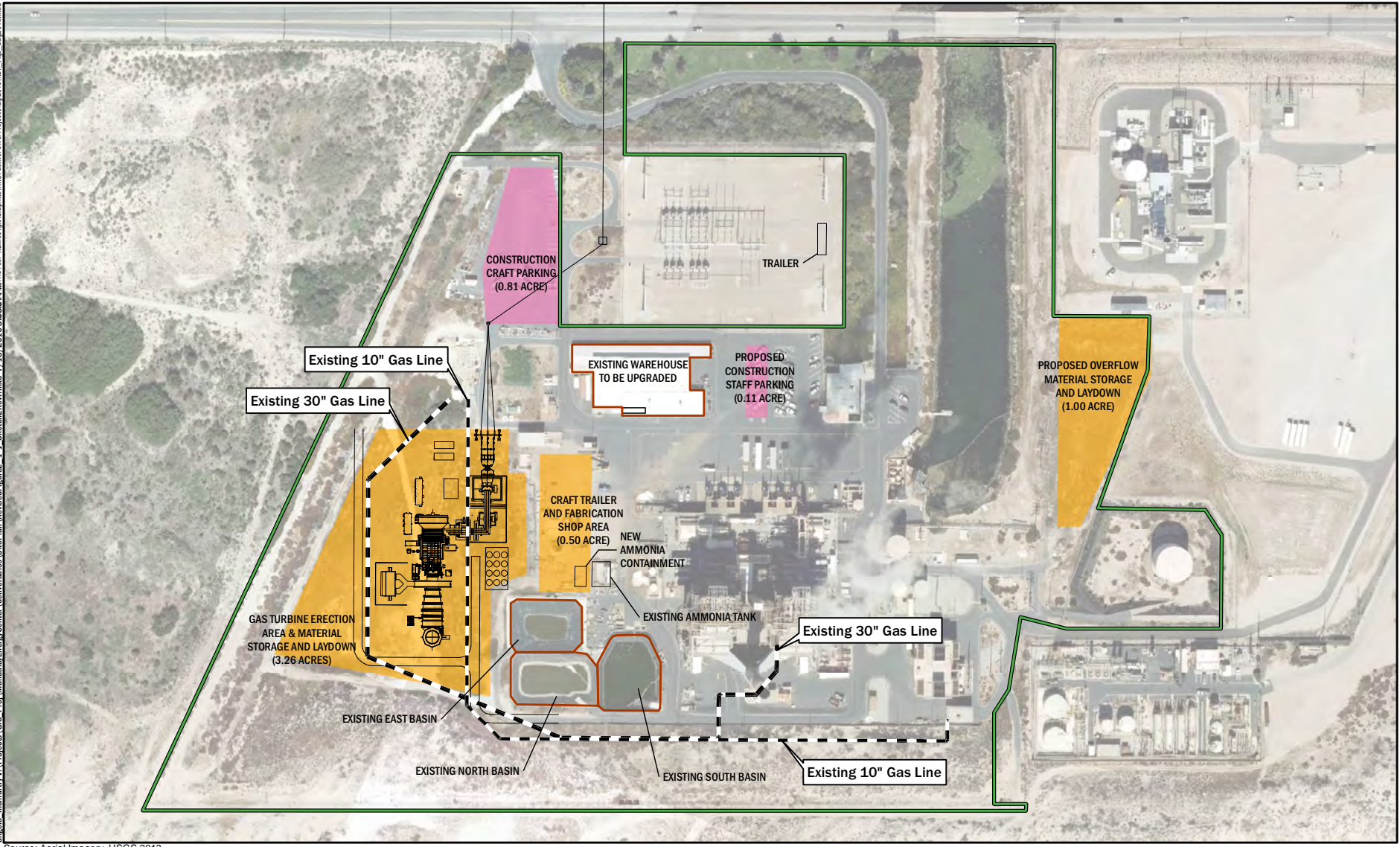

Source: Aerial Imagery, USGS 2013.

- Mandalay Generating Station Property
- Construction and Laydown Areas
- Existing Parking Used During Construction

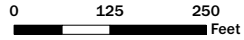

SITE PLAN

NRG
Puente Power Project
Oxnard, California
August 2016

REVISED FIGURE 2.1-1

08/25/16 1K \\1578sr-v2\k03\gis\Graphics\NRG Puente Power Project\Aug 2016\REV_ Figs_ aug2016.incd

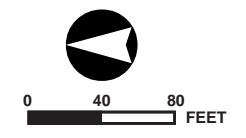
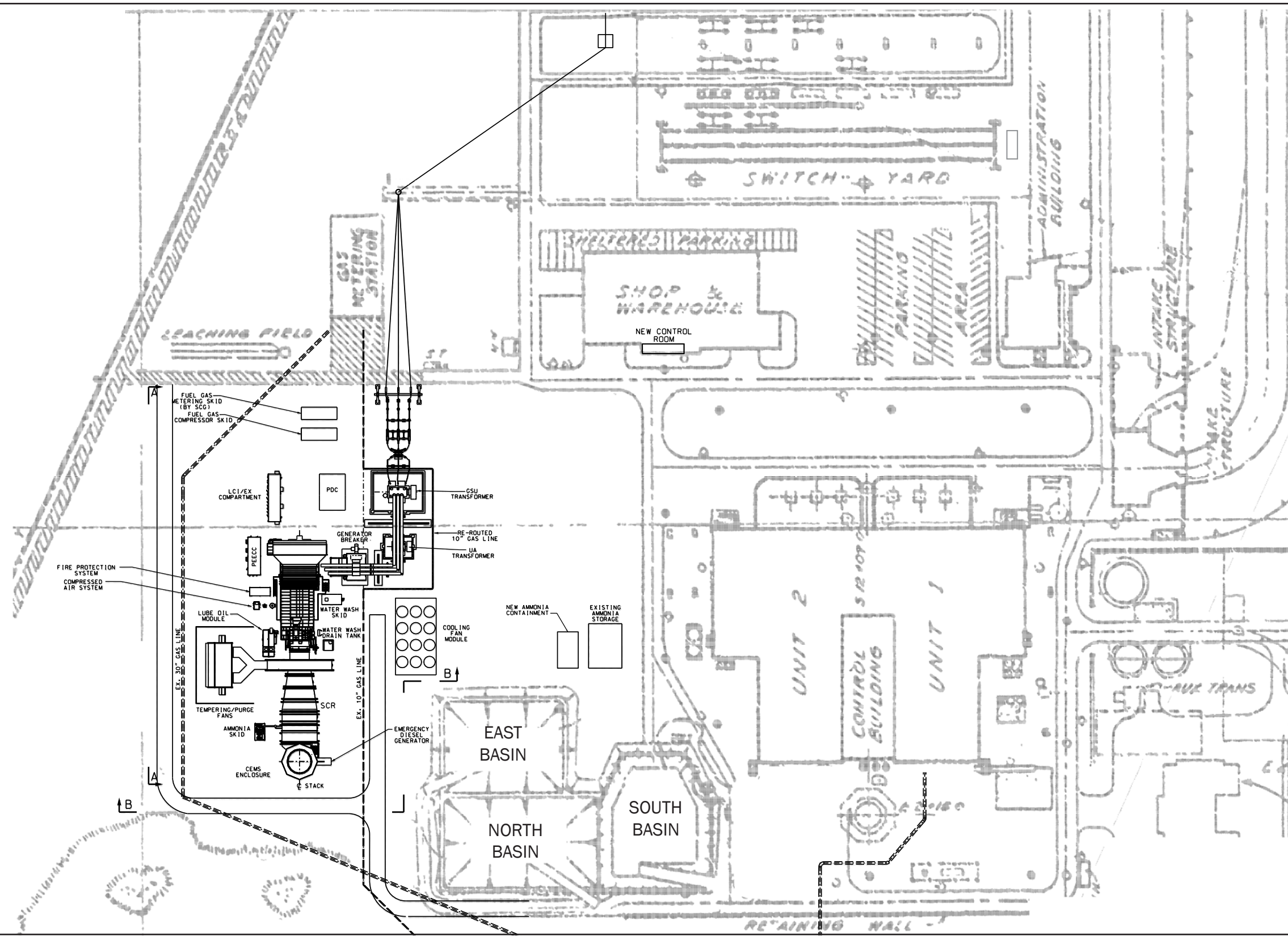

Source: URS DW. No. 31380-P029-MAN-SKETCH 2 REV. F, 7/12/16.

PLOT PLAN

NRG
Puente Power Project
Oxnard, California
August 2016

REVISED FIGURE 2.7-1

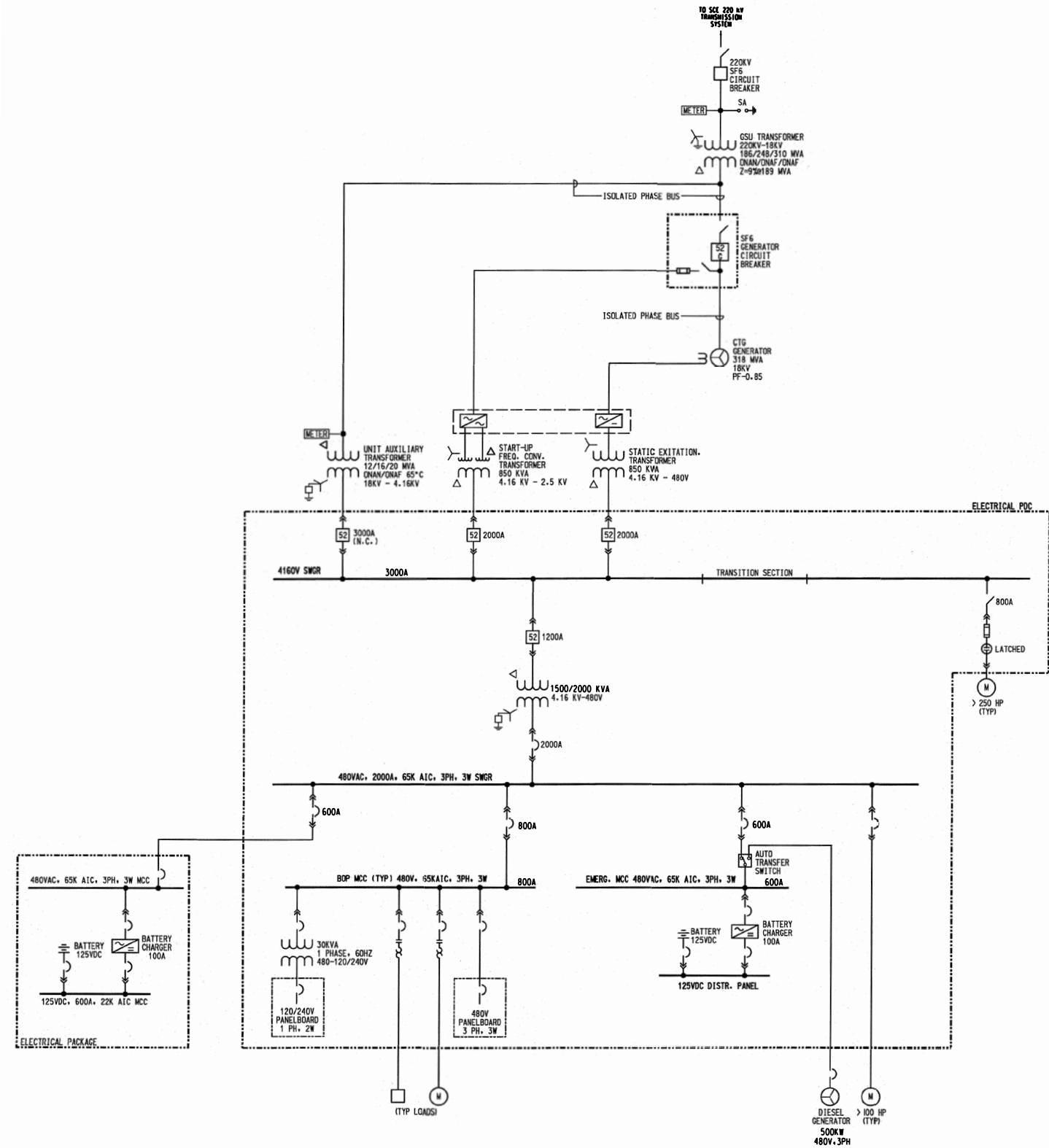

- NOTES:**
1. REVENUE METER IS PROVIDED AT THE HV SIDE OF THE GSU XFMR.
 2. ONE SET OF METERING EQUIPMENT IS PROVIDED ON THE HV SIDE OF THE UNIT AUX XFMR TO MEASURE THE UNIT AUXILIARY LOAD.
 3. RATINGS AND EQUIPMENT CONFIGURATION SHOWN ARE PRELIMINARY AND WILL BE FINALIZED DURING DETAIL DESIGN.

08/25/16 1k \\1578sr-v2\03\gis\Graphics\NRG Puente Power Project\Aug 2016\REV. Figs. aug2016.incd

Source:

SINGLE-LINE DIAGRAM - P3 UNIT

NRG
Puente Power Project
Oxnard, California
August 2016

REVISED FIGURE 2.7-5b

08/25/16 1K \\1578sr-v2\k03\gis\Graphics\NRG Puente Power Project\Aug 2016\REV_ Figs_ aug2016.incd

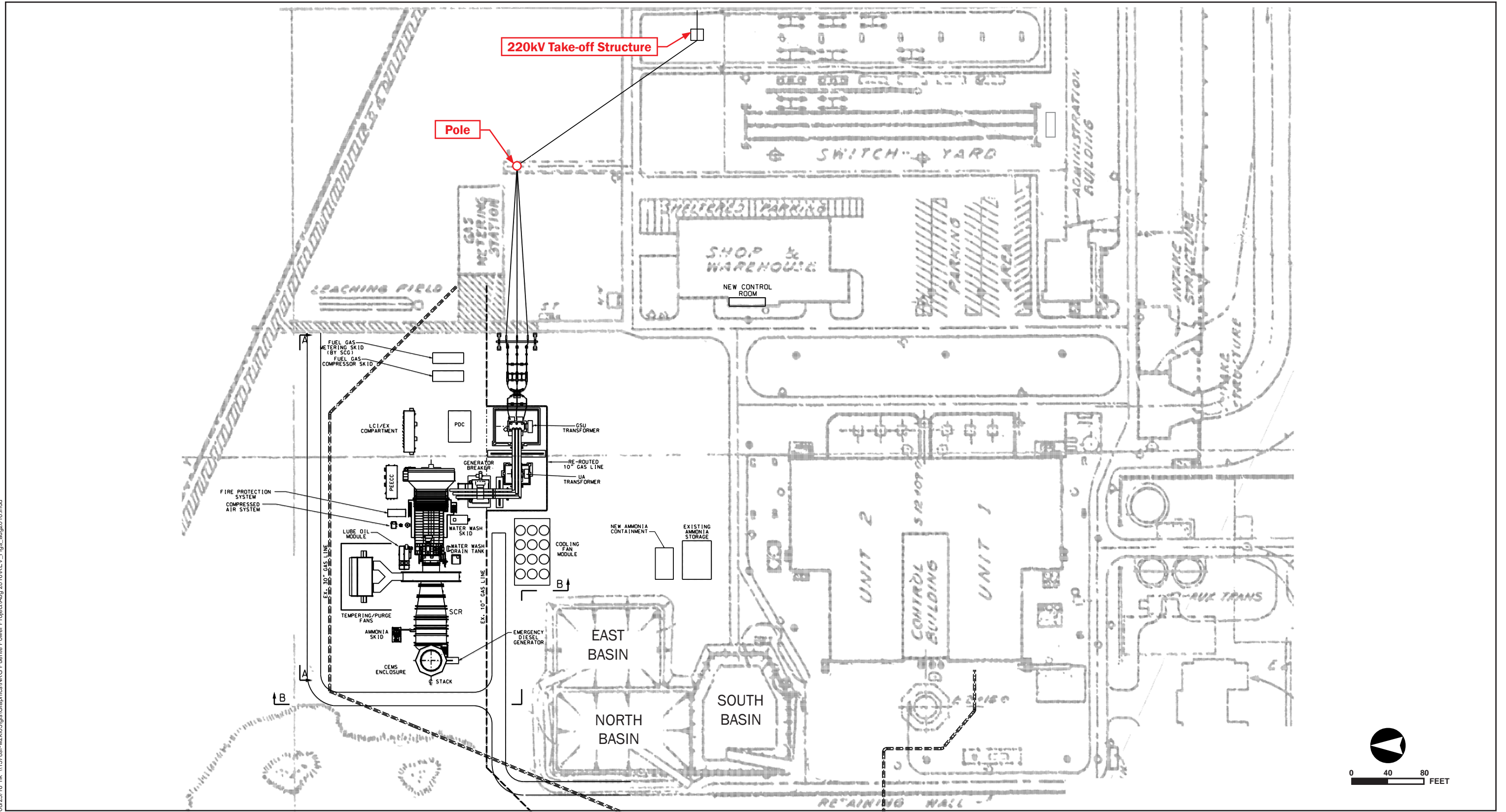

Source: URS DW. No. 31380-P029-MAN-SKETCH 2 REV. F, 7/12/16.

ELECTRICAL INTERCONNECTION TO THE SCE SWITCHYARD

NRG
Puente Power Project
Oxnard, California
August 2016

REVISED FIGURE 3-1

TAKE OFF STRUCTURE

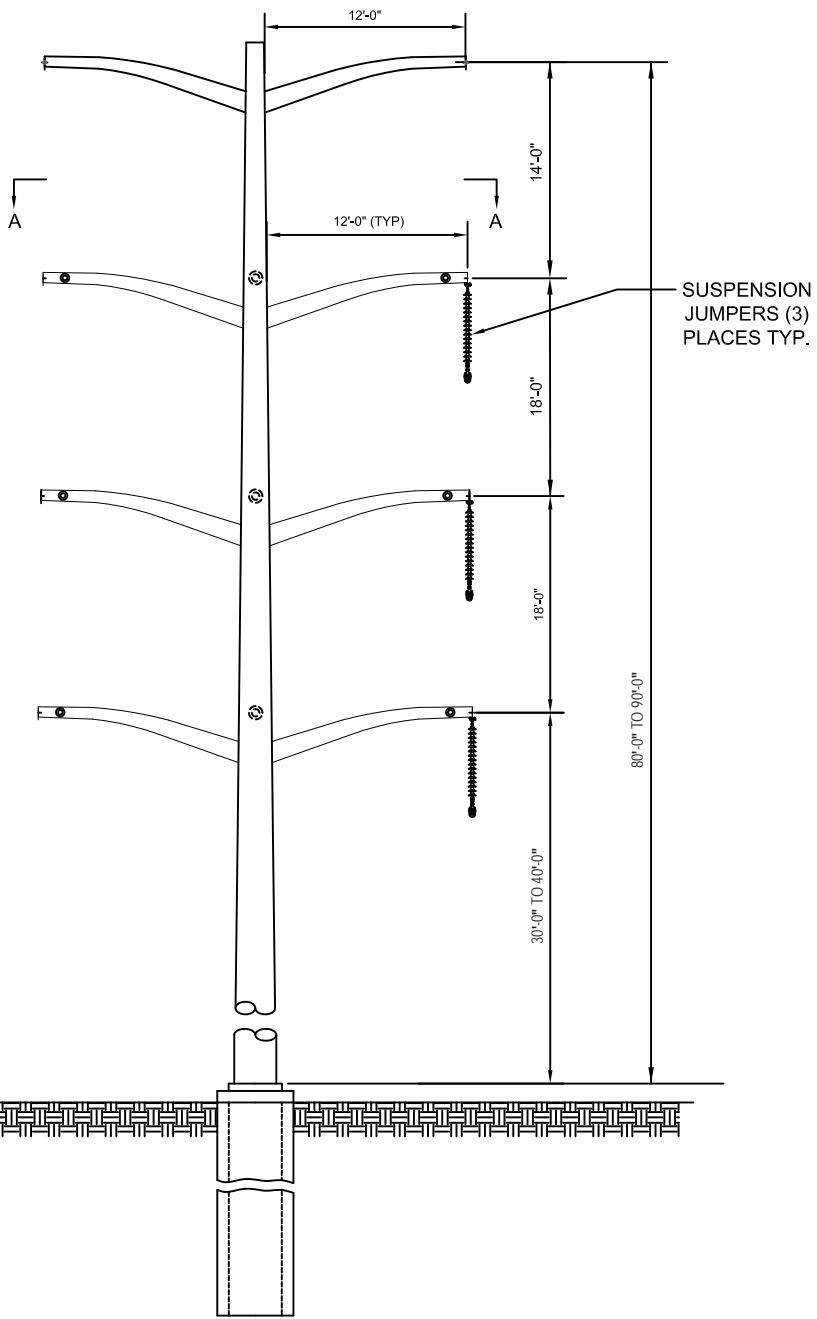
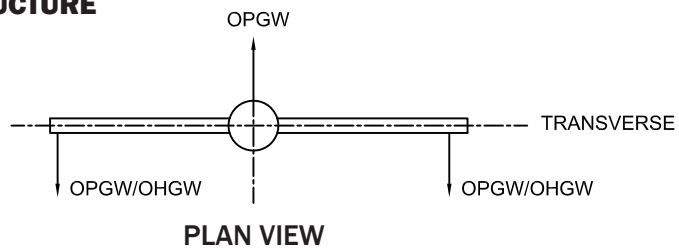

POLE

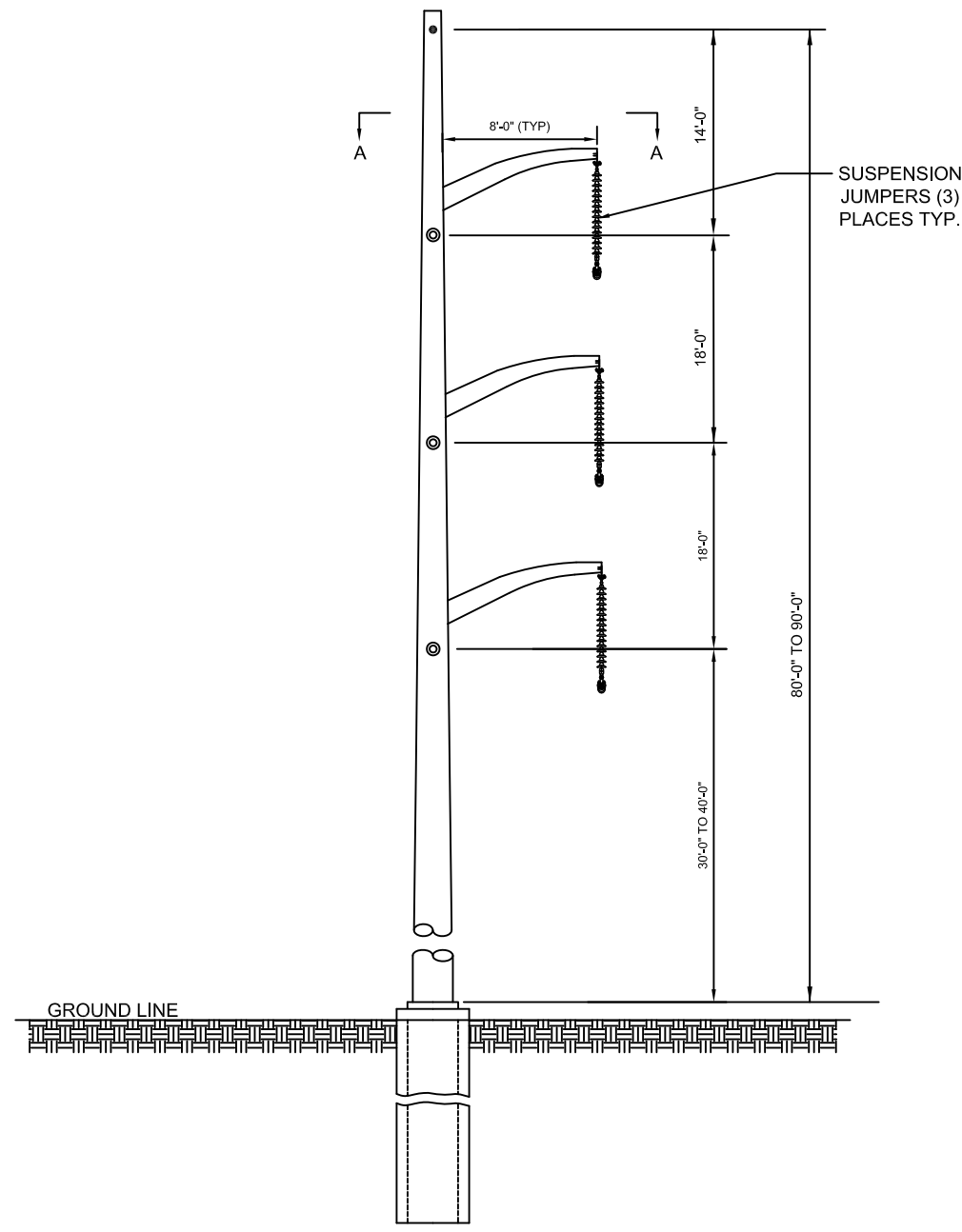
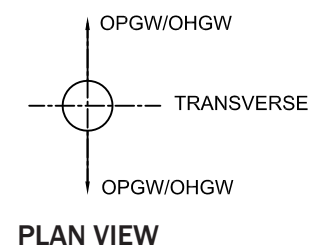

08/25/16 hk \\1578sr-v2\03\gis\Graphics\NRG Puente Power Project\Aug 2016\REV_Figs_aug2016.mdd

Source: URS DW. No. SKETCH 1: POLE OUTLINE, REV. A, 7/12/16.

Note: Dimensions are to holes for attachment where applicable.

TYPICAL HIGH VOLTAGE POLES



NRG
Puente Power Project
Oxnard, California
August 2016

REVISED FIGURE 3-2

08/25/16 hk \\1578sr-w2k103\gis\Graphics\NRG Puente Power Project\Aug 2016\REV_Figs_aug2016.mxd



Source Imagery, Esri 2013

-  Key Observation Point and Photo Direction
-  Puente Power Project Site
-  Mandalay Generating Station Property

Photograph Information

Time of photograph:	12:26 PM
Date of photograph:	2-6-15
Weather condition:	Cloudy
Bearing:	North
Latitude:	34°11'51.01"N
Longitude:	119°14'55.86"W
Distance to stack:	3,882 feet
Camera:	Nikon D700
Lens:	Nikon 50mm f/1.4D AF
Focal length:	50mm
Aperture:	F/14

Photograph above is intended to be viewed 12" from viewer's eyes when printed on 11" x 17" paper. The photograph below was cropped, top and bottom, to show a wide-angle view of the area; the area in yellow depicts the location of the above imagery.



Z:\Projects\NRG_Ventura_AFC\Layouts

**PHOTOGRAPHIC SIMULATION
WITHOUT MGS UNITS 1 AND 2
FROM KEY OBSERVATION POINT 1**



NRG
Puente Power Project
Oxnard, California
August 2016

REVISED FIGURE 4.13-4B

08/25/16 hk \\1578sr-w2k103\gis\Graphics\NRG Puente Power Project\Aug 2016\REV_Figs_aug2016.mxd



Source Imagery, Esri 2013

-  Key Observation Point and Photo Direction
-  Puente Power Project Site
-  Mandalay Generating Station Property

Photograph Information

Time of photograph:	1:02 PM
Date of photograph:	2-6-15
Weather condition:	Cloudy
Bearing:	North
Latitude:	34°12'6.52"N
Longitude:	119°15'5.03"W
Distance to stack:	2,216 feet
Camera:	Nikon D700
Lens:	Nikon 50mm f/1.4D AF
Focal length:	50mm
Aperture:	F/11

Photograph above is intended to be viewed 12" from viewer's eyes when printed on 11" x 17" paper. The photograph below was cropped, top and bottom, to show a wide-angle view of the area; the area in yellow depicts the location of the above imagery.



Z:\Projects\NRG_Ventura_AFC\Layouts

**PHOTOGRAPHIC SIMULATION
WITHOUT MGS UNITS 1 AND 2
FROM KEY OBSERVATION POINT 2**



August 2016 NRG
Puente Power Project
Oxnard, California

REVISED FIGURE 4.13-5B

08/25/16 hk \\1578sr-w2k103\gis\Graphics\NRG Puente Power Project\Aug 2016\REV_Figs_aug2016.mxd



Source Imagery, Esri 2013

-  Key Observation Point and Photo Direction
-  Puente Power Project Site
-  Mandalay Generating Station Property

Photograph Information

Time of photograph:	1:50 PM
Date of photograph:	2-6-15
Weather condition:	Cloudy
Bearing:	South
Latitude:	34°12'33.42"N
Longitude:	119°15'18.96"W
Distance to stack:	1,150 feet
Camera:	Nikon D700
Lens:	Nikon 50mm f/1.4D AF
Focal length:	50mm
Aperture:	F/13

Photograph above is intended to be viewed 12" from viewer's eyes when printed on 11" x 17" paper. The photograph below was cropped, top and bottom, to show a wide-angle view of the area; the area in yellow depicts the location of the above imagery.



Z:\Projects\NRG_Ventura_AFC\Layouts

**PHOTOGRAPHIC SIMULATION
WITHOUT MGS UNITS 1 AND 2
FROM KEY OBSERVATION POINT 3**



NRG
Puente Power Project
Oxnard, California
August 2016

REVISED FIGURE 4.13-6B

08/25/16 h.k. \11578sr-w2k103\gis\Graphics\NRG_Puente Power Project\Aug 2016\REV_ Figs_ aug2016.mxd



Source Imagery, Esri 2013

-  Key Observation Point and Photo Direction
-  Puente Power Project Site
-  Mandalay Generating Station Property

Photograph Information

Time of photograph: 4:17 PM
 Date of photograph: 2-6-15
 Weather condition: Partly Cloudy
 Bearing: Northwest
 Latitude: 34°12'3.06"N
 Longitude: 119°14'38.01"W
 Distance to stack: 3,516 feet
 Camera: Nikon D700
 Lens: Nikon 50mm f/1.4D AF
 Focal length: 50mm
 Aperture: F/13

Photograph above is intended to be viewed 12" from viewer's eyes when printed on 11" x 17" paper. The photograph below was cropped, top and bottom, to show a wide-angle view of the area; the area in yellow depicts the location of the above imagery.

Z:\Projects\NRG_Ventura_AFC\Layouts



**PHOTOGRAPHIC SIMULATION
WITHOUT MGS UNITS 1 AND 2
FROM KEY OBSERVATION POINT 5**

NRG
 Puente Power Project
 Oxnard, California
 August 2016