

## DOCKETED

<b>Docket Number:</b>	97-AFC-01C
<b>Project Title:</b>	High Desert Power Plant
<b>TN #:</b>	221316
<b>Document Title:</b>	Memo Regarding Supporting Documents for Stipulation
<b>Description:</b>	N/A
<b>Filer:</b>	Patty Paul
<b>Organization:</b>	California Energy Commission
<b>Submitter Role:</b>	Commission Staff
<b>Submission Date:</b>	9/26/2017 10:47:42 AM
<b>Docketed Date:</b>	9/26/2017

## Memorandum

Date: September 25, 2017  
Telephone: (916) 651-0966

To: Karen Douglas, Commissioner and Presiding Member  
Janea A. Scott, Commissioner and Associate Member

From: California Energy Commission – Leonidas Payne / Michelle Chester  
1516 Ninth Street Project Manager Staff Counsel  
Sacramento, CA 95814-5512

Subject: **HIGH DESERT POWER PROJECT—SUPPORTING DOCUMENTS FOR STIPULATION**

On September 11, 2017, the California Energy Commission Committee (Committee) assigned to conduct proceedings on the High Desert Power Project (HDPP) held a Prehearing Conference, at which the Comprehensive Stipulation and Agreement Between Parties (Stipulation),<sup>1</sup> filed on September 1, 2017, was discussed. In response to questions from the Committee at the Prehearing Conference regarding relevant water storage and supply agreements mentioned in the proposed Conditions of Certification in the Stipulation, Staff coordinated with the other parties to put together the following package of attachments for the Committee's reference.

**Attachment 1** is the "Reclaimed Water Services Agreement By And Between Victorville Water District and High Desert Power Trust." Condition of Certification SOIL&WATER-20 in the Stipulation requires Project Owner to provide the compliance project manager (CPM) a copy of the executed agreement for the long-term supply and delivery of treated recycled water to HDPP. Attachment 1 is the approved agreement, effective September 28, 2010.

**Attachment 2** is the 2007 "Storage Agreement Between Victorville Water District and Mojave Basin Area Watermaster" regarding injection. SOIL&WATER-2 requires Project Owner to provide the CPM and California Department of Fish and Wildlife a copy of the approved storage agreement for injection from the Mojave Basin Area Watermaster. Attachment 2 is the approved storage agreement for the injection of water, effective June 1, 2007 to May 31, 2012.

**Attachment 3** is the most recent amendment of the storage agreement for the injection of water (see Attachment 2), effective June 1, 2017 to June 30, 2022.

Additionally, the storage agreement for the percolation of water relevant to the Stipulation is docketed at TN 217996. The "Aquifer and Storage and Recovery Agreement" referenced in SOIL&WATER-17 of the Stipulation was filed in the original proceeding, Docket No. 97-AFC-01, at TN 13560.

---

<sup>1</sup> TN 221008

# **Attachment 1**

**RECLAIMED WATER SERVICE AGREEMENT**

**BY**

**AND**

**BETWEEN**

**VICTORVILLE WATER DISTRICT**

**AND**

**HIGH DESERT POWER TRUST**

## Table of Contents

		Page
ARTICLE 1 DEFINITIONS.....		2
Section 1.1	Definitions:	2
ARTICLE 2 WATER DELIVERY AND FACILITY CONSTRUCTION.....		6
Section 2.1	Effective Date, Term and Termination.	6
Section 2.2	Delivery of Water; Point of Delivery.	6
Section 2.3	Rates for Delivery; Other Payments.	9
Section 2.4	Water Quality.	10
Section 2.5	Facilities for Delivery of Water.	11
Section 2.6	Metering	13
Section 2.7	Force Majeure.	16
Section 2.8	Water Rights.	16
Section 2.9	Billing and Payment.	16
ARTICLE 3 MISCELLANEOUS .....		18
Section 3.1	Events of Default; VWD's Right to Suspend or Terminate.	18
Section 3.2	Facility Owner's Right to Terminate.	19
Section 3.3	Entire Agreement.	19
Section 3.4	Limitation of Remedies, Liability and Damages.	19
Section 3.5	Specific Enforcement.	20
Section 3.6	Indemnities.	20
Section 3.7	No Waiver.	22
Section 3.8	Notices.	22
Section 3.9	Headings; Section References.	23
Section 3.10	Severability.	23
Section 3.11	Binding Effect; Assignment.	23
Section 3.12	Attorneys' Fees.	24
Section 3.13	Representations and Warranties.	24
Section 3.14	Obligations Subject to Applicable Laws.	27
Section 3.15	Governing Law and Venue.	28
Section 3.16	Execution in Counterparts; Facsimile Signatures.	28
Section 3.17	Liabilities of Parties.	29
Section 3.18	Provisions with respect to the City	29

## RECLAIMED WATER SERVICE AGREEMENT

This Reclaimed Water Service Agreement (this "Agreement") is made and entered into on this 7th day of September, 2010, by and among the VICTORVILLE WATER DISTRICT, a county water district and subsidiary district of the City ("VWD"), HIGH DESERT POWER TRUST, a Delaware Business Trust ("HDPT" or the "Facility Owner"), for the High Desert Power Project, which is a combined cycle natural gas-fired electric generation facility located on the Southern California Logistics Airport at 19000 Perimeter Road, City of Victorville, CA 92394 (the "HDPT Facility") and, solely to the extent provided in Section 3.18 below, the CITY OF VICTORVILLE, a California municipal corporation and charter city (the "City"). Each of VWD and HDPT (or Facility Owner) is sometimes referred to herein individually as a "Party" and collectively as the "Parties."

### RECITALS

1. The Facility Owner desires to purchase Reclaimed Water (defined below) for the HDPT Facility.
2. The City obtains Reclaimed Water from the Victor Valley Wastewater Reclamation Authority ("VWVRA") wastewater treatment facility ("VWVRA Plant") pursuant to the Second Amended and Restated Agreement for Reclaimed Water Service between the City and VWVRA, dated August 23, 2005 (as supplemented or amended from time to time, the "VWVRA Agreement") and transports such Reclaimed Water through City's existing 16-inch trunk pipeline (the "Existing Trunk Pipeline") which traverses along the east side of the HDPT Facility. It is acknowledged that VWD will utilize the Existing Trunk Pipeline and the City will sell to VWD Reclaimed Water that is obtained under the VWVRA Agreement.
3. VWD is duly authorized to deliver Reclaimed Water to the HDPT Facility.
4. The California Energy Commission ("CEC") has or is expected to adopt revisions to the Conditions of Certification for Soil and Water Resources with respect to the HDPT Facility removing the existing prohibition on the use of Reclaimed Water at the HDPT Facility.
5. The City and HDPT are parties to a Water Service Agreement dated October 11, 2001 (the "2001 Water Service Agreement"), and HDPT and the Victor Valley Water District ("VVWD") entered into an agreement pertaining to the storage of water for the HDPT Facility dated as of January 18, 2000 (the "ASR Agreement"). The Local Agency Formation Commission consolidated the Baldy Mesa Water District and the Victor Valley Water District into the Victorville Water District ("VWD"), a county water district, which is a subsidiary district of the City of Victorville.
6. VWD is constructing a wastewater treatment plant (the "IWWTP"), located approximately one and one half (1 & 1/2) miles north of the HDPT Facility which, upon

completion, will provide an additional available source of Reclaimed Water for delivery by VWD hereunder.

7. VWD will construct the Offsite Capital Improvements (defined below) to connect the Existing Trunk Pipeline to the Onsite Capital Improvements (defined below). Facility Owner will construct the Onsite Capital Improvements to connect the Offsite Capital Improvements to the HDPT Facility.

8. Facility Owner has prepared a Title 22 Engineering Report For Recycled Water Use at the HDPT Facility which has been approved by the California Department of Public Health and is attached hereto as Exhibit D. Facility Owner recognizes potential penalties for violations of applicable laws, ordinances and regulatory agency requirements.

9. Facility Owner has applied to VWD to deliver Reclaimed Water to the HDPT Facility and has complied with all VWD prerequisites for entering into this Agreement and VWD desires to sell Reclaimed Water to the Facility Owner for the HDPT Facility.

NOW THEREFORE, the Parties (and the City solely as provided in Section 3.18) hereby agree as follows:

## **ARTICLE 1 DEFINITIONS**

### Section 1.1 Definitions.

“2001 Water Service Agreement” shall have the meaning given to such term in the recitals.

“Affiliate” of any Person means any other Person which directly or indirectly controls, is controlled by or is under common control with such Person, by ownership, contract or otherwise.

“Annual Quantity” shall have the meaning set forth in Section 2.2.a.1.

“Agreement” shall have the meaning given to such term in the preamble.

“Applicable Governmental Authority” means any federal or state government or political subdivision thereof, including all agencies and instrumentalities of such governments and subdivisions, but excluding: the City, VWD, any agency or instrumentality controlled by the City or VWD or by any official thereof.

“ASR Agreement” shall have the meaning given to such term in the recitals.

“Business Day” shall mean any day except a Friday, Saturday, Sunday, or a Federal Reserve Bank holiday.

“Capital Charges” shall have the meaning given to such term in Subsection 2.5.d.

“CEC” shall have the meaning given to such term in the recitals.

“CEC Conditions” shall have the meaning given to such term in Section 3.3.

“Change in Law” means the enactment or adoption, after the date of this Agreement, of any statute, rule or regulation by any Applicable Governmental Authority.

“City” shall mean the City of Victorville.

“Claiming Party” shall have the meaning given to such term in Subsection 2.7.

“Commercial Operations Date” shall mean the first day after the date on which: (i) the Offsite Capital Improvements are commercially operable and connected to the HDPT Facility; (ii) CEC has revised, on terms satisfactory to HDPT, the Conditions of Certification for Soil and Water Resources applicable to the HDPT Facility to remove the current prohibition on the use of reclaimed water at the HDPT Facility; and (iii) all other applicable permits needed for HDPT to use Reclaimed Water have been obtained on terms satisfactory to HDPT.

“Event of Bankruptcy” shall mean, with respect to any Person, the: (i) filing of a petition or otherwise commencing, authorizing or acquiescing in the commencement of a proceeding or cause of action by such Person under any bankruptcy, insolvency, reorganization or similar law, or having any such petition filed or commenced against it if such petition shall not be discharged within sixty (60) days; (ii) making an assignment or any general arrangement for the benefit of creditors; (iii) otherwise becoming bankrupt or insolvent (however evidenced); (iv) having a liquidator, administrator, receiver, trustee, conservator or similar official appointed with respect to it or any substantial portion of its property or assets; or (v) generally being unable to pay its debts as they fall due.

“Event of Default” shall have the meaning given to such term in Subsection 3.1.



“Facility Owner” shall have the meaning given to such term in the preamble.

“Force Majeure” means an event or circumstance which prevents one Party from performing one or more of its obligations under this Agreement, which particular event or circumstance was not anticipated as of the date hereof, which is not within the reasonable control of, or the result of the negligence of, the Claiming Party, and which, by the exercise of due diligence, the Claiming Party is unable to overcome or avoid or cause to be avoided, including, but not limited to, flood, storm, drought, strike, earthquake, epidemic, war, riot, civil disturbance, sabotage, act of God, or any condition or situation which either Party reasonably believes imminently endangers or is reasonably likely to imminently endanger life or property or any other cause beyond the control of the Party affected. Force Majeure shall not be based on: (i) the loss of Facility Owner’s markets; (ii) Facility Owner’s inability economically to use or resell the Reclaimed Water purchased hereunder; or (iii) VWD’s ability to sell Reclaimed Water at a price greater than the price payable by Facility Owner.

“HDPT” shall have the meaning given to such term in the preamble.

“HDPT Facility” shall have the meaning given to such term in the preamble.

“Instantaneous Rate” shall have the meaning set forth in Section 2.2.a.1.

“Interest Rate” shall mean twelve percent (12%) per annum.

“IWWTP” shall have the meaning given to such term in the recitals.

“Lender” shall mean any Person who has or will make a loan to Facility Owner or its affiliate to finance or refinance all or part of the costs of the HDPT Facility.

“Metering Point” shall have the meaning given to such term in Subsection 2.2.d.

“MWA” shall mean the Mojave Water Agency.

“Offsite Capital Improvements” shall have the meaning given to such term in Subsection 2.5.a.

“Onsite Capital Improvements” shall have the meaning given to such term in Subsection 2.5.a.

“Permitted Purposes” shall have the meaning given in such term in Subsection 2.2.c.

“Person” shall mean an individual, partnership, corporation, limited liability company, business trust, joint stock company, trust, unincorporated association, joint venture, firm, or other entity, or a governmental entity, division, agency, or official.

“Reclaimed Water” shall mean treated wastewater that meets the requirements for recycled water as set forth in California Code of Regulations (“CCR”) Title 22, Division 4, Chapter 3, Article 1, Section 60301.230 and CCR Title 22, Division 4, Chapter 3, Article 3, Section 60306.

“Requirements Notice” shall have the meaning given to such term in Subsection 2.2.f.1.

“Specified Permits” means the approvals, licenses, permits, authorizations, filings and registrations referred to in Sections 2.2.a.2 and 2.5.c and in the definition of Commercial Operations Date.

“Trunk Pipeline” shall mean the 18 inch water service pipeline to the HDPT property.

“VWWD” shall have the meaning given to such term in the recitals.

“VWRA” shall have the meaning given to such term in the recitals.

“VWRA Agreement” shall have the meaning given to such term in the recitals.

“VWRA Plant” shall have the meaning given to such term in the recitals.

“VWD” shall have the meaning given to such term in the preamble.

“VWD Ordinance” means Ordinance Number VWD-003, An Ordinance of the Board of Directors of the Victorville Water District Repealing Ordinance Number VWD-002, and Replacing it with this Ordinance No. VWD-003, Fixing Rates, Rules, and Regulations for Recycled Water Service, as adopted by the VWD Board of Directors on April 20, 2010.

“Water Fee” shall have the meaning given to such term in Section 2.3.a.

“Water Meter” means each of the standard instruments used to measure and record the respective volume of Reclaimed Water delivered by VWD to Facility Owner under this Agreement.

“Water Meter Facilities” means the Water Meter(s) and the valving, vaults and piping associated with such Water Meters.

## **ARTICLE 2 WATER DELIVERY AND FACILITY CONSTRUCTION**

### Section 2.1 Effective Date, Term and Termination; Obligations to Commence Service.

This Agreement shall become effective upon the date that both (i) this Agreement has been executed by both Parties and the City; and (ii) VWD Ordinance VWD-003 has become effective (the “Effective Date”). This Agreement shall terminate on the earlier of: (i) thirty (30) years from the date of this Agreement; (ii) as expressly provided for hereunder; or (iii) as may hereafter be mutually agreed in writing by Facility Owner and VWD. Upon any termination of this Agreement, neither Party will have any further responsibility under this Agreement except as described herein. VWD’s obligation to deliver Reclaimed Water hereunder shall commence on the Commercial Operations Date.

### Section 2.2 Delivery of Water; Point of Delivery.

#### a. Water Service.

1. Subject to the terms and conditions of this Agreement, VWD agrees to deliver to the Facility Owner at the Metering Point, all of the Reclaimed Water that HDPT requests from time to time up to (i) a maximum annual quantity of one thousand (1,000) acre-feet of Reclaimed Water per calendar year (such maximum annual quantity as may be increased from time to time pursuant to Section 2.2.a.2, the “Annual Quantity”) and (ii) a maximum instantaneous delivery rate of one thousand (1,000) gallons per minute (1,000 GPM) (such maximum instantaneous delivery rate as may be increased from time to time pursuant to Section 2.2.a.2, the “Instantaneous Rate”). If VWD is not able to deliver Reclaimed Water at any time, it shall notify the Facility Owner as soon as practicable of such fact. VWD shall deliver the

Reclaimed Water to Facility Owner hereunder at a minimum pressure of 35 psig. VWD and the Facility Owner acknowledge and agree that this Agreement does not impair the Facility Owner's rights to obtain water under the 2001 Water Service Agreement or the ASR Agreement and that Facility Owner shall be entitled to use such water as Facility Owner deems appropriate for the operation of the HDPT Facility.

2. Upon at least 30 days' prior written notice to VWD, Facility Owner may from time to time increase (i) the then applicable Annual Quantity to a quantity specified in such notice not to exceed 4,000 acre feet per year and/or (ii) the then applicable Instantaneous Rate to a quantity specified in such notice not to exceed 4,000 gallons per minute. Facility Owner shall not deliver such a notice until (i) any necessary CEC approval to use the increase in Reclaimed Water specified in such notice has been obtained and (ii) all other applicable permits required to be obtained by or on behalf of Facility Owner for such increase in the use of Reclaimed Water at the HDPT Facility have been obtained.

3. VWD shall deliver Reclaimed Water hereunder that is obtained solely from the VVWRA Plant; provided, however, VWD may deliver Reclaimed Water hereunder that is obtained in whole or in part from the IWWTP after such time as all applicable permits required for use of such source of Reclaimed Water at the HDPT Facility have been obtained.

b. Reliability of Service. VWD shall use reasonable best efforts (i) to minimize interruptions of deliveries of Reclaimed Water under this Agreement and (ii) to obtain sufficient Reclaimed Water. VWD shall use its best efforts to cause the City to preserve its rights and privileges under the VVWRA Agreement and to make the Existing Trunk Pipeline available for use by VWD to deliver Reclaimed Water to Facility Owner as contemplated by this Agreement, in each case except to the extent that any failure to do so could not reasonably be expected to adversely affect the ability of VWD to make deliveries of Reclaimed Water to Facility Owner as contemplated by this Agreement. In the event that at any time there is insufficient Reclaimed Water to supply HDPT as provided in this Agreement and the demands of other Reclaimed Water users, then VWD may reduce Reclaimed Water delivered to all Reclaimed Water users of City and/or VWD on a pro-rata basis in accordance with the available Reclaimed Water quantity

measured daily where each Reclaimed Water user's pro rata share shall be proportionate to such user's actual use of Reclaimed Water during the prior calendar year. In such event where VWD cannot deliver sufficient amounts of Reclaimed Water to Facility Owner and such event is caused by Force Majeure, such an event will not be considered a default of the VWD, provided that VWD shall deliver Reclaimed Water in the amounts contemplated by the immediately preceding sentence hereof.

c. Use of Water. The Facility Owner shall use all Reclaimed Water delivered hereunder only for use as cooling water and other permitted uses at the HDPT Facility (the "Permitted Purposes"). Facility Owner shall not sell, transfer or otherwise distribute any Reclaimed Water provided to it under this Agreement to any third party or use same for any purpose other than the Permitted Purposes, provided that the foregoing shall not prevent any proper disposal of Reclaimed Water.

d. Metering Point. Reclaimed Water shall be delivered to the Facility Owner at the point of connection located at the boundary of the HDPT Facility site at approximately the location depicted on Exhibit A attached hereto ("Metering Point"). The Facility Owner shall take title to and bear risk of loss of Reclaimed Water delivered hereunder at the Metering Point. VWD shall hold title to and bear risk of loss of the Reclaimed Water delivered hereunder prior to the Metering Point.

e. Responsibility for Water. VWD shall be responsible for the transportation of Reclaimed Water delivered hereunder to the Metering Point, and the Facility Owner shall be responsible for acceptance, transportation, treatment, control, use and disposal of Reclaimed Water delivered hereunder at and after the Metering Point.

f. Coordination of Deliveries. VWD and the Facility Owner shall coordinate the time and quantity of deliveries as follows:

1. Beginning ten (10) days prior to the Commercial Operation Date, Facility Owner will notify VWD of the anticipated daily requirements of Reclaimed Water for the upcoming seven (7) day period (the "Requirements Notice"). Facility Owner shall notify VWD

by telephone as soon as reasonably possible (but in no event later than twelve (12) hours) after learning of any material variance in the specified amounts for the upcoming seven (7) day period previously submitted to VWD in the Requirements Notice. VWD acknowledges and agrees that (i) the level of Reclaimed Water usage by the HDPT Facility will be affected by many factors not within the Facility Owner's control (including, without limitation, Reclaimed Water quality, the technical capabilities of and outages at the HDPT Facility and the level of operation of the HDPT Facility which will be affected by market conditions and by directives from the California Independent System Operator, any of its successors and customers of the HDPT Facility), (ii) the actual usage of Reclaimed Water by the HDPT Facility is likely to vary materially from the information provided under this Subsection 1 and (iii) that the information provided under this Subsection 1 shall not in any way limit the Facility Owner's rights to receive Reclaimed Water under this Agreement. Subject to the foregoing factors which are likely to affect actual usage levels, Facility Owner makes the following current non-binding estimate of its average annual level of usage of Reclaimed Water: an annual level equal to the then applicable Annual Quantity.

2. VWD shall notify Facility Owner of any planned events or activities which could have a material effect on the availability of Reclaimed Water to be furnished hereunder. VWD shall immediately notify Facility Owner of any material deviation from the above projections, as specified in Subsection 2.2.a.

g. VWD Ordinance. Facility Owner shall, subject to the terms of this Agreement and without duplication of its obligations under this Agreement, comply with the obligations applicable to Facility Owner under the VWD Ordinance.

### Section 2.3 Rates for Delivery; Other Payments.

a. Water Fee. Facility Owner shall pay VWD for all Reclaimed Water delivered under this Agreement from time to time at a unit rate equal to 60% of VWD's then current generally applicable potable water consumption rate (which would be a unit rate for Reclaimed Water of \$0.88 per hundred cubic feet as of the date this Agreement is entered into). Such amount to be paid for Reclaimed Water delivered in any given month shall be the "Water Fee"

for such month. Payment of the Water Fee shall cover and constitute payment of any “Consumption Charge” or other similar fee under the VWD Ordinance.

Notwithstanding the foregoing, to the extent that VWD’s costs of providing Reclaimed Water service increase because a Change in Law establishes stricter reclaimed water quality standards applicable to service under this Agreement. VWD shall be entitled to an increase in the charges payable by Facility Owner hereunder to reimburse VWD for a pro rata share of the incremental capital and operating costs incurred by VWD to comply with such change of standards. Unless the Parties otherwise agree, such increase shall be collected through an increase to the Water Fee with capital cost recovery being collected over the expected life of the new capital facilities. As used in this paragraph, “pro rata share” means a share of such costs based on the ration of the applicable Annual Quantity to the design annual capacity of the treatment plant (giving effect to such compliance activities) to treat reclaimed water to meet the stricter standards. VWD shall provide Facility Owner (i) at least 30 days prior notice and an opportunity to comment before the effectiveness of such increase and (ii) such information as Facility Owner may request from time to time regarding the basis and method of calculation of such increase. In no event shall the charges payable under this Agreement exceed the rate permitted by law.

b. Other Charges. As provided in Subsections 2.5.d. and e., the Facility Owner shall also pay to VWD any and all Capital Charges incurred. A charge shall be deemed to have been incurred during the month in which VWD was required to make the payment or provide the Reclaimed Water constituting such charge. Facility Owner acknowledges that some charges will be incurred and become due and payable prior to the Commercial Operations Date. Payment of the charges and fees set forth in Section 2.3 of this Agreement shall cover and constitute payment of any fees and charges payable under the VWD Ordinance.

#### Section 2.4 Water Quality.

a. VWD shall deliver Reclaimed Water to the HDPT Facility that meets the requirements for use of recycled water as set forth in CCR Title 22, Division 4, Chapter 3, Article 1, Section 60301.230 and CCR Title 22, Division 4, Chapter 3, Article 3, Section 60306,

and that does not exceed the limits set forth in Exhibit B attached hereto and incorporated by this reference. Facility Owner acknowledges that:

i. Interruptions of treatment or other upsets in the supplying wastewater treatment facility or facilities due to circumstances beyond the reasonable control of the applicable wastewater treatment facility operator may occur from time to time which may result in severe deterioration of or changes to the quality or specification of Reclaimed Water; and

ii. The Reclaimed Water is not potable. The Reclaimed Water supplied under this Agreement shall under no circumstances be used in a manner pursuant to which it could be consumed or ingested by humans or animals or applied to crops or used in any manner which violates the VWD Ordinance. Any such unauthorized use will be considered a breach of this Agreement.

b. DISCLAIMER OF WARRANTY. THIS AGREEMENT DOES NOT CONTAIN OR CONSTITUTE ANY EXPRESS OR IMPLIED WARRANTY OF MERCHANTABILITY OR FITNESS FOR A PARTICULAR PURPOSE WITH RESPECT TO THE RECLAIMED WATER TO BE PROVIDED HEREUNDER, AND ANY AND ALL EXPRESS OR IMPLIED WARRANTIES ARE HEREBY DISCLAIMED.

#### Section 2.5 Facilities for Delivery of Water.

a. Construction of Improvements. VWD shall be responsible for design and construction of the facilities and related infrastructure described on Exhibit C hereto and incorporated herein by this reference, as the same may be amended through the mutual written agreement of the Parties, through which VWD will deliver Reclaimed Water to the Facility Owner at the applicable Metering Point (the "Offsite Capital Improvements"). At the completion of construction, Facility Owner and VWD shall test the Offsite Capital Improvements pursuant to procedures that will be mutually agreed upon in writing by the Facility Owner and VWD. The Facility Owner shall also be responsible for designing and constructing facilities to connect with the Offsite Capital Improvements downstream of the applicable Metering Point. VWD and the Facility Owner will use commercially reasonable efforts to ensure that the Offsite Capital Improvements are commercially operative on or before November 1, 2010; however, in no event



shall either Party be responsible for any damages to the other Party which may be caused by any delay in making the improvements commercially operative by this date. VWD shall consult and cooperate with Facility Owner, and provide the Facility Owner with a reasonable opportunity to comment, on the design of the Offsite Capital Improvements.

Facility Owner shall be responsible for the design, construction and costs associated with the piping system and related facilities necessary to connect the Offsite Capital Improvements to the HDPT Facility (such proposed piping system and related facilities but not the HDPT Facility itself, shall comprise the “Onsite Capital Improvements”). The Onsite Capital Improvements constitute the applicable “On-site Facilities” of Facility Owner for purposes of the VWD Ordinance. The proposed design of the On-site Facilities has been reviewed and approved by VWD.

b. Use of Improvements. The Parties agree that VWD may use any additional unused capacity available in the Offsite Capital Improvements for such purposes as VWD deems appropriate provided that no such purpose will interfere with VWD’s ability to deliver Reclaimed Water to Facility Owner pursuant to the terms and conditions of this Agreement.

c. Permits. VWD shall be solely responsible for obtaining all necessary licenses, permits and approvals for construction of the Offsite Capital Improvements and the delivery of Reclaimed Water to the Metering Point hereunder (including any necessary consents from the United States Air Force or Southern California Logistics Airport Authority for construction of the Offsite Capital Improvements and the Onsite Capital Improvements). Facility Owner shall also be solely responsible for obtaining all other necessary licenses, permits and approvals for construction of the Facility Owner facilities to connect with the Offsite Capital Improvements downstream of the applicable Metering Point.

d. Capital Charges. The Facility Owner shall reimburse VWD for Capital Charges. “Capital Charges” shall consist of all of VWD’s costs of design, acquisition and construction of the Offsite Capital Improvements and reasonable administrative costs incurred by VWD with respect to the design, acquisition and construction of the Offsite Capital Improvements pursuant to this Agreement, which costs would include but not be limited to costs associated with

submitting any required applications or permits and costs associated with acquiring any required easements and rights of way. Construction and engineering costs of the components of such Capital Charges are attached hereto as Schedule A and incorporated by this reference. Additionally, "Capital Charges" shall include a one-time payment of the Reclaimed Water Connection and Alternate Reclaimed Water Fees set forth on Schedule B attached hereto and incorporated by this reference. Facility Owner acknowledges that VWD's contractors and subcontractors may be required to pay prevailing wages in connection with the Offsite Capital Improvements and that the Capital Charges payable by Facility Owner hereunder may be affected by such payment of prevailing wages. The Parties agree that payment by Facility Owner of the Capital Charges hereunder will constitute payment by Facility Owner in accordance with the VWD Ordinance of Facility Owner's fair share of the costs of construction of all facilities needed to supply and deliver Reclaimed Water to the HDPT Facility and of all connection fees, installation fees, alternate recycled water source charges and other similar charges.

#### Section 2.6 Metering

a. Water Meter. VWD shall furnish and install (at the Facility Owner's expense) one Water Meter near the Metering Point for Reclaimed Water to measure the quantities of Reclaimed Water delivered hereunder. The Water Meter shall be of a size, type and specification that meets all applicable regulatory standards for water utility metering. VWD (at Facility Owner's expense) will own, maintain and operate the Water Meter. Each Party may install and operate, at its own expense, other measuring and testing equipment on its side of the Metering Point which does not interfere with the Water Meter.

b. Measurement. For the purposes of billing or reporting under this Agreement, Reclaimed Water will be measured in one hundred (100) cubic feet units, as measured by the Water Meter to be located near the Metering Point.

c. Maintenance. VWD shall own, operate and maintain the Water Meter to permit an accurate determination of the quantity of the Reclaimed Water delivered under this Agreement and shall exercise reasonable care in the maintenance and operation of the Water

Meter so as to assure to the maximum extent reasonably practical an accurate determination of such quantity. The Water Meter shall be used as the basis for billing under this Agreement.

d. Alternative Measurement. In the event a Water Meter is out of service or registers inaccurately as set forth in Section 2.6.f, measurement shall be determined by:

1. any check meter installed by VWD (at VWD's option), if registering accurately;

2. any check meter installed by the Facility Owner, if registering accurately;

3. in the absence of an accurately registering check meter, by a mathematical calculation if upon a calibration test of the Water Meter a percentage error is ascertainable; or

4. in the absence of an accurately registering check meter and an ascertainable percentage of error, estimating by reference to quantities measured during periods of similar conditions when the Water Meter was registering accurately.

e. Testing. The accuracy of the Water Meters shall be tested and verified by VWD at least annually and with an opportunity for the Facility Owner to observe. If either Party has installed a check meter, such check meter shall be tested and verified by such Party at least annually and with an opportunity for the other Party to observe. In the event that Facility Owner notifies VWD that it desires a test of the Water Meter(s), VWD shall cooperate to secure a prompt verification of the accuracy of the Water Meter(s). The Facility Owner shall bear the cost of the annual testing of the Water Meter, and each Party shall bear the cost of the annual testing of any check meter, if any, installed by such Party. In the event that VWD requests any additional testing of the Water Meter(s), then if, in accordance with the provisions of this section, the Water Meter(s) is determined to be accurate or in error by not more than plus or minus two percent (2%), VWD shall bear the cost of the testing; otherwise the Facility Owner shall bear the cost of the testing.

f. Adjustments. If upon testing the Water Meter is found to be accurate or in error by not more than plus or minus two percent (2%), then previous recordings of the Water Meter

shall be considered accurate in computing deliveries of Reclaimed Water, as applicable, hereunder. If, upon testing, a Water Meter shall be found to be inaccurate by an amount exceeding plus or minus two percent (2%), then the Water Meter shall be promptly adjusted to record properly and any previous recordings by the Water Meter shall be corrected to zero error. If no reliable information exists as to the period over which the Water Meter registered inaccurately, it shall be assumed for correction purposes hereunder that such inaccuracy began at a point in time midway between the testing date and the last previous date on which the Water Meter was tested and found to be accurate, but in no case shall the adjustment be made for a period greater than one hundred-eighty (180) days. If the difference of the payments for Reclaimed Water actually made by the Facility Owner minus the adjusted payment is a negative number, that difference will be paid by Facility Owner to VWD. If the difference of the payments for Reclaimed Water actually made by the Facility Owner minus the adjusted payment is a positive number, that difference will be "paid" by VWD to Facility Owner by means of a credit to Facility Owner's future Reclaimed Water billings.

g. Records. The Facility Owner shall have the right to be present whenever VWD reads, cleans, changes, repairs, inspects, tests, calibrates or adjusts the Water Meter, and VWD shall give the Facility Owner ten (10) days prior written notice of any of such actions, unless time is of the essence and such notice cannot be given. The records from the Water Meter shall remain the property of VWD, but upon request VWD will submit to the Facility Owner its records with calculations, for inspection and verification, subject to return within ten (10) days after receipt thereof. Such records shall be kept by VWD in accordance with Section 2.6.h.

h. Facility Owner Inspections. The Facility Owner shall have the right to inspect and copy the charts and other measuring or testing data of VWD, at all times during VWD's business hours; but the reading, calibration and adjustment of such equipment shall be done only by VWD. VWD shall preserve all original test data and other similar records in its possession for a period of at least two (2) years.

Section 2.7 Force Majeure.

To the extent either Party is prevented by Force Majeure from carrying out, in whole or in part, its obligations under this Agreement (other than any obligation to make payments, which shall not be excused by Force Majeure), and such Party (the “Claiming Party”) gives notice of such Force Majeure event to the other Party as soon as practicable, then the Claiming Party shall be excused from the performance of its obligations with respect to this Agreement to the extent and for so long as prevented by the Force Majeure event. The Claiming Party shall use all reasonable efforts to remedy the Force Majeure as promptly as practicable. The non-Claiming Party shall not be required to perform or resume performance of its obligations to the Claiming Party corresponding to the obligations of the Claiming Party excused by Force Majeure until the Claiming Party resumes performance. For purposes of clarification, in no case shall the Facility Owner’s obligation to pay Capital Charges according to Exhibit B be abated as a result of VWD’s Force Majeure.

Section 2.8 Water Rights.

This Agreement is not intended to, and does not, create any water rights between the Parties. VWD hereby agrees that it will use its best efforts to cause the City not amend or terminate the VVWRA Agreement during the term of this Agreement and to make the Existing Trunk Pipeline available for use by VWD to deliver Reclaimed Water to Facility Owner as contemplated by this Agreement, except in each case to the extent that any such amendment or termination of the VVWRA Agreement or failure to make the Existing Trunk Pipeline available could not reasonably be expected to adversely affect the ability of VWD to make deliveries of Reclaimed Water to Facility Owner as contemplated by this Agreement.

Section 2.9 Billing and Payment.

a. Monthly Invoices. Unless otherwise specifically agreed upon by the Parties, the calendar month shall be the standard period for all billings and payments under this Agreement. As soon as practicable after the end of each month, VWD will render to the Facility Owner an invoice for the amounts due from Facility Owner with respect to the preceding month. Each month’s payment obligations shall include: (i) the Water Fee, as calculated for Reclaimed Water

delivered during such preceding month; (ii) the Capital Charge incurred during such preceding month; and (iii) information in reasonable detail showing the basis for and calculation of such fees and charges. For purposes of clarification and without in any way limiting the foregoing, the Capital Charge shall be due and payable even if no Reclaimed Water is delivered during one or more billing periods, and Facility Owner shall be obligated to make such payment according to the standard billing deadlines hereunder. The provisions of this Section 2.9 shall survive the termination of this Agreement as necessary to provide for the billing and payment of fees and charges that accrue prior to the date of termination.

b. Due Dates. Unless otherwise agreed by the Parties, each invoice under this Agreement shall be due and payable on or before the later of the twentieth (20th) day of the month following the month for which the invoice is rendered, or the tenth (10th) day after receipt of the invoice, provided that if such day is not a Business Day, then on the next Business Day. Facility Owner will make payments by electronic funds transfer, or by other mutually agreeable method(s), to the account designated by VWD. Any amounts not paid by the due date will be deemed delinquent and will accrue interest at the Interest Rate, such interest to be calculated from and including the due date to but excluding the date the delinquent amount is paid in full.

c. No Offsets. Payments due from Facility Owner to VWD pursuant to a monthly invoice hereunder must be paid in full and shall not be offset against any amounts owing from VWD to the Facility Owner, except as may be agreed to by VWD pursuant to Subsections 2.6.f and 2.9 of this Agreement.

d. Payment Disputes. A Party may, in good faith, dispute the correctness of any invoice or any adjustment to an invoice, rendered under this Agreement or adjust any invoice for any arithmetic or computational error within twelve (12) months of the date the invoice, or adjustment to an invoice, was rendered. In the event an invoice or portion thereof, or any other claim or adjustment arising hereunder, is disputed, payment of the full amount of the invoice shall be required to be made in accordance with the invoice, with notice of the objection given to VWD. Any invoice dispute or invoice adjustment shall be in writing and shall state the basis for the dispute or adjustment. Upon resolution of the dispute, any overpayment shall be returned

upon request or deducted by VWD from subsequent billings, with interest accrued at the Interest Rate from and including the date of such overpayment to but excluding the date repaid or deducted by VWD. Any dispute with respect to an invoice is waived unless the other Party is notified in accordance with this Subsection 2.9.d within twelve (12) months after the invoice is rendered or any specific adjustment to the invoice is made. Facility Owner shall have the right upon reasonable advance notice to the VWD to inspect and audit the books and records of VWD related to the amounts of any fees and charges hereunder.

### **ARTICLE 3 MISCELLANEOUS**

#### **Section 3.1 Events of Default; VWD's Right to Suspend or Terminate.**

a. Event of Default. An Event of Default shall mean, with respect to the Facility Owner, that (i) the Facility Owner has failed to make one or more payments when due hereunder, and has not remedied such failure within 15 days of receipt of written notice of such failure to make a payment from the VWD; (ii) an Event of Bankruptcy has occurred with respect to the Facility Owner; or (iii) a material breach by Facility Owner of Section 2.2.g of this Agreement which has not been remedied within 15 days (or such longer period as is reasonably necessary to effect such remedy, provided that Facility Owner diligently prosecutes such remedy to completion) of receipt of written notice of such breach.

b. VWD's Remedies. If an Event of Default has occurred, VWD may, at its option, either suspend deliveries of Reclaimed Water or terminate this Agreement upon thirty (30) days written notice to the Facility Owner or exercise any other remedies available at law or in equity; provided, however, if VWD delivers a notice to terminate, this Agreement shall nevertheless not so terminate if the applicable Event of Default is cured within such thirty (30) day period. Upon a termination of this Agreement VWD for an Event of Default, all unpaid Water Fees, Capital Charges, and any other amounts due to VWD under this Agreement, which have accrued for periods prior to the date of termination shall be due and payable, and shall be paid by Facility Owner on or before the 15th day after receipt of a final invoice from VWD listing such amounts.

Section 3.2 Facility Owner's Right to Terminate.

The Facility Owner may terminate this Agreement at any time upon one hundred eighty (180) days' advance written notice to VWD.

Section 3.3 Entire Agreement.

This Agreement contains the entire understanding between VWD and Facility Owner with respect to its subject matter, and supersedes all prior agreements, oral or written, and all prior or contemporaneous discussions or negotiations between VWD and Facility Owner related to its subject matter. For the avoidance of doubt, this Agreement does not amend, modify or supersede the ASR Agreement; provided, however, VWD (as successor to VVWD under the ASR Agreement) and Facility Owner acknowledge and agree that: (i) the Soil and Water Conditions of Certification as set forth in the CEC decision for the HDPT Facility (the "CEC Conditions") were incorporated in the ASR Agreement; (ii) the CEC has or may modify the CEC Conditions in connection with permitting the HDPT Facility to use Reclaimed Water or approving the construction of facilities in connection with such use; and (iii) such conditions as incorporated into the ASR Agreement shall be deemed to be modified as and when the CEC Conditions are modified by the CEC from time to time as described in clause (ii) above, and nothing in the ASR Agreement shall prohibit the delivery of Reclaimed Water to the HDPT Facility under this Agreement or the use of Reclaimed Water by the HDPT Facility. The recitals are incorporated into this Agreement as if set forth herein. This Agreement cannot be amended except in writing signed by both Parties.

Section 3.4 Limitation of Remedies, Liability and Damages.

a. LIMITATION OF VWD'S AND CITY'S LIABILITY. NOTWITHSTANDING ANY OF THE PROVISIONS IN THIS AGREEMENT TO THE CONTRARY, THE VWD'S AND CITY'S AGGREGATE TOTAL LIABILITY FOR ALL CLAIMS ASSERTED BY THE FACILITY OWNER UNDER THIS AGREEMENT FOR ANY REASON WHATSOEVER SHALL NOT EXCEED ONE MILLION DOLLARS (\$1,000,000.00).

b. LIMITATION OF REMEDIES AND DAMAGES. THE PARTIES CONFIRM THAT THE EXPRESS REMEDIES AND MEASURES OF DAMAGES



PROVIDED IN THIS AGREEMENT SATISFY THE ESSENTIAL PURPOSES HEREOF. FOR BREACH OF ANY PROVISION FOR WHICH AN EXPRESS MEASURE OF DAMAGES IS PROVIDED, SUCH EXPRESS MEASURE OF DAMAGES SHALL BE THE SOLE AND EXCLUSIVE REMEDY, THE OBLIGOR'S LIABILITY SHALL BE LIMITED AS SET FORTH IN SUCH PROVISION AND ALL OTHER REMEDIES OR DAMAGES AT LAW OR IN EQUITY ARE WAIVED. IF NO REMEDY OR MEASURE OF DAMAGES IS EXPRESSLY PROVIDED HEREIN, THE OBLIGOR'S LIABILITY SHALL BE LIMITED TO DIRECT ACTUAL DAMAGES ONLY, AS FURTHER LIMITED HEREUNDER, AND SUCH DIRECT ACTUAL DAMAGES SHALL BE THE SOLE AND EXCLUSIVE REMEDY AND ALL OTHER REMEDIES OR DAMAGES AT LAW OR IN EQUITY ARE WAIVED. UNLESS EXPRESSLY HEREIN PROVIDED, NEITHER PARTY SHALL BE LIABLE FOR CONSEQUENTIAL, INCIDENTAL, PUNITIVE, EXEMPLARY OR INDIRECT DAMAGES, LOST PROFITS OR OTHER BUSINESS INTERRUPTION DAMAGES, BY STATUTE, IN TORT OR CONTRACT, UNDER ANY INDEMNITY PROVISION OR OTHERWISE. IT IS THE INTENT OF THE PARTIES THAT THE LIMITATIONS HEREIN IMPOSED ON REMEDIES AND THE MEASURE OF DAMAGES BE WITHOUT REGARD TO THE CAUSE OR CAUSES RELATED THERETO, INCLUDING THE NEGLIGENCE OF ANY PARTY, WHETHER SUCH NEGLIGENCE BE SOLE, JOINT OR CONCURRENT, OR ACTIVE OR PASSIVE. TO THE EXTENT ANY DAMAGES REQUIRED TO BE PAID HEREUNDER ARE LIQUIDATED, THE PARTIES ACKNOWLEDGE THAT THE DAMAGES ARE DIFFICULT OR IMPOSSIBLE TO DETERMINE, OR OTHERWISE OBTAINING AN ADEQUATE REMEDY IS INCONVENIENT AND THE DAMAGES CALCULATED HEREUNDER CONSTITUTE A REASONABLE APPROXIMATION OF THE HARM OR LOSS. NOTHING IN THIS SECTION 3.4 SHALL LIMIT THE RIGHTS AND REMEDIES OF FACILITY OWNER UNDER SECTION 3.5.

Section 3.5 Specific Enforcement.

The Parties acknowledge that Reclaimed Water is essential to the operation of the HDPT Facility. Notwithstanding any other provision of this Agreement, the Facility Owner may seek specific performance of the obligations of VWD under this Agreement or of the City under Section 3.18. Should VWD or the City not be able to perform its obligations under this Agreement due to Force Majeure, such performance shall be excused and Facility Owner shall not be entitled to specific performance with respect to the obligations so excused.

Section 3.6 Indemnities.

(a) Indemnity by VWD.

VWD or the City, as applicable, agrees to indemnify HDPT and its Affiliates, and to hold it and them and, its and their officers, directors, employees, agents, successors and assigns, harmless, from and against any and all liabilities, claims, demands, litigation, or any other claims of whatever kind or nature resulting from, pertaining to, or occasioned by the construction or operation of the Offsite Capital Improvements or the breach of any representation, warranty or obligation of VWD or the City, as applicable, under this Agreement. Additionally, VWD specifically acknowledges and agrees to reimburse HDPT for any and all costs and expenses including, but not limited to, expert witness and attorneys' fees, incurred by HDPT in the defense of any such claim.

(b) Indemnity by HDPT.

HDPT agrees to indemnify VWD and the City, and to hold them and their respective officers, directors, employees, consultants, agents, successors and assigns, harmless, from and against any and all liabilities, claims, demands, litigation, or any other claims of whatever kind or nature resulting from, pertaining to, or occasioned by the construction or operation of the Onsite Capital Improvements or the use of the Reclaimed Water provided by VWD hereunder at the HDPT Facility or the breach of any representation, warranty or obligation of HDPT under this Agreement. Additionally, HDPT specifically acknowledges and agrees to reimburse VWD for any and all costs and expenses including, but not limited to, expert witness and attorneys' fees, incurred by VWD in the defense of any such claim.

Section 3.7 No Waiver.

Any failure or delay on the part of either Party to exercise any right, remedy, power, or privilege under this Agreement shall not constitute a waiver of the right, remedy, power, or privilege, and shall not preclude such Party from exercising or enforcing the right, remedy, power, or privilege or any other provision of this Agreement, on any subsequent occasion.

Section 3.8 Notices.

All notices or other communications required or desired to be given pursuant to this Agreement shall be in writing and shall be hand-delivered, or mailed by certified mail, return receipt requested, or sent by a reputable overnight courier service providing delivery confirmation. Each such notice or communication shall be deemed to be duly given: (i) when hand-delivered; (ii) three (3) Business Days after being mailed in any depository maintained by the United States Postal Service, with prepaid postage, certified, return receipt requested; or (iii) one (1) Business Day after being deposited for next day delivery with Federal Express, UPS or other reputable overnight courier. Each such notice or communication shall be addressed to the Parties at their respective addresses set forth below:

VWD or the City:

Victorville Water District

Attention: Reginald A. Lamson

14343 Civic Dr.

P.O. Box 5001

Victorville, CA 92395-5001

FACILITY OWNER:

High Desert Power Trust

Attn: M. Fred Strauss, P.G.

1044 N. 115<sup>th</sup> Street, Suite 400

Omaha, Nebraska 68154-4446

Provided, however, invoices and notices of interruptions of Reclaimed Water deliveries, communications under Section 2.2.f. and other notices of an operational nature shall be addressed to the Parties at their respective addresses set forth below:

VWD:

FACILITY OWNER:

Victorville Water District  
Attention: Reginald A. Lamson  
14343 Civic Dr.  
P.O. Box 5001  
Victorville, CA 92395-5001  
Phone: 760-955-2557

High Desert Power Trust  
Attn: Plant Manager  
19000 Perimeter Road, Suite 102  
Victorville, CA 92394  
Phone: 760-530-2300

Either Party may change its address(es) for notices under this Agreement by giving prior written notice to the other Party in accordance with this Section.

Section 3.9 Headings; Section References.

Captions and headings appearing in this Agreement are inserted solely as reference aids for the ease and convenience of the Parties; they shall be deemed not to define or limit the scope or substance of the provisions they introduce, nor shall they be used in construing the intent or effect of such provisions.

Section 3.10 Severability.

If any provision of this Agreement is finally determined by a court to be invalid or unenforceable as written, the provision shall, if possible, be enforced to the extent reasonable under the circumstances and otherwise shall be deemed deleted from this Agreement. The other provisions of this Agreement shall remain in full force and effect so long as the material purposes of the Agreement and understandings of the Parties are not impaired.

Section 3.11 Binding Effect; Assignment.

This Agreement shall be binding on and inure to the benefit of the Parties, and their respective successors and assigns. The Parties may not assign or otherwise transfer their rights under this Agreement except as follows:

a. Facility Owner shall have the right to sell, assign or transfer this Agreement and any and all of its rights, duties and obligations hereunder, in whole or in part, to High Desert Power Project, LLC or to any purchaser or successor in interest to the HDPT Facility, if and

when High Desert Power Project, LLC or such purchaser or successor, as applicable, fully assumes all of Facility Owner's past, present, and future obligations hereunder.

b. Facility Owner shall have the right to collaterally assign its right, title and interest in and to this Agreement to one or more Lenders and VWD agrees to enter into a customary consent to assignment agreement with respect to this Agreement as may reasonably be requested from time to time by such Lenders.

### Section 3.12 Attorneys' Fees.

In the event that any action or proceeding is brought by the Parties or the City to enforce one or more of the terms of this Agreement, to restrain an alleged violation of this Agreement, or to determine the validity of this Agreement or any part thereof, the prevailing Party in any such action or proceeding shall be entitled to recover from the other its reasonable costs and attorneys' fees, in addition to any other remedies available to it in law or equity. If both Parties are successful in one or more causes of action during any such proceeding, the costs and fees shall be apportioned as determined by the court.

### Section 3.13 Representations and Warranties.

a. Representations and Warranties of VWD. VWD hereby represents and warrants to Facility Owner as of the date hereof that:

i. Organization and Good Standing; Power and Authority. VWD is a county water district and subsidiary district of the City, duly formed, validly existing and in good standing under the laws of the State of California. VWD has all requisite power and authority to execute, deliver, and perform its obligations under this Agreement.

ii. Due Authorization; No Conflicts. The execution and delivery by VWD of this Agreement, and the performance by VWD of its obligations hereunder, have been duly authorized by all necessary actions on the part of VWD and do not and will not: (i) contravene its governing documents; (ii) conflict with, result in a breach of, or constitute a default under any note, bond, mortgage, indenture, deed of trust, license, contract or other agreement to which it is a party or by which any of its properties may be bound or affected; (iii) violate any order, writ,

injunction, decree, judgment, order, award, statute, law, rule, regulation or ordinance of any governmental authority applicable to it or any of its properties; or (iv) result in the creation of any lien, charge or encumbrance upon any of its properties pursuant to any of the foregoing.

iii. Binding Agreement. This Agreement has been duly executed and delivered on behalf of VWD and, assuming the due execution by Facility Owner and City hereto, constitutes a legal, valid and binding obligation of VWD, enforceable against it in accordance with its terms, except as such enforceability may be limited by bankruptcy, insolvency, reorganization, moratorium or similar laws affecting creditors' rights generally and by the application of principles of equity.

iv. No Proceedings. There are no actions, suits, investigations or other proceedings, at law or in equity, by or before any governmental authority or any other body pending or, to its knowledge, threatened against or affecting VWD or any of its properties (including, without limitation, this Agreement) which VWD reasonably expects to lead to a material adverse effect on (i) the validity or enforceability of this Agreement or (ii) VWD's ability to perform its obligations under this Agreement.

v. Consents and Approvals. Except for the Specified Permits, the execution, delivery and performance by VWD of its obligations under this Agreement do not and will not require any approval, consent, permit, license or other authorization of, or filing or registration with, or any other action by, any Person which has not been duly obtained, made or taken, and all such approvals, consents, permits, licenses, authorizations, filings, registrations and actions are in full force and effect, final and non-appealable.

vi. No Brokers. No finder, broker or agent has been employed, appointed or authorized to act on VWD's behalf in connection with the transactions contemplated by this Agreement for which the Facility Owner could become obligated.

vii. VVWRA Agreement. The VVWRA Agreement is in full force and effect. VWD has the rights from the City to purchase and receive quantities of Reclaimed Water obtained by the City under the VVWRA Agreement and to use the Existing Trunk Pipeline, in

each case as necessary to deliver Reclaimed Water to Facility Owner at the Metering Point as and when contemplated by this Agreement.

b. Representations and Warranties of Facility Owner. Facility Owner hereby represents and warrants to VWD as of the date hereof that:

i. Organization and Good Standing; Power and Authority. Facility Owner is a trust formed and validly existing under the laws of the State of Delaware and is duly qualified to transact business and is in good standing in the State of California and in each jurisdiction where failure to do so would have a material adverse effect on the performance by Facility Owner of its obligations under this Agreement. Facility Owner has all requisite power and authority to execute, deliver, and perform its obligations under this Agreement.

ii. Due Authorization; No Conflicts. The execution and delivery by Facility Owner of this Agreement, and the performance by Facility Owner of its obligations hereunder, have been duly authorized by all necessary actions on the part of Facility Owner and its trustee and do not and will not: (i) contravene its certificate of trust or any other governing documents; (ii) conflict with, result in a breach of, or constitute a default under any note, bond, mortgage, indenture, deed of trust, license, contract or other agreement to which it is a party or by which any of its properties may be bound or affected; (iii) violate any order, writ, injunction, decree, judgment, order, award, statute, law, rule, regulation or ordinance of any governmental authority applicable to it or any of its properties; or (iv) result in the creation of any lien, charge or encumbrance upon any of its properties pursuant to any of the foregoing, except in favor of the Lenders.

iii. Binding Agreements. This Agreement has been duly executed and delivered on behalf of Facility Owner and this Agreement, assuming the due execution by VWD and City hereto, constitutes a legal, valid and binding obligation of Facility Owner, enforceable against it in accordance with its terms, except as such enforceability may be limited by bankruptcy, insolvency, reorganization, moratorium or similar laws affecting creditors' rights generally and by the application of principles of equity.

iv. No Proceedings. There are no actions, suits or other proceedings, at law or in equity, by or before any governmental authority or any other body pending or, to the best of its knowledge, threatened against or affecting Facility Owner or any of its properties which Facility Owner reasonably expects to lead to a material adverse effect on (i) the validity or enforceability of this Agreement or (ii) the Facility Owner's ability to perform its obligations under this Agreement.

v. Consents and Approvals. Except for the Specified Permits, the execution, delivery and performance by Facility Owner of its obligations hereunder do not and will not, require any approval, consent, permit, license or other authorization of, or filing or registration with, or any other action by, any Person which has not been duly obtained, made or taken, and all such approvals, consents, permits, licenses, authorizations, filings, registrations and actions are in full force and effect, final and non-appealable.

vi. No Brokers. No finder, broker or agent has been employed, appointed or authorized to act on Facility Owner's behalf in connection with the transactions contemplated by this Agreement for which VWD could become obligated.

#### Section 3.14 Obligations Subject to Applicable Laws.

a. The Parties hereby expressly acknowledge the VWD Ordinance and agree that this Agreement is in accordance with and consistent with the VWD Ordinance. The Parties further acknowledge that VWD may in the future amend or augment the VWD Ordinance and nothing in this Agreement is intended to nor shall be interpreted to limit the legislative authority of VWD to implement or amend the VWD Ordinance in accordance with applicable law. Notwithstanding the foregoing, this Agreement shall control interpretation of the Parties respective rights, obligations and remedies with respect to the subject matter of this Agreement, and future amendments and modifications to the VWD Ordinance shall not modify or alter in any way the Parties' rights, obligations and remedies under this Agreement except by mutual written consent of the Parties; provided, however, if any Change of Law by an Applicable Governmental Authority requires the VWD to amend the Ordinance and to make such amendment applicable to the delivery of reclaimed water by VWD to, or the receipt or use of



reclaimed water by, the HDPT Facility, then such amendment shall apply to Facility Owner over any conflicting provision of this Agreement solely to the extent necessary to comply with such Change of Law. In such event, at the request of Facility Owner, the Parties shall negotiate in good faith in an effort to agree on an amendment to this Agreement to clarify the applicability of such Ordinance amendment to the HDPT Facility.

b. Nothing in this Section 3.14 shall be construed to prevent the application of any amendments to or modifications of the VWD Ordinance to Facility Owner and this Agreement to the extent that preventing such application or modification would constitute an unlawful surrender, abnegation, divestment, abridgement or bargaining away of any police powers that VWD may have.

Section 3.15 Governing Law and Venue.

This Agreement is a contract governed in accordance with the laws of the State of California. EXCEPT AS PROVIDED BY CALIFORNIA CODE OF CIVIL PROCEDURE SECTION 394, THE PARTIES HEREBY AGREE THAT VENUE FOR ANY ACTION BROUGHT TO ENFORCE THE TERMS OF THIS AGREEMENT SHALL BE IN A COURT OF COMPETENT JURISDICTION IN THE COUNTY OF SAN BERNARDINO, CALIFORNIA, AND CONSENT TO THE JURISDICTION THEREOF.

Section 3.16 Execution in Counterparts; Facsimile Signatures.

This Agreement may be executed in counterparts, each of which shall be deemed an original, but all of which together shall constitute one and the same instrument. The signature page of any counterpart may be detached therefrom without impairing the legal effect of the signature(s) thereon, provided such signature page is attached to any other counterpart identical thereto except for having an additional signature page executed by the other Party. Each Party agrees that the other Party may rely upon the facsimile signature of the other Party on this Agreement as constituting a duly authorized, irrevocable, actual, current delivery of this Agreement as fully as if this Agreement contained the original ink signature of the Party supplying a facsimile signature.

Section 3.17 Liabilities of Parties.

The liabilities of each Party hereunder shall be solely those of such Party, and no other Person shall have personal liability to make such payments, including such Party's certificate holders, officers, officials, directors, trustees, lenders, employees, or any trustee or agent of any of the foregoing.

Section 3.18 Provisions with respect to the City.

a. Undertakings. The City acknowledges that it will benefit from the continued operation of the HDPT Facility and the use of Reclaimed Water at the HDPT Facility. The City agrees that it shall (i) purchase Reclaimed Water from VVWRA under the VVWRA Agreement; (ii) transfer and deliver such Reclaimed Water to VWD; and (iii) make the Existing Trunk Pipeline available for use by VWD, in each case to the extent necessary to permit VWD to sell and deliver Reclaimed Water to Facility Owner in the quantities and at the times contemplated by this Agreement. The City shall (x) preserve its rights and privileges under the VVWRA Agreement and (y) not amend or terminate the VVWRA Agreement during the term of this Agreement, except in each case to the extent that any failure to preserve such rights and privileges under the VVWRA Agreement or amendment or termination of the VVWRA Agreement will not adversely affect the sale and delivery of Reclaimed Water by VWD to Facility Owner as contemplated by this Agreement. This Agreement does not amend, modify or supersede the 2001 Water Service Agreement; provided, however, the City and Facility Owner acknowledge and agree that: (i) the CEC Conditions were attached to the 2001 Water Service Agreement; (ii) the CEC has or may modify the CEC Conditions in connection with permitting the HDPT Facility to use Reclaimed Water and the construction of facilities in connection with such use; and (iii) such conditions as attached to the 2001 Water Service shall be deemed to be modified as and when the CEC Conditions are modified by the CEC from time to time as described in clause (ii) above, and nothing in the 2001 Water Service Agreement shall prohibit the delivery of Reclaimed Water to the HDPT Facility under this Agreement or the use of Reclaimed Water by the HDPT Facility. The rights and obligations of the City hereunder shall be limited to the provisions of this Section 3.18, provided that the provisions of Section 1.1 and Sections 3.5, 3.6, 3.7, 3.8, 3.9, 3.10, 3.11, 3.14, 3.15 and 3.16 of the Agreement shall apply to the

City solely in order to provide for interpretation, implementation and enforcement of the provisions of this Section 3.18.

b. Representations and Warranties of City. City hereby represents and warrants to Facility Owner as of the date hereof that:

i. **Organization and Good Standing; Power and Authority.** The City is a municipal corporation and a charter city, duly formed, validly existing and in good standing under the laws of the State of California. The City has all requisite power and authority to execute, deliver, and perform its obligations under this Agreement.

ii. **Due Authorization; No Conflicts.** The execution and delivery by City of this Agreement, and the performance by City of its obligations hereunder, have been duly authorized by all necessary actions on the part of City and do not and will not: (i) contravene its governing documents; (ii) conflict with, result in a breach of, or constitute a default under any note, bond, mortgage, indenture, deed of trust, license, contract or other agreement to which it is a party or by which any of its properties may be bound or affected; (iii) violate any order, writ, injunction, decree, judgment, order, award, statute, law, rule, regulation or ordinance of any governmental authority applicable to it or any of its properties; or (iv) result in the creation of any lien, charge or encumbrance upon any of its properties pursuant to any of the foregoing.

iii. **Binding Agreement.** This Agreement has been duly executed and delivered on behalf of City and, assuming the due execution by Facility Owner and VWD hereto, constitutes a legal, valid and binding obligation of City, enforceable against it in accordance with its terms, except as such enforceability may be limited by bankruptcy, insolvency, reorganization, moratorium or similar laws affecting creditors' rights generally and by the application of principles of equity.

iv. **No Proceedings.** There are no actions, suits, investigations or other proceedings, at law or in equity, by or before any governmental authority or any other body pending or, to its knowledge, threatened against or affecting City or any of its properties (including, without limitation, this Agreement) which City reasonably expects to lead to a

material adverse effect on (i) the validity or enforceability of this Agreement or (ii) City's ability to perform its obligations under this Agreement.

v. Consents and Approvals. The execution, delivery and performance by City of its obligations under this Agreement do not and will not require any approval, consent, permit, license or other authorization of, or filing or registration with, or any other action by, any Person which has not been duly obtained, made or taken, and all such approvals, consents, permits, licenses, authorizations, filings, registrations and actions are in full force and effect, final and non-appealable.

vi. No Brokers. No finder, broker or agent has been employed, appointed or authorized to act on City's behalf in connection with the transactions contemplated by this Agreement for which the Facility Owner could become obligated.

vii. VVWRA Agreement. The VVWRA Agreement is in full force and effect.

[SIGNATURE PAGES FOLLOW]

IN WITNESS WHEREOF, the Parties (and the City solely as provided in Section 3.18 of this Agreement) have caused this Agreement to be executed as of the date first written above by their duly authorized representatives.

Dated: September 10, 2010

HIGH DESERT POWER TRUST

By: High Desert Power Project, LLC,  
Certificate Trustee

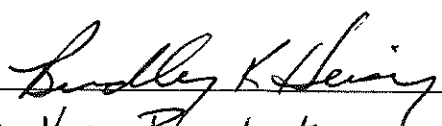
By:   
Title: Vice President

Dated: 9-28-10

VICTORVILLE WATER DISTRICT

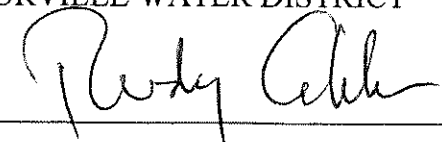
By:   
Rudy Cabriales, Chairman

Approved as to Form:

Attest:

  
District Secretary Counsel

Attest:

Approved as to Form

  
District Counsel Secretary

Risk Manager:

  
Chuck Buquet

Schedule A

Estimate of Cost of Offsite Capital Improvements

(Funded 100% by HDPT)

(1)	18-inch reclaimed pipeline (trunk pipeline to HDPT)	\$316,916
(2)	Engineering, Survey, Construction Management and Administration at a fixed 10%	<u>\$ 31,692</u>
	Total Schedule A Cost Estimate	\$348,608

NOTES:

- a) The above fee will be due 60 days after the execution of this contract.

Schedule B

(Funded 100% by HDPT)

Reclaimed Water Connection and Alternate Reclaimed Water Fees

(4,000 Gallons Per Minute (GPM) requested capacity)

- (1)  $4,000 \text{ GPM} = 4,000 \text{ GPM} \times 1.5 \text{ Fixture Units (FU)/GPM} = 6,000 \text{ FU}$
- (2) Reclaimed Water Service Connection Fee = \$3,012/Equivalent Capacity Unit (ECU)
- (3) Alternate Reclaimed Water Source Charge = \$1,302/ECU
- (4) Reclaimed Water Service Connection Fee =  $\$3,012/\text{ECU} \times 6,000 \text{ FU} / 20 \text{ FU} / 1 \text{ ECU} = \$903,600$ .
- (5) Alternate Reclaimed Water Source Charge =  $\$1,302/\text{ECU} \times 6,000 \text{ FU} / 20 \text{ FU} / 1 \text{ ECU} = \$390,600$ .
- (6) VVWRA Pump Station Modifications = \$14,567
- (7) Total Schedule B Fees =  $\$903,600 + \$390,600 + 14,567 = \$1,308,767$

NOTES:

- a) 1 GPM = 1.5 FU
- b) 1 ECU = 20 FU
- c) The above costs will be due 60 days after execution of this contract.
- d). The above VVWRA Pump Station modification costs include engineering and administration at a fixed 10%.

Exhibit A

Metering Point

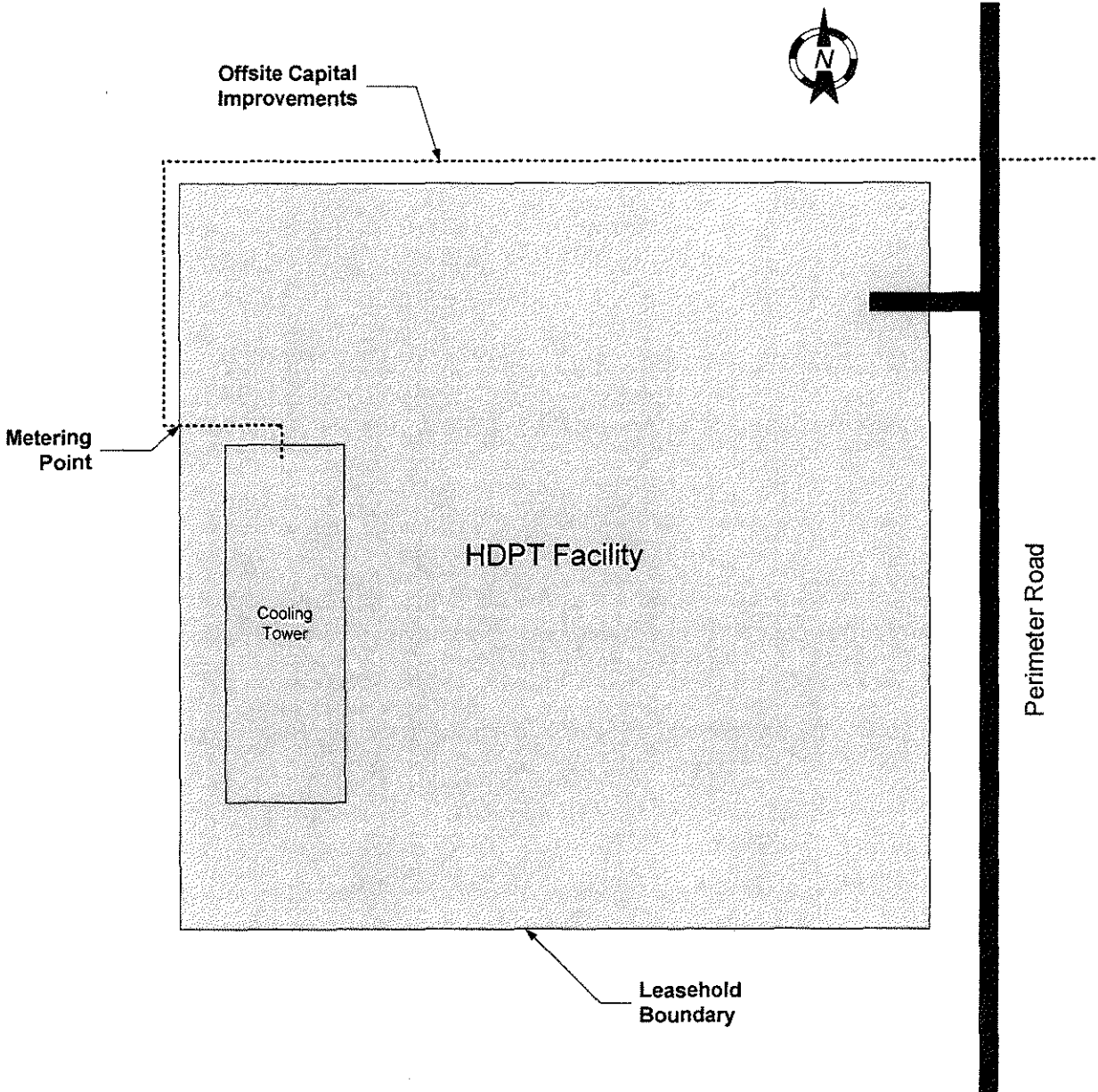



## Exhibit B

### Reclaimed Water Specifications

All Reclaimed Water delivered to the HDPT Facility at the Metering Point shall not exceed the following limits:

- (1) Silica: 40 mg/L maximum concentration, 3-day rolling average
- (2) Total Dissolved Solids: 450 mg/L maximum concentration, 3-day rolling average
- (3) Specific Conductance: 670  $\mu$ S/cm maximum concentration, 3-day rolling average
- (4) All concentration limits or other discharge limits applicable for direct discharge to surface water or groundwater from the applicable Reclaimed Water source under any applicable permits issued and in effect from time to time for such source from any federal, state, and local governmental authorities (e.g., National Pollutant Discharge Elimination System discharge limits; Regional Water Quality Control Board discharge limits; County Health Department discharge limits, etc.).

Exhibit C

Offsite Capital Improvements

(Funded 100% by HDPT)

- 18-inch reclaimed pipeline (Trunk Pipeline to HDPT, 1500 LF) including motor operated valves, meter assembly, backflow devices and fittings as shown on Exhibit A.

Exhibit D

---

*Final*

# **Engineering Report for Recycled Water Use by High Desert Power Project**

Prepared for  
**California Department of Public Health and  
California Regional Water Quality Control Board  
Lahontan Region**  
19000 Perimeter Road  
Victorville, California

May 2009

---

**CH2MHILL**

# Contents

---

Acronyms and Abbreviations .....	v
<b>1.0 Introduction.....</b>	<b>1-1</b>
1.1 Scope .....	1-1
1.2 Project Background .....	1-1
1.3 California Code of Regulations and Water Recycling Criteria .....	1-5
1.4 Report Organization .....	1-5
<b>2.0 Recycled Water System .....</b>	<b>2-1</b>
2.1 General.....	2-1
2.2 Rules and Regulations .....	2-1
2.3 Producer-Distributor-User.....	2-1
2.4 Source of Recycled Water Supply .....	2-1
2.5 Supplemental Water Supply.....	2-3
2.5.1 Treatment Processes.....	2-3
2.6 Monitoring and Reporting .....	2-3
2.7 Contingency Plan .....	2-4
<b>3.0 Transmission and Distribution Systems .....</b>	<b>3-1</b>
3.1 Recycled Water System.....	3-1
3.2 Water and Sewer Facilities.....	3-1
<b>4.0 Use Areas.....</b>	<b>4-1</b>
4.1 Specific Use.....	4-1
4.1.1 Cooling Tower Make-up Water.....	4-1
4.2 Use Site Administration .....	4-1
4.3 Use Area Design .....	4-2
4.3.1 Basic Design Features .....	4-2
4.3.2 Cooling Tower Features .....	4-2
4.3.3 Cross-connection Control.....	4-4
4.3.4 Signage Requirements .....	4-4
4.4 Use Area Inspections and Testing.....	4-5
4.4.1 Construction Inspection and Initial Testing .....	4-5
4.4.2 Ongoing Inspection and Testing .....	4-5
4.5 Employee Training.....	4-5
<b>5.0 References .....</b>	<b>5-1</b>

**Tables**

- 2-1 Title 22 Recycled Water Requirements
- 4-1 Selected Criteria for Cooling Tower System at HDPP

**Figures**

- 1-1 High Desert Power Project Vicinity Map
- 3-1 Area Map Including Existing Recycled Water Distribution Pipeline and Proposed HDPP Recycled Water Pipeline
- 4-1 Example of Signage at Site

**Appendices**

- A California Code of Regulations, Title 22 and Title 17 Excerpts
- B Guidelines for Preparing an Engineering Report
- C VVWRP Design Criteria
- D HDPP Water Treatment System Water Balance Diagram
- E Proposed Recycled Water Pipeline Drawing
- F Water and Sewer Drawings

# Acronyms and Abbreviations

---

°F	degrees Fahrenheit
ABS	aquifer banking system
afy	acre-feet per year
ASR	aquifer storage and recovery
AWWA	American Water Works Association
CA	California
CCR	California Code of Regulations
CDPH	California Department of Public Health
City	City of Victorville
DPH	Department of Public Health
gph	gallons per hour
gpm	gallons per minute
HDPP	High Desert Power Project
MF	microfiltration
mgd	milligrams per day
mg/L	milligrams per liter
mg-min/L	milligram-minutes per liter
ml	milliliter
MPN	most probable number
MW	megawatt
NTU	nephelometric turbidity units
ORP	oxidation-reduction potential
PVC	polyvinyl chloride
RO	reverse osmosis
RWQCB	Regional Water Quality Control Board
SCLA	Southern California Logistics Airport
SWP	State Water Project
UF	ultra-filtration
UV	ultraviolet
VVWRA	Victor Valley Water Reclamation Authority
VVWRP	Victor Valley Water Reclamation Plant
ZLD	Zero Liquid Discharge

**THIS PAGE INTENTIONALLY LEFT BLANK**

# 1.0 Introduction

---

## 1.1 Scope

This Engineering Report describes the conditions and level of service for use of recycled water as cooling tower make-up water at High Desert Power Project (HDPP) located at 19000 Perimeter Road, Victorville, California. The recycled water will be produced at the Victor Valley Water Reclamation Authority's (VVWRA's) water reclamation plant (VVWRP).

## 1.2 Project Background

HDPP is an 830 Megawatt (MW nominal output) natural gas-fired combined-cycle electric generating station. HDPP is located on a 25-acre parcel in the northeast corner of the Southern California Logistics Airport (SCLA), formerly part of George Air Force Base, in the City of Victorville (City), San Bernardino County, California. The land is owned by the U.S. Government and is leased to the City, which subleases the land to HDPP. Property to the south, east, and west is airport property.

HDPP is bordered to the east by Perimeter Road. To the west is previously graded but undeveloped land extending to the airport operations area. To the south are abandoned armament bunkers from George Air Force Base, a parking area with truck trailers, and a storage area for use by the airport. The project site is located in Section 24, Township 6 North, Range 5 West. Figure 1-1 illustrates the location of the HDPP and the area in its vicinity.

HDPP anticipates using a blend of recycled water and State Water Project (SWP) water for cooling tower make-up water. The recycled water to SWP water ratio will vary depending on the water quality of each source and the water demand. HDPP estimates an approximate usage of up to 1,000 acre-feet of recycled water per year.



**THIS PAGE INTENTIONALLY LEFT BLANK**

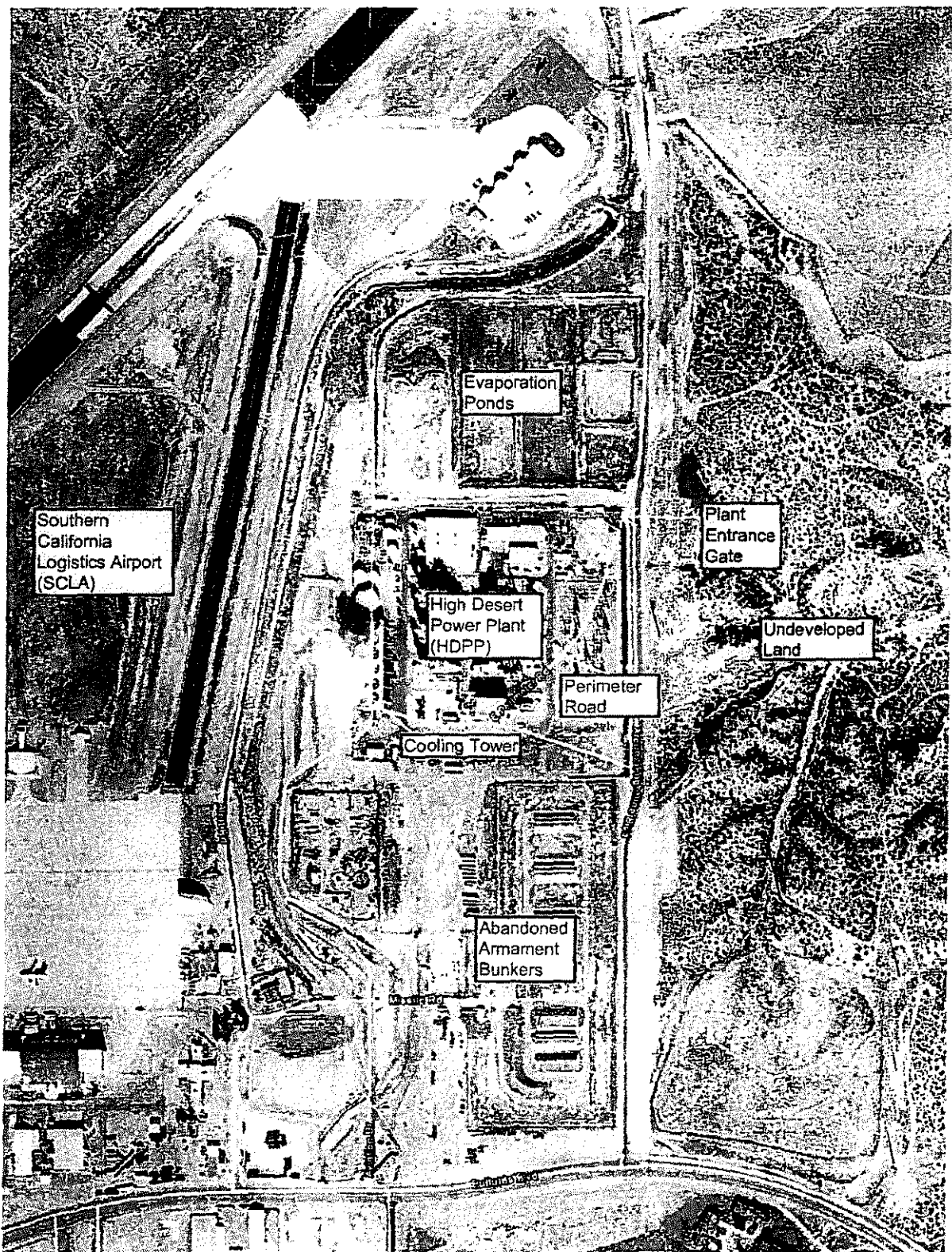

**FIGURE 1-1**  
 HDPP Vicinity Map  
 Victorville, CA



## 1.3 California Code of Regulations and Water Recycling Criteria

The California Department of Public Health (CDPH) oversees the use of recycled water under California Code of Regulations (CCR) Title 22 and Title 17, which ensure consistent, reliable water quality while protecting public health. Relevant excerpts from Title 22 and Title 17 are provided herein as Appendix A. Title 22 establishes the requirements for recycled water treatment, quality, and allowable use. Title 17 establishes the requirements for backflow protection of the potable water supply and cross-connection regulations.

The California Water Recycling Criteria in Sections 60301 through 60355, inclusive, of Title 22 prescribe the following:

- Recycled water quality and wastewater treatment requirements for the various types of uses
- Reliability features required in the treatment facilities to ensure safe performance
- Use area requirements pertaining to the actual recycled water use location

Preparation of this Engineering Report is required by Title 22. Furthermore, approval of this Engineering Report by the CDPH and the California Regional Water Quality Control Board (RWQCB), Lahontan Region is required before recycled water can be used at HDPP. This Engineering Report must be amended prior to any project modification and must describe the manner by which the project will comply with the Water Recycling Criteria.

Section 60323 specifies that the Engineering Report be prepared by a properly qualified engineer, registered in California, and experienced in the field of wastewater treatment. The CDPH has published "Guidelines for Preparation of an Engineering Report for the Production, Distribution, and Use of Recycled Water," (March 2001) as an additional aid to Engineering Report preparation. This Engineering Report follows these guidelines which are presented in Appendix B.

## 1.4 Report Organization

This Engineering Report is organized into the following five sections:

1. Introduction
2. Recycled Water System
3. Transmission and Distribution Systems
4. Use Area
5. References

The report also includes the following appendices:

- Appendix A - California Code of Regulations, Title 22 and Title 17 Excerpts
- Appendix B - Guidelines for the Preparation of an Engineering Report
- Appendix C - VVWRP Design Criteria
- Appendix D - HDPP Water Treatment System Water Balance Diagram
- Appendix E - Proposed Recycled Water Pipeline Drawings
- Appendix F - Water and Sewer Drawings

**THIS PAGE INTENTIONALLY LEFT BLANK**

## 2.0 Recycled Water System

---

### 2.1 General

This Section 2.0 provides an overview of the recycled water system including the rules and regulations governing the recycled water use, the agencies involved, and the recycled water system.

### 2.2 Rules and Regulations

The California and San Bernardino County regulatory requirements that apply to recycled water supply and facility installation include Title 22 and Title 17 of the CCR. The applicable rules, regulations, and guidelines provided in this report are as follows:

- Excerpts of Titles 22 and 17 of the CCR (see Appendix A)
- Guidelines for the Preparation of an Engineering Report for the Production, Distribution, and Use of Recycled Water (CDPH, 2001) (see Appendix B)

### 2.3 Producer–Distributor–User

This subsection describes the producer, distributor, and the user of the recycled water.

#### Producer

The VVWRA produces recycled water at the VVWRP. The VVWRA will provide the recycled water to the City.

#### Distributor

The City, through its Victorville Water District subsidiary, will distribute the recycled water obtained from the VVWRA to HDPP.

#### User

HDPP is the user of the recycled water.

### 2.4 Source of Recycled Water Supply

Currently, HDPP uses SWP water from the California Aqueduct as the primary source of cooling tower make-up water. HDPP proposes to use up to 1,000 acre-feet per year (afy) of recycled water in a blend with treated SWP water. The blend ratio will vary depending on the water quality of the recycled water and the SWP water, as well as the water demands of HDPP.

The VVWRP will produce the recycled water from municipal wastewater which has gone through sedimentation, oxidization, coagulation, filtration, and disinfection processes after having passed through screening, primary and secondary treatment processes (refer to Appendix C - VVWRP Design Criteria). Recycled water must meet the Title 22 requirements to be used for any application within California. The RWQCB-Lahontan region (Board Order No. R6V-2003-028) issued water recycling requirements for the system at the VVWRP which are consistent with Title 22. Table 2-1 provides the water quality requirements for Title 22 recycled water.

TABLE 2-1  
Title 22 Recycled Water Requirements

Parameter	Value
Turbidity	Less than 2 NTU Average
Turbidity	Greater than 5 NTU not more than 5 percent of the time during a 24-hour period
Turbidity	Less than 10 NTU at all times
Total Coliform Bacteria	2.2 MPN per 100 ml per sample, median reading not to exceed over any 7-day continuous period
Total Coliform Bacteria	23 MPN per 100 ml per sample, not to occur more than once within 30 days
Total Coliform Bacteria	240 MPN per 100 ml in any sample
Disinfection CT	Greater than or equal to 450 mg-min/L with a minimum modal contact time of at least 90 minutes under peak dry weather conditions

**NOTES:**

CT = The product of chlorine residual concentration and detention time  
 mgd = million gallons per day  
 mg-min/L = milligram-minutes per liter  
 ml = milliliters  
 MPN = most probable number  
 NTU = nephelometric turbidity units

Per Title 22 Section 60306, disinfected tertiary-treated water can be used for industrial purposes such as make-up for cooling towers. For the proposed use of recycled water at HDPP, VVWRA will produce water satisfying the previously listed requirements. VVWRA currently produces recycled water which is provided to the City and then to the Westwinds Golf Course in Victorville, California for irrigation. The proposed pipeline to the HDPP cooling tower will tap into this 16-inch diameter existing recycled water transmission pipeline on Perimeter Road between the VVWRP and the Westwinds Golf Course. VVWRP compliance with Title 22 requirements will be maintained during this modification and any future capacity expansions and operational improvements.

The VVWRA has filed a Title 22 Engineering Report and an amended Title 22 Engineering Report (with a chlorine contact basin tracer study) with the RWQCB-Lahontan and the CDPH. As capacity expansions and operational improvements are contemplated for the VVWRP, compliance with Title 22 requirements will be maintained.

## 2.5 Supplemental Water Supply

HDPP uses SWP water from the California Aqueduct as its primary source of water. However, when the SWP water is not available, HDPP withdraws and uses SWP water that has been previously injected into HDPP's Aquifer Banking System (ABS). A small amount of water is sometimes recycled for cooling tower use from the ABS ultrafiltration system, the filter backwash cleaning water, and the zero liquid discharge (ZLD) system. See Appendix D for a water balance diagram of the overall water treatment process.

### 2.5.1 Treatment Processes

The SWP water is treated at an onsite treatment facility before it is used for power plant operations or injected into the ABS when SWP water is available for that purpose.

The SWP water enters the plant at a flow rate of up to 5,856 gallons per minutes (gpm). The plant pre-treatment system for the SWP water includes suspended solids and turbidity removal. Clarified SWP water is supplied to the ABS system and the power block. The clarified SWP water that will be used as cooling tower make-up water is stored in the clarified water tank and pumped to the cooling tower basin as needed.

The existing supply line to the cooling tower basin has an air gap of more than 1 foot to prevent backflow and cross-connection. The maximum capacity of the make-up water pumps is 4,700 gpm, although typical daily water consumption averages between 2,500 to 3,000 gpm.

The blowdown from the cooling tower basin is treated through the ZLD system, consisting of a softener, microfiltration (MF) system, a reverse osmosis (RO) system and a crystallizer. The RO permeate supplies a portion of the cooling tower make-up water and all of the steam cycle make-up.

The ABS water treatment system, which operates separately from the SWP water treatment for cooling tower make-up, consists of a sand and granulated activated carbon filter and a UF system. A small flow of water coming from the UF backwash system supplies the cooling tower make-up water. The UF permeate is treated using ultraviolet (UV) disinfection prior to injection into the ABS injection/extraction wells.

Appendix D shows the existing water balance diagram of the HDPP water treatment system including the point where the recycled water will be introduced into the cooling tower basin.

Under no circumstances will the recycled water be cross-connected with other water systems. In addition, under no circumstances will the recycled water be allowed to enter the ABS. The treated SWP water will continue as the only source for the ABS injection wells.

## 2.6 Monitoring and Reporting

The VVWRA will be responsible for monitoring the quality of the recycled water. If the recycled water quality drops below the Title 22 recycled water criteria presented in Table 2-1, the VVWRA will not be permitted to provide recycled water to the City for



distribution to HDPP. Any noncompliance with the water recycling requirements must be reported to the RWQCB-Lahontan, San Bernardino County Department of Public Health (DPH) and the CDPH by the VVWRA.

## **2.7 Contingency Plan**

The recycled water system will have an in-line automated station to monitor the quality of the recycled water including conductivity, turbidity, and chlorine residual. If the recycled water does not meet the water quality requirements, an automated valve will shut-off recycled water to the cooling tower basin. Any shortfall will be made up with SWP water or water from the ABS system.

## **3.0 Transmission and Distribution Systems**

---

The proposed recycled water system for cooling tower make-up water will require the installation of a section of pipeline with an isolation valve, flow meter, flow totalizer, automated control station, and online water quality monitoring instrumentation.

The locations where the recycled water pipeline may cross other pipelines are identified in subsections 3.1 and 3.2 below. Cross-connection control protocol is described in subsection 4.3.3 of this report.

### **3.1 Recycled Water System**

The proposed 18-inch diameter HDPP recycled water pipeline will connect to the existing 16-inch diameter recycled water pipeline near the northeast corner of HDPP. The proposed 18-inch-diameter American Water Works Association (AWWA) C-905 polyvinyl chloride (PVC) underground pipeline will run westerly on the north side of the rip rap, and past the City's pump station before turning south along the west property boundary. Once the pipeline reaches the area by the northwest side of the cooling tower, it will travel easterly and daylight aboveground adjacent to the cooling tower, terminating in the new isolation and control valve station. The valve and control station piping will run aboveground to discharge into the cooling tower basin.

A drawing provided by the City to HDPP (not included in this report) and the site drawings shown in Appendix F indicate that the proposed 18-inch HDPP recycled water pipeline will not cross over or cross-connect with any active HDPP water pipeline inside the HDPP site.

Plans for the proposed recycled water system are included in Appendix E. The plan view of the existing 16-inch VVWRA recycled water pipeline and the proposed HDPP 18-inch line is shown on Figure 3-1. The proposed 18-inch recycled water pipeline will cross the City's existing 12-inch potable water pipeline in two places outside of the HDPP property boundary. The first crossing location is in the northwest corner outside the HDPP property line as shown in Appendix E, drawing # 2005-068-CP-001. The second crossing occurs when the recycled water pipeline turns east towards the cooling tower. In the second location, the City's 12-inch potable water pipeline runs parallel to the fence line on the west that marks the HDPP property line.

Appendix F illustrates the proposed 18-inch recycled water pipeline routing including the approximate entry point to the cooling tower on the Final Site Plan, includes the Piping and Instrumentation Diagram for Potable Water, and the sanitary sewer profile within the boundaries of the HDPP.

### **3.2 Water and Sewer Facilities**

Existing water pipelines are shown on the drawings in Appendix E and F. A drawing provided by the City to HDPP (but not included in this report) and the site drawings shown

in Appendix F indicate that the proposed 18-inch HDPP recycled water pipeline will not cross over any active HDPP water pipelines within the site boundaries.

The sewer pipeline that services the HDPP site enters the property from the south and runs to the administration building; therefore, there should be no crossing of the proposed 18-inch recycled water pipeline with the sewer based on a review of the site drawings shown in Appendix F.

Outside of the HDPP site boundary, the proposed 18-inch recycled water pipeline will cross the existing 12-inch City potable water main twice. These crossings will be field-verified prior to installation. In addition, abandoned piping, if discovered during installation, will be documented.

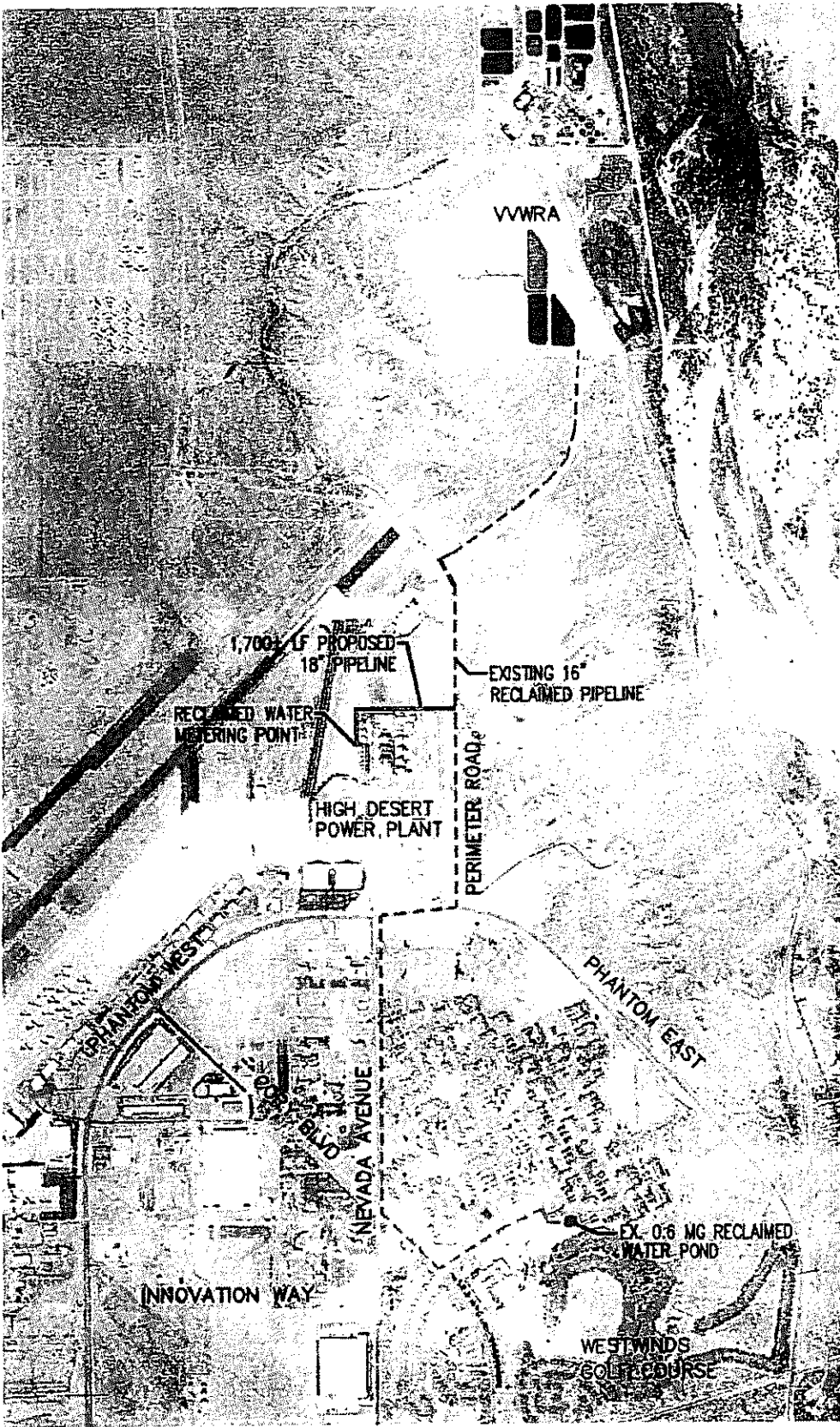

**FIGURE 3-1**  
 Area Map Including  
 Recycled Water  
 Distribution Pipeline  
 and Proposed HDPP  
 Recycled Water  
 Pipeline





## 4.0 Use Areas

---

According to the Recycled Water User Manual (2005), the permitted uses of tertiary-treated Title 22 recycled water include urban landscaping, agriculture, impoundments, and industrial uses. Two accepted industrial uses of recycled water include boiler feed requirements and make-up to cooling towers.

The use area will be at HDPP located in Section 24, Township 6 North, Range 5 West. Figure 3-1 presents the HDPP facilities and surrounding area. The description of the project location and surrounding area is provided in Section 1.2 of this report. Domestic water supply wells are located at least 1,000 feet outside the use area which is consistent with Title 22 Section 60310 requirements for separation of recycled water and potable water supply wells.

### 4.1 Specific Use

The recycled water will be used as partial make-up water for HDPP's cooling tower. Appendix F shows the HDPP site plan and point of use of the recycled water at the cooling tower.

#### 4.1.1 Cooling Tower Make-up Water

The cooling tower is operated on average 80 percent of the time, which varies depending on the power grid needs. HDPP anticipates using up to 1,000 afy of recycled water in a blend with treated SWP water. The blend ratio will vary depending on the water quality of the recycled water and the SWP water, as well as the water demands of HDPP.

### 4.2 Use Site Administration

HDPP has direct and sole control of the construction, operation and maintenance of piping within its property, including backflow prevention and onsite use. An HDPP supervisor shall be designated and will be responsible for the operation, maintenance, and monitoring of the recycled and potable water systems to ensure no cross-connections are made between the two systems. The design of the recycled water system on the HDPP site is such that cross-connection with any other water system onsite is impossible without performance of construction work to modify the system. Therefore, there will be no cross-connection between the recycled water and SWP water, potable water, or fire suppression systems.

HDPP facilities are restricted to a focused group of plant operators who can be identified and communicated with effectively using signage and training. The facility is not subject to access by the general public and site access is controlled by onsite personnel 24 hours a day, 7 days a week. In addition, the entire HDPP facility is surrounded by a fence.

As stated before, any cross-connection or backflow incident involving potable water would be reported to state and county health agencies.

## 4.3 Use Area Design

This subsection provides the details of the basic design features for recycled water use within HDPP, cross-connection and backflow prevention, and signage requirements.

### 4.3.1 Basic Design Features

The design and construction of the recycled water system will comply with the state and county regulations and guidelines. This specifically includes an air gap of at least one foot between the recycled water discharge pipe end and the cooling tower water in the basin. There is no direct connection of recycled water to the cooling tower water or any other equipment. This is the same discharge design as employed in the existing cooling tower make-up system using treated SWP water.

### 4.3.2 Cooling Tower Features

A cooling tower works on the principle of heat transfer between water and atmospheric air by creating water droplets through spraying and developing thin films of water in the tower fill, to expose large surface areas of water to air. This heat is thus transferred into the atmosphere. The heat-transfer process involves the following:

- Latent heat transfer due to vaporization of a small portion of the circulating cooling water
- Sensible heat transfer owing to the difference in temperature of water and air

The HDPP cooling tower is a GEA counter flow tower, located on the west side of the plant. The counter flow cooling tower consists of a wood framework with a system of water distribution pipes and nozzles within the framework. The heat exchange medium consists of PVC fill. The system also includes a basin to collect the cooled water and direct it back to the circulating pumps. Fans are employed to move the air through the fill as necessary for proper heat exchange. Drift eliminators are used to control drift loss from the tower.

The water to be cooled is transported to the distribution level by riser pipes external to the tower. The water flows from the risers into a horizontal distribution header pipe. From there it branches into a system of lateral distribution pipes, where nozzles spray the water upward in a predetermined pattern over the heat exchange medium (fill). Before the air flow is permitted to exit through the top of the tower, it must pass through the drift eliminators. These are simply a block of material shaped to cause the air to change directions and thus provide impact surfaces that prevent droplets from being carried out of the tower with the air flow. The falling water is caught by the cold water basin, which then directs the flow back to the circulation pumps. The normal water depth in the tower is about 6 to 12 inches below top of curb. The make-up water is accordingly adjusted to maintain this water level. Selected criteria are provided in Table 4-1.

**TABLE 4-1**  
**Selected Criteria for Cooling Tower System at HDPP**

<b>Criteria</b>	<b>Description</b>
<b>Thermal Performance</b>	
Water Flow – Maximum Capacity (gpm)	218,000
Hot/Cold Water Temperature (°F)	101/82.6
Drift (% Flow)	0.0006
Design Wet Bulb Temperature,(°F)	71.2
Evaporation Rate (gpm)	3,584
<b>Physical Details</b>	
No. of Cells	12
Nominal Cell Size (L x W x H) (feet)	54 x 42 x 46
Fans/Cell	1
Overall Tower Size (L x W x H) (feet)	324 x 84 x 56
Air Inlet Height (feet)	21
Number of Inlet Sides	2
<b>Fill Details</b>	
Type	Film
Model	CF1900
Height (feet)	5
Manufacturer	Brentwood
Material	PVC
Thickness (after form) (inch)	0.01
Support Method	Bottom
<b>Drift Eliminators</b>	
Type	Cellular
Model	D-15
No. of Layers	1
Manufacturer	GEA/Shepherd
Material	PVC
Thickness (before form) (inch)	0.015
<b>Distribution System</b>	
Type	Upspray
Inlet Diameter (inches)	42
Number of Inlets	6

**NOTES:**

°F = degrees Fahrenheit

gpm = gallons per minute

L x W x H = length times width times height

PVC = polyvinyl chloride



A 12.5 percent solution of sodium hypochlorite is used as a biocide to treat the recirculating water in the tower basin. Sodium hypochlorite feed into the basin is controlled using an oxidation-reduction potential (ORP) analyzer. Daily grab samples are analyzed to maintain a continuous free chlorine residual of 0.5 to 1.0 milligrams per liter (mg/L) in the cooling water. In addition to sodium hypochlorite, sulfuric acid (93 percent) is added for pH adjustment, corrosion inhibitor is added for corrosion control, and a dispersant is added to control hardness scaling.

### 4.3.3 Cross-connection Control

The recycled water system will be installed in accordance with CDPH guidelines. Recycled water piping to the cooling tower will be installed in compliance with required separation from other water pipelines and the cooling tower water basin. A cross-connection is any unprotected actual or potential connection between a public or an end user's water supply system and recycled water. No cross-connections between the onsite potable water or fire suppression systems and the recycled water pipeline are contemplated and would not be allowed under any circumstances. Recycled water piping to the cooling tower will terminate at the cooling tower basin. An air gap of at least one foot will separate the outlet of the recycled water pipeline from the water level in the basin.

### 4.3.4 Signage Requirements

All onsite recycled water piping will be identified to clearly differentiate it from onsite potable, process, and fire suppression water piping. Such identification entails wrapping recycled water piping with purple Mylar warning tape. Recycled water valves and outlets will be installed in such a manner that only authorized personnel have access. All aboveground portions of the incoming recycled water piping will be identified.

Signs will be posted at exposed recycled water assemblies that identify the use of recycled water. Each sign shall display an international symbol similar to Figure 4-1.

FIGURE 4-1  
Example of Signage at Site



Access to these facilities will be limited to trained HDPP personnel and qualified vendors. Public access to the HDPP, and hence the cooling tower area, is restricted.

## **4.4 Use Area Inspections and Testing**

### **4.4.1 Construction Inspection and Initial Testing**

Construction inspection and start-up testing will be conducted in accordance with methods developed by the City and VVWRA based on the requirements of Title 22 and Title 17. Copies of all inspection reports will be provided to the CDPH.

### **4.4.2 Ongoing Inspection and Testing**

Ongoing inspection and testing will be conducted in accordance with VVWRA inspection procedures based upon the principles provided in Title 22 and Title 17. The City will verify that signs have been installed and tamper-detect seals placed at initial startup of the recycled water services and during subsequent inspections. Prior to final operation of the recycled water system, a cross-connection inspection will be performed. In addition to the initial cross-connection control inspection, annual inspections will be performed by the City.

## **4.5 Employee Training**

A training session will be conducted by the City for the HDPP's supervisor on the approved and appropriate uses, guidelines, and stipulations regarding operation of the recycled water system. After training, the supervisor will be responsible for maintaining strict control of the onsite recycled water system and conducting follow-up education/training sessions.

**THIS PAGE INTENTIONALLY LEFT BLANK**

## 5.0 References

---

GEA Cooling Tower Specifications and Equipment Data Sheet.

Perry R. H. and Green D. W. (1997). "Perry's Chemical Engineer's Handbook," Seventh Edition.

Recycled Water User Manual. (2005). Los Angeles County Recycled Water Advisory Committee.

The Purple Book. (2001). California Health Laws Related to Recycled Water, June.

Vickers A. (2002). Handbook of Water Use and Conservation, pp. 288-303.

Water Treatment and Monitoring Plan, High Desert Power Project Aquifer Banking System. (2007). High Desert Power Project LLC and Victor Valley Water District, August.

**THIS PAGE INTENTIONALLY LEFT BLANK**

APPENDIX A  
**California Code of Regulations, Title 22 and Title 17**  
**Excerpts**

---



## **California Health Laws Related to Recycled Water**

### **"The Purple Book"**

#### ***Excerpts from the Health and Safety Code, Water Code, and Titles 22 and 17 of the California Code of Regulations***

***Last Update: June 2001***

*The document is meant to be an aid to staff of the Drinking Water Program within the Department of Health Services Division of Drinking Water and Environmental Management. It should not be relied upon by the regulated community as the State of California's representation of the law, since the published codes are the only official representations of the law.*

*Published codes are available on the Internet at <http://www.leginfo.ca.gov/> (statutes) and <http://ccr.oal.ca.gov/> (regulations). They are also available at law libraries -- call your County Bar Association for the nearest location.*

*Every effort has been made to assure the accuracy of this compilation. Readers who find an error or who are aware of an omission should contact Jeff Stone of DHS' Recycled Water Unit at [jstone1@dhs.ca.gov](mailto:jstone1@dhs.ca.gov).*



## Table of Contents

	Page
<b>HEALTH AND SAFETY CODE</b>	
Division 104. Environmental Health Services	
Part 12. Drinking Water	
Chapter 4. California Safe Drinking Water Act	
ARTICLE 7. Requirements and Compliance	
Section	
116551. Augmentation of source with recycled water	1
<b>Chapter 5. Water Equipment and Control</b>	
ARTICLE 2. Cross-Connection Control by Water Users	
Section	
116800. Control of users	1
116805. Fees	2
116810. Certification of device testers	2
116815. Purple pipe for recycled water	2
116820. Violations	3
<b>WATER CODE</b>	
Division 7. Water Quality	
<b>Chapter 2. Definitions</b>	
Section	
13050. Terms used in this division	4
13051. Injection well	7
13169. Groundwater protection program	7
13274. Public water system rights	8
<b>Chapter 6. Financial Assistance</b>	
ARTICLE 1. State Water Quality Control Fund	
Section	
13400. Definitions	8
13401. Fund's continuing existence	8

**ARTICLE 2. Loans to Local Agencies**

Section		
13410.	Applications	9
13411.	DHS consultation	9
13412.	Repayment	10
13413.	Construction halted under health department orders	10
13414.	Funding monies repaid	10
13415.	Loans for studies and investigations	11
13416.	Election required to enter into loan contract	11
13417.	Election procedure	11
13418.	Tahoe moratorium	12

**ARTICLE 2.5. Local Bonds**

Section		
13425.	Applications	13
13426.	Consultation with DHS on determinations	13
13427.	Agreement by applicant	13
13428.	Clean Water Bond Guarantee Fund	14
13429.	Investment of money in fund	14
13430.	Limitation on authorization to guarantee bonds	14
13431.	Limitation on amounts paid	14
13432.	Annual fee	15
13433.	Rules and procedures authority	15

**ARTICLE 3. State Water Pollution Cleanup and Abatement Account**

Section		
13440.	Fund established	15
13441.	Sources of payment into account; availability for expenditure	15
13441.5.	Loans from fund to account	16
13442.	Use of monies to assist in clean-up	16
13443.	Use of money for unforeseen water pollution	16

**Chapter 7. Reclamation**

**ARTICLE 1. Title**

Section		
13500.	Title	17

**ARTICLE 2. Legislative Findings and Intent**

Section		
13510.	Public interest	17

13511.	Findings	17
13512.	Legislative intention	17
ARTICLE 3. Financial Assistance		
Section		
13515.	Authority to loan	17
ARTICLE 4. Regulation		
Section		
13520.	Recycling criteria	18
13521.	DHS establish criteria	18
13522.	Abatement by DHS or LHD order	18
13522.5.	Reports	18
13522.6.	Failure to report	19
13522.7.	Injunction	19
13523.	DHS recommendation requirement	19
13523.1.	Master permit requirements	20
13523.5.	Salinity exception	20
13524.	Establishment of criteria	21
13525.	TRO and injunction	21
13525.5.	Violation	21
13526.	Misdemeanor	21
13527.	Priority in financial assistance	21
13528.	DHS powers	22
13529.	Unauthorized discharges of recycled water	22
13529.2	Requirements if unauthorized discharge occurs	22
13529.4	Penalties	23
ARTICLE 5. Surveys and Investigations		
Section		
13530.	Duties of the department	24
ARTICLE 6. Waste Water Regulation		
Section		
13540.	DHS authority for findings and regulations	24
13541.	Waste well	24
ARTICLE 7. Waste Water Reuse		
Section		
13550.	Legislative findings	24
13551.	Industry and irrigation for restricted use of potable water prohibited; use of recycled water	25

13552.	Restriction on Sections 13550 and 13551	26
13552.2.	Legislative findings	26
13552.4.	Authority to require use of recycled water for residential landscaping	26
13552.6.	Legislative findings	27
13552.8.	Recycled water for floor trap priming, cooling towers, and air-conditioning	27
13553.	Legislative findings	29
13553.1	Legislative findings	29
13554.	Recycled water for toilet and urinal flushing	30
13554.2.	DHS fees	30
13554.3.	State Board fees	32
13555.2.	Legislative intent	32
13555.3.	Separate pipelines	32
13556.	Acquisition and provision of recycled water for beneficial use	33

#### Chapter 7.5. Water Recycling Act of 1991

Section		
13575.	Recycling Act Title	33
13576.	Legislative findings	34
13577.	Water recycling goal	35
13579.	Identification of potential uses	35
13580.	Application for recycled water supply	36
13580.5	Agreements	36
13580.7	Public agency retail water suppliers	37
13580.8	Retail water supplier regulated by the PUC	38
13580.9	City of West Covina	39
13581.	Formal mediation process	40
13581.2	Process for a retail water supplier regulated by the PUC	40
13582.	Construction of chapter	41
13583.	Noncompliance	41

#### Chapter 22. Graywater for Home Irrigation

Section		
14875.	Application of chapter	41
14875.1.	Department	41
14876.	Graywater definition	41
14877.	Graywater system definition	42
14877.1.	DHS consult on standards	42
14877.2.	Local administration	42
14877.3.	City or county - more stringent	42

## **Title 22, CALIFORNIA CODE OF REGULATIONS**

### **DIVISION 4. ENVIRONMENTAL HEALTH**

#### **CHAPTER 1. INTRODUCTION**

##### **ARTICLE 1. Definitions**

Section		
60001.	Department	43
60003.	Director	43

#### **CHAPTER 2. REGULATIONS FOR THE IMPLEMENTATION OF THE CALIFORNIA ENVIRONMENTAL QUALITY ACT**

##### **ARTICLE 1. General Requirements and Categorical Exemptions**

Section		
60100.	General requirements	43
60101.	Specific activities within categorical exempt classes	43

#### **CHAPTER 3. WATER RECYCLING CRITERIA**

##### **ARTICLE 1 Definitions**

Section		
60301.	Definitions	45
60301.100.	Approved laboratory	45
60301.160.	Coagulated wastewater	45
60301.170.	Conventional treatment	45
60301.200.	Direct beneficial use	45
60301.220.	Disinfected secondary-2.2 recycled water	45
60301.225.	Disinfected secondary-23 recycled water	45
60301.230.	Disinfected tertiary recycled water	46
60301.240.	Drift	46
60301.245.	Drift eliminator	46
60301.250.	Dual plumbed system	47
60301.300.	F-Specific bacteriophage MS-2	47
60301.310.	Facility	47
60301.320.	Filtered wastewater	47
60301.330.	Food crops	48
60301.400.	Hose bibb	48
60301.550.	Landscape impoundment	48
60301.600.	Modal contact time	48
60301.620.	Nonrestricted recreational impoundment	48

*California Health Laws Related to Recycled Water*  
*Table of Contents*

*June 2001 Edition*

60301.630.	NTU	49
60301.650.	Oxidized wastewater	49
60301.660.	Peak dry weather design flow	49
60301.700.	Recycled water agency	49
60301.710.	Recycling plant	49
60301.740.	Regulatory agency	49
60301.750.	Restricted access golf course	49
60301.760.	Restricted recreational impoundment	50
60301.800.	Spray irrigation	50
60301.830.	Standby unit process	50
60301.900.	Undisinfected secondary recycled water	50
60301.920.	Use area	50
ARTICLE 2. Sources of Recycled Water		
Section		
60302.	Source specifications	50
ARTICLE 3. Uses of Recycled Water		
Section		
60303.	Exceptions	51
60304.	Use of recycled water for Irrigation	51
60305.	Use of recycled water for impoundments	53
60306.	Use of recycled water for cooling	53
60307.	Use of recycled water for other purposes	54
ARTICLE 4. Use Area Requirements.		
Section		
60310.	Use Area Requirements	55
ARTICLE 5. Dual Plumbed Recycled Water Systems		
Section		
60313.	General Requirements	59
60314.	Report Submittal	59
60315.	Design Requirements	60
60316.	Operation Requirements	60
ARTICLE 5.1. Groundwater recharge		
Section		
60320.	Groundwater recharge	61

ARTICLE 5.5. Other methods of treatment		
Section		
60320.5.	Other methods of treatment	62
ARTICLE 6. Sampling and analysis		
Section		
60321.	Sampling and Analysis	62
ARTICLE 7. Engineering Report and Operational Requirements		
Section		
60323.	Engineering report	62
60325.	Personnel	63
60327.	Maintenance	63
60329.	Operating records and reports	63
60331.	Bypass	64
ARTICLE 8. General Requirement of Design		
Section		
60333.	Flexibility of design	64
60335.	Alarms	64
60337.	Power supply	65
ARTICLE 9. Reliability Requirements for Primary Effluent		
Section		
60339.	Primary treatment	65
ARTICLE 10. Reliability Requirements for Full Treatment		
Section		
60341.	Emergency storage or disposal	65
60343.	Primary treatment	66
60345.	Biological treatment	67
60347.	Secondary sedimentation	67
60349.	Coagulation	67
60351.	Filtration	68
60353.	Disinfection	68
60355.	Other alternatives to reliability requirements	69

**Title 17, CALIFORNIA CODE OF REGULATIONS**

**DIVISION 1. STATE DEPARTMENT OF HEALTH SERVICES**

**CHAPTER 5. SANITATION (ENVIRONMENTAL)**

**GROUP 4. DRINKING WATER SUPPLIES**

**ARTICLE 1. General**

Section

7583.	Definitions	70
7584.	Responsibility and scope of program	71
7585.	Evaluation of hazard	72
7586.	User supervisor	72

**ARTICLE 2. Protection of Water System**

Section

7601.	Approval of backflow preventers	73
7602.	Construction of backflow preventers	73
7603.	Location of backflow preventers	73
7604.	Type of protection required	74
7605.	Testing and maintenance of backflow preventers	77

\* \* \* \* \*



## **HEALTH AND SAFETY CODE**

**Division 104. Environmental Health Services  
Part 12. Drinking Water  
Chapter 4. California Safe Drinking Water Act**

**Article 7. Requirements and Compliance**

**116551. Augmentation of source with recycled water**

The department shall not issue a permit to a public water system or amend a valid existing permit for the use of a reservoir as a source of supply that is directly augmented with recycled water, as defined in subdivision (n) of Section 13050 of the Water Code, unless the department does all of the following:

- (a) Performs an engineering evaluation that evaluates the proposed treatment technology and finds that the proposed technology will ensure that the recycled water meets or exceeds all applicable primary and secondary drinking water standards and poses no significant threat to public health.
- (b) Hold at least three duly noticed public hearings in the area where the recycled water is proposed to be used or supplied for human consumption to receive public testimony on that proposed use. The department shall make available to the public, not less than 10 days prior to the date of the first hearing held pursuant to this subdivision, the evaluations and findings made pursuant to subdivision (a).

**Chapter 5. Water Equipment and Control**

**Article 2. Cross-Connection Control by Water Users**

**116800. Control of users**

Local health officers may maintain programs for the control of cross-connections by water users, within the users' premises, where public exposure to drinking water contaminated by backflow may occur. The programs may include inspections within water users premises for the purpose of identifying cross-connection hazards and determining appropriate backflow protection. Water users shall comply with all orders, instructions, regulations, and notices from the local health officer with respect to the installation, testing, and maintenance of backflow prevention devices. The local health

officer may collect fees from those water users subject to inspection to offset the costs of implementing cross-connection control programs.

**116805. Fees**

(a) Local health officers may maintain programs, in cooperation with water suppliers, to protect against backflow through service connections into the public water supply, and, with the consent of the water supplier, may collect fees from the water supplier to offset the costs of implementing these programs.

(b) The fees authorized under this section and under Section 116800 shall be limited to the costs of administering these programs. At the discretion of the water supplier, the fees collected from the water supplier by the local health officer may be passed through to water users.

(c) Programs authorized under this section and Section 116800 shall be conducted in accordance with backflow protection regulations adopted by the department.

(d) Nothing in this article shall prevent a water supplier from directly charging those water users required to install backflow prevention devices for the costs of the programs authorized in this section and Section 116800.

**116810. Certification of device testers**

To assure that testing and maintenance of backflow prevention devices are performed by persons qualified to do testing and maintenance, local health officers may maintain programs for certification of backflow prevention device testers. The local health officer may suspend, revoke, or refuse to renew the certificate of a tester, if, after a hearing before the local health officer or his or her designee, the local health officer or his or her designee finds that the tester has practiced fraud or deception or has displayed gross negligence or misconduct in the performance of his or her duties as a certified backflow prevention device tester. The local health officer may collect fees from certified testers to offset the cost of the certification program provided pursuant to this section. The certification standards shall be consistent with the backflow protection regulations adopted by the department.

**116815. Purple pipe for recycled water**

(a) All pipes installed above or below the ground, on and after June 1, 1993, that are designed to carry recycled water, shall be colored purple or distinctively wrapped with purple tape.

(b) Subdivision (a) shall apply only in areas served by a water supplier delivering water for municipal and industrial purposes, and n no event shall apply to any of the following:

(1) Municipal or industrial facilities that have established a labeling or marking system for recycled water on their premises, as otherwise required by a local agency, that clearly distinguishes recycled water from potable water.

(2) Water delivered for agricultural use.

(c) For purposes of this section, "recycled water" has the same meaning as defined in subdivision (n) of Section 13050 of the Water Code.

#### **116820. Violations**

Any person who violates any provision of this article, violates any order of the local health officer pursuant to this article, or knowingly files a false statement or report required by the local health officer pursuant to this article is guilty of a misdemeanor punishable by a fine not exceeding five hundred dollars (\$500) or by imprisonment not exceeding 30 days in the county jail or by both such fine and imprisonment. Each day of a violation of any provision of this article or of any order of the local health officer beyond the time stated for compliance of the order shall be a separate offense.

## **WATER CODE**

### **Division 7. Water Quality Chapter 2. Definitions**

#### **13050. Terms used in this division**

As used in this division:

- (a) "State board" means the State Water Resources Control Board.
- (b) "Regional board" means any California regional water quality control board for a region as specified in Section 13200.
- (c) "Person" includes any city, county, district, the state, and the United States, to the extent authorized by federal law.
- (d) "Waste" includes sewage and any and all other waste substances, liquid, solid, gaseous, or radioactive, associated with human habitation, or of human or animal origin, or from any producing, manufacturing, or processing operation, including waste placed within containers of whatever nature prior to, and for purposes of, disposal.
- (e) "Waters of the state" means any surface water or groundwater, including saline waters, within the boundaries of the state.
- (f) "Beneficial uses" of the waters of the state that may be protected against quality degradation include, but are not limited to, domestic, municipal, agricultural and industrial supply; power generation; recreation; aesthetic enjoyment; navigation; and preservation and enhancement of fish, wildlife, and other aquatic resources or preserves.
- (g) "Quality of the water" refers to chemical, physical, biological, bacteriological, radiological, and other properties and characteristics of water which affect its use.
- (h) "Water quality objectives" means the limits or levels of water quality constituents or characteristics which are established for the reasonable protection of beneficial uses of water or the prevention of nuisance within a specific area.

(i) "Water quality control" means the regulation of any activity or factor which may affect the quality of the waters of the state and includes the prevention and correction of water pollution and nuisance.

(j) "Water quality control plan" consists of a designation or establishment for the waters within a specified area of all of the following:

(1) Beneficial uses to be protected.

(2) Water quality objectives.

(3) A program of implementation needed for achieving water quality objectives.

(k) "Contamination" means an impairment of the quality of the waters of the state by waste to a degree which creates a hazard to the public health through poisoning or through the spread of disease. "Contamination" includes any equivalent effect resulting from the disposal of waste, whether or not waters of the state are affected.

(l) (1) "Pollution" means an alteration of the quality of the waters of the state by waste to a degree which unreasonably affects either of the following:

(A) The waters for beneficial uses.

(B) Facilities which serve these beneficial uses.

(2) "Pollution" may include "contamination."

(m) "Nuisance" means anything which meets all of the following requirements:

(1) Is injurious to health, or is indecent or offensive to the senses, or an obstruction to the free use of property, so as to interfere with the comfortable enjoyment of life or property.

(2) Affects at the same time an entire community or neighborhood, or any considerable number of persons, although the extent of the annoyance or damage inflicted upon individuals may be unequal.

(3) Occurs during, or as a result of, the treatment or disposal of wastes.

(n) "Recycled water" means water which, as a result of treatment of waste, is suitable for a direct beneficial use or a controlled use that would not otherwise occur and is therefor considered a valuable resource.

(o) "Citizen or domiciliary" of the state includes a foreign corporation having substantial business contacts in the state or which is subject to service of process in this state.

(p) (1) "Hazardous substance" means either of the following:

(A) For discharge to surface waters, any substance determined to be a hazardous substance pursuant to Section 311(b)(2) of the Federal Water Pollution Control Act (33 U.S.C. Sec. 1251 et seq.).

(B) For discharge to groundwater, any substance listed as a hazardous waste or hazardous material pursuant to Section 25140 of the Health and Safety Code, without regard to whether the substance is intended to be used, reused, or discarded, except that "hazardous substance" does not include any substance excluded from Section 311 (b)(2) of the Federal Water Pollution Control Act because it is within the scope of Section 311(a)(1) of that act.

(2) "Hazardous substance" does not include any of the following:

(A) Nontoxic, nonflammable, and noncorrosive stormwater runoff drained from underground vaults, chambers, or manholes into gutters or storm sewers.

(B) Any pesticide which is applied for agricultural purposes or is applied in accordance with a cooperative agreement authorized by Section 116180 of the Health and Safety Code, and is not discharged accidentally or for purposes of disposal, the application of which is in compliance with all applicable state and federal laws and regulations.

(C) Any discharge to surface water of a quantity less than a reportable quantity as determined by regulations issued pursuant to Section 311(b)(4) of the Federal Water Pollution Control Act.

(D) Any discharge to land which results, or probably will result, in a discharge to groundwater if the amount of the discharge to land is less than a reportable quantity, as determined by regulations adopted pursuant to Section 13271, for substances listed as hazardous pursuant to Section 25140 of the Health and Safety Code. No discharge shall be deemed a discharge of a reportable quantity until regulations set a reportable quantity for the substance discharged.

(q) (1) "Mining waste" means all solid, semisolid, and liquid waste materials from the extraction, beneficiation, and processing of ores and minerals. Mining waste includes, but is not limited to, soil, waste rock, and overburden, as defined in Section 2732 of the Public Resources Code, and tailings, slag, and other processed waste materials, including cementitious materials that are managed at the cement manufacturing facility where the materials were generated.

(2) For the purposes of this subdivision, "cementitious material" means cement, cement kiln dust, clinker, and clinker dust.

(r) "Master recycling permit" means a permit issued to a supplier or a distributor, or both, of recycled water, that includes waste discharge requirements prescribed pursuant to Section 13263 and water recycling requirements prescribed pursuant to Section 13523.1.

#### **13051. Injection well**

As used in this division, "injection well" means any bored, drilled, or driven shaft, dug pit, or hole in the ground into which waste or fluid is discharged, and any associated subsurface appurtenances, and the depth of which is greater than the circumference of the shaft, pit, or hole.

#### **13169. Groundwater protection program**

(a) The state board is authorized to develop and implement a groundwater protection program as provided under the Safe Drinking Water Act, Section 300 and following of Title 42 of the United States Code, and any federal act that amends or supplements the Safe Drinking Water Act. The authority of the state board under this section includes, but is not limited to, the following:

(1) To apply for and accept state groundwater protection grants from the federal government.

(2) To take any additional action as may be necessary or appropriate to assure that the state's groundwater protection program complies with any federal regulations issued pursuant to the Safe Drinking Water Act or any federal act that amends or supplements the Safe Drinking Water Act.

(b) Nothing in this section is intended to expand the authority of the state board as authorized under the Porter-Cologne Water Quality Control Act (Div. 7 (commencing with Sec. 13000) Wat. C.).

**13274. Public water system rights**

(a) Notwithstanding any other provision of law, any public water system regulated by the State Department of Health Services shall have the same legal rights and remedies against a responsible party, when the water supply used by that public water system is contaminated, as those of a private land owner whose groundwater has been contaminated.

(b) For purposes of this section, "responsible party" has the same meaning as defined in Section 25323.5 of the Health and Safety Code.

**Chapter 6. Financial Assistance**  
**Article 1. State Water Quality Control Fund**

**13400. Definitions**

As used in this chapter, unless otherwise apparent from the context:

- (a) "Fund" means the State Water Quality Control Fund.
- (b) "Public agency" means any city, county, city and county, district, or other political subdivision of the state.
- (c) "Facilities" means:
  - (1) facilities for the collection, treatment, or export of waste when necessary to prevent water pollution,
  - (2) facilities to recycle wastewater and to convey recycled water,
  - (3) facilities or devices to conserve water, or
  - (4) any combination of the foregoing.

**13401. Fund's continuing existence**

(a) The State Water Quality Control Fund is continued in existence. The following moneys in the fund are appropriated, without regard to fiscal years, for expenditure by the state board in making loans to public agencies in accordance with this chapter:



(1) The balance of the original moneys deposited in the fund.

(2) Any money repaid to the fund.

(3) Any remaining balance of the money in the fund deposited therein after the specific appropriations for loans to the South Tahoe Public Utility District, the North Tahoe Public Utility District, the Tahoe City Public Utility District, the Truckee Sanitary District, and to any other governmental entity in the areas served by such districts have been made.

(b) Notwithstanding subdivision (a), upon the order of the state board, the money in the State Water Quality Control Fund shall be transferred to the State Water Pollution Control Revolving Fund.

## **Article 2. Loans to Local Agencies**

### **13410. Applications**

Applications for construction loans under this chapter shall include:

(a) A description of the proposed facilities.

(b) A statement of facts showing the necessity for the proposed facilities and showing that funds of the public agency are not available for financing such facilities and that the sale of revenue or general obligation bonds through private financial institutions is impossible or would impose an unreasonable burden on the public agency.

(c) A proposed plan for repaying the loan.

(d) Other information as required by the state board.

### **13411. DHS consultation**

Upon a determination by the state board, after consultation with the State Department of Health, that

(a) the facilities proposed by an applicant are necessary to the health or welfare of the inhabitants of the state,

(b) that the proposed facilities meet the needs of the applicant,

(c) that funds of the public agency are not available for financing such facilities and that the sale of revenue or general obligation bonds through private financial institutions is impossible or would impose an unreasonable burden on the public agency,

(d) that the proposed plan for repayment is feasible,

(e) in the case of facilities proposed under Section 13400(c)(1) that such facilities are necessary to prevent water pollution,

(f) in the case of facilities proposed under Section 13400(c)(2) that such facilities will produce recycled water and that the public agency has adopted a feasible program for use thereof, and

(g) in the case of facilities proposed under Section 13400(c)(3) that such facilities are a cost effective means of conserving water, the state board, subject to approval by the Director of Finance, may loan to the applicant such sum as it determines is not otherwise available to the public agency to construct the proposed facilities.

#### **13412. Repayment**

No loan shall be made to a public agency unless it executes an agreement with the state board under which it agrees to repay the amount of the loan, with interest, within 25 years at 50 percent of the average interest rate paid by the state on general obligation bonds sold in the calendar year immediately preceding the year in which the loan agreement is executed.

#### **13413. Construction halted under health department orders**

It is the policy of this state that, in making construction loans under this article, the state board should give special consideration to facilities proposed to be constructed by public agencies in areas in which further construction of buildings has been halted by order of the State Department of Health or a local health department, or both, or notice has been given that such an order is being considered; provided, however, that the public agencies designated in this section shall otherwise comply with and meet all requirements of other provisions of this chapter.

#### **13414. Funding monies repaid**

All money received in repayment of loans under this chapter shall be paid to the State Treasurer and credited to the fund.

**13415. Loans for studies and investigations**

(a) Loans may be made by the state board to public agencies to pay not more than one-half of the cost of studies and investigations made by such public agencies in connection with waste water reclamation.

(b) Not more than a total of two hundred thousand dollars (\$200,00) shall be loaned pursuant to this section in any fiscal year, and not more than fifty thousand dollars (\$50,000) shall be loaned to any public agency in any fiscal year pursuant to this section. In the event that less than two million dollars (\$2,000,000) is available in any fiscal year for loans under this article, then not more than 10 percent of the available amount shall be available for loans for studies and investigations pursuant to this section.

(c) Applications for such loans shall be made in such form, and shall contain such information, as may be required by the state board.

(d) Such loans shall be repaid within a period not to exceed 10 years, with interest at a rate established in the manner provided in Section 13412.

**13416. Election required to enter into loan contract**

Before a public agency may enter into a contract with the state board for a construction loan under this chapter, the public agency shall hold an election on the proposition of whether or not the public agency shall enter into the proposed contract and more than 50 percent of the votes cast at such election must be in favor of such proposition.

**13417. Election procedure**

The election shall be held in accordance with the following provisions:

(a) The procedure for holding an election on the incurring of bonded indebtedness by such public agency shall be utilized for an election of the proposed contract as nearly as the same may be applicable. Where the law applicable to such agency does not contain such bond election procedure, the procedure set forth in the Revenue Bond Law of 1941 (Chapter 6 (commencing with Section 54300) Part 1, Division 2, Title 5 of the Government Code), as it may now or hereafter be amended, shall be utilized as nearly as the same may be applicable.

(b) No particular form of ballot is required.

(c) The notice of the election shall include a statement of the time and place of the election, the purpose of the election, the general purpose of the contract, and the maximum amount of money to be borrowed from the state under the contract.

(d) The ballots for the election shall contain a brief statement of the general purpose of the contract substantially as stated in the notice of the election, shall state the maximum amount of money to be borrowed from the state under the contract, and shall contain the words "Execution of contract --Yes" and "Execution of contract--No."

(e) The election shall be held in the entire public agency except where the public agency proposes to contract with the state board on behalf of a specified portion, or of specified portions of the public agency, in which case the election shall be held in such portion or portions of the public agency only.

#### **13418. Tahoe moratorium**

Notwithstanding any provision of this chapter or any other provision of law, including, but not limited to, the provisions of Chapter 47 and 137 of the Statutes of 1966, First Extraordinary Session, Chapter 1679 of the Statutes of 1967, Chapter 1356 of the Statutes of 1969, and Chapter 920 of the Statutes of 1970, or the provisions of any existing loan contract entered into pursuant to this chapter or any other such provision of law, there shall be a two-year moratorium following the effective date of this section on that portion of the principal and interest payments otherwise required in repayment of funds heretofore loaned to the North Tahoe Public Utility District, the Tahoe City Public Utility District, the South Tahoe Public Utility District, the Truckee Sanitary District, the Squaw Valley County Water District, and the Alpine Springs County Water District pursuant to this chapter or any act of the Legislature authorizing a state loan for the purpose of permitting any such agency to construct necessary sewage and storm drainage facilities to prevent and control water pollution in the area served by such agency, equal in percentage, as determined by the Department of Finance, to the percentage of property tax revenues lost to the agency by reason of the adoption of Article XIII A of the California Constitution, unless moneys are otherwise available for such repayment from state allocations or the sale of bonds authorized on or before July 1, 1978, but unissued. The provisions of this section do not apply to any sums which are required to be repaid immediately or in accordance with an accelerated time schedule pursuant to a duly entered stipulated judgment between the State of California and the Tahoe City Public Utility District. Interest on loans shall accrue during the moratorium period and be repaid by the recipients of the loans, in addition to the normal principal and interest payments.

## **Article 2.5 Local Bonds**

### **13425. Applications**

Applications for guarantees for local agency bonds under this chapter shall include:

- (a) A description of the proposed facilities.
- (b) A financing plan for the proposed facilities, including the amount of debt and maximum term to maturity of the proposed local agency bond issue and identification of sources of revenue that will be dedicated to payment of principal and interest on the bonds.
- (c) Other information as required by the state board. The state board may provide that the application may be combined with applications for any other source of funds administered by the state board.

### **13426. Consultation with DHS on determinations**

The state board, subject to approval by the Director of Finance, may agree to provide a guarantee pursuant to this article for all or a specified part of the proposed local agency bond issue upon making, after consultation with the State Department of Health Services, all of the following determinations:

- (a) The facilities proposed by an applicant are necessary to the health or welfare of the inhabitants of the state and are consistent with water quality control plans adopted by regional boards.
- (b) The proposed facilities meet the needs of the applicant.
- (c) The proposed bond issue and plan repayment are sound and feasible.
- (d) In the case of facilities proposed under paragraph (2) of subdivision (c) of Section 13400, the facilities will produce recycled water and the applicant has adopted a feasible program for the use of the facilities. The state board may adopt criteria for ranking and setting priorities among applicants for those guarantees.

### **13427. Agreement by applicant**

No guarantee shall be extended to any applicant unless it executes an agreement with the state board under which the applicant agrees to the following provisions:

- (a) To proceed expeditiously with, and complete, the proposed project.
- (b) To commence operation of the project on completion, and to properly operate and maintain the work in accordance with applicable provisions of law.
- (c) To issue bonds and to levy fines, charges, assessments, or taxes to pay the principal of, and interest on, the bonds as described in the application.
- (d) To diligently and expeditiously collect those levies, including timely exercise of available legal remedies in the event of delinquency or default.
- (e) To act in accordance with such other provisions as the state board may require.

**13428. Clean Water Bond Guarantee Fund**

Notwithstanding Section 13340 of the Government Code, the money in the Clean Water Bond Guarantee Fund, which is hereby created, is continuously appropriated to the state board without regard to fiscal years for the purposes of this chapter.

**13429. Investment of money in fund**

Money in the Clean Water Bond Guarantee Fund not needed for making payments on guaranteed bonds pursuant to this chapter shall be invested pursuant to law. All proceeds of the investment shall be deposited in that fund to the extent permitted by federal law.

**13430. Limitation on authorization to guarantee bonds**

The state board's authorization to guarantee bonds under this article shall be limited to bonds with a total principal amount of not more than 10 times the amount in the Clean Water Bond Guarantee Fund at the time the state board determines to extend each guarantee pursuant to Section 13426.

**13431. Limitation on amounts paid**

Under no circumstances shall the amount paid out as a result of bond guarantees extended pursuant to this article exceed the amount in the Clean Water Bond Guarantee Fund. This article does not express or imply any commitment by the state board or any other agency of the state to pay any money or levy any charge or tax or otherwise exercise its faith and credit on behalf of any local agency or bondholder beyond the funds in the Clean Water Bond Guarantee Fund.

**13432. Annual Fee**

The state board may charge an annual fee not to exceed one-tenth of 1 percent of the principal amount of each bond issue that it guarantees for guarantee coverage. The state board may charge a lesser amount. The proceeds of any fee shall be paid into the Clean Water Bond Guarantee Fund.

**13433. Rules and procedures authority**

The state board shall, by regulation, prescribe rules and procedures for all of the following:

(a) To pay money from the Clean Water Bond Guarantee Fund to an insured local agency or bondholder in the event that the amount in the local agency's bond reserve fund falls below a minimum amount, or in the event of failure by the local agency to pay the principal of, or interest on, an insured bond issue on time, as the state board may require.

(b) To require, by court action if necessary, a local agency to raise sewer service charges, levy additional assessments, collect charges or assessments, or foreclose or otherwise sell property as needed to prevent a reduction in the local agency's bond reserve fund, or to prevent default, or to collect funds to repay to the fund any payments made pursuant to subdivision (a).

**Article 3. State Water Pollution Cleanup and Abatement Account**

**13440. Fund established**

There is in the State Water Quality Control Fund the State Water Pollution Cleanup and Abatement Account (hereinafter called the "account"), to be administered by the state board.

**13441. Sources of payment into account; availability for expenditure**

There is to be paid into the account all moneys from the following sources:

(a) All moneys appropriated by the Legislature for the account.

(b) All moneys contributed to the account by any person and accepted by the state board.

(c) One-half of all moneys collected by way of criminal penalty and all moneys collected civilly under any proceeding brought pursuant to any provision of this division.

(d) All moneys collected by the state board for the account under Section 13304.

The first unencumbered five hundred thousand dollars (\$500,000) paid into the account in any given fiscal year is available without regard to fiscal years, for expenditure by the state board in accordance with the provisions of this article. The next unencumbered five hundred thousand dollars (\$500,000), or any portion thereof, deposited in any given fiscal year, is available for expenditure by the state board for the purposes of this article, subject to the provisions set forth in Section 28 of the Budget Act of 1984 (Chapter 258 of the Statutes of 1984). The next unencumbered one million dollars (\$1,000,000) deposited in the account in any given fiscal year is available for expenditure by the state board for the purposes of Section 13443. The remaining unencumbered funds deposited in the account in any given fiscal year is available without regard to fiscal years to the state board for expenditure for the purposes set forth in Section 13442.

#### **13441.5. Loans from fund to account**

The State Treasurer, when requested by the state board and approved by the Director of Finance, shall transfer moneys in the nature of a loan from the State Water Quality Control Fund to the account created pursuant to Section 13440, which shall be repayable from the account to such fund; provided, that the moneys transferred from the fund to the account shall not exceed the sum of twenty-five thousand dollars (\$25,000) at any one time.

#### **13442. Use of monies to assist in clean-up**

Upon application by a public agency with authority to clean up a waste or abate the effects thereof, the state board may order moneys to be paid from the account to the agency to assist it in cleaning up the waste or abating its effects on waters of the state. The agency shall not become liable to the state board for repayment of such moneys, but this shall not be any defense to an action brought pursuant to subdivision (b) of Section 13304 for the recovery of moneys paid hereunder.

#### **13443. Use of money for unforeseen water pollution**

Upon application by a regional board that is attempting to remedy a significant unforeseen water pollution problem, posing an actual or potential public health threat, and for which the regional board does not have adequate resources budgeted, the state board may order moneys to be paid from the account to the regional board to assist it in responding to the problem.



**Chapter 7 Reclamation  
Article 1. Title**

**13500. Title**

This chapter shall be known as and may be cited as the Water Recycling Law.

**Article 2. Legislative Findings and Intent**

**13510. Public interest**

It is hereby declared that the people of the state have a primary interest in the development of facilities to recycle water containing waste to supplement existing surface and underground water supplies and to assist in meeting the future water requirements of the state.

**13511. Findings**

The Legislature finds and declares that a substantial portion of the future water requirements of this state may be economically met by beneficial use of recycled water. The Legislature further finds and declares that the utilization of recycled water by local communities for domestic, agricultural, industrial, recreational, and fish and wildlife purposes will contribute to the peace, health, safety and welfare of the people of the state. Use of recycled water constitutes the development of "new basic water supplies" as that term is used in Chapter 5 (commencing with Section 12880) of Part 6 of Division 6.

**13512. Legislative intention**

It is the intention of the Legislature that the state undertake all possible steps to encourage development of water recycling facilities so that recycled water may be made available to help meet the growing water requirements of the state.

**Article 3. Financial Assistance**

**13515. Authority to loan**

In order to implement the policy declarations of this chapter, the state board is authorized to provide loans for the development of water reclamation facilities, or for

studies and investigations in connection with water reclamation, pursuant to the provisions of Chapter 6 (commencing with Section 13400) of this division.

#### **Article 4. Regulation**

##### **13520. Recycling criteria**

As used in this article "recycling criteria" are the levels of constituents of recycled water, and means for assurance of reliability under the design concept which will result in recycled water safe from the standpoint of public health, for the uses to be made.

##### **13521. DHS establishes recycling criteria**

The State Department of Health Services shall establish uniform statewide recycling criteria for each varying type of use of recycled water where the use involves the protection of public health.

##### **13522. Abatement by DHS or local health officer**

(a) Whenever the State Department of Health Services or any local health officer finds that a contamination exists as a result of the use of recycled water, the department or local health officer shall order the contamination abated in accordance with the procedure provided for in Chapter 6 (commencing with Section 5400) of Part 3 of Division 5 of the Health and Safety Code.

(b) The use of recycled water in accordance with the uniform statewide recycling criteria established pursuant to Section 13521, for the purpose of this section, does not cause, constitute, or contribute to, any form of contamination, unless the department or the regional board determines that contamination exists.

##### **13522.5. Reports**

(a) Except as provided in subdivision (e), any person recycling or proposing to recycle water, or using or proposing to use recycled water, within any region for any purpose for which recycling criteria have been established, shall file with the appropriate regional board a report containing information required by the regional board.

(b) Except as provided in subdivision (e), every person recycling water or using recycled water shall file with the appropriate regional board a report of any material change or proposed change in the character of the recycled water or its use.

(c) Each report under this section shall be sworn to, or submitted under penalty of perjury.

(d) This section shall not be construed so as to require any report in the case of any producing, manufacturing, or processing operation involving the recycling of water solely for use in the producing, manufacturing, or processing operation.

(e) Except upon the written request of the regional board, a report is not required pursuant to this section from any user of recycled water which is being supplied by a supplier or distributor for whom a master recycling permit has been issued pursuant to Section 13523.1.

#### **13522.6. Failure to report**

Any person failing to furnish a report under Section 13522.5 when so requested by a regional board is guilty of a misdemeanor.

#### **13522.7. Injunction**

The Attorney General, at the request of the regional board, shall petition the superior court for the issuance of a temporary restraining order, temporary injunction or permanent injunction, or combination thereof, as may be appropriate, requiring any person not complying with Section 13522.5 to comply forthwith.

#### **13523. DHS recommendation requirement**

(a) Each regional board, after consulting with and receiving the recommendations of the State Department of Health Services and any party who has requested in writing to be consulted, and after any necessary hearing, shall, if in the judgment of the board, it is necessary to protect the public health, safety, or welfare, prescribe water reclamation requirements for water which is used or proposed to be used as reclaimed water.

(b) The requirements may be placed upon the person reclaiming water, the user, or both. The requirements shall be established in conformance with the uniform statewide reclamation criteria established pursuant to Section 13521. The regional board may require the submission of a preconstruction report for the purpose of determining compliance with the uniform statewide reclamation criteria. The requirements for a use of reclaimed water not addressed by the uniform statewide reclamation criteria shall be considered on a case-by-case basis.

**13523.1. Master permit requirements**

(a) Each regional board, after consulting with, and receiving the recommendations of, the State Department of Health Services and any party who has requested in writing to be consulted, with the consent of the proposed permittee, and after any necessary hearing, may, in lieu of issuing waste discharge requirements pursuant to Section 13263 or water reclamation requirements pursuant to Section 13523 for a user of reclaimed water, issue a master reclamation permit to a supplier or distributor, or both, of reclaimed water.

(b) A master reclamation permit shall include, at least, all of the following:

(1) Waste discharge requirements, adopted pursuant to Article 4 (commencing with Section 13260) of Chapter 4.

(2) A requirement that the permittee comply with the uniform statewide reclamation criteria established pursuant to Section 13521. Permit conditions for a use of reclaimed water not addressed by the uniform statewide water reclamation criteria shall be considered on a case-by-case basis.

(3) A requirement that the permittee establish and enforce rules or regulations for reclaimed water users, governing the design and construction of reclaimed water use facilities and the use of reclaimed water, in accordance with the uniform statewide reclamation criteria established pursuant to Section 13521.

(4) A requirement that the permittee submit a quarterly report summarizing reclaimed water use, including the total amount of reclaimed water supplied, the total number of reclaimed water use sites, and the locations of those sites, including the names of the hydrologic areas underlying the reclaimed water use sites.

(5) A requirement that the permittee conduct periodic inspections of the facilities of the reclaimed water users to monitor compliance by the users with the uniform statewide reclamation criteria established pursuant to Section 13521 and the requirements of the master reclamation permit.

(6) Any other requirements determined to be appropriate by the regional board.

**13523.5. Salinity exception**

A regional board may not deny issuance of water reclamation requirements to a project which violates only a salinity standard in the basin plan.

**13524. Establishment of criteria**

No person shall recycle water or use recycled water for any purpose for which recycling criteria have been established until water recycling requirements have been established pursuant to this article or a regional board determines that no requirements are necessary.

**13525. TRO and injunction**

Upon the refusal or failure of any person or persons recycling water or using recycled water to comply with the provisions of this article, the Attorney General, at the request of the regional board, shall petition the superior court for the issuance of a temporary restraining order, preliminary injunction, or permanent injunction, or combination thereof, as may be appropriate, prohibiting forthwith any person or persons from violating or threatening to violate the provisions of this article.

**13525.5. Violation**

Any person recycling water or using recycled water in violation of Section 13524, after such violation has been called to his attention in writing by the regional board, is guilty of a misdemeanor. Each day of such recycling or use shall constitute a separate offense.

**13526. Misdemeanor**

Any person who, after such action has been called to his attention in writing by the regional board, uses recycled water for any purpose for which recycling criteria have been established prior to the establishment of water recycling requirements, is guilty of a misdemeanor.

**13527. Priority in financial assistance**

(a) In administering any statewide program of financial assistance for water pollution or water quality control which may be delegated to it pursuant to Chapter 6 (commencing with Section 13400) of this division, the state board shall give added consideration to water quality control facilities providing optimum water recycling and use of recycled water.

(b) Nothing in this chapter prevents the appropriate regional board from establishing waste discharge requirements if a discharge is involved.

**13528. DHS powers**

No provision of this chapter shall be construed as affecting the existing powers of the State Department of Health Services.

**13529. Unauthorized discharges of recycled water**

The Legislature hereby finds and declares all of the following:

- (a) The purpose of Section 13529.2 is to establish notification requirements for unauthorized discharges of recycled water to waters of the state.
- (b) It is the intent of the Legislature in enacting this section to promote the efficient and safe use of recycled water.
- (c) The people of the state have a primary interest in the development of facilities to recycle water to supplement existing water supplies and to minimize the impacts of growing demand for new water on sensitive natural water bodies.
- (d) A substantial portion of the future water requirements of the state may be economically met by the beneficial use of recycled water.
- (e) The Legislature has established a statewide goal to recycle 700,000 acre-feet of water per year by the year 2000 and 1,000,000 acre-feet of water per year by the year 2010.
- (f) The use of recycled water has proven to be safe and the State Department of Health Services is drafting regulations to provide for expanded uses of recycled water.

**13529.2. Requirements if unauthorized discharge occurs**

(a) Any person who, without regard to intent or negligence, causes or permits an unauthorized discharge of 50,000 gallons or more of recycled water, as defined in subdivision (c), or 1,000 gallons or more of recycled water, as defined in subdivision (d), in or on any waters of the state, or causes or permits such unauthorized discharge to be discharged where it is, or probably will be, discharged in or on any waters of the state, shall, as soon as

- (1) that person has knowledge of the discharge,
- (2) notification is possible, and

(3) notification can be provided without substantially impeding cleanup or other emergency measures, immediately notify the appropriate regional board.

(b) For the purposes of this section, an unauthorized discharge means a discharge not authorized by waste discharge requirements pursuant to Article 4 of Chapter 4 (commencing with Section 13260), water reclamation requirements pursuant to Section 13523, a master reclamation permit pursuant to Section 13523.1, or any other provision of this division.

(c) For the purposes of this section, "recycled water" means wastewater treated as "disinfected tertiary 2.2 recycled water," as defined or described by the State Department of Health Services or wastewater receiving advanced treatment beyond disinfected tertiary 2.2 recycled water.

(d) For purposes of this section, "recycled water" means "recycled water," as defined in subdivision (n) of Section 13050, which is treated at a level less than "disinfected tertiary 2.2 recycled water," as defined or described by the State Department of Health Services.

(e) The requirements in this section supplement, and shall not supplant, any other provisions of law.

#### **13529.4. Penalties**

(a) Any person refusing or failing to provide the notice required by Section 13529.2, or as required by a condition of waste discharge requirements requiring notification of unauthorized releases of recycled water as defined in Section 13529.2, may be subject to administrative civil liability in an amount not to exceed the following:

(1) For the first violation, or a subsequent violation occurring more than 365 days from a previous violation, five thousand dollars (\$5,000).

(2) For a second violation occurring within 365 days of a previous violation, ten thousand dollars (\$10,000).

(3) For a third or subsequent violation occurring within 365 days of a previous violation, twenty-five thousand dollars (\$25,000).

(b) The penalties in this section supplement, and shall not supplant, any other provisions of law.

## **Article 5. Surveys and Investigations**

### **13530. Duties of the department**

The department, either independently or in cooperation with any person or any county, state, federal, or other agency, or on request of the state board, to the extent funds are allocated therefor, shall conduct surveys and investigations relating to the reclamation of water from waste pursuant to Section 230.

## **Article 6 Waste Water Regulation**

### **13540. DHS authority for findings and regulations**

No person shall construct, maintain or use any waste well extending to or into a subterranean water-bearing stratum that is used or intended to be used as, or is suitable for, a source of water supply for domestic purposes. Notwithstanding the foregoing, when a regional board finds that water quality considerations do not preclude controlled recharge of such stratum by direct injection, and when the State Department of Health Services, following a public hearing, finds the proposed recharge will not impair the quality of water in the receiving aquifer as a source of water supply for domestic purposes, recycled water may be injected by a well into such stratum. The State Department of Health Services may make and enforce such regulations pertaining thereto as it deems proper. Nothing in this section shall be construed to affect the authority of the state board or regional boards to prescribe and enforce requirements for such discharge.

### **13541. Waste well**

As used in this article, "waste well" includes any hole dug or drilled into the ground, used or intended to be used for the disposal of waste.

## **Article 7. Waste Water Reuse**

### **13550. Legislative findings**

(a) The Legislature hereby finds and declares that the use of potable domestic water for nonpotable uses, including, but not limited to, cemeteries, golf courses, parks, highway landscaped areas, and industrial and irrigation uses, is a waste or an unreasonable use of the water within the meaning of Section 2 of Article X of the California Constitution if recycled water is available which meets all of the following conditions, as determined by



the state board, after notice to any person or entity who may be ordered to use recycled water or to cease using potable water and a hearing held pursuant to Article 2 (commencing with Section 648) of Chapter 1.5 of Division 3 of Title 23 of the California Code of Regulations:

(1) The source of recycled water is of adequate quality for these uses and is available for these uses. In determining adequate quality, the state board shall consider all relevant factors, including, but not limited to, food and employee safety, and level and types of specific constituents in the recycled water affecting these uses, on a user-by-user basis. In addition, the state board shall consider the effect of the use of recycled water in lieu of potable water on the generation of hazardous waste and on the quality of wastewater discharges subject to regional, state, or federal permits.

(2) The recycled water may be furnished for these uses at a reasonable cost to the user. In determining reasonable cost, the state board shall consider all relevant factors, including, but not limited to, the present and projected costs of supplying, delivering, and treating potable domestic water for these uses and the present and projected costs of supplying and delivering recycled water for these uses, and shall find that the cost of supplying the treated recycled water is comparable to, or less than, the cost of supplying potable domestic water.

(3) After concurrence with the State Department of Health Services, the use of recycled water from the proposed source will not be detrimental to public health.

(4) The use of recycled water for these uses will not adversely affect downstream water rights, will not degrade water quality, and is determined not to be injurious to plantlife, fish, and wildlife.

(b) In making the determination pursuant to subdivision (a), the state board shall consider the impact of the cost and quality of the nonpotable water on each individual user.

(c) The state board may require a public agency or person subject to this article to furnish information which the state board determines to be relevant to making the determination required in subdivision (a).

**13551. Industry and irrigation for restricted use of potable water prohibited: use of recycled water**

A person or public agency, including a state agency, city, county, city and county, district, or any other political subdivision of the state, shall not use water from any

source of quality suitable for potable domestic use for nonpotable uses, including cemeteries, golf courses, parks, highway landscaped areas, and industrial and irrigation uses if suitable recycled water is available as provided in Section 13550; however, any use of recycled water in lieu of water suitable for potable domestic use shall, to the extent of the recycled water so used, be deemed to constitute a reasonable beneficial use of that water and the use of recycled water shall not cause any loss or diminution of any existing water right.

**13552. Restrictions on Sections 13550 and 13551**

The amendments to Sections 13550 and 13551 of the Water Code made during the first year of the 1991-92 Regular Session are not intended to alter any rights, remedies, or obligations which may exist prior to January 1, 1992, pursuant to, but not limited to, those sections or Chapter 8.5 (commencing with Section 1501) of Part 1 of Division 1 of the Public Utilities Code.

**13552.2. Legislative findings**

(a) The Legislature hereby finds and declares that the use of potable domestic water for the irrigation of residential landscaping is a waste or an unreasonable use of water within the meaning of Section 2 of Article X of the California Constitution if recycled water, for this use, is available to the residents and meets the requirements set forth in Section 13550, as determined by the state board after notice and a hearing.

(b) The state board may require a public agency or person subject to this section to submit information that the state board determines may be relevant in making the determination required in subdivision (a).

**13552.4. Authority to require use of recycled water for residential landscaping**

(a) Any public agency, including a state agency, city, county, city and county, district, or any other political subdivision of the state, may require the use of recycled water for irrigation of residential landscaping, if all of the following requirements are met:

(1) Recycled water, for this use, is available to the user and meets the requirements set forth in Section 13550, as determined by the state board after notice and a hearing.

(2) The use of recycled water does not cause any loss or diminution of any existing water right.

(3) The irrigation systems are constructed in accordance with Chapter 3 (commencing with Section 60301) of Division 4 of Title 22 of the California Code Regulations.

(b) This section applies to both of the following:

(1) New subdivisions for which the building permit is issued on or after March 15, 1994, or, if a building permit is not required, new structures for which construction begins on or after March 15, 1994, for which the State Department of Health Services has approved the use of recycled water.

(2) Any residence that is retrofitted to permit the use of recycled water for landscape irrigation and for which the State Department of Health Services has approved the use of recycled water.

(c) (1) Division 13 (commencing with Section 21000) of the Public Resources Code does not apply to any project which only involves the repiping, redesign, or use of recycled water for irrigation of residential landscaping necessary to comply with a requirement prescribed by a public agency under subdivision (a).

(2) The exemption in paragraph (1) does not apply to any project to develop recycled water, to construct conveyance facilities for recycled water, or any other project not specified in this subdivision.

#### **13552.6. Legislative findings**

(a) The Legislature hereby finds and declares that the use of potable domestic water for floor trap priming, cooling towers, and air-conditioning devices is a waste or an unreasonable use of water within the meaning of Section 2 of Article X of the California Constitution if recycled water, for these uses, is available to the user, and the water meets the requirements set forth in Section 13550, as determined by the state board after notice and a hearing.

(b) The state board may require a public agency or person subject to this section to submit information that the state board determines may be relevant in making the determination required in subdivision (a).

#### **13552.8. Recycled water for floor trap priming, cooling towers, and air-conditioning**

(a) Any public agency, including a state agency, city, county, city and county, district, or any other political subdivision of the state, may require the use of recycled water in floor

trap priming, cooling towers, and air-conditioning devices, if all of the following requirements are met:

(1) Recycled water, for these uses, is available to the user and meets the requirements set forth in Section 13550, as determined by the state board after notice and a hearing.

(2) The use of recycled water does not cause any loss or diminution of any existing water right.

(3) If public exposure to aerosols, mist, or spray may occur, appropriate mist mitigation or mist control is provided, such as the use of mist arrestors or the addition of biocides to the water in accordance with criteria established pursuant to Section 13521.

(4) The person intending to use recycled water has prepared an engineering report pursuant to Section 60323 of Title 22 of the California Code of Regulations that includes plumbing design, cross-connection control, and monitoring requirements for the public agency, which are in compliance with criteria established pursuant to Section 13521.

(b) This section applies to both of the following:

(1) New industrial facilities and subdivisions for which the building permit is issued on or after March 15, 1994, or, if a building permit is not required, new structures for which construction begins on or after March 15, 1994, for which the State Department of Health Services has approved the use of recycled water.

(2) Any structure that is retrofitted to permit the use of recycled water for floor traps, cooling towers, or air-conditioning devices, for which the State Department of Health Services has approved the use of recycled water.

(c) (1) Division 13 (commencing with Section 21000) of the Public Resources Code does not apply to any project which only involves the repiping, redesign, or use of recycled water for floor trap priming, cooling towers, or air-conditioning devices necessary to comply with a requirement prescribed by a public agency under subdivision (a).

(2) The exemption in paragraph (1) does not apply to any project to develop recycled water, to construct conveyance facilities for recycled water, or any other project not specified in this subdivision.

**13553. Legislative findings**

(a) The Legislature hereby finds and declares that the use of potable domestic water for toilet and urinal flushing in structures is a waste or an unreasonable use of water within the meaning of Section 2 of Article X of the California Constitution if recycled water, for these uses, is available to the user and meets the requirements set forth in Section 13550, as determined by the state board after notice and a hearing.

(b) The state board may require a public agency or person subject to this section to furnish whatever information may be relevant to making the determination required in subdivision (a).

(c) For the purposes of this section and Section 13554, "structure" or "structures" means commercial, retail, and office buildings, theaters, auditoriums, schools, hotels, apartments, barracks, dormitories, jails, prisons, and reformatories, and other structures as determined by the State Department of Health Services.

(d) Nothing in this section or Section 13554 applies to a pilot program adopted pursuant to Section 13553.1.

**13553.1. Legislative findings**

(a) The Legislature hereby finds and declares that certain coastal areas of the state have been using sea water to flush toilets and urinals as a means of conserving potable water; that this practice precludes the beneficial reuse of treated wastewater and has had a deleterious effect on the proper wastewater treatment process, and has led to corrosion of the sea water distribution pipelines and wastewater collection systems; and that this situation must be changed.

(b) There is a need for a pilot program to demonstrate that conversion to the use of recycled water in residential buildings for toilet and urinal flushing does not pose a threat to public health and safety.

(c) A city that is providing a separate distribution system for sea water for use in flushing toilets and urinals in residential structures may, by ordinance, authorize the use of recycled water for the flushing of toilets and urinals in residential structures if the level of treatment and the use of the recycled water meets the criteria set by the State Department of Health Services.

**13554. Recycled water for toilet and urinal flushing**

(a) Any public agency, including a state agency, city, county, city and county, district, or any other political subdivision of the state, may require the use of recycled water for toilet and urinal flushing in structures, except a mental hospital or other facility operated by a public agency for the treatment of persons with mental disorders, if all of the following requirements are met:

(1) Recycled water, for these uses, is available to the user and meets the requirements set forth in Section 13550, as determined by the state board after notice and a hearing.

(2) The use of recycled water does not cause any loss or diminution of any existing water right.

(3) The public agency has prepared an engineering report pursuant to Section 60323 of Title 22 of the California Code of Regulations that includes plumbing design, cross-connection control, and monitoring requirements for the use site, which are in compliance with criteria established pursuant to Section 13521.

(b) This section applies only to either of the following:

(1) New structures for which the building permit is issued on or after March 15, 1992, or, if a building permit is not required, new structures for which construction begins on or after March 15, 1992.

(2) Any construction pursuant to subdivision (a) for which the State Department of Health Services has, prior to January 1, 1992, approved the use of recycled water.

(c) Division 13 (commencing with Section 21000) of the Public Resources Code does not apply to any project which only involves the repiping, redesign, or use of recycled water by a structure necessary to comply with a requirement issued by a public agency under subdivision (a). This exemption does not apply to any project to develop recycled water, to construct conveyance facilities for recycled water, or any other project not specified in this subdivision.

**13554.2. DHS fees**

(a) Any person or entity proposing the use of recycled water shall reimburse the State Department of Health Services for reasonable costs that department actually incurs in performing duties pursuant to this chapter.

(b) (1) Upon a request from the person or entity proposing the use of recycled water, the State Department of Health Services shall, within a reasonable time after the receipt of the request, provide an estimate of the costs that it will reasonably incur in the performance of its duties pursuant to this chapter.

(2) For purposes of implementing subdivision (a), that department shall maintain a record of its costs. In determining those costs, that department may consider costs that include, but are not limited to, costs relating to personnel requirements, materials, travel, and office overhead. The amount of reimbursement shall be equal to, and may not exceed, that department's actual costs.

(c) With the consent of the person or entity proposing the use of recycled water, the State Department of Health Services may delegate all or part of the duties that department performs pursuant to this chapter within a county to a local health agency authorized by the board of supervisors to assume these duties, if, in the judgment of that department, the local health agency can perform these duties. Any person or entity proposing the use of recycled water shall reimburse the local health agency for reasonable costs that the local health agency actually incurs in the performance of its duties delegated pursuant to this subdivision.

(d) (1) Upon a request from the person or entity proposing the use of recycled water, the local health agency shall, within a reasonable time after the receipt of the request, provide an estimate of the cost it will reasonably incur in the performance of its duties delegated under subdivision (c).

(2) The local health agency, if delegated duties pursuant to subdivision (c), shall maintain a record of its costs that include, but is not limited to, costs relating to personnel requirements, materials, travel, and office overhead. The amount of reimbursement shall be equal to, and may not exceed, the local health agency's actual costs.

(e) The State Department of Health Services or local health agency shall complete its review of a proposed use of recycled water within a reasonable period of time. That department shall submit to the person or entity proposing the use of recycled water a written determination as to whether the proposal submitted is complete for purposes of review within 30 days from the date of receipt of the proposal and shall approve or disapprove the proposed use within 30 days from the date on which that department determines that the proposal is complete.

(f) An invoice for reimbursement of services rendered shall be submitted to the person or entity proposing the use of recycled water subsequent to completion of review of the

proposed use, or other services rendered, that specifies the number of hours spent by the State Department of Health Services or local health agency, specific tasks performed, and other costs actually incurred. Supporting documentation, including receipts, logs, timesheets, and other standard accounting documents, shall be maintained by that department or local health agency and copies, upon request, shall be provided to the person or entity proposing the use of recycled water.

(g) For the purposes of this section, "person or entity proposing the use of recycled water" means the producer or distributor of recycled water submitting a proposal to the department.

### **13554.3. State Board fees**

The State Water Resources Control Board may establish a reasonable schedule of fees by which it is reimbursed for the costs it incurs pursuant to Sections 13553 and 13554.

### **13555.2. Legislative intent**

The Legislature hereby finds and declares that many local agencies deliver recycled water for nonpotable uses and that the use of recycled water is an effective means of meeting the demands for new water caused by drought conditions or population increases in the state. It is the intent of the Legislature to encourage the design and construction of water delivery systems on private property that deliver water for both potable and nonpotable uses in separate pipelines.

### **13555.3. Separate pipelines**

(a) Water delivery systems on private property that could deliver recycled water for nonpotable uses described in Section 13550, that are constructed on and after January 1, 1993, shall be designed to ensure that the water to be used for only potable domestic uses is delivered, from the point of entry to the private property to be served, in a separate pipeline which is not used to deliver the recycled water.

(b) This section applies to water delivery systems on private property constructed within either of the following jurisdictions:

(1) One that has an urban water management plan that includes the intent to develop recycled water use.

(2) One that does not have an urban water management plan that includes recycled water use, but that is within five miles of a jurisdiction that does have an



urban water management plan that includes recycled water use, and has indicated a willingness to serve the water delivery system.

(c) This section does not preempt local regulation of the delivery of water for potable and nonpotable uses and any local governing body may adopt requirements which are more restrictive than the requirements of this section.

**13556. Acquisition and provision of recycled water for beneficial use**

In addition to any other authority provided in law, any water supplier described in subdivision (b) of Section 1745 may acquire, store, provide, sell, and deliver recycled water for any beneficial use, including, but not limited to, municipal, industrial, domestic, and irrigation uses, if the water use is in accordance with statewide recycling criteria and regulations established pursuant to this chapter.

**Chapter 7.5. Water Recycling Act of 1991**

**13575. Recycling Act title**

(a) This chapter shall be known and may be cited as the Water Recycling Act of 1991.

(b) As used in this chapter, the following terms have the following meanings:

(1) "Customer" means a person or entity that purchases water from a retail water supplier.

(2) "Entity responsible for groundwater replenishment" means any person or entity authorized by statute or court order to manage a groundwater basin and acquire water for groundwater replenishment.

(3) "Recycled water" has the same meaning as defined in subdivision (n) of Section 13050.

(4) "Recycled water producer" means any local public entity that produces recycled water.

(5) "Recycled water wholesaler" means any local public entity that distributes recycled water to retail water suppliers and which has constructed, or is constructing, a recycled water distribution system.

(6) "Retail water supplier" means any local entity, including a public agency, city, county, or private water company, that provides retail water service.

(7) "Retailer" means the retail water supplier in whose service area is located the property to which a customer requests the delivery of recycled water service.

**13576. Legislative findings**

The Legislature hereby makes the following findings and declarations:

- (a) The State of California is subject to periodic drought conditions.
- (b) The development of traditional water resources in California has not kept pace with the state's population, which is growing at the rate of over 700,000 per year and which is anticipated to reach 36 million by the year 2010.
- (c) There is a need for a reliable source of water for uses not related to the supply of potable water to protect investments in agriculture, greenbelts, and recreation and to replenish groundwater basins, and protect and enhance fisheries, wildlife habitat, and riparian areas.
- (d) The environmental benefits of recycled water include a reduced demand for water in the Sacramento-San Joaquin Delta which is otherwise needed to maintain water quality, reduced discharge of waste into the ocean, and the enhancement of groundwater basins, recreation, fisheries, and wetlands.
- (e) The use of recycled water has proven to be safe from a public health standpoint, and the State Department of Health Services is updating regulations for the use of recycled water.
- (f) The use of recycled water is a cost-effective, reliable method of helping to meet California's water supply needs.
- (g) The development of the infrastructure to distribute recycled water will provide jobs and enhance the economy of the state.
- (h) Retail water suppliers and recycled water producers and wholesalers should promote the substitution of recycled water for potable water and imported water in order to maximize the appropriate cost-effective use of recycled water in California.
- (i) Recycled water producers, retail water suppliers, and entities responsible for groundwater replenishment should cooperate in joint technical, economic, and

environmental studies, as appropriate, to determine the feasibility of providing recycled water service.

(j) Retail water suppliers and recycled water producers and wholesalers should be encouraged to enter into contracts to facilitate the service of recycled and potable water by the retail water suppliers in their service areas in the most efficient and cost-effective manner

(k) Recycled water producers and wholesalers and entities responsible for groundwater replenishment should be encouraged to enter into contracts to facilitate the use of recycled water for groundwater replenishment if recycled water is available and the authorities having jurisdiction approve its use.

(l) Wholesale prices set by recycled water producers and recycled water wholesalers, and rates that retail water suppliers are authorized to charge for recycled water, should reflect an equitable sharing of the costs and benefits associated with the development and use of recycled water.

#### **13577. Water recycling goal**

This chapter establishes a statewide goal to recycle a total of 700,000 acre-feet of water per year by the year 2000 and 1,000,000 acre-feet of water per year by the year 2010.

#### **13579. Identification of potential uses**

(a) In order to achieve the goals established in Section 13577, retail water suppliers shall identify potential uses for recycled water within their service areas, potential customers for recycled water service within their service areas, and, within a reasonable time, potential sources of recycled water.

(b) Recycled water producers and recycled water wholesalers may also identify potential uses for recycled water, and may assist retail water suppliers in identifying potential customers for recycled water service within the service areas of those retail water suppliers.

(c) Recycled water producers, retail water suppliers, and entities responsible for groundwater replenishment may cooperate in joint technical, economic, and environmental studies, as appropriate, to determine the feasibility of providing recycled water service and recycled water for groundwater replenishment consistent with the criteria set forth in paragraphs (1) to (3), inclusive, of subdivision (a) of Section 13550 and in accordance with Section 60320 of Title 22 of the California Code of Regulations.

**13580. Application for recycled water supply**

(a) A retail water supplier that has identified a potential use or customer pursuant to Section 13579 may apply to a recycled water producer or recycled water wholesaler for a recycled water supply.

(b) A recycled water producer or recycled water wholesaler that has identified a potential use or customer pursuant to Section 13579 may, in writing, request a retail water supplier to enter into an agreement to provide recycled water to the potential customer.

(c) A customer may request, in writing, a retailer to enter into an agreement to provide recycled water to the customer.

(d) (1) An entity responsible for groundwater replenishment that is a customer of a retail water supplier and that has identified the potential use of recycled water for groundwater replenishment purposes may, in writing, request that retail water supplier to enter into an agreement to provide recycled water for that purpose. That entity may not obtain recycled water for that purpose from a recycled water producer, a recycled water wholesaler, or another retail water supplier without the agreement of the entity's retail water supplier.

(2) An entity responsible for groundwater replenishment that is not a customer of a retail water supplier and that has identified the potential use of recycled water for groundwater replenishment purposes may, in writing, request a retail water supplier, a recycled water producer, or a recycled water wholesaler to enter into an agreement to provide recycled water for that purpose.

**13580.5. Agreements**

(a) (1) Subject to subdivision (e) of Section 13580.7, a retail water supplier that receives a request from a customer pursuant to subdivision (c) of Section 13580 shall enter into an agreement to provide recycled water, if recycled water is available, or can be made available, to the retail water supplier for sale to the customer.

(2) Notwithstanding paragraph (1), in accordance with a written agreement between a recycled water producer or a recycled water wholesaler and a retail water supplier, the retail water supplier may delegate to a recycled water producer or a recycled water wholesaler its responsibility under this section to provide recycled water.

(b) A customer may not obtain recycled water from a recycled water producer, a recycled water wholesaler, or a retail water supplier that is not the retailer without the agreement of the retailer.

(c) If either a recycled water producer or a recycled water wholesaler provides a customer of a retail water supplier with a written statement that it can and will provide recycled water to the retailer, the retail water supplier shall, not later than 120 days from the date on which the retail water supplier receives the written statement from the customer, by certified mail, return receipt requested, submit a written offer to the customer. A determination of availability pursuant to Section 13550 is not required.

(d) If the state board pursuant to Section 13550 makes a determination that there is available recycled water to serve a customer of a retail water supplier, the retail water supplier, not later than 120 days from the date on which the retail water supplier receives a copy of that determination from the customer, by certified mail, return receipt requested, shall submit a written offer to the customer.

#### **13580.7. Public Agency Retail Water Suppliers**

(a) This section applies only to a retail water supplier that is a public agency.

(b) A customer may request, in writing, a retail water supplier to enter into an agreement or adopt recycled water rates in order to provide recycled water service to the customer. The retail water supplier, by certified mail return receipt requested, shall submit a written offer to the customer not later than 120 days from the date on which the retail water supplier receives the written request from the customer.

(c) If no rate is in effect for recycled water service within the service area of a retail water supplier, the rate and conditions for recycled water service shall be established by contract between the retail water supplier and the customer, not later than 120 days from the date on which the customer requests a contract, or, by resolution or ordinance by the retail water supplier, not later than 120 days from the date on which the retail water supplier receives the customer's written request for an ordinance or resolution.

(d) A rate for recycled water service established by contract, ordinance, or resolution, shall reflect a reasonable relationship between the amount of the rate and the retail cost of obtaining or producing the recycled water, the cost of conveying the recycled water, and overhead expenses for providing recycled water service. Capital costs of facilities required to serve the customer shall be amortized over the economic life of the facility, or the length of time the customer agrees to purchase recycled water, whichever is less. The rate shall not exceed the estimated reasonable cost of providing the service, and

any additional costs agreed to by the customer for recycled water supplemental treatment.

(e) The rate for recycled water shall be comparable to, or less than, the retail water supplier's rate for potable water. If recycled water service cannot be provided at a rate comparable to, or less than, the rate for potable water, the retail water supplier is not required to provide the recycled water service, unless the customer agrees to pay a rate that reimburses the retail water supplier for the costs described in subdivision (c).

(f) The offer required by subdivisions (c) and (d) of Section 13580.5 shall identify all of the following:

- (1) The source for the recycled water.
- (2) The method of conveying the recycled water.
- (3) A schedule for delivery of the recycled water.
- (4) The terms of service.
- (5) The rate for the recycled water, including the per-unit cost for that water.
- (6) The costs necessary to provide service and the basis for determining those costs.

(g) This section does not apply to recycled water service rates established before January 1, 1999, or any amendments to those rates.

#### **13580.8. Retail water supplier regulated by the PUC**

(a) This section applies only to a retail water supplier that is regulated by the Public Utilities Commission.

(b) Rates for recycled water that is provided to the customer by a retail water supplier regulated by the Public Utilities Commission shall be established by the commission pursuant to Section 455.1 of the Public Utilities Code. A regulated water utility may request the commission to establish the rate or rates for the delivery of recycled or nonpotable water, with the objective of providing, where practicable, a reasonable economic incentive for the customer to purchase recycled or nonpotable water in place of potable water.

(c) A regulated water utility may propose a rate or rates for recycled or nonpotable water by tariff or by contract between the retail water supplier and the customer. Where the rate or rates are set by contract, the water utility and its customer shall meet, confer, and negotiate in good faith to establish a contract rate.

(d) The commission shall, as appropriate, provide a discount from the general metered rate of the water utility for potable water by either of the following means:

(1) Passing through to the customer the net reduction in cost to the water utility in purchasing and delivering recycled or nonpotable water as compared to the cost of purchasing and delivering potable water. (2) Granting to the customer a uniform discount from the water utility's general metered potable water rate when the discount in paragraph (1) is determined to be an insufficient incentive for the customer to convert to the use of recycled or nonpotable water. If the commission provides for a discount pursuant to this paragraph that is greater than the water utility's reduction in cost, the commission shall authorize the water utility to include the aggregate amount of that discount in its revenue requirements to be applied to, and recovered in, rates that are applicable to all general metered customers.

#### **13580.9. City of West Covina**

(a) Notwithstanding any other provision of law, and except as otherwise previously provided for in a contract agreed to by the customer and the City of West Covina, if the purchaser, contractor, or lessee of, or successor to, all or a portion of the water utility owned by the City of West Covina is a retail water supplier that is regulated by the Public Utilities Commission, rates for recycled or nonpotable water service to a closed hazardous waste and solid waste facility located within the boundaries of the City of West Covina for the purposes of irrigation, recreation, or dust suppression or any other use at that facility shall be established in accordance with subdivisions (a) to (e), inclusive, of Section 13580.7, and if there is a failure to agree on the terms and conditions of a recycled or nonpotable water supply agreement for the delivery of water for those purposes by that purchaser, contractor, lessee, or successor, Section 13581 shall apply.

(b) For the purpose of this section, nonpotable water that is not the result of the treatment of waste shall be treated as the equivalent of recycled water if it is suitable for a direct beneficial use or a controlled use that would not otherwise occur and is therefor considered a valuable resource, if the use of that water will not adversely affect downstream water rights, degrade water quality, or be injurious to plant life, fish, or wildlife, as provided by statute or by regulations of the State Department of Health Services and the state board or a regional board, as appropriate.

**13581. Formal mediation process**

(a) If there is a failure to agree on terms and conditions of a recycled water supply agreement involving a retail water supplier that is a public agency within 180 days from the date of the receipt of a request for recycled water pursuant to subdivision (c) of Section 13580, a written statement pursuant to subdivision (c) of Section 13580.5, or a determination of availability pursuant to subdivision (d) of Section 13580.5, any party may request a formal mediation process. The parties shall commence mediation within 60 days after the mediation request is made. If the parties cannot agree on a mediator, the director shall appoint a mediator. The mediator may recommend to the parties appropriate terms and conditions applicable to the service of recycled water. The cost for the services of the mediator shall be divided equally among the parties to the mediation and shall not exceed twenty thousand dollars (\$20,000).

(b) If the parties in mediation reach agreement, both parties together shall draft the contract for the recycled water service. The parties shall sign the contract within 30 days.

(c) If the parties in mediation fail to reach agreement, the affected retail water supplier shall, within 30 days, by resolution or ordinance, adopt a rate for recycled water service. The agency action shall be subject to validating proceedings pursuant to Chapter 9 (commencing with Section 860) of Part 2 of Title 10 of the Code of Civil Procedure, except that there shall not be a presumption in favor of the retail water supplier under the action taken to set the rate for recycled water service. The mediator shall file a report with the superior court setting forth the recommendations provided to the parties regarding appropriate terms and conditions applicable to the service of recycled water. Each party shall bear its own costs and attorney's fees.

**13581.2. Process for a retail water supplier regulated by the PUC**

If the retail water supplier is regulated by the Public Utilities Commission, and there is a failure to agree on terms and conditions of a recycle water supply agreement with a customer within 180 days from the date of the receipt of a request for recycled water pursuant to subdivision (c) of Section 13580, a written statement pursuant to subdivision (c) of Section 13580.5, or a determination of availability pursuant to subdivision (d) of Section 13580.5, the matter shall be submitted to the Public Utilities Commission for resolution, and the commission shall determine a contract rate or rates for recycled water as provided in Section 13580.8.



**13582. Construction of chapter**

This chapter is not intended to alter either of the following:

(a) Any rights, remedies, or obligations which may exist pursuant to Article 1.5 (commencing with Section 1210) of Chapter 1 of Part 2 of Division 2 of this code or Chapter 8.5 (commencing with Section 1501) of Part 1 of Division 1 of the Public Utilities Code.

(b) Any rates established or contracts entered into prior to January 1, 1999.

**13583. Noncompliance**

(a) If a retail water supplier that is a public agency does not comply with this chapter, the customer may petition a court for a writ of mandate pursuant to Chapter 2 (commencing with Section 1084) of Title 1 of Part 3 of the Code of Civil Procedure.

(b) If a retail water supplier is regulated by the Public Utilities Commission and does not comply with this chapter, the Public Utilities Commission may order the retailer to comply with this chapter after receiving a petition from the customer specifying the provisions of this chapter with which the retailer has failed to comply.

**Chapter 22. Graywater for Home Irrigation**

**14875. Application of chapter**

This chapter applies to the construction, installation, or alteration of graywater systems for subsurface irrigation and other safe uses.

**14875.1. Department Definition**

"Department" means the Department of Water Resources.

**14876. Graywater definition**

"Graywater" means untreated wastewater which has not been contaminated by any toilet discharge, has not been affected by infectious, contaminated, or unhealthy bodily wastes, and which does not present a threat from contamination by unhealthful processing, manufacturing, or operating wastes. Graywater includes wastewater from bathtubs, showers, bathroom washbasins, clothes washing machines, and laundry tubs but does not include wastewater from kitchen sinks or dishwashers.

**14877. Graywater system definition**

"Graywater system" means a system and devices, attached to the plumbing system for the sanitary distribution or use of graywater.

**14877.1. Consultation with DHS on standards**

(a) On or before January 1, 1997, the department, in consultation with the State Department of Health Services and the Center for Irrigation Technology at California State University, Fresno, shall adopt standards for the installation of graywater systems. In adopting these standards, the department shall consider, among other resources, "Appendix J," as adopted on September 29, 1992, by the International Association of Plumbing and Mechanical Officials, the graywater standard proposed for the latest edition of the Uniform Plumbing Code of the International Association of Plumbing and Mechanical Officials, the City of Los Angeles Graywater Pilot Project Final Report issued in November 1992, and the advice of the Center for Irrigation Technology at California State University, Fresno, on the installation depth for subsurface drip irrigation systems.

(b) The department shall include among the approved methods of subsurface irrigation, but shall not be limited to, drip systems.

(c) The department shall revise its graywater systems standards as needed.

**14877.2. Local administration**

A graywater system may be installed if the city or county having jurisdiction over the installation determines that the system complies with standards adopted by the department.

**14877.3. City or county—more stringent**

After a public hearing, a city or county may adopt, by ordinance, standards that prohibit the use of graywater or standards that are more restrictive than the standards adopted by the department, as appropriate for the local area.

## **Title 22 Code of Regulations**

### **DIVISION 4. ENVIRONMENTAL HEALTH CHAPTER 1. INTRODUCTION**

#### **ARTICLE 1. DEFINITIONS**

##### **60001. Department**

Whenever the term "department" is used in this division, it means the State Department of Health Services, unless otherwise specified.

##### **60003. Director**

Whenever the term "director" is used in this division, it means the Director, State Department of Health Services, unless otherwise specified.

### **CHAPTER 2. REGULATIONS FOR THE IMPLEMENTATION OF THE CALIFORNIA ENVIRONMENTAL QUALITY ACT**

#### **ARTICLE 1. GENERAL REQUIREMENTS AND CATEGORICAL EXEMPTIONS**

##### **60100. General requirements**

The Department of Health Services incorporates by reference the objectives, criteria, and procedures as delineated in Chapters 1, 2, 2.5, 2.6, 3, 4, 5, and 6, Division 13, Public Resources Code, Sections 21000 et seq., and the Guidelines for the Implementation of the California Environmental Quality Act, Title 14, Division 6, Chapter 3, California Administrative Code, Sections 15000 et seq.

##### **60101. Specific activities within categorical exempt classes**

The following specific activities are determined by the Department to fall within the classes of categorical exemptions set forth in Sections 15300 et seq. of Title 14 of the California Administrative Code:

- (a) Class 1: Existing Facilities.

(1) Any interior or exterior alteration of water treatment units, water supply systems, and pump station buildings where the alteration involves the addition, deletion, or modification of mechanical, electrical, or hydraulic controls.

(2) Maintenance, repair, replacement, or reconstruction to any water treatment process units, including structures, filters, pumps, and chlorinators.

(b) Class 2: Replacement or Reconstruction.

(1) Repair or replacement of any water service connections, meters, and valves for backflow prevention, air release, pressure regulating, shut-off and blow-off or flushing.

(2) Replacement or reconstruction of any existing water supply distribution lines, storage tanks and reservoirs of substantially the same size.

(3) Replacement or reconstruction of any water wells, pump stations and related appurtenances.

(c) Class 3: New Construction of Small Structures.

(1) Construction of any water supply and distribution lines of less than sixteen inches in diameter, and related appurtenances.

(2) Construction of any water storage tanks and reservoirs of less than 100,000 gallon capacity.

(d) Class 4: Minor Alterations to Land.

(1) Minor alterations to land, water, or vegetation on any officially existing designated wildlife management areas or fish production facilities for the purpose of reducing the environmental potential for nuisances or vector production.

(2) Any minor alterations to highway crossings for water supply and distribution lines.

**CHAPTER 3 WATER RECYCLING CRITERIA  
ARTICLE 1 DEFINITIONS**

**60301. Definitions**

**60301.100. Approved laboratory**

"Approved laboratory" means a laboratory that has been certified by the Department to perform microbiological analyses pursuant to section 116390, Health and Safety Code.

**60301.160. Coagulated wastewater**

"Coagulated wastewater" means oxidized wastewater in which colloidal and finely divided suspended matter have been destabilized and agglomerated upstream from a filter by the addition of suitable floc-forming chemicals.

**60301.170. Conventional treatment**

"Conventional treatment" means a treatment chain that utilizes a sedimentation unit process between the coagulation and filtration processes and produces an effluent that meets the definition for disinfected tertiary recycled water.

**60301.200. Direct beneficial use**

"Direct beneficial use" means the use of recycled water that has been transported from the point of treatment or production to the point of use without an intervening discharge to waters of the State.

**60301.220. Disinfected secondary-2.2 recycled water**

"Disinfected secondary-2.2 recycled water" means recycled water that has been oxidized and disinfected so that the median concentration of total coliform bacteria in the disinfected effluent does not exceed a most probable number (MPN) of 2.2 per 100 milliliters utilizing the bacteriological results of the last seven days for which analyses have been completed, and the number of total coliform bacteria does not exceed an MPN of 23 per 100 milliliters in more than one sample in any 30 day period.

**60301.225. Disinfected secondary-23 recycled water**

"Disinfected secondary-23 recycled water" means recycled water that has been oxidized and disinfected so that the median concentration of total coliform bacteria in the disinfected effluent does not exceed a most probable number (MPN) of 23 per 100

milliliters utilizing the bacteriological results of the last seven days for which analyses have been completed, and the number of total coliform bacteria does not exceed an MPN of 240 per 100 milliliters in more than one sample in any 30 day period.

**60301.230. Disinfected tertiary recycled water**

"Disinfected tertiary recycled water" means a filtered and subsequently disinfected wastewater that meets the following criteria:

(a) The filtered wastewater has been disinfected by either:

(1) A chlorine disinfection process following filtration that provides a CT (the product of total chlorine residual and modal contact time measured at the same point) value of not less than 450 milligram-minutes per liter at all times with a modal contact time of at least 90 minutes, based on peak dry weather design flow; or

(2) A disinfection process that, when combined with the filtration process, has been demonstrated to inactivate and/or remove 99.999 percent of the plaque-forming units of F-specific bacteriophage MS2, or polio virus in the wastewater. A virus that is at least as resistant to disinfection as polio virus may be used for purposes of the demonstration.

(b) The median concentration of total coliform bacteria measured in the disinfected effluent does not exceed an MPN of 2.2 per 100 milliliters utilizing the bacteriological results of the last seven days for which analyses have been completed and the number of total coliform bacteria does not exceed an MPN of 23 per 100 milliliters in more than one sample in any 30 day period. No sample shall exceed an MPN of 240 total coliform bacteria per 100 milliliters.

**60301.240. Drift**

"Drift" means the water that escapes to the atmosphere as water droplets from a cooling system.

**60301.245. Drift eliminator**

"Drift eliminator" means a feature of a cooling system that reduces to a minimum the generation of drift from the system.

**60301.250. Dual plumbed system**

"Dual plumbed system" or "dual plumbed" means a system that utilizes separate piping systems for recycled water and potable water within a facility and where the recycled water is used for either of the following purposes:

- (a) To serve plumbing outlets (excluding fire suppression systems) within a building or
- (b) Outdoor landscape irrigation at individual residences.

**60301.300. F-Specific bacteriophage MS-2**

"F-specific bacteriophage MS-2" means a strain of a specific type of virus that infects coliform bacteria that is traceable to the American Type Culture Collection (ATCC 15597B1) and is grown on lawns of *E. coli* (ATCC 15597).

**60301.310. Facility**

"Facility" means any type of building or structure, or a defined area of specific use that receives water for domestic use from a public water system as defined in section 116275 of the Health and Safety Code.

**60301.320. Filtered wastewater**

"Filtered wastewater" means an oxidized wastewater that meets the criteria in subsection (a) or (b):

(a) Has been coagulated and passed through natural undisturbed soils or a bed of filter media pursuant to the following:

(1) At a rate that does not exceed 5 gallons per minute per square foot of surface area in mono, dual or mixed media gravity, upflow or pressure filtration systems, or does not exceed 2 gallons per minute per square foot of surface area in traveling bridge automatic backwash filters; and

(2) So that the turbidity of the filtered wastewater does not exceed any of the following:

(A) An average of 2 NTU within a 24-hour period;

(B) 5 NTU more than 5 percent of the time within a 24-hour period; and

(C) 10 NTU at any time.

(b) Has been passed through a microfiltration, ultrafiltration, nanofiltration, or reverse osmosis membrane so that the turbidity of the filtered wastewater does not exceed any of the following:

- (1) 0.2 NTU more than 5 percent of the time within a 24-hour period; and
- (2) 0.5 NTU at any time.

**60301.330. Food crops**

"Food crops" means any crops intended for human consumption.

**60301.400. Hose bibb**

"Hose bibb" means a faucet or similar device to which a common garden hose can be readily attached.

**60301.550. Landscape impoundment**

"Landscape impoundment" means an impoundment in which recycled water is stored or used for aesthetic enjoyment or landscape irrigation, or which otherwise serves a similar function and is not intended to include public contact.

**60301.600. Modal contact time**

"Modal contact time" means the amount of time elapsed between the time that a tracer, such as salt or dye, is injected into the influent at the entrance to a chamber and the time that the highest concentration of the tracer is observed in the effluent from the chamber.

**60301.620. Nonrestricted recreational impoundment**

"Nonrestricted recreational impoundment" means an impoundment of recycled water, in which no limitations are imposed on body-contact water recreational activities.



**60301.630. NTU**

"NTU" (Nephelometric turbidity unit) means a measurement of turbidity as determined by the ratio of the intensity of light scattered by the sample to the intensity of incident light as measured by method 2130 B. in Standard Methods for the Examination of Water and Wastewater, 20th ed.; Eaton, A. D., Clesceri, L. S., and Greenberg, A. E., Eds; American Public Health Association: Washington, DC, 1995; p. 2-8.

**60301.650. Oxidized wastewater.**

"Oxidized wastewater" means wastewater in which the organic matter has been stabilized, is nonputrescible, and contains dissolved oxygen.

**60301.660. Peak dry weather design flow**

"Peak Dry Weather Design Flow" means the arithmetic mean of the maximum peak flow rates sustained over some period of time (for example three hours) during the maximum 24-hour dry weather period. Dry weather period is defined as periods of little or no rainfall.

**60301.700. Recycled wateragency.**

"Recycled water agency" means the public water system, or a publicly or privately owned or operated recycled water system, that delivers or proposes to deliver recycled water to a facility.

**60301.710. Recycling plant**

"Recycling plant" means an arrangement of devices, structures, equipment, processes and controls which produce recycled water.

**60301.740. Regulatory Agency**

"Regulatory agency" means the California Regional Water Quality Control Board(s) that have jurisdiction over the recycling plant and use areas.

**60301.750. Restricted access golf course**

"Restricted access golf course" means a golf course where public access is controlled so that areas irrigated with recycled water cannot be used as if they were part of a park, playground, or school yard and where irrigation is conducted only in areas and during periods when the golf course is not being used by golfers.

**60301.760. Restricted recreational impoundment**

"Restricted recreational impoundment" means an impoundment of recycled water in which recreation is limited to fishing, boating, and other non-body-contact water recreational activities.

**60301.800. Spray irrigation**

"Spray irrigation" means the application of recycled water to crops to maintain vegetation or support growth of vegetation by applying it from sprinklers.

**Section 60301.830. Standby Unit Process.**

"Standby unit process" means an alternate unit process or an equivalent alternative process which is maintained in operable condition and which is capable of providing comparable treatment of the actual flow through the unit for which it is a substitute.

**60301.900. Undisinfected secondary recycled water.**

"Undisinfected secondary recycled water" means oxidized wastewater.

**60301.920. Use area**

"Use area" means an area of recycled water use with defined boundaries. A use area may contain one or more facilities.

**ARTICLE 2. SOURCES OF RECYCLED WATER.**

**60302. Source specifications.**

The requirements in this chapter shall only apply to recycled water from sources that contain domestic waste, in whole or in part.

**ARTICLE 3. USES OF RECYCLED WATER.**

**60303. Exceptions**

The requirements set forth in this chapter shall not apply to the use of recycled water onsite at a water recycling plant, or wastewater treatment plant, provided access by the public to the area of onsite recycled water use is restricted.

**60304. Use of recycled water for irrigation**

(a) Recycled water used for the surface irrigation of the following shall be a disinfected tertiary recycled water, except that for filtration pursuant to Section 60301.320(a) coagulation need not be used as part of the treatment process provided that the filter effluent turbidity does not exceed 2 NTU, the turbidity of the influent to the filters is continuously measured, the influent turbidity does not exceed 5 NTU for more than 15 minutes and never exceeds 10 NTU, and that there is the capability to automatically activate chemical addition or divert the wastewater should the filter influent turbidity exceed 5 NTU for more than 15 minutes:

- (1) Food crops, including all edible root crops, where the recycled water comes into contact with the edible portion of the crop,
- (2) Parks and playgrounds,
- (3) School yards,
- (4) Residential landscaping,
- (5) Unrestricted access golf courses, and
- (6) Any other irrigation use not specified in this section and not prohibited by other sections of the California Code of Regulations.

(b) Recycled water used for the surface irrigation of food crops where the edible portion is produced above ground and not contacted by the recycled water shall be at least disinfected secondary-2.2 recycled water.

(c) Recycled water used for the surface irrigation of the following shall be at least disinfected secondary-2.3 recycled water:

- (1) Cemeteries,

- (2) Freeway landscaping,
  - (3) Restricted access golf courses,
  - (4) Ornamental nursery stock and sod farms where access by the general public is not restricted,
  - (5) Pasture for animals producing milk for human consumption, and
  - (6) Any nonedible vegetation where access is controlled so that the irrigated area cannot be used as if it were part of a park, playground or school yard
- (d) Recycled wastewater used for the surface irrigation of the following shall be at least undisinfected secondary recycled water:
- (1) Orchards where the recycled water does not come into contact with the edible portion of the crop,
  - (2) Vineyards where the recycled water does not come into contact with the edible portion of the crop,
  - (3) Non food-bearing trees (Christmas tree farms are included in this category provided no irrigation with recycled water occurs for a period of 14 days prior to harvesting or allowing access by the general public),
  - (4) Fodder and fiber crops and pasture for animals not producing milk for human consumption,
  - (5) Seed crops not eaten by humans,
  - (6) Food crops that must undergo commercial pathogen-destroying processing before being consumed by humans, and
  - (7) Ornamental nursery stock and sod farms provided no irrigation with recycled water occurs for a period of 14 days prior to harvesting, retail sale, or allowing access by the general public.
- (e) No recycled water used for irrigation, or soil that has been irrigated with recycled water, shall come into contact with the edible portion of food crops eaten raw by humans unless the recycled water complies with subsection (a).

**60305. Use of recycled water for impoundments.**

(a) Except as provided in subsection (b), recycled water used as a source of water supply for nonrestricted recreational impoundments shall be disinfected tertiary recycled water that has been subjected to conventional treatment.

(b) Disinfected tertiary recycled water that has not received conventional treatment may be used for nonrestricted recreational impoundments provided the recycled water is monitored for the presence of pathogenic organisms in accordance with the following:

(1) During the first 12 months of operation and use the recycled water shall be sampled and analyzed monthly for *Giardia*, enteric viruses, and *Cryptosporidium*. Following the first 12 months of use, the recycled water shall be sampled and analyzed quarterly for *Giardia*, enteric viruses, and *Cryptosporidium*. The ongoing monitoring may be discontinued after the first two years of operation with the approval of the department. This monitoring shall be in addition to the monitoring set forth in section 60321.

(2) The samples shall be taken at a point following disinfection and prior to the point where the recycled water enters the use impoundment. The samples shall be analyzed by an approved laboratory and the results submitted quarterly to the regulatory agency.

(c) The total coliform bacteria concentrations in recycled water used for nonrestricted recreational impoundments, measured at a point between the disinfection process and the point of entry to the use impoundment, shall comply with the criteria specified in section 60301.230 (b) for disinfected tertiary recycled water.

(d) Recycled water used as a source of supply for restricted recreational impoundments and for any publicly accessible impoundments at fish hatcheries shall be at least disinfected secondary-2.2 recycled water.

(e) Recycled water used as a source of supply for landscape impoundments that do not utilize decorative fountains shall be at least disinfected secondary-23 recycled water.

**60306. Use of recycled water for cooling**

(a) Recycled water used for industrial or commercial cooling or air conditioning that involves the use of a cooling tower, evaporative condenser, spraying or any mechanism that creates a mist shall be a disinfected tertiary recycled water.

(b) Use of recycled water for industrial or commercial cooling or air conditioning that does not involve the use of a cooling tower, evaporative condenser, spraying, or any mechanism that creates a mist shall be at least disinfected secondary-23 recycled water.

(c) Whenever a cooling system, using recycled water in conjunction with an air conditioning facility, utilizes a cooling tower or otherwise creates a mist that could come into contact with employees or members of the public, the cooling system shall comply with the following:

- (1) A drift eliminator shall be used whenever the cooling system is in operation.
- (2) A chlorine, or other, biocide shall be used to treat the cooling system recirculating water to minimize the growth of *Legionella* and other micro-organisms.

#### **60307. Use of recycled water for other purposes**

(a) Recycled water used for the following shall be disinfected tertiary recycled water, except that for filtration being provided pursuant to Section 60301.320(a) coagulation need not be used as part of the treatment process provided that the filter effluent turbidity does not exceed 2 NTU, the turbidity of the influent to the filters is continuously measured, the influent turbidity does not exceed 5 NTU for more than 15 minutes and never exceeds 10 NTU, and that there is the capability to automatically activate chemical addition or divert the wastewater should the filter influent turbidity exceed 5 NTU for more than 15 minutes:

- (1) Flushing toilets and urinals,
- (2) Priming drain traps,
- (3) Industrial process water that may come into contact with workers,
- (4) Structural fire fighting,
- (5) Decorative fountains,
- (6) Commercial laundries,
- (7) Consolidation of backfill around potable water pipelines,
- (8) Artificial snow making for commercial outdoor use, and

(9) Commercial car washes, including hand washes if the recycled water is not heated, where the general public is excluded from the washing process.

(b) Recycled water used for the following uses shall be at least disinfected secondary-23 recycled water:

- (1) Industrial boiler feed,
- (2) Nonstructural fire fighting,
- (3) Backfill consolidation around nonpotable piping,
- (4) Soil compaction,
- (5) Mixing concrete,
- (6) Dust control on roads and streets,
- (7) Cleaning roads, sidewalks and outdoor work areas and
- (8) Industrial process water that will not come into contact with workers.

(c) Recycled water used for flushing sanitary sewers shall be at least undisinfected secondary recycled water.

#### **ARTICLE 4. USE AREA REQUIREMENTS.**

##### **60310. Use area requirements**

(a) No irrigation with disinfected tertiary recycled water shall take place within 50 feet of any domestic water supply well unless all of the following conditions have been met:

- (1) A geological investigation demonstrates that an aquitard exists at the well between the uppermost aquifer being drawn from and the ground surface.
- (2) The well contains an annular seal that extends from the surface into the aquitard.
- (3) The well is housed to prevent any recycled water spray from coming into contact with the wellhead facilities.

- (4) The ground surface immediately around the wellhead is contoured to allow surface water to drain away from the well.
  - (5) The owner of the well approves of the elimination of the buffer zone requirement.
- (b) No impoundment of disinfected tertiary recycled water shall occur within 100 feet of any domestic water supply well.
- (c) No irrigation with, or impoundment of, disinfected secondary-2.2 or disinfected secondary-23 recycled water shall take place within 100 feet of any domestic water supply well.
- (d) No irrigation with, or impoundment of, undisinfected secondary recycled water shall take place within 150 feet of any domestic water supply well.
- (e) Any use of recycled water shall comply with the following:
- (1) Any irrigation runoff shall be confined to the recycled water use area, unless the runoff does not pose a public health threat and is authorized by the regulatory agency.
  - (2) Spray, mist, or runoff shall not enter dwellings, designated outdoor eating areas, or food handling facilities.
  - (3) Drinking water fountains shall be protected against contact with recycled water spray, mist, or runoff.
- (f) No spray irrigation of any recycled water, other than disinfected tertiary recycled water, shall take place within 100 feet of a residence or a place where public exposure could be similar to that of a park, playground, or school yard.
- (g) All use areas where recycled water is used that are accessible to the public shall be posted with signs that are visible to the public, in a size no less than 4 inches high by 8 inches wide, that include the following wording : "RECYCLED WATER - DO NOT DRINK". Each sign shall display an international symbol similar to that shown in figure 60310-A. The Department may accept alternative signage and wording, or an educational program, provided the applicant demonstrates to the Department that the alternative approach will assure an equivalent degree of public notification.



(h) Except as allowed under section 7604 of title 17, California Code of Regulations, no physical connection shall be made or allowed to exist between any recycled water system and any separate system conveying potable water.

(i) The portions of the recycled water piping system that are in areas subject to access by the general public shall not include any hose bibbs. Only quick couplers that differ from those used on the potable water system shall be used on the portions of the recycled water piping system in areas subject to public access.



Water Recycling Criteria  
FIGURE 60310-A

**ARTICLE 5. DUAL PLUMBED RECYCLED WATER SYSTEMS.**

**60313. General requirements.**

(a) No person other than a recycled water agency shall deliver recycled water to a dual-plumbed facility.

(b) No recycled water agency shall deliver recycled water for any internal use to any individually-owned residential units including free-standing structures, multiplexes, or condominiums.

(c) No recycled water agency shall deliver recycled water for internal use except for fire suppression systems, to any facility that produces or processes food products or beverages. For purposes of this Subsection, cafeterias or snack bars in a facility whose primary function does not involve the production or processing of foods or beverages are not considered facilities that produce or process foods or beverages.

(d) No recycled water agency shall deliver recycled water to a facility using a dual plumbed system unless the report required pursuant to section 13522.5 of the Water Code, and which meets the requirements set forth in section 60314, has been submitted to, and approved by, the regulatory agency.

**60314. Report submittal**

(a) For dual-plumbed recycled water systems, the report submitted pursuant to section 13522.5 of the Water Code shall contain the following information in addition to the information required by section 60323:

(1) A detailed description of the intended use area identifying the following:

(A) The number, location, and type of facilities within the use area proposing to use dual plumbed systems,

(B) The average number of persons estimated to be served by each facility on a daily basis,

(C) The specific boundaries of the proposed use area including a map showing the location of each facility to be served,

(D) The person or persons responsible for operation of the dual plumbed system at each facility, and

(E) The specific use to be made of the recycled water at each facility.

(2) Plans and specifications describing the following:

(A) Proposed piping system to be used,

(B) Pipe locations of both the recycled and potable systems,

(C) Type and location of the outlets and plumbing fixtures that will be accessible to the public, and

(D) The methods and devices to be used to prevent backflow of recycled water into the public water system.

(3) The methods to be used by the recycled water agency to assure that the installation and operation of the dual plumbed system will not result in cross connections between the recycled water piping system and the potable water piping system. This shall include a description of pressure, dye or other test methods to be used to test the system every four years.

(b) A master plan report that covers more than one facility or use site may be submitted provided the report includes the information required by this section. Plans and specifications for individual facilities covered by the report may be submitted at any time prior to the delivery of recycled water to the facility.

#### **60315. Design requirements**

The public water supply shall not be used as a backup or supplemental source of water for a dual-plumbed recycled water system unless the connection between the two systems is protected by an air gap separation which complies with the requirements of sections 7602 (a) and 7603 (a) of title 17, California Code of Regulations, and the approval of the public water system has been obtained.

#### **60316. Operation requirements**

(a) Prior to the initial operation of the dual-plumbed recycled water system and annually thereafter, the Recycled Water Agency shall ensure that the dual plumbed system within each facility and use area is inspected for possible cross connections with the potable water system. The recycled water system shall also be tested for possible cross connections at least once every four years. The testing shall be conducted in accordance with the method described in the report submitted pursuant to section 60314. The inspections and the testing shall be performed by a cross connection

control specialist certified by the California-Nevada section of the American Water Works Association or an organization with equivalent certification requirements. A written report documenting the result of the inspection or testing for the prior year shall be submitted to the department within 30 days following completion of the inspection or testing.

(b) The recycled water agency shall notify the department of any incidence of backflow from the dual-plumbed recycled water system into the potable water system within 24 hours of the discovery of the incident.

(c) Any backflow prevention device installed to protect the public water system serving the dual-plumbed recycled water system shall be inspected and maintained in accordance with section 7605 of Title 17, California Code of Regulations.

## **ARTICLE 5.1. GROUNDWATER RECHARGE**

### **60320. Groundwater recharge**

(a) Reclaimed water used for groundwater recharge of domestic water supply aquifers by surface spreading shall be at all times of a quality that fully protects public health. The State Department of Health Services' recommendations to the Regional Water Quality Control Boards for proposed groundwater recharge projects and for expansion of existing projects will be made on an individual case basis where the use of reclaimed water involves a potential risk to public health.

(b) The State Department of Health Services' recommendations will be based on all relevant aspects of each project, including the following factors: treatment provided; effluent quality and quantity; spreading area operations; soil characteristics; hydrogeology; residence time; and distance to withdrawal.

(c) The State Department of Health Services will hold a public hearing prior to making the final determination regarding the public health aspects of each groundwater recharge project. Final recommendations will be submitted to the Regional Water Quality Control Board in an expeditious manner.

## **ARTICLE 5.5. OTHER METHODS OF TREATMENT**

### **60320.5. Other methods of treatment**

Methods of treatment other than those included in this chapter and their reliability features may be accepted if the applicant demonstrates to the satisfaction of the State Department of Health that the methods of treatment and reliability features will assure an equal degree of treatment and reliability.

## **ARTICLE 6. SAMPLING AND ANALYSIS**

### **60321. Sampling and analysis**

- (a) Disinfected secondary-23, disinfected secondary-2.2, and disinfected tertiary recycled water shall be sampled at least once daily for total coliform bacteria. The samples shall be taken from the disinfected effluent and shall be analyzed by an approved laboratory.
- (b) Disinfected tertiary recycled water shall be continuously sampled for turbidity using a continuous turbidity meter and recorder following filtration. Compliance with the daily average operating filter effluent turbidity shall be determined by averaging the levels of recorded turbidity taken at four-hour intervals over a 24-hour period. Compliance with turbidity pursuant to section 60301.320 (a)(2)(B) and (b)(1) shall be determined using the levels of recorded turbidity taken at intervals of no more than 1.2-hours over a 24-hour period. Should the continuous turbidity meter and recorder fail, grab sampling at a minimum frequency of 1.2-hours may be substituted for a period of up to 24-hours. The results of the daily average turbidity determinations shall be reported quarterly to the regulatory agency.
- (c) The producer or supplier of the recycled water shall conduct the sampling required in subsections (a) and (b).

## **ARTICLE 7. ENGINEERING REPORT AND OPERATIONAL REQUIREMENTS**

### **60323. Engineering report**

- (a) No person shall produce or supply reclaimed water for direct reuse from a proposed water reclamation plant unless he files an engineering report.

(b) The report shall be prepared by a properly qualified engineer registered in California and experienced in the field of wastewater treatment, and shall contain a description of the design of the proposed reclamation system. The report shall clearly indicate the means for compliance with these regulations and any other features specified by the regulatory agency.

(c) The report shall contain a contingency plan which will assure that no untreated or inadequately treated wastewater will be delivered to the use area.

**60325. Personnel**

(a) Each reclamation plant shall be provided with a sufficient number of qualified personnel to operate the facility effectively so as to achieve the required level of treatment at all times.

(b) Qualified personnel shall be those meeting requirements established pursuant to Chapter 9 (commencing with Section 13625) of the Water Code.

**60327. Maintenance**

A preventive maintenance program shall be provided at each reclamation plant to ensure that all equipment is kept in a reliable operating condition.

**60329. Operating records and reports**

(a) Operating records shall be maintained at the reclamation plant or a central depository within the operating agency. These shall include: all analyses specified in the reclamation criteria; records of operational problems, plant and equipment breakdowns, and diversions to emergency storage or disposal; all corrective or preventive action taken.

(b) Process or equipment failures triggering an alarm shall be recorded and maintained as a separate record file. The recorded information shall include the time and cause of failure and corrective action taken.

(c) A monthly summary of operating records as specified under (a) of this section shall be filed monthly with the regulatory agency.

(d) Any discharge of untreated or partially treated wastewater to the use area, and the cessation of same, shall be reported immediately by telephone to the regulatory agency, the State Department of Health, and the local health officer.

**60331. Bypass**

There shall be no bypassing of untreated or partially treated wastewater from the reclamation plant or any intermediate unit processes to the point of use.

**ARTICLE 8. GENERAL REQUIREMENTS OF DESIGN**

**60333. Flexibility of design**

The design of process piping, equipment arrangement, and unit structures in the reclamation plant must allow for efficiency and convenience in operation and maintenance and provide flexibility of operation to permit the highest possible degree of treatment to be obtained under varying circumstances.

**60335. Alarms**

(a) Alarm devices required for various unit processes as specified in other sections of these regulations shall be installed to provide warning of:

- (1) Loss of power from the normal power supply.
- (2) Failure of a biological treatment process.
- (3) Failure of a disinfection process.
- (4) Failure of a coagulation process.
- (5) Failure of a filtration process.
- (6) Any other specific process failure for which warning is required by the regulatory agency.

(b) All required alarm devices shall be independent of the normal power supply of the reclamation plant.

(c) The person to be warned shall be the plant operator, superintendent, or any other responsible person designated by the management of the reclamation plant and capable of taking prompt corrective action.

(d) Individual alarm devices may be connected to a master alarm to sound at a location where it can be conveniently observed by the attendant. In case the reclamation plant is



not attended full time, the alarm(s) shall be connected to sound at a police station, fire station or other full time service unit with which arrangements have been made to alert the person in charge at times that the reclamation plant is unattended.

**60337. Power supply**

The power supply shall be provided with one of the following reliability features:

- (a) Alarm and standby power source.
- (b) Alarm and automatically actuated short-term retention or disposal provisions as specified in Section 60341.
- (c) Automatically actuated long-term storage or disposal provisions as specified in Section 60341.

**ARTICLE 9. RELIABILITY REQUIREMENTS FOR PRIMARY EFFLUENT**

**60339. Primary treatment**

Reclamation plants producing reclaimed water exclusively for uses for which primary effluent is permitted shall be provided with one of the following reliability features:

- (a) Multiple primary treatment units capable of producing primary effluent with one unit not in operation.
- (b) Long-term storage or disposal provisions as specified in Section 60341.

*Note: Use of primary effluent for recycled water is no longer allowed. [repeal of Section 60309, effective December 2000]*

**ARTICLE 10. RELIABILITY REQUIREMENTS FOR FULL TREATMENT**

**60341. Emergency storage or disposal**

(a) Where short-term retention or disposal provisions are used as a reliability feature, these shall consist of facilities reserved for the purpose of storing or disposing of untreated or partially treated wastewater for at least a 24-hour period. The facilities shall include all the necessary diversion devices, provisions for odor control, conduits, and pumping and pump back equipment. All of the equipment other than the pump back

equipment shall be either independent of the normal power supply or provided with a standby power source.

(b) Where long-term storage or disposal provisions are used as a reliability feature, these shall consist of ponds, reservoirs, percolation areas, downstream sewers leading to other treatment or disposal facilities or any other facilities reserved for the purpose of emergency storage or disposal of untreated or partially treated wastewater. These facilities shall be of sufficient capacity to provide disposal or storage of wastewater for at least 20 days, and shall include all the necessary diversion works, provisions for odor and nuisance control, conduits, and pumping and pump back equipment. All of the equipment other than the pump back equipment shall be either independent of the normal power supply or provided with a standby power source.

(c) Diversion to a less demanding reuse is an acceptable alternative to emergency disposal of partially treated wastewater provided that the quality of the partially treated wastewater is suitable for the less demanding reuse.

(d) Subject to prior approval by the regulatory agency, diversion to a discharge point which requires lesser quality of wastewater is an acceptable alternative to emergency disposal of partially treated wastewater.

(e) Automatically actuated short-term retention or disposal provisions and automatically actuated long-term storage or disposal provisions shall include, in addition to provisions of (a), (b), (c), or (d) of this section, all the necessary sensors, instruments, valves and other devices to enable fully automatic diversion of untreated or partially treated wastewater to approved emergency storage or disposal in the event of failure of a treatment process and a manual reset to prevent automatic restart until the failure is corrected.

#### **60343. Primary treatment**

All primary treatment unit processes shall be provided with one of the following reliability features:

(a) Multiple primary treatment units capable of producing primary effluent with one unit not in operation.

(b) Standby primary treatment unit process.

(c) Long-term storage or disposal provisions.

**60345. Biological treatment**

All biological treatment unit processes shall be provided with one of the following reliability features:

- (a) Alarm and multiple biological treatment units capable of producing oxidized wastewater with one unit not in operation.
- (b) Alarm, short-term retention or disposal provisions, and standby replacement equipment.
- (c) Alarm and long-term storage or disposal provisions.
- (d) Automatically actuated long-term storage or disposal provisions.

**60347. Secondary sedimentation**

All secondary sedimentation unit processes shall be provided with one of the following reliability features:

- (a) Multiple sedimentation units capable of treating the entire flow with one unit not in operation.
- (b) Standby sedimentation unit process.
- (c) Long-term storage or disposal provisions.

**60349. Coagulation**

(a) All coagulation unit processes shall be provided with the following mandatory features for uninterrupted coagulant feed:

- (1) Standby feeders,
- (2) Adequate chemical stowage and conveyance facilities,
- (3) Adequate reserve chemical supply, and
- (4) Automatic dosage control.

(b) All coagulation unit processes shall be provided with one of the following reliability features:

- (1) Alarm and multiple coagulation units capable of treating the entire flow with one unit not in operation;
- (2) Alarm, short-term retention or disposal provisions, and standby replacement equipment;
- (3) Alarm and long-term storage or disposal provisions;
- (4) Automatically actuated long-term storage or disposal provisions, or
- (5) Alarm and standby coagulation process.

#### **60351. Filtration**

All filtration unit processes shall be provided with one of the following reliability features:

- (a) Alarm and multiple filter units capable of treating the entire flow with one unit not in operation.
- (b) Alarm, short-term retention or disposal provisions and standby replacement equipment.
- (c) Alarm and long-term storage or disposal provisions.
- (d) Automatically actuated long-term storage or disposal provisions.
- (e) Alarm and standby filtration unit process.

#### **Section 60353. Disinfection**

(a) All disinfection unit processes where chlorine is used as the disinfectant shall be provided with the following features for uninterrupted chlorine feed:

- (1) Standby chlorine supply,
- (2) Manifold systems to connect chlorine cylinders,

- (3) Chlorine scales, and
- (4) Automatic devices for switching to full chlorine cylinders.

Automatic residual control of chlorine dosage, automatic measuring and recording of chlorine residual, and hydraulic performance studies may also be required.

(b) All disinfection unit processes where chlorine is used as the disinfectant shall be provided with one of the following reliability features:

- (1) Alarm and standby chlorinator;
- (2) Alarm, short-term retention or disposal provisions, and standby replacement equipment;
- (3) Alarm and long-term storage or disposal provisions;
- (4) Automatically actuated long-term storage or disposal provisions; or
- (5) Alarm and multiple point chlorination, each with independent power source, separate chlorinator, and separate chlorine supply.

#### **60355. Other alternatives to reliability requirements**

Other alternatives to reliability requirements set forth in Articles 8 to 10 may be accepted if the applicant demonstrates to the satisfaction of the State Department of Health that the proposed alternative will assure an equal degree of reliability.

## Title 17 Code of Regulations

**DIVISION 1. STATE DEPARTMENT OF HEALTH SERVICES  
CHAPTER 5. SANITATION (ENVIRONMENTAL)  
GROUP 4. DRINKING WATER SUPPLIES  
ARTICLE 1. GENERAL**

### **7583. Definitions**

In addition to the definitions in Section 4010.1 of the Health and Safety Code, the following terms are defined for the purpose of this Chapter

- (a) "Approved Water Supply" is a water supply whose potability is regulated by a State or local health agency.
- (b) "Auxiliary Water Supply" is any water supply other than that received from a public water system.
- (c) "Air-gap Separation (AG)" is a physical break between the supply line and a receiving vessel.
- (d) "AWWA Standard" is an official standard developed and approved by the American Water Works Association (AWWA).
- (e) "Cross-Connection" is an unprotected actual or potential connection between a potable water system used to supply water for drinking purposes and any source or system containing unapproved water or a substance that is not or cannot be approved as safe, wholesome, and potable. By-pass arrangements, jumper connections, removable sections, swivel or changeover devices, or other devices through which backflow could occur, shall be considered to be cross-connections.
- (f) "Double Check Valve Assembly (DC)" is an assembly of at least two independently acting check valves including tightly closing shut-off valves on each side of the check valve assembly and test cocks available for testing the watertightness of each check valve.
- (g) "Health Agency" means the California Department of Health Services, or the local health officer with respect to a small water system.
- (h) "Local Health Agency" means the county or city health authority.

- (i) "Reclaimed Water" is a wastewater which as a result of treatment is suitable for uses other than potable use.
- (j) "Reduced Pressure Principle Backflow Prevention Device (RP)" is a backflow preventer incorporating not less than two check valves, an automatically operated differential relief valve located between the two check valves, a tightly closing shut-off valve on each side of the check valve assembly, and equipped with necessary test cocks for testing.
- (k) "User Connection" is the point of connection of a user's piping to the water supplier's facilities.
- (l) "Water Supplier" is the person who owns or operates the public water system.
- (m) "Water User" is any person obtaining water from a public water supply.

#### **7584. Responsibility and scope of program**

The water supplier shall protect the public water supply from contamination by implementation of a cross-connection control program. The program, or any portion thereof, may be implemented directly by the water supplier or by means of a contract with the local health agency, or with another agency approved by the health agency. The water supplier's cross-connection control program shall for the purpose of addressing the requirements of Sections 7585 through 7605 include, but not be limited to, the following elements:

- (a) The adoption of operating rules or ordinances to implement the cross-connection program.
- (b) The conducting of surveys to identify water user premises where cross-connections are likely to occur,
- (c) The provisions of backflow protection by the water user at the user's connection or within the user's premises or both,
- (d) The provision of at least one person trained in cross-connection control to carry out the cross-connection program,
- (e) The establishment of a procedure or system for testing backflow preventers, and
- (f) The maintenance of records of locations, tests, and repairs of backflow preventers.

#### **7585. Evaluation of hazard**

The water supplier shall evaluate the degree of potential health hazard to the public water supply which may be created as a result of conditions existing on a user's premises. The water supplier, however, shall not be responsible for abatement of cross-connections which may exist within a user's premises. As a minimum, the evaluation should consider: the existence of cross-connections, the nature of materials handled on the property, the probability of a backflow occurring, the degree of piping system complexity and the potential for piping system modification. Special consideration shall be given to the premises of the following types of water users:

- (a) Premises where substances harmful to health are handled under pressure in a manner which could permit their entry into the public water system. This includes chemical or biological process waters and water from public water supplies which have deteriorated in sanitary quality.
- (b) Premises having an auxiliary water supply, unless the auxiliary supply is accepted as an additional source by the water supplier and is approved by the health agency.
- (c) Premises that have internal cross-connections that are not abated to the satisfaction of the water supplier or the health agency.
- (d) Premises where cross-connections are likely to occur and entry is restricted so that cross-connection inspections cannot be made with sufficient frequency or at sufficiently short notice to assure that cross-connections do not exist.
- (e) Premises having a repeated history of cross-connections being established or re-established.

#### **7586. User supervisor**

The health agency and water supplier may, at their discretion, require an industrial water user to designate a user supervisor when the water user's premises has a multipiping system that convey various types of fluids, some of which may be hazardous and where changes in the piping system are frequently made. The user supervisor shall be responsible for the avoidance of cross-connections during the installation, operation and maintenance of the water user's pipelines and equipment.



## **ARTICLE 2. PROTECTION OF WATER SYSTEM**

### **7601. Approval of backflow preventers**

Backflow preventers required by this Chapter shall have passed laboratory and field evaluation tests performed by a recognized testing organization which has demonstrated their competency to perform such tests to the Department.

### **7602. Construction of backflow preventers**

(a) Air-gap Separation. An Air-gap separation (AG) shall be at least double the diameter of the supply pipe, measured vertically from the flood rim of the receiving vessel to the supply pipe; however, in no case shall this separation be less than one inch.

(b) Double Check Valve Assembly. A required double check valve assembly (DC) shall, as a minimum, conform to the AWWA Standard C506-78 (R83) adopted on January 28, 1978 for Double Check Valve Type Backflow Preventive Devices which is herein incorporated by reference.

(c) Reduced Pressure Principle Backflow Prevention Device. A required reduced pressure principle backflow prevention device (RP) shall, as a minimum, conform to the AWWA Standard C506-78 (R83) adopted on January 28, 1978 for Reduced Pressure Principle Type Backflow Prevention Devices which is herein incorporated by reference.

### **7603. Location of backflow preventers**

(a) Air-gap Separation. An air-gap separation shall be located as close as practical to the user's connection and all piping between the user's connection and the receiving tank shall be entirely visible unless otherwise approved in writing by the water supplier and the health agency.

(b) Double Check Valve Assembly. A double check valve assembly shall be located as close as practical to the user's connection and shall be installed above grade, if possible, and in a manner where it is readily accessible for testing and maintenance.

(c) Reduced Pressure Principle Backflow Prevention Device. A reduced pressure principle backflow prevention device shall be located as close as practical to the user's connection and shall be installed a minimum of twelve inches (12") above grade and not more than thirty-six inches (36") above grade measured from the bottom of the device and with a minimum of twelve inches (12") side clearance.

**7604. Type of protection required.**

The type of protection that shall be provided to prevent backflow into the public water supply shall be commensurate with the degree of hazard that exists on the consumer's premises. The type of protective device that may be required (listed in an increasing level of protection) includes: Double check Valve Assembly--(DC), Reduced Pressure Principle Backflow Prevention Device--(RP) and an Air gap Separation--(AG). The water user may choose a higher level of protection than required by the water supplier. The minimum types of backflow protection required to protect the public water supply, at the water user's connection to premises with various degrees of hazard, are given in Table 1. Situations not covered in Table 1 shall be evaluated on a case-by-case basis and the appropriate backflow protection shall be determined by the water supplier or health agency.

TABLE 1  
 TYPE OF BACKFLOW PROTECTION REQUIRED

Degree of Hazard	Minimum Type of Backflow Prevention
(a) Sewage and Hazardous Substances	
(1) Premises where there are waste water pumping and/or treatment plants and there is no interconnection with the potable water system. This does not include a single-family residence that has a sewage lift pump. A RP be provided in lieu of an AG if approved by the health agency and water supplier.	AG
(2) Premises where hazardous substances are handled in any manner in which the substances may enter the potable water system. This does not include a single-family residence that has a sewage lift pump. A RP may be provided in lieu of an AG if approved by the health agency and water supplier.	AG
(3) Premises where there are irrigation systems into which fertilizers, herbicides, or pesticides are, or can be, injected.	RP
(b) Auxiliary Water Supplies	
(1) Premises where there is an unapproved auxiliary water supply which is interconnected with the public water system. A RP or DC may be provided in lieu of an AG if approved by the health agency and water supplier.	AG
(2) Premises where there is an unapproved auxiliary RP water supply and there are no interconnections with the public water system. A DC may be provided in lieu of a RP if approved by the health agency and water supplier.	RP

(c) Recycled water

(1) Premises where the public water system is used to supplement the recycled water supply. AG

(2) Premises where recycled water is used, other than as allowed in paragraph (3), and there is no interconnection with the potable water system. RP

(3) Residences using recycled water for landscape irrigation as part of an approved dual plumbed use area established pursuant to sections 60313 through 60316 unless the recycled water supplier obtains approval of the local public water supplier, or the Department if the water supplier is also the supplier of the recycled water, to utilize an alternative backflow protection plan that includes an annual inspection and annual shutdown test of the recycled water and potable water systems pursuant to subsection 60316(a). DC

(d) Fire Protection Systems

(1) Premises where the fire system is directly supplied from the public water system and there is an unapproved auxiliary water supply on or to the premises (not interconnected). DC

(2) Premises where the fire system is supplied from the public water system and interconnected with an unapproved auxiliary water supply. A RP may be provided in lieu of an AG if approved by the health agency and water supplier. AG

(3) Premises where the fire system is supplied from the public water system and where either elevated storage tanks or fire pumps which take suction from private reservoirs or tanks are used. DC

(4) Premises where the fire system is supplied from the public water system and where recycled water is used in a separate piping system within the same building. DC

(e) Dockside Watering Points and Marine Facilities

(1) Pier hydrants for supplying water to vessels for any purpose. RP

(2) Premises where there are marine facilities. RP

(f) Premises where entry is restricted so that inspections for cross-connections cannot be made with sufficient frequency or at sufficiently short notice to assure that do not exist. RP

(g) Premises where there is a repeated history of cross-connections being established or re-established. RP

**Section 7605. Testing and maintenance of backflow preventers**

(a) The water supplier shall assure that adequate maintenance and periodic testing are provided by the water user to ensure their proper operation.

(b) Backflow preventers shall be tested by persons who have demonstrated their competency in testing of these devices to the water supplier or health agency.

(c) Backflow preventers shall be tested at least annually or more frequently if determined to be necessary by the health agency or water supplier. When devices are found to be defective, they shall be repaired or replaced in accordance with the provisions of this Chapter.

(d) Backflow preventers shall be tested immediately after they are installed, relocated or repaired and not placed in service unless they are functioning as required.

(e) The water supplier shall notify the water user when testing of backflow preventers is needed. The notice shall contain the date when the test must be completed.

(f) Reports of testing and maintenance shall be maintained by the water supplier for a minimum of three years.

\* \* \* \* \*

APPENDIX B

## Guidelines for Preparing an Engineering Report



DEPARTMENT OF HEALTH SERVICES  
DIVISION OF DRINKING WATER AND ENVIRONMENTAL MANAGEMENT  
DRINKING WATER PROGRAM  
RECYCLED WATER UNIT



**GUIDELINES FOR THE  
PREPARATION OF AN ENGINEERING REPORT  
FOR THE PRODUCTION, DISTRIBUTION AND USE OF RECYCLED WATER**

**March 2001**

(Replaces September 1997 Version)

**1.0 INTRODUCTION**

The current State of California Water Recycling Criteria (adopted in December 2000) require the submission of an engineering report to the California Regional Water Quality Control Board (RWQCB) and the Department of Health Services (DHS) before recycled water projects are implemented. These reports must also be amended prior to any modification to existing projects. The purpose of an engineering report is to describe the manner by which a project will comply with the Water Recycling Criteria. The Water Recycling Criteria are contained in Sections 60301 through 60355, inclusive, of the California Code of Regulations, Title 22. The Criteria prescribe:

- \* Recycled water quality and wastewater treatment requirements for the various types of allowed uses,
- \* Use area requirements pertaining to the actual location of use of the recycled water (including dual plumbed facilities), and
- \* Reliability features required in the treatment facilities to ensure safe performance.

Section 60323 of the Water Recycling Criteria specifies that the engineering report be prepared by a properly qualified engineer, registered in California and experienced in the field of wastewater treatment.

Recycled water projects vary in complexity. Therefore, reports will vary in content, and the detail presented will depend on the scope of the proposed project and the number and nature of the agencies involved in the production, distribution, and use of the recycled water. The report should contain sufficient information



to assure the regulatory agencies that the degree and reliability of treatment is commensurate with the requirements for the proposed use, and that the distribution and use of the recycled water will not create a health hazard or nuisance.

The intent of these guidelines is to provide a framework to assist in developing a comprehensive report which addresses all necessary elements of a proposed or modified project. Such a report is necessary to allow for the required regulatory review and approval of a recycled water project.

References which may assist in addressing various project elements include:

- State of California Water Recycling Criteria (December 2000)
- State of California Regulations Relating to Cross-Connections
- California Waterworks Standards
- California Water Code
- Guidelines for the Distribution of Non-potable Water, (California-Nevada Section-AWWA, 1992)
- Guidelines For The On-Site Retrofit of Facilities Using Disinfected Tertiary Recycled Water (California-Nevada Section-AWWA, 1997)
- Manual of Cross-Connection Control/Procedures and Practices (DOHS)
- Ultraviolet Disinfection - Guidelines for Drinking Water and Water Reuse (NWRI/AWWARF, December 2000)

## **2.0 RECYCLED WATER PROJECT**

The following sections discuss the type of information that should be presented and described in the engineering report. Some sections may be applicable only to certain types of uses.

### **2.1 General**

The report shall identify all agencies or entities that will be involved in the design, treatment, distribution, construction, operation and maintenance of the recycled facilities, including a description of any legal arrangements outlining authorities and responsibilities between the

agencies with respect to treatment, distribution and use of recycled water. In areas where more than one agency/entity is involved in the reuse project, a description of arrangements for coordinating all reuse-related activities (e.g. line construction/repairs) shall be provided. An organizational chart may be useful.

## **2.2 Rules and Regulations**

The procedures, restrictions, and other requirements that will be imposed by the distributor and/or user should be described. In multiple projects covered under a Master Permit issued by the Regional Boards where the reuse oversight responsibility is delegated to the distributor and/or user, the requirements and restrictions should be codified into a set of enforceable rules and regulations. The rules and regulations should include a compliance program to be used to protect the public health and prevent cross connections. Describe in the report the adoption of enforceable rules and regulations that cover all of the design and construction, operation and maintenance of the distribution systems and use areas, as well as use area control measures. Provide a description of the organization of the agency or agencies who has the authority to implement and enforce the rules and regulations, and the responsibilities of pertinent personnel involved in the reuse program. Reference to any ordinances, rules of service, contractual arrangements, etc. should be provided.

## **2.3 Producer - Distributor - User**

The producer is the public or private entity that will treat and/or distribute the recycled water used in the project. Where more than one entity is involved in the treatment or distribution of the recycled water, the roles and responsibilities of each entity (i.e. producer, distributor, user) should be described.

## **2.4 Raw Wastewater**

Describe the chemical quality, including ranges with median and 95th percentile values;

Describe the source of the wastewater to be used and the proportion and types of industrial waste, and

Describe all source control programs.

## **2.5 Treatment Processes**

Provide a schematic of the treatment train;

Describe the treatment processes including loading rates and contact times;

All filtration design criteria should be provided (filtration and backwash rates, filter depth and media specifications, etc.). The expected turbidities of the filter influent (prior to the addition of chemicals) and the filter effluent should be stated;

State the chemicals that will be used, the method of mixing, the degree of mixing, the point of application, and the dosages. Also describe the chemical storage and handling facilities, and

Describe the operation and maintenance manuals available.

## **2.6 Plant Reliability Features**

The plant reliability features proposed to comply with Sections 60333 - 60355 of the Water Recycling Criteria should be described in detail. The discussion of each reliability feature should state under what conditions it will be actuated. When alarms are used to indicate system failure, the report should state where the alarm will be received, how the location is staffed, and who will be notified. The report should also state the hours that the plant will be staffed.

## **2.7 Supplemental Water Supply**

The report should describe all supplemental water supplies. The description should include:

- \* Purpose
- \* Source
- \* Quality
- \* Quantity available
- \* Cross-connection control and backflow prevention measures

## **2.8 Monitoring and Reporting**

The report should describe the planned monitoring and reporting program, including all monitoring required by the Water Recycling Criteria, and include the frequency and location of sampling. Where continuous analysis and recording equipment is used, the method and frequency of calibration

should be stated. All analyses shall be performed by a laboratory approved by the State Department of Health Services.

## **2.9 Contingency Plan**

Section 60323 (c) of the Water Recycling Criteria requires that the engineering report contain a contingency plan designed to prevent inadequately treated wastewater from being delivered to the user. The contingency plan should include:

- \* A list of conditions which would require an immediate diversion to take place;
- \* A description of the diversion procedures;
- \* A description of the diversion area including capacity, holding time and return capabilities;
- \* A description of plans for activation of supplemental supplies (if applicable);
- \* A plan for the disposal or treatment of any inadequately treated effluent;
- \* A description of fail safe features in the event of a power failure, and

A plan (including methods) for notifying the recycled water user(s), the regional board, the state and local health departments, and other agencies as appropriate, of any treatment failures that could result in the delivery of inadequately treated recycled water to the use area.

## **3.0 TRANSMISSION AND DISTRIBUTION SYSTEMS**

Maps and/or plans showing the location of the transmission facilities and the distribution system layout should be provided. The plans should include the ownership and location of all potable water lines, recycled water lines and sewer lines within the recycled water service area and use area(s).

## **4.0 USE AREAS**

The description of each use area should include:

- \* The type of land uses;
- \* The specific type of reuse proposed;

- \* The party(s) responsible for the distribution and use of the recycled water at the site;
- \* Identification of other governmental entities which may have regulatory jurisdiction over the re-use site such as the US Department of Agriculture, State Department of Health Services, Food and Drug Branch, the State Department of Health Services, Licensing and Certification Section, etc. These agencies should also be provided with a copy of the Title 22 Engineering Report for review and comment.
- \* Use area containment measures;
- \* A map showing:
  - Specific areas of use
  - Areas of public access
  - Surrounding land uses
  - The location and construction details of wells in or within 1000 feet of the use area
  - Location and type of signage
- \* The degree of potential access by employees or the public;
- \* For use areas where both potable and recycled water lines exist, a description of the cross-connection control procedures which will be used.

*In addition to the general information described above, the following should be provided for the following specific proposed uses:*

#### **4.1 Irrigation**

- Detailed plans showing all piping networks within the use area including recycled, potable, sewage and others as applicable.
- Description of what will be irrigated (e.g. landscape, specific food crop, etc.);
- Method of irrigation (e.g. spray, flood, or drip);
- The location of domestic water supply facilities in or adjacent to the use area;

- Site containment measures;
- Measures to be taken to minimize ponding;
- The direction of drainage and a description of the area to which the drainage will flow;
- A map and/or description of how the setback distances of Section 60310 will be maintained;
- Protection measures of drinking water fountains and designated outdoor eating areas, if applicable;
- Location and wording of public warning signs,
- The proposed irrigation schedule (if public access is included), and
- Measures to be taken to exclude or minimize public contact.

#### **4.2 Impoundments**

- The type of use or activity to be allowed on the impoundment;
- Description of the degree of public access;
- The conditions under which the impoundment can be expected to overflow and the expected frequency, and
- The direction of drainage and a description of the area to which the drainage will flow.

#### **4.3 Cooling**

- Type of cooling system (e.g. cooling tower, spray, condenser, etc.);
- Type of biocide to be used, if applicable;
- Type of drift eliminator to be used, if applicable, and
- Potential for employee or public exposure, and mitigative measures to be employed.

#### **4.4 Groundwater Recharge**

An assessment of potential impacts the proposal will have on underlying groundwater aquifers. The appropriate information

shall be determined through consultation with the Department on a case by case basis.

#### **4.5 Dual Plumbed Use Areas**

In accordance with Sections 60313 through 60316 of the Water Recycling Criteria.

#### **4.6 Other Industrial Uses**

The appropriate information shall be determined on a case by case basis.

#### **4.7 Use Area Design**

The report should discuss how domestic water distribution system shall be protected from the recycled water in accordance with the Regulations Relating to Cross-Connections and the California Waterworks Standards, and how the facilities will be designed to minimize the chance of recycled water leaving the designated use area. Any proposed deviation from the Water Recycling Criteria and necessity therefore, should be discussed in the report.

#### **4.8 Use Area Inspections and Monitoring**

The report should describe the use area inspection program. It should identify the locations at the use area where problems are most likely to occur (e.g. ponding, runoff, overspray, cross-connections, etc.) and the personnel in charge of the monitoring and reporting of use area problems.

#### **4.9 Employee Training**

The report should describe the training which use area employees will receive to ensure compliance with the Recycled Water Criteria, and identify the entity that will provide the training and its' frequency. The report should also identify any written manuals of practice to be made available to employees.

APPENDIX C

## **VWRP Design Criteria**

---





**APPENDIX A  
VICTOR VALLEY WASTEWATER RECLAMATION PLANT  
DESIGN CRITERIA**

Item	Criteria
<b><u>INFLUENT FLOW METER</u></b>	
Type	Magnetic
Size	20 in
Capacity	0-30 mgd
<b><u>PRELIMINARY TREATMENT</u></b>	
Mechanically Cleaned Bar Screens*	
Number	2
Capacity (ea)	10.5 mgd
Manually Cleaned Bar Screens	
Number	1
Capacity	10.5 mgd
Aerated Grit Chambers	
Number	2
Volume (ea)	5775 cu ft
Capacity of Grit Dewatering Unit	2000 lbs/hr
Grit Cyclone/Classifier	1
Capacity (ea)	20.6 mgd
Grit/Screenings Production	1.4 cy/d
<b><u>PRIMARY TREATMENT</u></b>	
Primary Clarifiers	
Type	Rectangular
Number	4
Sidewater Depth	9 ft
Length	117 ft
Width	17 ft
Average Surface Loading Rate	1,200 gpd/sf
Average Detention Time	1.35 hr
Average BOD5 Removal	39%
Average Suspended Solids Removal	71%
Total Capacity (assuming peaking factor)	9.5 MGD
Primary Sludge Pumps	
Number	4
Type	Centrifugal Vortex
Capacity (ea)	75 gpm
Total Head	50 psi

**APPENDIX A  
VICTOR VALLEY WASTEWATER RECLAMATION PLANT  
DESIGN CRITERIA**

Item	Criteria
<b><u>PARSHALL FLUME</u></b>	
Number	1
Size	18 in
Capacity	0.11-15.9 mgd
<b><u>FLOW EQUALIZATION BASINS</u></b>	
Basins	
Number	2
Total Volume	2.8 MG
Equalization Pumps	
Number	2
Capacity	4900 gpm @ 19 ft TDH
Equalization Aerators	
Number	8
Oxygen Transfer Rate, each	25 lbsO <sub>2</sub> /hr
Motor, each	10 HP
<b><u>SECONDARY TREATMENT</u></b>	
Aeration Basins	
Number of Basins	8
Basin Dimensions for Basin 1,2,3,4	30' x 115'
Basin Dimensions for Basin 5,6,7,8	40' x 104'
Basin Side Water Depth, each	15 ft
Total Volume	3.4 MG
Anoxic Zone Location	Basins 2, 3, 5, 7
Anoxic Dimensions	2@29' x 30', 2@20' x 40'
Total Anoxic Volume	0.37
Mode of Operation	Nitrification/Denitrification
Total Capacity at 6 hour HRT	12.25 MGD
WAS Pumps*	
Number	2
Type	Centrifugal
Capacity (ea)	350 gpm @ 25 ft TDH
RAS Pumps	
Number	4
Type	Variable Speed Submersible
Capacity (ea)	4000 gpm

**APPENDIX A  
VICTOR VALLEY WASTEWATER RECLAMATION PLANT  
DESIGN CRITERIA**

Item	Criteria
Mixed Liqor Volatile Suspended Solids	1250 - 2500 mg/L
F/M Ratio	0.1 - 0.3 d <sup>-1</sup>
Mean Cell Residence Time	8 - 20 days
<b>Secondary Clarifiers</b>	
Type	Circular
Number	6
Diameter	5 - 55 ft, 1 - 80 ft
Average Water Depth	14 ft
Total Volume	1.77 MG
Overflow Rate	800 gpd/sf
Capacity with largest unit out of service	9.5 MGD
<b><u>TERTIARY TREATMENT</u></b>	
<b>Rapid Mix Chamber</b>	
Number of Units	1
Length	10 ft
Width	5 ft
Average Water Depth	6.5 ft
Volume	325 cf
<b>Flocculators</b>	
Number of Cells	4
Number of Stages	2
Length of Each Cell	12.5 ft
Width of each Cell	12.5 ft
Average Water Depth	16 ft
Volume	2500 cf
<b>Low Head ABW Filters</b>	
Number of Units	2
Length	76 ft
Width	16 ft
Media Depth	
Sand	12 inch
Anthracite	12 inch
Filter Aids	Alum and Polymer
Max Filter Surface Loading Rate	2.0 gpm/sq ft
Capacity, (each unit)	3.5 MGD

**APPENDIX A  
VICTOR VALLEY WASTEWATER RECLAMATION PLANT  
DESIGN CRITERIA**

Item	Criteria
<b>Continuous Backwashing Filtration System</b>	
Type	DynaSand Filter
Number of Filter cells	6
Number of Filter modules	24
Filter Area per module	50 sq ft
Media Depth	40 in
Max Filter Surface Loading Rate	5.0 gpm/ sq ft
Total Capacity	8.75 MGD
<b><u>DISINFECTION</u></b>	
<b>Chlorine Contact Tank</b>	
Number of Units	3
Length	92.5 ft
Width	38 ft
Side Water Depth, average	9.5 ft
Capacity at 120 min detention time	9.5 MGD
<b>Chlorinators</b>	
Number of Chlorinators	2
Capacity, each	2000 lb/d
<b>Chlorine Storage</b>	
Number of Storage Tanks	14
Total Capacity	14 tons
<b><u>FINAL EFFLUENT</u></b>	
<b>Recycled Pump Station</b>	
Number of Pumps	2
Capacity/each	2,400 gpm
Horsepower	250 HP
<b>Plant Water Pump</b>	
Number of Service Water Pumps	3
Capacity/each	450 gpm @230 ft
Horsepower	1-35 HP and 2-50 HP
<b>Final Effluent Parshal Flume</b>	
Number	1
Size	18 inches
Capacity	0.11 - 15.9 mgd

**APPENDIX A  
VICTOR VALLEY WASTEWATER RECLAMATION PLANT  
DESIGN CRITERIA**

Item	Criteria
<i>Sludge Handling Facilities</i>	
DAF	
Number	2
Capacity	9.5 MGD
Anaerobic Digesters	
Number	3
Capacity	9.5 MGD
Mode	mesophilic
Percolation Ponds	
Number	6
Capacity	1.2 MGD annual average
Sludge Lagoons	
Number	3
Capacity/each	4.0 MG
Sludge Drying Beds	
Number	4
Capacity/each	1.0 MG



APPENDIX D

**HDPP Water Treatment System Water  
Balance Diagram**

---



# **Attachment 2**



22450 Headquarters Drive ♦ Apple Valley, California 92307  
Phone (760) 946-7000 ♦ Fax (760) 240-2642 ♦ www.mojavewater.org

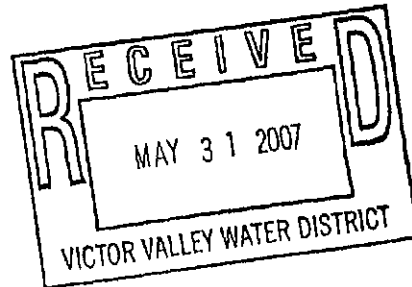

May 29, 2007

Victor Valley Water District  
17185 Yuma Street  
Victorville, CA 92392

Attention: Loraine Stevens

RE: Storage Agreement between Mojave Water Area Watermaster and Victor Valley Water District

Dear Loraine:

Enclosed for your records is a fully executed copy of the subject agreement, which was approved by the Watermaster at the May 23 meeting. Please feel free to contact me should you have any questions.

Sincerely,

Vickie Thornell  
Assistant to the General Manager

enclosure

vwwd stor agr ltr 052907.doc/watermaster/vt

**STORAGE AGREEMENT  
BETWEEN MOJAVE BASIN AREA WATERMASTER AND  
VICTOR VALLEY WATER DISTRICT**

This Storage Agreement ("Agreement") is entered into on May 2, 2007 pursuant to the Judgment After Trial in *City of Barstow, et. al. vs. City of Adelanto, et al.* Case No. 208568, Riverside County Superior Court ("Judgment") entered on January 10, 1996, and the Rules and Regulations of the Mojave Basin Area Watermaster ("Rules") adopted June 30, 1994, and revised December 11, 1996, and as may be amended from time to time.

**RECITALS**

- A. The Judgment in Paragraph 24.S authorizes the Mojave Basin Area Watermaster ("Watermaster") to enter into Storage Agreements with any Party to the Judgment in order to accommodate the acquisition of Supplemental Water.
- B. The Judgment directs Watermaster to adopt uniformly applicable rules for Storage Agreements, which are incorporated as Section 23 of the Watermaster's Rules and Regulations ("Rules"), and are incorporated herein.
- C. Watermaster has considered the availability of groundwater storage capacity in each Subarea and finds that capacity is available for water to be stored pursuant to this Agreement.
- D. On February 27, 2002, Victor Valley Water District ("VVWD"), a County Water District organized and operating pursuant to California Water Code Section 30000, et seq. ("Storer" or "VVWD"), entered into a Storage Agreement with the Watermaster in the Alto Subarea of the Mojave Basin for the period of June 1, 2002 through May 31, 2007 (the "Initial Storage Agreement"), to satisfy obligations that it might incur as a Party to the Judgment.
- E. VVWD desires to renew the Initial Storage Agreement with Watermaster, for an additional period of five (5) years, on the same terms and conditions, to satisfy obligations that Storer has incurred and may incur under this Agreement as a Party to the Judgment.
- F. This Agreement is intended to allow supplemental water to be stored in the groundwater basin for later extraction for High Desert Power Project ("HDPP") pursuant to section 10.2 of the "Aquifer Storage and Recovery Agreement for the High Desert Power Project" entered into February 3, 2000, between HDPP and VVWD. This Agreement is intended solely to address Storer's storage, extraction and conveyance of water required by the High Desert Power Project. Any additional uses other than stated above, will require a separate application and storage agreement between the Parties, consistent with CEC Soil & Water Condition 19. Because this Storage Agreement is applicable only to the High Desert Power Project, which is subject to the CEC Conditions as set forth in its Decision of May 2000, some of its terms may be inapplicable to other storage agreements.

## GENERAL CONDITIONS

- G. Terms per Judgment and Rules:** Defined terms used in this Agreement shall be incorporated from the Judgment and the Rules of the Watermaster, as may be amended from time to time.
- H. Subarea Storage:** This Agreement shall be for the utilization of available ground water storage capacity in the Alto Subarea by Storer for the pre-delivery of Supplemental Water to meet its obligations under this Agreement as a Party to the Judgment.
- I. Party in Good Standing:** Storer is a Party to the Judgment and is presently and shall remain in good standing at all times while this Agreement is in effect. Should Storer fail, due to its fault including its failure to perform any obligation to which it is or may hereafter be held under the Judgment or the Rules, to meet its obligations under this Agreement, or to abide by the terms of the Judgment or the Rules, this Agreement shall be voidable, at the option of the Watermaster, and upon due notice issued and specific action by the Watermaster, and subject to Storer's reasonable opportunity to cure the same.
- J. Stored Water Used to Meet Obligations:** Watermaster shall, if requested by Storer, credit stored Supplemental Water to meet Storer's future obligations incurred under this Agreement and the terms of the Judgment. Said credit shall be made upon application to the Watermaster Executive Officer. Obligations of Storer from the prior Water Year outstanding after October 31 of the following Water Year may be debited from Storer's account by Watermaster to the extent necessary to eliminate the outstanding obligation. Subject to Storer's rights as referenced in this Agreement, the Judgment and the Rules, only the biological and administrative assessments under the Judgment shall be charged to Storer for water extracted by Storer under this Agreement. Watermaster shall not be responsible for the extraction, conveyance or treatment of water stored or extracted pursuant to this Agreement.
- K. Watermaster Storage Accounting:** Watermaster shall calculate additions, extractions and losses of water stored under this Agreement, and maintain an annual account of all such water. Watermaster shall give due consideration to the operation of the Alto Subarea under the Physical Solution provisions of the Judgment when calculating additions, extractions and losses of water stored and extracted under this Agreement. The accounting by Watermaster shall consider the status of other Storage Agreements that may be in effect or under development.
- L. Annual Loss Assessment:** Watermaster shall annually determine and account for losses in stored water, and in so doing shall assume that stored water floats on top of the native ground water supplies. Accounting for all losses of water therefore assumes stored water would spill before native supplies in the event there are losses of water that would otherwise have replenished the Subarea. Stored water losses shall have an inverse priority to that specified in Paragraph M (i.e. Third Priority stored water is the first to spill).
- M. Delivery and Storage Priority for Supplemental Water:** Basin storage capacity and supplemental water delivery capacity vary from place to place. It will therefore be

necessary for Watermaster to annually determine storage capacity available in each Subarea and to consult with the Mojave Water Agency to determine their ability to deliver supplemental water. Based upon this information, Watermaster shall maintain priorities for delivery and storage of Supplemental Water as follows:

First Priority: Supplemental Water ordered by Watermaster from MWA for direct delivery to the Basin to meet the requirements of the Judgment;

Second Priority: Supplemental Water for delivery to the Basin for storage under Storage Agreements between Watermaster and MWA;

Third Priority: Supplemental Water for delivery to individual storage accounts of Parties to the Judgment.

- N. **Second and Third Priority:** Watermaster has entered into a second priority Storage Agreement with Mojave Water Agency ("MWA") to provide Supplemental Water to Watermaster to comply with the Judgment. Watermaster shall enter into Third Priority Storage Agreements with other Parties on the basis of the date of application to Watermaster. The priority based on date of application referenced in Rule 23D (a second priority in Rule 23D is equivalent to a third priority in this Agreement) is intended to preclude the over-subscription of storage capacity in the Basin.
- O. **Pro-rations of Limited Deliveries:** Simultaneous delivery request by more than one Party with Storage Agreements of equal priority may exceed the capacity of delivery facilities available. In this event, the facility capacity not used for First and Second priority deliveries shall be utilized to deliver water for each Third Priority Storer in proportion to their maximum annual storage as specified in Paragraph 3. The proportion shall be determined from each Storer's relative share (percentage) of the sum of all of the maximum annual storage under Agreement of the same (Third) priority requesting delivery.
- P. **Watermaster Controls Storage:** Watermaster and Storer acknowledge that no Party shall have any direct interest in or control over storage used under this Agreement by reason of the adjudicated right of such Party. Watermaster has sole custody and control of all groundwater storage rights in the Basin Area pursuant to the Physical Solution in the Judgment, the Rules and this Agreement.
- Q. **Laws Take Precedent Over this Agreement:** This Agreement does not supersede applicable Federal, State or Local regulatory requirements. Storer shall be solely responsible to meet all current and future Federal, State or Local requirements applicable to actions or consequences facilitated by this Agreement.
- R. **Measured Losses:** Measured losses will limit the recovery of water stored under this Agreement.
- S. **Water Quality:** The quality of Supplemental Water stored pursuant to this Agreement shall not be detrimental to the Subarea in which storage will occur, or to any other Party to the Judgment as established in the Operational and Monitoring Plans as specified in

paragraphs 7 and 8, as reasonably determined by Watermaster. Storer shall provide sufficient data to Watermaster to allow characterization of the quality of the water proposed for storage prior to execution of this Agreement.

- T. **Insurance:** Storer shall provide insurance sufficient to protect Storer and Watermaster against potential liability arising from the activities contemplated by this Agreement. Said insurance shall be satisfactory to Watermaster and shall be maintained during the life of this Agreement, including future extension or amendment.

### AGREEMENT

1. **Recitals and General Conditions:** The Recitals and General Conditions to this Agreement are incorporated in the Agreement as though set forth fully herein.
2. **Soil & Water 19:** This Agreement hereby incorporates the provisions of Soil & Water condition 19 of the California Energy Commission Decision in the Application for Certification for the High Desert Power Project, May 2000.
3. **Storage Limits:** Storer is hereby authorized by Watermaster to store not more than 13,000 acre-feet of Supplemental Water in the Alto Subarea of the Mojave Basin in any Water Year during the term of this Agreement. **Supplemental Water stored pursuant to this Agreement shall not exceed an annual cumulative balance of 13,000 acre-feet.**
4. **Duration of Agreement:** Storer may store up to the amount specified for not more than five (5) years from the date of this Agreement. Provided however, that if at the end of the five year term, or at the end of any of the next four (4), five (5) year periods thereafter, Storer has any water remaining in storage, the term of this Agreement shall be extended by action of Watermaster for five (5) additional years. The full term of this Agreement shall not exceed thirty (30) years. Watermaster may approve, deny with cause, and reasonably condition time extensions of this Agreement if necessary to maintain consistency with changes to the Judgment. In considering whether to deny with cause any extension of this Agreement, the Watermaster shall review the implementation of this Agreement to date and determine that the Alto Subarea has sufficient capacity to accommodate the water that would be stored under such extension, that the extension will not have a substantial adverse impact on any Producer or on the Basin and shall not be arbitrary and capricious. Unless specifically so ordered by the Court, changes to the Judgment shall not impact the initial five year Agreement or the remaining term of any five year extension and shall not impact withdrawal of previously stored water or injection of water to meet previously incurred obligations.
5. **Third Priority Storage:** Storer and Watermaster hereby agree that delivery under this Agreement shall have Third Priority under Paragraph M.
6. **Storage and Extraction:** The Operation Plan and Monitoring Plan shall provide information regarding storage and extraction of Supplemental Water, as required by Rule 23.F(1). Watermaster will authorize the storage of such Supplemental Water provided that it will not cause the total stored water in the Alto Subarea pursuant to this Agreement

to exceed the amounts set forth in Paragraph 3, above. The Storer's operations shall not have a substantial adverse impact on any Producer, as determined by the Watermaster.

7. **Operation Plan:** Storer has submitted to Watermaster an "Operational Plan", attached hereto as "Exhibit A", setting forth an estimated schedule identifying:
  - a. The source(s) and quality of Supplemental Water.
  - b. The method(s) of storage to be employed (such as spreading or injection);
  - c. The estimated amount(s) to be stored in the specified Subarea;
  - d. The time period during which storage will occur;
  - e. The time period during which the water will be taken from storage;
  - f. The method by which the water will be taken from storage;
  - g. An engineered map of facilities to be used for extraction, spreading, injection and delivery.
  
8. **Monitoring Plan:** Storer has submitted to Watermaster a "Monitoring Plan", attached hereto as "Exhibit B", setting forth an estimated schedule identifying:
  - a. The physical facilities that will be used to monitor the quality of the water to be stored;
  - b. The physical facilities that will be used to monitor changes to the quality of ground or surface water from the storage;
  - c. The physical facilities that will be used to monitor changes to ground water levels from the water stored;
  - d. The frequency of water quality and water level monitoring;
  - e. The water quality parameters that will be analyzed at a State certified laboratory;
  - f. An engineered map identifying the location of physical facilities that will be used for monitoring.

At each five-year renewal period, Watermaster may reasonably condition Storage Agreement renewal to require modification of the Monitoring Plan to incorporate improved technology that is necessary to mitigate a material deficiency in the collection and reporting of required data to the Watermaster.

9. **Facilities Responsibility of Storer:** All monitoring and construction of physical facilities shall be the responsibility of Storer and shall occur at no cost to Watermaster. Watermaster shall not be responsible for compliance with any environmental (California

Environmental Quality Act or National Environmental Policy Act) or other legal requirements pertaining to the implementation of this Agreement.

10. **Quarterly Reporting Requirements:** Storer shall report the following to Watermaster by the last day of the month next succeeding the end of the relevant quarter, i.e. January 31, April 30, July 31 and October 31:
  - a. The amount of Supplemental Water which Storer placed into or withdrew from storage under the Agreement;
  - b. Cumulative stored water balance of the relevant quarter;
  - c. The operations and monitoring results specified by Exhibits A and B.
11. **Watermaster Storage Accounting:** Watermaster shall use the reported data, along with other available data to:
  - a. Perform a "First-in, First-Out" accounting of water stored under this Agreement;
  - b. Assess each proposal to store Supplemental Water under this Agreement and determine whether the potential reasonably exists for material adverse affect on other Producers within the Subarea in which storage is to occur, and whether sufficient capacity exists in that groundwater aquifer;
  - c. Determine, at least annually, any losses of Supplemental Water stored pursuant to this Agreement.
12. **Loss Factors Considered:** Watermaster shall determine at least annually any losses of Supplemental Water stored pursuant to this Storage Agreement. Watermaster shall consider herein specified factors, including priority specified in this Agreement, affecting the loss of Supplemental Water stored pursuant to this Agreement including those that may occur at the time Supplemental Water is placed into storage.
13. **Potential Special Costs:** As provided in Watermaster's Rules and Regulations, Watermaster shall determine, annually, whether any special costs, damages or burdens have resulted from the implementation of this Agreement and shall notify Storer as to its determinations and the calculation of any amount due, and Storer shall pay such amount within thirty days.
14. **Dispute Resolution:** In the event there is a dispute between Storer and Watermaster regarding calculations, payments due, or other aspects of this Storage Agreement or its implementation that cannot be resolved, review of determinations by Watermaster shall be as per Section 36 of the Judgment. In the event any Party hereto shall commence legal proceedings against the other to enforce the terms hereof, or to declare rights hereunder, as the result of the breach of any covenant or condition of this Agreement, the prevailing Party in any such proceeding shall be entitled to recover from the losing Party his/her/its reasonable costs and attorney's fees, incurred in connection therewith. Except as otherwise expressly provided herein, all Parties shall bear their own costs and attorney's fees.



15. **Indemnification:** Except for resolution of disputes pursuant to Paragraph 14 above, Storer shall save and hold harmless Watermaster, its officers, agents and employees from any and all costs, damages or liability resulting from this Agreement or its implementation. Storer shall provide Watermaster with the defense, and the costs of the defense, including attorney's fees, of any action brought against Watermaster, its officers or employees arising or alleged to arise because of such Agreement for storage of Supplemental Water.
16. **Expired and Void Agreement:** The Agreement may become void if Storer ceases to be a party in good standing pursuant to Paragraph I. An expired or void Agreement shall mean that the Storer may no longer store Supplemental Water or extract water that has previously been stored under this Agreement, except that stored water may be extracted or credited to Storer's obligations under the Judgment within five (5) years following the date the Agreement expired or became void. Stored water not claimed by Storer within five (5) years subsequent to an expired or void Agreement shall accrue to the benefit of the storage Subarea, and not to the benefit of a specific Party or Parties.
17. **Non-Transferable:** This Agreement is not assignable or transferable, except to the lawful successor of either Party, and cannot in any way be hypothecated by Storer.
18. **Amendment:** This Agreement shall be amended only upon written agreement of the Parties.
19. **Entire Agreement:** This Agreement is the entire agreement between the Parties hereto with respect to the subject matter hereof and supersedes all prior agreements and understandings, whether oral or written, between the Parties with respect to the matters contained in this Agreement. Any waiver, modification, consent or acquiescence with respect to any provision of this Agreement shall be set forth in writing and duly executed by, or on behalf of the party to be bound thereby. No waiver by any party of any breach hereunder shall be deemed a waiver of any other or subsequent breach.
20. **Notices:** Any communication, notice or demand of any kind whatsoever which either party may be required or may desire to give to or serve upon the other shall be in writing and delivered by personal service (including courier service), by facsimile communication, by Federal Express, UPS or other overnight delivery, or by registered or certified mail, postage prepaid, return receipt requested; and shall be addressed to the General Manager of the applicable agency at its principle office. Any party may change its mailing address or facsimile number for notice by written notice given to the other in the manner provided in this Section. Any such communication, notice or demand shall be deemed to have been duly given or served on the date personally served, if by personal service; on the date of confirmed dispatch, if by facsimile communication; on the day after delivery if by "overnight courier;" on the third (3rd) day after being placed in the U.S. mail, if mailed first class, whether or not registered or certified.
21. **Governing Law:** This Agreement shall be governed by and construed in accordance with the laws of the State of California. The only venue and forum for the resolution of any dispute regarding the interpretation or enforcement of this Agreement shall be in the Superior Court of the State of California in and for the County of Riverside, Central

Judicial District, California, or such other forum as the Judgment may subsequently be assigned to. The Parties expressly waive the right to remove this action to Federal Court.

22. **Construction:** The language in all parts of this Agreement shall be in all cases construed simply, according to its fair meaning, and not strictly for or against any of the Parties hereto. Section headings of this Agreement are solely for convenience of reference and shall not govern the interpretation of any of the provisions of this Agreement. References to "Paragraphs" are to Paragraphs of this Agreement, unless otherwise specifically provided.
23. **Good Faith:** The Parties agree to perform their obligations herein in "good faith" and shall do all things reasonably necessary to carry out the intent and/or to implement the terms of this Agreement.
24. **Binding Effect:** All of the terms and provisions of this Agreement shall be binding upon and shall inure to the benefit of the Parties hereto and to their respective representatives, agents and lawful successors.
25. **Numbers and Gender:** Whenever required by the context, as used in this Agreement, the singular number shall include the plural, and the masculine gender shall include the feminine and neuter.
26. **Continued Validity:** If any provision of this Agreement, or its application to any person, place, or circumstance, is held by a court of competent jurisdiction to be invalid, unenforceable, or void, such provision shall be enforced to the greatest extent permitted by law, and the remainder of this Agreement shall remain in full force and effect.

This Agreement is effective as of June 1, 2007 and shall remain in effect until May 31, 2012, unless extended under the terms of this Agreement or by action of Watermaster.

**FOR WATERMASTER:**

  
\_\_\_\_\_  
Kirby Brill, Executive Officer

Date: May 24, 2007

**FOR STORER:**

  
\_\_\_\_\_  
Reginald Lamson, Acting General Manager

Date: May 2, 2007

***EXHIBIT "A"***

**VICTOR VALLEY WATER DISTRICT  
OPERATIONAL PLAN**

**Prepared for a Storage Agreement Between the Mojave Basin Area Watermaster and the  
Victor Valley Water District**

**January 2002**

## 1.0 OPERATIONAL PLAN

The operational plan describes the storage and recovery of water pursuant to the Water Storage Agreement between the Watermaster and Victor Valley Water District ("VVWD").

### 1.1 Supplemental Water

#### 1.1.1 Source

VVWD will store up to 13,000 acre-feet of water in the Alto Subarea of the Mojave Basin Area. The source of this water will be the California State Water Project ("SWP"). Under the Storage Agreement to which this Monitoring Plan is attached, VVWD will only use this stored water for the High Desert Power Project ("HDPP") and will only use it when direct SWP supplies from the Mojave Water Agency ("MWA") are unavailable.

#### 1.1.2 Quality

The water treatment for the water to be injected will include chemical coagulation, sedimentation, and granular media filtration, equivalent to "conventional" treatment. In addition water will receive membrane treatment to the ultrafiltration level. Finished water will be chloraminated.

Water quality shall be consistent with all applicable regulatory requirements and shall meet State drinking water standards.

Table OP-A, following, is entitled "Water Quality Comparison Treated SWP Water and Local Groundwater, and Compliance with Basin Plan Objectives," and is from the *Report of Waste Discharge*, prepared by Bookman-Edmonston and submitted to the Lahontan Regional Water Quality Control Board in May 2001. Table OP-A shows the estimated water quality of the injection water, and compares it with the quality of the SWP water before treatment as well as the quality of the existing groundwater. It also compares the projected quality of the blended groundwater with the groundwater Basin Plan Objectives (BPOs).

### 1.2 Facilities

The treatment plant will consist of facilities for the coagulation and sedimentation of the water as well as facilities for granular media filtration, full ultrafiltration and chloramination facilities. The facilities will also include a 200,000 gallon storage tank, a booster pumping station, injection water conveyance pipelines, and up to seven injection/extraction wells. The operation of the Treatment Plant is not the subject of this Plan.

Figure OP-1, General Location Map, shows the projected locations of the injection water conveyance pipelines and the injection/extraction wells, as well as the site of the HDPP. Note that treatment plant and booster pumping station are located within or near the HDPP site shown on Figure OP-1.

The booster pumping station will include two single speed 100 HP vertical turbine can style pumps, a two-way magnetic flow meter, surge control equipment, and all associated appurtenances installed outside on a concrete slab. The pumps are planned to have a capacity of 2,150 gpm when run together.

The proposed conveyance pipelines are shown on Fig. OP-1, and will consist of 18" pipe between the booster station located at the HDPP site and Well B, 16" pipe between Well B and Well E, 12" pipe between Well E and Wells D and F, and 10" pipe between Wells D and C and between Wells F and G.

Up to seven injection/extraction wells will be developed, and will be sized to provide 4,000 afy firm and 3,300 gpm peak extraction capacities, with one well serving as a backup to the HDPP during drought periods. Injection capacity is estimated to be approximately 360 gpm per well at 15 psi. Note that each year during the month of December the SWP is normally down for maintenance, so injection can only be planned for 11 months per year.

**Figure OP-2**, shows a typical design for a proposed injection extraction well. Note that it is proposed to control the direction of water flow with a downhole Baski flow control valve, not shown. In addition to controlling direction of flow, in injection mode the flow control valve also sets the flow rate.

**Figure OP-3** shows a typical floor plan for a proposed injection/extraction well. Each well will have monitoring and control equipment and chloramination treatment facilities. It is planned to chloraminate the extracted water as well as the injected water to minimize biological growth in the conveyance system to the HDPP.

Because chloramines are created by combining chlorine and ammonia, chloramination facilities will consist of an on-site sodium hypochlorite generator and ammonia addition facilities, as well as salt, hypochlorite and ammonia storage facilities and associated equipment and controls.

### 1.3 Locations, Amounts & Timing

#### 1.3.1 30 Year Plan

**Table OP-B**, attached, shows the projected annual injection and extraction amounts over a 30 year period.

The years 28-30 shown above are equivalent to a drought drawdown and the years 6-27 show extraction to the District on an annual fill/drawdown cycle. Note that this operating plan assumes that HDPP withdraws water for drought use only during the last three years of the 30-year period. If drought use occurs during some other portion of the 30-year period, a drawdown and refill cycle would occur that is not shown. Also note that 333 afy is withdrawn for use by the HDPP for process and cooling water during the month (normally December) that the SWP facilities are shut down for maintenance every year.

**WATER QUALITY COMPARISON  
TREATED SWP WATER AND LOCAL GROUNDWATER  
AND COMPLIANCE WITH BASIN PLAN OBJECTIVES**

Constituent	Unit	MCL (a)	100% MCL (1984-2000) Range	Typical (b) (c) Range	Estimated Change in Groundwater Quality	Ex. 015 Status (d) (e) (f) (g) (h) (i) (j) (k) (l) (m) (n) (o) (p) (q) (r) (s) (t) (u) (v) (w) (x) (y) (z) (aa) (ab) (ac) (ad) (ae) (af) (ag) (ah) (ai) (aj) (ak) (al) (am) (an) (ao) (ap) (aq) (ar) (as) (at) (au) (av) (aw) (ax) (ay) (az) (ba) (bb) (bc) (bd) (be) (bf) (bg) (bh) (bi) (bj) (bk) (bl) (bm) (bn) (bo) (bp) (bq) (br) (bs) (bt) (bu) (bv) (bw) (bx) (by) (bz) (ca) (cb) (cc) (cd) (ce) (cf) (cg) (ch) (ci) (cj) (ck) (cl) (cm) (cn) (co) (cp) (cq) (cr) (cs) (ct) (cu) (cv) (cw) (cx) (cy) (cz) (da) (db) (dc) (dd) (de) (df) (dg) (dh) (di) (dj) (dk) (dl) (dm) (dn) (do) (dp) (dq) (dr) (ds) (dt) (du) (dv) (dw) (dx) (dy) (dz) (ea) (eb) (ec) (ed) (ee) (ef) (eg) (eh) (ei) (ej) (ek) (el) (em) (en) (eo) (ep) (eq) (er) (es) (et) (eu) (ev) (ew) (ex) (ey) (ez) (fa) (fb) (fc) (fd) (fe) (ff) (fg) (fh) (fi) (fj) (fk) (fl) (fm) (fn) (fo) (fp) (fq) (fr) (fs) (ft) (fu) (fv) (fw) (fx) (fy) (fz) (ga) (gb) (gc) (gd) (ge) (gf) (gg) (gh) (gi) (gj) (gk) (gl) (gm) (gn) (go) (gp) (gq) (gr) (gs) (gt) (gu) (gv) (gw) (gx) (gy) (gz) (ha) (hb) (hc) (hd) (he) (hf) (hg) (hh) (hi) (hj) (hk) (hl) (hm) (hn) (ho) (hp) (hq) (hr) (hs) (ht) (hu) (hv) (hw) (hx) (hy) (hz) (ia) (ib) (ic) (id) (ie) (if) (ig) (ih) (ii) (ij) (ik) (il) (im) (in) (io) (ip) (iq) (ir) (is) (it) (iu) (iv) (iw) (ix) (iy) (iz) (ja) (jb) (jc) (jd) (je) (jf) (jg) (jh) (ji) (jj) (jk) (jl) (jm) (jn) (jo) (jp) (jq) (jr) (js) (jt) (ju) (jv) (jw) (jx) (jy) (jz) (ka) (kb) (kc) (kd) (ke) (kf) (kg) (kh) (ki) (kj) (kk) (kl) (km) (kn) (ko) (kp) (kq) (kr) (ks) (kt) (ku) (kv) (kw) (kx) (ky) (kz) (la) (lb) (lc) (ld) (le) (lf) (lg) (lh) (li) (lj) (lk) (ll) (lm) (ln) (lo) (lp) (lq) (lr) (ls) (lt) (lu) (lv) (lw) (lx) (ly) (lz) (ma) (mb) (mc) (md) (me) (mf) (mg) (mh) (mi) (mj) (mk) (ml) (mm) (mn) (mo) (mp) (mq) (mr) (ms) (mt) (mu) (mv) (mw) (mx) (my) (mz) (na) (nb) (nc) (nd) (ne) (nf) (ng) (nh) (ni) (nj) (nk) (nl) (nm) (nn) (no) (np) (nq) (nr) (ns) (nt) (nu) (nv) (nw) (nx) (ny) (nz) (oa) (ob) (oc) (od) (oe) (of) (og) (oh) (oi) (oj) (ok) (ol) (om) (on) (oo) (op) (oq) (or) (os) (ot) (ou) (ov) (ow) (ox) (oy) (oz) (pa) (pb) (pc) (pd) (pe) (pf) (pg) (ph) (pi) (pj) (pk) (pl) (pm) (pn) (po) (pp) (pq) (pr) (ps) (pt) (pu) (pv) (pw) (px) (py) (pz) (qa) (qb) (qc) (qd) (qe) (qf) (qg) (qh) (qi) (qj) (qk) (ql) (qm) (qn) (qo) (qp) (qq) (qr) (qs) (qt) (qu) (qv) (qw) (qx) (qy) (qz) (ra) (rb) (rc) (rd) (re) (rf) (rg) (rh) (ri) (rj) (rk) (rl) (rm) (rn) (ro) (rp) (rq) (rs) (rt) (ru) (rv) (rw) (rx) (ry) (rz) (sa) (sb) (sc) (sd) (se) (sf) (sg) (sh) (si) (sj) (sk) (sl) (sm) (sn) (so) (sp) (sq) (sr) (ss) (st) (su) (sv) (sw) (sx) (sy) (sz) (ta) (tb) (tc) (td) (te) (tf) (tg) (th) (ti) (tj) (tk) (tl) (tm) (tn) (to) (tp) (tq) (tr) (ts) (tt) (tu) (tv) (tw) (tx) (ty) (tz) (ua) (ub) (uc) (ud) (ue) (uf) (ug) (uh) (ui) (uj) (uk) (ul) (um) (un) (uo) (up) (uq) (ur) (us) (ut) (uu) (uv) (uw) (ux) (uy) (uz) (va) (vb) (vc) (vd) (ve) (vf) (vg) (vh) (vi) (vj) (vk) (vl) (vm) (vn) (vo) (vp) (vq) (vr) (vs) (vt) (vu) (vv) (vw) (vx) (vy) (vz) (wa) (wb) (wc) (wd) (we) (wf) (wg) (wh) (wi) (wj) (wk) (wl) (wm) (wn) (wo) (wp) (wq) (wr) (ws) (wt) (wu) (wv) (ww) (wx) (wy) (wz) (xa) (xb) (xc) (xd) (xe) (xf) (xg) (xh) (xi) (xj) (xk) (xl) (xm) (xn) (xo) (xp) (xq) (xr) (xs) (xt) (xu) (xv) (xw) (xx) (xy) (xz) (ya) (yb) (yc) (yd) (ye) (yf) (yg) (yh) (yi) (yj) (yk) (yl) (ym) (yn) (yo) (yp) (yq) (yr) (ys) (yt) (yu) (yv) (yw) (yx) (yy) (yz) (za) (zb) (zc) (zd) (ze) (zf) (zg) (zh) (zi) (zj) (zk) (zl) (zm) (zn) (zo) (zp) (zq) (zr) (zs) (zt) (zu) (zv) (zw) (zx) (zy) (zz)	Estimated Change in Groundwater Quality	Ex. 015 Status (d) (e) (f) (g) (h) (i) (j) (k) (l) (m) (n) (o) (p) (q) (r) (s) (t) (u) (v) (w) (x) (y) (z) (aa) (ab) (ac) (ad) (ae) (af) (ag) (ah) (ai) (aj) (ak) (al) (am) (an) (ao) (ap) (aq) (ar) (as) (at) (au) (av) (aw) (ax) (ay) (az) (ba) (bb) (bc) (bd) (be) (bf) (bg) (bh) (bi) (bj) (bk) (bl) (bm) (bn) (bo) (bp) (bq) (br) (bs) (bt) (bu) (bv) (bw) (bx) (by) (bz) (ca) (cb) (cc) (cd) (ce) (cf) (cg) (ch) (ci) (cj) (ck) (cl) (cm) (cn) (co) (cp) (cq) (cr) (cs) (ct) (cu) (cv) (cw) (cx) (cy) (cz) (da) (db) (dc) (dd) (de) (df) (dg) (dh) (di) (dj) (dk) (dl) (dm) (dn) (do) (dp) (dq) (dr) (ds) (dt) (du) (dv) (dw) (dx) (dy) (dz) (ea) (eb) (ec) (ed) (ee) (ef) (eg) (eh) (ei) (ej) (ek) (el) (em) (en) (eo) (ep) (eq) (er) (es) (et) (eu) (ev) (ew) (ex) (ey) (ez) (fa) (fb) (fc) (fd) (fe) (ff) (fg) (fh) (fi) (fj) (fk) (fl) (fm) (fn) (fo) (fp) (fq) (fr) (fs) (ft) (fu) (fv) (fw) (fx) (fy) (fz) (ga) (gb) (gc) (gd) (ge) (gf) (gg) (gh) (gi) (gj) (gk) (gl) (gm) (gn) (go) (gp) (gq) (gr) (gs) (gt) (gu) (gv) (gw) (gx) (gy) (gz) (ha) (hb) (hc) (hd) (he) (hf) (hg) (hh) (hi) (hj) (hk) (hl) (hm) (hn) (ho) (hp) (hq) (hr) (hs) (ht) (hu) (hv) (hw) (hx) (hy) (hz) (ia) (ib) (ic) (id) (ie) (if) (ig) (ih) (ii) (ij) (ik) (il) (im) (in) (io) (ip) (iq) (ir) (is) (it) (iu) (iv) (iw) (ix) (iy) (iz) (ja) (jb) (jc) (jd) (je) (jf) (jg) (jh) (ji) (jj) (jk) (jl) (jm) (jn) (jo) (jp) (jq) (jr) (js) (jt) (ju) (jv) (jw) (jx) (jy) (jz) (ka) (kb) (kc) (kd) (ke) (kf) (kg) (kh) (ki) (kj) (kk) (kl) (km) (kn) (ko) (kp) (kq) (kr) (ks) (kt) (ku) (kv) (kw) (kx) (ky) (kz) (la) (lb) (lc) (ld) (le) (lf) (lg) (lh) (li) (lj) (lk) (ll) (lm) (ln) (lo) (lp) (lq) (lr) (ls) (lt) (lu) (lv) (lw) (lx) (ly) (lz) (ma) (mb) (mc) (md) (me) (mf) (mg) (mh) (mi) (mj) (mk) (ml) (mm) (mn) (mo) (mp) (mq) (mr) (ms) (mt) (mu) (mv) (mw) (mx) (my) (mz) (na) (nb) (nc) (nd) (ne) (nf) (ng) (nh) (ni) (nj) (nk) (nl) (nm) (nn) (no) (np) (nq) (nr) (ns) (nt) (nu) (nv) (nw) (nx) (ny) (nz) (oa) (ob) (oc) (od) (oe) (of) (og) (oh) (oi) (oj) (ok) (ol) (om) (on) (oo) (op) (oq) (or) (os) (ot) (ou) (ov) (ow) (ox) (oy) (oz) (pa) (pb) (pc) (pd) (pe) (pf) (pg) (ph) (pi) (pj) (pk) (pl) (pm) (pn) (po) (pp) (pq) (pr) (ps) (pt) (pu) (pv) (pw) (px) (py) (pz) (qa) (qb) (qc) (qd) (qe) (qf) (qg) (qh) (qi) (qj) (qk) (ql) (qm) (qn) (qo) (qp) (qq) (qr) (qs) (qt) (qu) (qv) (qw) (qx) (qy) (qz) (ra) (rb) (rc) (rd) (re) (rf) (rg) (rh) (ri) (rj) (rk) (rl) (rm) (rn) (ro) (rp) (rq) (rs) (rt) (ru) (rv) (rw) (rx) (ry) (rz) (sa) (sb) (sc) (sd) (se) (sf) (sg) (sh) (si) (sj) (sk) (sl) (sm) (sn) (so) (sp) (sq) (sr) (ss) (st) (su) (sv) (sw) (sx) (sy) (sz) (ta) (tb) (tc) (td) (te) (tf) (tg) (th) (ti) (tj) (tk) (tl) (tm) (tn) (to) (tp) (tq) (tr) (ts) (tt) (tu) (tv) (tw) (tx) (ty) (tz) (ua) (ub) (uc) (ud) (ue) (uf) (ug) (uh) (ui) (uj) (uk) (ul) (um) (un) (uo) (up) (uq) (ur) (us) (ut) (uu) (uv) (uw) (ux) (uy) (uz) (va) (vb) (vc) (vd) (ve) (vf) (vg) (vh) (vi) (vj) (vk) (vl) (vm) (vn) (vo) (vp) (vq) (vr) (vs) (vt) (vu) (vv) (vw) (vx) (vy) (vz) (wa) (wb) (wc) (wd) (we) (wf) (wg) (wh) (wi) (wj) (wk) (wl) (wm) (wn) (wo) (wp) (wq) (wr) (ws) (wt) (wu) (wv) (ww) (wx) (wy) (wz) (xa) (xb) (xc) (xd) (xe) (xf) (xg) (xh) (xi) (xj) (xk) (xl) (xm) (xn) (xo) (xp) (xq) (xr) (xs) (xt) (xu) (xv) (xw) (xx) (xy) (xz) (ya) (yb) (yc) (yd) (ye) (yf) (yg) (yh) (yi) (yj) (yk) (yl) (ym) (yn) (yo) (yp) (yq) (yr) (ys) (yt) (yu) (yv) (yw) (yx) (yy) (yz) (za) (zb) (zc) (zd) (ze) (zf) (zg) (zh) (zi) (zj) (zk) (zl) (zm) (zn) (zo) (zp) (zq) (zr) (zs) (zt) (zu) (zv) (zw) (zx) (zy) (zz)	Compliance with BPOC		
Total Dissolved Solids (TDS)	mg/l (B)	500 (B)	118	314	138	73	0	-740	5	NA	Yes
Specific Conductance	µmhos/cm (C)	900 (B)	103	475	297	100	0	-1024	0	NA	Yes
Calcium (Ca)	mg/l	0	0	32	10	0	0	0	0	0	Yes
Magnesium (Mg)	mg/l	0	0	2	2	2	0	0	0	0	Yes
Sodium (Na)	mg/l	30	30	32	44	8	0	0	0	0	Yes
Chloride (Cl)	mg/l	0	0	44	2	0	0	0	0	0	Yes
Carbonate (CO <sub>3</sub> )	mg/l	0	0	0	0	0	0	0	0	0	Yes
Bicarbonate (HCO <sub>3</sub> )	mg/l	0	0	0	0	0	0	0	0	0	Yes
Sulfate (SO <sub>4</sub> )	mg/l	200 (F)	1	181	28	4	0	-120	38	12	Yes
Chloride (Cl)	mg/l	250 (F)	3	84	15	2	0	-121	51	36	Yes
Ammonia (NH <sub>3</sub> )	mg/l	0	0	0	0	0	0	0	0	0	Yes
Aluminum (Al)	mg/l	0	0	0	0	0	0	0	0	0	Yes
Iron (Fe)	mg/l	0	0	0	0	0	0	0	0	0	Yes
Copper (Cu)	mg/l	0	0	0	0	0	0	0	0	0	Yes
Zinc (Zn)	mg/l	0	0	0	0	0	0	0	0	0	Yes
Fluoride (F)	mg/l	1.5-2.0 (B)	0.5	0.30	0.20	0.18	0	-0.12	0.18	0.1	Yes
Lead (Pb)	mg/l	0.05 (B)	0.00	0.00	0.00	0.00	0	0.00	0.00	0.00	Yes
Cadmium (Cd)	mg/l	0.01 (B)	0.00	0.00	0.00	0.00	0	0.00	0.00	0.00	Yes
Mercury (Hg)	mg/l	0.0001 (B)	0.00	0.00	0.00	0.00	0	0.00	0.00	0.00	Yes
Chromium (Cr)	mg/l	0.1 (B)	0.00	0.00	0.00	0.00	0	0.00	0.00	0.00	Yes
Manganese (Mn)	mg/l	0.05 (B)	0.00	0.00	0.00	0.00	0	0.00	0.00	0.00	Yes
Barium (Ba)	mg/l	0.0001 (B)	0.00	0.00	0.00	0.00	0	0.00	0.00	0.00	Yes
Strontium (Sr)	mg/l	0.0001 (B)	0.00	0.00	0.00	0.00	0	0.00	0.00	0.00	Yes
Vanadium (V)	mg/l	0.0001 (B)	0.00	0.00	0.00	0.00	0	0.00	0.00	0.00	Yes
Antimony (Sb)	mg/l	0.0001 (B)	0.00	0.00	0.00	0.00	0	0.00	0.00	0.00	Yes
Thallium (Tl)	mg/l	0.0001 (B)	0.00	0.00	0.00	0.00	0	0.00	0.00	0.00	Yes
Chromium (Cr)	mg/l	0.05 (B)	0.00	0.00	0.00	0.00	0	0.00	0.00	0.00	Yes
Mercury (Hg)	mg/l	0.0001 (B)	0.00	0.00	0.00	0.00	0	0.00	0.00	0.00	Yes
Lead (Pb)	mg/l	0.05 (B)	0.00	0.00	0.00	0.00	0	0.00	0.00	0.00	Yes
Cadmium (Cd)	mg/l	0.01 (B)	0.00	0.00	0.00	0.00	0	0.00	0.00	0.00	Yes
Strontium (Sr)	mg/l	0.0001 (B)	0.00	0.00	0.00	0.00	0	0.00	0.00	0.00	Yes
Vanadium (V)	mg/l	0.0001 (B)	0.00	0.00	0.00	0.00	0	0.00	0.00	0.00	Yes
Antimony (Sb)	mg/l	0.0001 (B)	0.00	0.00	0.00	0.00	0	0.00	0.00	0.00	Yes
Thallium (Tl)	mg/l	0.0001 (B)	0.00	0.00	0.00	0.00	0	0.00	0.00	0.00	Yes
Chromium (Cr)	mg/l	0.05 (B)	0.00	0.00	0.00	0.00	0	0.00	0.00	0.00	Yes
Mercury (Hg)	mg/l	0.0001 (B)	0.00	0.00	0.00	0.00	0	0.00	0.00	0.00	Yes
Lead (Pb)	mg/l	0.05 (B)	0.00	0.00	0.00	0.00	0	0.00	0.00	0.00	Yes
Cadmium (Cd)	mg/l	0.01 (B)	0.00	0.00	0.00	0.00	0	0.00	0.00	0.00	Yes
Strontium (Sr)	mg/l	0.0001 (B)	0.00	0.00	0.00	0.00	0	0.00	0.00	0.00	Yes
Vanadium (V)	mg/l	0.0001 (B)	0.00	0.00	0.00	0.00	0	0.00	0.00	0.00	Yes
Antimony (Sb)	mg/l	0.0001 (B)	0.00	0.00	0.00	0.00	0	0.00	0.00	0.00	Yes
Thallium (Tl)	mg/l	0.0001 (B)	0.00	0.00	0.00	0.00	0	0.00	0.00	0.00	Yes
Chromium (Cr)	mg/l	0.05 (B)	0.00	0.00	0.00	0.00	0	0.00	0.00	0.00	Yes
Mercury (Hg)	mg/l	0.0001 (B)	0.00	0.00	0.00	0.00	0	0.00	0.00	0.00	Yes
Lead (Pb)	mg/l	0.05 (B)	0.00	0.00	0.00	0.00	0	0.00	0.00	0.00	Yes
Cadmium (Cd)	mg/l	0.01 (B)	0.00	0.00	0.00	0.00	0	0.00	0.00	0.00	Yes
Strontium (Sr)	mg/l	0.0001 (B)	0.00	0.00	0.00	0.00	0	0.00	0.00	0.00	Yes
Vanadium (V)	mg/l	0.0001 (B)	0.00	0.00	0.00	0.00	0	0.00	0.00	0.00	Yes
Antimony (Sb)	mg/l	0.0001 (B)	0.00	0.00	0.00	0.00	0	0.00	0.00	0.00	Yes
Thallium (Tl)	mg/l	0.0001 (B)	0.00	0.00	0.00	0.00	0	0.00	0.00	0.00	Yes
Chromium (Cr)	mg/l	0.05 (B)	0.00	0.00	0.00	0.00	0	0.00	0.00	0.00	Yes
Mercury (Hg)	mg/l	0.0001 (B)	0.00	0.00	0.00	0.00	0	0.00	0.00	0.00	Yes
Lead (Pb)	mg/l	0.05 (B)	0.00	0.00	0.00	0.00	0	0.00	0.00	0.00	Yes
Cadmium (Cd)	mg/l	0.01 (B)	0.00	0.00	0.00	0.00	0	0.00	0.00	0.00	Yes
Strontium (Sr)	mg/l	0.0001 (B)	0.00	0.00	0.00	0.00	0	0.00	0.00	0.00	Yes
Vanadium (V)	mg/l	0.0001 (B)	0.00	0.00	0.00	0.00	0	0.00	0.00	0.00	Yes
Antimony (Sb)	mg/l	0.0001 (B)	0.00	0.00	0.00	0.00	0	0.00	0.00	0.00	Yes
Thallium (Tl)	mg/l	0.0001 (B)	0.00	0.00	0.00	0.00	0	0.00	0.00	0.00	Yes

Notes:  
 (1) California Department of Health Services Drinking Water Maximum Contaminant Level  
 (2) milligrams per liter  
 (3) micrograms per cubic centimeter  
 (4) micrograms per liter  
 (5) micrograms per liter  
 (6) California Department of Health Services Drinking Water Secondary MCL  
 (7) California Department of Health Services Drinking Water Secondary MCL  
 (8) California Department of Health Services Drinking Water Secondary MCL  
 (9) Temperature dependent  
 (10) California Department of Health Services Drinking Water MCL Based upon 90% to compliance at the tap  
 (11) US Environmental Protection Agency Primary Drinking Water MCL Based upon 90% to compliance at the tap  
 (12) US Environmental Protection Agency Secondary Drinking Water MCL  
 (13) Maximum numbers treatment not detected levels  
 (14) Basin Plan compliance. The TDS and sulfate concentrations in treated SWP water will increase by 18 mg/l each due to the absorption of brine sulfate used in the cogeneration process.  
 (15) Data Not Reported  
 (16) Data Not Reported



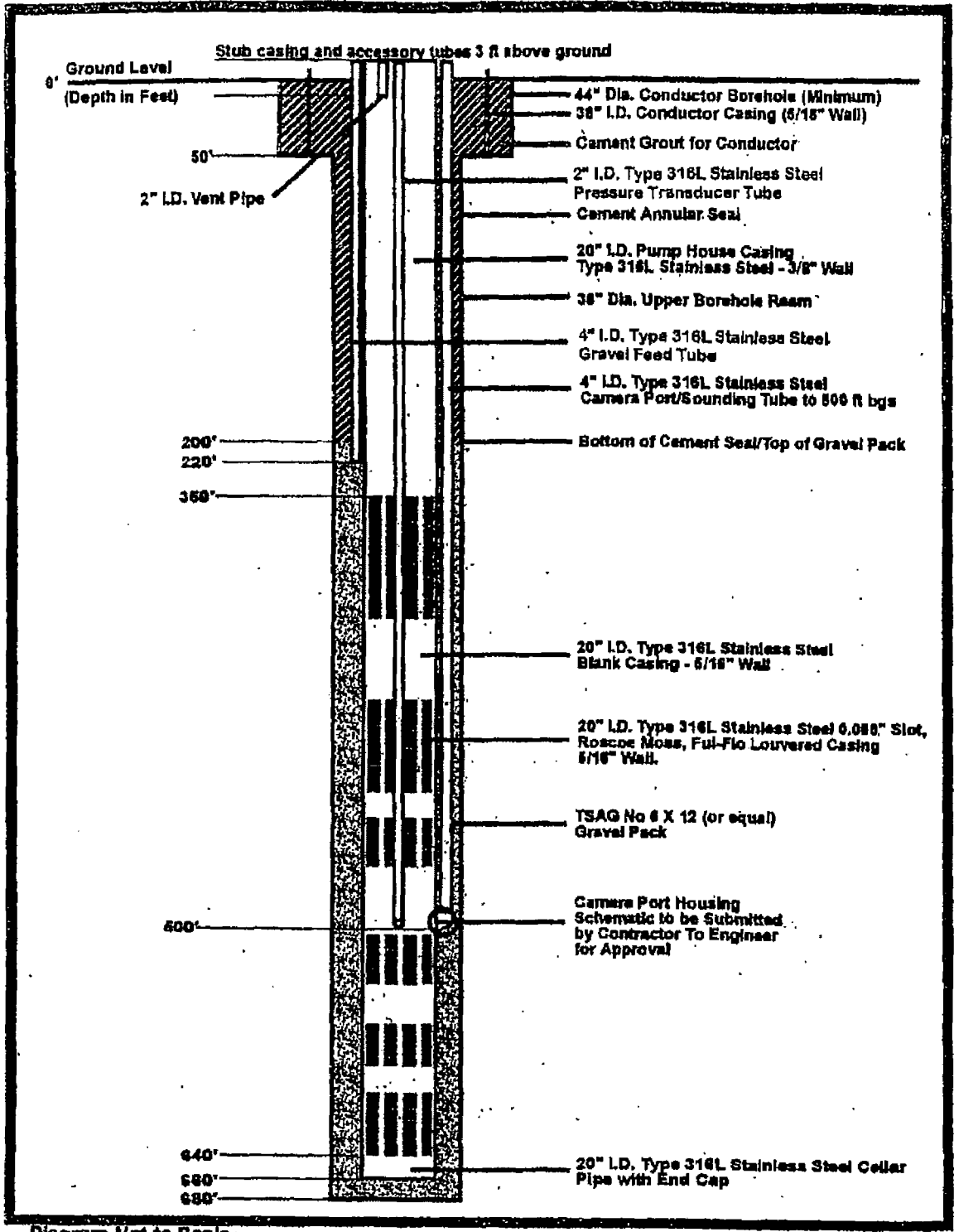
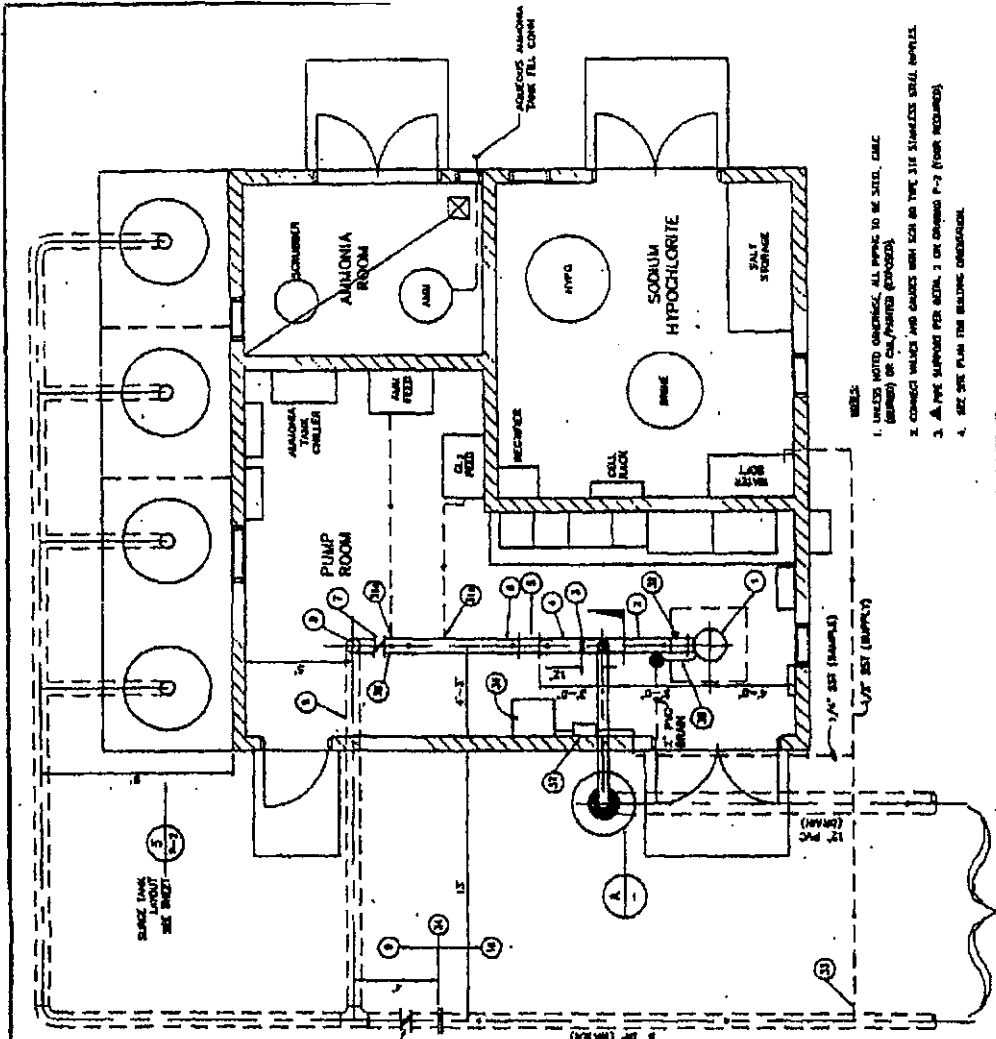

Diagram Not to Scale.  
Pilot hole to be drilled to 800 ft bgs.

**SCHEMATIC DIAGRAM  
PRELIMINARY WELL DESIGN DIAGRAM  
VVWD/HDPP PROJECT  
ASR WELL A**





- NOTES:
1. UNLESS NOTED OTHERWISE, ALL PIPING TO BE SHED. CABLE (BANDS) OR CABLE/POROUS (EXPOSED).
  2. CONNECT VALVES AND GANGES WITH SIZE ON TYPE 316 STAINLESS STEEL. APPROX.
  3. ALL PIPE SUPPORTS PER DETAIL 3 OR OTHERWISE P-2 (IF NOT REQUIRED).
  4. SEE SITE PLAN FOR BUILDING ORIENTATION.

TYPICAL WELLHEAD FLOOR PLAN  
SCALE 3/8"=1'-0"



VICTOR VALLEY WATER DISTRICT  
ASR WELLHEAD FACILITIES  
TYPICAL FLOOR PLAN AND NOTES  
SHEET NO. 11  
DATE 11/11/11  
DRAWN BY [Signature]  
CHECKED BY [Signature]

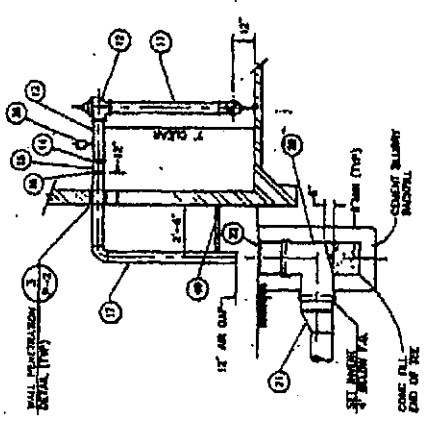

FLUSHLINE SECTION  
SCALE 3/8"=1'-0"

- CONSTRUCTION NOTES
1. PUMP AND MOTOR PER SPECIFICATIONS. SEE 3/P-1 FOR PUMP SIZE AND 1/P-3 FOR APPROXIMATIONS.
  2. 1/2" AIR CAP.
  3. 1/2" AIR CAP.
  4. 1/2" AIR CAP.
  5. 1/2" AIR CAP.
  6. 1/2" AIR CAP.
  7. 1/2" AIR CAP.
  8. 1/2" AIR CAP.
  9. 1/2" AIR CAP.
  10. 1/2" AIR CAP.
  11. 1/2" AIR CAP.
  12. 1/2" AIR CAP.
  13. 1/2" AIR CAP.
  14. 1/2" AIR CAP.
  15. 1/2" AIR CAP.
  16. 1/2" AIR CAP.
  17. 1/2" AIR CAP.
  18. 1/2" AIR CAP.
  19. 1/2" AIR CAP.
  20. 1/2" AIR CAP.
  21. 1/2" AIR CAP.
  22. 1/2" AIR CAP.
  23. 1/2" AIR CAP.
  24. 1/2" AIR CAP.
  25. 1/2" AIR CAP.
  26. 1/2" AIR CAP.
  27. 1/2" AIR CAP.
  28. 1/2" AIR CAP.
  29. 1/2" AIR CAP.
  30. 1/2" AIR CAP.
  31. 1/2" AIR CAP.
  32. 1/2" AIR CAP.
  33. 1/2" AIR CAP.
  34. 1/2" AIR CAP.
  35. 1/2" AIR CAP.
  36. 1/2" AIR CAP.
  37. 1/2" AIR CAP.
  38. 1/2" AIR CAP.
  39. 1/2" AIR CAP.
  40. 1/2" AIR CAP.
  41. 1/2" AIR CAP.
  42. 1/2" AIR CAP.
  43. 1/2" AIR CAP.
  44. 1/2" AIR CAP.
  45. 1/2" AIR CAP.
  46. 1/2" AIR CAP.
  47. 1/2" AIR CAP.
  48. 1/2" AIR CAP.
  49. 1/2" AIR CAP.
  50. 1/2" AIR CAP.
  51. 1/2" AIR CAP.
  52. 1/2" AIR CAP.
  53. 1/2" AIR CAP.
  54. 1/2" AIR CAP.
  55. 1/2" AIR CAP.
  56. 1/2" AIR CAP.
  57. 1/2" AIR CAP.
  58. 1/2" AIR CAP.
  59. 1/2" AIR CAP.
  60. 1/2" AIR CAP.
  61. 1/2" AIR CAP.
  62. 1/2" AIR CAP.
  63. 1/2" AIR CAP.
  64. 1/2" AIR CAP.
  65. 1/2" AIR CAP.
  66. 1/2" AIR CAP.
  67. 1/2" AIR CAP.
  68. 1/2" AIR CAP.
  69. 1/2" AIR CAP.
  70. 1/2" AIR CAP.
  71. 1/2" AIR CAP.
  72. 1/2" AIR CAP.
  73. 1/2" AIR CAP.
  74. 1/2" AIR CAP.
  75. 1/2" AIR CAP.
  76. 1/2" AIR CAP.
  77. 1/2" AIR CAP.
  78. 1/2" AIR CAP.
  79. 1/2" AIR CAP.
  80. 1/2" AIR CAP.
  81. 1/2" AIR CAP.
  82. 1/2" AIR CAP.
  83. 1/2" AIR CAP.
  84. 1/2" AIR CAP.
  85. 1/2" AIR CAP.
  86. 1/2" AIR CAP.
  87. 1/2" AIR CAP.
  88. 1/2" AIR CAP.
  89. 1/2" AIR CAP.
  90. 1/2" AIR CAP.
  91. 1/2" AIR CAP.
  92. 1/2" AIR CAP.
  93. 1/2" AIR CAP.
  94. 1/2" AIR CAP.
  95. 1/2" AIR CAP.
  96. 1/2" AIR CAP.
  97. 1/2" AIR CAP.
  98. 1/2" AIR CAP.
  99. 1/2" AIR CAP.
  100. 1/2" AIR CAP.



DESIGNED BY	DATE
CHECKED BY	DATE
DRAWN BY	DATE
PROJECT NO.	
SHEET NO.	
TOTAL SHEETS	
SCALE	
PROJECT NAME	
CITY	
COUNTY	
STATE	

Figure OP-3(1)

REPORT OF WASTE DISCHARGE AND ANTIDegradation ANALYSIS FOR THE  
 PROPOSED HIGH DESERT POWER PROJECT GROUNDWATER BANKING OPERATION

High Desert Power Project Groundwater Banking Operation.

Operation Year	SWP Water Injection (af)	Groundwater Extraction (af)	Groundwater Bank Balance (af)
1	4000	0	4000
2	4000	333	7667
3	4000	333	11334
4	1999	333	13000
5	0	333	12667
6	0	333	12334
7	0	333	12001
8	1332	333	13000
9	0	333	12667
10	0	333	12334
11	0	333	12001
12	1332	333	13000
13	0	333	12667
14	0	333	12334
15	0	333	12001
16	1332	333	13000
17	0	333	12667
18	0	333	12334
19	0	333	12001
20	1332	333	13000
21	0	333	12667
22	0	333	12334
23	0	333	12001

Table OP-B(1)

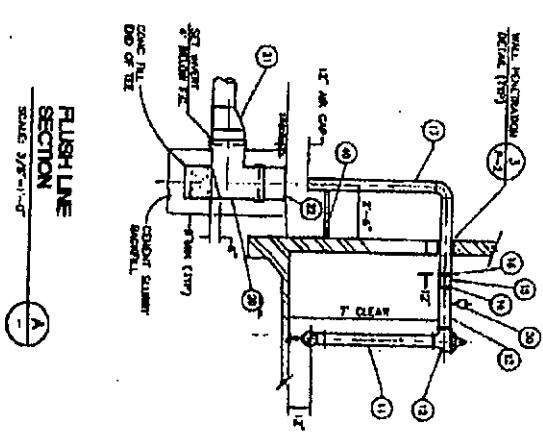

**FLUSH LINE SECTION**  
SCALE 3/8"=1'-0"

- CONSTRUCTION NOTES**
1. PUMP AND MOTOR PER SPECIFICATIONS SET 2/18-3 FOR PUMP BASE AND 1/18-3 FOR FOUNDATION.
  2. 6" x 6" P.C. OR TIE WITH NO. 3/4" HALF COMPANES.
  3. 1" DI. CONCRETE.
  4. 1" P.C. OR TIE.
  5. 1" DI. CONCRETE.
  6. 1" DI. CONCRETE.
  7. 1" DI. CONCRETE.
  8. 1" DI. CONCRETE.
  9. 1" DI. CONCRETE.
  10. 1" DI. CONCRETE.
  11. 1" DI. CONCRETE.
  12. 1" DI. CONCRETE.
  13. 1" DI. CONCRETE.
  14. 1" DI. CONCRETE.
  15. 1" DI. CONCRETE.
  16. 1" DI. CONCRETE.
  17. 1" DI. CONCRETE.
  18. 1" DI. CONCRETE.
  19. 1" DI. CONCRETE.
  20. 1" DI. CONCRETE.

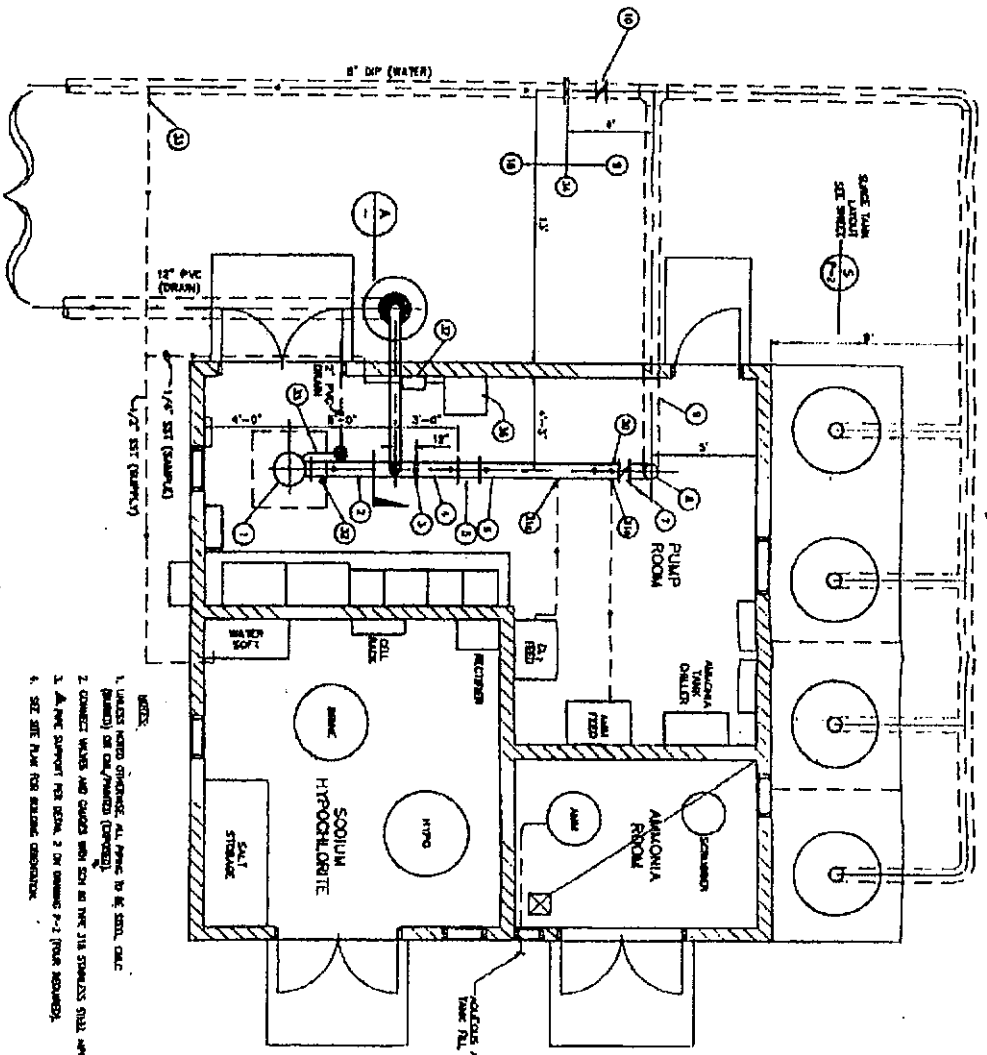

**TYPICAL WELLHEAD FLOOR PLAN**  
SCALE 3/8"=1'-0"

- INDEX**
1. UNLESS NOTED OTHERWISE, ALL PIPING TO BE STEEL, GALV. (PREFERRED) OR GALV./PREFERRED (CONCRETE).
  2. CONNECT WELLS AND CHASES WITH CON. IN THE 316 STAINLESS STEEL DETAILS.
  3. ALL PIPING SUPPORT FOR DETAIL 2 OR OTHERWISE P-2 FROM REQUIRED.
  4. SEE SEE PLAN FOR RELATIVE ORIENTATION.

PROJECT NO.	DATE	BY	CHECKED BY
<b>BOYLE</b>			
VICTOR VALLEY WATER DISTRICT			
ASR WELLHEAD FACILITIES			
TYPICAL FLOOR PLAN AND NOTES			
SCALE	DATE	BY	CHECKED BY

Figure OP-3(2)

REPORT OF WASTE DISCHARGE AND ANTI-DEGRADATION ANALYSIS FOR THE  
PROPOSED HIGH DESERT POWER PROJECT GROUNDWATER BANKING OPERATION

24	1332	333	13000
25	0	333	12667
26	0	333	12334
27	0	333	12001
28	999	4000	9000
29	0	4000	5000
30	0	4000	1000

Table OP-B(2)

For modeling purposes, and as shown on Table 4, the injection of SWP water occurs during the first 11 months of a given year and extraction occurs during the last month of the year. It should be noted that groundwater extraction for years 28 through 30 occurs in all months. This injection/extraction cycle corresponds to the maintenance schedule of the SWP. The SWP is typically shut down during December for annual maintenance. In addition, a minimum 1,000 af of banked SWP water will remain in the groundwater basin over the life of the project (see year 30 in Table 4) as directed in the Conditions of Certification to partially offset the overdraft currently observed in the Mojave River Basin. Additional treated SWP water will also be injected into the regional aquifer to replace banked water that migrates beyond the area of capture by the injection/extraction wells. Quantification of this "lost" water will be performed annually by the CEC as indicated in the Conditions of Certification.

## 5.2 BASIS OF IMPACT ASSESSMENT

The impacts of potential groundwater quality impacts as raised by the RWQCB in their letter to the HDPP dated July 21, 2000, and subsequent meetings in September and December 2000 and January and May 2001, were evaluated using the TRAN3D numerical model. Specifically, the RWQCB has raised concerns regarding potential introduction of or increases in inorganic constituents such as TDS, chloride, sulfate, surface water parasites (e.g., Giardia and Cryptosporidium), and trihalomethanes (THMs). The proposed water treatment processes (see Section 4) will remove Giardia, Cryptosporidium and viruses; however, TDS, chloride and sulfate will not be reduced owing to their relatively low concentrations in SWP water relative to CCR Title 22 drinking water standards. Chloramines will be used to disinfect the treated SWP water prior to injection. As a result, the potential for THM formation using this disinfection process is considered insignificant. Owing to the anticipated small increase in TDS, sulfate and chloride concentrations in the injected SWP water the TRAN3D model was used to estimate the potential increase in TDS concentrations at and in the vicinity of the proposed HDPP well field over the life of the project.

*Exhibit "B"*

**VICTOR VALLEY WATER DISTRICT MONITORING PLAN**

**Prepared for a Storage Agreement between the Mojave Basin Area Watermaster and the  
Victor Valley Water District**

January 2002

## 1.0 Monitoring Plan

### 1.1 Water Flow and Quality Monitoring

The treatment plant and booster station will be equipped with monitoring equipment to automatically and continuously measure flow and turbidity, as well as chlorine and ammonia for chloramination treatment control. Facilities for manual sampling for other water quality parameters will also be installed.

Each injection/extraction well will also have automatic and continuous monitoring of flow, chlorine and ammonia. The flow meter will be two-way to measure and record both injection and extraction amounts. Each well will also have facilities for manual sampling for water quality parameters. VVWD will monitor the injection wells.

All automatically monitored parameters at the wells and booster station will be recorded as well as be available to the District's central data acquisition and control system.

Table MP-A, attached, lists the chemical constituents to be monitored in the injected and extracted water, and the frequency with which water quality samples will be taken.

Table MP-B, below, shows the frequency with which water quality samples will be taken, by water quality constituent, as well as the monitoring frequency of ground water levels and flow rate.

**Table B**  
**Groundwater Monitoring**

<b>Parameter</b>	<b>Frequency of Monitoring</b>
Flow Rate	Continuous
Groundwater Levels	Quarterly
Water Quality:	Semi-Annually
Specific Conductance	Semi-Annually
PH	Semi-Annually
Temperature	Semi-Annually
General Minerals	Semi-Annually
General Physical Parameters	Semi-Annually
CCR Title 22 Metals	Semi-Annually
Trihalomethane Compounds:	Semi-Annually
-bromoform	Semi-Annually
-bromodichloromethane	Semi-Annually
-chloroform (trichloromethane)	Semi-Annually
-dibromochloromethane	Semi-Annually

## **1.2 Ground Water Level Monitoring**

Consistent with CEC Soil and Water Condition No. 10 (see Section 1.4) the District wells 21, 27, 32 and 37, and any other District wells within one mile of the injection/extraction wells, have been retrofitted with automatic groundwater level sensing equipment tied to the District's control system. In addition the District will request that Adelanto quarterly provide the District with groundwater level data on their Wells 4 and 8A. Water level data will also be collected from injection/extraction and monitoring wells. Groundwater levels will be reported quarterly to Watermaster.

Figure MP-A shows the locations of the wells where groundwater levels will be continuously monitored.

## **1.3 Injection Pressure Monitoring**

Injection wells shall be monitored for changes in pressure at a frequency sufficient to determine pressure trends. Data shall be reported to Watermaster on a quarterly basis.

## **1.4 Monitoring to Determine Losses**

Watermaster is required to determine losses on an annual basis. Losses and the effects of injection and extraction on operation of the High Desert Power Project (HDPP) are also key monitoring components for the California Energy Commission (CEC) Certification of the HDPP (May 2000, Docket No. 97-AFC-1). CEC Conditions of Certification require monitoring and reporting that are specific to operation of the storage and extraction program for the HDPP and are therefore pertinent to operations and monitoring requirements under this Storage Agreement. The District shall copy Watermaster with all reports and information it receives that are generated to comply with CEC Conditions of Certification-Soil and Water Nos. 5, 6, 8, 9, 10, 12, 13, 17 and 18.

## **1.5 Reporting**

Monitoring data shall be reported to Watermaster consistent with the schedule identified in Paragraph 10 of the Storage Agreement. The District shall provide Watermaster with a schematic indicating basic water system function and operation sufficient to aid Watermaster staff in determining the relationship between reported injection and extraction and facilities used.

**High Desert Power Plant & Victor Valley Water District  
Groundwater Banking Project  
Monitoring Program**

PARAMETERS	UNITS	FREQUENCY
<b>Continuous Injection Water Monitoring</b>		
Specific Conductance	umhos/cm	Continuous
Turbidity	NTU	Continuous
Combined Chlorine Residual	mg/L	Continuous
<b>Flow Monitoring</b>		
Inj/Ext Flow	Gallons	Continuous
Cumulative flow	Gallons	Continuous
Average Flow Rate	Gal per min.	Continuous
<b>Injection Water Chemistry Monitoring</b>		
<b>General Minerals</b>		
Total Dissolved Solids (TDS)	mg/L	Semi-annually
Specific Conductance	Umhos/cm	Semi-annually
Sulfate (SO4)	mg/L	Semi-annually
Chloride (Cl)	mg/L	Semi-annually
Calcium (Ca)	mg/L	Semi-annually
Magnesium (Mg)	mg/L	Semi-annually
Sodium (Na)	mg/L	Semi-annually
Potassium (K)	mg/L	Semi-annually
Bicarbonate (HCO3)	mg/L	Semi-annually
Hardness (as CaCO3)	mg/L	Semi-annually
Alkalinity (as CaCO3)	mg/L	Semi-annually
Fluoride (F)	mg/L	Semi-annually
Nitrate (as NO3)	mg/L	Semi-annually
Nitrite (as N)	mg/L	Semi-annually
Iron (Fe)	mg/L	Semi-annually
Manganese (Mn)	mg/L	Semi-annually
<b>Total Metals</b>		
Aluminum (Al)	mg/L	Semi-annually
Antimony (Sb)	mg/L	Semi-annually
Arsenic (As)	mg/L	Semi-annually
Barium (Ba)	mg/L	Semi-annually
Beryllium (Be)	mg/L	Semi-annually
Boron (B)	mg/L	Semi-annually
Cadmium (Cd)	mg/L	Semi-annually
Total Chromium (Cr)	mg/L	Semi-annually
Hexavalent Chromium (Cr VI)	mg/L	Semi-annually
Copper (Cu)	mg/L	Semi-annually
Lead (Pb)	mg/L	Semi-annually
Mercury (Hg)	mg/L	Semi-annually



PARAMETERS	UNITS	FREQUENCY
Nickel (Ni)	mg/L	Semi-annually
Selenium (Se)	mg/L	Semi-annually
Thallium (Th)	mg/L	Semi-annually
Zinc (Zn)	mg/L	Semi-annually
<b>General Physical Parameters</b>		
pH	Units	Semi-annually
Temperature	Deg. C	Semi-annually
Apparent Color	Units	Semi-annually
Odor	Units	Semi-annually
Turbidity	NTU	Daily
Methylene Blue Active Substances (MBAS)	mg/L	Semi-annually
<b>Other Constituents</b>		
Total Organic Carbon	mg/L	Semi-annually
Trihalomethane Formation Potential	Ug/L	Semi-annually
Total Trihalomethane Compounds	mg/L	Monthly
Coliform	mpn/100 ml	Monthly
Combined Chlorine Residual	mg/L	Daily
<b>Ground Water Monitoring</b>		
General Minerals	See Above	Semi-annually
General Physical Parameters	See Above	Semi-annually
Metals	See Above	Semi-annually
Total Trihalomethane Compounds	mg/L	Semi-annually
Groundwater Elevation	Feet above msl	Quarterly
<b>Sludge Monitoring</b>		
Quantity generated	Cubic yards	Quarterly
Quantity disposed offsite	Cubic yards	Quarterly
Classification (Haz, Desig, Non Haz Solid)		Quarterly
Final disposition of waste (location & dates of disposal)		Quarterly
<b>General Reporting - (Items to be included with annual reports)</b>		
Operation and maintenance performed		Annually
Narrative compliance evaluation		Annually
Water Treatment Plant Operator Certification		Annually
Compliance Calculations		Annually
Violations noted		Annually
Contact Name/Telephone #/email		Annually
WDID No. 6B360105004		Annually

Figure MP-A(2)

BEST BEST & KRIEGER LLP

A CALIFORNIA LIMITED LIABILITY PARTNERSHIP INCLUDING PROFESSIONAL CORPORATIONS

INDIAN WELLS  
(760) 568-2611

ONTARIO  
(909) 989-8584

LAWYERS

3750 UNIVERSITY AVENUE  
POST OFFICE BOX 1028  
RIVERSIDE, CALIFORNIA 92502-1028  
(909) 586-1450  
(909) 586-3083 FAX  
BBKLAW.COM

SAN DIEGO  
(619) 525-1300

ORANGE COUNTY  
(949) 260-0962

SACRAMENTO  
(916) 325-4000

STEVEN M. ANDERSON  
SMANDERSON@BBKLAW.COM

March 3, 2003

Kirby Brill, General Manager  
Mojave Water Agency  
22450 Headquarters Dr.,  
P.O. Box 1089  
Apple Valley, CA 92307

Re: High Desert Power Project Well Relocation

ROUTE TO	
BOD	
BRILL, K.	<input checked="" type="checkbox"/>
CAQUETTE, M.	<input checked="" type="checkbox"/>
WEEL, K.	
LIMBAUGH, M.	
MARTIN, G.	<input checked="" type="checkbox"/>
ECKHART, L.	
THORNELL, V.	
WIEGENSTEIN, V.	<i>orig</i>
MANCINELLI, B.	
JACKOWICH, V.	
<i>Carlson, K.</i>	<input checked="" type="checkbox"/>

Dear Mr. Brill.

Attached for your files please find a copy of a map showing the revised locations of the Aquifer Storage and Recovery Wells approved by the Regional Water Quality Control Board, Lahontan Region to be used to store and recover State Water Project water on behalf of the High Desert Power Project ("HDPP"). Wells F, G, H and K shown on the map have already been constructed or are currently under construction. Pump tests from Well K will help determine if and when Well M will be constructed. Please do not hesitate to contact me should you have any questions about this matter.

Sincerely,

Steven M. Anderson  
for BEST BEST & KRIEGER LLP

RECEIVED  
MOJAVE WATER AGENCY  
03 MAR -5 AM 9:41  
Enclosure

cc: Kenneth Stein, HDPP  
Richard Ransom, HDPP

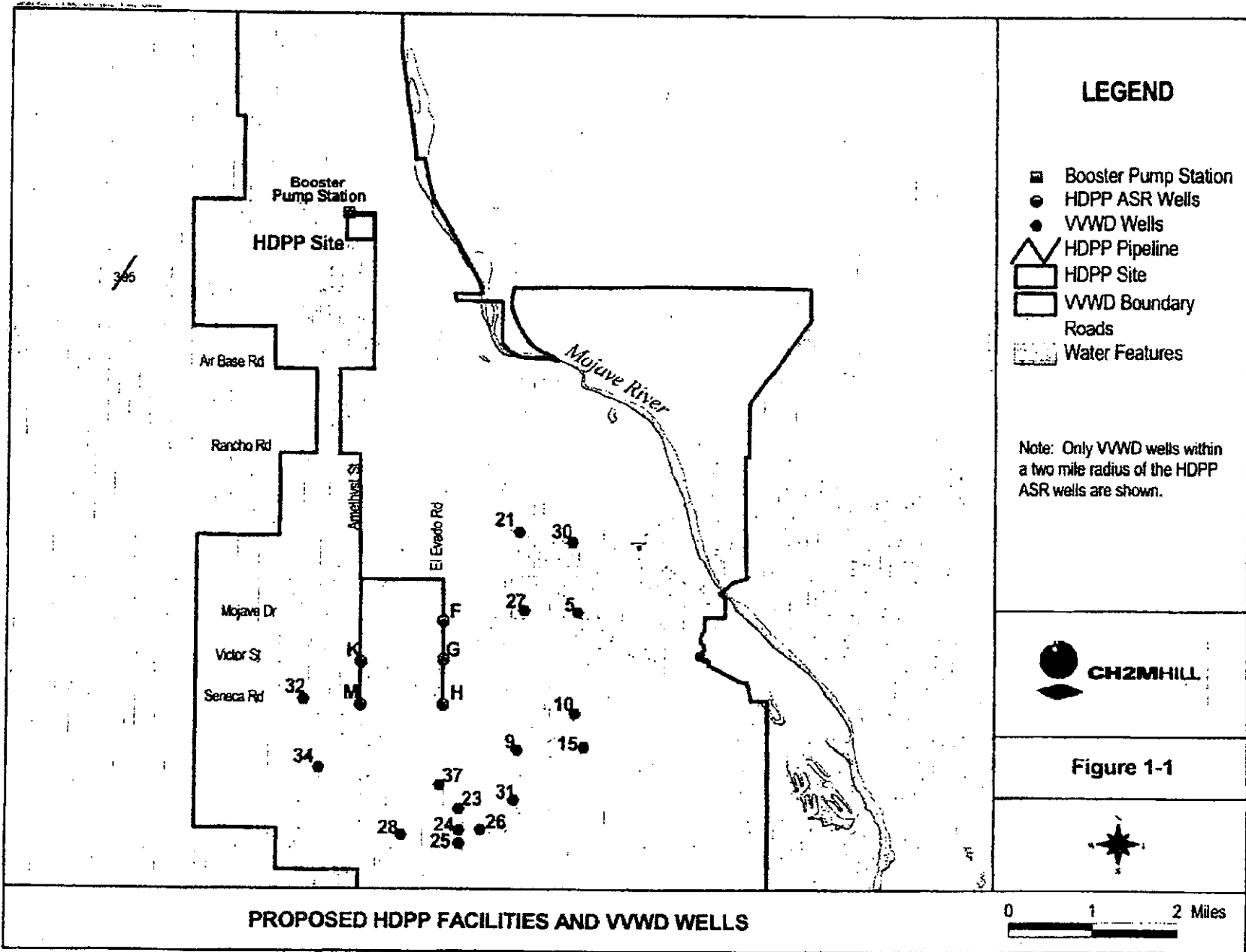

# **Attachment 3**

**AMENDMENT NUMBER:   3**  
**TO**  
**STANDARD SERVICE AGREEMENT**  
**BY AND BETWEEN**  
**VICTORVILLE WATER DISTRICT**  
**AND**  
**MOJAVE BASIN AREA WATERMASTER**  
**FOR**  
**WATER STORAGE SERVICES**

THIS AMENDMENT (the "Amendment") is made and entered in to this   24th   day of   May   2017, by and between the Victorville Water District, a County Water District and subsidiary district of the City of Victorville, organized and existing in the County of San Bernardino under and by virtue of the laws of the State of California (hereinafter referred to as "District"), and **Mojave Basin Area Watermaster**, hereinafter referred to as "Service Provider." The District and the Service Provider are sometimes hereinafter referred to as a "Party" or and collectively referred to as the "Parties" for water storage services.

**Recitals**

1. **WHEREAS**, the District has a Standard Services Agreement (hereinafter referred to as "Original Agreement") with the Service Provider to provide storage services, and;
2. **WHEREAS**, on or around May 24, 2007, Amendment 1 was issued to the Original Agreement to extend the Term of the Agreement, and add five (5) years, and;
3. **WHEREAS**, on or around May 15, 2012, Amendment 2 was issued to the Original Agreement to extend the Term of the Agreement through May 31, 2017, and;
4. **WHEREAS**, it is the desire of the Parties to issue Amendment 3 to renew the term of the Original Agreement for an additional five (5) years, through June 30, 2022.
5. **Now therefore**, in consideration of the covenants, conditions, and promises contained herein and for such other good and valuable consideration, receipt of which is hereby acknowledged, the Parties willing to amend the Original Contract as stated below.

**Contract Amendment**

**Duration of Agreement, Page 4, Paragraph 3**, – is amended as follows:

To extend the Original Agreement from June 1, 2017 through June 30, 2022.

Except as amended herein, the terms and conditions of the original Agreement and all previous amendments remain in full force and effect.

(SIGNATURES ON NEXT PAGE)

IN WITNESS WHEREOF, the Parties hereto have caused this Agreement to be executed as of the dates written below.

PARTY OF THE FIRST PART

PARTY OF THE SECOND PART

VICTORVILLE WATER DISTRICT

MOJAVE WATER AGENCY ACTING  
MOJAVE BASIN AREA WATERMASTER

By:   
Keith C. Metzler,  
Assistant City Manager

By:   
Kirby Brill,  
General Manager/Executive Officer

Dated: April 26 2017

Dated: 5/24/2017

VICTORVILLE WATER DISTRICT

APPROVED AS TO STANDARD FORM

By:   
Chuck Buquet,  
District Risk Manager

By:   
Andre de Bortnowsky,  
District Legal Counsel